

ENGINEERING TEST REPORT

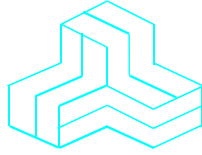

MOBEXCOM DVE
Model No.: DVE 800
FCC ID: LO6-DVE800

Applicant:

Futurecom Systems Group Inc.
3277 Langstaff Road
Concord, Ontario
CANADA, L4K 5P8

Tested in Accordance With

Federal Communications Commission (FCC)
47 CFR, Part 2 & 90

UltraTech's File No.: FSG-093_FCC90_Rev1

This Test report is Issued under the Authority of
Tri M. Luu, Professional Engineer,
Vice President of Engineering
UltraTech Group of Labs

Date: June 05, 2009



Report Prepared by: Dharmajit Solanki

Tested by: Hung Trinh, EMI/RFI Technician

Issued Date: June 05, 2009

Test Dates: February 6 to March 17, 2009

- *The results in this Test Report apply only to the sample(s) tested, and the sample tested is randomly selected.*
- *This report must not be used by the client to claim product endorsement by NVLAP or any agency of the US Government.*

UltraTech

3000 Bristol Circle, Oakville, Ontario, Canada, L6H 6G4
Tel.: (905) 829-1570 Fax.: (905) 829-8050

Website: www.ultratech-labs.com, Email: vic@ultratech-labs.com, Email: tri@ultratech-labs.com



0685



91038



1309



46390-2049



200093-0



SL2-IN-E-1119R



Korea KCC-RRL
CA2049

TABLE OF CONTENTS

EXHIBIT 1. INTRODUCTION	1
1.1. SCOPE.....	1
1.2. RELATED SUBMITTAL(S)/GRANT(S).....	1
1.3. NORMATIVE REFERENCES	1
EXHIBIT 2. PERFORMANCE ASSESSMENT	2
2.1. CLIENT INFORMATION	2
2.2. EQUIPMENT UNDER TEST (EUT) INFORMATION.....	2
2.3. EUT'S TECHNICAL SPECIFICATIONS.....	3
2.4. LIST OF EUT'S PORTS	3
2.5. ANCILLARY EQUIPMENT	3
2.6. DRAWING OF TEST SETUP	4
EXHIBIT 3. EUT OPERATING CONDITIONS AND CONFIGURATIONS DURING TESTS	5
3.1. CLIMATE TEST CONDITIONS.....	5
3.2. OPERATIONAL TEST CONDITIONS & ARRANGEMENT FOR TEST SIGNALS.....	5
EXHIBIT 4. SUMMARY OF TEST RESULTS	6
4.1. LOCATION OF TESTS	6
4.2. APPLICABILITY & SUMMARY OF EMISSION TEST	6
4.3. MODIFICATIONS INCORPORATED IN THE EUT FOR COMPLIANCE PURPOSES	6
4.4. DEVIATION OF STANDARD TEST PROCEDURES	6
EXHIBIT 5. MEASUREMENTS, EXAMINATIONS & TEST DATA FOR EMC EMISSIONS.....	7
5.1. TEST PROCEDURES.....	7
5.2. MEASUREMENT UNCERTAINTIES	7
5.3. MEASUREMENT EQUIPMENT USED:	7
5.4. ESSENTIAL/PRIMARY FUNCTIONS AS DECLARED BY THE MANUFACTURER:.....	7
5.5. RF POWER OUTPUT @ FCC 2.1046, 90.205 & 90.635	8
5.5.1. <i>LIMITS</i>	8
5.5.2. <i>METHOD OF MEASUREMENTS</i>	8
5.5.3. <i>TEST ARRANGEMENT</i>	8
5.5.4. <i>TEST DATA</i>	9
5.5.4.1. RF CONDUCTED OUTPUT POWER.....	9
5.6. FREQUENCY STABILITY [§§ 2.1055 & 90.213].....	10
5.6.1. <i>LIMITS</i>	10
5.6.2. <i>METHOD OF MEASUREMENTS</i>	10
5.6.3. <i>TEST ARRANGEMENT</i>	10
5.6.4. <i>TEST DATA</i>	11
5.7. AUDIO FREQUENCY RESPONSE [§ 2.1047(A)]	12
5.7.1. <i>LIMITS</i>	12
5.7.2. <i>METHOD OF MEASUREMENTS</i>	12
5.7.3. <i>TEST ARRANGEMENT</i>	12
5.7.4. <i>TEST DATA</i>	13
5.7.4.1. 12.5 KHZ CHANNEL SPACING, F3E, FREQUENCY OF ALL MODULATION STATES*	13
5.7.4.2. 25 KHZ CHANNEL SPACING, F3E, FREQUENCY OF ALL MODULATION STATES*	15
5.8. MODULATION LIMITING [§§ 2.1047(B) & 90.210].....	17
5.8.1. <i>LIMITS</i>	17

5.8.2.	<i>METHOD OF MEASUREMENTS</i>	17
5.8.3.	<i>TEST ARRANGEMENT</i>	17
5.8.4.	<i>TEST DATA</i>	18
5.8.4.1.	VOICE MODULATION LIMITING FOR 12.5 KHZ CHANNEL SPACING OPERATION.....	18
5.8.4.2.	VOICE MODULATION LIMITING FOR 25 KHZ CHANNEL SPACING OPERATION.....	20
5.8.4.3.	DIGITAL MODULATION LIMITING.....	22
5.9.	OCCUPIED BANDWIDTH & EMISSION MASK [§§ 2.1049, 90.209 & 90.210]	23
5.9.1.	<i>LIMITS</i>	23
5.9.2.	<i>METHOD OF MEASUREMENTS</i>	23
5.9.3.	<i>TEST ARRANGEMENT</i>	23
5.9.4.	<i>TEST DATA</i>	24
5.9.4.1.	99% OCCUPIED BANDWIDTH.....	24
5.9.4.2.	EMISSION MASKS	43
5.10.	TRANSMITTER ANTENNA POWER SPURIOUS/HARMONIC CONDUCTED EMISSIONS [§ 90.210 & 90.691] 83	
5.10.1.	<i>LIMITS</i>	83
5.10.2.	<i>METHOD OF MEASUREMENTS</i>	83
5.10.3.	<i>TEST ARRANGEMENT</i>	83
5.10.4.	<i>TEST DATA</i>	84
5.10.4.1.	NEAR LOWER FREQUENCY OF BOTH BANDS	84
5.10.4.2.	NEAR MIDDLE FREQUENCY OF BOTH BANDS	92
5.10.4.3.	NEAR HIGHER FREQUENCY OF BOTH BANDS	100
5.11.	TRANSMITTER SPURIOUS/HARMONIC RADIATED EMISSIONS [§ 90.210 & 90.691]	108
5.11.1.	<i>LIMITS</i>	108
5.11.2.	<i>METHOD OF MEASUREMENTS</i>	108
5.11.3.	<i>TEST ARRANGEMENT</i>	108
5.11.4.	<i>TEST DATA</i>	109
5.11.4.1.	NEAR LOWEST FREQUENCIES	109
5.11.4.2.	NEAR MIDDLE FREQUENCIES	110
5.11.4.3.	NEAR HIGHEST FREQUENCIES.....	111
5.12.	RF EXPOSURE REQUIREMENTS @ 1.1310 & 2.1091	112
5.12.1.	<i>LIMITS</i>	112
5.12.2.	<i>METHOD OF MEASUREMENTS</i>	112
5.12.3.	<i>EVALUATION OF RF EXPOSURE COMPLIANCE REQUIREMENTS</i>	113
EXHIBIT 6.	TEST EQUIPMENTS LIST	114
EXHIBIT 7.	MEASUREMENT UNCERTAINTY.....	116
7.1.	RADIATED EMISSION MEASUREMENT UNCERTAINTY	116
EXHIBIT 8.	MEASUREMENT METHODS	117
8.1.	CONDUCTED POWER MEASUREMENTS	117
8.2.	RADIATED POWER MEASUREMENTS (ERP & EIRP) USING SUBSTITUTION METHOD.....	118
8.2.1.	<i>MAXIMIZING RF EMISSION LEVEL (E-FIELD)</i>	118
8.2.2.	<i>MEASURING THE EIRP OF SPURIOUS/HARMONIC EMISSIONS USING SUBSTITUTION METHOD</i> ..	119
8.3.	FREQUENCY STABILITY.....	121
8.4.	EMISSION MASK.....	122
8.5.	SPURIOUS EMISSIONS (CONDUCTED).....	122

EXHIBIT 1. INTRODUCTION

1.1. SCOPE

Reference:	FCC Part 2 & 90
Title:	Telecommunication - Code of Federal Regulations, CFR 47, Part 2 & 90
Purpose of Test:	To obtain FCC Certification Authorization for Radio operating in the Frequency Band 806-824 MHz & 851-869 MHz (25 KHz and 12.5 KHz Channel Spacing).
Test Procedures:	Both conducted and radiated emissions measurements were conducted in accordance with TIA/EIA Standard TIA/EIA-603 (01-Nov-2002) – Land Mobile FM or PM Communications Equipment Measurement and performance Standards.

1.2. RELATED SUBMITTAL(S)/GRANT(S)

None

1.3. NORMATIVE REFERENCES

Publication	Year	Title
FCC CFR Parts 0-19, 80-End	2008	Code of Federal Regulations – Telecommunication
ANSI C63.4	2003	American National Standard for Methods of Measurement of Radio-Noise Emissions from Low-Voltage Electrical and Electronic Equipment in the Range of 9 kHz to 40 GHz
CISPR 16-1-1	2006	Specification for Radio Disturbance and Immunity measuring apparatus and methods
TIA/EIA 603, Edition C	2004	Land Mobile FM or PM Communications Equipment Measurement and Performance Standards

EXHIBIT 2. PERFORMANCE ASSESSMENT

2.1. CLIENT INFORMATION

APPLICANT	
Name:	Futurecom Systems Group Inc.
Address:	3277 Langstaff Road Concord, Ontario CANADA, L4K 5P8
Contact Person:	Mr. Tony Bombera Phone #: 905.660.5548 Fax #: 905.660.6858 Email Address: tonyb@futurecom.com

MANUFACTURER	
Name:	Futurecom Systems Group Inc.
Address:	3277 Langstaff Road Concord, Ontario CANADA, L4K 5P8
Contact Person:	Mr. Tony Bombera Phone #: 905.660.5548 Fax #: 905.660.6858 Email Address: tonyb@futurecom.com

2.2. EQUIPMENT UNDER TEST (EUT) INFORMATION

The following information (with the exception of the Date of Receipt) has been supplied by the applicant.

Brand Name:	Futurecom Systems Group Inc.
Product Name:	MOBEXCOM DVE
Model Name or Number:	DVE 800
Type of Equipment:	Licensed Non-Broadcast Station Transmitter
Power Supply:	13.8 VDC
Transmitting/Receiving Antenna Type:	Non-Integral
Application of EUT	Permits expanded operation for portable radios in DVE system

ULTRATECH GROUP OF LABS

3000 Bristol Circle, Oakville, Ontario, Canada L6H 6G4
 Tel. #: 905-829-1570, Fax. #: 905-829-8050, Email: vic@ultratech-labs.com, Website: <http://www.ultratech-labs.com>

File #: FSG-093_FCC90_Rev1
 June 05, 2009

- All test results contained in this engineering test report are traceable to National Institute of Standards and Technology (NIST)

2.3. EUT'S TECHNICAL SPECIFICATIONS

TRANSMITTER	
Equipment Type:	Mobile
Intended Operating Environment:	Vehicular
RF Output Power Rating (Variable):	3.0 W (max) 0.3 W (min)
Operating Frequency Range:	806-824 MHz & 851-869 MHz
Channel Spacing:	12.5 kHz & 25 kHz
Modulation Type:	FM, P25 (C4FM)
RF Input/Output Impedance:	50 Ohms
Occupied Bandwidth (99%):	10.62 kHz (16K0F3E) 9.90 kHz (11K0F3E) 8.26 kHz (8K10F1E, 8K10F1D)
Emission Designation*:	16K0F3E, 11K0F3E, 8K10F1E, 8K10F1D
Antenna Connector Type:	Mini UHF
Antenna Description:	¼ wave omni-directional antenna (Maximum Gain: 0 dBd)

* For an average case of commercial telephony, the Necessary Bandwidth is calculated as follows:

Channel Spacing = 25 KHz, D = 5 KHz max, K = 1, M = 3 KHz

$B_n = 2M + 2DK = 2(3) + 2(5)(1) = \mathbf{16\ KHz}$, Emission designation: 16K0F3E

Channel Spacing = 12.5 KHz, D = 2.5 KHz max, K = 1, M = 3 KHz

$B_n = 2M + 2DK = 2(3) + 2(2.5)(1) = \mathbf{11\ KHz}$, Emission designation: 11K0F3E

2.4. LIST OF EUT'S PORTS

Port Number	EUT's Port Description	Number of Identical Ports	Connector Type	Cable Type (Shielded/Non-shielded)
1	Antenna	1	Mini UHF (F)	Shielded
2	DC Power 13.8V	1	6 Pin Circular	Unshielded
3	AUX	1	9 Pin Circular	Shielded
4	Radio	1	20 Pin Circular	Shielded
5	Service Port	1	USB	Shielded

2.5. ANCILLARY EQUIPMENT

None

2.6. DRAWING OF TEST SETUP

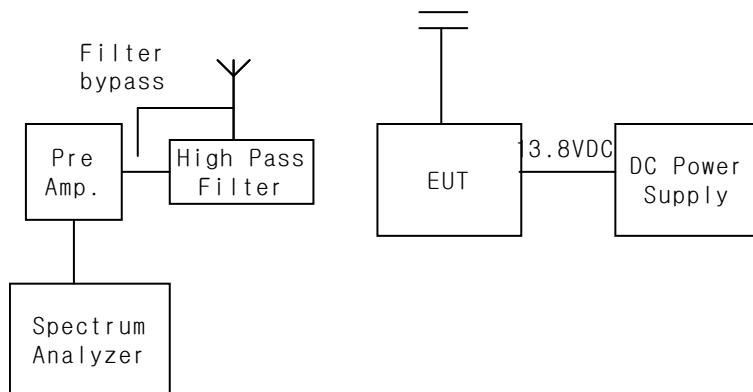

EXHIBIT 3. EUT OPERATING CONDITIONS AND CONFIGURATIONS DURING TESTS

3.1. CLIMATE TEST CONDITIONS

The climate conditions of the test environment are as follows:

Temperature:	21°C
Humidity:	53%
Pressure:	100 kPa
Power input source:	13.8 VDC

3.2. OPERATIONAL TEST CONDITIONS & ARRANGEMENT FOR TEST SIGNALS

Operating Modes:	The radio was operated in a continuous transmission mode with the carrier modulated as specified in the Test Data.
Special Test Software:	N/A
Special Hardware Used:	N/A
Transmitter Test Antenna:	The EUT is tested with the antenna port terminated with a 50 Ohms RF Load.

Transmitter Test Signals	
Frequency Band(s):	806-824 MHz 851-869 MHz
Test Frequencies: (Near lowest, near middle & near highest frequencies in the frequency range of operation.)	806.025, 821.025, 823.975 MHz (12.5 kHz Spacing) 851.025, 866.025, 868.975 MHz (12.5 kHz Spacing) 809.025, 816.500, 823.975 MHz (25kHz Spacing) 854.025, 861.500, 868.975 MHz (25kHz Spacing)
Transmitter Wanted Output Test Signals:	
Transmitter Power (measured maximum output power):	3.0 Watts High and 0.3 Watts Low
Normal Test Modulation:	F3E, F1E, F1D
Modulating signal source:	External

EXHIBIT 4. SUMMARY OF TEST RESULTS

4.1. LOCATION OF TESTS

All of the measurements described in this report were performed at Ultratech Group of Labs located in the city of Oakville, Province of Ontario, Canada.

- Powerline Conducted Emissions were performed in Ultratech's shielded room, 16'(L) by 12'(W) by 12'(H).
- Radiated Emissions were performed at the Ultratech's 3-10 TDK Semi-Anechoic Chamber situated in the Town of Oakville, province of Ontario. This test site has been calibrated in accordance with ANSI C63.4, and found to be in compliance with the requirements of Sec. 2.948 of the FCC Rules. The descriptions and site measurement data of the Oakville 3-10 TDK Semi-Anechoic Chamber has been filed with FCC office (FCC File No.: 91038) and Industry Canada office (Industry Canada File No.: 2049A-3). Expiry date of this test site is May 1, 2011.

4.2. APPLICABILITY & SUMMARY OF EMISSION TEST

FCC Section(s)	Test Requirements	Applicability (Yes/No)
90.205, 90.635 & 2.1046	RF Power Output	Yes
90.213 & 2.1055	Frequency Stability	Yes
90.242(b)(8) & 2.1047(a)	Audio Frequency Response	Not applicable to new standard. However, tests are conducted under FCC's recommendation.
90.210 & 2.1047(b)	Modulation Limiting	Yes
90.210, 90.691 & 2.1049	Emission Limitation & Emission Mask	Yes
90.210, 90.691, 2.1057 & 2.1051	Emission Limits - Spurious Emissions at Antenna Terminal	Yes
90.210, 90.691, 2.1057 & 2.1053	Emission Limits - Field Strength of Spurious Emissions	Yes
90.214	Transient Frequency Behavior	Not specified for these frequency band.
1.1307, 1.1310, 2.1091 & 2.1093	RF Exposure Limit	Yes

MOBEXCOM DVE, Model No.: DVE 800, by Futurecom System Group Inc. has also been tested and found to comply with **FCC Part 15, Subpart B - Radio Receivers and Class A Digital Devices**. The engineering test report has been documented and kept on file and it is available upon request.

4.3. MODIFICATIONS INCORPORATED IN THE EUT FOR COMPLIANCE PURPOSES

None

4.4. DEVIATION OF STANDARD TEST PROCEDURES

None

ULTRATECH GROUP OF LABS

3000 Bristol Circle, Oakville, Ontario, Canada L6H 6G4
 Tel. #: 905-829-1570, Fax. #: 905-829-8050, Email: vic@ultratech-labs.com, Website: <http://www.ultratech-labs.com>

File #: FSG-093_FCC90_Rev1
 June 05, 2009

- All test results contained in this engineering test report are traceable to National Institute of Standards and Technology (NIST)

EXHIBIT 5. MEASUREMENTS, EXAMINATIONS & TEST DATA FOR EMC EMISSIONS

5.1. TEST PROCEDURES

This section contains test results only. Details of test methods and procedures can be found in EXHIBIT 8. of this report

5.2. MEASUREMENT UNCERTAINTIES

The measurement uncertainties stated were calculated in accordance with requirements of UKAS Document NIS 81 with a confidence level of 95%. Please refer to EXHIBIT 7. for Measurement Uncertainties.

5.3. MEASUREMENT EQUIPMENT USED:

The measurement equipment used complied with the requirements of the Standards referenced in the Methods & Procedures ANSI C63.4:2003 and CISPR 16-1-1.

5.4. ESSENTIAL/PRIMARY FUNCTIONS AS DECLARED BY THE MANUFACTURER:

The essential function of the EUT is to permit expanded operation for portable radios in DVE system.

5.5. RF POWER OUTPUT @ FCC 2.1046, 90.205 & 90.635.

5.5.1. Limits

Please refer to FCC 47 CFR 90.635 for details.

(b) The maximum output power of the transmitter for mobile station is 100 watts (20dBw).

5.5.2. Method of Measurements

Refer to 8.1 of this report for measurement details

5.5.3. Test Arrangement

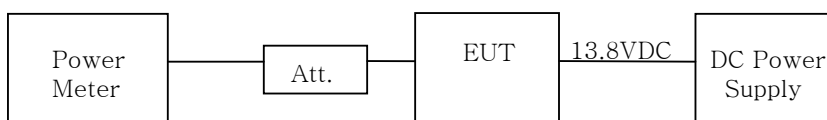

5.5.4. Test Data

5.5.4.1. RF Conducted Output Power

Frequency (MHz)	Measured Average Power (dBm)	Measured Average Power (Watts)	Power Rating (Watts)
High Power			
806.025	34.72	2.96	3
809.025	34.75	2.99	3
816.500	34.77	3.00	3
821.025	34.69	2.94	3
823.975	34.78	3.01	3
851.025	34.69	2.94	3
854.025	34.79	3.01	3
861.500	34.68	2.94	3
866.025	34.71	2.96	3
868.975	34.73	2.97	3
Low Power			
806.025	24.71	0.30	0.3
809.025	24.81	0.30	0.3
816.500	24.77	0.30	0.3
821.025	24.63	0.29	0.3
823.975	24.84	0.30	0.3
851.025	24.99	0.32	0.3
854.025	24.83	0.30	0.3
861.500	24.69	0.29	0.3
866.025	24.84	0.30	0.3
868.975	24.84	0.30	0.3

5.6. FREQUENCY STABILITY [§§ 2.1055 & 90.213]

5.6.1. Limits

§§ 90.213 Transmitters used in the service governed by this rule part must have minimum frequency stability as specified in the following table.

Frequency Range (MHz)	Mobile Stations (Over 2 Watts Output Power)	
	(ppm)	(ppm)
806-809 / 851-854	1.5	1.5
809-824 / 854-869	2.5	2.5

5.6.2. Method of Measurements

Refer to Section 8.3 of this report for measurement details.

5.6.3. Test Arrangement

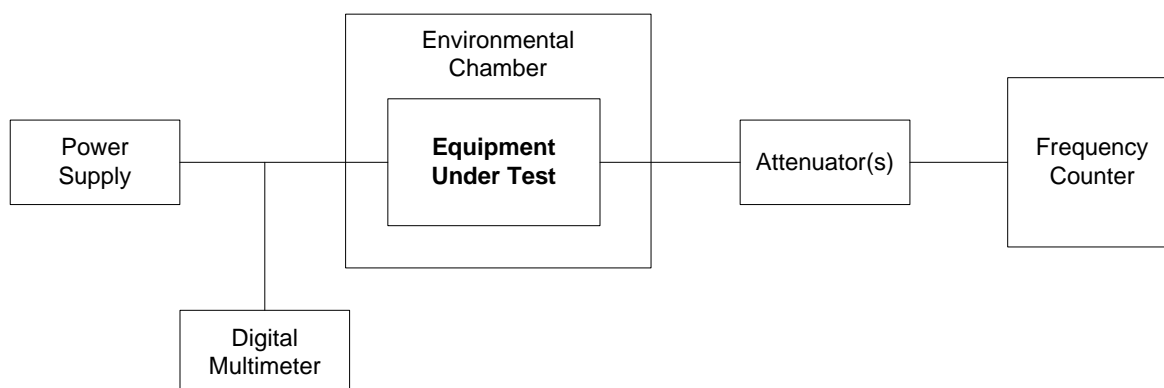

5.6.4. Test Data

Product Name: Model No.:	MOBEXCOM DVE DVE 800
Center Frequency:	806.025 MHz
Full Power Level:	34.81 dBm
Frequency Tolerance Limit:	± 1.5 ppm or ± 1209.0375 Hz
Max. Frequency Tolerance Measured:	229 Hz or 0.28 ppm
Input Voltage Rating:	13.8 VDC (nominal)

Ambient Temperature (°C)	CENTER FREQUENCY & RF POWER OUTPUT VARIATION		
	Supply Voltage (Nominal) 13.8 Vdc	Supply Voltage (Battery End Point) 11.7 Vdc	Supply Voltage (Battery Fully Charged) 15.87 Vdc
	Hz	Hz	Hz
-30	85	N/A	N/A
-20	128	N/A	N/A
-10	171	N/A	N/A
0	75	N/A	N/A
+10	-60	N/A	N/A
+20	00	16	-06
+30	-15	N/A	N/A
+40	134	N/A	N/A
+50	144	N/A	N/A
+60	229	N/A	N/A

5.7. AUDIO FREQUENCY RESPONSE [§ 2.1047(A)]

5.7.1. Limits

Recommended audio filter attenuation characteristics are given below:

RF Band	Audio band	Minimum Attenuation Rel. to 1 KHz Attenuation
406.1 – 960 MHz	3 –20 KHz 20 – 30 KHz	$60 \log_{10}(f/3)$ dB where f is in KHz 50dB

5.7.2. Method of Measurements

The rated audio input signal was applied to the input of the audio low-pass filter (or of all modulation stages) using an audio oscillator, this input signal level and its corresponding output signal were then measured and recorded using the FFT Digital Spectrum Analyzer. Tests were repeated at different audio signal frequencies from 0 to 50 KHz.

5.7.3. Test Arrangement

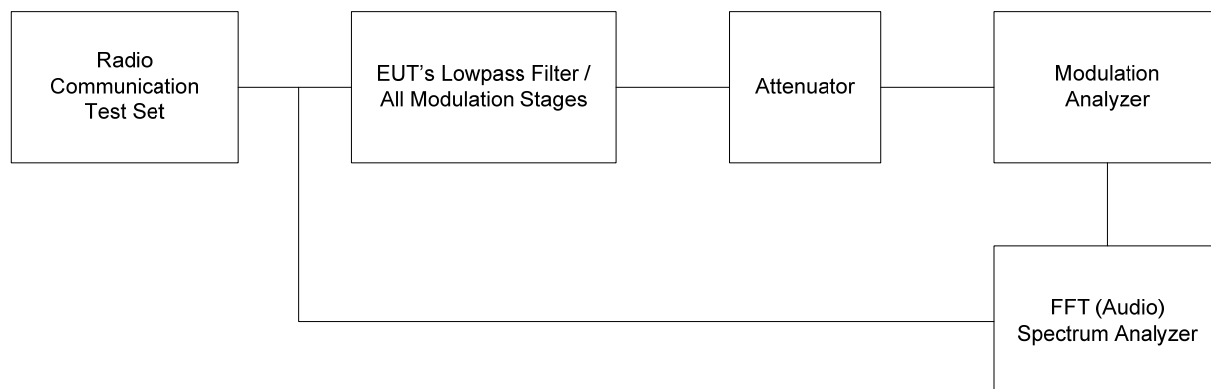

5.7.4. Test Data

5.7.4.1. 12.5 KHz Channel Spacing, F3E, Frequency of All Modulation States*

Note: Due to the difficulty of measuring the Frequency Response of the internal low-pass filter, the Frequency Response of All Modulation States are performed to show the roll-off at 3 KHz in comparison with the recommended audio filter attenuation.

Frequency (KHz)	Audio In (dBV)	Audio Out (dBV)	Attenuation (Out - In) (dB)	Attenuation Rel. KHz (dB)	Recommended Attenuation (dB)
0.1	-15.79	-25.68	-9.9	-21.3	--
0.2	-15.79	-19.36	-3.6	-15.0	--
0.4	-15.79	-12.08	3.7	-7.7	--
0.6	-15.79	-8.78	7.0	-4.4	--
0.8	-15.79	-6.65	9.1	-2.3	--
1.0	-15.79	-4.35	11.4	0.0	--
1.5	-15.79	-1.05	14.7	3.3	--
2.0	-15.79	1.2	17.0	5.6	--
2.5	-15.79	1.36	17.2	5.7	--
3.0	-15.79	0.72	16.5	5.1	0
3.5	-15.79	-0.65	15.1	3.7	-4
4.0	-15.79	-16.56	-0.8	-12.2	-7
4.5	-15.79	-39.0	-23.2	-34.7	-11
5.0	-15.79	-58.0	-42.2	-53.7	-13
6.0	-15.79	-65.0	-49.2	-60.7	-18
7.0	-15.79	-65.0	-49.2	-60.7	-22
8.0	-15.79	-65.0	-49.2	-60.7	-26
9.0	-15.79	-65.0	-49.2	-60.7	-29
10.0	-15.79	-65.0	-49.2	-60.7	-31
12.0	-15.79	-65.0	-49.2	-60.7	-36
14.0	-15.79	-65.0	-49.2	-60.7	-40
16.0	-15.79	-65.0	-49.2	-60.7	-44
18.0	-15.79	-65.0	-49.2	-60.7	-47
20.0	-15.79	-65.0	-49.2	-60.7	-49
22.0	-15.79	-65.0	-49.2	-60.7	-50
25.0	-15.79	-65.0	-49.2	-60.7	-50
30.0	-15.79	-65.0	-49.2	-60.7	-50
35.0	-15.79	-65.0	-49.2	-60.7	-50
40.0	-15.79	-65.0	-49.2	-60.7	-50
45.0	-15.79	-65.0	-49.2	-60.7	-50
50.0	-15.79	-65.0	-49.2	-60.7	-50

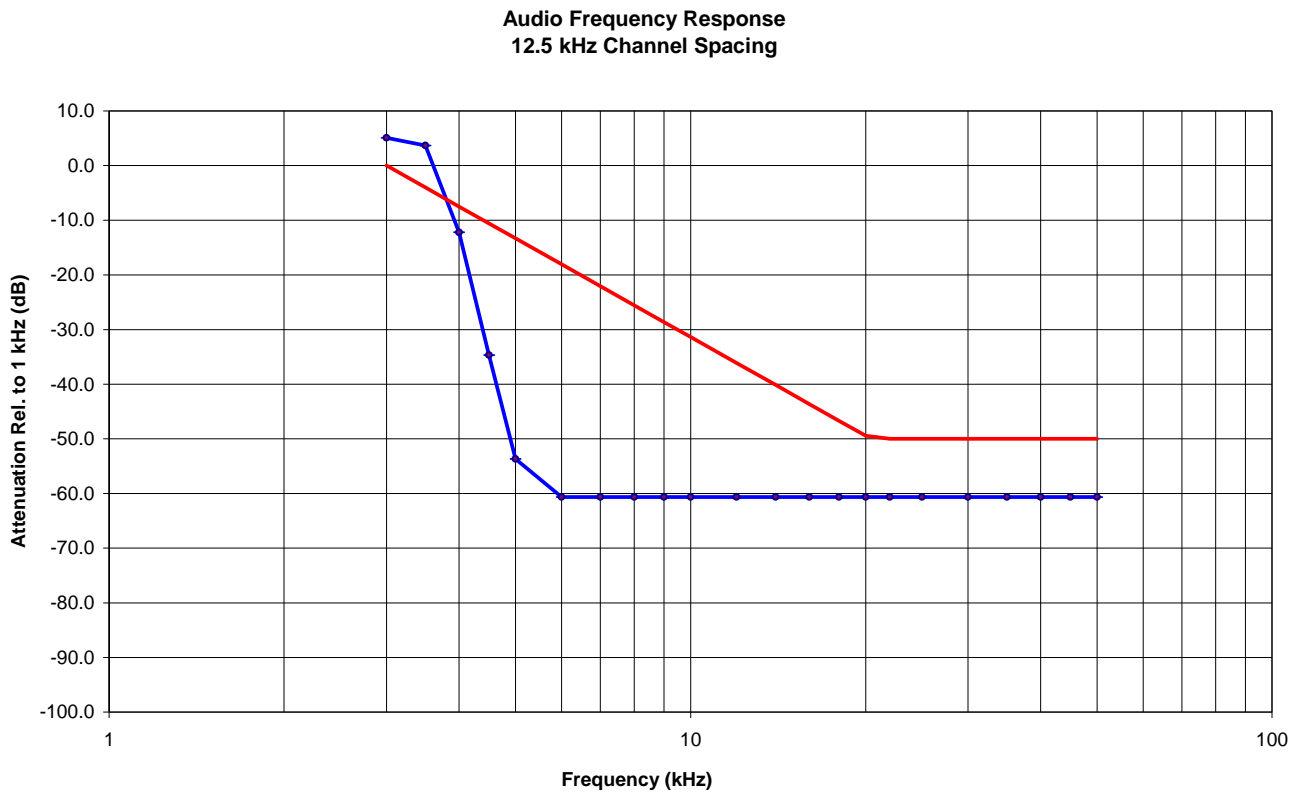

- All test results contained in this engineering test report are traceable to National Institute of Standards and Technology (NIST)

5.7.4.2. 25 KHz Channel Spacing, F3E, Frequency of All Modulation States*

Note: Due to the difficulty of measuring the Frequency Response of the internal low-pass filter, the Frequency Response of All Modulation States are performed to show the roll-off at 3 KHz in comparison with the recommended audio filter attenuation.

Frequency (KHz)	Audio In (dBV)	Audio Out (dBV)	Attenuation (Out - In) (dB)	Attenuation Rel. KHz (dB)	Recommended Attenuation (dB)
0.1	-6.64	-48.36	-41.7	-52.9	--
0.2	-6.64	-47.51	-40.9	-52.1	--
0.4	-6.64	-3.03	3.6	-7.6	--
0.6	-6.64	0.19	6.8	-4.4	--
0.8	-6.64	2.77	9.4	-1.8	--
1.0	-6.64	4.57	11.2	0.0	--
1.5	-6.64	5.08	11.7	0.5	--
2.0	-6.64	5	11.6	0.4	--
2.5	-6.64	4.95	11.6	0.4	--
3.0	-6.64	3.66	10.3	-0.9	0
3.5	-6.64	2.16	8.8	-2.4	-4
4.0	-6.64	-7.61	-1.0	-12.2	-7
4.5	-6.64	-7.62	-1.0	-12.2	-11
5.0	-6.64	-38.0	-31.4	-42.6	-13
6.0	-6.64	-58.0	-51.4	-62.6	-18
7.0	-6.64	-62.0	-55.4	-66.6	-22
8.0	-6.64	-62.0	-55.4	-66.6	-26
9.0	-6.64	-62.0	-55.4	-66.6	-29
10.0	-6.64	-62.0	-55.4	-66.6	-31
12.0	-6.64	-62.0	-55.4	-66.6	-36
14.0	-6.64	-62.0	-55.4	-66.6	-40
16.0	-6.64	-62.0	-55.4	-66.6	-44
18.0	-6.64	-62.0	-55.4	-66.6	-47
20.0	-6.64	-62.0	-55.4	-66.6	-49
22.0	-6.64	-62.0	-55.4	-66.6	-50
25.0	-6.64	-62.0	-55.4	-66.6	-50
30.0	-6.64	-62.0	-55.4	-66.6	-50
35.0	-6.64	-62.0	-55.4	-66.6	-50
40.0	-6.64	-62.0	-55.4	-66.6	-50
45.0	-6.64	-62.0	-55.4	-66.6	-50
50.0	-6.64	-62.0	-55.4	-66.6	-50

Audio Frequency Response
25 kHz Channel Spacing

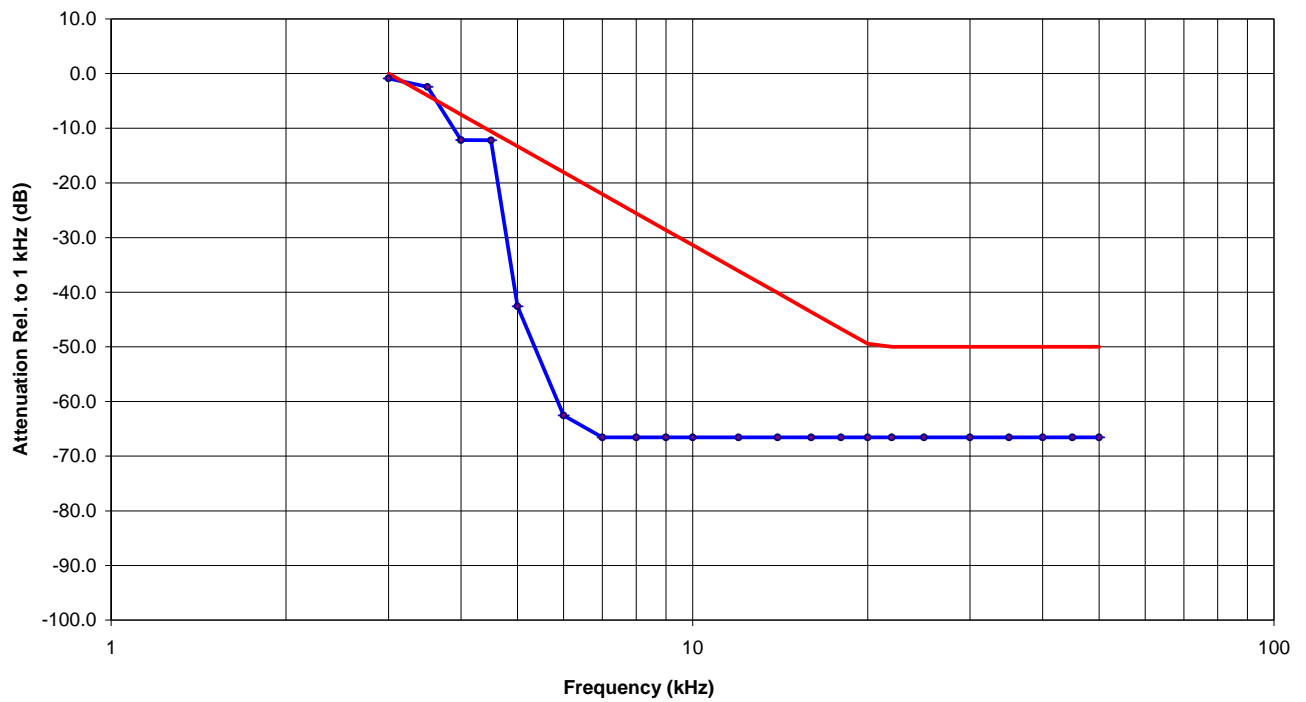

5.8. MODULATION LIMITING [§§ 2.1047(B) & 90.210]

5.8.1. Limits

Recommended frequency deviation characteristics are given below:

- 2.5 KHz for 12.5 KHz Channel Spacing System
- 5 KHz for 25 KHz Channel Spacing System

5.8.2. Method of Measurements

For Audio Transmitter: The carrier frequency deviation was measured with the tone input signal level varied from 0 Vp to audio input rating level plus 16 dB at frequencies 0.1, 0.5, 1.0, 3.0 and 5.0 KHz. The maximum deviation was recorded at each test condition.

For Data Transmitter with Maximum Frequency Deviation set by Factory: The EUT was set at maximum frequency deviation, and its peak frequency deviation was then measured using EUT's internal random data source.

5.8.3. Test Arrangement

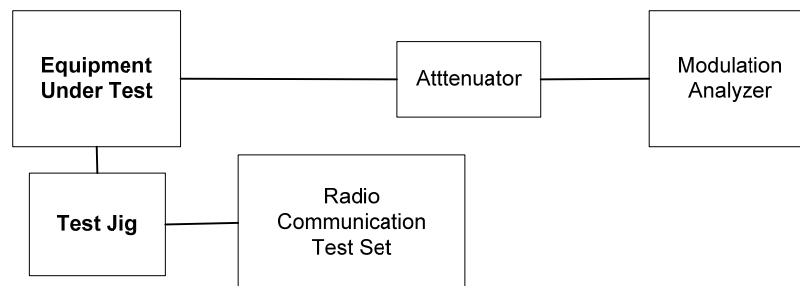

5.8.4. Test Data

5.8.4.1. Voice Modulation Limiting for 12.5 KHz Channel Spacing Operation

MODULATING SIGNAL LEVEL	PEAK FREQUENCY DEVIATION (KHz) at the following modulating frequency:					MAXIMUM LIMIT (KHz)
	0.1 KHz	0.5 KHz	1.0 KHz	3.0 KHz	5.0 KHz	
(mVrms)						
100	0.8	1.2	1.7	2.4	0.8	2.5
500	0.8	2.3	2.4	2.4	0.8	2.5
600	0.8	2.3	2.4	2.4	0.8	2.5
700	0.8	2.3	2.4	2.4	0.8	2.5
800	0.9	2.3	2.4	2.4	0.8	2.5
900	1.0	2.3	2.4	2.4	0.8	2.5
1000	1.0	2.3	2.4	2.4	0.8	2.5
1100	1.1	2.3	2.4	2.4	0.8	2.5
1200	1.1	2.3	2.4	2.4	0.8	2.5
1300	1.1	2.3	2.4	2.4	0.8	2.5
1400	1.2	2.3	2.4	2.4	0.8	2.5
1500	1.2	2.3	2.4	2.4	0.8	2.5
2000	1.5	2.3	2.4	2.4	0.8	2.5
2500	1.7	2.3	2.4	2.4	0.8	2.5
3000	1.9	2.3	2.4	2.4	0.8	2.5
3500	2.2	2.4	2.4	2.4	0.8	2.5

$$\begin{aligned} \text{Voice Signal Input Level} &= \text{STD MOD Level} + 16 \text{ dB} \\ &= 82 \text{ mVrms} + 16 \text{ dB} \\ &= 54.27 \text{ dB(mVrms)} \\ &= 517.0 \text{ mVrms} \end{aligned}$$

Modulation Frequency (KHz)	Peak Deviation (KHz)	Maximum Limit (KHz)
0.1	0.79	2.5
0.2	0.79	2.5
0.4	2.35	2.5
0.6	2.35	2.5
0.8	2.35	2.5
1.0	2.38	2.5
1.2	2.39	2.5
1.4	2.41	2.5
1.6	2.41	2.5
1.8	2.43	2.5
2.0	2.35	2.5
2.5	2.44	2.5
3.0	2.35	2.5
3.5	2.19	2.5
4.0	1.69	2.5
4.5	0.78	2.5
5.0	0.79	2.5
6.0	0.79	2.5
7.0	0.78	2.5
8.0	0.78	2.5
9.0	0.78	2.5
10.0	0.78	2.5

ULTRATECH GROUP OF LABS

3000 Bristol Circle, Oakville, Ontario, Canada L6H 6G4
 Tel. #: 905-829-1570, Fax. #: 905-829-8050, Email: vic@ultratech-labs.com, Website: <http://www.ultratech-labs.com>

File #: FSG-093_FCC90_Rev1
 June 05, 2009

- All test results contained in this engineering test report are traceable to National Institute of Standards and Technology (NIST)

5.8.4.2. Voice Modulation Limiting for 25 KHz Channel Spacing Operation

MODULATING SIGNAL LEVEL	PEAK FREQUENCY DEVIATION (KHz) at the following modulating frequency:					MAXIMUM LIMIT (KHz)
	0.1 KHz	0.5 KHz	1.0 KHz	3.0 KHz	5.0 KHz	
(mVrms)						
100	0.8	1.2	1.7	2.9	0.8	5.00
500	0.8	3.0	3.1	3.2	0.8	5.00
600	0.8	3.0	3.1	3.2	0.8	5.00
700	0.8	3.0	3.1	3.2	0.8	5.00
800	0.9	3.0	3.1	3.2	0.8	5.00
900	1.0	3.0	3.1	3.2	0.8	5.00
1000	1.1	3.0	3.1	3.2	0.8	5.00
1100	1.1	3.0	3.1	3.2	0.8	5.00
1200	1.2	3.0	3.1	3.2	0.8	5.00
1300	1.2	3.0	3.1	3.2	0.8	5.00
1400	1.2	3.0	3.1	3.2	0.8	5.00
1500	1.3	3.0	3.1	3.2	0.8	5.00
2000	1.5	3.0	3.1	3.2	0.8	5.00
2500	1.8	3.0	3.1	3.2	0.8	5.00
3000	2.1	3.0	3.1	3.2	0.8	5.00
3500	2.3	3.0	3.1	3.2	0.8	5.00

- All test results contained in this engineering test report are traceable to National Institute of Standards and Technology (NIST)

$$\begin{aligned}
 \text{Voice Signal Input Level} &= \text{STD MOD Level} + 16 \text{ dB} \\
 &= 230 \text{ mVrms} + 16 \text{ dB} \\
 &= 63.23 \text{ dB(mVrms)} \\
 &= 1450.0 \text{ mVrms}
 \end{aligned}$$

Modulation Frequency (KHz)	Peak Deviation (KHz)	Maximum Limit (KHz)
0.1	1.2	5.0
0.2	2.3	5.0
0.4	2.9	5.0
0.6	3.0	5.0
0.8	3.0	5.0
1.0	3.1	5.0
1.2	3.1	5.0
1.4	3.1	5.0
1.6	3.1	5.0
1.8	3.2	5.0
2.0	3.2	5.0
2.5	3.2	5.0
3.0	3.3	5.0
3.5	2.9	5.0
4.0	2.3	5.0
4.5	2.6	5.0
5.0	0.8	5.0
6.0	0.9	5.0
7.0	1.3	5.0
8.0	2.5	5.0
9.0	3.2	5.0
10.0	0.8	5.0

ULTRATECH GROUP OF LABS

3000 Bristol Circle, Oakville, Ontario, Canada L6H 6G4
 Tel. #: 905-829-1570, Fax. #: 905-829-8050, Email: vic@ultratech-labs.com, Website: <http://www.ultratech-labs.com>

File #: FSG-093_FCC90_Rev1
 June 05, 2009

- All test results contained in this engineering test report are traceable to National Institute of Standards and Technology (NIST)

5.8.4.3. Digital Modulation Limiting

Modulation	Peak Frequency Deviation (kHz)
F1E, F1D	3.21

- All test results contained in this engineering test report are traceable to National Institute of Standards and Technology (NIST)

5.9. OCCUPIED BANDWIDTH & EMISSION MASK [§§ 2.1049, 90.209 & 90.210]

5.9.1. Limits

§ 90.209 Bandwidth limitations: Transmitters designed to operate in 806-824 MHz and 851-869 MHz frequency bands must meet the bandwidth limitations in this section.

Emissions shall be attenuated below the mean output power of the transmitter as follows:

Frequency Range (MHz)	Channel Spacing (KHz)	Maximum Authorized BW (KHz)	Recommended Frequency Deviation (KHz)	FCC Applicable Mask
809-824/854-869	25.0	20.0	5.0	Mask B & G
806-809/851-854	12.5	20.0	2.5	Mask B & H

5.9.2. Method of Measurements

Refer to Section 8.4 of this report for measurement details and TIA 603-C.

5.9.3. Test Arrangement

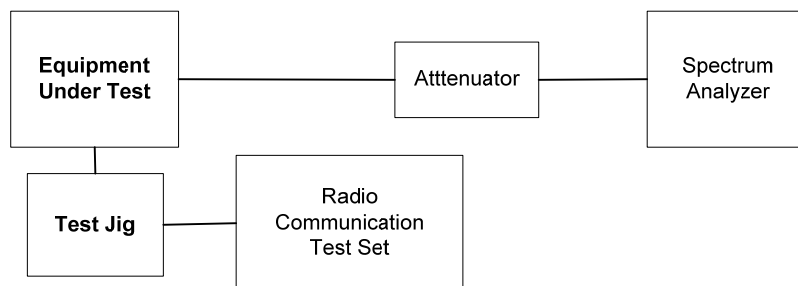

5.9.4. Test Data

5.9.4.1. 99% Occupied Bandwidth

Frequency (MHz)	Channel Spacing (KHz)	Modulation	*Measured 99% OBW at Maximum Freq. Deviation (KHz)	Maximum Authorized Bandwidth (KHz)
809.025	25	16K0F3E	10.46	20.0
816.500	25	16K0F3E	10.40	20.0
823.975	25	16K0F3E	10.40	20.0
854.025	25	16K0F3E	10.52	20.0
861.500	25	16K0F3E	10.52	20.0
868.975	25	16K0F3E	10.52	20.0
806.025	12.5	11K0F3E	9.86	11.25
821.025	12.5	11K0F3E	9.86	11.25
823.975	12.5	11K0F3E	9.86	11.25
851.025	12.5	11K0F3E	9.86	11.25
866.025	12.5	11K0F3E	9.86	11.25
868.975	12.5	11K0F3E	9.86	11.25
809.025	12.5	8K10F1E, 8K10F1D (Digital)	8.22	11.25
816.500	12.5	8K10F1E, 8K10F1D (Digital)	8.14	11.25
823.975	12.5	8K10F1E, 8K10F1D (Digital)	8.30	11.25
854.025	12.5	8K10F1E, 8K10F1D (Digital)	8.26	11.25
861.500	12.5	8K10F1E, 8K10F1D (Digital)	8.30	11.25
868.975	12.5	8K10F1E, 8K10F1D (Digital)	8.26	11.25

Note: 99% Occupied Bandwidth measurements were done using the built-in auto function of the analyzer.

*Refer to the following test data plots (1 through 18) for details.

Plot # 1:
 Occupied Bandwidth
 Carrier Frequency: 809.025 MHz
 Channel Spacing: 25.0 KHz
 Power: 3 W
 Modulation: 16K0F3E with 2.5 KHz sine wave signal

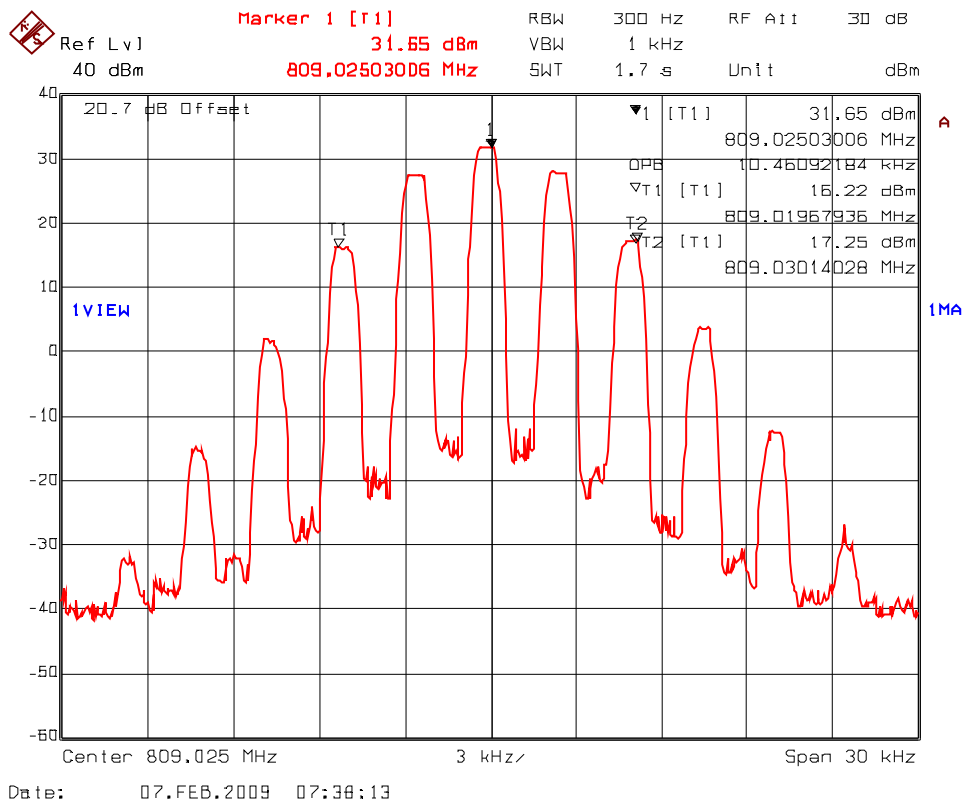

ULTRATECH GROUP OF LABS

3000 Bristol Circle, Oakville, Ontario, Canada L6H 6G4
 Tel. #: 905-829-1570, Fax. #: 905-829-8050, Email: vic@ultratech-labs.com, Website: <http://www.ultratech-labs.com>

File #: FSG-093_FCC90_Rev1
 June 05, 2009

- All test results contained in this engineering test report are traceable to National Institute of Standards and Technology (NIST)

Plot # 2.:
 Occupied Bandwidth
 Carrier Frequency: 816.500 MHz
 Channel Spacing: 25.0 KHz
 Power: 3 W
 Modulation: 16K0F3E with 2.5 KHz sine wave signal

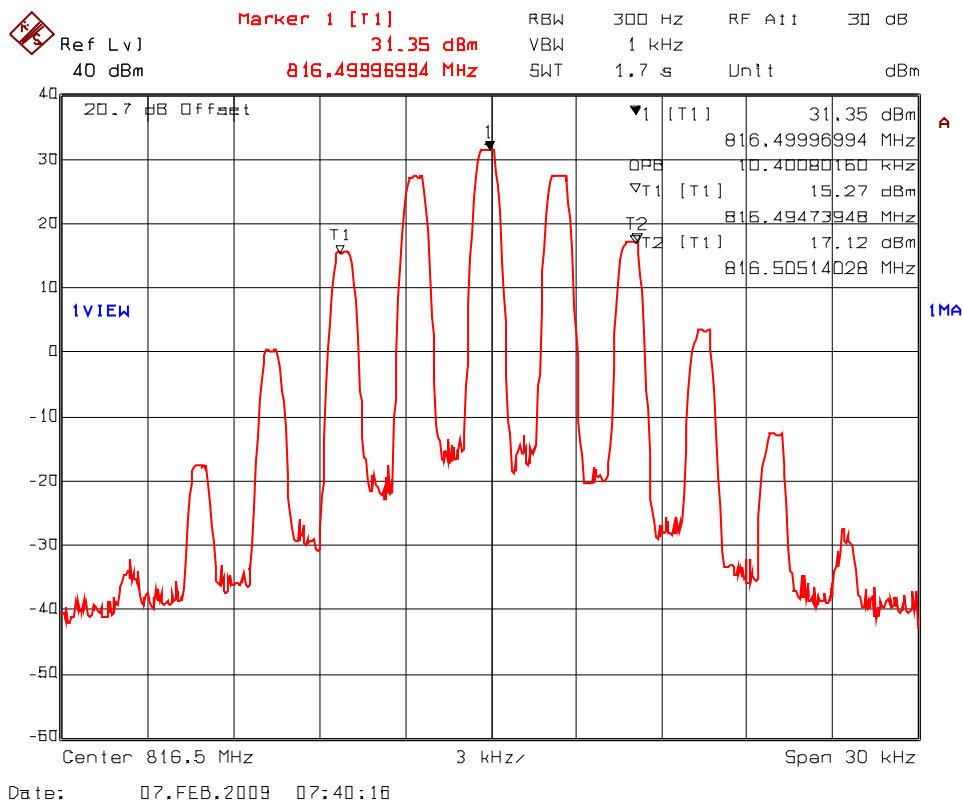

ULTRATECH GROUP OF LABS

3000 Bristol Circle, Oakville, Ontario, Canada L6H 6G4
 Tel. #: 905-829-1570, Fax. #: 905-829-8050, Email: vic@ultratech-labs.com, Website: <http://www.ultratech-labs.com>

File #: FSG-093_FCC90_Rev1
 June 05, 2009

- All test results contained in this engineering test report are traceable to National Institute of Standards and Technology (NIST)

Plot # 3.:
 Occupied Bandwidth
 Carrier Frequency: 823.975 MHz
 Channel Spacing: 25.0 KHz
 Power: 3 W
 Modulation: 16K0F3E with 2.5 KHz sine wave signal

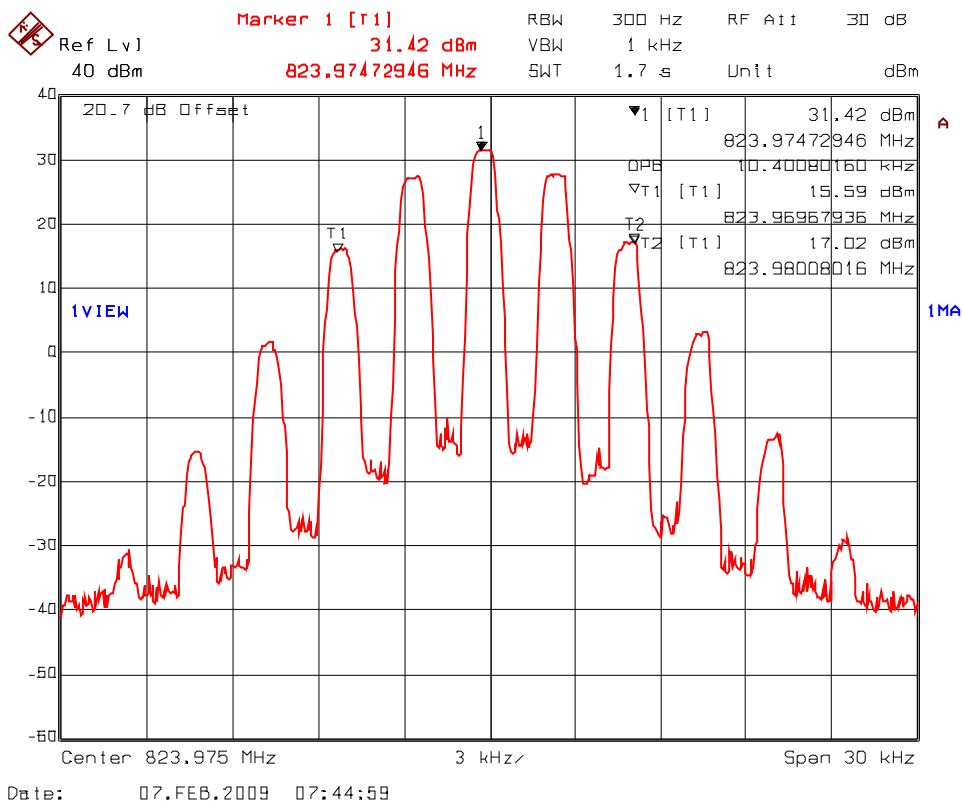

ULTRATECH GROUP OF LABS

3000 Bristol Circle, Oakville, Ontario, Canada L6H 6G4
 Tel. #: 905-829-1570, Fax. #: 905-829-8050, Email: vic@ultratech-labs.com, Website: <http://www.ultratech-labs.com>

File #: FSG-093_FCC90_Rev1
 June 05, 2009

- All test results contained in this engineering test report are traceable to National Institute of Standards and Technology (NIST)

Plot # 4.:
 Occupied Bandwidth
 Carrier Frequency: 854.025 MHz
 Channel Spacing: 25.0 KHz
 Power: 3 W
 Modulation: 16K0F3E with 2.5 KHz sine wave signal

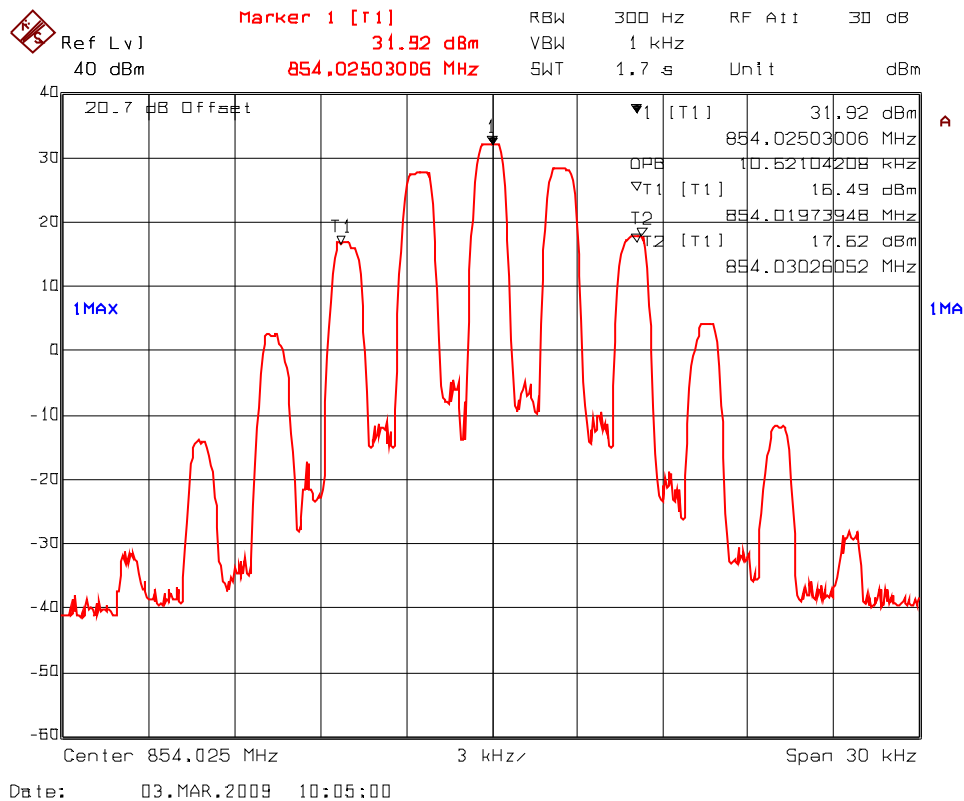

ULTRATECH GROUP OF LABS

3000 Bristol Circle, Oakville, Ontario, Canada L6H 6G4
 Tel. #: 905-829-1570, Fax. #: 905-829-8050, Email: vic@ultratech-labs.com, Website: <http://www.ultratech-labs.com>

File #: FSG-093_FCC90_Rev1
 June 05, 2009

- All test results contained in this engineering test report are traceable to National Institute of Standards and Technology (NIST)

Plot # 5.:
 Occupied Bandwidth
 Carrier Frequency: 861.500 MHz
 Channel Spacing: 25.0 KHz
 Power: 3 W
 Modulation: 16K0F3E with 2.5 KHz sine wave signal

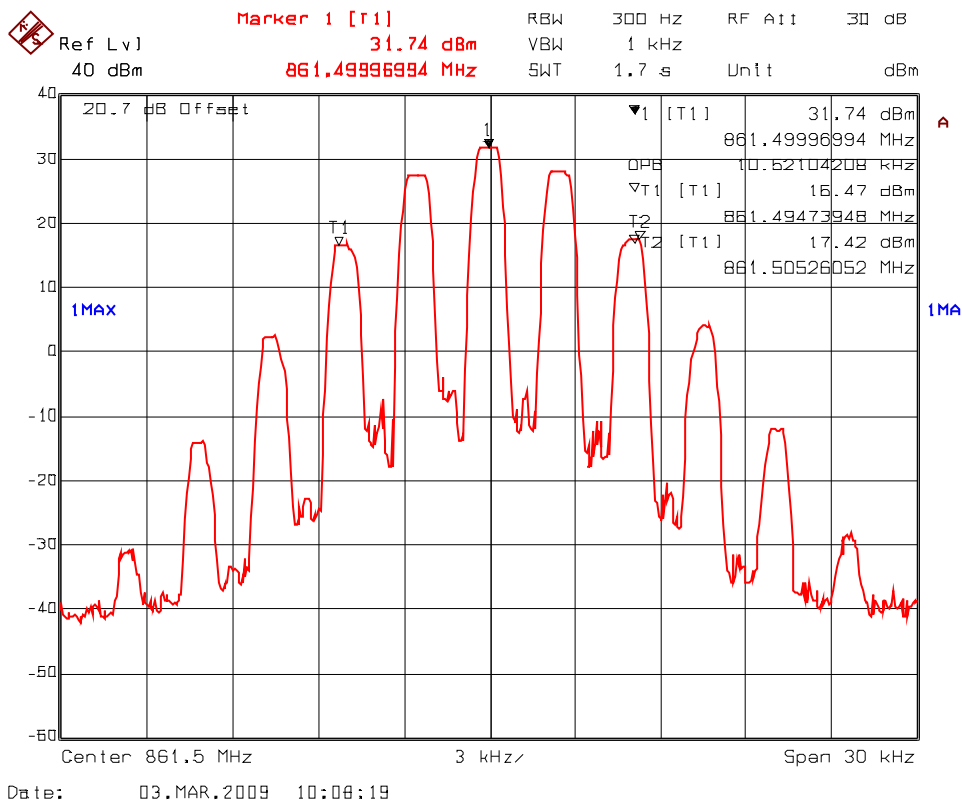

ULTRATECH GROUP OF LABS

3000 Bristol Circle, Oakville, Ontario, Canada L6H 6G4
 Tel. #: 905-829-1570, Fax. #: 905-829-8050, Email: vic@ultratech-labs.com, Website: <http://www.ultratech-labs.com>

File #: FSG-093_FCC90_Rev1
 June 05, 2009

- All test results contained in this engineering test report are traceable to National Institute of Standards and Technology (NIST)

Plot # 6.:
 Occupied Bandwidth
 Carrier Frequency: 868.975 MHz
 Channel Spacing: 25.0 KHz
 Power: 3 W
 Modulation: 16K0F3E with 2.5 KHz sine wave signal

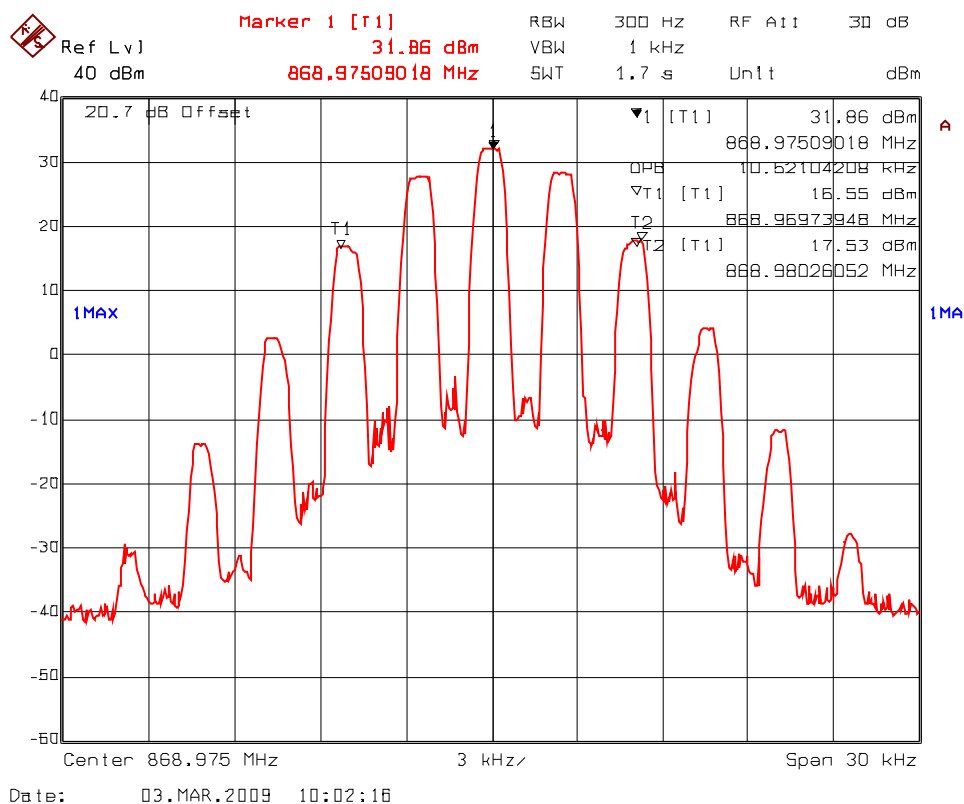

Plot # 7.:
 Occupied Bandwidth
 Carrier Frequency: 806.025 MHz
 Channel Spacing: 12.5 KHz
 Power: 3 W
 Modulation: 11K0F3E with 2.5 KHz sine wave signal

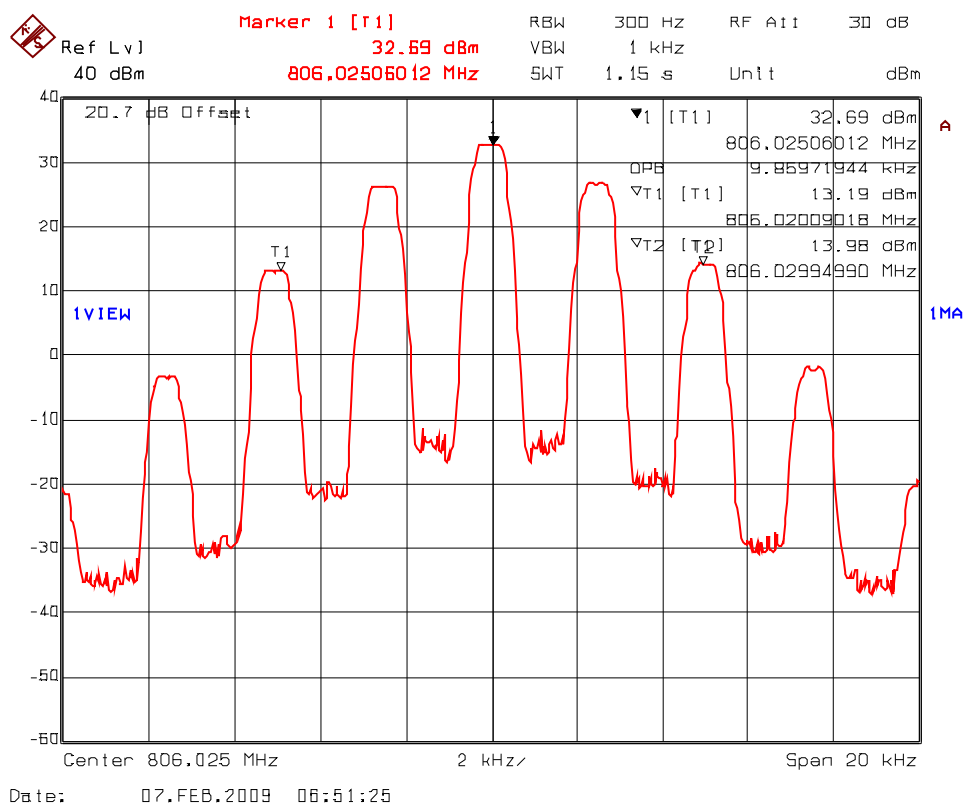

ULTRATECH GROUP OF LABS

3000 Bristol Circle, Oakville, Ontario, Canada L6H 6G4
 Tel. #: 905-829-1570, Fax. #: 905-829-8050, Email: vic@ultratech-labs.com, Website: <http://www.ultratech-labs.com>

File #: FSG-093_FCC90_Rev1
 June 05, 2009

- All test results contained in this engineering test report are traceable to National Institute of Standards and Technology (NIST)

Plot # 8.:
 Occupied Bandwidth
 Carrier Frequency: 821.025 MHz
 Channel Spacing: 12.5 KHz
 Power: 3 W
 Modulation: 11K0F3E with 2.5 KHz sine wave signal

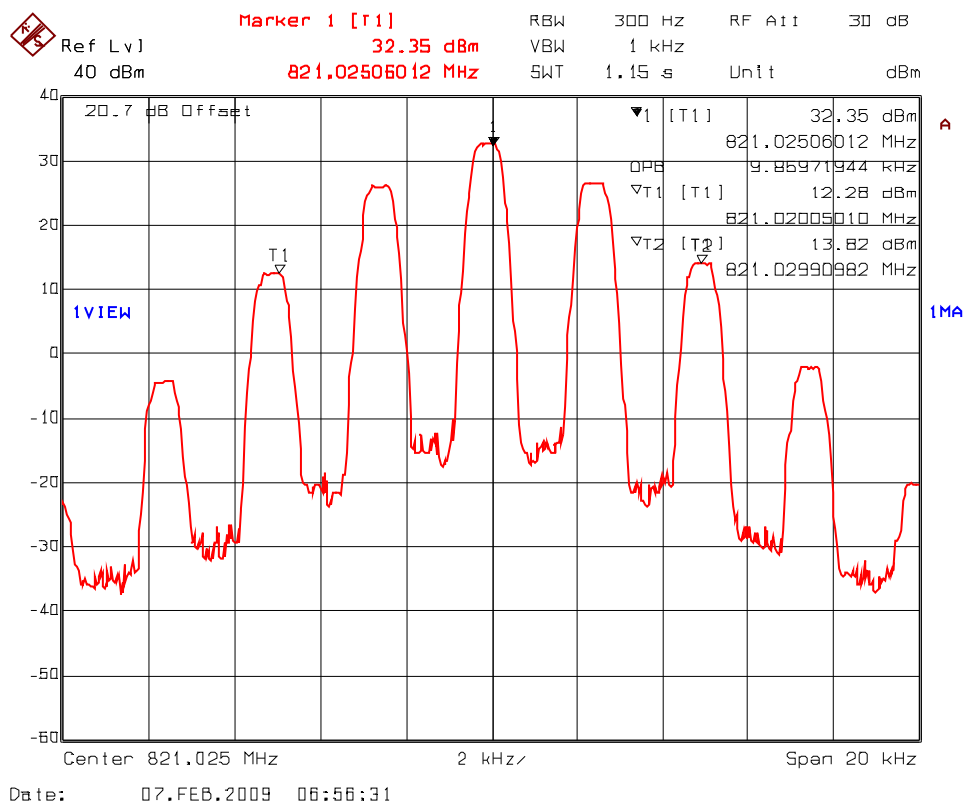

ULTRATECH GROUP OF LABS

3000 Bristol Circle, Oakville, Ontario, Canada L6H 6G4
 Tel. #: 905-829-1570, Fax. #: 905-829-8050, Email: vic@ultratech-labs.com, Website: <http://www.ultratech-labs.com>

File #: FSG-093_FCC90_Rev1
 June 05, 2009

- All test results contained in this engineering test report are traceable to National Institute of Standards and Technology (NIST)

Plot # 9:
 Occupied Bandwidth
 Carrier Frequency: 823.975 MHz
 Channel Spacing: 12.5 KHz
 Power: 3 W
 Modulation: 11K0F3E with 2.5 KHz sine wave signal

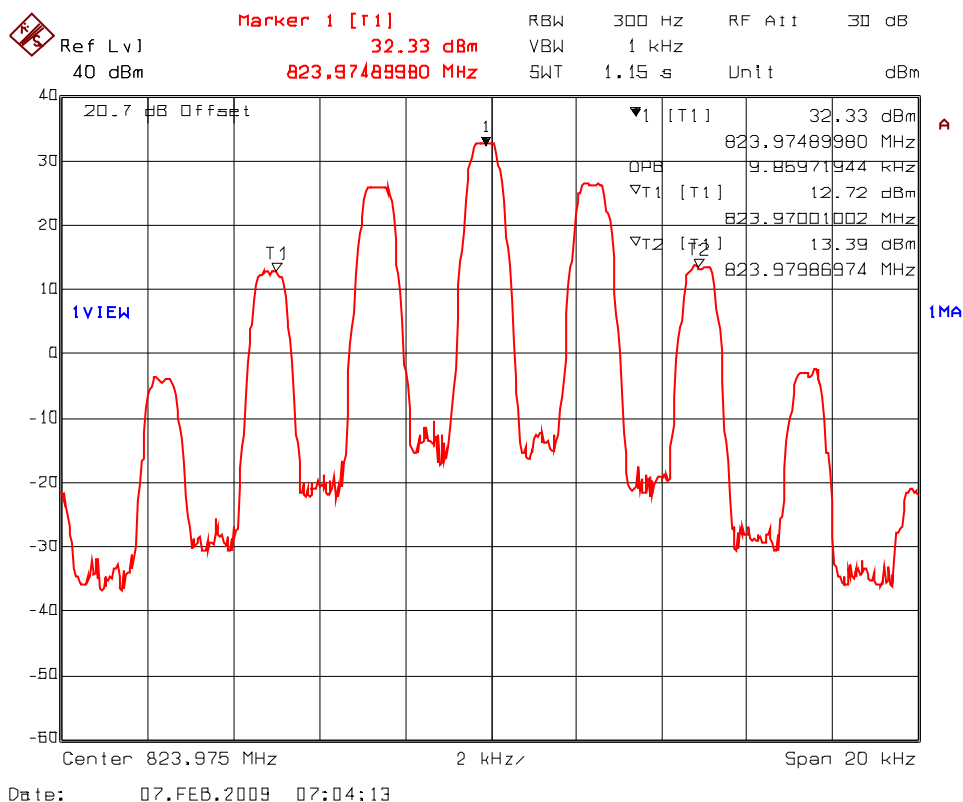

ULTRATECH GROUP OF LABS

3000 Bristol Circle, Oakville, Ontario, Canada L6H 6G4
 Tel. #: 905-829-1570, Fax. #: 905-829-8050, Email: vic@ultratech-labs.com, Website: <http://www.ultratech-labs.com>

File #: FSG-093_FCC90_Rev1
 June 05, 2009

- All test results contained in this engineering test report are traceable to National Institute of Standards and Technology (NIST)

Plot # 10.:
 Occupied Bandwidth
 Carrier Frequency: 851.025 MHz
 Channel Spacing: 12.5 KHz
 Power: 3 W
 Modulation: 11K0F3E with 2.5 KHz sine wave signal

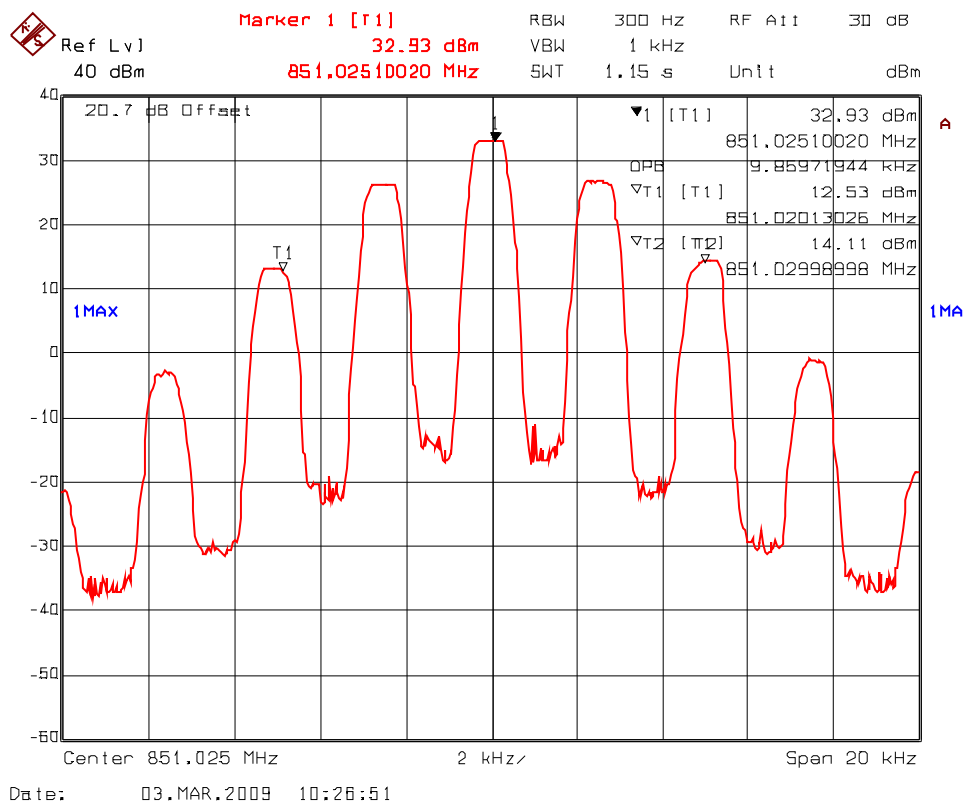

ULTRATECH GROUP OF LABS

3000 Bristol Circle, Oakville, Ontario, Canada L6H 6G4
 Tel. #: 905-829-1570, Fax. #: 905-829-8050, Email: vic@ultratech-labs.com, Website: <http://www.ultratech-labs.com>

File #: FSG-093_FCC90_Rev1
 June 05, 2009

- All test results contained in this engineering test report are traceable to National Institute of Standards and Technology (NIST)

Plot # 11.:
 Occupied Bandwidth
 Carrier Frequency: 866.025 MHz
 Channel Spacing: 12.5 KHz
 Power: 3 W
 Modulation: 11K0F3E with 2.5 KHz sine wave signal

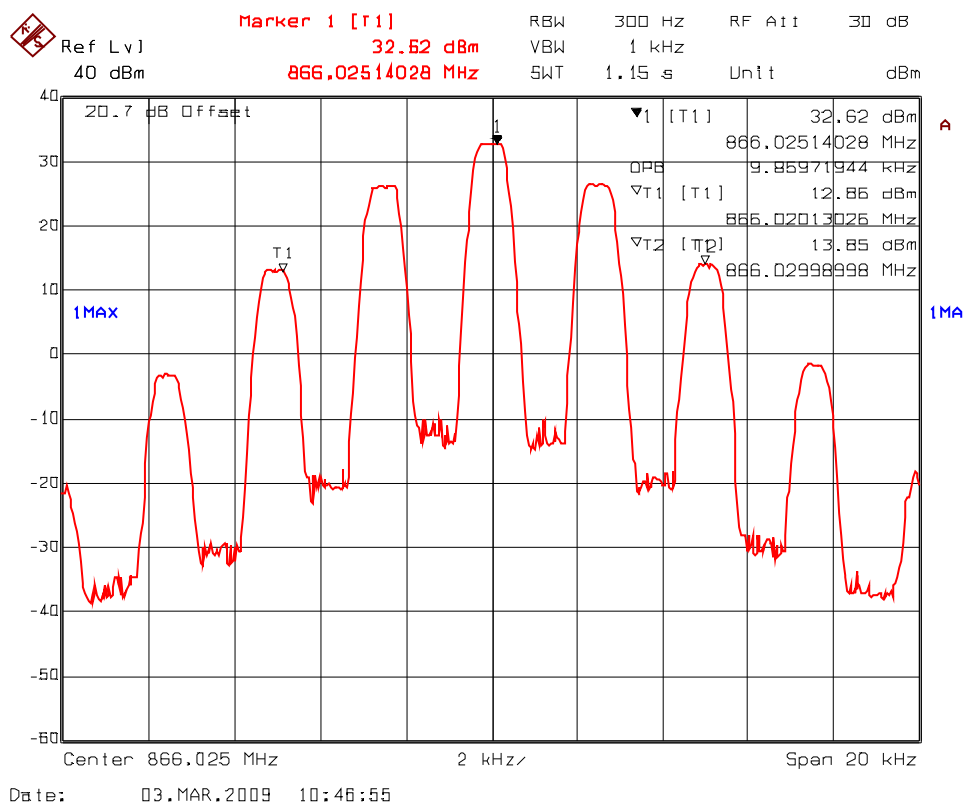

ULTRATECH GROUP OF LABS

3000 Bristol Circle, Oakville, Ontario, Canada L6H 6G4
 Tel. #: 905-829-1570, Fax. #: 905-829-8050, Email: vic@ultratech-labs.com, Website: <http://www.ultratech-labs.com>

File #: FSG-093_FCC90_Rev1
 June 05, 2009

- All test results contained in this engineering test report are traceable to National Institute of Standards and Technology (NIST)

Plot # 12.:
 Occupied Bandwidth
 Carrier Frequency: 868.975 MHz
 Channel Spacing: 12.5 KHz
 Power: 3 W
 Modulation: 11K0F3E with 2.5 KHz sine wave signal

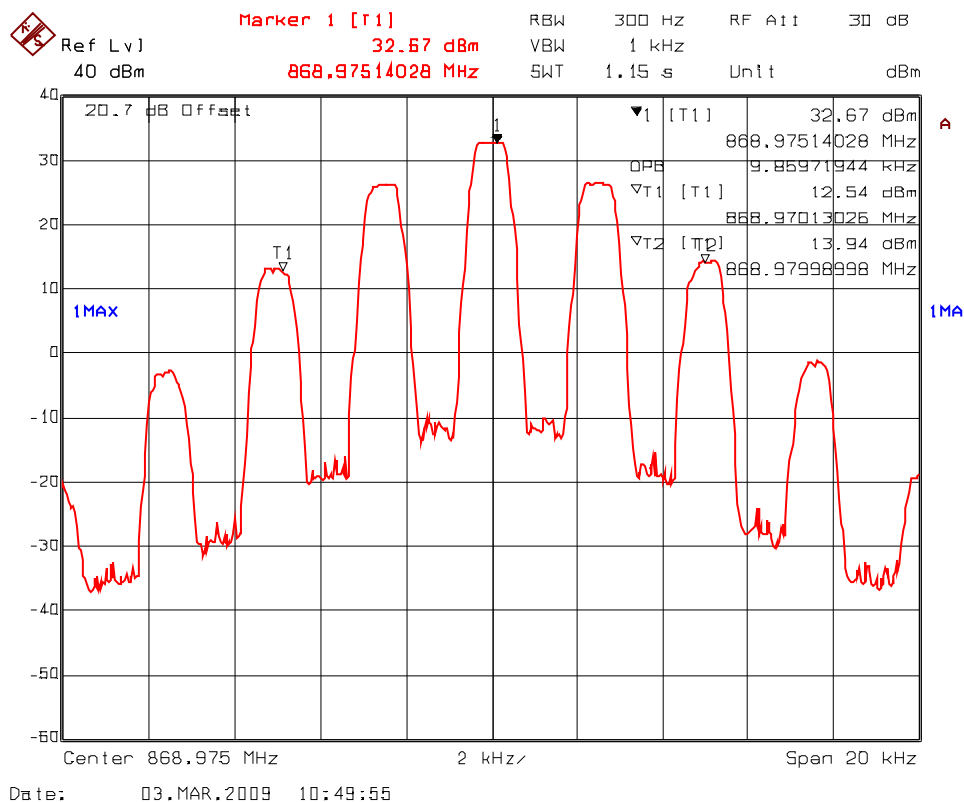

ULTRATECH GROUP OF LABS

3000 Bristol Circle, Oakville, Ontario, Canada L6H 6G4
 Tel. #: 905-829-1570, Fax. #: 905-829-8050, Email: vic@ultratech-labs.com, Website: <http://www.ultratech-labs.com>

File #: FSG-093_FCC90_Rev1
 June 05, 2009

- All test results contained in this engineering test report are traceable to National Institute of Standards and Technology (NIST)

Plot # 13.:
 Occupied Bandwidth
 Carrier Frequency: 809.025 MHz
 Channel Spacing: 12.5 KHz
 Power: 3 W
 Modulation: 8K10F1E, 8K10F1D (Digital)

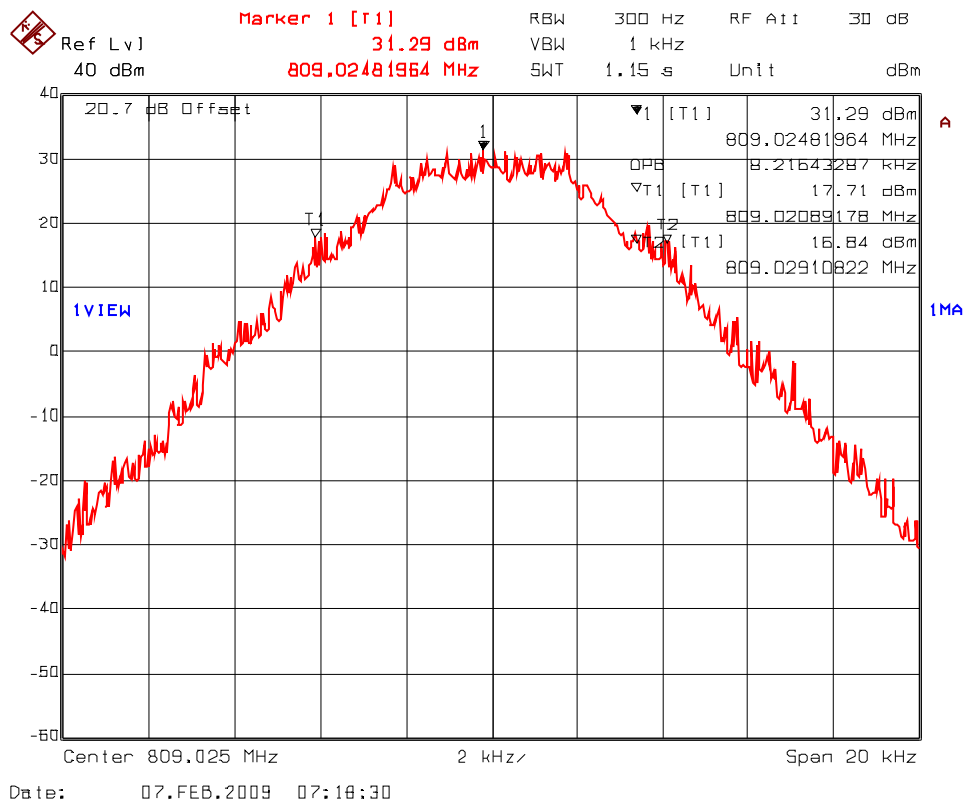

ULTRATECH GROUP OF LABS

3000 Bristol Circle, Oakville, Ontario, Canada L6H 6G4
 Tel. #: 905-829-1570, Fax. #: 905-829-8050, Email: vic@ultratech-labs.com, Website: <http://www.ultratech-labs.com>

File #: FSG-093_FCC90_Rev1
 June 05, 2009

- All test results contained in this engineering test report are traceable to National Institute of Standards and Technology (NIST)

Plot # 14.:
 Occupied Bandwidth
 Carrier Frequency: 816.500 MHz
 Channel Spacing: 12.5 KHz
 Power: 3 W
 Modulation: 8K10F1E, 8K10F1D (Digital)

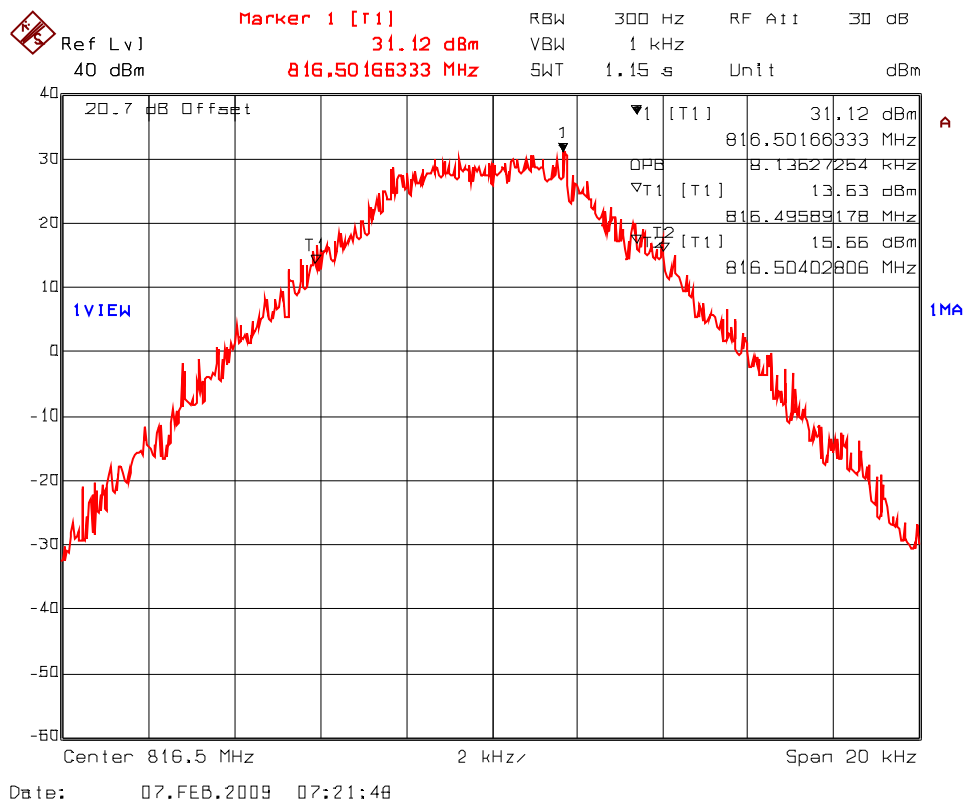

ULTRATECH GROUP OF LABS

3000 Bristol Circle, Oakville, Ontario, Canada L6H 6G4
 Tel. #: 905-829-1570, Fax. #: 905-829-8050, Email: vic@ultratech-labs.com, Website: <http://www.ultratech-labs.com>

File #: FSG-093_FCC90_Rev1
 June 05, 2009

- All test results contained in this engineering test report are traceable to National Institute of Standards and Technology (NIST)

Plot # 15.:
 Occupied Bandwidth
 Carrier Frequency: 823.975 MHz
 Channel Spacing: 12.5 KHz
 Power: 3 W
 Modulation: 8K10F1E, 8K10F1D (Digital)

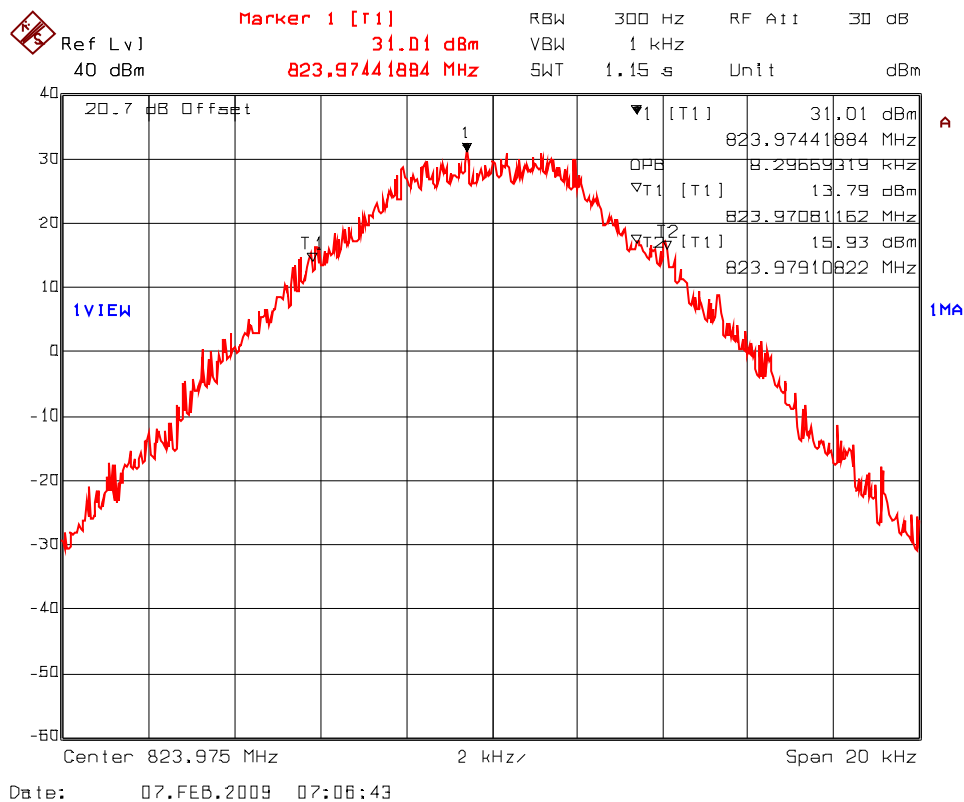

ULTRATECH GROUP OF LABS

3000 Bristol Circle, Oakville, Ontario, Canada L6H 6G4
 Tel. #: 905-829-1570, Fax. #: 905-829-8050, Email: vic@ultratech-labs.com, Website: <http://www.ultratech-labs.com>

File #: FSG-093_FCC90_Rev1
 June 05, 2009

- All test results contained in this engineering test report are traceable to National Institute of Standards and Technology (NIST)

Plot # 16.:
 Occupied Bandwidth
 Carrier Frequency: 854.025 MHz
 Channel Spacing: 12.5 KHz
 Power: 3 W
 Modulation: 8K10F1E, 8K10F1D (Digital)

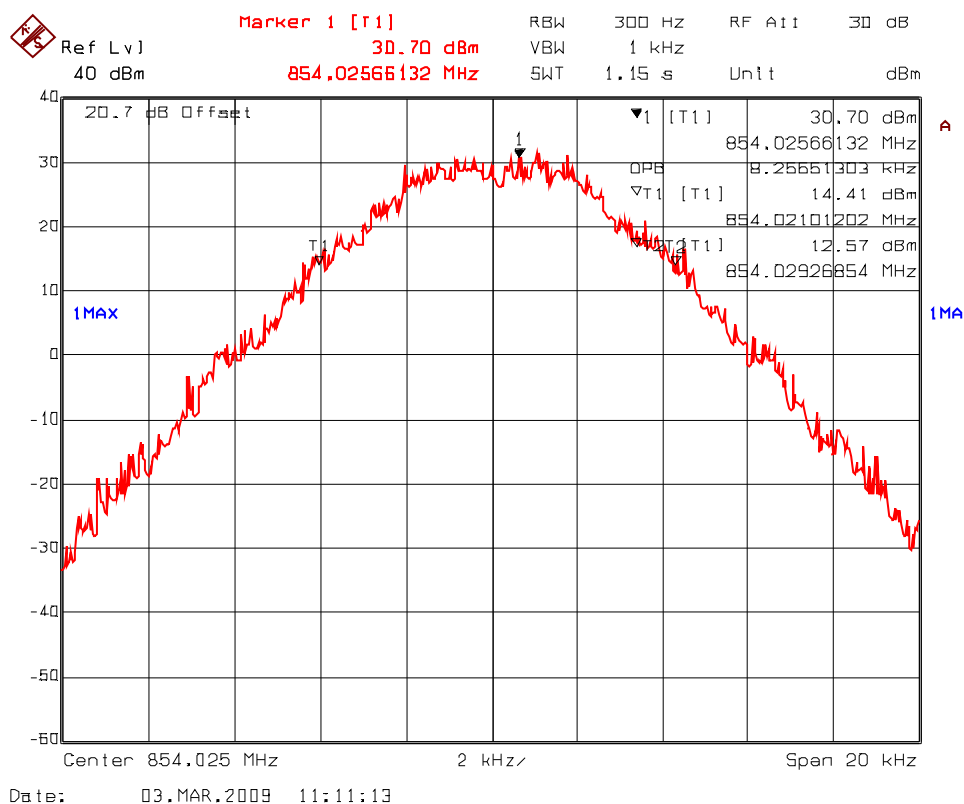

ULTRATECH GROUP OF LABS

3000 Bristol Circle, Oakville, Ontario, Canada L6H 6G4
 Tel. #: 905-829-1570, Fax. #: 905-829-8050, Email: vic@ultratech-labs.com, Website: <http://www.ultratech-labs.com>

File #: FSG-093_FCC90_Rev1
 June 05, 2009

- All test results contained in this engineering test report are traceable to National Institute of Standards and Technology (NIST)

Plot # 17.:
 Occupied Bandwidth
 Carrier Frequency: 861.500 MHz
 Channel Spacing: 12.5 KHz
 Power: 3 W
 Modulation: 8K10F1E, 8K10F1D (Digital)

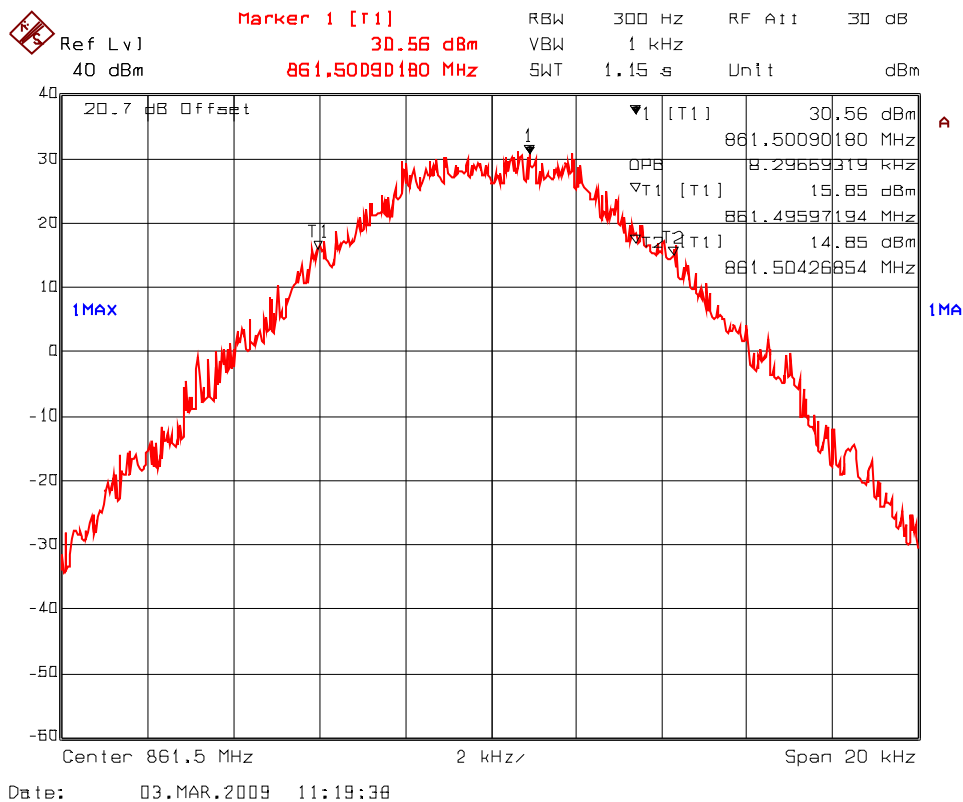

ULTRATECH GROUP OF LABS

3000 Bristol Circle, Oakville, Ontario, Canada L6H 6G4
 Tel. #: 905-829-1570, Fax. #: 905-829-8050, Email: vic@ultratech-labs.com, Website: <http://www.ultratech-labs.com>

File #: FSG-093_FCC90_Rev1
 June 05, 2009

- All test results contained in this engineering test report are traceable to National Institute of Standards and Technology (NIST)

Plot # 18.:
 Occupied Bandwidth
 Carrier Frequency: 868.975 MHz
 Channel Spacing: 12.5 KHz
 Power: 3 W
 Modulation: 8K10F1E, 8K10F1D (Digital)

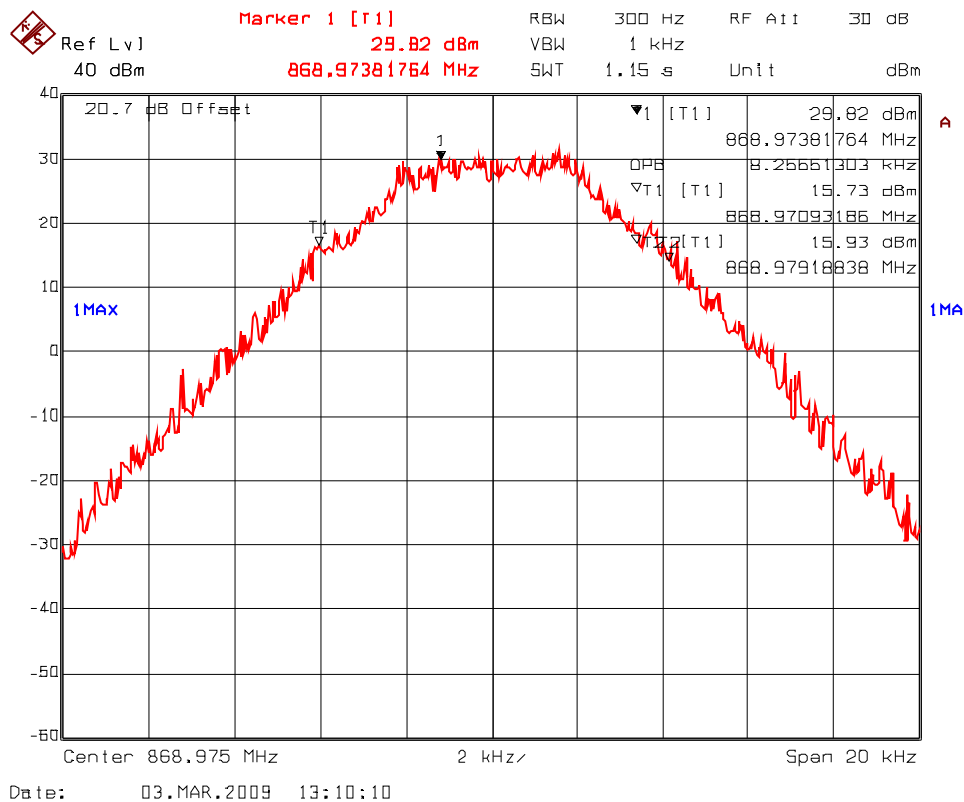

ULTRATECH GROUP OF LABS

3000 Bristol Circle, Oakville, Ontario, Canada L6H 6G4
 Tel. #: 905-829-1570, Fax. #: 905-829-8050, Email: vic@ultratech-labs.com, Website: <http://www.ultratech-labs.com>

File #: FSG-093_FCC90_Rev1
 June 05, 2009

- All test results contained in this engineering test report are traceable to National Institute of Standards and Technology (NIST)

5.9.4.2. Emission Masks

Conform. See the following test data plots (19 through 58) for details.

Plot # 19.:
Emission Mask B
Carrier Frequency: 809.025 MHz
Channel Spacing: 25 KHz
Power: 3 W
Modulation: 16K0F3E with 2.5KHz sine wave

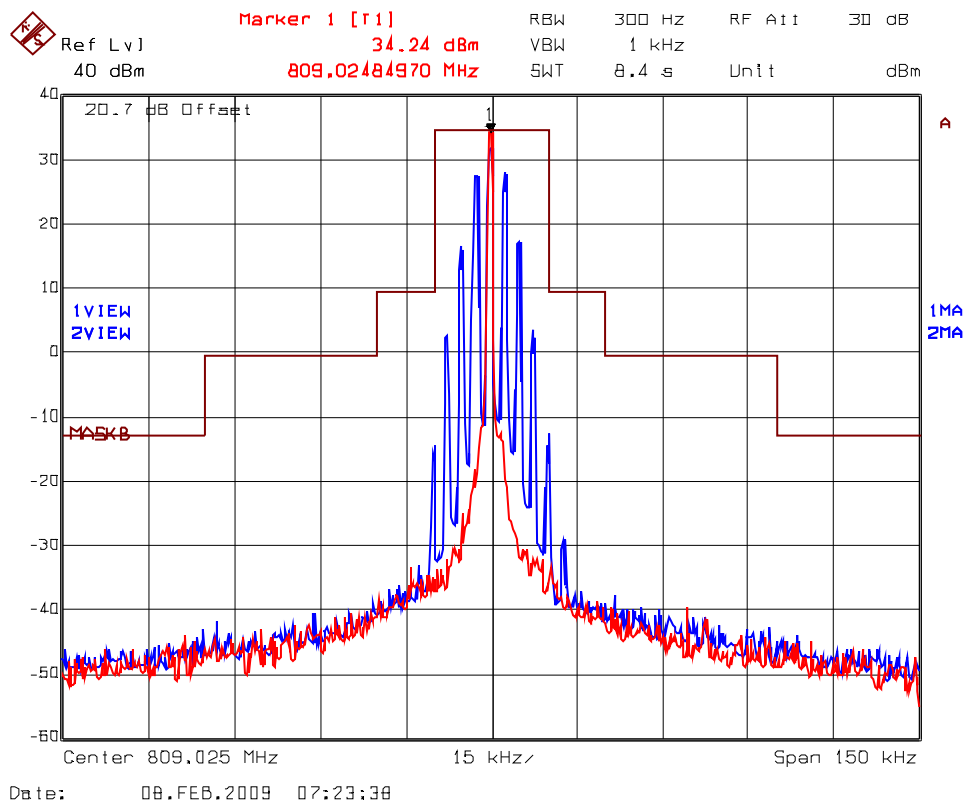

ULTRATECH GROUP OF LABS

3000 Bristol Circle, Oakville, Ontario, Canada L6H 6G4
Tel. #: 905-829-1570, Fax. #: 905-829-8050, Email: vic@ultratech-labs.com, Website: <http://www.ultratech-labs.com>

File #: FSG-093_FCC90_Rev1
June 05, 2009

- All test results contained in this engineering test report are traceable to National Institute of Standards and Technology (NIST)

Plot # 20.:
Emission Mask B
Carrier Frequency: 816.500 MHz
Channel Spacing: 25 KHz
Power: 3 W
Modulation: 16K0F3E with 2.5KHz sine wave

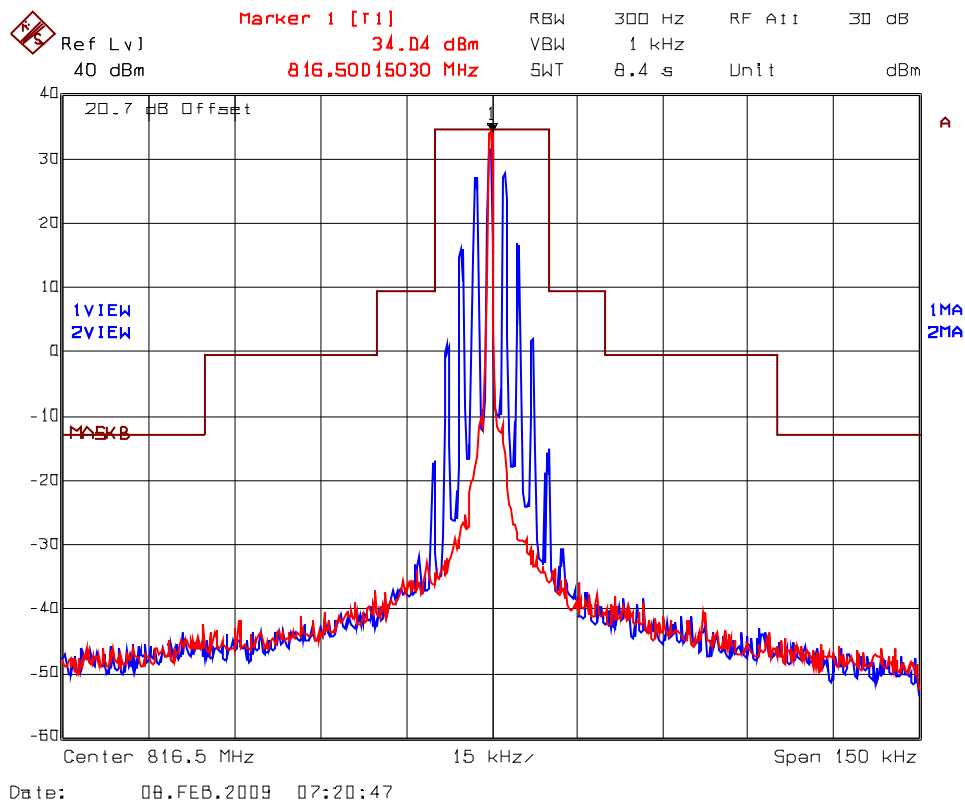

ULTRATECH GROUP OF LABS

3000 Bristol Circle, Oakville, Ontario, Canada L6H 6G4
Tel. #: 905-829-1570, Fax. #: 905-829-8050, Email: vic@ultratech-labs.com, Website: <http://www.ultratech-labs.com>

File #: FSG-093_FCC90_Rev1
June 05, 2009

- All test results contained in this engineering test report are traceable to National Institute of Standards and Technology (NIST)

Plot # 21.:
Emission Mask B
Carrier Frequency: 823.975 MHz
Channel Spacing: 25 KHz
Power: 3 W
Modulation: 16K0F3E with 2.5KHz sine wave

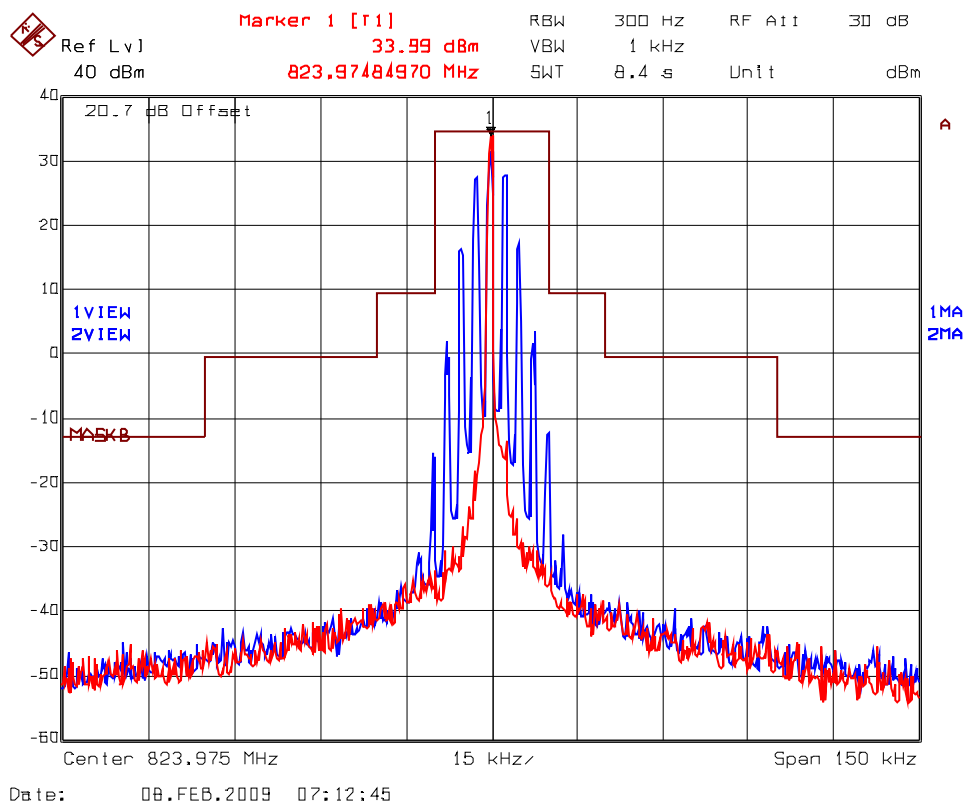

ULTRATECH GROUP OF LABS

3000 Bristol Circle, Oakville, Ontario, Canada L6H 6G4
Tel. #: 905-829-1570, Fax. #: 905-829-8050, Email: vic@ultratech-labs.com, Website: <http://www.ultratech-labs.com>

File #: FSG-093_FCC90_Rev1
June 05, 2009

- All test results contained in this engineering test report are traceable to National Institute of Standards and Technology (NIST)

Plot # 22.:
Emission Mask B
Carrier Frequency: 854.025 MHz
Channel Spacing: 25 KHz
Power: 3 W
Modulation: 16K0F3E with 2.5KHz sine wave

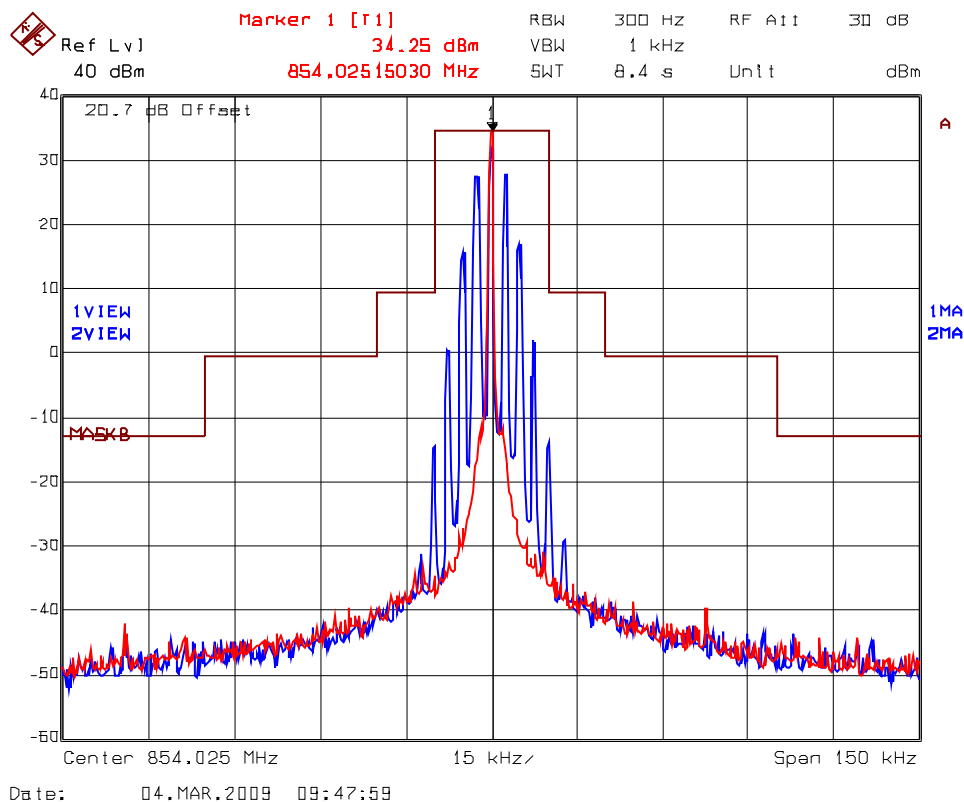

ULTRATECH GROUP OF LABS

3000 Bristol Circle, Oakville, Ontario, Canada L6H 6G4
Tel. #: 905-829-1570, Fax. #: 905-829-8050, Email: vic@ultratech-labs.com, Website: <http://www.ultratech-labs.com>

File #: FSG-093_FCC90_Rev1
June 05, 2009

- All test results contained in this engineering test report are traceable to National Institute of Standards and Technology (NIST)

Plot # 23.:
Emission Mask B
Carrier Frequency: 861.500 MHz
Channel Spacing: 25 KHz
Power: 3 W
Modulation: 16K0F3E with 2.5KHz sine wave

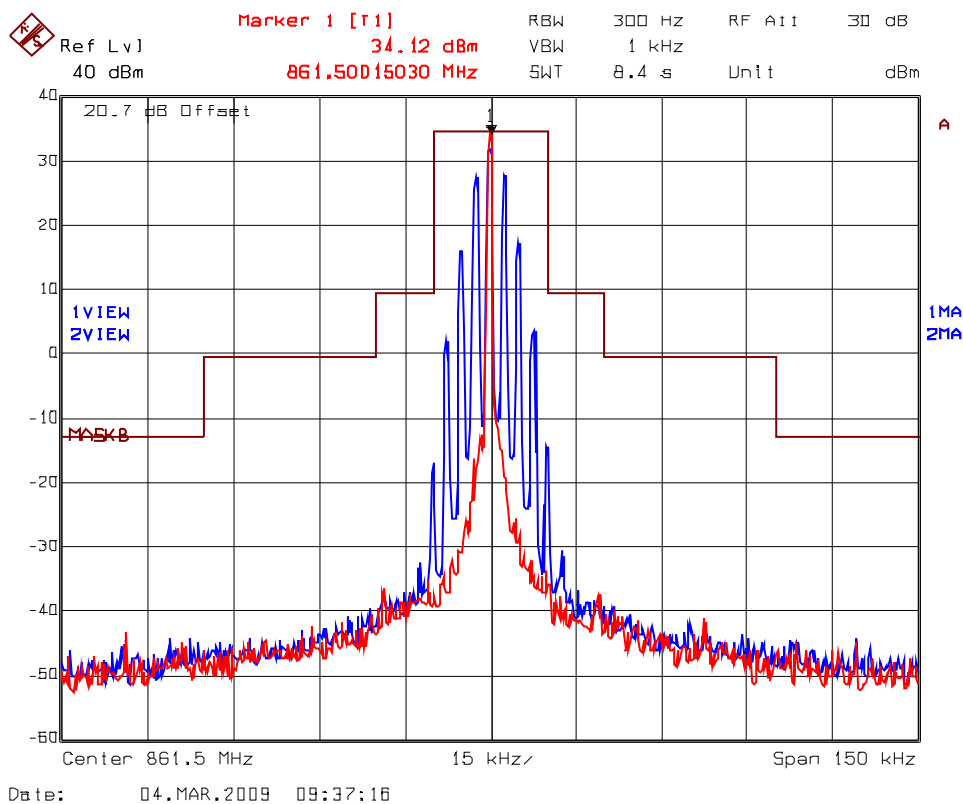

ULTRATECH GROUP OF LABS

3000 Bristol Circle, Oakville, Ontario, Canada L6H 6G4
Tel. #: 905-829-1570, Fax. #: 905-829-8050, Email: vic@ultratech-labs.com, Website: <http://www.ultratech-labs.com>

File #: FSG-093_FCC90_Rev1
June 05, 2009

- All test results contained in this engineering test report are traceable to National Institute of Standards and Technology (NIST)

Plot # 24.:
Emission Mask B
Carrier Frequency: 868.975 MHz
Channel Spacing: 25 KHz
Power: 3 W
Modulation: 16K0F3E with 2.5KHz sine wave

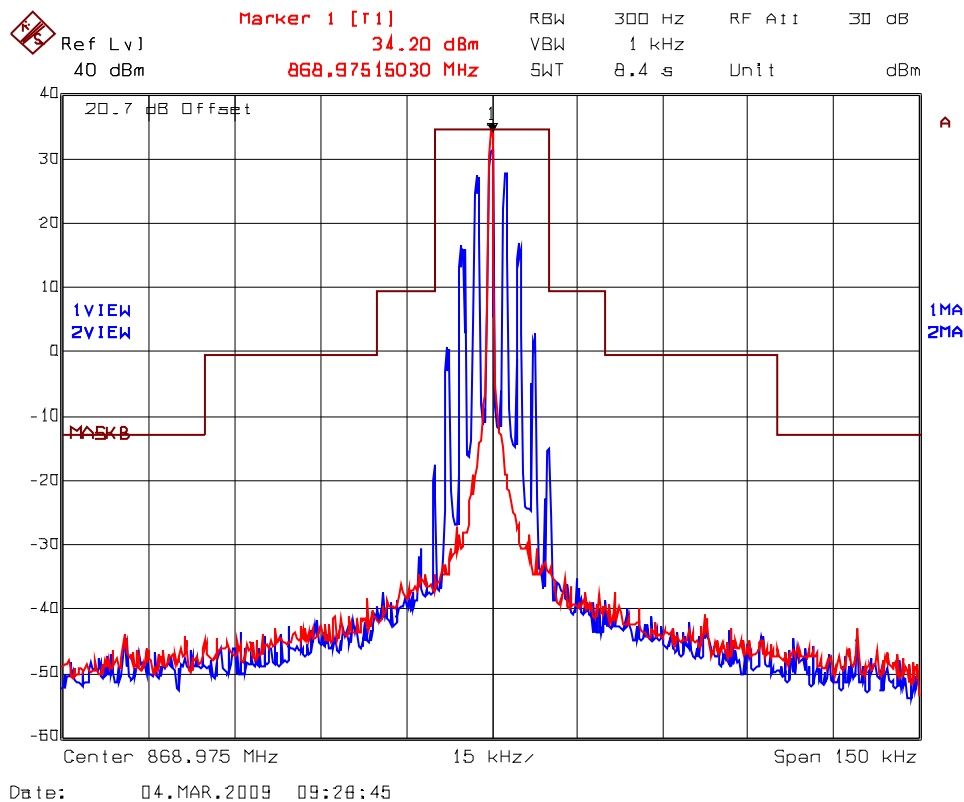

ULTRATECH GROUP OF LABS

3000 Bristol Circle, Oakville, Ontario, Canada L6H 6G4
Tel. #: 905-829-1570, Fax. #: 905-829-8050, Email: vic@ultratech-labs.com, Website: <http://www.ultratech-labs.com>

File #: FSG-093_FCC90_Rev1
June 05, 2009

- All test results contained in this engineering test report are traceable to National Institute of Standards and Technology (NIST)

Plot # 25.:
Emission Mask B
Carrier Frequency: 809.025 MHz
Channel Spacing: 25 KHz
Power: 0.3 W
Modulation: 16K0F3E with 2.5KHz sine wave

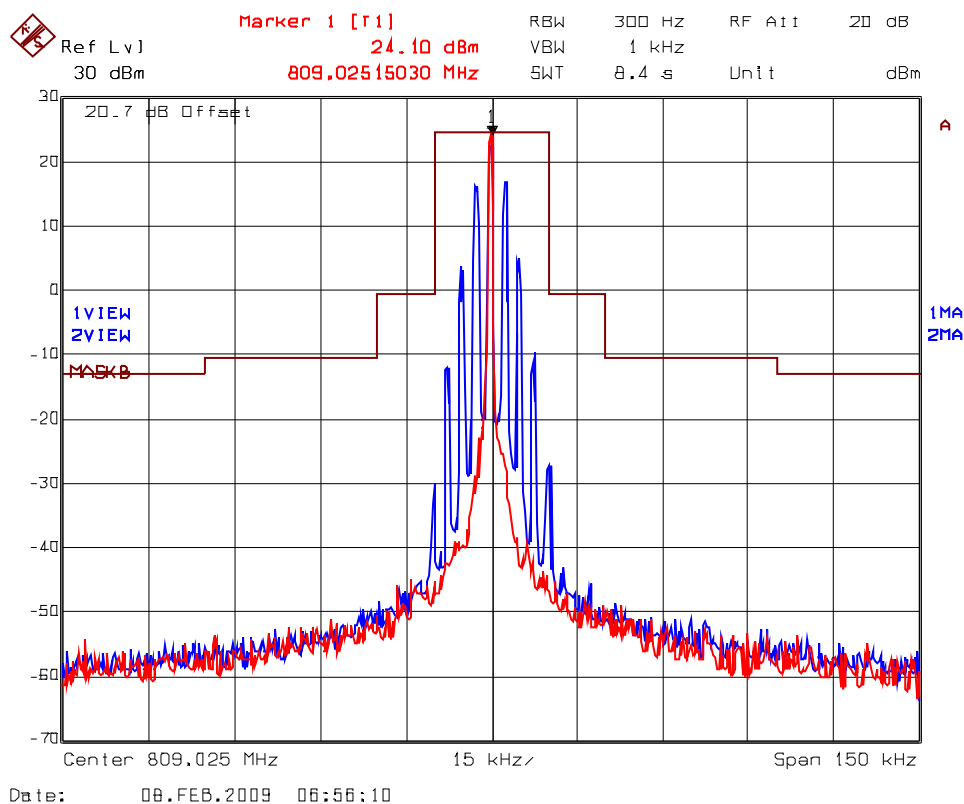

ULTRATECH GROUP OF LABS

3000 Bristol Circle, Oakville, Ontario, Canada L6H 6G4
Tel. #: 905-829-1570, Fax. #: 905-829-8050, Email: vic@ultratech-labs.com, Website: <http://www.ultratech-labs.com>

File #: FSG-093_FCC90_Rev1
June 05, 2009

- All test results contained in this engineering test report are traceable to National Institute of Standards and Technology (NIST)

Plot # 26.:
Emission Mask B
Carrier Frequency: 816.500 MHz
Channel Spacing: 25 KHz
Power: 0.3 W
Modulation: 16K0F3E with 2.5KHz sine wave

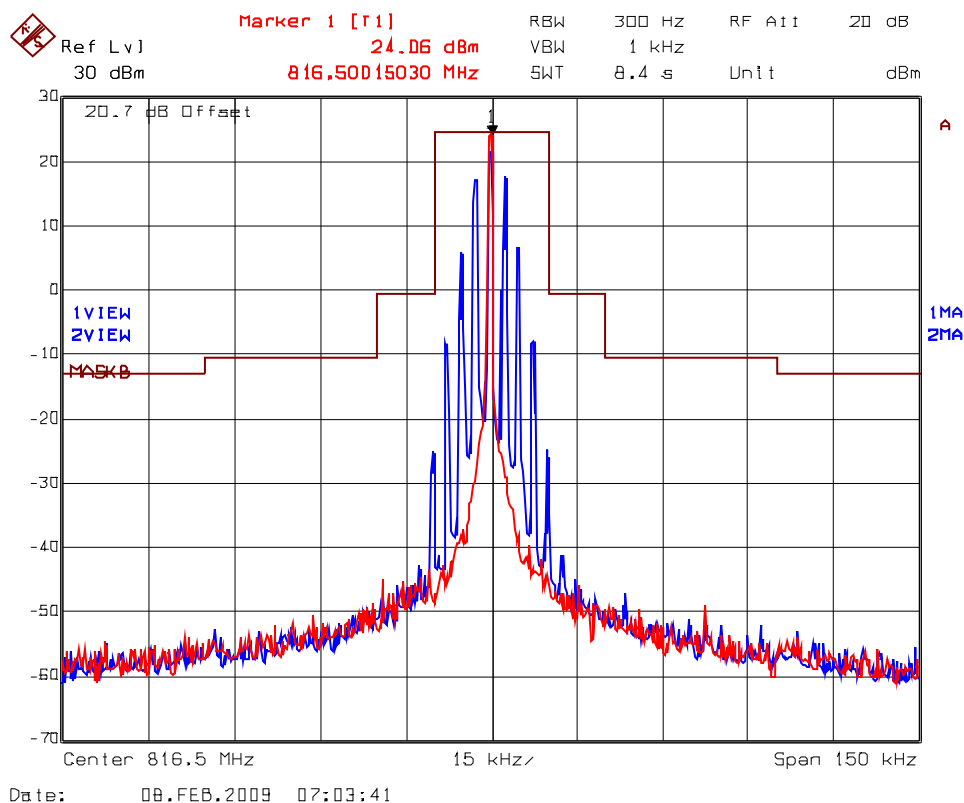

ULTRATECH GROUP OF LABS

3000 Bristol Circle, Oakville, Ontario, Canada L6H 6G4
Tel. #: 905-829-1570, Fax. #: 905-829-8050, Email: vic@ultratech-labs.com, Website: <http://www.ultratech-labs.com>

File #: FSG-093_FCC90_Rev1
June 05, 2009

- All test results contained in this engineering test report are traceable to National Institute of Standards and Technology (NIST)

Plot # 27.:
Emission Mask B
Carrier Frequency: 823.975 MHz
Channel Spacing: 25 KHz
Power: 0.3 W
Modulation: 16K0F3E with 2.5KHz sine wave

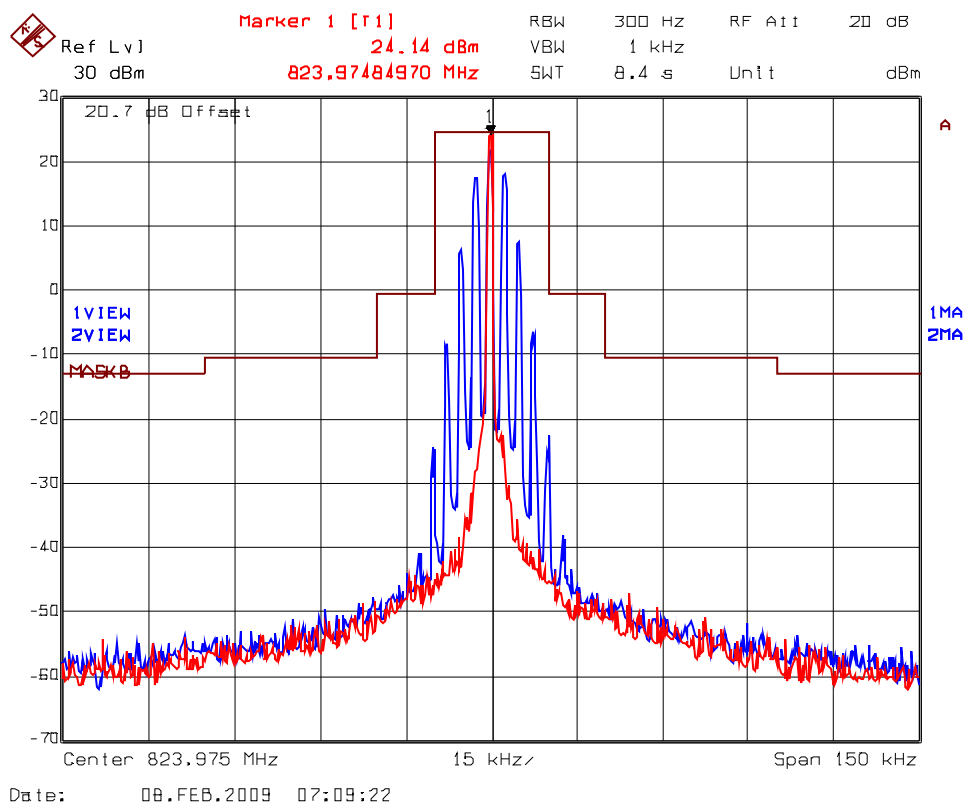

ULTRATECH GROUP OF LABS

3000 Bristol Circle, Oakville, Ontario, Canada L6H 6G4
Tel. #: 905-829-1570, Fax. #: 905-829-8050, Email: vic@ultratech-labs.com, Website: <http://www.ultratech-labs.com>

File #: FSG-093_FCC90_Rev1
June 05, 2009

- All test results contained in this engineering test report are traceable to National Institute of Standards and Technology (NIST)

Plot # 28.:
Emission Mask B
Carrier Frequency: 854.025 MHz
Channel Spacing: 25 KHz
Power: 0.3 W
Modulation: 16K0F3E with 2.5KHz sine wave

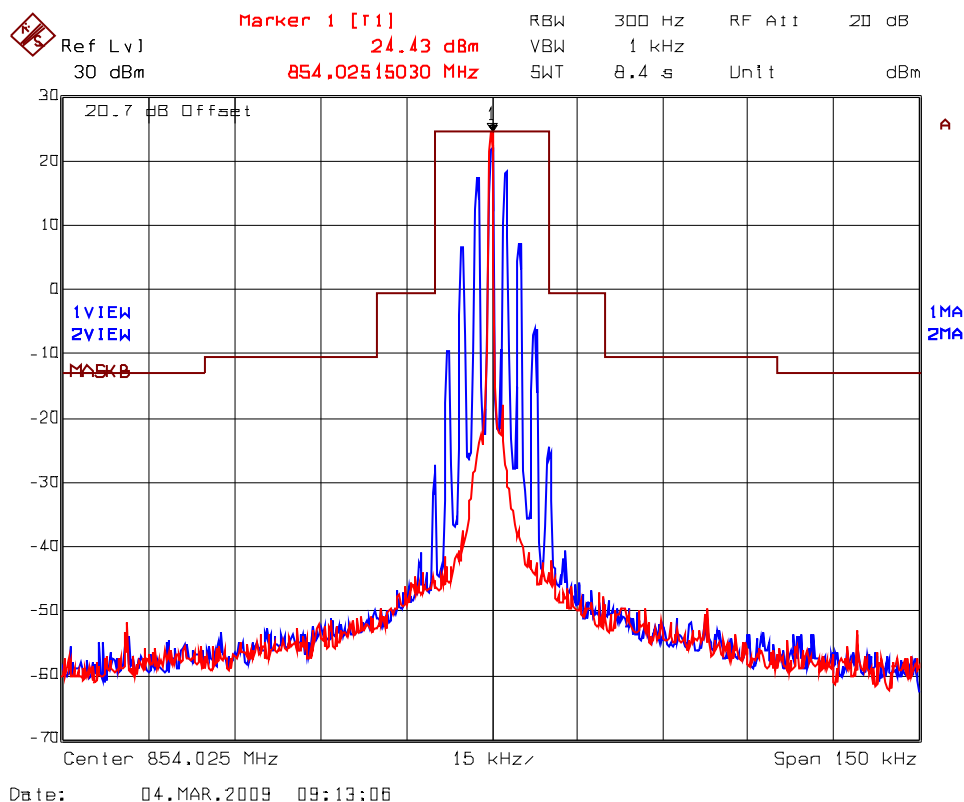

ULTRATECH GROUP OF LABS

3000 Bristol Circle, Oakville, Ontario, Canada L6H 6G4
Tel. #: 905-829-1570, Fax. #: 905-829-8050, Email: vic@ultratech-labs.com, Website: <http://www.ultratech-labs.com>

File #: FSG-093_FCC90_Rev1
June 05, 2009

- All test results contained in this engineering test report are traceable to National Institute of Standards and Technology (NIST)

Plot # 29.:
Emission Mask B
Carrier Frequency: 861.500 MHz
Channel Spacing: 25 KHz
Power: 0.3 W
Modulation: 16K0F3E with 2.5KHz sine wave

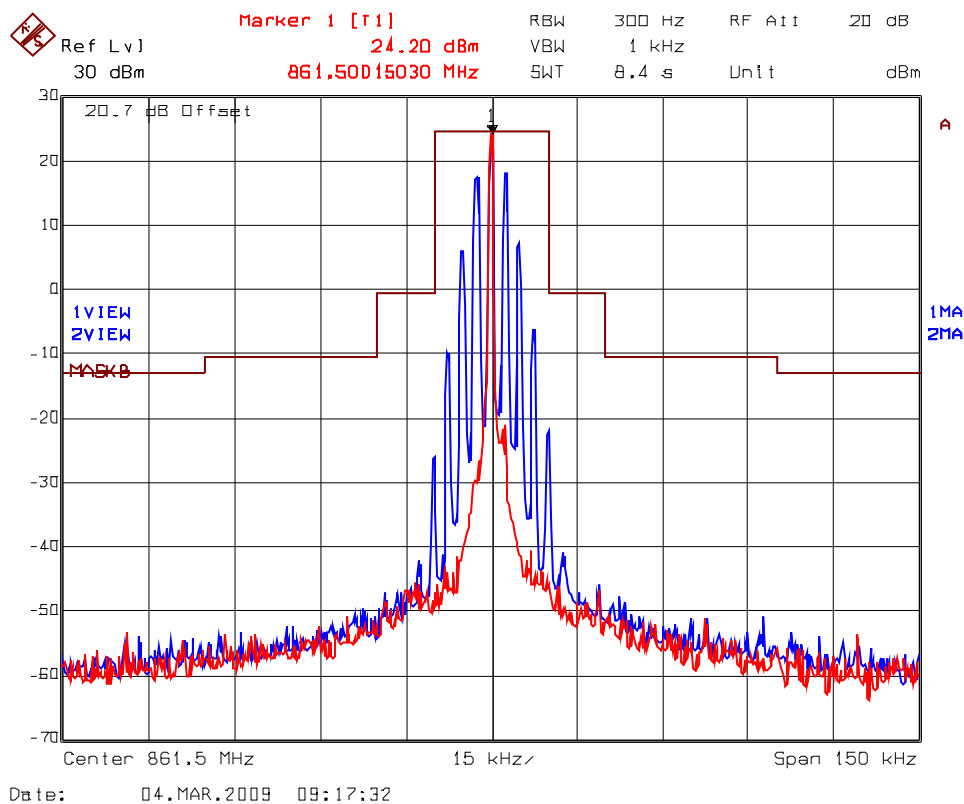

ULTRATECH GROUP OF LABS

3000 Bristol Circle, Oakville, Ontario, Canada L6H 6G4
Tel. #: 905-829-1570, Fax. #: 905-829-8050, Email: vic@ultratech-labs.com, Website: <http://www.ultratech-labs.com>

File #: FSG-093_FCC90_Rev1
June 05, 2009

- All test results contained in this engineering test report are traceable to National Institute of Standards and Technology (NIST)

Plot # 30.:
Emission Mask B
Carrier Frequency: 868.975 MHz
Channel Spacing: 25 KHz
Power: 0.3 W
Modulation: 16K0F3E with 2.5KHz sine wave

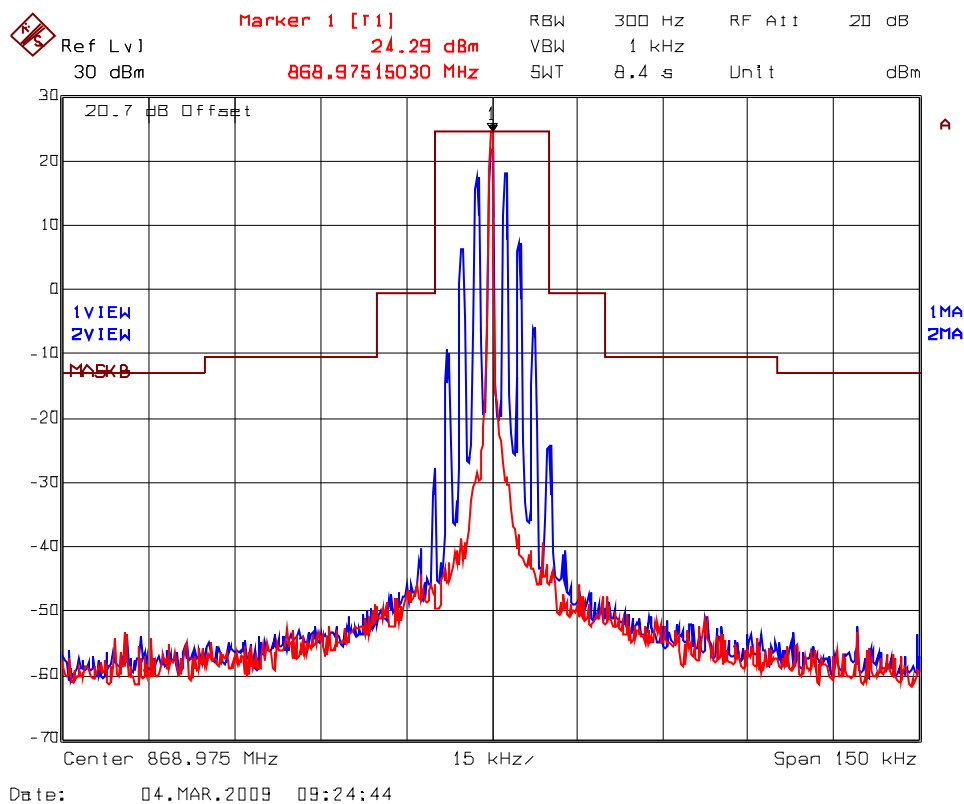

ULTRATECH GROUP OF LABS

3000 Bristol Circle, Oakville, Ontario, Canada L6H 6G4
Tel. #: 905-829-1570, Fax. #: 905-829-8050, Email: vic@ultratech-labs.com, Website: <http://www.ultratech-labs.com>

File #: FSG-093_FCC90_Rev1
June 05, 2009

- All test results contained in this engineering test report are traceable to National Institute of Standards and Technology (NIST)

Plot # 31.:
Emission Mask B
Carrier Frequency: 806.025 MHz
Channel Spacing: 12.5 KHz
Power: 3 W
Modulation: 11K0F3E with 2.5KHz sine wave

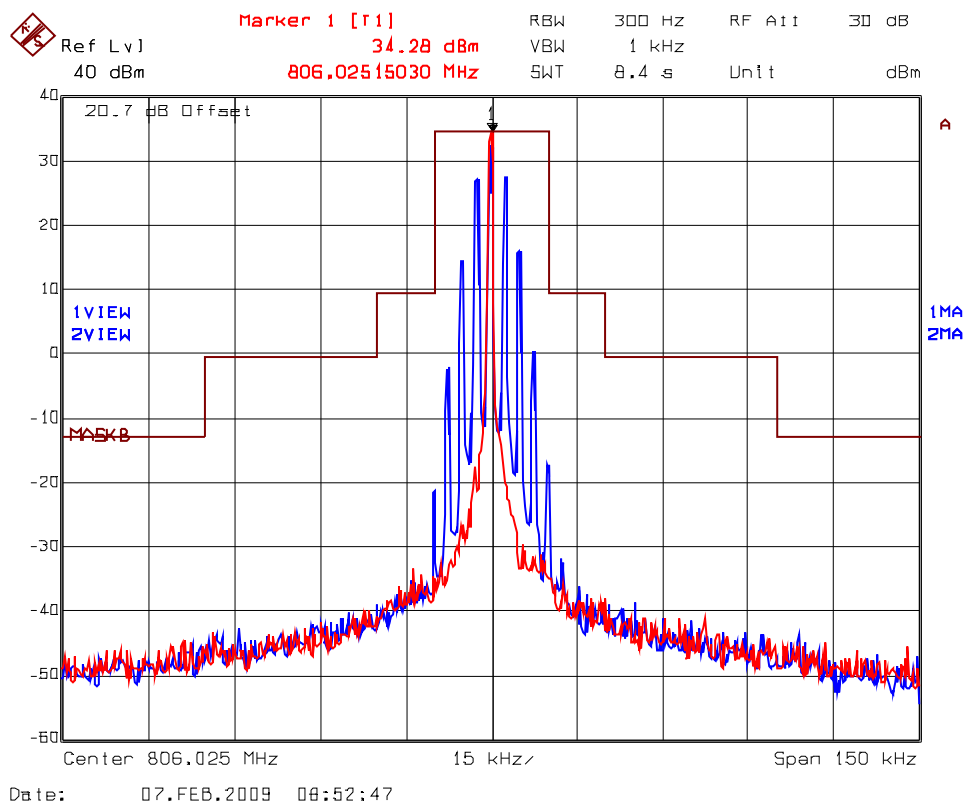

ULTRATECH GROUP OF LABS

3000 Bristol Circle, Oakville, Ontario, Canada L6H 6G4
Tel. #: 905-829-1570, Fax. #: 905-829-8050, Email: vic@ultratech-labs.com, Website: <http://www.ultratech-labs.com>

File #: FSG-093_FCC90_Rev1
June 05, 2009

- All test results contained in this engineering test report are traceable to National Institute of Standards and Technology (NIST)

Plot # 32.:
Emission Mask B
Carrier Frequency: 808.975 MHz
Channel Spacing: 12.5 KHz
Power: 3 W
Modulation: 11K0F3E with 2.5KHz sine wave

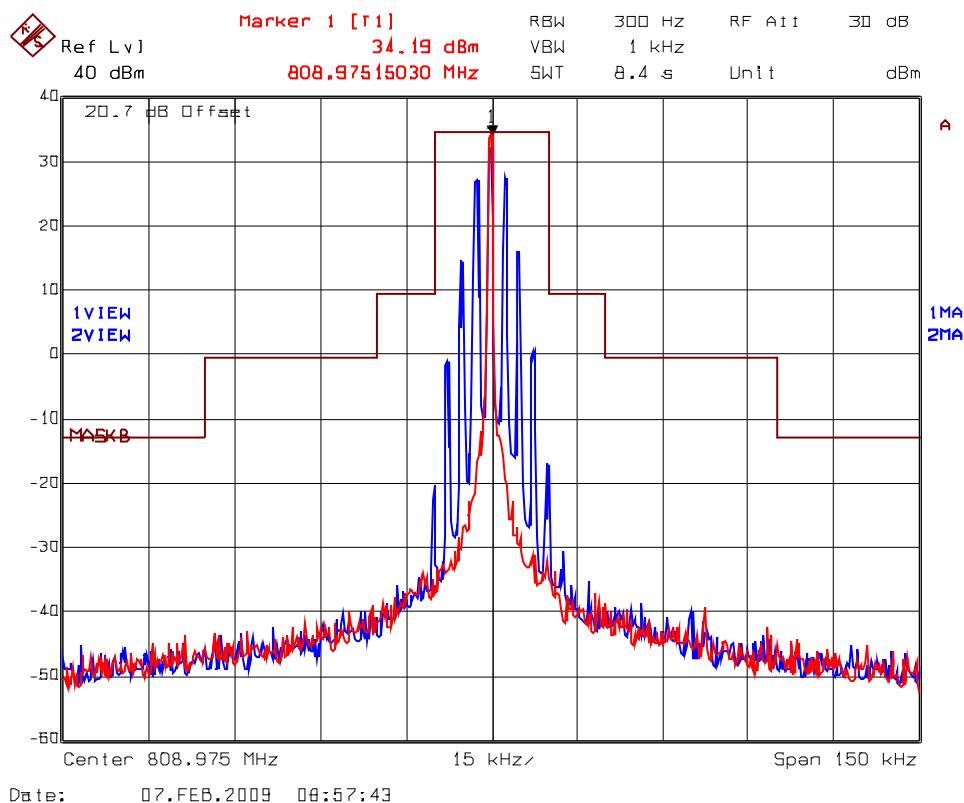

ULTRATECH GROUP OF LABS

3000 Bristol Circle, Oakville, Ontario, Canada L6H 6G4
Tel. #: 905-829-1570, Fax. #: 905-829-8050, Email: vic@ultratech-labs.com, Website: <http://www.ultratech-labs.com>

File #: FSG-093_FCC90_Rev1
June 05, 2009

- All test results contained in this engineering test report are traceable to National Institute of Standards and Technology (NIST)

Plot # 33.:
Emission Mask B
Carrier Frequency: 851.025 MHz
Channel Spacing: 12.5 KHz
Power: 3 W
Modulation: 11K0F3E with 2.5KHz sine wave

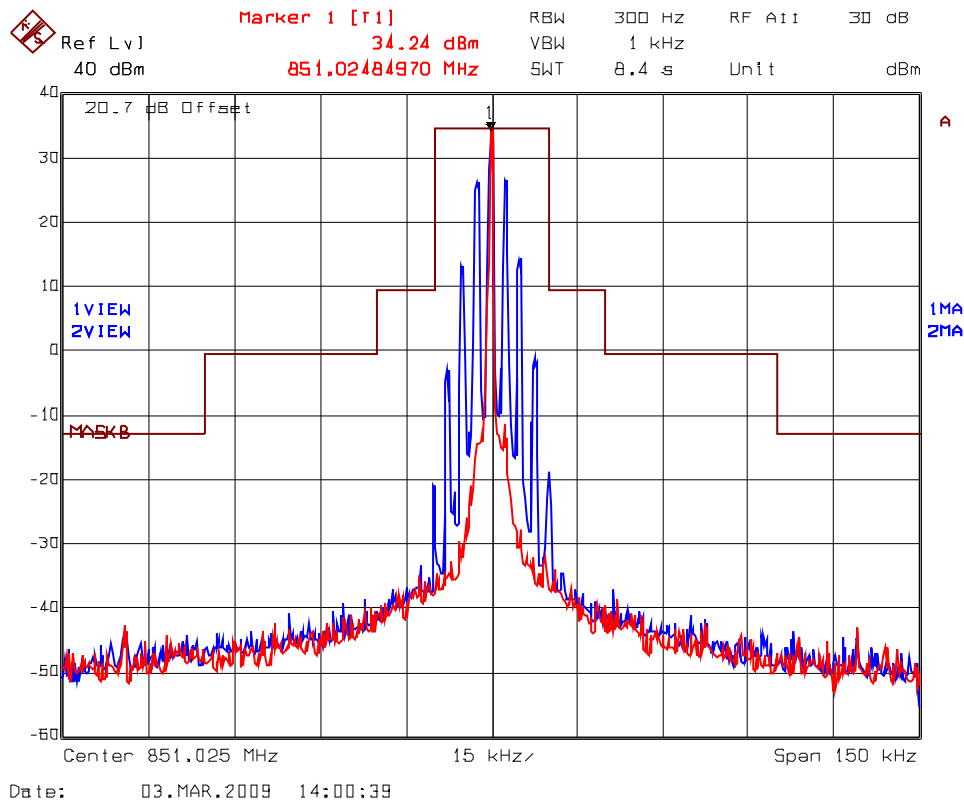

ULTRATECH GROUP OF LABS

3000 Bristol Circle, Oakville, Ontario, Canada L6H 6G4
Tel. #: 905-829-1570, Fax. #: 905-829-8050, Email: vic@ultratech-labs.com, Website: <http://www.ultratech-labs.com>

File #: FSG-093_FCC90_Rev1
June 05, 2009

- All test results contained in this engineering test report are traceable to National Institute of Standards and Technology (NIST)

Plot # 34.:
Emission Mask B
Carrier Frequency: 853.975 MHz
Channel Spacing: 12.5 KHz
Power: 3 W
Modulation: 11K0F3E with 2.5KHz sine wave

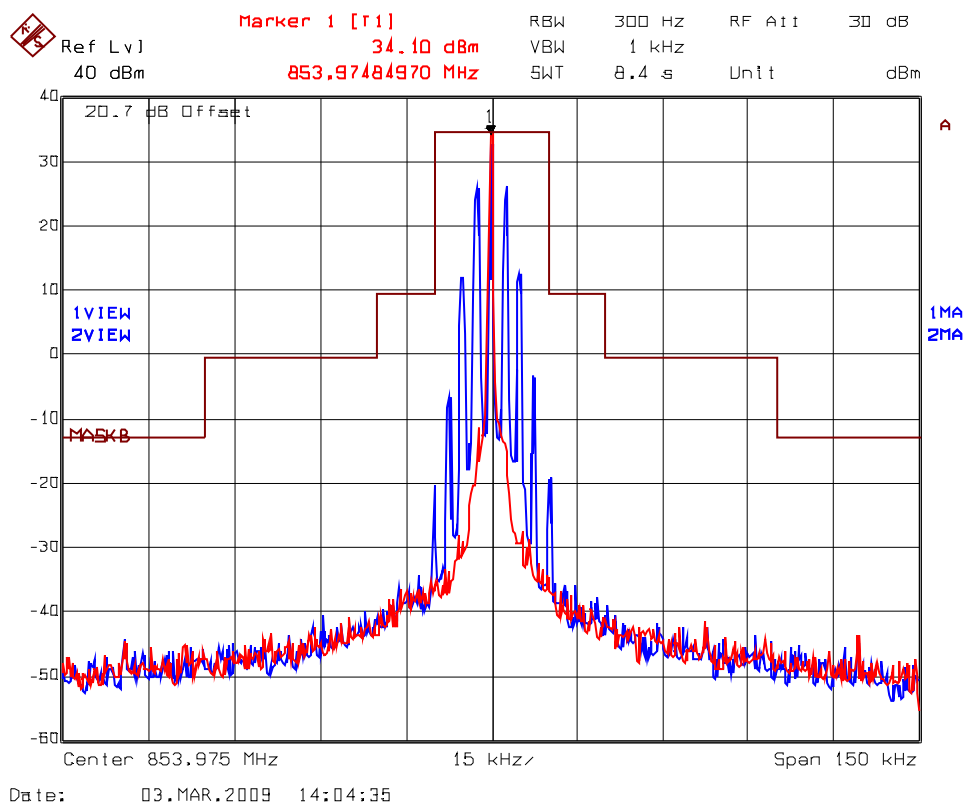

ULTRATECH GROUP OF LABS

3000 Bristol Circle, Oakville, Ontario, Canada L6H 6G4
Tel. #: 905-829-1570, Fax. #: 905-829-8050, Email: vic@ultratech-labs.com, Website: <http://www.ultratech-labs.com>

File #: FSG-093_FCC90_Rev1
June 05, 2009

- All test results contained in this engineering test report are traceable to National Institute of Standards and Technology (NIST)

Plot # 35.:
Emission Mask B
Carrier Frequency: 806.025 MHz
Channel Spacing: 12.5 KHz
Power: 0.3 W
Modulation: 11K0F3E with 2.5KHz sine wave

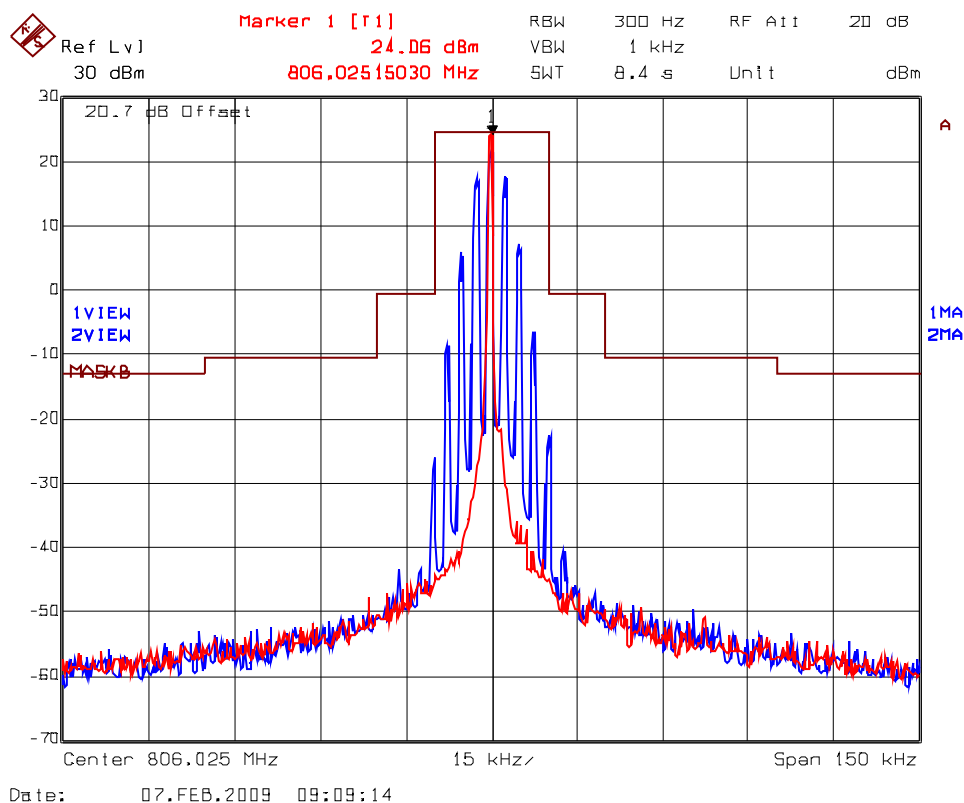

ULTRATECH GROUP OF LABS

3000 Bristol Circle, Oakville, Ontario, Canada L6H 6G4
Tel. #: 905-829-1570, Fax. #: 905-829-8050, Email: vic@ultratech-labs.com, Website: <http://www.ultratech-labs.com>

File #: FSG-093_FCC90_Rev1
June 05, 2009

- All test results contained in this engineering test report are traceable to National Institute of Standards and Technology (NIST)

Plot # 36.:
Emission Mask B
Carrier Frequency: 808.975 MHz
Channel Spacing: 12.5 KHz
Power: 0.3 W
Modulation: 11K0F3E with 2.5KHz sine wave

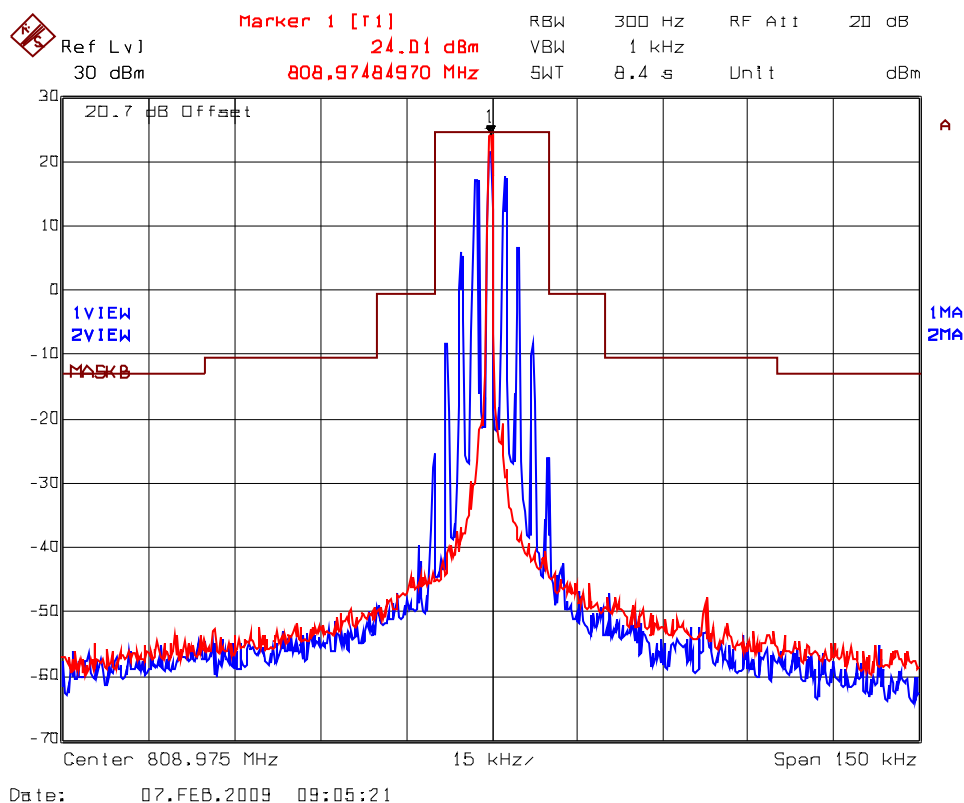

ULTRATECH GROUP OF LABS

3000 Bristol Circle, Oakville, Ontario, Canada L6H 6G4
Tel. #: 905-829-1570, Fax. #: 905-829-8050, Email: vic@ultratech-labs.com, Website: <http://www.ultratech-labs.com>

File #: FSG-093_FCC90_Rev1
June 05, 2009

- All test results contained in this engineering test report are traceable to National Institute of Standards and Technology (NIST)

Plot # 37.:
Emission Mask B
Carrier Frequency: 851.025 MHz
Channel Spacing: 12.5 KHz
Power: 0.3 W
Modulation: 11K0F3E with 2.5KHz sine wave

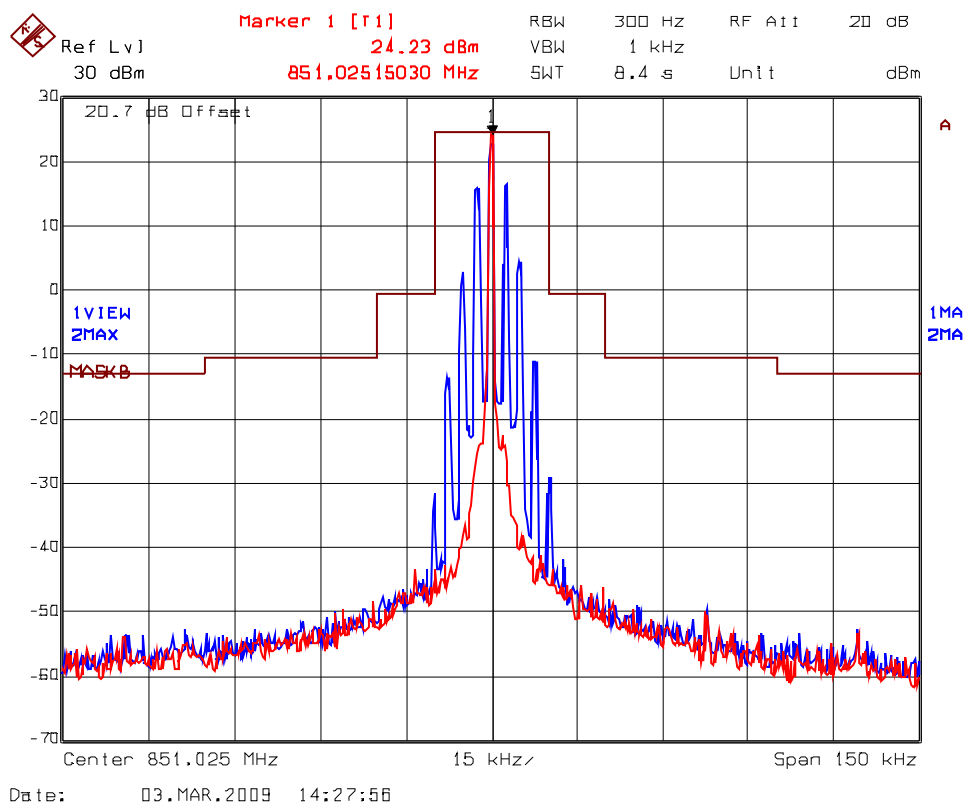

ULTRATECH GROUP OF LABS

3000 Bristol Circle, Oakville, Ontario, Canada L6H 6G4
Tel. #: 905-829-1570, Fax. #: 905-829-8050, Email: vic@ultratech-labs.com, Website: <http://www.ultratech-labs.com>

File #: FSG-093_FCC90_Rev1
June 05, 2009

- All test results contained in this engineering test report are traceable to National Institute of Standards and Technology (NIST)

Plot # 38.:
Emission Mask B
Carrier Frequency: 853.975 MHz
Channel Spacing: 12.5 KHz
Power: 0.3 W
Modulation: 11K0F3E with 2.5KHz sine wave

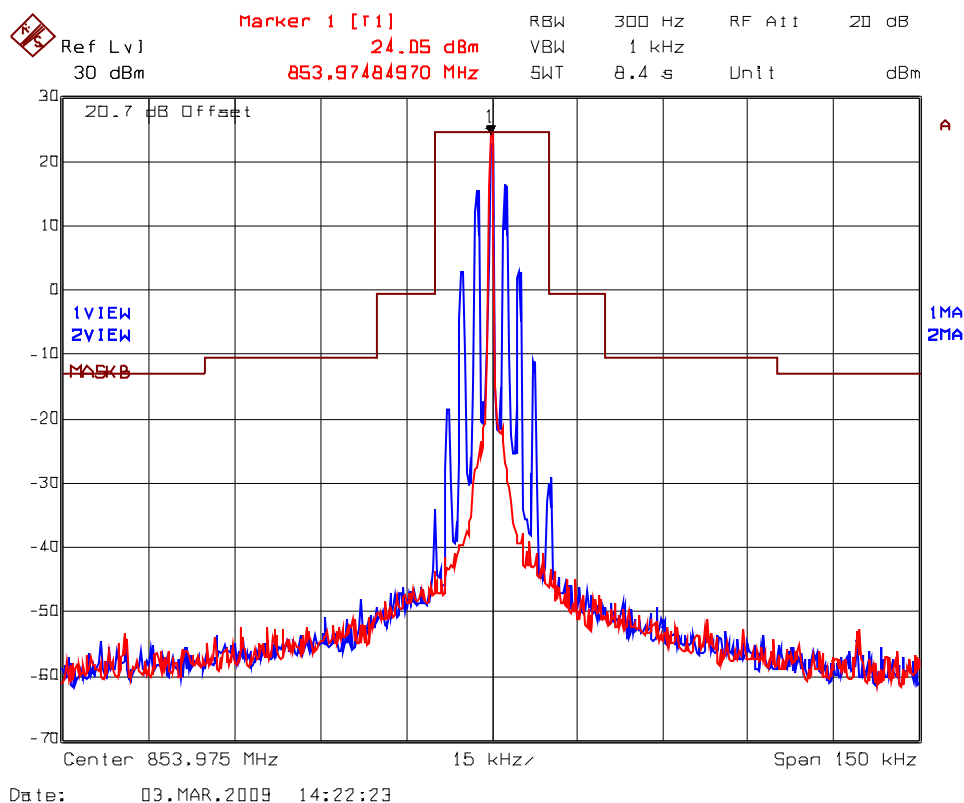

ULTRATECH GROUP OF LABS

3000 Bristol Circle, Oakville, Ontario, Canada L6H 6G4
Tel. #: 905-829-1570, Fax. #: 905-829-8050, Email: vic@ultratech-labs.com, Website: <http://www.ultratech-labs.com>

File #: FSG-093_FCC90_Rev1
June 05, 2009

- All test results contained in this engineering test report are traceable to National Institute of Standards and Technology (NIST)

Plot # 39.:
Emission Mask H
Carrier Frequency: 806.025 MHz
Channel Spacing: 12.5 KHz
Power: 3 W
Modulation: 8K10F1E, 8K0F1D

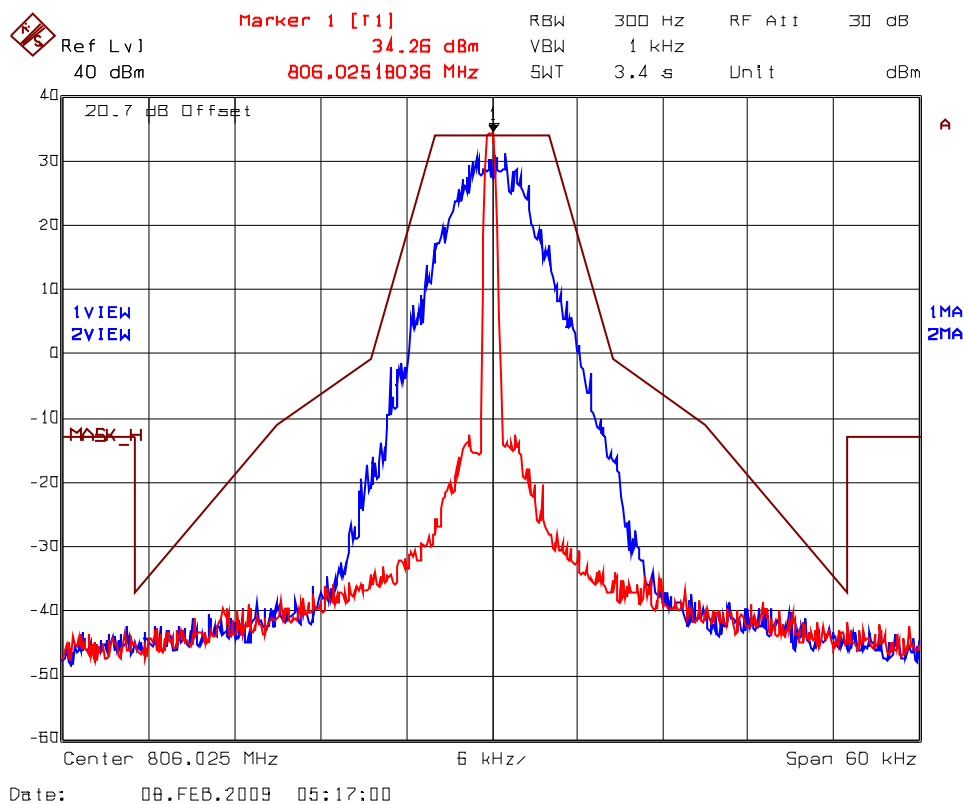

ULTRATECH GROUP OF LABS

3000 Bristol Circle, Oakville, Ontario, Canada L6H 6G4
Tel. #: 905-829-1570, Fax. #: 905-829-8050, Email: vic@ultratech-labs.com, Website: <http://www.ultratech-labs.com>

File #: FSG-093_FCC90_Rev1
June 05, 2009

- All test results contained in this engineering test report are traceable to National Institute of Standards and Technology (NIST)

Plot # 40.:
Emission Mask H
Carrier Frequency: 808.975 MHz
Channel Spacing: 12.5 KHz
Power: 3 W
Modulation: 8K10F1E, 8K0F1D

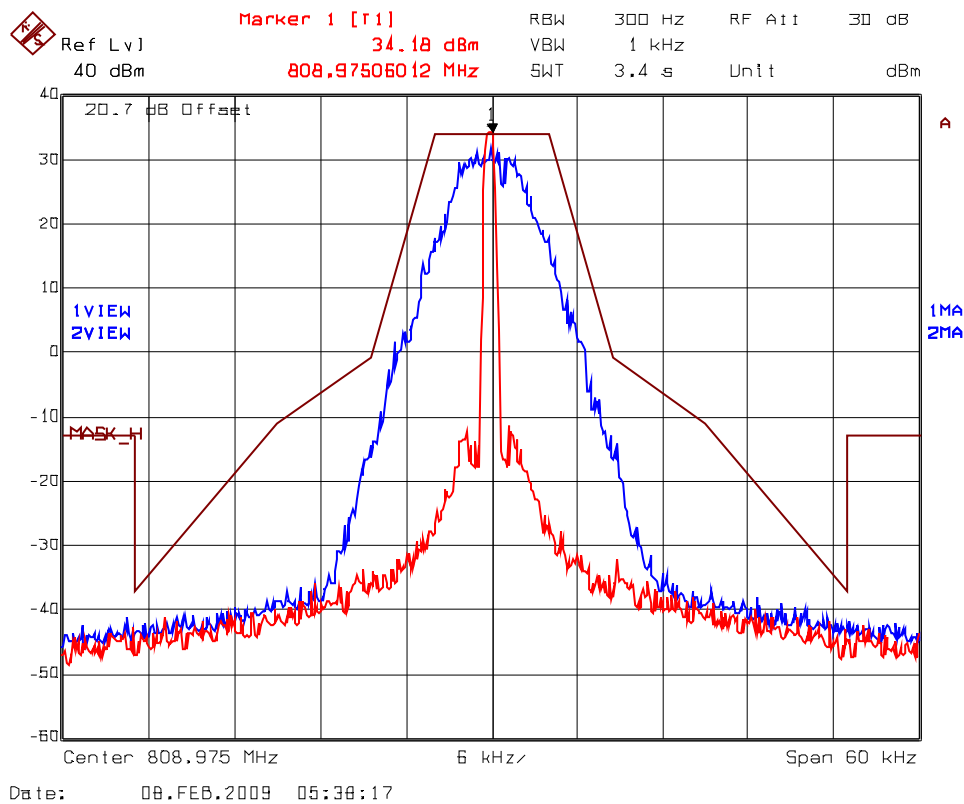

ULTRATECH GROUP OF LABS

3000 Bristol Circle, Oakville, Ontario, Canada L6H 6G4
Tel. #: 905-829-1570, Fax. #: 905-829-8050, Email: vic@ultratech-labs.com, Website: <http://www.ultratech-labs.com>

File #: FSG-093_FCC90_Rev1
June 05, 2009

- All test results contained in this engineering test report are traceable to National Institute of Standards and Technology (NIST)

Plot # 41.:
Emission Mask H
Carrier Frequency: 851.025 MHz
Channel Spacing: 12.5 KHz
Power: 3 W
Modulation: 8K10F1E, 8K0F1D

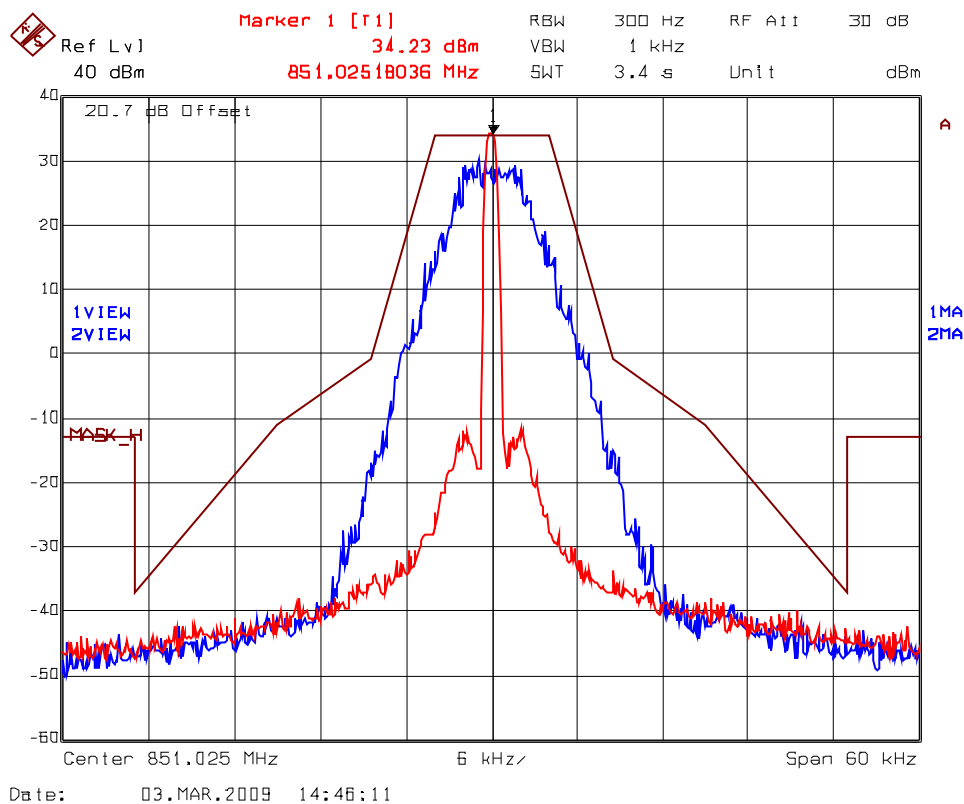

ULTRATECH GROUP OF LABS

3000 Bristol Circle, Oakville, Ontario, Canada L6H 6G4
Tel. #: 905-829-1570, Fax. #: 905-829-8050, Email: vic@ultratech-labs.com, Website: <http://www.ultratech-labs.com>

File #: FSG-093_FCC90_Rev1
June 05, 2009

- All test results contained in this engineering test report are traceable to National Institute of Standards and Technology (NIST)

Plot # 42.:
Emission Mask H
Carrier Frequency: 853.975 MHz
Channel Spacing: 12.5 KHz
Power: 3 W
Modulation: 8K10F1E, 8K0F1D

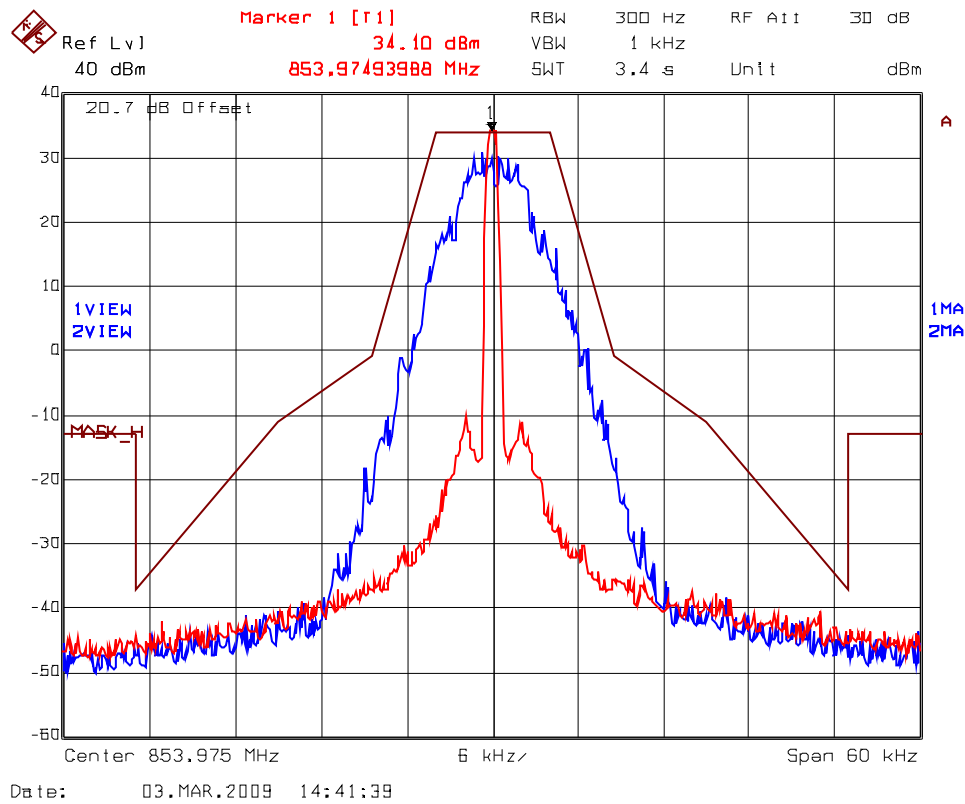

ULTRATECH GROUP OF LABS

3000 Bristol Circle, Oakville, Ontario, Canada L6H 6G4
Tel. #: 905-829-1570, Fax. #: 905-829-8050, Email: vic@ultratech-labs.com, Website: <http://www.ultratech-labs.com>

File #: FSG-093_FCC90_Rev1
June 05, 2009

- All test results contained in this engineering test report are traceable to National Institute of Standards and Technology (NIST)

Plot # 43.:
Emission Mask H
Carrier Frequency: 806.025 MHz
Channel Spacing: 12.5 KHz
Power: 0.3 W
Modulation: 8K10F1E, 8K0F1D

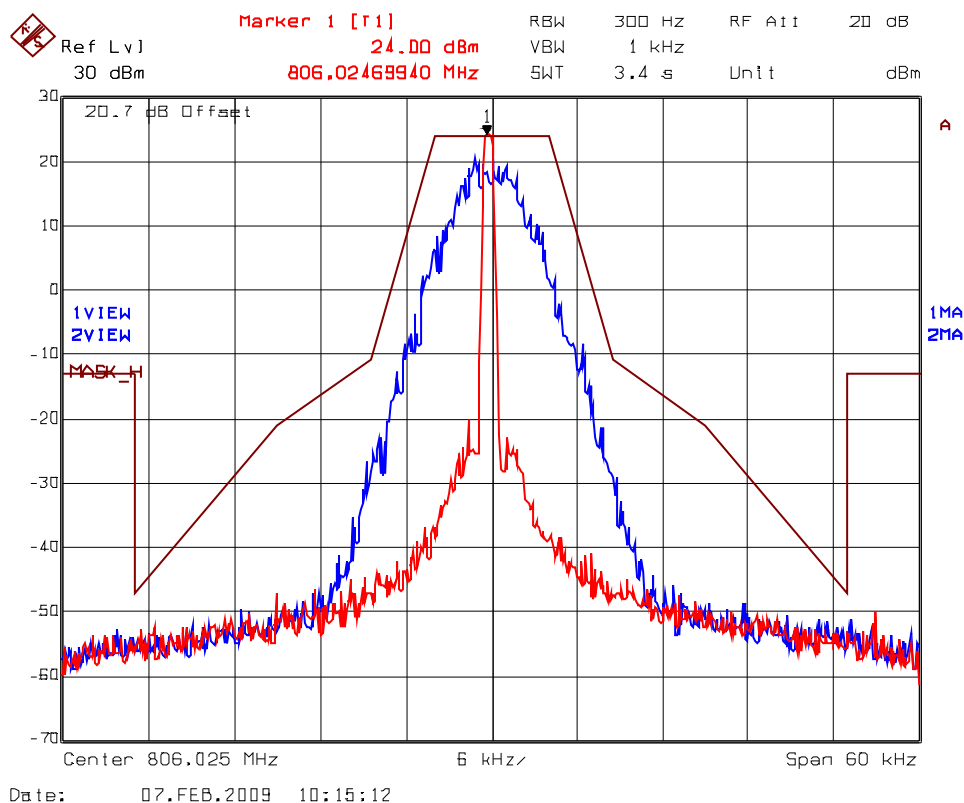

ULTRATECH GROUP OF LABS

3000 Bristol Circle, Oakville, Ontario, Canada L6H 6G4
Tel. #: 905-829-1570, Fax. #: 905-829-8050, Email: vic@ultratech-labs.com, Website: <http://www.ultratech-labs.com>

File #: FSG-093_FCC90_Rev1
June 05, 2009

- All test results contained in this engineering test report are traceable to National Institute of Standards and Technology (NIST)

Plot # 44.:
Emission Mask H
Carrier Frequency: 808.975 MHz
Channel Spacing: 12.5 KHz
Power: 0.3 W
Modulation: 8K10F1E, 8K0F1D

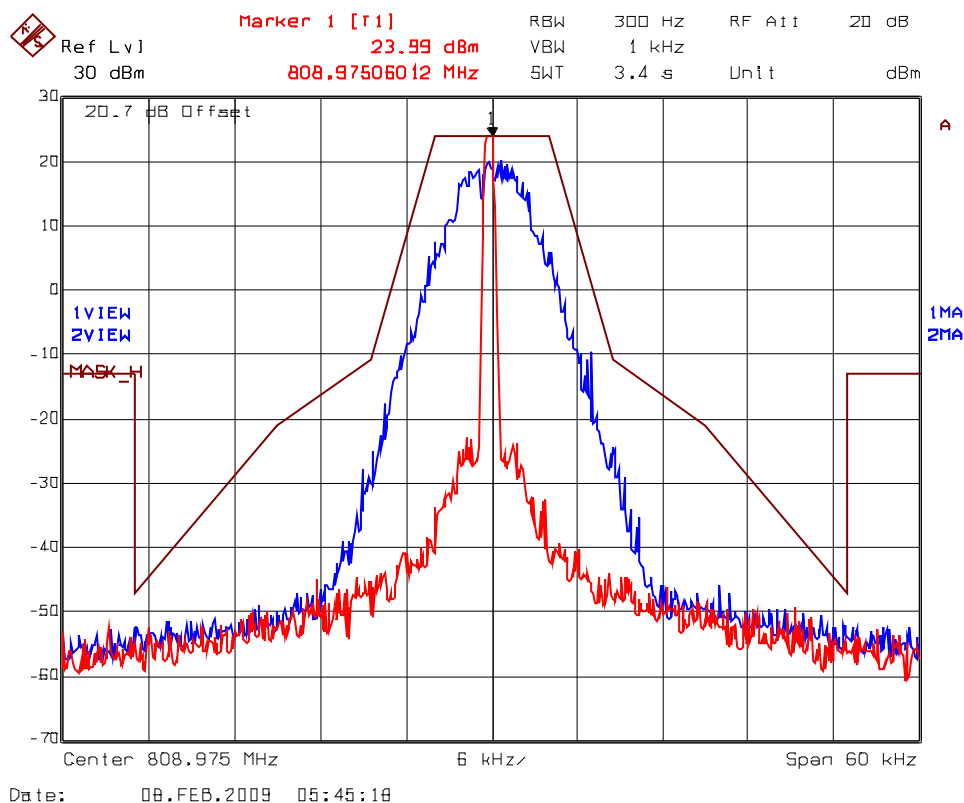

ULTRATECH GROUP OF LABS

3000 Bristol Circle, Oakville, Ontario, Canada L6H 6G4
Tel. #: 905-829-1570, Fax. #: 905-829-8050, Email: vic@ultratech-labs.com, Website: <http://www.ultratech-labs.com>

File #: FSG-093_FCC90_Rev1
June 05, 2009

- All test results contained in this engineering test report are traceable to National Institute of Standards and Technology (NIST)

Plot # 45.:
Emission Mask H
Carrier Frequency: 851.025 MHz
Channel Spacing: 12.5 KHz
Power: 0.3 W
Modulation: 8K10F1E, 8K0F1D

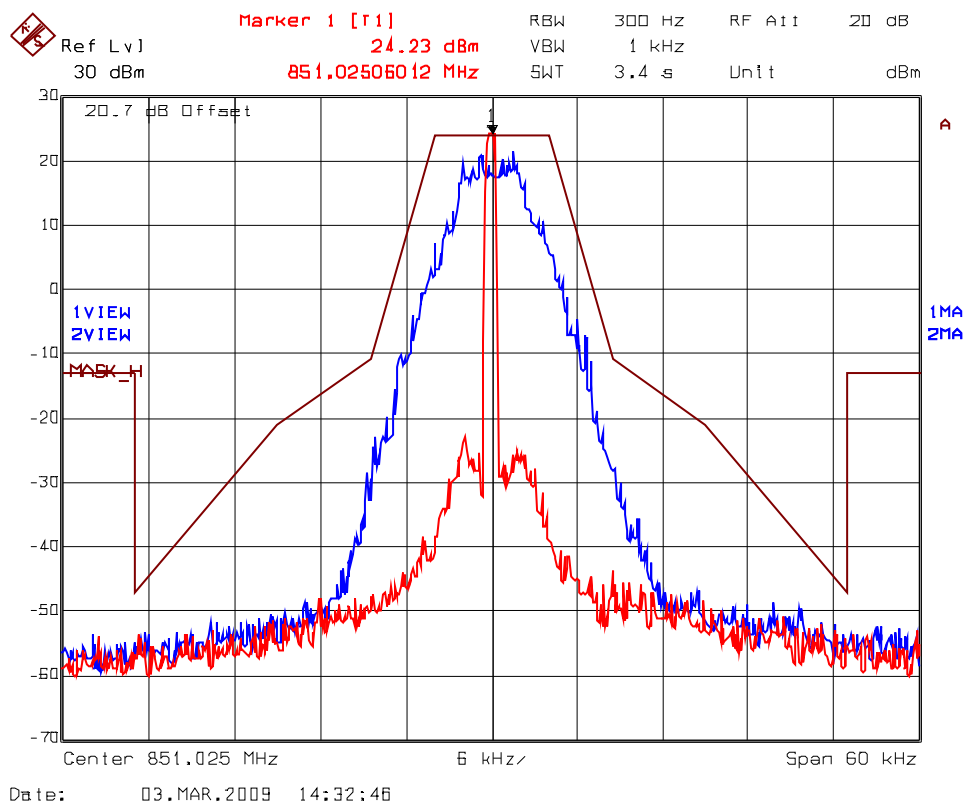

ULTRATECH GROUP OF LABS

3000 Bristol Circle, Oakville, Ontario, Canada L6H 6G4
Tel. #: 905-829-1570, Fax. #: 905-829-8050, Email: vic@ultratech-labs.com, Website: <http://www.ultratech-labs.com>

File #: FSG-093_FCC90_Rev1
June 05, 2009

- All test results contained in this engineering test report are traceable to National Institute of Standards and Technology (NIST)

Plot # 46.:
Emission Mask H
Carrier Frequency: 853.975 MHz
Channel Spacing: 12.5 KHz
Power: 0.3 W
Modulation: 8K10F1E, 8K0F1D

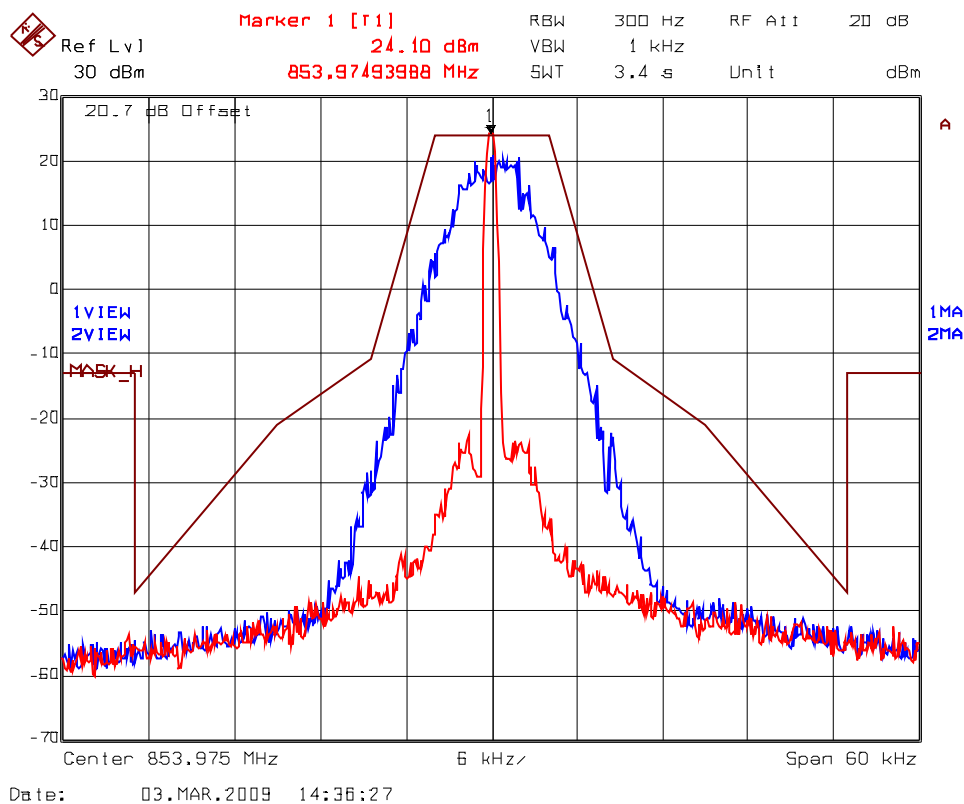

ULTRATECH GROUP OF LABS

3000 Bristol Circle, Oakville, Ontario, Canada L6H 6G4
Tel. #: 905-829-1570, Fax. #: 905-829-8050, Email: vic@ultratech-labs.com, Website: <http://www.ultratech-labs.com>

File #: FSG-093_FCC90_Rev1
June 05, 2009

- All test results contained in this engineering test report are traceable to National Institute of Standards and Technology (NIST)

Plot # 47.:
Emission Mask G
Carrier Frequency: 809.025 MHz
Channel Spacing: 12.5 KHz
Power: 3 W
Modulation: 8K10F1E, 8K0F1D

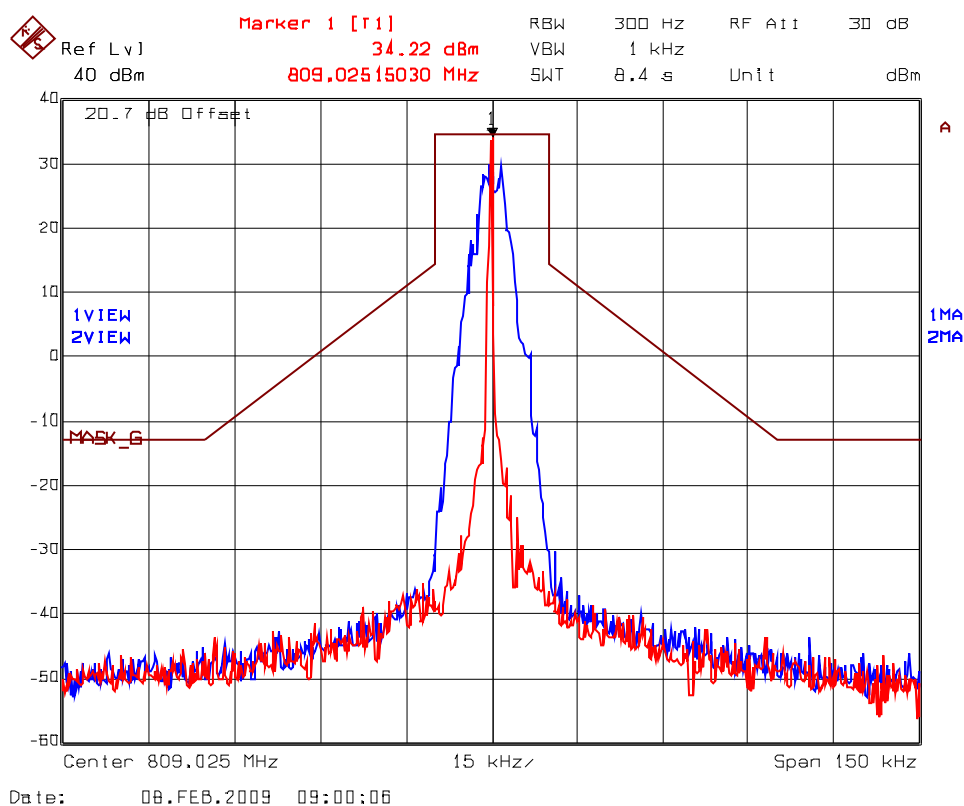

ULTRATECH GROUP OF LABS

3000 Bristol Circle, Oakville, Ontario, Canada L6H 6G4
Tel. #: 905-829-1570, Fax. #: 905-829-8050, Email: vic@ultratech-labs.com, Website: <http://www.ultratech-labs.com>

File #: FSG-093_FCC90_Rev1
June 05, 2009

- All test results contained in this engineering test report are traceable to National Institute of Standards and Technology (NIST)

Plot # 48.:
Emission Mask G
Carrier Frequency: 816.500 MHz
Channel Spacing: 12.5 KHz
Power: 3 W
Modulation: 8K10F1E, 8K0F1D

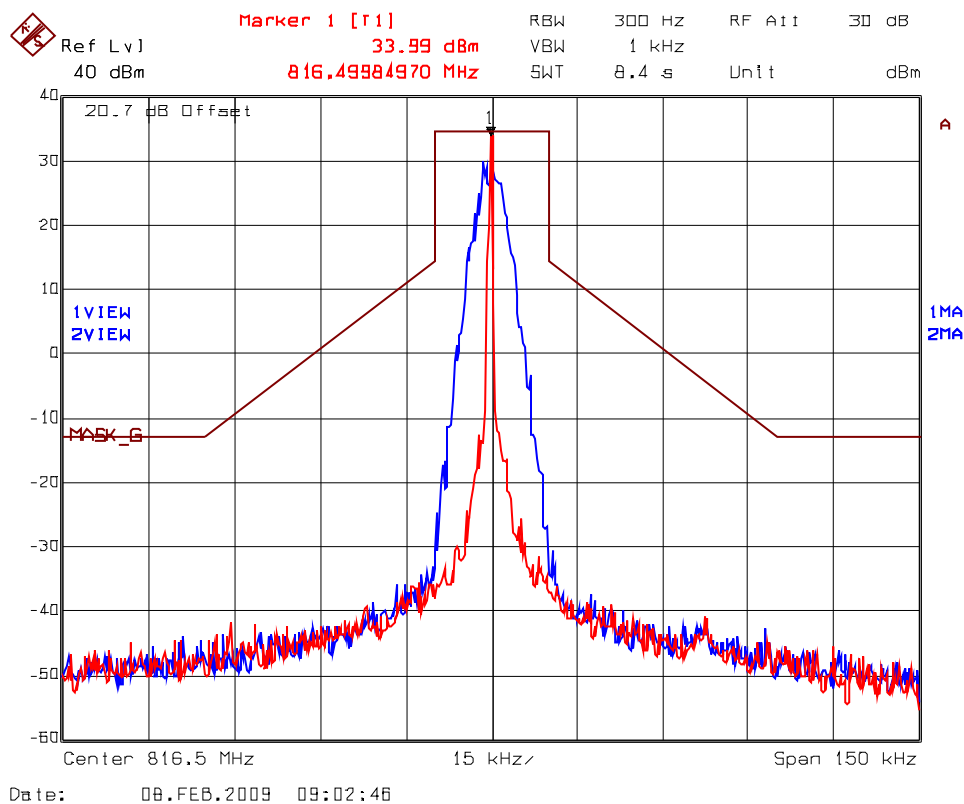

ULTRATECH GROUP OF LABS

3000 Bristol Circle, Oakville, Ontario, Canada L6H 6G4
Tel. #: 905-829-1570, Fax. #: 905-829-8050, Email: vic@ultratech-labs.com, Website: <http://www.ultratech-labs.com>

File #: FSG-093_FCC90_Rev1
June 05, 2009

- All test results contained in this engineering test report are traceable to National Institute of Standards and Technology (NIST)

Plot # 49.:
Emission Mask G
Carrier Frequency: 823.975 MHz
Channel Spacing: 12.5 KHz
Power: 3 W
Modulation: 8K10F1E, 8K0F1D

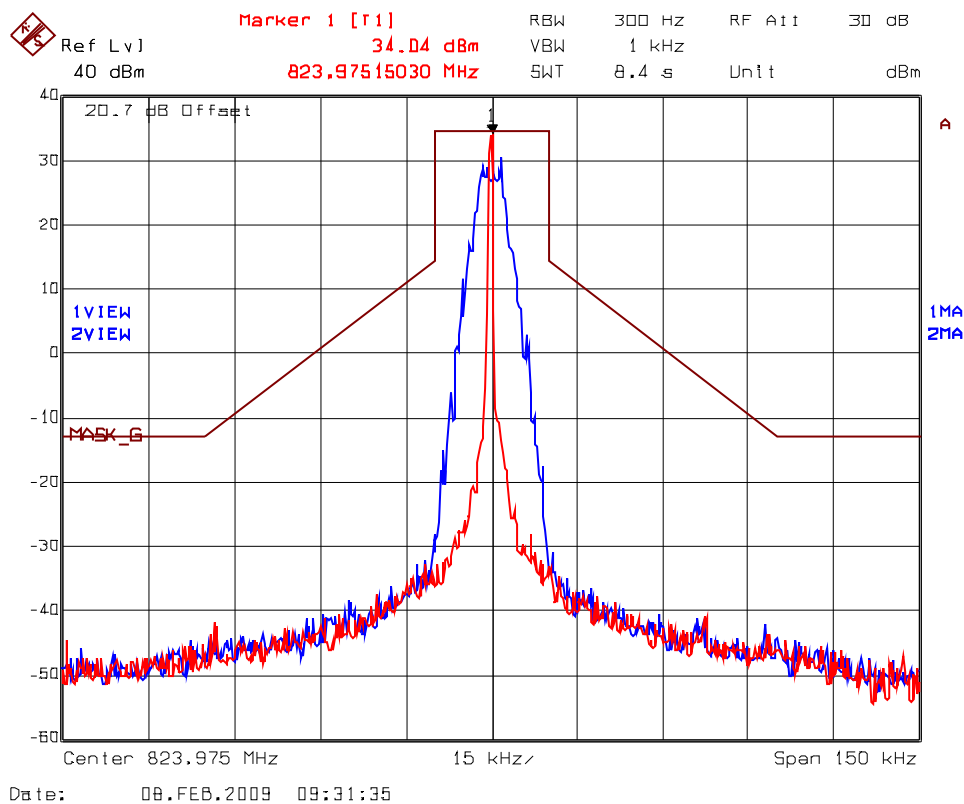

ULTRATECH GROUP OF LABS

3000 Bristol Circle, Oakville, Ontario, Canada L6H 6G4
Tel. #: 905-829-1570, Fax. #: 905-829-8050, Email: vic@ultratech-labs.com, Website: <http://www.ultratech-labs.com>

File #: FSG-093_FCC90_Rev1
June 05, 2009

- All test results contained in this engineering test report are traceable to National Institute of Standards and Technology (NIST)

Plot # 50.:
Emission Mask G
Carrier Frequency: 854.025 MHz
Channel Spacing: 12.5 KHz
Power: 3 W
Modulation: 8K10F1E, 8K0F1D

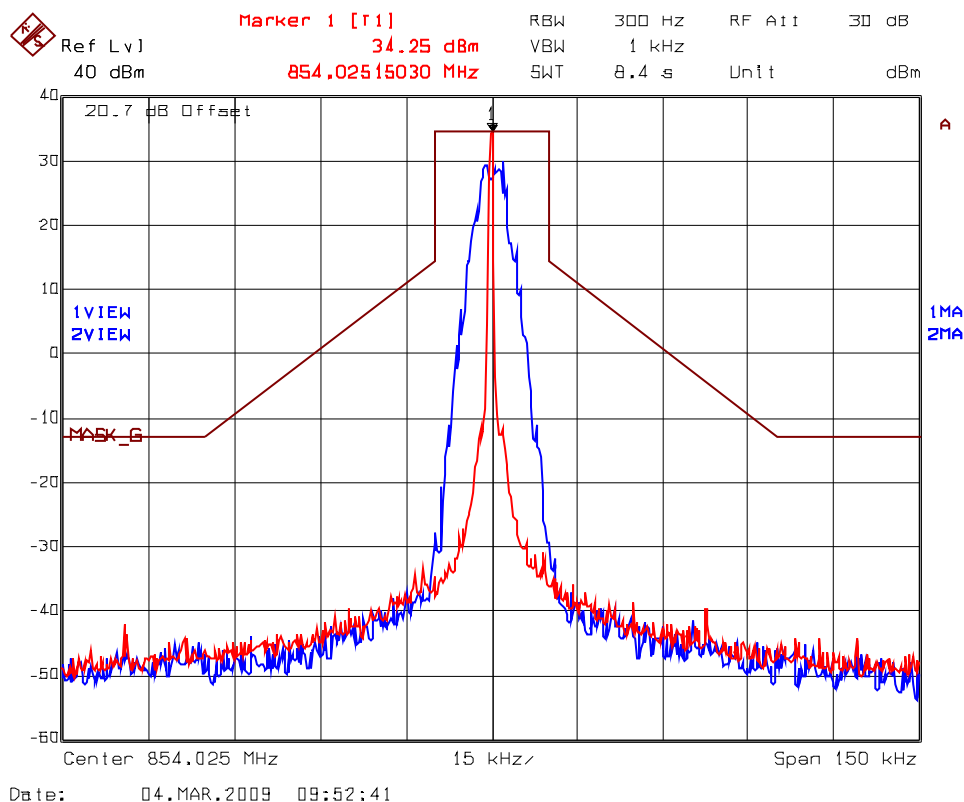

ULTRATECH GROUP OF LABS

3000 Bristol Circle, Oakville, Ontario, Canada L6H 6G4
Tel. #: 905-829-1570, Fax. #: 905-829-8050, Email: vic@ultratech-labs.com, Website: <http://www.ultratech-labs.com>

File #: FSG-093_FCC90_Rev1
June 05, 2009

- All test results contained in this engineering test report are traceable to National Institute of Standards and Technology (NIST)

Plot # 51.:
Emission Mask G
Carrier Frequency: 861.500 MHz
Channel Spacing: 12.5 KHz
Power: 3 W
Modulation: 8K10F1E, 8K0F1D

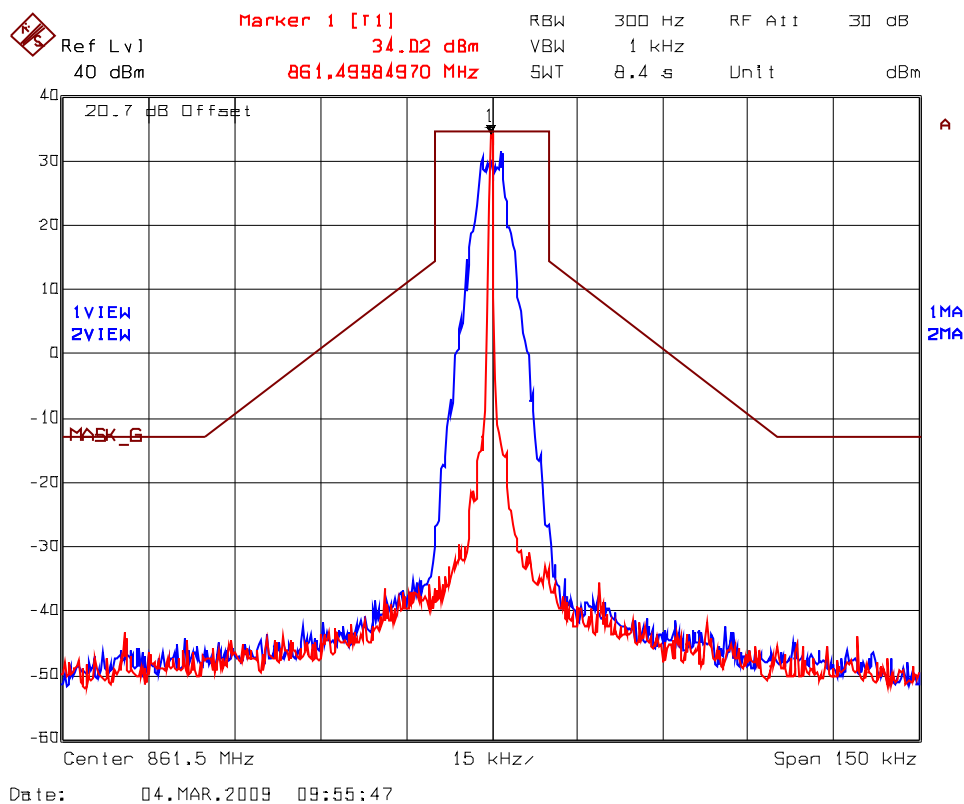

ULTRATECH GROUP OF LABS

3000 Bristol Circle, Oakville, Ontario, Canada L6H 6G4
Tel. #: 905-829-1570, Fax. #: 905-829-8050, Email: vic@ultratech-labs.com, Website: <http://www.ultratech-labs.com>

File #: FSG-093_FCC90_Rev1
June 05, 2009

- All test results contained in this engineering test report are traceable to National Institute of Standards and Technology (NIST)

Plot # 52.:
Emission Mask G
Carrier Frequency: 868.975 MHz
Channel Spacing: 12.5 KHz
Power: 3 W
Modulation: 8K10F1E, 8K0F1D

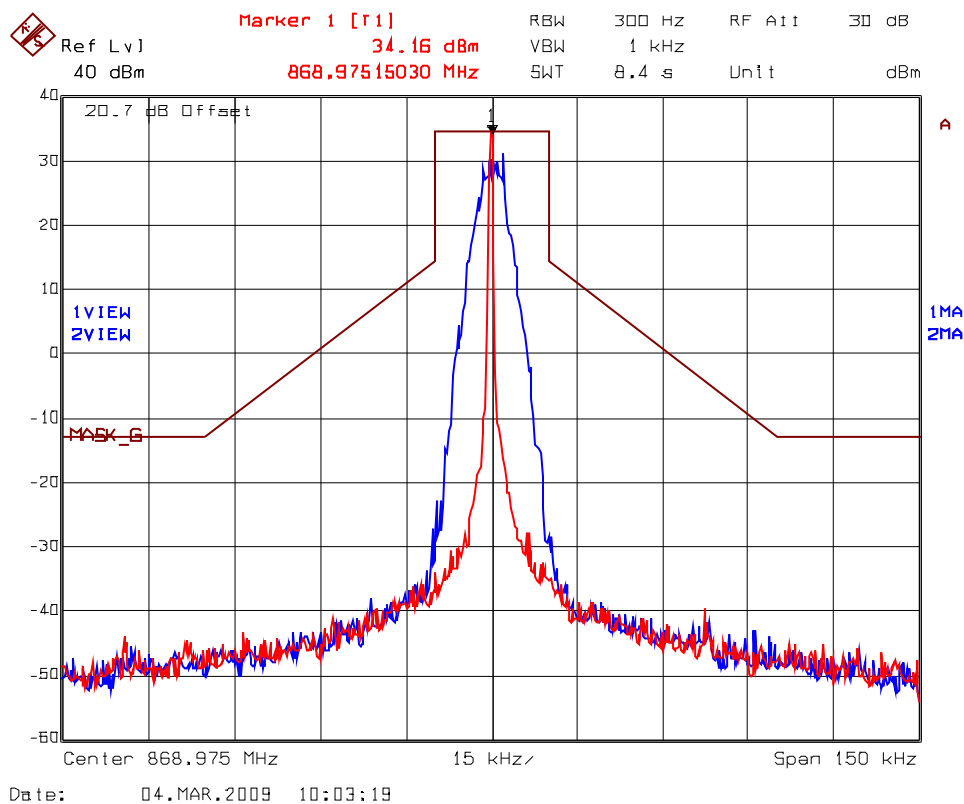

ULTRATECH GROUP OF LABS

3000 Bristol Circle, Oakville, Ontario, Canada L6H 6G4
Tel. #: 905-829-1570, Fax. #: 905-829-8050, Email: vic@ultratech-labs.com, Website: <http://www.ultratech-labs.com>

File #: FSG-093_FCC90_Rev1
June 05, 2009

- All test results contained in this engineering test report are traceable to National Institute of Standards and Technology (NIST)

Plot # 53.:
Emission Mask G
Carrier Frequency: 809.025 MHz
Channel Spacing: 12.5 KHz
Power: 0.3 W
Modulation: 8K10F1E, 8K0F1D

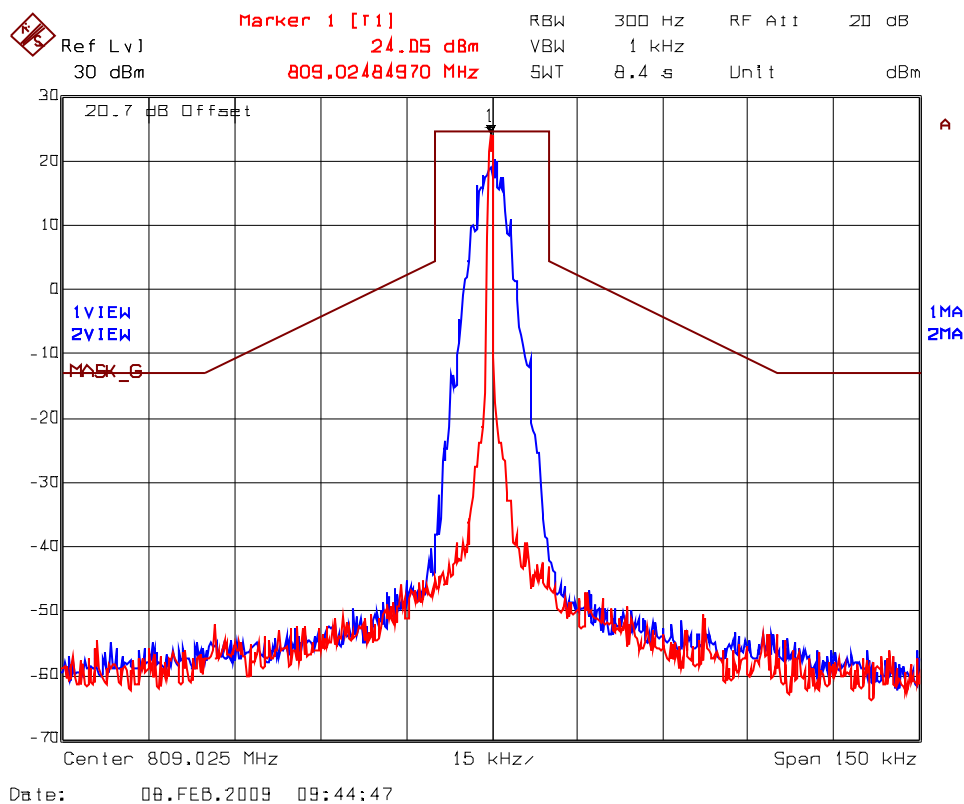

ULTRATECH GROUP OF LABS

3000 Bristol Circle, Oakville, Ontario, Canada L6H 6G4
Tel. #: 905-829-1570, Fax. #: 905-829-8050, Email: vic@ultratech-labs.com, Website: <http://www.ultratech-labs.com>

File #: FSG-093_FCC90_Rev1
June 05, 2009

- All test results contained in this engineering test report are traceable to National Institute of Standards and Technology (NIST)

Plot # 54.:
Emission Mask G
Carrier Frequency: 816.500 MHz
Channel Spacing: 12.5 KHz
Power: 0.3 W
Modulation: 8K10F1E, 8K0F1D

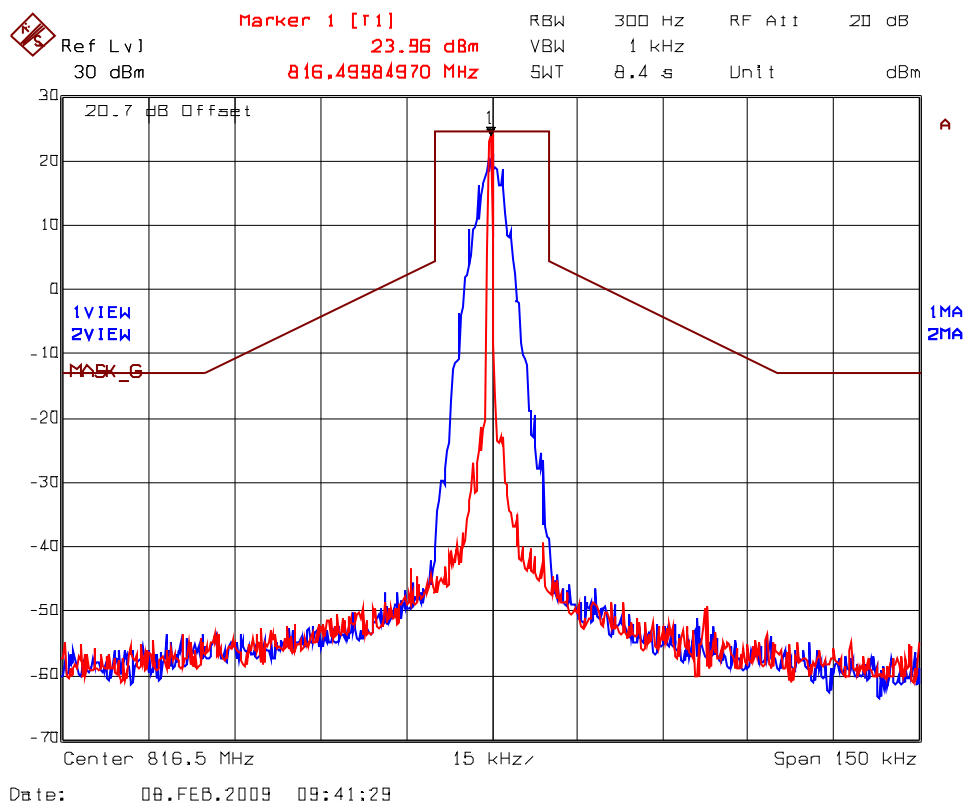

ULTRATECH GROUP OF LABS

3000 Bristol Circle, Oakville, Ontario, Canada L6H 6G4
Tel. #: 905-829-1570, Fax. #: 905-829-8050, Email: vic@ultratech-labs.com, Website: <http://www.ultratech-labs.com>

File #: FSG-093_FCC90_Rev1
June 05, 2009

- All test results contained in this engineering test report are traceable to National Institute of Standards and Technology (NIST)

Plot # 55.:
Emission Mask G
Carrier Frequency: 823.975 MHz
Channel Spacing: 12.5 KHz
Power: 0.3 W
Modulation: 8K10F1E, 8K0F1D

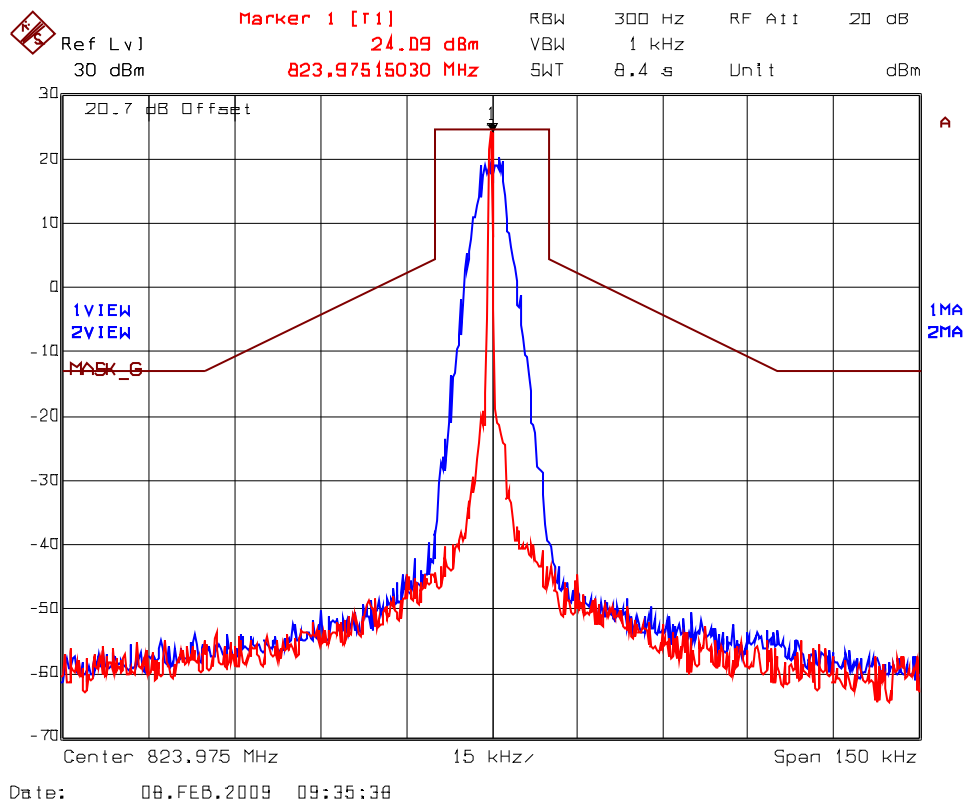

ULTRATECH GROUP OF LABS

3000 Bristol Circle, Oakville, Ontario, Canada L6H 6G4
Tel. #: 905-829-1570, Fax. #: 905-829-8050, Email: vic@ultratech-labs.com, Website: <http://www.ultratech-labs.com>

File #: FSG-093_FCC90_Rev1
June 05, 2009

- All test results contained in this engineering test report are traceable to National Institute of Standards and Technology (NIST)

Plot # 56.:
Emission Mask G
Carrier Frequency: 854.025 MHz
Channel Spacing: 12.5 KHz
Power: 0.3 W
Modulation: 8K10F1E, 8K0F1D

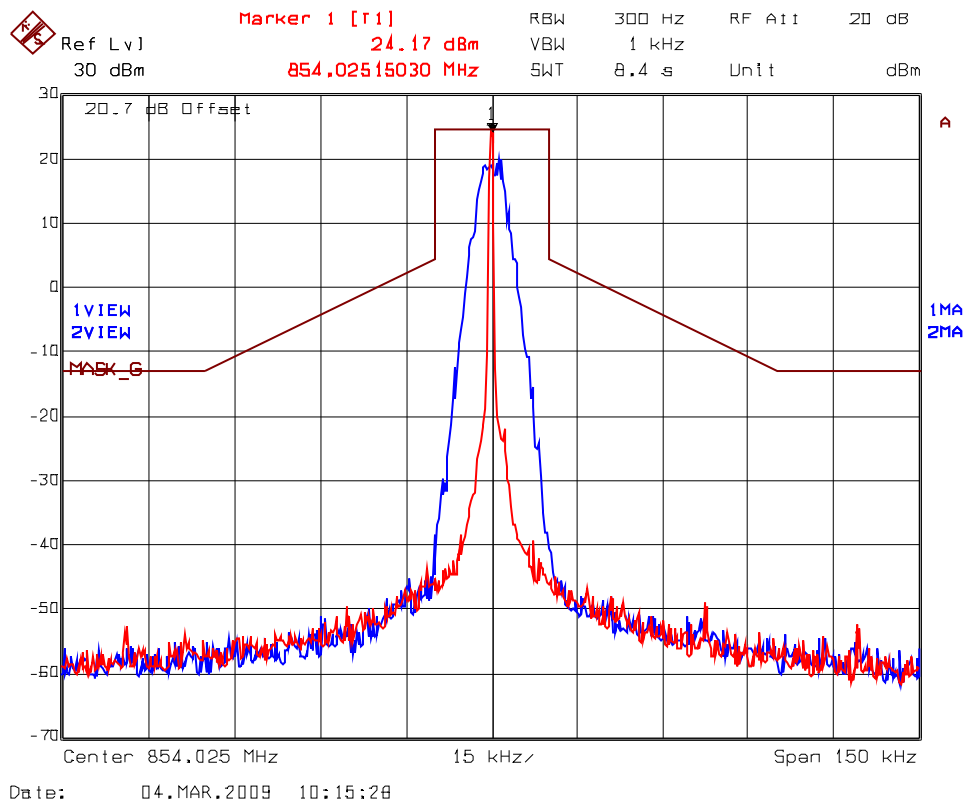

ULTRATECH GROUP OF LABS

3000 Bristol Circle, Oakville, Ontario, Canada L6H 6G4
Tel. #: 905-829-1570, Fax. #: 905-829-8050, Email: vic@ultratech-labs.com, Website: <http://www.ultratech-labs.com>

File #: FSG-093_FCC90_Rev1
June 05, 2009

- All test results contained in this engineering test report are traceable to National Institute of Standards and Technology (NIST)

Plot # 57.:
Emission Mask G
Carrier Frequency: 861.500 MHz
Channel Spacing: 12.5 KHz
Power: 0.3 W
Modulation: 8K10F1E, 8K0F1D

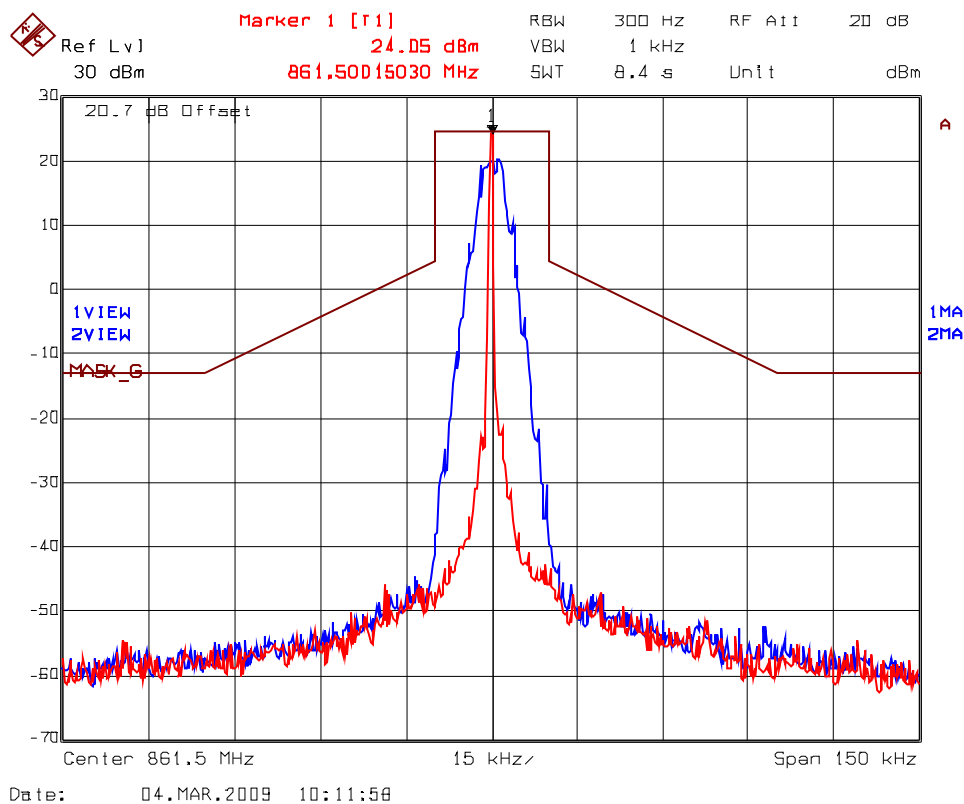

ULTRATECH GROUP OF LABS

3000 Bristol Circle, Oakville, Ontario, Canada L6H 6G4
Tel. #: 905-829-1570, Fax. #: 905-829-8050, Email: vic@ultratech-labs.com, Website: <http://www.ultratech-labs.com>

File #: FSG-093_FCC90_Rev1
June 05, 2009

- All test results contained in this engineering test report are traceable to National Institute of Standards and Technology (NIST)

Plot # 58.:
Emission Mask G
Carrier Frequency: 868.975 MHz
Channel Spacing: 12.5 KHz
Power: 0.3 W
Modulation: 8K10F1E, 8K0F1D

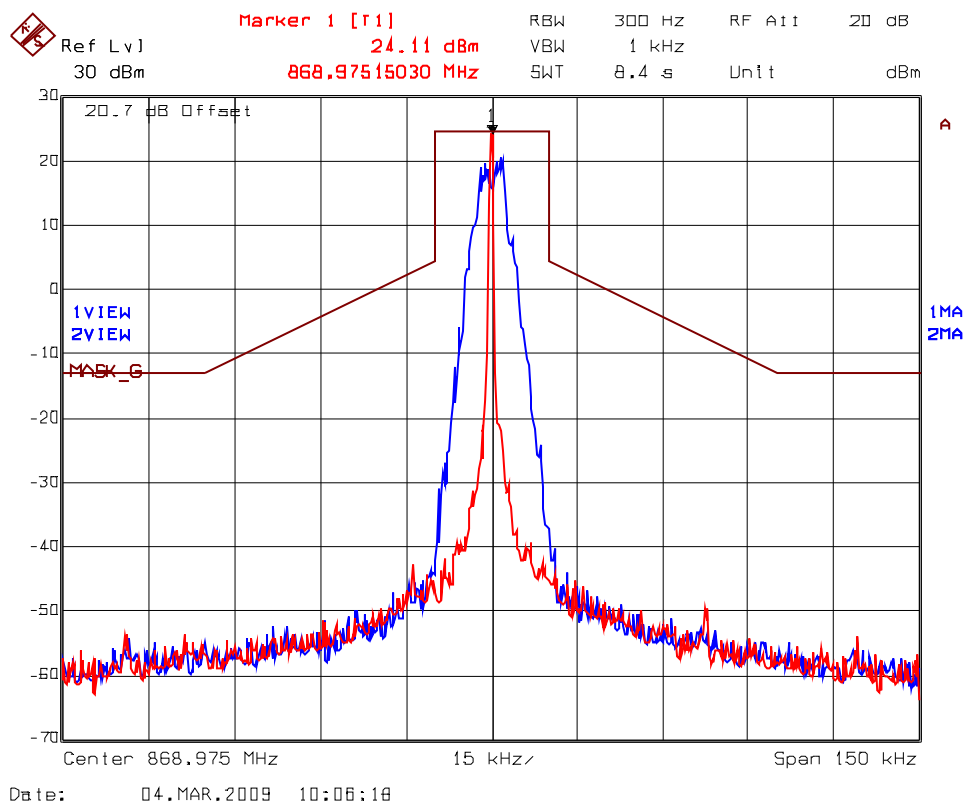

ULTRATECH GROUP OF LABS

3000 Bristol Circle, Oakville, Ontario, Canada L6H 6G4
Tel. #: 905-829-1570, Fax. #: 905-829-8050, Email: vic@ultratech-labs.com, Website: <http://www.ultratech-labs.com>

File #: FSG-093_FCC90_Rev1
June 05, 2009

- All test results contained in this engineering test report are traceable to National Institute of Standards and Technology (NIST)

5.10. TRANSMITTER ANTENNA POWER SPURIOUS/HARMONIC CONDUCTED EMISSIONS [§ 90.210 & 90.691]

5.10.1. Limits

Emissions shall be attenuated below the mean output power of the transmitter as follows:

FCC Rules	Frequency Range	Attenuation Limit (dBc)
90.210(b)	10 MHz to Lowest frequency of the radio to 10 th harmonic of the highest frequency of the radio	At least 43 + 10 log(P) or -13 dBm
90.210(h)	10 MHz to Lowest frequency of the radio to 10 th harmonic of the highest frequency of the radio	At least 43 + 10 log(P) or -13 dBm
90.691(a)(1)	For any frequency removed from the EA licensee's frequency block by up to and including 37.5 kHz, the power of any emission shall be attenuated below the transmitter power (P) in watts by at least 116 Log ₁₀ (f/6.1) decibels or 50 + 10 Log ₁₀ (P) decibels or 80 decibels, whichever is the lesser attenuation, where f is the frequency removed from the center of the outer channel in the block in kilohertz and where f is greater than 12.5 kHz.	
90.691(a)(2)	For any frequency removed from the EA licensee's frequency block greater than 37.5 kHz, the power of any emission shall be attenuated below the transmitter power (P) in watts by at least 43 + 10Log ₁₀ (P) decibels or 80 decibels, whichever is the lesser attenuation, where f is the frequency removed from the center of the outer channel in the block in kilohertz and where f is greater than 37.5 kHz.	

5.10.2. Method of Measurements

Refer to Section 8.5 of this report for measurement details.

5.10.3. Test Arrangement

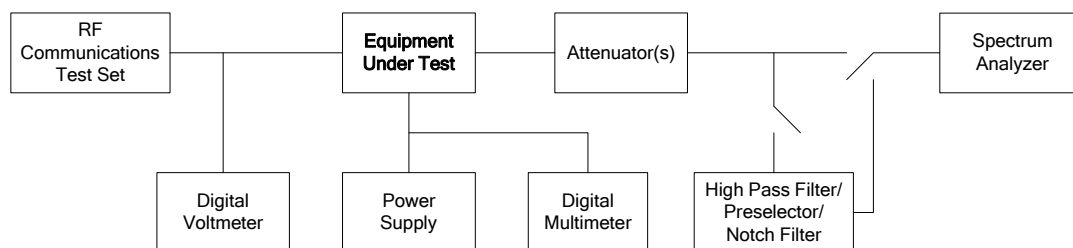

5.10.4. Test Data

5.10.4.1. Near Lower Frequency of both bands

Plot # 59.:
Spurious Emissions at Antenna Terminals
Carrier Frequency: 806.025 MHz
Power: 3 W

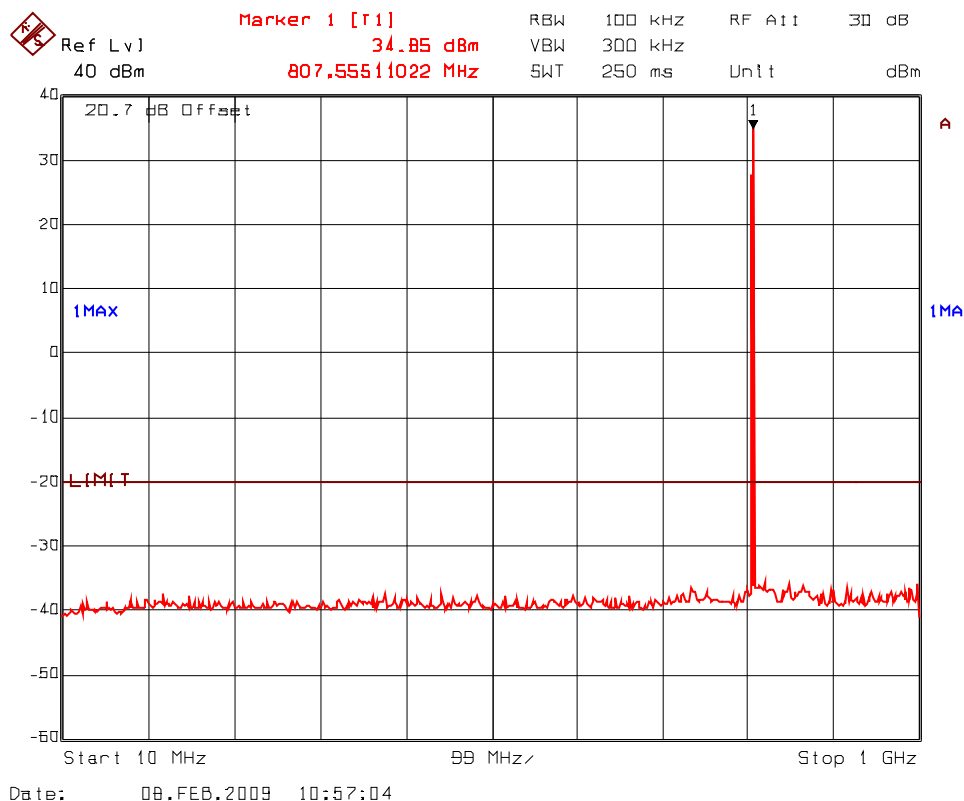

Plot # 60.:
 Spurious Emissions at Antenna Terminals
 Carrier Frequency: 806.025 MHz
 Power: 3 W

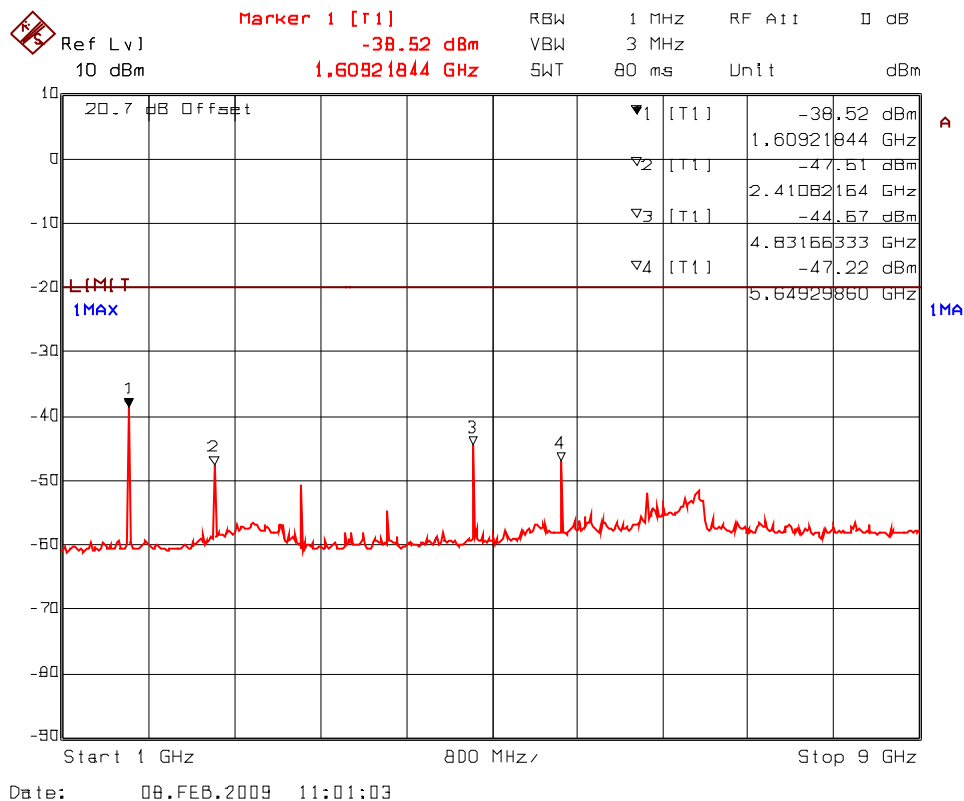

ULTRATECH GROUP OF LABS

3000 Bristol Circle, Oakville, Ontario, Canada L6H 6G4
 Tel. #: 905-829-1570, Fax. #: 905-829-8050, Email: vic@ultratech-labs.com, Website: <http://www.ultratech-labs.com>

File #: FSG-093_FCC90_Rev1
 June 05, 2009

- All test results contained in this engineering test report are traceable to National Institute of Standards and Technology (NIST)

Plot # 61.:
 Spurious Emissions at Antenna Terminals
 Carrier Frequency: 806.025 MHz
 Power: 0.3 W

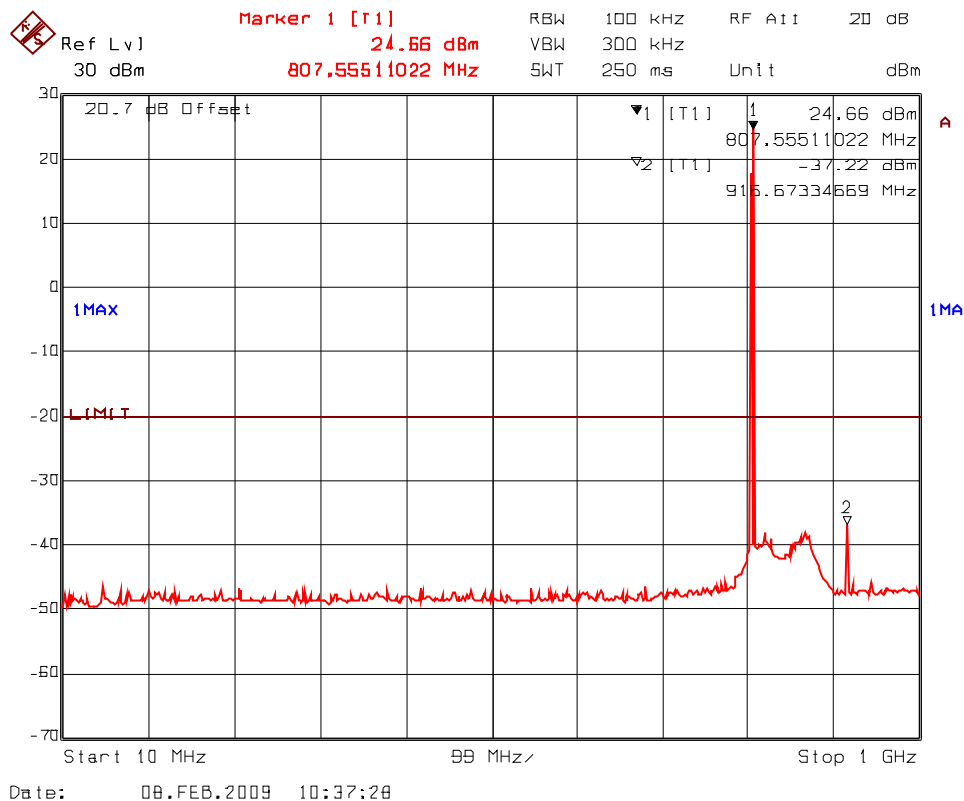

ULTRATECH GROUP OF LABS

3000 Bristol Circle, Oakville, Ontario, Canada L6H 6G4
 Tel. #: 905-829-1570, Fax. #: 905-829-8050, Email: vic@ultratech-labs.com, Website: <http://www.ultratech-labs.com>

File #: FSG-093_FCC90_Rev1
 June 05, 2009

- All test results contained in this engineering test report are traceable to National Institute of Standards and Technology (NIST)

Plot # 62.:
Spurious Emissions at Antenna Terminals
Carrier Frequency: 806.025 MHz
Power: 0.3 W

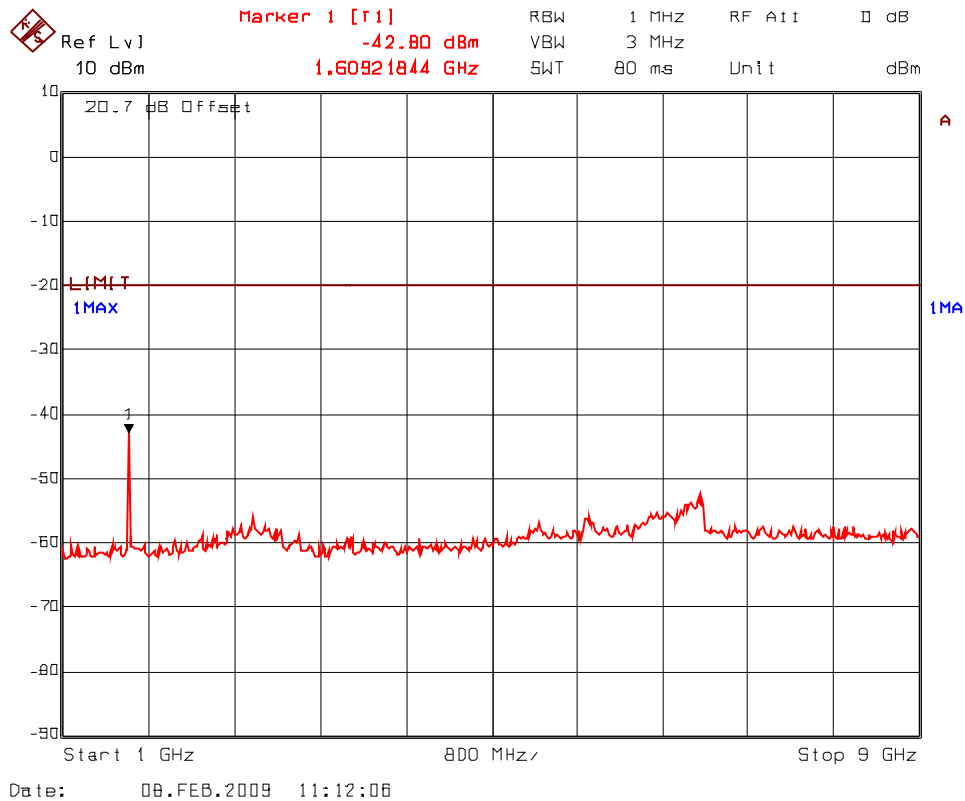

ULTRATECH GROUP OF LABS

3000 Bristol Circle, Oakville, Ontario, Canada L6H 6G4
Tel. #: 905-829-1570, Fax. #: 905-829-8050, Email: vic@ultratech-labs.com, Website: <http://www.ultratech-labs.com>

File #: FSG-093_FCC90_Rev1
June 05, 2009

- All test results contained in this engineering test report are traceable to National Institute of Standards and Technology (NIST)

Plot # 63.:
Spurious Emissions at Antenna Terminals
Carrier Frequency: 851.025 MHz
Power: 3 W

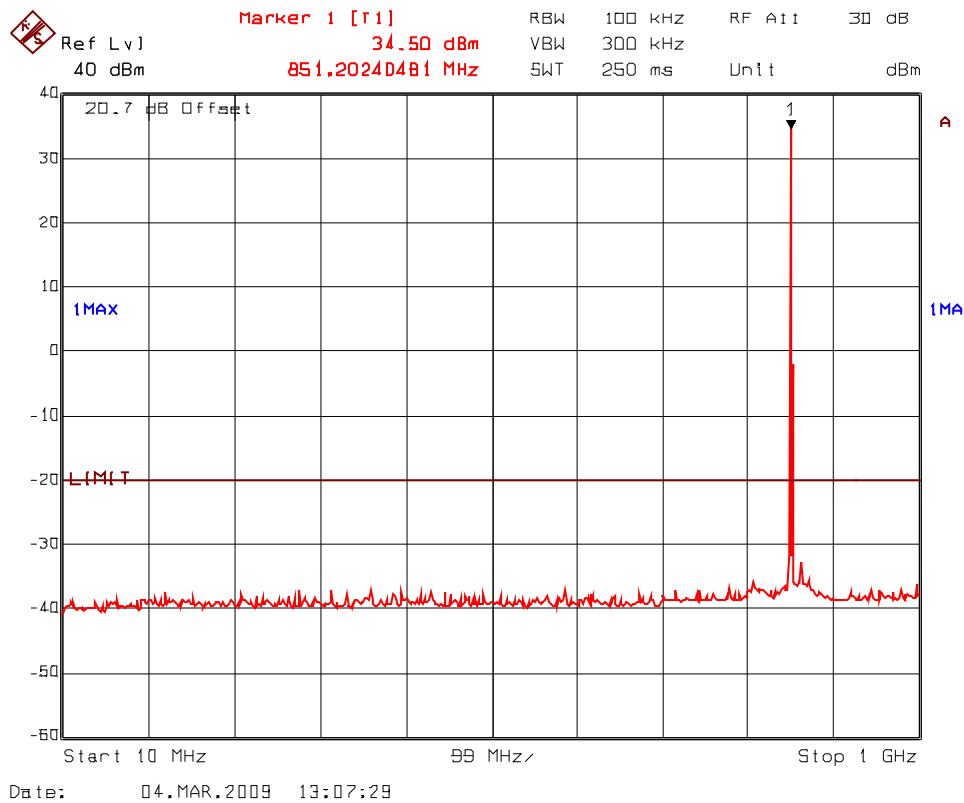

ULTRATECH GROUP OF LABS

3000 Bristol Circle, Oakville, Ontario, Canada L6H 6G4
Tel. #: 905-829-1570, Fax. #: 905-829-8050, Email: vic@ultratech-labs.com, Website: <http://www.ultratech-labs.com>

File #: FSG-093_FCC90_Rev1
June 05, 2009

- All test results contained in this engineering test report are traceable to National Institute of Standards and Technology (NIST)

Plot # 64.:
 Spurious Emissions at Antenna Terminals
 Carrier Frequency: 851.025 MHz
 Power: 3 W

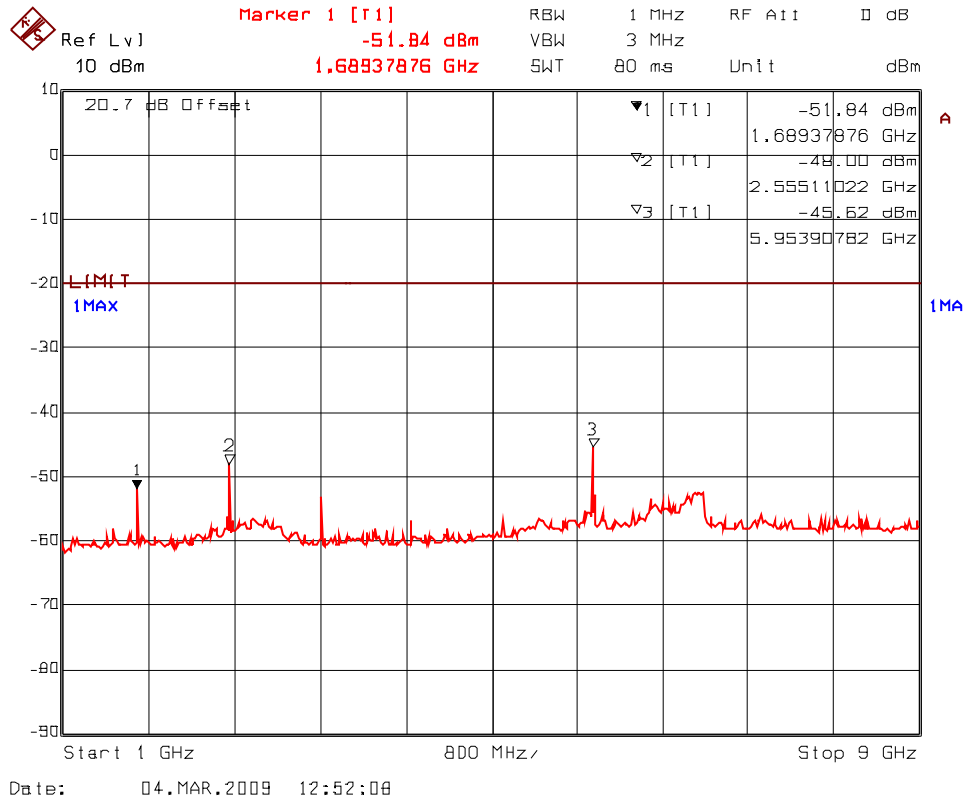

ULTRATECH GROUP OF LABS

3000 Bristol Circle, Oakville, Ontario, Canada L6H 6G4
 Tel. #: 905-829-1570, Fax. #: 905-829-8050, Email: vic@ultratech-labs.com, Website: <http://www.ultratech-labs.com>

File #: FSG-093_FCC90_Rev1
 June 05, 2009

- All test results contained in this engineering test report are traceable to National Institute of Standards and Technology (NIST)

Plot # 65.:
Spurious Emissions at Antenna Terminals
Carrier Frequency: 851.025 MHz
Power: 0.3 W

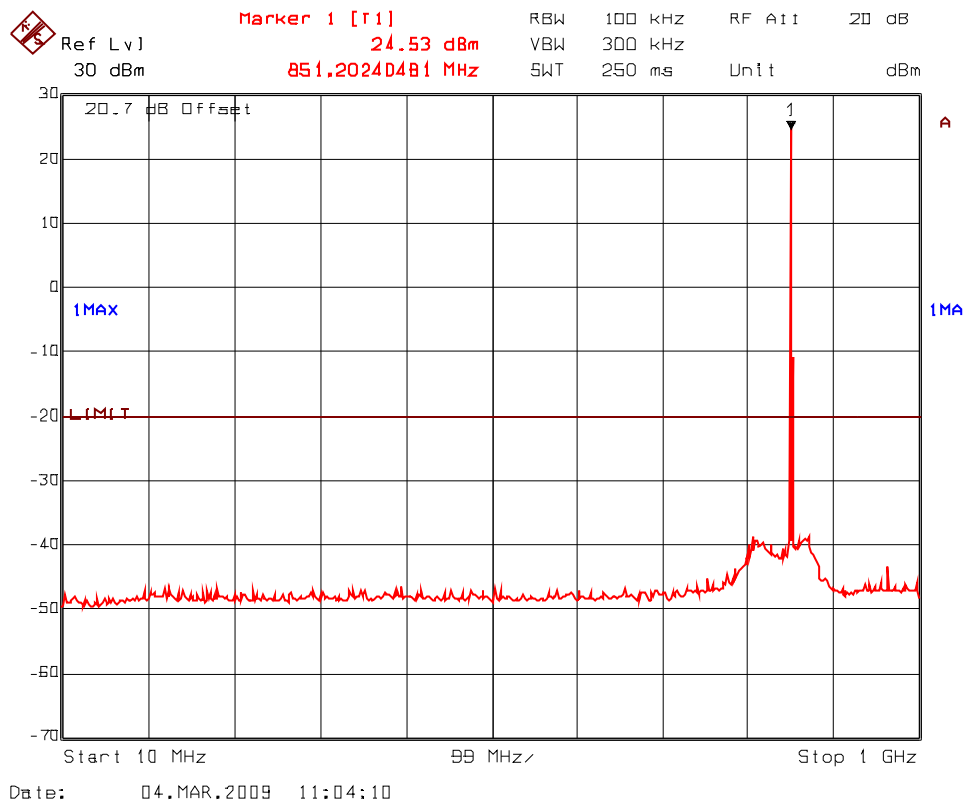

ULTRATECH GROUP OF LABS

3000 Bristol Circle, Oakville, Ontario, Canada L6H 6G4
Tel. #: 905-829-1570, Fax. #: 905-829-8050, Email: vic@ultratech-labs.com, Website: <http://www.ultratech-labs.com>

File #: FSG-093_FCC90_Rev1
June 05, 2009

- All test results contained in this engineering test report are traceable to National Institute of Standards and Technology (NIST)

Plot # 66.:
Spurious Emissions at Antenna Terminals
Carrier Frequency: 851.025 MHz
Power: 0.3 W

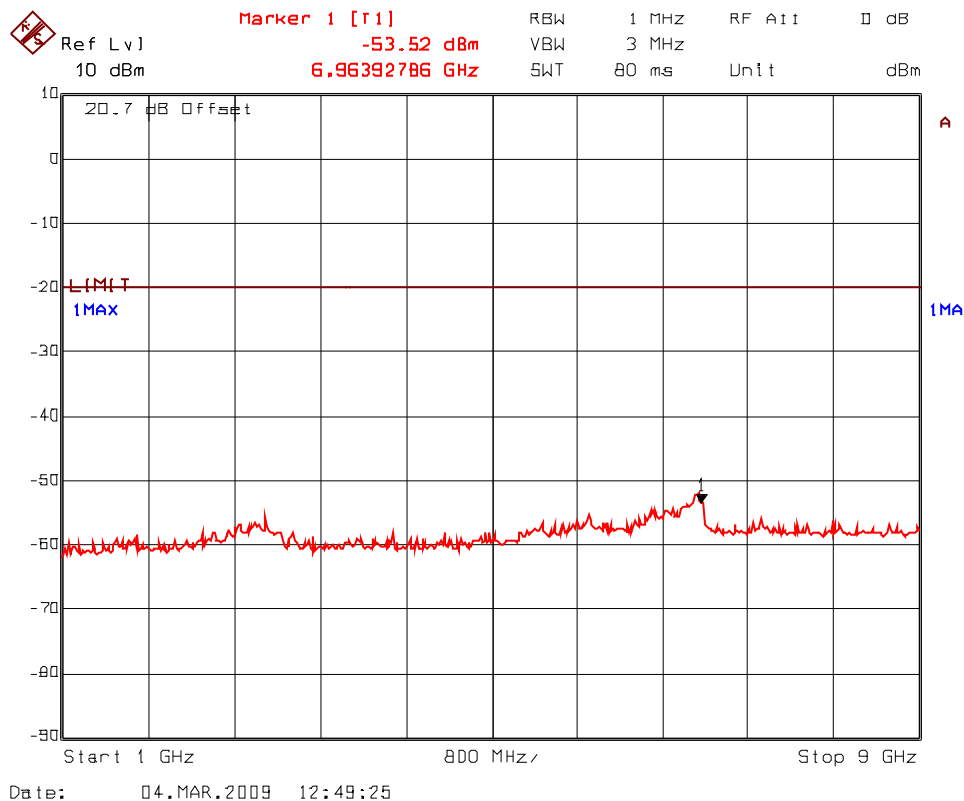

ULTRATECH GROUP OF LABS

3000 Bristol Circle, Oakville, Ontario, Canada L6H 6G4
Tel. #: 905-829-1570, Fax. #: 905-829-8050, Email: vic@ultratech-labs.com, Website: <http://www.ultratech-labs.com>

File #: FSG-093_FCC90_Rev1
June 05, 2009

- All test results contained in this engineering test report are traceable to National Institute of Standards and Technology (NIST)

5.10.4.2. Near Middle Frequency of both bands

Plot # 67.:
Spurious Emissions at Antenna Terminals
Carrier Frequency: 816.500 MHz
Power: 3 W

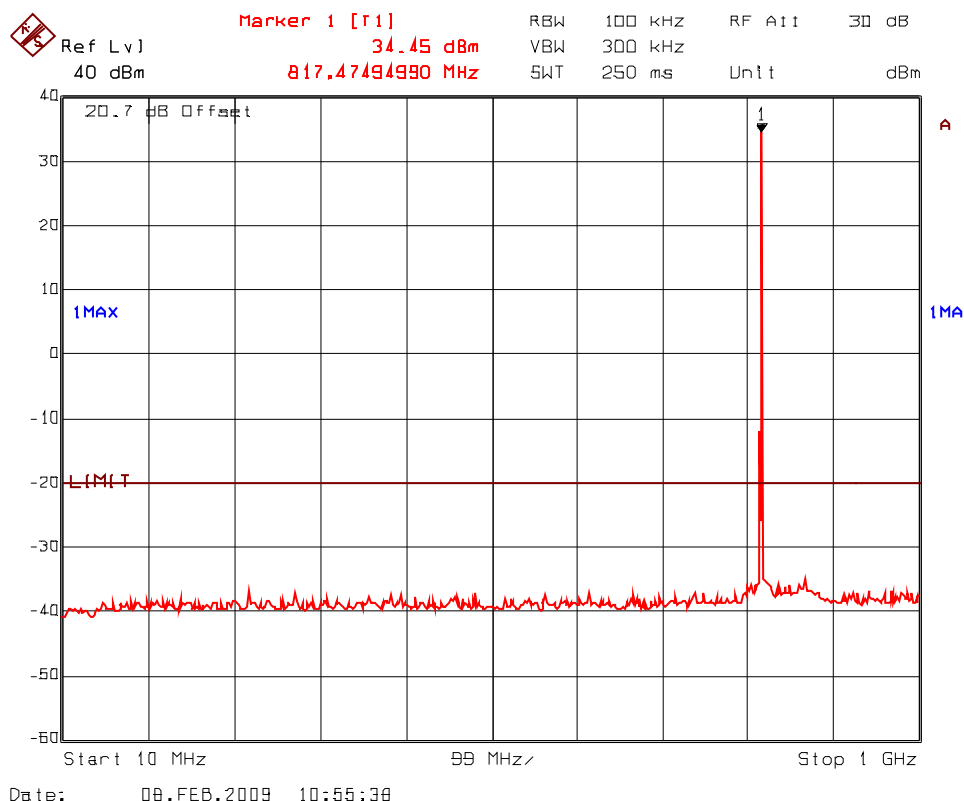

ULTRATECH GROUP OF LABS

3000 Bristol Circle, Oakville, Ontario, Canada L6H 6G4
Tel. #: 905-829-1570, Fax. #: 905-829-8050, Email: vic@ultratech-labs.com, Website: <http://www.ultratech-labs.com>

File #: FSG-093_FCC90_Rev1
June 05, 2009

- All test results contained in this engineering test report are traceable to National Institute of Standards and Technology (NIST)

Plot # 68.:
 Spurious Emissions at Antenna Terminals
 Carrier Frequency: 816.500 MHz
 Power: 3 W

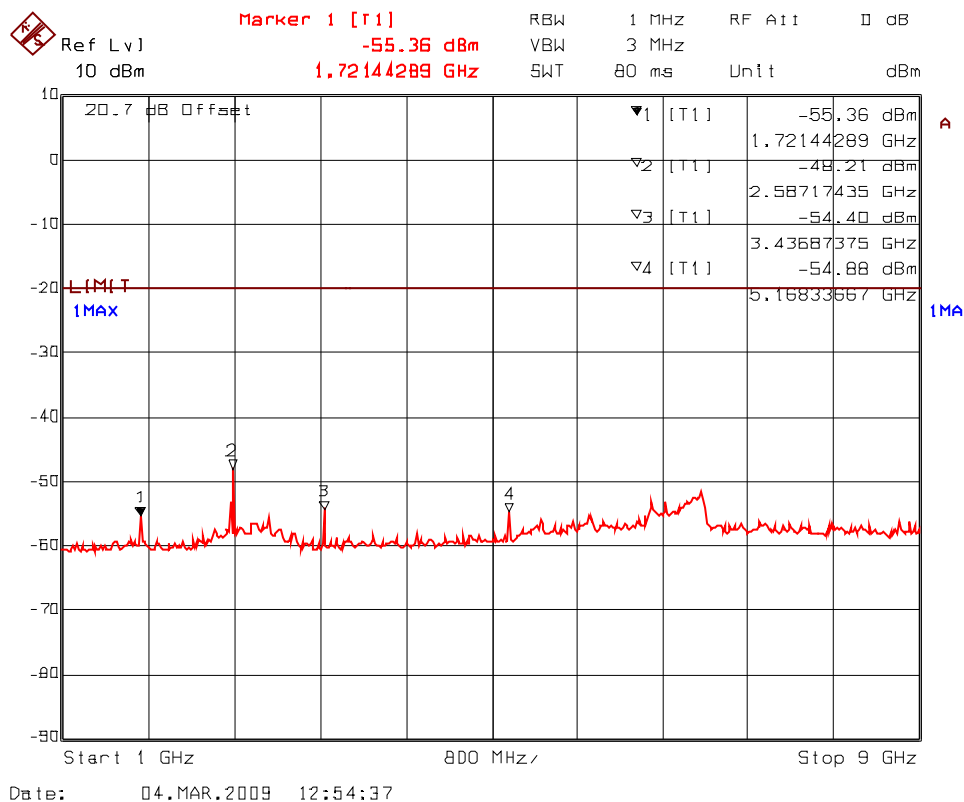

ULTRATECH GROUP OF LABS

3000 Bristol Circle, Oakville, Ontario, Canada L6H 6G4
 Tel. #: 905-829-1570, Fax. #: 905-829-8050, Email: vic@ultratech-labs.com, Website: <http://www.ultratech-labs.com>

File #: FSG-093_FCC90_Rev1
 June 05, 2009

- All test results contained in this engineering test report are traceable to National Institute of Standards and Technology (NIST)

Plot # 69.:
Spurious Emissions at Antenna Terminals
Carrier Frequency: 816.500 MHz
Power: 0.3 W

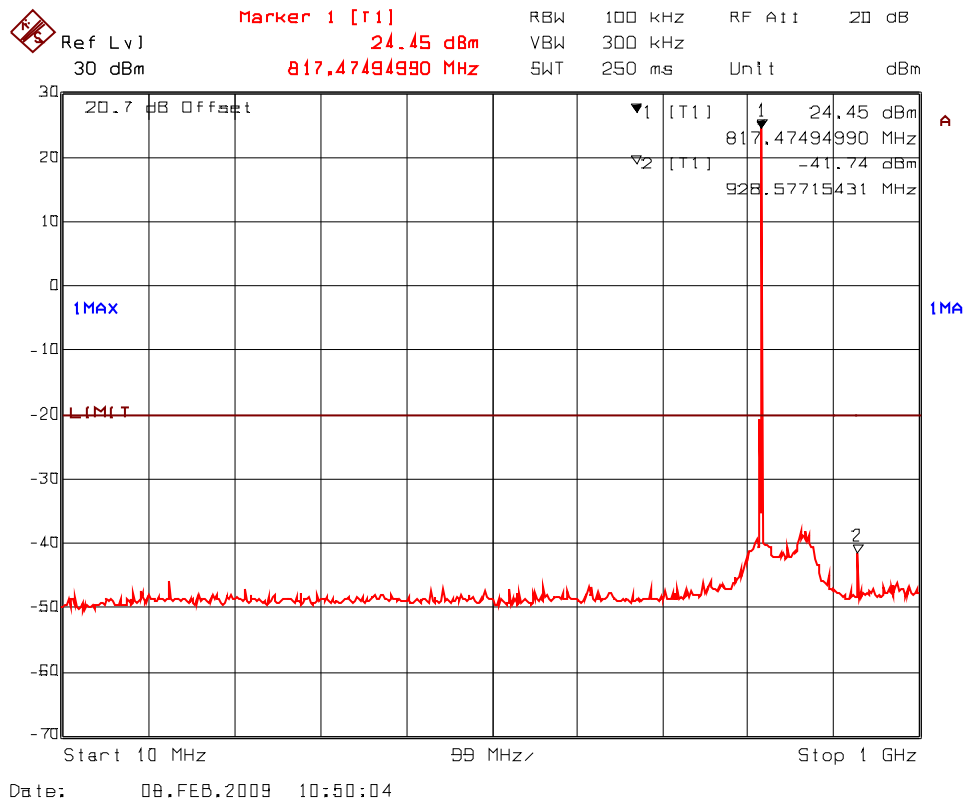

ULTRATECH GROUP OF LABS

3000 Bristol Circle, Oakville, Ontario, Canada L6H 6G4
Tel. #: 905-829-1570, Fax. #: 905-829-8050, Email: vic@ultratech-labs.com, Website: <http://www.ultratech-labs.com>

File #: FSG-093_FCC90_Rev1
June 05, 2009

- All test results contained in this engineering test report are traceable to National Institute of Standards and Technology (NIST)

Plot # 70.:
Spurious Emissions at Antenna Terminals
Carrier Frequency: 816.500 MHz
Power: 0.3 W

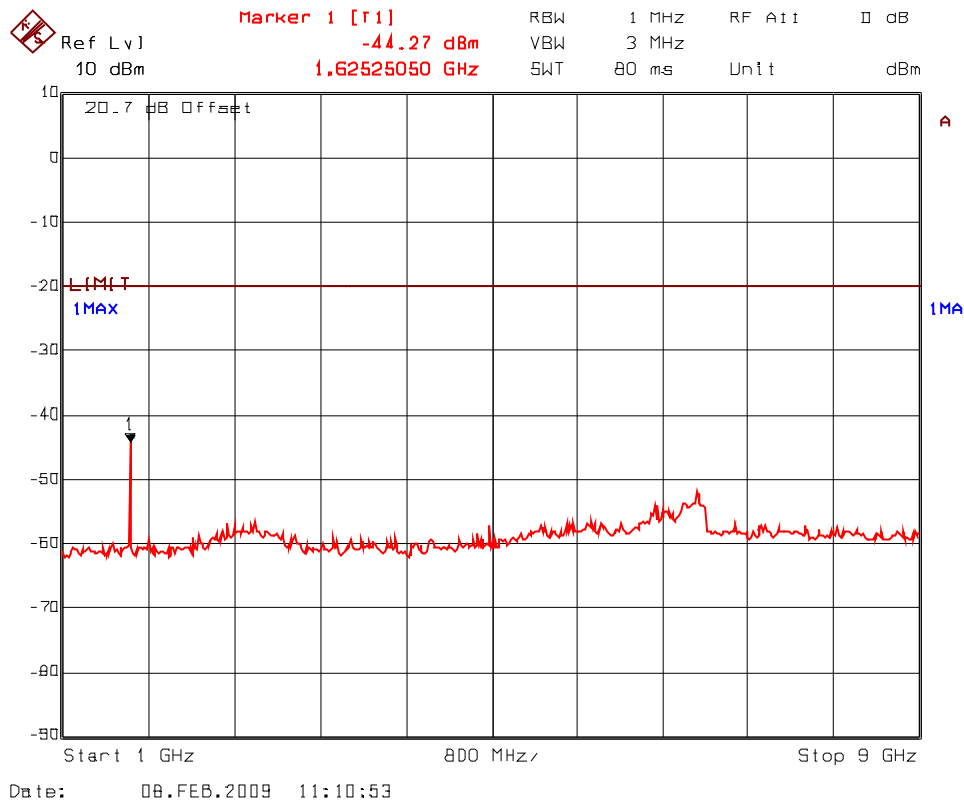

ULTRATECH GROUP OF LABS

3000 Bristol Circle, Oakville, Ontario, Canada L6H 6G4
Tel. #: 905-829-1570, Fax. #: 905-829-8050, Email: vic@ultratech-labs.com, Website: <http://www.ultratech-labs.com>

File #: FSG-093_FCC90_Rev1
June 05, 2009

- All test results contained in this engineering test report are traceable to National Institute of Standards and Technology (NIST)

Plot # 71.:
Spurious Emissions at Antenna Terminals
Carrier Frequency: 861.500 MHz
Power: 3 W

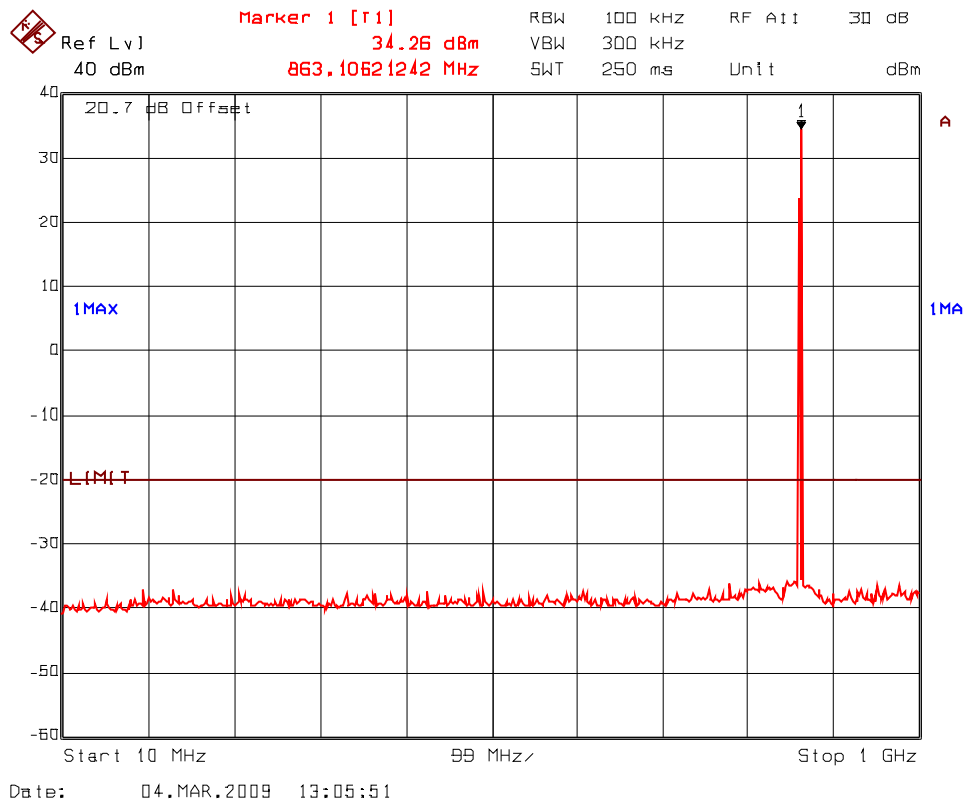

ULTRATECH GROUP OF LABS

3000 Bristol Circle, Oakville, Ontario, Canada L6H 6G4
Tel. #: 905-829-1570, Fax. #: 905-829-8050, Email: vic@ultratech-labs.com, Website: <http://www.ultratech-labs.com>

File #: FSG-093_FCC90_Rev1
June 05, 2009

- All test results contained in this engineering test report are traceable to National Institute of Standards and Technology (NIST)

Plot # 72.:
 Spurious Emissions at Antenna Terminals
 Carrier Frequency: 861.500 MHz
 Power: 3 W

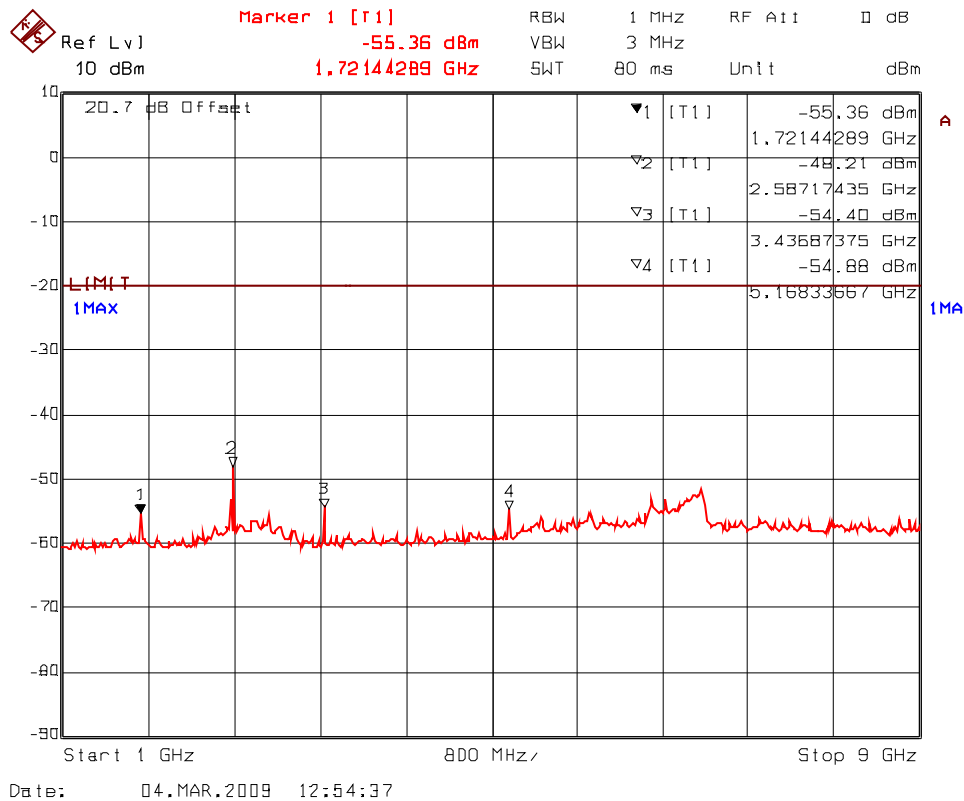

ULTRATECH GROUP OF LABS

3000 Bristol Circle, Oakville, Ontario, Canada L6H 6G4
 Tel. #: 905-829-1570, Fax. #: 905-829-8050, Email: vic@ultratech-labs.com, Website: <http://www.ultratech-labs.com>

File #: FSG-093_FCC90_Rev1
 June 05, 2009

- All test results contained in this engineering test report are traceable to National Institute of Standards and Technology (NIST)

Plot # 73.:
Spurious Emissions at Antenna Terminals
Carrier Frequency: 861.500 MHz
Power: 0.3 W

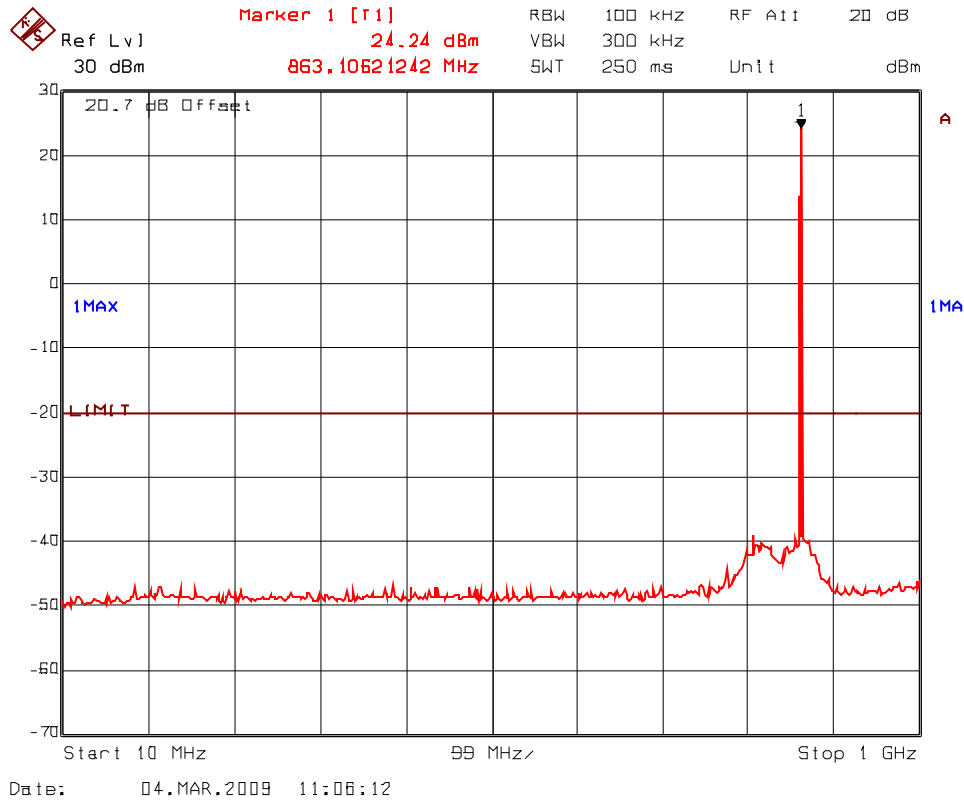

ULTRATECH GROUP OF LABS

3000 Bristol Circle, Oakville, Ontario, Canada L6H 6G4
Tel. #: 905-829-1570, Fax. #: 905-829-8050, Email: vic@ultratech-labs.com, Website: <http://www.ultratech-labs.com>

File #: FSG-093_FCC90_Rev1
June 05, 2009

- All test results contained in this engineering test report are traceable to National Institute of Standards and Technology (NIST)

Plot # 74.:
Spurious Emissions at Antenna Terminals
Carrier Frequency: 861.500 MHz
Power: 0.3 W

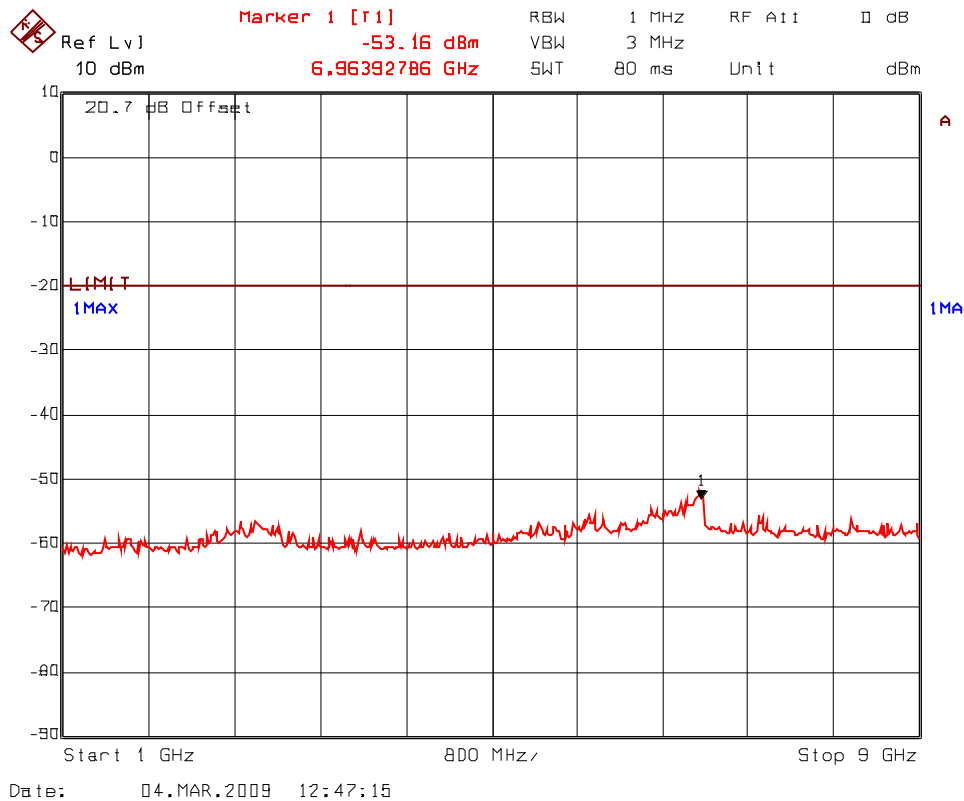

ULTRATECH GROUP OF LABS

3000 Bristol Circle, Oakville, Ontario, Canada L6H 6G4
Tel. #: 905-829-1570, Fax. #: 905-829-8050, Email: vic@ultratech-labs.com, Website: <http://www.ultratech-labs.com>

File #: FSG-093_FCC90_Rev1
June 05, 2009

- All test results contained in this engineering test report are traceable to National Institute of Standards and Technology (NIST)

5.10.4.3. Near Higher Frequency of both bands

Plot # 75.:
Spurious Emissions at Antenna Terminals
Carrier Frequency: 823.975 MHz
Power: 3 W

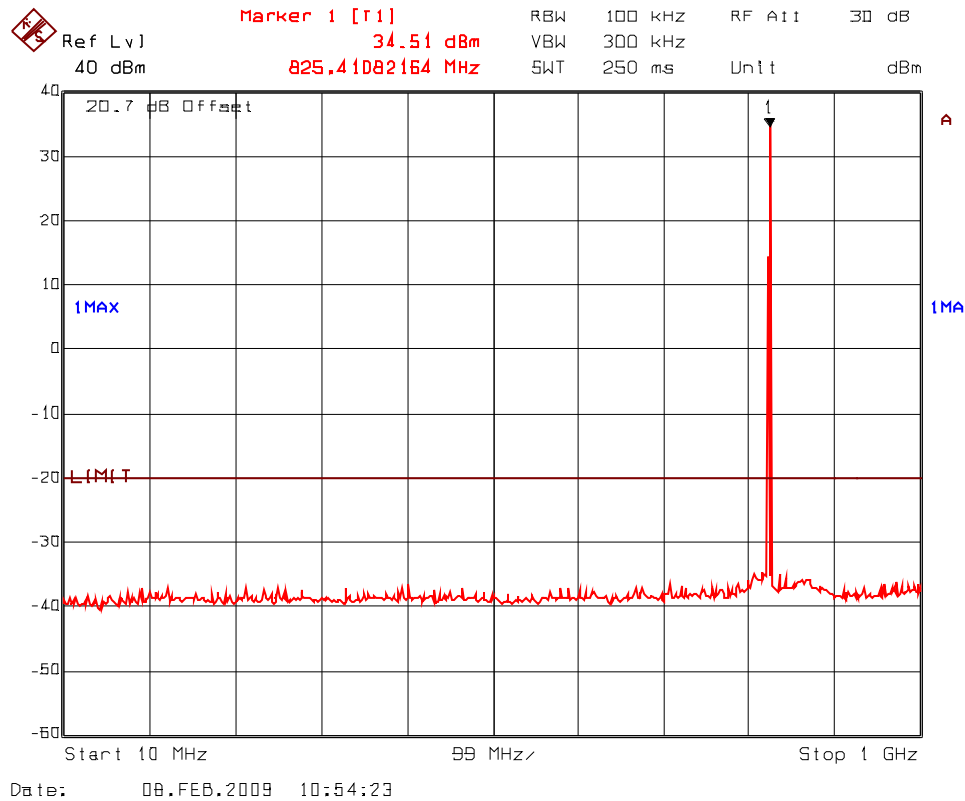

Plot # 76.:
 Spurious Emissions at Antenna Terminals
 Carrier Frequency: 823.975 MHz
 Power: 3 W

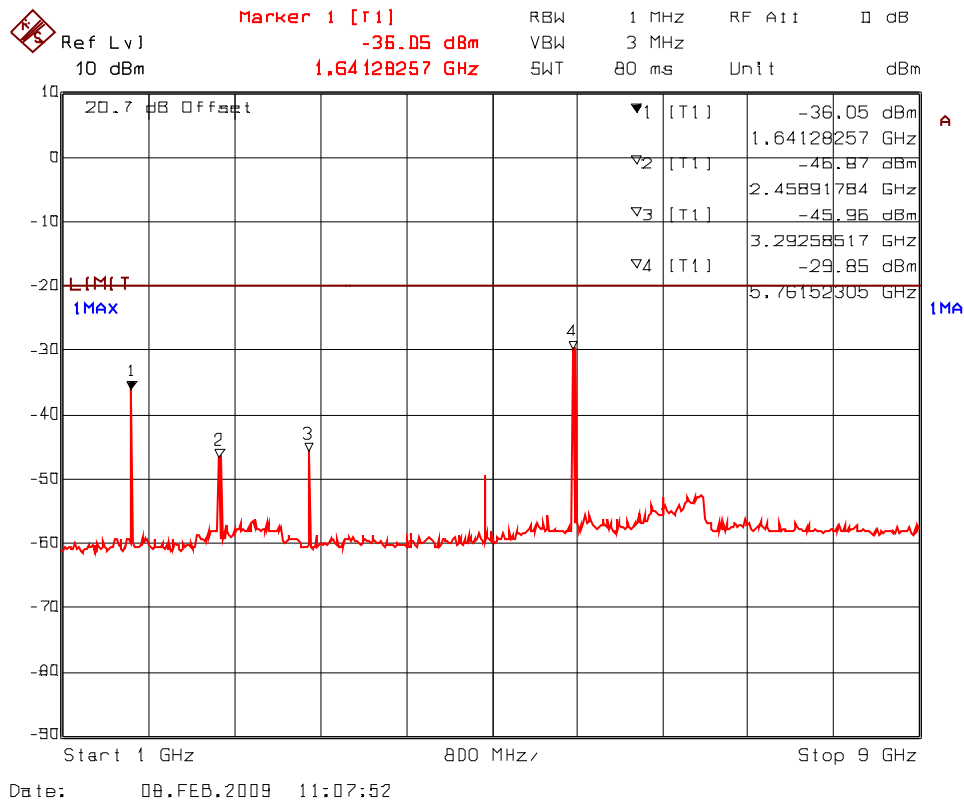

ULTRATECH GROUP OF LABS

3000 Bristol Circle, Oakville, Ontario, Canada L6H 6G4
 Tel. #: 905-829-1570, Fax. #: 905-829-8050, Email: vic@ultratech-labs.com, Website: <http://www.ultratech-labs.com>

File #: FSG-093_FCC90_Rev1
 June 05, 2009

- All test results contained in this engineering test report are traceable to National Institute of Standards and Technology (NIST)

Plot # 77.:
Spurious Emissions at Antenna Terminals
Carrier Frequency: 823.975 MHz
Power: 0.3 W

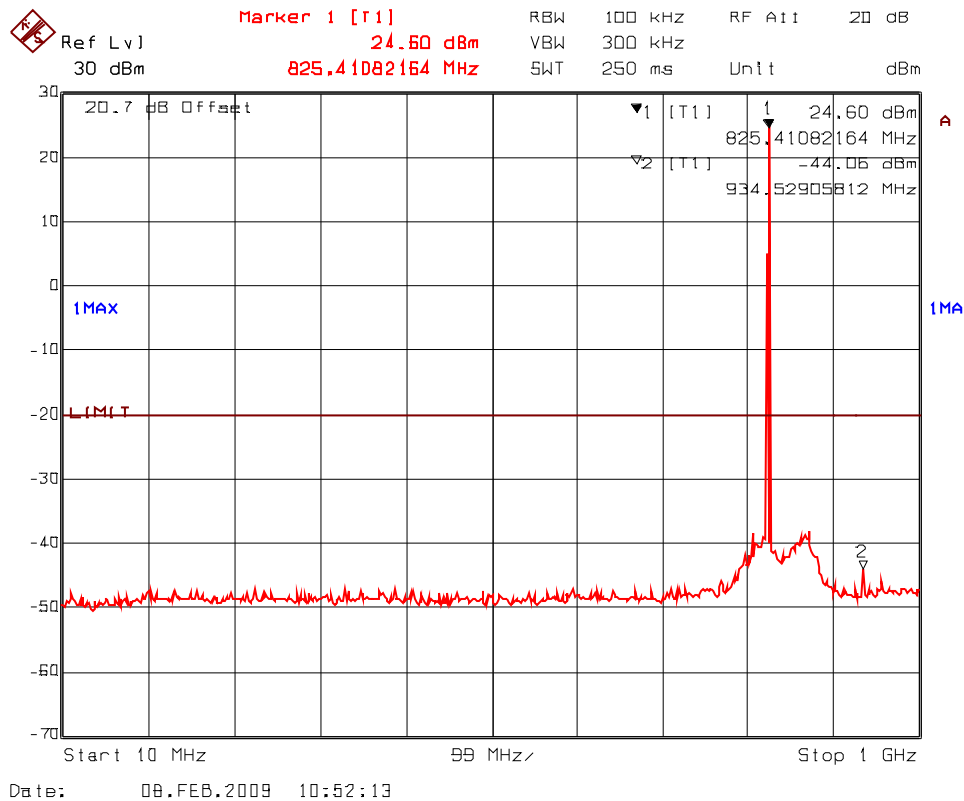

ULTRATECH GROUP OF LABS

3000 Bristol Circle, Oakville, Ontario, Canada L6H 6G4
Tel. #: 905-829-1570, Fax. #: 905-829-8050, Email: vic@ultratech-labs.com, Website: <http://www.ultratech-labs.com>

File #: FSG-093_FCC90_Rev1
June 05, 2009

- All test results contained in this engineering test report are traceable to National Institute of Standards and Technology (NIST)

Plot # 78.:
Spurious Emissions at Antenna Terminals
Carrier Frequency: 823.975 MHz
Power: 0.3 W

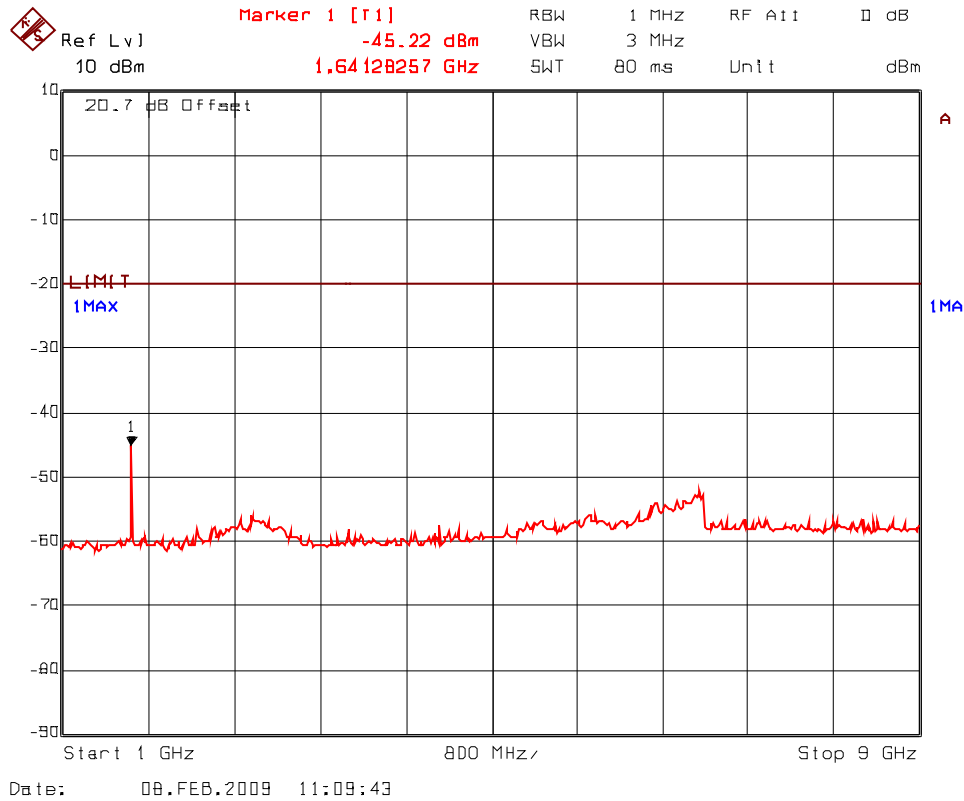

ULTRATECH GROUP OF LABS

3000 Bristol Circle, Oakville, Ontario, Canada L6H 6G4
Tel. #: 905-829-1570, Fax. #: 905-829-8050, Email: vic@ultratech-labs.com, Website: <http://www.ultratech-labs.com>

File #: FSG-093_FCC90_Rev1
June 05, 2009

- All test results contained in this engineering test report are traceable to National Institute of Standards and Technology (NIST)

Plot # 79.:
Spurious Emissions at Antenna Terminals
Carrier Frequency: 868.975 MHz
Power: 3 W

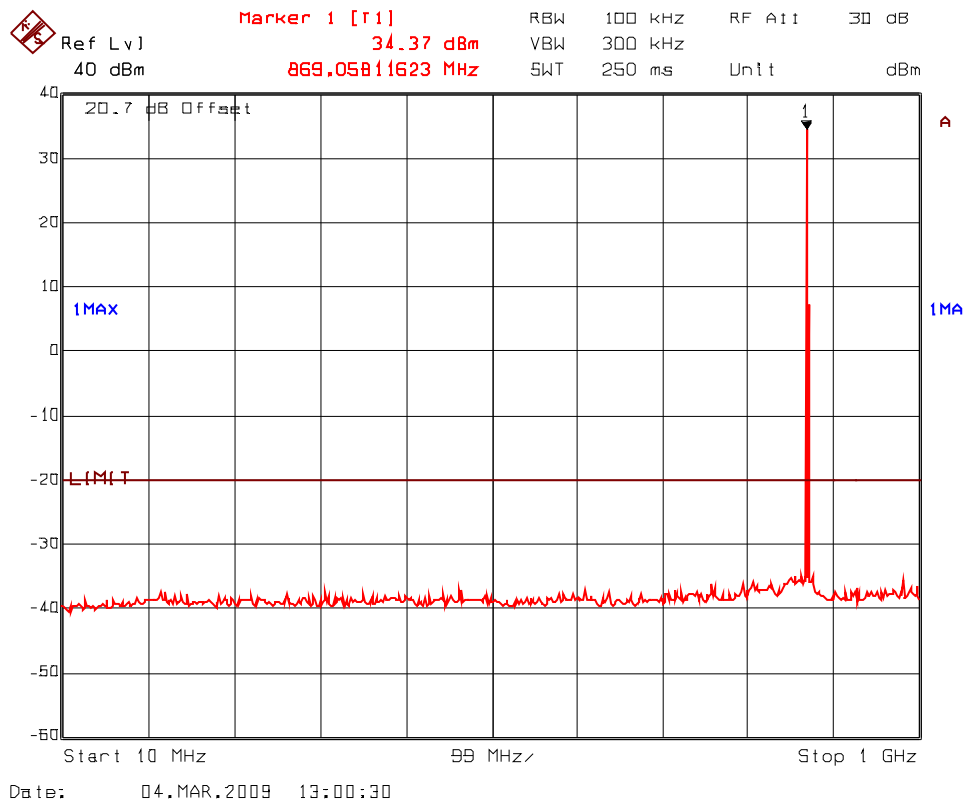

ULTRATECH GROUP OF LABS

3000 Bristol Circle, Oakville, Ontario, Canada L6H 6G4
Tel. #: 905-829-1570, Fax. #: 905-829-8050, Email: vic@ultratech-labs.com, Website: <http://www.ultratech-labs.com>

File #: FSG-093_FCC90_Rev1
June 05, 2009

- All test results contained in this engineering test report are traceable to National Institute of Standards and Technology (NIST)

Plot # 80.:
 Spurious Emissions at Antenna Terminals
 Carrier Frequency: 868.975 MHz
 Power: 3 W

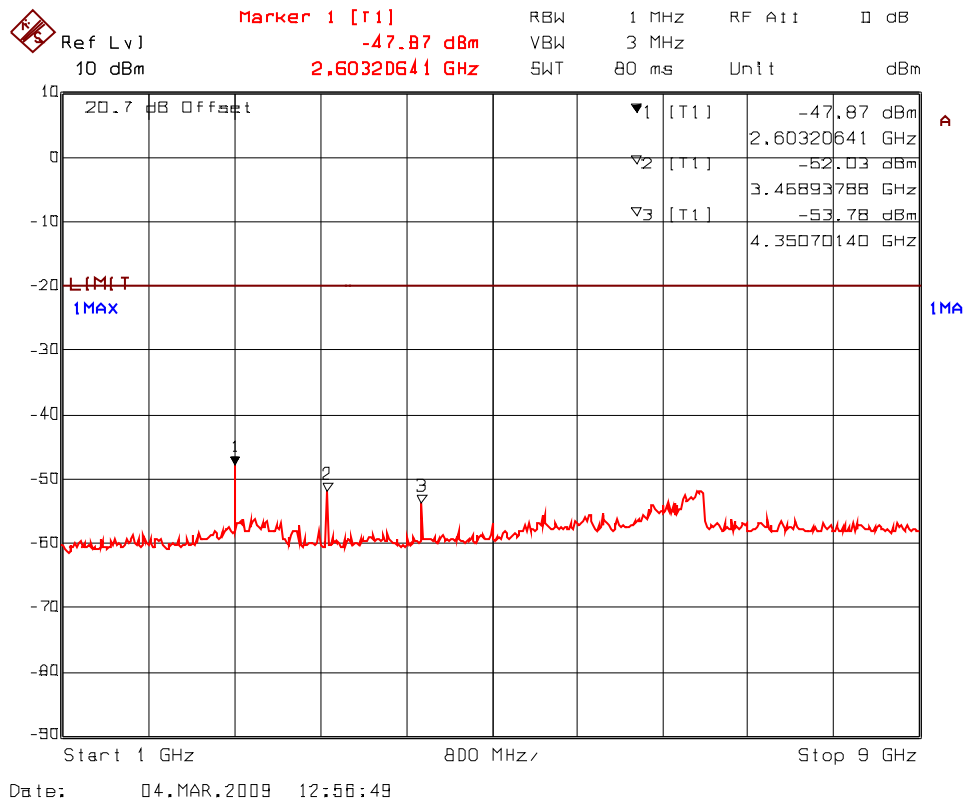

ULTRATECH GROUP OF LABS

3000 Bristol Circle, Oakville, Ontario, Canada L6H 6G4
 Tel. #: 905-829-1570, Fax. #: 905-829-8050, Email: vic@ultratech-labs.com, Website: <http://www.ultratech-labs.com>

File #: FSG-093_FCC90_Rev1
 June 05, 2009

- All test results contained in this engineering test report are traceable to National Institute of Standards and Technology (NIST)

Plot # 81.:
Spurious Emissions at Antenna Terminals
Carrier Frequency: 868.975 MHz
Power: 0.3 W

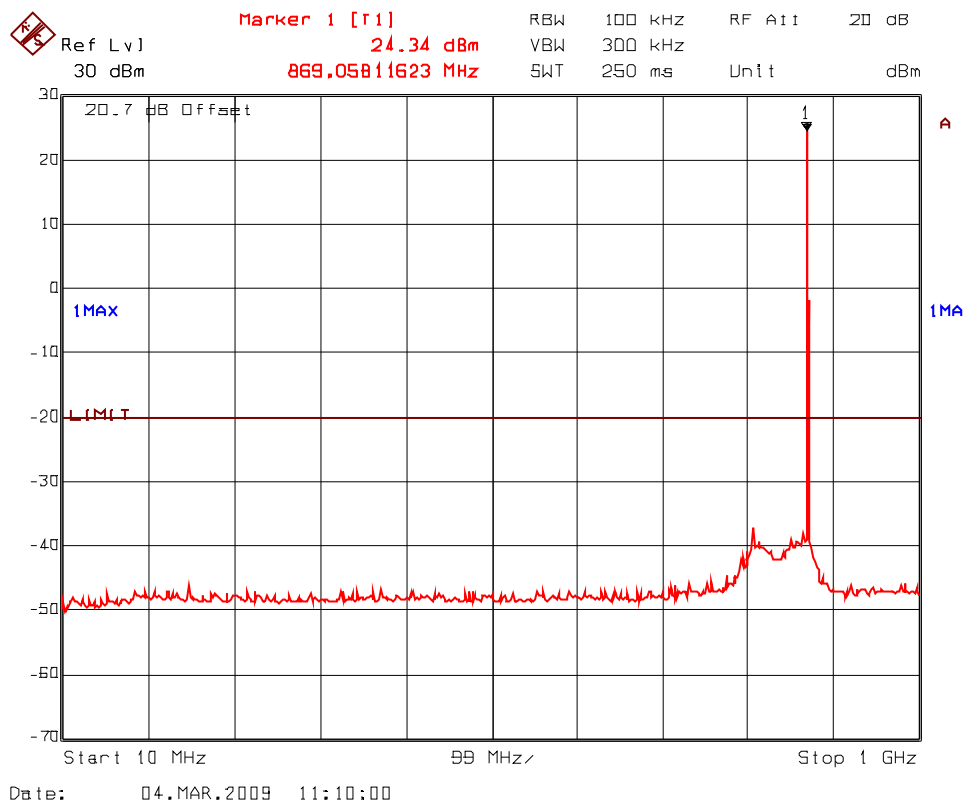

ULTRATECH GROUP OF LABS

3000 Bristol Circle, Oakville, Ontario, Canada L6H 6G4
Tel. #: 905-829-1570, Fax. #: 905-829-8050, Email: vic@ultratech-labs.com, Website: <http://www.ultratech-labs.com>

File #: FSG-093_FCC90_Rev1
June 05, 2009

- All test results contained in this engineering test report are traceable to National Institute of Standards and Technology (NIST)

Plot # 82.:
Spurious Emissions at Antenna Terminals
Carrier Frequency: 868.975 MHz
Power: 0.3 W

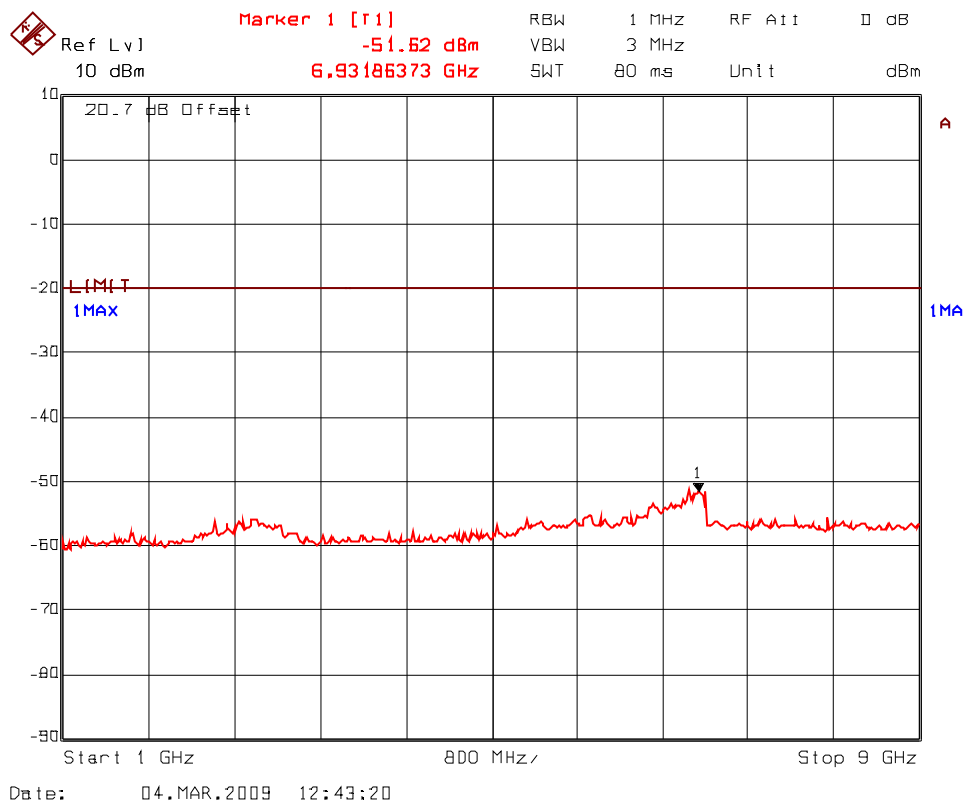

ULTRATECH GROUP OF LABS

3000 Bristol Circle, Oakville, Ontario, Canada L6H 6G4
Tel. #: 905-829-1570, Fax. #: 905-829-8050, Email: vic@ultratech-labs.com, Website: <http://www.ultratech-labs.com>

File #: FSG-093_FCC90_Rev1
June 05, 2009

- All test results contained in this engineering test report are traceable to National Institute of Standards and Technology (NIST)

5.11. TRANSMITTER SPURIOUS/HARMONIC RADIATED EMISSIONS [§ 90.210 & 90.691]

5.11.1. Limits

Emissions shall be attenuated below the mean output power of the transmitter as follows:

FCC Rules	Frequency Range	Attenuation Limit (dBc)
90.210(b)	10 MHz to Lowest frequency of the radio to 10 th harmonic of the highest frequency of the radio	At least 43 + 10 log(P) or -13 dBm
90.210(h)	10 MHz to Lowest frequency of the radio to 10 th harmonic of the highest frequency of the radio	At least 43 + 10 log(P) or -13 dBm
90.691(a)(1)	For any frequency removed from the EA licensee's frequency block by up to and including 37.5 kHz, the power of any emission shall be attenuated below the transmitter power (P) in watts by at least 116 Log ₁₀ (f/6.1) decibels or 50 + 10 Log ₁₀ (P) decibels or 80 decibels, whichever is the lesser attenuation, where f is the frequency removed from the center of the outer channel in the block in kilohertz and where f is greater than 12.5 kHz.	
90.691(a)(2)	For any frequency removed from the EA licensee's frequency block greater than 37.5 kHz, the power of any emission shall be attenuated below the transmitter power (P) in watts by at least 43 + 10Log ₁₀ (P) decibels or 80 decibels, whichever is the lesser attenuation, where f is the frequency removed from the center of the outer channel in the block in kilohertz and where f is greater than 37.5 kHz.	

5.11.2. Method of Measurements

The spurious/harmonic ERP measurements are using substitution method specified in Section 8.2 of this report.

5.11.3. Test Arrangement

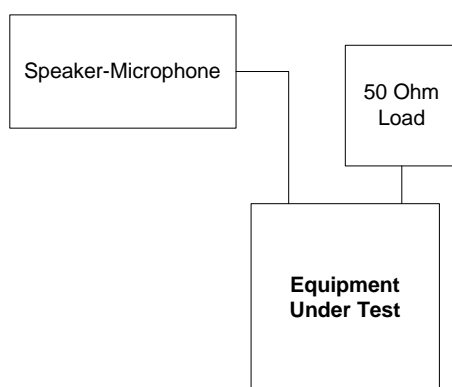

5.11.4. Test Data

Remarks:

- The RF spurious/harmonic emission characteristics for different channel spacing are indistinguishable. Therefore, the following radiated emissions were performed at high, middle & low frequencies of both bands. Also the more stringent limit of $50 + 10 \text{ Log}_{10}(P)$ or -20dBm for EA based systems is applied as worst case.
- The radiated emissions were performed with high power setting (3 Watts) at 3 meters distance to represents the worst-case test configuration.
- The emissions were scanned from 30 MHz to 10^{th} harmonics; all emissions within 20 dB below the limits were recorded.

5.11.4.1. Near Lowest Frequencies

Carrier Frequency (MHz): 806.025
Power_{conducted} (dBm): 34.72
Limit (dBm): -20.0

Frequency (MHz)	E-Field (dB μ V/m)	EMI Detector (Peak/QP)	Antenna Polarization (H/V)	ERP measured (dBm)	Limit (dBm)	Margin (dB)
806.025	--	--	--	--	--	--
806.025	--	--	--	--	--	--
1612.050	78.14	Peak	V	-23.03	-20	-3.0
1612.050	75.31	Peak	H	-25.86	-20	-5.9
4836.150	63.26	Peak	V	-39.71	-20	-19.7

All other emissions found are more than 20 dB below the limits

Carrier Frequency (MHz): 851.025
Power_{conducted} (dBm): 34.69
Limit (dBm): -20.0

Frequency (MHz)	E-Field (dB μ V/m)	EMI Detector (Peak/QP)	Antenna Polarization (H/V)	ERP measured (dBm)	Limit (dBm)	Margin (dB)
851.025	--	--	--	--	--	--
851.025	--	--	--	--	--	--
1702.050	71.74	Peak	V	-29.33	-20	-9.3
1702.050	68.37	Peak	H	-32.70	-20	-12.7
3404.100	62.66	Peak	V	-38.60	-20	-18.6
3404.100	61.74	Peak	H	-39.52	-20	-19.5

All emissions found are more than 20 dB below the limits

ULTRATECH GROUP OF LABS

3000 Bristol Circle, Oakville, Ontario, Canada L6H 6G4
 Tel. #: 905-829-1570, Fax. #: 905-829-8050, Email: vic@ultratech-labs.com, Website: <http://www.ultratech-labs.com>

File #: FSG-093_FCC90_Rev1
 June 05, 2009

- All test results contained in this engineering test report are traceable to National Institute of Standards and Technology (NIST)

5.11.4.2. Near Middle Frequencies

Carrier Frequency (MHz): 816.500
Power_{conducted} (dBm): 34.77
Limit (dBm): -20.0

Frequency (MHz)	E-Field (dB μ V/m)	EMI Detector (Peak/QP)	Antenna Polarization (H/V)	ERP measured (dBm)	Limit (dBm)	Margin (dB)
816.500	--	--	--	--	--	--
816.500	--	--	--	--	--	--
1633.000	77.21	Peak	V	-23.86	-20	-3.9
1633.000	77.21	Peak	H	-23.86	-20	-3.9

All emissions found are more than 20 dB below the limits

Carrier Frequency (MHz): 861.500
Power_{conducted} (dBm): 34.68
Limit (dBm): -20.0

Frequency (MHz)	E-Field (dB μ V/m)	EMI Detector (Peak/QP)	Antenna Polarization (H/V)	ERP measured (dBm)	Limit (dBm)	Margin (dB)
861.500	--	--	--	--	--	--
861.500	--	--	--	--	--	--
1723.000	67.34	Peak	V	-33.73	-20	-13.7
1723.000	69.86	Peak	H	-31.21	-20	-11.2

All other emissions found are more than 20 dB below the limits

5.11.4.3. Near Highest Frequencies

Carrier Frequency (MHz): 823.975
Power conducted (dBm): 34.78
Limit (dBm): -20.0

Frequency (MHz)	E-Field (dBµV/m)	EMI Detector (Peak/QP)	Antenna Polarization (H/V)	ERP measured (dBm)	Limit (dBm)	Margin (dB)
823.975	--	--	--	--	--	--
823.975	--	--	--	--	--	--
1647.950	78.89	Peak	V	-22.18	-20	-2.2
1647.950	76.76	Peak	H	-24.31	-20	-4.3
3295.900	61.89	Peak	V	-39.37	-20	-19.4
4119.875	66.89	Peak	V	-34.18	-20	-14.2
4119.875	66.12	Peak	H	-34.95	-20	-15.0

All emissions found are more than 20 dB below the limits

Carrier Frequency (MHz): 868.975
Power conducted (dBm): 34.71
Limit (dBm): -20.0

Frequency (MHz)	E-Field (dBµV/m)	EMI Detector (Peak/QP)	Antenna Polarization (H/V)	ERP measured (dBm)	Limit (dBm)	Margin (dB)
868.975	--	--	--	--	--	--
868.975	--	--	--	--	--	--
1737.950	64.31	Peak	V	-36.76	-20	-16.8
1737.950	62.52	Peak	H	-38.55	-20	-18.6

All emissions found are more than 20 dB below the limits

5.12. RF EXPOSURE REQUIREMENTS @ 1.1310 & 2.1091

5.12.1. Limits

- **FCC 1.1310:-** The criteria listed in the following table shall be used to evaluate the environmental impact of human exposure to radio-frequency (RF) radiation as specified in 1.1307(b).

LIMITS FOR MAXIMUM PERMISSIBLE EXPOSURE (MPE)

Frequency Range (MHz)	Electric Field Strength (V/m)	Magnetic Field Strength (A/m)	Power Density (mW/cm ²)	Average Time (minutes)
(A) Limits for Occupational/Control Exposures				
300-1500	F/300	6
(B) Limits for General Population/Uncontrolled Exposure				
300-1500	F/1500	6

F = Frequency in MHz

5.12.2. Method of Measurements

Refer to FCC @ 1.1310 and 2.1091

- In order to demonstrate compliance with MPE requirements (see Section 2.1091), the following information is typically needed:
 - (1) Calculation that estimates the minimum separation distance (20 cm or more) between an antenna and persons required to satisfy power density limits defined for free space.
 - (2) Antenna installation and device operating instructions for installers (professional/unskilled users), and the parties responsible for ensuring compliance with the RF exposure requirement
 - (3) Any caution statements and/or warning labels that are necessary in order to comply with the exposure limits
 - (4) Any other RF exposure related issues that may affect MPE compliance

Calculation Method of RF Safety Distance:

$$S = \frac{PG}{4\pi \cdot r^2} = \frac{EIRP}{4\pi \cdot r^2}$$

Where: P: power input to the antenna in mW
 EIRP: Equivalent (effective) isotropic radiated power.
 S: power density mW/cm²
 G: numeric gain of antenna relative to isotropic radiator
 r: distance to centre of radiation in cm

FCC radio frequency exposure limits may be exceeded at distances closer than r cm from the antenna of this device

$$r = \sqrt{\frac{PG}{4\pi \cdot S}} = \sqrt{\frac{EIRP}{4\pi \cdot S}}$$

FCC radio frequency exposure limits may not be exceeded at distances closer than r cm from the antenna of this device

5.12.3. Evaluation of RF Exposure Compliance Requirements

Lowest Frequency, **F[MHz]** = 806

MPE Limit for Occupational/Controlled Exposure, **S_{controlled}[mW/cm²]** = F / 300 = 806 / 300 = 2.69

MPE Limit for General Population/Uncontrolled Exposure, **S_{uncontrolled}[mW/cm²]** = F / 1500 = 806 / 1500 = 0.537

Maximum RF Power conducted, **P_{conducted}[dBm]** = 34.81

Maximum Antenna Gain, **G[dBd]** = 0

Maximum EIRP, **P_{EIRP}[dBm]** = 34.81 + 2.15 = 36.96

Calculated RF Safety Distance for Occupational/Controlled Exposure, **r_{safety_controlled}[cm]** = 12.2

Calculated RF Safety Distance for General Population/Uncontrolled Exposure, **r_{safety_uncontrolled}[cm]** = 27.2

Specified Safety Separation Distance in User's Manual = **28 cm**

Antenna Gain (dBd)	Maximum EIRP (dBm)	Calculated RF Safety Distances (cm)	Specified Separation distance (cm)	Compliance
0	36.96	12.2 & 27.2	28	Complies

EXHIBIT 6. TEST EQUIPMENTS LIST

Test Instruments	Manufacturer	Model No.	Serial No.	Operating Range
Attenuator	Weinschel	46-20-34	BM1347	DC – 18 GHz
Attenuator	Weinschel	46-30-34	BM5354	DC – 18 GHz
BiConiLog Antenna	Emco	3142	10005	0.03 – 2 GHz
BiConiLog Antenna	ETS-Lindgren	3142B	1575	26 MHz – 2 GHz
Communication test set	Hewlett Packard	8920B	US39064699	AF SG DC – 20 kHz
EMC Analyzer	Hewlett Packard	8593EM	...	9kHz – 22 GHz
FFT (audio) EMI Receiver	Advantest	R9211E	82020336	10 mHz – 100 kHz, 1 MHz Input Impedance
High Pass Filter	Mini-Circuits	SHP-250	9027-12	Cut off 230 MHz
High Pass Filter	Mini-Circuits	SHP-300	10427	Cut off 230 MHz
High Pass Filter	Mini-Circuits	SHP-600	19949	Cut off 560 MHz
High Pass Filter	Mini-Circuits	SHP-800	15542	Cut off 800 MHz
Horn Antenna	Emco	3155	9701-5061	1 – 18 GHz
Horn Antenna	Emco	3155	9911-5955	1 – 18 GHz
Infinium Oscilloscope	Hewlett Packard	54810A	US38380192	500 MHz, 1 GSa/s
Low Pass Filter	Mini-Circuits	BLP-100	15542	Cut off 98 MHz
Notch Filter	K & L	3TNF-100/200-N	UW316-1	100-200 MHz
Notch Filter	K & L	3TNF-250/500-N	UU041-1	250-500 MHz
Notch Filter	K & L	3TNF-500-1000- N/N	470	500-1000 MHz
Microwave Frequency Counter	EIP	545A	2683	10 Hz – 18 GHz
Modulation Analyzer	Hewlett Packard	8910B	3226A04606	150 kHz – 1300 MHz
Power Divider	Mini-Circuits	15542	105	1 MHz – 1 GHz

ULTRATECH GROUP OF LABS

3000 Bristol Circle, Oakville, Ontario, Canada L6H 6G4
 Tel. #: 905-829-1570, Fax. #: 905-829-8050, Email: vic@ultratech-labs.com, Website: <http://www.ultratech-labs.com>

File #: FSG-093_FCC90_Rev1
 June 05, 2009

- All test results contained in this engineering test report are traceable to National Institute of Standards and Technology (NIST)

Power Meter	Hewlett Packard	437B	3.13E+09	10 kHz – 50 GHz
Power Sensor	Hewlett Packard	8481A	1150A15143	9 kHz – 26.5 GHz
Preselector	Advantest	R3551	92970002	9 kHz – 1GHz
RF Amplifier	Com-Power	PA-103		1 MHz – 1 GHz
RF Amplifier	Hewlett Packard	84498	3008A00769	1 – 26.5 GHz
Signal Generator	Hewlett Packard	83752B	3610A00457	0.01- 20 GHz
Spectrum Analyzer	Rohde & Schwarz	FSEK20/B4/B21	834157/005	9 kHz – 40 GHz
Spectrum Analyzer	Rohde & Schwarz	FSEK30	100077	20 Hz – 40 GHz
Spectrum Analyzer	Advantest	R3271	15050203	100 Hz – 26.5 GHz
Spectrum Analyzer / EMI Receiver	Hewlett Packard	8546A	3650A00371	9 kHz – 6.5 GHz Built-in amplifier 30dB
Temperature & Humidity Chamber	Tenney	T5	9723B	-40 °C – +80 °C range

ULTRATECH GROUP OF LABS

3000 Bristol Circle, Oakville, Ontario, Canada L6H 6G4
 Tel. #: 905-829-1570, Fax. #: 905-829-8050, Email: vic@ultratech-labs.com, Website: <http://www.ultratech-labs.com>

File #: FSG-093_FCC90_Rev1
 June 05, 2009

- All test results contained in this engineering test report are traceable to National Institute of Standards and Technology (NIST)

EXHIBIT 7. MEASUREMENT UNCERTAINTY

The measurement uncertainties stated were calculated in accordance with the requirements of NIST Technical Note 1297 and NIS 81 (1994).

7.1. RADIATED EMISSION MEASUREMENT UNCERTAINTY

CONTRIBUTION (Radiated Emissions)	PROBABILITY DISTRIBUTION	UNCERTAINTY (\pm dB)	
		3 m	10 m
Antenna Factor Calibration	Normal (k=2)	± 1.0	± 1.0
Cable Loss Calibration	Normal (k=2)	± 0.3	± 0.5
EMI Receiver specification	Rectangular	± 1.5	± 1.5
Antenna Directivity	Rectangular	+0.5	+0.5
Antenna factor variation with height	Rectangular	± 2.0	± 0.5
Antenna phase center variation	Rectangular	0.0	± 0.2
Antenna factor frequency interpolation	Rectangular	± 0.25	± 0.25
Measurement distance variation	Rectangular	± 0.6	± 0.4
Site imperfections	Rectangular	± 2.0	± 2.0
Mismatch: Receiver VRC $\Gamma_1 = 0.2$ Antenna VRC $\Gamma_R = 0.67(\text{Bi}) 0.3 (\text{Lp})$ Uncertainty limits $20\text{Log}(1+\Gamma_1\Gamma_R)$	U-Shaped	+1.1 -1.25	± 0.5
System repeatability	Std. Deviation	± 0.5	± 0.5
Repeatability of EUT		-	-
Combined standard uncertainty	Normal	+2.19 / -2.21	+1.74 / -1.72
Expanded uncertainty U	Normal (k=2)	+4.38 / -4.42	+3.48 / -3.44

Calculation for maximum uncertainty when 3m biconical antenna including a factor of k = 2 is used:

$$U = 2u_c(y) = 2x(+2.19) = +4.38 \text{ dB} \quad \text{And} \quad U = 2u_c(y) = 2x(-2.21) = -4.42 \text{ dB}$$

EXHIBIT 8. MEASUREMENT METHODS

8.1. CONDUCTED POWER MEASUREMENTS

- The following shall be applied to the combination(s) of the radio device and its intended antenna(e).
- If the RF level is user adjustable, all measurements shall be made with the highest power level available to the user for that combination.
- The following method of measurement shall apply to both conducted and radiated measurements.
- The radiated measurements are performed at the Ultratech Calibrated Open Field Test Site.
- The measurement shall be performed using normal operation of the equipment with modulation.

Test procedure shall be as follows:

Step 1: Duty Cycle measurements if the transmitter's transmission is transient

- Using a EMI Receiver with the frequency span set to 0 Hz and the sweep time set at a suitable value to capture the envelope peaks and the duty cycle of the transmitter output signal;
- The duty cycle of the transmitter, $x = \text{Tx on} / (\text{Tx on} + \text{Tx off})$ with $0 < x < 1$, is measure and recorded in the test report. For the purpose of testing, the equipment shall be operated with a duty cycle that is equal or more than 0.1.

Step 2: Calculation of Average EIRP. See Figure 1

- The average output power of the transmitter shall be determined using a wideband, calibrated RF average power meter with the power sensor with an integration period that exceeds the repetition period of the transmitter by a factor 5 or more. The observed value shall be recorded as "A" (in dBm);
- The e.i.r.p. shall be calculated from the above measured power output "A", the observed duty cycle x, and the applicable antenna assembly gain "G" in dBi, according to the formula:

$$\text{EIRP} = \text{A} + \text{G} + 10\log(1/x)$$

{X = 1 for continuous transmission => $10\log(1/x) = 0$ dB}

Figure 1.

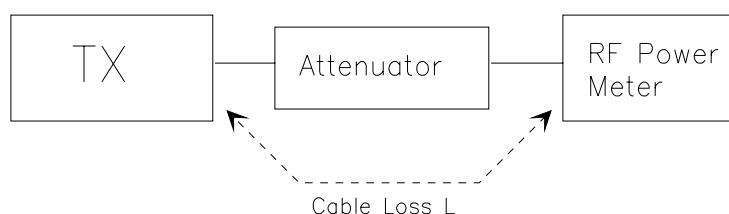

- All test results contained in this engineering test report are traceable to National Institute of Standards and Technology (NIST)

8.2. RADIATED POWER MEASUREMENTS (ERP & EIRP) USING SUBSTITUTION METHOD

8.2.1. MAXIMIZING RF EMISSION LEVEL (E-FIELD)

- (a) The measurements were performed with full rf output power and modulation.
- (b) Test was performed at listed 3m open area test site (listed with FCC, IC, ITI, NVLAP, ACA & VCCI).
- (c) The transmitter under test was placed at the specified height on a non-conducting turntable (80 cm height)
- (d) The BICONILOG antenna (20 MHz to 1 GHz) or HORN antenna (1 GHz to 18 GHz) was used for measuring.
- (e) Load an appropriate correction factors file in EMI Receiver for correcting the field strength reading level

Total Correction Factor recorded in the EMI Receiver = Cable Loss + Antenna Factor
 $E \text{ (dB}\mu\text{V/m)} = \text{Reading (dB}\mu\text{V)} + \text{Total Correction Factor (dB/m)}$

- (f) Set the EMI Receiver and #2 as follows:

Center Frequency: test frequency
Resolution BW: 100 KHz
Video BW: same
Detector Mode: positive
Average: off
Span: 3 x the signal bandwidth

- (g) The test antenna was lowered or raised from 1 to 4 meters until the maximum signal level was detected.
- (h) The transmitter was rotated through 360° about a vertical axis until a higher maximum signal was received.
- (i) The test antenna was lowered or raised again from 1 to 4 meters until a maximum was obtained. This level was recorded.
- (j) The recorded reading was corrected to the true field strength level by adding the antenna factor, cable loss and subtracting the pre-amplifier gain.
- (k) The above steps were repeated with both transmitters' antenna and test receiving antenna placed in vertical and horizontal polarization. Both readings with the antennas placed in vertical and horizontal polarization shall be recorded.
- (l) Repeat for all different test signal frequencies.

8.2.2. Measuring the EIRP of Spurious/Harmonic Emissions using Substitution Method

- (a) Set the EMI Receiver (for measuring E-Field) and Receiver #2 (for measuring EIRP) as follows:

Center Frequency: equal to the signal source
Resolution BW: 100 KHz
Video BW: VBW > RBW
Detector Mode: positive
Average: off
Span: 3 x the signal bandwidth

- (b) Load an appropriate correction factors file in EMI Receiver for correcting the field strength reading level

Total Correction Factor recorded in the EMI Receiver = Cable Loss + Antenna Factor
 $E \text{ (dBuV/m)} = \text{Reading (dBuV)} + \text{Total Correction Factor (dB/m)}$

- (c) Select the frequency and E-field levels obtained in the Section 8.2.1 for ERP/EIRP measurements.
(d) Substitute the EUT by a signal generator and one of the following transmitting antenna (substitution antenna):
 - ◆ DIPOLE antenna for frequency from 30-1000 MHz or
 - ◆ HORN antenna for frequency above 1 GHz }.(e) Mount the transmitting antenna at 1.5 meter high from the ground plane.
(f) Use one of the following antenna as a receiving antenna:
 - ◆ DIPOLE antenna for frequency from 30-1000 MHz or
 - ◆ HORN antenna for frequency above 1 GHz }.(g) If the DIPOLE antenna is used, tune it's elements to the frequency as specified in the calibration manual.
(h) Adjust both transmitting and receiving antenna in a VERTICAL polarization.
(i) Tune the EMI Receivers to the test frequency.
(j) Lower or raise the test antenna from 1 to 4 meters until the maximum signal level was detected.
(k) The transmitter was rotated through 360° about a vertical axis until a higher maximum signal was received.
(l) Lower or raise the test antenna from 1 to 4 meters until the maximum signal level was detected.
(m) Adjust input signal to the substitution antenna until an equal or a known related level to that detected from the transmitter was obtained in the test receiver.
(n) Record the power level read from the Average Power Meter and calculate the ERP/EIRP as follows:

$$P = P1 - L1 = (P2 + L2) - L1 = P3 + A + L2 - L1$$

$$\text{EIRP} = P + G1 = P3 + L2 - L1 + A + G1$$

$$\text{ERP} = \text{EIRP} - 2.15 \text{ dB}$$

$$\text{Total Correction factor in EMI Receiver \# 2} = L2 - L1 + G1$$

Where: P: Actual RF Power fed into the substitution antenna port after corrected.
P1: Power output from the signal generator
P2: Power measured at attenuator A input
P3: Power reading on the Average Power Meter
EIRP: EIRP after correction
ERP: ERP after correction

- (o) Adjust both transmitting and receiving antenna in a HORIZONTAL polarization, then repeat step (k) to (o)
(p) Repeat step (d) to (o) for different test frequency
(q) Repeat steps (c) to (j) with the substitution antenna oriented in horizontal polarization.
(r) Actual gain of the EUT's antenna is the difference of the measured EIRP and measured RF power at the RF port. Correct the antenna gain if necessary.

Figure 2.

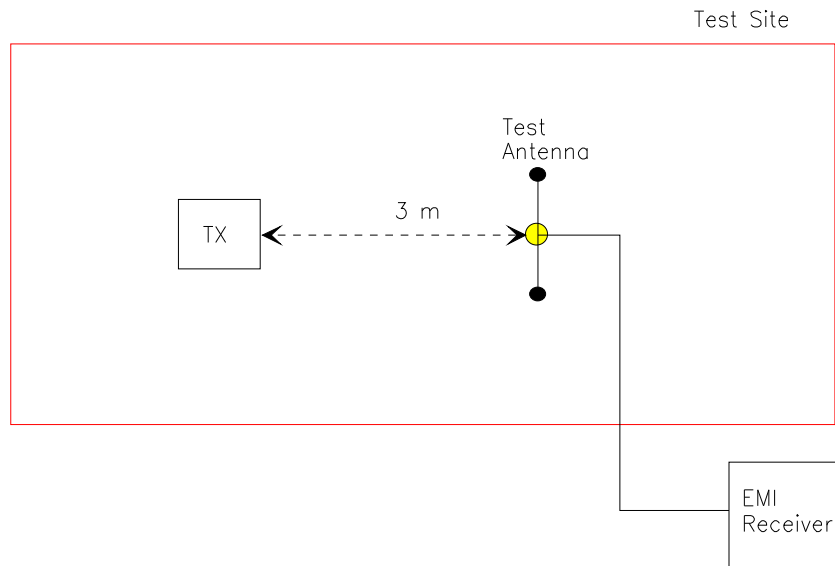
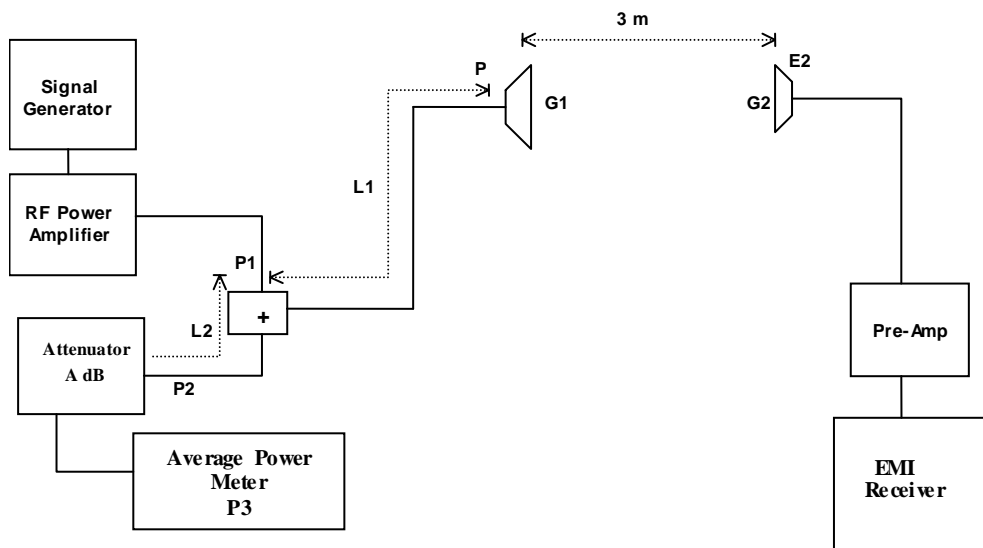

Figure 3.



8.3. FREQUENCY STABILITY

Refer to FCC @ 2.1055.

- (a) The frequency stability shall be measured with variation of ambient temperature as follows: From -30 to +50 centigrade except that specified in subparagraph (2) & (3) of this paragraph.
- (b) Frequency measurements shall be made at extremes of the specified temperature range and at intervals of not more than 10 centigrade through the range. A period of time sufficient to stabilize all of the components of the oscillator circuit at each temperature level shall be allowed prior to frequency measurement. The short-term transient effects on the frequency of the transmitter due to keying (except for broadcast transmitters) and any heating element cycling normally occurring at each ambient temperature level also shall be shown. Only the portion or portions of the transmitter containing the frequency determining and stability circuitry need be subjected to the temperature variation test.
- (d) The frequency stability supply shall be measured with variation of primary supply voltage as follows:
 - (1) Vary primary supply voltage from 85 to 115 percent of the nominal value for other than hand carried battery equipment.
 - (2) For hand carried, battery powered equipment, reduce primary supply voltage to the battery operating end point which shall be specified by the manufacturer.
 - (3) The supply voltage shall be measured at the input to the cable normally provide with the equipment, or at the power supply terminals if cables are not normally provided. Effects on frequency of transmitter keying (except for broadcast transmitters) and any heating element cycling at the nominal supply voltage and at each extreme also shall be shown.
- (e) When deemed necessary, the Commission may require tests of frequency stability under conditions in addition to those specifically set out in paragraphs (a), (b), (c) and (d) of this section. (For example, measurements showing the effect of proximity to large metal objects, or of various types of antennas, may be required for portable equipment).

8.4. EMISSION MASK

Voice or Digital Modulation Through a Voice Input Port @ 2.1049(c)(i):- The transmitter was modulated by a 2.5 KHz tone signal at an input level 16 dB greater than that required to produce 50% modulation (e.g.: ± 2.5 KHz peak deviation at 1 KHz modulating frequency). The input level was established at the frequency of maximum response of the audio modulating circuit.

Digital Modulation Through a Data Input Port @ 2.1049(h):- Transmitters employing digital modulation techniques - when modulated by an input signal such that its amplitude and symbol rate represent the maximum rated conditions under which the equipment will be operated. The signal shall be applied through any filter networks, pseudo-random generators or other devices required in normal service. Additionally, the Emission Masks shall be shown for operation with any devices used for modifying the spectrum when such devices are operational at the discretion of the user.

The following EMI Receiver bandwidth shall be used for measurement of Emission Mask/Out-of-Band Emission measurements:

- (1) For 25 KHz Channel Spacing: RBW = 300 Hz
- (2) For 12.5 KHz or 6.25 KHz Channel Spacings: RBW = 100 Hz

The all cases the Video Bandwidth shall be equal or greater than the measuring bandwidth.

8.5. SPURIOUS EMISSIONS (CONDUCTED)

With transmitter modulation characteristics described in Out-of-Band Emissions measurements @ 2.1049, the transmitter spurious and harmonic emissions were scanned. The spurious and harmonic emissions were measured with the EMI Receiver controls set as RBW = 30 KHz minimum , VBW \geq RBW and SWEEP TIME = AUTO). The transmitter was operated at a full rated power output, and modulated as follows:

FCC 47 CFR 2.1057 - Frequency spectrum to be investigated: The spectrum was investigated from the lowest radio generated in the equipment up to at least the 10th harmonic of the carrier frequency or to the highest frequency practicable in the present state of the art of measuring techniques, whichever is lower. Particular attention should be paid to harmonics and subharmonics of the carrier frequency. Radiation at the frequencies of multiplier stages should be checked. The amplitude of spurious emissions which are attenuated more than 20 dB below the permissible value need not be reported.

FCC 47 CFR 2.1051 - Spurious Emissions at Antenna Terminal: The radio frequency voltage or powers generated within the equipment and appearing on a spurious frequency shall be checked at the equipment output terminals when properly loaded with a suitable artificial antenna. Curves or equivalent data shall show the magnitude of the harmonic and other spurious emission that can be detected when the equipment is operated under the conditions specified in 2.1049 as appropriate. The magnitude of spurious emissions, which are attenuated more than 20 dB below the permissible value, need not be specified.