

DFS MEASUREMENT REPORT

FCC ID: LNQWF186W
Applicant: Actiontec Electronics Inc.
Product: Wi-Fi 6 Indoor AP
Model No.: WF-186W, WF-186H
Brand Name: Actiontec
FCC Classification: Unlicensed National Information Infrastructure (NII)
FCC Rule Part(s): Part 15 Subpart E (Section 15.407)
Type of Device: Master
Result: Complies
Received Date: 2023-06-19
Test Date: 2023-06-29 ~ 2023-07-28

Reviewed By:

Kevin Guo

Approved By:

Robin Wu



The test results relate only to the samples tested.

This equipment has been shown to be capable of compliance with the applicable technical standards as indicated in the measurement report and was tested in accordance with the measurement procedures specified in KDB 905462. Test results reported herein relate only to the item(s) tested.

The test report shall not be reproduced except in full without the written approval of MRT Technology (Suzhou) Co., Ltd.

Revision History

| Report No. | Version | Description | Issue Date | Note |
|---------------|---------|-------------------------------|------------|---------|
| 2305RSU014-U4 | V01 | Initial Report | 2023-09-16 | Invalid |
| 2305RSU014-U4 | V02 | Correct the Bluetooth version | 2023-10-26 | Valid |
| | | | | |

CONTENTS

| Description | Page |
|--|-----------|
| 1. General Information | 5 |
| 1.1. Applicant | 5 |
| 1.2. Manufacturer | 5 |
| 1.3. Testing Facility | 5 |
| 1.4. Product Information..... | 6 |
| 1.5. Radio Specification under Test | 6 |
| 1.6. Working Frequencies | 7 |
| 1.7. Antenna Details..... | 8 |
| 2. Test Configuration | 9 |
| 2.1. Test Mode..... | 9 |
| 2.2. Test Channel | 9 |
| 2.3. Applied Standards..... | 9 |
| 2.4. Test Environment Condition | 9 |
| 3. DFS Detection Thresholds and Radar Test Waveforms | 10 |
| 3.1. Applicability | 10 |
| 3.2. DFS Devices Requirements..... | 11 |
| 3.3. DFS Detection Threshold Values..... | 13 |
| 3.4. Parameters of DFS Test Signals..... | 14 |
| 3.5. Conducted Test Setup..... | 17 |
| 4. Measuring Instrument | 18 |
| 5. Test Result..... | 19 |
| 5.1. Summary..... | 19 |
| 5.2. Radar Waveform Calibration Measurement..... | 20 |
| 5.2.1. Calibration Setup | 20 |
| 5.2.2. Calibration Procedure | 20 |
| 5.2.3. Calibration & Channel Loading Result..... | 20 |
| 5.3. NII Detection Bandwidth Measurement | 21 |
| 5.3.1. Test Limit | 21 |
| 5.3.2. Test Procedure..... | 21 |
| 5.3.3. Test Result | 22 |
| 5.4. Initial Channel Availability Check Time Measurement | 23 |
| 5.4.1. Test Limit | 23 |
| 5.4.2. Test Procedure..... | 23 |
| 5.4.3. Test Result | 23 |
| 5.5. Radar Burst at the Beginning of the Channel Availability Check Time Measurement | 24 |

| | | |
|---|--|------------|
| 5.5.1. | Test Limit | 24 |
| 5.5.2. | Test Procedure | 24 |
| 5.5.3. | Test Result | 24 |
| 5.6. | Radar Burst at the End of the Channel Availability Check Time Measurement | 25 |
| 5.6.1. | Test Limit | 25 |
| 5.6.2. | Test Procedure | 25 |
| 5.6.3. | Test Result | 25 |
| 5.7. | In-Service Monitoring for Channel Move Time, Channel Closing Transmission Time and Non-Occupancy Period Measurement | 26 |
| 5.7.1. | Test Limit | 26 |
| 5.7.2. | Test Procedure | 26 |
| 5.7.3. | Test Result | 26 |
| 5.8. | Statistical Performance Check Measurement..... | 27 |
| 5.8.1. | Test Limit | 27 |
| 5.8.2. | Test Procedure | 27 |
| 5.8.3. | Test Result | 27 |
| Appendix A – Test Result | | 28 |
| A.1 | Calibration Test Result | 28 |
| A.2 | Channel Loading Test Result | 30 |
| A.3 | NII Detection Bandwidth Test Result..... | 32 |
| A.4 | Initial Channel Availability Check Time Test Result | 38 |
| A.5 | Radar Burst at the Beginning of the Channel Availability Check Time Test Result | 39 |
| A.6 | Radar Burst at the End of the Channel Availability Check Time Test Result | 40 |
| A.7 | In-Service Monitoring for Channel Move Time, Channel Closing Transmission Time and Non-Occupancy Period Test Result | 41 |
| A.8 | Statistical Performance Check..... | 43 |
| Appendix B – Test Setup Photograph | | 186 |
| Appendix C – EUT Photograph | | 187 |

1. General Information

1.1. Applicant

Actiontec Electronics Inc.

2445 Augustine Drive Suite 501, Santa Clara, California 95054, United States

1.2. Manufacturer

Actiontec Electronics Inc.

2445 Augustine Drive Suite 501, Santa Clara, California 95054, United States

1.3. Testing Facility

| | |
|-------------------------------------|--|
| <input checked="" type="checkbox"/> | <p>Test Site – MRT Suzhou Laboratory</p> <hr/> <p>Laboratory Location (Suzhou - Wuzhong) D8 Building, No.2 Tian'edang Rd., Wuzhong Economic Development Zone, Suzhou, China</p> <p>Laboratory Location (Suzhou - SIP) 4b Building, Liando U Valley, No.200 Xingpu Rd., Shengpu Town, Suzhou Industrial Park, China</p> <hr/> <p>Laboratory Accreditations</p> <p>A2LA: 3628.01 CNAS: L10551</p> <p>FCC: CN1166 ISED: CN0001</p> <p>VCCI: <input type="checkbox"/>R-20025 <input type="checkbox"/>G-20034 <input type="checkbox"/>C-20020 <input type="checkbox"/>T-20020</p> <p style="padding-left: 100px;"><input type="checkbox"/>R-20141 <input type="checkbox"/>G-20134 <input type="checkbox"/>C-20103 <input type="checkbox"/>T-20104</p> |
| <input type="checkbox"/> | <p>Test Site – MRT Shenzhen Laboratory</p> <hr/> <p>Laboratory Location (Shenzhen) 1G, Building A, Junxiangda Building, Zhongshanyuan Road West, Nanshan District, Shenzhen, China</p> <hr/> <p>Laboratory Accreditations</p> <p>A2LA: 3628.02 CNAS: L10551</p> <p>FCC: CN1284 ISED: CN0105</p> |
| <input type="checkbox"/> | <p>Test Site – MRT Taiwan Laboratory</p> <hr/> <p>Laboratory Location (Taiwan) No. 38, Fuxing 2nd Rd., Guishan Dist., Taoyuan City 333, Taiwan (R.O.C.)</p> <hr/> <p>Laboratory Accreditations</p> <p>TAF: L3261-190725</p> <p>FCC: 291082, TW3261 ISED: TW3261</p> |

1.4. Product Information

| | |
|---|----------------------------|
| Product Name | Wi-Fi 6 Indoor AP |
| Model No. | WF-186W, WF-186H |
| EUT Serial No. | 1JM232300032 |
| Wi-Fi Specification | 802.11a/b/g/n/ac/ax |
| Bluetooth Specification | V5.1 single mode, BLE only |
| Antenna Information | Refer to Section 1.7 |
| Working Voltage | By PoE |
| <p>Note:</p> <ol style="list-style-type: none"> The information of EUT was provided by the manufacturer, and the accuracy of the information shall be the responsibility of the manufacturer. The model difference is the WF-186H removes two LAN ports from the WF-186W, others are exactly the same. WF-186W is selected for the test in this report. | |

1.5. Radio Specification under Test

| | |
|--|--|
| Frequency Range | <p>For 802.11a/n-HT20/ac-VHT20/ax-HE20: 5260~5320MHz, 5500~5720MHz</p> <p>For 802.11n-HT40/ac-VHT40/ax-HE40: 5270~5310MHz, 5510~5710MHz</p> <p>For 802.11ac-VHT80/ax-HE80: 5290MHz, 5530MHz, 5610 MHz, 5690MHz</p> <p>For 802.11ac-VHT160/ax-HE160: 5250MHz, 5570MHz</p> |
| Type of Modulation | <p>802.11a/n/ac: OFDM</p> <p>802.11ax: OFDMA</p> |
| Data Rate | <p>802.11a: 6/9/12/18/24/36/48/54Mbps</p> <p>802.11n: up to 300Mbps</p> <p>802.11ac: up to 1733.3Mbps</p> <p>802.11ax: up to 2402Mbps</p> |
| Power-on cycle | Requires 95.8 seconds to complete its power-on cycle |
| Uniform Spreading (For DFS Frequency Band) | For the 5250-5350MHz, 5470-5725 MHz bands, the Master device provides, on aggregate, uniform loading of the spectrum across all devices by selecting an operating channel among the available channels using a random algorithm. |

1.6. Working Frequencies

802.11a/n-HT20/ac-VHT20/ax-HE20

| Channel | Frequency | Channel | Frequency | Channel | Frequency |
|---------|-----------|---------|-----------|---------|-----------|
| 52 | 5260 MHz | 56 | 5280 MHz | 60 | 5300 MHz |
| 64 | 5320 MHz | 100 | 5500 MHz | 104 | 5520 MHz |
| 108 | 5540 MHz | 112 | 5560 MHz | 116 | 5580 MHz |
| 120 | 5600 MHz | 124 | 5620 MHz | 128 | 5640 MHz |
| 132 | 5660 MHz | 136 | 5680 MHz | 140 | 5700 MHz |
| 144 | 5720 MHz | -- | -- | -- | -- |

802.11n-HT40/ac-VHT40/ax-HE40

| Channel | Frequency | Channel | Frequency | Channel | Frequency |
|---------|-----------|---------|-----------|---------|-----------|
| 54 | 5270 MHz | 62 | 5310 MHz | 102 | 5510 MHz |
| 110 | 5550 MHz | 118 | 5590 MHz | 126 | 5630 MHz |
| 134 | 5670 MHz | 142 | 5710 MHz | -- | -- |

802.11ac-VHT80/ax-HE80

| Channel | Frequency | Channel | Frequency | Channel | Frequency |
|---------|-----------|---------|-----------|---------|-----------|
| 58 | 5290 MHz | 106 | 5530 MHz | 122 | 5610 MHz |
| 138 | 5690 MHz | -- | -- | -- | -- |

802.11ac-VHT160/ax-HE160

| Channel | Frequency | Channel | Frequency | Channel | Frequency |
|---------|-----------|---------|-----------|---------|-----------|
| 50 | 5250 MHz | 114 | 5570 MHz | -- | -- |

1.7. Antenna Details

| Antenna Type | Frequency (MHz) | TX Paths | Antenna Gain (dBi) | | Directional Gain (dBi) | |
|---------------|-----------------|----------|--------------------|-------|------------------------|--------------|
| | | | Ant 0 | Ant 1 | Correlated | Uncorrelated |
| Wi-Fi Antenna | | | | | | |
| PIFA | 2412 ~ 2462 | 2 | 3.75 | 3.20 | 5.34 | 2.34 |
| | 5180 ~ 5320 | 2 | 5.96 | 4.47 | 7.14 | 1.36 |
| | 5500 ~ 5720 | 2 | 5.63 | 3.89 | 7.33 | 4.39 |
| | 5745 ~ 5825 | 2 | 5.12 | 4.38 | 6.71 | 3.80 |

Note:

- The antenna gain and directional gain refer to manufacturer's antenna specification.
- The device supports CDD Mode and STBC mode, details refer to the table as below.
- CDD signals are correlated, the directional gain as follows,
 For power measurements: Array Gain = 0 dB for $N_{ANT} \leq 4$, the directional gain = max antenna gain + array gain
 For power spectral density (PSD) measurements: the max directional gain (each angle) = $10 \log[(10^{G1/20} + 10^{G2/20} + \dots + 10^{GN/20})^2 / N_{ANT}]$
- STBC signals are uncorrelated, the directional gain as follows,
 the max directional gain (each angle) = $10 \log[(10^{G1/10} + 10^{G2/10} + \dots + 10^{GN/10}) / N_{ANT}]$

| Test Mode | T _x Paths | CDD Mode | STBC Mode |
|---------------|----------------------|----------|-----------|
| Wi-Fi 2.4G | | | |
| 802.11b/g | 2 | √ | X |
| 802.11n/ax | 2 | X | √ |
| Wi-Fi 5G | | | |
| 802.11a | 2 | √ | X |
| 802.11n/ac/ax | 2 | X | √ |

Note: "√" means "Support", "X" means "Not support".

2. Test Configuration

2.1. Test Mode

| |
|----------------------------|
| Mode 1: Working on AP mode |
|----------------------------|

2.2. Test Channel

| Test Mode | Test Channel | Test Frequency |
|----------------|--------------|----------------|
| 802.11ax-HE20 | 100 | 5500 MHz |
| 802.11ax-HE40 | 102 | 5510 MHz |
| 802.11ax-HE80 | 106 | 5530 MHz |
| 802.11ax-HE160 | 50 | 5250 MHz |
| 802.11ax-HE160 | 114 | 5570 MHz |

2.3. Applied Standards

According to the specifications of the manufacturer, the EUT must comply with the requirements of the following standards:

- FCC Part 15.407 Section (h)(2)
- KDB 905462 D02v02
- KDB 905462 D04v01

2.4. Test Environment Condition

| | |
|---------------------|------------|
| Ambient Temperature | 15 ~ 35°C |
| Relative Humidity | 20 ~ 75%RH |

3. DFS Detection Thresholds and Radar Test Waveforms

3.1. Applicability

The following table from FCC KDB 905462 D02 NII DFS Compliance Procedures New Rules v02 lists the applicable requirements for the DFS testing.

| Requirement | Operational Mode | | |
|---------------------------------|------------------|--------------------------------|-----------------------------|
| | Master | Client Without Radar Detection | Client With Radar Detection |
| Non-Occupancy Period | Yes | Not required | Yes |
| DFS Detection Threshold | Yes | Not required | Yes |
| Channel Availability Check Time | Yes | Not required | Not required |
| U-NII Detection Bandwidth | Yes | Not required | Yes |

Table 3-1: Applicability of DFS Requirements Prior to Use of a Channel

| Requirement | Operational Mode | |
|-----------------------------------|--|--------------------------------|
| | Master Device or Client With Radar Detection | Client Without Radar Detection |
| DFS Detection Threshold | Yes | Not required |
| Channel Closing Transmission Time | Yes | Yes |
| Channel Move Time | Yes | Yes |
| U-NII Detection Bandwidth | Yes | Not required |

| Additional requirements for devices with multiple bandwidth modes | Master Device or Client with Radar Detection | Client Without Radar Detection |
|---|--|--|
| U-NII Detection Bandwidth and Statistical Performance Check | All BW modes must be tested | Not required |
| Channel Move Time and Channel Closing Transmission Time | Test using widest BW mode available | Test using the widest BW mode available for the link |
| All other tests | Any single BW mode | Not required |

Note: Frequencies selected for statistical performance check should include several frequencies within the radar detection bandwidth and frequencies near the edge of the radar detection bandwidth. For 802.11 devices it is suggested to select frequencies in each of the bonded 20 MHz channels and the channel center frequency.

Table 3-2: Applicability of DFS Requirements during normal operation

3.2. DFS Devices Requirements

Per FCC KDB 905462 D02 NII DFS Compliance Procedures New Rules v02 the following are the requirements for Master Devices:

- (a) The Master Device will use DFS in order to detect Radar Waveforms with received signal strength above the DFS Detection Threshold in the 5250 ~ 5350 MHz and 5470 ~ 5725 MHz bands. DFS is not required in the 5150 ~ 5250 MHz or 5725 ~ 5825 MHz bands.
- (b) Before initiating a network on a Channel, the Master Device will perform a Channel Availability Check for a specified time duration (Channel Availability Check Time) to ensure that there is no radar system operating on the Channel, using DFS described under subsection a) above.
- (c) The Master Device initiates a U-NII network by transmitting control signals that will enable other U-NII devices to Associate with the Master Device.
- (d) During normal operation, the Master Device will monitor the Channel (In-Service Monitoring) to ensure that there is no radar system operating on the Channel, using DFS described under a).
- (e) If the Master Device has detected a Radar Waveform during In-Service Monitoring as described under d), the Operating Channel of the U-NII network is no longer an Available Channel. The Master Device will instruct all associated Client Device(s) to stop transmitting on this Channel within the Channel Move Time. The transmissions during the Channel Move Time will be limited to the Channel Closing Transmission Time.
- (f) Once the Master Device has detected a Radar Waveform it will not utilize the Channel for the duration of the Non-Occupancy Period.
- (g) If the Master Device delegates the In-Service Monitoring to a Client Device, then the combination will be tested to the requirements described under d) through f) above.

Channel Move Time and Channel Closing Transmission Time requirements are listed in the following table.

| Parameter | Value |
|---|--|
| Non-occupancy period | Minimum 30 minutes |
| Channel Availability Check Time | 60 seconds |
| Channel Move Time | 10 seconds See Note 1. |
| Channel Closing Transmission Time | 200 milliseconds + an aggregate of 60 milliseconds over remaining 10 second period. See Notes 1 and 2. |
| U-NII Detection Bandwidth | Minimum 100% of the U-NII 99% transmission power bandwidth. See Note 3. |
| <p>Note 1: Channel Move Time and the Channel Closing Transmission Time should be performed with Radar Type 0. The measurement timing begins at the end of the Radar Type 0 burst.</p> <p>Note 2: The Channel Closing Transmission Time is comprised of 200 milliseconds starting at the beginning of the Channel Move Time plus any additional intermittent control signals required to facilitate a Channel move (an aggregate of 60 milliseconds) during the remainder of the 10 second period. The aggregate duration of control signals will not count quiet periods in between transmissions.</p> <p>Note 3: During the U-NII Detection Bandwidth detection test, radar type 0 should be used. For each frequency step the minimum percentage of detection is 90 percent. Measurements are performed with no data traffic.</p> | |

Table 3-3: DFS Response Requirements

3.3. DFS Detection Threshold Values

The DFS detection thresholds are defined for Master devices and Client Devices with In-service monitoring.

These detection thresholds are listed in the following table.

| Maximum Transmit Power | Value (See Notes 1, 2, and 3) |
|--|----------------------------------|
| EIRP \geq 200 milliwatt | -64 dBm |
| EIRP < 200 milliwatt and power spectral density < 10 dBm/MHz | -62 dBm |
| EIRP < 200 milliwatt that do not meet the power spectral density requirement | -64 dBm |
| <p>Note 1: This is the level at the input of the receiver assuming a 0 dBi receive antenna.</p> <p>Note 2: Throughout these test procedures an additional 1 dB has been added to the amplitude of the test transmission waveforms to account for variations in measurement equipment. This will ensure that the test signal is at or above the detection threshold level to trigger a DFS response.</p> <p>Note3: EIRP is based on the highest antenna gain. For MIMO devices refer to KDB Publication 662911 D01.</p> | |

Table 3-4: Detection Thresholds for Master Devices and Client Devices with Radar Detection

3.4. Parameters of DFS Test Signals

This section provides the parameters for required test waveforms, minimum percentage of successful detections, and the minimum number of trials that must be used for determining DFS conformance. Step intervals of 0.1 microsecond for Pulse Width, 1 microsecond for PRI, 1 MHz for chirp width and 1 for the number of pulses will be utilized for the random determination of specific test waveforms.

Short Pulse Radar Test Waveforms

| Radar Type | Pulse Width (μsec) | PRI (μsec) | Number of Pulses | Minimum Percentage of Successful Detection | Minimum Number of Trials |
|--|--------------------|---|--|--|--------------------------|
| 0 | 1 | 1428 | 18 | See Note 1 | See Note 1 |
| 1 | 1 | Test A: 15 unique PRI values randomly selected from the list of 23 PRI values in Table 3-6 | $\text{Roundup} \left\{ \left(\frac{1}{360} \right) \cdot \left(\frac{19 \cdot 10^6}{\text{PRI}_{\mu\text{sec}}} \right) \right\}$ | 60% | 30 |
| | | Test B: 15 unique PRI values randomly selected within the range of 518-3066 μsec, with a minimum increment of 1 μsec, excluding PRI values selected in Test A | | | |
| 2 | 1-5 | 150-230 | 23-29 | 60% | 30 |
| 3 | 6-10 | 200-500 | 16-18 | 60% | 30 |
| 4 | 11-20 | 200-500 | 12-16 | 60% | 30 |
| Aggregate (Radar Types 1-4) | | | | 80% | 120 |
| Note: Short Pulse Radar Type 0 should be used for the detection bandwidth test, channel move time, and channel closing time tests. | | | | | |

Table 3-5: Parameters for Short Pulse Radar Waveforms

A minimum of 30 unique waveforms are required for each of the Short Pulse Radar Types 2 through 4. If more than 30 waveforms are used for Short Pulse Radar Types 2 through 4, then each additional waveform must also be unique and not repeated from the previous waveforms.

| Pulse Repetition Frequency Number | Pulse Repetition Frequency (Pulses Per Second) | Pulse Repetition Interval (Microseconds) |
|-----------------------------------|--|--|
| 1 | 1930.5 | 518 |
| 2 | 1858.7 | 538 |
| 3 | 1792.1 | 558 |
| 4 | 1730.1 | 578 |
| 5 | 1672.2 | 598 |
| 6 | 1618.1 | 618 |
| 7 | 1567.4 | 638 |
| 8 | 1519.8 | 658 |
| 9 | 1474.9 | 678 |
| 10 | 1432.7 | 698 |
| 11 | 1392.8 | 718 |
| 12 | 1355 | 738 |
| 13 | 1319.3 | 758 |
| 14 | 1285.3 | 778 |
| 15 | 1253.1 | 798 |
| 16 | 1222.5 | 818 |
| 17 | 1193.3 | 838 |
| 18 | 1165.6 | 858 |
| 19 | 1139 | 878 |
| 20 | 1113.6 | 898 |
| 21 | 1089.3 | 918 |
| 22 | 1066.1 | 938 |
| 23 | 326.2 | 3066 |

Table 3-6: Pulse Repetition Intervals Values for Test A

Long Pulse Radar Test Waveform

| Radar Type | Pulse Width (μsec) | Chirp Width (MHz) | PRI (μsec) | Number of Pulses per Burst | Number of Bursts | Minimum Percentage of Successful Detection | Minimum Number of Trials |
|------------|--------------------|-------------------|-------------|----------------------------|------------------|--|--------------------------|
| 5 | 50 - 100 | 5 - 20 | 1000 - 2000 | 1 - 3 | 8 - 20 | 80% | 30 |

Table 3-7: Parameters for Long Pulse Radar Waveforms

The parameters for this waveform are randomly chosen. Thirty unique waveforms are required for the Long Pulse Radar Type waveforms. If more than 30 waveforms are used for the Long Pulse Radar Type waveforms, then each additional waveform must also be unique and not repeated from the previous waveforms.

Frequency Hopping Radar Test Waveform

| Radar Type | Pulse Width (μsec) | PRI (μsec) | Pulses Per Hop | Hopping Rate (kHz) | Hopping Sequence Length (msec) | Minimum Percentage of Successful Detection | Minimum Number of Trials |
|------------|--------------------|------------|----------------|--------------------|--------------------------------|--|--------------------------|
| 6 | 1 | 333 | 9 | 0.333 | 300 | 70% | 30 |

Table 3-8: Parameters for Frequency Hopping Radar Waveforms

For the Frequency Hopping Radar Type, the same Burst parameters are used for each waveform. The hopping sequence is different for each waveform and a 100-length segment is selected from the hopping sequence defined by the following algorithm:

The first frequency in a hopping sequence is selected randomly from the group of 475 integer frequencies from 5250 – 5724MHz. Next, the frequency that was just chosen is removed from the group and a frequency is randomly selected from the remaining 474 frequencies in the group. This process continues until all 475 frequencies are chosen for the set. For selection of a random frequency, the frequencies remaining within the group are always treated as equally likely.

3.5. Conducted Test Setup

The FCC KDB 905462 D02 NII DFS Compliance Procedures New Rules v02 describes a radiated test setup and a conducted test setup. The conducted test setup was used for this testing. Figure 3-1 shows the typical test setup.

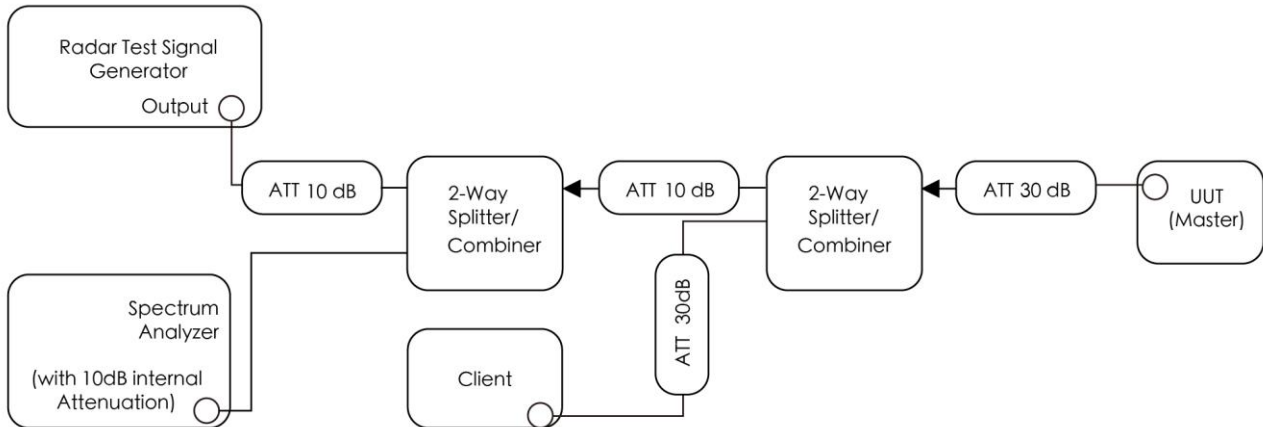

Figure 3-1: Conducted Test Setup where UUT is a Master and Radar Test Waveforms are injected into the Masters

4. Measuring Instrument

| Instrument Name | Manufacturer | Model No. | Asset No. | Cali. Interval | Cal. Due Date | Test Site |
|------------------|--------------|-----------|-------------|----------------|---------------|-----------|
| Signal Generator | Keysight | N5182B | MRTSUE06605 | 1 year | 2023-10-25 | SIP-TR2 |
| Signal Analyzer | Keysight | N9010B | MRTSUE07028 | 1 year | 2023-11-25 | SIP-TR2 |
| Thermohygrometer | testo | 608-H1 | MRTSUE11109 | 1 year | 2024-03-03 | SIP-TR2 |

Client Information

| Instrument | Manufacturer | Type No. | Certification Number |
|--------------|--------------|----------|----------------------|
| Wi-Fi Module | Intel | AX200NGW | FCC ID: PD9AX200NG |

| Software | Version | Manufacturer | Function |
|---------------|----------|--------------|-------------------|
| Signal Studio | V2.2.0.0 | Keysight | DFS Test Software |

5. Test Result

5.1. Summary

| Parameter | Verdict | Reference |
|--|---------|-------------|
| NII Detection Bandwidth Measurement | Pass | Section 5.3 |
| Initial Channel Availability Check Time | Pass | Section 5.4 |
| Radar Burst at the Beginning of the Channel Availability Check Time | Pass | Section 5.5 |
| Radar Burst at the End of the Channel Availability Check Time | Pass | Section 5.6 |
| In-Service Monitoring for Channel Move Time, Channel Closing Transmission Time | Pass | Section 5.7 |
| Non-Occupancy Period | Pass | Section 5.7 |
| Statistical Performance Check | Pass | Section 5.8 |

5.2. Radar Waveform Calibration Measurement

5.2.1. Calibration Setup

The conducted test setup was used for this calibration testing. Figure 3-2 shows the typical test setup.

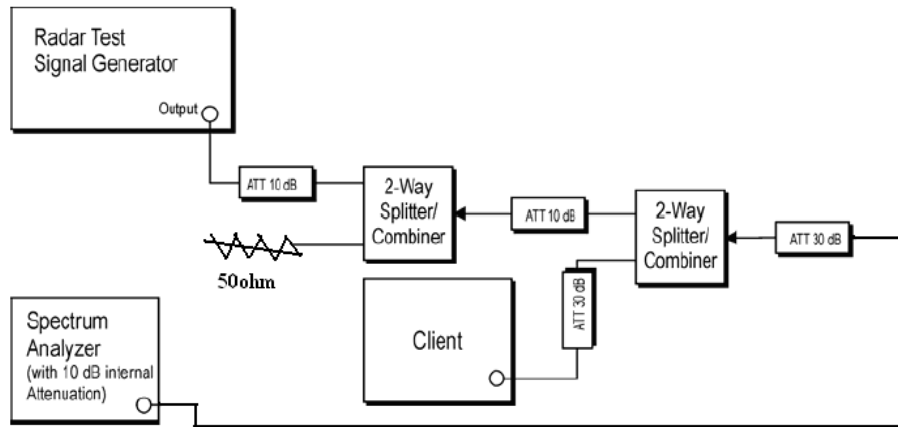

Figure 3-2: Conducted Test Setup

5.2.2. Calibration Procedure

The Interference Radar Detection Threshold Level is $(-64\text{dBm}) + (0) [\text{dBi}] + 1 \text{ dB} = -63 \text{ dBm}$ that had been taken into account the output power range and antenna gain. The above equipment setup was used to calibrate the conducted Radar Waveform. A vector signal generator was utilized to establish the test signal level for each radar type. During this process there were replace 50ohm terminal form Master and Client device and no transmissions by either the Master or Client Device. The spectrum analyzer was switched to the zero span (Time Domain) at the frequency of the Radar Waveform generator. Peak detection was used. The spectrum analyzer resolution bandwidth (RBW) and video bandwidth (VBW) were set to at least 3MHz. The vector signal generator amplitude was set so that the power level measured at the spectrum analyzer was $(-64\text{dBm}) + (0) [\text{dBi}] + 1 \text{ dB} = -63\text{dBm}$. Capture the spectrum analyzer plots on short pulse radar types, long pulse radar type and hopping radar waveform.

5.2.3. Calibration & Channel Loading Result

Refer to Appendix A.1 & A.2.

5.3. NII Detection Bandwidth Measurement

5.3.1. Test Limit

Minimum 100% of the NII 99% transmission power bandwidth. During the U-NII Detection Bandwidth detection test, each frequency step the minimum percentage of detection is 90 percent. Measurements are performed with no data traffic.

5.3.2. Test Procedure

1. Adjust the equipment to produce a single Burst of any one of the Short Pulse Radar Types 0-4 in Table 3-5 at the center frequency of the EUT Operating Channel at the specified DFS Detection Threshold level.
2. The generating equipment is configured as shown in the Conducted Test Setup above section 3.5.
3. The EUT is set up as a stand-alone device (no associated Client or Master, as appropriate) and no traffic. Frame based systems will be set to a talk/listen ratio reflecting the worst case (maximum) that is user configurable during this test.
4. Generate a single radar Burst, and note the response of the EUT. Repeat for a minimum of 10 trials. The EUT must detect the Radar Waveform using the specified U-NII Detection Bandwidth criterion shown in Table 3-5. In cases where the channel bandwidth may exceed past the DFS band edge on specific channels (i.e., 802.11ac or wideband frame based systems) select a channel that has the entire emission bandwidth within the DFS band. If this is not possible, test the detection BW to the DFS band edge.
5. Starting at the center frequency of the UUT operating Channel, increase the radar frequency in 5 MHz steps, repeating the above test sequence, until the detection rate falls below the U-NII Detection Bandwidth criterion specified in Table 3-3. Repeat this measurement in 1MHz steps at frequencies 5 MHz below where the detection rate begins to fall. Record the highest frequency (denote as FH) at which detection is greater than or equal to the U-NII Detection Bandwidth criterion. Recording the detection rate at frequencies above FH is not required to demonstrate compliance.
6. Starting at the center frequency of the EUT operating Channel, decrease the radar frequency in 1 MHz steps, repeating the above item 4 test sequence, until the detection rate falls below the U-NII Detection Bandwidth criterion. Record the lowest frequency (denote as FL) at which detection is greater than or equal to the U-NII Detection Bandwidth criterion. Recording the detection rate at frequencies below FL is not required to demonstrate compliance.
7. The U-NII Detection Bandwidth is calculated as follows: $U\text{-NII Detection Bandwidth} = FH - FL$
8. The U-NII Detection Bandwidth must be at least 100% of the EUT transmitter 99% power, otherwise, the

EUT does not comply with DFS requirements.

5.3.3. Test Result

Refer to Appendix A.3.

5.4. Initial Channel Availability Check Time Measurement

5.4.1. Test Limit

The EUT shall perform a Channel Availability Check to ensure that there is no radar operating on the channel. After power-up sequence, receive at least 1 minute on the intended operating frequency.

5.4.2. Test Procedure

1. The U-NII devices will be powered on and be instructed to operate on the appropriate U-NII Channel that must incorporate DFS functions. At the same time the EUT is powered on, the spectrum analyzer will be set to zero span mode with a 3 MHz RBW and 3 MHz VBW on the Channel occupied by the radar (Chr) with a 2.5 minute sweep time. The spectrum analyzer's sweep will be started at the same time power is applied to the U-NII device.
2. The EUT should not transmit any beacon or data transmissions until at least 1 minute after the completion of the power-on cycle.
3. Confirm that the EUT initiates transmission on the channel. Measurement system showing its nominal noise floor is marker1.

5.4.3. Test Result

Refer to Appendix A.4.

5.5. Radar Burst at the Beginning of the Channel Availability Check Time Measurement

5.5.1. Test Limit

In beginning of the Channel Availability Check (CAC) Time, radar is detected on this channel, select another intended channel and perform a CAC on that channel.

5.5.2. Test Procedure

1. The steps below define the procedure to verify successful radar detection on the selected Channel during a period equal to the Channel Availability Check Time and avoidance of operation on that Channel when a radar Burst with a level equal to the DFS Detection Threshold + 1 dB occurs at the beginning of the Channel Availability Check Time.
2. The EUT is in completion power-up cycle (from T0 to T1). T1 denotes the instant when the EUT has completed its power-up sequence. The Channel Availability Check Time commences at instant T1 and will end no sooner than T1 + 60 seconds. A single Burst of one of Short Pulse Radar Types 0-4 at DFS Detection Threshold + 1 dB will commence within a 6 second window starting at T1.
3. Visual indication on the EUT of successful detection of the radar Burst will be recorded and reported. Observation of emissions will continue for 2.5 minutes after the radar Burst has been generated. Verify that during the 2.5 minutes measurement window no EUT transmissions occurred.

5.5.3. Test Result

Refer to Appendix A.5.

5.6. Radar Burst at the End of the Channel Availability Check Time Measurement

5.6.1. Test Limit

In the end of Channel Availability Check (CAC) Time, radar is detected on this channel, select another intended channel and perform a CAC on that channel.

5.6.2. Test Procedure

1. The steps below define the procedure to verify successful radar detection on the selected Channel during a period equal to the Channel Availability Check Time and avoidance of operation on that Channel when a radar Burst with a level equal to the DFS Detection Threshold + 1 dB occurs at the beginning of the Channel Availability Check Time.
2. The EUT is powered on at T0. T1 denotes the instant when the EUT has completed its power-up sequence. The Channel Availability Check Time commences at instant T1 and will end no sooner than T1 + 60 seconds. A single Burst of one of Short Pulse Radar Types 0-4 at DFS Detection Threshold + 1 dB will commence within a 6 second window starting at T1+ 54 seconds.
3. Visual indication on the EUT of successful detection of the radar Burst will be recorded and reported. Observation of emissions will continue for 2.5 minutes after the radar Burst has been generated. Verify that during the 2.5 minutes measurement window no EUT transmissions occurred.

5.6.3. Test Result

Refer to Appendix A.6.

5.7. In-Service Monitoring for Channel Move Time, Channel Closing Transmission Time and Non-Occupancy Period Measurement

5.7.1. Test Limit

The EUT has In-Service Monitoring function to continuously monitor the radar signals. If the radar is detected, must leave the channel (Shutdown). The Channel Move Time to cease all transmissions on the current channel upon detection of a Radar Waveform above the DFS Detection Threshold within 10 sec. The total duration of Channel Closing Transmission Time is 260ms, consisting of data signals and the aggregate of control signals, by a U-NII device during the Channel Move Time. The Non-Occupancy Period time is 30 minute during which a Channel will not be utilized after a Radar Waveform is detected on that Channel.

5.7.2. Test Procedure

1. The test should be performed with Radar Type 0. The measurement timing begins at the end of the Radar Type 0.
2. When the radar burst with a level equal to the DFS Detection Threshold + 1dB is generated on the Operating Channel of the U-NII device. A U-NII device operating as a Master Device will associate with the Client Device at Channel. Stream the MPEG test file from the Master Device to the Client Device on the selected Channel for the entire period of the test. At time T0 the Radar Waveform generator sends a Burst of pulses for each of the radar types at Detection Threshold + 1dB.
3. Observe the transmissions of the EUT at the end of the radar Burst on the Operating Channel. Measure and record the transmissions from the EUT during the observation time (Channel Move Time).
4. Measurement of the aggregate duration of the Channel Closing Transmission Time method. With the spectrum analyzer set to zero span tuned to the center frequency of the EUT operating channel at the radar simulated frequency, peak detection, and max hold, the dwell time per bin is given by: $Dwell (1.5ms) = S (12 \text{ sec}) / B (8000)$; where Dwell is the dwell time per spectrum analyzer sampling bin, S is the sweep time and B is the number of spectrum analyzer sampling bins. An upper bound of the aggregate duration of the intermittent control signals of Channel Closing Transmission Time is calculated by: $C = N \times Dwell$; where C is the Closing Time, N is the number of spectrum analyzer sampling bins showing a U-NII transmission and Dwell is the dwell time per bin.
5. Measure the EUT for more than 30 minutes following the channel close/move time to verify that the EUT does not resume any transmissions on this Channel.

5.7.3. Test Result

Refer to Appendix A.7.

5.8. Statistical Performance Check Measurement

5.8.1. Test Limit

The minimum percentage of successful detection requirements found in below table when a radar burst with a level equal to the DFS Detection Threshold + 1dB is generated on the Operating Channel of the U-NII device (In- Service Monitoring).

| Radar Type | Minimum Number of Trails | Detection Probability |
|-----------------------------|-----------------------------------|-----------------------|
| 0 | 30 | $P_d \geq 60\%$ |
| 1 | 30(15 of test A and 15 of test B) | $P_d \geq 60\%$ |
| 2 | 30 | $P_d \geq 60\%$ |
| 3 | 30 | $P_d \geq 60\%$ |
| 4 | 30 | $P_d \geq 60\%$ |
| Aggregate (Radar Types 1-4) | 120 | $P_d \geq 80\%$ |
| 5 | 30 | $P_d \geq 80\%$ |
| 6 | 30 | $P_d \geq 70\%$ |

Note: The percentage of successful detection is calculated by:
 $(\text{Total Waveform Detections} / \text{Total Waveform Trails}) * 100 = \text{Probability of Detection Radar Waveform}$
 In addition an aggregate minimum percentage of successful detection across all Short Pulse Radar Types 1-4 is required and is calculated as follows: $(P_{d1} + P_{d2} + P_{d3} + P_{d4}) / 4$.

5.8.2. Test Procedure

1. Stream the MPEG test file from the Master Device to the Client Device on the test Channel for the entire period of the test.
2. At time T0 the Radar Waveform generator sends the individual waveform for each of the Radar Types 1-6, at levels equal to the DFS Detection Threshold + 1dB, on the Operating Channel.
3. Observe the transmissions of the EUT at the end of the Burst on the Operating Channel for duration greater than 10 seconds for Short Pulse Radar Types 0 to ensure detection occurs.
4. Observe the transmissions of the EUT at the end of the Burst on the Operating Channel for duration greater than 22 seconds for Long Pulse Radar Type 5 to ensure detection occurs.
5. The device can utilize a test mode to demonstrate when detection occurs to prevent the need to reset the device between trial runs.
6. The Minimum number of trails, minimum percentage of successful detection and the average minimum percentage of successful detection are found in below table

5.8.3. Test Result

Refer to Appendix A.8.

Appendix A – Test Result

A.1 Calibration Test Result

| | | | |
|-----------|------------|---------------|------------|
| Test Site | SIP-TR2 | Test Engineer | Alisa Deng |
| Test Date | 2023-06-29 | | |

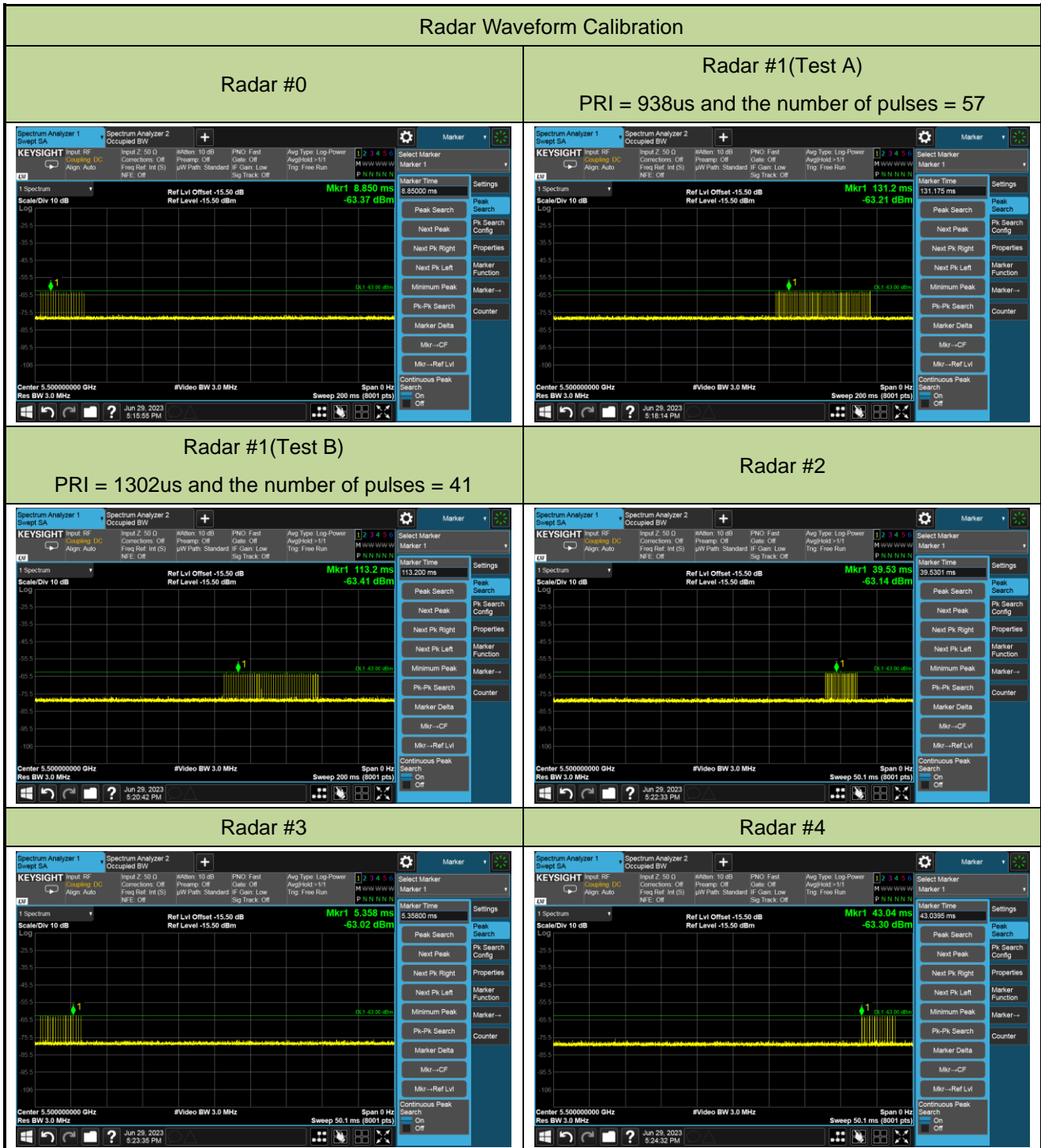



A.2 Channel Loading Test Result

| | | | |
|-----------|------------|---------------|------------|
| Test Site | SIP-TR2 | Test Engineer | Alisa Deng |
| Test Date | 2023-07-05 | | |

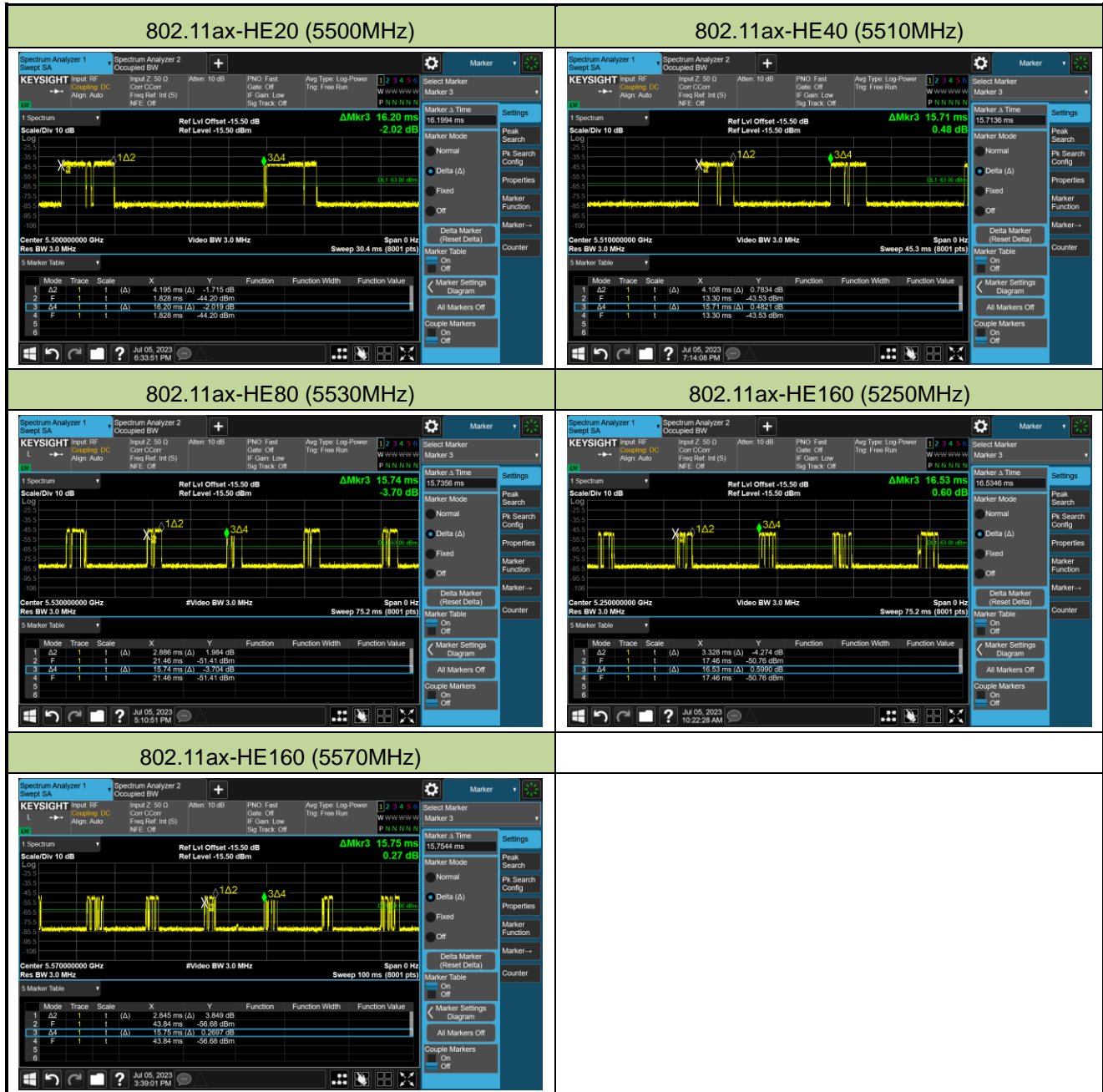

| Test Mode | Test Frequency | Packet ratio | Requirement ratio | Test Result |
|----------------|----------------|--------------|-------------------|-------------|
| 802.11ax-HE20 | 5500 MHz | 25.80% | ≥ 17% | Pass |
| 802.11ax-HE40 | 5510 MHz | 26.10% | ≥ 17% | Pass |
| 802.11ax-HE80 | 5530 MHz | 18.33% | ≥ 17% | Pass |
| 802.11ax-HE160 | 5250 MHz | 20.13% | ≥ 17% | Pass |
| 802.11ax-HE160 | 5570 MHz | 18.06% | ≥ 17% | Pass |

Note: System testing was performed with the designated iperf test file. This file is used by IP and Frame based systems for loading the test channel during the In-service compliance testing of the U-NII device.
Packet ratio = Time On / (Time On + Off Time).

A.3 NII Detection Bandwidth Test Result

| | | | |
|-----------|--|---------------|------------|
| Test Site | SIP-TR2 | Test Engineer | Alisa Deng |
| Test Date | 2023-07-01 | | |
| Test Item | Detection Bandwidth (802.11ax-HE20 mode - 5500MHz) | | |

| Radar Frequency (MHz) | DFS Detection Trials (1=Detection, 0= No Detection) | | | | | | | | | | Detection Rate (%) |
|--------------------------|---|---|---|---|---|---|---|---|---|----|--------------------|
| | 1 | 2 | 3 | 4 | 5 | 6 | 7 | 8 | 9 | 10 | |
| 5489 | 0 | 0 | 0 | 0 | 0 | 0 | 0 | 0 | 0 | 0 | 0% |
| 5490 FL | 1 | 1 | 1 | 1 | 1 | 1 | 1 | 1 | 1 | 1 | 100% |
| 5495 | 1 | 1 | 1 | 1 | 1 | 1 | 1 | 1 | 1 | 1 | 100% |
| 5500 | 1 | 1 | 1 | 1 | 1 | 1 | 1 | 1 | 1 | 1 | 100% |
| 5505 | 1 | 1 | 1 | 1 | 1 | 1 | 1 | 1 | 1 | 1 | 100% |
| 5510 FH | 1 | 1 | 1 | 1 | 1 | 1 | 1 | 1 | 1 | 1 | 100% |
| 5511 | 0 | 0 | 0 | 0 | 0 | 0 | 0 | 0 | 0 | 0 | 0% |

Note 1: All NII channels for this device have identical Channel bandwidths. Therefore, all DFS testing was done at 5500MHz. The 99% channel bandwidth is 18.831MHz. (See the 99% BW section of the RF report for further measurement details).

Note 2: Detection Bandwidth = FH - FL = 5510MHz – 5490MHz = 20MHz

Note 3: NII Detection Bandwidth Min. Limit (MHz): 18.831MHz x 100% = 18.831MHz.

| | | | |
|-----------|--|---------------|------------|
| Test Site | SIP-TR2 | Test Engineer | Alisa Deng |
| Test Date | 2023-07-01 | | |
| Test Item | Detection Bandwidth (802.11ax-HE40 mode - 5510MHz) | | |

| Radar Frequency (MHz) | DFS Detection Trials (1=Detection, 0= No Detection) | | | | | | | | | | Detection Rate (%) |
|--------------------------|---|---|---|---|---|---|---|---|---|----|--------------------|
| | 1 | 2 | 3 | 4 | 5 | 6 | 7 | 8 | 9 | 10 | |
| 5489 | 0 | 0 | 0 | 0 | 0 | 0 | 0 | 0 | 0 | 0 | 0% |
| 5490 FL | 1 | 1 | 1 | 1 | 1 | 1 | 1 | 1 | 1 | 1 | 100% |
| 5495 | 1 | 1 | 1 | 1 | 1 | 1 | 1 | 1 | 1 | 1 | 100% |
| 5500 | 1 | 1 | 1 | 1 | 1 | 1 | 1 | 1 | 1 | 1 | 100% |
| 5505 | 1 | 1 | 1 | 1 | 1 | 1 | 1 | 1 | 1 | 1 | 100% |
| 5510 | 1 | 1 | 1 | 1 | 1 | 1 | 1 | 1 | 1 | 1 | 100% |
| 5515 | 1 | 1 | 1 | 1 | 1 | 1 | 1 | 1 | 1 | 1 | 100% |
| 5520 | 1 | 1 | 1 | 1 | 1 | 1 | 1 | 1 | 1 | 1 | 100% |
| 5525 | 1 | 1 | 1 | 1 | 1 | 1 | 1 | 1 | 1 | 1 | 100% |
| 5530 FH | 1 | 1 | 1 | 1 | 1 | 1 | 1 | 1 | 1 | 1 | 100% |
| 5531 | 0 | 0 | 0 | 0 | 0 | 0 | 0 | 0 | 0 | 0 | 0% |

Note 1: All NII channels for this device have identical Channel bandwidths. Therefore, all DFS testing was done at 5510MHz. The 99% channel bandwidth is 37.571MHz. (See the 99% BW section of the RF report for further measurement details).

Note 2: Detection Bandwidth = FH - FL = 5530MHz - 5490MHz = 40MHz.

Note 3: NII Detection Bandwidth Min. Limit (MHz): 37.571MHz x 100% = 37.571MHz.

| | | | |
|-----------|--|---------------|------------|
| Test Site | SIP-TR2 | Test Engineer | Alisa Deng |
| Test Date | 2023-07-01 | | |
| Test Item | Detection Bandwidth (802.11ax-HE80 mode - 5530MHz) | | |

| Radar Frequency (MHz) | DFS Detection Trials (1=Detection, 0= No Detection) | | | | | | | | | | Detection Rate (%) |
|--------------------------|---|---|---|---|---|---|---|---|---|----|--------------------|
| | 1 | 2 | 3 | 4 | 5 | 6 | 7 | 8 | 9 | 10 | |
| 5489 | 0 | 0 | 0 | 0 | 0 | 0 | 0 | 0 | 0 | 0 | 0% |
| 5490 FL | 1 | 1 | 1 | 1 | 1 | 1 | 1 | 1 | 1 | 1 | 100% |
| 5495 | 1 | 1 | 1 | 1 | 1 | 1 | 1 | 1 | 1 | 1 | 100% |
| 5500 | 1 | 1 | 1 | 1 | 1 | 1 | 1 | 1 | 1 | 1 | 100% |
| 5505 | 1 | 1 | 1 | 1 | 1 | 1 | 1 | 1 | 1 | 1 | 100% |
| 5510 | 1 | 1 | 1 | 1 | 1 | 1 | 1 | 1 | 1 | 1 | 100% |
| 5515 | 1 | 1 | 1 | 1 | 1 | 1 | 1 | 1 | 1 | 1 | 100% |
| 5520 | 1 | 1 | 1 | 1 | 1 | 1 | 1 | 1 | 1 | 1 | 100% |
| 5525 | 1 | 1 | 1 | 1 | 1 | 1 | 1 | 1 | 1 | 1 | 100% |
| 5530 | 1 | 1 | 1 | 1 | 1 | 1 | 1 | 1 | 1 | 1 | 100% |
| 5535 | 1 | 1 | 1 | 1 | 1 | 1 | 1 | 1 | 1 | 1 | 100% |
| 5540 | 1 | 1 | 1 | 1 | 1 | 1 | 1 | 1 | 1 | 1 | 100% |
| 5545 | 1 | 1 | 1 | 1 | 1 | 1 | 1 | 1 | 1 | 1 | 100% |
| 5550 | 1 | 1 | 1 | 1 | 1 | 1 | 1 | 1 | 1 | 1 | 100% |
| 5555 | 1 | 1 | 1 | 1 | 1 | 1 | 1 | 1 | 1 | 1 | 100% |
| 5560 | 1 | 1 | 1 | 1 | 1 | 1 | 1 | 1 | 1 | 1 | 100% |
| 5565 | 1 | 1 | 1 | 1 | 1 | 1 | 1 | 1 | 1 | 1 | 100% |
| 5570 FH | 1 | 1 | 1 | 1 | 1 | 1 | 1 | 1 | 1 | 1 | 100% |
| 5571 | 0 | 0 | 0 | 0 | 0 | 0 | 0 | 0 | 0 | 0 | 0% |

Note 1: All NII channels for this device have identical Channel bandwidths. Therefore, all DFS testing was done at 5530MHz. The 99% channel bandwidth is 76.800MHz. (See the 99% BW section of the RF report for further measurement details).

Note 2: Detection Bandwidth = FH - FL = 5570MHz - 5490MHz = 80MHz.

Note 3: NII Detection Bandwidth Min. Limit (MHz): 76.800MHz x 100% = 76.800MHz.

| | | | |
|-----------|---|---------------|------------|
| Test Site | SIP-TR2 | Test Engineer | Alisa Deng |
| Test Date | 2023-07-01 | | |
| Test Item | Detection Bandwidth (802.11ax-HE160 mode - 5250MHz) | | |

| Radar Frequency (MHz) | DFS Detection Trials (1=Detection, 0= No Detection) | | | | | | | | | | Detection Rate (%) |
|--------------------------|---|---|---|---|---|---|---|---|---|----|--------------------|
| | 1 | 2 | 3 | 4 | 5 | 6 | 7 | 8 | 9 | 10 | |
| 5250 FL | 1 | 1 | 1 | 1 | 1 | 1 | 1 | 1 | 1 | 1 | 100% |
| 5255 | 1 | 1 | 1 | 1 | 1 | 1 | 1 | 1 | 1 | 1 | 100% |
| 5260 | 1 | 1 | 1 | 1 | 1 | 1 | 1 | 1 | 1 | 1 | 100% |
| 5265 | 1 | 1 | 1 | 1 | 1 | 1 | 1 | 1 | 1 | 1 | 100% |
| 5270 | 1 | 1 | 1 | 1 | 1 | 1 | 1 | 1 | 1 | 1 | 100% |
| 5275 | 1 | 1 | 1 | 1 | 1 | 1 | 1 | 1 | 1 | 1 | 100% |
| 5280 | 1 | 1 | 1 | 1 | 1 | 1 | 1 | 1 | 1 | 1 | 100% |
| 5285 | 1 | 1 | 1 | 1 | 1 | 1 | 1 | 1 | 1 | 1 | 100% |
| 5290 | 1 | 1 | 1 | 1 | 1 | 1 | 1 | 1 | 1 | 1 | 100% |
| 5295 | 1 | 1 | 1 | 1 | 1 | 1 | 1 | 1 | 1 | 1 | 100% |
| 5300 | 1 | 1 | 1 | 1 | 1 | 1 | 1 | 1 | 1 | 1 | 100% |
| 5305 | 1 | 1 | 1 | 1 | 1 | 1 | 1 | 1 | 1 | 1 | 100% |
| 5310 | 1 | 1 | 1 | 1 | 1 | 1 | 1 | 1 | 1 | 1 | 100% |
| 5315 | 1 | 1 | 1 | 1 | 1 | 1 | 1 | 1 | 1 | 1 | 100% |
| 5320 | 1 | 1 | 1 | 1 | 1 | 1 | 1 | 1 | 1 | 1 | 100% |
| 5325 | 1 | 1 | 1 | 1 | 1 | 1 | 1 | 1 | 1 | 1 | 100% |
| 5330 FH | 1 | 1 | 1 | 1 | 1 | 1 | 1 | 1 | 1 | 1 | 100% |
| 5331 | 0 | 0 | 0 | 0 | 0 | 0 | 0 | 0 | 0 | 0 | 0% |

Note 1: All NII channels for this device have identical Channel bandwidths. Therefore, all DFS testing was done at 5250MHz. The 99% channel bandwidth within U-NII Band-2A is 77.415MHz ($99\% \text{ BW} / 2 = 154.83\text{MHz} / 2 = 77.415\text{MHz}$). (See the 99% BW section of the RF report for further measurement details).

Note 2: Detection Bandwidth = FH - FL = 5330MHz - 5250MHz = 80MHz.

Note 3: NII Detection Bandwidth Min. Limit (MHz): $77.415\text{MHz} \times 100\% = 77.415\text{MHz}$.

| | | | |
|-----------|---|---------------|------------|
| Test Site | SIP-TR2 | Test Engineer | Alisa Deng |
| Test Date | 2023-07-01 | | |
| Test Item | Detection Bandwidth (802.11ax-HE160 mode - 5570MHz) | | |

| Radar Frequency (MHz) | DFS Detection Trials (1=Detection, 0= No Detection) | | | | | | | | | | Detection Rate (%) |
|--------------------------|---|---|---|---|---|---|---|---|---|----|--------------------|
| | 1 | 2 | 3 | 4 | 5 | 6 | 7 | 8 | 9 | 10 | |
| 5489 | 0 | 0 | 0 | 0 | 0 | 0 | 0 | 0 | 0 | 0 | 0% |
| 5490 FL | 1 | 1 | 1 | 1 | 1 | 1 | 1 | 1 | 1 | 1 | 100% |
| 5495 | 1 | 1 | 1 | 1 | 1 | 1 | 1 | 1 | 1 | 1 | 100% |
| 5505 | 1 | 1 | 1 | 1 | 1 | 1 | 1 | 1 | 1 | 1 | 100% |
| 5510 | 1 | 1 | 1 | 1 | 1 | 1 | 1 | 1 | 1 | 1 | 100% |
| 5515 | 1 | 1 | 1 | 1 | 1 | 1 | 1 | 1 | 1 | 1 | 100% |
| 5520 | 1 | 1 | 1 | 1 | 1 | 1 | 1 | 1 | 1 | 1 | 100% |
| 5525 | 1 | 1 | 1 | 1 | 1 | 1 | 1 | 1 | 1 | 1 | 100% |
| 5530 | 1 | 1 | 1 | 1 | 1 | 1 | 1 | 1 | 1 | 1 | 100% |
| 5535 | 1 | 1 | 1 | 1 | 1 | 1 | 1 | 1 | 1 | 1 | 100% |
| 5540 | 1 | 1 | 1 | 1 | 1 | 1 | 1 | 1 | 1 | 1 | 100% |
| 5545 | 1 | 1 | 1 | 1 | 1 | 1 | 1 | 1 | 1 | 1 | 100% |
| 5550 | 1 | 1 | 1 | 1 | 1 | 1 | 1 | 1 | 1 | 1 | 100% |
| 5555 | 1 | 1 | 1 | 1 | 1 | 1 | 1 | 1 | 1 | 1 | 100% |
| 5560 | 1 | 1 | 1 | 1 | 1 | 1 | 1 | 1 | 1 | 1 | 100% |
| 5565 | 1 | 1 | 1 | 1 | 1 | 1 | 1 | 1 | 1 | 1 | 100% |
| 5570 | 1 | 1 | 1 | 1 | 1 | 1 | 1 | 1 | 1 | 1 | 100% |
| 5575 | 1 | 1 | 1 | 1 | 1 | 1 | 1 | 1 | 1 | 1 | 100% |
| 5580 | 1 | 1 | 1 | 1 | 1 | 1 | 1 | 1 | 1 | 1 | 100% |
| 5585 | 1 | 1 | 1 | 1 | 1 | 1 | 1 | 1 | 1 | 1 | 100% |
| 5590 | 1 | 1 | 1 | 1 | 1 | 1 | 1 | 1 | 1 | 1 | 100% |
| 5595 | 1 | 1 | 1 | 1 | 1 | 1 | 1 | 1 | 1 | 1 | 100% |
| 5600 | 1 | 1 | 1 | 1 | 1 | 1 | 1 | 1 | 1 | 1 | 100% |
| 5605 | 1 | 1 | 1 | 1 | 1 | 1 | 1 | 1 | 1 | 1 | 100% |
| 5610 | 1 | 1 | 1 | 1 | 1 | 1 | 1 | 1 | 1 | 1 | 100% |
| 5615 | 1 | 1 | 1 | 1 | 1 | 1 | 1 | 1 | 1 | 1 | 100% |
| 5620 | 1 | 1 | 1 | 1 | 1 | 1 | 1 | 1 | 1 | 1 | 100% |
| 5625 | 1 | 1 | 1 | 1 | 1 | 1 | 1 | 1 | 1 | 1 | 100% |
| 5630 | 1 | 1 | 1 | 1 | 1 | 1 | 1 | 1 | 1 | 1 | 100% |
| 5635 | 1 | 1 | 1 | 1 | 1 | 1 | 1 | 1 | 1 | 1 | 100% |
| 5640 | 1 | 1 | 1 | 1 | 1 | 1 | 1 | 1 | 1 | 1 | 100% |
| 5645 | 1 | 1 | 1 | 1 | 1 | 1 | 1 | 1 | 1 | 1 | 100% |

| | | | | | | | | | | | |
|---------|---|---|---|---|---|---|---|---|---|---|------|
| 5650 FH | 1 | 1 | 1 | 1 | 1 | 1 | 1 | 1 | 1 | 1 | 100% |
| 5651 | 0 | 0 | 0 | 0 | 0 | 0 | 0 | 0 | 0 | 0 | 0% |

Note 1: All NII channels for this device have identical Channel bandwidths. Therefore, all DFS testing was done at 5570MHz. The 99% channel bandwidth is 154.56MHz. (See the 99% BW section of the RF report for further measurement details).

Note 2: Detection Bandwidth = FH - FL = 5650MHz – 5490MHz = 160MHz

Note 3: NII Detection Bandwidth Min. Limit (MHz): 154.56MHz x 100% = 154.56MHz.

A.4 Initial Channel Availability Check Time Test Result

| | | | |
|-----------|--|---------------|------------|
| Test Site | SIP-TR2 | Test Engineer | Alisa Deng |
| Test Date | 2023-06-29 | | |
| Test Item | Initial Channel Availability Check Time (802.11ax-HE20 mode - 5500MHz) | | |

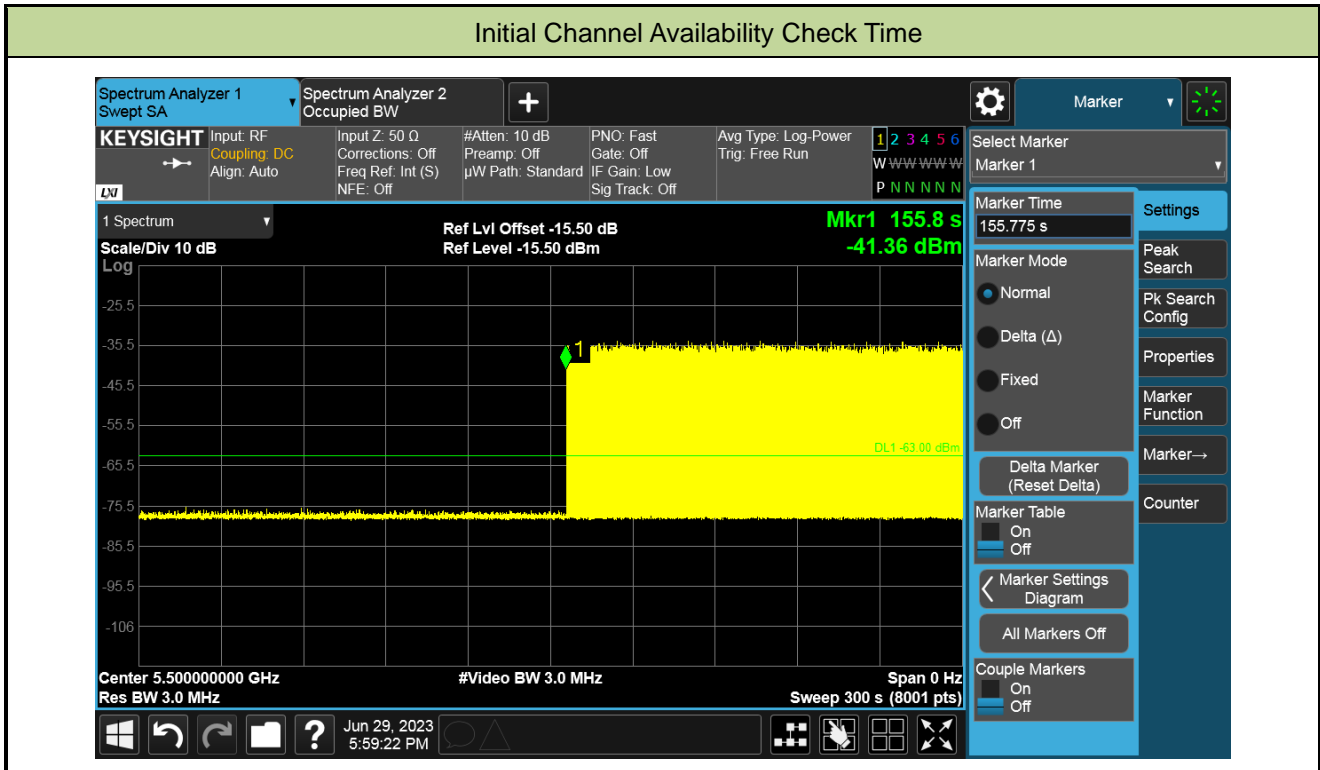

Note: The EUT does not transmit any beacon or data transmissions until at least 1 minute after the completion of the power-on cycle (95.8 sec). Initial beacons/data transmissions are indicated by marker 1 (155.8 sec).

A.5 Radar Burst at the Beginning of the Channel Availability Check Time Test Result

| | | | |
|-----------|---|---------------|------------|
| Test Site | SIP-TR2 | Test Engineer | Alisa Deng |
| Test Date | 2023-06-30 | | |
| Test Item | Beginning of the Channel Availability Check Time (802.11ax-HE20 mode - 5500MHz) | | |

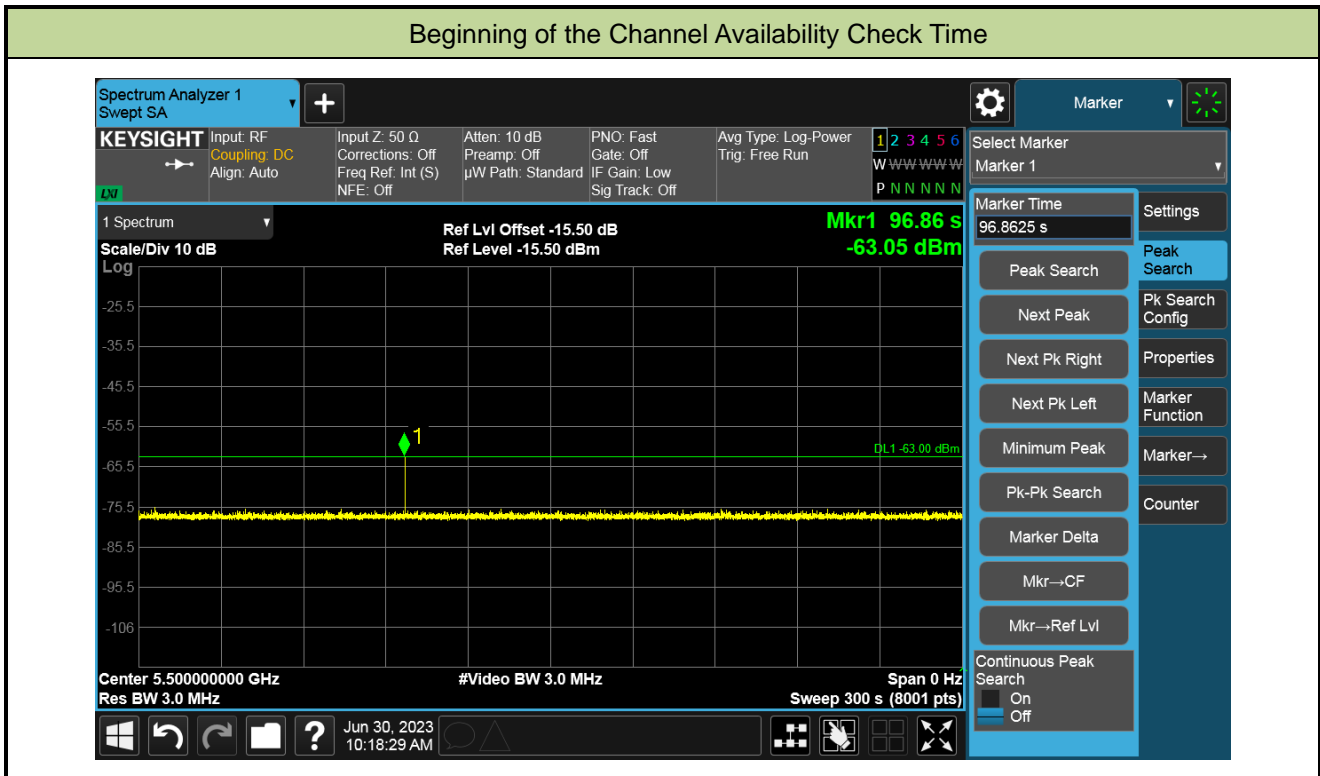

A.6 Radar Burst at the End of the Channel Availability Check Time Test Result

| | | | |
|-----------|---|---------------|------------|
| Test Site | SIP-TR2 | Test Engineer | Alisa Deng |
| Test Date | 2023-06-30 | | |
| Test Item | End of the Channel Availability Check Time (802.11ax-HE20 mode - 5500MHz) | | |

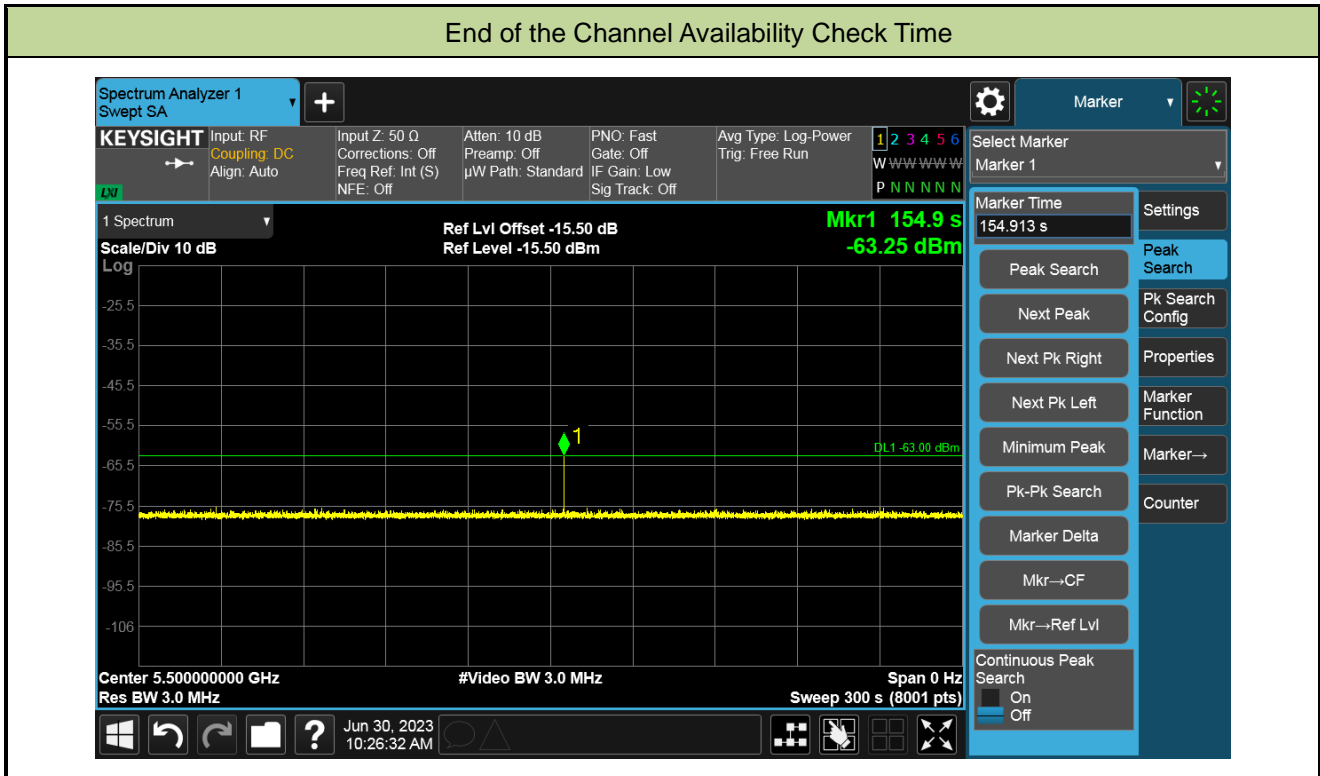

A.7 In-Service Monitoring for Channel Move Time, Channel Closing Transmission Time and Non-Occupancy Period Test Result

| | | | |
|-----------|---|---------------|------------|
| Test Site | SIP-TR2 | Test Engineer | Alisa Deng |
| Test Date | 2023-07-28 | | |
| Test Item | Channel Move Time and Channel Closing Transmission Time (802.11ax-HE160 mode - 5250MHz) | | |

Channel Move Time and Channel Closing Transmission Time

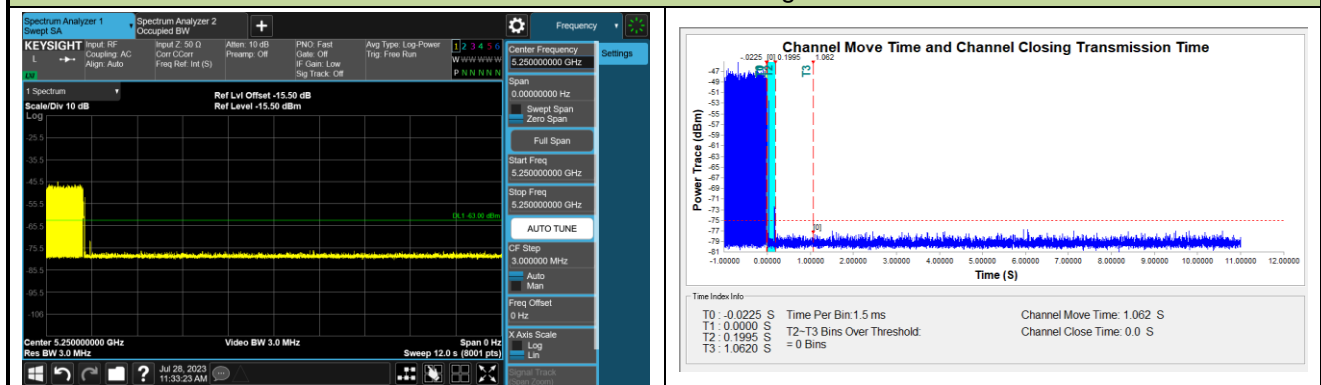

Non-Occupancy Period

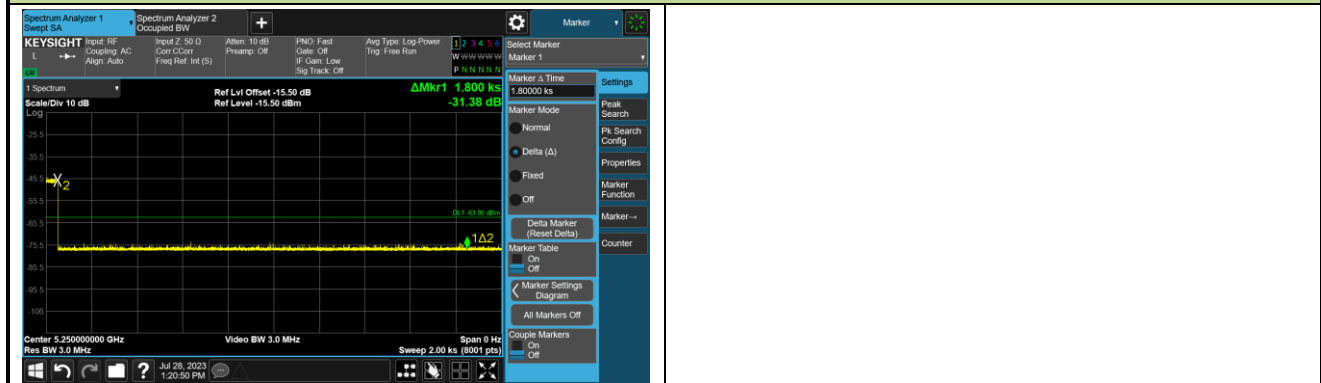

| Parameter | Test Result | Limit |
|---|-------------|----------|
| Channel Move Time (s) | 1.062s | <10s |
| Channel Closing Transmission Time (ms) (Note) | 0ms | < 60ms |
| Non-Occupancy Period (min) | ≥ 30min | ≥ 30 min |

Note: The Channel Closing Transmission Time is comprised of 200 milliseconds starting at the beginning of the Channel Move Time plus any additional intermittent control signals required to facilitate a Channel move (an aggregate of 60 milliseconds) during the remainder of the 10 seconds period. The aggregate duration of control signals will not count quiet periods in between transmissions.

| | | | |
|-----------|---|---------------|------------|
| Test Site | SIP-TR2 | Test Engineer | Alisa Deng |
| Test Date | 2023-07-04 ~ 2023-07-28 | | |
| Test Item | Channel Move Time and Channel Closing Transmission Time (802.11ax-HE160 mode - 5570MHz) | | |

Channel Move Time and Channel Closing Transmission Time

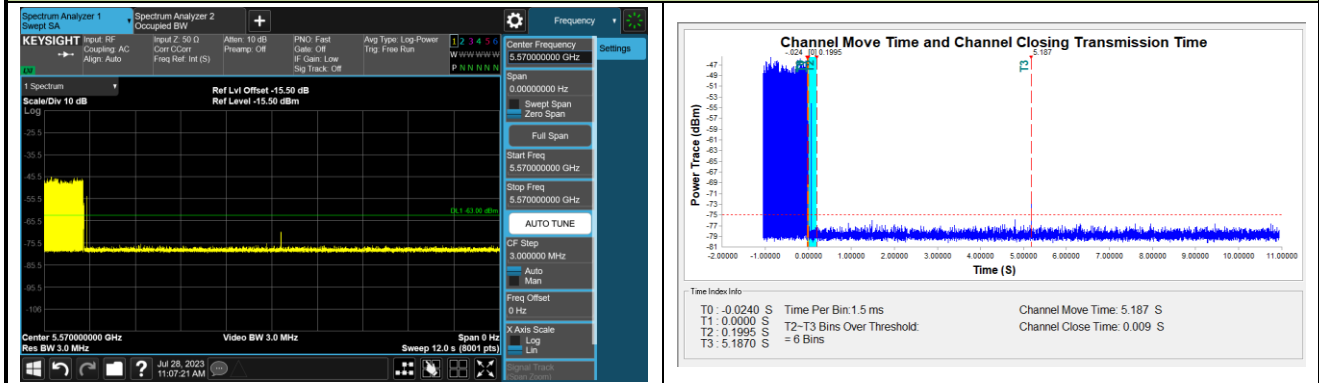

Non-Occupancy Period

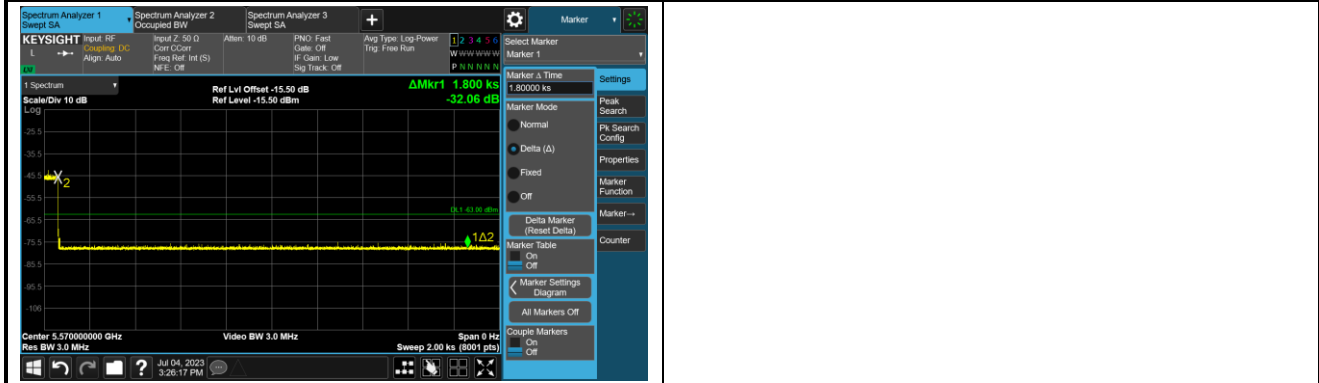

| Parameter | Test Result | Limit |
|---|-------------|----------|
| Channel Move Time (s) | 5.187s | <10s |
| Channel Closing Transmission Time (ms) (Note) | 9ms | < 60ms |
| Non-Occupancy Period (min) | ≥ 30min | ≥ 30 min |

Note: The Channel Closing Transmission Time is comprised of 200 milliseconds starting at the beginning of the Channel Move Time plus any additional intermittent control signals required to facilitate a Channel move (an aggregate of 60 milliseconds) during the remainder of the 10 seconds period. The aggregate duration of control signals will not count quiet periods in between transmissions.

A.8 Statistical Performance Check

| | | | |
|-----------|---|---------------|------------|
| Test Site | SIP-TR2 | Test Engineer | Alisa Deng |
| Test Date | 2023-07-04 | | |
| Test Item | Radar Statistical Performance Check (802.11ax-HE20 – 5500MHz) | | |

| Radar Type 1-4 - Radar Statistical Performance | | | | | | | | |
|--|--------------------|-------------------------|--------------------|-------------------------|--------------------|-------------------------|--------------------|-------------------------|
| Trial | Radar Type 1 | | Radar Type 2 | | Radar Type 3 | | Radar Type 4 | |
| | Frequency (MHz) | 1=detect 0=no detect | Frequency (MHz) | 1=detect 0=no detect | Frequency (MHz) | 1=detect 0=no detect | Frequency (MHz) | 1=detect 0=no detect |
| 0 | 5509 | 1 | 5500 | 1 | 5503 | 1 | 5495 | 1 |
| 1 | 5502 | 1 | 5509 | 1 | 5497 | 0 | 5491 | 1 |
| 2 | 5509 | 1 | 5499 | 1 | 5505 | 1 | 5495 | 1 |
| 3 | 5503 | 1 | 5505 | 1 | 5498 | 1 | 5502 | 1 |
| 4 | 5501 | 1 | 5492 | 1 | 5504 | 1 | 5494 | 1 |
| 5 | 5508 | 1 | 5497 | 1 | 5502 | 1 | 5498 | 1 |
| 6 | 5492 | 1 | 5493 | 1 | 5507 | 1 | 5490 | 1 |
| 7 | 5509 | 1 | 5492 | 1 | 5496 | 1 | 5505 | 1 |
| 8 | 5501 | 1 | 5506 | 1 | 5508 | 1 | 5510 | 1 |
| 9 | 5493 | 1 | 5496 | 1 | 5491 | 1 | 5503 | 1 |
| 10 | 5492 | 1 | 5499 | 1 | 5497 | 1 | 5503 | 0 |
| 11 | 5493 | 1 | 5493 | 1 | 5504 | 1 | 5495 | 0 |
| 12 | 5510 | 1 | 5509 | 1 | 5500 | 1 | 5490 | 0 |
| 13 | 5497 | 1 | 5506 | 1 | 5507 | 1 | 5510 | 1 |
| 14 | 5492 | 1 | 5491 | 1 | 5510 | 1 | 5496 | 1 |
| 15 | 5490 | 1 | 5492 | 1 | 5490 | 1 | 5497 | 1 |
| 16 | 5508 | 0 | 5510 | 1 | 5503 | 1 | 5495 | 1 |
| 17 | 5499 | 1 | 5509 | 1 | 5497 | 1 | 5501 | 1 |
| 18 | 5498 | 1 | 5505 | 1 | 5495 | 1 | 5494 | 1 |
| 19 | 5492 | 1 | 5493 | 1 | 5507 | 1 | 5501 | 0 |
| 20 | 5495 | 1 | 5507 | 1 | 5498 | 1 | 5500 | 1 |
| 21 | 5494 | 1 | 5500 | 1 | 5505 | 1 | 5499 | 0 |
| 22 | 5500 | 1 | 5490 | 1 | 5496 | 1 | 5496 | 1 |
| 23 | 5508 | 1 | 5498 | 1 | 5490 | 1 | 5504 | 1 |
| 24 | 5497 | 1 | 5491 | 1 | 5492 | 1 | 5508 | 1 |
| 25 | 5503 | 1 | 5495 | 1 | 5506 | 1 | 5492 | 1 |
| 26 | 5503 | 1 | 5499 | 1 | 5492 | 1 | 5495 | 1 |



| Radar Type 1-4 - Radar Statistical Performance | | | | | | | | |
|--|-----------------|-------------------------|-----------------|-------------------------|-----------------|-------------------------|-----------------|-------------------------|
| Trial | Radar Type 1 | | Radar Type 2 | | Radar Type 3 | | Radar Type 4 | |
| | Frequency (MHz) | 1=detect 0=no detect | Frequency (MHz) | 1=detect 0=no detect | Frequency (MHz) | 1=detect 0=no detect | Frequency (MHz) | 1=detect 0=no detect |
| 27 | 5496 | 1 | 5495 | 1 | 5494 | 1 | 5496 | 0 |
| 28 | 5491 | 1 | 5491 | 1 | 5500 | 1 | 5498 | 1 |
| 29 | 5502 | 1 | 5501 | 1 | 5493 | 1 | 5510 | 1 |
| Probability: | 96.7% | | 100.0% | | 96.7% | | 80.0% | |
| Aggregate: | 93.35% (>80%) | | | | | | | |

| Radar Type 1 - Radar Waveform | | | | | | | Radar Type 2 - Radar Waveform | | | | | | |
|-------------------------------|----------|------------|------------------|----------|------------------|----------------------|-------------------------------|----------|------------|------------------|----------|------------------|----------------------|
| | Trial Id | Radar Type | Pulse Width (us) | PRI (us) | Number of Pulses | Waveform Length (us) | | Trial Id | Radar Type | Pulse Width (us) | PRI (us) | Number of Pulses | Waveform Length (us) |
| Download | 0 | Type 1 | 1.0 | 658.0 | 81 | 53298.0 | Download | 0 | Type 2 | 1.2 | 182.0 | 23 | 4186.0 |
| Download | 1 | Type 1 | 1.0 | 738.0 | 72 | 53136.0 | Download | 1 | Type 2 | 2.7 | 201.0 | 25 | 5025.0 |
| Download | 2 | Type 1 | 1.0 | 518.0 | 102 | 52836.0 | Download | 2 | Type 2 | 2.5 | 173.0 | 25 | 4325.0 |
| Download | 3 | Type 1 | 1.0 | 858.0 | 62 | 53196.0 | Download | 3 | Type 2 | 4.8 | 215.0 | 29 | 6235.0 |
| Download | 4 | Type 1 | 1.0 | 938.0 | 57 | 53466.0 | Download | 4 | Type 2 | 2.9 | 202.0 | 26 | 5252.0 |
| Download | 5 | Type 1 | 1.0 | 698.0 | 76 | 53048.0 | Download | 5 | Type 2 | 4.8 | 161.0 | 29 | 4669.0 |
| Download | 6 | Type 1 | 1.0 | 538.0 | 99 | 53262.0 | Download | 6 | Type 2 | 4.9 | 157.0 | 29 | 4553.0 |
| Download | 7 | Type 1 | 1.0 | 678.0 | 78 | 52884.0 | Download | 7 | Type 2 | 4.0 | 203.0 | 28 | 5684.0 |
| Download | 8 | Type 1 | 1.0 | 578.0 | 92 | 53176.0 | Download | 8 | Type 2 | 4.2 | 225.0 | 28 | 6300.0 |
| Download | 9 | Type 1 | 1.0 | 798.0 | 67 | 53466.0 | Download | 9 | Type 2 | 4.1 | 191.0 | 28 | 5348.0 |
| Download | 10 | Type 1 | 1.0 | 898.0 | 59 | 52982.0 | Download | 10 | Type 2 | 3.4 | 155.0 | 27 | 4165.0 |
| Download | 11 | Type 1 | 1.0 | 598.0 | 89 | 53222.0 | Download | 11 | Type 2 | 4.1 | 168.0 | 28 | 4704.0 |
| Download | 12 | Type 1 | 1.0 | 638.0 | 83 | 52954.0 | Download | 12 | Type 2 | 1.3 | 171.0 | 23 | 3933.0 |
| Download | 13 | Type 1 | 1.0 | 778.0 | 68 | 52904.0 | Download | 13 | Type 2 | 1.5 | 185.0 | 23 | 4255.0 |
| Download | 14 | Type 1 | 1.0 | 838.0 | 63 | 52794.0 | Download | 14 | Type 2 | 2.6 | 167.0 | 25 | 4175.0 |
| Download | 15 | Type 1 | 1.0 | 2455.0 | 22 | 54010.0 | Download | 15 | Type 2 | 2.5 | 163.0 | 25 | 4075.0 |
| Download | 16 | Type 1 | 1.0 | 715.0 | 74 | 52910.0 | Download | 16 | Type 2 | 2.9 | 184.0 | 26 | 4784.0 |
| Download | 17 | Type 1 | 1.0 | 2035.0 | 26 | 52910.0 | Download | 17 | Type 2 | 1.8 | 179.0 | 24 | 4296.0 |
| Download | 18 | Type 1 | 1.0 | 1567.0 | 34 | 53278.0 | Download | 18 | Type 2 | 4.5 | 223.0 | 29 | 6467.0 |
| Download | 19 | Type 1 | 1.0 | 971.0 | 55 | 53405.0 | Download | 19 | Type 2 | 1.0 | 170.0 | 23 | 3910.0 |
| Download | 20 | Type 1 | 1.0 | 2354.0 | 23 | 54142.0 | Download | 20 | Type 2 | 5.0 | 199.0 | 29 | 5771.0 |
| Download | 21 | Type 1 | 1.0 | 522.0 | 102 | 53244.0 | Download | 21 | Type 2 | 3.2 | 224.0 | 26 | 5824.0 |
| Download | 22 | Type 1 | 1.0 | 623.0 | 85 | 52955.0 | Download | 22 | Type 2 | 4.4 | 150.0 | 28 | 4200.0 |
| Download | 23 | Type 1 | 1.0 | 1429.0 | 37 | 52873.0 | Download | 23 | Type 2 | 4.5 | 190.0 | 28 | 5320.0 |
| Download | 24 | Type 1 | 1.0 | 1862.0 | 29 | 53998.0 | Download | 24 | Type 2 | 4.6 | 180.0 | 29 | 5220.0 |
| Download | 25 | Type 1 | 1.0 | 1894.0 | 28 | 53032.0 | Download | 25 | Type 2 | 1.5 | 187.0 | 23 | 4301.0 |
| Download | 26 | Type 1 | 1.0 | 2756.0 | 20 | 55120.0 | Download | 26 | Type 2 | 2.0 | 154.0 | 24 | 3696.0 |
| Download | 27 | Type 1 | 1.0 | 2345.0 | 23 | 53935.0 | Download | 27 | Type 2 | 5.0 | 193.0 | 29 | 5697.0 |
| Download | 28 | Type 1 | 1.0 | 1569.0 | 34 | 53346.0 | Download | 28 | Type 2 | 2.7 | 188.0 | 26 | 4888.0 |
| Download | 29 | Type 1 | 1.0 | 2592.0 | 21 | 54432.0 | Download | 29 | Type 2 | 2.5 | 152.0 | 25 | 3800.0 |



| Radar Type 3 - Radar Waveform | | | | | | | Radar Type 4 - Radar Waveform | | | | | | |
|-------------------------------|----------|------------|------------------|----------|------------------|----------------------|-------------------------------|----------|------------|------------------|----------|------------------|----------------------|
| | Trial Id | Radar Type | Pulse Width (us) | PRI (us) | Number of Pulses | Waveform Length (us) | | Trial Id | Radar Type | Pulse Width (us) | PRI (us) | Number of Pulses | Waveform Length (us) |
| Download | 0 | Type 3 | 6.2 | 302.0 | 16 | 4832.0 | Download | 0 | Type 4 | 11.4 | 302.0 | 12 | 3624.0 |
| Download | 1 | Type 3 | 7.7 | 210.0 | 17 | 3570.0 | Download | 1 | Type 4 | 14.8 | 210.0 | 14 | 2940.0 |
| Download | 2 | Type 3 | 7.5 | 252.0 | 17 | 4284.0 | Download | 2 | Type 4 | 14.3 | 252.0 | 13 | 3276.0 |
| Download | 3 | Type 3 | 9.8 | 468.0 | 18 | 8424.0 | Download | 3 | Type 4 | 19.4 | 468.0 | 16 | 7488.0 |
| Download | 4 | Type 3 | 7.9 | 214.0 | 17 | 3636.0 | Download | 4 | Type 4 | 15.4 | 214.0 | 14 | 2996.0 |
| Download | 5 | Type 3 | 9.8 | 422.0 | 18 | 7596.0 | Download | 5 | Type 4 | 19.4 | 422.0 | 16 | 6752.0 |
| Download | 6 | Type 3 | 9.9 | 417.0 | 18 | 7506.0 | Download | 6 | Type 4 | 19.7 | 417.0 | 16 | 6672.0 |
| Download | 7 | Type 3 | 9.0 | 280.0 | 18 | 5040.0 | Download | 7 | Type 4 | 17.8 | 280.0 | 15 | 4200.0 |
| Download | 8 | Type 3 | 9.2 | 271.0 | 18 | 4878.0 | Download | 8 | Type 4 | 18.2 | 271.0 | 15 | 4065.0 |
| Download | 9 | Type 3 | 9.1 | 451.0 | 18 | 8118.0 | Download | 9 | Type 4 | 18.0 | 451.0 | 15 | 6765.0 |
| Download | 10 | Type 3 | 8.4 | 351.0 | 17 | 5967.0 | Download | 10 | Type 4 | 16.4 | 351.0 | 14 | 4914.0 |
| Download | 11 | Type 3 | 9.1 | 429.0 | 18 | 7722.0 | Download | 11 | Type 4 | 18.0 | 429.0 | 15 | 6435.0 |
| Download | 12 | Type 3 | 6.3 | 270.0 | 16 | 4320.0 | Download | 12 | Type 4 | 11.7 | 270.0 | 12 | 3240.0 |
| Download | 13 | Type 3 | 6.5 | 315.0 | 16 | 5040.0 | Download | 13 | Type 4 | 12.2 | 315.0 | 12 | 3780.0 |
| Download | 14 | Type 3 | 7.6 | 303.0 | 17 | 5151.0 | Download | 14 | Type 4 | 14.6 | 303.0 | 14 | 4242.0 |
| Download | 15 | Type 3 | 7.5 | 471.0 | 17 | 8007.0 | Download | 15 | Type 4 | 14.3 | 471.0 | 13 | 6123.0 |
| Download | 16 | Type 3 | 7.9 | 262.0 | 17 | 4454.0 | Download | 16 | Type 4 | 15.2 | 262.0 | 14 | 3668.0 |
| Download | 17 | Type 3 | 6.8 | 305.0 | 16 | 4880.0 | Download | 17 | Type 4 | 12.8 | 305.0 | 13 | 3965.0 |
| Download | 18 | Type 3 | 9.5 | 336.0 | 18 | 6048.0 | Download | 18 | Type 4 | 18.8 | 336.0 | 16 | 5376.0 |
| Download | 19 | Type 3 | 6.0 | 401.0 | 16 | 6416.0 | Download | 19 | Type 4 | 11.0 | 401.0 | 12 | 4812.0 |
| Download | 20 | Type 3 | 10.0 | 457.0 | 18 | 8226.0 | Download | 20 | Type 4 | 20.0 | 457.0 | 16 | 7312.0 |
| Download | 21 | Type 3 | 8.2 | 475.0 | 17 | 8075.0 | Download | 21 | Type 4 | 16.0 | 475.0 | 14 | 6650.0 |
| Download | 22 | Type 3 | 9.4 | 290.0 | 18 | 5220.0 | Download | 22 | Type 4 | 18.5 | 290.0 | 16 | 4640.0 |
| Download | 23 | Type 3 | 9.5 | 215.0 | 18 | 3870.0 | Download | 23 | Type 4 | 18.7 | 215.0 | 16 | 3440.0 |
| Download | 24 | Type 3 | 9.6 | 207.0 | 18 | 3726.0 | Download | 24 | Type 4 | 19.1 | 207.0 | 16 | 3312.0 |
| Download | 25 | Type 3 | 6.5 | 412.0 | 16 | 6592.0 | Download | 25 | Type 4 | 12.2 | 412.0 | 12 | 4944.0 |
| Download | 26 | Type 3 | 7.0 | 419.0 | 16 | 6704.0 | Download | 26 | Type 4 | 13.2 | 419.0 | 13 | 5447.0 |
| Download | 27 | Type 3 | 10.0 | 208.0 | 18 | 3744.0 | Download | 27 | Type 4 | 20.0 | 208.0 | 16 | 3328.0 |
| Download | 28 | Type 3 | 7.7 | 354.0 | 17 | 6018.0 | Download | 28 | Type 4 | 14.9 | 354.0 | 14 | 4956.0 |
| Download | 29 | Type 3 | 7.5 | 330.0 | 17 | 5610.0 | Download | 29 | Type 4 | 14.4 | 330.0 | 13 | 4290.0 |

| Radar Type 5 - Radar Statistical Performance | | | | | |
|--|------------------|-------------------------------|---------------|------------------|-------------------------------|
| Trail # | Test Freq. (MHz) | 1=Detection 0=No Detection | Trail # | Test Freq. (MHz) | 1=Detection 0=No Detection |
| 0 | 5500 | 1 | 15 | 5495 | 1 |
| 1 | 5500 | 1 | 16 | 5495 | 1 |
| 2 | 5500 | 1 | 17 | 5494 | 1 |
| 3 | 5500 | 1 | 18 | 5498 | 1 |
| 4 | 5500 | 1 | 19 | 5493 | 1 |
| 5 | 5500 | 1 | 20 | 5501 | 1 |
| 6 | 5500 | 1 | 21 | 5504 | 1 |
| 7 | 5500 | 1 | 22 | 5502 | 1 |
| 8 | 5500 | 1 | 23 | 5502 | 1 |
| 9 | 5500 | 1 | 24 | 5502 | 1 |
| 10 | 5496 | 1 | 25 | 5507 | 1 |
| 11 | 5497 | 1 | 26 | 5506 | 1 |
| 12 | 5493 | 1 | 27 | 5501 | 1 |
| 13 | 5493 | 1 | 28 | 5505 | 1 |
| 14 | 5495 | 1 | 29 | 5505 | 1 |
| Detection Percentage (%) | | | 100.0% | | |

Type 5 Radar Waveform_0

| Download | 0 | Type 5 | 8 | 1.5000000 | 12.0000000 | 5.500000000 | | | |
|----------|---|----------|-------------------|------------------|-------------------|----------------------------|------------|------------|------------|
| | | Burst ID | Burst Offset (us) | Pulse Width (us) | Chirp Width (MHz) | Number of Pulses per Burst | PRI-1 (us) | PRI-2 (us) | PRI-3 (us) |
| | | 0 | 443341.0 | 52.6 | 5 | 1 | 1388.0 | - | - |
| | | 1 | 805475.0 | 71.4 | 5 | 2 | 1882.0 | 1974.0 | - |
| | | 2 | 1169013.0 | 68.3 | 5 | 2 | 1926.0 | 1064.0 | - |
| | | 3 | 35054.0 | 96.6 | 5 | 3 | 1344.0 | 1115.0 | 1446.0 |
| | | 4 | 388161.0 | 74.3 | 5 | 2 | 1711.0 | 1227.0 | - |
| | | 5 | 760570.0 | 96.7 | 5 | 3 | 1263.0 | 1039.0 | 1966.0 |
| | | 6 | 1123440.0 | 98.0 | 5 | 3 | 1479.0 | 1287.0 | 1357.0 |
| | | 7 | 1486449.0 | 87.7 | 5 | 3 | 1112.0 | 1121.0 | 1678.0 |

Type 5 Radar Waveform_1

| Download | 1 | Type 5 | 13 | 0.9230769 | 12.0000000 | 5.500000000 | | | |
|----------|---|----------|-------------------|------------------|-------------------|----------------------------|------------|------------|------------|
| | | Burst ID | Burst Offset (us) | Pulse Width (us) | Chirp Width (MHz) | Number of Pulses per Burst | PRI-1 (us) | PRI-2 (us) | PRI-3 (us) |
| | | 0 | 216878.0 | 89.7 | 11 | 3 | 1209.0 | 1853.0 | 1383.0 |
| | | 1 | 440111.0 | 88.9 | 11 | 3 | 1178.0 | 1017.0 | 1339.0 |
| | | 2 | 683347.0 | 80.0 | 11 | 2 | 1337.0 | 1894.0 | - |
| | | 3 | 885410.0 | 88.9 | 11 | 3 | 1475.0 | 1778.0 | 1046.0 |
| | | 4 | 190033.0 | 54.0 | 11 | 1 | 1542.0 | - | - |
| | | 5 | 413576.0 | 56.8 | 11 | 1 | 1449.0 | - | - |
| | | 6 | 636017.0 | 70.1 | 11 | 2 | 1443.0 | 1571.0 | - |
| | | 7 | 859322.0 | 68.7 | 11 | 2 | 1514.0 | 1328.0 | - |
| | | 8 | 162086.0 | 73.3 | 11 | 2 | 1969.0 | 1937.0 | - |
| | | 9 | 386140.0 | 60.4 | 11 | 1 | 1217.0 | - | - |
| | | 10 | 608410.0 | 93.4 | 11 | 3 | 1113.0 | 1021.0 | 1063.0 |
| | | 11 | 833352.0 | 50.3 | 11 | 1 | 1159.0 | - | - |
| | | 12 | 134460.0 | 99.9 | 11 | 3 | 1709.0 | 1426.0 | 1905.0 |

Type 5 Radar Waveform_2

| Download | 2 | Type 5 | 12 | 1.0000000 | 12.0000000 | 5.500000000 | | | |
|----------|---|----------|-------------------|------------------|-------------------|----------------------------|------------|------------|------------|
| | | Burst ID | Burst Offset (us) | Pulse Width (us) | Chirp Width (MHz) | Number of Pulses per Burst | PRI-1 (us) | PRI-2 (us) | PRI-3 (us) |
| | | 0 | 368070.0 | 77.7 | 10 | 2 | 1220.0 | 1161.0 | - |
| | | 1 | 628497.0 | 91.6 | 10 | 3 | 1818.0 | 1609.0 | 1372.0 |
| | | 2 | 870705.0 | 92.7 | 10 | 3 | 1160.0 | 1102.0 | 1575.0 |
| | | 3 | 116073.0 | 94.8 | 10 | 3 | 1268.0 | 1957.0 | 1208.0 |
| | | 4 | 358552.0 | 56.8 | 10 | 1 | 1587.0 | - | - |
| | | 5 | 600613.0 | 62.4 | 10 | 1 | 1729.0 | - | - |
| | | 6 | 839949.0 | 99.8 | 10 | 3 | 1452.0 | 1895.0 | 1670.0 |
| | | 7 | 86403.0 | 71.4 | 10 | 2 | 1665.0 | 1940.0 | - |
| | | 8 | 328040.0 | 68.7 | 10 | 2 | 1816.0 | 1851.0 | - |
| | | 9 | 569019.0 | 97.6 | 10 | 3 | 1648.0 | 1218.0 | 1961.0 |
| | | 10 | 812281.0 | 75.8 | 10 | 2 | 1347.0 | 1145.0 | - |
| | | 11 | 56800.0 | 94.9 | 10 | 3 | 1439.0 | 1461.0 | 1349.0 |

Type 5 Radar Waveform_3

| Download | 3 | Type 5 | 20 | 0.6000000 | 12.0000000 | 5.500000000 | | | |
|----------|---|----------|-------------------|------------------|-------------------|----------------------------|------------|------------|------------|
| | | Burst ID | Burst Offset (us) | Pulse Width (us) | Chirp Width (MHz) | Number of Pulses per Burst | PRI-1 (us) | PRI-2 (us) | PRI-3 (us) |
| | | 0 | 179076.0 | 60.9 | 19 | 1 | 1832.0 | - | - |
| | | 1 | 323028.0 | 89.8 | 19 | 3 | 1573.0 | 1019.0 | 1310.0 |
| | | 2 | 469159.0 | 66.0 | 19 | 1 | 1915.0 | - | - |
| | | 3 | 16054.0 | 89.3 | 19 | 3 | 1434.0 | 1927.0 | 1314.0 |
| | | 4 | 160715.0 | 71.0 | 19 | 2 | 1962.0 | 1692.0 | - |
| | | 5 | 305959.0 | 80.4 | 19 | 2 | 1170.0 | 1289.0 | - |
| | | 6 | 451725.0 | 60.0 | 19 | 1 | 1341.0 | - | - |
| | | 7 | 594147.0 | 94.0 | 19 | 3 | 1249.0 | 1246.0 | 1626.0 |
| | | 8 | 142947.0 | 83.8 | 19 | 3 | 1055.0 | 1382.0 | 1018.0 |
| | | 9 | 287256.0 | 85.8 | 19 | 3 | 1473.0 | 1353.0 | 1400.0 |
| | | 10 | 431324.0 | 88.2 | 19 | 3 | 1474.0 | 1830.0 | 1510.0 |
| | | 11 | 579362.0 | 62.4 | 19 | 1 | 1002.0 | - | - |
| | | 12 | 125236.0 | 73.1 | 19 | 2 | 1202.0 | 1724.0 | - |
| | | 13 | 270707.0 | 54.3 | 19 | 1 | 1464.0 | - | - |
| | | 14 | 413487.0 | 91.0 | 19 | 3 | 1186.0 | 1954.0 | 1755.0 |
| | | 15 | 560771.0 | 61.4 | 19 | 1 | 1745.0 | - | - |
| | | 16 | 107226.0 | 70.2 | 19 | 2 | 1950.0 | 1938.0 | - |
| | | 17 | 251766.0 | 99.9 | 19 | 3 | 1151.0 | 1295.0 | 1527.0 |
| | | 18 | 397912.0 | 58.0 | 19 | 1 | 1581.0 | - | - |
| | | 19 | 541138.0 | 69.3 | 19 | 2 | 1710.0 | 1975.0 | - |

Type 5 Radar Waveform_4

| Download | 4 | Type 5 | 14 | 0.8571429 | 12.0000000 | 5.500000000 | | | | |
|----------|---|----------|-------------------|------------------|-------------------|----------------------------|------------|------------|------------|--|
| | | Burst ID | Burst Offset (us) | Pulse Width (us) | Chirp Width (MHz) | Number of Pulses per Burst | PRI-1 (us) | PRI-2 (us) | PRI-3 (us) | |
| | | 0 | 127830.0 | 94.4 | 12 | 3 | 1770.0 | 1780.0 | 1399.0 | |
| | | 1 | 334927.0 | 84.4 | 12 | 3 | 1588.0 | 1292.0 | 1016.0 | |
| | | 2 | 542842.0 | 75.0 | 12 | 2 | 1231.0 | 1129.0 | - | |
| | | 3 | 749676.0 | 79.9 | 12 | 2 | 1732.0 | 1173.0 | - | |
| | | 4 | 102580.0 | 75.7 | 12 | 2 | 1800.0 | 1417.0 | - | |
| | | 5 | 310365.0 | 51.8 | 12 | 1 | 1338.0 | - | - | |
| | | 6 | 517310.0 | 67.4 | 12 | 2 | 1177.0 | 1176.0 | - | |
| | | 7 | 722415.0 | 84.3 | 12 | 3 | 1491.0 | 1481.0 | 1986.0 | |
| | | 8 | 76914.0 | 98.3 | 12 | 3 | 1590.0 | 1841.0 | 1506.0 | |
| | | 9 | 284727.0 | 66.3 | 12 | 1 | 1551.0 | - | - | |
| | | 10 | 491490.0 | 70.9 | 12 | 2 | 1680.0 | 1157.0 | - | |
| | | 11 | 697492.0 | 91.4 | 12 | 3 | 1166.0 | 1493.0 | 1645.0 | |
| | | 12 | 51667.0 | 54.1 | 12 | 1 | 1427.0 | - | - | |
| | | 13 | 258293.0 | 94.1 | 12 | 3 | 1708.0 | 1368.0 | 1364.0 | |

Type 5 Radar Waveform_5

| Download | 5 | Type 5 | 20 | 0.6000000 | 12.0000000 | 5.500000000 | | | | |
|----------|---|----------|-------------------|------------------|-------------------|----------------------------|------------|------------|------------|--|
| | | Burst ID | Burst Offset (us) | Pulse Width (us) | Chirp Width (MHz) | Number of Pulses per Burst | PRI-1 (us) | PRI-2 (us) | PRI-3 (us) | |
| | | 0 | 324903.0 | 93.2 | 19 | 3 | 1030.0 | 1869.0 | 1432.0 | |
| | | 1 | 470452.0 | 67.1 | 19 | 2 | 1448.0 | 1511.0 | - | |
| | | 2 | 18284.0 | 54.0 | 19 | 1 | 1286.0 | - | - | |
| | | 3 | 163026.0 | 79.4 | 19 | 2 | 1777.0 | 1138.0 | - | |
| | | 4 | 308445.0 | 52.2 | 19 | 1 | 1736.0 | - | - | |
| | | 5 | 452423.0 | 80.0 | 19 | 2 | 1842.0 | 1371.0 | - | |
| | | 6 | 375.0 | 83.4 | 19 | 3 | 1604.0 | 1722.0 | 1219.0 | |
| | | 7 | 145472.0 | 56.4 | 19 | 1 | 1747.0 | - | - | |
| | | 8 | 290912.0 | 66.1 | 19 | 1 | 1037.0 | - | - | |
| | | 9 | 433631.0 | 92.0 | 19 | 3 | 1190.0 | 1671.0 | 1676.0 | |
| | | 10 | 580609.0 | 53.3 | 19 | 1 | 1900.0 | - | - | |
| | | 11 | 127343.0 | 80.2 | 19 | 2 | 1388.0 | 1561.0 | - | |
| | | 12 | 272342.0 | 71.6 | 19 | 2 | 1318.0 | 1203.0 | - | |
| | | 13 | 417969.0 | 52.4 | 19 | 1 | 1490.0 | - | - | |
| | | 14 | 561861.0 | 71.5 | 19 | 2 | 1087.0 | 1748.0 | - | |
| | | 15 | 109336.0 | 88.4 | 19 | 3 | 1049.0 | 1767.0 | 1066.0 | |
| | | 16 | 255078.0 | 51.2 | 19 | 1 | 1146.0 | - | - | |
| | | 17 | 399207.0 | 68.9 | 19 | 2 | 1498.0 | 1312.0 | - | |
| | | 18 | 543512.0 | 89.5 | 19 | 3 | 1033.0 | 1029.0 | 1332.0 | |
| | | 19 | 91898.0 | 56.5 | 19 | 1 | 1468.0 | - | - | |

Type 5 Radar Waveform_6

| Download | 6 | Type 5 | 20 | 0.6000000 | 12.0000000 | 5.500000000 | | | | |
|----------|---|----------|-------------------|------------------|-------------------|----------------------------|------------|------------|------------|--|
| | | Burst ID | Burst Offset (us) | Pulse Width (us) | Chirp Width (MHz) | Number of Pulses per Burst | PRI-1 (us) | PRI-2 (us) | PRI-3 (us) | |
| | | 0 | 236939.0 | 50.5 | 20 | 1 | 1776.0 | - | - | |
| | | 1 | 380814.0 | 76.6 | 20 | 2 | 1805.0 | 1870.0 | - | |
| | | 2 | 527096.0 | 64.7 | 20 | 1 | 1797.0 | - | - | |
| | | 3 | 73705.0 | 86.1 | 20 | 3 | 1142.0 | 1172.0 | 1679.0 | |
| | | 4 | 219009.0 | 63.6 | 20 | 1 | 1935.0 | - | - | |
| | | 5 | 363349.0 | 69.2 | 20 | 2 | 1669.0 | 1431.0 | - | |
| | | 6 | 509134.0 | 62.9 | 20 | 1 | 1904.0 | - | - | |
| | | 7 | 56009.0 | 75.8 | 20 | 2 | 1471.0 | 1356.0 | - | |
| | | 8 | 200310.0 | 95.7 | 20 | 3 | 1971.0 | 1297.0 | 1140.0 | |
| | | 9 | 345559.0 | 67.5 | 20 | 2 | 1892.0 | 1136.0 | - | |
| | | 10 | 491777.0 | 64.8 | 20 | 1 | 1282.0 | - | - | |
| | | 11 | 38058.0 | 96.8 | 20 | 3 | 1793.0 | 1687.0 | 1075.0 | |
| | | 12 | 183391.0 | 58.3 | 20 | 1 | 1558.0 | - | - | |
| | | 13 | 327635.0 | 79.0 | 20 | 2 | 1477.0 | 1714.0 | - | |
| | | 14 | 474108.0 | 61.1 | 20 | 1 | 1008.0 | - | - | |
| | | 15 | 20337.0 | 73.8 | 20 | 2 | 1111.0 | 1456.0 | - | |
| | | 16 | 165486.0 | 57.3 | 20 | 1 | 1655.0 | - | - | |
| | | 17 | 309285.0 | 90.8 | 20 | 3 | 1153.0 | 1348.0 | 1693.0 | |
| | | 18 | 453009.0 | 97.6 | 20 | 3 | 1663.0 | 1680.0 | 1873.0 | |
| | | 19 | 2486.0 | 78.0 | 20 | 2 | 1865.0 | 1597.0 | - | |

Type 5 Radar Waveform_7

| Download | 7 | Type 5 | 17 | 0.7058824 | 12.0000000 | 5.500000000 | | | | |
|----------|---|----------|-------------------|------------------|-------------------|----------------------------|------------|------------|------------|--|
| | | Burst ID | Burst Offset (us) | Pulse Width (us) | Chirp Width (MHz) | Number of Pulses per Burst | PRI-1 (us) | PRI-2 (us) | PRI-3 (us) | |
| | | 0 | 173070.0 | 86.0 | 17 | 3 | 1792.0 | 1529.0 | 1015.0 | |
| | | 1 | 343271.0 | 87.9 | 17 | 3 | 1392.0 | 1773.0 | 1061.0 | |
| | | 2 | 514340.0 | 68.2 | 17 | 2 | 1012.0 | 1991.0 | - | |
| | | 3 | 684887.0 | 83.1 | 17 | 2 | 1492.0 | 1433.0 | - | |
| | | 4 | 152458.0 | 76.5 | 17 | 2 | 1519.0 | 1221.0 | - | |
| | | 5 | 321845.0 | 95.5 | 17 | 3 | 1914.0 | 1701.0 | 1623.0 | |
| | | 6 | 493143.0 | 80.2 | 17 | 2 | 1585.0 | 1702.0 | - | |
| | | 7 | 665356.0 | 65.0 | 17 | 1 | 1369.0 | - | - | |
| | | 8 | 131684.0 | 62.7 | 17 | 1 | 1500.0 | - | - | |
| | | 9 | 302703.0 | 59.9 | 17 | 1 | 1071.0 | - | - | |
| | | 10 | 473675.0 | 65.0 | 17 | 1 | 1022.0 | - | - | |
| | | 11 | 644449.0 | 51.9 | 17 | 1 | 1216.0 | - | - | |
| | | 12 | 110709.0 | 51.9 | 17 | 1 | 1067.0 | - | - | |
| | | 13 | 280039.0 | 97.7 | 17 | 3 | 1212.0 | 1963.0 | 1921.0 | |
| | | 14 | 450206.0 | 93.6 | 17 | 3 | 1821.0 | 1618.0 | 1340.0 | |
| | | 15 | 623479.0 | 66.6 | 17 | 1 | 1124.0 | - | - | |
| | | 16 | 89586.0 | 52.4 | 17 | 1 | 1594.0 | - | - | |

Type 5 Radar Waveform_8

| Download | 8 | Type 5 | 18 | 0.6666667 | 12.0000000 | 5.500000000 | | | | |
|----------|---|----------|-------------------|------------------|-------------------|----------------------------|------------|------------|------------|--|
| | | Burst ID | Burst Offset (us) | Pulse Width (us) | Chirp Width (MHz) | Number of Pulses per Burst | PRI-1 (us) | PRI-2 (us) | PRI-3 (us) | |
| | | 0 | 245380.0 | 68.0 | 17 | 2 | 1408.0 | 1589.0 | - | |
| | | 1 | 406965.0 | 65.8 | 17 | 1 | 1978.0 | - | - | |
| | | 2 | 567142.0 | 83.1 | 17 | 2 | 1647.0 | 1537.0 | - | |
| | | 3 | 64590.0 | 67.0 | 17 | 2 | 1883.0 | 1144.0 | - | |
| | | 4 | 225944.0 | 57.5 | 17 | 1 | 1847.0 | - | - | |
| | | 5 | 387355.0 | 60.7 | 17 | 1 | 1553.0 | - | - | |
| | | 6 | 546604.0 | 98.6 | 17 | 3 | 1032.0 | 1336.0 | 1685.0 | |
| | | 7 | 44779.0 | 77.1 | 17 | 2 | 1276.0 | 1526.0 | - | |
| | | 8 | 206181.0 | 56.6 | 17 | 1 | 1531.0 | - | - | |
| | | 9 | 386644.0 | 71.9 | 17 | 2 | 1901.0 | 1175.0 | - | |
| | | 10 | 526711.0 | 92.7 | 17 | 3 | 1253.0 | 1374.0 | 1549.0 | |
| | | 11 | 24911.0 | 91.4 | 17 | 3 | 1233.0 | 1224.0 | 1301.0 | |
| | | 12 | 185434.0 | 97.7 | 17 | 3 | 1085.0 | 1872.0 | 1703.0 | |
| | | 13 | 346596.0 | 81.1 | 17 | 2 | 1880.0 | 1624.0 | - | |
| | | 14 | 508955.0 | 60.5 | 17 | 1 | 1516.0 | - | - | |
| | | 15 | 5119.0 | 71.4 | 17 | 2 | 1048.0 | 1182.0 | - | |
| | | 16 | 166363.0 | 61.5 | 17 | 1 | 1838.0 | - | - | |
| | | 17 | 327153.0 | 70.5 | 17 | 2 | 1042.0 | 1715.0 | - | |

Type 5 Radar Waveform_9

| Download | 9 | Type 5 | 18 | 0.6666667 | 12.0000000 | 5.500000000 | | | | |
|----------|---|----------|-------------------|------------------|-------------------|----------------------------|------------|------------|------------|--|
| | | Burst ID | Burst Offset (us) | Pulse Width (us) | Chirp Width (MHz) | Number of Pulses per Burst | PRI-1 (us) | PRI-2 (us) | PRI-3 (us) | |
| | | 0 | 489188.0 | 62.6 | 17 | 1 | 1375.0 | - | - | |
| | | 1 | 650574.0 | 58.3 | 17 | 1 | 1342.0 | - | - | |
| | | 2 | 146316.0 | 81.7 | 17 | 2 | 1555.0 | 1130.0 | - | |
| | | 3 | 308107.0 | 59.6 | 17 | 1 | 1054.0 | - | - | |
| | | 4 | 468294.0 | 68.1 | 17 | 2 | 1813.0 | 1006.0 | - | |
| | | 5 | 627962.0 | 89.0 | 17 | 3 | 1370.0 | 1772.0 | 1192.0 | |
| | | 6 | 126114.0 | 98.0 | 17 | 3 | 1472.0 | 1320.0 | 1810.0 | |
| | | 7 | 288121.0 | 63.0 | 17 | 1 | 1288.0 | - | - | |
| | | 8 | 447434.0 | 85.8 | 17 | 3 | 1874.0 | 1076.0 | 1391.0 | |
| | | 9 | 610728.0 | 52.4 | 17 | 1 | 1444.0 | - | - | |
| | | 10 | 106768.0 | 62.8 | 17 | 1 | 1909.0 | - | - | |
| | | 11 | 266896.0 | 94.9 | 17 | 3 | 1414.0 | 1554.0 | 1661.0 | |
| | | 12 | 429203.0 | 60.7 | 17 | 1 | 1931.0 | - | - | |
| | | 13 | 588629.0 | 85.5 | 17 | 3 | 1211.0 | 1533.0 | 1207.0 | |
| | | 14 | 86464.0 | 94.6 | 17 | 3 | 1419.0 | 1967.0 | 1924.0 | |
| | | 15 | 247812.0 | 71.4 | 17 | 2 | 1171.0 | 1599.0 | - | |
| | | 16 | 407834.0 | 89.4 | 17 | 3 | 1808.0 | 1497.0 | 1079.0 | |
| | | 17 | 569787.0 | 74.9 | 17 | 2 | 1503.0 | 1333.0 | - | |

Type 5 Radar Waveform_10

| Download | 10 | Type 5 | 15 | 0.8000000 | 12.0000000 | 5.496000000 | | | | |
|----------|----|----------|-------------------|------------------|-------------------|----------------------------|------------|------------|------------|--|
| | | Burst ID | Burst Offset (us) | Pulse Width (us) | Chirp Width (MHz) | Number of Pulses per Burst | PRI-1 (us) | PRI-2 (us) | PRI-3 (us) | |
| | | 0 | 80579.0 | 64.4 | 14 | 1 | 1108.0 | - | - | |
| | | 1 | 274328.0 | 60.9 | 14 | 1 | 1128.0 | - | - | |
| | | 2 | 466880.0 | 78.4 | 14 | 2 | 1627.0 | 1550.0 | - | |
| | | 3 | 660530.0 | 77.2 | 14 | 2 | 1305.0 | 1394.0 | - | |
| | | 4 | 56606.0 | 69.7 | 14 | 2 | 1223.0 | 1389.0 | - | |
| | | 5 | 250260.0 | 55.9 | 14 | 1 | 1774.0 | - | - | |
| | | 6 | 443119.0 | 69.9 | 14 | 2 | 1659.0 | 1440.0 | - | |
| | | 7 | 638528.0 | 73.6 | 14 | 2 | 1412.0 | 1518.0 | - | |
| | | 8 | 32720.0 | 87.6 | 14 | 3 | 1154.0 | 1877.0 | 1139.0 | |
| | | 9 | 226239.0 | 73.7 | 14 | 2 | 1117.0 | 1275.0 | - | |
| | | 10 | 420274.0 | 65.0 | 14 | 1 | 1270.0 | - | - | |
| | | 11 | 613005.0 | 78.9 | 14 | 2 | 1147.0 | 1406.0 | - | |
| | | 12 | 8973.0 | 54.5 | 14 | 1 | 1733.0 | - | - | |
| | | 13 | 202247.0 | 80.6 | 14 | 2 | 1306.0 | 1730.0 | - | |
| | | 14 | 394425.0 | 90.4 | 14 | 3 | 1465.0 | 1833.0 | 1977.0 | |

Type 5 Radar Waveform_11

| Download | 11 | Type 5 | 18 | 0.6666667 | 12.0000000 | 5.497000000 | | | | |
|----------|----|----------|-------------------|------------------|-------------------|----------------------------|------------|------------|------------|--|
| | | Burst ID | Burst Offset (us) | Pulse Width (us) | Chirp Width (MHz) | Number of Pulses per Burst | PRI-1 (us) | PRI-2 (us) | PRI-3 (us) | |
| | | 0 | 490580.0 | 77.1 | 17 | 2 | 1634.0 | 1041.0 | - | |
| | | 1 | 651476.0 | 81.0 | 17 | 2 | 1309.0 | 1512.0 | - | |
| | | 2 | 148923.0 | 58.3 | 17 | 1 | 1530.0 | - | - | |
| | | 3 | 309710.0 | 70.7 | 17 | 2 | 1201.0 | 1463.0 | - | |
| | | 4 | 471639.0 | 58.3 | 17 | 1 | 1413.0 | - | - | |
| | | 5 | 630082.0 | 97.8 | 17 | 3 | 1725.0 | 1422.0 | 1316.0 | |
| | | 6 | 128584.0 | 94.2 | 17 | 3 | 1174.0 | 1250.0 | 1520.0 | |
| | | 7 | 289640.0 | 69.1 | 17 | 2 | 1612.0 | 1586.0 | - | |
| | | 8 | 449324.0 | 94.6 | 17 | 3 | 1488.0 | 1897.0 | 1622.0 | |
| | | 9 | 611993.0 | 75.0 | 17 | 2 | 1090.0 | 1535.0 | - | |
| | | 10 | 108707.0 | 96.2 | 17 | 3 | 1756.0 | 1574.0 | 1088.0 | |
| | | 11 | 270512.0 | 64.3 | 17 | 1 | 1495.0 | - | - | |
| | | 12 | 431697.0 | 61.7 | 17 | 1 | 1712.0 | - | - | |
| | | 13 | 593215.0 | 61.1 | 17 | 1 | 1436.0 | - | - | |
| | | 14 | 89356.0 | 57.2 | 17 | 1 | 1194.0 | - | - | |
| | | 15 | 249716.0 | 96.8 | 17 | 3 | 1089.0 | 1644.0 | 1215.0 | |
| | | 16 | 410706.0 | 76.3 | 17 | 2 | 1611.0 | 1918.0 | - | |
| | | 17 | 571478.0 | 91.7 | 17 | 3 | 1065.0 | 1110.0 | 1424.0 | |

Type 5 Radar Waveform_12

| Download | 12 | Type 5 | 9 | 1.3333333 | 12.0000000 | 5.493000000 | | | | |
|----------|----|----------|-------------------|------------------|-------------------|----------------------------|------------|------------|------------|--|
| | | Burst ID | Burst Offset (us) | Pulse Width (us) | Chirp Width (MHz) | Number of Pulses per Burst | PRI-1 (us) | PRI-2 (us) | PRI-3 (us) | |
| | | 0 | 138746.0 | 85.6 | 6 | 3 | 1196.0 | 1343.0 | 1812.0 | |
| | | 1 | 462059.0 | 56.9 | 6 | 1 | 1489.0 | - | - | |
| | | 2 | 785345.0 | 50.5 | 6 | 1 | 1027.0 | - | - | |
| | | 3 | 1105205.0 | 92.1 | 6 | 3 | 1758.0 | 1442.0 | 1753.0 | |
| | | 4 | 98957.0 | 85.5 | 6 | 3 | 1979.0 | 1784.0 | 1740.0 | |
| | | 5 | 421247.0 | 88.7 | 6 | 3 | 1155.0 | 1656.0 | 1906.0 | |
| | | 6 | 744579.0 | 75.7 | 6 | 2 | 1083.0 | 1668.0 | - | |
| | | 7 | 1065071.0 | 89.7 | 6 | 3 | 1666.0 | 1898.0 | 1949.0 | |
| | | 8 | 59312.0 | 94.6 | 6 | 3 | 1860.0 | 1225.0 | 1908.0 | |

Type 5 Radar Waveform_13

| Download | 13 | Type 5 | 9 | 1.3333333 | 12.0000000 | 5.493000000 | | | | |
|----------|----|----------|-------------------|------------------|-------------------|----------------------------|------------|------------|------------|--|
| | | Burst ID | Burst Offset (us) | Pulse Width (us) | Chirp Width (MHz) | Number of Pulses per Burst | PRI-1 (us) | PRI-2 (us) | PRI-3 (us) | |
| | | 0 | 382368.0 | 51.4 | 7 | 1 | 1888.0 | - | - | |
| | | 1 | 704673.0 | 74.3 | 7 | 2 | 1876.0 | 1169.0 | - | |
| | | 2 | 1026446.0 | 98.0 | 7 | 3 | 1210.0 | 1567.0 | 1386.0 | |
| | | 3 | 19678.0 | 56.8 | 7 | 1 | 1642.0 | - | - | |
| | | 4 | 341986.0 | 98.0 | 7 | 3 | 1835.0 | 1007.0 | 1401.0 | |
| | | 5 | 664672.0 | 82.2 | 7 | 2 | 1878.0 | 1686.0 | - | |
| | | 6 | 988792.0 | 54.4 | 7 | 1 | 1396.0 | - | - | |
| | | 7 | 1309162.0 | 83.6 | 7 | 3 | 1345.0 | 1579.0 | 1180.0 | |
| | | 8 | 302856.0 | 54.4 | 7 | 1 | 1713.0 | - | - | |

Type 5 Radar Waveform_14

| Download | 14 | Type 5 | 13 | 0.9230769 | 12.0000000 | 5.495000000 | | | | |
|----------|----|----------|-------------------|------------------|-------------------|----------------------------|------------|------------|------------|--|
| | | Burst ID | Burst Offset (us) | Pulse Width (us) | Chirp Width (MHz) | Number of Pulses per Burst | PRI-1 (us) | PRI-2 (us) | PRI-3 (us) | |
| | | 0 | 431447.0 | 86.3 | 11 | 3 | 1727.0 | 1750.0 | 1560.0 | |
| | | 1 | 656428.0 | 50.6 | 11 | 1 | 1771.0 | - | - | |
| | | 2 | 879268.0 | 81.0 | 11 | 2 | 1379.0 | 1026.0 | - | |
| | | 3 | 181792.0 | 77.2 | 11 | 2 | 1630.0 | 1261.0 | - | |
| | | 4 | 404648.0 | 70.3 | 11 | 2 | 1886.0 | 1726.0 | - | |
| | | 5 | 627824.0 | 91.9 | 11 | 3 | 1485.0 | 1000.0 | 1162.0 | |
| | | 6 | 849886.0 | 83.9 | 11 | 3 | 1293.0 | 1864.0 | 1494.0 | |
| | | 7 | 154485.0 | 52.1 | 11 | 1 | 1796.0 | - | - | |
| | | 8 | 377413.0 | 73.6 | 11 | 2 | 1761.0 | 1283.0 | - | |
| | | 9 | 599312.0 | 91.7 | 11 | 3 | 1459.0 | 1675.0 | 1807.0 | |
| | | 10 | 825353.0 | 58.1 | 11 | 1 | 1183.0 | - | - | |
| | | 11 | 127013.0 | 62.4 | 11 | 1 | 1429.0 | - | - | |
| | | 12 | 349893.0 | 80.4 | 11 | 2 | 1754.0 | 1381.0 | - | |

Type 5 Radar Waveform_15

| Download | 15 | Type 5 | 12 | 1.0000000 | 12.0000000 | 5.495000000 | | | | |
|----------|----|----------|-------------------|------------------|-------------------|----------------------------|------------|------------|------------|--|
| | | Burst ID | Burst Offset (us) | Pulse Width (us) | Chirp Width (MHz) | Number of Pulses per Burst | PRI-1 (us) | PRI-2 (us) | PRI-3 (us) | |
| | | 0 | 821381.0 | 76.9 | 10 | 2 | 1126.0 | 1271.0 | - | |
| | | 1 | 861450.0 | 88.8 | 10 | 3 | 1313.0 | 1779.0 | 1478.0 | |
| | | 2 | 107419.0 | 87.2 | 10 | 3 | 1640.0 | 1200.0 | 1959.0 | |
| | | 3 | 349159.0 | 68.9 | 10 | 2 | 1903.0 | 1834.0 | - | |
| | | 4 | 591193.0 | 73.6 | 10 | 2 | 1546.0 | 1501.0 | - | |
| | | 5 | 832333.0 | 89.8 | 10 | 3 | 1187.0 | 1617.0 | 1023.0 | |
| | | 6 | 77687.0 | 85.1 | 10 | 3 | 1593.0 | 1232.0 | 1984.0 | |
| | | 7 | 318789.0 | 95.6 | 10 | 3 | 1829.0 | 1836.0 | 1965.0 | |
| | | 8 | 561173.0 | 69.6 | 10 | 2 | 1707.0 | 1760.0 | - | |
| | | 9 | 802107.0 | 95.0 | 10 | 3 | 1242.0 | 1598.0 | 1566.0 | |
| | | 10 | 48060.0 | 68.6 | 10 | 2 | 1050.0 | 1613.0 | - | |
| | | 11 | 290288.0 | 53.1 | 10 | 1 | 1406.0 | - | - | |

Type 5 Radar Waveform_16

| Download | 16 | Type 5 | 14 | 0.8571429 | 12.0000000 | 5.495000000 | | | | |
|----------|----|----------|-------------------|------------------|-------------------|----------------------------|------------|------------|------------|--|
| | | Burst ID | Burst Offset (us) | Pulse Width (us) | Chirp Width (MHz) | Number of Pulses per Burst | PRI-1 (us) | PRI-2 (us) | PRI-3 (us) | |
| | | 0 | 454727.0 | 92.7 | 12 | 3 | 1569.0 | 1522.0 | 1307.0 | |
| | | 1 | 661456.0 | 94.8 | 12 | 3 | 1664.0 | 1047.0 | 1801.0 | |
| | | 2 | 15530.0 | 96.7 | 12 | 3 | 1944.0 | 1970.0 | 1956.0 | |
| | | 3 | 222750.0 | 68.1 | 12 | 2 | 1248.0 | 1939.0 | - | |
| | | 4 | 428928.0 | 98.2 | 12 | 3 | 1327.0 | 1742.0 | 1973.0 | |
| | | 5 | 636739.0 | 82.1 | 12 | 2 | 1958.0 | 1543.0 | - | |
| | | 6 | 845835.0 | 57.3 | 12 | 1 | 1415.0 | - | - | |
| | | 7 | 197368.0 | 77.5 | 12 | 2 | 1038.0 | 1504.0 | - | |
| | | 8 | 405056.0 | 52.7 | 12 | 1 | 1696.0 | - | - | |
| | | 9 | 612467.0 | 60.5 | 12 | 1 | 1783.0 | - | - | |
| | | 10 | 818720.0 | 75.6 | 12 | 2 | 1453.0 | 1580.0 | - | |
| | | 11 | 172074.0 | 60.7 | 12 | 1 | 1466.0 | - | - | |
| | | 12 | 379595.0 | 58.4 | 12 | 1 | 1482.0 | - | - | |
| | | 13 | 584827.0 | 86.7 | 12 | 3 | 1366.0 | 1856.0 | 1601.0 | |

Type 5 Radar Waveform_17

| Download | 17 | Type 5 | 10 | 1.2000000 | 12.0000000 | 5.494000000 | | | | |
|----------|----|----------|-------------------|------------------|-------------------|----------------------------|------------|------------|------------|--|
| | | Burst ID | Burst Offset (us) | Pulse Width (us) | Chirp Width (MHz) | Number of Pulses per Burst | PRI-1 (us) | PRI-2 (us) | PRI-3 (us) | |
| | | 0 | 1113221.0 | 58.7 | 8 | 1 | 1302.0 | - | - | |
| | | 1 | 205124.0 | 58.2 | 8 | 1 | 2000.0 | - | - | |
| | | 2 | 495459.0 | 83.3 | 8 | 2 | 1322.0 | 1205.0 | - | |
| | | 3 | 786368.0 | 65.1 | 8 | 1 | 1759.0 | - | - | |
| | | 4 | 1075244.0 | 84.1 | 8 | 3 | 1469.0 | 1020.0 | 1222.0 | |
| | | 5 | 169058.0 | 81.6 | 8 | 2 | 1976.0 | 1982.0 | - | |
| | | 6 | 459592.0 | 82.2 | 8 | 2 | 1127.0 | 1643.0 | - | |
| | | 7 | 750012.0 | 71.0 | 8 | 2 | 1385.0 | 1298.0 | - | |
| | | 8 | 1039423.0 | 97.5 | 8 | 3 | 1258.0 | 1119.0 | 1430.0 | |
| | | 9 | 133600.0 | 59.2 | 8 | 1 | 1507.0 | - | - | |

Type 5 Radar Waveform_18

| Download | 18 | Type 5 | 19 | 0.6315789 | 12.0000000 | 5.498000000 | | | | |
|----------|----|----------|-------------------|------------------|-------------------|----------------------------|------------|------------|------------|--|
| | | Burst ID | Burst Offset (us) | Pulse Width (us) | Chirp Width (MHz) | Number of Pulses per Burst | PRI-1 (us) | PRI-2 (us) | PRI-3 (us) | |
| | | 0 | 222298.0 | 69.7 | 18 | 2 | 1738.0 | 1890.0 | - | |
| | | 1 | 375133.0 | 79.0 | 18 | 2 | 1165.0 | 1562.0 | - | |
| | | 2 | 528572.0 | 58.6 | 18 | 1 | 1628.0 | - | - | |
| | | 3 | 51439.0 | 64.7 | 18 | 1 | 1197.0 | - | - | |
| | | 4 | 203125.0 | 98.6 | 18 | 3 | 1244.0 | 1677.0 | 1981.0 | |
| | | 5 | 357021.0 | 58.9 | 18 | 1 | 1538.0 | - | - | |
| | | 6 | 509592.0 | 66.6 | 18 | 1 | 1826.0 | - | - | |
| | | 7 | 32598.0 | 55.6 | 18 | 1 | 1362.0 | - | - | |
| | | 8 | 185471.0 | 62.3 | 18 | 1 | 1277.0 | - | - | |
| | | 9 | 337471.0 | 74.0 | 18 | 2 | 1565.0 | 1329.0 | - | |
| | | 10 | 489271.0 | 77.6 | 18 | 2 | 1768.0 | 1993.0 | - | |
| | | 11 | 13720.0 | 97.1 | 18 | 3 | 1470.0 | 1106.0 | 1105.0 | |
| | | 12 | 165707.0 | 87.2 | 18 | 3 | 1996.0 | 1230.0 | 1583.0 | |
| | | 13 | 317848.0 | 84.0 | 18 | 3 | 1827.0 | 1044.0 | 1682.0 | |
| | | 14 | 471229.0 | 75.4 | 18 | 2 | 1505.0 | 1304.0 | - | |
| | | 15 | 625411.0 | 59.6 | 18 | 1 | 1109.0 | - | - | |
| | | 16 | 147726.0 | 50.8 | 18 | 1 | 1641.0 | - | - | |
| | | 17 | 299778.0 | 84.9 | 18 | 3 | 1068.0 | 1045.0 | 1053.0 | |
| | | 18 | 452221.0 | 77.6 | 18 | 2 | 1548.0 | 1572.0 | - | |

Type 5 Radar Waveform_19

| Download | 19 | Type 5 | 8 | 1.5000000 | 12.0000000 | 5.493000000 | | | | |
|----------|----|----------|-------------------|------------------|-------------------|----------------------------|------------|------------|------------|--|
| | | Burst ID | Burst Offset (us) | Pulse Width (us) | Chirp Width (MHz) | Number of Pulses per Burst | PRI-1 (us) | PRI-2 (us) | PRI-3 (us) | |
| | | 0 | 1441554.0 | 66.4 | 5 | 1 | 1662.0 | - | - | |
| | | 1 | 306572.0 | 63.1 | 5 | 1 | 1849.0 | - | - | |
| | | 2 | 669102.0 | 76.4 | 5 | 2 | 1945.0 | 1735.0 | - | |
| | | 3 | 1033690.0 | 60.5 | 5 | 1 | 1239.0 | - | - | |
| | | 4 | 1394681.0 | 87.0 | 5 | 3 | 1285.0 | 1058.0 | 1584.0 | |
| | | 5 | 261627.0 | 81.1 | 5 | 2 | 1135.0 | 1790.0 | - | |
| | | 6 | 624583.0 | 76.8 | 5 | 2 | 1987.0 | 1254.0 | - | |
| | | 7 | 988734.0 | 62.2 | 5 | 1 | 1513.0 | - | - | |

Type 5 Radar Waveform_20

| Download | 20 | Type 5 | 20 | 0.6000000 | 12.0000000 | 5.501000000 | | | | |
|----------|----|----------|-------------------|------------------|-------------------|----------------------------|------------|------------|------------|--|
| | | Burst ID | Burst Offset (us) | Pulse Width (us) | Chirp Width (MHz) | Number of Pulses per Burst | PRI-1 (us) | PRI-2 (us) | PRI-3 (us) | |
| | | 0 | 539680.0 | 54.5 | 20 | 1 | 1698.0 | - | - | |
| | | 1 | 86656.0 | 60.9 | 20 | 1 | 1899.0 | - | - | |
| | | 2 | 230987.0 | 87.1 | 20 | 3 | 1264.0 | 1508.0 | 1003.0 | |
| | | 3 | 376161.0 | 71.0 | 20 | 2 | 1273.0 | 1596.0 | - | |
| | | 4 | 521332.0 | 71.7 | 20 | 2 | 1390.0 | 1081.0 | - | |
| | | 5 | 68403.0 | 97.4 | 20 | 3 | 1831.0 | 1762.0 | 1654.0 | |
| | | 6 | 213053.0 | 87.5 | 20 | 3 | 1284.0 | 1299.0 | 1534.0 | |
| | | 7 | 357444.0 | 98.5 | 20 | 3 | 1787.0 | 1451.0 | 1095.0 | |
| | | 8 | 503075.0 | 69.2 | 20 | 2 | 1867.0 | 1086.0 | - | |
| | | 9 | 50812.0 | 73.4 | 20 | 2 | 1863.0 | 1311.0 | - | |
| | | 10 | 195215.0 | 92.7 | 20 | 3 | 1652.0 | 1098.0 | 1480.0 | |
| | | 11 | 340391.0 | 79.0 | 20 | 2 | 1582.0 | 1450.0 | - | |
| | | 12 | 484346.0 | 93.8 | 20 | 3 | 1103.0 | 1131.0 | 1817.0 | |
| | | 13 | 32889.0 | 93.9 | 20 | 3 | 1204.0 | 1907.0 | 1744.0 | |
| | | 14 | 177783.0 | 69.9 | 20 | 2 | 1811.0 | 1188.0 | - | |
| | | 15 | 322238.0 | 98.5 | 20 | 3 | 1206.0 | 1163.0 | 1252.0 | |
| | | 16 | 466217.0 | 84.4 | 20 | 3 | 1091.0 | 1861.0 | 1515.0 | |
| | | 17 | 15195.0 | 59.0 | 20 | 1 | 1499.0 | - | - | |
| | | 18 | 160391.0 | 61.6 | 20 | 1 | 1346.0 | - | - | |
| | | 19 | 304808.0 | 71.0 | 20 | 2 | 1764.0 | 1101.0 | - | |

Type 5 Radar Waveform_21

| Download | 21 | Type 5 | 15 | 0.8000000 | 12.0000000 | 5.504000000 | | | | |
|----------|----|----------|-------------------|------------------|-------------------|----------------------------|------------|------------|------------|--|
| | | Burst ID | Burst Offset (us) | Pulse Width (us) | Chirp Width (MHz) | Number of Pulses per Burst | PRI-1 (us) | PRI-2 (us) | PRI-3 (us) | |
| | | 0 | 598757.0 | 99.4 | 13 | 3 | 1972.0 | 1788.0 | 1059.0 | |
| | | 1 | 791479.0 | 89.7 | 13 | 3 | 1559.0 | 1749.0 | 1646.0 | |
| | | 2 | 189789.0 | 74.4 | 13 | 2 | 1691.0 | 1024.0 | - | |
| | | 3 | 383351.0 | 80.8 | 13 | 2 | 1214.0 | 1097.0 | - | |
| | | 4 | 574593.0 | 97.3 | 13 | 3 | 1859.0 | 1910.0 | 1616.0 | |
| | | 5 | 767953.0 | 93.4 | 13 | 3 | 1884.0 | 1385.0 | 1576.0 | |
| | | 6 | 165939.0 | 81.1 | 13 | 2 | 1447.0 | 1423.0 | - | |
| | | 7 | 358449.0 | 96.1 | 13 | 3 | 1502.0 | 1255.0 | 1930.0 | |
| | | 8 | 550938.0 | 93.3 | 13 | 3 | 1654.0 | 1600.0 | 1809.0 | |
| | | 9 | 745867.0 | 68.4 | 13 | 2 | 1402.0 | 1532.0 | - | |
| | | 10 | 142088.0 | 71.6 | 13 | 2 | 1080.0 | 1997.0 | - | |
| | | 11 | 334437.0 | 83.6 | 13 | 3 | 1397.0 | 1942.0 | 1947.0 | |
| | | 12 | 528378.0 | 71.8 | 13 | 2 | 1541.0 | 1941.0 | - | |
| | | 13 | 721140.0 | 96.8 | 13 | 3 | 1191.0 | 1317.0 | 1435.0 | |
| | | 14 | 118447.0 | 62.0 | 13 | 1 | 1955.0 | - | - | |

Type 5 Radar Waveform_22

| Download | 22 | Type 5 | 18 | 0.6666667 | 12.0000000 | 5.502000000 | | | | |
|----------|----|----------|-------------------|------------------|-------------------|----------------------------|------------|------------|------------|--|
| | | Burst ID | Burst Offset (us) | Pulse Width (us) | Chirp Width (MHz) | Number of Pulses per Burst | PRI-1 (us) | PRI-2 (us) | PRI-3 (us) | |
| | | 0 | 258753.0 | 94.8 | 18 | 3 | 1705.0 | 1123.0 | 1988.0 | |
| | | 1 | 420563.0 | 75.2 | 18 | 2 | 1114.0 | 1681.0 | - | |
| | | 2 | 582899.0 | 53.0 | 18 | 1 | 1269.0 | - | - | |
| | | 3 | 78802.0 | 55.9 | 18 | 1 | 1936.0 | - | - | |
| | | 4 | 238840.0 | 99.8 | 18 | 3 | 1697.0 | 1650.0 | 1857.0 | |
| | | 5 | 399263.0 | 99.8 | 18 | 3 | 1467.0 | 1752.0 | 1990.0 | |
| | | 6 | 560233.0 | 85.6 | 18 | 3 | 1943.0 | 1380.0 | 1241.0 | |
| | | 7 | 58947.0 | 56.2 | 18 | 1 | 1902.0 | - | - | |
| | | 8 | 219152.0 | 86.2 | 18 | 3 | 1335.0 | 2000.0 | 1651.0 | |
| | | 9 | 381701.0 | 58.2 | 18 | 1 | 1376.0 | - | - | |
| | | 10 | 542922.0 | 55.9 | 18 | 1 | 1540.0 | - | - | |
| | | 11 | 38889.0 | 83.9 | 18 | 3 | 1614.0 | 1946.0 | 1720.0 | |
| | | 12 | 200080.0 | 72.5 | 18 | 2 | 1674.0 | 1004.0 | - | |
| | | 13 | 360029.0 | 93.2 | 18 | 3 | 1062.0 | 1843.0 | 1775.0 | |
| | | 14 | 521475.0 | 77.9 | 18 | 2 | 1721.0 | 1823.0 | - | |
| | | 15 | 19203.0 | 76.2 | 18 | 2 | 1496.0 | 1279.0 | - | |
| | | 16 | 180131.0 | 78.0 | 18 | 2 | 1741.0 | 1354.0 | - | |
| | | 17 | 341077.0 | 69.4 | 18 | 2 | 1404.0 | 1673.0 | - | |

Type 5 Radar Waveform_23

| Download | 23 | Type 5 | 19 | 0.6315789 | 12.0000000 | 5.502000000 | | | | |
|----------|----|----------|-------------------|------------------|-------------------|----------------------------|------------|------------|------------|--|
| | | Burst ID | Burst Offset (us) | Pulse Width (us) | Chirp Width (MHz) | Number of Pulses per Burst | PRI-1 (us) | PRI-2 (us) | PRI-3 (us) | |
| | | 0 | 476409.0 | 55.8 | 18 | 1 | 1840.0 | - | - | |
| | | 1 | 629378.0 | 62.9 | 18 | 1 | 1603.0 | - | - | |
| | | 2 | 152116.0 | 64.9 | 18 | 1 | 1913.0 | - | - | |
| | | 3 | 303561.0 | 86.5 | 18 | 3 | 1051.0 | 1717.0 | 1766.0 | |
| | | 4 | 457727.0 | 56.2 | 18 | 1 | 1660.0 | - | - | |
| | | 5 | 609064.0 | 73.7 | 18 | 2 | 1319.0 | 1825.0 | - | |
| | | 6 | 133216.0 | 78.3 | 18 | 2 | 1082.0 | 1251.0 | - | |
| | | 7 | 286357.0 | 66.2 | 18 | 1 | 1168.0 | - | - | |
| | | 8 | 437113.0 | 91.4 | 18 | 3 | 1116.0 | 1798.0 | 1324.0 | |
| | | 9 | 591677.0 | 55.1 | 18 | 1 | 1667.0 | - | - | |
| | | 10 | 114535.0 | 50.7 | 18 | 1 | 1689.0 | - | - | |
| | | 11 | 267424.0 | 51.8 | 18 | 1 | 1403.0 | - | - | |
| | | 12 | 420186.0 | 59.0 | 18 | 1 | 1517.0 | - | - | |
| | | 13 | 573165.0 | 57.2 | 18 | 1 | 1331.0 | - | - | |
| | | 14 | 95190.0 | 97.1 | 18 | 3 | 1743.0 | 1802.0 | 1615.0 | |
| | | 15 | 247979.0 | 81.9 | 18 | 2 | 1257.0 | 1716.0 | - | |
| | | 16 | 400171.0 | 75.2 | 18 | 2 | 1509.0 | 1879.0 | - | |
| | | 17 | 552671.0 | 73.2 | 18 | 2 | 1934.0 | 1291.0 | - | |
| | | 18 | 76751.0 | 81.4 | 18 | 2 | 1547.0 | 1361.0 | - | |

Type 5 Radar Waveform_24

| Download | 24 | Type 5 | 19 | 0.6315789 | 12.0000000 | 5.502000000 | | | | |
|----------|----|----------|-------------------|------------------|-------------------|----------------------------|------------|------------|------------|--|
| | | Burst ID | Burst Offset (us) | Pulse Width (us) | Chirp Width (MHz) | Number of Pulses per Burst | PRI-1 (us) | PRI-2 (us) | PRI-3 (us) | |
| | | 0 | 229833.0 | 53.0 | 19 | 1 | 1235.0 | - | - | |
| | | 1 | 382858.0 | 61.8 | 19 | 1 | 1323.0 | - | - | |
| | | 2 | 534461.0 | 71.2 | 19 | 2 | 1325.0 | 1238.0 | - | |
| | | 3 | 58111.0 | 63.8 | 19 | 1 | 1373.0 | - | - | |
| | | 4 | 209845.0 | 83.5 | 19 | 3 | 1620.0 | 1226.0 | 1846.0 | |
| | | 5 | 362190.0 | 88.2 | 19 | 3 | 1164.0 | 1998.0 | 1001.0 | |
| | | 6 | 515723.0 | 72.6 | 19 | 2 | 1148.0 | 1350.0 | - | |
| | | 7 | 38053.0 | 91.4 | 19 | 3 | 1631.0 | 1595.0 | 1855.0 | |
| | | 8 | 192095.0 | 59.5 | 19 | 1 | 1484.0 | - | - | |
| | | 9 | 345012.0 | 58.6 | 19 | 1 | 1303.0 | - | - | |
| | | 10 | 497857.0 | 52.9 | 19 | 1 | 1578.0 | - | - | |
| | | 11 | 20457.0 | 65.4 | 19 | 1 | 1378.0 | - | - | |
| | | 12 | 172285.0 | 92.3 | 19 | 3 | 1719.0 | 1896.0 | 1457.0 | |
| | | 13 | 324865.0 | 93.7 | 19 | 3 | 1073.0 | 1141.0 | 1636.0 | |
| | | 14 | 479256.0 | 64.1 | 19 | 1 | 1025.0 | - | - | |
| | | 15 | 1631.0 | 66.0 | 19 | 1 | 1260.0 | - | - | |
| | | 16 | 153780.0 | 83.9 | 19 | 3 | 1118.0 | 1789.0 | 1300.0 | |
| | | 17 | 305818.0 | 97.2 | 19 | 3 | 1096.0 | 1728.0 | 1629.0 | |
| | | 18 | 460387.0 | 58.2 | 19 | 1 | 1069.0 | - | - | |

Type 5 Radar Waveform_25

| Download | 25 | Type 5 | 9 | 1.3333333 | 12.0000000 | 5.507000000 | | | | |
|----------|----|----------|-------------------|------------------|-------------------|----------------------------|------------|------------|------------|--|
| | | Burst ID | Burst Offset (us) | Pulse Width (us) | Chirp Width (MHz) | Number of Pulses per Burst | PRI-1 (us) | PRI-2 (us) | PRI-3 (us) | |
| | | 0 | 1294598.0 | 69.0 | 7 | 2 | 1122.0 | 1296.0 | - | |
| | | 1 | 286364.0 | 79.3 | 7 | 2 | 1234.0 | 1684.0 | - | |
| | | 2 | 608921.0 | 77.7 | 7 | 2 | 1920.0 | 1240.0 | - | |
| | | 3 | 930649.0 | 83.5 | 7 | 3 | 1099.0 | 1992.0 | 1326.0 | |
| | | 4 | 1255842.0 | 58.4 | 7 | 1 | 1247.0 | - | - | |
| | | 5 | 246475.0 | 80.4 | 7 | 2 | 1694.0 | 1999.0 | - | |
| | | 6 | 569767.0 | 55.4 | 7 | 1 | 1795.0 | - | - | |
| | | 7 | 890292.0 | 84.4 | 7 | 3 | 1989.0 | 1428.0 | 1980.0 | |
| | | 8 | 1212587.0 | 99.2 | 7 | 3 | 1952.0 | 1355.0 | 1839.0 | |

Type 5 Radar Waveform_26

| Download | 26 | Type 5 | 11 | 1.0909091 | 12.0000000 | 5.506000000 | | | | |
|----------|----|----------|-------------------|------------------|-------------------|----------------------------|------------|------------|------------|--|
| | | Burst ID | Burst Offset (us) | Pulse Width (us) | Chirp Width (MHz) | Number of Pulses per Burst | PRI-1 (us) | PRI-2 (us) | PRI-3 (us) | |
| | | 0 | 168981.0 | 98.8 | 8 | 3 | 1699.0 | 1334.0 | 1150.0 | |
| | | 1 | 432692.0 | 86.8 | 8 | 3 | 1625.0 | 1011.0 | 1181.0 | |
| | | 2 | 695333.0 | 90.6 | 8 | 3 | 1951.0 | 1923.0 | 1524.0 | |
| | | 3 | 960855.0 | 67.9 | 8 | 2 | 1462.0 | 1387.0 | - | |
| | | 4 | 136836.0 | 54.6 | 8 | 1 | 1633.0 | - | - | |
| | | 5 | 400226.0 | 94.9 | 8 | 3 | 1639.0 | 1077.0 | 1074.0 | |
| | | 6 | 664308.0 | 74.9 | 8 | 2 | 1564.0 | 1536.0 | - | |
| | | 7 | 929540.0 | 57.6 | 8 | 1 | 1454.0 | - | - | |
| | | 8 | 103956.0 | 84.6 | 8 | 3 | 1919.0 | 1700.0 | 1545.0 | |
| | | 9 | 367467.0 | 99.1 | 8 | 3 | 1718.0 | 1198.0 | 1708.0 | |
| | | 10 | 631797.0 | 81.4 | 8 | 2 | 1359.0 | 1763.0 | - | |

Type 5 Radar Waveform_27

| Download | 27 | Type 5 | 20 | 0.6000000 | 12.0000000 | 5.501000000 | | | |
|----------|----|----------|-------------------|------------------|-------------------|----------------------------|------------|------------|------------|
| | | Burst ID | Burst Offset (us) | Pulse Width (us) | Chirp Width (MHz) | Number of Pulses per Burst | PRI-1 (us) | PRI-2 (us) | PRI-3 (us) |
| | | 0 | 491171.0 | 98.3 | 20 | 3 | 1143.0 | 1256.0 | 1043.0 |
| | | 1 | 39204.0 | 83.7 | 20 | 3 | 1893.0 | 1828.0 | 1132.0 |
| | | 2 | 184003.0 | 82.4 | 20 | 2 | 1437.0 | 1933.0 | - |
| | | 3 | 328922.0 | 68.7 | 20 | 2 | 1281.0 | 1695.0 | - |
| | | 4 | 474765.0 | 57.6 | 20 | 1 | 1658.0 | - | - |
| | | 5 | 21435.0 | 88.5 | 20 | 3 | 1421.0 | 1278.0 | 1845.0 |
| | | 6 | 165755.0 | 89.8 | 20 | 3 | 1544.0 | 1932.0 | 1418.0 |
| | | 7 | 312097.0 | 58.5 | 20 | 1 | 1035.0 | - | - |
| | | 8 | 456967.0 | 58.2 | 20 | 1 | 1557.0 | - | - |
| | | 9 | 3649.0 | 94.9 | 20 | 3 | 1539.0 | 1455.0 | 1158.0 |
| | | 10 | 148040.0 | 91.2 | 20 | 3 | 1034.0 | 1637.0 | 1968.0 |
| | | 11 | 293875.0 | 63.2 | 20 | 1 | 1704.0 | - | - |
| | | 12 | 437295.0 | 84.7 | 20 | 3 | 1060.0 | 1521.0 | 1420.0 |
| | | 13 | 583061.0 | 67.0 | 20 | 2 | 1525.0 | 1229.0 | - |
| | | 14 | 131017.0 | 54.2 | 20 | 1 | 1149.0 | - | - |
| | | 15 | 276228.0 | 52.0 | 20 | 1 | 1213.0 | - | - |
| | | 16 | 420375.0 | 75.4 | 20 | 2 | 1592.0 | 1152.0 | - |
| | | 17 | 564887.0 | 78.3 | 20 | 2 | 1862.0 | 1243.0 | - |
| | | 18 | 113071.0 | 62.8 | 20 | 1 | 1445.0 | - | - |
| | | 19 | 256895.0 | 83.4 | 20 | 3 | 1478.0 | 1195.0 | 1891.0 |

Type 5 Radar Waveform_28

| Download | 28 | Type 5 | 13 | 0.9230769 | 12.0000000 | 5.505000000 | | | |
|----------|----|----------|-------------------|------------------|-------------------|----------------------------|------------|------------|------------|
| | | Burst ID | Burst Offset (us) | Pulse Width (us) | Chirp Width (MHz) | Number of Pulses per Burst | PRI-1 (us) | PRI-2 (us) | PRI-3 (us) |
| | | 0 | 620146.0 | 78.0 | 11 | 2 | 1857.0 | 1280.0 | - |
| | | 1 | 844638.0 | 53.8 | 11 | 1 | 1487.0 | - | - |
| | | 2 | 146299.0 | 73.4 | 11 | 2 | 1734.0 | 1409.0 | - |
| | | 3 | 368917.0 | 92.7 | 11 | 3 | 1100.0 | 1358.0 | 1917.0 |
| | | 4 | 592501.0 | 72.7 | 11 | 2 | 1610.0 | 1570.0 | - |
| | | 5 | 816046.0 | 68.0 | 11 | 2 | 1605.0 | 1078.0 | - |
| | | 6 | 118746.0 | 85.0 | 11 | 3 | 1014.0 | 1084.0 | 1591.0 |
| | | 7 | 342627.0 | 60.7 | 11 | 1 | 1267.0 | - | - |
| | | 8 | 564586.0 | 97.4 | 11 | 3 | 1367.0 | 1352.0 | 1167.0 |
| | | 9 | 788704.0 | 68.7 | 11 | 2 | 1125.0 | 1377.0 | - |
| | | 10 | 91451.0 | 56.5 | 11 | 1 | 1964.0 | - | - |
| | | 11 | 314335.0 | 81.4 | 11 | 2 | 1837.0 | 1635.0 | - |
| | | 12 | 537145.0 | 84.8 | 11 | 3 | 1259.0 | 1563.0 | 1031.0 |

Type 5 Radar Waveform_29

| Download | 29 | Type 5 | 12 | 1.0000000 | 12.0000000 | 5.505000000 | | | |
|----------|----|----------|-------------------|------------------|-------------------|----------------------------|------------|------------|------------|
| | | Burst ID | Burst Offset (us) | Pulse Width (us) | Chirp Width (MHz) | Number of Pulses per Burst | PRI-1 (us) | PRI-2 (us) | PRI-3 (us) |
| | | 0 | 825707.0 | 65.8 | 11 | 1 | 1416.0 | - | - |
| | | 1 | 69281.0 | 59.9 | 11 | 1 | 1852.0 | - | - |
| | | 2 | 310454.0 | 85.4 | 11 | 3 | 1274.0 | 1688.0 | 1804.0 |
| | | 3 | 551862.0 | 97.0 | 11 | 3 | 1803.0 | 1272.0 | 1632.0 |
| | | 4 | 795509.0 | 59.0 | 11 | 1 | 1875.0 | - | - |
| | | 5 | 39421.0 | 75.9 | 11 | 2 | 1822.0 | 1057.0 | - |
| | | 6 | 281360.0 | 69.9 | 11 | 2 | 1294.0 | 1137.0 | - |
| | | 7 | 522565.0 | 90.7 | 11 | 3 | 1411.0 | 1156.0 | 1308.0 |
| | | 8 | 763870.0 | 97.0 | 11 | 3 | 1052.0 | 1286.0 | 1911.0 |
| | | 9 | 9627.0 | 76.1 | 11 | 2 | 1985.0 | 1523.0 | - |
| | | 10 | 251937.0 | 54.3 | 11 | 1 | 1009.0 | - | - |
| | | 11 | 493823.0 | 57.5 | 11 | 1 | 1820.0 | - | - |

| Radar Type 6 - Radar Statistical Performance | | | |
|--|-------------------------------|--------------|-------------------------------|
| Trail # | 1=Detection 0=No Detection | Trail # | 1=Detection 0=No Detection |
| 0 | 1 | 15 | 1 |
| 1 | 1 | 16 | 1 |
| 2 | 0 | 17 | 1 |
| 3 | 1 | 18 | 1 |
| 4 | 1 | 19 | 1 |
| 5 | 0 | 20 | 1 |
| 6 | 1 | 21 | 1 |
| 7 | 1 | 22 | 1 |
| 8 | 1 | 23 | 0 |
| 9 | 1 | 24 | 1 |
| 10 | 1 | 25 | 1 |
| 11 | 1 | 26 | 1 |
| 12 | 1 | 27 | 1 |
| 13 | 1 | 28 | 1 |
| 14 | 1 | 29 | 1 |
| Detection Percentage (%) | | 90.0% | |

Type 6 Radar Waveform_0

| Download | 0 | Type 6 | 1.0 | 333.3 | 9 | 0.3333 | 300.0000000 | 4 |
|----------|---|----------------------|------|-------|------|--------|-------------|---|
| | | Frequency List (MHz) | 0 | 1 | 2 | 3 | 4 | |
| | | 0 | 5524 | 5287 | 5528 | 5420 | 5348 | |
| | | 5 | 5369 | 5644 | 5608 | 5351 | 5304 | |
| | | 10 | 5612 | 5434 | 5323 | 5291 | 5489 | |
| | | 15 | 5374 | 5419 | 5309 | 5313 | 5347 | |
| | | 20 | 5437 | 5330 | 5532 | 5267 | 5654 | |
| | | 25 | 5720 | 5443 | 5490 | 5655 | 5308 | |
| | | 30 | 5431 | 5494 | 5527 | 5624 | 5251 | |
| | | 35 | 5495 | 5322 | 5686 | 5667 | 5389 | |
| | | 40 | 5623 | 5467 | 5709 | 5649 | 5507 | |
| | | 45 | 5297 | 5277 | 5519 | 5549 | 5651 | |
| | | 50 | 5541 | 5675 | 5343 | 5500 | 5512 | |
| | | 55 | 5586 | 5342 | 5376 | 5617 | 5475 | |
| | | 60 | 5418 | 5539 | 5716 | 5483 | 5592 | |
| | | 65 | 5666 | 5371 | 5271 | 5358 | 5661 | |
| | | 70 | 5379 | 5386 | 5602 | 5290 | 5674 | |
| | | 75 | 5628 | 5573 | 5326 | 5673 | 5405 | |
| | | 80 | 5625 | 5696 | 5554 | 5497 | 5672 | |
| | | 85 | 5427 | 5687 | 5282 | 5701 | 5463 | |
| | | 90 | 5413 | 5600 | 5478 | 5329 | 5266 | |
| | | 95 | 5352 | 5576 | 5393 | 5688 | 5265 | |

Type 6 Radar Waveform_1

| Download | 1 | Type 6 | 1.0 | 333.3 | 9 | 0.3333 | 300.0000000 | 3 |
|----------|---|----------------------|------|-------|------|--------|-------------|---|
| | | Frequency List (MHz) | 0 | 1 | 2 | 3 | 4 | |
| | | 0 | 5304 | 5526 | 5464 | 5581 | 5568 | |
| | | 5 | 5411 | 5666 | 5683 | 5417 | 5608 | |
| | | 10 | 5543 | 5698 | 5364 | 5486 | 5510 | |
| | | 15 | 5365 | 5449 | 5315 | 5261 | 5539 | |
| | | 20 | 5445 | 5399 | 5375 | 5621 | 5715 | |
| | | 25 | 5669 | 5372 | 5547 | 5524 | 5351 | |
| | | 30 | 5544 | 5265 | 5646 | 5258 | 5347 | |
| | | 35 | 5288 | 5439 | 5291 | 5475 | 5600 | |
| | | 40 | 5506 | 5472 | 5629 | 5276 | 5620 | |
| | | 45 | 5396 | 5689 | 5257 | 5565 | 5350 | |
| | | 50 | 5542 | 5395 | 5250 | 5702 | 5630 | |
| | | 55 | 5498 | 5665 | 5688 | 5373 | 5564 | |
| | | 60 | 5483 | 5507 | 5724 | 5443 | 5478 | |
| | | 65 | 5424 | 5357 | 5371 | 5286 | 5652 | |
| | | 70 | 5471 | 5595 | 5345 | 5327 | 5329 | |
| | | 75 | 5521 | 5631 | 5353 | 5671 | 5348 | |
| | | 80 | 5476 | 5643 | 5306 | 5370 | 5579 | |
| | | 85 | 5469 | 5374 | 5662 | 5678 | 5461 | |
| | | 90 | 5569 | 5391 | 5718 | 5518 | 5609 | |
| | | 95 | 5311 | 5703 | 5277 | 5690 | 5324 | |

Type 6 Radar Waveform_2

| Download | 2 | Type 6 | 1.0 | 333.3 | 9 | 0.3333 | 300.0000000 | 4 |
|----------|---|----------------------|------|-------|------|--------|-------------|---|
| | | Frequency List (MHz) | 0 | 1 | 2 | 3 | 4 | |
| | | 0 | 5462 | 5290 | 5400 | 5267 | 5410 | |
| | | 5 | 5453 | 5591 | 5283 | 5580 | 5340 | |
| | | 10 | 5377 | 5487 | 5405 | 5584 | 5531 | |
| | | 15 | 5576 | 5418 | 5306 | 5256 | 5565 | |
| | | 20 | 5316 | 5613 | 5688 | 5333 | 5521 | |
| | | 25 | 5478 | 5651 | 5558 | 5490 | 5433 | |
| | | 30 | 5697 | 5386 | 5545 | 5330 | 5530 | |
| | | 35 | 5562 | 5628 | 5611 | 5345 | 5652 | |
| | | 40 | 5567 | 5516 | 5714 | 5703 | 5572 | |
| | | 45 | 5526 | 5403 | 5429 | 5271 | 5426 | |
| | | 50 | 5278 | 5719 | 5699 | 5609 | 5401 | |
| | | 55 | 5327 | 5279 | 5363 | 5357 | 5272 | |
| | | 60 | 5672 | 5669 | 5612 | 5366 | 5373 | |
| | | 65 | 5393 | 5581 | 5467 | 5358 | 5260 | |
| | | 70 | 5474 | 5444 | 5321 | 5355 | 5674 | |
| | | 75 | 5485 | 5375 | 5502 | 5311 | 5509 | |
| | | 80 | 5455 | 5513 | 5571 | 5543 | 5379 | |
| | | 85 | 5582 | 5696 | 5498 | 5713 | 5630 | |
| | | 90 | 5717 | 5352 | 5684 | 5398 | 5354 | |
| | | 95 | 5500 | 5573 | 5593 | 5645 | 5331 | |

Type 6 Radar Waveform_3

| Download | 3 | Type 6 | 1.0 | 333.3 | 9 | 0.3333 | 300.0000000 | 2 |
|----------|---|----------------------|------|-------|------|--------|-------------|---|
| | | Frequency List (MHz) | 0 | 1 | 2 | 3 | 4 | |
| | | 0 | 5717 | 5529 | 5336 | 5428 | 5630 | |
| | | 5 | 5495 | 5613 | 5358 | 5268 | 5547 | |
| | | 10 | 5308 | 5373 | 5446 | 5304 | 5552 | |
| | | 15 | 5541 | 5703 | 5521 | 5351 | 5448 | |
| | | 20 | 5364 | 5634 | 5257 | 5702 | 5661 | |
| | | 25 | 5599 | 5470 | 5681 | 5377 | 5592 | |
| | | 30 | 5532 | 5419 | 5654 | 5601 | 5659 | |
| | | 35 | 5365 | 5469 | 5621 | 5455 | 5403 | |
| | | 40 | 5525 | 5260 | 5505 | 5281 | 5711 | |
| | | 45 | 5632 | 5423 | 5584 | 5456 | 5694 | |
| | | 50 | 5622 | 5602 | 5329 | 5333 | 5522 | |
| | | 55 | 5589 | 5372 | 5657 | 5328 | 5401 | |
| | | 60 | 5362 | 5444 | 5667 | 5467 | 5534 | |
| | | 65 | 5322 | 5429 | 5413 | 5295 | 5270 | |
| | | 70 | 5527 | 5721 | 5574 | 5671 | 5675 | |
| | | 75 | 5314 | 5643 | 5605 | 5518 | 5483 | |
| | | 80 | 5563 | 5619 | 5302 | 5576 | 5568 | |
| | | 85 | 5263 | 5379 | 5424 | 5593 | 5678 | |
| | | 90 | 5490 | 5392 | 5517 | 5690 | 5432 | |
| | | 95 | 5512 | 5374 | 5628 | 5577 | 5679 | |

Type 6 Radar Waveform_4

| Download | 4 | Type 6 | 1.0 | 333.3 | 9 | 0.3333 | 300.0000000 | 7 |
|----------|---|----------------------|------|-------|------|--------|-------------|---|
| | | Frequency List (MHz) | 0 | 1 | 2 | 3 | 4 | |
| | | 0 | 5497 | 5293 | 5272 | 5589 | 5472 | |
| | | 5 | 5634 | 5538 | 5433 | 5431 | 5376 | |
| | | 10 | 5714 | 5637 | 5487 | 5499 | 5573 | |
| | | 15 | 5629 | 5355 | 5624 | 5396 | 5262 | |
| | | 20 | 5372 | 5325 | 5295 | 5694 | 5322 | |
| | | 25 | 5409 | 5481 | 5626 | 5574 | 5308 | |
| | | 30 | 5611 | 5719 | 5336 | 5563 | 5608 | |
| | | 35 | 5712 | 5251 | 5556 | 5439 | 5498 | |
| | | 40 | 5343 | 5443 | 5521 | 5708 | 5464 | |
| | | 45 | 5532 | 5506 | 5642 | 5509 | 5581 | |
| | | 50 | 5401 | 5303 | 5380 | 5519 | 5345 | |
| | | 55 | 5400 | 5302 | 5710 | 5562 | 5476 | |
| | | 60 | 5299 | 5530 | 5527 | 5656 | 5276 | |
| | | 65 | 5493 | 5413 | 5280 | 5271 | 5368 | |
| | | 70 | 5720 | 5565 | 5548 | 5599 | 5707 | |
| | | 75 | 5577 | 5520 | 5651 | 5273 | 5515 | |
| | | 80 | 5628 | 5661 | 5340 | 5632 | 5558 | |
| | | 85 | 5686 | 5639 | 5555 | 5282 | 5266 | |
| | | 90 | 5310 | 5546 | 5635 | 5263 | 5590 | |
| | | 95 | 5682 | 5696 | 5369 | 5496 | 5621 | |

Type 6 Radar Waveform_5

| Download | 5 | Type 6 | 1.0 | 333.3 | 9 | 0.3333 | 300.0000000 | 3 |
|----------|---|----------------------|------|-------|------|--------|-------------|---|
| | | Frequency List (MHz) | 0 | 1 | 2 | 3 | 4 | |
| | | 0 | 5277 | 5532 | 5683 | 5275 | 5692 | |
| | | 5 | 5676 | 5560 | 5508 | 5497 | 5583 | |
| | | 10 | 5548 | 5426 | 5528 | 5694 | 5594 | |
| | | 15 | 5620 | 5482 | 5252 | 5344 | 5454 | |
| | | 20 | 5380 | 5394 | 5711 | 5308 | 5607 | |
| | | 25 | 5375 | 5649 | 5612 | 5585 | 5660 | |
| | | 30 | 5713 | 5294 | 5568 | 5459 | 5383 | |
| | | 35 | 5650 | 5328 | 5522 | 5709 | 5353 | |
| | | 40 | 5434 | 5523 | 5381 | 5664 | 5705 | |
| | | 45 | 5393 | 5512 | 5589 | 5603 | 5562 | |
| | | 50 | 5371 | 5479 | 5431 | 5608 | 5643 | |
| | | 55 | 5722 | 5490 | 5673 | 5270 | 5659 | |
| | | 60 | 5601 | 5416 | 5359 | 5558 | 5695 | |
| | | 65 | 5404 | 5455 | 5360 | 5351 | 5293 | |
| | | 70 | 5693 | 5677 | 5369 | 5627 | 5707 | |
| | | 75 | 5484 | 5273 | 5445 | 5592 | 5267 | |
| | | 80 | 5339 | 5324 | 5680 | 5304 | 5502 | |
| | | 85 | 5414 | 5511 | 5410 | 5372 | 5403 | |
| | | 90 | 5378 | 5255 | 5408 | 5263 | 5642 | |
| | | 95 | 5475 | 5485 | 5640 | 5691 | 5700 | |

Type 6 Radar Waveform_6

| Download | 6 | Type 6 | 1.0 | 333.3 | 9 | 0.3333 | 300.0000000 | 1 |
|----------|---|----------------------|------|-------|------|--------|-------------|---|
| | | Frequency List (MHz) | 0 | 1 | 2 | 3 | 4 | |
| | | 0 | 5532 | 5296 | 5619 | 5436 | 5437 | |
| | | 5 | 5718 | 5485 | 5583 | 5660 | 5315 | |
| | | 10 | 5479 | 5690 | 5569 | 5414 | 5615 | |
| | | 15 | 5708 | 5512 | 5258 | 5389 | 5646 | |
| | | 20 | 5291 | 5560 | 5652 | 5300 | 5580 | |
| | | 25 | 5641 | 5598 | 5340 | 5689 | 5694 | |
| | | 30 | 5280 | 5658 | 5525 | 5674 | 5262 | |
| | | 35 | 5678 | 5314 | 5516 | 5318 | 5484 | |
| | | 40 | 5364 | 5273 | 5606 | 5319 | 5429 | |
| | | 45 | 5702 | 5322 | 5492 | 5672 | 5661 | |
| | | 50 | 5518 | 5628 | 5655 | 5482 | 5697 | |
| | | 55 | 5369 | 5666 | 5581 | 5618 | 5467 | |
| | | 60 | 5313 | 5382 | 5643 | 5717 | 5402 | |
| | | 65 | 5284 | 5644 | 5343 | 5287 | 5252 | |
| | | 70 | 5629 | 5365 | 5301 | 5680 | 5693 | |
| | | 75 | 5603 | 5453 | 5393 | 5375 | 5426 | |
| | | 80 | 5377 | 5595 | 5539 | 5387 | 5559 | |
| | | 85 | 5470 | 5522 | 5267 | 5597 | 5379 | |
| | | 90 | 5640 | 5608 | 5537 | 5330 | 5638 | |
| | | 95 | 5626 | 5373 | 5367 | 5268 | 5511 | |

Type 6 Radar Waveform_7

| Download | 7 | Type 6 | 1.0 | 333.3 | 9 | 0.3333 | 300.0000000 | 4 |
|----------|---|----------------------|------|-------|------|--------|-------------|---|
| | | Frequency List (MHz) | 0 | 1 | 2 | 3 | 4 | |
| | | 0 | 5690 | 5535 | 5652 | 5500 | 5279 | |
| | | 5 | 5382 | 5507 | 5658 | 5348 | 5619 | |
| | | 10 | 5410 | 5479 | 5707 | 5512 | 5636 | |
| | | 15 | 5321 | 5639 | 5361 | 5434 | 5363 | |
| | | 20 | 5299 | 5251 | 5389 | 5553 | 5529 | |
| | | 25 | 5450 | 5543 | 5318 | 5253 | 5322 | |
| | | 30 | 5547 | 5482 | 5414 | 5511 | 5401 | |
| | | 35 | 5453 | 5607 | 5686 | 5637 | 5278 | |
| | | 40 | 5587 | 5689 | 5257 | 5669 | 5629 | |
| | | 45 | 5472 | 5280 | 5719 | 5571 | 5523 | |
| | | 50 | 5504 | 5356 | 5533 | 5311 | 5667 | |
| | | 55 | 5513 | 5294 | 5572 | 5657 | 5590 | |
| | | 60 | 5345 | 5588 | 5344 | 5640 | 5582 | |
| | | 65 | 5593 | 5379 | 5497 | 5522 | 5335 | |
| | | 70 | 5437 | 5287 | 5683 | 5542 | 5579 | |
| | | 75 | 5625 | 5325 | 5421 | 5407 | 5524 | |
| | | 80 | 5390 | 5376 | 5606 | 5556 | 5665 | |
| | | 85 | 5563 | 5364 | 5327 | 5314 | 5722 | |
| | | 90 | 5594 | 5435 | 5428 | 5702 | 5336 | |
| | | 95 | 5374 | 5520 | 5539 | 5373 | 5271 | |

Type 6 Radar Waveform_8

| Download | 8 | Type 6 | 1.0 | 333.3 | 9 | 0.3333 | 300.000000 | 5 |
|----------|---|----------------------|------|-------|------|--------|------------|---|
| | | Frequency List (MHz) | 0 | 1 | 2 | 3 | 4 | |
| | | 0 | 5470 | 5299 | 5588 | 5661 | 5499 | |
| | | 5 | 5424 | 5432 | 5258 | 5511 | 5351 | |
| | | 10 | 5719 | 5268 | 5273 | 5707 | 5657 | |
| | | 15 | 5409 | 5291 | 5464 | 5382 | 5555 | |
| | | 20 | 5307 | 5320 | 5631 | 5381 | 5526 | |
| | | 25 | 5399 | 5649 | 5519 | 5287 | 5461 | |
| | | 30 | 5533 | 5439 | 5532 | 5663 | 5696 | |
| | | 35 | 5592 | 5698 | 5482 | 5315 | 5667 | |
| | | 40 | 5426 | 5297 | 5670 | 5434 | 5318 | |
| | | 45 | 5558 | 5355 | 5363 | 5680 | 5624 | |
| | | 50 | 5410 | 5283 | 5584 | 5497 | 5490 | |
| | | 55 | 5457 | 5372 | 5508 | 5561 | 5474 | |
| | | 60 | 5712 | 5651 | 5466 | 5294 | 5308 | |
| | | 65 | 5542 | 5415 | 5329 | 5414 | 5613 | |
| | | 70 | 5606 | 5458 | 5536 | 5564 | 5388 | |
| | | 75 | 5301 | 5500 | 5632 | 5295 | 5513 | |
| | | 80 | 5456 | 5385 | 5303 | 5290 | 5506 | |
| | | 85 | 5687 | 5645 | 5683 | 5626 | 5392 | |
| | | 90 | 5342 | 5408 | 5402 | 5556 | 5428 | |
| | | 95 | 5691 | 5644 | 5703 | 5413 | 5274 | |

Type 6 Radar Waveform_9

| Download | 9 | Type 6 | 1.0 | 333.3 | 9 | 0.3333 | 300.000000 | 5 |
|----------|---|----------------------|------|-------|------|--------|------------|---|
| | | Frequency List (MHz) | 0 | 1 | 2 | 3 | 4 | |
| | | 0 | 5250 | 5538 | 5524 | 5347 | 5341 | |
| | | 5 | 5466 | 5454 | 5333 | 5577 | 5558 | |
| | | 10 | 5650 | 5629 | 5314 | 5427 | 5678 | |
| | | 15 | 5400 | 5418 | 5567 | 5272 | 5693 | |
| | | 20 | 5486 | 5572 | 5470 | 5499 | 5683 | |
| | | 25 | 5251 | 5377 | 5623 | 5321 | 5503 | |
| | | 30 | 5422 | 5396 | 5437 | 5419 | 5634 | |
| | | 35 | 5278 | 5565 | 5362 | 5477 | 5511 | |
| | | 40 | 5315 | 5390 | 5335 | 5446 | 5263 | |
| | | 45 | 5677 | 5675 | 5708 | 5635 | 5586 | |
| | | 50 | 5313 | 5304 | 5670 | 5480 | 5562 | |
| | | 55 | 5327 | 5532 | 5603 | 5402 | 5478 | |
| | | 60 | 5483 | 5292 | 5337 | 5606 | 5491 | |
| | | 65 | 5354 | 5539 | 5684 | 5416 | 5259 | |
| | | 70 | 5311 | 5618 | 5434 | 5543 | 5641 | |
| | | 75 | 5656 | 5610 | 5369 | 5553 | 5413 | |
| | | 80 | 5459 | 5673 | 5453 | 5620 | 5350 | |
| | | 85 | 5601 | 5555 | 5599 | 5456 | 5349 | |
| | | 90 | 5557 | 5445 | 5345 | 5662 | 5497 | |
| | | 95 | 5573 | 5639 | 5682 | 5252 | 5508 | |

Type 6 Radar Waveform_10

| Download | 10 | Type 6 | 1.0 | 333.3 | 9 | 0.3333 | 300.0000000 | 3 |
|----------|----|----------------------|------|-------|------|--------|-------------|---|
| | | Frequency List (MHz) | 0 | 1 | 2 | 3 | 4 | |
| | | 0 | 5505 | 5302 | 5460 | 5508 | 5561 | |
| | | 5 | 5379 | 5408 | 5265 | 5290 | 5484 | |
| | | 10 | 5418 | 5355 | 5622 | 5699 | 5488 | |
| | | 15 | 5545 | 5670 | 5472 | 5464 | 5701 | |
| | | 20 | 5555 | 5610 | 5462 | 5474 | 5578 | |
| | | 25 | 5580 | 5252 | 5311 | 5353 | 5487 | |
| | | 30 | 5589 | 5714 | 5298 | 5405 | 5646 | |
| | | 35 | 5718 | 5592 | 5676 | 5560 | 5449 | |
| | | 40 | 5342 | 5312 | 5319 | 5315 | 5529 | |
| | | 45 | 5321 | 5255 | 5562 | 5510 | 5409 | |
| | | 50 | 5686 | 5675 | 5514 | 5723 | 5383 | |
| | | 55 | 5434 | 5655 | 5621 | 5406 | 5257 | |
| | | 60 | 5567 | 5520 | 5690 | 5283 | 5332 | |
| | | 65 | 5440 | 5390 | 5371 | 5479 | 5694 | |
| | | 70 | 5372 | 5411 | 5467 | 5410 | 5502 | |
| | | 75 | 5301 | 5278 | 5447 | 5330 | 5623 | |
| | | 80 | 5669 | 5261 | 5450 | 5397 | 5369 | |
| | | 85 | 5559 | 5313 | 5318 | 5650 | 5704 | |
| | | 90 | 5644 | 5722 | 5451 | 5544 | 5606 | |
| | | 95 | 5590 | 5538 | 5281 | 5537 | 5564 | |

Type 6 Radar Waveform_11

| Download | 11 | Type 6 | 1.0 | 333.3 | 9 | 0.3333 | 300.0000000 | 3 |
|----------|----|----------------------|------|-------|------|--------|-------------|---|
| | | Frequency List (MHz) | 0 | 1 | 2 | 3 | 4 | |
| | | 0 | 5663 | 5638 | 5396 | 5669 | 5403 | |
| | | 5 | 5647 | 5401 | 5483 | 5428 | 5594 | |
| | | 10 | 5415 | 5682 | 5342 | 5720 | 5576 | |
| | | 15 | 5575 | 5676 | 5517 | 5278 | 5709 | |
| | | 20 | 5721 | 5551 | 5445 | 5362 | 5527 | |
| | | 25 | 5308 | 5356 | 5389 | 5684 | 5297 | |
| | | 30 | 5310 | 5605 | 5363 | 5437 | 5496 | |
| | | 35 | 5442 | 5506 | 5515 | 5643 | 5387 | |
| | | 40 | 5582 | 5309 | 5723 | 5295 | 5612 | |
| | | 45 | 5282 | 5352 | 5289 | 5585 | 5262 | |
| | | 50 | 5337 | 5570 | 5571 | 5291 | 5370 | |
| | | 55 | 5440 | 5377 | 5386 | 5257 | 5465 | |
| | | 60 | 5719 | 5516 | 5704 | 5630 | 5486 | |
| | | 65 | 5329 | 5581 | 5371 | 5497 | 5444 | |
| | | 70 | 5328 | 5414 | 5316 | 5461 | 5482 | |
| | | 75 | 5421 | 5324 | 5258 | 5450 | 5690 | |
| | | 80 | 5447 | 5592 | 5272 | 5373 | 5413 | |
| | | 85 | 5388 | 5604 | 5477 | 5367 | 5412 | |
| | | 90 | 5457 | 5618 | 5593 | 5265 | 5435 | |
| | | 95 | 5543 | 5648 | 5601 | 5652 | 5613 | |

Type 6 Radar Waveform_12

| Download | 12 | Type 6 | 1.0 | 333.3 | 9 | 0.3333 | 300.000000 | 1 |
|----------|----|----------------------|------|-------|------|--------|------------|---|
| | | Frequency List (MHz) | 0 | 1 | 2 | 3 | 4 | |
| | | 0 | 5443 | 5402 | 5332 | 5355 | 5623 | |
| | | 5 | 5689 | 5326 | 5558 | 5591 | 5346 | |
| | | 10 | 5471 | 5437 | 5440 | 5266 | 5664 | |
| | | 15 | 5702 | 5304 | 5465 | 5470 | 5620 | |
| | | 20 | 5315 | 5492 | 5543 | 5418 | 5250 | |
| | | 25 | 5379 | 5511 | 5557 | 5423 | 5251 | |
| | | 30 | 5661 | 5267 | 5345 | 5515 | 5257 | |
| | | 35 | 5479 | 5684 | 5713 | 5646 | 5517 | |
| | | 40 | 5354 | 5348 | 5325 | 5306 | 5555 | |
| | | 45 | 5275 | 5695 | 5340 | 5264 | 5714 | |
| | | 50 | 5640 | 5286 | 5313 | 5378 | 5635 | |
| | | 55 | 5514 | 5662 | 5720 | 5560 | 5637 | |
| | | 60 | 5422 | 5410 | 5551 | 5342 | 5650 | |
| | | 65 | 5356 | 5435 | 5365 | 5413 | 5641 | |
| | | 70 | 5678 | 5613 | 5314 | 5362 | 5420 | |
| | | 75 | 5451 | 5541 | 5467 | 5409 | 5359 | |
| | | 80 | 5271 | 5706 | 5387 | 5444 | 5312 | |
| | | 85 | 5272 | 5718 | 5336 | 5605 | 5353 | |
| | | 90 | 5577 | 5463 | 5350 | 5686 | 5252 | |
| | | 95 | 5721 | 5648 | 5724 | 5333 | 5425 | |

Type 6 Radar Waveform_13

| Download | 13 | Type 6 | 1.0 | 333.3 | 9 | 0.3333 | 300.000000 | 3 |
|----------|----|----------------------|------|-------|------|--------|------------|---|
| | | Frequency List (MHz) | 0 | 1 | 2 | 3 | 4 | |
| | | 0 | 5698 | 5641 | 5268 | 5516 | 5465 | |
| | | 5 | 5256 | 5348 | 5633 | 5657 | 5533 | |
| | | 10 | 5655 | 5260 | 5478 | 5635 | 5287 | |
| | | 15 | 5354 | 5407 | 5510 | 5662 | 5628 | |
| | | 20 | 5481 | 5530 | 5632 | 5391 | 5328 | |
| | | 25 | 5617 | 5661 | 5457 | 5293 | 5550 | |
| | | 30 | 5699 | 5560 | 5289 | 5552 | 5618 | |
| | | 35 | 5300 | 5509 | 5324 | 5431 | 5668 | |
| | | 40 | 5263 | 5490 | 5400 | 5484 | 5255 | |
| | | 45 | 5303 | 5398 | 5317 | 5504 | 5462 | |
| | | 50 | 5364 | 5564 | 5458 | 5361 | 5375 | |
| | | 55 | 5674 | 5275 | 5456 | 5319 | 5547 | |
| | | 60 | 5587 | 5355 | 5383 | 5265 | 5693 | |
| | | 65 | 5557 | 5384 | 5401 | 5623 | 5685 | |
| | | 70 | 5517 | 5392 | 5338 | 5379 | 5323 | |
| | | 75 | 5610 | 5390 | 5514 | 5381 | 5487 | |
| | | 80 | 5543 | 5344 | 5604 | 5650 | 5299 | |
| | | 85 | 5322 | 5696 | 5609 | 5498 | 5385 | |
| | | 90 | 5267 | 5469 | 5568 | 5703 | 5330 | |
| | | 95 | 5706 | 5404 | 5666 | 5694 | 5642 | |

Type 6 Radar Waveform_14

| Download | 14 | Type 6 | 1.0 | 333.3 | 9 | 0.3333 | 300.000000 | 2 |
|----------|----|----------------------|------|-------|------|--------|------------|---|
| | | Frequency List (MHz) | 0 | 1 | 2 | 3 | 4 | |
| | | 0 | 5478 | 5405 | 5679 | 5580 | 5685 | |
| | | 5 | 5298 | 5273 | 5708 | 5345 | 5382 | |
| | | 10 | 5586 | 5621 | 5519 | 5355 | 5308 | |
| | | 15 | 5268 | 5481 | 5510 | 5555 | 5379 | |
| | | 20 | 5636 | 5550 | 5471 | 5624 | 5364 | |
| | | 25 | 5404 | 5655 | 5290 | 5491 | 5335 | |
| | | 30 | 5536 | 5656 | 5300 | 5441 | 5275 | |
| | | 35 | 5282 | 5391 | 5402 | 5477 | 5604 | |
| | | 40 | 5514 | 5676 | 5255 | 5397 | 5316 | |
| | | 45 | 5613 | 5386 | 5359 | 5370 | 5392 | |
| | | 50 | 5638 | 5415 | 5653 | 5659 | 5305 | |
| | | 55 | 5563 | 5628 | 5465 | 5668 | 5277 | |
| | | 60 | 5690 | 5566 | 5639 | 5380 | 5333 | |
| | | 65 | 5340 | 5455 | 5328 | 5284 | 5383 | |
| | | 70 | 5617 | 5716 | 5692 | 5338 | 5292 | |
| | | 75 | 5684 | 5371 | 5291 | 5365 | 5707 | |
| | | 80 | 5610 | 5341 | 5324 | 5553 | 5499 | |
| | | 85 | 5417 | 5661 | 5271 | 5680 | 5432 | |
| | | 90 | 5572 | 5321 | 5353 | 5373 | 5280 | |
| | | 95 | 5283 | 5314 | 5286 | 5389 | 5596 | |

Type 6 Radar Waveform_15

| Download | 15 | Type 6 | 1.0 | 333.3 | 9 | 0.3333 | 300.000000 | 4 |
|----------|----|----------------------|------|-------|------|--------|------------|---|
| | | Frequency List (MHz) | 0 | 1 | 2 | 3 | 4 | |
| | | 0 | 5258 | 5644 | 5615 | 5266 | 5527 | |
| | | 5 | 5437 | 5295 | 5308 | 5508 | 5569 | |
| | | 10 | 5517 | 5410 | 5657 | 5550 | 5329 | |
| | | 15 | 5356 | 5608 | 5613 | 5600 | 5571 | |
| | | 20 | 5547 | 5716 | 5412 | 5713 | 5337 | |
| | | 25 | 5670 | 5507 | 5548 | 5394 | 5525 | |
| | | 30 | 5474 | 5425 | 5418 | 5690 | 5570 | |
| | | 35 | 5421 | 5482 | 5673 | 5252 | 5443 | |
| | | 40 | 5597 | 5614 | 5495 | 5720 | 5593 | |
| | | 45 | 5566 | 5417 | 5423 | 5656 | 5646 | |
| | | 50 | 5339 | 5466 | 5267 | 5627 | 5276 | |
| | | 55 | 5582 | 5655 | 5472 | 5639 | 5330 | |
| | | 60 | 5442 | 5342 | 5522 | 5489 | 5585 | |
| | | 65 | 5581 | 5282 | 5376 | 5665 | 5598 | |
| | | 70 | 5562 | 5451 | 5369 | 5620 | 5565 | |
| | | 75 | 5668 | 5297 | 5261 | 5324 | 5352 | |
| | | 80 | 5543 | 5504 | 5621 | 5299 | 5338 | |
| | | 85 | 5519 | 5553 | 5341 | 5322 | 5609 | |
| | | 90 | 5529 | 5422 | 5403 | 5578 | 5710 | |
| | | 95 | 5298 | 5599 | 5265 | 5684 | 5409 | |

Type 6 Radar Waveform_16

| Download | 16 | Type 6 | 1.0 | 333.3 | 9 | 0.3333 | 300.0000000 | 4 |
|----------|----|----------------------|------|-------|------|--------|-------------|---|
| | | Frequency List (MHz) | 0 | 1 | 2 | 3 | 4 | |
| | | 0 | 5416 | 5408 | 5551 | 5427 | 5272 | |
| | | 5 | 5479 | 5695 | 5383 | 5671 | 5301 | |
| | | 10 | 5351 | 5674 | 5698 | 5270 | 5350 | |
| | | 15 | 5444 | 5638 | 5619 | 5548 | 5288 | |
| | | 20 | 5555 | 5310 | 5353 | 5705 | 5558 | |
| | | 25 | 5456 | 5276 | 5595 | 5462 | 5516 | |
| | | 30 | 5411 | 5570 | 5633 | 5367 | 5293 | |
| | | 35 | 5463 | 5573 | 5469 | 5405 | 5282 | |
| | | 40 | 5302 | 5552 | 5391 | 5649 | 5475 | |
| | | 45 | 5476 | 5543 | 5522 | 5515 | 5517 | |
| | | 50 | 5356 | 5305 | 5571 | 5464 | 5536 | |
| | | 55 | 5370 | 5291 | 5610 | 5459 | 5607 | |
| | | 60 | 5287 | 5451 | 5315 | 5628 | 5404 | |
| | | 65 | 5706 | 5497 | 5490 | 5365 | 5620 | |
| | | 70 | 5355 | 5623 | 5414 | 5644 | 5256 | |
| | | 75 | 5608 | 5449 | 5333 | 5320 | 5614 | |
| | | 80 | 5402 | 5358 | 5335 | 5714 | 5280 | |
| | | 85 | 5382 | 5704 | 5494 | 5568 | 5670 | |
| | | 90 | 5584 | 5292 | 5495 | 5591 | 5393 | |
| | | 95 | 5379 | 5719 | 5348 | 5407 | 5504 | |

Type 6 Radar Waveform_17

| Download | 17 | Type 6 | 1.0 | 333.3 | 9 | 0.3333 | 300.0000000 | 2 |
|----------|----|----------------------|------|-------|------|--------|-------------|---|
| | | Frequency List (MHz) | 0 | 1 | 2 | 3 | 4 | |
| | | 0 | 5671 | 5647 | 5487 | 5588 | 5589 | |
| | | 5 | 5521 | 5717 | 5458 | 5359 | 5605 | |
| | | 10 | 5282 | 5463 | 5264 | 5368 | 5371 | |
| | | 15 | 5435 | 5290 | 5722 | 5593 | 5480 | |
| | | 20 | 5563 | 5476 | 5391 | 5319 | 5283 | |
| | | 25 | 5349 | 5308 | 5479 | 5699 | 5496 | |
| | | 30 | 5558 | 5300 | 5527 | 5373 | 5616 | |
| | | 35 | 5602 | 5286 | 5362 | 5659 | 5596 | |
| | | 40 | 5385 | 5393 | 5403 | 5388 | 5481 | |
| | | 45 | 5553 | 5257 | 5436 | 5529 | 5333 | |
| | | 50 | 5398 | 5691 | 5568 | 5542 | 5603 | |
| | | 55 | 5418 | 5652 | 5490 | 5585 | 5581 | |
| | | 60 | 5297 | 5707 | 5574 | 5655 | 5351 | |
| | | 65 | 5285 | 5546 | 5692 | 5438 | 5723 | |
| | | 70 | 5641 | 5620 | 5690 | 5577 | 5472 | |
| | | 75 | 5513 | 5314 | 5572 | 5724 | 5658 | |
| | | 80 | 5627 | 5421 | 5332 | 5434 | 5597 | |
| | | 85 | 5345 | 5619 | 5443 | 5452 | 5590 | |
| | | 90 | 5326 | 5377 | 5428 | 5448 | 5363 | |
| | | 95 | 5395 | 5601 | 5451 | 5502 | 5622 | |

Type 6 Radar Waveform_18

| Download | 18 | Type 6 | 1.0 | 333.3 | 9 | 0.3333 | 300.000000 | 2 |
|----------|----|----------------------|------|-------|------|--------|------------|---|
| | | Frequency List (MHz) | 0 | 1 | 2 | 3 | 4 | |
| | | 0 | 5451 | 5411 | 5423 | 5274 | 5334 | |
| | | 5 | 5563 | 5642 | 5533 | 5425 | 5337 | |
| | | 10 | 5688 | 5252 | 5305 | 5392 | 5523 | |
| | | 15 | 5417 | 5350 | 5638 | 5672 | 5474 | |
| | | 20 | 5332 | 5311 | 5256 | 5712 | 5257 | |
| | | 25 | 5585 | 5328 | 5530 | 5697 | 5664 | |
| | | 30 | 5484 | 5588 | 5390 | 5266 | 5377 | |
| | | 35 | 5633 | 5333 | 5670 | 5532 | 5468 | |
| | | 40 | 5331 | 5643 | 5482 | 5410 | 5340 | |
| | | 45 | 5494 | 5485 | 5695 | 5619 | 5631 | |
| | | 50 | 5329 | 5362 | 5365 | 5444 | 5653 | |
| | | 55 | 5404 | 5455 | 5620 | 5462 | 5590 | |
| | | 60 | 5539 | 5520 | 5428 | 5604 | 5387 | |
| | | 65 | 5652 | 5349 | 5289 | 5424 | 5251 | |
| | | 70 | 5490 | 5596 | 5649 | 5449 | 5592 | |
| | | 75 | 5559 | 5295 | 5282 | 5439 | 5316 | |
| | | 80 | 5707 | 5359 | 5536 | 5405 | 5613 | |
| | | 85 | 5327 | 5573 | 5691 | 5716 | 5617 | |
| | | 90 | 5693 | 5263 | 5259 | 5445 | 5503 | |
| | | 95 | 5347 | 5293 | 5580 | 5554 | 5597 | |

Type 6 Radar Waveform_19

| Download | 19 | Type 6 | 1.0 | 333.3 | 9 | 0.3333 | 300.000000 | 1 |
|----------|----|----------------------|------|-------|------|--------|------------|---|
| | | Frequency List (MHz) | 0 | 1 | 2 | 3 | 4 | |
| | | 0 | 5706 | 5650 | 5359 | 5435 | 5651 | |
| | | 5 | 5702 | 5664 | 5608 | 5588 | 5544 | |
| | | 10 | 5522 | 5613 | 5346 | 5283 | 5413 | |
| | | 15 | 5611 | 5453 | 5586 | 5486 | 5482 | |
| | | 20 | 5711 | 5273 | 5400 | 5704 | 5600 | |
| | | 25 | 5584 | 5313 | 5432 | 5564 | 5264 | |
| | | 30 | 5441 | 5542 | 5606 | 5405 | 5468 | |
| | | 35 | 5429 | 5371 | 5648 | 5269 | 5408 | |
| | | 40 | 5479 | 5717 | 5513 | 5423 | 5552 | |
| | | 45 | 5538 | 5485 | 5528 | 5568 | 5670 | |
| | | 50 | 5720 | 5627 | 5684 | 5456 | 5398 | |
| | | 55 | 5368 | 5601 | 5426 | 5274 | 5694 | |
| | | 60 | 5422 | 5365 | 5466 | 5629 | 5553 | |
| | | 65 | 5326 | 5447 | 5458 | 5410 | 5351 | |
| | | 70 | 5339 | 5572 | 5418 | 5712 | 5276 | |
| | | 75 | 5504 | 5372 | 5695 | 5383 | 5547 | |
| | | 80 | 5446 | 5262 | 5378 | 5708 | 5624 | |
| | | 85 | 5464 | 5439 | 5307 | 5699 | 5297 | |
| | | 90 | 5519 | 5462 | 5558 | 5428 | 5666 | |
| | | 95 | 5560 | 5623 | 5692 | 5612 | 5546 | |

Type 6 Radar Waveform_20

| Download | 20 | Type 6 | 1.0 | 333.3 | 9 | 0.3333 | 300.0000000 | 5 |
|----------|----|----------------------|------|-------|------|--------|-------------|---|
| | | Frequency List (MHz) | 0 | 1 | 2 | 3 | 4 | |
| | | 0 | 5389 | 5414 | 5295 | 5596 | 5396 | |
| | | 5 | 5269 | 5589 | 5683 | 5276 | 5373 | |
| | | 10 | 5453 | 5402 | 5387 | 5478 | 5434 | |
| | | 15 | 5699 | 5671 | 5556 | 5631 | 5678 | |
| | | 20 | 5490 | 5311 | 5392 | 5677 | 5391 | |
| | | 25 | 5436 | 5516 | 5633 | 5598 | 5306 | |
| | | 30 | 5539 | 5398 | 5446 | 5316 | 5329 | |
| | | 35 | 5447 | 5559 | 5700 | 5639 | 5498 | |
| | | 40 | 5685 | 5256 | 5682 | 5551 | 5476 | |
| | | 45 | 5646 | 5493 | 5506 | 5610 | 5591 | |
| | | 50 | 5372 | 5404 | 5721 | 5334 | 5450 | |
| | | 55 | 5628 | 5644 | 5352 | 5558 | 5420 | |
| | | 60 | 5397 | 5403 | 5317 | 5351 | 5666 | |
| | | 65 | 5509 | 5355 | 5502 | 5362 | 5581 | |
| | | 70 | 5339 | 5430 | 5530 | 5354 | 5663 | |
| | | 75 | 5451 | 5567 | 5290 | 5357 | 5370 | |
| | | 80 | 5281 | 5482 | 5547 | 5707 | 5701 | |
| | | 85 | 5641 | 5640 | 5695 | 5428 | 5425 | |
| | | 90 | 5635 | 5578 | 5712 | 5637 | 5472 | |
| | | 95 | 5705 | 5709 | 5401 | 5358 | 5576 | |

Type 6 Radar Waveform_21

| Download | 21 | Type 6 | 1.0 | 333.3 | 9 | 0.3333 | 300.0000000 | 3 |
|----------|----|----------------------|------|-------|------|--------|-------------|---|
| | | Frequency List (MHz) | 0 | 1 | 2 | 3 | 4 | |
| | | 0 | 5644 | 5653 | 5706 | 5282 | 5713 | |
| | | 5 | 5311 | 5611 | 5283 | 5439 | 5580 | |
| | | 10 | 5287 | 5666 | 5428 | 5673 | 5455 | |
| | | 15 | 5690 | 5701 | 5562 | 5676 | 5395 | |
| | | 20 | 5401 | 5471 | 5252 | 5481 | 5650 | |
| | | 25 | 5279 | 5385 | 5719 | 5262 | 5632 | |
| | | 30 | 5445 | 5355 | 5661 | 5468 | 5624 | |
| | | 35 | 5586 | 5593 | 5317 | 5509 | 5524 | |
| | | 40 | 5339 | 5620 | 5316 | 5473 | 5575 | |
| | | 45 | 5376 | 5589 | 5571 | 5637 | 5280 | |
| | | 50 | 5297 | 5520 | 5273 | 5475 | 5357 | |
| | | 55 | 5306 | 5714 | 5368 | 5532 | 5482 | |
| | | 60 | 5681 | 5658 | 5451 | 5398 | 5609 | |
| | | 65 | 5708 | 5699 | 5479 | 5454 | 5415 | |
| | | 70 | 5427 | 5526 | 5259 | 5477 | 5416 | |
| | | 75 | 5335 | 5533 | 5495 | 5257 | 5711 | |
| | | 80 | 5295 | 5698 | 5361 | 5640 | 5634 | |
| | | 85 | 5391 | 5503 | 5629 | 5485 | 5457 | |
| | | 90 | 5268 | 5467 | 5668 | 5396 | 5462 | |
| | | 95 | 5323 | 5291 | 5641 | 5310 | 5655 | |

Type 6 Radar Waveform_22

| Download | 22 | Type 6 | 1.0 | 333.3 | 9 | 0.3333 | 300.000000 | 2 |
|----------|----|----------------------|------|-------|------|--------|------------|---|
| | | Frequency List (MHz) | 0 | 1 | 2 | 3 | 4 | |
| | | 0 | 5424 | 5417 | 5642 | 5346 | 5458 | |
| | | 5 | 5353 | 5633 | 5358 | 5505 | 5312 | |
| | | 10 | 5693 | 5455 | 5469 | 5296 | 5476 | |
| | | 15 | 5303 | 5665 | 5721 | 5587 | 5409 | |
| | | 20 | 5637 | 5668 | 5473 | 5623 | 5545 | |
| | | 25 | 5712 | 5447 | 5366 | 5666 | 5487 | |
| | | 30 | 5414 | 5401 | 5717 | 5444 | 5250 | |
| | | 35 | 5266 | 5389 | 5567 | 5423 | 5363 | |
| | | 40 | 5422 | 5558 | 5556 | 5470 | 5407 | |
| | | 45 | 5356 | 5672 | 5629 | 5697 | 5524 | |
| | | 50 | 5534 | 5621 | 5348 | 5609 | 5474 | |
| | | 55 | 5419 | 5260 | 5463 | 5436 | 5661 | |
| | | 60 | 5647 | 5626 | 5490 | 5415 | 5379 | |
| | | 65 | 5400 | 5337 | 5404 | 5465 | 5457 | |
| | | 70 | 5264 | 5403 | 5388 | 5703 | 5500 | |
| | | 75 | 5559 | 5316 | 5310 | 5605 | 5513 | |
| | | 80 | 5695 | 5543 | 5451 | 5468 | 5583 | |
| | | 85 | 5636 | 5655 | 5327 | 5680 | 5479 | |
| | | 90 | 5610 | 5723 | 5477 | 5302 | 5394 | |
| | | 95 | 5364 | 5405 | 5392 | 5597 | 5582 | |

Type 6 Radar Waveform_23

| Download | 23 | Type 6 | 1.0 | 333.3 | 9 | 0.3333 | 300.000000 | 6 |
|----------|----|----------------------|------|-------|------|--------|------------|---|
| | | Frequency List (MHz) | 0 | 1 | 2 | 3 | 4 | |
| | | 0 | 5679 | 5656 | 5578 | 5507 | 5300 | |
| | | 5 | 5492 | 5558 | 5433 | 5668 | 5616 | |
| | | 10 | 5624 | 5719 | 5607 | 5491 | 5497 | |
| | | 15 | 5391 | 5480 | 5293 | 5669 | 5304 | |
| | | 20 | 5417 | 5706 | 5562 | 5596 | 5661 | |
| | | 25 | 5553 | 5470 | 5700 | 5529 | 5303 | |
| | | 30 | 5269 | 5519 | 5394 | 5642 | 5292 | |
| | | 35 | 5454 | 5660 | 5720 | 5337 | 5299 | |
| | | 40 | 5602 | 5496 | 5699 | 5564 | 5336 | |
| | | 45 | 5280 | 5687 | 5275 | 5314 | 5410 | |
| | | 50 | 5322 | 5399 | 5698 | 5297 | 5266 | |
| | | 55 | 5258 | 5592 | 5653 | 5255 | 5688 | |
| | | 60 | 5315 | 5571 | 5338 | 5444 | 5677 | |
| | | 65 | 5349 | 5373 | 5358 | 5296 | 5692 | |
| | | 70 | 5465 | 5451 | 5557 | 5588 | 5379 | |
| | | 75 | 5347 | 5575 | 5620 | 5605 | 5618 | |
| | | 80 | 5294 | 5467 | 5518 | 5446 | 5318 | |
| | | 85 | 5414 | 5429 | 5634 | 5409 | 5475 | |
| | | 90 | 5345 | 5714 | 5328 | 5627 | 5661 | |
| | | 95 | 5461 | 5355 | 5659 | 5500 | 5604 | |

Type 6 Radar Waveform_24

| Download | 24 | Type 6 | 1.0 | 333.3 | 9 | 0.3333 | 300.000000 | 5 |
|----------|----|----------------------|------|-------|------|--------|------------|---|
| | | Frequency List (MHz) | 0 | 1 | 2 | 3 | 4 | |
| | | 0 | 5459 | 5420 | 5514 | 5668 | 5520 | |
| | | 5 | 5534 | 5580 | 5508 | 5356 | 5348 | |
| | | 10 | 5458 | 5605 | 5648 | 5686 | 5518 | |
| | | 15 | 5479 | 5607 | 5396 | 5714 | 5496 | |
| | | 20 | 5328 | 5397 | 5647 | 5554 | 5589 | |
| | | 25 | 5699 | 5513 | 5281 | 5671 | 5259 | |
| | | 30 | 5289 | 5701 | 5643 | 5482 | 5431 | |
| | | 35 | 5545 | 5553 | 5398 | 5613 | 5685 | |
| | | 40 | 5337 | 5464 | 5561 | 5316 | 5363 | |
| | | 45 | 5676 | 5286 | 5498 | 5450 | 5312 | |
| | | 50 | 5595 | 5446 | 5546 | 5271 | 5549 | |
| | | 55 | 5659 | 5347 | 5502 | 5516 | 5629 | |
| | | 60 | 5639 | 5390 | 5403 | 5296 | 5685 | |
| | | 65 | 5566 | 5495 | 5537 | 5437 | 5560 | |
| | | 70 | 5355 | 5306 | 5544 | 5265 | 5273 | |
| | | 75 | 5278 | 5717 | 5253 | 5550 | 5631 | |
| | | 80 | 5581 | 5592 | 5568 | 5257 | 5474 | |
| | | 85 | 5524 | 5301 | 5588 | 5657 | 5673 | |
| | | 90 | 5351 | 5651 | 5697 | 5266 | 5261 | |
| | | 95 | 5445 | 5638 | 5600 | 5285 | 5341 | |

Type 6 Radar Waveform_25

| Download | 25 | Type 6 | 1.0 | 333.3 | 9 | 0.3333 | 300.000000 | 6 |
|----------|----|----------------------|------|-------|------|--------|------------|---|
| | | Frequency List (MHz) | 0 | 1 | 2 | 3 | 4 | |
| | | 0 | 5617 | 5659 | 5450 | 5354 | 5362 | |
| | | 5 | 5576 | 5505 | 5583 | 5519 | 5555 | |
| | | 10 | 5389 | 5394 | 5689 | 5406 | 5539 | |
| | | 15 | 5470 | 5259 | 5499 | 5284 | 5688 | |
| | | 20 | 5336 | 5466 | 5588 | 5643 | 5542 | |
| | | 25 | 5587 | 5365 | 5484 | 5300 | 5293 | |
| | | 30 | 5710 | 5653 | 5658 | 5474 | 5320 | |
| | | 35 | 5660 | 5570 | 5636 | 5349 | 5648 | |
| | | 40 | 5262 | 5452 | 5275 | 5704 | 5558 | |
| | | 45 | 5572 | 5296 | 5446 | 5706 | 5637 | |
| | | 50 | 5577 | 5501 | 5401 | 5418 | 5532 | |
| | | 55 | 5537 | 5500 | 5461 | 5368 | 5630 | |
| | | 60 | 5476 | 5667 | 5465 | 5701 | 5722 | |
| | | 65 | 5348 | 5400 | 5458 | 5298 | 5520 | |
| | | 70 | 5563 | 5286 | 5331 | 5265 | 5416 | |
| | | 75 | 5385 | 5319 | 5494 | 5363 | 5644 | |
| | | 80 | 5589 | 5288 | 5574 | 5437 | 5716 | |
| | | 85 | 5639 | 5430 | 5493 | 5347 | 5357 | |
| | | 90 | 5685 | 5567 | 5709 | 5283 | 5316 | |
| | | 95 | 5526 | 5626 | 5703 | 5580 | 5593 | |

Type 6 Radar Waveform_26

| Download | 26 | Type 6 | 1.0 | 333.3 | 9 | 0.3333 | 300.0000000 | 6 |
|----------|----|----------------------|------|-------|------|--------|-------------|---|
| | | Frequency List (MHz) | 0 | 1 | 2 | 3 | 4 | |
| | | 0 | 5397 | 5423 | 5386 | 5515 | 5582 | |
| | | 5 | 5618 | 5527 | 5658 | 5585 | 5287 | |
| | | 10 | 5320 | 5255 | 5601 | 5560 | 5558 | |
| | | 15 | 5289 | 5505 | 5329 | 5405 | 5344 | |
| | | 20 | 5632 | 5626 | 5635 | 5378 | 5314 | |
| | | 25 | 5687 | 5404 | 5327 | 5277 | 5542 | |
| | | 30 | 5615 | 5689 | 5589 | 5480 | 5709 | |
| | | 35 | 5252 | 5620 | 5326 | 5651 | 5291 | |
| | | 40 | 5376 | 5688 | 5469 | 5555 | 5501 | |
| | | 45 | 5276 | 5529 | 5337 | 5353 | 5416 | |
| | | 50 | 5278 | 5552 | 5587 | 5619 | 5476 | |
| | | 55 | 5250 | 5454 | 5565 | 5504 | 5605 | |
| | | 60 | 5357 | 5503 | 5390 | 5388 | 5379 | |
| | | 65 | 5427 | 5671 | 5384 | 5707 | 5253 | |
| | | 70 | 5576 | 5303 | 5506 | 5663 | 5513 | |
| | | 75 | 5685 | 5699 | 5385 | 5462 | 5715 | |
| | | 80 | 5271 | 5484 | 5586 | 5483 | 5400 | |
| | | 85 | 5336 | 5512 | 5593 | 5678 | 5691 | |
| | | 90 | 5363 | 5719 | 5352 | 5343 | 5300 | |
| | | 95 | 5371 | 5510 | 5524 | 5499 | 5331 | |

Type 6 Radar Waveform_27

| Download | 27 | Type 6 | 1.0 | 333.3 | 9 | 0.3333 | 300.0000000 | 4 |
|----------|----|----------------------|------|-------|------|--------|-------------|---|
| | | Frequency List (MHz) | 0 | 1 | 2 | 3 | 4 | |
| | | 0 | 5652 | 5284 | 5322 | 5676 | 5424 | |
| | | 5 | 5282 | 5452 | 5258 | 5273 | 5591 | |
| | | 10 | 5629 | 5447 | 5296 | 5699 | 5581 | |
| | | 15 | 5646 | 5416 | 5608 | 5277 | 5694 | |
| | | 20 | 5255 | 5701 | 5567 | 5724 | 5488 | |
| | | 25 | 5266 | 5641 | 5415 | 5508 | 5361 | |
| | | 30 | 5528 | 5572 | 5332 | 5721 | 5678 | |
| | | 35 | 5276 | 5343 | 5479 | 5662 | 5702 | |
| | | 40 | 5556 | 5626 | 5612 | 5552 | 5333 | |
| | | 45 | 5634 | 5250 | 5390 | 5618 | 5292 | |
| | | 50 | 5454 | 5603 | 5442 | 5323 | 5438 | |
| | | 55 | 5408 | 5366 | 5384 | 5475 | 5259 | |
| | | 60 | 5522 | 5448 | 5697 | 5689 | 5325 | |
| | | 65 | 5628 | 5620 | 5523 | 5375 | 5492 | |
| | | 70 | 5666 | 5362 | 5661 | 5658 | 5257 | |
| | | 75 | 5696 | 5486 | 5368 | 5551 | 5392 | |
| | | 80 | 5583 | 5252 | 5355 | 5460 | 5477 | |
| | | 85 | 5547 | 5451 | 5511 | 5677 | 5466 | |
| | | 90 | 5656 | 5709 | 5317 | 5426 | 5494 | |
| | | 95 | 5422 | 5478 | 5434 | 5501 | 5308 | |

Type 6 Radar Waveform_28

| Download | 28 | Type 6 | 1.0 | 333.3 | 9 | 0.3333 | 300.0000000 | 5 |
|----------|----|----------------------|------|-------|------|--------|-------------|---|
| | | Frequency List (MHz) | 0 | 1 | 2 | 3 | 4 | |
| | | 0 | 5432 | 5523 | 5258 | 5362 | 5644 | |
| | | 5 | 5324 | 5474 | 5333 | 5436 | 5323 | |
| | | 10 | 5560 | 5711 | 5337 | 5419 | 5602 | |
| | | 15 | 5259 | 5543 | 5322 | 5411 | 5263 | |
| | | 20 | 5392 | 5508 | 5716 | 5461 | 5629 | |
| | | 25 | 5590 | 5521 | 5612 | 5395 | 5458 | |
| | | 30 | 5417 | 5529 | 5547 | 5495 | 5498 | |
| | | 35 | 5415 | 5531 | 5309 | 5254 | 5576 | |
| | | 40 | 5541 | 5639 | 5564 | 5377 | 5646 | |
| | | 45 | 5262 | 5614 | 5695 | 5308 | 5443 | |
| | | 50 | 5505 | 5643 | 5630 | 5654 | 5290 | |
| | | 55 | 5265 | 5267 | 5626 | 5556 | 5678 | |
| | | 60 | 5446 | 5388 | 5687 | 5393 | 5271 | |
| | | 65 | 5451 | 5569 | 5359 | 5274 | 5544 | |
| | | 70 | 5478 | 5291 | 5686 | 5637 | 5617 | |
| | | 75 | 5701 | 5648 | 5651 | 5677 | 5300 | |
| | | 80 | 5596 | 5624 | 5715 | 5455 | 5580 | |
| | | 85 | 5672 | 5423 | 5720 | 5345 | 5598 | |
| | | 90 | 5699 | 5709 | 5367 | 5472 | 5690 | |
| | | 95 | 5494 | 5464 | 5431 | 5481 | 5575 | |

Type 6 Radar Waveform_29

| Download | 29 | Type 6 | 1.0 | 333.3 | 9 | 0.3333 | 300.0000000 | 4 |
|----------|----|----------------------|------|-------|------|--------|-------------|---|
| | | Frequency List (MHz) | 0 | 1 | 2 | 3 | 4 | |
| | | 0 | 5590 | 5287 | 5669 | 5426 | 5486 | |
| | | 5 | 5366 | 5399 | 5408 | 5599 | 5530 | |
| | | 10 | 5491 | 5597 | 5378 | 5614 | 5623 | |
| | | 15 | 5250 | 5670 | 5339 | 5367 | 5603 | |
| | | 20 | 5271 | 5558 | 5449 | 5330 | 5434 | |
| | | 25 | 5420 | 5442 | 5724 | 5338 | 5429 | |
| | | 30 | 5500 | 5306 | 5647 | 5318 | 5554 | |
| | | 35 | 5622 | 5580 | 5407 | 5490 | 5380 | |
| | | 40 | 5722 | 5502 | 5617 | 5643 | 5569 | |
| | | 45 | 5594 | 5303 | 5496 | 5295 | 5519 | |
| | | 50 | 5331 | 5705 | 5379 | 5563 | 5589 | |
| | | 55 | 5316 | 5400 | 5417 | 5377 | 5435 | |
| | | 60 | 5361 | 5438 | 5692 | 5652 | 5518 | |
| | | 65 | 5298 | 5484 | 5685 | 5363 | 5616 | |
| | | 70 | 5561 | 5294 | 5535 | 5613 | 5576 | |
| | | 75 | 5573 | 5293 | 5319 | 5280 | 5455 | |
| | | 80 | 5609 | 5405 | 5404 | 5480 | 5690 | |
| | | 85 | 5533 | 5611 | 5483 | 5340 | 5310 | |
| | | 90 | 5552 | 5472 | 5529 | 5532 | 5478 | |
| | | 95 | 5627 | 5376 | 5448 | 5536 | 5559 | |

| | | | |
|-----------|---|---------------|------------|
| Test Site | SIP-TR2 | Test Engineer | Alisa Deng |
| Test Date | 2023-07-04 | | |
| Test Item | Radar Statistical Performance Check (802.11ax-HE40 – 5510MHz) | | |

| Radar Type 1-4 - Radar Statistical Performance | | | | | | | | |
|--|-----------------|-------------------------|-----------------|-------------------------|-----------------|-------------------------|-----------------|-------------------------|
| Trial | Radar Type 1 | | Radar Type 2 | | Radar Type 3 | | Radar Type 4 | |
| | Frequency (MHz) | 1=detect 0=no detect | Frequency (MHz) | 1=detect 0=no detect | Frequency (MHz) | 1=detect 0=no detect | Frequency (MHz) | 1=detect 0=no detect |
| 0 | 5523 | 1 | 5522 | 1 | 5490 | 1 | 5504 | 1 |
| 1 | 5504 | 1 | 5507 | 1 | 5496 | 1 | 5519 | 1 |
| 2 | 5519 | 1 | 5517 | 1 | 5509 | 1 | 5506 | 1 |
| 3 | 5493 | 1 | 5510 | 1 | 5499 | 1 | 5495 | 1 |
| 4 | 5522 | 1 | 5496 | 1 | 5491 | 1 | 5521 | 1 |
| 5 | 5530 | 1 | 5490 | 1 | 5527 | 1 | 5494 | 1 |
| 6 | 5507 | 1 | 5509 | 1 | 5502 | 1 | 5515 | 1 |
| 7 | 5523 | 1 | 5528 | 1 | 5499 | 1 | 5503 | 1 |
| 8 | 5511 | 1 | 5497 | 1 | 5518 | 1 | 5506 | 1 |
| 9 | 5510 | 1 | 5520 | 1 | 5530 | 1 | 5490 | 1 |
| 10 | 5497 | 1 | 5524 | 1 | 5516 | 1 | 5517 | 0 |
| 11 | 5518 | 1 | 5513 | 1 | 5493 | 1 | 5506 | 1 |
| 12 | 5498 | 1 | 5510 | 1 | 5495 | 1 | 5495 | 1 |
| 13 | 5530 | 1 | 5524 | 1 | 5494 | 1 | 5511 | 0 |
| 14 | 5490 | 1 | 5506 | 1 | 5514 | 0 | 5524 | 1 |
| 15 | 5519 | 1 | 5513 | 1 | 5491 | 1 | 5491 | 1 |
| 16 | 5504 | 1 | 5500 | 1 | 5492 | 1 | 5519 | 1 |
| 17 | 5515 | 1 | 5495 | 1 | 5505 | 1 | 5530 | 1 |
| 18 | 5527 | 1 | 5493 | 1 | 5527 | 1 | 5515 | 1 |
| 19 | 5502 | 1 | 5520 | 1 | 5491 | 1 | 5497 | 1 |
| 20 | 5524 | 1 | 5521 | 1 | 5500 | 1 | 5527 | 0 |
| 21 | 5527 | 1 | 5511 | 1 | 5504 | 1 | 5510 | 1 |
| 22 | 5516 | 1 | 5518 | 1 | 5503 | 1 | 5507 | 0 |
| 23 | 5511 | 1 | 5530 | 1 | 5510 | 1 | 5505 | 0 |
| 24 | 5512 | 1 | 5517 | 1 | 5502 | 1 | 5512 | 1 |
| 25 | 5493 | 1 | 5510 | 1 | 5505 | 0 | 5502 | 1 |
| 26 | 5494 | 1 | 5512 | 1 | 5525 | 1 | 5525 | 0 |

| Radar Type 1-4 - Radar Statistical Performance | | | | | | | | |
|--|-----------------|-------------------------|-----------------|-------------------------|-----------------|-------------------------|-----------------|-------------------------|
| Trial | Radar Type 1 | | Radar Type 2 | | Radar Type 3 | | Radar Type 4 | |
| | Frequency (MHz) | 1=detect 0=no detect | Frequency (MHz) | 1=detect 0=no detect | Frequency (MHz) | 1=detect 0=no detect | Frequency (MHz) | 1=detect 0=no detect |
| 27 | 5498 | 1 | 5510 | 1 | 5514 | 1 | 5512 | 1 |
| 28 | 5513 | 1 | 5505 | 1 | 5507 | 1 | 5530 | 1 |
| 29 | 5526 | 1 | 5500 | 1 | 5528 | 0 | 5521 | 1 |
| Probability: | 100.0% | | 100.0% | | 90.0% | | 80.0% | |
| Aggregate: | 92.5% (>80%) | | | | | | | |

| Radar Type 1 - Radar Waveform | | | | | | | Radar Type 2 - Radar Waveform | | | | | | |
|-------------------------------|----------|------------|------------------|----------|------------------|----------------------|-------------------------------|----------|------------|------------------|----------|------------------|----------------------|
| | Trial Id | Radar Type | Pulse Width (us) | PRI (us) | Number of Pulses | Waveform Length (us) | | Trial Id | Radar Type | Pulse Width (us) | PRI (us) | Number of Pulses | Waveform Length (us) |
| Download | 0 | Type 1 | 1.0 | 658.0 | 81 | 53298.0 | Download | 0 | Type 2 | 3.3 | 186.0 | 27 | 5022.0 |
| Download | 1 | Type 1 | 1.0 | 798.0 | 67 | 53466.0 | Download | 1 | Type 2 | 3.9 | 167.0 | 28 | 4676.0 |
| Download | 2 | Type 1 | 1.0 | 778.0 | 66 | 52904.0 | Download | 2 | Type 2 | 1.2 | 199.0 | 23 | 4577.0 |
| Download | 3 | Type 1 | 1.0 | 818.0 | 65 | 53170.0 | Download | 3 | Type 2 | 1.5 | 205.0 | 24 | 4920.0 |
| Download | 4 | Type 1 | 1.0 | 3066.0 | 18 | 55188.0 | Download | 4 | Type 2 | 4.8 | 190.0 | 29 | 5510.0 |
| Download | 5 | Type 1 | 1.0 | 838.0 | 63 | 52794.0 | Download | 5 | Type 2 | 4.3 | 203.0 | 28 | 5684.0 |
| Download | 6 | Type 1 | 1.0 | 938.0 | 57 | 53466.0 | Download | 6 | Type 2 | 2.6 | 222.0 | 25 | 5550.0 |
| Download | 7 | Type 1 | 1.0 | 698.0 | 76 | 53048.0 | Download | 7 | Type 2 | 2.0 | 221.0 | 24 | 5304.0 |
| Download | 8 | Type 1 | 1.0 | 518.0 | 102 | 52636.0 | Download | 8 | Type 2 | 4.7 | 218.0 | 29 | 6322.0 |
| Download | 9 | Type 1 | 1.0 | 618.0 | 86 | 53148.0 | Download | 9 | Type 2 | 1.6 | 228.0 | 24 | 5472.0 |
| Download | 10 | Type 1 | 1.0 | 538.0 | 99 | 53262.0 | Download | 10 | Type 2 | 2.3 | 155.0 | 25 | 3875.0 |
| Download | 11 | Type 1 | 1.0 | 578.0 | 92 | 53176.0 | Download | 11 | Type 2 | 3.2 | 197.0 | 26 | 5122.0 |
| Download | 12 | Type 1 | 1.0 | 558.0 | 95 | 53010.0 | Download | 12 | Type 2 | 4.1 | 226.0 | 28 | 6328.0 |
| Download | 13 | Type 1 | 1.0 | 918.0 | 58 | 53244.0 | Download | 13 | Type 2 | 3.6 | 164.0 | 27 | 4428.0 |
| Download | 14 | Type 1 | 1.0 | 678.0 | 78 | 52884.0 | Download | 14 | Type 2 | 1.4 | 185.0 | 23 | 4255.0 |
| Download | 15 | Type 1 | 1.0 | 708.0 | 75 | 53100.0 | Download | 15 | Type 2 | 5.0 | 172.0 | 29 | 4988.0 |
| Download | 16 | Type 1 | 1.0 | 2147.0 | 25 | 53675.0 | Download | 16 | Type 2 | 4.6 | 209.0 | 29 | 6061.0 |
| Download | 17 | Type 1 | 1.0 | 2420.0 | 22 | 53240.0 | Download | 17 | Type 2 | 4.3 | 166.0 | 28 | 4648.0 |
| Download | 18 | Type 1 | 1.0 | 914.0 | 58 | 53012.0 | Download | 18 | Type 2 | 4.6 | 225.0 | 29 | 6525.0 |
| Download | 19 | Type 1 | 1.0 | 1182.0 | 45 | 53190.0 | Download | 19 | Type 2 | 2.6 | 154.0 | 25 | 3850.0 |
| Download | 20 | Type 1 | 1.0 | 618.0 | 86 | 53148.0 | Download | 20 | Type 2 | 1.5 | 210.0 | 23 | 4830.0 |
| Download | 21 | Type 1 | 1.0 | 1404.0 | 38 | 53352.0 | Download | 21 | Type 2 | 4.2 | 175.0 | 26 | 4900.0 |
| Download | 22 | Type 1 | 1.0 | 2305.0 | 23 | 53015.0 | Download | 22 | Type 2 | 5.0 | 196.0 | 29 | 5684.0 |
| Download | 23 | Type 1 | 1.0 | 1299.0 | 41 | 53259.0 | Download | 23 | Type 2 | 1.8 | 227.0 | 24 | 5448.0 |
| Download | 24 | Type 1 | 1.0 | 1602.0 | 33 | 52866.0 | Download | 24 | Type 2 | 5.0 | 230.0 | 29 | 6670.0 |
| Download | 25 | Type 1 | 1.0 | 659.0 | 81 | 53379.0 | Download | 25 | Type 2 | 4.1 | 208.0 | 28 | 5824.0 |
| Download | 26 | Type 1 | 1.0 | 520.0 | 102 | 53040.0 | Download | 26 | Type 2 | 1.4 | 151.0 | 23 | 3473.0 |
| Download | 27 | Type 1 | 1.0 | 667.0 | 80 | 53360.0 | Download | 27 | Type 2 | 3.5 | 152.0 | 27 | 4104.0 |
| Download | 28 | Type 1 | 1.0 | 1807.0 | 30 | 54210.0 | Download | 28 | Type 2 | 3.8 | 158.0 | 27 | 4266.0 |
| Download | 29 | Type 1 | 1.0 | 2712.0 | 20 | 54240.0 | Download | 29 | Type 2 | 1.7 | 156.0 | 24 | 3744.0 |



| Radar Type 3 - Radar Waveform | | | | | | | Radar Type 4 - Radar Waveform | | | | | | |
|-------------------------------|----------|------------|------------------|----------|------------------|----------------------|-------------------------------|----------|------------|------------------|----------|------------------|----------------------|
| | Trial Id | Radar Type | Pulse Width (us) | PRI (us) | Number of Pulses | Waveform Length (us) | | Trial Id | Radar Type | Pulse Width (us) | PRI (us) | Number of Pulses | Waveform Length (us) |
| Download | 0 | Type 3 | 8.3 | 321.0 | 17 | 5457.0 | Download | 0 | Type 4 | 16.2 | 321.0 | 14 | 4494.0 |
| Download | 1 | Type 3 | 8.9 | 369.0 | 18 | 6642.0 | Download | 1 | Type 4 | 17.5 | 369.0 | 15 | 5535.0 |
| Download | 2 | Type 3 | 6.2 | 200.0 | 16 | 3200.0 | Download | 2 | Type 4 | 11.6 | 200.0 | 12 | 2400.0 |
| Download | 3 | Type 3 | 6.5 | 338.0 | 16 | 5408.0 | Download | 3 | Type 4 | 12.3 | 338.0 | 12 | 4056.0 |
| Download | 4 | Type 3 | 9.6 | 443.0 | 18 | 7974.0 | Download | 4 | Type 4 | 19.5 | 443.0 | 16 | 7088.0 |
| Download | 5 | Type 3 | 9.3 | 216.0 | 18 | 3888.0 | Download | 5 | Type 4 | 18.3 | 216.0 | 16 | 3456.0 |
| Download | 6 | Type 3 | 7.6 | 499.0 | 17 | 8483.0 | Download | 6 | Type 4 | 14.7 | 499.0 | 14 | 6996.0 |
| Download | 7 | Type 3 | 7.0 | 302.0 | 16 | 4832.0 | Download | 7 | Type 4 | 13.3 | 302.0 | 13 | 3926.0 |
| Download | 8 | Type 3 | 9.7 | 496.0 | 18 | 8928.0 | Download | 8 | Type 4 | 19.3 | 496.0 | 16 | 7936.0 |
| Download | 9 | Type 3 | 6.6 | 417.0 | 16 | 6672.0 | Download | 9 | Type 4 | 12.3 | 417.0 | 12 | 5004.0 |
| Download | 10 | Type 3 | 7.3 | 208.0 | 17 | 3536.0 | Download | 10 | Type 4 | 14.0 | 208.0 | 13 | 2704.0 |
| Download | 11 | Type 3 | 8.2 | 323.0 | 17 | 5491.0 | Download | 11 | Type 4 | 16.0 | 323.0 | 14 | 4522.0 |
| Download | 12 | Type 3 | 9.1 | 360.0 | 18 | 6480.0 | Download | 12 | Type 4 | 17.9 | 360.0 | 15 | 5400.0 |
| Download | 13 | Type 3 | 8.6 | 315.0 | 17 | 5355.0 | Download | 13 | Type 4 | 16.9 | 315.0 | 15 | 4725.0 |
| Download | 14 | Type 3 | 6.4 | 405.0 | 16 | 6480.0 | Download | 14 | Type 4 | 11.9 | 405.0 | 12 | 4860.0 |
| Download | 15 | Type 3 | 10.0 | 251.0 | 18 | 4518.0 | Download | 15 | Type 4 | 20.0 | 251.0 | 16 | 4016.0 |
| Download | 16 | Type 3 | 9.6 | 449.0 | 18 | 8082.0 | Download | 16 | Type 4 | 19.0 | 449.0 | 16 | 7184.0 |
| Download | 17 | Type 3 | 9.3 | 324.0 | 18 | 5832.0 | Download | 17 | Type 4 | 18.5 | 324.0 | 16 | 5184.0 |
| Download | 18 | Type 3 | 9.6 | 312.0 | 18 | 5616.0 | Download | 18 | Type 4 | 19.1 | 312.0 | 16 | 4992.0 |
| Download | 19 | Type 3 | 7.6 | 203.0 | 17 | 3451.0 | Download | 19 | Type 4 | 14.5 | 203.0 | 13 | 2639.0 |
| Download | 20 | Type 3 | 6.5 | 340.0 | 16 | 5440.0 | Download | 20 | Type 4 | 12.1 | 340.0 | 12 | 4080.0 |
| Download | 21 | Type 3 | 9.2 | 270.0 | 18 | 4860.0 | Download | 21 | Type 4 | 18.2 | 270.0 | 15 | 4050.0 |
| Download | 22 | Type 3 | 10.0 | 420.0 | 18 | 7560.0 | Download | 22 | Type 4 | 20.0 | 420.0 | 16 | 6720.0 |
| Download | 23 | Type 3 | 6.8 | 271.0 | 16 | 4336.0 | Download | 23 | Type 4 | 12.8 | 271.0 | 13 | 3523.0 |
| Download | 24 | Type 3 | 10.0 | 370.0 | 18 | 6660.0 | Download | 24 | Type 4 | 20.0 | 370.0 | 16 | 5920.0 |
| Download | 25 | Type 3 | 9.1 | 284.0 | 18 | 5112.0 | Download | 25 | Type 4 | 18.0 | 284.0 | 15 | 4260.0 |
| Download | 26 | Type 3 | 6.4 | 412.0 | 16 | 6592.0 | Download | 26 | Type 4 | 11.9 | 412.0 | 12 | 4944.0 |
| Download | 27 | Type 3 | 8.5 | 326.0 | 17 | 5542.0 | Download | 27 | Type 4 | 16.5 | 326.0 | 15 | 4890.0 |
| Download | 28 | Type 3 | 8.8 | 429.0 | 18 | 7722.0 | Download | 28 | Type 4 | 17.4 | 429.0 | 15 | 6435.0 |
| Download | 29 | Type 3 | 6.7 | 239.0 | 16 | 3824.0 | Download | 29 | Type 4 | 12.6 | 239.0 | 12 | 2868.0 |

| Radar Type 5 - Radar Statistical Performance | | | | | |
|--|------------------|-------------------------------|---------------|------------------|-------------------------------|
| Trail # | Test Freq. (MHz) | 1=Detection 0=No Detection | Trail # | Test Freq. (MHz) | 1=Detection 0=No Detection |
| 0 | 5510 | 1 | 15 | 5499 | 1 |
| 1 | 5510 | 1 | 16 | 5499 | 1 |
| 2 | 5510 | 1 | 17 | 5498 | 1 |
| 3 | 5510 | 1 | 18 | 5499 | 1 |
| 4 | 5510 | 1 | 19 | 5496 | 1 |
| 5 | 5510 | 1 | 20 | 5526 | 1 |
| 6 | 5510 | 1 | 21 | 5522 | 1 |
| 7 | 5510 | 1 | 22 | 5521 | 1 |
| 8 | 5510 | 1 | 23 | 5526 | 1 |
| 9 | 5510 | 1 | 24 | 5521 | 1 |
| 10 | 5495 | 1 | 25 | 5522 | 1 |
| 11 | 5496 | 1 | 26 | 5526 | 1 |
| 12 | 5498 | 1 | 27 | 5523 | 1 |
| 13 | 5497 | 1 | 28 | 5522 | 1 |
| 14 | 5494 | 1 | 29 | 5526 | 1 |
| Detection Percentage (%) | | | 100.0% | | |

Type 5 Radar Waveform_0

| Download | 0 | Type 5 | 15 | 0.80000000 | 12.00000000 | 5.510000000 | | | |
|----------|---|----------|-------------------|------------------|-------------------|----------------------------|------------|------------|------------|
| | | Burst ID | Burst Offset (us) | Pulse Width (us) | Chirp Width (MHz) | Number of Pulses per Burst | PRI-1 (us) | PRI-2 (us) | PRI-3 (us) |
| | | 0 | 651537.0 | 78.8 | 14 | 2 | 1897.0 | 1857.0 | - |
| | | 1 | 48337.0 | 86.1 | 14 | 3 | 1862.0 | 1976.0 | 1061.0 |
| | | 2 | 242214.0 | 53.3 | 14 | 1 | 1470.0 | - | - |
| | | 3 | 436731.0 | 57.2 | 14 | 1 | 1747.0 | - | - |
| | | 4 | 627443.0 | 96.9 | 14 | 3 | 1828.0 | 1002.0 | 1314.0 |
| | | 5 | 24584.0 | 90.4 | 14 | 3 | 1855.0 | 1842.0 | 1185.0 |
| | | 6 | 217962.0 | 70.4 | 14 | 2 | 1142.0 | 1815.0 | - |
| | | 7 | 411842.0 | 62.8 | 14 | 1 | 1827.0 | - | - |
| | | 8 | 602753.0 | 95.9 | 14 | 3 | 1517.0 | 1977.0 | 1856.0 |
| | | 9 | 834.0 | 57.3 | 14 | 1 | 1650.0 | - | - |
| | | 10 | 194205.0 | 66.8 | 14 | 2 | 1372.0 | 1319.0 | - |
| | | 11 | 387356.0 | 78.0 | 14 | 2 | 1252.0 | 1895.0 | - |
| | | 12 | 579368.0 | 88.5 | 14 | 3 | 1916.0 | 1398.0 | 1549.0 |
| | | 13 | 774013.0 | 82.9 | 14 | 2 | 1299.0 | 1712.0 | - |
| | | 14 | 170693.0 | 55.0 | 14 | 1 | 1256.0 | - | - |

Type 5 Radar Waveform_1

| Download | 1 | Type 5 | 17 | 0.7058824 | 12.00000000 | 5.510000000 | | | |
|----------|---|----------|-------------------|------------------|-------------------|----------------------------|------------|------------|------------|
| | | Burst ID | Burst Offset (us) | Pulse Width (us) | Chirp Width (MHz) | Number of Pulses per Burst | PRI-1 (us) | PRI-2 (us) | PRI-3 (us) |
| | | 0 | 320493.0 | 99.9 | 16 | 3 | 1010.0 | 1226.0 | 1170.0 |
| | | 1 | 489725.0 | 94.4 | 16 | 3 | 1863.0 | 1929.0 | 1246.0 |
| | | 2 | 660082.0 | 91.5 | 16 | 3 | 1969.0 | 1109.0 | 1557.0 |
| | | 3 | 128984.0 | 94.7 | 16 | 3 | 1215.0 | 1703.0 | 1307.0 |
| | | 4 | 299689.0 | 69.7 | 16 | 2 | 1043.0 | 1936.0 | - |
| | | 5 | 471217.0 | 56.5 | 16 | 1 | 1407.0 | - | - |
| | | 6 | 639783.0 | 90.0 | 16 | 3 | 1285.0 | 1333.0 | 1323.0 |
| | | 7 | 107971.0 | 100.0 | 16 | 3 | 1050.0 | 1851.0 | 1656.0 |
| | | 8 | 279337.0 | 60.1 | 16 | 1 | 1347.0 | - | - |
| | | 9 | 448071.0 | 99.7 | 16 | 3 | 1647.0 | 1809.0 | 1238.0 |
| | | 10 | 617942.0 | 89.0 | 16 | 3 | 1831.0 | 1858.0 | 1220.0 |
| | | 11 | 87422.0 | 55.4 | 16 | 1 | 1313.0 | - | - |
| | | 12 | 257468.0 | 80.7 | 16 | 2 | 1665.0 | 1923.0 | - |
| | | 13 | 427048.0 | 85.3 | 16 | 3 | 1701.0 | 1369.0 | 1748.0 |
| | | 14 | 599578.0 | 59.0 | 16 | 1 | 1882.0 | - | - |
| | | 15 | 66340.0 | 65.9 | 16 | 1 | 1672.0 | - | - |
| | | 16 | 236010.0 | 89.0 | 16 | 3 | 1324.0 | 1822.0 | 1860.0 |

Type 5 Radar Waveform_2

| Download | 2 | Type 5 | 8 | 1.50000000 | 12.00000000 | 5.510000000 | | | |
|----------|---|----------|-------------------|------------------|-------------------|----------------------------|------------|------------|------------|
| | | Burst ID | Burst Offset (us) | Pulse Width (us) | Chirp Width (MHz) | Number of Pulses per Burst | PRI-1 (us) | PRI-2 (us) | PRI-3 (us) |
| | | 0 | 868084.0 | 64.9 | 6 | 1 | 1408.0 | - | - |
| | | 1 | 1231531.0 | 62.1 | 6 | 1 | 1420.0 | - | - |
| | | 2 | 96389.0 | 57.2 | 6 | 1 | 1641.0 | - | - |
| | | 3 | 459519.0 | 68.1 | 6 | 2 | 1200.0 | 1318.0 | - |
| | | 4 | 822431.0 | 80.7 | 6 | 2 | 1276.0 | 1741.0 | - |
| | | 5 | 1186578.0 | 55.1 | 6 | 1 | 1851.0 | - | - |
| | | 6 | 51552.0 | 89.0 | 6 | 3 | 1065.0 | 1479.0 | 1249.0 |
| | | 7 | 414067.0 | 88.4 | 6 | 3 | 1602.0 | 1918.0 | 1581.0 |

Type 5 Radar Waveform_3

| Download | 3 | Type 5 | 9 | 1.3333333 | 12.00000000 | 5.510000000 | | | |
|----------|---|----------|-------------------|------------------|-------------------|----------------------------|------------|------------|------------|
| | | Burst ID | Burst Offset (us) | Pulse Width (us) | Chirp Width (MHz) | Number of Pulses per Burst | PRI-1 (us) | PRI-2 (us) | PRI-3 (us) |
| | | 0 | 691007.0 | 82.3 | 7 | 2 | 1363.0 | 1878.0 | - |
| | | 1 | 1013023.0 | 97.7 | 7 | 3 | 1351.0 | 1643.0 | 1000.0 |
| | | 2 | 6103.0 | 64.3 | 7 | 1 | 1049.0 | - | - |
| | | 3 | 328385.0 | 93.9 | 7 | 3 | 1894.0 | 1294.0 | 1255.0 |
| | | 4 | 650475.0 | 88.9 | 7 | 3 | 1940.0 | 1550.0 | 1379.0 |
| | | 5 | 973948.0 | 67.1 | 7 | 2 | 1527.0 | 1595.0 | - |
| | | 6 | 1297299.0 | 71.3 | 7 | 2 | 1262.0 | 1108.0 | - |
| | | 7 | 288570.0 | 91.7 | 7 | 3 | 1483.0 | 1993.0 | 1501.0 |
| | | 8 | 612447.0 | 66.3 | 7 | 1 | 1259.0 | - | - |

Type 5 Radar Waveform_4

| Download | 4 | Type 5 | 20 | 0.6000000 | 12.0000000 | 5.510000000 | | | |
|----------|-------------------|------------------|-------------------|----------------------------|------------|-------------|------------|--|--|
| Burst ID | Burst Offset (us) | Pulse Width (us) | Chirp Width (MHz) | Number of Pulses per Burst | PRI-1 (us) | PRI-2 (us) | PRI-3 (us) | | |
| 0 | 418939.0 | 76.8 | 19 | 2 | 1922.0 | 1555.0 | - | | |
| 1 | 565445.0 | 55.6 | 19 | 1 | 1540.0 | - | - | | |
| 2 | 111782.0 | 80.5 | 19 | 2 | 1481.0 | 1917.0 | - | | |
| 3 | 257141.0 | 55.6 | 19 | 1 | 1853.0 | - | - | | |
| 4 | 402485.0 | 54.5 | 19 | 1 | 1444.0 | - | - | | |
| 5 | 545218.0 | 94.4 | 19 | 3 | 1452.0 | 1508.0 | 1146.0 | | |
| 6 | 93815.0 | 88.9 | 19 | 3 | 1554.0 | 1309.0 | 1448.0 | | |
| 7 | 238350.0 | 86.1 | 19 | 3 | 1866.0 | 1179.0 | 1111.0 | | |
| 8 | 382582.0 | 93.2 | 19 | 3 | 1612.0 | 1781.0 | 1198.0 | | |
| 9 | 529605.0 | 57.6 | 19 | 1 | 1633.0 | - | - | | |
| 10 | 76316.0 | 57.8 | 19 | 1 | 1981.0 | - | - | | |
| 11 | 220529.0 | 85.0 | 19 | 3 | 1941.0 | 1214.0 | 1056.0 | | |
| 12 | 364841.0 | 89.7 | 19 | 3 | 1624.0 | 1019.0 | 1872.0 | | |
| 13 | 510265.0 | 77.6 | 19 | 2 | 1354.0 | 1991.0 | - | | |
| 14 | 58201.0 | 86.9 | 19 | 3 | 1575.0 | 1756.0 | 1209.0 | | |
| 15 | 202659.0 | 91.4 | 19 | 3 | 1796.0 | 1103.0 | 1521.0 | | |
| 16 | 347970.0 | 77.8 | 19 | 2 | 1134.0 | 1805.0 | - | | |
| 17 | 494019.0 | 63.0 | 19 | 1 | 1432.0 | - | - | | |
| 18 | 40520.0 | 76.3 | 19 | 2 | 1657.0 | 1286.0 | - | | |
| 19 | 185289.0 | 75.7 | 19 | 2 | 1816.0 | 1244.0 | - | | |

Type 5 Radar Waveform_5

| Download | 5 | Type 5 | 18 | 0.6666667 | 12.0000000 | 5.510000000 | | | |
|----------|-------------------|------------------|-------------------|----------------------------|------------|-------------|------------|--|--|
| Burst ID | Burst Offset (us) | Pulse Width (us) | Chirp Width (MHz) | Number of Pulses per Burst | PRI-1 (us) | PRI-2 (us) | PRI-3 (us) | | |
| 0 | 366638.0 | 86.9 | 17 | 3 | 1304.0 | 1133.0 | 1148.0 | | |
| 1 | 527558.0 | 69.2 | 17 | 2 | 1914.0 | 1542.0 | - | | |
| 2 | 25150.0 | 89.2 | 17 | 3 | 1829.0 | 1601.0 | 1267.0 | | |
| 3 | 186704.0 | 52.4 | 17 | 1 | 1112.0 | - | - | | |
| 4 | 347764.0 | 56.3 | 17 | 1 | 1797.0 | - | - | | |
| 5 | 507025.0 | 87.4 | 17 | 3 | 1073.0 | 1686.0 | 1638.0 | | |
| 6 | 5404.0 | 58.8 | 17 | 1 | 1045.0 | - | - | | |
| 7 | 166169.0 | 75.6 | 17 | 2 | 1905.0 | 1808.0 | - | | |
| 8 | 328052.0 | 56.1 | 17 | 1 | 1492.0 | - | - | | |
| 9 | 488898.0 | 71.3 | 17 | 2 | 1068.0 | 1076.0 | - | | |
| 10 | 649180.0 | 82.5 | 17 | 2 | 1592.0 | 1478.0 | - | | |
| 11 | 146469.0 | 67.6 | 17 | 2 | 1740.0 | 1497.0 | - | | |
| 12 | 308225.0 | 63.7 | 17 | 1 | 1395.0 | - | - | | |
| 13 | 469711.0 | 64.4 | 17 | 1 | 1201.0 | - | - | | |
| 14 | 631070.0 | 58.4 | 17 | 1 | 1241.0 | - | - | | |
| 15 | 126929.0 | 53.4 | 17 | 1 | 1772.0 | - | - | | |
| 16 | 286965.0 | 85.5 | 17 | 3 | 1495.0 | 1380.0 | 1717.0 | | |
| 17 | 447231.0 | 83.4 | 17 | 3 | 1992.0 | 1212.0 | 1843.0 | | |

Type 5 Radar Waveform_6

| Download | 6 | Type 5 | 13 | 0.9230769 | 12.0000000 | 5.510000000 | | | |
|----------|-------------------|------------------|-------------------|----------------------------|------------|-------------|------------|--|--|
| Burst ID | Burst Offset (us) | Pulse Width (us) | Chirp Width (MHz) | Number of Pulses per Burst | PRI-1 (us) | PRI-2 (us) | PRI-3 (us) | | |
| 0 | 846151.0 | 60.4 | 11 | 1 | 1841.0 | - | - | | |
| 1 | 148160.0 | 67.8 | 11 | 2 | 1222.0 | 1757.0 | - | | |
| 2 | 371494.0 | 68.3 | 11 | 2 | 1254.0 | 1275.0 | - | | |
| 3 | 594756.0 | 82.1 | 11 | 2 | 1499.0 | 1030.0 | - | | |
| 4 | 816486.0 | 87.5 | 11 | 3 | 1047.0 | 1885.0 | 1341.0 | | |
| 5 | 120518.0 | 97.5 | 11 | 3 | 1247.0 | 1733.0 | 1176.0 | | |
| 6 | 343903.0 | 81.1 | 11 | 2 | 1228.0 | 1543.0 | - | | |
| 7 | 567787.0 | 53.4 | 11 | 1 | 1666.0 | - | - | | |
| 8 | 788520.0 | 92.7 | 11 | 3 | 1663.0 | 1417.0 | 1775.0 | | |
| 9 | 93193.0 | 70.1 | 11 | 2 | 1505.0 | 1400.0 | - | | |
| 10 | 316461.0 | 77.5 | 11 | 2 | 1279.0 | 1342.0 | - | | |
| 11 | 540095.0 | 52.4 | 11 | 1 | 1948.0 | - | - | | |
| 12 | 763479.0 | 61.0 | 11 | 1 | 1971.0 | - | - | | |

Type 5 Radar Waveform_7

| Download | 7 | Type 5 | 11 | 1.0909091 | 12.0000000 | 5.510000000 | | | |
|----------|---|----------|-------------------|------------------|-------------------|----------------------------|------------|------------|------------|
| | | Burst ID | Burst Offset (us) | Pulse Width (us) | Chirp Width (MHz) | Number of Pulses per Burst | PRI-1 (us) | PRI-2 (us) | PRI-3 (us) |
| | | 0 | 77759.0 | 54.1 | 9 | 1 | 1901.0 | - | - |
| | | 1 | 340992.0 | 95.1 | 9 | 3 | 1835.0 | 1062.0 | 1825.0 |
| | | 2 | 606443.0 | 66.0 | 9 | 1 | 1099.0 | - | - |
| | | 3 | 869308.0 | 79.4 | 9 | 2 | 1574.0 | 1338.0 | - |
| | | 4 | 45244.0 | 57.5 | 9 | 1 | 1456.0 | - | - |
| | | 5 | 309468.0 | 66.4 | 9 | 1 | 1467.0 | - | - |
| | | 6 | 573318.0 | 78.1 | 9 | 2 | 1023.0 | 1154.0 | - |
| | | 7 | 835335.0 | 99.4 | 9 | 3 | 1714.0 | 1113.0 | 1996.0 |
| | | 8 | 12685.0 | 67.1 | 9 | 2 | 1292.0 | 1171.0 | - |
| | | 9 | 276177.0 | 85.5 | 9 | 3 | 1204.0 | 1742.0 | 1449.0 |
| | | 10 | 541105.0 | 63.2 | 9 | 1 | 1548.0 | - | - |

Type 5 Radar Waveform_8

| Download | 8 | Type 5 | 19 | 0.6315789 | 12.0000000 | 5.510000000 | | | |
|----------|---|----------|-------------------|------------------|-------------------|----------------------------|------------|------------|------------|
| | | Burst ID | Burst Offset (us) | Pulse Width (us) | Chirp Width (MHz) | Number of Pulses per Burst | PRI-1 (us) | PRI-2 (us) | PRI-3 (us) |
| | | 0 | 464564.0 | 79.9 | 19 | 2 | 1433.0 | 1719.0 | - |
| | | 1 | 616840.0 | 71.8 | 19 | 2 | 1357.0 | 1935.0 | - |
| | | 2 | 141102.0 | 75.1 | 19 | 2 | 1197.0 | 1337.0 | - |
| | | 3 | 292927.0 | 90.3 | 19 | 3 | 1401.0 | 1532.0 | 1182.0 |
| | | 4 | 445709.0 | 71.3 | 19 | 2 | 1513.0 | 1754.0 | - |
| | | 5 | 598121.0 | 75.2 | 19 | 2 | 1330.0 | 1909.0 | - |
| | | 6 | 122235.0 | 89.1 | 19 | 2 | 1458.0 | 1463.0 | - |
| | | 7 | 273741.0 | 83.5 | 19 | 3 | 1422.0 | 1952.0 | 1752.0 |
| | | 8 | 428352.0 | 55.9 | 19 | 1 | 1187.0 | - | - |
| | | 9 | 578078.0 | 94.5 | 19 | 3 | 1793.0 | 1287.0 | 1538.0 |
| | | 10 | 103720.0 | 52.5 | 19 | 1 | 1303.0 | - | - |
| | | 11 | 256549.0 | 58.4 | 19 | 1 | 1384.0 | - | - |
| | | 12 | 409157.0 | 57.3 | 19 | 1 | 1744.0 | - | - |
| | | 13 | 562146.0 | 54.8 | 19 | 1 | 1482.0 | - | - |
| | | 14 | 84602.0 | 81.7 | 19 | 2 | 1631.0 | 1821.0 | - |
| | | 15 | 236451.0 | 91.8 | 19 | 3 | 1903.0 | 1635.0 | 1217.0 |
| | | 16 | 389675.0 | 71.3 | 19 | 2 | 1523.0 | 1297.0 | - |
| | | 17 | 543408.0 | 52.8 | 19 | 1 | 1363.0 | - | - |
| | | 18 | 65720.0 | 94.8 | 19 | 3 | 1622.0 | 1006.0 | 1937.0 |

Type 5 Radar Waveform_9

| Download | 9 | Type 5 | 9 | 1.3333333 | 12.0000000 | 5.510000000 | | | |
|----------|---|----------|-------------------|------------------|-------------------|----------------------------|------------|------------|------------|
| | | Burst ID | Burst Offset (us) | Pulse Width (us) | Chirp Width (MHz) | Number of Pulses per Burst | PRI-1 (us) | PRI-2 (us) | PRI-3 (us) |
| | | 0 | 461367.0 | 88.8 | 7 | 3 | 1836.0 | 1814.0 | 1419.0 |
| | | 1 | 784602.0 | 96.1 | 7 | 3 | 1127.0 | 1086.0 | 1011.0 |
| | | 2 | 1108379.0 | 53.7 | 7 | 1 | 1802.0 | - | - |
| | | 3 | 99816.0 | 60.3 | 7 | 1 | 1394.0 | - | - |
| | | 4 | 422146.0 | 78.4 | 7 | 2 | 1928.0 | 1692.0 | - |
| | | 5 | 744958.0 | 72.6 | 7 | 2 | 1885.0 | 1174.0 | - |
| | | 6 | 1065665.0 | 97.7 | 7 | 3 | 1951.0 | 1998.0 | 1510.0 |
| | | 7 | 59908.0 | 85.1 | 7 | 3 | 1697.0 | 1095.0 | 1193.0 |
| | | 8 | 383139.0 | 50.8 | 7 | 1 | 1125.0 | - | - |

Type 5 Radar Waveform_10

| Download | 10 | Type 5 | 12 | 1.0000000 | 12.0000000 | 5.495000000 | | | |
|----------|----|----------|-------------------|------------------|-------------------|----------------------------|------------|------------|------------|
| | | Burst ID | Burst Offset (us) | Pulse Width (us) | Chirp Width (MHz) | Number of Pulses per Burst | PRI-1 (us) | PRI-2 (us) | PRI-3 (us) |
| | | 0 | 527999.0 | 87.0 | 10 | 3 | 1130.0 | 1434.0 | 1453.0 |
| | | 1 | 771326.0 | 57.3 | 10 | 1 | 1726.0 | - | - |
| | | 2 | 15110.0 | 84.0 | 10 | 3 | 1524.0 | 1967.0 | 1870.0 |
| | | 3 | 256677.0 | 93.3 | 10 | 3 | 1649.0 | 1208.0 | 1202.0 |
| | | 4 | 498808.0 | 82.3 | 10 | 2 | 1620.0 | 1272.0 | - |
| | | 5 | 741796.0 | 55.1 | 10 | 1 | 1334.0 | - | - |
| | | 6 | 983633.0 | 52.1 | 10 | 1 | 1709.0 | - | - |
| | | 7 | 227587.0 | 65.7 | 10 | 1 | 1147.0 | - | - |
| | | 8 | 468822.0 | 72.4 | 10 | 2 | 1673.0 | 1640.0 | - |
| | | 9 | 709643.0 | 90.9 | 10 | 3 | 1737.0 | 1790.0 | 1057.0 |
| | | 10 | 952683.0 | 82.2 | 10 | 2 | 1186.0 | 1704.0 | - |
| | | 11 | 197365.0 | 67.4 | 10 | 2 | 1169.0 | 1911.0 | - |

Type 5 Radar Waveform_11

| Download | 11 | Type 5 | 15 | 0.8000000 | 12.0000000 | 5.498000000 | | | |
|----------|----|----------|-------------------|------------------|-------------------|----------------------------|------------|------------|------------|
| | | Burst ID | Burst Offset (us) | Pulse Width (us) | Chirp Width (MHz) | Number of Pulses per Burst | PRI-1 (us) | PRI-2 (us) | PRI-3 (us) |
| | | 0 | 351790.0 | 51.0 | 13 | 1 | 1396.0 | - | - |
| | | 1 | 543401.0 | 94.1 | 13 | 3 | 1402.0 | 1145.0 | 1868.0 |
| | | 2 | 735697.0 | 96.5 | 13 | 3 | 1982.0 | 1945.0 | 1213.0 |
| | | 3 | 134174.0 | 66.6 | 13 | 1 | 1819.0 | - | - |
| | | 4 | 328005.0 | 51.5 | 13 | 1 | 1219.0 | - | - |
| | | 5 | 519305.0 | 86.6 | 13 | 3 | 1361.0 | 1850.0 | 1727.0 |
| | | 6 | 714961.0 | 58.6 | 13 | 1 | 1780.0 | - | - |
| | | 7 | 110092.0 | 74.5 | 13 | 2 | 1743.0 | 1796.0 | - |
| | | 8 | 303702.0 | 75.8 | 13 | 2 | 1283.0 | 1091.0 | - |
| | | 9 | 496642.0 | 74.7 | 13 | 2 | 1531.0 | 1660.0 | - |
| | | 10 | 690933.0 | 56.7 | 13 | 1 | 1990.0 | - | - |
| | | 11 | 86248.0 | 96.6 | 13 | 3 | 1545.0 | 1424.0 | 1032.0 |
| | | 12 | 279633.0 | 72.3 | 13 | 2 | 1684.0 | 1377.0 | - |
| | | 13 | 471872.0 | 96.8 | 13 | 3 | 1520.0 | 1608.0 | 1691.0 |
| | | 14 | 667710.0 | 65.2 | 13 | 1 | 1253.0 | - | - |

Type 5 Radar Waveform_12

| Download | 12 | Type 5 | 17 | 0.7058824 | 12.0000000 | 5.498000000 | | | |
|----------|----|----------|-------------------|------------------|-------------------|----------------------------|------------|------------|------------|
| | | Burst ID | Burst Offset (us) | Pulse Width (us) | Chirp Width (MHz) | Number of Pulses per Burst | PRI-1 (us) | PRI-2 (us) | PRI-3 (us) |
| | | 0 | 55177.0 | 76.2 | 17 | 2 | 1059.0 | 1734.0 | - |
| | | 1 | 226067.0 | 61.5 | 17 | 1 | 1644.0 | - | - |
| | | 2 | 395221.0 | 96.7 | 17 | 3 | 1892.0 | 1143.0 | 1530.0 |
| | | 3 | 566697.0 | 67.7 | 17 | 2 | 1707.0 | 1140.0 | - |
| | | 4 | 34192.0 | 73.6 | 17 | 2 | 1063.0 | 1316.0 | - |
| | | 5 | 204023.0 | 90.2 | 17 | 3 | 1613.0 | 1504.0 | 1980.0 |
| | | 6 | 374865.0 | 68.2 | 17 | 2 | 1498.0 | 1950.0 | - |
| | | 7 | 544834.0 | 96.5 | 17 | 3 | 1514.0 | 1089.0 | 1352.0 |
| | | 8 | 13130.0 | 98.7 | 17 | 3 | 1755.0 | 1794.0 | 1289.0 |
| | | 9 | 183948.0 | 60.5 | 17 | 1 | 1804.0 | - | - |
| | | 10 | 354710.0 | 59.2 | 17 | 1 | 1801.0 | - | - |
| | | 11 | 524676.0 | 76.2 | 17 | 2 | 1770.0 | 1098.0 | - |
| | | 12 | 696762.0 | 52.2 | 17 | 1 | 1268.0 | - | - |
| | | 13 | 162875.0 | 52.7 | 17 | 1 | 1972.0 | - | - |
| | | 14 | 333694.0 | 66.0 | 17 | 1 | 1763.0 | - | - |
| | | 15 | 503802.0 | 69.3 | 17 | 2 | 1025.0 | 1664.0 | - |
| | | 16 | 674024.0 | 80.5 | 17 | 2 | 1221.0 | 1807.0 | - |

Type 5 Radar Waveform_13

| Download | 13 | Type 5 | 16 | 0.7500000 | 12.0000000 | 5.497000000 | | | |
|----------|----|----------|-------------------|------------------|-------------------|----------------------------|------------|------------|------------|
| | | Burst ID | Burst Offset (us) | Pulse Width (us) | Chirp Width (MHz) | Number of Pulses per Burst | PRI-1 (us) | PRI-2 (us) | PRI-3 (us) |
| | | 0 | 150487.0 | 70.7 | 15 | 2 | 1720.0 | 1489.0 | - |
| | | 1 | 331855.0 | 77.4 | 15 | 2 | 1597.0 | 1054.0 | - |
| | | 2 | 511873.0 | 87.7 | 15 | 3 | 1496.0 | 1431.0 | 1526.0 |
| | | 3 | 695577.0 | 54.0 | 15 | 1 | 1348.0 | - | - |
| | | 4 | 128551.0 | 57.2 | 15 | 1 | 1027.0 | - | - |
| | | 5 | 308609.0 | 93.7 | 15 | 3 | 1634.0 | 1500.0 | 1736.0 |
| | | 6 | 490434.0 | 76.9 | 15 | 2 | 1346.0 | 1838.0 | - |
| | | 7 | 671016.0 | 66.0 | 15 | 3 | 1008.0 | 1753.0 | 1028.0 |
| | | 8 | 105569.0 | 89.0 | 15 | 3 | 1535.0 | 1787.0 | 1989.0 |
| | | 9 | 287820.0 | 60.6 | 15 | 1 | 1042.0 | - | - |
| | | 10 | 468251.0 | 75.1 | 15 | 2 | 1378.0 | 1603.0 | - |
| | | 11 | 650692.0 | 62.3 | 15 | 1 | 1525.0 | - | - |
| | | 12 | 83769.0 | 50.6 | 15 | 1 | 1315.0 | - | - |
| | | 13 | 264394.0 | 87.5 | 15 | 3 | 1457.0 | 1090.0 | 1462.0 |
| | | 14 | 446147.0 | 71.0 | 15 | 2 | 1195.0 | 1429.0 | - |
| | | 15 | 625338.0 | 85.5 | 15 | 3 | 1516.0 | 1852.0 | 1723.0 |

Type 5 Radar Waveform_14

| Download | 14 | Type 5 | 9 | 1.3333333 | 12.0000000 | 5.494000000 | | | |
|----------|----|----------|-------------------|------------------|-------------------|----------------------------|------------|------------|------------|
| | | Burst ID | Burst Offset (us) | Pulse Width (us) | Chirp Width (MHz) | Number of Pulses per Burst | PRI-1 (us) | PRI-2 (us) | PRI-3 (us) |
| | | 0 | 108974.0 | 89.9 | 6 | 3 | 1579.0 | 1404.0 | 1618.0 |
| | | 1 | 431589.0 | 75.9 | 6 | 2 | 1632.0 | 1874.0 | - |
| | | 2 | 755141.0 | 54.1 | 6 | 1 | 1696.0 | - | - |
| | | 3 | 1076557.0 | 75.7 | 6 | 2 | 1994.0 | 1614.0 | - |
| | | 4 | 69362.0 | 73.2 | 6 | 2 | 1987.0 | 1018.0 | - |
| | | 5 | 392591.0 | 58.6 | 6 | 1 | 1031.0 | - | - |
| | | 6 | 715102.0 | 77.2 | 6 | 2 | 1136.0 | 1039.0 | - |
| | | 7 | 1037595.0 | 82.8 | 6 | 2 | 1610.0 | 1020.0 | - |
| | | 8 | 29583.0 | 97.6 | 6 | 3 | 1491.0 | 1566.0 | 1589.0 |

Type 5 Radar Waveform_15

| Download | 15 | Type 5 | 20 | 0.6000000 | 12.0000000 | 5.499000000 | | | |
|----------|----|----------|-------------------|------------------|-------------------|----------------------------|------------|------------|------------|
| | | Burst ID | Burst Offset (us) | Pulse Width (us) | Chirp Width (MHz) | Number of Pulses per Burst | PRI-1 (us) | PRI-2 (us) | PRI-3 (us) |
| | | 0 | 157846.0 | 97.9 | 20 | 3 | 1037.0 | 1854.0 | 1005.0 |
| | | 1 | 303542.0 | 56.1 | 20 | 1 | 1685.0 | - | - |
| | | 2 | 447115.0 | 92.3 | 20 | 3 | 1317.0 | 1141.0 | 1277.0 |
| | | 3 | 594322.0 | 60.4 | 20 | 1 | 1121.0 | - | - |
| | | 4 | 140525.0 | 56.4 | 20 | 1 | 1823.0 | - | - |
| | | 5 | 284955.0 | 71.7 | 20 | 2 | 1943.0 | 1236.0 | - |
| | | 6 | 430921.0 | 59.8 | 20 | 1 | 1487.0 | - | - |
| | | 7 | 575845.0 | 55.3 | 20 | 1 | 1730.0 | - | - |
| | | 8 | 122557.0 | 76.3 | 20 | 2 | 1233.0 | 1071.0 | - |
| | | 9 | 267206.0 | 75.8 | 20 | 2 | 1840.0 | 1158.0 | - |
| | | 10 | 410352.0 | 95.0 | 20 | 3 | 1834.0 | 1680.0 | 1869.0 |
| | | 11 | 557974.0 | 59.1 | 20 | 1 | 1728.0 | - | - |
| | | 12 | 104811.0 | 61.1 | 20 | 1 | 1677.0 | - | - |
| | | 13 | 249556.0 | 68.9 | 20 | 2 | 1097.0 | 1459.0 | - |
| | | 14 | 394673.0 | 67.8 | 20 | 2 | 1007.0 | 1218.0 | - |
| | | 15 | 538860.0 | 69.8 | 20 | 2 | 1771.0 | 1332.0 | - |
| | | 16 | 66686.0 | 81.7 | 20 | 2 | 1605.0 | 1795.0 | - |
| | | 17 | 230965.0 | 84.6 | 20 | 3 | 1533.0 | 1493.0 | 1443.0 |
| | | 18 | 376566.0 | 79.6 | 20 | 2 | 1084.0 | 1536.0 | - |
| | | 19 | 519535.0 | 93.2 | 20 | 3 | 1260.0 | 1883.0 | 1670.0 |

Type 5 Radar Waveform_16

| Download | 16 | Type 5 | 19 | 0.6315789 | 12.0000000 | 5.499000000 | | | |
|----------|----|----------|-------------------|------------------|-------------------|----------------------------|------------|------------|------------|
| | | Burst ID | Burst Offset (us) | Pulse Width (us) | Chirp Width (MHz) | Number of Pulses per Burst | PRI-1 (us) | PRI-2 (us) | PRI-3 (us) |
| | | 0 | 72364.0 | 84.1 | 19 | 3 | 1944.0 | 1336.0 | 1366.0 |
| | | 1 | 224519.0 | 98.1 | 19 | 3 | 1721.0 | 1512.0 | 1123.0 |
| | | 2 | 377637.0 | 73.0 | 19 | 2 | 1410.0 | 1285.0 | - |
| | | 3 | 529100.0 | 88.3 | 19 | 3 | 1258.0 | 1472.0 | 1224.0 |
| | | 4 | 53696.0 | 90.7 | 19 | 3 | 1345.0 | 1235.0 | 1355.0 |
| | | 5 | 206687.0 | 62.3 | 19 | 1 | 1593.0 | - | - |
| | | 6 | 358555.0 | 76.8 | 19 | 2 | 1590.0 | 1621.0 | - |
| | | 7 | 512168.0 | 61.9 | 19 | 1 | 1718.0 | - | - |
| | | 8 | 34943.0 | 93.7 | 19 | 3 | 1764.0 | 1069.0 | 1139.0 |
| | | 9 | 187779.0 | 57.3 | 19 | 1 | 1886.0 | - | - |
| | | 10 | 340852.0 | 62.0 | 19 | 1 | 1234.0 | - | - |
| | | 11 | 493663.0 | 50.1 | 19 | 1 | 1321.0 | - | - |
| | | 12 | 16250.0 | 54.8 | 19 | 1 | 1782.0 | - | - |
| | | 13 | 169021.0 | 56.4 | 19 | 1 | 1688.0 | - | - |
| | | 14 | 321760.0 | 59.4 | 19 | 1 | 1745.0 | - | - |
| | | 15 | 471390.0 | 87.6 | 19 | 3 | 2000.0 | 1933.0 | 1959.0 |
| | | 16 | 624130.0 | 84.6 | 19 | 3 | 1964.0 | 1682.0 | 1271.0 |
| | | 17 | 149798.0 | 75.6 | 19 | 2 | 1786.0 | 1600.0 | - |
| | | 18 | 302593.0 | 82.6 | 19 | 2 | 1427.0 | 1048.0 | - |

Type 5 Radar Waveform_17

| Download | 17 | Type 5 | 18 | 0.6666667 | 12.0000000 | 5.498000000 | | | |
|----------|----|----------|-------------------|------------------|-------------------|----------------------------|------------|------------|------------|
| | | Burst ID | Burst Offset (us) | Pulse Width (us) | Chirp Width (MHz) | Number of Pulses per Burst | PRI-1 (us) | PRI-2 (us) | PRI-3 (us) |
| | | 0 | 479176.0 | 88.9 | 18 | 3 | 1588.0 | 1412.0 | 1385.0 |
| | | 1 | 642631.0 | 65.2 | 18 | 1 | 1454.0 | - | - |
| | | 2 | 138786.0 | 57.0 | 18 | 1 | 1300.0 | - | - |
| | | 3 | 299055.0 | 74.3 | 18 | 2 | 1983.0 | 1761.0 | - |
| | | 4 | 461210.0 | 61.6 | 18 | 1 | 1782.0 | - | - |
| | | 5 | 620750.0 | 76.0 | 18 | 2 | 1820.0 | 1779.0 | - |
| | | 6 | 118673.0 | 76.4 | 18 | 2 | 1115.0 | 1502.0 | - |
| | | 7 | 279391.0 | 78.8 | 18 | 2 | 1729.0 | 1683.0 | - |
| | | 8 | 441543.0 | 56.9 | 18 | 1 | 1465.0 | - | - |
| | | 9 | 600258.0 | 86.4 | 18 | 3 | 1206.0 | 1322.0 | 1826.0 |
| | | 10 | 98945.0 | 55.8 | 18 | 1 | 1875.0 | - | - |
| | | 11 | 259259.0 | 91.6 | 18 | 3 | 1207.0 | 1329.0 | 1687.0 |
| | | 12 | 420532.0 | 74.0 | 18 | 2 | 1562.0 | 1700.0 | - |
| | | 13 | 580873.0 | 97.7 | 18 | 3 | 1237.0 | 1153.0 | 1506.0 |
| | | 14 | 78785.0 | 89.7 | 18 | 3 | 1451.0 | 1409.0 | 1537.0 |
| | | 15 | 240385.0 | 63.4 | 18 | 1 | 1746.0 | - | - |
| | | 16 | 400002.0 | 99.9 | 18 | 3 | 1585.0 | 1382.0 | 1473.0 |
| | | 17 | 561316.0 | 83.1 | 18 | 2 | 1979.0 | 1630.0 | - |

Type 5 Radar Waveform_18

| Download | 18 | Type 5 | 19 | 0.6315789 | 12.0000000 | 5.499000000 | | | |
|----------|----|----------|-------------------|------------------|-------------------|----------------------------|------------|------------|------------|
| | | Burst ID | Burst Offset (us) | Pulse Width (us) | Chirp Width (MHz) | Number of Pulses per Burst | PRI-1 (us) | PRI-2 (us) | PRI-3 (us) |
| | | 0 | 56155.0 | 53.9 | 19 | 1 | 1250.0 | - | - |
| | | 1 | 208695.0 | 69.7 | 19 | 2 | 1205.0 | 1052.0 | - |
| | | 2 | 360416.0 | 94.1 | 19 | 3 | 1150.0 | 1075.0 | 1616.0 |
| | | 3 | 512311.0 | 95.0 | 19 | 3 | 1374.0 | 1818.0 | 1079.0 |
| | | 4 | 37117.0 | 98.0 | 19 | 3 | 1750.0 | 1114.0 | 1877.0 |
| | | 5 | 189968.0 | 61.6 | 19 | 1 | 1949.0 | - | - |
| | | 6 | 342235.0 | 68.9 | 19 | 2 | 1710.0 | 1080.0 | - |
| | | 7 | 495704.0 | 63.8 | 19 | 1 | 1560.0 | - | - |
| | | 8 | 18386.0 | 94.8 | 19 | 3 | 1837.0 | 1450.0 | 1565.0 |
| | | 9 | 171276.0 | 54.2 | 19 | 1 | 1587.0 | - | - |
| | | 10 | 323863.0 | 54.7 | 19 | 1 | 1988.0 | - | - |
| | | 11 | 477093.0 | 59.5 | 19 | 1 | 1282.0 | - | - |
| | | 12 | 627526.0 | 80.2 | 19 | 2 | 1722.0 | 1995.0 | - |
| | | 13 | 151582.0 | 85.2 | 19 | 3 | 1725.0 | 1900.0 | 1571.0 |
| | | 14 | 305382.0 | 56.0 | 19 | 1 | 1311.0 | - | - |
| | | 15 | 458286.0 | 51.9 | 19 | 1 | 1251.0 | - | - |
| | | 16 | 607965.0 | 90.8 | 19 | 3 | 1189.0 | 1360.0 | 1997.0 |
| | | 17 | 133312.0 | 77.9 | 19 | 2 | 1539.0 | 1570.0 | - |
| | | 18 | 285505.0 | 77.1 | 19 | 2 | 1939.0 | 1679.0 | - |

Type 5 Radar Waveform_19

| Download | 19 | Type 5 | 13 | 0.9230789 | 12.0000000 | 5.498000000 | | | |
|----------|----|----------|-------------------|------------------|-------------------|----------------------------|------------|------------|------------|
| | | Burst ID | Burst Offset (us) | Pulse Width (us) | Chirp Width (MHz) | Number of Pulses per Burst | PRI-1 (us) | PRI-2 (us) | PRI-3 (us) |
| | | 0 | 641552.0 | 73.7 | 11 | 2 | 1104.0 | 1789.0 | - |
| | | 1 | 866099.0 | 61.4 | 11 | 1 | 1416.0 | - | - |
| | | 2 | 167980.0 | 62.3 | 11 | 1 | 1364.0 | - | - |
| | | 3 | 391567.0 | 64.3 | 11 | 1 | 1263.0 | - | - |
| | | 4 | 613618.0 | 83.6 | 11 | 3 | 1310.0 | 1194.0 | 1034.0 |
| | | 5 | 836528.0 | 69.8 | 11 | 2 | 1689.0 | 1986.0 | - |
| | | 6 | 140215.0 | 75.5 | 11 | 2 | 1362.0 | 1503.0 | - |
| | | 7 | 362856.0 | 87.9 | 11 | 3 | 1553.0 | 1159.0 | 1519.0 |
| | | 8 | 587807.0 | 65.7 | 11 | 1 | 1248.0 | - | - |
| | | 9 | 807963.0 | 88.1 | 11 | 3 | 1766.0 | 1876.0 | 1261.0 |
| | | 10 | 112854.0 | 52.5 | 11 | 1 | 1810.0 | - | - |
| | | 11 | 336585.0 | 65.2 | 11 | 1 | 1003.0 | - | - |
| | | 12 | 558387.0 | 93.0 | 11 | 3 | 1486.0 | 1156.0 | 1373.0 |

Type 5 Radar Waveform_20

| Download | 20 | Type 5 | 9 | 1.3333333 | 12.0000000 | 5.528000000 | | | |
|----------|----|----------|-------------------|------------------|-------------------|----------------------------|------------|------------|------------|
| | | Burst ID | Burst Offset (us) | Pulse Width (us) | Chirp Width (MHz) | Number of Pulses per Burst | PRI-1 (us) | PRI-2 (us) | PRI-3 (us) |
| | | 0 | 1132242.0 | 59.5 | 7 | 1 | 1430.0 | - | - |
| | | 1 | 123401.0 | 54.5 | 7 | 1 | 1060.0 | - | - |
| | | 2 | 445692.0 | 80.7 | 7 | 2 | 1681.0 | 1848.0 | - |
| | | 3 | 769401.0 | 55.9 | 7 | 1 | 1469.0 | - | - |
| | | 4 | 1089256.0 | 88.5 | 7 | 3 | 1784.0 | 1767.0 | 1776.0 |
| | | 5 | 83349.0 | 94.0 | 7 | 3 | 1974.0 | 1777.0 | 1306.0 |
| | | 6 | 406292.0 | 67.3 | 7 | 2 | 1388.0 | 1067.0 | - |
| | | 7 | 727830.0 | 95.4 | 7 | 3 | 1144.0 | 1871.0 | 1708.0 |
| | | 8 | 1052676.0 | 55.3 | 7 | 1 | 1413.0 | - | - |

Type 5 Radar Waveform_21

| Download | 21 | Type 5 | 18 | 0.666667 | 12.000000 | 5.522000000 | | | | |
|----------|----|----------|-------------------|------------------|-------------------|----------------------------|------------|------------|------------|--|
| | | Burst ID | Burst Offset (us) | Pulse Width (us) | Chirp Width (MHz) | Number of Pulses per Burst | PRI-1 (us) | PRI-2 (us) | PRI-3 (us) | |
| | | 0 | 21762.0 | 97.9 | 17 | 3 | 1365.0 | 1844.0 | 1528.0 | |
| | | 1 | 182649.0 | 81.2 | 17 | 2 | 1611.0 | 1859.0 | - | |
| | | 2 | 343700.0 | 72.2 | 17 | 2 | 1676.0 | 1399.0 | - | |
| | | 3 | 504724.0 | 74.0 | 17 | 2 | 1832.0 | 1135.0 | - | |
| | | 4 | 1988.0 | 97.5 | 17 | 3 | 1879.0 | 1281.0 | 1196.0 | |
| | | 5 | 163396.0 | 56.1 | 17 | 1 | 1191.0 | - | - | |
| | | 6 | 323981.0 | 70.6 | 17 | 2 | 1035.0 | 1824.0 | - | |
| | | 7 | 483107.0 | 85.5 | 17 | 3 | 1735.0 | 1898.0 | 1783.0 | |
| | | 8 | 645998.0 | 72.0 | 17 | 2 | 1471.0 | 1359.0 | - | |
| | | 9 | 143532.0 | 56.9 | 17 | 1 | 1117.0 | - | - | |
| | | 10 | 304730.0 | 61.8 | 17 | 1 | 1594.0 | - | - | |
| | | 11 | 464070.0 | 86.4 | 17 | 3 | 1257.0 | 1488.0 | 1648.0 | |
| | | 12 | 626199.0 | 76.2 | 17 | 2 | 1172.0 | 1623.0 | - | |
| | | 13 | 123311.0 | 71.6 | 17 | 2 | 1231.0 | 1705.0 | - | |
| | | 14 | 283868.0 | 91.7 | 17 | 3 | 1393.0 | 1298.0 | 1223.0 | |
| | | 15 | 446206.0 | 55.4 | 17 | 1 | 1529.0 | - | - | |
| | | 16 | 607185.0 | 60.4 | 17 | 1 | 1899.0 | - | - | |
| | | 17 | 103407.0 | 75.1 | 17 | 2 | 1639.0 | 1778.0 | - | |

Type 5 Radar Waveform_22

| Download | 22 | Type 5 | 20 | 0.600000 | 12.000000 | 5.521000000 | | | | |
|----------|----|----------|-------------------|------------------|-------------------|----------------------------|------------|------------|------------|--|
| | | Burst ID | Burst Offset (us) | Pulse Width (us) | Chirp Width (MHz) | Number of Pulses per Burst | PRI-1 (us) | PRI-2 (us) | PRI-3 (us) | |
| | | 0 | 237938.0 | 72.4 | 20 | 2 | 1440.0 | 1389.0 | - | |
| | | 1 | 382364.0 | 73.8 | 20 | 2 | 1789.0 | 1674.0 | - | |
| | | 2 | 529205.0 | 53.1 | 20 | 1 | 1016.0 | - | - | |
| | | 3 | 75226.0 | 75.7 | 20 | 2 | 1173.0 | 1961.0 | - | |
| | | 4 | 219559.0 | 92.3 | 20 | 3 | 1232.0 | 1975.0 | 1063.0 | |
| | | 5 | 363883.0 | 89.0 | 20 | 3 | 1439.0 | 1887.0 | 1544.0 | |
| | | 6 | 510852.0 | 61.8 | 20 | 1 | 1788.0 | - | - | |
| | | 7 | 57592.0 | 50.0 | 20 | 1 | 1082.0 | - | - | |
| | | 8 | 202256.0 | 75.7 | 20 | 2 | 1609.0 | 1225.0 | - | |
| | | 9 | 347592.0 | 54.5 | 20 | 1 | 1966.0 | - | - | |
| | | 10 | 493000.0 | 50.0 | 20 | 1 | 1522.0 | - | - | |
| | | 11 | 39699.0 | 63.4 | 20 | 1 | 1110.0 | - | - | |
| | | 12 | 183920.0 | 96.9 | 20 | 3 | 1192.0 | 1328.0 | 1921.0 | |
| | | 13 | 329752.0 | 60.5 | 20 | 1 | 1919.0 | - | - | |
| | | 14 | 474008.0 | 81.7 | 20 | 2 | 1131.0 | 1792.0 | - | |
| | | 15 | 21714.0 | 68.3 | 20 | 2 | 1912.0 | 1768.0 | - | |
| | | 16 | 166934.0 | 63.6 | 20 | 1 | 1551.0 | - | - | |
| | | 17 | 311362.0 | 81.1 | 20 | 2 | 1122.0 | 1799.0 | - | |
| | | 18 | 454613.0 | 92.1 | 20 | 3 | 1475.0 | 1812.0 | 1675.0 | |
| | | 19 | 3916.0 | 59.6 | 20 | 1 | 1128.0 | - | - | |

Type 5 Radar Waveform_23

| Download | 23 | Type 5 | 10 | 1.200000 | 12.000000 | 5.526000000 | | | | |
|----------|----|----------|-------------------|------------------|-------------------|----------------------------|------------|------------|------------|--|
| | | Burst ID | Burst Offset (us) | Pulse Width (us) | Chirp Width (MHz) | Number of Pulses per Burst | PRI-1 (us) | PRI-2 (us) | PRI-3 (us) | |
| | | 0 | 298132.0 | 72.4 | 8 | 2 | 1455.0 | 1561.0 | - | |
| | | 1 | 588567.0 | 69.4 | 8 | 2 | 1558.0 | 1216.0 | - | |
| | | 2 | 878680.0 | 67.2 | 8 | 2 | 1927.0 | 1178.0 | - | |
| | | 3 | 1169160.0 | 80.3 | 8 | 2 | 1811.0 | 1093.0 | - | |
| | | 4 | 262775.0 | 66.0 | 8 | 1 | 1181.0 | - | - | |
| | | 5 | 552237.0 | 95.7 | 8 | 3 | 1898.0 | 1149.0 | 1126.0 | |
| | | 6 | 844367.0 | 53.4 | 8 | 1 | 1055.0 | - | - | |
| | | 7 | 1135049.0 | 56.6 | 8 | 1 | 1161.0 | - | - | |
| | | 8 | 226590.0 | 83.3 | 8 | 2 | 1839.0 | 1302.0 | - | |
| | | 9 | 516846.0 | 83.0 | 8 | 2 | 1791.0 | 1397.0 | - | |

Type 5 Radar Waveform_24

| Download | 24 | Type 5 | 20 | 0.6000000 | 12.0000000 | 5.521000000 | | | |
|----------|----|----------|-------------------|------------------|-------------------|----------------------------|------------|------------|------------|
| | | Burst ID | Burst Offset (us) | Pulse Width (us) | Chirp Width (MHz) | Number of Pulses per Burst | PRI-1 (us) | PRI-2 (us) | PRI-3 (us) |
| | | 0 | 401820.0 | 89.0 | 20 | 3 | 1654.0 | 1155.0 | 1358.0 |
| | | 1 | 548401.0 | 50.5 | 20 | 1 | 1907.0 | - | - |
| | | 2 | 95181.0 | 78.1 | 20 | 2 | 1058.0 | 2000.0 | - |
| | | 3 | 240301.0 | 68.8 | 20 | 2 | 1038.0 | 1167.0 | - |
| | | 4 | 384243.0 | 95.0 | 20 | 3 | 1017.0 | 1320.0 | 1485.0 |
| | | 5 | 529501.0 | 71.6 | 20 | 2 | 1668.0 | 1403.0 | - |
| | | 6 | 77525.0 | 52.1 | 20 | 1 | 1689.0 | - | - |
| | | 7 | 222238.0 | 72.1 | 20 | 2 | 1327.0 | 1425.0 | - |
| | | 8 | 365443.0 | 89.0 | 20 | 3 | 1552.0 | 1999.0 | 1881.0 |
| | | 9 | 512181.0 | 83.2 | 20 | 2 | 1391.0 | 1081.0 | - |
| | | 10 | 59632.0 | 62.2 | 20 | 1 | 1873.0 | - | - |
| | | 11 | 203660.0 | 97.5 | 20 | 3 | 1890.0 | 1051.0 | 1962.0 |
| | | 12 | 349489.0 | 80.4 | 20 | 2 | 1163.0 | 1175.0 | - |
| | | 13 | 495538.0 | 66.0 | 20 | 1 | 1012.0 | - | - |
| | | 14 | 41635.0 | 85.5 | 20 | 3 | 1368.0 | 1053.0 | 1293.0 |
| | | 15 | 187052.0 | 58.5 | 20 | 1 | 1157.0 | - | - |
| | | 16 | 331980.0 | 60.1 | 20 | 1 | 1716.0 | - | - |
| | | 17 | 476884.0 | 51.2 | 20 | 1 | 1965.0 | - | - |
| | | 18 | 23915.0 | 54.6 | 20 | 1 | 1371.0 | - | - |
| | | 19 | 169095.0 | 57.9 | 20 | 1 | 1392.0 | - | - |

Type 5 Radar Waveform_25

| Download | 25 | Type 5 | 18 | 0.6666667 | 12.0000000 | 5.522000000 | | | |
|----------|----|----------|-------------------|------------------|-------------------|----------------------------|------------|------------|------------|
| | | Burst ID | Burst Offset (us) | Pulse Width (us) | Chirp Width (MHz) | Number of Pulses per Burst | PRI-1 (us) | PRI-2 (us) | PRI-3 (us) |
| | | 0 | 349356.0 | 57.9 | 17 | 1 | 1243.0 | - | - |
| | | 1 | 510776.0 | 60.5 | 17 | 1 | 1199.0 | - | - |
| | | 2 | 6704.0 | 63.3 | 17 | 1 | 1278.0 | - | - |
| | | 3 | 168011.0 | 50.8 | 17 | 1 | 1559.0 | - | - |
| | | 4 | 329307.0 | 52.6 | 17 | 1 | 1586.0 | - | - |
| | | 5 | 490692.0 | 52.9 | 17 | 1 | 1203.0 | - | - |
| | | 6 | 651799.0 | 56.5 | 17 | 1 | 1702.0 | - | - |
| | | 7 | 147887.0 | 72.9 | 17 | 2 | 1188.0 | 1511.0 | - |
| | | 8 | 309316.0 | 59.6 | 17 | 1 | 1849.0 | - | - |
| | | 9 | 468355.0 | 96.7 | 17 | 3 | 1978.0 | 1541.0 | 1438.0 |
| | | 10 | 629706.0 | 85.6 | 17 | 3 | 1853.0 | 1119.0 | 1274.0 |
| | | 11 | 128246.0 | 55.2 | 17 | 1 | 1690.0 | - | - |
| | | 12 | 289150.0 | 66.7 | 17 | 2 | 1269.0 | 1280.0 | - |
| | | 13 | 449136.0 | 92.8 | 17 | 3 | 1242.0 | 1445.0 | 1460.0 |
| | | 14 | 612450.0 | 65.5 | 17 | 1 | 1288.0 | - | - |
| | | 15 | 107869.0 | 99.6 | 17 | 3 | 1515.0 | 1954.0 | 1356.0 |
| | | 16 | 268574.0 | 85.4 | 17 | 3 | 1447.0 | 1100.0 | 1817.0 |
| | | 17 | 430071.0 | 78.0 | 17 | 2 | 1040.0 | 1985.0 | - |

Type 5 Radar Waveform_26

| Download | 26 | Type 5 | 9 | 1.3333333 | 12.0000000 | 5.526000000 | | | |
|----------|----|----------|-------------------|------------------|-------------------|----------------------------|------------|------------|------------|
| | | Burst ID | Burst Offset (us) | Pulse Width (us) | Chirp Width (MHz) | Number of Pulses per Burst | PRI-1 (us) | PRI-2 (us) | PRI-3 (us) |
| | | 0 | 1186199.0 | 65.5 | 6 | 1 | 1390.0 | - | - |
| | | 1 | 177344.0 | 60.1 | 6 | 1 | 1013.0 | - | - |
| | | 2 | 500300.0 | 66.1 | 6 | 1 | 1476.0 | - | - |
| | | 3 | 821660.0 | 91.6 | 6 | 3 | 1001.0 | 1381.0 | 1774.0 |
| | | 4 | 1143652.0 | 92.1 | 6 | 3 | 1567.0 | 1120.0 | 1906.0 |
| | | 5 | 137508.0 | 58.9 | 6 | 1 | 1343.0 | - | - |
| | | 6 | 459407.0 | 97.4 | 6 | 3 | 1904.0 | 1418.0 | 1349.0 |
| | | 7 | 783119.0 | 75.0 | 6 | 2 | 1151.0 | 1021.0 | - |
| | | 8 | 1103375.0 | 89.1 | 6 | 3 | 1428.0 | 1908.0 | 1957.0 |

Type 5 Radar Waveform_27

| Download | 27 | Type 5 | 15 | 0.8000000 | 12.0000000 | 5.523000000 | | | |
|----------|----|----------|-------------------|------------------|-------------------|----------------------------|------------|------------|------------|
| | | Burst ID | Burst Offset (us) | Pulse Width (us) | Chirp Width (MHz) | Number of Pulses per Burst | PRI-1 (us) | PRI-2 (us) | PRI-3 (us) |
| | | 0 | 58593.0 | 51.1 | 14 | 1 | 1301.0 | - | - |
| | | 1 | 250925.0 | 94.9 | 14 | 3 | 1934.0 | 1785.0 | 1942.0 |
| | | 2 | 446169.0 | 57.4 | 14 | 1 | 1022.0 | - | - |
| | | 3 | 637717.0 | 85.5 | 14 | 3 | 1072.0 | 1855.0 | 1078.0 |
| | | 4 | 34733.0 | 52.2 | 14 | 1 | 1296.0 | - | - |
| | | 5 | 228395.0 | 51.9 | 14 | 1 | 1466.0 | - | - |
| | | 6 | 421096.0 | 75.4 | 14 | 2 | 1629.0 | 1671.0 | - |
| | | 7 | 614419.0 | 75.0 | 14 | 2 | 1227.0 | 1946.0 | - |
| | | 8 | 10845.0 | 78.5 | 14 | 2 | 1731.0 | 1564.0 | - |
| | | 9 | 203538.0 | 87.2 | 14 | 3 | 1891.0 | 1803.0 | 1682.0 |
| | | 10 | 397245.0 | 77.2 | 14 | 2 | 1627.0 | 1773.0 | - |
| | | 11 | 591676.0 | 66.1 | 14 | 1 | 1739.0 | - | - |
| | | 12 | 781344.0 | 92.1 | 14 | 3 | 1833.0 | 1968.0 | 1938.0 |
| | | 13 | 180698.0 | 65.1 | 14 | 1 | 1405.0 | - | - |
| | | 14 | 373813.0 | 79.3 | 14 | 2 | 1615.0 | 1004.0 | - |

Type 5 Radar Waveform_28

| Download | 28 | Type 5 | 17 | 0.7058824 | 12.0000000 | 5.522000000 | | | |
|----------|----|----------|-------------------|------------------|-------------------|----------------------------|------------|------------|------------|
| | | Burst ID | Burst Offset (us) | Pulse Width (us) | Chirp Width (MHz) | Number of Pulses per Burst | PRI-1 (us) | PRI-2 (us) | PRI-3 (us) |
| | | 0 | 500961.0 | 62.4 | 16 | 1 | 1625.0 | - | - |
| | | 1 | 669226.0 | 92.4 | 16 | 3 | 1435.0 | 1765.0 | 1088.0 |
| | | 2 | 137709.0 | 97.7 | 16 | 3 | 1546.0 | 1846.0 | 1308.0 |
| | | 3 | 309227.0 | 57.0 | 16 | 1 | 1376.0 | - | - |
| | | 4 | 479042.0 | 80.7 | 16 | 2 | 1902.0 | 1015.0 | - |
| | | 5 | 647469.0 | 87.7 | 16 | 3 | 1915.0 | 1637.0 | 1599.0 |
| | | 6 | 117367.0 | 50.5 | 16 | 1 | 1064.0 | - | - |
| | | 7 | 286909.0 | 85.9 | 16 | 3 | 1509.0 | 1129.0 | 1845.0 |
| | | 8 | 458518.0 | 73.1 | 16 | 2 | 1160.0 | 1024.0 | - |
| | | 9 | 628991.0 | 82.1 | 16 | 2 | 1375.0 | 1029.0 | - |
| | | 10 | 95885.0 | 85.7 | 16 | 3 | 1312.0 | 1760.0 | 1107.0 |
| | | 11 | 265912.0 | 94.6 | 16 | 3 | 1138.0 | 1490.0 | 1970.0 |
| | | 12 | 435837.0 | 91.9 | 16 | 3 | 1572.0 | 1387.0 | 1893.0 |
| | | 13 | 608589.0 | 66.4 | 16 | 1 | 1693.0 | - | - |
| | | 14 | 74999.0 | 66.4 | 16 | 2 | 1480.0 | 1984.0 | - |
| | | 15 | 245916.0 | 54.4 | 16 | 1 | 1864.0 | - | - |
| | | 16 | 416752.0 | 53.5 | 16 | 1 | 1713.0 | - | - |

Type 5 Radar Waveform_29

| Download | 29 | Type 5 | 10 | 1.2000000 | 12.0000000 | 5.526000000 | | | |
|----------|----|----------|-------------------|------------------|-------------------|----------------------------|------------|------------|------------|
| | | Burst ID | Burst Offset (us) | Pulse Width (us) | Chirp Width (MHz) | Number of Pulses per Burst | PRI-1 (us) | PRI-2 (us) | PRI-3 (us) |
| | | 0 | 998753.0 | 77.7 | 7 | 2 | 1556.0 | 1423.0 | - |
| | | 1 | 92174.0 | 63.9 | 7 | 1 | 1335.0 | - | - |
| | | 2 | 382943.0 | 55.3 | 7 | 1 | 1182.0 | - | - |
| | | 3 | 672584.0 | 78.1 | 7 | 2 | 1569.0 | 1577.0 | - |
| | | 4 | 964443.0 | 52.1 | 7 | 1 | 1177.0 | - | - |
| | | 5 | 56379.0 | 61.1 | 7 | 1 | 1033.0 | - | - |
| | | 6 | 346299.0 | 83.4 | 7 | 3 | 1461.0 | 1101.0 | 1464.0 |
| | | 7 | 637595.0 | 53.2 | 7 | 1 | 1706.0 | - | - |
| | | 8 | 925578.0 | 91.3 | 7 | 3 | 1386.0 | 1868.0 | 1861.0 |
| | | 9 | 20533.0 | 67.7 | 7 | 2 | 1474.0 | 1183.0 | - |

| Radar Type 6 - Radar Statistical Performance | | | |
|--|-------------------------------|--------------|-------------------------------|
| Trail # | 1=Detection 0=No Detection | Trail # | 1=Detection 0=No Detection |
| 0 | 1 | 15 | 1 |
| 1 | 1 | 16 | 1 |
| 2 | 1 | 17 | 1 |
| 3 | 1 | 18 | 1 |
| 4 | 1 | 19 | 1 |
| 5 | 1 | 20 | 1 |
| 6 | 1 | 21 | 1 |
| 7 | 1 | 22 | 1 |
| 8 | 1 | 23 | 1 |
| 9 | 1 | 24 | 1 |
| 10 | 1 | 25 | 1 |
| 11 | 1 | 26 | 1 |
| 12 | 1 | 27 | 1 |
| 13 | 1 | 28 | 1 |
| 14 | 0 | 29 | 1 |
| Detection Percentage (%) | | 96.7% | |

Type 6 Radar Waveform_0

| Download | 0 | Type 6 | 1.0 | 333.3 | 9 | 0.3333 | 300.000000 | 9 |
|----------|---|----------------------|------|-------|------|--------|------------|---|
| | | Frequency List (MHz) | 0 | 1 | 2 | 3 | 4 | |
| | | 0 | 5524 | 5287 | 5528 | 5420 | 5348 | |
| | | 5 | 5369 | 5644 | 5608 | 5351 | 5304 | |
| | | 10 | 5612 | 5434 | 5323 | 5291 | 5489 | |
| | | 15 | 5374 | 5419 | 5309 | 5313 | 5347 | |
| | | 20 | 5437 | 5330 | 5532 | 5267 | 5654 | |
| | | 25 | 5720 | 5443 | 5490 | 5655 | 5308 | |
| | | 30 | 5431 | 5484 | 5527 | 5624 | 5251 | |
| | | 35 | 5495 | 5322 | 5686 | 5667 | 5389 | |
| | | 40 | 5623 | 5467 | 5709 | 5649 | 5507 | |
| | | 45 | 5297 | 5277 | 5519 | 5549 | 5651 | |
| | | 50 | 5541 | 5675 | 5343 | 5500 | 5512 | |
| | | 55 | 5586 | 5342 | 5376 | 5617 | 5475 | |
| | | 60 | 5418 | 5539 | 5716 | 5483 | 5592 | |
| | | 65 | 5666 | 5371 | 5271 | 5358 | 5661 | |
| | | 70 | 5379 | 5386 | 5602 | 5290 | 5674 | |
| | | 75 | 5628 | 5573 | 5326 | 5673 | 5405 | |
| | | 80 | 5625 | 5696 | 5554 | 5497 | 5672 | |
| | | 85 | 5427 | 5687 | 5282 | 5701 | 5463 | |
| | | 90 | 5413 | 5600 | 5478 | 5329 | 5266 | |
| | | 95 | 5352 | 5576 | 5393 | 5688 | 5265 | |

Type 6 Radar Waveform_1

| Download | 1 | Type 6 | 1.0 | 333.3 | 9 | 0.3333 | 300.000000 | 8 |
|----------|---|----------------------|------|-------|------|--------|------------|---|
| | | Frequency List (MHz) | 0 | 1 | 2 | 3 | 4 | |
| | | 0 | 5304 | 5526 | 5464 | 5581 | 5568 | |
| | | 5 | 5411 | 5666 | 5683 | 5417 | 5608 | |
| | | 10 | 5543 | 5698 | 5364 | 5486 | 5510 | |
| | | 15 | 5365 | 5449 | 5315 | 5261 | 5539 | |
| | | 20 | 5445 | 5399 | 5375 | 5621 | 5715 | |
| | | 25 | 5669 | 5372 | 5547 | 5524 | 5351 | |
| | | 30 | 5544 | 5265 | 5646 | 5258 | 5347 | |
| | | 35 | 5288 | 5439 | 5291 | 5475 | 5600 | |
| | | 40 | 5506 | 5472 | 5629 | 5276 | 5620 | |
| | | 45 | 5396 | 5689 | 5257 | 5565 | 5350 | |
| | | 50 | 5542 | 5395 | 5250 | 5702 | 5630 | |
| | | 55 | 5498 | 5685 | 5688 | 5373 | 5564 | |
| | | 60 | 5483 | 5507 | 5724 | 5443 | 5478 | |
| | | 65 | 5424 | 5357 | 5371 | 5286 | 5652 | |
| | | 70 | 5471 | 5595 | 5345 | 5327 | 5329 | |
| | | 75 | 5521 | 5631 | 5353 | 5671 | 5348 | |
| | | 80 | 5476 | 5643 | 5306 | 5370 | 5579 | |
| | | 85 | 5469 | 5374 | 5662 | 5678 | 5461 | |
| | | 90 | 5569 | 5391 | 5718 | 5518 | 5609 | |
| | | 95 | 5311 | 5703 | 5277 | 5690 | 5324 | |

Type 6 Radar Waveform_2

| Download | 2 | Type 6 | 1.0 | 333.3 | 9 | 0.3333 | 300.0000000 | 8 |
|----------|---|----------------------|------|-------|------|--------|-------------|---|
| | | Frequency List (MHz) | 0 | 1 | 2 | 3 | 4 | |
| | | 0 | 5462 | 5290 | 5400 | 5267 | 5410 | |
| | | 5 | 5453 | 5591 | 5283 | 5580 | 5340 | |
| | | 10 | 5377 | 5487 | 5405 | 5584 | 5531 | |
| | | 15 | 5576 | 5418 | 5306 | 5256 | 5565 | |
| | | 20 | 5316 | 5613 | 5688 | 5333 | 5521 | |
| | | 25 | 5478 | 5651 | 5558 | 5490 | 5433 | |
| | | 30 | 5697 | 5386 | 5545 | 5330 | 5530 | |
| | | 35 | 5562 | 5628 | 5611 | 5345 | 5652 | |
| | | 40 | 5567 | 5516 | 5714 | 5703 | 5572 | |
| | | 45 | 5526 | 5403 | 5429 | 5271 | 5426 | |
| | | 50 | 5278 | 5719 | 5699 | 5609 | 5401 | |
| | | 55 | 5327 | 5279 | 5363 | 5357 | 5272 | |
| | | 60 | 5672 | 5669 | 5612 | 5366 | 5373 | |
| | | 65 | 5393 | 5581 | 5467 | 5358 | 5260 | |
| | | 70 | 5474 | 5444 | 5321 | 5355 | 5674 | |
| | | 75 | 5485 | 5375 | 5502 | 5311 | 5509 | |
| | | 80 | 5455 | 5513 | 5571 | 5543 | 5379 | |
| | | 85 | 5582 | 5696 | 5498 | 5713 | 5630 | |
| | | 90 | 5717 | 5352 | 5684 | 5398 | 5354 | |
| | | 95 | 5500 | 5573 | 5593 | 5645 | 5331 | |

Type 6 Radar Waveform_3

| Download | 3 | Type 6 | 1.0 | 333.3 | 9 | 0.3333 | 300.0000000 | 10 |
|----------|---|----------------------|------|-------|------|--------|-------------|----|
| | | Frequency List (MHz) | 0 | 1 | 2 | 3 | 4 | |
| | | 0 | 5717 | 5529 | 5336 | 5428 | 5630 | |
| | | 5 | 5495 | 5613 | 5358 | 5268 | 5547 | |
| | | 10 | 5308 | 5373 | 5446 | 5304 | 5552 | |
| | | 15 | 5541 | 5703 | 5521 | 5351 | 5448 | |
| | | 20 | 5364 | 5634 | 5257 | 5702 | 5661 | |
| | | 25 | 5599 | 5470 | 5681 | 5377 | 5592 | |
| | | 30 | 5532 | 5419 | 5654 | 5601 | 5659 | |
| | | 35 | 5365 | 5469 | 5621 | 5455 | 5403 | |
| | | 40 | 5525 | 5260 | 5505 | 5281 | 5711 | |
| | | 45 | 5632 | 5423 | 5584 | 5456 | 5694 | |
| | | 50 | 5622 | 5602 | 5329 | 5333 | 5522 | |
| | | 55 | 5589 | 5372 | 5657 | 5328 | 5401 | |
| | | 60 | 5362 | 5444 | 5667 | 5467 | 5534 | |
| | | 65 | 5322 | 5429 | 5413 | 5295 | 5270 | |
| | | 70 | 5527 | 5721 | 5574 | 5671 | 5675 | |
| | | 75 | 5314 | 5643 | 5605 | 5518 | 5483 | |
| | | 80 | 5563 | 5619 | 5302 | 5576 | 5568 | |
| | | 85 | 5263 | 5379 | 5424 | 5593 | 5678 | |
| | | 90 | 5490 | 5392 | 5517 | 5690 | 5432 | |
| | | 95 | 5512 | 5374 | 5628 | 5577 | 5679 | |

Type 6 Radar Waveform_4

| Download | 4 | Type 6 | 1.0 | 333.3 | 9 | 0.3333 | 300.0000000 | 12 |
|----------|---|----------------------|------|-------|------|--------|-------------|----|
| | | Frequency List (MHz) | 0 | 1 | 2 | 3 | 4 | |
| | | 0 | 5497 | 5293 | 5272 | 5589 | 5472 | |
| | | 5 | 5634 | 5538 | 5433 | 5431 | 5376 | |
| | | 10 | 5714 | 5637 | 5487 | 5499 | 5573 | |
| | | 15 | 5629 | 5355 | 5624 | 5396 | 5262 | |
| | | 20 | 5372 | 5325 | 5295 | 5694 | 5322 | |
| | | 25 | 5409 | 5481 | 5626 | 5574 | 5308 | |
| | | 30 | 5611 | 5719 | 5336 | 5563 | 5608 | |
| | | 35 | 5712 | 5251 | 5556 | 5439 | 5498 | |
| | | 40 | 5343 | 5443 | 5521 | 5708 | 5464 | |
| | | 45 | 5532 | 5506 | 5642 | 5509 | 5581 | |
| | | 50 | 5401 | 5303 | 5380 | 5519 | 5345 | |
| | | 55 | 5400 | 5302 | 5710 | 5562 | 5476 | |
| | | 60 | 5299 | 5530 | 5527 | 5656 | 5276 | |
| | | 65 | 5493 | 5413 | 5260 | 5271 | 5368 | |
| | | 70 | 5720 | 5565 | 5548 | 5599 | 5707 | |
| | | 75 | 5577 | 5520 | 5651 | 5273 | 5515 | |
| | | 80 | 5628 | 5661 | 5340 | 5632 | 5558 | |
| | | 85 | 5686 | 5639 | 5555 | 5282 | 5266 | |
| | | 90 | 5310 | 5546 | 5635 | 5263 | 5590 | |
| | | 95 | 5682 | 5696 | 5369 | 5496 | 5621 | |

Type 6 Radar Waveform_5

| Download | 5 | Type 6 | 1.0 | 333.3 | 9 | 0.3333 | 300.0000000 | 8 |
|----------|---|----------------------|------|-------|------|--------|-------------|---|
| | | Frequency List (MHz) | 0 | 1 | 2 | 3 | 4 | |
| | | 0 | 5277 | 5532 | 5683 | 5275 | 5692 | |
| | | 5 | 5676 | 5560 | 5508 | 5497 | 5583 | |
| | | 10 | 5548 | 5426 | 5528 | 5694 | 5594 | |
| | | 15 | 5620 | 5482 | 5252 | 5344 | 5454 | |
| | | 20 | 5380 | 5394 | 5711 | 5308 | 5607 | |
| | | 25 | 5375 | 5649 | 5612 | 5585 | 5660 | |
| | | 30 | 5713 | 5294 | 5568 | 5459 | 5383 | |
| | | 35 | 5650 | 5326 | 5522 | 5709 | 5353 | |
| | | 40 | 5434 | 5523 | 5381 | 5664 | 5705 | |
| | | 45 | 5393 | 5512 | 5589 | 5603 | 5562 | |
| | | 50 | 5371 | 5479 | 5431 | 5608 | 5643 | |
| | | 55 | 5722 | 5490 | 5673 | 5270 | 5659 | |
| | | 60 | 5601 | 5416 | 5359 | 5558 | 5695 | |
| | | 65 | 5404 | 5455 | 5360 | 5351 | 5293 | |
| | | 70 | 5693 | 5677 | 5369 | 5627 | 5707 | |
| | | 75 | 5484 | 5273 | 5445 | 5592 | 5267 | |
| | | 80 | 5339 | 5324 | 5680 | 5304 | 5502 | |
| | | 85 | 5414 | 5511 | 5410 | 5372 | 5403 | |
| | | 90 | 5378 | 5255 | 5408 | 5263 | 5642 | |
| | | 95 | 5475 | 5485 | 5640 | 5691 | 5700 | |

Type 6 Radar Waveform_6

| Download | 6 | Type 6 | 1.0 | 333.3 | 9 | 0.3333 | 300.000000 | 7 |
|----------|---|----------------------|------|-------|------|--------|------------|---|
| | | Frequency List (MHz) | 0 | 1 | 2 | 3 | 4 | |
| | | 0 | 5532 | 5296 | 5619 | 5436 | 5437 | |
| | | 5 | 5718 | 5485 | 5583 | 5660 | 5315 | |
| | | 10 | 5479 | 5690 | 5569 | 5414 | 5615 | |
| | | 15 | 5708 | 5512 | 5258 | 5389 | 5646 | |
| | | 20 | 5291 | 5560 | 5652 | 5300 | 5580 | |
| | | 25 | 5641 | 5598 | 5340 | 5689 | 5694 | |
| | | 30 | 5280 | 5658 | 5525 | 5674 | 5262 | |
| | | 35 | 5678 | 5314 | 5516 | 5318 | 5484 | |
| | | 40 | 5364 | 5273 | 5606 | 5319 | 5429 | |
| | | 45 | 5702 | 5322 | 5492 | 5672 | 5661 | |
| | | 50 | 5518 | 5628 | 5655 | 5482 | 5697 | |
| | | 55 | 5369 | 5666 | 5581 | 5618 | 5467 | |
| | | 60 | 5313 | 5382 | 5643 | 5717 | 5402 | |
| | | 65 | 5284 | 5644 | 5343 | 5287 | 5252 | |
| | | 70 | 5629 | 5365 | 5301 | 5680 | 5693 | |
| | | 75 | 5603 | 5453 | 5393 | 5375 | 5426 | |
| | | 80 | 5377 | 5595 | 5539 | 5387 | 5559 | |
| | | 85 | 5470 | 5522 | 5267 | 5597 | 5379 | |
| | | 90 | 5640 | 5608 | 5537 | 5330 | 5638 | |
| | | 95 | 5626 | 5373 | 5367 | 5268 | 5511 | |

Type 6 Radar Waveform_7

| Download | 7 | Type 6 | 1.0 | 333.3 | 9 | 0.3333 | 300.000000 | 12 |
|----------|---|----------------------|------|-------|------|--------|------------|----|
| | | Frequency List (MHz) | 0 | 1 | 2 | 3 | 4 | |
| | | 0 | 5690 | 5535 | 5652 | 5500 | 5279 | |
| | | 5 | 5382 | 5507 | 5658 | 5348 | 5619 | |
| | | 10 | 5410 | 5479 | 5707 | 5512 | 5636 | |
| | | 15 | 5321 | 5639 | 5361 | 5434 | 5363 | |
| | | 20 | 5299 | 5251 | 5389 | 5553 | 5529 | |
| | | 25 | 5450 | 5543 | 5318 | 5253 | 5322 | |
| | | 30 | 5547 | 5482 | 5414 | 5511 | 5401 | |
| | | 35 | 5453 | 5607 | 5686 | 5637 | 5278 | |
| | | 40 | 5587 | 5689 | 5257 | 5669 | 5629 | |
| | | 45 | 5472 | 5280 | 5719 | 5571 | 5523 | |
| | | 50 | 5504 | 5356 | 5533 | 5311 | 5667 | |
| | | 55 | 5513 | 5294 | 5572 | 5657 | 5590 | |
| | | 60 | 5345 | 5588 | 5344 | 5640 | 5582 | |
| | | 65 | 5593 | 5379 | 5497 | 5522 | 5335 | |
| | | 70 | 5437 | 5287 | 5683 | 5542 | 5579 | |
| | | 75 | 5625 | 5325 | 5421 | 5407 | 5524 | |
| | | 80 | 5390 | 5376 | 5606 | 5556 | 5665 | |
| | | 85 | 5563 | 5364 | 5327 | 5314 | 5722 | |
| | | 90 | 5594 | 5435 | 5428 | 5702 | 5336 | |
| | | 95 | 5374 | 5520 | 5539 | 5373 | 5271 | |

Type 6 Radar Waveform_8

| Download | 8 | Type 6 | 1.0 | 333.3 | 9 | 0.3333 | 300.0000000 | 9 |
|----------|---|----------------------|------|-------|------|--------|-------------|---|
| | | Frequency List (MHz) | 0 | 1 | 2 | 3 | 4 | |
| | | 0 | 5470 | 5299 | 5588 | 5661 | 5499 | |
| | | 5 | 5424 | 5432 | 5258 | 5511 | 5351 | |
| | | 10 | 5719 | 5268 | 5273 | 5707 | 5657 | |
| | | 15 | 5409 | 5291 | 5464 | 5382 | 5555 | |
| | | 20 | 5307 | 5320 | 5631 | 5381 | 5526 | |
| | | 25 | 5399 | 5649 | 5519 | 5287 | 5461 | |
| | | 30 | 5533 | 5439 | 5532 | 5663 | 5696 | |
| | | 35 | 5592 | 5698 | 5482 | 5315 | 5667 | |
| | | 40 | 5426 | 5297 | 5670 | 5434 | 5318 | |
| | | 45 | 5558 | 5355 | 5363 | 5680 | 5624 | |
| | | 50 | 5410 | 5283 | 5584 | 5497 | 5490 | |
| | | 55 | 5457 | 5372 | 5508 | 5561 | 5474 | |
| | | 60 | 5712 | 5651 | 5466 | 5294 | 5308 | |
| | | 65 | 5542 | 5415 | 5329 | 5414 | 5613 | |
| | | 70 | 5606 | 5458 | 5536 | 5564 | 5388 | |
| | | 75 | 5301 | 5500 | 5632 | 5295 | 5513 | |
| | | 80 | 5456 | 5385 | 5303 | 5290 | 5506 | |
| | | 85 | 5687 | 5645 | 5683 | 5626 | 5392 | |
| | | 90 | 5342 | 5408 | 5402 | 5556 | 5428 | |
| | | 95 | 5691 | 5644 | 5703 | 5413 | 5274 | |

Type 6 Radar Waveform_9

| Download | 9 | Type 6 | 1.0 | 333.3 | 9 | 0.3333 | 300.0000000 | 7 |
|----------|---|----------------------|------|-------|------|--------|-------------|---|
| | | Frequency List (MHz) | 0 | 1 | 2 | 3 | 4 | |
| | | 0 | 5250 | 5538 | 5524 | 5347 | 5341 | |
| | | 5 | 5466 | 5454 | 5333 | 5577 | 5558 | |
| | | 10 | 5650 | 5629 | 5314 | 5427 | 5678 | |
| | | 15 | 5400 | 5418 | 5567 | 5272 | 5693 | |
| | | 20 | 5486 | 5572 | 5470 | 5499 | 5683 | |
| | | 25 | 5251 | 5377 | 5623 | 5321 | 5503 | |
| | | 30 | 5422 | 5396 | 5437 | 5419 | 5634 | |
| | | 35 | 5278 | 5565 | 5362 | 5477 | 5511 | |
| | | 40 | 5315 | 5390 | 5335 | 5446 | 5263 | |
| | | 45 | 5677 | 5675 | 5708 | 5635 | 5586 | |
| | | 50 | 5313 | 5304 | 5670 | 5480 | 5562 | |
| | | 55 | 5327 | 5532 | 5603 | 5402 | 5478 | |
| | | 60 | 5483 | 5292 | 5337 | 5606 | 5491 | |
| | | 65 | 5354 | 5539 | 5684 | 5416 | 5259 | |
| | | 70 | 5311 | 5618 | 5434 | 5543 | 5641 | |
| | | 75 | 5656 | 5610 | 5369 | 5553 | 5413 | |
| | | 80 | 5459 | 5673 | 5453 | 5620 | 5350 | |
| | | 85 | 5601 | 5555 | 5599 | 5456 | 5349 | |
| | | 90 | 5557 | 5445 | 5345 | 5662 | 5497 | |
| | | 95 | 5573 | 5639 | 5682 | 5252 | 5508 | |

Type 6 Radar Waveform_10

| Download | 10 | Type 6 | 1.0 | 333.3 | 9 | 0.3333 | 300.000000 | 7 |
|----------|----|----------------------|------|-------|------|--------|------------|---|
| | | Frequency List (MHz) | 0 | 1 | 2 | 3 | 4 | |
| | | 0 | 5505 | 5302 | 5460 | 5508 | 5561 | |
| | | 5 | 5379 | 5408 | 5265 | 5290 | 5484 | |
| | | 10 | 5418 | 5355 | 5622 | 5699 | 5488 | |
| | | 15 | 5545 | 5670 | 5472 | 5464 | 5701 | |
| | | 20 | 5555 | 5610 | 5462 | 5474 | 5578 | |
| | | 25 | 5580 | 5252 | 5311 | 5353 | 5487 | |
| | | 30 | 5589 | 5714 | 5298 | 5405 | 5646 | |
| | | 35 | 5718 | 5592 | 5676 | 5560 | 5449 | |
| | | 40 | 5342 | 5312 | 5319 | 5315 | 5529 | |
| | | 45 | 5321 | 5255 | 5562 | 5510 | 5409 | |
| | | 50 | 5686 | 5675 | 5514 | 5723 | 5383 | |
| | | 55 | 5434 | 5655 | 5621 | 5406 | 5257 | |
| | | 60 | 5567 | 5520 | 5690 | 5283 | 5332 | |
| | | 65 | 5440 | 5390 | 5371 | 5479 | 5694 | |
| | | 70 | 5372 | 5411 | 5467 | 5410 | 5502 | |
| | | 75 | 5301 | 5278 | 5447 | 5330 | 5623 | |
| | | 80 | 5669 | 5261 | 5450 | 5397 | 5369 | |
| | | 85 | 5559 | 5313 | 5318 | 5650 | 5704 | |
| | | 90 | 5644 | 5722 | 5451 | 5544 | 5606 | |
| | | 95 | 5590 | 5538 | 5281 | 5537 | 5564 | |

Type 6 Radar Waveform_11

| Download | 11 | Type 6 | 1.0 | 333.3 | 9 | 0.3333 | 300.000000 | 7 |
|----------|----|----------------------|------|-------|------|--------|------------|---|
| | | Frequency List (MHz) | 0 | 1 | 2 | 3 | 4 | |
| | | 0 | 5663 | 5638 | 5396 | 5669 | 5403 | |
| | | 5 | 5647 | 5401 | 5483 | 5428 | 5594 | |
| | | 10 | 5415 | 5682 | 5342 | 5720 | 5576 | |
| | | 15 | 5575 | 5676 | 5517 | 5278 | 5709 | |
| | | 20 | 5721 | 5551 | 5445 | 5362 | 5527 | |
| | | 25 | 5308 | 5356 | 5389 | 5684 | 5297 | |
| | | 30 | 5310 | 5605 | 5363 | 5437 | 5496 | |
| | | 35 | 5442 | 5506 | 5515 | 5643 | 5387 | |
| | | 40 | 5582 | 5309 | 5723 | 5295 | 5612 | |
| | | 45 | 5282 | 5352 | 5289 | 5585 | 5262 | |
| | | 50 | 5337 | 5570 | 5571 | 5291 | 5370 | |
| | | 55 | 5440 | 5377 | 5386 | 5257 | 5465 | |
| | | 60 | 5719 | 5516 | 5704 | 5630 | 5486 | |
| | | 65 | 5329 | 5581 | 5371 | 5497 | 5444 | |
| | | 70 | 5328 | 5414 | 5316 | 5461 | 5482 | |
| | | 75 | 5421 | 5324 | 5258 | 5450 | 5690 | |
| | | 80 | 5447 | 5592 | 5272 | 5373 | 5413 | |
| | | 85 | 5388 | 5604 | 5477 | 5367 | 5412 | |
| | | 90 | 5457 | 5618 | 5593 | 5265 | 5435 | |
| | | 95 | 5543 | 5648 | 5601 | 5652 | 5613 | |

Type 6 Radar Waveform_12

| Download | 12 | Type 6 | 1.0 | 333.3 | 9 | 0.3333 | 300.000000 | 5 |
|----------|----|----------------------|------|-------|------|--------|------------|---|
| | | Frequency List (MHz) | 0 | 1 | 2 | 3 | 4 | |
| | | 0 | 5443 | 5402 | 5332 | 5355 | 5623 | |
| | | 5 | 5689 | 5326 | 5558 | 5591 | 5346 | |
| | | 10 | 5471 | 5437 | 5440 | 5266 | 5664 | |
| | | 15 | 5702 | 5304 | 5465 | 5470 | 5620 | |
| | | 20 | 5315 | 5492 | 5543 | 5418 | 5250 | |
| | | 25 | 5379 | 5511 | 5557 | 5423 | 5251 | |
| | | 30 | 5661 | 5267 | 5345 | 5515 | 5257 | |
| | | 35 | 5479 | 5684 | 5713 | 5646 | 5517 | |
| | | 40 | 5354 | 5348 | 5325 | 5306 | 5555 | |
| | | 45 | 5275 | 5695 | 5340 | 5264 | 5714 | |
| | | 50 | 5640 | 5286 | 5313 | 5378 | 5635 | |
| | | 55 | 5514 | 5662 | 5720 | 5560 | 5637 | |
| | | 60 | 5422 | 5410 | 5551 | 5342 | 5650 | |
| | | 65 | 5356 | 5435 | 5365 | 5413 | 5641 | |
| | | 70 | 5678 | 5613 | 5314 | 5362 | 5420 | |
| | | 75 | 5451 | 5541 | 5467 | 5409 | 5359 | |
| | | 80 | 5271 | 5706 | 5387 | 5444 | 5312 | |
| | | 85 | 5272 | 5718 | 5336 | 5605 | 5353 | |
| | | 90 | 5577 | 5463 | 5350 | 5686 | 5252 | |
| | | 95 | 5721 | 5648 | 5724 | 5333 | 5425 | |

Type 6 Radar Waveform_13

| Download | 13 | Type 6 | 1.0 | 333.3 | 9 | 0.3333 | 300.000000 | 7 |
|----------|----|----------------------|------|-------|------|--------|------------|---|
| | | Frequency List (MHz) | 0 | 1 | 2 | 3 | 4 | |
| | | 0 | 5698 | 5641 | 5268 | 5516 | 5465 | |
| | | 5 | 5256 | 5348 | 5633 | 5657 | 5533 | |
| | | 10 | 5655 | 5280 | 5478 | 5635 | 5287 | |
| | | 15 | 5354 | 5407 | 5510 | 5662 | 5628 | |
| | | 20 | 5481 | 5530 | 5632 | 5391 | 5328 | |
| | | 25 | 5617 | 5661 | 5457 | 5293 | 5550 | |
| | | 30 | 5699 | 5560 | 5289 | 5552 | 5618 | |
| | | 35 | 5300 | 5509 | 5324 | 5431 | 5668 | |
| | | 40 | 5263 | 5490 | 5400 | 5484 | 5255 | |
| | | 45 | 5303 | 5398 | 5317 | 5504 | 5462 | |
| | | 50 | 5364 | 5564 | 5458 | 5361 | 5375 | |
| | | 55 | 5674 | 5275 | 5456 | 5319 | 5547 | |
| | | 60 | 5587 | 5355 | 5383 | 5265 | 5693 | |
| | | 65 | 5557 | 5384 | 5401 | 5623 | 5685 | |
| | | 70 | 5517 | 5392 | 5338 | 5379 | 5323 | |
| | | 75 | 5610 | 5390 | 5514 | 5381 | 5487 | |
| | | 80 | 5543 | 5344 | 5604 | 5650 | 5299 | |
| | | 85 | 5322 | 5696 | 5609 | 5498 | 5385 | |
| | | 90 | 5267 | 5463 | 5568 | 5703 | 5330 | |
| | | 95 | 5706 | 5404 | 5666 | 5694 | 5642 | |

Type 6 Radar Waveform_14

| Download | 14 | Type 6 | 1.0 | 333.3 | 9 | 0.3333 | 300.0000000 | 5 |
|----------|----|----------------------|------|-------|------|--------|-------------|---|
| | | Frequency List (MHz) | 0 | 1 | 2 | 3 | 4 | |
| | | 0 | 5478 | 5405 | 5679 | 5580 | 5685 | |
| | | 5 | 5298 | 5273 | 5708 | 5345 | 5362 | |
| | | 10 | 5586 | 5621 | 5519 | 5355 | 5308 | |
| | | 15 | 5268 | 5481 | 5510 | 5555 | 5379 | |
| | | 20 | 5636 | 5550 | 5471 | 5624 | 5364 | |
| | | 25 | 5404 | 5655 | 5290 | 5491 | 5335 | |
| | | 30 | 5536 | 5656 | 5300 | 5441 | 5275 | |
| | | 35 | 5282 | 5391 | 5402 | 5477 | 5604 | |
| | | 40 | 5514 | 5676 | 5255 | 5397 | 5316 | |
| | | 45 | 5613 | 5386 | 5359 | 5370 | 5392 | |
| | | 50 | 5638 | 5415 | 5653 | 5659 | 5305 | |
| | | 55 | 5563 | 5628 | 5465 | 5668 | 5277 | |
| | | 60 | 5690 | 5566 | 5639 | 5380 | 5333 | |
| | | 65 | 5340 | 5455 | 5328 | 5294 | 5383 | |
| | | 70 | 5617 | 5716 | 5692 | 5338 | 5292 | |
| | | 75 | 5684 | 5371 | 5291 | 5385 | 5707 | |
| | | 80 | 5610 | 5341 | 5324 | 5553 | 5499 | |
| | | 85 | 5417 | 5661 | 5271 | 5680 | 5432 | |
| | | 90 | 5572 | 5321 | 5353 | 5373 | 5280 | |
| | | 95 | 5283 | 5314 | 5286 | 5389 | 5596 | |

Type 6 Radar Waveform_15

| Download | 15 | Type 6 | 1.0 | 333.3 | 9 | 0.3333 | 300.0000000 | 10 |
|----------|----|----------------------|------|-------|------|--------|-------------|----|
| | | Frequency List (MHz) | 0 | 1 | 2 | 3 | 4 | |
| | | 0 | 5258 | 5644 | 5615 | 5266 | 5527 | |
| | | 5 | 5437 | 5295 | 5308 | 5508 | 5569 | |
| | | 10 | 5517 | 5410 | 5657 | 5550 | 5329 | |
| | | 15 | 5356 | 5608 | 5613 | 5600 | 5571 | |
| | | 20 | 5547 | 5716 | 5412 | 5713 | 5337 | |
| | | 25 | 5670 | 5507 | 5548 | 5394 | 5525 | |
| | | 30 | 5474 | 5425 | 5418 | 5690 | 5570 | |
| | | 35 | 5421 | 5482 | 5673 | 5252 | 5443 | |
| | | 40 | 5597 | 5614 | 5495 | 5720 | 5593 | |
| | | 45 | 5566 | 5417 | 5423 | 5656 | 5646 | |
| | | 50 | 5339 | 5466 | 5267 | 5627 | 5276 | |
| | | 55 | 5582 | 5655 | 5472 | 5639 | 5330 | |
| | | 60 | 5442 | 5342 | 5522 | 5489 | 5585 | |
| | | 65 | 5581 | 5282 | 5376 | 5665 | 5598 | |
| | | 70 | 5562 | 5451 | 5369 | 5620 | 5565 | |
| | | 75 | 5668 | 5297 | 5261 | 5324 | 5352 | |
| | | 80 | 5543 | 5504 | 5621 | 5299 | 5338 | |
| | | 85 | 5519 | 5553 | 5341 | 5322 | 5609 | |
| | | 90 | 5529 | 5422 | 5403 | 5578 | 5710 | |
| | | 95 | 5298 | 5599 | 5265 | 5684 | 5409 | |

Type 6 Radar Waveform_16

| Download | 16 | Type 6 | 1.0 | 333.3 | 9 | 0.3333 | 300.0000000 | 8 |
|----------|----|----------------------|------|-------|------|--------|-------------|---|
| | | Frequency List (MHz) | 0 | 1 | 2 | 3 | 4 | |
| | | 0 | 5416 | 5408 | 5551 | 5427 | 5272 | |
| | | 5 | 5479 | 5695 | 5383 | 5671 | 5301 | |
| | | 10 | 5351 | 5674 | 5698 | 5270 | 5350 | |
| | | 15 | 5444 | 5638 | 5619 | 5548 | 5288 | |
| | | 20 | 5555 | 5310 | 5353 | 5705 | 5558 | |
| | | 25 | 5456 | 5276 | 5595 | 5462 | 5516 | |
| | | 30 | 5411 | 5570 | 5633 | 5367 | 5293 | |
| | | 35 | 5463 | 5573 | 5469 | 5405 | 5282 | |
| | | 40 | 5302 | 5552 | 5391 | 5649 | 5475 | |
| | | 45 | 5476 | 5543 | 5522 | 5515 | 5517 | |
| | | 50 | 5356 | 5305 | 5571 | 5464 | 5536 | |
| | | 55 | 5370 | 5291 | 5610 | 5459 | 5607 | |
| | | 60 | 5287 | 5451 | 5315 | 5628 | 5404 | |
| | | 65 | 5706 | 5497 | 5490 | 5365 | 5620 | |
| | | 70 | 5355 | 5623 | 5414 | 5644 | 5256 | |
| | | 75 | 5608 | 5449 | 5333 | 5320 | 5614 | |
| | | 80 | 5402 | 5358 | 5335 | 5714 | 5280 | |
| | | 85 | 5382 | 5704 | 5494 | 5568 | 5670 | |
| | | 90 | 5584 | 5292 | 5495 | 5591 | 5393 | |
| | | 95 | 5379 | 5719 | 5348 | 5407 | 5504 | |

Type 6 Radar Waveform_17

| Download | 17 | Type 6 | 1.0 | 333.3 | 9 | 0.3333 | 300.0000000 | 6 |
|----------|----|----------------------|------|-------|------|--------|-------------|---|
| | | Frequency List (MHz) | 0 | 1 | 2 | 3 | 4 | |
| | | 0 | 5671 | 5647 | 5487 | 5588 | 5589 | |
| | | 5 | 5521 | 5717 | 5458 | 5359 | 5605 | |
| | | 10 | 5282 | 5463 | 5264 | 5368 | 5371 | |
| | | 15 | 5435 | 5290 | 5722 | 5593 | 5480 | |
| | | 20 | 5563 | 5476 | 5391 | 5319 | 5283 | |
| | | 25 | 5349 | 5308 | 5479 | 5699 | 5496 | |
| | | 30 | 5558 | 5300 | 5527 | 5373 | 5616 | |
| | | 35 | 5602 | 5286 | 5362 | 5659 | 5596 | |
| | | 40 | 5385 | 5393 | 5403 | 5388 | 5481 | |
| | | 45 | 5553 | 5257 | 5436 | 5529 | 5333 | |
| | | 50 | 5398 | 5691 | 5568 | 5542 | 5603 | |
| | | 55 | 5418 | 5652 | 5490 | 5585 | 5581 | |
| | | 60 | 5297 | 5707 | 5574 | 5655 | 5351 | |
| | | 65 | 5285 | 5546 | 5692 | 5438 | 5723 | |
| | | 70 | 5641 | 5620 | 5690 | 5577 | 5472 | |
| | | 75 | 5513 | 5314 | 5572 | 5724 | 5658 | |
| | | 80 | 5627 | 5421 | 5332 | 5434 | 5597 | |
| | | 85 | 5345 | 5619 | 5443 | 5452 | 5590 | |
| | | 90 | 5326 | 5377 | 5428 | 5448 | 5363 | |
| | | 95 | 5395 | 5601 | 5451 | 5502 | 5622 | |

Type 6 Radar Waveform_18

| Download | 18 | Type 6 | 1.0 | 333.3 | 9 | 0.3333 | 300.0000000 | 4 |
|----------|----|----------------------|------|-------|------|--------|-------------|---|
| | | Frequency List (MHz) | 0 | 1 | 2 | 3 | 4 | |
| | | 0 | 5451 | 5411 | 5423 | 5274 | 5334 | |
| | | 5 | 5563 | 5642 | 5533 | 5425 | 5337 | |
| | | 10 | 5688 | 5252 | 5305 | 5392 | 5523 | |
| | | 15 | 5417 | 5350 | 5638 | 5672 | 5474 | |
| | | 20 | 5332 | 5311 | 5256 | 5712 | 5257 | |
| | | 25 | 5585 | 5328 | 5530 | 5697 | 5664 | |
| | | 30 | 5484 | 5588 | 5390 | 5266 | 5377 | |
| | | 35 | 5633 | 5333 | 5670 | 5532 | 5468 | |
| | | 40 | 5331 | 5643 | 5482 | 5410 | 5340 | |
| | | 45 | 5494 | 5485 | 5695 | 5619 | 5631 | |
| | | 50 | 5329 | 5362 | 5365 | 5444 | 5653 | |
| | | 55 | 5404 | 5455 | 5620 | 5462 | 5590 | |
| | | 60 | 5539 | 5520 | 5428 | 5604 | 5387 | |
| | | 65 | 5652 | 5349 | 5289 | 5424 | 5251 | |
| | | 70 | 5490 | 5596 | 5649 | 5449 | 5592 | |
| | | 75 | 5559 | 5295 | 5262 | 5439 | 5316 | |
| | | 80 | 5707 | 5359 | 5536 | 5405 | 5613 | |
| | | 85 | 5327 | 5573 | 5691 | 5716 | 5617 | |
| | | 90 | 5693 | 5263 | 5259 | 5445 | 5503 | |
| | | 95 | 5347 | 5293 | 5580 | 5554 | 5597 | |

Type 6 Radar Waveform_19

| Download | 19 | Type 6 | 1.0 | 333.3 | 9 | 0.3333 | 300.0000000 | 5 |
|----------|----|----------------------|------|-------|------|--------|-------------|---|
| | | Frequency List (MHz) | 0 | 1 | 2 | 3 | 4 | |
| | | 0 | 5706 | 5650 | 5359 | 5435 | 5651 | |
| | | 5 | 5702 | 5664 | 5608 | 5588 | 5544 | |
| | | 10 | 5522 | 5613 | 5346 | 5283 | 5413 | |
| | | 15 | 5611 | 5453 | 5586 | 5486 | 5482 | |
| | | 20 | 5711 | 5273 | 5400 | 5704 | 5600 | |
| | | 25 | 5584 | 5313 | 5432 | 5564 | 5264 | |
| | | 30 | 5441 | 5542 | 5606 | 5405 | 5468 | |
| | | 35 | 5429 | 5371 | 5648 | 5269 | 5408 | |
| | | 40 | 5479 | 5717 | 5513 | 5423 | 5552 | |
| | | 45 | 5538 | 5485 | 5528 | 5568 | 5670 | |
| | | 50 | 5720 | 5627 | 5684 | 5456 | 5398 | |
| | | 55 | 5368 | 5601 | 5426 | 5274 | 5694 | |
| | | 60 | 5422 | 5365 | 5466 | 5629 | 5553 | |
| | | 65 | 5326 | 5447 | 5458 | 5410 | 5351 | |
| | | 70 | 5339 | 5572 | 5418 | 5712 | 5276 | |
| | | 75 | 5504 | 5372 | 5695 | 5383 | 5547 | |
| | | 80 | 5446 | 5262 | 5378 | 5708 | 5624 | |
| | | 85 | 5464 | 5439 | 5307 | 5699 | 5297 | |
| | | 90 | 5519 | 5462 | 5558 | 5428 | 5666 | |
| | | 95 | 5560 | 5623 | 5692 | 5612 | 5546 | |

Type 6 Radar Waveform_20

| Download | 20 | Type 6 | 1.0 | 333.3 | 9 | 0.3333 | 300.0000000 | 6 |
|----------|----|----------------------|------|-------|------|--------|-------------|---|
| | | Frequency List (MHz) | 0 | 1 | 2 | 3 | 4 | |
| | | 0 | 5389 | 5414 | 5295 | 5596 | 5396 | |
| | | 5 | 5269 | 5589 | 5683 | 5276 | 5373 | |
| | | 10 | 5453 | 5402 | 5387 | 5478 | 5434 | |
| | | 15 | 5699 | 5671 | 5556 | 5631 | 5678 | |
| | | 20 | 5490 | 5311 | 5392 | 5677 | 5391 | |
| | | 25 | 5436 | 5516 | 5633 | 5598 | 5306 | |
| | | 30 | 5539 | 5398 | 5446 | 5316 | 5329 | |
| | | 35 | 5447 | 5559 | 5700 | 5639 | 5498 | |
| | | 40 | 5685 | 5256 | 5682 | 5551 | 5476 | |
| | | 45 | 5646 | 5493 | 5506 | 5610 | 5591 | |
| | | 50 | 5372 | 5404 | 5721 | 5334 | 5450 | |
| | | 55 | 5628 | 5644 | 5352 | 5558 | 5420 | |
| | | 60 | 5397 | 5403 | 5317 | 5351 | 5666 | |
| | | 65 | 5509 | 5355 | 5502 | 5362 | 5581 | |
| | | 70 | 5339 | 5430 | 5530 | 5354 | 5663 | |
| | | 75 | 5451 | 5567 | 5290 | 5357 | 5370 | |
| | | 80 | 5281 | 5482 | 5547 | 5707 | 5701 | |
| | | 85 | 5641 | 5640 | 5695 | 5428 | 5425 | |
| | | 90 | 5635 | 5578 | 5712 | 5637 | 5472 | |
| | | 95 | 5705 | 5709 | 5401 | 5358 | 5576 | |

Type 6 Radar Waveform_21

| Download | 21 | Type 6 | 1.0 | 333.3 | 9 | 0.3333 | 300.0000000 | 6 |
|----------|----|----------------------|------|-------|------|--------|-------------|---|
| | | Frequency List (MHz) | 0 | 1 | 2 | 3 | 4 | |
| | | 0 | 5644 | 5653 | 5706 | 5282 | 5713 | |
| | | 5 | 5311 | 5611 | 5283 | 5439 | 5580 | |
| | | 10 | 5287 | 5666 | 5428 | 5673 | 5455 | |
| | | 15 | 5690 | 5701 | 5562 | 5676 | 5395 | |
| | | 20 | 5401 | 5471 | 5252 | 5481 | 5650 | |
| | | 25 | 5279 | 5385 | 5719 | 5262 | 5632 | |
| | | 30 | 5445 | 5355 | 5661 | 5468 | 5624 | |
| | | 35 | 5586 | 5593 | 5317 | 5509 | 5524 | |
| | | 40 | 5339 | 5620 | 5316 | 5473 | 5575 | |
| | | 45 | 5376 | 5589 | 5571 | 5637 | 5280 | |
| | | 50 | 5297 | 5520 | 5273 | 5475 | 5357 | |
| | | 55 | 5306 | 5714 | 5368 | 5532 | 5482 | |
| | | 60 | 5681 | 5658 | 5451 | 5398 | 5609 | |
| | | 65 | 5708 | 5699 | 5479 | 5454 | 5415 | |
| | | 70 | 5427 | 5526 | 5259 | 5477 | 5416 | |
| | | 75 | 5335 | 5533 | 5495 | 5257 | 5711 | |
| | | 80 | 5295 | 5698 | 5361 | 5640 | 5634 | |
| | | 85 | 5391 | 5503 | 5629 | 5485 | 5457 | |
| | | 90 | 5268 | 5467 | 5668 | 5396 | 5462 | |
| | | 95 | 5323 | 5291 | 5641 | 5310 | 5655 | |

Type 6 Radar Waveform_22

| Download | 22 | Type 6 | 1.0 | 333.3 | 9 | 0.3333 | 300.0000000 | 4 |
|----------|----|----------------------|------|-------|------|--------|-------------|---|
| | | Frequency List (MHz) | 0 | 1 | 2 | 3 | 4 | |
| | | 0 | 5424 | 5417 | 5642 | 5346 | 5458 | |
| | | 5 | 5353 | 5633 | 5358 | 5505 | 5312 | |
| | | 10 | 5693 | 5455 | 5469 | 5296 | 5476 | |
| | | 15 | 5303 | 5665 | 5721 | 5587 | 5409 | |
| | | 20 | 5637 | 5668 | 5473 | 5623 | 5545 | |
| | | 25 | 5712 | 5447 | 5366 | 5666 | 5487 | |
| | | 30 | 5414 | 5401 | 5717 | 5444 | 5250 | |
| | | 35 | 5266 | 5389 | 5567 | 5423 | 5363 | |
| | | 40 | 5422 | 5558 | 5556 | 5470 | 5407 | |
| | | 45 | 5356 | 5672 | 5629 | 5697 | 5524 | |
| | | 50 | 5534 | 5621 | 5348 | 5609 | 5474 | |
| | | 55 | 5419 | 5260 | 5463 | 5436 | 5661 | |
| | | 60 | 5647 | 5626 | 5490 | 5415 | 5379 | |
| | | 65 | 5400 | 5337 | 5404 | 5465 | 5457 | |
| | | 70 | 5264 | 5403 | 5388 | 5703 | 5500 | |
| | | 75 | 5559 | 5316 | 5310 | 5605 | 5513 | |
| | | 80 | 5695 | 5543 | 5451 | 5468 | 5583 | |
| | | 85 | 5636 | 5655 | 5327 | 5680 | 5479 | |
| | | 90 | 5610 | 5723 | 5477 | 5302 | 5394 | |
| | | 95 | 5364 | 5405 | 5392 | 5597 | 5582 | |

Type 6 Radar Waveform_23

| Download | 23 | Type 6 | 1.0 | 333.3 | 9 | 0.3333 | 300.0000000 | 9 |
|----------|----|----------------------|------|-------|------|--------|-------------|---|
| | | Frequency List (MHz) | 0 | 1 | 2 | 3 | 4 | |
| | | 0 | 5679 | 5656 | 5578 | 5507 | 5300 | |
| | | 5 | 5492 | 5558 | 5433 | 5668 | 5616 | |
| | | 10 | 5624 | 5719 | 5607 | 5491 | 5497 | |
| | | 15 | 5391 | 5480 | 5293 | 5669 | 5304 | |
| | | 20 | 5417 | 5706 | 5562 | 5596 | 5661 | |
| | | 25 | 5553 | 5470 | 5700 | 5529 | 5303 | |
| | | 30 | 5269 | 5519 | 5394 | 5642 | 5292 | |
| | | 35 | 5454 | 5660 | 5720 | 5337 | 5299 | |
| | | 40 | 5602 | 5496 | 5699 | 5564 | 5336 | |
| | | 45 | 5280 | 5687 | 5275 | 5314 | 5410 | |
| | | 50 | 5322 | 5399 | 5698 | 5297 | 5266 | |
| | | 55 | 5258 | 5592 | 5653 | 5255 | 5688 | |
| | | 60 | 5315 | 5571 | 5338 | 5444 | 5677 | |
| | | 65 | 5349 | 5373 | 5358 | 5296 | 5692 | |
| | | 70 | 5465 | 5451 | 5557 | 5588 | 5379 | |
| | | 75 | 5347 | 5575 | 5620 | 5605 | 5618 | |
| | | 80 | 5294 | 5467 | 5518 | 5446 | 5318 | |
| | | 85 | 5414 | 5429 | 5634 | 5409 | 5475 | |
| | | 90 | 5345 | 5714 | 5328 | 5627 | 5681 | |
| | | 95 | 5461 | 5355 | 5659 | 5500 | 5604 | |

Type 6 Radar Waveform_24

| Download | 24 | Type 6 | 1.0 | 333.3 | 9 | 0.3333 | 300.0000000 | 11 |
|----------|----|----------------------|------|-------|------|--------|-------------|----|
| | | Frequency List (MHz) | 0 | 1 | 2 | 3 | 4 | |
| | | 0 | 5459 | 5420 | 5514 | 5668 | 5520 | |
| | | 5 | 5534 | 5580 | 5508 | 5356 | 5348 | |
| | | 10 | 5458 | 5605 | 5648 | 5686 | 5518 | |
| | | 15 | 5479 | 5607 | 5396 | 5714 | 5496 | |
| | | 20 | 5328 | 5397 | 5647 | 5554 | 5569 | |
| | | 25 | 5699 | 5513 | 5281 | 5671 | 5259 | |
| | | 30 | 5289 | 5701 | 5643 | 5462 | 5431 | |
| | | 35 | 5545 | 5553 | 5398 | 5613 | 5685 | |
| | | 40 | 5337 | 5464 | 5561 | 5316 | 5363 | |
| | | 45 | 5676 | 5286 | 5496 | 5450 | 5312 | |
| | | 50 | 5595 | 5446 | 5546 | 5271 | 5549 | |
| | | 55 | 5659 | 5347 | 5502 | 5516 | 5629 | |
| | | 60 | 5639 | 5390 | 5403 | 5298 | 5665 | |
| | | 65 | 5566 | 5495 | 5537 | 5437 | 5560 | |
| | | 70 | 5355 | 5306 | 5544 | 5265 | 5273 | |
| | | 75 | 5278 | 5717 | 5253 | 5550 | 5631 | |
| | | 80 | 5581 | 5592 | 5568 | 5257 | 5474 | |
| | | 85 | 5524 | 5301 | 5588 | 5657 | 5673 | |
| | | 90 | 5351 | 5651 | 5697 | 5266 | 5261 | |
| | | 95 | 5445 | 5638 | 5600 | 5285 | 5341 | |

Type 6 Radar Waveform_25

| Download | 25 | Type 6 | 1.0 | 333.3 | 9 | 0.3333 | 300.0000000 | 9 |
|----------|----|----------------------|------|-------|------|--------|-------------|---|
| | | Frequency List (MHz) | 0 | 1 | 2 | 3 | 4 | |
| | | 0 | 5617 | 5659 | 5450 | 5354 | 5362 | |
| | | 5 | 5576 | 5505 | 5583 | 5519 | 5555 | |
| | | 10 | 5389 | 5394 | 5689 | 5406 | 5539 | |
| | | 15 | 5470 | 5259 | 5499 | 5284 | 5688 | |
| | | 20 | 5336 | 5466 | 5588 | 5643 | 5542 | |
| | | 25 | 5587 | 5365 | 5484 | 5300 | 5293 | |
| | | 30 | 5710 | 5653 | 5658 | 5474 | 5320 | |
| | | 35 | 5660 | 5570 | 5636 | 5349 | 5648 | |
| | | 40 | 5262 | 5452 | 5275 | 5704 | 5558 | |
| | | 45 | 5572 | 5296 | 5446 | 5706 | 5637 | |
| | | 50 | 5577 | 5501 | 5401 | 5418 | 5532 | |
| | | 55 | 5537 | 5500 | 5461 | 5368 | 5630 | |
| | | 60 | 5476 | 5667 | 5465 | 5701 | 5722 | |
| | | 65 | 5348 | 5400 | 5458 | 5298 | 5520 | |
| | | 70 | 5563 | 5286 | 5331 | 5265 | 5416 | |
| | | 75 | 5385 | 5319 | 5494 | 5363 | 5644 | |
| | | 80 | 5589 | 5288 | 5574 | 5437 | 5716 | |
| | | 85 | 5639 | 5430 | 5493 | 5347 | 5357 | |
| | | 90 | 5685 | 5567 | 5709 | 5283 | 5316 | |
| | | 95 | 5526 | 5626 | 5703 | 5580 | 5593 | |

Type 6 Radar Waveform_26

| Download | 26 | Type 6 | 1.0 | 333.3 | 9 | 0.3333 | 300.000000 | 13 |
|----------|----|----------------------|------|-------|------|--------|------------|----|
| | | Frequency List (MHz) | 0 | 1 | 2 | 3 | 4 | |
| | | 0 | 5397 | 5423 | 5386 | 5515 | 5582 | |
| | | 5 | 5618 | 5527 | 5658 | 5585 | 5287 | |
| | | 10 | 5320 | 5255 | 5601 | 5560 | 5558 | |
| | | 15 | 5289 | 5505 | 5329 | 5405 | 5344 | |
| | | 20 | 5632 | 5626 | 5635 | 5378 | 5314 | |
| | | 25 | 5687 | 5404 | 5327 | 5277 | 5542 | |
| | | 30 | 5615 | 5689 | 5569 | 5480 | 5709 | |
| | | 35 | 5252 | 5620 | 5326 | 5651 | 5291 | |
| | | 40 | 5376 | 5688 | 5469 | 5555 | 5501 | |
| | | 45 | 5276 | 5529 | 5337 | 5353 | 5416 | |
| | | 50 | 5278 | 5552 | 5587 | 5619 | 5476 | |
| | | 55 | 5250 | 5454 | 5565 | 5504 | 5605 | |
| | | 60 | 5357 | 5503 | 5390 | 5388 | 5379 | |
| | | 65 | 5427 | 5671 | 5384 | 5707 | 5253 | |
| | | 70 | 5576 | 5303 | 5506 | 5663 | 5513 | |
| | | 75 | 5685 | 5699 | 5385 | 5462 | 5715 | |
| | | 80 | 5271 | 5484 | 5586 | 5483 | 5400 | |
| | | 85 | 5336 | 5512 | 5593 | 5678 | 5691 | |
| | | 90 | 5363 | 5719 | 5352 | 5343 | 5300 | |
| | | 95 | 5371 | 5510 | 5524 | 5499 | 5331 | |

Type 6 Radar Waveform_27

| Download | 27 | Type 6 | 1.0 | 333.3 | 9 | 0.3333 | 300.000000 | 8 |
|----------|----|----------------------|------|-------|------|--------|------------|---|
| | | Frequency List (MHz) | 0 | 1 | 2 | 3 | 4 | |
| | | 0 | 5652 | 5284 | 5322 | 5676 | 5424 | |
| | | 5 | 5282 | 5452 | 5258 | 5273 | 5591 | |
| | | 10 | 5629 | 5447 | 5296 | 5699 | 5581 | |
| | | 15 | 5646 | 5416 | 5608 | 5277 | 5694 | |
| | | 20 | 5255 | 5701 | 5567 | 5724 | 5488 | |
| | | 25 | 5266 | 5641 | 5415 | 5508 | 5361 | |
| | | 30 | 5528 | 5572 | 5332 | 5721 | 5678 | |
| | | 35 | 5276 | 5343 | 5479 | 5662 | 5702 | |
| | | 40 | 5556 | 5626 | 5612 | 5552 | 5333 | |
| | | 45 | 5634 | 5250 | 5390 | 5618 | 5292 | |
| | | 50 | 5454 | 5603 | 5442 | 5323 | 5438 | |
| | | 55 | 5408 | 5366 | 5384 | 5475 | 5259 | |
| | | 60 | 5522 | 5448 | 5697 | 5689 | 5325 | |
| | | 65 | 5628 | 5620 | 5523 | 5375 | 5492 | |
| | | 70 | 5666 | 5362 | 5661 | 5658 | 5257 | |
| | | 75 | 5696 | 5486 | 5368 | 5551 | 5392 | |
| | | 80 | 5583 | 5252 | 5355 | 5460 | 5477 | |
| | | 85 | 5547 | 5451 | 5511 | 5677 | 5466 | |
| | | 90 | 5656 | 5709 | 5317 | 5426 | 5494 | |
| | | 95 | 5422 | 5478 | 5434 | 5501 | 5308 | |

Type 6 Radar Waveform_28

| Download | 28 | Type 6 | 1.0 | 333.3 | 9 | 0.3333 | 300.0000000 | 8 |
|----------|----|----------------------|------|-------|------|--------|-------------|---|
| | | Frequency List (MHz) | 0 | 1 | 2 | 3 | 4 | |
| | | 0 | 5432 | 5523 | 5258 | 5362 | 5644 | |
| | | 5 | 5324 | 5474 | 5333 | 5436 | 5323 | |
| | | 10 | 5560 | 5711 | 5337 | 5419 | 5602 | |
| | | 15 | 5259 | 5543 | 5322 | 5411 | 5263 | |
| | | 20 | 5392 | 5508 | 5716 | 5461 | 5629 | |
| | | 25 | 5590 | 5521 | 5612 | 5395 | 5458 | |
| | | 30 | 5417 | 5529 | 5547 | 5495 | 5498 | |
| | | 35 | 5415 | 5531 | 5309 | 5254 | 5576 | |
| | | 40 | 5541 | 5639 | 5564 | 5377 | 5646 | |
| | | 45 | 5262 | 5614 | 5695 | 5308 | 5443 | |
| | | 50 | 5505 | 5643 | 5630 | 5654 | 5290 | |
| | | 55 | 5265 | 5267 | 5626 | 5556 | 5678 | |
| | | 60 | 5446 | 5388 | 5687 | 5393 | 5271 | |
| | | 65 | 5451 | 5569 | 5359 | 5274 | 5544 | |
| | | 70 | 5478 | 5291 | 5686 | 5637 | 5617 | |
| | | 75 | 5701 | 5648 | 5651 | 5677 | 5300 | |
| | | 80 | 5596 | 5624 | 5715 | 5455 | 5580 | |
| | | 85 | 5672 | 5423 | 5720 | 5345 | 5598 | |
| | | 90 | 5699 | 5709 | 5367 | 5472 | 5690 | |
| | | 95 | 5494 | 5464 | 5431 | 5481 | 5575 | |

Type 6 Radar Waveform_29

| Download | 29 | Type 6 | 1.0 | 333.3 | 9 | 0.3333 | 300.0000000 | 7 |
|----------|----|----------------------|------|-------|------|--------|-------------|---|
| | | Frequency List (MHz) | 0 | 1 | 2 | 3 | 4 | |
| | | 0 | 5590 | 5287 | 5669 | 5426 | 5486 | |
| | | 5 | 5366 | 5399 | 5408 | 5599 | 5530 | |
| | | 10 | 5491 | 5597 | 5378 | 5614 | 5623 | |
| | | 15 | 5250 | 5670 | 5339 | 5367 | 5603 | |
| | | 20 | 5271 | 5558 | 5449 | 5330 | 5434 | |
| | | 25 | 5420 | 5442 | 5724 | 5338 | 5429 | |
| | | 30 | 5500 | 5306 | 5647 | 5318 | 5554 | |
| | | 35 | 5622 | 5580 | 5407 | 5490 | 5380 | |
| | | 40 | 5722 | 5502 | 5617 | 5643 | 5569 | |
| | | 45 | 5594 | 5303 | 5496 | 5295 | 5519 | |
| | | 50 | 5331 | 5705 | 5379 | 5563 | 5589 | |
| | | 55 | 5316 | 5400 | 5417 | 5377 | 5435 | |
| | | 60 | 5361 | 5438 | 5692 | 5652 | 5518 | |
| | | 65 | 5298 | 5484 | 5685 | 5363 | 5616 | |
| | | 70 | 5561 | 5294 | 5535 | 5613 | 5576 | |
| | | 75 | 5573 | 5293 | 5319 | 5280 | 5455 | |
| | | 80 | 5609 | 5405 | 5404 | 5480 | 5690 | |
| | | 85 | 5533 | 5611 | 5483 | 5340 | 5310 | |
| | | 90 | 5552 | 5472 | 5529 | 5532 | 5478 | |
| | | 95 | 5627 | 5376 | 5448 | 5536 | 5559 | |

| | | | |
|-----------|---|---------------|------------|
| Test Site | SIP-TR2 | Test Engineer | Alisa Deng |
| Test Date | 2023-07-05 | | |
| Test Item | Radar Statistical Performance Check (802.11ax-HE80 – 5530MHz) | | |

| Radar Type 1-4 - Radar Statistical Performance | | | | | | | | |
|--|-----------------|-------------------------|-----------------|-------------------------|-----------------|-------------------------|-----------------|-------------------------|
| Trial | Radar Type 1 | | Radar Type 2 | | Radar Type 3 | | Radar Type 4 | |
| | Frequency (MHz) | 1=detect 0=no detect | Frequency (MHz) | 1=detect 0=no detect | Frequency (MHz) | 1=detect 0=no detect | Frequency (MHz) | 1=detect 0=no detect |
| 0 | 5501 | 1 | 5567 | 1 | 5510 | 1 | 5557 | 1 |
| 1 | 5536 | 1 | 5493 | 1 | 5541 | 1 | 5532 | 1 |
| 2 | 5519 | 1 | 5533 | 1 | 5511 | 1 | 5503 | 1 |
| 3 | 5490 | 1 | 5493 | 1 | 5531 | 0 | 5565 | 1 |
| 4 | 5524 | 1 | 5495 | 1 | 5554 | 1 | 5564 | 0 |
| 5 | 5509 | 1 | 5570 | 1 | 5553 | 1 | 5533 | 1 |
| 6 | 5510 | 1 | 5541 | 1 | 5568 | 1 | 5530 | 1 |
| 7 | 5522 | 1 | 5538 | 1 | 5543 | 1 | 5525 | 1 |
| 8 | 5569 | 1 | 5493 | 0 | 5493 | 1 | 5507 | 1 |
| 9 | 5570 | 1 | 5555 | 1 | 5520 | 1 | 5518 | 1 |
| 10 | 5530 | 1 | 5530 | 1 | 5563 | 1 | 5516 | 1 |
| 11 | 5521 | 1 | 5557 | 1 | 5543 | 1 | 5525 | 1 |
| 12 | 5535 | 1 | 5490 | 1 | 5530 | 1 | 5570 | 1 |
| 13 | 5570 | 0 | 5565 | 1 | 5534 | 0 | 5511 | 1 |
| 14 | 5562 | 1 | 5554 | 1 | 5570 | 1 | 5524 | 1 |
| 15 | 5506 | 1 | 5545 | 1 | 5560 | 1 | 5522 | 1 |
| 16 | 5517 | 1 | 5547 | 1 | 5539 | 1 | 5554 | 1 |
| 17 | 5561 | 1 | 5570 | 1 | 5519 | 1 | 5544 | 1 |
| 18 | 5528 | 1 | 5512 | 1 | 5566 | 1 | 5510 | 1 |
| 19 | 5510 | 1 | 5495 | 1 | 5552 | 1 | 5490 | 1 |
| 20 | 5565 | 1 | 5491 | 1 | 5501 | 1 | 5540 | 0 |
| 21 | 5550 | 1 | 5493 | 1 | 5516 | 1 | 5502 | 0 |
| 22 | 5563 | 1 | 5545 | 1 | 5545 | 1 | 5497 | 1 |
| 23 | 5553 | 1 | 5523 | 1 | 5554 | 0 | 5554 | 1 |
| 24 | 5567 | 1 | 5516 | 1 | 5490 | 1 | 5567 | 1 |
| 25 | 5560 | 1 | 5514 | 1 | 5512 | 1 | 5494 | 0 |
| 26 | 5497 | 1 | 5512 | 1 | 5529 | 1 | 5536 | 0 |

| Radar Type 1-4 - Radar Statistical Performance | | | | | | | | |
|--|-------------------------|-------------------------|-----------------|-------------------------|-----------------|-------------------------|-----------------|-------------------------|
| Trial | Radar Type 1 | | Radar Type 2 | | Radar Type 3 | | Radar Type 4 | |
| | Frequency (MHz) | 1=detect 0=no detect | Frequency (MHz) | 1=detect 0=no detect | Frequency (MHz) | 1=detect 0=no detect | Frequency (MHz) | 1=detect 0=no detect |
| 27 | 5531 | 1 | 5549 | 1 | 5525 | 1 | 5528 | 0 |
| 28 | 5493 | 1 | 5560 | 1 | 5517 | 1 | 5545 | 1 |
| 29 | 5551 | 1 | 5556 | 1 | 5506 | 1 | 5567 | 1 |
| Probability: | 96.7% | | 96.7% | | 90.0% | | 80.0% | |
| Aggregate: | 90.85% (>80%) | | | | | | | |

| Radar Type 1 - Radar Waveform | | | | | | | Radar Type 2 - Radar Waveform | | | | | | |
|-------------------------------|----------|------------|------------------|----------|------------------|----------------------|-------------------------------|----------|------------|------------------|----------|------------------|----------------------|
| | Trial Id | Radar Type | Pulse Width (us) | PRI (us) | Number of Pulses | Waveform Length (us) | | Trial Id | Radar Type | Pulse Width (us) | PRI (us) | Number of Pulses | Waveform Length (us) |
| Download | 0 | Type 1 | 1.0 | 558.0 | 95 | 53010.0 | Download | 0 | Type 2 | 1.4 | 207.0 | 23 | 4761.0 |
| Download | 1 | Type 1 | 1.0 | 758.0 | 70 | 53060.0 | Download | 1 | Type 2 | 1.0 | 150.0 | 23 | 3450.0 |
| Download | 2 | Type 1 | 1.0 | 678.0 | 78 | 52884.0 | Download | 2 | Type 2 | 4.1 | 208.0 | 28 | 5824.0 |
| Download | 3 | Type 1 | 1.0 | 3066.0 | 18 | 55188.0 | Download | 3 | Type 2 | 2.4 | 178.0 | 25 | 4450.0 |
| Download | 4 | Type 1 | 1.0 | 658.0 | 81 | 53288.0 | Download | 4 | Type 2 | 2.5 | 195.0 | 25 | 4875.0 |
| Download | 5 | Type 1 | 1.0 | 578.0 | 92 | 53176.0 | Download | 5 | Type 2 | 3.7 | 164.0 | 27 | 4428.0 |
| Download | 6 | Type 1 | 1.0 | 778.0 | 68 | 52904.0 | Download | 6 | Type 2 | 4.5 | 189.0 | 28 | 5292.0 |
| Download | 7 | Type 1 | 1.0 | 638.0 | 83 | 52954.0 | Download | 7 | Type 2 | 4.1 | 224.0 | 28 | 6272.0 |
| Download | 8 | Type 1 | 1.0 | 918.0 | 58 | 53244.0 | Download | 8 | Type 2 | 1.1 | 153.0 | 23 | 3519.0 |
| Download | 9 | Type 1 | 1.0 | 838.0 | 63 | 52794.0 | Download | 9 | Type 2 | 3.1 | 228.0 | 26 | 5928.0 |
| Download | 10 | Type 1 | 1.0 | 518.0 | 102 | 52836.0 | Download | 10 | Type 2 | 1.2 | 220.0 | 23 | 5060.0 |
| Download | 11 | Type 1 | 1.0 | 738.0 | 72 | 53136.0 | Download | 11 | Type 2 | 2.3 | 223.0 | 25 | 5575.0 |
| Download | 12 | Type 1 | 1.0 | 698.0 | 76 | 53048.0 | Download | 12 | Type 2 | 2.8 | 159.0 | 26 | 4134.0 |
| Download | 13 | Type 1 | 1.0 | 718.0 | 74 | 53132.0 | Download | 13 | Type 2 | 1.7 | 203.0 | 24 | 4872.0 |
| Download | 14 | Type 1 | 1.0 | 818.0 | 65 | 53170.0 | Download | 14 | Type 2 | 4.2 | 225.0 | 28 | 6300.0 |
| Download | 15 | Type 1 | 1.0 | 1932.0 | 28 | 54096.0 | Download | 15 | Type 2 | 3.5 | 186.0 | 27 | 5022.0 |
| Download | 16 | Type 1 | 1.0 | 1452.0 | 37 | 53724.0 | Download | 16 | Type 2 | 2.2 | 198.0 | 25 | 4950.0 |
| Download | 17 | Type 1 | 1.0 | 2383.0 | 23 | 54809.0 | Download | 17 | Type 2 | 2.8 | 170.0 | 26 | 4420.0 |
| Download | 18 | Type 1 | 1.0 | 2388.0 | 23 | 54924.0 | Download | 18 | Type 2 | 4.7 | 182.0 | 29 | 5278.0 |
| Download | 19 | Type 1 | 1.0 | 1815.0 | 30 | 54450.0 | Download | 19 | Type 2 | 4.2 | 210.0 | 28 | 5880.0 |
| Download | 20 | Type 1 | 1.0 | 1431.0 | 37 | 52947.0 | Download | 20 | Type 2 | 2.0 | 155.0 | 24 | 3720.0 |
| Download | 21 | Type 1 | 1.0 | 1864.0 | 29 | 54056.0 | Download | 21 | Type 2 | 1.1 | 157.0 | 23 | 3611.0 |
| Download | 22 | Type 1 | 1.0 | 1016.0 | 52 | 52832.0 | Download | 22 | Type 2 | 1.6 | 190.0 | 24 | 4560.0 |
| Download | 23 | Type 1 | 1.0 | 1591.0 | 34 | 54094.0 | Download | 23 | Type 2 | 3.2 | 200.0 | 26 | 5200.0 |
| Download | 24 | Type 1 | 1.0 | 920.0 | 58 | 53360.0 | Download | 24 | Type 2 | 1.3 | 172.0 | 23 | 3956.0 |
| Download | 25 | Type 1 | 1.0 | 1973.0 | 27 | 53271.0 | Download | 25 | Type 2 | 2.7 | 192.0 | 25 | 4800.0 |
| Download | 26 | Type 1 | 1.0 | 833.0 | 64 | 53312.0 | Download | 26 | Type 2 | 4.9 | 181.0 | 29 | 5249.0 |
| Download | 27 | Type 1 | 1.0 | 1960.0 | 27 | 52920.0 | Download | 27 | Type 2 | 1.9 | 173.0 | 24 | 4152.0 |
| Download | 28 | Type 1 | 1.0 | 2467.0 | 22 | 54274.0 | Download | 28 | Type 2 | 5.0 | 184.0 | 29 | 5336.0 |
| Download | 29 | Type 1 | 1.0 | 2410.0 | 22 | 53020.0 | Download | 29 | Type 2 | 5.0 | 179.0 | 29 | 5191.0 |

| Radar Type 3 - Radar Waveform | | | | | | | Radar Type 4 - Radar Waveform | | | | | | |
|-------------------------------|----------|------------|------------------|----------|------------------|----------------------|-------------------------------|----------|------------|------------------|----------|------------------|----------------------|
| | Trial Id | Radar Type | Pulse Width (us) | PRI (us) | Number of Pulses | Waveform Length (us) | | Trial Id | Radar Type | Pulse Width (us) | PRI (us) | Number of Pulses | Waveform Length (us) |
| Download | 0 | Type 3 | 6.4 | 339.0 | 16 | 5424.0 | Download | 0 | Type 4 | 11.8 | 339.0 | 12 | 4068.0 |
| Download | 1 | Type 3 | 6.0 | 225.0 | 16 | 3600.0 | Download | 1 | Type 4 | 11.1 | 225.0 | 12 | 2700.0 |
| Download | 2 | Type 3 | 9.1 | 451.0 | 18 | 8118.0 | Download | 2 | Type 4 | 17.9 | 451.0 | 15 | 6765.0 |
| Download | 3 | Type 3 | 7.4 | 209.0 | 17 | 3553.0 | Download | 3 | Type 4 | 14.2 | 209.0 | 13 | 2717.0 |
| Download | 4 | Type 3 | 7.5 | 369.0 | 17 | 6273.0 | Download | 4 | Type 4 | 14.5 | 369.0 | 13 | 4797.0 |
| Download | 5 | Type 3 | 8.7 | 312.0 | 18 | 5616.0 | Download | 5 | Type 4 | 17.1 | 312.0 | 15 | 4680.0 |
| Download | 6 | Type 3 | 9.5 | 280.0 | 18 | 5040.0 | Download | 6 | Type 4 | 18.7 | 280.0 | 16 | 4480.0 |
| Download | 7 | Type 3 | 9.1 | 325.0 | 18 | 5850.0 | Download | 7 | Type 4 | 17.8 | 325.0 | 15 | 4875.0 |
| Download | 8 | Type 3 | 6.1 | 418.0 | 16 | 6688.0 | Download | 8 | Type 4 | 11.3 | 418.0 | 12 | 5016.0 |
| Download | 9 | Type 3 | 8.1 | 284.0 | 17 | 4828.0 | Download | 9 | Type 4 | 15.6 | 284.0 | 14 | 3976.0 |
| Download | 10 | Type 3 | 6.2 | 483.0 | 16 | 7728.0 | Download | 10 | Type 4 | 11.6 | 483.0 | 12 | 5796.0 |
| Download | 11 | Type 3 | 7.3 | 289.0 | 17 | 4913.0 | Download | 11 | Type 4 | 14.0 | 289.0 | 13 | 3757.0 |
| Download | 12 | Type 3 | 7.8 | 375.0 | 17 | 6375.0 | Download | 12 | Type 4 | 15.1 | 375.0 | 14 | 5250.0 |
| Download | 13 | Type 3 | 6.7 | 404.0 | 16 | 6464.0 | Download | 13 | Type 4 | 12.6 | 404.0 | 12 | 4848.0 |
| Download | 14 | Type 3 | 9.2 | 328.0 | 18 | 5904.0 | Download | 14 | Type 4 | 18.2 | 328.0 | 16 | 5248.0 |
| Download | 15 | Type 3 | 8.5 | 338.0 | 17 | 5746.0 | Download | 15 | Type 4 | 16.6 | 338.0 | 15 | 5070.0 |
| Download | 16 | Type 3 | 7.2 | 239.0 | 16 | 3824.0 | Download | 16 | Type 4 | 13.7 | 239.0 | 13 | 3107.0 |
| Download | 17 | Type 3 | 7.8 | 290.0 | 17 | 4930.0 | Download | 17 | Type 4 | 15.0 | 290.0 | 14 | 4080.0 |
| Download | 18 | Type 3 | 9.7 | 384.0 | 18 | 6912.0 | Download | 18 | Type 4 | 19.3 | 384.0 | 16 | 6144.0 |
| Download | 19 | Type 3 | 9.2 | 247.0 | 18 | 4446.0 | Download | 19 | Type 4 | 18.1 | 247.0 | 15 | 3705.0 |
| Download | 20 | Type 3 | 7.0 | 470.0 | 16 | 7520.0 | Download | 20 | Type 4 | 13.3 | 470.0 | 13 | 6110.0 |
| Download | 21 | Type 3 | 6.1 | 232.0 | 16 | 3712.0 | Download | 21 | Type 4 | 11.4 | 232.0 | 12 | 2784.0 |
| Download | 22 | Type 3 | 6.6 | 389.0 | 16 | 6224.0 | Download | 22 | Type 4 | 12.5 | 389.0 | 12 | 4668.0 |
| Download | 23 | Type 3 | 8.2 | 258.0 | 17 | 4386.0 | Download | 23 | Type 4 | 16.0 | 258.0 | 14 | 3612.0 |
| Download | 24 | Type 3 | 6.3 | 324.0 | 16 | 5184.0 | Download | 24 | Type 4 | 11.8 | 324.0 | 12 | 3888.0 |
| Download | 25 | Type 3 | 7.7 | 330.0 | 17 | 5610.0 | Download | 25 | Type 4 | 14.8 | 330.0 | 14 | 4620.0 |
| Download | 26 | Type 3 | 9.9 | 393.0 | 18 | 7074.0 | Download | 26 | Type 4 | 19.8 | 393.0 | 16 | 6288.0 |
| Download | 27 | Type 3 | 6.9 | 425.0 | 16 | 6800.0 | Download | 27 | Type 4 | 13.1 | 425.0 | 13 | 5525.0 |
| Download | 28 | Type 3 | 10.0 | 230.0 | 18 | 4140.0 | Download | 28 | Type 4 | 19.9 | 230.0 | 16 | 3680.0 |
| Download | 29 | Type 3 | 10.0 | 215.0 | 18 | 3870.0 | Download | 29 | Type 4 | 19.9 | 215.0 | 16 | 3440.0 |

| Radar Type 5 - Radar Statistical Performance | | | | | |
|--|------------------|-------------------------------|--------------|------------------|-------------------------------|
| Trail # | Test Freq. (MHz) | 1=Detection 0=No Detection | Trail # | Test Freq. (MHz) | 1=Detection 0=No Detection |
| 0 | 5530 | 1 | 15 | 5497 | 1 |
| 1 | 5530 | 1 | 16 | 5495 | 1 |
| 2 | 5530 | 1 | 17 | 5496 | 1 |
| 3 | 5530 | 0 | 18 | 5499 | 1 |
| 4 | 5530 | 1 | 19 | 5498 | 1 |
| 5 | 5530 | 1 | 20 | 5565 | 1 |
| 6 | 5530 | 1 | 21 | 5566 | 1 |
| 7 | 5530 | 1 | 22 | 5566 | 1 |
| 8 | 5530 | 1 | 23 | 5563 | 1 |
| 9 | 5530 | 1 | 24 | 5566 | 1 |
| 10 | 5494 | 1 | 25 | 5564 | 1 |
| 11 | 5496 | 1 | 26 | 5560 | 1 |
| 12 | 5496 | 1 | 27 | 5565 | 1 |
| 13 | 5494 | 1 | 28 | 5560 | 1 |
| 14 | 5498 | 1 | 29 | 5560 | 1 |
| Detection Percentage (%) | | | 96.7% | | |

Type 5 Radar Waveform_0

| Download | 0 | Type 5 | 9 | 1.3333333 | 12.0000000 | 5.530000000 | | | | |
|----------|---|----------|-------------------|------------------|-------------------|----------------------------|------------|------------|------------|--|
| | | Burst ID | Burst Offset (us) | Pulse Width (us) | Chirp Width (MHz) | Number of Pulses per Burst | PRI-1 (us) | PRI-2 (us) | PRI-3 (us) | |
| | | 0 | 453860.0 | 54.9 | 6 | 1 | 1141.0 | - | - | |
| | | 1 | 776704.0 | 50.7 | 6 | 1 | 1579.0 | - | - | |
| | | 2 | 1097827.0 | 88.3 | 6 | 3 | 1001.0 | 1277.0 | 1807.0 | |
| | | 3 | 90821.0 | 67.9 | 6 | 2 | 1596.0 | 1630.0 | - | |
| | | 4 | 413639.0 | 69.4 | 6 | 2 | 1461.0 | 1042.0 | - | |
| | | 5 | 735168.0 | 84.1 | 6 | 3 | 1654.0 | 1445.0 | 1643.0 | |
| | | 6 | 1057744.0 | 92.8 | 6 | 3 | 1153.0 | 1554.0 | 1594.0 | |
| | | 7 | 51044.0 | 87.9 | 6 | 3 | 1669.0 | 1578.0 | 1032.0 | |
| | | 8 | 374278.0 | 52.0 | 6 | 1 | 1089.0 | - | - | |

Type 5 Radar Waveform_1

| Download | 1 | Type 5 | 8 | 1.5000000 | 12.0000000 | 5.530000000 | | | | |
|----------|---|----------|-------------------|------------------|-------------------|----------------------------|------------|------------|------------|--|
| | | Burst ID | Burst Offset (us) | Pulse Width (us) | Chirp Width (MHz) | Number of Pulses per Burst | PRI-1 (us) | PRI-2 (us) | PRI-3 (us) | |
| | | 0 | 784081.0 | 75.8 | 5 | 2 | 1144.0 | 1002.0 | - | |
| | | 1 | 1148179.0 | 53.6 | 5 | 1 | 1073.0 | - | - | |
| | | 2 | 12779.0 | 67.0 | 5 | 2 | 1022.0 | 1238.0 | - | |
| | | 3 | 375927.0 | 72.8 | 5 | 2 | 1206.0 | 1457.0 | - | |
| | | 4 | 739839.0 | 58.9 | 5 | 1 | 1123.0 | - | - | |
| | | 5 | 1100437.0 | 90.1 | 5 | 3 | 1646.0 | 1719.0 | 1733.0 | |
| | | 6 | 1485148.0 | 81.1 | 5 | 2 | 1752.0 | 1150.0 | - | |
| | | 7 | 331431.0 | 65.3 | 5 | 1 | 1595.0 | - | - | |

Type 5 Radar Waveform_2

| Download | 2 | Type 5 | 17 | 0.7058824 | 12.0000000 | 5.530000000 | | | | |
|----------|---|----------|-------------------|------------------|-------------------|----------------------------|------------|------------|------------|--|
| | | Burst ID | Burst Offset (us) | Pulse Width (us) | Chirp Width (MHz) | Number of Pulses per Burst | PRI-1 (us) | PRI-2 (us) | PRI-3 (us) | |
| | | 0 | 326017.0 | 72.4 | 17 | 2 | 1164.0 | 1673.0 | - | |
| | | 1 | 495252.0 | 96.1 | 17 | 3 | 1504.0 | 1177.0 | 1982.0 | |
| | | 2 | 666024.0 | 89.1 | 17 | 3 | 1291.0 | 1340.0 | 1276.0 | |
| | | 3 | 134719.0 | 63.2 | 17 | 1 | 1711.0 | - | - | |
| | | 4 | 305441.0 | 52.2 | 17 | 1 | 1854.0 | - | - | |
| | | 5 | 476697.0 | 58.4 | 17 | 1 | 1104.0 | - | - | |
| | | 6 | 645712.0 | 77.6 | 17 | 2 | 1763.0 | 1426.0 | - | |
| | | 7 | 113645.0 | 54.5 | 17 | 1 | 1941.0 | - | - | |
| | | 8 | 283606.0 | 71.1 | 17 | 2 | 1884.0 | 1956.0 | - | |
| | | 9 | 453627.0 | 96.4 | 17 | 3 | 1069.0 | 1385.0 | 1767.0 | |
| | | 10 | 626088.0 | 61.7 | 17 | 1 | 1650.0 | - | - | |
| | | 11 | 92229.0 | 99.1 | 17 | 3 | 1139.0 | 1759.0 | 1981.0 | |
| | | 12 | 262596.0 | 99.3 | 17 | 3 | 1039.0 | 1392.0 | 1507.0 | |
| | | 13 | 432841.0 | 84.4 | 17 | 3 | 1068.0 | 1174.0 | 1695.0 | |
| | | 14 | 604967.0 | 52.1 | 17 | 1 | 1746.0 | - | - | |
| | | 15 | 71413.0 | 85.1 | 17 | 3 | 1000.0 | 1212.0 | 1430.0 | |
| | | 16 | 242510.0 | 63.4 | 17 | 1 | 1371.0 | - | - | |

Type 5 Radar Waveform_3

| Download | 3 | Type 5 | 12 | 1.0000000 | 12.0000000 | 5.530000000 | | | | |
|----------|---|----------|-------------------|------------------|-------------------|----------------------------|------------|------------|------------|--|
| | | Burst ID | Burst Offset (us) | Pulse Width (us) | Chirp Width (MHz) | Number of Pulses per Burst | PRI-1 (us) | PRI-2 (us) | PRI-3 (us) | |
| | | 0 | 595294.0 | 74.6 | 10 | 2 | 1418.0 | 1072.0 | - | |
| | | 1 | 826296.0 | 70.3 | 10 | 2 | 1800.0 | 1806.0 | - | |
| | | 2 | 71818.0 | 72.1 | 10 | 2 | 1617.0 | 1170.0 | - | |
| | | 3 | 313055.0 | 89.2 | 10 | 3 | 1367.0 | 1698.0 | 1031.0 | |
| | | 4 | 554115.0 | 97.6 | 10 | 3 | 1437.0 | 1764.0 | 1765.0 | |
| | | 5 | 796788.0 | 66.8 | 10 | 2 | 1664.0 | 1620.0 | - | |
| | | 6 | 41819.0 | 70.7 | 10 | 2 | 1505.0 | 1456.0 | - | |
| | | 7 | 284003.0 | 61.5 | 10 | 1 | 1660.0 | - | - | |
| | | 8 | 524381.0 | 93.0 | 10 | 3 | 1694.0 | 1465.0 | 1823.0 | |
| | | 9 | 766258.0 | 99.5 | 10 | 3 | 1037.0 | 1525.0 | 1700.0 | |
| | | 10 | 12051.0 | 65.2 | 10 | 1 | 1537.0 | - | - | |
| | | 11 | 254306.0 | 61.1 | 10 | 1 | 1159.0 | - | - | |

Type 5 Radar Waveform_4

| Download | 4 | Type 5 | 13 | 0.9230769 | 12.0000000 | 5.530000000 | | | | |
|----------|---|----------|-------------------|------------------|-------------------|----------------------------|------------|------------|------------|--|
| | | Burst ID | Burst Offset (us) | Pulse Width (us) | Chirp Width (MHz) | Number of Pulses per Burst | PRI-1 (us) | PRI-2 (us) | PRI-3 (us) | |
| | | 0 | 456735.0 | 88.4 | 11 | 3 | 1613.0 | 1214.0 | 1511.0 | |
| | | 1 | 679087.0 | 92.5 | 11 | 3 | 1513.0 | 1791.0 | 1670.0 | |
| | | 2 | 904154.0 | 71.1 | 11 | 2 | 1313.0 | 1220.0 | - | |
| | | 3 | 206451.0 | 83.4 | 11 | 3 | 1846.0 | 1413.0 | 1142.0 | |
| | | 4 | 430819.0 | 61.4 | 11 | 1 | 1062.0 | - | - | |
| | | 5 | 653836.0 | 53.0 | 11 | 1 | 1907.0 | - | - | |
| | | 6 | 675406.0 | 92.0 | 11 | 3 | 1156.0 | 1361.0 | 1323.0 | |
| | | 7 | 179609.0 | 64.7 | 11 | 1 | 1306.0 | - | - | |
| | | 8 | 403272.0 | 54.3 | 11 | 1 | 1066.0 | - | - | |
| | | 9 | 626586.0 | 52.6 | 11 | 1 | 1512.0 | - | - | |
| | | 10 | 847261.0 | 92.4 | 11 | 3 | 1328.0 | 1497.0 | 1758.0 | |
| | | 11 | 152116.0 | 60.6 | 11 | 1 | 1023.0 | - | - | |
| | | 12 | 375375.0 | 63.4 | 11 | 1 | 1932.0 | - | - | |

Type 5 Radar Waveform_5

| Download | 5 | Type 5 | 16 | 0.7500000 | 12.0000000 | 5.530000000 | | | | |
|----------|---|----------|-------------------|------------------|-------------------|----------------------------|------------|------------|------------|--|
| | | Burst ID | Burst Offset (us) | Pulse Width (us) | Chirp Width (MHz) | Number of Pulses per Burst | PRI-1 (us) | PRI-2 (us) | PRI-3 (us) | |
| | | 0 | 484737.0 | 98.3 | 15 | 3 | 1955.0 | 1329.0 | 1014.0 | |
| | | 1 | 665968.0 | 85.7 | 15 | 3 | 1534.0 | 1080.0 | 1264.0 | |
| | | 2 | 100826.0 | 81.1 | 15 | 2 | 1776.0 | 1937.0 | - | |
| | | 3 | 281348.0 | 88.8 | 15 | 3 | 1070.0 | 1926.0 | 1976.0 | |
| | | 4 | 463887.0 | 52.7 | 15 | 1 | 1996.0 | - | - | |
| | | 5 | 643126.0 | 91.4 | 15 | 3 | 1560.0 | 1661.0 | 1296.0 | |
| | | 6 | 78735.0 | 51.4 | 15 | 1 | 1771.0 | - | - | |
| | | 7 | 259670.0 | 82.0 | 15 | 2 | 1885.0 | 1422.0 | - | |
| | | 8 | 441856.0 | 59.4 | 15 | 1 | 1462.0 | - | - | |
| | | 9 | 620391.0 | 84.3 | 15 | 3 | 1969.0 | 1472.0 | 1634.0 | |
| | | 10 | 56330.0 | 69.7 | 15 | 2 | 1278.0 | 1084.0 | - | |
| | | 11 | 238017.0 | 59.0 | 15 | 1 | 1252.0 | - | - | |
| | | 12 | 418628.0 | 76.2 | 15 | 2 | 1266.0 | 1741.0 | - | |
| | | 13 | 599262.0 | 74.9 | 15 | 2 | 1836.0 | 1836.0 | - | |
| | | 14 | 33978.0 | 79.3 | 15 | 2 | 1341.0 | 1565.0 | - | |
| | | 15 | 215164.0 | 68.3 | 15 | 2 | 1681.0 | 1051.0 | - | |

Type 5 Radar Waveform_6

| Download | 6 | Type 5 | 19 | 0.6315769 | 12.0000000 | 5.530000000 | | | | |
|----------|---|----------|-------------------|------------------|-------------------|----------------------------|------------|------------|------------|--|
| | | Burst ID | Burst Offset (us) | Pulse Width (us) | Chirp Width (MHz) | Number of Pulses per Burst | PRI-1 (us) | PRI-2 (us) | PRI-3 (us) | |
| | | 0 | 334460.0 | 51.6 | 18 | 1 | 1131.0 | - | - | |
| | | 1 | 487314.0 | 59.2 | 18 | 1 | 1221.0 | - | - | |
| | | 2 | 9833.0 | 58.9 | 18 | 1 | 1544.0 | - | - | |
| | | 3 | 162674.0 | 62.4 | 18 | 1 | 1397.0 | - | - | |
| | | 4 | 314377.0 | 93.4 | 18 | 3 | 1055.0 | 1092.0 | 1518.0 | |
| | | 5 | 467742.0 | 62.8 | 18 | 2 | 1021.0 | 1196.0 | - | |
| | | 6 | 620877.0 | 55.9 | 18 | 1 | 1715.0 | - | - | |
| | | 7 | 143286.0 | 90.6 | 18 | 3 | 1047.0 | 1648.0 | 1160.0 | |
| | | 8 | 296732.0 | 65.6 | 18 | 1 | 1300.0 | - | - | |
| | | 9 | 447475.0 | 87.9 | 18 | 3 | 1315.0 | 1180.0 | 1777.0 | |
| | | 10 | 600726.0 | 81.4 | 18 | 2 | 1924.0 | 1187.0 | - | |
| | | 11 | 125022.0 | 60.1 | 18 | 1 | 1391.0 | - | - | |
| | | 12 | 277086.0 | 70.3 | 18 | 2 | 1655.0 | 1498.0 | - | |
| | | 13 | 430732.0 | 59.0 | 18 | 1 | 1349.0 | - | - | |
| | | 14 | 581937.0 | 71.9 | 18 | 2 | 1417.0 | 1709.0 | - | |
| | | 15 | 105964.0 | 78.0 | 18 | 2 | 1085.0 | 1682.0 | - | |
| | | 16 | 259114.0 | 61.4 | 18 | 1 | 1201.0 | - | - | |
| | | 17 | 410993.0 | 75.8 | 18 | 2 | 1171.0 | 1572.0 | - | |
| | | 18 | 561824.0 | 99.3 | 18 | 3 | 1542.0 | 1762.0 | 1316.0 | |

Type 5 Radar Waveform_7

| Download | 7 | Type 5 | 17 | 0.7058824 | 12.0000000 | 5.530000000 | | | |
|----------|---|----------|-------------------|------------------|-------------------|----------------------------|------------|------------|------------|
| | | Burst ID | Burst Offset (us) | Pulse Width (us) | Chirp Width (MHz) | Number of Pulses per Burst | PRI-1 (us) | PRI-2 (us) | PRI-3 (us) |
| | | 0 | 97405.0 | 81.1 | 17 | 2 | 1309.0 | 1998.0 | - |
| | | 1 | 267549.0 | 89.6 | 17 | 3 | 1487.0 | 1040.0 | 1443.0 |
| | | 2 | 438573.0 | 72.7 | 17 | 2 | 1434.0 | 1273.0 | - |
| | | 3 | 607864.0 | 90.2 | 17 | 3 | 1503.0 | 1007.0 | 1873.0 |
| | | 4 | 78601.0 | 58.1 | 17 | 1 | 1609.0 | - | - |
| | | 5 | 247430.0 | 63.7 | 17 | 1 | 1552.0 | - | - |
| | | 6 | 417602.0 | 79.2 | 17 | 2 | 1183.0 | 1463.0 | - |
| | | 7 | 587152.0 | 78.9 | 17 | 2 | 1865.0 | 1966.0 | - |
| | | 8 | 55551.0 | 58.2 | 17 | 1 | 1742.0 | - | - |
| | | 9 | 226470.0 | 51.4 | 17 | 1 | 1298.0 | - | - |
| | | 10 | 396291.0 | 74.4 | 17 | 2 | 1964.0 | 1219.0 | - |
| | | 11 | 564572.0 | 85.3 | 17 | 3 | 1961.0 | 1983.0 | 1900.0 |
| | | 12 | 34470.0 | 78.2 | 17 | 2 | 1548.0 | 1117.0 | - |
| | | 13 | 205371.0 | 62.7 | 17 | 1 | 1468.0 | - | - |
| | | 14 | 374292.0 | 96.4 | 17 | 3 | 1747.0 | 1618.0 | 1702.0 |
| | | 15 | 546735.0 | 52.7 | 17 | 1 | 1883.0 | - | - |
| | | 16 | 13440.0 | 93.5 | 17 | 3 | 1474.0 | 1225.0 | 1099.0 |

Type 5 Radar Waveform_8

| Download | 8 | Type 5 | 8 | 1.5000000 | 12.0000000 | 5.530000000 | | | |
|----------|---|----------|-------------------|------------------|-------------------|----------------------------|------------|------------|------------|
| | | Burst ID | Burst Offset (us) | Pulse Width (us) | Chirp Width (MHz) | Number of Pulses per Burst | PRI-1 (us) | PRI-2 (us) | PRI-3 (us) |
| | | 0 | 391187.0 | 83.4 | 5 | 3 | 1691.0 | 1467.0 | 1904.0 |
| | | 1 | 754605.0 | 98.2 | 5 | 3 | 1241.0 | 1109.0 | 1030.0 |
| | | 2 | 1117313.0 | 70.0 | 5 | 2 | 1841.0 | 1899.0 | - |
| | | 3 | 1482130.0 | 65.5 | 5 | 1 | 1793.0 | - | - |
| | | 4 | 346855.0 | 79.8 | 5 | 2 | 1690.0 | 1953.0 | - |
| | | 5 | 709364.0 | 90.6 | 5 | 3 | 1942.0 | 1078.0 | 1477.0 |
| | | 6 | 1073211.0 | 73.2 | 5 | 2 | 1728.0 | 1178.0 | - |
| | | 7 | 1437551.0 | 64.9 | 5 | 1 | 1605.0 | - | - |

Type 5 Radar Waveform_9

| Download | 9 | Type 5 | 14 | 0.8571429 | 12.0000000 | 5.530000000 | | | |
|----------|---|----------|-------------------|------------------|-------------------|----------------------------|------------|------------|------------|
| | | Burst ID | Burst Offset (us) | Pulse Width (us) | Chirp Width (MHz) | Number of Pulses per Burst | PRI-1 (us) | PRI-2 (us) | PRI-3 (us) |
| | | 0 | 172752.0 | 60.0 | 13 | 1 | 1621.0 | - | - |
| | | 1 | 379065.0 | 91.3 | 13 | 3 | 1394.0 | 1058.0 | 1820.0 |
| | | 2 | 587642.0 | 61.6 | 13 | 1 | 1755.0 | - | - |
| | | 3 | 795203.0 | 50.3 | 13 | 1 | 1644.0 | - | - |
| | | 4 | 147205.0 | 62.3 | 13 | 1 | 1553.0 | - | - |
| | | 5 | 353108.0 | 91.8 | 13 | 3 | 1680.0 | 1896.0 | 1847.0 |
| | | 6 | 560477.0 | 97.6 | 13 | 3 | 1750.0 | 1146.0 | 1310.0 |
| | | 7 | 769439.0 | 50.3 | 13 | 1 | 1874.0 | - | - |
| | | 8 | 121348.0 | 75.6 | 13 | 2 | 1870.0 | 1774.0 | - |
| | | 9 | 328394.0 | 98.2 | 13 | 3 | 1326.0 | 1143.0 | 1057.0 |
| | | 10 | 535953.0 | 78.8 | 13 | 2 | 1667.0 | 1013.0 | - |
| | | 11 | 742227.0 | 78.9 | 13 | 2 | 1805.0 | 1979.0 | - |
| | | 12 | 95830.0 | 69.0 | 13 | 2 | 2000.0 | 1825.0 | - |
| | | 13 | 303743.0 | 50.8 | 13 | 1 | 1128.0 | - | - |

Type 5 Radar Waveform_10

| Download | 10 | Type 5 | 8 | 1.5000000 | 12.0000000 | 5.494000000 | | | |
|----------|----|----------|-------------------|------------------|-------------------|----------------------------|------------|------------|------------|
| | | Burst ID | Burst Offset (us) | Pulse Width (us) | Chirp Width (MHz) | Number of Pulses per Burst | PRI-1 (us) | PRI-2 (us) | PRI-3 (us) |
| | | 0 | 893390.0 | 98.7 | 6 | 3 | 1496.0 | 1494.0 | 1460.0 |
| | | 1 | 1258221.0 | 64.1 | 6 | 1 | 1934.0 | - | - |
| | | 2 | 123552.0 | 53.8 | 6 | 1 | 1097.0 | - | - |
| | | 3 | 485961.0 | 97.7 | 6 | 3 | 1676.0 | 1348.0 | 1526.0 |
| | | 4 | 849061.0 | 89.2 | 6 | 3 | 1086.0 | 1255.0 | 1493.0 |
| | | 5 | 1211776.0 | 91.3 | 6 | 3 | 1344.0 | 1096.0 | 1583.0 |
| | | 6 | 78761.0 | 52.5 | 6 | 1 | 1331.0 | - | - |
| | | 7 | 442105.0 | 53.1 | 6 | 1 | 1772.0 | - | - |

Type 5 Radar Waveform_11

| Download | 11 | Type 5 | 12 | 1.0000000 | 12.0000000 | 5.496000000 | | | | |
|----------|----|----------|-------------------|------------------|-------------------|----------------------------|------------|------------|------------|--|
| | | Burst ID | Burst Offset (us) | Pulse Width (us) | Chirp Width (MHz) | Number of Pulses per Burst | PRI-1 (us) | PRI-2 (us) | PRI-3 (us) | |
| | | 0 | 534851.0 | 97.5 | 10 | 3 | 1559.0 | 1737.0 | 1849.0 | |
| | | 1 | 777224.0 | 74.0 | 10 | 2 | 1812.0 | 1936.0 | - | |
| | | 2 | 22851.0 | 56.2 | 10 | 1 | 1251.0 | - | - | |
| | | 3 | 264435.0 | 78.5 | 10 | 2 | 1029.0 | 1898.0 | - | |
| | | 4 | 505372.0 | 94.7 | 10 | 3 | 1730.0 | 1400.0 | 1539.0 | |
| | | 5 | 749069.0 | 63.2 | 10 | 1 | 1606.0 | - | - | |
| | | 6 | 991525.0 | 55.7 | 10 | 1 | 1290.0 | - | - | |
| | | 7 | 234176.0 | 83.8 | 10 | 3 | 1466.0 | 1779.0 | 1688.0 | |
| | | 8 | 477080.0 | 51.3 | 10 | 1 | 1649.0 | - | - | |
| | | 9 | 717033.0 | 99.1 | 10 | 3 | 1835.0 | 1263.0 | 1576.0 | |
| | | 10 | 957831.0 | 99.6 | 10 | 3 | 1920.0 | 1475.0 | 1901.0 | |
| | | 11 | 204871.0 | 75.3 | 10 | 2 | 1053.0 | 1824.0 | - | |

Type 5 Radar Waveform_12

| Download | 12 | Type 5 | 13 | 0.9230769 | 12.0000000 | 5.496000000 | | | | |
|----------|----|----------|-------------------|------------------|-------------------|----------------------------|------------|------------|------------|--|
| | | Burst ID | Burst Offset (us) | Pulse Width (us) | Chirp Width (MHz) | Number of Pulses per Burst | PRI-1 (us) | PRI-2 (us) | PRI-3 (us) | |
| | | 0 | 411551.0 | 98.1 | 12 | 3 | 1012.0 | 1729.0 | 1883.0 | |
| | | 1 | 635600.0 | 72.4 | 12 | 2 | 1096.0 | 1523.0 | - | |
| | | 2 | 858758.0 | 67.6 | 12 | 2 | 1347.0 | 1359.0 | - | |
| | | 3 | 161597.0 | 78.6 | 12 | 2 | 1016.0 | 1744.0 | - | |
| | | 4 | 384132.0 | 96.0 | 12 | 3 | 1293.0 | 1866.0 | 1205.0 | |
| | | 5 | 608799.0 | 59.6 | 12 | 1 | 1563.0 | - | - | |
| | | 6 | 830839.0 | 76.8 | 12 | 2 | 1782.0 | 1393.0 | - | |
| | | 7 | 134006.0 | 84.9 | 12 | 3 | 1161.0 | 1163.0 | 1101.0 | |
| | | 8 | 367990.0 | 52.5 | 12 | 1 | 1006.0 | - | - | |
| | | 9 | 581158.0 | 64.6 | 12 | 1 | 1740.0 | - | - | |
| | | 10 | 803891.0 | 67.5 | 12 | 2 | 1083.0 | 1481.0 | - | |
| | | 11 | 106587.0 | 73.9 | 12 | 2 | 1383.0 | 1568.0 | - | |
| | | 12 | 329524.0 | 74.4 | 12 | 2 | 1930.0 | 1641.0 | - | |

Type 5 Radar Waveform_13

| Download | 13 | Type 5 | 10 | 1.2000000 | 12.0000000 | 5.494000000 | | | | |
|----------|----|----------|-------------------|------------------|-------------------|----------------------------|------------|------------|------------|--|
| | | Burst ID | Burst Offset (us) | Pulse Width (us) | Chirp Width (MHz) | Number of Pulses per Burst | PRI-1 (us) | PRI-2 (us) | PRI-3 (us) | |
| | | 0 | 719440.0 | 82.5 | 7 | 2 | 1063.0 | 1671.0 | - | |
| | | 1 | 1008268.0 | 99.5 | 7 | 3 | 1766.0 | 1370.0 | 1432.0 | |
| | | 2 | 103018.0 | 55.8 | 7 | 1 | 1631.0 | - | - | |
| | | 3 | 393735.0 | 61.7 | 7 | 1 | 1403.0 | - | - | |
| | | 4 | 683350.0 | 82.1 | 7 | 2 | 1869.0 | 1429.0 | - | |
| | | 5 | 975104.0 | 51.4 | 7 | 1 | 1435.0 | - | - | |
| | | 6 | 67174.0 | 81.9 | 7 | 2 | 1035.0 | 1378.0 | - | |
| | | 7 | 357901.0 | 62.3 | 7 | 1 | 1492.0 | - | - | |
| | | 8 | 648830.0 | 56.8 | 7 | 1 | 1025.0 | - | - | |
| | | 9 | 936319.0 | 93.9 | 7 | 3 | 1931.0 | 1358.0 | 1946.0 | |

Type 5 Radar Waveform_14

| Download | 14 | Type 5 | 18 | 0.666667 | 12.000000 | 5.49800000 | | | | |
|----------|----|----------|-------------------|------------------|-------------------|----------------------------|------------|------------|------------|--|
| | | Burst ID | Burst Offset (us) | Pulse Width (us) | Chirp Width (MHz) | Number of Pulses per Burst | PRI-1 (us) | PRI-2 (us) | PRI-3 (us) | |
| | | 0 | 17380.0 | 87.6 | 17 | 3 | 1597.0 | 1044.0 | 1088.0 | |
| | | 1 | 178124.0 | 94.1 | 17 | 3 | 1367.0 | 1261.0 | 1248.0 | |
| | | 2 | 338139.0 | 83.8 | 17 | 3 | 1829.0 | 1877.0 | 1803.0 | |
| | | 3 | 498935.0 | 97.2 | 17 | 3 | 1785.0 | 1875.0 | 1124.0 | |
| | | 4 | 660227.0 | 84.4 | 17 | 3 | 1061.0 | 1909.0 | 1046.0 | |
| | | 5 | 158223.0 | 94.6 | 17 | 3 | 1438.0 | 1020.0 | 1837.0 | |
| | | 6 | 318715.0 | 91.9 | 17 | 3 | 1997.0 | 1168.0 | 1451.0 | |
| | | 7 | 479353.0 | 96.8 | 17 | 3 | 1499.0 | 1984.0 | 1036.0 | |
| | | 8 | 641203.0 | 79.8 | 17 | 2 | 1861.0 | 1356.0 | - | |
| | | 9 | 138758.0 | 79.3 | 17 | 2 | 1208.0 | 1543.0 | - | |
| | | 10 | 299389.0 | 93.8 | 17 | 3 | 1152.0 | 1325.0 | 1136.0 | |
| | | 11 | 461591.0 | 52.7 | 17 | 1 | 1610.0 | - | - | |
| | | 12 | 621205.0 | 76.3 | 17 | 2 | 1551.0 | 1856.0 | - | |
| | | 13 | 118460.0 | 96.6 | 17 | 3 | 1905.0 | 1681.0 | 1753.0 | |
| | | 14 | 279452.0 | 75.3 | 17 | 2 | 1947.0 | 1973.0 | - | |
| | | 15 | 442078.0 | 51.7 | 17 | 1 | 1076.0 | - | - | |
| | | 16 | 601005.0 | 79.5 | 17 | 2 | 1882.0 | 1950.0 | - | |
| | | 17 | 99302.0 | 64.5 | 17 | 1 | 1334.0 | - | - | |

Type 5 Radar Waveform_15

| Download | 15 | Type 5 | 16 | 0.750000 | 12.000000 | 5.49700000 | | | | |
|----------|----|----------|-------------------|------------------|-------------------|----------------------------|------------|------------|------------|--|
| | | Burst ID | Burst Offset (us) | Pulse Width (us) | Chirp Width (MHz) | Number of Pulses per Burst | PRI-1 (us) | PRI-2 (us) | PRI-3 (us) | |
| | | 0 | 292787.0 | 67.7 | 14 | 2 | 1629.0 | 1049.0 | - | |
| | | 1 | 474579.0 | 50.6 | 14 | 1 | 1822.0 | - | - | |
| | | 2 | 655284.0 | 82.8 | 14 | 2 | 1540.0 | 1140.0 | - | |
| | | 3 | 89345.0 | 56.4 | 14 | 1 | 1570.0 | - | - | |
| | | 4 | 270278.0 | 82.4 | 14 | 2 | 1247.0 | 1939.0 | - | |
| | | 5 | 452254.0 | 54.1 | 14 | 1 | 1780.0 | - | - | |
| | | 6 | 634286.0 | 62.1 | 14 | 1 | 1112.0 | - | - | |
| | | 7 | 66964.0 | 63.7 | 14 | 1 | 1813.0 | - | - | |
| | | 8 | 247505.0 | 100.0 | 14 | 3 | 1628.0 | 1619.0 | 1332.0 | |
| | | 9 | 429016.0 | 72.1 | 14 | 2 | 1357.0 | 1963.0 | - | |
| | | 10 | 609979.0 | 69.2 | 14 | 2 | 1490.0 | 1990.0 | - | |
| | | 11 | 44466.0 | 97.6 | 14 | 3 | 1259.0 | 1305.0 | 1704.0 | |
| | | 12 | 225749.0 | 67.7 | 14 | 2 | 1778.0 | 1102.0 | - | |
| | | 13 | 407445.0 | 62.9 | 14 | 1 | 1971.0 | - | - | |
| | | 14 | 587304.0 | 91.3 | 14 | 3 | 1598.0 | 1158.0 | 1198.0 | |
| | | 15 | 22217.0 | 78.6 | 14 | 2 | 1335.0 | 1970.0 | - | |

Type 5 Radar Waveform_16

| Download | 16 | Type 5 | 11 | 1.090909 | 12.000000 | 5.49500000 | | | | |
|----------|----|----------|-------------------|------------------|-------------------|----------------------------|------------|------------|------------|--|
| | | Burst ID | Burst Offset (us) | Pulse Width (us) | Chirp Width (MHz) | Number of Pulses per Burst | PRI-1 (us) | PRI-2 (us) | PRI-3 (us) | |
| | | 0 | 296228.0 | 80.1 | 9 | 2 | 1292.0 | 1684.0 | - | |
| | | 1 | 559403.0 | 84.5 | 9 | 3 | 1008.0 | 1322.0 | 1972.0 | |
| | | 2 | 824897.0 | 62.1 | 9 | 1 | 1718.0 | - | - | |
| | | 3 | 1089627.0 | 62.5 | 9 | 1 | 1151.0 | - | - | |
| | | 4 | 263216.0 | 92.4 | 9 | 3 | 1770.0 | 1626.0 | 1685.0 | |
| | | 5 | 526970.0 | 90.3 | 9 | 3 | 1652.0 | 1582.0 | 1010.0 | |
| | | 6 | 792290.0 | 60.6 | 9 | 1 | 1811.0 | - | - | |
| | | 7 | 1054768.0 | 67.8 | 9 | 2 | 1769.0 | 1756.0 | - | |
| | | 8 | 230776.0 | 87.8 | 9 | 3 | 1723.0 | 1421.0 | 1944.0 | |
| | | 9 | 493855.0 | 94.7 | 9 | 3 | 1999.0 | 1925.0 | 1751.0 | |
| | | 10 | 758418.0 | 80.7 | 9 | 2 | 1809.0 | 1918.0 | - | |

Type 5 Radar Waveform_17

| Download | 17 | Type 5 | 13 | 0.9230769 | 12.000000 | 5.49600000 | | | | |
|----------|----|----------|-------------------|------------------|-------------------|----------------------------|------------|------------|------------|--|
| | | Burst ID | Burst Offset (us) | Pulse Width (us) | Chirp Width (MHz) | Number of Pulses per Burst | PRI-1 (us) | PRI-2 (us) | PRI-3 (us) | |
| | | 0 | 864645.0 | 79.8 | 12 | 2 | 1384.0 | 1985.0 | - | |
| | | 1 | 168103.0 | 73.2 | 12 | 2 | 1736.0 | 1045.0 | - | |
| | | 2 | 392005.0 | 59.3 | 12 | 1 | 1132.0 | - | - | |
| | | 3 | 613799.0 | 86.4 | 12 | 3 | 1071.0 | 1081.0 | 1686.0 | |
| | | 4 | 837766.0 | 80.4 | 12 | 2 | 1268.0 | 1446.0 | - | |
| | | 5 | 140621.0 | 72.0 | 12 | 2 | 1535.0 | 1173.0 | - | |
| | | 6 | 363567.0 | 67.3 | 12 | 2 | 1402.0 | 1995.0 | - | |
| | | 7 | 586087.0 | 94.7 | 12 | 3 | 1254.0 | 1374.0 | 1601.0 | |
| | | 8 | 811296.0 | 56.2 | 12 | 1 | 1549.0 | - | - | |
| | | 9 | 113308.0 | 61.0 | 12 | 1 | 1226.0 | - | - | |
| | | 10 | 336129.0 | 81.1 | 12 | 2 | 1795.0 | 1501.0 | - | |
| | | 11 | 560227.0 | 61.7 | 12 | 1 | 1615.0 | - | - | |
| | | 12 | 781865.0 | 79.7 | 12 | 2 | 1859.0 | 1926.0 | - | |

Type 5 Radar Waveform_18

| Download | 18 | Type 5 | 19 | 0.6315789 | 12.0000000 | 5.499000000 | | | |
|----------|----|----------|-------------------|------------------|-------------------|----------------------------|------------|------------|------------|
| | | Burst ID | Burst Offset (us) | Pulse Width (us) | Chirp Width (MHz) | Number of Pulses per Burst | PRI-1 (us) | PRI-2 (us) | PRI-3 (us) |
| | | 0 | 58295.0 | 85.0 | 19 | 3 | 1958.0 | 1126.0 | 1929.0 |
| | | 1 | 211026.0 | 70.6 | 19 | 2 | 1244.0 | 1479.0 | - |
| | | 2 | 362569.0 | 94.7 | 19 | 3 | 1033.0 | 1407.0 | 1968.0 |
| | | 3 | 515921.0 | 69.8 | 19 | 2 | 1637.0 | 1256.0 | - |
| | | 4 | 39676.0 | 77.5 | 19 | 2 | 1745.0 | 1705.0 | - |
| | | 5 | 192128.0 | 82.2 | 19 | 2 | 1245.0 | 1842.0 | - |
| | | 6 | 345582.0 | 61.6 | 19 | 1 | 1217.0 | - | - |
| | | 7 | 496476.0 | 80.8 | 19 | 2 | 1910.0 | 1821.0 | - |
| | | 8 | 20982.0 | 61.5 | 19 | 1 | 1304.0 | - | - |
| | | 9 | 172847.0 | 97.7 | 19 | 3 | 1115.0 | 1851.0 | 1952.0 |
| | | 10 | 326680.0 | 66.5 | 19 | 1 | 1353.0 | - | - |
| | | 11 | 476585.0 | 90.8 | 19 | 3 | 1923.0 | 1799.0 | 1500.0 |
| | | 12 | 2140.0 | 89.6 | 19 | 3 | 1423.0 | 1853.0 | 1892.0 |
| | | 13 | 154595.0 | 66.9 | 19 | 2 | 1192.0 | 1818.0 | - |
| | | 14 | 306969.0 | 72.1 | 19 | 2 | 1933.0 | 1227.0 | - |
| | | 15 | 459788.0 | 77.4 | 19 | 2 | 1458.0 | 1145.0 | - |
| | | 16 | 611182.0 | 90.0 | 19 | 3 | 1246.0 | 1121.0 | 1420.0 |
| | | 17 | 136163.0 | 64.9 | 19 | 1 | 1410.0 | - | - |
| | | 18 | 288546.0 | 68.7 | 19 | 2 | 1043.0 | 1354.0 | - |

Type 5 Radar Waveform_19

| Download | 19 | Type 5 | 18 | 0.6666667 | 12.0000000 | 5.498000000 | | | |
|----------|----|----------|-------------------|------------------|-------------------|----------------------------|------------|------------|------------|
| | | Burst ID | Burst Offset (us) | Pulse Width (us) | Chirp Width (MHz) | Number of Pulses per Burst | PRI-1 (us) | PRI-2 (us) | PRI-3 (us) |
| | | 0 | 464186.0 | 87.8 | 17 | 3 | 1506.0 | 1433.0 | 1679.0 |
| | | 1 | 625703.0 | 73.4 | 17 | 2 | 1710.0 | 1902.0 | - |
| | | 2 | 123546.0 | 82.4 | 17 | 2 | 1249.0 | 1890.0 | - |
| | | 3 | 283957.0 | 90.5 | 17 | 3 | 1529.0 | 1622.0 | 1194.0 |
| | | 4 | 444447.0 | 90.7 | 17 | 3 | 1439.0 | 1712.0 | 1409.0 |
| | | 5 | 605797.0 | 85.7 | 17 | 3 | 1107.0 | 1233.0 | 1379.0 |
| | | 6 | 103597.0 | 88.9 | 17 | 3 | 1398.0 | 1342.0 | 1223.0 |
| | | 7 | 264796.0 | 75.6 | 17 | 2 | 1280.0 | 1519.0 | - |
| | | 8 | 426592.0 | 50.3 | 17 | 1 | 1558.0 | - | - |
| | | 9 | 587335.0 | 68.3 | 17 | 2 | 1125.0 | 1075.0 | - |
| | | 10 | 83694.0 | 85.1 | 17 | 3 | 1611.0 | 1338.0 | 1843.0 |
| | | 11 | 244736.0 | 67.5 | 17 | 2 | 1399.0 | 1993.0 | - |
| | | 12 | 404657.0 | 99.0 | 17 | 3 | 1754.0 | 1897.0 | 1286.0 |
| | | 13 | 566193.0 | 72.8 | 17 | 2 | 1721.0 | 1991.0 | - |
| | | 14 | 64082.0 | 82.5 | 17 | 2 | 1852.0 | 1279.0 | - |
| | | 15 | 224955.0 | 77.6 | 17 | 2 | 1974.0 | 1318.0 | - |
| | | 16 | 366011.0 | 71.8 | 17 | 2 | 1419.0 | 1567.0 | - |
| | | 17 | 545559.0 | 95.7 | 17 | 3 | 1330.0 | 1787.0 | 1600.0 |

Type 5 Radar Waveform_20

| Download | 20 | Type 5 | 11 | 1.0909091 | 12.0000000 | 5.565000000 | | | |
|----------|----|----------|-------------------|------------------|-------------------|----------------------------|------------|------------|------------|
| | | Burst ID | Burst Offset (us) | Pulse Width (us) | Chirp Width (MHz) | Number of Pulses per Burst | PRI-1 (us) | PRI-2 (us) | PRI-3 (us) |
| | | 0 | 72502.0 | 90.8 | 9 | 3 | 1232.0 | 1288.0 | 1416.0 |
| | | 1 | 335812.0 | 90.4 | 9 | 3 | 1626.0 | 1406.0 | 1724.0 |
| | | 2 | 601021.0 | 55.5 | 9 | 1 | 1639.0 | - | - |
| | | 3 | 864319.0 | 83.1 | 9 | 2 | 1224.0 | 1528.0 | - |
| | | 4 | 40018.0 | 99.9 | 9 | 3 | 1110.0 | 1351.0 | 1810.0 |
| | | 5 | 304122.0 | 68.3 | 9 | 2 | 1111.0 | 1155.0 | - |
| | | 6 | 567782.0 | 75.6 | 9 | 2 | 1362.0 | 1651.0 | - |
| | | 7 | 830063.0 | 92.8 | 9 | 3 | 1903.0 | 1761.0 | 1375.0 |
| | | 8 | 7556.0 | 95.7 | 9 | 3 | 1082.0 | 1444.0 | 1653.0 |
| | | 9 | 270967.0 | 90.9 | 9 | 3 | 1726.0 | 1127.0 | 1948.0 |
| | | 10 | 535919.0 | 55.0 | 9 | 1 | 1677.0 | - | - |

Type 5 Radar Waveform_21

| Download | 21 | Type 5 | 8 | 1.5000000 | 12.0000000 | 5.566000000 | | | | |
|----------|----|----------|-------------------|------------------|-------------------|----------------------------|------------|------------|------------|--|
| | | Burst ID | Burst Offset (us) | Pulse Width (us) | Chirp Width (MHz) | Number of Pulses per Burst | PRI-1 (us) | PRI-2 (us) | PRI-3 (us) | |
| | | 0 | 1098664.0 | 95.3 | 5 | 3 | 1831.0 | 1284.0 | 1181.0 | |
| | | 1 | 1462815.0 | 67.2 | 5 | 2 | 1585.0 | 1283.0 | - | |
| | | 2 | 329007.0 | 66.2 | 5 | 1 | 1855.0 | - | - | |
| | | 3 | 691560.0 | 96.1 | 5 | 3 | 1130.0 | 1428.0 | 1015.0 | |
| | | 4 | 1055632.0 | 62.4 | 5 | 1 | 1954.0 | - | - | |
| | | 5 | 1417161.0 | 74.0 | 5 | 2 | 1927.0 | 1922.0 | - | |
| | | 6 | 284321.0 | 56.2 | 5 | 1 | 1484.0 | - | - | |
| | | 7 | 647651.0 | 52.6 | 5 | 1 | 1732.0 | - | - | |

Type 5 Radar Waveform_22

| Download | 22 | Type 5 | 10 | 1.2000000 | 12.0000000 | 5.566000000 | | | | |
|----------|----|----------|-------------------|------------------|-------------------|----------------------------|------------|------------|------------|--|
| | | Burst ID | Burst Offset (us) | Pulse Width (us) | Chirp Width (MHz) | Number of Pulses per Burst | PRI-1 (us) | PRI-2 (us) | PRI-3 (us) | |
| | | 0 | 807542.0 | 80.1 | 7 | 2 | 1796.0 | 1488.0 | - | |
| | | 1 | 1099857.0 | 54.0 | 7 | 1 | 1024.0 | - | - | |
| | | 2 | 191180.0 | 84.2 | 7 | 3 | 1624.0 | 1210.0 | 1250.0 | |
| | | 3 | 481210.0 | 88.7 | 7 | 3 | 1828.0 | 1297.0 | 1003.0 | |
| | | 4 | 772997.0 | 56.6 | 7 | 1 | 1414.0 | - | - | |
| | | 5 | 1063285.0 | 61.2 | 7 | 1 | 1872.0 | - | - | |
| | | 6 | 155750.0 | 62.4 | 7 | 1 | 1802.0 | - | - | |
| | | 7 | 445940.0 | 76.4 | 7 | 2 | 1781.0 | 1122.0 | - | |
| | | 8 | 736166.0 | 80.2 | 7 | 2 | 1508.0 | 1571.0 | - | |
| | | 9 | 1026565.0 | 67.5 | 7 | 2 | 1567.0 | 1386.0 | - | |

Type 5 Radar Waveform_23

| Download | 23 | Type 5 | 15 | 0.8000000 | 12.0000000 | 5.563000000 | | | | |
|----------|----|----------|-------------------|------------------|-------------------|----------------------------|------------|------------|------------|--|
| | | Burst ID | Burst Offset (us) | Pulse Width (us) | Chirp Width (MHz) | Number of Pulses per Burst | PRI-1 (us) | PRI-2 (us) | PRI-3 (us) | |
| | | 0 | 79851.0 | 68.0 | 13 | 2 | 1312.0 | 1077.0 | - | |
| | | 1 | 273806.0 | 57.1 | 13 | 1 | 1486.0 | - | - | |
| | | 2 | 464995.0 | 89.4 | 13 | 3 | 1716.0 | 1659.0 | 2000.0 | |
| | | 3 | 661145.0 | 50.3 | 13 | 1 | 1234.0 | - | - | |
| | | 4 | 56026.0 | 81.8 | 13 | 2 | 1004.0 | 1337.0 | - | |
| | | 5 | 248767.0 | 99.2 | 13 | 3 | 1320.0 | 1346.0 | 1967.0 | |
| | | 6 | 442451.0 | 74.6 | 13 | 2 | 1678.0 | 1546.0 | - | |
| | | 7 | 637157.0 | 63.1 | 13 | 1 | 1390.0 | - | - | |
| | | 8 | 32232.0 | 54.7 | 13 | 1 | 1473.0 | - | - | |
| | | 9 | 225638.0 | 73.6 | 13 | 2 | 1118.0 | 1282.0 | - | |
| | | 10 | 419753.0 | 64.1 | 13 | 1 | 1120.0 | - | - | |
| | | 11 | 613165.0 | 64.9 | 13 | 1 | 1566.0 | - | - | |
| | | 12 | 8344.0 | 97.9 | 13 | 3 | 1590.0 | 1734.0 | 1172.0 | |
| | | 13 | 201424.0 | 90.0 | 13 | 3 | 1382.0 | 1176.0 | 1365.0 | |
| | | 14 | 394289.0 | 98.0 | 13 | 3 | 1311.0 | 1992.0 | 1041.0 | |

Type 5 Radar Waveform_24

| Download | 24 | Type 5 | 9 | 1.3333333 | 12.0000000 | 5.566000000 | | | | |
|----------|----|----------|-------------------|------------------|-------------------|----------------------------|------------|------------|------------|--|
| | | Burst ID | Burst Offset (us) | Pulse Width (us) | Chirp Width (MHz) | Number of Pulses per Burst | PRI-1 (us) | PRI-2 (us) | PRI-3 (us) | |
| | | 0 | 982003.0 | 70.5 | 6 | 2 | 1442.0 | 1415.0 | - | |
| | | 1 | 1305813.0 | 55.1 | 6 | 1 | 1707.0 | - | - | |
| | | 2 | 297263.0 | 51.1 | 6 | 1 | 1189.0 | - | - | |
| | | 3 | 619584.0 | 68.8 | 6 | 2 | 1561.0 | 1274.0 | - | |
| | | 4 | 942649.0 | 71.4 | 6 | 2 | 1275.0 | 1027.0 | - | |
| | | 5 | 1262986.0 | 86.6 | 6 | 3 | 1401.0 | 1599.0 | 1911.0 | |
| | | 6 | 256758.0 | 98.8 | 6 | 3 | 1632.0 | 1699.0 | 1521.0 | |
| | | 7 | 580055.0 | 76.2 | 6 | 2 | 1203.0 | 1129.0 | - | |
| | | 8 | 902203.0 | 74.9 | 6 | 2 | 1935.0 | 1373.0 | - | |

Type 5 Radar Waveform_25

| Download | 25 | Type 5 | 13 | 0.9230769 | 12.0000000 | 5.564000000 | | | | |
|----------|----|----------|-------------------|------------------|-------------------|----------------------------|------------|------------|------------|--|
| | | Burst ID | Burst Offset (us) | Pulse Width (us) | Chirp Width (MHz) | Number of Pulses per Burst | PRI-1 (us) | PRI-2 (us) | PRI-3 (us) | |
| | | 0 | 845902.0 | 91.7 | 11 | 3 | 1186.0 | 1989.0 | 1308.0 | |
| | | 1 | 150257.0 | 91.6 | 11 | 3 | 1079.0 | 1067.0 | 1336.0 | |
| | | 2 | 373906.0 | 56.6 | 11 | 1 | 1966.0 | - | - | |
| | | 3 | 597468.0 | 51.6 | 11 | 1 | 1714.0 | - | - | |
| | | 4 | 819111.0 | 99.0 | 11 | 3 | 1380.0 | 1280.0 | 1113.0 | |
| | | 5 | 122885.0 | 71.8 | 11 | 2 | 1464.0 | 1287.0 | - | |
| | | 6 | 345413.0 | 87.4 | 11 | 3 | 1236.0 | 1689.0 | 1635.0 | |
| | | 7 | 566225.0 | 91.9 | 11 | 3 | 1106.0 | 1471.0 | 1914.0 | |
| | | 8 | 791511.0 | 95.5 | 11 | 3 | 1175.0 | 1569.0 | 1166.0 | |
| | | 9 | 95366.0 | 75.3 | 11 | 2 | 1789.0 | 1200.0 | - | |
| | | 10 | 318573.0 | 77.7 | 11 | 2 | 1555.0 | 1270.0 | - | |
| | | 11 | 540933.0 | 83.8 | 11 | 3 | 1301.0 | 1696.0 | 1239.0 | |
| | | 12 | 766439.0 | 65.7 | 11 | 1 | 1038.0 | - | - | |

Type 5 Radar Waveform_26

| Download | 26 | Type 5 | 20 | 0.6000000 | 12.0000000 | 5.560000000 | | | | |
|----------|----|----------|-------------------|------------------|-------------------|----------------------------|------------|------------|------------|--|
| | | Burst ID | Burst Offset (us) | Pulse Width (us) | Chirp Width (MHz) | Number of Pulses per Burst | PRI-1 (us) | PRI-2 (us) | PRI-3 (us) | |
| | | 0 | 43694.0 | 94.9 | 20 | 3 | 1672.0 | 1817.0 | 1536.0 | |
| | | 1 | 188541.0 | 85.5 | 20 | 3 | 1191.0 | 1720.0 | 1019.0 | |
| | | 2 | 333467.0 | 67.1 | 20 | 2 | 1564.0 | 1722.0 | - | |
| | | 3 | 478191.0 | 71.5 | 20 | 2 | 1608.0 | 1675.0 | - | |
| | | 4 | 26128.0 | 99.3 | 20 | 3 | 1345.0 | 1975.0 | 1531.0 | |
| | | 5 | 171077.0 | 69.3 | 20 | 2 | 1065.0 | 1666.0 | - | |
| | | 6 | 315626.0 | 82.7 | 20 | 2 | 1364.0 | 1949.0 | - | |
| | | 7 | 459106.0 | 88.6 | 20 | 3 | 1483.0 | 1616.0 | 1815.0 | |
| | | 8 | 8392.0 | 65.2 | 20 | 1 | 1735.0 | - | - | |
| | | 9 | 153544.0 | 56.2 | 20 | 1 | 1524.0 | - | - | |
| | | 10 | 297360.0 | 94.3 | 20 | 3 | 1253.0 | 1094.0 | 1848.0 | |
| | | 11 | 441506.0 | 90.7 | 20 | 3 | 1830.0 | 1527.0 | 1317.0 | |
| | | 12 | 586061.0 | 86.1 | 20 | 3 | 1450.0 | 1640.0 | 1412.0 | |
| | | 13 | 135760.0 | 56.1 | 20 | 1 | 1103.0 | - | - | |
| | | 14 | 280976.0 | 61.3 | 20 | 1 | 1179.0 | - | - | |
| | | 15 | 426048.0 | 57.6 | 20 | 1 | 1405.0 | - | - | |
| | | 16 | 570696.0 | 58.7 | 20 | 1 | 1960.0 | - | - | |
| | | 17 | 117532.0 | 81.0 | 20 | 2 | 1788.0 | 1026.0 | - | |
| | | 18 | 262344.0 | 69.2 | 20 | 2 | 1541.0 | 1327.0 | - | |
| | | 19 | 407194.0 | 80.9 | 20 | 2 | 1449.0 | 1381.0 | - | |

Type 5 Radar Waveform_27

| Download | 27 | Type 5 | 11 | 1.0909091 | 12.0000000 | 5.585000000 | | | | |
|----------|----|----------|-------------------|------------------|-------------------|----------------------------|------------|------------|------------|--|
| | | Burst ID | Burst Offset (us) | Pulse Width (us) | Chirp Width (MHz) | Number of Pulses per Burst | PRI-1 (us) | PRI-2 (us) | PRI-3 (us) | |
| | | 0 | 1006899.0 | 64.4 | 8 | 1 | 1668.0 | - | - | |
| | | 1 | 181872.0 | 58.6 | 8 | 1 | 1431.0 | - | - | |
| | | 2 | 444891.0 | 90.2 | 8 | 3 | 1452.0 | 1489.0 | 1454.0 | |
| | | 3 | 708169.0 | 92.6 | 8 | 3 | 1602.0 | 1562.0 | 1593.0 | |
| | | 4 | 972852.0 | 73.0 | 8 | 2 | 1916.0 | 1436.0 | - | |
| | | 5 | 149305.0 | 64.1 | 8 | 1 | 1574.0 | - | - | |
| | | 6 | 412994.0 | 82.9 | 8 | 2 | 1028.0 | 1886.0 | - | |
| | | 7 | 675611.0 | 86.2 | 8 | 3 | 1840.0 | 1857.0 | 1237.0 | |
| | | 8 | 940697.0 | 72.2 | 8 | 2 | 1557.0 | 1408.0 | - | |
| | | 9 | 116677.0 | 69.5 | 8 | 2 | 1093.0 | 1272.0 | - | |
| | | 10 | 380621.0 | 72.6 | 8 | 2 | 1005.0 | 1538.0 | - | |

Type 5 Radar Waveform_28

| Download | 28 | Type 5 | 20 | 0.6000000 | 12.0000000 | 5.560000000 | | | | |
|----------|----|----------|-------------------|------------------|-------------------|----------------------------|------------|------------|------------|--|
| | | Burst ID | Burst Offset (us) | Pulse Width (us) | Chirp Width (MHz) | Number of Pulses per Burst | PRI-1 (us) | PRI-2 (us) | PRI-3 (us) | |
| | | 0 | 354198.0 | 62.2 | 20 | 1 | 1945.0 | - | - | |
| | | 1 | 499367.0 | 64.2 | 20 | 1 | 1798.0 | - | - | |
| | | 2 | 46247.0 | 54.8 | 20 | 1 | 1808.0 | - | - | |
| | | 3 | 191282.0 | 60.2 | 20 | 1 | 1951.0 | - | - | |
| | | 4 | 336363.0 | 65.6 | 20 | 1 | 1888.0 | - | - | |
| | | 5 | 481953.0 | 51.6 | 20 | 1 | 1231.0 | - | - | |
| | | 6 | 28225.0 | 100.0 | 20 | 3 | 1803.0 | 1350.0 | 1880.0 | |
| | | 7 | 172728.0 | 87.3 | 20 | 3 | 1522.0 | 1743.0 | 1059.0 | |
| | | 8 | 318170.0 | 79.5 | 20 | 2 | 1199.0 | 1299.0 | - | |
| | | 9 | 460741.0 | 93.6 | 20 | 3 | 1919.0 | 1994.0 | 1607.0 | |
| | | 10 | 10452.0 | 86.4 | 20 | 3 | 1731.0 | 1591.0 | 1581.0 | |
| | | 11 | 155208.0 | 76.5 | 20 | 2 | 1959.0 | 1303.0 | - | |
| | | 12 | 299297.0 | 85.4 | 20 | 3 | 1844.0 | 1575.0 | 1114.0 | |
| | | 13 | 445995.0 | 62.3 | 20 | 1 | 1476.0 | - | - | |
| | | 14 | 591617.0 | 60.9 | 20 | 1 | 1009.0 | - | - | |
| | | 15 | 137871.0 | 62.9 | 20 | 1 | 1133.0 | - | - | |
| | | 16 | 283076.0 | 65.7 | 20 | 1 | 1216.0 | - | - | |
| | | 17 | 427149.0 | 76.0 | 20 | 2 | 1184.0 | 1642.0 | - | |
| | | 18 | 571132.0 | 84.2 | 20 | 3 | 1533.0 | 1091.0 | 1080.0 | |
| | | 19 | 119124.0 | 86.8 | 20 | 3 | 1889.0 | 1876.0 | 1645.0 | |

Type 5 Radar Waveform_29

| Download | 29 | Type 5 | 20 | 0.6000000 | 12.0000000 | 5.560000000 | | | | |
|----------|----|----------|-------------------|------------------|-------------------|----------------------------|------------|------------|------------|--|
| | | Burst ID | Burst Offset (us) | Pulse Width (us) | Chirp Width (MHz) | Number of Pulses per Burst | PRI-1 (us) | PRI-2 (us) | PRI-3 (us) | |
| | | 0 | 264053.0 | 94.3 | 20 | 3 | 1258.0 | 1453.0 | 1067.0 | |
| | | 1 | 410302.0 | 58.5 | 20 | 1 | 1376.0 | - | - | |
| | | 2 | 555190.0 | 52.8 | 20 | 1 | 1697.0 | - | - | |
| | | 3 | 102074.0 | 51.2 | 20 | 1 | 1228.0 | - | - | |
| | | 4 | 246110.0 | 86.3 | 20 | 3 | 1218.0 | 1242.0 | 1636.0 | |
| | | 5 | 390811.0 | 95.3 | 20 | 3 | 1530.0 | 1064.0 | 1235.0 | |
| | | 6 | 536090.0 | 74.6 | 20 | 2 | 1074.0 | 1988.0 | - | |
| | | 7 | 83838.0 | 98.5 | 20 | 3 | 1448.0 | 1197.0 | 1056.0 | |
| | | 8 | 228110.0 | 85.2 | 20 | 3 | 1657.0 | 1801.0 | 1154.0 | |
| | | 9 | 372406.0 | 86.4 | 20 | 3 | 1485.0 | 1509.0 | 1786.0 | |
| | | 10 | 516460.0 | 96.5 | 20 | 3 | 1887.0 | 1586.0 | 1658.0 | |
| | | 11 | 66276.0 | 66.3 | 20 | 1 | 1427.0 | - | - | |
| | | 12 | 210304.0 | 95.8 | 20 | 3 | 1827.0 | 1556.0 | 1285.0 | |
| | | 13 | 354458.0 | 83.6 | 20 | 3 | 1938.0 | 1913.0 | 1207.0 | |
| | | 14 | 500687.0 | 82.0 | 20 | 2 | 1368.0 | 1380.0 | - | |
| | | 15 | 48245.0 | 76.5 | 20 | 2 | 1794.0 | 1480.0 | - | |
| | | 16 | 192839.0 | 81.3 | 20 | 2 | 1832.0 | 1845.0 | - | |
| | | 17 | 336750.0 | 95.9 | 20 | 3 | 1366.0 | 1665.0 | 1912.0 | |
| | | 18 | 481400.0 | 95.8 | 20 | 3 | 1491.0 | 1701.0 | 1343.0 | |
| | | 19 | 30514.0 | 55.9 | 20 | 1 | 1389.0 | - | - | |

| Radar Type 6 - Radar Statistical Performance | | | |
|--|-------------------------------|--------------|-------------------------------|
| Trail # | 1=Detection 0=No Detection | Trail # | 1=Detection 0=No Detection |
| 0 | 1 | 15 | 0 |
| 1 | 1 | 16 | 1 |
| 2 | 1 | 17 | 1 |
| 3 | 1 | 18 | 1 |
| 4 | 1 | 19 | 1 |
| 5 | 1 | 20 | 1 |
| 6 | 1 | 21 | 1 |
| 7 | 1 | 22 | 1 |
| 8 | 1 | 23 | 1 |
| 9 | 1 | 24 | 1 |
| 10 | 1 | 25 | 1 |
| 11 | 1 | 26 | 1 |
| 12 | 1 | 27 | 1 |
| 13 | 1 | 28 | 1 |
| 14 | 1 | 29 | 1 |
| Detection Percentage (%) | | 96.7% | |

Type 6 Radar Waveform_0

| Download | 0 | Type 6 | 1.0 | 333.3 | 9 | 0.3333 | 300.000000 | 17 |
|----------|---|----------------------|------|-------|------|--------|------------|----|
| | | Frequency List (MHz) | 0 | 1 | 2 | 3 | 4 | |
| | | 0 | 5596 | 5623 | 5257 | 5598 | 5369 | |
| | | 5 | 5696 | 5400 | 5284 | 5470 | 5506 | |
| | | 10 | 5576 | 5441 | 5583 | 5452 | 5274 | |
| | | 15 | 5439 | 5326 | 5328 | 5650 | 5500 | |
| | | 20 | 5495 | 5554 | 5683 | 5570 | 5462 | |
| | | 25 | 5604 | 5270 | 5483 | 5435 | 5666 | |
| | | 30 | 5447 | 5675 | 5310 | 5443 | 5509 | |
| | | 35 | 5518 | 5494 | 5251 | 5278 | 5393 | |
| | | 40 | 5693 | 5613 | 5394 | 5612 | 5667 | |
| | | 45 | 5312 | 5635 | 5527 | 5586 | 5531 | |
| | | 50 | 5292 | 5287 | 5412 | 5386 | 5587 | |
| | | 55 | 5298 | 5642 | 5671 | 5626 | 5406 | |
| | | 60 | 5250 | 5588 | 5523 | 5356 | 5490 | |
| | | 65 | 5498 | 5630 | 5656 | 5649 | 5472 | |
| | | 70 | 5352 | 5476 | 5569 | 5557 | 5383 | |
| | | 75 | 5638 | 5590 | 5537 | 5396 | 5339 | |
| | | 80 | 5504 | 5401 | 5382 | 5254 | 5300 | |
| | | 85 | 5458 | 5544 | 5317 | 5398 | 5372 | |
| | | 90 | 5427 | 5322 | 5603 | 5461 | 5429 | |
| | | 95 | 5431 | 5536 | 5665 | 5280 | 5640 | |

Type 6 Radar Waveform_1

| Download | 1 | Type 6 | 1.0 | 333.3 | 9 | 0.3333 | 300.000000 | 22 |
|----------|---|----------------------|------|-------|------|--------|------------|----|
| | | Frequency List (MHz) | 0 | 1 | 2 | 3 | 4 | |
| | | 0 | 5376 | 5484 | 5668 | 5284 | 5686 | |
| | | 5 | 5263 | 5325 | 5359 | 5633 | 5713 | |
| | | 10 | 5507 | 5705 | 5624 | 5647 | 5295 | |
| | | 15 | 5527 | 5453 | 5431 | 5598 | 5692 | |
| | | 20 | 5503 | 5720 | 5721 | 5562 | 5435 | |
| | | 25 | 5492 | 5597 | 5539 | 5603 | 5489 | |
| | | 30 | 5632 | 5525 | 5329 | 5330 | 5609 | |
| | | 35 | 5290 | 5404 | 5667 | 5707 | 5301 | |
| | | 40 | 5395 | 5491 | 5610 | 5701 | 5495 | |
| | | 45 | 5275 | 5628 | 5365 | 5522 | 5306 | |
| | | 50 | 5287 | 5582 | 5478 | 5488 | 5356 | |
| | | 55 | 5574 | 5444 | 5461 | 5545 | 5280 | |
| | | 60 | 5571 | 5292 | 5420 | 5446 | 5302 | |
| | | 65 | 5313 | 5447 | 5666 | 5521 | 5291 | |
| | | 70 | 5576 | 5418 | 5550 | 5516 | 5352 | |
| | | 75 | 5661 | 5258 | 5585 | 5314 | 5506 | |
| | | 80 | 5595 | 5464 | 5566 | 5699 | 5285 | |
| | | 85 | 5553 | 5509 | 5271 | 5646 | 5546 | |
| | | 90 | 5537 | 5602 | 5540 | 5309 | 5381 | |
| | | 95 | 5684 | 5408 | 5534 | 5259 | 5663 | |

Type 6 Radar Waveform_2

| Download | 2 | Type 6 | 1.0 | 333.3 | 9 | 0.3333 | 300.000000 | 15 |
|----------|---|----------------------|------|-------|------|--------|------------|----|
| | | Frequency List (MHz) | 0 | 1 | 2 | 3 | 4 | |
| | | 0 | 5631 | 5723 | 5604 | 5445 | 5431 | |
| | | 5 | 5305 | 5347 | 5434 | 5321 | 5542 | |
| | | 10 | 5438 | 5591 | 5665 | 5367 | 5316 | |
| | | 15 | 5518 | 5580 | 5534 | 5643 | 5409 | |
| | | 20 | 5511 | 5411 | 5662 | 5651 | 5408 | |
| | | 25 | 5283 | 5449 | 5414 | 5637 | 5531 | |
| | | 30 | 5451 | 5589 | 5265 | 5369 | 5527 | |
| | | 35 | 5372 | 5700 | 5561 | 5654 | 5678 | |
| | | 40 | 5384 | 5333 | 5256 | 5704 | 5630 | |
| | | 45 | 5475 | 5358 | 5418 | 5312 | 5657 | |
| | | 50 | 5463 | 5633 | 5567 | 5311 | 5287 | |
| | | 55 | 5398 | 5658 | 5516 | 5261 | 5712 | |
| | | 60 | 5252 | 5272 | 5514 | 5396 | 5605 | |
| | | 65 | 5698 | 5336 | 5553 | 5593 | 5277 | |
| | | 70 | 5579 | 5267 | 5526 | 5306 | 5304 | |
| | | 75 | 5566 | 5616 | 5376 | 5357 | 5624 | |
| | | 80 | 5563 | 5285 | 5413 | 5323 | 5270 | |
| | | 85 | 5377 | 5322 | 5419 | 5269 | 5702 | |
| | | 90 | 5608 | 5477 | 5666 | 5443 | 5538 | |
| | | 95 | 5436 | 5668 | 5257 | 5387 | 5457 | |

Type 6 Radar Waveform_3

| Download | 3 | Type 6 | 1.0 | 333.3 | 9 | 0.3333 | 300.000000 | 16 |
|----------|---|----------------------|------|-------|------|--------|------------|----|
| | | Frequency List (MHz) | 0 | 1 | 2 | 3 | 4 | |
| | | 0 | 5411 | 5487 | 5540 | 5606 | 5273 | |
| | | 5 | 5444 | 5272 | 5509 | 5484 | 5274 | |
| | | 10 | 5380 | 5706 | 5562 | 5337 | 5707 | |
| | | 15 | 5688 | 5601 | 5422 | 5480 | 5603 | |
| | | 20 | 5643 | 5381 | 5646 | 5398 | 5617 | |
| | | 25 | 5671 | 5670 | 5437 | 5546 | 5383 | |
| | | 30 | 5618 | 5347 | 5511 | 5316 | 5357 | |
| | | 35 | 5332 | 5592 | 5482 | 5467 | 5271 | |
| | | 40 | 5399 | 5701 | 5559 | 5455 | 5441 | |
| | | 45 | 5647 | 5471 | 5674 | 5533 | 5639 | |
| | | 50 | 5684 | 5656 | 5609 | 5622 | 5475 | |
| | | 55 | 5352 | 5296 | 5477 | 5538 | 5426 | |
| | | 60 | 5657 | 5573 | 5291 | 5715 | 5345 | |
| | | 65 | 5641 | 5530 | 5356 | 5287 | 5263 | |
| | | 70 | 5679 | 5591 | 5502 | 5434 | 5668 | |
| | | 75 | 5447 | 5547 | 5721 | 5629 | 5632 | |
| | | 80 | 5521 | 5687 | 5463 | 5711 | 5663 | |
| | | 85 | 5286 | 5462 | 5720 | 5276 | 5667 | |
| | | 90 | 5564 | 5392 | 5451 | 5552 | 5555 | |
| | | 95 | 5491 | 5652 | 5630 | 5269 | 5265 | |

Type 6 Radar Waveform_4

| Download | 4 | Type 6 | 1.0 | 333.3 | 9 | 0.3333 | 300.000000 | 13 |
|----------|---|----------------------|------|-------|------|--------|------------|----|
| | | Frequency List (MHz) | 0 | 1 | 2 | 3 | 4 | |
| | | 0 | 5666 | 5251 | 5476 | 5292 | 5493 | |
| | | 5 | 5486 | 5294 | 5584 | 5647 | 5481 | |
| | | 10 | 5678 | 5644 | 5369 | 5282 | 5358 | |
| | | 15 | 5694 | 5262 | 5643 | 5636 | 5318 | |
| | | 20 | 5430 | 5646 | 5641 | 5257 | 5354 | |
| | | 25 | 5437 | 5250 | 5723 | 5376 | 5705 | |
| | | 30 | 5712 | 5326 | 5503 | 5598 | 5295 | |
| | | 35 | 5545 | 5650 | 5407 | 5485 | 5506 | |
| | | 40 | 5321 | 5684 | 5639 | 5698 | 5391 | |
| | | 45 | 5435 | 5524 | 5464 | 5409 | 5340 | |
| | | 50 | 5260 | 5270 | 5432 | 5469 | 5663 | |
| | | 55 | 5306 | 5296 | 5458 | 5667 | 5591 | |
| | | 60 | 5699 | 5498 | 5496 | 5538 | 5580 | |
| | | 65 | 5265 | 5498 | 5537 | 5359 | 5724 | |
| | | 70 | 5682 | 5343 | 5478 | 5393 | 5637 | |
| | | 75 | 5546 | 5528 | 5264 | 5413 | 5588 | |
| | | 80 | 5275 | 5460 | 5431 | 5566 | 5669 | |
| | | 85 | 5346 | 5557 | 5685 | 5327 | 5440 | |
| | | 90 | 5287 | 5717 | 5333 | 5661 | 5258 | |
| | | 95 | 5271 | 5475 | 5671 | 5690 | 5389 | |

Type 6 Radar Waveform_5

| Download | 5 | Type 6 | 1.0 | 333.3 | 9 | 0.3333 | 300.000000 | 11 |
|----------|---|----------------------|------|-------|------|--------|------------|----|
| | | Frequency List (MHz) | 0 | 1 | 2 | 3 | 4 | |
| | | 0 | 5349 | 5490 | 5412 | 5356 | 5335 | |
| | | 5 | 5528 | 5694 | 5659 | 5713 | 5310 | |
| | | 10 | 5609 | 5433 | 5410 | 5380 | 5379 | |
| | | 15 | 5307 | 5389 | 5271 | 5681 | 5510 | |
| | | 20 | 5438 | 5715 | 5582 | 5724 | 5424 | |
| | | 25 | 5325 | 5674 | 5451 | 5577 | 5264 | |
| | | 30 | 5279 | 5690 | 5460 | 5338 | 5544 | |
| | | 35 | 5365 | 5314 | 5595 | 5521 | 5260 | |
| | | 40 | 5517 | 5635 | 5255 | 5622 | 5404 | |
| | | 45 | 5695 | 5320 | 5415 | 5607 | 5666 | |
| | | 50 | 5480 | 5351 | 5663 | 5516 | 5311 | |
| | | 55 | 5456 | 5633 | 5413 | 5676 | 5493 | |
| | | 60 | 5332 | 5321 | 5281 | 5644 | 5322 | |
| | | 65 | 5658 | 5340 | 5616 | 5572 | 5293 | |
| | | 70 | 5667 | 5454 | 5352 | 5509 | 5636 | |
| | | 75 | 5275 | 5277 | 5669 | 5457 | 5626 | |
| | | 80 | 5566 | 5511 | 5309 | 5274 | 5553 | |
| | | 85 | 5688 | 5722 | 5723 | 5482 | 5593 | |
| | | 90 | 5673 | 5686 | 5601 | 5717 | 5426 | |
| | | 95 | 5605 | 5374 | 5471 | 5647 | 5417 | |

Type 6 Radar Waveform_6

| Download | 6 | Type 6 | 1.0 | 333.3 | 9 | 0.3333 | 300.000000 | 17 |
|----------|---|----------------------|------|-------|------|--------|------------|----|
| | | Frequency List (MHz) | 0 | 1 | 2 | 3 | 4 | |
| | | 0 | 5604 | 5254 | 5348 | 5517 | 5555 | |
| | | 5 | 5570 | 5716 | 5259 | 5401 | 5443 | |
| | | 10 | 5697 | 5451 | 5575 | 5400 | 5298 | |
| | | 15 | 5516 | 5374 | 5251 | 5702 | 5349 | |
| | | 20 | 5406 | 5523 | 5338 | 5397 | 5591 | |
| | | 25 | 5526 | 5654 | 5681 | 5418 | 5676 | |
| | | 30 | 5417 | 5553 | 5696 | 5563 | 5356 | |
| | | 35 | 5686 | 5317 | 5413 | 5431 | 5571 | |
| | | 40 | 5560 | 5644 | 5692 | 5627 | 5395 | |
| | | 45 | 5690 | 5724 | 5533 | 5616 | 5539 | |
| | | 50 | 5362 | 5545 | 5456 | 5260 | 5467 | |
| | | 55 | 5689 | 5391 | 5312 | 5303 | 5353 | |
| | | 60 | 5446 | 5689 | 5720 | 5701 | 5562 | |
| | | 65 | 5289 | 5652 | 5307 | 5618 | 5600 | |
| | | 70 | 5318 | 5310 | 5430 | 5311 | 5478 | |
| | | 75 | 5304 | 5490 | 5527 | 5387 | 5450 | |
| | | 80 | 5441 | 5498 | 5454 | 5469 | 5369 | |
| | | 85 | 5518 | 5710 | 5461 | 5305 | 5412 | |
| | | 90 | 5475 | 5703 | 5656 | 5421 | 5584 | |
| | | 95 | 5477 | 5493 | 5566 | 5384 | 5250 | |

Type 6 Radar Waveform_7

| Download | 7 | Type 6 | 1.0 | 333.3 | 9 | 0.3333 | 300.000000 | 16 |
|----------|---|----------------------|------|-------|------|--------|------------|----|
| | | Frequency List (MHz) | 0 | 1 | 2 | 3 | 4 | |
| | | 0 | 5384 | 5493 | 5284 | 5678 | 5397 | |
| | | 5 | 5709 | 5641 | 5334 | 5564 | 5724 | |
| | | 10 | 5374 | 5583 | 5492 | 5295 | 5421 | |
| | | 15 | 5386 | 5643 | 5477 | 5296 | 5516 | |
| | | 20 | 5357 | 5475 | 5561 | 5330 | 5370 | |
| | | 25 | 5479 | 5378 | 5382 | 5310 | 5332 | |
| | | 30 | 5460 | 5565 | 5671 | 5470 | 5383 | |
| | | 35 | 5495 | 5302 | 5685 | 5566 | 5345 | |
| | | 40 | 5410 | 5518 | 5498 | 5312 | 5311 | |
| | | 45 | 5556 | 5375 | 5298 | 5307 | 5586 | |
| | | 50 | 5503 | 5415 | 5393 | 5413 | 5634 | |
| | | 55 | 5279 | 5679 | 5655 | 5581 | 5606 | |
| | | 60 | 5274 | 5482 | 5611 | 5534 | 5459 | |
| | | 65 | 5546 | 5647 | 5288 | 5713 | 5591 | |
| | | 70 | 5614 | 5455 | 5294 | 5304 | 5313 | |
| | | 75 | 5365 | 5309 | 5270 | 5350 | 5568 | |
| | | 80 | 5497 | 5706 | 5605 | 5451 | 5638 | |
| | | 85 | 5372 | 5292 | 5286 | 5612 | 5577 | |
| | | 90 | 5260 | 5453 | 5319 | 5720 | 5711 | |
| | | 95 | 5466 | 5580 | 5691 | 5661 | 5596 | |

Type 6 Radar Waveform_8

| Download | 8 | Type 6 | 1.0 | 333.3 | 9 | 0.3333 | 300.0000000 | 8 |
|----------|---|----------------------|------|-------|------|--------|-------------|---|
| | | Frequency List (MHz) | 0 | 1 | 2 | 3 | 4 | |
| | | 0 | 5639 | 5257 | 5695 | 5364 | 5617 | |
| | | 5 | 5276 | 5663 | 5409 | 5252 | 5456 | |
| | | 10 | 5683 | 5372 | 5533 | 5490 | 5442 | |
| | | 15 | 5474 | 5295 | 5483 | 5719 | 5708 | |
| | | 20 | 5365 | 5641 | 5502 | 5419 | 5343 | |
| | | 25 | 5367 | 5327 | 5585 | 5414 | 5366 | |
| | | 30 | 5454 | 5331 | 5411 | 5622 | 5678 | |
| | | 35 | 5634 | 5393 | 5481 | 5341 | 5356 | |
| | | 40 | 5724 | 5601 | 5339 | 5552 | 5308 | |
| | | 45 | 5485 | 5258 | 5381 | 5268 | 5293 | |
| | | 50 | 5291 | 5569 | 5464 | 5723 | 5577 | |
| | | 55 | 5526 | 5368 | 5597 | 5296 | 5425 | |
| | | 60 | 5720 | 5611 | 5301 | 5576 | 5388 | |
| | | 65 | 5593 | 5586 | 5662 | 5627 | 5349 | |
| | | 70 | 5250 | 5699 | 5290 | 5413 | 5592 | |
| | | 75 | 5285 | 5704 | 5319 | 5493 | 5549 | |
| | | 80 | 5459 | 5510 | 5487 | 5672 | 5624 | |
| | | 85 | 5351 | 5358 | 5609 | 5392 | 5278 | |
| | | 90 | 5715 | 5385 | 5323 | 5267 | 5363 | |
| | | 95 | 5428 | 5359 | 5692 | 5445 | 5659 | |

Type 6 Radar Waveform_9

| Download | 9 | Type 6 | 1.0 | 333.3 | 9 | 0.3333 | 300.0000000 | 19 |
|----------|---|----------------------|------|-------|------|--------|-------------|----|
| | | Frequency List (MHz) | 0 | 1 | 2 | 3 | 4 | |
| | | 0 | 5322 | 5496 | 5631 | 5525 | 5362 | |
| | | 5 | 5318 | 5588 | 5484 | 5285 | 5614 | |
| | | 10 | 5636 | 5574 | 5463 | 5562 | 5325 | |
| | | 15 | 5586 | 5289 | 5425 | 5276 | 5710 | |
| | | 20 | 5443 | 5508 | 5316 | 5633 | 5654 | |
| | | 25 | 5313 | 5615 | 5400 | 5641 | 5440 | |
| | | 30 | 5288 | 5626 | 5396 | 5401 | 5298 | |
| | | 35 | 5277 | 5494 | 5270 | 5563 | 5684 | |
| | | 40 | 5317 | 5305 | 5713 | 5464 | 5326 | |
| | | 45 | 5692 | 5655 | 5545 | 5515 | 5434 | |
| | | 50 | 5303 | 5470 | 5556 | 5551 | 5486 | |
| | | 55 | 5622 | 5594 | 5265 | 5466 | 5521 | |
| | | 60 | 5695 | 5295 | 5539 | 5312 | 5611 | |
| | | 65 | 5566 | 5656 | 5617 | 5405 | 5535 | |
| | | 70 | 5373 | 5416 | 5441 | 5261 | 5663 | |
| | | 75 | 5666 | 5530 | 5711 | 5620 | 5268 | |
| | | 80 | 5361 | 5309 | 5348 | 5553 | 5275 | |
| | | 85 | 5548 | 5355 | 5694 | 5291 | 5432 | |
| | | 90 | 5369 | 5424 | 5499 | 5537 | 5376 | |
| | | 95 | 5346 | 5590 | 5327 | 5311 | 5709 | |

Type 6 Radar Waveform_10

| Download | 10 | Type 6 | 1.0 | 333.3 | 9 | 0.3333 | 300.0000000 | 21 |
|----------|----|----------------------|------|-------|------|--------|-------------|----|
| | | Frequency List (MHz) | 0 | 1 | 2 | 3 | 4 | |
| | | 0 | 5577 | 5260 | 5567 | 5686 | 5679 | |
| | | 5 | 5360 | 5610 | 5559 | 5481 | 5492 | |
| | | 10 | 5545 | 5425 | 5615 | 5308 | 5484 | |
| | | 15 | 5553 | 5452 | 5689 | 5334 | 5617 | |
| | | 20 | 5284 | 5401 | 5384 | 5500 | 5289 | |
| | | 25 | 5521 | 5603 | 5419 | 5719 | 5434 | |
| | | 30 | 5683 | 5329 | 5720 | 5366 | 5548 | |
| | | 35 | 5696 | 5340 | 5672 | 5647 | 5659 | |
| | | 40 | 5402 | 5292 | 5690 | 5460 | 5302 | |
| | | 45 | 5721 | 5693 | 5547 | 5270 | 5445 | |
| | | 50 | 5421 | 5446 | 5566 | 5523 | 5601 | |
| | | 55 | 5317 | 5269 | 5505 | 5579 | 5441 | |
| | | 60 | 5565 | 5394 | 5631 | 5466 | 5527 | |
| | | 65 | 5596 | 5582 | 5513 | 5560 | 5602 | |
| | | 70 | 5391 | 5412 | 5607 | 5359 | 5516 | |
| | | 75 | 5290 | 5712 | 5622 | 5635 | 5597 | |
| | | 80 | 5682 | 5511 | 5488 | 5255 | 5524 | |
| | | 85 | 5525 | 5372 | 5345 | 5273 | 5653 | |
| | | 90 | 5390 | 5415 | 5406 | 5341 | 5375 | |
| | | 95 | 5458 | 5549 | 5393 | 5259 | 5306 | |

Type 6 Radar Waveform_11

| Download | 11 | Type 6 | 1.0 | 333.3 | 9 | 0.3333 | 300.0000000 | 13 |
|----------|----|----------------------|------|-------|------|--------|-------------|----|
| | | Frequency List (MHz) | 0 | 1 | 2 | 3 | 4 | |
| | | 0 | 5357 | 5499 | 5503 | 5372 | 5424 | |
| | | 5 | 5535 | 5634 | 5644 | 5699 | 5379 | |
| | | 10 | 5689 | 5656 | 5505 | 5641 | 5579 | |
| | | 15 | 5317 | 5334 | 5292 | 5470 | 5422 | |
| | | 20 | 5589 | 5262 | 5312 | 5455 | 5622 | |
| | | 25 | 5348 | 5468 | 5250 | 5693 | 5677 | |
| | | 30 | 5484 | 5322 | 5419 | 5479 | 5288 | |
| | | 35 | 5441 | 5670 | 5338 | 5472 | 5628 | |
| | | 40 | 5700 | 5299 | 5553 | 5673 | 5630 | |
| | | 45 | 5345 | 5701 | 5332 | 5297 | 5617 | |
| | | 50 | 5612 | 5261 | 5457 | 5459 | 5294 | |
| | | 55 | 5260 | 5536 | 5426 | 5321 | 5411 | |
| | | 60 | 5359 | 5528 | 5336 | 5509 | 5638 | |
| | | 65 | 5698 | 5682 | 5486 | 5679 | 5519 | |
| | | 70 | 5614 | 5688 | 5581 | 5604 | 5717 | |
| | | 75 | 5253 | 5492 | 5265 | 5268 | 5305 | |
| | | 80 | 5435 | 5342 | 5565 | 5653 | 5329 | |
| | | 85 | 5378 | 5660 | 5527 | 5296 | 5654 | |
| | | 90 | 5539 | 5287 | 5381 | 5395 | 5658 | |
| | | 95 | 5410 | 5456 | 5340 | 5386 | 5663 | |

Type 6 Radar Waveform_12

| Download | 12 | Type 6 | 1. 0 | 333. 3 | 9 | 0. 3333 | 300. 0000000 | 18 |
|----------|----|----------------------|------|--------|------|---------|--------------|----|
| | | Frequency List (MHz) | 0 | 1 | 2 | 3 | 4 | |
| | | 0 | 5612 | 5263 | 5439 | 5533 | 5266 | |
| | | 5 | 5541 | 5557 | 5709 | 5332 | 5528 | |
| | | 10 | 5310 | 5478 | 5319 | 5698 | 5526 | |
| | | 15 | 5254 | 5706 | 5420 | 5327 | 5678 | |
| | | 20 | 5636 | 5363 | 5581 | 5710 | 5675 | |
| | | 25 | 5307 | 5350 | 5452 | 5502 | 5389 | |
| | | 30 | 5679 | 5634 | 5699 | 5474 | 5714 | |
| | | 35 | 5618 | 5379 | 5712 | 5575 | 5584 | |
| | | 40 | 5652 | 5555 | 5566 | 5465 | 5393 | |
| | | 45 | 5482 | 5653 | 5713 | 5403 | 5279 | |
| | | 50 | 5597 | 5551 | 5323 | 5668 | 5701 | |
| | | 55 | 5722 | 5583 | 5548 | 5413 | 5484 | |
| | | 60 | 5457 | 5507 | 5486 | 5453 | 5666 | |
| | | 65 | 5345 | 5537 | 5458 | 5577 | 5433 | |
| | | 70 | 5574 | 5289 | 5373 | 5428 | 5619 | |
| | | 75 | 5463 | 5664 | 5443 | 5476 | 5362 | |
| | | 80 | 5396 | 5473 | 5517 | 5378 | 5561 | |
| | | 85 | 5281 | 5498 | 5339 | 5285 | 5556 | |
| | | 90 | 5646 | 5341 | 5377 | 5492 | 5250 | |
| | | 95 | 5427 | 5359 | 5429 | 5523 | 5292 | |

Type 6 Radar Waveform_13

| Download | 13 | Type 6 | 1. 0 | 333. 3 | 9 | 0. 3333 | 300. 0000000 | 18 |
|----------|----|----------------------|------|--------|------|---------|--------------|----|
| | | Frequency List (MHz) | 0 | 1 | 2 | 3 | 4 | |
| | | 0 | 5295 | 5502 | 5375 | 5597 | 5486 | |
| | | 5 | 5583 | 5482 | 5309 | 5398 | 5280 | |
| | | 10 | 5716 | 5364 | 5360 | 5418 | 5547 | |
| | | 15 | 5342 | 5358 | 5426 | 5372 | 5718 | |
| | | 20 | 5686 | 5327 | 5304 | 5670 | 5683 | |
| | | 25 | 5466 | 5256 | 5553 | 5653 | 5536 | |
| | | 30 | 5431 | 5568 | 5591 | 5439 | 5723 | |
| | | 35 | 5437 | 5660 | 5470 | 5508 | 5253 | |
| | | 40 | 5498 | 5491 | 5638 | 5504 | 5705 | |
| | | 45 | 5390 | 5411 | 5633 | 5321 | 5461 | |
| | | 50 | 5332 | 5484 | 5427 | 5499 | 5719 | |
| | | 55 | 5315 | 5448 | 5527 | 5261 | 5270 | |
| | | 60 | 5674 | 5276 | 5381 | 5684 | 5651 | |
| | | 65 | 5595 | 5646 | 5517 | 5407 | 5613 | |
| | | 70 | 5265 | 5369 | 5567 | 5445 | 5414 | |
| | | 75 | 5622 | 5690 | 5543 | 5402 | 5442 | |
| | | 80 | 5454 | 5672 | 5488 | 5658 | 5714 | |
| | | 85 | 5480 | 5459 | 5401 | 5569 | 5301 | |
| | | 90 | 5675 | 5557 | 5617 | 5490 | 5463 | |
| | | 95 | 5308 | 5541 | 5566 | 5279 | 5621 | |

Type 6 Radar Waveform_14

| Download | 14 | Type 6 | 1.0 | 333.3 | 9 | 0.3333 | 300.0000000 | 17 |
|----------|----|----------------------|------|-------|------|--------|-------------|----|
| | | Frequency List (MHz) | 0 | 1 | 2 | 3 | 4 | |
| | | 0 | 5550 | 5266 | 5311 | 5283 | 5328 | |
| | | 5 | 5625 | 5504 | 5384 | 5561 | 5467 | |
| | | 10 | 5628 | 5401 | 5516 | 5568 | 5333 | |
| | | 15 | 5388 | 5529 | 5417 | 5532 | 5694 | |
| | | 20 | 5396 | 5342 | 5662 | 5656 | 5354 | |
| | | 25 | 5583 | 5281 | 5282 | 5570 | 5473 | |
| | | 30 | 5554 | 5548 | 5654 | 5400 | 5257 | |
| | | 35 | 5324 | 5503 | 5509 | 5330 | 5343 | |
| | | 40 | 5442 | 5373 | 5387 | 5718 | 5404 | |
| | | 45 | 5422 | 5385 | 5274 | 5303 | 5675 | |
| | | 50 | 5295 | 5501 | 5271 | 5374 | 5449 | |
| | | 55 | 5699 | 5389 | 5352 | 5338 | 5341 | |
| | | 60 | 5427 | 5569 | 5463 | 5356 | 5649 | |
| | | 65 | 5475 | 5261 | 5273 | 5614 | 5722 | |
| | | 70 | 5539 | 5519 | 5361 | 5317 | 5602 | |
| | | 75 | 5585 | 5435 | 5598 | 5609 | 5721 | |
| | | 80 | 5711 | 5459 | 5364 | 5664 | 5325 | |
| | | 85 | 5255 | 5351 | 5377 | 5307 | 5496 | |
| | | 90 | 5665 | 5413 | 5558 | 5621 | 5652 | |
| | | 95 | 5371 | 5657 | 5655 | 5588 | 5322 | |

Type 6 Radar Waveform_15

| Download | 15 | Type 6 | 1.0 | 333.3 | 9 | 0.3333 | 300.0000000 | 14 |
|----------|----|----------------------|------|-------|------|--------|-------------|----|
| | | Frequency List (MHz) | 0 | 1 | 2 | 3 | 4 | |
| | | 0 | 5330 | 5505 | 5722 | 5444 | 5548 | |
| | | 5 | 5289 | 5429 | 5362 | 5724 | 5296 | |
| | | 10 | 5461 | 5417 | 5442 | 5711 | 5589 | |
| | | 15 | 5421 | 5515 | 5632 | 5462 | 5605 | |
| | | 20 | 5562 | 5283 | 5276 | 5629 | 5717 | |
| | | 25 | 5532 | 5387 | 5386 | 5604 | 5443 | |
| | | 30 | 5408 | 5297 | 5649 | 5552 | 5463 | |
| | | 35 | 5652 | 5672 | 5656 | 5423 | 5266 | |
| | | 40 | 5426 | 5380 | 5613 | 5384 | 5647 | |
| | | 45 | 5496 | 5487 | 5480 | 5438 | 5636 | |
| | | 50 | 5654 | 5376 | 5346 | 5590 | 5569 | |
| | | 55 | 5318 | 5637 | 5653 | 5579 | 5389 | |
| | | 60 | 5323 | 5467 | 5506 | 5288 | 5259 | |
| | | 65 | 5395 | 5409 | 5305 | 5588 | 5307 | |
| | | 70 | 5531 | 5551 | 5686 | 5250 | 5388 | |
| | | 75 | 5495 | 5320 | 5286 | 5625 | 5253 | |
| | | 80 | 5416 | 5701 | 5611 | 5379 | 5298 | |
| | | 85 | 5309 | 5708 | 5269 | 5424 | 5381 | |
| | | 90 | 5668 | 5306 | 5599 | 5575 | 5472 | |
| | | 95 | 5502 | 5434 | 5450 | 5522 | 5676 | |

| Type 6 Radar Waveform_16 | | | | | | | | | |
|--------------------------|----|----------------------|------|-------|------|--------|-------------|----|--|
| Download | 16 | Type 6 | 1.0 | 333.3 | 9 | 0.3333 | 300.0000000 | 11 | |
| | | Frequency List (MHz) | 0 | 1 | 2 | 3 | 4 | | |
| | | 0 | 5585 | 5386 | 5658 | 5605 | 5390 | | |
| | | 5 | 5331 | 5451 | 5437 | 5412 | 5503 | | |
| | | 10 | 5681 | 5483 | 5431 | 5610 | 5509 | | |
| | | 15 | 5642 | 5260 | 5410 | 5441 | 5613 | | |
| | | 20 | 5631 | 5699 | 5268 | 5602 | 5508 | | |
| | | 25 | 5384 | 5590 | 5490 | 5638 | 5654 | | |
| | | 30 | 5332 | 5365 | 5512 | 5326 | 5275 | | |
| | | 35 | 5468 | 5334 | 5337 | 5580 | 5696 | | |
| | | 40 | 5378 | 5381 | 5479 | 5476 | 5570 | | |
| | | 45 | 5538 | 5491 | 5426 | 5433 | 5552 | | |
| | | 50 | 5397 | 5679 | 5392 | 5640 | 5350 | | |
| | | 55 | 5607 | 5294 | 5586 | 5596 | 5671 | | |
| | | 60 | 5330 | 5566 | 5355 | 5254 | 5624 | | |
| | | 65 | 5517 | 5354 | 5380 | 5469 | 5253 | | |
| | | 70 | 5712 | 5471 | 5279 | 5633 | 5270 | | |
| | | 75 | 5299 | 5478 | 5635 | 5705 | 5687 | | |
| | | 80 | 5265 | 5387 | 5372 | 5395 | 5637 | | |
| | | 85 | 5371 | 5534 | 5592 | 5256 | 5357 | | |
| | | 90 | 5448 | 5364 | 5557 | 5389 | 5604 | | |
| | | 95 | 5578 | 5386 | 5663 | 5720 | 5449 | | |

| Type 6 Radar Waveform_17 | | | | | | | | | |
|--------------------------|----|----------------------|------|-------|------|--------|-------------|----|--|
| Download | 17 | Type 6 | 1.0 | 333.3 | 9 | 0.3333 | 300.0000000 | 12 | |
| | | Frequency List (MHz) | 0 | 1 | 2 | 3 | 4 | | |
| | | 0 | 5365 | 5605 | 5594 | 5291 | 5610 | | |
| | | 5 | 5373 | 5376 | 5512 | 5478 | 5710 | | |
| | | 10 | 5721 | 5470 | 5524 | 5626 | 5631 | | |
| | | 15 | 5597 | 5294 | 5363 | 5455 | 5633 | | |
| | | 20 | 5621 | 5322 | 5262 | 5357 | 5575 | | |
| | | 25 | 5396 | 5711 | 5318 | 5691 | 5672 | | |
| | | 30 | 5696 | 5252 | 5570 | 5644 | 5456 | | |
| | | 35 | 5264 | 5584 | 5348 | 5419 | 5592 | | |
| | | 40 | 5634 | 5618 | 5475 | 5408 | 5653 | | |
| | | 45 | 5499 | 5544 | 5313 | 5309 | 5253 | | |
| | | 50 | 5448 | 5293 | 5690 | 5538 | 5561 | | |
| | | 55 | 5387 | 5405 | 5643 | 5628 | 5361 | | |
| | | 60 | 5275 | 5495 | 5619 | 5398 | 5311 | | |
| | | 65 | 5678 | 5563 | 5349 | 5693 | 5632 | | |
| | | 70 | 5452 | 5353 | 5464 | 5447 | 5713 | | |
| | | 75 | 5602 | 5390 | 5442 | 5255 | 5259 | | |
| | | 80 | 5416 | 5529 | 5532 | 5702 | 5407 | | |
| | | 85 | 5265 | 5525 | 5668 | 5501 | 5620 | | |
| | | 90 | 5593 | 5327 | 5611 | 5706 | 5438 | | |
| | | 95 | 5346 | 5343 | 5660 | 5587 | 5370 | | |

Type 6 Radar Waveform_18

| Download | 18 | Type 6 | 1.0 | 333.3 | 9 | 0.3333 | 300.0000000 | 18 |
|----------|----|----------------------|------|-------|------|--------|-------------|----|
| | | Frequency List (MHz) | 0 | 1 | 2 | 3 | 4 | |
| | | 0 | 5523 | 5369 | 5530 | 5452 | 5512 | |
| | | 5 | 5398 | 5587 | 5641 | 5539 | 5652 | |
| | | 10 | 5356 | 5565 | 5346 | 5588 | 5421 | |
| | | 15 | 5500 | 5350 | 5532 | 5391 | 5678 | |
| | | 20 | 5349 | 5548 | 5662 | 5660 | 5521 | |
| | | 25 | 5320 | 5706 | 5263 | 5682 | 5279 | |
| | | 30 | 5467 | 5252 | 5293 | 5308 | 5547 | |
| | | 35 | 5632 | 5262 | 5258 | 5297 | 5572 | |
| | | 40 | 5286 | 5472 | 5715 | 5436 | 5261 | |
| | | 45 | 5557 | 5578 | 5429 | 5499 | 5479 | |
| | | 50 | 5416 | 5431 | 5629 | 5515 | 5577 | |
| | | 55 | 5699 | 5614 | 5282 | 5526 | 5695 | |
| | | 60 | 5327 | 5445 | 5344 | 5609 | 5627 | |
| | | 65 | 5599 | 5559 | 5488 | 5435 | 5621 | |
| | | 70 | 5441 | 5313 | 5423 | 5672 | 5474 | |
| | | 75 | 5510 | 5456 | 5507 | 5693 | 5595 | |
| | | 80 | 5602 | 5643 | 5367 | 5410 | 5385 | |
| | | 85 | 5466 | 5265 | 5393 | 5413 | 5492 | |
| | | 90 | 5617 | 5342 | 5277 | 5723 | 5366 | |
| | | 95 | 5422 | 5719 | 5700 | 5288 | 5310 | |

Type 6 Radar Waveform_19

| Download | 19 | Type 6 | 1.0 | 333.3 | 9 | 0.3333 | 300.0000000 | 15 |
|----------|----|----------------------|------|-------|------|--------|-------------|----|
| | | Frequency List (MHz) | 0 | 1 | 2 | 3 | 4 | |
| | | 0 | 5303 | 5608 | 5466 | 5613 | 5672 | |
| | | 5 | 5554 | 5420 | 5662 | 5329 | 5271 | |
| | | 10 | 5486 | 5620 | 5606 | 5444 | 5673 | |
| | | 15 | 5676 | 5451 | 5472 | 5448 | 5542 | |
| | | 20 | 5540 | 5557 | 5619 | 5438 | 5521 | |
| | | 25 | 5550 | 5512 | 5724 | 5424 | 5643 | |
| | | 30 | 5402 | 5571 | 5711 | 5585 | 5501 | |
| | | 35 | 5588 | 5447 | 5638 | 5428 | 5415 | |
| | | 40 | 5651 | 5572 | 5380 | 5510 | 5526 | |
| | | 45 | 5469 | 5644 | 5416 | 5441 | 5615 | |
| | | 50 | 5553 | 5465 | 5536 | 5508 | 5568 | |
| | | 55 | 5714 | 5375 | 5342 | 5292 | 5421 | |
| | | 60 | 5411 | 5691 | 5262 | 5634 | 5290 | |
| | | 65 | 5335 | 5576 | 5635 | 5391 | 5616 | |
| | | 70 | 5693 | 5427 | 5456 | 5637 | 5302 | |
| | | 75 | 5631 | 5443 | 5630 | 5437 | 5382 | |
| | | 80 | 5453 | 5658 | 5599 | 5322 | 5546 | |
| | | 85 | 5306 | 5470 | 5480 | 5334 | 5694 | |
| | | 90 | 5641 | 5611 | 5657 | 5623 | 5376 | |
| | | 95 | 5356 | 5289 | 5265 | 5406 | 5679 | |

Type 6 Radar Waveform_20

| Download | 20 | Type 6 | 1.0 | 333.3 | 9 | 0.3333 | 300.0000000 | 17 |
|----------|----|----------------------|------|-------|------|--------|-------------|----|
| | | Frequency List (MHz) | 0 | 1 | 2 | 3 | 4 | |
| | | 0 | 5558 | 5372 | 5402 | 5677 | 5514 | |
| | | 5 | 5596 | 5345 | 5262 | 5492 | 5478 | |
| | | 10 | 5417 | 5409 | 5269 | 5639 | 5694 | |
| | | 15 | 5289 | 5578 | 5575 | 5493 | 5259 | |
| | | 20 | 5548 | 5626 | 5657 | 5430 | 5494 | |
| | | 25 | 5341 | 5461 | 5355 | 5528 | 5444 | |
| | | 30 | 5557 | 5668 | 5325 | 5653 | 5311 | |
| | | 35 | 5489 | 5254 | 5699 | 5665 | 5662 | |
| | | 40 | 5508 | 5463 | 5448 | 5291 | 5466 | |
| | | 45 | 5573 | 5396 | 5524 | 5576 | 5606 | |
| | | 50 | 5255 | 5315 | 5684 | 5601 | 5537 | |
| | | 55 | 5697 | 5530 | 5423 | 5482 | 5715 | |
| | | 60 | 5556 | 5540 | 5381 | 5682 | 5669 | |
| | | 65 | 5333 | 5633 | 5525 | 5574 | 5650 | |
| | | 70 | 5419 | 5290 | 5510 | 5459 | 5486 | |
| | | 75 | 5278 | 5590 | 5412 | 5418 | 5439 | |
| | | 80 | 5709 | 5449 | 5343 | 5614 | 5546 | |
| | | 85 | 5623 | 5433 | 5672 | 5299 | 5270 | |
| | | 90 | 5414 | 5334 | 5347 | 5629 | 5313 | |
| | | 95 | 5616 | 5398 | 5282 | 5476 | 5487 | |

Type 6 Radar Waveform_21

| Download | 21 | Type 6 | 1.0 | 333.3 | 9 | 0.3333 | 300.0000000 | 15 |
|----------|----|----------------------|------|-------|------|--------|-------------|----|
| | | Frequency List (MHz) | 0 | 1 | 2 | 3 | 4 | |
| | | 0 | 5338 | 5611 | 5363 | 5259 | 5638 | |
| | | 5 | 5367 | 5337 | 5558 | 5307 | 5348 | |
| | | 10 | 5673 | 5310 | 5359 | 5715 | 5377 | |
| | | 15 | 5705 | 5678 | 5538 | 5451 | 5459 | |
| | | 20 | 5317 | 5598 | 5519 | 5467 | 5704 | |
| | | 25 | 5313 | 5254 | 5711 | 5486 | 5446 | |
| | | 30 | 5625 | 5540 | 5427 | 5606 | 5628 | |
| | | 35 | 5442 | 5592 | 5343 | 5576 | 5347 | |
| | | 40 | 5546 | 5386 | 5434 | 5463 | 5405 | |
| | | 45 | 5279 | 5607 | 5634 | 5659 | 5617 | |
| | | 50 | 5666 | 5385 | 5652 | 5271 | 5360 | |
| | | 55 | 5641 | 5718 | 5672 | 5534 | 5430 | |
| | | 60 | 5669 | 5627 | 5298 | 5495 | 5474 | |
| | | 65 | 5610 | 5433 | 5445 | 5697 | 5496 | |
| | | 70 | 5559 | 5335 | 5549 | 5284 | 5345 | |
| | | 75 | 5399 | 5691 | 5602 | 5490 | 5613 | |
| | | 80 | 5406 | 5593 | 5334 | 5449 | 5465 | |
| | | 85 | 5493 | 5292 | 5642 | 5699 | 5565 | |
| | | 90 | 5629 | 5415 | 5257 | 5498 | 5410 | |
| | | 95 | 5396 | 5531 | 5471 | 5510 | 5597 | |

Type 6 Radar Waveform_22

| Download | 22 | Type 6 | 1.0 | 333.3 | 9 | 0.3333 | 300.000000 | 17 |
|----------|----|----------------------|------|-------|------|--------|------------|----|
| | | Frequency List (MHz) | 0 | 1 | 2 | 3 | 4 | |
| | | 0 | 5496 | 5375 | 5274 | 5524 | 5576 | |
| | | 5 | 5302 | 5292 | 5412 | 5721 | 5514 | |
| | | 10 | 5657 | 5462 | 5351 | 5554 | 5261 | |
| | | 15 | 5368 | 5357 | 5306 | 5583 | 5265 | |
| | | 20 | 5467 | 5386 | 5539 | 5511 | 5440 | |
| | | 25 | 5592 | 5640 | 5286 | 5358 | 5270 | |
| | | 30 | 5625 | 5432 | 5582 | 5280 | 5579 | |
| | | 35 | 5426 | 5533 | 5388 | 5490 | 5661 | |
| | | 40 | 5251 | 5324 | 5674 | 5557 | 5334 | |
| | | 45 | 5259 | 5690 | 5692 | 5712 | 5407 | |
| | | 50 | 5542 | 5561 | 5703 | 5360 | 5488 | |
| | | 55 | 5431 | 5331 | 5387 | 5353 | 5401 | |
| | | 60 | 5701 | 5711 | 5572 | 5702 | 5418 | |
| | | 65 | 5700 | 5423 | 5549 | 5643 | 5337 | |
| | | 70 | 5500 | 5531 | 5482 | 5562 | 5705 | |
| | | 75 | 5508 | 5253 | 5391 | 5380 | 5468 | |
| | | 80 | 5615 | 5271 | 5469 | 5590 | 5529 | |
| | | 85 | 5352 | 5404 | 5456 | 5484 | 5607 | |
| | | 90 | 5275 | 5338 | 5580 | 5263 | 5381 | |
| | | 95 | 5283 | 5519 | 5413 | 5586 | 5455 | |

Type 6 Radar Waveform_23

| Download | 23 | Type 6 | 1.0 | 333.3 | 9 | 0.3333 | 300.000000 | 17 |
|----------|----|----------------------|------|-------|------|--------|------------|----|
| | | Frequency List (MHz) | 0 | 1 | 2 | 3 | 4 | |
| | | 0 | 5276 | 5614 | 5685 | 5321 | 5344 | |
| | | 5 | 5314 | 5487 | 5409 | 5721 | 5588 | |
| | | 10 | 5348 | 5392 | 5274 | 5282 | 5456 | |
| | | 15 | 5484 | 5312 | 5531 | 5457 | 5475 | |
| | | 20 | 5552 | 5480 | 5600 | 5413 | 5383 | |
| | | 25 | 5589 | 5489 | 5462 | 5304 | 5667 | |
| | | 30 | 5539 | 5398 | 5353 | 5624 | 5431 | |
| | | 35 | 5659 | 5271 | 5501 | 5500 | 5334 | |
| | | 40 | 5640 | 5439 | 5554 | 5641 | 5714 | |
| | | 45 | 5298 | 5653 | 5290 | 5294 | 5418 | |
| | | 50 | 5262 | 5279 | 5546 | 5384 | 5432 | |
| | | 55 | 5619 | 5285 | 5577 | 5550 | 5372 | |
| | | 60 | 5355 | 5401 | 5534 | 5719 | 5646 | |
| | | 65 | 5585 | 5607 | 5303 | 5700 | 5468 | |
| | | 70 | 5565 | 5411 | 5681 | 5467 | 5538 | |
| | | 75 | 5361 | 5720 | 5250 | 5527 | 5466 | |
| | | 80 | 5532 | 5587 | 5724 | 5352 | 5516 | |
| | | 85 | 5676 | 5704 | 5586 | 5647 | 5270 | |
| | | 90 | 5269 | 5318 | 5628 | 5430 | 5544 | |
| | | 95 | 5536 | 5306 | 5328 | 5543 | 5702 | |

Type 6 Radar Waveform_24

| Download | 24 | Type 6 | 1.0 | 333.3 | 9 | 0.3333 | 300.0000000 | 22 |
|----------|----|----------------------|------|-------|------|--------|-------------|----|
| | | Frequency List (MHz) | 0 | 1 | 2 | 3 | 4 | |
| | | 0 | 5531 | 5378 | 5621 | 5371 | 5638 | |
| | | 5 | 5386 | 5714 | 5562 | 5572 | 5453 | |
| | | 10 | 5519 | 5612 | 5433 | 5372 | 5303 | |
| | | 15 | 5544 | 5514 | 5415 | 5576 | 5649 | |
| | | 20 | 5718 | 5518 | 5592 | 5271 | 5441 | |
| | | 25 | 5692 | 5566 | 5338 | 5709 | 5685 | |
| | | 30 | 5496 | 5613 | 5505 | 5444 | 5473 | |
| | | 35 | 5715 | 5455 | 5424 | 5436 | 5417 | |
| | | 40 | 5578 | 5679 | 5551 | 5570 | 5694 | |
| | | 45 | 5381 | 5711 | 5721 | 5559 | 5672 | |
| | | 50 | 5438 | 5330 | 5635 | 5682 | 5279 | |
| | | 55 | 5332 | 5670 | 5369 | 5343 | 5484 | |
| | | 60 | 5366 | 5545 | 5689 | 5681 | 5321 | |
| | | 65 | 5499 | 5297 | 5665 | 5260 | 5560 | |
| | | 70 | 5426 | 5569 | 5561 | 5677 | 5342 | |
| | | 75 | 5400 | 5360 | 5308 | 5533 | 5487 | |
| | | 80 | 5255 | 5563 | 5479 | 5296 | 5280 | |
| | | 85 | 5359 | 5370 | 5435 | 5275 | 5352 | |
| | | 90 | 5522 | 5640 | 5447 | 5599 | 5520 | |
| | | 95 | 5380 | 5431 | 5267 | 5497 | 5538 | |

Type 6 Radar Waveform_25

| Download | 25 | Type 6 | 1.0 | 333.3 | 9 | 0.3333 | 300.0000000 | 17 |
|----------|----|----------------------|------|-------|------|--------|-------------|----|
| | | Frequency List (MHz) | 0 | 1 | 2 | 3 | 4 | |
| | | 0 | 5311 | 5617 | 5557 | 5532 | 5383 | |
| | | 5 | 5428 | 5261 | 5637 | 5260 | 5282 | |
| | | 10 | 5353 | 5401 | 5474 | 5567 | 5324 | |
| | | 15 | 5632 | 5641 | 5518 | 5621 | 5366 | |
| | | 20 | 5394 | 5312 | 5459 | 5681 | 5359 | |
| | | 25 | 5537 | 5390 | 5323 | 5670 | 5372 | |
| | | 30 | 5373 | 5671 | 5453 | 5279 | 5642 | |
| | | 35 | 5612 | 5331 | 5348 | 5577 | 5329 | |
| | | 40 | 5275 | 5597 | 5516 | 5347 | 5548 | |
| | | 45 | 5499 | 5674 | 5464 | 5294 | 5299 | |
| | | 50 | 5446 | 5614 | 5381 | 5724 | 5505 | |
| | | 55 | 5698 | 5423 | 5571 | 5385 | 5663 | |
| | | 60 | 5692 | 5613 | 5256 | 5504 | 5673 | |
| | | 65 | 5468 | 5635 | 5407 | 5270 | 5560 | |
| | | 70 | 5517 | 5287 | 5466 | 5668 | 5584 | |
| | | 75 | 5536 | 5441 | 5723 | 5652 | 5564 | |
| | | 80 | 5697 | 5280 | 5484 | 5633 | 5502 | |
| | | 85 | 5442 | 5488 | 5308 | 5709 | 5607 | |
| | | 90 | 5665 | 5600 | 5281 | 5289 | 5307 | |
| | | 95 | 5274 | 5654 | 5262 | 5534 | 5562 | |

Type 6 Radar Waveform_26

| Download | 26 | Type 6 | 1.0 | 333.3 | 9 | 0.3333 | 300.0000000 | 18 |
|----------|----|----------------------|------|-------|------|--------|-------------|----|
| | | Frequency List (MHz) | 0 | 1 | 2 | 3 | 4 | |
| | | 0 | 5566 | 5381 | 5493 | 5693 | 5700 | |
| | | 5 | 5567 | 5661 | 5712 | 5326 | 5489 | |
| | | 10 | 5284 | 5665 | 5515 | 5287 | 5345 | |
| | | 15 | 5720 | 5293 | 5621 | 5666 | 5558 | |
| | | 20 | 5402 | 5478 | 5400 | 5673 | 5332 | |
| | | 25 | 5425 | 5717 | 5526 | 5396 | 5406 | |
| | | 30 | 5415 | 5560 | 5410 | 5568 | 5431 | |
| | | 35 | 5462 | 5276 | 5519 | 5619 | 5352 | |
| | | 40 | 5718 | 5589 | 5680 | 5454 | 5587 | |
| | | 45 | 5545 | 5331 | 5654 | 5547 | 5255 | |
| | | 50 | 5711 | 5424 | 5315 | 5432 | 5338 | |
| | | 55 | 5706 | 5611 | 5525 | 5575 | 5385 | |
| | | 60 | 5663 | 5267 | 5421 | 5449 | 5505 | |
| | | 65 | 5294 | 5581 | 5608 | 5694 | 5596 | |
| | | 70 | 5252 | 5565 | 5538 | 5523 | 5433 | |
| | | 75 | 5512 | 5344 | 5391 | 5401 | 5429 | |
| | | 80 | 5483 | 5442 | 5386 | 5343 | 5481 | |
| | | 85 | 5456 | 5633 | 5502 | 5651 | 5285 | |
| | | 90 | 5380 | 5388 | 5290 | 5384 | 5323 | |
| | | 95 | 5664 | 5383 | 5578 | 5709 | 5585 | |

Type 6 Radar Waveform_27

| Download | 27 | Type 6 | 1.0 | 333.3 | 9 | 0.3333 | 300.0000000 | 16 |
|----------|----|----------------------|------|-------|------|--------|-------------|----|
| | | Frequency List (MHz) | 0 | 1 | 2 | 3 | 4 | |
| | | 0 | 5724 | 5620 | 5429 | 5379 | 5445 | |
| | | 5 | 5609 | 5683 | 5312 | 5489 | 5696 | |
| | | 10 | 5690 | 5454 | 5556 | 5482 | 5366 | |
| | | 15 | 5711 | 5420 | 5614 | 5275 | 5313 | |
| | | 20 | 5547 | 5438 | 5287 | 5305 | 5691 | |
| | | 25 | 5569 | 5254 | 5500 | 5440 | 5457 | |
| | | 30 | 5449 | 5367 | 5686 | 5680 | 5660 | |
| | | 35 | 5318 | 5610 | 5415 | 5505 | 5428 | |
| | | 40 | 5288 | 5392 | 5352 | 5639 | 5260 | |
| | | 45 | 5537 | 5630 | 5405 | 5598 | 5678 | |
| | | 50 | 5491 | 5483 | 5524 | 5529 | 5324 | |
| | | 55 | 5479 | 5290 | 5679 | 5634 | 5299 | |
| | | 60 | 5586 | 5434 | 5595 | 5624 | 5431 | |
| | | 65 | 5643 | 5535 | 5559 | 5456 | 5368 | |
| | | 70 | 5707 | 5606 | 5296 | 5488 | 5303 | |
| | | 75 | 5282 | 5446 | 5437 | 5382 | 5681 | |
| | | 80 | 5496 | 5698 | 5550 | 5503 | 5478 | |
| | | 85 | 5651 | 5536 | 5283 | 5465 | 5300 | |
| | | 90 | 5616 | 5714 | 5628 | 5455 | 5390 | |
| | | 95 | 5395 | 5289 | 5470 | 5265 | 5554 | |

Type 6 Radar Waveform_28

| Download | 28 | Type 6 | 1.0 | 333.3 | 9 | 0.3333 | 300.000000 | 16 |
|----------|----|----------------------|------|-------|------|--------|------------|----|
| | | Frequency List (MHz) | 0 | 1 | 2 | 3 | 4 | |
| | | 0 | 5504 | 5384 | 5385 | 5443 | 5287 | |
| | | 5 | 5651 | 5608 | 5387 | 5652 | 5525 | |
| | | 10 | 5524 | 5340 | 5694 | 5677 | 5324 | |
| | | 15 | 5450 | 5255 | 5659 | 5467 | 5321 | |
| | | 20 | 5713 | 5379 | 5279 | 5278 | 5579 | |
| | | 25 | 5518 | 5457 | 5604 | 5474 | 5499 | |
| | | 30 | 5435 | 5426 | 5357 | 5480 | 5701 | |
| | | 35 | 5308 | 5658 | 5643 | 5267 | 5371 | |
| | | 40 | 5330 | 5592 | 5636 | 5567 | 5517 | |
| | | 45 | 5458 | 5388 | 5554 | 5667 | 5534 | |
| | | 50 | 5613 | 5352 | 5336 | 5512 | 5433 | |
| | | 55 | 5498 | 5605 | 5428 | 5276 | 5436 | |
| | | 60 | 5266 | 5570 | 5632 | 5571 | 5294 | |
| | | 65 | 5251 | 5646 | 5304 | 5396 | 5509 | |
| | | 70 | 5464 | 5262 | 5566 | 5580 | 5363 | |
| | | 75 | 5606 | 5479 | 5617 | 5475 | 5439 | |
| | | 80 | 5600 | 5492 | 5484 | 5290 | 5401 | |
| | | 85 | 5406 | 5620 | 5331 | 5612 | 5344 | |
| | | 90 | 5553 | 5368 | 5577 | 5303 | 5649 | |
| | | 95 | 5395 | 5275 | 5412 | 5640 | 5555 | |

Type 6 Radar Waveform_29

| Download | 29 | Type 6 | 1.0 | 333.3 | 9 | 0.3333 | 300.000000 | 12 |
|----------|----|----------------------|------|-------|------|--------|------------|----|
| | | Frequency List (MHz) | 0 | 1 | 2 | 3 | 4 | |
| | | 0 | 5284 | 5623 | 5301 | 5604 | 5507 | |
| | | 5 | 5693 | 5630 | 5462 | 5340 | 5257 | |
| | | 10 | 5455 | 5260 | 5300 | 5408 | 5412 | |
| | | 15 | 5577 | 5358 | 5704 | 5659 | 5329 | |
| | | 20 | 5307 | 5320 | 5368 | 5251 | 5467 | |
| | | 25 | 5370 | 5660 | 5708 | 5508 | 5638 | |
| | | 30 | 5324 | 5281 | 5641 | 5606 | 5596 | |
| | | 35 | 5317 | 5579 | 5433 | 5557 | 5678 | |
| | | 40 | 5551 | 5268 | 5633 | 5496 | 5497 | |
| | | 45 | 5321 | 5429 | 5511 | 5275 | 5430 | |
| | | 50 | 5585 | 5702 | 5650 | 5280 | 5700 | |
| | | 55 | 5387 | 5670 | 5479 | 5441 | 5381 | |
| | | 60 | 5573 | 5344 | 5516 | 5541 | 5607 | |
| | | 65 | 5601 | 5618 | 5352 | 5473 | 5578 | |
| | | 70 | 5399 | 5440 | 5696 | 5695 | 5589 | |
| | | 75 | 5626 | 5710 | 5716 | 5306 | 5629 | |
| | | 80 | 5375 | 5566 | 5439 | 5442 | 5488 | |
| | | 85 | 5587 | 5449 | 5719 | 5552 | 5701 | |
| | | 90 | 5310 | 5402 | 5706 | 5688 | 5613 | |
| | | 95 | 5634 | 5266 | 5459 | 5471 | 5501 | |

| | | | |
|-----------|--|---------------|------------|
| Test Site | SIP-TR2 | Test Engineer | Alisa Deng |
| Test Date | 2023-07-05 | | |
| Test Item | Radar Statistical Performance Check (802.11ax-HE160 – 5250MHz) | | |

| Radar Type 1-4 - Radar Statistical Performance | | | | | | | | |
|--|-----------------|-------------------------|-----------------|-------------------------|-----------------|-------------------------|-----------------|-------------------------|
| Trial | Radar Type 1 | | Radar Type 2 | | Radar Type 3 | | Radar Type 4 | |
| | Frequency (MHz) | 1=detect 0=no detect | Frequency (MHz) | 1=detect 0=no detect | Frequency (MHz) | 1=detect 0=no detect | Frequency (MHz) | 1=detect 0=no detect |
| 0 | 5289 | 1 | 5315 | 1 | 5282 | 1 | 5279 | 1 |
| 1 | 5275 | 1 | 5295 | 1 | 5261 | 1 | 5320 | 1 |
| 2 | 5314 | 1 | 5288 | 1 | 5278 | 1 | 5289 | 1 |
| 3 | 5281 | 1 | 5305 | 1 | 5321 | 1 | 5250 | 1 |
| 4 | 5279 | 1 | 5285 | 1 | 5296 | 1 | 5330 | 0 |
| 5 | 5270 | 1 | 5310 | 1 | 5270 | 1 | 5328 | 0 |
| 6 | 5327 | 1 | 5277 | 1 | 5289 | 1 | 5320 | 1 |
| 7 | 5330 | 1 | 5250 | 1 | 5280 | 1 | 5321 | 0 |
| 8 | 5305 | 1 | 5287 | 1 | 5292 | 1 | 5295 | 1 |
| 9 | 5250 | 1 | 5330 | 1 | 5254 | 1 | 5271 | 1 |
| 10 | 5257 | 1 | 5290 | 1 | 5271 | 1 | 5310 | 1 |
| 11 | 5270 | 1 | 5280 | 1 | 5325 | 1 | 5326 | 1 |
| 12 | 5301 | 1 | 5258 | 1 | 5307 | 1 | 5327 | 1 |
| 13 | 5330 | 1 | 5272 | 1 | 5254 | 1 | 5297 | 1 |
| 14 | 5299 | 1 | 5298 | 1 | 5250 | 1 | 5251 | 1 |
| 15 | 5298 | 1 | 5322 | 1 | 5290 | 1 | 5314 | 1 |
| 16 | 5301 | 1 | 5324 | 1 | 5274 | 1 | 5263 | 1 |
| 17 | 5250 | 1 | 5319 | 1 | 5320 | 1 | 5262 | 1 |
| 18 | 5329 | 1 | 5312 | 1 | 5330 | 1 | 5274 | 1 |
| 19 | 5306 | 1 | 5290 | 1 | 5273 | 0 | 5290 | 1 |
| 20 | 5294 | 1 | 5323 | 1 | 5278 | 1 | 5272 | 1 |
| 21 | 5297 | 1 | 5287 | 1 | 5330 | 1 | 5288 | 1 |
| 22 | 5282 | 1 | 5293 | 1 | 5282 | 1 | 5281 | 0 |
| 23 | 5311 | 1 | 5315 | 1 | 5288 | 1 | 5264 | 1 |
| 24 | 5328 | 1 | 5283 | 1 | 5275 | 1 | 5285 | 0 |
| 25 | 5299 | 1 | 5281 | 1 | 5290 | 1 | 5296 | 1 |
| 26 | 5290 | 1 | 5304 | 1 | 5328 | 1 | 5284 | 0 |



| Radar Type 1-4 - Radar Statistical Performance | | | | | | | | |
|--|-----------------|-------------------------|-----------------|-------------------------|-----------------|-------------------------|-----------------|-------------------------|
| Trial | Radar Type 1 | | Radar Type 2 | | Radar Type 3 | | Radar Type 4 | |
| | Frequency (MHz) | 1=detect 0=no detect | Frequency (MHz) | 1=detect 0=no detect | Frequency (MHz) | 1=detect 0=no detect | Frequency (MHz) | 1=detect 0=no detect |
| 27 | 5265 | 1 | 5253 | 1 | 5315 | 1 | 5297 | 1 |
| 28 | 5263 | 1 | 5309 | 1 | 5254 | 0 | 5282 | 1 |
| 29 | 5270 | 1 | 5298 | 1 | 5308 | 1 | 5264 | 1 |
| Probability: | 100.0% | | 100.0% | | 93.3% | | 80.0% | |
| Aggregate: | 93.33% (>80%) | | | | | | | |

| Radar Type 1 - Radar Waveform | | | | | | | Radar Type 2 - Radar Waveform | | | | | | |
|-------------------------------|----------|------------|------------------|----------|------------------|----------------------|-------------------------------|----------|------------|------------------|----------|------------------|----------------------|
| | Trial Id | Radar Type | Pulse Width (us) | PRI (us) | Number of Pulses | Waveform Length (us) | | Trial Id | Radar Type | Pulse Width (us) | PRI (us) | Number of Pulses | Waveform Length (us) |
| Download | 0 | Type 1 | 1.0 | 558.0 | 95 | 53010.0 | Download | 0 | Type 2 | 3.5 | 211.0 | 27 | 5697.0 |
| Download | 1 | Type 1 | 1.0 | 818.0 | 65 | 53170.0 | Download | 1 | Type 2 | 2.2 | 197.0 | 25 | 4925.0 |
| Download | 2 | Type 1 | 1.0 | 938.0 | 57 | 53466.0 | Download | 2 | Type 2 | 2.9 | 153.0 | 26 | 3978.0 |
| Download | 3 | Type 1 | 1.0 | 698.0 | 76 | 53048.0 | Download | 3 | Type 2 | 3.3 | 151.0 | 27 | 4077.0 |
| Download | 4 | Type 1 | 1.0 | 598.0 | 89 | 53222.0 | Download | 4 | Type 2 | 4.4 | 183.0 | 28 | 5124.0 |
| Download | 5 | Type 1 | 1.0 | 518.0 | 102 | 52836.0 | Download | 5 | Type 2 | 3.2 | 206.0 | 26 | 5356.0 |
| Download | 6 | Type 1 | 1.0 | 618.0 | 86 | 53148.0 | Download | 6 | Type 2 | 2.2 | 173.0 | 25 | 4325.0 |
| Download | 7 | Type 1 | 1.0 | 898.0 | 59 | 52982.0 | Download | 7 | Type 2 | 2.0 | 162.0 | 24 | 3888.0 |
| Download | 8 | Type 1 | 1.0 | 678.0 | 78 | 52884.0 | Download | 8 | Type 2 | 1.6 | 230.0 | 24 | 5520.0 |
| Download | 9 | Type 1 | 1.0 | 3066.0 | 18 | 55188.0 | Download | 9 | Type 2 | 4.6 | 157.0 | 29 | 4553.0 |
| Download | 10 | Type 1 | 1.0 | 878.0 | 61 | 53558.0 | Download | 10 | Type 2 | 4.3 | 195.0 | 28 | 5460.0 |
| Download | 11 | Type 1 | 1.0 | 858.0 | 62 | 53196.0 | Download | 11 | Type 2 | 1.4 | 210.0 | 23 | 4830.0 |
| Download | 12 | Type 1 | 1.0 | 638.0 | 83 | 52954.0 | Download | 12 | Type 2 | 1.5 | 202.0 | 24 | 4848.0 |
| Download | 13 | Type 1 | 1.0 | 658.0 | 81 | 53298.0 | Download | 13 | Type 2 | 3.8 | 163.0 | 27 | 4401.0 |
| Download | 14 | Type 1 | 1.0 | 778.0 | 68 | 52804.0 | Download | 14 | Type 2 | 3.0 | 222.0 | 26 | 5772.0 |
| Download | 15 | Type 1 | 1.0 | 2734.0 | 20 | 54680.0 | Download | 15 | Type 2 | 2.0 | 187.0 | 24 | 4488.0 |
| Download | 16 | Type 1 | 1.0 | 2884.0 | 19 | 54796.0 | Download | 16 | Type 2 | 3.9 | 207.0 | 28 | 5796.0 |
| Download | 17 | Type 1 | 1.0 | 2768.0 | 20 | 55360.0 | Download | 17 | Type 2 | 1.2 | 212.0 | 23 | 4876.0 |
| Download | 18 | Type 1 | 1.0 | 1313.0 | 41 | 53833.0 | Download | 18 | Type 2 | 4.8 | 160.0 | 29 | 4640.0 |
| Download | 19 | Type 1 | 1.0 | 2026.0 | 27 | 54702.0 | Download | 19 | Type 2 | 1.6 | 220.0 | 24 | 5280.0 |
| Download | 20 | Type 1 | 1.0 | 2244.0 | 24 | 53856.0 | Download | 20 | Type 2 | 2.6 | 168.0 | 25 | 4200.0 |
| Download | 21 | Type 1 | 1.0 | 2746.0 | 20 | 54920.0 | Download | 21 | Type 2 | 2.1 | 205.0 | 25 | 5125.0 |
| Download | 22 | Type 1 | 1.0 | 2698.0 | 20 | 53960.0 | Download | 22 | Type 2 | 2.3 | 224.0 | 25 | 5600.0 |
| Download | 23 | Type 1 | 1.0 | 1461.0 | 37 | 54057.0 | Download | 23 | Type 2 | 4.6 | 217.0 | 29 | 6293.0 |
| Download | 24 | Type 1 | 1.0 | 2787.0 | 19 | 52953.0 | Download | 24 | Type 2 | 1.7 | 218.0 | 24 | 5232.0 |
| Download | 25 | Type 1 | 1.0 | 2885.0 | 19 | 54435.0 | Download | 25 | Type 2 | 1.2 | 171.0 | 23 | 3933.0 |
| Download | 26 | Type 1 | 1.0 | 1146.0 | 47 | 53862.0 | Download | 26 | Type 2 | 4.3 | 150.0 | 28 | 4200.0 |
| Download | 27 | Type 1 | 1.0 | 704.0 | 75 | 52800.0 | Download | 27 | Type 2 | 4.4 | 223.0 | 28 | 6244.0 |
| Download | 28 | Type 1 | 1.0 | 2705.0 | 20 | 54100.0 | Download | 28 | Type 2 | 2.0 | 229.0 | 24 | 5496.0 |
| Download | 29 | Type 1 | 1.0 | 2530.0 | 21 | 53130.0 | Download | 29 | Type 2 | 4.2 | 219.0 | 28 | 6132.0 |



| Radar Type 3 - Radar Waveform | | | | | | | Radar Type 4 - Radar Waveform | | | | | | |
|-------------------------------|----------|------------|------------------|----------|------------------|----------------------|-------------------------------|----------|------------|------------------|----------|------------------|----------------------|
| | Trial Id | Radar Type | Pulse Width (us) | PRI (us) | Number of Pulses | Waveform Length (us) | | Trial Id | Radar Type | Pulse Width (us) | PRI (us) | Number of Pulses | Waveform Length (us) |
| Download | 0 | Type 3 | 8.5 | 358.0 | 17 | 6086.0 | Download | 0 | Type 4 | 16.6 | 358.0 | 15 | 5370.0 |
| Download | 1 | Type 3 | 7.2 | 384.0 | 16 | 6144.0 | Download | 1 | Type 4 | 13.8 | 384.0 | 13 | 4992.0 |
| Download | 2 | Type 3 | 7.9 | 399.0 | 17 | 6783.0 | Download | 2 | Type 4 | 15.2 | 399.0 | 14 | 5586.0 |
| Download | 3 | Type 3 | 8.3 | 382.0 | 17 | 6494.0 | Download | 3 | Type 4 | 16.2 | 382.0 | 14 | 5348.0 |
| Download | 4 | Type 3 | 9.4 | 296.0 | 18 | 5328.0 | Download | 4 | Type 4 | 18.6 | 296.0 | 16 | 4736.0 |
| Download | 5 | Type 3 | 8.2 | 408.0 | 17 | 6936.0 | Download | 5 | Type 4 | 16.0 | 408.0 | 14 | 5712.0 |
| Download | 6 | Type 3 | 7.2 | 362.0 | 16 | 5792.0 | Download | 6 | Type 4 | 13.7 | 362.0 | 13 | 4706.0 |
| Download | 7 | Type 3 | 7.0 | 347.0 | 16 | 5552.0 | Download | 7 | Type 4 | 13.3 | 347.0 | 13 | 4511.0 |
| Download | 8 | Type 3 | 6.6 | 341.0 | 16 | 5456.0 | Download | 8 | Type 4 | 12.5 | 341.0 | 12 | 4092.0 |
| Download | 9 | Type 3 | 9.6 | 352.0 | 18 | 6336.0 | Download | 9 | Type 4 | 19.0 | 352.0 | 16 | 5632.0 |
| Download | 10 | Type 3 | 9.3 | 248.0 | 18 | 4464.0 | Download | 10 | Type 4 | 18.3 | 248.0 | 16 | 3968.0 |
| Download | 11 | Type 3 | 6.4 | 370.0 | 16 | 5920.0 | Download | 11 | Type 4 | 12.0 | 370.0 | 12 | 4440.0 |
| Download | 12 | Type 3 | 6.5 | 427.0 | 16 | 6832.0 | Download | 12 | Type 4 | 12.3 | 427.0 | 12 | 5124.0 |
| Download | 13 | Type 3 | 8.8 | 449.0 | 18 | 8082.0 | Download | 13 | Type 4 | 17.3 | 449.0 | 15 | 6735.0 |
| Download | 14 | Type 3 | 8.0 | 340.0 | 17 | 5780.0 | Download | 14 | Type 4 | 15.5 | 340.0 | 14 | 4760.0 |
| Download | 15 | Type 3 | 7.0 | 271.0 | 16 | 4336.0 | Download | 15 | Type 4 | 13.2 | 271.0 | 13 | 3523.0 |
| Download | 16 | Type 3 | 8.9 | 228.0 | 18 | 4104.0 | Download | 16 | Type 4 | 17.6 | 228.0 | 15 | 3420.0 |
| Download | 17 | Type 3 | 6.2 | 433.0 | 16 | 6928.0 | Download | 17 | Type 4 | 11.6 | 433.0 | 12 | 5196.0 |
| Download | 18 | Type 3 | 9.8 | 471.0 | 18 | 8478.0 | Download | 18 | Type 4 | 19.6 | 471.0 | 16 | 7536.0 |
| Download | 19 | Type 3 | 6.6 | 326.0 | 16 | 5216.0 | Download | 19 | Type 4 | 12.5 | 326.0 | 12 | 3912.0 |
| Download | 20 | Type 3 | 7.6 | 282.0 | 17 | 4454.0 | Download | 20 | Type 4 | 14.6 | 282.0 | 13 | 3406.0 |
| Download | 21 | Type 3 | 7.1 | 439.0 | 16 | 7024.0 | Download | 21 | Type 4 | 13.6 | 439.0 | 13 | 5707.0 |
| Download | 22 | Type 3 | 7.3 | 313.0 | 17 | 5321.0 | Download | 22 | Type 4 | 14.0 | 313.0 | 13 | 4069.0 |
| Download | 23 | Type 3 | 9.6 | 379.0 | 18 | 6822.0 | Download | 23 | Type 4 | 19.2 | 379.0 | 16 | 6064.0 |
| Download | 24 | Type 3 | 6.7 | 240.0 | 16 | 3840.0 | Download | 24 | Type 4 | 12.7 | 240.0 | 12 | 2880.0 |
| Download | 25 | Type 3 | 6.2 | 232.0 | 16 | 3712.0 | Download | 25 | Type 4 | 11.5 | 232.0 | 12 | 2784.0 |
| Download | 26 | Type 3 | 9.3 | 278.0 | 18 | 5004.0 | Download | 26 | Type 4 | 18.5 | 278.0 | 16 | 4448.0 |
| Download | 27 | Type 3 | 9.4 | 391.0 | 18 | 7038.0 | Download | 27 | Type 4 | 18.7 | 391.0 | 16 | 6256.0 |
| Download | 28 | Type 3 | 7.0 | 447.0 | 16 | 7152.0 | Download | 28 | Type 4 | 13.3 | 447.0 | 13 | 5811.0 |
| Download | 29 | Type 3 | 9.2 | 361.0 | 18 | 6498.0 | Download | 29 | Type 4 | 18.2 | 361.0 | 15 | 5415.0 |

| Radar Type 5 - Radar Statistical Performance | | | | | |
|--|------------------|-------------------------------|---------------|------------------|-------------------------------|
| Trail # | Test Freq. (MHz) | 1=Detection 0=No Detection | Trail # | Test Freq. (MHz) | 1=Detection 0=No Detection |
| 0 | 5250 | 1 | 15 | 5214 | 1 |
| 1 | 5250 | 1 | 16 | 5218 | 1 |
| 2 | 5250 | 1 | 17 | 5214 | 1 |
| 3 | 5250 | 1 | 18 | 5219 | 1 |
| 4 | 5250 | 1 | 19 | 5214 | 1 |
| 5 | 5250 | 1 | 20 | 5284 | 1 |
| 6 | 5250 | 1 | 21 | 5285 | 1 |
| 7 | 5250 | 1 | 22 | 5285 | 1 |
| 8 | 5250 | 1 | 23 | 5281 | 1 |
| 9 | 5250 | 1 | 24 | 5286 | 1 |
| 10 | 5218 | 1 | 25 | 5286 | 1 |
| 11 | 5214 | 1 | 26 | 5282 | 1 |
| 12 | 5214 | 1 | 27 | 5282 | 1 |
| 13 | 5218 | 1 | 28 | 5285 | 1 |
| 14 | 5216 | 1 | 29 | 5282 | 1 |
| Detection Percentage (%) | | | 100.0% | | |

Type 5 Radar Waveform_0

| Download | 0 | Type 5 | 16 | 0.7500000 | 12.0000000 | 5.250000000 | | | |
|----------|---|----------|-------------------|------------------|-------------------|----------------------------|------------|------------|------------|
| | | Burst ID | Burst Offset (us) | Pulse Width (us) | Chirp Width (MHz) | Number of Pulses per Burst | PRI-1 (us) | PRI-2 (us) | PRI-3 (us) |
| | | 0 | 644577.0 | 81.0 | 14 | 2 | 1640.0 | 1554.0 | - |
| | | 1 | 79033.0 | 65.4 | 14 | 1 | 1891.0 | - | - |
| | | 2 | 259953.0 | 73.2 | 14 | 2 | 1580.0 | 1804.0 | - |
| | | 3 | 441268.0 | 78.6 | 14 | 2 | 1722.0 | 1260.0 | - |
| | | 4 | 620619.0 | 92.0 | 14 | 3 | 1843.0 | 1335.0 | 1994.0 |
| | | 5 | 56620.0 | 77.7 | 14 | 2 | 1288.0 | 1444.0 | - |
| | | 6 | 238369.0 | 65.2 | 14 | 1 | 1121.0 | - | - |
| | | 7 | 419942.0 | 62.9 | 14 | 1 | 1217.0 | - | - |
| | | 8 | 601623.0 | 58.2 | 14 | 1 | 1120.0 | - | - |
| | | 9 | 34260.0 | 94.3 | 14 | 3 | 1259.0 | 1072.0 | 1179.0 |
| | | 10 | 215049.0 | 90.5 | 14 | 3 | 1210.0 | 1277.0 | 1918.0 |
| | | 11 | 397188.0 | 56.0 | 14 | 1 | 1940.0 | - | - |
| | | 12 | 579230.0 | 57.2 | 14 | 1 | 1147.0 | - | - |
| | | 13 | 11952.0 | 84.9 | 14 | 3 | 1151.0 | 1815.0 | 1014.0 |
| | | 14 | 193316.0 | 75.1 | 14 | 2 | 1112.0 | 1200.0 | - |
| | | 15 | 375148.0 | 62.3 | 14 | 1 | 1327.0 | - | - |

Type 5 Radar Waveform_1

| Download | 1 | Type 5 | 12 | 1.0000000 | 12.0000000 | 5.250000000 | | | |
|----------|---|----------|-------------------|------------------|-------------------|----------------------------|------------|------------|------------|
| | | Burst ID | Burst Offset (us) | Pulse Width (us) | Chirp Width (MHz) | Number of Pulses per Burst | PRI-1 (us) | PRI-2 (us) | PRI-3 (us) |
| | | 0 | 740150.0 | 86.4 | 9 | 3 | 1929.0 | 1201.0 | 1529.0 |
| | | 1 | 984293.0 | 53.4 | 9 | 1 | 1879.0 | - | - |
| | | 2 | 227811.0 | 97.4 | 9 | 3 | 1445.0 | 1261.0 | 1082.0 |
| | | 3 | 470560.0 | 58.4 | 9 | 1 | 1377.0 | - | - |
| | | 4 | 711462.0 | 69.8 | 9 | 2 | 1646.0 | 1546.0 | - |
| | | 5 | 954398.0 | 64.5 | 9 | 1 | 1960.0 | - | - |
| | | 6 | 198106.0 | 66.9 | 9 | 2 | 1881.0 | 1626.0 | - |
| | | 7 | 439951.0 | 95.1 | 9 | 3 | 1256.0 | 1233.0 | 1552.0 |
| | | 8 | 682536.0 | 59.4 | 9 | 1 | 1945.0 | - | - |
| | | 9 | 924702.0 | 53.2 | 9 | 1 | 1830.0 | - | - |
| | | 10 | 168217.0 | 91.4 | 9 | 3 | 1917.0 | 1254.0 | 1044.0 |
| | | 11 | 409440.0 | 92.7 | 9 | 3 | 1872.0 | 1725.0 | 1313.0 |

Type 5 Radar Waveform_2

| Download | 2 | Type 5 | 14 | 0.8571429 | 12.0000000 | 5.250000000 | | | |
|----------|---|----------|-------------------|------------------|-------------------|----------------------------|------------|------------|------------|
| | | Burst ID | Burst Offset (us) | Pulse Width (us) | Chirp Width (MHz) | Number of Pulses per Burst | PRI-1 (us) | PRI-2 (us) | PRI-3 (us) |
| | | 0 | 559451.0 | 62.8 | 12 | 1 | 1702.0 | - | - |
| | | 1 | 763590.0 | 89.6 | 12 | 3 | 1860.0 | 1993.0 | 1767.0 |
| | | 2 | 118941.0 | 52.8 | 12 | 1 | 1790.0 | - | - |
| | | 3 | 326363.0 | 65.3 | 12 | 1 | 1863.0 | - | - |
| | | 4 | 534012.0 | 55.1 | 12 | 1 | 1516.0 | - | - |
| | | 5 | 741403.0 | 64.7 | 12 | 1 | 1661.0 | - | - |
| | | 6 | 93024.0 | 92.1 | 12 | 3 | 1793.0 | 1761.0 | 1567.0 |
| | | 7 | 300363.0 | 72.5 | 12 | 2 | 1931.0 | 1209.0 | - |
| | | 8 | 508735.0 | 63.5 | 12 | 1 | 1038.0 | - | - |
| | | 9 | 715091.0 | 73.3 | 12 | 2 | 1135.0 | 1428.0 | - |
| | | 10 | 67827.0 | 56.1 | 12 | 1 | 1888.0 | - | - |
| | | 11 | 274429.0 | 95.2 | 12 | 3 | 1252.0 | 1651.0 | 1545.0 |
| | | 12 | 482652.0 | 59.0 | 12 | 1 | 1937.0 | - | - |
| | | 13 | 688791.0 | 75.5 | 12 | 2 | 1916.0 | 1601.0 | - |

Type 5 Radar Waveform_3

| Download | 3 | Type 5 | 15 | 0.8000000 | 12.0000000 | 5.250000000 | | | |
|----------|---|----------|-------------------|------------------|-------------------|----------------------------|------------|------------|------------|
| | | Burst ID | Burst Offset (us) | Pulse Width (us) | Chirp Width (MHz) | Number of Pulses per Burst | PRI-1 (us) | PRI-2 (us) | PRI-3 (us) |
| | | 0 | 39389.0 | 71.6 | 14 | 2 | 1329.0 | 1838.0 | - |
| | | 1 | 233170.0 | 55.1 | 14 | 1 | 1372.0 | - | - |
| | | 2 | 425057.0 | 91.6 | 14 | 3 | 1665.0 | 1675.0 | 1410.0 |
| | | 3 | 620135.0 | 55.2 | 14 | 1 | 1912.0 | - | - |
| | | 4 | 15618.0 | 55.3 | 14 | 1 | 1407.0 | - | - |
| | | 5 | 208526.0 | 93.3 | 14 | 3 | 1132.0 | 1561.0 | 1677.0 |
| | | 6 | 402361.0 | 76.0 | 14 | 2 | 1639.0 | 1009.0 | - |
| | | 7 | 594712.0 | 90.0 | 14 | 3 | 1097.0 | 1821.0 | 1110.0 |
| | | 8 | 788489.0 | 67.2 | 14 | 2 | 1597.0 | 1695.0 | - |
| | | 9 | 185159.0 | 75.6 | 14 | 2 | 1378.0 | 1262.0 | - |
| | | 10 | 378319.0 | 78.4 | 14 | 2 | 1320.0 | 1792.0 | - |
| | | 11 | 571770.0 | 74.9 | 14 | 2 | 1033.0 | 1828.0 | - |
| | | 12 | 766493.0 | 64.4 | 14 | 1 | 1411.0 | - | - |
| | | 13 | 161545.0 | 66.5 | 14 | 1 | 1620.0 | - | - |
| | | 14 | 354213.0 | 98.6 | 14 | 3 | 1021.0 | 1018.0 | 1746.0 |

Type 5 Radar Waveform_4

| Download | 4 | Type 5 | 18 | 0.666667 | 12.000000 | 5.25000000 | | | |
|----------|---|----------|-------------------|------------------|-------------------|----------------------------|------------|------------|------------|
| | | Burst ID | Burst Offset (us) | Pulse Width (us) | Chirp Width (MHz) | Number of Pulses per Burst | PRI-1 (us) | PRI-2 (us) | PRI-3 (us) |
| | | 0 | 456008.0 | 78.1 | 18 | 2 | 1392.0 | 1897.0 | - |
| | | 1 | 617174.0 | 69.2 | 18 | 2 | 1714.0 | 1278.0 | - |
| | | 2 | 114238.0 | 68.7 | 18 | 3 | 1943.0 | 1104.0 | 1239.0 |
| | | 3 | 275047.0 | 86.4 | 18 | 3 | 1383.0 | 1102.0 | 1413.0 |
| | | 4 | 436085.0 | 72.5 | 18 | 2 | 1799.0 | 1650.0 | - |
| | | 5 | 586586.0 | 50.0 | 18 | 1 | 1616.0 | - | - |
| | | 6 | 94627.0 | 68.7 | 18 | 2 | 1498.0 | 1549.0 | - |
| | | 7 | 254948.0 | 91.4 | 18 | 3 | 1408.0 | 1832.0 | 1435.0 |
| | | 8 | 416670.0 | 75.1 | 18 | 2 | 1340.0 | 1474.0 | - |
| | | 9 | 579201.0 | 50.8 | 18 | 1 | 1061.0 | - | - |
| | | 10 | 74657.0 | 92.6 | 18 | 3 | 1747.0 | 1067.0 | 1518.0 |
| | | 11 | 234854.0 | 92.8 | 18 | 3 | 1835.0 | 1885.0 | 1849.0 |
| | | 12 | 397748.0 | 52.5 | 18 | 1 | 1292.0 | - | - |
| | | 13 | 556858.0 | 98.9 | 18 | 3 | 1080.0 | 1364.0 | 1543.0 |
| | | 14 | 55131.0 | 63.1 | 18 | 1 | 1184.0 | - | - |
| | | 15 | 215604.0 | 97.4 | 18 | 3 | 1247.0 | 1237.0 | 1550.0 |
| | | 16 | 377536.0 | 52.2 | 18 | 1 | 1880.0 | - | - |
| | | 17 | 536142.0 | 99.4 | 18 | 3 | 1611.0 | 1565.0 | 1944.0 |

Type 5 Radar Waveform_5

| Download | 5 | Type 5 | 15 | 0.800000 | 12.000000 | 5.25000000 | | | |
|----------|---|----------|-------------------|------------------|-------------------|----------------------------|------------|------------|------------|
| | | Burst ID | Burst Offset (us) | Pulse Width (us) | Chirp Width (MHz) | Number of Pulses per Burst | PRI-1 (us) | PRI-2 (us) | PRI-3 (us) |
| | | 0 | 42117.0 | 94.4 | 13 | 3 | 1218.0 | 1718.0 | 1925.0 |
| | | 1 | 235071.0 | 92.9 | 13 | 3 | 1429.0 | 1537.0 | 1532.0 |
| | | 2 | 429464.0 | 61.7 | 13 | 1 | 1787.0 | - | - |
| | | 3 | 623307.0 | 53.5 | 13 | 1 | 1465.0 | - | - |
| | | 4 | 18441.0 | 54.2 | 13 | 1 | 1497.0 | - | - |
| | | 5 | 211160.0 | 98.0 | 13 | 3 | 1588.0 | 1933.0 | 1525.0 |
| | | 6 | 404171.0 | 98.1 | 13 | 3 | 1584.0 | 1403.0 | 1647.0 |
| | | 7 | 599790.0 | 66.6 | 13 | 1 | 1013.0 | - | - |
| | | 8 | 791850.0 | 72.8 | 13 | 2 | 1361.0 | 1384.0 | - |
| | | 9 | 187860.0 | 72.3 | 13 | 2 | 1812.0 | 1333.0 | - |
| | | 10 | 381291.0 | 77.3 | 13 | 2 | 1107.0 | 1685.0 | - |
| | | 11 | 573918.0 | 87.0 | 13 | 3 | 1251.0 | 1336.0 | 1205.0 |
| | | 12 | 767890.0 | 80.3 | 13 | 2 | 1731.0 | 1162.0 | - |
| | | 13 | 164471.0 | 50.2 | 13 | 1 | 1119.0 | - | - |
| | | 14 | 357406.0 | 75.6 | 13 | 2 | 1351.0 | 1595.0 | - |

Type 5 Radar Waveform_6

| Download | 6 | Type 5 | 11 | 1.090909 | 12.000000 | 5.25000000 | | | |
|----------|---|----------|-------------------|------------------|-------------------|----------------------------|------------|------------|------------|
| | | Burst ID | Burst Offset (us) | Pulse Width (us) | Chirp Width (MHz) | Number of Pulses per Burst | PRI-1 (us) | PRI-2 (us) | PRI-3 (us) |
| | | 0 | 751675.0 | 73.9 | 9 | 2 | 1659.0 | 1348.0 | - |
| | | 1 | 1013838.0 | 85.4 | 9 | 3 | 1570.0 | 1467.0 | 1778.0 |
| | | 2 | 191675.0 | 54.0 | 9 | 1 | 1865.0 | - | - |
| | | 3 | 455013.0 | 67.4 | 9 | 2 | 1914.0 | 1836.0 | - |
| | | 4 | 719904.0 | 58.8 | 9 | 1 | 1905.0 | - | - |
| | | 5 | 981855.0 | 86.6 | 9 | 3 | 1312.0 | 1519.0 | 1472.0 |
| | | 6 | 158964.0 | 75.4 | 9 | 2 | 1181.0 | 1887.0 | - |
| | | 7 | 423494.0 | 52.8 | 9 | 1 | 1283.0 | - | - |
| | | 8 | 687425.0 | 63.8 | 9 | 1 | 1818.0 | - | - |
| | | 9 | 862029.0 | 66.4 | 9 | 1 | 1286.0 | - | - |
| | | 10 | 128594.0 | 54.3 | 9 | 1 | 1969.0 | - | - |

Type 5 Radar Waveform_7

| Download | 7 | Type 5 | 11 | 1.090909 | 12.000000 | 5.25000000 | | | |
|----------|---|----------|-------------------|------------------|-------------------|----------------------------|------------|------------|------------|
| | | Burst ID | Burst Offset (us) | Pulse Width (us) | Chirp Width (MHz) | Number of Pulses per Burst | PRI-1 (us) | PRI-2 (us) | PRI-3 (us) |
| | | 0 | 390879.0 | 62.8 | 9 | 1 | 1458.0 | - | - |
| | | 1 | 855304.0 | 50.4 | 9 | 1 | 1129.0 | - | - |
| | | 2 | 918357.0 | 73.5 | 9 | 2 | 1412.0 | 1202.0 | - |
| | | 3 | 93843.0 | 91.2 | 9 | 3 | 1127.0 | 1420.0 | 1957.0 |
| | | 4 | 358442.0 | 54.1 | 9 | 1 | 1126.0 | - | - |
| | | 5 | 621253.0 | 78.3 | 9 | 2 | 1824.0 | 1919.0 | - |
| | | 6 | 884932.0 | 76.1 | 9 | 2 | 1985.0 | 1750.0 | - |
| | | 7 | 81472.0 | 75.5 | 9 | 2 | 1024.0 | 1984.0 | - |
| | | 8 | 325215.0 | 70.0 | 9 | 2 | 1679.0 | 1688.0 | - |
| | | 9 | 588838.0 | 73.6 | 9 | 2 | 1644.0 | 1983.0 | - |
| | | 10 | 852177.0 | 86.8 | 9 | 3 | 1989.0 | 1068.0 | 1030.0 |

Type 5 Radar Waveform_8

| Download | 8 | Type 5 | 10 | 1.2000000 | 12.0000000 | 5.250000000 | | | |
|----------|---|----------|-------------------|------------------|-------------------|----------------------------|------------|------------|------------|
| | | Burst ID | Burst Offset (us) | Pulse Width (us) | Chirp Width (MHz) | Number of Pulses per Burst | PRI-1 (us) | PRI-2 (us) | PRI-3 (us) |
| | | 0 | 31871.0 | 74.6 | 7 | 2 | 1915.0 | 1315.0 | - |
| | | 1 | 322495.0 | 64.9 | 7 | 1 | 1856.0 | - | - |
| | | 2 | 611544.0 | 90.8 | 7 | 3 | 1953.0 | 1293.0 | 1619.0 |
| | | 3 | 901550.0 | 88.3 | 7 | 3 | 1663.0 | 1298.0 | 1706.0 |
| | | 4 | 1194152.0 | 55.9 | 7 | 1 | 1962.0 | - | - |
| | | 5 | 286307.0 | 77.2 | 7 | 2 | 1609.0 | 1894.0 | - |
| | | 6 | 576146.0 | 96.4 | 7 | 3 | 1564.0 | 1264.0 | 1402.0 |
| | | 7 | 868214.0 | 64.0 | 7 | 1 | 1390.0 | - | - |
| | | 8 | 1155630.0 | 88.1 | 7 | 3 | 1574.0 | 1975.0 | 1238.0 |
| | | 9 | 250692.0 | 70.6 | 7 | 2 | 1781.0 | 1105.0 | - |

Type 5 Radar Waveform_9

| Download | 9 | Type 5 | 19 | 0.6315789 | 12.0000000 | 5.250000000 | | | |
|----------|---|----------|-------------------|------------------|-------------------|----------------------------|------------|------------|------------|
| | | Burst ID | Burst Offset (us) | Pulse Width (us) | Chirp Width (MHz) | Number of Pulses per Burst | PRI-1 (us) | PRI-2 (us) | PRI-3 (us) |
| | | 0 | 283259.0 | 92.3 | 19 | 3 | 1859.0 | 1770.0 | 1196.0 |
| | | 1 | 436456.0 | 67.2 | 19 | 2 | 1635.0 | 1478.0 | - |
| | | 2 | 589253.0 | 78.6 | 19 | 2 | 1232.0 | 1401.0 | - |
| | | 3 | 113099.0 | 63.5 | 19 | 1 | 1643.0 | - | - |
| | | 4 | 266025.0 | 59.0 | 19 | 1 | 1295.0 | - | - |
| | | 5 | 417733.0 | 79.9 | 19 | 2 | 1813.0 | 1221.0 | - |
| | | 6 | 569166.0 | 93.5 | 19 | 3 | 1657.0 | 1032.0 | 1457.0 |
| | | 7 | 94267.0 | 62.8 | 19 | 1 | 1728.0 | - | - |
| | | 8 | 246883.0 | 69.0 | 19 | 2 | 1022.0 | 1070.0 | - |
| | | 9 | 398189.0 | 90.0 | 19 | 3 | 1385.0 | 1124.0 | 1732.0 |
| | | 10 | 549301.0 | 98.0 | 19 | 3 | 1064.0 | 1972.0 | 1587.0 |
| | | 11 | 75041.0 | 87.1 | 19 | 3 | 1507.0 | 1697.0 | 1942.0 |
| | | 12 | 227034.0 | 100.0 | 19 | 3 | 1617.0 | 1618.0 | 1736.0 |
| | | 13 | 378754.0 | 85.1 | 19 | 3 | 1848.0 | 1689.0 | 1851.0 |
| | | 14 | 531227.0 | 97.7 | 19 | 3 | 1720.0 | 1228.0 | 1730.0 |
| | | 15 | 56393.0 | 93.2 | 19 | 3 | 1381.0 | 1504.0 | 1522.0 |
| | | 16 | 208978.0 | 81.7 | 19 | 2 | 1354.0 | 1623.0 | - |
| | | 17 | 361170.0 | 68.2 | 19 | 2 | 1935.0 | 1500.0 | - |
| | | 18 | 512512.0 | 99.0 | 19 | 3 | 1216.0 | 1711.0 | 1735.0 |

Type 5 Radar Waveform_10

| Download | 10 | Type 5 | 18 | 0.6886667 | 12.0000000 | 5.218000000 | | | |
|----------|----|----------|-------------------|------------------|-------------------|----------------------------|------------|------------|------------|
| | | Burst ID | Burst Offset (us) | Pulse Width (us) | Chirp Width (MHz) | Number of Pulses per Burst | PRI-1 (us) | PRI-2 (us) | PRI-3 (us) |
| | | 0 | 39948.0 | 60.9 | 17 | 1 | 1334.0 | - | - |
| | | 1 | 201143.0 | 54.7 | 17 | 1 | 1893.0 | - | - |
| | | 2 | 361351.0 | 80.3 | 17 | 2 | 1980.0 | 1786.0 | - |
| | | 3 | 524158.0 | 51.9 | 17 | 1 | 1185.0 | - | - |
| | | 4 | 19964.0 | 87.2 | 17 | 3 | 1608.0 | 1449.0 | 1858.0 |
| | | 5 | 181480.0 | 60.8 | 17 | 1 | 1174.0 | - | - |
| | | 6 | 341297.0 | 89.2 | 17 | 3 | 1186.0 | 1950.0 | 1116.0 |
| | | 7 | 502556.0 | 76.6 | 17 | 2 | 1909.0 | 1547.0 | - |
| | | 8 | 195.0 | 70.5 | 17 | 2 | 1883.0 | 1857.0 | - |
| | | 9 | 161156.0 | 80.7 | 17 | 2 | 1631.0 | 1363.0 | - |
| | | 10 | 321110.0 | 98.2 | 17 | 3 | 1827.0 | 1442.0 | 1801.0 |
| | | 11 | 484513.0 | 56.5 | 17 | 1 | 1025.0 | - | - |
| | | 12 | 642488.0 | 99.8 | 17 | 3 | 1956.0 | 1386.0 | 1253.0 |
| | | 13 | 141469.0 | 78.3 | 17 | 2 | 1337.0 | 1003.0 | - |
| | | 14 | 301654.0 | 83.7 | 17 | 3 | 1319.0 | 1167.0 | 1907.0 |
| | | 15 | 462888.0 | 70.6 | 17 | 2 | 1826.0 | 1690.0 | - |
| | | 16 | 623724.0 | 83.2 | 17 | 2 | 1638.0 | 1877.0 | - |
| | | 17 | 121025.0 | 94.9 | 17 | 3 | 1911.0 | 1924.0 | 1769.0 |

Type 5 Radar Waveform_11

| Download | 11 | Type 5 | 9 | 1.3333333 | 12.0000000 | 5.214000000 | | | |
|----------|----|----------|-------------------|------------------|-------------------|----------------------------|------------|------------|------------|
| | | Burst ID | Burst Offset (us) | Pulse Width (us) | Chirp Width (MHz) | Number of Pulses per Burst | PRI-1 (us) | PRI-2 (us) | PRI-3 (us) |
| | | 0 | 566531.0 | 77.7 | 6 | 2 | 1092.0 | 1131.0 | - |
| | | 1 | 887933.0 | 95.2 | 6 | 3 | 1682.0 | 1152.0 | 1555.0 |
| | | 2 | 1210821.0 | 98.4 | 6 | 3 | 1153.0 | 1422.0 | 1166.0 |
| | | 3 | 203884.0 | 82.7 | 6 | 2 | 1456.0 | 1060.0 | - |
| | | 4 | 527195.0 | 62.7 | 6 | 1 | 1137.0 | - | - |
| | | 5 | 650017.0 | 51.0 | 6 | 1 | 1572.0 | - | - |
| | | 6 | 1170026.0 | 83.6 | 6 | 3 | 1544.0 | 1600.0 | 1817.0 |
| | | 7 | 163735.0 | 88.9 | 6 | 3 | 1979.0 | 1930.0 | 1782.0 |
| | | 8 | 486351.0 | 87.5 | 6 | 3 | 1096.0 | 1005.0 | 1892.0 |

Type 5 Radar Waveform_12

| Download | 12 | Type 5 | 9 | 1.3333333 | 12.0000000 | 5.214000000 | | | |
|----------|----|----------|-------------------|------------------|-------------------|----------------------------|------------|------------|------------|
| | | Burst ID | Burst Offset (us) | Pulse Width (us) | Chirp Width (MHz) | Number of Pulses per Burst | PRI-1 (us) | PRI-2 (us) | PRI-3 (us) |
| | | 0 | 810133.0 | 65.0 | 7 | 1 | 1733.0 | - | - |
| | | 1 | 1133492.0 | 55.7 | 7 | 1 | 1258.0 | - | - |
| | | 2 | 124206.0 | 90.7 | 7 | 3 | 1034.0 | 1825.0 | 1404.0 |
| | | 3 | 447480.0 | 62.7 | 7 | 1 | 1487.0 | - | - |
| | | 4 | 768620.0 | 95.6 | 7 | 3 | 1700.0 | 1852.0 | 1175.0 |
| | | 5 | 1092386.0 | 78.2 | 7 | 2 | 1854.0 | 1001.0 | - |
| | | 6 | 84692.0 | 65.0 | 7 | 1 | 1257.0 | - | - |
| | | 7 | 407083.0 | 77.2 | 7 | 2 | 1630.0 | 1847.0 | - |
| | | 8 | 730699.0 | 65.9 | 7 | 1 | 1501.0 | - | - |

Type 5 Radar Waveform_13

| Download | 13 | Type 5 | 17 | 0.7058824 | 12.0000000 | 5.218000000 | | | |
|----------|----|----------|-------------------|------------------|-------------------|----------------------------|------------|------------|------------|
| | | Burst ID | Burst Offset (us) | Pulse Width (us) | Chirp Width (MHz) | Number of Pulses per Burst | PRI-1 (us) | PRI-2 (us) | PRI-3 (us) |
| | | 0 | 557570.0 | 61.9 | 16 | 1 | 1145.0 | - | - |
| | | 1 | 23738.0 | 65.3 | 16 | 1 | 1592.0 | - | - |
| | | 2 | 193788.0 | 91.5 | 16 | 3 | 1633.0 | 1530.0 | 1190.0 |
| | | 3 | 365520.0 | 52.6 | 16 | 1 | 1290.0 | - | - |
| | | 4 | 535378.0 | 69.8 | 16 | 2 | 1400.0 | 1240.0 | - |
| | | 5 | 2698.0 | 53.3 | 16 | 1 | 1443.0 | - | - |
| | | 6 | 173305.0 | 72.9 | 16 | 2 | 1414.0 | 1011.0 | - |
| | | 7 | 343575.0 | 82.2 | 16 | 2 | 1978.0 | 1144.0 | - |
| | | 8 | 513911.0 | 70.9 | 16 | 2 | 1279.0 | 1988.0 | - |
| | | 9 | 682885.0 | 83.5 | 16 | 3 | 1365.0 | 1694.0 | 1678.0 |
| | | 10 | 151069.0 | 98.3 | 16 | 3 | 1494.0 | 1321.0 | 1553.0 |
| | | 11 | 323393.0 | 58.8 | 16 | 1 | 1353.0 | - | - |
| | | 12 | 494449.0 | 66.2 | 16 | 1 | 1089.0 | - | - |
| | | 13 | 664751.0 | 64.5 | 16 | 1 | 1759.0 | - | - |
| | | 14 | 131406.0 | 64.4 | 16 | 1 | 1721.0 | - | - |
| | | 15 | 300778.0 | 98.4 | 16 | 3 | 1197.0 | 1822.0 | 1967.0 |
| | | 16 | 472688.0 | 54.0 | 16 | 1 | 1842.0 | - | - |

Type 5 Radar Waveform_14

| Download | 14 | Type 5 | 14 | 0.8571429 | 12.0000000 | 5.218000000 | | | |
|----------|----|----------|-------------------|------------------|-------------------|----------------------------|------------|------------|------------|
| | | Burst ID | Burst Offset (us) | Pulse Width (us) | Chirp Width (MHz) | Number of Pulses per Burst | PRI-1 (us) | PRI-2 (us) | PRI-3 (us) |
| | | 0 | 781192.0 | 73.1 | 13 | 2 | 1499.0 | 1142.0 | - |
| | | 1 | 134096.0 | 50.6 | 13 | 1 | 1604.0 | - | - |
| | | 2 | 341088.0 | 78.2 | 13 | 2 | 1350.0 | 1515.0 | - |
| | | 3 | 547005.0 | 92.0 | 13 | 3 | 1649.0 | 1768.0 | 1430.0 |
| | | 4 | 754516.0 | 79.2 | 13 | 2 | 1941.0 | 1999.0 | - |
| | | 5 | 108449.0 | 68.3 | 13 | 2 | 1250.0 | 1049.0 | - |
| | | 6 | 315181.0 | 98.4 | 13 | 3 | 1489.0 | 1248.0 | 1172.0 |
| | | 7 | 522283.0 | 73.3 | 13 | 2 | 1712.0 | 1926.0 | - |
| | | 8 | 730046.0 | 74.2 | 13 | 2 | 1287.0 | 1460.0 | - |
| | | 9 | 82825.0 | 70.9 | 13 | 2 | 1878.0 | 1308.0 | - |
| | | 10 | 269900.0 | 79.9 | 13 | 2 | 1775.0 | 1520.0 | - |
| | | 11 | 497099.0 | 67.9 | 13 | 2 | 1301.0 | 1798.0 | - |
| | | 12 | 705219.0 | 52.5 | 13 | 1 | 1901.0 | - | - |
| | | 13 | 57332.0 | 78.3 | 13 | 2 | 1693.0 | 1223.0 | - |

Type 5 Radar Waveform_15

| Download | 15 | Type 5 | 11 | 1.0909091 | 12.0000000 | 5.214000000 | | | |
|----------|----|----------|-------------------|------------------|-------------------|----------------------------|------------|------------|------------|
| | | Burst ID | Burst Offset (us) | Pulse Width (us) | Chirp Width (MHz) | Number of Pulses per Burst | PRI-1 (us) | PRI-2 (us) | PRI-3 (us) |
| | | 0 | 336163.0 | 84.7 | 8 | 3 | 1502.0 | 1803.0 | 1973.0 |
| | | 1 | 601517.0 | 51.0 | 8 | 1 | 1557.0 | - | - |
| | | 2 | 864782.0 | 67.8 | 8 | 2 | 1614.0 | 1123.0 | - |
| | | 3 | 40583.0 | 58.6 | 8 | 1 | 1192.0 | - | - |
| | | 4 | 304394.0 | 67.9 | 8 | 2 | 1505.0 | 1401.0 | - |
| | | 5 | 568959.0 | 53.3 | 8 | 1 | 1586.0 | - | - |
| | | 6 | 832422.0 | 75.0 | 8 | 2 | 1268.0 | 1275.0 | - |
| | | 7 | 8021.0 | 75.3 | 8 | 2 | 1053.0 | 1039.0 | - |
| | | 8 | 271473.0 | 95.1 | 8 | 3 | 1488.0 | 1784.0 | 1306.0 |
| | | 9 | 536543.0 | 59.8 | 8 | 1 | 1328.0 | - | - |
| | | 10 | 799465.0 | 80.6 | 8 | 2 | 1150.0 | 1995.0 | - |