



FCC RADIO TEST REPORT-WIFI

FCC ID:LNQSBWD700A

Product : ScreenBeam Enterprise Wireless Display Receiver

Trade Name : Actiontec

Model Name : SBWD700A

Serial Model : N/A

Report No. : NTEK-2014NT09281643F3

Prepared for

Actiontec Electronics, Inc.

760 North Mary Ave., Sunnyvale, CA 94085 USA

Prepared by

Shenzhen NTEK Testing Technology Co., Ltd.

1/F, Building E, Fenda Science Park, Sanwei Community, Xixiang Street
Bao'an District, Shenzhen P.R. China

Tel.: +86-0755-61156588 Fax.: +86-0755-61156599

Website: www.ntek.org.cn

TEST RESULT CERTIFICATION

Applicant's name Actiontec Electronics, Inc.

Address 760 North Mary Ave., Sunnyvale, CA 94085 USA

Manufacturer's Name... Actiontec Electronics, Inc.

Address 760 North Mary Ave., Sunnyvale, CA 94085 USA

Product description

Product name ScreenBeam Enterprise Wireless Display Receiver

Model and/or type reference SBWD700A

Serial Model N/A

Standards FCC Part15.247: 01 Oct. 2013

Test procedure ANSI C63.4-2003 and KDB 558074: June 5, 2014

This device described above has been tested by NTEK, and the test results show that the equipment under test (EUT) is in compliance with the FCC requirements. And it is applicable only to the tested sample identified in the report.

This report shall not be reproduced except in full, without the written approval of NTEK, this document may be altered or revised by NTEK, personal only, and shall be noted in the revision of the document.

Date of Test

Date (s) of performance of tests 28 Sep. 2014 ~16 Oct. 2014

Date of Issue..... 16 Oct. 2014

Test Result..... **Pass**

Testing Engineer : Kyle Xu
(Kyle Xu)

Technical Manager : Brown Lu
(Brown Lu)

Authorized Signatory : Bill Yao
(Bill Yao)

Table of Contents

| | Page |
|---|-------------|
| 1 . SUMMARY OF TEST RESULTS | 5 |
| 1.1 TEST FACILITY | 6 |
| 1.2 MEASUREMENT UNCERTAINTY | 6 |
| 2 . GENERAL INFORMATION | 7 |
| 2.1 GENERAL DESCRIPTION OF EUT | 7 |
| 2.2 DESCRIPTION OF TEST MODES | 10 |
| 2.3 BLOCK DIGRAM SHOWING THE CONFIGURATION OF SYSTEM TESTED | 11 |
| 2.4 DESCRIPTION OF SUPPORT UNITS(CONDUCTED MODE) | 12 |
| 2.5 EQUIPMENTS LIST FOR ALL TEST ITEMS | 13 |
| 3 . EMC EMISSION TEST | 14 |
| 3.1 CONDUCTED EMISSION MEASUREMENT | 14 |
| 3.1.1 POWER LINE CONDUCTED EMISSION LIMITS | 14 |
| 3.1.2 TEST PROCEDURE | 15 |
| 3.1.3 DEVIATION FROM TEST STANDARD | 15 |
| 3.1.4 TEST SETUP | 15 |
| 3.1.5 EUT OPERATING CONDITIONS | 15 |
| 3.1.6 TEST RESULTS | 16 |
| 3.2 RADIATED EMISSION MEASUREMENT | 20 |
| 3.2.1 RADIATED EMISSION LIMITS | 20 |
| 3.2.2 TEST PROCEDURE | 21 |
| 3.2.3 DEVIATION FROM TEST STANDARD | 21 |
| 3.2.4 TEST SETUP | 22 |
| 3.2.5 EUT OPERATING CONDITIONS | 23 |
| 3.2.6 TEST RESULTS (BETWEEN 9KHZ – 30 MHZ) | 24 |
| 3.2.7 TEST RESULTS (BETWEEN 30MHZ – 1GHZ) | 25 |
| 3.2.8 TEST RESULTS (ABOVE 1000 MHZ) | 29 |
| 4 . POWER SPECTRAL DENSITY TEST | 31 |
| 4.1 APPLIED PROCEDURES / LIMIT | 31 |
| 4.1.1 TEST PROCEDURE | 31 |
| 4.1.2 DEVIATION FROM STANDARD | 31 |
| 4.1.3 TEST SETUP | 31 |
| 4.1.4 EUT OPERATION CONDITIONS | 31 |
| 4.1.5 TEST RESULTS | 32 |
| 5 . BANDWIDTH TEST | 46 |
| 5.1 APPLIED PROCEDURES / LIMIT | 46 |
| 5.1.1 TEST PROCEDURE | 46 |

Table of Contents

| | Page |
|---|-------------|
| TEST SETUP | 46 |
| 5.1.2 EUT OPERATION CONDITIONS | 46 |
| 5.1.3 TEST RESULTS | 47 |
| 6 . PEAK OUTPUT POWER TEST | 61 |
| 6.1 APPLIED PROCEDURES / LIMIT | 61 |
| 6.1.1 TEST PROCEDURE | 61 |
| 6.1.2 DEVIATION FROM STANDARD | 61 |
| 6.1.3 TEST SETUP | 61 |
| 6.1.4 EUT OPERATION CONDITIONS | 61 |
| 6.1.5 TEST RESULTS | 62 |
| 7 . 100 KHZ BANDWIDTH OF FREQUENCY BAND EDGE | 64 |
| 7.1 DEVIATION FROM STANDARD | 64 |
| 7.2 TEST SETUP | 64 |
| 7.3 EUT OPERATION CONDITIONS | 64 |
| 7.4 TEST RESULTS | 65 |
| 8 . ANTENNA REQUIREMENT | 74 |
| 8.1 STANDARD REQUIREMENT | 74 |
| 8.2 EUT ANTENNA | 74 |
| 9 . EUT TEST PHOTO | 75 |
| APPENDIX-PHOTOGRAPHS OF EUT CONSTRUCTIONAL DETAILS | |

1. SUMMARY OF TEST RESULTS

Test procedures according to the technical standards:

| FCC Part15 (15.247) , Subpart C | | | |
|---------------------------------|----------------------------|----------|--------|
| Standard Section | Test Item | Judgment | Remark |
| 15.207 | Conducted Emission | PASS | |
| 15.247 (a)(2) | 6dB Bandwidth | PASS | |
| 15.247 (b) | Peak Output Power | PASS | |
| 15.247 (c) | Radiated Spurious Emission | PASS | |
| 15.247 (d) | Power Spectral Density | PASS | |
| 15.205 | Band Edge Emission | PASS | |
| 15.203 | Antenna Requirement | PASS | |

NOTE:

(1) "N/A" denotes test is not applicable in this Test Report

1.1 TEST FACILITY

NTEK Testing Technology Co., Ltd

Add.:1/F, Building E, Fenda Science Park, Sanwei Community, Xixiang Street, Bao'an District, Shenzhen P.R. China.

FCC Registration No.:238937; IC Registration No.:9270A-1

CNAS Registration No.:L5516

1.2 MEASUREMENT UNCERTAINTY

The reported uncertainty of measurement $y \pm U$, where expanded uncertainty U is based on a standard uncertainty multiplied by a coverage factor of $k=2$, providing a level of confidence of approximately 95 %.

| No. | Item | Uncertainty |
|-----|------------------------------|-------------------------|
| 1 | Conducted Emission Test | $\pm 1.38\text{dB}$ |
| 2 | RF power,conducted | $\pm 0.16\text{dB}$ |
| 3 | Spurious emissions,conducted | $\pm 0.21\text{dB}$ |
| 4 | All emissions,radiated(<1G) | $\pm 4.68\text{dB}$ |
| 5 | All emissions,radiated(>1G) | $\pm 4.89\text{dB}$ |
| 6 | Temperature | $\pm 0.5^\circ\text{C}$ |
| 7 | Humidity | $\pm 2\%$ |

2. GENERAL INFORMATION

2.1 GENERAL DESCRIPTION OF EUT

| | | |
|------------------------|--|---|
| Equipment | ScreenBeam Enterprise Wireless Display Receiver | |
| Trade Name | Actiontec | |
| Model Name | SBWD700A | |
| Product Description | The EUT is a ScreenBeam Enterprise Wireless Display Receiver | |
| | Operation Frequency: | 802.11b/g/n(20MHz):2412~2462 MHz 802.11n(40MHz):2422~2452 MHz |
| | Modulation Type: | CCK/OFDM/DBPSK/DAPSK |
| | Bit Rate of Transmitter | 802.11b:11/5.5/2/1 Mbps 802.11g:54/48/36/24/18/12/9/6Mbps 802.11n(20MHz):150/144.44/130/117/115.56/104/86.67/78/52/6.5Mbps 802.11n(40MHz):300/270/240/180/150/120/108/90/54 Mbps |
| | Number Of Channel | 802.11b/g/n20MHz:11CH 802.11n40MHz:7CH |
| | Max.Output Power(Conducted): | 17.26 dBm |
| | Operation Frequency: | 5725 MHz ~ 5850 MHz |
| | Modulation Type: | OFDM (BPSK / QPSK / 16QAM / 64QAM) |
| | Max.Output Power(Conducted): | 12.50 dBm |
| | Antenna Designation: | Please see Note 3. |
| | Antenna Gain (dBi) | Please see Note 3. |
| | Based on the application, features, or specification exhibited in User's Manual, the EUT is considered as an ITE/Computing Device. More details of EUT technical specification, please refer to the User's Manual. | |
| | Channel List | Please refer to the Note 2. |
| Ratings | DC 5.0V,2.0A | |
| Adapter | Mode: WA-10P05FU Input: 100-240V~, 50/60Hz, 0.3A MAX Output: 5.0V---, 2.0A | |
| Battery | N/A | |
| Connecting I/O Port(s) | Please refer to the User's Manual | |

Note:

1. For a more detailed features description, please refer to the manufacturer's specifications or the User's Manual.

2. 2.4GHz

| Channel List for 802.11b/g/n(20 MHz) | | | | | | | |
|--------------------------------------|-----------------|---------|-----------------|---------|-----------------|---------|-----------------|
| Channel | Frequency (MHz) | Channel | Frequency (MHz) | Channel | Frequency (MHz) | Channel | Frequency (MHz) |
| 01 | 2412 | 04 | 2427 | 07 | 2442 | 10 | 2457 |
| 02 | 2417 | 05 | 2432 | 08 | 2447 | 11 | 2462 |
| 03 | 2422 | 06 | 2437 | 09 | 2452 | - | - |

| Channel List for 802.11n(40MHz) | | | | | | | |
|---------------------------------|-----------------|---------|-----------------|---------|-----------------|---------|-----------------|
| Channel | Frequency (MHz) | Channel | Frequency (MHz) | Channel | Frequency (MHz) | Channel | Frequency (MHz) |
| 03 | 2422 | 06 | 2437 | 09 | 2452 | - | - |
| 04 | 2427 | 07 | 2442 | - | - | - | - |
| 05 | 2432 | 08 | 2447 | - | - | - | - |

5GHz

| 802.11a/n20 MHz Carrier Frequency Channel | | | | | | | |
|---|-----------------|---------|-----------------|---------|-----------------|---------|-----------------|
| Channel | Frequency (MHz) | Channel | Frequency (MHz) | Channel | Frequency (MHz) | Channel | Frequency (MHz) |
| 149 | 5745 | 153 | 5765 | 157 | 5785 | 161 | 5805 |
| 165 | 5825 | - | - | - | - | - | - |

| 802.11n 40MHzCarrier Frequency Channel | | | | | | | |
|--|-----------------|---------|-----------------|---------|-----------------|---------|-----------------|
| Channel | Frequency (MHz) | Channel | Frequency (MHz) | Channel | Frequency (MHz) | Channel | Frequency (MHz) |
| 151 | 5755 | 155 | 5775 | 159 | 5795 | - | - |

3.

Table for Filed Antenna

| Brand | Model Name | Antenna Type | Gain (dBi) | NOTE |
|-------|------------|--------------|------------|--------------|
| N/A | N/A | PCB antenna | 2.4G:3.6 | Wifi Antenna |
| N/A | N/A | PCB antenna | 5G:3.2 | Wifi Antenna |

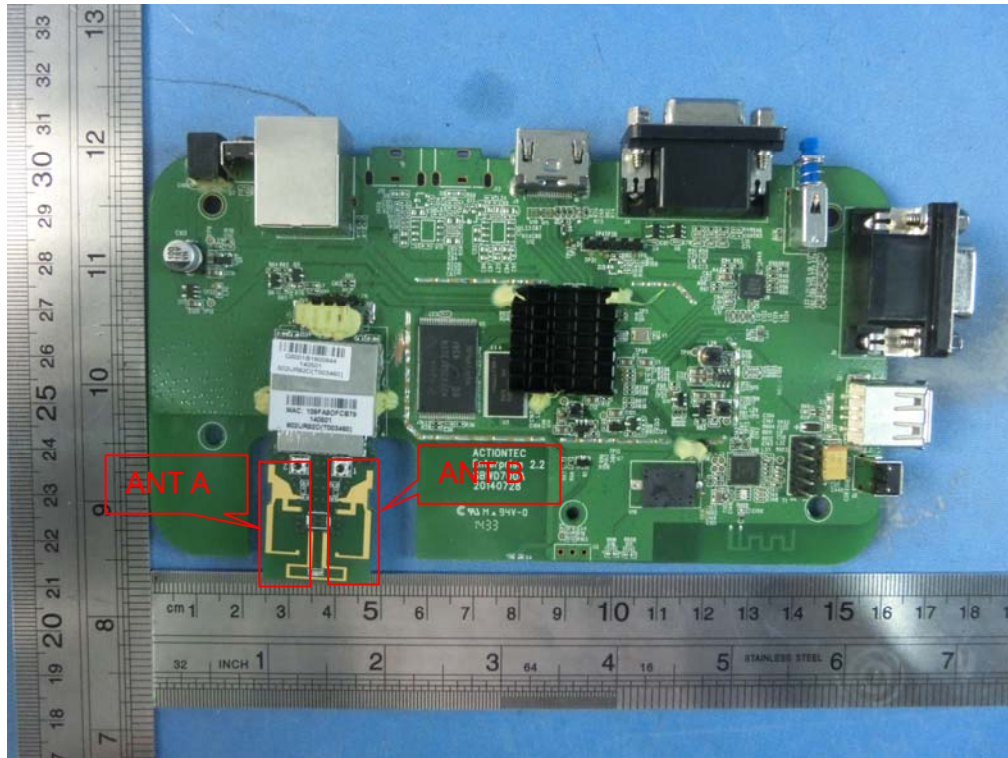

The Control software(tool_WIFI.exe) can control antenna A B ,
 For 2.4GHz mode, antenna A B are transmitting,two antennas simultaneously transmit.
 And the data is recorded for radiated emission and band edge.
 For 5GHz mode,antenna A B are transmitting Two antennas simultaneously transmit.
 And the data is recorded for radiated emission, and band edge.
 For MIMO mode , Directional gain= $G_{ANT} + 10\log(N)$ dbi =6.61dbi in 2.4GHz
 Directional gain= $G_{ANT} + 10\log(N)$ dbi =6.21dbi in 5GHz
 802.11a/b/g/n 2.4GHz & 5GHz has MIMO mode.

2.2 DESCRIPTION OF TEST MODES

To investigate the maximum EMI emission characteristics generates from EUT, the test system was pre-scanning tested base on the consideration of following EUT operation mode or test configuration mode which possible have effect on EMI emission level. Each of these EUT operation mode(s) or test configuration mode(s) mentioned above was evaluated respectively.

| Pretest Mode | Description |
|--------------|------------------------------------|
| Mode 1 | 802.11b CH1/ CH6/ CH11 |
| Mode 2 | 802.11g CH1/ CH6/ CH11 |
| Mode 3 | 802.11n20 CH1/ CH6/ CH11 |
| Mode 4 | 802.11n40 CH3/ CH6/ CH9 |
| Mode 5 | Link Mode |
| Mode 6 | 802.11a /n 20 CH149/ CH157/ CH 165 |
| Mode 7 | 802.11n40 CH 151 / CH 159 |

| For Conducted Emission | |
|------------------------|-------------|
| Final Test Mode | Description |
| Mode 5 | Link Mode |

| For Radiated Emission | |
|-----------------------|----------------------------------|
| Final Test Mode | Description |
| Mode 1 | 802.11b CH1/ CH6/ CH11 |
| Mode 2 | 802.11g CH1/ CH6/ CH11 |
| Mode 3 | 802.11n20 CH1/ CH6/ CH11 |
| Mode 4 | 802.11n40 CH3/ CH6/ CH 9 |
| Mode 5 | Link Mode |
| Mode 6 | 802.11a /n20 CH149/ CH157/ CH165 |
| Mode 7 | 802.11n40 CH151 / CH159 |

Note:

- (1) The measurements are performed at the highest, middle, lowest available channels.
- (2) The measurements are performed at all Bit Rate of Transmitter, the worst data was reported

2.3 BLOCK DIGRAM SHOWING THE CONFIGURATION OF SYSTEM TESTED

Conducted Emission Test

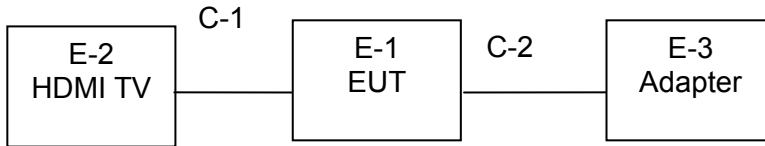

Radiated Emission Test

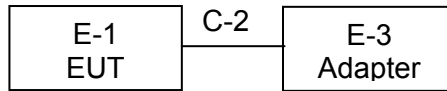

2.4 DESCRIPTION OF SUPPORT UNITS(CONDUCTED MODE)

The EUT has been tested as an independent unit together with other necessary accessories or support units. The following support units or accessories were used to form a representative test configuration during the tests.

| Item | Equipment | Brand | Model/Type No. | Series No. | Note |
|------|---|-----------|----------------|------------|------|
| E-1 | ScreenBeam Enterprise Wireless Display Receiver | Actiontec | SBWD700A | N/A | EUT |
| E-2 | TV | SONY | KDL-24EX520 | N/A | |
| E-3 | Adapter | Actiontec | WA-10P05FU | N/A | |
| | | | | | |
| | | | | | |

| Item | Shielded Type | Ferrite Core | Length | Note |
|------|---------------|--------------|--------|------|
| C-1 | NO | NO | 100cm | |
| C-2 | NO | NO | 80cm | |
| | | | | |
| | | | | |

Note:

- (1) The support equipment was authorized by Declaration of Confirmation.
- (2) For detachable type I/O cable should be specified the length in cm in 『Length』 column.

2.5 EQUIPMENTS LIST FOR ALL TEST ITEMS

Radiation Test equipment

| Item | Kind of Equipment | Manufacturer | Type No. | Serial No. | Last calibration | Calibrated until | Calibration period |
|------|--------------------|--------------|-------------|--------------|------------------|------------------|--------------------|
| 1 | Spectrum Analyzer | Agilent | E4407B | MY45108040 | 2014.07.06 | 2015.07.05 | 1 year |
| 2 | Test Receiver | R&S | ESPI | 101318 | 2014.06.06 | 2015.06.05 | 1 year |
| 3 | Bilog Antenna | TESEQ | CBL6111D | 31216 | 2014.07.06 | 2015.07.05 | 1 year |
| 4 | 50Ω Coaxial Switch | Anritsu | MP59B | 6200264416 | 2014.06.06 | 2015.06.05 | 1 year |
| 5 | Spectrum Analyzer | ADVANTEST | R3132 | 150900201 | 2014.06.06 | 2015.06.05 | 1 year |
| 6 | Horn Antenna | EM | EM-AH-10180 | 2011071402 | 2014.07.06 | 2015.07.05 | 1 year |
| 7 | Horn Ant | Schwarzbeck | BBHA 9170 | 9170-181 | 2014.07.06 | 2015.07.05 | 1 year |
| 8 | Amplifier | EM | EM-30180 | 060538 | 2013.12.22 | 2014.12.21 | 1 year |
| 9 | Loop Antenna | ARA | PLA-1030/B | 1029 | 2014.06.06 | 2015.06.05 | 1 year |
| 10 | Power Meter | R&S | NRVS | 100696 | 2014.07.06 | 2015.07.05 | 1 year |
| 11 | Power Sensor | R&S | URV5-Z4 | 0395.1619.05 | 2014.07.06 | 2015.07.05 | 1 year |

Conduction Test equipment

| Item | Kind of Equipment | Manufacturer | Type No. | Serial No. | Last calibration | Calibrated until | Calibration period |
|------|-----------------------|--------------|----------|------------|------------------|------------------|--------------------|
| 1 | Test Receiver | R&S | ESCI | 101160 | 2014.06.06 | 2015.06.05 | 1 year |
| 2 | LISN | R&S | ENV216 | 101313 | 2014.08.24 | 2015.08.23 | 1 year |
| 3 | LISN | EMCO | 3816/2 | 00042990 | 2014.06.06 | 2015.06.05 | 1 year |
| 4 | 50Ω Coaxial Switch | Anritsu | MP59B | 6200264417 | 2014.06.06 | 2015.06.05 | 1 year |
| 5 | Passive Voltage Probe | R&S | ESH2-Z3 | 100196 | 2014.06.06 | 2015.06.05 | 1 year |
| 6 | Absorbing clamp | R&S | MOS-21 | 100423 | 2014.06.06 | 2015.06.05 | 1 year |

| | | | | | | | |
|---|-------------|-----|----------|--------|------------|------------|--------|
| 1 | Attenuation | MCE | 24-10-34 | BN9258 | 2014.06.06 | 2015.06.05 | 1 year |
|---|-------------|-----|----------|--------|------------|------------|--------|

3. EMC EMISSION TEST

3.1 CONDUCTED EMISSION MEASUREMENT

3.1.1 POWER LINE CONDUCTED EMISSION Limits (Frequency Range 150KHz-30MHz)

| FREQUENCY (MHz) | Class A (dBuV) | | Class B (dBuV) | | Standard |
|-----------------|----------------|---------|----------------|-----------|----------|
| | Quasi-peak | Average | Quasi-peak | Average | |
| 0.15 -0.5 | 79.00 | 66.00 | 66 - 56 * | 56 - 46 * | CISPR |
| 0.50 -5.0 | 73.00 | 60.00 | 56.00 | 46.00 | CISPR |
| 5.0 -30.0 | 73.00 | 60.00 | 60.00 | 50.00 | CISPR |

| | | | | | |
|-----------|-------|-------|-----------|-----------|-----|
| 0.15 -0.5 | 79.00 | 66.00 | 66 - 56 * | 56 - 46 * | FCC |
| 0.50 -5.0 | 73.00 | 60.00 | 56.00 | 46.00 | FCC |
| 5.0 -30.0 | 73.00 | 60.00 | 60.00 | 50.00 | FCC |

Note:

- (1) The tighter limit applies at the band edges.
- (2) The limit of " * " marked band means the limitation decreases linearly with the logarithm of the frequency in the range.

The following table is the setting of the receiver

| Receiver Parameters | Setting |
|---------------------|----------|
| Attenuation | 10 dB |
| Start Frequency | 0.15 MHz |
| Stop Frequency | 30 MHz |
| IF Bandwidth | 9 kHz |

3.1.2 TEST PROCEDURE

- a. The EUT was placed 0.8 meters from the horizontal ground plane with EUT being connected to the power mains through a line impedance stabilization network (LISN). All other support equipments powered from additional LISN(s). The LISN provide 50 Ohm/ 50uH of coupling impedance for the measuring instrument.
- b. Interconnecting cables that hang closer than 40 cm to the ground plane shall be folded back and forth in the center forming a bundle 30 to 40 cm long.
- c. I/O cables that are not connected to a peripheral shall be bundled in the center. The end of the cable may be terminated, if required, using the correct terminating impedance. The overall length shall not exceed 1 m.
- d. LISN at least 80 cm from nearest part of EUT chassis.
- e. For the actual test configuration, please refer to the related Item –EUT Test Photos.

3.1.3 DEVIATION FROM TEST STANDARD

No deviation

3.1.4 TEST SETUP

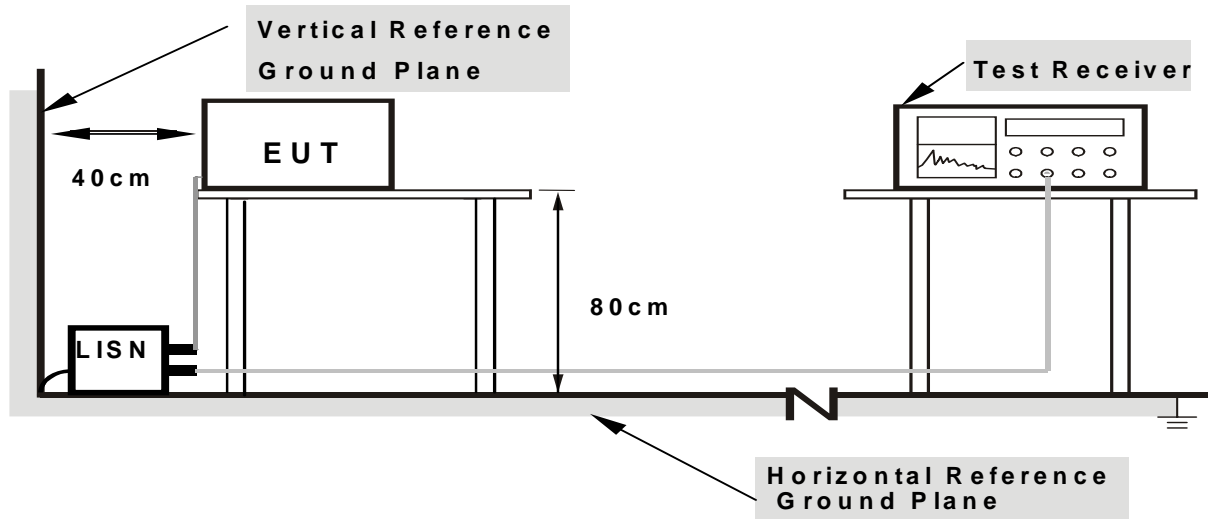

- Note:**
- 1. Support units were connected to second LISN.
 - 2. Both of LISNs (AMN) are 80 cm from EUT and at least 80 from other units and other metal planes

3.1.5 EUT OPERATING CONDITIONS

The EUT was configured for testing in a typical fashion (as a customer would normally use it). The EUT has been programmed to continuously transmit during test. This operating condition was tested and used to collect the included data.

3.1.6 TEST RESULTS

| | | | |
|----------------|---|---------------------|--------------|
| EUT : | ScreenBeam Enterprise Wireless Display Receiver | Model Name. : | SBWD700A |
| Temperature : | 26 °C | Relative Humidity : | 56% |
| Pressure : | 1010hPa | Phase : | L |
| Test Voltage : | DC 5V From adapter AC120V/60Hz | Test Mode : | Mode 5(2.4G) |

| Frequency (MHz) | Meter Reading (dBμV) | Factor (dB) | Emission Level (dBμV) | Limits (dBμV) | Margin (dB) | Remark |
|-----------------|----------------------|-------------|-----------------------|---------------|-------------|--------|
| 0.1940 | 47.11 | 9.51 | 56.62 | 63.86 | -7.24 | QP |
| 0.1940 | 27.74 | 9.51 | 37.25 | 53.86 | -16.61 | AVG |
| 0.2977 | 43.65 | 9.50 | 53.15 | 60.30 | -7.15 | QP |
| 0.2977 | 26.65 | 9.50 | 36.15 | 50.30 | -14.15 | AVG |
| 0.4061 | 41.08 | 9.50 | 50.58 | 57.73 | -7.15 | QP |
| 0.4061 | 33.68 | 9.50 | 43.18 | 47.73 | -4.55 | AVG |
| 0.7178 | 31.98 | 9.53 | 41.51 | 56.00 | -14.49 | QP |
| 0.7178 | 21.58 | 9.53 | 31.11 | 46.00 | -14.89 | AVG |
| 1.0740 | 25.77 | 9.53 | 35.30 | 56.00 | -20.70 | QP |
| 1.0740 | 17.86 | 9.53 | 27.39 | 46.00 | -18.61 | AVG |
| 1.5180 | 34.06 | 9.54 | 43.60 | 56.00 | -12.40 | QP |
| 1.5180 | 13.82 | 9.54 | 23.36 | 46.00 | -22.64 | AVG |

Remark:
 1. All readings are Quasi-Peak and Average values.
 2. Factor = Insertion Loss + Cable Loss.

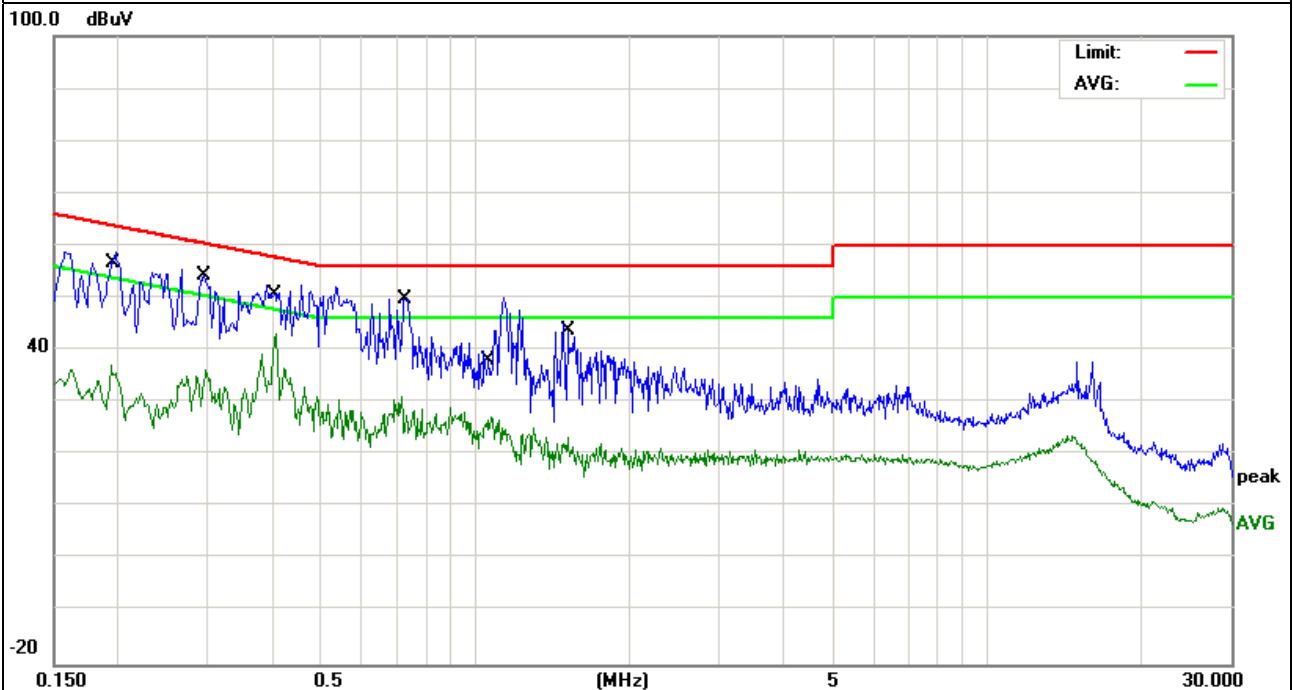

| | | | |
|----------------|---|---------------------|--------------|
| EUT : | ScreenBeam Enterprise Wireless Display Receiver | Model Name. : | SBWD700A |
| Temperature : | 26 °C | Relative Humidity : | 56% |
| Pressure : | 1010hPa | Phase : | N |
| Test Voltage : | DC 5V From adapter AC120V/60Hz | Test Mode : | Mode 5(2.4G) |

| Frequency (MHz) | Meter Reading (dBμV) | Factor (dB) | Emission Level (dBμV) | Limits (dBμV) | Margin (dB) | Remark |
|-----------------|----------------------|-------------|-----------------------|---------------|-------------|--------|
| 0.2020 | 49.86 | 9.49 | 59.35 | 63.52 | -4.17 | QP |
| 0.2020 | 26.68 | 9.49 | 36.17 | 53.52 | -17.35 | AVG |
| 0.2898 | 44.21 | 9.50 | 53.71 | 60.53 | -6.82 | QP |
| 0.2898 | 25.21 | 9.50 | 34.71 | 50.53 | -15.82 | AVG |
| 0.3996 | 39.89 | 9.50 | 49.39 | 57.86 | -8.47 | QP |
| 0.3996 | 30.98 | 9.50 | 40.48 | 47.86 | -7.38 | AVG |
| 0.5738 | 28.31 | 9.51 | 37.82 | 56.00 | -18.18 | QP |
| 0.5738 | 19.19 | 9.51 | 28.70 | 46.00 | -17.30 | AVG |
| 1.1458 | 23.41 | 9.53 | 32.94 | 56.00 | -23.06 | QP |
| 1.1458 | 13.12 | 9.53 | 22.65 | 46.00 | -23.35 | AVG |
| 14.4298 | 22.41 | 9.83 | 32.24 | 60.00 | -27.76 | QP |
| 14.4298 | 14.00 | 9.83 | 23.83 | 50.00 | -26.17 | AVG |

Remark:

1. All readings are Quasi-Peak and Average values.
2. Factor = Insertion Loss + Cable Loss.

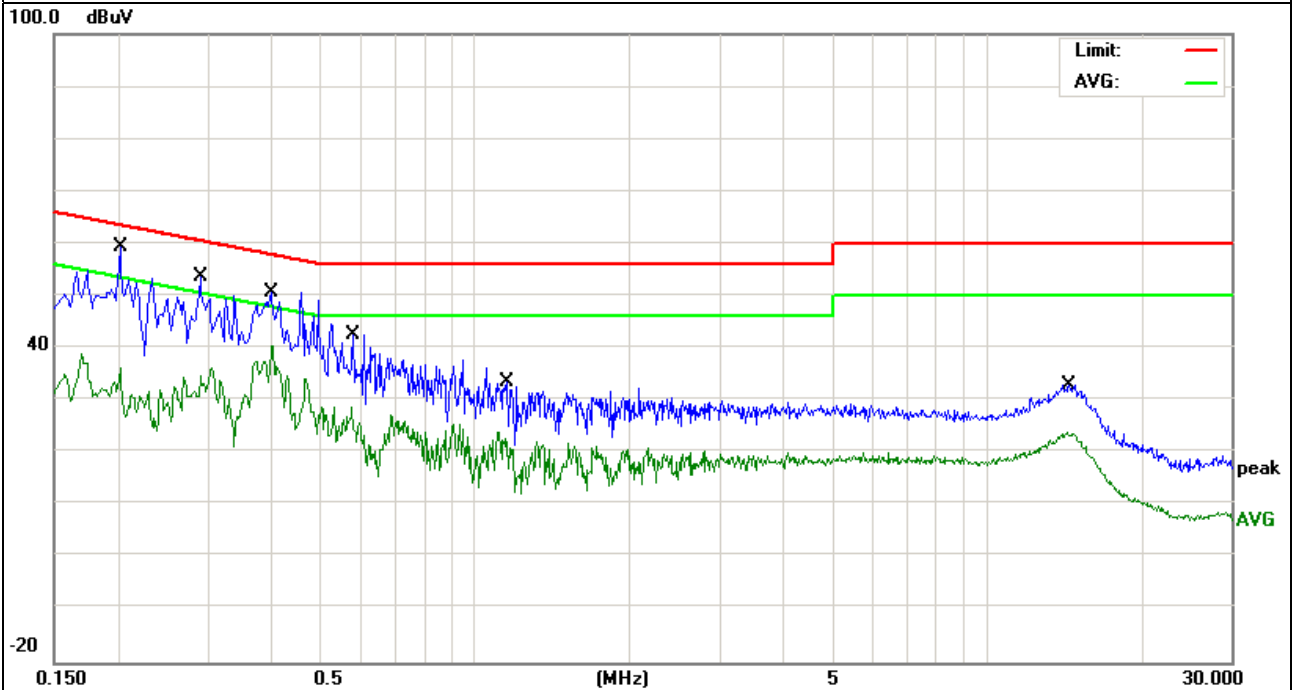

| | | | |
|----------------|---|---------------------|------------|
| EUT : | ScreenBeam Enterprise Wireless Display Receiver | Model Name. : | SBWD700A |
| Temperature : | 26 °C | Relative Humidity : | 56% |
| Pressure : | 1010hPa | Phase : | L |
| Test Voltage : | DC 5V From adapter AC120V/60Hz | Test Mode : | Mode 5(5G) |

| Frequency (MHz) | Meter Reading (dBμV) | Factor (dB) | Emission Level (dBμV) | Limits (dBμV) | Margin (dB) | Remark |
|-----------------|----------------------|-------------|-----------------------|---------------|-------------|--------|
| 0.1940 | 44.11 | 9.51 | 53.62 | 63.86 | -10.24 | QP |
| 0.1940 | 24.74 | 9.51 | 34.25 | 53.86 | -19.61 | AVG |
| 0.4061 | 39.58 | 9.50 | 49.08 | 57.73 | -8.65 | QP |
| 0.4061 | 32.18 | 9.50 | 41.68 | 47.73 | -6.05 | AVG |
| 0.5420 | 38.21 | 9.51 | 47.72 | 56.00 | -8.28 | QP |
| 0.5420 | 19.52 | 9.51 | 29.03 | 46.00 | -16.97 | AVG |
| 0.6935 | 31.12 | 9.53 | 40.65 | 56.00 | -15.35 | QP |
| 0.6935 | 19.66 | 9.53 | 29.19 | 46.00 | -16.81 | AVG |
| 4.4218 | 19.65 | 9.60 | 29.25 | 56.00 | -26.75 | QP |
| 4.4218 | 11.62 | 9.60 | 21.22 | 46.00 | -24.78 | AVG |
| 14.7096 | 22.09 | 9.83 | 31.92 | 60.00 | -28.08 | QP |
| 14.7096 | 12.28 | 9.83 | 22.11 | 50.00 | -27.89 | AVG |

Remark:

1. All readings are Quasi-Peak and Average values.
2. Factor = Insertion Loss + Cable Loss.

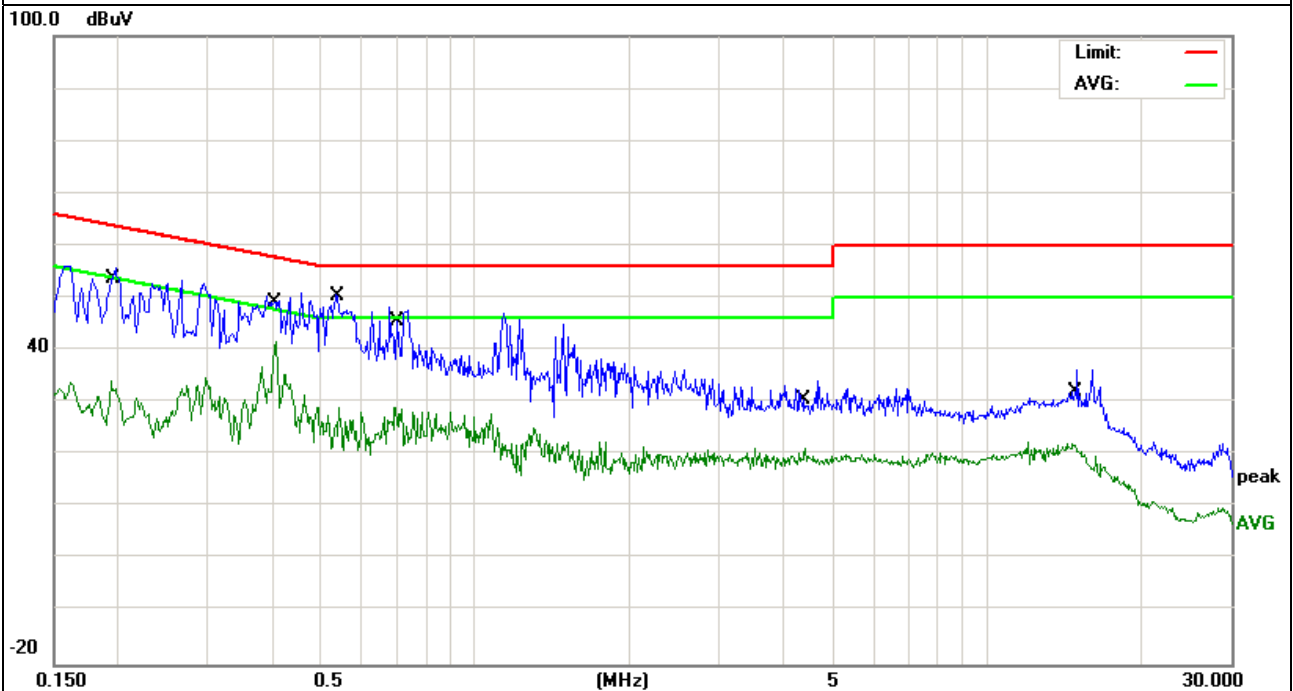

| | | | |
|----------------|---|---------------------|------------|
| EUT : | ScreenBeam Enterprise Wireless Display Receiver | Model Name. : | SBWD700A |
| Temperature : | 26 °C | Relative Humidity : | 56% |
| Pressure : | 1010hPa | Phase : | N |
| Test Voltage : | DC 5V From adapter AC120V/60Hz | Test Mode : | Mode 5(5G) |

| Frequency (MHz) | Meter Reading (dBμV) | Factor (dB) | Emission Level (dBμV) | Limits (dBμV) | Margin (dB) | Remark |
|-----------------|----------------------|-------------|-----------------------|---------------|-------------|--------|
| 0.1700 | 40.30 | 9.57 | 49.87 | 64.96 | -15.09 | QP |
| 0.1700 | 29.52 | 9.57 | 39.09 | 54.96 | -15.87 | AVG |
| 0.3183 | 40.07 | 9.50 | 49.57 | 59.75 | -10.18 | QP |
| 0.3183 | 28.64 | 9.50 | 38.14 | 49.75 | -11.61 | AVG |
| 0.4304 | 33.95 | 9.51 | 43.46 | 57.24 | -13.78 | QP |
| 0.4304 | 25.99 | 9.51 | 35.50 | 47.24 | -11.74 | AVG |
| 0.6860 | 29.51 | 9.53 | 39.04 | 56.00 | -16.96 | QP |
| 0.6860 | 18.76 | 9.53 | 28.29 | 46.00 | -17.71 | AVG |
| 0.9300 | 24.27 | 9.53 | 33.80 | 56.00 | -22.20 | QP |
| 0.9300 | 17.46 | 9.53 | 26.99 | 46.00 | -19.01 | AVG |
| 14.4298 | 25.91 | 9.83 | 35.74 | 60.00 | -24.26 | QP |
| 14.4298 | 17.50 | 9.83 | 27.33 | 50.00 | -22.67 | AVG |

Remark:

1. All readings are Quasi-Peak and Average values.
2. Factor = Insertion Loss + Cable Loss.

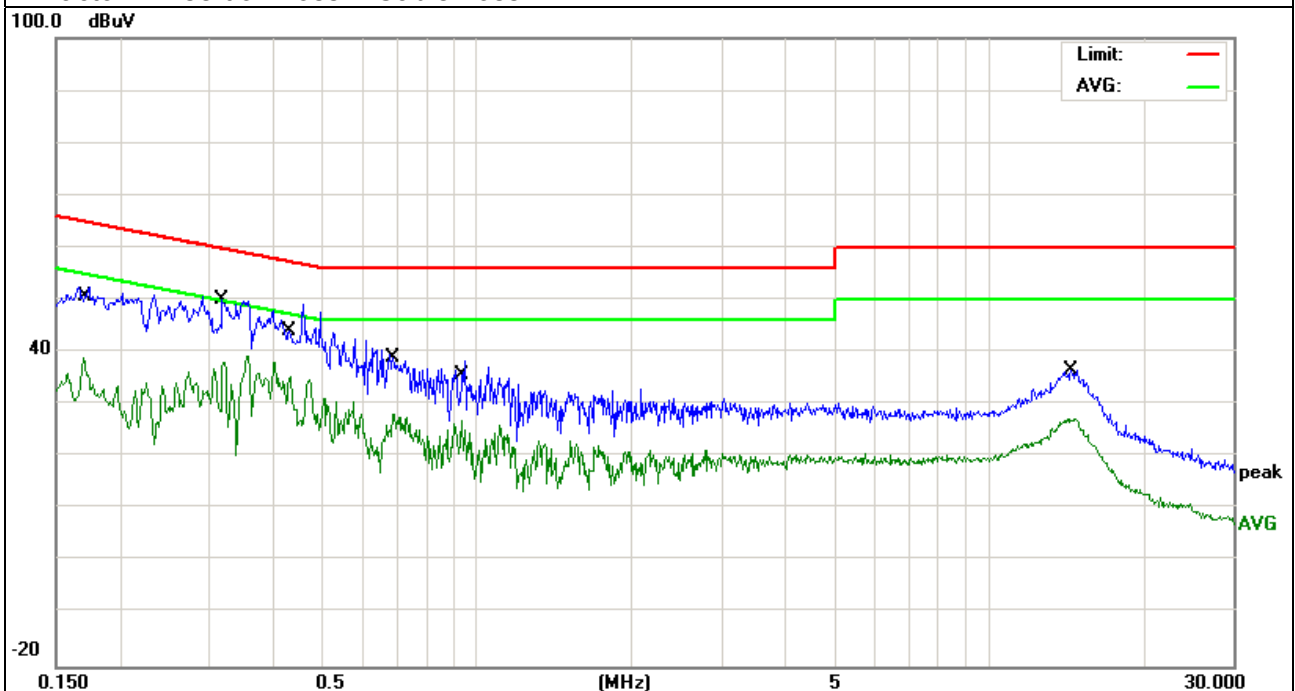

3.2 RADIATED EMISSION MEASUREMENT

3.2.1 RADIATED EMISSION LIMITS (Frequency Range 9kHz-1000MHz)

20dBc in any 100 kHz bandwidth outside the operating frequency band. In case the emission fall within the restricted band specified on 15.205(a), then the 15.209(a) limit in the table below has to be followed.

| Frequencies (MHz) | Field Strength (microrvolts/meter) | Measurement Distance (meters) |
|-------------------|------------------------------------|-------------------------------|
| 0.009~0.490 | 2400/F(KHz) | 300 |
| 0.490~1.705 | 24000/F(KHz) | 30 |
| 1.705~30.0 | 30 | 30 |
| 30~88 | 100 | 3 |
| 88~216 | 150 | 3 |
| 216~960 | 200 | 3 |
| Above 960 | 500 | 3 |

LIMITS OF RADIATED EMISSION MEASUREMENT (Above 1000MHz)

| FREQUENCY (MHz) | dBuV/m@at 3M | |
|-----------------|--------------|---------|
| | PEAK | AVERAGE |
| Above 1000 | 74 | 54 |

Notes:

- (1) The limit for radiated test was performed according to FCC PART 15C.
- (2) The tighter limit applies at the band edges.
- (3) Emission level (dBuV/m)=20log Emission level (uV/m).

| Spectrum Parameter | Setting |
|---------------------------------------|--|
| Attenuation | Auto |
| Start Frequency | 1000 MHz |
| Stop Frequency | 10th carrier harmonic |
| RB / VB (emission in restricted band) | 1 MHz / 1 MHz for Peak, 1 MHz / 10Hz for Average |

| Receiver Parameter | Setting |
|------------------------|----------------------------------|
| Attenuation | Auto |
| Start ~ Stop Frequency | 9kHz~150kHz / RB 200Hz for QP |
| Start ~ Stop Frequency | 150kHz~30MHz / RB 9kHz for QP |
| Start ~ Stop Frequency | 30MHz~1000MHz / RB 120kHz for QP |

3.2.2 TEST PROCEDURE

- a. The measuring distance of at 3 m shall be used for measurements at frequency up to 1GHz. For frequencies above 1GHz, any suitable measuring distance may be used.
- b. The EUT was placed on the top of a rotating table 0.8 meters above the ground at a 3 meter open area test site. The table was rotated 360 degrees to determine the position of the highest radiation.
- c. The height of the equipment or of the substitution antenna shall be 0.8 m; the height of the test antenna shall vary between 1 m to 4 m. Both horizontal and vertical polarizations of the antenna are set to make the measurement.
- d. The initial step in collecting conducted emission data is a spectrum analyzer peak detector mode pre-scanning the measurement frequency range. Significant peaks are then marked and then Quasi Peak detector mode re-measured.
- e. If the Peak Mode measured value compliance with and lower than Quasi Peak Mode Limit, the EUT shall be deemed to meet QP Limits and then no additional QP Mode measurement performed.
- f. For the actual test configuration, please refer to the related Item –EUT Test Photos.

Note:

Both horizontal and vertical antenna polarities were tested and performed pretest to three orthogonal axis. The worst case emissions were reported

During the radiated emission test, the Spectrum Analyzer was set with the following configurations:

| Frequency Band (MHz) | Function | Resolution bandwidth | Video Bandwidth |
|----------------------|----------|----------------------|-----------------|
| 30 to 1000 | QP | 100 kHz | 100 kHz |
| Above 1000 | Peak | 1 MHz | 1 MHz |
| | Peak | 1 MHz | 10 Hz |

3.2.3 DEVIATION FROM TEST STANDARD

No deviation

3.2.4 TEST SETUP

(A) Radiated Emission Test-Up Frequency Below 30MHz

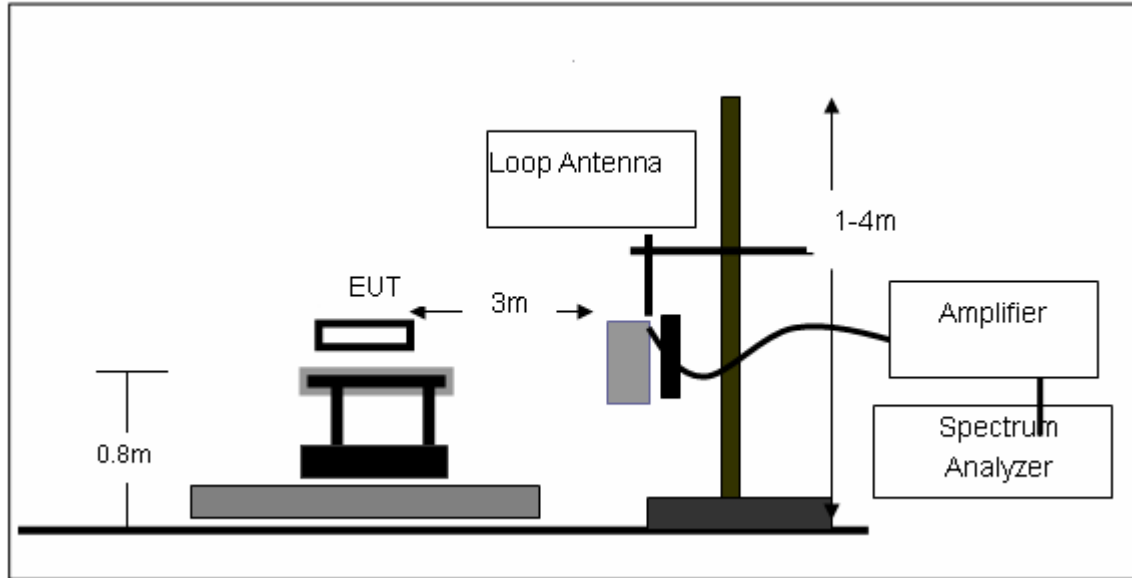

(B) Radiated Emission Test-Up Frequency 30MHz~1GHz

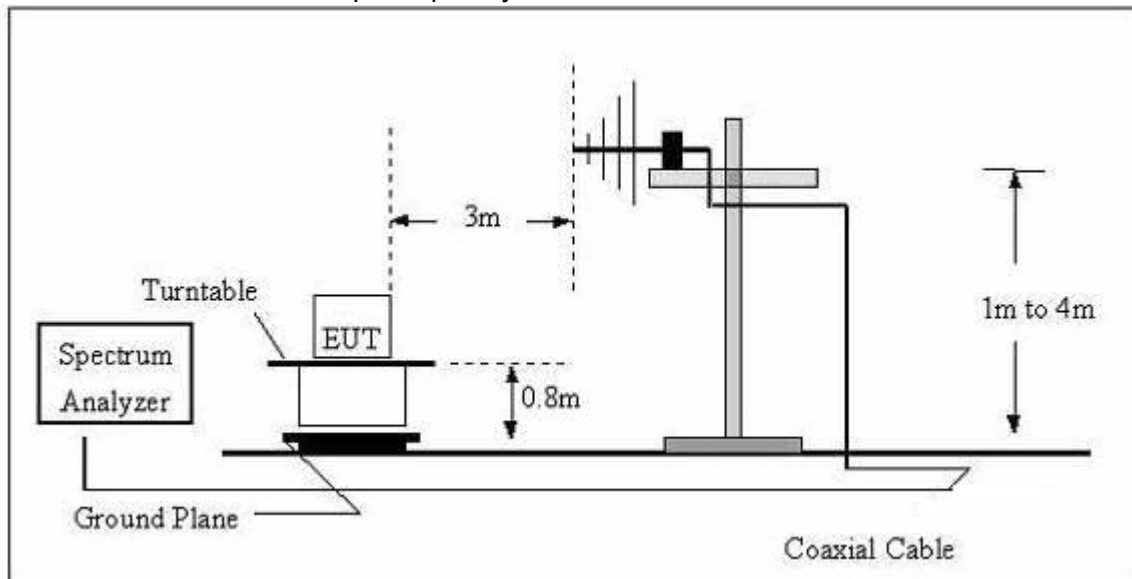

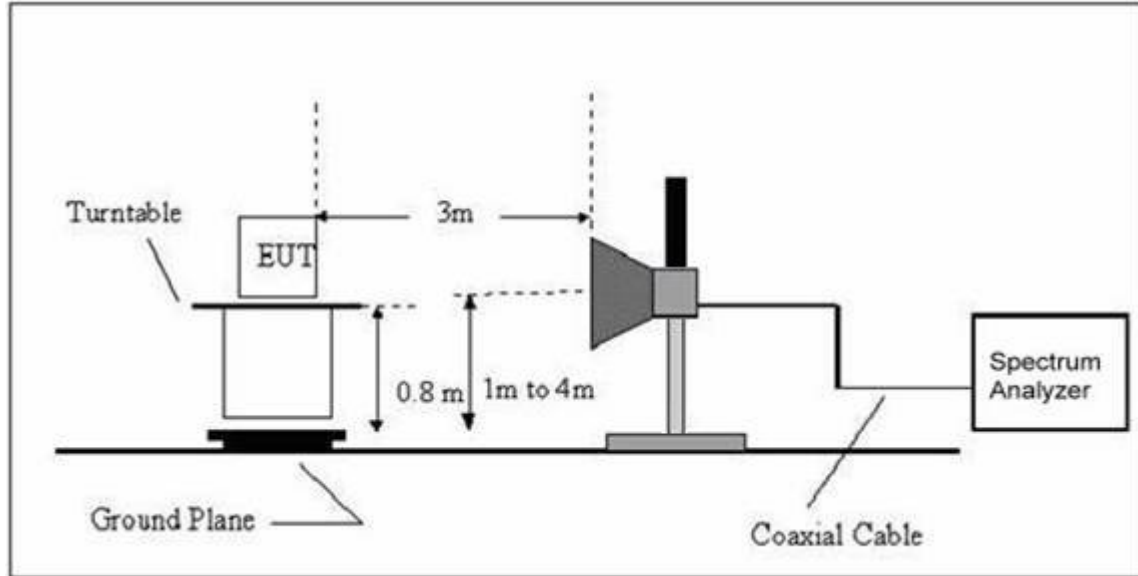
(C) Radiated Emission Test-Up Frequency Above 1GHz**3.2.5 EUT OPERATING CONDITIONS**

The EUT tested system was configured as the statements of 2.4 Unless otherwise a special operating condition is specified in the follows during the testing.

3.2.6 TEST RESULTS (BETWEEN 9KHZ – 30 MHZ)

| | | | |
|--------------|---|--------------------|-----------------------------------|
| EUT: | ScreenBeam Enterprise Wireless Display Receiver | Model Name. : | SBWD700A |
| Temperature: | 20 °C | Relative Humidity: | 48% |
| Pressure: | 1010 hPa | Test Voltage : | DC 5V From adapter AC120V/60Hz |
| Test Mode : | TX | Polarization : | -- |

| Freq. (MHz) | Reading (dBuV/m) | Limit (dBuV/m) | Margin (dB) | State P/F |
|----------------|---------------------|-------------------|----------------|--------------|
| -- | -- | -- | -- | N/A |
| -- | -- | -- | -- | N/A |

NOTE:

The amplitude of spurious emissions which are attenuated by more than 20dB below the permissible value has no need to be reported.

Distance extrapolation factor = $40 \log (\text{specific distance}/\text{test distance})(\text{dB})$;

Limit line = specific limits(dBuv) + distance extrapolation factor.

3.2.7 TEST RESULTS (BETWEEN 30MHZ – 1GHZ)

| | | | |
|---------------|---|---------------------|--------------------------------|
| EUT : | ScreenBeam Enterprise Wireless Display Receiver | Model Name : | SBWD700A |
| Temperature : | 20 °C | Relative Humidity : | 48% |
| Pressure : | 1010 hPa | Test Voltage : | DC 5V From adapter AC120V/60Hz |
| Test Mode : | TX (2.4G) | | |

| Polar (H/V) | Frequency | Meter Reading | Factor | Emission Level | Limits | Margin | Remark |
|-------------|-----------|---------------|--------|----------------|----------|--------|--------|
| | (MHz) | (dBuV) | (dB) | (dBuV/m) | (dBuV/m) | (dB) | |
| V | 50.7637 | 22.28 | 10.47 | 32.75 | 40.00 | -7.25 | QP |
| V | 121.1230 | 18.40 | 12.07 | 30.47 | 43.50 | -13.03 | QP |
| V | 213.0149 | 19.29 | 11.66 | 30.95 | 43.50 | -12.55 | QP |
| V | 314.3765 | 24.13 | 14.75 | 38.88 | 46.00 | -7.12 | QP |
| V | 332.5187 | 22.77 | 15.51 | 38.28 | 46.00 | -7.72 | QP |
| V | 744.8659 | 14.06 | 25.96 | 40.02 | 46.00 | -5.98 | QP |

Remark:

Absolute Level= ReadingLevel+ Factor, Margin= Absolute Level - Limit

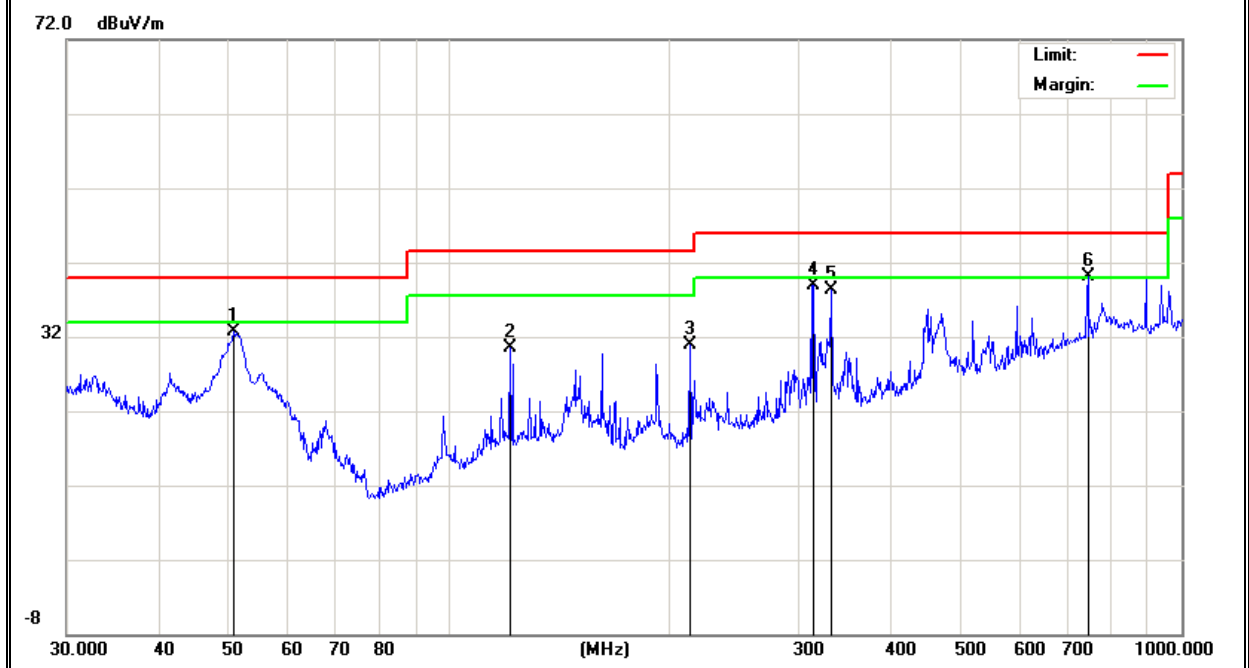

| Polar (H/V) | Frequency | Meter Reading | Factor | Emission Level | Limits | Margin | Remark |
|-------------|-----------|---------------|--------|----------------|----------|--------|--------|
| | (MHz) | (dBuV) | (dB) | (dBuV/m) | (dBuV/m) | (dB) | |
| H | 51.8430 | 15.81 | 10.16 | 25.97 | 40.00 | -14.03 | QP |
| H | 312.1792 | 25.29 | 14.66 | 39.95 | 46.00 | -6.05 | QP |
| H | 446.4141 | 23.01 | 19.23 | 42.24 | 46.00 | -3.76 | QP |
| H | 524.5538 | 23.06 | 20.81 | 43.87 | 46.00 | -2.13 | QP |
| H | 744.8659 | 16.65 | 25.96 | 42.61 | 46.00 | -3.39 | QP |
| H | 893.8567 | 15.11 | 27.03 | 42.14 | 46.00 | -3.86 | QP |

Remark:

Absolute Level= ReadingLevel+ Factor, Margin= Absolute Level - Limit

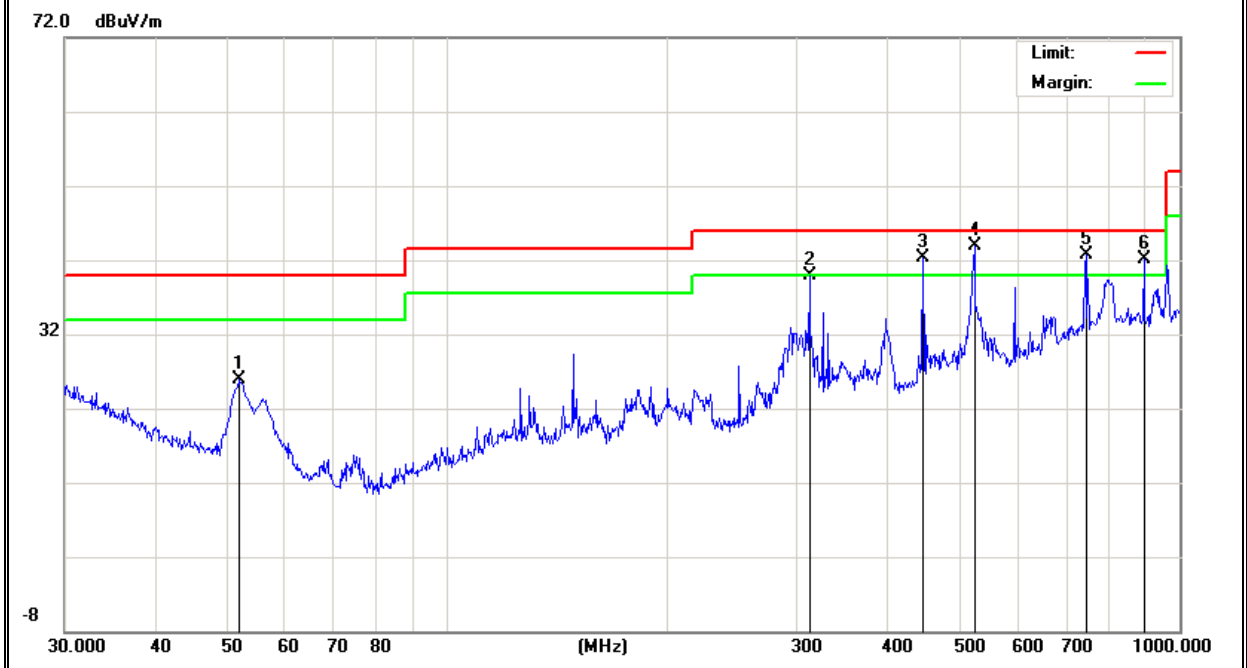

| | | | |
|---------------|---|---------------------|-----------------------------------|
| EUT : | ScreenBeam Enterprise Wireless Display Receiver | Model Name : | SBWD700A |
| Temperature : | 20 °C | Relative Humidity : | 48% |
| Pressure : | 1010 hPa | Test Voltage : | DC 5V From adapter AC120V/60Hz |
| Test Mode : | TX(5.0G) | | |

| Polar (H/V) | Frequency | Meter Reading | Factor | Emission Level | Limits | Margin | Remark |
|-------------|-----------|---------------|--------|----------------|----------|--------|--------|
| | (MHz) | (dBuV) | (dB) | (dBuV/m) | (dBuV/m) | (dB) | |
| V | 52.0251 | 17.16 | 10.11 | 27.27 | 40.00 | -12.73 | QP |
| V | 109.4116 | 19.66 | 9.89 | 29.55 | 43.50 | -13.95 | QP |
| V | 312.1792 | 16.49 | 14.66 | 31.15 | 46.00 | -14.85 | QP |
| V | 446.4141 | 18.45 | 19.23 | 37.68 | 46.00 | -8.32 | QP |
| V | 526.3967 | 19.28 | 20.84 | 40.12 | 46.00 | -5.88 | QP |
| V | 742.2586 | 14.66 | 25.90 | 40.56 | 46.00 | -5.44 | QP |

Remark:

Absolute Level= ReadingLevel+ Factor, Margin= Absolute Level - Limit

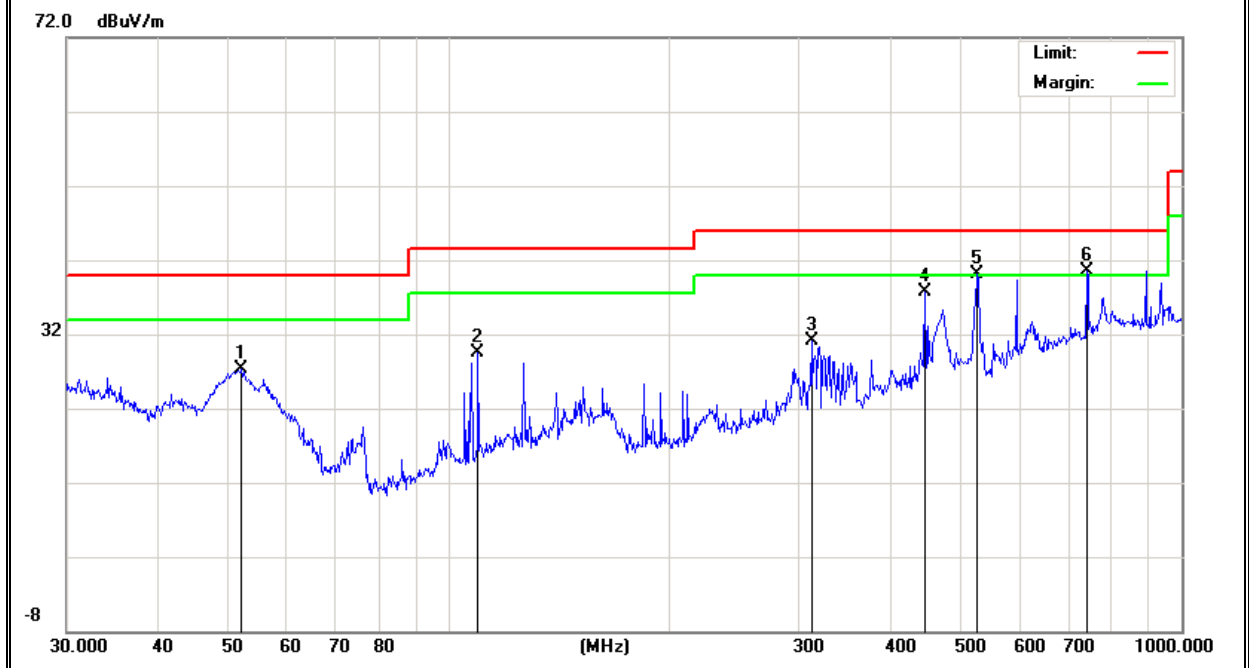

| Polar (H/V) | Frequency | Meter Reading | Factor | Emission Level | Limits | Margin | Remark |
|-------------|-----------|---------------|--------|----------------|----------|--------|--------|
| | (MHz) | (dBuV) | (dB) | (dBuV/m) | (dBuV/m) | (dB) | |
| H | 42.0065 | 13.86 | 12.90 | 26.76 | 40.00 | -13.24 | QP |
| H | 49.7068 | 15.87 | 10.77 | 26.64 | 40.00 | -13.36 | QP |
| H | 163.1818 | 18.06 | 10.51 | 28.57 | 43.50 | -14.93 | QP |
| H | 470.5230 | 15.25 | 19.70 | 34.95 | 46.00 | -11.05 | QP |
| H | 526.3967 | 18.25 | 20.84 | 39.09 | 46.00 | -6.91 | QP |
| H | 948.7608 | 12.18 | 27.32 | 39.50 | 46.00 | -6.50 | QP |

Remark:

Absolute Level= ReadingLevel+ Factor, Margin= Absolute Level - Limit

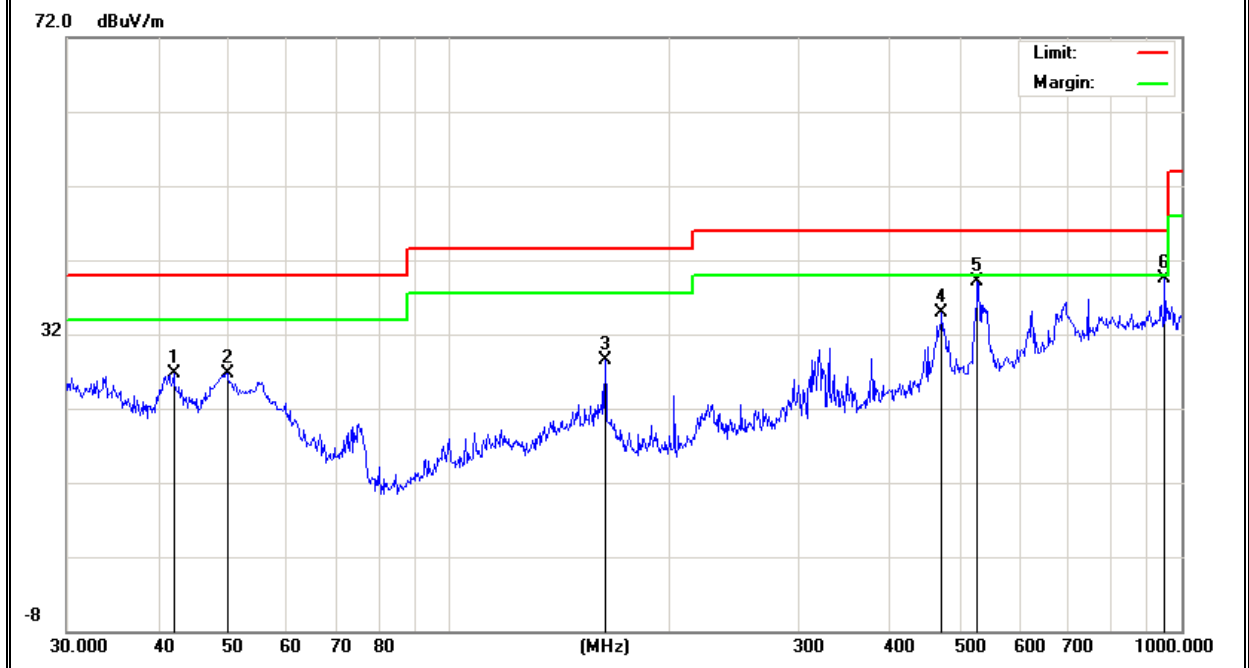

3.2.8 TEST RESULTS (ABOVE 1000 MHZ)

| | | | |
|---------------|--|---------------------|-----------------------------------|
| EUT : | ScreenBeam Enterprise Wireless Display Receiver | Model Name : | SBWD700A |
| Temperature : | 20 °C | Relative Humidity : | 48% |
| Pressure : | 1010 hPa | Test Voltage : | DC 5V From adapter AC120V/60Hz |
| Test Mode : | TX (2.4G) | | |

| Polar (H/V) | Frequency | Meter Reading | Factor | Emission Level | Limits | Margin | Remark |
|--|-----------|------------------|--------|-------------------|----------|--------|--------|
| | (MHz) | (dBuV) | (dB) | (dBuV/m) | (dBuV/m) | (dB) | |
| Low Channel (2412 MHz)-Above 1G | | | | | | | |
| Vertical | 4824.000 | 45.13 | 10.44 | 55.57 | 74 | -18.43 | Pk |
| Vertical | 4824.000 | 28.38 | 10.44 | 38.82 | 54 | -15.18 | Av |
| Vertical | 7236.000 | 37.12 | 12.39 | 49.51 | 74 | -24.49 | Pk |
| Horizontal | 4824.000 | 44.67 | 10.44 | 55.11 | 74 | -18.89 | Pk |
| Horizontal | 4824.000 | 25.59 | 10.44 | 36.03 | 54 | -17.97 | Av |
| Horizontal | 7236.000 | 32.17 | 12.39 | 44.56 | 74 | -29.44 | Pk |
| Mid Channel (2437 MHz)-Above 1G | | | | | | | |
| Vertical | 4874.000 | 45.98 | 10.4 | 56.38 | 74 | -17.62 | Pk |
| Vertical | 4874.000 | 34.84 | 10.4 | 45.24 | 54 | -8.76 | Av |
| Vertical | 7311.000 | 37.71 | 12.75 | 50.46 | 74 | -23.54 | Pk |
| Horizontal | 4874.000 | 45.32 | 10.4 | 55.72 | 74 | -18.28 | Pk |
| Horizontal | 4874.000 | 29.19 | 10.4 | 39.59 | 54 | -14.41 | Av |
| Horizontal | 7311.000 | 31.56 | 12.75 | 44.31 | 74 | -29.69 | Pk |
| High Channel (2462 MHz)- Above 1G | | | | | | | |
| Vertical | 4924.000 | 43.63 | 10.39 | 54.02 | 74 | -19.98 | Pk |
| Vertical | 4924.000 | 34.38 | 10.39 | 44.77 | 54 | -9.23 | Av |
| Vertical | 7386.000 | 37.24 | 12.68 | 49.92 | 74 | -24.08 | Pk |
| Horizontal | 4924.000 | 46.96 | 10.39 | 57.35 | 74 | -16.65 | Pk |
| Horizontal | 4924.000 | 28.92 | 10.39 | 39.31 | 54 | -14.69 | Av |
| Horizontal | 7386.000 | 38.23 | 12.68 | 50.91 | 74 | -23.09 | Pk |

Note: "802.11b" mode is the worst mode. When PK value is lower than the Average value limit, average didn't record.

| | | | |
|---------------|--|---------------------|-----------------------------------|
| EUT : | ScreenBeam Enterprise Wireless Display Receiver | Model Name : | SBWD700A |
| Temperature : | 20 °C | Relative Humidity : | 48% |
| Pressure : | 1010 hPa | Test Voltage : | DC 5V From adapter AC120V/60Hz |
| Test Mode : | TX (5.0G) | | |

| Polar (H/V) | Frequency | Meter Reading | Factor | Emission Level | Limits | Margin | Remark |
|------------------------------------|-----------|------------------|--------|-------------------|----------|--------|--------|
| | (MHz) | (dBuV) | (dB) | (dBuV/m) | (dBuV/m) | (dB) | |
| Low Channel (5745 MHz)-Above 1G | | | | | | | |
| Vertical | 11490.000 | 35.77 | 14.21 | 49.98 | 74 | -24.02 | Pk |
| Vertical | 17235.000 | 32.14 | 16.09 | 48.23 | 74 | -25.77 | Pk |
| Horizontal | 11490.000 | 35.47 | 14.21 | 49.68 | 74 | -24.32 | Pk |
| Horizontal | 17235.000 | 33.38 | 16.09 | 49.47 | 74 | -24.53 | Pk |
| middle Channel (5785 MHz)-Above 1G | | | | | | | |
| Vertical | 11570.000 | 34.76 | 14.51 | 49.27 | 74 | -24.73 | Pk |
| Vertical | 17355.000 | 36.89 | 16.15 | 53.04 | 74 | -20.96 | Pk |
| Horizontal | 11570.000 | 35.42 | 14.51 | 49.93 | 74 | -24.07 | Pk |
| Horizontal | 17355.000 | 35.18 | 16.15 | 51.33 | 74 | -22.67 | Pk |
| High Channel (5825 MHz)-Above 1G | | | | | | | |
| Vertical | 11590.000 | 36.53 | 14.55 | 51.08 | 74 | -22.92 | Pk |
| Vertical | 17385.000 | 34.64 | 16.18 | 50.82 | 74 | -23.18 | Pk |
| Horizontal | 11590.000 | 35.72 | 14.55 | 50.27 | 74 | -23.73 | Pk |
| Horizontal | 17385.000 | 36.62 | 16.18 | 52.80 | 74 | -21.20 | Pk |

Note: "802.11a(5G)" mode is the worst mode. When PK value is lower than the Average value limit, average didn't record.

4. POWER SPECTRAL DENSITY TEST

4.1 APPLIED PROCEDURES / LIMIT

| FCC Part15 (15.247) , Subpart C | | | | |
|---------------------------------|------------------------|------------------------|-----------------------|--------|
| Section | Test Item | Limit | Frequency Range (MHz) | Result |
| 15.247 | Power Spectral Density | 8 dBm (in any 3KHz) | 2400-2483.5 | PASS |

4.1.1 TEST PROCEDURE

1. Set analyzer center frequency to DTS channel center frequency.
2. Set the span to 1.5 times the DTS channel bandwidth.
3. 3 kHz \leq Set the RBW \leq 100 kHz.
4. Set the VBW \geq 3 x RBW.
5. Detector = peak.
6. Sweep time = auto couple.
7. Trace mode = max hold.
8. Allow trace to fully stabilize.
9. Use the peak marker function to determine the maximum amplitude level within the RBW.
10. If measured value exceeds limit, reduce RBW (no less than 3 kHz) and repeat.

4.1.2 DEVIATION FROM STANDARD

No deviation.

4.1.3 TEST SETUP



4.1.4 EUT OPERATION CONDITIONS

The EUT tested system was configured as the statements of 2.1 Unless otherwise a special operating condition is specified in the follows during the testing.

4.1.5 TEST RESULTS

| | | | |
|---------------|---|---------------------|-----------------------------------|
| EUT : | ScreenBeam Enterprise Wireless Display Receiver | Model Name : | SBWD700A |
| Temperature : | 25 °C | Relative Humidity : | 56% |
| Pressure : | 1015 hPa | Test Voltage : | DC 5V From adapter AC120V/60Hz |
| Test Mode : | TX b Mode /CH01, CH06, CH11 | | |

| Frequency | Power Density A (dBm) | Power Density B (dBm) | total power density (dBm) | Limit (dBm) | Result |
|-----------|-----------------------|-----------------------|---------------------------|-------------|--------|
| 2412 MHz | -16.33 | -16.64 | -13.47 | 7.39 | PASS |
| 2437 MHz | -15.63 | -16.12 | -13.21 | 7.39 | PASS |
| 2462 MHz | -15.38 | -15.76 | -12.56 | 7.39 | PASS |

NOTE: A(B) Represent the value of antenna A and B, The worst data is A Antenna a ,only shown Antenna A Plot.

For 2.4G mode , Limit =8-6.61+6=7.39dBm for output power.

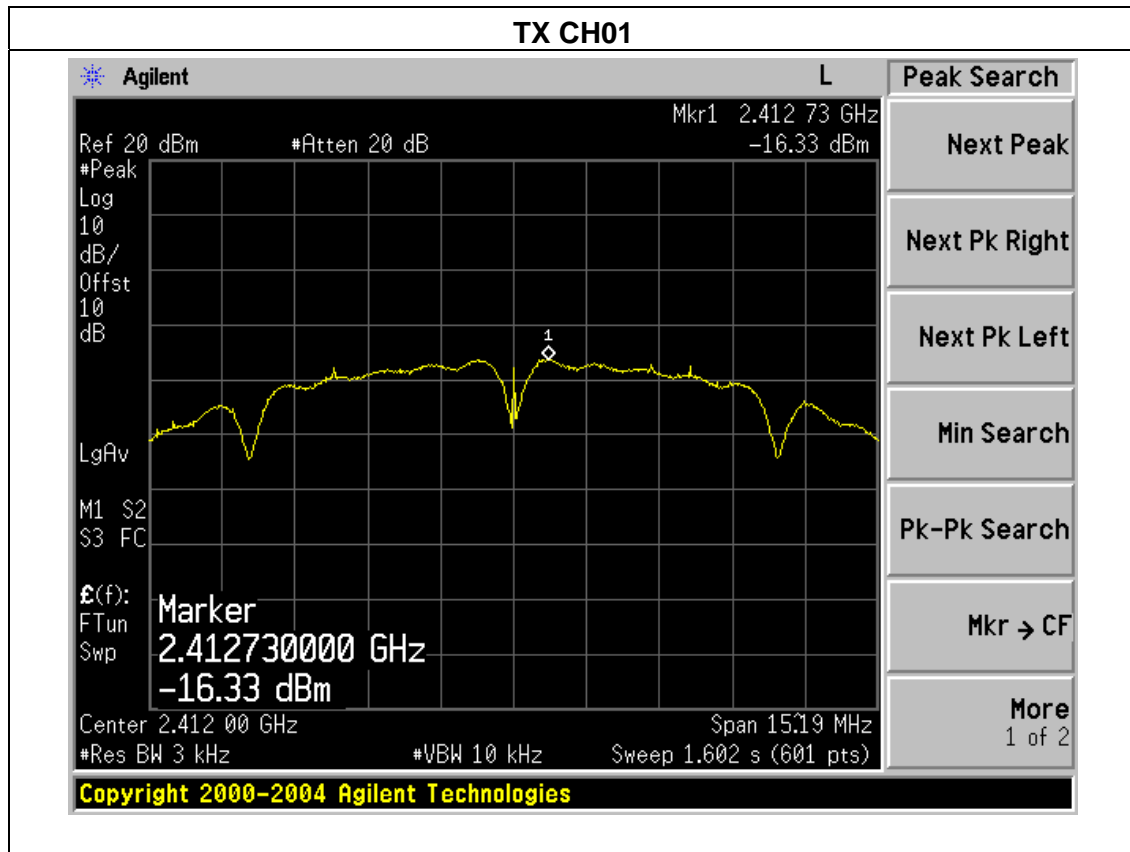

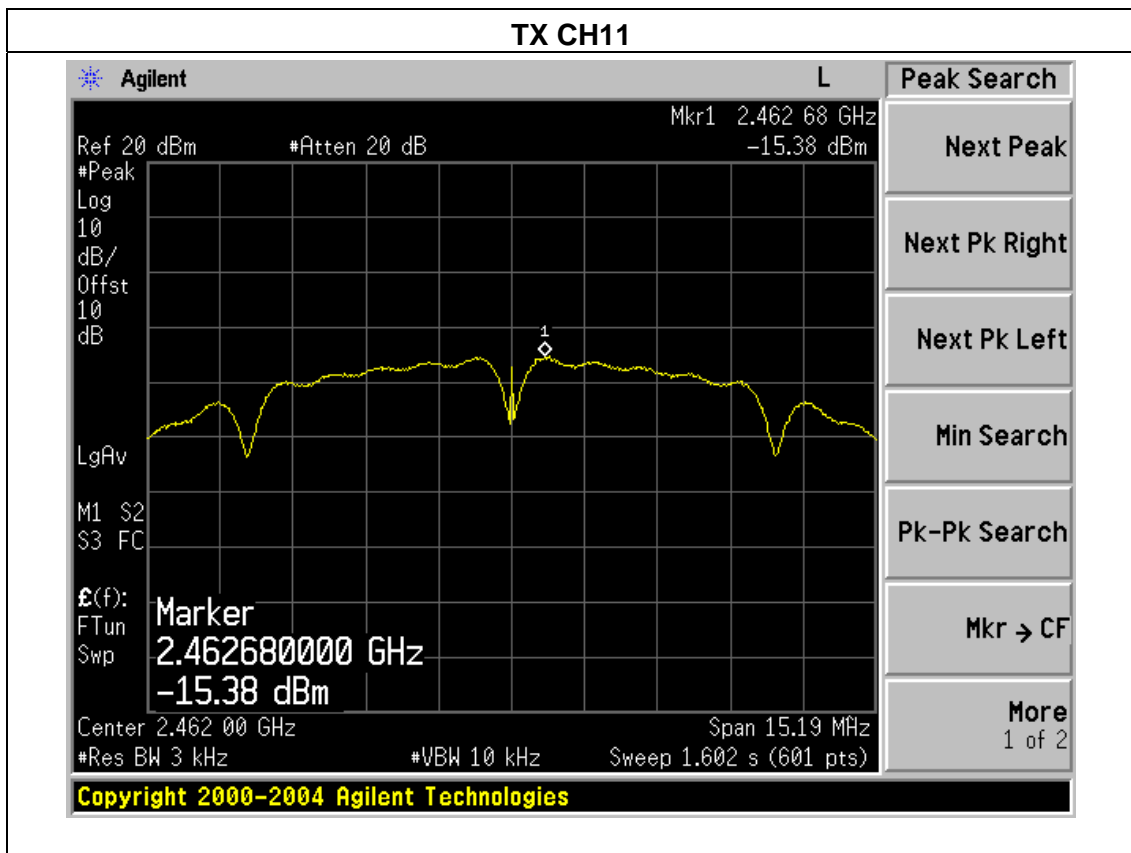
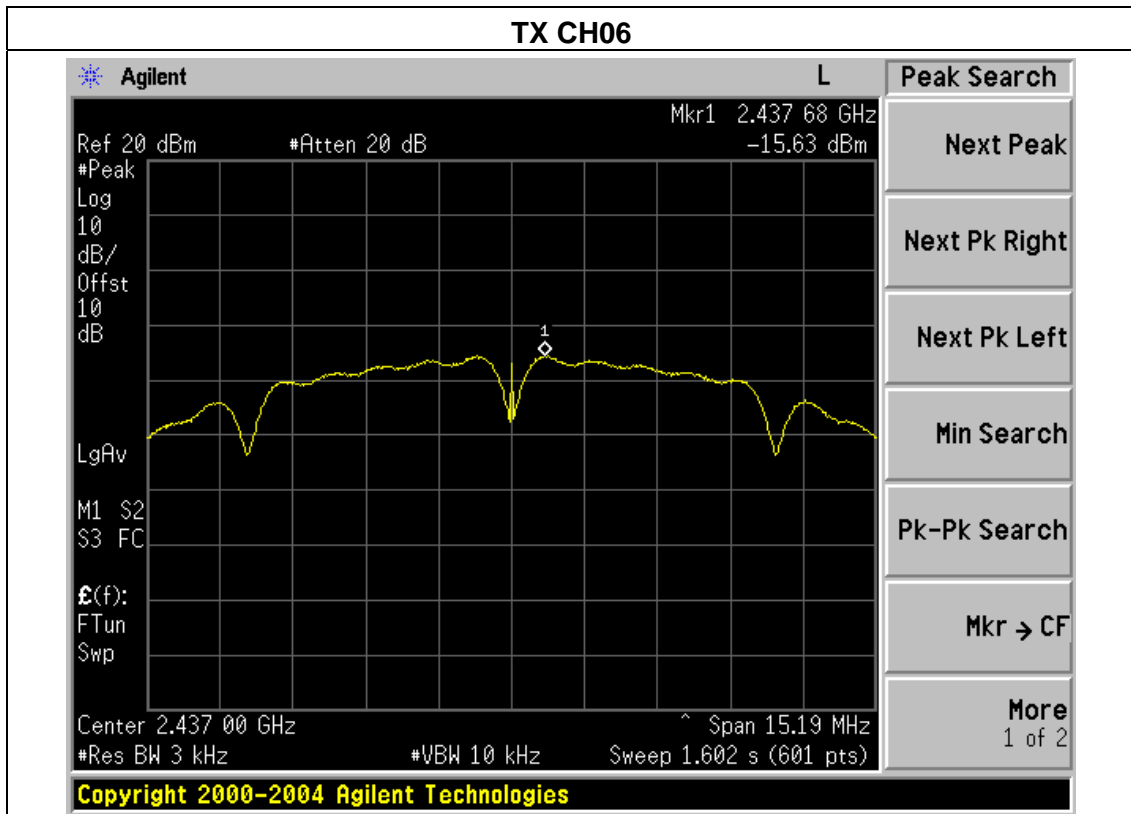

| | | | |
|---------------|--|---------------------|-----------------------------------|
| EUT : | ScreenBeam Enterprise Wireless Display Receiver | Model Name : | SBWD700A |
| Temperature : | 25 °C | Relative Humidity : | 56% |
| Pressure : | 1015 hPa | Test Voltage : | DC 5V From adapter AC120V/60Hz |
| Test Mode : | TX g Mode /CH01, CH06, CH11 | | |

| Frequency | Power Density A (dBm) | Power Density B (dBm) | total power density (dBm) | Limit (dBm) | Result |
|-----------|-----------------------|-----------------------|---------------------------|-------------|--------|
| 2412 MHz | -20.93 | -21.41 | -18.15 | 7.39 | PASS |
| 2437 MHz | -20.62 | -21.13 | -18.02 | 7.39 | PASS |
| 2462 MHz | -20.20 | -20.76 | -17.46 | 7.39 | PASS |

NOTE: A(B) Represent the value of antenna A and B, The worst data is A Antenna , only shown Antenna A Plot.

For 2.4G mode , Limit =8-6.61+6=7.39dBm for output power..

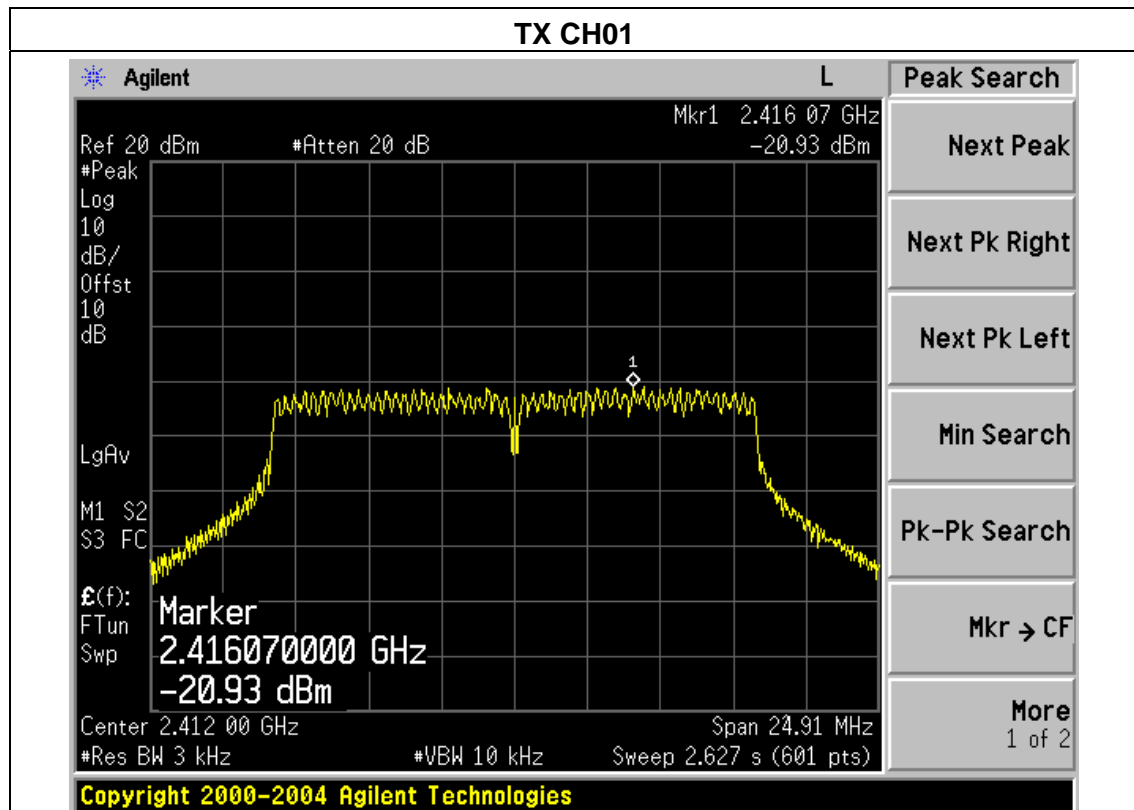

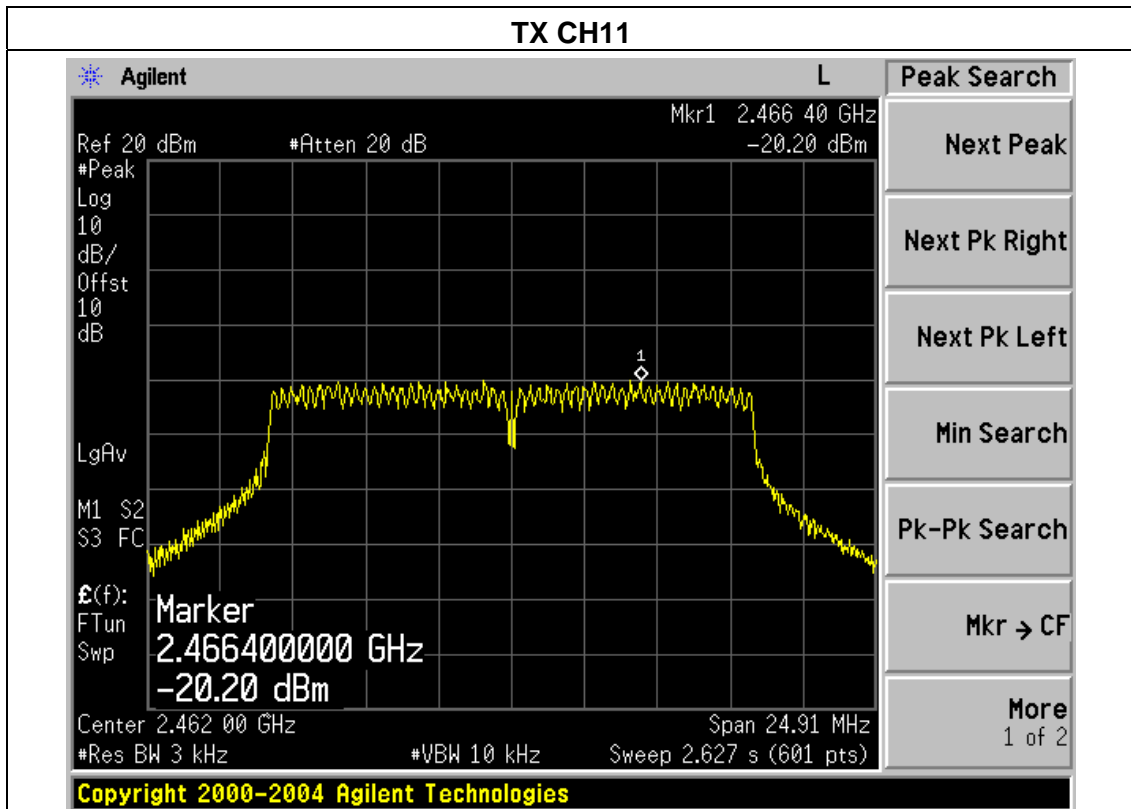
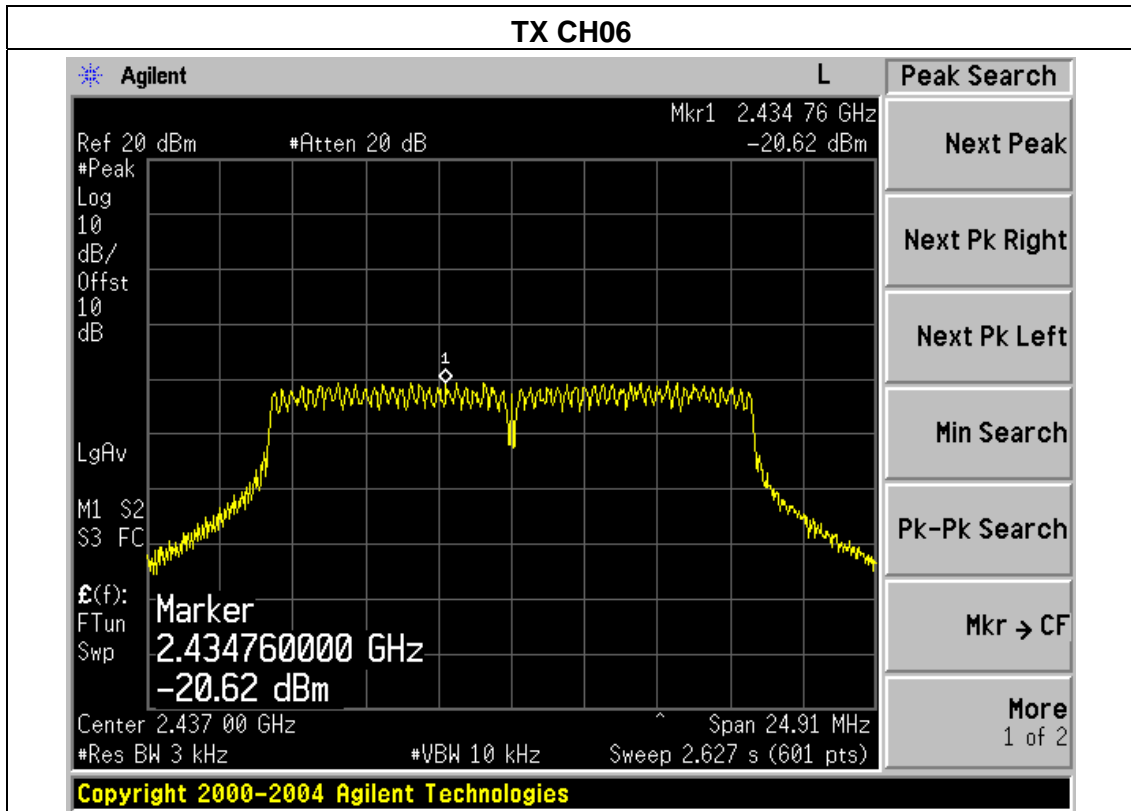

| | | | |
|---------------|---|---------------------|--------------------------------|
| EUT : | ScreenBeam Enterprise Wireless Display Receiver | Model Name : | SBWD700A |
| Temperature : | 25 °C | Relative Humidity : | 56% |
| Pressure : | 1015 hPa | Test Voltage : | DC 5V From adapter AC120V/60Hz |
| Test Mode : | TX n Mode (20MHz)/CH01, CH06, CH11 | | |

| Frequency | Power Density A (dBm) | Power Density B (dBm) | total power density (dBm) | Limit (dBm) | Result |
|-----------|-----------------------|-----------------------|---------------------------|-------------|--------|
| 2412 MHz | -21.78 | -22.31 | -19.03 | 7.39 | PASS |
| 2437 MHz | -21.14 | -21.82 | -18.79 | 7.39 | PASS |
| 2462 MHz | -21.42 | -22.03 | -18.70 | 7.39 | PASS |

NOTE: A(B) Represent the value of antenna A and B, The worst data is A Antenna a ,only shown Antenna A Plot.

For 2.4G mode , Limit $8-6.61+6=7.39$ dBm for output power.

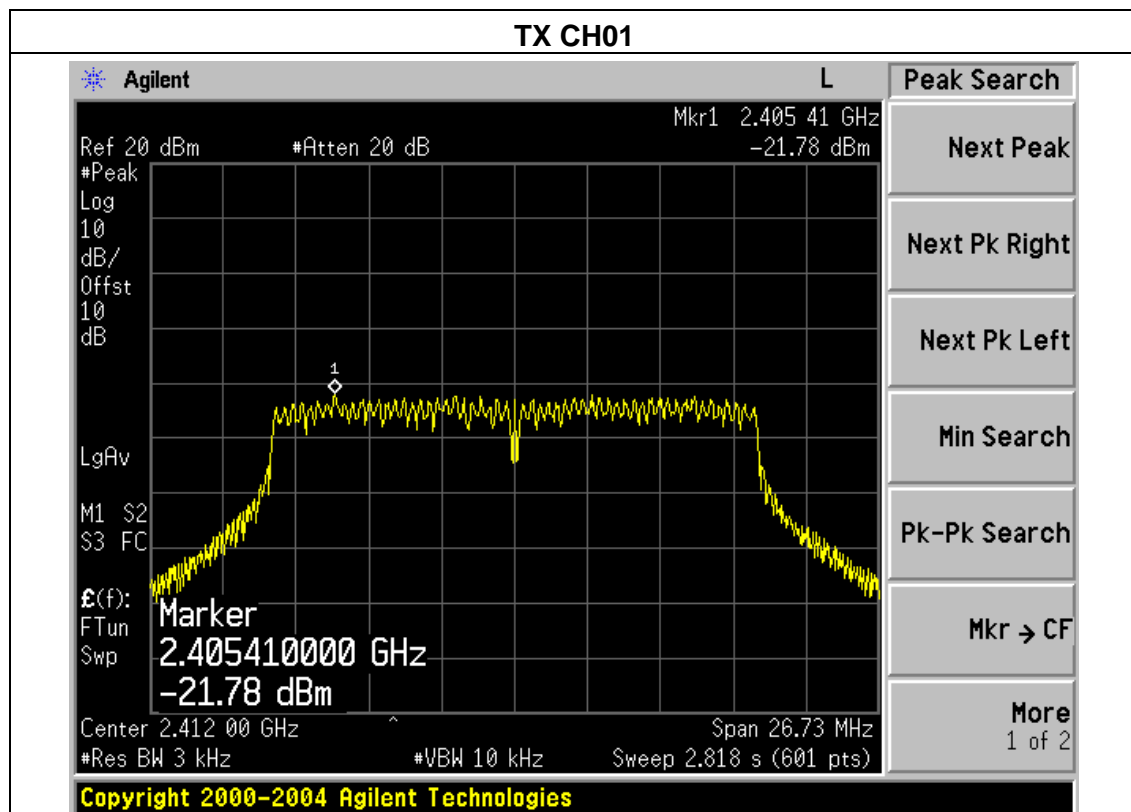

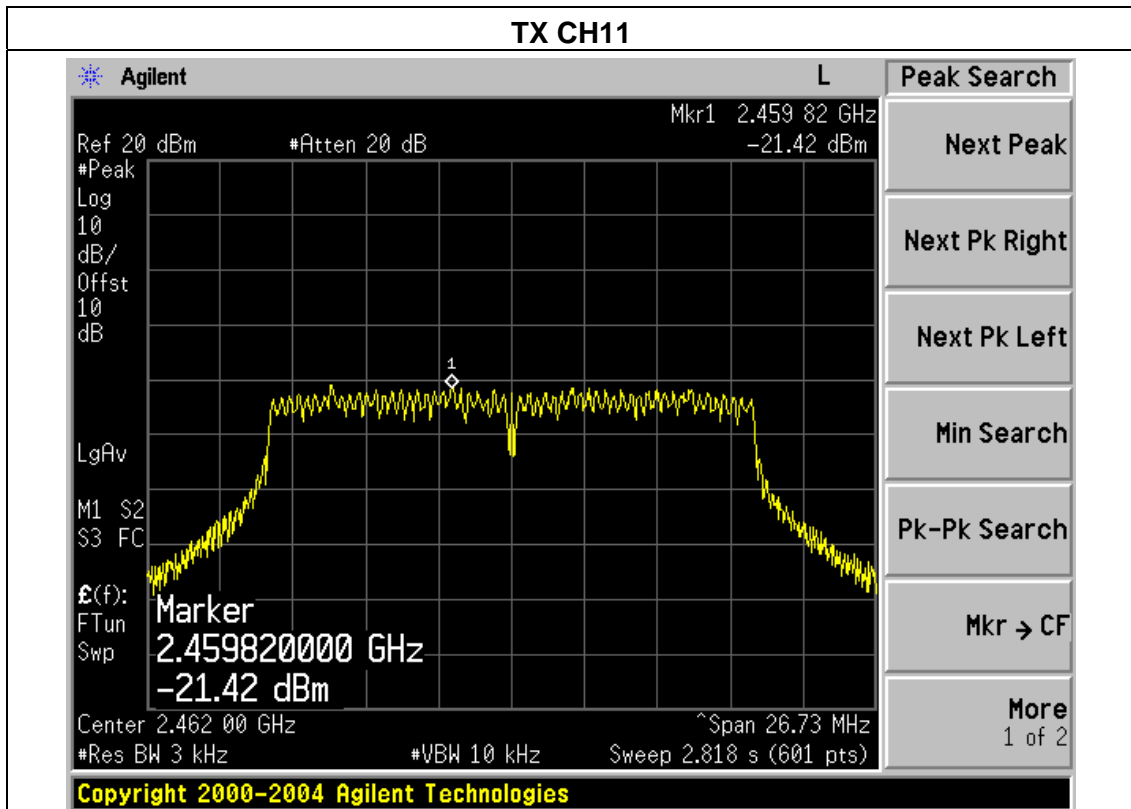
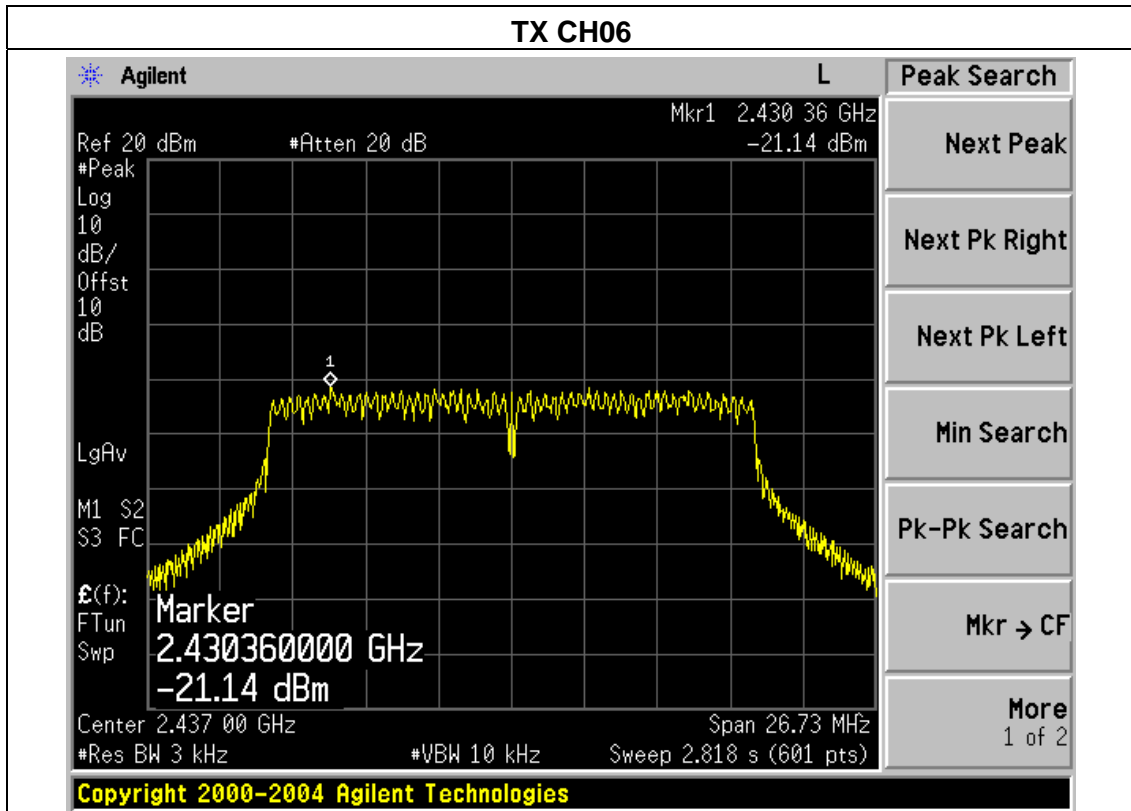

| | | | |
|---------------|---|---------------------|--------------------------------|
| EUT : | ScreenBeam Enterprise Wireless Display Receiver | Model Name : | SBWD700A |
| Temperature : | 25 °C | Relative Humidity : | 56% |
| Pressure : | 1015 hPa | Test Voltage : | DC 5V From adapter AC120V/60Hz |
| Test Mode : | TX n Mode (40MHz)/CH03, CH06, CH09 | | |

| Frequency | Power Density A (dBm) | Power Density B (dBm) | total power density (dBm) | Limit (dBm) | Result |
|-----------|-----------------------|-----------------------|---------------------------|-------------|--------|
| 2422 MHz | -22.91 | -23.45 | -20.16 | 7.39 | PASS |
| 2437 MHz | -22.65 | -23.16 | -20.02 | 7.39 | PASS |
| 2452 MHz | -22.44 | -22.92 | -19.66 | 7.39 | PASS |

NOTE: A(B) Represent the value of antenna A and B, The worst data is A Antenna a ,only shown Antenna A Plot.

. For 2.4G mode , Limit =8-6.61+6=7.39dBm for output power.

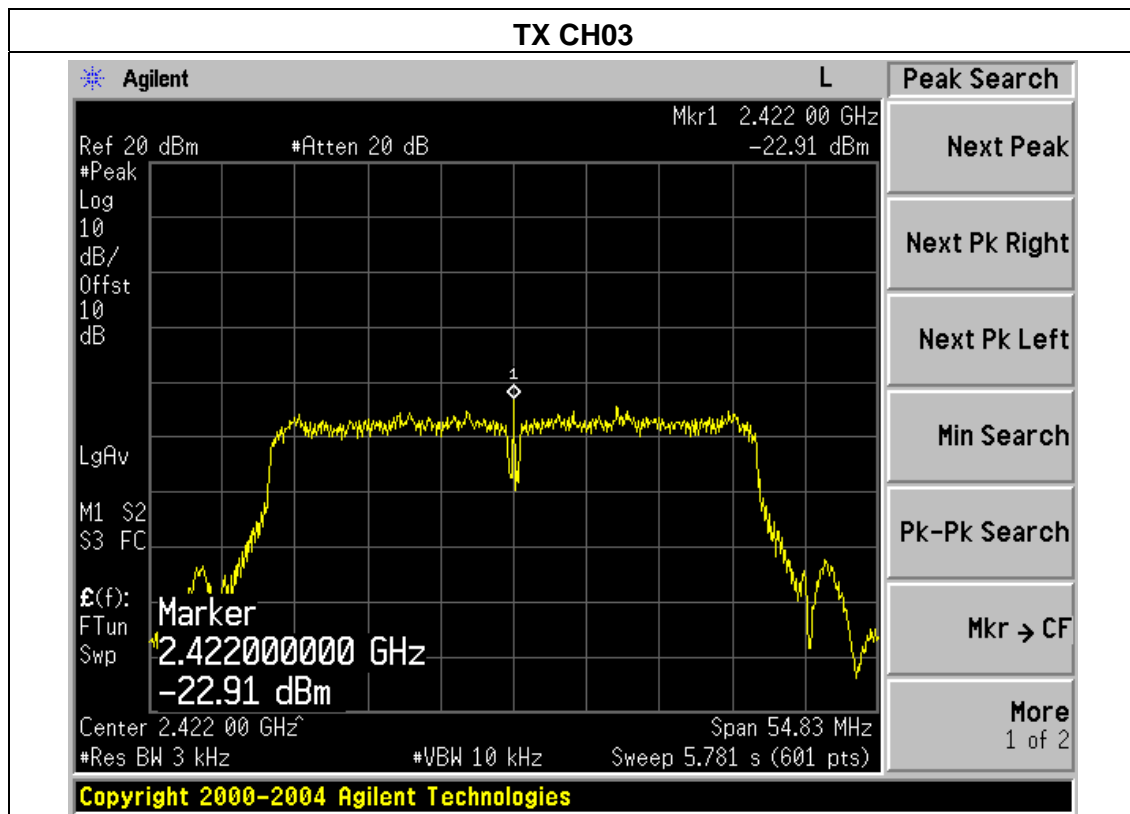

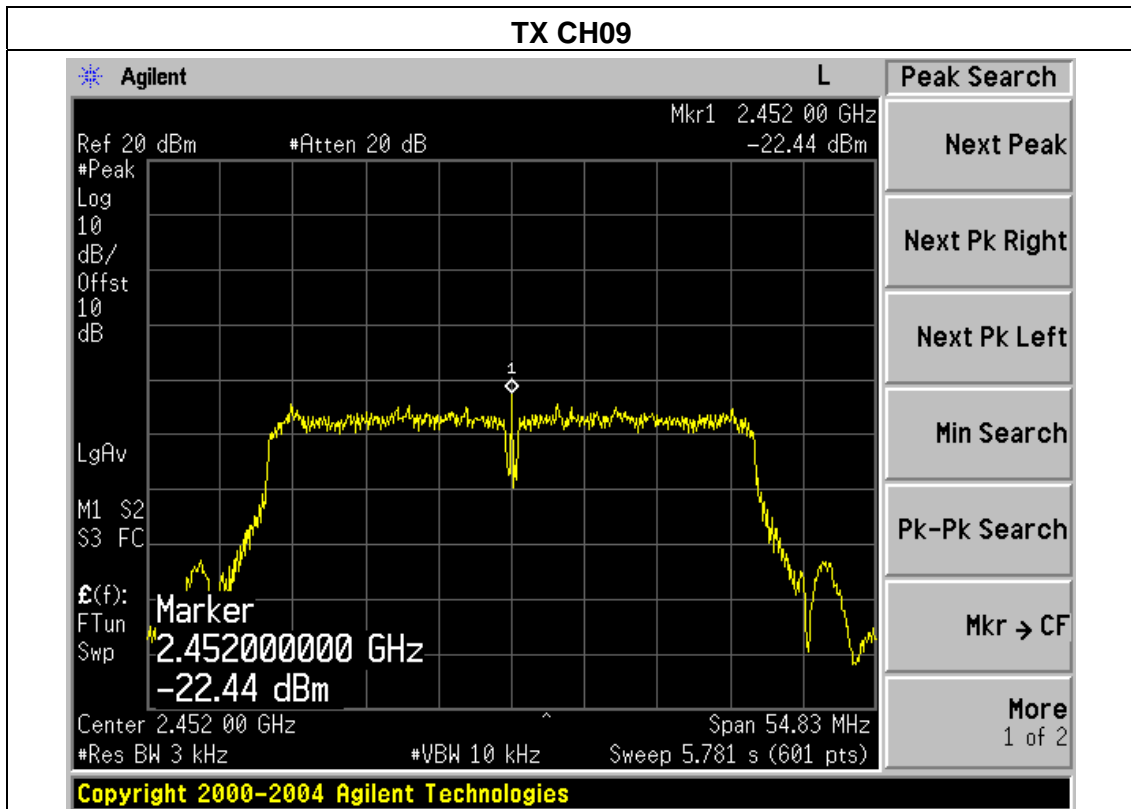
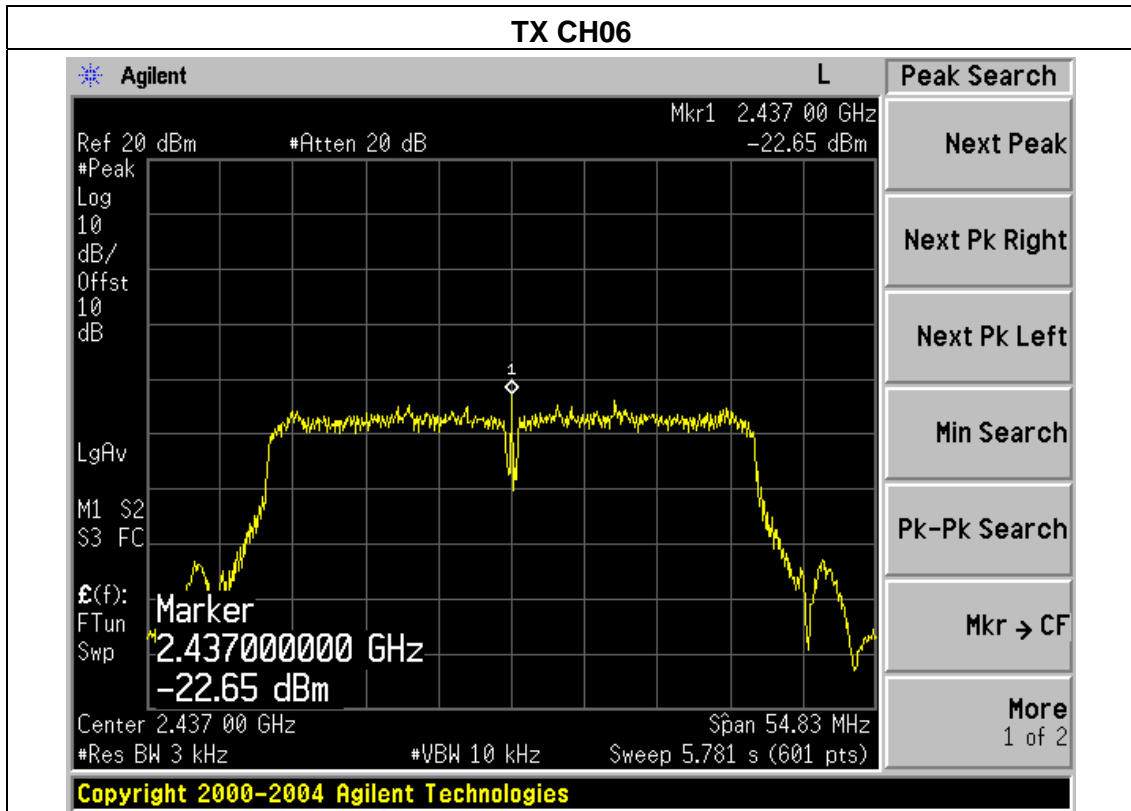

| | | | |
|---------------|---|---------------------|--------------------------------|
| EUT : | ScreenBeam Enterprise Wireless Display Receiver | Model Name : | SBWD700A |
| Temperature : | 25 °C | Relative Humidity : | 56% |
| Pressure : | 1015 hPa | Test Voltage : | DC 5V From adapter AC120V/60Hz |
| Test Mode : | TX a Mode /CH149, CH157, CH165 | | |

| Frequency | Power Density A (dBm) | Power Density B (dBm) | total power density (dBm) | Limit (dBm) | Result |
|-----------|-----------------------|-----------------------|---------------------------|-------------|--------|
| 5745MHz | -21.55 | -22.01 | -18.76 | 7.79 | PASS |
| 5785 MHz | -22.00 | -22.46 | -18.97 | 7.79 | PASS |
| 5825 MHz | -21.69 | -22.13 | -18.89 | 7.79 | PASS |

Note: A (B) Represent the value of antenna A and B, The worst data is A Antenna a ,only shown Antenna A Plot.

For 5G mode , Limit = $8-6.21+6=7.79$ dBm for output power.

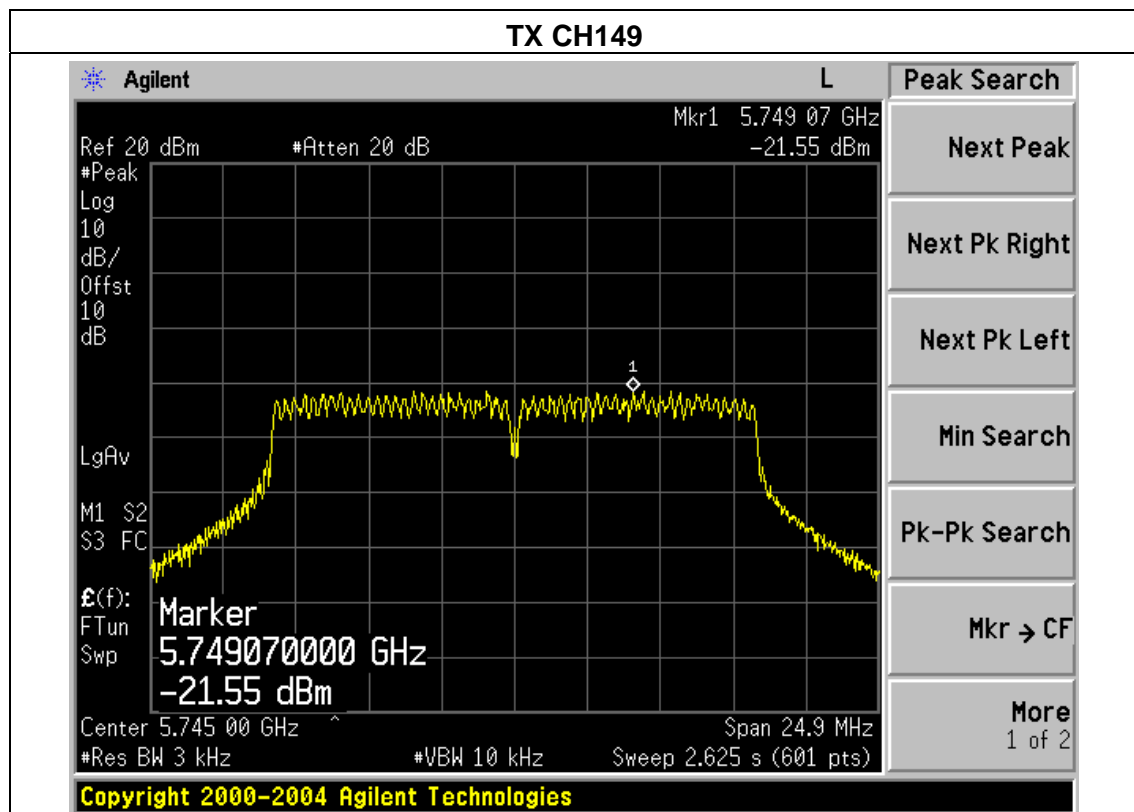

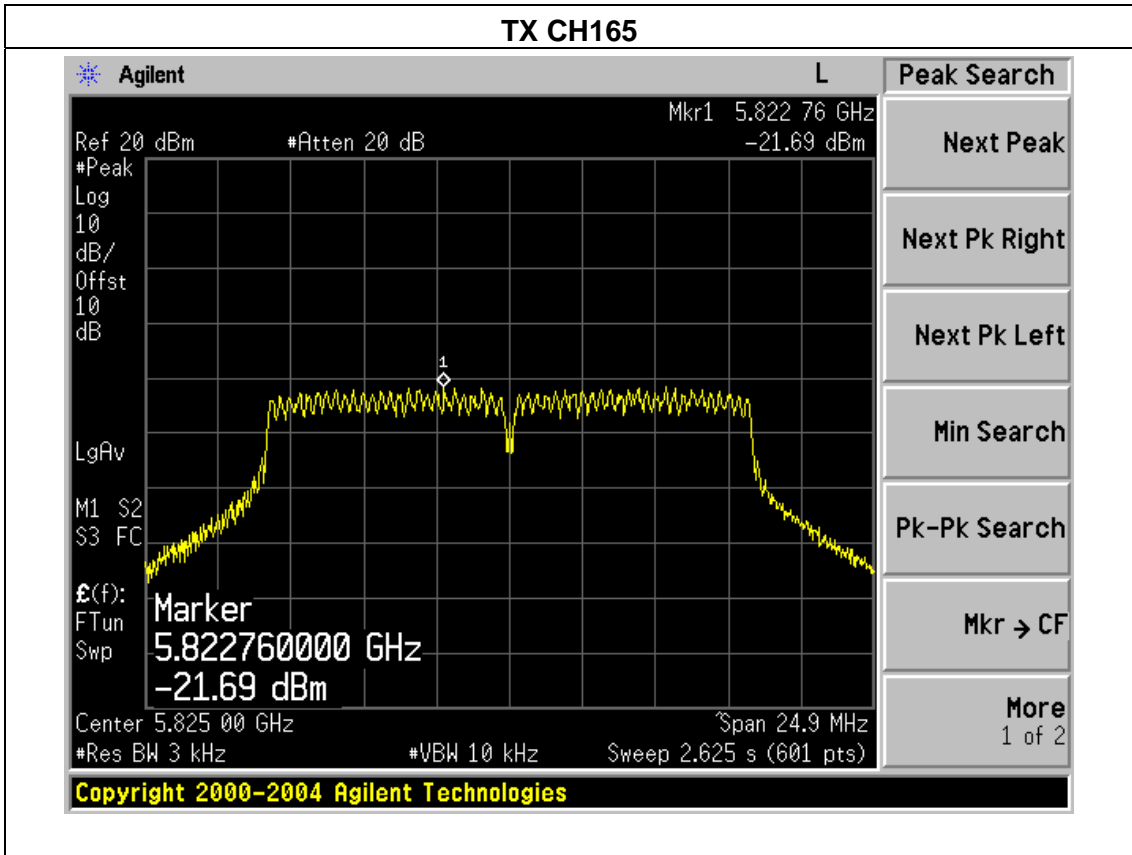
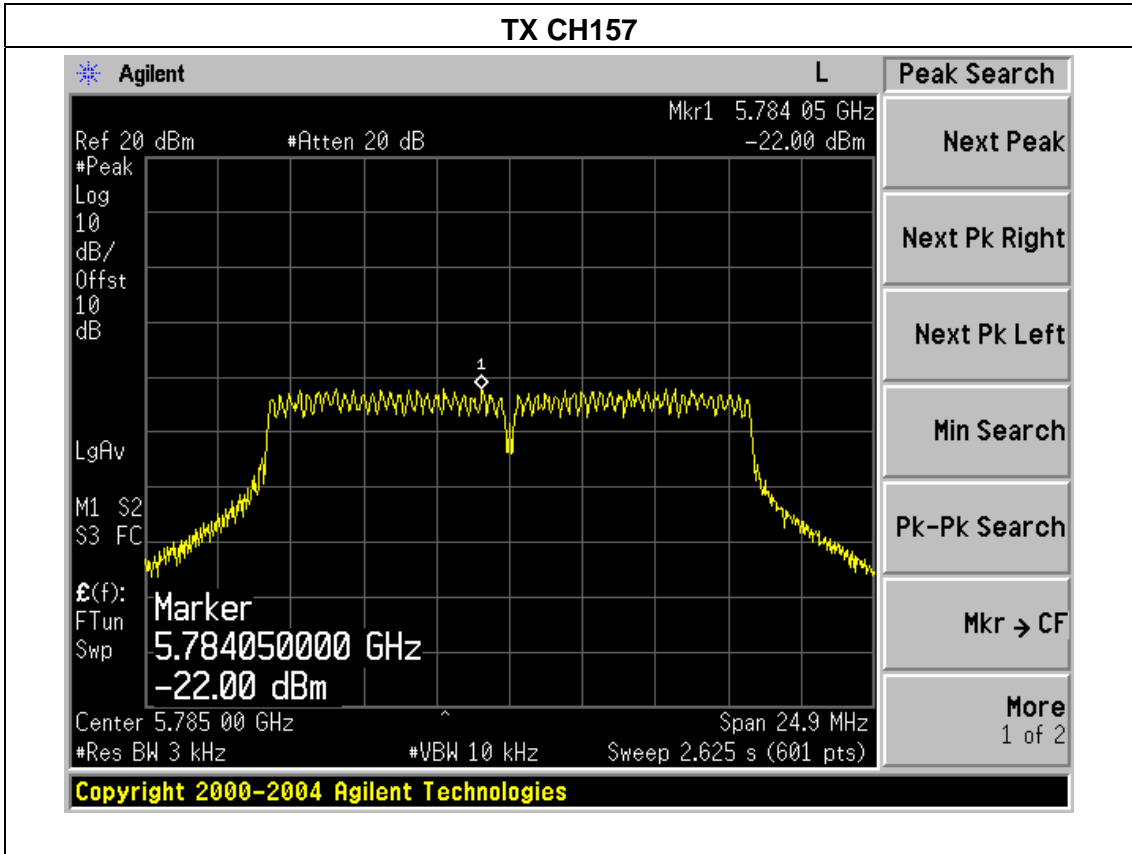

| | | | |
|---------------|---|---------------------|--------------------------------|
| EUT : | ScreenBeam Enterprise Wireless Display Receiver | Model Name : | SBWD700A |
| Temperature : | 25 °C | Relative Humidity : | 56% |
| Pressure : | 1015 hPa | Test Voltage : | DC 5V From adapter AC120V/60Hz |
| Test Mode : | TX n(20) Mode(5G) /CH149, CH157, CH165 | | |

| Frequency | Power Density A (dBm) | Power Density B (dBm) | total power density (dBm) | Limit (dBm) | Result |
|-----------|-----------------------|-----------------------|---------------------------|-------------|--------|
| 5745MHz | -22.40 | -22.97 | -19.67 | 7.79 | PASS |
| 5785 MHz | -22.63 | -23.06 | -19.71 | 7.79 | PASS |
| 5825 MHz | -22.63 | -23.12 | -19.86 | 7.79 | PASS |

Note: A (B) Represent the value of antenna A and B, The worst data is A Antenna a ,only shown Antenna A Plot.

For 5G mode , Limit = $8-6.21+6=7.79$ dBm for output power.

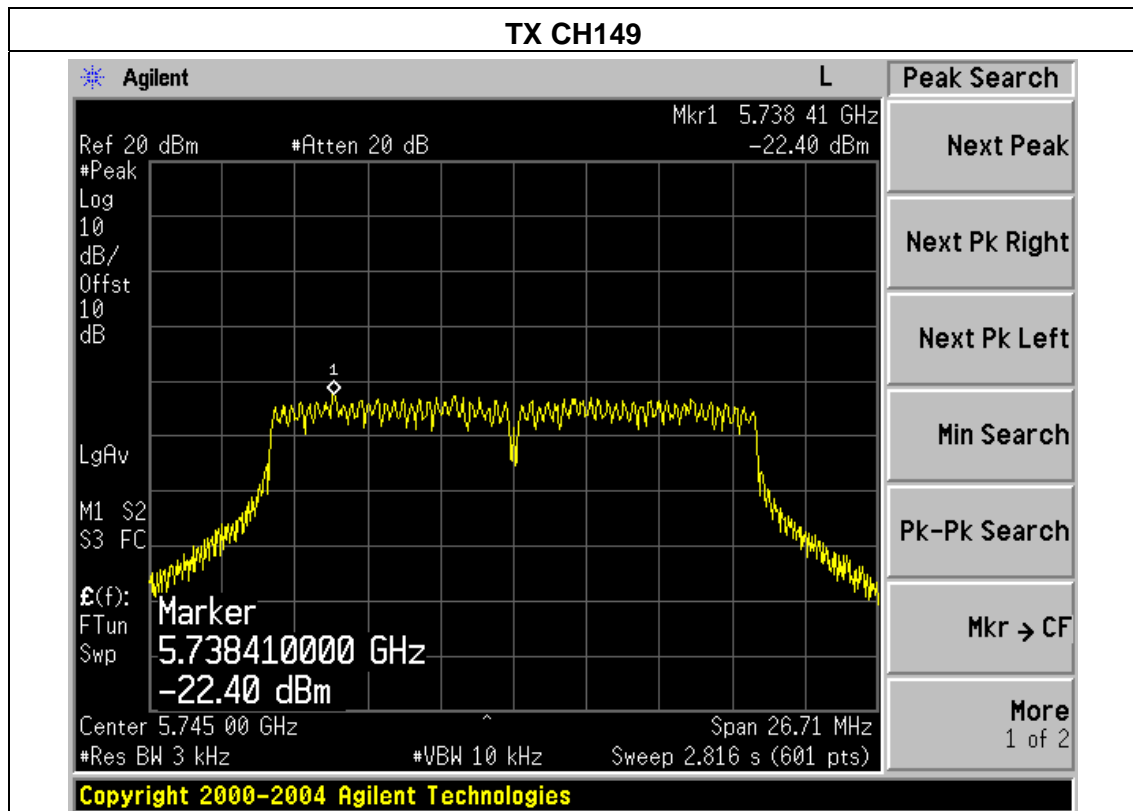

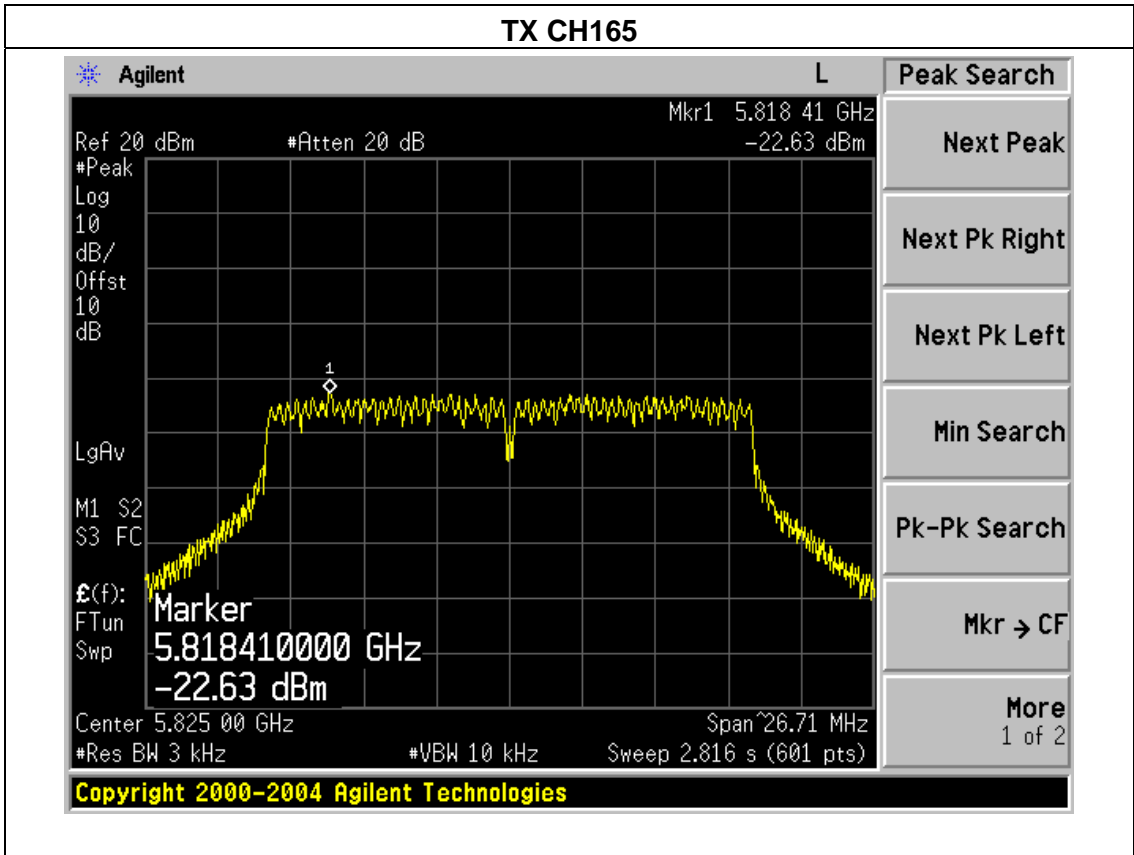
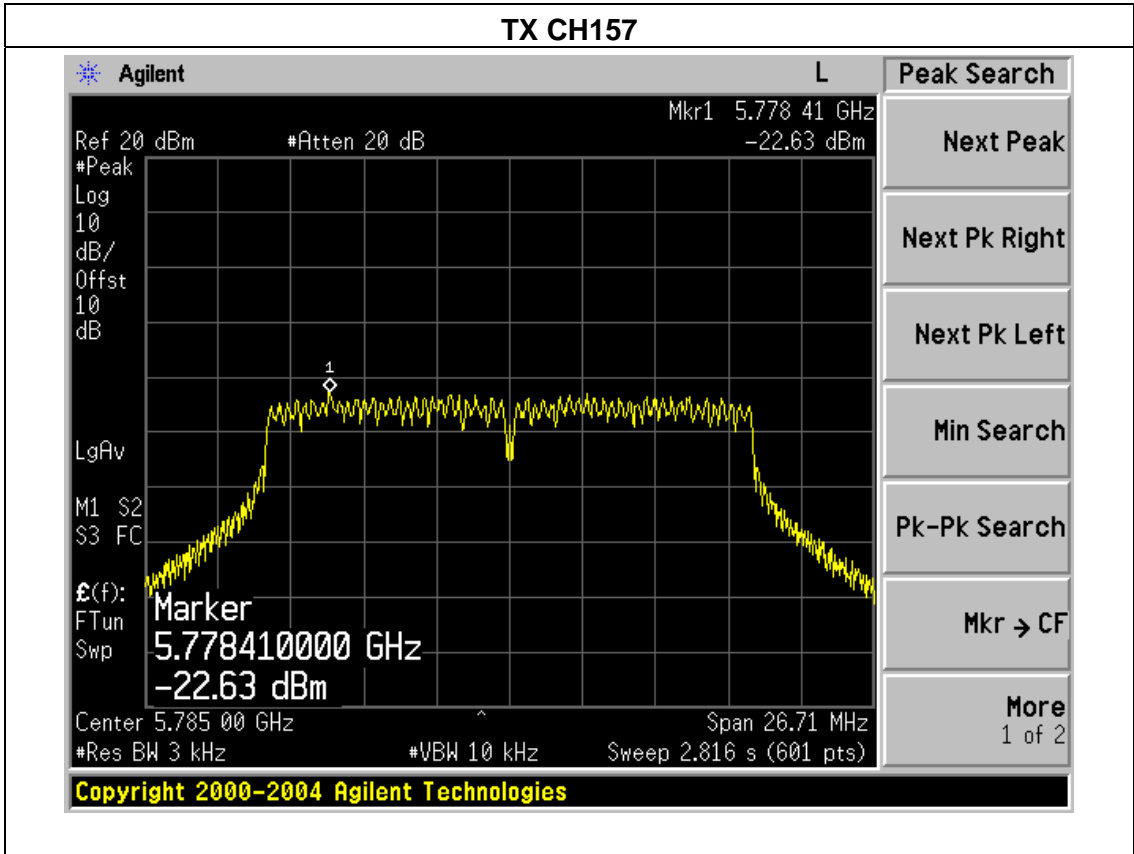

| | | | |
|---------------|---|---------------------|--------------------------------|
| EUT : | ScreenBeam Enterprise Wireless Display Receiver | Model Name : | SBWD700A |
| Temperature : | 25 °C | Relative Humidity : | 56% |
| Pressure : | 1015 hPa | Test Voltage : | DC 5V From adapter AC120V/60Hz |
| Test Mode : | TX n40 Mode(5G) /CH151, CH159 | | |

| Frequency | Power Density A (dBm) | Power Density B (dBm) | total power density (dBm) | Limit (dBm) | Result |
|-----------|-----------------------|-----------------------|---------------------------|-------------|--------|
| 5755 MHz | -25.16 | -25.76 | -22.44 | 7.79 | PASS |
| 5795 MHz | -26.63 | -27.11 | -23.02 | 7.79 | PASS |

Note: A (B) Represent the value of antenna A and B, The worst data is A Antenna a ,only shown Antenna A Plot.

For5G mode , Limit = $8-6.21+6=7.79$ dBm for output power.

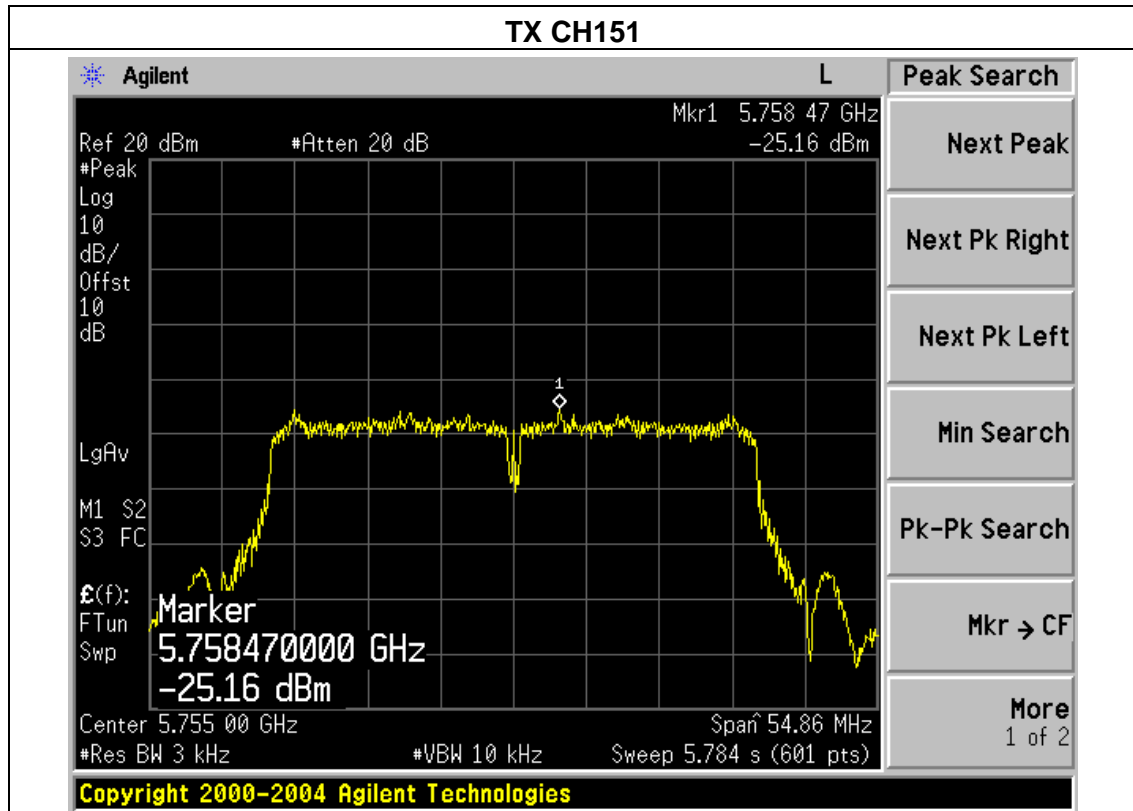

TX CH159

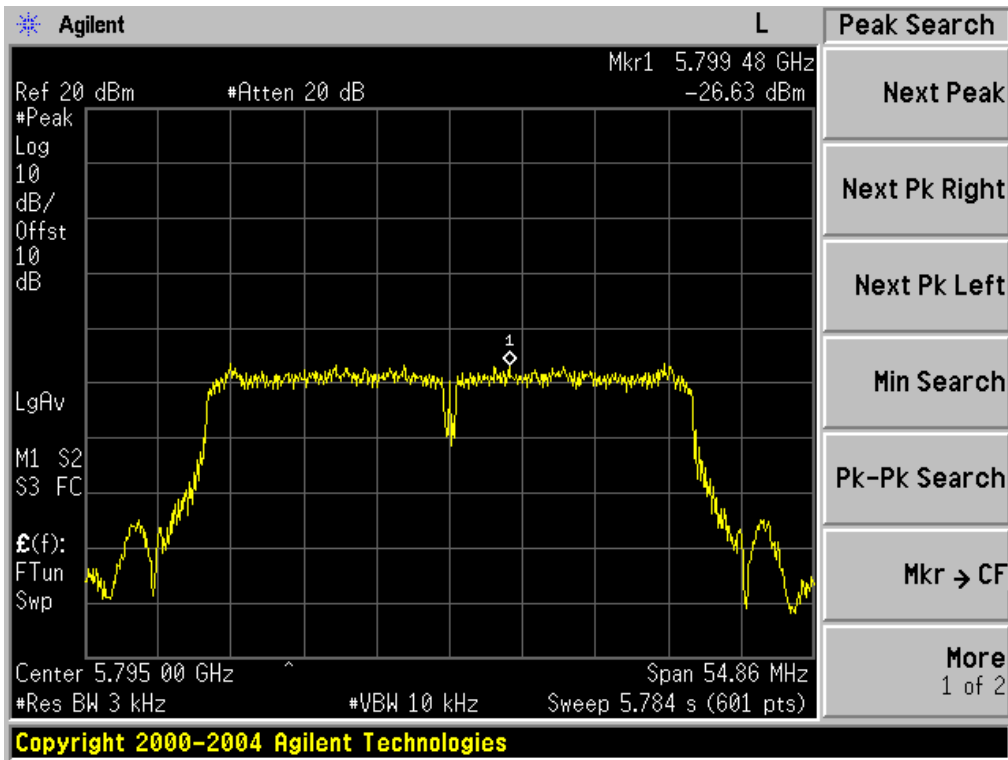

5. BANDWIDTH TEST

5.1 APPLIED PROCEDURES / LIMIT

| FCC Part15 (15.247) , Subpart C | | | | |
|---------------------------------|-----------|---|-----------------------|--------|
| Section | Test Item | Limit | Frequency Range (MHz) | Result |
| 15.247(a)(2) | Bandwidth | $\geq 500\text{KHz}$ (6dB bandwidth) | 2400-2483.5 | PASS |

5.1.1 TEST PROCEDURE

1. Set RBW = 100 kHz.
2. Set the video bandwidth (VBW) $\geq 3 \times$ RBW.
3. Detector = Peak.
4. Trace mode = max hold.
5. Sweep = auto couple.
6. Allow the trace to stabilize.
7. Measure the maximum width of the emission that is constrained by the frequencies associated with the two outermost amplitude points (upper and lower) that are attenuated by 6 dB relative to the maximum level measured in the fundamental emission.

TEST SETUP

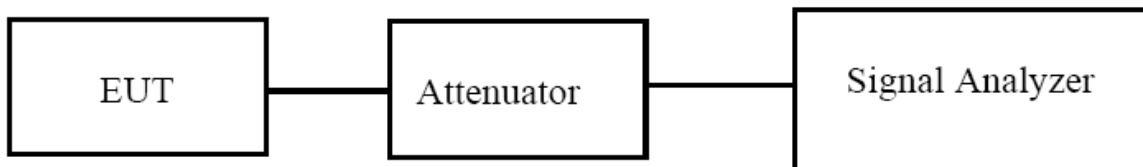

5.1.2 EUT OPERATION CONDITIONS

The EUT tested system was configured as the statements of 2.4 Unless otherwise a special operating condition is specified in the follows during the testing.

5.1.3 TEST RESULTS

| | | | |
|---------------|---|---------------------|--------------------------------|
| EUT : | ScreenBeam Enterprise Wireless Display Receiver | Model Name : | SBWD700A |
| Temperature : | 25 °C | Relative Humidity : | 56% |
| Pressure : | 1012 hPa | Test Voltage : | DC 5V From adapter AC120V/60Hz |
| Test Mode : | TX b Mode /CH01, CH06, CH11 | | |

| Channel | Frequency (MHz) | 6dB bandwidth (MHz) | | Limit (kHz) | Result |
|---------|-----------------|---------------------|--------|-------------|--------|
| | | ANT A | ANT B | | |
| Low | 2412 | 10.123 | 10.037 | 500 | Pass |
| Middle | 2437 | 10.118 | 10.058 | 500 | Pass |
| High | 2462 | 10.123 | 10.063 | 500 | Pass |

Note: A (B) Represent the value of antenna A and B, The worst data is A Antenna a , only shown Antenna A Plot.

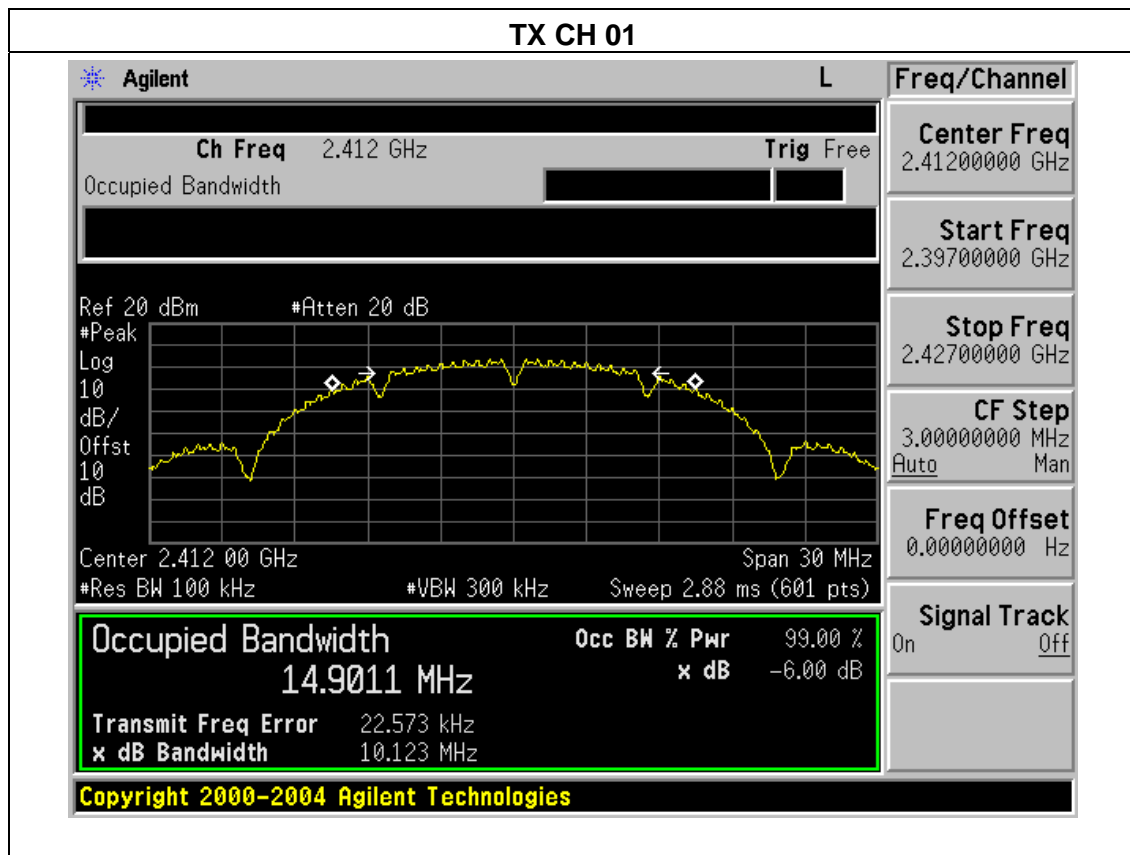

TX CH 06

| | | | |
|---|--|--|--|
| L | | Freq/Channel | |
| Ch Freq 2.437 GHz Trig Free | | Center Freq 2.43700000 GHz | |
| Occupied Bandwidth | | Start Freq 2.42200000 GHz | |
| Center 2.437000000 GHz | | Stop Freq 2.45200000 GHz | |
| Ref 20 dBm #Atten 20 dB | | CF Step 3.00000000 MHz Auto Man | |
| | | Freq Offset 0.00000000 Hz | |
| Center 2.437 00 GHz Span 30 MHz #Res BW 100 kHz #VBW 300 kHz Sweep 2.88 ms (601 pts) | | Signal Track On Off | |
| Occupied Bandwidth | | Occ BW % Pwr 99.00 % | |
| 14.8798 MHz | | x dB -6.00 dB | |
| Transmit Freq Error 11.281 kHz | | | |
| x dB Bandwidth 10.118 MHz | | | |
| Copyright 2000-2004 Agilent Technologies | | | |

TX CH 11

| | | | |
|---|--|--|--|
| L | | Freq/Channel | |
| Ch Freq 2.462 GHz Trig Free | | Center Freq 2.46200000 GHz | |
| Occupied Bandwidth | | Start Freq 2.44700000 GHz | |
| Center 2.462000000 GHz | | Stop Freq 2.47700000 GHz | |
| Ref 20 dBm #Atten 20 dB | | CF Step 3.00000000 MHz Auto Man | |
| | | Freq Offset 0.00000000 Hz | |
| Center 2.462 00 GHz Span 30 MHz #Res BW 100 kHz #VBW 300 kHz Sweep 2.88 ms (601 pts) | | Signal Track On Off | |
| Occupied Bandwidth | | Occ BW % Pwr 99.00 % | |
| 14.9274 MHz | | x dB -6.00 dB | |
| Transmit Freq Error -6.614 kHz | | | |
| x dB Bandwidth 10.123 MHz | | | |
| Copyright 2000-2004 Agilent Technologies | | | |

| | | | |
|---------------|---|---------------------|--------------------------------|
| EUT : | ScreenBeam Enterprise Wireless Display Receiver | Model Name : | SBWD700A |
| Temperature : | 25 °C | Relative Humidity : | 60% |
| Pressure : | 1012 hPa | Test Voltage : | DC 5V From adapter AC120V/60Hz |
| Test Mode : | TX g Mode /CH01, CH06, CH11 | | |

| Channel | Frequency (MHz) | 6dB bandwidth (MHz) | | Limit (kHz) | Result |
|---------|-----------------|---------------------|--------|-------------|--------|
| | | ANT A | ANT B | | |
| Low | 2412 | 16.566 | 16.342 | 500 | Pass |
| Middle | 2437 | 16.604 | 16.353 | 500 | Pass |
| High | 2462 | 16.581 | 16.251 | 500 | Pass |

Note: A (B) Represent the value of antenna A and B, The worst data is A Antenna a ,only shown Antenna A Plot.

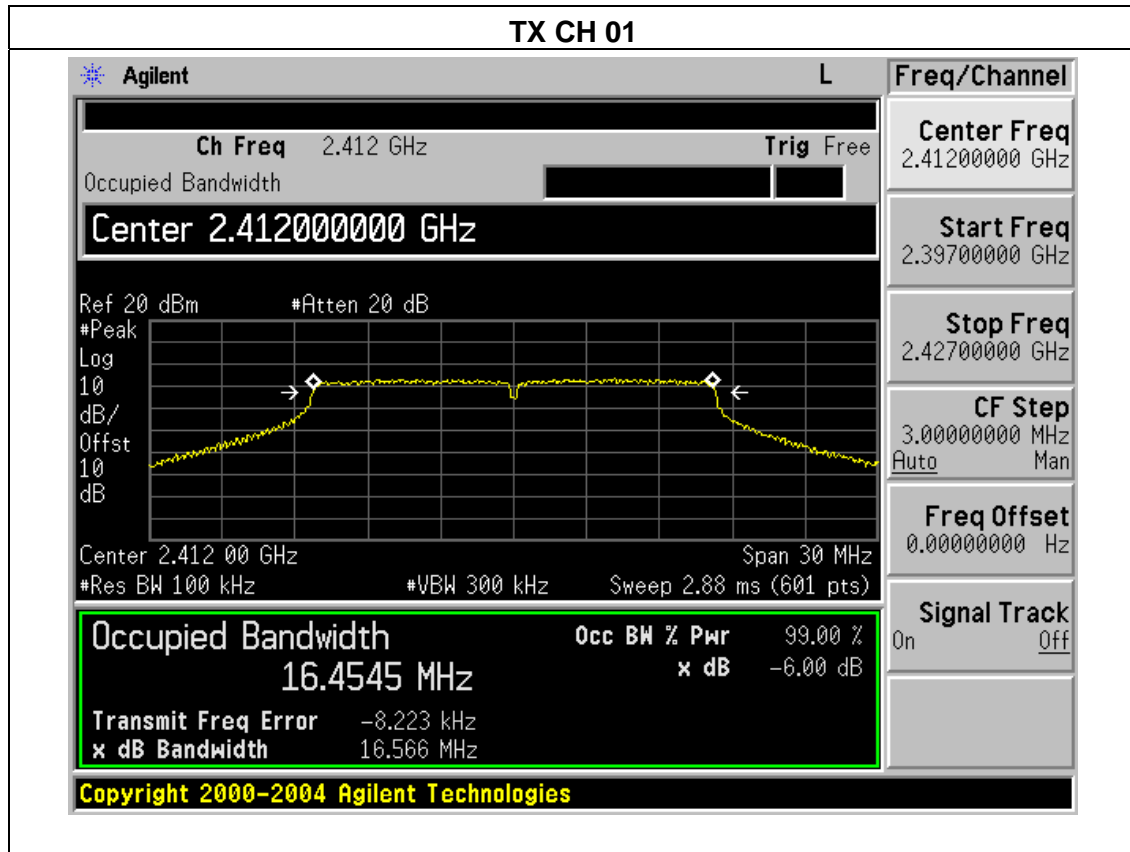

TX CH 06

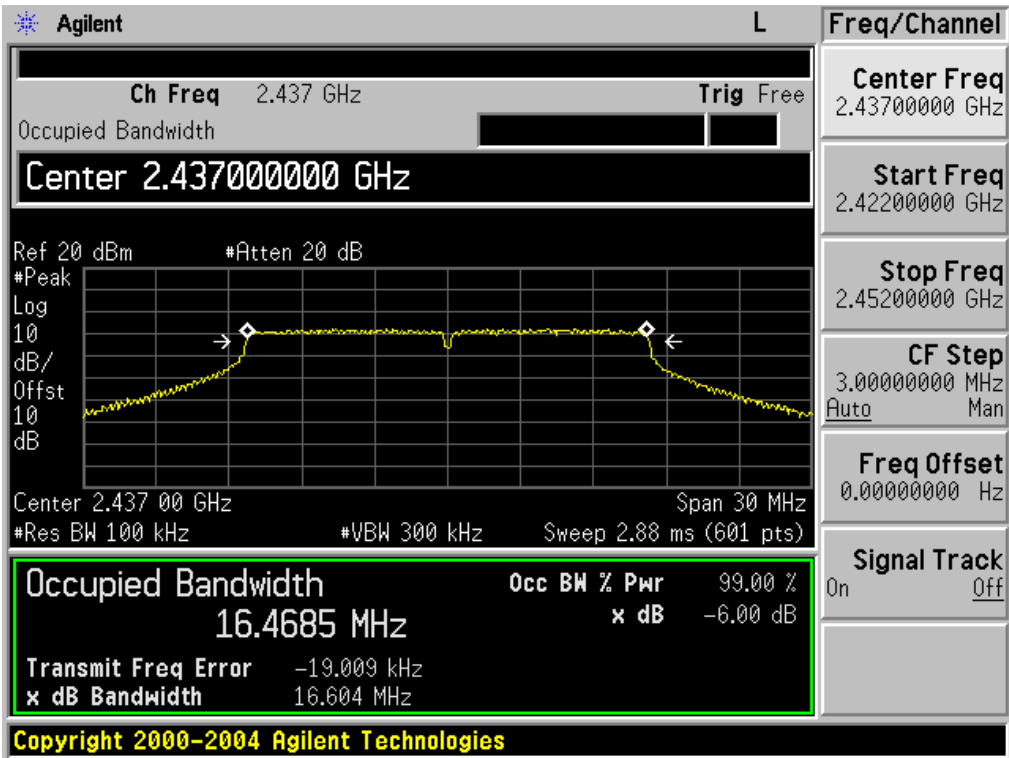

TX CH 11

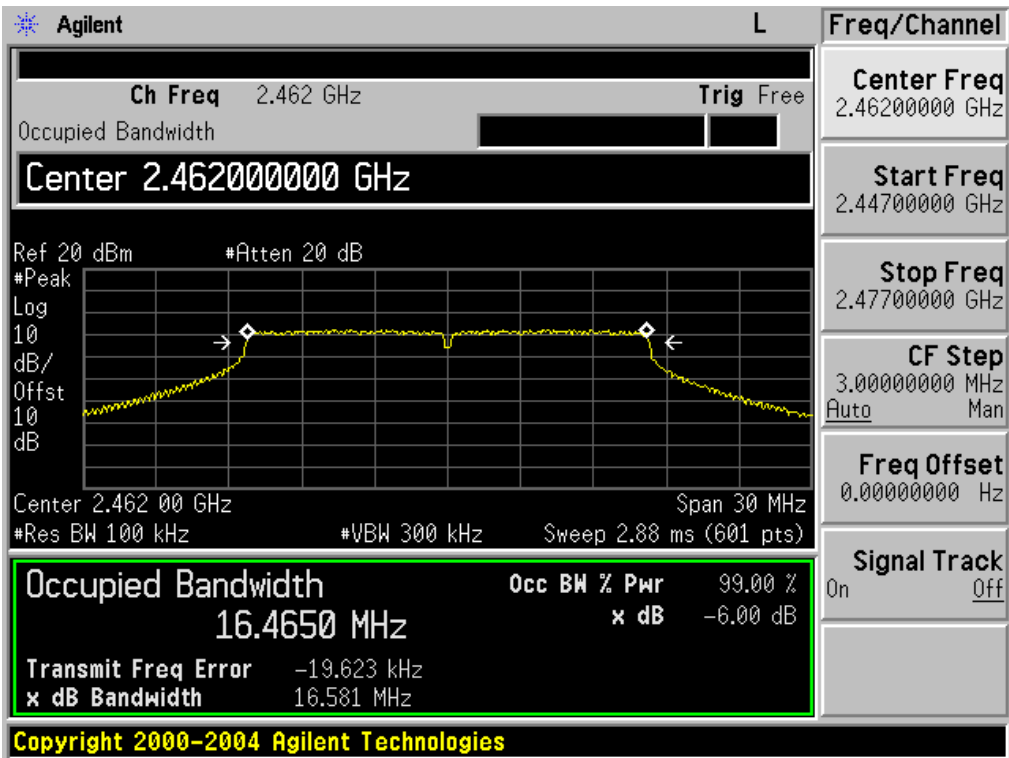

| | | | |
|---------------|---|---------------------|--------------------------------|
| EUT : | ScreenBeam Enterprise Wireless Display Receiver | Model Name : | SBWD700A |
| Temperature : | 25 °C | Relative Humidity : | 56% |
| Pressure : | 1012 hPa | Test Voltage : | DC 5V From adapter AC120V/60Hz |
| Test Mode : | TX n Mode(20M) /CH01, CH06, CH11 | | |

| Channel | Frequency (MHz) | 6dB bandwidth (MHz) | | Limit (kHz) | Result |
|---------|-----------------|---------------------|--------|-------------|--------|
| | | ANT A | ANT B | | |
| Low | 2412 | 17.813 | 17.578 | 500 | Pass |
| Middle | 2437 | 17.805 | 17.479 | 500 | Pass |
| High | 2462 | 17.816 | 17.523 | 500 | Pass |

Note: A (B) Represent the value of antenna A and B, The worst data is A Antenna a ,only shown Antenna A Plot.

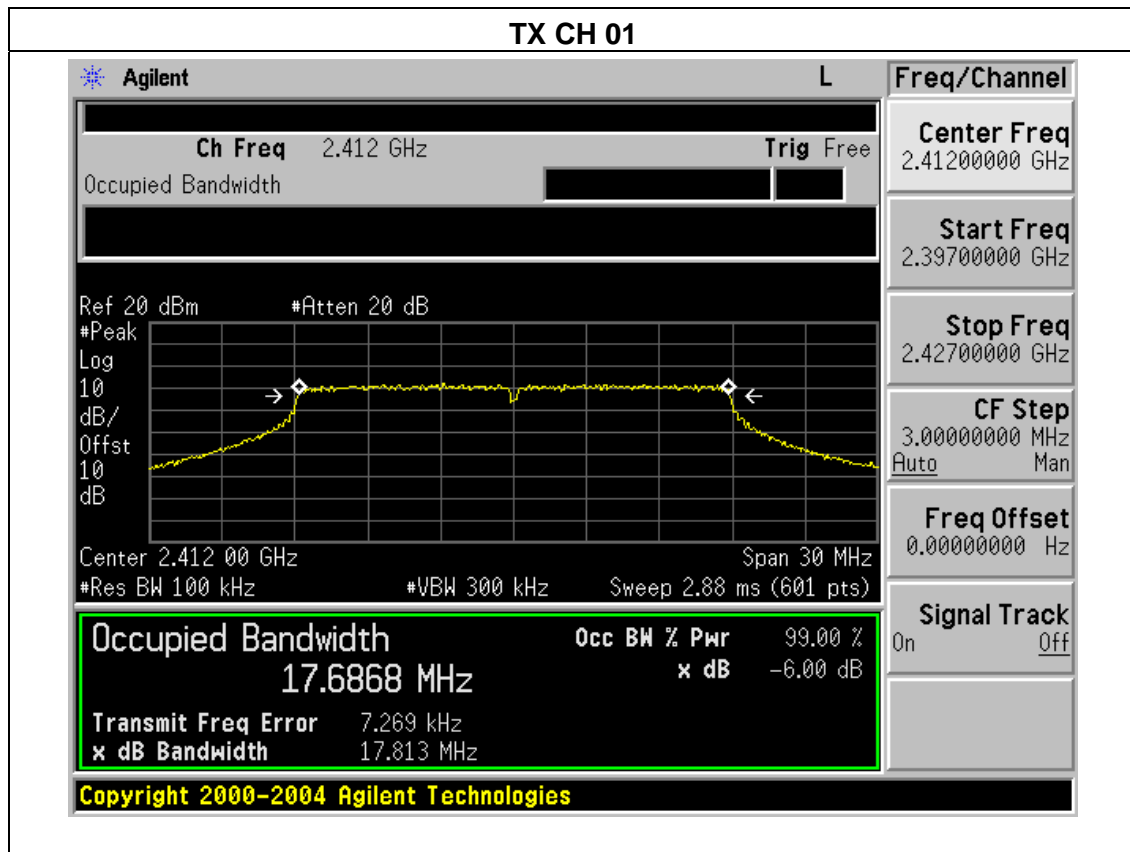

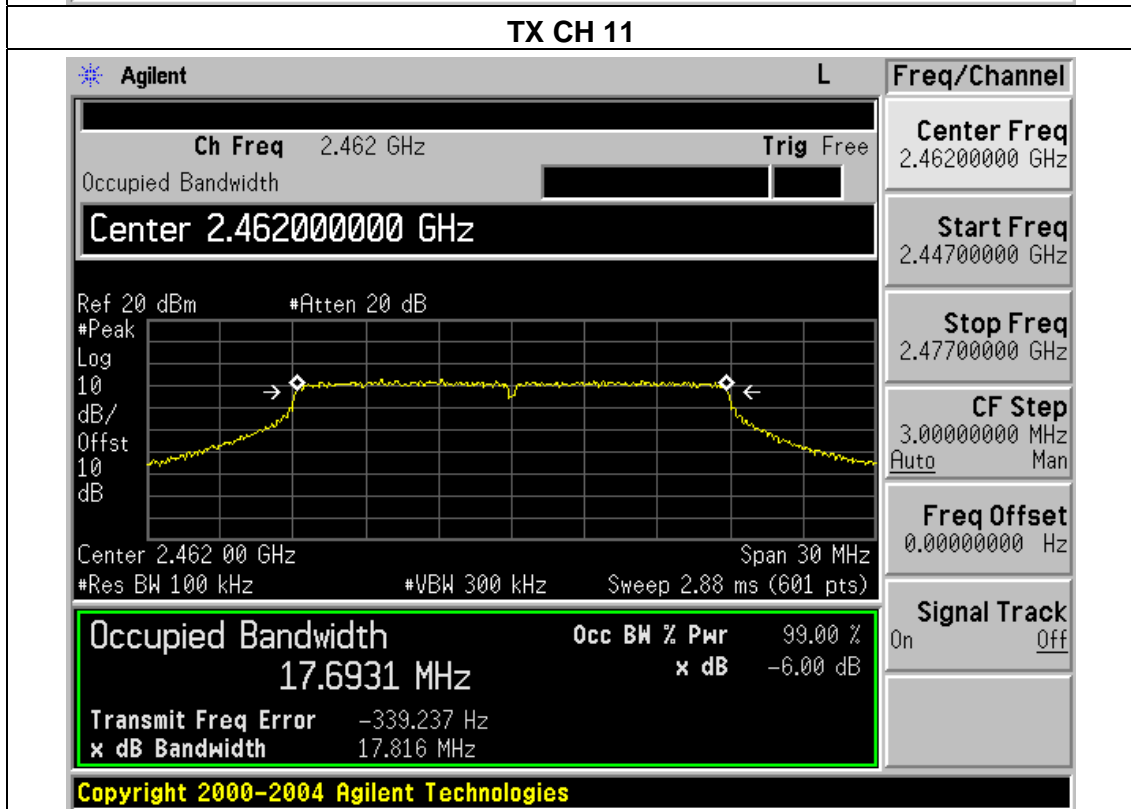
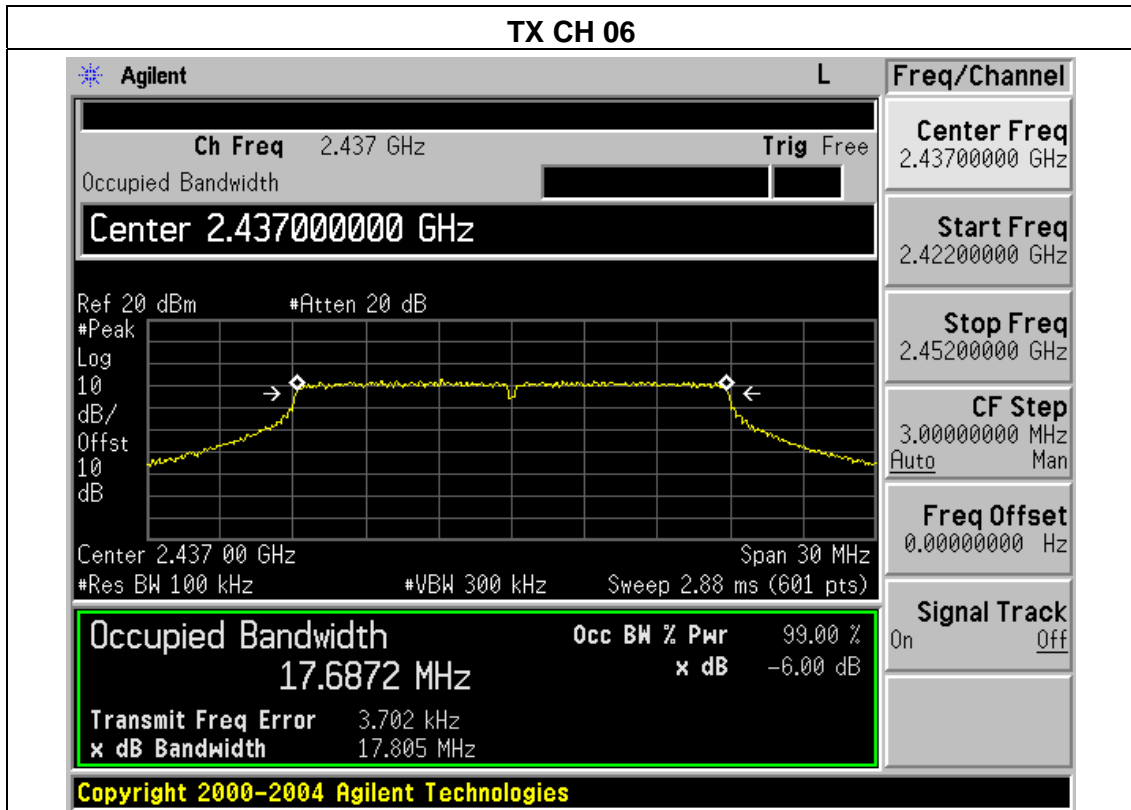

| | | | |
|---------------|---|---------------------|--------------------------------|
| EUT : | ScreenBeam Enterprise Wireless Display Receiver | Model Name : | SBWD700A |
| Temperature : | 25 °C | Relative Humidity : | 56% |
| Pressure : | 1012 hPa | Test Voltage : | DC 5V From adapter AC120V/60Hz |
| Test Mode : | TX n Mode(40M) /CH03, CH06, CH09 | | |

| Channel | Frequency (MHz) | 6dB bandwidth (MHz) | | Limit (kHz) | Result |
|---------|-----------------|---------------------|--------|-------------|--------|
| | | ANT A | ANT B | | |
| Low | 2422 | 36.544 | 36.464 | 500 | Pass |
| Middle | 2437 | 36.551 | 36.349 | 500 | Pass |
| High | 2452 | 36.541 | 36.463 | 500 | Pass |

Note: A (B) Represent the value of antenna A and B, The worst data is A Antenna a ,only shown Antenna A Plot.

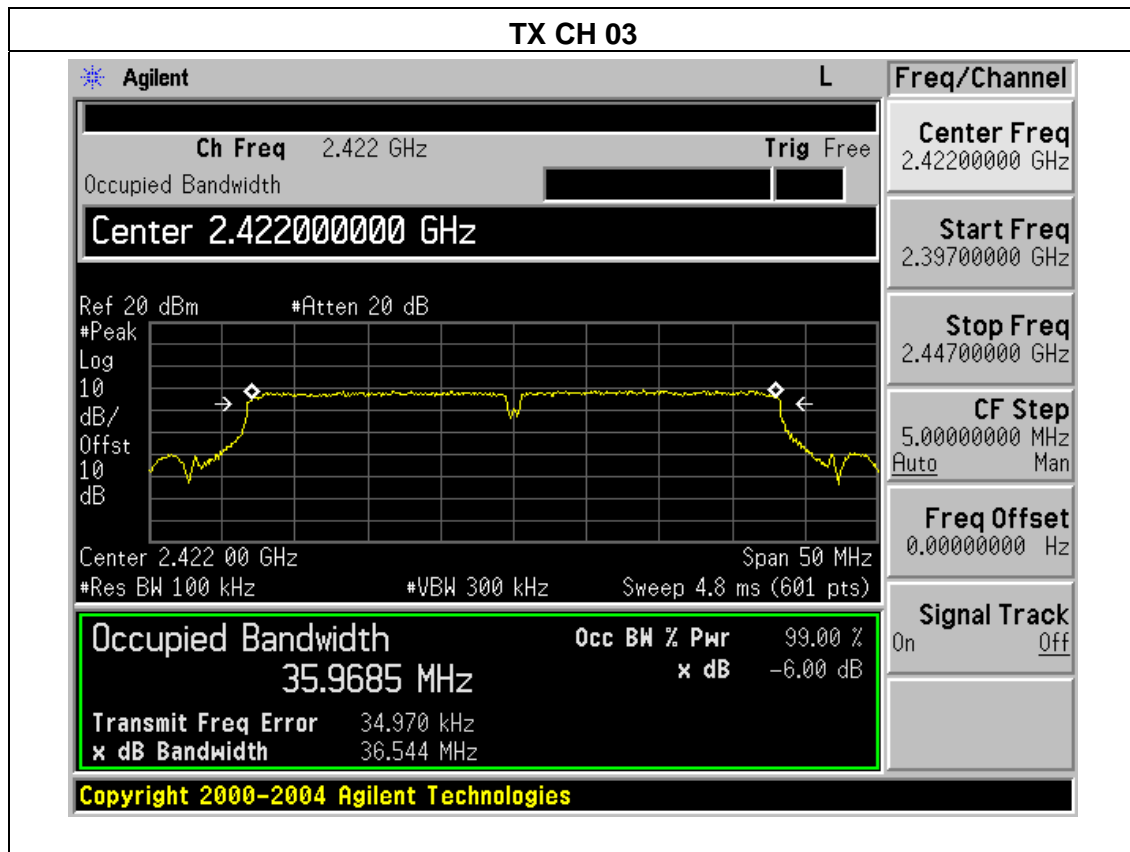

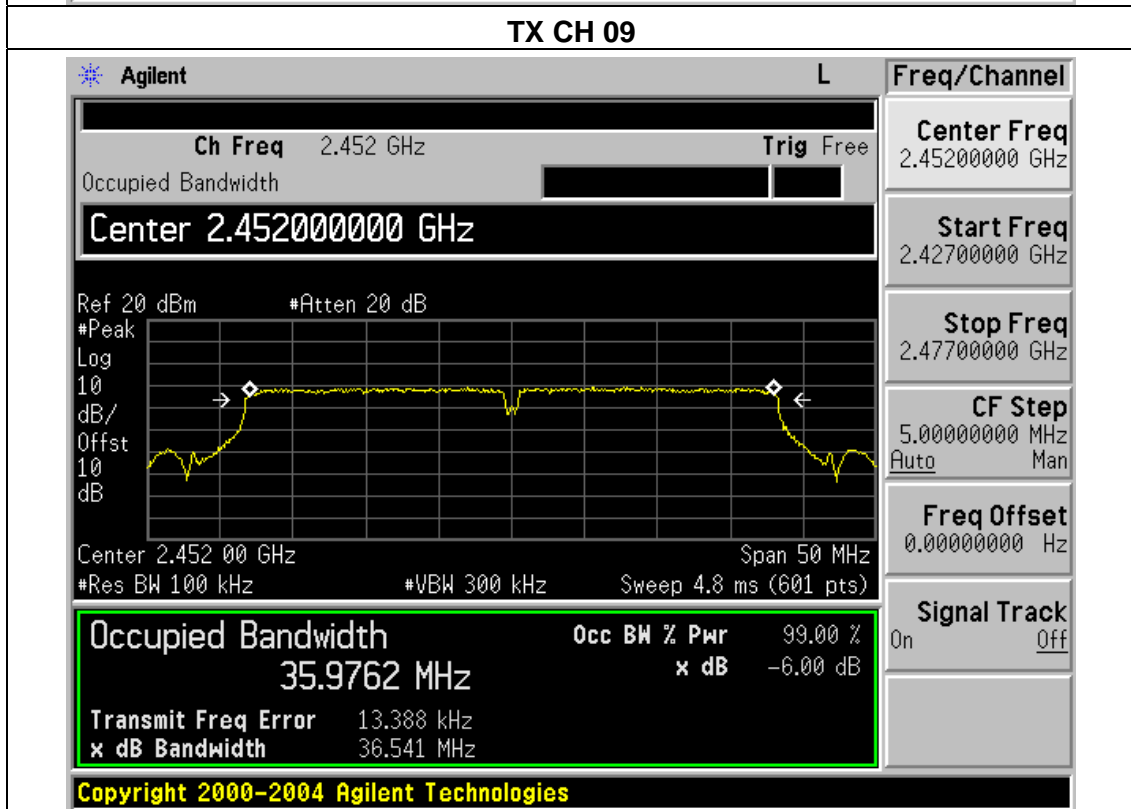
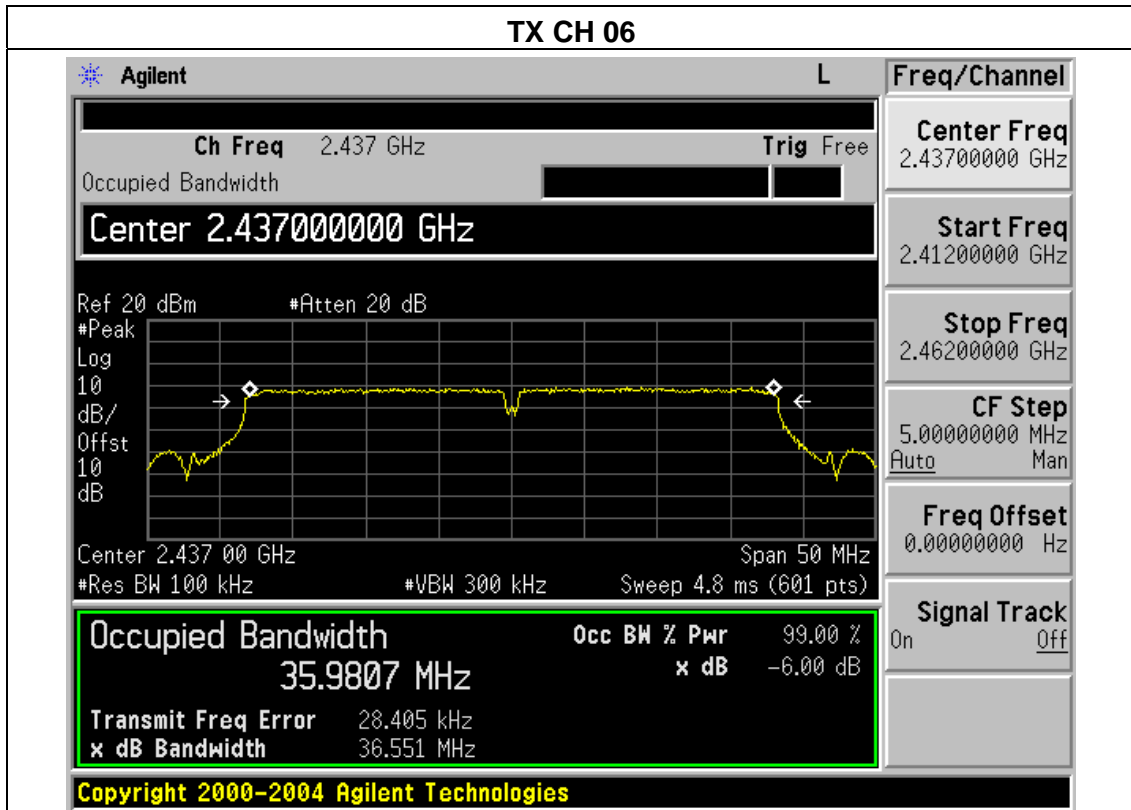

| | | | |
|---------------|--|---------------------|-----------------------------------|
| EUT : | ScreenBeam Enterprise Wireless Display Receiver | Model Name : | SBWD700A |
| Temperature : | 25 °C | Relative Humidity : | 56% |
| Pressure : | 1012 hPa | Test Voltage : | DC 5V From adapter AC120V/60Hz |
| Test Mode : | TX a Mode /CH149, CH157, CH165 | | |

| Channel | Frequency (MHz) | 6dB bandwidth (MHz) | | Limit (kHz) | Result |
|---------|-----------------|---------------------|--------|-------------|--------|
| | | ANT A | ANT B | | |
| Low | 5745 | 16.599 | 16.365 | 500 | Pass |
| Middle | 5785 | 16.596 | 16.454 | 500 | Pass |
| High | 5825 | 16.596 | 16.368 | 500 | Pass |

Note: A (B) Represent the value of antenna A and B, The worst data is A Antenna a ,only shown Antenna A Plot.

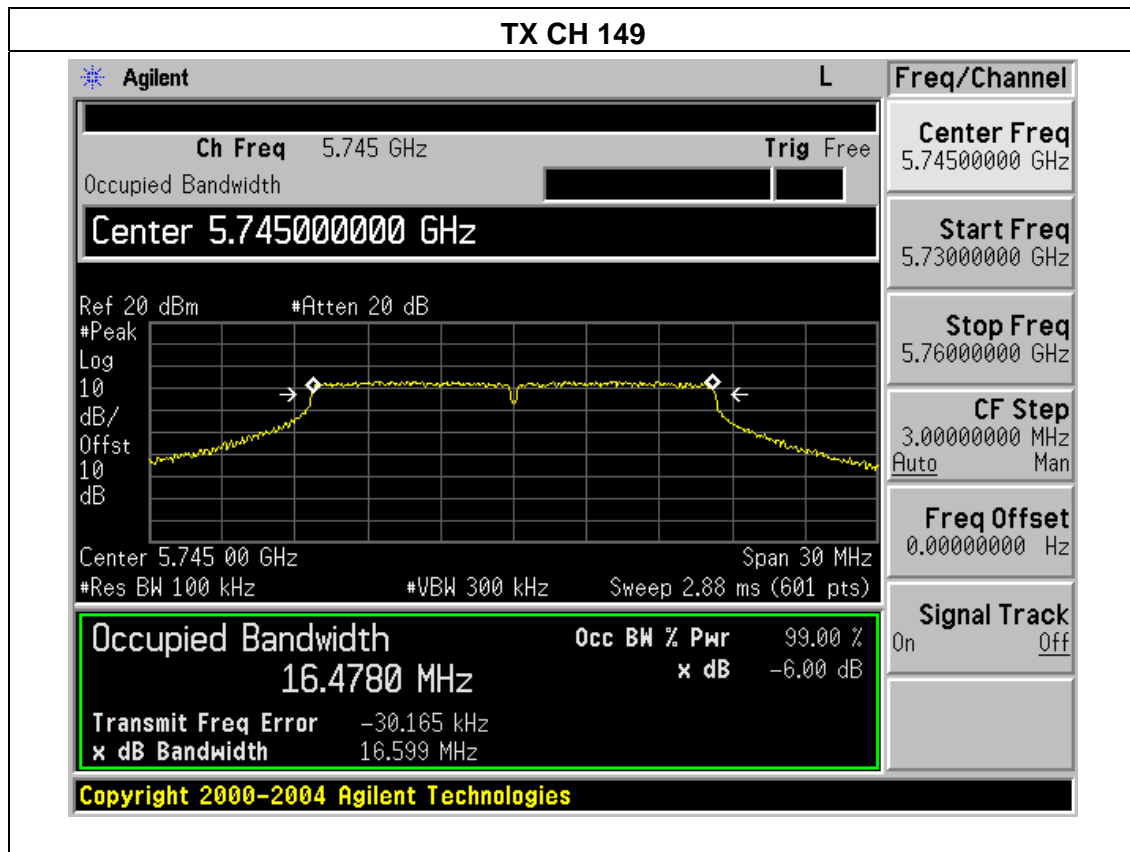

TX CH 157

Agilent
L

Ch Freq 5.785 GHz Trig Free

Occupied Bandwidth

Center 5.785000000 GHz

Ref 20 dBm #Atten 20 dB

Center 5.785 00 GHz Span 30 MHz

#Res BW 100 kHz #VBW 300 kHz Sweep 2.88 ms (601 pts)

Freq/Channel

Center Freq 5.78500000 GHz

Start Freq 5.77000000 GHz

Stop Freq 5.80000000 GHz

CF Step 3.00000000 MHz
Auto Man

Freq Offset 0.00000000 Hz

Signal Track On Off

| | | |
|----------------------------|---------------------|----------|
| Occupied Bandwidth | Occ BW % Pwr | 99.00 % |
| 16.4767 MHz | x dB | -6.00 dB |
| Transmit Freq Error | -29.609 kHz | |
| x dB Bandwidth | 16.596 MHz | |

Copyright 2000-2004 Agilent Technologies

TX CH 165

Agilent
L

Ch Freq 5.825 GHz Trig Free

Occupied Bandwidth

Center 5.825000000 GHz

Ref 20 dBm #Atten 20 dB

Center 5.825 00 GHz Span 30 MHz

#Res BW 100 kHz #VBW 300 kHz Sweep 2.88 ms (601 pts)

Freq/Channel

Center Freq 5.82500000 GHz

Start Freq 5.81000000 GHz

Stop Freq 5.84000000 GHz

CF Step 3.00000000 MHz
Auto Man

Freq Offset 0.00000000 Hz

Signal Track On Off

| | | |
|----------------------------|---------------------|----------|
| Occupied Bandwidth | Occ BW % Pwr | 99.00 % |
| 16.4737 MHz | x dB | -6.00 dB |
| Transmit Freq Error | -18.158 kHz | |
| x dB Bandwidth | 16.596 MHz | |

Copyright 2000-2004 Agilent Technologies

| | | | |
|---------------|--|---------------------|-----------------------------------|
| EUT : | ScreenBeam Enterprise Wireless Display Receiver | Model Name : | SBWD700A |
| Temperature : | 25 °C | Relative Humidity : | 56% |
| Pressure : | 1012 hPa | Test Voltage : | DC 5V From adapter AC120V/60Hz |
| Test Mode : | TX n(20) Mode(5G) /CH149, CH157, CH165 | | |

| Channel | Frequency (MHz) | 6dB bandwidth (MHz) | | Limit (kHz) | Result |
|---------|-----------------|---------------------|--------|-------------|--------|
| | | ANT A | ANT B | | |
| Low | 5745 | 17.778 | 17.531 | 500 | Pass |
| Middle | 5785 | 17.803 | 17.493 | 500 | Pass |
| High | 5825 | 17.806 | 17.611 | 500 | Pass |

Note: A (B) Represent the value of antenna A and B, The worst data is A Antenna a , only shown Antenna A Plot.

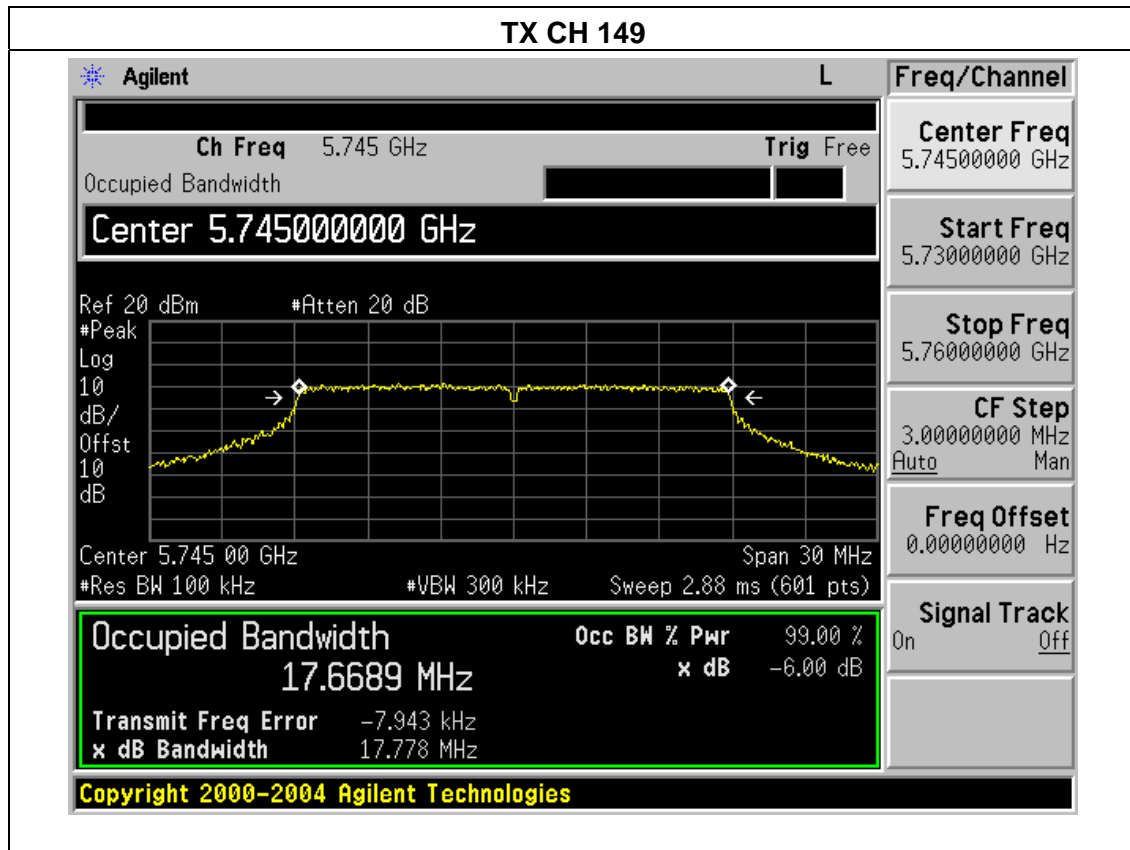

TX CH 157

| | | | |
|---|--|--|--|
| L | | Freq/Channel | |
| Ch Freq 5.785 GHz Trig Free | | Center Freq 5.78500000 GHz | |
| Occupied Bandwidth | | Start Freq 5.77000000 GHz | |
| Center 5.78500000 GHz | | Stop Freq 5.80000000 GHz | |
| Ref 20 dBm #Atten 20 dB | | CF Step 3.00000000 MHz Auto Man | |
| | | Freq Offset 0.00000000 Hz | |
| Center 5.785 00 GHz Span 30 MHz #Res BW 100 kHz #VBW 300 kHz Sweep 2.88 ms (601 pts) | | Signal Track On Off | |
| Occupied Bandwidth | | Occ BW % Pwr 99.00 % | |
| 17.6730 MHz | | x dB -6.00 dB | |
| Transmit Freq Error -5.601 kHz | | | |
| x dB Bandwidth 17.803 MHz | | | |
| Copyright 2000-2004 Agilent Technologies | | | |

TX CH 165

| | | | |
|---|--|--|--|
| L | | Freq/Channel | |
| Ch Freq 5.825 GHz Trig Free | | Center Freq 5.82500000 GHz | |
| Occupied Bandwidth | | Start Freq 5.81000000 GHz | |
| Center 5.82500000 GHz | | Stop Freq 5.84000000 GHz | |
| Ref 20 dBm #Atten 20 dB | | CF Step 3.00000000 MHz Auto Man | |
| | | Freq Offset 0.00000000 Hz | |
| Center 5.825 00 GHz Span 30 MHz #Res BW 100 kHz #VBW 300 kHz Sweep 2.88 ms (601 pts) | | Signal Track On Off | |
| Occupied Bandwidth | | Occ BW % Pwr 99.00 % | |
| 17.6871 MHz | | x dB -6.00 dB | |
| Transmit Freq Error -376.040 Hz | | | |
| x dB Bandwidth 17.806 MHz | | | |
| Copyright 2000-2004 Agilent Technologies | | | |

| | | | |
|---------------|--|---------------------|-----------------------------------|
| EUT : | ScreenBeam Enterprise Wireless Display Receiver | Model Name : | SBWD700A |
| Temperature : | 25 °C | Relative Humidity : | 56% |
| Pressure : | 1012 hPa | Test Voltage : | DC 5V From adapter AC120V/60Hz |
| Test Mode : | TX n40 Mode(5G) /CH151, CH159 | | |

| Channel | Frequency (MHz) | 6dB bandwidth (MHz) | | Limit (kHz) | Result |
|---------|-----------------|---------------------|--------|-------------|--------|
| | | ANT A | ANT B | | |
| Low | 5755 | 36.564 | 36.352 | 500 | Pass |
| High | 5795 | 36.568 | 36.344 | 500 | Pass |

Note: A (B) Represent the value of antenna A and B, The worst data is A Antenna a , only shown Antenna A Plot.

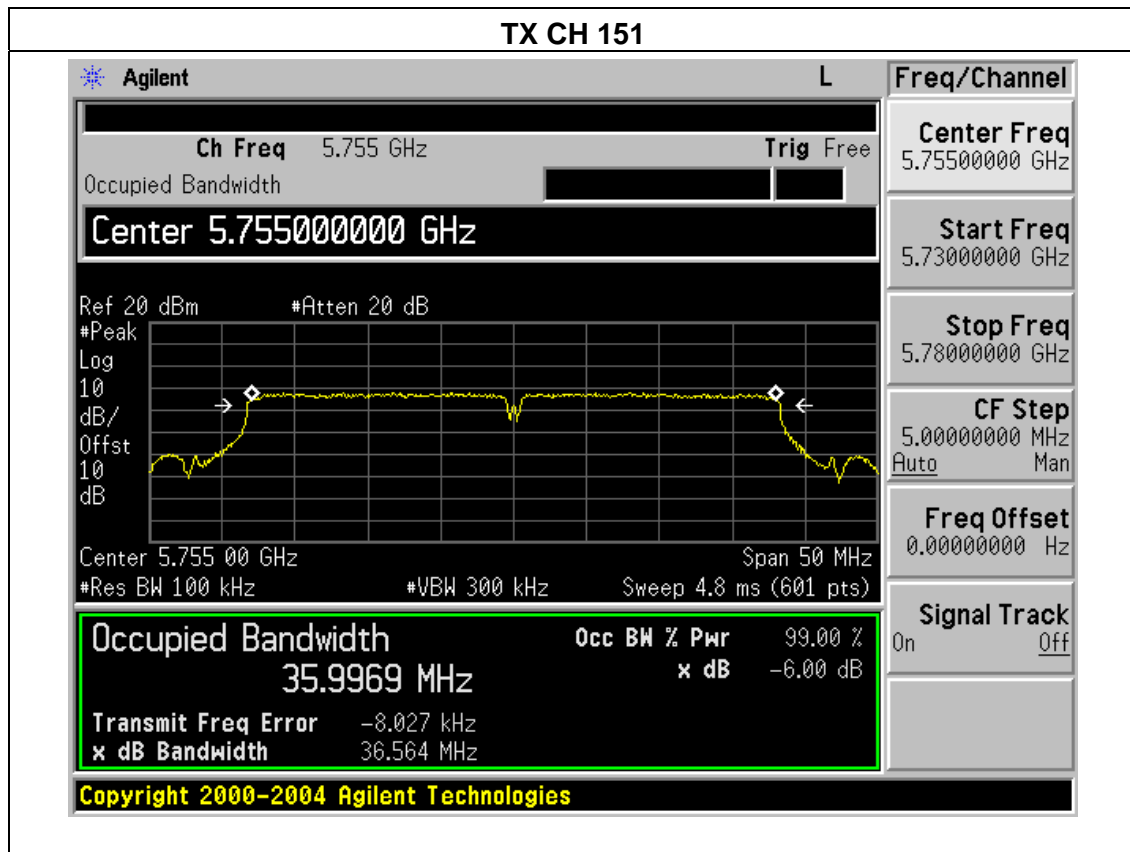

TX CH 159

| | | | |
|--|--|-------------------------------------|--|
| | | L | Freq/Channel |
| Ch Freq 5.795 GHz | | Trig Free | Center Freq 5.79500000 GHz |
| Occupied Bandwidth | | | Start Freq 5.77000000 GHz |
| Center 5.79500000 GHz | | | Stop Freq 5.82000000 GHz |
| Ref 20 dBm #Atten 20 dB | | | CF Step 5.00000000 MHz Auto Man |
| #Peak Log 10 dB/ Offst 10 dB | | | |
| Center 5.795 00 GHz | | Span 50 MHz | |
| #Res BW 100 kHz | | #VBW 300 kHz Sweep 4.8 ms (601 pts) | |
| Occupied Bandwidth | | Occ BW % Pwr 99.00 % | Signal Track On Off |
| 35.9981 MHz | | x dB -6.00 dB | |
| Transmit Freq Error 7.212 kHz | | | |
| x dB Bandwidth 36.568 MHz | | | |
| Copyright 2000-2004 Agilent Technologies | | | |

6. PEAK OUTPUT POWER TEST

6.1 APPLIED PROCEDURES / LIMIT

| FCC Part15 (15.247) , Subpart C | | | | |
|---------------------------------|-------------------|-----------------|-----------------------|--------|
| Section | Test Item | Limit | Frequency Range (MHz) | Result |
| 15.247(b)(3) | Peak Output Power | 1 watt or 30dBm | 2400-2483.5 | PASS |

6.1.1 TEST PROCEDURE

- a. The EUT was directly connected to the Power meter

6.1.2 DEVIATION FROM STANDARD

No deviation.

6.1.3 TEST SETUP

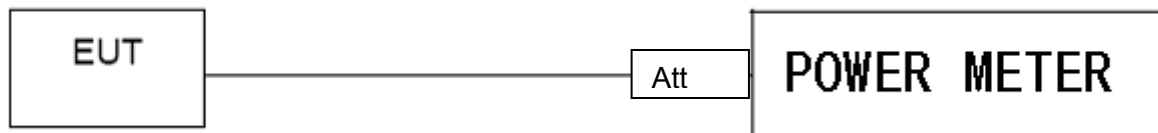

6.1.4 EUT OPERATION CONDITIONS

The EUT tested system was configured as the statements of 2.4 Unless otherwise a special operating condition is specified in the follows during the testing.

6.1.5 TEST RESULTS

| | | | |
|---------------|---|---------------------|-----------------------------------|
| EUT : | ScreenBeam Enterprise Wireless Display Receiver | Model Name : | SBWD700A |
| Temperature : | 25 °C | Relative Humidity : | 60% |
| Pressure : | 1012 hPa | Test Voltage : | DC 5V From adapter AC120V/60Hz |
| Test Mode : | TX b/g/n(20M, 40M) Mode | | |

| Test Channel | Frequency (MHz) | Maximum output power. Antenna port | | | | Total Power | | LIMIT (dBm) |
|----------------------------|-----------------|------------------------------------|-------|------------|-------|-------------|------------|-------------|
| | | (PK) (dBm) | | (AV) (dBm) | | (PK) (dBm) | (AV) (dBm) | |
| | | ANT A | ANT B | ANT A | ANT B | dBm | dBm | |
| TX 802.11b Mode | | | | | | | | |
| CH01 | 2412 | 14.62 | 13.69 | 11.25 | 10.52 | 17.19 | 13.91 | 29.39 |
| CH06 | 2437 | 14.74 | 13.84 | 11.31 | 10.11 | 17.26 | 13.73 | 29.39 |
| CH11 | 2462 | 14.51 | 13.71 | 11.43 | 10.42 | 17.14 | 13.96 | 29.39 |
| TX 802.11g Mode | | | | | | | | |
| CH01 | 2412 | 11.73 | 10.35 | 8.24 | 7.22 | 14.10 | 10.77 | 29.39 |
| CH06 | 2437 | 11.71 | 10.42 | 8.46 | 7.45 | 14.13 | 10.87 | 29.39 |
| CH11 | 2462 | 11.75 | 10.47 | 8.31 | 7.36 | 14.17 | 10.87 | 29.39 |
| TX 802.11n/20M Mode | | | | | | | | |
| CH01 | 2412 | 9.92 | 8.73 | 6.76 | 5.31 | 12.38 | 9.11 | 29.39 |
| CH06 | 2437 | 9.91 | 8.58 | 6.84 | 5.42 | 12.31 | 9.15 | 29.39 |
| CH11 | 2462 | 9.92 | 8.72 | 6.61 | 5.72 | 12.37 | 9.20 | 29.39 |
| TX 802.11n/40M Mode | | | | | | | | |
| CH03 | 2422 | 9.23 | 8.24 | 6.21 | 5.61 | 11.77 | 8.93 | 29.39 |
| CH06 | 2437 | 9.46 | 8.53 | 6.37 | 5.52 | 11.90 | 8.89 | 29.39 |
| CH09 | 2452 | 9.52 | 8.65 | 6.32 | 5.44 | 12.12 | 8.91 | 29.39 |

For 2.4G mode , Limit =30-6.61+6=29.39dBm for output power.

| | | | |
|---------------|---|---------------------|-----------------------------------|
| EUT : | ScreenBeam Enterprise Wireless Display Receiver | Model Name : | SBWD700A |
| Temperature : | 25 °C | Relative Humidity : | 60% |
| Pressure : | 1012 hPa | Test Voltage : | DC 5V From adapter AC120V/60Hz |
| Test Mode : | TX a/n(5G) Mode | | |

| Test Channel | Frequency (MHz) | Maximum output power. Antenna port | | | | Total Power | | LIMIT dBm |
|---------------------------|--------------------|------------------------------------|-------|------------|-------|-------------|-------|--------------|
| | | (PK) (dBm) | | (AV) (dBm) | | (PK) | (AV) | |
| | | ANT A | ANT B | ANT A | ANT B | dBm | dBm | |
| TX 802.11a Mode | | | | | | | | |
| CH149 | 5745 | 9.76 | 9.21 | 7.02 | 6.71 | 12.50 | 9.88 | 29.79 |
| CH157 | 5785 | 9.52 | 9.13 | 7.37 | 6.69 | 12.47 | 9.87 | 29.79 |
| CH165 | 5825 | 9.67 | 9.02 | 7.24 | 6.72 | 12.37 | 10.00 | 29.79 |
| TX 802.11 n20 Mode | | | | | | | | |
| CH149 | 5745 | 9.31 | 8.56 | 6.42 | 5.42 | 11.96 | 8.96 | 29.79 |
| CH157 | 5785 | 9.35 | 8.65 | 6.48 | 5.58 | 12.00 | 9.03 | 29.79 |
| CH165 | 5825 | 9.16 | 8.35 | 6.22 | 5.47 | 11.78 | 8.87 | 29.79 |
| TX 802.11 n40 Mode | | | | | | | | |
| CH151 | 5755 | 8.52 | 7.76 | 5.26 | 4.55 | 11.17 | 7.93 | 29.79 |
| CH159 | 5795 | 8.37 | 7.52 | 5.17 | 4.38 | 11.06 | 7.85 | 29.79 |

For 5G mode, Limit = 30 - 6.21 + 6 = 29.79 dBm for output power

7. 100 KHZ BANDWIDTH OF FREQUENCY BAND EDGE

APPLICABLE STANDARD

In any 100 kHz bandwidth outside the frequency band in which the spread spectrum or digitally modulated intentional radiator is operating, the radio frequency power that is produced by the intentional radiator shall be at least 20 dB below that in the 100 kHz bandwidth within the band that contains the highest level of the desired power, based on either an RF conducted or a radiated measurement, provided the transmitter demonstrates compliance with the peak conducted power limits. If the transmitter complies with the conducted power limits based on the use of RMS averaging over a time interval, as permitted under paragraph (b)(3) of this section, the attenuation required under this paragraph shall be 30 dB instead of 20 dB. Attenuation below the general limits specified in §15.209(a) is not required. In addition, radiated emissions which fall in the restricted bands, as defined in §15.205(a), must also comply with the radiated emission limits specified in §15.209(a) (see §15.205(c)).

TEST PROCEDURE

- a) Check the calibration of the measuring instrument using either an internal calibrator or a known signal from an external generator.
- b) Position the EUT without connection to measurement instrument. Turn on the EUT and connect its antenna terminal to measurement instrument via a low loss cable. Then set it to any one measured frequency within its operating range, and make sure the instrument is operated in its linear range.
- c) Set RBW to 100 kHz and VBW of spectrum analyzer to 300 kHz with a convenient frequency span including 100 kHz bandwidth from band edge.
- d) Measure the highest amplitude appearing on spectral display and set it as a reference level. Plot the graph with marking the highest point and edge frequency.
- e) Repeat above procedures until all measured frequencies were complete.

7.1 DEVIATION FROM STANDARD

No deviation.

7.2 TEST SETUP

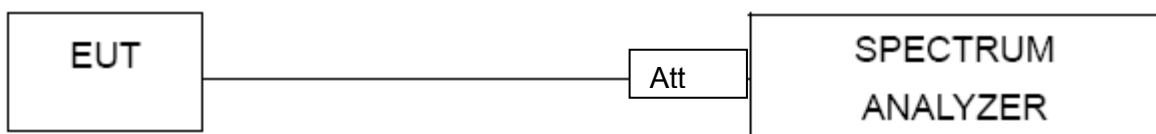

7.3 EUT OPERATION CONDITIONS

The EUT tested system was configured as the statements of 2.4 Unless otherwise a special operating condition is specified in the follows during the testing.

7.4 TEST RESULTS

| | | | |
|---------------|--|---------------------|-----------------------------------|
| EUT : | ScreenBeam Enterprise Wireless Display Receiver | Model Name : | SBWD700A |
| Temperature : | 25 °C | Relative Humidity : | 56% |
| Pressure : | 1012 hPa | Test Voltage : | DC 5V From adapter AC120V/60Hz |

| Frequency Band | Delta Peak to band emission (dBc) | > Limit (dBc) | Result |
|-------------------|-----------------------------------|---------------|--------|
| 802.11b mode | | | |
| Left-band | 37.80 | 20 | Pass |
| Right-band | 57.44 | 20 | Pass |
| 802.11g mode | | | |
| Left-band | 28.89 | 20 | Pass |
| Right-band | 49.25 | 20 | Pass |
| 802.11n-HT20 mode | | | |
| Left-band | 29.46 | 20 | Pass |
| Right-band | 50.96 | 20 | Pass |
| 802.11n-HT40 mode | | | |
| Left-band | 29.80 | 20 | Pass |
| Right-band | 45.94 | 20 | Pass |

| Frequency Band | Delta Peak to band emission (dBc) | > Limit (dBc) | Result |
|----------------|-----------------------------------|---------------|--------|
| 802.11a mode | | | |
| Left-band | 43.94 | 20 | Pass |
| Right-band | 51.07 | 20 | Pass |
| 802.11n20 mode | | | |
| Left-band | 43.56 | 20 | Pass |
| Right-band | 49.16 | 20 | Pass |
| 802.11n40 mode | | | |
| Left-band | 39.26 | 20 | Pass |
| Right-band | 44.31 | 20 | Pass |

Radiated band edge:

| Frequency (MHz) | Meter Reading (dBμV) | Factor (dB) | Emission Level (dBμV/m) | Limits (dBμV/m) | Margin (dB) | Detector Type | Comment |
|---------------------|-------------------------|----------------|----------------------------|--------------------|----------------|---------------|------------|
| 802.11b | | | | | | | |
| 2390 | 53.91 | -13.06 | 40.85 | 74 | -33.15 | peak | Vertical |
| 2390 | 55.75 | -13.06 | 42.69 | 74 | -31.31 | peak | Horizontal |
| 2483.5 | 55.56 | -12.78 | 42.78 | 74 | -31.22 | peak | Vertical |
| 2483.5 | 56.35 | -12.78 | 43.57 | 74 | -30.43 | peak | Horizontal |
| 802.11g | | | | | | | |
| 2390 | 53.34 | -13.06 | 40.28 | 74 | -33.72 | peak | Vertical |
| 2390 | 53.41 | -13.06 | 40.35 | 74 | -33.65 | peak | Horizontal |
| 2483.5 | 52.31 | -12.78 | 39.53 | 74 | -34.47 | peak | Vertical |
| 2483.5 | 54.43 | -12.78 | 41.65 | 74 | -32.35 | peak | Horizontal |
| 802.11n (20) | | | | | | | |
| 2390 | 55.42 | -13.06 | 42.36 | 74 | -31.64 | peak | Vertical |
| 2390 | 53.34 | -13.06 | 40.28 | 74 | -33.72 | peak | Horizontal |
| 2483.5 | 55.24 | -12.78 | 42.46 | 74 | -31.54 | peak | Vertical |
| 2483.5 | 57.32 | -12.78 | 44.54 | 74 | -29.46 | peak | Horizontal |
| 802.11n (40) | | | | | | | |
| 2390 | 54.29 | -13.06 | 41.23 | 74 | -32.77 | 54.29 | Vertical |
| 2390 | 48.38 | -13.06 | 35.32 | 74 | -38.68 | 48.38 | Horizontal |
| 2483.5 | 53.71 | -12.78 | 40.93 | 74 | -33.07 | 53.71 | Vertical |
| 2483.5 | 51.45 | -12.78 | 38.67 | 74 | -35.33 | 51.45 | Horizontal |

| Frequency (MHz) | Meter Reading (dBμV) | Factor (dB) | Emission Level (dBμV/m) | Limits (dBμV/m) | Margin (dB) | Detector Type | Comment |
|---------------------|-------------------------|----------------|----------------------------|--------------------|----------------|---------------|------------|
| 802.11a-5G | | | | | | | |
| 5725 | 42.13 | 11.79 | 53.92 | 74 | -20.08 | peak | Vertical |
| 5725 | 41.54 | 11.79 | 53.33 | 74 | -20.67 | peak | Horizontal |
| 5850 | 40.21 | 11.93 | 52.14 | 74 | -21.86 | peak | Vertical |
| 5850 | 41.04 | 11.93 | 52.97 | 74 | -21.03 | peak | Horizontal |
| 802.11n20-5G | | | | | | | |
| 5725 | 41.85 | 11.79 | 53.64 | 74 | -20.36 | peak | Vertical |
| 5725 | 40.19 | 11.79 | 51.98 | 74 | -22.02 | peak | Horizontal |
| 5850 | 41.71 | 11.93 | 53.64 | 74 | -20.36 | peak | Vertical |
| 5850 | 40.81 | 11.93 | 52.74 | 74 | -21.26 | peak | Horizontal |
| 802.11n40-5G | | | | | | | |
| 5725 | 39.62 | 11.79 | 51.41 | 74 | -22.59 | peak | Vertical |
| 5725 | 38.32 | 11.79 | 50.11 | 74 | -23.89 | peak | Horizontal |
| 5850 | 37.76 | 11.93 | 49.69 | 74 | -24.31 | peak | Vertical |
| 5850 | 33.26 | 11.93 | 45.19 | 74 | -28.81 | peak | Horizontal |

Note: Test method to see chapter 3.2 . When PK value is lower than the Average value limit, average not record.

802.11b: Band Edge, Right Side

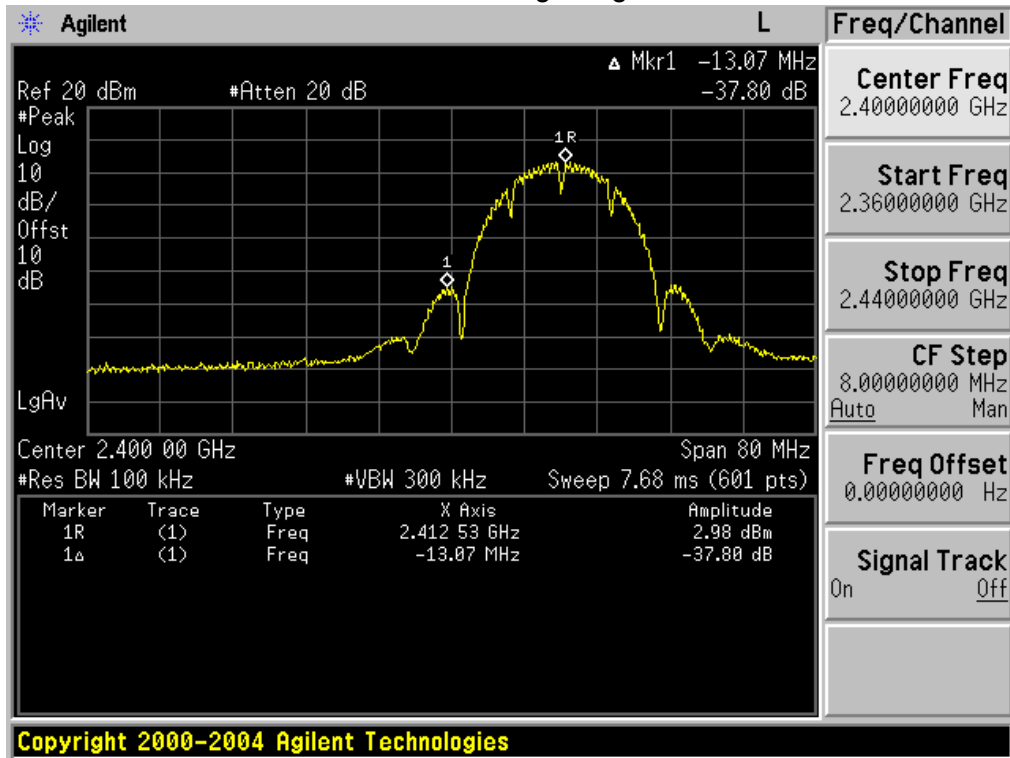

802.11b: Band Edge, Left Side

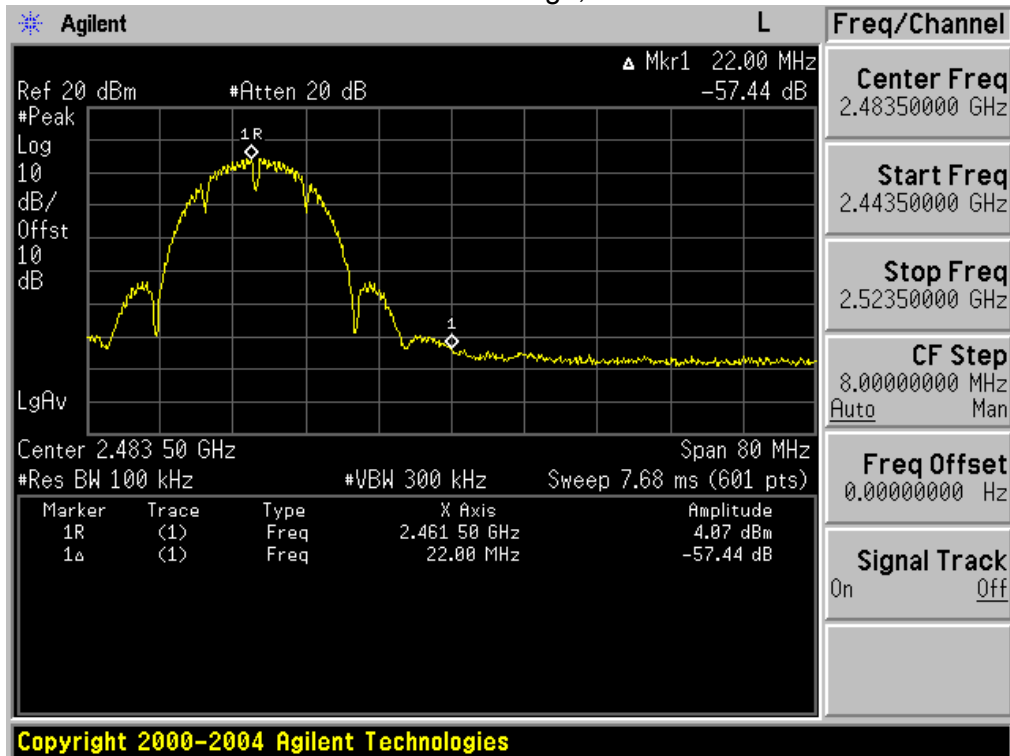

802.11g: Band Edge, Right Side

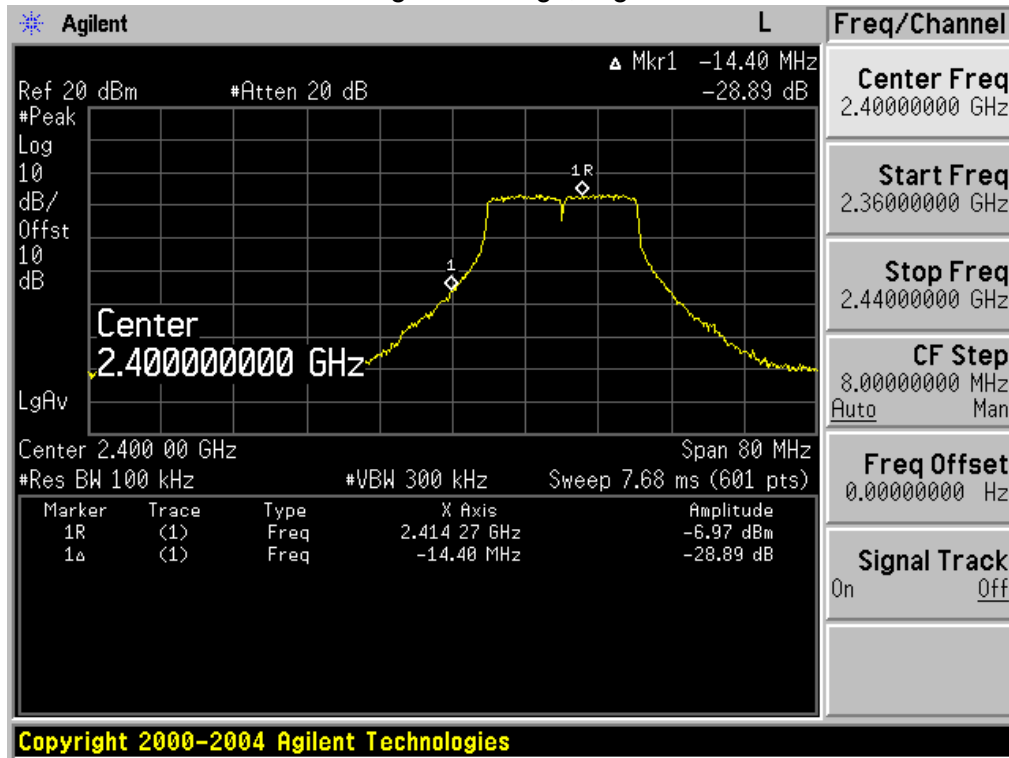

802.11g: Band Edge, Left Side

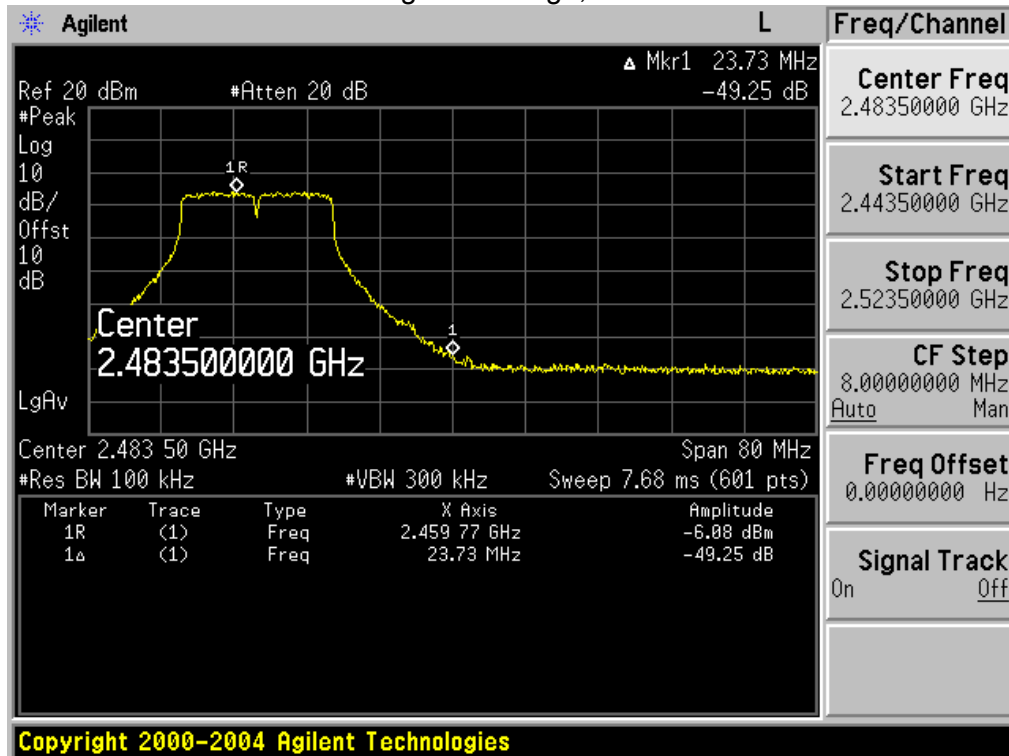

802.11n-HT20: Band Edge, Right Side

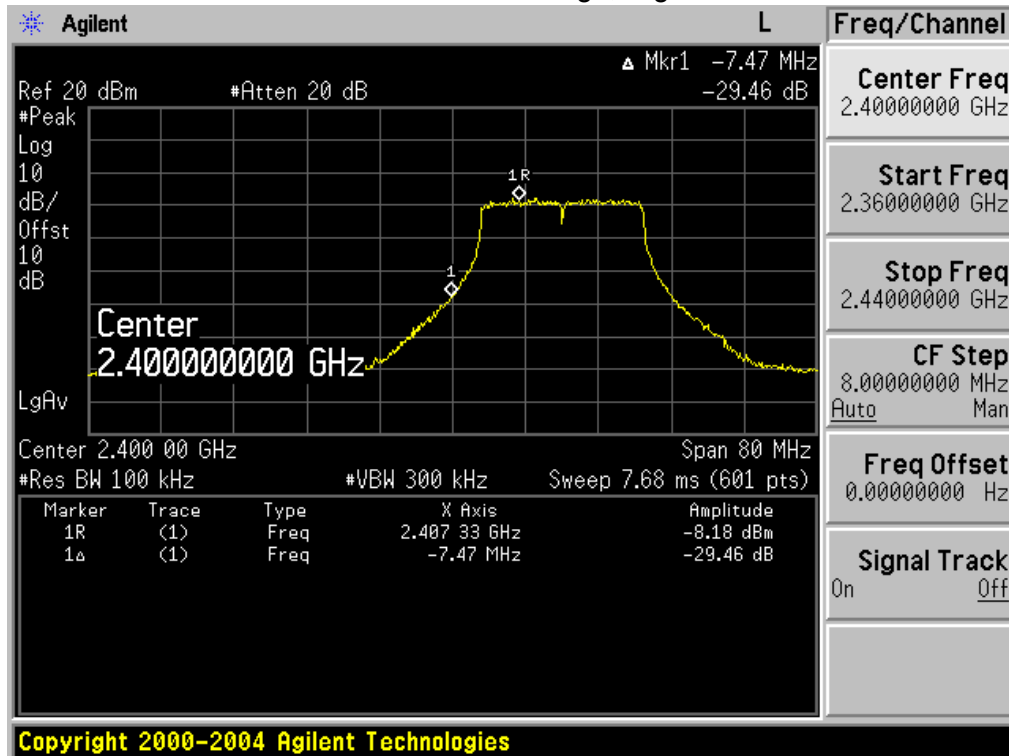

802.11n-HT20: Band Edge, Left Side

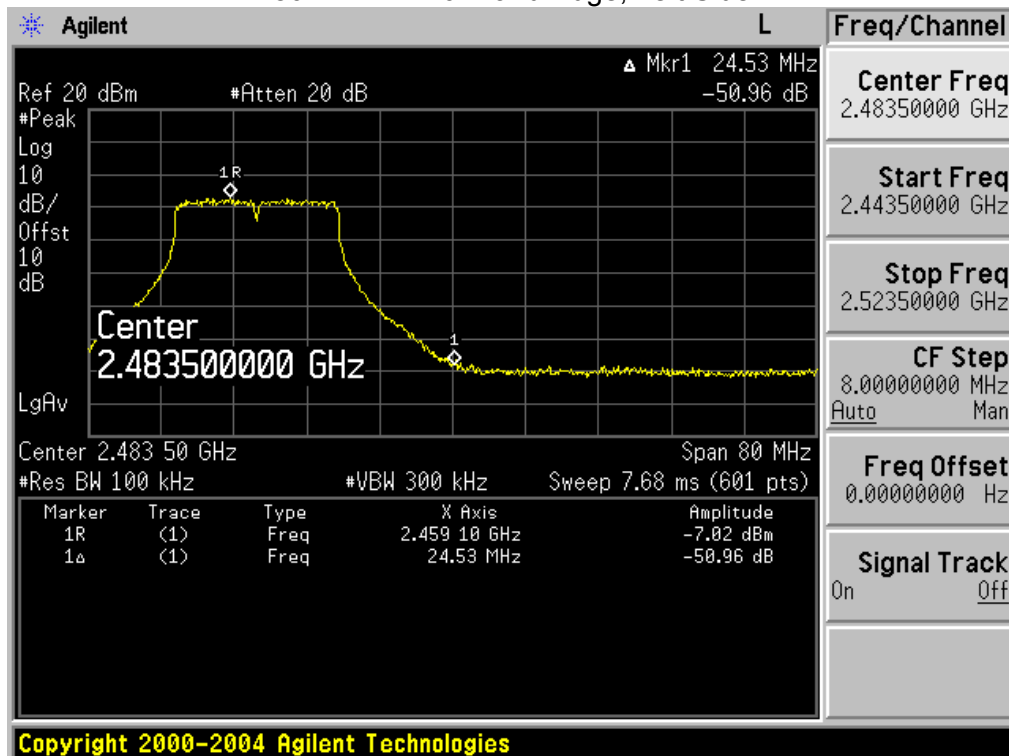

802.11n-HT40: Band Edge, Right Side

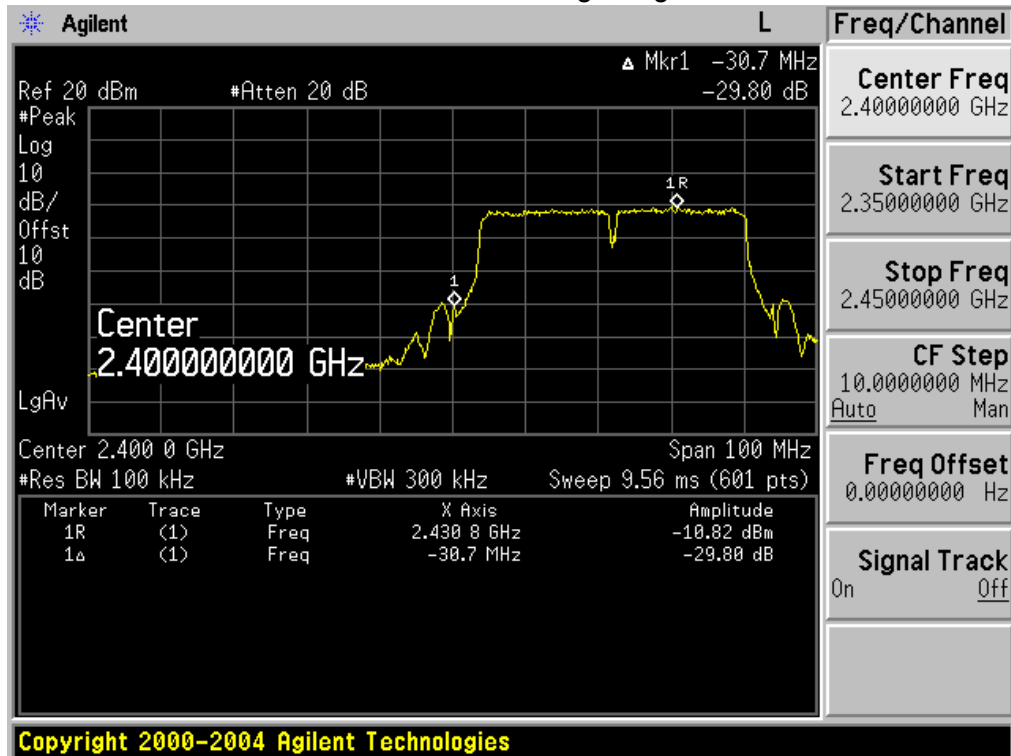

802.11n-HT40: Band Edge, Left Side

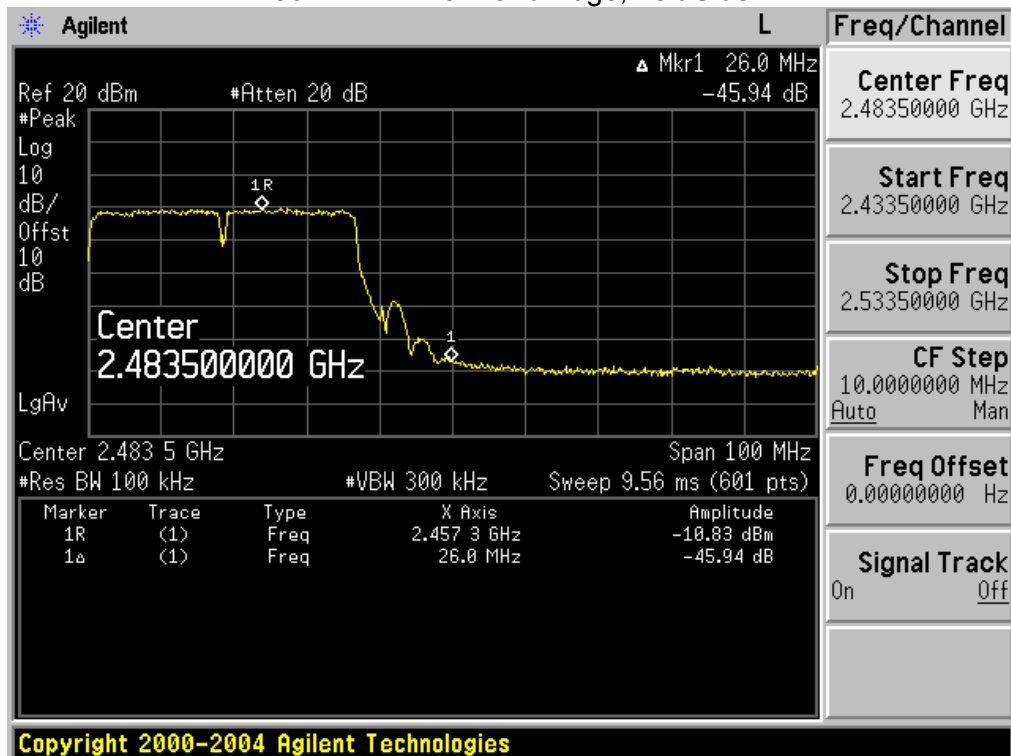

802.11a: Band Edge, Right Side

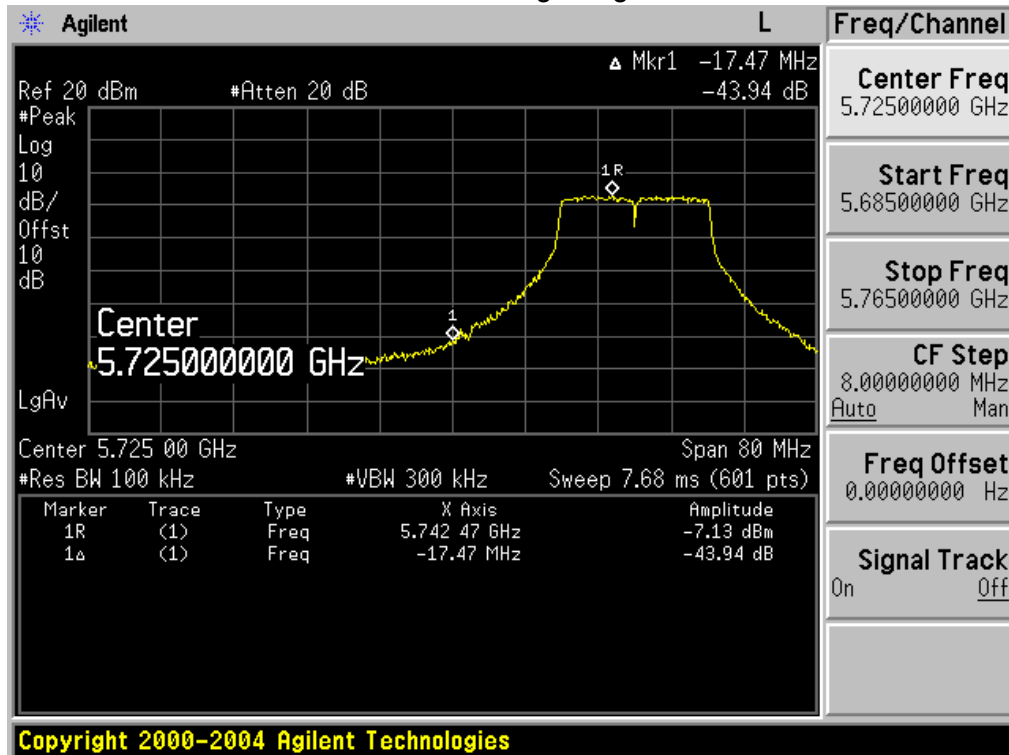

802.11a: Band Edge, Left Side

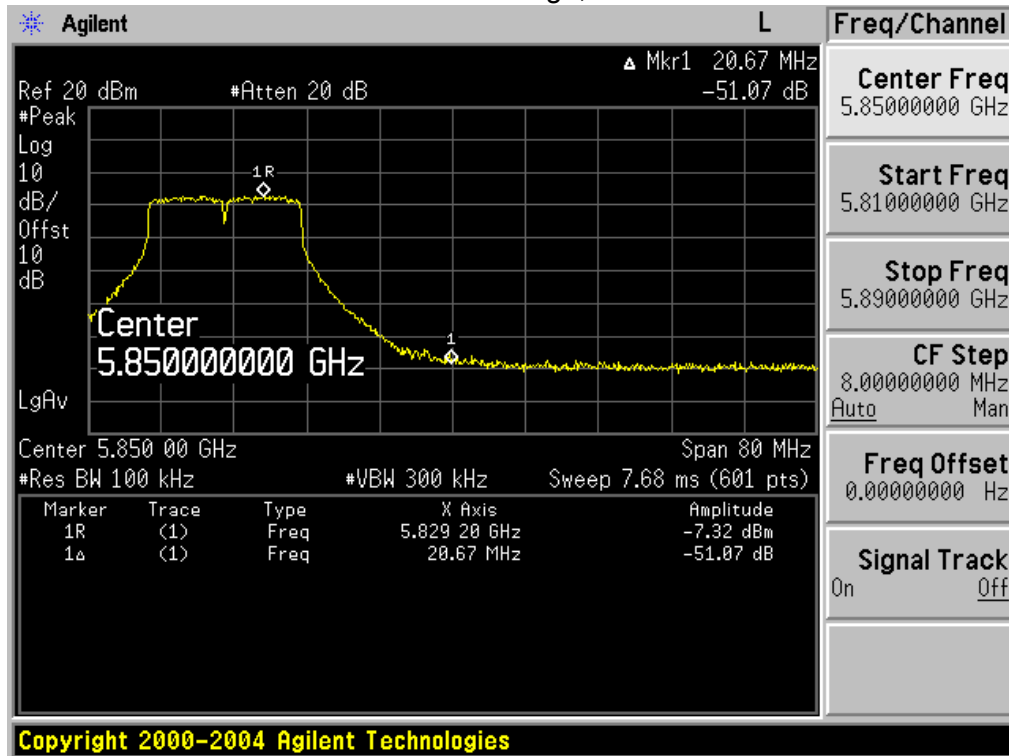

802.11n20(5G): Band Edge, Right Side

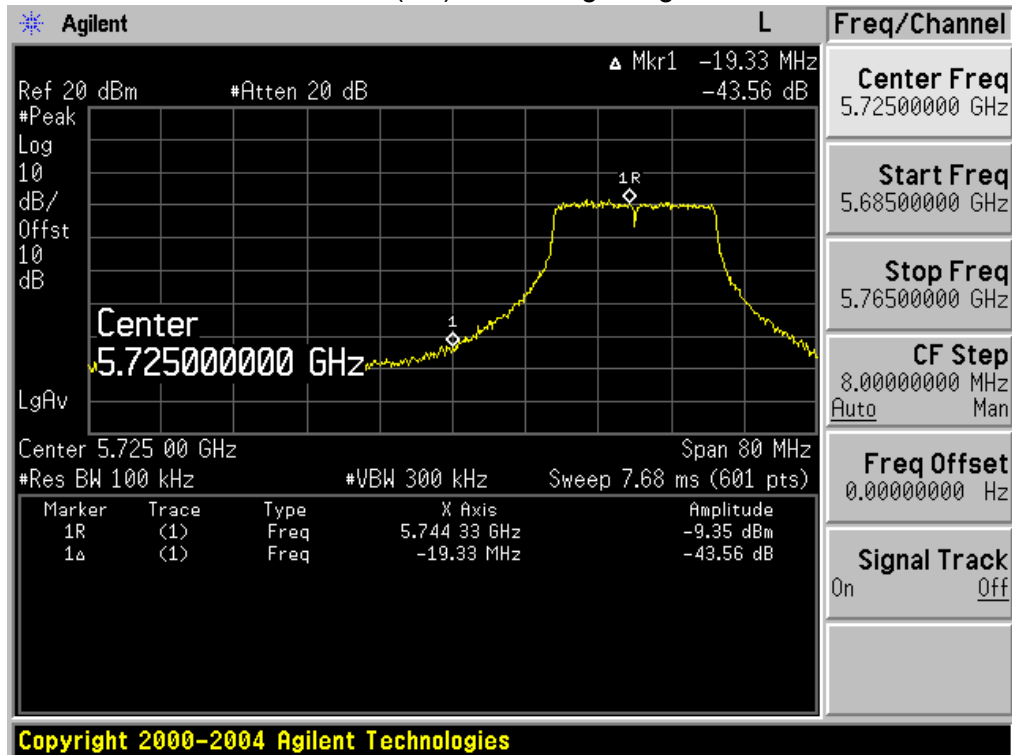

802.11n20(5G): Band Edge, Left Side

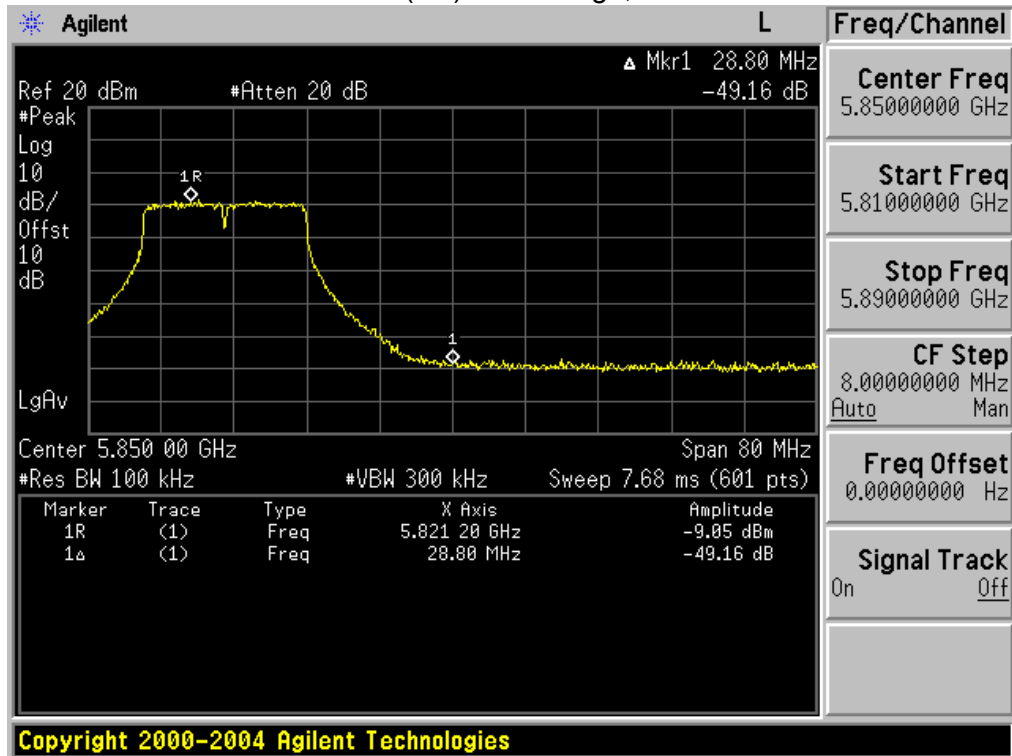

802.11n40(5G): Band Edge, Right Side

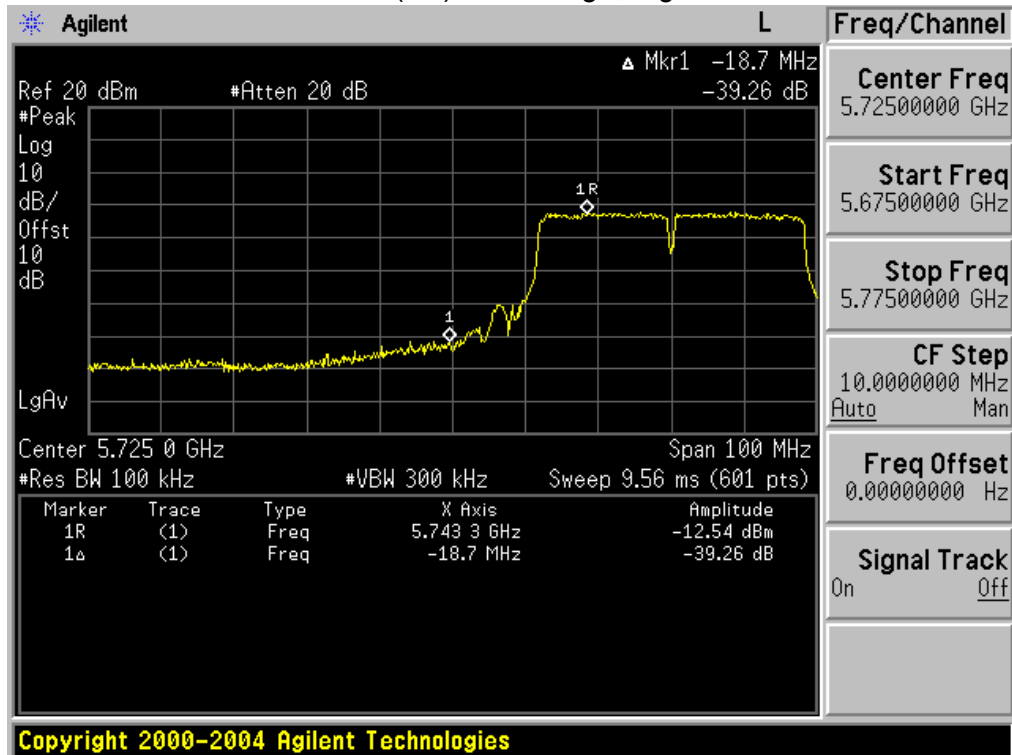

802.11n40(5G): Band Edge, Left Side

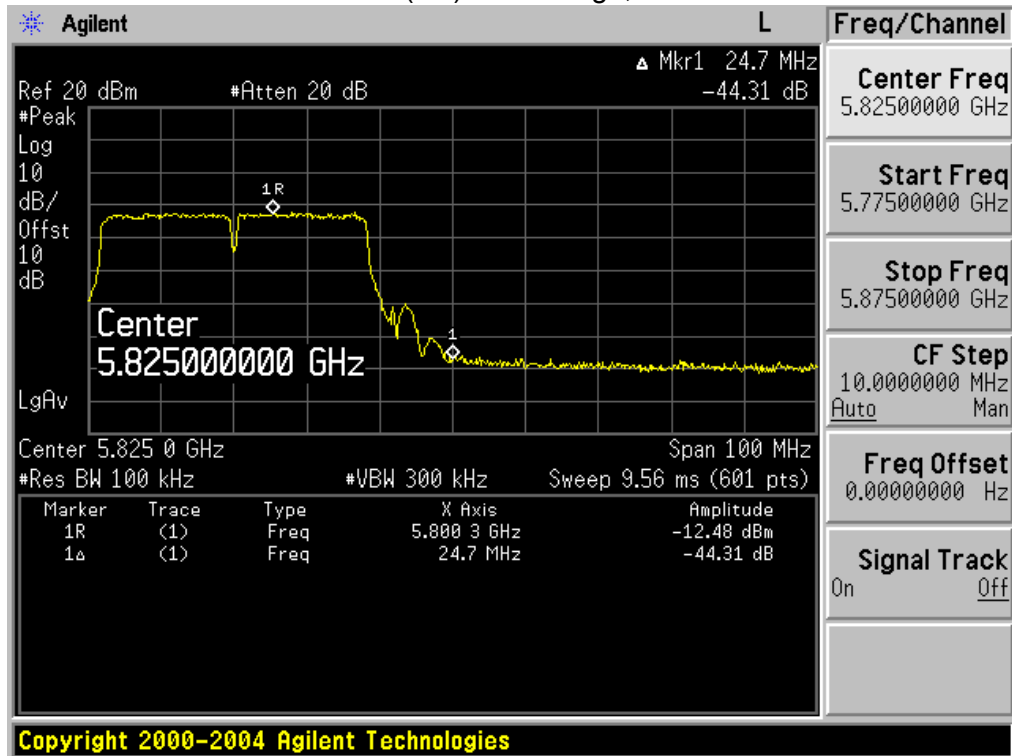

8. ANTENNA REQUIREMENT

8.1 STANDARD REQUIREMENT

15.203 requirement: For intentional device, according to 15.203: an intentional radiator shall be designed to ensure that no antenna other than that furnished by the responsible party shall be used with the device.

8.2 EUT ANTENNA

The EUT antenna is PCB antenna. It comply with the standard requirement.

9. EUT TEST PHOTO

Radiated Measurement Photos

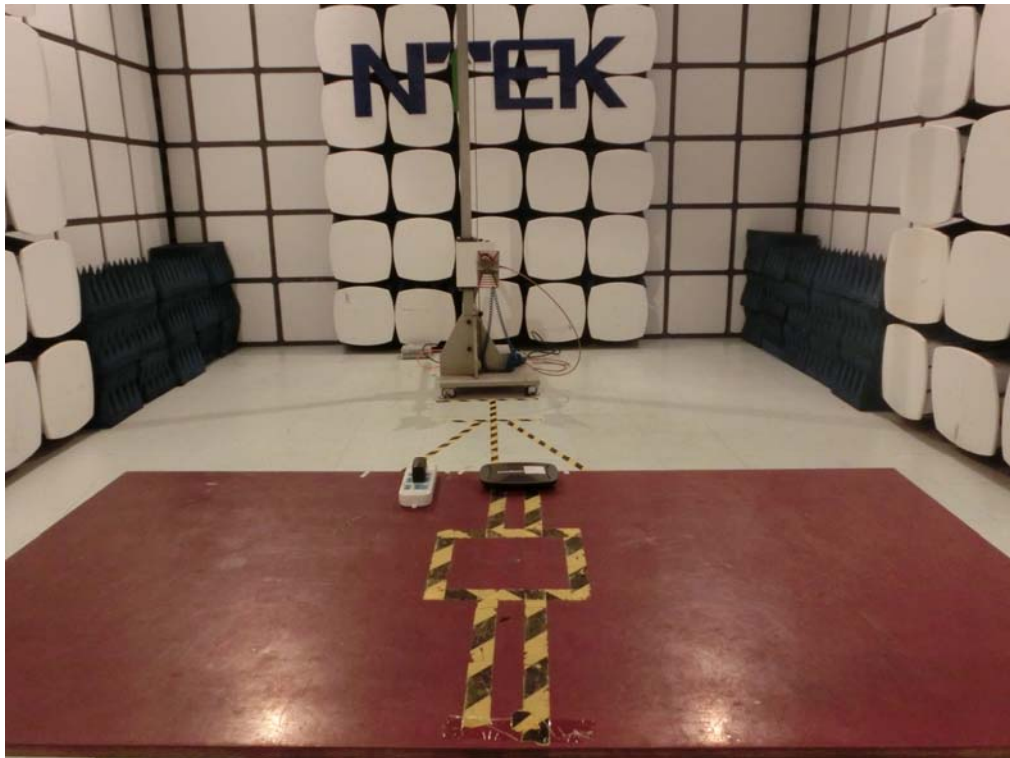

Conducted Measurement Photos

