

# FCC RADIO TEST REPORT

## FCC ID: LNQSBWD3100

**Product :** ScreenBeam OPS Wireless Display  
Module  
**Trade Mark :** ScreenBeam  
**Model Name :** SBWD3100  
**Family Model :** N/A  
**Report No. :** S19052104007003

### Prepared for

Actiontec Electronics Inc

3301 Olcott St Santa Clara, CA 95054 United States

### Prepared by

Shenzhen NTEK Testing Technology Co., Ltd.  
1/F, Building E, Fenda Science Park, Sanwei Community,  
Xixiang Street Bao'an District, Shenzhen 518126 P.R. China  
Tel.: +86-755-6115 6588  
Fax.: +86-755-6115 6599  
Website: <http://www.ntek.org.cn>

TEST RESULT CERTIFICATION

Applicant's name : Actiontec Electronics Inc
Address : 3301 Olcott St Santa Clara, CA 95054 United States
Manufacturer's Name : Actiontec Electronics Inc
Address : 3301 Olcott St Santa Clara, CA 95054 United States
Product description : ScreenBeam OPS Wireless Display Module
Product name : ScreenBeam OPS Wireless Display Module
Model and/or type reference : SBWD3100
Family Model : N/A
Standards : FCC Part15.407

Test procedure : ANSI C63.10-2013 and KDB 789033 D02 General UNII Test Procedures New Rules v01r01
FCC KDB 662911 D01 Multiple Transmitter Output v02r01
FCC KDB 662911 D02 MIMO With Cross Polarized Antenna V01

This device described above has been tested by NTEK, and the test results show that the equipment under test (EUT) is in compliance with the FCC requirements/ the Industry Canada requirements.. And it is applicable only to the tested sample identified in the report.

This report shall not be reproduced except in full, without the written approval of NTEK, this document may be altered or revised by NTEK, personnel only, and shall be noted in the revision of the document.

Date of Test :
Date (s) of performance of tests : 27 Dec. 2018 ~ 08 Jul. 2019
Date of Issue : 11 Jul. 2019
Test Result : Pass

Testing Engineer : [Signature: Mary Hu]
(Mary Hu)

Technical Manager : [Signature: Jason Chen]
(Jason Chen)

Authorized Signatory : [Signature: Sam Chen]
(Sam Chen)

**Table of Contents**

	<b>Page</b>
<b>1 . SUMMARY OF TEST RESULTS</b>	<b>6</b>
1.1 FACILITIES AND ACCREDITATIONS	7
1.2 MEASUREMENT UNCERTAINTY	7
<b>2 . GENERAL INFORMATION</b>	<b>8</b>
2.1 GENERAL DESCRIPTION OF EUT	8
2.2 DESCRIPTION OF TEST MODES	12
2.3 BLOCK DIGRAM SHOWING THE CONFIGURATION OF SYSTEM TESTED	13
2.4 DESCRIPTION OF SUPPORT UNITS(CONDUCTED MODE)	14
2.5 EQUIPMENTS LIST FOR ALL TEST ITEMS	15
<b>3 . EMC EMISSION TEST</b>	<b>17</b>
3.1 CONDUCTED EMISSION MEASUREMENT	17
3.1.1 APPLICABLE STANDARD	17
3.1.2 CONFORMANCE LIMIT	17
3.1.3 TEST CONFIGURATION	17
3.1.4 TEST PROCEDURE	17
3.2 RADIATED EMISSION MEASUREMENT	22
3.2.1 APPLICABLE STANDARD	22
3.2.2 CONFORMANCE LIMIT	22
3.2.3 MEASURING INSTRUMENTS	22
3.2.4 TEST CONFIGURATION	23
3.2.5 TEST PROCEDURE	24
3.2.6 TEST RESULTS (9KHZ – 30 MHZ)	25
3.2.7 TEST RESULTS (30MHZ – 1GHZ)	26
3.2.8 TEST RESULTS (1GHZ-18GHZ)	30
3.2.9 TEST RESULTS (18GHZ-40GHZ)	32
3.2.10 SPURIOUS EMISSION IN RESTRICTED BAND 4.5GHZ~5.150 GHZ& 5.350GHZ~5460GHZ	36
<b>4 . POWER SPECTRAL DENSITY TEST</b>	<b>37</b>
4.1 APPLIED PROCEDURES / LIMIT	37
4.2 TEST PROCEDURE	38
4.3 DEVIATION FROM STANDARD	38
4.4 TEST SETUP	38
4.5 EUT OPERATION CONDITIONS	38
4.6 TEST RESULTS	39
<b>5 . 26DB &amp; 99% EMISSION BANDWIDTH</b>	<b>53</b>
5.1 APPLIED PROCEDURES / LIMIT	53
5.2 TEST PROCEDURE	53
5.3 EUT OPERATION CONDITIONS	54

**Table of Contents**

	<b>Page</b>
<b>5.4 TEST RESULTS</b>	<b>55</b>
<b>6 . MINIMUM 6 DB BANDWIDTH</b>	<b>63</b>
6.1 APPLIED PROCEDURES / LIMIT	63
6.2 TEST PROCEDURE	63
6.3 DEVIATION FROM STANDARD	63
6.4 TEST SETUP	63
6.5 EUT OPERATION CONDITIONS	63
6.6 TEST RESULTS	64
<b>7 . MAXIMUM CONDUCTED OUTPUT POWER</b>	<b>68</b>
7.1 PPLIED PROCEDURES / LIMIT	68
7.2 TEST PROCEDURE	68
7.3 DEVIATION FROM STANDARD	70
7.4 TEST SETUP	70
7.5 EUT OPERATION CONDITIONS	70
7.6 TEST RESULTS	71
<b>8 . OUT OF BAND EMISSIONS</b>	<b>75</b>
8.1 APPLICABLE STANDARD	75
8.2 TEST PROCEDURE	75
8.3 DEVIATION FROM STANDARD	75
8.4 TEST SETUP	75
8.5 EUT OPERATION CONDITIONS	76
8.6 TEST RESULTS	77
<b>9.SPURIOUS RF CONDUCTED EMISSIONS</b>	<b>84</b>
9.1CONFORMANCE LIMIT	84
9.2MEASURING INSTRUMENTS	84
9.3TEST SETUP	84
9.4TEST PROCEDURE	84
9.5TEST RESULTS	84
<b>10. FREQUENCY STABILITY MEASUREMENT</b>	<b>99</b>
10.1 LIMIT	99
10.2 TEST PROCEDURES	99
10.3 TEST SETUP LAYOUT	99
10.4 EUT OPERATION DURING TEST	99
10.5 TEST RESULTS	100
<b>11. ANTENNA REQUIREMENT</b>	<b>106</b>
11.1 STANDARD REQUIREMENT	106
11.2 EUT ANTENNA	106

### Revision History

Report No.	Version	Description	Issued Date
S19052104007003	Rev.01	Initial issue of report	Jul. 11, 2019

**1. SUMMARY OF TEST RESULTS**

Test procedures according to the technical standards:

<b>FCC Part15 (15.407) , Subpart E</b>			
Standard Section	Test Item	Judgment	Remark
15.207	AC Power Line Conducted Emissions	PASS	
15.209(a), 15.407 (b)(1) 15.407 (b)(4) 15.407 (b)(6) 15.205	Spurious Radiated Emissions & Restricted bands Emissions	PASS	
15.407 (a)(1) 15.407 (a)(3) 15.1049	26 dB and 99% Emission Bandwidth	PASS	
15.407(e)	Minimum 6 dB bandwidth	PASS	
15.407 (a)(1) 15.407 (a)(3)	Maximum Conducted Output Power	PASS	
2.1051, 15.407(b)(1) 15.407(b)(4)	Band Edge	PASS	
15.407 (a)(1) 15.407 (a)(3)	Power Spectral Density	PASS	
2.1051, 15.407(b)	Spurious Emissions at Antenna Terminals	PASS	
15.407(g)	Frequency Stability	PASS	
15.203	Antenna Requirement	PASS	

NOTE:

(1) "N/A" denotes test is not applicable in this Test Report

**1.1 FACILITIES AND ACCREDITATIONS**

**FACILITIES**

All measurement facilities used to collect the measurement data are located at 1/F, Building E, Fenda Science Park, Sanwei Community, Xixiang Street, Bao'an District, Shenzhen 518126 P.R. China.

The sites are constructed in conformance with the requirements of ANSI C63.7, ANSI C63.10 and CISPR Publication 22.

**LABORATORY ACCREDITATIONS AND LISTINGS**

Site Description

- CNAS-Lab. : The Laboratory has been assessed and proved to be in compliance with CNAS-CL01:2006 (identical to ISO/IEC 17025:2005)  
The Certificate Registration Number is L5516.
- IC-Registration : The Certificate Registration Number is 9270A.  
CAB identifier:CN0074
- FCC- Accredited : Test Firm Registration Number: 463705.  
Designation Number: CN1184
- A2LA-Lab. : The Certificate Registration Number is 4298.01  
This laboratory is accredited in accordance with the recognized International Standard ISO/IEC 17025:2005 General requirements for the competence of testing and calibration laboratories.  
This accreditation demonstrates technical competence for a defined scope and the operation of a laboratory quality management system (refer to joint ISO-ILAC-IAF Communiqué dated 8 January 2009).
- Name of Firm : Shenzhen NTEK Testing Technology Co., Ltd.
- Site Location : 1/F, Building E, Fenda Science Park, Sanwei Community, Xixiang Street, Bao'an District, Shenzhen 518126 P.R. China.

**1.2 MEASUREMENT UNCERTAINTY**

The reported uncertainty of measurement  $y \pm U$ , where expanded uncertainty  $U$  is based on a standard uncertainty multiplied by a coverage factor of  $k=2$ , providing a level of confidence of approximately 95 %.

No.	Item	Uncertainty
1	Conducted Emission Test	$\pm 2.80\text{dB}$
2	RF power, conducted	$\pm 0.16\text{dB}$
3	Spurious emissions, conducted	$\pm 0.21\text{dB}$
4	All emissions, radiated(30MHz~1GHz)	$\pm 2.64\text{dB}$
5	All emissions, radiated(1GHz~6GHz)	$\pm 2.40\text{dB}$
6	All emissions, radiated(> 6GHz)	$\pm 2.52\text{dB}$
7	Temperature	$\pm 0.5\text{C}$
8	Humidity	$\pm 2\%$

**2. GENERAL INFORMATION**

**2.1 GENERAL DESCRIPTION OF EUT**

Equipment	ScreenBeam OPS Wireless Display Module		
Trade Mark	ScreenBeam		
Model Name	SBWD3100		
FCC ID	LNQSBWD3100		
Product Description	Mode Supported	<input checked="" type="checkbox"/> 802.11a <input checked="" type="checkbox"/> 802.11n(HT20) <input checked="" type="checkbox"/> 802.11n(HT40) <input checked="" type="checkbox"/> 802.11ac(HT20) <input checked="" type="checkbox"/> 802.11ac(HT40) <input checked="" type="checkbox"/> 802.11ac(HT80)	
	Data Rate	802.11a: 6,9,12,18,24,36,48,54Mbps; 802.11n(HT20/HT40):MCS0~MCS23 802.11ac(VHT20): NSS1/NSS2, MCS0~MCS8 ; NSS3, MCS0~MCS9 802.11ac(VHT40/80): NSS1/NSS2/NSS3, MCS0~MCS9	
	Modulation	OFDM with BPSK/QPSK/16QAM/64QAM/256QAM	
	Operating Frequency Range	<input checked="" type="checkbox"/> U-NII-1: 5150 MHz ~5250MHz <input type="checkbox"/> U-NII-2A: 5250MHz~5350MHz <input type="checkbox"/> U-NII-2C: 5470MHz~5725MHz <input checked="" type="checkbox"/> U-NII-3: 5725 MHz ~5850 MHz	
	Function:	<input type="checkbox"/> Outdoor AP <input checked="" type="checkbox"/> Indoor AP <input type="checkbox"/> Fixed P2P <input type="checkbox"/> Client device	
	Antenna Type	See Table for Filed Antenna	
	Smart system	<input checked="" type="checkbox"/> SISO for 802.11a/n/ac <input checked="" type="checkbox"/> MIMO for 802.11n/ac	
	Antenna Gain	See Table for Filed Antenna	
	Based on the application, features, or specification exhibited in User's Manual, More details of EUT technical specification, please refer to the User's Manual.		
	Ratings	DC 12V-19V, 3A	
Adapter	N/A		
Battery	N/A		
Connecting I/O Port(s)	Please refer to the User's Manual		
HW Version	1AD		
SW Version	11.0.x.0		

Note:

- For a more detailed features description, please refer to the manufacturer's specifications or the User's Manual.



2. Frequency and Channel list:

Band	20MHz		40MHz		80MHz	
	Channel	Frequency	Channel	Frequency	Channel	Frequency
U-NII-1	36	5180 MHz	38	5190 MHz	42	5210 MHz
	40	5200 MHz	46	5230 MHz	-	-
	44	5220 MHz				
	48	5240 MHz				
U-NII-3	149	5745 MHz	151	5755 MHz	155	5775 MHz
	153	5765 MHz	159	5795 MHz		
	157	5785 MHz				
	161	5805 MHz				
	165	5825 MHz				

The EUT has two modules, namely module 8822 and module 2447. This report just recorded the data for module 2447.

The module has three antennas, and different modes support different transmit mode what describe as Following form:

Antenna	Antenna Type	Antenna Gain(dBi)
		5G
0	PIFA	3.37
1	PIFA	4.28
2	PIFA	3.67

ANT connector plot:

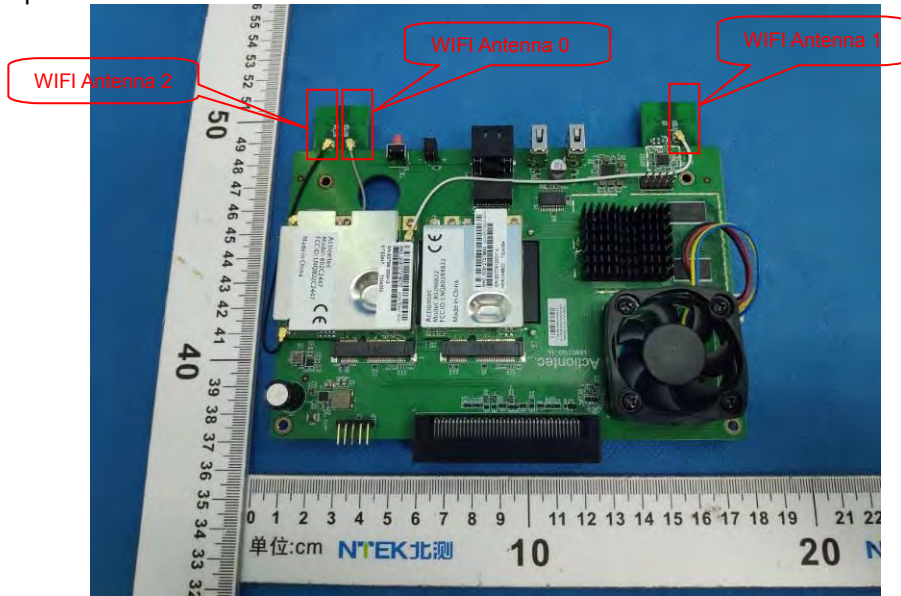

Mode	Tx/Rx
802.11a	1Tx, 1Rx
802.11n/ac	1Tx/3Tx, 3Rx

For MIMO mode, Directional gain= $10\log[(10^{G_0/20} + 10^{G_1/20} + 10^{G_2/20})^2 / N_{ANT}]$  dBi =8.56dbi in 5.0GHz  
802.11n/ac 5GHz has MIMO mode.

Note: G0 means antenna gain for ANT 0 in dBi.  
G1 means antenna gain for ANT 1 in dBi.  
G2 means antenna gain for ANT 2 in dBi.  
 $N_{ANT}$  means the number of Antennas.

5G Band:

For IEEE 802.11a mode (1TX, 1RX):

The EUT can support both 1TX and 1RX functions.

For 1TX

Only one Chain can be used as transmitting and receiving antenna.

For IEEE 802.11n mode (1TX/3TX, 3RX):

The EUT can support both 1TX and 3TX functions.

For 1TX

Only one Chain can be used as transmitting antenna. When MCS 0~7 enable without TX-Beamforming/STBC. All three antennas could receive simultaneously.

For 3TX

Chain 0, Chain 1 and Chain 2 can be used as transmitting/receiving antenna. When TX-Beamforming/STBC enable/MCS 16~23 enable.

Ant 0, Ant 1 and Ant 2 could transmit/receive simultaneously.

Only 3TX function was selected to test and record in the report, the 1TX test results were covered by 3TX Test results.

For IEEE 802.11ac mode (1TX/3TX, 3RX):

The EUT can support both 1TX and 3TX functions.

For 1TX

Only one Chain can be used as transmitting antenna. When 1SS MCS 0~9 enable without TX-Beamforming/STBC.

Chain 0, Chain 1 and Chain 2 could receive simultaneously.

For 3TX

Chain 0, Chain 1 and Chain 2 can be used as transmitting/receiving antenna. When TX-Beamforming/STBC enable/3SS MCS 0~9 enable.

Chain 0, Chain 1 and Chain 2 could transmit/receive simultaneously.

Only 3TX function was selected to test and record in the report, the 1TX test results were covered by 3TX Test results.

**2.2 DESCRIPTION OF TEST MODES**

To investigate the maximum EMI emission characteristics generates from EUT, the test system was pre-scanning tested base on the consideration of following EUT operation mode or test configuration mode which possible have effect on EMI emission level. Each of these EUT operation mode(s) or test configuration mode(s) mentioned above was evaluated respectively.

Test Items	Mode	Data Rate	Channel	Ant
AC Power Line Conducted Emissions	Normal Link	-	-	-
Maximum Conducted Output Power	11a/n(20)/ac(20)	6 Mbps/ MCS0/ VHT1MCS0	36/40/48/149/157/165	0/1/2
	11n(40)/ac(40)	MCS0/ VHT1MCS0	38/46/151/159	0/1/2
	11ac(80)	MCS0/ VHT1MCS0	42/155	0/1/2
Power Spectral Density	11a/n(20)/ac(20)	6 Mbps/ MCS0	36/40/48/149/157/165	0/1/2
	11n(40)/ac(40)	MCS0	38/46/151/159	0/1/2
	11ac(80)	MCS0	42/155	0/1/2
26 dB and 99% Emission Bandwidth	11a/n(20)/ac(20)	6 Mbps/ MCS0	36/40/48/149/157/165	0/1/2
	11n(40)/ac(40)	MCS0	38/46/151/159	0/1/2
	11ac(80)	MCS0	42/155	0/1/2
Minimum 6 dB bandwidth	11a/n(20)/ac(20)	6 Mbps/ MCS0	36/40/48/149/157/165	0/1/2
	11n(40)/ac(40)	MCS0	38/46/151/159	0/1/2
	11ac(80)	MCS0	42/155	0/1/2
Radiated Emissions Below 1GHz	Normal Link	-	-	-
Radiated Emissions Above 1GHz	11a/n(20)/ac(20)	6 Mbps/ MCS0	36/40/48/149/157/165	-
	11n(40)/ac(40)	MCS0	38/46/151/159	-
	11ac(80)	MCS0	42/155	-
Band Edge Emissions	11a/n(20)/ac(20)	6 Mbps/ MCS0	36/40/48/149/157/165	0/1/2
	11n(40)/ac(40)	MCS0	38/46/151/159	0/1/2
	11ac(80)	MCS0	42/155	0/1/2

Note:

- (1) The measurements are performed at the highest, middle, lowest available channels.
- (2) The measurements are performed at all Bit Rate of Transmitter, the worst data was reported

2.3 BLOCK DIGRAM SHOWING THE CONFIGURATION OF SYSTEM TESTED

For AC Conducted Emission Mode

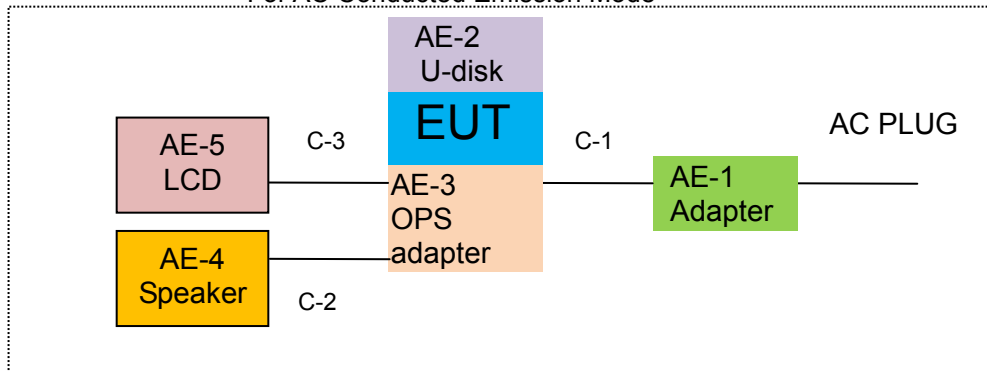

For Radiated Test Cases

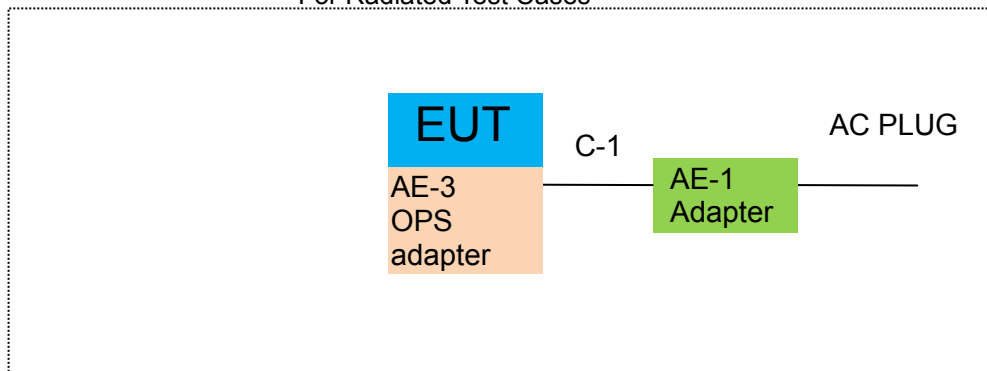

For Conducted Test Cases

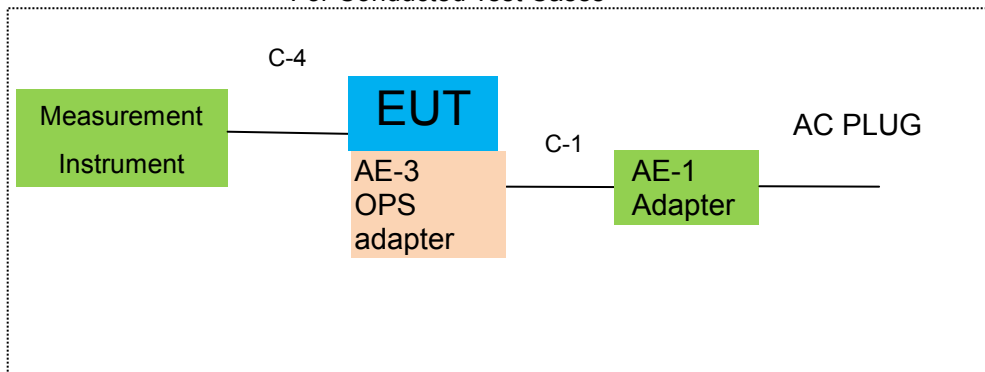

Note: The temporary antenna connector is soldered on the PCB board in order to perform conducted tests and this temporary antenna connector is listed in the equipment list.

**2.4 DESCRIPTION OF SUPPORT UNITS(CONDUCTED MODE)**

The EUT has been tested as an independent unit together with other necessary accessories or support units. The following support units or accessories were used to form a representative test configuration during the tests.

Item	Equipment	Brand	Model/Type No.	Series No.	Note
AE-1	Adapter	N/A	N/A	N/A	
AE-2	U-disk	N/A	N/A	N/A	
AE-3	OPS adapter board	N/A	N/A	N/A	
AE-4	Speaker	N/A	N/A	N/A	
AE-5	LCD	N/A	N/A	N/A	

Item	Cable Type	Shielded Type	Ferrite Core	Length	Note
C-1	Power Cable	NO	NO	1.2m	
C-2	Audio Cable	NO	NO	1.2m	
C-3	HDMI Cable	YES	YES	1.2m	
C-4	RF Cable	YES	NO	0.1m	

Note:

- (1) The support equipment was authorized by Declaration of Confirmation.
- (2) For detachable type I/O cable should be specified the length in cm in 『Length』 column.

**2.5 EQUIPMENTS LIST FOR ALL TEST ITEMS**

Radiation& Conducted Test equipment

Item	Kind of Equipment	Manufacturer	Type No.	Serial No.	Last calibration	Calibrated until	Calibration period
1	Spectrum Analyzer	Agilent	E4440A	MY41000130	2018.05.19 2019.05.13	2019.05.18 2020.05.12	1 year
2	Spectrum Analyzer	Agilent	N9020A	MY49100060	2018.10.08	2019.10.07	1 year
3	Spectrum Analyzer	R&S	FSV40	101417	2018.10.08	2019.10.07	1 year
4	Test Receiver	R&S	ESPI7	101318	2018.05.19 2019.05.13	2019.05.18 2020.05.12	1 year
5	Bilog Antenna	TESEQ	CBL6111D	31216	2018.04.19 2019.04.15	2019.04.18 2020.04.14	1 year
6	50Ω Coaxial Switch	Anritsu	MP59B	6200983705	2018.05.19	2020.05.18	2 year
7	Horn Antenna	EM	EM-AH-1018 0	2011071402	2018.04.19 2019.04.15	2019.04.18 2020.04.14	1 year
8	Amplifier	EMC	EMC051835 SE	980246	2018.08.05	2019.08.04	1 year
9	Active Loop Antenna	SCHWARZBECK	FMZB 1519 B	055	2018.12.11	2019.12.10	1 year
10	Power Meter	DARE	RPR3006W	15I00041SN O84	2018.08.05	2019.08.04	1 year
11	Test Cable (9KHz-30MHz)	N/A	R-01	N/A	2017.04.21	2020.04.20	3 year
12	Test Cable (30MHz-1GHz)	N/A	R-02	N/A	2017.04.21	2020.04.20	3 year
13	High Test Cable(1G-40GHz)	N/A	R-03	N/A	2017.04.21	2020.04.20	3 year
14	High Test Cable(1G-40GHz)	N/A	R-04	N/A	2017.04.21	2020.04.20	3 year
15	Filter	TRILTHIC	2400MHz	29	2017.04.19	2020.04.18	3 year
16	temporary antenna connector (Note)	NTS	R001	N/A	N/A	N/A	N/A
17	Low Noise Amplifier	B&Z	BZ-P540-550 850-452727	16476-11729	2018.04.19 2019.04.15	2019.04.18 2020.04.14	1 year
18	Broadband Horn Antenna	SCHWARZBECK	BBHA 9170	803	2018.12.11	2019.12.10	1 year

Note:

We will use the temporary antenna connector (soldered on the PCB board) When conducted test  
And this temporary antenna connector is listed within the instrument list

AC Conduction Test equipment

Item	Kind of Equipment	Manufacturer	Type No.	Serial No.	Last calibration	Calibrated until	Calibration period
1	Test Receiver	R&S	ESCI	101160	2018.05.19 2019.05.13	2019.05.18 2020.05.12	1 year
2	LISN	R&S	ENV216	101313	2018.04.19 2019.04.15	2019.04.18 2020.04.14	1 year
3	LISN	SCHWARZBECK	NNLK 8129	8129245	2018.05.19 2019.05.13	2019.05.18 2020.05.12	1 year
4	50Ω Coaxial Switch	ANRITSU CORP	MP59B	6200983704	2018.05.19	2020.05.18	3 year
5	Test Cable (9KHz-30MHz)	N/A	C01	N/A	2017.04.21	2020.04.20	3 year
6	Test Cable (9KHz-30MHz)	N/A	C02	N/A	2017.04.21	2020.04.20	3 year
7	Test Cable (9KHz-30MHz)	N/A	C03	N/A	2017.04.21	2020.04.20	3 year

Note: Each piece of equipment is scheduled for calibration once a year except the Test Cable& Aux Equipment which is scheduled for calibration every 3 years.



### 3. EMC EMISSION TEST

#### 3.1 CONDUCTED EMISSION MEASUREMENT

##### 3.1.1 APPLICABLE STANDARD

According to FCC Part 15.207(a) and KDB 174176 D01 Line Conducted FAQ v01r01

##### 3.1.2 CONFORMANCE LIMIT

Frequency(MHz)	Conducted Emission Limit	
	Quasi-peak	Average
0.15-0.5	66-56*	56-46*
0.5-5.0	56	46
5.0-30.0	60	50

Note: 1. \*Decreases with the logarithm of the frequency  
 2. The lower limit shall apply at the transition frequencies  
 3. The limit decreases in line with the logarithm of the frequency in the range of 0.15 to 0.50MHz.

##### 3.1.3 TEST CONFIGURATION

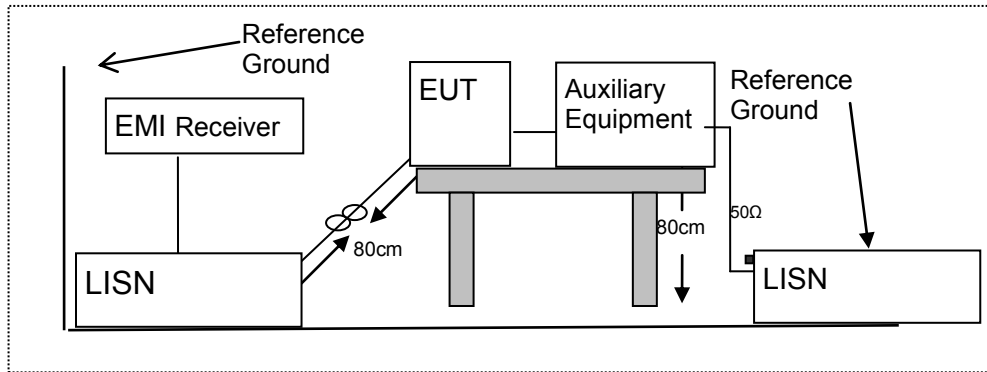

##### 3.1.4 TEST PROCEDURE

According to the requirements in Section 13.1.4.1 of ANSI C63.10-2013 Conducted emissions the EUT measured in the frequency range between 0.15 MHz and 30 MHz using CISPR Quasi-Peak and average detector mode.

1. The EUT was placed 0.4 meter from the conducting wall of the shielding room.
2. The EUT was placed on a table which is 0.8m above ground plane.
3. Connect EUT to the power mains through a line impedance stabilization network (LISN). All other support equipments powered from additional LISN(s). The LISN provide 50 Ohm/ 50uH of coupling impedance for the measuring instrument.
4. Interconnecting cables that hang closer than 40 cm to the ground plane shall be folded back and forth in the center forming a bundle 30 to 40cm long.
5. I/O cables that are not connected to a peripheral shall be bundled in the center. The end of the cable may be terminated, if required, using the correct terminating impedance. The overall length shall not exceed 1 m.
6. LISN at least 80 cm from nearest part of EUT chassis.
7. The frequency range from 150KHz to 30MHz was searched.
8. Set the test-receiver system to Peak Detect Function and specified bandwidth(IF bandwidth=9KHz) with Maximum Hold Mode
9. For the actual test configuration, please refer to the related Item –EUT Test Photos.

EUT :	ScreenBeam OPS Wireless Display Module	Model Name. :	SBWD3100
Temperature :	26 °C	Relative Humidity :	56%
Pressure :	1010hPa	Phase :	L
Test Voltage :	DC 19V from Adapter AC 120V/60Hz	Test Mode :	Normal link

Frequency (MHz)	Reading Level (dBμV)	Correct Factor (dB)	Measure-ment (dBμV)	Limits (dBμV)	Margin (dB)	Remark
0.1500	42.69	9.75	52.44	65.99	-13.55	QP
0.1500	20.29	9.75	30.04	55.99	-25.95	AVG
0.2671	30.73	9.75	40.48	61.20	-20.72	QP
0.2671	12.03	9.75	21.78	51.20	-29.42	AVG
0.4699	32.57	9.74	42.31	56.52	-14.21	QP
0.4699	24.71	9.74	34.45	46.52	-12.07	AVG
10.8658	27.34	10.02	37.36	60.00	-22.64	QP
10.8658	16.82	10.02	26.84	50.00	-23.16	AVG
17.6298	25.11	10.16	35.27	60.00	-24.73	QP
17.6298	13.43	10.16	23.59	50.00	-26.41	AVG
27.1619	32.00	10.59	42.59	60.00	-17.41	QP
27.1619	19.88	10.59	30.47	50.00	-19.53	AVG

Remark:

1. All readings are Quasi-Peak and Average values.
2. Factor = Insertion Loss + Cable Loss.

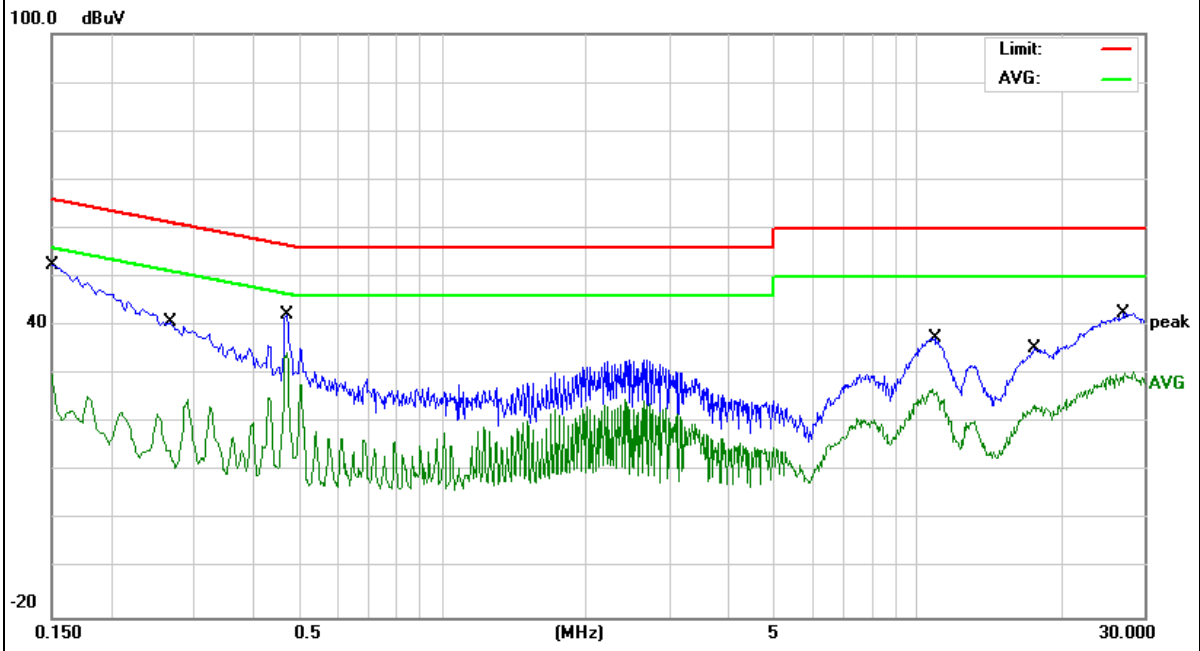

EUT :	ScreenBeam OPS Wireless Display Module	Model Name. :	SBWD3100
Temperature :	26 °C	Relative Humidity :	56%
Pressure :	1010hPa	Phase :	N
Test Voltage :	DC 19V from Adapter AC 120V/60Hz	Test Mode :	Normal link

Frequency (MHz)	Reading Level (dBμV)	Correct Factor (dB)	Measure-ment (dBμV)	Limits (dBμV)	Margin (dB)	Remark
0.1580	41.77	9.74	51.51	65.56	-14.05	QP
0.1580	15.88	9.74	25.62	55.56	-29.94	AVG
0.4339	30.46	9.75	40.21	57.18	-16.97	QP
0.4339	21.45	9.75	31.20	47.18	-15.98	AVG
0.5020	30.02	9.75	39.77	56.00	-16.23	QP
0.5020	22.22	9.75	31.97	46.00	-14.03	AVG
10.7898	25.41	10.05	35.46	60.00	-24.54	QP
10.7898	14.85	10.05	24.90	50.00	-25.10	AVG
13.0219	25.29	10.07	35.36	60.00	-24.64	QP
13.0219	13.78	10.07	23.85	50.00	-26.15	AVG
27.6619	31.55	10.53	42.08	60.00	-17.92	QP
27.6619	19.42	10.53	29.95	50.00	-20.05	AVG

Remark:

1. All readings are Quasi-Peak and Average values.
2. Factor = Insertion Loss + Cable Loss.

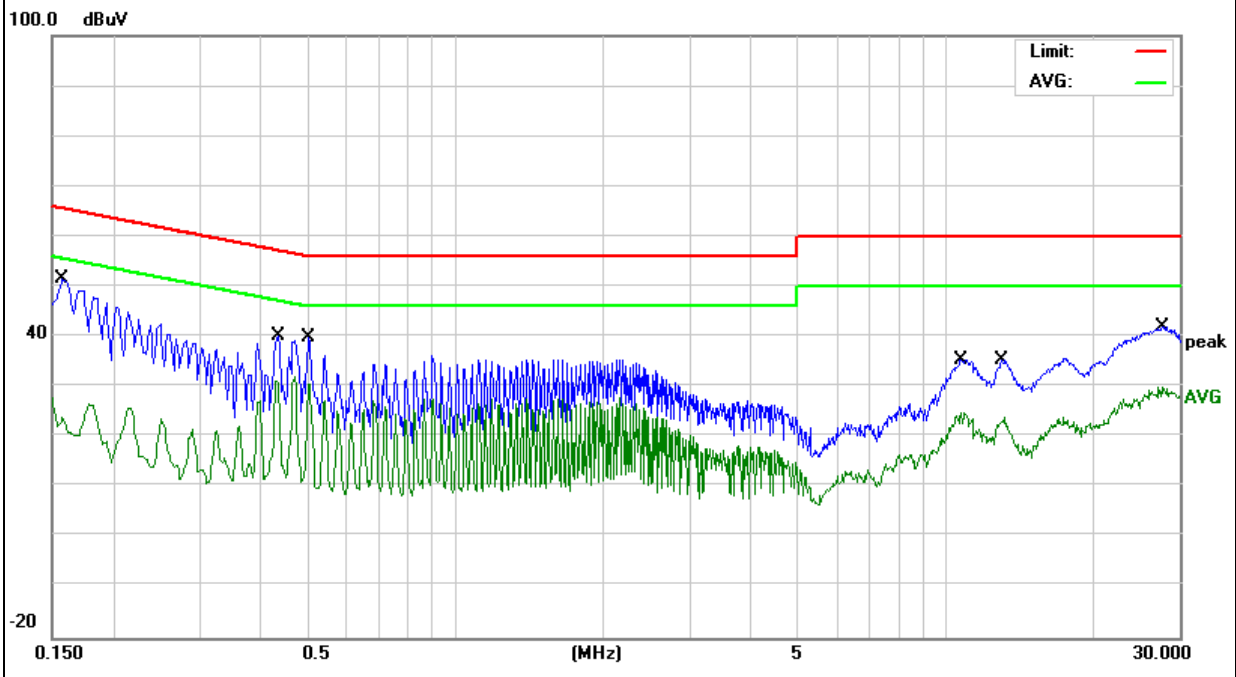

EUT :	ScreenBeam OPS Wireless Display Module	Model Name. :	SBWD3100
Temperature :	26 °C	Relative Humidity :	56%
Pressure :	1010hPa	Phase :	L
Test Voltage :	DC 19V from Adapter AC 240V/60Hz	Test Mode :	Normal link

Frequency (MHz)	Reading Level (dBμV)	Correct Factor (dB)	Measure-ment (dBμV)	Limits (dBμV)	Margin (dB)	Remark
0.1660	41.39	9.76	51.15	65.15	-14.00	QP
0.1660	12.95	9.76	22.71	55.15	-32.44	AVG
0.2419	33.90	9.76	43.66	62.03	-18.37	QP
0.2419	12.06	9.76	21.82	52.03	-30.21	AVG
0.4660	33.71	9.74	43.45	56.58	-13.13	QP
0.4660	25.42	9.74	35.16	46.58	-11.42	AVG
0.5020	26.78	9.74	36.52	56.00	-19.48	QP
0.5020	18.81	9.74	28.55	46.00	-17.45	AVG
18.2419	26.36	10.17	36.53	60.00	-23.47	QP
18.2419	16.12	10.17	26.29	50.00	-23.71	AVG
28.5620	33.05	10.50	43.55	60.00	-16.45	QP
28.5620	21.24	10.50	31.74	50.00	-18.26	AVG

Remark:

1. All readings are Quasi-Peak and Average values.
2. Factor = Insertion Loss + Cable Loss.

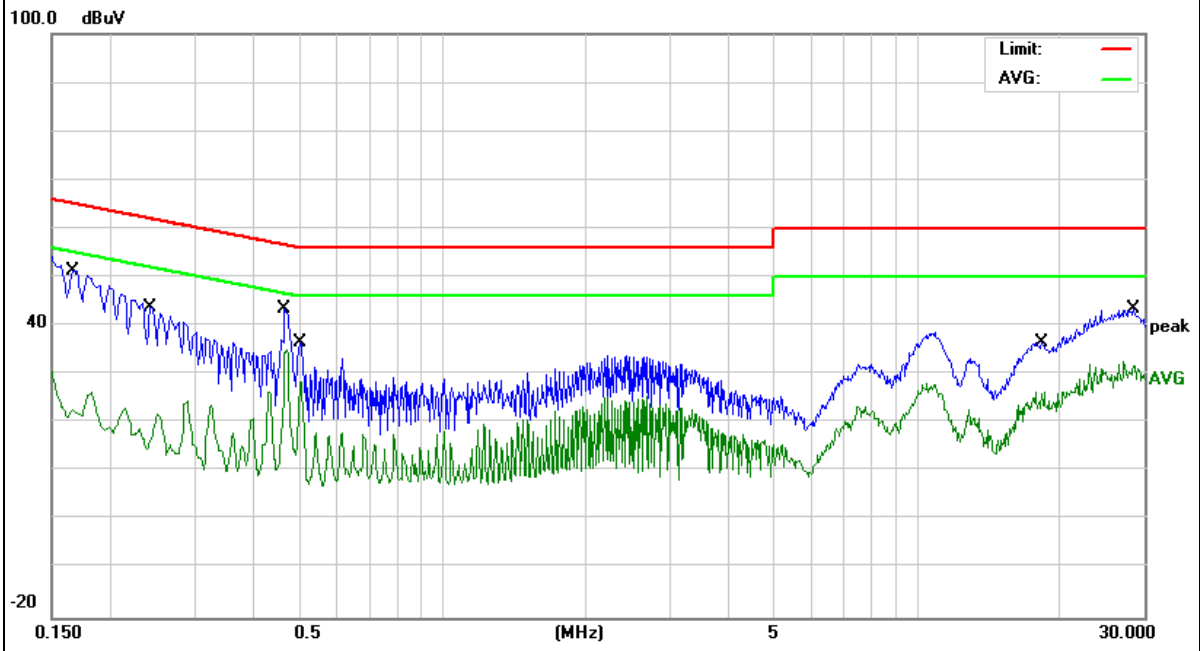

EUT :	ScreenBeam OPS Wireless Display Module	Model Name. :	SBWD3100
Temperature :	26 °C	Relative Humidity :	56%
Pressure :	1010hPa	Phase :	N
Test Voltage :	DC 19V from Adapter AC 240V/60Hz	Test Mode :	Normal link

Frequency (MHz)	Reading Level (dBμV)	Correct Factor (dB)	Measure-ment (dBμV)	Limits (dBμV)	Margin (dB)	Remark
0.1539	42.73	9.74	52.47	65.78	-13.31	QP
0.1539	18.96	9.74	28.70	55.78	-27.08	AVG
0.4339	31.62	9.75	41.37	57.18	-15.81	QP
0.4339	22.44	9.75	32.19	47.18	-14.99	AVG
0.4697	33.26	9.75	43.01	56.52	-13.51	QP
0.4697	26.28	9.75	36.03	46.52	-10.49	AVG
0.5060	32.53	9.75	42.28	56.00	-13.72	QP
0.5060	23.85	9.75	33.60	46.00	-12.40	AVG
10.7896	25.85	10.05	35.90	60.00	-24.10	QP
10.7896	15.18	10.05	25.23	50.00	-24.77	AVG
25.8736	30.85	10.61	41.46	60.00	-18.54	QP
25.8736	20.26	10.61	30.87	50.00	-19.13	AVG

Remark:

1. All readings are Quasi-Peak and Average values.
2. Factor = Insertion Loss + Cable Loss.

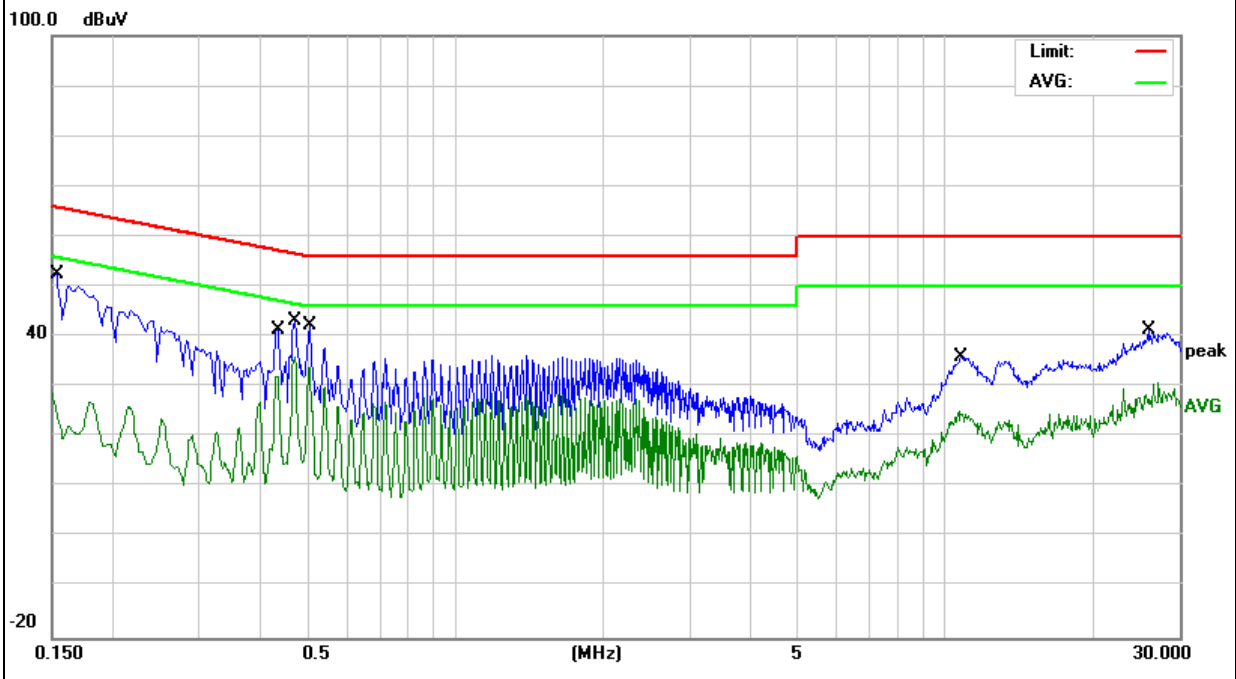

### 3.2 RADIATED EMISSION MEASUREMENT

#### 3.2.1 APPLICABLE STANDARD

According to FCC Part 15.407(d) and 15.209

#### 3.2.2 CONFORMANCE LIMIT

According to FCC Part 15.407(b)(7): radiated emissions which fall in the restricted bands, as defined in §15.205(a), must also comply with the radiated emission limits specified in §15.209(a) (see §15.205(c)).  
According to FCC Part 15.205, Restricted bands

MHz	MHz	MHz	GHz
0.090-0.110	16.42-16.423	399.9-410	4.5-5.15
0.495-0.505	16.69475-16.69525	608-614	5.35-5.46
2.1735-2.1905	16.80425-16.80475	960-1240	7.25-7.75
4.125-4.128	25.5-25.67	1300-1427	8.025-8.5
4.17725-4.17775	37.5-38.25	1435-1626.5	9.0-9.2
4.20725-4.20775	73-74.6	1645.5-1646.5	9.3-9.5
6.215-6.218	74.8-75.2	1660-1710	10.6-12.7
6.26775-6.26825	123-138	2200-2300	14.47-14.5
8.291-8.294	149.9-150.05	2310-2390	15.35-16.2
8.362-8.366	156.52475-156.52525	2483.5-2500	17.7-21.4
8.37625-8.38675	156.7-156.9	2690-2900	22.01-23.12
8.41425-8.41475	162.0125-167.17	3260-3267	23.6-24.0
12.29-12.293	167.72-173.2	3332-3339	31.2-31.8
12.51975-12.52025	240-285	3345.8-3358	36.43-36.5
12.57675-12.57725	322-335.4	3600-4400	(2)
13.36-13.41			

20dBc in any 100 kHz bandwidth outside the operating frequency band. In case the emission fall within the restricted band specified on 15.205(a), then the 15.209(a) limit in the table below has to be followed.

Restricted Frequency(MHz)	Field Strength (µV/m)	Field Strength (dBµV/m)	Measurement Distance
0.009~0.490	2400/F(KHz)	20 log (uV/m)	300
0.490~1.705	24000/F(KHz)	20 log (uV/m)	30
1.705~30.0	30	29.5	30
30-88	100	40	3
88-216	150	43.5	3
216-960	200	46	3
Above 960	500	54	3

#### Limits of Radiated Emission Measurement(Above 1000MHz)

Frequency(MHz)	Class B (dBuV/m) (at 3M)	
	PEAK	AVERAGE
Above 1000	74	54

- Remark : 1. Emission level in dBuV/m=20 log (uV/m)  
 2. Measurement was performed at an antenna to the closed point of EUT distance of meters.  
 3. For Frequency 9kHz~30MHz:  
 Distance extrapolation factor =40log(Specific distance/ test distance)(dB);  
 Limit line=Specific limits(dBuV) + distance extrapolation factor.  
 For Frequency above 30MHz:  
 Distance extrapolation factor =20log(Specific distance/ test distance)(dB);  
 Limit line=Specific limits(dBuV) + distance extrapolation factor.

#### 3.2.3 MEASURING INSTRUMENTS

The Measuring equipment is listed in the section 6.3 of this test report.

### 3.2.4 TEST CONFIGURATION

(a) For radiated emissions below 30MHz

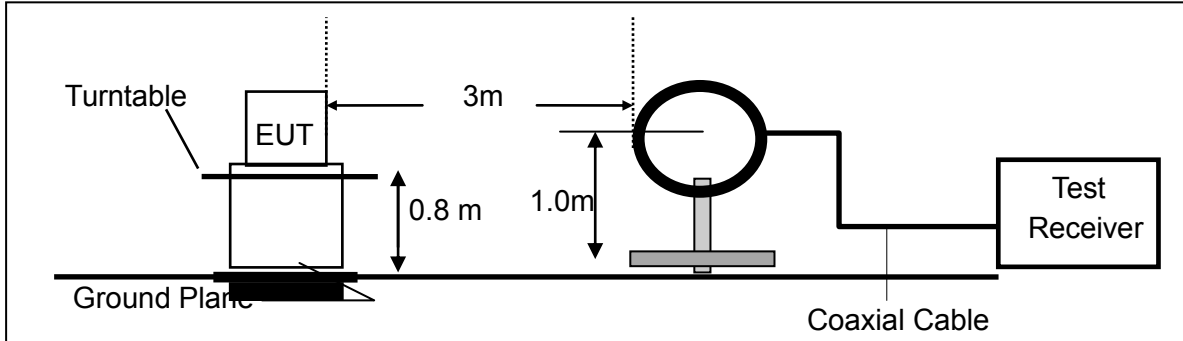

(b) For radiated emissions from 30MHz to 1000MHz

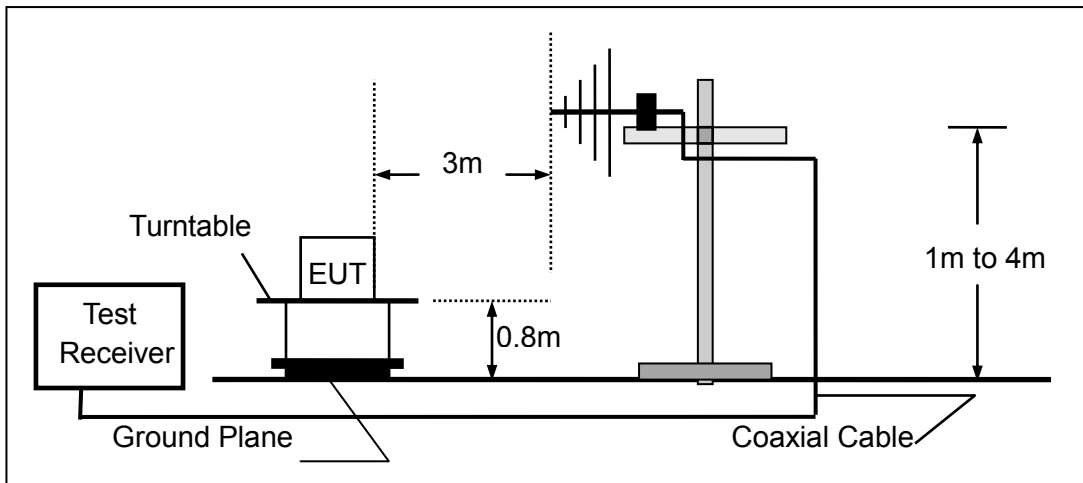

(c) For radiated emissions above 1000MHz

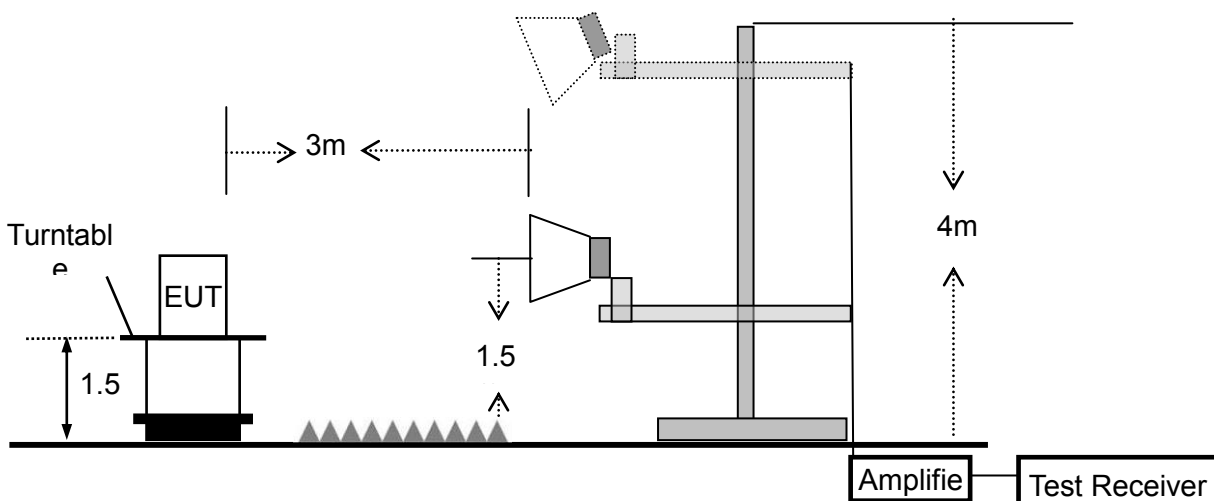

**3.2.5 TEST PROCEDURE**

The test site semi-anechoic chamber has met the requirement of NSA tolerance 4 dB according to the standards: ANSI C63.10-2013. The test distance is 3m. The setup is according to the requirements in Section 13.1.4.1 of ANSI C63.10-2013 and CAN/CSA-CEI/IEC CISPR 22.

This test is required for any spurious emission that falls in a Restricted Band, as defined in Section 15.205. It must be performed with the highest gain of each type of antenna proposed for use with the EUT.

Use the following spectrum analyzer settings:

Spectrum Parameter	Setting
Attenuation	Auto
Start Frequency	1000 MHz
Stop Frequency	10th carrier harmonic
RB / VB (emission in restricted band)	1 MHz / 1 MHz for Peak, 1 MHz / 10Hz for Average

Receiver Parameter	Setting
Attenuation	Auto
Start ~ Stop Frequency	9kHz~150kHz / RB 200Hz for QP
Start ~ Stop Frequency	150kHz~30MHz / RB 9kHz for QP
Start ~ Stop Frequency	30MHz~1000MHz / RB 120kHz for QP

- a. The measuring distance of at 3 m shall be used for measurements at frequency up to 1GHz. For frequencies above 1GHz, any suitable measuring distance may be used.
- b. The EUT was placed on the top of a rotating table 0.8 m for below 1GHz and 1.5m for above 1GHz the ground at a 3 meter. The table was rotated 360 degrees to determine the position of the highest radiation.
- c. The height of the equipment or of the substitution antenna shall be 0.8 m for below 1GHz and 1.5m for above 1GHz; the height of the test antenna shall vary between 1 m to 4 m. Both horizontal and vertical polarizations of the antenna are set to make the measurement.
- d. The initial step in collecting conducted emission data is a spectrum analyzer peak detector mode pre-scanning the measurement frequency range. Significant peaks are then marked and then Quasi Peak detector mode re-measured.
- e. If the Peak Mode measured value compliance with and lower than Quasi Peak Mode Limit, the EUT shall be deemed to meet QP Limits and then no additional QP Mode measurement performed.
- f. For the actual test configuration, please refer to the related Item –EUT Test Photos.

Note:

Both horizontal and vertical antenna polarities were tested and performed pretest to three orthogonal axis. The worst case emissions were reported

During the radiated emission test, the Spectrum Analyzer was set with the following configurations:

Frequency Band (MHz)	Function	Resolution bandwidth	Video Bandwidth
30 to 1000	QP	120 kHz	300 kHz
Above 1000	Peak	1 MHz	1 MHz
	Average	1 MHz	10 Hz

Note: for the frequency ranges below 30 MHz, a narrower RBW is used for these ranges but the measured value should add a RBW correction factor (RBWCF) where  $RBWCF [dB] = 10 \cdot \lg(100 [kHz] / \text{narrower RBW [kHz]})$ . , the narrower RBW is 1 kHz and RBWCF is 20 dB for the frequency 9 kHz to 150 kHz, and the narrower RBW is 10 kHz and RBWCF is 10 dB for the frequency 150 kHz to 30 MHz.



**3.2.6 TEST RESULTS (9KHZ – 30 MHZ)**

EUT:	ScreenBeam OPS Wireless Display Module	Model Name. :	SBWD3100
Temperature:	20 °C	Relative Humidity:	48%
Pressure:	1010 hPa	Test Voltage :	DC 19V
Test Mode :	TX	Polarization :	--

Freq.	Reading	Limit	Margin	State
(MHz)	(dBuV/m)	(dBuV/m)	(dB)	P/F
--	--	--	--	N/A
--	--	--	--	N/A

**NOTE:**

The amplitude of spurious emissions which are attenuated by more than 20dB below the permissible value has no need to be reported.

3.2.7 TEST RESULTS (30MHZ – 1GHZ)

EUT :	ScreenBeam OPS Wireless Display Module	Model Name. :	SBWD3100
Temperature :	20 °C	Relative Humidity :	48%
Pressure :	1010 hPa	Test Voltage :	DC 19V
Test Mode :	TX(5.2G)- 802.11n40 (High CH)		

All the modulation modes have been tested, and the worst result was report as below:

Polar (H/V)	Frequency	Meter Reading	Factor	Emission Level	Limits	Margin	Remark
	(MHz)	(dBuV)	(dB)	(dBuV/m)	(dBuV/m)	(dB)	
V	37.9450	15.92	15.27	31.19	40.00	-8.81	QP
V	119.8555	16.18	13.18	29.36	43.50	-14.14	QP
V	167.8241	16.08	11.38	27.46	43.50	-16.04	QP
V	399.0300	15.00	19.57	34.57	46.00	-11.43	QP
V	675.2078	8.84	25.01	33.85	46.00	-12.15	QP
V	938.8324	6.03	30.85	36.88	46.00	-9.12	QP

Remark:

Absolute Level= Reading Level+ Factor, Margin= Absolute Level - Limit

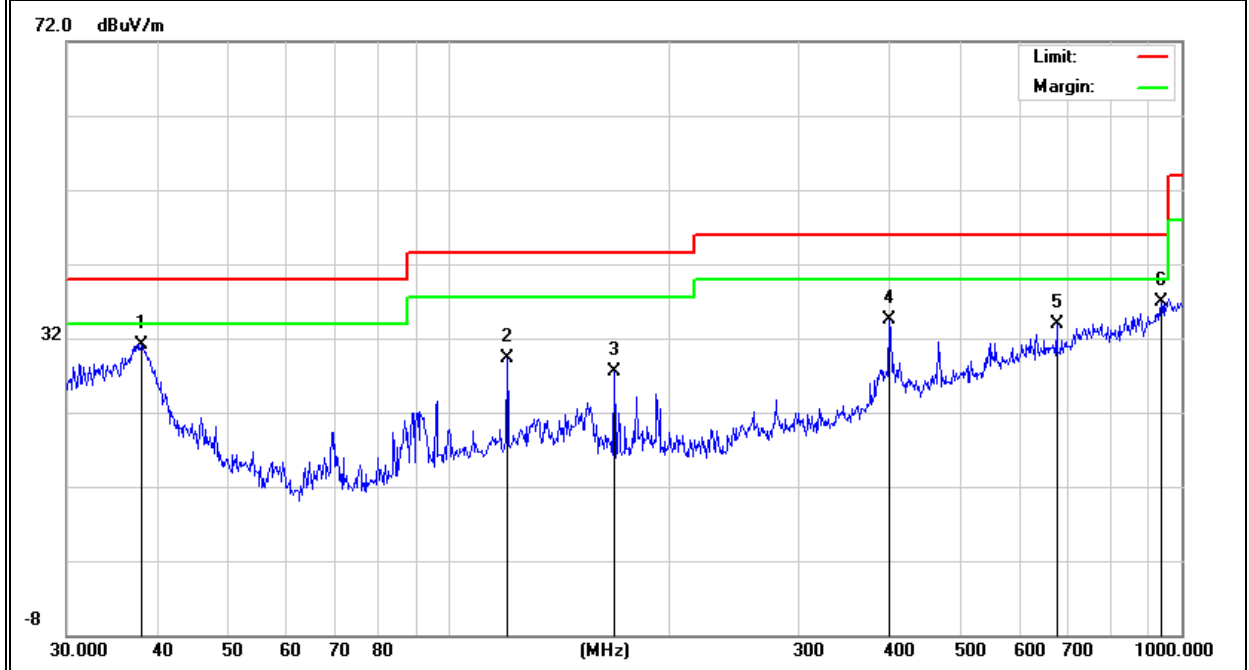

Polar (H/V)	Frequency	Meter Reading	Factor	Emission Level	Limits	Margin	Remark
	(MHz)	(dBuV)	(dB)	(dBuV/m)	(dBuV/m)	(dB)	
H	96.0986	14.26	11.08	25.34	43.50	-18.16	QP
H	119.8555	20.43	13.18	33.61	43.50	-9.89	QP
H	167.8242	19.40	11.38	30.78	43.50	-12.72	QP
H	191.7450	22.69	10.07	32.76	43.50	-10.74	QP
H	399.0300	18.51	19.57	38.08	46.00	-7.92	QP
H	948.7608	5.42	31.09	36.51	46.00	-9.49	QP

**Remark:**

Absolute Level= Reading Level+ Factor, Margin= Absolute Level - Limit

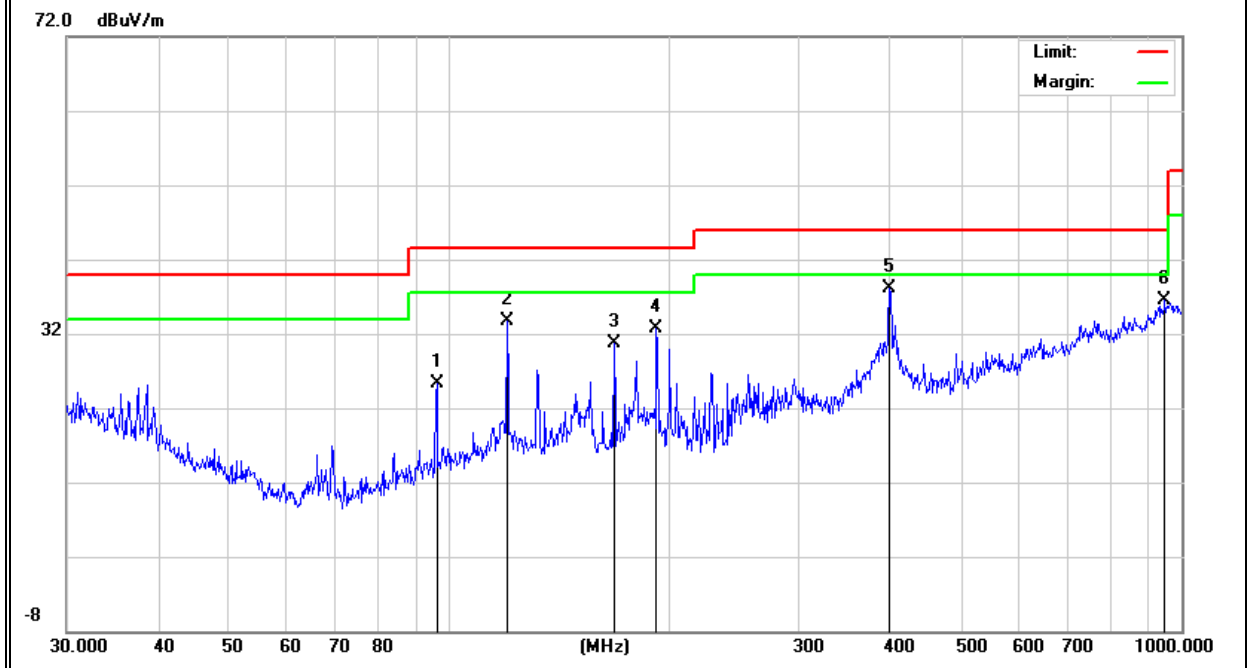

EUT :	ScreenBeam OPS Wireless Display Module	Model Name. :	SBWD3100
Temperature :	20 °C	Relative Humidity :	48%
Pressure :	1010 hPa	Test Voltage :	DC 19V
Test Mode :	TX(5.8G) - 802.11ac20 (High CH)		

Polar (H/V)	Frequency	Meter Reading	Factor	Emission Level	Limits	Margin	Remark
	(MHz)	(dBuV)	(dB)	(dBuV/m)	(dBuV/m)	(dB)	
V	37.6798	16.18	15.42	31.60	40.00	-8.40	QP
V	119.8555	16.00	13.18	29.18	43.50	-14.32	QP
V	167.8241	15.11	11.38	26.49	43.50	-17.01	QP
V	399.0300	14.35	19.57	33.92	46.00	-12.08	QP
V	768.7481	7.85	27.46	35.31	46.00	-10.69	QP
V	962.1621	6.25	31.17	37.42	54.00	-16.58	QP

**Remark:**

Absolute Level= Reading Level+ Factor, Margin= Absolute Level - Limit

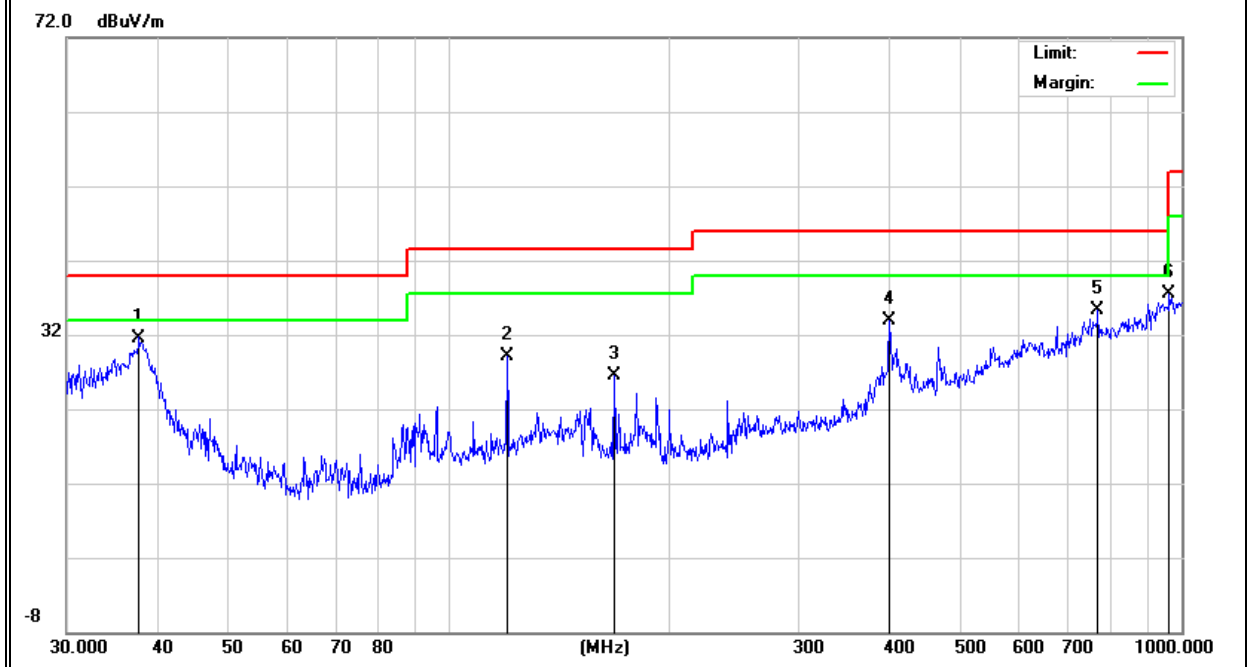

Polar (H/V)	Frequency	Meter Reading	Factor	Emission Level	Limits	Margin	Remark
	(MHz)	(dBuV)	(dB)	(dBuV/m)	(dBuV/m)	(dB)	
H	119.8555	19.08	13.18	32.26	43.50	-11.24	QP
H	167.8242	18.77	11.38	30.15	43.50	-13.35	QP
H	191.7450	19.56	10.07	29.63	43.50	-13.87	QP
H	400.4318	19.28	19.64	38.92	46.00	-7.08	QP
H	760.7036	5.99	27.59	33.58	46.00	-12.42	QP
H	848.0561	5.39	28.57	33.96	46.00	-12.04	QP

**Remark:**

Absolute Level= Reading Level+ Factor, Margin= Absolute Level - Limit

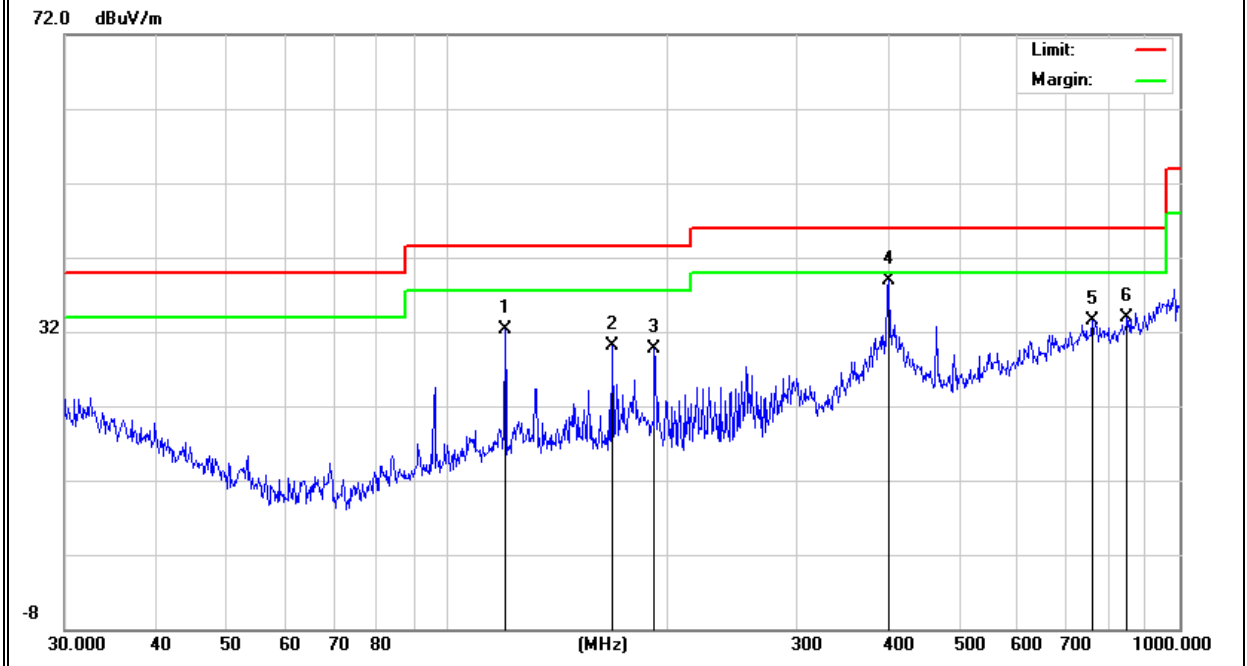

**3.2.8 TEST RESULTS (1GHz-18GHz)**

EUT :	ScreenBeam OPS Wireless Display Module	Model Name. :	SBWD3100
Temperature :	20 °C	Relative Humidity :	48%
Pressure :	1010 hPa	Test Voltage :	DC 19V
Test Mode :	TX(5.2G) - 802.11n40_5150~5250MHz		

Polar	Frequency	Meter Reading	Cable loss	Antenna Factor	Preamp Factor	Emission Level	Limits	Margin	Detector Type
(H/V)	(MHz)	(dBuV)	(dB)	dB/m	(dB)	(dBuV/m)	(dBuV/m)	(dB)	
Low Channel (5190 MHz)-Above 1G									
Vertical	3015.421	61.79	5.94	35.40	44.00	59.13	74.00	-14.87	Pk
Vertical	3015.421	41.23	5.94	35.40	44.00	38.57	54.00	-15.43	AV
Vertical	10360	61.15	8.46	39.75	44.50	64.86	74.00	-9.14	Pk
Vertical	10360	41.66	8.46	39.75	44.50	45.37	54.00	-8.63	AV
Vertical	15540	56.30	10.12	38.80	44.10	61.12	74.00	-12.88	Pk
Vertical	15540	37.32	10.12	38.80	42.70	43.54	54.00	-10.46	AV
Horizontal	2981.435	61.19	5.94	35.18	44.00	58.31	74.00	-15.69	Pk
Horizontal	2981.435	43.00	5.94	35.18	44.00	40.12	54.00	-13.88	AV
Horizontal	10360	57.64	8.46	38.71	44.50	60.31	74.00	-13.69	Pk
Horizontal	10360	41.20	8.46	38.71	44.50	43.87	54.00	-10.13	AV
Horizontal	15540	57.61	10.12	38.38	44.10	62.01	74.00	-11.99	Pk
Horizontal	15540	41.19	10.12	38.38	44.10	45.59	54.00	-8.41	AV
middle Channel (5230 MHz)-Above 1G									
Vertical	2062.53	60.96	7.10	37.24	43.50	61.8	74.00	-12.20	Pk
Vertical	2062.53	44.13	7.10	37.24	43.50	44.97	54.00	-9.03	AV
Vertical	10460	62.57	8.46	37.68	44.50	64.21	74.00	-9.79	Pk
Vertical	10460	40.88	8.46	37.68	44.50	42.52	54.00	-11.48	AV
Vertical	15690	58.62	10.12	38.80	44.10	63.44	74.00	-10.56	Pk
Vertical	15690	37.64	10.12	38.80	42.70	43.86	54.00	-10.14	AV
Horizontal	2827.5	63.29	7.10	37.24	43.50	64.13	74.00	-9.87	Pk
Horizontal	2827.5	42.01	7.10	37.24	43.50	42.85	54.00	-11.15	AV
Horizontal	10460	58.67	8.46	38.57	44.50	61.2	74.00	-12.80	Pk
Horizontal	10460	40.63	8.46	38.57	44.50	43.16	54.00	-10.84	AV
Horizontal	15690	60.82	10.12	38.38	44.10	65.22	74.00	-8.78	Pk

Note: "802.11n40 (5G)" MIMO mode is the worst mode.

The amplitude of spurious emissions that are attenuated by more than 20dB below the permissible value has no need to be reported.

Emission level (dBuV/m) = 20 log Emission level (uV/m).

Corrected Reading: Antenna Factor + Cable Loss + Read Level - Preamp Factor = Level.

EUT :	ScreenBeam OPS Wireless Display Module	Model Name. :	SBWD3100
Temperature :	20 °C	Relative Humidity :	48%
Pressure :	1010 hPa	Test Voltage :	DC 19V
Test Mode :	TX (5.8G) -- 802.11ac20_5725~5850MHz		

Polar	Frequency	Meter Reading	Cable loss	Antenna Factor	Preamp Factor	Emission Level	Limits	Margin	Detector Type
(H/V)	(MHz)	(dBuV)	(dB)	dB/m	(dB)	(dBuV/m)	(dBuV/m)	(dB)	
Low Channel (5745 MHz)-Above 1G									
Vertical	2806.690	64.46	5.94	35.40	44.00	61.80	74.00	-12.20	Pk
Vertical	2806.690	45.63	5.94	35.40	44.00	42.97	54.00	-11.03	AV
Vertical	11490.000	62.73	8.46	39.75	44.50	66.44	74.00	-7.56	Pk
Vertical	11490.000	43.52	8.46	39.75	44.50	47.23	54.00	-6.77	AV
Vertical	17235.000	58.97	10.12	38.80	44.10	63.79	74.00	-10.21	Pk
Vertical	17235.000	39.97	10.12	38.80	42.70	46.19	54.00	-7.81	AV
Horizontal	2911.524	64.76	5.94	35.18	44.00	61.88	74.00	-12.12	Pk
Horizontal	2911.524	46.47	5.94	35.18	44.00	43.59	54.00	-10.41	AV
Horizontal	11490.000	62.70	8.46	38.71	44.50	65.37	74.00	-8.63	Pk
Horizontal	11490.000	40.33	8.46	38.71	44.50	43.00	54.00	-11.00	AV
Horizontal	17235.000	60.20	10.12	38.38	44.10	64.60	74.00	-9.40	Pk
Horizontal	17235.000	42.67	10.12	38.38	44.10	47.07	54.00	-6.93	AV
middle Channel (5785 MHz)-Above 1G									
Vertical	3762.873	63.67	6.48	36.35	44.05	62.45	74.00	-11.55	Pk
Vertical	3762.873	42.54	6.48	36.35	44.05	41.32	54.00	-12.68	AV
Vertical	11570.350	63.33	8.47	37.88	44.51	65.17	74.00	-8.83	Pk
Vertical	11570.350	45.00	8.47	37.88	44.51	46.84	54.00	-7.16	AV
Vertical	17355.350	63.20	10.12	38.80	44.10	68.02	74.00	-5.98	Pk
Vertical	17355.350	42.66	10.12	38.80	42.70	48.88	54.00	-5.12	AV
Horizontal	3561.375	61.43	6.48	36.37	44.05	60.23	74.00	-13.77	Pk
Horizontal	3561.375	43.66	6.48	36.37	44.05	42.46	54.00	-11.54	AV
Horizontal	11570.350	60.32	8.47	38.64	44.50	62.93	74.00	-11.07	Pk
Horizontal	11570.350	43.26	8.47	38.64	44.50	45.87	54.00	-8.13	AV
Horizontal	17355.350	62.92	10.12	38.38	44.10	67.32	74.00	-6.68	Pk
Horizontal	17355.350	43.67	10.12	38.38	44.10	48.07	54.00	-5.93	AV
High Channel (5825 MHz)-Above 1G									
Vertical	3906.978	60.90	7.10	37.24	43.50	61.74	74.00	-12.26	Pk
Vertical	3906.978	42.82	7.10	37.24	43.50	43.66	54.00	-10.34	AV
Vertical	11650.350	60.76	8.46	37.68	44.50	62.40	74.00	-11.60	Pk
Vertical	11650.350	43.49	8.46	37.68	44.50	45.13	54.00	-8.87	AV
Vertical	17475.350	59.62	10.12	38.80	44.10	64.44	74.00	-9.56	Pk
Vertical	17475.350	39.87	10.12	38.80	42.70	46.09	54.00	-7.91	AV
Horizontal	3912.589	61.47	7.10	37.24	43.50	62.31	74.00	-11.69	Pk
Horizontal	3912.589	42.50	7.10	37.24	43.50	43.34	54.00	-10.66	AV
Horizontal	11650.350	62.70	8.46	38.57	44.50	65.23	74.00	-8.77	Pk
Horizontal	11650.350	43.16	8.46	38.57	44.50	45.69	54.00	-8.31	AV
Horizontal	17475.350	60.33	10.12	38.38	44.10	64.73	74.00	-9.27	Pk
Horizontal	17475.350	44.42	10.12	38.38	44.10	48.82	54.00	-5.18	AV

Note: "802.11ac20 (5G)" MIMO mode is the worst mode.

The amplitude of spurious emissions that are attenuated by more than 20dB below the permissible value has no need to be reported.

Emission level (dBuV/m) = 20 log Emission level (uV/m).

Corrected Reading: Antenna Factor + Cable Loss + Read Level - Preamp Factor = Level.

**3.2.9 TEST RESULTS (18GHZ-40GHZ)**

EUT :	ScreenBeam OPS Wireless Display Module	Model Name. :	SBWD3100
Temperature :	20 °C	Relative Humidity :	48%
Pressure :	1010 hPa	Test Voltage :	DC 19V
Test Mode :	TX (5.2G)-5150 MHz ~5250MHz(802.11n40 MIMO mode is the worst mode); TX (5.8G)-5725 MHz ~5850 MHz(802.11ac20 MIMO mode is the worst mode)		

All the modulation modes have been tested, and the worst mode data was report as below:

Low Channel (5190 MHz)-Above 1G

Horizontal

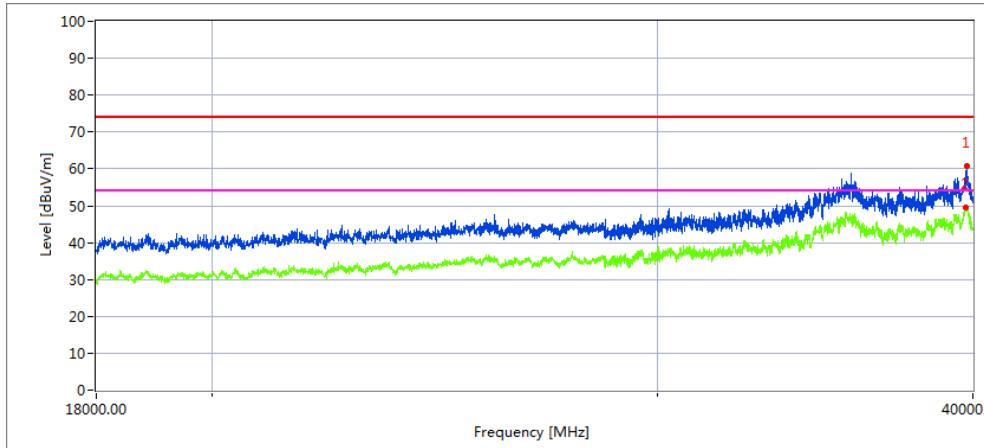

Frequency MHz	Pre-scan Level MaxPeak dBuV/m	Final Test Level MaxPeak dBuV/m	Limit MaxPeak dBuV/m	Margin dB
39771.332	60.7	55.9	74.0	18.1
39746.312	46.2	46.1	54.0	7.9

Vertical

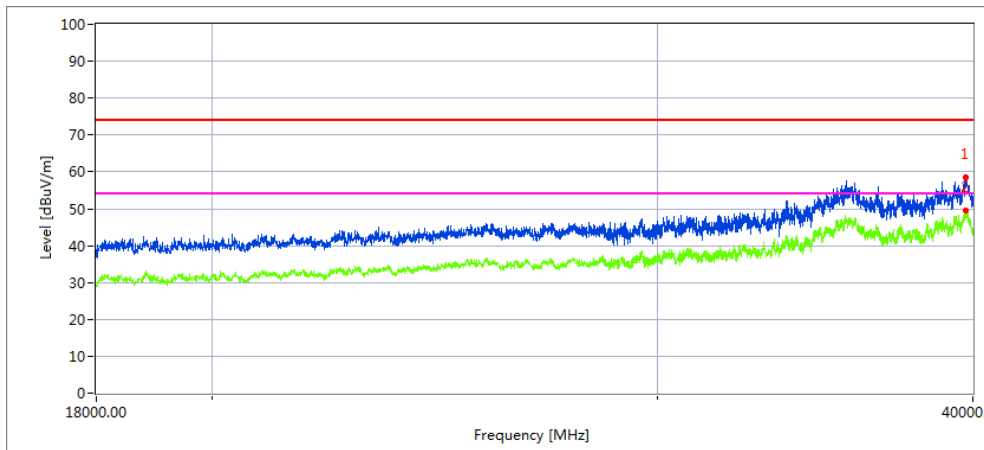

Frequency MHz	Pre-scan Level MaxPeak dBuV/m	Final Test Level MaxPeak dBuV/m	Limit MaxPeak dBuV/m	Margin dB
39736.872	58.4	57.3	74.0	16.7
39755.142	56.2	45.6	54.0	8.4



High Channel (5230 MHz)-Above 1G

Horizontal

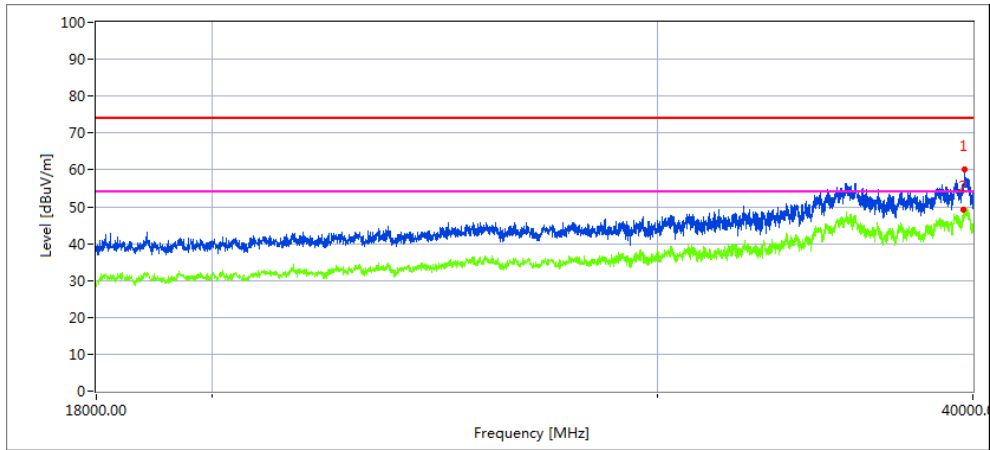

Frequency MHz	Pre-scan Level MaxPeak dBuV/m	Final Test Level MaxPeak dBuV/m	Limit MaxPeak dBuV/m	Margin dB
39701.268	60.1	58.0	74.0	16.0
39660.514	49.4	45.4	54.0	8.6

Vertical

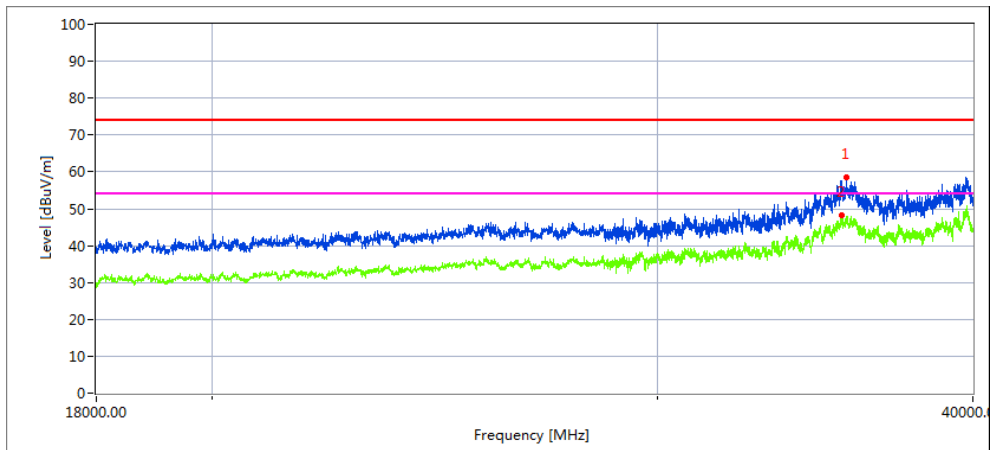

Frequency MHz	Pre-scan Level MaxPeak dBuV/m	Final Test Level MaxPeak dBuV/m	Limit MaxPeak dBuV/m	Margin dB
35651.004	58.6	48.8	74.0	25.2
35480.504	55.1	45.1	54.0	8.9

Low Channel (5745 MHz)-Above 1G

Horizontal

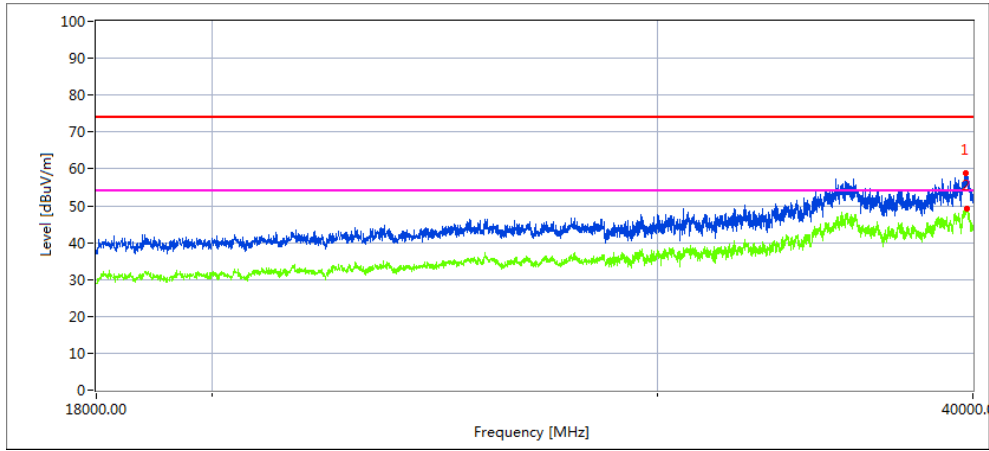

Frequency MHz	Pre-scan Level MaxPeak dBuV/m	Final Test Level MaxPeak dBuV/m	Limit MaxPeak dBuV/m	Margin dB
39759.474	58.7	56.8	74.0	17.2
39766.396	48.5	46.8	54.0	7.2

Vertical

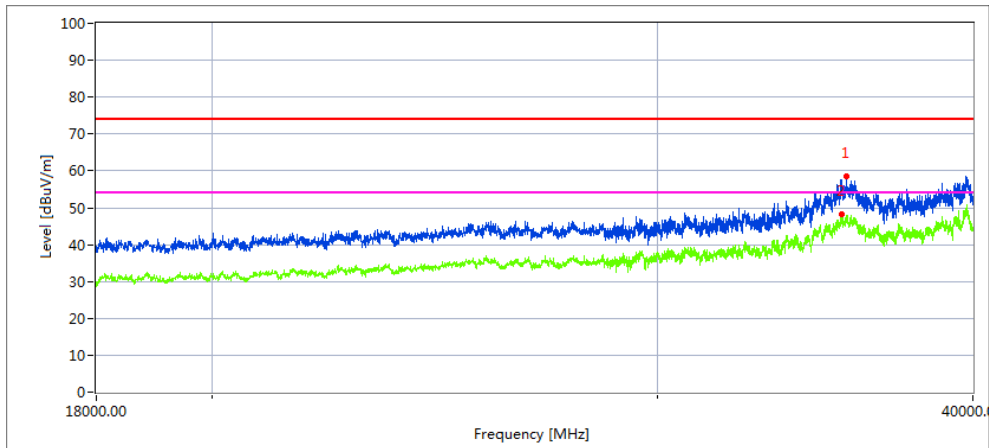

Frequency MHz	Pre-scan Level MaxPeak dBuV/m	Final Test Level MaxPeak dBuV/m	Limit MaxPeak dBuV/m	Margin dB
35651.004	58.6	48.8	74.0	25.2
35480.504	45.1	40.1	54.0	13.9

High Channel (5825 MHz)-Above 1G

Horizontal

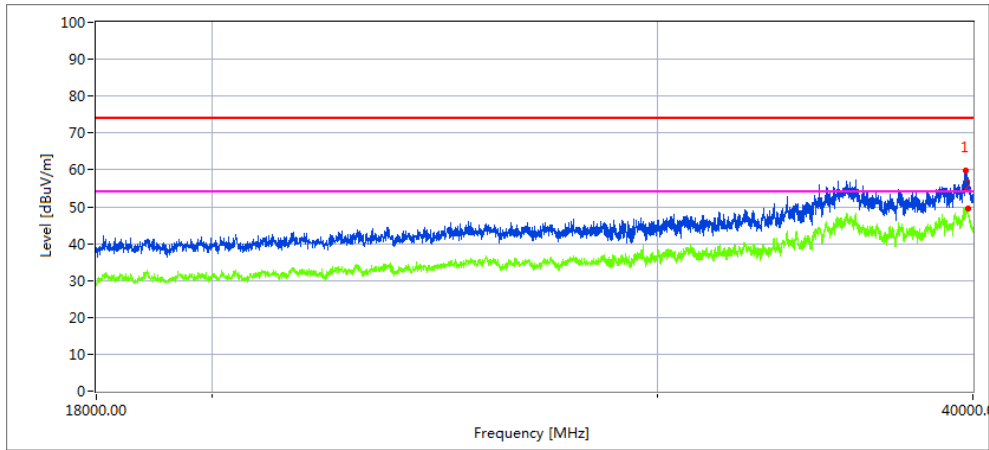

Frequency MHz	Pre-scan Level MaxPeak dBuV/m	Final Test Level MaxPeak dBuV/m	Limit MaxPeak dBuV/m	Margin dB
39742.576	59.9	58.0	74.0	16.0
39817.454	47.7	44.0	54.0	10.0

Vertical

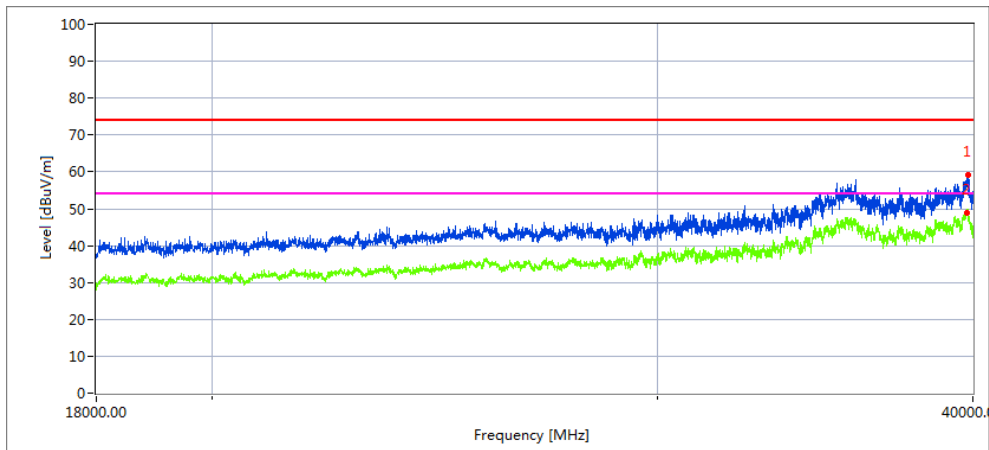

Frequency MHz	Pre-scan Level MaxPeak dBuV/m	Final Test Level MaxPeak dBuV/m	Limit MaxPeak dBuV/m	Margin dB
39815.224	59.1	55.4	74.0	18.6
39776.374	35.8	33.3	54.0	20.7

**3.2.10 SPURIOUS EMISSION IN RESTRICTED BAND 4.5GHZ~5.150 GHZ& 5.350GHZ~5460GHZ**

All the modulation modes have been tested, The report just record the worst data mode.

Frequency (MHz)	Meter Reading (dBμV)	Cable Loss (dB)	Antenna Factor dB/m	Preamp Factor (dB)	Emission Level (dBμV/m)	Limits (dBμV/m)	Margin (dB)	Detector Type	Comment
5.2G WIFI-802.11ac20 MIMO Mode									
4500.00	45.13	5.2	35.6	44.2	41.73	74	-32.27	Pk	Horizontal
4500.00	29.79	5.2	35.6	44.2	26.39	54	-27.61	AV	Horizontal
4500.00	47.64	5.2	35.6	44.2	44.24	74	-29.76	Pk	Vertical
4500.00	33.84	5.2	35.6	44.2	30.44	54	-23.56	AV	Vertical
5150.00	69.65	5.36	35.66	44.22	66.45	74	-7.55	Pk	Horizontal
5150.00	53.94	5.36	35.66	44.22	50.74	54	-3.26	AV	Horizontal
5150.00	68.77	5.36	35.66	44.22	65.57	74	-8.43	Pk	Vertical
5150.00	52.49	5.36	35.66	44.22	49.29	54	-4.71	AV	Vertical
5350.00	54.69	5.68	35.68	44.22	51.83	74	-22.17	Pk	Vertical
5350.00	36.87	5.68	35.68	44.22	34.01	54	-19.99	AV	Vertical
5350.00	50.5	5.68	35.68	44.22	47.64	74	-26.36	Pk	Horizontal
5350.00	34.41	5.68	35.68	44.22	31.55	54	-22.45	AV	Horizontal

Note: (1) Emission Level= Antenna Factor + Cable Loss + Read Level - Preamp Factor  
 (2) "802.11ac20 MIMO " mode is the worst mode. When PK value is lower than the Average value limit, average don't record.

## 4. POWER SPECTRAL DENSITY TEST

### 4.1 APPLIED PROCEDURES / LIMIT

#### According to FCC §15.407(a)

For the band 5.15-5.25 GHz,

- (i) For an outdoor access point operating in the band 5.15-5.25 GHz, the maximum power spectral density shall not exceed 17 dBm in any 1 megahertz band. If transmitting antennas of directional gain greater than 6 dBi are used, both the maximum conducted output power and the maximum power spectral density shall be reduced by the amount in dB that the directional gain of the antenna exceeds 6 dBi. The maximum e.i.r.p. at any elevation angle above 30 degrees as measured from the horizon must not exceed 125 mW (21 dBm).
- (ii) For an indoor access point operating in the band 5.15-5.25 GHz, the maximum power spectral density shall not exceed 17 dBm in any 1 megahertz band. If transmitting antennas of directional gain greater than 6 dBi are used, both the maximum conducted output power and the maximum power spectral density shall be reduced by the amount in dB that the directional gain of the antenna exceeds 6 dBi.
- (iii) For fixed point-to-point access points operating in the band 5.15-5.25 GHz, the maximum power spectral density shall not exceed 17 dBm in any 1 megahertz band. Fixed point-to-point U-NII devices may employ antennas with directional gain up to 23 dBi without any corresponding reduction in the maximum conducted output power or maximum power spectral density. For fixed point-to-point transmitters that employ a directional antenna gain greater than 23 dBi, a 1 dB reduction in maximum conducted output power and maximum power spectral density is required for each 1 dB of antenna gain in excess of 23 dBi. Fixed, point-to-point operations exclude the use of point-to-multipoint systems, omnidirectional applications, and multiple collocated transmitters transmitting the same information. The operator of the U-NII device, or if the equipment is professionally installed, the installer, is responsible for ensuring that systems employing high gain directional antennas are used exclusively for fixed, point-to-point operations.
- (iv) For client devices in the 5.15-5.25 GHz band, the maximum power spectral density shall not exceed 11 dBm in any 1 megahertz band. If transmitting antennas of directional gain greater than 6 dBi are used, both the maximum conducted output power and the maximum power spectral density shall be reduced by the amount in dB that the directional gain of the antenna exceeds 6 dBi.

For the band 5.725-5.85 GHz

- (3) For the band 5.725-5.85 GHz, the maximum power spectral density shall not exceed 30 dBm in any 500-kHz band. If transmitting antennas of directional gain greater than 6 dBi are used, both the maximum conducted output power and the maximum power spectral density shall be reduced by the amount in dB that the directional gain of the antenna exceeds 6 dBi.

**4.2 TEST PROCEDURE**

For devices operating in the bands 5.15-5.25 GHz, 5.25-5.35 GHz, and 5.47-5.725 GHz, the above procedures make use of 1 MHz RBW to satisfy directly the 1 MHz reference bandwidth specified in § 15.407(a)(5). For devices operating in the band 5.725-5.85 GHz, the rules specify a measurement bandwidth of 500 kHz. Many spectrum analyzers do not have 500 kHz RBW, thus a narrower RBW may need to be used. The rules permit the use of a RBWs less than 1 MHz, or 500 kHz, “provided that the measured power is integrated over the full reference bandwidth” to show the total power over the specified measurement bandwidth (i.e., 1 MHz, or 500 kHz). If measurements are performed using a reduced resolution bandwidth (< 1 MHz, or < 500 kHz) and integrated over 1 MHz, or 500 KHz bandwidth, the following adjustments to the procedures apply:

- a) Set  $RBW \geq 1/T$ , where T is defined in section II.B.I.a).
- b) Set  $VBW \geq 3 RBW$ .
- c) If measurement bandwidth of Maximum PSD is specified in 500 kHz, add  $10\log(500\text{kHz}/RBW)$  to the measured result, whereas  $RBW (< 500 \text{ KHz})$  is the reduced resolution bandwidth of the spectrum analyzer set during measurement.
- d) If measurement bandwidth of Maximum PSD is specified in 1 MHz, add  $10\log(1\text{MHz}/RBW)$  to the measured result, whereas  $RBW (< 1 \text{ MHz})$  is the reduced resolution bandwidth of spectrum analyzer set during measurement.
- e) Care must be taken to ensure that the measurements are performed during a period of continuous transmission or are corrected upward for duty cycle.

Note: As a practical matter, it is recommended to use reduced RBW of 100 KHz for the sections 5.c) and 5.d) above, since  $RBW=100 \text{ KHz}$  is available on nearly all spectrum analyzers.

**4.3 DEVIATION FROM STANDARD**

No deviation.

**4.4 TEST SETUP**



**4.5 EUT OPERATION CONDITIONS**

The EUT tested system was configured as the statements of 2.1 Unless otherwise a special operating condition is specified in the follows during the testing.

**4.6 TEST RESULTS**

EUT :	ScreenBeam OPS Wireless Display Module	Model Name. :	SBWD3100
Temperature :	25 °C	Relative Humidity :	56%
Pressure :	1015 hPa	Test Voltage :	DC 19V
Test Mode :	TX Frequency Band I (5150-5250MHz)		

Note: 0(1/2) Represent the value of antenna 0, 1 and 2, The worst data for SISO mode is Antenna 1, for MIMO mode is Antenna 0, only shown worst Antenna Plot.

EUT has three antennas, and different modes support different transmit mode what describe as Following form:

Mode	Tx/Rx
802.11a	1Tx, 1Rx
802.11n/ac	1Tx /3Tx, 3Rx

SISO Mode:

Mode	Frequency (MHz)	Measured Power Density (dBm / MHz)			Limit (dBm / MHz)	Result
		ANT 0	ANT 1	ANT 2		
802.11 a	5185	10.032	11.111	11.477	17.00	PASS
	5200	12.032	12.628	11.312	17.00	PASS
	5240	11.480	12.456	11.532	17.00	PASS
802.11 n20	5185	9.189	10.705	11.467	17.00	PASS
	5200	11.058	11.480	11.074	17.00	PASS
	5240	11.270	10.984	11.207	17.00	PASS
802.11 n40	5190	5.973	6.207	5.708	17.00	PASS
	5230	7.915	7.352	7.869	17.00	PASS
802.11 ac20	5185	9.147	10.713	11.043	17.00	PASS
	5200	10.639	10.861	10.786	17.00	PASS
	5240	10.784	10.638	10.696	17.00	PASS
802.11 ac40	5190	7.009	5.500	5.478	17.00	PASS
	5230	6.971	6.929	6.642	17.00	PASS
802.11 ac80	5210	2.313	1.850	2.755	17.00	PASS

MIMO mode

Mode	Frequency (MHz)	Measured Power Density (dBm / MHz)			Total power density (dBm / MHz)	Limit (dBm / MHz)	Result
		ANT 0	ANT 1	ANT 2			
802.11 n20	5185	7.700	7.715	7.309	12.350	14.44	PASS
	5200	7.731	7.908	7.327	12.433	14.44	PASS
	5240	8.313	7.118	7.421	12.419	14.44	PASS
802.11 n40	5190	5.108	5.005	4.765	9.733	14.44	PASS
	5230	5.879	6.353	4.850	10.510	14.44	PASS
802.11 ac20	5185	7.440	7.549	7.377	12.227	14.44	PASS
	5200	7.398	8.213	7.353	12.444	14.44	PASS
	5240	7.650	7.968	7.558	12.500	14.44	PASS
802.11 ac40	5190	4.114	4.342	5.340	9.403	14.44	PASS
	5230	5.913	5.583	4.376	10.111	14.44	PASS
802.11 ac80	5210	2.830	1.365	2.466	7.035	14.44	PASS

Note: 1. Calculate power density= Measured Power Density+10log(1MHz/RBW)

RBW=1MHz

2. For 802.11n/ac 5GHz has MIMO mode. Directional gain=8.56dbi  
 8.56dbi>6.0dbi so power density limit= 17-(8.56-6)=14.44dBm/MHz



SISO Mode-ANT 1

(802.11a) PSD plot on channel 36



(802.11n20) PSD plot on channel 36

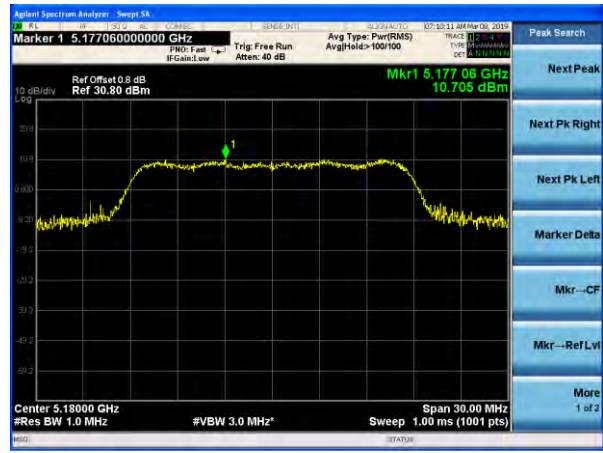

(802.11a) PSD plot on channel 40



(802.11n20) PSD plot on channel 40



(802.11a) PSD plot on channel 48

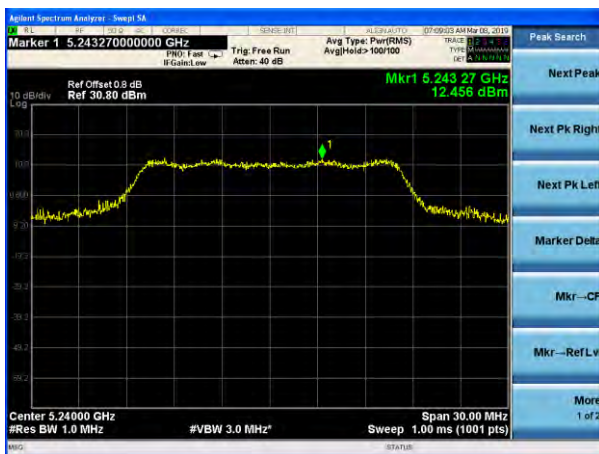

(802.11n20) PSD plot on channel 48



(802.11n40) PSD plot on channel 38

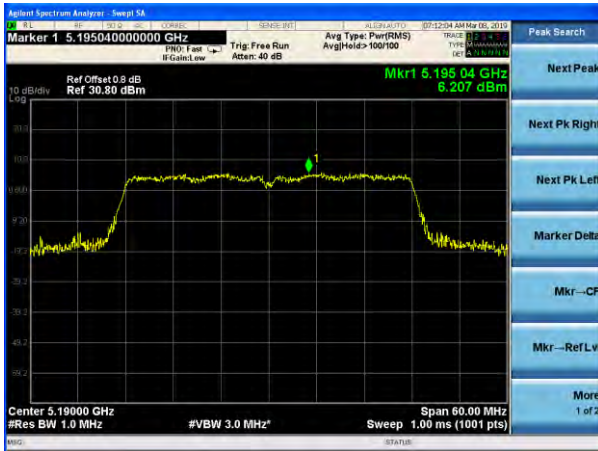

(802.11ac20) PSD plot on channel 36



(802.11n40) PSD plot on channel 46



(802.11ac20) PSD plot on channel 40

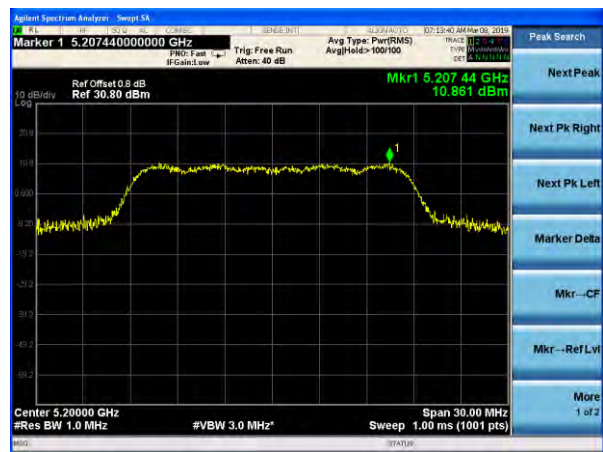

(802.11ac20) PSD plot on channel 48



(802.11ac40) PSD plot on channel 38



(802.11ac80) PSD plot on channel 42

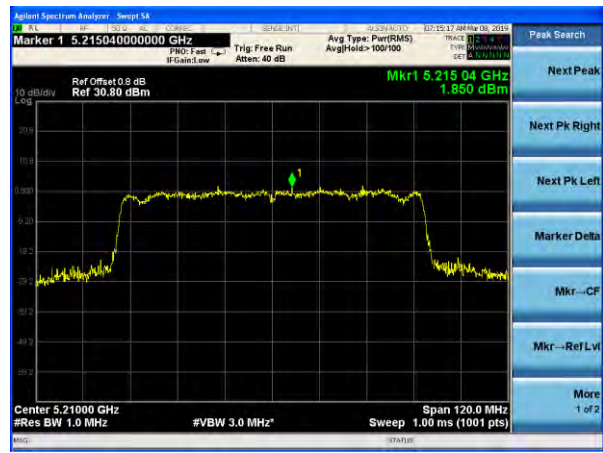

(802.11ac40) PSD plot on channel 46



MIMO Mode-ANT 0

(802.11n20) PSD plot on channel 36



(802.11n40) PSD plot on channel 38



(802.11n20) PSD plot on channel 40



(802.11n40) PSD plot on channel 46



(802.11n20) PSD plot on channel 48



(802.11ac20) PSD plot on channel 36



(802.11ac40) PSD plot on channel 38



(802.11ac20) PSD plot on channel 40

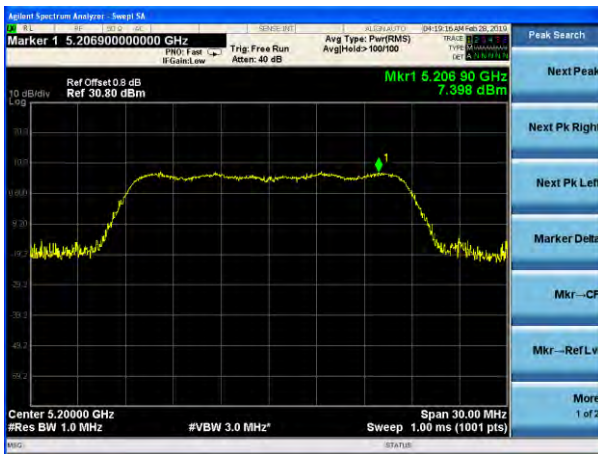

(802.11ac40) PSD plot on channel 46



(802.11ac20) PSD plot on channel 48

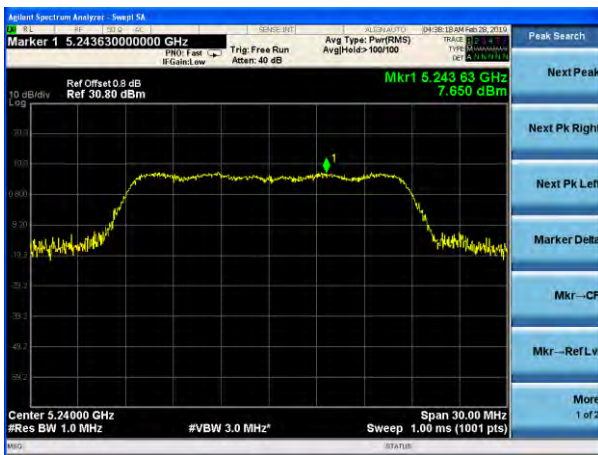

(802.11ac80) PSD plot on channel 42

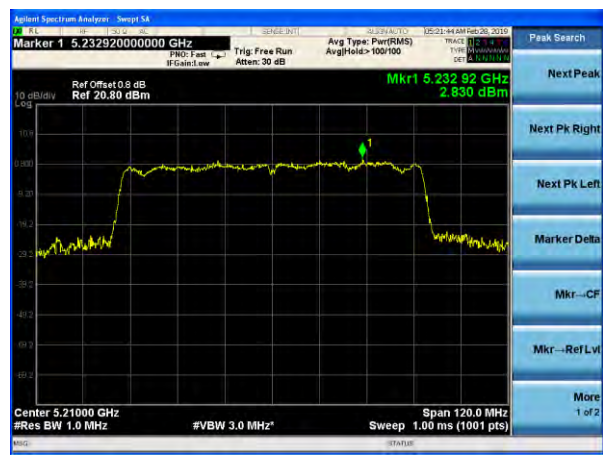

EUT :	ScreenBeam OPS Wireless Display Module	Model Name. :	SBWD3100
Temperature :	25 °C	Relative Humidity :	56%
Pressure :	1015 hPa	Test Voltage :	DC 19V
Test Mode :	TX Frequency Band 3 (5725-5850MHz)		

Note: 0(1/2) Represent the value of antenna 0, 1 and 2, The worst data for SISO mode is Antenna 0, for MIMO mode is Antenna 2, only shown worst Antenna Plot.

EUT has three antennas, and different modes support different transmit mode what describe as Following form:

Mode	Tx/Rx
802.11a	1Tx, 1Rx
802.11n/ac	1Tx /3Tx, 3Rx

SISO Mode:

Mode	Frequency (MHz)	Measured Power Density (dBm)			Calculate power density (dBm)(Note 1)			Limit (dBm)	Result
		ANT 0	ANT 1	ANT 2	ANT 0	ANT 1	ANT 2		
802.11 a	5745	10.115	11.064	11.218	10.029	10.978	11.132	30	PASS
	5785	10.634	10.561	11.468	10.548	10.475	11.382	30	PASS
	5825	11.526	11.125	11.603	11.440	11.039	11.517	30	PASS
802.11 n20	5745	11.219	9.987	9.924	11.133	9.901	9.838	30	PASS
	5785	10.765	10.901	11.210	10.679	10.815	11.124	30	PASS
	5825	12.217	11.082	10.324	12.131	10.996	10.238	30	PASS
802.11 n40	5755	7.325	6.306	6.552	7.239	6.220	6.466	30	PASS
	5795	8.397	6.603	7.841	8.311	6.517	7.755	30	PASS
802.11 ac20	5745	11.256	9.656	11.013	11.170	9.570	10.927	30	PASS
	5785	11.208	10.424	11.109	11.122	10.338	11.023	30	PASS
	5825	11.540	11.321	10.728	11.454	11.235	10.642	30	PASS
802.11 ac40	5755	7.267	5.626	6.654	7.181	5.540	6.568	30	PASS
	5795	7.919	6.257	7.273	7.833	6.171	7.187	30	PASS
802.11 ac80	5775	5.163	4.065	4.129	5.077	3.979	4.043	30	PASS

MIMO Mode:

Mode	Frequency (MHz)	Measured Power Density (dBm)			Total power density (dBm)	Calculate power density (dBm)(Note 1)	Limit (dBm)	Result
		ANT 0	ANT 1	ANT 2				
802.11 n20	5745	10.440	9.948	9.558	14.768	14.682	27.44	PASS
	5785	10.188	10.471	11.269	15.438	15.352	27.44	PASS
	5825	11.070	10.710	11.143	15.750	15.664	27.44	PASS
802.11 n40	5755	7.204	7.591	6.968	12.033	11.947	27.44	PASS
	5795	7.226	7.462	7.584	12.198	12.112	27.44	PASS
802.11 ac20	5745	9.099	8.986	9.610	14.011	13.925	27.44	PASS
	5785	10.077	10.627	11.047	15.373	15.287	27.44	PASS
	5825	11.615	11.683	11.898	16.505	16.419	27.44	PASS
802.11 ac40	5755	6.388	6.373	7.045	11.385	11.299	27.44	PASS
	5795	6.372	6.319	7.279	11.451	11.365	27.44	PASS
802.11 ac80	5775	4.563	4.699	4.991	9.526	9.440	27.44	PASS

Note:

- (1) Calculate power density= Measured Power Density+10log(500kHz/RBW)= Measured Power Density+(-0.086)  
RBW=0.51MHz
- (2) For 802.11n/ac 5GHz has MIMO mode. Directional gain=8.56dbi  
8.56dbi>6.0dbi so power density limit= 30-(8.56-6)=27.44dBm/MHz

SISO Mode-ANT 0

(802.11a) PSD plot on channel 149



(802.11n20) PSD plot on channel 149



(802.11a) PSD plot on channel 157



(802.11n20) PSD plot on channel 157



(802.11a) PSD plot on channel 165



(802.11n20) PSD plot on channel 165





(802.11n40) PSD plot on channel 151



(802.11ac20) PSD plot on channel 149



(802.11n40) PSD plot on channel 159



(802.11ac20) PSD plot on channel 157

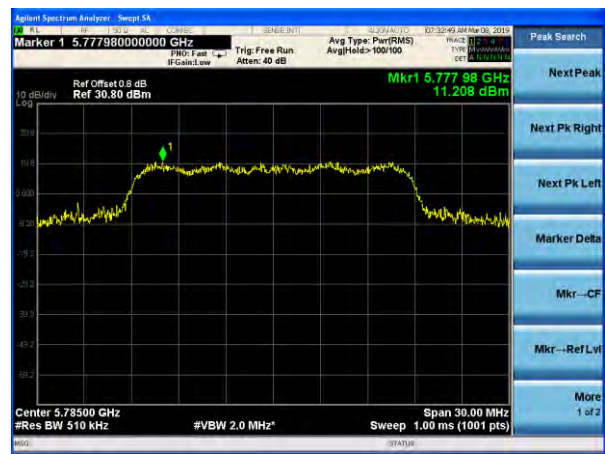

(802.11ac20) PSD plot on channel 165



(802.11ac40) PSD plot on channel 151



(802.11ac80) PSD plot on channel 155



(802.11ac40) PSD plot on channel 159



MIMO Mode-ANT 2

(802.11n20) PSD plot on channel 149



(802.11n40) PSD plot on channel 151



(802.11n20) PSD plot on channel 157



(802.11n40) PSD plot on channel 159



(802.11n20) PSD plot on channel 165



(802.11ac20) PSD plot on channel 149



(802.11ac40) PSD plot on channel 151



(802.11ac20) PSD plot on channel 157



(802.11ac40) PSD plot on channel 159



(802.11ac20) PSD plot on channel 165



(802.11ac80) PSD plot on channel 155



**5. 26DB & 99% EMISSION BANDWIDTH**

**5.1 APPLIED PROCEDURES / LIMIT**

The maximum power spectral density is measured as a conducted emission by direct connection of a calibrated test instrument to the equipment under test. If the device cannot be connected directly, alternative techniques acceptable to the Commission may be used. Measurements in the 5.725-5.85 GHz band are made over a reference bandwidth of 500 kHz or the 26 dB emission bandwidth of the device, whichever is less. Measurements in the 5.15-5.25 GHz, 5.25-5.35 GHz, and the 5.47-5.725 GHz bands are made over a bandwidth of 1 MHz or the 26 dB emission bandwidth of the device, whichever is less. A narrower resolution bandwidth can be used, provided that the measured power is integrated over the full reference bandwidth.

**5.2 TEST PROCEDURE**

- a) Set RBW = approximately 1% of the emission bandwidth.
- b) Set the VBW > RBW.
- c) Detector = Peak.
- d) Trace mode = max hold.
- e) Measure the maximum width of the emission that is 26 dB down from the maximum of the emission. Compare this with the RBW setting of the analyzer. Readjust RBW and repeat measurement as needed until the RBW/EBW ratio is approximately 1%.

The following procedure shall be used for measuring (99 %) power bandwidth:

1. Set center frequency to the nominal EUT channel center frequency.
2. Set span = 1.5 times to 5.0 times the OBW.
3. Set RBW = 1 % to 5 % of the OBW
4. Set VBW ≥ 3 · RBW
5. Video averaging is not permitted. Where practical, a sample detection and single sweep mode shall be used. Otherwise, peak detection and max hold mode (until the trace stabilizes) shall be used.
6. Use the 99 % power bandwidth function of the instrument (if available).
7. If the instrument does not have a 99 % power bandwidth function, the trace data points are recovered and directly summed in power units. The recovered amplitude data points, beginning at the lowest frequency, are placed in a running sum until 0.5 % of the total is reached; that frequency is recorded as the lower frequency. The process is repeated until 99.5 % of the total is reached; that frequency is recorded as the upper frequency. The 99% occupied bandwidth is the difference between these two frequencies.

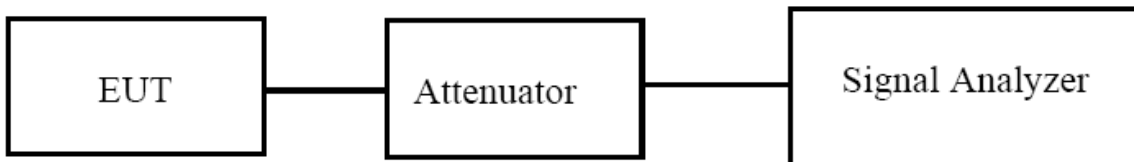

### 5.3 EUT OPERATION CONDITIONS

The EUT tested system was configured as the statements of 2.4 Unless otherwise a special operating condition is specified in the follows during the testing.

**5.4 TEST RESULTS**

EUT :	ScreenBeam OPS Wireless Display Module	Model Name. :	SBWD3100
Temperature :	25 °C	Relative Humidity :	56%
Pressure :	1012 hPa	Test Voltage :	DC 19V
Test Mode :	TX Frequency Band I (5150-5250MHz)		

Note: 0(1/2) Represent the value of antenna 0, 1 and 2, The worst data is Antenna 2, only shown Antenna 2 Plot.

Mode	Channel	Frequency (MHz)	99% bandwidth (MHz)			26dB bandwidth (MHz)			Result
			ANT 0	ANT 1	ANT 2	ANT 0	ANT 1	ANT 2	
802.11a	CH36	5180	20.749	21.762	19.004	37.91	39.97	36.92	Pass
	CH40	5200	22.539	21.349	23.196	39.18	39.50	39.84	Pass
	CH48	5240	23.968	23.657	23.172	39.91	39.64	39.59	Pass
802.11 n20	CH36	5180	18.277	22.157	20.600	36.61	39.74	39.50	Pass
	CH40	5200	22.999	22.079	22.956	39.92	39.87	39.90	Pass
	CH48	5240	25.249	20.638	22.870	39.96	39.55	39.89	Pass
802.11 n40	CH 38	5190	36.386	36.293	36.170	41.16	40.73	40.14	Pass
	CH 46	5230	37.054	37.316	36.912	71.30	79.43	75.75	Pass
802.11 ac20	CH36	5180	18.290	19.254	22.061	35.93	39.21	39.91	Pass
	CH40	5200	21.697	20.216	22.295	39.95	39.64	39.42	Pass
	CH48	5240	24.236	21.614	21.239	39.84	39.95	39.95	Pass
802.11 ac40	CH 38	5190	36.311	36.279	36.199	42.01	42.62	55.55	Pass
	CH 46	5230	37.037	39.132	36.960	74.35	79.49	76.58	Pass
802.11 ac80	CH 42	5210	75.902	75.845	76.005	81.55	86.77	93.30	Pass

Test plot

(802.11a) -26dB&99%Bandwidth plot on channel 36



(802.11 n20) -26dB&99%Bandwidth plot on channel 36

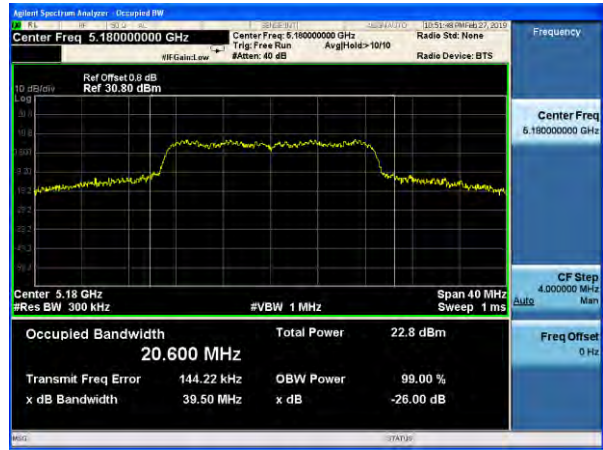

(802.11a) -26dB&99%Bandwidth plot on channel 40



(802.11 n20) -26dB&99%Bandwidth plot on channel 40

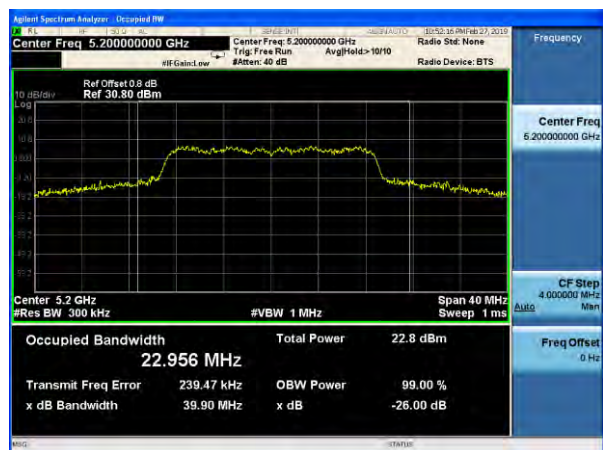

(802.11a) -26dB&99%Bandwidth plot on channel 48

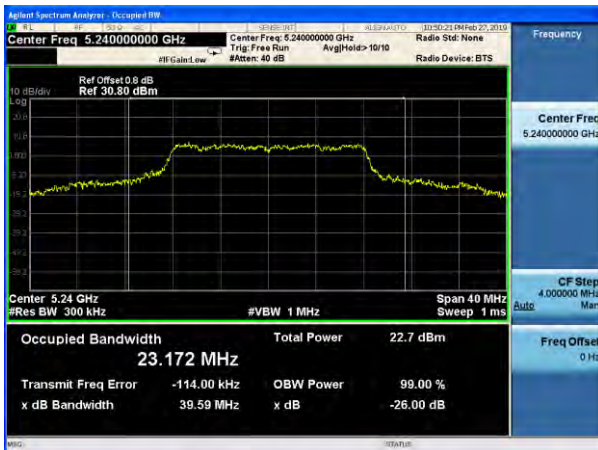

(802.11 n20) -26dB&99%Bandwidth plot on channel 48





Test plot

(802.11 n40) -26dB&99%Bandwidth plot on channel 38

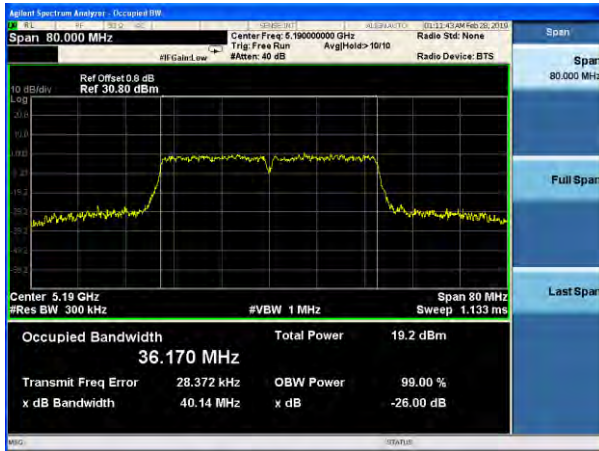

(802.11 AC20) -26dB&99%Bandwidth plot on channel 36



(802.11 n40) -26dB&99%Bandwidth plot on channel 46



(802.11 AC20) -26dB&99%Bandwidth plot on channel 40



(802.11 AC20) -26dB&99%Bandwidth plot on channel 48



Test plot

(802.11 AC40) -26dB&99%Bandwidth plot on channel 38

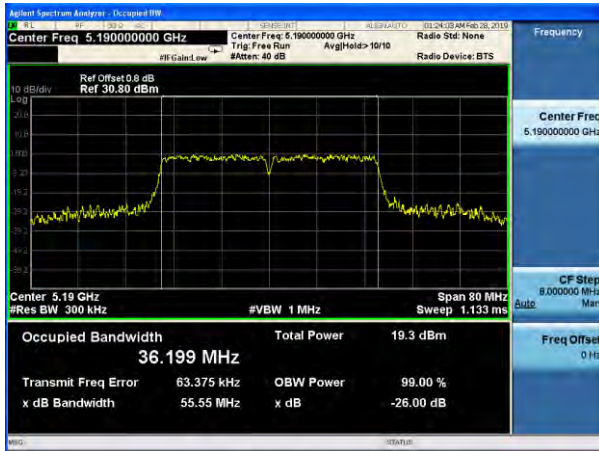

(802.11 AC80) -26dB&99%Bandwidth plot on channel 42

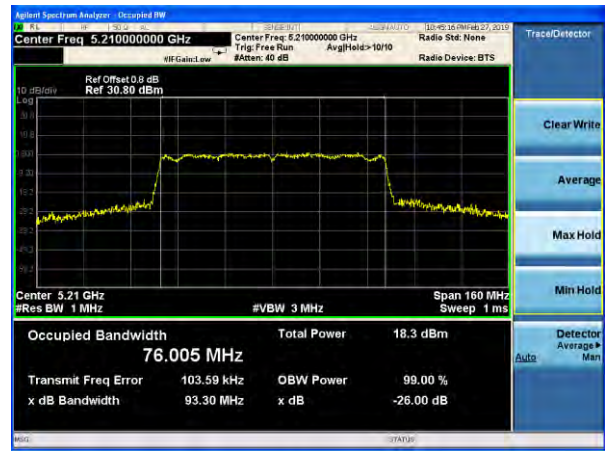

(802.11 AC40) -26dB&99%Bandwidth plot on channel 46

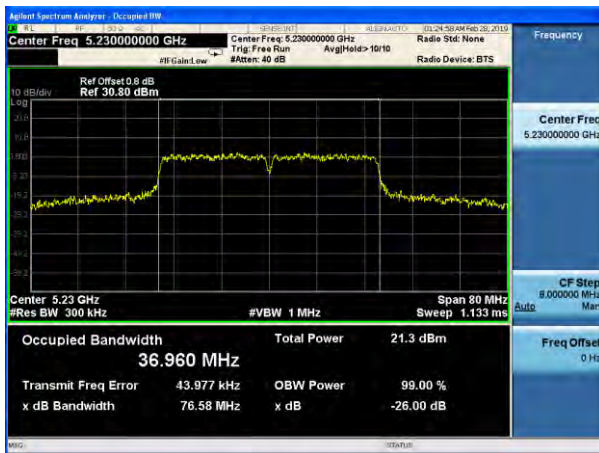

EUT :	ScreenBeam OPS Wireless Display Module	Model Name. :	SBWD3100
Temperature :	25 °C	Relative Humidity :	56%
Pressure :	1012 hPa	Test Voltage :	DC 19V
Test Mode :	TX Frequency Band 3(5725-5850MHz)		

Note: 0(1/2) Represent the value of antenna 0, 1 and 2, The worst data is Antenna 2, only shown Antenna 2 Plot.

Mode	Channel	Frequency (MHz)	99% bandwidth (MHz)			26dB bandwidth (MHz)			Result
			ANT 0	ANT 1	ANT 2	ANT 0	ANT 1	ANT 2	
802.11a	CH149	5745	22.896	27.236	24.886	39.96	39.98	39.70	Pass
	CH157	5785	23.052	23.148	25.409	39.56	39.53	39.79	Pass
	CH165	5825	21.708	23.732	25.621	39.12	39.46	39.62	Pass
802.11 n20	CH149	5745	23.032	26.243	24.778	39.91	39.99	39.87	Pass
	CH157	5785	22.159	22.531	19.518	39.98	39.94	39.40	Pass
	CH165	5825	21.394	23.238	21.996	38.90	39.77	39.58	Pass
802.11 n40	CH151	5755	43.554	49.487	49.534	79.91	79.82	79.97	Pass
	CH159	5795	48.357	44.045	42.129	79.89	79.78	79.98	Pass
802.11 ac20	CH149	5745	25.597	23.251	26.217	39.98	39.54	39.97	Pass
	CH157	5785	24.371	21.420	24.916	39.90	39.76	39.91	Pass
	CH165	5825	21.378	23.836	21.319	39.67	39.80	39.98	Pass
802.11 ac40	CH151	5755	41.972	46.395	51.159	79.90	79.97	79.97	Pass
	CH159	5795	43.009	43.437	49.829	79.93	79.24	79.96	Pass
802.11 ac80	CH155	5775	81.846	84.983	95.293	156.4	157.7	158.3	Pass

Test plot

(802.11a) -26dB&99%Bandwidth plot on channel 149



(802.11 n20) -26dB&99%Bandwidth plot on channel 149



(802.11a) -26dB&99%Bandwidth plot on channel 157



(802.11 n20) -26dB&99%Bandwidth plot on channel 157



(802.11a) -26dB&99%Bandwidth plot on channel 165



(802.11 n20) -26dB&99%Bandwidth plot on channel 165



Test plot

(802.11 n40) -26dB&99%Bandwidth plot on channel 151

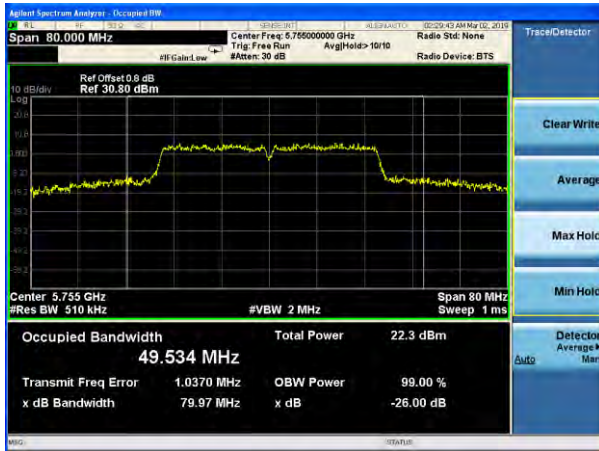

(802.11 ac20) -26dB&99%Bandwidth plot on channel 149



(802.11 n40) -26dB&99%Bandwidth plot on channel 159



(802.11 ac20) -26dB&99%Bandwidth plot on channel 157



(802.11 ac20) -26dB&99%Bandwidth plot on channel 165

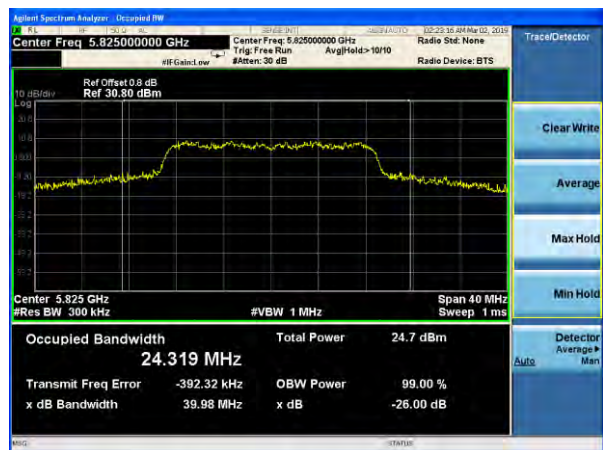

Test plot

(802.11 ac40) -26dB&99%Bandwidth plot on channel 151



(802.11 ac80) -26dB&99%Bandwidth plot on channel 155

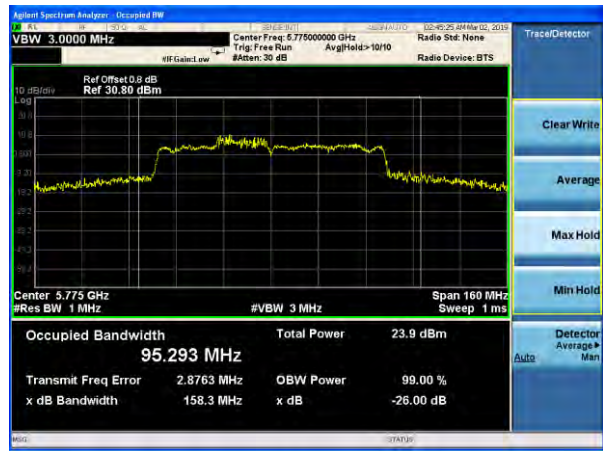

(802.11 ac40) -26dB&99%Bandwidth plot on channel 159



**6. MINIMUM 6 DB BANDWIDTH**

**6.1 APPLIED PROCEDURES / LIMIT**

**According to FCC §15.407(e)**

(e) Within the 5.725-5.85 GHz band, the minimum 6 dB bandwidth of U-NII devices shall be at least 500 kHz.

**6.2 TEST PROCEDURE**

Section 15.407(e) specifies the minimum 6 dB emission bandwidth of at least 500 KHz for the band 5.715-5.85 GHz. The following procedure shall be used for measuring this bandwidth:

- a) Set RBW = 100 kHz.
- b) Set the video bandwidth (VBW)  $\geq 3 \times$  RBW.
- c) Detector = Peak.
- d) Trace mode = max hold.
- e) Sweep = auto couple.
- f) Allow the trace to stabilize.
- g) Measure the maximum width of the emission that is constrained by the frequencies associated with the two outermost amplitude points (upper and lower frequencies) that are attenuated by 6 dB relative to the maximum level measured in the fundamental emission.

**6.3 DEVIATION FROM STANDARD**

No deviation.

**6.4 TEST SETUP**

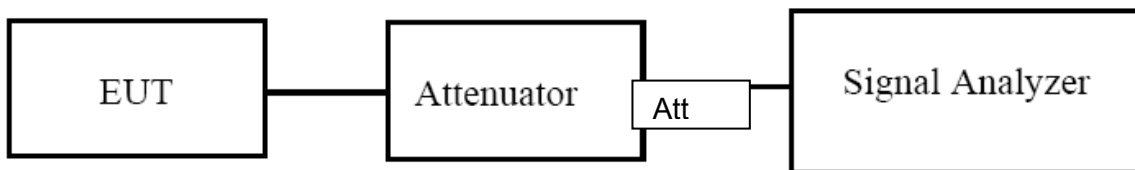

**6.5 EUT OPERATION CONDITIONS**

The EUT tested system was configured as the statements of 2.4 Unless otherwise a special operating condition is specified in the follows during the testing.

**6.6 TEST RESULTS**

EUT :	ScreenBeam OPS Wireless Display Module	Model Name. :	SBWD3100
Temperature :	25 °C	Relative Humidity :	56%
Pressure :	1012 hPa	Test Voltage :	DC 19V
Test Mode :	TX Frequency Band 3(5725-5850MHz)		

Note: 0(1/2) Represent the value of antenna 0, 1 and 2, The worst data is Antenna 0, only shown Antenna 0 Plot.

Mode	Channel	Frequency (MHz)	-6dB bandwidth (MHz)			Limit (KHz)	Result
			ANT 0	ANT 1	ANT 2		
802.11a	149	5745	16.38	16.34	16.38	≧ 500	Pass
	157	5785	16.36	16.32	16.36	≧ 500	Pass
	165	5825	16.34	16.34	16.31	≧ 500	Pass
802.11 n20	149	5745	17.24	17.55	17.28	≧ 500	Pass
	157	5785	17.53	16.92	17.55	≧ 500	Pass
	165	5825	17.02	17.20	17.53	≧ 500	Pass
802.11 n40	151	5755	36.05	35.69	36.06	≧ 500	Pass
	159	5795	35.99	35.76	36.05	≧ 500	Pass
802.11 ac20	149	5745	17.30	17.28	17.55	≧ 500	Pass
	157	5785	17.49	17.27	17.55	≧ 500	Pass
	165	5825	17.53	17.21	17.23	≧ 500	Pass
802.11 ac40	149	5745	36.29	36.03	36.06	≧ 500	Pass
	157	5785	36.30	36.04	36.27	≧ 500	Pass
802.11 ac80	155	5775	76.12	75.57	76.09	≧ 500	Pass



Test plot

(802.11a) 6dB Bandwidth plot on channel 149



(802.11 n20) 6dB Bandwidth plot on channel 149

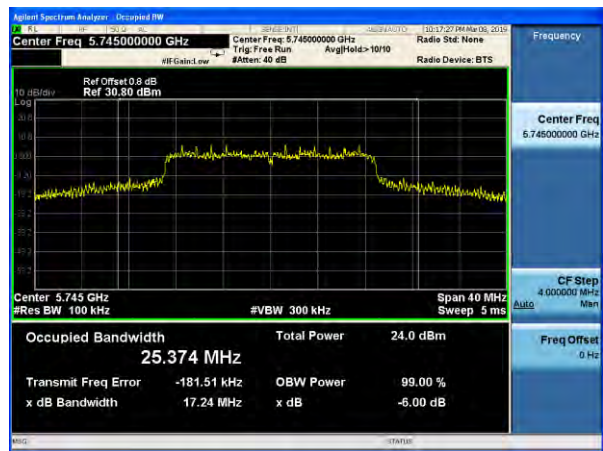

(802.11a) 6dB Bandwidth plot on channel 157



(802.11 n20) 6dB Bandwidth plot on channel 157

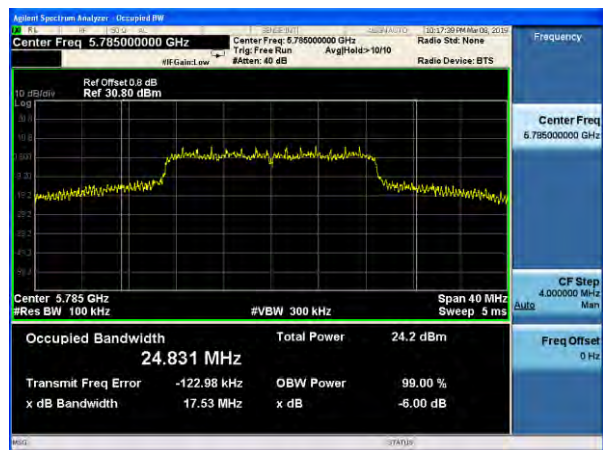

(802.11a) 6dB Bandwidth plot on channel 165



(802.11 n20) 6dB Bandwidth plot on channel 165

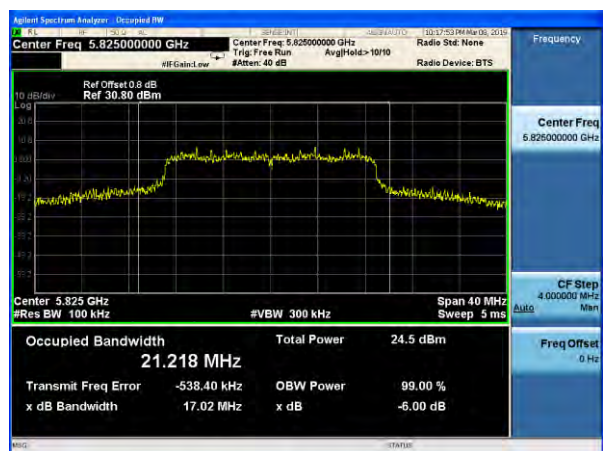

Test plot

(802.11 n40) 6dB Bandwidth plot on channel 151

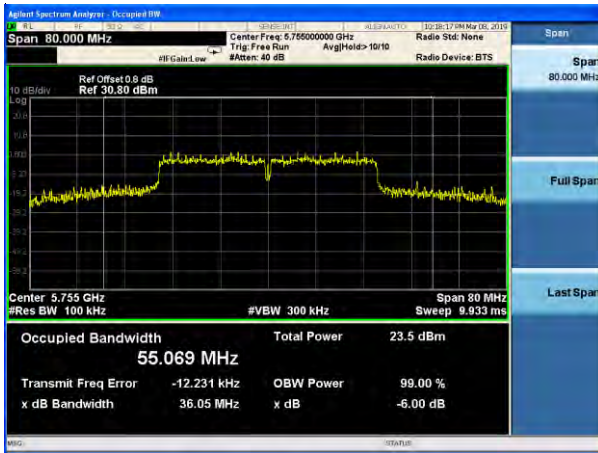

(802.11 AC20) 6dB Bandwidth plot on channel 149

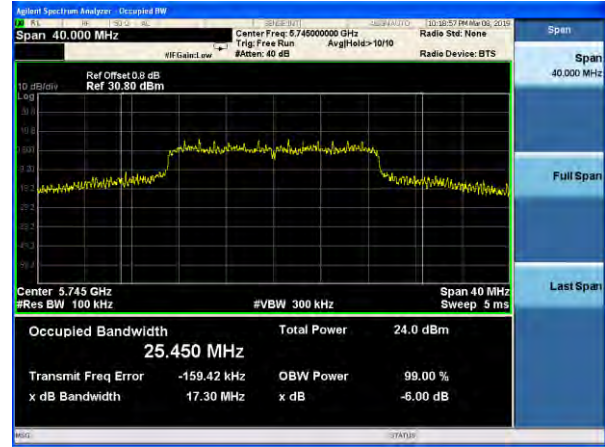

(802.11 n40) 6dB Bandwidth plot on channel 159

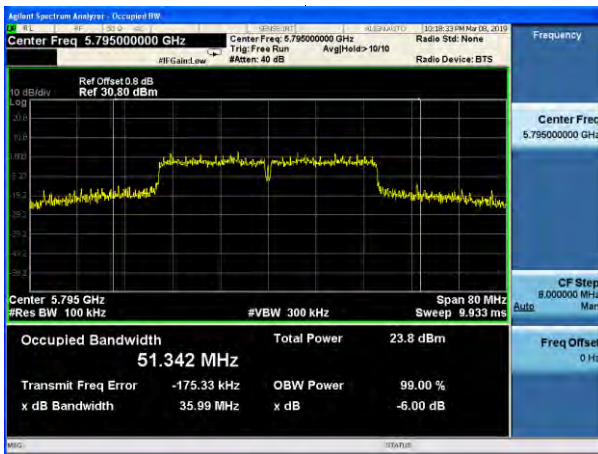

(802.11 AC20) 6dB Bandwidth plot on channel 157



(802.11 AC20) 6dB Bandwidth plot on channel 165

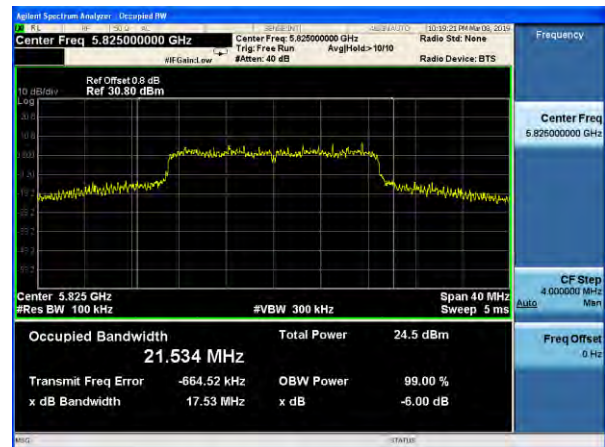

Test plot

(802.11 AC40) 6dB Bandwidth plot on channel 151

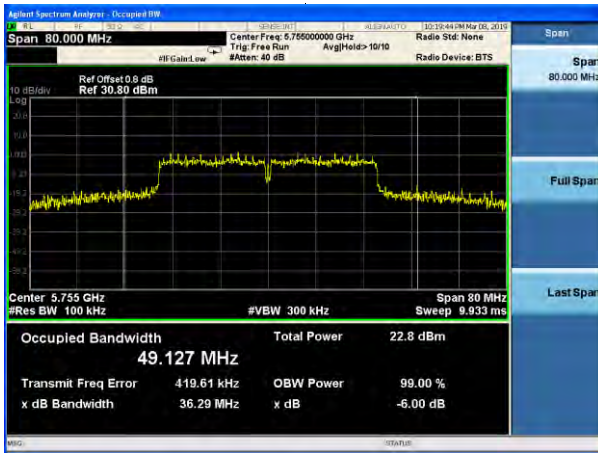

(802.11 AC80) 6dB Bandwidth plot on channel 155

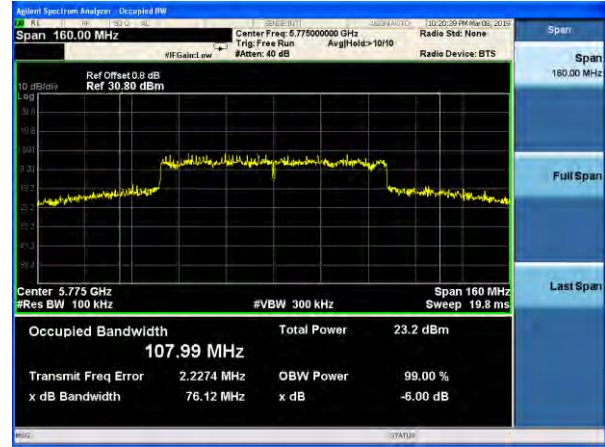

(802.11 AC40) 6dB Bandwidth plot on channel 159

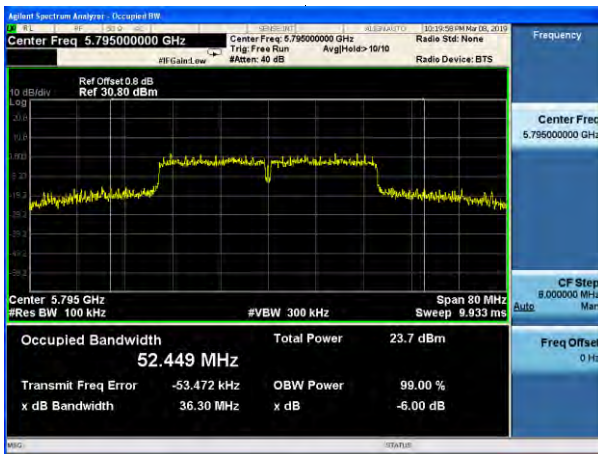

**7. MAXIMUM CONDUCTED OUTPUT POWER**

**7.1 APPLIED PROCEDURES / LIMIT**

**According to FCC §15.407**

The maximum conducted output power should not exceed:

Frequency Band(MHz)	Limit
5150~5250	1W( For an indoor access point)
5725~5850	1W

Note: where B is the 26 dB emission bandwidth in megahertz.

**7.2 TEST PROCEDURE**

· Maximum conducted output power may be measured using a spectrum analyzer/EMI receiver or an RF power meter.

1. Device Configuration

If possible, configure or modify the operation of the EUT so that it transmits continuously at its maximum power control level (see section II.B.).

a) The intent is to test at 100 percent duty cycle; however a small reduction in duty cycle (to no lower than 98 percent) is permitted if required by the EUT for amplitude control purposes. Manufacturers are expected to provide software to the test lab to permit such continuous operation.

b) If continuous transmission (or at least 98 percent duty cycle) cannot be achieved due to hardware limitations (e.g., overheating), the EUT shall be operated at its maximum power control level with the transmit duration as long as possible and the duty cycle as high as possible.

2. Measurement using a Spectrum Analyzer or EMI Receiver (SA)

Measurement of maximum conducted output power using a spectrum analyzer requires integrating the spectrum across a frequency span that encompasses, at a minimum, either the EBW or the 99-percent occupied bandwidth of the signal.<sup>1</sup> However, the EBW must be used to determine bandwidth dependent limits on maximum conducted output power in accordance with § 15.407(a).

a) The test method shall be selected as follows: (i) Method SA-1 or SA-1 Alternative (averaging with the EUT transmitting at full power throughout each sweep) shall be applied if either of the following conditions can be satisfied:

- The EUT transmits continuously (or with a duty cycle  $\geq 98$  percent).
- Sweep triggering or gating can be implemented in a way that the device transmits at the maximum power control level throughout the duration of each of the instrument sweeps to be averaged. This condition can generally be achieved by triggering the instrument's sweep if the duration of the sweep (with the analyzer configured as in Method SA-1, below) is equal to or shorter than the duration T of each transmission from the EUT and if those transmissions exhibit full power throughout their durations.

(ii) Method SA-2 or SA-2 Alternative (averaging across on and off times of the EUT transmissions, followed by duty cycle correction) shall be applied if the conditions of (i) cannot be achieved and the transmissions exhibit a constant duty cycle during the measurement duration. Duty cycle will be considered to be constant if variations are less than  $\pm 2$  percent.

(iii) Method SA-3 (RMS detection with max hold) or SA-3 Alternative (reduced VBW with max hold) shall be applied if the conditions of (i) and (ii) cannot be achieved.

b) Method SA-1 (trace averaging with the EUT transmitting at full power throughout each sweep): (i) Set span to encompass the entire emission bandwidth (EBW) (or, alternatively, the entire 99% occupied bandwidth) of the signal.

(ii) Set RBW = 1 MHz.

(iii) Set VBW  $\geq 3$  MHz.

(iv) Number of points in sweep  $\geq 2$  Span / RBW. (This ensures that bin-to-bin spacing is  $\leq$  RBW/2, so that narrowband signals are not lost between frequency bins.)

(v) Sweep time = auto.

(vi) Detector = RMS (i.e., power averaging), if available. Otherwise, use sample detector mode.

(vii) If transmit duty cycle  $< 98$  percent, use a video trigger with the trigger level set to enable triggering only on full power pulses. Transmitter must operate at maximum power control level for the entire duration of every sweep. If the EUT transmits continuously (i.e., with no off intervals) or at duty cycle  $\geq 98$  percent, and if each transmission is entirely at the maximum power control level, then the trigger shall be set to "free run".

(viii) Trace average at least 100 traces in power averaging (i.e., RMS) mode.

(ix) Compute power by integrating the spectrum across the EBW (or, alternatively, the entire 99% occupied bandwidth) of the signal using the instrument's band power measurement function with band limits set equal to the EBW (or occupied bandwidth) band edges. If the instrument does not have a band power function, sum the spectrum

### 7.3 DEVIATION FROM STANDARD

No deviation.

### 7.4 TEST SETUP

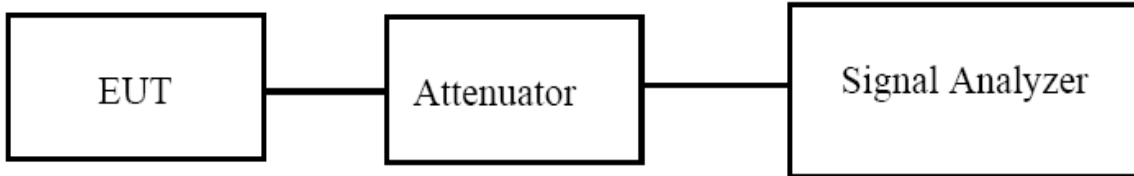

### 7.5 EUT OPERATION CONDITIONS

The EUT tested system was configured as the statements of 2.4 Unless otherwise a special operating condition is specified in the follows during the testing.

**7.6 TEST RESULTS**

EUT :	ScreenBeam OPS Wireless Display Module	Model Name. :	SBWD3100
Temperature :	25 °C	Relative Humidity :	60%
Pressure :	1012 hPa	Test Voltage :	DC 19V
Test Mode :	TX (5G) Mode Frequency Band 1 (5150-5250MHz)		

Note:

EUT has three antennas, and different modes support different transmit mode what describe as Following form:

Mode	Tx/Rx
802.11a	1Tx, 1Rx
802.11n/ac	1Tx /3Tx, 3Rx

SISO Mode:

Test Channel	Frequency (MHz)	Maximum output power. Antenna port (AV) (dBm)			Total Power (AV) dBm	LIMIT dBm	Result
		ANT 0	ANT 1	ANT 2			
<b>TX 802.11a Mode</b>							
CH36	5180	17.4	17.6	18.3	-	30	Pass
CH40	5200	18.6	17.9	18.8	-	30	Pass
CH48	5240	18.4	18.2	18.7	-	30	Pass
<b>TX 802.11 n20M Mode</b>							
CH36	5180	16.6	17.1	18.4	-	30	Pass
CH40	5200	18.4	17.3	18.4	-	30	Pass
CH48	5240	18.4	18.0	18.5	-	30	Pass
<b>TX 802.11 n40M Mode</b>							
CH38	5190	15.6	15.3	15.1	-	30	Pass
CH46	5230	17.0	16.9	17.1	-	30	Pass
<b>TX 802.11 AC20M Mode</b>							
CH36	5180	16.5	17.5	18.3	-	30	Pass
CH40	5200	18.2	17.5	18.2	-	30	Pass
CH48	5240	18.3	17.7	18.2	-	30	Pass
<b>TX 802.11 AC40M Mode</b>							
CH38	5190	15.7	15.3	15.1	-	30	Pass
CH46	5230	16.5	17.1	17.1	-	30	Pass
<b>TX 802.11 AC80M Mode</b>							
CH42	5210	14.2	13.8	14.3	-	30	Pass

MIMO Mode:

Test Channel	Frequency	Maximum output power. Antenna port			Total Power	LIMIT	Result
		(AV) (dBm)			(AV)		
	(MHz)	ANT 0	ANT 1	ANT 2	dBm	dBm	
<b>TX 802.11 n20M Mode</b>							
CH36	5180	15.9	16.0	15.1	20.46	27.44	Pass
CH40	5200	15.3	15.3	14.6	19.85	27.44	Pass
CH48	5240	15.3	16.0	14.8	20.17	27.44	Pass
<b>TX 802.11 n40M Mode</b>							
CH38	5190	15.8	15.1	15.2	20.15	27.44	Pass
CH46	5230	16.9	17.1	16.7	21.67	27.44	Pass
<b>TX 802.11 AC20M Mode</b>							
CH36	5180	14.9	14.9	14.2	19.45	27.44	Pass
CH40	5200	15.6	15.9	15.2	20.35	27.44	Pass
CH48	5240	15.5	15.6	14.7	20.06	27.44	Pass
<b>TX 802.11 AC40M Mode</b>							
CH38	5190	15.0	14.9	15.5	19.91	27.44	Pass
CH46	5230	16.7	17.0	16.6	21.54	27.44	Pass
<b>TX 802.11 AC80M Mode</b>							
CH42	5210	13.8	13.9	13.3	18.45	27.44	Pass

Note: For 802.11n/ac 5GHz has MIMO mode. Directional gain=8.56dbi  
 $8.56\text{dbi} > 6.0\text{dbi}$  so power density limit=  $30 - (8.56 - 6) = 27.44$  in dBm



EUT :	ScreenBeam OPS Wireless Display Module	Model Name. :	SBWD3100
Temperature :	25 °C	Relative Humidity :	60%
Pressure :	1012 hPa	Test Voltage :	DC 19V
Test Mode :	TX (5G) Mode Frequency Band 3 (5725-5850MHz)		

Note:

EUT has three antennas, and different modes support different transmit mode what describe as Following form:

Mode	Tx/Rx
802.11a	1Tx, 1Rx
802.11n/ac	1Tx /3Tx, 3Rx

SISO Mode:

Test Channel	Frequency (MHz)	Maximum output power. Antenna port (AV) (dBm)			Total Power (AV) dBm	LIMIT dBm	Result
		ANT 0	ANT 1	ANT 2			
		<b>TX 802.11a Mode</b>					
CH149	5745	17.8	18.4	18.6	-	30	Pass
CH157	5785	17.9	18.1	18.5	-	30	Pass
CH165	5825	17.9	19.8	19.0	-	30	Pass
<b>TX 802.11 n20M Mode</b>							
CH149	5745	18.2	18.5	18.3	-	30	Pass
CH157	5785	17.6	18.7	18.6	-	30	Pass
CH165	5825	17.9	19.0	19.1	-	30	Pass
<b>TX 802.11 n40M Mode</b>							
CH151	5755	17.0	17.9	17.8	-	30	Pass
CH159	5795	18.0	18.2	17.5	-	30	Pass
<b>TX 802.11 AC20M Mode</b>							
CH149	5745	18.1	17.9	18.9	-	30	Pass
CH157	5785	18.0	18.0	18.6	-	30	Pass
CH165	5825	17.8	19.0	19.3	-	30	Pass
<b>TX 802.11 AC40M Mode</b>							
CH151	5755	17.3	17.5	17.9	-	30	Pass
CH159	5795	17.5	18.1	18.5	-	30	Pass
<b>TX 802.11 AC80M Mode</b>							
CH155	5775	16.7	17.4	17.7	-	30	Pass

MIMO Mode:

Test Channel	Frequency	Maximum output power. Antenna port			Total Power	LIMIT	Result
		(AV) (dBm)			(AV)		
	(MHz)	ANT 0	ANT 1	ANT 2	dBm	dBm	
<b>TX 802.11 n20M Mode</b>							
CH149	5745	17.8	17.9	17.9	22.64	27.44	Pass
CH157	5785	18.5	18.9	19.1	23.61	27.44	Pass
CH165	5825	18.4	18.9	18.5	23.38	27.44	Pass
<b>TX 802.11 n40M Mode</b>							
CH151	5755	17.2	18.1	17.3	22.32	27.44	Pass
CH159	5795	17.4	17.5	17.2	22.14	27.44	Pass
<b>TX 802.11 AC20M Mode</b>							
CH149	5745	18.6	19.3	19.0	23.75	27.44	Pass
CH157	5785	18.4	19.0	18.9	23.55	27.44	Pass
CH165	5825	17.9	18.4	18.5	23.05	27.44	Pass
<b>TX 802.11 AC40M Mode</b>							
CH151	5755	17.7	17.2	18.0	22.42	27.44	Pass
CH159	5795	17.6	18.2	17.0	22.40	27.44	Pass
<b>TX 802.11 AC80M Mode</b>							
CH155	5775	16.5	17.2	16.9	21.65	27.44	Pass

Note: For 802.11n/ac 5GHz has MIMO mode. Directional gain=8.56dbi  
 $8.56\text{dbi} > 6.0\text{dbi}$  so power density limit=  $30 - (8.56 - 6) = 27.44$  in dBm.

## 8. OUT OF BAND EMISSIONS

### 8.1 APPLICABLE STANDARD

#### According to FCC §15.407(b)

Undesirable emission limits. Except as shown in paragraph (b)(7) of this section, the maximum emissions outside of the frequency bands of operation shall be attenuated in accordance with the following limits:

- (1) For transmitters operating in the 5.15-5.25 GHz band: All emissions outside of the 5.15-5.35 GHz band shall not exceed an e.i.r.p. of  $-27$  dBm/MHz.
- (2) For transmitters operating in the 5.25-5.35 GHz band: All emissions outside of the 5.15-5.35 GHz band shall not exceed an e.i.r.p. of  $-27$  dBm/MHz.
- (3) For transmitters operating in the 5.47-5.725 GHz band: All emissions outside of the 5.47-5.725 GHz band shall not exceed an e.i.r.p. of  $-27$  dBm/MHz.
- (4) For the band 5.725-5.85 GHz, the maximum conducted output power over the frequency band of operation shall not exceed 1 W. In addition, the maximum power spectral density shall not exceed 30 dBm in any 500-kHz band. If transmitting antennas of directional gain greater than 6 dBi are used, both the maximum conducted output power and the maximum power spectral density shall be reduced by the amount in dB that the directional gain of the antenna exceeds 6 dBi.

### 8.2 TEST PROCEDURE

1. Check the calibration of the measuring instrument using either an internal calibrator or a known signal from an external generator.
2. Position the EUT without connection to measurement instrument. Turn on the EUT and connect its antenna terminal to measurement instrument via a low loss cable. Then set it to any one measured frequency within its operating range, and make sure the instrument is operated in its linear range.
3. Set RBW of spectrum analyzer to 1 MHz with a convenient frequency span.
4. Measure the highest amplitude appearing on spectral display and set it as a reference level. Plot the graph with marking the highest point and edge frequency.
5. Repeat above procedures until all measured frequencies were complete.

### 8.3 DEVIATION FROM STANDARD

No deviation.

### 8.4 TEST SETUP

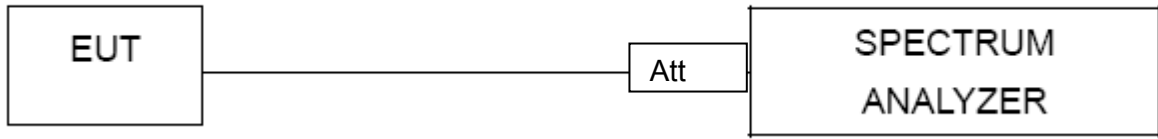

**8.5 EUT OPERATION CONDITIONS**

The EUT tested system was configured as the statements of 2.4 Unless otherwise a special operating condition is specified in the follows during the testing.

**8.6 TEST RESULTS**

EUT :	ScreenBeam OPS Wireless Display Module	Model Name. :	SBWD3100
Temperature :	25 °C	Relative Humidity :	56%
Pressure :	1012 hPa	Test Voltage :	DC 19V

Note: 0(1/2) Represent the value of antenna 0, 1 and 2, The worst data is Antenna 1, only shown Antenna 1 Plot.

5.2G

5.15~5.25 GHz

(802.11a) Band Edge, Left Side

(802.11n20) Band Edge, Left Side



(802.11a) Band Edge, Right Side

(802.11n20) Band Edge, Right Side

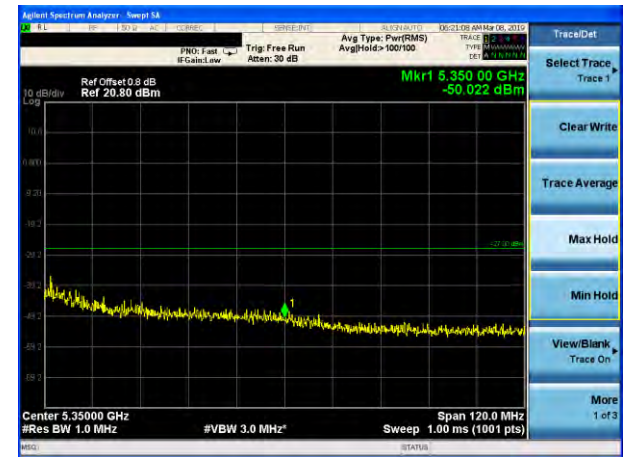
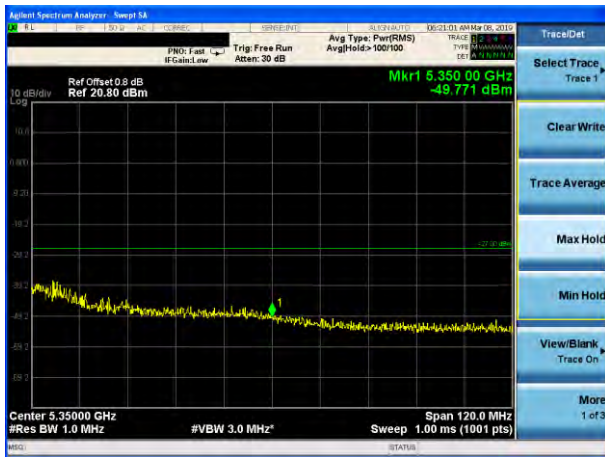

5.15~5.25 GHz

(802.11n40) Band Edge, Left Side

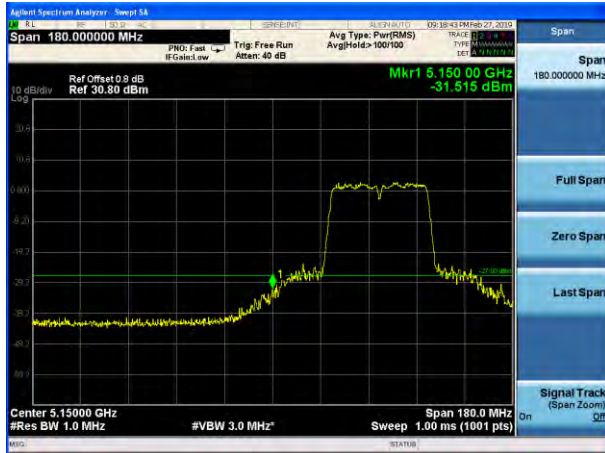

(802.11ac20) Band Edge, Left Side



(802.11n40) Band Edge, Right Side

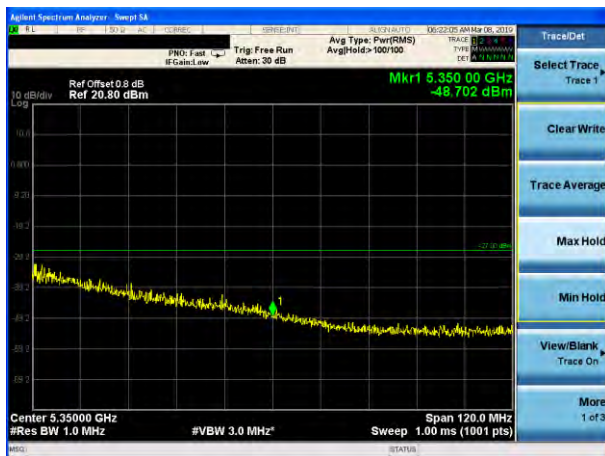

(802.11ac20) Band Edge, Right Side

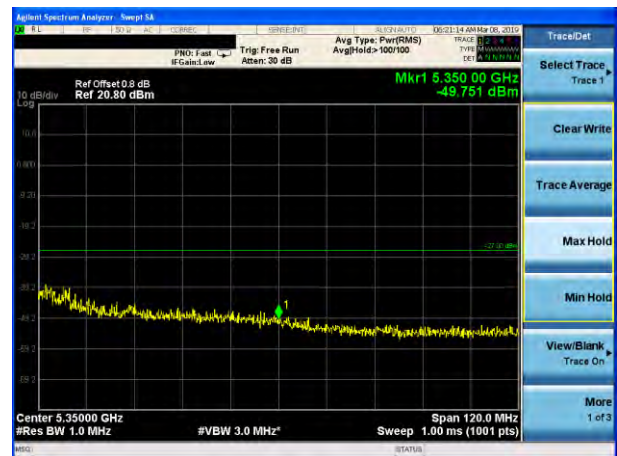

5.15~5.25 GHz

(802.11ac40) Band Edge, Left Side

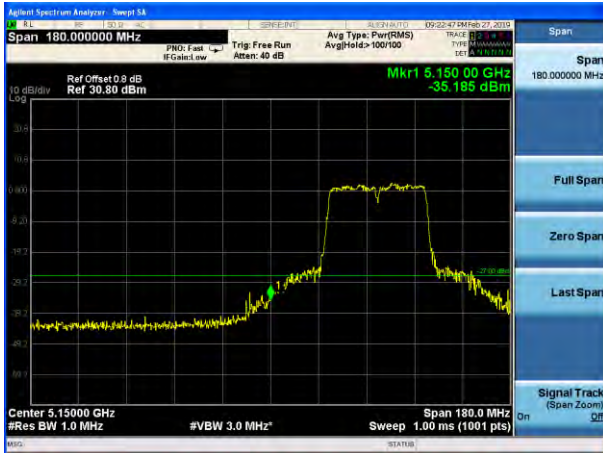

(802.11ac80) Band Edge, Left Side



(802.11ac40) Band Edge, Right Side

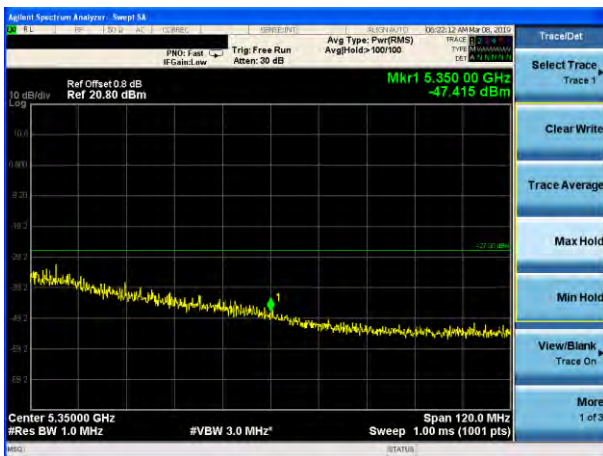

(802.11ac80) Band Edge, Right Side





5.8G

5.725~5.85 GHz

(802.11a) Band Edge, Left Side

(802.11n20) Band Edge, Left Side

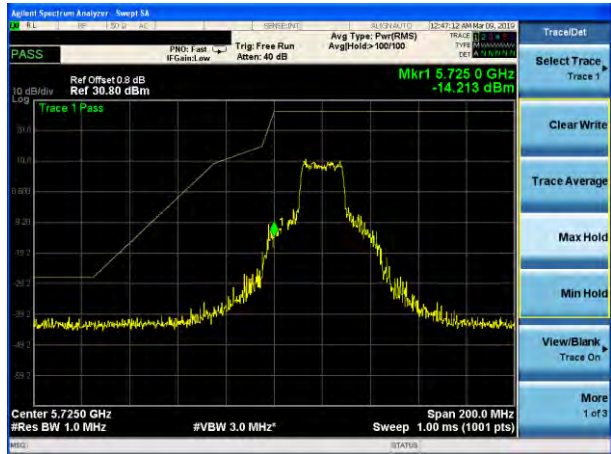

(802.11a) Band Edge, Right Side

(802.11n20) Band Edge, Right Side

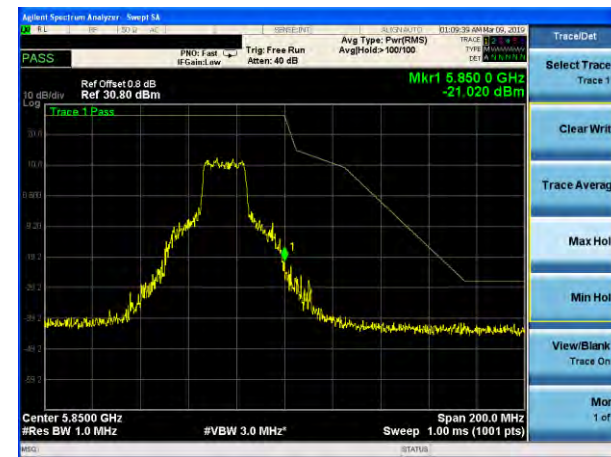
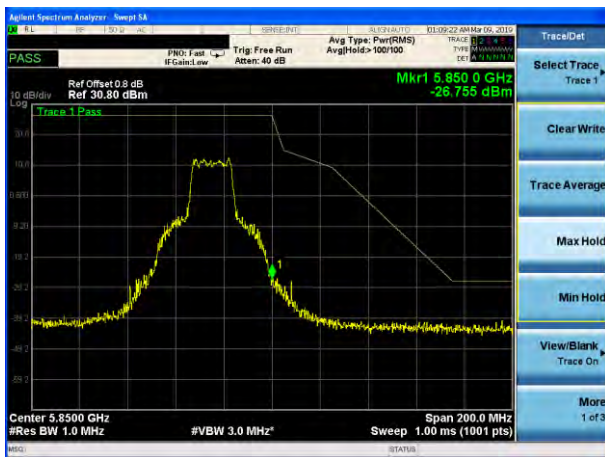

5.725~5.85 GHz

(802.11n40) Band Edge, Left Side



(802.11ac20) Band Edge, Left Side

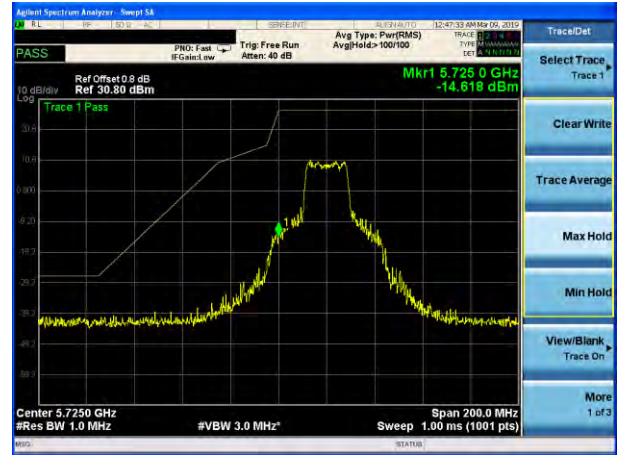

(802.11n40) Band Edge, Right Side



(802.11ac20) Band Edge, Right Side

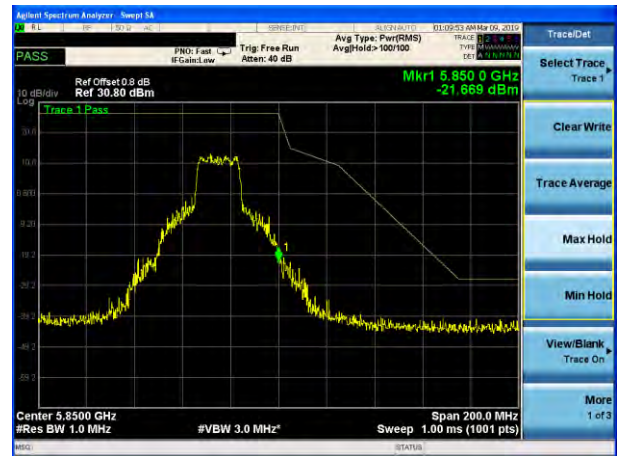

5.725~5.85 GHz

(802.11ac40) Band Edge, Left Side



(802.11ac80) Band Edge, Left Side



(802.11ac40) Band Edge, Right Side



(802.11ac80) Band Edge, Right Side

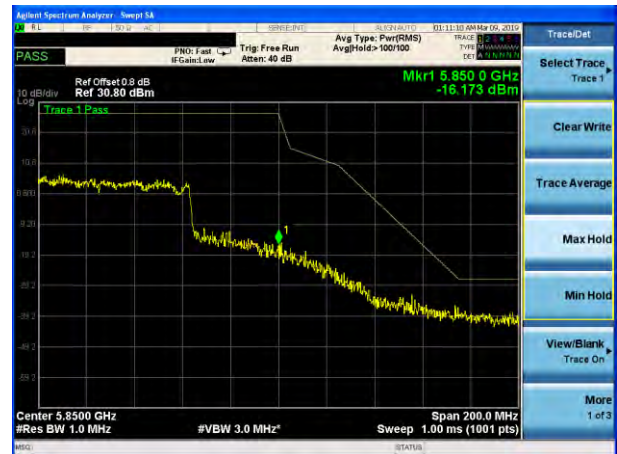

## 9.SPURIOUS RF CONDUCTED EMISSIONS

### 9.1 CONFORMANCE LIMIT

1. Below -27dB of the highest emission level in operating band.
2. Fall in the restricted bands listed in section 15.205. The maximum permitted average field strength is listed in section 15.209.

### 9.2 MEASURING INSTRUMENTS

The Measuring equipment is listed in the section 6.3 of this test report.

### 9.3 TEST SETUP

Please refer to Section 6.1 of this test report.

### 9.4 TEST PROCEDURE

The Spurious RF conducted emissions compliance of RF radiated emission should be measured by following 789033 D02 General U-NII Test Procedures New Rules v02r01, maximizing the emission by rotating the EUT, measuring the emission while the EUT is situated in three orthogonal planes (if appropriate), adjusting the measurement antenna height and polarization etc. Set RBW=1MHz and VBW= 3MHz to measure the peak field strength, and measure frequency range from 9KHz to 26.5GHz.

### 9.5 TEST RESULTS

Remark: The measurement frequency range is from 9KHz to the 10th harmonic of the fundamental frequency. The lowest, middle and highest channels are tested to verify the spurious emissions and band edge measurement data.

Note: 1.0(1/2) Represent the value of antenna 0, 1 and 2, The worst data is Antenna 1, only shown Antenna 1 Plot.

5.2G

Test Plot

802.11a on channel 36

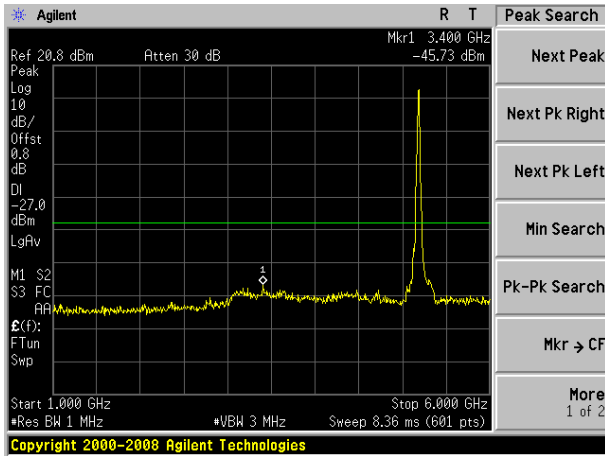

802.11a on channel 40

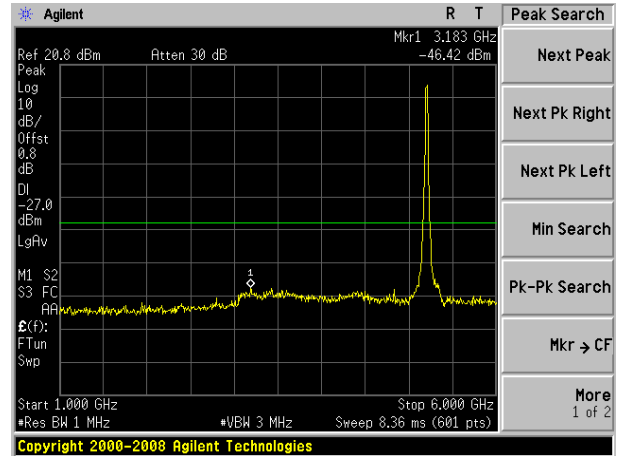

802.11a on channel 36

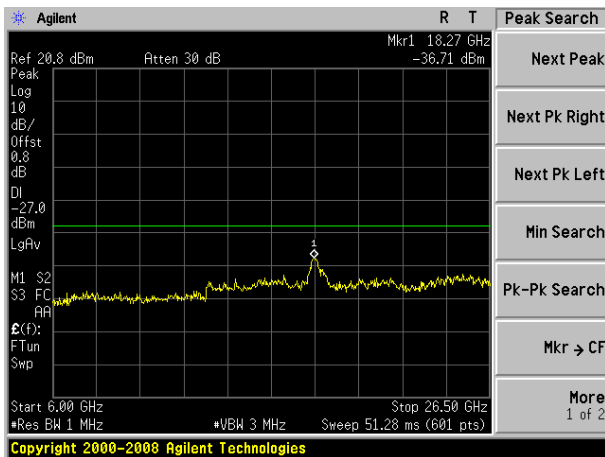

802.11a on channel 40

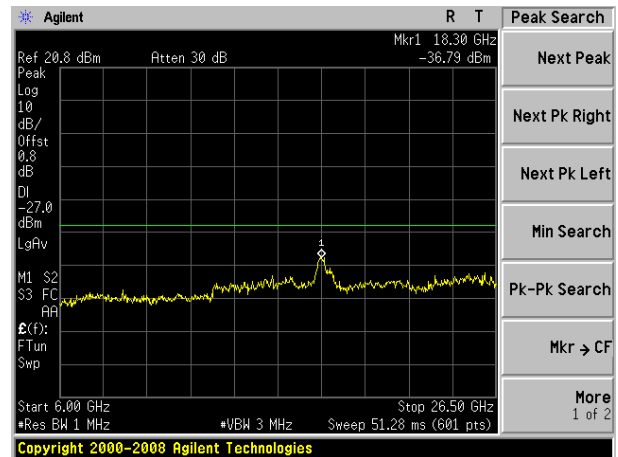

Test Plot

802.11a on channel 48

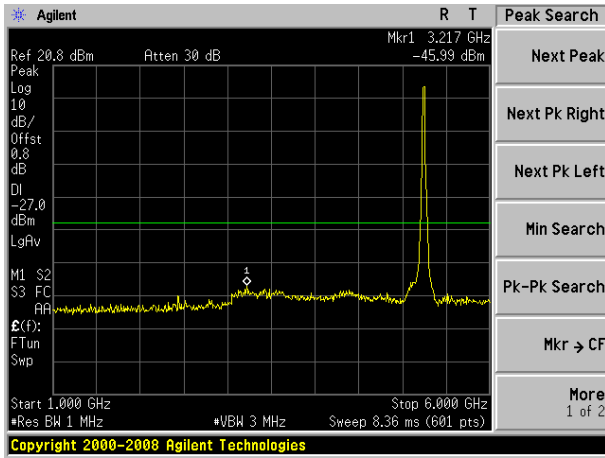

802.11n20 on channel 36

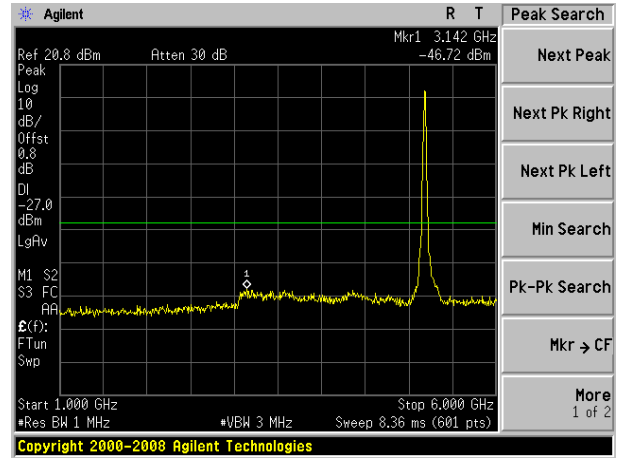

802.11a on channel 48

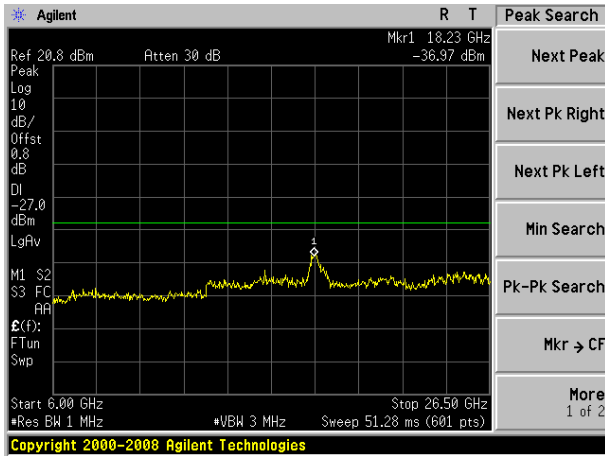

802.11n20 on channel 36

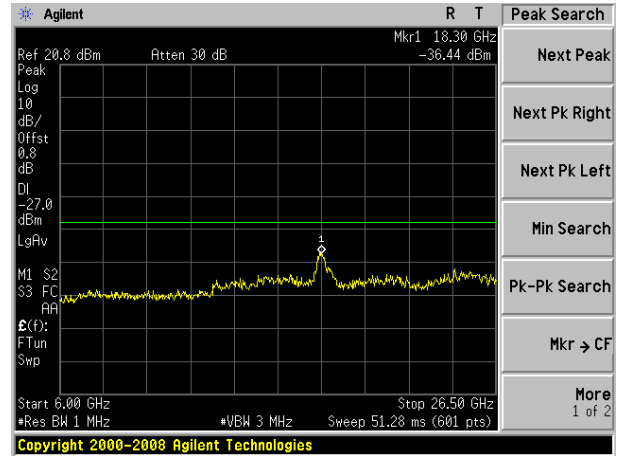

Test Plot

802.11n20 on channel 40

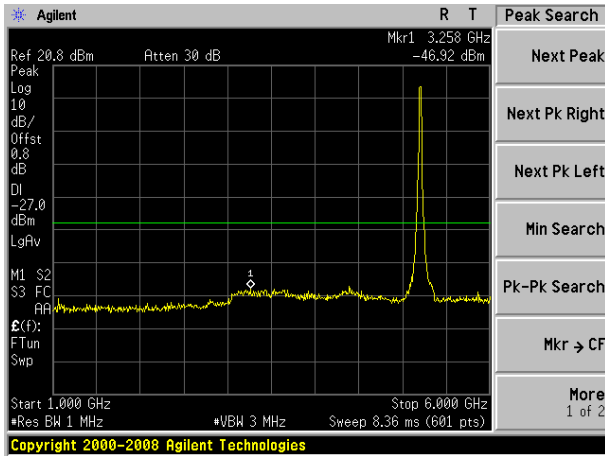

802.11n20 on channel 48

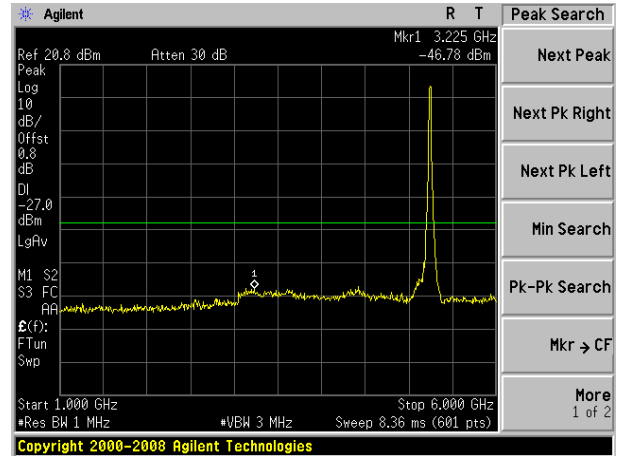

802.11n20 on channel 40

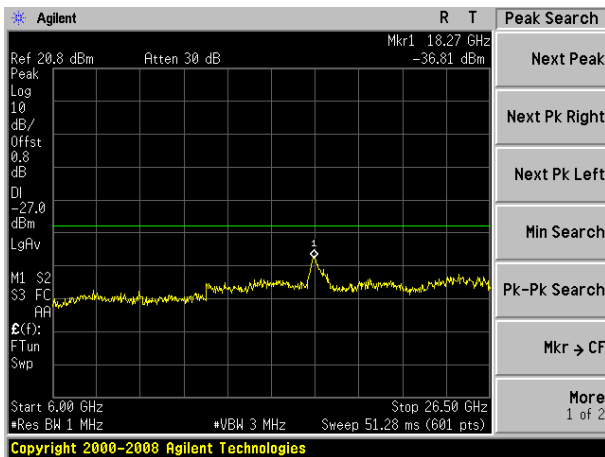

802.11n20 on channel 48

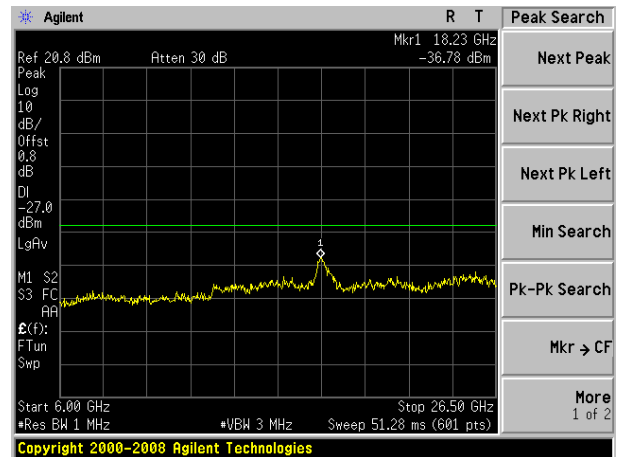

Test Plot

802.11n40 on channel 38

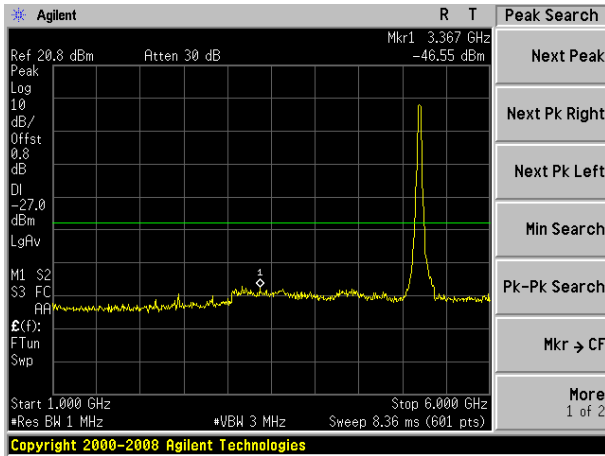

802.11n40 on channel 46

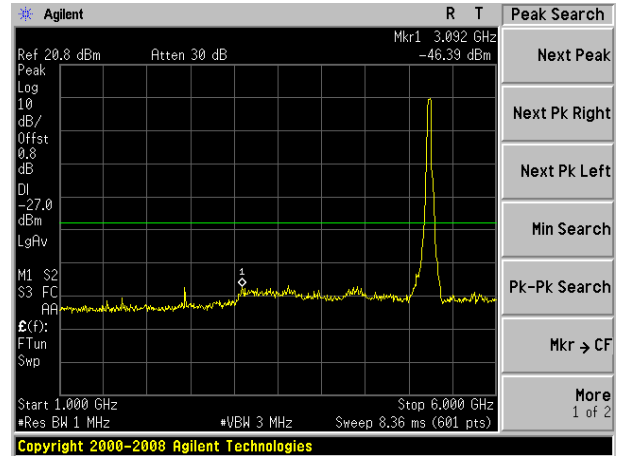

802.11n40 on channel 38

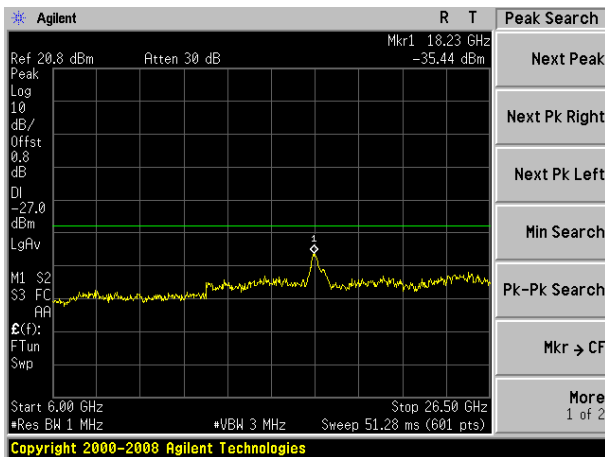

802.11n40 on channel 46

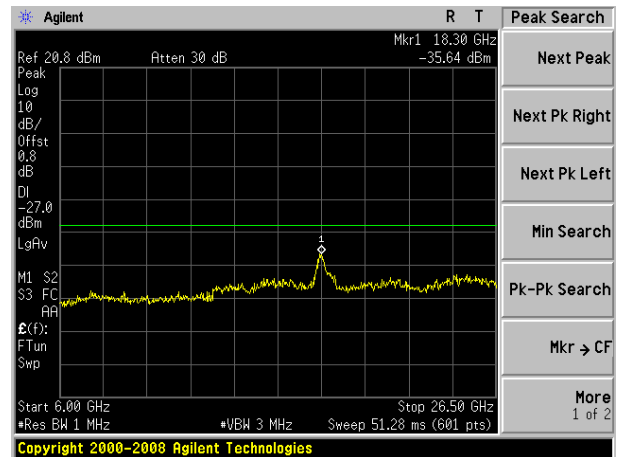



Test Plot

802.11ac20 on channel 36

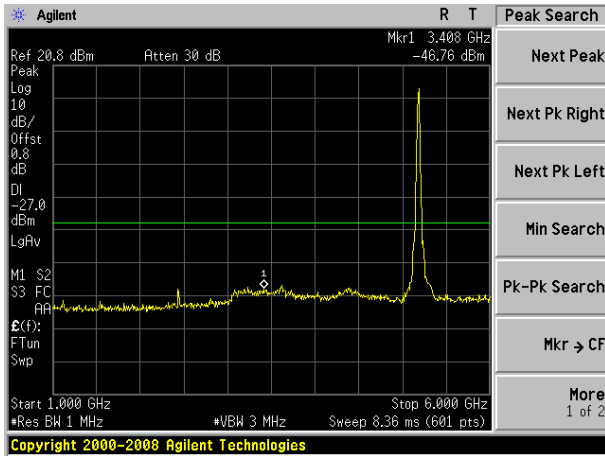

802.11ac20 on channel 40

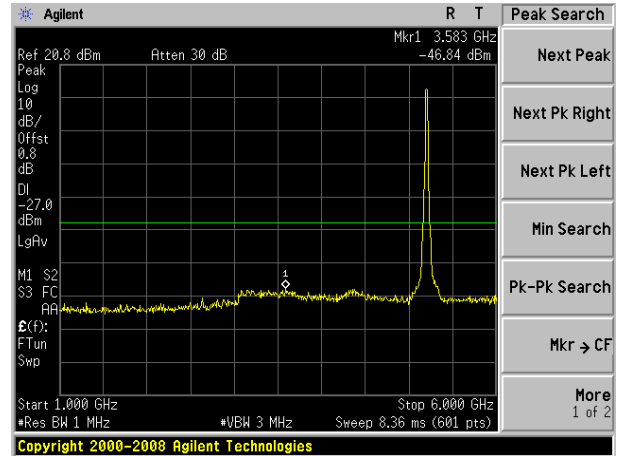

802.11ac20 on channel 36

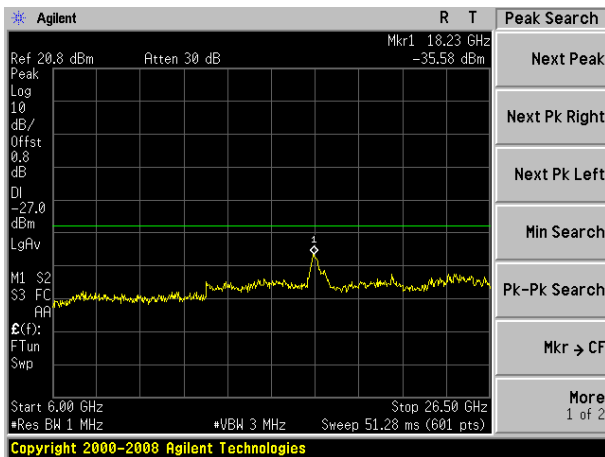

802.11ac20 on channel 40

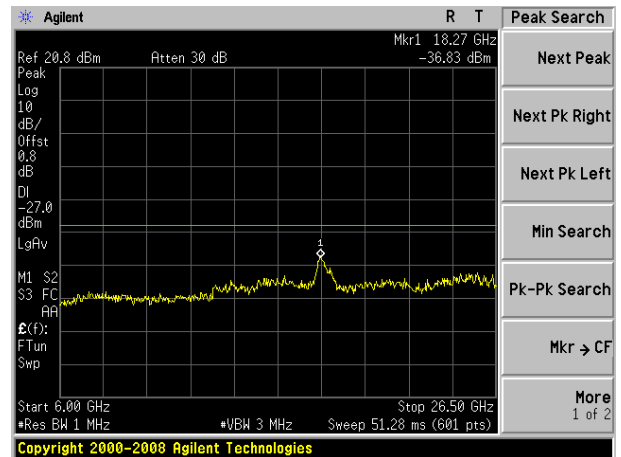

Test Plot

802.11ac20 on channel 48

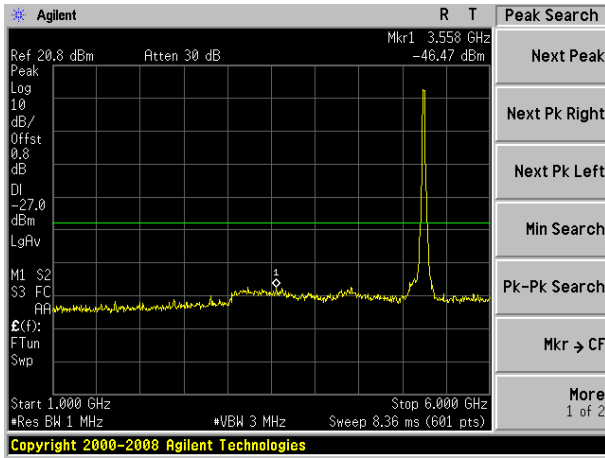

802.11ac40 on channel 38

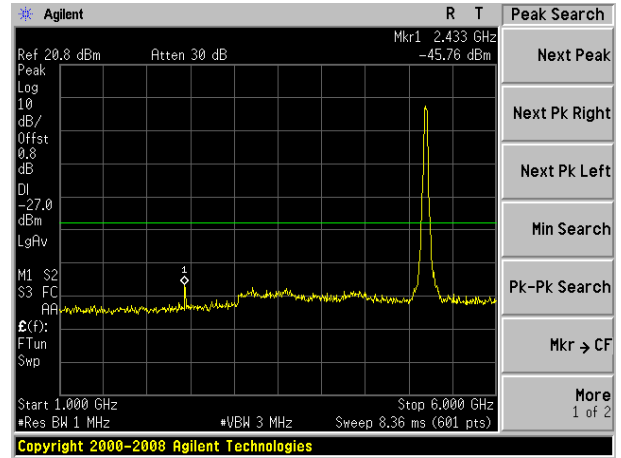

802.11ac20 on channel 48

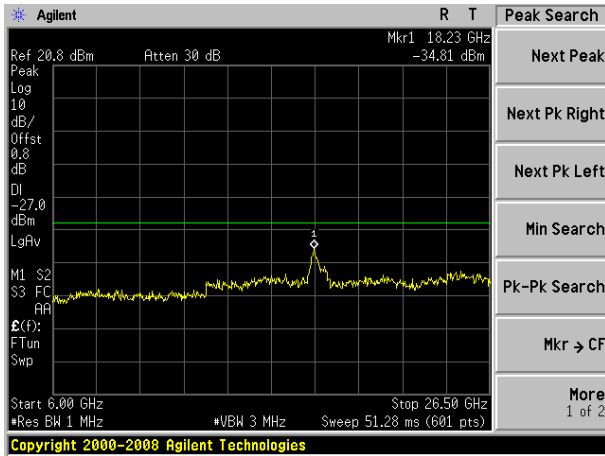

802.11ac40 on channel 38

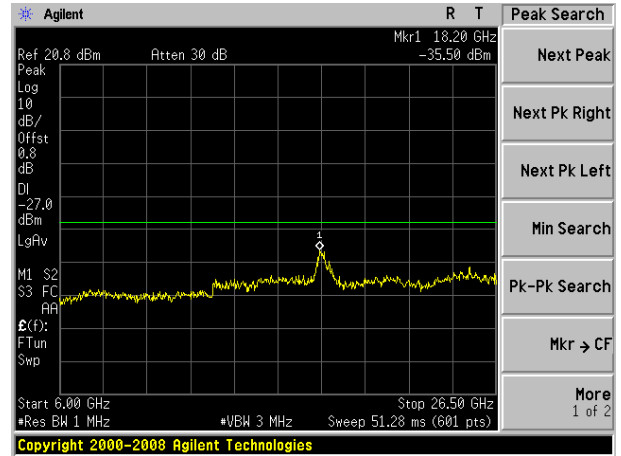

Test Plot

802.11ac40 on channel 46

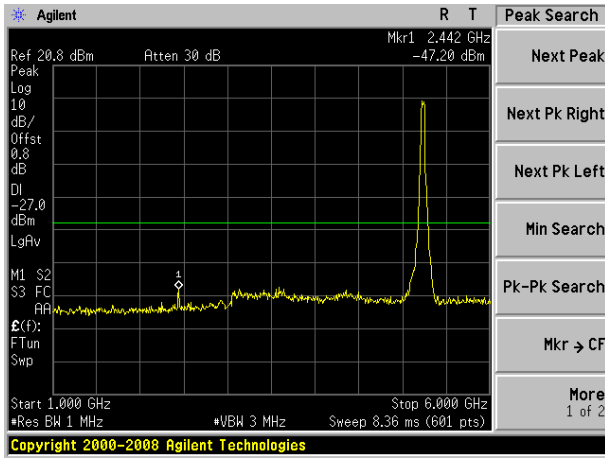

802.11ac80 on channel 42

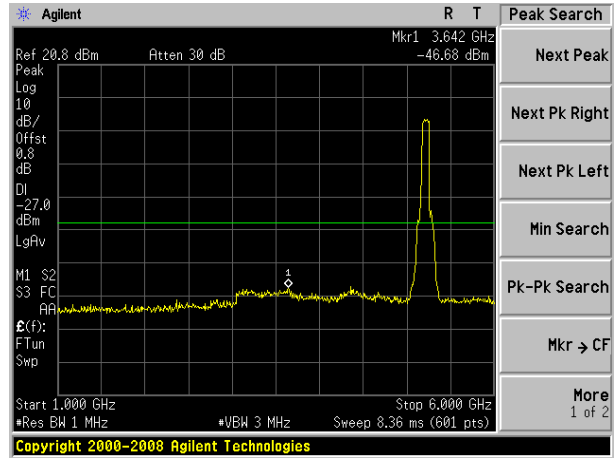

802.11 ac40 on channel 46

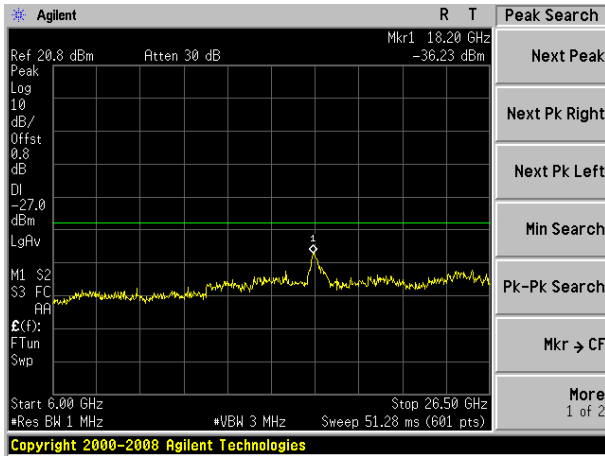

802.11 ac80 on channel 42

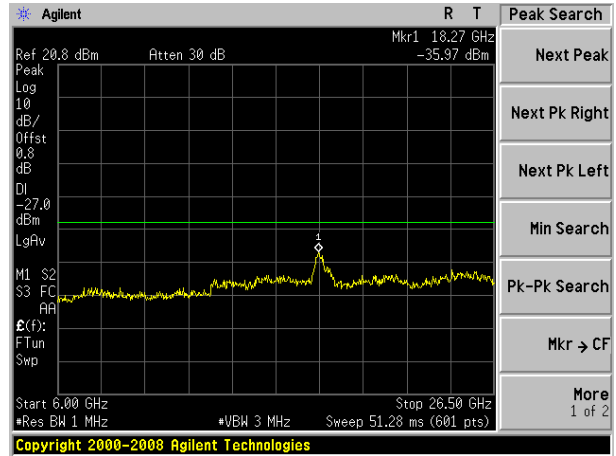

5.8G

Test Plot

802.11a on channel 149

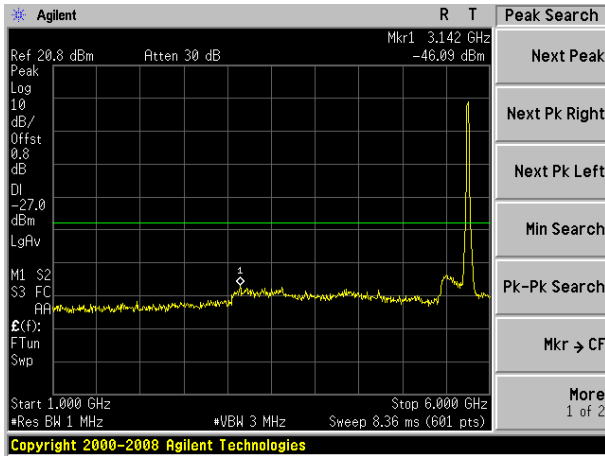

802.11a on channel 157

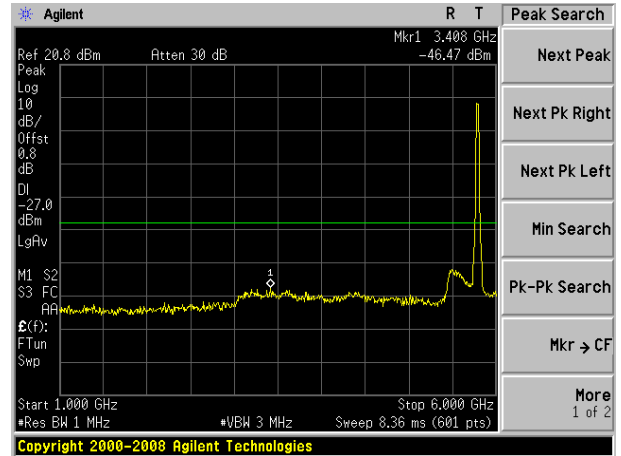

802.11a on channel 149

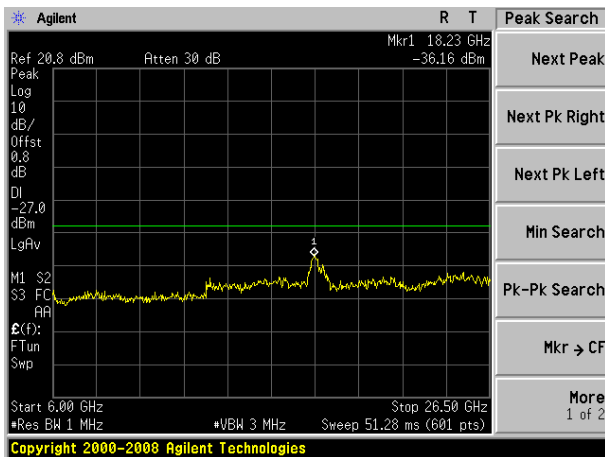

802.11a on channel 157

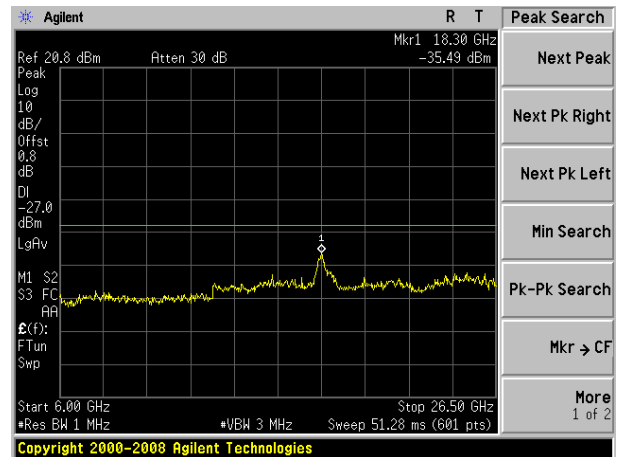

Test Plot

802.11a on channel 165

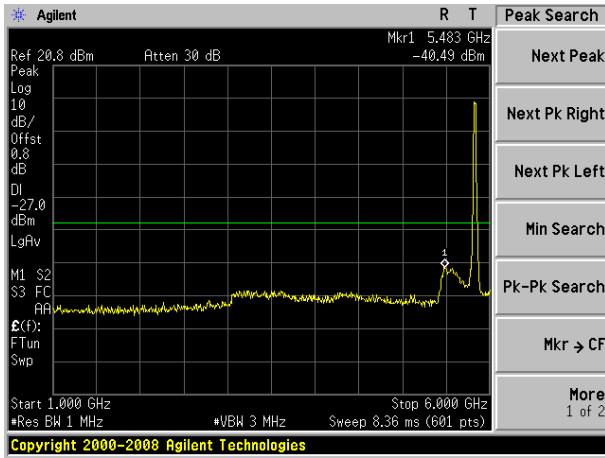

802.11n20 on channel 149

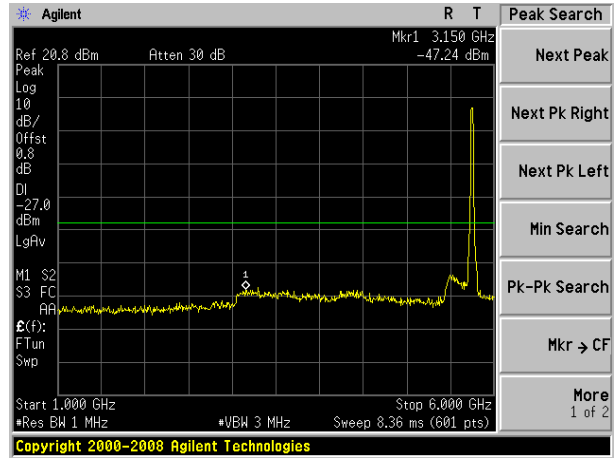

802.11a on channel 165

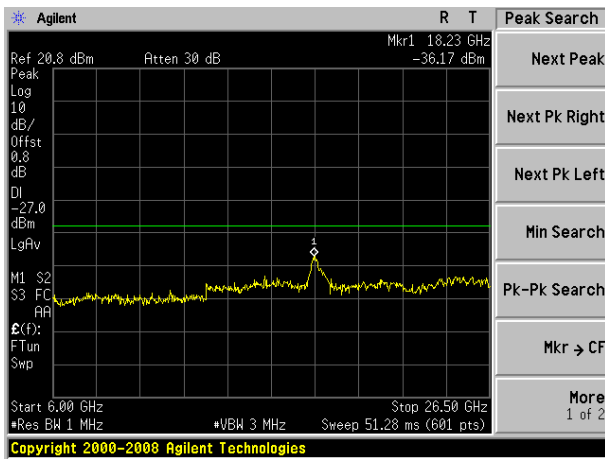

802.11n20 on channel 149

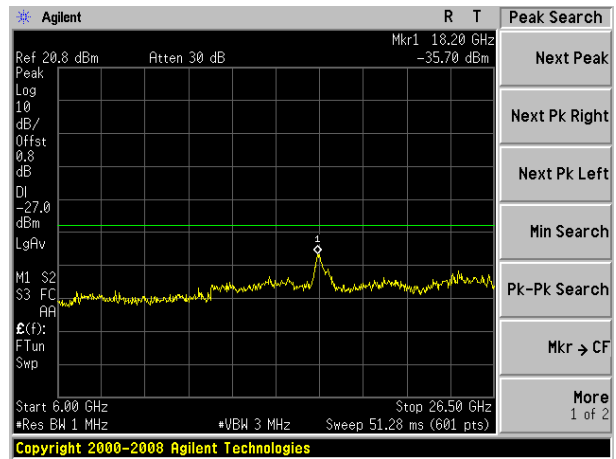

Test Plot

802.11n20 on channel 157

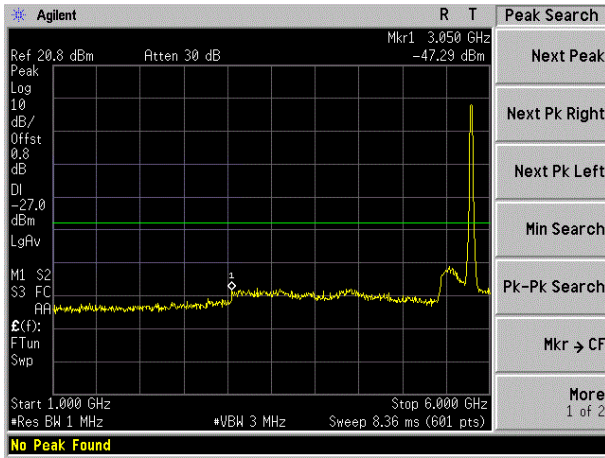

802.11n20 on channel 165

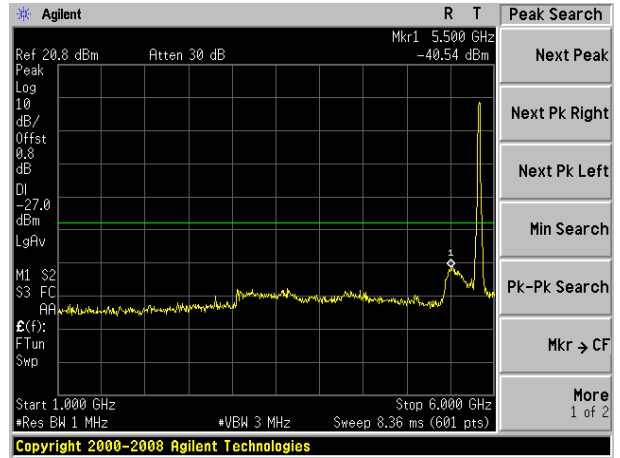

802.11n20 on channel 157

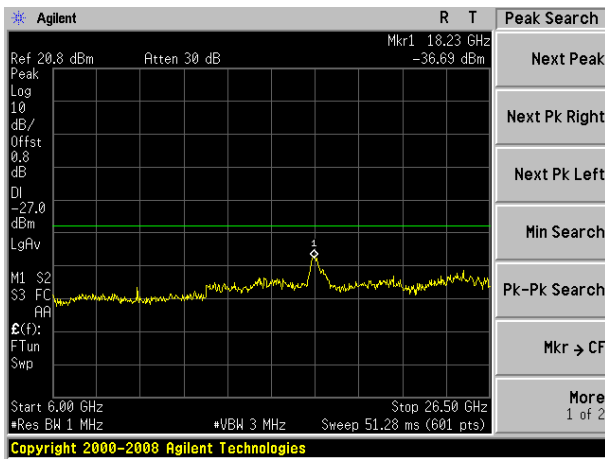

802.11n20 on channel 165

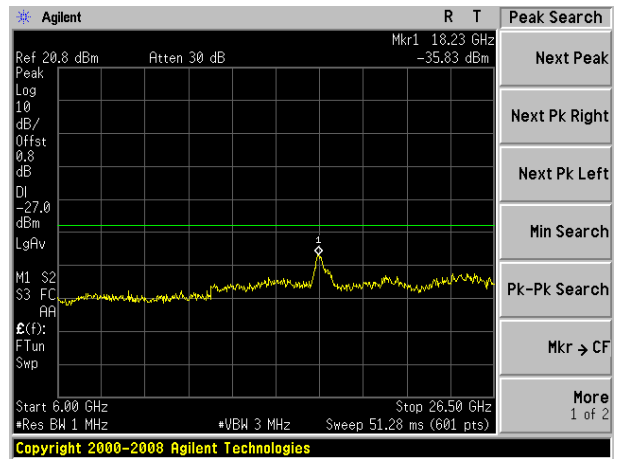

Test Plot

802.11n40 on channel 151

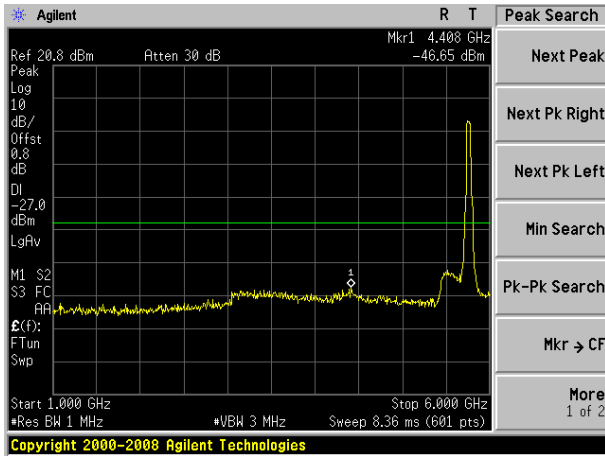

802.11n40 on channel 159

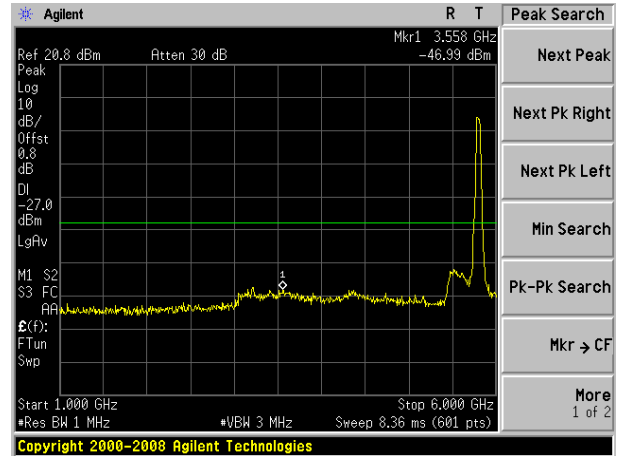

802.11n40 on channel 151

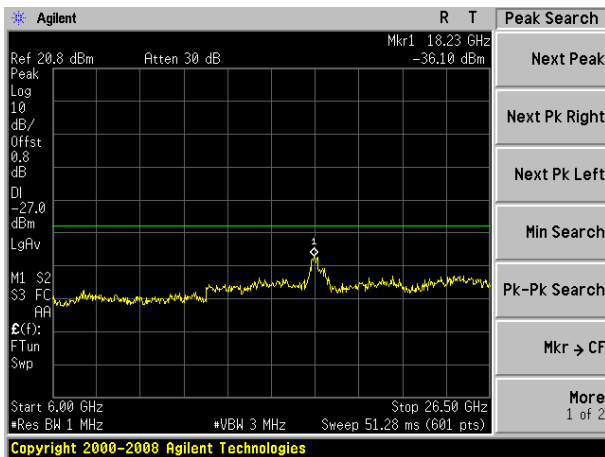

802.11n40 on channel 159

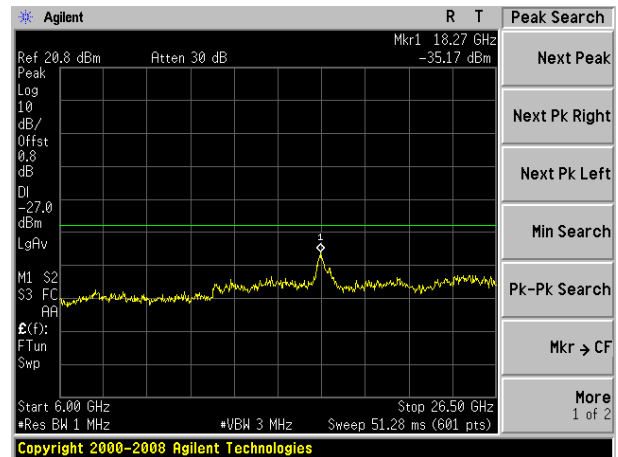

Test Plot

802.11ac20 on channel 149

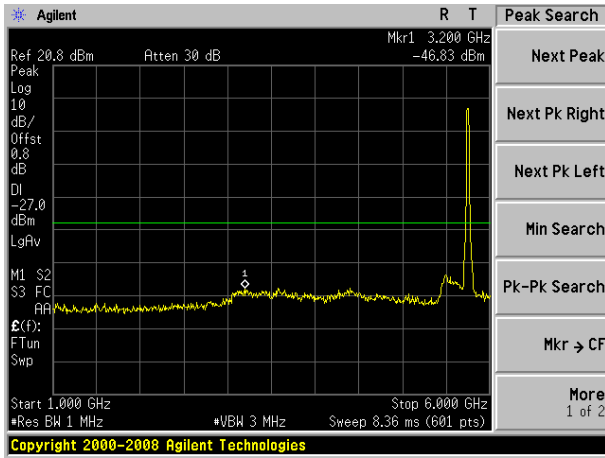

802.11ac20 on channel 157

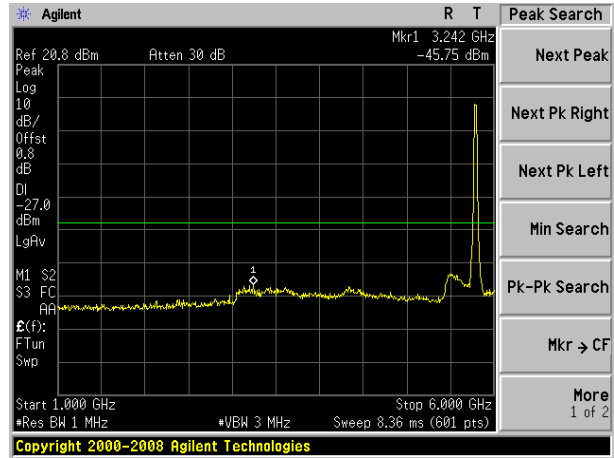

802.11ac20 on channel 149

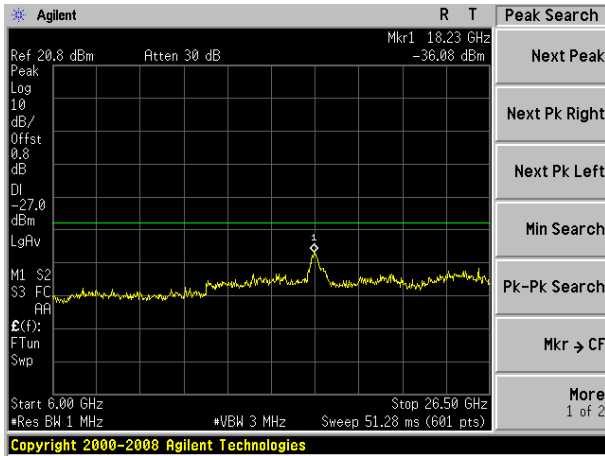

802.11ac20 on channel 157

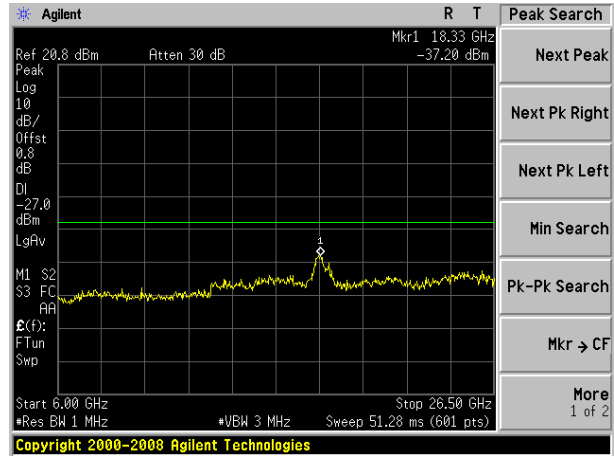



Test Plot

802.11ac20 on channel 165

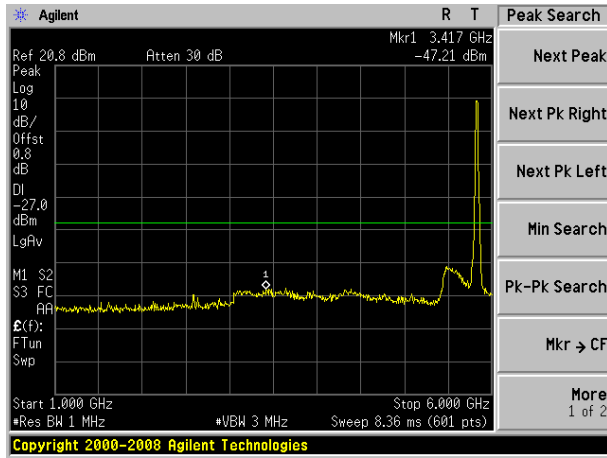

802.11ac40 on channel 151

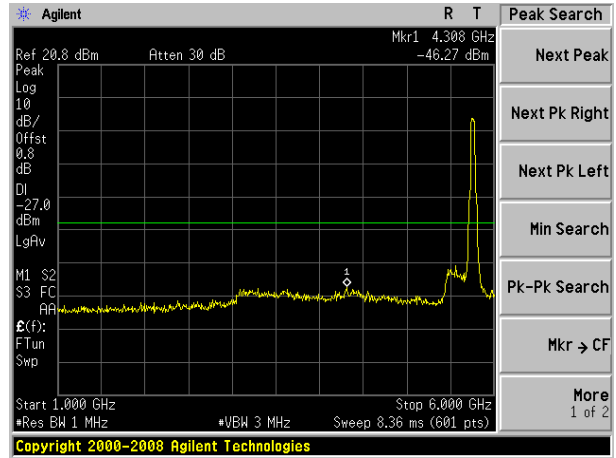

802.11ac20 on channel 165

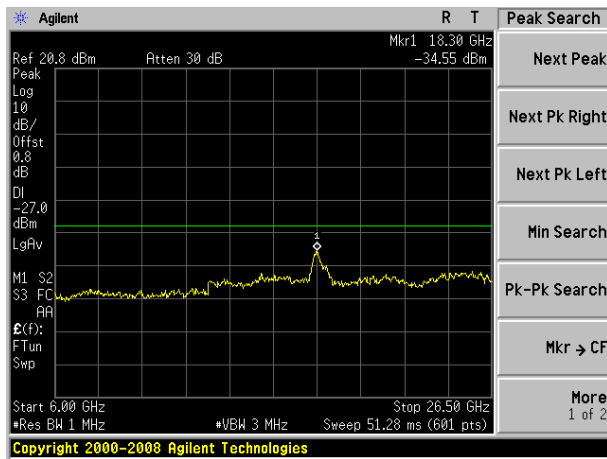

802.11ac40 on channel 151

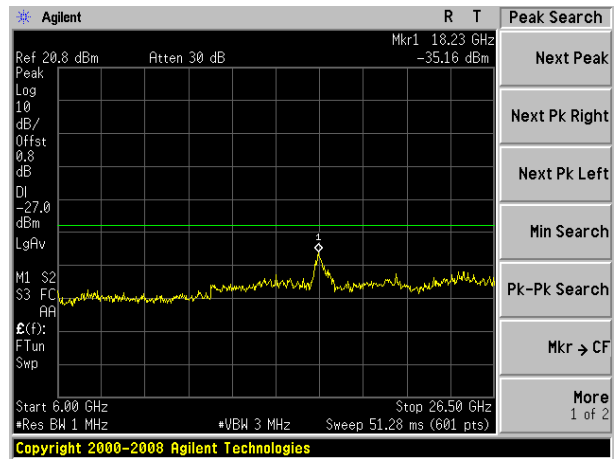

Test Plot

802.11ac40 on channel 159

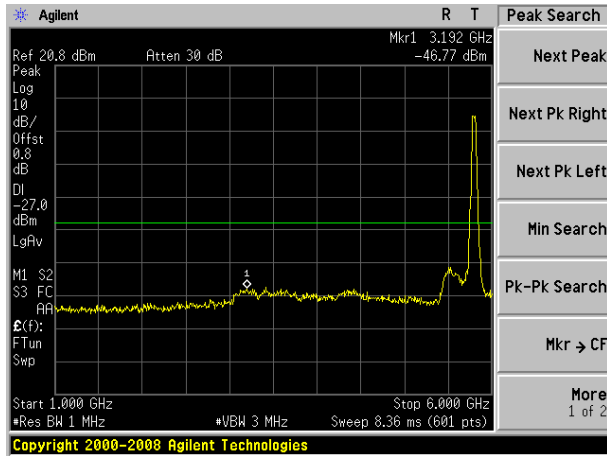

802.11ac80 on channel 155

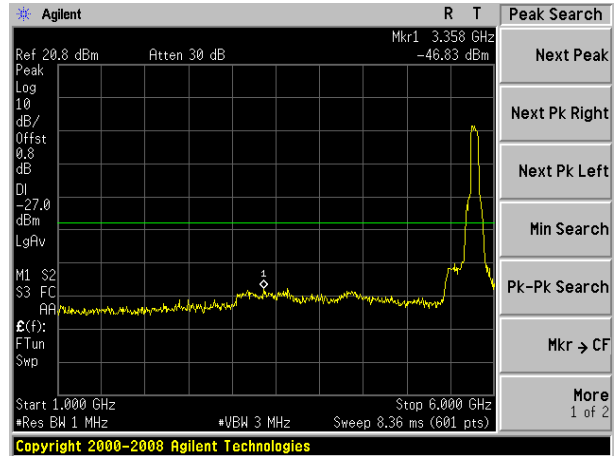

802.11 ac40 on channel 159

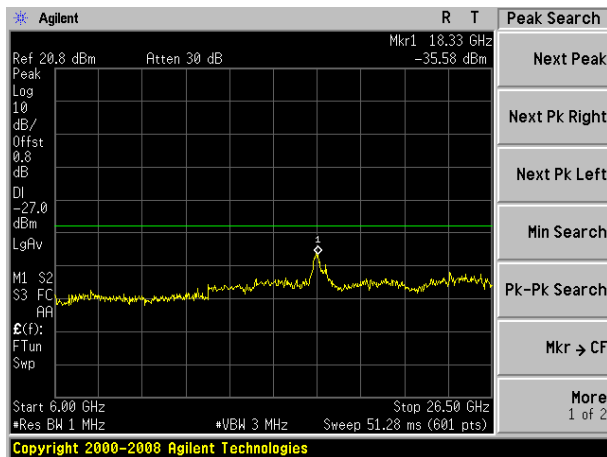

802.11 ac80 on channel 155

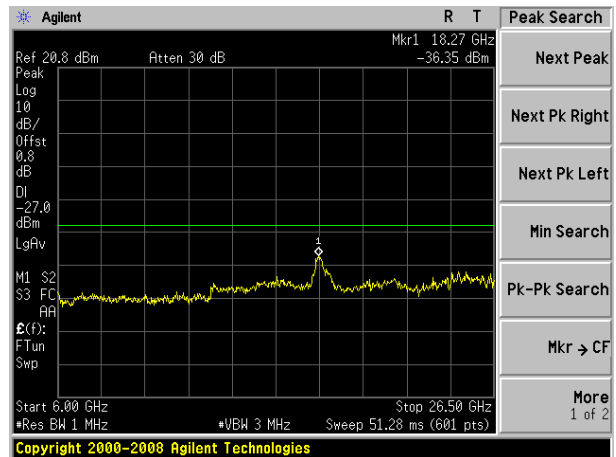

## 10. Frequency Stability Measurement

### 10.1 LIMIT

Manufacturers of U-NII devices are responsible for ensuring frequency stability such that an emission is maintained within the band of operation under all conditions of normal operation as specified in the user's manual.

The transmitter center frequency tolerance shall be  $\pm 20$  ppm maximum for the 5 GHz band (IEEE 802.11n specification).

### 10.2 TEST PROCEDURES

1. The transmitter output (antenna port) was connected to the spectrum analyzer.
2. EUT have transmitted absence of modulation signal and fixed channelize.
3. Set the spectrum analyzer span to view the entire absence of modulation emissions bandwidth.
4. Set RBW = 10 kHz, VBW = 10 kHz with peak detector and maxhold settings.
5.  $f_c$  is declaring of channel frequency. Then the frequency error formula is  $(f_c - f) / f_c \times 10^6$  ppm and the limit is less than  $\pm 20$  ppm (IEEE 802.11n specification).
6. The test extreme voltage is to change the primary supply voltage from 85 to 115 percent of the nominal value
7. Extreme temperature is  $-20^\circ\text{C} \sim 70^\circ\text{C}$ .

### 10.3 TEST SETUP LAYOUT

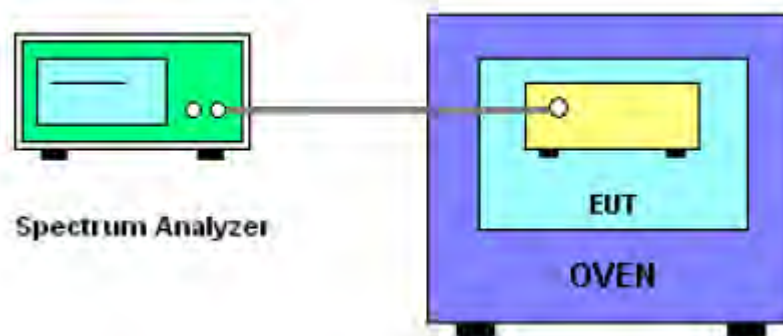

### 10.4 EUT OPERATION DURING TEST

The EUT was programmed to be in continuously un-modulation transmitting mode.

**10.5 TEST RESULTS**

EUT :	ScreenBeam OPS Wireless Display Module	Model Name. :	SBWD3100
Temperature :	25 °C	Relative Humidity :	56%
Pressure :	1012 hPa	Test Voltage :	DC 19V
Test Mode :	TX Frequency Band I (5150-5250MHz)		

**Voltage vs. Frequency Stability**

TEST CONDITIONS				Reference Frequency: 5180MHz			
				f	fc	Max. Deviation (MHz)	Max. Deviation (ppm)
T nom (°C)	20	V nom (V)	19.00	5180.0296	5180	0.0296	-5.7143
		V max (V)	21.85	5180.0421	5180	0.0421	-8.1274
		V min (V)	16.15	5180.0532	5180	0.0532	-10.2703
Limits				Within 5150-5250MHz			
Result				Complies			

**Temperature vs. Frequency Stability**

TEST CONDITIONS				Reference Frequency: 5180MHz			
				f	fc	Max. Deviation (MHz)	Max. Deviation (ppm)
V nom (V)	19	T (°C)	-20	5180.0632	5180	0.0632	-12.2008
		T (°C)	-10	5180.0211	5180	0.0211	-4.0734
		T (°C)	0	5180.0794	5180	0.0794	-15.3282
		T (°C)	10	5180.0235	5180	0.0235	-4.5367
		T (°C)	20	5180.0652	5180	0.0652	-12.5869
		T (°C)	30	5180.0217	5180	0.0217	-4.1892
		T (°C)	40	5180.0332	5180	0.0332	-6.4093
		T (°C)	50	5180.0298	5180	0.0298	-5.7529
		T (°C)	60	5180.0469	5180	0.0469	-9.0541
		T (°C)	70	5180.0264	5180	0.0264	-5.0965
Limits				Within 5150-5250MHz			
Result				Complies			

Voltage vs. Frequency Stability

TEST CONDITIONS				Reference Frequency: 5200MHz			
				f	fc	Max. Deviation (MHz)	Max. Deviation (ppm)
T nom (°C)	20	V nom (V)	19.00	5200.0417	5200	0.0417	-8.0192
		V max (V)	21.85	5200.0362	5200	0.0362	-6.9615
		V min (V)	16.15	5200.0411	5200	0.0411	-7.9038
Limits				Within 5150-5250MHz			
Result				Complies			

Temperature vs. Frequency Stability

TEST CONDITIONS				Reference Frequency: 5200MHz			
				f	fc	Max. Deviation (MHz)	Max. Deviation (ppm)
V nom (V)	19	T (°C)	-20	5200.0629	5200	0.0629	-12.0962
		T (°C)	-10	5200.0362	5200	0.0362	-6.9615
		T (°C)	0	5200.0421	5200	0.0421	-8.0962
		T (°C)	10	5200.0291	5200	0.0291	-5.5962
		T (°C)	20	5200.0174	5200	0.0174	-3.3462
		T (°C)	30	5200.0633	5200	0.0633	-12.1731
		T (°C)	40	5200.0417	5200	0.0417	-8.0192
		T (°C)	50	5200.0623	5200	0.0623	-11.9808
		T (°C)	60	5200.0342	5200	0.0342	-6.5769
		T (°C)	70	5200.0422	5200	0.0422	-8.1154
Limits				Within 5150-5250MHz			
Result				Complies			

Voltage vs. Frequency Stability

TEST CONDITIONS				Reference Frequency: 5240MHz			
				f	fc	Max. Deviation (MHz)	Max. Deviation (ppm)
T nom (°C)	20	V nom (V)	19.00	5240.0316	5240	0.0316	-6.0305
		V max (V)	21.85	5240.0178	5240	0.0178	-3.3969
		V min (V)	16.15	5240.0238	5240	0.0238	-4.5420
Limits				Within 5150-5250MHz			
Result				Complies			

Temperature vs. Frequency Stability

TEST CONDITIONS				Reference Frequency: 5240MHz			
				f	fc	Max. Deviation (MHz)	Max. Deviation (ppm)
V nom (V)	19	T (°C)	-20	5240.0532	5240	0.0532	-10.1527
		T (°C)	-10	5240.0187	5240	0.0187	-3.5687
		T (°C)	0	5240.0369	5240	0.0369	-7.0420
		T (°C)	10	5240.0258	5240	0.0258	-4.9237
		T (°C)	20	5240.0713	5240	0.0713	-13.6069
		T (°C)	30	5240.0621	5240	0.0621	-11.8511
		T (°C)	40	5240.0392	5240	0.0392	-7.4809
		T (°C)	50	5240.0256	5240	0.0256	-4.8855
		T (°C)	60	5240.0392	5240	0.0392	-7.4809
T (°C)	70	5240.0225	5240	0.0225	-4.2939		
Limits				Within 5150-5250MHz			
Result				Complies			

EUT :	ScreenBeam OPS Wireless Display Module	Model Name. :	SBWD3100
Temperature :	25 °C	Relative Humidity :	56%
Pressure :	1012 hPa	Test Voltage :	DC 19V
Test Mode :	TX Frequency Band III (5725-5850MHz)		

Voltage vs. Frequency Stability

TEST CONDITIONS				Reference Frequency: 5745MHz			
				f	fc	Max. Deviation (MHz)	Max. Deviation (ppm)
T nom (°C)	20	V nom (V)	19.00	5745.0195	5745	0.0195	-3.3943
		V max (V)	21.85	5745.0263	5745	0.0263	-4.5779
		V min (V)	16.15	5745.0369	5745	0.0369	-6.4230
Limits				Within 5725-5850MHz			
Result				Complies			

Temperature vs. Frequency Stability

TEST CONDITIONS				Reference Frequency: 5745MHz			
				f	fc	Max. Deviation (MHz)	Max. Deviation (ppm)
V nom (V)	19	T (°C)	-20	5745.0418	5745	0.0418	-7.2759
		T (°C)	-10	5745.0285	5745	0.0285	-4.9608
		T (°C)	0	5745.0261	5745	0.0261	-4.5431
		T (°C)	10	5745.0385	5745	0.0385	-6.7015
		T (°C)	20	5745.0421	5745	0.0421	-7.3281
		T (°C)	30	5745.0419	5745	0.0419	-7.2933
		T (°C)	40	5745.0362	5745	0.0362	-6.3011
		T (°C)	50	5745.0289	5745	0.0289	-5.0305
		T (°C)	60	5745.0421	5745	0.0421	-7.3281
		T (°C)	70	5745.0623	5745	0.0623	-10.8442
Limits				Within 5725-5850MHz			
Result				Complies			

Voltage vs. Frequency Stability

TEST CONDITIONS				Reference Frequency: 5785MHz			
				f	fc	Max. Deviation (MHz)	Max. Deviation (ppm)
T nom (°C)	20	V nom (V)	19.00	5785.0421	5785	0.0421	-7.2774
		V max (V)	21.85	5785.0623	5785	0.0623	-10.7692
		V min (V)	16.15	5785.0264	5785	0.0264	-4.5635
Limits				Within 5725-5850MHz			
Result				Complies			

Temperature vs. Frequency Stability

TEST CONDITIONS				Reference Frequency: 5785MHz			
				f	fc	Max. Deviation (MHz)	Max. Deviation (ppm)
V nom (V)	19	T (°C)	-20	5785.0512	5785	0.0512	-8.8505
		T (°C)	-10	5785.0491	5785	0.0491	-8.4875
		T (°C)	0	5785.0436	5785	0.0436	-7.5367
		T (°C)	10	5785.0362	5785	0.0362	-6.2576
		T (°C)	20	5785.0411	5785	0.0411	-7.1046
		T (°C)	30	5785.0493	5785	0.0493	-8.5220
		T (°C)	40	5785.0264	5785	0.0264	-4.5635
		T (°C)	50	5785.0365	5785	0.0365	-6.3094
		T (°C)	60	5785.0416	5785	0.0416	-7.1910
		T (°C)	70	5785.0422	5785	0.0422	-7.2947
Limits				Within 5725-5850MHz			
Result				Complies			



Voltage vs. Frequency Stability

TEST CONDITIONS				Reference Frequency: 5825MHz			
				f	fc	Max. Deviation (MHz)	Max. Deviation (ppm)
T nom (°C)	20	V nom (V)	19.00	5825.0341	5825	0.0341	-5.8541
		V max (V)	21.85	5825.0255	5825	0.0255	-4.3777
		V min (V)	16.15	5825.0319	5825	0.0319	-5.4764
Limits				Within 5725-5850MHz			
Result				Complies			

Temperature vs. Frequency Stability

TEST CONDITIONS				Reference Frequency: 5825MHz			
				f	fc	Max. Deviation (MHz)	Max. Deviation (ppm)
V nom (V)	19	T (°C)	-20	5825.0416	5825	0.0416	-7.1416
		T (°C)	-10	5825.0362	5825	0.0362	-6.2146
		T (°C)	0	5825.0417	5825	0.0417	-7.1588
		T (°C)	10	5825.0326	5825	0.0326	-5.5966
		T (°C)	20	5825.0624	5825	0.0624	-10.7124
		T (°C)	30	5825.0227	5825	0.0227	-3.8970
		T (°C)	40	5825.0256	5825	0.0256	-4.3948
		T (°C)	50	5825.0632	5825	0.0632	-10.8498
		T (°C)	60	5825.0264	5825	0.0264	-4.5322
		T (°C)	70	5825.0326	5825	0.0326	-5.5966
Limits				Within 5725-5850MHz			
Result				Complies			

**11. ANTENNA REQUIREMENT**

**11.1 STANDARD REQUIREMENT**

15.203 requirement: For intentional device, according to 15.203: an intentional radiator shall be designed to ensure that no antenna other than that furnished by the responsible party shall be used with the device.

**11.2 EUT ANTENNA**

The module has three antennas, and different modes support different transmit mode what describe as Following form:

Antenna	Antenna Type	Antenna Gain(dBi)
		5G
0	PIFA	3.37
1	PIFA	4.28
2	PIFA	3.67

Mode	Tx/Rx
802.11a	1Tx, 1Rx
802.11n/ac	1Tx/3Tx, 3Rx

ANT connector plot:

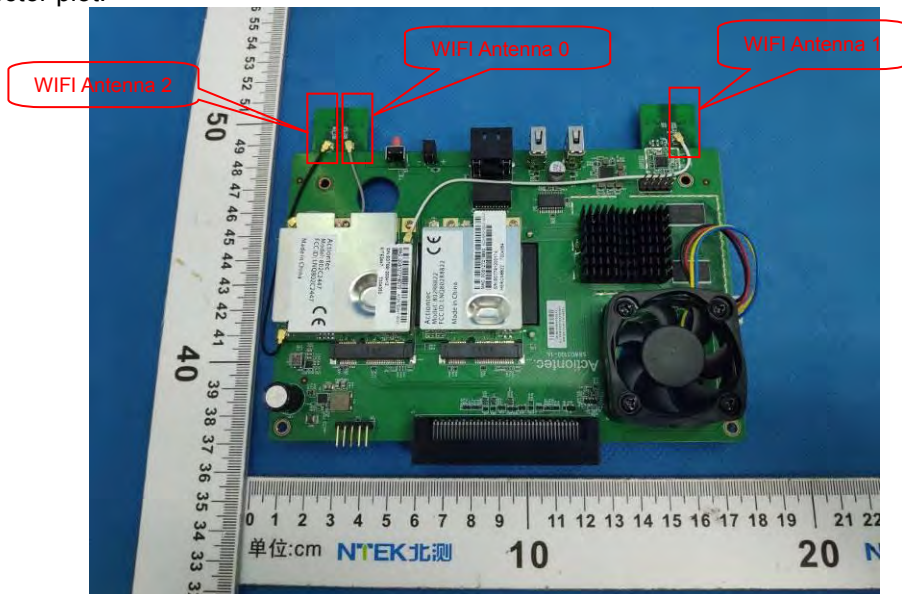

It comply with the standard requirement.

END OF REPORT