

FCC RADIO TEST REPORT

FCC ID:LNQMWTV3TX

Product : MyWirelessTV3 Wireless HD Transmitter,
4K Wireless HD Connection Kit

Trade Mark : Actiontec

Model Name : MWTV3TX

Serial Model : MWTV3KIT

Report No. : NTEK-2017NT08175779F

Prepared for

Actiontec Electronics, Inc.

760 North Mary Ave., Sunnyvale, CA 94085 USA

Prepared by

Shenzhen NTEK Testing Technology Co., Ltd.
1/F, Building E, Fenda Science Park, Sanwei Community,
Xixiang Street Bao'an District, Shenzhen 518126 P.R. China
Tel.: +86-755-6115 9388
Fax.: +86-755-6115 6599
Website:<http://www.ntek.org.cn>



TEST RESULT CERTIFICATION

Applicant's name : Actiontec Electronics, Inc.
 Address : 760 North Mary Ave., Sunnyvale, CA 94085 USA
Manufacturer's Name : Actiontec Electronics, Inc.
 Address : 760 North Mary Ave., Sunnyvale, CA 94085 USA

Product description

Product name..... : MyWirelessTV3 Wireless HD Transmitter,
 4K Wireless HD Connection Kit
 Model and/or type reference : MWTV3TX
 Serial Model : MWTV3KIT

Standards : FCC Part15.407

Test procedure ANSI C63.10-2013 and KDB 789033 D02 General UNII Test
 Procedures New Rules v01r01
 FCC KDB 662911 D01 Multiple Transmitter Output v02r01
 FCC KDB 662911 D02 MIMO With Cross Polarized Antenna V01

This device described above has been tested by NTEK, and the test results show that the equipment under test (EUT) is in compliance with the FCC requirements/ the Industry Canada requirements.. And it is applicable only to the tested sample identified in the report.

This report shall not be reproduced except in full, without the written approval of NTEK, this document may be altered or revised by NTEK, personnel only, and shall be noted in the revision of the document.

Date of Test.....
 Date (s) of performance of tests..... 17 Aug. 2017 ~ 12 Sep. 2017
 Date of Issue..... 12 Sep. 2017
 Test Result..... **Pass**

Testing Engineer : Eileen Liu.
 (Eileen Liu)

Technical Manager : Jason Chen
 (Jason Chen)

Authorized Signatory : Sam. Chen
 (Sam Chen)

Table of Contents

	Page
1 . SUMMARY OF TEST RESULTS	6
1.1 FACILITIES AND ACCREDITATIONS	7
1.2 MEASUREMENT UNCERTAINTY	7
2 . GENERAL INFORMATION	8
2.1 GENERAL DESCRIPTION OF EUT	8
2.2 DESCRIPTION OF TEST MODES	13
2.3 BLOCK DIGRAM SHOWING THE CONFIGURATION OF SYSTEM TESTED	14
2.4 DESCRIPTION OF SUPPORT UNITS(CONDUCTED MODE)	15
2.5 EQUIPMENTS LIST FOR ALL TEST ITEMS	16
3 . EMC EMISSION TEST	18
3.1 CONDUCTED EMISSION MEASUREMENT	18
3.1.1 POWER LINE CONDUCTED EMISSION LIMITS	18
3.1.2 TEST PROCEDURE	19
3.1.3 DEVIATION FROM TEST STANDARD	19
3.1.4 TEST SETUP	19
3.1.5 EUT OPERATING CONDITIONS	19
3.2 RADIATED EMISSION MEASUREMENT	24
3.2.1 APPLICABLE STANDARD	24
3.2.2 CONFORMANCE LIMIT	24
3.2.3 MEASURING INSTRUMENTS	24
3.2.4 TEST CONFIGURATION	25
3.2.5 TEST PROCEDURE	26
3.2.6 TEST RESULTS (9KHZ – 30 MHZ)	27
3.2.7 TEST RESULTS (30MHZ – 1GHZ)	28
3.2.8 TEST RESULTS (1GHZ-26GHZ)	32
3.2.9 TEST RESULTS (26GHZ-40GHZ)	34
4 . POWER SPECTRAL DENSITY TEST	40
4.1 APPLIED PROCEDURES / LIMIT	40
4.2 TEST PROCEDURE	41
4.3 DEVIATION FROM STANDARD	41
4.4 TEST SETUP	41
4.5 EUT OPERATION CONDITIONS	41
4.6 TEST RESULTS	42
5 . 26DB & 99% EMISSION BANDWIDTH	50
5.1 APPLIED PROCEDURES / LIMIT	50
5.2 TEST PROCEDURE	50
5.3 EUT OPERATION CONDITIONS	51
5.4 TEST RESULTS	52

Table of Contents

	Page
6 . MINIMUM 6 DB BANDWIDTH	60
6.1 APPLIED PROCEDURES / LIMIT	60
6.2 TEST PROCEDURE	60
6.3 DEVIATION FROM STANDARD	60
6.4 TEST SETUP	60
6.5 EUT OPERATION CONDITIONS	60
6.6 TEST RESULTS	61
7 . MAXIMUM CONDUCTED OUTPUT POWER	69
7.1 PPLIED PROCEDURES / LIMIT	69
7.2 TEST PROCEDURE	69
7.3 DEVIATION FROM STANDARD	71
7.4 TEST SETUP	71
7.5 EUT OPERATION CONDITIONS	71
7.6 TEST RESULTS	72
8 . OUT OF BAND EMISSIONS	74
8.1 APPLICABLE STANDARD	74
8.2 TEST PROCEDURE	74
8.3 DEVIATION FROM STANDARD	74
8.4 TEST SETUP	74
8.5 EUT OPERATION CONDITIONS	74
8.6 TEST RESULTS	75
9.SPURIOUS RF CONDUCTED EMISSIONS	82
9.1CONFORMANCE LIMIT	82
9.2MEASURING INSTRUMENTS	82
9.3TEST SETUP	82
9.4TEST PROCEDURE	82
9.5TEST RESULTS	82
10. FREQUENCY STABILITY MEASUREMENT	97
10.1 LIMIT	97
10.2 TEST PROCEDURES	97
10.3 TEST SETUP LAYOUT	97
10.4 EUT OPERATION DURING TEST	97
10.5 TEST RESULTS	98
11. ANTENNA REQUIREMENT	104
11.1 STANDARD REQUIREMENT	104
11.2 EUT ANTENNA	104

1. SUMMARY OF TEST RESULTS

Test procedures according to the technical standards:

FCC Part15 (15.407) , Subpart E			
Standard Section	Test Item	Judgment	Remark
15.207	AC Power Line Conducted Emissions	PASS	
15.209(a), 15.407 (b)(1) 15.407 (b)(4) 15.407 (b)(6)	Spurious Radiated Emissions	PASS	(Outsourcing)
15.407 (a)(1) 15.407 (a)(3) 15.1049	26 dB and 99% Emission Bandwidth	PASS	
15.407(e)	Minimum 6 dB bandwidth	PASS	
15.407 (a)(1) (ii) ^{Note(2)} 15.407 (a)(3)	Maximum Conducted Output Power	PASS	
2.1051, 15.407(b)(1) 15.407(b)(4)	Band Edge	PASS	
15.407 (a)(1) (ii) ^{Note(2)} 15.407 (a)(3)	Power Spectral Density	PASS	
2.1051, 15.407(b)	Spurious Emissions at Antenna Terminals	PASS	
15.203	Antenna Requirement	PASS	

NOTE:

(1) "N/A" denotes test is not applicable in this Test Report

Outsourcing: The 26G-40G Spurious Radiated Emissions in this test were outsourced:

Test firm name: Shenzhen Academy of Metrology and Quality Inspec

Designation No.: CN1165

Test firm Registration No.: 582918

(2) The product is an indoor access point operating in the band 5.15-5.25 GHz.

1.1 FACILITIES AND ACCREDITATIONS

FACILITIES

All measurement facilities used to collect the measurement data are located at 1/F, Building E, Fenda Science Park, Sanwei Community, Xixiang Street, Bao'an District, Shenzhen 518126 P.R. China.

The sites are constructed in conformance with the requirements of ANSI C63.7, ANSI C63.10 and CISPR Publication 22.

LABORATORY ACCREDITATIONS AND LISTINGS

Site Description

CNAS-Lab. : The Laboratory has been assessed and proved to be in compliance with CNAS-CL01:2006 (identical to ISO/IEC 17025:2005)
 The Certificate Registration Number is L5516.

IC-Registration The Certificate Registration Number is 9270A-1.

FCC- Accredited Test Firm Registration Number: 463705.
 Designation Number: CN1184

A2LA-Lab. The Certificate Registration Number is 4298.01
 This laboratory is accredited in accordance with the recognized International Standard ISO/IEC 17025:2005 General requirements for the competence of testing and calibration laboratories.
 This accreditation demonstrates technical competence for a defined scope and the operation of a laboratory quality management system (refer to joint ISO-ILAC-IAF Communiqué dated 8 January 2009).

Name of Firm : Shenzhen NTEK Testing Technology Co., Ltd.

Site Location : 1/F, Building E, Fenda Science Park, Sanwei Community, Xixiang Street, Bao'an District, Shenzhen 518126 P.R. China.

1.2 MEASUREMENT UNCERTAINTY

The reported uncertainty of measurement $y \pm U$, where expanded uncertainty U is based on a standard uncertainty multiplied by a coverage factor of $k=2$, providing a level of confidence of approximately 95 %.

No.	Item	Uncertainty
1	Conducted Emission Test	$\pm 2.80\text{dB}$
2	RF power, conducted	$\pm 0.16\text{dB}$
3	Spurious emissions, conducted	$\pm 0.21\text{dB}$
4	All emissions, radiated(30MHz~1GHz)	$\pm 2.64\text{dB}$
5	All emissions, radiated(1GHz~6GHz)	$\pm 2.40\text{dB}$
6	All emissions, radiated(> 6GHz)	$\pm 2.52\text{dB}$
7	Temperature	$\pm 0.5\text{C}$
8	Humidity	$\pm 2\%$

2. GENERAL INFORMATION

2.1 GENERAL DESCRIPTION OF EUT

Equipment	MyWirelessTV3 Wireless HD Transmitter, 4K Wireless HD Connection Kit	
Trade Mark	Actiontec	
Model Name	MWTV3TX	
FCC ID	LNQMWTV3TX	
Product Description	IEEE 802.11 WLAN Mode Supported	<input checked="" type="checkbox"/> 802.11a/AC(20MHz channel bandwidth) <input checked="" type="checkbox"/> 802.11n/AC(20MHz channel bandwidth) <input checked="" type="checkbox"/> 802.11n/AC(40MHz channel bandwidth) <input checked="" type="checkbox"/> 802.11AC(80MHz channel bandwidth)
	Data Rate	802.11 a: 6,9,12,18,24,36,48,54Mbps; 802.11n(HT20):MCS0-MCS15; 802.11n(HT40):MCS0-MCS15; 802.11AC: NSS1,MCS0-MCS9,NSS2,MCS0-MCS9;
	Modulation	OFDM with BPSK/QPSK/16QAM/64QAM/256QAM for 802.11a/n/ac;
	Operating Frequency Range	<input checked="" type="checkbox"/> 5180-5240MHz for 802.11a/n(HT20)/ac20; 5190-5230MHz for 802.11n(HT40)/ac40; 5210MHz for 802.11 ac80; <input checked="" type="checkbox"/> 5745-5825 MHz for 802.11a/n(HT20)/ac20; 5755-5795 MHz for 802.11a/n(HT40)/ac40; 5775MHz for 802.11 ac80;
	Number of Channels	<input checked="" type="checkbox"/> 4 channels for 802.11a/n20/ac20 in the 5180-5240MHz band ; 2 channels for 802.11 n40/ac40 in the 5190-5230MHz band ; 1 channels for 802.11 ac80 in the 5210MHz band ; <input checked="" type="checkbox"/> 5 channels for 802.11a/n20/ac20 in the 5745-5825MHz band ; 2 channels for 802.11 n40/ac40 in the 5755-5795MHz band ; 1 channels for 802.11 ac80 in the 5775MHz band ;
	Antenna Type	Antenna A/B: PIFA Antenna
	Smart system	<input checked="" type="checkbox"/> SISO for 802.11a <input checked="" type="checkbox"/> MIMO for 802.11n/ac
	Antenna Gain	See Table for Filed Antenna
	Based on the application, features, or specification exhibited in User's Manual, More details of EUT technical specification, please refer to the User's Manual.	
Ratings	DC 5V from Adapter	
Adapter	Model: WB-10E05FU Input: AC 100~240V 50~60Hz 0.4A Max Output:5V, 2A	
Battery	N/A	
Connecting I/O Port(s)	Please refer to the User's Manual	
Hardware Version:	2A.	
Software Version:	v5.2.4_r21609_tcpmu.20170309_beta_0.43_20170424	

Note:

1. For a more detailed features description, please refer to the manufacturer's specifications or the User's Manual.
2. Frequency and Channel list for 802.11a/n(20MHz) band I (5180-5240MHz):

802.11a/n/ac(20MHz) Carrier Frequency Channel							
Channel	Frequency (MHz)	Channel	Frequency (MHz)	Channel	Frequency (MHz)	Channel	Frequency (MHz)
36	5180	44	5220	-	-	-	-
40	5200	48	5240	-	-	-	-

Frequency and Channel list for 802.11n(40MHz) band I (5190-5230MHz):

802.11n /ac(40MHz) Carrier Frequency Channel							
Channel	Frequency (MHz)	Channel	Frequency (MHz)	Channel	Frequency (MHz)	Channel	Frequency (MHz)
38	5190	-	-	-	-	-	-
46	5230	-	-	-	-	-	-

802.11ac (80MHz) Carrier Frequency Channel	
Channel	Frequency (MHz)
42	5210

Frequency and Channel list for 802.11a/n(20 MHz) band IV (5745-5825MHz):

802.11a/n/ac(20 MHz) Carrier Frequency Channel							
Channel	Frequency (MHz)	Channel	Frequency (MHz)	Channel	Frequency (MHz)	Channel	Frequency (MHz)
149	5745	153	5765	157	5785	161	5805
165	5825	-	-	-	-	-	-

Frequency and Channel list for 802.11n(40MHz) band IV (5755-5795MHz):

802.11n/ac 40MHz Carrier Frequency Channel					
Channel	Frequency (MHz)	Channel	Frequency (MHz)	Channel	Frequency (MHz)
151	5755	159	5795	-	-

802.11ac 80MHz Carrier Frequency Channel	
Channel	Frequency (MHz)
155	5775

The EUT has two types of antenna.

Antenna	Brand	Model Name (P/N)	Antenna Type	Connector	Antenna Gain(dBi)	
					5.2G	5.8G
A(main)	Wha Yu	C787-510139-A(X5)	Dipole(PCB)	I-PEX	3.8	4.0
B(aux)	Wha Yu	C787-510138-A(X4)	Dipole(PCB)	I-PEX	6.4	5.2

Note: The EUT has two types of antenna.

Only the highest antenna gain for each type has been recorded in this test report, please refer to antenna list for more antenna information.

5G Band:

For IEEE 802.11a mode (1TX, 2RX):

The EUT can support both 1TX and 2RX functions.

For 1TX

Only Chain 1 can be used as transmitting antenna.

Chain 1 and Chain 2 could receive simultaneously.

For IEEE 802.11n mode (1TX/2TX, 2RX):

The EUT can support both 1TX and 2TX functions.

For 1TX

Only Chain 1 can be used as transmitting antenna. When MCS 0~7 enable without TX-Beamforming/STBC.

Chain 1 and Chain 2 could receive simultaneously.

For 2TX

Both Chain 1 and Chain 2 can be used as transmitting/receiving antenna. When TX-Beamforming/STBC enable/MCS 8~15 enable.

Chain 1 and Chain 2 could both transmit/receive simultaneously.

Only 2TX function was selected to test and record in the report, the 1TX test results were covered by 2TX Test results.

For IEEE 802.11ac mode (1TX/2TX, 2RX):

The EUT can support both 1TX and 2TX functions.

For 1TX

Only Chain 1 can be used as transmitting antenna. When 1SS MCS 0~9 enable without TX-Beamforming/STBC.

Chain 1 and Chain 2 could receive simultaneously.

For 2TX

Both Chain 1 and Chain 2 can be used as transmitting/receiving antenna. When TX-Beamforming/STBC enable/2SS MCS 0~9 enable.

Chain 1 and Chain 2 could both transmit/receive simultaneously.

Only 2TX function was selected to test and record in the report, the 1TX test results were covered by 2TX Test results.

2.2 DESCRIPTION OF TEST MODES

To investigate the maximum EMI emission characteristics generates from EUT, the test system was pre-scanning tested base on the consideration of following EUT operation mode or test configuration mode which possible have effect on EMI emission level. Each of these EUT operation mode(s) or test configuration mode(s) mentioned above was evaluated respectively.

Pretest Mode	Description
Mode 1	Normal Link Mode
Mode 2	802.11a/n/ac 20 CH36/ CH40/ CH 48 802.11a /n/ac 20 CH149/ CH157/ CH 165
Mode 3	802.11n/ac40 CH38/ CH 46 802.11n/ac40 CH 151 / CH 159
Mode 4	802.11ac80 CH42/CH 155

For Radiated Emission	
Final Test Mode	Description
Mode 1	Normal Link Mode
Mode 2	802.11a/n/ac 20 CH36/ CH40/ CH 48 802.11a /n/ac 20 CH149/ CH157/ CH 165
Mode 3	802.11n/ac40 CH38/ CH 46 802.11n/ac40 CH 151 / CH 159
Mode 4	802.11 ac80 CH42/CH 155

Note:

- (1) The measurements are performed at the highest, middle, lowest available channels.
- (2) The measurements are performed at all Bit Rate of Transmitter, the worst data was reported

2.3 BLOCK DIGRAM SHOWING THE CONFIGURATION OF SYSTEM TESTED

For AC Conducted Emission Mode

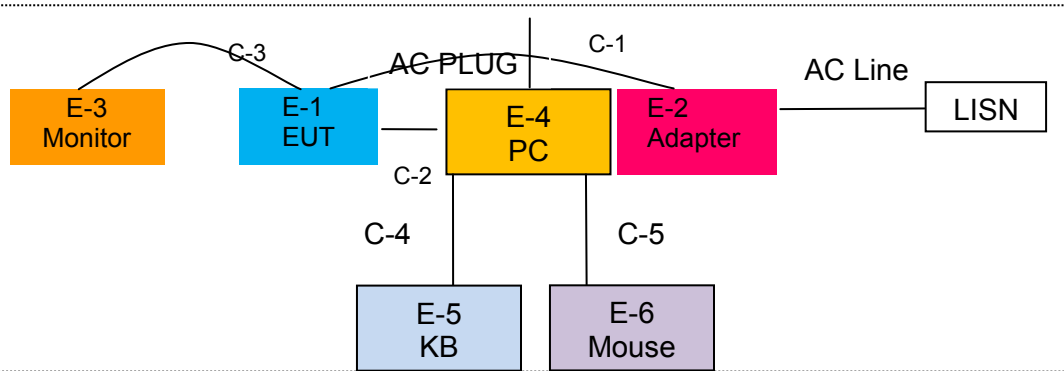

Radiated Spurious Emission Test

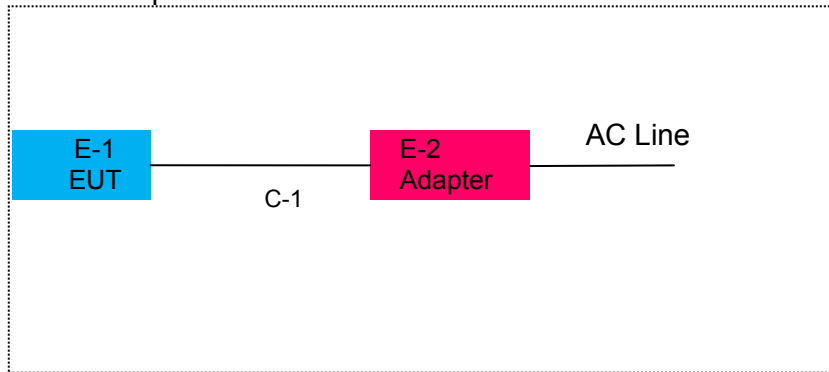

For Conducted Test Cases

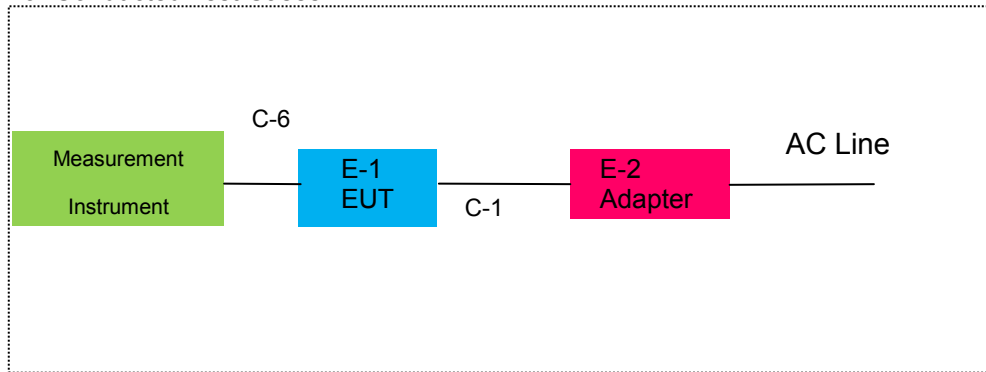

2.4 DESCRIPTION OF SUPPORT UNITS(CONDUCTED MODE)

The EUT has been tested as an independent unit together with other necessary accessories or support units. The following support units or accessories were used to form a representative test configuration during the tests.

Item	Equipment	Brand	Model/Type No.	ID No.	Note
E-1	MyWirelessTV3 Wireless HD Transmitter,, 4K Wireless HD Connection Kit	Actiontec	MWTV3TX	N/A	EUT
E-2	Adapter	APD	WB-10E05FU	N/A	
E-3	Monitor	SHARP	LCD-32MS46A	N/A	Peripherals
E-4	Personal computer	DELL	FT4Y23X	N/A	Peripherals
E-5	Keyboard	DELL	SK-8185	N/A	Peripherals
E-6	Mouse	DELL	MS111-P	N/A	Peripherals

Item	Cable Type	Shielded Type	Ferrite Core	Length	Note
C-1	Power Cable	NO	NO	1.5m	
C-2	HDMI Cable	NO	NO	0.9m	
C-3	HDMI Cable	NO	NO	0.9m	
C-4	Keyboard Cable	NO	NO	1.0m	
C-5	Mouse Cable	NO	NO	1.0m	
C-6	RF Cable	NO	NO	0.5m	

Note:

- (1) The support equipment was authorized by Declaration of Confirmation.
- (2) For detachable type I/O cable should be specified the length in cm in 『Length』 column.

2.5 EQUIPMENTS LIST FOR ALL TEST ITEMS

Radiation Test equipment

Item	Kind of Equipment	Manufacturer	Type No.	Serial No.	Last calibration	Calibrated until	Calibration period
1	Spectrum Analyzer	Agilent	E4407B	MY45108040	2017.06.06	2018.06.05	1 year
2	Spectrum Analyzer	Agilent	N9020A	MY49100060	2016.11.10	2017.11.09	1 year
3	EMI Test Receiver	Agilent	N9038A	MY53227146	2017.06.06	2018.06.05	1 year
4	Test Receiver	R&S	ESPI	101318	2017.06.06	2018.06.05	1 year
5	Bilog Antenna	TESEQ	CBL6111D	31216	2017.04.09	2018.04.08	1 year
6	50Ω Coaxial Switch	Anritsu	MP59B	6200983705	2017.06.06	2018.06.05	1 year
7	Horn Antenna	EM	EM-AH-10180	2011071402	2017.04.09	2018.04.08	1 year
8	Horn Ant	Schwarzbeck	BBHA 9170	9170-181	2017.07.06	2018.07.05	1 year
9	Amplifier	EMC	EMC051835SE	980246	2017.08.09	2018.08.08	1 year
10	Amplifier	MITEQ	TTA1840-35-HG	177156	2017.06.06	2018.06.05	1 year
11	Loop Antenna	ARA	PLA-1030/B	1029	2017.06.06	2018.06.05	1 year
12	Power Meter	DARE	RPR3006W	15100041SN084	2017.08.09	2018.08.08	1 year
13	Test Cable (9KHz-30MHz)	N/A	R-01	N/A	2017.04.21	2020.04.20	3 year
14	Test Cable (30MHz-1GHz)	N/A	R-02	N/A	2017.04.21	2020.04.20	3 year
15	High Test Cable(1G-40G Hz)	N/A	R-03	N/A	2017.04.21	2020.04.20	3 year
16	High Test Cable(1G-40G Hz)	N/A	R-04	N/A	2017.04.21	2020.04.20	3 year
17	temporary antenna connector (Note)	NTS	R001	N/A	N/A	N/A	N/A

Note:

We will use the temporary antenna connector (soldered on the PCB board) When conducted test And this temporary antenna connector is listed within the instrument list

Conduction Test equipment

Item	Kind of Equipment	Manufacturer	Type No.	Serial No.	Last calibration	Calibrated until	Calibration period
1	Test Receiver	R&S	ESCI	101160	2017.06.06	2018.06.05	1 year
2	LISN	R&S	ENV216	101313	2017.04.19	2018.04.18	1 year
3	LISN	SCHWARZBECK	NNLK 8129	8129245	2017.06.06	2018.06.05	1 year
4	50Ω Coaxial Switch	ANRITSU CORP	MP59B	6200983704	2017.06.06	2018.06.05	1 year
5	Test Cable (9KHz-30MHz)	N/A	C01	N/A	2017.04.21	2020.04.20	3 year
6	Test Cable (9KHz-30MHz)	N/A	C02	N/A	2017.04.21	2020.04.20	3 year
7	Test Cable (9KHz-30MHz)	N/A	C03	N/A	2017.04.21	2020.04.20	3 year

1	Filter	TRILTHIC	2400MHz	29	2017.04.19	2018.04.18	1 year
---	--------	----------	---------	----	------------	------------	--------

Note: Each piece of equipment is scheduled for calibration once a year.

3. EMC EMISSION TEST

3.1 CONDUCTED EMISSION MEASUREMENT

3.1.1 POWER LINE CONDUCTED EMISSION Limits (Frequency Range 150KHz-30MHz)

FREQUENCY (MHz)	Class B (dBuV)		Standard
	Quasi-peak	Average	
0.15 -0.5	66 - 56 *	56 - 46 *	CISPR
0.50 -5.0	56.00	46.00	CISPR
5.0 -30.0	60.00	50.00	CISPR

0.15 -0.5	66 - 56 *	56 - 46 *	FCC/ RSS-247
0.50 -5.0	56.00	46.00	FCC/ RSS-247
5.0 -30.0	60.00	50.00	FCC/ RSS-247

Note:

- (1) The tighter limit applies at the band edges.
- (2) The limit of " * " marked band means the limitation decreases linearly with the logarithm of the frequency in the range.

The following table is the setting of the receiver

Receiver Parameters	Setting
Attenuation	10 dB
Start Frequency	0.15 MHz
Stop Frequency	30 MHz
IF Bandwidth	9 kHz

3.1.2 TEST PROCEDURE

- a. The EUT was placed 0.8 meters from the horizontal ground plane with EUT being connected to the power mains through a line impedance stabilization network (LISN). All other support equipments powered from additional LISN(s). The LISN provide 50 Ohm/ 50uH of coupling impedance for the measuring instrument.
- b. Interconnecting cables that hang closer than 40 cm to the ground plane shall be folded back and forth in the center forming a bundle 30 to 40 cm long.
- c. I/O cables that are not connected to a peripheral shall be bundled in the center. The end of the cable may be terminated, if required, using the correct terminating impedance. The overall length shall not exceed 1 m.
- d. LISN at least 80 cm from nearest part of EUT chassis.
- e. For the actual test configuration, please refer to the related Item –EUT Test Photos.

3.1.3 DEVIATION FROM TEST STANDARD

No deviation

3.1.4 TEST SETUP

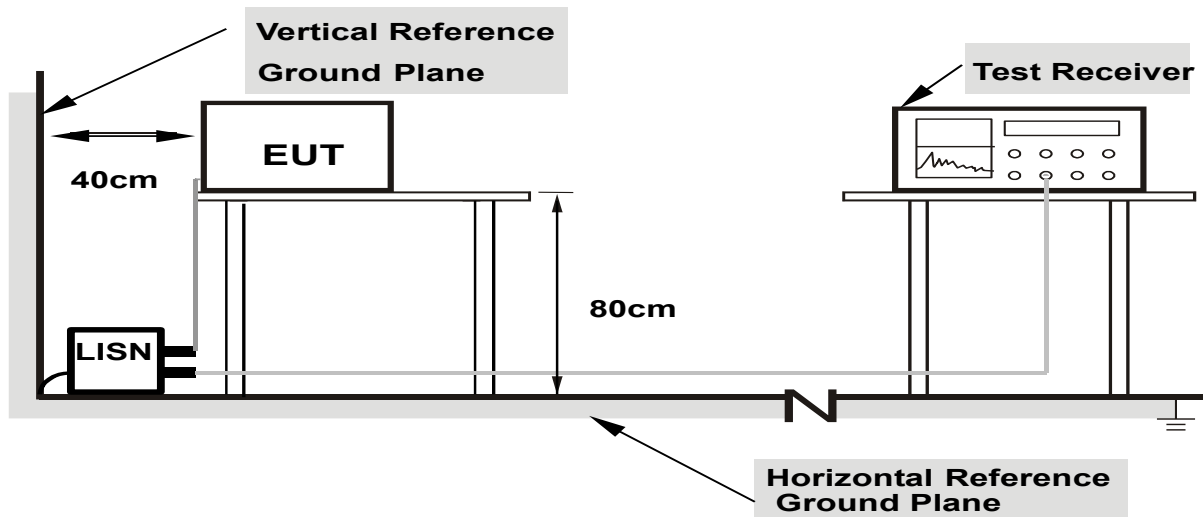

- Note: 1.Support units were connected to second LISN.**
2.Both of LISNs (AMN) are 80 cm from EUT and at least 80 from other units and other metal planes

3.1.5 EUT OPERATING CONDITIONS

The EUT was configured for testing in a typical fashion (as a customer would normally use it). The EUT has been programmed to continuously transmit during test. This operating condition was tested and used to collect the included data.

EUT :	MyWirelessTV3 Wireless HD Transmitter, 4K Wireless HD Connection Kit	Model Name. :	MWTV3TX
Temperature :	26 °C	Relative Humidity :	56%
Pressure :	1010hPa	Phase :	L
Test Voltage :	DC 5V from Adapter AC 120V/60Hz	Test Mode :	Mode 1

Frequency (MHz)	Reading Level (dBμV)	Correct Factor (dB)	Measure-ment (dBμV)	Limits (dBμV)	Margin (dB)	Remark
0.1940	46.57	9.82	56.39	63.86	-7.47	QP
0.1940	16.84	9.82	26.66	53.86	-27.20	AVG
0.3220	38.38	9.82	48.20	59.65	-11.45	QP
0.3220	20.89	9.82	30.71	49.65	-18.94	AVG
2.5059	27.76	9.94	37.70	56.00	-18.30	QP
2.5059	18.01	9.94	27.95	46.00	-18.05	AVG
24.1099	32.96	10.30	43.26	60.00	-16.74	QP
24.1099	24.75	10.30	35.05	50.00	-14.95	AVG

Remark:

- All readings are Quasi-Peak and Average values.
- Factor = Insertion Loss + Cable Loss.

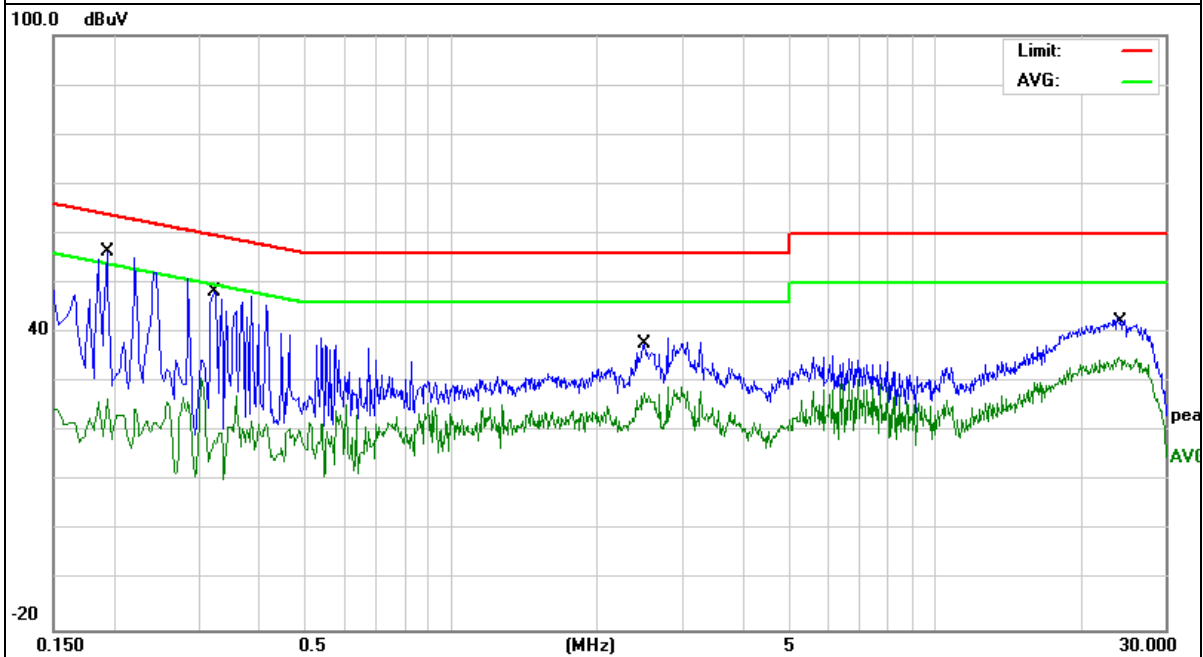

EUT :	MyWirelessTV3 Wireless HD Transmitter, 4K Wireless HD Connection Kit	Model Name. :	MWTV3TX
Temperature :	26 °C	Relative Humidity :	56%
Pressure :	1010hPa	Phase :	N
Test Voltage :	DC 5V from Adapter AC 120V/60Hz	Test Mode :	Mode 1

Frequency (MHz)	Reading Level (dBμV)	Correct Factor (dB)	Measure-ment (dBμV)	Limits (dBμV)	Margin (dB)	Remark
0.1620	49.76	9.92	59.68	65.36	-5.68	QP
0.1620	18.91	9.92	28.83	55.36	-26.53	AVG
0.2938	39.21	9.92	49.13	60.41	-11.28	QP
0.2938	22.04	9.92	31.96	50.41	-18.45	AVG
2.5419	27.39	9.94	37.33	56.00	-18.67	QP
2.5419	17.86	9.94	27.80	46.00	-18.20	AVG
24.1020	32.22	10.37	42.59	60.00	-17.41	QP
24.1020	23.38	10.37	33.75	50.00	-16.25	AVG

Remark:

1. All readings are Quasi-Peak and Average values.
2. Factor = Insertion Loss + Cable Loss.

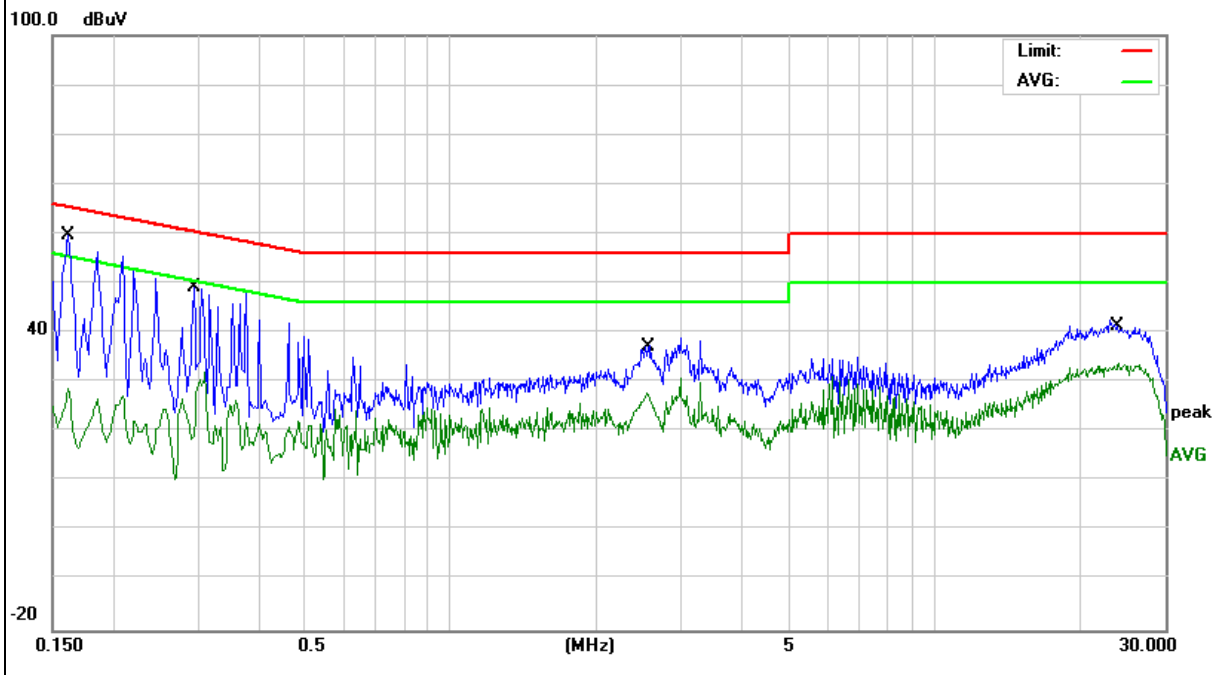

EUT :	MyWirelessTV3 Wireless HD Transmitter, 4K Wireless HD Connection Kit	Model Name. :	MWTV3TX
Temperature :	26 °C	Relative Humidity :	56%
Pressure :	1010hPa	Phase :	L
Test Voltage :	DC 5V from Adapter AC 240V/60Hz	Test Mode :	Mode 1

Frequency (MHz)	Reading Level (dBμV)	Correct Factor (dB)	Measure-ment (dBμV)	Limits (dBμV)	Margin (dB)	Remark
0.3140	25.64	9.82	35.46	59.86	-24.40	QP
0.3140	22.76	9.82	32.58	49.86	-17.28	AVG
0.4099	24.24	9.83	34.07	57.65	-23.58	QP
0.4099	20.93	9.83	30.76	47.65	-16.89	AVG
0.6620	26.14	9.83	35.97	56.00	-20.03	QP
0.6620	22.41	9.83	32.24	46.00	-13.76	AVG
2.9860	31.76	10.05	41.81	56.00	-14.19	QP
2.9860	20.49	10.05	30.54	46.00	-15.46	AVG
24.1060	32.19	10.30	42.49	60.00	-17.51	QP
24.1060	23.75	10.30	34.05	50.00	-15.95	AVG

Remark:

1. All readings are Quasi-Peak and Average values.
2. Factor = Insertion Loss + Cable Loss.

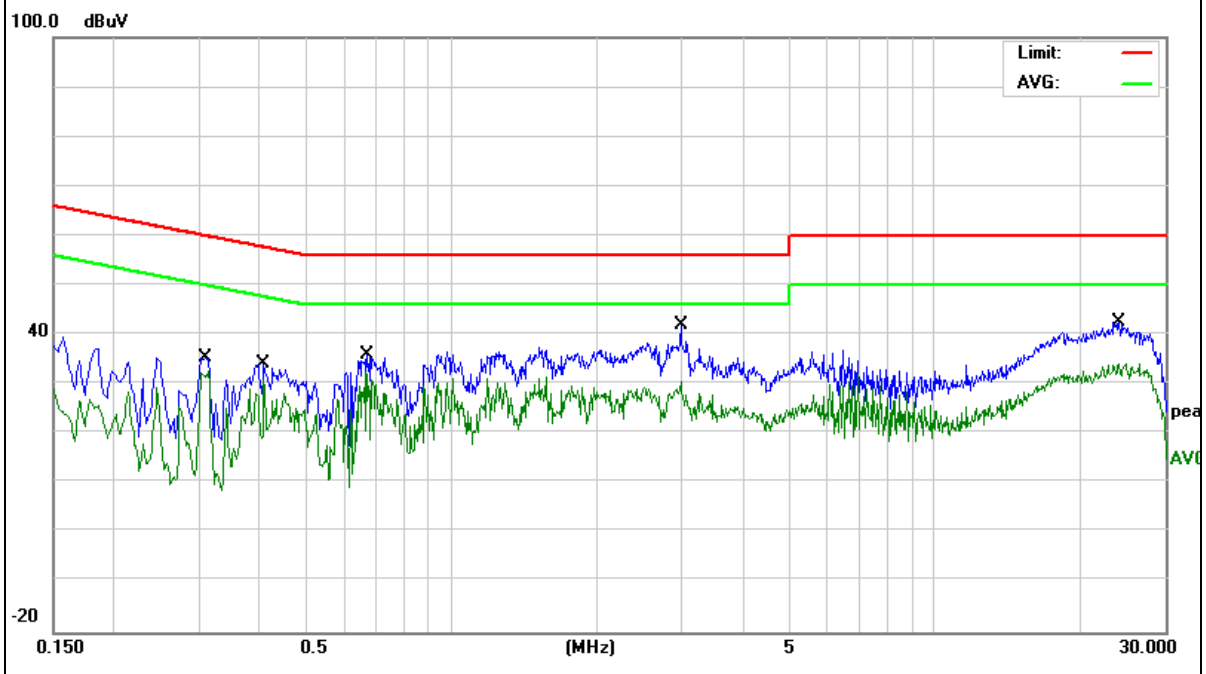

EUT :	MyWirelessTV3 Wireless HD Transmitter, 4K Wireless HD Connection Kit	Model Name. :	MWTV3TX
Temperature :	26 °C	Relative Humidity :	56%
Pressure :	1010hPa	Phase :	N
Test Voltage :	DC 5V from Adapter AC 240V/60Hz	Test Mode :	Mode 1

Frequency (MHz)	Reading Level (dB μ V)	Correct Factor (dB)	Measure-ment (dB μ V)	Limits (dB μ V)	Margin (dB)	Remark
0.2500	25.14	9.92	35.06	61.75	-26.69	QP
0.2500	19.48	9.92	29.40	51.75	-22.35	AVG
0.3059	25.89	9.92	35.81	60.08	-24.27	QP
0.3059	23.57	9.92	33.49	50.08	-16.59	AVG
0.6979	25.43	9.93	35.36	56.00	-20.64	QP
0.6979	21.73	9.93	31.66	46.00	-14.34	AVG
2.9900	31.82	9.95	41.77	56.00	-14.23	QP
2.9900	24.77	9.95	34.72	46.00	-11.28	AVG
23.6179	32.68	10.35	43.03	60.00	-16.97	QP
23.6179	23.38	10.35	33.73	50.00	-16.27	AVG

Remark:

1. All readings are Quasi-Peak and Average values.
2. Factor = Insertion Loss + Cable Loss.

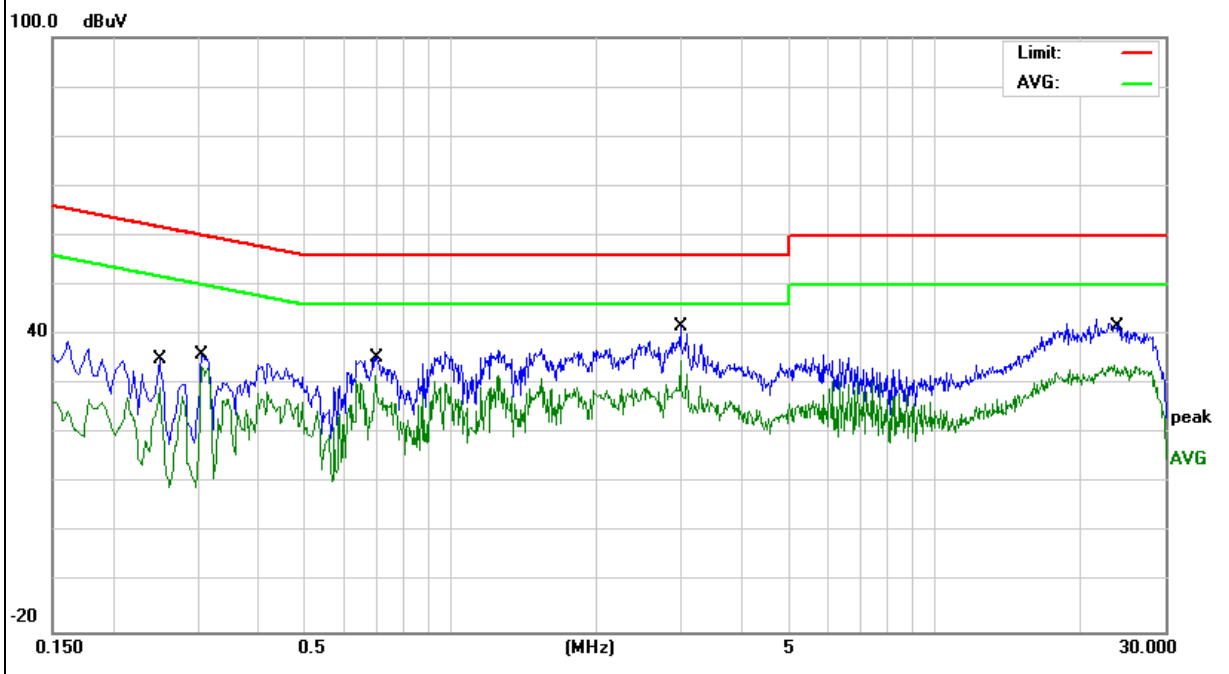

3.2 RADIATED EMISSION MEASUREMENT

3.2.1 APPLICABLE STANDARD

According to FCC Part 15.407(d) and 15.209

3.2.2 CONFORMANCE LIMIT

According to FCC Part 15.407(b)(7): radiated emissions which fall in the restricted bands, as defined in §15.205(a), must also comply with the radiated emission limits specified in §15.209(a) (see §15.205(c)).
According to FCC Part 15.205, Restricted bands

MHz	MHz	MHz	GHz
0.090-0.110	16.42-16.423	399.9-410	4.5-5.15
10.495-0.505	16.69475-16.69525	608-614	5.35-5.46
2.1735-2.1905	16.80425-16.80475	960-1240	7.25-7.75
4.125-4.128	25.5-25.67	1300-1427	8.025-8.5
4.17725-4.17775	37.5-38.25	1435-1626.5	9.0-9.2
4.20725-4.20775	73-74.6	1645.5-1646.5	9.3-9.5
6.215-6.218	74.8-75.2	1660-1710	10.6-12.7
6.26775-6.26825	123-138	2200-2300	14.47-14.5
8.291-8.294	149.9-150.05	2310-2390	15.35-16.2
8.362-8.366	156.52475-156.52525	2483.5-2500	17.7-21.4
8.37625-8.38675	156.7-156.9	2690-2900	22.01-23.12
8.41425-8.41475	162.0125-167.17	3260-3267	23.6-24.0
12.29-12.293	167.72-173.2	3332-3339	31.2-31.8
12.51975-12.52025	240-285	3345.8-3358	36.43-36.5
12.57675-12.57725	322-335.4	3600-4400	(2)
13.36-13.41			

20dBc in any 100 kHz bandwidth outside the operating frequency band. In case the emission fall within the restricted band specified on 15.205(a), then the 15.209(a) limit in the table below has to be followed.

Restricted Frequency(MHz)	Field Strength ($\mu\text{V/m}$)	Field Strength ($\text{dB}\mu\text{V/m}$)	Measurement Distance
0.009~0.490	2400/F(KHz)	20 log ($\mu\text{V/m}$)	300
0.490~1.705	2400/F(KHz)	20 log ($\mu\text{V/m}$)	30
1.705~30.0	30	29.5	30
30-88	100	40	3
88-216	150	43.5	3
216-960	200	46	3
Above 960	500	54	3

Limits of Radiated Emission Measurement(Above 1000MHz)

Frequency(MHz)	Class B ($\text{dB}\mu\text{V/m}$) (at 3M)	
	PEAK	AVERAGE
Above 1000	74	54

Remark : 1. Emission level in $\text{dB}\mu\text{V/m} = 20 \log (\mu\text{V/m})$
 2. Measurement was performed at an antenna to the closed point of EUT distance of meters.
 3. Distance extrapolation factor = $40 \log (\text{Specific distance} / \text{test distance})$ (dB);
 Limit line = Specific limits ($\text{dB}\mu\text{V}$) + distance extrapolation factor.

3.2.3 MEASURING INSTRUMENTS

The Measuring equipment is listed in the section 6.3 of this test report.

3.2.4 TEST CONFIGURATION

(a) For radiated emissions below 30MHz

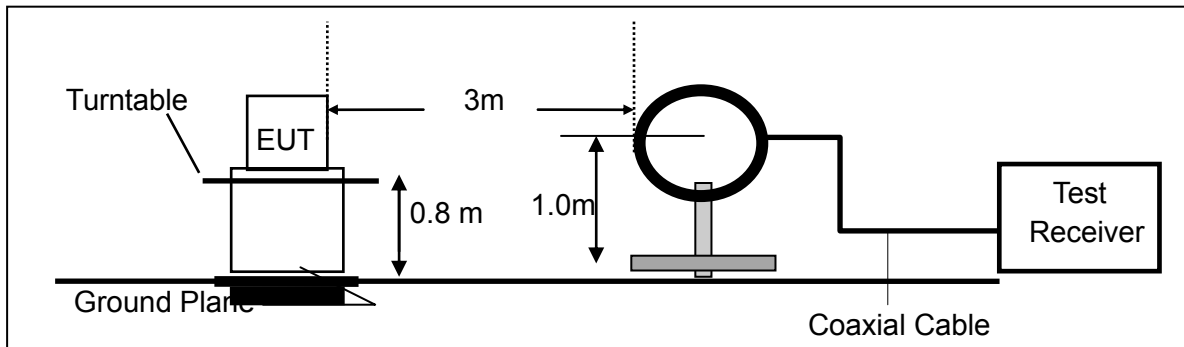

(b) For radiated emissions from 30MHz to 1000MHz

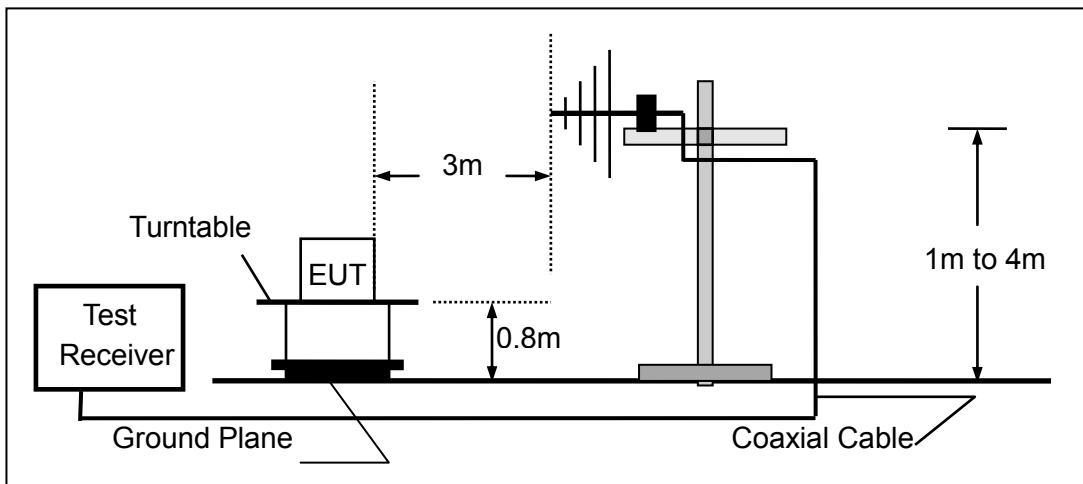

(c) For radiated emissions above 1000MHz

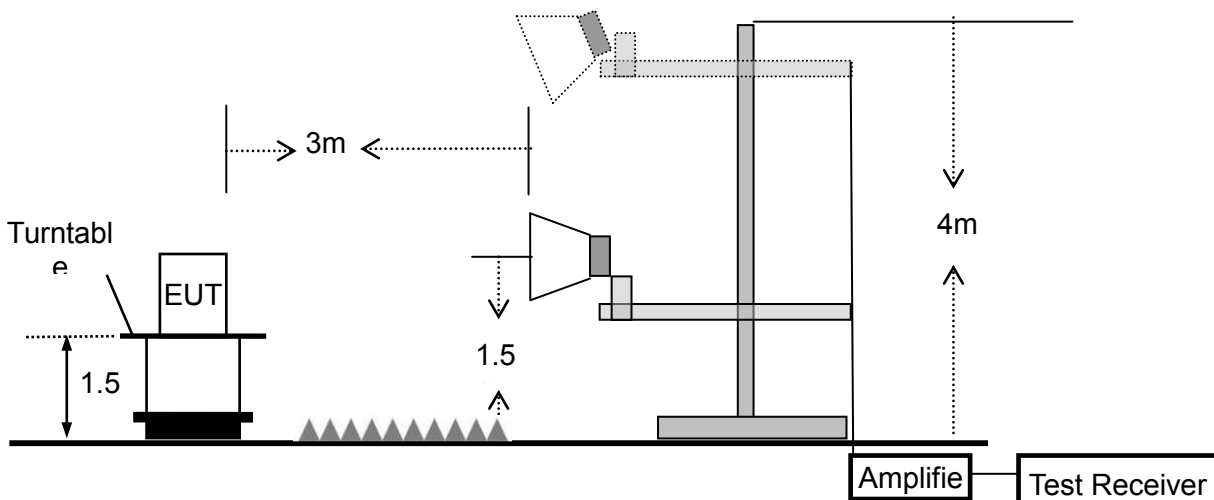

3.2.5 TEST PROCEDURE

The test site semi-anechoic chamber has met the requirement of NSA tolerance 4 dB according to the standards: ANSI C63.10-2013. The test distance is 3m. The setup is according to the requirements in Section 13.1.4.1 of ANSI C63.10-2013 and CAN/CSA-CEI/IEC CISPR 22.

This test is required for any spurious emission that falls in a Restricted Band, as defined in Section 15.205. It must be performed with the highest gain of each type of antenna proposed for use with the EUT.

Use the following spectrum analyzer settings:

Spectrum Parameter	Setting
Attenuation	Auto
Start Frequency	1000 MHz
Stop Frequency	10th carrier harmonic
RB / VB (emission in restricted band)	1 MHz / 1 MHz for Peak, 1 MHz / 10Hz for Average

Receiver Parameter	Setting
Attenuation	Auto
Start ~ Stop Frequency	9kHz~150kHz / RB 200Hz for QP
Start ~ Stop Frequency	150kHz~30MHz / RB 9kHz for QP
Start ~ Stop Frequency	30MHz~1000MHz / RB 120kHz for QP

- The measuring distance of at 3 m shall be used for measurements at frequency up to 1GHz. For frequencies above 1GHz, any suitable measuring distance may be used.
- The EUT was placed on the top of a rotating table 0.8 m for below 1GHz and 1.5m for above 1GHz the ground at a 3 meter. The table was rotated 360 degrees to determine the position of the highest radiation.
- The height of the equipment or of the substitution antenna shall be 0.8 m for below 1GHz and 1.5m for above 1GHz; the height of the test antenna shall vary between 1 m to 4 m. Both horizontal and vertical polarizations of the antenna are set to make the measurement.
- The initial step in collecting conducted emission data is a spectrum analyzer peak detector mode pre-scanning the measurement frequency range. Significant peaks are then marked and then Quasi Peak detector mode re-measured.
- If the Peak Mode measured value compliance with and lower than Quasi Peak Mode Limit, the EUT shall be deemed to meet QP Limits and then no additional QP Mode measurement performed.
- For the actual test configuration, please refer to the related Item –EUT Test Photos.

Note:

Both horizontal and vertical antenna polarities were tested and performed pretest to three orthogonal axis. The worst case emissions were reported

During the radiated emission test, the Spectrum Analyzer was set with the following configurations:

Frequency Band (MHz)	Function	Resolution bandwidth	Video Bandwidth
30 to 1000	QP	120 kHz	300 kHz
Above 1000	Peak	1 MHz	1 MHz
	Average	1 MHz	10 Hz

Note: for the frequency ranges below 30 MHz, a narrower RBW is used for these ranges but the measured value should add a RBW correction factor (RBWCF) where $RBWCF [dB] = 10 \cdot \lg(100 [kHz] / \text{narrower RBW [kHz]})$. , the narrower RBW is 1 kHz and RBWCF is 20 dB for the frequency 9 kHz to 150 kHz, and the narrower RBW is 10 kHz and RBWCF is 10 dB for the frequency 150 kHz to 30 MHz.

3.2.6 TEST RESULTS (9KHZ – 30 MHZ)

EUT:	MyWirelessTV3 Wireless HD Transmitter, 4K Wireless HD Connection Kit	Model Name. :	MWTV3TX
Temperature:	20 °C	Relative Humidity:	48%
Pressure:	1010 hPa	Test Voltage :	DC 5V
Test Mode :	TX	Polarization :	--

Freq.	Reading	Limit	Margin	State
(MHz)	(dBuV/m)	(dBuV/m)	(dB)	P/F
--	--	--	--	N/A
--	--	--	--	N/A

NOTE:

The amplitude of spurious emissions which are attenuated by more than 20dB below the permissible value has no need to be reported.

Distance extrapolation factor = $40 \log (\text{specific distance}/\text{test distance})(\text{dB})$;

Limit line = specific limits(dBuv) + distance extrapolation factor.

3.2.7 TEST RESULTS (30MHZ – 1GHZ)

EUT :	MyWirelessTV3 Wireless HD Transmitter, 4K Wireless HD Connection Kit	Model Name. :	MWTV3TX
Temperature :	20 °C	Relative Humidity :	48%
Pressure :	1010 hPa	Test Voltage :	DC 5V
Test Mode :	TX(5.2G)- 802.11AC20 (High CH)		

Polar (H/V)	Frequency	Meter Reading	Factor	Emission Level	Limits	Margin	Remark
	(MHz)	(dBuV)	(dB)	(dBuV/m)	(dBuV/m)	(dB)	
V	30.2107	13.79	21.11	34.90	40.00	-5.10	QP
V	90.5374	22.06	11.80	33.86	43.50	-9.64	QP
V	148.4410	25.23	11.30	36.53	43.50	-6.97	QP
V	446.4141	22.07	16.08	38.15	46.00	-7.85	QP
V	744.8659	16.22	22.39	38.61	46.00	-7.39	QP
V	893.8567	16.36	24.51	40.87	46.00	-5.13	QP

Remark:

Absolute Level= ReadingLevel+ Factor, Margin= Absolute Level - Limit

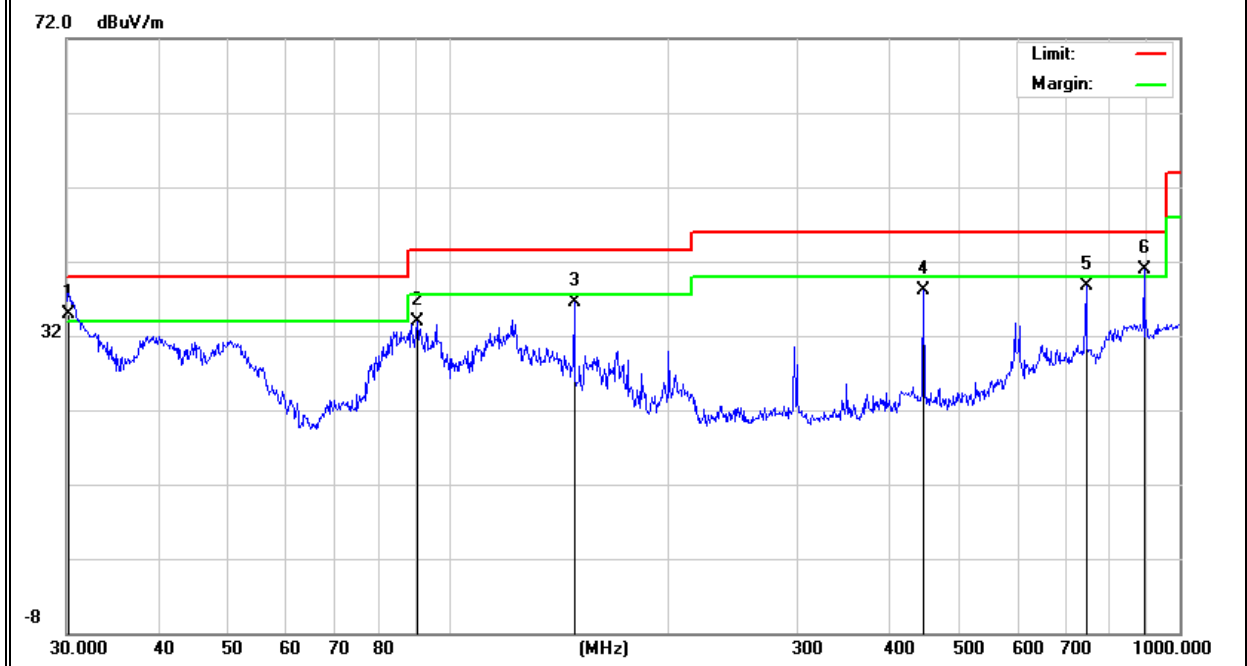

Polar (H/V)	Frequency	Meter Reading	Factor	Emission Level	Limits	Margin	Remark
	(MHz)	(dBuV)	(dB)	(dBuV/m)	(dBuV/m)	(dB)	
H	30.5304	13.88	20.97	34.85	40.00	-5.15	QP
H	148.4410	25.48	11.30	36.78	43.50	-6.72	QP
H	297.2241	19.64	14.66	34.30	46.00	-11.70	QP
H	595.1326	20.87	18.84	39.71	46.00	-6.29	QP
H	744.8659	18.57	22.39	40.96	46.00	-5.04	QP
H	893.8567	17.55	24.51	42.06	46.00	-3.94	QP

Remark:

Absolute Level= ReadingLevel+ Factor, Margin= Absolute Level - Limit

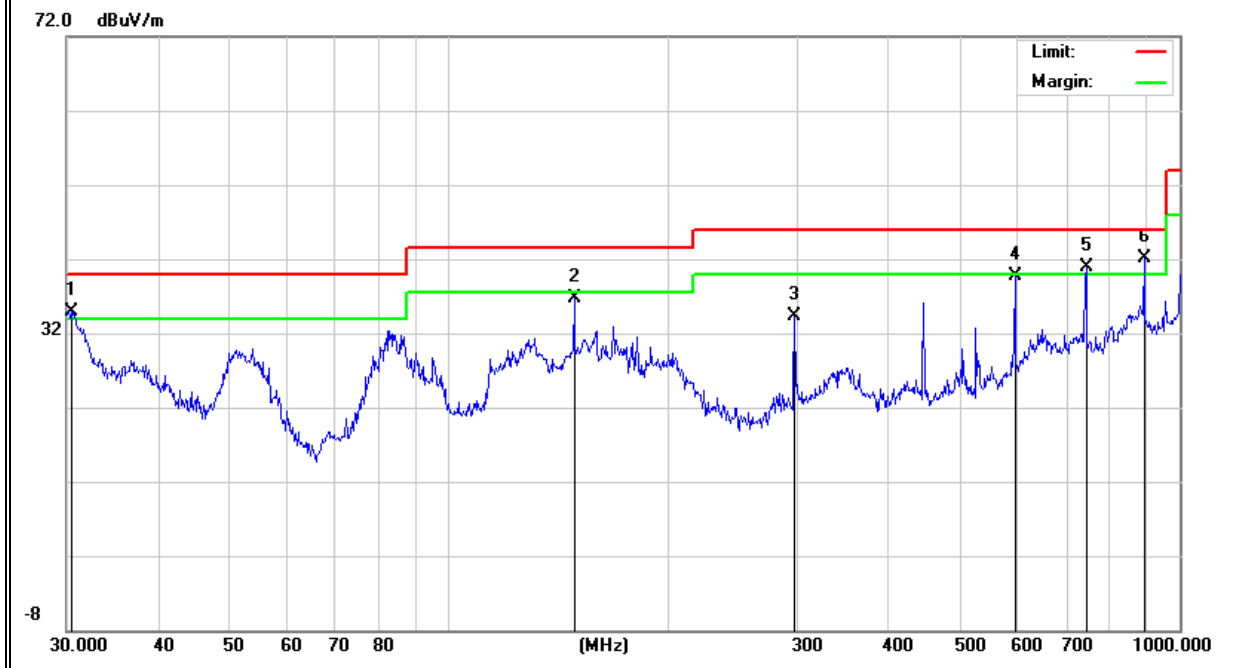

EUT :	MyWirelessTV3 Wireless HD Transmitter, 4K Wireless HD Connection Kit	Model Name. :	MWTV3TX
Temperature :	20 °C	Relative Humidity :	48%
Pressure :	1010 hPa	Test Voltage :	DC 5V
Test Mode :	TX(5.8G) - 802.11N20 (High CH)		

Polar (H/V)	Frequency	Meter Reading	Factor	Emission Level	Limits	Margin	Remark
	(MHz)	(dBuV)	(dB)	(dBuV/m)	(dBuV/m)	(dB)	
V	30.2104	15.59	21.11	36.70	40.00	-3.30	QP
V	90.5374	24.56	11.80	36.36	43.50	-7.14	QP
V	297.2241	20.81	14.66	35.47	46.00	-10.53	QP
V	446.4141	19.07	16.08	35.15	46.00	-10.85	QP
V	744.8659	16.22	22.39	38.61	46.00	-7.39	QP
V	893.8567	14.86	24.51	39.37	46.00	-6.63	QP

Remark:

Absolute Level= ReadingLevel+ Factor, Margin= Absolute Level - Limit

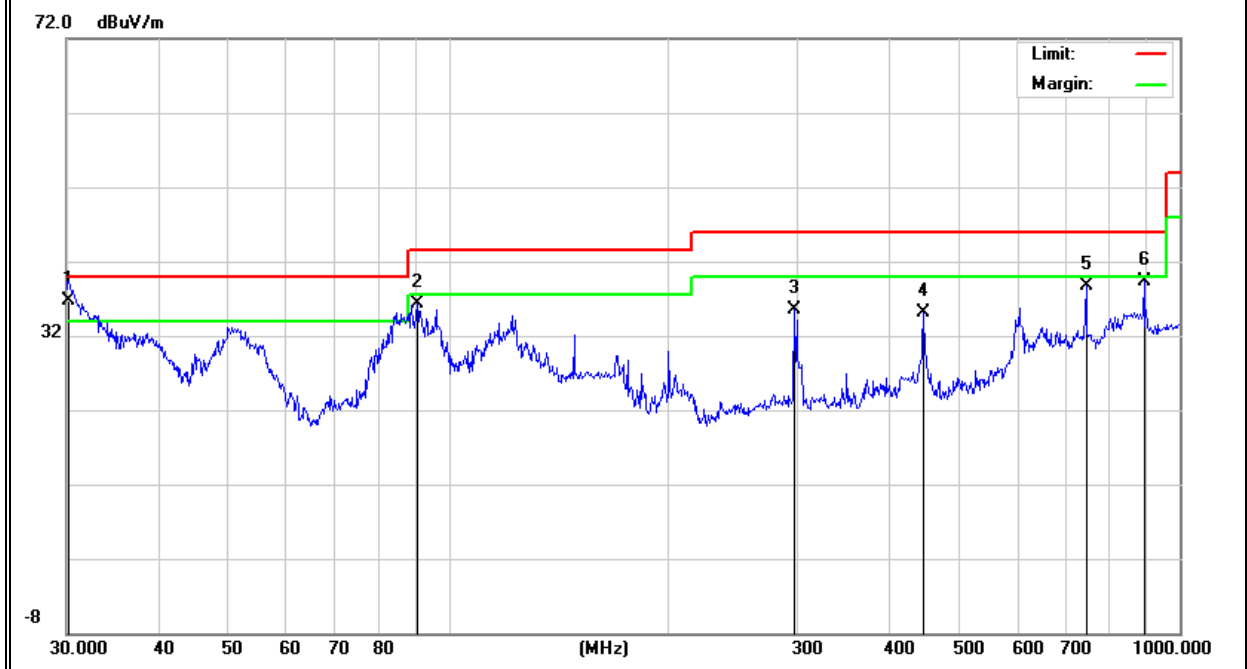

Polar (H/V)	Frequency	Meter Reading	Factor	Emission Level	Limits	Margin	Remark
	(MHz)	(dBuV)	(dB)	(dBuV/m)	(dBuV/m)	(dB)	
H	31.6202	14.98	20.50	35.48	40.00	-4.52	QP
H	148.4410	22.48	11.30	33.78	43.50	-9.72	QP
H	297.2241	23.64	14.66	38.30	46.00	-7.70	QP
H	446.4141	22.99	16.08	39.07	46.00	-6.93	QP
H	595.1326	19.87	18.84	38.71	46.00	-7.29	QP
H	893.8567	16.55	24.51	41.06	46.00	-4.94	QP

Remark:

Absolute Level= ReadingLevel+ Factor, Margin= Absolute Level - Limit

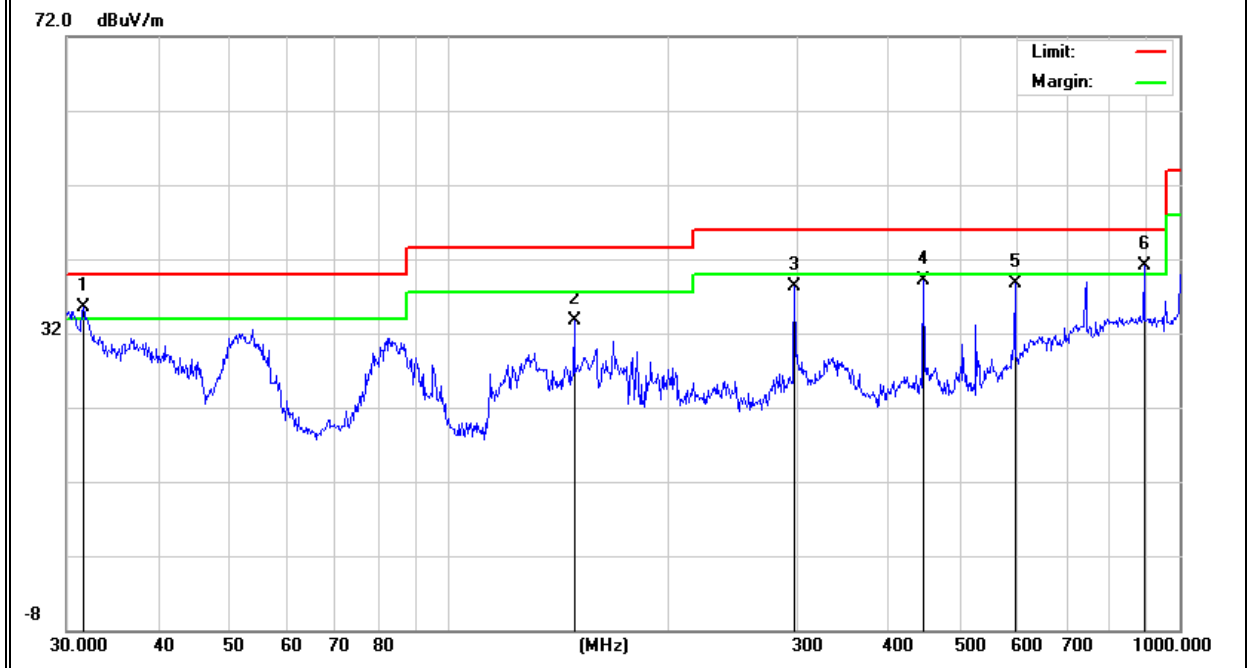

3.2.8 TEST RESULTS (1GHz-26.5GHz)

EUT :	MyWirelessTV3 Wireless HD Transmitter, 4K Wireless HD Connection Kit	Model Name. :	MWTV3TX
Temperature :	20 °C	Relative Humidity :	48%
Pressure :	1010 hPa	Test Voltage :	DC 5V
Test Mode :	TX(5.2G) - 802.11AC20 _5180~5240MHz		

Polar	Frequency	Meter Reading	Cable loss	Antenna Factor	Preamp Factor	Emission Level	Limits	Margin	Detector Type
(H/V)	(MHz)	(dBuV)	(dB)	dB/m	(dB)	(dBuV/m)	(dBuV/m)	(dB)	
Low Channel (5180 MHz)-Above 1G									
Vertical	4434.263	63.35	5.94	35.40	44.00	60.69	74.00	-13.31	Pk
Vertical	4434.263	44.41	5.94	35.40	44.00	41.75	54.00	-12.25	AV
Vertical	10370.114	62.58	8.46	39.75	44.50	66.29	74.00	-7.71	Pk
Vertical	10370.114	41.19	8.46	39.75	44.50	44.9	54.00	-9.1	AV
Vertical	15540.205	61.17	10.12	38.80	44.10	65.99	74.00	-8.01	Pk
Vertical	15540.205	39.98	10.12	38.80	42.70	46.2	54.00	-7.8	AV
Horizontal	4434.367	62.25	5.94	35.18	44.00	59.37	74.00	-14.63	Pk
Horizontal	4434.367	42.24	5.94	35.18	44.00	39.36	54.00	-14.64	AV
Horizontal	10370.346	59.98	8.46	38.71	44.50	62.65	74.00	-11.35	Pk
Horizontal	10370.346	42.31	8.46	38.71	44.50	44.98	54.00	-9.02	AV
Horizontal	10540.102	58.63	10.12	38.38	44.10	63.03	74.00	-10.97	Pk
Horizontal	10540.102	39.12	10.12	38.38	44.10	43.52	54.00	-10.48	AV
middle Channel (5200 MHz)-Above 1G									
Vertical	4592.111	61.74	6.48	36.35	44.05	60.52	74.00	-13.48	Pk
Vertical	4592.111	42.64	6.48	36.35	44.05	41.42	54.00	-12.58	AV
Vertical	10401.266	60.55	8.47	37.88	44.51	62.39	74.00	-11.61	Pk
Vertical	10401.266	43.62	8.47	37.88	44.51	45.46	54.00	-8.54	AV
Vertical	15600.101	57.79	10.12	38.8	44.10	62.61	74.00	-11.39	Pk
Vertical	15600.101	37.41	10.12	38.8	42.70	43.63	54.00	-10.37	AV
Horizontal	4592.362	60.52	6.48	36.37	44.05	59.32	74.00	-14.68	Pk
Horizontal	4592.362	42.65	6.48	36.37	44.05	41.45	54.00	-12.55	AV
Horizontal	10400.142	59.98	8.47	38.64	44.50	62.59	74.00	-11.41	Pk
Horizontal	10400.142	43.32	8.47	38.64	44.50	45.93	54.00	-8.07	AV
Horizontal	15600.249	60.12	10.12	38.38	44.10	64.52	74.00	-9.48	Pk
Horizontal	15600.249	39.98	10.12	38.38	44.10	44.38	54.00	-9.62	AV
High Channel (5240 MHz)-Above 1G									
Vertical	4739.923	62.23	7.10	37.24	43.50	63.07	74.00	-10.93	Pk
Vertical	4739.923	43.21	7.10	37.24	43.50	44.05	54.00	-9.95	AV
Vertical	10480.226	59.58	8.46	37.68	44.50	61.22	74.00	-12.78	Pk
Vertical	10480.226	39.64	8.46	37.68	44.50	41.28	54.00	-12.72	AV
Vertical	15720.228	62.22	10.12	38.8	44.10	67.04	74.00	-6.96	Pk
Vertical	15720.228	40.1	10.12	38.8	42.70	46.32	54.00	-7.68	AV
Horizontal	4739.103	61.13	7.10	37.24	43.50	61.97	74.00	-12.03	Pk
Horizontal	4739.103	42.25	7.10	37.24	43.50	43.09	54.00	-10.91	AV
Horizontal	10481.207	63.03	8.46	38.57	44.50	65.56	74.00	-8.44	Pk
Horizontal	10481.207	44.46	8.46	38.57	44.50	46.99	54.00	-7.01	AV
Horizontal	15720.229	59.95	10.12	38.38	44.10	64.35	74.00	-9.65	Pk
Horizontal	15720.229	42.26	10.12	38.38	44.10	46.66	54.00	-7.34	AV

Note: "802.11AC20(5G)" mode is the worst mode. PK value is lower than the Average value limit, So average didn't record.

The amplitude of spurious emissions that are attenuated by more than 20dB below the permissible value has no need to be reported.

Emission level (dBuV/m) = 20 log Emission level (uV/m).

Corrected Reading: Antenna Factor + Cable Loss + Read Level - Preamp Factor = Level.

EUT :	MyWirelessTV3 Wireless HD Transmitter, 4K Wireless HD Connection Kit	Model Name. :	MWTV3TX
Temperature :	20 °C	Relative Humidity :	48%
Pressure :	1010 hPa	Test Voltage :	DC 5V
Test Mode :	TX (5.8G) -- 802.11N20 _5745~5825MHz		

Polar	Frequency	Meter Reading	Cable loss	Antenna Factor	Preamp Factor	Emission Level	Limits	Margin	Detector Type
(H/V)	(MHz)	(dBuV)	(dB)	dB/m	(dB)	(dBuV/m)	(dBuV/m)	(dB)	
Low Channel (5745 MHz)-Above 1G									
Vertical	4679.195	64.41	5.94	35.40	44.00	61.75	74.00	-12.25	Pk
Vertical	4679.195	44.45	5.94	35.40	44.00	41.79	54.00	-12.21	AV
Vertical	11490.364	60.63	8.46	39.75	44.50	64.34	74.00	-9.66	Pk
Vertical	11490.364	41.18	8.46	39.75	44.50	44.89	54.00	-9.11	AV
Vertical	17235.101	52.27	10.12	38.80	44.10	57.09	74.00	-16.91	Pk
Vertical	17235.101	39.67	10.12	38.80	42.70	45.89	54.00	-8.11	AV
Horizontal	4679.332	60.79	5.94	35.18	44.00	57.91	74.00	-16.09	Pk
Horizontal	4679.332	43.52	5.94	35.18	44.00	40.64	54.00	-13.36	AV
Horizontal	11490.164	58.95	8.46	38.71	44.50	61.62	74.00	-12.38	Pk
Horizontal	11490.164	39.62	8.46	38.71	44.50	42.29	54.00	-11.71	AV
Horizontal	17235.196	59.41	10.12	38.38	44.10	63.81	74.00	-10.19	Pk
Horizontal	17235.196	40.12	10.12	38.38	44.10	44.52	54.00	-9.48	AV
middle Channel (5785 MHz)-Above 1G									
Vertical	4592.228	58.62	6.48	36.35	44.05	57.4	74.00	-16.6	Pk
Vertical	4592.228	42.25	6.48	36.35	44.05	41.03	54.00	-12.97	AV
Vertical	11570.203	60.63	8.47	37.88	44.51	62.47	74.00	-11.53	Pk
Vertical	11570.203	41.17	8.47	37.88	44.51	43.01	54.00	-10.99	AV
Vertical	17355.147	60.59	10.12	38.8	44.10	65.41	74.00	-8.59	Pk
Vertical	17355.147	39.97	10.12	38.8	42.70	46.19	54.00	-7.81	AV
Horizontal	4592.526	60.53	6.48	36.37	44.05	59.33	74.00	-14.67	Pk
Horizontal	4592.526	42.29	6.48	36.37	44.05	41.09	54.00	-12.91	AV
Horizontal	11570.123	59.67	8.47	38.64	44.50	62.28	74.00	-11.72	Pk
Horizontal	11570.123	43.26	8.47	38.64	44.50	45.87	54.00	-8.13	AV
Horizontal	17355.269	59.57	10.12	38.38	44.10	63.97	74.00	-10.03	Pk
Horizontal	17355.269	41.12	10.12	38.38	44.10	45.52	54.00	-8.48	AV
High Channel (5825 MHz)-Above 1G									
Vertical	6039.199	56.96	7.10	37.24	43.50	57.8	74.00	-16.2	Pk
Vertical	6039.199	40.21	7.10	37.24	43.50	41.05	54.00	-12.95	AV
Vertical	11652.562	59.95	8.46	37.68	44.50	61.59	74.00	-12.41	Pk
Vertical	11652.562	42.26	8.46	37.68	44.50	43.9	54.00	-10.1	AV
Vertical	17473.128	59.96	10.12	38.8	44.10	64.78	74.00	-9.22	Pk
Vertical	17473.128	41.15	10.12	38.8	42.70	47.37	54.00	-6.63	AV
Horizontal	6039.232	60.53	7.10	37.24	43.50	61.37	74.00	-12.63	Pk
Horizontal	6039.232	41.07	7.10	37.24	43.50	41.91	54.00	-12.09	AV
Horizontal	11652.319	60.53	8.46	38.57	44.50	63.06	74.00	-10.94	Pk
Horizontal	11652.319	41.11	8.46	38.57	44.50	43.64	54.00	-10.36	AV
Horizontal	17474.062	58.95	10.12	38.38	44.10	63.35	74.00	-10.65	Pk
Horizontal	17474.062	39.67	10.12	38.38	44.10	44.07	54.00	-9.93	AV

Note:"802.11N20(5G)" mode is the worst mode. PK value is lower than the Average value limit, So average didn't record.

The amplitude of spurious emissions that are attenuated by more than 20dB below the permissible value has no need to be reported.

Emission level (dBuV/m) = 20 log Emission level (uV/m).

Corrected Reading: Antenna Factor + Cable Loss + Read Level - Preamp Factor = Level.

3.2.9 TEST RESULTS (26.5GHZ-40GHZ)

EUT :	MyWirelessTV3 Wireless HD Transmitter, 4K Wireless HD Connection Kit	Model Name. :	MWTV3TX
Temperature :	20 °C	Relative Humidity :	48%
Pressure :	1010 hPa	Test Voltage :	DC 5V
Test Mode :	TX (5.2G)-802.11AC20 5180MHz~5240MHz , TX (5.8G)-802.11 n20 5745MHz~5825MHz		

All the modulation modes have been tested, and the worst result was report as below:

Low Channel (5180 MHz)-Above 1G

Horizontal

FCC Electric Field Strength 26.5-40GHz

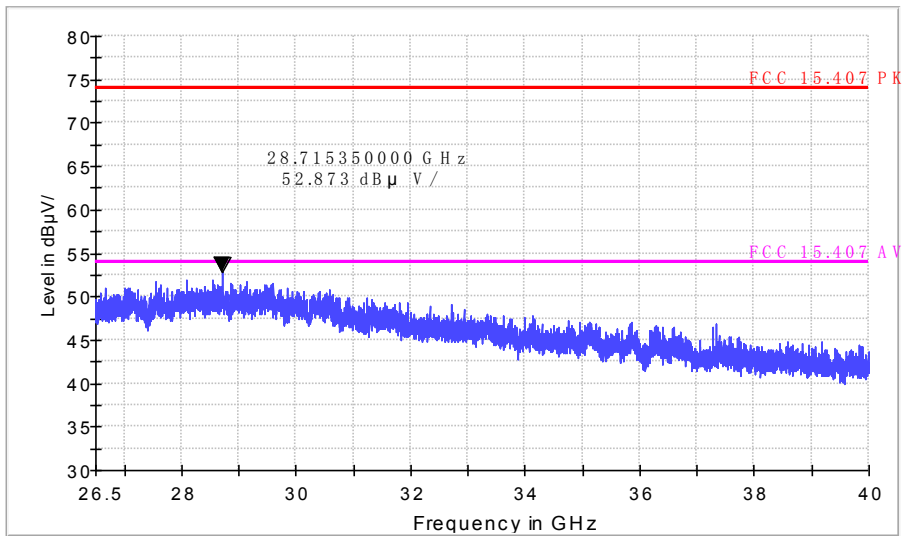

Vertical

FCC Electric Field Strength 26.5-40GHz

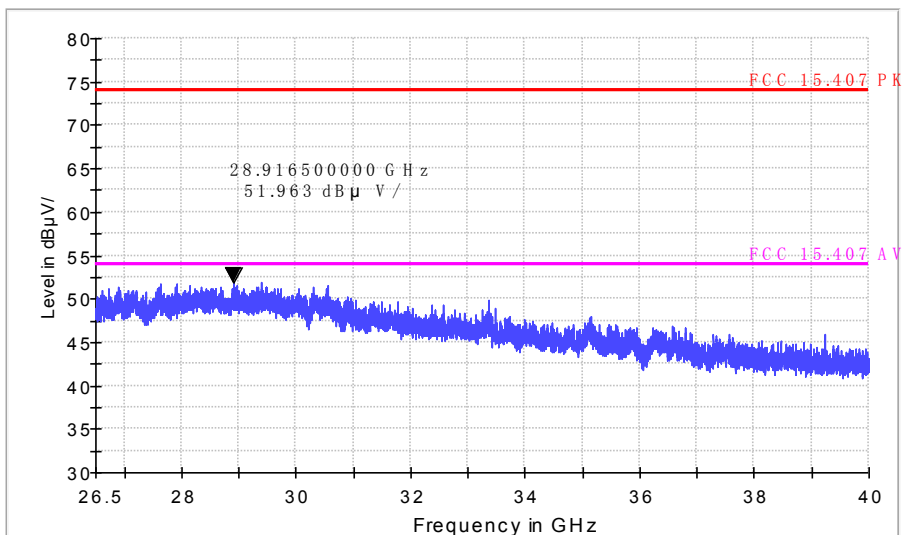

Middle Channel (5200 MHz)-Above 1G

Horizontal

FCC Electric Field Strength 26.5-40GHz

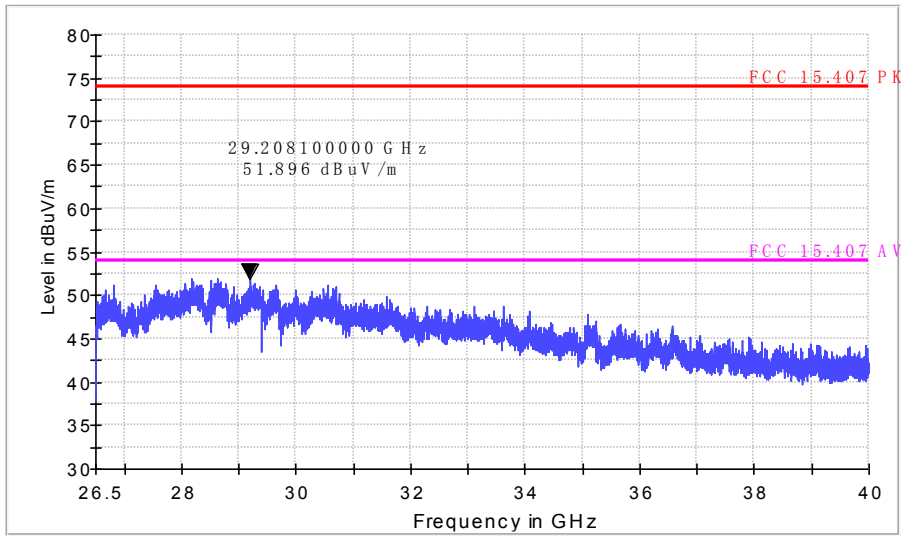

Vertical

FCC Electric Field Strength 26.5-40GHz

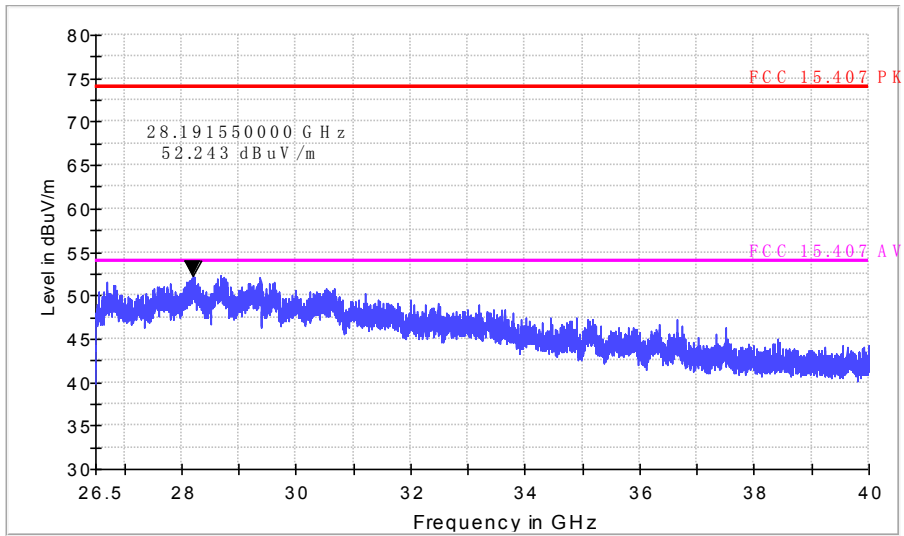

High Channel (5240 MHz)-Above 1G

Horizontal

FCC Electric Field Strength 26.5-40GHz

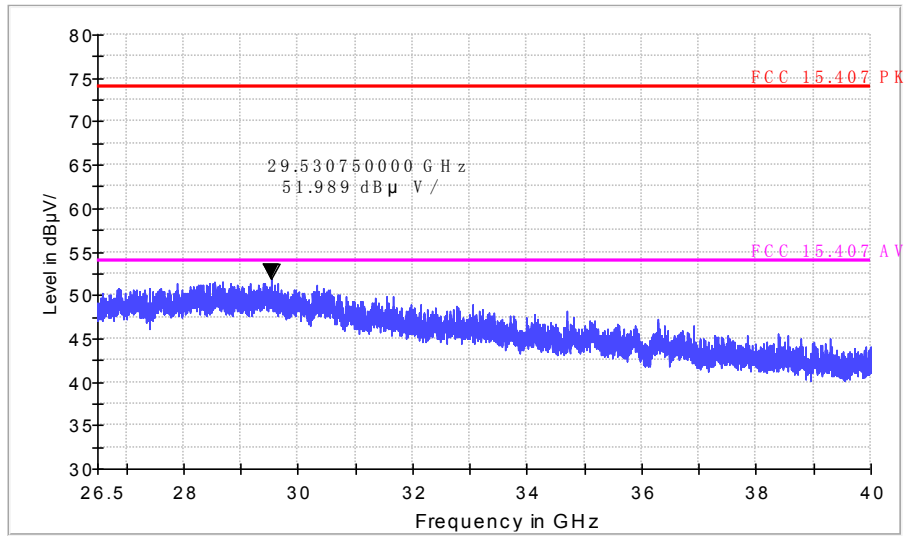

Vertical

FCC Electric Field Strength 26.5-40GHz

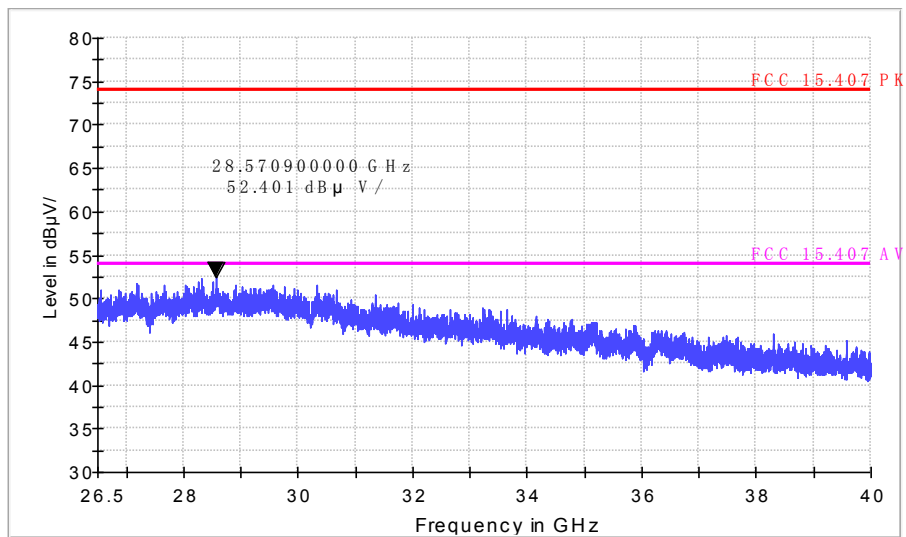

Low Channel (5745 MHz)-Above 1G

Horizontal

FCC Electric Field Strength 26.5-40GHz

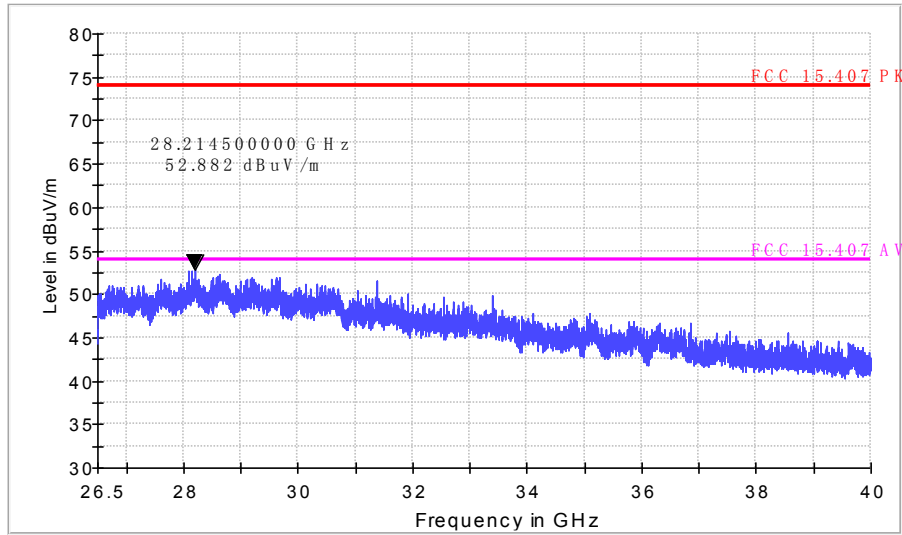

Vertical

FCC Electric Field Strength 26.5-40GHz

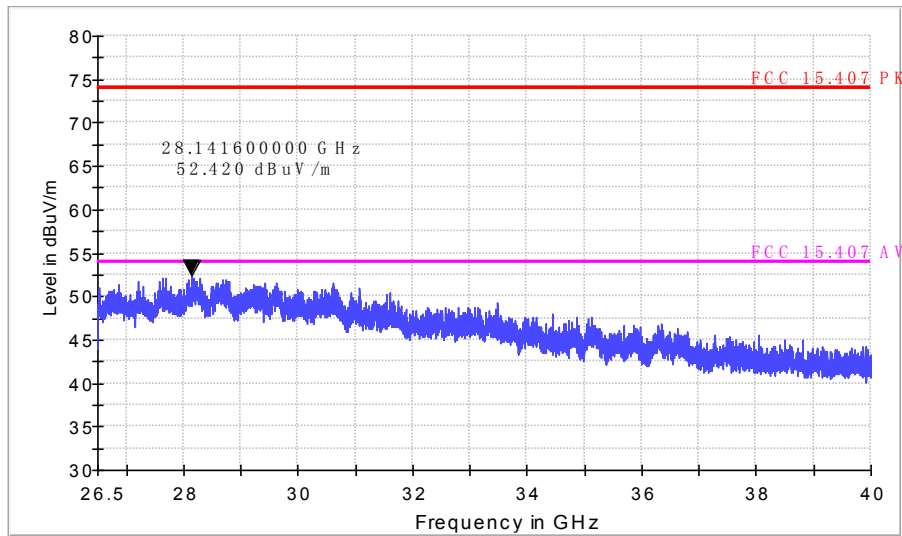

Middle Channel (5785 MHz)-Above 1G

Horizontal

FCC Electric Field Strength 26.5-40GHz

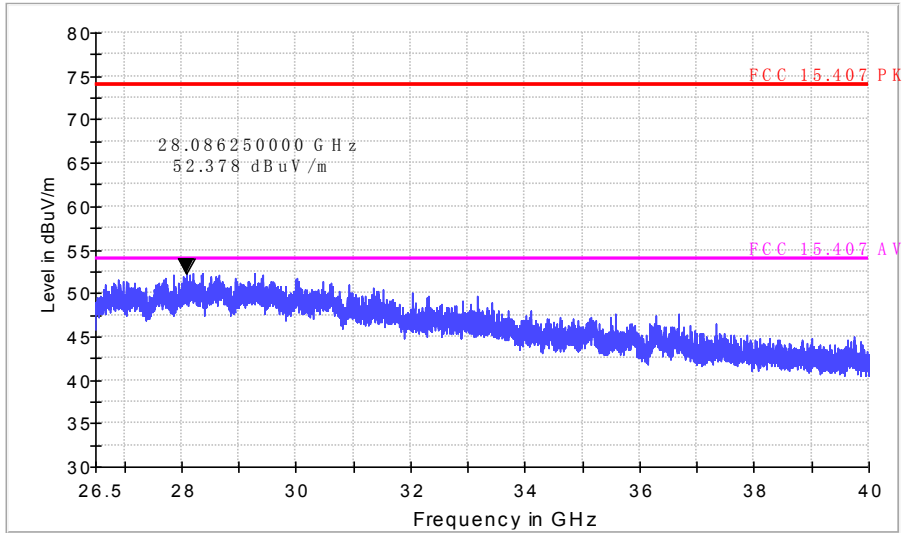

Vertical

FCC Electric Field Strength 26.5-40GHz

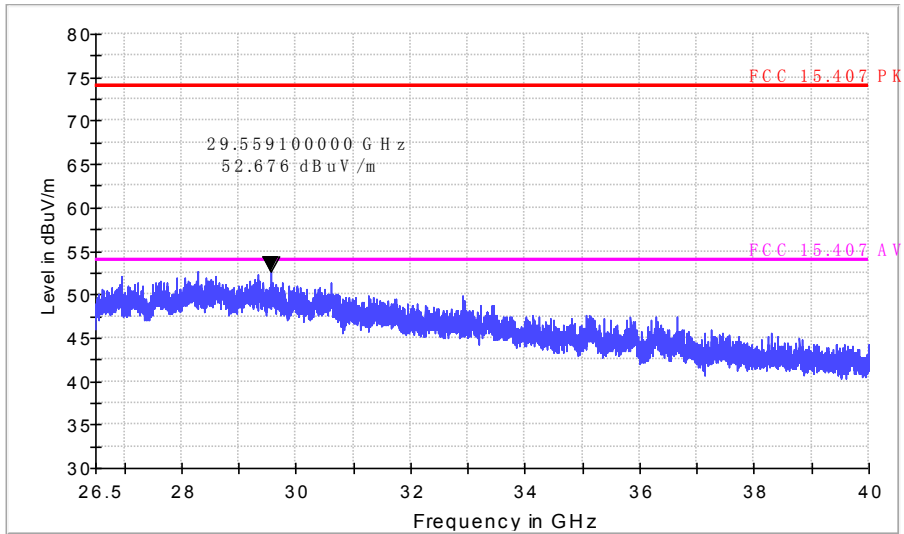

High Channel (5825 MHz)-Above 1G

Horizontal

FCC Electric Field Strength 26.5-40GHz

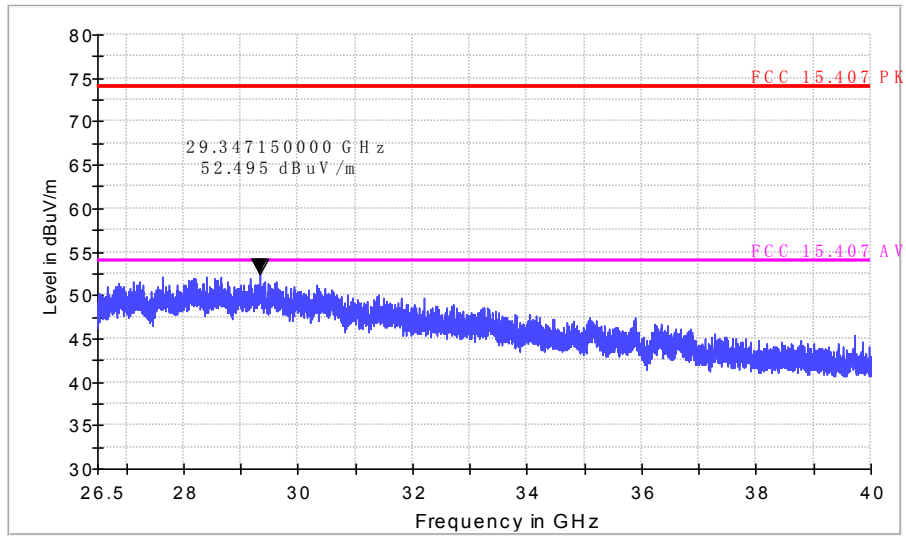

Vertical

FCC Electric Field Strength 26.5-40GHz

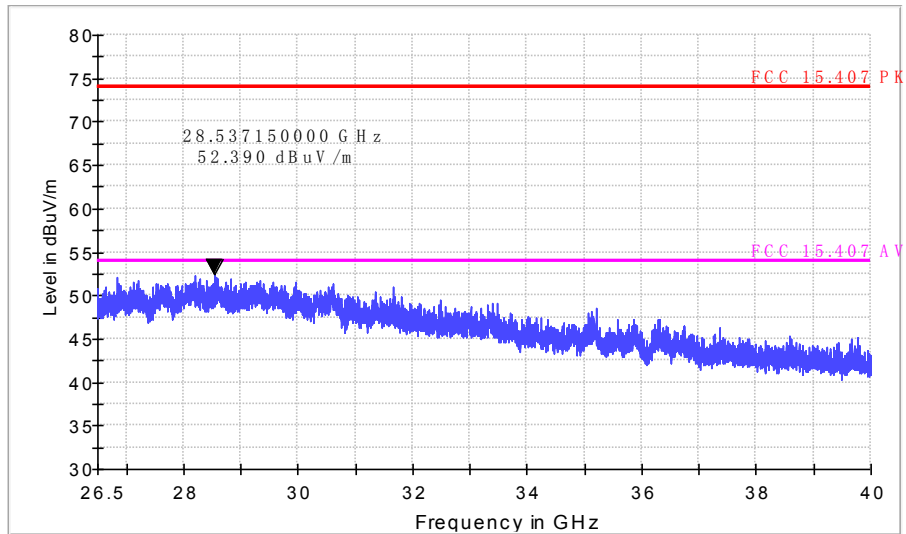

4. POWER SPECTRAL DENSITY TEST

4.1 APPLIED PROCEDURES / LIMIT

According to FCC §15.407(a)(3)

For the band 5.15-5.25 GHz,

(i) For an outdoor access point operating in the band 5.15-5.25 GHz, the maximum power spectral density shall not exceed 17 dBm in any 1 megahertz band. If transmitting antennas of directional gain greater than 6 dBi are used, both the maximum conducted output power and the maximum power spectral density shall be reduced by the amount in dB that the directional gain of the antenna exceeds 6 dBi. The maximum e.i.r.p. at any elevation angle above 30 degrees as measured from the horizon must not exceed 125 mW (21 dBm).

(ii) For an indoor access point operating in the band 5.15-5.25 GHz, the maximum power spectral density shall not exceed 17 dBm in any 1 megahertz band. If transmitting antennas of directional gain greater than 6 dBi are used, both the maximum conducted output power and the maximum power spectral density shall be reduced by the amount in dB that the directional gain of the antenna exceeds 6 dBi.

(iii) For fixed point-to-point access points operating in the band 5.15-5.25 GHz, the maximum power spectral density shall not exceed 17 dBm in any 1 megahertz band. Fixed point-to-point U-NII devices may employ antennas with directional gain up to 23 dBi without any corresponding reduction in the maximum conducted output power or maximum power spectral density. For fixed point-to-point transmitters that employ a directional antenna gain greater than 23 dBi, a 1 dB reduction in maximum conducted output power and maximum power spectral density is required for each 1 dB of antenna gain in excess of 23 dBi. Fixed, point-to-point operations exclude the use of point-to-multipoint systems, omnidirectional applications, and multiple collocated transmitters transmitting the same information. The operator of the U-NII device, or if the equipment is professionally installed, the installer, is responsible for ensuring that systems employing high gain directional antennas are used exclusively for fixed, point-to-point operations.

(iv) For client devices in the 5.15-5.25 GHz band, the maximum power spectral density shall not exceed 11 dBm in any 1 megahertz band. If transmitting antennas of directional gain greater than 6 dBi are used, both the maximum conducted output power and the maximum power spectral density shall be reduced by the amount in dB that the directional gain of the antenna exceeds 6 dBi.

For the band 5.725-5.85 GHz

(3) For the band 5.725-5.85 GHz, the maximum power spectral density shall not exceed 30 dBm in any 500-kHz band. If transmitting antennas of directional gain greater than 6 dBi are used, both the maximum conducted output power and the maximum power spectral density shall be reduced by the amount in dB that the directional gain of the antenna exceeds 6 dBi.

,

4.2 TEST PROCEDURE

For devices operating in the bands 5.15-5.25 GHz, 5.25-5.35 GHz, and 5.47-5.725 GHz, the above procedures make use of 1 MHz RBW to satisfy directly the 1 MHz reference bandwidth specified in § 15.407(a)(5). For devices operating in the band 5.725-5.85 GHz, the rules specify a measurement bandwidth of 500 kHz. Many spectrum analyzers do not have 500 kHz RBW, thus a narrower RBW may need to be used. The rules permit the use of a RBWs less than 1 MHz, or 500 kHz, “provided that the measured power is integrated over the full reference bandwidth” to show the total power over the specified measurement bandwidth (i.e., 1 MHz, or 500 kHz). If measurements are performed using a reduced resolution bandwidth (< 1 MHz, or < 500 kHz) and integrated over 1 MHz, or 500 KHz bandwidth, the following adjustments to the procedures apply:

- a) Set $RBW \geq 1/T$, where T is defined in section II.B.I.a).
- b) Set $VBW \geq 3 RBW$.
- c) If measurement bandwidth of Maximum PSD is specified in 500 kHz, add $10\log(500\text{kHz}/RBW)$ to the measured result, whereas $RBW (< 500 \text{ KHz})$ is the reduced resolution bandwidth of the spectrum analyzer set during measurement.
- d) If measurement bandwidth of Maximum PSD is specified in 1 MHz, add $10\log(1\text{MHz}/RBW)$ to the measured result, whereas $RBW (< 1 \text{ MHz})$ is the reduced resolution bandwidth of spectrum analyzer set during measurement.
- e) Care must be taken to ensure that the measurements are performed during a period of continuous transmission or are corrected upward for duty cycle.

Note: As a practical matter, it is recommended to use reduced RBW of 100 KHz for the sections 5.c) and 5.d) above, since $RBW=100 \text{ KHz}$ is available on nearly all spectrum analyzers.

4.3 DEVIATION FROM STANDARD

No deviation.

4.4 TEST SETUP



4.5 EUT OPERATION CONDITIONS

The EUT tested system was configured as the statements of 2.1 Unless otherwise a special operating condition is specified in the follows during the testing.

4.6 TEST RESULTS

EUT :	MyWirelessTV3 Wireless HD Transmitter, 4K Wireless HD Connection Kit	Model Name. :	MWTV3TX
Temperature :	25 °C	Relative Humidity :	56%
Pressure :	1015 hPa	Test Voltage :	DC 5V
Test Mode :	TX Frequency Band I (5150-5250MHz)		

Note: A(B) Represent the value of antenna A and B, The worst data is Antenna A ,only shown Antenna A Plot.

EUT has two antennas, and different modes support different transmit mode what describe as Following form:

Mode	Tx/Rx
802.11a	1TX, 2RX
802.11n/ac	1TX/2TX, 2RX

Mode	Frequency	Measured Power Density (dBm/MHz)		Total power density (dBm/MHz)	Calculate power density (dBm/MHz)(Note 1)		Limit (dBm/MHz)		Result
		ANT A	ANT B		ANT A	ANT B	ANT A	ANT B	
802.11 a	5185 MHz	11.599	10.007	-	11.599	10.007	17	16.6	PASS
	5200 MHz	12.004	10.314	-	12.004	10.314	17	16.6	PASS
	5240 MHz	11.950	10.431	-	11.950	10.431	17	16.6	PASS
802.11 n20	5185 MHz	12.228	9.022	13.925	13.925		14.7		PASS
	5200 MHz	11.575	9.689	13.744	13.744		14.7		PASS
	5240 MHz	12.441	10.372	14.539	14.539		14.7		PASS
802.11 n40	5190 MHz	8.136	4.990	9.852	9.852		14.7		PASS
	5230 MHz	8.896	5.169	10.431	10.431		14.7		PASS
802.11 AC20	5185 MHz	11.887	10.428	14.229	14.229		14.7		PASS
	5200 MHz	12.682	10.138	14.604	14.604		14.7		PASS
	5240 MHz	12.180	10.231	14.324	14.324		14.7		PASS
802.11 AC40	5190 MHz	9.343	5.930	10.974	10.974		14.7		PASS
	5230 MHz	9.478	6.729	11.328	11.328		14.7		PASS
802.11 AC80	5210 MHz	5.901	4.364	8.210	8.210		14.7		PASS

Note: 1. Calculate power density= Measured Power Density+10log(1MHz/RBW) RBW=1MHz

2. For 802.11n/ac 5GHz has MIMO mode.Direction gain=8.30dbi
 $8.30 \text{ dbi} > 6.0 \text{ dbi}$ so power density limit= $17 - (8.30 - 6) = 14.7 \text{ dBm/MHz}$;

3. For 802.11a mode.ANT B Directional gain=6.4dbi
 $6.4 \text{ dbi} > 6.0 \text{ dbi}$ so power density limit= $17 - (6.4 - 6) = 16.6 \text{ dBm/MHz}$

(802.11a) PSD plot on channel 36

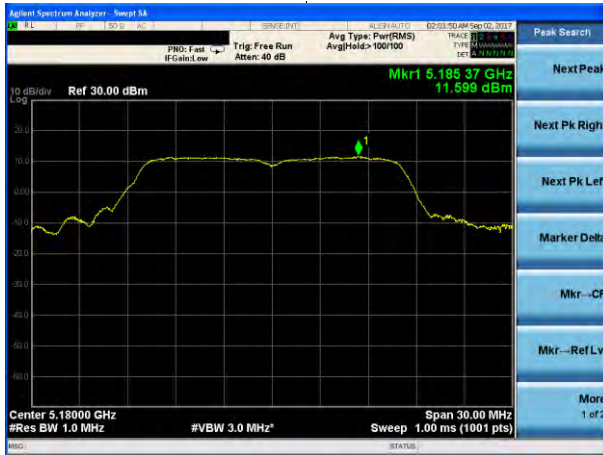

(802.11n20) PSD plot on channel 36



(802.11a) PSD plot on channel 40



(802.11n20) PSD plot on channel 40



(802.11a) PSD plot on channel 48



(802.11n20) PSD plot on channel 48



(802.11n40) PSD plot on channel 38



(802.11ac20) PSD plot on channel 36

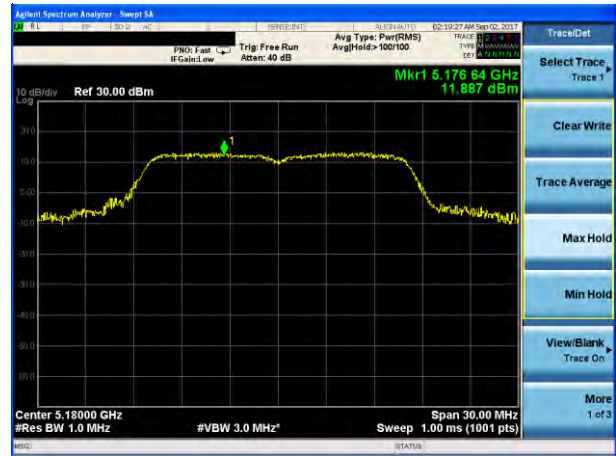

(802.11n40) PSD plot on channel 46



(802.11ac20) PSD plot on channel 40

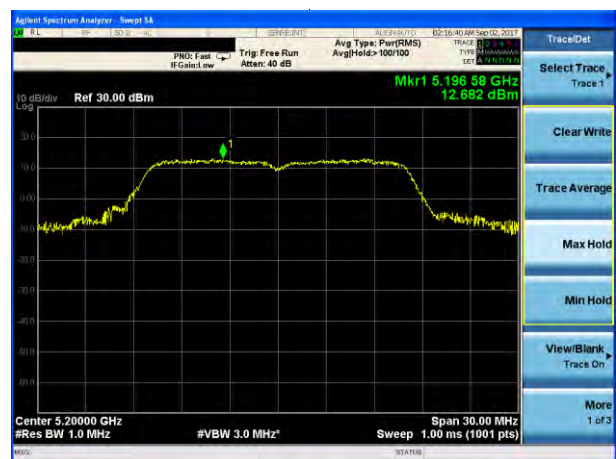

(802.11ac20) PSD plot on channel 48

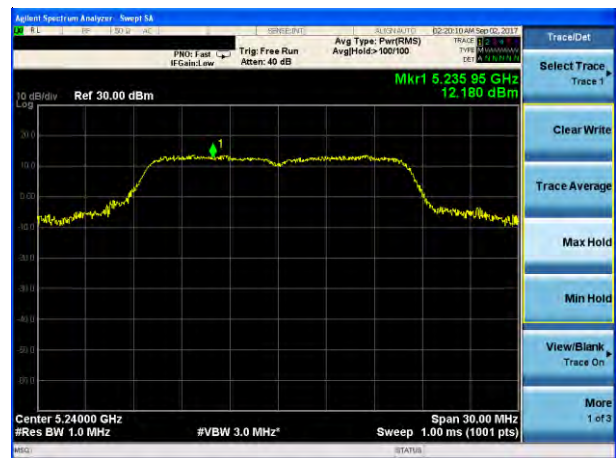

(802.11ac40) PSD plot on channel 38



(802.11ac80) PSD plot on channel 42



(802.11ac40) PSD plot on channel 46



EUT :	MyWirelessTV3 Wireless HD Transmitter, 4K Wireless HD Connection Kit	Model Name. :	MWTV3TX
Temperature :	25 °C	Relative Humidity :	56%
Pressure :	1015 hPa	Test Voltage :	DC 5V
Test Mode :	TX Frequency Band IV (5745-5825MHz)		

Note: A(B) Represent the value of antenna A and B, The worst data is Antenna A ,only shown Antenna A Plot.

EUT has two antennas, and different modes support different transmit mode what describe as Following form:

Mode	Tx/Rx
802.11a	1TX, 2RX
802.11n/ac	1TX/2TX, 2RX

Mode	Frequency	Measured Power Density (dBm/MHz)		Total power density (dBm/MHz)	Calculate power density (dBm/MHz)(Note 1)		Limit (dBm/MHz)	Result
		ANT A	ANT B		ANT A	ANT B		
802.11 a	5745 MHz	7.741	7.399	-	7.741	7.399	30	PASS
	5785 MHz	8.688	8.509	-	8.688	8.509	30	PASS
	5825 MHz	8.288	7.761	-	8.288	7.761	30	PASS
802.11 n20	5745 MHz	7.059	6.545	9.820	9.820		28.35	PASS
	5785 MHz	8.018	7.481	10.768	10.768		28.35	PASS
	5825 MHz	8.053	7.545	10.817	10.817		28.35	PASS
802.11 n40	5755 MHz	5.096	4.614	7.872	7.872		28.35	PASS
	5795 MHz	5.487	4.979	8.251	8.251		28.35	PASS
802.11 AC20	5745 MHz	7.921	7.209	10.590	10.590		28.35	PASS
	5785 MHz	7.757	7.956	10.868	10.868		28.35	PASS
	5825 MHz	6.803	7.168	10.000	10.000		28.35	PASS
802.11 AC40	5755 MHz	5.565	4.116	7.911	7.911		28.35	PASS
	5795 MHz	6.245	5.950	9.110	9.110		28.35	PASS
802.11 AC80	5775 MHz	2.632	1.109	4.947	4.947		28.35	PASS

Note:

(1) Calculate power density= Measured Power Density+10log(500kHz/RBW)
 RBW=0.51MHz,

So the Calculate power density= Measured Power Density+2.92

(2) For 802.11n/ac 5GHz has MIMO mode.Directional gain=7.65dbi

7.65 dbi>6.0 dbi so power density limit= 30-(7.65-6)=28.35

(802.11a) PSD plot on channel 149



(802.11n20) PSD plot on channel 149



(802.11a) PSD plot on channel 157



(802.11n20) PSD plot on channel 157

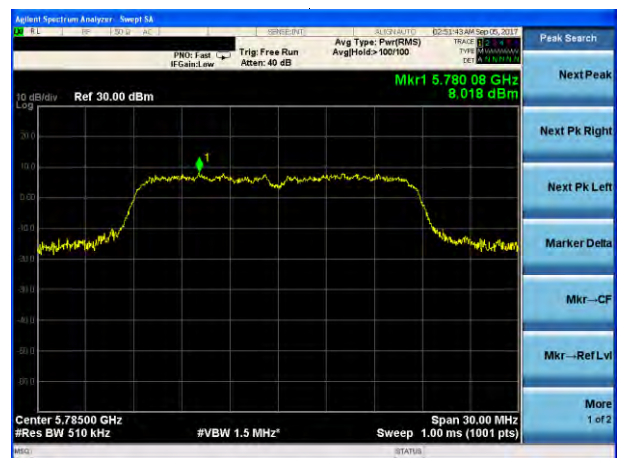

(802.11a) PSD plot on channel 165



(802.11n20) PSD plot on channel 165

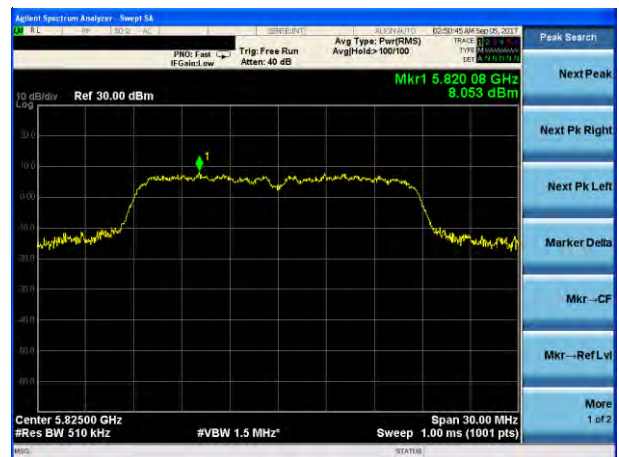

(802.11n40) PSD plot on channel 151



(802.11ac20) PSD plot on channel 149



(802.11n40) PSD plot on channel 159



(802.11ac20) PSD plot on channel 157

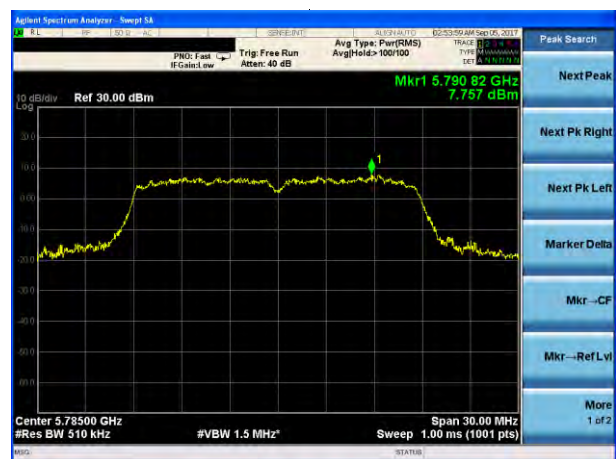

(802.11ac20) PSD plot on channel 165

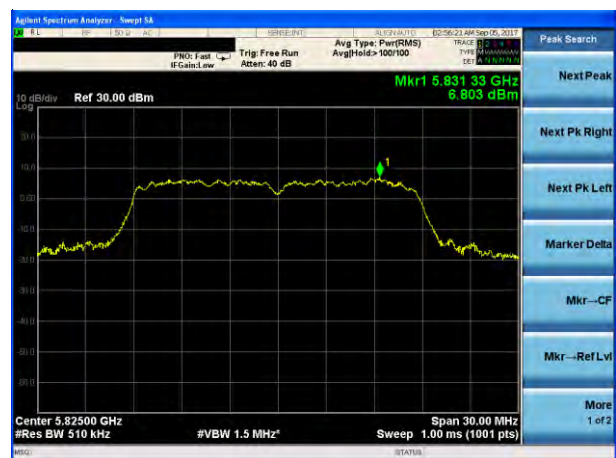

(802.11ac40) PSD plot on channel 151



(802.11ac80) PSD plot on channel 155



(802.11ac40) PSD plot on channel 159

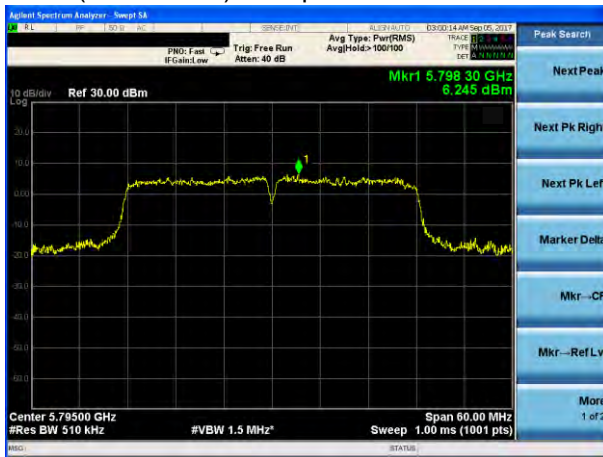

5. 26DB & 99% EMISSION BANDWIDTH

5.1 APPLIED PROCEDURES / LIMIT

The maximum power spectral density is measured as a conducted emission by direct connection of a calibrated test instrument to the equipment under test. If the device cannot be connected directly, alternative techniques acceptable to the Commission may be used. Measurements in the 5.725-5.85 GHz band are made over a reference bandwidth of 500 kHz or the 26 dB emission bandwidth of the device, whichever is less. Measurements in the 5.15-5.25 GHz, 5.25-5.35 GHz, and the 5.47-5.725 GHz bands are made over a bandwidth of 1 MHz or the 26 dB emission bandwidth of the device, whichever is less. A narrower resolution bandwidth can be used, provided that the measured power is integrated over the full reference bandwidth.

5.2 TEST PROCEDURE

- a) Set RBW = approximately 1% of the emission bandwidth.
- b) Set the VBW > RBW.
- c) Detector = Peak.
- d) Trace mode = max hold.
- e) Measure the maximum width of the emission that is 26 dB down from the maximum of the emission. Compare this with the RBW setting of the analyzer. Readjust RBW and repeat measurement as needed until the RBW/EBW ratio is approximately 1%.

The following procedure shall be used for measuring (99 %) power bandwidth:

1. Set center frequency to the nominal EUT channel center frequency.
2. Set span = 1.5 times to 5.0 times the OBW.
3. Set RBW = 1 % to 5 % of the OBW
4. Set VBW $\geq 3 \cdot$ RBW
5. Video averaging is not permitted. Where practical, a sample detection and single sweep mode shall be used. Otherwise, peak detection and max hold mode (until the trace stabilizes) shall be used.
6. Use the 99 % power bandwidth function of the instrument (if available).
7. If the instrument does not have a 99 % power bandwidth function, the trace data points are recovered and directly summed in power units. The recovered amplitude data points, beginning at the lowest frequency, are placed in a running sum until 0.5 % of the total is reached; that frequency is recorded as the lower frequency. The process is repeated until 99.5 % of the total is reached; that frequency is recorded as the upper frequency. The 99% occupied bandwidth is the difference between these two frequencies.

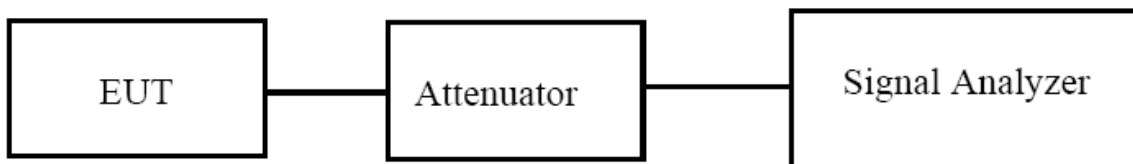

5.3 EUT OPERATION CONDITIONS

The EUT tested system was configured as the statements of 2.4 Unless otherwise a special operating condition is specified in the follows during the testing.

5.4 TEST RESULTS

EUT :	MyWirelessTV3 Wireless HD Transmitter, 4K Wireless HD Connection Kit	Model Name. :	MWTV3TX
Temperature :	25 °C	Relative Humidity :	56%
Pressure :	1012 hPa	Test Voltage :	DC 5V
Test Mode :	TX Frequency Band I (5150-5250MHz)		

Note: A(B) Represent the value of antenna A and B, The worst data is Antenna A, only shown Antenna A Plot.

EUT has two antennas, and different modes support different transmit mode what describe as Following form:

Mode	Tx/Rx
802.11a	1TX, 2RX
802.11n/ac	1TX/2TX, 2RX

Mode	Channel	Frequency (MHz)	99% bandwidth(MHz)	99% bandwidth(MHz)	26dB bandwidth (MHz)	26dB bandwidth (MHz)	Result
			Antenna A	Antenna B	Antenna A	Antenna B	
802.11a	CH36	5180	17.687	16.855	33.89	29.51	Pass
	CH40	5200	19.745	17.896	36.43	33.02	Pass
	CH48	5240	21.381	18.726	37.34	34.82	Pass
802.11 n20	CH36	5180	18.132	17.741	31.54	30.95	Pass
	CH40	5200	18.337	17.703	35.31	34.91	Pass
	CH48	5240	18.298	17.748	34.11	33.35	Pass
802.11 n40	CH 38	5190	45.443	38.017	76.19	67.80	Pass
	CH 46	5230	45.954	40.026	76.23	74.41	Pass
802.11 AC20	CH36	5180	23.532	19.725	38.15	36.50	Pass
	CH40	5200	24.429	20.726	39.94	37.67	Pass
	CH48	5240	23.543	21.704	38.21	37.30	Pass
802.11 AC40	CH 38	5190	50.691	45.968	76.59	75.23	Pass
	CH 46	5230	49.802	38.965	76.49	75.21	Pass
802.11 AC80	CH 42	5210	75.736	75.229	98.20	95.02	Pass

Test plot

(802.11a) -26dB&99%Bandwidth plot on channel 36



(802.11 n20) -26dB&99%Bandwidth plot on channel 36



(802.11a) -26dB&99%Bandwidth plot on channel 40



(802.11 n20) -26dB&99%Bandwidth plot on channel 40

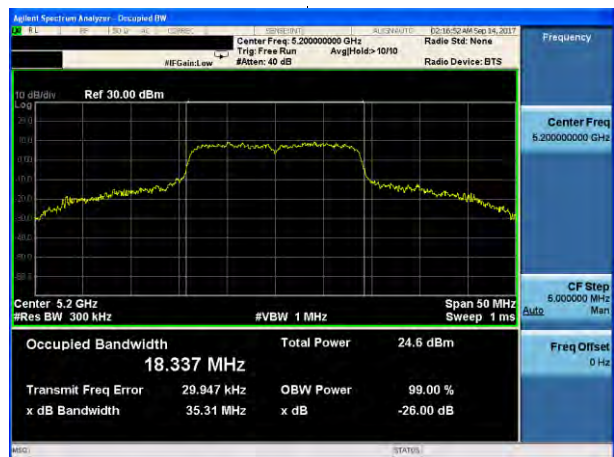

(802.11a) -26dB&99%Bandwidth plot on channel 48



(802.11 n20) -26dB&99%Bandwidth plot on channel 48

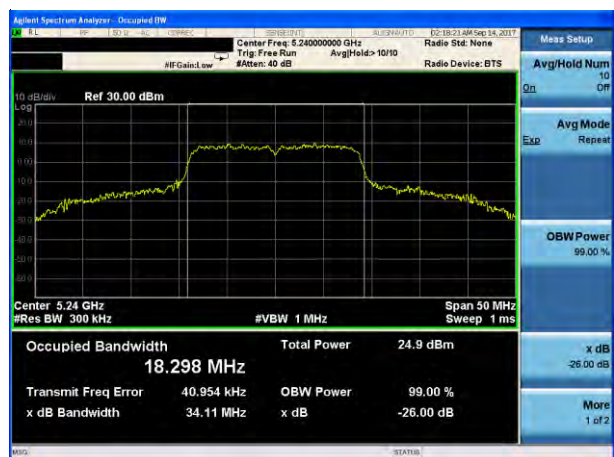

Test plot

(802.11 n40) -26dB&99%Bandwidth plot on channel 38



(802.11 AC20) -26dB&99%Bandwidth plot on channel 36



(802.11 n40) -26dB&99%Bandwidth plot on channel 46

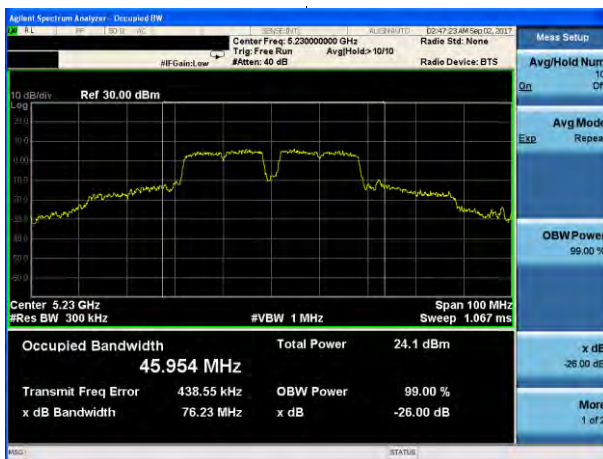

(802.11 AC20) -26dB&99%Bandwidth plot on channel 40



(802.11 AC20) -26dB&99%Bandwidth plot on channel 48



Test plot

(802.11 AC40) -26dB&99%Bandwidth plot on channel 38



(802.11 AC80) -26dB&99%Bandwidth plot on channel 42



(802.11 AC40) -26dB&99%Bandwidth plot on channel 46

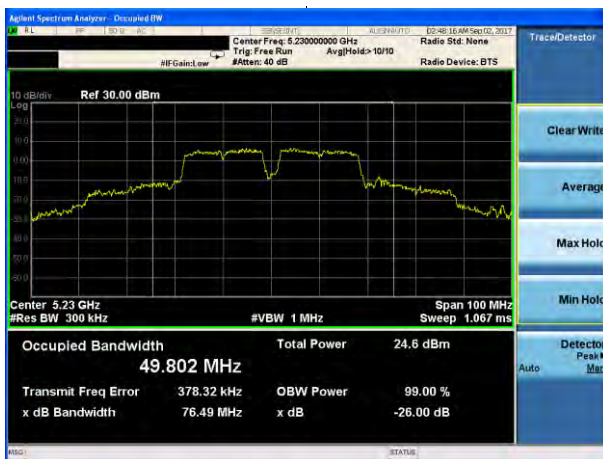

EUT :	MyWirelessTV3 Wireless HD Transmitter, 4K Wireless HD Connection Kit	Model Name. :	MWTV3TX
Temperature :	25 °C	Relative Humidity :	56%
Pressure :	1012 hPa	Test Voltage :	DC 5V
Test Mode :	TX Frequency Band IV(5745-5850MHz)		

Note: A(B) Represent the value of antenna A and B, The worst data is Antenna A, only shown Antenna A Plot.

EUT has two antennas, and different modes support different transmit mode what describe as Following form:

Mode	Tx/Rx
802.11a	1TX, 2RX
802.11n/ac	1TX/2TX, 2RX

Mode	Channel	Frequency (MHz)	99% bandwidth(MHz)	99% bandwidth(MHz)	26dB bandwidth (MHz)	26dB bandwidth (MHz)	Result
			Antenna A	Antenna B	Antenna A	Antenna B	
802.11a	CH149	5745	16.973	15.634	27.91	26.54	Pass
	CH157	5785	17.517	16.277	33.90	30.19	Pass
	CH165	5825	19.041	18.513	36.46	34.09	Pass
802.11 n20	CH149	5745	17.809	17.746	24.99	22.76	Pass
	CH157	5785	17.997	17.753	29.53	28.15	Pass
	CH165	5825	18.060	17.741	33.43	32.20	Pass
802.11 n40	CH151	5755	36.460	36.047	67.08	66.90	Pass
	CH159	5795	36.846	36.022	69.64	68.21	Pass
802.11 AC20	CH149	5745	17.873	17.761	25.57	25.07	Pass
	CH157	5785	17.954	17.734	28.47	27.47	Pass
	CH165	5825	18.510	17.765	35.95	34.29	Pass
802.11 AC40	CH151	5755	36.276	36.037	50.05	43.57	Pass
	CH159	5795	36.701	35.995	69.20	58.26	Pass
802.11 AC80	CH155	5775	75.033	74.632	90.28	88.76	Pass

Test plot

(802.11a) -26dB&99%Bandwidth plot on channel 149



(802.11 n20) -26dB&99%Bandwidth plot on channel 149

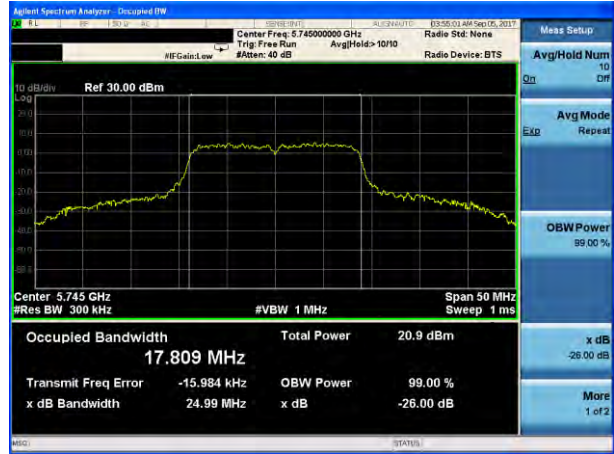

(802.11a) -26dB&99%Bandwidth plot on channel 157



(802.11 n20) -26dB&99%Bandwidth plot on channel 157

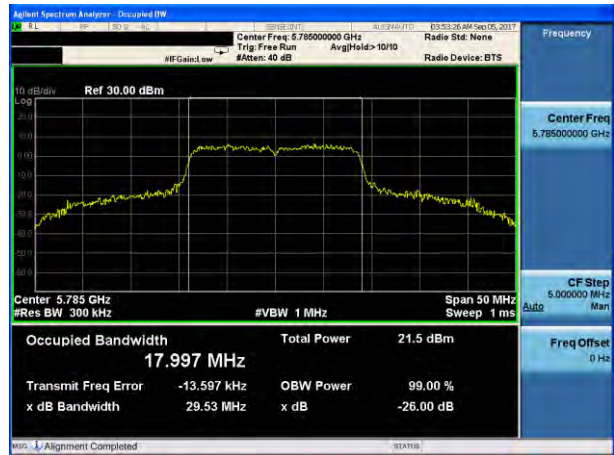

(802.11a) -26dB&99%Bandwidth plot on channel 165



(802.11 n20) -26dB&99%Bandwidth plot on channel 165

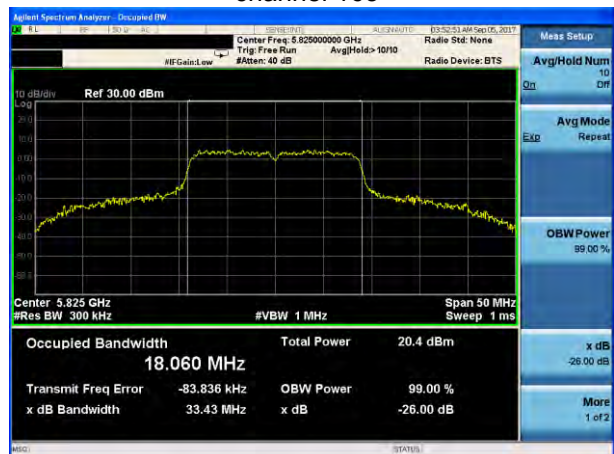

Test plot

(802.11 n40) -26dB&99%Bandwidth plot on channel 151

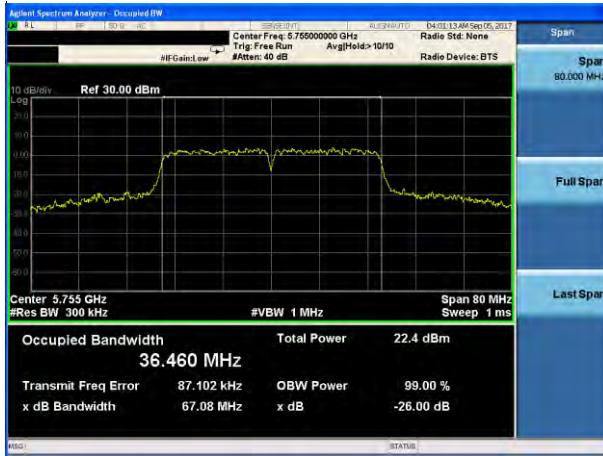

(802.11 AC20) -26dB&99%Bandwidth plot on channel 149

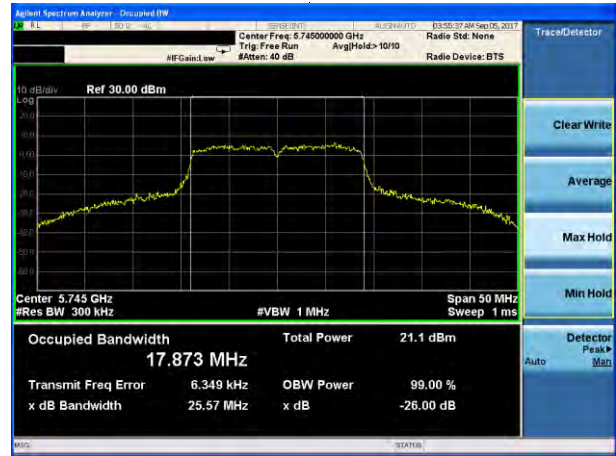

(802.11 n40) -26dB&99%Bandwidth plot on channel 159



(802.11 AC20) -26dB&99%Bandwidth plot on channel 157



(802.11 AC20) -26dB&99%Bandwidth plot on channel 165

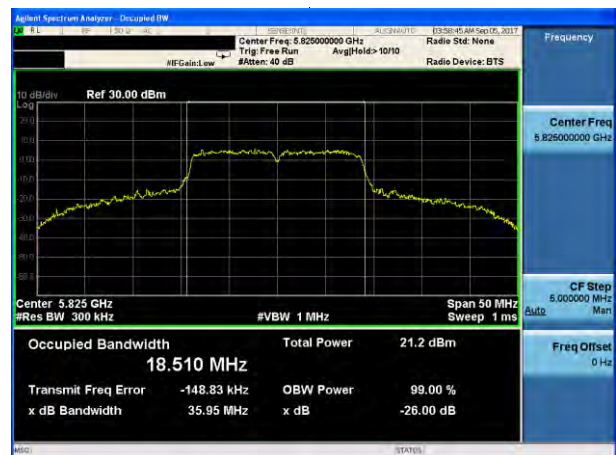

Test plot

(802.11 AC40) -26dB&99%Bandwidth plot on channel 151

(802.11 AC80) -26dB&99%Bandwidth plot on channel 155

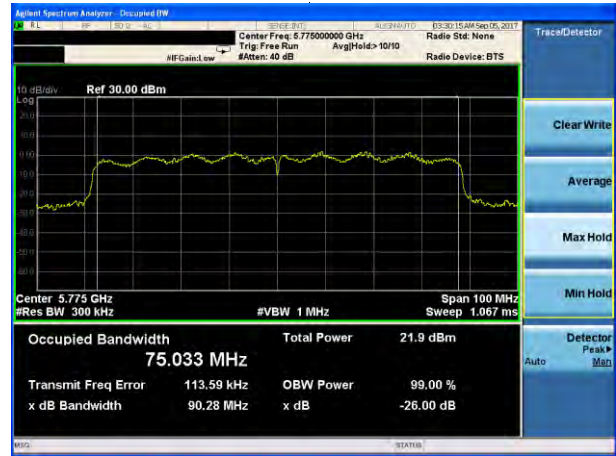
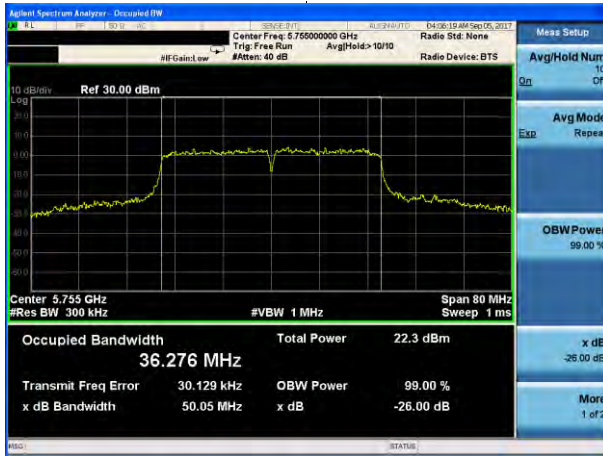

(802.11 AC40) -26dB&99%Bandwidth plot on channel 159

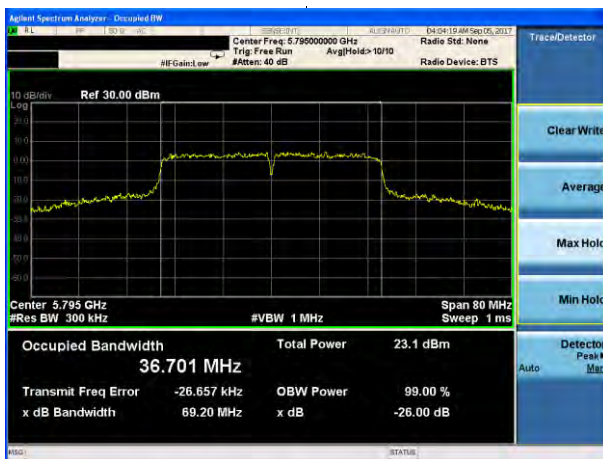

6. MINIMUM 6 DB BANDWIDTH

6.1 APPLIED PROCEDURES / LIMIT

According to FCC §15.407(e)

(e) Within the 5.725-5.85 GHz band, the minimum 6 dB bandwidth of U-NII devices shall be at least 500 kHz.

6.2 TEST PROCEDURE

Section 15.407(e) specifies the minimum 6 dB emission bandwidth of at least 500 KHz for the band 5.715-5.85 GHz. The following procedure shall be used for measuring this bandwidth:

- a) Set RBW = 100 kHz.
- b) Set the video bandwidth (VBW) $\geq 3 \times$ RBW.
- c) Detector = Peak.
- d) Trace mode = max hold.
- e) Sweep = auto couple.
- f) Allow the trace to stabilize.
- g) Measure the maximum width of the emission that is constrained by the frequencies associated with the two outermost amplitude points (upper and lower frequencies) that are attenuated by 6 dB relative to the maximum level measured in the fundamental emission.

6.3 DEVIATION FROM STANDARD

No deviation.

6.4 TEST SETUP

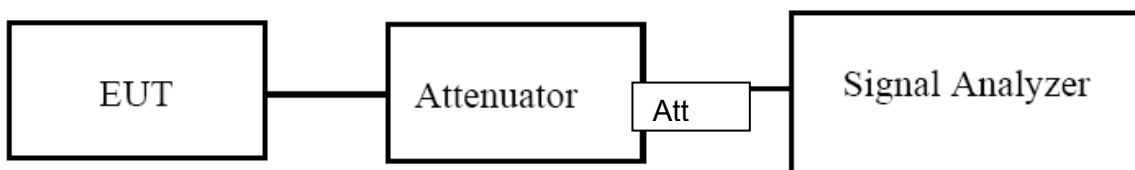

6.5 EUT OPERATION CONDITIONS

The EUT tested system was configured as the statements of 2.4 Unless otherwise a special operating condition is specified in the follows during the testing.

6.6 TEST RESULTS

EUT :	MyWirelessTV3 Wireless HD Transmitter, 4K Wireless HD Connection Kit	Model Name. :	MWTV3TX
Temperature :	25 °C	Relative Humidity :	56%
Pressure :	1012 hPa	Test Voltage :	DC 5V
Test Mode :	TX Frequency Band I (5150-5250MHz)		

Note: A(B) Represent the value of antenna A and B, The worst data is Antenna A, only shown Antenna A Plot.

EUT has two antennas, and different modes support different transmit mode what describe as Following form:

Mode	Tx/Rx
802.11a	1TX, 2RX
802.11n/ac	1TX/2TX, 2RX

Mode	Channel	Frequency (MHz)	6dB bandwidth (MHz)	6dB bandwidth (MHz)	Limit (KHz)	Result
			Antenna A	Antenna B		
802.11a	CH36	5180	16.49	15.15	$\cong 500$	Pass
	CH40	5200	16.48	15.89	$\cong 500$	Pass
	CH48	5240	16.48	15.90	$\cong 500$	Pass
802.11n20	CH36	5180	17.69	16.79	$\cong 500$	Pass
	CH40	5200	17.71	16.89	$\cong 500$	Pass
	CH48	5240	17.70	16.98	$\cong 500$	Pass
802.11n40	CH 38	5190	36.46	36.17	$\cong 500$	Pass
	CH 46	5230	36.45	36.15	$\cong 500$	Pass
802.11AC20	CH36	5180	16.47	16.04	$\cong 500$	Pass
	CH40	5200	16.48	16.29	$\cong 500$	Pass
	CH48	5240	16.49	16.13	$\cong 500$	Pass
802.11AC40	CH 38	5190	36.43	36.18	$\cong 500$	Pass
	CH 46	5230	36.47	36.09	$\cong 500$	Pass
802.11AC80	CH 42	5210	76.01	75.79	$\cong 500$	Pass

Test plot

(802.11a) 6dB Bandwidth plot on channel 36

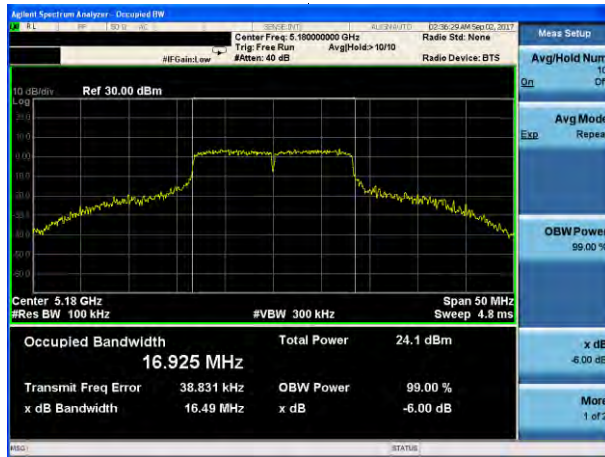

(802.11 n20) 6dB Bandwidth plot on channel 36



(802.11a) 6dB Bandwidth plot on channel 40



(802.11 n20) 6dB Bandwidth plot on channel 40

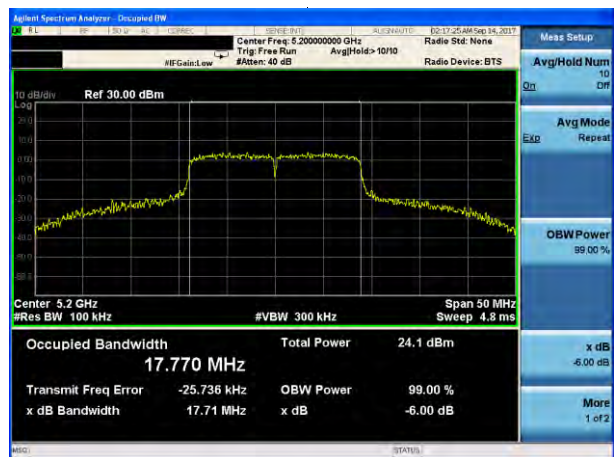

(802.11a) 6dB Bandwidth plot on channel 48



(802.11 n20) 6dB Bandwidth plot on channel 48

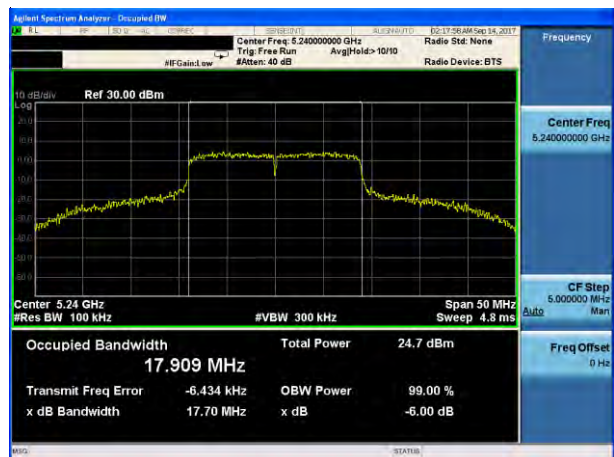

Test plot

(802.11 n40) 6dB Bandwidth plot on channel 38

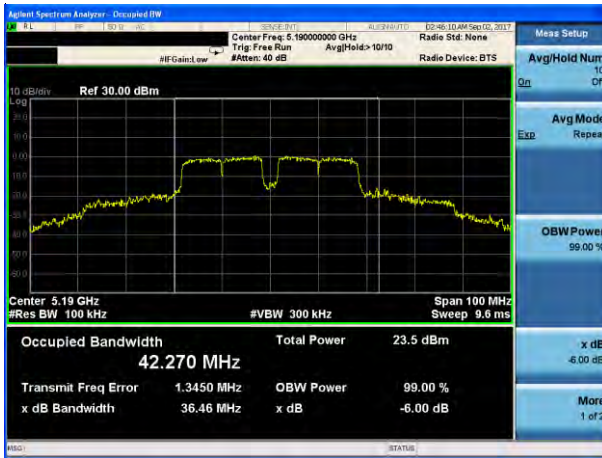

(802.11 AC20) 6dB Bandwidth plot on channel 36

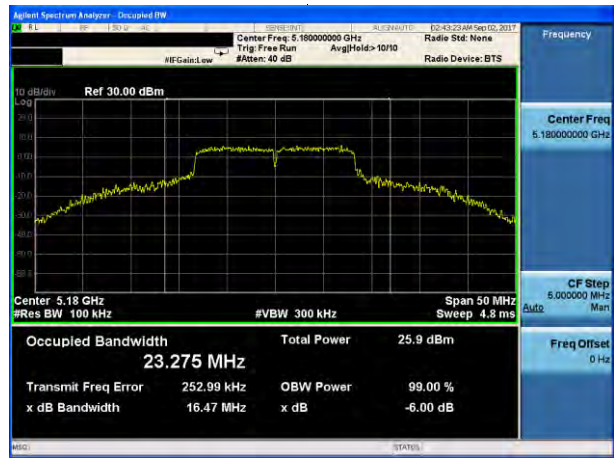

(802.11 n40) 6dB Bandwidth plot on channel 46



(802.11 AC20) 6dB Bandwidth plot on channel 40



(802.11 AC20) 6dB Bandwidth plot on channel 48

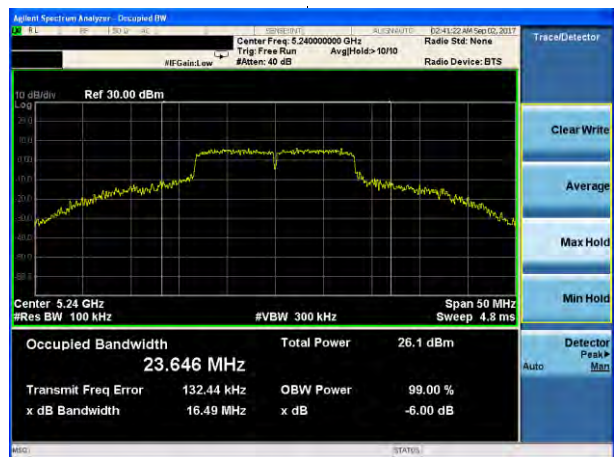

Test plot

(802.11 AC40) 6dB Bandwidth plot on channel 38

(802.11 AC80) 6dB Bandwidth plot on channel 42



(802.11 AC40) 6dB Bandwidth plot on channel 46

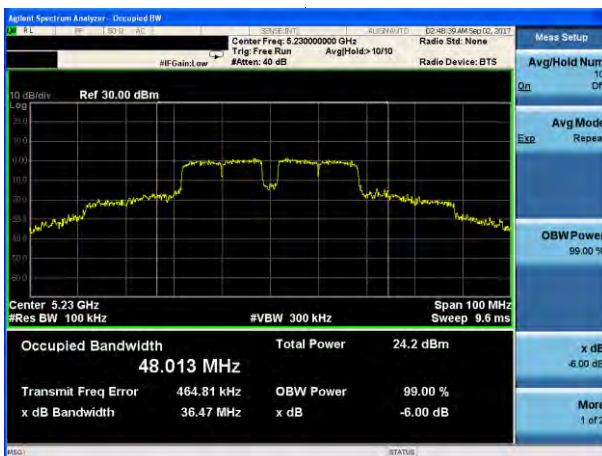

EUT :	MyWirelessTV3 Wireless HD Transmitter, 4K Wireless HD Connection Kit	Model Name. :	MWTV3TX
Temperature :	25 °C	Relative Humidity :	60%
Pressure :	1012 hPa	Test Voltage :	DC 5V
Test Mode :	TX (5G) Mode Frequency Band IV (5725-5825MHz)		

Note: A(B) Represent the value of antenna A and B, The worst data is Antenna A ,only shown Antenna A Plot.

EUT has two antennas, and different modes support different transmit mode what describe as Following form:

Mode	Tx/Rx
802.11a	1TX, 2RX
802.11n/ac	1TX/2TX, 2RX

Mode	Channel	Frequency (MHz)	-6dB bandwidth (MHz)	-6dB bandwidth (MHz)	Limit (KHz)	Result
			Antenna A	Antenna B		
802.11a	149	5745	16.52	16.15	≧ 500	Pass
	157	5785	16.51	16.12	≧ 500	Pass
	165	5825	16.52	16.30	≧ 500	Pass
802.11 n20	149	5745	17.69	17.15	≧ 500	Pass
	157	5785	17.66	17.01	≧ 500	Pass
	165	5825	17.67	17.16	≧ 500	Pass
802.11 n40	151	5755	36.49	36.14	≧ 500	Pass
	159	5795	36.46	36.17	≧ 500	Pass
802.11 AC20	149	5745	17.72	17.12	≧ 500	Pass
	157	5785	17.73	17.11	≧ 500	Pass
	165	5825	17.75	17.16	≧ 500	Pass
802.11 AC40	149	5745	36.47	36.04	≧ 500	Pass
	157	5785	36.47	36.20	≧ 500	Pass
802.11 AC80	155	5775	75.33	75.27	≧ 500	Pass

Test plot

(802.11a) 6dB Bandwidth plot on channel 149

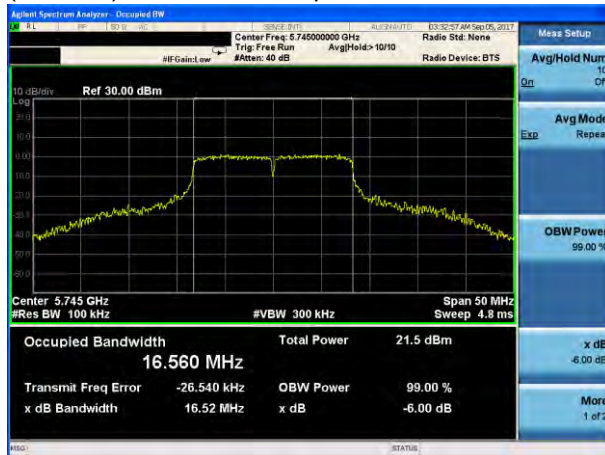

(802.11 n20) 6dB Bandwidth plot on channel 149

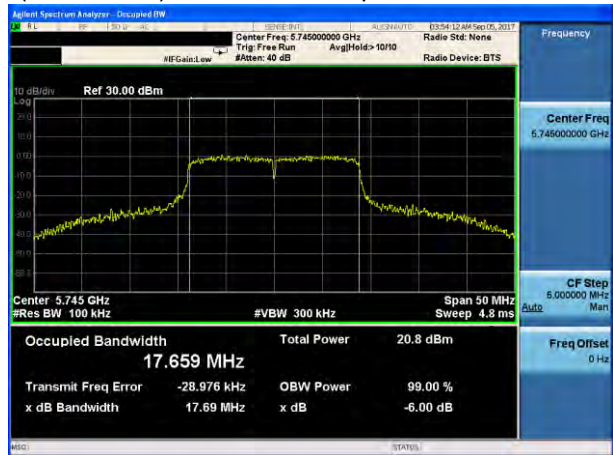

(802.11a) 6dB Bandwidth plot on channel 157

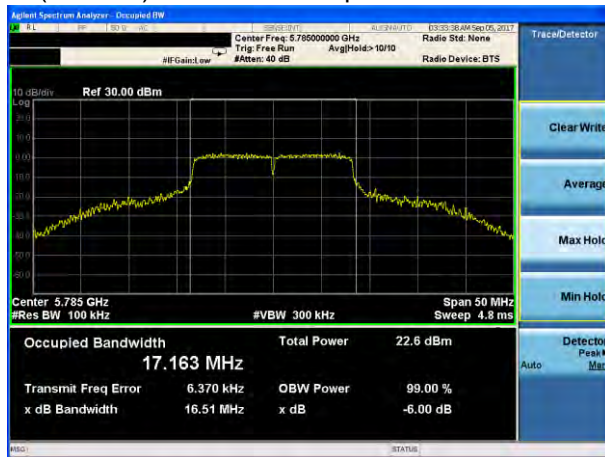

(802.11 n20) 6dB Bandwidth plot on channel 157

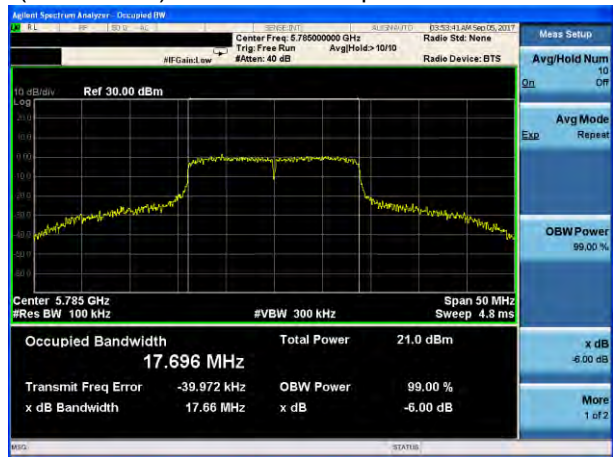

(802.11a) 6dB Bandwidth plot on channel 165

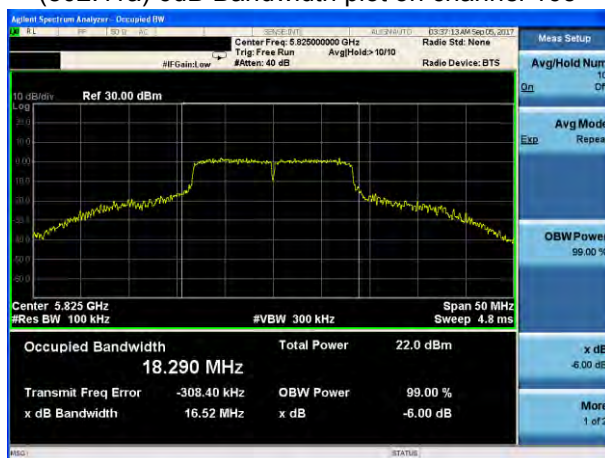

(802.11 n20) 6dB Bandwidth plot on channel 165

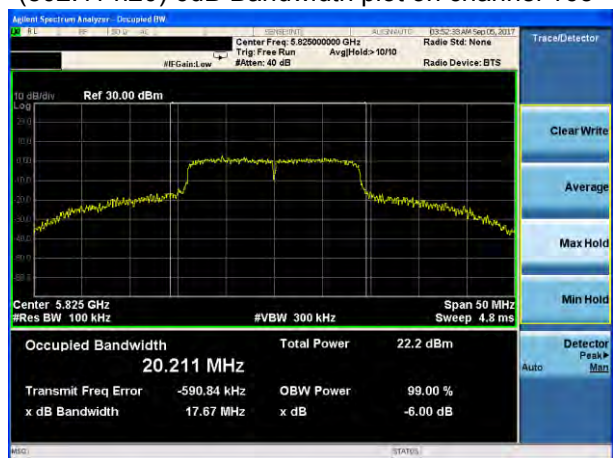

Test plot

(802.11 n40) 6dB Bandwidth plot on channel 151

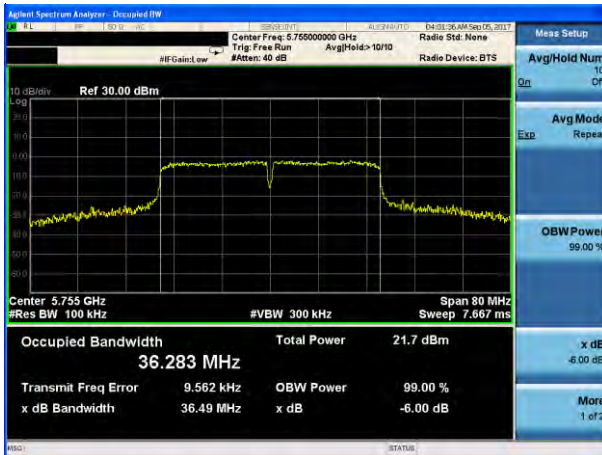

(802.11 AC20) 6dB Bandwidth plot on channel 149

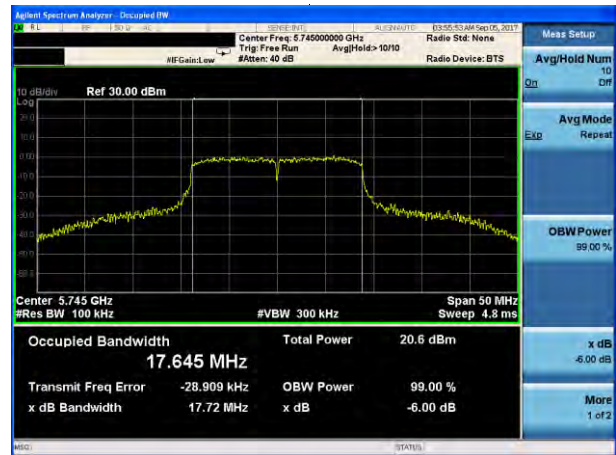

(802.11 n40) 6dB Bandwidth plot on channel 159

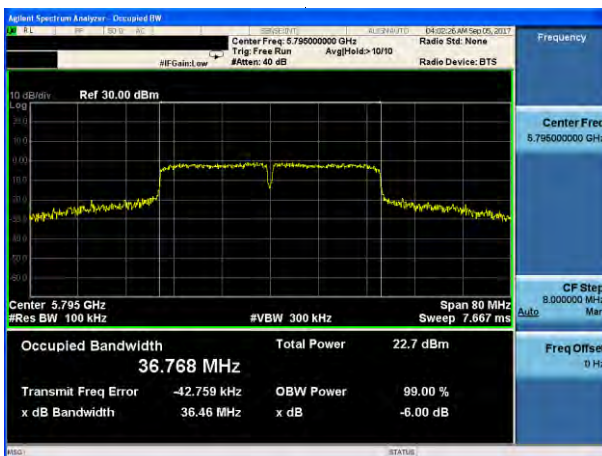

(802.11 AC20) 6dB Bandwidth plot on channel 157

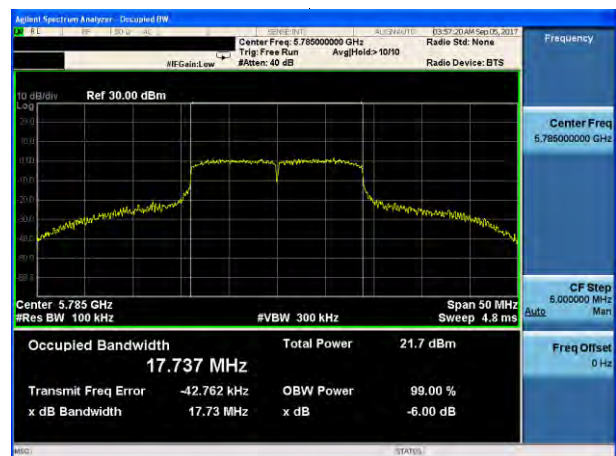

(802.11 AC20) 6dB Bandwidth plot on channel 165

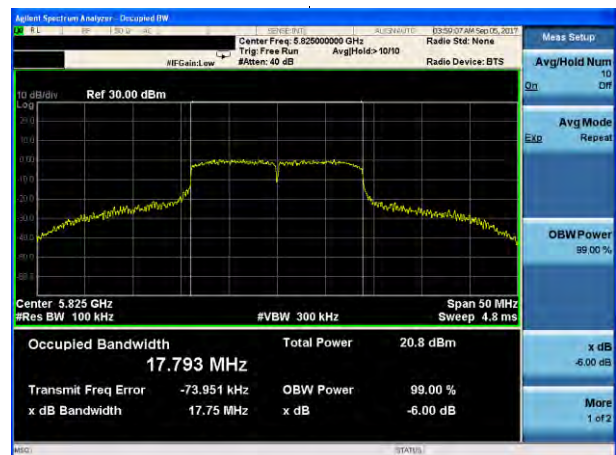

Test plot

(802.11 AC40) 6dB Bandwidth plot on channel 151

(802.11 AC80) 6dB Bandwidth plot on channel 155

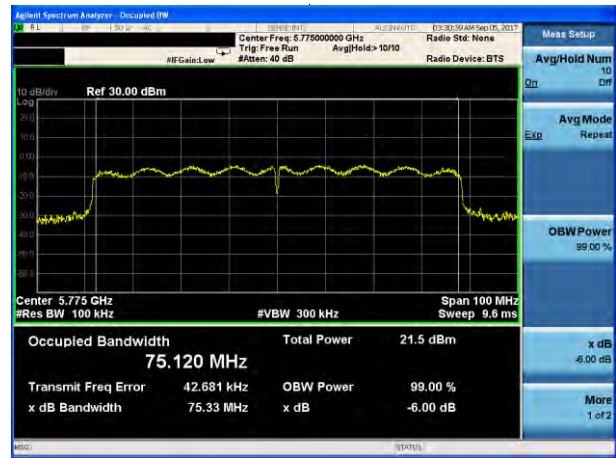
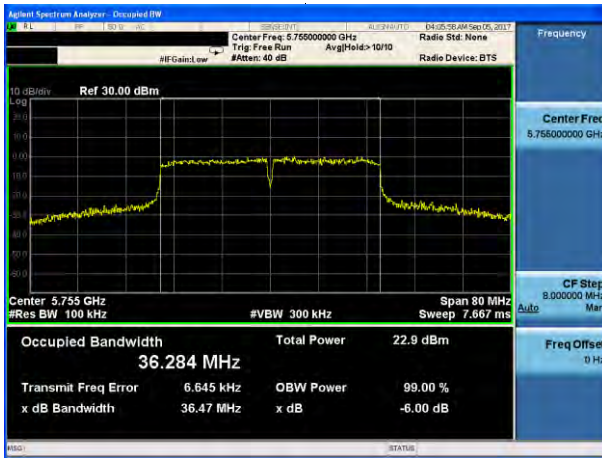

(802.11 AC40) 6dB Bandwidth plot on channel 159

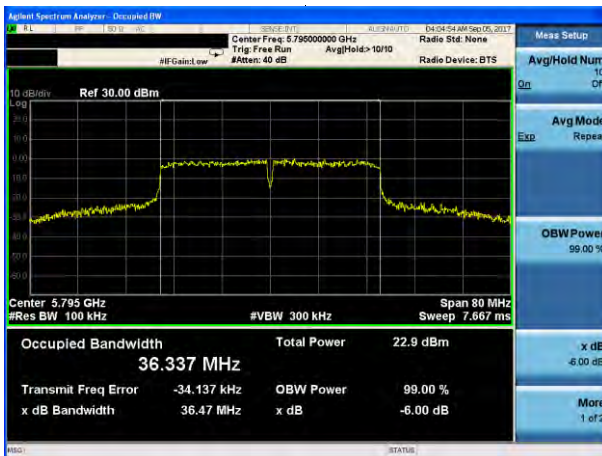

7. MAXIMUM CONDUCTED OUTPUT POWER

7.1 PPLIED PROCEDURES / LIMIT

According to FCC §15.407

The maximum conducted output power should not exceed:

Frequency Band(MHz)	Limit
5150~5250	1W(For an indoor access point)
5725~5850	1W

7.2 TEST PROCEDURE

· Maximum conducted output power may be measured using a spectrum analyzer/EMI receiver or an RF power meter.

1. Device Configuration

If possible, configure or modify the operation of the EUT so that it transmits continuously at its maximum power control level (see section II.B.).

a) The intent is to test at 100 percent duty cycle; however a small reduction in duty cycle (to no lower than 98 percent) is permitted if required by the EUT for amplitude control purposes. Manufacturers are expected to provide software to the test lab to permit such continuous operation.

b) If continuous transmission (or at least 98 percent duty cycle) cannot be achieved due to hardware limitations (e.g., overheating), the EUT shall be operated at its maximum power control level with the transmit duration as long as possible and the duty cycle as high as possible.

2. Measurement using a Spectrum Analyzer or EMI Receiver (SA)

Measurement of maximum conducted output power using a spectrum analyzer requires integrating the spectrum across a frequency span that encompasses, at a minimum, either the EBW or the 99-percent occupied bandwidth of the signal.¹ However, the EBW must be used to determine bandwidth dependent limits on maximum conducted output power in accordance with § 15.407(a).

a) The test method shall be selected as follows: (i) Method SA-1 or SA-1 Alternative (averaging with the EUT transmitting at full power throughout each sweep) shall be applied if either of the following conditions can be satisfied:

- The EUT transmits continuously (or with a duty cycle ≥ 98 percent).
- Sweep triggering or gating can be implemented in a way that the device transmits at the maximum power control level throughout the duration of each of the instrument sweeps to be averaged. This condition can generally be achieved by triggering the instrument's sweep if the duration of the sweep (with the analyzer configured as in Method SA-1, below) is equal to or shorter than the duration T of each transmission from the EUT and if those transmissions exhibit full power throughout their durations.

(ii) Method SA-2 or SA-2 Alternative (averaging across on and off times of the EUT transmissions, followed by duty cycle correction) shall be applied if the conditions of (i) cannot be achieved and the transmissions exhibit a constant duty cycle during the measurement duration. Duty cycle will be considered to be constant if variations are less than ± 2 percent.

(iii) Method SA-3 (RMS detection with max hold) or SA-3 Alternative (reduced VBW with max hold) shall be applied if the conditions of (i) and (ii) cannot be achieved.

b) Method SA-1 (trace averaging with the EUT transmitting at full power throughout each sweep): (i) Set span to encompass the entire emission bandwidth (EBW) (or, alternatively, the entire 99% occupied bandwidth) of the signal.

(ii) Set RBW = 1 MHz.

(iii) Set VBW ≥ 3 MHz.

(iv) Number of points in sweep ≥ 2 Span / RBW. (This ensures that bin-to-bin spacing is \leq RBW/2, so that narrowband signals are not lost between frequency bins.)

(v) Sweep time = auto.

(vi) Detector = RMS (i.e., power averaging), if available. Otherwise, use sample detector mode.

(vii) If transmit duty cycle < 98 percent, use a video trigger with the trigger level set to enable triggering only on full power pulses. Transmitter must operate at maximum power control level for the entire duration of every sweep. If the EUT transmits continuously (i.e., with no off intervals) or at duty cycle ≥ 98 percent, and if each transmission is entirely at the maximum power control level, then the trigger shall be set to "free run".

(viii) Trace average at least 100 traces in power averaging (i.e., RMS) mode.

(ix) Compute power by integrating the spectrum across the EBW (or, alternatively, the entire 99% occupied bandwidth) of the signal using the instrument's band power measurement function with band limits set equal to the EBW (or occupied bandwidth) band edges. If the instrument does not have a band power function, sum the spectrum

7.3 DEVIATION FROM STANDARD

No deviation.

7.4 TEST SETUP

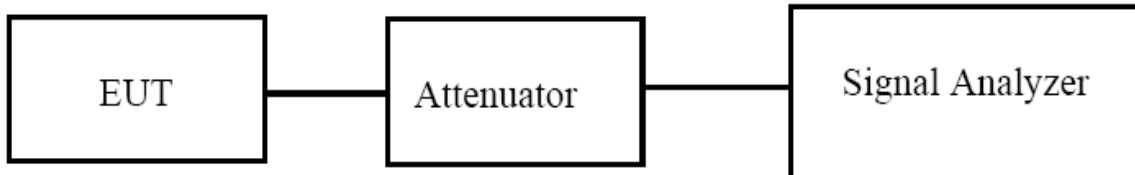

7.5 EUT OPERATION CONDITIONS

The EUT tested system was configured as the statements of 2.4 Unless otherwise a special operating condition is specified in the follows during the testing.

7.6 TEST RESULTS

EUT :	MyWirelessTV3 Wireless HD Transmitter, 4K Wireless HD Connection Kit	Model Name. :	MWTV3TX
Temperature :	25 °C	Relative Humidity :	60%
Pressure :	1012 hPa	Test Voltage :	DC 5V
Test Mode :	TX (5G) Mode Frequency Band I (5150-5250MHz)		

Note: EUT has two antennas, and different modes support different transmit mode what describe as Following form:

Mode	Tx/Rx
802.11a	1TX, 2RX
802.11n/ac	1TX/2TX, 2RX

Test Channel	Frequency	Maximum output power. Antenna port		Total Power	LIMIT (dBm)		Result
		(AV) (dBm)		(AV)			
	(MHz)	ANT A	ANT B	dBm	ANT A	ANT B	
TX 802.11a Mode							
CH36	5180	18.6	18.5	–	30	29.6	Pass
CH40	5200	19.1	18.8	–	30	29.6	Pass
CH48	5240	18.9	18.7	–	30	29.6	Pass
TX 802.11 n20M Mode							
CH36	5180	19.3	18.9	22.11	27.7		Pass
CH40	5200	19.5	19.1	22.31	27.7		Pass
CH48	5240	19.2	19.2	22.21	27.7		Pass
TX 802.11 n40M Mode							
CH38	5190	17.6	17.3	20.46	27.7		Pass
CH46	5230	17.4	17.1	20.26	27.7		Pass
TX 802.11 AC20M Mode							
CH36	5180	19.3	19.8	22.57	27.7		Pass
CH40	5200	19.2	19.7	22.47	27.7		Pass
CH48	5240	18.9	19.4	22.17	27.7		Pass
TX 802.11 AC40M Mode							
CH38	5190	17.4	17.2	20.31	27.7		Pass
CH46	5230	17.7	17.4	20.56	27.7		Pass
TX 802.11 AC80M Mode							
CH42	5210	16.5	15.6	19.08	27.7		Pass

Note: 1. For 802.11n/ac 5GHz has MIMO mode. Directional gain=8.30dbi

$$8.30 \text{ dbi} > 6.0 \text{ dbi} \text{ so power density limit} = 30 - (8.30 - 6) = 27.7$$

2. For 802.11a mode. ANT B Directional gain=6.4dbi

$$6.4 \text{ dbi} > 6.0 \text{ dbi} \text{ so power density limit} = 30 - (6.4 - 6) = 29.6 \text{ dBm/MHz}$$

EUT :	MyWirelessTV3 Wireless HD Transmitter, 4K Wireless HD Connection Kit	Model Name. :	MWTV3TX
Temperature :	25 °C	Relative Humidity :	60%
Pressure :	1012 hPa	Test Voltage :	DC 5V
Test Mode :	TX (5G) Mode Frequency Band IV (5725-5825MHz)		

Note:

EUT has two antennas, and different modes support different transmit mode what describe as Following form:

Mode	Tx/Rx
802.11a	1TX, 2RX
802.11n/ac	1TX/2TX, 2RX

Test Channel	Frequency	Maximum output power. Antenna port		Total Power	LIMIT	Result
		(AV) (dBm)		(AV)		
	(MHz)	ANT A	ANT B	dBm	dBm	
TX 802.11a Mode						
CH 149	5745	19.7	19.2	-	30	Pass
CH 157	5785	19.6	19.5	-	30	Pass
CH 165	5825	19.8	19.6	-	30	Pass
TX 802.11 n20M Mode						
CH 149	5745	19.2	19.5	22.36	28.35	Pass
CH 157	5785	19.9	19.1	22.53	28.35	Pass
CH 165	5825	19.7	19.0	22.37	28.35	Pass
TX 802.11 n40M Mode						
CH 151	5755	18.2	18.3	21.26	28.35	Pass
CH 159	5795	18.4	18.1	21.26	28.35	Pass
TX 802.11 AC20M Mode						
CH 149	5745	19.3	19.2	22.26	28.35	Pass
CH 157	5785	19.1	19.0	22.06	28.35	Pass
CH 165	5825	19.7	19.3	22.51	28.35	Pass
TX 802.11 AC40M Mode						
CH 151	5755	17.9	17.8	20.86	28.35	Pass
CH 159	5795	18.2	17.7	20.97	28.35	Pass
TX 802.11 AC80M Mode						
CH 155	5775	17.7	17.5	20.61	28.35	Pass

Note: For 802.11n/ac 5GHz has MIMO mode. Directional gain=7.65dbi

$7.65 \text{ dbi} > 6.0 \text{ dbi}$ so power density limit = $30 - (7.65 - 6) = 28.35$

8. OUT OF BAND EMISSIONS

8.1 APPLICABLE STANDARD

According to FCC §15.407(b)

Undesirable emission limits. Except as shown in paragraph (b)(7) of this section, the maximum emissions outside of the frequency bands of operation shall be attenuated in accordance with the following limits:

(1) For transmitters operating in the 5.15-5.25 GHz band: All emissions outside of the 5.15-5.35 GHz band shall not exceed an e.i.r.p. of -27 dBm/MHz.

(2) For transmitters operating in the 5.725-5.85 GHz band: All emissions within the frequency range from the band edge to 10 MHz above or below the band edge shall not exceed an e.i.r.p. of -17 dBm/MHz; for frequencies 10 MHz or greater above or below the band edge, emissions shall not exceed an e.i.r.p. of -27 dBm/MHz.

8.2 TEST PROCEDURE

1. Check the calibration of the measuring instrument using either an internal calibrator or a known signal from an external generator.
2. Position the EUT without connection to measurement instrument. Turn on the EUT and connect its antenna terminal to measurement instrument via a low loss cable. Then set it to any one measured frequency within its operating range, and make sure the instrument is operated in its linear range.
3. Set RBW of spectrum analyzer to 1 MHz with a convenient frequency span.
4. Measure the highest amplitude appearing on spectral display and set it as a reference level. Plot the graph with marking the highest point and edge frequency.
5. Repeat above procedures until all measured frequencies were complete.

8.3 DEVIATION FROM STANDARD

No deviation.

8.4 TEST SETUP

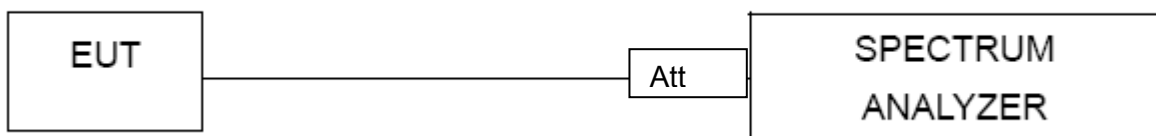

8.5 EUT OPERATION CONDITIONS

The EUT tested system was configured as the statements of 2.4 Unless otherwise a special operating condition is specified in the follows during the testing.

8.6 TEST RESULTS

EUT :	MyWirelessTV3 Wireless HD Transmitter, 4K Wireless HD Connection Kit	Model Name. :	MWTV3TX
Temperature :	25 °C	Relative Humidity :	56%
Pressure :	1012 hPa	Test Voltage :	DC 5V

Note: A(B) Represent the value of antenna A and B, The worst data is Antenna A ,only shown Antenna A Plot.

EUT has two antennas, and different modes support different transmit mode what describe as Following form:

Mode	Tx/Rx
802.11a	1TX, 2RX
802.11n/ac	1TX/2TX, 2RX

5.2G

5.15~5.25 GHz

(802.11a) Band Edge, Left Side

(802.11n20) Band Edge, Left Side



(802.11a) Band Edge, Right Side

(802.11n20) Band Edge, Right Side

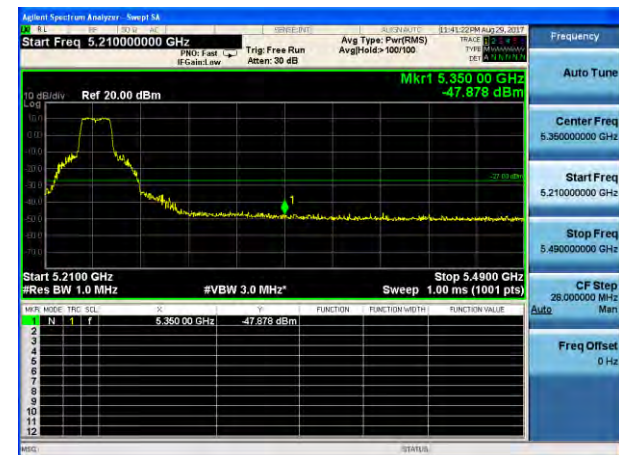
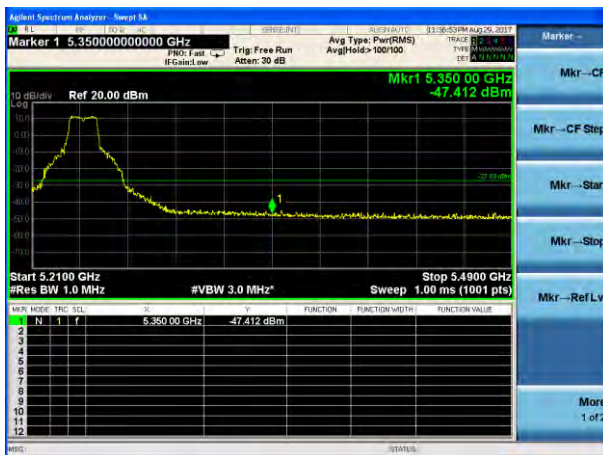

5.15~5.25 GHz

(802.11n40) Band Edge, Left Side

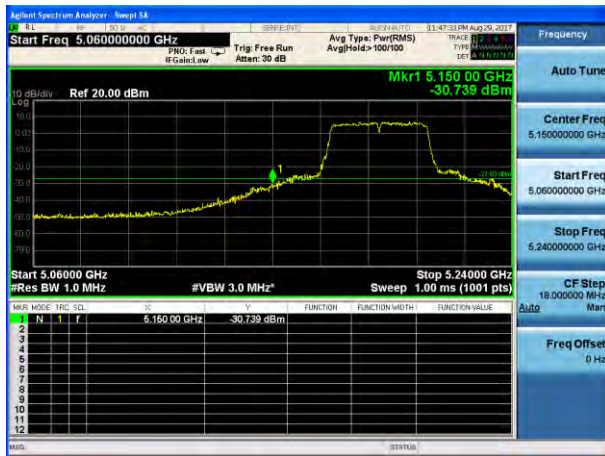

(802.11ac20) Band Edge, Left Side



(802.11n40) Band Edge, Right Side



(802.11ac20) Band Edge, Right Side



5.15~5.25 GHz

(802.11ac40) Band Edge, Left Side



(802.11ac80) Band Edge, Left Side



(802.11ac40) Band Edge, Right Side



(802.11ac80) Band Edge, Right Side



5.8G

5.75~5.85 GHz

(802.11a) Band Edge, Left Side

(802.11n20) Band Edge, Left Side

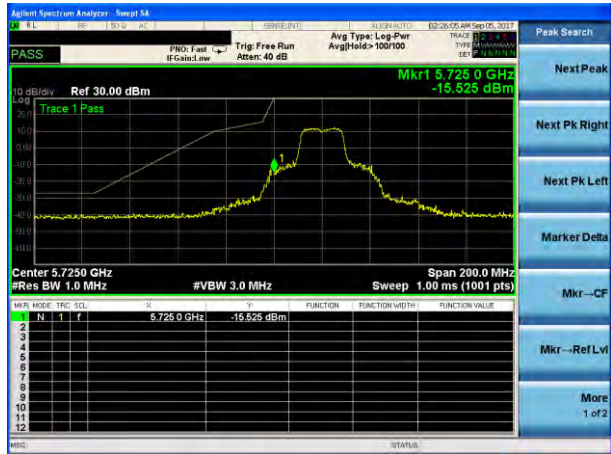
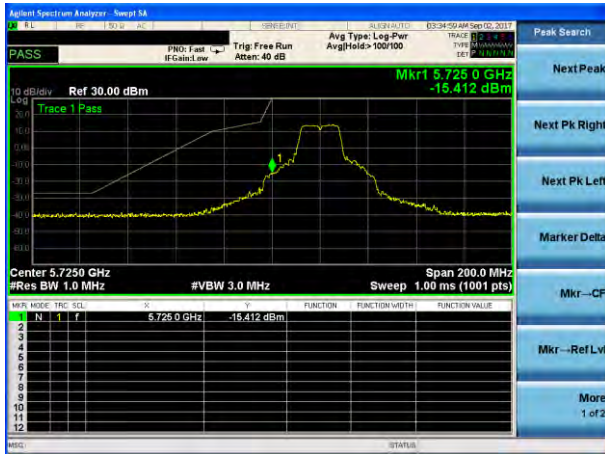

(802.11a) Band Edge, Right Side

(802.11n20) Band Edge, Right Side

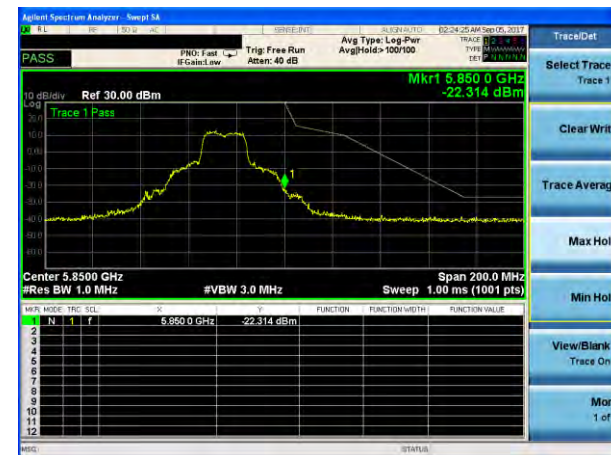
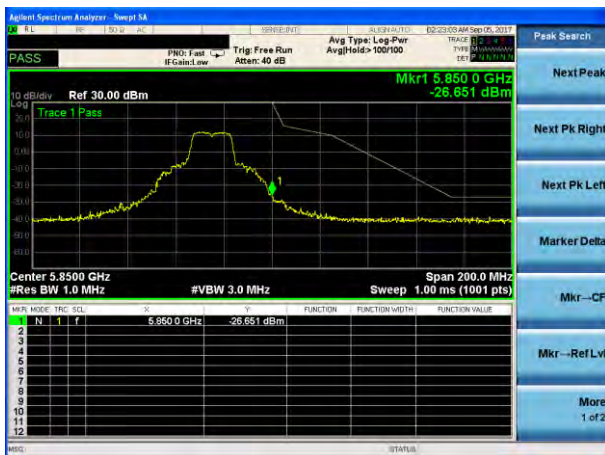

5.75~5.85 GHz

(802.11n40) Band Edge, Left Side



(802.11ac20) Band Edge, Left Side

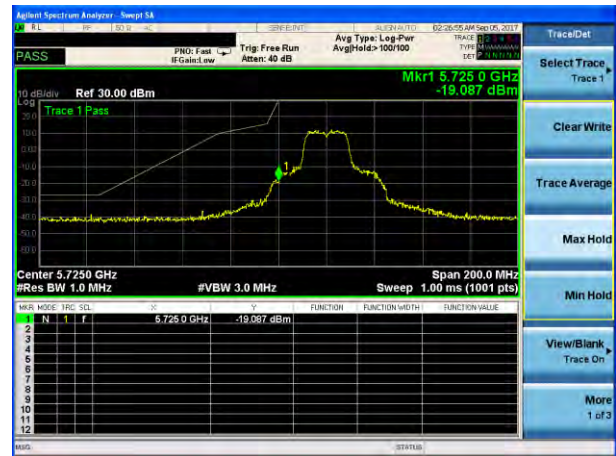

(802.11n40) Band Edge, Right Side



(802.11ac20) Band Edge, Right Side

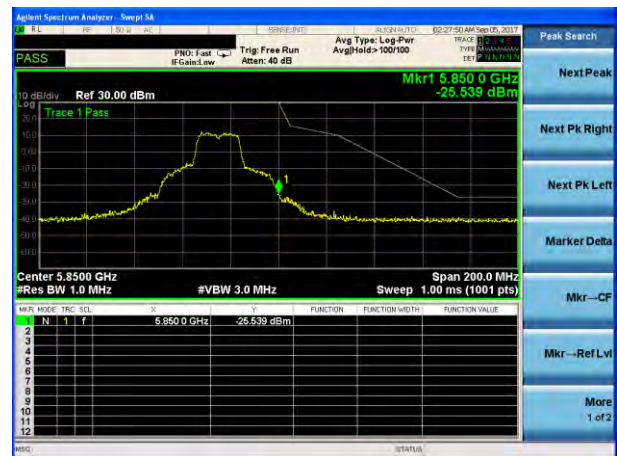

5.75~5.83 GHz

(802.11ac40) Band Edge, Left Side



(802.11ac80) Band Edge, Left Side



(802.11ac40) Band Edge, Right Side



(802.11ac80) Band Edge, Right Side



9.SPURIOUS RF CONDUCTED EMISSIONS

9.1CONFORMANCE LIMIT

1. Below -20dB of the highest emission level in operating band.
2. Fall in the restricted bands listed in section 15.205. The maximum permitted average field strength is listed in section 15.209.

9.2MEASURING INSTRUMENTS

The Measuring equipment is listed in the section 6.3 of this test report.

9.3TEST SETUP

Please refer to Section 6.1 of this test report.

9.4TEST PROCEDURE

The Spurious RF conducted emissions compliance of RF radiated emission should be measured by following the guidance in ANSI C63.10-2013 with respect to maximizing the emission by rotating the EUT, measuring the emission while the EUT is situated in three orthogonal planes (if appropriate), adjusting the measurement antenna height and polarization etc. Set RBW=100kHz and VBW= 300KHz to measure the peak field strength , and mwasure frequency range from 9KHz to 26.5GHz.

9.5TEST RESULTS

Remark: The measurement frequency range is from 9KHz to the 10th harmonic of the fundamental frequency. The lowest, middle and highest channels are tested to verify the spurious emissions and bandege measurement data.

Note: A(B) Represent the value of antenna A and B, The worst data is Antenna A ,only shown Antenna A Plot.

EUT has two antennas, and different modes support different transmit mode what describe as Following form:

Mode	Tx/Rx
802.11a	1TX, 2RX
802.11n/ac	1TX/2TX, 2RX

5.2G Test Plot

802.11a on channel 36

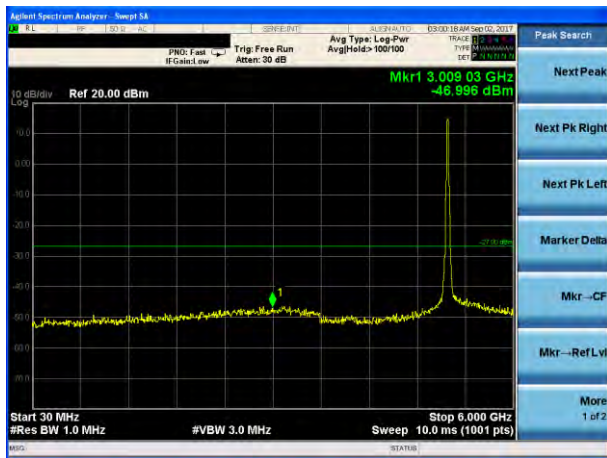

802.11a on channel 40

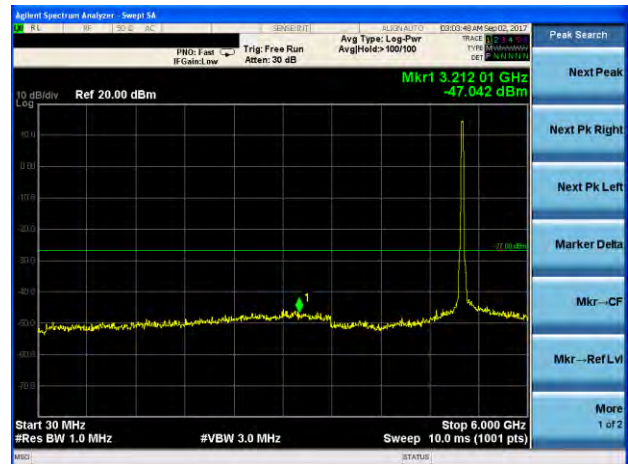

802.11a on channel 36



802.11a on channel 40



Test Plot

802.11a on channel 48

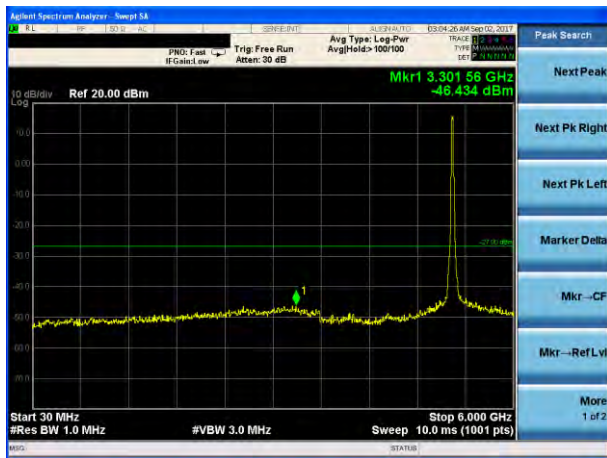

802.11n20 on channel 36

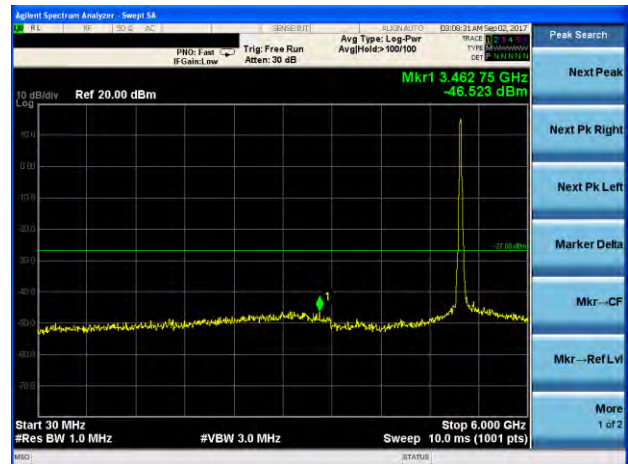

802.11a on channel 48



802.11n20 on channel 36



Test Plot

802.11n20 on channel 40

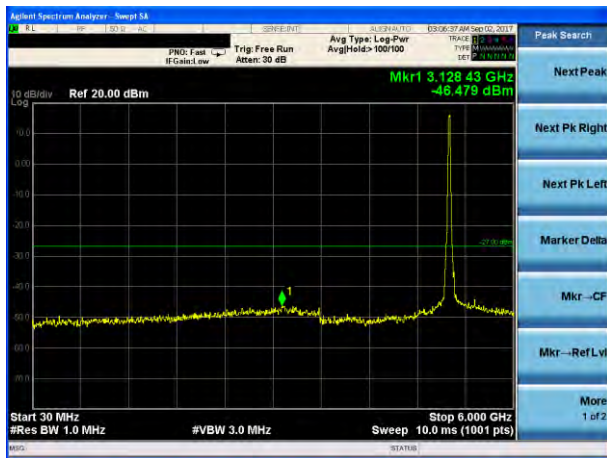

802.11n20 on channel 48



802.11n20 on channel 40



802.11n20 on channel 48



Test Plot

802.11n40 on channel 38

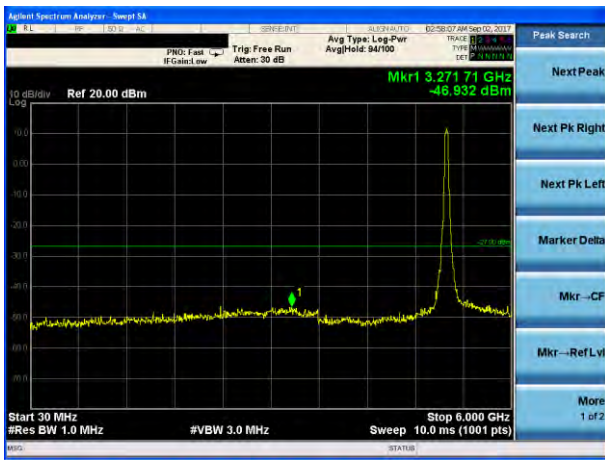

802.11n40 on channel 46

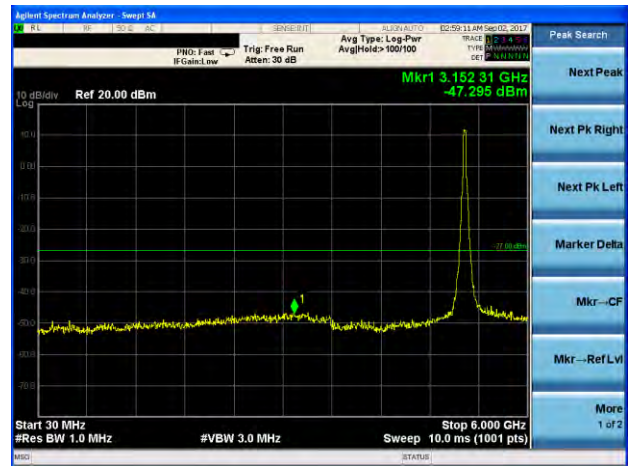

802.11n40 on channel 38



802.11n40 on channel 46



Test Plot

802.11ac20 on channel 36

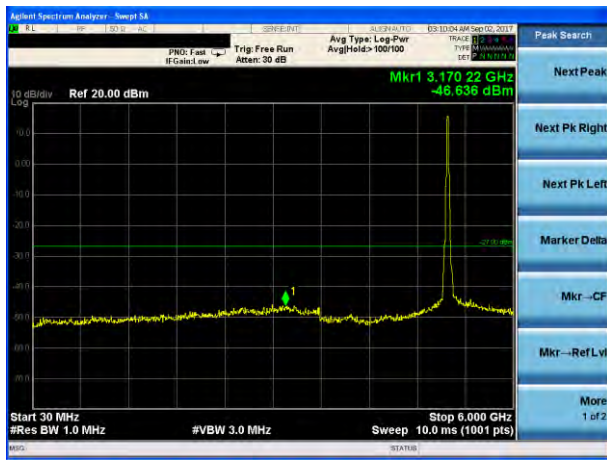

802.11ac20 on channel 40

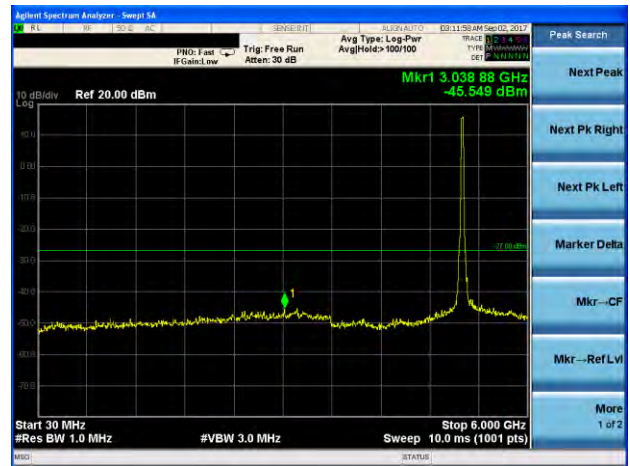

802.11ac20 on channel 36



802.11ac20 on channel 40



Test Plot

802.11ac20 on channel 48



802.11ac40 on channel 38

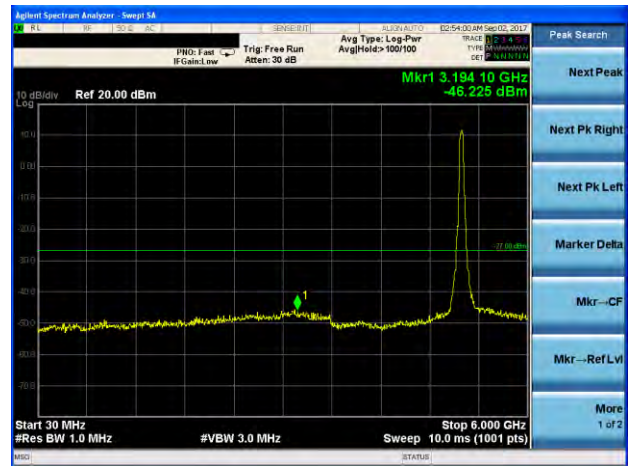

802.11ac20 on channel 48



802.11ac40 on channel 38



Test Plot

802.11ac40 on channel 46



802.11ac80 on channel 42

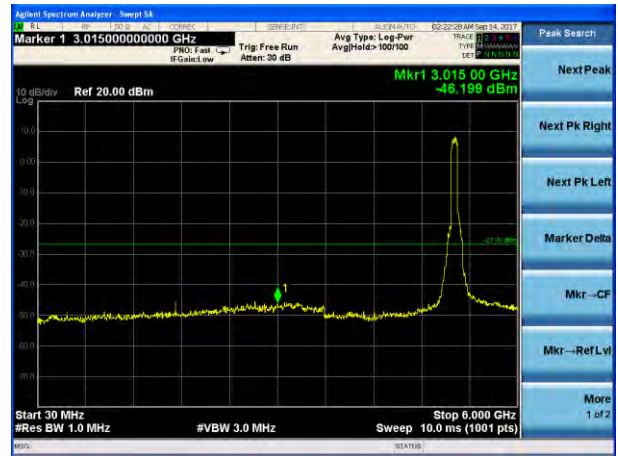

802.11 ac40 on channel 46



802.11 ac80 on channel 42



5.8G Test Plot

802.11a on channel 149



802.11a on channel 157



802.11a on channel 149



802.11a on channel 157



Test Plot

802.11a on channel 165

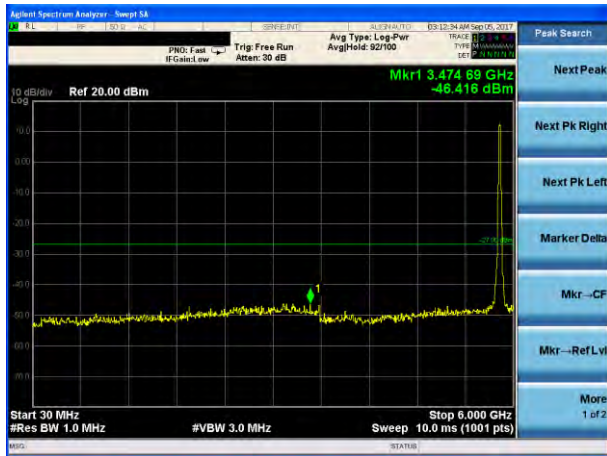

802.11n20 on channel 149



802.11a on channel 165



802.11n20 on channel 149



Test Plot

802.11n20 on channel 157



802.11n20 on channel 165



802.11n20 on channel 157



802.11n20 on channel 165



Test Plot

802.11n40 on channel 151



802.11n40 on channel 159



802.11n40 on channel 151



802.11n40 on channel 159



Test Plot

802.11ac20 on channel 149



802.11ac20 on channel 157



802.11ac20 on channel 149



802.11ac20 on channel 157



Test Plot

802.11ac20 on channel 165

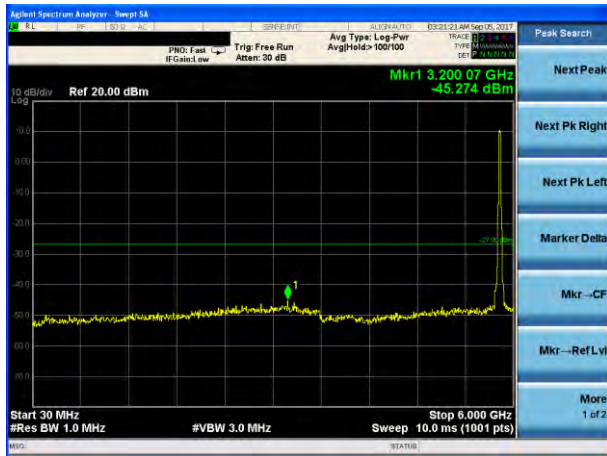

802.11ac40 on channel 151



802.11ac20 on channel 165



802.11ac40 on channel 151



Test Plot

802.11ac40 on channel 159



802.11ac80 on channel 155



802.11 ac40 on channel 159



802.11 ac80 on channel 155



10. Frequency Stability Measurement

10.1 LIMIT

Manufactures of U-NII devices are responsible for ensuring frequency stability such that an emission is maintained within the band of operation under all conditions of normal operation as specified in the user's manual.

The transmitter center frequency tolerance shall be ± 20 ppm maximum for the 5 GHz band (IEEE 802.11n specification).

10.2 TEST PROCEDURES

1. The transmitter output (antenna port) was connected to the spectrum analyzer.
2. EUT have transmitted absence of modulation signal and fixed channelize.
3. Set the spectrum analyzer span to view the entire absence of modulation emissions bandwidth.
4. Set RBW = 10 kHz, VBW = 10 kHz with peak detector and maxhold settings.
5. f_c is declaring of channel frequency. Then the frequency error formula is $(f_c - f) / f_c \times 10^6$ ppm and the limit is less than ± 20 ppm (IEEE 802.11n specification).
6. The test extreme voltage is to change the primary supply voltage from 85 to 115 percent of the nominal value
7. Extreme temperature is $-20^\circ\text{C} \sim 70^\circ\text{C}$.

10.3 TEST SETUP LAYOUT

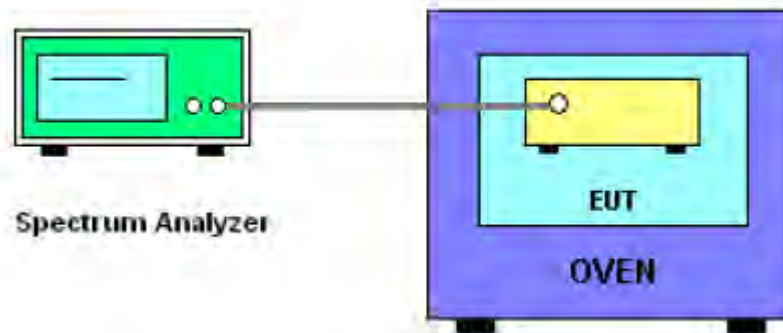

10.4 EUT OPERATION DURING TEST

The EUT was programmed to be in continuously un-modulation transmitting mode.

10.5 TEST RESULTS

EUT :	MyWirelessTV3 Wireless HD Transmitter, 4K Wireless HD Connection Kit	Model Name. :	MWTV3TX
Temperature :	25 °C	Relative Humidity :	56%
Pressure :	1012 hPa	Test Voltage :	DC 5V
Test Mode :	TX Frequency Band I (5150-5250MHz)		

Voltage vs. Frequency Stability

TEST CONDITIONS				Reference Frequency: 5180MHz			
				f	fc	Max. Deviation (MHz)	Max. Deviation (ppm)
T nom (°C)	20	V nom (V)	5.00	5180.0063	5180	0.0063	-1.2162
		V max (V)	5.75	5180.0024	5180	0.0024	-0.4633
		V min (V)	4.25	5180.0109	5180	0.0109	-2.1042
Limits				± 20 ppm			
Result				Complies			

Temperature vs. Frequency Stability

TEST CONDITIONS				Reference Frequency: 5180MHz			
				f	fc	Max. Deviation (MHz)	Max. Deviation (ppm)
V nom (V)	5	T (°C)	-20	5180.0113	5180	0.0113	-2.1815
		T (°C)	-10	5180.0096	5180	0.0096	-1.8533
		T (°C)	0	5180.0074	5180	0.0074	-1.4286
		T (°C)	10	5180.0101	5180	0.0101	-1.9498
		T (°C)	20	5180.0100	5180	0.0100	-1.9305
		T (°C)	30	5180.0121	5180	0.0121	-2.3359
		T (°C)	40	5180.0117	5180	0.0117	-2.2587
		T (°C)	50	5180.0092	5180	0.0092	-1.7761
		T (°C)	60	5180.0085	5180	0.0085	-1.6409
		T (°C)	70	5180.0096	5180	0.0096	-1.8533
Limits				± 20 ppm			
Result				Complies			

Voltage vs. Frequency Stability

TEST CONDITIONS				Reference Frequency: 5200MHz			
				f	fc	Max. Deviation (MHz)	Max. Deviation (ppm)
T nom (°C)	20	V nom (V)	5.00	5200.0123	5200	0.0123	-2.3654
		V max (V)	5.75	5200.0099	5200	0.0099	-1.9038
		V min (V)	4.25	5200.0104	5200	0.0104	-2.0000
Limits				± 20 ppm			
Result				Complies			

Temperature vs. Frequency Stability

TEST CONDITIONS				Reference Frequency: 5200MHz			
				f	fc	Max. Deviation (MHz)	Max. Deviation (ppm)
V nom (V)	5	T (°C)	-20	5200.0069	5200	0.0069	-1.3269
		T (°C)	-10	5200.0102	5200	0.0102	-1.9615
		T (°C)	0	5200.0104	5200	0.0104	-2.0000
		T (°C)	10	5200.0100	5200	0.0100	-1.9231
		T (°C)	20	5200.0079	5200	0.0079	-1.5192
		T (°C)	30	5200.0093	5200	0.0093	-1.7885
		T (°C)	40	5200.0097	5200	0.0097	-1.8654
		T (°C)	50	5200.0123	5200	0.0123	-2.3654
		T (°C)	60	5200.0118	5200	0.0118	-2.2692
		T (°C)	70	5200.0113	5200	0.0113	-2.1731
Limits				± 20 ppm			
Result				Complies			

Voltage vs. Frequency Stability

TEST CONDITIONS				Reference Frequency: 5240MHz			
				f	fc	Max. Deviation (MHz)	Max. Deviation (ppm)
T nom (°C)	20	V nom (V)	5.00	5240.0102	5240	0.0102	-1.9466
		V max (V)	5.75	5240.0107	5240	0.0107	-2.0420
		V min (V)	4.25	5240.0105	5240	0.0105	-2.0038
Limits				± 20 ppm			
Result				Complies			

Temperature vs. Frequency Stability

TEST CONDITIONS				Reference Frequency: 5240MHz			
				f	fc	Max. Deviation (MHz)	Max. Deviation (ppm)
V nom (V)	5	T (°C)	-20	5240.0098	5240	0.0098	-1.8702
		T (°C)	-10	5240.0097	5240	0.0097	-1.8511
		T (°C)	0	5240.0107	5240	0.0107	-2.0420
		T (°C)	10	5240.0132	5240	0.0132	-2.5191
		T (°C)	20	5240.0114	5240	0.0114	-2.1756
		T (°C)	30	5240.0116	5240	0.0116	-2.2137
		T (°C)	40	5240.0107	5240	0.0107	-2.0420
		T (°C)	50	5240.0102	5240	0.0102	-1.9466
		T (°C)	60	5240.0104	5240	0.0104	-1.9847
		T (°C)	70	5240.0103	5240	0.0103	-1.9656
Limits				± 20 ppm			
Result				Complies			

EUT :	MyWirelessTV3 Wireless HD Transmitter, 4K Wireless HD Connection Kit	Model Name. :	MWTV3TX
Temperature :	25 °C	Relative Humidity :	56%
Pressure :	1012 hPa	Test Voltage :	DC 5V
Test Mode :	TX Frequency(5745-5850MHz)		

TEST CONDITIONS				Reference Frequency: 5745MHz			
				f	fc	Max. Deviation (MHz)	Max. Deviation (ppm)
T nom (°C)	20	V nom (V)	5.00	5745.00294	5745	0.00294	-0.5126
		V max (V)	5.75	5745.00123	5745	0.00123	-0.2148
		V min (V)	4.25	5745.00937	5745	0.00937	-1.6304
Limits				± 20 ppm			
Result				Complies			

Voltage vs. Frequency Stability

Temperature vs. Frequency Stability

TEST CONDITIONS				Reference Frequency: 5745MHz			
				f	fc	Max. Deviation (MHz)	Max. Deviation (ppm)
V nom (V)	5	T (°C)	-20	5745.00226	5745	0.00226	-0.3930
		T (°C)	-10	5745.00856	5745	0.00856	-1.4906
		T (°C)	0	5745.01080	5745	0.01080	-1.8803
		T (°C)	10	5745.00947	5745	0.00947	-1.6484
		T (°C)	20	5745.00693	5745	0.00693	-1.2067
		T (°C)	30	5745.00401	5745	0.00401	-0.6979
		T (°C)	40	5745.00395	5745	0.00395	-0.6879
		T (°C)	50	5745.00760	5745	0.00760	-1.3234
		T (°C)	60	5745.00441	5745	0.00441	-0.7674
		T (°C)	70	5745.00326	5745	0.00326	-0.5680
Limits				± 20 ppm			
Result				Complies			

Voltage vs. Frequency Stability

TEST CONDITIONS				Reference Frequency: 5785MHz			
				f	fc	Max. Deviation (MHz)	Max. Deviation (ppm)
T nom (°C)	20	V nom (V)	5.00	5785.00823	5785	0.00823	-1.4231
		V max (V)	5.75	5785.00355	5785	0.00355	-0.6142
		V min (V)	4.25	5785.00622	5785	0.00622	-1.0746
Limits				± 20 ppm			
Result				Complies			

Temperature vs. Frequency Stability

TEST CONDITIONS				Reference Frequency: 5785MHz			
				f	fc	Max. Deviation (MHz)	Max. Deviation (ppm)
V nom (V)	5	T (°C)	-20	5785.00709	5785	0.00709	-1.2248
		T (°C)	-10	5785.00885	5785	0.00885	-1.5303
		T (°C)	0	5785.01218	5785	0.01218	-2.1060
		T (°C)	10	5785.01067	5785	0.01067	-1.8441
		T (°C)	20	5785.00242	5785	0.00242	-0.4184
		T (°C)	30	5785.01241	5785	0.01241	-2.1458
		T (°C)	40	5785.00020	5785	0.00020	-0.0354
		T (°C)	50	5785.01178	5785	0.01178	-2.0362
		T (°C)	60	5785.00515	5785	0.00515	-0.8907
		T (°C)	70	5785.01272	5785	0.01272	-2.1994
Limits				± 20 ppm			
Result				Complies			

Voltage vs. Frequency Stability

TEST CONDITIONS				Reference Frequency: 5825MHz			
				f	fc	Max. Deviation (MHz)	Max. Deviation (ppm)
T nom (°C)	20	V nom (V)	5.00	5825.00259	5825	0.00259	-0.4449
		V max (V)	5.75	5825.00688	5825	0.00688	-1.1816
		V min (V)	4.25	5825.00758	5825	0.00758	-1.3012
Limits				± 20 ppm			
Result				Complies			

Temperature vs. Frequency Stability

TEST CONDITIONS				Reference Frequency: 5825MHz			
				f	fc	Max. Deviation (MHz)	Max. Deviation (ppm)
V nom (V)	5	T (°C)	-20	5825.00003	5825	0.00003	-0.0058
		T (°C)	-10	5825.00130	5825	0.00130	-0.2233
		T (°C)	0	5825.00903	5825	0.00903	-1.5504
		T (°C)	10	5825.00465	5825	0.00465	-0.7976
		T (°C)	20	5825.01034	5825	0.01034	-1.7755
		T (°C)	30	5825.00301	5825	0.00301	-0.5169
		T (°C)	40	5825.00351	5825	0.00351	-0.6033
		T (°C)	50	5825.00817	5825	0.00817	-1.4018
		T (°C)	60	5825.00651	5825	0.00651	-1.1184
		T (°C)	70	5825.00187	5825	0.00187	-0.3203
Limits				± 20 ppm			
Result				Complies			

11. ANTENNA REQUIREMENT

11.1 STANDARD REQUIREMENT

15.203 requirement: For intentional device, according to 15.203: an intentional radiator shall be designed to ensure that no antenna other than that furnished by the responsible party shall be used with the device.

11.2 EUT ANTENNA

Antenna	Brand	Model Name (P/N)	Antenna Type	Connector	Antenna Gain(dBi)	
					5.2G	5.8G
A(main)	Wha Yu	C787-510139-A(X5)	Dipole(PCB)	I-PEX	3.8	4.0
B(aux)	Wha Yu	C787-510138-A(X4)	Dipole(PCB)	I-PEX	6.4	5.2

The EUT antenna is permanent attached antenna. It comply with the standard requirement.

END OF REPORT