

FCC PART 15.407

TEST REPORT

For

Actiontec Electronics, Inc.

760 North Mary Avenue Sunnyvale, CA 94085, USA

FCC ID: LNQMWTV2TX

Report Type: Original Report	Product Type: MyWirelessTV 2 Wireless HD Transmitter
Test Engineer: Dean Liu	<i>Dean Liu</i>
Report Number: R2SH140320052-00B	
Report Date: 2014-05-20	
Reviewed By: Sula Huang RF Engineer	<i>Sula Huang</i>
Test Laboratory: Bay Area Compliance Laboratories Corp. (Dongguan) No.69 Pulongcun, Puxinhu Industrial Zone, Tangxia, Dongguan, Guangdong, China Tel: +86-769-86858888 Fax: +86-769-86858891 www.baclcorp.com.cn	

Note: This test report is prepared for the customer shown above and for the device described herein. It may not be duplicated or used in part without prior written consent from Bay Area Compliance Laboratories Corp. (Dongguan). This report is valid only with a valid digital signature. The digital signature may be available only under the Adobe software above version 7.0.

TABLE OF CONTENTS

GENERAL INFORMATION.....	4
PRODUCT DESCRIPTION FOR EQUIPMENT UNDER TEST (EUT).....	4
ANTENNA INFORMATION.....	4
OBJECTIVE.....	4
RELATED SUBMITTAL(S)/GRANT(S).....	4
TEST METHODOLOGY.....	4
TEST FACILITY.....	5
SYSTEM TEST CONFIGURATION.....	6
DESCRIPTION OF TEST CONFIGURATION.....	6
EUT EXERCISE SOFTWARE.....	6
EQUIPMENT MODIFICATIONS.....	6
SUPPORT EQUIPMENT LIST AND DETAILS.....	7
EXTERNAL CABLE.....	7
BLOCK DIAGRAM OF TEST SETUP.....	7
SUMMARY OF TEST RESULTS.....	8
FCC §15.407(f) & §1.1310 & §2.1091- MAXIMUM PERMISSIBLE EXPOSURE (MPE).....	9
APPLICABLE STANDARD.....	9
FCC §15.203 – ANTENNA REQUIREMENT.....	10
APPLICABLE STANDARD.....	10
ANTENNA CONNECTOR CONSTRUCTION.....	10
FCC §15.407 (b) (6) §15.207 (a) – CONDUCTED EMISSIONS.....	11
APPLICABLE STANDARD.....	11
MEASUREMENT UNCERTAINTY.....	11
EUT SETUP.....	11
EMI TEST RECEIVER SETUP.....	12
CORRECTED AMPLITUDE & MARGIN CALCULATION.....	12
TEST EQUIPMENT LIST AND DETAILS.....	12
TEST PROCEDURE.....	13
TEST RESULTS SUMMARY.....	13
TEST DATA.....	13
FCC §15.209, §15.205 & §15.407(b) (1) (6) (7) – UNDESIRABLE EMISSION & RESTRICTED BANDS.....	16
APPLICABLE STANDARD.....	16
MEASUREMENT UNCERTAINTY.....	16
EUT SETUP.....	17
EMI TEST RECEIVER & SPECTRUM ANALYZER SETUP.....	17
TEST PROCEDURE.....	18
CORRECTED AMPLITUDE & MARGIN CALCULATION.....	18
TEST EQUIPMENT LIST AND DETAILS.....	19
TEST RESULTS SUMMARY.....	19
TEST DATA.....	19
FCC §15.407(b) (1) (2) (3) (4) – OUT OF BAND EMISSIONS.....	50
APPLICABLE STANDARD.....	50
TEST PROCEDURE.....	50
TEST EQUIPMENT LIST AND DETAILS.....	50
TEST DATA.....	51
FCC §15.407(a) (1) – 26 dB OCCUPIED BANDWIDTH.....	58

APPLICABLE STANDARD58
TEST EQUIPMENT LIST AND DETAILS.....58
TEST PROCEDURE58
TEST DATA58

FCC §15.407(a) (1) – CONDUCTED TRANSMITTER OUTPUT POWER.....68
APPLICABLE STANDARD68
TEST EQUIPMENT LIST AND DETAILS.....68
TEST PROCEDURE68
TEST DATA69

FCC §15.407(a) (1) (5) - POWER SPECTRAL DENSITY78
APPLICABLE STANDARD78
TEST PROCEDURE78
TEST EQUIPMENT LIST AND DETAILS.....78
TEST DATA79

FCC §15.407(a) (6) – PEAK EXCURSION RATIO88
APPLICABLE STANDARD88
TEST PROCEDURE88
TEST EQUIPMENT LIST AND DETAILS.....88
TEST DATA88

GENERAL INFORMATION

Product Description for Equipment under Test (EUT)

The *Actiontec Electronics, Inc.*'s product, model number: *MWTV2Tx (FCC ID: LNQMWTV2TX)* or ("EUT") in this report is a *MyWirelessTV 2 Wireless HD Transmitter*, which was measured approximately: 12.0 cm (L) x 10.4 cm (W) x 2.8 cm (H), rated input voltage: DC 5.0V from adapter.

Adapter information: Actiontec
 Model name: WA-10P05FU
 Input: 100-240Vac, 50-60Hz, 0.3A Max
 Output: DC 5V, 2A

All measurement and test data in this report was gathered from production sample serial number: 140320052 (Assigned by BACL, Dongguan). The EUT was received on 2014-03-21.

Antenna information

Chain	Manufacturer	Model Name	Antenna Type	Max. Antenna Gain
0	Wha Yu	C787-510126-A	Dipole (PCB)	2400-2500MHz: 3.03dBi 4900-5825MHz: 5.14dBi
1	Wha Yu	C787-510126-A	Dipole (PCB)	2400-2500MHz: 3.03dBi 4900-5825MHz: 5.14dBi

Objective

This type approval report is prepared on behalf of *Actiontec Electronics, Inc.* in accordance with Part 2-Subpart J, Part 15-Subparts A, B and E of the Federal Communication Commissions rules.

The tests were performed in order to determine compliance with FCC Part 15, Subpart E, section 15.203, 15.205, 15.207, 15.209 and 15.407 rules.

Related Submittal(s)/Grant(s)

FCC Part 15C DTS submissions with FCC ID: *LNQMWTV2TX*

Test Methodology

All measurements contained in this report were conducted with ANSI C63.4-2003, American National Standard for Methods of Measurement of Radio-Noise Emissions from Low-Voltage Electrical and Electronic Equipment in the range of 9 kHz to 40 GHz.

All emissions measurement was performed and Bay Area Compliance Laboratories Corp. (Dongguan).

Test Facility

The Test site used by Bay Area Compliance Laboratories Corp. (Dongguan) to collect test data is located on the No.69 Pulongcun, Puxinhu Industrial Zone, Tangxia, Dongguan, Guangdong, China

Test site at Bay Area Compliance Laboratories Corp. (Dongguan) has been fully described in reports submitted to the Federal Communication Commission (FCC). The details of these reports have been found to be in compliance with the requirements of Section 2.948 of the FCC Rules on February 02, 2012. The facility also complies with the radiated and AC line conducted test site criteria set forth in ANSI C63.4-2003.

The Federal Communications Commission has the reports on file and is listed under FCC Registration No.: 273710. The test site has been approved by the FCC for public use and is listed in the FCC Public Access Link (PAL) database.

SYSTEM TEST CONFIGURATION

Description of Test Configuration

The EUT was configured for testing in an engineering mode which was provided by the manufacturer.

For 5150~5250 MHz band, 7 channels are provided to testing:

Channel	Frequency (MHz)	Channel	Frequency (MHz)
36	5180	44	5220
38	5190	46	5230
40	5200	48	5240
42	5210	/	/

For 802.11a, 802.11n ht20, Channel 36, 40 and 48 was tested, for 802.11n ht40, Channel 38, 46 were tested.

The worst-case data rates are determined to be as follows for each mode based upon investigations by measuring the average power and PSD across all data rates bandwidths, and modulations.

EUT Exercise Software

The software “AR6kArt2Win_SW.3110” was used for testing, which was provided by manufacturer. The worst condition (maximum power) was setting by the software as following table:

Test Mode	Test Software Version	AR6kArt2Win_SW.3110		
802.11 A	Test Frequency	5180MHz	5200MHz	5240MHz
	Data Rate	6Mbps	6Mbps	6Mbps
	Power Level Setting Chain0	12.5	15.5	15.5
	Power Level Setting Chain1	12.5	15.5	15.5
5G 802.11n ht20	Test Frequency	5180MHz	5200MHz	5240MHz
	Data Rate	MCS8	MCS8	MCS8
	Power Level Setting Chain0	12	15.5	15.5
	Power Level Setting Chain1	12	15.5	15.5
5G 802.11n ht40	Test Frequency	5190MHz	5230MHz	
	Data Rate	MCS8	MCS8	
	Power Level Setting Chain0	9	15.5	
	Power Level Setting Chain1	9	15.5	

Equipment Modifications

No modification was made to the EUT tested.

Support Equipment List and Details

Manufacturer	Description	Model	Serial Number
SAMSUNG	Monitor	S22C330H	ZXDCHTHD101491K
ACER	Laptop	V3-551G-10462G50Makk	NXM0ACN0042410363C3400
Kingston	USB Disk	8GB	U01
Kingston	USB Disk	8GB	U02

External Cable

Cable Description	Shielding Type	Ferrite Core	Length (m)	From Port	To
Adapter DC Cable	No	No	1.58	Adapter	EUT
HDMI Cable	Yes	No	1.20	HDMI Port of Monitor	EUT
HDMI Cable	Yes	No	0.92	HDMI Port of Laptop	EUT
IR blaster Cable	No	No	1.53	IR Port of EUT	IR blaster

Block Diagram of Test Setup

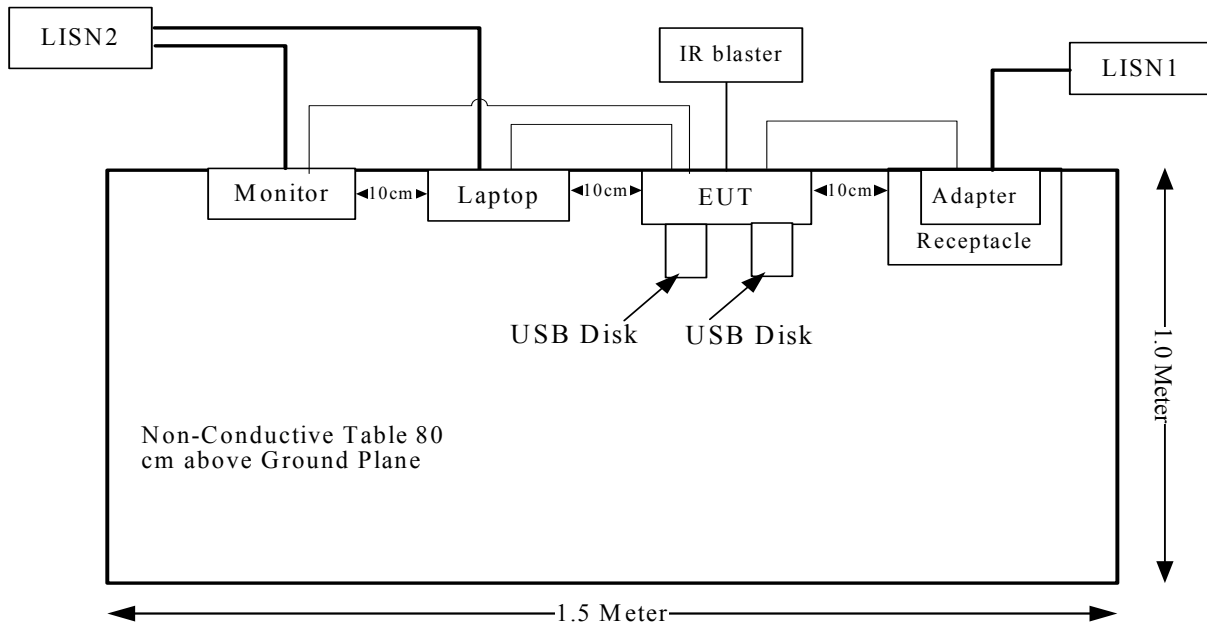

SUMMARY OF TEST RESULTS

FCC Rules	Description of Test	Result
FCC §15.407 (f) & §1.1310 & §2.1091	Maximum Permissible Exposure	Compliance
§15.203	Antenna Requirement	Compliance
§15.407(b)(6)& §15.207(a)	Conducted Emissions	Compliance
§15.205& §15.209 &§15.407(b) (1),(6),(7)	Undesirable Emission& Restricted Bands	Compliance
§15.407(b) (1),(2),(3),(4)	Out Of Band Emissions	Compliance
§15.407(a) (1)	26 dB Bandwidth	Compliance
§15.407(a)(1),	Conducted Transmitter Output Power	Compliance
§15.407 (a)(1),(5)	Power Spectral Density	Compliance
§15.407(a)(6)	Peak Excursion Ratio	Compliance

FCC §15.407(f) & §1.1310 & §2.1091- MAXIMUM PERMISSIBLE EXPOSURE (MPE)

Applicable Standard

According to subpart 15.407(f) and subpart §1.1310, systems operating under the provisions of this section shall be operated in a manner that ensures that the public is not exposed to radio frequency energy level in excess of the Commission’s guidelines.

Limits for Maximum Permissible Exposure (MPE) (§1.1310, §2.1091)

(B) Limits for General Population/Uncontrolled Exposure				
Frequency Range (MHz)	Electric Field Strength (V/m)	Magnetic Field Strength (A/m)	Power Density (mW/cm ²)	Averaging Time (minutes)
0.3–1.34	614	1.63	*(100)	30
1.34–30	824/f	2.19/f	*(180/f ²)	30
30–300	27.5	0.073	0.2	30
300–1500	/	/	f/1500	30
1500–100,000	/	/	1.0	30

f = frequency in MHz; * = Plane-wave equivalent power density;

According to §1.1310 and §2.1091 RF exposure is calculated.

Calculated Formulary:

Predication of MPE limit at a given distance

$S = PG/4\pi R^2$ = power density (in appropriate units, e.g. mW/cm²);

P = power input to the antenna (in appropriate units, e.g., mW);

G = power gain of the antenna in the direction of interest relative to an isotropic radiator, the power gain factor, is normally numeric gain;

R = distance to the center of radiation of the antenna (appropriate units, e.g., cm);

Calculated Data:

Mode	Frequency (MHz)	Antenna Gain		Conducted Power		Evaluation Distance (cm)	Power Density (mW/cm ²)	MPE Limit (mW/cm ²)
		(dBi)	(numeric)	(dBm)	(mW)			
802.11a	5200	5.14	3.27	14.53	28.38	20	0.018	1.0
5G-802.11n HT20	5200	5.14	3.27	14.38	27.42	20	0.018	1.0
5G-802.11n HT40	5230	5.14	3.27	14.24	26.55	20	0.017	1.0

Result: The device meet FCC MPE at 20 cm distance

FCC §15.203 – ANTENNA REQUIREMENT

Applicable Standard

According to § 15.203, An intentional radiator shall be designed to ensure that no antenna other than that furnished by the responsible party shall be used with the device. The use of a permanently attached antenna or of an antenna that uses a unique coupling to the intentional radiator shall be considered sufficient to comply with the provisions of this section. The manufacturer may design the unit so that a broken antenna can be replaced by the user, but the use of a standard antenna jack or electrical connector is prohibited.

And according to FCC 47 CFR section 15.407 (a)(1),if transmitting antennas of directional gain greater than 6 dBi are used, both the maximum conducted output power and the peak power spectral density shall be reduced by the amount in dB that the directional gain of the antenna exceeds 6 dBi.

Antenna Connector Construction

This product used two internal dipole antennas which were connected to the mainboard with I-PEX socket, the maximum gain is 3.03dBi for 2.4G band and 5.14dBi for 5G band, which fulfill the requirement of this section, and please refer to the EUT photos.

Result: Compliance.

FCC §15.407 (b) (6) §15.207 (a) – CONDUCTED EMISSIONS

Applicable Standard

FCC §15.207, §15.407(b) (6)

Measurement Uncertainty

Compliance or non-compliance with a disturbance limit shall be determined in the following manner:

If U_{lab} is less than or equal to U_{cispr} of Table 1, then:

- compliance is deemed to occur if no measured disturbance level exceeds the disturbance limit;
- non-compliance is deemed to occur if any measured disturbance level exceeds the disturbance limit.

If U_{lab} is greater than U_{cispr} of Table 1, then:

- compliance is deemed to occur if no measured disturbance level, increased by $(U_{lab} - U_{cispr})$, exceeds the disturbance limit;
- non-compliance is deemed to occur if any measured disturbance level, increased by $(U_{lab} - U_{cispr})$, exceeds the disturbance limit.

Based on CISPR 16-4-2: 2011, measurement uncertainty of conducted disturbance at mains port using AMN at Bay Area Compliance Laboratories Corp. (Dongguan) is 3.46 dB (150 kHz to 30 MHz).

Table 1 – Values of U_{cispr}

Measurement	U_{cispr}
Conducted disturbance at mains port using AMN (150 kHz to 30 MHz)	3.4 dB

EUT Setup

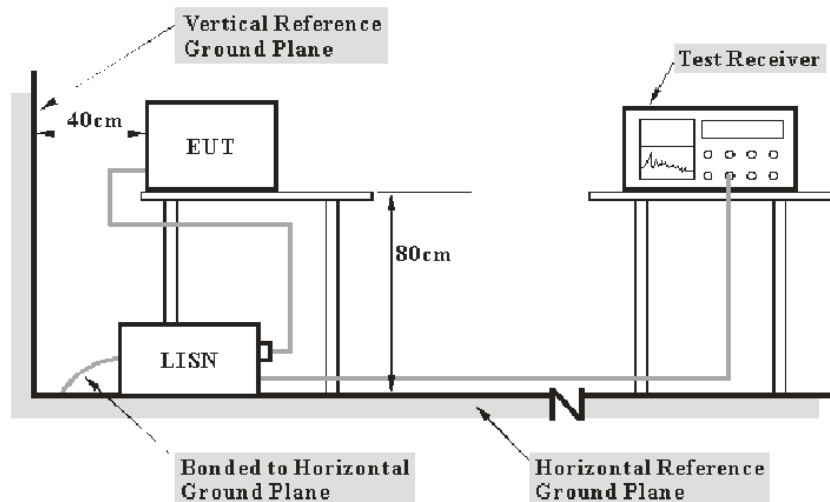

- Note: 1. Support units were connected to second LISN.
 2. Both of LISNs (AMN) 80 cm from EUT and at the least 80 cm from other units and other metal planes support units.

The setup of EUT is according with per ANSI C63.4-2003 measurement procedure. The specification used was with the FCC Part 15.207 limits.

The spacing between the peripherals was 10 cm.

The adapter was connected to a 120VAC/60 Hz power source.

EMI Test Receiver Setup

The EMI test receiver was set to investigate the spectrum from 150 kHz to 30 MHz.

During the conducted emission test, the EMI test receiver was set with the following configurations:

Frequency Range	IF B/W
150 kHz – 30 MHz	9 kHz

Corrected Amplitude & Margin Calculation

The basic equation is as follows:

$$V_C = V_R + A_C + VDF$$

$$C_f = A_C + VDF$$

Herein,

V_C (cord. Reading): corrected voltage amplitude

V_R : reading voltage amplitude

A_C : attenuation caused by cable loss

VDF: voltage division factor of AMN

C_f : Correction Factor

The “**Margin**” column of the following data tables indicates the degree of compliance within the applicable limit. For example, a margin of 7dB means the emission is 7dB below the maximum limit. The equation for margin calculation is as follows:

$$\text{Margin} = \text{Limit} - \text{Corrected Amplitude}$$

Test Equipment List and Details

Manufacturer	Description	Model	Serial Number	Calibration Date	Calibration Due Date
R&S	EMI Test Receiver	ESCS 30	830245/006	2013-11-20	2014-11-19
R&S	Two-line V-network	ENV216	3560.6550.12	2014-01-22	2015-01-21
R&S	L.I.S.N	ESH3-Z5	100113	N/A	N/A
R&S	Test Software	EMC32	Version8.53.0	N/A	N/A

* **Statement of Traceability:** Bay Area Compliance Laboratories Corp. (Dongguan) attests that all calibrations have been performed, traceable to National Primary Standards and International System of Units (SI).

Test Procedure

During the conducted emission test, the adapter was connected to the first LISN and the other support equipments were connected to the outlet of the second LISN.

Maximizing procedure was performed on the six (6) highest emissions of the EUT.

All data was recorded in the Quasi-peak and average detection mode.

Test Results Summary

According to the recorded data in following table, the EUT complied with the FCC Part 15.207, with the worst margin reading of:

7.1 dB at 0.381043 MHz in the Neutral conducted mode

Test Data

Environmental Conditions

Temperature:	25.2 °C
Relative Humidity:	54 %
ATM Pressure:	100.9 kPa

The testing was performed by Dean Liu on 2014-04-28.

Test Mode: Transmitting

AC120 V, 60 Hz, Line:

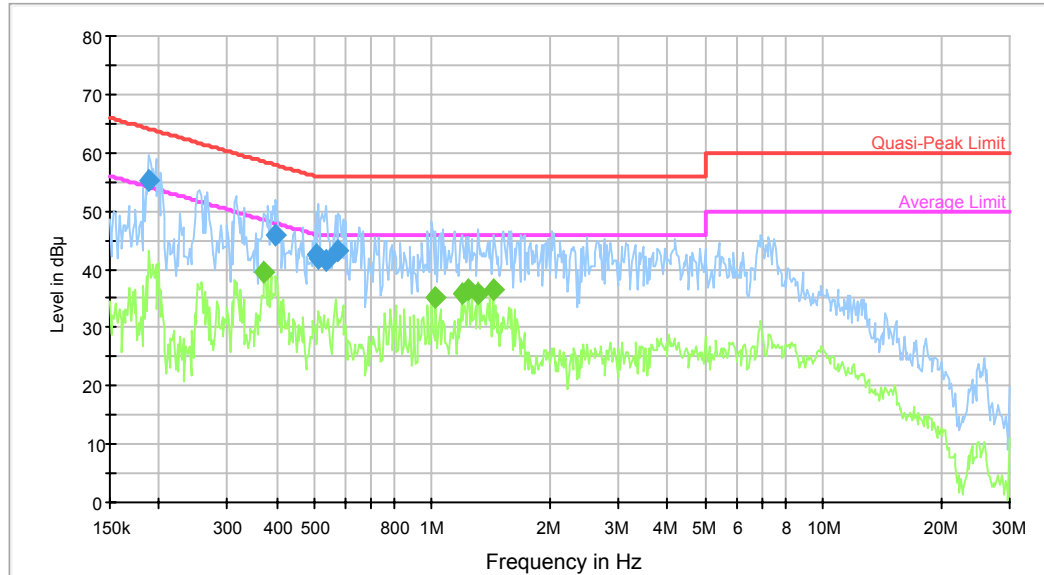

Frequency (MHz)	QuasiPeak (dBμV)	Bandwidth (kHz)	Line	Corr. (dB)	Margin (dB)	Limit (dBμV)	Comment
0.188994	55.3	9.000	L1	10.1	8.8	64.1	Compliance
0.399703	45.9	9.000	L1	10.0	11.9	57.9	Compliance
0.503608	42.4	9.000	L1	10.0	13.6	56.0	Compliance
0.511698	42.0	9.000	L1	10.0	14.0	56.0	Compliance
0.536756	41.4	9.000	L1	9.9	14.6	56.0	Compliance
0.576662	43.3	9.000	L1	9.9	12.7	56.0	Compliance

Frequency (MHz)	Average (dBμV)	Bandwidth (kHz)	Line	Corr. (dB)	Margin (dB)	Limit (dBμV)	Comment
0.372042	39.4	9.000	L1	10.1	9.1	48.5	Compliance
1.023481	35.2	9.000	L1	9.7	10.8	46.0	Compliance
1.190776	35.7	9.000	L1	9.7	10.3	46.0	Compliance
1.239175	36.4	9.000	L1	9.7	9.6	46.0	Compliance
1.310256	35.8	9.000	L1	9.7	10.2	46.0	Compliance
1.430284	36.6	9.000	L1	9.7	9.4	46.0	Compliance

AC120 V, 60 Hz, Neutral:

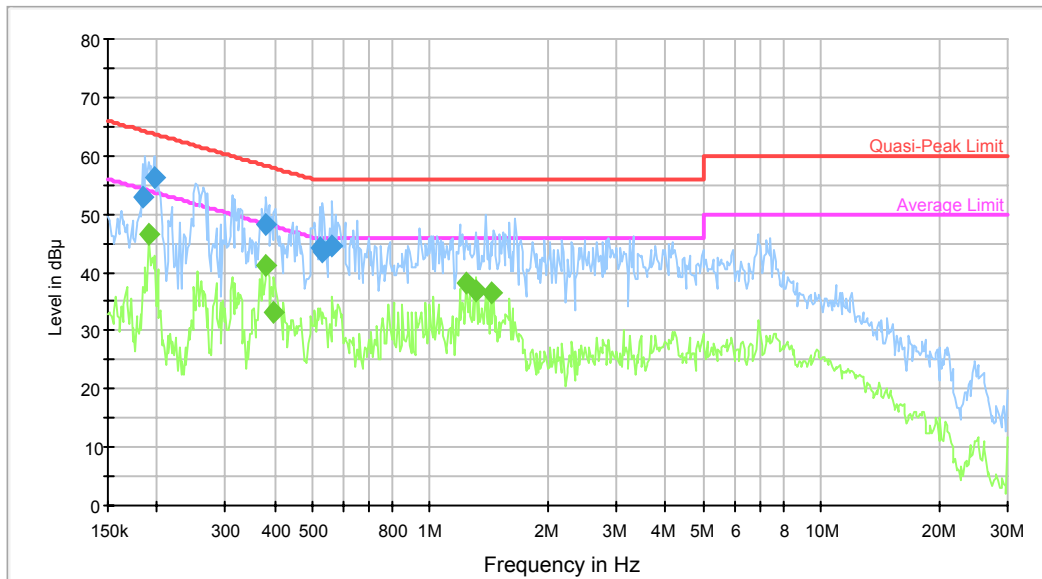

Frequency (MHz)	QuasiPeak (dBμV)	Bandwidth (kHz)	Line	Corr. (dB)	Margin (dB)	Limit (dBμV)	Comment
0.184529	52.8	9.000	N	10.5	11.5	64.3	Compliance
0.196675	56.2	9.000	N	10.7	7.5	63.7	Compliance
0.381043	48.3	9.000	N	10.3	10.0	58.3	Compliance
0.524077	44.3	9.000	N	10.0	11.7	56.0	Compliance
0.532496	43.5	9.000	N	9.9	12.5	56.0	Compliance
0.563041	44.4	9.000	N	9.9	11.6	56.0	Compliance

Frequency (MHz)	Average (dBμV)	Bandwidth (kHz)	Line	Corr. (dB)	Margin (dB)	Limit (dBμV)	Comment
0.190505	46.7	9.000	N	10.6	7.3	54.0	Compliance
0.381043	41.2	9.000	N	10.3	7.1	48.3	Compliance
0.399703	33.1	9.000	N	10.2	14.7	47.9	Compliance
1.239175	38.3	9.000	N	9.8	7.7	46.0	Compliance
1.310256	36.9	9.000	N	9.8	9.1	46.0	Compliance
1.430284	36.6	9.000	N	9.8	9.4	46.0	Compliance

FCC §15.209, §15.205 & §15.407(b) (1) (6) (7) – UNDESIRABLE EMISSION & RESTRICTED BANDS

Applicable Standard

FCC §15.407 (b) (1), (6), (7); §15.209; §15.205;

For transmitters operating in the 5.15–5.25 GHz band: all emissions outside of the 5.15–5.35 GHz band shall not exceed an EIRP of –27 dBm/MHz.

Unwanted emissions below 1 GHz must comply with the general field strength limits set forth in §15.209.

According to KDB 789033 D01 General UNII Test Procedures v01, emission shall be computed as:
 $E[\text{dB}\mu\text{V}/\text{m}] = \text{EIRP}[\text{dBm}] + 95.2$, for $d = 3$ meters.

Measurement Uncertainty

Compliance or non-compliance with a disturbance limit shall be determined in the following manner:

If U_{lab} is less than or equal to U_{cispr} of Table 1, then:

- compliance is deemed to occur if no measured disturbance level exceeds the disturbance limit;
- non-compliance is deemed to occur if any measured disturbance level exceeds the disturbance limit.

If U_{lab} is greater than U_{cispr} of Table 1, then:

- compliance is deemed to occur if no measured disturbance level, increased by $(U_{\text{lab}} - U_{\text{cispr}})$, exceeds the disturbance limit;
- non-compliance is deemed to occur if any measured disturbance level, increased by $(U_{\text{lab}} - U_{\text{cispr}})$, exceeds the disturbance limit.

Based on CISPR 16-4-2: 2011, measurement uncertainty of radiated emission at a distance of 3m at Bay Area Compliance Laboratories Corp. (Dongguan) is:

30M~200MHz: 5.0 dB

200M~1GHz: 6.2 dB

1G~6GHz: 4.45 dB

6G~18GHz: 5.23 dB

Table 1 – Values of U_{cispr}

Measurement	U_{cispr}
Radiated disturbance (electric field strength at an OATS or in a SAC) (30 MHz to 1000 MHz)	6.3 dB
Radiated disturbance (electric field strength in a FAR) (1 GHz to 6 GHz)	5.2 dB
Radiated disturbance (electric field strength in a FAR) (6 GHz to 18 GHz)	5.5 dB

EUT Setup

Below 1 G:

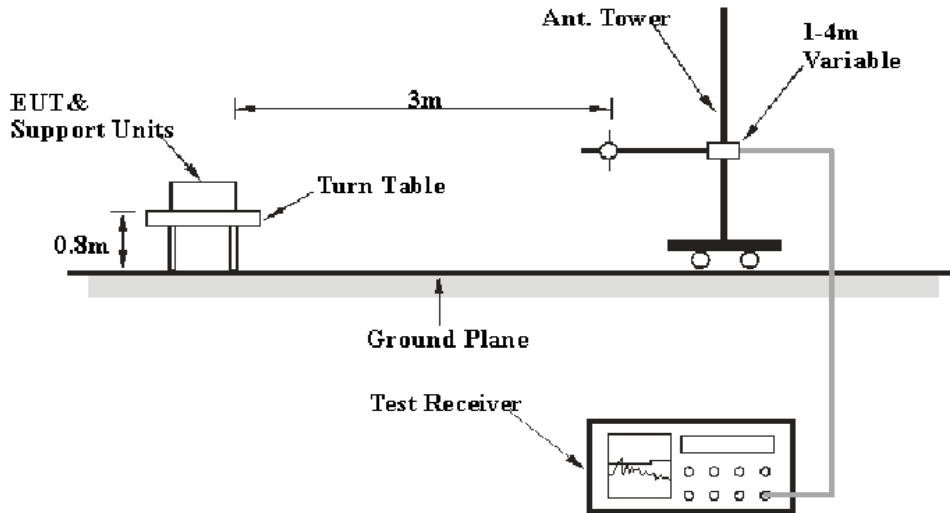

Above 1 G:

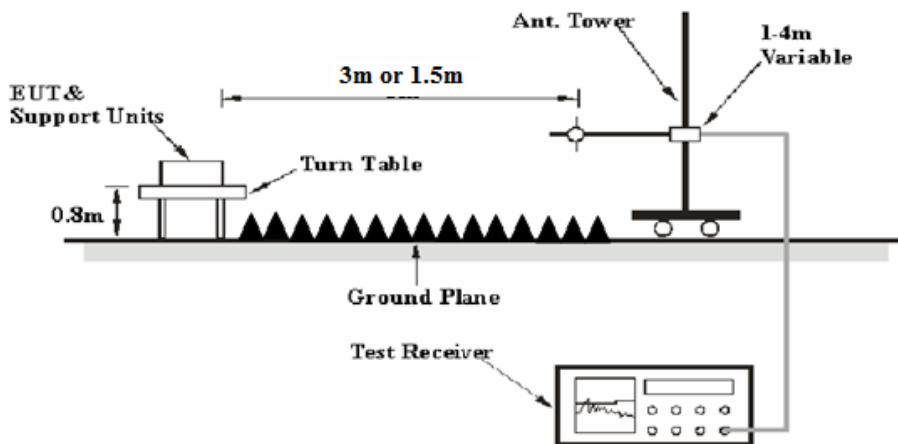

The radiated emission tests were performed in the 3 meters chamber, using the setup accordance with the ANSI C63.4-2003. The specification used was the FCC 15.209, and FCC 15.407 limits.

The external I/O cables were draped along the test table and formed a bundle 30 to 40 cm long in the middle.

The spacing between the peripherals was 10 cm.

The adapter was connected to a 120 VAC/60 Hz power source,

EMI Test Receiver & Spectrum Analyzer Setup

The system was investigated from 30 MHz to 40 GHz.

During the radiated emission test, the EMI test receiver & Spectrum Analyzer Setup were set with the following configurations:

Frequency Range	RBW	Video B/W	IF B/W	Detector
30 MHz – 1000 MHz	120 kHz	300 kHz	120 kHz	QP
Above 1 GHz	1MHz	3 MHz	/	PK
	1MHz	10 Hz	/	Ave.

Test Procedure

During the radiated emission test, the adapter was connected to the first AC floor outlet and the other support equipments were connected to the second AC floor outlet.

Maximizing procedure was performed on the highest emissions to ensure that the EUT complied with all installation combinations.

Data was recorded in Quasi-peak detection mode for frequency range of 30 MHz-1GHz, peak and Average detection modes for frequencies above 1GHz.

According to C63.4, the above 1G test result shall be extrapolated to the specified distance using an extrapolation factor of 20dB/decade from 3m to 1.5m

Distance extrapolation factor = $20 \log(\text{specific distance [3m]}/\text{test distance [1.5m]})$ dB

Extrapolation result = Corrected Amplitude (dB μ V/m) - distance extrapolation factor (6dB)

or Limit line = Specific limits(dB μ V) + distance extrapolation factor (6dB)

Corrected Amplitude & Margin Calculation

The Corrected Amplitude is calculated by adding the Antenna Loss and Cable Loss, and subtracting the Amplifier Gain from the Meter Reading. The basic equation is as follows:

$$\text{Corrected Amplitude} = \text{Meter Reading} + \text{Antenna Loss} + \text{Cable Loss} - \text{Amplifier Gain}$$

The “**Margin**” column of the following data tables indicates the degree of compliance with the applicable limit. For example, a margin of 7dB means the emission is 7dB below the limit. The equation for margin calculation is as follows:

$$\text{Margin} = \text{Limit} - \text{Extrapolation result}$$

Test Equipment List and Details

Manufacturer	Description	Model	Serial Number	Calibration Date	Calibration Due Date
R&S	EMI Test Receiver	ESCI	100224	2014-05-05	2015-05-04
Sunol Sciences	Antenna	JB3	A060611-1	2011-09-06	2014-09-05
HP	Amplifier	8447E	2434A02181	2013-09-06	2014-09-05
R&S	Spectrum Analyzer	FSEM	DE31388	2014-05-05	2015-05-04
ETS LINDGREN	Horn Antenna	3115	000 527 35	2012-09-06	2015-09-05
Mini-Circuit	Amplifier	ZVA-213-S+	054201245	2014-02-19	2015-02-18
R&S	Spectrum Analyzer	FSP 38	100478	2013-06-16	2014-06-15
Ducommun Technologies	Horn Antenna	ARH-4223-02	1007726-01 1304	2013-06-16	2014-06-15
Ducommun Technologies	Horn Antenna	ARH-2823-02	1007726-01 1302	2013-06-16	2014-06-15
Quinstar	Amplifier	QLW-18405536-JO	15964001001	2013-09-06	2014-09-05

* **Statement of Traceability:** Bay Area Compliance Laboratories Corp. (Dongguan) attests that all calibrations have been performed, traceable to National Primary Standards and International System of Units (SI).

Test Results Summary

According to the recorded data in following table, the EUT complied with the FCC Title 47, Part 15, Subpart C, Section 15.205, 15.209 and 15.407, with the worst margin reading of:

3.58 dB at 5350 MHz in the Horizontal polarization for 802.11n ht40 Mode

Test Data

Environmental Conditions

Temperature:	23.4~23.7 °C
Relative Humidity:	64~68 %
ATM Pressure:	100.3~100.8 kPa

The testing was performed by Dean Liu from 2014-05-07 to 2014-05-09.

Mode: Transmitting

Note: For above 1GHz, the test distance is 1.5m.
802.11a Mode:

Frequency (MHz)	Receiver		Rx Antenna		Cable loss (dB)	Amplifier Gain (dB)	Corrected Amplitude (dBµV/m)	Extrapolation result (dBµV/m)	Limit (dBµV/m)	Margin (dB)
	Reading (dBµV)	Detector (PK/QP/AV)	Polar (H/V)	Factor (dB)						
Low Channel:5180 MHz										
5180	67.43	PK	H	31.46	5.94	0.00	104.83	98.83	N/A	N/A
5180	58.58	AV	H	31.46	5.94	0.00	95.98	89.98	N/A	N/A
5180	59.14	PK	V	31.46	5.94	0.00	96.54	90.54	N/A	N/A
5180	50.34	AV	V	31.46	5.94	0.00	87.74	81.74	N/A	N/A
5150	32.03	PK	H	31.40	6.03	0.00	69.46	63.46	74.00	10.54
5150	18.37	AV	H	31.40	6.03	0.00	55.80	49.80	54.00	4.20
10360	31.08	PK	H	36.97	8.60	25.52	51.13	45.13	74.00	28.87
10360	19.22	AV	H	36.97	8.60	25.52	39.27	33.27	54.00	20.73
15540	31.49	PK	H	37.43	14.71	24.98	58.65	52.65	74.00	21.35
15540	19.02	AV	H	37.43	14.71	24.98	46.18	40.18	54.00	13.82
3263	31.54	PK	H	28.04	6.16	27.32	38.42	32.42	74.00	41.58
3263	14.08	AV	H	28.04	6.16	27.32	20.96	14.96	54.00	39.04
2745	30.59	PK	H	26.54	5.13	27.52	34.74	28.74	74.00	45.26
2745	13.84	AV	H	26.54	5.13	27.52	17.99	11.99	54.00	42.01
331	30.10	QP	H	14.68	2.16	21.60	25.34	/	46.00	20.66
Middle Channel:5200 MHz										
5200	71.07	PK	H	31.50	5.88	0.00	108.45	102.45	N/A	N/A
5200	62.58	AV	H	31.50	5.88	0.00	99.96	93.96	N/A	N/A
5200	70.37	PK	V	31.50	5.88	0.00	107.75	101.75	N/A	N/A
5200	61.98	AV	V	31.50	5.88	0.00	99.36	93.36	N/A	N/A
10400	31.73	PK	H	36.98	8.57	25.50	51.78	45.78	74.00	28.22
10400	19.17	AV	H	36.98	8.57	25.50	39.22	33.22	54.00	20.78
15600	32.08	PK	H	37.32	14.61	24.69	59.32	53.32	74.00	20.68
15600	18.02	AV	H	37.32	14.61	24.69	45.26	39.26	54.00	14.74
3263	30.34	PK	H	28.04	6.16	27.32	37.22	31.22	74.00	42.78
3263	14.36	AV	H	28.04	6.16	27.32	21.24	15.24	54.00	38.76
2745	31.39	PK	H	26.54	5.13	27.52	35.54	29.54	74.00	44.46
2745	13.72	AV	H	26.54	5.13	27.52	17.87	11.87	54.00	42.13
331	30.30	QP	H	14.68	2.16	21.60	25.54	/	46.00	20.46
256	27.80	QP	H	12.27	1.92	21.49	20.50	/	46.00	25.50

High Channel:5240 MHz										
5240	70.94	PK	H	31.58	5.82	0.00	108.34	102.34	N/A	N/A
5240	62.42	AV	H	31.58	5.82	0.00	99.82	93.82	N/A	N/A
5240	70.37	PK	V	31.58	5.82	0.00	107.77	101.77	N/A	N/A
5240	61.78	AV	V	31.58	5.82	0.00	99.18	93.18	N/A	N/A
5350	29.34	PK	H	31.80	6.11	0.00	67.25	61.25	74.00	12.75
5350	18.24	AV	H	31.80	6.11	0.00	56.15	50.15	54.00	3.85
10480	31.69	PK	H	37.00	8.51	26.01	51.19	45.19	74.00	28.81
10480	19.42	AV	H	37.00	8.51	26.01	38.92	32.92	54.00	21.08
15720	31.95	PK	H	37.10	14.42	24.92	58.55	52.55	74.00	21.45
15720	17.96	AV	H	37.10	14.42	24.92	44.56	38.56	54.00	15.44
3263	30.19	PK	H	28.04	6.16	27.32	37.07	31.07	74.00	42.93
3263	14.27	AV	H	28.04	6.16	27.32	21.15	15.15	54.00	38.85
2745	31.22	PK	H	26.54	5.13	27.52	35.37	29.37	74.00	44.63
2745	13.69	AV	H	26.54	5.13	27.52	17.84	11.84	54.00	42.16
331	30.00	QP	H	14.68	2.16	21.60	25.24	/	46.00	20.76

*Within measurement uncertainty!

802.11n ht20 Mode:

Frequency (MHz)	Receiver		Rx Antenna		Cable loss (dB)	Amplifier Gain (dB)	Corrected Amplitude (dBµV/m)	Extrapolation result (dBµV/m)	Limit (dBµV/m)	Margin (dB)
	Reading (dBµV)	Detector (PK/QP/AV)	Polar (H/V)	Factor (dB)						
Low Channel:5180 MHz										
5180	69.34	PK	H	31.46	5.94	0.00	106.74	100.74	N/A	N/A
5180	60.38	AV	H	31.46	5.94	0.00	97.78	91.78	N/A	N/A
5180	68.14	PK	V	31.46	5.94	0.00	105.54	99.54	N/A	N/A
5180	59.22	AV	V	31.46	5.94	0.00	96.62	90.62	N/A	N/A
5150	31.99	PK	H	31.40	6.03	0.00	69.42	63.42	68.20	4.78
5150	18.32	AV	H	31.40	6.03	0.00	55.75	49.75	54.00	4.25
10360	31.06	PK	H	36.97	8.60	25.52	51.11	45.11	74.00	28.89
10360	19.28	AV	H	36.97	8.60	25.52	39.33	33.33	54.00	20.67
15540	31.42	PK	H	37.43	14.71	24.98	58.58	52.58	74.00	21.42
15540	18.82	AV	H	37.43	14.71	24.98	45.98	39.98	54.00	14.02
3263	31.53	PK	H	28.04	6.16	27.32	38.41	32.41	54.00	21.59
3263	14.05	AV	H	28.04	6.16	27.32	20.93	14.93	74.00	59.07
2745	30.57	PK	H	26.54	5.13	27.52	34.72	28.72	74.00	45.28
2745	13.66	AV	H	26.54	5.13	27.52	17.81	11.81	54.00	42.19
331	30.15	QP	H	14.68	2.16	21.60	25.39	/	46.00	20.61
Middle Channel:5200 MHz										
5200	70.89	PK	H	31.50	5.88	0.00	108.27	102.27	N/A	N/A
5200	62.39	AV	H	31.50	5.88	0.00	99.77	93.77	N/A	N/A
5200	69.27	PK	V	31.50	5.88	0.00	106.65	100.65	N/A	N/A
5200	61.79	AV	V	31.50	5.88	0.00	99.17	93.17	N/A	N/A
10400	31.58	PK	H	36.98	8.57	25.50	51.63	45.63	74.00	28.37
10400	19.37	AV	H	36.98	8.57	25.50	39.42	33.42	54.00	20.58
15600	31.91	PK	H	37.32	14.61	24.69	59.15	53.15	74.00	20.85
15600	17.94	AV	H	37.32	14.61	24.69	45.18	39.18	54.00	14.82
3263	30.26	PK	H	28.04	6.16	27.32	37.14	31.14	54.00	22.86
3263	14.24	AV	H	28.04	6.16	27.32	21.12	15.12	74.00	58.88
2745	31.32	PK	H	26.54	5.13	27.52	35.47	29.47	74.00	44.53
2745	13.6	AV	H	26.54	5.13	27.52	17.75	11.75	54.00	42.25
331	29.8	QP	H	14.68	2.16	21.60	25.04	/	46.00	20.96
256	27.7	QP	H	12.27	1.92	21.49	20.40	/	46.00	25.60

High Channel:5240 MHz										
5240	70.85	PK	H	31.58	5.82	0.00	108.25	102.25	N/A	N/A
5240	62.27	AV	H	31.58	5.82	0.00	99.67	93.67	N/A	N/A
5240	69.35	PK	V	31.58	5.82	0.00	106.75	100.75	N/A	N/A
5240	61.72	AV	V	31.58	5.82	0.00	99.12	93.12	N/A	N/A
5350	29.31	PK	H	31.80	6.11	0.00	67.22	61.22	74.00	12.78
5350	18.19	AV	H	31.80	6.11	0.00	56.10	50.10	54.00	3.90
10480	31.61	PK	H	37.00	8.51	26.01	51.11	45.11	74.00	28.89
10480	19.41	AV	H	37.00	8.51	26.01	38.91	32.91	54.00	21.09
15720	31.95	PK	H	37.10	14.42	24.92	58.55	52.55	74.00	21.45
15720	17.89	AV	H	37.10	14.42	24.92	44.49	38.49	54.00	15.51
3263	31.1	PK	H	28.04	6.16	27.32	37.98	31.98	74.00	42.02
3263	14.17	AV	H	28.04	6.16	27.32	21.05	15.05	54.00	38.95
2745	31.16	PK	H	26.54	5.13	27.52	35.31	29.31	74.00	44.69
2745	13.62	AV	H	26.54	5.13	27.52	17.77	11.77	54.00	42.23
331	29.9	QP	H	14.68	2.16	21.60	25.14	/	46.00	20.86

*Within measurement uncertainty!

802.11n ht40 Mode:

Frequency (MHz)	Receiver		Rx Antenna		Cable loss (dB)	Amplifier Gain (dB)	Corrected Amplitude (dBµV/m)	Extrapolation result (dBµV/m)	Limit (dBµV/m)	Margin (dB)
	Reading (dBµV)	Detector (PK/QP/AV)	Polar (H/V)	Factor (dB)						
Low Channel:5190 MHz										
5190	60.33	PK	H	31.48	5.91	0.00	97.72	91.72	N/A	N/A
5190	51.22	AV	H	31.48	5.91	0.00	88.61	82.61	N/A	N/A
5190	60.14	PK	V	31.48	5.91	0.00	97.53	91.53	N/A	N/A
5190	49.5	AV	V	31.48	5.91	0.00	86.89	80.89	N/A	N/A
5150	31.47	PK	H	31.40	6.03	0.00	68.90	62.90	74.00	11.10
5150	18.23	AV	H	31.40	6.03	0.00	55.66	49.66	54.00	4.34
10380	30.92	PK	H	36.98	8.59	25.51	50.98	44.98	74.00	29.02
10380	18.68	AV	H	36.98	8.59	25.51	38.74	32.74	54.00	21.26
15570	30.76	PK	H	37.37	14.66	24.83	57.96	51.96	74.00	22.04
15570	18.51	AV	H	37.37	14.66	24.83	45.71	39.71	54.00	14.29
3263	31.35	PK	H	28.04	6.16	27.32	38.23	32.23	74.00	41.77
3263	13.41	AV	H	28.04	6.16	27.32	20.29	14.29	54.00	39.71
2745	29.58	PK	H	26.54	5.13	27.52	33.73	27.73	74.00	46.27
2745	12.95	AV	H	26.54	5.13	27.52	17.10	11.10	54.00	42.90
331	29	QP	H	14.68	2.16	21.60	24.24	/	46.00	21.76
High Channel:5230 MHz										
5230	65.09	PK	H	31.56	5.84	0.00	102.49	96.49	N/A	N/A
5230	56.87	AV	H	31.56	5.84	0.00	94.27	88.27	N/A	N/A
5230	64.54	PK	V	31.56	5.84	0.00	101.94	95.94	N/A	N/A
5230	55.63	AV	V	31.56	5.84	0.00	93.03	87.03	N/A	N/A
5350	29.12	PK	H	31.80	6.11	0.00	67.03	61.03	74.00	12.97
5350	18.51	AV	H	31.80	6.11	0.00	56.42	50.42	54.00	3.58
10460	30.89	PK	H	36.99	8.52	25.88	50.52	44.52	74.00	29.48
10460	18.92	AV	H	36.99	8.52	25.88	38.55	32.55	54.00	21.45
15690	31.47	PK	H	37.16	14.47	24.87	58.23	52.23	74.00	21.77
15690	17.8	AV	H	37.16	14.47	24.87	44.56	38.56	54.00	15.44
3263	30.26	PK	H	28.04	6.16	27.32	37.14	31.14	74.00	42.86
3263	13.4	AV	H	28.04	6.16	27.32	20.28	14.28	54.00	39.72
2745	30.89	PK	H	26.54	5.13	27.52	35.04	29.04	74.00	44.96
2745	12.67	AV	H	26.54	5.13	27.52	16.82	10.82	54.00	43.18
331	29.3	QP	H	14.68	2.16	21.60	24.54	/	46.00	21.46

*Within measurement uncertainty!

Conducted Spurious Emission at Antenna Port

Mode	Channel	Frequency	Conducted Spurious Emissions (dBm)				Result
		MHz	Chain 0	Chain 1	Total	Limits	
802.11a	Low	5180	-31.21	-31.32	/	-27	PASS
	Middle	5200	-32.38	-32.32	/	-27	PASS
	High	5240	-32.13	-31.88	/	-27	PASS
802.11n ht20	Low	5180	-32.00	-32.92	-29.43	-27	PASS
	Middle	5200	-33.30	-32.52	-29.88	-27	PASS
	High	5240	-32.26	-33.11	-29.65	-27	PASS
802.11n ht40	Low	5190	-32.61	-32.06	-29.32	-27	PASS
	High	5230	-32.56	-33.33	-29.92	-27	PASS

Note: Offset= Antenna Gain(dBi)+Cable loss(dB)

Chain 0: 802.11a Low Channel 30MHz-1GHz

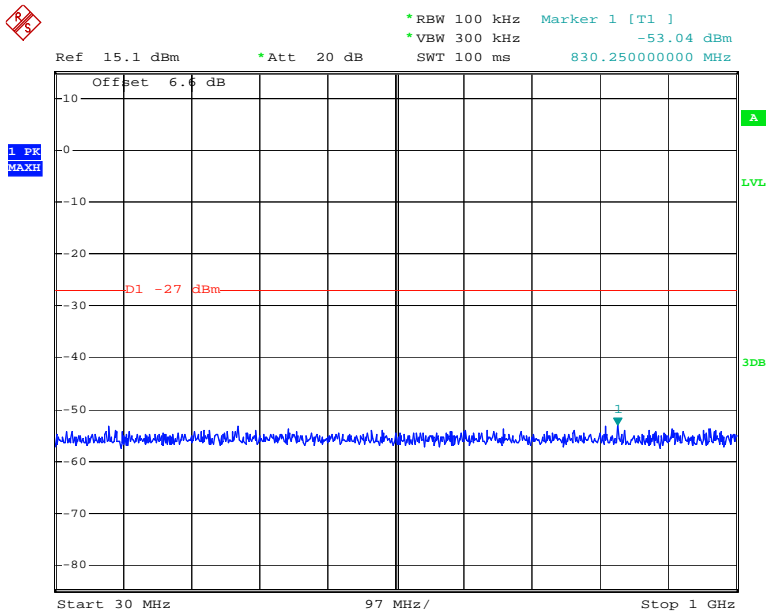

Date: 7.MAY.2014 13:04:52

Chain 0: 802.11a Low Channel 1GHz-26.5GHz

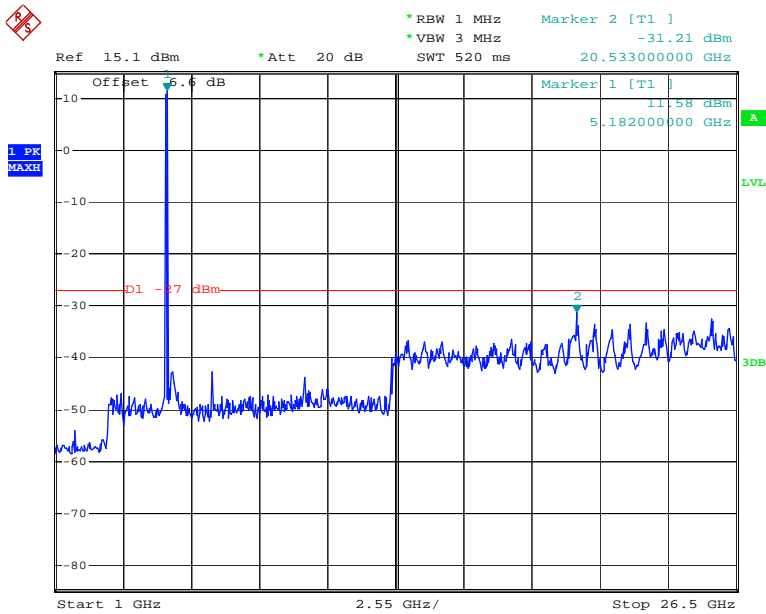

Date: 7.MAY.2014 13:06:10

Chain 0: 802.11a Low Channel 26.5GHz-40GHz

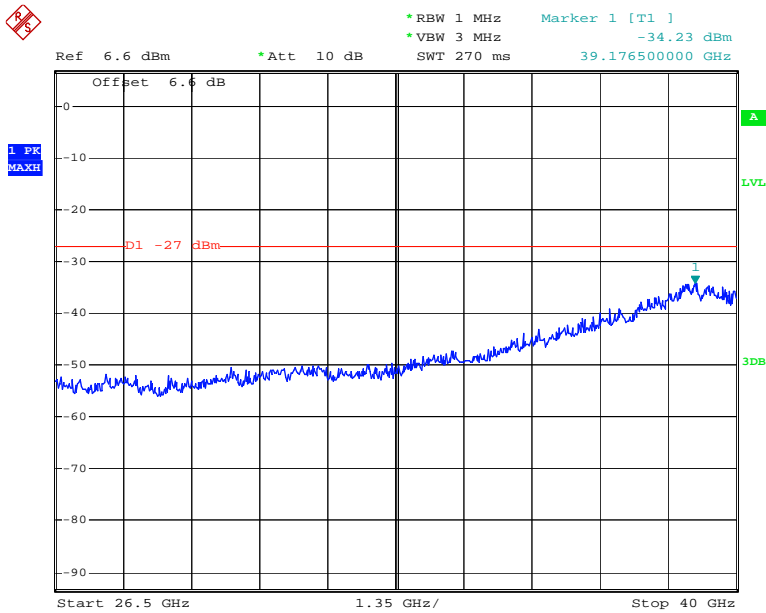

Date: 7.MAY.2014 13:07:01

Chain 0: 802.11a Middle Channel 30MHz-1GHz

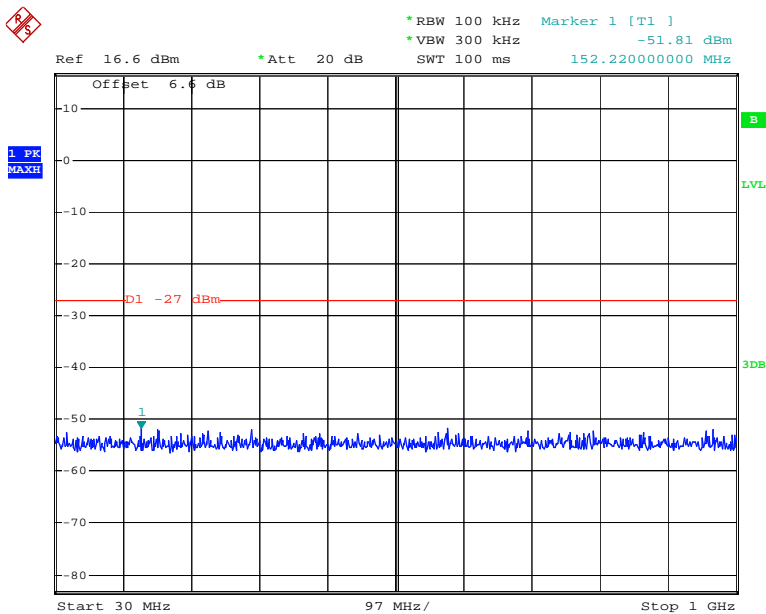

Date: 7.MAY.2014 13:20:59

Chain 0: 802.11a Middle Channel 1GHz -26.5GHz

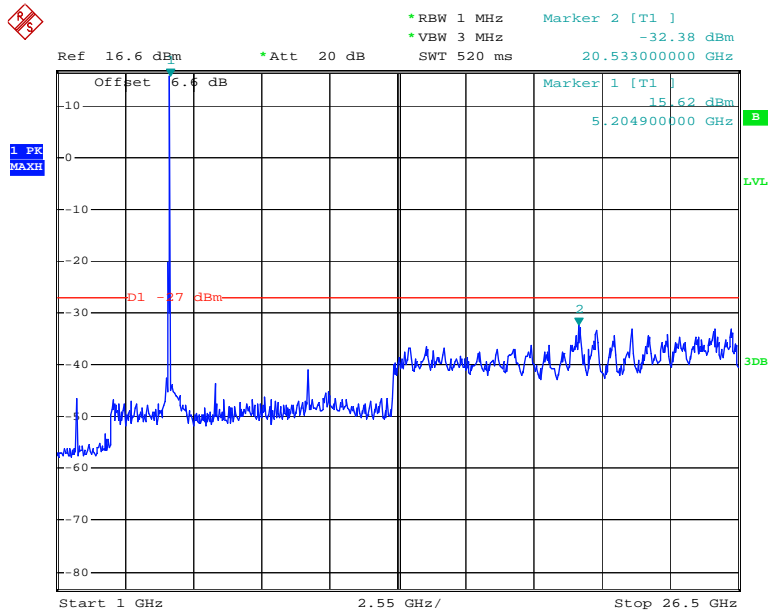

Date: 7.MAY.2014 13:20:36

Chain 0: 802.11a Middle Channel 26.5GHz-40GHz

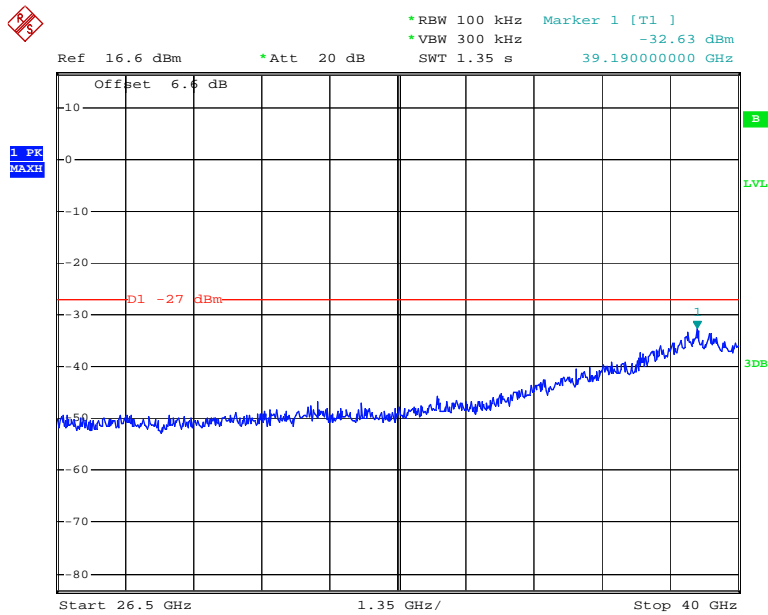

Date: 7.MAY.2014 13:21:34

Chain 0: 802.11a High Channel 30MHz-1GHz

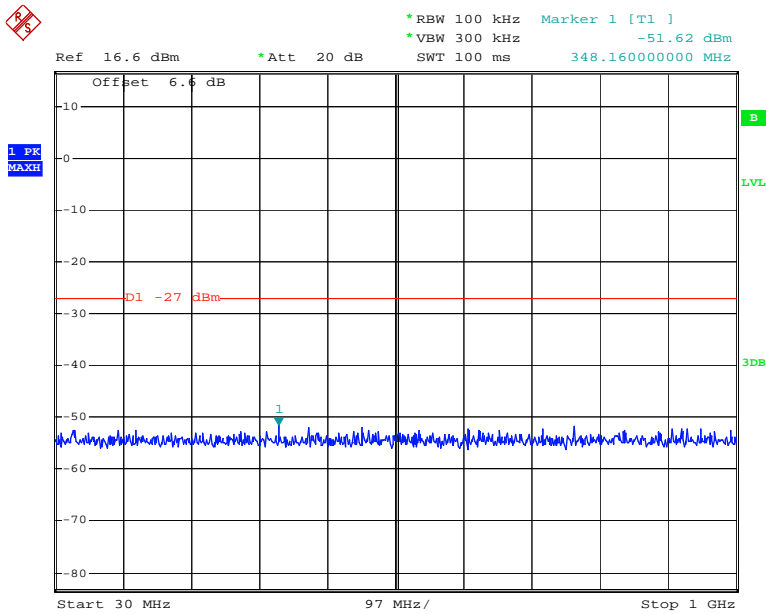

Date: 7.MAY.2014 13:34:55

Chain 0: 802.11a High Channel 1GHz-26.5GHz

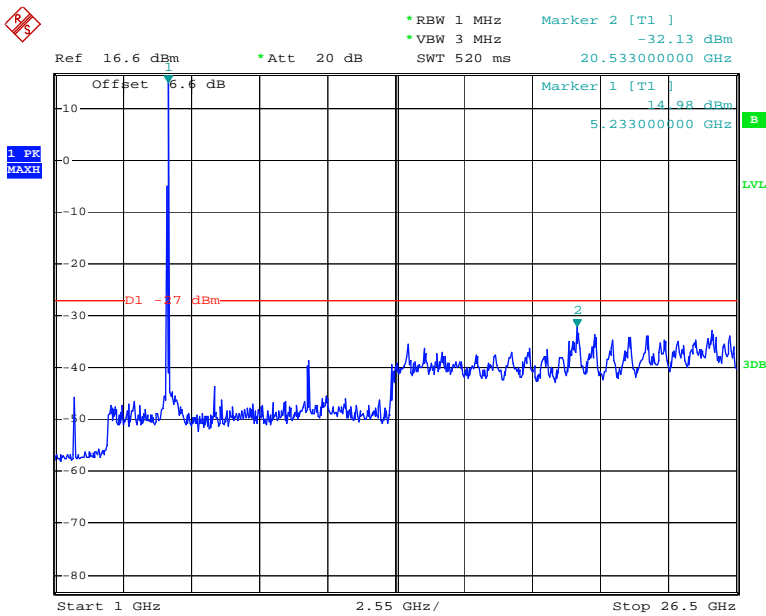

Date: 7.MAY.2014 13:35:27

Chain 0: 802.11a High Channel 26.5GHz-40GHz

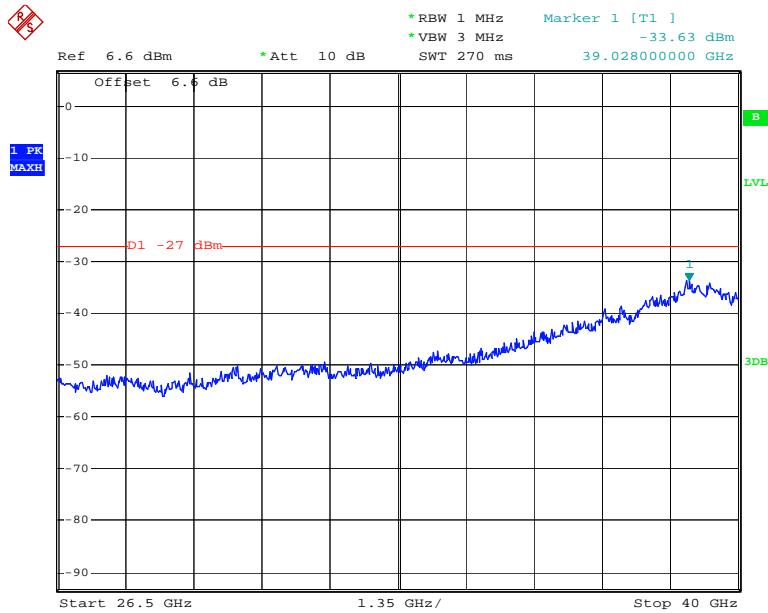

Date: 7.MAY.2014 13:35:54

Chain 1: 802.11a Low Channel 30MHz-1GHz

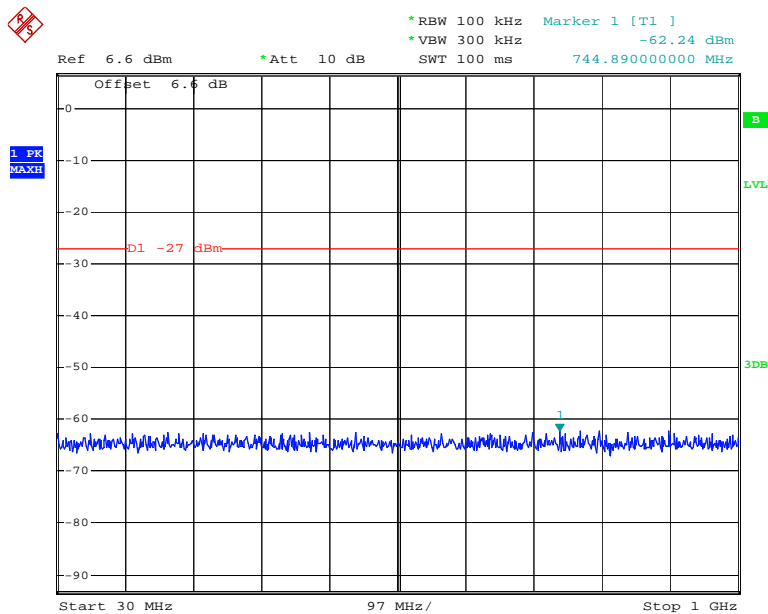

Date: 9.MAY.2014 17:06:33

Chain 1: 802.11a Low Channel 1GHz-26.5GHz

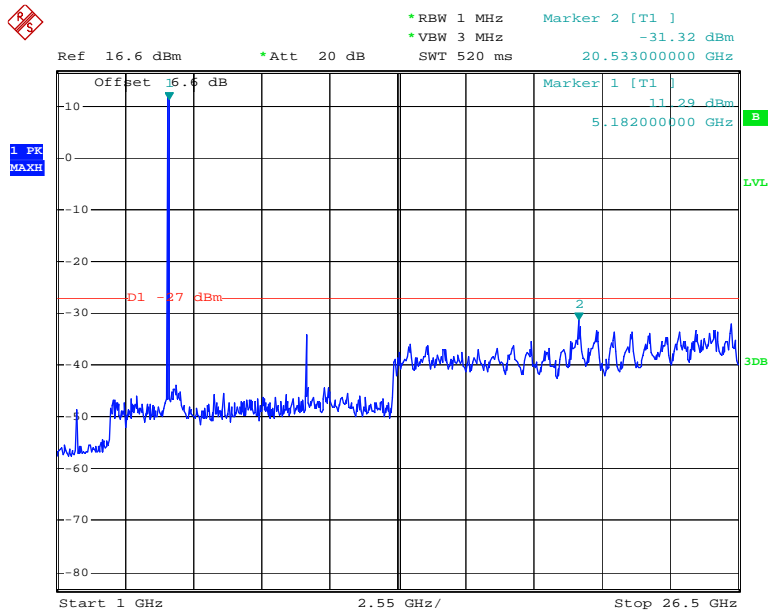

Date: 9.MAY.2014 17:05:22

Chain 1: 802.11a Low Channel 26.5GHz-40GHz

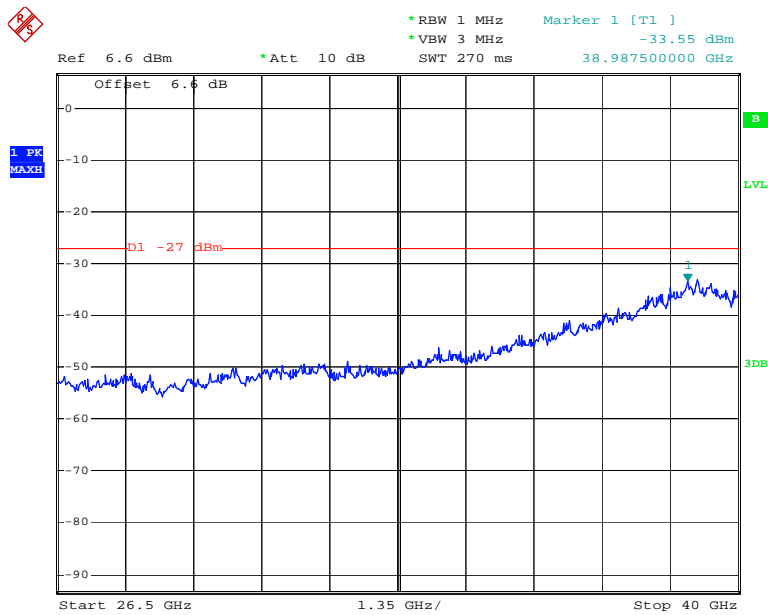

Date: 9.MAY.2014 17:06:09

Chain 1: 802.11a Middle Channel 30MHz-1GHz

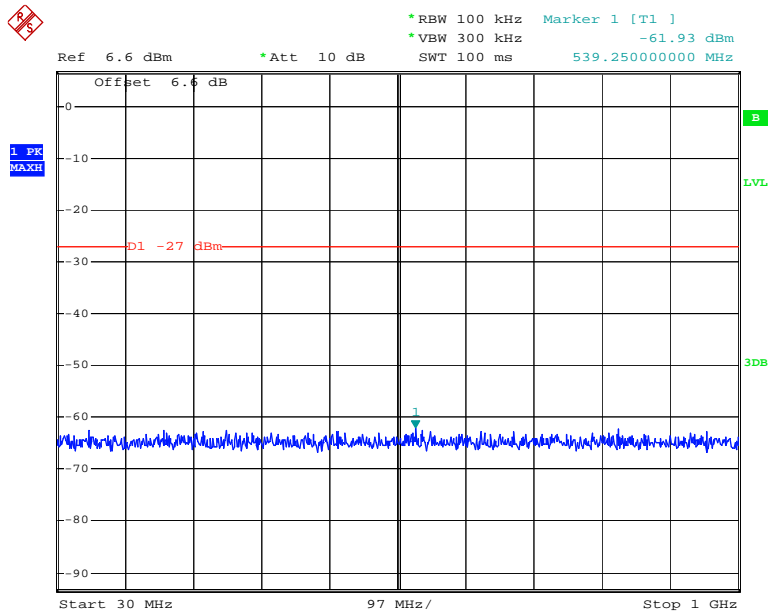

Date: 9.MAY.2014 17:17:45

Chain 1: 802.11a Middle Channel 1GHz -26.5GHz

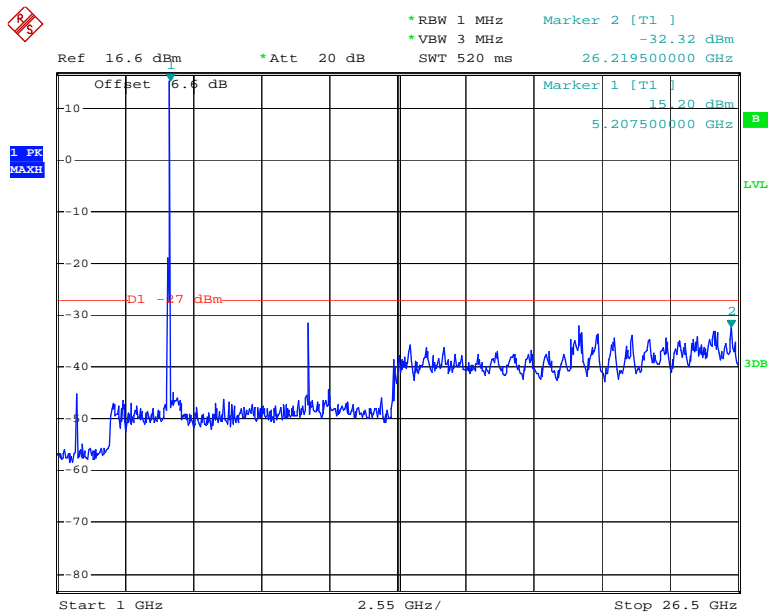

Date: 9.MAY.2014 17:16:01

Chain 1: 802.11a Middle Channel 26.5GHz-40GHz

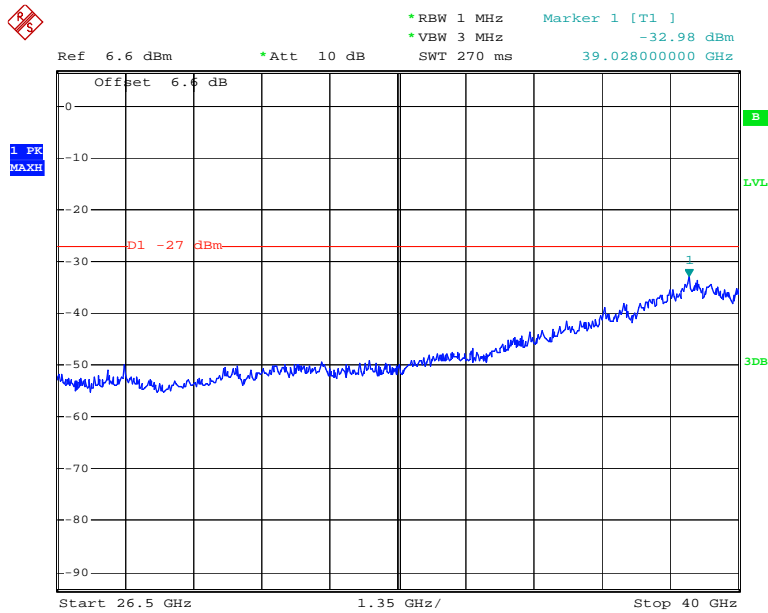

Date: 9.MAY.2014 17:17:15

Chain 1: 802.11a High Channel 30MHz-1GHz

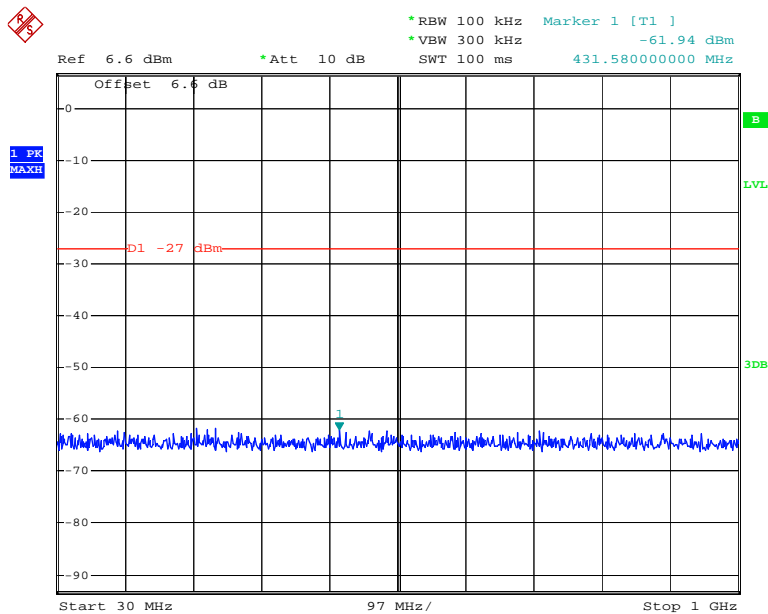

Date: 9.MAY.2014 17:39:40

Chain 1: 802.11a High Channel 1GHz-26.5GHz

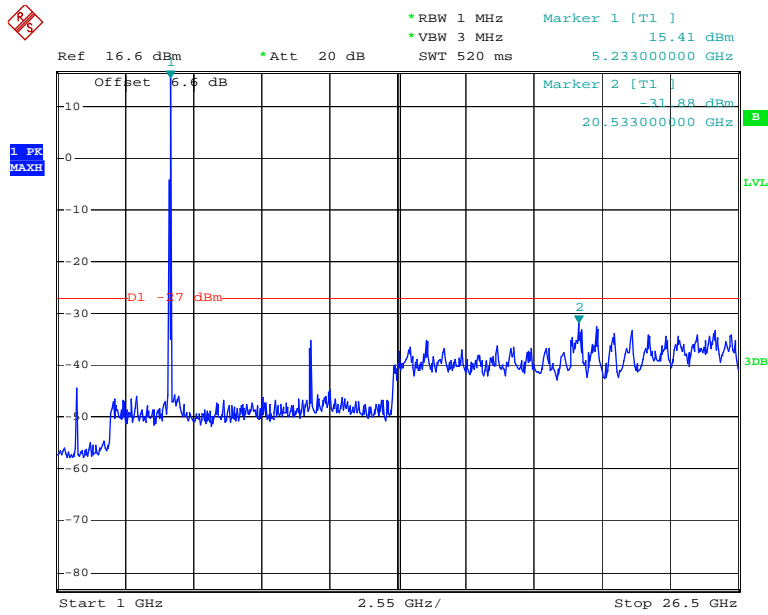

Date: 9.MAY.2014 17:38:35

Chain 1: 802.11a High Channel 26.5GHz-40GHz

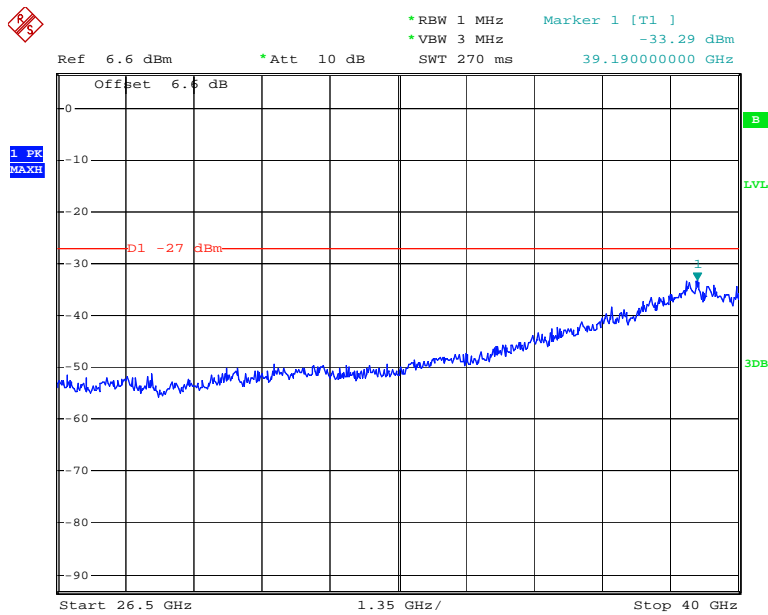

Date: 9.MAY.2014 17:39:11

Chain 0: 802.11n ht20 Low Channel 30MHz-1GHz

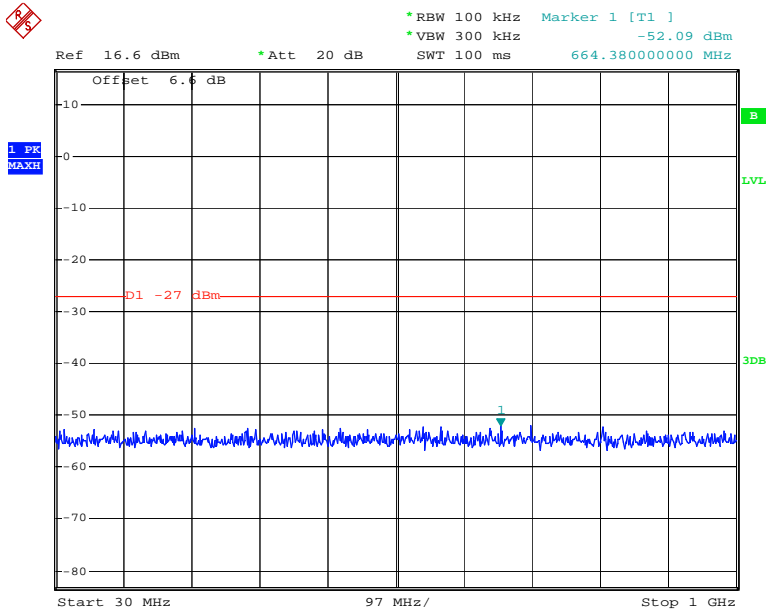

Date: 7.MAY.2014 13:48:26

Chain 0: 802.11n ht20 Low Channel 1GHz-26.5GHz

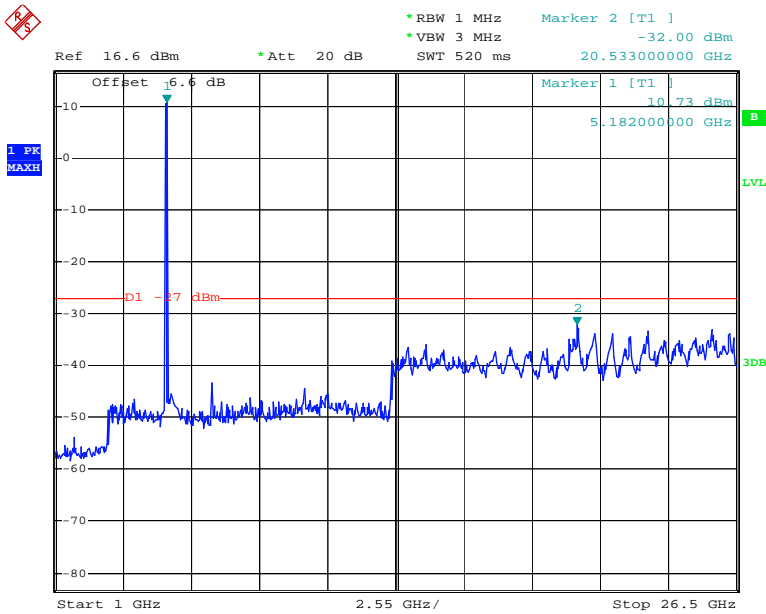

Date: 7.MAY.2014 13:48:58

Chain 0: 802.11n ht20 Low Channel 26.5GHz-40GHz

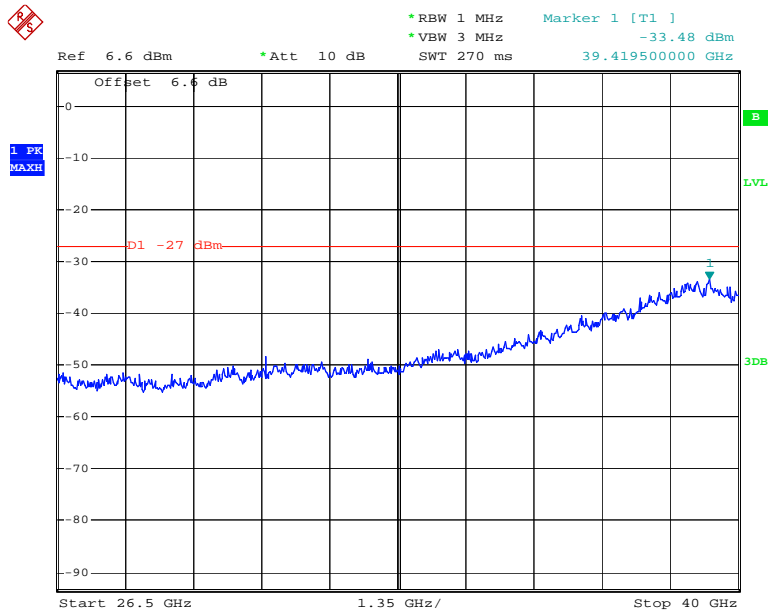

Date: 7.MAY.2014 13:49:31

Chain 0: 802.11n ht20 Middle Channel 30MHz-1GHz

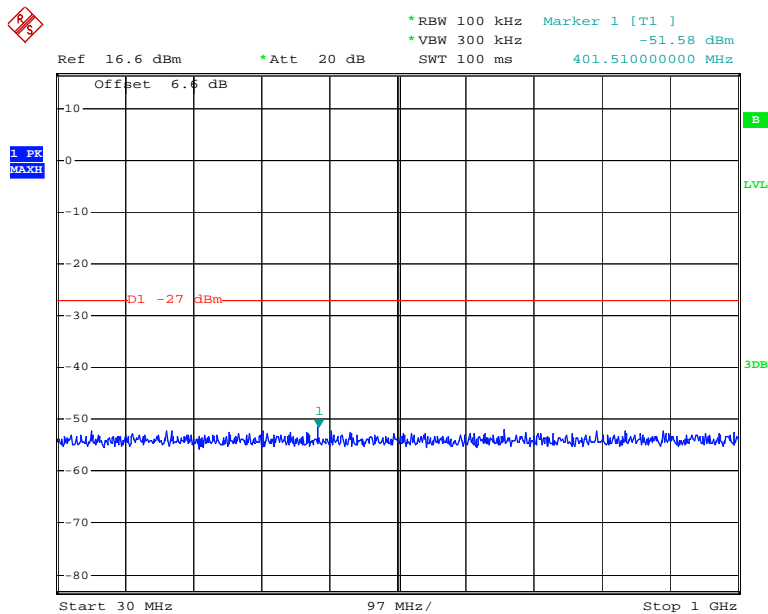

Date: 7.MAY.2014 14:03:54

Chain 0: 802.11n ht20 Middle Channel 1GHz -26.5GHz

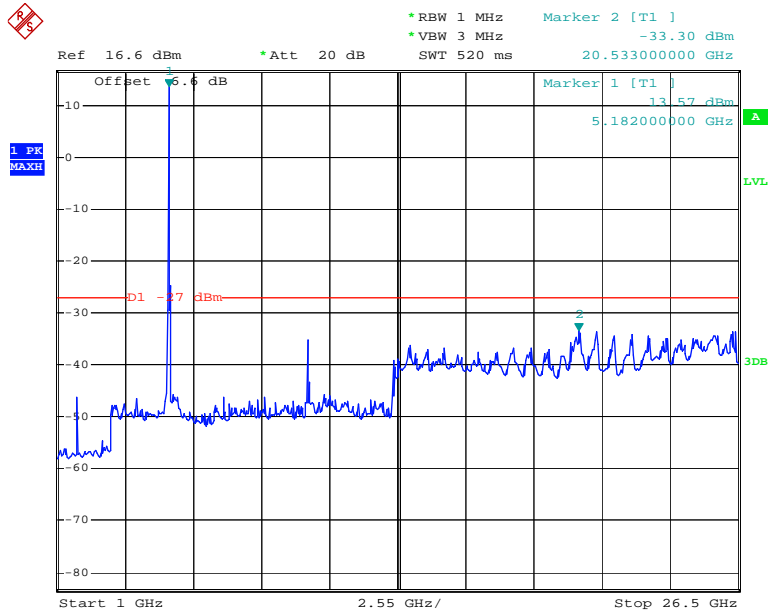

Date: 7.MAY.2014 15:50:28

Chain 0: 802.11n ht20 Middle Channel 26.5GHz-40GHz

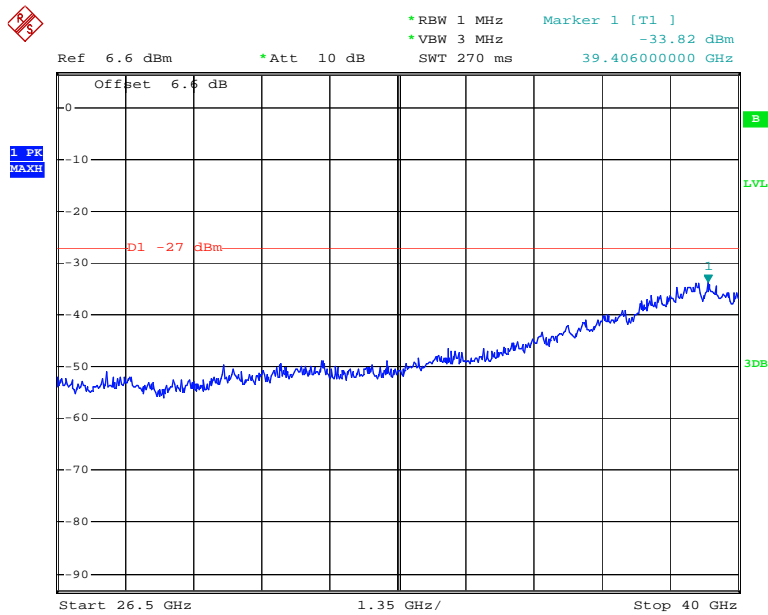

Date: 7.MAY.2014 14:34:22

Chain 0: 802.11n ht20 High Channel 30MHz-1GHz

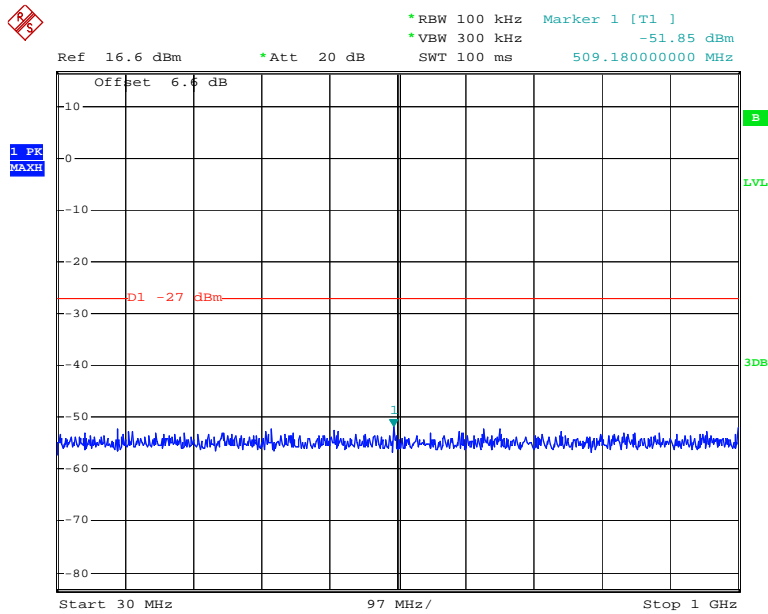

Date: 7.MAY.2014 14:18:05

Chain 0: 802.11n ht20 High Channel 1GHz-26.5GHz

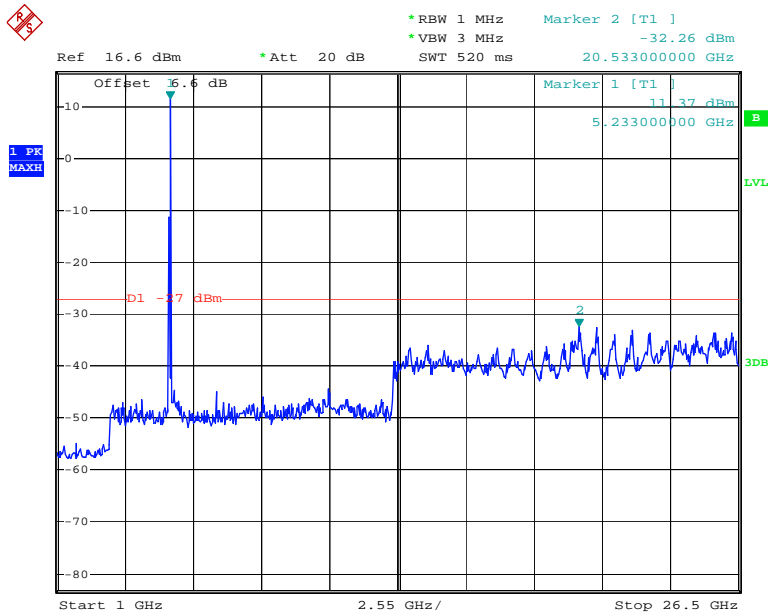

Date: 7.MAY.2014 14:17:36

Chain 0: 802.11n ht20 High Channel 26.5GHz-40GHz

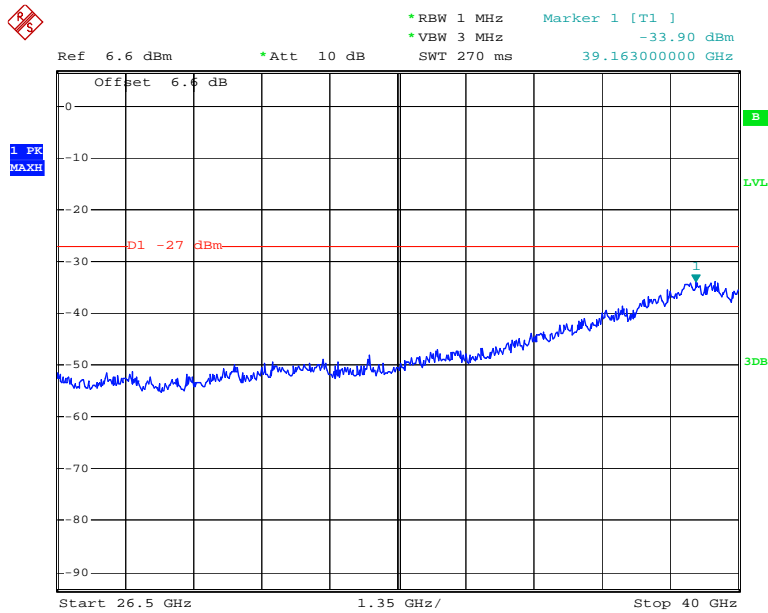

Date: 7.MAY.2014 14:34:47

Chain 1: 802.11n ht20 Low Channel 30MHz-1GHz

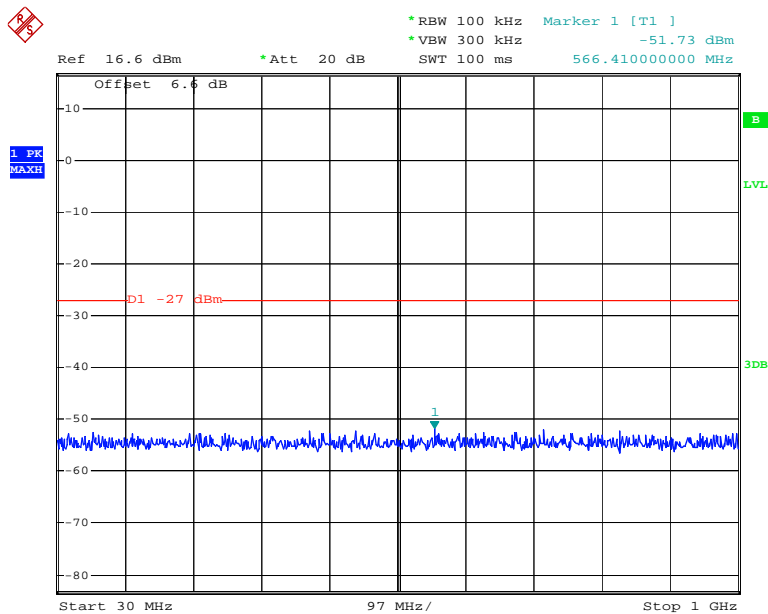

Date: 7.MAY.2014 13:54:42

Chain 1: 802.11n ht20 Low Channel 1GHz-26.5GHz

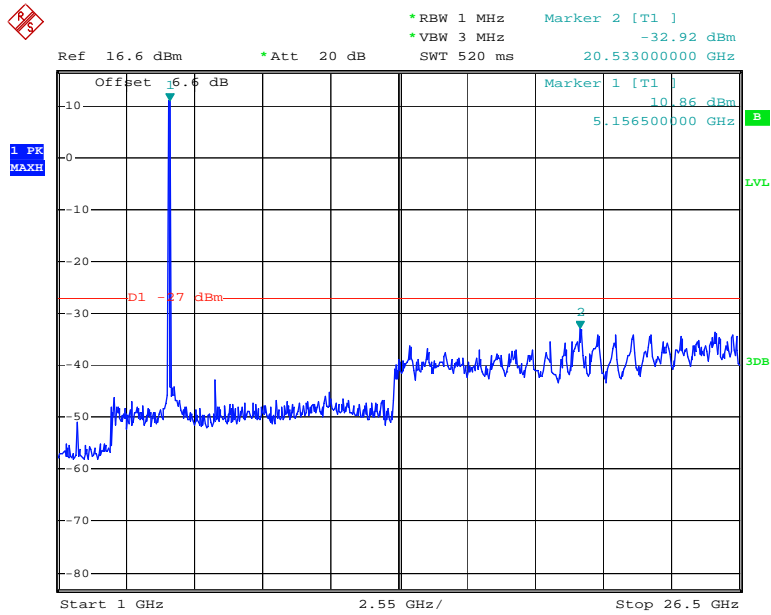

Date: 7.MAY.2014 13:55:10

Chain 1: 802.11n ht20 Low Channel 26.5GHz-40GHz

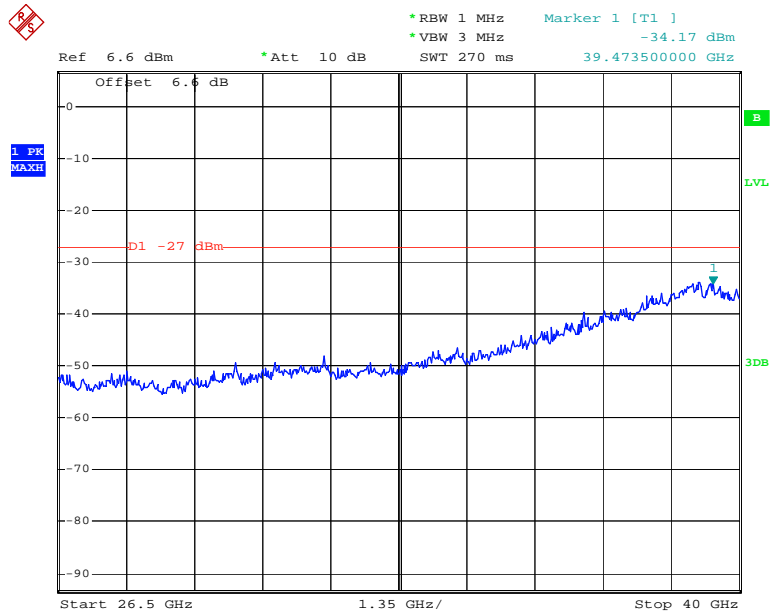

Date: 7.MAY.2014 13:55:47

Chain 1: 802.11n ht20 Middle Channel 30MHz-1GHz

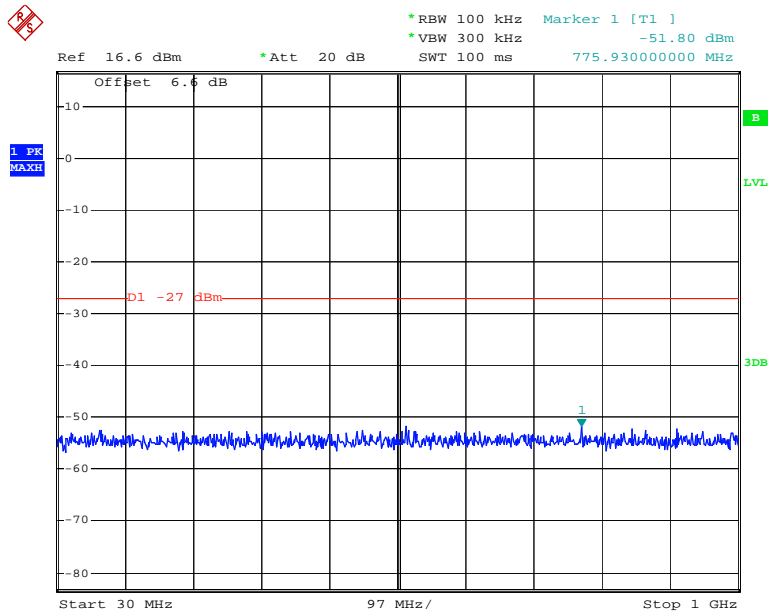

Date: 7.MAY.2014 14:09:39

Chain 1: 802.11n ht20 Middle Channel 1GHz -26.5GHz

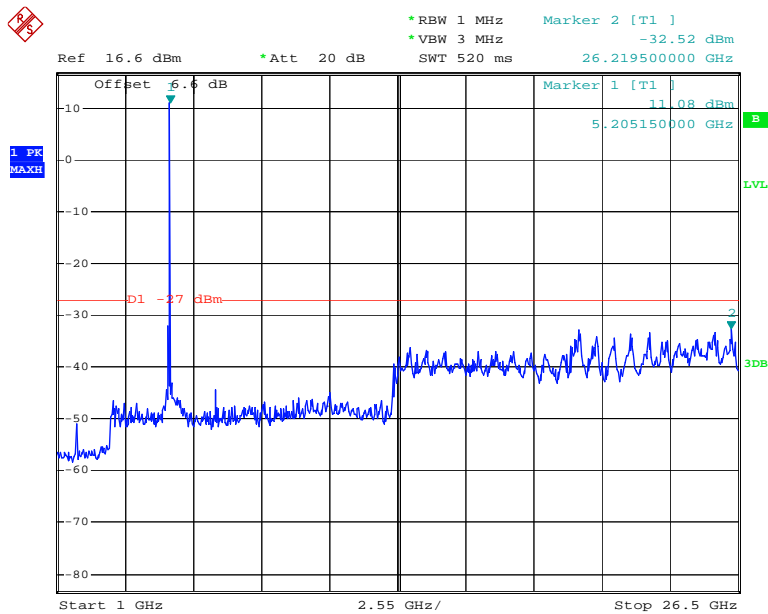

Date: 7.MAY.2014 14:09:15

Chain 1: 802.11n ht20 Middle Channel 26.5GHz-40GHz

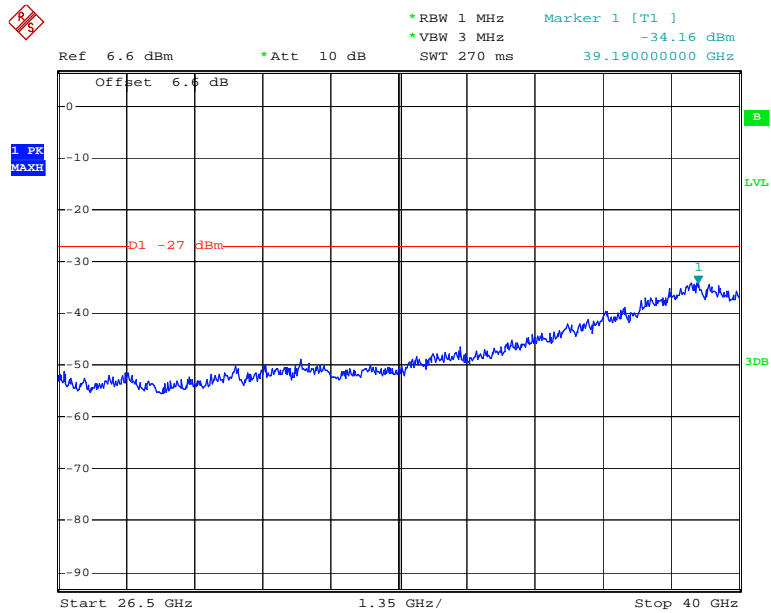

Date: 7.MAY.2014 14:24:54

Chain 1: 802.11n ht20 High Channel 30MHz-1GHz

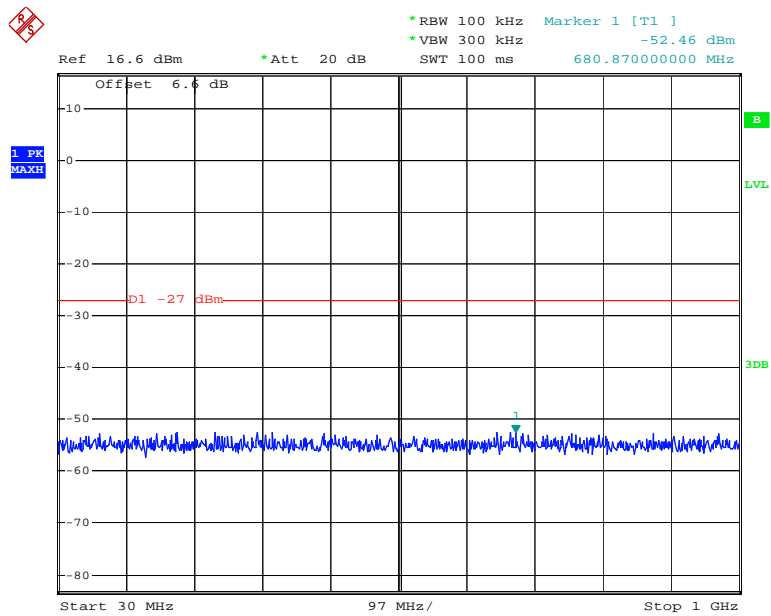

Date: 7.MAY.2014 14:24:31

Chain 1: 802.11n ht20 High Channel 1GHz-26.5GHz

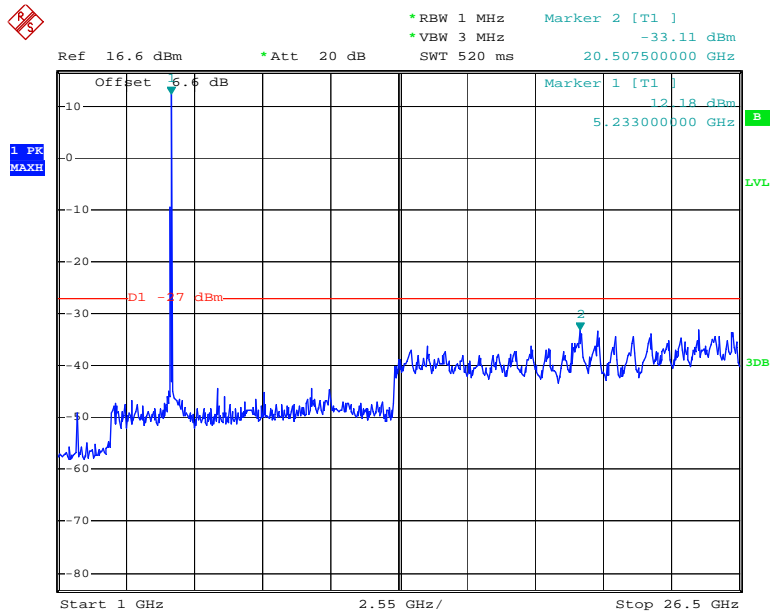

Date: 7.MAY.2014 14:24:10

Chain 1: 802.11n ht20 High Channel 26.5GHz-40GHz

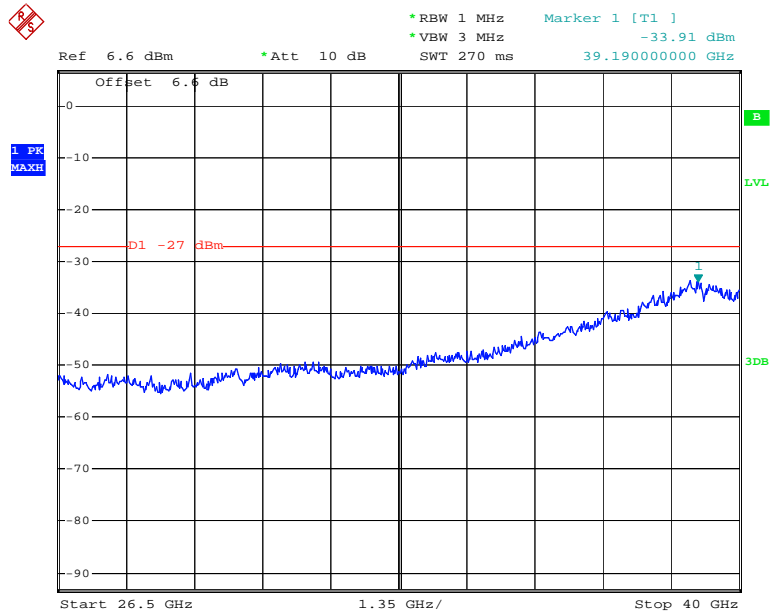

Date: 7.MAY.2014 14:35:10

Chain 0: 802.11n ht40 Low Channel 30MHz-1GHz

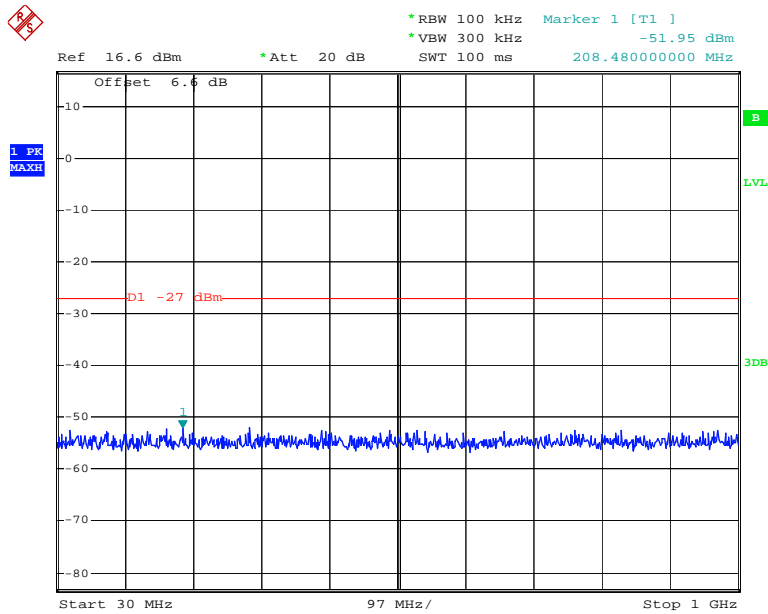

Date: 7.MAY.2014 14:48:26

Chain 0: 802.11n ht40 Low Channel 1GHz-26.5GHz

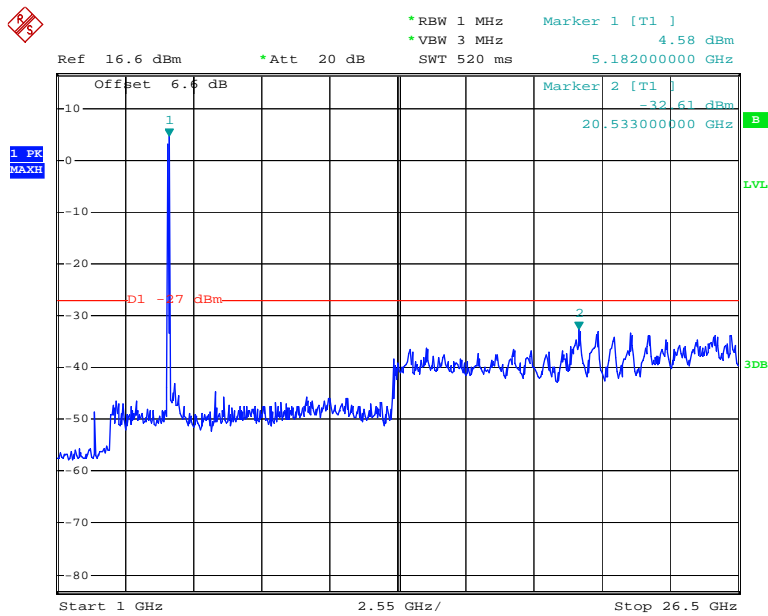

Date: 7.MAY.2014 14:46:25

Chain 0: 802.11n ht40 Low Channel 26.5-40GHz

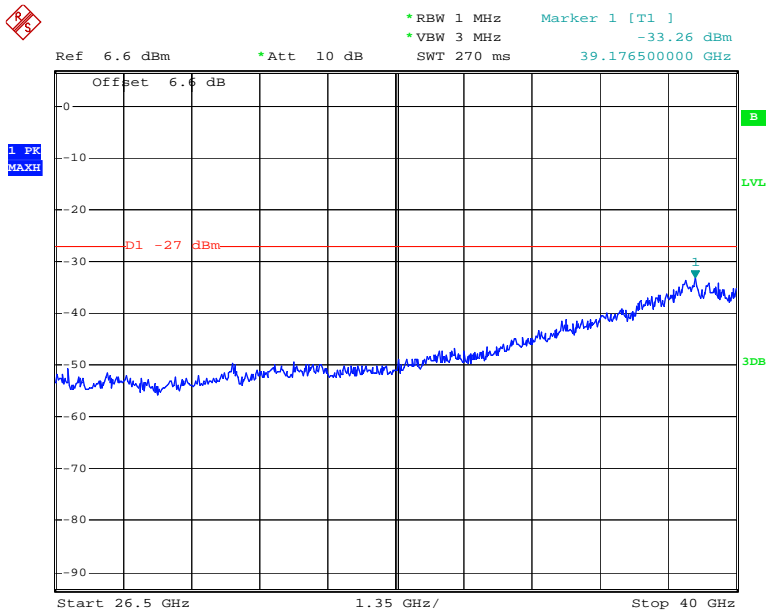

Date: 7.MAY.2014 14:49:01

Chain 0: 802.11n ht40 High Channel 30MHz-1GHz

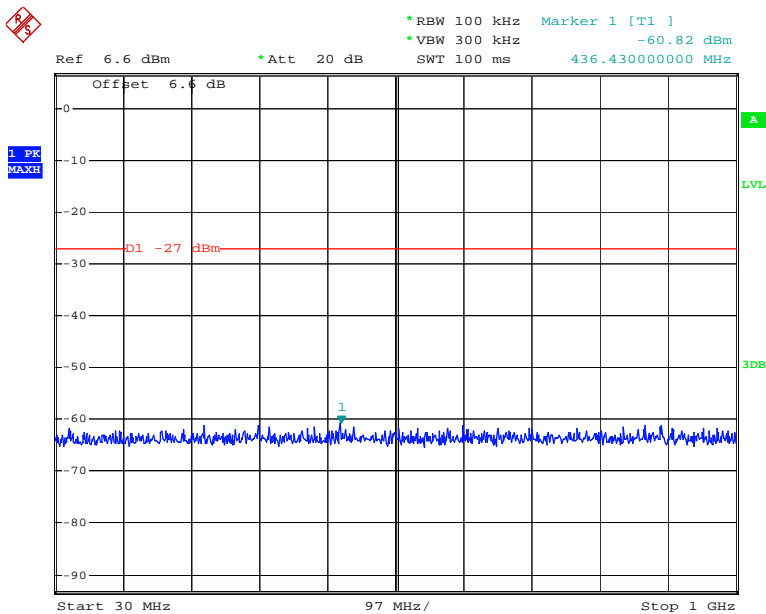

Date: 7.MAY.2014 15:16:05

Chain 0: 802.11n ht40 High Channel 1GHz-26.5GHz

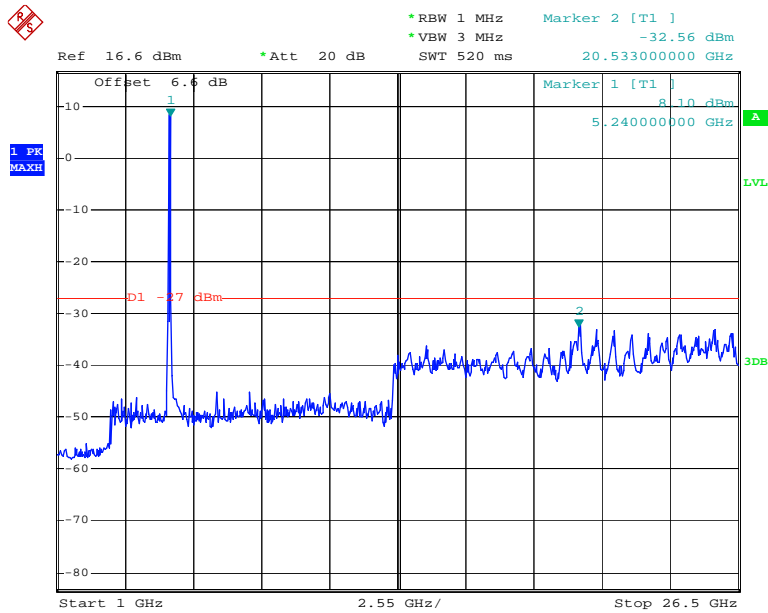

Date: 7.MAY.2014 15:15:06

Chain 0: 802.11n ht40 High Channel 26.5GHz-40GHz

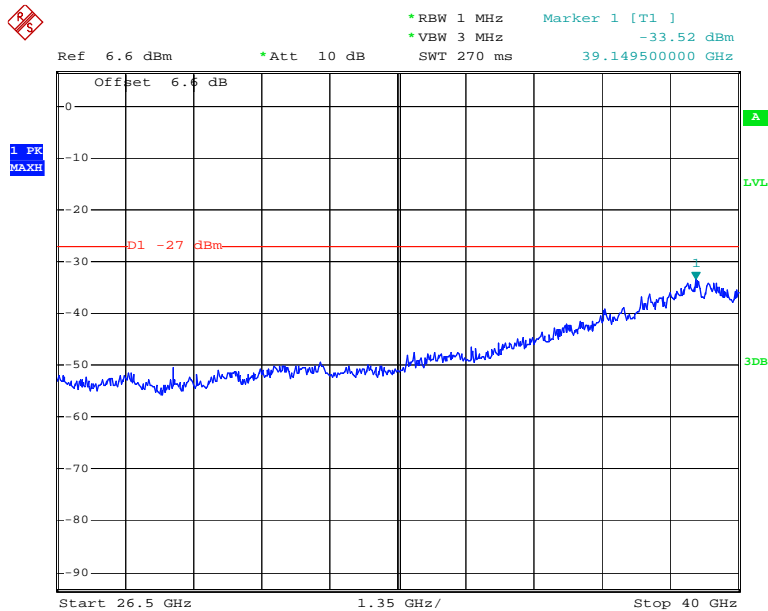

Date: 7.MAY.2014 15:15:38

Chain 1: 802.11n ht40 Low Channel 30MHz-1GHz

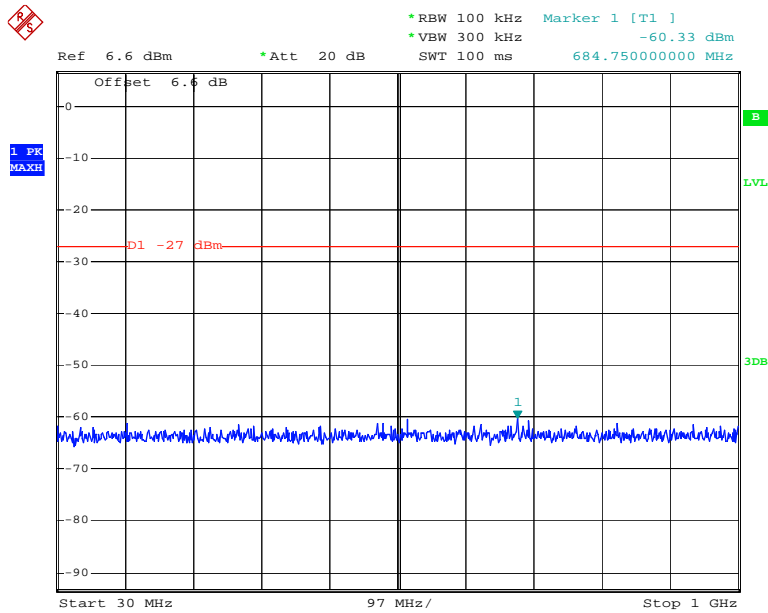

Date: 7.MAY.2014 14:56:51

Chain 1: 802.11n ht40 Low Channel 1GHz-26.5GHz

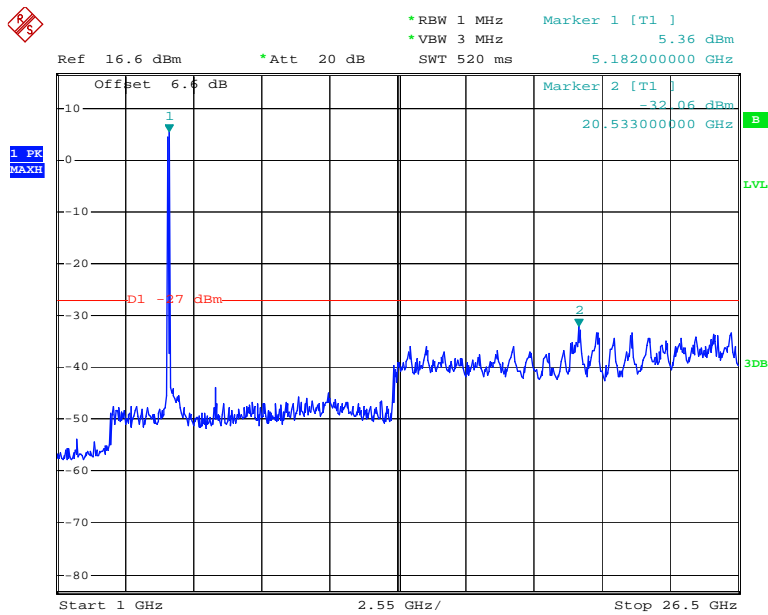

Date: 7.MAY.2014 14:55:48

Chain 1: 802.11n ht40 Low Channel 26.5GHz-40GHz

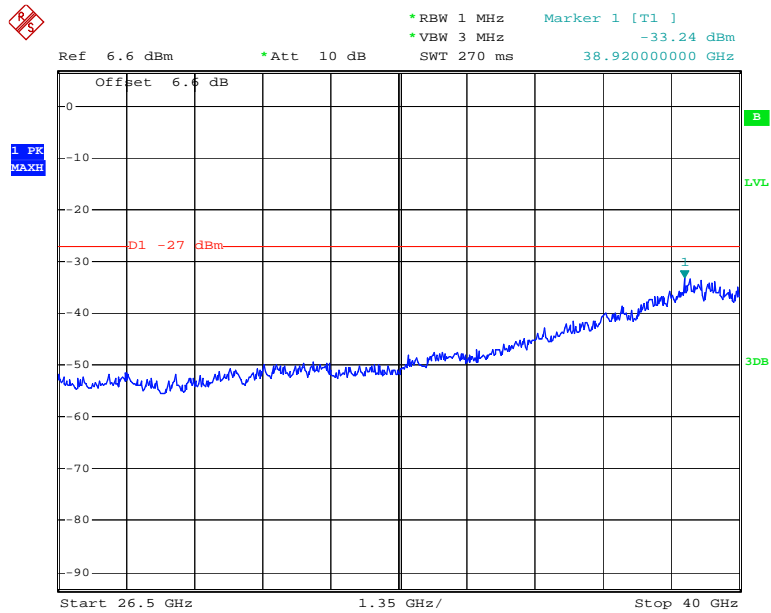

Date: 7.MAY.2014 14:56:15

Chain 1: 802.11n ht40 High Channel 30MHz-1GHz

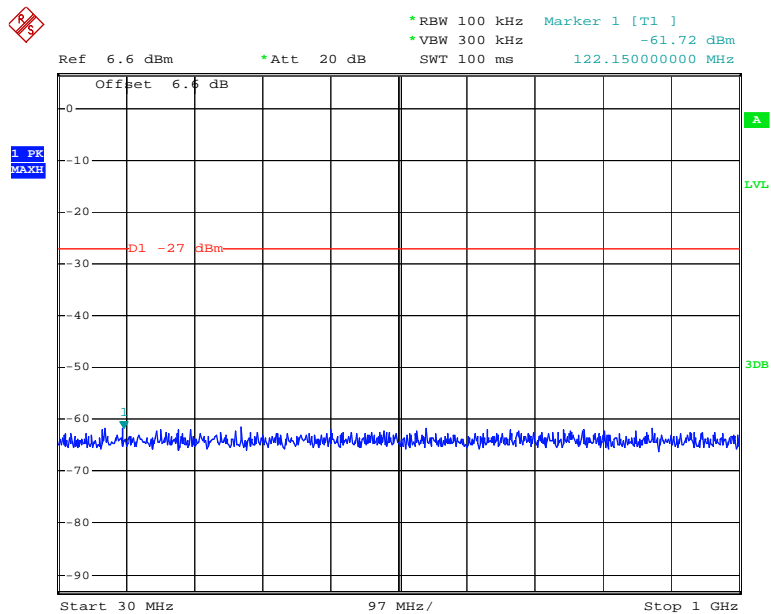

Date: 7.MAY.2014 15:27:46

Chain 1: 802.11n ht40 High Channel 1GHz-26.5GHz

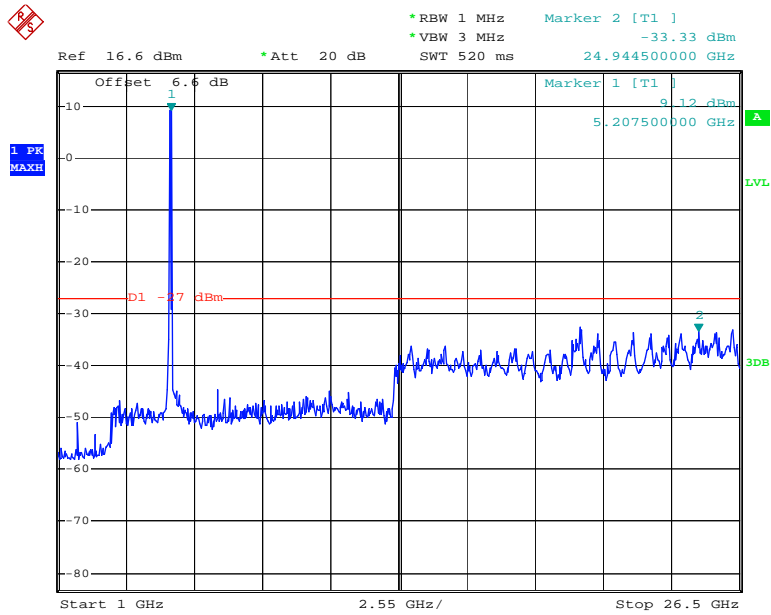

Date: 7.MAY.2014 15:26:57

Chain 1: 802.11n ht40 High Channel 26.5GHz-40GHz

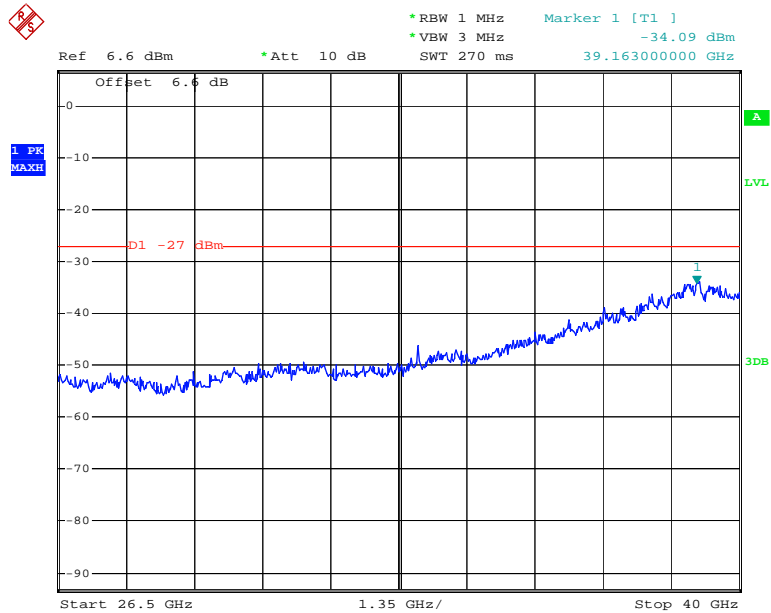

Date: 7.MAY.2014 15:27:22

FCC §15.407(b) (1) (2) (3) (4) – OUT OF BAND EMISSIONS

Applicable Standard

FCC §15.407 (b) (1),(2), (3), (4),;

For transmitters operating in the 5.15–5.25 GHz band: all emissions outside of the 5.15–5.35 GHz band shall not exceed an EIRP of –27 dBm/MHz.

For transmitters operating in the 5.25–5.35 GHz band: all emissions outside of the 5.15–5.35 GHz band shall not exceed an EIRP of –27 dBm/MHz. Devices operating in the 5.25–5.35 GHz band that generate emissions in the 5.15–5.25 GHz band must meet all applicable technical requirements for operation in the 5.15–5.25 GHz band (including indoor use) or alternatively meet an out-of-band emission EIRP limit of –27 dBm/MHz in the 5.15–5.25 GHz band.

For transmitters operating in the 5.47–5.725 GHz band: all emissions outside of the 5.47–5.725 GHz band shall not exceed an EIRP of –27 dBm/MHz.

For transmitters operating in the 5.725–5.825 GHz band: all emissions within the frequency range from the band edge to 10 MHz above or below the band edge shall not exceed an EIRP of –17 dBm/MHz; for frequencies 10 MHz or greater above or below the band edge, emissions shall not exceed an EIRP of –27 dBm/MHz.

Test Procedure

1. Check the calibration of the measuring instrument using either an internal calibration or a known signal from an external generator.
2. Position the EUT without connection to measurement instrument. Turn on the EUT and connect its antenna terminal to measurement instrument via a low loss cable. Then set it to any one measured frequency within its operating range, and make sure the instrument is operated in its linear range.
3. Set RBW to 1 MHz and VBW to 3MHz of spectrum analyzer. Offset the antenna gain and cable loss.
4. Measure the highest amplitude appearing on spectral display and set it as a reference level. Plot the graph with marking the highest point and edge frequency.
5. Repeat above procedures until all measured frequencies were complete.

Test Equipment List and Details

Manufacturer	Description	Model	Serial Number	Calibration Date	Calibration Due Date
R&S	Spectrum Analyzer	FSP 38	100478	2013-06-16	2014-06-15

* **Statement of Traceability:** Bay Area Compliance Laboratories Corp. (Dongguan) attests that all calibrations have been performed, traceable to National Primary Standards and International System of Units (SI).

Test Data

Environmental Conditions

Temperature:	24.2~25.6°C
Relative Humidity:	64~68 %
ATM Pressure:	100.3~100.8 kPa

The testing was performed by Dean Liu from 2014-05-07 to 2014-05-09.

Please refer to the following table and plots.

Test mode	Frequency (MHz)	Worst Reading Level (dBm)			Limit (dBm)	Result
		Chain0	Chain1	Chain0+1		
802.11a	Left	-29.36	-28.87	/	-27	PASS
	Right	-42.38	-36.33	/	-27	PASS
802.11n ht20	Left	-30.98	-38.63	-30.29	-27	PASS
	Right	-44.39	-43.82	-41.09	-27	PASS
802.11n ht40	Left	-30.82	-35.67	-29.59	-27	PASS
	Right	-43.22	-44.11	-40.63	-27	PASS

Note: Offset= Antenna Gain(dBi)+Cable loss(dB)

Chain 0: 802.11a Band Edge, Left Side

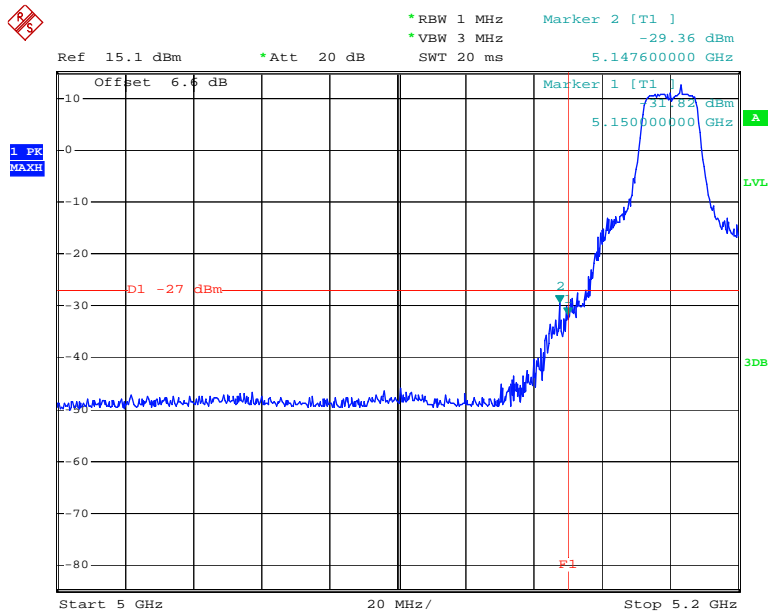

Date: 7.MAY.2014 11:59:20

Chain 0: 802.11a Band Edge, Right Side

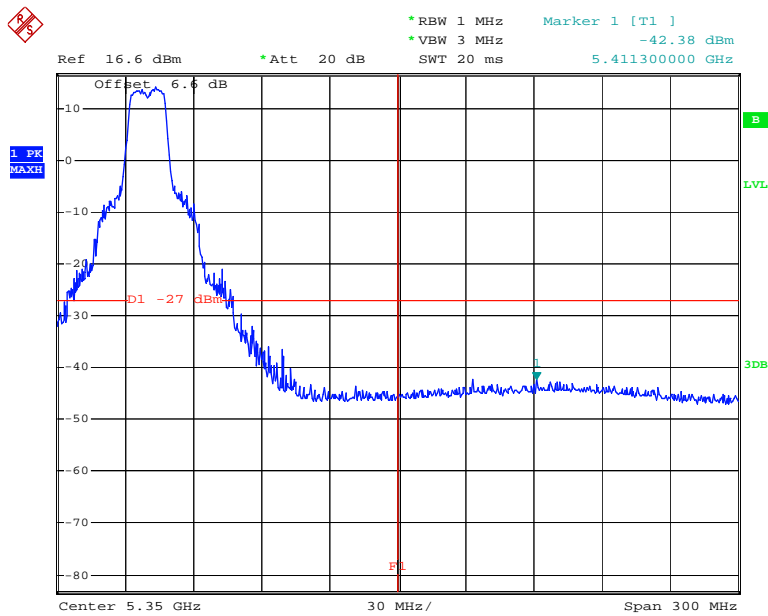

Date: 7.MAY.2014 13:26:03

Chain 1: 802.11a Band Edge, Left Side

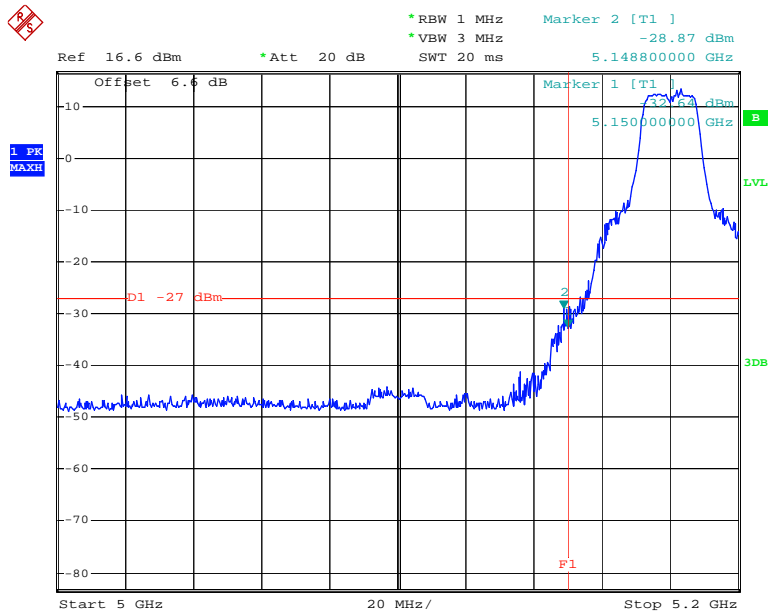

Date: 9.MAY.2014 16:58:40

Chain 1: 802.11a Band Edge, Right Side

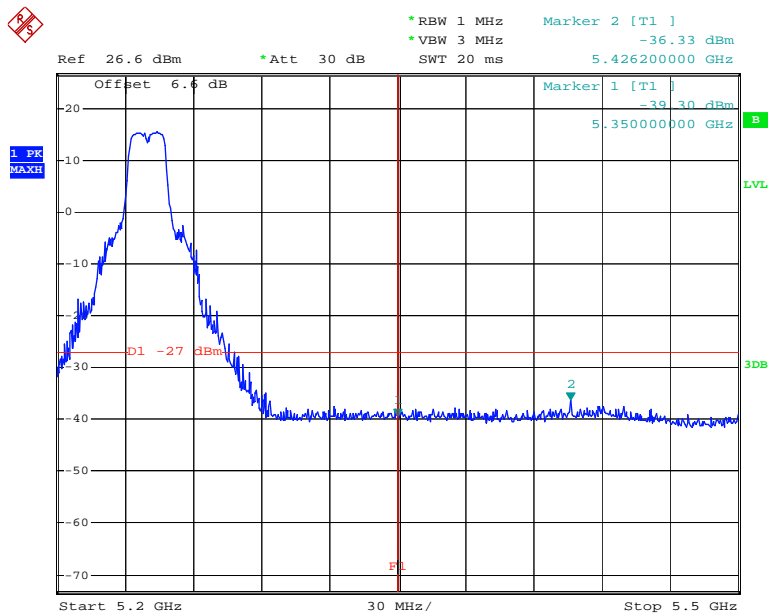

Date: 9.MAY.2014 17:41:50

Chain 0: 802.11n ht20 Band Edge, Left Side

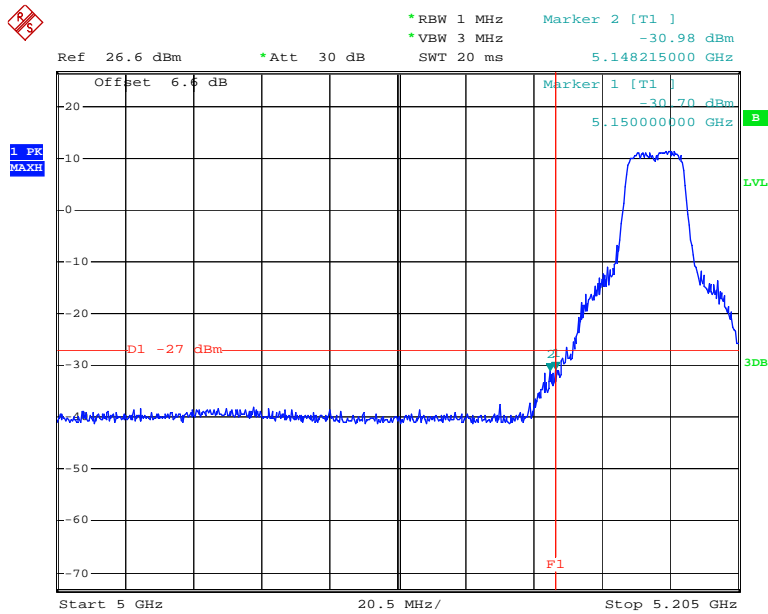

Date: 7.MAY.2014 13:47:36

Chain 0: 802.11n ht20 Band Edge, Right Side

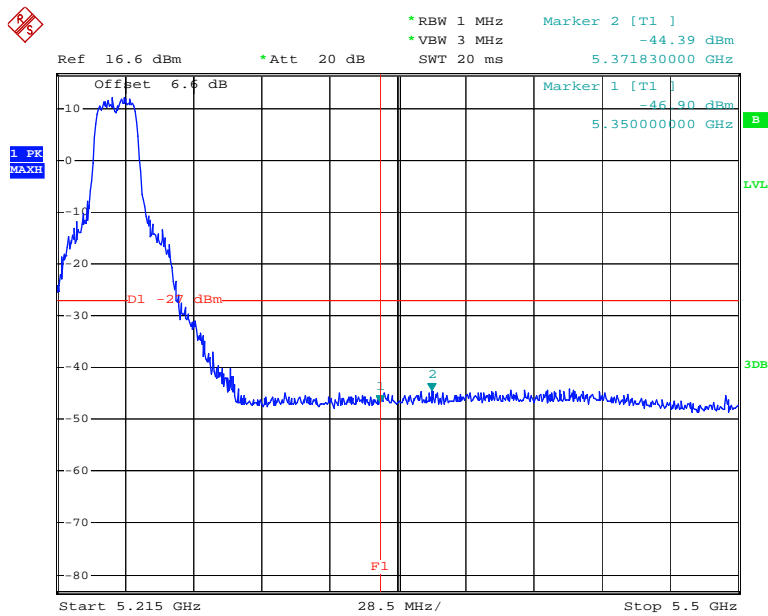

Date: 7.MAY.2014 14:16:13

Chain 1: 802.11n ht20 Band Edge, Left Side

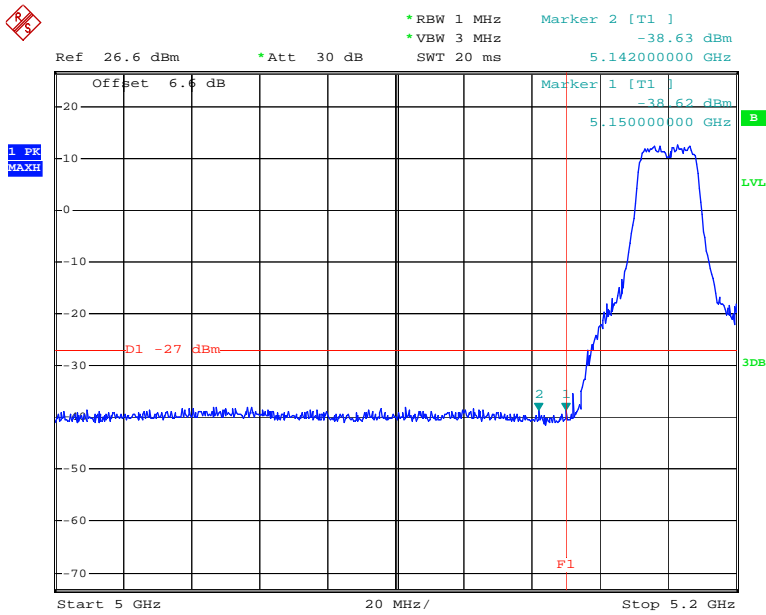

Date: 7.MAY.2014 13:56:49

Chain 1: 802.11n ht20 Band Edge, Right Side

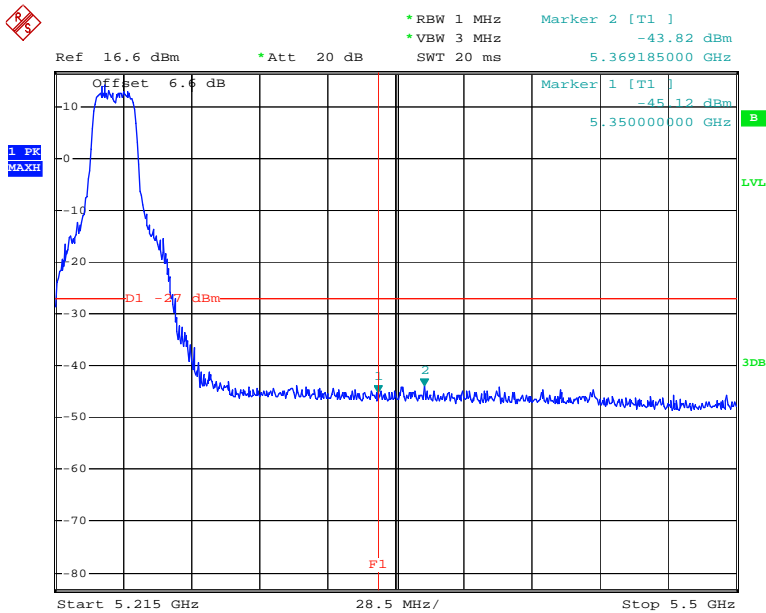

Date: 7.MAY.2014 14:23:42

Chain 0: 802.11n ht40 Band Edge, Left Side

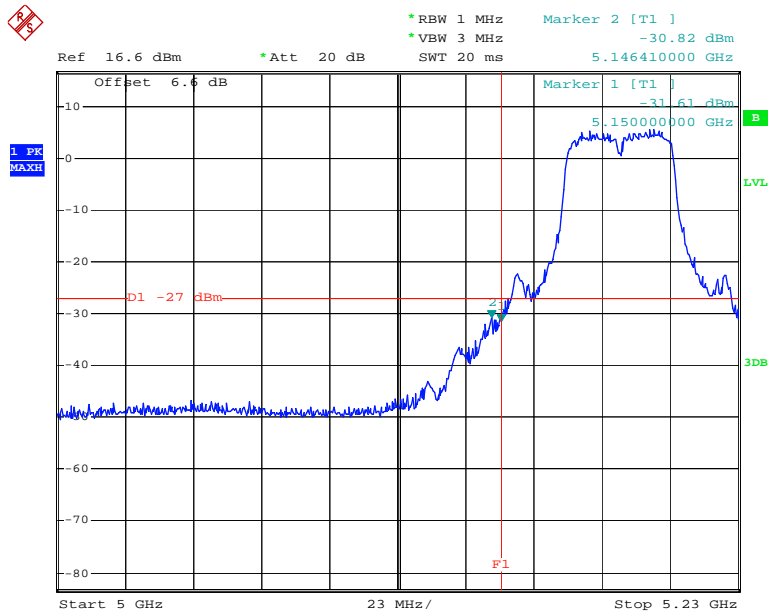

Date: 7.MAY.2014 14:47:58

Chain 0: 802.11n ht40 Band Edge, Right Side

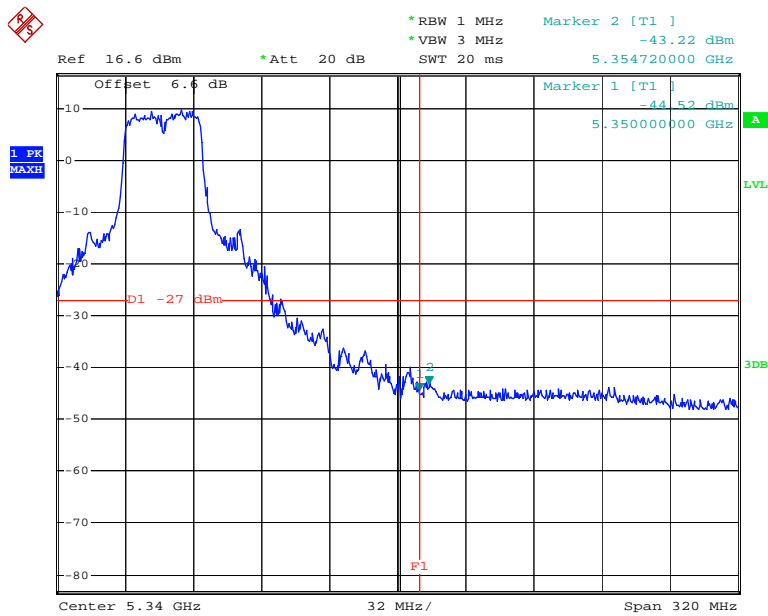

Date: 7.MAY.2014 15:10:50

Chain 1: 802.11n ht40 Band Edge, Left Side

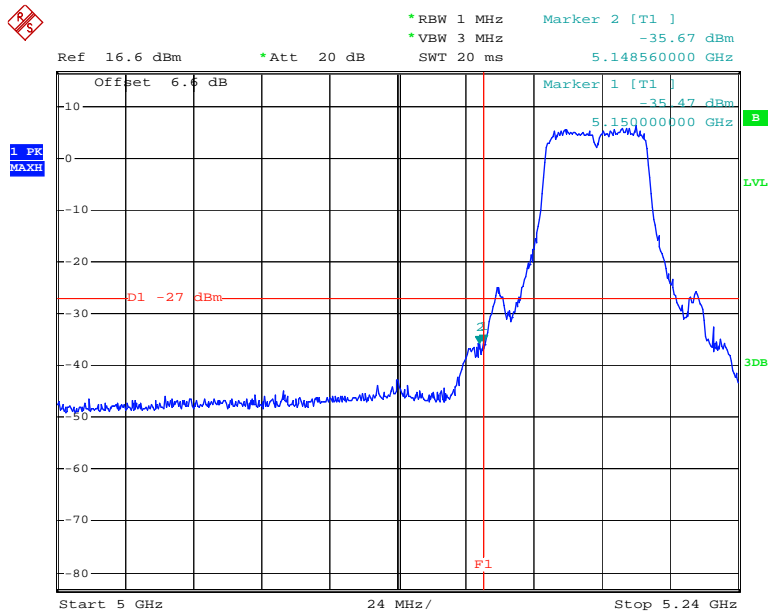

Date: 7.MAY.2014 14:55:16

Chain 1: 802.11n ht40 Band Edge, Right Side

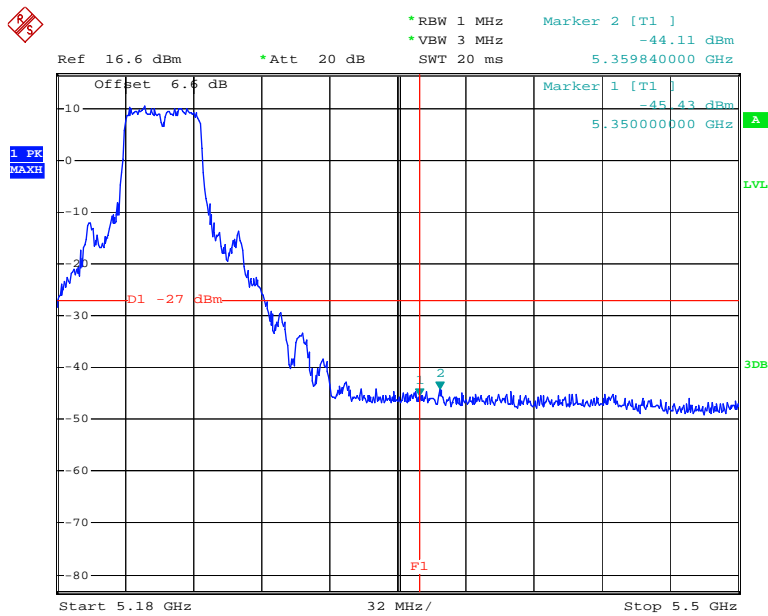

Date: 7.MAY.2014 15:26:23

FCC §15.407(a) (1) – 26 dB OCCUPIED BANDWIDTH

Applicable Standard

For the band 5.15–5.25 GHz, the maximum conducted output power over the frequency band of operation shall not exceed the lesser of 50 mW or $4 \text{ dBm} + 10 \log B$, where B is the 26–dB emission bandwidth in MHz. In addition, the peak power spectral density shall not exceed 4 dBm in any 1–MHz band. If transmitting antennas of directional gain greater than 6 dBi are used, both the maximum conducted output power and the peak power spectral density shall be reduced by the amount in dB that the directional gain of the antenna exceeds 6 dBi.

Test Equipment List and Details

Manufacturer	Description	Model	Serial Number	Calibration Date	Calibration Due Date
R&S	Spectrum Analyzer	FSP 38	100478	2013-06-16	2014-06-15

* **Statement of Traceability:** Bay Area Compliance Laboratories Corp. (Dongguan) attests that all calibrations have been performed, traceable to National Primary Standards and International System of Units (SI).

Test Procedure

6. Check the calibration of the measuring instrument using either an internal calibrator or a known signal from an external generator.
7. Position the EUT without connection to measurement instrument. Turn on the EUT and connect it to measurement instrument. Then set it to any one convenient frequency within its operating range. Set a reference level on the measuring instrument equal to the highest peak value.
8. Use a RBW = approximately 1% of the emission bandwidth. Set the VBW > RBW. Use a peak detector. Do not use the Max Hold function. Rather, use the view button to capture the emission. Measure maximum width of the emission that is 26 dB down from the peak of the emission. Compare this with the RBW setting of the analyzer. Readjust RBW and repeat, measurement as needed until the RBW/EBW ratio is approximately 1%.
9. Repeat above procedures until all frequencies measured were complete.

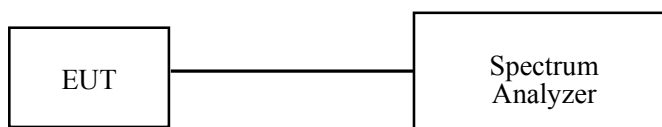

Test Data

Environmental Conditions

Temperature:	24.2~27 °C
Relative Humidity:	61~64 %
ATM Pressure:	99.7~100.8 kPa

The testing was performed by Dean Liu from 2014-05-07 to 2014-05-15.

Test Result: Pass.

Please refer to the following tables and plots.

Test mode: Transmitting

Test mode	Channel	Frequency	26 dB Bandwidth(MHz)	
		(MHz)	Chain0	Chain1
802.11a	Low	5180	31.12	24.60
	Middle	5200	40.80	40.20
	High	5240	38.05	41.80
802.11n ht20	Low	5180	27.57	24.20
	Middle	5200	30.65	31.95
	High	5240	33.00	26.20
802.11n ht40	Low	5190	50.20	47.50
	High	5230	74.80	74.30

Chain 0: 802.11a Low Channel

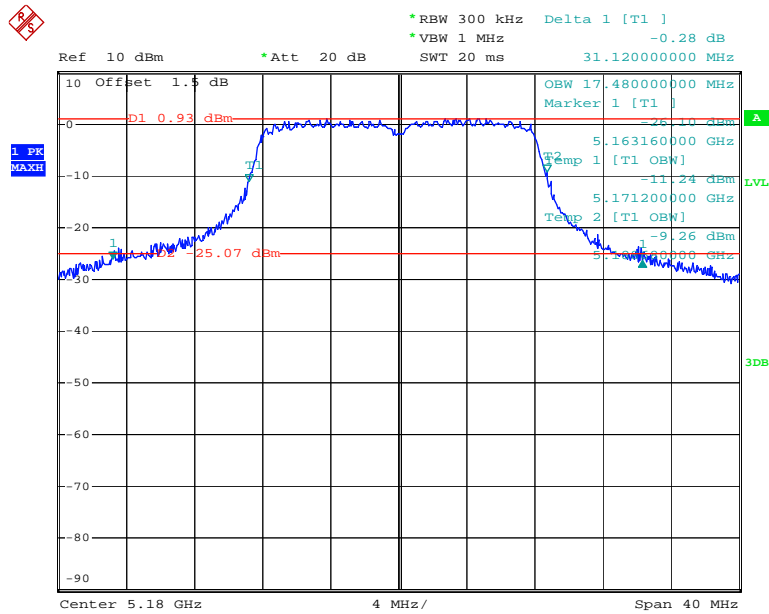

Date: 7.MAY.2014 11:45:40

Chain 0: 802.11a Middle Channel

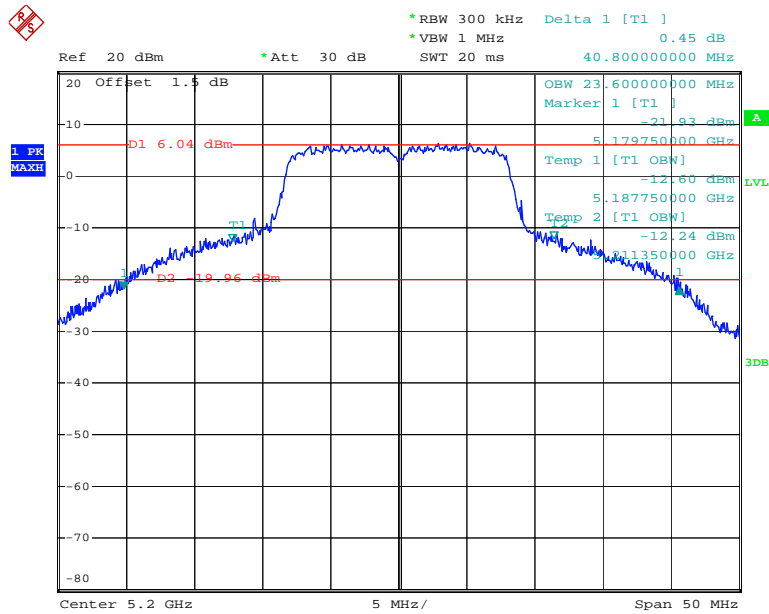

Date: 12.MAY.2014 18:56:24

Chain 0: 802.11a High Channel

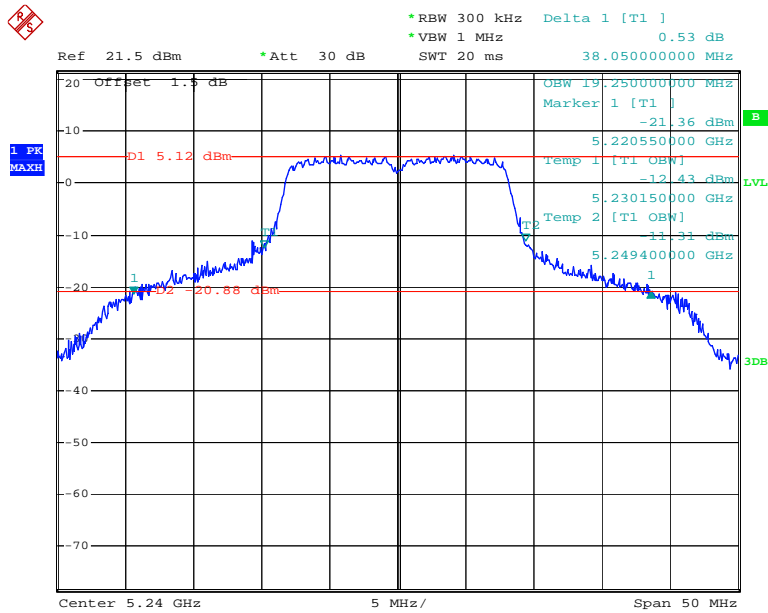

Date: 7.MAY.2014 13:28:54

Chain 1: 802.11a Low Channel

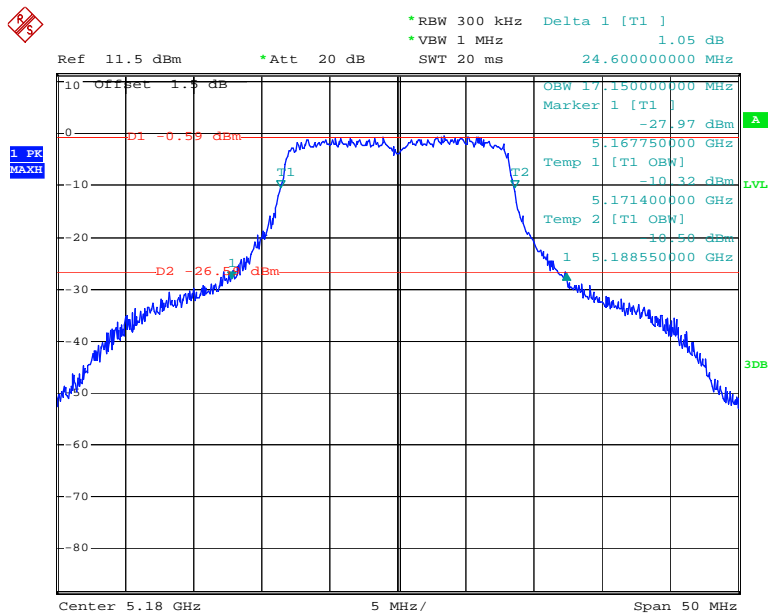

Date: 9.MAY.2014 16:54:15

Chain 1: 802.11a Middle Channel

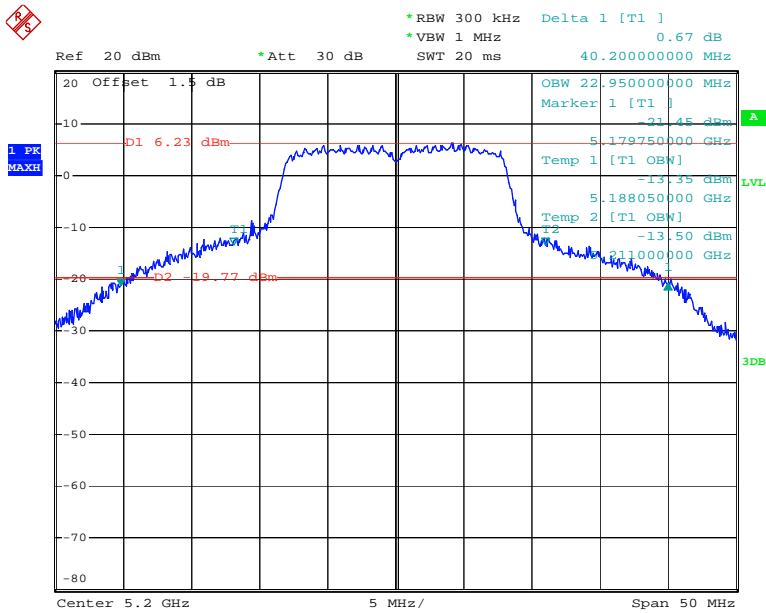

Date: 12.MAY.2014 18:49:24

Chain 1: 802.11a High Channel

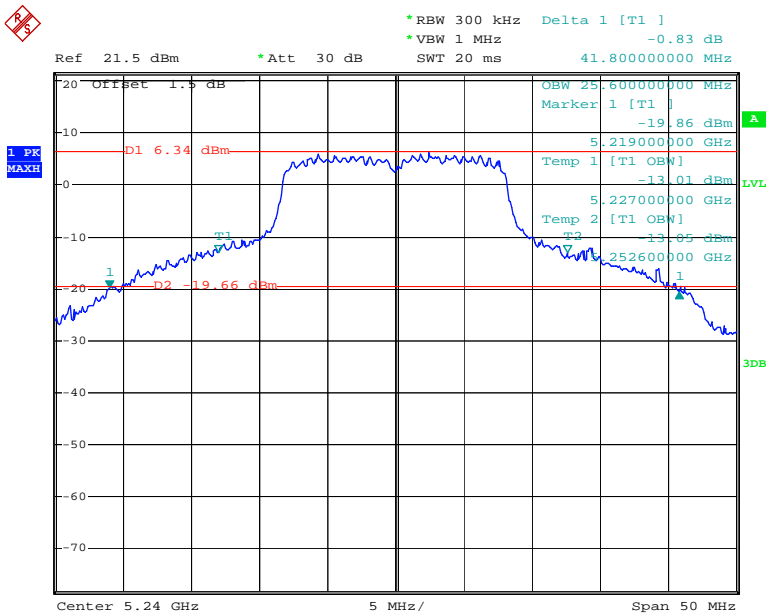

Date: 9.MAY.2014 14:57:03

Chain 0:802.11n ht20 Low Channel

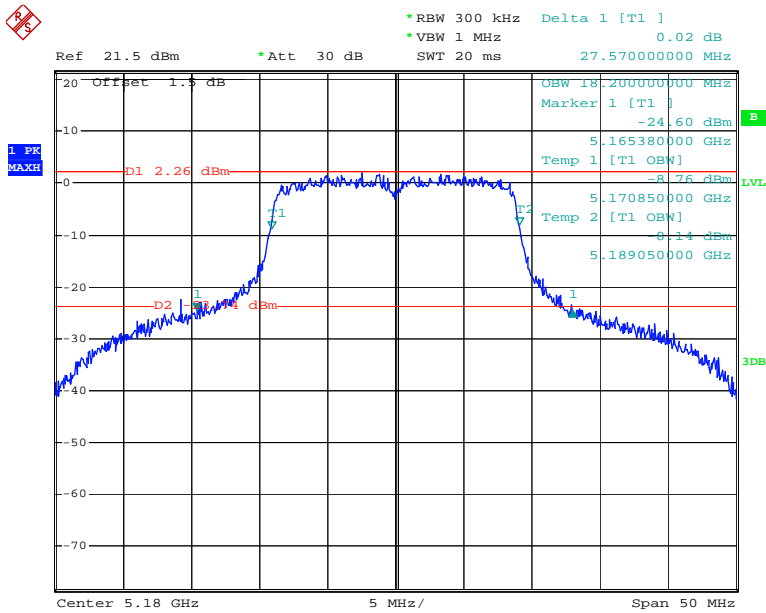

Date: 7.MAY.2014 13:41:50

Chain 0:802.11n ht20 Middle Channel

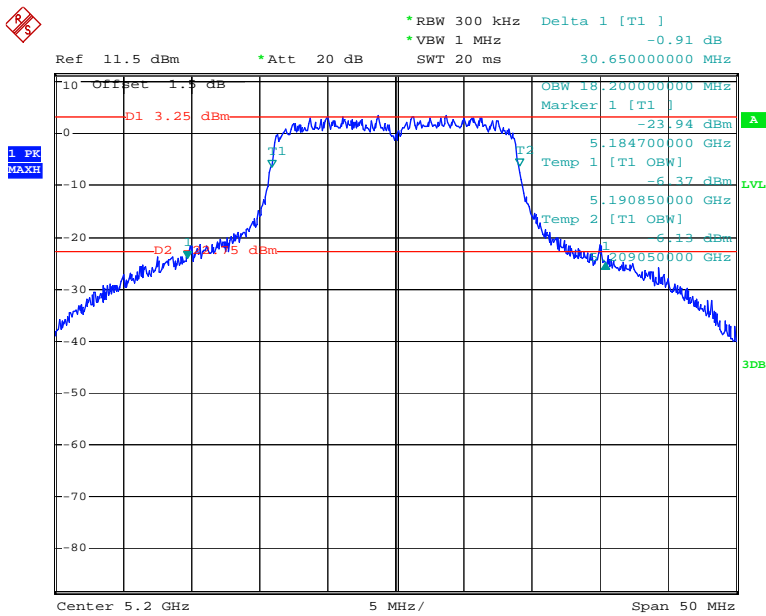

Date: 13.MAY.2014 13:17:42

Chain 0:802.11n ht20 High Channel

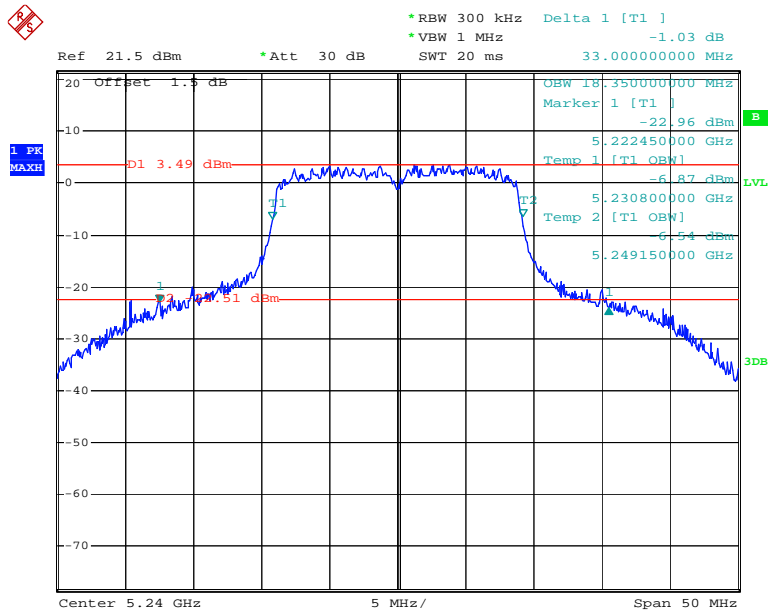

Date: 15.MAY.2014 11:40:58

Chain 1:802.11n ht20 Low Channel

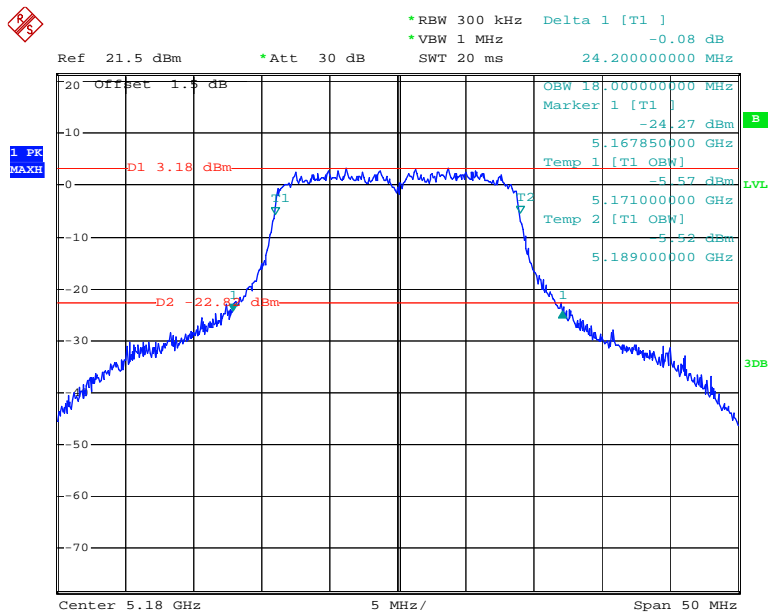

Date: 7.MAY.2014 13:51:24

Chain 1:802.11n ht20 Middle Channel

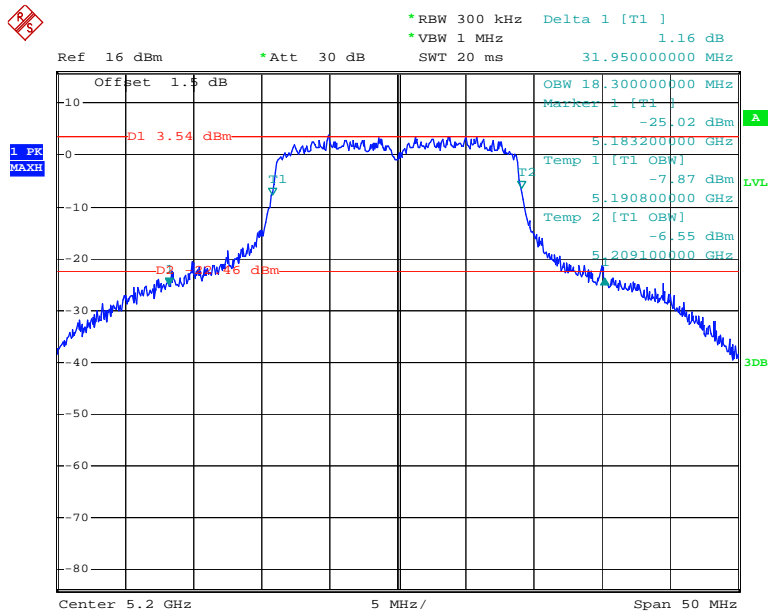

Date: 13.MAY.2014 13:22:15

Chain 1:802.11n ht20 High Channel

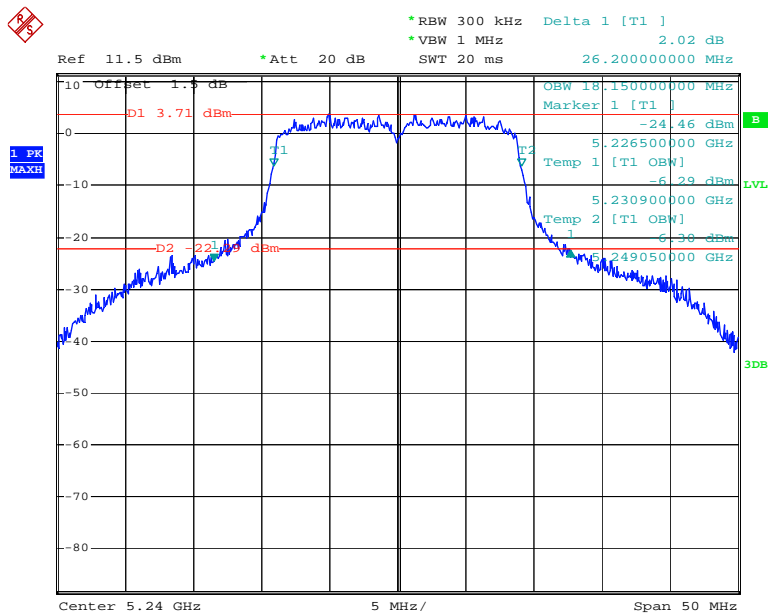

Date: 7.MAY.2014 14:20:17

Chain 0:802.11n ht40 Low Channel

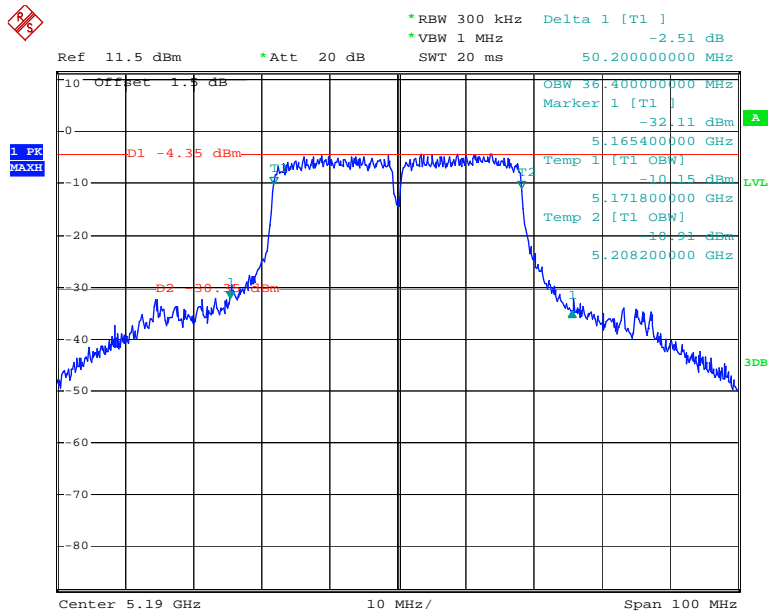

Date: 7.MAY.2014 17:43:08

Chain 0:802.11n ht40 High Channel

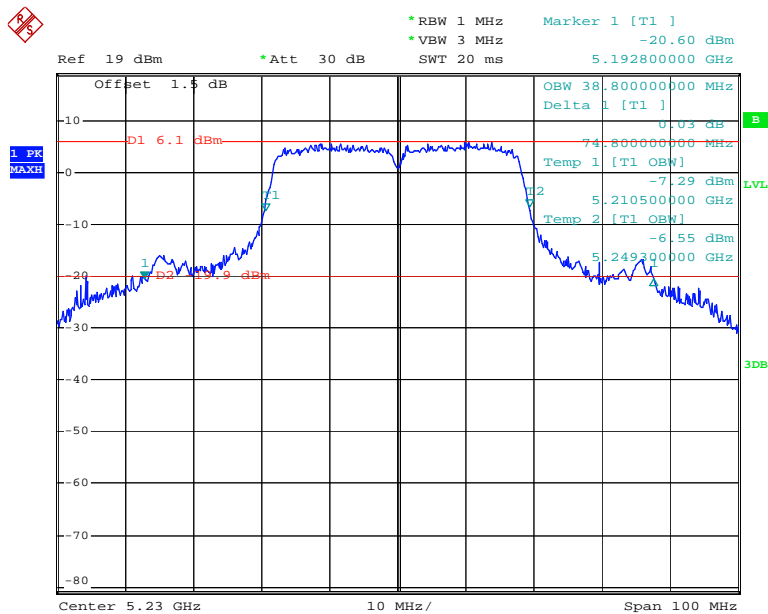

Date: 15.MAY.2014 11:58:44

Chain 1:802.11n ht40 Low Channel

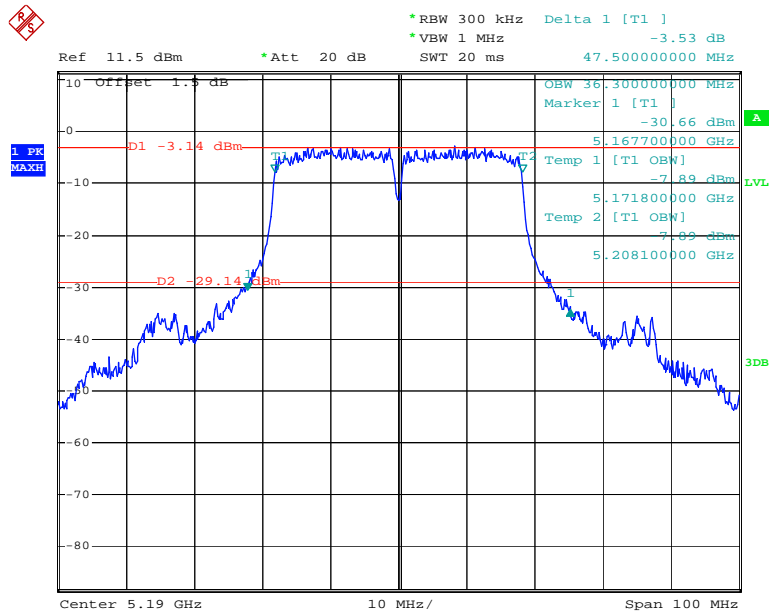

Date: 7.MAY.2014 17:44:18

Chain 1:802.11n ht40 High Channel

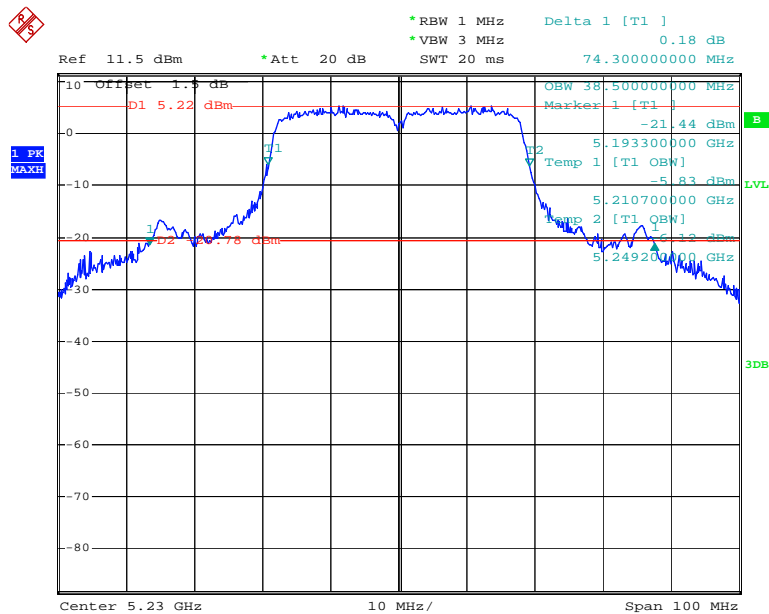

Date: 15.MAY.2014 13:11:45

FCC §15.407(a) (1) – CONDUCTED TRANSMITTER OUTPUT POWER

Applicable Standard

For the band 5.15–5.25 GHz, the maximum conducted output power over the frequency band of operation shall not exceed the lesser of 50 mW or $4 \text{ dBm} + 10 \log B$, where B is the 26-dB emission bandwidth in MHz. In addition, the peak power spectral density shall not exceed 4 dBm in any 1-MHz band. If transmitting antennas of directional gain greater than 6 dBi are used, both the maximum conducted output power and the peak power spectral density shall be reduced by the amount in dB that the directional gain of the antenna exceeds 6 dBi.

Test Equipment List and Details

Manufacturer	Description	Model	Serial Number	Calibration Date	Calibration Due Date
R&S	Spectrum Analyzer	FSP 38	100478	2013-06-16	2014-06-15

* **Statement of Traceability:** Bay Area Compliance Laboratories Corp. (Dongguan) attests that all calibrations have been performed, traceable to National Primary Standards and International System of Units (SI).

Test Procedure

1. Check the calibration of the measuring instrument using either an internal calibrator or a known signal from an external generator.
2. Position the EUT was set without connection to measurement instrument. Turn on the EUT and connect its antenna terminal to measurement instrument via a low loss cable. Then set it to any one measured frequency within its operating range, and make sure the instrument is operated in its linear range.
3. Set span to encompass the entire emission bandwidth (EBW) of the signal. Set RBW = 1 MHz. Set VBW \geq 3 MHz. Use sample detector mode Use a video trigger with the trigger level set to enable triggering only on full power pulses. Transmitter must operate at full control power for entire sweep of every sweep. If the device transmits continuously, with no off intervals or reduced power intervals, the trigger may be set to “free run”. Trace average 100 traces in power averaging mode. Compute power by integrating the spectrum across the 26 dB EBW of the signal. The integration can be performed using the spectrum analyzer’s band power measurement function with band limits set equal to the EBW band edges or by summing power levels in each 1 MHz band in linear power terms. The 1 MHz band power levels to be summed can be obtained by averaging, in linear power terms, power levels in each frequency bin across the 1 MHz.
4. Repeat above procedures until all frequencies measured were complete.

Test Data

Environmental Conditions

Temperature:	24.2~27 °C
Relative Humidity:	61~64 %
ATM Pressure:	99.7~100.8 kPa

The testing was performed by Dean Liu from 2014-05-07 to 2014-05-15.

Test Mode: Transmitting

Test mode	Channel	Frequency	Conducted Output Power (dBm)			Limit	Result
		(MHz)	Chain0	Chain1	Chain0+1	(dBm)	
802.11a	Low	5180	9.35	10.1	/	17	PASS
	Middle	5200	14.53	14.38	/	17	PASS
	High	5240	13.68	13.78	/	17	PASS
802.11n ht20	Low	5180	10.10	10.67	13.40	17	PASS
	Middle	5200	11.34	11.40	14.38	17	PASS
	High	5240	11.20	11.03	14.13	17	PASS
802.11n ht40	Low	5190	6.01	7.01	9.55	17	PASS
	High	5230	11.37	11.09	14.24	17	PASS

Chain 0: 802.11a RF Output Power, Low Channel

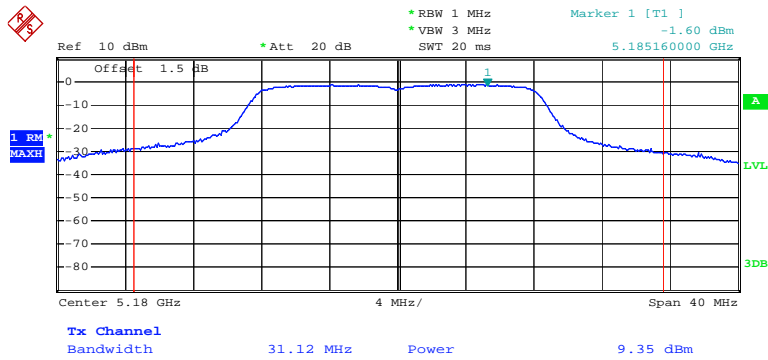

Date: 7.MAY.2014 11:47:07

Chain 0: 802.11a RF Output Power, Middle Channel

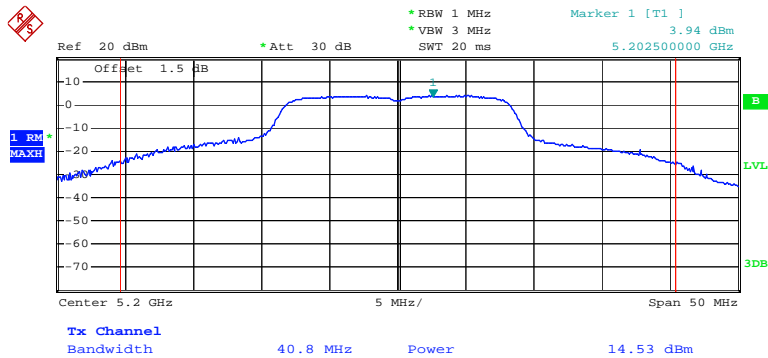

Date: 12.MAY.2014 18:56:57

Chain 0: 802.11a RF Output Power, High Channel

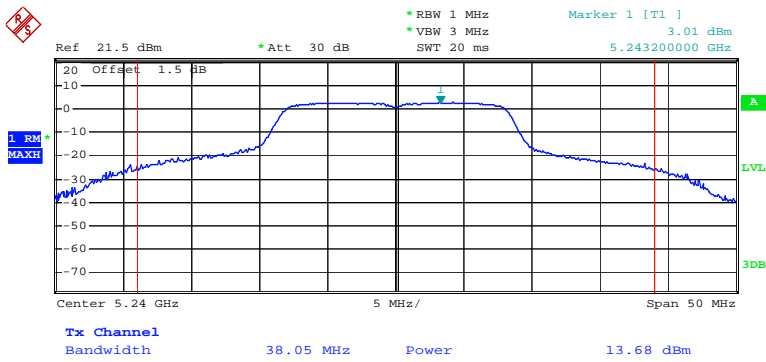

Date: 7.MAY.2014 13:31:51

Chain 1: 802.11a RF Output Power, Low Channel

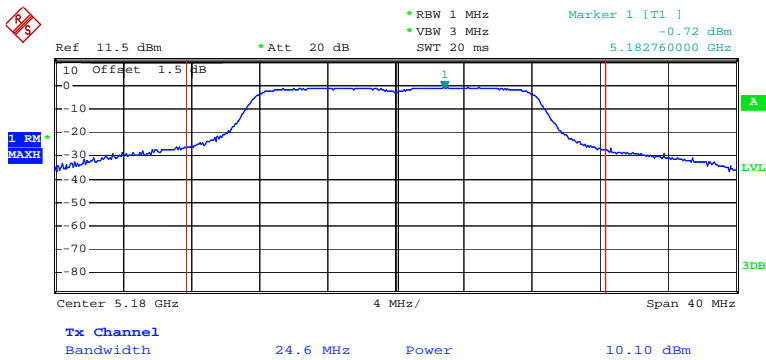

Date: 9.MAY.2014 17:11:32

Chain 1: 802.11a RF Output Power, Middle Channel

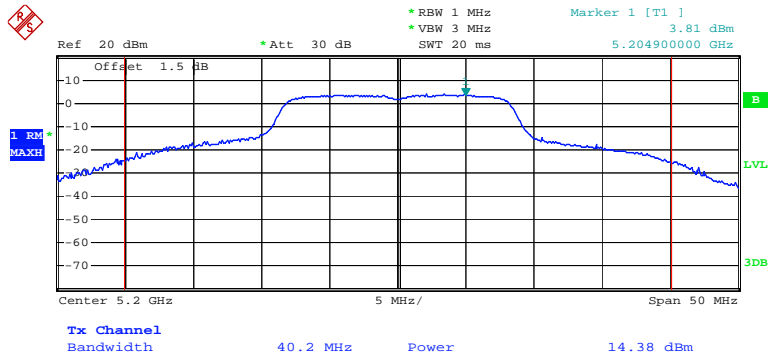

Date: 12.MAY.2014 18:50:47

Chain 1: 802.11a RF Output Power, High Channel

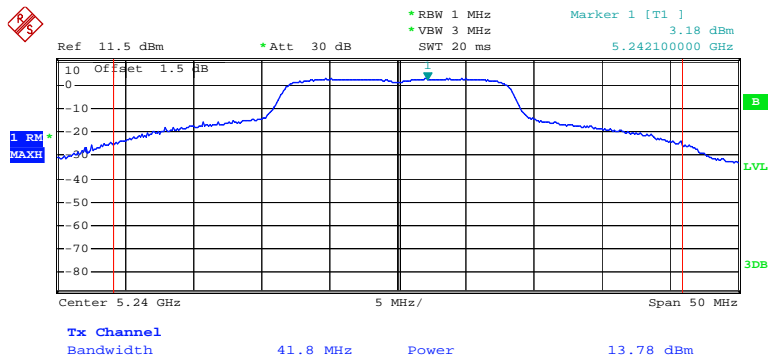

Date: 13.MAY.2014 15:11:20

Chain 0:802.11n ht20 RF Output Power, Low Channel

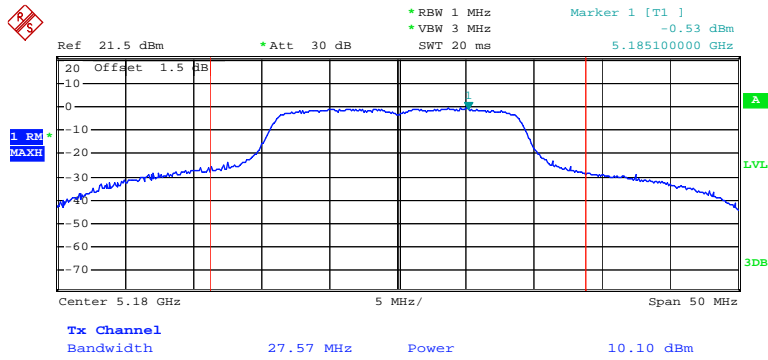

Date: 7.MAY.2014 13:42:43

Chain 0:802.11n ht20 RF Output Power, Middle Channel

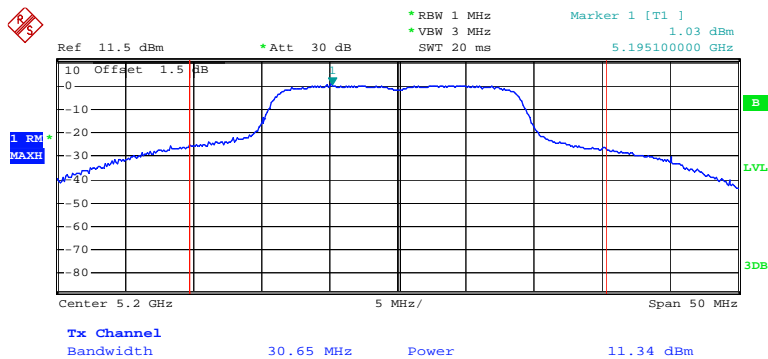

Date: 13.MAY.2014 15:08:11

Chain 0:802.11n ht20 RF Output Power, High Channel

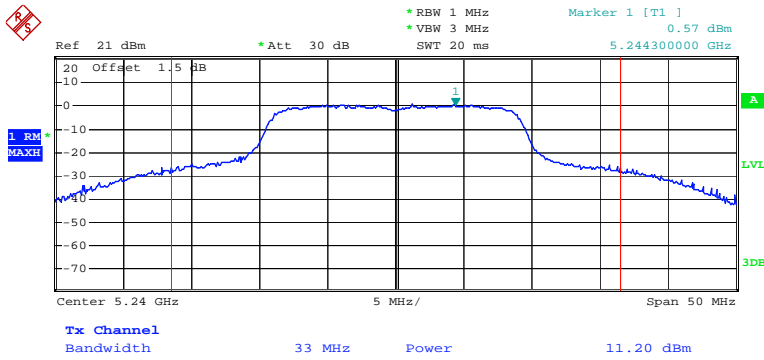

Date: 15.MAY.2014 11:41:21

Chain 1:802.11n ht20 RF Output Power, Low Channel

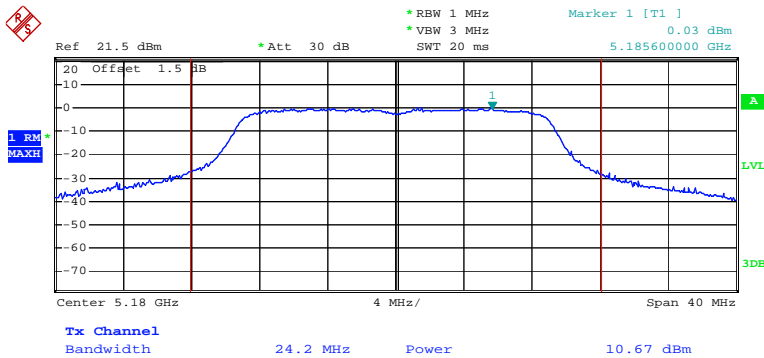

Date: 7.MAY.2014 13:52:13

Chain 1:802.11n ht20 RF Output Power, Middle Channel

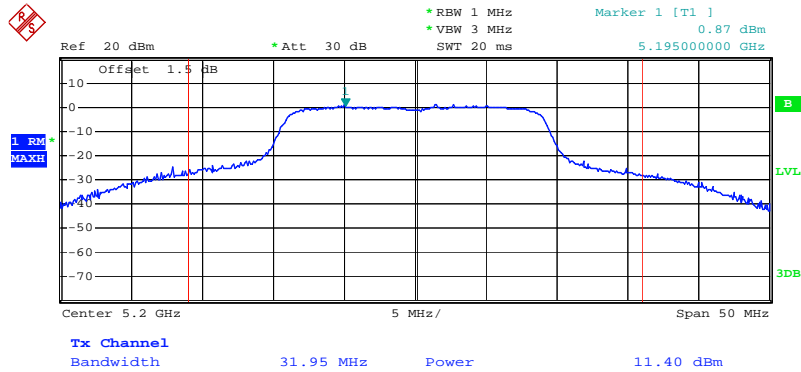

Date: 13.MAY.2014 13:22:50

Chain 1:802.11n ht20 RF Output Power, High Channel

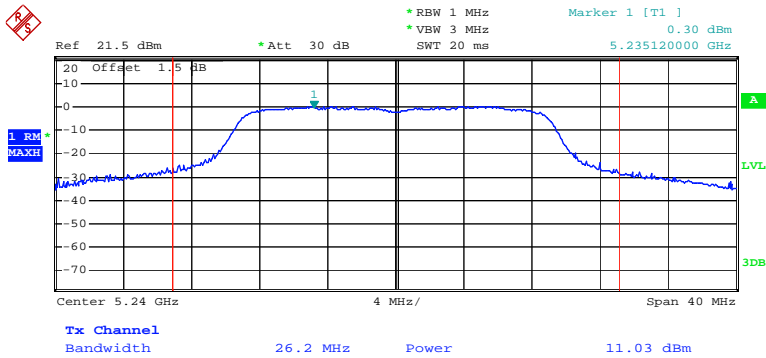

Date: 7.MAY.2014 14:21:32

Chain 0:802.11n ht40 RF Output Power, Low Channel

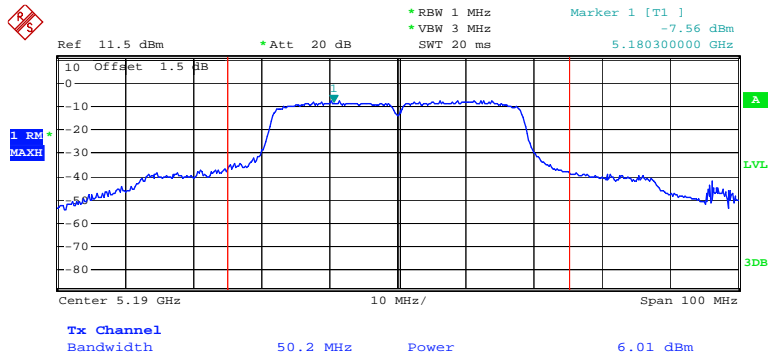

Date: 7.MAY.2014 14:41:36

Chain 0:802.11n ht40 RF Output Power, High Channel

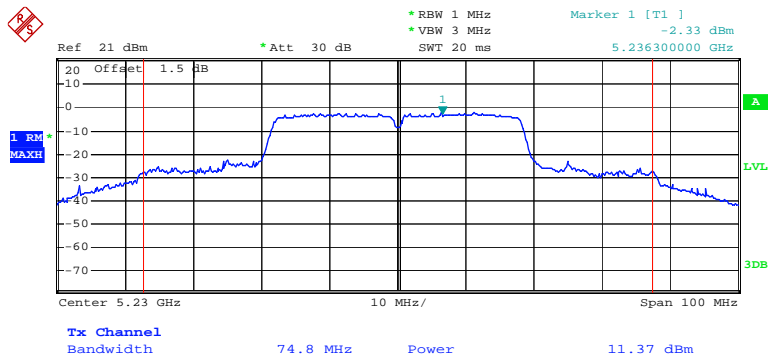

Date: 15.MAY.2014 11:59:17

Chain 1:802.11n ht40 RF Output Power, Low Channel

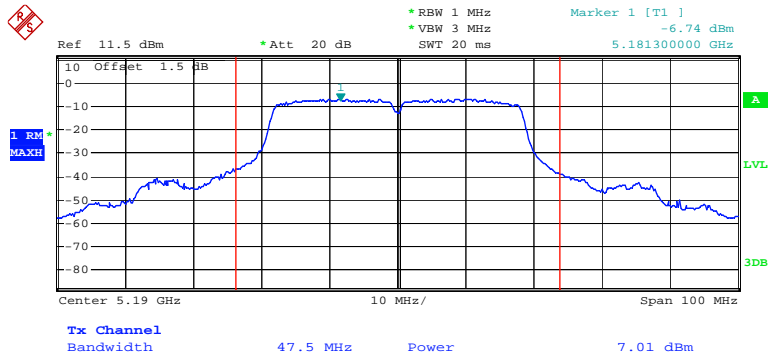

Date: 7.MAY.2014 14:51:47

Chain 1:802.11n ht40 RF Output Power, High Channel

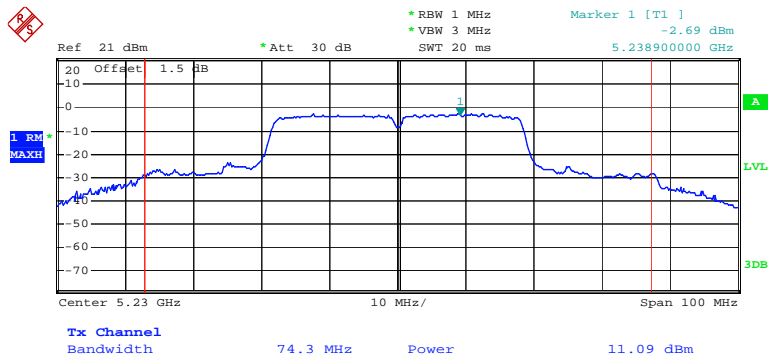

Date: 15.MAY.2014 13:12:29

FCC §15.407(a) (1) (5) - POWER SPECTRAL DENSITY

Applicable Standard

For the band 5.15–5.25 GHz, the maximum conducted output power over the frequency band of operation shall not exceed the lesser of 50 mW or $4 \text{ dBm} + 10 \log B$, where B is the 26-dB emission bandwidth in MHz. In addition, the peak power spectral density shall not exceed 4 dBm in any 1-MHz band. If transmitting antennas of directional gain greater than 6 dBi are used, both the maximum conducted output power and the peak power spectral density shall be reduced by the amount in dB that the directional gain of the antenna exceeds 6 dBi.

The peak power spectral density is measured as a conducted emission by direct connection of a calibrated test instrument to the equipment under test. If the device cannot be connected directly, alternative techniques acceptable to the Commission may be used. Measurements are made over a bandwidth of 1 MHz or the 26 dB emission bandwidth of the device, whichever is less. A resolution bandwidth less than the measurement bandwidth can be used, provided that the measured power is integrated to show total power over the measurement bandwidth. If the resolution bandwidth is approximately equal to the measurement bandwidth, and much less than the emission bandwidth of the equipment under test, the measured results shall be corrected to account for any difference between the resolution bandwidth of the test instrument and its actual noise bandwidth.

Test Procedure

1. Check the calibration of the measuring instrument using either an internal calibrator or a known signal from an external generator.
2. Position the EUT was set without connection to measurement instrument. Turn on the EUT and connect its antenna terminal to measurement instrument via a low loss cable. Then set it to any one measured frequency within its operating range, and make sure the instrument is operated in its linear range.
3. Use sample detector and power averaging (not video averaging) mode. Set RBW= 1 MHz, VBW > 1 MHz. The PPSD is the highest level found across the emission in any 1-MHz band after 100 sweeps of averaging. This method is permitted only if the transmission pulse or sequence of pulses remains at maximum transmits power throughout each of the 100 sweeps of averaging and that the interval between pulses is not included in any of the sweeps.
4. Repeat above procedures until all frequencies measured were complete.

Test Equipment List and Details

Manufacturer	Description	Model	Serial Number	Calibration Date	Calibration Due Date
R&S	Spectrum Analyzer	FSP 38	100478	2013-06-16	2014-06-15

* **Statement of Traceability:** Bay Area Compliance Laboratories Corp. (Dongguan) attests that all calibrations have been performed, traceable to National Primary Standards and International System of Units (SI).

Test Data**Environmental Conditions**

Temperature:	24.2~27 °C
Relative Humidity:	61~64 %
ATM Pressure:	99.7~100.8 kPa

The testing was performed by Dean Liu from 2014-05-07 to 2014-05-15.

Test Mode: Transmitting

Test mode	Channel	PSD (dBm/1MHz)			Limit (dBm/1MHz)	Result
		Chain0	Chain1	Chain0+1		
802.11a	Low	-1.44	-0.69	/	≤4	Pass
	Middle	3.86	3.87	/	≤4	Pass
	High	2.90	3.12	/	≤4	Pass
802.11n ht20	Low	-0.66	0.15	2.77	≤4	Pass
	Middle	0.81	0.94	3.89	≤4	Pass
	High	0.88	0.81	3.86	≤4	Pass
802.11n ht40	Low	-7.68	-6.71	-4.16	≤4	Pass
	High	-1.83	-2.58	0.82	≤4	Pass

Chain 0: Power Spectral Density, 802.11a Low Channel

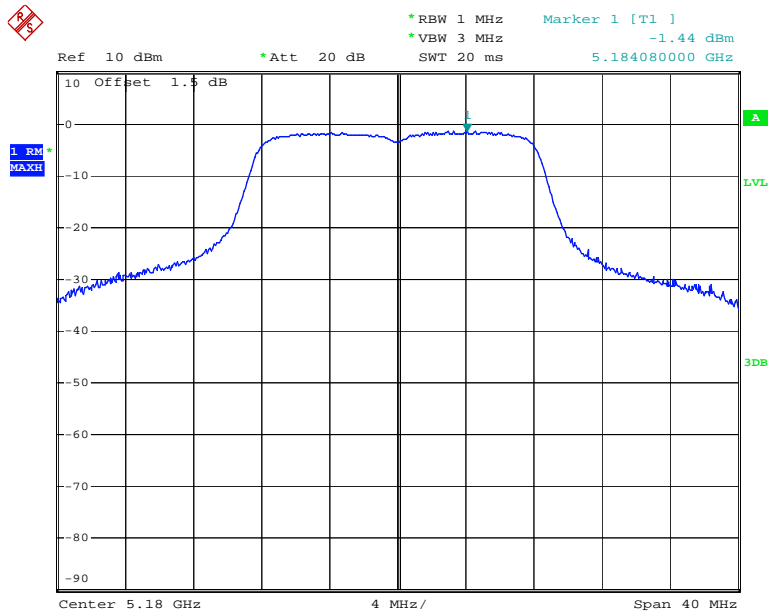

Date: 7.MAY.2014 11:48:05

Chain 0: Power Spectral Density, 802.11a Middle Channel

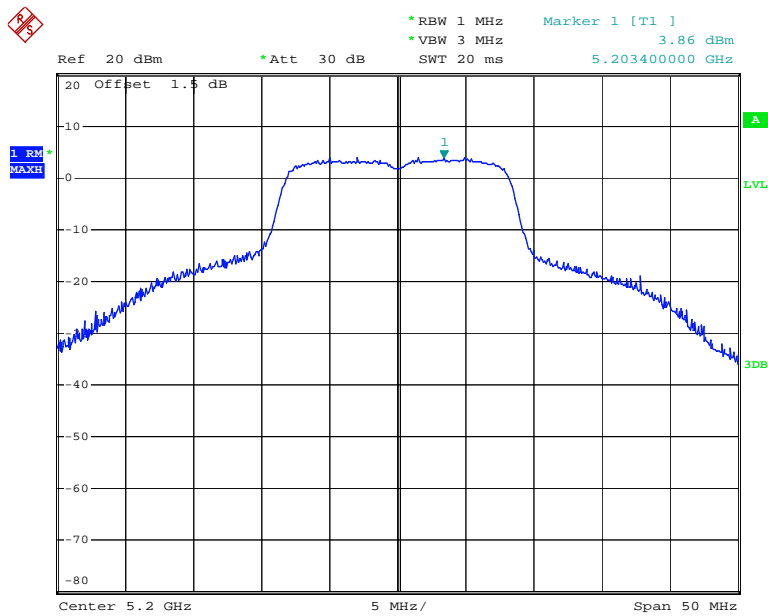

Date: 12.MAY.2014 18:55:13

Chain 0: Power Spectral Density, 802.11a High Channel

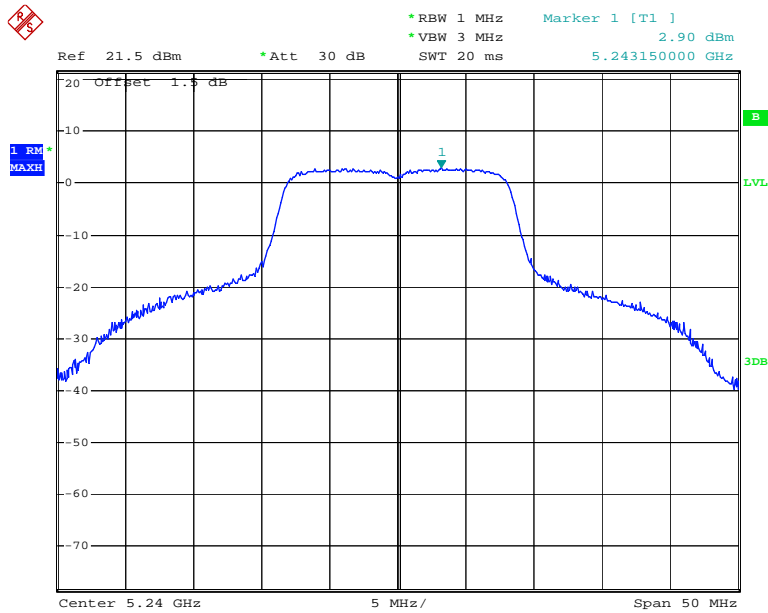

Date: 7.MAY.2014 13:33:03

Chain 1: Power Spectral Density, 802.11a Low Channel

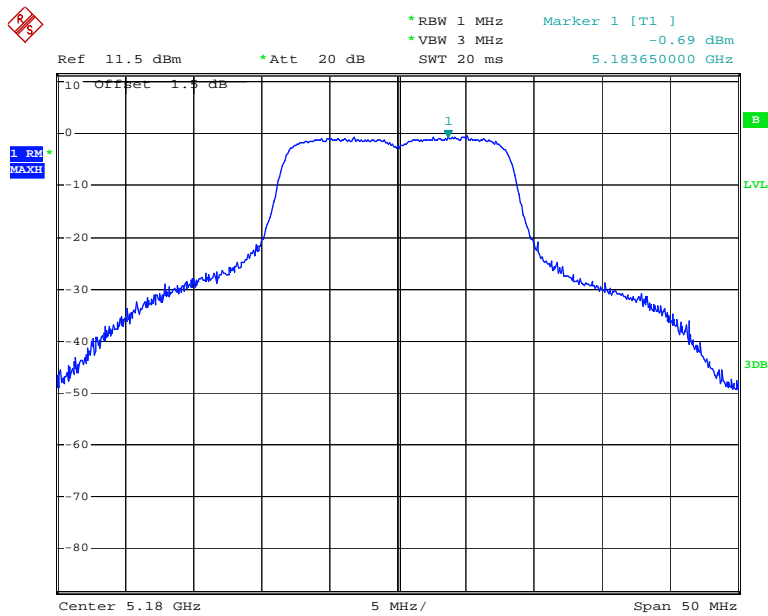

Date: 9.MAY.2014 17:07:22

Chain 1: Power Spectral Density, 802.11a Middle Channel

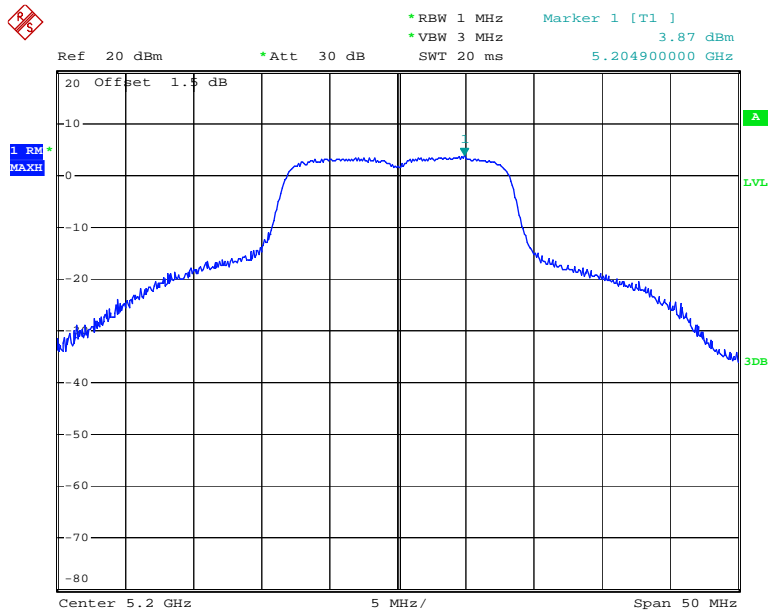

Date: 12.MAY.2014 18:47:22

Chain 1: Power Spectral Density, 802.11a High Channel

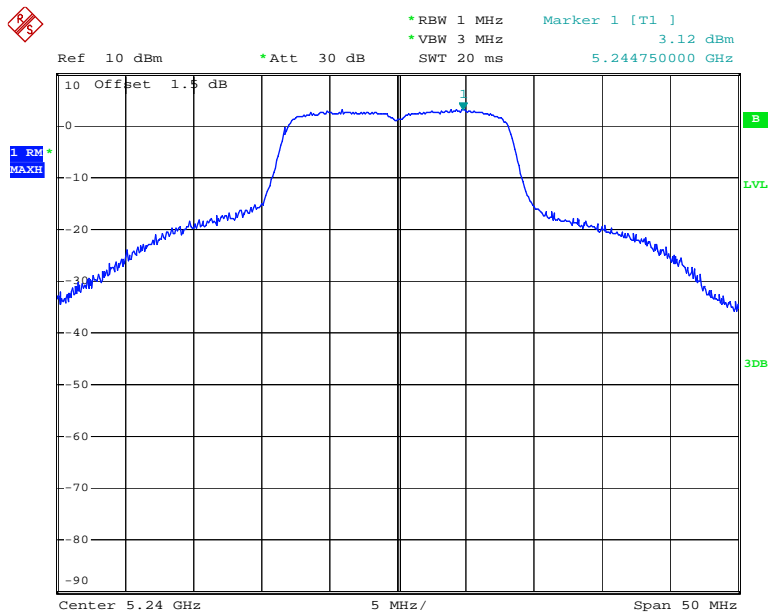

Date: 9.MAY.2014 17:26:57

Chain 0: Power Spectral Density, 802.11n ht20 Low Channel

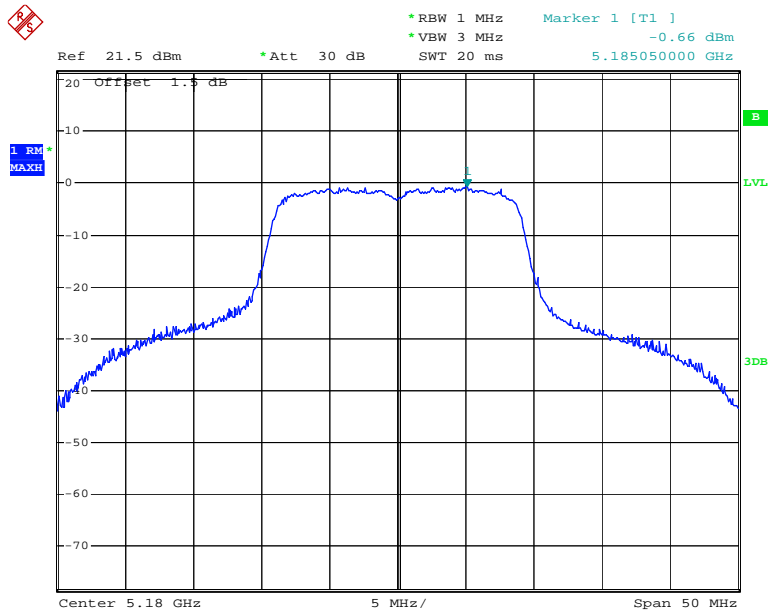

Date: 7.MAY.2014 13:43:17

Chain 0: Power Spectral Density, 802.11n ht20 Middle Channel

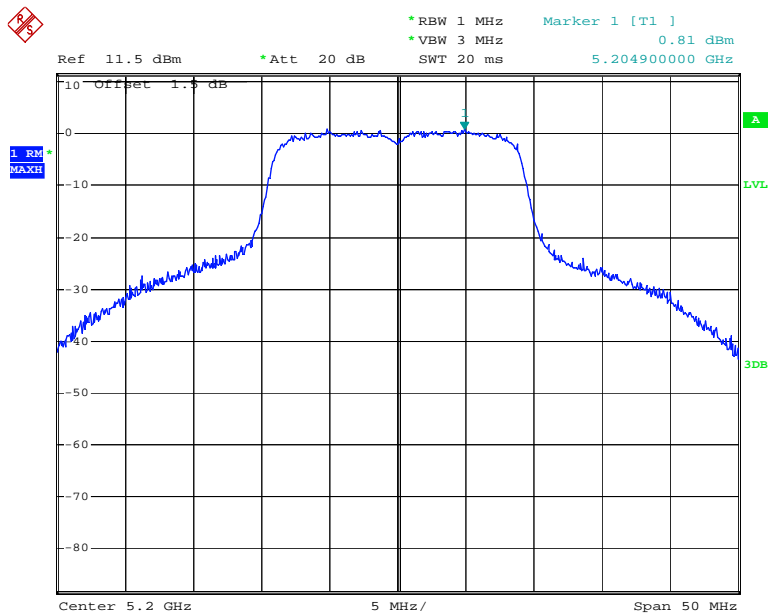

Date: 13.MAY.2014 13:19:45

Chain 0: Power Spectral Density, 802.11n ht20 High Channel

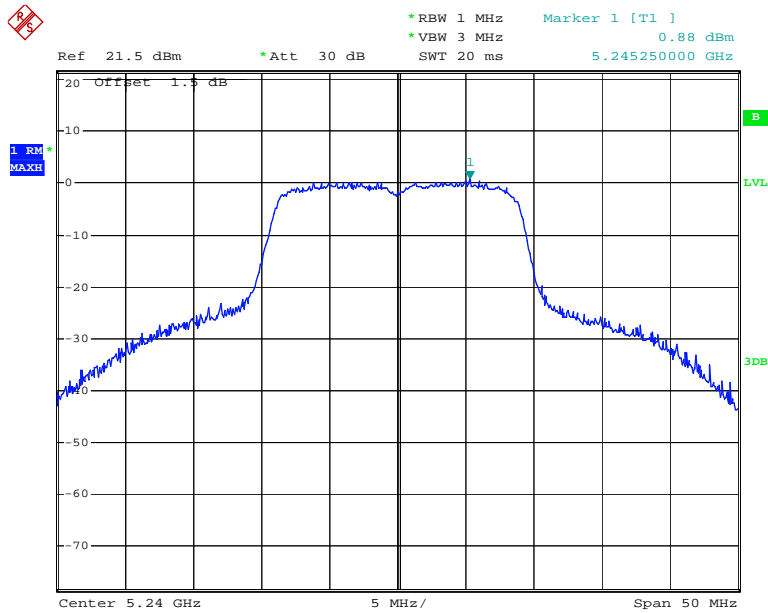

Date: 15.MAY.2014 11:43:33

Chain 1: Power Spectral Density, 802.11 n ht20 Low Channel

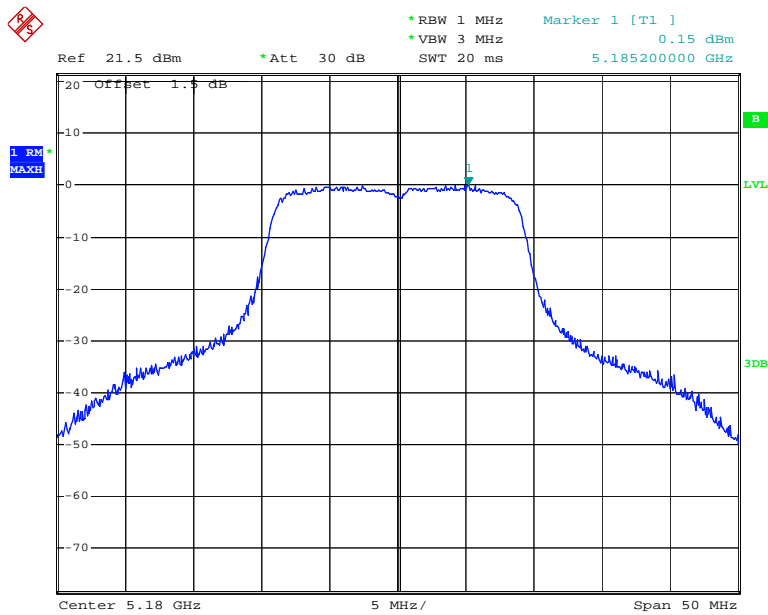

Date: 7.MAY.2014 13:52:58

Chain 1:Power Spectral Density, 802.11n ht20 Middle Channel

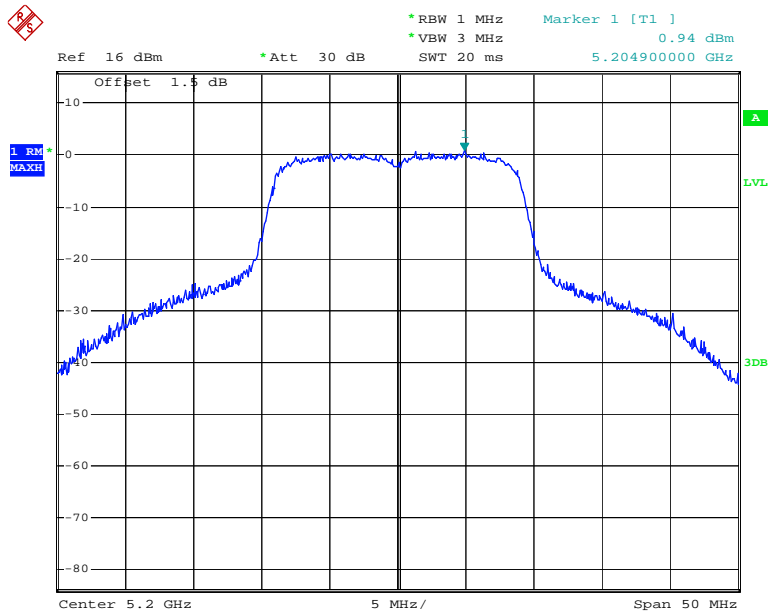

Date: 13.MAY.2014 13:23:51

Chain 1:Power Spectral Density, 802.11n ht20 High Channel

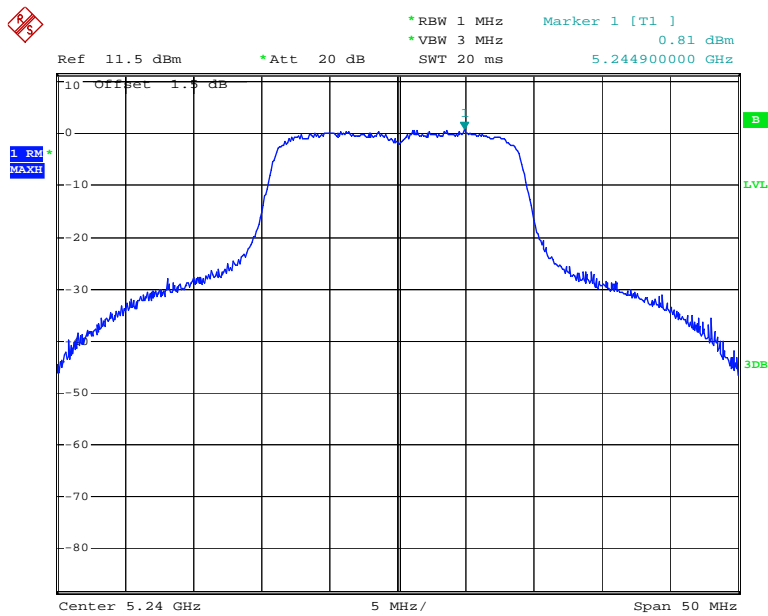

Date: 7.MAY.2014 14:22:21

Chain 0:Power Spectral Density, 802.11n ht40 Low Channel

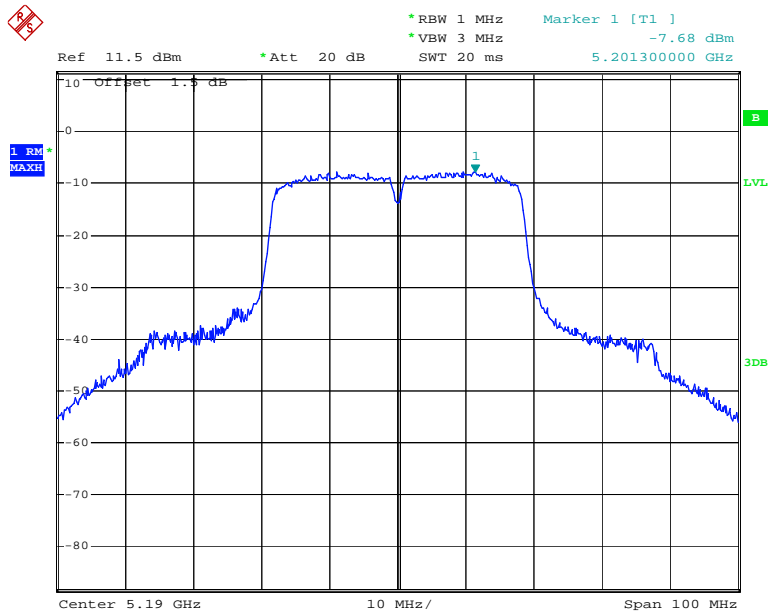

Date: 7.MAY.2014 14:42:09

Chain 0:Power Spectral Density, 802.11n ht40 High Channel

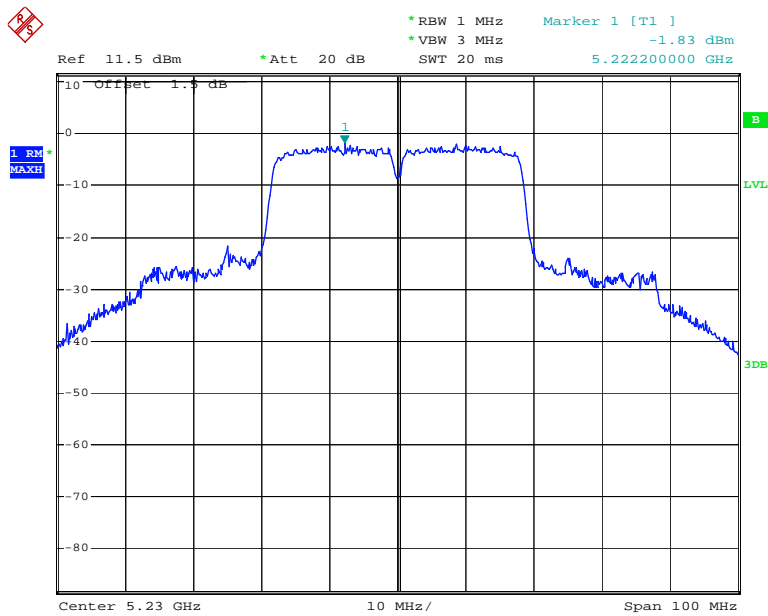

Date: 15.MAY.2014 11:59:41

Chain 1:Power Spectral Density, 802.11n ht40 Low Channel

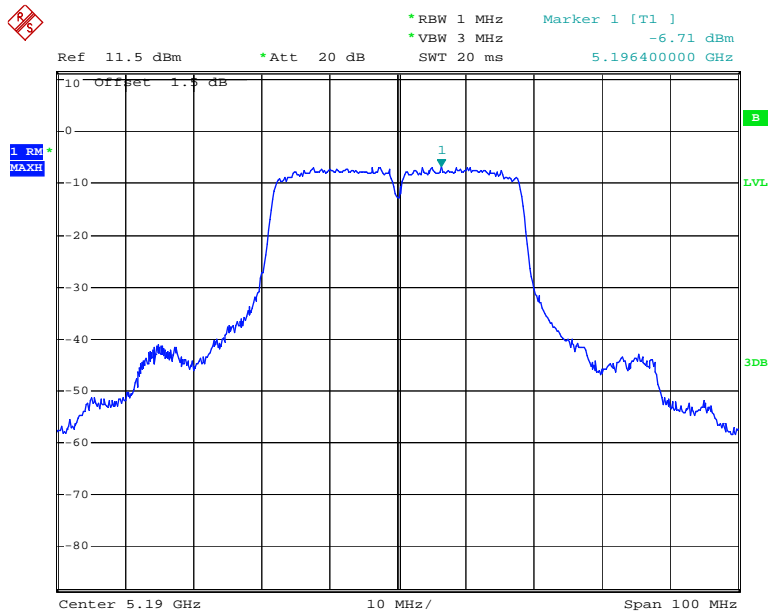

Date: 7.MAY.2014 14:52:18

Chain 1:Power Spectral Density, 802.11n ht40 High Channel

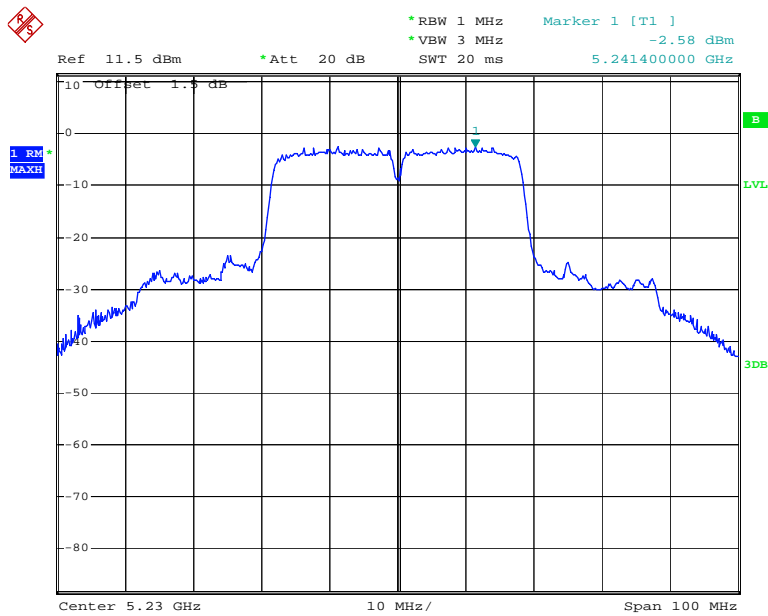

Date: 15.MAY.2014 13:13:25

FCC §15.407(a) (6) – PEAK EXCURSION RATIO

Applicable Standard

According to §15.407(a) (6), the ratio of the peak excursion of the modulation envelope (measured using a peak hold function) to the maximum conducted output power (measured as specified above) shall not exceed 13 dB across any 1 MHz bandwidth or the emission bandwidth whichever is less.

Test Procedure

Set the spectrum analyzer span to view the entire emission bandwidth. The largest difference between the following two traces must be ≤ 13 dB for all frequencies across the emission bandwidth. Submit a plot.

1st Trace:

- Set RBW = 1 MHz, VBW ≥ 3 MHz with peak detector and maxhold settings.

2nd Trace:

- create the 2nd trace using the settings described in the setion “FCC §15.407(a)(1) – CONDUCTED TRANSMITTER OUTPUT POWER”.

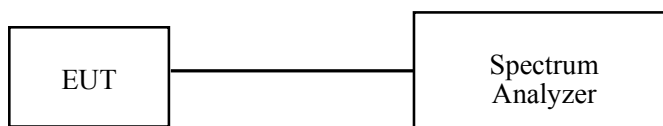

Test Equipment List and Details

Manufacturer	Description	Model	Serial Number	Calibration Date	Calibration Due Date
R&S	Spectrum Analyzer	FSP 38	100478	2013-06-16	2014-06-15

* **Statement of Traceability:** Bay Area Compliance Laboratories Corp. (Dongguan) attests that all calibrations have been performed, traceable to National Primary Standards and International System of Units (SI).

Test Data

Environmental Conditions

Temperature:	24.2~27 °C
Relative Humidity:	61~64 %
ATM Pressure:	99.7~100.8 kPa

The testing was performed by Dean Liu from 2014-05-07 to 2014-05-15.

Test Mode: Transmitting

Test mode	Channel	Peak Excursion Ratio (dB)		Limit (dB)	Result
		Chain0	Chain1		
802.11a	Low	8.33	8.74	≤13	PASS
	Middle	7.86	8.24	≤13	PASS
	High	7.97	8.18	≤13	PASS
802.11n ht20	Low	7.89	7.92	≤13	PASS
	Middle	7.85	7.46	≤13	PASS
	High	7.97	8.40	≤13	PASS
802.11n ht40	Low	7.61	8.11	≤13	PASS
	High	7.48	7.40	≤13	PASS

Chain 0: 802.11a Peak Excursion, High Channel

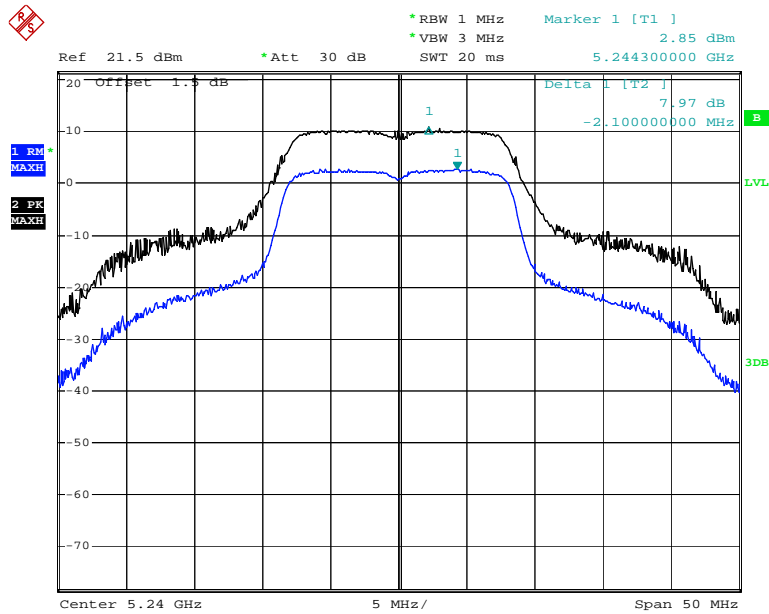

Date: 7.MAY.2014 13:33:58

Chain 1: 802.11a Peak Excursion, Low Channel

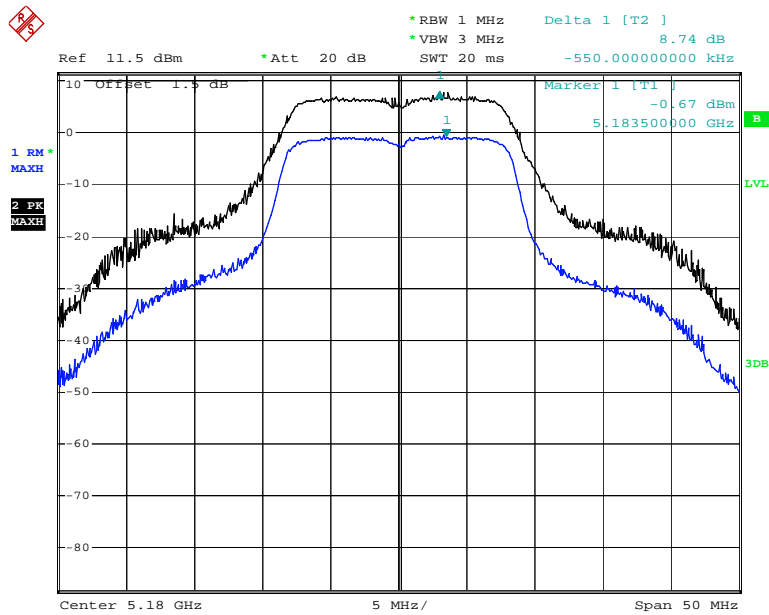

Date: 9.MAY.2014 17:07:43

Chain 1: 802.11a Peak Excursion, Middle Channel

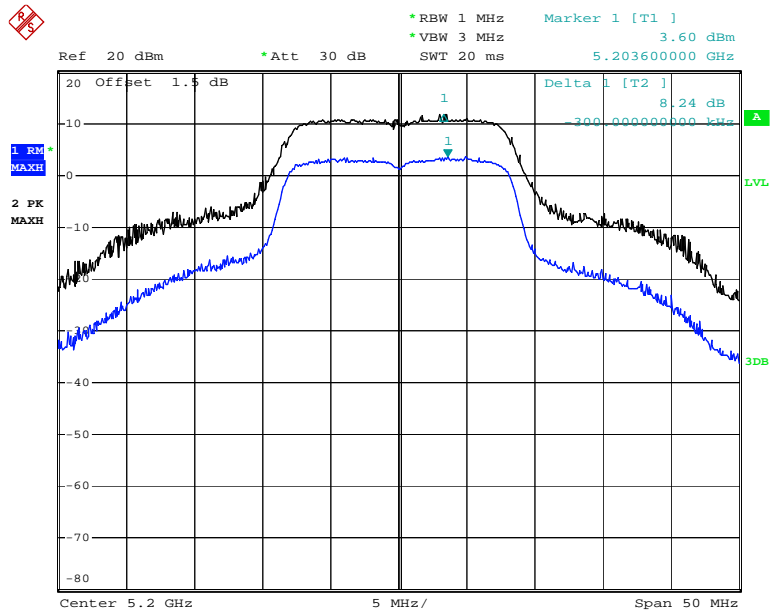

Date: 12.MAY.2014 18:53:05

Chain 1: 802.11a Peak Excursion, High Channel

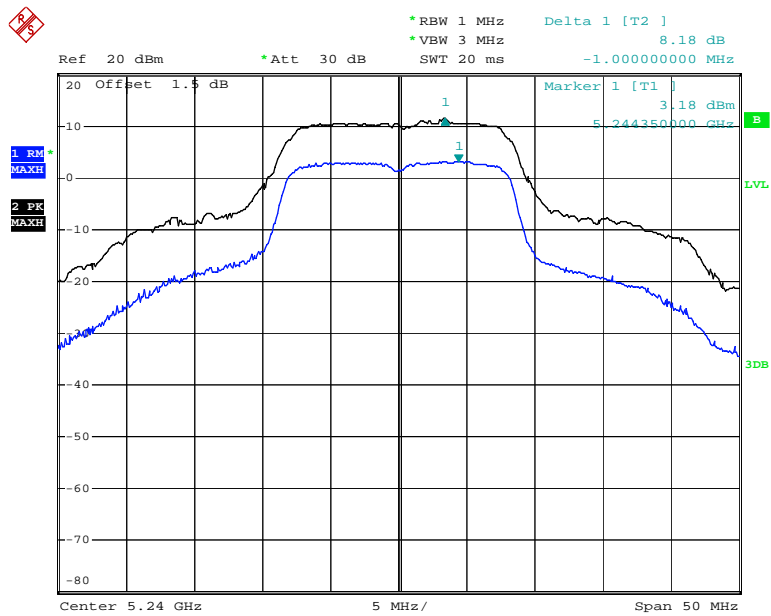

Date: 9.MAY.2014 17:37:24

Chain 0:802.11 n ht20 Peak Excursion, Low Channel

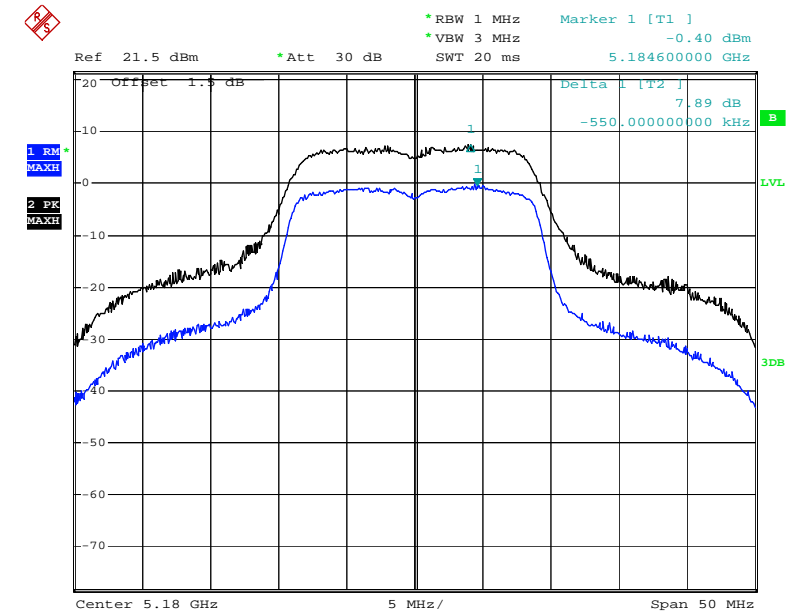

Date: 7.MAY.2014 13:45:50

Chain 0:802.11 n ht20 Peak Excursion, Middle Channel

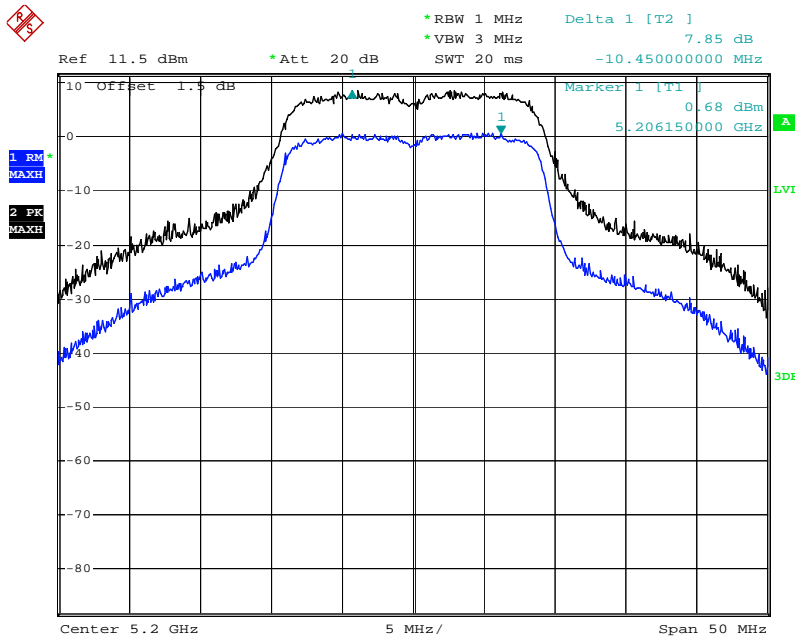

Date: 13.MAY.2014 13:20:22

Chain 0:802.11 n ht20 Peak Excursion, High Channel

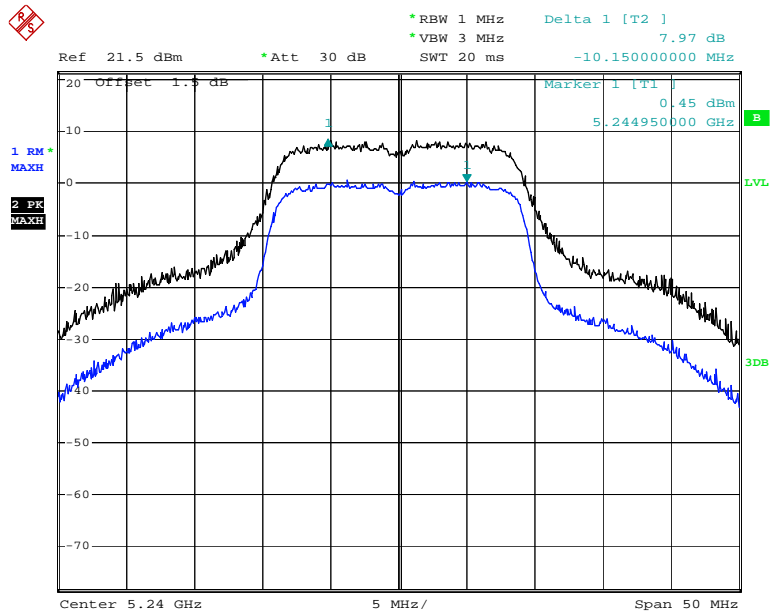

Date: 15.MAY.2014 11:42:51

Chain 1:802.11 n ht20 Peak Excursion, Low Channel

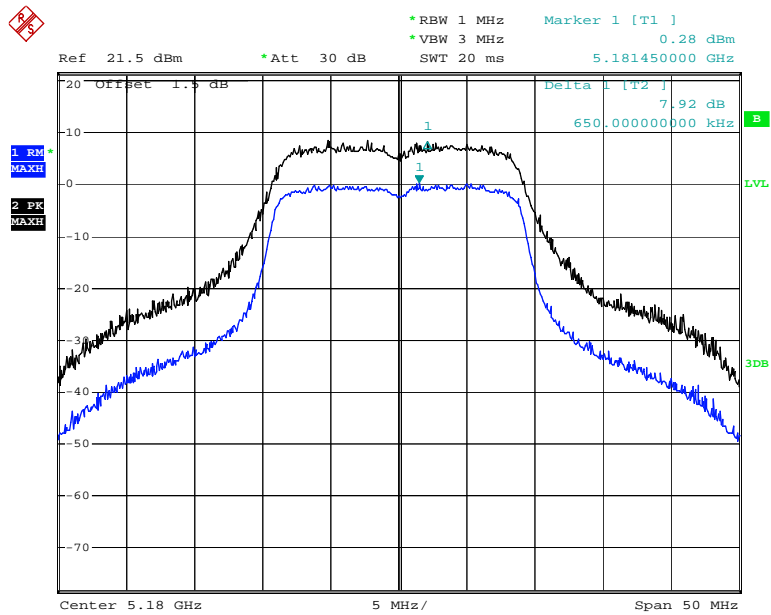

Date: 7.MAY.2014 13:53:31

Chain 1:802.11 n ht20 Peak Excursion, Middle Channel

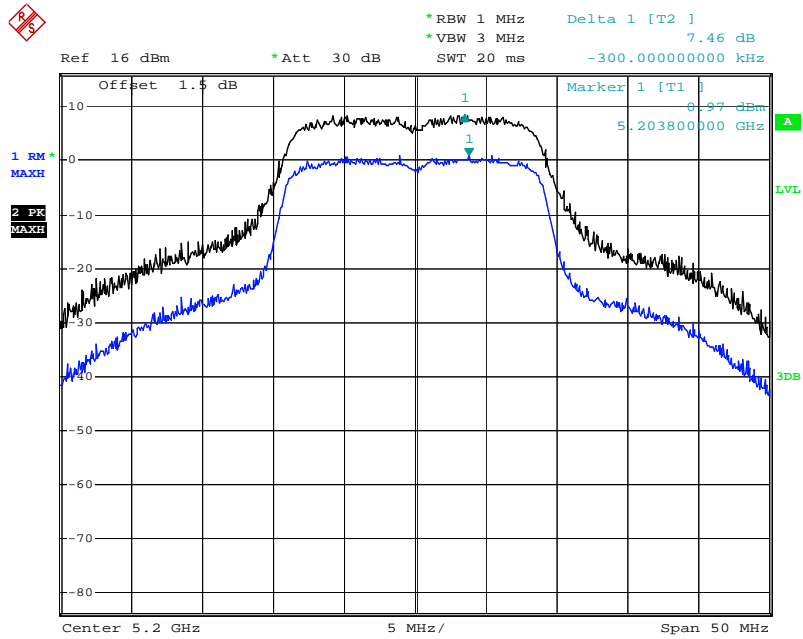

Date: 13.MAY.2014 13:25:14

Chain 1:802.11 n ht20 Peak Excursion, High Channel

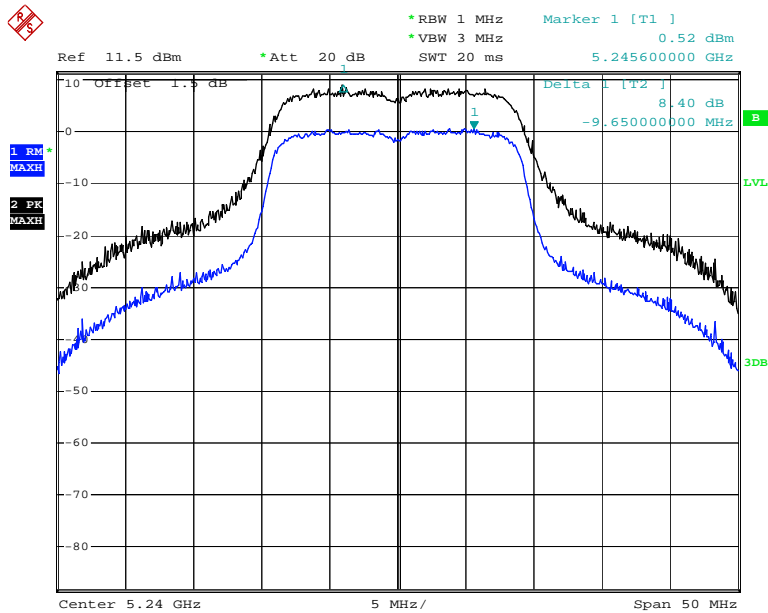

Date: 7.MAY.2014 14:22:49

Chain 0:802.11 n ht40 Peak Excursion, Low Channel

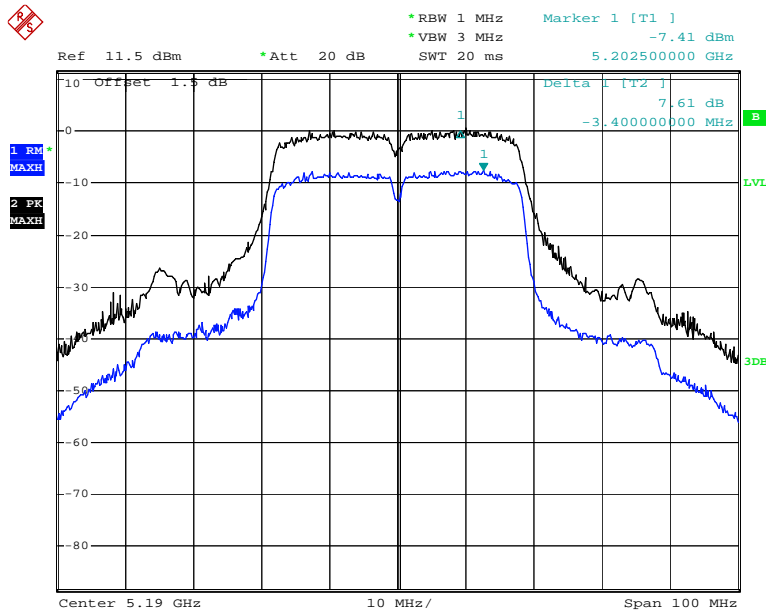

Date: 7.MAY.2014 14:45:30

Chain 0:802.11 n ht40 Peak Excursion, High Channel

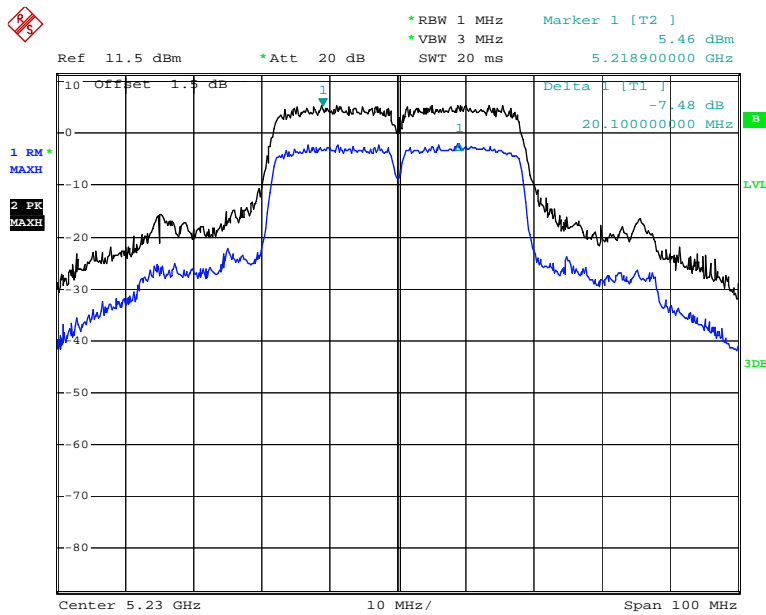

Date: 15.MAY.2014 11:59:57

Chain 1:802.11 n ht40 Peak Excursion, Low Channel

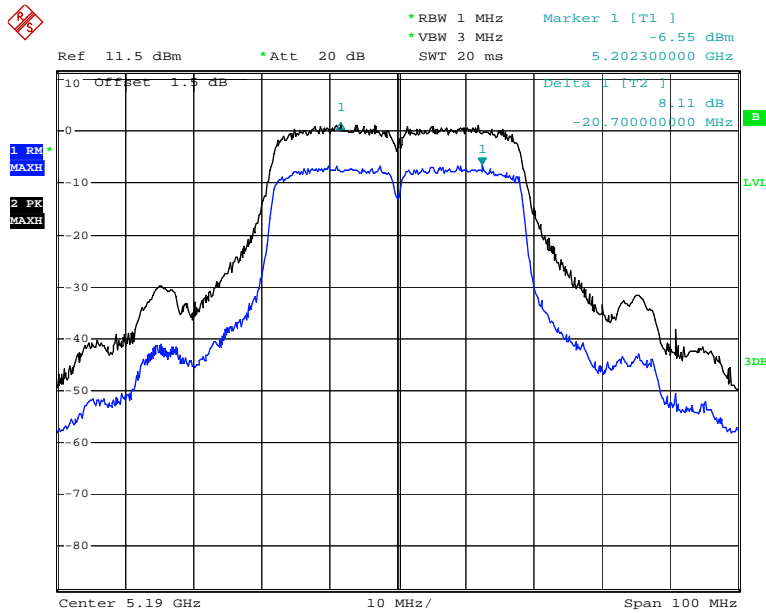

Date: 7.MAY.2014 14:53:01

Chain 1:802.11 n ht40 Peak Excursion, High Channel

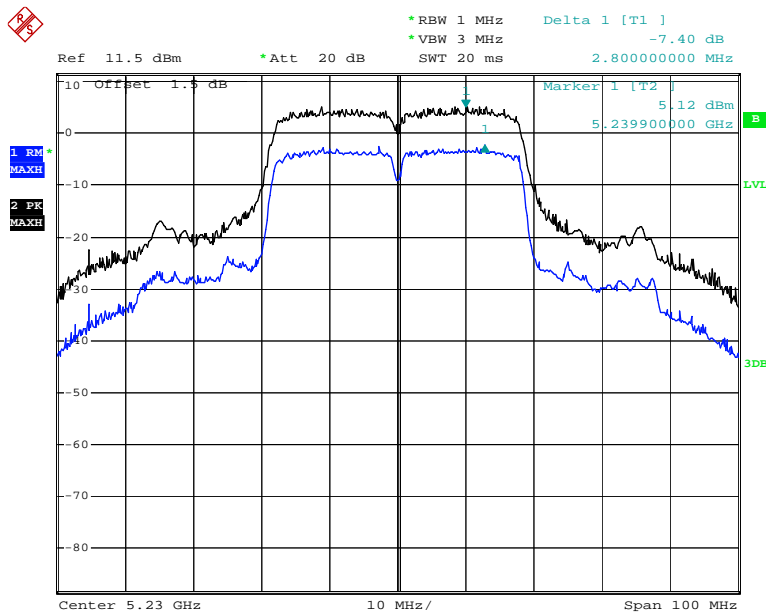

Date: 15.MAY.2014 13:13:53

***** END OF REPORT *****