



# FCC TEST REPORT (15.407)

**REPORT NO.:** RF130502C19-1  
**MODEL NO.:** 802RUN2  
**FCC ID:** LNQ802RUN2  
**RECEIVED:** May 02, 2013  
**TESTED:** May 07 ~ May 11, 2013  
**ISSUED:** May 27, 2013

**APPLICANT:** Actiontec Electronics, Inc.

**ADDRESS:** 760 North Mary Ave. Sunyvale, CA 94085

**ISSUED BY:** Bureau Veritas Consumer Products Services  
(H.K.) Ltd., Taoyuan Branch

**LAB ADDRESS:** No. 47, 14th Ling, Chia Pau Vil., Lin Kou Dist.,  
New Taipei City, Taiwan, R.O.C.

**TEST LOCATION:** No. 19, Hwa Ya 2nd Rd, Wen Hwa Tsuen, Kwei  
Shan Hsiang, Taoyuan Hsien 333, Taiwan, R.O.C.

This report should not be used by the client to claim product certification, approval, or endorsement by TAF or any government agencies.



This report is for your exclusive use. Any copying or replication of this report to or for any other person or entity, or use of our name or trademark, is permitted only with our prior written permission. This report sets forth our findings solely with respect to the test samples identified herein. The results set forth in this report are not indicative or representative of the quality or characteristics of the lot from which a test sample was taken or any similar or identical product unless specifically and expressly noted. Our report includes all of the tests requested by you and the results thereof based upon the information that you provided to us. You have 60 days from date of issuance of this report to notify us of any material error or omission caused by our negligence, provided, however, that such notice shall be in writing and shall specifically address the issue you wish to raise. A failure to raise such issue within the prescribed time shall constitute your unqualified acceptance of the completeness of this report, the tests conducted and the correctness of the report contents. Unless specific mention, the uncertainty of measurement has been explicitly taken into account to declare the compliance or non-compliance to the specification.



# TABLE OF CONTENTS

RELEASE CONTROL RECORD .....	4
1. CERTIFICATION .....	5
2. SUMMARY OF TEST RESULTS .....	6
2.1 MEASUREMENT UNCERTAINTY .....	6
3. GENERAL INFORMATION .....	7
3.1 GENERAL DESCRIPTION OF EUT .....	7
3.2 DESCRIPTION OF TEST MODES .....	8
3.2.1 TEST MODE APPLICABILITY AND TESTED CHANNEL DETAIL .....	9
3.3 DUTY CYCLE OF TEST SIGNAL .....	11
3.4 DESCRIPTION OF SUPPORT UNITS .....	12
3.4.1 CONFIGURATION OF SYSTEM UNDER TEST .....	12
3.5 GENERAL DESCRIPTION OF APPLIED STANDARDS .....	12
4. TEST TYPES AND RESULTS .....	13
4.1 RADIATED EMISSION AND BANDEDGE MEASUREMENT .....	13
4.1.1 LIMITS OF RADIATED EMISSION AND BANDEDGE MEASUREMENT .....	13
4.1.2 LIMITS OF UNWANTED EMISSION OUT OF THE RESTRICTED BANDS .....	13
4.1.3 TEST INSTRUMENTS .....	14
4.1.4 TEST PROCEDURES .....	15
4.1.5 DEVIATION FROM TEST STANDARD .....	15
4.1.6 TEST SETUP .....	16
4.1.7 EUT OPERATING CONDITION .....	16
4.1.8 TEST RESULTS .....	17
4.2 CONDUCTED EMISSION MEASUREMENT .....	26
4.2.1 LIMITS OF CONDUCTED EMISSION MEASUREMENT .....	26
4.2.2 TEST INSTRUMENTS .....	26
4.2.3 TEST PROCEDURES .....	27
4.2.4 DEVIATION FROM TEST STANDARD .....	27
4.2.5 TEST SETUP .....	27
4.2.6 EUT OPERATING CONDITIONS .....	27
4.2.7 TEST RESULTS .....	28
4.3 PEAK TRANSMIT POWER MEASUREMENT .....	30
4.3.1 LIMITS OF PEAK TRANSMIT POWER MEASUREMENT .....	30
4.3.2 TEST SETUP .....	30
4.3.3 TEST INSTRUMENTS .....	30
4.3.4 TEST PROCEDURE .....	31
4.3.5 DEVIATION FROM TEST STANDARD .....	31
4.3.6 EUT OPERATING CONDITIONS .....	31
4.3.7 TEST RESULTS .....	32
4.4 PEAK POWER SPECTRAL DENSITY MEASUREMENT .....	34
4.4.1 LIMITS OF PEAK POWER SPECTRAL DENSITY MEASUREMENT .....	34
4.4.2 TEST SETUP .....	34
4.4.3 TEST INSTRUMENTS .....	34
4.4.4 TEST PROCEDURES .....	34
4.4.5 DEVIATION FROM TEST STANDARD .....	34
4.4.6 EUT OPERATING CONDITIONS .....	34
4.4.7 TEST RESULTS .....	35
4.5 PEAK POWER EXCURSION MEASUREMENT .....	36
4.5.1 LIMITS OF PEAK POWER EXCURSION MEASUREMENT .....	36
4.5.2 TEST SETUP .....	36
4.5.3 TEST INSTRUMENTS .....	36



4.5.4	TEST PROCEDURE .....	36
4.5.5	DEVIATION FROM TEST STANDARD .....	36
4.5.6	EUT OPERATING CONDITIONS.....	36
4.5.7	TEST RESULTS.....	37
4.6	FREQUENCY STABILITY .....	39
4.6.1	LIMITS OF FREQUENCY STABILITY MEASUREMENT .....	39
4.6.2	TEST SETUP .....	39
4.6.3	TEST INSTRUMENTS .....	39
4.6.4	TEST PROCEDURE .....	40
4.6.5	DEVIATION FROM TEST STANDARD .....	40
4.6.6	EUT OPERATING CONDITION .....	40
4.6.7	TEST RESULTS.....	41
5.	PHOTOGRAPHS OF THE TEST CONFIGURATION .....	42
6.	INFORMATION ON THE TESTING LABORATORIES.....	43
7.	APPENDIX A – MODIFICATIONS RECORDERS FOR ENGINEERING CHANGES TO THE EUT BY THE LAB .....	44



A D T

## RELEASE CONTROL RECORD

ISSUE NO.	REASON FOR CHANGE	DATE ISSUED
RF130502C19-1	Original release	May 27, 2013



# 1. CERTIFICATION

**PRODUCT:** Wireless Dual-Band USB Module

**MODEL:** 802RUN2

**BRAND:** Actiontec

**APPLICANT:** Actiontec Electronics, Inc.

**TESTED:** May 07 ~ May 11, 2013

**TEST SAMPLE:** ENGINEERING SAMPLE

**STANDARDS: FCC Part 15, Subpart E (Section 15.407)**

ANSI C63.10-2009

The above equipment (model: 802RUN2) has been tested by **Bureau Veritas Consumer Products Services (H.K.) Ltd., Taoyuan Branch**, and found compliance with the requirement of the above standards. The test record, data evaluation & Equipment Under Test (EUT) configurations represented herein are true and accurate accounts of the measurements of the sample's EMC characteristics under the conditions specified in this report.

**PREPARED BY :**  , **DATE :** May 27, 2013  
Pettie Chen / Senior Specialist

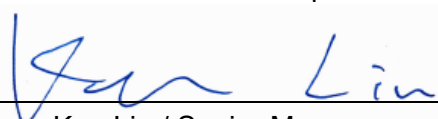
**APPROVED BY :**  , **DATE :** May 27, 2013  
Ken Liu / Senior Manager

## 2. SUMMARY OF TEST RESULTS

The EUT has been tested according to the following specifications:

APPLIED STANDARD: FCC PART 15, SUBPART E (SECTION 15.407)			
STANDARD SECTION	TEST TYPE	RESULT	REMARK
15.407(b)(6)	AC Power Conducted Emission	PASS	Meet the requirement of limit. Minimum passing margin is -13.09dB at 0.43906MHz.
15.407(b/1/2/3) (b)(6)	Radiated Emissions	PASS	Meet the requirement of limit. Minimum passing margin is -2.0dB at 10400.00MHz.
15.407(a/1/2)	Max Average Transmit Power	PASS	Meet the requirement of limit.
15.407(a)(6)	Peak Power Excursion	PASS	Meet the requirement of limit.
15.407(a/1/2)	Peak Power Spectral Density	PASS	Meet the requirement of limit.
15.407(g)	Frequency Stability	PASS	Meet the requirement of limit.
15.203	Antenna Requirement	PASS	No antenna connector is used.

### 2.1 MEASUREMENT UNCERTAINTY

Where relevant, the following measurement uncertainty levels have been estimated for tests performed on the EUT as specified in CISPR 16-4-2:

MEASUREMENT	FREQUENCY	UNCERTAINTY
Conducted emissions	9kHz~30MHz	2.44 dB
Radiated emissions	30MHz ~ 200MHz	3.34 dB
	200MHz ~ 1000MHz	3.35 dB
	1GHz ~ 18GHz	2.26 dB
	18GHz ~ 40GHz	1.94 dB

This uncertainty represents an expanded uncertainty expressed at approximately the 95% confidence level using a coverage factor of  $k = 2$ .

### 3. GENERAL INFORMATION

#### 3.1 GENERAL DESCRIPTION OF EUT

<b>EUT</b>	Wireless Dual-Band USB Module
<b>MODEL NO.</b>	802RUN2
<b>POWER SUPPLY</b>	3.3Vdc (host equipment)
<b>MODULATION TYPE</b>	64QAM, 16QAM, QPSK, BPSK
<b>MODULATION TECHNOLOGY</b>	OFDM
<b>TRANSFER RATE</b>	802.11a: 54.0/ 48.0/ 36.0/ 24.0/ 18.0/ 12.0/ 9.0/ 6.0Mbps 802.11n: up to 300.0Mbps
<b>OPERATING FREQUENCY</b>	5180.0 ~ 5240.0MHz
<b>NUMBER OF CHANNEL</b>	4 for 802.11a, 802.11n (20MHz) 2 for 802.11n (40MHz)
<b>OUTPUT POWER</b>	45.087mW
<b>ANTENNA TYPE</b>	Printed antenna with 3.2dBi gain
<b>ANTENNA CONNECTOR</b>	NA
<b>DATA CABLE</b>	NA
<b>I/O PORTS</b>	Refer to user's manual
<b>ACCESSORY DEVICES</b>	NA

**NOTE:**

- The EUT provides two completed transmitters and two receivers.

MODULATION MODE	TX FUNCTION
802.11b	1TX
802.11g	1TX
802.11a	1TX
802.11n (20MHz)	2TX
802.11n (40MHz)	2TX

- The above EUT information is declared by manufacturer and for more detailed features description, please refer to the manufacturer's specifications or user's manual.



### 3.2 DESCRIPTION OF TEST MODES

4 channels are provided for 802.11a, 802.11n (20MHz):

CHANNEL	FREQUENCY	CHANNEL	FREQUENCY
36	5180MHz	44	5220MHz
40	5200MHz	48	5240MHz

2 channels are provided for 802.11n (40MHz):

CHANNEL	FREQUENCY	CHANNEL	FREQUENCY
38	5190MHz	46	5230MHz



### 3.2.1 TEST MODE APPLICABILITY AND TESTED CHANNEL DETAIL

EUT CONFIGURE MODE	APPLICABLE TO				DESCRIPTION
	RE≥1G	RE<1G	PLC	APCM	
-	√	√	√	√	-

Where **RE≥1G**: Radiated Emission above 1GHz      **RE<1G**: Radiated Emission below 1GHz  
**PLC**: Power Line Conducted Emission      **APCM**: Antenna Port Conducted Measurement

**NOTE:**  
The EUT had been pre-tested on the positioned of each 3 axis. The worst case was found when positioned on **X-plane**.

#### **RADIATED EMISSION TEST (ABOVE 1GHz):**

- Pre-Scan has been conducted to determine the worst-case mode from all possible combinations between available modulations, data rates and antenna ports (if EUT with antenna diversity architecture).
- Following channel(s) was (were) selected for the final test as listed below.

EUT CONFIGURE MODE	MODE	AVAILABLE CHANNEL	TESTED CHANNEL	MODULATION TECHNOLOGY	MODULATION TYPE	DATA RATE (Mbps)
-	802.11a	36 to 48	36, 40, 48	OFDM	BPSK	6.0
-	802.11n (20MHz)	36 to 48	36, 40, 48	OFDM	BPSK	7.2
-	802.11n (40MHz)	38 to 46	38, 46	OFDM	BPSK	15.0

#### **RADIATED EMISSION TEST (BELOW 1GHz):**

- Pre-Scan has been conducted to determine the worst-case mode from all possible combinations between available modulations, data rates and antenna ports (if EUT with antenna diversity architecture).
- Following channel(s) was (were) selected for the final test as listed below.

EUT CONFIGURE MODE	MODE	AVAILABLE CHANNEL	TESTED CHANNEL	MODULATION TECHNOLOGY	MODULATION TYPE	DATA RATE (Mbps)
-	802.11n (20MHz)	36 to 48	40	OFDM	BPSK	7.2

#### **POWER LINE CONDUCTED EMISSION TEST:**

- Pre-Scan has been conducted to determine the worst-case mode from all possible combinations between available modulations, data rates and antenna ports (if EUT with antenna diversity architecture).
- Following channel(s) was (were) selected for the final test as listed below.

EUT CONFIGURE MODE	MODE	AVAILABLE CHANNEL	TESTED CHANNEL	MODULATION TECHNOLOGY	MODULATION TYPE	DATA RATE (Mbps)
-	802.11n (20MHz)	36 to 48	40	OFDM	BPSK	7.2



**ANTENNA PORT CONDUCTED MEASUREMENT:**

- This item includes all test value of each mode, but only includes spectrum plot of worst value of each mode.
- Pre-Scan has been conducted to determine the worst-case mode from all possible combinations between available modulations, data rates and antenna ports (if EUT with antenna diversity architecture).
- Following channel(s) was (were) selected for the final test as listed below.

EUT CONFIGURE MODE	MODE	AVAILABLE CHANNEL	TESTED CHANNEL	MODULATION TECHNOLOGY	MODULATION TYPE	DATA RATE (Mbps)
-	802.11a	36 to 48	36, 40, 48	OFDM	BPSK	6.0
-	802.11n (20MHz)	36 to 48	36, 40, 48	OFDM	BPSK	7.2
-	802.11n (40MHz)	38 to 46	38, 46	OFDM	BPSK	15.0

**TEST CONDITION:**

APPLICABLE TO	ENVIRONMENTAL CONDITIONS	INPUT POWER	TESTED BY
RE≥1G	25deg. C, 70%RH	120Vac, 60Hz	Alan Wu
RE<1G	25deg. C, 70%RH	120Vac, 60Hz	Alan Wu
PLC	25deg. C, 70%RH	120Vac, 60Hz	Alan Wu
APCM	24deg. C, 64%RH	120Vac, 60Hz	Match Tsui



A D T

### 3.3 DUTY CYCLE OF TEST SIGNAL

Duty cycle of test signal is > 98 %, duty factor is not required.

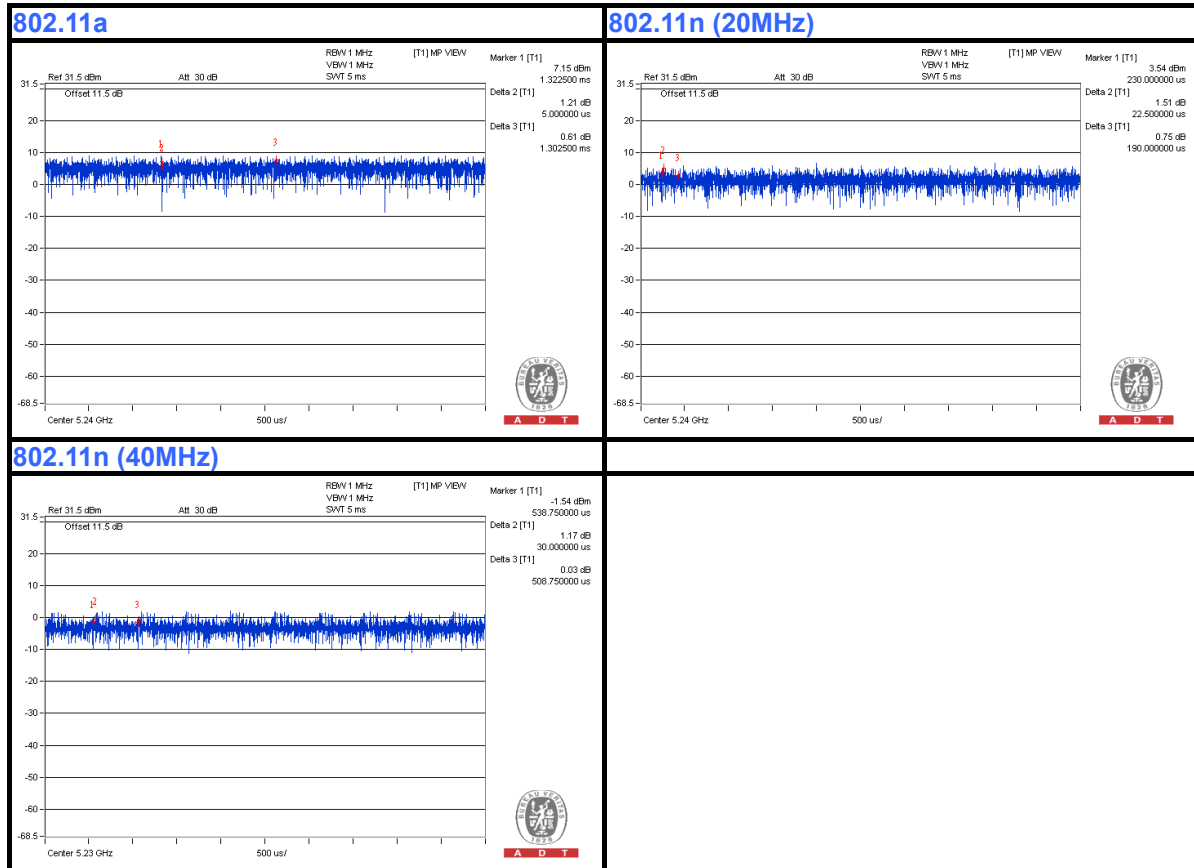

### 3.4 DESCRIPTION OF SUPPORT UNITS

The EUT has been tested as an independent unit together with other necessary accessories or support units. The following support units or accessories were used to form a representative test configuration during the tests.

NO.	PRODUCT	BRAND	MODEL NO.	SERIAL NO.	FCC ID
1	Notebook	DELL	E5420	33MJMQ1	FCC DoC Approved

NO.	SIGNAL CABLE DESCRIPTION OF THE ABOVE SUPPORT UNITS
1	0.2m USB cable

**NOTE:** All power cords of the above support units are non-shielded (1.8m).

#### 3.4.1 CONFIGURATION OF SYSTEM UNDER TEST

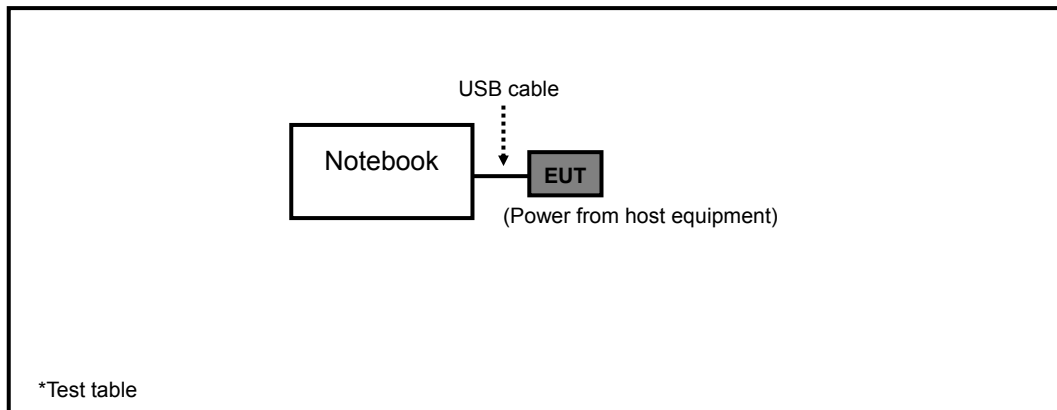

### 3.5 GENERAL DESCRIPTION OF APPLIED STANDARDS

The EUT is a RF Product. According to the specifications of the manufacturer, it must comply with the requirements of the following standards:

**FCC Part 15, Subpart E (15.407)**

**789033 D01 General UNII Test Procedures v01 r02**

**662911 D01 Multiple Transmitter Output v01 r02**

**ANSI C63.10-2009**

All test items have been performed and recorded as per the above standards.

## 4. TEST TYPES AND RESULTS

### 4.1 RADIATED EMISSION AND BANDEDGE MEASUREMENT

#### 4.1.1 LIMITS OF RADIATED EMISSION AND BANDEDGE MEASUREMENT

Radiated emissions which fall in the restricted bands must comply with the radiated emission limits specified as below table:

FREQUENCIES (MHz)	FIELD STRENGTH (microvolts/meter)	MEASUREMENT DISTANCE (meters)
0.009 ~ 0.490	2400/F(kHz)	300
0.490 ~ 1.705	24000/F(kHz)	30
1.705 ~ 30.0	30	30
30 ~ 88	100	3
88 ~ 216	150	3
216 ~ 960	200	3
Above 960	500	3

**NOTE:**

1. The lower limit shall apply at the transition frequencies.
2. Emission level (dBuV/m) = 20 log Emission level (uV/m).
3. For frequencies above 1000MHz, the field strength limits are based on average detector, however, the peak field strength of any emission shall not exceed the maximum permitted average limits, specified above by more than 20dB under any condition of modulation.

#### 4.1.2 LIMITS OF UNWANTED EMISSION OUT OF THE RESTRICTED BANDS

APPLICABLE TO	LIMIT	
√	FIELD STRENGTH AT 3m (dBμV/m)	
	PK	AV
	74	54
	EIRP LIMIT (dBm)	EQUIVALENT FIELD STRENGTH AT 3m (dBμV/m)
	PK	PK
	-27	68.3

**NOTE:** The following formula is used to convert the equipment isotropic radiated power (eirp) to field strength:

$$E = \frac{1000000\sqrt{30P}}{3} \mu\text{V/m, where P is the eirp (Watts).}$$



#### 4.1.3 TEST INSTRUMENTS

DESCRIPTION & MANUFACTURER	MODEL NO.	SERIAL NO.	DATE OF CALIBRATION	DUE DATE OF CALIBRATION
Test Receiver ROHDE & SCHWARZ	ESIB7	100212	Aug. 06, 2012	Aug. 05, 2013
Spectrum Analyzer ROHDE & SCHWARZ	FSP40	100039	Jan. 31, 2013	Jan. 30, 2014
BILOG Antenna SCHWARZBECK	VULB9168	9168-160	Mar. 20, 2013	Mar. 19, 2014
HORN Antenna SCHWARZBECK	9120D	209	Sep. 03, 2012	Sep. 02, 2013
HORN Antenna SCHWARZBECK	BBHA 9170	148	Jul. 11, 2012	Jul. 10, 2013
Loop Antenna	HFH2-Z2	100070	Jan. 31, 2012	Jan. 30, 2014
Preamplifier Agilent	8447D	2944A10633	Oct. 25, 2012	Oct. 24, 2013
Preamplifier Agilent	8449B	3008A01964	Oct. 25, 2012	Oct. 24, 2013
RF signal cable HUBER+SUHNNER	SUCOFLEX 104	250723/4	Aug. 28, 2012	Aug. 27, 2013
RF signal cable HUBER+SUHNNER	SUCOFLEX 106	12738/6+309224/ 4	Aug. 28, 2012	Aug. 27, 2013
Software BV ADT	ADT_Radiated_ V7.6.15.9.2	NA	NA	NA
Antenna Tower inn-co GmbH	MA 4000	013303	NA	NA
Antenna Tower Controller inn-co GmbH	CO2000	017303	NA	NA
Turn Table BV ADT	TT100	TT93021703	NA	NA
Turn Table Controller BV ADT	SC100	SC93021703	NA	NA
26GHz ~ 40GHz Amplifier	EM26400	815221	Oct. 25, 2012	Oct. 24, 2013
High Speed Peak Power Meter	ML2495A	0824012	Aug. 22, 2012	Aug. 21, 2013
Power Sensor	MA2411B	0738171	Jul. 30, 2012	Jul. 29, 2013
WIT Standard Temperature And Humidity Chamber	TH-4S-C	W981030	Jun. 13, 2012	Jun. 12, 2013

- NOTE:**
1. The calibration interval of the above test instruments is 12 months and the calibrations are traceable to NML/ROC and NIST/USA.
  2. The calibration interval of the loop antenna is 24 months and the calibrations are traceable to NML/ROC and NIST/USA.
  3. The test was performed in HwaYa Chamber 3.
  4. The horn antenna and HP preamplifier (model: 8449B) are used only for the measurement of emission frequency above 1GHz if tested.
  5. The FCC Site Registration No. is 988962.
  6. The IC Site Registration No. is IC 7450F-3.

#### 4.1.4 TEST PROCEDURES

- a. The EUT was placed on the top of a rotating table 0.8 meters above the ground at a 3 meter semi-anechoic chamber. The table was rotated 360 degrees to determine the position of the highest radiation.
- b. The EUT was set 3 meters away from the interference-receiving antenna, which was mounted on the top of a variable-height antenna tower.
- c. The antenna is a broadband antenna, and its height is varied from one meter to four meters above the ground to determine the maximum value of the field strength. Both horizontal and vertical polarizations of the antenna are set to make the measurement.
- d. For each suspected emission, the EUT was arranged to its worst case and then the antenna was tuned to heights from 1 meter to 4 meters and the rotatable table was turned from 0 degrees to 360 degrees to find the maximum reading.
- e. The test-receiver system was set to Peak Detect Function and Specified Bandwidth with Maximum Hold Mode.
- f. If the emission level of the EUT in peak mode was 10dB lower than the limit specified, then testing could be stopped and the peak values of the EUT would be reported. Otherwise the emissions that did not have 10dB margin would be re-tested one by one using peak, quasi-peak or average method as specified and then reported in a data sheet.

**NOTE:**

1. The resolution bandwidth and video bandwidth of test receiver/spectrum analyzer is 120kHz for Peak detection (PK) and Quasi-peak detection (QP) at frequency below 1GHz.
2. The resolution bandwidth of test receiver/spectrum analyzer is 1MHz and video bandwidth is 3MHz for Peak detection at frequency above 1GHz.
3. The resolution bandwidth of test receiver/spectrum analyzer is 1MHz and the video bandwidth is 1kHz for Average detection (AV) at frequency above 1GHz.
4. All modes of operation were investigated and the worst-case emissions are reported.

#### 4.1.5 DEVIATION FROM TEST STANDARD

No deviation.

#### 4.1.6 TEST SETUP

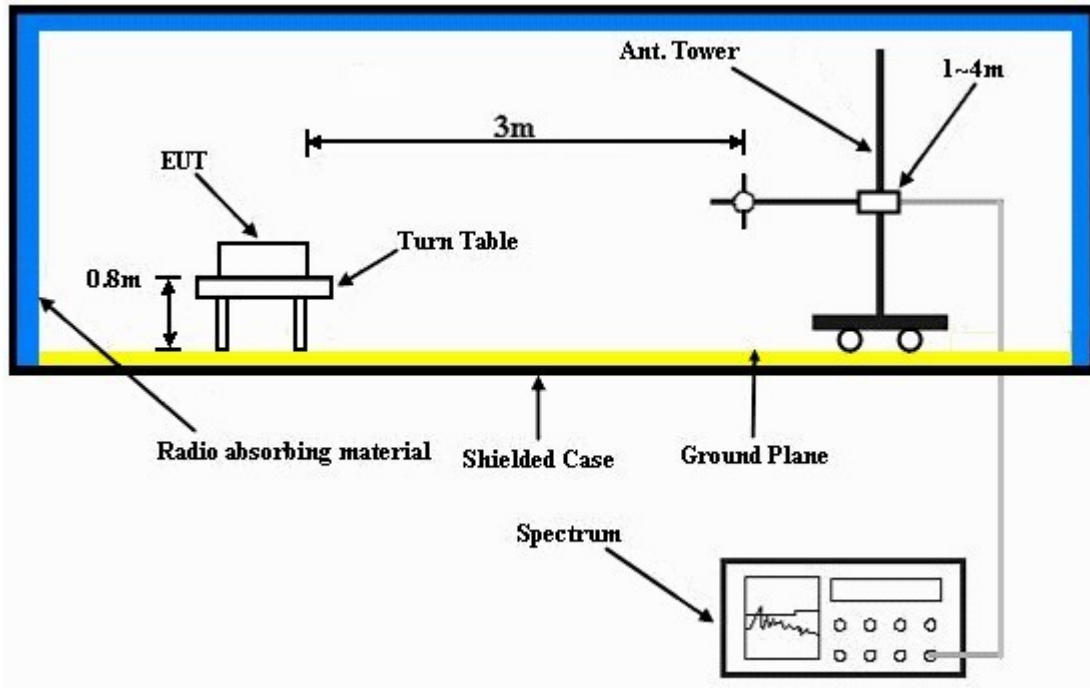

For the actual test configuration, please refer to the attached file (Test Setup Photo).

#### 4.1.7 EUT OPERATING CONDITION

- Connected the EUT with notebook by USB cable and placed them on the testing table.
- The notebook system ran a test program (provided by manufacturer) to enable EUT under charging condition.
- The necessary accessories enable the system in full functions.



## 4.1.8 TEST RESULTS

### ABOVE 1GHz DATA

#### 802.11a

EUT TEST CONDITION		MEASUREMENT DETAIL	
CHANNEL	Channel 36	FREQUENCY RANGE	1 ~ 40GHz
INPUT POWER (SYSTEM)	120Vac, 60 Hz	DETECTOR FUNCTION	Peak (PK) Average (AV)
ENVIRONMENTAL CONDITIONS	24deg. C, 67%RH	TESTED BY	Alan Wu

ANTENNA POLARITY & TEST DISTANCE: HORIZONTAL AT 3 M								
NO.	FREQ. (MHz)	EMISSION LEVEL (dBuV/m)	LIMIT (dBuV/m)	MARGIN (dB)	ANTENNA HEIGHT (m)	TABLE ANGLE (Degree)	RAW VALUE (dBuV)	CORRECTION FACTOR (dB/m)
1	5150.00	58.5 PK	74.0	-15.5	1.00 H	353	20.80	37.70
2	5150.00	45.2 AV	54.0	-8.8	1.00 H	353	7.50	37.70
3	*5180.00	107.0 PK			1.00 H	357	69.30	37.70
4	*5180.00	98.1 AV			1.00 H	357	60.40	37.70
5	#10360.00	63.1 PK	74.0	-10.9	1.49 H	316	14.30	48.80
6	#10360.00	50.1 AV	54.0	-3.9	1.49 H	316	1.30	48.80
ANTENNA POLARITY & TEST DISTANCE: VERTICAL AT 3 M								
NO.	FREQ. (MHz)	EMISSION LEVEL (dBuV/m)	LIMIT (dBuV/m)	MARGIN (dB)	ANTENNA HEIGHT (m)	TABLE ANGLE (Degree)	RAW VALUE (dBuV)	CORRECTION FACTOR (dB/m)
1	5150.00	57.3 PK	74.0	-16.7	1.28 V	258	19.60	37.70
2	5150.00	44.7 AV	54.0	-9.3	1.28 V	258	7.00	37.70
3	*5180.00	97.3 PK			1.25 V	251	59.60	37.70
4	*5180.00	88.4 AV			1.25 V	251	50.70	37.70
5	#10360.00	57.9 PK	74.0	-16.1	1.00 V	264	9.10	48.80
6	#10360.00	45.5 AV	54.0	-8.5	1.00 V	264	-3.30	48.80

#### REMARKS:

1. Emission level (dBuV/m) = Raw Value (dBuV) + Correction Factor (dB/m).
2. Correction Factor (dB/m) = Antenna Factor (dB/m) + Cable Factor (dB).
3. The other emission levels were very low against the limit.
4. Margin value = Emission level – Limit value.
5. " \* ": Fundamental frequency.
6. "#": The radiated frequency is out the restricted band.



EUT TEST CONDITION		MEASUREMENT DETAIL	
CHANNEL	Channel 40	FREQUENCY RANGE	1 ~ 40GHz
INPUT POWER (SYSTEM)	120Vac, 60 Hz	DETECTOR FUNCTION	Peak (PK) Average (AV)
ENVIRONMENTAL CONDITIONS	24deg. C, 67%RH	TESTED BY	Alan Wu

ANTENNA POLARITY & TEST DISTANCE: HORIZONTAL AT 3 M								
NO.	FREQ. (MHz)	EMISSION LEVEL (dBuV/m)	LIMIT (dBuV/m)	MARGIN (dB)	ANTENNA HEIGHT (m)	TABLE ANGLE (Degree)	RAW VALUE (dBuV)	CORRECTION FACTOR (dB/m)
1	*5200.00	107.2 PK			1.00 H	14	69.40	37.80
2	*5200.00	97.9 AV			1.00 H	14	60.10	37.80
3	#10400.00	65.7 PK	74.0	-8.3	1.35 H	19	16.80	48.90
4	#10400.00	52.0 AV	54.0	-2.0	1.35 H	19	3.10	48.90
ANTENNA POLARITY & TEST DISTANCE: VERTICAL AT 3 M								
NO.	FREQ. (MHz)	EMISSION LEVEL (dBuV/m)	LIMIT (dBuV/m)	MARGIN (dB)	ANTENNA HEIGHT (m)	TABLE ANGLE (Degree)	RAW VALUE (dBuV)	CORRECTION FACTOR (dB/m)
1	*5200.00	99.2 PK			1.64 V	86	61.40	37.80
2	*5200.00	89.7 AV			1.64 V	86	51.90	37.80
3	#10400.00	58.6 PK	74.0	-15.4	1.01 V	266	9.70	48.90
4	#10400.00	46.0 AV	54.0	-8.0	1.01 V	266	-2.90	48.90

**REMARKS:**

1. Emission level (dBuV/m) = Raw Value (dBuV) + Correction Factor (dB/m).
2. Correction Factor (dB/m) = Antenna Factor (dB/m) + Cable Factor (dB).
3. The other emission levels were very low against the limit.
4. Margin value = Emission level – Limit value.
5. “ \* “: Fundamental frequency.
6. “#”: The radiated frequency is out the restricted band.



A D T

EUT TEST CONDITION		MEASUREMENT DETAIL	
CHANNEL	Channel 48	FREQUENCY RANGE	1 ~ 40GHz
INPUT POWER (SYSTEM)	120Vac, 60 Hz	DETECTOR FUNCTION	Peak (PK) Average (AV)
ENVIRONMENTAL CONDITIONS	24deg. C, 67%RH	TESTED BY	Alan Wu

ANTENNA POLARITY & TEST DISTANCE: HORIZONTAL AT 3 M								
NO.	FREQ. (MHz)	EMISSION LEVEL (dBuV/m)	LIMIT (dBuV/m)	MARGIN (dB)	ANTENNA HEIGHT (m)	TABLE ANGLE (Degree)	RAW VALUE (dBuV)	CORRECTION FACTOR (dB/m)
1	5150.00	57.0 PK	74.0	-17.0	1.00 H	16	19.30	37.70
2	5150.00	44.1 AV	54.0	-9.9	1.00 H	16	6.40	37.70
3	*5240.00	108.1 PK			1.00 H	16	70.30	37.80
4	*5240.00	98.9 AV			1.00 H	16	61.10	37.80
5	#10480.00	63.2 PK	74.0	-10.8	1.47 H	12	14.00	49.20
6	#10480.00	50.2 AV	54.0	-3.8	1.47 H	12	1.00	49.20
ANTENNA POLARITY & TEST DISTANCE: VERTICAL AT 3 M								
NO.	FREQ. (MHz)	EMISSION LEVEL (dBuV/m)	LIMIT (dBuV/m)	MARGIN (dB)	ANTENNA HEIGHT (m)	TABLE ANGLE (Degree)	RAW VALUE (dBuV)	CORRECTION FACTOR (dB/m)
1	5150.00	56.5 PK	74.0	-17.5	1.61 V	132	18.80	37.70
2	5150.00	43.5 AV	54.0	-10.5	1.61 V	132	5.80	37.70
3	*5240.00	99.7 PK			1.63 V	136	61.90	37.80
4	*5240.00	90.2 AV			1.63 V	136	52.40	37.80
5	#10480.00	58.4 PK	74.0	-15.6	1.02 V	261	9.20	49.20
6	#10480.00	45.0 AV	54.0	-9.0	1.02 V	261	-4.20	49.20

**REMARKS:**

1. Emission level (dBuV/m) = Raw Value (dBuV) + Correction Factor (dB/m).
2. Correction Factor (dB/m) = Antenna Factor (dB/m) + Cable Factor (dB).
3. The other emission levels were very low against the limit.
4. Margin value = Emission level – Limit value.
5. “ \* “: Fundamental frequency.
6. “#”:The radiated frequency is out the restricted band.



A D T

802.11n (20MHz)

EUT TEST CONDITION		MEASUREMENT DETAIL	
CHANNEL	Channel 36	FREQUENCY RANGE	1 ~ 40GHz
INPUT POWER (SYSTEM)	120Vac, 60 Hz	DETECTOR FUNCTION	Peak (PK) Average (AV)
ENVIRONMENTAL CONDITIONS	24deg. C, 67%RH	TESTED BY	Alan Wu

ANTENNA POLARITY & TEST DISTANCE: HORIZONTAL AT 3 M								
NO.	FREQ. (MHz)	EMISSION LEVEL (dBuV/m)	LIMIT (dBuV/m)	MARGIN (dB)	ANTENNA HEIGHT (m)	TABLE ANGLE (Degree)	RAW VALUE (dBuV)	CORRECTION FACTOR (dB/m)
1	5150.00	54.5 PK	74.0	-19.5	1.08 H	135	16.80	37.70
2	5150.00	42.5 AV	54.0	-11.5	1.08 H	135	4.80	37.70
3	*5180.00	99.2 PK			1.08 H	135	61.50	37.70
4	*5180.00	88.3 AV			1.08 H	135	50.60	37.70
5	#10360.00	57.5 PK	74.0	-16.5	1.32 H	45	8.70	48.80
6	#10360.00	44.6 AV	54.0	-9.4	1.32 H	45	-4.20	48.80

ANTENNA POLARITY & TEST DISTANCE: VERTICAL AT 3 M								
NO.	FREQ. (MHz)	EMISSION LEVEL (dBuV/m)	LIMIT (dBuV/m)	MARGIN (dB)	ANTENNA HEIGHT (m)	TABLE ANGLE (Degree)	RAW VALUE (dBuV)	CORRECTION FACTOR (dB/m)
1	5150.00	53.6 PK	74.0	-20.4	1.00 V	253	15.90	37.70
2	5150.00	42.3 AV	54.0	-11.7	1.00 V	253	4.60	37.70
3	*5180.00	87.5 PK			1.00 V	253	49.80	37.70
4	*5180.00	77.7 AV			1.00 V	253	40.00	37.70
5	#10360.00	58.1 PK	74.0	-15.9	1.36 V	44	9.30	48.80
6	#10360.00	44.4 AV	54.0	-9.6	1.36 V	44	-4.40	48.80

REMARKS:

1. Emission level (dBuV/m) = Raw Value (dBuV) + Correction Factor (dB/m).
2. Correction Factor (dB/m) = Antenna Factor (dB/m) + Cable Factor (dB).
3. The other emission levels were very low against the limit.
4. Margin value = Emission level – Limit value.
5. " \* ": Fundamental frequency.
6. "#": The radiated frequency is out the restricted band.



A D T

EUT TEST CONDITION		MEASUREMENT DETAIL	
CHANNEL	Channel 40	FREQUENCY RANGE	1 ~ 40GHz
INPUT POWER (SYSTEM)	120Vac, 60 Hz	DETECTOR FUNCTION	Peak (PK) Average (AV)
ENVIRONMENTAL CONDITIONS	24deg. C, 67%RH	TESTED BY	Alan Wu

ANTENNA POLARITY & TEST DISTANCE: HORIZONTAL AT 3 M								
NO.	FREQ. (MHz)	EMISSION LEVEL (dBuV/m)	LIMIT (dBuV/m)	MARGIN (dB)	ANTENNA HEIGHT (m)	TABLE ANGLE (Degree)	RAW VALUE (dBuV)	CORRECTION FACTOR (dB/m)
1	*5200.00	102.5 PK			1.05 H	137	64.70	37.80
2	*5200.00	91.0 AV			1.05 H	137	53.20	37.80
3	#10400.00	59.6 PK	74.0	-14.4	1.25 H	32	10.70	48.90
4	#10400.00	46.0 AV	54.0	-8.0	1.25 H	32	-2.90	48.90
ANTENNA POLARITY & TEST DISTANCE: VERTICAL AT 3 M								
NO.	FREQ. (MHz)	EMISSION LEVEL (dBuV/m)	LIMIT (dBuV/m)	MARGIN (dB)	ANTENNA HEIGHT (m)	TABLE ANGLE (Degree)	RAW VALUE (dBuV)	CORRECTION FACTOR (dB/m)
1	*5200.00	93.8 PK			1.07 V	128	56.00	37.80
2	*5200.00	82.9 AV			1.07 V	128	45.10	37.80
3	#10400.00	58.6 PK	74.0	-15.4	1.45 V	63	9.70	48.90
4	#10400.00	45.3 AV	54.0	-8.7	1.45 V	63	-3.60	48.90

**REMARKS:**

1. Emission level (dBuV/m) = Raw Value (dBuV) + Correction Factor (dB/m).
2. Correction Factor (dB/m) = Antenna Factor (dB/m) + Cable Factor (dB).
3. The other emission levels were very low against the limit.
4. Margin value = Emission level – Limit value.
5. “ \* “: Fundamental frequency.
6. “#”:The radiated frequency is out the restricted band.



A D T

EUT TEST CONDITION		MEASUREMENT DETAIL	
CHANNEL	Channel 48	FREQUENCY RANGE	1 ~ 40GHz
INPUT POWER (SYSTEM)	120Vac, 60 Hz	DETECTOR FUNCTION	Peak (PK) Average (AV)
ENVIRONMENTAL CONDITIONS	24deg. C, 67%RH	TESTED BY	Alan Wu

ANTENNA POLARITY & TEST DISTANCE: HORIZONTAL AT 3 M								
NO.	FREQ. (MHz)	EMISSION LEVEL (dBuV/m)	LIMIT (dBuV/m)	MARGIN (dB)	ANTENNA HEIGHT (m)	TABLE ANGLE (Degree)	RAW VALUE (dBuV)	CORRECTION FACTOR (dB/m)
1	*5240.00	102.8 PK			1.18 H	31	65.00	37.80
2	*5240.00	92.5 AV			1.18 H	31	54.70	37.80
3	5350.00	54.9 PK	74.0	-19.1	1.18 H	31	16.90	38.00
4	5350.00	42.8 AV	54.0	-11.2	1.18 H	31	4.80	38.00
5	#10480.00	58.9 PK	74.0	-15.1	1.36 H	258	9.70	49.20
6	#10480.00	45.2 AV	54.0	-8.8	1.36 H	258	-4.00	49.20
ANTENNA POLARITY & TEST DISTANCE: VERTICAL AT 3 M								
NO.	FREQ. (MHz)	EMISSION LEVEL (dBuV/m)	LIMIT (dBuV/m)	MARGIN (dB)	ANTENNA HEIGHT (m)	TABLE ANGLE (Degree)	RAW VALUE (dBuV)	CORRECTION FACTOR (dB/m)
1	*5240.00	96.3 PK			1.19 V	128	58.50	37.80
2	*5240.00	86.0 AV			1.19 V	128	48.20	37.80
3	5350.00	54.3 PK	74.0	-19.7	1.19 V	128	16.30	38.00
4	5350.00	41.9 AV	54.0	-12.1	1.19 V	128	3.90	38.00
5	#10480.00	57.9 PK	74.0	-16.1	1.00 V	22	8.70	49.20
6	#10480.00	44.8 AV	54.0	-9.2	1.00 V	22	-4.40	49.20

**REMARKS:**

1. Emission level (dBuV/m) = Raw Value (dBuV) + Correction Factor (dB/m).
2. Correction Factor (dB/m) = Antenna Factor (dB/m) + Cable Factor (dB).
3. The other emission levels were very low against the limit.
4. Margin value = Emission level – Limit value.
5. “ \* “: Fundamental frequency.
6. "#":The radiated frequency is out the restricted band.



A D T

802.11n (40MHz)

EUT TEST CONDITION		MEASUREMENT DETAIL	
CHANNEL	Channel 38	FREQUENCY RANGE	1 ~ 40GHz
INPUT POWER (SYSTEM)	120Vac, 60 Hz	DETECTOR FUNCTION	Peak (PK) Average (AV)
ENVIRONMENTAL CONDITIONS	24deg. C, 67%RH	TESTED BY	Alan Wu

ANTENNA POLARITY & TEST DISTANCE: HORIZONTAL AT 3 M								
NO.	FREQ. (MHz)	EMISSION LEVEL (dBuV/m)	LIMIT (dBuV/m)	MARGIN (dB)	ANTENNA HEIGHT (m)	TABLE ANGLE (Degree)	RAW VALUE (dBuV)	CORRECTION FACTOR (dB/m)
1	5150.00	54.1 PK	74.0	-19.9	1.19 H	37	16.40	37.70
2	5150.00	43.0 AV	54.0	-11.0	1.19 H	37	5.30	37.70
3	*5190.00	99.1 PK			1.19 H	37	61.40	37.70
4	*5190.00	88.5 AV			1.19 H	37	50.80	37.70
5	#10380.00	58.9 PK	74.0	-15.1	1.24 H	44	10.00	48.90
6	#10380.00	45.4 AV	54.0	-8.6	1.24 H	44	-3.50	48.90
ANTENNA POLARITY & TEST DISTANCE: VERTICAL AT 3 M								
NO.	FREQ. (MHz)	EMISSION LEVEL (dBuV/m)	LIMIT (dBuV/m)	MARGIN (dB)	ANTENNA HEIGHT (m)	TABLE ANGLE (Degree)	RAW VALUE (dBuV)	CORRECTION FACTOR (dB/m)
1	5150.00	53.2 PK	74.0	-20.8	1.18 V	122	15.50	37.70
2	5150.00	42.2 AV	54.0	-11.8	1.18 V	122	4.50	37.70
3	*5190.00	90.4 PK			1.18 V	122	52.70	37.70
4	*5190.00	81.2 AV			1.18 V	122	43.50	37.70
5	#10380.00	57.5 PK	74.0	-16.5	1.54 V	62	8.60	48.90
6	#10380.00	44.2 AV	54.0	-9.8	1.54 V	62	-4.70	48.90

REMARKS:

1. Emission level (dBuV/m) = Raw Value (dBuV) + Correction Factor (dB/m).
2. Correction Factor (dB/m) = Antenna Factor (dB/m) + Cable Factor (dB).
3. The other emission levels were very low against the limit.
4. Margin value = Emission level – Limit value.
5. " \* ": Fundamental frequency.
6. "#": The radiated frequency is out the restricted band.



A D T

EUT TEST CONDITION		MEASUREMENT DETAIL	
CHANNEL	Channel 46	FREQUENCY RANGE	1 ~ 40GHz
INPUT POWER (SYSTEM)	120Vac, 60 Hz	DETECTOR FUNCTION	Peak (PK) Average (AV)
ENVIRONMENTAL CONDITIONS	24deg. C, 67%RH	TESTED BY	Alan Wu

**ANTENNA POLARITY & TEST DISTANCE: HORIZONTAL AT 3 M**

NO.	FREQ. (MHz)	EMISSION LEVEL (dBuV/m)	LIMIT (dBuV/m)	MARGIN (dB)	ANTENNA HEIGHT (m)	TABLE ANGLE (Degree)	RAW VALUE (dBuV)	CORRECTION FACTOR (dB/m)
1	*5230.00	99.2 PK			1.17 H	39	61.40	37.80
2	*5230.00	89.7 AV			1.17 H	39	51.90	37.80
3	5350.00	56.4 PK	74.0	-17.6	1.17 H	39	18.40	38.00
4	5350.00	43.2 AV	54.0	-10.8	1.17 H	39	5.20	38.00
5	#10460.00	58.1 PK	74.0	-15.9	1.00 H	254	9.00	49.10
6	#10460.00	46.2 AV	54.0	-7.8	1.00 H	254	-2.90	49.10

**ANTENNA POLARITY & TEST DISTANCE: VERTICAL AT 3 M**

NO.	FREQ. (MHz)	EMISSION LEVEL (dBuV/m)	LIMIT (dBuV/m)	MARGIN (dB)	ANTENNA HEIGHT (m)	TABLE ANGLE (Degree)	RAW VALUE (dBuV)	CORRECTION FACTOR (dB/m)
1	*5230.00	92.5 PK			1.19 V	120	54.70	37.80
2	*5230.00	81.9 AV			1.19 V	120	44.10	37.80
3	5350.00	55.4 PK	74.0	-18.6	1.19 V	120	17.40	38.00
4	5350.00	42.5 AV	54.0	-11.5	1.19 V	120	4.50	38.00
5	#10460.00	57.7 PK	74.0	-16.3	1.12 V	325	8.60	49.10
6	#10460.00	44.8 AV	54.0	-9.2	1.12 V	325	-4.30	49.10

**REMARKS:**

1. Emission level (dBuV/m) = Raw Value (dBuV) + Correction Factor (dB/m).
2. Correction Factor (dB/m) = Antenna Factor (dB/m) + Cable Factor (dB).
3. The other emission levels were very low against the limit.
4. Margin value = Emission level – Limit value.
5. “ \* “: Fundamental frequency.
6. "#":The radiated frequency is out the restricted band.





A D T

**BELOW 1GHz WORST-CASE DATA : 802.11n (20MHz)**

EUT TEST CONDITION		MEASUREMENT DETAIL	
CHANNEL	Channel 40	FREQUENCY RANGE	Below 1000MHz
INPUT POWER (SYSTEM)	120Vac, 60 Hz	DETECTOR FUNCTION	Quasi-Peak
ENVIRONMENTAL CONDITIONS	25deg. C, 70%RH	TESTED BY	Alan Wu

**ANTENNA POLARITY & TEST DISTANCE: HORIZONTAL AT 3 M**

NO.	FREQ. (MHz)	EMISSION LEVEL (dBuV/m)	LIMIT (dBuV/m)	MARGIN (dB)	ANTENNA HEIGHT (m)	TABLE ANGLE (Degree)	RAW VALUE (dBuV)	CORRECTION FACTOR (dB/m)
1	158.22	19.6 QP	43.5	-23.9	1.50 H	204	5.70	13.90
2	339.04	26.6 QP	46.0	-19.4	1.00 H	8	10.80	15.80
3	638.46	27.6 QP	46.0	-18.4	2.00 H	203	4.50	23.10
4	751.23	32.5 QP	46.0	-13.5	1.00 H	125	7.60	24.90
5	799.84	32.7 QP	46.0	-13.3	1.00 H	20	6.90	25.80
6	877.61	29.5 QP	46.0	-16.5	1.00 H	8	2.50	27.00

**ANTENNA POLARITY & TEST DISTANCE: VERTICAL AT 3 M**

NO.	FREQ. (MHz)	EMISSION LEVEL (dBuV/m)	LIMIT (dBuV/m)	MARGIN (dB)	ANTENNA HEIGHT (m)	TABLE ANGLE (Degree)	RAW VALUE (dBuV)	CORRECTION FACTOR (dB/m)
1	97.95	17.4 QP	43.5	-26.1	1.24 V	4	7.50	9.90
2	339.04	18.9 QP	46.0	-27.1	1.50 V	101	3.10	15.80
3	558.75	24.1 QP	46.0	-21.9	1.50 V	194	2.70	21.40
4	720.12	27.7 QP	46.0	-18.3	3.00 V	135	3.30	24.40
5	795.95	32.7 QP	46.0	-13.3	1.00 V	226	7.00	25.70
6	879.55	32.9 QP	46.0	-13.1	1.00 V	280	5.80	27.10

**REMARKS:**

1. Emission level (dBuV/m) = Raw Value (dBuV) + Correction Factor (dB/m).
2. Correction Factor (dB/m) = Antenna Factor (dB/m) + Cable Factor (dB).
3. The other emission levels were very low against the limit.
4. Margin value = Emission level – Limit value.

## 4.2 CONDUCTED EMISSION MEASUREMENT

### 4.2.1 LIMITS OF CONDUCTED EMISSION MEASUREMENT

FREQUENCY OF EMISSION (MHz)	CONDUCTED LIMIT (dB $\mu$ V)	
	Quasi-peak	Average
0.15 ~ 0.5	66 to 56	56 to 46
0.5 ~ 5	56	46
5 ~ 30	60	50

- NOTE:** 1. The lower limit shall apply at the transition frequencies.
2. The limit decreases in line with the logarithm of the frequency in the range of 0.15 to 0.50MHz.
3. All emanations from a class A/B digital device or system, including any network of conductors and apparatus connected thereto, shall not exceed the level of field strengths specified above.

### 4.2.2 TEST INSTRUMENTS

DESCRIPTION & MANUFACTURER	MODEL NO.	SERIAL NO.	DATE OF CALIBRATION	DUE DATE OF CALIBRATION
Test Receiver ROHDE & SCHWARZ	ESCS30	100288	Nov. 09, 2012	Nov. 08, 2013
RF signal cable Woken	5D-FB	Cable-HYCO2-01	Dec. 28, 2012	Dec. 27, 2013
LISN ROHDE & SCHWARZ (EUT)	ESH2-Z5	100100	Dec. 21, 2012	Dec. 20, 2013
LISN ROHDE & SCHWARZ (Peripheral)	ESH3-Z5	100311	Jul. 06, 2012	Jul. 05, 2013
Software ADT	BV ADT_Cond_ V7.3.7.3	NA	NA	NA

- NOTE:** 1. The calibration interval of the above test instruments is 12 months and the calibrations are traceable to NML/ROC and NIST/USA.
2. The test was performed in HwaYa Shielded Room 2.
3. The VCCI Site Registration No. is C-2047.

#### 4.2.3 TEST PROCEDURES

- The EUT was placed 0.4 meters from the conducting wall of the shielded room with EUT being connected to the power mains through a line impedance stabilization network (LISN). Other support units were connected to the power mains through another LISN. The two LISNs provide 50 ohm/ 50uH of coupling impedance for the measuring instrument.
- Both lines of the power mains connected to the EUT were checked for maximum conducted interference.
- The frequency range from 150kHz to 30MHz was searched. Emission levels under (Limit - 20dB) was not recorded.

**NOTE:** All modes of operation were investigated and the worst-case emissions are reported.

#### 4.2.4 DEVIATION FROM TEST STANDARD

No deviation.

#### 4.2.5 TEST SETUP

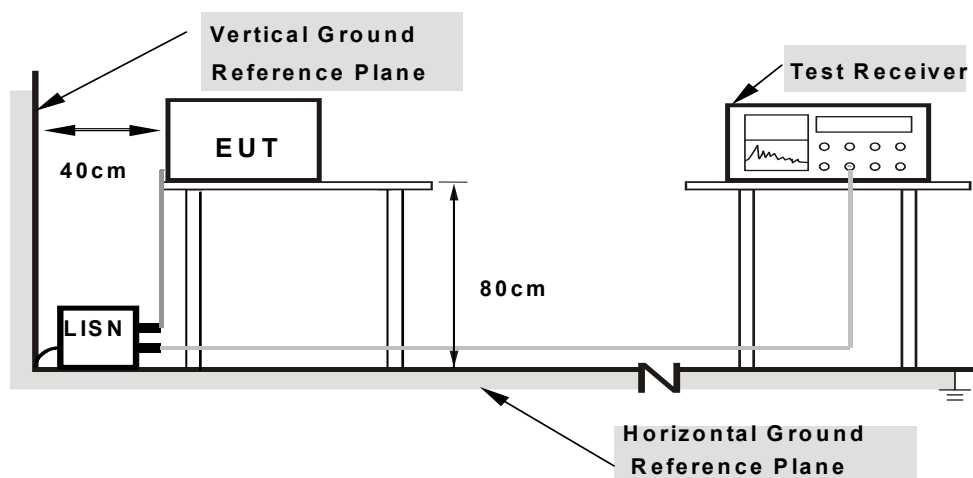

- Note:**
- Support units were connected to second LISN.
  - Both of LISNs (AMN) are 80 cm from EUT and at least 80 cm from other units and other metal planes

For the actual test configuration, please refer to the attached file (Test Setup Photo).

#### 4.2.6 EUT OPERATING CONDITIONS

Same as 4.1.6.

### 4.2.7 TEST RESULTS

**CONDUCTED WORST-CASE DATA : 802.11n (20MHz)**

<b>PHASE</b>	Line 1	<b>6dB BANDWIDTH</b>	9kHz
--------------	--------	----------------------	------

No	Freq. [MHz]	Corr. Factor (dB)	Reading Value		Emission Level		Limit		Margin	
			[dB (uV)]		[dB (uV)]		[dB (uV)]		(dB)	
			Q.P.	AV.	Q.P.	AV.	Q.P.	AV.	Q.P.	AV.
1	0.18906	0.17	45.47	37.10	45.64	37.27	64.08	54.08	-18.44	-16.81
2	0.25156	0.18	38.06	30.31	38.24	30.49	61.71	51.71	-23.47	-21.22
3	0.31406	0.19	31.22	27.82	31.41	28.01	59.86	49.86	-28.45	-21.85
4	0.38438	0.21	29.82	19.83	30.03	20.04	58.18	48.18	-28.16	-28.15
5	0.50156	0.22	31.21	28.54	31.43	28.76	56.00	46.00	-24.57	-17.24
6	10.02734	0.43	41.06	35.11	41.49	35.54	60.00	50.00	-18.51	-14.46

- REMARKS:**
1. Q.P. and AV. are abbreviations of quasi-peak and average individually.
  2. The emission levels of other frequencies were very low against the limit.
  3. Margin value = Emission level - Limit value
  4. Correction factor = Insertion loss + Cable loss
  5. Emission Level = Correction Factor + Reading Value.

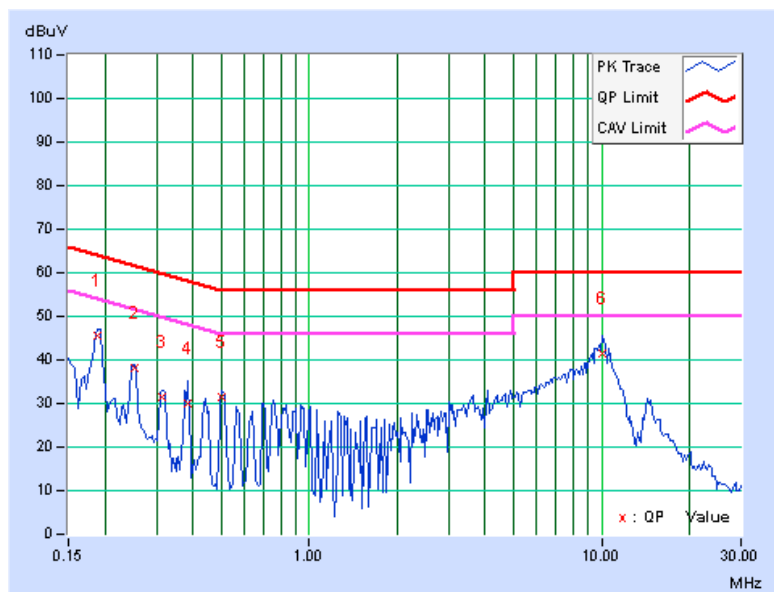

PHASE	Line 2	6dB BANDWIDTH	9kHz
-------	--------	---------------	------

No	Freq. [MHz]	Corr. Factor (dB)	Reading Value		Emission Level		Limit		Margin	
			[dB (uV)]		[dB (uV)]		[dB (uV)]		(dB)	
			Q.P.	AV.	Q.P.	AV.	Q.P.	AV.	Q.P.	AV.
1	0.18906	0.18	45.91	38.27	46.09	38.45	64.08	54.08	-17.99	-15.63
2	0.25156	0.20	39.98	34.69	40.18	34.89	61.71	51.71	-21.53	-16.82
3	0.38438	0.24	34.71	21.61	34.95	21.85	58.18	48.18	-23.23	-26.33
<b>4</b>	<b>0.43906</b>	<b>0.25</b>	<b>35.87</b>	<b>33.74</b>	<b>36.12</b>	<b>33.99</b>	<b>57.08</b>	<b>47.08</b>	<b>-20.96</b>	<b>-13.09</b>
5	0.50938	0.25	32.77	22.97	33.02	23.22	56.00	46.00	-22.98	-22.78
6	10.16016	0.48	39.77	33.20	40.25	33.68	60.00	50.00	-19.75	-16.32

- REMARKS:**
1. Q.P. and AV. are abbreviations of quasi-peak and average individually.
  2. The emission levels of other frequencies were very low against the limit.
  3. Margin value = Emission level - Limit value
  4. Correction factor = Insertion loss + Cable loss
  5. Emission Level = Correction Factor + Reading Value.

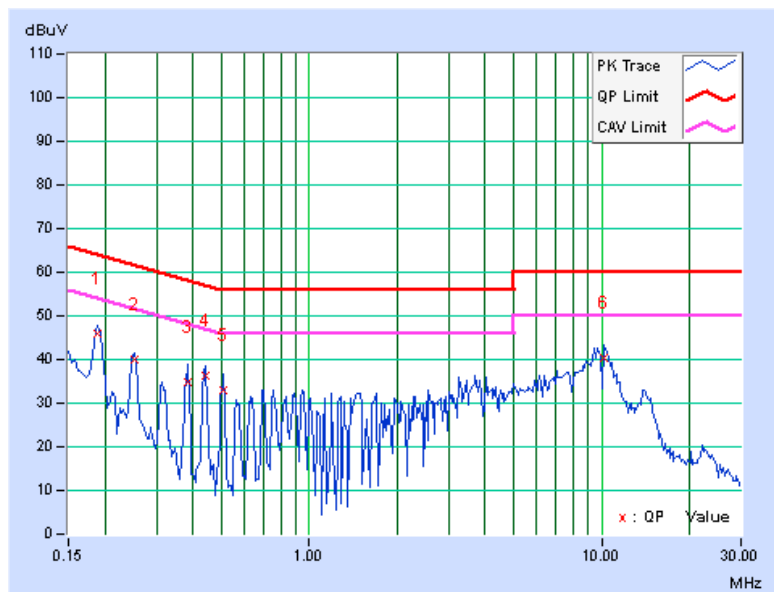

### 4.3 PEAK TRANSMIT POWER MEASUREMENT

#### 4.3.1 LIMITS OF PEAK TRANSMIT POWER MEASUREMENT

FREQUENCY BAND	LIMIT
5.15 ~ 5.25GHz	The lesser of 50mW (17dBm) or 4dBm + 10logB

**NOTE:** Where B is the 26dB emission bandwidth in MHz.

Per KDB 662911 D01 Multiple Transmitter Output v01r02 Method of conducted output power measurement on IEEE 802.11 devices,

Array Gain = 0 dB (i.e., no array gain) for NANT ≤ 4;

Array Gain = 0 dB (i.e., no array gain) for channel widths ≥ 40 MHz for any NANT;

Array Gain = 5 log(NANT/NSS) dB or 3 dB, whichever is less for 20-MHz channel widths with NANT ≥ 5.

For power measurements on all other devices: Array Gain = 10 log(NANT/NSS) dB.

#### 4.3.2 TEST SETUP

##### FOR POWER OUTPUT MEASUREMENT

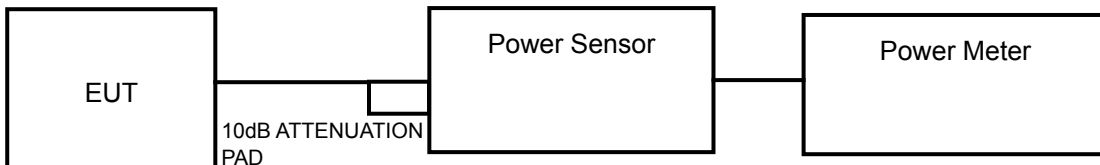

##### FOR 26dB BANDWIDTH

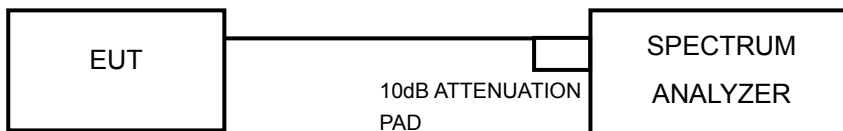

#### 4.3.3 TEST INSTRUMENTS

Refer to section 4.1.3 to get information of above instrument.

#### 4.3.4 TEST PROCEDURE

##### FOR AVERAGE POWER MEASUREMENT

Method PM is used to perform output power measurement, trigger and gating function of wide band power meter is enabled to measure max output power of TX on burst. Duty factor is not added to measured value.

##### FOR 26dB BANDWIDTH

- 1) Set RBW = approximately 1% of the emission bandwidth.
- 2) Set the VBW > RBW.
- 3) Detector = Peak.
- 4) Trace mode = max hold.
- 5) Measure the maximum width of the emission that is 26 dB down from the peak of the emission. Compare this with the RBW setting of the analyzer. Readjust RBW and repeat measurement as needed until the RBW/EBW ratio is approximately 1%.

#### 4.3.5 DEVIATION FROM TEST STANDARD

No deviation.

#### 4.3.6 EUT OPERATING CONDITIONS

The software provided by client to enable the EUT under transmission condition continuously at specific channel frequencies individually.



### 4.3.7 TEST RESULTS

#### POWER OUTPUT:

##### 802.11a

CHANNEL	CHANNEL FREQUENCY (MHz)	AVERAGE POWER (mW)	AVERAGE POWER (dBm)	POWER LIMIT (dBm)	PASS/FAIL
36	5180	37.844	15.78	17	PASS
40	5200	35.645	15.52	17	PASS
48	5240	35.237	15.47	17	PASS

##### 802.11n (20MHz)

CHAN.	CHAN. FREQ. (MHz)	AVERAGE POWER (dBm)		TOTAL POWER (mW)	TOTAL POWER (dBm)	POWER LIMIT (dBm)	PASS / FAIL
		CHAIN 0	CHAIN 1				
36	5180	13.28	13.16	41.982	16.23	17	PASS
40	5200	13.27	13.36	42.909	16.33	17	PASS
48	5240	13.21	13.11	41.405	16.17	17	PASS

##### 802.11n (40MHz)

CHAN.	CHAN. FREQ. (MHz)	AVERAGE POWER (dBm)		TOTAL POWER (mW)	TOTAL POWER (dBm)	POWER LIMIT (dBm)	PASS / FAIL
		CHAIN 0	CHAIN 1				
38	5190	13.57	13.49	45.087	16.54	17	PASS
46	5230	13.59	13.39	44.683	16.50	17	PASS





**26dB BANDWIDTH:**

**802.11a**

CHANNEL	CHANNEL FREQUENCY (MHz)	26dBc BANDWIDTH (MHz)	PASS / FAIL
36	5180	31.89	PASS
40	5200	33.49	PASS
48	5240	33.58	PASS

**802.11n (20MHz)**

CHANNEL	CHANNEL FREQUENCY (MHz)	26dBc BANDWIDTH (MHz)		PASS / FAIL
		CHAIN 0	CHAIN 1	
36	5180	23.25	23.19	PASS
40	5200	23.00	23.08	PASS
48	5240	23.01	22.88	PASS

**802.11n (40MHz)**

CHANNEL	CHANNEL FREQUENCY (MHz)	26dBc BANDWIDTH (MHz)		PASS / FAIL
		CHAIN 0	CHAIN 1	
38	5190	42.78	42.32	PASS
46	5230	42.60	42.36	PASS

#### 4.4 PEAK POWER SPECTRAL DENSITY MEASUREMENT

##### 4.4.1 LIMITS OF PEAK POWER SPECTRAL DENSITY MEASUREMENT

FREQUENCY BAND	LIMIT
5.15 ~ 5.25GHz	4dBm

##### 4.4.2 TEST SETUP

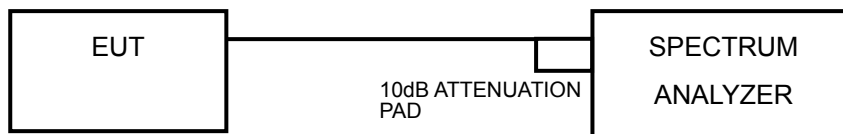

##### 4.4.3 TEST INSTRUMENTS

Refer to section 4.1.3 to get information of above instrument.

##### 4.4.4 TEST PROCEDURES

Using method SA-1 alternative

- 1) Set span to encompass the entire emission bandwidth (EBW) of the signal.
- 2) Set RBW = 30 KHz, Set VBW  $\geq$  1 MHz, Detector = RMS
- 3) Set Channel power measure = 1MHz
- 4) Sweep time = 30ms.
- 5) Perform a single sweep.
- 6) Record the max value

##### 4.4.5 DEVIATION FROM TEST STANDARD

No deviation.

##### 4.4.6 EUT OPERATING CONDITIONS

Same as 4.3.6.



#### 4.4.7 TEST RESULTS

##### 802.11a

CHANNEL	FREQUENCY (MHz)	PSD (dBm)	MAXIMUM LIMIT (dBm)	PASS/FAIL
36	5180	3.90	4	PASS
40	5200	3.41	4	PASS
48	5240	3.51	4	PASS

##### 802.11n (20MHz)

CHAN.	CHAN. FREQ. (MHz)	PSD (dBm)		TOTAL POWER DENSITY (dBm)	MAX. LIMIT (dBm)	PASS / FAIL
		CHAIN 0	CHAIN 1			
36	5180	0.08	0.95	3.55	3.79	PASS
40	5200	0.73	0.76	3.76	3.79	PASS
48	5240	0.03	0.83	3.46	3.79	PASS

- NOTE:** 1. Method 1 of power density measurement of KDB 662911 is using for calculating total power density. Total power density is summing entire spectra across corresponding frequency bins on the various outputs by computer.
2. Directional gain =  $3.2\text{dBi} + 10\log(2) = 6.21\text{dBi} > 6\text{dBi}$  , so the power density limit shall be reduced to  $4-(6.21-6) = 3.79\text{dBm}$ .

##### 802.11n (40MHz)

CHAN.	CHAN. FREQ. (MHz)	PSD (dBm)		TOTAL POWER DENSITY (dBm)	MAX. LIMIT (dBm)	PASS / FAIL
		CHAIN 0	CHAIN 1			
38	5190	-1.11	-2.37	1.32	3.79	PASS
46	5230	-3.02	-1.68	0.71	3.79	PASS

- NOTE:** 1. Method 1 of power density measurement of KDB 662911 is using for calculating total power density. Total power density is summing entire spectra across corresponding frequency bins on the various outputs by computer.
2. Directional gain =  $3.2\text{dBi} + 10\log(2) = 6.21\text{dBi} > 6\text{dBi}$  , so the power density limit shall be reduced to  $4-(6.21-6) = 3.79\text{dBm}$ .

## 4.5 PEAK POWER EXCURSION MEASUREMENT

### 4.5.1 LIMITS OF PEAK POWER EXCURSION MEASUREMENT

Shall not exceed 13 dB

### 4.5.2 TEST SETUP



### 4.5.3 TEST INSTRUMENTS

Refer to section 4.1.3 to get information of above instrument.

### 4.5.4 TEST PROCEDURE

- 1) Set RBW = 1 MHz, VBW  $\geq$  3 MHz, Detector = peak.
- 2) Trace mode = max-hold. Allow the sweeps to continue until the trace stabilizes.
- 3) Use the peak search function to find the peak of the spectrum.
- 4) Measure the PPSD.
- 5) Compute the ratio of the maximum of the peak-max-hold spectrum to the PPSD.

### 4.5.5 DEVIATION FROM TEST STANDARD

No deviation.

### 4.5.6 EUT OPERATING CONDITIONS

Same as 4.2.6



A D T

### 4.5.7 TEST RESULTS

#### 802.11a

CHANNEL	CHANNEL FREQUENCY (MHz)	PEAK VALUE (dBm)	PPSD (dBm)	PEAK EXCURSION (dB)	LIMIT (dB)	PASS/FAIL
36	5180	13.37	3.90	9.47	13	PASS
40	5200	13.12	3.41	9.71	13	PASS
48	5240	13.34	3.51	9.83	13	PASS

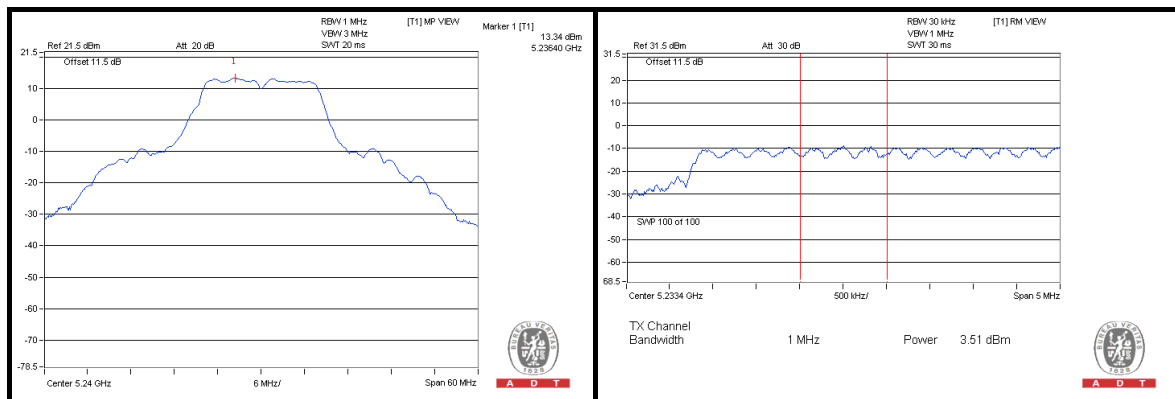



802.11n (20MHz)

CHAN.	CHAN. FREQ. (MHz)	PEAK VALUE (dBm)		PPSD (dBm)		PEAK EXCURSION (dB)		LIMIT (dB)	PASS/ FAIL
		CHAIN 0	CHAIN 1	CHAIN 0	CHAIN 1	CHAIN 0	CHAIN 1		
36	5180	11.76	11.30	0.08	0.95	11.68	10.35	13	PASS
40	5200	11.38	10.76	0.73	0.76	10.65	10.00	13	PASS
48	5240	10.75	11.70	0.03	0.83	10.72	10.87	13	PASS

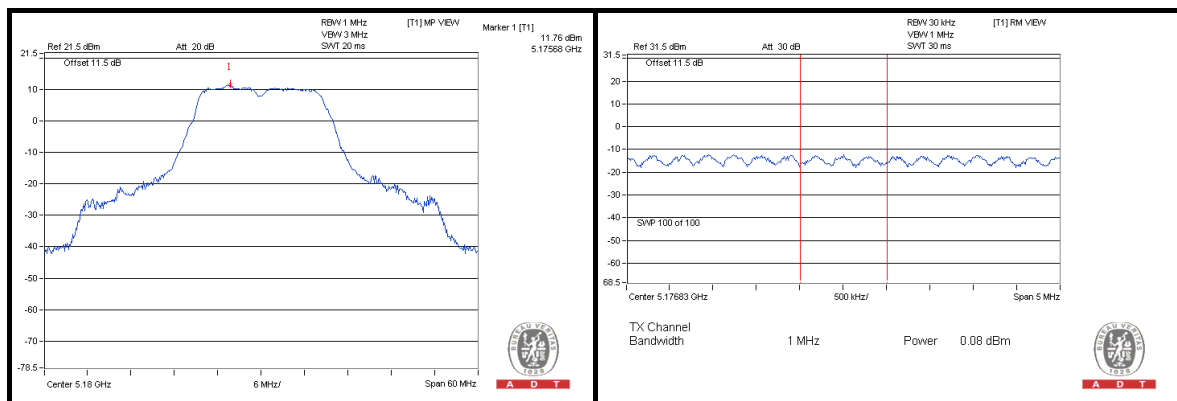

802.11n (40MHz)

CHAN.	CHAN. FREQ. (MHz)	PEAK VALUE (dBm)		PPSD (dBm)		PEAK EXCURSION (dB)		LIMIT (dB)	PASS/ FAIL
		CHAIN 0	CHAIN 1	CHAIN 0	CHAIN 1	CHAIN 0	CHAIN 1		
38	5190	9.08	9.78	-1.11	-2.37	10.19	12.15	13	PASS
46	5230	8.37	8.78	-3.02	-1.68	11.39	10.46	13	PASS

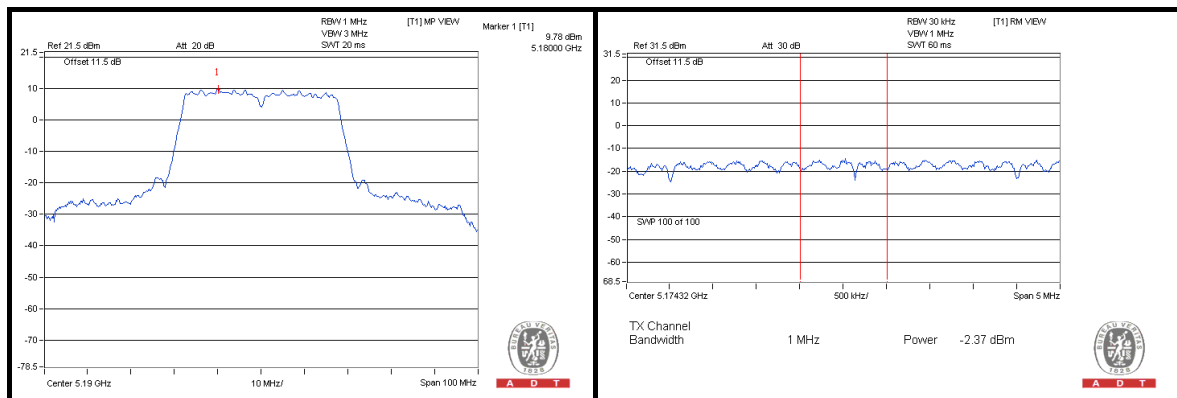

## 4.6 FREQUENCY STABILITY

### 4.6.1 LIMITS OF FREQUENCY STABILITY MEASUREMENT

The frequency of the carrier signal shall be maintained within band of operation

### 4.6.2 TEST SETUP

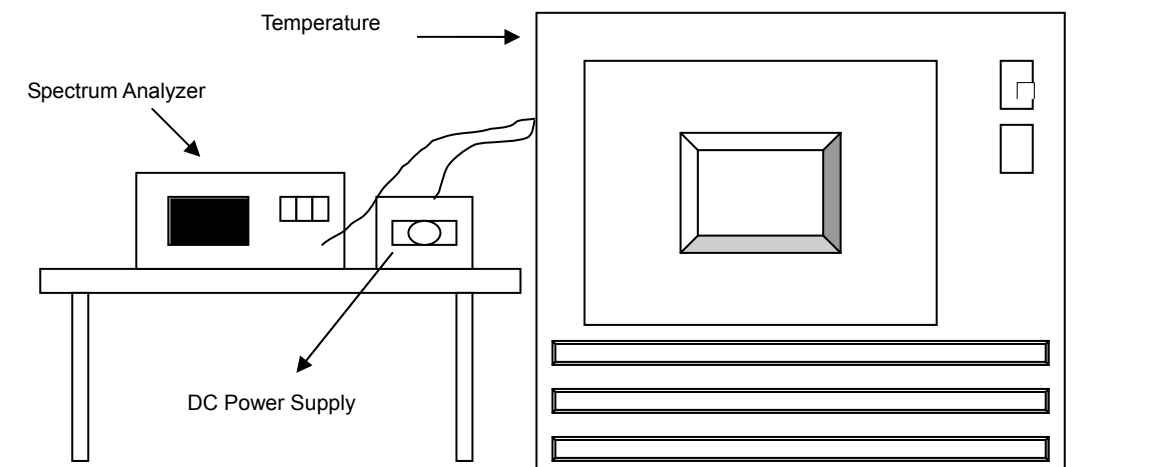

### 4.6.3 TEST INSTRUMENTS

Refer to section 4.1.3 to get information of above instrument.

#### 4.6.4 TEST PROCEDURE

- a. The EUT was placed inside the environmental test chamber and powered by nominal DC voltage.
- b. Turn the EUT on and couple its output to a spectrum analyzer.
- c. Turn the EUT off and set the chamber to the highest temperature specified.
- d. Allow sufficient time (approximately 30 min) for the temperature of the chamber to stabilize, turn the EUT on and measure the operating frequency after 2, 5, and 10 minutes.
- e. Repeat step 2 and 3 with the temperature chamber set to the lowest temperature.
- f. The test chamber was allowed to stabilize at +20 degree C for a minimum of 30 minutes. The supply voltage was then adjusted on the EUT from 85% to 115% and the frequency record.

#### 4.6.5 DEVIATION FROM TEST STANDARD

No deviation.

#### 4.6.6 EUT OPERATING CONDITION

Set the EUT transmit at un-modulation mode to test frequency stability.





#### 4.6.7 TEST RESULTS

FREQUENCY STABILITY VERSUS TEMP.									
OPERATING FREQUENCY: 5200MHz									
TEMP. (°C)	POWER SUPPLY (Vdc)	0 MINUTE		2 MINUTE		5 MINUTE		10 MINUTE	
		Measured Frequency (MHz)	Frequency Drift (ppm)	Measured Frequency (MHz)	Frequency Drift (ppm)	Measured Frequency (MHz)	Frequency Drift (ppm)	Measured Frequency (MHz)	Frequency Drift (ppm)
55	3.3	5199.9812	-0.00036	5199.9800	-0.00038	5199.9786	-0.00041	5199.9748	-0.00048
50	3.3	5200.0067	0.00013	5200.0016	0.00003	5200.0094	0.00018	5200.0059	0.00011
40	3.3	5199.9814	-0.00036	5199.9826	-0.00033	5199.9874	-0.00024	5199.9891	-0.00021
30	3.3	5199.9739	-0.00050	5199.9707	-0.00056	5199.9793	-0.00040	5199.9731	-0.00052
20	3.3	5199.9905	-0.00018	5199.9909	-0.00018	5199.9938	-0.00012	5199.9859	-0.00027
10	3.3	5200.0127	0.00024	5200.0109	0.00021	5200.0194	0.00037	5200.0125	0.00024
0	3.3	5199.9856	-0.00028	5199.9856	-0.00028	5199.9767	-0.00045	5199.9863	-0.00026
-10	3.3	5200.0060	0.00012	5200.0043	0.00008	5200.0074	0.00014	5200.0111	0.00021
-20	3.3	5199.9812	-0.00036	5199.9800	-0.00038	5199.9786	-0.00041	5199.9748	-0.00048
-30	3.3	5200.0067	0.00013	5200.0016	0.00003	5200.0094	0.00018	5200.0059	0.00011

FREQUENCY STABILITY VERSUS VOLTAGE									
OPERATING FREQUENCY: 5200MHz									
TEMP. (°C)	POWER SUPPLY (Vdc)	0 MINUTE		2 MINUTE		5 MINUTE		10 MINUTE	
		Measured Frequency (MHz)	Frequency Drift (ppm)	Measured Frequency (MHz)	Frequency Drift (ppm)	Measured Frequency (MHz)	Frequency Drift (ppm)	Measured Frequency (MHz)	Frequency Drift (ppm)
20	2.8	5199.9732	-0.00052	5199.9712	-0.00055	5199.9792	-0.00040	5199.9744	-0.00049
	3.3	5199.9739	-0.00050	5199.9707	-0.00056	5199.9793	-0.00040	5199.9731	-0.00052
	3.8	5199.9730	-0.00052	5199.9714	-0.00055	5199.9799	-0.00039	5199.9745	-0.00049



A D T

## 5. PHOTOGRAPHS OF THE TEST CONFIGURATION

Please refer to the attached file (Test Setup Photo).



## 6. INFORMATION ON THE TESTING LABORATORIES

We, Bureau Veritas Consumer Products Services (H.K.) Ltd., Taoyuan Branch, were founded in 1988 to provide our best service in EMC, Radio, Telecom and Safety consultation. Our laboratories are accredited and approved according to ISO/IEC 17025.

If you have any comments, please feel free to contact us at the following:

**Linko EMC/RF Lab:**

Tel: 886-2-26052180

Fax: 886-2-26051924

**Hsin Chu EMC/RF Lab:**

Tel: 886-3-5935343

Fax: 886-3-5935342

**Hwa Ya EMC/RF/Safety Telecom Lab:**

Tel: 886-3-3183232

Fax: 886-3-3270892

**Email:** [service.adt@tw.bureauveritas.com](mailto:service.adt@tw.bureauveritas.com)

**Web Site:** [www.bureauveritas-adt.com](http://www.bureauveritas-adt.com)

The address and road map of all our labs can be found in our web site also.



A D T

## **7. APPENDIX A – MODIFICATIONS RECORDERS FOR ENGINEERING CHANGES TO THE EUT BY THE LAB**

No modifications were made to the EUT by the lab during the test.

**---END---**