

# RF MEASUREMENT REPORT

---

**FCC ID:** LNQ-WF825  
**Applicant:** Actiontec Electronics Inc.  
**Product:** Tri-band Wi-Fi 7 Wireless AP  
**Model No.:** GRBE330C, WF-825  
**FCC Classification:** 15E 6GHz Low Power Indoor Access Point (6ID)  
**FCC Rule Part(s):** Part 15 Subpart E (Section 15.407)  
**Result:** Complies  
**Received Date:** 2023-12-04  
**Test Date:** 2023-12-22 ~ 2024-03-07

**Reviewed By:**

\_\_\_\_\_  
Kevin Guo

**Approved By:**

\_\_\_\_\_  
Robin Wu



The test results relate only to the samples tested.

This equipment has been shown to be capable of compliance with the applicable technical standards as indicated in the measurement report and was tested in accordance with the measurement procedures specified in KDB789033. Test results reported herein relate only to the item(s) tested.

The test report shall not be reproduced except in full without the written approval of MRT Technology (Suzhou) Co., Ltd.

**Revision History**

Report No.	Version	Description	Issue Date	Note
2312RSU008-U5	V01	Initial Report	2024-03-13	Valid

## CONTENTS

Description	Page
<b>1. General Information .....</b>	<b>6</b>
1.1. Applicant .....	6
1.2. Manufacturer .....	6
1.3. Testing Facility .....	6
1.4. Product Information .....	7
1.5. Radio Specification under Test .....	7
1.6. Working Frequencies .....	8
1.7. Antenna Details .....	9
<b>2. Test Configuration .....</b>	<b>11</b>
2.1. Test Mode .....	11
2.2. Test System Connection Diagram .....	12
2.3. Test Software .....	12
2.4. Applied Standards .....	13
2.5. Test Environment Condition .....	13
<b>3. Antenna Requirements .....</b>	<b>14</b>
<b>4. Measuring Instrument .....</b>	<b>15</b>
<b>5. Decision Rules and Measurement Uncertainty .....</b>	<b>17</b>
5.1. Decision Rules .....	17
5.2. Measurement Uncertainty .....	17
<b>6. Test Result .....</b>	<b>18</b>
6.1. Summary .....	18
6.2. 26dB Bandwidth Measurement .....	19
6.2.1. Test Limit .....	19
6.2.2. Test Procedure .....	19
6.2.3. Test Setting .....	19
6.2.4. Test Setup .....	20
6.2.5. Test Result .....	20
6.3. Output Power Measurement .....	21
6.3.1. Test Limit .....	21
6.3.2. Test Procedure .....	21
6.3.3. Test Setting .....	21
6.3.4. Test Setup .....	22
6.3.5. Test Result .....	22
6.4. Power Spectral Density Measurement .....	23
6.4.1. Test Limit .....	23

6.4.2.	Test Procedure .....	23
6.4.3.	Test Setting .....	23
6.4.4.	Test Setup.....	24
6.4.5.	Test Result .....	24
6.5.	In-Band Emission Measurement .....	25
6.5.1.	Test Limit .....	25
6.5.2.	Test Procedure .....	25
6.5.3.	Test Setting .....	25
6.5.4.	Test Setup.....	26
6.5.5.	Test Result .....	26
6.6.	Frequency Stability Measurement.....	27
6.6.1.	Test Limit .....	27
6.6.2.	Test Procedure .....	27
6.6.3.	Test Setup.....	27
6.6.4.	Test Result .....	28
6.7.	Contention Based Protocol Measurement .....	29
6.7.1.	Test Limit .....	29
6.7.2.	Test Procedure .....	29
6.7.3.	Test Setting .....	29
6.7.4.	Test Setup.....	30
6.7.5.	Test Result .....	30
6.8.	Radiated Spurious Emission Measurement .....	31
6.8.1.	Test Limit .....	31
6.8.2.	Test Procedure .....	31
6.8.3.	Test Setting .....	32
6.8.4.	Test Setup.....	34
6.8.5.	Test Result .....	35
6.9.	Radiated Restricted Band Edge Measurement.....	36
6.9.1.	Test Limit .....	36
6.9.2.	Test Procedure .....	38
6.9.3.	Test Setting .....	38
6.9.4.	Test Setup.....	39
6.9.5.	Test Result .....	39
6.10.	AC Conducted Emissions Measurement.....	40
6.10.1.	Test Limit .....	40
6.10.2.	Test Setup.....	40
6.10.3.	Test Result.....	40
<b>Appendix A – Test Result.....</b>		<b>41</b>

A.1	Duty Cycle Test Result .....	41
A.2	26dB Bandwidth Test Result .....	43
A.3	Output Power Test Result .....	64
A.4	Power Spectral Density Test Result .....	69
A.5	In-Band Emission Measurement .....	93
A.6	Frequency Stability Test Result .....	140
A.7	Contention Based Protocol Test Result .....	141
A.8	Radiated Spurious Emission Test Result .....	154
A.9	Radiated Restricted Band Edge Test Result .....	276
A.10	AC Conducted Emissions Test Result .....	364
<b>Appendix B – Test Setup Photograph .....</b>		<b>366</b>
<b>Appendix C – EUT Photograph .....</b>		<b>367</b>

## 1. General Information

### 1.1. Applicant

Actiontec Electronics Inc.

2445 Augustine Drive Suite 501, Santa Clara, California 95054, United States

### 1.2. Manufacturer

Actiontec Electronics Inc.

2445 Augustine Drive Suite 501, Santa Clara, California 95054, United States

### 1.3. Testing Facility

<input checked="" type="checkbox"/>	<b>Test Site – MRT Suzhou Laboratory</b>
	<b>Laboratory Location (Suzhou - Wuzhong)</b> D8 Building, No.2 Tian'edang Rd., Wuzhong Economic Development Zone, Suzhou, China
	<b>Laboratory Location (Suzhou - SIP)</b> 4b Building, Liando U Valley, No.200 Xingpu Rd., Shengpu Town, Suzhou Industrial Park, China
	<b>Laboratory Accreditations</b>
	A2LA: 3628.01 <span style="float: right;">CNAS: L10551</span> FCC: CN1166 <span style="float: right;">ISED: CN0001</span> VCCI: <input type="checkbox"/> R-20025 <input type="checkbox"/> G-20034 <input type="checkbox"/> C-20020 <input type="checkbox"/> T-20020 <input type="checkbox"/> R-20141 <input type="checkbox"/> G-20134 <input type="checkbox"/> C-20103 <input type="checkbox"/> T-20104
<input type="checkbox"/>	<b>Test Site – MRT Shenzhen Laboratory</b>
	<b>Laboratory Location (Shenzhen)</b> 1G, Building A, Junxiangda Building, Zhongshanyuan Road West, Nanshan District, Shenzhen, China
	<b>Laboratory Accreditations</b>
	A2LA: 3628.02 <span style="float: right;">CNAS: L10551</span> FCC: CN1284 <span style="float: right;">ISED: CN0105</span>
<input type="checkbox"/>	<b>Test Site – MRT Taiwan Laboratory</b>
	<b>Laboratory Location (Taiwan)</b> No. 38, Fuxing 2nd Rd., Guishan Dist., Taoyuan City 333, Taiwan (R.O.C.)
	<b>Laboratory Accreditations</b>
	TAF: 3261 FCC: 291082, TW3261 <span style="float: right;">ISED: TW3261</span>

#### 1.4. Product Information

Product Name	Tri-band Wi-Fi 7 Wireless AP
Model No.	GRBE330C, WF-825
EUT Identification No.	20240130Sample#02(Conducted Testing) 20240112Sample#01(Radiated Testing)
Wi-Fi Specification	802.11a/b/g/n/ac/ax/be
Bluetooth Specification	V5.0 (Single mode, LE only)
Antenna Information	Refer to Section 1.7
Accessory	
Adapter	Model: KL-WA150400-Q1 Input: 100-240V ~ 50/60Hz 2.0A Output: 15.0V = 4.0A
Notes:	
<ol style="list-style-type: none"> <li>There is not any hardware or software differences between GRBE330C and WF-825, only for different brand.</li> <li>The information of EUT was provided by the manufacturer, and the accuracy of the information shall be the responsibility of the manufacturer.</li> </ol>	

#### 1.5. Radio Specification under Test

Frequency Range	For 802.11a/ax-HE20/be-EHT20: 5955 ~ 7095 MHz For 802.11ax-HE40/be-EHT40: 5965 ~ 7085 MHz For 802.11ax-HE80/be-EHT80: 5985 ~ 7025 MHz For 802.11ax-HE160/be-EHT160: 6025 ~ 6985 MHz For 802.11be-EHT320: 6105 ~ 6905 MHz	
Type of Modulation	802.11a: OFDM 802.11ax/be: OFDMA	
Data Rate	802.11a: 6/9/12/18/24/36/48/54Mbps 802.11ax: up to 4804Mbps 802.11be: up to 11528Mbps	
Channel Puncturing Function	<input type="checkbox"/> Supported	<input checked="" type="checkbox"/> Unsupported
Support RU	<input checked="" type="checkbox"/> Full RU	<input type="checkbox"/> Partial RU

## 1.6. Working Frequencies

### 802.11a/ax-HE20/be-EHT20

Channel	Frequency	Channel	Frequency	Channel	Frequency
1	5955 MHz	5	5975 MHz	9	5995 MHz
13	6015 MHz	17	6035 MHz	21	6055 MHz
25	6075 MHz	29	6095 MHz	33	6115 MHz
37	6135 MHz	41	6155 MHz	45	6175 MHz
49	6195 MHz	53	6215 MHz	57	6235 MHz
61	6255 MHz	65	6275 MHz	69	6295 MHz
73	6315 MHz	77	6335 MHz	81	6355 MHz
85	6375 MHz	89	6395 MHz	93	6415 MHz
97	6435 MHz	101	6455 MHz	105	6475 MHz
109	5495 MHz	113	6515 MHz	117	6535 MHz
121	6555 MHz	125	6575 MHz	129	6595 MHz
133	6615 MHz	137	6635 MHz	141	6655 MHz
145	6675 MHz	149	6695 MHz	153	6715 MHz
157	6735 MHz	161	6755 MHz	165	6775 MHz
169	6795 MHz	173	6815 MHz	177	6835 MHz
181	6855 MHz	185	6875 MHz	189	6895 MHz
193	6915 MHz	197	6935 MHz	201	6955 MHz
205	6975 MHz	209	6995 MHz	213	7015 MHz
217	7035 MHz	221	7055 MHz	225	7075 MHz
229	7095 MHz	--	--	--	--

### 802.11ax-HE40/be-EHT40

Channel	Frequency	Channel	Frequency	Channel	Frequency
3	5965 MHz	11	6005 MHz	19	6045 MHz
27	6085 MHz	35	6125 MHz	43	6165 MHz
51	6205 MHz	59	6245 MHz	67	6285 MHz
75	6325 MHz	83	6365 MHz	91	6405 MHz
99	6445 MHz	107	6485 MHz	115	6525 MHz
123	6565 MHz	131	6605 MHz	139	6645 MHz
147	6685 MHz	155	6725 MHz	163	6765 MHz
171	6805 MHz	179	6845 MHz	187	6885 MHz
195	6925 MHz	203	6965 MHz	211	7005 MHz
219	7045 MHz	227	7085 MHz	--	--



## 802.11ax-HE80/be-EHT80

Channel	Frequency	Channel	Frequency	Channel	Frequency
7	5985 MHz	23	6065 MHz	39	6145 MHz
55	6225 MHz	71	6305 MHz	87	6385 MHz
103	6465 MHz	119	6545 MHz	135	6625 MHz
151	6705 MHz	167	6785 MHz	183	6865 MHz
199	6945 MHz	215	7025 MHz	--	--

## 802.11ax-HE160/be-EHT160

Channel	Frequency	Channel	Frequency	Channel	Frequency
15	6025 MHz	47	6185 MHz	79	6345 MHz
111	6505 MHz	143	6665 MHz	175	6825 MHz
207	6985 MHz	--	--	--	--

## 802.11be-EHT320

Channel	Frequency	Channel	Frequency	Channel	Frequency
31	6105 MHz	63	6265 MHz	95	6425 MHz
127	6585 MHz	159	6745 MHz	191	6905 MHz

## 1.7. Antenna Details

Antenna Type	Frequency (MHz)	TX Paths	Antenna Gain (dBi)				Directional Gain (dBi)	
			Ant 0	Ant 1	Ant 2	Ant 3	Correlated	Uncorrelated
Wi-Fi Antenna								
PIFA	2412 ~ 2462	4	3.72	3.73	3.79	3.59	5.49	0.23
	5180 ~ 5825	4	4.40	4.82	4.57	4.34	6.74	1.45
	5925 ~ 7125	4	4.50	4.88	4.91	4.70	6.90	1.27

## Remark:

- The antenna gain and directional gain refer to manufacturer's antenna specification.
- The device supports CDD Mode, STBC mode and SISO mode, details refer to the table as below.
- CDD signals are correlated, the directional gain as follows,  
 For power measurements: Array Gain = 0 dB for  $N_{ANT} \leq 4$ , the directional gain = max antenna gain + array gain  
 For power spectral density (PSD) measurements: the max directional gain (each angle) =  $10 \log[(10^{G1/20} + 10^{G2/20} + \dots + 10^{GN/20})^2 / N_{ANT}]$
- STBC signals are uncorrelated, the directional gain as follows,  
 the max directional gain (each angle) =  $10 \log[(10^{G1/10} + 10^{G2/10} + \dots + 10^{GN/10}) / N_{ANT}]$

Test Mode	T <sub>x</sub> Paths	SISO	CDD Mode	STBC Mode
<b>Wi-Fi 2.4G</b>				
802.11b/g	4	X	√	X
802.11n/ax	4	X	X	√
<b>Wi-Fi 5G</b>				
802.11a	4	X	√	X
802.11n/ac/ax/be	4	X	X	√
<b>Wi-Fi 6G</b>				
802.11a	1 (Ant 0)	√	X	X
802.11a	4	X	√	X
802.11ax/be	4	X	X	√
Remark: "√" means "Support", "X" means "Not support".				

## 2. Test Configuration

### 2.1. Test Mode

Mode 1: Transmit by 802.11a (6Mbps) _ Nss=1 (CDD Mode)
Mode 2: Transmit by 802.11a (6Mbps) _ Nss=1 (SISO Mode)
Mode 3: Transmit by 802.11ax-HE20 (MCS0) _ Nss=4 (STBC Mode)
Mode 4: Transmit by 802.11ax-HE40 (MCS0) _ Nss=4 (STBC Mode)
Mode 5: Transmit by 802.11ax-HE80 (MCS0) _ Nss=4 (STBC Mode)
Mode 6: Transmit by 802.11 ax-HE160 (MCS0) _ Nss=4 (STBC Mode)
Mode 7: Transmit by 802.11be-EHT20 (MCS0) _ Nss=4 (STBC Mode)
Mode 8: Transmit by 802.11be-EHT40 (MCS0) _ Nss=4 (STBC Mode)
Mode 9: Transmit by 802.11be-EHT80 (MCS0) _ Nss=4 (STBC Mode)
Mode 10: Transmit by 802.11be-EHT160 (MCS0) _ Nss=4 (STBC Mode)
Mode 11: Transmit by 802.11be-EHT320 (MCS0) _ Nss=4 (STBC Mode)
Notes: <ol style="list-style-type: none"><li>1. For Radiated emission, the modulation and the data rate picked for testing are determined by the Max. RF conducted power.</li><li>2. For CDD mode, this device supports 4 Nss and power level is the same of spatial multiplexing. The worst case is Nss=1.</li><li>3. EUT supports one configuration only in 802.11ax/be full RU mode.</li><li>4. All modes of operation and data rates were investigated, so all RF test requirements shall be executed at the worse data rate which power is the greatest.</li></ol>

## 2.2. Test System Connection Diagram

The device was tested per the guidance ANSI C63.10: 2013 was used to reference the appropriate EUT setup for radiated emissions testing and AC line conducted testing.

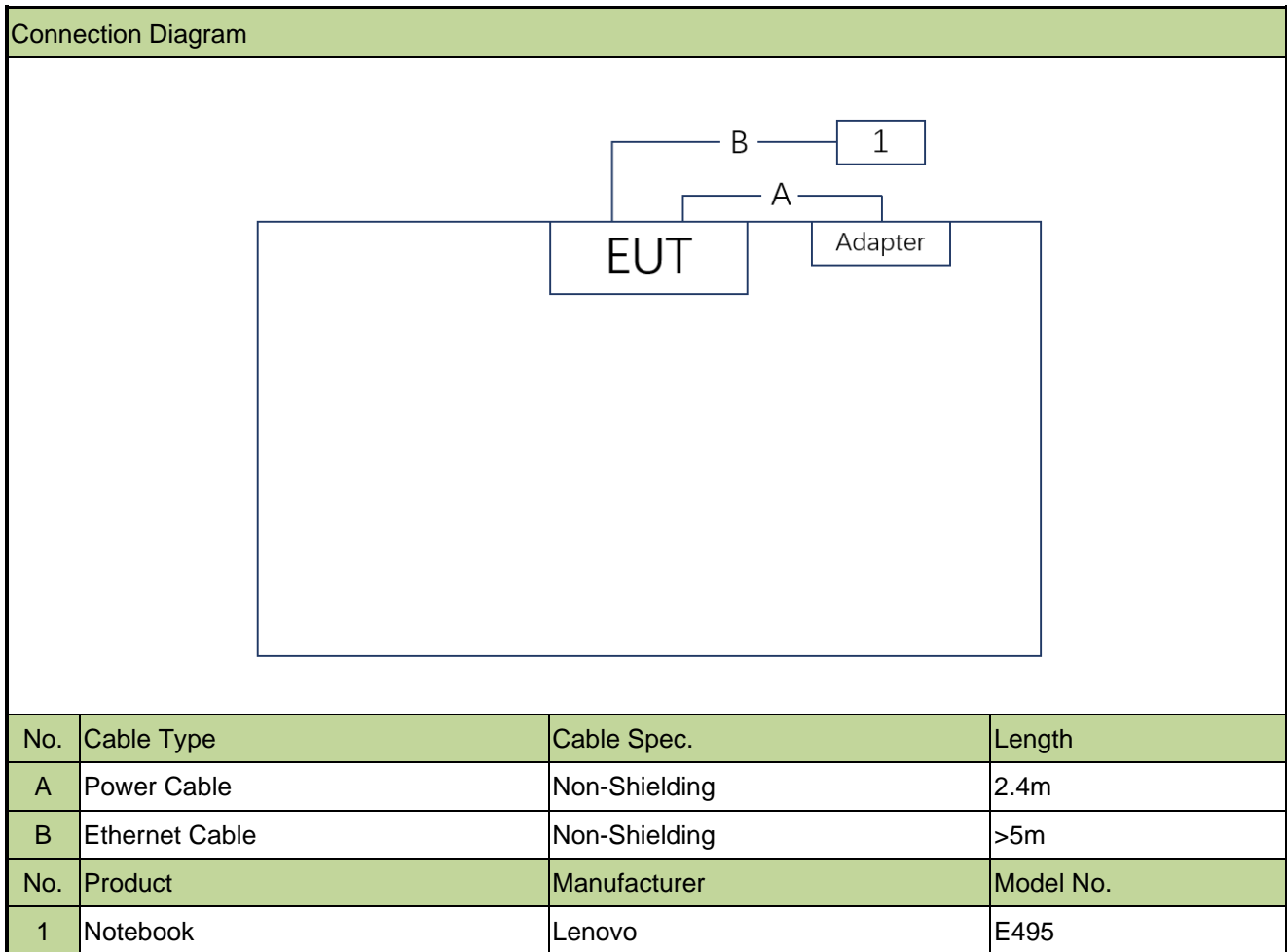

## 2.3. Test Software

The test utility software used during testing was "QRCT", and the version was 3.0.268.0.

Note: Final power setting please refer to operational description

## 2.4. Applied Standards

According to the specifications of the manufacturer, the EUT must comply with the requirements of the following standards:

- ANSI C63.10-2013
- FCC KDB 789033 D02v02r01
- FCC KDB 987594 D02v02r01
- FCC KDB 987594 D04v02
- FCC KDB 662911 D01v02r01
- FCC KDB 414788 D01v01r01
- FCC KDB 412172 D01v01r01

## 2.5. Test Environment Condition

Ambient Temperature	15 ~ 35°C
Relative Humidity	20 ~ 75%RH

### 3. Antenna Requirements

Excerpt from §15.407(a)(9) of the FCC Rules/Regulations:

Access points operating under the provisions of paragraphs (a)(5) and (a)(6) of this section must employ a permanently attached integrated antenna.

- The antenna of the device is built in and locked inside the enclosure.

Conclusion:

The device complies with the requirement of §15.407(a)(9).

#### 4. Measuring Instrument

Instrument	Manufacturer	Model No.	Asset No.	Cali. Interval	Cali. Due Date	Test Site
Anechoic Chamber	RIKEN	SIP-AC1	MRTSUE06554	1 year	2024-12-21	SIP-AC1
Horn Antenna	R&S	HF907	MRTSUE06610	1 year	2024-06-17	SIP-AC1
Thermohygrometer	testo	608-H1	MRTSUE06616	1 year	2024-10-28	SIP-AC1
TRILOG Antenna	Schwarzbeck	VULB 9168	MRTSUE06645	1 year	2024-07-13	SIP-AC1
Preamplifier	MRT	AMP-AC1	MRTSUE11265	1 year	2024-11-03	SIP-AC1
EMI Test Receiver	R&S	ESR3	MRTSUE06185	1 year	2024-12-17	SIP-AC1
Preamplifier	EMCI	EMC184045SE	MRTSUE06602	1 year	2024-10-09	SIP-AC1
Loop Antenna	Schwarzbeck	FMZB 1519 B	MRTSUE06937	1 year	2025-01-27	SIP-AC1
Signal Analyzer	Keysight	N9010B	MRTSUE06559	1 year	2024-05-23	SIP-AC1
Signal Analyzer	Keysight	N9010B	MRTSUE06603	1 year	2024-09-27	SIP-AC3
Horn Antenna	Schwarzbeck	BBHA 9170	MRTSUE06599	1 year	2024-09-24	SIP-AC1
Preamplifier	Schwarzbeck	BBV 9721	MRTSUE06121	1 year	2024-06-07	SIP-AC3
Horn Antenna	R&S	HF907	MRTSUE06611	1 year	2024-07-14	SIP-AC3
Thermohygrometer	testo	608-H1	MRTSUE06619	1 year	2024-10-28	SIP-AC3
Preamplifier	EMCI	EMC012645SE	MRTSUE06642	1 year	2025-01-11	SIP-AC3
Anechoic Chamber	RIKEN	SIP-AC3	MRTSUE06782	1 year	2024-12-21	SIP-AC3
Horn Antenna	Schwarzbeck	BBHA 9120D	MRTSUE06023	1 year	2024-08-09	WZ-AC1
Preamplifier	Agilent	83017A	MRTSUE06076	1 year	2024-05-07	WZ-AC1
Anechoic Chamber	TDK	WZ-AC1	MRTSUE06212	1 year	2024-04-20	WZ-AC1
Signal Analyzer	Keysight	N9010B	MRTSUE06607	1 year	2024-10-23	WZ-AC1
Preamplifier	EMCI	EMC051845SE	MRTSUE06987	1 year	2024-09-07	WZ-AC1
Thermohygrometer	testo	608-H1	MRTSUE11039	1 year	2024-10-25	WZ-AC1
Two-Line V-Network	R&S	ENV216	MRTSUE06003	1 year	2024-05-23	SIP-SR2
EMI Test Receiver	R&S	ESR3	MRTSUE06612	1 year	2024-05-23	SIP-SR2
Four-Line V-Network	R&S	ENV432	MRTSUE06614	1 year	2024-10-23	SIP-SR2
Thermohygrometer	testo	608-H1	MRTSUE06621	1 year	2024-11-03	SIP-SR2
Shielding Room	MIX-BEP	SIP-SR2	MRTSUE06949	5 years	2024-10-23	SIP-SR2
Temperature Chamber	BAOYT	BYG-408CS	MRTSUE06847	1 year	2025-02-03	SIP-TR1
Thermohygrometer	testo	608-H1	MRTSUE11022	1 year	2024-10-28	SIP-TR1
USB Power Sensor	Keysight	U2021XA	MRTSUE06596	1 year	2024-07-31	SIP-TR1
Pxle Microwave Vector Signal Source test set	Keysight	M9384B	MRTSUE06994	1 year	2024-09-05	SIP-TR1
Signal Analyzer	Keysight	N9010B	MRTSUE07036	1 year	2025-02-03	SIP-TR1

---

Software	Version	Function
EMI Software	V3.0.0	EMI Test Software
BenchVue Power Meter	2019	Power
Controller_MF 7802BS	1.02	RE Antenna & Turntable



## 5. Decision Rules and Measurement Uncertainty

### 5.1. Decision Rules

The Decision Rule is based on Simple Acceptance in accordance with ISO Guide 98-4: 2012 Clause 8.2. (Measurement uncertainty is not taken into account when stating conformity with a specified requirement.)

### 5.2. Measurement Uncertainty

Where relevant, the following test uncertainty levels have been estimated for tests performed on the EUT as specified in CISPR 16-4-2. This uncertainty represents an expanded uncertainty expressed at approximately the 95% confidence level using a coverage factor of  $k = 2$ .

<b>AC Conducted Emission Measurement</b>
The maximum measurement uncertainty is evaluated as: 9kHz~150kHz: 3.58dB 150kHz~30MHz: 3.20dB
<b>Radiated Emission Measurement</b>
The maximum measurement uncertainty is evaluated as: Coaxial: 9kHz~30MHz: 2.61dB Coplanar: 9kHz~30MHz: 2.62dB Horizontal: 30MHz~200MHz: 3.79dB 200MHz~1GHz: 3.91dB 1GHz~40GHz: 4.99dB Vertical: 30MHz~200MHz: 4.06dB 200MHz~1GHz: 5.21dB 1GHz~40GHz: 4.90dB
<b>Spurious Emissions, Conducted</b>
Measuring Uncertainty for a Level of Confidence of 95% ( $U=2Uc(y)$ ): 2.2dB
<b>Output Power</b>
Measuring Uncertainty for a Level of Confidence of 95% ( $U=2Uc(y)$ ): 1.4dB
<b>Power Spectrum Density</b>
Measuring Uncertainty for a Level of Confidence of 95% ( $U=2Uc(y)$ ): 2.2dB
<b>Occupied Bandwidth</b>
Measuring Uncertainty for a Level of Confidence of 95% ( $U=2Uc(y)$ ): 2.7%

## 6. Test Result

### 6.1. Summary

FCC Section(s)	Test Description	Test Condition	Verdict
15.407(a)(10)	26dB Bandwidth	Conducted	Pass
15.407(a)(5)	Maximum Equivalent Isotropically Radiated Power (EIRP)		Pass
15.407(a)(5)	Maximum Power Spectral Density (EIRP)		Pass
15.407(b)(7)	In-Band Emission		Pass
15.407(d)(6)	Contention-Based Protocol		Pass
15.407(b)(6)	Unwanted Emissions	Radiated	Pass
15.407(b)(9), (10)	General Field Strength (Restricted Bands and Radiated Emission)		Pass
15.207	AC Conducted Emissions 150kHz - 30MHz	Line Conducted	Pass

#### Notes:

- The analyzer plots shown in this section were all taken with a correction table loaded into the analyzer. The correction table was used to account for the losses of the cables and attenuators used as part of the system to connect the EUT to the analyzer at all frequencies of interest.
- For radiated emission test, every axis (X, Y, Z) was also verified. The test results shown in the following sections represent the worst-case emissions.

## 6.2. 26dB Bandwidth Measurement

### 6.2.1. Test Limit

The maximum transmitter channel bandwidth for U–NII devices in the 5.925–7.125 GHz band is 320 megahertz.

### 6.2.2. Test Procedure

KDB 789033 D02v02r01- Section II)C)1) (26dB Bandwidth)

KDB 789033 D02v02r01- Section II)D) (99% Bandwidth)

### 6.2.3. Test Setting

#### 26dB Bandwidth

1. The analyzers' automatic bandwidth measurement capability was used to perform the 26dB bandwidth
2. RBW = approximately 1% of the emission bandwidth.
3. VBW > RBW
4. Detector = Peak.
5. Trace mode = max hold.
6. Measure the maximum width of the emission that is 26 dB down from the maximum of the emission.  
Compare this with the RBW setting of the analyzer. Readjust RBW and repeat measurement as needed until the RBW/EBW ratio is approximately 1%.

#### 99% Bandwidth

1. Set center frequency to the nominal EUT channel center frequency.
2. RBW = 1% to 5% of the OBW
3. VBW  $\geq 3 \times$  RBW
4. Span = 1.5 times to 5 times the OBW
5. Detector = peak
6. Trace mode = max hold
7. Allow the trace to stabilize
8. Use the 99% power bandwidth function of the instrument.

#### 6.2.4. Test Setup

Spectrum Analyzer

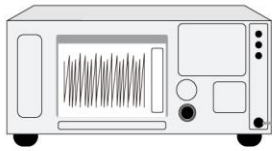

DC Block  
&  
Attenuator



#### 6.2.5. Test Result

Refer to Appendix A.2.

### 6.3. Output Power Measurement

#### 6.3.1. Test Limit

For an indoor access point operating in the 5.925-7.125 GHz band, the maximum EIRP over the frequency band of operation must not exceed 30 dBm.

#### 6.3.2. Test Procedure

KDB 789033D02v02r01- Section II)A)1

KDB 789033D02v02r01- Section II)E)2)b) Method SA-2

#### 6.3.3. Test Setting

1. Analyzer was set to the center frequency of the UNII channel under investigation
2. Span was set to encompass the entire 26dB EBW of the signal.
3. RBW = 1MHz
4. VBW = 3MHz
5. Number of sweep points  $\geq 2 \times (\text{span} / \text{RBW})$
6. Detector = power averaging (Average)
7. Sweep time = auto
8. Trigger = free run
9. Trace average at least 100 traces in power averaging (rms) mode; however, the number of traces to be averaged shall be increased above 100 as needed to ensure that the average accurately represents the true average over the on and off periods of the transmitter.
10. Use the channel power function on the instrument to measure the power of the spectrum and record its value.
11. Add  $10 \cdot \log(1/x)$ , where x is the duty cycle, to the measured power in order to compute the average power during the actual transmission times (because the measurement represents an average over both the on and off times of the transmission). For example, add  $10 \cdot \log(1/0.25) = 6$  dB if the duty cycle is 25 percent.

### 6.3.4. Test Setup

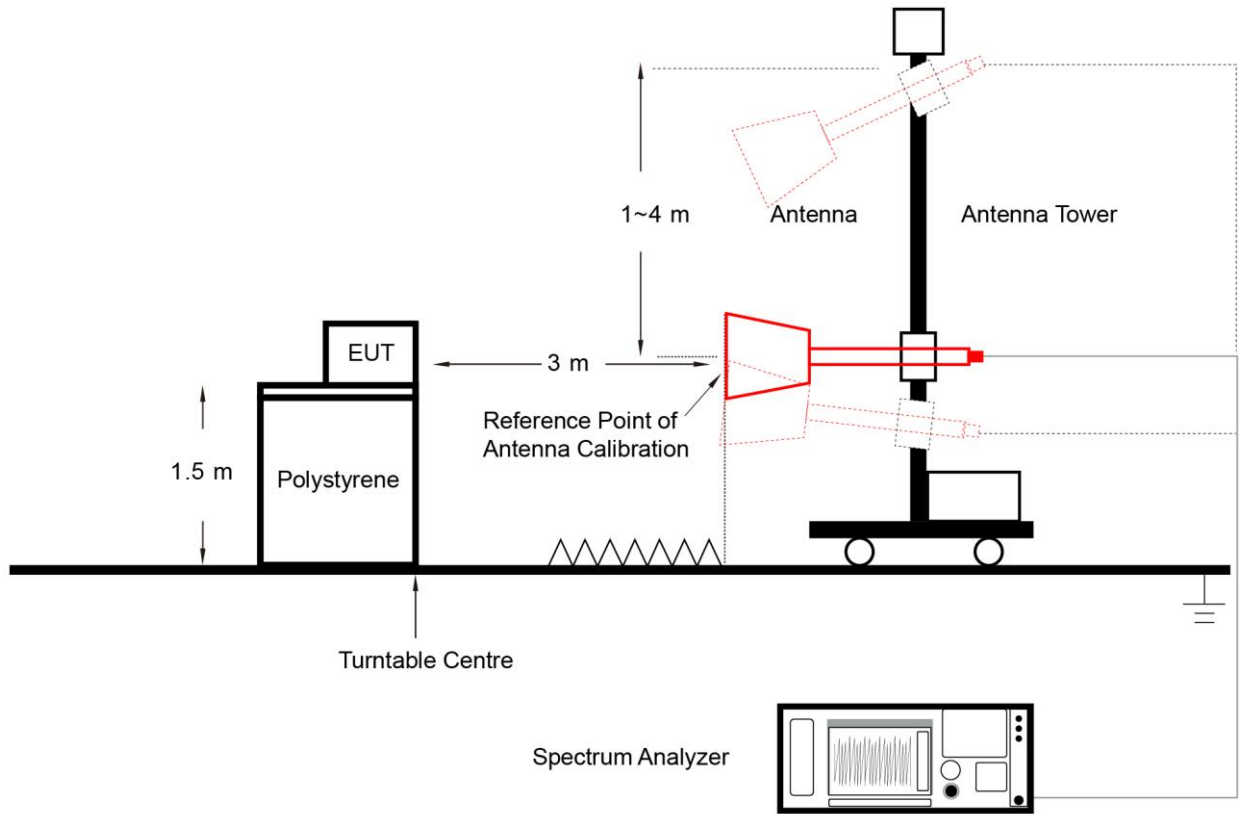

### 6.3.5. Test Result

Refer to Appendix A.3.

## 6.4. Power Spectral Density Measurement

### 6.4.1. Test Limit

For an indoor access point operating in the 5.925-7.125 GHz band, the maximum power spectral density must not exceed 5 dBm EIRP in any 1-megahertz band.

### 6.4.2. Test Procedure

KDB 789033D02v02r01- Section II)A)1

KDB 789033 D02v02r01-Section II)F)

### 6.4.3. Test Setting

1. Analyzer was set to the center frequency of the UNII channel under investigation
2. Span was set to encompass the entire 26dB EBW of the signal.
3. RBW = 1MHz
4. VBW = 3MHz
5. Number of sweep points  $\geq 2 \times (\text{span} / \text{RBW})$
6. Detector = power averaging (Average)
7. Sweep time = auto
8. Trigger = free run
9. Trace average at least 100 traces in power averaging (rms) mode; however, the number of traces to be averaged shall be increased above 100 as needed to ensure that the average accurately represents the true average over the on and off periods of the transmitter.
10. Use the peak search function on the instrument to find the peak of the spectrum and record its value.
11. Add  $10 \cdot \log(1/x)$ , where x is the duty cycle, to the measured power in order to compute the average power during the actual transmission times (because the measurement represents an average over both the on and off times of the transmission). For example, add  $10 \cdot \log(1/0.25) = 6$  dB if the duty cycle is 25 percent.

### 6.4.4. Test Setup

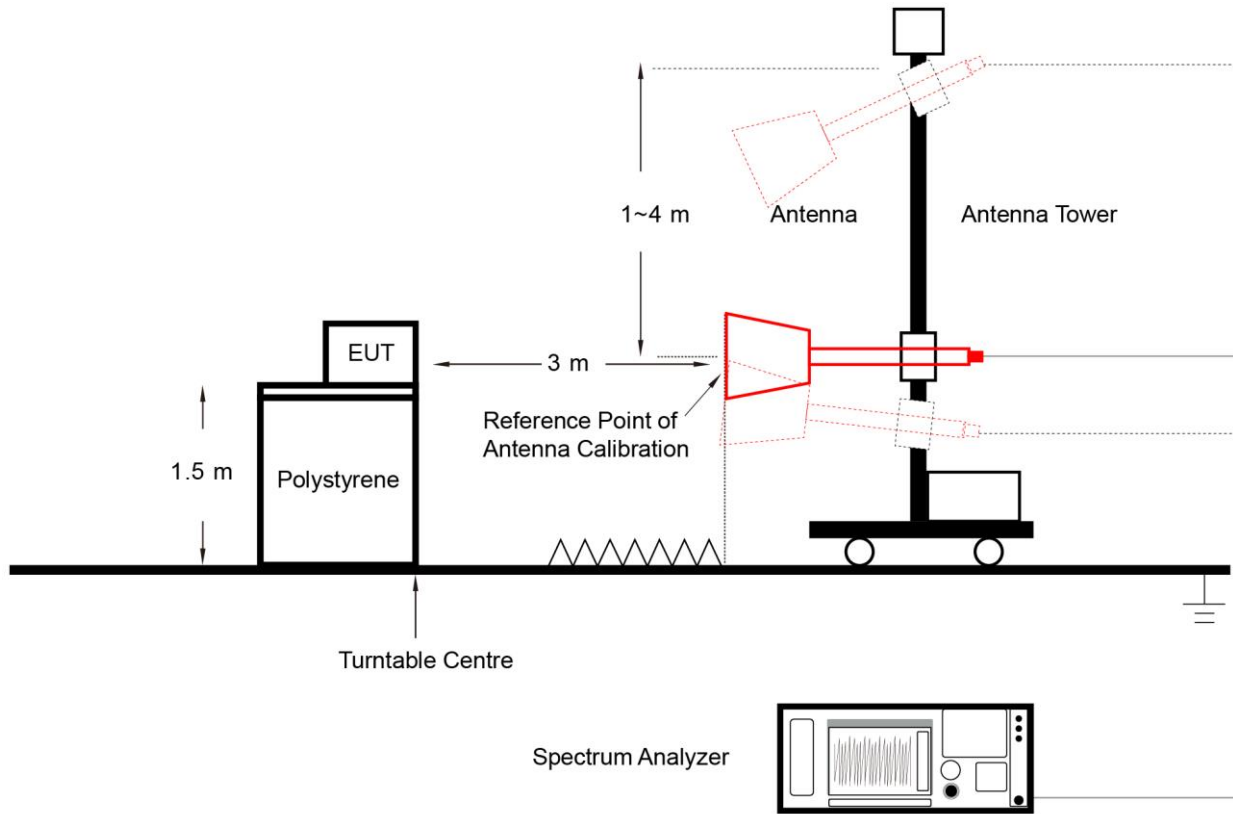

### 6.4.5. Test Result

Refer to Appendix A.4.



## 6.5. In-Band Emission Measurement

### 6.5.1. Test Limit

Suppressed by 20 dB at 1 MHz outside of the channel edge.

(The channel edge is defined as the 26-dB point on either side of the carrier center frequency.)

Suppressed by 28 dB at one channel bandwidth from the channel center.

Suppressed by 40 dB at one- and one-half times the channel bandwidth from the channel center.

### 6.5.2. Test Procedure

KDB 789033D02v02r01- Section II)A)1

KDB 987594 D02v01r01- Section J

### 6.5.3. Test Setting

#### Emissions Mask Reference Level Measurement

1. Set the span to encompass the entire 26 dB EBW of the signal.
2. Set RBW = same RBW used for 26 dB EBW measurement.
3. Set VBW  $\geq 3 \times$  RBW.
4. Number of points in sweep  $\geq [2 \times \text{span} / \text{RBW}]$ .
5. Sweep time = auto.
6. Detector = RMS.
7. Trace average at least 100 traces in power averaging (rms) mode.
8. Use the peak search function on the instrument to find the peak of the spectrum.

#### In-Band Emission

1. Using the measuring equipment limit line function, develop the emissions mask based on rule.
2. Adjust the span to encompass the entire mask as necessary.
3. Clear trace.
4. Trace average at least 100 traces in power averaging (rms) mode.
5. Adjust the reference level as necessary so that the crest of the channel touches the top of the emission mask.

### 6.5.4. Test Setup

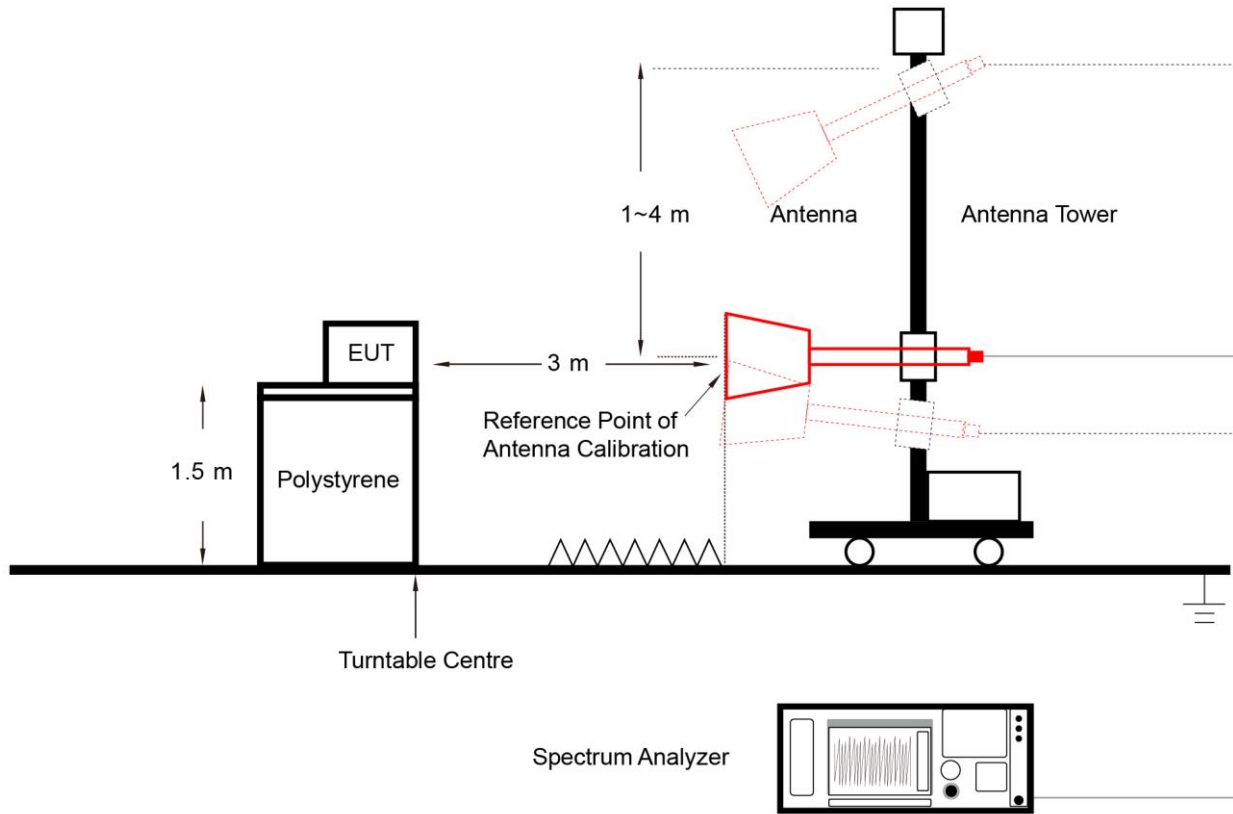

### 6.5.5. Test Result

Refer to Appendix A.5.

## 6.6. Frequency Stability Measurement

### 6.6.1. Test Limit

Manufactures of U-NII devices are responsible for ensuring frequency stability such that an emission is maintained within the band of operation under all conditions of normal operation as specified in the user's manual.

### 6.6.2. Test Procedure

#### **Frequency Stability Under Temperature Variations:**

The equipment under test was connected to an external AC or DC power supply and input rated voltage. RF output was connected to a frequency counter or spectrum analyzer via feed through attenuators. The EUT was placed inside the temperature chamber. Set the spectrum analyzer RBW low enough to obtain the desired frequency resolution and measure EUT 20°C operating frequency as reference frequency. Turn EUT off and set the chamber temperature to highest. After the temperature stabilized for approximately 30 minutes recorded the frequency. Repeat step measure with 10°C decreased per stage until the lowest temperature reached.

#### **Frequency Stability Under Voltage Variations:**

Set chamber temperature to 20°C. Use a variable AC power supply / DC power source to power the EUT and set the voltage to rated voltage. Set the spectrum analyzer RBW low enough to obtain the desired frequency resolution and recorded the frequency.

Reduce the input voltage to specify extreme voltage variation ( $\pm 15\%$ ) and endpoint, record the maximum frequency change.

### 6.6.3. Test Setup

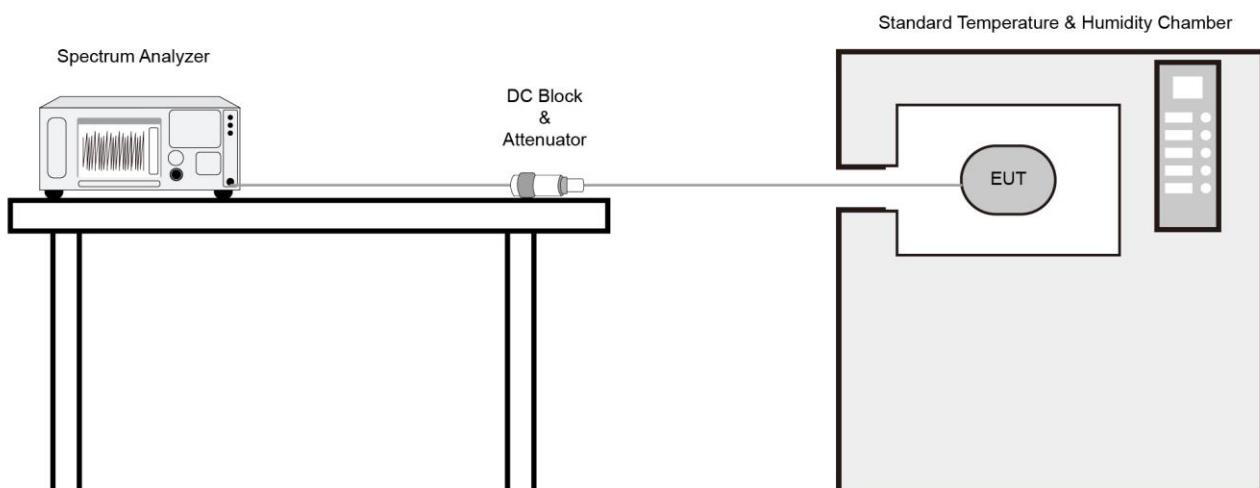

#### **6.6.4. Test Result**

Refer to Appendix A.6.

## **6.7. Contention Based Protocol Measurement**

### **6.7.1. Test Limit**

Unlicensed indoor low power device must detect co-channel radio frequency power that is at least -62dBm (The threshold is referenced to a 0dBi antenna gain.) or low.

Indoor low power device must detect an AWGN signal with 90% (or better) level of certainty.

### **6.7.2. Test Procedure**

KDB 987594 D02v02r01- Section I

### **6.7.3. Test Setting**

1. Configure the EUT to transmit with a constant duty cycle.
2. Set the operating parameters of the EUT including power level, operating frequency, modulation and bandwidth.
3. Set the signal analyzer center frequency to the nominal EUT channel center frequency. The span range of the signal analyzer shall be between two times and five times the OBW of the EUT.

Connect the output port of the EUT to the signal analyzer 2. Ensure that the attenuator 2 provides enough attenuation to not overload the signal analyzer 2 receiver.

4. Monitoring the signal analyzer 2, verify the EUT is operating and transmitting with the parameters set at step two.
5. Using an AWGN signal source, generate a 10 MHz-wide AWGN signal. Use Table 1 of KDB 987594 to determine the center frequency of the 10 MHz AWGN signal relative to the EUT's channel bandwidth and center frequency.
6. Set the AWGN signal power to an extremely low level. Connect the AWGN signal source, via a 3-dB splitter, to the signal analyzer 1 and the EUT as shown in below figure.
7. Transmit the AWGN signal (RF ON) and verify its characteristics on the signal analyzer 1.
8. Monitor the signal analyzer 2 to verify if the AWGN signal has been detected and the EUT has ceased transmission. If the EUT continues to transmit, then incrementally increase the AWGN signal power level until the EUT stops transmitting.
9. Determine and record the AWGN signal power level (at the EUT's antenna port) at which the EUT ceased transmission. Repeat the procedure at least 10 times to verify the EUT can detect an AWGN signal with 90% (or better) level of certainty.
10. Refer to Table 1 to determine number of times the detection threshold testing needs to be repeated. If

testing is required more than once, then go back to step 5, choose a different center frequency for the AWGN signal and repeat the process.

#### 6.7.4. Test Setup

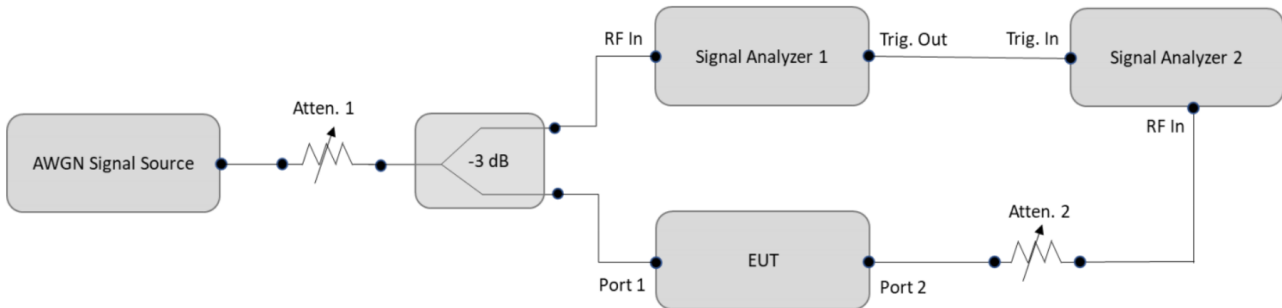

#### 6.7.5. Test Result

Refer to Appendix A.7.

**6.8. Radiated Spurious Emission Measurement**

**6.8.1. Test Limit**

For 15.407(b)(5) requirement

For transmitters operating within the 5.925-7.125 GHz band: Any emissions outside of the 5.925-7.125 GHz band must not exceed an EIRP. of -27 dBm/MHz.

Refer to 987594 D02 U-NII 6GHz EMC Measurement v02r01 clause G

Use guidance in KDB 789033 for measurements below 1000 MHz and above 1000 MHz. Unwanted emissions outside of restricted bands are measured with a RMS detector. In addition, 15.35(b) applies where the peak emissions must be limited to no more than 20 dB above the average limit.

All out of band emissions appearing in a restricted band as specified in Section 15.205 of the Title 47CFR must not exceed the limits shown in Table per Section 15.209.

FCC Part 15 Subpart C Paragraph 15.209		
Frequency [MHz]	Field Strength [uV/m]	Measured Distance [Meters]
0.009 - 0.490	2400/F (kHz)	300
0.490 - 1.705	24000/F (kHz)	30
1.705 - 30	30	30
30 - 88	100	3
88 - 216	150	3
216 - 960	200	3
Above 960	500	3

**6.8.2. Test Procedure**

KDB 789033 D02v02r01-Section II)G)

### 6.8.3. Test Setting

**Table 1 - RBW as a function of frequency**

Frequency	RBW
9 ~ 150 kHz	200 ~ 300 Hz
0.15 ~ 30 MHz	9 ~ 10 kHz
30 ~ 1000 MHz	100 ~ 120 kHz
> 1000MHz	1MHz

#### **Quasi-Peak Measurements below 1GHz**

1. Analyzer center frequency was set to the frequency of the radiated spurious emission of interest
2. Span was set greater than 1MHz
3. RBW = as specified in Table 1
4. Detector = CISPR quasi-peak
5. Sweep time = auto couple
6. Trace was allowed to stabilize

#### **Peak Measurements above 1GHz**

1. Analyzer center frequency was set to the frequency of the radiated spurious emission of interest
2. RBW = 1MHz
3. VBW = 3MHz
4. Detector = peak
5. Sweep time = auto couple
6. Trace mode = max hold
7. Trace was allowed to stabilize



**Average Measurements above 1GHz (Method VB)**

1. Analyzer center frequency was set to the frequency of the radiated spurious emission of interest
2. RBW = 1MHz
3. VBW; If the EUT is configured to transmit with duty cycle  $\geq 98\%$ , set VBW = 10 Hz.

If the EUT duty cycle is  $< 98\%$ , set VBW  $\geq 1/T$ . T is the minimum transmission duration.

4. As an alternative, the instrument may be set to linear detector mode. Ensure that video filtering is applied in linear voltage domain (rather than in a log or dB domain). Some instruments require linear display mode in order to accomplish this. Others have a setting for Average-VBW Type, which can be set to "Voltage" regardless of the display mode
5. Detector = Peak
6. Sweep time = auto
7. Trace mode = max hold
8. Allow max hold to run for at least 50 times (1/duty cycle) traces

**6.8.4. Test Setup**

Below 30MHz Test Setup:

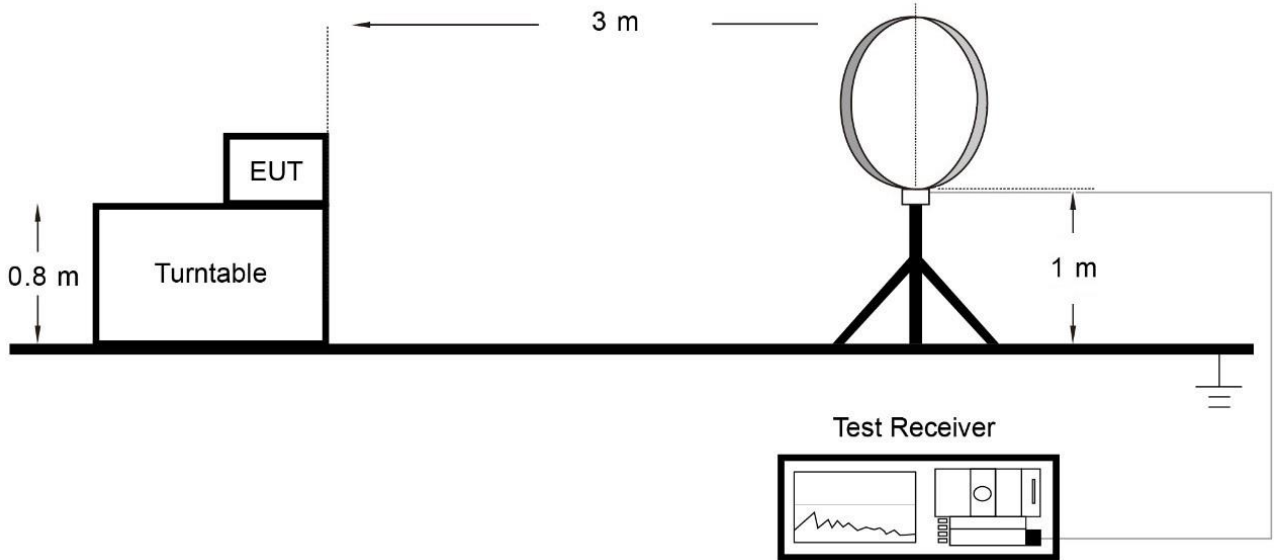

Below 1GHz Test Setup:

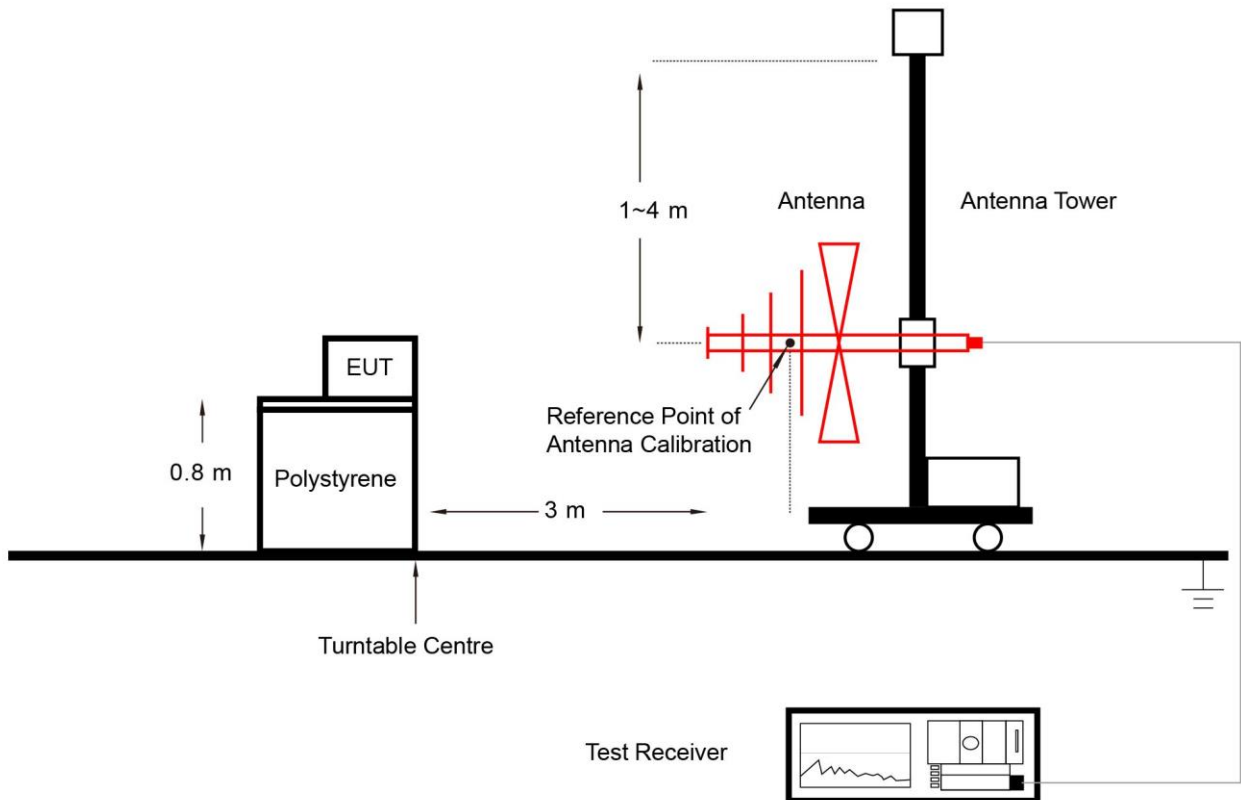

Above 1GHz Test Setup:

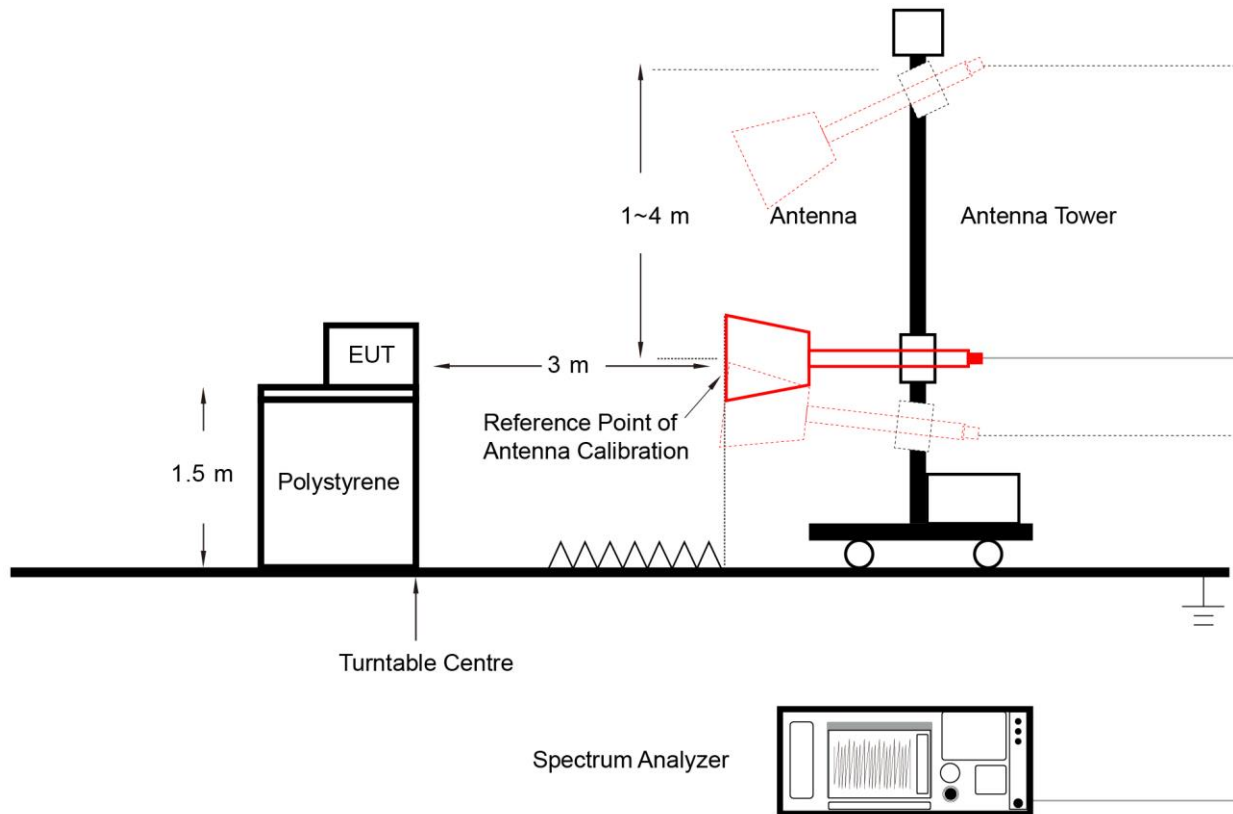

**6.8.5. Test Result**

Refer to Appendix A.8.

## 6.9. Radiated Restricted Band Edge Measurement

### 6.9.1. Test Limit

**For 15.205 requirement:**

Radiated emissions which fall in the restricted bands, as defined in Section 15.205(a) of FCC part 15, must also comply with the radiated emission limits specified in Section 15.209(a).

Frequency (MHz)	Frequency (MHz)	Frequency (MHz)	Frequency (GHz)
0.090 - 0.110	16.42 - 16.423	399.9 - 410	4.5 - 5.15
<sup>1</sup> 0.495 - 0.505	16.69475 - 16.69525	608 - 614	5.35 - 5.46
2.1735 - 2.1905	16.80425 - 16.80475	960 - 1240	7.25 - 7.75
4.125 - 4.128	25.5 - 25.67	1300 - 1427	8.025 - 8.5
4.17725 - 4.17775	37.5 - 38.25	1435 - 1626.5	9.0 - 9.2
4.20725 - 4.20775	73 - 74.6	1645.5 - 1646.5	9.3 - 9.5
6.215 - 6.218	74.8 - 75.2	1660 - 1710	10.6 - 12.7
6.26775 - 6.26825	108 - 121.94	1718.8 - 1722.2	13.25 - 13.4
6.31175 - 6.31225	123 - 138	2200 - 2300	14.47 - 14.5
8.291 - 8.294	149.9 - 150.05	2310 - 2390	15.35 - 16.2
8.362 - 8.366	156.52475 - 156.52525	2483.5 - 2500	17.7 - 21.4
8.37625 - 8.38675	156.7 - 156.9	2690 - 2900	22.01 - 23.12
8.41425 - 8.41475	162.0125 - 167.17	3260 - 3267	23.6 - 24.0
12.29 - 12.293	167.72 - 173.2	3332 - 3339	31.2 - 31.8
12.51975 - 12.52025	240 - 285	3345.8 - 3358	36.43 - 36.5
12.57675 - 12.57725	322 - 335.4	3600 - 4400	( <sup>2</sup> )
13.36 - 13.41	--	--	--

**For 15.407(b)(5) requirement:**

For transmitters operating within the 5.925-7.125 GHz band: Any emissions outside of the 5.925-7.125 GHz band must not exceed an EIRP. of -27 dBm/MHz.

Refer to 987594 D02 U-NII 6GHz EMC Measurement v02r01 clause G - Unwanted Emission Measurement Use guidance in KDB 789033 for measurements below 1000 MHz and above 1000 MHz. Unwanted emissions outside of restricted bands are measured with a RMS detector. In addition, 15.35(b) applies where the peak emissions must be limited to no more than 20 dB above the average limit.

All out of band emissions appearing in a restricted band as specified in Section 15.205 of the Title 47CFR must not exceed the limits shown in Table per Section 15.209.

FCC Part 15 Subpart C Paragraph 15.209		
Frequency [MHz]	Field Strength [uV/m]	Measured Distance [Meters]
0.009 - 0.490	2400/F (kHz)	300
0.490 - 1.705	24000/F (kHz)	30
1.705 - 30	30	30
30 - 88	100	3
88 - 216	150	3
216 - 960	200	3
Above 960	500	3

### 6.9.2. Test Procedure

KDB 789033 D02v02r01-Section II)G)

### 6.9.3. Test Setting

#### **Peak Measurements above 1GHz**

1. Analyzer center frequency was set to the frequency of the radiated spurious emission of interest
2. RBW = 1MHz
3. VBW = 3MHz
4. Detector = Peak
5. Sweep time = Auto couple
6. Trace mode = Max hold
7. Trace was allowed to stabilize

#### **Average Measurements above 1GHz (Method VB)**

1. Analyzer center frequency was set to the frequency of the radiated spurious emission of interest
2. RBW = 1MHz
3. VBW; If the EUT is configured to transmit with duty cycle  $\geq 98\%$ , set VBW = 10 Hz.  
If the EUT duty cycle is  $< 98\%$ , set VBW  $\geq 1/T$ . T is the minimum transmission duration.
4. As an alternative, the instrument may be set to linear detector mode. Ensure that video filtering is applied in linear voltage domain (rather than in a log or dB domain). Some instruments require linear display mode in order to accomplish this. Others have a setting for Average-VBW Type, which can be set to "Voltage" regardless of the display mode
5. Detector = Peak
6. Sweep time = Auto
7. Trace mode = Max hold
8. Trace was allowed to stabilize

### 6.9.4. Test Setup

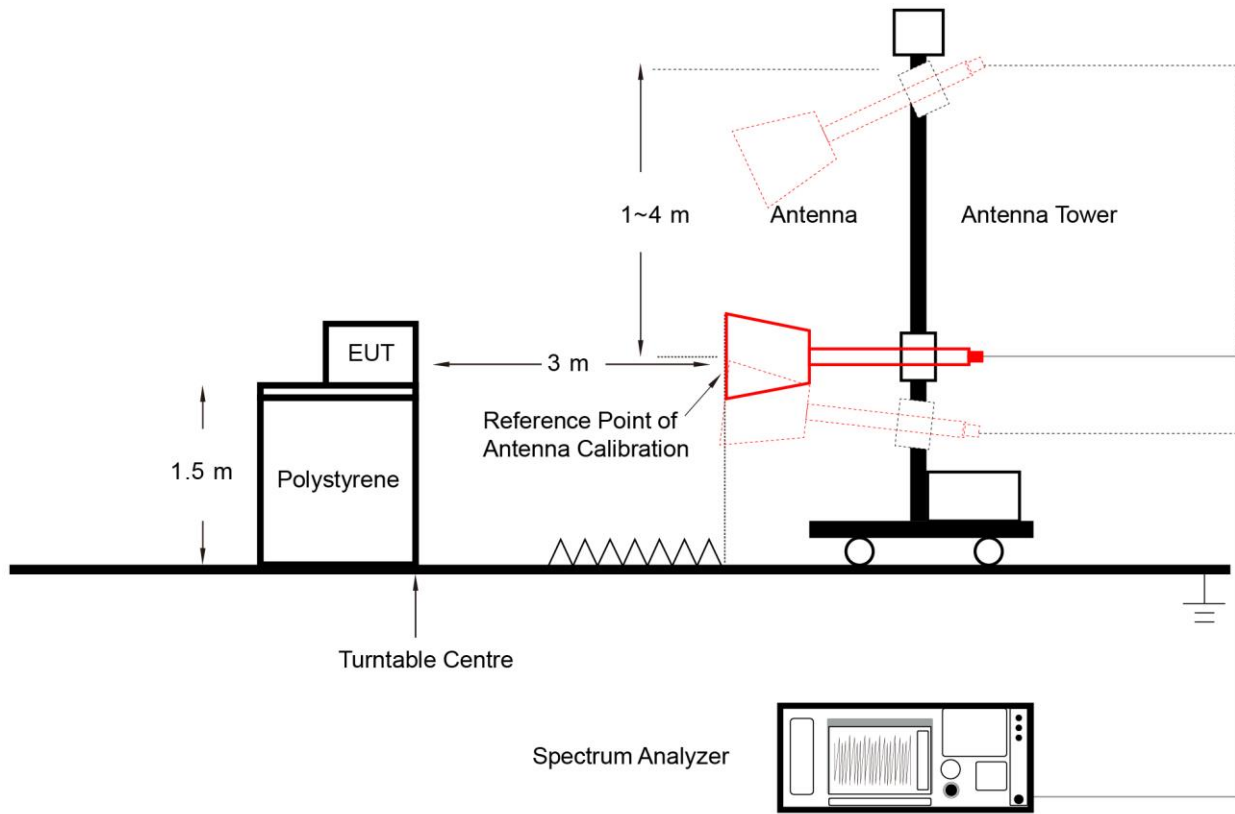

### 6.9.5. Test Result

Refer to Appendix A.9.

## 6.10. AC Conducted Emissions Measurement

### 6.10.1. Test Limit

FCC Part 15.207 Limits		
Frequency (MHz)	QP (dBuV)	AV (dBuV)
0.15 - 0.50	66 - 56	56 - 46
0.50 - 5.0	56	46
5.0 - 30	60	50

Note 1: The lower limit shall apply at the transition frequencies.

Note 2: The limit decreases linearly with the logarithm of the frequency in the range 0.15MHz to 0.5MHz.

### 6.10.2. Test Setup

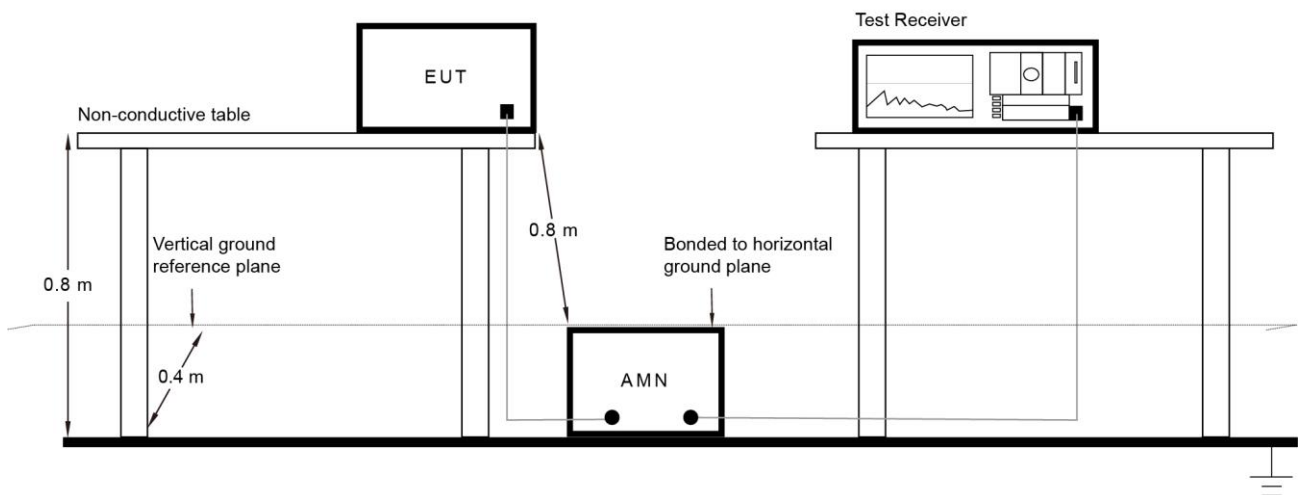

### 6.10.3. Test Result

Refer to Appendix A.10.



## Appendix A – Test Result

### A.1 Duty Cycle Test Result

Test Site	SIP-TR1	Test Engineer	Alisa Deng
Test Date	2024-02-01		

Test Mode	Duty Cycle	Test Mode	Duty Cycle
802.11a	98.84%	802.11be-EHT20	99.45%
802.11ax-HE20	99.45%	802.11be-EHT40	99.09%
802.11ax-HE40	98.73%	802.11be-EHT80	98.91%
802.11ax-HE80	99.08%	802.11be-EHT160	99.27%
802.11ax-HE160	99.45%	802.11be-EHT320	99.49%

Duty Cycle (T = Transmission Duration)

802.11a (T = 1.968ms)

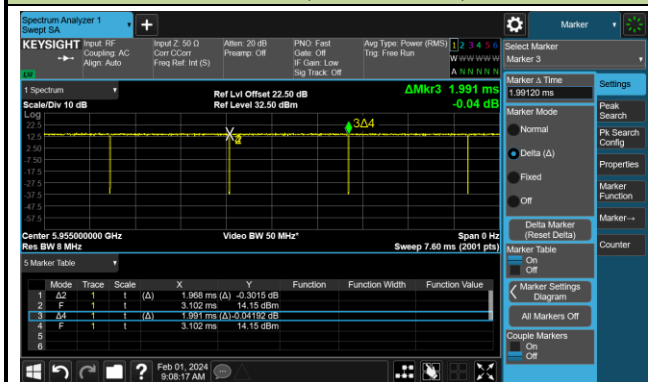

802.11ax-HE20 (T = 5.430ms)

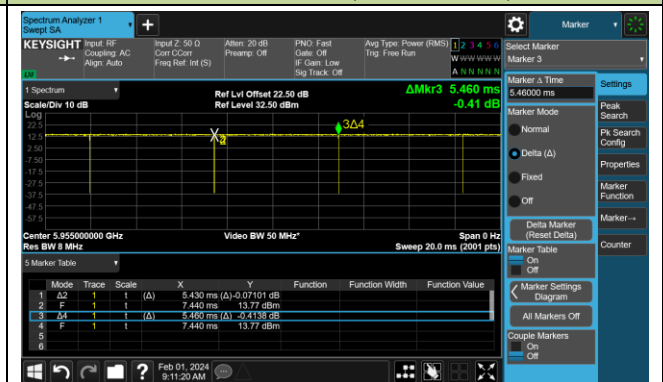

802.11ax-HE40 (T = 5.430ms)

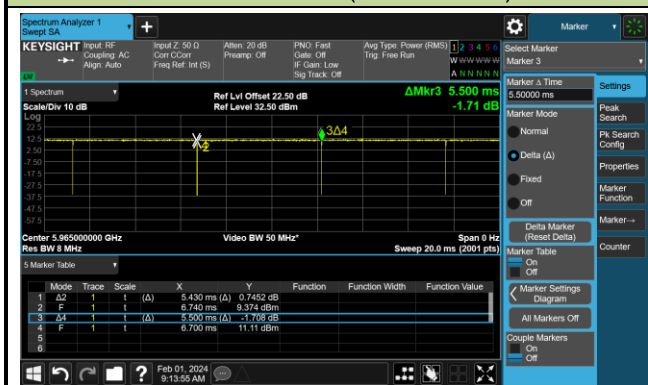

802.11ax-HE80 (T = 5.410ms)

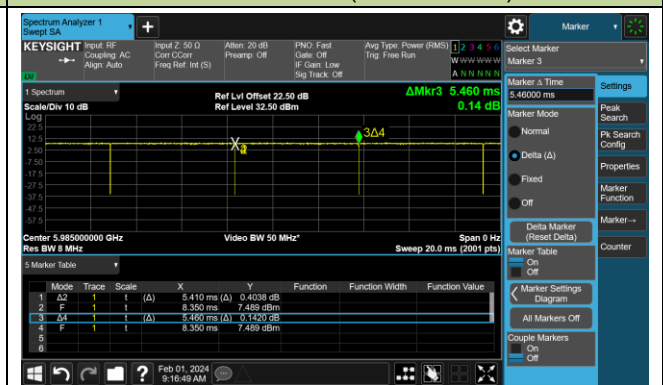

### Duty Cycle (T = Transmission Duration)

802.11ax-HE160 (T = 5.430ms)

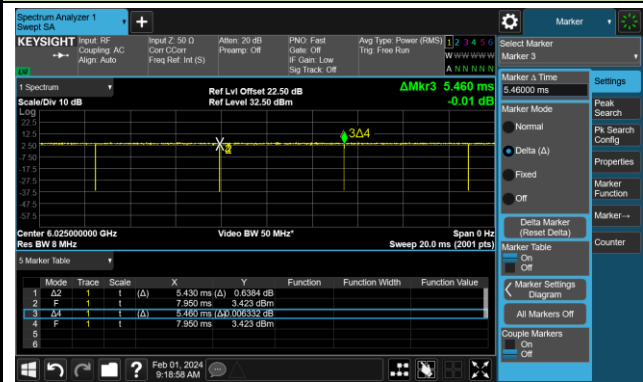

802.11be-EHT20 (T = 5.440ms)

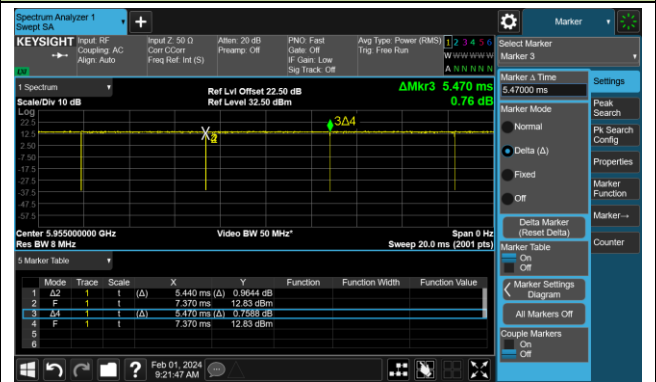

802.11be-EHT40 (T = 5.430ms)

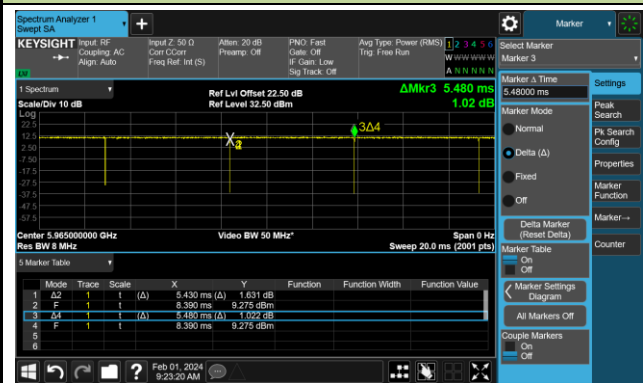

802.11be-EHT80 (T = 5.420ms)

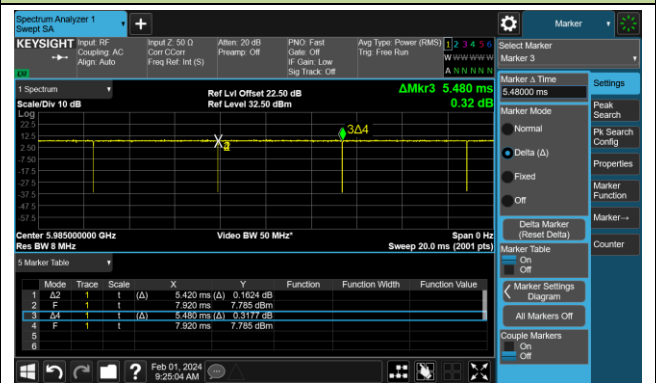

802.11be-EHT160 (T = 5.430ms)

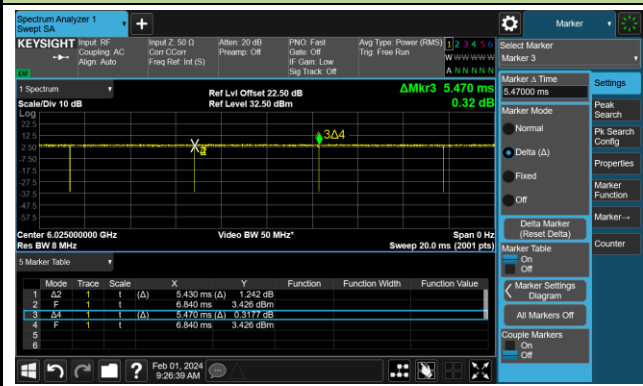

802.11be-EHT320 (T = 5.443ms)

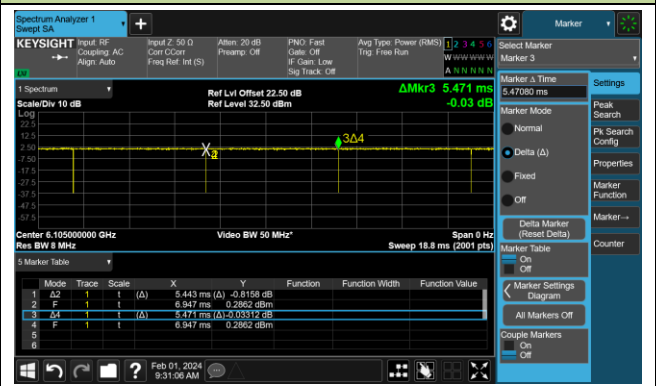

**A.2 26dB Bandwidth Test Result**

Test Site	SIP-TR1	Test Engineer	Alisa Deng
Test Date	2024-02-04 ~ 2024-03-07		

Test Mode	Data Rate/ MCS	Channel No.	Frequency (MHz)	26dB Bandwidth (MHz)	99% Bandwidth (MHz)	Test Limit (MHz)
802.11a	6Mbps	1	5955	21.86	16.671	≤ 320
802.11a	6Mbps	49	6195	21.77	16.692	≤ 320
802.11a	6Mbps	93	6415	21.84	16.705	≤ 320
802.11a	6Mbps	97	6435	21.82	16.734	≤ 320
802.11a	6Mbps	105	6475	21.48	16.725	≤ 320
802.11a	6Mbps	113	6515	21.51	16.694	≤ 320
802.11a	6Mbps	117	6535	21.83	16.668	≤ 320
802.11a	6Mbps	149	6695	21.37	16.654	≤ 320
802.11a	6Mbps	181	6855	21.83	16.718	≤ 320
802.11a	6Mbps	185	6875	21.30	16.651	≤ 320
802.11a	6Mbps	189	6895	21.81	16.674	≤ 320
802.11a	6Mbps	209	6995	21.68	16.714	≤ 320
802.11a	6Mbps	229	7095	21.76	16.702	≤ 320
802.11ax-HE20	MCS0	1	5955	22.25	19.061	≤ 320
802.11ax-HE20	MCS0	49	6195	22.77	19.096	≤ 320
802.11ax-HE20	MCS0	93	6415	23.02	19.115	≤ 320
802.11ax-HE20	MCS0	97	6435	22.69	19.082	≤ 320
802.11ax-HE20	MCS0	105	6475	22.60	19.130	≤ 320
802.11ax-HE20	MCS0	113	6515	22.58	19.075	≤ 320
802.11ax-HE20	MCS0	117	6535	22.96	19.183	≤ 320
802.11ax-HE20	MCS0	149	6695	22.55	19.092	≤ 320
802.11ax-HE20	MCS0	181	6855	22.76	19.100	≤ 320
802.11ax-HE20	MCS0	185	6875	22.87	19.066	≤ 320
802.11ax-HE20	MCS0	189	6895	23.23	19.067	≤ 320
802.11ax-HE20	MCS0	209	6995	23.20	19.109	≤ 320
802.11ax-HE20	MCS0	229	7095	22.65	19.049	≤ 320

Test Mode	Data Rate/ MCS	Channel No.	Frequency (MHz)	26dB Bandwidth (MHz)	99% Bandwidth (MHz)	Test Limit (MHz)
802.11ax-HE40	MCS0	3	5965	44.35	38.020	≤ 320
802.11ax-HE40	MCS0	51	6205	44.41	38.042	≤ 320
802.11ax-HE40	MCS0	91	6405	43.90	38.076	≤ 320
802.11ax-HE40	MCS0	99	6445	44.31	38.040	≤ 320
802.11ax-HE40	MCS0	107	6485	43.84	37.963	≤ 320
802.11ax-HE40	MCS0	115	6525	44.34	38.029	≤ 320
802.11ax-HE40	MCS0	123	6565	44.49	38.014	≤ 320
802.11ax-HE40	MCS0	147	6685	43.46	37.939	≤ 320
802.11ax-HE40	MCS0	179	6845	44.24	38.045	≤ 320
802.11ax-HE40	MCS0	187	6885	44.65	38.035	≤ 320
802.11ax-HE40	MCS0	195	6925	43.66	38.071	≤ 320
802.11ax-HE40	MCS0	211	7005	43.83	38.037	≤ 320
802.11ax-HE40	MCS0	227	7085	43.82	38.041	≤ 320
802.11ax-HE80	MCS0	7	5985	88.90	77.625	≤ 320
802.11ax-HE80	MCS0	55	6225	89.44	77.766	≤ 320
802.11ax-HE80	MCS0	87	6385	89.11	77.729	≤ 320
802.11ax-HE80	MCS0	103	6465	88.94	77.680	≤ 320
802.11ax-HE80	MCS0	119	6545	89.87	77.796	≤ 320
802.11ax-HE80	MCS0	135	6625	90.05	77.626	≤ 320
802.11ax-HE80	MCS0	151	6705	88.30	77.697	≤ 320
802.11ax-HE80	MCS0	167	6785	90.67	77.803	≤ 320
802.11ax-HE80	MCS0	183	6865	89.28	77.756	≤ 320
802.11ax-HE80	MCS0	199	6945	88.09	77.805	≤ 320
802.11ax-HE80	MCS0	215	7025	88.41	77.678	≤ 320
802.11ax-HE160	MCS0	15	6025	172.1	157.22	≤ 320
802.11ax-HE160	MCS0	47	6185	172.0	156.97	≤ 320
802.11ax-HE160	MCS0	79	6345	173.6	157.07	≤ 320
802.11ax-HE160	MCS0	111	6505	171.3	156.78	≤ 320
802.11ax-HE160	MCS0	143	6665	171.4	156.93	≤ 320
802.11ax-HE160	MCS0	175	6825	171.0	157.20	≤ 320
802.11ax-HE160	MCS0	207	6985	171.9	157.35	≤ 320

Test Mode	Data Rate/ MCS	Channel No.	Frequency (MHz)	26dB Bandwidth (MHz)	99% Bandwidth (MHz)	Test Limit (MHz)
802.11be-EHT20	MCS0	1	5955	22.91	19.057	≤ 320
802.11be-EHT20	MCS0	49	6195	22.75	19.093	≤ 320
802.11be-EHT20	MCS0	93	6415	22.97	19.098	≤ 320
802.11be-EHT20	MCS0	97	6435	22.93	19.065	≤ 320
802.11be-EHT20	MCS0	105	6475	22.59	19.083	≤ 320
802.11be-EHT20	MCS0	113	6515	22.08	19.067	≤ 320
802.11be-EHT20	MCS0	117	6535	22.45	19.061	≤ 320
802.11be-EHT20	MCS0	149	6695	22.32	19.074	≤ 320
802.11be-EHT20	MCS0	181	6855	22.69	19.073	≤ 320
802.11be-EHT20	MCS0	185	6875	22.81	19.088	≤ 320
802.11be-EHT20	MCS0	189	6895	22.81	19.090	≤ 320
802.11be-EHT20	MCS0	209	6995	23.25	19.078	≤ 320
802.11be-EHT20	MCS0	229	7095	23.03	19.045	≤ 320
802.11be-EHT40	MCS0	3	5965	43.55	38.062	≤ 320
802.11be-EHT40	MCS0	51	6205	44.37	38.030	≤ 320
802.11be-EHT40	MCS0	91	6405	43.65	38.018	≤ 320
802.11be-EHT40	MCS0	99	6445	44.69	38.012	≤ 320
802.11be-EHT40	MCS0	107	6485	44.05	38.047	≤ 320
802.11be-EHT40	MCS0	115	6525	43.52	38.008	≤ 320
802.11be-EHT40	MCS0	123	6565	43.89	38.049	≤ 320
802.11be-EHT40	MCS0	147	6685	43.97	38.046	≤ 320
802.11be-EHT40	MCS0	179	6845	43.63	38.049	≤ 320
802.11be-EHT40	MCS0	187	6885	43.67	38.070	≤ 320
802.11be-EHT40	MCS0	195	6925	44.21	38.028	≤ 320
802.11be-EHT40	MCS0	211	7005	43.79	38.031	≤ 320
802.11be-EHT40	MCS0	227	7085	43.11	37.999	≤ 320

Test Mode	Data Rate/ MCS	Channel No.	Frequency (MHz)	26dB Bandwidth (MHz)	99% Bandwidth (MHz)	Test Limit (MHz)
802.11be-EHT80	MCS0	7	5985	88.46	77.711	≤ 320
802.11be-EHT80	MCS0	55	6225	89.56	77.759	≤ 320
802.11be-EHT80	MCS0	87	6385	86.66	77.720	≤ 320
802.11be-EHT80	MCS0	103	6465	87.89	77.641	≤ 320
802.11be-EHT80	MCS0	119	6545	88.64	77.692	≤ 320
802.11be-EHT80	MCS0	135	6625	89.51	77.812	≤ 320
802.11be-EHT80	MCS0	151	6705	88.74	77.760	≤ 320
802.11be-EHT80	MCS0	167	6785	88.83	77.671	≤ 320
802.11be-EHT80	MCS0	183	6865	87.61	77.712	≤ 320
802.11be-EHT80	MCS0	199	6945	89.17	77.627	≤ 320
802.11be-EHT80	MCS0	215	7025	87.88	77.758	≤ 320
802.11be-EHT160	MCS0	15	6025	173.4	157.17	≤ 320
802.11be-EHT160	MCS0	47	6185	169.8	157.15	≤ 320
802.11be-EHT160	MCS0	79	6345	174.7	156.99	≤ 320
802.11be-EHT160	MCS0	111	6505	173.6	156.56	≤ 320
802.11be-EHT160	MCS0	143	6665	172.6	156.91	≤ 320
802.11be-EHT160	MCS0	175	6825	171.2	157.08	≤ 320
802.11be-EHT160	MCS0	207	6985	176.7	156.91	≤ 320
802.11be-EHT320	MCS0	31	6105	487.8	318.04	≤ 320
802.11be-EHT320	MCS0	63	6265	598.5	318.30	≤ 320
802.11be-EHT320	MCS0	95	6425	536.2	316.56	≤ 320
802.11be-EHT320	MCS0	127	6585	583.0	316.96	≤ 320
802.11be-EHT320	MCS0	159	6745	516.1	318.62	≤ 320
802.11be-EHT320	MCS0	191	6905	532.3	319.00	≤ 320

## Notes:

For channels with a nominal bandwidth less than 320 MHz compliance is demonstrated by way of the 26 dB EBW.

For channels with a nominal bandwidth of 320 MHz compliance is demonstrated by way of the 99% BW.

## 802.11a 26dB Bandwidth

### Channel 1 (5955MHz)      Channel 49 (6195MHz)

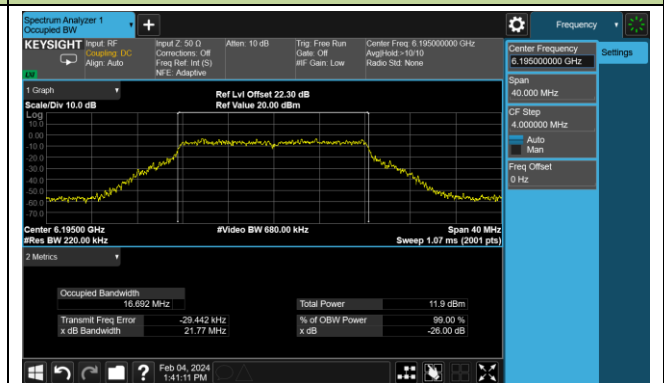
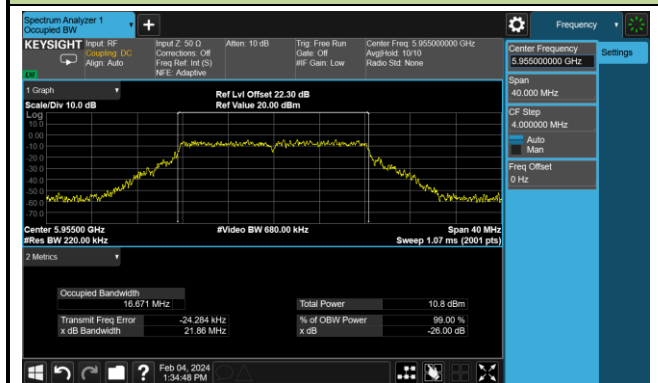

### Channel 93 (6415MHz)      Channel 97 (6435MHz)

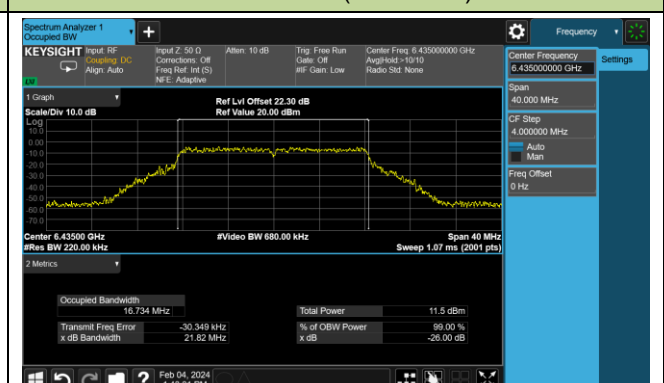
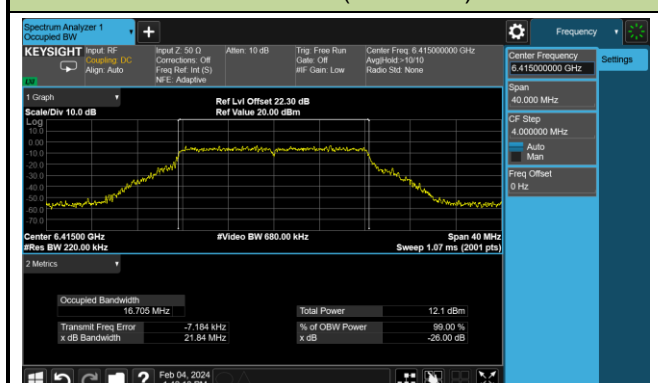

### Channel 105 (6475MHz)      Channel 113 (6515MHz)

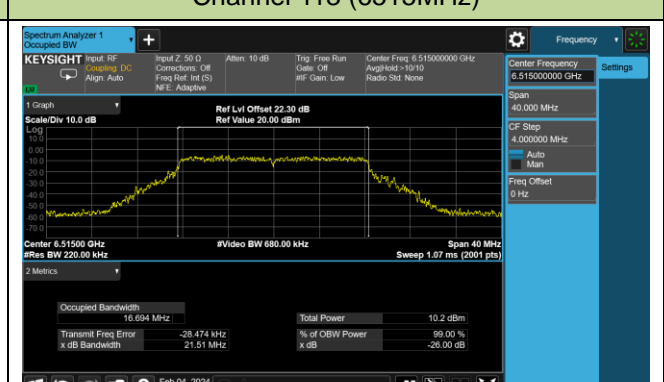
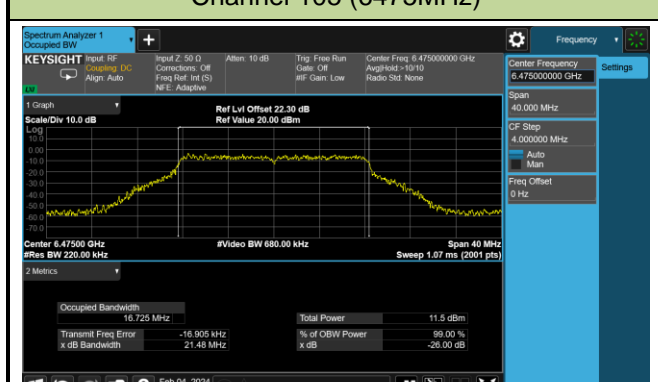

### Channel 117 (6535MHz)      Channel 149 (6695MHz)

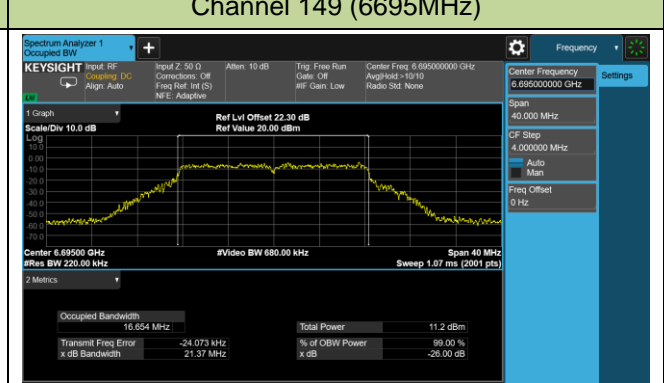
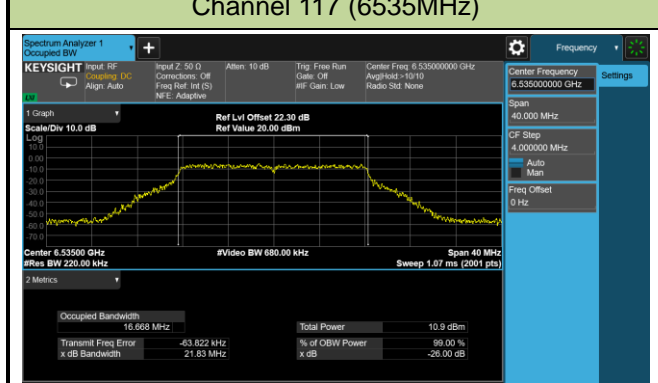

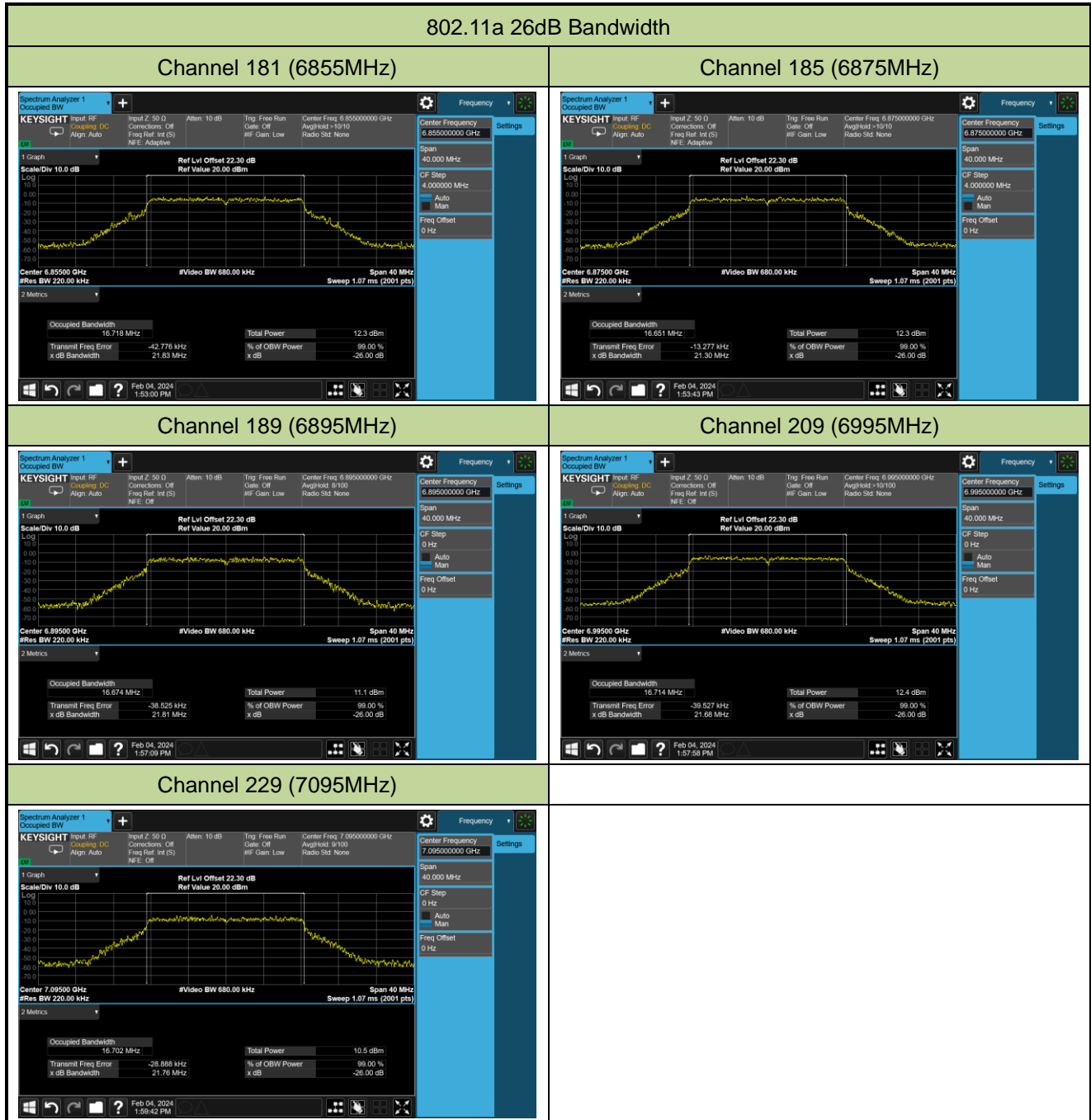





802.11ax-HE20 26dB Bandwidth

Channel 181 (6855MHz)

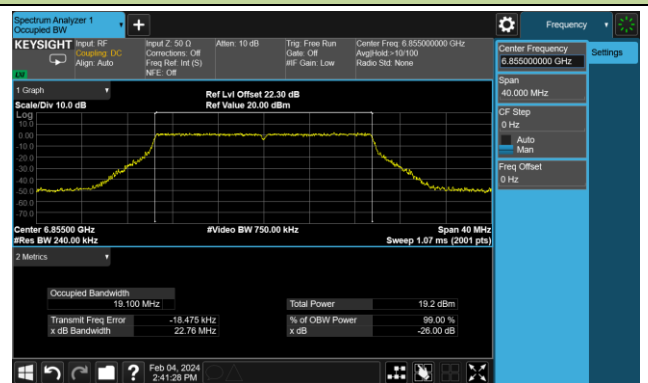

Channel 185 (6875MHz)



Channel 189 (6895MHz)

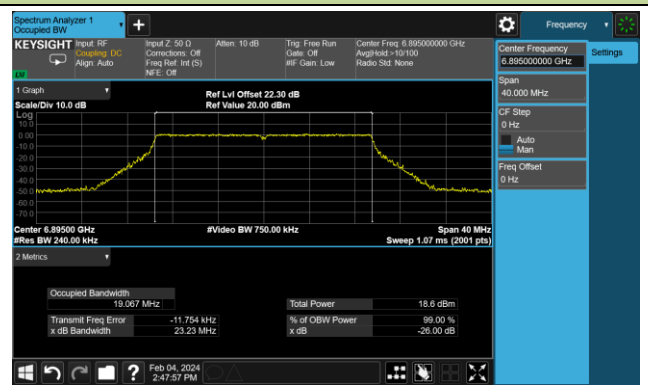

Channel 209 (6995MHz)

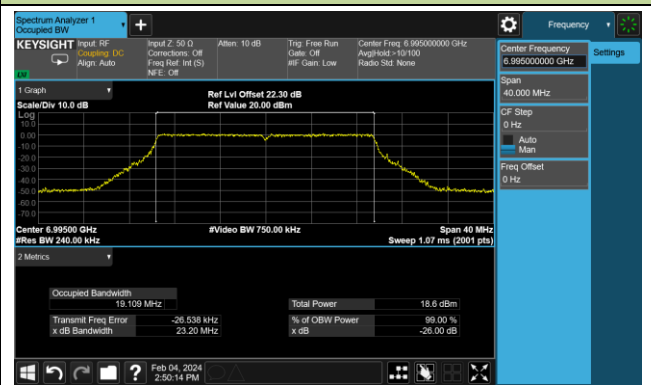

Channel 229 (7095MHz)



802.11ax-HE40 26dB Bandwidth

Channel 3 (5965MHz)

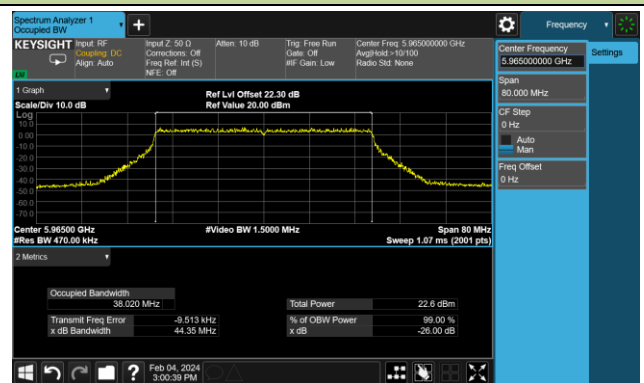

Channel 51 (6205MHz)

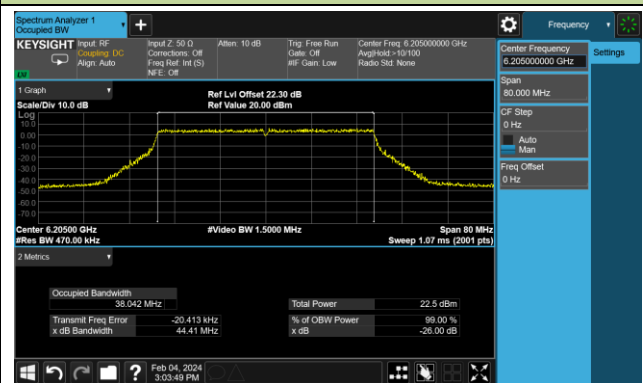

Channel 91 (6405MHz)



Channel 99 (6445MHz)

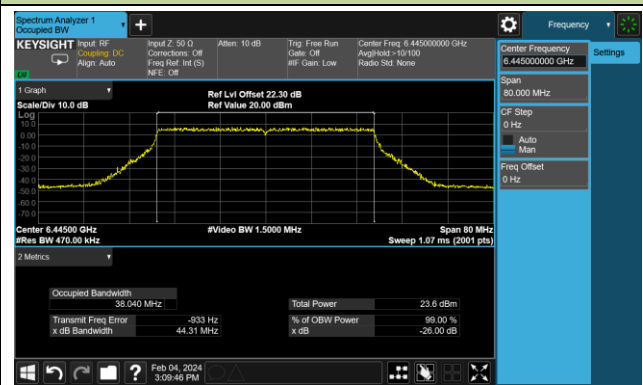

Channel 107 (6485MHz)



Channel 115 (6525MHz)

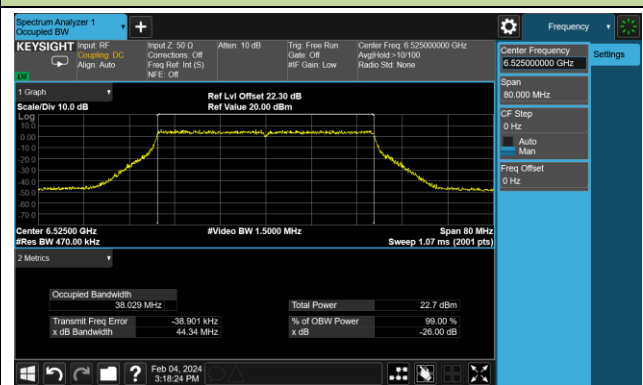

Channel 123 (6565MHz)



Channel 147 (6685MHz)

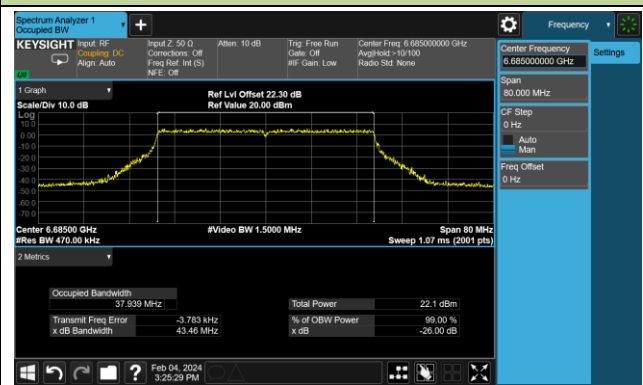

802.11ax-HE40 26dB Bandwidth

Channel 179 (6845MHz)

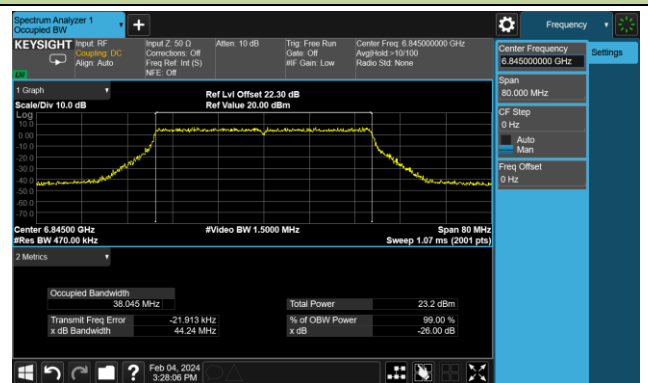

Channel 187 (6885MHz)

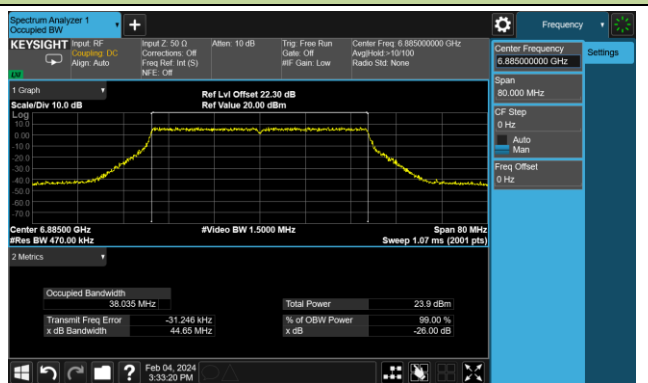

Channel 195 (6925MHz)

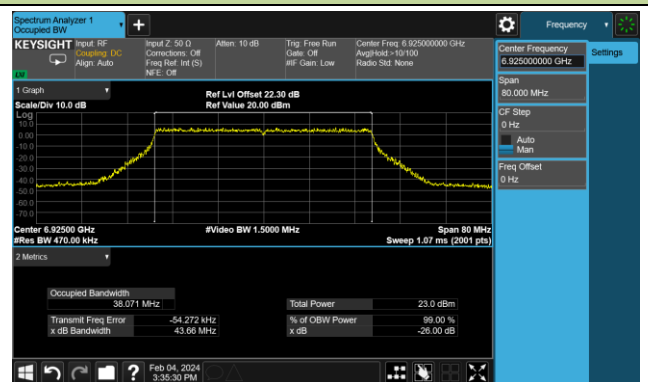

Channel 211 (7005MHz)

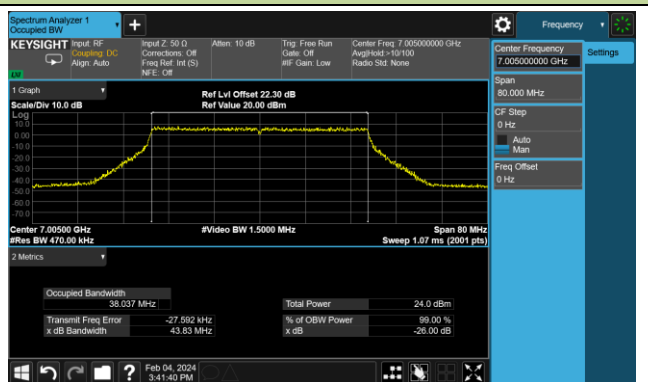

Channel 227 (7085MHz)

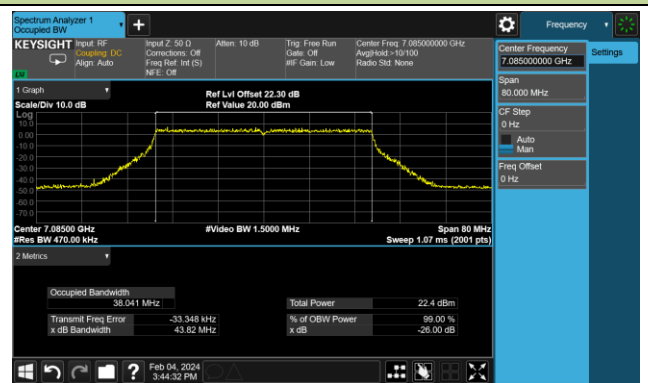

## 802.11ax-HE80 26dB Bandwidth

## Channel 7 (5985MHz)

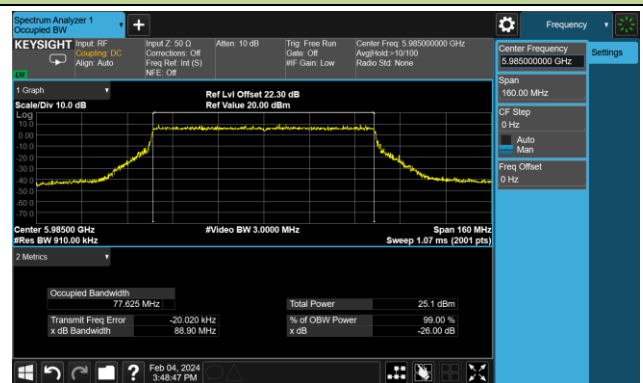

## Channel 55 (6225MHz)

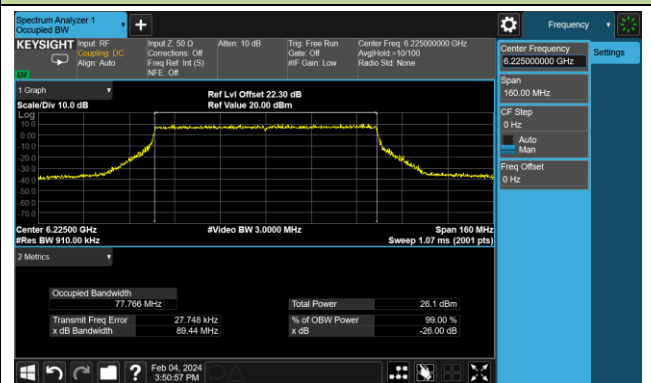

## Channel 87 (6385MHz)

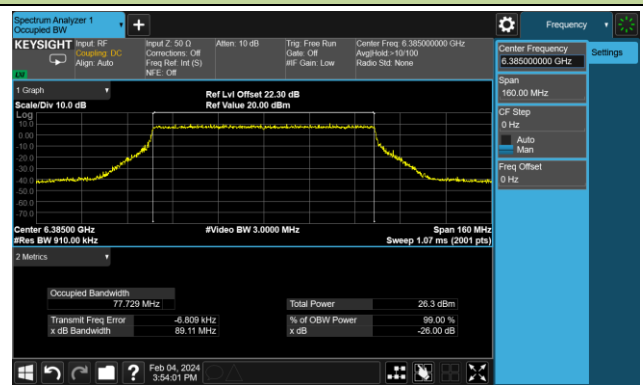

## Channel 103 (6465MHz)

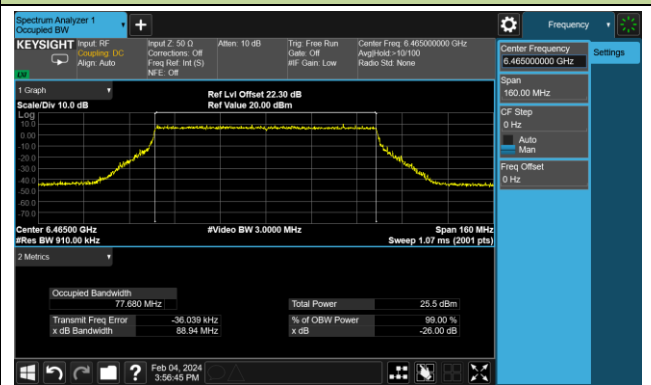

## Channel 119 (6545MHz)

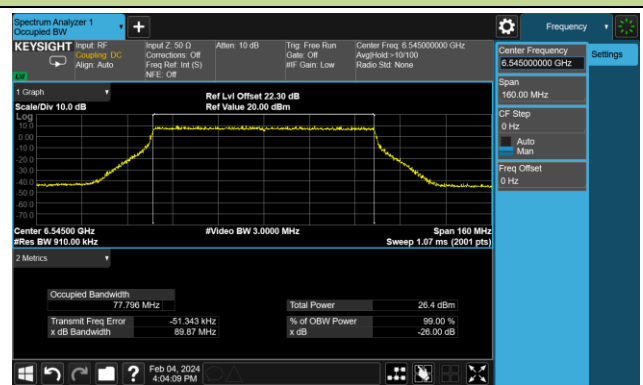

## Channel 135 (6625MHz)



## Channel 151 (6705MHz)



## Channel 167 (6785MHz)

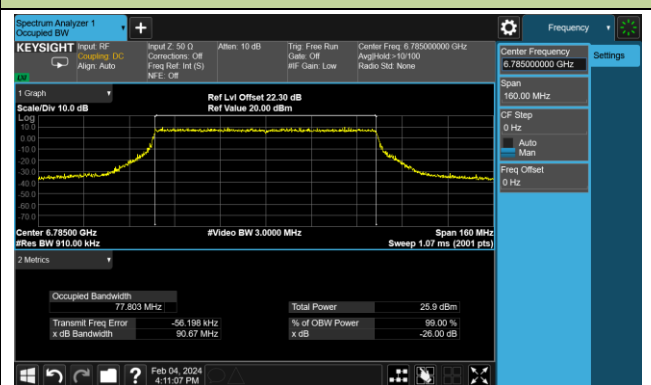

802.11ax-HE80 26dB Bandwidth

Channel 183 (6865MHz)

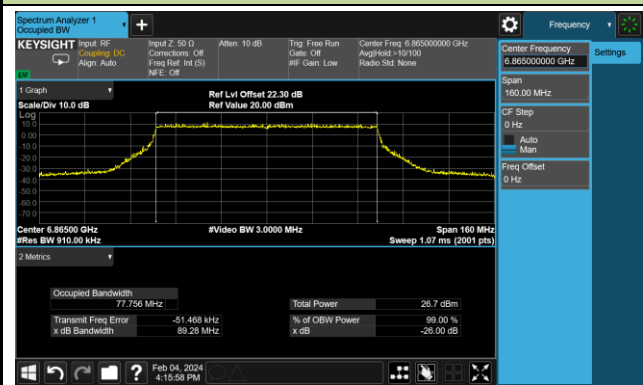

Channel 199 (6945MHz)

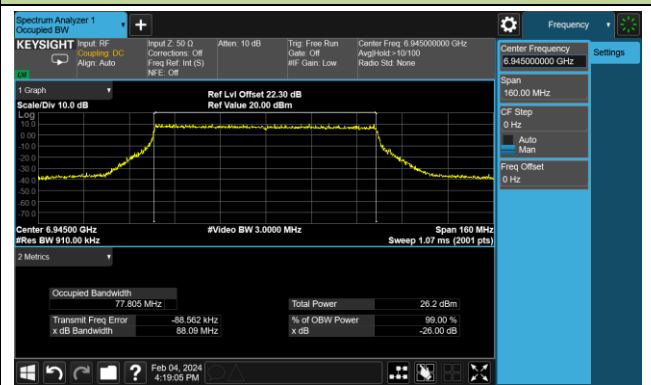

Channel 215 (7025MHz)

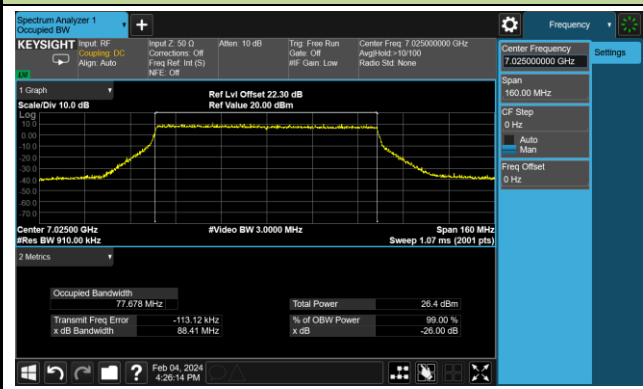

802.11ax-HE160 26dB Bandwidth

Channel 15 (6025MHz)

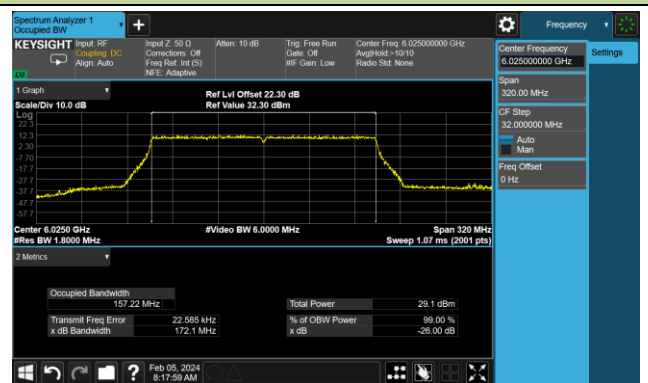

Channel 47 (6185MHz)

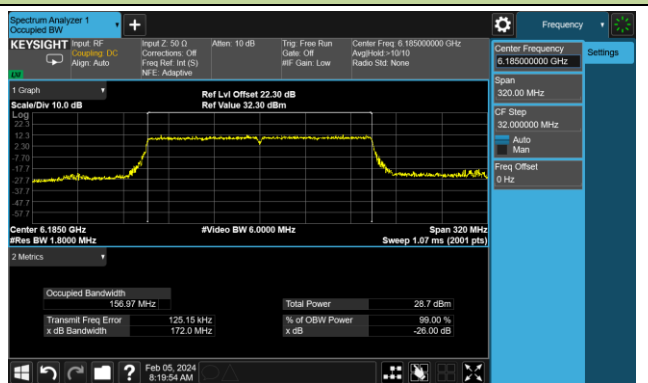

Channel 79 (6345MHz)

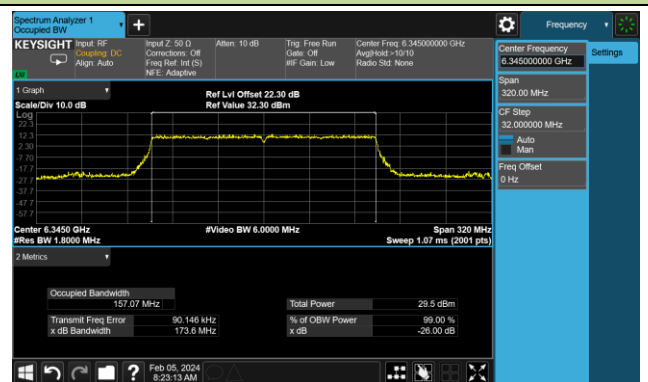

Channel 111 (6505MHz)

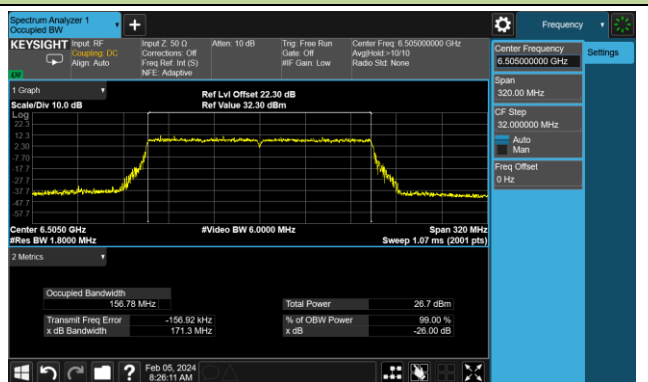

Channel 143 (6665MHz)



Channel 175 (6825MHz)

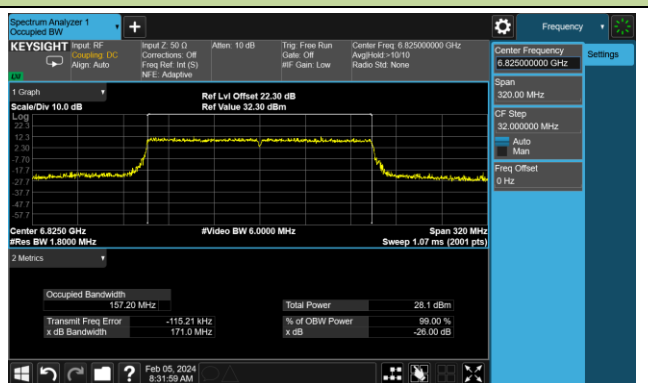

Channel 207 (6985MHz)

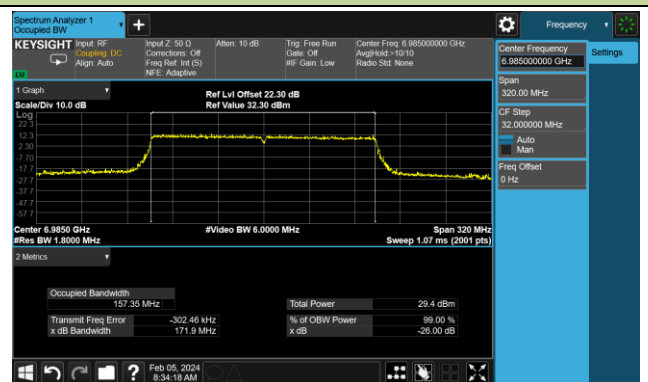

802.11be-EHT20 26dB Bandwidth

Channel 1 (5955MHz)

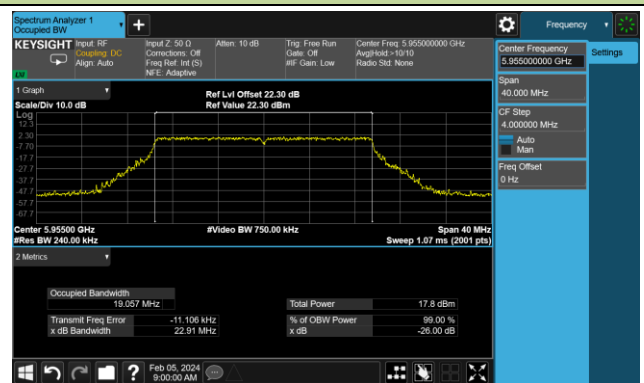

Channel 49 (6195MHz)

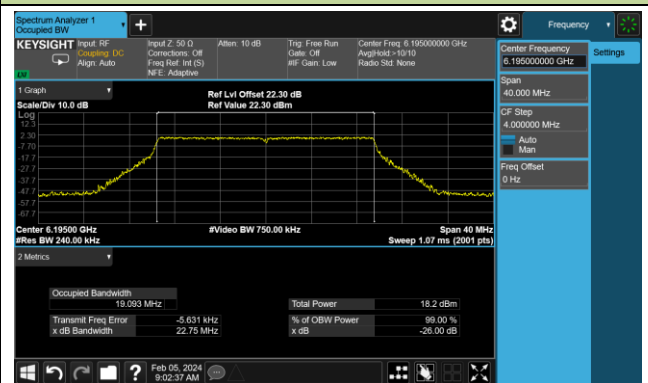

Channel 93 (6415MHz)

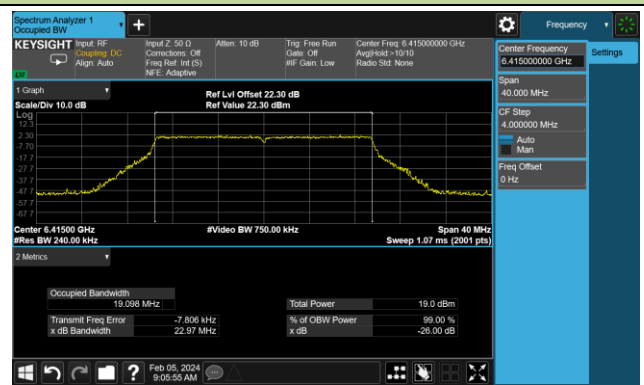

Channel 97 (6435MHz)

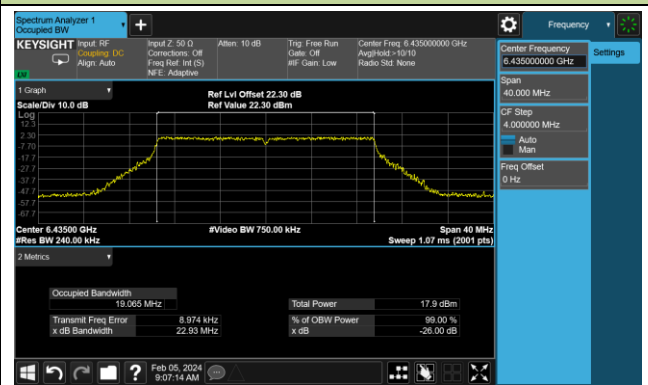

Channel 105 (6475MHz)

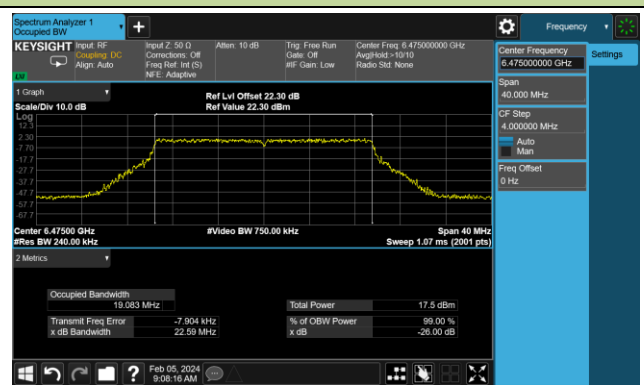

Channel 113 (6515MHz)

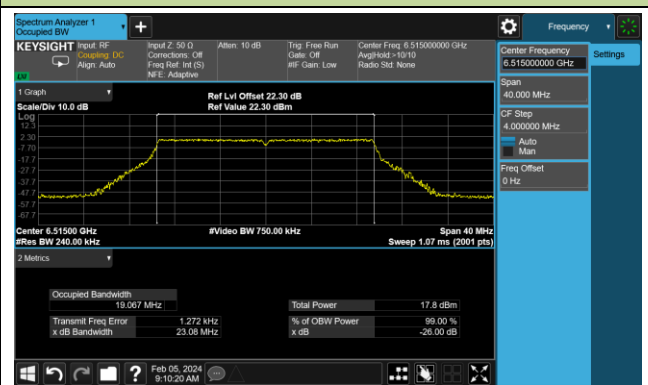

Channel 117 (6535MHz)

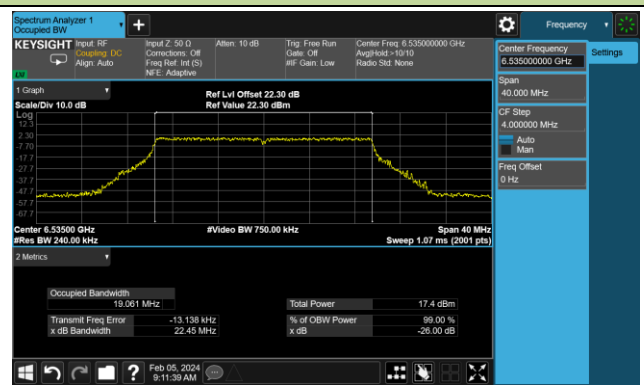

Channel 149 (6695MHz)

