

# GALTRONICS

WHEN CONNECTIONS COUNT



# **CIG WF-710GF WiFi Antenna Performance Report**

WE'RE MAKING WAVES

Galtronics Project: 8036

Prepared by Zack  
May 8<sup>th</sup> , 2024

*zack*

# TEST INFORMATION

Instrument	Manufacturer	Model No.	Asset No.	Cali. Interval	Cali. Due Date
ENA Network Analyzer	KEYSIGHT	E5071C	MY46730234	1 Year	2025/2/28
RF Switch Box	HWA-TECH	Z9916A-NO1	N/A	N/A	N/A
SP24 Chamber	HWA-TECH	555	N/A	1 Year	2024/12/1
Horn Antenna	HWA-TECH	TN3112	N/A	1 Year	2024/12/1

# TEST CONFIGURATION



Test instrument



Chamber

## Test Method

The “great circle” cut method, whereby the Measurement Antenna remains fixed and the EUT is rotated about two axes in sequential order. The radiated RF performance of the Equipment Under Test (EUT) is measured by sampling the radiated transmit power of the mobile at various locations surrounding the device. A three-dimensional characterization of the 'transmit' performance of the EUT is pieced together by analyzing the data from the spatially distributed measurements.

Data points taken every 3 degrees in the theta and in the phi axes are deemed sufficient to fully characterize the EUT's Far-Field radiation pattern and total radiated power All of the measured power values will be integrated.

Test Condition	Test Engineer	Test Environment ( °C / %)	Test Date
Radiated	Zack. You	20-24 / 45-60	10.11.2023~10.13.2023
<b>Band (MHz)</b>		<b>Test Frequency (MHz)</b>	
2400-2484		2400 / 2450 / 2484	
5170-5835		5170/ 5350/5550/5750/5835	
5945-7125		5945/6300/6500/6800/7125	
<b>Testing Location</b>			
Galtronics	Suzhou, China Design Center Galtronics Electronics (Wuxi) Co.		

Because the antennas are fixed in location within the device the directional antenna gain for MIMO is calculated over a sphere using the raw spatial data taken at 3 degree steps of theta and phi for each antenna using the equations from KDB 662911 D01.

The correlated antenna gain was calculated using KDB 662911 D01, F(2)(d)(i). The uncorrelated antenna gain was calculated using KDB 662911 D01, F(2)(d)(ii).

The uncorrelated and correlated gains were calculated for each point in the spatial data, and the highest values reported.

Note :

KDB 662911 D01, F(2)(d)(i)

$$\text{Correlated Gain} = 10 \log \left[ \left( 10^{\frac{G_1}{20}} + 10^{\frac{G_2}{20}} + \dots + 10^{\frac{G_n}{20}} \right)^2 / N_{Ant.} \right] \text{ dBi}$$

KDB 662911 D01, F(2)(d)(ii)

$$\text{Uncorrelated Gain} = 10 \log \left[ \left( 10^{\frac{G_1}{10}} + 10^{\frac{G_2}{10}} + \dots + 10^{\frac{G_n}{10}} \right) / N_{Ant.} \right] \text{ dBi}$$

$N_{Ant.}$  : Number of antenna

$G_n$  : Gain of antenna

# ANTENNA

Antenna	Assy Number	Part Number	Manufacturer
天线	组件编号	零件编号	制造商
2G0	02102073-08036-1	60-2912-03-1	Galtronics
2G1	02102073-08036-2	60-2912-03-2	Galtronics
5G0	02102142-08036-1	60-2890-03	Galtronics
5G1	02102142-08036-2	60-2890-03-1	Galtronics
6G0	02102475-08036-1	60-2991-03-2	Galtronics
6G1	02102475-08036-2	60-2991-03-1	Galtronics
6G2	02102475-08036-3	60-7124-03	Galtronics
6G3	02102475-08036-4	60-7124-03	Galtronics

Galtronics Factory:Galtronics Electronics (Wuxi) Co. No. 1, Xishi Road, Wuxi New District Jiangsu Province 214028, China

# Introduction

- » Galtronics developed an antenna solution for CIG WF-710GF
- » There are 9 antennas :
  - Two Cabled PCB WIFI 2.4GHz antennas:- 2G0 and 2G1.
  - Two Cabled PCB WIFI 5GHz antennas :- 5G0 and 5G1.
  - Four Cabled PCB WIFI 6GHz antennas :- 6G0,6G1,6G2 and 6G3.
  - One Onboard PCB BLE antenna:- BT
- » The operating frequency of 2.4GHz is 2.4 GHz-2.484GHz.
- » The operating frequency of BLE is 2.4 GHz-2.5 GHz.
- » The operating frequency of 5GHz is 5.17GHz-5.835GHz.
- » The operating frequency of 6GHz is 5.945GHz-7.125GHz.
- » Measured return loss, isolation, peak gain, efficiency, Correlated gain,UnCorrelated gain and gain patterns of the antennas



# Antenna Location

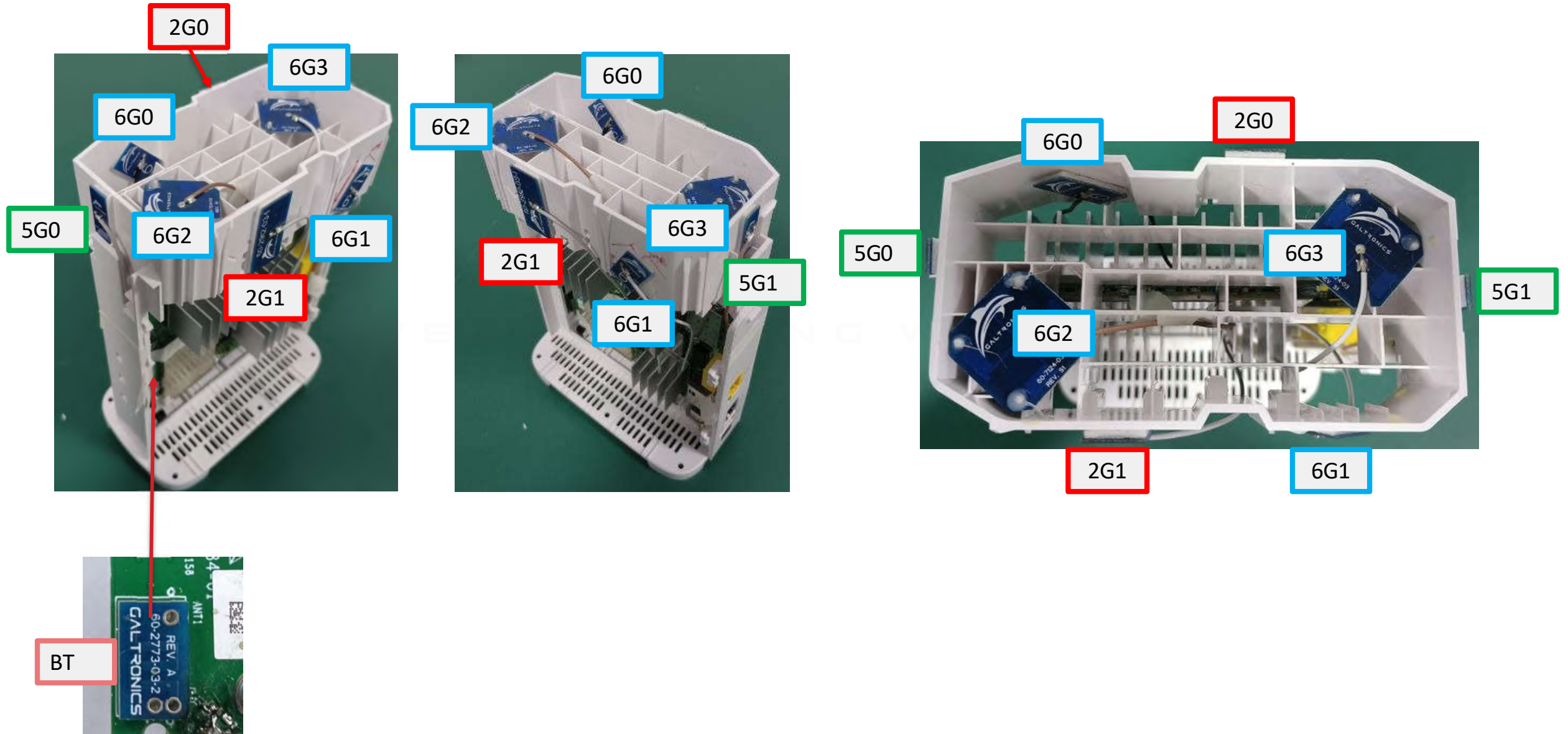

# Antenna Environment



# Chamber Coordinates

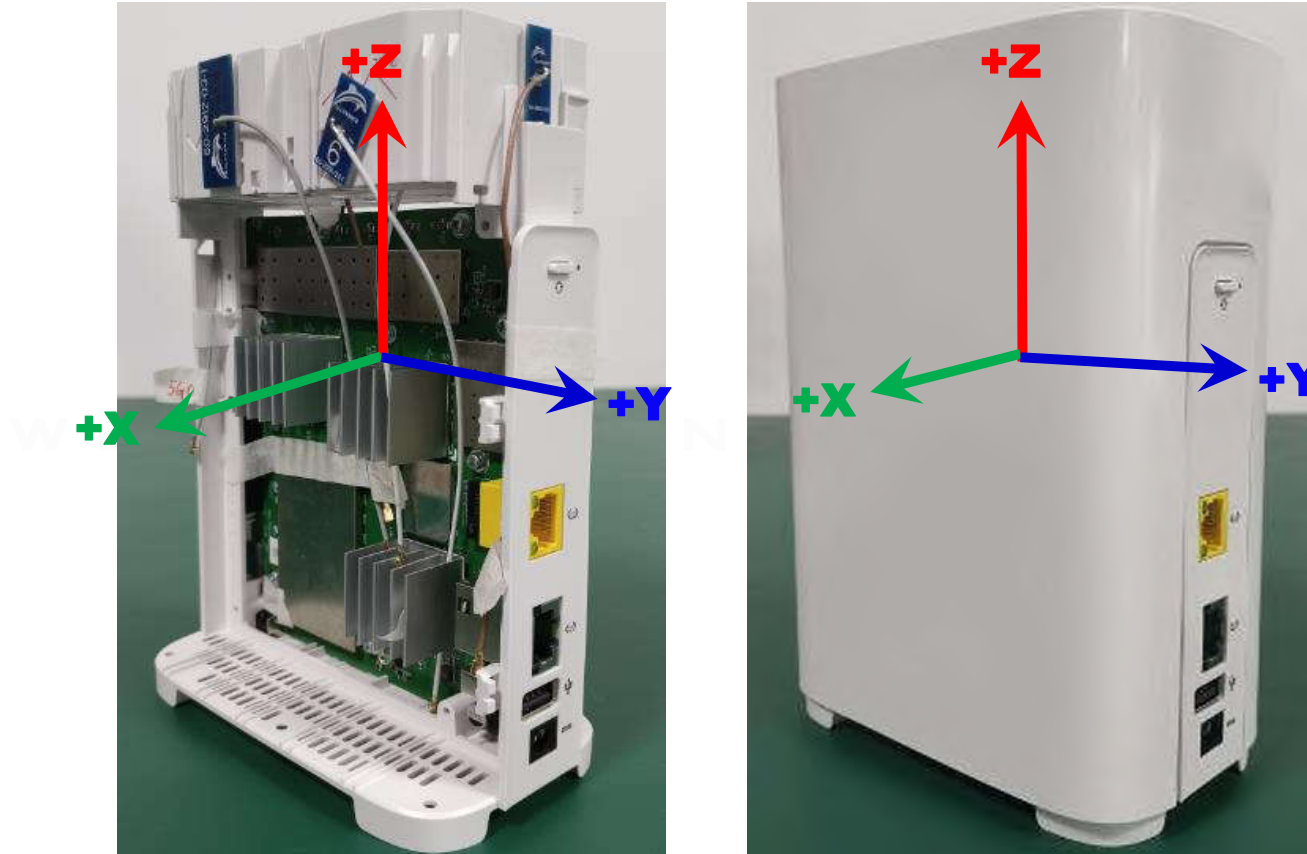

# Matching Network for BT

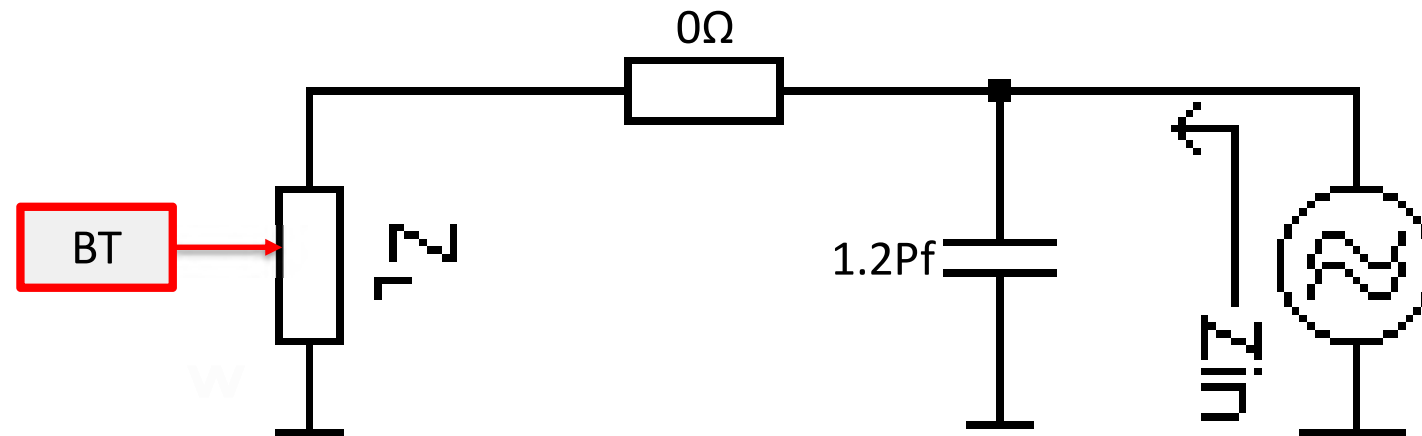

# Antenna Orientation

	Antenna Orientation
2G0	V
2G1	V
5G0	V
5G1	V
6G0	45°
6G1	30°
6G2	H-POL
6G3	H-POL
BT	Mix

V = vertical  
H = horizontal

# WiFi Antenna Performance Summary

Antenna	Worst Return loss (dB)	Average Efficiency (%)	Highest Peak Gain (dB)	Mutual Isolation (dB) 2.4 GHz Band			Mutual Isolation (dB) 5GHz Band		Mutual Isolation (dB) 6GHz Band			
				2G0	2G1	BT	5G0	5G1	6G0	6G1	6G2	6G3
2G0	-12.1	70.45	3.64			-25.9	-37	-34.7	-30.2	-30.7	-28.9	-24.3
2G1	-11.7	72.51	3.81	-20.9		-32.7	-33.4	-36	-32.2	-27.7	-25	-30.1
BT	-13.3	54.3	2.36				-50.0	-60.8	-42.9	-43.6	-42.4	-54.4
5G0	-12.2	70.22	4.85	-36.1	-29.6	-34.6			-29.4	-29.1	-32.4	-32.1
5G1	-13.5	70.07	4.46	-34.1	-31.9	-33.9	-31.4		-32.2	-30.8	-32	-31.8
6G0	-15.9	69.12	4.38	-36.6	-40.7	-25.5	-28	-38.2				
6G1	-10.6	69.94	4.48	-33.3	-32.5	-41.5	-32.1	-32.4	-31.5			
6G2	-13.9	65.05	3.51	-43.1	-38.8	-47.0	-41.3	-36.8	-27.2	-26.5		
6G3	-12.4	65.14	3.65	-40.1	-44.3	-56.4	-34.6	-32.9	-33.8	-27.5	-25.2	

# Gain & Efficiency summary

2G0	Freq(MHz)	Peak Gain(dBi)	Directivity(dBi)	Efficiency(%)
	2400	3.64	5.15	70.54
	2450	3.41	4.80	72.66
	2484	3.16	4.83	68.14
<b>Average</b>				<b>70.45</b>

2G1	Freq(MHz)	Peak Gain(dBi)	Directivity(dBi)	Efficiency(%)
	2400	3.81	5.21	72.33
	2450	3.81	5.12	73.93
	2484	3.68	5.16	71.26
<b>Average</b>				<b>72.51</b>

5G0	Freq(MHz)	Peak Gain(dBi)	Directivity(dBi)	Efficiency(%)
	5170	4.78	6.52	67.02
	5350	4.85	6.30	71.68
	5550	4.70	6.02	73.86
	5750	4.56	6.19	68.66
	5835	4.69	6.25	69.89
<b>Average</b>				<b>70.22</b>

5G1	Freq(MHz)	Peak Gain(dBi)	Directivity(dBi)	Efficiency(%)
	5170	4.19	5.89	67.60
	5350	4.17	5.64	71.33
	5550	4.20	5.74	70.17
	5750	4.46	5.83	72.91
	5835	4.01	5.66	68.34
<b>Average</b>				<b>70.07</b>

# Gain & Efficiency summary

6G0	Freq(MHz)	Peak Gain(dBi)	Directivity(dBi)	Efficiency(%)
	5945	4.05	5.77	67.30
	6300	4.31	5.66	73.21
	6500	4.25	5.97	67.39
	6800	4.10	5.68	69.58
	7125	4.38	6.05	68.13
	<b>Average</b>			<b>69.12</b>

6G1	Freq(MHz)	Peak Gain(dBi)	Directivity(dBi)	Efficiency(%)
	5945	4.22	5.72	70.84
	6300	4.29	5.67	72.72
	6500	4.34	6.00	68.20
	6800	4.48	5.97	71.02
	7125	3.92	5.66	66.93
	<b>Average</b>			<b>69.94</b>

6G2	Freq(MHz)	Peak Gain(dBi)	Directivity(dBi)	Efficiency(%)
	5945	3.51	5.37	65.15
	6300	3.22	5.13	64.46
	6500	3.33	5.18	65.32
	6800	3.48	5.26	66.45
	7125	3.16	5.11	63.86
	<b>Average</b>			<b>65.05</b>

6G3	Freq(MHz)	Peak Gain(dBi)	Directivity(dBi)	Efficiency(%)
	5945	3.65	5.41	66.62
	6300	3.12	4.97	65.26
	6500	3.41	5.39	63.33
	6800	3.27	5.09	65.78
	7125	3.62	5.51	64.70
	<b>Average</b>			<b>65.14</b>



## Gain & Efficiency summary

BT	Freq(MHz)	Peak Gain(dBi)	Directivity(dBi)	Efficiency(%)
	2400	2.10	4.98	51.61
	2450	2.32	5.06	53.21
	2500	2.36	4.72	58.09
	Average			54.30

## Correlated/UnCorrelated Gain Calculation formula

$$\text{Correlated Gain} = 10 \log \left[ \left( 10^{\frac{G_1}{20}} + 10^{\frac{G_2}{20}} + \dots + 10^{\frac{G_n}{20}} \right)^2 / N_{Ant.} \right] \text{ dBi}$$

$$\text{Uncorrelated Gain} = 10 \log \left[ \left( 10^{\frac{G_1}{10}} + 10^{\frac{G_2}{10}} + \dots + 10^{\frac{G_n}{10}} \right) / N_{Ant.} \right] \text{ dBi}$$

$N_{Ant.}$  : Number of antenna

$G_n$  : Gain of antenna

## Correlated Gain(2GHz)

Frequeccy (MHz)	Degree		Gain (dBi)		Correlated Gain (dBi) -H Pol
	Theta	Phi	2G0	2G1	
2400	90	150	1.92	-10.39	0.80
2450	105	225	-0.41	-4.87	0.66
2484	105	225	-0.52	-4.90	0.57

Frequeccy (MHz)	Degree		Gain (dBi)		Correlated Gain (dBi) -V Pol
	Theta	Phi	2G0	2G1	
2400	90	15	0.89	2.64	4.82
2450	60	354	0.37	3.28	4.95
2484	60	357	0.45	3.23	4.96

## UnCorrelated Gain(2GHz)

Frequeccy (MHz)	Degree		Gain(dBi)		UnCorrelated Gain(dBi) -H Pol
	Theta	Phi	2G0	2G1	
2400	90	150	1.92	-10.39	-0.84
2450	90	150	1.74	-11.68	-1.07
2484	90	150	1.44	-12.58	-1.40

Frequeccy (MHz)	Degree		Gain(dBi)		UnCorrelated Gain(dBi) -V Pol
	Theta	Phi	2G0	2G1	
2400	60	351	0.04	3.14	1.86
2450	60	354	0.37	3.28	2.06
2484	60	354	0.40	3.26	2.06

## Correlated Gain(5GHz)

Frequeccy (MHz)	Degree		Gain(dBi)		Correlated Gain(dBi)-H Pol
	Theta	Phi	5G0	5G1	
5170	15	330	-9.61	2.14	1.13
5350	15	330	-7.63	2.00	1.47
5550	105	60	-1.89	-3.59	0.31
5750	105	60	-2.72	-3.43	-0.06
5835	105	60	-2.40	-3.08	0.28

WE'RE MAKING WAVES

Frequeccy (MHz)	Degree		Gain(dBi)		Correlated Gain(dBi)-V Pol
	Theta	Phi	5G0	5G1	
5170	90	33	4.47	1.68	6.20
5350	87	30	4.52	2.42	6.54
5550	78	30	3.55	3.67	6.62
5750	75	27	2.76	4.14	6.49
5835	75	18	3.89	3.28	6.60

## UnCorrelated Gain(5GHz)

Frequeccy (MHz)	Degree		Gain(dBi)		UnCorrelated Gain(dBi)-H Pol
	Theta	Phi	5G0	5G1	
5170	15	330	-9.61	2.14	-0.59
5350	15	330	-7.63	2.00	-0.56
5550	15	315	-8.64	0.65	-1.88
5750	15	315	-13.77	0.20	-2.64
5835	15	330	-6.54	-0.41	-2.47

WE'RE MAKING WAVES

Frequeccy (MHz)	Degree		Gain(dBi)		UnCorrelated Gain(dBi)-V Pol
	Theta	Phi	5G0	5G1	
5170	90	30	4.58	1.47	3.30
5350	87	30	4.52	2.42	3.60
5550	78	30	3.55	3.67	3.61
5750	75	27	2.76	4.14	3.50
5835	75	18	3.89	3.28	3.59

## Correlated Gain(6GHz)

Frequeccy (MHz)	Degree		Gain(dBi)				Correlated Gain(dBi)-H Pol
	Theta	Phi	6G0	6G1	6G2	6G3	
5945	90	0	-0.59	-4.60	1.50	0.11	5.40
6300	102	195	-0.23	-1.85	-0.54	-0.39	5.29
6500	105	195	-2.61	-4.39	0.14	-0.67	4.31
6800	75	0	-6.41	1.34	0.13	1.20	5.59
7125	105	135	-4.93	-5.55	0.75	2.95	5.08

WE'RE MAKING WAVES

Frequeccy (MHz)	Degree		Gain(dBi)				Correlated Gain(dBi)-V Pol
	Theta	Phi	6G0	6G1	6G2	6G3	
5945	90	345	-4.48	-0.78	-1.84	-4.44	3.29
6300	102	255	-0.15	3.65	-6.81	-14.24	3.96
6500	102	177	-3.13	0.95	-3.00	-5.21	3.72
6800	90	3	-2.42	-0.54	-4.03	-6.59	2.90
7125	75	330	-0.54	-0.06	-6.90	-6.87	3.04

## UnCorrelated Gain(6GHz)

Frequeccy (MHz)	Degree		Gain (dBi)				UnCorrelated Gain(dBi) -H Pol
	Theta	Phi	6G0	6G1	6G2	6G3	
5945	90	0	-0.59	-4.60	1.50	0.11	-0.39
6300	105	60	-6.61	-2.59	1.30	1.79	-0.42
6500	105	288	-23.32	-3.85	2.11	0.33	-1.08
6800	75	0	-6.41	1.34	0.13	1.20	-0.07
7125	105	135	-4.93	-5.55	0.75	2.95	-0.27

WE'RE MAKING WAVES

Frequeccy (MHz)	Degree		Gain (dBi)				UnCorrelated Gain(dBi) -V Pol
	Theta	Phi	6G0	6G1	6G2	6G3	
5945	105	255	-6.42	3.87	-11.24	-14.44	-1.58
6300	105	255	-0.72	3.90	-6.42	-15.13	-0.51
6500	105	267	-6.78	3.81	-3.06	-14.39	-1.05
6800	105	255	-4.73	4.21	-7.61	-17.07	-1.02
7125	105	255	-7.46	3.57	-10.88	-11.18	-1.85



# System Coverage- Gain [dB]

## 2450MHz

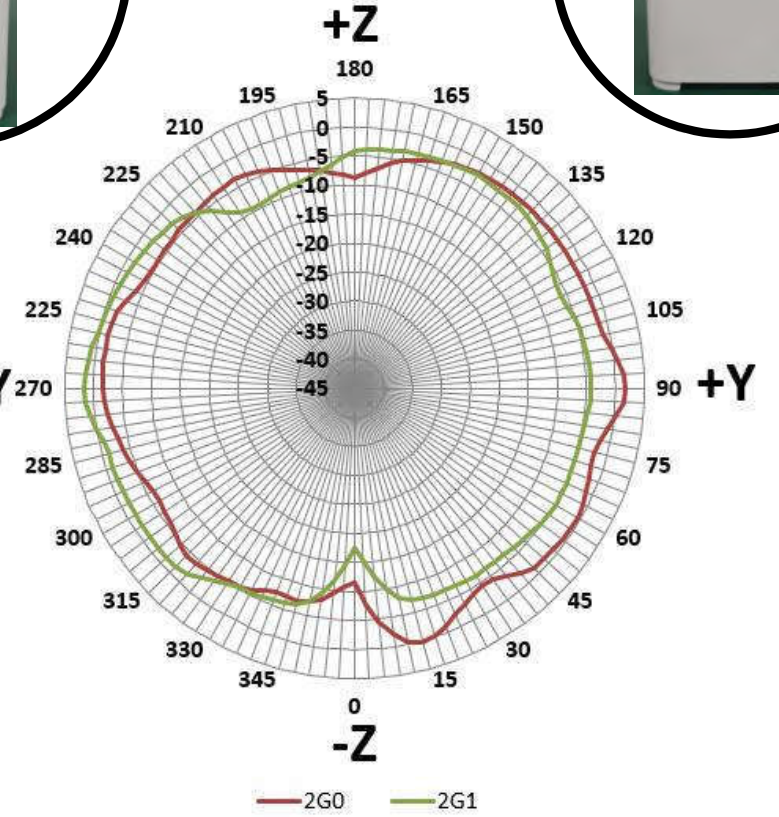
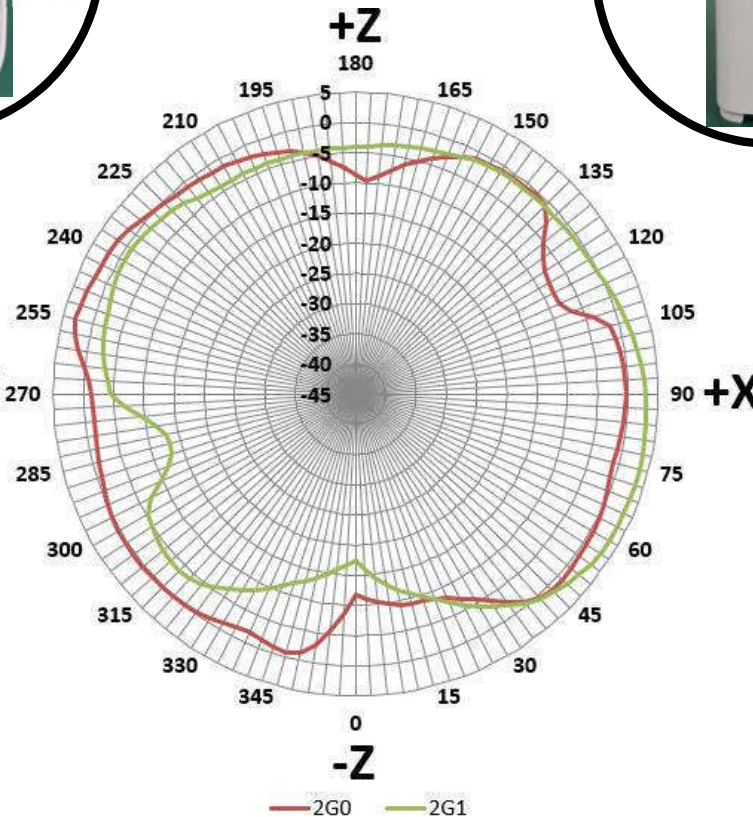
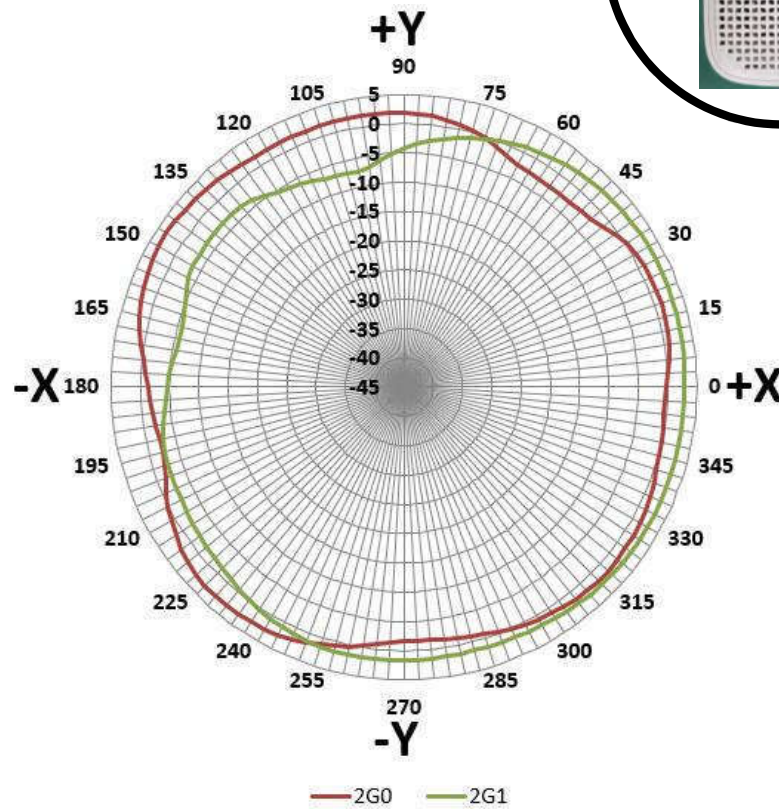
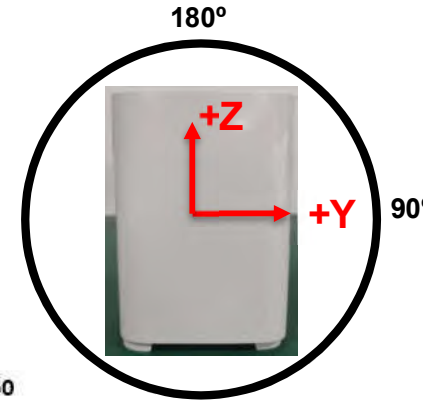
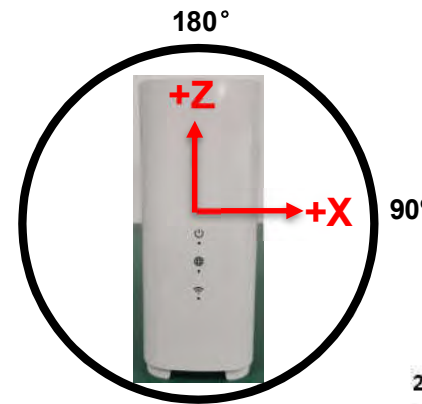
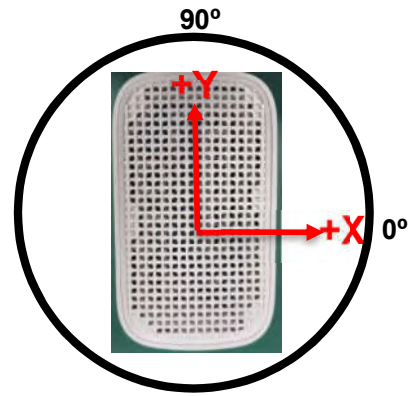

# System Coverage- Gain [dB]

## 5350MHz

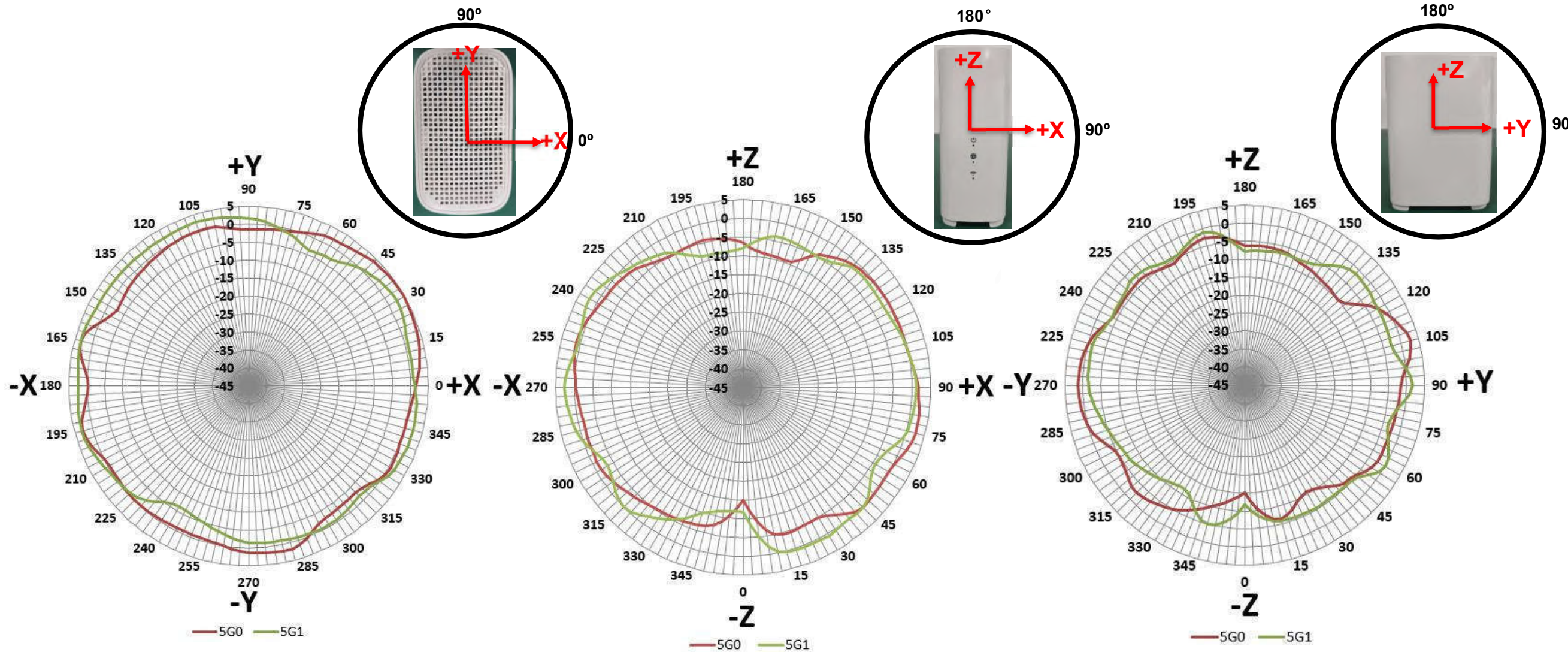

# System Coverage- Gain [dB]

## 5750MHz

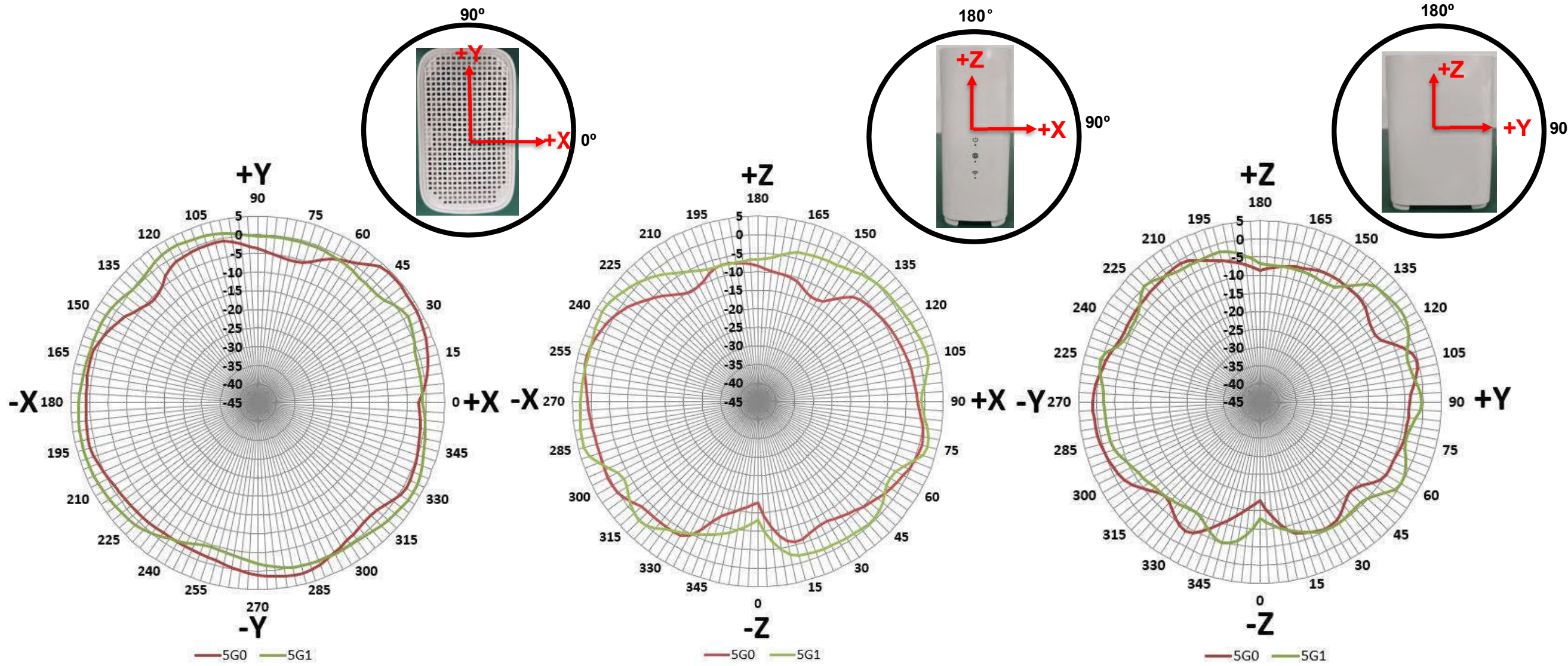

# System Coverage- Gain [dB] 5945MHz

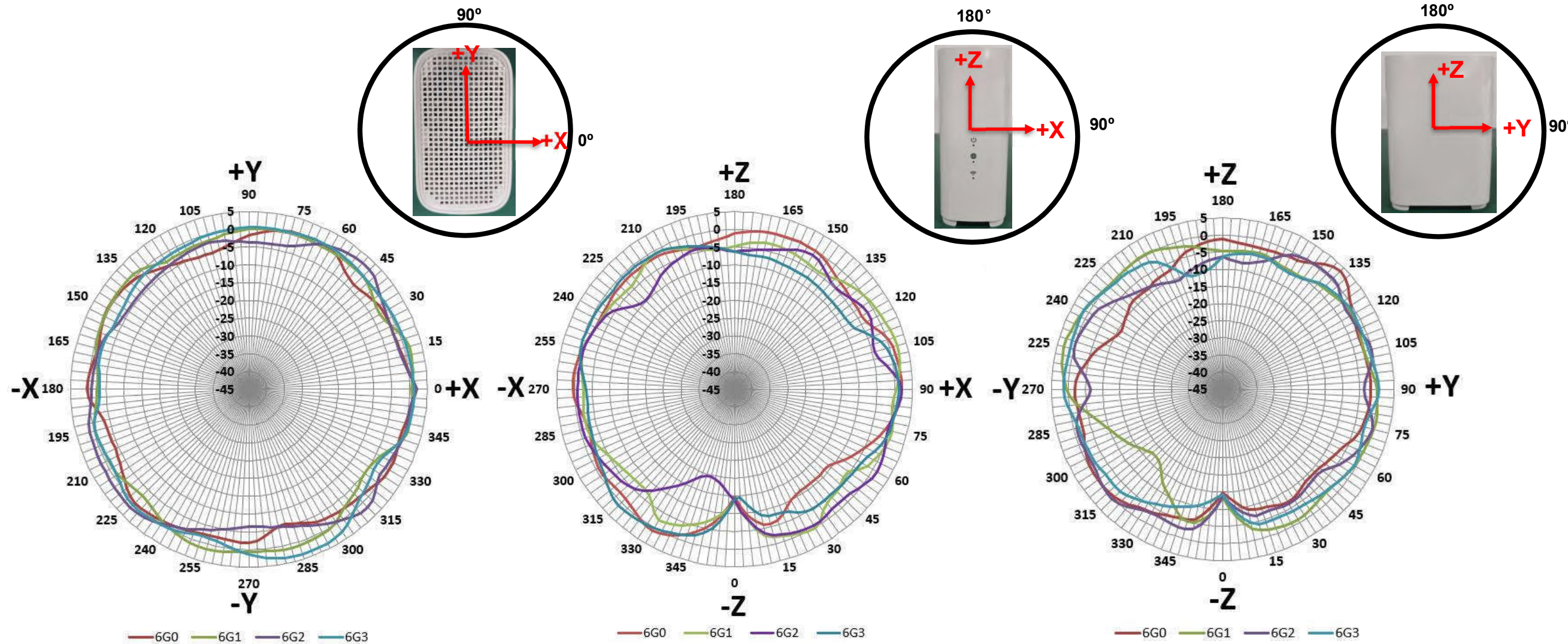

# System Coverage- Gain [dB] 6500MHz

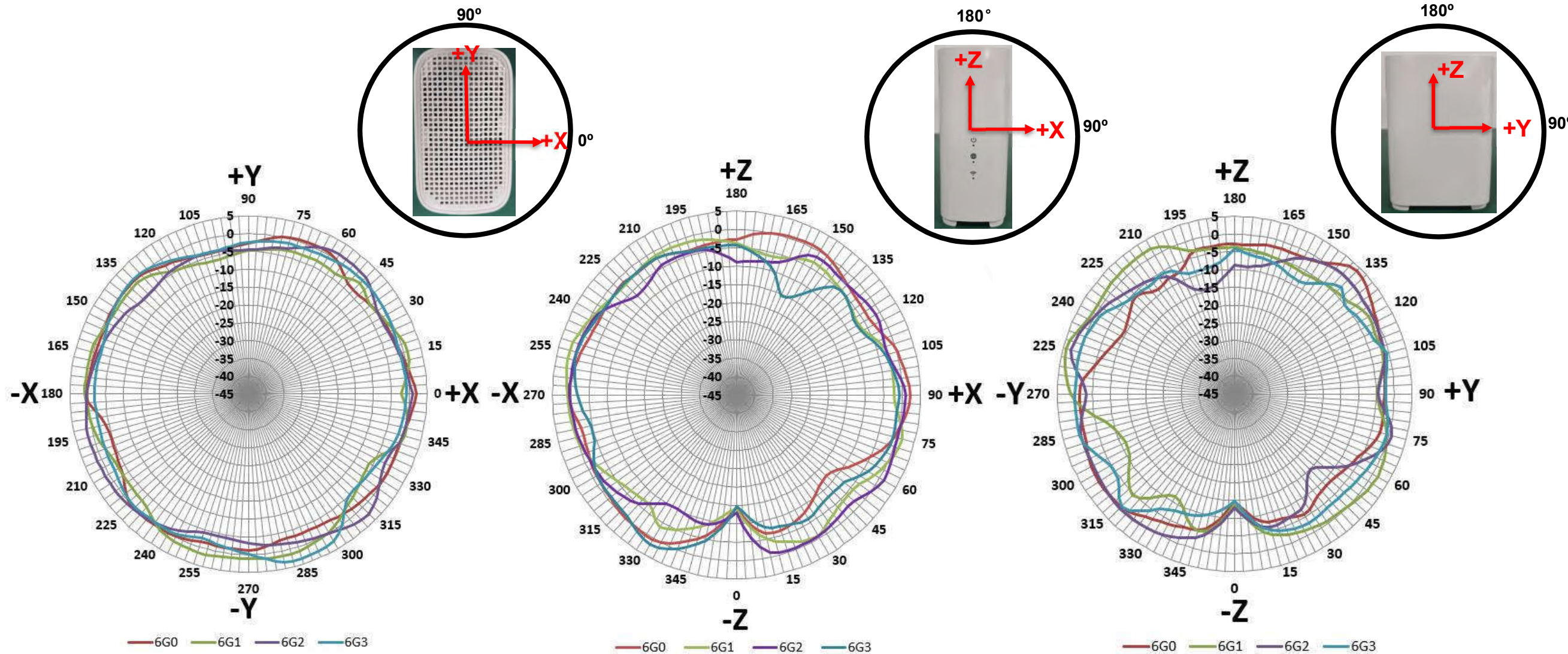

# System Coverage- Gain [dB]

## 7125MHz

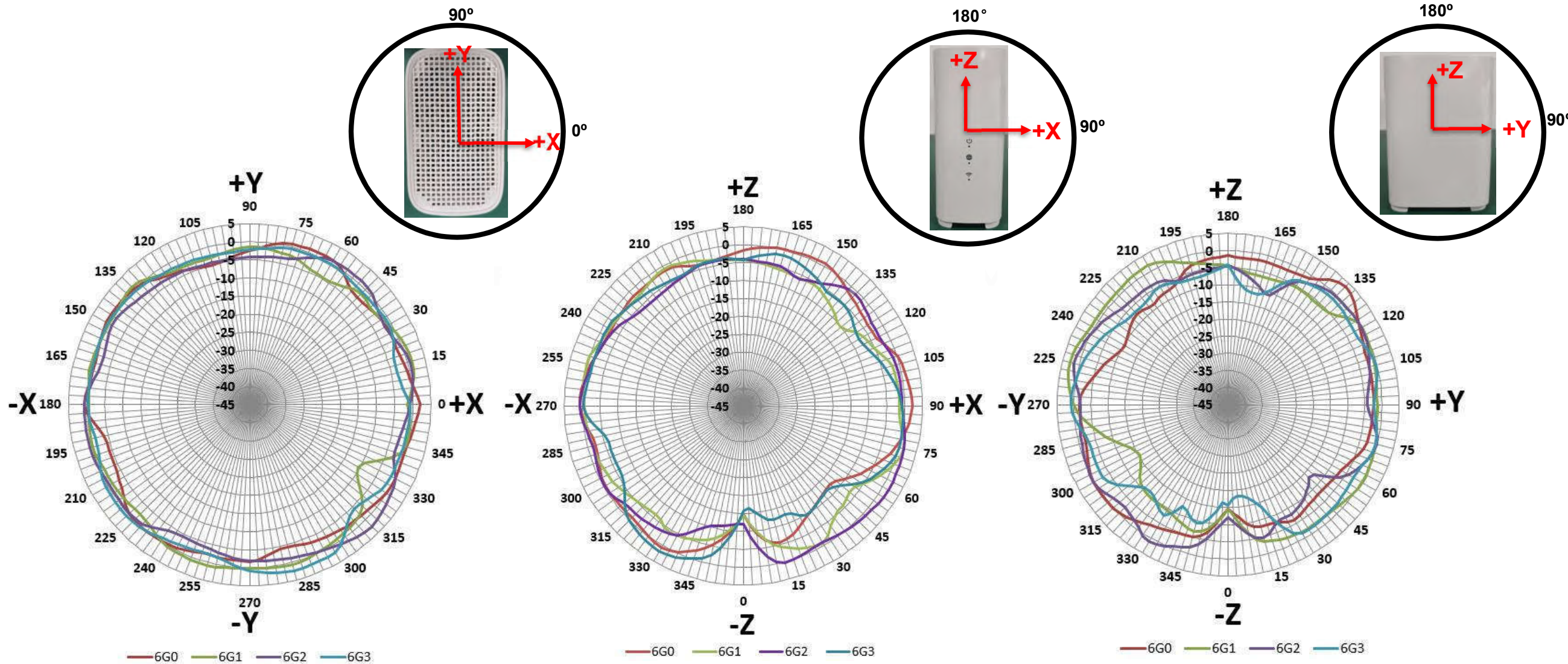

# Antenna Return Loss and Isolation of 2.4GHz

Port1 = 2G0

Port2 = 2G1

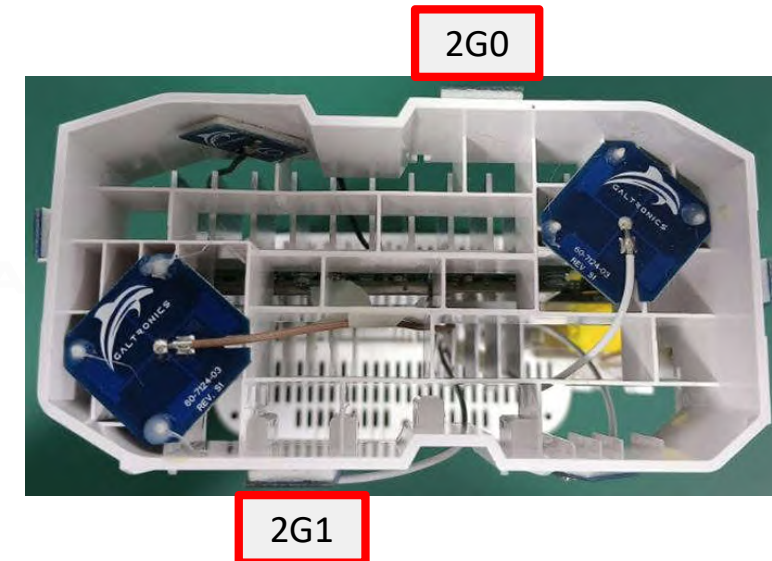
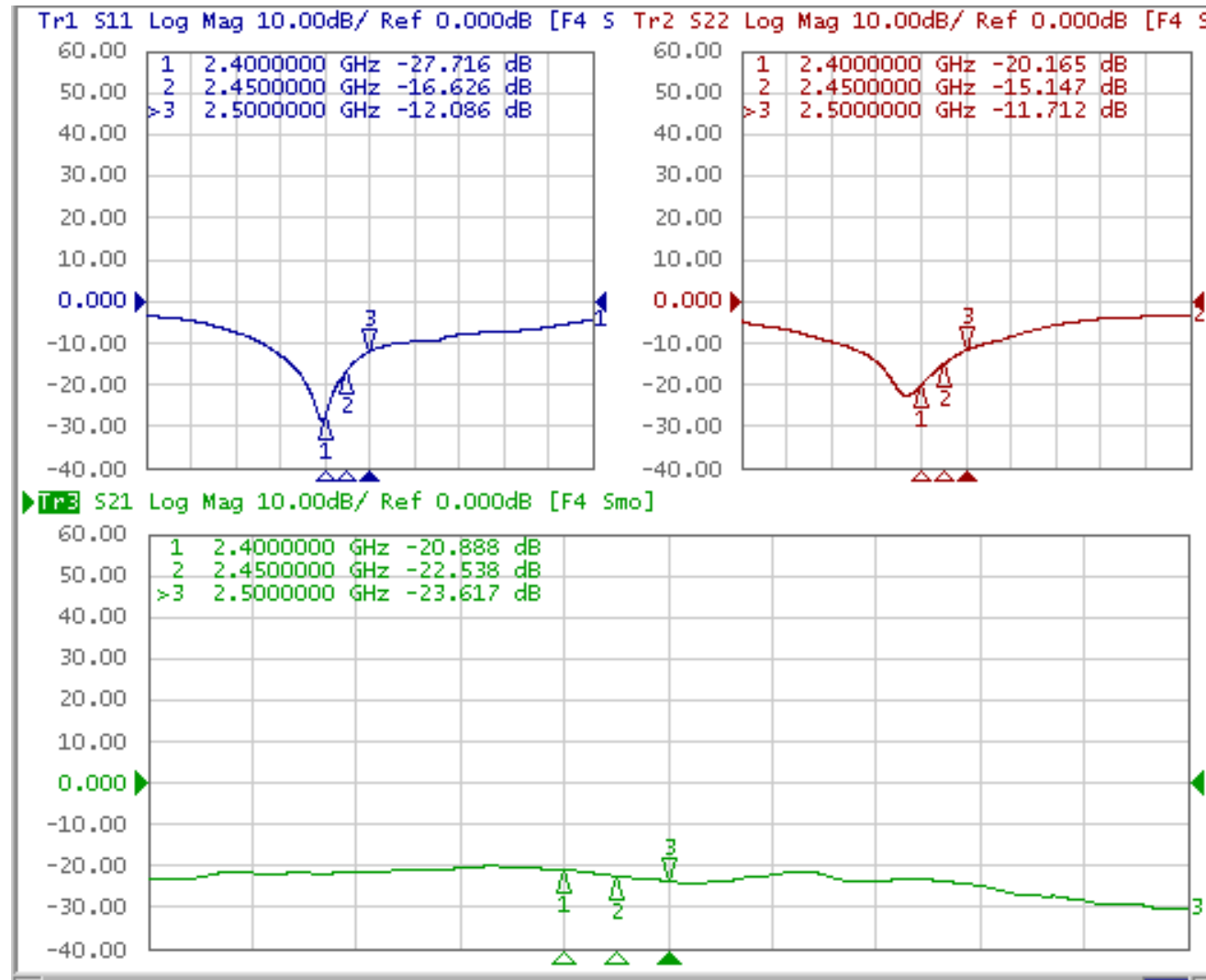

# Antenna Return Loss and Isolation of 5GHz

Port 1 = 5G0

Port 2 = 5G1

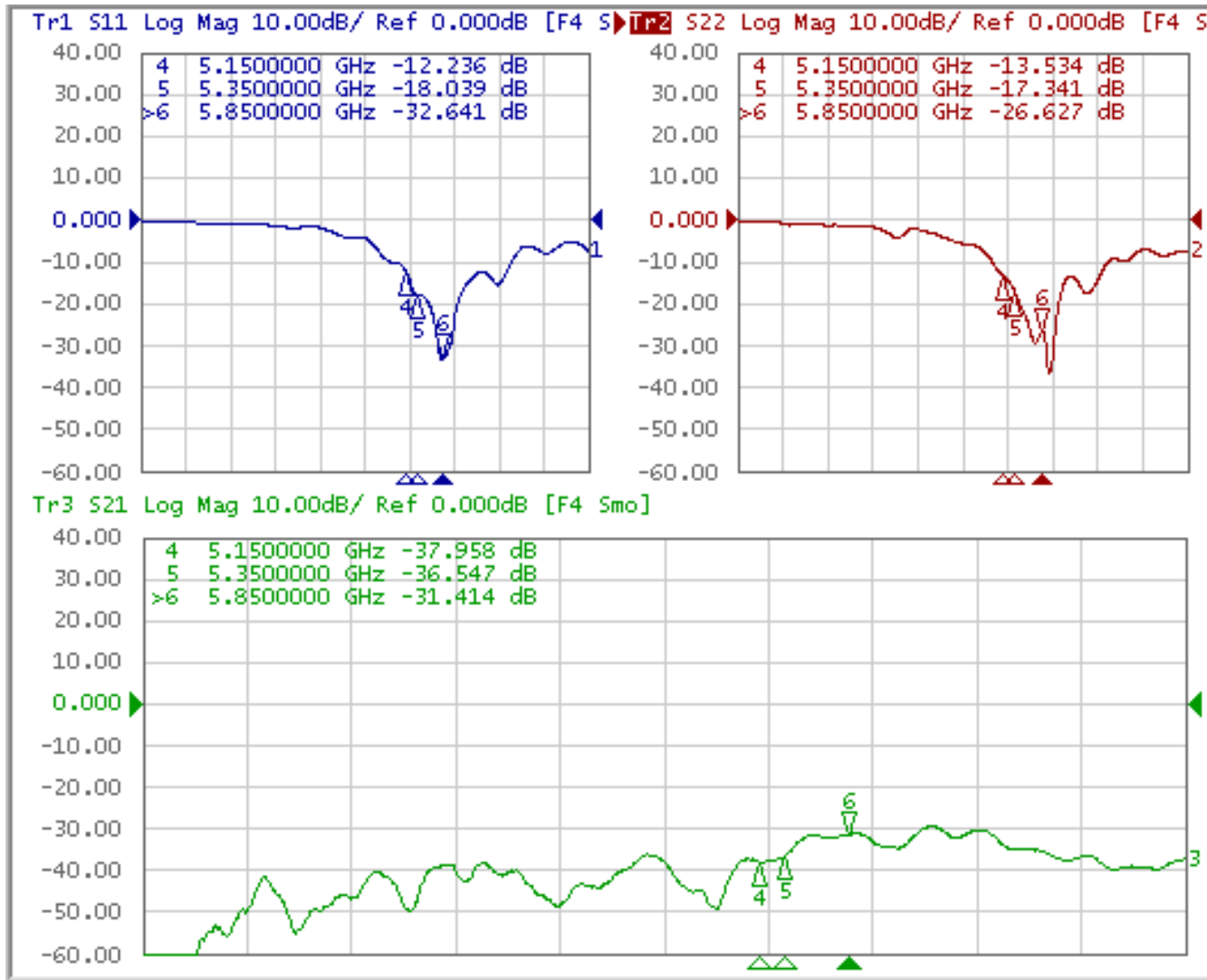

5G0

5G1



# Antenna Return Loss of 6GHz

- Port1= 6G0
- Port2= 6G1
- Port3= 6G2
- Port4= 6G3

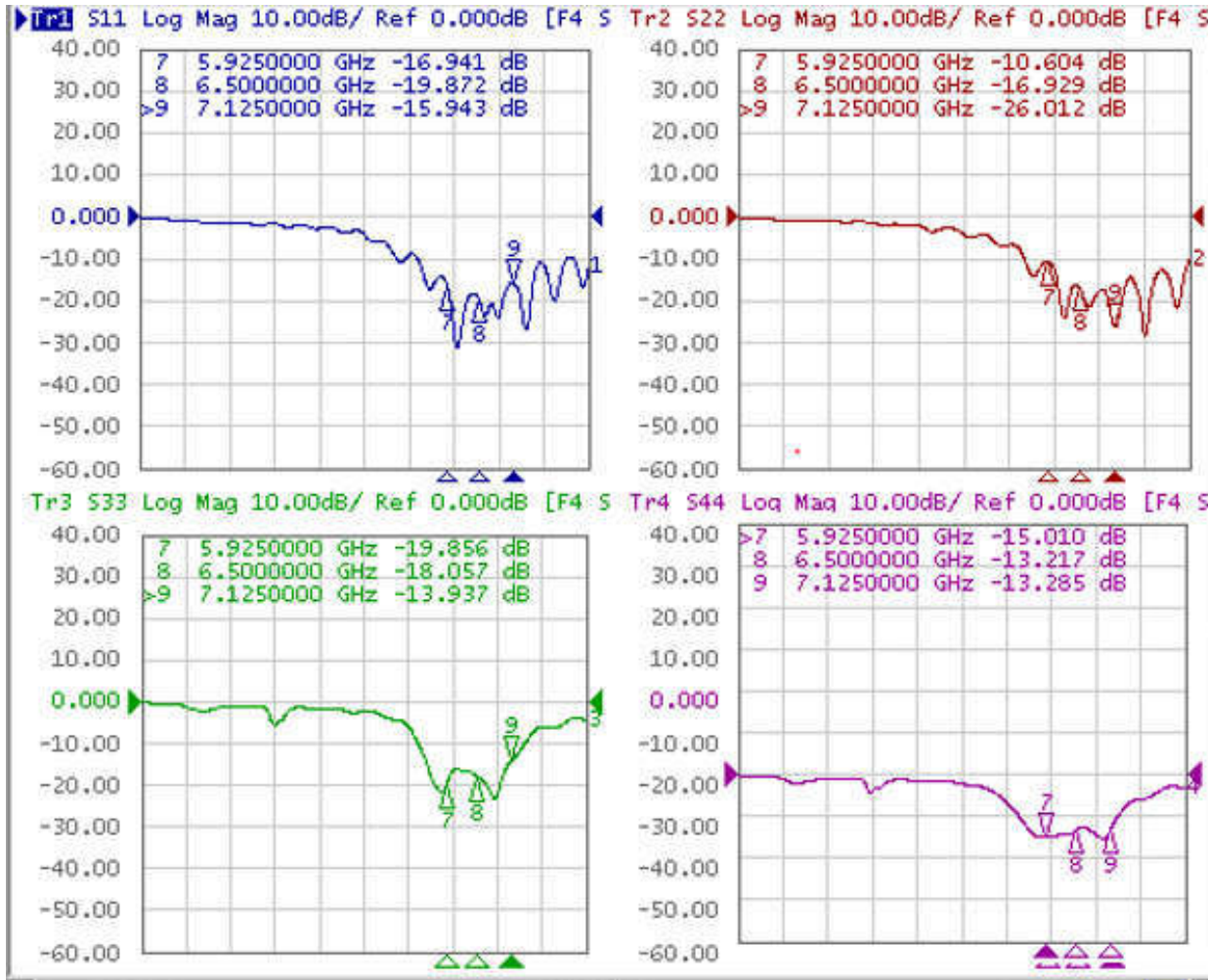

# Antenna Return Loss of BT

Port 1 = BT

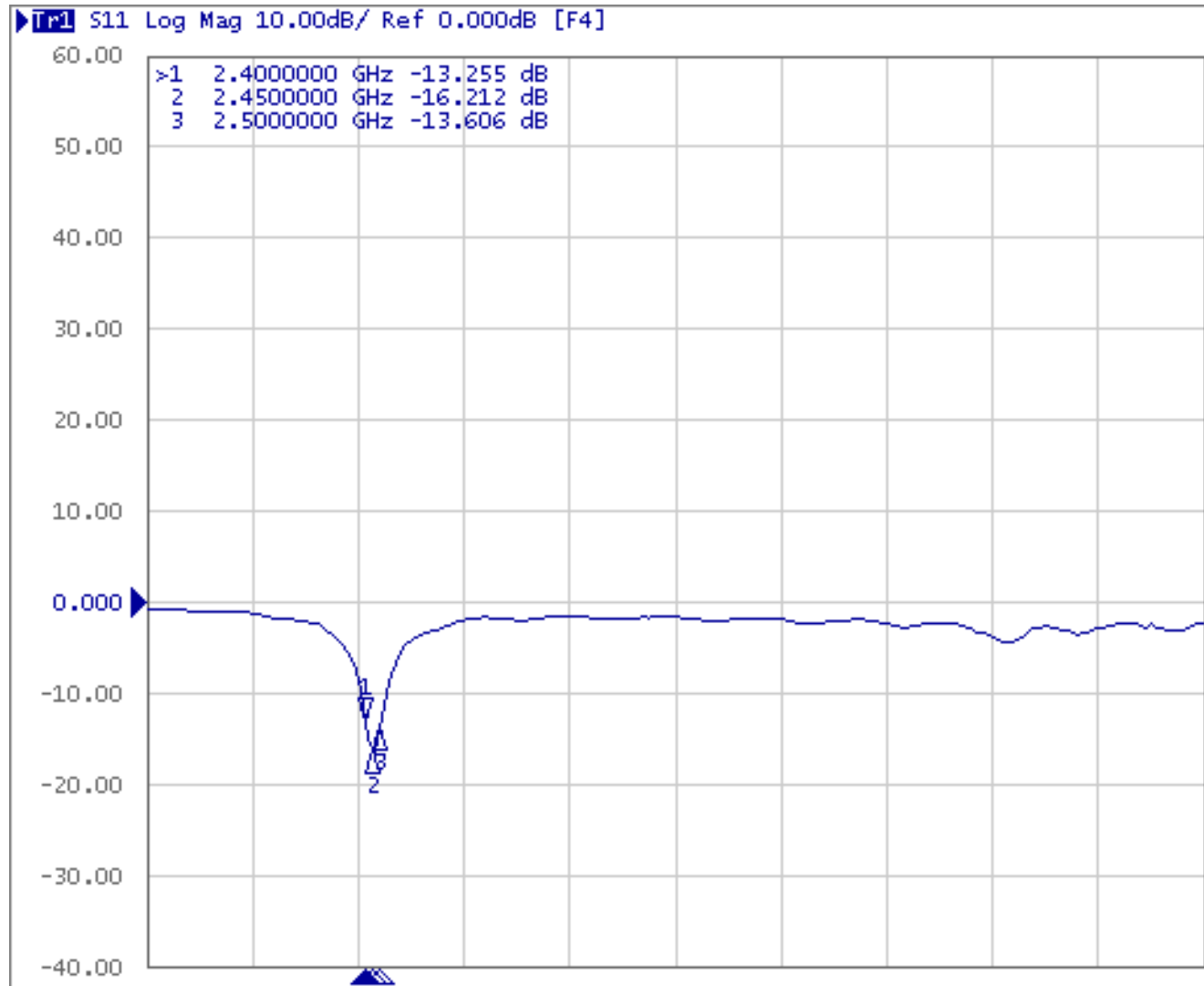

BT

WAVES

# Antenna Isolation of 6GHz

- Port1= 6G0
- Port2= 6G1
- Port3= 6G2
- Port4= 6G3

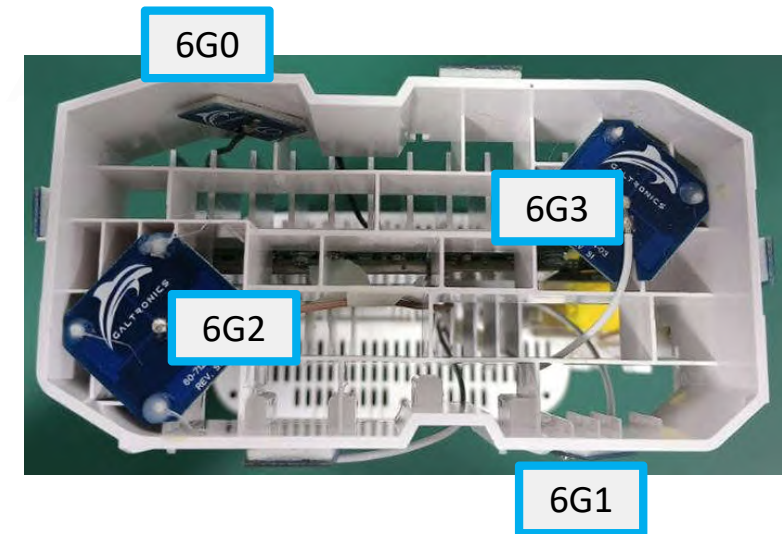
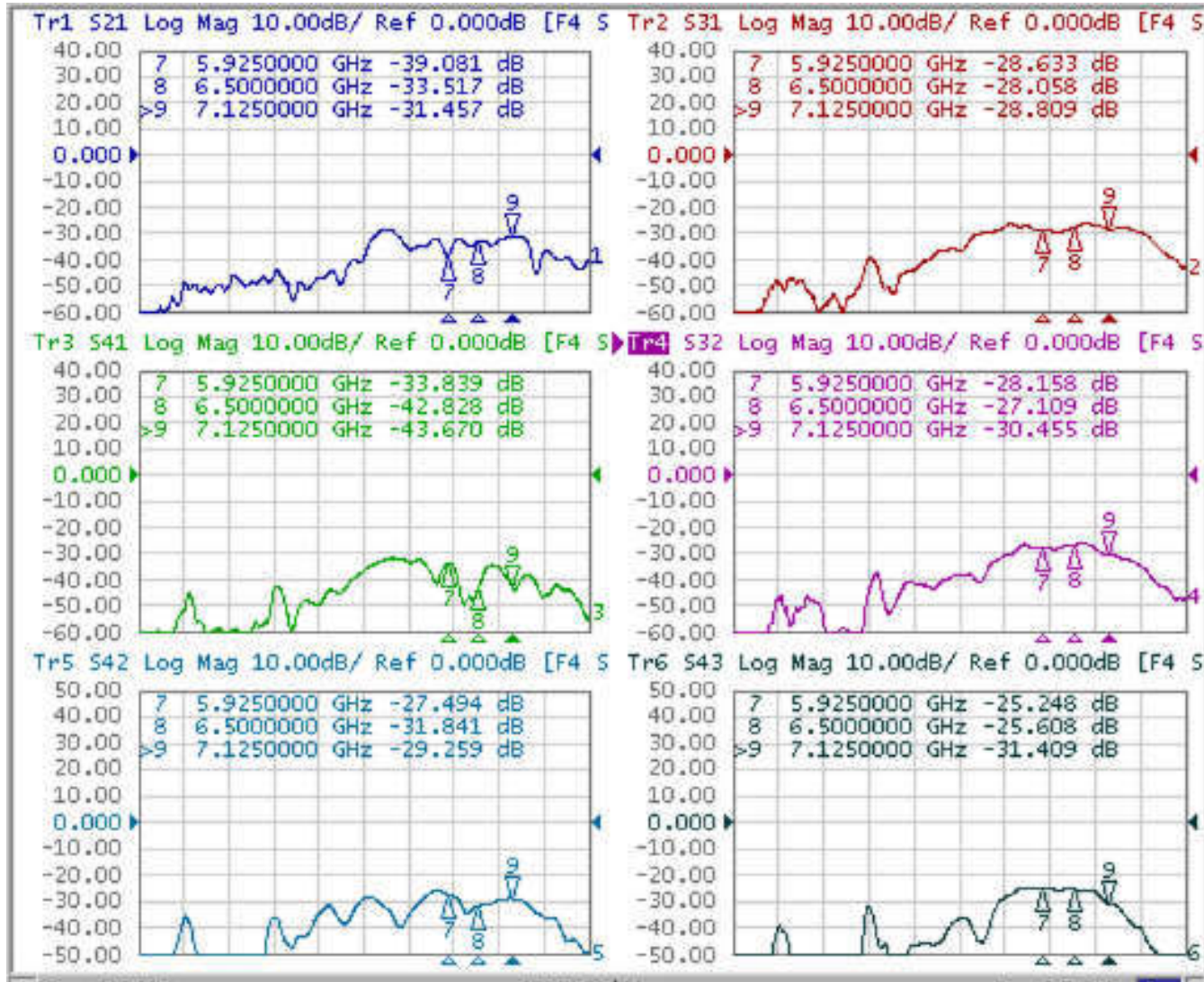

# Antenna Isolation of the 2.4GHz and 5GHz

- Port1= 2G0
- Port2= 2G1
- Port3= 5G0
- Port4= 5G1

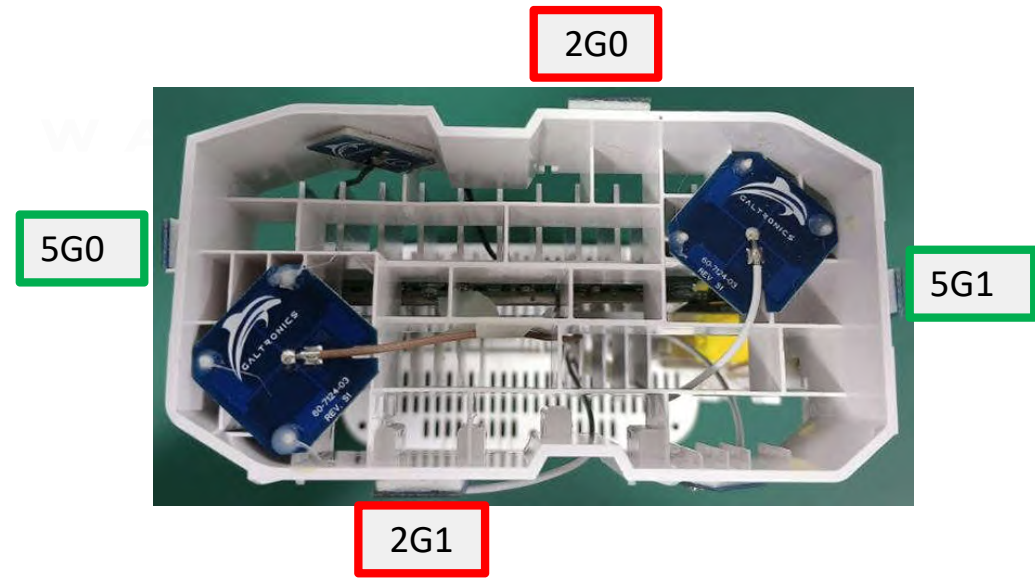
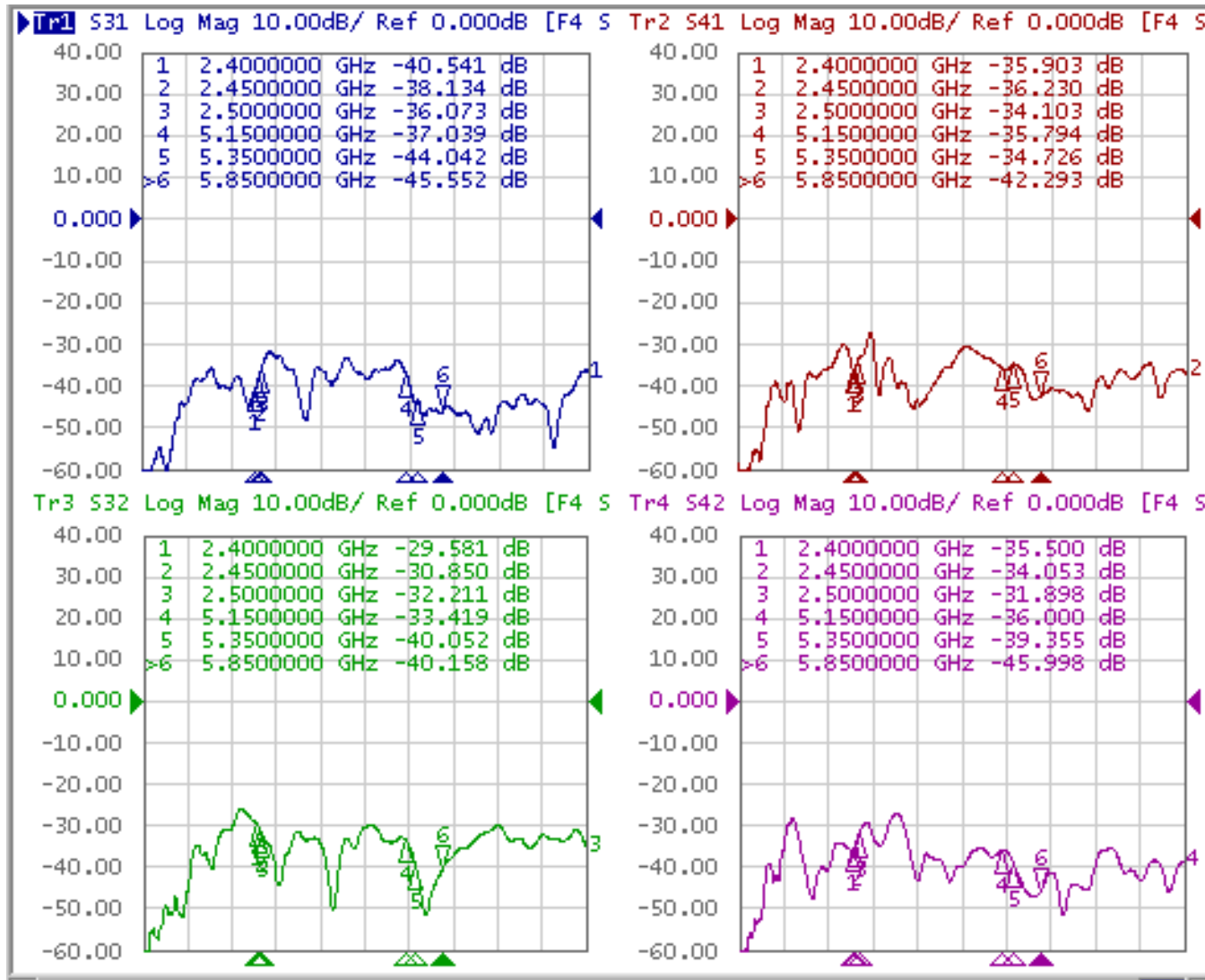

# Antenna Isolation of the 2.4GHz and 6GHz

- Port1= 2G0
- Port2= 2G1
- Port3= 6G0
- Port4= 6G1

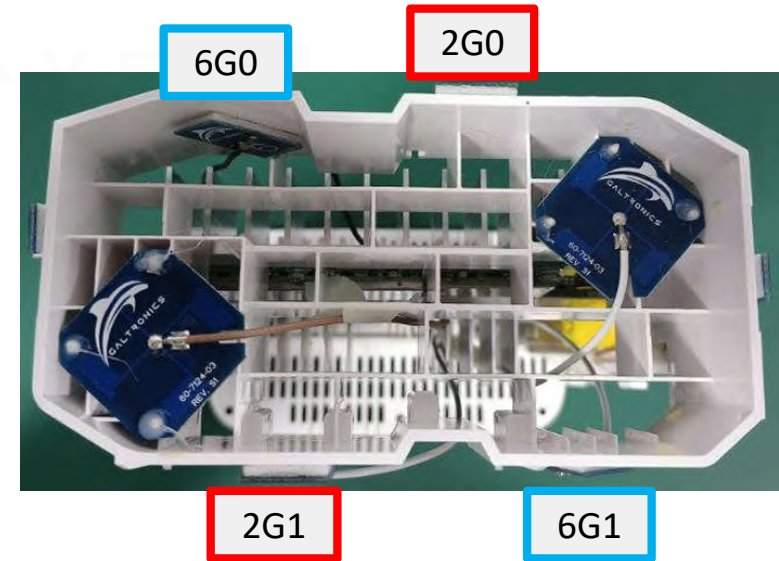
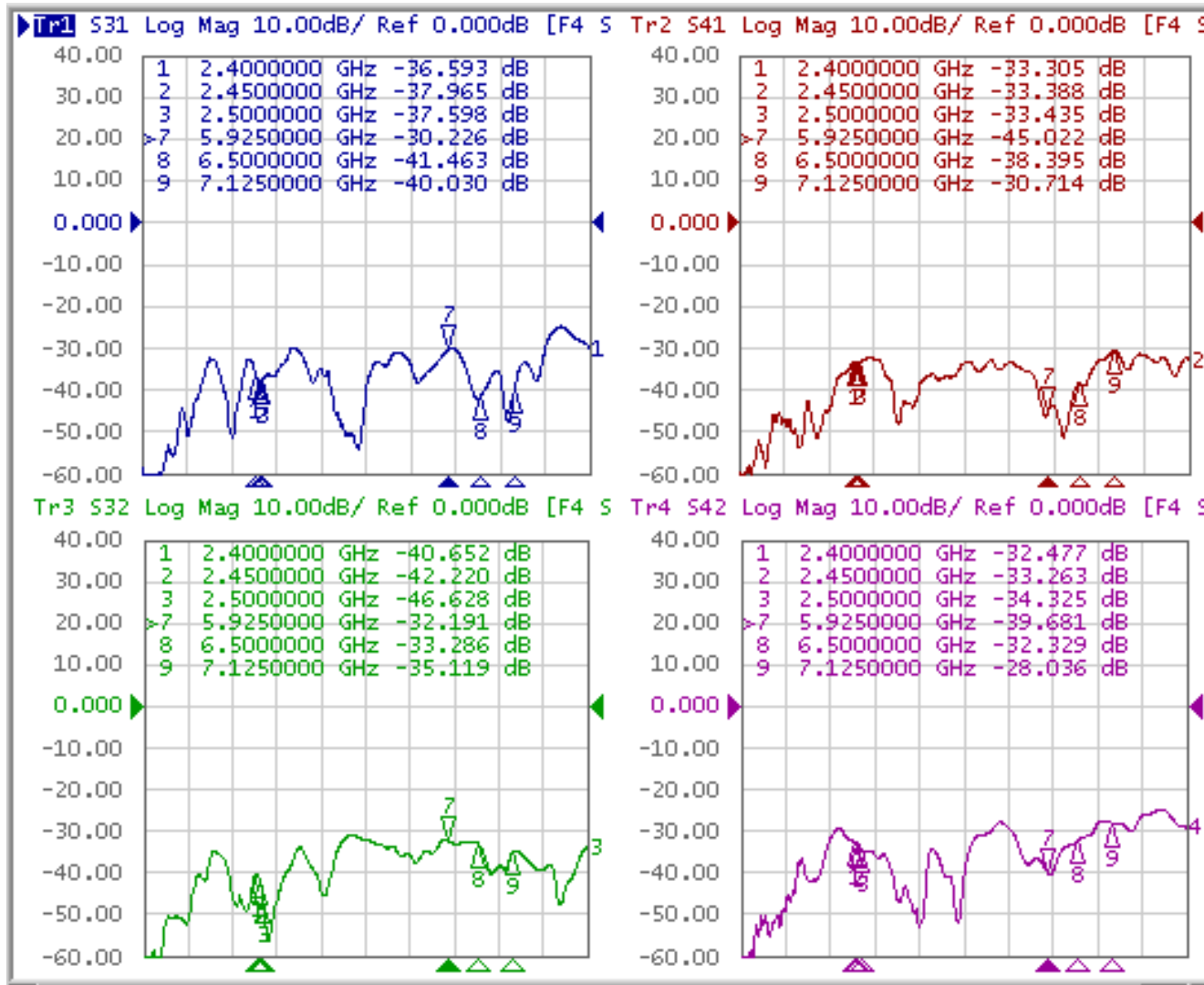

# Antenna Isolation of the 2.4GHz and 6GHz

- Port1= 2G0
- Port2= 2G1
- Port3= 6G2
- Port4= 6G3

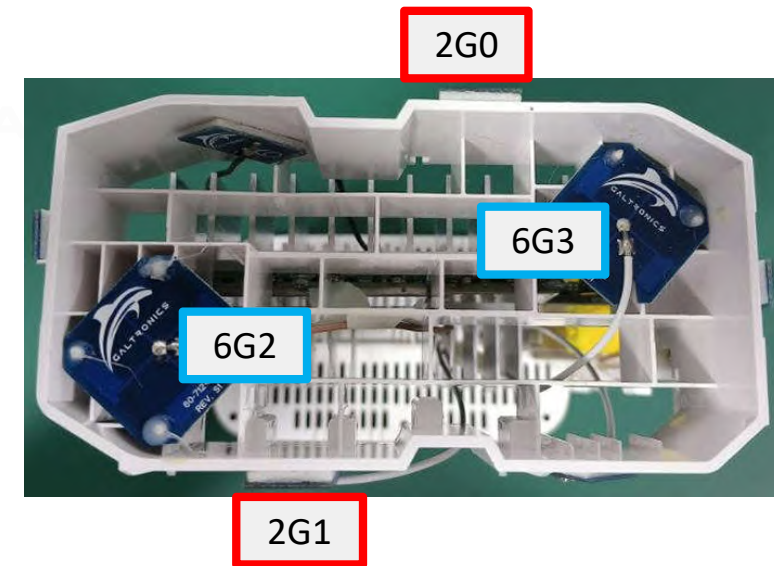
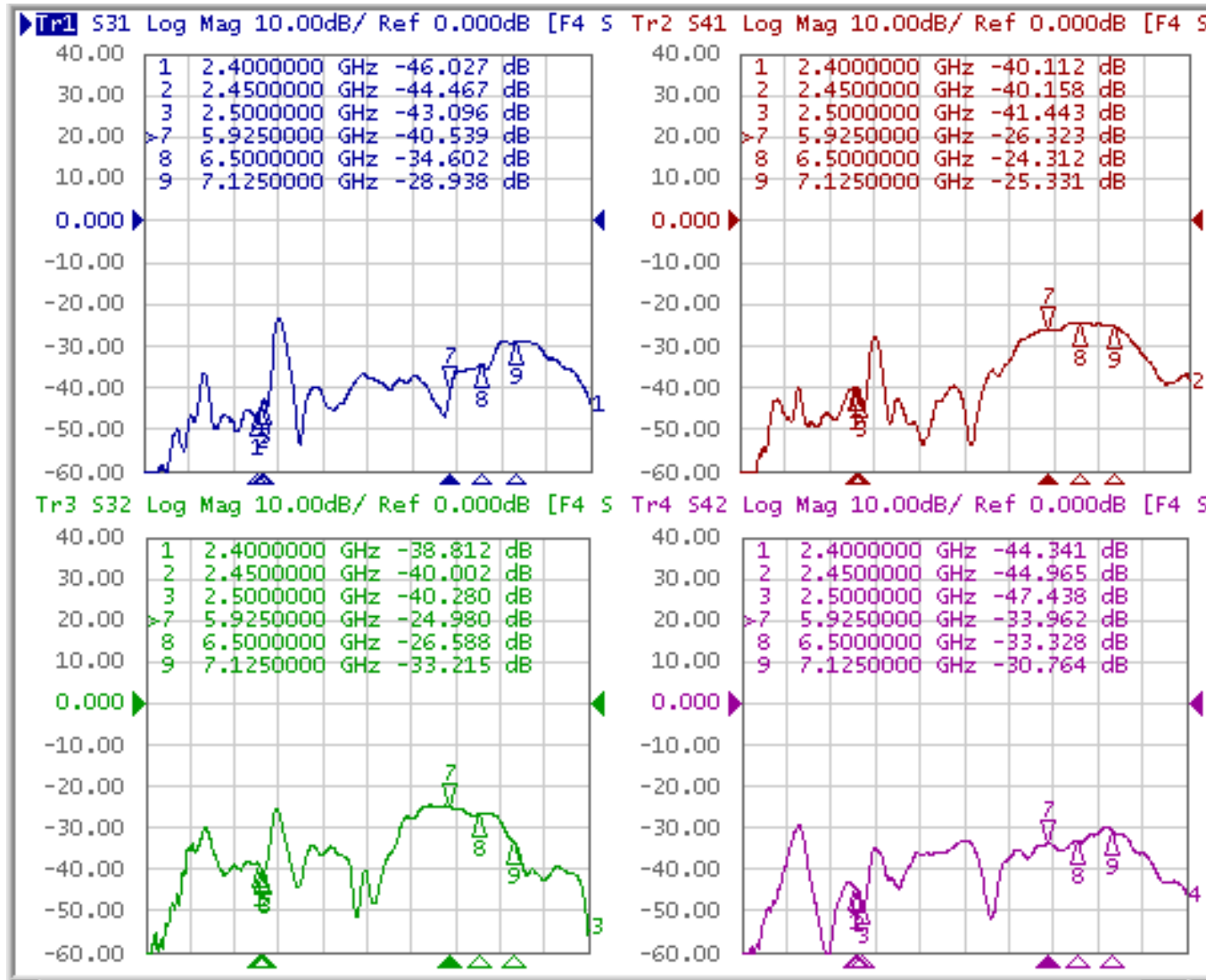

# Antenna Isolation of the 5GHz and 6GHz

Port 1 = 5G0

Port 2 = 5G1

Port 3 = 6G0

Port 4 = 6G1

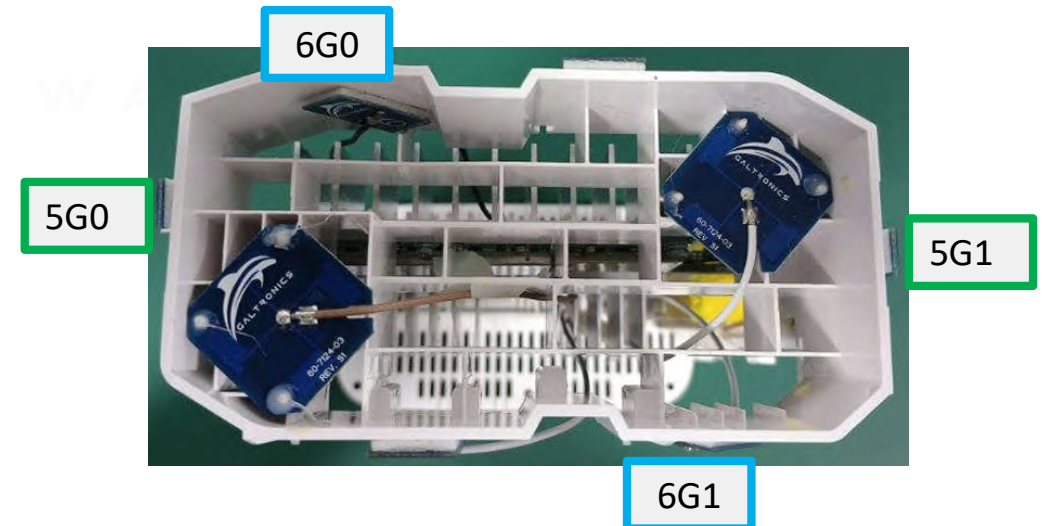
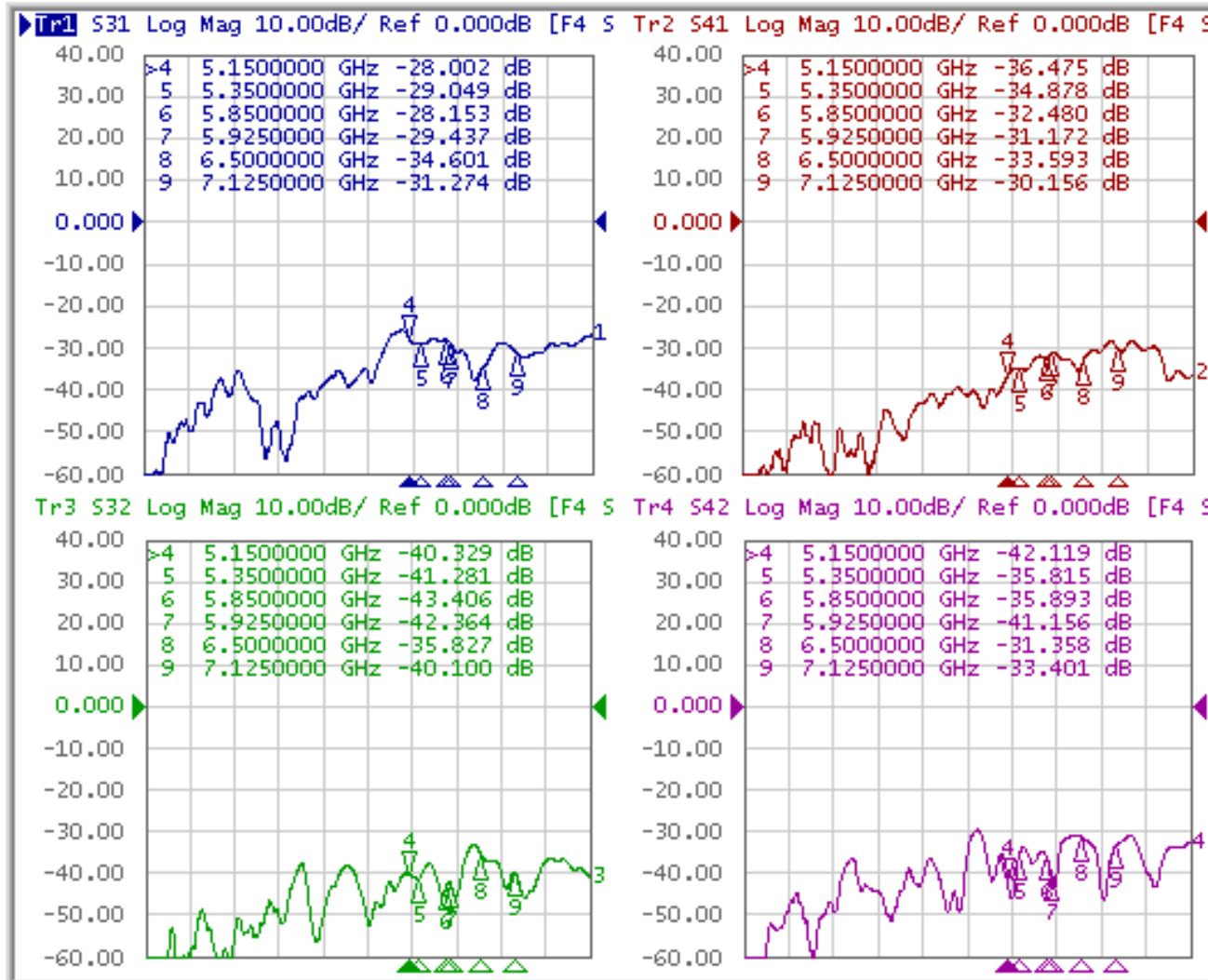

# Antenna Isolation of the 5GHz and 6GHz

- Port 1 = 5G0
- Port 2 = 5G1
- Port 3 = 6G2
- Port 4 = 6G3

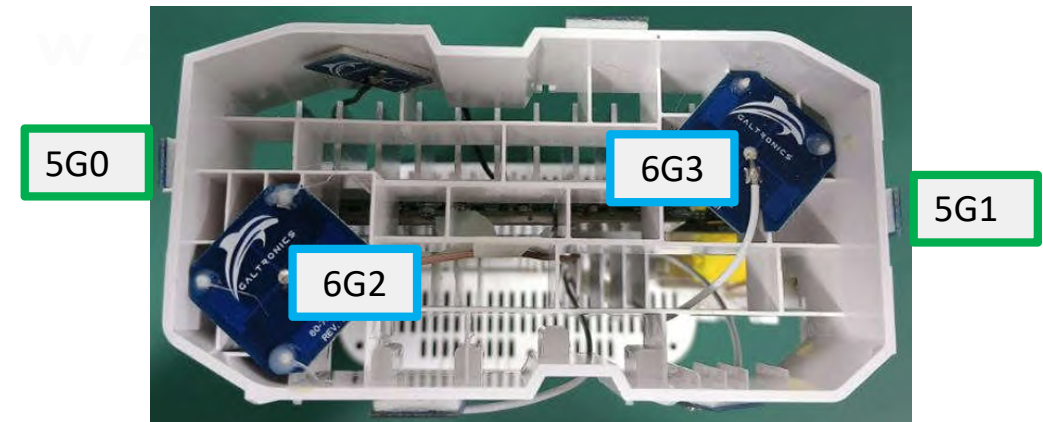
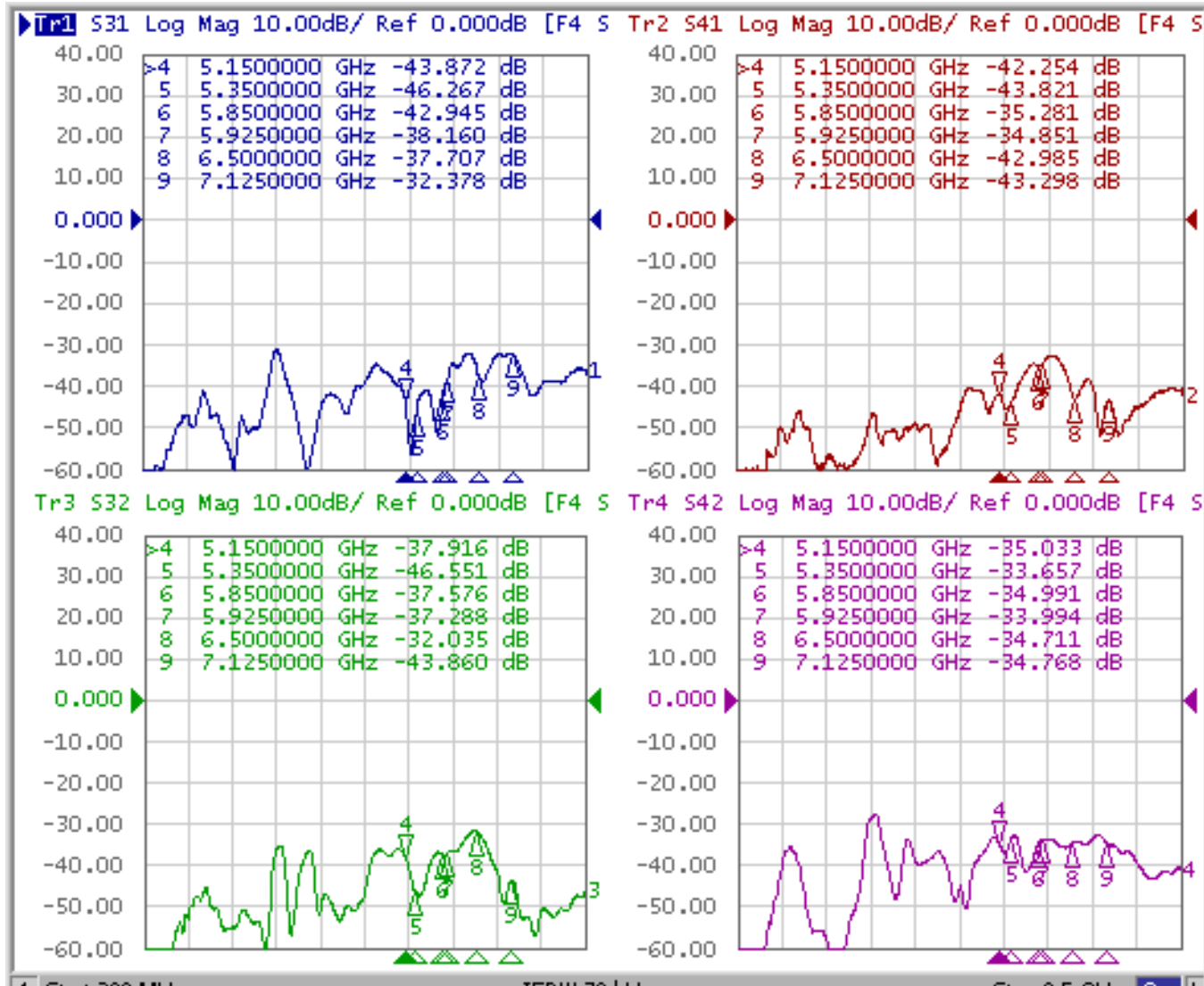



# Antenna Isolation of the BT and 2.4GHz

- Port 1 = 2G0
- Port 2 = 2G1
- Port 3 = BT

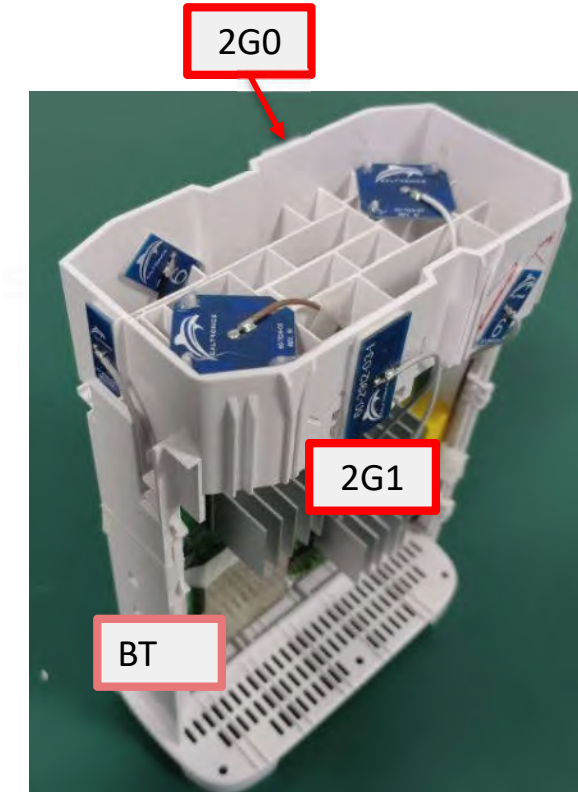
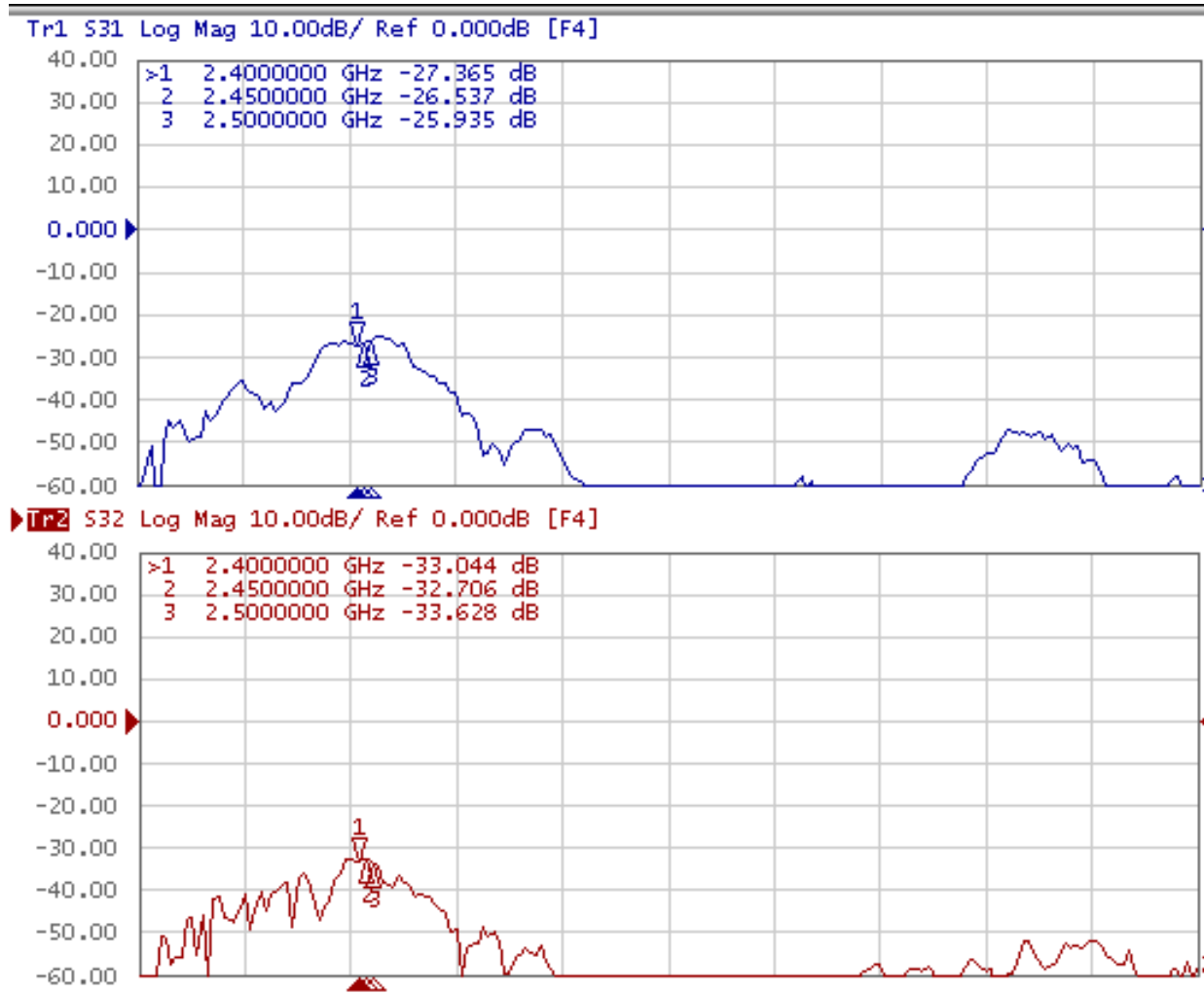

WAVES

# Antenna Isolation of the BT and 5GHz

- Port 1 = 5G0
- Port 2 = 5G1
- Port 3 = BT

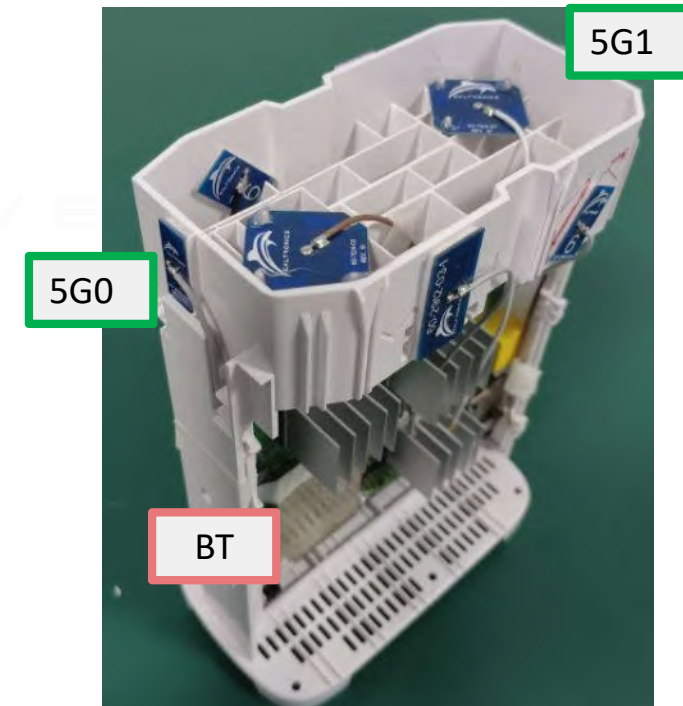
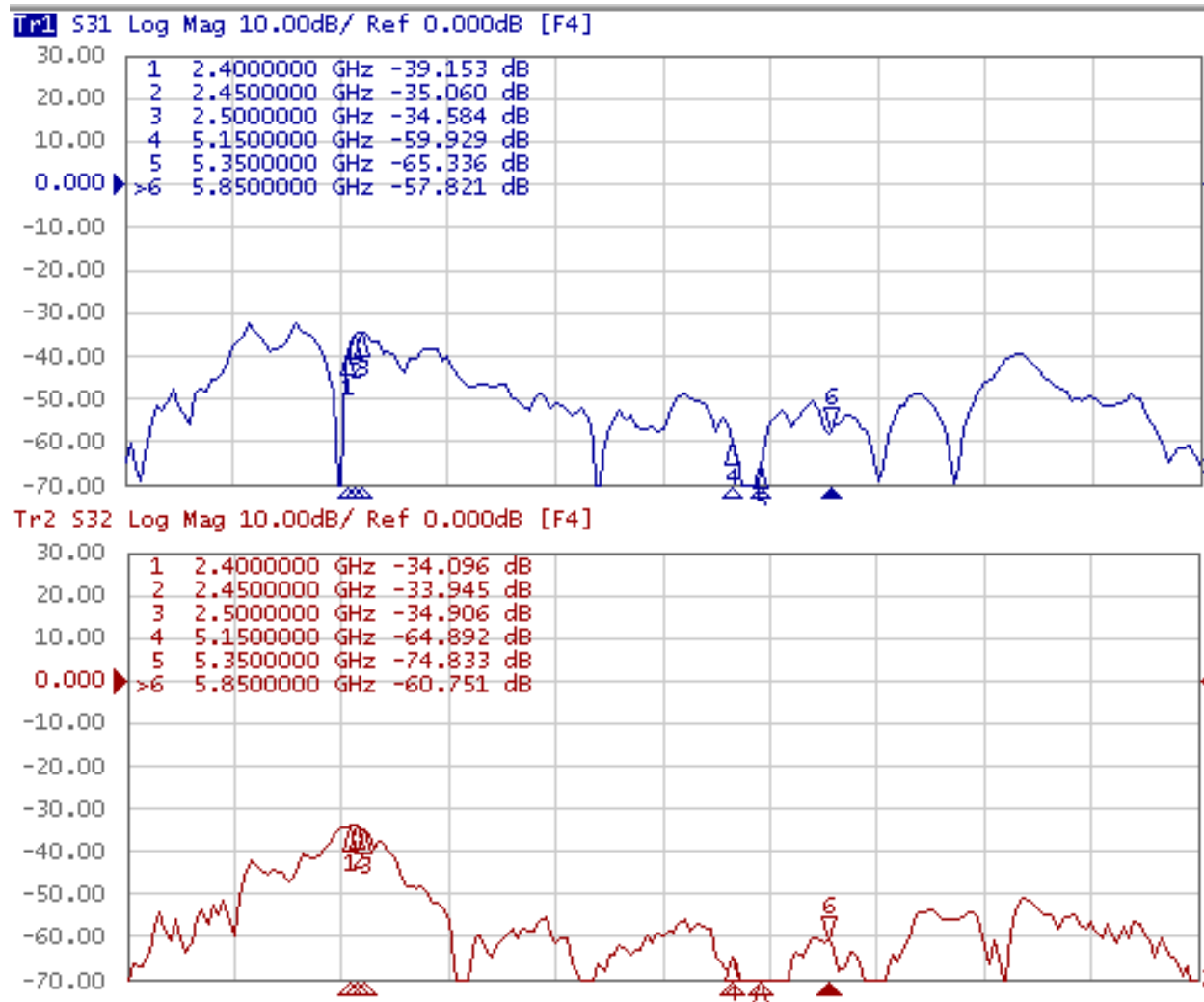

WAVE

# Antenna Isolation of the BT and 6GHz

- Port 1 = 6G0
- Port 2 = 6G1
- Port 3 = BT

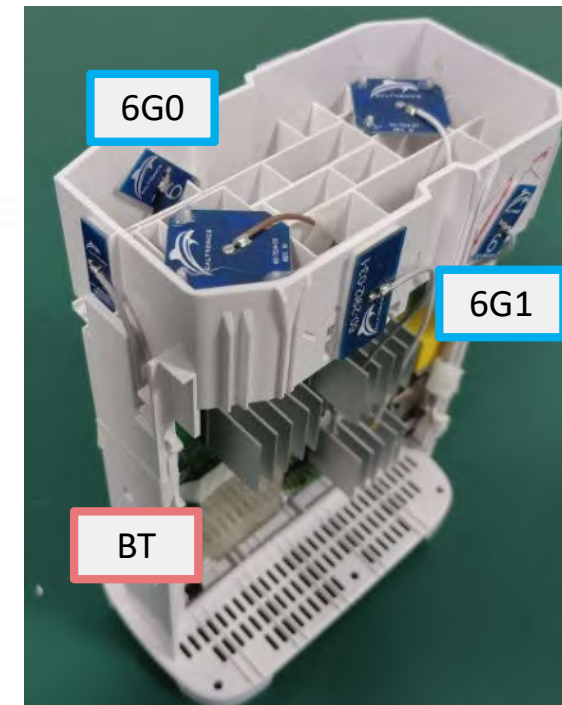
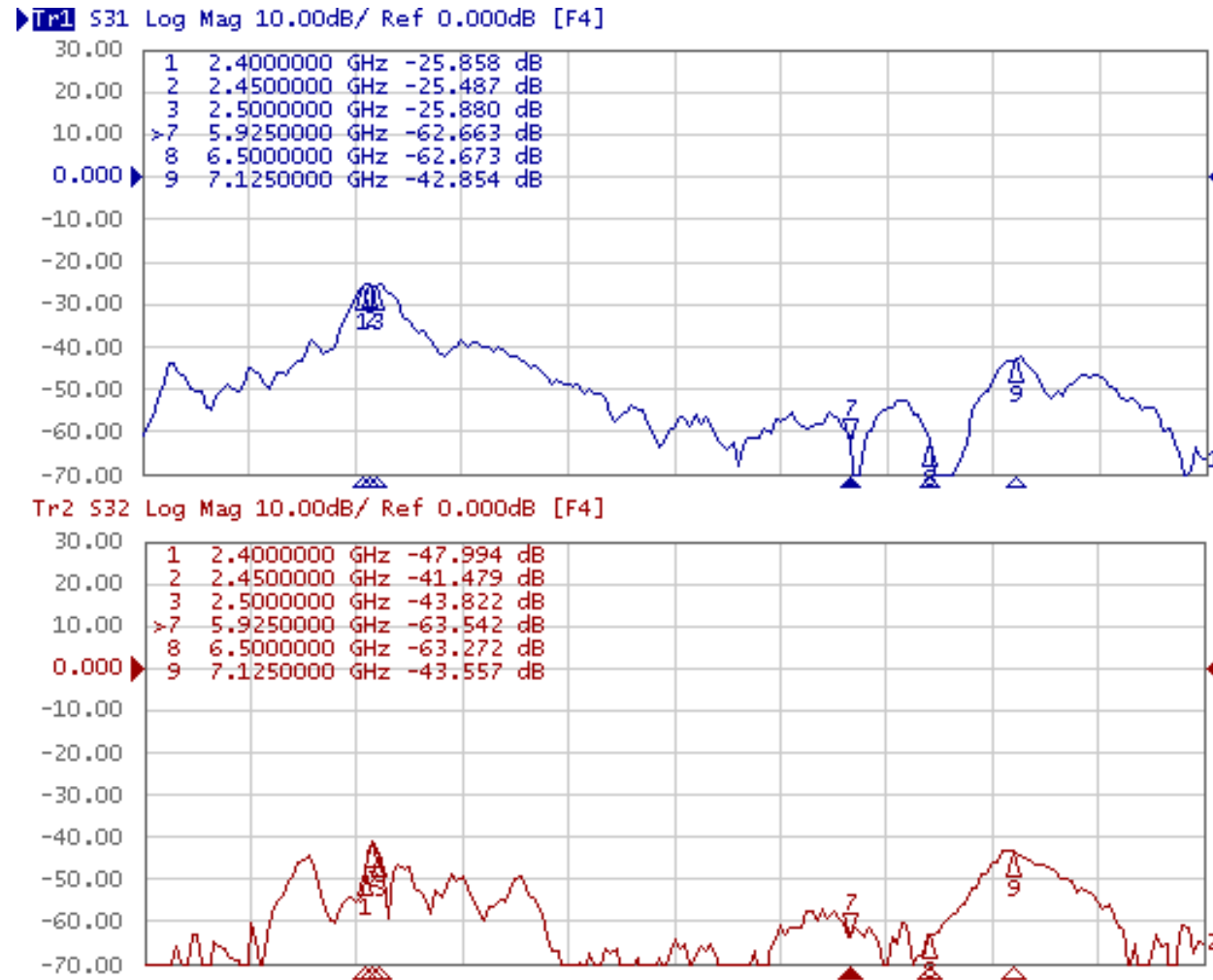

WAVE

# Antenna Isolation of the BT and 6GHz

- Port 1 = 6G2
- Port 2 = 6G3
- Port 3 = BT

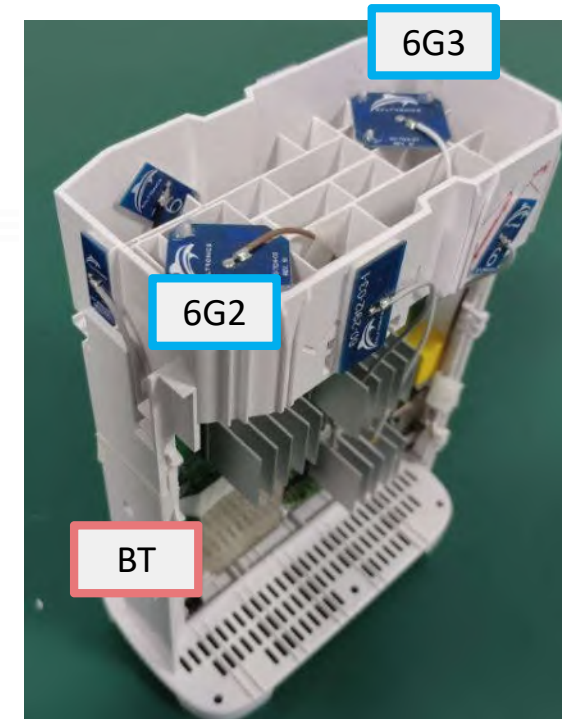
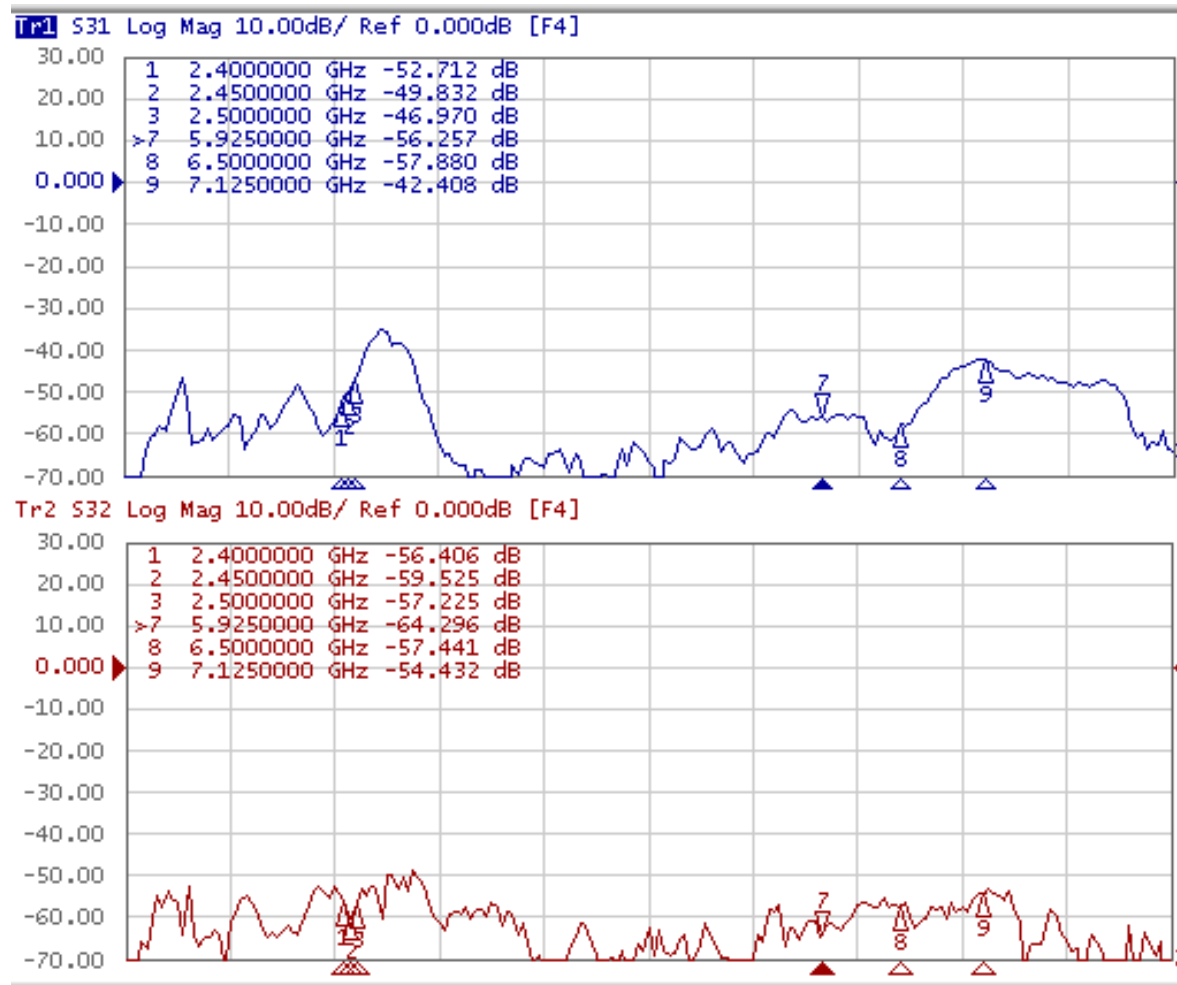

G W A V E

# Power Sum-2.4GHz Band- Azimuth(XY)

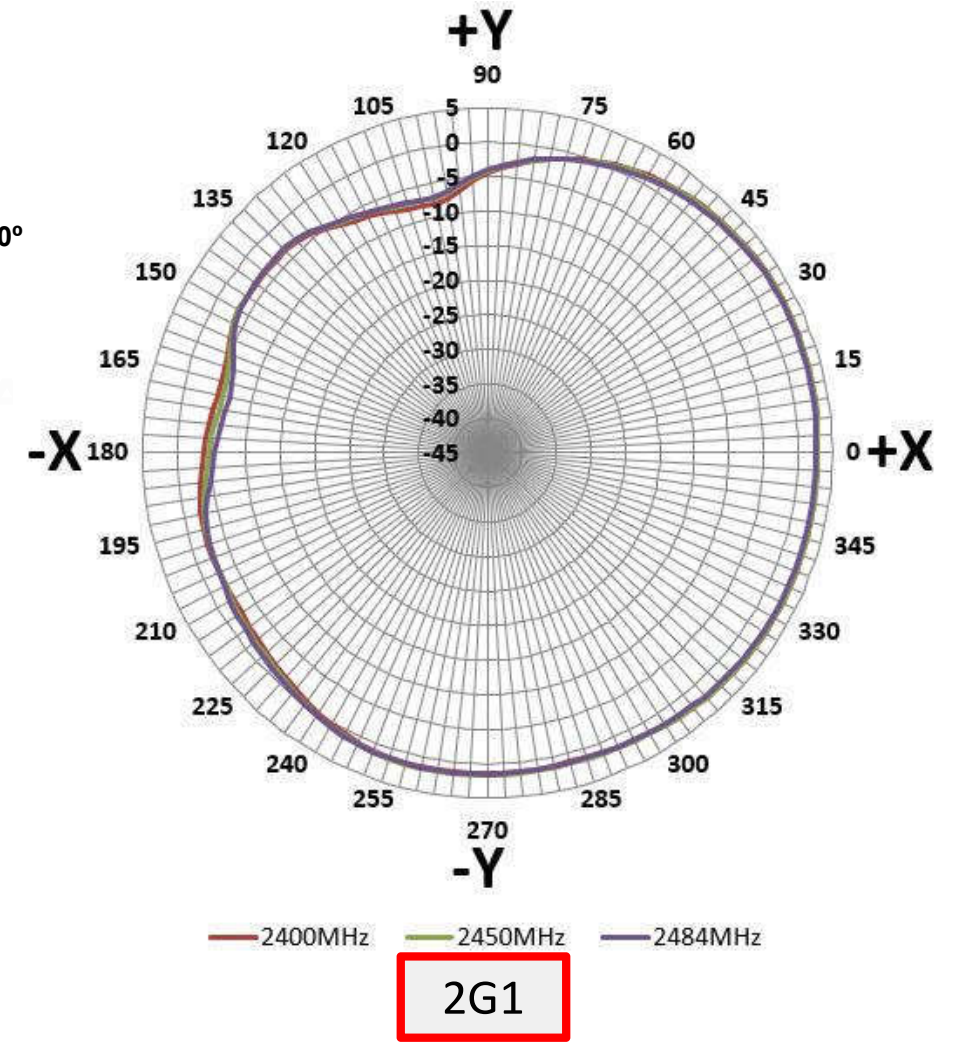
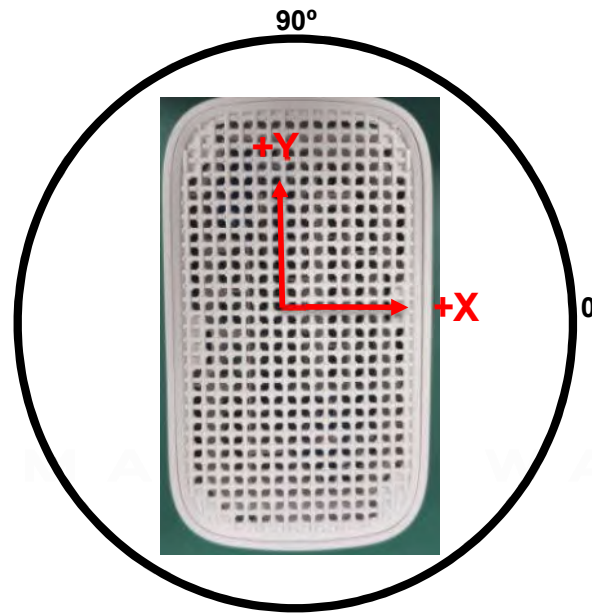
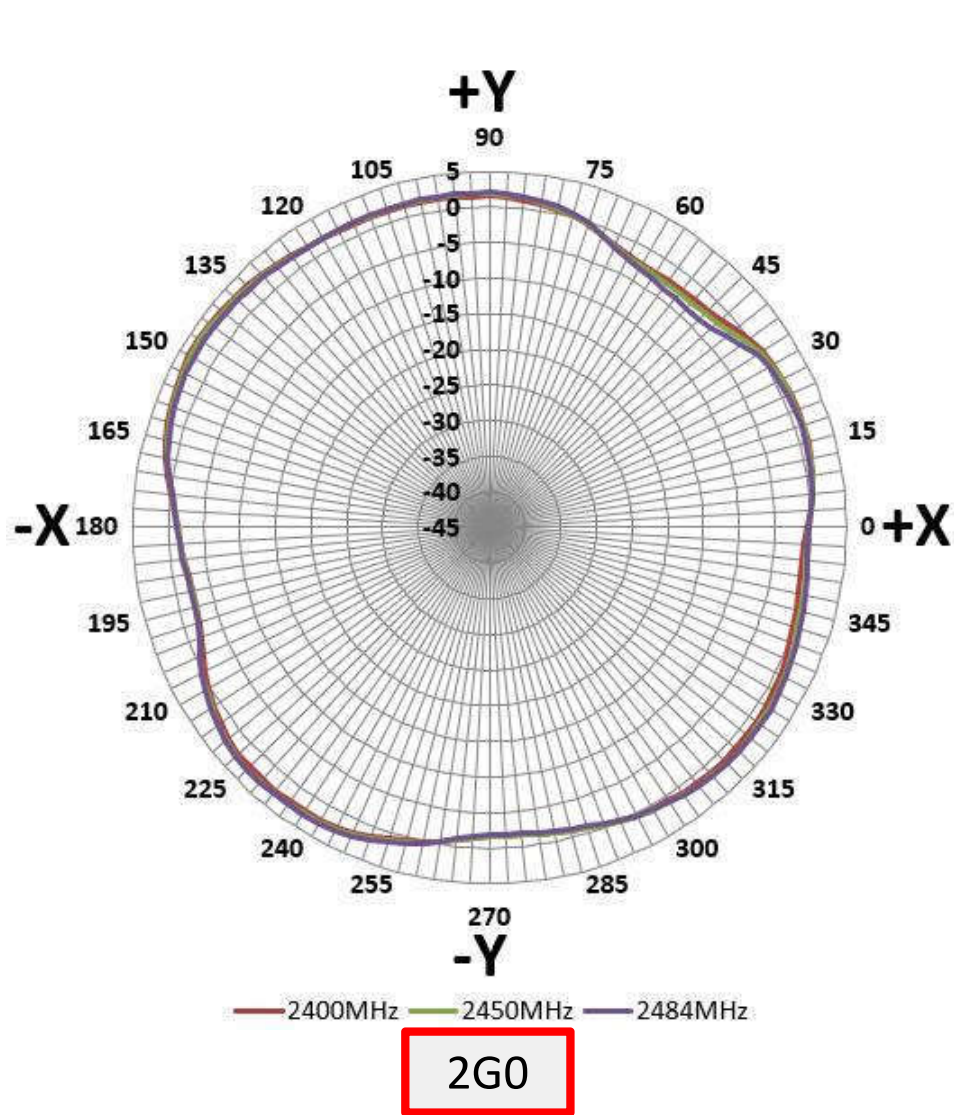

# Power Sum-2.4GHz Band- Elevation Cut (ZX)

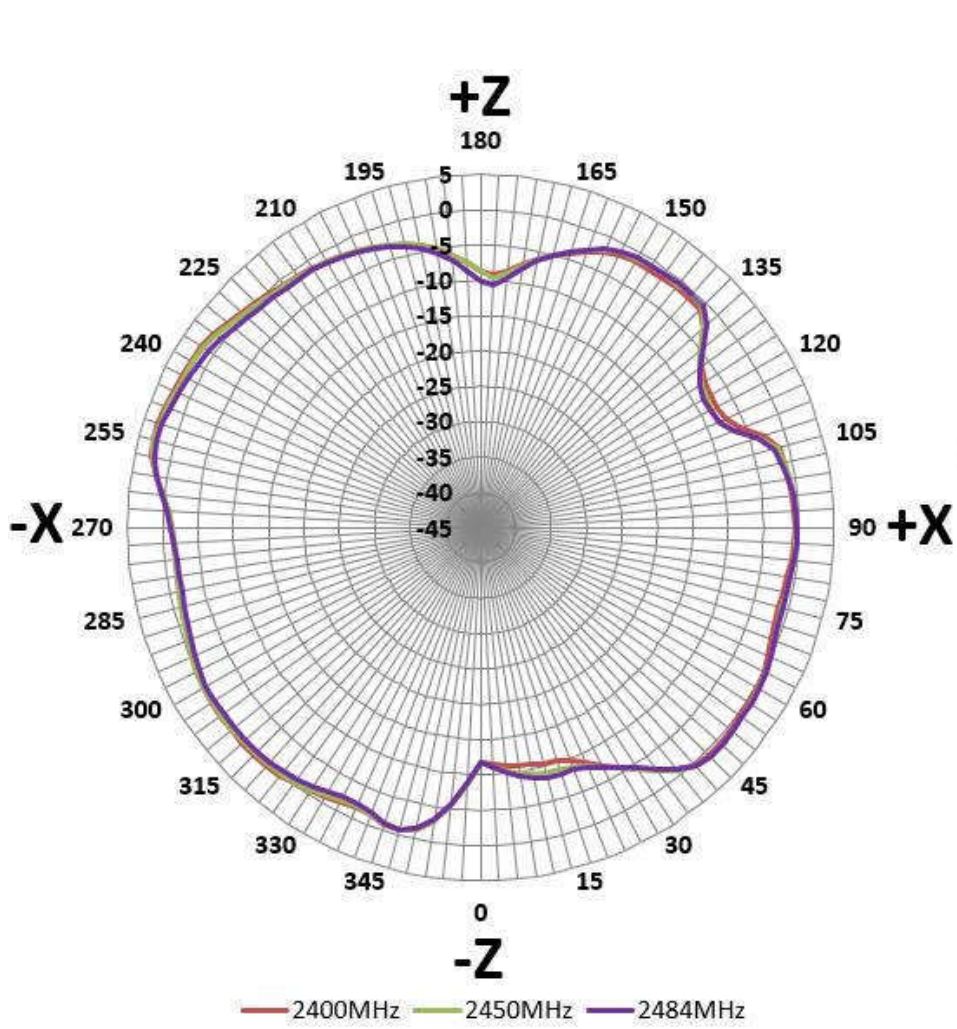

**2G0**

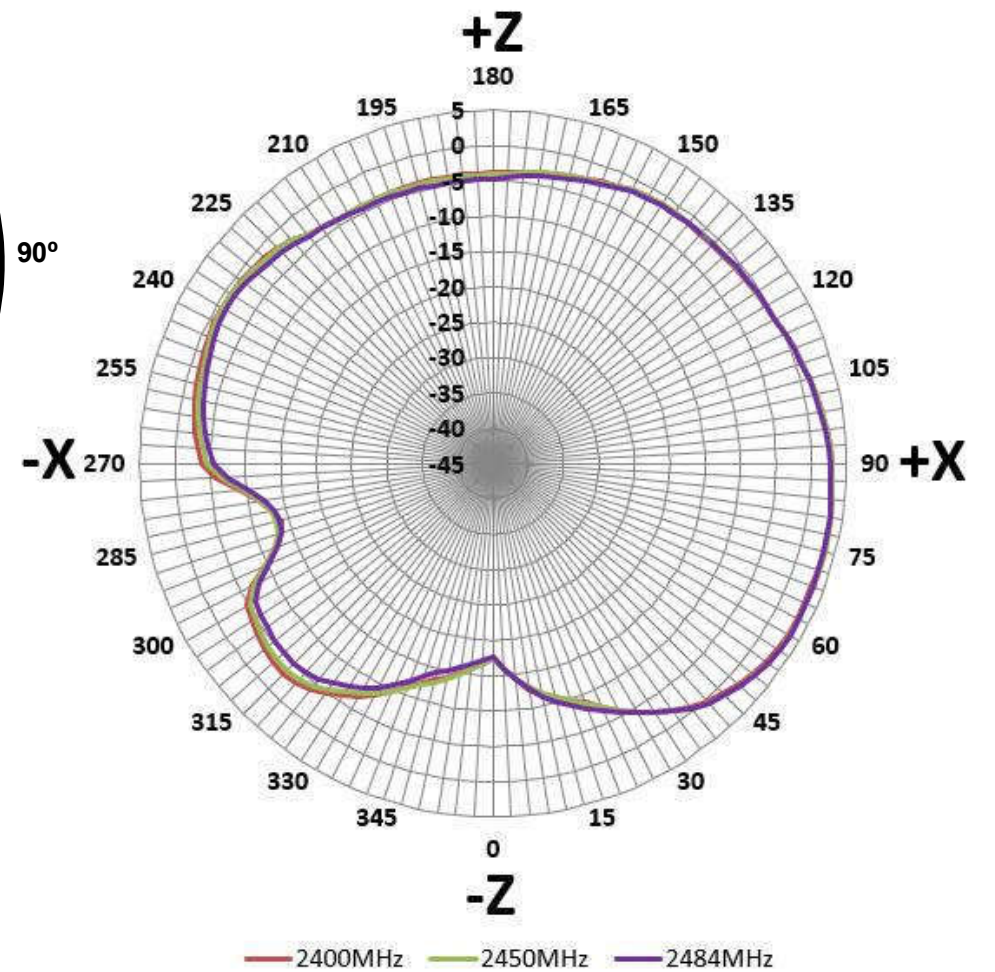
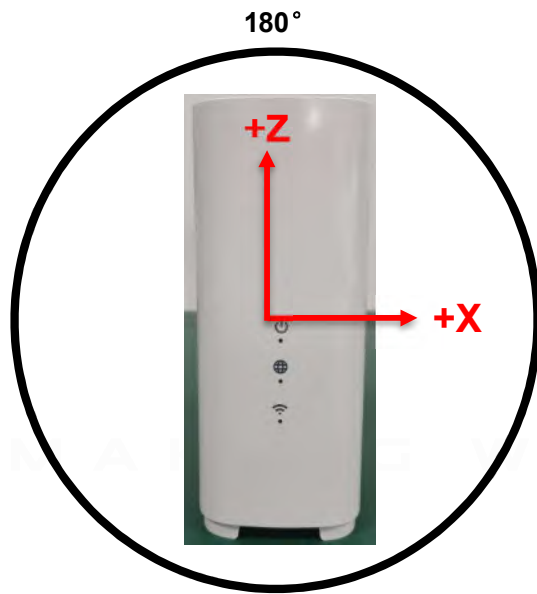

**2G1**

# Power Sum-2.4GHz Band- Elevation Cut (ZY)

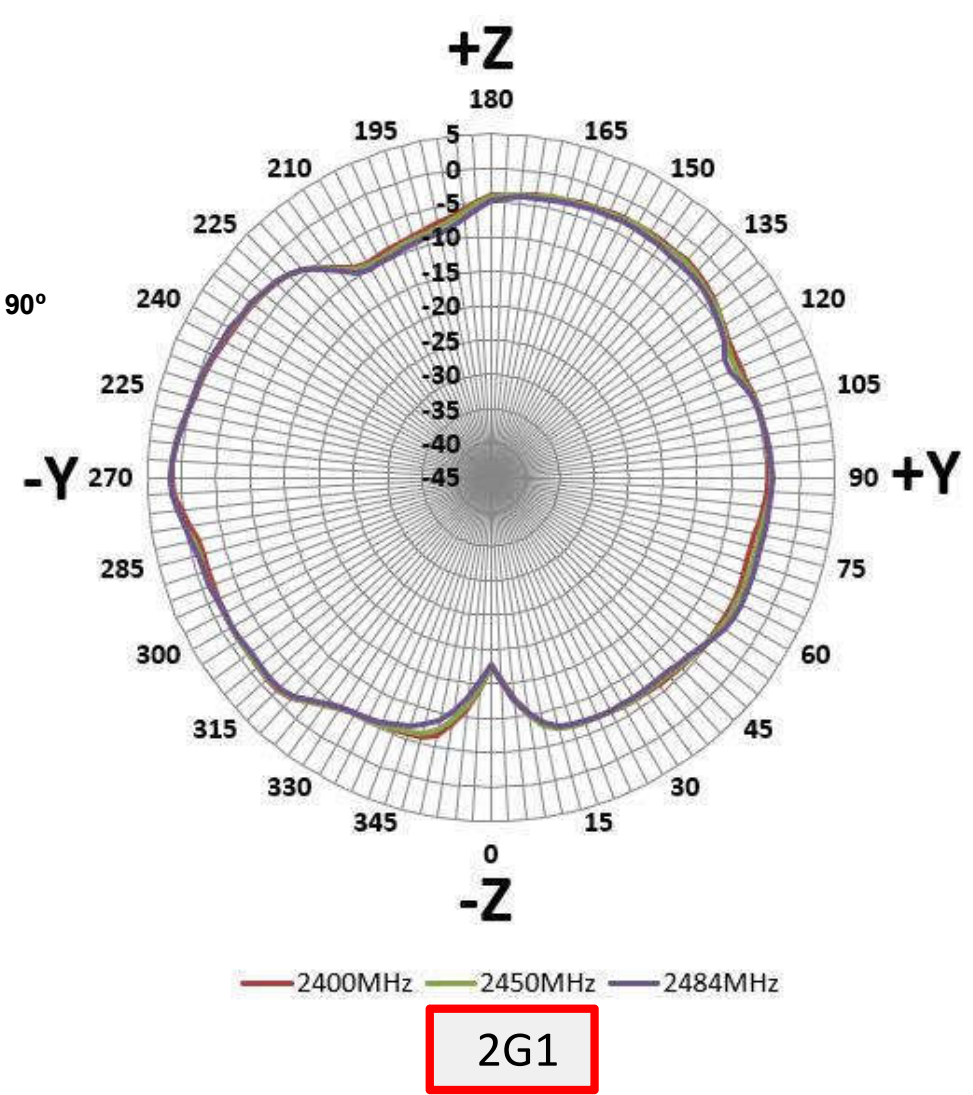
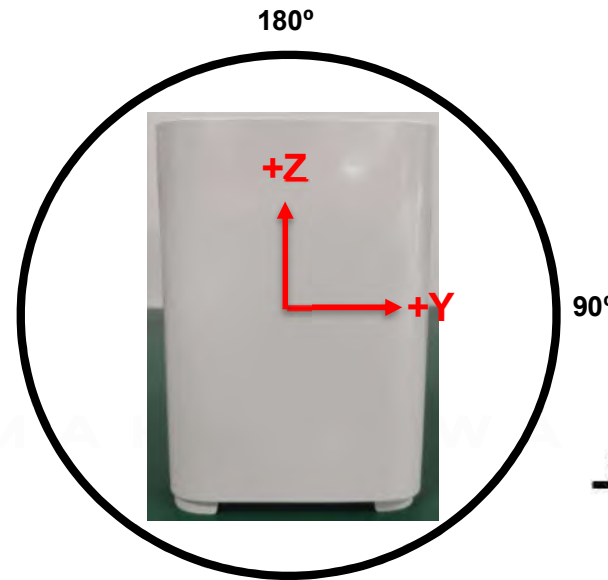
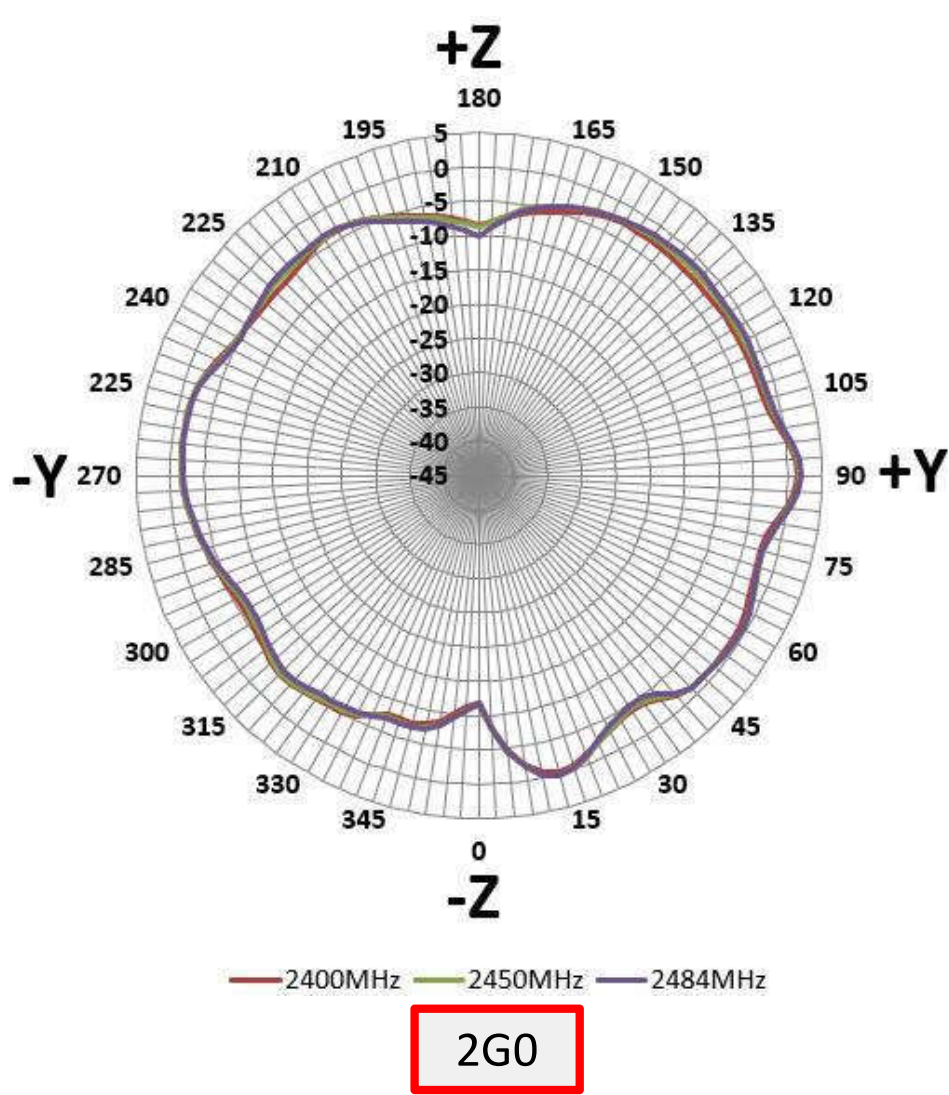

# Power Sum-5GHz Band- Azimuth(XY)

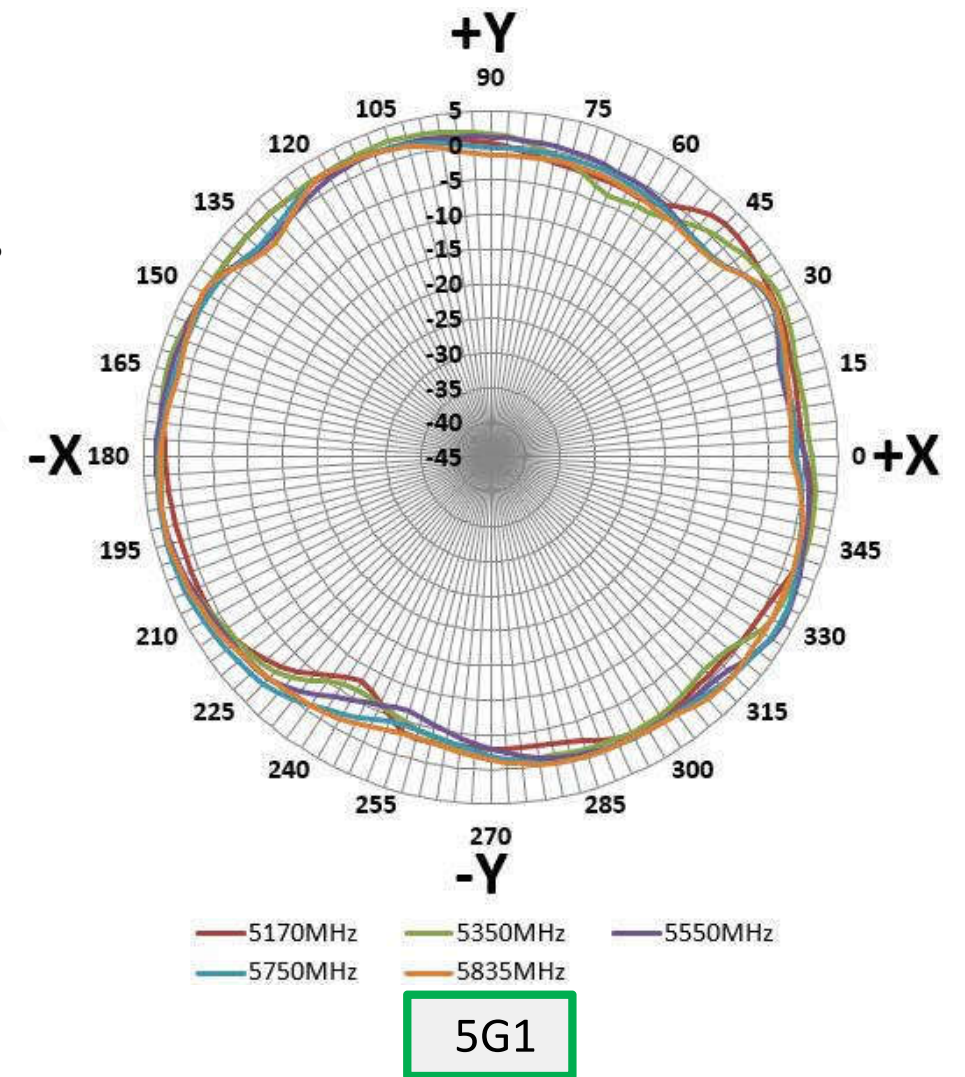
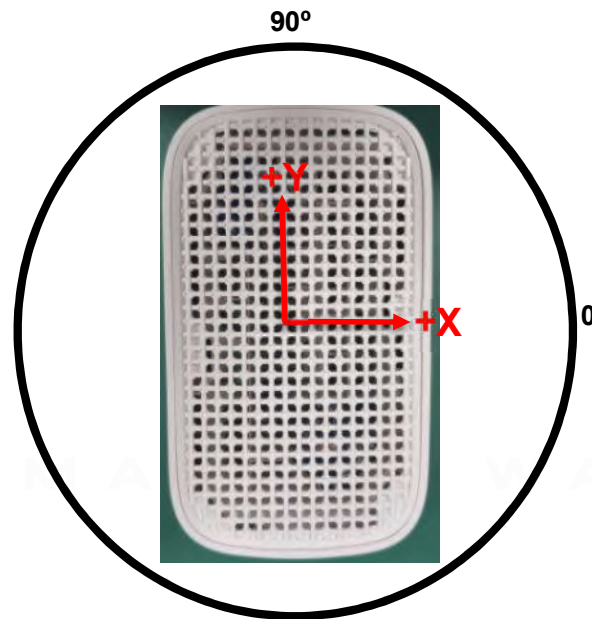
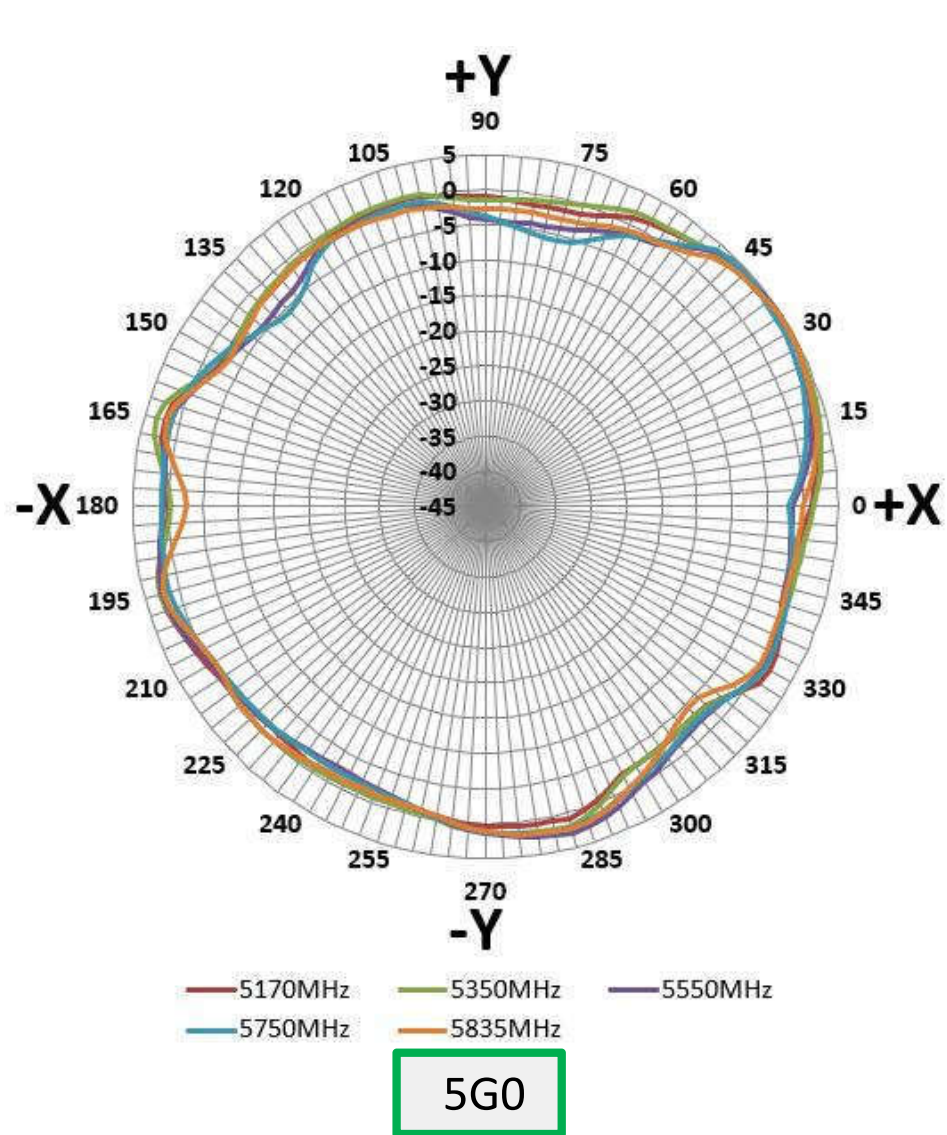



# Power Sum-5GHz Band- Elevation Cut (ZX)

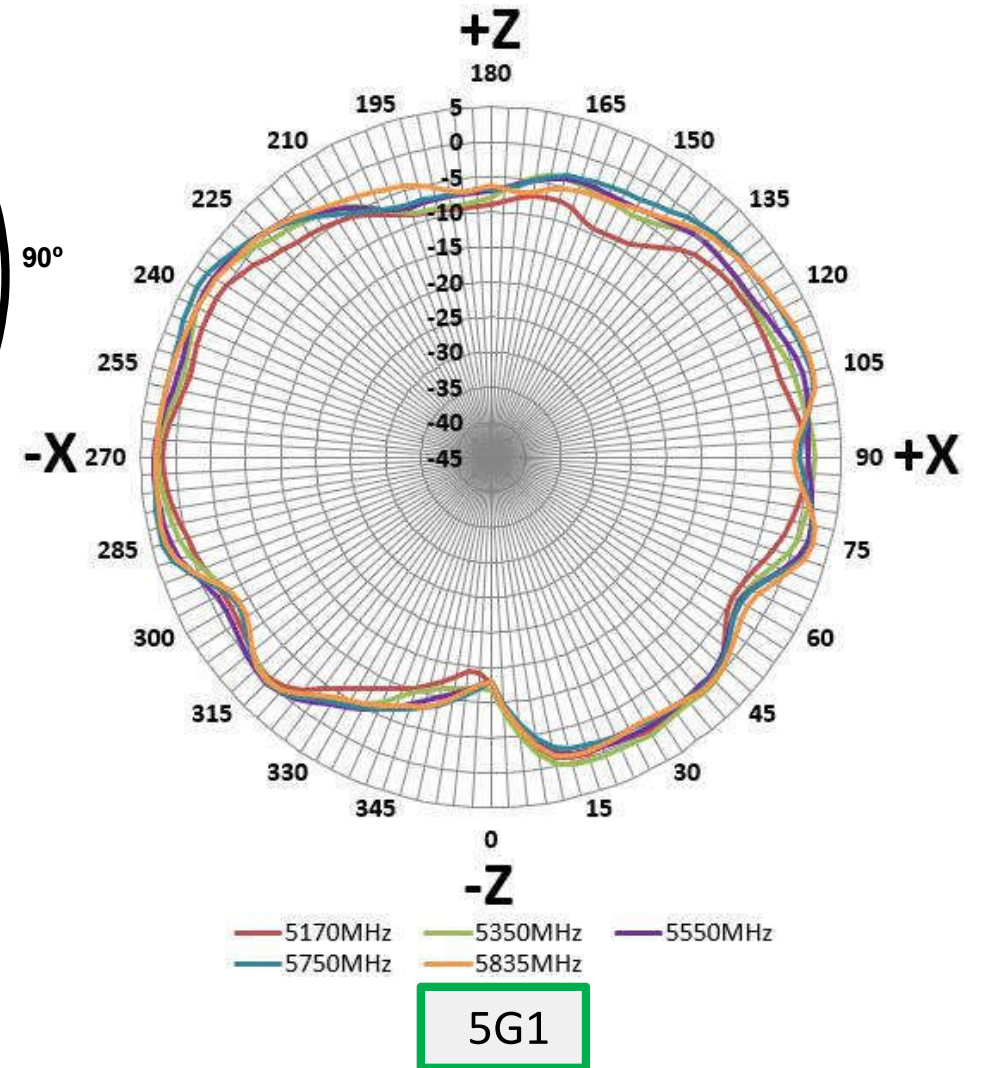
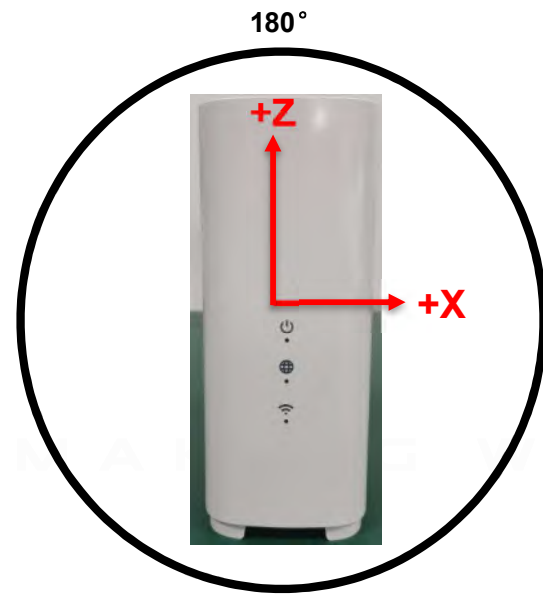
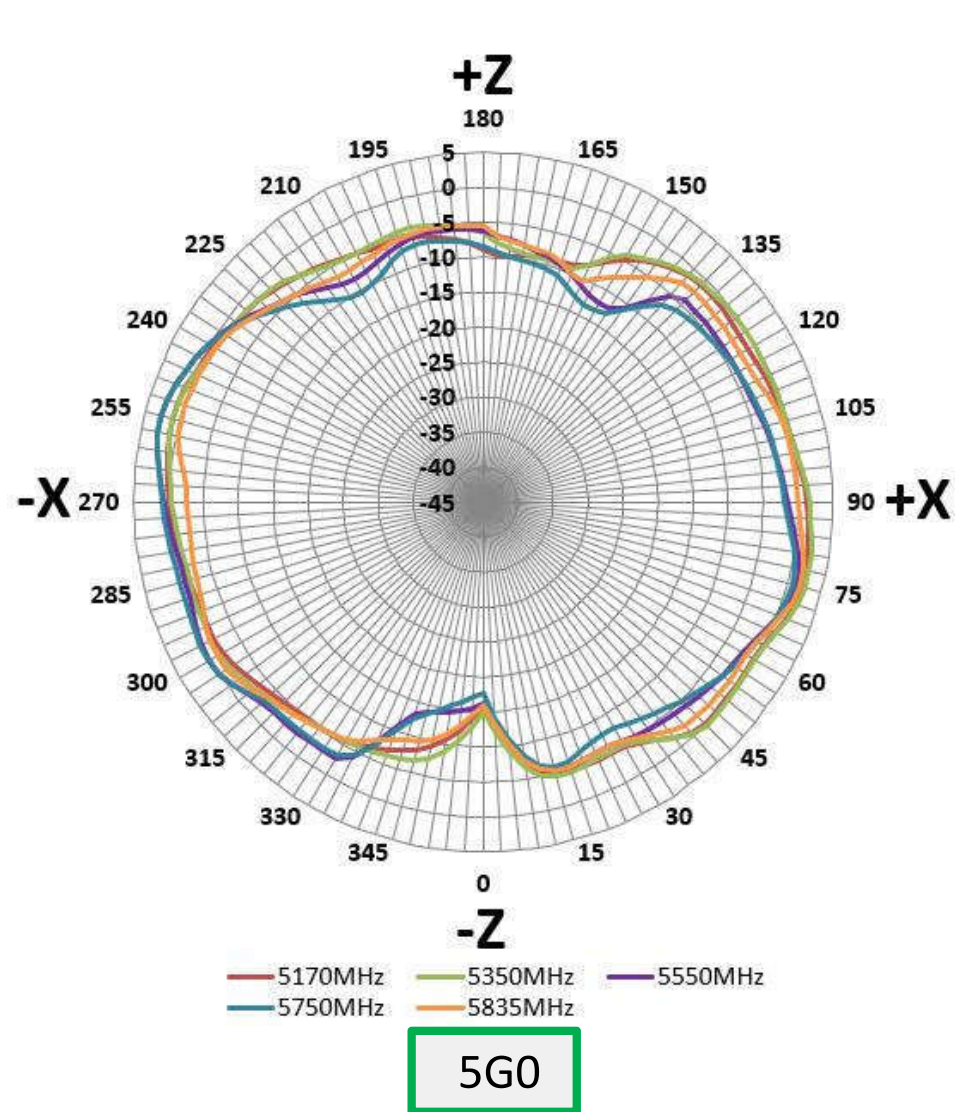

# Power Sum-5GHz Band- Elevation Cut (ZY)

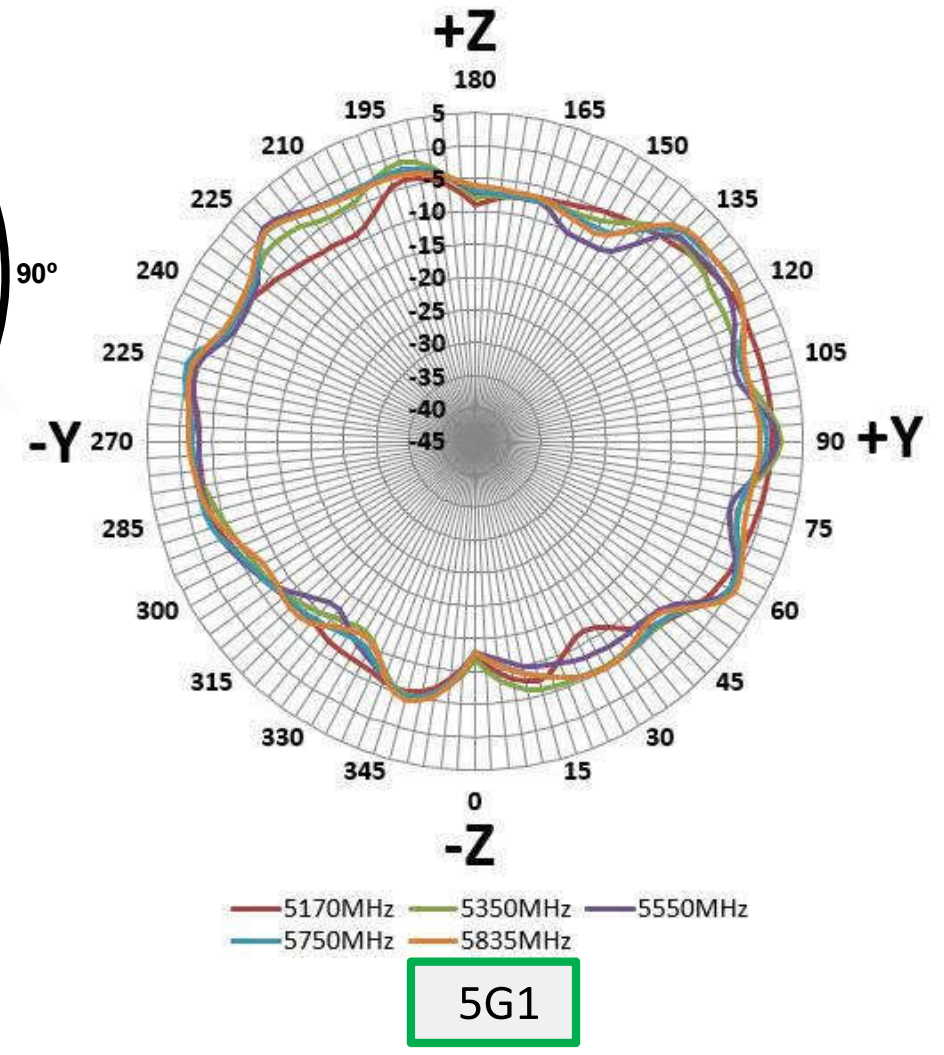
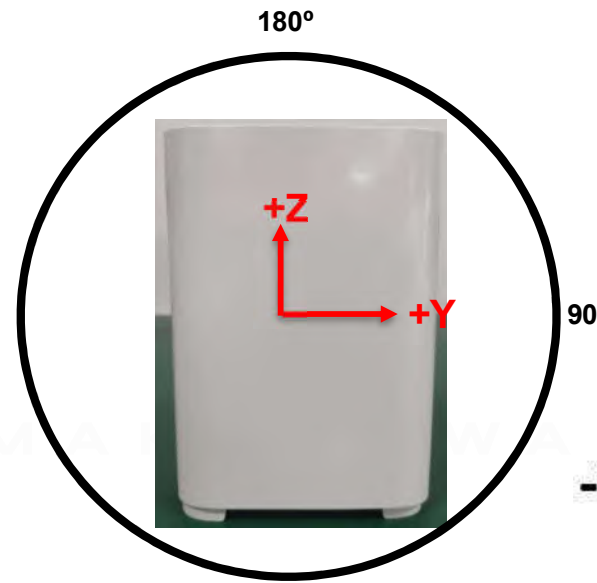
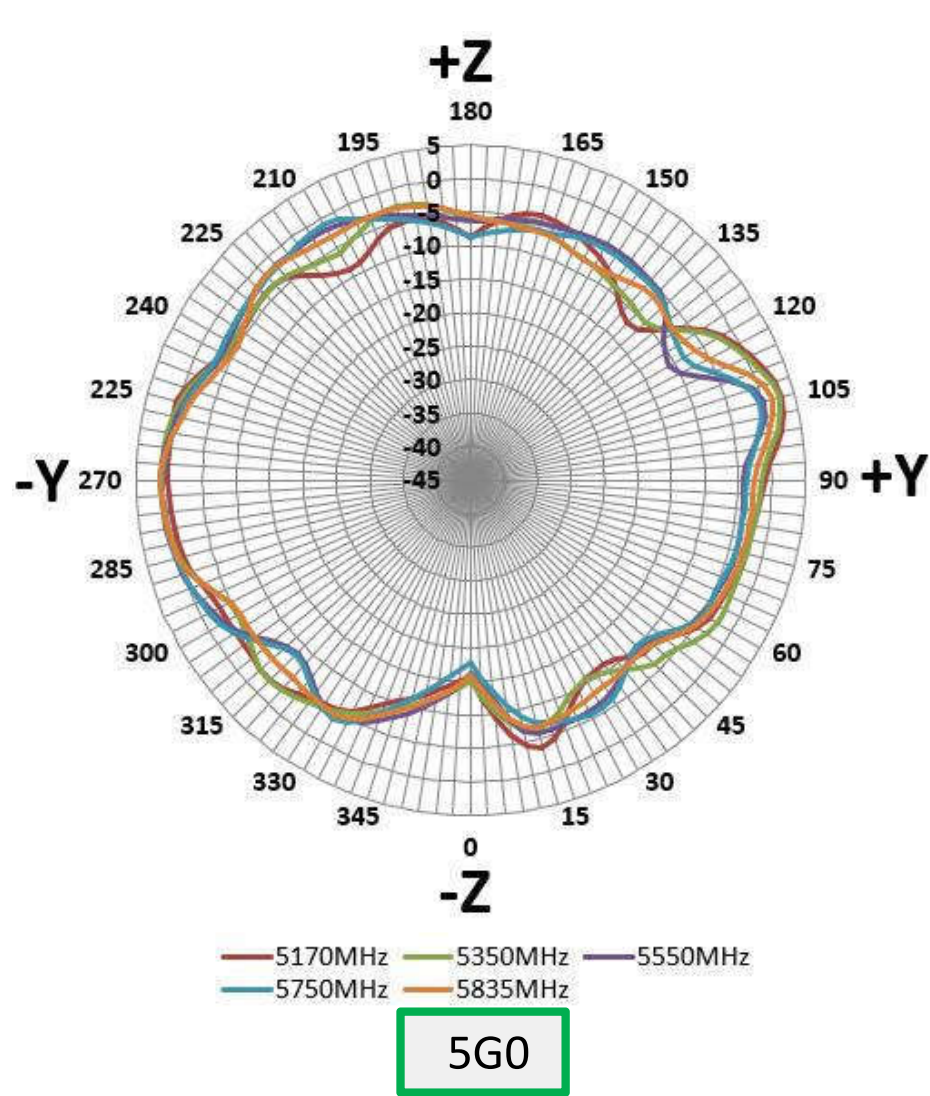

# Power Sum-6GHz Band- Azimuth(XY)

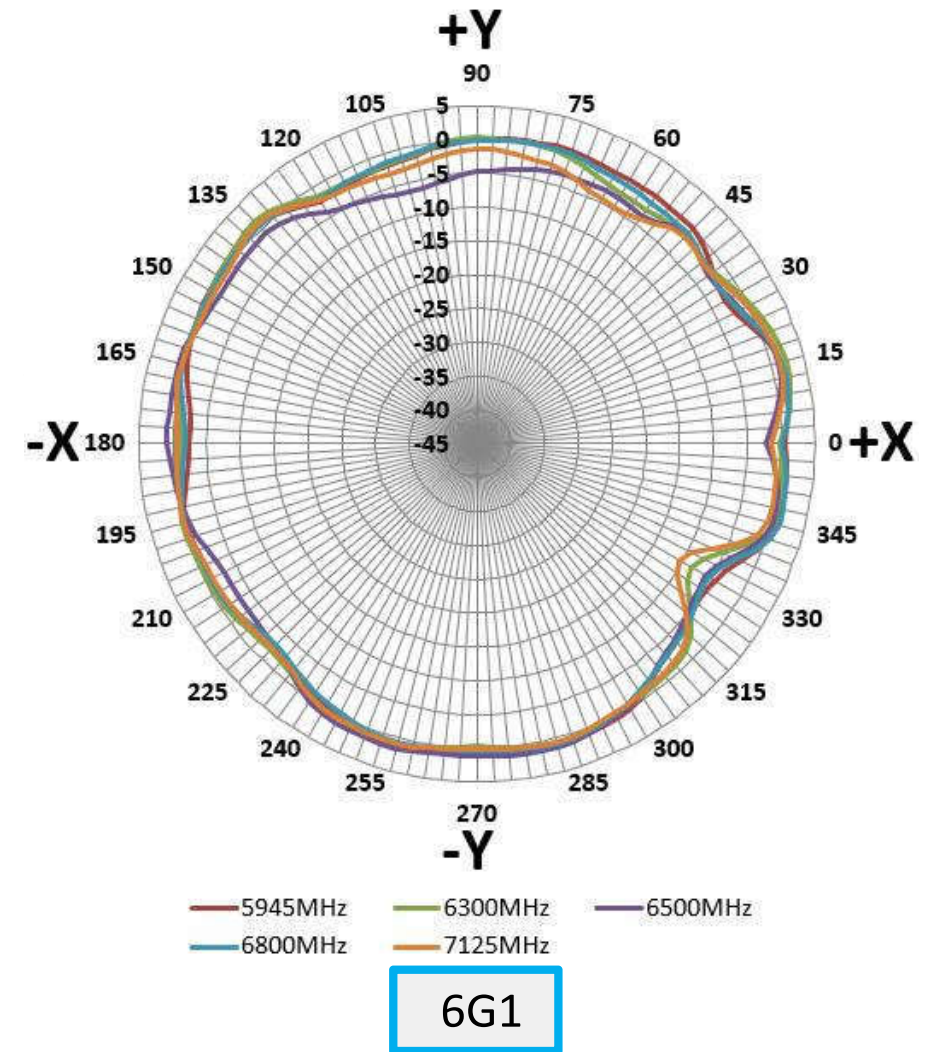
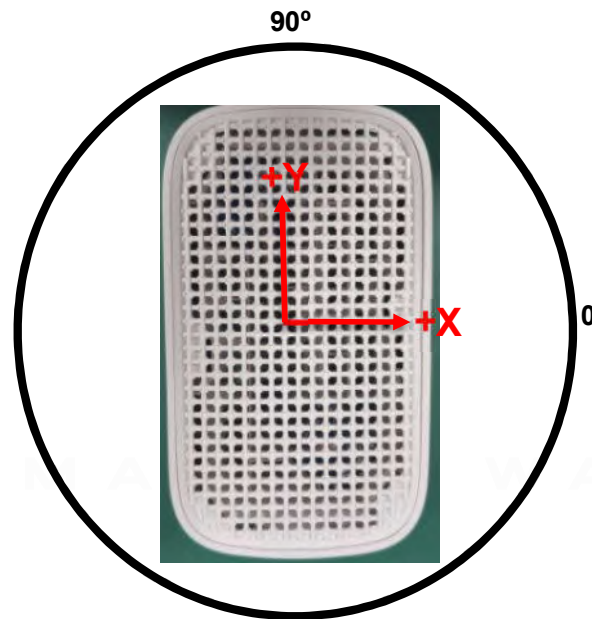
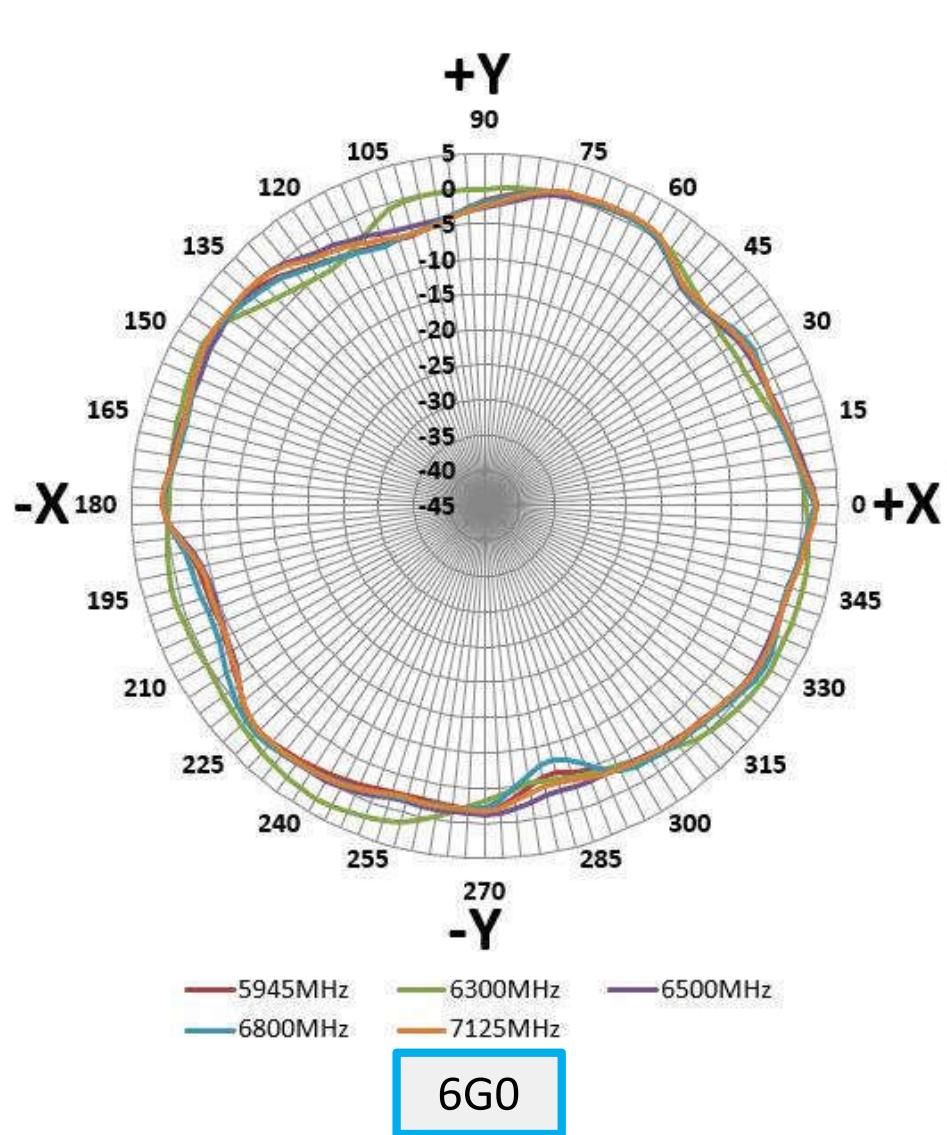

# Power Sum-6GHz Band- Azimuth(XY)

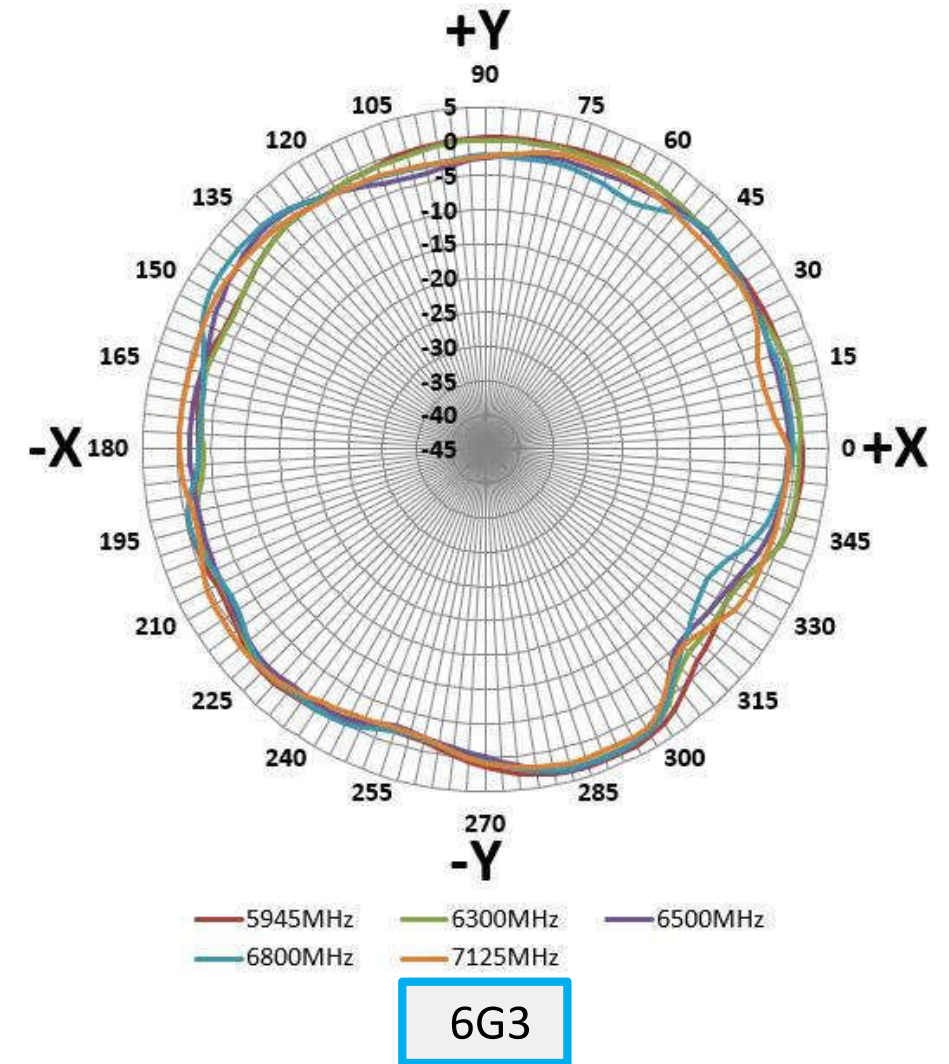
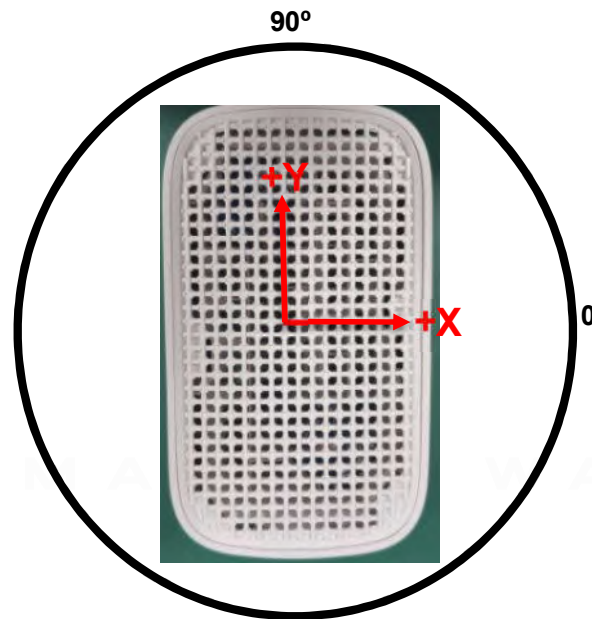
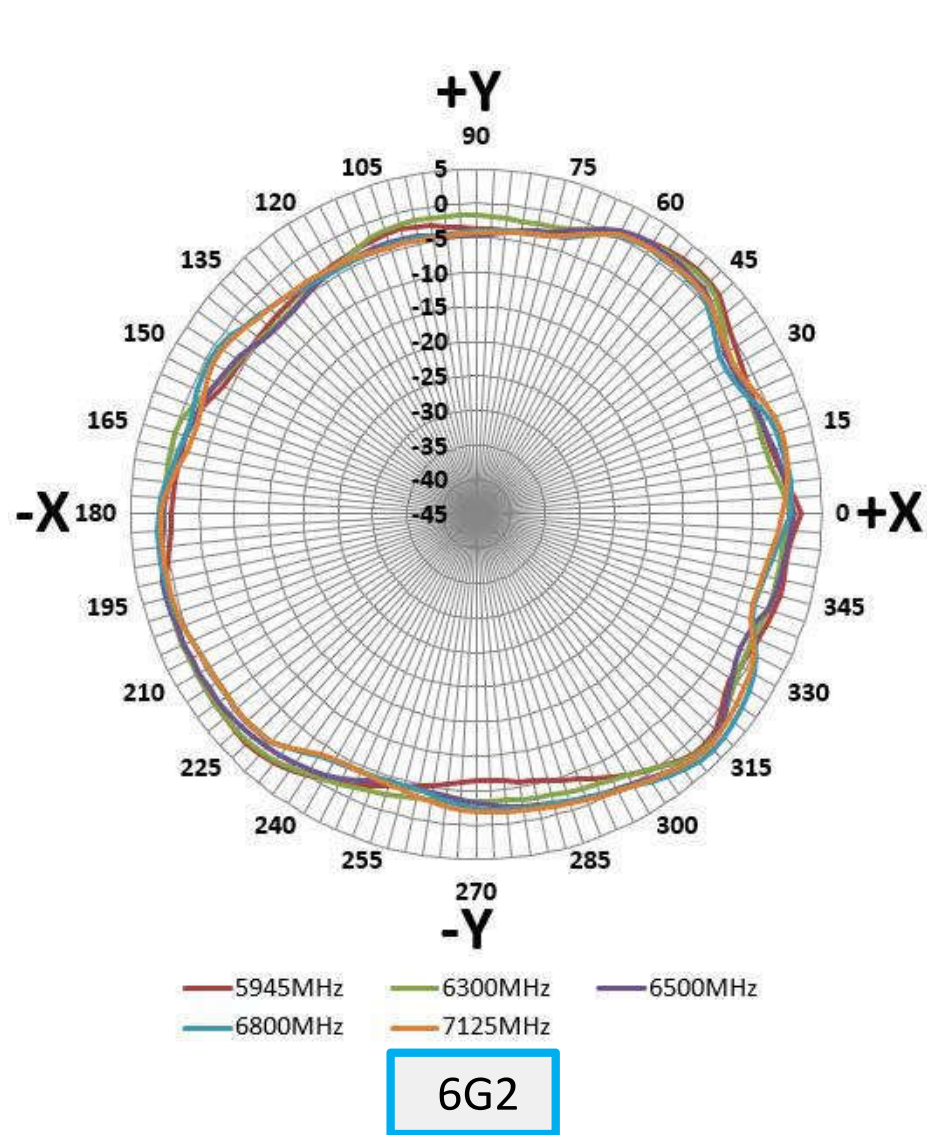

# Power Sum-6GHz Band- Elevation Cut (ZX)

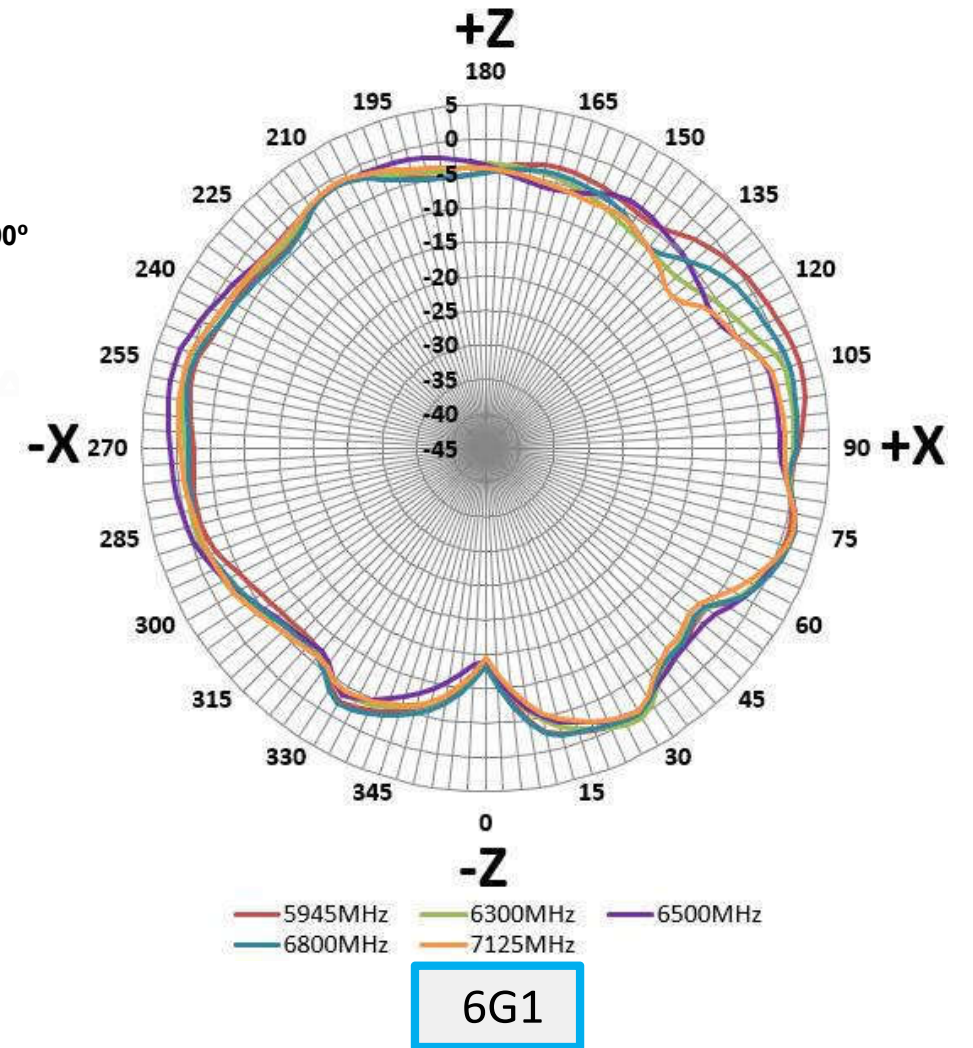
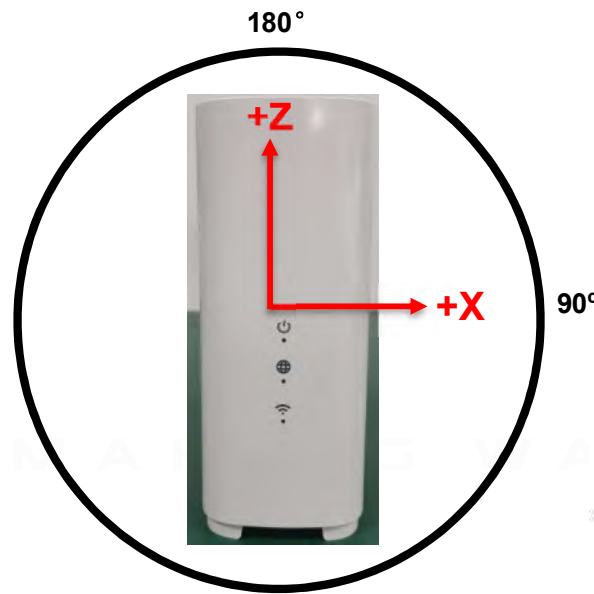
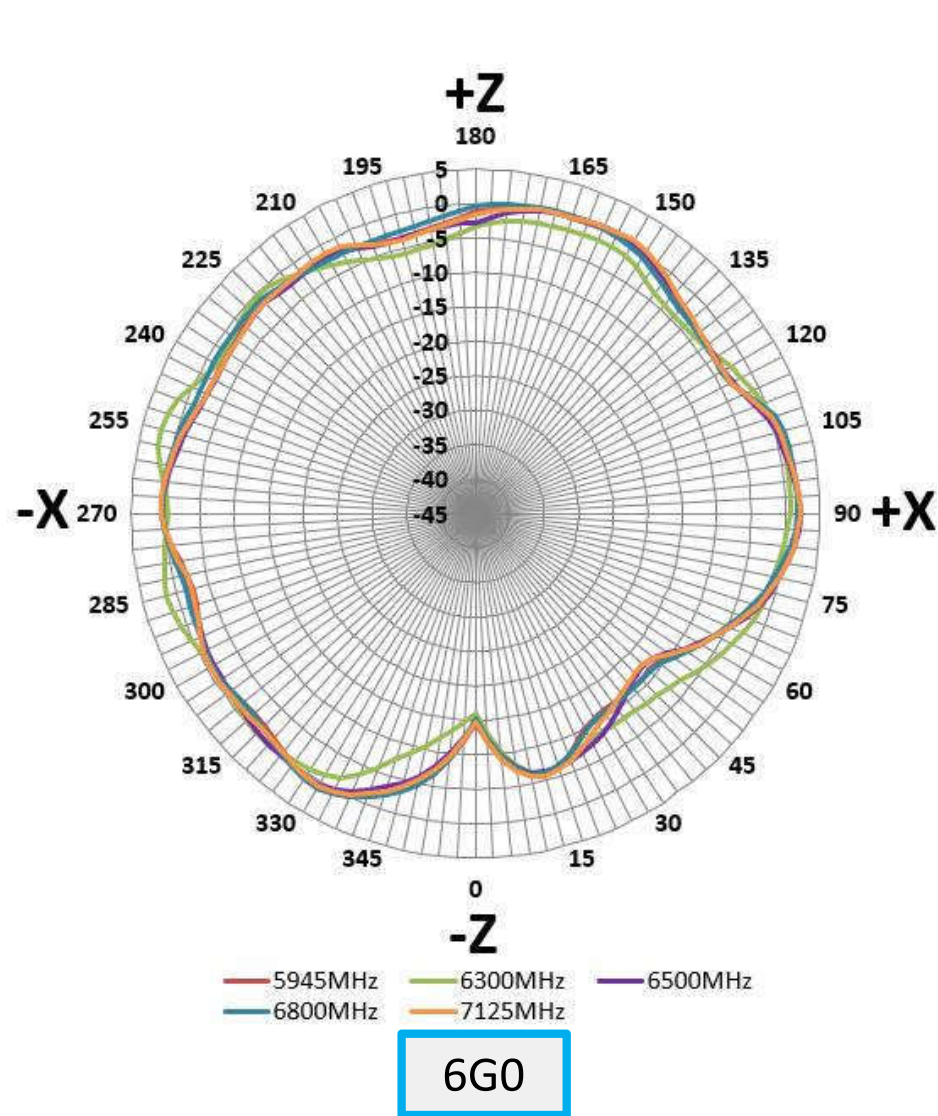

# Power Sum-6GHz Band- Elevation Cut (ZX)

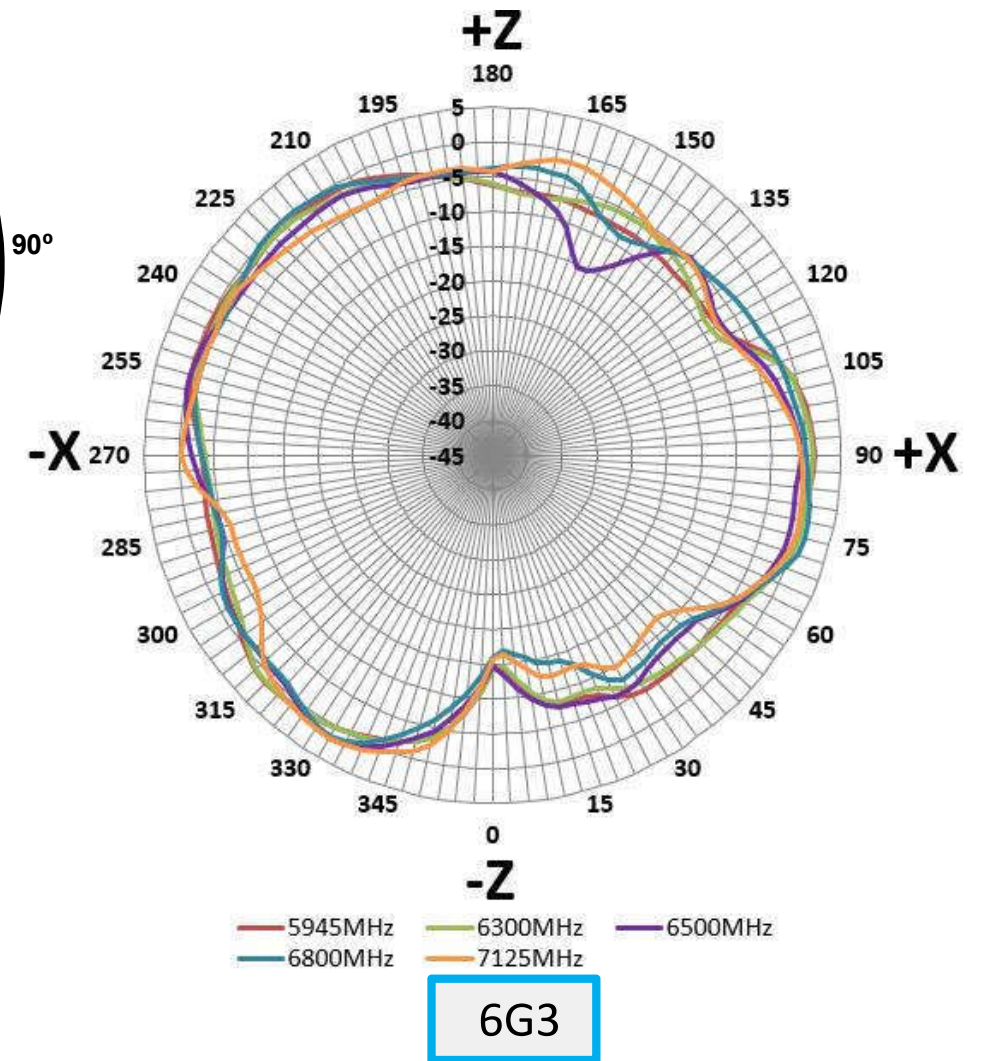
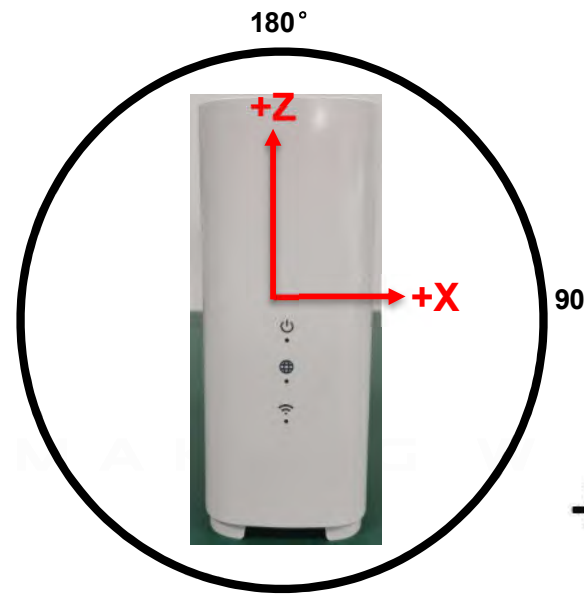
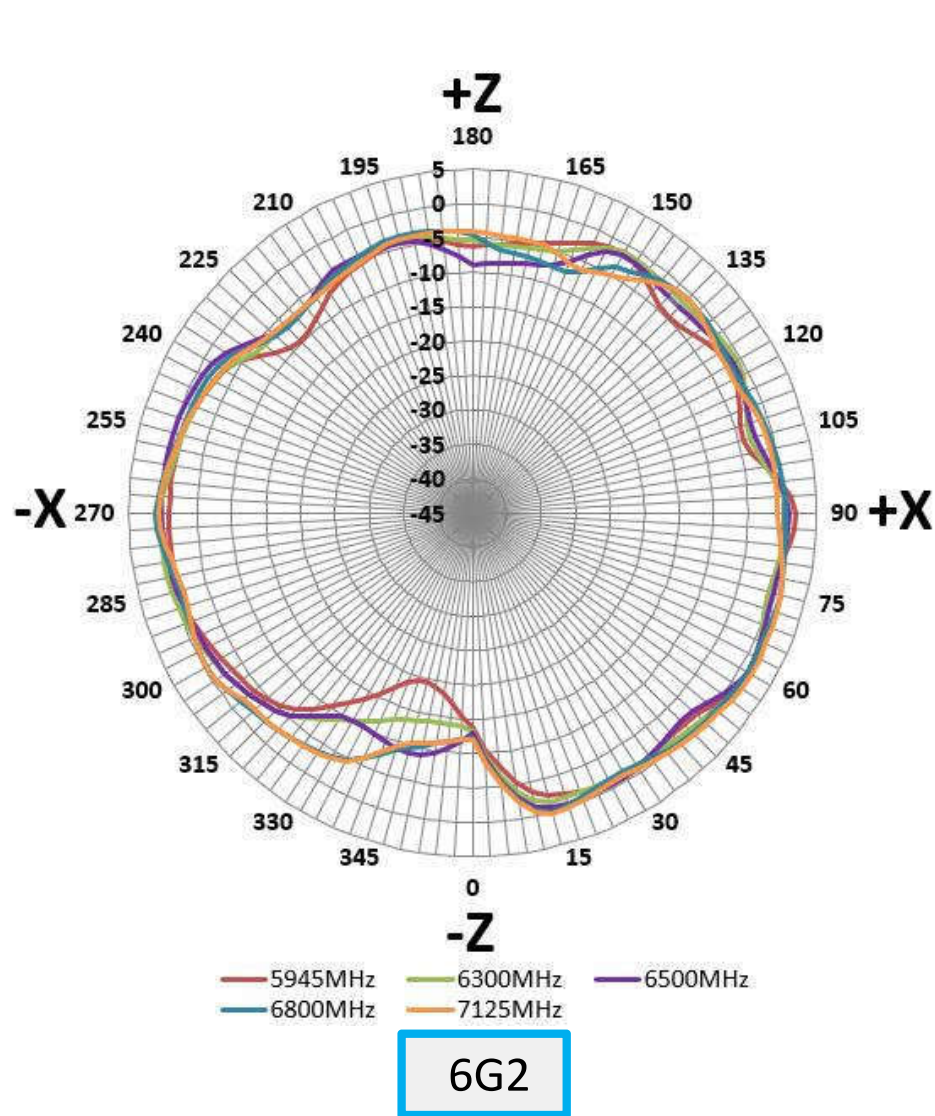

# Power Sum-6GHz Band- Elevation Cut (ZY)

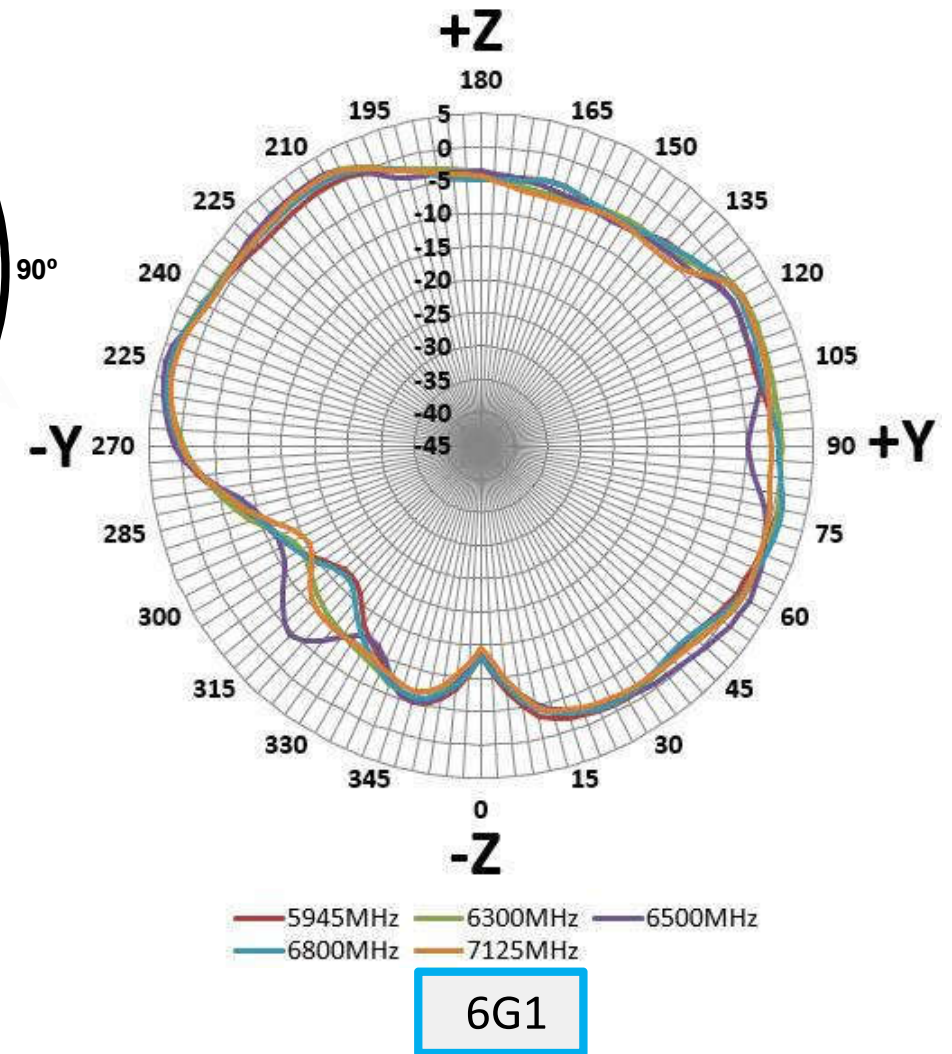
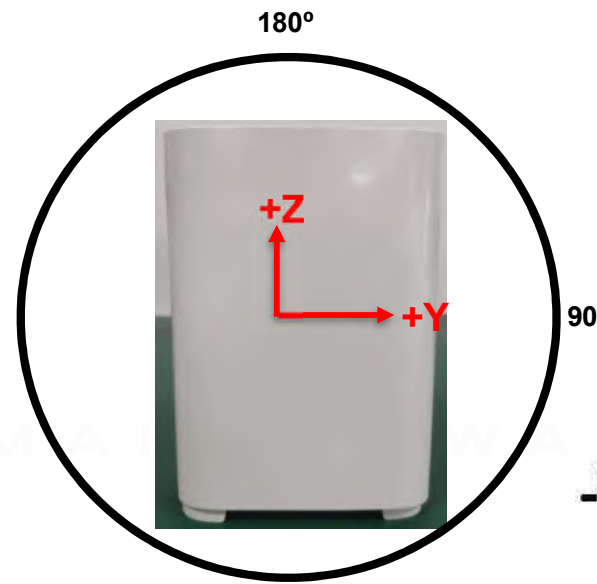
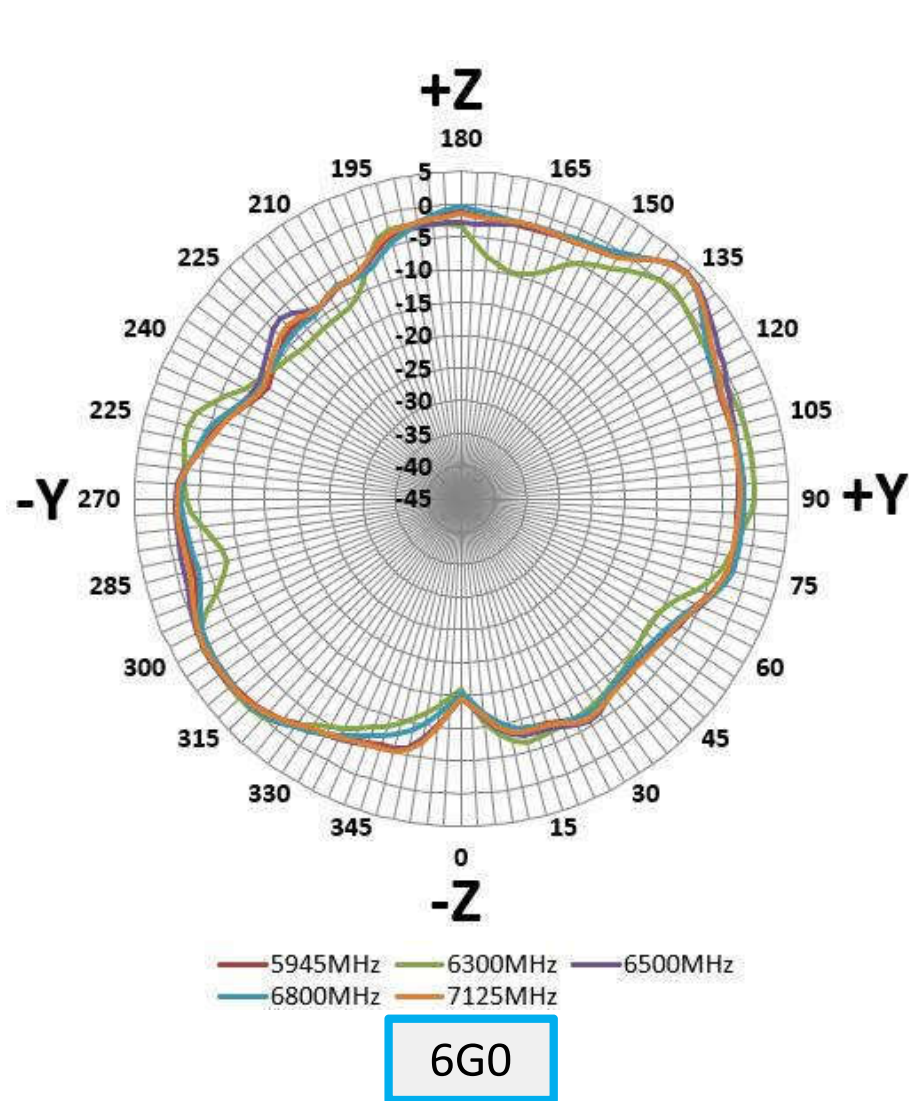

# Power Sum-6GHz Band- Elevation Cut (ZY)

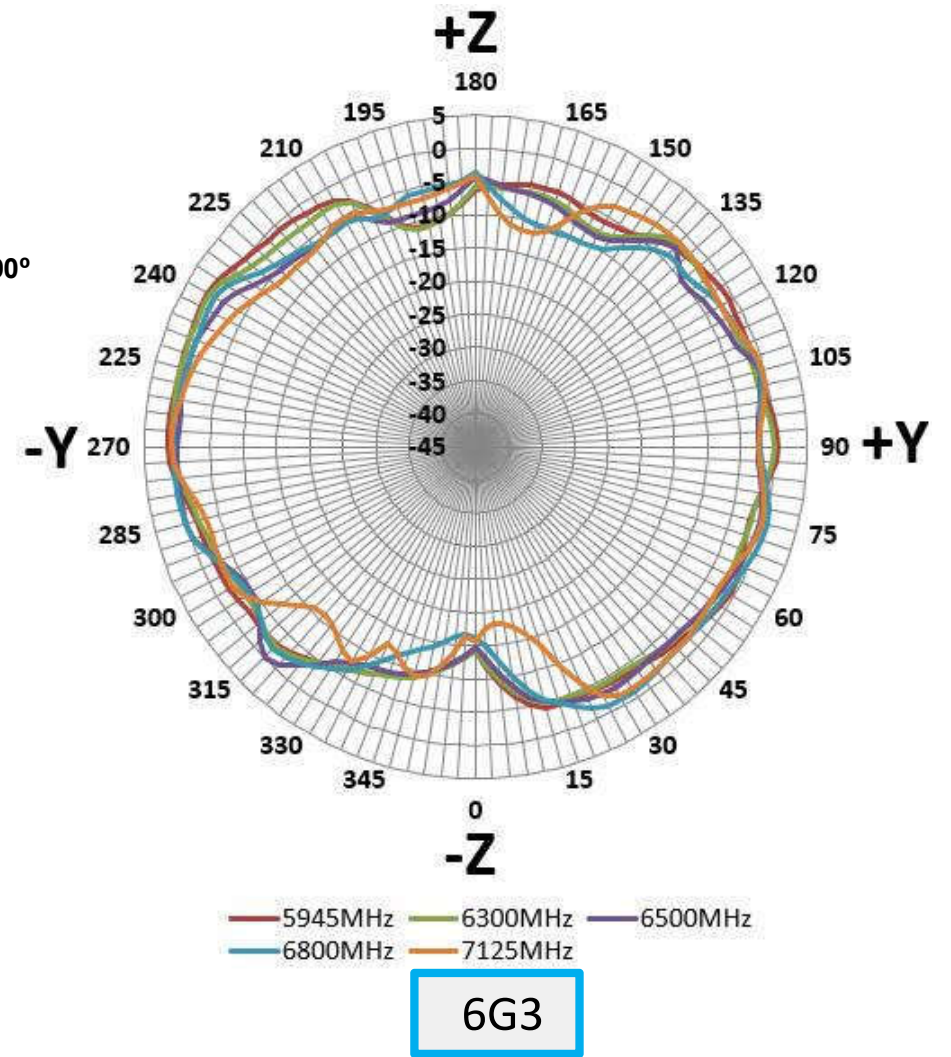
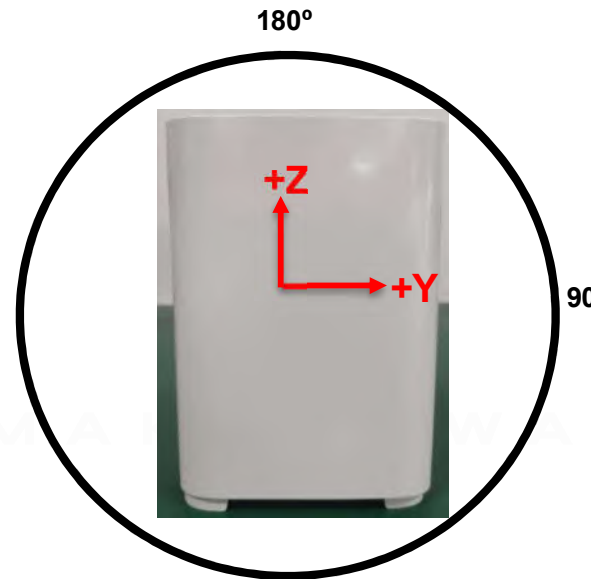
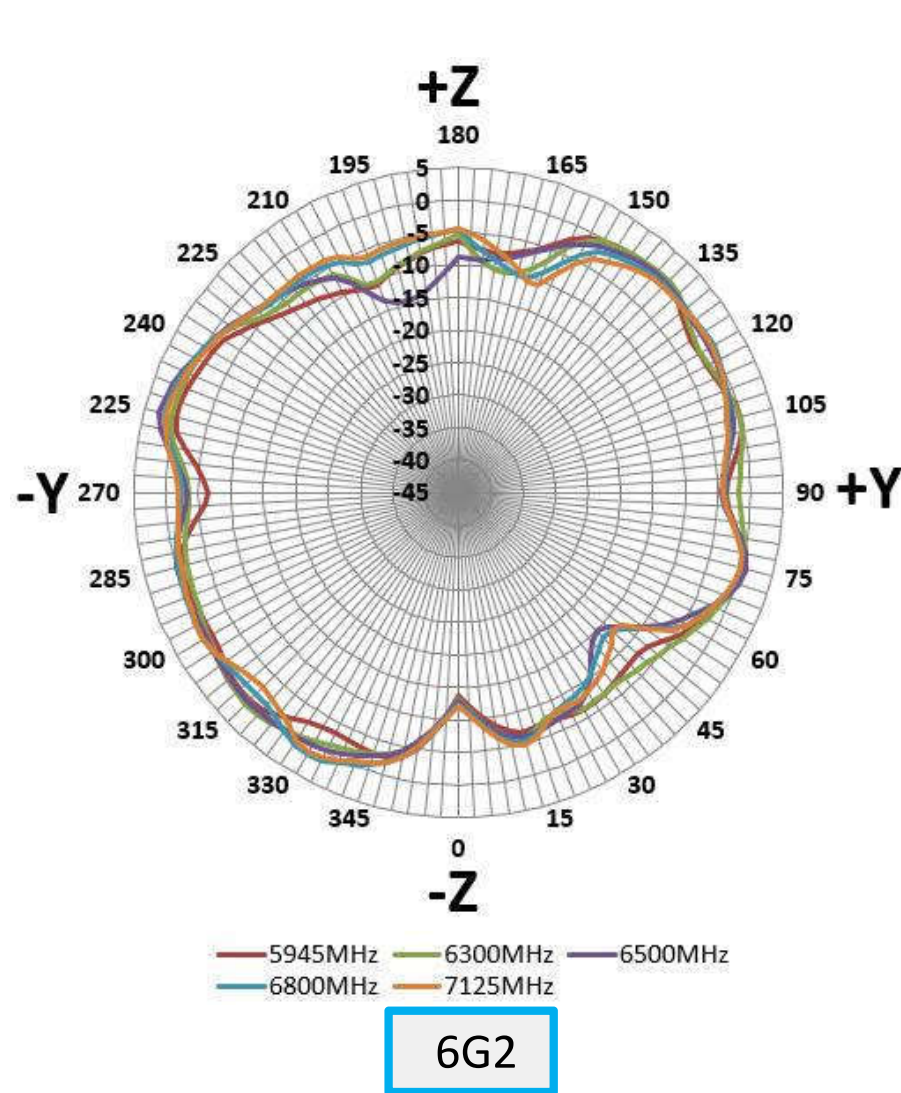



# Power Sum-BT

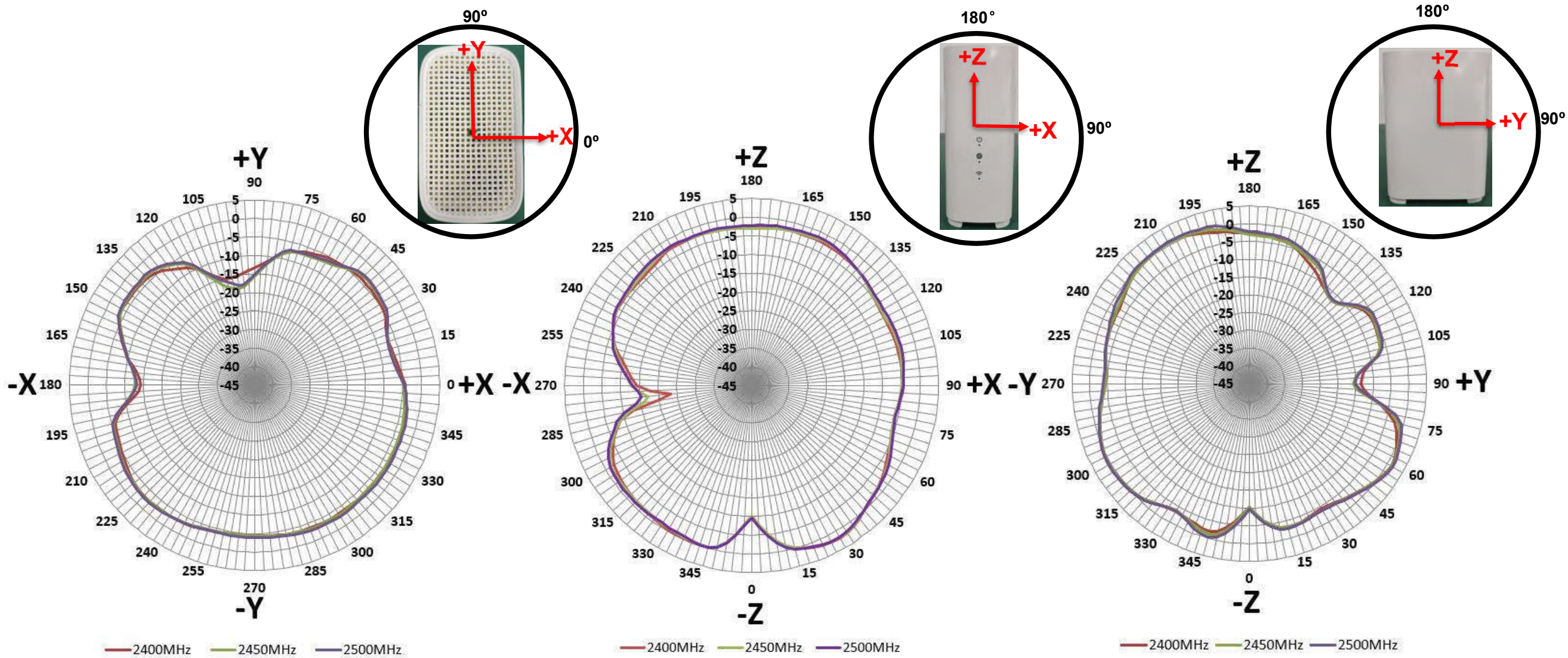

# Our Contact

WWW.GALTRONICS.COM

## Social Media



## Contact

- ✉ info@galtronics.com
- ☎ + 1-480-496-5100
- 📍 8930 S. Beck Avenue, Suite # 103 Tempe, Arizona 85284-2891, USA

### USA Design Center

**Galtronics USA Inc.**  
 8930 South Beck Avenue  
 Suite #103  
 Tempe, AZ 85284 USA  
 Tel: +1-480-496-5100

### Ottawa, Canada Design Center

**Galtronics Canada Inc.**  
 200 Terence Mathews Crescent,  
 Unit A  
 Kanata, ON K2M 2C6 Canada

### Suzhou, China Design Center

**Galtronics Electronics (Wuxi) Co.**  
 No.28, Jinxing Road, Metallurgical  
 Industrial Park( Jinfeng Town),  
 Zhangjiagang City, Jiangsu, China

### China Factory

**Galtronics Electronics (Wuxi) Co.**  
 No. 1, Xishi Road,  
 Wuxi New District  
 Jiangsu Province 214028, China  
 Tel: +86-510-8866-5500

### Corporate Headquarters

**Baylin Technologies Inc.,**  
 60 Columbia Way  
 Suite 205  
 Markham, ON L3R 0C9 Canada

### Korea Design Center

**Galtronics Korea Co.**  
 #B214, Innoplex Bldg.,306, Sinwon-ro,  
 Yeongtong-gu, Suwon-si, Gyeonggi-do,  
 16675 Korea  
 Tel: + 82-32-227-0771

### Vietnam Factory

**Galtronics Vietnam**  
 Lot G1 , G2, Que Vo Industrial  
 Park, Phuong Lieu commune,  
 Que Vo district, Bac Ninh  
 province, Vietnam

# Thank You!

We Look Forward To Working Together

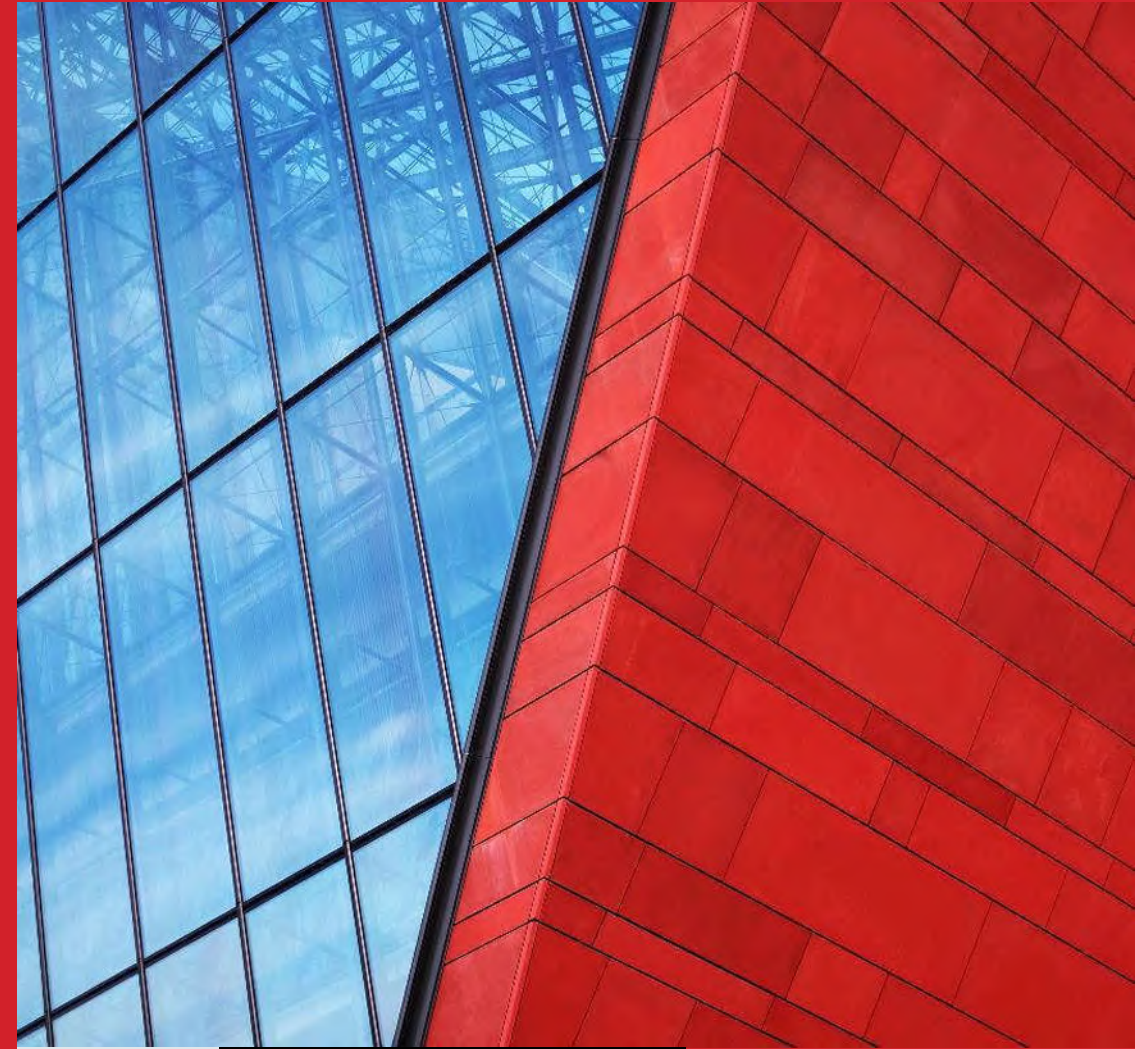

Frequency		2G0			2G1		
H-Pol		2400MHz	2450MHz	2484MHz	2400MHz	2450MHz	2484MHz
theta	phi						
0	0	-15.78	-15.62	-15.66	-22.32	-21.37	-20.98
0	3	-15.77	-15.61	-15.65	-22.29	-21.36	-20.98
0	6	-15.75	-15.59	-15.63	-22.24	-21.34	-20.97
0	9	-15.72	-15.56	-15.61	-22.18	-21.31	-20.97
0	12	-15.69	-15.52	-15.58	-22.10	-21.28	-20.96
0	15	-15.65	-15.48	-15.55	-22.02	-21.24	-20.95
0	18	-15.60	-15.43	-15.51	-21.92	-21.19	-20.94
0	21	-15.53	-15.37	-15.45	-21.78	-21.13	-20.93
0	24	-15.46	-15.29	-15.39	-21.62	-21.05	-20.91
0	27	-15.38	-15.21	-15.32	-21.45	-20.97	-20.89
0	30	-15.30	-15.13	-15.25	-21.29	-20.90	-20.87
0	33	-15.22	-15.05	-15.18	-21.13	-20.81	-20.85
0	36	-15.13	-14.96	-15.10	-20.96	-20.73	-20.83
0	39	-15.04	-14.87	-15.02	-20.79	-20.64	-20.81
0	42	-14.95	-14.78	-14.95	-20.62	-20.55	-20.79
0	45	-14.86	-14.69	-14.87	-20.46	-20.46	-20.77
0	48	-14.78	-14.60	-14.80	-20.31	-20.38	-20.75
0	51	-14.69	-14.52	-14.72	-20.16	-20.30	-20.73
0	54	-14.61	-14.44	-14.65	-20.02	-20.22	-20.70
0	57	-14.54	-14.36	-14.59	-19.88	-20.14	-20.68
0	60	-14.47	-14.29	-14.52	-19.76	-20.07	-20.67
0	63	-14.40	-14.22	-14.47	-19.66	-20.01	-20.65
0	66	-14.34	-14.16	-14.41	-19.55	-19.95	-20.63
0	69	-14.28	-14.10	-14.36	-19.45	-19.89	-20.62
0	72	-14.23	-14.05	-14.32	-19.38	-19.84	-20.60
0	75	-14.20	-14.02	-14.29	-19.32	-19.80	-20.59
0	78	-14.17	-13.99	-14.26	-19.27	-19.78	-20.58
0	81	-14.15	-13.96	-14.24	-19.23	-19.75	-20.58
0	84	-14.12	-13.94	-14.22	-19.20	-19.73	-20.57
0	87	-14.11	-13.93	-14.21	-19.17	-19.72	-20.57
0	90	-14.10	-13.92	-14.20	-19.16	-19.71	-20.57
0	93	-14.11	-13.93	-14.21	-19.17	-19.72	-20.57
0	96	-14.12	-13.94	-14.22	-19.20	-19.73	-20.57
0	99	-14.15	-13.96	-14.24	-19.23	-19.75	-20.58
0	102	-14.17	-13.99	-14.26	-19.27	-19.78	-20.58
0	105	-14.20	-14.02	-14.29	-19.32	-19.80	-20.59
0	108	-14.23	-14.05	-14.32	-19.38	-19.84	-20.60
0	111	-14.28	-14.10	-14.36	-19.45	-19.89	-20.62
0	114	-14.34	-14.16	-14.41	-19.55	-19.95	-20.63
0	117	-14.40	-14.22	-14.47	-19.66	-20.01	-20.65
0	120	-14.47	-14.29	-14.52	-19.76	-20.07	-20.67
0	123	-14.54	-14.36	-14.59	-19.88	-20.14	-20.68
0	126	-14.61	-14.44	-14.65	-20.02	-20.22	-20.70
0	129	-14.69	-14.52	-14.72	-20.16	-20.30	-20.73
0	132	-14.78	-14.60	-14.80	-20.31	-20.38	-20.75
0	135	-14.86	-14.69	-14.87	-20.46	-20.46	-20.77
0	138	-14.95	-14.78	-14.95	-20.62	-20.55	-20.79
0	141	-15.04	-14.87	-15.02	-20.79	-20.64	-20.81
0	144	-15.13	-14.96	-15.10	-20.96	-20.73	-20.83
0	147	-15.22	-15.05	-15.18	-21.13	-20.81	-20.85
0	150	-15.30	-15.13	-15.25	-21.29	-20.90	-20.87
0	153	-15.38	-15.21	-15.32	-21.45	-20.97	-20.89
0	156	-15.46	-15.29	-15.39	-21.62	-21.05	-20.91
0	159	-15.53	-15.37	-15.45	-21.78	-21.13	-20.93
0	162	-15.60	-15.43	-15.51	-21.92	-21.19	-20.94

0	165	-15.65	-15.48	-15.55	-22.02	-21.24	-20.95
0	168	-15.69	-15.52	-15.58	-22.11	-21.28	-20.96
0	171	-15.72	-15.56	-15.61	-22.19	-21.32	-20.97
0	174	-15.75	-15.59	-15.64	-22.26	-21.35	-20.98
0	177	-15.77	-15.61	-15.65	-22.30	-21.37	-20.98
0	180	-15.78	-15.62	-15.66	-22.32	-21.37	-20.98
0	183	-15.77	-15.61	-15.65	-22.30	-21.37	-20.98
0	186	-15.75	-15.59	-15.64	-22.26	-21.35	-20.98
0	189	-15.72	-15.56	-15.61	-22.19	-21.32	-20.97
0	192	-15.69	-15.52	-15.58	-22.11	-21.28	-20.96
0	195	-15.65	-15.48	-15.55	-22.02	-21.24	-20.95
0	198	-15.60	-15.43	-15.51	-21.92	-21.19	-20.94
0	201	-15.53	-15.37	-15.45	-21.78	-21.13	-20.93
0	204	-15.46	-15.29	-15.39	-21.62	-21.05	-20.91
0	207	-15.38	-15.21	-15.32	-21.45	-20.97	-20.89
0	210	-15.30	-15.13	-15.25	-21.29	-20.90	-20.87
0	213	-15.22	-15.05	-15.18	-21.13	-20.81	-20.85
0	216	-15.13	-14.96	-15.10	-20.96	-20.73	-20.83
0	219	-15.04	-14.87	-15.02	-20.79	-20.64	-20.81
0	222	-14.95	-14.78	-14.95	-20.62	-20.55	-20.79
0	225	-14.86	-14.69	-14.87	-20.46	-20.46	-20.77
0	228	-14.78	-14.60	-14.80	-20.31	-20.38	-20.75
0	231	-14.69	-14.52	-14.72	-20.16	-20.30	-20.73
0	234	-14.61	-14.44	-14.65	-20.02	-20.22	-20.70
0	237	-14.54	-14.36	-14.59	-19.88	-20.14	-20.68
0	240	-14.47	-14.29	-14.52	-19.76	-20.07	-20.67
0	243	-14.40	-14.22	-14.47	-19.66	-20.01	-20.65
0	246	-14.34	-14.16	-14.41	-19.55	-19.95	-20.63
0	249	-14.28	-14.10	-14.36	-19.45	-19.89	-20.62
0	252	-14.23	-14.05	-14.32	-19.38	-19.84	-20.60
0	255	-14.20	-14.02	-14.29	-19.32	-19.80	-20.59
0	258	-14.17	-13.99	-14.26	-19.27	-19.78	-20.58
0	261	-14.15	-13.96	-14.24	-19.23	-19.75	-20.58
0	264	-14.12	-13.94	-14.22	-19.20	-19.73	-20.57
0	267	-14.11	-13.93	-14.21	-19.17	-19.72	-20.57
0	270	-14.10	-13.92	-14.20	-19.16	-19.71	-20.57
0	273	-14.11	-13.93	-14.21	-19.17	-19.72	-20.57
0	276	-14.12	-13.94	-14.22	-19.20	-19.73	-20.57
0	279	-14.15	-13.96	-14.24	-19.23	-19.75	-20.58
0	282	-14.17	-13.99	-14.26	-19.27	-19.78	-20.58
0	285	-14.20	-14.02	-14.29	-19.32	-19.80	-20.59
0	288	-14.23	-14.05	-14.32	-19.38	-19.84	-20.60
0	291	-14.28	-14.10	-14.36	-19.45	-19.89	-20.62
0	294	-14.34	-14.16	-14.41	-19.55	-19.95	-20.63
0	297	-14.40	-14.22	-14.47	-19.66	-20.01	-20.65
0	300	-14.47	-14.29	-14.52	-19.76	-20.07	-20.67
0	303	-14.54	-14.36	-14.59	-19.88	-20.14	-20.68
0	306	-14.61	-14.44	-14.65	-20.02	-20.22	-20.70
0	309	-14.69	-14.52	-14.72	-20.16	-20.30	-20.73
0	312	-14.78	-14.60	-14.80	-20.31	-20.38	-20.75
0	315	-14.86	-14.69	-14.87	-20.46	-20.46	-20.77
0	318	-14.95	-14.78	-14.95	-20.62	-20.55	-20.79
0	321	-15.04	-14.87	-15.02	-20.79	-20.64	-20.81
0	324	-15.13	-14.96	-15.10	-20.96	-20.73	-20.83
0	327	-15.22	-15.05	-15.18	-21.13	-20.81	-20.85
0	330	-15.30	-15.13	-15.25	-21.29	-20.90	-20.87
0	333	-15.38	-15.21	-15.32	-21.45	-20.97	-20.89
0	336	-15.46	-15.29	-15.39	-21.62	-21.05	-20.91

0	339	-15.53	-15.37	-15.45	-21.78	-21.13	-20.93
0	342	-15.60	-15.43	-15.51	-21.92	-21.19	-20.94
0	345	-15.65	-15.48	-15.55	-22.02	-21.24	-20.95
0	348	-15.69	-15.52	-15.58	-22.10	-21.28	-20.96
0	351	-15.72	-15.56	-15.61	-22.18	-21.31	-20.97
0	354	-15.75	-15.59	-15.63	-22.24	-21.34	-20.97
0	357	-15.77	-15.61	-15.65	-22.29	-21.36	-20.98
0	360	-15.78	-15.62	-15.66	-22.32	-21.37	-20.98
3	0	-15.10	-14.11	-13.88	-19.58	-19.30	-19.27
3	3	-14.77	-13.95	-13.71	-19.39	-19.04	-19.00
3	6	-14.45	-13.79	-13.54	-19.22	-18.81	-18.76
3	9	-14.15	-13.62	-13.38	-19.05	-18.60	-18.55
3	12	-13.87	-13.45	-13.22	-18.91	-18.43	-18.37
3	15	-13.62	-13.29	-13.07	-18.78	-18.29	-18.23
3	18	-13.39	-13.12	-12.93	-18.65	-18.17	-18.12
3	21	-13.18	-12.96	-12.80	-18.53	-18.06	-18.00
3	24	-12.98	-12.79	-12.67	-18.42	-17.97	-17.91
3	27	-12.79	-12.62	-12.55	-18.34	-17.91	-17.85
3	30	-12.59	-12.44	-12.41	-18.31	-17.88	-17.83
3	33	-12.40	-12.26	-12.27	-18.32	-17.91	-17.85
3	36	-12.20	-12.06	-12.12	-18.35	-17.97	-17.92
3	39	-12.01	-11.87	-11.96	-18.38	-18.07	-18.01
3	42	-11.82	-11.67	-11.81	-18.43	-18.18	-18.13
3	45	-11.64	-11.49	-11.65	-18.48	-18.31	-18.26
3	48	-11.46	-11.30	-11.49	-18.57	-18.46	-18.43
3	51	-11.29	-11.11	-11.31	-18.71	-18.66	-18.68
3	54	-11.12	-10.93	-11.13	-18.87	-18.90	-18.96
3	57	-10.97	-10.76	-10.97	-19.06	-19.15	-19.24
3	60	-10.83	-10.62	-10.82	-19.23	-19.41	-19.49
3	63	-10.71	-10.48	-10.69	-19.44	-19.72	-19.73
3	66	-10.59	-10.34	-10.55	-19.68	-20.11	-20.00
3	69	-10.48	-10.22	-10.43	-19.92	-20.50	-20.24
3	72	-10.40	-10.13	-10.34	-20.10	-20.78	-20.41
3	75	-10.35	-10.08	-10.28	-20.17	-20.90	-20.48
3	78	-10.32	-10.05	-10.26	-20.05	-20.76	-20.38
3	81	-10.29	-10.03	-10.24	-19.74	-20.40	-20.13
3	84	-10.27	-10.02	-10.23	-19.34	-19.93	-19.80
3	87	-10.26	-10.01	-10.22	-18.93	-19.44	-19.45
3	90	-10.26	-10.00	-10.22	-18.59	-19.05	-19.17
3	93	-10.27	-10.02	-10.24	-18.32	-18.74	-18.94
3	96	-10.32	-10.08	-10.30	-18.03	-18.42	-18.71
3	99	-10.37	-10.15	-10.38	-17.77	-18.13	-18.49
3	102	-10.44	-10.24	-10.47	-17.57	-17.89	-18.30
3	105	-10.52	-10.33	-10.57	-17.46	-17.71	-18.14
3	108	-10.59	-10.43	-10.67	-17.42	-17.58	-18.00
3	111	-10.69	-10.54	-10.80	-17.38	-17.45	-17.85
3	114	-10.79	-10.67	-10.95	-17.35	-17.35	-17.73
3	117	-10.91	-10.80	-11.10	-17.33	-17.28	-17.65
3	120	-11.04	-10.94	-11.25	-17.32	-17.26	-17.61
3	123	-11.18	-11.09	-11.41	-17.37	-17.28	-17.61
3	126	-11.33	-11.26	-11.58	-17.50	-17.32	-17.61
3	129	-11.50	-11.43	-11.76	-17.68	-17.40	-17.61
3	132	-11.68	-11.62	-11.95	-17.89	-17.48	-17.60
3	135	-11.86	-11.80	-12.13	-18.11	-17.58	-17.60
3	138	-12.05	-11.98	-12.31	-18.35	-17.70	-17.64
3	141	-12.25	-12.17	-12.50	-18.64	-17.88	-17.74
3	144	-12.46	-12.37	-12.69	-18.97	-18.09	-17.88
3	147	-12.67	-12.57	-12.88	-19.33	-18.34	-18.05

3	150	-12.88	-12.79	-13.08	-19.71	-18.61	-18.24
3	153	-13.10	-13.02	-13.29	-20.19	-18.99	-18.49
3	156	-13.33	-13.26	-13.52	-20.80	-19.51	-18.85
3	159	-13.56	-13.52	-13.75	-21.41	-20.06	-19.25
3	162	-13.78	-13.76	-13.97	-21.88	-20.53	-19.65
3	165	-13.98	-14.00	-14.17	-22.11	-20.82	-19.99
3	168	-14.18	-14.24	-14.37	-22.15	-20.97	-20.31
3	171	-14.37	-14.48	-14.56	-22.19	-21.11	-20.64
3	174	-14.55	-14.71	-14.74	-22.22	-21.21	-20.94
3	177	-14.73	-14.91	-14.90	-22.24	-21.28	-21.16
3	180	-14.88	-15.06	-15.03	-22.25	-21.30	-21.24
3	183	-15.02	-15.16	-15.13	-22.20	-21.23	-21.15
3	186	-15.15	-15.22	-15.21	-22.09	-21.03	-20.91
3	189	-15.26	-15.28	-15.28	-21.92	-20.78	-20.60
3	192	-15.39	-15.35	-15.36	-21.74	-20.50	-20.28
3	195	-15.53	-15.46	-15.46	-21.56	-20.27	-20.02
3	198	-15.67	-15.80	-15.63	-21.38	-20.07	-19.82
3	201	-15.81	-16.42	-15.84	-21.18	-19.87	-19.64
3	204	-15.98	-17.11	-16.08	-20.96	-19.68	-19.46
3	207	-16.19	-17.68	-16.30	-20.73	-19.49	-19.30
3	210	-16.47	-17.91	-16.47	-20.48	-19.29	-19.13
3	213	-17.40	-17.87	-16.57	-20.21	-19.09	-18.98
3	216	-19.12	-17.76	-16.65	-19.91	-18.88	-18.82
3	219	-21.07	-17.64	-16.71	-19.60	-18.68	-18.67
3	222	-22.66	-17.54	-16.80	-19.28	-18.47	-18.53
3	225	-23.32	-17.50	-16.94	-18.96	-18.27	-18.40
3	228	-22.89	-17.67	-17.52	-18.65	-18.07	-18.29
3	231	-21.87	-18.09	-18.65	-18.33	-17.88	-18.18
3	234	-20.66	-18.59	-19.94	-18.01	-17.69	-18.08
3	237	-19.65	-19.01	-21.00	-17.70	-17.51	-17.98
3	240	-19.22	-19.18	-21.44	-17.43	-17.33	-17.89
3	243	-19.28	-19.12	-20.92	-17.17	-17.15	-17.80
3	246	-19.41	-18.95	-19.66	-16.91	-16.96	-17.69
3	249	-19.58	-18.71	-18.08	-16.68	-16.78	-17.60
3	252	-19.71	-18.40	-16.62	-16.48	-16.64	-17.53
3	255	-19.77	-18.07	-15.71	-16.35	-16.57	-17.49
3	258	-19.34	-17.49	-15.24	-16.26	-16.53	-17.47
3	261	-18.29	-16.59	-14.84	-16.18	-16.50	-17.46
3	264	-16.99	-15.61	-14.51	-16.11	-16.48	-17.46
3	267	-15.79	-14.77	-14.27	-16.06	-16.47	-17.45
3	270	-15.06	-14.31	-14.14	-16.05	-16.46	-17.44
3	273	-14.71	-14.15	-14.09	-16.08	-16.48	-17.41
3	276	-14.44	-14.03	-14.05	-16.17	-16.53	-17.38
3	279	-14.21	-13.94	-14.03	-16.30	-16.59	-17.34
3	282	-14.03	-13.85	-13.99	-16.44	-16.66	-17.30
3	285	-13.87	-13.75	-13.95	-16.58	-16.73	-17.28
3	288	-13.73	-13.63	-13.84	-16.72	-16.79	-17.26
3	291	-13.60	-13.49	-13.68	-16.87	-16.85	-17.25
3	294	-13.48	-13.36	-13.51	-17.04	-16.91	-17.24
3	297	-13.41	-13.27	-13.38	-17.22	-16.98	-17.23
3	300	-13.38	-13.23	-13.32	-17.43	-17.07	-17.23
3	303	-13.40	-13.25	-13.32	-17.66	-17.17	-17.24
3	306	-13.48	-13.29	-13.33	-17.93	-17.31	-17.28
3	309	-13.60	-13.37	-13.34	-18.22	-17.46	-17.34
3	312	-13.73	-13.46	-13.35	-18.55	-17.63	-17.41
3	315	-13.88	-13.56	-13.36	-18.90	-17.80	-17.49
3	318	-14.06	-13.74	-13.45	-19.36	-17.99	-17.57
3	321	-14.30	-14.01	-13.64	-19.96	-18.21	-17.69

3	324	-14.58	-14.34	-13.90	-20.54	-18.43	-17.82
3	327	-14.90	-14.67	-14.17	-20.99	-18.67	-17.96
3	330	-15.23	-14.95	-14.40	-21.17	-18.90	-18.11
3	333	-15.68	-15.21	-14.63	-21.17	-19.16	-18.32
3	336	-16.26	-15.49	-14.90	-21.16	-19.47	-18.58
3	339	-16.84	-15.75	-15.14	-21.13	-19.76	-18.84
3	342	-17.29	-15.93	-15.32	-21.11	-19.98	-19.06
3	345	-17.47	-16.00	-15.40	-21.07	-20.06	-19.16
3	348	-17.37	-15.91	-15.33	-20.96	-20.04	-19.20
3	351	-17.09	-15.66	-15.13	-20.73	-19.96	-19.23
3	354	-16.61	-15.26	-14.81	-20.40	-19.81	-19.25
3	357	-15.95	-14.74	-14.39	-20.01	-19.60	-19.26
3	360	-15.10	-14.11	-13.88	-19.58	-19.30	-19.27
6	0	-14.69	-13.10	-12.53	-17.12	-17.41	-17.70
6	3	-14.00	-12.70	-12.14	-16.78	-16.94	-17.20
6	6	-13.35	-12.32	-11.77	-16.47	-16.51	-16.74
6	9	-12.76	-11.95	-11.43	-16.21	-16.14	-16.33
6	12	-12.23	-11.62	-11.12	-16.00	-15.84	-15.99
6	15	-11.77	-11.30	-10.84	-15.87	-15.64	-15.74
6	18	-11.38	-11.01	-10.61	-15.78	-15.48	-15.53
6	21	-11.03	-10.75	-10.40	-15.70	-15.34	-15.34
6	24	-10.72	-10.50	-10.21	-15.64	-15.23	-15.18
6	27	-10.42	-10.25	-10.02	-15.60	-15.15	-15.07
6	30	-10.12	-9.99	-9.81	-15.59	-15.12	-15.03
6	33	-9.82	-9.71	-9.60	-15.65	-15.20	-15.08
6	36	-9.52	-9.42	-9.38	-15.83	-15.40	-15.23
6	39	-9.23	-9.12	-9.16	-16.09	-15.68	-15.44
6	42	-8.95	-8.84	-8.94	-16.38	-16.00	-15.70
6	45	-8.69	-8.56	-8.71	-16.67	-16.34	-15.97
6	48	-8.43	-8.28	-8.45	-17.00	-16.70	-16.32
6	51	-8.16	-8.00	-8.18	-17.38	-17.15	-16.80
6	54	-7.91	-7.73	-7.91	-17.81	-17.65	-17.35
6	57	-7.69	-7.48	-7.67	-18.25	-18.19	-17.90
6	60	-7.51	-7.27	-7.46	-18.69	-18.73	-18.39
6	63	-7.34	-7.09	-7.26	-19.20	-19.39	-18.87
6	66	-7.19	-6.90	-7.07	-19.79	-20.19	-19.40
6	69	-7.05	-6.74	-6.90	-20.36	-20.97	-19.89
6	72	-6.95	-6.62	-6.78	-20.79	-21.56	-20.24
6	75	-6.90	-6.57	-6.73	-20.96	-21.79	-20.38
6	78	-6.88	-6.57	-6.73	-20.74	-21.54	-20.20
6	81	-6.87	-6.56	-6.73	-20.19	-20.91	-19.76
6	84	-6.86	-6.56	-6.73	-19.46	-20.07	-19.17
6	87	-6.86	-6.56	-6.73	-18.70	-19.20	-18.54
6	90	-6.85	-6.56	-6.73	-18.07	-18.48	-18.01
6	93	-6.88	-6.59	-6.77	-17.54	-17.87	-17.55
6	96	-6.95	-6.69	-6.87	-16.99	-17.26	-17.08
6	99	-7.05	-6.82	-7.02	-16.48	-16.68	-16.63
6	102	-7.17	-6.97	-7.19	-16.06	-16.18	-16.22
6	105	-7.28	-7.12	-7.35	-15.77	-15.80	-15.89
6	108	-7.40	-7.27	-7.53	-15.56	-15.48	-15.60
6	111	-7.54	-7.44	-7.74	-15.38	-15.18	-15.32
6	114	-7.70	-7.63	-7.96	-15.22	-14.92	-15.08
6	117	-7.87	-7.83	-8.20	-15.12	-14.75	-14.90
6	120	-8.05	-8.04	-8.43	-15.09	-14.68	-14.81
6	123	-8.24	-8.25	-8.67	-15.14	-14.70	-14.78
6	126	-8.45	-8.48	-8.91	-15.27	-14.73	-14.76
6	129	-8.68	-8.71	-9.15	-15.47	-14.79	-14.74
6	132	-8.92	-8.96	-9.41	-15.71	-14.87	-14.73



6	135	-9.17	-9.21	-9.67	-15.97	-14.96	-14.73
6	138	-9.44	-9.48	-9.94	-16.29	-15.13	-14.80
6	141	-9.73	-9.75	-10.21	-16.73	-15.42	-15.01
6	144	-10.04	-10.03	-10.50	-17.26	-15.80	-15.30
6	147	-10.36	-10.33	-10.79	-17.83	-16.25	-15.65
6	150	-10.68	-10.65	-11.10	-18.42	-16.72	-16.03
6	153	-11.01	-11.00	-11.43	-19.19	-17.37	-16.53
6	156	-11.36	-11.38	-11.78	-20.16	-18.26	-17.20
6	159	-11.72	-11.79	-12.15	-21.13	-19.19	-17.96
6	162	-12.07	-12.19	-12.50	-21.86	-19.97	-18.70
6	165	-12.41	-12.57	-12.84	-22.16	-20.43	-19.31
6	168	-12.72	-12.95	-13.15	-22.15	-20.65	-19.85
6	171	-13.03	-13.33	-13.45	-22.13	-20.83	-20.41
6	174	-13.32	-13.69	-13.75	-22.11	-20.98	-20.91
6	177	-13.61	-14.03	-14.02	-22.08	-21.07	-21.27
6	180	-13.89	-14.33	-14.26	-22.04	-21.11	-21.40
6	183	-14.15	-14.55	-14.47	-21.93	-20.96	-21.22
6	186	-14.40	-14.73	-14.65	-21.71	-20.61	-20.75
6	189	-14.64	-14.90	-14.82	-21.43	-20.14	-20.14
6	192	-14.90	-15.11	-15.00	-21.14	-19.65	-19.53
6	195	-15.20	-15.40	-15.23	-20.87	-19.25	-19.05
6	198	-15.50	-16.08	-15.56	-20.63	-18.94	-18.70
6	201	-15.80	-17.20	-15.97	-20.40	-18.65	-18.38
6	204	-16.14	-18.42	-16.42	-20.16	-18.37	-18.09
6	207	-16.59	-19.40	-16.86	-19.90	-18.10	-17.81
6	210	-17.19	-19.80	-17.22	-19.61	-17.81	-17.53
6	213	-18.93	-19.78	-17.48	-19.27	-17.52	-17.26
6	216	-22.09	-19.72	-17.68	-18.88	-17.22	-17.00
6	219	-25.63	-19.66	-17.88	-18.46	-16.92	-16.74
6	222	-28.51	-19.60	-18.13	-18.02	-16.63	-16.50
6	225	-29.70	-19.58	-18.50	-17.59	-16.34	-16.29
6	228	-28.97	-19.91	-19.63	-17.15	-16.05	-16.08
6	231	-27.24	-20.72	-21.69	-16.69	-15.76	-15.90
6	234	-25.17	-21.67	-24.00	-16.23	-15.48	-15.72
6	237	-23.44	-22.48	-25.88	-15.78	-15.19	-15.55
6	240	-22.72	-22.81	-26.66	-15.37	-14.92	-15.39
6	243	-22.83	-22.71	-25.74	-14.96	-14.61	-15.21
6	246	-23.10	-22.43	-23.50	-14.55	-14.27	-15.02
6	249	-23.42	-22.02	-20.71	-14.17	-13.95	-14.85
6	252	-23.69	-21.51	-18.14	-13.86	-13.71	-14.71
6	255	-23.81	-20.95	-16.57	-13.65	-13.59	-14.65
6	258	-23.07	-19.98	-15.80	-13.51	-13.56	-14.63
6	261	-21.26	-18.47	-15.14	-13.38	-13.53	-14.61
6	264	-19.01	-16.82	-14.61	-13.28	-13.51	-14.60
6	267	-16.93	-15.38	-14.22	-13.22	-13.49	-14.59
6	270	-15.63	-14.55	-13.98	-13.19	-13.49	-14.57
6	273	-15.00	-14.21	-13.85	-13.25	-13.52	-14.53
6	276	-14.49	-13.95	-13.76	-13.41	-13.60	-14.47
6	279	-14.07	-13.75	-13.69	-13.62	-13.71	-14.39
6	282	-13.72	-13.56	-13.61	-13.86	-13.82	-14.31
6	285	-13.42	-13.35	-13.50	-14.09	-13.91	-14.25
6	288	-13.12	-13.08	-13.28	-14.29	-13.99	-14.20
6	291	-12.82	-12.78	-12.97	-14.51	-14.06	-14.15
6	294	-12.57	-12.50	-12.64	-14.74	-14.12	-14.11
6	297	-12.39	-12.29	-12.35	-14.99	-14.21	-14.08
6	300	-12.32	-12.21	-12.19	-15.28	-14.31	-14.07
6	303	-12.36	-12.22	-12.11	-15.63	-14.45	-14.09
6	306	-12.44	-12.26	-12.05	-16.02	-14.65	-14.16

6	309	-12.57	-12.31	-12.01	-16.47	-14.89	-14.26
6	312	-12.73	-12.39	-11.97	-16.96	-15.15	-14.38
6	315	-12.91	-12.48	-11.96	-17.49	-15.42	-14.51
6	318	-13.16	-12.70	-12.08	-18.21	-15.71	-14.66
6	321	-13.53	-13.12	-12.37	-19.14	-16.05	-14.85
6	324	-13.98	-13.64	-12.77	-20.07	-16.40	-15.08
6	327	-14.49	-14.16	-13.19	-20.78	-16.77	-15.33
6	330	-15.03	-14.61	-13.57	-21.07	-17.13	-15.60
6	333	-15.76	-15.03	-13.94	-21.02	-17.55	-15.97
6	336	-16.73	-15.48	-14.37	-20.89	-18.04	-16.45
6	339	-17.71	-15.90	-14.77	-20.70	-18.50	-16.94
6	342	-18.46	-16.20	-15.06	-20.46	-18.85	-17.34
6	345	-18.76	-16.31	-15.18	-20.20	-18.98	-17.53
6	348	-18.59	-16.16	-15.06	-19.84	-18.92	-17.59
6	351	-18.09	-15.72	-14.71	-19.32	-18.74	-17.63
6	354	-17.27	-15.04	-14.15	-18.68	-18.43	-17.67
6	357	-16.14	-14.16	-13.42	-17.93	-17.99	-17.69
6	360	-14.69	-13.10	-12.53	-17.12	-17.41	-17.70
9	0	-14.48	-12.48	-11.59	-15.12	-15.86	-16.34
9	3	-13.47	-11.83	-10.98	-14.66	-15.23	-15.66
9	6	-12.52	-11.22	-10.41	-14.25	-14.65	-15.04
9	9	-11.66	-10.66	-9.89	-13.89	-14.15	-14.49
9	12	-10.90	-10.14	-9.43	-13.64	-13.75	-14.04
9	15	-10.25	-9.68	-9.04	-13.51	-13.48	-13.69
9	18	-9.72	-9.28	-8.70	-13.45	-13.29	-13.41
9	21	-9.25	-8.92	-8.42	-13.41	-13.12	-13.15
9	24	-8.83	-8.58	-8.16	-13.38	-12.98	-12.93
9	27	-8.43	-8.26	-7.90	-13.35	-12.89	-12.78
9	30	-8.04	-7.91	-7.64	-13.35	-12.86	-12.73
9	33	-7.64	-7.55	-7.36	-13.46	-12.97	-12.80
9	36	-7.26	-7.18	-7.08	-13.76	-13.26	-13.01
9	39	-6.90	-6.81	-6.81	-14.18	-13.68	-13.30
9	42	-6.55	-6.45	-6.53	-14.65	-14.16	-13.65
9	45	-6.22	-6.10	-6.24	-15.12	-14.64	-14.03
9	48	-5.89	-5.76	-5.93	-15.62	-15.17	-14.52
9	51	-5.57	-5.41	-5.59	-16.19	-15.80	-15.17
9	54	-5.26	-5.08	-5.26	-16.82	-16.51	-15.92
9	57	-4.99	-4.78	-4.95	-17.48	-17.26	-16.68
9	60	-4.78	-4.54	-4.70	-18.13	-18.03	-17.36
9	63	-4.59	-4.33	-4.48	-18.91	-18.98	-18.07
9	66	-4.42	-4.12	-4.26	-19.84	-20.14	-18.84
9	69	-4.27	-3.93	-4.07	-20.73	-21.27	-19.55
9	72	-4.16	-3.81	-3.93	-21.39	-22.12	-20.07
9	75	-4.12	-3.76	-3.88	-21.65	-22.46	-20.28
9	78	-4.12	-3.76	-3.89	-21.35	-22.13	-20.05
9	81	-4.12	-3.77	-3.89	-20.58	-21.29	-19.47
9	84	-4.12	-3.78	-3.91	-19.56	-20.17	-18.69
9	87	-4.13	-3.80	-3.93	-18.50	-19.01	-17.86
9	90	-4.13	-3.81	-3.95	-17.62	-18.02	-17.14
9	93	-4.17	-3.88	-4.03	-16.86	-17.17	-16.48
9	96	-4.27	-4.01	-4.18	-16.09	-16.30	-15.79
9	99	-4.40	-4.19	-4.38	-15.37	-15.47	-15.11
9	102	-4.56	-4.38	-4.60	-14.76	-14.75	-14.51
9	105	-4.71	-4.58	-4.83	-14.32	-14.19	-14.02
9	108	-4.87	-4.78	-5.07	-13.99	-13.72	-13.60
9	111	-5.05	-5.00	-5.34	-13.69	-13.27	-13.21
9	114	-5.25	-5.24	-5.63	-13.44	-12.90	-12.86
9	117	-5.46	-5.49	-5.93	-13.28	-12.64	-12.61

9	120	-5.68	-5.75	-6.22	-13.21	-12.54	-12.49
9	123	-5.91	-6.00	-6.51	-13.27	-12.55	-12.45
9	126	-6.16	-6.27	-6.79	-13.42	-12.59	-12.42
9	129	-6.43	-6.54	-7.08	-13.64	-12.65	-12.39
9	132	-6.71	-6.83	-7.38	-13.91	-12.73	-12.38
9	135	-7.01	-7.13	-7.68	-14.21	-12.82	-12.37
9	138	-7.33	-7.43	-8.00	-14.62	-13.04	-12.49
9	141	-7.67	-7.75	-8.32	-15.21	-13.45	-12.80
9	144	-8.04	-8.08	-8.66	-15.91	-14.00	-13.25
9	147	-8.41	-8.43	-9.01	-16.68	-14.63	-13.78
9	150	-8.80	-8.81	-9.38	-17.46	-15.29	-14.33
9	153	-9.20	-9.24	-9.78	-18.45	-16.16	-15.05
9	156	-9.63	-9.72	-10.22	-19.68	-17.32	-16.00
9	159	-10.07	-10.22	-10.67	-20.89	-18.52	-17.05
9	162	-10.51	-10.72	-11.12	-21.81	-19.52	-18.06
9	165	-10.92	-11.20	-11.54	-22.18	-20.07	-18.87
9	168	-11.32	-11.67	-11.93	-22.16	-20.31	-19.56
9	171	-11.69	-12.13	-12.31	-22.09	-20.51	-20.27
9	174	-12.07	-12.58	-12.68	-21.98	-20.67	-20.88
9	177	-12.43	-13.02	-13.04	-21.85	-20.77	-21.32
9	180	-12.81	-13.44	-13.38	-21.71	-20.80	-21.49
9	183	-13.17	-13.81	-13.68	-21.48	-20.60	-21.21
9	186	-13.53	-14.12	-13.96	-21.14	-20.08	-20.51
9	189	-13.89	-14.44	-14.23	-20.74	-19.41	-19.61
9	192	-14.27	-14.82	-14.53	-20.34	-18.73	-18.72
9	195	-14.70	-15.31	-14.88	-20.00	-18.19	-18.04
9	198	-15.13	-16.25	-15.34	-19.72	-17.80	-17.58
9	201	-15.56	-17.70	-15.91	-19.47	-17.45	-17.17
9	204	-16.07	-19.24	-16.51	-19.23	-17.13	-16.80
9	207	-16.71	-20.46	-17.10	-18.97	-16.80	-16.45
9	210	-17.55	-20.97	-17.61	-18.67	-16.47	-16.11
9	213	-19.90	-20.98	-18.00	-18.31	-16.14	-15.77
9	216	-24.09	-20.98	-18.31	-17.89	-15.81	-15.45
9	219	-28.76	-20.98	-18.62	-17.42	-15.47	-15.14
9	222	-32.56	-20.99	-19.01	-16.94	-15.14	-14.85
9	225	-34.13	-21.00	-19.57	-16.45	-14.79	-14.57
9	228	-33.19	-21.45	-21.11	-15.93	-14.44	-14.31
9	231	-30.94	-22.51	-23.82	-15.37	-14.08	-14.06
9	234	-28.25	-23.78	-26.83	-14.80	-13.72	-13.82
9	237	-26.01	-24.84	-29.28	-14.24	-13.35	-13.59
9	240	-25.06	-25.28	-30.29	-13.72	-12.99	-13.36
9	243	-25.21	-25.15	-29.07	-13.19	-12.57	-13.10
9	246	-25.56	-24.78	-26.12	-12.65	-12.10	-12.83
9	249	-25.99	-24.23	-22.44	-12.14	-11.65	-12.57
9	252	-26.34	-23.55	-19.06	-11.71	-11.31	-12.36
9	255	-26.49	-22.81	-17.01	-11.43	-11.14	-12.26
9	258	-25.54	-21.58	-16.03	-11.25	-11.09	-12.22
9	261	-23.23	-19.69	-15.22	-11.08	-11.05	-12.20
9	264	-20.33	-17.61	-14.56	-10.95	-11.02	-12.18
9	267	-17.64	-15.78	-14.06	-10.86	-11.00	-12.16
9	270	-15.93	-14.67	-13.73	-10.82	-11.00	-12.13
9	273	-15.06	-14.16	-13.53	-10.90	-11.04	-12.07
9	276	-14.35	-13.76	-13.39	-11.11	-11.14	-11.98
9	279	-13.77	-13.45	-13.27	-11.39	-11.28	-11.88
9	282	-13.28	-13.16	-13.14	-11.70	-11.43	-11.78
9	285	-12.85	-12.84	-12.96	-11.99	-11.56	-11.70
9	288	-12.43	-12.45	-12.65	-12.25	-11.65	-11.64
9	291	-12.01	-12.02	-12.22	-12.52	-11.73	-11.57

9	294	-11.66	-11.63	-11.77	-12.81	-11.81	-11.51
9	297	-11.41	-11.34	-11.37	-13.13	-11.91	-11.47
9	300	-11.31	-11.22	-11.13	-13.50	-12.03	-11.46
9	303	-11.35	-11.23	-10.99	-13.94	-12.22	-11.49
9	306	-11.44	-11.26	-10.88	-14.45	-12.48	-11.59
9	309	-11.58	-11.31	-10.79	-15.03	-12.79	-11.74
9	312	-11.75	-11.37	-10.73	-15.67	-13.14	-11.90
9	315	-11.95	-11.45	-10.70	-16.35	-13.49	-12.08
9	318	-12.26	-11.70	-10.85	-17.28	-13.88	-12.29
9	321	-12.74	-12.21	-11.22	-18.49	-14.31	-12.55
9	324	-13.34	-12.87	-11.72	-19.69	-14.78	-12.85
9	327	-14.02	-13.56	-12.26	-20.61	-15.26	-13.19
9	330	-14.73	-14.14	-12.74	-20.98	-15.73	-13.55
9	333	-15.69	-14.71	-13.24	-20.89	-16.27	-14.05
9	336	-16.95	-15.32	-13.81	-20.66	-16.89	-14.69
9	339	-18.22	-15.89	-14.35	-20.31	-17.47	-15.35
9	342	-19.20	-16.31	-14.75	-19.90	-17.91	-15.88
9	345	-19.59	-16.47	-14.91	-19.45	-18.08	-16.13
9	348	-19.38	-16.29	-14.76	-18.89	-17.99	-16.21
9	351	-18.76	-15.75	-14.32	-18.15	-17.73	-16.26
9	354	-17.73	-14.91	-13.63	-17.25	-17.29	-16.31
9	357	-16.30	-13.81	-12.71	-16.23	-16.67	-16.33
9	360	-14.48	-12.48	-11.59	-15.12	-15.86	-16.34
12	0	-14.40	-12.17	-11.03	-13.78	-14.82	-15.28
12	3	-13.16	-11.34	-10.27	-13.25	-14.08	-14.52
12	6	-12.01	-10.56	-9.56	-12.75	-13.40	-13.83
12	9	-10.95	-9.83	-8.91	-12.35	-12.81	-13.21
12	12	-10.02	-9.17	-8.33	-12.06	-12.35	-12.70
12	15	-9.23	-8.59	-7.83	-11.93	-12.04	-12.30
12	18	-8.56	-8.07	-7.40	-11.89	-11.82	-11.97
12	21	-7.98	-7.62	-7.03	-11.87	-11.62	-11.67
12	24	-7.45	-7.19	-6.70	-11.85	-11.47	-11.41
12	27	-6.96	-6.79	-6.38	-11.83	-11.36	-11.23
12	30	-6.49	-6.37	-6.05	-11.83	-11.32	-11.17
12	33	-6.03	-5.95	-5.72	-11.96	-11.45	-11.25
12	36	-5.59	-5.52	-5.41	-12.31	-11.77	-11.47
12	39	-5.18	-5.11	-5.09	-12.80	-12.24	-11.79
12	42	-4.79	-4.71	-4.78	-13.35	-12.77	-12.18
12	45	-4.43	-4.33	-4.47	-13.91	-13.32	-12.59
12	48	-4.08	-3.97	-4.13	-14.50	-13.93	-13.13
12	51	-3.74	-3.60	-3.77	-15.19	-14.67	-13.88
12	54	-3.42	-3.25	-3.42	-15.94	-15.50	-14.73
12	57	-3.15	-2.94	-3.10	-16.75	-16.39	-15.62
12	60	-2.93	-2.69	-2.84	-17.57	-17.32	-16.44
12	63	-2.74	-2.47	-2.61	-18.58	-18.49	-17.31
12	66	-2.56	-2.25	-2.38	-19.80	-19.95	-18.30
12	69	-2.41	-2.07	-2.18	-20.99	-21.37	-19.23
12	72	-2.30	-1.94	-2.04	-21.88	-22.45	-19.92
12	75	-2.26	-1.89	-1.99	-22.23	-22.88	-20.18
12	78	-2.27	-1.89	-1.99	-21.86	-22.50	-19.93
12	81	-2.27	-1.91	-2.01	-20.91	-21.53	-19.27
12	84	-2.29	-1.93	-2.04	-19.65	-20.24	-18.39
12	87	-2.30	-1.96	-2.08	-18.34	-18.88	-17.43
12	90	-2.32	-2.00	-2.13	-17.25	-17.71	-16.58
12	93	-2.38	-2.09	-2.23	-16.33	-16.68	-15.78
12	96	-2.50	-2.25	-2.41	-15.38	-15.61	-14.92
12	99	-2.66	-2.45	-2.65	-14.49	-14.58	-14.07
12	102	-2.84	-2.68	-2.91	-13.74	-13.68	-13.31

12	105	-3.02	-2.91	-3.18	-13.21	-12.99	-12.70
12	108	-3.20	-3.14	-3.46	-12.81	-12.43	-12.19
12	111	-3.41	-3.40	-3.77	-12.44	-11.90	-11.70
12	114	-3.63	-3.68	-4.11	-12.14	-11.45	-11.27
12	117	-3.87	-3.96	-4.45	-11.94	-11.13	-10.97
12	120	-4.12	-4.25	-4.78	-11.86	-11.02	-10.84
12	123	-4.38	-4.53	-5.10	-11.93	-11.03	-10.82
12	126	-4.66	-4.82	-5.41	-12.10	-11.08	-10.81
12	129	-4.95	-5.12	-5.72	-12.36	-11.16	-10.79
12	132	-5.25	-5.42	-6.04	-12.68	-11.26	-10.79
12	135	-5.57	-5.73	-6.35	-13.02	-11.38	-10.78
12	138	-5.90	-6.04	-6.67	-13.51	-11.65	-10.93
12	141	-6.24	-6.35	-6.99	-14.20	-12.16	-11.33
12	144	-6.60	-6.68	-7.31	-15.04	-12.83	-11.89
12	147	-6.98	-7.02	-7.64	-15.95	-13.60	-12.55
12	150	-7.37	-7.40	-8.01	-16.86	-14.39	-13.24
12	153	-7.78	-7.83	-8.42	-17.99	-15.40	-14.11
12	156	-8.21	-8.32	-8.88	-19.38	-16.72	-15.26
12	159	-8.66	-8.84	-9.35	-20.75	-18.07	-16.52
12	162	-9.11	-9.37	-9.83	-21.78	-19.18	-17.70
12	165	-9.55	-9.89	-10.28	-22.19	-19.76	-18.63
12	168	-9.97	-10.39	-10.72	-22.14	-19.97	-19.41
12	171	-10.38	-10.90	-11.14	-22.00	-20.15	-20.19
12	174	-10.79	-11.41	-11.56	-21.79	-20.29	-20.86
12	177	-11.21	-11.92	-11.98	-21.54	-20.38	-21.34
12	180	-11.65	-12.44	-12.39	-21.28	-20.41	-21.52
12	183	-12.10	-12.94	-12.79	-20.93	-20.14	-21.14
12	186	-12.55	-13.42	-13.17	-20.44	-19.46	-20.21
12	189	-13.02	-13.91	-13.55	-19.91	-18.60	-19.01
12	192	-13.53	-14.48	-13.97	-19.39	-17.74	-17.84
12	195	-14.08	-15.17	-14.44	-18.98	-17.10	-17.01
12	198	-14.63	-16.31	-15.02	-18.69	-16.67	-16.48
12	201	-15.18	-17.92	-15.71	-18.44	-16.29	-16.02
12	204	-15.82	-19.61	-16.44	-18.21	-15.96	-15.61
12	207	-16.63	-20.95	-17.14	-17.97	-15.64	-15.25
12	210	-17.69	-21.55	-17.77	-17.68	-15.31	-14.90
12	213	-20.44	-21.63	-18.25	-17.35	-15.00	-14.57
12	216	-25.26	-21.66	-18.64	-16.97	-14.70	-14.27
12	219	-30.59	-21.69	-19.02	-16.56	-14.41	-13.99
12	222	-34.92	-21.73	-19.51	-16.11	-14.11	-13.71
12	225	-36.70	-21.80	-20.19	-15.64	-13.77	-13.43
12	228	-35.63	-22.37	-21.97	-15.10	-13.40	-13.14
12	231	-33.07	-23.59	-25.07	-14.50	-13.00	-12.86
12	234	-30.02	-25.02	-28.49	-13.86	-12.57	-12.57
12	237	-27.46	-26.20	-31.25	-13.22	-12.14	-12.28
12	240	-26.39	-26.69	-32.40	-12.62	-11.71	-11.99
12	243	-26.55	-26.53	-31.00	-12.02	-11.21	-11.67
12	246	-26.94	-26.10	-27.61	-11.38	-10.66	-11.30
12	249	-27.41	-25.46	-23.40	-10.78	-10.12	-10.96
12	252	-27.80	-24.67	-19.52	-10.28	-9.70	-10.67
12	255	-27.97	-23.82	-17.17	-9.93	-9.47	-10.51
12	258	-26.91	-22.44	-16.06	-9.70	-9.38	-10.43
12	261	-24.33	-20.36	-15.14	-9.50	-9.30	-10.38
12	264	-21.07	-18.06	-14.40	-9.33	-9.24	-10.34
12	267	-18.02	-16.02	-13.82	-9.21	-9.20	-10.30
12	270	-16.04	-14.72	-13.42	-9.17	-9.19	-10.25
12	273	-14.97	-14.03	-13.14	-9.26	-9.24	-10.17
12	276	-14.09	-13.50	-12.94	-9.48	-9.36	-10.07

12	279	-13.35	-13.06	-12.77	-9.79	-9.52	-9.97
12	282	-12.73	-12.66	-12.59	-10.14	-9.69	-9.88
12	285	-12.20	-12.25	-12.35	-10.46	-9.84	-9.81
12	288	-11.69	-11.76	-11.97	-10.76	-9.96	-9.77
12	291	-11.19	-11.24	-11.45	-11.08	-10.07	-9.72
12	294	-10.76	-10.76	-10.91	-11.42	-10.19	-9.69
12	297	-10.46	-10.42	-10.44	-11.80	-10.32	-9.67
12	300	-10.35	-10.28	-10.15	-12.24	-10.48	-9.66
12	303	-10.38	-10.29	-9.98	-12.75	-10.72	-9.70
12	306	-10.48	-10.31	-9.84	-13.35	-11.02	-9.83
12	309	-10.62	-10.35	-9.72	-14.04	-11.39	-10.01
12	312	-10.80	-10.40	-9.64	-14.79	-11.79	-10.23
12	315	-11.01	-10.47	-9.61	-15.59	-12.20	-10.45
12	318	-11.37	-10.74	-9.78	-16.67	-12.65	-10.69
12	321	-11.94	-11.32	-10.19	-18.06	-13.16	-11.00
12	324	-12.68	-12.08	-10.76	-19.44	-13.71	-11.35
12	327	-13.50	-12.88	-11.37	-20.50	-14.26	-11.75
12	330	-14.35	-13.59	-11.93	-20.92	-14.80	-12.17
12	333	-15.48	-14.28	-12.52	-20.80	-15.41	-12.73
12	336	-16.96	-15.06	-13.23	-20.48	-16.10	-13.45
12	339	-18.43	-15.79	-13.90	-20.01	-16.75	-14.19
12	342	-19.57	-16.32	-14.40	-19.45	-17.23	-14.77
12	345	-20.03	-16.53	-14.60	-18.85	-17.42	-15.06
12	348	-19.81	-16.34	-14.45	-18.16	-17.32	-15.13
12	351	-19.13	-15.77	-13.99	-17.28	-17.01	-15.19
12	354	-18.01	-14.86	-13.25	-16.23	-16.49	-15.24
12	357	-16.43	-13.65	-12.26	-15.06	-15.76	-15.27
12	360	-14.40	-12.17	-11.03	-13.78	-14.82	-15.28
15	0	-14.39	-12.09	-10.85	-13.29	-14.43	-14.57
15	3	-13.09	-11.21	-10.05	-12.73	-13.65	-13.88
15	6	-11.87	-10.37	-9.29	-12.21	-12.94	-13.24
15	9	-10.75	-9.58	-8.59	-11.78	-12.33	-12.67
15	12	-9.74	-8.86	-7.95	-11.48	-11.84	-12.18
15	15	-8.85	-8.19	-7.38	-11.35	-11.51	-11.79
15	18	-8.08	-7.58	-6.88	-11.32	-11.28	-11.45
15	21	-7.38	-7.01	-6.42	-11.30	-11.07	-11.13
15	24	-6.75	-6.48	-6.00	-11.29	-10.91	-10.86
15	27	-6.17	-5.99	-5.61	-11.28	-10.80	-10.67
15	30	-5.64	-5.51	-5.23	-11.27	-10.76	-10.60
15	33	-5.14	-5.05	-4.87	-11.39	-10.86	-10.66
15	36	-4.68	-4.61	-4.53	-11.68	-11.13	-10.84
15	39	-4.25	-4.20	-4.21	-12.11	-11.52	-11.10
15	42	-3.87	-3.81	-3.89	-12.61	-11.98	-11.43
15	45	-3.53	-3.45	-3.59	-13.12	-12.47	-11.78
15	48	-3.22	-3.12	-3.28	-13.70	-13.05	-12.28
15	51	-2.93	-2.80	-2.97	-14.41	-13.79	-13.00
15	54	-2.67	-2.51	-2.67	-15.21	-14.65	-13.85
15	57	-2.45	-2.24	-2.39	-16.08	-15.60	-14.75
15	60	-2.25	-2.02	-2.16	-17.00	-16.59	-15.62
15	63	-2.07	-1.80	-1.93	-18.18	-17.90	-16.61
15	66	-1.89	-1.58	-1.70	-19.66	-19.58	-17.79
15	69	-1.74	-1.39	-1.50	-21.12	-21.24	-18.92
15	72	-1.63	-1.26	-1.35	-22.23	-22.52	-19.76
15	75	-1.59	-1.21	-1.30	-22.68	-23.02	-20.10
15	78	-1.59	-1.22	-1.31	-22.25	-22.63	-19.84
15	81	-1.60	-1.23	-1.33	-21.16	-21.63	-19.17
15	84	-1.62	-1.26	-1.37	-19.72	-20.28	-18.26
15	87	-1.64	-1.30	-1.41	-18.23	-18.85	-17.28

15	90	-1.67	-1.35	-1.47	-17.00	-17.60	-16.38
15	93	-1.73	-1.44	-1.58	-15.96	-16.47	-15.52
15	96	-1.86	-1.61	-1.78	-14.90	-15.26	-14.57
15	99	-2.03	-1.83	-2.03	-13.91	-14.10	-13.62
15	102	-2.22	-2.07	-2.31	-13.09	-13.09	-12.77
15	105	-2.40	-2.31	-2.59	-12.52	-12.34	-12.10
15	108	-2.60	-2.55	-2.88	-12.12	-11.75	-11.54
15	111	-2.82	-2.82	-3.21	-11.76	-11.21	-11.00
15	114	-3.05	-3.11	-3.57	-11.46	-10.75	-10.54
15	117	-3.30	-3.41	-3.93	-11.26	-10.43	-10.22
15	120	-3.56	-3.71	-4.27	-11.19	-10.32	-10.10
15	123	-3.83	-4.01	-4.60	-11.27	-10.34	-10.10
15	126	-4.13	-4.32	-4.94	-11.48	-10.42	-10.11
15	129	-4.43	-4.63	-5.27	-11.80	-10.53	-10.14
15	132	-4.74	-4.94	-5.58	-12.18	-10.68	-10.16
15	135	-5.04	-5.23	-5.87	-12.59	-10.85	-10.20
15	138	-5.33	-5.49	-6.12	-13.13	-11.17	-10.39
15	141	-5.61	-5.72	-6.35	-13.87	-11.73	-10.82
15	144	-5.90	-5.96	-6.56	-14.75	-12.44	-11.42
15	147	-6.19	-6.21	-6.80	-15.70	-13.25	-12.12
15	150	-6.50	-6.51	-7.07	-16.66	-14.07	-12.86
15	153	-6.83	-6.86	-7.40	-17.83	-15.12	-13.79
15	156	-7.18	-7.26	-7.79	-19.28	-16.48	-15.01
15	159	-7.53	-7.70	-8.21	-20.70	-17.85	-16.34
15	162	-7.91	-8.17	-8.64	-21.77	-18.95	-17.58
15	165	-8.29	-8.64	-9.07	-22.19	-19.49	-18.56
15	168	-8.68	-9.13	-9.50	-22.11	-19.65	-19.37
15	171	-9.08	-9.64	-9.94	-21.88	-19.77	-20.16
15	174	-9.50	-10.18	-10.39	-21.55	-19.87	-20.85
15	177	-9.94	-10.75	-10.85	-21.17	-19.93	-21.34
15	180	-10.42	-11.35	-11.33	-20.77	-19.95	-21.52
15	183	-10.93	-11.98	-11.81	-20.28	-19.61	-21.03
15	186	-11.48	-12.63	-12.29	-19.64	-18.77	-19.84
15	189	-12.07	-13.34	-12.80	-18.96	-17.70	-18.33
15	192	-12.70	-14.12	-13.34	-18.34	-16.68	-16.90
15	195	-13.38	-15.01	-13.93	-17.88	-15.97	-15.94
15	198	-14.05	-16.29	-14.63	-17.57	-15.55	-15.40
15	201	-14.72	-17.99	-15.44	-17.32	-15.19	-14.94
15	204	-15.50	-19.71	-16.28	-17.10	-14.88	-14.55
15	207	-16.46	-21.08	-17.09	-16.89	-14.60	-14.23
15	210	-17.71	-21.71	-17.79	-16.65	-14.36	-13.95
15	213	-20.68	-21.81	-18.32	-16.40	-14.15	-13.73
15	216	-25.71	-21.87	-18.74	-16.15	-13.98	-13.55
15	219	-31.24	-21.91	-19.15	-15.90	-13.81	-13.39
15	222	-35.70	-21.96	-19.67	-15.60	-13.63	-13.22
15	225	-37.54	-22.06	-20.39	-15.26	-13.40	-13.01
15	228	-36.42	-22.67	-22.26	-14.79	-13.08	-12.76
15	231	-33.76	-23.94	-25.48	-14.20	-12.67	-12.48
15	234	-30.58	-25.41	-29.03	-13.53	-12.20	-12.16
15	237	-27.92	-26.63	-31.90	-12.86	-11.72	-11.83
15	240	-26.80	-27.14	-33.08	-12.23	-11.24	-11.50
15	243	-26.97	-26.97	-31.64	-11.60	-10.73	-11.11
15	246	-27.37	-26.51	-28.12	-10.94	-10.16	-10.66
15	249	-27.85	-25.84	-23.73	-10.30	-9.60	-10.21
15	252	-28.26	-25.02	-19.69	-9.76	-9.14	-9.83
15	255	-28.43	-24.12	-17.19	-9.38	-8.84	-9.58
15	258	-27.35	-22.71	-15.99	-9.11	-8.67	-9.44
15	261	-24.71	-20.60	-14.98	-8.86	-8.51	-9.32

15	264	-21.37	-18.27	-14.17	-8.66	-8.39	-9.23
15	267	-18.19	-16.16	-13.53	-8.52	-8.30	-9.15
15	270	-16.05	-14.73	-13.05	-8.46	-8.27	-9.07
15	273	-14.81	-13.88	-12.70	-8.54	-8.32	-8.99
15	276	-13.76	-13.20	-12.44	-8.75	-8.44	-8.91
15	279	-12.86	-12.62	-12.22	-9.03	-8.61	-8.84
15	282	-12.11	-12.10	-11.99	-9.36	-8.80	-8.80
15	285	-11.49	-11.60	-11.69	-9.68	-8.97	-8.78
15	288	-10.91	-11.04	-11.24	-9.99	-9.13	-8.78
15	291	-10.36	-10.45	-10.67	-10.34	-9.29	-8.81
15	294	-9.89	-9.92	-10.08	-10.73	-9.47	-8.84
15	297	-9.56	-9.54	-9.58	-11.16	-9.67	-8.88
15	300	-9.44	-9.39	-9.26	-11.65	-9.90	-8.93
15	303	-9.47	-9.40	-9.09	-12.22	-10.18	-9.02
15	306	-9.56	-9.42	-8.95	-12.88	-10.51	-9.17
15	309	-9.70	-9.45	-8.83	-13.63	-10.89	-9.37
15	312	-9.88	-9.49	-8.75	-14.45	-11.30	-9.60
15	315	-10.09	-9.55	-8.72	-15.31	-11.73	-9.85
15	318	-10.48	-9.83	-8.88	-16.46	-12.21	-10.12
15	321	-11.14	-10.46	-9.31	-17.92	-12.75	-10.45
15	324	-11.99	-11.29	-9.89	-19.36	-13.33	-10.82
15	327	-12.94	-12.18	-10.53	-20.46	-13.91	-11.23
15	330	-13.91	-12.97	-11.13	-20.90	-14.47	-11.66
15	333	-15.17	-13.79	-11.80	-20.76	-15.08	-12.21
15	336	-16.80	-14.73	-12.62	-20.36	-15.78	-12.90
15	339	-18.42	-15.62	-13.42	-19.79	-16.43	-13.58
15	342	-19.66	-16.28	-14.03	-19.13	-16.91	-14.12
15	345	-20.16	-16.54	-14.27	-18.45	-17.10	-14.38
15	348	-19.94	-16.35	-14.12	-17.70	-16.99	-14.45
15	351	-19.26	-15.79	-13.71	-16.78	-16.67	-14.50
15	354	-18.12	-14.87	-13.02	-15.73	-16.14	-14.54
15	357	-16.50	-13.63	-12.06	-14.56	-15.39	-14.56
15	360	-14.39	-12.09	-10.85	-13.29	-14.43	-14.57
18	0	-15.18	-12.84	-11.43	-13.40	-14.47	-14.15
18	3	-13.70	-11.80	-10.52	-12.85	-13.73	-13.58
18	6	-12.31	-10.81	-9.67	-12.34	-13.04	-13.06
18	9	-11.03	-9.89	-8.87	-11.92	-12.45	-12.58
18	12	-9.89	-9.03	-8.14	-11.61	-11.96	-12.16
18	15	-8.88	-8.24	-7.48	-11.46	-11.62	-11.80
18	18	-7.99	-7.52	-6.88	-11.40	-11.37	-11.48
18	21	-7.18	-6.84	-6.32	-11.35	-11.13	-11.15
18	24	-6.45	-6.20	-5.81	-11.32	-10.95	-10.87
18	27	-5.80	-5.62	-5.34	-11.29	-10.82	-10.67
18	30	-5.23	-5.10	-4.91	-11.29	-10.77	-10.60
18	33	-4.71	-4.63	-4.52	-11.36	-10.83	-10.64
18	36	-4.24	-4.18	-4.16	-11.56	-11.00	-10.75
18	39	-3.82	-3.77	-3.83	-11.86	-11.25	-10.92
18	42	-3.45	-3.41	-3.53	-12.22	-11.56	-11.13
18	45	-3.16	-3.10	-3.26	-12.60	-11.90	-11.37
18	48	-2.93	-2.85	-3.01	-13.08	-12.36	-11.76
18	51	-2.73	-2.61	-2.78	-13.73	-13.02	-12.37
18	54	-2.56	-2.41	-2.57	-14.50	-13.83	-13.12
18	57	-2.41	-2.23	-2.38	-15.38	-14.74	-13.96
18	60	-2.27	-2.06	-2.21	-16.31	-15.72	-14.81
18	63	-2.14	-1.90	-2.03	-17.62	-17.10	-15.88
18	66	-2.01	-1.74	-1.85	-19.37	-18.95	-17.24
18	69	-1.89	-1.59	-1.70	-21.13	-20.82	-18.59
18	72	-1.81	-1.49	-1.58	-22.49	-22.28	-19.62



18	75	-1.78	-1.45	-1.54	-23.04	-22.86	-20.02
18	78	-1.79	-1.46	-1.55	-22.56	-22.49	-19.79
18	81	-1.80	-1.48	-1.57	-21.36	-21.54	-19.17
18	84	-1.82	-1.51	-1.61	-19.78	-20.25	-18.33
18	87	-1.84	-1.54	-1.66	-18.15	-18.86	-17.39
18	90	-1.87	-1.59	-1.72	-16.81	-17.63	-16.52
18	93	-1.94	-1.68	-1.84	-15.70	-16.44	-15.63
18	96	-2.06	-1.84	-2.03	-14.56	-15.15	-14.61
18	99	-2.22	-2.05	-2.28	-13.51	-13.88	-13.58
18	102	-2.40	-2.28	-2.55	-12.66	-12.79	-12.65
18	105	-2.58	-2.51	-2.82	-12.10	-12.02	-11.94
18	108	-2.77	-2.75	-3.11	-11.73	-11.45	-11.36
18	111	-2.99	-3.01	-3.43	-11.41	-10.94	-10.81
18	114	-3.22	-3.29	-3.78	-11.16	-10.51	-10.34
18	117	-3.47	-3.58	-4.12	-10.99	-10.22	-10.01
18	120	-3.72	-3.87	-4.45	-10.92	-10.11	-9.89
18	123	-3.99	-4.16	-4.78	-11.02	-10.15	-9.90
18	126	-4.29	-4.48	-5.12	-11.28	-10.26	-9.95
18	129	-4.59	-4.80	-5.46	-11.66	-10.43	-10.02
18	132	-4.88	-5.08	-5.74	-12.12	-10.64	-10.12
18	135	-5.12	-5.30	-5.93	-12.60	-10.88	-10.23
18	138	-5.32	-5.45	-6.05	-13.22	-11.27	-10.48
18	141	-5.49	-5.57	-6.13	-14.05	-11.88	-10.95
18	144	-5.65	-5.67	-6.20	-15.01	-12.65	-11.58
18	147	-5.81	-5.79	-6.28	-16.01	-13.48	-12.31
18	150	-5.99	-5.94	-6.40	-16.97	-14.32	-13.08
18	153	-6.18	-6.14	-6.58	-18.05	-15.36	-14.09
18	156	-6.38	-6.39	-6.84	-19.30	-16.66	-15.44
18	159	-6.59	-6.69	-7.14	-20.49	-17.94	-16.87
18	162	-6.81	-7.01	-7.47	-21.37	-18.91	-18.13
18	165	-7.07	-7.37	-7.81	-21.72	-19.30	-18.97
18	168	-7.36	-7.76	-8.18	-21.58	-19.28	-19.51
18	171	-7.69	-8.21	-8.58	-21.20	-19.24	-20.01
18	174	-8.07	-8.72	-9.02	-20.67	-19.16	-20.41
18	177	-8.48	-9.28	-9.48	-20.08	-19.07	-20.68
18	180	-8.92	-9.88	-9.97	-19.52	-18.95	-20.78
18	183	-9.43	-10.54	-10.48	-18.89	-18.48	-20.23
18	186	-10.00	-11.29	-11.02	-18.13	-17.53	-18.89
18	189	-10.64	-12.11	-11.60	-17.37	-16.38	-17.21
18	192	-11.33	-13.00	-12.23	-16.71	-15.33	-15.67
18	195	-12.06	-13.97	-12.90	-16.27	-14.67	-14.72
18	198	-12.79	-15.26	-13.69	-15.99	-14.31	-14.24
18	201	-13.53	-16.88	-14.60	-15.76	-13.99	-13.81
18	204	-14.37	-18.52	-15.55	-15.56	-13.73	-13.47
18	207	-15.40	-19.84	-16.44	-15.42	-13.55	-13.24
18	210	-16.71	-20.50	-17.18	-15.33	-13.49	-13.14
18	213	-19.54	-20.68	-17.73	-15.29	-13.50	-13.12
18	216	-24.14	-20.79	-18.15	-15.26	-13.52	-13.12
18	219	-29.14	-20.86	-18.56	-15.24	-13.54	-13.11
18	222	-33.15	-20.97	-19.06	-15.21	-13.55	-13.10
18	225	-34.80	-21.14	-19.76	-15.16	-13.56	-13.08
18	228	-33.78	-21.72	-21.44	-14.92	-13.41	-12.97
18	231	-31.35	-22.78	-24.24	-14.41	-13.04	-12.72
18	234	-28.45	-23.98	-27.30	-13.74	-12.52	-12.37
18	237	-26.02	-24.96	-29.76	-13.03	-11.96	-11.98
18	240	-25.01	-25.37	-30.77	-12.39	-11.44	-11.59
18	243	-25.13	-25.20	-29.47	-11.77	-10.91	-11.14
18	246	-25.43	-24.74	-26.28	-11.09	-10.32	-10.59

18	249	-25.79	-24.08	-22.30	-10.43	-9.72	-10.03
18	252	-26.09	-23.27	-18.60	-9.85	-9.20	-9.52
18	255	-26.22	-22.40	-16.28	-9.43	-8.83	-9.17
18	258	-25.26	-21.10	-15.12	-9.11	-8.56	-8.93
18	261	-22.90	-19.22	-14.15	-8.81	-8.31	-8.71
18	264	-19.90	-17.14	-13.35	-8.56	-8.10	-8.53
18	267	-17.02	-15.23	-12.72	-8.38	-7.96	-8.40
18	270	-15.02	-13.88	-12.22	-8.32	-7.90	-8.34
18	273	-13.81	-13.03	-11.85	-8.38	-7.95	-8.31
18	276	-12.75	-12.31	-11.56	-8.55	-8.06	-8.29
18	279	-11.84	-11.70	-11.32	-8.78	-8.23	-8.28
18	282	-11.08	-11.15	-11.06	-9.06	-8.42	-8.27
18	285	-10.46	-10.63	-10.75	-9.34	-8.61	-8.27
18	288	-9.90	-10.08	-10.29	-9.65	-8.81	-8.31
18	291	-9.37	-9.50	-9.73	-10.03	-9.04	-8.40
18	294	-8.93	-8.98	-9.16	-10.47	-9.30	-8.54
18	297	-8.62	-8.61	-8.69	-10.97	-9.59	-8.69
18	300	-8.50	-8.47	-8.41	-11.50	-9.89	-8.85
18	303	-8.53	-8.48	-8.28	-12.11	-10.22	-9.02
18	306	-8.62	-8.50	-8.16	-12.83	-10.58	-9.21
18	309	-8.75	-8.54	-8.07	-13.62	-10.98	-9.43
18	312	-8.92	-8.59	-8.01	-14.48	-11.41	-9.67
18	315	-9.12	-8.65	-7.99	-15.38	-11.85	-9.93
18	318	-9.51	-8.93	-8.15	-16.54	-12.36	-10.22
18	321	-10.19	-9.55	-8.55	-17.98	-12.92	-10.55
18	324	-11.07	-10.38	-9.10	-19.40	-13.50	-10.92
18	327	-12.06	-11.28	-9.73	-20.48	-14.08	-11.31
18	330	-13.07	-12.11	-10.33	-20.91	-14.62	-11.71
18	333	-14.37	-13.02	-11.06	-20.74	-15.20	-12.20
18	336	-16.05	-14.10	-11.98	-20.30	-15.83	-12.79
18	339	-17.73	-15.14	-12.89	-19.67	-16.40	-13.37
18	342	-19.02	-15.92	-13.59	-18.95	-16.83	-13.82
18	345	-19.53	-16.23	-13.87	-18.23	-16.99	-14.02
18	348	-19.39	-16.11	-13.79	-17.47	-16.89	-14.07
18	351	-18.94	-15.72	-13.53	-16.60	-16.58	-14.10
18	354	-18.12	-15.06	-13.07	-15.62	-16.07	-14.13
18	357	-16.88	-14.10	-12.38	-14.55	-15.37	-14.14
18	360	-15.18	-12.84	-11.43	-13.40	-14.47	-14.15
21	0	-17.05	-14.62	-12.80	-13.65	-14.56	-13.85
21	3	-15.08	-13.15	-11.61	-13.13	-13.89	-13.38
21	6	-13.26	-11.77	-10.49	-12.66	-13.27	-12.94
21	9	-11.61	-10.51	-9.46	-12.25	-12.72	-12.53
21	12	-10.16	-9.37	-8.53	-11.93	-12.26	-12.16
21	15	-8.95	-8.38	-7.71	-11.73	-11.89	-11.84
21	18	-7.93	-7.51	-6.98	-11.60	-11.58	-11.51
21	21	-7.01	-6.71	-6.31	-11.49	-11.29	-11.19
21	24	-6.20	-5.99	-5.70	-11.40	-11.04	-10.90
21	27	-5.50	-5.35	-5.16	-11.34	-10.87	-10.69
21	30	-4.91	-4.80	-4.69	-11.32	-10.80	-10.61
21	33	-4.37	-4.30	-4.26	-11.37	-10.83	-10.63
21	36	-3.88	-3.83	-3.86	-11.48	-10.92	-10.69
21	39	-3.45	-3.41	-3.51	-11.67	-11.05	-10.78
21	42	-3.10	-3.07	-3.21	-11.89	-11.22	-10.89
21	45	-2.87	-2.82	-2.98	-12.15	-11.41	-11.03
21	48	-2.71	-2.64	-2.80	-12.52	-11.73	-11.30
21	51	-2.57	-2.48	-2.65	-13.07	-12.27	-11.79
21	54	-2.45	-2.35	-2.51	-13.78	-12.97	-12.45
21	57	-2.37	-2.25	-2.41	-14.60	-13.80	-13.20

21	60	-2.32	-2.18	-2.33	-15.52	-14.70	-13.99
21	63	-2.30	-2.14	-2.27	-16.94	-16.10	-15.12
21	66	-2.28	-2.10	-2.21	-18.96	-18.09	-16.66
21	69	-2.26	-2.07	-2.16	-21.07	-20.16	-18.24
21	72	-2.25	-2.05	-2.13	-22.71	-21.79	-19.47
21	75	-2.25	-2.04	-2.12	-23.38	-22.44	-19.97
21	78	-2.25	-2.05	-2.13	-22.86	-22.12	-19.77
21	81	-2.27	-2.07	-2.17	-21.56	-21.28	-19.25
21	84	-2.30	-2.10	-2.22	-19.84	-20.13	-18.53
21	87	-2.34	-2.14	-2.29	-18.08	-18.86	-17.70
21	90	-2.38	-2.19	-2.37	-16.65	-17.70	-16.89
21	93	-2.45	-2.28	-2.50	-15.46	-16.49	-15.97
21	96	-2.57	-2.43	-2.69	-14.26	-15.11	-14.83
21	99	-2.72	-2.63	-2.93	-13.16	-13.74	-13.65
21	102	-2.89	-2.85	-3.20	-12.28	-12.55	-12.59
21	105	-3.06	-3.06	-3.46	-11.73	-11.75	-11.80
21	108	-3.25	-3.29	-3.73	-11.41	-11.21	-11.21
21	111	-3.46	-3.54	-4.04	-11.13	-10.71	-10.65
21	114	-3.69	-3.80	-4.36	-10.91	-10.31	-10.17
21	117	-3.93	-4.07	-4.67	-10.76	-10.04	-9.84
21	120	-4.16	-4.32	-4.95	-10.71	-9.94	-9.72
21	123	-4.42	-4.60	-5.24	-10.82	-10.00	-9.75
21	126	-4.71	-4.91	-5.55	-11.12	-10.15	-9.83
21	129	-4.98	-5.20	-5.82	-11.56	-10.37	-9.96
21	132	-5.21	-5.41	-6.03	-12.08	-10.65	-10.12
21	135	-5.34	-5.49	-6.10	-12.64	-10.97	-10.31
21	138	-5.40	-5.49	-6.07	-13.41	-11.46	-10.64
21	141	-5.44	-5.48	-6.00	-14.49	-12.23	-11.21
21	144	-5.48	-5.46	-5.91	-15.69	-13.15	-11.95
21	147	-5.51	-5.45	-5.83	-16.83	-14.11	-12.79
21	150	-5.55	-5.45	-5.80	-17.73	-15.00	-13.67
21	153	-5.60	-5.48	-5.84	-18.48	-15.95	-14.89
21	156	-5.65	-5.57	-5.95	-19.23	-17.05	-16.52
21	159	-5.71	-5.71	-6.11	-19.88	-18.08	-18.16
21	162	-5.77	-5.87	-6.30	-20.34	-18.85	-19.44
21	165	-5.86	-6.05	-6.51	-20.52	-19.16	-19.95
21	168	-6.00	-6.29	-6.75	-20.28	-19.04	-19.90
21	171	-6.21	-6.61	-7.06	-19.67	-18.72	-19.76
21	174	-6.48	-7.01	-7.43	-18.85	-18.27	-19.54
21	177	-6.80	-7.47	-7.84	-17.99	-17.75	-19.27
21	180	-7.14	-7.96	-8.27	-17.23	-17.21	-18.94
21	183	-7.54	-8.53	-8.74	-16.50	-16.49	-18.19
21	186	-8.05	-9.21	-9.27	-15.70	-15.51	-16.88
21	189	-8.63	-9.98	-9.85	-14.94	-14.50	-15.38
21	192	-9.27	-10.82	-10.49	-14.35	-13.66	-14.07
21	195	-9.94	-11.71	-11.17	-14.05	-13.20	-13.33
21	198	-10.62	-12.84	-11.99	-13.94	-13.02	-13.02
21	201	-11.32	-14.22	-12.95	-13.85	-12.87	-12.76
21	204	-12.13	-15.63	-13.96	-13.78	-12.75	-12.56
21	207	-13.10	-16.82	-14.90	-13.74	-12.68	-12.42
21	210	-14.29	-17.56	-15.67	-13.72	-12.65	-12.38
21	213	-16.59	-17.92	-16.23	-13.86	-12.78	-12.47
21	216	-20.15	-18.18	-16.68	-14.21	-13.10	-12.69
21	219	-23.96	-18.39	-17.10	-14.61	-13.48	-12.95
21	222	-26.99	-18.61	-17.59	-14.95	-13.80	-13.17
21	225	-28.23	-18.90	-18.23	-15.10	-13.94	-13.26
21	228	-27.45	-19.34	-19.44	-14.94	-13.80	-13.17
21	231	-25.59	-19.93	-21.24	-14.54	-13.46	-12.94

21	234	-23.37	-20.52	-23.15	-13.99	-12.98	-12.61
21	237	-21.51	-20.97	-24.65	-13.37	-12.44	-12.22
21	240	-20.73	-21.15	-25.27	-12.78	-11.92	-11.82
21	243	-20.75	-20.98	-24.27	-12.16	-11.34	-11.31
21	246	-20.81	-20.52	-21.83	-11.43	-10.64	-10.65
21	249	-20.88	-19.87	-18.77	-10.68	-9.93	-9.94
21	252	-20.93	-19.09	-15.93	-10.02	-9.29	-9.29
21	255	-20.96	-18.29	-14.11	-9.53	-8.82	-8.84
21	258	-20.24	-17.24	-13.17	-9.15	-8.47	-8.51
21	261	-18.48	-15.82	-12.39	-8.79	-8.14	-8.20
21	264	-16.24	-14.29	-11.75	-8.49	-7.86	-7.94
21	267	-14.08	-12.89	-11.22	-8.28	-7.67	-7.77
21	270	-12.57	-11.88	-10.80	-8.21	-7.60	-7.70
21	273	-11.64	-11.21	-10.47	-8.25	-7.64	-7.71
21	276	-10.83	-10.64	-10.21	-8.39	-7.75	-7.73
21	279	-10.13	-10.15	-9.98	-8.58	-7.92	-7.76
21	282	-9.54	-9.71	-9.75	-8.81	-8.11	-7.80
21	285	-9.06	-9.29	-9.47	-9.06	-8.31	-7.84
21	288	-8.63	-8.84	-9.09	-9.37	-8.54	-7.94
21	291	-8.22	-8.37	-8.61	-9.79	-8.83	-8.11
21	294	-7.87	-7.95	-8.14	-10.28	-9.16	-8.33
21	297	-7.63	-7.64	-7.76	-10.83	-9.51	-8.57
21	300	-7.54	-7.53	-7.57	-11.42	-9.88	-8.80
21	303	-7.57	-7.54	-7.50	-12.08	-10.27	-9.03
21	306	-7.65	-7.57	-7.44	-12.85	-10.70	-9.28
21	309	-7.77	-7.62	-7.40	-13.70	-11.17	-9.55
21	312	-7.92	-7.68	-7.37	-14.61	-11.65	-9.82
21	315	-8.11	-7.76	-7.36	-15.54	-12.15	-10.12
21	318	-8.46	-8.03	-7.50	-16.70	-12.70	-10.43
21	321	-9.06	-8.58	-7.86	-18.11	-13.30	-10.76
21	324	-9.85	-9.31	-8.37	-19.48	-13.91	-11.11
21	327	-10.74	-10.12	-8.95	-20.51	-14.49	-11.47
21	330	-11.66	-10.91	-9.53	-20.92	-15.00	-11.84
21	333	-12.90	-11.85	-10.29	-20.74	-15.50	-12.27
21	336	-14.54	-13.04	-11.29	-20.26	-16.01	-12.77
21	339	-16.19	-14.20	-12.30	-19.58	-16.47	-13.25
21	342	-17.46	-15.09	-13.07	-18.82	-16.81	-13.62
21	345	-17.97	-15.44	-13.39	-18.08	-16.93	-13.78
21	348	-17.97	-15.44	-13.38	-17.35	-16.83	-13.81
21	351	-17.91	-15.39	-13.35	-16.53	-16.53	-13.82
21	354	-17.77	-15.26	-13.26	-15.63	-16.05	-13.84
21	357	-17.50	-15.02	-13.09	-14.67	-15.39	-13.85
21	360	-17.05	-14.62	-12.80	-13.65	-14.56	-13.85
24	0	-19.28	-16.75	-14.44	-13.95	-14.67	-13.61
24	3	-16.72	-14.75	-12.90	-13.47	-14.09	-13.22
24	6	-14.36	-12.89	-11.46	-13.04	-13.54	-12.85
24	9	-12.26	-11.21	-10.15	-12.65	-13.05	-12.50
24	12	-10.46	-9.75	-8.99	-12.33	-12.60	-12.18
24	15	-9.03	-8.54	-7.99	-12.08	-12.22	-11.87
24	18	-7.88	-7.53	-7.12	-11.88	-11.85	-11.56
24	21	-6.88	-6.62	-6.34	-11.69	-11.48	-11.23
24	24	-6.01	-5.82	-5.64	-11.52	-11.16	-10.93
24	27	-5.27	-5.14	-5.03	-11.41	-10.94	-10.72
24	30	-4.66	-4.56	-4.52	-11.37	-10.85	-10.64
24	33	-4.11	-4.04	-4.05	-11.39	-10.86	-10.64
24	36	-3.59	-3.54	-3.62	-11.45	-10.88	-10.66
24	39	-3.15	-3.11	-3.24	-11.54	-10.91	-10.68
24	42	-2.82	-2.79	-2.95	-11.65	-10.96	-10.72

24	45	-2.64	-2.61	-2.78	-11.78	-11.02	-10.76
24	48	-2.56	-2.52	-2.69	-12.04	-11.21	-10.94
24	51	-2.49	-2.45	-2.60	-12.51	-11.63	-11.33
24	54	-2.44	-2.39	-2.54	-13.14	-12.22	-11.88
24	57	-2.41	-2.35	-2.50	-13.90	-12.94	-12.55
24	60	-2.40	-2.34	-2.49	-14.76	-13.73	-13.26
24	63	-2.43	-2.37	-2.51	-16.26	-15.10	-14.42
24	66	-2.51	-2.45	-2.57	-18.54	-17.19	-16.13
24	69	-2.62	-2.55	-2.65	-20.96	-19.41	-17.92
24	72	-2.72	-2.66	-2.74	-22.88	-21.17	-19.33
24	75	-2.80	-2.73	-2.83	-23.66	-21.89	-19.91
24	78	-2.85	-2.79	-2.90	-23.11	-21.62	-19.76
24	81	-2.90	-2.83	-2.96	-21.72	-20.92	-19.37
24	84	-2.94	-2.87	-3.04	-19.88	-19.95	-18.81
24	87	-2.98	-2.91	-3.12	-18.02	-18.86	-18.14
24	90	-3.05	-2.98	-3.23	-16.51	-17.80	-17.44
24	93	-3.14	-3.09	-3.39	-15.27	-16.61	-16.50
24	96	-3.27	-3.24	-3.60	-14.02	-15.15	-15.22
24	99	-3.42	-3.44	-3.85	-12.88	-13.66	-13.84
24	102	-3.58	-3.65	-4.11	-11.97	-12.39	-12.59
24	105	-3.76	-3.85	-4.37	-11.44	-11.55	-11.71
24	108	-3.95	-4.07	-4.65	-11.15	-11.02	-11.09
24	111	-4.17	-4.32	-4.95	-10.91	-10.55	-10.52
24	114	-4.40	-4.58	-5.26	-10.72	-10.17	-10.04
24	117	-4.63	-4.82	-5.53	-10.59	-9.91	-9.72
24	120	-4.84	-5.03	-5.74	-10.55	-9.82	-9.60
24	123	-5.05	-5.22	-5.92	-10.67	-9.89	-9.64
24	126	-5.27	-5.43	-6.09	-11.00	-10.07	-9.76
24	129	-5.47	-5.61	-6.23	-11.49	-10.36	-9.94
24	132	-5.62	-5.74	-6.33	-12.08	-10.71	-10.16
24	135	-5.68	-5.79	-6.37	-12.71	-11.10	-10.43
24	138	-5.64	-5.73	-6.26	-13.72	-11.75	-10.87
24	141	-5.56	-5.57	-6.00	-15.22	-12.74	-11.60
24	144	-5.44	-5.37	-5.70	-16.80	-13.90	-12.51
24	147	-5.32	-5.18	-5.44	-18.08	-15.04	-13.53
24	150	-5.21	-5.06	-5.32	-18.66	-15.96	-14.57
24	153	-5.11	-4.99	-5.30	-18.74	-16.76	-15.90
24	156	-4.99	-4.93	-5.29	-18.80	-17.58	-17.61
24	159	-4.87	-4.88	-5.28	-18.85	-18.30	-19.31
24	162	-4.79	-4.84	-5.28	-18.88	-18.82	-20.61
24	165	-4.76	-4.83	-5.28	-18.89	-19.02	-21.13
24	168	-4.79	-4.90	-5.35	-18.54	-18.73	-20.80
24	171	-4.87	-5.07	-5.55	-17.67	-17.99	-19.96
24	174	-5.00	-5.32	-5.83	-16.54	-17.01	-18.83
24	177	-5.16	-5.63	-6.16	-15.40	-15.99	-17.63
24	180	-5.33	-5.95	-6.50	-14.51	-15.12	-16.57
24	183	-5.59	-6.36	-6.89	-13.78	-14.30	-15.52
24	186	-5.98	-6.89	-7.36	-13.04	-13.41	-14.34
24	189	-6.46	-7.53	-7.91	-12.38	-12.59	-13.22
24	192	-7.00	-8.23	-8.52	-11.91	-11.98	-12.36
24	195	-7.56	-8.98	-9.18	-11.72	-11.75	-11.97
24	198	-8.13	-9.87	-9.97	-11.75	-11.76	-11.89
24	201	-8.77	-10.96	-10.95	-11.80	-11.78	-11.82
24	204	-9.49	-12.10	-11.98	-11.90	-11.82	-11.77
24	207	-10.33	-13.14	-12.94	-12.01	-11.87	-11.74
24	210	-11.30	-13.93	-13.73	-12.16	-11.93	-11.73
24	213	-12.92	-14.55	-14.35	-12.55	-12.23	-11.92
24	216	-15.23	-15.15	-14.88	-13.28	-12.85	-12.36

24	219	-17.64	-15.66	-15.38	-14.10	-13.56	-12.88
24	222	-19.54	-16.01	-15.85	-14.78	-14.15	-13.33
24	225	-20.31	-16.14	-16.33	-15.05	-14.40	-13.51
24	228	-19.87	-16.14	-16.89	-14.94	-14.28	-13.43
24	231	-18.81	-16.14	-17.52	-14.65	-13.96	-13.21
24	234	-17.49	-16.13	-18.10	-14.23	-13.52	-12.88
24	237	-16.31	-16.12	-18.53	-13.74	-13.00	-12.50
24	240	-15.62	-16.11	-18.70	-13.25	-12.48	-12.09
24	243	-15.37	-15.93	-18.06	-12.63	-11.85	-11.53
24	246	-15.21	-15.46	-16.50	-11.84	-11.03	-10.75
24	249	-15.09	-14.81	-14.55	-10.99	-10.17	-9.91
24	252	-14.93	-14.08	-12.71	-10.22	-9.39	-9.13
24	255	-14.68	-13.39	-11.52	-9.64	-8.82	-8.58
24	258	-14.04	-12.65	-10.88	-9.21	-8.40	-8.18
24	261	-12.95	-11.77	-10.35	-8.80	-8.01	-7.81
24	264	-11.68	-10.88	-9.91	-8.45	-7.68	-7.50
24	267	-10.49	-10.08	-9.54	-8.21	-7.45	-7.28
24	270	-9.64	-9.49	-9.23	-8.12	-7.37	-7.20
24	273	-9.10	-9.08	-8.97	-8.16	-7.41	-7.22
24	276	-8.63	-8.73	-8.76	-8.27	-7.52	-7.26
24	279	-8.23	-8.43	-8.58	-8.43	-7.69	-7.33
24	282	-7.89	-8.16	-8.39	-8.63	-7.88	-7.42
24	285	-7.61	-7.89	-8.18	-8.86	-8.09	-7.52
24	288	-7.34	-7.58	-7.88	-9.16	-8.34	-7.67
24	291	-7.08	-7.25	-7.52	-9.59	-8.66	-7.90
24	294	-6.86	-6.95	-7.17	-10.13	-9.04	-8.18
24	297	-6.70	-6.73	-6.91	-10.72	-9.45	-8.47
24	300	-6.65	-6.65	-6.81	-11.35	-9.88	-8.77
24	303	-6.67	-6.66	-6.81	-12.06	-10.33	-9.06
24	306	-6.74	-6.70	-6.81	-12.90	-10.84	-9.37
24	309	-6.84	-6.76	-6.81	-13.81	-11.38	-9.69
24	312	-6.98	-6.84	-6.81	-14.77	-11.94	-10.02
24	315	-7.14	-6.93	-6.81	-15.73	-12.50	-10.34
24	318	-7.42	-7.16	-6.93	-16.88	-13.10	-10.67
24	321	-7.91	-7.61	-7.24	-18.25	-13.75	-11.00
24	324	-8.54	-8.20	-7.69	-19.56	-14.40	-11.33
24	327	-9.26	-8.88	-8.22	-20.55	-14.98	-11.66
24	330	-10.03	-9.57	-8.75	-20.94	-15.45	-11.99
24	333	-11.01	-10.40	-9.44	-20.74	-15.85	-12.36
24	336	-12.27	-11.45	-10.35	-20.22	-16.23	-12.78
24	339	-13.64	-12.55	-11.32	-19.50	-16.57	-13.17
24	342	-14.93	-13.58	-12.20	-18.71	-16.80	-13.47
24	345	-15.97	-14.38	-12.83	-17.96	-16.89	-13.59
24	348	-16.79	-14.99	-13.28	-17.25	-16.79	-13.59
24	351	-17.55	-15.56	-13.70	-16.49	-16.50	-13.60
24	354	-18.23	-16.05	-14.04	-15.69	-16.04	-13.60
24	357	-18.81	-16.45	-14.30	-14.84	-15.42	-13.61
24	360	-19.28	-16.75	-14.44	-13.95	-14.67	-13.61
27	0	-21.15	-18.53	-15.82	-14.20	-14.77	-13.34
27	3	-18.09	-16.08	-13.98	-13.78	-14.25	-13.04
27	6	-15.28	-13.82	-12.27	-13.39	-13.76	-12.74
27	9	-12.79	-11.80	-10.73	-13.03	-13.31	-12.46
27	12	-10.71	-10.07	-9.36	-12.70	-12.88	-12.18
27	15	-9.10	-8.68	-8.22	-12.43	-12.49	-11.91
27	18	-7.85	-7.55	-7.24	-12.16	-12.09	-11.61
27	21	-6.77	-6.55	-6.35	-11.89	-11.69	-11.29
27	24	-5.86	-5.69	-5.57	-11.66	-11.32	-10.99
27	27	-5.10	-4.96	-4.90	-11.50	-11.04	-10.77

27	30	-4.47	-4.37	-4.36	-11.44	-10.90	-10.66
27	33	-3.92	-3.83	-3.88	-11.44	-10.85	-10.64
27	36	-3.39	-3.32	-3.42	-11.45	-10.81	-10.62
27	39	-2.94	-2.89	-3.03	-11.48	-10.78	-10.61
27	42	-2.63	-2.59	-2.76	-11.51	-10.76	-10.60
27	45	-2.50	-2.48	-2.65	-11.54	-10.76	-10.59
27	48	-2.50	-2.48	-2.65	-11.71	-10.88	-10.71
27	51	-2.49	-2.48	-2.65	-12.11	-11.21	-11.04
27	54	-2.48	-2.48	-2.65	-12.68	-11.70	-11.51
27	57	-2.48	-2.49	-2.65	-13.39	-12.32	-12.10
27	60	-2.48	-2.50	-2.65	-14.19	-13.00	-12.75
27	63	-2.54	-2.57	-2.71	-15.73	-14.32	-13.91
27	66	-2.70	-2.73	-2.86	-18.20	-16.44	-15.72
27	69	-2.91	-2.95	-3.06	-20.86	-18.72	-17.66
27	72	-3.11	-3.16	-3.27	-22.99	-20.56	-19.20
27	75	-3.27	-3.32	-3.45	-23.86	-21.31	-19.83
27	78	-3.37	-3.42	-3.58	-23.28	-21.10	-19.74
27	81	-3.45	-3.51	-3.70	-21.83	-20.55	-19.49
27	84	-3.53	-3.59	-3.83	-19.92	-19.77	-19.11
27	87	-3.61	-3.68	-3.96	-17.97	-18.87	-18.64
27	90	-3.72	-3.79	-4.12	-16.42	-17.95	-18.11
27	93	-3.85	-3.94	-4.33	-15.15	-16.79	-17.20
27	96	-4.01	-4.13	-4.59	-13.86	-15.27	-15.75
27	99	-4.18	-4.34	-4.88	-12.69	-13.67	-14.12
27	102	-4.37	-4.57	-5.17	-11.77	-12.29	-12.64
27	105	-4.57	-4.79	-5.45	-11.25	-11.42	-11.65
27	108	-4.79	-5.04	-5.76	-10.99	-10.90	-11.02
27	111	-5.05	-5.32	-6.10	-10.77	-10.44	-10.44
27	114	-5.31	-5.59	-6.43	-10.59	-10.07	-9.96
27	117	-5.54	-5.81	-6.67	-10.48	-9.83	-9.64
27	120	-5.70	-5.95	-6.76	-10.44	-9.74	-9.52
27	123	-5.82	-6.02	-6.76	-10.58	-9.82	-9.58
27	126	-5.93	-6.08	-6.75	-10.94	-10.05	-9.73
27	129	-6.02	-6.13	-6.74	-11.47	-10.39	-9.96
27	132	-6.08	-6.16	-6.72	-12.10	-10.80	-10.25
27	135	-6.10	-6.17	-6.70	-12.79	-11.27	-10.58
27	138	-6.02	-6.07	-6.54	-13.94	-12.10	-11.16
27	141	-5.82	-5.80	-6.18	-15.65	-13.41	-12.09
27	144	-5.54	-5.45	-5.73	-17.47	-14.88	-13.24
27	147	-5.25	-5.09	-5.30	-18.91	-16.21	-14.48
27	150	-4.99	-4.80	-4.99	-19.50	-17.08	-15.69
27	153	-4.73	-4.56	-4.78	-19.36	-17.61	-17.08
27	156	-4.44	-4.30	-4.58	-18.98	-18.09	-18.77
27	159	-4.16	-4.07	-4.42	-18.44	-18.48	-20.39
27	162	-3.95	-3.90	-4.30	-17.80	-18.75	-21.62
27	165	-3.86	-3.83	-4.25	-17.14	-18.84	-22.11
27	168	-3.84	-3.85	-4.29	-16.29	-18.36	-21.44
27	171	-3.82	-3.91	-4.39	-15.14	-17.15	-19.80
27	174	-3.81	-3.99	-4.55	-13.90	-15.62	-17.69
27	177	-3.80	-4.10	-4.74	-12.77	-14.13	-15.67
27	180	-3.80	-4.22	-4.94	-11.95	-13.08	-14.24
27	183	-3.90	-4.45	-5.23	-11.34	-12.36	-13.27
27	186	-4.17	-4.83	-5.64	-10.75	-11.66	-12.35
27	189	-4.56	-5.33	-6.14	-10.26	-11.08	-11.57
27	192	-5.01	-5.90	-6.72	-9.93	-10.67	-11.02
27	195	-5.47	-6.49	-7.33	-9.80	-10.52	-10.82
27	198	-5.95	-7.19	-8.09	-9.86	-10.56	-10.84
27	201	-6.52	-8.04	-9.04	-10.04	-10.70	-10.91

27	204	-7.16	-8.96	-10.06	-10.30	-10.90	-11.01
27	207	-7.86	-9.85	-11.04	-10.62	-11.15	-11.14
27	210	-8.61	-10.64	-11.84	-10.97	-11.42	-11.29
27	213	-9.61	-11.40	-12.57	-11.62	-11.96	-11.65
27	216	-10.89	-12.21	-13.30	-12.65	-12.82	-12.29
27	219	-12.16	-12.94	-13.95	-13.76	-13.75	-13.00
27	222	-13.13	-13.47	-14.42	-14.64	-14.50	-13.57
27	225	-13.52	-13.68	-14.59	-15.00	-14.81	-13.81
27	228	-13.36	-13.56	-14.51	-14.92	-14.70	-13.72
27	231	-12.95	-13.25	-14.30	-14.72	-14.40	-13.49
27	234	-12.40	-12.83	-13.98	-14.41	-13.98	-13.15
27	237	-11.83	-12.35	-13.60	-14.04	-13.48	-12.75
27	240	-11.34	-11.89	-13.19	-13.64	-12.96	-12.32
27	243	-10.94	-11.42	-12.59	-13.05	-12.27	-11.71
27	246	-10.56	-10.88	-11.74	-12.20	-11.35	-10.85
27	249	-10.19	-10.31	-10.80	-11.26	-10.36	-9.90
27	252	-9.81	-9.76	-9.95	-10.38	-9.46	-9.03
27	255	-9.41	-9.29	-9.35	-9.74	-8.81	-8.41
27	258	-8.95	-8.86	-8.98	-9.27	-8.35	-7.97
27	261	-8.44	-8.45	-8.66	-8.82	-7.92	-7.55
27	264	-7.94	-8.06	-8.40	-8.43	-7.56	-7.20
27	267	-7.50	-7.73	-8.17	-8.17	-7.31	-6.96
27	270	-7.19	-7.48	-7.96	-8.07	-7.22	-6.87
27	273	-6.98	-7.30	-7.77	-8.11	-7.26	-6.90
27	276	-6.82	-7.15	-7.61	-8.20	-7.38	-6.96
27	279	-6.67	-7.02	-7.47	-8.34	-7.54	-7.06
27	282	-6.55	-6.90	-7.32	-8.52	-7.74	-7.18
27	285	-6.43	-6.75	-7.16	-8.72	-7.95	-7.31
27	288	-6.29	-6.57	-6.95	-9.02	-8.21	-7.50
27	291	-6.16	-6.35	-6.69	-9.46	-8.55	-7.76
27	294	-6.04	-6.15	-6.45	-10.00	-8.96	-8.07
27	297	-5.95	-5.99	-6.27	-10.62	-9.41	-8.40
27	300	-5.92	-5.93	-6.20	-11.27	-9.87	-8.73
27	303	-5.94	-5.95	-6.20	-12.02	-10.38	-9.07
27	306	-5.99	-5.98	-6.21	-12.91	-10.95	-9.43
27	309	-6.07	-6.04	-6.24	-13.89	-11.56	-9.81
27	312	-6.17	-6.11	-6.27	-14.90	-12.19	-10.18
27	315	-6.30	-6.20	-6.31	-15.89	-12.80	-10.53
27	318	-6.51	-6.39	-6.43	-17.03	-13.45	-10.87
27	321	-6.87	-6.73	-6.70	-18.37	-14.15	-11.20
27	324	-7.34	-7.19	-7.08	-19.63	-14.83	-11.52
27	327	-7.89	-7.72	-7.52	-20.58	-15.41	-11.82
27	330	-8.51	-8.30	-8.00	-20.95	-15.83	-12.11
27	333	-9.28	-9.03	-8.63	-20.73	-16.12	-12.42
27	336	-10.30	-9.98	-9.46	-20.17	-16.40	-12.76
27	339	-11.47	-11.05	-10.41	-19.40	-16.62	-13.06
27	342	-12.73	-12.17	-11.36	-18.56	-16.77	-13.28
27	345	-14.00	-13.24	-12.22	-17.81	-16.83	-13.36
27	348	-15.28	-14.27	-12.99	-17.12	-16.73	-13.36
27	351	-16.64	-15.31	-13.73	-16.42	-16.45	-13.36
27	354	-18.08	-16.37	-14.45	-15.70	-16.01	-13.36
27	357	-19.58	-17.44	-15.15	-14.96	-15.44	-13.35
27	360	-21.15	-18.53	-15.82	-14.20	-14.77	-13.34
30	0	-21.93	-19.28	-16.40	-14.30	-14.80	-12.99
30	3	-18.67	-16.65	-14.44	-13.94	-14.32	-12.79
30	6	-15.67	-14.23	-12.63	-13.60	-13.85	-12.58
30	9	-13.03	-12.06	-10.98	-13.27	-13.41	-12.37
30	12	-10.82	-10.21	-9.54	-12.96	-12.99	-12.15



30	15	-9.13	-8.74	-8.32	-12.68	-12.60	-11.92
30	18	-7.82	-7.53	-7.27	-12.38	-12.20	-11.65
30	21	-6.70	-6.46	-6.30	-12.07	-11.80	-11.35
30	24	-5.74	-5.54	-5.45	-11.80	-11.43	-11.05
30	27	-4.96	-4.77	-4.74	-11.59	-11.13	-10.82
30	30	-4.34	-4.18	-4.20	-11.50	-10.96	-10.69
30	33	-3.79	-3.68	-3.74	-11.49	-10.86	-10.64
30	36	-3.28	-3.20	-3.31	-11.47	-10.78	-10.60
30	39	-2.86	-2.80	-2.95	-11.46	-10.72	-10.56
30	42	-2.56	-2.53	-2.70	-11.46	-10.68	-10.54
30	45	-2.45	-2.43	-2.61	-11.46	-10.66	-10.53
30	48	-2.46	-2.44	-2.62	-11.59	-10.77	-10.64
30	51	-2.47	-2.47	-2.64	-11.96	-11.07	-10.94
30	54	-2.50	-2.51	-2.68	-12.51	-11.52	-11.39
30	57	-2.52	-2.56	-2.73	-13.20	-12.08	-11.94
30	60	-2.56	-2.62	-2.78	-13.97	-12.72	-12.55
30	63	-2.65	-2.73	-2.89	-15.52	-13.98	-13.70
30	66	-2.82	-2.91	-3.07	-18.06	-16.04	-15.53
30	69	-3.04	-3.13	-3.30	-20.81	-18.28	-17.51
30	72	-3.27	-3.36	-3.54	-23.02	-20.08	-19.08
30	75	-3.46	-3.56	-3.76	-23.93	-20.82	-19.73
30	78	-3.62	-3.74	-3.97	-23.34	-20.66	-19.69
30	81	-3.76	-3.91	-4.18	-21.87	-20.24	-19.57
30	84	-3.91	-4.07	-4.39	-19.93	-19.63	-19.39
30	87	-4.07	-4.25	-4.62	-17.96	-18.90	-19.14
30	90	-4.24	-4.45	-4.87	-16.39	-18.13	-18.85
30	93	-4.44	-4.68	-5.17	-15.10	-17.02	-18.01
30	96	-4.67	-4.94	-5.52	-13.80	-15.45	-16.40
30	99	-4.91	-5.22	-5.88	-12.62	-13.76	-14.49
30	102	-5.16	-5.50	-6.24	-11.70	-12.29	-12.75
30	105	-5.41	-5.77	-6.57	-11.19	-11.37	-11.63
30	108	-5.70	-6.07	-6.91	-10.93	-10.86	-10.98
30	111	-6.05	-6.41	-7.28	-10.72	-10.40	-10.40
30	114	-6.37	-6.72	-7.62	-10.55	-10.04	-9.93
30	117	-6.61	-6.96	-7.87	-10.45	-9.80	-9.61
30	120	-6.71	-7.05	-7.97	-10.41	-9.71	-9.50
30	123	-6.70	-7.03	-7.91	-10.55	-9.81	-9.56
30	126	-6.69	-6.97	-7.78	-10.93	-10.07	-9.74
30	129	-6.66	-6.87	-7.58	-11.49	-10.46	-10.02
30	132	-6.63	-6.75	-7.34	-12.17	-10.94	-10.37
30	135	-6.59	-6.61	-7.09	-12.90	-11.48	-10.77
30	138	-6.44	-6.38	-6.75	-14.11	-12.52	-11.49
30	141	-6.13	-6.01	-6.29	-15.92	-14.19	-12.68
30	144	-5.72	-5.56	-5.77	-17.84	-16.02	-14.12
30	147	-5.29	-5.10	-5.28	-19.36	-17.53	-15.61
30	150	-4.91	-4.71	-4.88	-19.98	-18.23	-16.94
30	153	-4.54	-4.34	-4.53	-19.68	-18.35	-18.27
30	156	-4.15	-3.94	-4.18	-18.91	-18.44	-19.75
30	159	-3.77	-3.58	-3.87	-17.84	-18.52	-21.12
30	162	-3.45	-3.30	-3.64	-16.68	-18.56	-22.13
30	165	-3.24	-3.18	-3.56	-15.60	-18.58	-22.52
30	168	-3.10	-3.16	-3.58	-14.48	-17.93	-21.61
30	171	-2.98	-3.15	-3.62	-13.19	-16.35	-19.38
30	174	-2.89	-3.13	-3.69	-11.92	-14.39	-16.60
30	177	-2.82	-3.13	-3.77	-10.84	-12.58	-14.06
30	180	-2.80	-3.12	-3.88	-10.15	-11.48	-12.51
30	183	-2.88	-3.24	-4.08	-9.72	-10.93	-11.75
30	186	-3.11	-3.55	-4.45	-9.35	-10.44	-11.08

30	189	-3.44	-3.98	-4.93	-9.05	-10.05	-10.54
30	192	-3.82	-4.49	-5.48	-8.85	-9.79	-10.19
30	195	-4.21	-5.01	-6.07	-8.77	-9.69	-10.06
30	198	-4.65	-5.60	-6.78	-8.87	-9.78	-10.12
30	201	-5.20	-6.33	-7.69	-9.14	-10.02	-10.28
30	204	-5.80	-7.14	-8.68	-9.53	-10.38	-10.52
30	207	-6.44	-7.96	-9.65	-10.00	-10.79	-10.81
30	210	-7.06	-8.73	-10.48	-10.50	-11.24	-11.12
30	213	-7.80	-9.57	-11.26	-11.28	-11.91	-11.63
30	216	-8.66	-10.51	-12.09	-12.41	-12.89	-12.40
30	219	-9.49	-11.39	-12.83	-13.60	-13.90	-13.21
30	222	-10.11	-12.04	-13.36	-14.54	-14.70	-13.85
30	225	-10.36	-12.30	-13.56	-14.92	-15.03	-14.11
30	228	-10.31	-12.15	-13.37	-14.86	-14.92	-14.01
30	231	-10.19	-11.76	-12.86	-14.69	-14.62	-13.75
30	234	-10.00	-11.23	-12.19	-14.45	-14.19	-13.36
30	237	-9.78	-10.65	-11.49	-14.14	-13.69	-12.90
30	240	-9.54	-10.13	-10.88	-13.80	-13.16	-12.42
30	243	-9.19	-9.60	-10.35	-13.24	-12.45	-11.76
30	246	-8.69	-9.02	-9.79	-12.37	-11.48	-10.85
30	249	-8.12	-8.44	-9.26	-11.38	-10.42	-9.87
30	252	-7.59	-7.93	-8.80	-10.46	-9.47	-8.97
30	255	-7.21	-7.57	-8.44	-9.78	-8.80	-8.33
30	258	-6.93	-7.32	-8.18	-9.30	-8.33	-7.88
30	261	-6.68	-7.10	-7.96	-8.83	-7.89	-7.45
30	264	-6.46	-6.92	-7.77	-8.43	-7.52	-7.09
30	267	-6.29	-6.77	-7.60	-8.16	-7.27	-6.85
30	270	-6.16	-6.64	-7.43	-8.05	-7.17	-6.75
30	273	-6.08	-6.54	-7.28	-8.09	-7.21	-6.78
30	276	-6.01	-6.46	-7.14	-8.18	-7.33	-6.86
30	279	-5.95	-6.38	-7.01	-8.31	-7.49	-6.96
30	282	-5.90	-6.31	-6.87	-8.49	-7.69	-7.10
30	285	-5.83	-6.21	-6.72	-8.68	-7.90	-7.24
30	288	-5.75	-6.06	-6.52	-8.96	-8.16	-7.43
30	291	-5.65	-5.87	-6.28	-9.38	-8.51	-7.69
30	294	-5.55	-5.68	-6.05	-9.90	-8.92	-8.00
30	297	-5.47	-5.54	-5.88	-10.50	-9.38	-8.33
30	300	-5.44	-5.48	-5.81	-11.14	-9.86	-8.67
30	303	-5.45	-5.48	-5.81	-11.90	-10.38	-9.03
30	306	-5.48	-5.50	-5.81	-12.83	-10.99	-9.43
30	309	-5.53	-5.53	-5.82	-13.87	-11.63	-9.84
30	312	-5.59	-5.57	-5.83	-14.93	-12.29	-10.24
30	315	-5.66	-5.61	-5.84	-15.96	-12.92	-10.61
30	318	-5.81	-5.74	-5.92	-17.11	-13.59	-10.96
30	321	-6.09	-6.00	-6.15	-18.42	-14.33	-11.30
30	324	-6.46	-6.38	-6.47	-19.67	-15.03	-11.62
30	327	-6.91	-6.82	-6.87	-20.59	-15.61	-11.92
30	330	-7.42	-7.32	-7.29	-20.96	-15.98	-12.17
30	333	-8.08	-7.97	-7.87	-20.71	-16.21	-12.40
30	336	-8.97	-8.86	-8.68	-20.08	-16.41	-12.64
30	339	-10.04	-9.92	-9.62	-19.23	-16.57	-12.84
30	342	-11.25	-11.07	-10.62	-18.33	-16.68	-12.98
30	345	-12.55	-12.24	-11.57	-17.55	-16.72	-13.04
30	348	-14.01	-13.45	-12.49	-16.89	-16.62	-13.04
30	351	-15.70	-14.77	-13.44	-16.23	-16.35	-13.04
30	354	-17.61	-16.19	-14.40	-15.58	-15.94	-13.03
30	357	-19.69	-17.69	-15.39	-14.94	-15.42	-13.01
30	360	-21.93	-19.28	-16.40	-14.30	-14.80	-12.99

33	0	-21.03	-18.48	-15.79	-14.17	-14.51	-12.45
33	3	-17.94	-15.98	-13.91	-13.90	-14.09	-12.37
33	6	-15.09	-13.67	-12.17	-13.64	-13.68	-12.27
33	9	-12.57	-11.60	-10.58	-13.37	-13.29	-12.14
33	12	-10.46	-9.83	-9.19	-13.11	-12.92	-12.00
33	15	-8.84	-8.41	-8.01	-12.86	-12.57	-11.85
33	18	-7.58	-7.23	-6.98	-12.57	-12.21	-11.65
33	21	-6.48	-6.18	-6.02	-12.26	-11.84	-11.38
33	24	-5.55	-5.27	-5.18	-11.96	-11.50	-11.11
33	27	-4.80	-4.53	-4.49	-11.72	-11.22	-10.88
33	30	-4.22	-3.98	-3.99	-11.60	-11.04	-10.75
33	33	-3.74	-3.55	-3.60	-11.56	-10.92	-10.69
33	36	-3.29	-3.15	-3.25	-11.52	-10.82	-10.63
33	39	-2.92	-2.82	-2.95	-11.49	-10.74	-10.59
33	42	-2.66	-2.60	-2.76	-11.47	-10.69	-10.57
33	45	-2.57	-2.52	-2.68	-11.46	-10.67	-10.56
33	48	-2.57	-2.53	-2.69	-11.60	-10.78	-10.67
33	51	-2.58	-2.55	-2.72	-11.96	-11.08	-10.96
33	54	-2.59	-2.59	-2.76	-12.52	-11.53	-11.41
33	57	-2.61	-2.64	-2.81	-13.21	-12.09	-11.95
33	60	-2.63	-2.70	-2.87	-13.99	-12.72	-12.55
33	63	-2.70	-2.79	-2.98	-15.53	-13.93	-13.63
33	66	-2.84	-2.94	-3.14	-18.05	-15.87	-15.31
33	69	-3.02	-3.13	-3.35	-20.79	-17.98	-17.15
33	72	-3.23	-3.34	-3.59	-22.99	-19.67	-18.69
33	75	-3.43	-3.56	-3.84	-23.89	-20.36	-19.47
33	78	-3.63	-3.79	-4.11	-23.34	-20.28	-19.70
33	81	-3.84	-4.06	-4.42	-21.95	-20.07	-19.89
33	84	-4.08	-4.36	-4.77	-20.11	-19.75	-20.04
33	87	-4.34	-4.68	-5.15	-18.23	-19.34	-20.13
33	90	-4.62	-5.02	-5.56	-16.69	-18.86	-20.16
33	93	-4.95	-5.40	-6.01	-15.40	-17.87	-19.42
33	96	-5.33	-5.80	-6.52	-14.06	-16.19	-17.61
33	99	-5.75	-6.24	-7.07	-12.83	-14.27	-15.35
33	102	-6.19	-6.72	-7.64	-11.88	-12.57	-13.25
33	105	-6.64	-7.22	-8.21	-11.33	-11.54	-11.94
33	108	-7.18	-7.88	-8.89	-11.07	-11.01	-11.24
33	111	-7.82	-8.70	-9.69	-10.84	-10.54	-10.62
33	114	-8.44	-9.50	-10.45	-10.67	-10.17	-10.11
33	117	-8.90	-10.11	-11.02	-10.55	-9.92	-9.78
33	120	-9.09	-10.36	-11.24	-10.51	-9.84	-9.65
33	123	-9.00	-10.16	-11.01	-10.68	-9.94	-9.73
33	126	-8.77	-9.67	-10.40	-11.13	-10.24	-9.93
33	129	-8.44	-9.00	-9.59	-11.78	-10.69	-10.25
33	132	-8.06	-8.29	-8.74	-12.55	-11.26	-10.66
33	135	-7.67	-7.65	-8.00	-13.36	-11.89	-11.13
33	138	-7.24	-7.08	-7.35	-14.59	-13.13	-12.19
33	141	-6.71	-6.48	-6.69	-16.34	-15.15	-14.05
33	144	-6.13	-5.89	-6.05	-18.17	-17.34	-16.20
33	147	-5.55	-5.33	-5.45	-19.60	-19.10	-18.14
33	150	-5.03	-4.82	-4.94	-20.18	-19.82	-19.36
33	153	-4.52	-4.31	-4.45	-19.73	-19.70	-20.04
33	156	-3.99	-3.80	-3.96	-18.58	-19.37	-20.65
33	159	-3.50	-3.33	-3.52	-17.05	-18.87	-21.14
33	162	-3.09	-2.97	-3.21	-15.45	-18.26	-21.47
33	165	-2.81	-2.77	-3.09	-14.10	-17.59	-21.59
33	168	-2.62	-2.68	-3.09	-12.88	-16.43	-20.60
33	171	-2.45	-2.60	-3.10	-11.56	-14.66	-18.22

33	174	-2.31	-2.54	-3.11	-10.34	-12.72	-15.29
33	177	-2.22	-2.50	-3.13	-9.40	-11.07	-12.68
33	180	-2.18	-2.49	-3.16	-8.92	-10.18	-11.23
33	183	-2.27	-2.60	-3.30	-8.74	-9.84	-10.69
33	186	-2.50	-2.89	-3.64	-8.60	-9.56	-10.24
33	189	-2.83	-3.31	-4.11	-8.49	-9.34	-9.88
33	192	-3.21	-3.80	-4.67	-8.42	-9.20	-9.65
33	195	-3.59	-4.30	-5.24	-8.39	-9.15	-9.57
33	198	-4.03	-4.86	-5.92	-8.56	-9.31	-9.68
33	201	-4.56	-5.56	-6.77	-9.01	-9.74	-9.98
33	204	-5.16	-6.33	-7.72	-9.63	-10.32	-10.39
33	207	-5.78	-7.13	-8.66	-10.32	-10.98	-10.87
33	210	-6.41	-7.90	-9.51	-10.98	-11.60	-11.35
33	213	-7.17	-8.78	-10.38	-11.77	-12.33	-11.98
33	216	-8.08	-9.80	-11.33	-12.76	-13.25	-12.81
33	219	-8.95	-10.76	-12.20	-13.74	-14.15	-13.65
33	222	-9.61	-11.48	-12.83	-14.49	-14.83	-14.29
33	225	-9.87	-11.76	-13.08	-14.78	-15.10	-14.55
33	228	-9.86	-11.66	-12.94	-14.71	-14.97	-14.41
33	231	-9.82	-11.40	-12.58	-14.50	-14.61	-14.03
33	234	-9.76	-11.03	-12.09	-14.20	-14.09	-13.49
33	237	-9.68	-10.62	-11.56	-13.84	-13.50	-12.88
33	240	-9.59	-10.21	-11.07	-13.45	-12.90	-12.27
33	243	-9.34	-9.75	-10.57	-12.88	-12.17	-11.56
33	246	-8.86	-9.19	-10.03	-12.06	-11.23	-10.67
33	249	-8.27	-8.60	-9.48	-11.15	-10.24	-9.73
33	252	-7.71	-8.07	-8.98	-10.31	-9.35	-8.90
33	255	-7.30	-7.69	-8.60	-9.69	-8.73	-8.30
33	258	-7.01	-7.42	-8.32	-9.24	-8.29	-7.87
33	261	-6.76	-7.20	-8.08	-8.81	-7.88	-7.47
33	264	-6.54	-7.01	-7.87	-8.44	-7.54	-7.14
33	267	-6.35	-6.84	-7.68	-8.19	-7.31	-6.91
33	270	-6.19	-6.68	-7.50	-8.10	-7.22	-6.82
33	273	-6.06	-6.55	-7.32	-8.13	-7.27	-6.85
33	276	-5.95	-6.43	-7.16	-8.22	-7.38	-6.93
33	279	-5.85	-6.32	-7.01	-8.35	-7.55	-7.04
33	282	-5.76	-6.21	-6.85	-8.51	-7.74	-7.17
33	285	-5.66	-6.08	-6.68	-8.69	-7.95	-7.31
33	288	-5.54	-5.90	-6.45	-8.93	-8.20	-7.49
33	291	-5.40	-5.68	-6.19	-9.28	-8.52	-7.72
33	294	-5.27	-5.46	-5.92	-9.71	-8.89	-7.99
33	297	-5.18	-5.29	-5.70	-10.21	-9.30	-8.29
33	300	-5.14	-5.20	-5.57	-10.75	-9.73	-8.59
33	303	-5.14	-5.16	-5.49	-11.43	-10.20	-8.92
33	306	-5.15	-5.13	-5.43	-12.29	-10.74	-9.28
33	309	-5.15	-5.11	-5.38	-13.25	-11.32	-9.67
33	312	-5.15	-5.10	-5.35	-14.24	-11.91	-10.05
33	315	-5.16	-5.09	-5.34	-15.18	-12.49	-10.40
33	318	-5.25	-5.17	-5.41	-16.24	-13.11	-10.73
33	321	-5.48	-5.39	-5.59	-17.45	-13.79	-11.06
33	324	-5.82	-5.72	-5.87	-18.60	-14.44	-11.38
33	327	-6.23	-6.11	-6.21	-19.45	-14.98	-11.65
33	330	-6.68	-6.55	-6.59	-19.79	-15.34	-11.86
33	333	-7.28	-7.15	-7.12	-19.56	-15.55	-12.03
33	336	-8.10	-7.99	-7.90	-18.97	-15.75	-12.20
33	339	-9.12	-9.01	-8.83	-18.20	-15.90	-12.33
33	342	-10.27	-10.13	-9.81	-17.39	-16.00	-12.43
33	345	-11.52	-11.29	-10.77	-16.72	-16.04	-12.46

33	348	-12.95	-12.50	-11.70	-16.17	-15.97	-12.46
33	351	-14.66	-13.83	-12.67	-15.64	-15.76	-12.46
33	354	-16.60	-15.28	-13.68	-15.13	-15.43	-12.46
33	357	-18.73	-16.84	-14.72	-14.64	-15.01	-12.46
33	360	-21.03	-18.48	-15.79	-14.17	-14.51	-12.45
36	0	-18.90	-16.57	-14.34	-13.80	-13.77	-11.76
36	3	-16.17	-14.35	-12.62	-13.69	-13.52	-11.76
36	6	-13.66	-12.29	-11.02	-13.55	-13.27	-11.75
36	9	-11.43	-10.46	-9.58	-13.39	-13.01	-11.73
36	12	-9.58	-8.89	-8.32	-13.22	-12.75	-11.70
36	15	-8.16	-7.64	-7.26	-13.03	-12.49	-11.67
36	18	-7.05	-6.60	-6.35	-12.79	-12.21	-11.58
36	21	-6.08	-5.67	-5.50	-12.49	-11.89	-11.39
36	24	-5.25	-4.86	-4.76	-12.18	-11.59	-11.17
36	27	-4.60	-4.23	-4.17	-11.91	-11.33	-10.96
36	30	-4.11	-3.79	-3.77	-11.75	-11.15	-10.84
36	33	-3.74	-3.47	-3.49	-11.66	-11.02	-10.77
36	36	-3.41	-3.18	-3.24	-11.59	-10.89	-10.71
36	39	-3.14	-2.94	-3.04	-11.53	-10.79	-10.66
36	42	-2.95	-2.79	-2.91	-11.49	-10.72	-10.63
36	45	-2.84	-2.73	-2.86	-11.47	-10.70	-10.62
36	48	-2.79	-2.73	-2.87	-11.61	-10.81	-10.73
36	51	-2.75	-2.74	-2.88	-11.99	-11.11	-11.02
36	54	-2.72	-2.74	-2.90	-12.55	-11.56	-11.45
36	57	-2.71	-2.75	-2.92	-13.25	-12.11	-11.98
36	60	-2.70	-2.76	-2.95	-14.03	-12.73	-12.57
36	63	-2.74	-2.81	-3.02	-15.57	-13.84	-13.48
36	66	-2.84	-2.94	-3.17	-18.06	-15.60	-14.86
36	69	-2.99	-3.11	-3.37	-20.75	-17.52	-16.42
36	72	-3.17	-3.32	-3.62	-22.91	-19.10	-17.89
36	75	-3.36	-3.55	-3.88	-23.80	-19.86	-19.01
36	78	-3.58	-3.83	-4.21	-23.33	-20.02	-19.89
36	81	-3.85	-4.19	-4.63	-22.15	-20.16	-20.74
36	84	-4.18	-4.63	-5.14	-20.57	-20.26	-21.48
36	87	-4.55	-5.11	-5.70	-18.90	-20.33	-21.99
36	90	-4.97	-5.63	-6.31	-17.47	-20.35	-22.19
36	93	-5.47	-6.20	-6.97	-16.15	-19.57	-21.34
36	96	-6.09	-6.84	-7.74	-14.73	-17.70	-19.27
36	99	-6.80	-7.56	-8.59	-13.40	-15.37	-16.68
36	102	-7.57	-8.37	-9.52	-12.33	-13.25	-14.27
36	105	-8.36	-9.29	-10.52	-11.73	-12.00	-12.76
36	108	-9.38	-10.66	-11.88	-11.43	-11.43	-11.95
36	111	-10.65	-12.54	-13.62	-11.17	-10.93	-11.23
36	114	-11.91	-14.45	-15.35	-10.98	-10.53	-10.64
36	117	-12.86	-15.94	-16.68	-10.85	-10.27	-10.25
36	120	-13.24	-16.54	-17.21	-10.80	-10.18	-10.11
36	123	-12.98	-15.97	-16.59	-11.03	-10.31	-10.19
36	126	-12.31	-14.56	-15.06	-11.62	-10.66	-10.41
36	129	-11.40	-12.73	-13.07	-12.44	-11.19	-10.77
36	132	-10.41	-10.88	-11.09	-13.39	-11.85	-11.22
36	135	-9.52	-9.45	-9.58	-14.33	-12.60	-11.77
36	138	-8.69	-8.41	-8.49	-15.52	-14.07	-13.34
36	141	-7.79	-7.44	-7.49	-17.09	-16.47	-16.24
36	144	-6.90	-6.56	-6.58	-18.66	-19.07	-19.51
36	147	-6.05	-5.77	-5.78	-19.87	-21.16	-22.18
36	150	-5.30	-5.06	-5.09	-20.36	-22.02	-23.29
36	153	-4.61	-4.39	-4.45	-19.72	-21.57	-23.05
36	156	-3.92	-3.73	-3.81	-18.14	-20.41	-22.42

36	159	-3.29	-3.14	-3.26	-16.09	-18.85	-21.51
36	162	-2.78	-2.68	-2.85	-14.03	-17.17	-20.44
36	165	-2.43	-2.40	-2.66	-12.45	-15.67	-19.31
36	168	-2.18	-2.25	-2.60	-11.21	-14.13	-17.68
36	171	-1.97	-2.12	-2.56	-9.95	-12.37	-15.37
36	174	-1.79	-2.01	-2.52	-8.85	-10.69	-12.95
36	177	-1.67	-1.95	-2.50	-8.06	-9.41	-10.96
36	180	-1.63	-1.92	-2.50	-7.76	-8.86	-9.97
36	183	-1.72	-2.03	-2.62	-7.77	-8.79	-9.69
36	186	-1.95	-2.31	-2.93	-7.81	-8.74	-9.46
36	189	-2.28	-2.72	-3.39	-7.88	-8.70	-9.28
36	192	-2.66	-3.19	-3.92	-7.97	-8.67	-9.17
36	195	-3.05	-3.68	-4.47	-8.08	-8.66	-9.13
36	198	-3.48	-4.22	-5.11	-8.48	-8.96	-9.33
36	201	-4.01	-4.89	-5.90	-9.29	-9.70	-9.83
36	204	-4.59	-5.63	-6.80	-10.31	-10.68	-10.52
36	207	-5.22	-6.41	-7.71	-11.33	-11.68	-11.27
36	210	-5.85	-7.19	-8.58	-12.12	-12.48	-11.95
36	213	-6.62	-8.10	-9.52	-12.77	-13.16	-12.66
36	216	-7.54	-9.18	-10.60	-13.43	-13.88	-13.51
36	219	-8.44	-10.22	-11.61	-14.02	-14.53	-14.32
36	222	-9.15	-10.99	-12.36	-14.43	-14.99	-14.93
36	225	-9.48	-11.30	-12.65	-14.59	-15.17	-15.17
36	228	-9.57	-11.25	-12.59	-14.46	-14.97	-14.94
36	231	-9.64	-11.12	-12.41	-14.12	-14.46	-14.35
36	234	-9.69	-10.93	-12.15	-13.64	-13.76	-13.55
36	237	-9.72	-10.70	-11.85	-13.10	-12.99	-12.69
36	240	-9.73	-10.45	-11.54	-12.57	-12.27	-11.91
36	243	-9.55	-10.09	-11.14	-12.00	-11.53	-11.15
36	246	-9.12	-9.57	-10.61	-11.30	-10.68	-10.32
36	249	-8.56	-8.99	-10.03	-10.58	-9.83	-9.50
36	252	-7.99	-8.44	-9.48	-9.94	-9.09	-8.79
36	255	-7.56	-8.02	-9.04	-9.47	-8.58	-8.28
36	258	-7.24	-7.72	-8.71	-9.11	-8.22	-7.91
36	261	-6.96	-7.45	-8.42	-8.77	-7.89	-7.57
36	264	-6.70	-7.21	-8.15	-8.49	-7.62	-7.28
36	267	-6.46	-7.00	-7.91	-8.29	-7.44	-7.09
36	270	-6.26	-6.80	-7.67	-8.22	-7.37	-7.02
36	273	-6.08	-6.62	-7.45	-8.25	-7.41	-7.05
36	276	-5.93	-6.45	-7.25	-8.32	-7.53	-7.13
36	279	-5.79	-6.30	-7.06	-8.43	-7.70	-7.24
36	282	-5.65	-6.14	-6.86	-8.57	-7.90	-7.37
36	285	-5.52	-5.97	-6.65	-8.71	-8.09	-7.51
36	288	-5.37	-5.77	-6.39	-8.88	-8.30	-7.66
36	291	-5.22	-5.53	-6.10	-9.11	-8.54	-7.84
36	294	-5.08	-5.30	-5.81	-9.38	-8.82	-8.04
36	297	-4.96	-5.09	-5.55	-9.70	-9.11	-8.26
36	300	-4.88	-4.95	-5.36	-10.07	-9.42	-8.49
36	303	-4.82	-4.84	-5.20	-10.54	-9.77	-8.73
36	306	-4.77	-4.74	-5.06	-11.15	-10.15	-9.00
36	309	-4.72	-4.66	-4.94	-11.84	-10.56	-9.28
36	312	-4.70	-4.61	-4.85	-12.57	-10.98	-9.57
36	315	-4.68	-4.59	-4.82	-13.28	-11.41	-9.84
36	318	-4.76	-4.65	-4.88	-14.10	-11.89	-10.11
36	321	-4.95	-4.84	-5.03	-15.05	-12.42	-10.40
36	324	-5.25	-5.11	-5.26	-15.96	-12.94	-10.67
36	327	-5.61	-5.45	-5.55	-16.65	-13.39	-10.91
36	330	-6.01	-5.83	-5.87	-16.91	-13.73	-11.10

36	333	-6.56	-6.38	-6.35	-16.78	-13.97	-11.24
36	336	-7.34	-7.17	-7.08	-16.43	-14.21	-11.37
36	339	-8.29	-8.13	-7.96	-15.97	-14.40	-11.49
36	342	-9.38	-9.19	-8.89	-15.51	-14.53	-11.58
36	345	-10.54	-10.25	-9.79	-15.12	-14.58	-11.63
36	348	-11.83	-11.34	-10.64	-14.83	-14.55	-11.67
36	351	-13.34	-12.53	-11.53	-14.54	-14.45	-11.71
36	354	-15.04	-13.80	-12.44	-14.28	-14.29	-11.74
36	357	-16.90	-15.15	-13.37	-14.03	-14.07	-11.76
36	360	-18.90	-16.57	-14.34	-13.80	-13.77	-11.76
39	0	-16.35	-14.30	-12.60	-13.28	-12.80	-11.02
39	3	-14.05	-12.39	-11.06	-13.28	-12.76	-11.17
39	6	-11.94	-10.64	-9.64	-13.27	-12.69	-11.28
39	9	-10.08	-9.07	-8.37	-13.25	-12.60	-11.36
39	12	-8.52	-7.75	-7.27	-13.22	-12.49	-11.40
39	15	-7.35	-6.71	-6.38	-13.19	-12.37	-11.42
39	18	-6.42	-5.86	-5.62	-13.05	-12.20	-11.38
39	21	-5.61	-5.09	-4.91	-12.77	-11.96	-11.28
39	24	-4.93	-4.44	-4.30	-12.43	-11.69	-11.15
39	27	-4.39	-3.93	-3.84	-12.11	-11.45	-11.03
39	30	-4.03	-3.62	-3.56	-11.90	-11.26	-10.94
39	33	-3.78	-3.42	-3.41	-11.78	-11.12	-10.87
39	36	-3.58	-3.27	-3.28	-11.67	-10.98	-10.81
39	39	-3.42	-3.14	-3.18	-11.58	-10.85	-10.76
39	42	-3.29	-3.05	-3.12	-11.52	-10.77	-10.73
39	45	-3.17	-2.99	-3.08	-11.49	-10.74	-10.71
39	48	-3.06	-2.93	-3.06	-11.63	-10.85	-10.82
39	51	-2.96	-2.89	-3.05	-12.02	-11.15	-11.10
39	54	-2.87	-2.85	-3.03	-12.60	-11.59	-11.52
39	57	-2.80	-2.83	-3.03	-13.31	-12.13	-12.03
39	60	-2.78	-2.82	-3.02	-14.11	-12.73	-12.59
39	63	-2.81	-2.86	-3.07	-15.63	-13.70	-13.37
39	66	-2.88	-2.97	-3.21	-18.07	-15.15	-14.50
39	69	-2.99	-3.12	-3.40	-20.71	-16.79	-15.82
39	72	-3.12	-3.32	-3.65	-22.82	-18.31	-17.20
39	75	-3.28	-3.54	-3.92	-23.69	-19.39	-18.47
39	78	-3.50	-3.85	-4.28	-23.33	-20.16	-19.84
39	81	-3.83	-4.30	-4.81	-22.41	-20.88	-21.39
39	84	-4.25	-4.86	-5.46	-21.14	-21.49	-22.85
39	87	-4.74	-5.50	-6.20	-19.77	-21.91	-23.93
39	90	-5.29	-6.19	-6.99	-18.51	-22.06	-24.35
39	93	-5.97	-6.95	-7.88	-17.19	-21.20	-23.42
39	96	-6.84	-7.84	-8.92	-15.68	-19.09	-21.14
39	99	-7.85	-8.87	-10.11	-14.20	-16.48	-18.29
39	102	-8.96	-10.06	-11.44	-12.99	-14.11	-15.63
39	105	-10.14	-11.43	-12.91	-12.29	-12.71	-13.93
39	108	-11.70	-13.62	-15.04	-11.95	-12.08	-12.99
39	111	-13.70	-16.74	-17.89	-11.66	-11.53	-12.14
39	114	-15.70	-19.97	-20.77	-11.43	-11.09	-11.45
39	117	-17.23	-22.50	-23.00	-11.29	-10.81	-10.99
39	120	-17.84	-23.52	-23.90	-11.23	-10.70	-10.82
39	123	-17.38	-22.52	-22.85	-11.53	-10.85	-10.90
39	126	-16.21	-20.05	-20.25	-12.29	-11.26	-11.15
39	129	-14.64	-16.86	-16.92	-13.33	-11.88	-11.53
39	132	-12.99	-13.74	-13.67	-14.45	-12.64	-12.03
39	135	-11.55	-11.44	-11.32	-15.48	-13.50	-12.63
39	138	-10.30	-9.91	-9.77	-16.59	-15.19	-14.60
39	141	-9.01	-8.54	-8.40	-17.91	-17.93	-18.34

39	144	-7.77	-7.33	-7.19	-19.17	-20.90	-22.60
39	147	-6.62	-6.27	-6.15	-20.12	-23.29	-26.09
39	150	-5.63	-5.35	-5.27	-20.49	-24.27	-27.54
39	153	-4.75	-4.51	-4.48	-19.68	-23.38	-26.68
39	156	-3.90	-3.70	-3.72	-17.66	-21.16	-24.52
39	159	-3.14	-3.00	-3.07	-15.08	-18.31	-21.69
39	162	-2.53	-2.45	-2.58	-12.60	-15.50	-18.81
39	165	-2.12	-2.11	-2.32	-10.87	-13.41	-16.51
39	168	-1.83	-1.91	-2.20	-9.71	-11.86	-14.57
39	171	-1.58	-1.73	-2.10	-8.60	-10.33	-12.55
39	174	-1.37	-1.59	-2.02	-7.67	-9.00	-10.73
39	177	-1.24	-1.50	-1.97	-7.02	-8.07	-9.41
39	180	-1.19	-1.47	-1.95	-6.78	-7.71	-8.88
39	183	-1.28	-1.57	-2.07	-6.83	-7.74	-8.85
39	186	-1.51	-1.85	-2.37	-6.98	-7.81	-8.82
39	189	-1.85	-2.25	-2.80	-7.21	-7.93	-8.80
39	192	-2.23	-2.71	-3.31	-7.50	-8.08	-8.78
39	195	-2.63	-3.18	-3.83	-7.84	-8.27	-8.78
39	198	-3.06	-3.71	-4.43	-8.60	-8.86	-9.08
39	201	-3.57	-4.36	-5.18	-9.94	-10.03	-9.85
39	204	-4.15	-5.08	-6.02	-11.45	-11.42	-10.86
39	207	-4.78	-5.85	-6.90	-12.76	-12.70	-11.90
39	210	-5.42	-6.63	-7.77	-13.49	-13.54	-12.76
39	213	-6.18	-7.56	-8.79	-13.77	-14.04	-13.51
39	216	-7.09	-8.70	-9.98	-14.00	-14.50	-14.32
39	219	-8.00	-9.79	-11.12	-14.19	-14.87	-15.06
39	222	-8.75	-10.62	-11.98	-14.30	-15.13	-15.59
39	225	-9.20	-10.94	-12.32	-14.35	-15.22	-15.80
39	228	-9.43	-10.94	-12.31	-14.13	-14.94	-15.46
39	231	-9.64	-10.92	-12.30	-13.58	-14.22	-14.61
39	234	-9.80	-10.89	-12.27	-12.86	-13.26	-13.49
39	237	-9.91	-10.85	-12.24	-12.11	-12.27	-12.34
39	240	-9.94	-10.80	-12.19	-11.49	-11.45	-11.42
39	243	-9.79	-10.59	-11.97	-10.96	-10.74	-10.67
39	246	-9.41	-10.14	-11.48	-10.43	-10.01	-9.92
39	249	-8.91	-9.57	-10.86	-9.93	-9.33	-9.23
39	252	-8.38	-8.99	-10.22	-9.51	-8.77	-8.66
39	255	-7.95	-8.53	-9.71	-9.21	-8.40	-8.26
39	258	-7.60	-8.17	-9.31	-8.97	-8.15	-7.98
39	261	-7.26	-7.84	-8.94	-8.76	-7.93	-7.72
39	264	-6.93	-7.53	-8.59	-8.58	-7.75	-7.51
39	267	-6.63	-7.25	-8.26	-8.46	-7.63	-7.37
39	270	-6.37	-6.98	-7.95	-8.41	-7.59	-7.31
39	273	-6.15	-6.74	-7.66	-8.43	-7.64	-7.35
39	276	-5.94	-6.52	-7.40	-8.49	-7.77	-7.43
39	279	-5.75	-6.31	-7.14	-8.57	-7.94	-7.54
39	282	-5.58	-6.11	-6.89	-8.66	-8.12	-7.66
39	285	-5.41	-5.89	-6.62	-8.74	-8.29	-7.78
39	288	-5.24	-5.66	-6.33	-8.82	-8.42	-7.88
39	291	-5.07	-5.41	-6.02	-8.90	-8.56	-7.99
39	294	-4.92	-5.16	-5.71	-8.99	-8.70	-8.11
39	297	-4.78	-4.93	-5.43	-9.10	-8.85	-8.23
39	300	-4.66	-4.75	-5.19	-9.24	-9.01	-8.36
39	303	-4.56	-4.59	-4.97	-9.44	-9.18	-8.50
39	306	-4.46	-4.43	-4.75	-9.74	-9.37	-8.64
39	309	-4.37	-4.29	-4.55	-10.09	-9.56	-8.78
39	312	-4.31	-4.19	-4.41	-10.48	-9.78	-8.94
39	315	-4.29	-4.15	-4.36	-10.88	-10.01	-9.10



39	318	-4.35	-4.21	-4.40	-11.38	-10.30	-9.29
39	321	-4.52	-4.36	-4.52	-12.02	-10.65	-9.50
39	324	-4.77	-4.59	-4.71	-12.64	-11.01	-9.71
39	327	-5.09	-4.88	-4.94	-13.12	-11.36	-9.92
39	330	-5.44	-5.20	-5.20	-13.31	-11.66	-10.09
39	333	-5.95	-5.69	-5.62	-13.29	-11.94	-10.23
39	336	-6.70	-6.44	-6.30	-13.26	-12.22	-10.37
39	339	-7.62	-7.34	-7.11	-13.21	-12.47	-10.49
39	342	-8.63	-8.31	-7.97	-13.18	-12.66	-10.60
39	345	-9.68	-9.25	-8.77	-13.16	-12.74	-10.70
39	348	-10.79	-10.17	-9.52	-13.17	-12.76	-10.78
39	351	-12.02	-11.14	-10.28	-13.18	-12.78	-10.85
39	354	-13.37	-12.16	-11.04	-13.21	-12.79	-10.92
39	357	-14.81	-13.21	-11.82	-13.24	-12.80	-10.98
39	360	-16.35	-14.30	-12.60	-13.28	-12.80	-11.02
42	0	-14.21	-12.40	-11.15	-12.68	-11.80	-10.32
42	3	-12.28	-10.76	-9.76	-12.95	-11.98	-10.56
42	6	-10.50	-9.25	-8.48	-13.12	-12.10	-10.77
42	9	-8.94	-7.91	-7.34	-13.23	-12.17	-10.95
42	12	-7.64	-6.79	-6.38	-13.28	-12.20	-11.07
42	15	-6.66	-5.94	-5.63	-13.29	-12.21	-11.11
42	18	-5.90	-5.25	-5.01	-13.19	-12.15	-11.10
42	21	-5.23	-4.62	-4.43	-12.92	-11.98	-11.09
42	24	-4.66	-4.09	-3.93	-12.58	-11.75	-11.07
42	27	-4.24	-3.70	-3.58	-12.25	-11.53	-11.04
42	30	-3.97	-3.50	-3.42	-12.03	-11.35	-11.02
42	33	-3.82	-3.41	-3.37	-11.88	-11.21	-10.98
42	36	-3.72	-3.34	-3.33	-11.74	-11.06	-10.93
42	39	-3.63	-3.29	-3.31	-11.63	-10.92	-10.88
42	42	-3.55	-3.25	-3.29	-11.55	-10.83	-10.84
42	45	-3.45	-3.20	-3.26	-11.52	-10.79	-10.83
42	48	-3.32	-3.13	-3.22	-11.67	-10.90	-10.93
42	51	-3.17	-3.05	-3.19	-12.06	-11.19	-11.20
42	54	-3.03	-2.97	-3.15	-12.66	-11.63	-11.60
42	57	-2.92	-2.92	-3.12	-13.39	-12.16	-12.08
42	60	-2.88	-2.89	-3.11	-14.20	-12.75	-12.61
42	63	-2.90	-2.93	-3.16	-15.71	-13.62	-13.31
42	66	-2.94	-3.02	-3.28	-18.11	-14.90	-14.26
42	69	-3.01	-3.15	-3.46	-20.69	-16.37	-15.41
42	72	-3.10	-3.33	-3.70	-22.75	-17.82	-16.67
42	75	-3.21	-3.53	-3.96	-23.60	-19.05	-17.96
42	78	-3.42	-3.85	-4.35	-23.34	-20.18	-19.63
42	81	-3.81	-4.36	-4.94	-22.66	-21.37	-21.75
42	84	-4.32	-5.01	-5.70	-21.71	-22.44	-23.84
42	87	-4.93	-5.77	-6.56	-20.64	-23.21	-25.44
42	90	-5.59	-6.59	-7.50	-19.58	-23.50	-26.08
42	93	-6.41	-7.50	-8.55	-18.32	-22.59	-25.13
42	96	-7.46	-8.59	-9.81	-16.72	-20.37	-22.78
42	99	-8.69	-9.88	-11.28	-15.10	-17.62	-19.84
42	102	-10.07	-11.38	-12.93	-13.74	-15.10	-17.07
42	105	-11.53	-13.11	-14.78	-12.96	-13.61	-15.27
42	108	-13.53	-15.98	-17.54	-12.57	-12.91	-14.23
42	111	-16.14	-20.12	-21.31	-12.25	-12.30	-13.27
42	114	-18.75	-24.45	-25.15	-11.99	-11.81	-12.48
42	117	-20.76	-27.85	-28.14	-11.83	-11.49	-11.95
42	120	-21.57	-29.23	-29.35	-11.77	-11.38	-11.76
42	123	-20.94	-27.88	-27.94	-12.13	-11.54	-11.84
42	126	-19.37	-24.52	-24.47	-13.03	-12.00	-12.10

42	129	-17.26	-20.22	-20.04	-14.23	-12.69	-12.50
42	132	-15.06	-16.05	-15.76	-15.49	-13.55	-13.02
42	135	-13.20	-13.06	-12.73	-16.54	-14.50	-13.66
42	138	-11.61	-11.13	-10.82	-17.52	-16.33	-15.90
42	141	-10.00	-9.43	-9.14	-18.60	-19.26	-20.24
42	144	-8.47	-7.95	-7.68	-19.58	-22.43	-25.19
42	147	-7.08	-6.68	-6.45	-20.30	-24.97	-29.25
42	150	-5.91	-5.60	-5.43	-20.58	-26.01	-30.94
42	153	-4.88	-4.62	-4.52	-19.61	-24.71	-29.46
42	156	-3.91	-3.71	-3.67	-17.21	-21.53	-25.81
42	159	-3.05	-2.92	-2.95	-14.20	-17.53	-21.20
42	162	-2.36	-2.30	-2.40	-11.38	-13.79	-16.86
42	165	-1.91	-1.92	-2.08	-9.56	-11.39	-13.98
42	168	-1.59	-1.68	-1.92	-8.53	-10.05	-12.25
42	171	-1.32	-1.47	-1.78	-7.59	-8.82	-10.66
42	174	-1.10	-1.31	-1.68	-6.82	-7.82	-9.34
42	177	-0.95	-1.21	-1.61	-6.30	-7.15	-8.45
42	180	-0.89	-1.17	-1.59	-6.11	-6.90	-8.12
42	183	-0.98	-1.27	-1.70	-6.19	-6.95	-8.14
42	186	-1.22	-1.55	-1.99	-6.42	-7.11	-8.19
42	189	-1.56	-1.94	-2.40	-6.76	-7.34	-8.28
42	192	-1.95	-2.39	-2.89	-7.19	-7.65	-8.40
42	195	-2.34	-2.86	-3.39	-7.68	-8.00	-8.54
42	198	-2.77	-3.37	-3.97	-8.73	-8.87	-9.06
42	201	-3.29	-4.01	-4.68	-10.50	-10.42	-10.12
42	204	-3.87	-4.72	-5.49	-12.43	-12.17	-11.42
42	207	-4.49	-5.48	-6.35	-13.99	-13.68	-12.69
42	210	-5.13	-6.26	-7.21	-14.63	-14.47	-13.64
42	213	-5.89	-7.18	-8.22	-14.60	-14.73	-14.36
42	216	-6.79	-8.29	-9.41	-14.52	-14.95	-15.08
42	219	-7.70	-9.38	-10.59	-14.39	-15.11	-15.69
42	222	-8.49	-10.25	-11.55	-14.23	-15.22	-16.13
42	225	-9.02	-10.71	-12.10	-14.04	-15.25	-16.29
42	228	-9.38	-10.89	-12.36	-13.61	-14.87	-15.84
42	231	-9.71	-11.04	-12.59	-12.85	-13.93	-14.73
42	234	-9.98	-11.15	-12.76	-11.94	-12.71	-13.30
42	237	-10.16	-11.22	-12.87	-11.09	-11.51	-11.90
42	240	-10.22	-11.25	-12.92	-10.48	-10.63	-10.88
42	243	-10.10	-11.10	-12.74	-10.08	-10.00	-10.19
42	246	-9.78	-10.71	-12.30	-9.70	-9.40	-9.54
42	249	-9.34	-10.19	-11.70	-9.39	-8.88	-8.97
42	252	-8.87	-9.64	-11.08	-9.14	-8.48	-8.53
42	255	-8.45	-9.17	-10.53	-8.98	-8.25	-8.25
42	258	-8.06	-8.76	-10.07	-8.88	-8.13	-8.07
42	261	-7.64	-8.35	-9.60	-8.79	-8.03	-7.92
42	264	-7.23	-7.94	-9.15	-8.72	-7.95	-7.80
42	267	-6.85	-7.56	-8.71	-8.67	-7.90	-7.71
42	270	-6.52	-7.22	-8.31	-8.66	-7.88	-7.69
42	273	-6.24	-6.91	-7.94	-8.67	-7.94	-7.72
42	276	-5.99	-6.63	-7.59	-8.70	-8.08	-7.80
42	279	-5.76	-6.36	-7.25	-8.74	-8.26	-7.91
42	282	-5.54	-6.10	-6.93	-8.77	-8.42	-8.01
42	285	-5.34	-5.85	-6.61	-8.78	-8.50	-8.08
42	288	-5.15	-5.58	-6.28	-8.75	-8.52	-8.11
42	291	-4.97	-5.32	-5.96	-8.66	-8.53	-8.14
42	294	-4.81	-5.06	-5.64	-8.55	-8.54	-8.17
42	297	-4.66	-4.83	-5.35	-8.46	-8.55	-8.19
42	300	-4.52	-4.62	-5.08	-8.43	-8.56	-8.22

42	303	-4.39	-4.42	-4.81	-8.43	-8.57	-8.24
42	306	-4.25	-4.21	-4.53	-8.46	-8.58	-8.26
42	309	-4.13	-4.03	-4.28	-8.50	-8.59	-8.27
42	312	-4.05	-3.90	-4.10	-8.55	-8.60	-8.30
42	315	-4.01	-3.85	-4.03	-8.61	-8.62	-8.33
42	318	-4.07	-3.90	-4.06	-8.74	-8.70	-8.40
42	321	-4.21	-4.02	-4.14	-8.99	-8.88	-8.54
42	324	-4.43	-4.20	-4.27	-9.31	-9.12	-8.71
42	327	-4.70	-4.43	-4.43	-9.63	-9.39	-8.89
42	330	-5.01	-4.70	-4.62	-9.93	-9.64	-9.05
42	333	-5.48	-5.14	-4.99	-10.19	-9.89	-9.20
42	336	-6.22	-5.84	-5.60	-10.44	-10.16	-9.36
42	339	-7.12	-6.69	-6.36	-10.70	-10.45	-9.52
42	342	-8.09	-7.58	-7.15	-10.96	-10.71	-9.66
42	345	-9.04	-8.42	-7.88	-11.22	-10.95	-9.80
42	348	-9.97	-9.19	-8.53	-11.50	-11.15	-9.92
42	351	-10.96	-9.98	-9.18	-11.79	-11.34	-10.03
42	354	-12.00	-10.77	-9.84	-12.08	-11.51	-10.14
42	357	-13.08	-11.58	-10.49	-12.38	-11.67	-10.23
42	360	-14.21	-12.40	-11.15	-12.68	-11.80	-10.32
45	0	-13.32	-11.60	-10.54	-12.07	-11.00	-9.77
45	3	-11.53	-10.07	-9.21	-12.53	-11.35	-10.04
45	6	-9.90	-8.66	-7.99	-12.88	-11.63	-10.29
45	9	-8.46	-7.42	-6.91	-13.13	-11.85	-10.50
45	12	-7.27	-6.39	-6.01	-13.28	-11.99	-10.67
45	15	-6.38	-5.62	-5.32	-13.34	-12.04	-10.79
45	18	-5.69	-4.99	-4.75	-13.23	-11.99	-10.87
45	21	-5.07	-4.42	-4.22	-12.96	-11.86	-10.94
45	24	-4.55	-3.95	-3.78	-12.63	-11.70	-11.00
45	27	-4.17	-3.61	-3.48	-12.30	-11.53	-11.03
45	30	-3.95	-3.45	-3.36	-12.08	-11.39	-11.05
45	33	-3.85	-3.40	-3.35	-11.93	-11.26	-11.04
45	36	-3.77	-3.37	-3.35	-11.79	-11.12	-11.01
45	39	-3.72	-3.34	-3.34	-11.67	-10.99	-10.98
45	42	-3.66	-3.32	-3.34	-11.59	-10.90	-10.96
45	45	-3.58	-3.29	-3.33	-11.56	-10.86	-10.95
45	48	-3.47	-3.23	-3.32	-11.71	-10.96	-11.04
45	51	-3.32	-3.15	-3.29	-12.12	-11.25	-11.30
45	54	-3.17	-3.08	-3.27	-12.73	-11.67	-11.68
45	57	-3.06	-3.02	-3.24	-13.49	-12.19	-12.15
45	60	-3.01	-3.00	-3.23	-14.32	-12.76	-12.65
45	63	-3.02	-3.02	-3.28	-15.83	-13.60	-13.28
45	66	-3.04	-3.10	-3.39	-18.18	-14.81	-14.14
45	69	-3.07	-3.21	-3.56	-20.71	-16.22	-15.18
45	72	-3.12	-3.35	-3.78	-22.73	-17.65	-16.35
45	75	-3.18	-3.53	-4.03	-23.56	-18.92	-17.61
45	78	-3.38	-3.83	-4.42	-23.37	-20.19	-19.39
45	81	-3.81	-4.36	-5.03	-22.88	-21.57	-21.77
45	84	-4.42	-5.06	-5.81	-22.18	-22.85	-24.17
45	87	-5.12	-5.87	-6.71	-21.35	-23.78	-26.04
45	90	-5.87	-6.74	-7.69	-20.49	-24.15	-26.78
45	93	-6.75	-7.72	-8.81	-19.30	-23.28	-25.90
45	96	-7.84	-8.89	-10.16	-17.67	-21.18	-23.73
45	99	-9.12	-10.28	-11.74	-15.95	-18.55	-20.99
45	102	-10.55	-11.91	-13.53	-14.49	-16.13	-18.38
45	105	-12.09	-13.79	-15.54	-13.64	-14.64	-16.62
45	108	-14.26	-16.94	-18.56	-13.24	-13.88	-15.53
45	111	-17.11	-21.51	-22.71	-12.89	-13.20	-14.52

45	114	-19.99	-26.30	-26.96	-12.61	-12.66	-13.68
45	117	-22.21	-30.07	-30.27	-12.43	-12.30	-13.10
45	120	-23.10	-31.60	-31.60	-12.37	-12.16	-12.89
45	123	-22.41	-30.09	-30.05	-12.74	-12.34	-12.98
45	126	-20.67	-26.37	-26.22	-13.69	-12.84	-13.23
45	129	-18.34	-21.61	-21.33	-14.92	-13.58	-13.63
45	132	-15.92	-17.00	-16.62	-16.19	-14.48	-14.16
45	135	-13.87	-13.72	-13.31	-17.20	-15.48	-14.80
45	138	-12.15	-11.64	-11.25	-18.07	-17.31	-17.06
45	141	-10.41	-9.80	-9.45	-18.98	-20.18	-21.47
45	144	-8.76	-8.21	-7.89	-19.80	-23.26	-26.49
45	147	-7.27	-6.85	-6.57	-20.39	-25.71	-30.62
45	150	-6.02	-5.70	-5.49	-20.62	-26.72	-32.34
45	153	-4.94	-4.67	-4.54	-19.53	-25.19	-30.52
45	156	-3.92	-3.72	-3.66	-16.89	-21.47	-26.09
45	159	-3.02	-2.89	-2.90	-13.60	-16.87	-20.58
45	162	-2.31	-2.25	-2.33	-10.58	-12.68	-15.55
45	165	-1.83	-1.84	-2.00	-8.75	-10.20	-12.51
45	168	-1.51	-1.60	-1.82	-7.86	-9.07	-11.06
45	171	-1.22	-1.38	-1.67	-7.06	-8.08	-9.77
45	174	-0.99	-1.21	-1.55	-6.43	-7.29	-8.75
45	177	-0.84	-1.10	-1.48	-6.01	-6.77	-8.07
45	180	-0.79	-1.06	-1.45	-5.86	-6.59	-7.83
45	183	-0.88	-1.16	-1.56	-5.95	-6.65	-7.86
45	186	-1.12	-1.44	-1.84	-6.21	-6.84	-7.94
45	189	-1.46	-1.82	-2.26	-6.59	-7.12	-8.07
45	192	-1.85	-2.28	-2.73	-7.08	-7.49	-8.25
45	195	-2.24	-2.74	-3.23	-7.63	-7.91	-8.46
45	198	-2.67	-3.25	-3.79	-8.77	-8.90	-9.13
45	201	-3.19	-3.88	-4.49	-10.67	-10.64	-10.44
45	204	-3.76	-4.59	-5.29	-12.75	-12.58	-12.02
45	207	-4.38	-5.35	-6.14	-14.42	-14.19	-13.48
45	210	-5.03	-6.12	-7.00	-15.11	-14.93	-14.46
45	213	-5.78	-7.03	-8.00	-15.03	-15.05	-15.06
45	216	-6.66	-8.10	-9.16	-14.80	-15.14	-15.61
45	219	-7.56	-9.16	-10.32	-14.48	-15.21	-16.06
45	222	-8.36	-10.06	-11.32	-14.09	-15.25	-16.37
45	225	-8.96	-10.63	-12.02	-13.67	-15.26	-16.49
45	228	-9.42	-10.98	-12.49	-13.06	-14.80	-15.96
45	231	-9.85	-11.28	-12.92	-12.18	-13.67	-14.65
45	234	-10.22	-11.52	-13.27	-11.23	-12.25	-13.00
45	237	-10.47	-11.69	-13.51	-10.40	-10.91	-11.44
45	240	-10.56	-11.75	-13.59	-9.87	-10.01	-10.40
45	243	-10.46	-11.62	-13.45	-9.57	-9.48	-9.78
45	246	-10.19	-11.29	-13.07	-9.30	-8.98	-9.21
45	249	-9.82	-10.84	-12.56	-9.08	-8.58	-8.74
45	252	-9.41	-10.35	-11.99	-8.94	-8.30	-8.40
45	255	-9.01	-9.89	-11.46	-8.89	-8.19	-8.25
45	258	-8.59	-9.44	-10.95	-8.90	-8.20	-8.20
45	261	-8.10	-8.94	-10.39	-8.91	-8.20	-8.16
45	264	-7.59	-8.43	-9.81	-8.92	-8.20	-8.13
45	267	-7.11	-7.94	-9.25	-8.94	-8.21	-8.12
45	270	-6.71	-7.50	-8.73	-8.94	-8.22	-8.11
45	273	-6.37	-7.12	-8.26	-8.94	-8.27	-8.14
45	276	-6.07	-6.77	-7.81	-8.92	-8.39	-8.20
45	279	-5.79	-6.44	-7.38	-8.90	-8.53	-8.28
45	282	-5.54	-6.12	-6.98	-8.87	-8.65	-8.34
45	285	-5.32	-5.83	-6.60	-8.83	-8.69	-8.37

45	288	-5.12	-5.55	-6.25	-8.73	-8.66	-8.34
45	291	-4.93	-5.28	-5.92	-8.52	-8.56	-8.29
45	294	-4.77	-5.02	-5.61	-8.27	-8.42	-8.21
45	297	-4.61	-4.79	-5.31	-8.01	-8.28	-8.13
45	300	-4.47	-4.57	-5.04	-7.80	-8.15	-8.05
45	303	-4.33	-4.36	-4.75	-7.62	-8.01	-7.97
45	306	-4.18	-4.13	-4.45	-7.43	-7.85	-7.87
45	309	-4.04	-3.94	-4.18	-7.26	-7.70	-7.77
45	312	-3.95	-3.79	-3.98	-7.13	-7.59	-7.70
45	315	-3.91	-3.74	-3.90	-7.09	-7.54	-7.67
45	318	-3.95	-3.77	-3.91	-7.12	-7.58	-7.70
45	321	-4.07	-3.86	-3.96	-7.22	-7.68	-7.80
45	324	-4.26	-3.99	-4.02	-7.37	-7.82	-7.93
45	327	-4.49	-4.16	-4.11	-7.55	-7.99	-8.07
45	330	-4.75	-4.36	-4.21	-7.74	-8.17	-8.21
45	333	-5.20	-4.74	-4.50	-8.00	-8.38	-8.36
45	336	-5.93	-5.40	-5.06	-8.37	-8.66	-8.54
45	339	-6.83	-6.21	-5.78	-8.79	-8.98	-8.73
45	342	-7.78	-7.07	-6.55	-9.25	-9.30	-8.91
45	345	-8.70	-7.87	-7.25	-9.70	-9.61	-9.08
45	348	-9.56	-8.60	-7.89	-10.13	-9.89	-9.23
45	351	-10.46	-9.33	-8.53	-10.59	-10.17	-9.37
45	354	-11.38	-10.08	-9.19	-11.07	-10.45	-9.51
45	357	-12.34	-10.83	-9.86	-11.56	-10.72	-9.64
45	360	-13.32	-11.60	-10.54	-12.07	-11.00	-9.77
48	0	-14.83	-12.65	-11.10	-11.28	-10.31	-9.30
48	3	-12.63	-10.85	-9.64	-11.89	-10.74	-9.55
48	6	-10.62	-9.20	-8.31	-12.39	-11.11	-9.77
48	9	-8.87	-7.76	-7.13	-12.77	-11.40	-9.98
48	12	-7.45	-6.58	-6.15	-13.01	-11.60	-10.17
48	15	-6.45	-5.72	-5.41	-13.10	-11.67	-10.33
48	18	-5.72	-5.06	-4.82	-13.00	-11.64	-10.48
48	21	-5.07	-4.46	-4.27	-12.77	-11.57	-10.61
48	24	-4.55	-3.97	-3.81	-12.49	-11.47	-10.73
48	27	-4.17	-3.63	-3.49	-12.23	-11.38	-10.83
48	30	-3.95	-3.46	-3.36	-12.07	-11.31	-10.91
48	33	-3.85	-3.40	-3.35	-12.01	-11.25	-10.97
48	36	-3.77	-3.36	-3.34	-11.95	-11.19	-11.00
48	39	-3.72	-3.33	-3.33	-11.90	-11.14	-11.04
48	42	-3.66	-3.31	-3.32	-11.87	-11.10	-11.08
48	45	-3.60	-3.28	-3.32	-11.86	-11.09	-11.14
48	48	-3.51	-3.25	-3.33	-12.03	-11.21	-11.30
48	51	-3.41	-3.22	-3.34	-12.48	-11.52	-11.60
48	54	-3.32	-3.19	-3.36	-13.14	-11.98	-12.00
48	57	-3.25	-3.17	-3.38	-13.94	-12.54	-12.47
48	60	-3.22	-3.16	-3.41	-14.82	-13.14	-12.97
48	63	-3.23	-3.18	-3.47	-16.29	-13.95	-13.57
48	66	-3.25	-3.25	-3.59	-18.53	-15.08	-14.33
48	69	-3.29	-3.37	-3.76	-20.91	-16.39	-15.22
48	72	-3.34	-3.51	-3.98	-22.80	-17.72	-16.24
48	75	-3.41	-3.67	-4.22	-23.57	-18.93	-17.37
48	78	-3.62	-3.97	-4.59	-23.43	-20.19	-19.03
48	81	-4.05	-4.46	-5.14	-23.06	-21.59	-21.29
48	84	-4.66	-5.12	-5.84	-22.51	-22.89	-23.61
48	87	-5.36	-5.88	-6.66	-21.86	-23.84	-25.41
48	90	-6.11	-6.70	-7.55	-21.15	-24.22	-26.13
48	93	-6.97	-7.63	-8.59	-20.05	-23.59	-25.42
48	96	-8.03	-8.76	-9.87	-18.45	-22.04	-23.68

48	99	-9.26	-10.11	-11.38	-16.72	-20.08	-21.54
48	102	-10.62	-11.68	-13.08	-15.26	-18.21	-19.58
48	105	-12.10	-13.48	-14.98	-14.47	-16.93	-18.42
48	108	-14.14	-16.43	-17.80	-14.16	-16.12	-17.88
48	111	-16.82	-20.68	-21.66	-13.90	-15.36	-17.42
48	114	-19.52	-25.11	-25.60	-13.69	-14.73	-17.05
48	117	-21.59	-28.59	-28.67	-13.57	-14.29	-16.80
48	120	-22.42	-30.00	-29.91	-13.52	-14.13	-16.71
48	123	-21.73	-28.58	-28.44	-13.85	-14.27	-16.69
48	126	-19.98	-25.04	-24.83	-14.67	-14.64	-16.68
48	129	-17.66	-20.53	-20.22	-15.73	-15.21	-16.67
48	132	-15.26	-16.16	-15.78	-16.77	-15.90	-16.67
48	135	-13.26	-13.07	-12.68	-17.55	-16.66	-16.67
48	138	-11.61	-11.11	-10.75	-18.12	-18.08	-18.14
48	141	-9.99	-9.40	-9.07	-18.69	-20.30	-21.66
48	144	-8.45	-7.92	-7.62	-19.19	-22.70	-25.87
48	147	-7.07	-6.65	-6.40	-19.53	-24.61	-29.39
48	150	-5.90	-5.57	-5.39	-19.66	-25.40	-30.86
48	153	-4.87	-4.60	-4.50	-18.60	-23.91	-29.10
48	156	-3.90	-3.70	-3.67	-16.02	-20.32	-24.81
48	159	-3.04	-2.91	-2.97	-12.84	-15.90	-19.51
48	162	-2.36	-2.29	-2.42	-9.95	-11.91	-14.70
48	165	-1.89	-1.90	-2.10	-8.29	-9.64	-11.89
48	168	-1.57	-1.65	-1.90	-7.57	-8.71	-10.64
48	171	-1.28	-1.43	-1.74	-6.94	-7.91	-9.55
48	174	-1.05	-1.26	-1.61	-6.45	-7.28	-8.70
48	177	-0.90	-1.14	-1.52	-6.13	-6.87	-8.14
48	180	-0.84	-1.10	-1.49	-6.02	-6.72	-7.93
48	183	-0.93	-1.20	-1.60	-6.16	-6.83	-7.99
48	186	-1.16	-1.47	-1.88	-6.53	-7.12	-8.15
48	189	-1.50	-1.85	-2.28	-7.08	-7.55	-8.40
48	192	-1.89	-2.30	-2.76	-7.74	-8.08	-8.71
48	195	-2.30	-2.77	-3.26	-8.44	-8.67	-9.08
48	198	-2.76	-3.32	-3.85	-9.58	-9.71	-9.94
48	201	-3.33	-4.02	-4.62	-11.25	-11.34	-11.45
48	204	-3.99	-4.82	-5.50	-13.01	-13.08	-13.15
48	207	-4.70	-5.67	-6.44	-14.40	-14.47	-14.60
48	210	-5.42	-6.52	-7.37	-14.97	-15.04	-15.34
48	213	-6.25	-7.48	-8.40	-14.84	-15.03	-15.57
48	216	-7.21	-8.58	-9.56	-14.51	-15.00	-15.76
48	219	-8.19	-9.67	-10.72	-14.04	-14.95	-15.90
48	222	-9.07	-10.61	-11.74	-13.51	-14.88	-16.00
48	225	-9.74	-11.25	-12.47	-12.98	-14.79	-16.03
48	228	-10.28	-11.69	-13.02	-12.33	-14.25	-15.47
48	231	-10.80	-12.09	-13.54	-11.50	-13.07	-14.10
48	234	-11.23	-12.42	-13.96	-10.64	-11.63	-12.41
48	237	-11.54	-12.64	-14.25	-9.94	-10.33	-10.85
48	240	-11.65	-12.73	-14.36	-9.57	-9.55	-9.90
48	243	-11.56	-12.65	-14.30	-9.42	-9.18	-9.42
48	246	-11.33	-12.44	-14.15	-9.29	-8.86	-9.00
48	249	-11.00	-12.14	-13.91	-9.20	-8.60	-8.67
48	252	-10.61	-11.79	-13.63	-9.13	-8.43	-8.45
48	255	-10.22	-11.42	-13.32	-9.11	-8.37	-8.37
48	258	-9.75	-10.95	-12.87	-9.16	-8.44	-8.43
48	261	-9.15	-10.34	-12.21	-9.26	-8.60	-8.60
48	264	-8.51	-9.67	-11.45	-9.38	-8.80	-8.80
48	267	-7.89	-9.00	-10.67	-9.49	-8.96	-8.96
48	270	-7.37	-8.42	-9.97	-9.53	-9.03	-9.03

48	273	-6.95	-7.92	-9.34	-9.50	-9.03	-9.01
48	276	-6.56	-7.45	-8.71	-9.40	-9.01	-8.96
48	279	-6.20	-7.00	-8.09	-9.26	-8.98	-8.89
48	282	-5.88	-6.59	-7.53	-9.10	-8.93	-8.80
48	285	-5.60	-6.22	-7.04	-8.92	-8.89	-8.70
48	288	-5.36	-5.88	-6.61	-8.68	-8.76	-8.57
48	291	-5.14	-5.56	-6.22	-8.35	-8.53	-8.39
48	294	-4.94	-5.26	-5.86	-7.98	-8.24	-8.19
48	297	-4.77	-4.99	-5.53	-7.62	-7.94	-7.99
48	300	-4.60	-4.74	-5.21	-7.31	-7.69	-7.81
48	303	-4.44	-4.49	-4.89	-7.01	-7.45	-7.63
48	306	-4.27	-4.24	-4.54	-6.71	-7.19	-7.44
48	309	-4.12	-4.01	-4.23	-6.43	-6.96	-7.27
48	312	-4.01	-3.84	-4.00	-6.24	-6.79	-7.15
48	315	-3.97	-3.78	-3.91	-6.16	-6.72	-7.10
48	318	-4.00	-3.80	-3.91	-6.18	-6.75	-7.12
48	321	-4.09	-3.84	-3.91	-6.23	-6.81	-7.20
48	324	-4.23	-3.92	-3.91	-6.31	-6.91	-7.30
48	327	-4.41	-4.03	-3.91	-6.42	-7.03	-7.42
48	330	-4.62	-4.15	-3.91	-6.54	-7.17	-7.55
48	333	-5.02	-4.46	-4.11	-6.75	-7.36	-7.70
48	336	-5.71	-5.06	-4.61	-7.10	-7.64	-7.90
48	339	-6.59	-5.84	-5.32	-7.54	-7.98	-8.12
48	342	-7.57	-6.71	-6.10	-8.02	-8.33	-8.34
48	345	-8.57	-7.57	-6.85	-8.50	-8.67	-8.54
48	348	-9.60	-8.43	-7.58	-8.98	-8.99	-8.71
48	351	-10.76	-9.38	-8.38	-9.50	-9.31	-8.87
48	354	-12.02	-10.40	-9.23	-10.06	-9.64	-9.02
48	357	-13.39	-11.50	-10.14	-10.66	-9.97	-9.17
48	360	-14.83	-12.65	-11.10	-11.28	-10.31	-9.30
51	0	-18.45	-15.17	-12.43	-10.24	-9.61	-8.84
51	3	-15.26	-12.74	-10.68	-10.95	-10.02	-9.01
51	6	-12.35	-10.52	-9.08	-11.57	-10.41	-9.19
51	9	-9.85	-8.59	-7.67	-12.07	-10.72	-9.36
51	12	-7.90	-7.06	-6.52	-12.40	-10.95	-9.53
51	15	-6.63	-6.00	-5.66	-12.52	-11.04	-9.70
51	18	-5.82	-5.24	-4.99	-12.47	-11.06	-9.87
51	21	-5.12	-4.58	-4.38	-12.36	-11.07	-10.04
51	24	-4.57	-4.05	-3.88	-12.23	-11.08	-10.21
51	27	-4.17	-3.67	-3.53	-12.12	-11.08	-10.38
51	30	-3.95	-3.48	-3.38	-12.07	-11.10	-10.56
51	33	-3.84	-3.41	-3.35	-12.09	-11.13	-10.72
51	36	-3.75	-3.35	-3.32	-12.16	-11.20	-10.87
51	39	-3.69	-3.30	-3.30	-12.26	-11.29	-11.03
51	42	-3.64	-3.27	-3.29	-12.38	-11.40	-11.21
51	45	-3.61	-3.26	-3.29	-12.54	-11.54	-11.44
51	48	-3.58	-3.27	-3.31	-12.83	-11.79	-11.75
51	51	-3.56	-3.29	-3.37	-13.37	-12.20	-12.16
51	54	-3.55	-3.32	-3.45	-14.08	-12.74	-12.63
51	57	-3.54	-3.35	-3.55	-14.91	-13.36	-13.15
51	60	-3.54	-3.39	-3.65	-15.82	-14.01	-13.70
51	63	-3.56	-3.46	-3.77	-17.22	-14.78	-14.25
51	66	-3.63	-3.56	-3.92	-19.22	-15.73	-14.85
51	69	-3.73	-3.70	-4.11	-21.29	-16.80	-15.51
51	72	-3.86	-3.87	-4.32	-22.92	-17.89	-16.26
51	75	-4.01	-4.07	-4.58	-23.58	-18.96	-17.14
51	78	-4.24	-4.36	-4.91	-23.48	-20.17	-18.50
51	81	-4.61	-4.77	-5.34	-23.20	-21.57	-20.41

51	84	-5.09	-5.29	-5.88	-22.79	-22.89	-22.37
51	87	-5.66	-5.91	-6.50	-22.28	-23.88	-23.90
51	90	-6.30	-6.59	-7.21	-21.72	-24.27	-24.51
51	93	-7.10	-7.42	-8.09	-20.72	-24.02	-24.13
51	96	-8.15	-8.47	-9.20	-19.15	-23.38	-23.21
51	99	-9.37	-9.71	-10.53	-17.47	-22.52	-22.12
51	102	-10.71	-11.15	-12.02	-16.11	-21.61	-21.20
51	105	-12.10	-12.75	-13.64	-15.52	-20.83	-20.82
51	108	-13.88	-15.21	-15.98	-15.47	-20.07	-21.16
51	111	-16.13	-18.65	-19.11	-15.43	-19.22	-21.96
51	114	-18.34	-22.19	-22.29	-15.40	-18.43	-22.92
51	117	-20.03	-24.96	-24.76	-15.38	-17.84	-23.72
51	120	-20.70	-26.07	-25.75	-15.37	-17.61	-24.05
51	123	-20.00	-24.83	-24.50	-15.63	-17.64	-23.57
51	126	-18.24	-21.76	-21.41	-16.25	-17.71	-22.43
51	129	-15.93	-17.84	-17.48	-16.98	-17.82	-21.06
51	132	-13.59	-14.08	-13.71	-17.60	-17.96	-19.91
51	135	-11.72	-11.44	-11.10	-17.86	-18.13	-19.43
51	138	-10.29	-9.81	-9.51	-17.84	-18.67	-20.24
51	141	-8.93	-8.40	-8.13	-17.77	-19.69	-22.18
51	144	-7.68	-7.18	-6.95	-17.67	-20.84	-24.50
51	147	-6.55	-6.13	-5.94	-17.53	-21.79	-26.44
51	150	-5.57	-5.23	-5.11	-17.36	-22.18	-27.26
51	153	-4.68	-4.40	-4.37	-16.33	-20.94	-25.77
51	156	-3.83	-3.62	-3.69	-14.13	-17.94	-22.16
51	159	-3.08	-2.95	-3.10	-11.49	-14.26	-17.70
51	162	-2.47	-2.40	-2.64	-9.16	-10.97	-13.67
51	165	-2.04	-2.04	-2.33	-7.88	-9.16	-11.35
51	168	-1.72	-1.79	-2.10	-7.41	-8.48	-10.35
51	171	-1.44	-1.56	-1.91	-7.01	-7.91	-9.49
51	174	-1.20	-1.38	-1.75	-6.71	-7.47	-8.82
51	177	-1.05	-1.26	-1.64	-6.51	-7.19	-8.38
51	180	-0.99	-1.22	-1.60	-6.44	-7.08	-8.22
51	183	-1.07	-1.31	-1.70	-6.72	-7.31	-8.36
51	186	-1.29	-1.56	-1.96	-7.44	-7.90	-8.73
51	189	-1.62	-1.93	-2.35	-8.41	-8.72	-9.26
51	192	-2.02	-2.38	-2.82	-9.46	-9.63	-9.90
51	195	-2.44	-2.86	-3.33	-10.39	-10.48	-10.57
51	198	-2.98	-3.50	-4.00	-11.35	-11.47	-11.61
51	201	-3.70	-4.37	-4.94	-12.46	-12.68	-13.11
51	204	-4.56	-5.38	-6.03	-13.51	-13.87	-14.67
51	207	-5.48	-6.45	-7.17	-14.29	-14.77	-15.90
51	210	-6.39	-7.48	-8.25	-14.60	-15.13	-16.40
51	213	-7.42	-8.57	-9.37	-14.40	-15.04	-16.32
51	216	-8.59	-9.80	-10.61	-13.90	-14.82	-16.09
51	219	-9.77	-11.01	-11.81	-13.22	-14.48	-15.76
51	222	-10.83	-12.03	-12.84	-12.51	-14.07	-15.34
51	225	-11.61	-12.74	-13.57	-11.88	-13.63	-14.87
51	228	-12.21	-13.21	-14.04	-11.28	-12.89	-14.03
51	231	-12.78	-13.64	-14.43	-10.60	-11.77	-12.68
51	234	-13.27	-13.99	-14.76	-9.96	-10.56	-11.20
51	237	-13.60	-14.23	-15.04	-9.50	-9.57	-9.95
51	240	-13.72	-14.32	-15.30	-9.31	-9.10	-9.30
51	243	-13.63	-14.30	-15.58	-9.33	-9.00	-9.09
51	246	-13.40	-14.25	-15.85	-9.39	-8.92	-8.91
51	249	-13.07	-14.18	-16.10	-9.46	-8.85	-8.78
51	252	-12.68	-14.08	-16.27	-9.56	-8.82	-8.69
51	255	-12.26	-13.96	-16.34	-9.65	-8.80	-8.66



51	258	-11.71	-13.59	-16.05	-9.81	-8.98	-8.86
51	261	-10.97	-12.85	-15.30	-10.04	-9.40	-9.34
51	264	-10.15	-11.92	-14.30	-10.28	-9.90	-9.91
51	267	-9.35	-10.97	-13.22	-10.47	-10.31	-10.38
51	270	-8.68	-10.16	-12.27	-10.55	-10.49	-10.58
51	273	-8.12	-9.49	-11.40	-10.45	-10.40	-10.48
51	276	-7.59	-8.84	-10.50	-10.20	-10.15	-10.21
51	279	-7.11	-8.23	-9.60	-9.85	-9.82	-9.85
51	282	-6.67	-7.66	-8.78	-9.45	-9.45	-9.47
51	285	-6.29	-7.15	-8.08	-9.07	-9.10	-9.11
51	288	-5.96	-6.68	-7.50	-8.66	-8.73	-8.78
51	291	-5.67	-6.25	-6.97	-8.19	-8.31	-8.43
51	294	-5.40	-5.86	-6.50	-7.69	-7.88	-8.07
51	297	-5.16	-5.50	-6.06	-7.22	-7.48	-7.74
51	300	-4.94	-5.17	-5.65	-6.81	-7.13	-7.47
51	303	-4.72	-4.83	-5.23	-6.42	-6.81	-7.21
51	306	-4.49	-4.49	-4.81	-6.02	-6.49	-6.95
51	309	-4.29	-4.18	-4.43	-5.66	-6.20	-6.73
51	312	-4.15	-3.96	-4.13	-5.40	-5.99	-6.57
51	315	-4.10	-3.88	-3.95	-5.30	-5.91	-6.51
51	318	-4.12	-3.88	-3.85	-5.31	-5.93	-6.53
51	321	-4.18	-3.90	-3.77	-5.33	-5.98	-6.59
51	324	-4.27	-3.92	-3.71	-5.37	-6.05	-6.68
51	327	-4.39	-3.95	-3.67	-5.43	-6.14	-6.79
51	330	-4.54	-3.99	-3.65	-5.49	-6.25	-6.90
51	333	-4.87	-4.22	-3.83	-5.66	-6.43	-7.07
51	336	-5.50	-4.75	-4.30	-5.98	-6.72	-7.31
51	339	-6.36	-5.51	-4.97	-6.40	-7.08	-7.57
51	342	-7.38	-6.41	-5.74	-6.88	-7.46	-7.84
51	345	-8.49	-7.35	-6.54	-7.35	-7.82	-8.06
51	348	-9.83	-8.44	-7.41	-7.83	-8.16	-8.24
51	351	-11.56	-9.81	-8.46	-8.36	-8.51	-8.41
51	354	-13.62	-11.42	-9.66	-8.95	-8.87	-8.57
51	357	-15.93	-13.22	-10.99	-9.58	-9.23	-8.71
51	360	-18.45	-15.17	-12.43	-10.24	-9.61	-8.84
54	0	-22.77	-18.16	-14.01	-9.16	-8.96	-8.44
54	3	-18.42	-15.01	-11.95	-9.90	-9.32	-8.52
54	6	-14.44	-12.13	-10.05	-10.59	-9.64	-8.63
54	9	-11.06	-9.65	-8.39	-11.16	-9.93	-8.75
54	12	-8.47	-7.70	-7.03	-11.57	-10.16	-8.88
54	15	-6.90	-6.40	-6.04	-11.79	-10.33	-9.03
54	18	-5.98	-5.53	-5.26	-11.87	-10.45	-9.19
54	21	-5.21	-4.77	-4.56	-11.92	-10.53	-9.37
54	24	-4.61	-4.17	-3.99	-11.95	-10.60	-9.58
54	27	-4.19	-3.74	-3.58	-12.00	-10.68	-9.81
54	30	-3.96	-3.52	-3.40	-12.07	-10.79	-10.05
54	33	-3.84	-3.43	-3.35	-12.20	-10.95	-10.33
54	36	-3.75	-3.35	-3.31	-12.40	-11.16	-10.64
54	39	-3.67	-3.29	-3.28	-12.66	-11.42	-10.98
54	42	-3.63	-3.26	-3.26	-12.97	-11.72	-11.35
54	45	-3.61	-3.24	-3.25	-13.33	-12.06	-11.76
54	48	-3.63	-3.27	-3.30	-13.80	-12.49	-12.23
54	51	-3.69	-3.35	-3.42	-14.43	-13.04	-12.80
54	54	-3.77	-3.46	-3.59	-15.19	-13.67	-13.40
54	57	-3.86	-3.58	-3.78	-16.05	-14.35	-14.00
54	60	-3.96	-3.71	-3.97	-16.97	-15.04	-14.55
54	63	-4.08	-3.85	-4.15	-18.26	-15.74	-15.02
54	66	-4.23	-4.01	-4.35	-19.99	-16.49	-15.44

54	69	-4.42	-4.20	-4.57	-21.72	-17.28	-15.87
54	72	-4.62	-4.42	-4.81	-23.07	-18.12	-16.35
54	75	-4.84	-4.66	-5.07	-23.61	-19.00	-16.94
54	78	-5.08	-4.92	-5.34	-23.54	-20.09	-17.90
54	81	-5.34	-5.21	-5.63	-23.35	-21.39	-19.23
54	84	-5.65	-5.56	-5.95	-23.07	-22.68	-20.63
54	87	-6.03	-5.97	-6.33	-22.71	-23.73	-21.80
54	90	-6.49	-6.47	-6.80	-22.30	-24.31	-22.45
54	93	-7.21	-7.16	-7.48	-21.45	-24.58	-22.66
54	96	-8.26	-8.11	-8.40	-20.03	-24.80	-22.79
54	99	-9.51	-9.25	-9.52	-18.47	-24.98	-22.89
54	102	-10.84	-10.53	-10.76	-17.22	-25.09	-23.02
54	105	-12.10	-11.88	-12.05	-16.70	-25.13	-23.25
54	108	-13.51	-13.71	-13.76	-16.75	-24.83	-24.40
54	111	-15.17	-16.09	-15.95	-16.87	-24.09	-26.69
54	114	-16.75	-18.49	-18.15	-17.04	-23.13	-29.33
54	117	-17.93	-20.33	-19.83	-17.21	-22.19	-31.51
54	120	-18.40	-21.07	-20.50	-17.37	-21.49	-32.42
54	123	-17.69	-20.06	-19.51	-17.54	-21.02	-31.37
54	126	-15.92	-17.57	-17.08	-17.73	-20.61	-28.87
54	129	-13.64	-14.41	-13.99	-17.92	-20.24	-25.88
54	132	-11.39	-11.39	-11.06	-18.05	-19.89	-23.38
54	135	-9.71	-9.33	-9.06	-18.11	-19.57	-22.33
54	138	-8.57	-8.11	-7.89	-17.89	-19.30	-22.37
54	141	-7.56	-7.08	-6.89	-17.31	-19.09	-22.48
54	144	-6.65	-6.19	-6.05	-16.48	-18.88	-22.60
54	147	-5.83	-5.43	-5.32	-15.51	-18.60	-22.70
54	150	-5.09	-4.74	-4.71	-14.54	-18.20	-22.74
54	153	-4.39	-4.10	-4.17	-13.24	-16.98	-21.64
54	156	-3.71	-3.50	-3.67	-11.49	-14.74	-18.95
54	159	-3.10	-2.97	-3.24	-9.70	-12.17	-15.63
54	162	-2.59	-2.52	-2.88	-8.25	-9.95	-12.64
54	165	-2.21	-2.21	-2.60	-7.56	-8.77	-10.92
54	168	-1.92	-1.96	-2.36	-7.38	-8.39	-10.19
54	171	-1.64	-1.73	-2.13	-7.24	-8.06	-9.56
54	174	-1.41	-1.55	-1.94	-7.13	-7.81	-9.07
54	177	-1.25	-1.42	-1.81	-7.07	-7.66	-8.75
54	180	-1.19	-1.38	-1.76	-7.04	-7.60	-8.64
54	183	-1.27	-1.46	-1.85	-7.56	-8.02	-8.88
54	186	-1.49	-1.71	-2.10	-8.83	-9.05	-9.53
54	189	-1.82	-2.07	-2.47	-10.40	-10.38	-10.43
54	192	-2.21	-2.51	-2.93	-11.84	-11.69	-11.42
54	195	-2.65	-3.00	-3.44	-12.71	-12.65	-12.35
54	198	-3.28	-3.73	-4.20	-13.14	-13.34	-13.43
54	201	-4.19	-4.79	-5.33	-13.51	-14.03	-14.75
54	204	-5.28	-6.05	-6.67	-13.80	-14.62	-16.04
54	207	-6.46	-7.38	-8.04	-14.00	-15.04	-17.03
54	210	-7.60	-8.61	-9.30	-14.07	-15.19	-17.42
54	213	-8.85	-9.88	-10.54	-13.78	-14.98	-17.13
54	216	-10.28	-11.28	-11.87	-13.07	-14.43	-16.40
54	219	-11.70	-12.63	-13.14	-12.16	-13.68	-15.41
54	222	-12.95	-13.76	-14.20	-11.27	-12.87	-14.34
54	225	-13.84	-14.50	-14.87	-10.65	-12.14	-13.37
54	228	-14.49	-14.95	-15.23	-10.21	-11.37	-12.33
54	231	-15.10	-15.31	-15.47	-9.80	-10.46	-11.12
54	234	-15.60	-15.60	-15.67	-9.45	-9.60	-9.95
54	237	-15.94	-15.84	-15.90	-9.20	-8.96	-9.08
54	240	-16.07	-16.04	-16.22	-9.11	-8.71	-8.74

54	243	-15.98	-16.24	-16.82	-9.19	-8.74	-8.75
54	246	-15.73	-16.43	-17.69	-9.41	-8.84	-8.80
54	249	-15.38	-16.59	-18.61	-9.70	-8.98	-8.87
54	252	-14.95	-16.71	-19.33	-10.03	-9.16	-8.96
54	255	-14.49	-16.75	-19.62	-10.32	-9.37	-9.07
54	258	-13.86	-16.40	-19.29	-10.64	-9.79	-9.48
54	261	-12.98	-15.53	-18.44	-11.02	-10.50	-10.29
54	264	-11.98	-14.37	-17.27	-11.38	-11.28	-11.21
54	267	-11.01	-13.15	-16.01	-11.65	-11.90	-11.97
54	270	-10.18	-12.13	-14.86	-11.76	-12.16	-12.28
54	273	-9.48	-11.29	-13.75	-11.59	-11.95	-12.08
54	276	-8.81	-10.46	-12.55	-11.14	-11.42	-11.56
54	279	-8.20	-9.66	-11.35	-10.53	-10.71	-10.87
54	282	-7.64	-8.91	-10.25	-9.86	-9.96	-10.14
54	285	-7.15	-8.25	-9.32	-9.26	-9.31	-9.53
54	288	-6.72	-7.66	-8.57	-8.69	-8.73	-8.99
54	291	-6.33	-7.11	-7.89	-8.07	-8.13	-8.45
54	294	-5.98	-6.60	-7.28	-7.45	-7.55	-7.93
54	297	-5.66	-6.13	-6.72	-6.87	-7.03	-7.47
54	300	-5.37	-5.71	-6.19	-6.37	-6.60	-7.10
54	303	-5.08	-5.28	-5.66	-5.91	-6.22	-6.78
54	306	-4.78	-4.84	-5.14	-5.43	-5.84	-6.47
54	309	-4.51	-4.45	-4.65	-5.00	-5.51	-6.20
54	312	-4.32	-4.16	-4.26	-4.70	-5.28	-6.02
54	315	-4.25	-4.01	-4.00	-4.59	-5.19	-5.95
54	318	-4.26	-3.96	-3.83	-4.59	-5.21	-5.96
54	321	-4.29	-3.92	-3.67	-4.59	-5.24	-6.02
54	324	-4.34	-3.88	-3.55	-4.60	-5.30	-6.10
54	327	-4.40	-3.86	-3.46	-4.61	-5.37	-6.19
54	330	-4.48	-3.86	-3.43	-4.62	-5.45	-6.30
54	333	-4.74	-4.04	-3.60	-4.74	-5.62	-6.48
54	336	-5.33	-4.54	-4.03	-5.03	-5.92	-6.75
54	339	-6.19	-5.27	-4.68	-5.42	-6.29	-7.06
54	342	-7.24	-6.18	-5.45	-5.87	-6.69	-7.37
54	345	-8.43	-7.17	-6.27	-6.31	-7.07	-7.62
54	348	-10.09	-8.49	-7.29	-6.77	-7.42	-7.82
54	351	-12.49	-10.35	-8.62	-7.29	-7.79	-8.00
54	354	-15.50	-12.65	-10.22	-7.87	-8.17	-8.17
54	357	-18.97	-15.29	-12.04	-8.49	-8.56	-8.31
54	360	-22.77	-18.16	-14.01	-9.16	-8.96	-8.44
57	0	-26.38	-20.68	-15.34	-8.24	-8.47	-8.16
57	3	-21.09	-16.97	-13.07	-8.98	-8.76	-8.17
57	6	-16.26	-13.59	-10.98	-9.66	-9.03	-8.21
57	9	-12.16	-10.67	-9.14	-10.25	-9.29	-8.28
57	12	-9.05	-8.38	-7.62	-10.74	-9.51	-8.35
57	15	-7.21	-6.88	-6.50	-11.10	-9.71	-8.44
57	18	-6.18	-5.87	-5.61	-11.34	-9.86	-8.56
57	21	-5.33	-5.01	-4.80	-11.52	-9.99	-8.73
57	24	-4.67	-4.32	-4.13	-11.68	-10.11	-8.95
57	27	-4.21	-3.83	-3.65	-11.84	-10.24	-9.20
57	30	-3.97	-3.58	-3.43	-12.06	-10.42	-9.48
57	33	-3.85	-3.46	-3.36	-12.34	-10.69	-9.84
57	36	-3.75	-3.36	-3.30	-12.68	-11.05	-10.31
57	39	-3.68	-3.29	-3.26	-13.06	-11.49	-10.85
57	42	-3.64	-3.24	-3.23	-13.50	-11.97	-11.43
57	45	-3.62	-3.23	-3.22	-13.99	-12.48	-12.00
57	48	-3.68	-3.28	-3.30	-14.58	-13.06	-12.64
57	51	-3.82	-3.44	-3.51	-15.30	-13.74	-13.36

57	54	-4.03	-3.65	-3.78	-16.11	-14.47	-14.08
57	57	-4.26	-3.88	-4.08	-17.00	-15.21	-14.74
57	60	-4.48	-4.10	-4.36	-17.92	-15.90	-15.26
57	63	-4.72	-4.33	-4.62	-19.11	-16.53	-15.62
57	66	-4.99	-4.58	-4.90	-20.60	-17.11	-15.90
57	69	-5.27	-4.85	-5.18	-22.07	-17.70	-16.15
57	72	-5.55	-5.11	-5.44	-23.18	-18.33	-16.44
57	75	-5.79	-5.34	-5.67	-23.63	-19.06	-16.81
57	78	-5.98	-5.54	-5.83	-23.60	-19.96	-17.34
57	81	-6.13	-5.70	-5.96	-23.51	-21.03	-18.01
57	84	-6.27	-5.87	-6.09	-23.38	-22.18	-18.79
57	87	-6.46	-6.08	-6.24	-23.21	-23.31	-19.62
57	90	-6.73	-6.36	-6.47	-23.00	-24.34	-20.45
57	93	-7.35	-6.92	-6.93	-22.33	-25.38	-21.24
57	96	-8.42	-7.81	-7.72	-21.05	-26.52	-22.01
57	99	-9.71	-8.91	-8.70	-19.60	-27.55	-22.87
57	102	-11.02	-10.07	-9.74	-18.41	-28.30	-23.88
57	105	-12.10	-11.14	-10.71	-17.91	-28.60	-25.14
57	108	-13.08	-12.31	-11.79	-18.02	-28.31	-27.51
57	111	-14.11	-13.66	-13.06	-18.29	-27.59	-31.13
57	114	-15.04	-14.94	-14.28	-18.60	-26.61	-34.98
57	117	-15.71	-15.90	-15.18	-18.87	-25.56	-38.04
57	120	-15.97	-16.27	-15.54	-18.98	-24.64	-39.28
57	123	-15.26	-15.48	-14.79	-18.94	-23.88	-38.03
57	126	-13.49	-13.53	-12.96	-18.85	-23.13	-34.95
57	129	-11.26	-11.08	-10.65	-18.70	-22.38	-31.02
57	132	-9.14	-8.76	-8.48	-18.51	-21.57	-27.25
57	135	-7.69	-7.24	-7.06	-18.28	-20.66	-24.62
57	138	-6.86	-6.41	-6.28	-17.63	-19.61	-23.11
57	141	-6.18	-5.73	-5.64	-16.41	-18.42	-21.91
57	144	-5.59	-5.16	-5.11	-14.87	-17.15	-20.85
57	147	-5.06	-4.66	-4.65	-13.31	-15.85	-19.78
57	150	-4.55	-4.19	-4.25	-12.02	-14.60	-18.55
57	153	-4.03	-3.74	-3.90	-10.85	-13.21	-16.93
57	156	-3.53	-3.32	-3.58	-9.60	-11.65	-15.02
57	159	-3.07	-2.93	-3.31	-8.48	-10.17	-13.13
57	162	-2.67	-2.60	-3.06	-7.66	-9.04	-11.57
57	165	-2.36	-2.34	-2.83	-7.35	-8.52	-10.64
57	168	-2.10	-2.12	-2.59	-7.36	-8.41	-10.16
57	171	-1.85	-1.91	-2.35	-7.41	-8.32	-9.74
57	174	-1.64	-1.73	-2.14	-7.50	-8.26	-9.42
57	177	-1.49	-1.60	-1.99	-7.61	-8.21	-9.20
57	180	-1.44	-1.56	-1.93	-7.75	-8.20	-9.13
57	183	-1.51	-1.64	-2.02	-8.57	-8.81	-9.47
57	186	-1.73	-1.88	-2.26	-10.29	-10.27	-10.35
57	189	-2.06	-2.24	-2.63	-12.30	-12.06	-11.53
57	192	-2.46	-2.68	-3.08	-13.97	-13.63	-12.77
57	195	-2.92	-3.18	-3.59	-14.66	-14.46	-13.84
57	198	-3.62	-3.97	-4.42	-14.60	-14.72	-14.87
57	201	-4.69	-5.19	-5.70	-14.41	-14.93	-16.02
57	204	-5.99	-6.65	-7.23	-14.15	-15.09	-17.09
57	207	-7.38	-8.17	-8.79	-13.82	-15.20	-17.87
57	210	-8.72	-9.57	-10.18	-13.46	-15.23	-18.18
57	213	-10.15	-10.98	-11.52	-12.85	-14.86	-17.67
57	216	-11.76	-12.52	-12.94	-11.91	-13.92	-16.39
57	219	-13.36	-14.00	-14.28	-10.89	-12.72	-14.73
57	222	-14.74	-15.22	-15.35	-10.02	-11.54	-13.09
57	225	-15.70	-15.99	-15.96	-9.54	-10.68	-11.85

57	228	-16.38	-16.39	-16.22	-9.35	-10.05	-10.90
57	231	-17.01	-16.69	-16.38	-9.19	-9.44	-9.95
57	234	-17.52	-16.93	-16.50	-9.06	-8.92	-9.12
57	237	-17.86	-17.16	-16.66	-8.98	-8.55	-8.54
57	240	-17.99	-17.43	-16.91	-8.95	-8.41	-8.31
57	243	-17.89	-17.78	-17.67	-9.09	-8.50	-8.38
57	246	-17.63	-18.20	-19.03	-9.45	-8.74	-8.56
57	249	-17.25	-18.59	-20.53	-9.94	-9.08	-8.82
57	252	-16.79	-18.88	-21.76	-10.46	-9.50	-9.15
57	255	-16.29	-18.99	-22.26	-10.92	-9.93	-9.51
57	258	-15.59	-18.60	-21.90	-11.38	-10.59	-10.18
57	261	-14.60	-17.62	-20.96	-11.91	-11.54	-11.24
57	264	-13.47	-16.30	-19.68	-12.41	-12.52	-12.37
57	267	-12.35	-14.92	-18.27	-12.78	-13.30	-13.28
57	270	-11.40	-13.75	-16.97	-12.93	-13.61	-13.65
57	273	-10.61	-12.77	-15.68	-12.68	-13.30	-13.37
57	276	-9.85	-11.78	-14.25	-12.05	-12.52	-12.65
57	279	-9.15	-10.84	-12.80	-11.19	-11.49	-11.69
57	282	-8.51	-9.96	-11.47	-10.28	-10.41	-10.70
57	285	-7.94	-9.18	-10.36	-9.48	-9.52	-9.87
57	288	-7.43	-8.49	-9.48	-8.77	-8.77	-9.17
57	291	-6.97	-7.86	-8.70	-8.02	-8.02	-8.46
57	294	-6.54	-7.27	-7.99	-7.30	-7.32	-7.80
57	297	-6.15	-6.73	-7.34	-6.63	-6.70	-7.22
57	300	-5.80	-6.23	-6.71	-6.07	-6.20	-6.77
57	303	-5.43	-5.72	-6.08	-5.55	-5.76	-6.40
57	306	-5.05	-5.21	-5.46	-5.04	-5.35	-6.05
57	309	-4.72	-4.74	-4.88	-4.59	-4.99	-5.75
57	312	-4.47	-4.37	-4.40	-4.25	-4.74	-5.54
57	315	-4.38	-4.14	-4.06	-4.10	-4.65	-5.46
57	318	-4.38	-4.01	-3.82	-4.06	-4.65	-5.48
57	321	-4.38	-3.90	-3.60	-4.02	-4.67	-5.52
57	324	-4.39	-3.81	-3.43	-3.99	-4.70	-5.59
57	327	-4.39	-3.76	-3.31	-3.98	-4.75	-5.67
57	330	-4.40	-3.73	-3.26	-3.97	-4.80	-5.76
57	333	-4.61	-3.90	-3.41	-4.07	-4.95	-5.94
57	336	-5.18	-4.37	-3.83	-4.31	-5.24	-6.23
57	339	-6.03	-5.08	-4.44	-4.66	-5.62	-6.58
57	342	-7.11	-5.97	-5.19	-5.06	-6.03	-6.93
57	345	-8.35	-6.98	-6.02	-5.46	-6.42	-7.21
57	348	-10.25	-8.47	-7.13	-5.89	-6.80	-7.43
57	351	-13.23	-10.74	-8.70	-6.39	-7.19	-7.64
57	354	-17.05	-13.63	-10.65	-6.96	-7.60	-7.83
57	357	-21.51	-17.00	-12.89	-7.58	-8.02	-8.01
57	360	-26.38	-20.68	-15.34	-8.24	-8.47	-8.16
60	0	-27.90	-21.73	-15.90	-7.70	-8.20	-8.05
60	3	-22.29	-17.91	-13.66	-8.42	-8.47	-8.05
60	6	-17.17	-14.41	-11.59	-9.08	-8.72	-8.05
60	9	-12.81	-11.39	-9.76	-9.68	-8.95	-8.06
60	12	-9.51	-9.00	-8.21	-10.20	-9.15	-8.07
60	15	-7.53	-7.37	-7.01	-10.64	-9.34	-8.08
60	18	-6.41	-6.25	-6.01	-10.97	-9.48	-8.13
60	21	-5.47	-5.29	-5.08	-11.24	-9.60	-8.25
60	24	-4.74	-4.50	-4.29	-11.49	-9.71	-8.44
60	27	-4.23	-3.95	-3.73	-11.74	-9.84	-8.66
60	30	-3.98	-3.65	-3.47	-12.05	-10.02	-8.92
60	33	-3.86	-3.51	-3.38	-12.41	-10.34	-9.32
60	36	-3.77	-3.39	-3.31	-12.80	-10.81	-9.91

60	39	-3.70	-3.30	-3.25	-13.24	-11.40	-10.63
60	42	-3.65	-3.24	-3.22	-13.72	-12.03	-11.39
60	45	-3.64	-3.22	-3.21	-14.26	-12.66	-12.11
60	48	-3.74	-3.32	-3.33	-14.90	-13.32	-12.83
60	51	-4.00	-3.56	-3.63	-15.66	-14.06	-13.63
60	54	-4.36	-3.90	-4.03	-16.50	-14.83	-14.40
60	57	-4.75	-4.26	-4.46	-17.40	-15.58	-15.08
60	60	-5.10	-4.58	-4.83	-18.32	-16.26	-15.56
60	63	-5.45	-4.91	-5.19	-19.44	-16.85	-15.86
60	66	-5.84	-5.27	-5.59	-20.80	-17.38	-16.09
60	69	-6.21	-5.62	-5.96	-22.13	-17.89	-16.28
60	72	-6.53	-5.91	-6.23	-23.16	-18.46	-16.49
60	75	-6.72	-6.07	-6.34	-23.64	-19.12	-16.76
60	78	-6.81	-6.14	-6.33	-23.73	-19.97	-17.09
60	81	-6.86	-6.18	-6.33	-23.81	-20.97	-17.46
60	84	-6.90	-6.21	-6.33	-23.87	-22.08	-17.90
60	87	-6.96	-6.25	-6.32	-23.90	-23.22	-18.41
60	90	-7.06	-6.32	-6.32	-23.91	-24.35	-19.04
60	93	-7.59	-6.76	-6.63	-23.41	-25.63	-19.88
60	96	-8.68	-7.70	-7.41	-22.20	-27.13	-21.02
60	99	-10.01	-8.88	-8.41	-20.76	-28.55	-22.42
60	102	-11.26	-10.01	-9.41	-19.55	-29.61	-24.06
60	105	-12.10	-10.84	-10.15	-19.05	-30.02	-25.89
60	108	-12.62	-11.42	-10.72	-19.11	-29.74	-28.82
60	111	-13.11	-11.99	-11.28	-19.25	-29.01	-33.00
60	114	-13.51	-12.48	-11.78	-19.43	-28.02	-37.34
60	117	-13.78	-12.82	-12.12	-19.57	-26.93	-40.75
60	120	-13.88	-12.95	-12.26	-19.63	-25.94	-42.13
60	123	-13.18	-12.29	-11.65	-19.57	-25.07	-40.80
60	126	-11.47	-10.69	-10.17	-19.39	-24.19	-37.47
60	129	-9.33	-8.69	-8.33	-19.11	-23.27	-33.15
60	132	-7.35	-6.83	-6.63	-18.76	-22.25	-28.84
60	135	-6.11	-5.67	-5.57	-18.34	-21.10	-25.55
60	138	-5.52	-5.10	-5.06	-17.40	-19.59	-23.21
60	141	-5.06	-4.65	-4.65	-15.76	-17.71	-21.05
60	144	-4.68	-4.28	-4.31	-13.81	-15.73	-19.11
60	147	-4.34	-3.95	-4.03	-11.96	-13.91	-17.39
60	150	-3.99	-3.65	-3.79	-10.64	-12.50	-15.89
60	153	-3.63	-3.35	-3.58	-9.69	-11.37	-14.50
60	156	-3.28	-3.07	-3.40	-8.78	-10.28	-13.16
60	159	-2.95	-2.82	-3.24	-8.00	-9.34	-11.99
60	162	-2.66	-2.59	-3.08	-7.47	-8.68	-11.08
60	165	-2.42	-2.40	-2.92	-7.27	-8.43	-10.54
60	168	-2.22	-2.22	-2.73	-7.33	-8.45	-10.25
60	171	-2.02	-2.05	-2.52	-7.50	-8.50	-10.00
60	174	-1.85	-1.89	-2.32	-7.75	-8.58	-9.81
60	177	-1.73	-1.78	-2.17	-8.09	-8.68	-9.69
60	180	-1.68	-1.74	-2.11	-8.48	-8.82	-9.64
60	183	-1.76	-1.83	-2.20	-9.47	-9.57	-10.00
60	186	-1.99	-2.07	-2.44	-11.24	-11.17	-10.92
60	189	-2.32	-2.43	-2.80	-13.21	-13.03	-12.14
60	192	-2.74	-2.88	-3.25	-14.82	-14.57	-13.40
60	195	-3.22	-3.39	-3.76	-15.48	-15.22	-14.47
60	198	-3.96	-4.20	-4.61	-15.30	-15.23	-15.44
60	201	-5.12	-5.45	-5.93	-14.85	-15.24	-16.51
60	204	-6.52	-6.95	-7.51	-14.22	-15.24	-17.49
60	207	-8.00	-8.52	-9.12	-13.51	-15.25	-18.20
60	210	-9.41	-9.97	-10.55	-12.83	-15.25	-18.48

60	213	-10.88	-11.43	-11.92	-12.01	-14.73	-17.79
60	216	-12.52	-13.04	-13.39	-10.96	-13.48	-16.09
60	219	-14.13	-14.57	-14.76	-9.94	-11.92	-13.95
60	222	-15.52	-15.84	-15.84	-9.15	-10.49	-11.95
60	225	-16.49	-16.61	-16.42	-8.84	-9.62	-10.65
60	228	-17.17	-17.00	-16.63	-8.84	-9.19	-9.90
60	231	-17.80	-17.27	-16.75	-8.84	-8.82	-9.22
60	234	-18.31	-17.50	-16.85	-8.84	-8.52	-8.66
60	237	-18.66	-17.72	-16.98	-8.84	-8.32	-8.28
60	240	-18.79	-18.00	-17.19	-8.84	-8.25	-8.14
60	243	-18.69	-18.40	-18.00	-9.01	-8.38	-8.24
60	246	-18.42	-18.90	-19.55	-9.45	-8.72	-8.52
60	249	-18.03	-19.39	-21.31	-10.05	-9.22	-8.92
60	252	-17.55	-19.77	-22.75	-10.69	-9.79	-9.40
60	255	-17.03	-19.91	-23.34	-11.25	-10.36	-9.90
60	258	-16.30	-19.51	-22.97	-11.84	-11.14	-10.67
60	261	-15.25	-18.47	-22.00	-12.52	-12.20	-11.78
60	264	-14.06	-17.10	-20.67	-13.16	-13.27	-12.94
60	267	-12.90	-15.65	-19.21	-13.64	-14.10	-13.85
60	270	-11.91	-14.42	-17.84	-13.83	-14.43	-14.22
60	273	-11.11	-13.38	-16.48	-13.52	-14.07	-13.91
60	276	-10.35	-12.33	-14.94	-12.76	-13.17	-13.12
60	279	-9.64	-11.31	-13.39	-11.73	-11.97	-12.06
60	282	-9.00	-10.38	-11.96	-10.65	-10.73	-10.97
60	285	-8.41	-9.57	-10.80	-9.72	-9.71	-10.05
60	288	-7.88	-8.87	-9.89	-8.91	-8.87	-9.26
60	291	-7.39	-8.24	-9.10	-8.08	-8.04	-8.47
60	294	-6.94	-7.67	-8.39	-7.28	-7.27	-7.72
60	297	-6.52	-7.12	-7.72	-6.55	-6.58	-7.06
60	300	-6.12	-6.60	-7.07	-5.95	-6.04	-6.56
60	303	-5.71	-6.05	-6.39	-5.42	-5.57	-6.14
60	306	-5.27	-5.49	-5.70	-4.91	-5.11	-5.75
60	309	-4.88	-4.97	-5.06	-4.47	-4.72	-5.42
60	312	-4.58	-4.54	-4.52	-4.12	-4.45	-5.19
60	315	-4.44	-4.25	-4.13	-3.92	-4.35	-5.11
60	318	-4.39	-4.05	-3.84	-3.80	-4.34	-5.11
60	321	-4.35	-3.87	-3.57	-3.71	-4.34	-5.14
60	324	-4.32	-3.73	-3.35	-3.63	-4.33	-5.18
60	327	-4.30	-3.63	-3.20	-3.58	-4.33	-5.23
60	330	-4.30	-3.60	-3.15	-3.56	-4.33	-5.30
60	333	-4.49	-3.76	-3.29	-3.64	-4.43	-5.45
60	336	-5.05	-4.20	-3.66	-3.85	-4.70	-5.75
60	339	-5.90	-4.88	-4.23	-4.16	-5.08	-6.11
60	342	-6.98	-5.74	-4.94	-4.51	-5.50	-6.49
60	345	-8.23	-6.72	-5.74	-4.88	-5.90	-6.81
60	348	-10.23	-8.27	-6.88	-5.29	-6.29	-7.08
60	351	-13.45	-10.74	-8.57	-5.79	-6.72	-7.34
60	354	-17.64	-13.93	-10.71	-6.36	-7.18	-7.58
60	357	-22.54	-17.65	-13.19	-7.01	-7.68	-7.82
60	360	-27.90	-21.73	-15.90	-7.70	-8.20	-8.05
63	0	-26.55	-20.80	-15.52	-7.43	-8.08	-8.05
63	3	-21.50	-17.51	-13.72	-8.17	-8.38	-7.98
63	6	-16.88	-14.48	-12.03	-8.85	-8.65	-7.94
63	9	-12.94	-11.84	-10.50	-9.46	-8.88	-7.91
63	12	-9.89	-9.68	-9.13	-9.98	-9.07	-7.90
63	15	-7.99	-8.11	-7.96	-10.40	-9.19	-7.90
63	18	-6.80	-6.91	-6.85	-10.71	-9.25	-7.91
63	21	-5.77	-5.82	-5.77	-10.96	-9.30	-7.96

63	24	-4.96	-4.93	-4.82	-11.18	-9.33	-8.04
63	27	-4.42	-4.31	-4.13	-11.41	-9.38	-8.14
63	30	-4.23	-4.02	-3.82	-11.69	-9.46	-8.27
63	33	-4.23	-3.94	-3.76	-12.02	-9.70	-8.59
63	36	-4.24	-3.87	-3.70	-12.39	-10.19	-9.21
63	39	-4.25	-3.83	-3.66	-12.79	-10.82	-10.00
63	42	-4.26	-3.80	-3.64	-13.25	-11.52	-10.84
63	45	-4.27	-3.78	-3.63	-13.77	-12.19	-11.61
63	48	-4.44	-3.93	-3.80	-14.40	-12.87	-12.35
63	51	-4.83	-4.28	-4.22	-15.16	-13.61	-13.15
63	54	-5.35	-4.75	-4.78	-16.01	-14.39	-13.93
63	57	-5.89	-5.25	-5.36	-16.92	-15.17	-14.63
63	60	-6.33	-5.66	-5.83	-17.86	-15.90	-15.18
63	63	-6.71	-6.03	-6.25	-18.93	-16.58	-15.59
63	66	-7.10	-6.44	-6.70	-20.17	-17.21	-15.93
63	69	-7.46	-6.81	-7.10	-21.42	-17.84	-16.23
63	72	-7.74	-7.08	-7.40	-22.55	-18.52	-16.51
63	75	-7.87	-7.18	-7.51	-23.40	-19.27	-16.79
63	78	-7.91	-7.18	-7.51	-24.08	-20.16	-17.04
63	81	-7.93	-7.17	-7.49	-24.73	-21.17	-17.25
63	84	-7.95	-7.17	-7.47	-25.27	-22.24	-17.45
63	87	-7.97	-7.16	-7.46	-25.65	-23.31	-17.72
63	90	-8.01	-7.16	-7.45	-25.80	-24.33	-18.08
63	93	-8.49	-7.58	-7.79	-25.27	-25.43	-18.75
63	96	-9.56	-8.59	-8.60	-23.99	-26.67	-19.84
63	99	-10.81	-9.79	-9.56	-22.42	-27.81	-21.25
63	102	-11.85	-10.79	-10.37	-21.03	-28.66	-22.89
63	105	-12.29	-11.21	-10.71	-20.27	-28.99	-24.67
63	108	-12.27	-11.19	-10.69	-20.04	-28.71	-27.36
63	111	-12.22	-11.14	-10.63	-19.89	-28.00	-31.15
63	114	-12.13	-11.04	-10.55	-19.77	-27.02	-35.05
63	117	-12.01	-10.92	-10.43	-19.64	-25.96	-38.10
63	120	-11.87	-10.77	-10.29	-19.46	-24.99	-39.34
63	123	-11.12	-10.08	-9.65	-19.22	-24.13	-38.16
63	126	-9.54	-8.67	-8.34	-18.95	-23.26	-35.20
63	129	-7.63	-6.98	-6.77	-18.61	-22.34	-31.34
63	132	-5.90	-5.44	-5.35	-18.19	-21.33	-27.43
63	135	-4.87	-4.51	-4.51	-17.67	-20.18	-24.34
63	138	-4.42	-4.08	-4.13	-16.63	-18.64	-21.97
63	141	-4.07	-3.74	-3.82	-14.97	-16.70	-19.68
63	144	-3.79	-3.46	-3.58	-13.06	-14.67	-17.59
63	147	-3.55	-3.23	-3.39	-11.31	-12.86	-15.81
63	150	-3.32	-3.03	-3.24	-10.13	-11.58	-14.45
63	153	-3.09	-2.85	-3.13	-9.36	-10.69	-13.35
63	156	-2.86	-2.68	-3.04	-8.66	-9.86	-12.32
63	159	-2.66	-2.54	-2.97	-8.08	-9.18	-11.46
63	162	-2.49	-2.42	-2.89	-7.69	-8.71	-10.85
63	165	-2.36	-2.31	-2.81	-7.54	-8.54	-10.58
63	168	-2.25	-2.21	-2.70	-7.65	-8.60	-10.52
63	171	-2.15	-2.11	-2.57	-7.95	-8.76	-10.48
63	174	-2.07	-2.03	-2.44	-8.39	-9.01	-10.44
63	177	-2.01	-1.97	-2.34	-8.93	-9.32	-10.42
63	180	-1.99	-1.94	-2.30	-9.50	-9.67	-10.41
63	183	-2.09	-2.05	-2.41	-10.48	-10.47	-10.71
63	186	-2.36	-2.33	-2.70	-11.95	-11.83	-11.46
63	189	-2.76	-2.76	-3.13	-13.52	-13.32	-12.45
63	192	-3.25	-3.28	-3.65	-14.76	-14.52	-13.48
63	195	-3.79	-3.84	-4.23	-15.26	-15.02	-14.33



63	198	-4.57	-4.66	-5.08	-15.03	-15.00	-15.09
63	201	-5.72	-5.84	-6.33	-14.44	-14.93	-15.91
63	204	-7.07	-7.23	-7.78	-13.64	-14.82	-16.65
63	207	-8.47	-8.65	-9.25	-12.77	-14.67	-17.20
63	210	-9.77	-9.96	-10.53	-12.00	-14.50	-17.41
63	213	-11.06	-11.27	-11.74	-11.19	-13.83	-16.68
63	216	-12.45	-12.68	-13.02	-10.25	-12.49	-14.93
63	219	-13.79	-14.02	-14.20	-9.36	-10.93	-12.76
63	222	-14.93	-15.12	-15.13	-8.69	-9.57	-10.80
63	225	-15.75	-15.80	-15.65	-8.43	-8.86	-9.67
63	228	-16.34	-16.15	-15.85	-8.45	-8.64	-9.18
63	231	-16.89	-16.39	-15.98	-8.49	-8.45	-8.76
63	234	-17.34	-16.59	-16.07	-8.57	-8.31	-8.43
63	237	-17.65	-16.79	-16.19	-8.66	-8.22	-8.21
63	240	-17.76	-17.06	-16.40	-8.77	-8.19	-8.13
63	243	-17.69	-17.47	-17.18	-9.03	-8.35	-8.27
63	246	-17.49	-17.99	-18.67	-9.51	-8.77	-8.63
63	249	-17.19	-18.52	-20.36	-10.11	-9.37	-9.14
63	252	-16.83	-18.92	-21.74	-10.77	-10.04	-9.73
63	255	-16.43	-19.09	-22.31	-11.39	-10.70	-10.31
63	258	-15.81	-18.73	-21.98	-12.08	-11.52	-11.08
63	261	-14.88	-17.83	-21.13	-12.91	-12.58	-12.09
63	264	-13.81	-16.61	-19.95	-13.70	-13.64	-13.11
63	267	-12.75	-15.33	-18.64	-14.30	-14.45	-13.90
63	270	-11.86	-14.21	-17.41	-14.53	-14.78	-14.21
63	273	-11.13	-13.23	-16.14	-14.20	-14.41	-13.91
63	276	-10.44	-12.22	-14.69	-13.37	-13.47	-13.14
63	279	-9.79	-11.24	-13.21	-12.24	-12.24	-12.12
63	282	-9.19	-10.34	-11.85	-11.07	-10.96	-11.04
63	285	-8.64	-9.56	-10.76	-10.06	-9.90	-10.12
63	288	-8.12	-8.92	-9.91	-9.18	-9.03	-9.32
63	291	-7.64	-8.36	-9.18	-8.29	-8.16	-8.48
63	294	-7.19	-7.84	-8.53	-7.43	-7.34	-7.69
63	297	-6.76	-7.34	-7.91	-6.66	-6.63	-6.99
63	300	-6.35	-6.83	-7.27	-6.02	-6.05	-6.45
63	303	-5.90	-6.27	-6.59	-5.48	-5.55	-6.00
63	306	-5.43	-5.70	-5.89	-4.97	-5.09	-5.57
63	309	-4.99	-5.14	-5.22	-4.52	-4.69	-5.21
63	312	-4.64	-4.67	-4.65	-4.16	-4.39	-4.96
63	315	-4.43	-4.32	-4.22	-3.92	-4.23	-4.86
63	318	-4.32	-4.06	-3.88	-3.74	-4.15	-4.87
63	321	-4.22	-3.82	-3.57	-3.57	-4.09	-4.87
63	324	-4.15	-3.62	-3.31	-3.44	-4.04	-4.87
63	327	-4.10	-3.48	-3.13	-3.36	-4.00	-4.87
63	330	-4.08	-3.43	-3.06	-3.32	-3.99	-4.88
63	333	-4.27	-3.57	-3.18	-3.39	-4.08	-4.98
63	336	-4.79	-3.98	-3.52	-3.56	-4.32	-5.25
63	339	-5.59	-4.59	-4.02	-3.82	-4.65	-5.62
63	342	-6.61	-5.37	-4.66	-4.13	-5.04	-6.01
63	345	-7.78	-6.28	-5.39	-4.45	-5.43	-6.37
63	348	-9.69	-7.75	-6.47	-4.85	-5.84	-6.69
63	351	-12.76	-10.12	-8.15	-5.36	-6.32	-7.02
63	354	-16.75	-13.22	-10.29	-5.98	-6.86	-7.35
63	357	-21.43	-16.84	-12.79	-6.68	-7.45	-7.70
63	360	-26.55	-20.80	-15.52	-7.43	-8.08	-8.05
66	0	-23.34	-18.59	-14.62	-7.20	-7.99	-8.06
66	3	-19.42	-16.27	-13.56	-8.03	-8.34	-8.00
66	6	-15.84	-14.12	-12.51	-8.79	-8.64	-7.94

66	9	-12.74	-12.19	-11.48	-9.44	-8.88	-7.88
66	12	-10.29	-10.52	-10.47	-9.93	-9.03	-7.81
66	15	-8.63	-9.16	-9.46	-10.23	-9.09	-7.75
66	18	-7.47	-7.95	-8.32	-10.38	-9.04	-7.69
66	21	-6.44	-6.78	-7.04	-10.48	-8.93	-7.61
66	24	-5.61	-5.78	-5.85	-10.56	-8.80	-7.54
66	27	-5.05	-5.08	-4.98	-10.65	-8.69	-7.48
66	30	-4.85	-4.82	-4.63	-10.78	-8.65	-7.46
66	33	-4.90	-4.84	-4.63	-11.00	-8.80	-7.66
66	36	-5.04	-4.88	-4.64	-11.29	-9.20	-8.17
66	39	-5.24	-4.95	-4.64	-11.65	-9.77	-8.88
66	42	-5.48	-5.03	-4.65	-12.07	-10.41	-9.66
66	45	-5.75	-5.14	-4.66	-12.54	-11.04	-10.39
66	48	-6.14	-5.40	-4.88	-13.13	-11.69	-11.11
66	51	-6.69	-5.88	-5.45	-13.88	-12.45	-11.92
66	54	-7.32	-6.46	-6.18	-14.76	-13.27	-12.75
66	57	-7.89	-7.03	-6.91	-15.71	-14.13	-13.54
66	60	-8.30	-7.47	-7.49	-16.70	-14.99	-14.24
66	63	-8.59	-7.80	-7.93	-17.77	-15.85	-14.89
66	66	-8.84	-8.12	-8.34	-18.97	-16.75	-15.57
66	69	-9.06	-8.40	-8.72	-20.25	-17.66	-16.18
66	72	-9.24	-8.63	-9.05	-21.54	-18.60	-16.64
66	75	-9.36	-8.78	-9.31	-22.78	-19.53	-16.88
66	78	-9.44	-8.88	-9.51	-24.18	-20.52	-16.95
66	81	-9.49	-8.94	-9.66	-25.75	-21.59	-17.00
66	84	-9.54	-8.99	-9.79	-27.23	-22.63	-17.03
66	87	-9.60	-9.05	-9.94	-28.33	-23.56	-17.08
66	90	-9.69	-9.16	-10.13	-28.76	-24.28	-17.16
66	93	-10.09	-9.55	-10.48	-28.14	-24.89	-17.50
66	96	-10.85	-10.30	-10.97	-26.63	-25.47	-18.23
66	99	-11.72	-11.15	-11.48	-24.71	-25.96	-19.25
66	102	-12.44	-11.85	-11.88	-22.89	-26.31	-20.46
66	105	-12.74	-12.14	-12.04	-21.65	-26.44	-21.75
66	108	-12.55	-11.91	-11.80	-20.97	-26.18	-23.71
66	111	-12.04	-11.33	-11.18	-20.43	-25.50	-26.51
66	114	-11.31	-10.51	-10.32	-19.97	-24.59	-29.42
66	117	-10.48	-9.59	-9.37	-19.52	-23.58	-31.70
66	120	-9.63	-8.70	-8.46	-19.01	-22.65	-32.63
66	123	-8.54	-7.67	-7.47	-18.47	-21.81	-31.77
66	126	-7.12	-6.40	-6.27	-17.95	-20.95	-29.59
66	129	-5.63	-5.12	-5.08	-17.40	-20.04	-26.73
66	132	-4.38	-4.04	-4.08	-16.79	-19.06	-23.80
66	135	-3.64	-3.39	-3.50	-16.05	-17.98	-21.42
66	138	-3.28	-3.04	-3.20	-14.95	-16.61	-19.46
66	141	-2.98	-2.76	-2.94	-13.47	-14.93	-17.50
66	144	-2.75	-2.53	-2.74	-11.90	-13.22	-15.69
66	147	-2.58	-2.37	-2.60	-10.54	-11.75	-14.19
66	150	-2.47	-2.27	-2.55	-9.70	-10.79	-13.15
66	153	-2.38	-2.21	-2.54	-9.23	-10.18	-12.41
66	156	-2.30	-2.16	-2.53	-8.81	-9.65	-11.73
66	159	-2.24	-2.12	-2.53	-8.49	-9.21	-11.19
66	162	-2.20	-2.09	-2.53	-8.27	-8.92	-10.82
66	165	-2.19	-2.09	-2.53	-8.19	-8.81	-10.68
66	168	-2.20	-2.09	-2.53	-8.37	-8.94	-10.73
66	171	-2.22	-2.10	-2.53	-8.85	-9.28	-10.86
66	174	-2.27	-2.12	-2.53	-9.51	-9.76	-11.05
66	177	-2.32	-2.15	-2.53	-10.24	-10.31	-11.27
66	180	-2.39	-2.18	-2.54	-10.93	-10.85	-11.52

66	183	-2.57	-2.35	-2.69	-11.73	-11.57	-11.89
66	186	-2.95	-2.75	-3.10	-12.71	-12.51	-12.43
66	189	-3.46	-3.30	-3.69	-13.67	-13.46	-13.03
66	192	-4.06	-3.95	-4.37	-14.40	-14.20	-13.58
66	195	-4.71	-4.62	-5.08	-14.69	-14.49	-13.96
66	198	-5.54	-5.46	-5.95	-14.40	-14.39	-14.22
66	201	-6.64	-6.55	-7.09	-13.66	-14.11	-14.46
66	204	-7.86	-7.75	-8.33	-12.69	-13.70	-14.65
66	207	-9.06	-8.93	-9.51	-11.70	-13.22	-14.79
66	210	-10.09	-9.94	-10.48	-10.89	-12.70	-14.84
66	213	-11.00	-10.87	-11.30	-10.18	-11.89	-14.23
66	216	-11.89	-11.79	-12.10	-9.43	-10.72	-12.76
66	219	-12.71	-12.65	-12.81	-8.75	-9.49	-10.97
66	222	-13.40	-13.34	-13.38	-8.26	-8.52	-9.42
66	225	-13.90	-13.79	-13.74	-8.07	-8.12	-8.65
66	228	-14.29	-14.04	-13.92	-8.11	-8.13	-8.47
66	231	-14.66	-14.21	-14.03	-8.20	-8.13	-8.33
66	234	-14.95	-14.35	-14.12	-8.35	-8.13	-8.22
66	237	-15.16	-14.51	-14.24	-8.52	-8.14	-8.15
66	240	-15.23	-14.73	-14.44	-8.73	-8.15	-8.13
66	243	-15.22	-15.14	-15.15	-9.05	-8.35	-8.31
66	246	-15.17	-15.73	-16.49	-9.55	-8.85	-8.78
66	249	-15.11	-16.35	-18.01	-10.17	-9.54	-9.42
66	252	-15.02	-16.83	-19.25	-10.84	-10.31	-10.13
66	255	-14.91	-17.03	-19.76	-11.50	-11.04	-10.79
66	258	-14.59	-16.80	-19.54	-12.30	-11.89	-11.53
66	261	-13.99	-16.20	-18.96	-13.28	-12.94	-12.42
66	264	-13.22	-15.38	-18.14	-14.23	-13.97	-13.28
66	267	-12.42	-14.48	-17.22	-14.95	-14.76	-13.94
66	270	-11.71	-13.66	-16.31	-15.24	-15.07	-14.19
66	273	-11.11	-12.86	-15.30	-14.89	-14.69	-13.90
66	276	-10.51	-11.98	-14.08	-14.01	-13.75	-13.16
66	279	-9.93	-11.09	-12.81	-12.83	-12.49	-12.16
66	282	-9.37	-10.26	-11.61	-11.59	-11.19	-11.10
66	285	-8.84	-9.55	-10.64	-10.53	-10.10	-10.19
66	288	-8.34	-8.97	-9.88	-9.59	-9.19	-9.36
66	291	-7.87	-8.46	-9.23	-8.64	-8.29	-8.51
66	294	-7.42	-7.98	-8.63	-7.72	-7.43	-7.68
66	297	-6.98	-7.52	-8.06	-6.88	-6.68	-6.94
66	300	-6.54	-7.02	-7.45	-6.20	-6.07	-6.37
66	303	-6.07	-6.47	-6.79	-5.61	-5.56	-5.91
66	306	-5.58	-5.88	-6.08	-5.07	-5.09	-5.47
66	309	-5.10	-5.30	-5.40	-4.60	-4.68	-5.10
66	312	-4.71	-4.78	-4.80	-4.20	-4.37	-4.83
66	315	-4.43	-4.38	-4.34	-3.91	-4.16	-4.68
66	318	-4.23	-4.06	-3.96	-3.69	-4.02	-4.61
66	321	-4.05	-3.75	-3.59	-3.48	-3.90	-4.55
66	324	-3.90	-3.49	-3.28	-3.31	-3.80	-4.51
66	327	-3.80	-3.31	-3.07	-3.19	-3.74	-4.48
66	330	-3.77	-3.24	-2.99	-3.14	-3.72	-4.47
66	333	-3.93	-3.36	-3.09	-3.20	-3.79	-4.57
66	336	-4.38	-3.70	-3.37	-3.33	-3.99	-4.81
66	339	-5.07	-4.23	-3.81	-3.54	-4.27	-5.14
66	342	-5.95	-4.90	-4.35	-3.79	-4.61	-5.52
66	345	-6.97	-5.68	-4.98	-4.07	-4.97	-5.89
66	348	-8.62	-6.96	-5.98	-4.45	-5.39	-6.25
66	351	-11.30	-9.07	-7.56	-4.97	-5.91	-6.66
66	354	-14.79	-11.82	-9.61	-5.63	-6.53	-7.09

66	357	-18.87	-15.05	-12.00	-6.38	-7.23	-7.56
66	360	-23.34	-18.59	-14.62	-7.20	-7.99	-8.06
69	0	-19.50	-15.95	-13.54	-7.02	-7.91	-8.08
69	3	-16.89	-14.71	-13.27	-7.96	-8.32	-8.03
69	6	-14.48	-13.51	-12.86	-8.79	-8.62	-7.96
69	9	-12.36	-12.37	-12.34	-9.46	-8.84	-7.87
69	12	-10.61	-11.28	-11.74	-9.91	-8.96	-7.76
69	15	-9.29	-10.25	-11.08	-10.08	-9.00	-7.64
69	18	-8.22	-9.15	-10.08	-10.03	-8.87	-7.46
69	21	-7.23	-7.96	-8.68	-9.91	-8.56	-7.19
69	24	-6.41	-6.88	-7.23	-9.77	-8.19	-6.92
69	27	-5.85	-6.09	-6.09	-9.65	-7.87	-6.71
69	30	-5.64	-5.79	-5.63	-9.60	-7.74	-6.62
69	33	-5.76	-5.84	-5.64	-9.68	-7.85	-6.76
69	36	-6.08	-5.99	-5.68	-9.87	-8.13	-7.12
69	39	-6.52	-6.21	-5.75	-10.17	-8.55	-7.64
69	42	-7.02	-6.48	-5.83	-10.53	-9.03	-8.24
69	45	-7.51	-6.76	-5.94	-10.93	-9.55	-8.84
69	48	-8.08	-7.18	-6.28	-11.46	-10.15	-9.51
69	51	-8.80	-7.77	-6.96	-12.20	-10.91	-10.33
69	54	-9.53	-8.43	-7.81	-13.10	-11.80	-11.22
69	57	-10.12	-9.03	-8.64	-14.10	-12.76	-12.13
69	60	-10.44	-9.45	-9.29	-15.14	-13.75	-12.99
69	63	-10.56	-9.71	-9.74	-16.25	-14.86	-13.93
69	66	-10.64	-9.91	-10.13	-17.50	-16.11	-14.98
69	69	-10.70	-10.09	-10.49	-18.86	-17.42	-15.97
69	72	-10.76	-10.26	-10.85	-20.34	-18.69	-16.69
69	75	-10.84	-10.45	-11.23	-21.91	-19.81	-16.98
69	78	-10.95	-10.66	-11.69	-23.99	-20.92	-16.91
69	81	-11.07	-10.86	-12.21	-26.60	-22.09	-16.77
69	84	-11.21	-11.07	-12.71	-29.18	-23.15	-16.59
69	87	-11.37	-11.29	-13.11	-31.15	-23.92	-16.44
69	90	-11.56	-11.55	-13.34	-31.94	-24.21	-16.38
69	93	-11.87	-11.90	-13.45	-31.20	-24.16	-16.48
69	96	-12.33	-12.36	-13.54	-29.36	-24.01	-16.75
69	99	-12.80	-12.82	-13.62	-26.99	-23.78	-17.16
69	102	-13.18	-13.17	-13.66	-24.66	-23.51	-17.66
69	105	-13.33	-13.31	-13.68	-22.95	-23.20	-18.22
69	108	-12.90	-12.82	-13.15	-21.84	-22.77	-19.24
69	111	-11.81	-11.58	-11.82	-20.89	-22.13	-20.84
69	114	-10.35	-9.96	-10.09	-20.03	-21.36	-22.56
69	117	-8.83	-8.30	-8.33	-19.21	-20.53	-23.93
69	120	-7.54	-6.96	-6.96	-18.37	-19.72	-24.49
69	123	-6.39	-5.85	-5.88	-17.50	-18.92	-24.00
69	126	-5.16	-4.74	-4.80	-16.65	-18.07	-22.74
69	129	-4.01	-3.72	-3.83	-15.81	-17.18	-21.06
69	132	-3.09	-2.90	-3.07	-14.96	-16.26	-19.31
69	135	-2.53	-2.40	-2.61	-14.09	-15.32	-17.83
69	138	-2.22	-2.11	-2.35	-13.04	-14.22	-16.51
69	141	-1.95	-1.85	-2.13	-11.85	-12.97	-15.12
69	144	-1.74	-1.65	-1.96	-10.70	-11.75	-13.82
69	147	-1.60	-1.52	-1.84	-9.81	-10.75	-12.76
69	150	-1.55	-1.47	-1.80	-9.36	-10.16	-12.09
69	153	-1.57	-1.49	-1.83	-9.23	-9.85	-11.70
69	156	-1.64	-1.54	-1.88	-9.12	-9.58	-11.35
69	159	-1.73	-1.61	-1.96	-9.03	-9.37	-11.08
69	162	-1.84	-1.69	-2.05	-8.98	-9.23	-10.90
69	165	-1.95	-1.78	-2.14	-8.96	-9.18	-10.83

69	168	-2.06	-1.86	-2.23	-9.25	-9.41	-10.99
69	171	-2.20	-1.97	-2.33	-9.97	-9.99	-11.38
69	174	-2.37	-2.09	-2.45	-10.89	-10.74	-11.87
69	177	-2.57	-2.25	-2.60	-11.77	-11.49	-12.34
69	180	-2.82	-2.45	-2.79	-12.40	-12.06	-12.67
69	183	-3.17	-2.79	-3.14	-12.81	-12.51	-12.88
69	186	-3.68	-3.33	-3.73	-13.21	-12.97	-13.09
69	189	-4.30	-4.00	-4.46	-13.55	-13.36	-13.26
69	192	-4.99	-4.74	-5.25	-13.79	-13.65	-13.38
69	195	-5.70	-5.48	-6.03	-13.88	-13.75	-13.43
69	198	-6.58	-6.34	-6.91	-13.53	-13.52	-13.33
69	201	-7.67	-7.37	-7.97	-12.67	-12.92	-13.07
69	204	-8.79	-8.41	-9.02	-11.57	-12.13	-12.69
69	207	-9.74	-9.31	-9.89	-10.49	-11.28	-12.24
69	210	-10.35	-9.91	-10.41	-9.72	-10.55	-11.77
69	213	-10.69	-10.28	-10.65	-9.18	-9.83	-11.05
69	216	-10.96	-10.58	-10.84	-8.66	-9.02	-10.02
69	219	-11.18	-10.83	-10.98	-8.21	-8.27	-8.94
69	222	-11.36	-11.03	-11.11	-7.90	-7.71	-8.09
69	225	-11.51	-11.20	-11.25	-7.78	-7.49	-7.75
69	228	-11.64	-11.33	-11.38	-7.83	-7.52	-7.77
69	231	-11.73	-11.42	-11.48	-7.97	-7.61	-7.82
69	234	-11.82	-11.51	-11.58	-8.17	-7.75	-7.90
69	237	-11.91	-11.61	-11.71	-8.42	-7.92	-8.00
69	240	-12.02	-11.76	-11.90	-8.69	-8.12	-8.12
69	243	-12.19	-12.15	-12.52	-9.06	-8.48	-8.44
69	246	-12.43	-12.81	-13.68	-9.58	-9.07	-9.03
69	249	-12.66	-13.54	-14.98	-10.21	-9.80	-9.78
69	252	-12.84	-14.13	-16.04	-10.90	-10.59	-10.55
69	255	-12.91	-14.37	-16.48	-11.59	-11.34	-11.24
69	258	-12.82	-14.28	-16.39	-12.48	-12.21	-11.93
69	261	-12.58	-14.05	-16.14	-13.59	-13.25	-12.71
69	264	-12.25	-13.71	-15.77	-14.68	-14.24	-13.43
69	267	-11.87	-13.32	-15.33	-15.52	-15.00	-13.96
69	270	-11.49	-12.90	-14.85	-15.85	-15.29	-14.16
69	273	-11.08	-12.38	-14.20	-15.50	-14.92	-13.88
69	276	-10.58	-11.69	-13.30	-14.60	-13.97	-13.16
69	279	-10.04	-10.92	-12.28	-13.39	-12.71	-12.18
69	282	-9.50	-10.17	-11.29	-12.12	-11.39	-11.15
69	285	-8.99	-9.53	-10.46	-11.01	-10.28	-10.23
69	288	-8.53	-9.01	-9.82	-10.03	-9.35	-9.40
69	291	-8.07	-8.55	-9.25	-9.02	-8.41	-8.52
69	294	-7.62	-8.12	-8.71	-8.03	-7.52	-7.67
69	297	-7.17	-7.67	-8.17	-7.14	-6.73	-6.90
69	300	-6.71	-7.19	-7.61	-6.40	-6.09	-6.31
69	303	-6.23	-6.64	-6.96	-5.77	-5.57	-5.83
69	306	-5.71	-6.04	-6.27	-5.19	-5.09	-5.38
69	309	-5.21	-5.44	-5.59	-4.67	-4.68	-5.00
69	312	-4.76	-4.89	-4.98	-4.24	-4.34	-4.71
69	315	-4.42	-4.45	-4.48	-3.91	-4.10	-4.52
69	318	-4.14	-4.07	-4.05	-3.65	-3.92	-4.39
69	321	-3.88	-3.69	-3.64	-3.40	-3.75	-4.28
69	324	-3.65	-3.37	-3.28	-3.20	-3.61	-4.19
69	327	-3.50	-3.15	-3.02	-3.05	-3.52	-4.14
69	330	-3.44	-3.06	-2.93	-3.00	-3.49	-4.12
69	333	-3.57	-3.16	-3.01	-3.04	-3.55	-4.20
69	336	-3.94	-3.44	-3.25	-3.15	-3.71	-4.42
69	339	-4.50	-3.87	-3.61	-3.32	-3.96	-4.73

69	342	-5.22	-4.42	-4.07	-3.53	-4.26	-5.09
69	345	-6.05	-5.06	-4.60	-3.76	-4.58	-5.45
69	348	-7.41	-6.13	-5.49	-4.11	-5.00	-5.85
69	351	-9.61	-7.90	-6.95	-4.65	-5.57	-6.32
69	354	-12.47	-10.23	-8.85	-5.34	-6.26	-6.85
69	357	-15.83	-12.96	-11.09	-6.15	-7.05	-7.44
69	360	-19.50	-15.95	-13.54	-7.02	-7.91	-8.08
72	0	-16.29	-13.73	-12.63	-6.91	-7.87	-8.10
72	3	-14.73	-13.34	-12.62	-7.89	-8.31	-8.07
72	6	-13.28	-12.87	-12.59	-8.72	-8.61	-7.98
72	9	-11.96	-12.34	-12.54	-9.35	-8.79	-7.86
72	12	-10.79	-11.74	-12.47	-9.76	-8.88	-7.71
72	15	-9.80	-11.10	-12.38	-9.91	-8.91	-7.54
72	18	-8.88	-10.22	-11.71	-9.75	-8.70	-7.26
72	21	-7.97	-9.07	-10.26	-9.37	-8.19	-6.83
72	24	-7.18	-7.91	-8.56	-8.93	-7.59	-6.37
72	27	-6.62	-7.02	-7.14	-8.55	-7.08	-6.01
72	30	-6.41	-6.66	-6.55	-8.40	-6.87	-5.86
72	33	-6.58	-6.75	-6.58	-8.44	-6.93	-5.95
72	36	-7.04	-6.99	-6.66	-8.57	-7.11	-6.17
72	39	-7.66	-7.34	-6.78	-8.77	-7.38	-6.51
72	42	-8.35	-7.73	-6.94	-9.01	-7.71	-6.91
72	45	-8.98	-8.13	-7.12	-9.30	-8.07	-7.35
72	48	-9.67	-8.65	-7.54	-9.75	-8.59	-7.94
72	51	-10.50	-9.33	-8.29	-10.48	-9.36	-8.76
72	54	-11.31	-10.05	-9.19	-11.39	-10.30	-9.71
72	57	-11.92	-10.67	-10.06	-12.43	-11.35	-10.73
72	60	-12.16	-11.06	-10.74	-13.51	-12.46	-11.73
72	63	-12.14	-11.24	-11.20	-14.66	-13.79	-12.90
72	66	-12.09	-11.37	-11.58	-15.97	-15.42	-14.30
72	69	-12.04	-11.48	-11.93	-17.44	-17.14	-15.65
72	72	-12.00	-11.60	-12.31	-19.09	-18.75	-16.66
72	75	-11.98	-11.76	-12.75	-20.91	-20.04	-17.06
72	78	-12.07	-12.04	-13.41	-23.55	-21.14	-16.96
72	81	-12.28	-12.42	-14.26	-27.07	-22.24	-16.71
72	84	-12.55	-12.85	-15.11	-30.62	-23.20	-16.39
72	87	-12.84	-13.24	-15.76	-33.37	-23.87	-16.07
72	90	-13.08	-13.55	-16.02	-34.48	-24.13	-15.83
72	93	-13.29	-13.79	-15.98	-33.63	-23.82	-15.66
72	96	-13.51	-14.02	-15.87	-31.51	-23.06	-15.49
72	99	-13.71	-14.22	-15.68	-28.76	-22.04	-15.34
72	102	-13.86	-14.36	-15.44	-26.01	-21.00	-15.23
72	105	-13.92	-14.42	-15.14	-23.90	-20.13	-15.19
72	108	-13.27	-13.70	-14.15	-22.43	-19.46	-15.42
72	111	-11.67	-11.91	-12.20	-21.11	-18.85	-15.98
72	114	-9.60	-9.61	-9.82	-19.91	-18.26	-16.64
72	117	-7.55	-7.37	-7.55	-18.77	-17.65	-17.19
72	120	-6.01	-5.76	-5.94	-17.64	-16.98	-17.43
72	123	-4.89	-4.66	-4.85	-16.48	-16.24	-17.23
72	126	-3.83	-3.65	-3.86	-15.34	-15.42	-16.74
72	129	-2.89	-2.77	-3.01	-14.24	-14.59	-16.06
72	132	-2.15	-2.08	-2.35	-13.24	-13.77	-15.32
72	135	-1.67	-1.64	-1.93	-12.36	-13.01	-14.65
72	138	-1.37	-1.36	-1.67	-11.52	-12.22	-13.94
72	141	-1.10	-1.10	-1.44	-10.66	-11.37	-13.13
72	144	-0.89	-0.91	-1.26	-9.90	-10.59	-12.34
72	147	-0.75	-0.77	-1.14	-9.36	-10.01	-11.71
72	150	-0.70	-0.73	-1.10	-9.15	-9.74	-11.39

72	153	-0.76	-0.77	-1.14	-9.17	-9.69	-11.26
72	156	-0.93	-0.89	-1.24	-9.23	-9.64	-11.16
72	159	-1.16	-1.06	-1.39	-9.33	-9.61	-11.08
72	162	-1.41	-1.25	-1.56	-9.46	-9.59	-11.03
72	165	-1.67	-1.44	-1.74	-9.61	-9.58	-11.01
72	168	-1.91	-1.63	-1.93	-10.12	-9.93	-11.28
72	171	-2.18	-1.84	-2.14	-11.11	-10.78	-11.91
72	174	-2.47	-2.09	-2.39	-12.23	-11.80	-12.67
72	177	-2.81	-2.38	-2.69	-13.16	-12.65	-13.30
72	180	-3.20	-2.72	-3.04	-13.54	-13.00	-13.57
72	183	-3.69	-3.20	-3.57	-13.51	-13.00	-13.53
72	186	-4.31	-3.86	-4.30	-13.43	-12.99	-13.42
72	189	-5.01	-4.62	-5.14	-13.30	-12.97	-13.26
72	192	-5.76	-5.42	-6.01	-13.14	-12.94	-13.05
72	195	-6.50	-6.18	-6.80	-12.95	-12.91	-12.81
72	198	-7.38	-7.02	-7.63	-12.43	-12.53	-12.36
72	201	-8.44	-7.99	-8.56	-11.49	-11.64	-11.60
72	204	-9.45	-8.92	-9.42	-10.38	-10.52	-10.72
72	207	-10.22	-9.61	-10.05	-9.38	-9.46	-9.86
72	210	-10.52	-9.88	-10.30	-8.74	-8.72	-9.18
72	213	-10.39	-9.75	-10.14	-8.39	-8.24	-8.63
72	216	-10.06	-9.45	-9.77	-8.08	-7.79	-8.07
72	219	-9.67	-9.09	-9.32	-7.82	-7.41	-7.58
72	222	-9.32	-8.79	-8.94	-7.65	-7.15	-7.24
72	225	-9.13	-8.66	-8.78	-7.59	-7.05	-7.10
72	228	-9.07	-8.67	-8.81	-7.65	-7.10	-7.16
72	231	-9.02	-8.71	-8.89	-7.81	-7.26	-7.31
72	234	-8.98	-8.76	-9.03	-8.05	-7.49	-7.54
72	237	-8.95	-8.83	-9.19	-8.33	-7.77	-7.81
72	240	-8.95	-8.91	-9.39	-8.64	-8.09	-8.12
72	243	-9.13	-9.24	-9.93	-9.04	-8.54	-8.59
72	246	-9.57	-9.92	-10.90	-9.58	-9.19	-9.28
72	249	-10.12	-10.71	-11.99	-10.22	-9.96	-10.09
72	252	-10.61	-11.39	-12.89	-10.92	-10.78	-10.90
72	255	-10.88	-11.75	-13.28	-11.65	-11.56	-11.58
72	258	-10.99	-11.85	-13.30	-12.60	-12.43	-12.22
72	261	-11.08	-11.94	-13.32	-13.81	-13.45	-12.90
72	264	-11.15	-12.01	-13.34	-15.00	-14.43	-13.51
72	267	-11.20	-12.05	-13.35	-15.91	-15.15	-13.95
72	270	-11.21	-12.06	-13.35	-16.28	-15.44	-14.12
72	273	-11.06	-11.87	-13.12	-15.92	-15.07	-13.85
72	276	-10.68	-11.39	-12.53	-15.02	-14.12	-13.14
72	279	-10.15	-10.74	-11.75	-13.80	-12.85	-12.19
72	282	-9.60	-10.07	-10.94	-12.51	-11.53	-11.17
72	285	-9.10	-9.50	-10.26	-11.38	-10.42	-10.26
72	288	-8.67	-9.06	-9.73	-10.37	-9.47	-9.42
72	291	-8.23	-8.64	-9.24	-9.32	-8.50	-8.52
72	294	-7.80	-8.23	-8.76	-8.29	-7.59	-7.64
72	297	-7.35	-7.81	-8.26	-7.36	-6.77	-6.85
72	300	-6.89	-7.35	-7.73	-6.57	-6.11	-6.23
72	303	-6.39	-6.81	-7.12	-5.91	-5.57	-5.73
72	306	-5.84	-6.19	-6.45	-5.29	-5.08	-5.28
72	309	-5.30	-5.57	-5.77	-4.74	-4.66	-4.88
72	312	-4.81	-4.99	-5.15	-4.27	-4.30	-4.57
72	315	-4.42	-4.51	-4.63	-3.91	-4.03	-4.35
72	318	-4.08	-4.09	-4.16	-3.61	-3.82	-4.19
72	321	-3.74	-3.67	-3.69	-3.33	-3.61	-4.05
72	324	-3.45	-3.30	-3.29	-3.09	-3.45	-3.94

72	327	-3.25	-3.03	-3.00	-2.93	-3.33	-3.86
72	330	-3.18	-2.93	-2.89	-2.87	-3.29	-3.83
72	333	-3.28	-3.02	-2.96	-2.91	-3.35	-3.91
72	336	-3.58	-3.24	-3.16	-3.00	-3.50	-4.12
72	339	-4.04	-3.60	-3.47	-3.15	-3.73	-4.42
72	342	-4.63	-4.05	-3.86	-3.34	-4.00	-4.77
72	345	-5.30	-4.58	-4.32	-3.55	-4.31	-5.14
72	348	-6.41	-5.47	-5.12	-3.90	-4.73	-5.56
72	351	-8.20	-6.96	-6.47	-4.45	-5.33	-6.08
72	354	-10.55	-8.92	-8.25	-5.16	-6.08	-6.69
72	357	-13.29	-11.22	-10.34	-5.99	-6.93	-7.37
72	360	-16.29	-13.73	-12.63	-6.91	-7.87	-8.10
75	0	-14.94	-12.80	-12.25	-6.86	-7.85	-8.13
75	3	-13.80	-12.73	-12.57	-7.84	-8.29	-8.09
75	6	-12.72	-12.52	-12.77	-8.62	-8.56	-7.98
75	9	-11.73	-12.22	-12.87	-9.20	-8.71	-7.83
75	12	-10.82	-11.85	-12.91	-9.55	-8.76	-7.64
75	15	-10.01	-11.45	-12.91	-9.67	-8.77	-7.44
75	18	-9.21	-10.74	-12.31	-9.44	-8.50	-7.08
75	21	-8.39	-9.66	-10.87	-8.88	-7.86	-6.54
75	24	-7.67	-8.50	-9.16	-8.22	-7.09	-5.95
75	27	-7.15	-7.57	-7.73	-7.66	-6.44	-5.49
75	30	-6.96	-7.20	-7.13	-7.43	-6.17	-5.30
75	33	-7.14	-7.29	-7.16	-7.45	-6.21	-5.36
75	36	-7.60	-7.55	-7.27	-7.53	-6.33	-5.51
75	39	-8.24	-7.91	-7.43	-7.66	-6.50	-5.73
75	42	-8.94	-8.32	-7.63	-7.82	-6.72	-6.02
75	45	-9.59	-8.74	-7.86	-8.01	-6.98	-6.34
75	48	-10.31	-9.28	-8.30	-8.40	-7.42	-6.84
75	51	-11.16	-9.99	-9.01	-9.08	-8.15	-7.63
75	54	-11.99	-10.72	-9.86	-9.99	-9.09	-8.60
75	57	-12.61	-11.35	-10.68	-11.02	-10.18	-9.66
75	60	-12.86	-11.71	-11.33	-12.10	-11.34	-10.73
75	63	-12.81	-11.87	-11.79	-13.27	-12.83	-12.05
75	66	-12.71	-11.97	-12.17	-14.63	-14.75	-13.72
75	69	-12.59	-12.05	-12.52	-16.19	-16.82	-15.35
75	72	-12.48	-12.15	-12.90	-17.95	-18.71	-16.60
75	75	-12.44	-12.30	-13.37	-19.92	-20.13	-17.09
75	78	-12.54	-12.59	-14.11	-22.88	-21.23	-16.99
75	81	-12.80	-13.05	-15.08	-26.91	-22.28	-16.74
75	84	-13.13	-13.57	-16.07	-31.03	-23.18	-16.38
75	87	-13.46	-14.05	-16.84	-34.23	-23.80	-15.99
75	90	-13.70	-14.38	-17.15	-35.51	-24.03	-15.63
75	93	-13.88	-14.61	-17.09	-34.63	-23.53	-15.23
75	96	-14.06	-14.82	-16.93	-32.41	-22.29	-14.74
75	99	-14.22	-15.00	-16.67	-29.51	-20.71	-14.26
75	102	-14.33	-15.12	-16.33	-26.59	-19.16	-13.90
75	105	-14.37	-15.16	-15.92	-24.28	-18.05	-13.76
75	108	-13.62	-14.32	-14.75	-22.57	-17.36	-13.78
75	111	-11.77	-12.25	-12.52	-21.00	-16.80	-13.82
75	114	-9.39	-9.61	-9.83	-19.55	-16.30	-13.87
75	117	-7.08	-7.08	-7.31	-18.19	-15.80	-13.91
75	120	-5.41	-5.31	-5.56	-16.91	-15.23	-13.93
75	123	-4.29	-4.20	-4.45	-15.65	-14.58	-13.86
75	126	-3.27	-3.20	-3.46	-14.41	-13.87	-13.69
75	129	-2.38	-2.35	-2.63	-13.26	-13.15	-13.45
75	132	-1.68	-1.67	-1.97	-12.26	-12.47	-13.18
75	135	-1.19	-1.21	-1.53	-11.47	-11.87	-12.91



75	138	-0.84	-0.88	-1.22	-10.79	-11.29	-12.56
75	141	-0.52	-0.59	-0.94	-10.15	-10.68	-12.10
75	144	-0.27	-0.35	-0.72	-9.60	-10.14	-11.63
75	147	-0.10	-0.19	-0.57	-9.22	-9.75	-11.27
75	150	-0.04	-0.13	-0.51	-9.07	-9.60	-11.13
75	153	-0.13	-0.19	-0.57	-9.11	-9.61	-11.13
75	156	-0.36	-0.36	-0.71	-9.23	-9.66	-11.14
75	159	-0.67	-0.59	-0.91	-9.40	-9.73	-11.16
75	162	-1.03	-0.86	-1.15	-9.62	-9.82	-11.18
75	165	-1.38	-1.14	-1.39	-9.88	-9.93	-11.21
75	168	-1.73	-1.42	-1.66	-10.48	-10.37	-11.51
75	171	-2.11	-1.74	-1.99	-11.53	-11.23	-12.19
75	174	-2.52	-2.11	-2.37	-12.68	-12.23	-12.99
75	177	-2.98	-2.52	-2.80	-13.61	-13.04	-13.65
75	180	-3.47	-2.98	-3.28	-14.00	-13.38	-13.93
75	183	-4.04	-3.55	-3.90	-13.88	-13.31	-13.83
75	186	-4.68	-4.23	-4.67	-13.55	-13.11	-13.55
75	189	-5.38	-4.98	-5.52	-13.09	-12.82	-13.15
75	192	-6.10	-5.74	-6.37	-12.56	-12.46	-12.67
75	195	-6.82	-6.46	-7.12	-12.02	-12.07	-12.17
75	198	-7.67	-7.25	-7.87	-11.32	-11.43	-11.49
75	201	-8.66	-8.14	-8.68	-10.39	-10.48	-10.55
75	204	-9.60	-8.97	-9.42	-9.43	-9.42	-9.54
75	207	-10.31	-9.59	-9.96	-8.63	-8.49	-8.64
75	210	-10.58	-9.83	-10.17	-8.17	-7.91	-8.06
75	213	-10.27	-9.51	-9.83	-7.96	-7.59	-7.69
75	216	-9.52	-8.76	-9.02	-7.78	-7.31	-7.37
75	219	-8.59	-7.86	-8.06	-7.64	-7.09	-7.10
75	222	-7.77	-7.11	-7.25	-7.55	-6.94	-6.92
75	225	-7.32	-6.80	-6.91	-7.52	-6.88	-6.86
75	228	-7.16	-6.80	-6.94	-7.58	-6.94	-6.93
75	231	-7.03	-6.82	-7.02	-7.74	-7.12	-7.12
75	234	-6.93	-6.84	-7.15	-7.97	-7.37	-7.40
75	237	-6.86	-6.87	-7.31	-8.26	-7.69	-7.74
75	240	-6.83	-6.91	-7.51	-8.57	-8.03	-8.11
75	243	-7.02	-7.18	-7.94	-8.97	-8.51	-8.63
75	246	-7.50	-7.77	-8.69	-9.53	-9.19	-9.38
75	249	-8.13	-8.52	-9.57	-10.19	-10.00	-10.22
75	252	-8.76	-9.25	-10.39	-10.92	-10.84	-11.04
75	255	-9.26	-9.79	-10.94	-11.67	-11.64	-11.72
75	258	-9.68	-10.20	-11.28	-12.65	-12.52	-12.33
75	261	-10.12	-10.59	-11.60	-13.89	-13.53	-12.96
75	264	-10.51	-10.94	-11.87	-15.12	-14.49	-13.52
75	267	-10.79	-11.18	-12.05	-16.07	-15.21	-13.92
75	270	-10.89	-11.27	-12.12	-16.44	-15.49	-14.07
75	273	-10.77	-11.14	-11.97	-16.09	-15.12	-13.80
75	276	-10.46	-10.82	-11.60	-15.18	-14.17	-13.12
75	279	-10.03	-10.37	-11.09	-13.97	-12.91	-12.18
75	282	-9.56	-9.89	-10.55	-12.67	-11.59	-11.18
75	285	-9.14	-9.47	-10.06	-11.53	-10.47	-10.28
75	288	-8.75	-9.09	-9.64	-10.51	-9.51	-9.42
75	291	-8.36	-8.73	-9.21	-9.44	-8.55	-8.50
75	294	-7.96	-8.35	-8.78	-8.40	-7.63	-7.58
75	297	-7.53	-7.94	-8.32	-7.45	-6.80	-6.76
75	300	-7.08	-7.50	-7.82	-6.65	-6.12	-6.12
75	303	-6.56	-6.96	-7.25	-5.96	-5.56	-5.60
75	306	-5.98	-6.35	-6.60	-5.34	-5.04	-5.12
75	309	-5.39	-5.71	-5.93	-4.77	-4.59	-4.70

75	312	-4.85	-5.11	-5.30	-4.29	-4.21	-4.37
75	315	-4.42	-4.60	-4.76	-3.91	-3.93	-4.15
75	318	-4.05	-4.15	-4.27	-3.58	-3.69	-4.00
75	321	-3.68	-3.69	-3.76	-3.26	-3.47	-3.86
75	324	-3.37	-3.28	-3.31	-2.99	-3.29	-3.76
75	327	-3.15	-2.99	-3.00	-2.80	-3.17	-3.68
75	330	-3.07	-2.88	-2.87	-2.73	-3.12	-3.66
75	333	-3.17	-2.96	-2.94	-2.77	-3.18	-3.74
75	336	-3.44	-3.17	-3.13	-2.87	-3.34	-3.95
75	339	-3.85	-3.49	-3.41	-3.04	-3.59	-4.27
75	342	-4.38	-3.90	-3.78	-3.24	-3.88	-4.63
75	345	-4.99	-4.38	-4.21	-3.48	-4.21	-5.02
75	348	-5.99	-5.20	-4.98	-3.84	-4.65	-5.45
75	351	-7.62	-6.57	-6.28	-4.40	-5.26	-6.00
75	354	-9.74	-8.37	-8.00	-5.11	-6.02	-6.64
75	357	-12.22	-10.49	-10.03	-5.95	-6.90	-7.35
75	360	-14.94	-12.80	-12.25	-6.86	-7.85	-8.13
78	0	-14.99	-13.02	-12.40	-6.89	-7.90	-8.29
78	3	-13.78	-12.86	-12.61	-7.77	-8.21	-8.21
78	6	-12.66	-12.60	-12.73	-8.45	-8.40	-8.06
78	9	-11.64	-12.25	-12.80	-8.92	-8.50	-7.85
78	12	-10.74	-11.84	-12.82	-9.20	-8.53	-7.61
78	15	-9.96	-11.39	-12.82	-9.29	-8.54	-7.34
78	18	-9.24	-10.68	-12.26	-9.01	-8.23	-6.91
78	21	-8.51	-9.66	-10.91	-8.35	-7.50	-6.28
78	24	-7.89	-8.59	-9.30	-7.56	-6.63	-5.62
78	27	-7.44	-7.76	-7.95	-6.90	-5.90	-5.11
78	30	-7.28	-7.42	-7.38	-6.62	-5.60	-4.90
78	33	-7.43	-7.50	-7.43	-6.63	-5.63	-4.94
78	36	-7.84	-7.73	-7.54	-6.68	-5.71	-5.05
78	39	-8.40	-8.04	-7.72	-6.75	-5.83	-5.23
78	42	-9.01	-8.41	-7.93	-6.85	-5.99	-5.46
78	45	-9.57	-8.78	-8.18	-6.97	-6.18	-5.72
78	48	-10.20	-9.26	-8.58	-7.29	-6.56	-6.16
78	51	-10.96	-9.89	-9.21	-7.92	-7.23	-6.89
78	54	-11.69	-10.55	-9.95	-8.78	-8.13	-7.82
78	57	-12.24	-11.12	-10.66	-9.77	-9.18	-8.86
78	60	-12.46	-11.46	-11.24	-10.82	-10.31	-9.93
78	63	-12.42	-11.61	-11.66	-11.97	-11.84	-11.35
78	66	-12.33	-11.71	-12.02	-13.34	-13.89	-13.21
78	69	-12.22	-11.79	-12.35	-14.94	-16.11	-15.06
78	72	-12.13	-11.89	-12.71	-16.76	-18.16	-16.49
78	75	-12.09	-12.04	-13.16	-18.79	-19.69	-17.06
78	78	-12.19	-12.32	-13.85	-21.85	-20.86	-16.99
78	81	-12.46	-12.76	-14.78	-26.05	-21.98	-16.79
78	84	-12.81	-13.27	-15.72	-30.35	-22.93	-16.50
78	87	-13.18	-13.77	-16.46	-33.69	-23.60	-16.17
78	90	-13.48	-14.17	-16.75	-35.04	-23.85	-15.84
78	93	-13.77	-14.53	-16.72	-34.10	-23.23	-15.42
78	96	-14.08	-14.89	-16.65	-31.76	-21.70	-14.87
78	99	-14.37	-15.22	-16.53	-28.70	-19.78	-14.29
78	102	-14.58	-15.45	-16.36	-25.64	-17.96	-13.81
78	105	-14.66	-15.54	-16.16	-23.26	-16.75	-13.53
78	108	-13.90	-14.69	-15.13	-21.53	-16.10	-13.41
78	111	-12.03	-12.59	-12.91	-19.95	-15.59	-13.33
78	114	-9.62	-9.90	-10.17	-18.51	-15.15	-13.27
78	117	-7.26	-7.31	-7.55	-17.19	-14.73	-13.20
78	120	-5.53	-5.47	-5.71	-15.98	-14.26	-13.11

78	123	-4.35	-4.27	-4.52	-14.84	-13.73	-12.98
78	126	-3.25	-3.20	-3.46	-13.74	-13.17	-12.83
78	129	-2.29	-2.28	-2.55	-12.74	-12.61	-12.66
78	132	-1.51	-1.53	-1.83	-11.88	-12.09	-12.48
78	135	-0.95	-0.99	-1.31	-11.21	-11.62	-12.30
78	138	-0.52	-0.58	-0.91	-10.64	-11.16	-12.07
78	141	-0.12	-0.21	-0.56	-10.10	-10.67	-11.80
78	144	0.20	0.10	-0.26	-9.64	-10.24	-11.54
78	147	0.42	0.30	-0.07	-9.33	-9.92	-11.34
78	150	0.50	0.38	0.00	-9.21	-9.80	-11.26
78	153	0.41	0.31	-0.06	-9.24	-9.83	-11.27
78	156	0.16	0.11	-0.23	-9.34	-9.90	-11.31
78	159	-0.20	-0.16	-0.47	-9.48	-10.00	-11.37
78	162	-0.60	-0.48	-0.76	-9.66	-10.14	-11.44
78	165	-1.00	-0.81	-1.06	-9.87	-10.29	-11.53
78	168	-1.43	-1.19	-1.41	-10.38	-10.67	-11.80
78	171	-1.94	-1.65	-1.87	-11.26	-11.34	-12.30
78	174	-2.50	-2.17	-2.39	-12.25	-12.09	-12.87
78	177	-3.08	-2.73	-2.96	-13.04	-12.69	-13.34
78	180	-3.66	-3.29	-3.54	-13.37	-12.94	-13.53
78	183	-4.26	-3.88	-4.19	-13.20	-12.82	-13.39
78	186	-4.88	-4.52	-4.92	-12.75	-12.51	-13.03
78	189	-5.52	-5.18	-5.68	-12.15	-12.08	-12.51
78	192	-6.17	-5.83	-6.41	-11.49	-11.58	-11.94
78	195	-6.81	-6.45	-7.04	-10.89	-11.09	-11.38
78	198	-7.54	-7.12	-7.65	-10.26	-10.50	-10.74
78	201	-8.38	-7.85	-8.29	-9.53	-9.75	-9.97
78	204	-9.17	-8.53	-8.85	-8.82	-8.97	-9.18
78	207	-9.76	-9.03	-9.26	-8.25	-8.30	-8.49
78	210	-9.99	-9.23	-9.42	-7.94	-7.86	-8.01
78	213	-9.60	-8.84	-9.01	-7.81	-7.59	-7.69
78	216	-8.66	-7.92	-8.04	-7.70	-7.35	-7.40
78	219	-7.52	-6.82	-6.89	-7.61	-7.15	-7.16
78	222	-6.52	-5.90	-5.92	-7.56	-7.02	-7.00
78	225	-6.00	-5.51	-5.51	-7.54	-6.98	-6.94
78	228	-5.85	-5.52	-5.54	-7.59	-7.02	-7.00
78	231	-5.73	-5.54	-5.63	-7.70	-7.16	-7.16
78	234	-5.63	-5.57	-5.77	-7.88	-7.36	-7.40
78	237	-5.57	-5.61	-5.94	-8.10	-7.61	-7.70
78	240	-5.55	-5.66	-6.15	-8.34	-7.89	-8.03
78	243	-5.73	-5.91	-6.55	-8.69	-8.30	-8.50
78	246	-6.18	-6.45	-7.22	-9.19	-8.93	-9.19
78	249	-6.79	-7.14	-8.01	-9.81	-9.67	-9.99
78	252	-7.44	-7.85	-8.78	-10.49	-10.46	-10.76
78	255	-8.00	-8.43	-9.37	-11.20	-11.20	-11.40
78	258	-8.54	-8.94	-9.84	-12.12	-12.03	-11.98
78	261	-9.15	-9.48	-10.31	-13.29	-12.99	-12.57
78	264	-9.72	-9.97	-10.72	-14.47	-13.91	-13.10
78	267	-10.15	-10.33	-11.01	-15.36	-14.60	-13.48
78	270	-10.31	-10.46	-11.12	-15.72	-14.87	-13.63
78	273	-10.23	-10.39	-11.04	-15.40	-14.53	-13.38
78	276	-10.01	-10.20	-10.81	-14.57	-13.66	-12.73
78	279	-9.71	-9.93	-10.49	-13.45	-12.49	-11.85
78	282	-9.38	-9.63	-10.14	-12.25	-11.27	-10.90
78	285	-9.06	-9.34	-9.80	-11.18	-10.21	-10.03
78	288	-8.76	-9.06	-9.47	-10.19	-9.29	-9.19
78	291	-8.44	-8.75	-9.13	-9.14	-8.34	-8.26
78	294	-8.10	-8.41	-8.75	-8.10	-7.42	-7.34

78	297	-7.73	-8.04	-8.34	-7.15	-6.59	-6.51
78	300	-7.31	-7.63	-7.89	-6.36	-5.91	-5.86
78	303	-6.80	-7.12	-7.35	-5.70	-5.33	-5.32
78	306	-6.19	-6.51	-6.72	-5.08	-4.79	-4.82
78	309	-5.55	-5.86	-6.05	-4.53	-4.32	-4.39
78	312	-4.96	-5.24	-5.41	-4.07	-3.93	-4.06
78	315	-4.50	-4.72	-4.87	-3.69	-3.65	-3.87
78	318	-4.12	-4.25	-4.36	-3.37	-3.44	-3.76
78	321	-3.76	-3.77	-3.84	-3.06	-3.25	-3.68
78	324	-3.44	-3.35	-3.37	-2.80	-3.10	-3.61
78	327	-3.22	-3.05	-3.04	-2.62	-2.99	-3.56
78	330	-3.14	-2.94	-2.91	-2.55	-2.95	-3.55
78	333	-3.24	-3.01	-2.97	-2.60	-3.03	-3.64
78	336	-3.52	-3.22	-3.16	-2.74	-3.23	-3.89
78	339	-3.94	-3.55	-3.45	-2.95	-3.52	-4.25
78	342	-4.47	-3.97	-3.82	-3.21	-3.88	-4.66
78	345	-5.09	-4.45	-4.25	-3.50	-4.26	-5.09
78	348	-6.10	-5.29	-5.03	-3.90	-4.73	-5.56
78	351	-7.71	-6.68	-6.35	-4.47	-5.35	-6.13
78	354	-9.82	-8.51	-8.09	-5.18	-6.11	-6.78
78	357	-12.29	-10.66	-10.15	-6.00	-6.97	-7.50
78	360	-14.99	-13.02	-12.40	-6.89	-7.90	-8.29
81	0	-15.09	-13.53	-12.76	-6.97	-8.02	-8.62
81	3	-13.79	-13.17	-12.75	-7.68	-8.11	-8.45
81	6	-12.58	-12.75	-12.73	-8.19	-8.16	-8.22
81	9	-11.51	-12.28	-12.69	-8.52	-8.19	-7.93
81	12	-10.58	-11.77	-12.65	-8.70	-8.20	-7.61
81	15	-9.84	-11.22	-12.59	-8.75	-8.20	-7.25
81	18	-9.19	-10.48	-12.02	-8.44	-7.87	-6.74
81	21	-8.56	-9.53	-10.77	-7.71	-7.09	-6.03
81	24	-8.03	-8.58	-9.30	-6.83	-6.15	-5.31
81	27	-7.67	-7.86	-8.07	-6.10	-5.37	-4.75
81	30	-7.53	-7.57	-7.56	-5.80	-5.04	-4.52
81	33	-7.67	-7.65	-7.61	-5.80	-5.06	-4.55
81	36	-8.04	-7.85	-7.73	-5.82	-5.11	-4.64
81	39	-8.54	-8.15	-7.91	-5.84	-5.19	-4.78
81	42	-9.07	-8.48	-8.14	-5.88	-5.29	-4.95
81	45	-9.53	-8.81	-8.39	-5.92	-5.42	-5.16
81	48	-9.99	-9.19	-8.76	-6.16	-5.73	-5.55
81	51	-10.51	-9.66	-9.31	-6.72	-6.34	-6.22
81	54	-11.00	-10.15	-9.94	-7.52	-7.17	-7.10
81	57	-11.36	-10.57	-10.55	-8.45	-8.16	-8.11
81	60	-11.51	-10.85	-11.04	-9.44	-9.22	-9.17
81	63	-11.48	-10.99	-11.39	-10.55	-10.68	-10.66
81	66	-11.42	-11.09	-11.68	-11.91	-12.67	-12.68
81	69	-11.34	-11.17	-11.96	-13.52	-14.87	-14.73
81	72	-11.28	-11.27	-12.26	-15.36	-16.94	-16.33
81	75	-11.25	-11.42	-12.64	-17.40	-18.57	-16.97
81	78	-11.37	-11.70	-13.21	-20.48	-19.92	-16.95
81	81	-11.68	-12.13	-13.97	-24.72	-21.26	-16.87
81	84	-12.10	-12.65	-14.76	-29.06	-22.42	-16.76
81	87	-12.56	-13.18	-15.42	-32.45	-23.24	-16.61
81	90	-12.97	-13.67	-15.79	-33.81	-23.55	-16.44
81	93	-13.39	-14.17	-15.96	-32.72	-22.83	-16.04
81	96	-13.90	-14.74	-16.10	-30.03	-21.05	-15.35
81	99	-14.38	-15.27	-16.21	-26.59	-18.84	-14.54
81	102	-14.73	-15.66	-16.28	-23.24	-16.80	-13.81
81	105	-14.87	-15.81	-16.31	-20.83	-15.53	-13.34

81	108	-14.14	-14.99	-15.46	-19.29	-14.94	-13.09
81	111	-12.32	-12.95	-13.35	-17.95	-14.48	-12.89
81	114	-9.97	-10.32	-10.64	-16.77	-14.10	-12.73
81	117	-7.62	-7.75	-8.00	-15.72	-13.75	-12.59
81	120	-5.85	-5.85	-6.08	-14.76	-13.37	-12.44
81	123	-4.57	-4.55	-4.79	-13.84	-12.95	-12.28
81	126	-3.37	-3.36	-3.61	-12.97	-12.53	-12.13
81	129	-2.30	-2.31	-2.58	-12.17	-12.11	-11.98
81	132	-1.40	-1.44	-1.74	-11.50	-11.73	-11.86
81	135	-0.75	-0.81	-1.12	-10.99	-11.41	-11.78
81	138	-0.22	-0.31	-0.63	-10.57	-11.12	-11.72
81	141	0.26	0.15	-0.18	-10.18	-10.82	-11.66
81	144	0.66	0.53	0.19	-9.85	-10.55	-11.62
81	147	0.93	0.79	0.44	-9.62	-10.37	-11.59
81	150	1.03	0.88	0.53	-9.54	-10.30	-11.58
81	153	0.94	0.80	0.46	-9.55	-10.32	-11.61
81	156	0.69	0.60	0.27	-9.59	-10.39	-11.69
81	159	0.34	0.30	-0.01	-9.66	-10.48	-11.79
81	162	-0.07	-0.06	-0.33	-9.75	-10.59	-11.90
81	165	-0.49	-0.43	-0.68	-9.85	-10.71	-12.01
81	168	-1.01	-0.91	-1.14	-10.12	-10.90	-12.12
81	171	-1.68	-1.54	-1.75	-10.62	-11.19	-12.26
81	174	-2.42	-2.26	-2.45	-11.18	-11.49	-12.39
81	177	-3.17	-2.98	-3.16	-11.63	-11.73	-12.50
81	180	-3.85	-3.64	-3.83	-11.82	-11.83	-12.53
81	183	-4.48	-4.25	-4.49	-11.64	-11.69	-12.38
81	186	-5.11	-4.86	-5.19	-11.17	-11.33	-11.98
81	189	-5.71	-5.45	-5.86	-10.57	-10.85	-11.44
81	192	-6.27	-5.98	-6.44	-9.95	-10.33	-10.86
81	195	-6.76	-6.42	-6.84	-9.45	-9.87	-10.34
81	198	-7.22	-6.80	-7.12	-9.04	-9.44	-9.84
81	201	-7.70	-7.19	-7.38	-8.62	-8.96	-9.30
81	204	-8.12	-7.52	-7.60	-8.23	-8.50	-8.78
81	207	-8.42	-7.75	-7.74	-7.94	-8.10	-8.32
81	210	-8.54	-7.84	-7.80	-7.79	-7.83	-7.99
81	213	-8.16	-7.47	-7.42	-7.73	-7.64	-7.74
81	216	-7.26	-6.60	-6.51	-7.67	-7.47	-7.50
81	219	-6.17	-5.56	-5.44	-7.63	-7.33	-7.31
81	222	-5.22	-4.69	-4.53	-7.61	-7.23	-7.17
81	225	-4.75	-4.32	-4.16	-7.60	-7.20	-7.12
81	228	-4.64	-4.33	-4.19	-7.62	-7.22	-7.16
81	231	-4.55	-4.36	-4.29	-7.66	-7.28	-7.26
81	234	-4.48	-4.40	-4.45	-7.73	-7.38	-7.41
81	237	-4.44	-4.46	-4.64	-7.82	-7.50	-7.60
81	240	-4.42	-4.54	-4.86	-7.93	-7.64	-7.82
81	243	-4.59	-4.79	-5.24	-8.14	-7.91	-8.18
81	246	-5.01	-5.29	-5.87	-8.50	-8.37	-8.74
81	249	-5.59	-5.93	-6.60	-8.97	-8.94	-9.41
81	252	-6.21	-6.61	-7.34	-9.51	-9.56	-10.08
81	255	-6.77	-7.19	-7.95	-10.06	-10.16	-10.64
81	258	-7.36	-7.75	-8.51	-10.83	-10.85	-11.15
81	261	-8.04	-8.38	-9.10	-11.85	-11.70	-11.68
81	264	-8.69	-8.96	-9.63	-12.88	-12.52	-12.17
81	267	-9.17	-9.39	-10.01	-13.68	-13.13	-12.52
81	270	-9.36	-9.55	-10.16	-14.01	-13.38	-12.65
81	273	-9.33	-9.53	-10.12	-13.76	-13.11	-12.43
81	276	-9.26	-9.46	-10.00	-13.11	-12.43	-11.86
81	279	-9.14	-9.35	-9.84	-12.22	-11.50	-11.08

81	282	-9.01	-9.23	-9.65	-11.24	-10.50	-10.23
81	285	-8.87	-9.10	-9.45	-10.34	-9.60	-9.44
81	288	-8.70	-8.93	-9.23	-9.43	-8.74	-8.65
81	291	-8.48	-8.70	-8.97	-8.42	-7.83	-7.77
81	294	-8.22	-8.43	-8.66	-7.40	-6.91	-6.89
81	297	-7.92	-8.11	-8.32	-6.46	-6.08	-6.08
81	300	-7.59	-7.76	-7.94	-5.69	-5.40	-5.45
81	303	-7.12	-7.29	-7.44	-5.05	-4.82	-4.91
81	306	-6.50	-6.69	-6.83	-4.46	-4.27	-4.40
81	309	-5.83	-6.03	-6.16	-3.93	-3.79	-3.95
81	312	-5.20	-5.40	-5.51	-3.49	-3.42	-3.64
81	315	-4.72	-4.88	-4.96	-3.18	-3.20	-3.51
81	318	-4.34	-4.41	-4.46	-2.93	-3.07	-3.49
81	321	-3.96	-3.93	-3.93	-2.71	-2.96	-3.47
81	324	-3.65	-3.50	-3.47	-2.52	-2.87	-3.46
81	327	-3.42	-3.20	-3.13	-2.40	-2.81	-3.46
81	330	-3.34	-3.09	-3.00	-2.35	-2.79	-3.45
81	333	-3.44	-3.16	-3.07	-2.42	-2.89	-3.57
81	336	-3.73	-3.38	-3.26	-2.60	-3.14	-3.87
81	339	-4.17	-3.72	-3.55	-2.88	-3.50	-4.29
81	342	-4.73	-4.15	-3.93	-3.21	-3.92	-4.78
81	345	-5.37	-4.66	-4.37	-3.56	-4.37	-5.27
81	348	-6.38	-5.52	-5.17	-4.00	-4.88	-5.79
81	351	-7.98	-6.96	-6.52	-4.59	-5.52	-6.39
81	354	-10.04	-8.86	-8.32	-5.29	-6.27	-7.07
81	357	-12.45	-11.09	-10.44	-6.09	-7.11	-7.82
81	360	-15.09	-13.53	-12.76	-6.97	-8.02	-8.62
84	0	-15.22	-14.13	-13.18	-7.05	-8.17	-9.01
84	3	-13.79	-13.51	-13.13	-7.58	-8.15	-8.73
84	6	-12.47	-12.88	-13.00	-7.90	-8.11	-8.40
84	9	-11.32	-12.25	-12.80	-8.07	-8.03	-8.02
84	12	-10.37	-11.62	-12.54	-8.14	-7.93	-7.61
84	15	-9.66	-10.97	-12.25	-8.15	-7.81	-7.17
84	18	-9.10	-10.22	-11.58	-7.83	-7.39	-6.57
84	21	-8.58	-9.35	-10.43	-7.07	-6.57	-5.80
84	24	-8.15	-8.54	-9.16	-6.16	-5.63	-5.03
84	27	-7.86	-7.93	-8.13	-5.39	-4.86	-4.44
84	30	-7.75	-7.69	-7.71	-5.05	-4.54	-4.20
84	33	-7.90	-7.77	-7.76	-5.02	-4.55	-4.22
84	36	-8.25	-7.97	-7.89	-5.00	-4.58	-4.29
84	39	-8.71	-8.25	-8.08	-4.99	-4.62	-4.39
84	42	-9.15	-8.55	-8.32	-4.98	-4.68	-4.53
84	45	-9.48	-8.82	-8.56	-4.97	-4.75	-4.69
84	48	-9.72	-9.09	-8.90	-5.16	-5.00	-5.03
84	51	-9.96	-9.38	-9.37	-5.66	-5.54	-5.64
84	54	-10.17	-9.67	-9.90	-6.38	-6.30	-6.47
84	57	-10.31	-9.92	-10.39	-7.23	-7.21	-7.43
84	60	-10.37	-10.12	-10.79	-8.13	-8.19	-8.46
84	63	-10.36	-10.25	-11.07	-9.18	-9.52	-9.96
84	66	-10.33	-10.35	-11.29	-10.52	-11.35	-12.06
84	69	-10.30	-10.43	-11.49	-12.10	-13.41	-14.24
84	72	-10.27	-10.53	-11.72	-13.91	-15.42	-16.00
84	75	-10.26	-10.68	-12.01	-15.93	-17.12	-16.83
84	78	-10.40	-10.96	-12.44	-18.96	-18.69	-17.02
84	81	-10.76	-11.40	-12.98	-23.14	-20.32	-17.16
84	84	-11.27	-11.93	-13.58	-27.42	-21.78	-17.27
84	87	-11.82	-12.51	-14.16	-30.76	-22.83	-17.34
84	90	-12.35	-13.06	-14.65	-32.10	-23.23	-17.37

84	93	-12.93	-13.71	-15.11	-30.84	-22.43	-16.99
84	96	-13.65	-14.50	-15.58	-27.76	-20.46	-16.08
84	99	-14.35	-15.25	-16.00	-23.88	-18.03	-14.94
84	102	-14.88	-15.83	-16.31	-20.26	-15.81	-13.88
84	105	-15.09	-16.05	-16.42	-17.92	-14.51	-13.20
84	108	-14.39	-15.27	-15.63	-16.72	-13.98	-12.84
84	111	-12.65	-13.33	-13.65	-15.74	-13.57	-12.55
84	114	-10.37	-10.81	-11.08	-14.92	-13.24	-12.31
84	117	-8.08	-8.30	-8.52	-14.21	-12.95	-12.11
84	120	-6.28	-6.37	-6.58	-13.54	-12.65	-11.94
84	123	-4.90	-4.95	-5.18	-12.87	-12.32	-11.78
84	126	-3.57	-3.61	-3.86	-12.23	-11.99	-11.63
84	129	-2.37	-2.41	-2.68	-11.65	-11.68	-11.50
84	132	-1.35	-1.41	-1.70	-11.18	-11.43	-11.41
84	135	-0.59	-0.67	-0.97	-10.83	-11.26	-11.38
84	138	0.01	-0.08	-0.40	-10.57	-11.15	-11.42
84	141	0.58	0.46	0.14	-10.34	-11.05	-11.53
84	144	1.04	0.90	0.58	-10.14	-10.97	-11.69
84	147	1.36	1.21	0.88	-10.00	-10.92	-11.85
84	150	1.48	1.32	0.99	-9.93	-10.90	-11.98
84	153	1.40	1.24	0.92	-9.89	-10.92	-12.11
84	156	1.17	1.03	0.71	-9.85	-10.97	-12.25
84	159	0.85	0.72	0.41	-9.83	-11.03	-12.38
84	162	0.45	0.34	0.05	-9.81	-11.08	-12.48
84	165	0.02	-0.07	-0.33	-9.80	-11.11	-12.51
84	168	-0.56	-0.64	-0.88	-9.81	-11.06	-12.43
84	171	-1.39	-1.45	-1.65	-9.82	-10.95	-12.21
84	174	-2.32	-2.37	-2.53	-9.84	-10.79	-11.91
84	177	-3.23	-3.25	-3.39	-9.85	-10.59	-11.56
84	180	-4.00	-3.97	-4.09	-9.85	-10.39	-11.23
84	183	-4.69	-4.60	-4.73	-9.67	-10.11	-10.87
84	186	-5.40	-5.24	-5.38	-9.23	-9.72	-10.44
84	189	-6.04	-5.80	-5.97	-8.69	-9.29	-9.99
84	192	-6.50	-6.21	-6.38	-8.21	-8.89	-9.57
84	195	-6.68	-6.36	-6.54	-7.95	-8.60	-9.21
84	198	-6.69	-6.35	-6.51	-7.86	-8.39	-8.91
84	201	-6.70	-6.32	-6.40	-7.78	-8.21	-8.63
84	204	-6.70	-6.26	-6.25	-7.72	-8.05	-8.38
84	207	-6.70	-6.19	-6.05	-7.68	-7.92	-8.16
84	210	-6.70	-6.11	-5.83	-7.67	-7.81	-7.97
84	213	-6.40	-5.75	-5.39	-7.67	-7.72	-7.80
84	216	-5.66	-5.04	-4.66	-7.67	-7.64	-7.63
84	219	-4.76	-4.23	-3.86	-7.67	-7.57	-7.49
84	222	-4.00	-3.55	-3.22	-7.67	-7.51	-7.39
84	225	-3.64	-3.28	-2.96	-7.67	-7.47	-7.35
84	228	-3.58	-3.29	-3.00	-7.64	-7.43	-7.36
84	231	-3.53	-3.33	-3.11	-7.58	-7.39	-7.38
84	234	-3.49	-3.39	-3.28	-7.51	-7.37	-7.42
84	237	-3.47	-3.48	-3.49	-7.46	-7.34	-7.47
84	240	-3.46	-3.58	-3.72	-7.43	-7.34	-7.54
84	243	-3.61	-3.83	-4.10	-7.50	-7.44	-7.74
84	246	-4.00	-4.30	-4.68	-7.70	-7.70	-8.15
84	249	-4.53	-4.89	-5.38	-8.00	-8.07	-8.68
84	252	-5.11	-5.52	-6.09	-8.34	-8.50	-9.22
84	255	-5.64	-6.08	-6.71	-8.71	-8.91	-9.68
84	258	-6.20	-6.66	-7.33	-9.28	-9.45	-10.12
84	261	-6.85	-7.31	-8.00	-10.12	-10.14	-10.60
84	264	-7.48	-7.92	-8.62	-10.99	-10.84	-11.03

84	267	-7.98	-8.39	-9.07	-11.68	-11.38	-11.35
84	270	-8.26	-8.62	-9.25	-11.96	-11.60	-11.48
84	273	-8.37	-8.68	-9.24	-11.79	-11.42	-11.29
84	276	-8.47	-8.72	-9.22	-11.35	-10.95	-10.82
84	279	-8.54	-8.76	-9.18	-10.73	-10.30	-10.16
84	282	-8.58	-8.78	-9.14	-10.03	-9.57	-9.43
84	285	-8.60	-8.79	-9.08	-9.33	-8.87	-8.74
84	288	-8.56	-8.74	-8.98	-8.54	-8.11	-8.03
84	291	-8.45	-8.60	-8.81	-7.58	-7.23	-7.21
84	294	-8.29	-8.39	-8.57	-6.57	-6.31	-6.37
84	297	-8.08	-8.14	-8.29	-5.63	-5.47	-5.60
84	300	-7.85	-7.87	-7.97	-4.89	-4.79	-5.00
84	303	-7.46	-7.47	-7.54	-4.28	-4.22	-4.49
84	306	-6.86	-6.89	-6.94	-3.70	-3.66	-3.99
84	309	-6.17	-6.23	-6.27	-3.19	-3.18	-3.57
84	312	-5.51	-5.59	-5.61	-2.80	-2.83	-3.27
84	315	-5.02	-5.06	-5.06	-2.57	-2.69	-3.15
84	318	-4.64	-4.60	-4.57	-2.44	-2.68	-3.16
84	321	-4.26	-4.14	-4.06	-2.33	-2.67	-3.19
84	324	-3.94	-3.72	-3.60	-2.24	-2.66	-3.24
84	327	-3.72	-3.43	-3.28	-2.18	-2.65	-3.30
84	330	-3.64	-3.32	-3.15	-2.16	-2.65	-3.38
84	333	-3.75	-3.40	-3.22	-2.25	-2.77	-3.57
84	336	-4.06	-3.63	-3.42	-2.49	-3.07	-3.93
84	339	-4.53	-3.99	-3.72	-2.83	-3.50	-4.41
84	342	-5.13	-4.45	-4.11	-3.23	-4.01	-4.96
84	345	-5.80	-4.98	-4.56	-3.65	-4.51	-5.50
84	348	-6.82	-5.88	-5.38	-4.13	-5.06	-6.07
84	351	-8.37	-7.37	-6.77	-4.73	-5.72	-6.72
84	354	-10.37	-9.32	-8.62	-5.43	-6.47	-7.43
84	357	-12.68	-11.62	-10.80	-6.21	-7.29	-8.19
84	360	-15.22	-14.13	-13.18	-7.05	-8.17	-9.01
87	0	-15.32	-14.64	-13.54	-7.13	-8.29	-9.34
87	3	-13.75	-13.76	-13.37	-7.35	-8.25	-8.95
87	6	-12.31	-12.91	-13.09	-7.49	-8.12	-8.53
87	9	-11.07	-12.12	-12.73	-7.56	-7.93	-8.08
87	12	-10.09	-11.37	-12.31	-7.58	-7.70	-7.59
87	15	-9.44	-10.68	-11.85	-7.58	-7.43	-7.08
87	18	-9.00	-9.96	-11.13	-7.27	-6.92	-6.42
87	21	-8.60	-9.20	-10.11	-6.52	-6.08	-5.61
87	24	-8.28	-8.52	-9.05	-5.62	-5.18	-4.81
87	27	-8.08	-8.02	-8.22	-4.84	-4.46	-4.21
87	30	-8.00	-7.83	-7.88	-4.47	-4.16	-3.97
87	33	-8.15	-7.91	-7.94	-4.40	-4.16	-3.98
87	36	-8.51	-8.11	-8.08	-4.34	-4.17	-4.03
87	39	-8.93	-8.37	-8.29	-4.29	-4.19	-4.10
87	42	-9.29	-8.63	-8.54	-4.27	-4.21	-4.20
87	45	-9.44	-8.84	-8.78	-4.26	-4.24	-4.33
87	48	-9.44	-9.00	-9.09	-4.42	-4.44	-4.61
87	51	-9.43	-9.14	-9.47	-4.86	-4.92	-5.18
87	54	-9.42	-9.27	-9.89	-5.50	-5.61	-5.95
87	57	-9.42	-9.39	-10.28	-6.26	-6.44	-6.86
87	60	-9.42	-9.51	-10.58	-7.08	-7.33	-7.85
87	63	-9.42	-9.62	-10.79	-8.06	-8.52	-9.31
87	66	-9.42	-9.71	-10.95	-9.33	-10.16	-11.38
87	69	-9.42	-9.80	-11.10	-10.85	-12.04	-13.59
87	72	-9.42	-9.91	-11.27	-12.60	-13.94	-15.50
87	75	-9.42	-10.07	-11.49	-14.54	-15.66	-16.66



87	78	-9.58	-10.35	-11.81	-17.46	-17.42	-17.26
87	81	-9.99	-10.79	-12.22	-21.51	-19.36	-17.78
87	84	-10.57	-11.34	-12.69	-25.66	-21.15	-18.19
87	87	-11.21	-11.94	-13.19	-28.90	-22.47	-18.47
87	90	-11.83	-12.56	-13.70	-30.21	-22.98	-18.56
87	93	-12.56	-13.33	-14.31	-28.83	-22.12	-18.07
87	96	-13.48	-14.32	-15.06	-25.49	-20.02	-16.87
87	99	-14.39	-15.29	-15.79	-21.37	-17.45	-15.37
87	102	-15.08	-16.03	-16.34	-17.64	-15.13	-13.98
87	105	-15.35	-16.33	-16.56	-15.49	-13.82	-13.11
87	108	-14.69	-15.59	-15.82	-14.64	-13.33	-12.68
87	111	-13.02	-13.74	-13.96	-13.99	-12.95	-12.33
87	114	-10.81	-11.31	-11.52	-13.48	-12.66	-12.03
87	117	-8.56	-8.85	-9.06	-13.03	-12.41	-11.80
87	120	-6.74	-6.90	-7.11	-12.59	-12.17	-11.63
87	123	-5.27	-5.38	-5.61	-12.13	-11.90	-11.48
87	126	-3.82	-3.90	-4.15	-11.68	-11.64	-11.34
87	129	-2.48	-2.54	-2.82	-11.27	-11.40	-11.22
87	132	-1.34	-1.41	-1.70	-10.94	-11.23	-11.15
87	135	-0.49	-0.57	-0.88	-10.72	-11.17	-11.12
87	138	0.18	0.07	-0.23	-10.59	-11.19	-11.22
87	141	0.80	0.67	0.36	-10.50	-11.26	-11.48
87	144	1.32	1.17	0.86	-10.42	-11.33	-11.81
87	147	1.67	1.50	1.19	-10.34	-11.39	-12.12
87	150	1.80	1.63	1.32	-10.25	-11.42	-12.35
87	153	1.72	1.55	1.24	-10.16	-11.42	-12.51
87	156	1.52	1.33	1.03	-10.08	-11.42	-12.66
87	159	1.21	1.02	0.72	-9.99	-11.41	-12.79
87	162	0.84	0.63	0.34	-9.89	-11.41	-12.88
87	165	0.43	0.21	-0.08	-9.75	-11.40	-12.91
87	168	-0.21	-0.44	-0.70	-9.51	-11.20	-12.67
87	171	-1.16	-1.39	-1.61	-9.16	-10.71	-12.07
87	174	-2.25	-2.46	-2.63	-8.74	-10.08	-11.28
87	177	-3.29	-3.47	-3.58	-8.33	-9.45	-10.50
87	180	-4.10	-4.22	-4.29	-7.98	-8.95	-9.90
87	183	-4.77	-4.79	-4.83	-7.64	-8.56	-9.45
87	186	-5.43	-5.35	-5.34	-7.28	-8.15	-9.00
87	189	-6.01	-5.83	-5.78	-6.96	-7.80	-8.61
87	192	-6.42	-6.16	-6.09	-6.73	-7.54	-8.31
87	195	-6.58	-6.28	-6.21	-6.64	-7.44	-8.15
87	198	-6.47	-6.16	-6.05	-6.72	-7.48	-8.09
87	201	-6.19	-5.84	-5.65	-6.92	-7.56	-8.05
87	204	-5.81	-5.40	-5.12	-7.17	-7.66	-8.02
87	207	-5.38	-4.92	-4.55	-7.39	-7.75	-7.99
87	210	-4.98	-4.49	-4.06	-7.53	-7.78	-7.95
87	213	-4.50	-4.03	-3.58	-7.59	-7.78	-7.88
87	216	-3.92	-3.49	-3.05	-7.64	-7.76	-7.80
87	219	-3.34	-2.97	-2.54	-7.69	-7.75	-7.71
87	222	-2.90	-2.58	-2.17	-7.71	-7.72	-7.62
87	225	-2.72	-2.43	-2.03	-7.72	-7.69	-7.54
87	228	-2.71	-2.45	-2.07	-7.64	-7.60	-7.46
87	231	-2.70	-2.50	-2.19	-7.45	-7.43	-7.38
87	234	-2.69	-2.58	-2.36	-7.22	-7.24	-7.30
87	237	-2.69	-2.68	-2.57	-7.02	-7.08	-7.25
87	240	-2.69	-2.80	-2.81	-6.94	-7.02	-7.23
87	243	-2.82	-3.05	-3.17	-6.97	-7.06	-7.34
87	246	-3.17	-3.48	-3.72	-7.06	-7.20	-7.63
87	249	-3.65	-4.02	-4.37	-7.20	-7.39	-8.02

87	252	-4.18	-4.60	-5.04	-7.38	-7.62	-8.43
87	255	-4.67	-5.14	-5.66	-7.58	-7.87	-8.81
87	258	-5.17	-5.69	-6.28	-7.98	-8.26	-9.18
87	261	-5.73	-6.30	-6.97	-8.66	-8.84	-9.62
87	264	-6.29	-6.89	-7.62	-9.40	-9.44	-10.03
87	267	-6.80	-7.40	-8.14	-10.00	-9.91	-10.33
87	270	-7.19	-7.74	-8.42	-10.24	-10.11	-10.45
87	273	-7.51	-7.96	-8.53	-10.14	-9.99	-10.30
87	276	-7.81	-8.17	-8.63	-9.86	-9.70	-9.91
87	279	-8.07	-8.34	-8.71	-9.46	-9.27	-9.36
87	282	-8.25	-8.45	-8.76	-8.99	-8.77	-8.75
87	285	-8.32	-8.49	-8.77	-8.49	-8.25	-8.15
87	288	-8.30	-8.46	-8.73	-7.81	-7.60	-7.51
87	291	-8.27	-8.39	-8.62	-6.90	-6.74	-6.74
87	294	-8.21	-8.29	-8.46	-5.89	-5.82	-5.95
87	297	-8.14	-8.15	-8.25	-4.95	-4.95	-5.22
87	300	-8.04	-7.99	-8.02	-4.21	-4.28	-4.64
87	303	-7.76	-7.66	-7.65	-3.62	-3.74	-4.16
87	306	-7.19	-7.11	-7.07	-3.04	-3.20	-3.69
87	309	-6.51	-6.45	-6.39	-2.54	-2.74	-3.28
87	312	-5.84	-5.80	-5.73	-2.19	-2.41	-2.99
87	315	-5.34	-5.28	-5.19	-2.05	-2.29	-2.89
87	318	-4.98	-4.84	-4.71	-2.04	-2.30	-2.91
87	321	-4.62	-4.40	-4.22	-2.04	-2.34	-2.97
87	324	-4.30	-4.00	-3.78	-2.03	-2.39	-3.07
87	327	-4.09	-3.72	-3.47	-2.03	-2.47	-3.19
87	330	-4.00	-3.61	-3.35	-2.03	-2.55	-3.33
87	333	-4.13	-3.70	-3.42	-2.14	-2.75	-3.58
87	336	-4.47	-3.95	-3.63	-2.42	-3.11	-4.01
87	339	-4.99	-4.34	-3.94	-2.82	-3.59	-4.54
87	342	-5.63	-4.82	-4.34	-3.29	-4.12	-5.13
87	345	-6.35	-5.39	-4.81	-3.76	-4.67	-5.73
87	348	-7.37	-6.32	-5.64	-4.27	-5.25	-6.34
87	351	-8.87	-7.83	-7.06	-4.87	-5.91	-7.01
87	354	-10.76	-9.80	-8.93	-5.56	-6.64	-7.74
87	357	-12.94	-12.11	-11.13	-6.32	-7.44	-8.51
87	360	-15.32	-14.64	-13.54	-7.13	-8.29	-9.34
90	0	-15.37	-14.86	-13.69	-7.16	-8.35	-9.47
90	3	-13.65	-13.77	-13.32	-7.16	-8.24	-9.02
90	6	-12.08	-12.76	-12.90	-7.16	-8.04	-8.55
90	9	-10.75	-11.85	-12.44	-7.15	-7.77	-8.05
90	12	-9.76	-11.04	-11.95	-7.15	-7.45	-7.52
90	15	-9.20	-10.36	-11.43	-7.14	-7.10	-6.98
90	18	-8.91	-9.73	-10.74	-6.84	-6.55	-6.29
90	21	-8.66	-9.11	-9.88	-6.13	-5.73	-5.47
90	24	-8.47	-8.57	-9.03	-5.27	-4.88	-4.67
90	27	-8.35	-8.19	-8.39	-4.52	-4.21	-4.07
90	30	-8.31	-8.05	-8.13	-4.15	-3.94	-3.84
90	33	-8.42	-8.12	-8.20	-4.06	-3.94	-3.85
90	36	-8.70	-8.29	-8.37	-3.99	-3.94	-3.88
90	39	-9.03	-8.51	-8.61	-3.94	-3.94	-3.93
90	42	-9.31	-8.73	-8.88	-3.90	-3.94	-4.00
90	45	-9.42	-8.88	-9.13	-3.89	-3.94	-4.08
90	48	-9.38	-8.97	-9.39	-4.04	-4.10	-4.33
90	51	-9.28	-9.05	-9.68	-4.43	-4.54	-4.85
90	54	-9.16	-9.11	-9.98	-5.01	-5.18	-5.57
90	57	-9.06	-9.18	-10.26	-5.70	-5.95	-6.44
90	60	-9.02	-9.26	-10.49	-6.45	-6.77	-7.39

90	63	-9.02	-9.34	-10.67	-7.34	-7.85	-8.79
90	66	-9.03	-9.43	-10.80	-8.52	-9.32	-10.79
90	69	-9.04	-9.53	-10.93	-9.94	-11.03	-12.99
90	72	-9.05	-9.65	-11.08	-11.58	-12.82	-15.01
90	75	-9.07	-9.81	-11.28	-13.40	-14.52	-16.45
90	78	-9.25	-10.09	-11.55	-16.17	-16.42	-17.47
90	81	-9.68	-10.52	-11.91	-20.05	-18.62	-18.42
90	84	-10.27	-11.08	-12.33	-24.03	-20.71	-19.22
90	87	-10.95	-11.70	-12.80	-27.15	-22.27	-19.78
90	90	-11.61	-12.35	-13.30	-28.40	-22.88	-19.98
90	93	-12.44	-13.21	-13.99	-27.08	-21.99	-19.34
90	96	-13.52	-14.35	-14.89	-23.87	-19.86	-17.80
90	99	-14.59	-15.49	-15.79	-19.94	-17.23	-15.88
90	102	-15.41	-16.37	-16.49	-16.42	-14.87	-14.12
90	105	-15.74	-16.72	-16.77	-14.47	-13.56	-13.08
90	108	-15.09	-16.00	-16.06	-13.80	-13.09	-12.62
90	111	-13.44	-14.18	-14.27	-13.29	-12.73	-12.24
90	114	-11.26	-11.78	-11.92	-12.90	-12.44	-11.93
90	117	-9.01	-9.32	-9.52	-12.56	-12.21	-11.70
90	120	-7.15	-7.34	-7.57	-12.22	-11.99	-11.52
90	123	-5.60	-5.73	-5.98	-11.84	-11.76	-11.37
90	126	-4.05	-4.14	-4.41	-11.46	-11.53	-11.24
90	129	-2.59	-2.67	-2.95	-11.12	-11.33	-11.13
90	132	-1.36	-1.43	-1.73	-10.85	-11.19	-11.05
90	135	-0.45	-0.54	-0.84	-10.69	-11.13	-11.03
90	138	0.24	0.13	-0.17	-10.61	-11.19	-11.16
90	141	0.89	0.76	0.45	-10.55	-11.33	-11.50
90	144	1.42	1.27	0.97	-10.51	-11.49	-11.92
90	147	1.79	1.62	1.32	-10.46	-11.62	-12.32
90	150	1.92	1.74	1.44	-10.39	-11.68	-12.58
90	153	1.85	1.67	1.37	-10.30	-11.67	-12.72
90	156	1.65	1.45	1.15	-10.19	-11.65	-12.86
90	159	1.36	1.13	0.83	-10.05	-11.62	-12.97
90	162	0.99	0.74	0.45	-9.89	-11.57	-13.05
90	165	0.59	0.31	0.02	-9.68	-11.52	-13.08
90	168	-0.07	-0.36	-0.64	-9.27	-11.16	-12.71
90	171	-1.08	-1.37	-1.62	-8.60	-10.37	-11.81
90	174	-2.23	-2.51	-2.71	-7.84	-9.39	-10.67
90	177	-3.31	-3.56	-3.69	-7.15	-8.47	-9.59
90	180	-4.14	-4.31	-4.37	-6.69	-7.86	-8.86
90	183	-4.78	-4.85	-4.81	-6.41	-7.49	-8.41
90	186	-5.40	-5.36	-5.22	-6.15	-7.14	-7.99
90	189	-5.94	-5.79	-5.55	-5.94	-6.85	-7.64
90	192	-6.32	-6.08	-5.78	-5.80	-6.66	-7.40
90	195	-6.46	-6.19	-5.86	-5.75	-6.59	-7.31
90	198	-6.25	-5.97	-5.63	-5.89	-6.70	-7.37
90	201	-5.74	-5.42	-5.05	-6.24	-6.98	-7.52
90	204	-5.06	-4.70	-4.30	-6.67	-7.31	-7.70
90	207	-4.38	-3.99	-3.57	-7.08	-7.60	-7.84
90	210	-3.83	-3.44	-3.01	-7.32	-7.73	-7.90
90	213	-3.38	-3.02	-2.60	-7.45	-7.75	-7.89
90	216	-2.90	-2.59	-2.19	-7.57	-7.77	-7.84
90	219	-2.48	-2.21	-1.83	-7.66	-7.78	-7.78
90	222	-2.17	-1.94	-1.57	-7.73	-7.78	-7.70
90	225	-2.06	-1.84	-1.48	-7.75	-7.79	-7.62
90	228	-2.06	-1.86	-1.52	-7.62	-7.68	-7.50
90	231	-2.06	-1.91	-1.62	-7.33	-7.41	-7.32
90	234	-2.07	-2.00	-1.78	-6.98	-7.10	-7.14

90	237	-2.09	-2.10	-1.98	-6.68	-6.83	-7.00
90	240	-2.10	-2.22	-2.20	-6.56	-6.72	-6.94
90	243	-2.24	-2.46	-2.53	-6.59	-6.76	-7.03
90	246	-2.55	-2.85	-3.02	-6.66	-6.87	-7.26
90	249	-2.98	-3.34	-3.61	-6.78	-7.03	-7.59
90	252	-3.46	-3.87	-4.24	-6.93	-7.22	-7.94
90	255	-3.91	-4.37	-4.82	-7.10	-7.43	-8.26
90	258	-4.37	-4.89	-5.42	-7.47	-7.78	-8.63
90	261	-4.89	-5.47	-6.09	-8.08	-8.31	-9.06
90	264	-5.42	-6.06	-6.74	-8.76	-8.86	-9.48
90	267	-5.93	-6.58	-7.29	-9.30	-9.30	-9.80
90	270	-6.37	-7.00	-7.68	-9.52	-9.48	-9.93
90	273	-6.80	-7.35	-7.95	-9.45	-9.40	-9.80
90	276	-7.25	-7.69	-8.20	-9.23	-9.16	-9.46
90	279	-7.64	-7.98	-8.40	-8.92	-8.83	-8.98
90	282	-7.94	-8.18	-8.54	-8.54	-8.42	-8.44
90	285	-8.06	-8.26	-8.59	-8.13	-7.99	-7.91
90	288	-8.08	-8.25	-8.56	-7.52	-7.39	-7.30
90	291	-8.10	-8.23	-8.50	-6.62	-6.55	-6.56
90	294	-8.11	-8.20	-8.39	-5.61	-5.62	-5.78
90	297	-8.12	-8.16	-8.26	-4.66	-4.74	-5.06
90	300	-8.12	-8.10	-8.10	-3.93	-4.07	-4.50
90	303	-7.92	-7.86	-7.78	-3.36	-3.53	-4.02
90	306	-7.41	-7.34	-7.22	-2.79	-3.01	-3.56
90	309	-6.76	-6.69	-6.55	-2.31	-2.56	-3.16
90	312	-6.12	-6.04	-5.89	-1.96	-2.24	-2.88
90	315	-5.65	-5.54	-5.36	-1.84	-2.13	-2.78
90	318	-5.31	-5.12	-4.90	-1.84	-2.14	-2.81
90	321	-4.98	-4.70	-4.43	-1.86	-2.20	-2.88
90	324	-4.70	-4.33	-4.01	-1.89	-2.28	-3.00
90	327	-4.50	-4.06	-3.71	-1.93	-2.39	-3.14
90	330	-4.42	-3.96	-3.59	-1.98	-2.52	-3.31
90	333	-4.56	-4.06	-3.67	-2.13	-2.75	-3.60
90	336	-4.95	-4.33	-3.88	-2.45	-3.15	-4.06
90	339	-5.52	-4.75	-4.21	-2.88	-3.66	-4.64
90	342	-6.22	-5.27	-4.62	-3.38	-4.23	-5.27
90	345	-6.99	-5.88	-5.11	-3.87	-4.80	-5.89
90	348	-8.01	-6.82	-5.95	-4.40	-5.39	-6.52
90	351	-9.42	-8.29	-7.34	-5.00	-6.05	-7.19
90	354	-11.17	-10.20	-9.17	-5.66	-6.76	-7.91
90	357	-13.18	-12.42	-11.33	-6.38	-7.53	-8.67
90	360	-15.37	-14.86	-13.69	-7.16	-8.35	-9.47
93	0	-14.73	-14.30	-13.31	-7.14	-8.30	-9.42
93	3	-12.98	-13.13	-12.78	-7.13	-8.12	-8.94
93	6	-11.37	-12.06	-12.27	-7.09	-7.87	-8.45
93	9	-10.04	-11.13	-11.77	-7.02	-7.56	-7.93
93	12	-9.14	-10.38	-11.28	-6.93	-7.21	-7.39
93	15	-8.80	-9.84	-10.81	-6.82	-6.83	-6.84
93	18	-8.80	-9.44	-10.27	-6.46	-6.26	-6.16
93	21	-8.80	-9.07	-9.69	-5.78	-5.50	-5.36
93	24	-8.80	-8.77	-9.14	-5.00	-4.71	-4.58
93	27	-8.80	-8.57	-8.74	-4.33	-4.09	-4.00
93	30	-8.80	-8.50	-8.59	-4.00	-3.83	-3.77
93	33	-8.95	-8.62	-8.72	-3.91	-3.82	-3.78
93	36	-9.30	-8.92	-9.04	-3.85	-3.80	-3.80
93	39	-9.73	-9.28	-9.46	-3.79	-3.79	-3.83
93	42	-10.09	-9.59	-9.87	-3.76	-3.79	-3.87
93	45	-10.24	-9.74	-10.18	-3.75	-3.79	-3.93

93	48	-10.16	-9.76	-10.38	-3.89	-3.94	-4.14
93	51	-9.99	-9.77	-10.55	-4.26	-4.35	-4.63
93	54	-9.78	-9.78	-10.71	-4.79	-4.95	-5.31
93	57	-9.60	-9.79	-10.86	-5.44	-5.68	-6.14
93	60	-9.53	-9.81	-11.02	-6.13	-6.46	-7.05
93	63	-9.53	-9.85	-11.18	-6.96	-7.45	-8.32
93	66	-9.52	-9.93	-11.32	-8.03	-8.80	-10.09
93	69	-9.52	-10.03	-11.46	-9.33	-10.37	-12.14
93	72	-9.52	-10.17	-11.64	-10.83	-12.06	-14.21
93	75	-9.52	-10.33	-11.85	-12.50	-13.74	-16.07
93	78	-9.70	-10.63	-12.17	-15.09	-15.75	-17.95
93	81	-10.19	-11.13	-12.60	-18.73	-18.18	-20.01
93	84	-10.86	-11.76	-13.11	-22.48	-20.54	-21.92
93	87	-11.62	-12.47	-13.65	-25.41	-22.33	-23.31
93	90	-12.36	-13.18	-14.19	-26.60	-23.03	-23.86
93	93	-13.27	-14.08	-14.84	-25.73	-22.26	-22.89
93	96	-14.44	-15.21	-15.64	-23.59	-20.38	-20.56
93	99	-15.60	-16.34	-16.41	-20.90	-18.05	-17.70
93	102	-16.49	-17.20	-16.99	-18.34	-15.91	-15.12
93	105	-16.85	-17.54	-17.22	-16.62	-14.62	-13.68
93	108	-16.14	-16.78	-16.51	-15.65	-14.04	-13.14
93	111	-14.34	-14.87	-14.73	-14.83	-13.59	-12.72
93	114	-11.97	-12.36	-12.38	-14.14	-13.22	-12.39
93	117	-9.55	-9.79	-9.97	-13.54	-12.91	-12.13
93	120	-7.57	-7.73	-8.00	-13.01	-12.61	-11.92
93	123	-5.97	-6.08	-6.38	-12.51	-12.30	-11.74
93	126	-4.37	-4.46	-4.77	-12.05	-11.99	-11.56
93	129	-2.90	-2.96	-3.27	-11.64	-11.72	-11.42
93	132	-1.64	-1.70	-2.00	-11.30	-11.53	-11.32
93	135	-0.71	-0.78	-1.08	-11.05	-11.45	-11.28
93	138	0.02	-0.07	-0.37	-10.88	-11.48	-11.43
93	141	0.69	0.58	0.29	-10.75	-11.55	-11.77
93	144	1.25	1.12	0.83	-10.64	-11.64	-12.18
93	147	1.64	1.49	1.21	-10.53	-11.71	-12.53
93	150	1.78	1.62	1.34	-10.39	-11.74	-12.69
93	153	1.71	1.55	1.27	-10.23	-11.71	-12.70
93	156	1.53	1.35	1.07	-10.06	-11.64	-12.71
93	159	1.26	1.05	0.77	-9.86	-11.53	-12.72
93	162	0.92	0.69	0.41	-9.63	-11.37	-12.72
93	165	0.54	0.29	0.01	-9.34	-11.19	-12.73
93	168	-0.09	-0.36	-0.63	-8.81	-10.69	-12.30
93	171	-1.06	-1.34	-1.59	-8.00	-9.76	-11.27
93	174	-2.18	-2.45	-2.66	-7.12	-8.66	-9.97
93	177	-3.23	-3.46	-3.61	-6.34	-7.66	-8.77
93	180	-4.00	-4.17	-4.22	-5.88	-7.03	-8.00
93	183	-4.58	-4.65	-4.58	-5.66	-6.70	-7.58
93	186	-5.14	-5.11	-4.90	-5.46	-6.39	-7.20
93	189	-5.61	-5.48	-5.17	-5.31	-6.15	-6.89
93	192	-5.94	-5.74	-5.34	-5.21	-5.99	-6.69
93	195	-6.07	-5.84	-5.41	-5.17	-5.93	-6.61
93	198	-5.83	-5.59	-5.17	-5.33	-6.07	-6.71
93	201	-5.24	-4.97	-4.57	-5.70	-6.43	-6.94
93	204	-4.47	-4.17	-3.80	-6.18	-6.85	-7.23
93	207	-3.72	-3.40	-3.06	-6.62	-7.22	-7.46
93	210	-3.15	-2.84	-2.52	-6.91	-7.39	-7.56
93	213	-2.72	-2.44	-2.15	-7.07	-7.42	-7.55
93	216	-2.29	-2.05	-1.78	-7.21	-7.45	-7.51
93	219	-1.92	-1.73	-1.47	-7.34	-7.47	-7.46

93	222	-1.65	-1.49	-1.25	-7.42	-7.48	-7.40
93	225	-1.55	-1.41	-1.17	-7.45	-7.48	-7.33
93	228	-1.56	-1.43	-1.20	-7.32	-7.37	-7.22
93	231	-1.57	-1.48	-1.29	-7.02	-7.11	-7.03
93	234	-1.58	-1.55	-1.43	-6.67	-6.79	-6.84
93	237	-1.60	-1.65	-1.60	-6.37	-6.52	-6.68
93	240	-1.63	-1.76	-1.78	-6.25	-6.41	-6.62
93	243	-1.75	-1.97	-2.06	-6.30	-6.47	-6.71
93	246	-2.04	-2.32	-2.49	-6.44	-6.64	-6.95
93	249	-2.42	-2.75	-3.00	-6.64	-6.88	-7.28
93	252	-2.86	-3.23	-3.55	-6.89	-7.16	-7.65
93	255	-3.27	-3.70	-4.09	-7.15	-7.44	-7.99
93	258	-3.71	-4.19	-4.65	-7.57	-7.83	-8.37
93	261	-4.20	-4.74	-5.27	-8.20	-8.37	-8.84
93	264	-4.73	-5.31	-5.90	-8.86	-8.91	-9.30
93	267	-5.24	-5.85	-6.48	-9.38	-9.34	-9.64
93	270	-5.72	-6.32	-6.95	-9.59	-9.51	-9.78
93	273	-6.21	-6.76	-7.37	-9.51	-9.43	-9.67
93	276	-6.73	-7.22	-7.78	-9.30	-9.20	-9.38
93	279	-7.21	-7.62	-8.14	-8.98	-8.88	-8.97
93	282	-7.59	-7.93	-8.40	-8.59	-8.48	-8.49
93	285	-7.80	-8.08	-8.49	-8.17	-8.06	-8.01
93	288	-7.90	-8.14	-8.48	-7.55	-7.46	-7.43
93	291	-7.98	-8.18	-8.46	-6.66	-6.62	-6.69
93	294	-8.05	-8.21	-8.42	-5.65	-5.69	-5.90
93	297	-8.09	-8.23	-8.37	-4.70	-4.81	-5.17
93	300	-8.11	-8.24	-8.30	-3.98	-4.13	-4.59
93	303	-7.93	-8.06	-8.06	-3.41	-3.60	-4.12
93	306	-7.48	-7.59	-7.57	-2.84	-3.07	-3.65
93	309	-6.91	-7.00	-6.95	-2.36	-2.62	-3.24
93	312	-6.37	-6.41	-6.33	-2.02	-2.30	-2.96
93	315	-5.99	-5.97	-5.84	-1.90	-2.19	-2.85
93	318	-5.75	-5.64	-5.44	-1.90	-2.20	-2.88
93	321	-5.52	-5.31	-5.04	-1.92	-2.26	-2.95
93	324	-5.33	-5.02	-4.68	-1.96	-2.34	-3.06
93	327	-5.19	-4.82	-4.42	-2.00	-2.45	-3.20
93	330	-5.14	-4.74	-4.32	-2.06	-2.58	-3.37
93	333	-5.36	-4.87	-4.41	-2.22	-2.82	-3.66
93	336	-5.91	-5.23	-4.65	-2.57	-3.23	-4.14
93	339	-6.70	-5.75	-5.02	-3.02	-3.76	-4.73
93	342	-7.61	-6.38	-5.48	-3.54	-4.35	-5.38
93	345	-8.52	-7.08	-6.01	-4.04	-4.93	-6.01
93	348	-9.48	-7.97	-6.80	-4.56	-5.51	-6.62
93	351	-10.60	-9.20	-8.00	-5.13	-6.14	-7.27
93	354	-11.86	-10.70	-9.55	-5.76	-6.82	-7.96
93	357	-13.25	-12.42	-11.34	-6.43	-7.54	-8.68
93	360	-14.73	-14.30	-13.31	-7.14	-8.30	-9.42
96	0	-13.20	-12.96	-12.38	-7.11	-8.18	-9.29
96	3	-11.64	-11.80	-11.73	-7.08	-7.95	-8.80
96	6	-10.27	-10.74	-11.13	-7.00	-7.66	-8.29
96	9	-9.18	-9.87	-10.61	-6.87	-7.33	-7.77
96	12	-8.46	-9.28	-10.20	-6.71	-6.96	-7.23
96	15	-8.20	-9.07	-9.92	-6.53	-6.56	-6.68
96	18	-8.27	-9.07	-9.72	-6.15	-6.01	-6.02
96	21	-8.47	-9.09	-9.54	-5.50	-5.29	-5.24
96	24	-8.76	-9.11	-9.40	-4.78	-4.56	-4.49
96	27	-9.10	-9.15	-9.30	-4.18	-3.99	-3.94
96	30	-9.46	-9.20	-9.27	-3.87	-3.74	-3.72

96	33	-9.96	-9.49	-9.54	-3.79	-3.71	-3.72
96	36	-10.66	-10.11	-10.20	-3.73	-3.68	-3.73
96	39	-11.39	-10.84	-11.00	-3.68	-3.67	-3.75
96	42	-11.95	-11.44	-11.70	-3.65	-3.66	-3.77
96	45	-12.18	-11.69	-12.04	-3.63	-3.65	-3.80
96	48	-12.04	-11.63	-12.11	-3.77	-3.80	-4.00
96	51	-11.70	-11.50	-12.15	-4.12	-4.20	-4.45
96	54	-11.29	-11.33	-12.18	-4.63	-4.78	-5.12
96	57	-10.93	-11.19	-12.22	-5.25	-5.48	-5.92
96	60	-10.75	-11.13	-12.28	-5.90	-6.22	-6.79
96	63	-10.70	-11.15	-12.38	-6.66	-7.15	-7.90
96	66	-10.66	-11.21	-12.53	-7.65	-8.38	-9.40
96	69	-10.63	-11.30	-12.72	-8.83	-9.82	-11.21
96	72	-10.61	-11.43	-12.95	-10.19	-11.41	-13.25
96	75	-10.61	-11.57	-13.22	-11.72	-13.05	-15.43
96	78	-10.85	-11.93	-13.66	-14.08	-15.18	-18.46
96	81	-11.47	-12.61	-14.32	-17.40	-17.88	-22.48
96	84	-12.32	-13.46	-15.07	-20.82	-20.56	-26.53
96	87	-13.26	-14.36	-15.78	-23.50	-22.60	-29.66
96	90	-14.14	-15.17	-16.32	-24.58	-23.41	-30.92
96	93	-15.14	-16.01	-16.76	-24.42	-22.89	-29.40
96	96	-16.37	-16.97	-17.19	-23.97	-21.60	-25.73
96	99	-17.56	-17.88	-17.56	-23.32	-19.94	-21.24
96	102	-18.46	-18.55	-17.82	-22.55	-18.32	-17.26
96	105	-18.82	-18.81	-17.92	-21.74	-17.15	-15.12
96	108	-17.97	-17.97	-17.19	-20.65	-16.38	-14.43
96	111	-15.83	-15.85	-15.36	-19.16	-15.71	-13.90
96	114	-13.04	-13.10	-12.94	-17.53	-15.11	-13.49
96	117	-10.24	-10.32	-10.47	-16.02	-14.58	-13.16
96	120	-8.06	-8.15	-8.48	-14.91	-14.10	-12.88
96	123	-6.43	-6.50	-6.87	-14.13	-13.63	-12.60
96	126	-4.87	-4.93	-5.30	-13.45	-13.17	-12.34
96	129	-3.47	-3.50	-3.84	-12.86	-12.75	-12.11
96	132	-2.26	-2.28	-2.60	-12.35	-12.42	-11.95
96	135	-1.33	-1.35	-1.64	-11.92	-12.22	-11.89
96	138	-0.54	-0.59	-0.86	-11.55	-12.10	-11.99
96	141	0.20	0.14	-0.12	-11.24	-12.03	-12.21
96	144	0.82	0.74	0.49	-10.97	-11.97	-12.47
96	147	1.25	1.16	0.92	-10.69	-11.90	-12.69
96	150	1.41	1.31	1.08	-10.39	-11.79	-12.79
96	153	1.36	1.25	1.02	-10.07	-11.63	-12.74
96	156	1.22	1.09	0.85	-9.75	-11.41	-12.61
96	159	1.00	0.85	0.60	-9.42	-11.12	-12.41
96	162	0.73	0.54	0.30	-9.05	-10.79	-12.15
96	165	0.42	0.20	-0.04	-8.62	-10.39	-11.86
96	168	-0.13	-0.37	-0.61	-7.98	-9.74	-11.23
96	171	-1.02	-1.27	-1.49	-7.14	-8.77	-10.15
96	174	-2.05	-2.28	-2.47	-6.26	-7.71	-8.92
96	177	-3.00	-3.19	-3.33	-5.53	-6.78	-7.81
96	180	-3.67	-3.81	-3.87	-5.14	-6.22	-7.12
96	183	-4.14	-4.20	-4.15	-4.98	-5.93	-6.75
96	186	-4.59	-4.57	-4.41	-4.84	-5.68	-6.42
96	189	-4.96	-4.86	-4.61	-4.74	-5.48	-6.15
96	192	-5.22	-5.07	-4.74	-4.67	-5.35	-5.98
96	195	-5.32	-5.14	-4.79	-4.65	-5.30	-5.91
96	198	-5.09	-4.90	-4.56	-4.79	-5.44	-6.01
96	201	-4.51	-4.30	-4.00	-5.15	-5.78	-6.24
96	204	-3.78	-3.54	-3.28	-5.60	-6.19	-6.51

96	207	-3.06	-2.81	-2.59	-6.01	-6.53	-6.74
96	210	-2.52	-2.28	-2.09	-6.27	-6.69	-6.83
96	213	-2.13	-1.93	-1.76	-6.41	-6.72	-6.82
96	216	-1.75	-1.58	-1.44	-6.53	-6.73	-6.79
96	219	-1.42	-1.29	-1.17	-6.63	-6.75	-6.76
96	222	-1.18	-1.09	-0.98	-6.70	-6.76	-6.71
96	225	-1.09	-1.02	-0.91	-6.73	-6.76	-6.66
96	228	-1.10	-1.03	-0.94	-6.64	-6.68	-6.58
96	231	-1.11	-1.08	-1.01	-6.45	-6.51	-6.47
96	234	-1.13	-1.15	-1.12	-6.21	-6.30	-6.36
96	237	-1.16	-1.24	-1.26	-6.02	-6.13	-6.26
96	240	-1.19	-1.34	-1.41	-5.94	-6.05	-6.23
96	243	-1.31	-1.52	-1.65	-6.02	-6.14	-6.33
96	246	-1.56	-1.82	-2.00	-6.24	-6.38	-6.60
96	249	-1.90	-2.20	-2.44	-6.56	-6.72	-6.97
96	252	-2.28	-2.62	-2.92	-6.92	-7.09	-7.37
96	255	-2.67	-3.04	-3.39	-7.29	-7.45	-7.74
96	258	-3.07	-3.50	-3.91	-7.77	-7.89	-8.16
96	261	-3.55	-4.02	-4.48	-8.42	-8.45	-8.66
96	264	-4.06	-4.57	-5.09	-9.08	-9.00	-9.14
96	267	-4.58	-5.12	-5.67	-9.59	-9.42	-9.51
96	270	-5.08	-5.63	-6.21	-9.79	-9.59	-9.65
96	273	-5.61	-6.15	-6.74	-9.71	-9.52	-9.57
96	276	-6.19	-6.70	-7.30	-9.48	-9.31	-9.36
96	279	-6.74	-7.22	-7.81	-9.14	-9.01	-9.04
96	282	-7.20	-7.65	-8.20	-8.73	-8.64	-8.67
96	285	-7.49	-7.91	-8.41	-8.29	-8.25	-8.28
96	288	-7.67	-8.06	-8.49	-7.66	-7.66	-7.75
96	291	-7.83	-8.20	-8.56	-6.76	-6.82	-7.02
96	294	-7.95	-8.30	-8.61	-5.76	-5.87	-6.21
96	297	-8.04	-8.37	-8.64	-4.82	-4.98	-5.44
96	300	-8.07	-8.40	-8.65	-4.10	-4.30	-4.85
96	303	-7.90	-8.24	-8.49	-3.54	-3.76	-4.36
96	306	-7.51	-7.84	-8.09	-2.99	-3.24	-3.87
96	309	-7.03	-7.35	-7.57	-2.51	-2.78	-3.45
96	312	-6.61	-6.90	-7.07	-2.18	-2.47	-3.16
96	315	-6.41	-6.62	-6.70	-2.06	-2.35	-3.05
96	318	-6.37	-6.47	-6.43	-2.07	-2.36	-3.07
96	321	-6.33	-6.33	-6.17	-2.09	-2.42	-3.13
96	324	-6.31	-6.22	-5.94	-2.14	-2.50	-3.23
96	327	-6.29	-6.15	-5.79	-2.19	-2.60	-3.36
96	330	-6.29	-6.12	-5.73	-2.26	-2.72	-3.51
96	333	-6.71	-6.34	-5.85	-2.44	-2.96	-3.79
96	336	-7.74	-6.89	-6.17	-2.80	-3.38	-4.27
96	339	-9.05	-7.65	-6.64	-3.27	-3.92	-4.87
96	342	-10.30	-8.48	-7.18	-3.79	-4.50	-5.51
96	345	-11.18	-9.23	-7.76	-4.29	-5.07	-6.12
96	348	-11.74	-9.93	-8.41	-4.78	-5.62	-6.71
96	351	-12.24	-10.65	-9.22	-5.31	-6.21	-7.32
96	354	-12.68	-11.39	-10.17	-5.88	-6.84	-7.95
96	357	-13.00	-12.17	-11.23	-6.48	-7.49	-8.61
96	360	-13.20	-12.96	-12.38	-7.11	-8.18	-9.29
99	0	-11.31	-11.32	-11.23	-7.05	-8.00	-9.10
99	3	-10.03	-10.30	-10.51	-7.01	-7.73	-8.60
99	6	-8.99	-9.45	-9.90	-6.89	-7.43	-8.09
99	9	-8.21	-8.80	-9.42	-6.72	-7.09	-7.57
99	12	-7.72	-8.39	-9.12	-6.51	-6.71	-7.04
99	15	-7.55	-8.25	-9.01	-6.28	-6.31	-6.51



99	18	-7.71	-8.35	-9.06	-5.88	-5.78	-5.87
99	21	-8.15	-8.62	-9.21	-5.27	-5.11	-5.12
99	24	-8.75	-9.02	-9.43	-4.61	-4.43	-4.41
99	27	-9.44	-9.48	-9.71	-4.05	-3.90	-3.88
99	30	-10.12	-9.97	-10.03	-3.78	-3.66	-3.68
99	33	-10.99	-10.70	-10.67	-3.70	-3.62	-3.68
99	36	-12.13	-11.74	-11.71	-3.64	-3.59	-3.68
99	39	-13.27	-12.82	-12.84	-3.59	-3.57	-3.69
99	42	-14.15	-13.67	-13.76	-3.56	-3.56	-3.69
99	45	-14.50	-14.01	-14.13	-3.55	-3.55	-3.70
99	48	-14.27	-13.87	-14.09	-3.67	-3.69	-3.87
99	51	-13.74	-13.55	-14.01	-4.01	-4.08	-4.31
99	54	-13.08	-13.17	-13.90	-4.51	-4.65	-4.95
99	57	-12.50	-12.84	-13.81	-5.09	-5.32	-5.73
99	60	-12.20	-12.71	-13.78	-5.71	-6.04	-6.56
99	63	-12.11	-12.72	-13.84	-6.42	-6.89	-7.55
99	66	-12.04	-12.77	-14.00	-7.32	-8.01	-8.84
99	69	-11.98	-12.85	-14.23	-8.39	-9.33	-10.43
99	72	-11.94	-12.95	-14.53	-9.62	-10.82	-12.35
99	75	-11.93	-13.08	-14.86	-11.00	-12.42	-14.60
99	78	-12.24	-13.53	-15.50	-12.88	-14.65	-18.66
99	81	-13.02	-14.43	-16.52	-15.37	-17.62	-24.87
99	84	-14.09	-15.57	-17.62	-18.07	-20.62	-31.47
99	87	-15.24	-16.68	-18.50	-20.57	-22.93	-36.71
99	90	-16.27	-17.55	-18.86	-22.47	-23.86	-38.85
99	93	-17.35	-18.24	-18.86	-23.97	-23.60	-36.72
99	96	-18.60	-18.94	-18.83	-25.42	-22.94	-31.58
99	99	-19.78	-19.56	-18.79	-26.66	-22.04	-25.30
99	102	-20.67	-20.00	-18.74	-27.53	-21.06	-19.76
99	105	-21.02	-20.16	-18.67	-27.85	-20.16	-16.83
99	108	-19.99	-19.22	-17.86	-26.94	-19.32	-15.96
99	111	-17.44	-16.87	-15.94	-24.67	-18.40	-15.31
99	114	-14.15	-13.83	-13.45	-21.80	-17.48	-14.81
99	117	-10.92	-10.81	-10.93	-19.06	-16.62	-14.40
99	120	-8.53	-8.53	-8.92	-17.17	-15.87	-14.03
99	123	-6.90	-6.92	-7.36	-16.06	-15.21	-13.64
99	126	-5.42	-5.43	-5.86	-15.12	-14.59	-13.26
99	129	-4.11	-4.10	-4.48	-14.31	-14.02	-12.94
99	132	-2.99	-2.96	-3.28	-13.60	-13.53	-12.71
99	135	-2.07	-2.04	-2.31	-12.95	-13.12	-12.62
99	138	-1.24	-1.22	-1.47	-12.36	-12.82	-12.65
99	141	-0.43	-0.43	-0.65	-11.84	-12.58	-12.71
99	144	0.25	0.24	0.04	-11.36	-12.36	-12.78
99	147	0.73	0.71	0.52	-10.88	-12.12	-12.84
99	150	0.91	0.88	0.70	-10.39	-11.83	-12.87
99	153	0.88	0.84	0.66	-9.87	-11.45	-12.74
99	156	0.78	0.73	0.54	-9.35	-11.01	-12.40
99	159	0.64	0.55	0.36	-8.83	-10.50	-11.91
99	162	0.46	0.33	0.14	-8.29	-9.95	-11.34
99	165	0.24	0.08	-0.11	-7.72	-9.37	-10.75
99	168	-0.21	-0.40	-0.59	-7.03	-8.62	-9.98
99	171	-0.99	-1.18	-1.36	-6.22	-7.69	-8.95
99	174	-1.90	-2.07	-2.22	-5.43	-6.75	-7.86
99	177	-2.73	-2.87	-2.99	-4.82	-5.97	-6.92
99	180	-3.28	-3.38	-3.44	-4.51	-5.50	-6.34
99	183	-3.63	-3.68	-3.67	-4.41	-5.27	-6.01
99	186	-3.95	-3.94	-3.87	-4.33	-5.07	-5.73
99	189	-4.22	-4.15	-4.03	-4.27	-4.91	-5.51

99	192	-4.40	-4.29	-4.13	-4.23	-4.81	-5.36
99	195	-4.47	-4.34	-4.17	-4.22	-4.77	-5.30
99	198	-4.26	-4.13	-3.96	-4.35	-4.89	-5.38
99	201	-3.76	-3.61	-3.46	-4.66	-5.16	-5.54
99	204	-3.11	-2.94	-2.82	-5.05	-5.49	-5.74
99	207	-2.48	-2.29	-2.19	-5.40	-5.76	-5.91
99	210	-2.00	-1.83	-1.76	-5.60	-5.88	-5.98
99	213	-1.65	-1.51	-1.46	-5.68	-5.89	-5.97
99	216	-1.31	-1.21	-1.17	-5.76	-5.89	-5.94
99	219	-1.01	-0.95	-0.93	-5.82	-5.89	-5.90
99	222	-0.80	-0.77	-0.77	-5.85	-5.89	-5.87
99	225	-0.72	-0.70	-0.70	-5.87	-5.89	-5.85
99	228	-0.72	-0.71	-0.73	-5.85	-5.87	-5.85
99	231	-0.74	-0.76	-0.79	-5.80	-5.83	-5.85
99	234	-0.76	-0.82	-0.88	-5.73	-5.78	-5.85
99	237	-0.79	-0.90	-0.99	-5.68	-5.73	-5.85
99	240	-0.83	-0.99	-1.12	-5.66	-5.71	-5.85
99	243	-0.94	-1.15	-1.31	-5.78	-5.83	-5.97
99	246	-1.16	-1.41	-1.61	-6.10	-6.15	-6.27
99	249	-1.46	-1.74	-1.97	-6.54	-6.57	-6.68
99	252	-1.80	-2.11	-2.38	-7.02	-7.04	-7.13
99	255	-2.15	-2.49	-2.81	-7.49	-7.48	-7.54
99	258	-2.54	-2.91	-3.27	-8.04	-7.97	-7.99
99	261	-2.99	-3.40	-3.81	-8.72	-8.55	-8.52
99	264	-3.49	-3.93	-4.39	-9.39	-9.12	-9.02
99	267	-4.01	-4.48	-4.98	-9.90	-9.55	-9.40
99	270	-4.52	-5.02	-5.55	-10.10	-9.72	-9.56
99	273	-5.08	-5.61	-6.16	-10.01	-9.66	-9.51
99	276	-5.71	-6.25	-6.82	-9.75	-9.48	-9.38
99	279	-6.32	-6.87	-7.46	-9.38	-9.21	-9.19
99	282	-6.84	-7.40	-8.00	-8.94	-8.88	-8.95
99	285	-7.20	-7.76	-8.34	-8.47	-8.52	-8.67
99	288	-7.44	-7.99	-8.56	-7.82	-7.96	-8.21
99	291	-7.66	-8.21	-8.75	-6.92	-7.11	-7.49
99	294	-7.84	-8.38	-8.90	-5.93	-6.15	-6.65
99	297	-7.97	-8.50	-9.01	-5.00	-5.24	-5.84
99	300	-8.01	-8.54	-9.04	-4.29	-4.55	-5.21
99	303	-7.89	-8.41	-8.91	-3.73	-4.00	-4.70
99	306	-7.59	-8.10	-8.59	-3.19	-3.47	-4.19
99	309	-7.23	-7.73	-8.20	-2.73	-3.02	-3.75
99	312	-6.94	-7.42	-7.85	-2.41	-2.70	-3.44
99	315	-6.81	-7.29	-7.65	-2.28	-2.58	-3.32
99	318	-6.85	-7.31	-7.58	-2.30	-2.59	-3.34
99	321	-6.95	-7.37	-7.52	-2.33	-2.64	-3.39
99	324	-7.12	-7.46	-7.47	-2.38	-2.71	-3.47
99	327	-7.34	-7.58	-7.44	-2.44	-2.80	-3.58
99	330	-7.60	-7.73	-7.43	-2.52	-2.92	-3.70
99	333	-8.46	-8.25	-7.63	-2.72	-3.15	-3.96
99	336	-10.10	-9.26	-8.14	-3.08	-3.56	-4.42
99	339	-11.97	-10.42	-8.80	-3.55	-4.09	-5.01
99	342	-13.49	-11.36	-9.45	-4.06	-4.66	-5.63
99	345	-14.13	-11.76	-9.93	-4.54	-5.20	-6.22
99	348	-14.08	-11.75	-10.26	-5.00	-5.71	-6.76
99	351	-13.86	-11.73	-10.57	-5.48	-6.25	-7.32
99	354	-13.38	-11.66	-10.84	-5.99	-6.81	-7.90
99	357	-12.56	-11.53	-11.06	-6.51	-7.39	-8.49
99	360	-11.31	-11.32	-11.23	-7.05	-8.00	-9.10
102	0	-9.63	-9.85	-10.20	-6.98	-7.78	-8.86

102	3	-8.63	-8.99	-9.48	-6.89	-7.50	-8.36
102	6	-7.90	-8.35	-8.94	-6.74	-7.19	-7.86
102	9	-7.40	-7.92	-8.57	-6.54	-6.84	-7.36
102	12	-7.13	-7.68	-8.36	-6.30	-6.48	-6.85
102	15	-7.04	-7.60	-8.29	-6.04	-6.08	-6.33
102	18	-7.27	-7.79	-8.44	-5.64	-5.58	-5.72
102	21	-7.88	-8.30	-8.84	-5.07	-4.95	-5.01
102	24	-8.73	-9.01	-9.40	-4.46	-4.33	-4.35
102	27	-9.70	-9.83	-10.06	-3.97	-3.84	-3.85
102	30	-10.64	-10.64	-10.74	-3.72	-3.62	-3.65
102	33	-11.81	-11.69	-11.69	-3.64	-3.57	-3.64
102	36	-13.32	-13.06	-13.01	-3.58	-3.53	-3.63
102	39	-14.83	-14.45	-14.35	-3.53	-3.51	-3.63
102	42	-15.98	-15.52	-15.40	-3.50	-3.49	-3.62
102	45	-16.44	-15.94	-15.83	-3.49	-3.48	-3.62
102	48	-16.15	-15.75	-15.74	-3.61	-3.62	-3.78
102	51	-15.43	-15.27	-15.55	-3.94	-3.99	-4.19
102	54	-14.57	-14.70	-15.31	-4.41	-4.53	-4.80
102	57	-13.81	-14.23	-15.12	-4.96	-5.17	-5.54
102	60	-13.42	-14.03	-15.04	-5.54	-5.85	-6.32
102	63	-13.31	-14.04	-15.10	-6.20	-6.64	-7.21
102	66	-13.22	-14.09	-15.27	-7.01	-7.64	-8.33
102	69	-13.15	-14.16	-15.54	-7.97	-8.84	-9.74
102	72	-13.10	-14.26	-15.86	-9.08	-10.22	-11.50
102	75	-13.09	-14.38	-16.23	-10.31	-11.75	-13.66
102	78	-13.45	-14.91	-16.97	-11.83	-14.08	-18.48
102	81	-14.37	-16.04	-18.18	-13.71	-17.30	-26.52
102	84	-15.61	-17.42	-19.50	-15.84	-20.61	-35.31
102	87	-16.92	-18.69	-20.56	-18.10	-23.19	-42.40
102	90	-18.06	-19.54	-20.99	-20.37	-24.24	-45.31
102	93	-19.17	-20.04	-20.91	-23.11	-24.15	-42.69
102	96	-20.43	-20.51	-20.67	-26.42	-23.92	-36.35
102	99	-21.60	-20.89	-20.30	-29.61	-23.58	-28.63
102	102	-22.46	-21.14	-19.83	-32.02	-23.16	-21.83
102	105	-22.80	-21.24	-19.27	-32.97	-22.69	-18.26
102	108	-21.63	-20.21	-18.10	-31.77	-21.96	-17.25
102	111	-18.72	-17.66	-16.07	-28.81	-20.87	-16.49
102	114	-15.01	-14.38	-13.62	-25.06	-19.61	-15.91
102	117	-11.42	-11.16	-11.19	-21.49	-18.37	-15.43
102	120	-8.88	-8.81	-9.24	-19.07	-17.36	-14.99
102	123	-7.27	-7.24	-7.72	-17.68	-16.54	-14.53
102	126	-5.86	-5.83	-6.29	-16.52	-15.78	-14.09
102	129	-4.64	-4.58	-4.98	-15.53	-15.07	-13.70
102	132	-3.60	-3.51	-3.83	-14.65	-14.44	-13.41
102	135	-2.70	-2.61	-2.87	-13.82	-13.89	-13.23
102	138	-1.86	-1.77	-2.01	-13.04	-13.43	-13.15
102	141	-1.03	-0.96	-1.15	-12.34	-13.05	-13.10
102	144	-0.32	-0.26	-0.42	-11.69	-12.69	-13.06
102	147	0.18	0.22	0.09	-11.05	-12.31	-13.01
102	150	0.36	0.41	0.28	-10.38	-11.85	-12.92
102	153	0.35	0.38	0.26	-9.67	-11.27	-12.63
102	156	0.30	0.32	0.19	-8.94	-10.58	-12.04
102	159	0.23	0.21	0.09	-8.22	-9.84	-11.28
102	162	0.13	0.08	-0.05	-7.52	-9.08	-10.46
102	165	0.01	-0.08	-0.21	-6.86	-8.36	-9.68
102	168	-0.34	-0.46	-0.59	-6.18	-7.60	-8.87
102	171	-1.00	-1.14	-1.25	-5.45	-6.76	-7.93
102	174	-1.79	-1.92	-2.01	-4.78	-5.96	-7.00

102	177	-2.50	-2.61	-2.69	-4.28	-5.33	-6.23
102	180	-2.96	-3.03	-3.09	-4.06	-4.96	-5.75
102	183	-3.20	-3.23	-3.28	-4.02	-4.78	-5.48
102	186	-3.43	-3.41	-3.44	-3.98	-4.63	-5.24
102	189	-3.60	-3.55	-3.57	-3.95	-4.51	-5.05
102	192	-3.72	-3.65	-3.65	-3.94	-4.43	-4.92
102	195	-3.77	-3.68	-3.68	-3.93	-4.40	-4.88
102	198	-3.60	-3.50	-3.50	-4.04	-4.49	-4.92
102	201	-3.17	-3.06	-3.05	-4.32	-4.69	-5.02
102	204	-2.62	-2.48	-2.48	-4.64	-4.93	-5.14
102	207	-2.07	-1.93	-1.93	-4.93	-5.13	-5.23
102	210	-1.65	-1.52	-1.53	-5.06	-5.21	-5.28
102	213	-1.33	-1.24	-1.26	-5.09	-5.21	-5.27
102	216	-1.01	-0.96	-1.00	-5.10	-5.20	-5.24
102	219	-0.73	-0.72	-0.78	-5.11	-5.18	-5.21
102	222	-0.54	-0.55	-0.63	-5.13	-5.17	-5.19
102	225	-0.46	-0.49	-0.57	-5.15	-5.17	-5.18
102	228	-0.47	-0.50	-0.59	-5.18	-5.18	-5.20
102	231	-0.48	-0.54	-0.64	-5.23	-5.22	-5.25
102	234	-0.51	-0.60	-0.72	-5.29	-5.29	-5.34
102	237	-0.54	-0.67	-0.81	-5.37	-5.37	-5.44
102	240	-0.58	-0.76	-0.92	-5.47	-5.46	-5.56
102	243	-0.68	-0.90	-1.08	-5.70	-5.67	-5.78
102	246	-0.89	-1.13	-1.34	-6.11	-6.05	-6.12
102	249	-1.16	-1.42	-1.66	-6.63	-6.52	-6.54
102	252	-1.47	-1.76	-2.02	-7.20	-7.03	-6.99
102	255	-1.80	-2.11	-2.40	-7.74	-7.51	-7.41
102	258	-2.16	-2.50	-2.83	-8.34	-8.04	-7.88
102	261	-2.60	-2.97	-3.34	-9.07	-8.67	-8.43
102	264	-3.09	-3.49	-3.90	-9.77	-9.27	-8.95
102	267	-3.61	-4.04	-4.49	-10.29	-9.72	-9.34
102	270	-4.13	-4.59	-5.08	-10.50	-9.90	-9.49
102	273	-4.71	-5.21	-5.74	-10.39	-9.84	-9.48
102	276	-5.36	-5.92	-6.48	-10.11	-9.69	-9.43
102	279	-6.02	-6.62	-7.22	-9.70	-9.47	-9.36
102	282	-6.59	-7.22	-7.85	-9.21	-9.19	-9.26
102	285	-6.98	-7.65	-8.30	-8.70	-8.87	-9.14
102	288	-7.27	-7.95	-8.61	-8.03	-8.33	-8.78
102	291	-7.52	-8.22	-8.90	-7.12	-7.47	-8.05
102	294	-7.74	-8.44	-9.14	-6.13	-6.49	-7.16
102	297	-7.88	-8.60	-9.30	-5.22	-5.55	-6.29
102	300	-7.94	-8.65	-9.36	-4.52	-4.84	-5.62
102	303	-7.85	-8.57	-9.26	-3.97	-4.29	-5.09
102	306	-7.65	-8.36	-9.03	-3.44	-3.75	-4.55
102	309	-7.40	-8.12	-8.76	-2.98	-3.29	-4.09
102	312	-7.20	-7.92	-8.53	-2.66	-2.97	-3.76
102	315	-7.12	-7.83	-8.43	-2.54	-2.84	-3.63
102	318	-7.20	-7.90	-8.46	-2.56	-2.86	-3.64
102	321	-7.45	-8.11	-8.55	-2.59	-2.89	-3.68
102	324	-7.82	-8.41	-8.68	-2.64	-2.95	-3.74
102	327	-8.29	-8.79	-8.85	-2.70	-3.03	-3.81
102	330	-8.82	-9.21	-9.05	-2.78	-3.12	-3.91
102	333	-9.98	-9.99	-9.50	-2.97	-3.34	-4.14
102	336	-11.94	-11.22	-10.27	-3.33	-3.73	-4.58
102	339	-14.08	-12.55	-11.12	-3.79	-4.24	-5.14
102	342	-15.81	-13.62	-11.81	-4.28	-4.79	-5.74
102	345	-16.52	-14.05	-12.09	-4.74	-5.29	-6.28
102	348	-16.26	-13.90	-12.03	-5.16	-5.76	-6.78

102	351	-15.46	-13.41	-11.84	-5.60	-6.25	-7.29
102	354	-14.10	-12.59	-11.49	-6.05	-6.75	-7.81
102	357	-12.16	-11.41	-10.95	-6.51	-7.26	-8.33
102	360	-9.63	-9.85	-10.20	-6.98	-7.78	-8.86
105	0	-8.69	-9.05	-9.60	-6.88	-7.54	-8.60
105	3	-7.89	-8.31	-8.92	-6.74	-7.25	-8.12
105	6	-7.35	-7.81	-8.46	-6.56	-6.94	-7.63
105	9	-7.02	-7.52	-8.18	-6.33	-6.61	-7.14
105	12	-6.87	-7.37	-8.04	-6.07	-6.25	-6.65
105	15	-6.83	-7.34	-8.00	-5.80	-5.87	-6.15
105	18	-7.09	-7.58	-8.21	-5.41	-5.40	-5.58
105	21	-7.77	-8.20	-8.76	-4.89	-4.82	-4.93
105	24	-8.72	-9.08	-9.54	-4.36	-4.25	-4.31
105	27	-9.80	-10.07	-10.41	-3.92	-3.81	-3.84
105	30	-10.85	-11.03	-11.26	-3.70	-3.60	-3.64
105	33	-12.15	-12.20	-12.33	-3.62	-3.55	-3.61
105	36	-13.82	-13.69	-13.70	-3.56	-3.51	-3.58
105	39	-15.48	-15.17	-15.06	-3.51	-3.48	-3.57
105	42	-16.75	-16.30	-16.11	-3.48	-3.47	-3.56
105	45	-17.26	-16.75	-16.53	-3.47	-3.46	-3.55
105	48	-16.92	-16.53	-16.43	-3.58	-3.59	-3.70
105	51	-16.13	-15.99	-16.19	-3.88	-3.92	-4.08
105	54	-15.17	-15.35	-15.90	-4.31	-4.41	-4.64
105	57	-14.33	-14.81	-15.66	-4.82	-5.00	-5.31
105	60	-13.93	-14.58	-15.56	-5.34	-5.62	-6.04
105	63	-13.84	-14.60	-15.63	-5.94	-6.33	-6.83
105	66	-13.77	-14.65	-15.81	-6.67	-7.22	-7.83
105	69	-13.72	-14.74	-16.08	-7.54	-8.30	-9.09
105	72	-13.69	-14.85	-16.42	-8.53	-9.56	-10.69
105	75	-13.68	-14.99	-16.81	-9.62	-11.01	-12.70
105	78	-14.06	-15.58	-17.59	-10.90	-13.38	-17.80
105	81	-15.01	-16.80	-18.88	-12.43	-16.82	-26.73
105	84	-16.29	-18.25	-20.29	-14.19	-20.42	-36.64
105	87	-17.64	-19.57	-21.42	-16.18	-23.25	-44.67
105	90	-18.81	-20.37	-21.89	-18.38	-24.39	-47.98
105	93	-19.93	-20.78	-21.76	-21.59	-24.36	-45.15
105	96	-21.18	-21.13	-21.42	-25.93	-24.28	-38.33
105	99	-22.34	-21.42	-20.90	-30.33	-24.14	-30.01
105	102	-23.20	-21.61	-20.26	-33.75	-23.97	-22.69
105	105	-23.54	-21.68	-19.52	-35.12	-23.75	-18.87
105	108	-22.30	-20.61	-18.22	-33.80	-23.15	-17.79
105	111	-19.24	-17.98	-16.14	-30.55	-21.99	-16.98
105	114	-15.35	-14.60	-13.69	-26.43	-20.56	-16.37
105	117	-11.61	-11.30	-11.30	-22.51	-19.13	-15.87
105	120	-9.01	-8.92	-9.37	-19.86	-17.98	-15.39
105	123	-7.42	-7.36	-7.86	-18.36	-17.10	-14.90
105	126	-6.04	-5.97	-6.44	-17.11	-16.27	-14.45
105	129	-4.85	-4.75	-5.15	-16.04	-15.51	-14.04
105	132	-3.84	-3.71	-4.03	-15.09	-14.82	-13.71
105	135	-2.99	-2.85	-3.11	-14.18	-14.21	-13.49
105	138	-2.20	-2.07	-2.28	-13.33	-13.69	-13.35
105	141	-1.43	-1.31	-1.48	-12.56	-13.25	-13.26
105	144	-0.77	-0.66	-0.79	-11.85	-12.84	-13.19
105	147	-0.32	-0.21	-0.31	-11.13	-12.40	-13.09
105	150	-0.14	-0.05	-0.13	-10.38	-11.86	-12.94
105	153	-0.15	-0.06	-0.13	-9.54	-11.14	-12.52
105	156	-0.16	-0.09	-0.16	-8.65	-10.27	-11.75
105	159	-0.19	-0.13	-0.20	-7.76	-9.33	-10.78

105	162	-0.22	-0.20	-0.26	-6.94	-8.41	-9.79
105	165	-0.26	-0.28	-0.33	-6.25	-7.63	-8.93
105	168	-0.52	-0.57	-0.62	-5.62	-6.90	-8.14
105	171	-1.09	-1.17	-1.22	-4.98	-6.15	-7.30
105	174	-1.79	-1.88	-1.93	-4.42	-5.48	-6.52
105	177	-2.43	-2.51	-2.57	-4.02	-4.96	-5.88
105	180	-2.82	-2.88	-2.94	-3.86	-4.68	-5.48
105	183	-3.02	-3.05	-3.11	-3.84	-4.54	-5.24
105	186	-3.20	-3.19	-3.26	-3.84	-4.43	-5.03
105	189	-3.35	-3.31	-3.38	-3.83	-4.34	-4.86
105	192	-3.44	-3.38	-3.46	-3.83	-4.29	-4.75
105	195	-3.48	-3.41	-3.49	-3.83	-4.27	-4.72
105	198	-3.32	-3.24	-3.32	-3.93	-4.34	-4.74
105	201	-2.93	-2.83	-2.90	-4.19	-4.50	-4.81
105	204	-2.42	-2.31	-2.35	-4.49	-4.70	-4.89
105	207	-1.91	-1.79	-1.83	-4.74	-4.86	-4.95
105	210	-1.52	-1.41	-1.45	-4.85	-4.93	-4.98
105	213	-1.22	-1.14	-1.19	-4.85	-4.92	-4.97
105	216	-0.91	-0.87	-0.94	-4.85	-4.91	-4.95
105	219	-0.63	-0.63	-0.73	-4.85	-4.89	-4.93
105	222	-0.44	-0.47	-0.58	-4.85	-4.87	-4.91
105	225	-0.37	-0.41	-0.52	-4.85	-4.87	-4.90
105	228	-0.37	-0.42	-0.54	-4.87	-4.89	-4.93
105	231	-0.39	-0.46	-0.59	-4.95	-4.96	-5.01
105	234	-0.42	-0.52	-0.66	-5.07	-5.07	-5.13
105	237	-0.45	-0.59	-0.75	-5.22	-5.21	-5.28
105	240	-0.49	-0.67	-0.85	-5.40	-5.36	-5.45
105	243	-0.59	-0.81	-1.00	-5.69	-5.62	-5.70
105	246	-0.79	-1.03	-1.24	-6.18	-6.03	-6.06
105	249	-1.05	-1.30	-1.54	-6.78	-6.52	-6.48
105	252	-1.35	-1.62	-1.88	-7.41	-7.05	-6.94
105	255	-1.67	-1.96	-2.25	-8.01	-7.56	-7.36
105	258	-2.02	-2.35	-2.66	-8.67	-8.13	-7.83
105	261	-2.46	-2.81	-3.16	-9.45	-8.80	-8.37
105	264	-2.94	-3.32	-3.71	-10.20	-9.44	-8.88
105	267	-3.46	-3.87	-4.30	-10.76	-9.92	-9.28
105	270	-3.98	-4.43	-4.90	-10.98	-10.11	-9.47
105	273	-4.57	-5.06	-5.58	-10.85	-10.07	-9.53
105	276	-5.24	-5.79	-6.35	-10.53	-9.95	-9.57
105	279	-5.91	-6.52	-7.12	-10.07	-9.76	-9.60
105	282	-6.49	-7.16	-7.80	-9.52	-9.53	-9.63
105	285	-6.90	-7.61	-8.28	-8.97	-9.26	-9.63
105	288	-7.18	-7.93	-8.64	-8.27	-8.74	-9.34
105	291	-7.44	-8.22	-8.96	-7.36	-7.88	-8.62
105	294	-7.65	-8.47	-9.23	-6.37	-6.86	-7.68
105	297	-7.80	-8.63	-9.42	-5.46	-5.89	-6.75
105	300	-7.85	-8.69	-9.49	-4.77	-5.16	-6.03
105	303	-7.79	-8.63	-9.41	-4.22	-4.60	-5.48
105	306	-7.64	-8.47	-9.23	-3.69	-4.05	-4.91
105	309	-7.45	-8.28	-9.01	-3.24	-3.57	-4.42
105	312	-7.30	-8.11	-8.83	-2.92	-3.24	-4.07
105	315	-7.24	-8.05	-8.75	-2.80	-3.12	-3.94
105	318	-7.37	-8.17	-8.83	-2.81	-3.13	-3.94
105	321	-7.75	-8.51	-9.06	-2.83	-3.15	-3.96
105	324	-8.30	-8.99	-9.39	-2.87	-3.19	-3.99
105	327	-8.97	-9.57	-9.79	-2.91	-3.24	-4.03
105	330	-9.71	-10.19	-10.20	-2.97	-3.30	-4.09
105	333	-11.00	-11.13	-10.84	-3.14	-3.49	-4.28

105	336	-13.00	-12.51	-11.77	-3.48	-3.86	-4.69
105	339	-15.12	-13.94	-12.74	-3.92	-4.34	-5.23
105	342	-16.82	-15.07	-13.51	-4.39	-4.86	-5.80
105	345	-17.51	-15.53	-13.82	-4.82	-5.33	-6.31
105	348	-17.14	-15.25	-13.64	-5.21	-5.76	-6.76
105	351	-16.05	-14.44	-13.11	-5.62	-6.19	-7.22
105	354	-14.26	-13.11	-12.26	-6.03	-6.63	-7.68
105	357	-11.80	-11.31	-11.08	-6.45	-7.08	-8.14
105	360	-8.69	-9.05	-9.60	-6.88	-7.54	-8.60
108	0	-8.38	-8.80	-9.38	-6.61	-7.19	-8.21
108	3	-7.67	-8.13	-8.75	-6.46	-6.93	-7.77
108	6	-7.23	-7.71	-8.35	-6.27	-6.65	-7.33
108	9	-6.98	-7.48	-8.14	-6.05	-6.35	-6.88
108	12	-6.87	-7.38	-8.05	-5.81	-6.03	-6.43
108	15	-6.85	-7.36	-8.03	-5.55	-5.69	-5.98
108	18	-7.12	-7.62	-8.28	-5.20	-5.27	-5.46
108	21	-7.80	-8.29	-8.92	-4.76	-4.75	-4.87
108	24	-8.75	-9.22	-9.79	-4.30	-4.25	-4.31
108	27	-9.82	-10.24	-10.76	-3.93	-3.85	-3.88
108	30	-10.84	-11.21	-11.66	-3.73	-3.64	-3.67
108	33	-12.07	-12.31	-12.65	-3.65	-3.58	-3.61
108	36	-13.62	-13.67	-13.86	-3.58	-3.53	-3.56
108	39	-15.15	-14.99	-15.03	-3.53	-3.49	-3.52
108	42	-16.31	-15.99	-15.91	-3.49	-3.47	-3.50
108	45	-16.78	-16.39	-16.26	-3.48	-3.46	-3.49
108	48	-16.44	-16.16	-16.14	-3.58	-3.57	-3.62
108	51	-15.64	-15.62	-15.87	-3.84	-3.86	-3.95
108	54	-14.69	-14.97	-15.54	-4.22	-4.28	-4.44
108	57	-13.89	-14.42	-15.27	-4.66	-4.79	-5.02
108	60	-13.55	-14.20	-15.15	-5.12	-5.33	-5.65
108	63	-13.56	-14.24	-15.24	-5.65	-5.94	-6.34
108	66	-13.60	-14.36	-15.49	-6.31	-6.72	-7.21
108	69	-13.65	-14.56	-15.85	-7.08	-7.66	-8.31
108	72	-13.73	-14.80	-16.29	-7.96	-8.78	-9.72
108	75	-13.82	-15.09	-16.77	-8.93	-10.07	-11.50
108	78	-14.27	-15.80	-17.60	-10.02	-12.31	-16.18
108	81	-15.23	-17.07	-18.87	-11.30	-15.63	-24.45
108	84	-16.46	-18.50	-20.22	-12.79	-19.13	-33.65
108	87	-17.70	-19.67	-21.30	-14.49	-21.90	-41.13
108	90	-18.71	-20.20	-21.73	-16.43	-23.03	-44.21
108	93	-19.57	-20.27	-21.55	-19.47	-23.01	-41.70
108	96	-20.47	-20.32	-21.06	-23.73	-22.97	-35.64
108	99	-21.28	-20.36	-20.32	-28.12	-22.90	-28.25
108	102	-21.86	-20.38	-19.44	-31.55	-22.82	-21.74
108	105	-22.09	-20.39	-18.48	-32.94	-22.70	-18.33
108	108	-20.94	-19.39	-17.09	-31.75	-22.22	-17.34
108	111	-18.10	-16.92	-15.08	-28.82	-21.17	-16.61
108	114	-14.48	-13.76	-12.82	-25.10	-19.85	-16.06
108	117	-11.01	-10.68	-10.63	-21.54	-18.51	-15.59
108	120	-8.59	-8.46	-8.86	-19.11	-17.44	-15.14
108	123	-7.11	-7.01	-7.44	-17.70	-16.60	-14.69
108	126	-5.82	-5.71	-6.12	-16.51	-15.82	-14.26
108	129	-4.71	-4.57	-4.92	-15.50	-15.09	-13.88
108	132	-3.78	-3.61	-3.89	-14.59	-14.42	-13.55
108	135	-3.02	-2.84	-3.06	-13.72	-13.82	-13.31
108	138	-2.34	-2.17	-2.35	-12.90	-13.31	-13.15
108	141	-1.68	-1.53	-1.66	-12.17	-12.88	-13.04
108	144	-1.12	-0.98	-1.08	-11.48	-12.46	-12.94

108	147	-0.74	-0.61	-0.68	-10.78	-12.01	-12.81
108	150	-0.59	-0.47	-0.53	-10.03	-11.47	-12.62
108	153	-0.60	-0.48	-0.54	-9.18	-10.73	-12.14
108	156	-0.61	-0.50	-0.56	-8.25	-9.80	-11.31
108	159	-0.63	-0.55	-0.60	-7.33	-8.81	-10.29
108	162	-0.66	-0.61	-0.65	-6.49	-7.87	-9.27
108	165	-0.70	-0.68	-0.71	-5.83	-7.10	-8.42
108	168	-0.95	-0.97	-1.00	-5.27	-6.44	-7.70
108	171	-1.51	-1.57	-1.61	-4.72	-5.79	-6.96
108	174	-2.19	-2.28	-2.35	-4.25	-5.21	-6.29
108	177	-2.83	-2.93	-3.03	-3.92	-4.78	-5.75
108	180	-3.25	-3.34	-3.46	-3.80	-4.55	-5.41
108	183	-3.50	-3.56	-3.69	-3.80	-4.46	-5.20
108	186	-3.73	-3.76	-3.90	-3.81	-4.39	-5.02
108	189	-3.91	-3.92	-4.07	-3.82	-4.33	-4.87
108	192	-4.04	-4.02	-4.19	-3.83	-4.29	-4.77
108	195	-4.09	-4.06	-4.23	-3.85	-4.28	-4.74
108	198	-3.92	-3.88	-4.05	-3.97	-4.35	-4.77
108	201	-3.49	-3.44	-3.59	-4.22	-4.51	-4.84
108	204	-2.93	-2.87	-3.01	-4.51	-4.71	-4.92
108	207	-2.37	-2.30	-2.43	-4.76	-4.88	-5.00
108	210	-1.94	-1.87	-1.99	-4.87	-4.95	-5.02
108	213	-1.59	-1.54	-1.67	-4.88	-4.94	-5.02
108	216	-1.24	-1.22	-1.34	-4.89	-4.94	-5.01
108	219	-0.93	-0.93	-1.06	-4.89	-4.93	-5.00
108	222	-0.70	-0.73	-0.86	-4.90	-4.93	-4.99
108	225	-0.62	-0.65	-0.78	-4.91	-4.93	-4.99
108	228	-0.62	-0.66	-0.80	-4.95	-4.96	-5.02
108	231	-0.63	-0.69	-0.84	-5.04	-5.04	-5.11
108	234	-0.65	-0.74	-0.90	-5.18	-5.16	-5.25
108	237	-0.67	-0.80	-0.98	-5.34	-5.32	-5.42
108	240	-0.70	-0.87	-1.07	-5.54	-5.50	-5.60
108	243	-0.79	-1.00	-1.22	-5.87	-5.77	-5.85
108	246	-0.99	-1.23	-1.47	-6.39	-6.18	-6.22
108	249	-1.27	-1.53	-1.79	-7.04	-6.69	-6.65
108	252	-1.59	-1.87	-2.15	-7.75	-7.25	-7.11
108	255	-1.92	-2.22	-2.54	-8.44	-7.79	-7.55
108	258	-2.30	-2.64	-3.00	-9.26	-8.44	-8.04
108	261	-2.76	-3.15	-3.57	-10.27	-9.24	-8.61
108	264	-3.28	-3.72	-4.21	-11.24	-10.01	-9.17
108	267	-3.82	-4.31	-4.86	-11.98	-10.60	-9.62
108	270	-4.35	-4.89	-5.48	-12.28	-10.83	-9.88
108	273	-4.93	-5.50	-6.13	-12.10	-10.78	-10.00
108	276	-5.57	-6.18	-6.84	-11.63	-10.65	-10.10
108	279	-6.20	-6.83	-7.53	-10.97	-10.44	-10.18
108	282	-6.72	-7.39	-8.11	-10.23	-10.19	-10.23
108	285	-7.05	-7.76	-8.50	-9.51	-9.90	-10.25
108	288	-7.25	-8.00	-8.77	-8.71	-9.34	-9.95
108	291	-7.43	-8.22	-9.01	-7.75	-8.44	-9.20
108	294	-7.57	-8.39	-9.20	-6.75	-7.38	-8.22
108	297	-7.66	-8.51	-9.33	-5.84	-6.37	-7.25
108	300	-7.69	-8.55	-9.38	-5.14	-5.60	-6.50
108	303	-7.64	-8.49	-9.30	-4.57	-5.01	-5.91
108	306	-7.51	-8.34	-9.12	-4.01	-4.43	-5.32
108	309	-7.36	-8.16	-8.91	-3.54	-3.93	-4.80
108	312	-7.24	-8.01	-8.73	-3.21	-3.57	-4.42
108	315	-7.19	-7.94	-8.65	-3.09	-3.44	-4.27
108	318	-7.37	-8.11	-8.80	-3.09	-3.44	-4.26



108	321	-7.87	-8.57	-9.17	-3.09	-3.44	-4.25
108	324	-8.58	-9.22	-9.71	-3.09	-3.45	-4.25
108	327	-9.42	-9.97	-10.33	-3.09	-3.45	-4.24
108	330	-10.31	-10.74	-10.95	-3.09	-3.45	-4.24
108	333	-11.61	-11.81	-11.78	-3.20	-3.58	-4.39
108	336	-13.47	-13.26	-12.90	-3.49	-3.91	-4.75
108	339	-15.39	-14.75	-14.04	-3.89	-4.35	-5.24
108	342	-16.89	-15.90	-14.92	-4.32	-4.83	-5.76
108	345	-17.50	-16.37	-15.27	-4.71	-5.25	-6.22
108	348	-17.11	-16.03	-15.01	-5.07	-5.63	-6.62
108	351	-15.95	-15.06	-14.26	-5.44	-6.01	-7.02
108	354	-14.08	-13.50	-13.04	-5.82	-6.40	-7.41
108	357	-11.54	-11.40	-11.40	-6.21	-6.79	-7.81
108	360	-8.38	-8.80	-9.38	-6.61	-7.19	-8.21
111	0	-8.16	-8.63	-9.24	-6.09	-6.69	-7.63
111	3	-7.55	-8.05	-8.68	-5.99	-6.50	-7.29
111	6	-7.18	-7.69	-8.34	-5.86	-6.29	-6.93
111	9	-6.99	-7.51	-8.17	-5.70	-6.05	-6.57
111	12	-6.92	-7.44	-8.10	-5.51	-5.80	-6.19
111	15	-6.91	-7.43	-8.09	-5.31	-5.53	-5.81
111	18	-7.18	-7.71	-8.38	-5.04	-5.18	-5.36
111	21	-7.88	-8.43	-9.12	-4.68	-4.75	-4.85
111	24	-8.83	-9.40	-10.11	-4.30	-4.31	-4.36
111	27	-9.87	-10.44	-11.14	-3.98	-3.95	-3.96
111	30	-10.83	-11.36	-12.03	-3.80	-3.75	-3.74
111	33	-11.87	-12.30	-12.88	-3.70	-3.66	-3.64
111	36	-13.12	-13.39	-13.82	-3.62	-3.58	-3.56
111	39	-14.32	-14.41	-14.69	-3.56	-3.51	-3.50
111	42	-15.23	-15.17	-15.33	-3.52	-3.47	-3.46
111	45	-15.58	-15.47	-15.58	-3.51	-3.46	-3.44
111	48	-15.28	-15.25	-15.44	-3.59	-3.55	-3.54
111	51	-14.55	-14.70	-15.09	-3.81	-3.79	-3.81
111	54	-13.68	-14.05	-14.67	-4.13	-4.14	-4.20
111	57	-12.96	-13.51	-14.31	-4.50	-4.55	-4.67
111	60	-12.65	-13.28	-14.17	-4.90	-5.00	-5.18
111	63	-12.72	-13.39	-14.33	-5.36	-5.51	-5.75
111	66	-12.90	-13.68	-14.74	-5.94	-6.17	-6.47
111	69	-13.18	-14.10	-15.33	-6.63	-6.96	-7.38
111	72	-13.52	-14.61	-16.01	-7.40	-7.91	-8.54
111	75	-13.90	-15.14	-16.69	-8.24	-9.00	-9.99
111	78	-14.62	-15.96	-17.59	-9.17	-10.83	-13.64
111	81	-15.75	-17.15	-18.79	-10.23	-13.52	-20.00
111	84	-16.98	-18.38	-20.00	-11.45	-16.36	-27.06
111	87	-17.99	-19.35	-20.94	-12.85	-18.66	-32.77
111	90	-18.43	-19.75	-21.32	-14.43	-19.69	-35.13
111	93	-18.49	-19.62	-20.97	-16.88	-19.84	-33.38
111	96	-18.54	-19.26	-20.05	-20.29	-19.96	-29.15
111	99	-18.57	-18.71	-18.78	-23.80	-20.05	-23.99
111	102	-18.59	-18.03	-17.34	-26.53	-20.10	-19.42
111	105	-18.59	-17.27	-15.94	-27.63	-20.12	-16.97
111	108	-17.66	-15.93	-14.43	-26.76	-19.82	-16.23
111	111	-15.34	-13.81	-12.65	-24.60	-19.04	-15.67
111	114	-12.40	-11.37	-10.79	-21.83	-18.02	-15.25
111	117	-9.57	-9.07	-9.04	-19.15	-16.96	-14.89
111	120	-7.60	-7.37	-7.62	-17.25	-16.08	-14.52
111	123	-6.39	-6.19	-6.46	-16.07	-15.38	-14.13
111	126	-5.33	-5.14	-5.38	-15.06	-14.70	-13.78
111	129	-4.42	-4.22	-4.42	-14.18	-14.06	-13.45

111	132	-3.66	-3.45	-3.60	-13.37	-13.45	-13.14
111	135	-3.04	-2.83	-2.95	-12.59	-12.88	-12.88
111	138	-2.48	-2.28	-2.39	-11.85	-12.39	-12.66
111	141	-1.94	-1.77	-1.86	-11.18	-11.95	-12.49
111	144	-1.48	-1.33	-1.40	-10.54	-11.53	-12.33
111	147	-1.16	-1.03	-1.09	-9.90	-11.07	-12.13
111	150	-1.05	-0.91	-0.97	-9.22	-10.54	-11.86
111	153	-1.06	-0.94	-1.00	-8.44	-9.84	-11.34
111	156	-1.11	-1.00	-1.07	-7.59	-8.99	-10.55
111	159	-1.19	-1.11	-1.17	-6.75	-8.09	-9.62
111	162	-1.29	-1.25	-1.31	-6.00	-7.25	-8.71
111	165	-1.42	-1.41	-1.48	-5.42	-6.58	-7.95
111	168	-1.75	-1.78	-1.87	-4.95	-6.01	-7.31
111	171	-2.37	-2.45	-2.57	-4.50	-5.46	-6.68
111	174	-3.12	-3.24	-3.39	-4.12	-4.97	-6.10
111	177	-3.83	-3.98	-4.17	-3.85	-4.62	-5.64
111	180	-4.33	-4.49	-4.71	-3.75	-4.45	-5.36
111	183	-4.68	-4.82	-5.08	-3.76	-4.40	-5.18
111	186	-5.02	-5.13	-5.43	-3.78	-4.36	-5.03
111	189	-5.30	-5.39	-5.72	-3.82	-4.33	-4.91
111	192	-5.49	-5.57	-5.92	-3.87	-4.31	-4.83
111	195	-5.56	-5.64	-5.99	-3.92	-4.31	-4.80
111	198	-5.36	-5.44	-5.79	-4.06	-4.37	-4.83
111	201	-4.86	-4.93	-5.27	-4.29	-4.53	-4.91
111	204	-4.20	-4.26	-4.60	-4.57	-4.73	-5.00
111	207	-3.54	-3.58	-3.91	-4.80	-4.90	-5.09
111	210	-3.01	-3.05	-3.36	-4.93	-4.99	-5.14
111	213	-2.57	-2.61	-2.89	-4.97	-5.02	-5.16
111	216	-2.12	-2.15	-2.39	-5.00	-5.03	-5.18
111	219	-1.72	-1.74	-1.95	-5.02	-5.04	-5.19
111	222	-1.43	-1.44	-1.63	-5.04	-5.06	-5.20
111	225	-1.30	-1.33	-1.50	-5.08	-5.08	-5.23
111	228	-1.29	-1.34	-1.51	-5.16	-5.15	-5.29
111	231	-1.28	-1.35	-1.53	-5.28	-5.26	-5.41
111	234	-1.27	-1.36	-1.56	-5.45	-5.42	-5.58
111	237	-1.27	-1.39	-1.61	-5.66	-5.62	-5.77
111	240	-1.27	-1.42	-1.66	-5.91	-5.84	-5.99
111	243	-1.35	-1.53	-1.79	-6.27	-6.14	-6.26
111	246	-1.56	-1.77	-2.06	-6.83	-6.58	-6.64
111	249	-1.87	-2.11	-2.42	-7.51	-7.11	-7.08
111	252	-2.22	-2.50	-2.85	-8.28	-7.70	-7.55
111	255	-2.59	-2.91	-3.30	-9.09	-8.31	-8.03
111	258	-3.02	-3.41	-3.87	-10.19	-9.11	-8.63
111	261	-3.56	-4.05	-4.62	-11.64	-10.14	-9.37
111	264	-4.16	-4.75	-5.44	-13.09	-11.17	-10.09
111	267	-4.75	-5.42	-6.22	-14.21	-11.95	-10.66
111	270	-5.28	-6.00	-6.87	-14.66	-12.27	-10.91
111	273	-5.81	-6.54	-7.43	-14.37	-12.19	-10.96
111	276	-6.38	-7.10	-8.00	-13.61	-11.98	-11.01
111	279	-6.90	-7.60	-8.50	-12.57	-11.68	-11.04
111	282	-7.28	-7.96	-8.86	-11.46	-11.30	-11.05
111	285	-7.43	-8.13	-9.02	-10.45	-10.88	-11.06
111	288	-7.43	-8.15	-9.05	-9.47	-10.22	-10.74
111	291	-7.43	-8.18	-9.07	-8.41	-9.23	-9.94
111	294	-7.43	-8.19	-9.09	-7.36	-8.11	-8.90
111	297	-7.43	-8.20	-9.10	-6.41	-7.04	-7.86
111	300	-7.43	-8.21	-9.11	-5.67	-6.22	-7.06
111	303	-7.39	-8.15	-9.04	-5.06	-5.59	-6.45

111	306	-7.30	-8.03	-8.87	-4.48	-4.98	-5.84
111	309	-7.19	-7.87	-8.67	-3.99	-4.45	-5.30
111	312	-7.10	-7.74	-8.50	-3.62	-4.05	-4.89
111	315	-7.07	-7.69	-8.43	-3.43	-3.85	-4.67
111	318	-7.30	-7.92	-8.63	-3.34	-3.77	-4.58
111	321	-7.93	-8.51	-9.17	-3.28	-3.70	-4.51
111	324	-8.81	-9.33	-9.92	-3.22	-3.65	-4.45
111	327	-9.82	-10.28	-10.77	-3.19	-3.61	-4.42
111	330	-10.83	-11.21	-11.60	-3.18	-3.60	-4.40
111	333	-12.14	-12.39	-12.64	-3.27	-3.71	-4.52
111	336	-13.87	-13.93	-13.99	-3.49	-3.97	-4.82
111	339	-15.60	-15.46	-15.33	-3.80	-4.32	-5.21
111	342	-16.95	-16.65	-16.36	-4.14	-4.71	-5.64
111	345	-17.49	-17.12	-16.77	-4.45	-5.06	-6.01
111	348	-17.07	-16.74	-16.44	-4.75	-5.37	-6.34
111	351	-15.87	-15.64	-15.46	-5.06	-5.69	-6.66
111	354	-13.94	-13.88	-13.89	-5.39	-6.01	-6.98
111	357	-11.35	-11.52	-11.80	-5.73	-6.35	-7.31
111	360	-8.16	-8.63	-9.24	-6.09	-6.69	-7.63
114	0	-7.99	-8.50	-9.13	-5.47	-6.12	-6.98
114	3	-7.49	-8.02	-8.66	-5.45	-6.02	-6.75
114	6	-7.19	-7.72	-8.38	-5.39	-5.90	-6.50
114	9	-7.04	-7.57	-8.23	-5.31	-5.74	-6.22
114	12	-6.98	-7.52	-8.18	-5.20	-5.56	-5.94
114	15	-6.97	-7.51	-8.17	-5.08	-5.37	-5.63
114	18	-7.26	-7.82	-8.51	-4.90	-5.11	-5.27
114	21	-7.99	-8.59	-9.35	-4.63	-4.76	-4.84
114	24	-8.95	-9.61	-10.45	-4.33	-4.40	-4.41
114	27	-9.96	-10.65	-11.53	-4.06	-4.08	-4.05
114	30	-10.80	-11.48	-12.35	-3.88	-3.88	-3.82
114	33	-11.59	-12.19	-12.98	-3.78	-3.75	-3.69
114	36	-12.45	-12.93	-13.60	-3.68	-3.63	-3.57
114	39	-13.24	-13.60	-14.15	-3.61	-3.54	-3.48
114	42	-13.82	-14.08	-14.53	-3.55	-3.48	-3.42
114	45	-14.04	-14.27	-14.68	-3.53	-3.46	-3.40
114	48	-13.79	-14.05	-14.51	-3.60	-3.53	-3.47
114	51	-13.18	-13.53	-14.09	-3.78	-3.71	-3.67
114	54	-12.45	-12.92	-13.59	-4.04	-3.98	-3.97
114	57	-11.83	-12.40	-13.17	-4.35	-4.31	-4.32
114	60	-11.58	-12.18	-12.99	-4.68	-4.66	-4.71
114	63	-11.73	-12.38	-13.25	-5.07	-5.08	-5.15
114	66	-12.13	-12.91	-13.89	-5.58	-5.62	-5.72
114	69	-12.69	-13.64	-14.77	-6.19	-6.27	-6.44
114	72	-13.33	-14.44	-15.73	-6.86	-7.04	-7.34
114	75	-13.97	-15.18	-16.59	-7.57	-7.90	-8.44
114	78	-14.77	-16.02	-17.51	-8.36	-9.21	-10.84
114	81	-15.83	-17.05	-18.59	-9.24	-11.03	-14.82
114	84	-16.89	-18.04	-19.63	-10.23	-12.96	-19.16
114	87	-17.71	-18.79	-20.40	-11.32	-14.59	-22.66
114	90	-18.03	-19.09	-20.70	-12.52	-15.53	-24.10
114	93	-17.81	-18.70	-20.11	-14.21	-15.95	-23.25
114	96	-17.22	-17.71	-18.61	-16.42	-16.31	-21.21
114	99	-16.36	-16.34	-16.61	-18.65	-16.59	-18.70
114	102	-15.37	-14.84	-14.54	-20.37	-16.77	-16.46
114	105	-14.34	-13.44	-12.79	-21.06	-16.84	-15.20
114	108	-13.02	-12.00	-11.31	-20.56	-16.66	-14.75
114	111	-11.27	-10.36	-9.83	-19.33	-16.20	-14.42
114	114	-9.39	-8.70	-8.42	-17.72	-15.59	-14.17

114	117	-7.67	-7.21	-7.16	-16.11	-14.93	-13.93
114	120	-6.41	-6.07	-6.13	-14.88	-14.34	-13.67
114	123	-5.52	-5.22	-5.29	-14.01	-13.82	-13.39
114	126	-4.75	-4.46	-4.52	-13.23	-13.28	-13.12
114	129	-4.08	-3.81	-3.84	-12.52	-12.75	-12.86
114	132	-3.52	-3.26	-3.27	-11.85	-12.22	-12.59
114	135	-3.05	-2.81	-2.82	-11.19	-11.72	-12.33
114	138	-2.62	-2.41	-2.43	-10.56	-11.25	-12.07
114	141	-2.21	-2.03	-2.06	-9.97	-10.82	-11.83
114	144	-1.86	-1.70	-1.76	-9.40	-10.38	-11.58
114	147	-1.62	-1.48	-1.54	-8.82	-9.93	-11.30
114	150	-1.53	-1.39	-1.46	-8.23	-9.42	-10.94
114	153	-1.57	-1.44	-1.52	-7.57	-8.80	-10.43
114	156	-1.68	-1.58	-1.67	-6.86	-8.09	-9.73
114	159	-1.86	-1.79	-1.89	-6.17	-7.36	-8.94
114	162	-2.07	-2.05	-2.17	-5.55	-6.68	-8.18
114	165	-2.32	-2.34	-2.48	-5.08	-6.14	-7.55
114	168	-2.77	-2.84	-3.00	-4.70	-5.66	-7.00
114	171	-3.49	-3.61	-3.81	-4.33	-5.19	-6.44
114	174	-4.34	-4.49	-4.74	-4.01	-4.78	-5.95
114	177	-5.14	-5.33	-5.62	-3.80	-4.49	-5.55
114	180	-5.74	-5.94	-6.28	-3.72	-4.38	-5.31
114	183	-6.19	-6.39	-6.78	-3.73	-4.37	-5.18
114	186	-6.64	-6.83	-7.27	-3.78	-4.36	-5.06
114	189	-7.02	-7.20	-7.69	-3.85	-4.35	-4.97
114	192	-7.29	-7.46	-7.98	-3.93	-4.35	-4.91
114	195	-7.39	-7.56	-8.09	-4.02	-4.35	-4.88
114	198	-7.17	-7.34	-7.88	-4.17	-4.41	-4.92
114	201	-6.60	-6.78	-7.33	-4.39	-4.56	-5.00
114	204	-5.85	-6.04	-6.60	-4.65	-4.75	-5.11
114	207	-5.08	-5.27	-5.83	-4.87	-4.93	-5.22
114	210	-4.46	-4.64	-5.18	-5.02	-5.06	-5.30
114	213	-3.94	-4.09	-4.57	-5.10	-5.12	-5.36
114	216	-3.40	-3.50	-3.90	-5.15	-5.16	-5.40
114	219	-2.90	-2.96	-3.28	-5.19	-5.20	-5.44
114	222	-2.53	-2.55	-2.82	-5.25	-5.25	-5.49
114	225	-2.33	-2.36	-2.61	-5.32	-5.31	-5.56
114	228	-2.26	-2.32	-2.58	-5.44	-5.42	-5.67
114	231	-2.20	-2.28	-2.56	-5.61	-5.58	-5.83
114	234	-2.16	-2.25	-2.54	-5.83	-5.78	-6.03
114	237	-2.13	-2.23	-2.53	-6.09	-6.03	-6.26
114	240	-2.12	-2.22	-2.52	-6.40	-6.30	-6.52
114	243	-2.20	-2.32	-2.63	-6.81	-6.65	-6.83
114	246	-2.43	-2.59	-2.92	-7.39	-7.12	-7.22
114	249	-2.76	-2.97	-3.33	-8.10	-7.68	-7.67
114	252	-3.15	-3.42	-3.82	-8.92	-8.31	-8.17
114	255	-3.54	-3.87	-4.33	-9.82	-8.99	-8.70
114	258	-4.03	-4.47	-5.03	-11.21	-9.97	-9.42
114	261	-4.67	-5.27	-6.00	-13.16	-11.28	-10.36
114	264	-5.36	-6.11	-7.03	-15.17	-12.61	-11.31
114	267	-5.99	-6.87	-7.94	-16.74	-13.64	-12.03
114	270	-6.48	-7.39	-8.52	-17.37	-14.06	-12.32
114	273	-6.87	-7.74	-8.86	-16.95	-13.94	-12.30
114	276	-7.24	-8.06	-9.17	-15.87	-13.63	-12.26
114	279	-7.56	-8.32	-9.41	-14.43	-13.17	-12.19
114	282	-7.79	-8.50	-9.58	-12.91	-12.62	-12.09
114	285	-7.87	-8.56	-9.64	-11.60	-12.04	-11.97
114	288	-7.80	-8.49	-9.57	-10.45	-11.25	-11.55

114	291	-7.63	-8.33	-9.39	-9.26	-10.15	-10.68
114	294	-7.42	-8.12	-9.16	-8.12	-8.94	-9.59
114	297	-7.23	-7.91	-8.92	-7.10	-7.80	-8.51
114	300	-7.11	-7.76	-8.74	-6.29	-6.92	-7.67
114	303	-7.06	-7.66	-8.59	-5.63	-6.23	-7.02
114	306	-7.00	-7.56	-8.43	-5.01	-5.59	-6.39
114	309	-6.96	-7.47	-8.30	-4.47	-5.02	-5.83
114	312	-6.93	-7.41	-8.20	-4.06	-4.58	-5.38
114	315	-6.92	-7.39	-8.16	-3.79	-4.30	-5.10
114	318	-7.21	-7.67	-8.43	-3.63	-4.13	-4.93
114	321	-7.97	-8.39	-9.11	-3.48	-3.98	-4.78
114	324	-9.01	-9.40	-10.07	-3.37	-3.86	-4.67
114	327	-10.17	-10.52	-11.14	-3.29	-3.78	-4.59
114	330	-11.28	-11.59	-12.17	-3.27	-3.75	-4.56
114	333	-12.58	-12.87	-13.40	-3.32	-3.82	-4.65
114	336	-14.19	-14.48	-14.95	-3.47	-4.01	-4.86
114	339	-15.77	-16.06	-16.47	-3.68	-4.27	-5.16
114	342	-16.98	-17.26	-17.64	-3.91	-4.55	-5.47
114	345	-17.46	-17.74	-18.11	-4.14	-4.81	-5.75
114	348	-17.03	-17.32	-17.70	-4.36	-5.05	-5.99
114	351	-15.78	-16.11	-16.52	-4.61	-5.30	-6.23
114	354	-13.81	-14.19	-14.66	-4.88	-5.56	-6.48
114	357	-11.19	-11.63	-12.17	-5.17	-5.84	-6.73
114	360	-7.99	-8.50	-9.13	-5.47	-6.12	-6.98
117	0	-7.82	-8.36	-9.00	-4.90	-5.58	-6.38
117	3	-7.43	-7.98	-8.62	-4.90	-5.56	-6.24
117	6	-7.20	-7.74	-8.40	-4.90	-5.51	-6.08
117	9	-7.08	-7.62	-8.28	-4.89	-5.42	-5.89
117	12	-7.04	-7.58	-8.24	-4.88	-5.32	-5.68
117	15	-7.03	-7.57	-8.23	-4.86	-5.21	-5.46
117	18	-7.34	-7.92	-8.63	-4.78	-5.03	-5.17
117	21	-8.12	-8.77	-9.58	-4.59	-4.77	-4.82
117	24	-9.11	-9.85	-10.78	-4.35	-4.46	-4.45
117	27	-10.07	-10.87	-11.89	-4.12	-4.18	-4.12
117	30	-10.77	-11.56	-12.57	-3.95	-3.98	-3.89
117	33	-11.26	-11.99	-12.93	-3.84	-3.83	-3.74
117	36	-11.73	-12.39	-13.25	-3.74	-3.69	-3.59
117	39	-12.13	-12.72	-13.50	-3.64	-3.57	-3.47
117	42	-12.41	-12.95	-13.67	-3.58	-3.49	-3.39
117	45	-12.52	-13.04	-13.74	-3.56	-3.46	-3.36
117	48	-12.33	-12.85	-13.56	-3.61	-3.51	-3.41
117	51	-11.87	-12.41	-13.13	-3.75	-3.64	-3.55
117	54	-11.33	-11.89	-12.62	-3.95	-3.84	-3.76
117	57	-10.87	-11.45	-12.19	-4.20	-4.08	-4.02
117	60	-10.68	-11.26	-12.01	-4.46	-4.35	-4.30
117	63	-10.92	-11.57	-12.35	-4.79	-4.68	-4.64
117	66	-11.53	-12.33	-13.22	-5.23	-5.12	-5.09
117	69	-12.37	-13.34	-14.37	-5.76	-5.66	-5.66
117	72	-13.26	-14.38	-15.55	-6.34	-6.26	-6.33
117	75	-14.05	-15.24	-16.51	-6.95	-6.92	-7.09
117	78	-14.85	-16.00	-17.37	-7.61	-7.75	-8.38
117	81	-15.77	-16.81	-18.28	-8.36	-8.81	-10.27
117	84	-16.64	-17.55	-19.11	-9.16	-9.93	-12.26
117	87	-17.29	-18.09	-19.71	-9.99	-10.94	-13.83
117	90	-17.54	-18.30	-19.94	-10.81	-11.69	-14.47
117	93	-17.01	-17.64	-19.11	-11.77	-12.26	-14.38
117	96	-15.67	-15.98	-17.05	-12.89	-12.80	-14.17
117	99	-13.90	-13.83	-14.40	-13.96	-13.25	-13.88

117	102	-12.09	-11.68	-11.80	-14.76	-13.57	-13.60
117	105	-10.60	-10.01	-9.89	-15.07	-13.69	-13.39
117	108	-9.41	-8.78	-8.61	-14.89	-13.62	-13.25
117	111	-8.23	-7.63	-7.44	-14.45	-13.44	-13.13
117	114	-7.13	-6.58	-6.42	-13.84	-13.19	-13.03
117	117	-6.17	-5.68	-5.55	-13.18	-12.90	-12.91
117	120	-5.41	-4.97	-4.86	-12.60	-12.61	-12.77
117	123	-4.80	-4.40	-4.28	-12.07	-12.30	-12.62
117	126	-4.25	-3.89	-3.77	-11.53	-11.92	-12.44
117	129	-3.78	-3.45	-3.33	-10.99	-11.51	-12.24
117	132	-3.39	-3.09	-2.97	-10.44	-11.08	-12.03
117	135	-3.07	-2.80	-2.71	-9.91	-10.65	-11.80
117	138	-2.78	-2.55	-2.50	-9.39	-10.24	-11.54
117	141	-2.51	-2.31	-2.31	-8.88	-9.82	-11.25
117	144	-2.28	-2.12	-2.15	-8.38	-9.39	-10.93
117	147	-2.13	-1.98	-2.04	-7.87	-8.94	-10.57
117	150	-2.07	-1.93	-2.00	-7.37	-8.48	-10.18
117	153	-2.14	-2.01	-2.09	-6.83	-7.95	-9.68
117	156	-2.33	-2.23	-2.34	-6.26	-7.38	-9.07
117	159	-2.61	-2.56	-2.69	-5.71	-6.80	-8.42
117	162	-2.95	-2.95	-3.12	-5.22	-6.27	-7.79
117	165	-3.33	-3.37	-3.57	-4.84	-5.82	-7.25
117	168	-3.88	-3.97	-4.21	-4.52	-5.42	-6.77
117	171	-4.69	-4.82	-5.09	-4.21	-5.02	-6.27
117	174	-5.61	-5.76	-6.06	-3.95	-4.67	-5.83
117	177	-6.47	-6.65	-6.99	-3.77	-4.42	-5.49
117	180	-7.13	-7.32	-7.71	-3.70	-4.33	-5.29
117	183	-7.66	-7.86	-8.29	-3.72	-4.33	-5.19
117	186	-8.17	-8.38	-8.87	-3.79	-4.34	-5.10
117	189	-8.62	-8.82	-9.37	-3.89	-4.36	-5.04
117	192	-8.93	-9.13	-9.72	-4.00	-4.38	-4.99
117	195	-9.05	-9.25	-9.86	-4.12	-4.40	-4.98
117	198	-8.82	-9.04	-9.66	-4.29	-4.48	-5.02
117	201	-8.25	-8.49	-9.15	-4.50	-4.63	-5.11
117	204	-7.48	-7.77	-8.46	-4.74	-4.81	-5.24
117	207	-6.69	-7.00	-7.72	-4.96	-4.99	-5.37
117	210	-6.03	-6.34	-7.06	-5.13	-5.14	-5.49
117	213	-5.46	-5.73	-6.40	-5.24	-5.23	-5.57
117	216	-4.87	-5.08	-5.66	-5.32	-5.31	-5.65
117	219	-4.32	-4.46	-4.94	-5.39	-5.38	-5.73
117	222	-3.88	-3.96	-4.37	-5.48	-5.46	-5.82
117	225	-3.61	-3.67	-4.04	-5.59	-5.57	-5.94
117	228	-3.47	-3.52	-3.88	-5.76	-5.73	-6.09
117	231	-3.35	-3.40	-3.75	-5.97	-5.94	-6.29
117	234	-3.25	-3.30	-3.64	-6.24	-6.19	-6.53
117	237	-3.19	-3.23	-3.58	-6.55	-6.48	-6.81
117	240	-3.17	-3.21	-3.55	-6.91	-6.81	-7.10
117	243	-3.26	-3.32	-3.67	-7.37	-7.21	-7.45
117	246	-3.50	-3.60	-3.97	-7.96	-7.70	-7.85
117	249	-3.85	-4.00	-4.40	-8.68	-8.28	-8.32
117	252	-4.25	-4.48	-4.92	-9.53	-8.95	-8.85
117	255	-4.66	-4.96	-5.46	-10.50	-9.70	-9.43
117	258	-5.20	-5.64	-6.25	-12.12	-10.84	-10.28
117	261	-5.92	-6.56	-7.36	-14.47	-12.43	-11.42
117	264	-6.67	-7.51	-8.52	-16.93	-14.06	-12.57
117	267	-7.31	-8.29	-9.46	-18.87	-15.33	-13.47
117	270	-7.68	-8.66	-9.90	-19.66	-15.84	-13.83
117	273	-7.86	-8.75	-9.99	-19.15	-15.68	-13.78

117	276	-8.01	-8.82	-10.06	-17.85	-15.26	-13.65
117	279	-8.14	-8.88	-10.12	-16.13	-14.65	-13.45
117	282	-8.21	-8.91	-10.15	-14.32	-13.94	-13.19
117	285	-8.24	-8.93	-10.16	-12.80	-13.21	-12.89
117	288	-8.09	-8.77	-9.99	-11.50	-12.29	-12.32
117	291	-7.74	-8.39	-9.58	-10.18	-11.09	-11.37
117	294	-7.32	-7.93	-9.08	-8.93	-9.78	-10.24
117	297	-6.96	-7.53	-8.62	-7.82	-8.56	-9.13
117	300	-6.81	-7.32	-8.34	-6.93	-7.61	-8.26
117	303	-6.81	-7.26	-8.22	-6.20	-6.87	-7.57
117	306	-6.81	-7.21	-8.11	-5.54	-6.18	-6.92
117	309	-6.81	-7.17	-8.02	-4.96	-5.58	-6.33
117	312	-6.81	-7.15	-7.96	-4.50	-5.09	-5.86
117	315	-6.80	-7.14	-7.94	-4.17	-4.75	-5.52
117	318	-7.14	-7.46	-8.25	-3.93	-4.49	-5.28
117	321	-8.01	-8.30	-9.07	-3.71	-4.26	-5.06
117	324	-9.19	-9.46	-10.21	-3.53	-4.07	-4.89
117	327	-10.48	-10.73	-11.46	-3.40	-3.95	-4.77
117	330	-11.66	-11.92	-12.65	-3.36	-3.90	-4.72
117	333	-12.93	-13.26	-14.01	-3.39	-3.95	-4.78
117	336	-14.45	-14.89	-15.69	-3.48	-4.06	-4.91
117	339	-15.90	-16.48	-17.32	-3.60	-4.22	-5.10
117	342	-16.99	-17.68	-18.57	-3.74	-4.40	-5.31
117	345	-17.42	-18.15	-19.06	-3.88	-4.58	-5.49
117	348	-16.97	-17.70	-18.60	-4.03	-4.75	-5.66
117	351	-15.70	-16.41	-17.28	-4.22	-4.93	-5.83
117	354	-13.69	-14.37	-15.17	-4.43	-5.14	-6.01
117	357	-11.03	-11.66	-12.39	-4.65	-5.35	-6.19
117	360	-7.82	-8.36	-9.00	-4.90	-5.58	-6.38
120	0	-7.60	-8.15	-8.79	-4.53	-5.17	-5.93
120	3	-7.33	-7.88	-8.53	-4.59	-5.17	-5.85
120	6	-7.17	-7.72	-8.38	-4.63	-5.15	-5.74
120	9	-7.09	-7.64	-8.30	-4.65	-5.12	-5.61
120	12	-7.06	-7.61	-8.27	-4.66	-5.08	-5.45
120	15	-7.05	-7.60	-8.26	-4.66	-5.03	-5.28
120	18	-7.40	-7.99	-8.70	-4.60	-4.92	-5.06
120	21	-8.24	-8.93	-9.76	-4.47	-4.71	-4.76
120	24	-9.27	-10.07	-11.03	-4.29	-4.46	-4.44
120	27	-10.20	-11.07	-12.13	-4.12	-4.21	-4.14
120	30	-10.72	-11.59	-12.65	-3.98	-4.02	-3.92
120	33	-10.93	-11.74	-12.75	-3.88	-3.87	-3.75
120	36	-11.11	-11.86	-12.83	-3.76	-3.72	-3.59
120	39	-11.25	-11.96	-12.88	-3.67	-3.59	-3.45
120	42	-11.34	-12.02	-12.92	-3.60	-3.49	-3.35
120	45	-11.37	-12.04	-12.93	-3.57	-3.46	-3.32
120	48	-11.26	-11.92	-12.79	-3.61	-3.49	-3.36
120	51	-11.00	-11.63	-12.46	-3.71	-3.58	-3.46
120	54	-10.68	-11.29	-12.07	-3.86	-3.72	-3.62
120	57	-10.41	-11.00	-11.74	-4.04	-3.89	-3.81
120	60	-10.30	-10.88	-11.60	-4.25	-4.08	-4.02
120	63	-10.60	-11.25	-12.00	-4.52	-4.34	-4.30
120	66	-11.35	-12.17	-12.99	-4.90	-4.71	-4.69
120	69	-12.34	-13.34	-14.27	-5.36	-5.17	-5.17
120	72	-13.35	-14.49	-15.53	-5.86	-5.66	-5.69
120	75	-14.17	-15.32	-16.48	-6.37	-6.17	-6.22
120	78	-14.89	-15.92	-17.19	-6.93	-6.74	-6.83
120	81	-15.64	-16.49	-17.89	-7.58	-7.39	-7.54
120	84	-16.33	-16.99	-18.50	-8.25	-8.08	-8.28

120	87	-16.82	-17.33	-18.94	-8.89	-8.74	-9.00
120	90	-17.01	-17.46	-19.10	-9.44	-9.32	-9.62
120	93	-16.31	-16.66	-18.14	-9.98	-9.88	-10.21
120	96	-14.57	-14.68	-15.79	-10.53	-10.46	-10.83
120	99	-12.34	-12.16	-12.83	-11.03	-10.98	-11.38
120	102	-10.19	-9.77	-10.02	-11.38	-11.36	-11.78
120	105	-8.67	-8.13	-8.14	-11.52	-11.50	-11.95
120	108	-7.72	-7.15	-7.08	-11.49	-11.49	-11.96
120	111	-6.88	-6.32	-6.16	-11.42	-11.47	-11.97
120	114	-6.16	-5.60	-5.40	-11.30	-11.43	-11.98
120	117	-5.53	-5.00	-4.77	-11.17	-11.38	-11.99
120	120	-4.99	-4.49	-4.26	-11.01	-11.32	-11.99
120	123	-4.50	-4.03	-3.80	-10.78	-11.20	-11.96
120	126	-4.03	-3.61	-3.38	-10.43	-10.97	-11.87
120	129	-3.62	-3.24	-3.02	-10.01	-10.67	-11.75
120	132	-3.30	-2.96	-2.77	-9.57	-10.34	-11.59
120	135	-3.10	-2.79	-2.66	-9.14	-10.01	-11.43
120	138	-2.97	-2.71	-2.64	-8.72	-9.68	-11.23
120	141	-2.86	-2.64	-2.62	-8.28	-9.31	-10.95
120	144	-2.77	-2.58	-2.61	-7.83	-8.91	-10.62
120	147	-2.71	-2.54	-2.60	-7.38	-8.49	-10.24
120	150	-2.69	-2.53	-2.60	-6.94	-8.06	-9.85
120	153	-2.79	-2.64	-2.72	-6.48	-7.60	-9.38
120	156	-3.05	-2.94	-3.05	-5.99	-7.09	-8.80
120	159	-3.44	-3.37	-3.51	-5.52	-6.58	-8.19
120	162	-3.89	-3.87	-4.05	-5.09	-6.10	-7.60
120	165	-4.36	-4.38	-4.60	-4.75	-5.70	-7.10
120	168	-4.98	-5.03	-5.27	-4.46	-5.33	-6.64
120	171	-5.80	-5.87	-6.12	-4.17	-4.96	-6.18
120	174	-6.71	-6.78	-7.04	-3.93	-4.63	-5.77
120	177	-7.55	-7.63	-7.90	-3.75	-4.40	-5.45
120	180	-8.19	-8.27	-8.57	-3.69	-4.31	-5.28
120	183	-8.70	-8.79	-9.13	-3.72	-4.32	-5.21
120	186	-9.19	-9.29	-9.67	-3.81	-4.34	-5.15
120	189	-9.62	-9.72	-10.14	-3.94	-4.37	-5.11
120	192	-9.91	-10.02	-10.47	-4.08	-4.41	-5.08
120	195	-10.03	-10.13	-10.60	-4.23	-4.46	-5.07
120	198	-9.84	-9.97	-10.47	-4.40	-4.55	-5.11
120	201	-9.36	-9.56	-10.13	-4.61	-4.70	-5.22
120	204	-8.72	-9.00	-9.66	-4.84	-4.88	-5.37
120	207	-8.04	-8.40	-9.13	-5.06	-5.06	-5.52
120	210	-7.45	-7.84	-8.63	-5.24	-5.22	-5.67
120	213	-6.92	-7.29	-8.07	-5.38	-5.35	-5.78
120	216	-6.35	-6.67	-7.41	-5.49	-5.46	-5.90
120	219	-5.82	-6.06	-6.73	-5.59	-5.57	-6.01
120	222	-5.36	-5.53	-6.13	-5.71	-5.69	-6.15
120	225	-5.05	-5.16	-5.70	-5.86	-5.84	-6.31
120	228	-4.83	-4.91	-5.39	-6.06	-6.04	-6.50
120	231	-4.64	-4.67	-5.11	-6.31	-6.28	-6.74
120	234	-4.48	-4.47	-4.87	-6.61	-6.58	-7.01
120	237	-4.37	-4.34	-4.71	-6.96	-6.91	-7.32
120	240	-4.33	-4.29	-4.65	-7.36	-7.28	-7.65
120	243	-4.43	-4.40	-4.76	-7.84	-7.71	-8.03
120	246	-4.67	-4.68	-5.06	-8.43	-8.22	-8.45
120	249	-5.01	-5.09	-5.48	-9.15	-8.83	-8.94
120	252	-5.41	-5.56	-5.98	-10.01	-9.52	-9.49
120	255	-5.81	-6.03	-6.49	-11.00	-10.32	-10.11
120	258	-6.34	-6.68	-7.23	-12.69	-11.58	-11.07



120	261	-7.07	-7.56	-8.26	-15.20	-13.36	-12.38
120	264	-7.80	-8.45	-9.32	-17.84	-15.21	-13.72
120	267	-8.37	-9.14	-10.15	-19.92	-16.66	-14.76
120	270	-8.59	-9.42	-10.48	-20.77	-17.24	-15.18
120	273	-8.58	-9.41	-10.48	-20.26	-17.06	-15.10
120	276	-8.56	-9.36	-10.47	-18.98	-16.57	-14.88
120	279	-8.52	-9.28	-10.44	-17.25	-15.87	-14.56
120	282	-8.46	-9.19	-10.41	-15.43	-15.05	-14.16
120	285	-8.40	-9.08	-10.38	-13.87	-14.22	-13.72
120	288	-8.16	-8.79	-10.11	-12.49	-13.21	-13.03
120	291	-7.71	-8.26	-9.54	-11.06	-11.91	-12.00
120	294	-7.19	-7.67	-8.86	-9.69	-10.51	-10.82
120	297	-6.76	-7.19	-8.28	-8.47	-9.21	-9.68
120	300	-6.58	-7.00	-8.00	-7.51	-8.19	-8.77
120	303	-6.59	-7.00	-7.94	-6.73	-7.41	-8.05
120	306	-6.61	-7.00	-7.90	-6.03	-6.69	-7.38
120	309	-6.64	-7.01	-7.87	-5.42	-6.05	-6.77
120	312	-6.69	-7.02	-7.85	-4.91	-5.53	-6.27
120	315	-6.75	-7.03	-7.84	-4.54	-5.14	-5.90
120	318	-7.17	-7.40	-8.20	-4.23	-4.82	-5.60
120	321	-8.13	-8.33	-9.13	-3.94	-4.53	-5.32
120	324	-9.40	-9.59	-10.39	-3.70	-4.28	-5.09
120	327	-10.75	-10.96	-11.77	-3.54	-4.11	-4.94
120	330	-11.96	-12.21	-13.05	-3.48	-4.05	-4.88
120	333	-13.21	-13.56	-14.45	-3.49	-4.08	-4.91
120	336	-14.63	-15.16	-16.12	-3.54	-4.14	-4.99
120	339	-15.98	-16.69	-17.73	-3.61	-4.22	-5.09
120	342	-16.98	-17.85	-18.95	-3.69	-4.32	-5.21
120	345	-17.37	-18.30	-19.43	-3.77	-4.42	-5.32
120	348	-16.91	-17.83	-18.93	-3.87	-4.53	-5.43
120	351	-15.60	-16.48	-17.52	-4.00	-4.67	-5.54
120	354	-13.54	-14.35	-15.29	-4.16	-4.82	-5.66
120	357	-10.84	-11.54	-12.35	-4.33	-4.99	-5.79
120	360	-7.60	-8.15	-8.79	-4.53	-5.17	-5.93
123	0	-7.28	-7.74	-8.31	-4.33	-4.87	-5.61
123	3	-7.06	-7.52	-8.10	-4.39	-4.87	-5.56
123	6	-6.92	-7.38	-7.98	-4.44	-4.86	-5.48
123	9	-6.85	-7.31	-7.91	-4.46	-4.85	-5.37
123	12	-6.83	-7.29	-7.89	-4.46	-4.84	-5.24
123	15	-6.82	-7.28	-7.88	-4.47	-4.82	-5.10
123	18	-7.16	-7.66	-8.30	-4.43	-4.74	-4.90
123	21	-7.96	-8.55	-9.30	-4.33	-4.57	-4.65
123	24	-8.93	-9.63	-10.50	-4.20	-4.36	-4.37
123	27	-9.77	-10.56	-11.53	-4.06	-4.15	-4.10
123	30	-10.19	-10.99	-12.00	-3.95	-3.97	-3.89
123	33	-10.30	-11.06	-12.06	-3.85	-3.83	-3.73
123	36	-10.39	-11.11	-12.10	-3.74	-3.68	-3.56
123	39	-10.45	-11.15	-12.14	-3.64	-3.54	-3.41
123	42	-10.49	-11.18	-12.16	-3.56	-3.44	-3.31
123	45	-10.51	-11.18	-12.17	-3.54	-3.41	-3.27
123	48	-10.50	-11.18	-12.15	-3.56	-3.43	-3.31
123	51	-10.48	-11.16	-12.11	-3.63	-3.49	-3.39
123	54	-10.45	-11.14	-12.06	-3.74	-3.59	-3.52
123	57	-10.43	-11.12	-12.01	-3.87	-3.71	-3.68
123	60	-10.42	-11.11	-11.99	-4.01	-3.84	-3.85
123	63	-10.78	-11.55	-12.44	-4.22	-4.04	-4.08
123	66	-11.65	-12.61	-13.53	-4.54	-4.35	-4.41
123	69	-12.75	-13.91	-14.87	-4.93	-4.74	-4.81

123	72	-13.81	-15.05	-16.07	-5.35	-5.16	-5.25
123	75	-14.53	-15.64	-16.74	-5.78	-5.58	-5.70
123	78	-15.00	-15.82	-17.00	-6.24	-6.04	-6.17
123	81	-15.44	-15.96	-17.22	-6.76	-6.56	-6.71
123	84	-15.81	-16.07	-17.39	-7.30	-7.10	-7.28
123	87	-16.06	-16.14	-17.50	-7.82	-7.63	-7.84
123	90	-16.16	-16.17	-17.54	-8.26	-8.11	-8.37
123	93	-15.46	-15.40	-16.63	-8.67	-8.58	-8.91
123	96	-13.76	-13.51	-14.39	-9.09	-9.07	-9.48
123	99	-11.59	-11.13	-11.59	-9.47	-9.52	-10.02
123	102	-9.53	-8.89	-8.97	-9.75	-9.87	-10.46
123	105	-8.11	-7.42	-7.29	-9.88	-10.07	-10.73
123	108	-7.29	-6.61	-6.41	-9.91	-10.16	-10.88
123	111	-6.58	-5.94	-5.68	-9.93	-10.24	-11.01
123	114	-5.98	-5.38	-5.07	-9.95	-10.30	-11.11
123	117	-5.46	-4.90	-4.57	-9.96	-10.33	-11.18
123	120	-5.00	-4.47	-4.16	-9.96	-10.35	-11.20
123	123	-4.53	-4.05	-3.77	-9.88	-10.31	-11.20
123	126	-4.07	-3.63	-3.39	-9.68	-10.21	-11.20
123	129	-3.67	-3.27	-3.08	-9.40	-10.06	-11.20
123	132	-3.38	-3.02	-2.85	-9.07	-9.89	-11.20
123	135	-3.27	-2.93	-2.77	-8.76	-9.70	-11.19
123	138	-3.29	-2.95	-2.80	-8.43	-9.47	-11.11
123	141	-3.32	-3.00	-2.88	-8.06	-9.17	-10.89
123	144	-3.38	-3.09	-3.01	-7.66	-8.82	-10.58
123	147	-3.45	-3.20	-3.17	-7.24	-8.43	-10.21
123	150	-3.54	-3.33	-3.34	-6.84	-8.04	-9.84
123	153	-3.75	-3.57	-3.62	-6.41	-7.60	-9.38
123	156	-4.12	-3.97	-4.06	-5.95	-7.10	-8.80
123	159	-4.61	-4.48	-4.59	-5.49	-6.58	-8.16
123	162	-5.16	-5.05	-5.17	-5.08	-6.10	-7.55
123	165	-5.71	-5.60	-5.75	-4.75	-5.69	-7.05
123	168	-6.32	-6.22	-6.37	-4.47	-5.33	-6.60
123	171	-7.05	-6.95	-7.08	-4.19	-4.97	-6.14
123	174	-7.80	-7.69	-7.81	-3.95	-4.65	-5.74
123	177	-8.49	-8.36	-8.47	-3.78	-4.42	-5.44
123	180	-9.00	-8.88	-8.99	-3.72	-4.34	-5.29
123	183	-9.41	-9.30	-9.43	-3.76	-4.35	-5.26
123	186	-9.81	-9.71	-9.86	-3.87	-4.38	-5.22
123	189	-10.14	-10.06	-10.23	-4.02	-4.43	-5.20
123	192	-10.37	-10.30	-10.49	-4.19	-4.48	-5.18
123	195	-10.46	-10.39	-10.59	-4.35	-4.55	-5.18
123	198	-10.35	-10.32	-10.54	-4.53	-4.65	-5.23
123	201	-10.06	-10.14	-10.43	-4.75	-4.81	-5.35
123	204	-9.67	-9.88	-10.29	-4.98	-5.00	-5.52
123	207	-9.27	-9.61	-10.15	-5.20	-5.19	-5.71
123	210	-8.91	-9.36	-10.06	-5.40	-5.37	-5.87
123	213	-8.60	-9.15	-10.01	-5.56	-5.52	-6.02
123	216	-8.28	-8.93	-9.98	-5.70	-5.66	-6.17
123	219	-7.97	-8.70	-9.95	-5.83	-5.81	-6.33
123	222	-7.68	-8.45	-9.90	-5.98	-5.97	-6.50
123	225	-7.43	-8.17	-9.84	-6.17	-6.16	-6.70
123	228	-7.19	-7.77	-9.43	-6.39	-6.39	-6.92
123	231	-6.95	-7.26	-8.56	-6.66	-6.66	-7.19
123	234	-6.74	-6.75	-7.56	-6.96	-6.97	-7.48
123	237	-6.59	-6.35	-6.72	-7.32	-7.32	-7.81
123	240	-6.53	-6.19	-6.38	-7.73	-7.71	-8.17
123	243	-6.58	-6.26	-6.45	-8.21	-8.16	-8.56

123	246	-6.73	-6.45	-6.65	-8.79	-8.68	-8.99
123	249	-6.93	-6.72	-6.93	-9.49	-9.28	-9.49
123	252	-7.17	-7.04	-7.26	-10.32	-9.99	-10.06
123	255	-7.42	-7.36	-7.61	-11.29	-10.81	-10.72
123	258	-7.77	-7.81	-8.13	-12.97	-12.16	-11.78
123	261	-8.26	-8.44	-8.87	-15.47	-14.11	-13.30
123	264	-8.76	-9.09	-9.63	-18.09	-16.15	-14.86
123	267	-9.15	-9.59	-10.23	-20.17	-17.75	-16.09
123	270	-9.31	-9.79	-10.47	-21.02	-18.40	-16.58
123	273	-9.25	-9.74	-10.45	-20.59	-18.21	-16.47
123	276	-9.09	-9.62	-10.41	-19.49	-17.68	-16.15
123	279	-8.87	-9.43	-10.35	-18.01	-16.94	-15.69
123	282	-8.61	-9.21	-10.26	-16.40	-16.08	-15.14
123	285	-8.35	-8.98	-10.16	-14.94	-15.19	-14.55
123	288	-7.99	-8.60	-9.84	-13.54	-14.11	-13.75
123	291	-7.49	-8.03	-9.21	-12.02	-12.71	-12.63
123	294	-6.97	-7.44	-8.51	-10.51	-11.21	-11.39
123	297	-6.58	-6.97	-7.93	-9.16	-9.82	-10.20
123	300	-6.41	-6.78	-7.69	-8.10	-8.73	-9.26
123	303	-6.43	-6.79	-7.70	-7.27	-7.91	-8.51
123	306	-6.48	-6.83	-7.72	-6.54	-7.16	-7.82
123	309	-6.55	-6.89	-7.75	-5.90	-6.51	-7.20
123	312	-6.66	-6.97	-7.80	-5.36	-5.96	-6.68
123	315	-6.78	-7.06	-7.85	-4.94	-5.53	-6.27
123	318	-7.28	-7.53	-8.30	-4.57	-5.16	-5.92
123	321	-8.33	-8.55	-9.35	-4.23	-4.80	-5.59
123	324	-9.67	-9.88	-10.73	-3.94	-4.51	-5.32
123	327	-11.06	-11.27	-12.17	-3.74	-4.31	-5.13
123	330	-12.23	-12.49	-13.43	-3.66	-4.23	-5.06
123	333	-13.34	-13.69	-14.65	-3.67	-4.24	-5.07
123	336	-14.54	-15.04	-16.01	-3.69	-4.25	-5.09
123	339	-15.64	-16.29	-17.28	-3.71	-4.28	-5.13
123	342	-16.44	-17.22	-18.22	-3.74	-4.31	-5.18
123	345	-16.75	-17.58	-18.58	-3.78	-4.34	-5.23
123	348	-16.29	-17.11	-18.09	-3.83	-4.40	-5.28
123	351	-15.00	-15.77	-16.69	-3.92	-4.48	-5.35
123	354	-12.99	-13.69	-14.52	-4.04	-4.60	-5.43
123	357	-10.37	-10.98	-11.68	-4.18	-4.73	-5.52
123	360	-7.28	-7.74	-8.31	-4.33	-4.87	-5.61
126	0	-6.89	-7.14	-7.53	-4.17	-4.61	-5.34
126	3	-6.59	-6.84	-7.26	-4.23	-4.61	-5.30
126	6	-6.41	-6.66	-7.10	-4.26	-4.60	-5.22
126	9	-6.32	-6.56	-7.02	-4.28	-4.60	-5.13
126	12	-6.28	-6.53	-6.99	-4.29	-4.59	-5.02
126	15	-6.28	-6.52	-6.98	-4.29	-4.58	-4.90
126	18	-6.53	-6.80	-7.30	-4.26	-4.51	-4.73
126	21	-7.14	-7.48	-8.06	-4.17	-4.37	-4.50
126	24	-7.89	-8.33	-9.02	-4.06	-4.19	-4.25
126	27	-8.58	-9.11	-9.90	-3.95	-4.00	-4.01
126	30	-9.00	-9.57	-10.44	-3.85	-3.85	-3.82
126	33	-9.17	-9.76	-10.68	-3.76	-3.71	-3.66
126	36	-9.30	-9.90	-10.84	-3.65	-3.56	-3.50
126	39	-9.40	-10.01	-10.98	-3.55	-3.42	-3.37
126	42	-9.50	-10.12	-11.13	-3.48	-3.32	-3.27
126	45	-9.64	-10.28	-11.33	-3.45	-3.29	-3.23
126	48	-9.80	-10.48	-11.56	-3.47	-3.30	-3.25
126	51	-9.97	-10.70	-11.83	-3.51	-3.35	-3.32
126	54	-10.17	-10.96	-12.14	-3.57	-3.41	-3.43

126	57	-10.41	-11.28	-12.50	-3.66	-3.50	-3.55
126	60	-10.72	-11.66	-12.94	-3.75	-3.59	-3.69
126	63	-11.41	-12.41	-13.70	-3.91	-3.75	-3.88
126	66	-12.53	-13.58	-14.84	-4.16	-4.01	-4.16
126	69	-13.76	-14.83	-16.03	-4.47	-4.33	-4.50
126	72	-14.75	-15.82	-16.98	-4.81	-4.67	-4.86
126	75	-15.15	-16.23	-17.37	-5.15	-5.02	-5.23
126	78	-15.14	-16.13	-17.24	-5.51	-5.38	-5.61
126	81	-15.11	-15.84	-16.90	-5.92	-5.79	-6.03
126	84	-15.05	-15.41	-16.40	-6.35	-6.22	-6.46
126	87	-14.98	-14.88	-15.77	-6.75	-6.64	-6.91
126	90	-14.88	-14.28	-15.07	-7.11	-7.03	-7.34
126	93	-14.18	-13.23	-13.84	-7.42	-7.41	-7.79
126	96	-12.63	-11.56	-11.91	-7.73	-7.79	-8.27
126	99	-10.70	-9.67	-9.74	-8.02	-8.16	-8.73
126	102	-8.88	-7.96	-7.79	-8.26	-8.47	-9.14
126	105	-7.65	-6.82	-6.53	-8.44	-8.71	-9.45
126	108	-6.94	-6.16	-5.83	-8.59	-8.90	-9.67
126	111	-6.34	-5.62	-5.25	-8.73	-9.07	-9.86
126	114	-5.83	-5.17	-4.78	-8.85	-9.22	-10.02
126	117	-5.40	-4.78	-4.39	-8.94	-9.33	-10.17
126	120	-5.02	-4.45	-4.08	-8.97	-9.38	-10.32
126	123	-4.65	-4.13	-3.79	-8.94	-9.40	-10.48
126	126	-4.29	-3.81	-3.52	-8.85	-9.41	-10.65
126	129	-3.98	-3.53	-3.28	-8.73	-9.42	-10.81
126	132	-3.76	-3.34	-3.13	-8.59	-9.43	-10.92
126	135	-3.67	-3.27	-3.07	-8.43	-9.43	-10.97
126	138	-3.73	-3.33	-3.14	-8.20	-9.34	-10.90
126	141	-3.88	-3.50	-3.32	-7.89	-9.10	-10.72
126	144	-4.10	-3.74	-3.59	-7.52	-8.77	-10.46
126	147	-4.36	-4.03	-3.91	-7.13	-8.39	-10.16
126	150	-4.65	-4.34	-4.25	-6.75	-8.02	-9.83
126	153	-5.04	-4.75	-4.68	-6.35	-7.61	-9.40
126	156	-5.59	-5.30	-5.26	-5.91	-7.11	-8.81
126	159	-6.23	-5.93	-5.91	-5.47	-6.58	-8.15
126	162	-6.87	-6.56	-6.56	-5.07	-6.09	-7.52
126	165	-7.45	-7.13	-7.12	-4.76	-5.69	-7.01
126	168	-7.98	-7.64	-7.63	-4.49	-5.34	-6.57
126	171	-8.52	-8.16	-8.12	-4.23	-5.00	-6.12
126	174	-9.03	-8.66	-8.59	-4.01	-4.70	-5.72
126	177	-9.48	-9.10	-9.01	-3.86	-4.49	-5.44
126	180	-9.82	-9.46	-9.36	-3.80	-4.41	-5.33
126	183	-10.11	-9.75	-9.65	-3.85	-4.42	-5.33
126	186	-10.39	-10.02	-9.90	-3.97	-4.47	-5.32
126	189	-10.62	-10.25	-10.13	-4.14	-4.53	-5.32
126	192	-10.78	-10.45	-10.35	-4.33	-4.61	-5.32
126	195	-10.84	-10.61	-10.57	-4.51	-4.69	-5.32
126	198	-10.81	-10.72	-10.76	-4.71	-4.81	-5.37
126	201	-10.75	-10.81	-10.93	-4.93	-4.98	-5.52
126	204	-10.68	-10.88	-11.10	-5.17	-5.18	-5.72
126	207	-10.62	-10.97	-11.31	-5.41	-5.39	-5.93
126	210	-10.59	-11.10	-11.61	-5.62	-5.59	-6.13
126	213	-10.65	-11.42	-12.41	-5.81	-5.77	-6.32
126	216	-10.78	-11.95	-13.81	-5.98	-5.95	-6.51
126	219	-10.94	-12.53	-15.38	-6.15	-6.13	-6.70
126	222	-11.07	-12.99	-16.64	-6.33	-6.33	-6.92
126	225	-11.12	-13.19	-17.16	-6.54	-6.56	-7.15
126	228	-11.03	-12.77	-16.31	-6.78	-6.82	-7.41

126	231	-10.79	-11.77	-14.26	-7.05	-7.10	-7.69
126	234	-10.50	-10.57	-11.81	-7.35	-7.42	-8.00
126	237	-10.21	-9.56	-9.76	-7.69	-7.77	-8.34
126	240	-10.03	-9.13	-8.90	-8.09	-8.17	-8.72
126	243	-9.92	-9.11	-8.90	-8.56	-8.62	-9.12
126	246	-9.82	-9.09	-8.91	-9.12	-9.13	-9.55
126	249	-9.73	-9.08	-8.92	-9.79	-9.72	-10.05
126	252	-9.68	-9.08	-8.93	-10.58	-10.42	-10.63
126	255	-9.65	-9.07	-8.95	-11.52	-11.25	-11.33
126	258	-9.69	-9.18	-9.11	-13.17	-12.70	-12.53
126	261	-9.79	-9.44	-9.48	-15.66	-14.83	-14.29
126	264	-9.89	-9.75	-9.91	-18.29	-17.09	-16.15
126	267	-9.99	-10.00	-10.27	-20.37	-18.86	-17.61
126	270	-10.03	-10.11	-10.42	-21.21	-19.59	-18.21
126	273	-9.90	-10.02	-10.37	-20.88	-19.38	-18.04
126	276	-9.57	-9.78	-10.25	-20.00	-18.84	-17.60
126	279	-9.13	-9.44	-10.08	-18.79	-18.06	-16.96
126	282	-8.65	-9.07	-9.86	-17.44	-17.16	-16.22
126	285	-8.22	-8.71	-9.63	-16.14	-16.23	-15.46
126	288	-7.78	-8.27	-9.25	-14.75	-15.08	-14.53
126	291	-7.27	-7.72	-8.67	-13.12	-13.58	-13.31
126	294	-6.78	-7.18	-8.05	-11.44	-11.96	-11.99
126	297	-6.42	-6.77	-7.57	-9.92	-10.46	-10.75
126	300	-6.28	-6.60	-7.37	-8.75	-9.30	-9.76
126	303	-6.30	-6.63	-7.39	-7.88	-8.44	-8.99
126	306	-6.38	-6.70	-7.46	-7.11	-7.67	-8.28
126	309	-6.50	-6.81	-7.57	-6.43	-6.99	-7.65
126	312	-6.66	-6.96	-7.71	-5.86	-6.41	-7.10
126	315	-6.85	-7.14	-7.88	-5.40	-5.94	-6.66
126	318	-7.45	-7.72	-8.50	-4.99	-5.53	-6.27
126	321	-8.62	-8.88	-9.74	-4.61	-5.14	-5.91
126	324	-10.06	-10.31	-11.26	-4.28	-4.81	-5.59
126	327	-11.45	-11.71	-12.72	-4.04	-4.56	-5.36
126	330	-12.49	-12.77	-13.79	-3.92	-4.43	-5.26
126	333	-13.28	-13.60	-14.57	-3.88	-4.38	-5.22
126	336	-14.05	-14.43	-15.32	-3.84	-4.34	-5.19
126	339	-14.71	-15.15	-15.96	-3.81	-4.31	-5.17
126	342	-15.18	-15.66	-16.40	-3.79	-4.29	-5.16
126	345	-15.36	-15.85	-16.57	-3.79	-4.28	-5.15
126	348	-14.93	-15.41	-16.11	-3.81	-4.30	-5.16
126	351	-13.73	-14.18	-14.82	-3.86	-4.34	-5.19
126	354	-11.90	-12.31	-12.87	-3.94	-4.41	-5.22
126	357	-9.58	-9.91	-10.39	-4.05	-4.50	-5.27
126	360	-6.89	-7.14	-7.53	-4.17	-4.61	-5.34
129	0	-6.50	-6.51	-6.69	-4.04	-4.37	-5.09
129	3	-6.12	-6.10	-6.31	-4.08	-4.37	-5.06
129	6	-5.86	-5.84	-6.07	-4.10	-4.37	-5.00
129	9	-5.71	-5.69	-5.95	-4.11	-4.36	-4.91
129	12	-5.64	-5.63	-5.91	-4.12	-4.35	-4.81
129	15	-5.63	-5.62	-5.90	-4.12	-4.33	-4.71
129	18	-5.78	-5.79	-6.11	-4.09	-4.27	-4.56
129	21	-6.17	-6.23	-6.63	-4.01	-4.15	-4.35
129	24	-6.67	-6.81	-7.31	-3.91	-3.99	-4.13
129	27	-7.19	-7.40	-8.01	-3.81	-3.82	-3.91
129	30	-7.59	-7.88	-8.58	-3.72	-3.68	-3.74
129	33	-7.87	-8.21	-8.99	-3.63	-3.55	-3.59
129	36	-8.11	-8.51	-9.35	-3.53	-3.41	-3.44
129	39	-8.34	-8.79	-9.71	-3.44	-3.28	-3.32

129	42	-8.59	-9.10	-10.09	-3.37	-3.18	-3.22
129	45	-8.89	-9.47	-10.55	-3.34	-3.15	-3.19
129	48	-9.23	-9.91	-11.12	-3.35	-3.16	-3.21
129	51	-9.62	-10.43	-11.79	-3.37	-3.19	-3.26
129	54	-10.05	-11.01	-12.53	-3.41	-3.24	-3.35
129	57	-10.55	-11.64	-13.30	-3.45	-3.30	-3.45
129	60	-11.11	-12.32	-14.06	-3.51	-3.38	-3.56
129	63	-11.99	-13.25	-14.97	-3.61	-3.50	-3.72
129	66	-13.21	-14.44	-16.03	-3.81	-3.71	-3.96
129	69	-14.47	-15.62	-17.05	-4.05	-3.98	-4.24
129	72	-15.44	-16.53	-17.81	-4.32	-4.26	-4.55
129	75	-15.84	-16.90	-18.11	-4.59	-4.54	-4.85
129	78	-15.70	-16.59	-17.71	-4.87	-4.84	-5.16
129	81	-15.34	-15.78	-16.69	-5.18	-5.16	-5.50
129	84	-14.80	-14.68	-15.29	-5.51	-5.50	-5.86
129	87	-14.16	-13.46	-13.78	-5.83	-5.84	-6.22
129	90	-13.48	-12.32	-12.41	-6.12	-6.16	-6.57
129	93	-12.51	-11.13	-11.05	-6.38	-6.46	-6.93
129	96	-11.13	-9.75	-9.53	-6.64	-6.76	-7.29
129	99	-9.62	-8.38	-8.05	-6.87	-7.05	-7.66
129	102	-8.26	-7.18	-6.78	-7.10	-7.32	-8.00
129	105	-7.30	-6.36	-5.92	-7.30	-7.57	-8.30
129	108	-6.68	-5.82	-5.38	-7.51	-7.79	-8.57
129	111	-6.15	-5.36	-4.91	-7.73	-8.00	-8.80
129	114	-5.70	-4.98	-4.52	-7.92	-8.19	-9.02
129	117	-5.33	-4.67	-4.23	-8.06	-8.37	-9.25
129	120	-5.05	-4.44	-4.02	-8.13	-8.54	-9.48
129	123	-4.80	-4.24	-3.86	-8.14	-8.71	-9.78
129	126	-4.58	-4.05	-3.71	-8.15	-8.89	-10.12
129	129	-4.39	-3.90	-3.60	-8.15	-9.05	-10.44
129	132	-4.26	-3.79	-3.52	-8.16	-9.17	-10.68
129	135	-4.21	-3.75	-3.49	-8.16	-9.22	-10.78
129	138	-4.31	-3.86	-3.60	-8.06	-9.14	-10.73
129	141	-4.56	-4.13	-3.88	-7.80	-8.94	-10.58
129	144	-4.93	-4.51	-4.28	-7.45	-8.66	-10.37
129	147	-5.36	-4.95	-4.74	-7.06	-8.34	-10.11
129	150	-5.81	-5.40	-5.21	-6.69	-8.01	-9.82
129	153	-6.38	-5.96	-5.78	-6.31	-7.61	-9.41
129	156	-7.12	-6.67	-6.50	-5.88	-7.11	-8.81
129	159	-7.92	-7.43	-7.27	-5.45	-6.58	-8.14
129	162	-8.65	-8.12	-7.96	-5.06	-6.08	-7.49
129	165	-9.18	-8.62	-8.45	-4.76	-5.69	-6.98
129	168	-9.55	-8.96	-8.77	-4.52	-5.36	-6.55
129	171	-9.86	-9.25	-9.03	-4.29	-5.04	-6.12
129	174	-10.13	-9.50	-9.25	-4.09	-4.76	-5.74
129	177	-10.36	-9.73	-9.46	-3.96	-4.56	-5.47
129	180	-10.54	-9.93	-9.66	-3.91	-4.49	-5.37
129	183	-10.69	-10.12	-9.84	-3.96	-4.51	-5.38
129	186	-10.80	-10.27	-9.99	-4.09	-4.56	-5.39
129	189	-10.90	-10.41	-10.14	-4.27	-4.64	-5.40
129	192	-11.01	-10.57	-10.31	-4.47	-4.74	-5.43
129	195	-11.14	-10.78	-10.54	-4.67	-4.84	-5.46
129	198	-11.30	-11.04	-10.83	-4.87	-4.98	-5.54
129	201	-11.47	-11.35	-11.20	-5.11	-5.16	-5.71
129	204	-11.67	-11.73	-11.68	-5.36	-5.38	-5.93
129	207	-11.91	-12.19	-12.28	-5.62	-5.61	-6.17
129	210	-12.20	-12.74	-13.02	-5.86	-5.83	-6.40
129	213	-12.74	-13.76	-14.83	-6.07	-6.04	-6.62

129	216	-13.56	-15.33	-17.95	-6.28	-6.26	-6.85
129	219	-14.44	-17.01	-21.39	-6.48	-6.49	-7.10
129	222	-15.13	-18.34	-24.17	-6.69	-6.73	-7.36
129	225	-15.41	-18.89	-25.32	-6.93	-6.99	-7.63
129	228	-15.30	-18.28	-23.96	-7.18	-7.27	-7.92
129	231	-15.01	-16.79	-20.70	-7.45	-7.57	-8.22
129	234	-14.62	-14.94	-16.74	-7.73	-7.89	-8.55
129	237	-14.19	-13.26	-13.29	-8.06	-8.24	-8.90
129	240	-13.80	-12.26	-11.55	-8.45	-8.65	-9.29
129	243	-13.44	-11.82	-11.11	-8.89	-9.09	-9.71
129	246	-13.05	-11.45	-10.74	-9.43	-9.60	-10.15
129	249	-12.65	-11.16	-10.47	-10.06	-10.18	-10.66
129	252	-12.28	-10.94	-10.29	-10.82	-10.87	-11.26
129	255	-11.94	-10.78	-10.23	-11.72	-11.71	-11.99
129	258	-11.67	-10.68	-10.25	-13.34	-13.22	-13.31
129	261	-11.44	-10.61	-10.27	-15.81	-15.51	-15.30
129	264	-11.21	-10.55	-10.31	-18.44	-17.93	-17.40
129	267	-10.96	-10.48	-10.33	-20.51	-19.85	-19.07
129	270	-10.66	-10.37	-10.35	-21.36	-20.63	-19.75
129	273	-10.23	-10.13	-10.25	-21.11	-20.43	-19.53
129	276	-9.70	-9.75	-10.00	-20.43	-19.87	-18.96
129	279	-9.11	-9.27	-9.67	-19.48	-19.07	-18.15
129	282	-8.53	-8.78	-9.29	-18.37	-18.14	-17.23
129	285	-8.04	-8.34	-8.94	-17.25	-17.18	-16.30
129	288	-7.56	-7.89	-8.54	-15.90	-15.97	-15.24
129	291	-7.06	-7.39	-8.04	-14.16	-14.37	-13.93
129	294	-6.60	-6.92	-7.56	-12.32	-12.64	-12.54
129	297	-6.28	-6.57	-7.20	-10.63	-11.03	-11.25
129	300	-6.15	-6.44	-7.05	-9.36	-9.81	-10.22
129	303	-6.19	-6.48	-7.10	-8.44	-8.91	-9.42
129	306	-6.30	-6.58	-7.21	-7.63	-8.12	-8.69
129	309	-6.46	-6.75	-7.39	-6.93	-7.42	-8.05
129	312	-6.68	-6.97	-7.63	-6.33	-6.82	-7.49
129	315	-6.93	-7.23	-7.92	-5.83	-6.32	-7.02
129	318	-7.66	-7.96	-8.75	-5.39	-5.87	-6.60
129	321	-9.00	-9.33	-10.30	-4.99	-5.46	-6.22
129	324	-10.56	-10.91	-12.05	-4.63	-5.10	-5.88
129	327	-11.93	-12.28	-13.50	-4.36	-4.81	-5.61
129	330	-12.71	-13.01	-14.11	-4.18	-4.63	-5.44
129	333	-13.03	-13.27	-14.13	-4.06	-4.50	-5.33
129	336	-13.31	-13.48	-14.15	-3.96	-4.39	-5.23
129	339	-13.52	-13.64	-14.16	-3.88	-4.31	-5.16
129	342	-13.66	-13.75	-14.17	-3.82	-4.25	-5.11
129	345	-13.71	-13.79	-14.17	-3.80	-4.23	-5.09
129	348	-13.32	-13.39	-13.75	-3.81	-4.23	-5.09
129	351	-12.26	-12.31	-12.62	-3.83	-4.24	-5.09
129	354	-10.67	-10.70	-10.94	-3.88	-4.26	-5.09
129	357	-8.70	-8.71	-8.91	-3.94	-4.31	-5.09
129	360	-6.50	-6.51	-6.69	-4.04	-4.37	-5.09
132	0	-6.21	-6.01	-6.01	-3.91	-4.17	-4.89
132	3	-5.79	-5.56	-5.58	-3.93	-4.16	-4.86
132	6	-5.47	-5.24	-5.29	-3.94	-4.15	-4.80
132	9	-5.25	-5.02	-5.12	-3.94	-4.14	-4.72
132	12	-5.12	-4.89	-5.03	-3.94	-4.12	-4.63
132	15	-5.08	-4.85	-5.00	-3.94	-4.09	-4.53
132	18	-5.17	-4.96	-5.14	-3.92	-4.03	-4.39
132	21	-5.40	-5.23	-5.48	-3.85	-3.92	-4.21
132	24	-5.72	-5.61	-5.96	-3.75	-3.78	-4.01

132	27	-6.08	-6.04	-6.50	-3.65	-3.64	-3.82
132	30	-6.42	-6.45	-7.02	-3.57	-3.51	-3.67
132	33	-6.74	-6.86	-7.51	-3.49	-3.40	-3.53
132	36	-7.10	-7.30	-8.04	-3.40	-3.27	-3.40
132	39	-7.48	-7.78	-8.63	-3.31	-3.15	-3.28
132	42	-7.90	-8.30	-9.27	-3.25	-3.06	-3.19
132	45	-8.35	-8.88	-9.98	-3.23	-3.03	-3.16
132	48	-8.86	-9.54	-10.84	-3.23	-3.04	-3.18
132	51	-9.44	-10.31	-11.87	-3.25	-3.06	-3.22
132	54	-10.07	-11.14	-12.98	-3.27	-3.11	-3.29
132	57	-10.75	-12.01	-14.05	-3.29	-3.16	-3.38
132	60	-11.49	-12.87	-15.01	-3.33	-3.22	-3.47
132	63	-12.49	-13.89	-15.94	-3.41	-3.33	-3.61
132	66	-13.77	-15.09	-16.94	-3.56	-3.51	-3.82
132	69	-15.04	-16.24	-17.84	-3.75	-3.73	-4.07
132	72	-16.01	-17.10	-18.49	-3.97	-3.97	-4.33
132	75	-16.39	-17.44	-18.74	-4.18	-4.21	-4.60
132	78	-16.11	-16.92	-18.05	-4.40	-4.46	-4.87
132	81	-15.38	-15.62	-16.35	-4.65	-4.74	-5.17
132	84	-14.37	-13.91	-14.14	-4.92	-5.02	-5.48
132	87	-13.27	-12.17	-11.94	-5.18	-5.31	-5.79
132	90	-12.26	-10.77	-10.28	-5.43	-5.58	-6.08
132	93	-11.22	-9.65	-9.08	-5.66	-5.83	-6.37
132	96	-10.05	-8.55	-7.95	-5.89	-6.07	-6.65
132	99	-8.87	-7.53	-6.95	-6.12	-6.31	-6.92
132	102	-7.84	-6.68	-6.12	-6.34	-6.54	-7.20
132	105	-7.08	-6.06	-5.52	-6.55	-6.78	-7.48
132	108	-6.52	-5.59	-5.07	-6.77	-7.01	-7.75
132	111	-6.01	-5.16	-4.65	-7.00	-7.25	-8.02
132	114	-5.59	-4.80	-4.30	-7.21	-7.48	-8.28
132	117	-5.27	-4.55	-4.07	-7.40	-7.71	-8.56
132	120	-5.09	-4.43	-3.98	-7.55	-7.94	-8.86
132	123	-4.99	-4.39	-3.98	-7.67	-8.21	-9.25
132	126	-4.91	-4.35	-3.98	-7.79	-8.51	-9.72
132	129	-4.85	-4.33	-3.99	-7.89	-8.79	-10.17
132	132	-4.81	-4.31	-3.99	-7.96	-8.99	-10.51
132	135	-4.80	-4.30	-4.00	-7.98	-9.07	-10.65
132	138	-4.93	-4.44	-4.14	-7.89	-9.01	-10.60
132	141	-5.27	-4.78	-4.50	-7.66	-8.84	-10.48
132	144	-5.75	-5.27	-5.00	-7.34	-8.59	-10.30
132	147	-6.30	-5.82	-5.56	-6.99	-8.30	-10.07
132	150	-6.85	-6.37	-6.11	-6.65	-8.00	-9.82
132	153	-7.54	-7.02	-6.77	-6.29	-7.62	-9.42
132	156	-8.43	-7.84	-7.59	-5.87	-7.12	-8.82
132	159	-9.34	-8.68	-8.42	-5.44	-6.58	-8.13
132	162	-10.10	-9.37	-9.09	-5.05	-6.07	-7.47
132	165	-10.52	-9.76	-9.45	-4.77	-5.68	-6.95
132	168	-10.68	-9.90	-9.57	-4.55	-5.37	-6.54
132	171	-10.80	-10.01	-9.65	-4.35	-5.07	-6.12
132	174	-10.90	-10.09	-9.71	-4.18	-4.81	-5.76
132	177	-10.98	-10.17	-9.77	-4.06	-4.63	-5.50
132	180	-11.05	-10.26	-9.85	-4.01	-4.56	-5.41
132	183	-11.11	-10.37	-9.95	-4.06	-4.58	-5.42
132	186	-11.16	-10.46	-10.04	-4.19	-4.64	-5.44
132	189	-11.20	-10.57	-10.16	-4.38	-4.74	-5.47
132	192	-11.25	-10.70	-10.30	-4.58	-4.85	-5.51
132	195	-11.34	-10.88	-10.49	-4.79	-4.96	-5.56
132	198	-11.52	-11.18	-10.81	-5.00	-5.11	-5.67



132	201	-11.85	-11.66	-11.33	-5.25	-5.31	-5.86
132	204	-12.30	-12.30	-12.05	-5.52	-5.55	-6.10
132	207	-12.85	-13.07	-12.96	-5.79	-5.80	-6.37
132	210	-13.46	-13.96	-14.06	-6.05	-6.04	-6.63
132	213	-14.50	-15.60	-16.68	-6.29	-6.29	-6.89
132	216	-16.07	-18.16	-21.21	-6.53	-6.55	-7.17
132	219	-17.73	-20.89	-26.22	-6.77	-6.82	-7.46
132	222	-19.05	-23.07	-30.27	-7.02	-7.11	-7.77
132	225	-19.58	-23.97	-31.94	-7.29	-7.41	-8.09
132	228	-19.39	-23.14	-30.17	-7.55	-7.71	-8.42
132	231	-18.89	-21.12	-25.91	-7.82	-8.02	-8.75
132	234	-18.22	-18.59	-20.70	-8.11	-8.35	-9.10
132	237	-17.48	-16.24	-16.09	-8.43	-8.72	-9.48
132	240	-16.82	-14.76	-13.64	-8.80	-9.13	-9.90
132	243	-16.22	-14.01	-12.88	-9.24	-9.59	-10.34
132	246	-15.59	-13.41	-12.29	-9.75	-10.10	-10.82
132	249	-14.95	-12.92	-11.84	-10.35	-10.68	-11.35
132	252	-14.32	-12.49	-11.49	-11.08	-11.38	-11.99
132	255	-13.73	-12.09	-11.20	-11.94	-12.22	-12.76
132	258	-13.18	-11.74	-10.97	-13.53	-13.76	-14.15
132	261	-12.67	-11.45	-10.79	-15.97	-16.11	-16.24
132	264	-12.17	-11.18	-10.64	-18.56	-18.60	-18.44
132	267	-11.66	-10.89	-10.47	-20.62	-20.58	-20.19
132	270	-11.10	-10.54	-10.25	-21.45	-21.38	-20.90
132	273	-10.46	-10.09	-9.93	-21.26	-21.17	-20.65
132	276	-9.75	-9.54	-9.52	-20.72	-20.61	-19.97
132	279	-9.03	-8.96	-9.07	-19.95	-19.80	-19.03
132	282	-8.36	-8.41	-8.63	-19.04	-18.85	-17.96
132	285	-7.82	-7.95	-8.25	-18.07	-17.87	-16.92
132	288	-7.33	-7.51	-7.87	-16.76	-16.61	-15.77
132	291	-6.85	-7.07	-7.48	-14.96	-14.94	-14.38
132	294	-6.43	-6.67	-7.12	-12.99	-13.13	-12.94
132	297	-6.14	-6.39	-6.86	-11.16	-11.45	-11.61
132	300	-6.02	-6.28	-6.76	-9.81	-10.18	-10.55
132	303	-6.07	-6.33	-6.82	-8.86	-9.26	-9.73
132	306	-6.21	-6.47	-6.99	-8.02	-8.44	-8.99
132	309	-6.42	-6.69	-7.24	-7.30	-7.73	-8.34
132	312	-6.69	-6.97	-7.57	-6.68	-7.12	-7.77
132	315	-7.00	-7.30	-7.94	-6.15	-6.59	-7.28
132	318	-7.83	-8.14	-8.86	-5.69	-6.12	-6.84
132	321	-9.31	-9.62	-10.48	-5.27	-5.69	-6.44
132	324	-10.96	-11.28	-12.27	-4.90	-5.31	-6.08
132	327	-12.30	-12.63	-13.73	-4.60	-5.00	-5.79
132	330	-12.86	-13.18	-14.33	-4.38	-4.77	-5.58
132	333	-12.84	-13.12	-14.20	-4.21	-4.59	-5.42
132	336	-12.77	-12.97	-13.87	-4.06	-4.43	-5.28
132	339	-12.66	-12.73	-13.38	-3.93	-4.30	-5.17
132	342	-12.51	-12.42	-12.79	-3.85	-4.21	-5.08
132	345	-12.34	-12.06	-12.16	-3.82	-4.18	-5.02
132	348	-11.86	-11.46	-11.37	-3.82	-4.17	-4.98
132	351	-10.90	-10.47	-10.31	-3.82	-4.17	-4.95
132	354	-9.56	-9.18	-9.04	-3.84	-4.17	-4.92
132	357	-7.96	-7.67	-7.59	-3.86	-4.17	-4.90
132	360	-6.21	-6.01	-6.01	-3.91	-4.17	-4.89
135	0	-6.09	-5.81	-5.73	-3.77	-3.99	-4.73
135	3	-5.66	-5.35	-5.29	-3.77	-3.98	-4.69
135	6	-5.31	-4.99	-4.98	-3.77	-3.97	-4.63
135	9	-5.06	-4.74	-4.77	-3.77	-3.95	-4.56

135	12	-4.90	-4.59	-4.66	-3.76	-3.92	-4.47
135	15	-4.85	-4.54	-4.62	-3.76	-3.89	-4.38
135	18	-4.92	-4.62	-4.73	-3.73	-3.83	-4.26
135	21	-5.09	-4.83	-5.01	-3.67	-3.73	-4.10
135	24	-5.34	-5.13	-5.42	-3.59	-3.61	-3.93
135	27	-5.63	-5.49	-5.89	-3.50	-3.48	-3.77
135	30	-5.93	-5.86	-6.36	-3.43	-3.38	-3.63
135	33	-6.25	-6.27	-6.87	-3.36	-3.28	-3.50
135	36	-6.65	-6.77	-7.48	-3.28	-3.17	-3.38
135	39	-7.11	-7.35	-8.17	-3.21	-3.08	-3.26
135	42	-7.61	-7.98	-8.93	-3.16	-3.00	-3.18
135	45	-8.15	-8.65	-9.75	-3.13	-2.98	-3.15
135	48	-8.75	-9.41	-10.74	-3.14	-2.99	-3.16
135	51	-9.43	-10.28	-11.93	-3.16	-3.01	-3.21
135	54	-10.17	-11.22	-13.19	-3.18	-3.05	-3.27
135	57	-10.95	-12.17	-14.39	-3.22	-3.11	-3.35
135	60	-11.77	-13.10	-15.40	-3.26	-3.17	-3.44
135	63	-12.81	-14.15	-16.34	-3.34	-3.27	-3.57
135	66	-14.08	-15.36	-17.30	-3.47	-3.43	-3.77
135	69	-15.31	-16.49	-18.16	-3.64	-3.64	-4.00
135	72	-16.25	-17.33	-18.77	-3.83	-3.87	-4.26
135	75	-16.62	-17.66	-19.00	-4.02	-4.09	-4.51
135	78	-16.24	-17.05	-18.19	-4.22	-4.32	-4.77
135	81	-15.28	-15.53	-16.17	-4.45	-4.58	-5.05
135	84	-14.00	-13.57	-13.61	-4.69	-4.85	-5.35
135	87	-12.65	-11.61	-11.14	-4.94	-5.11	-5.64
135	90	-11.51	-10.14	-9.41	-5.17	-5.37	-5.91
135	93	-10.51	-9.09	-8.33	-5.40	-5.60	-6.17
135	96	-9.48	-8.11	-7.38	-5.62	-5.82	-6.41
135	99	-8.50	-7.23	-6.55	-5.84	-6.04	-6.66
135	102	-7.65	-6.50	-5.88	-6.07	-6.26	-6.90
135	105	-7.00	-5.95	-5.38	-6.28	-6.48	-7.16
135	108	-6.47	-5.51	-4.96	-6.51	-6.72	-7.43
135	111	-5.97	-5.09	-4.58	-6.73	-6.97	-7.71
135	114	-5.54	-4.75	-4.26	-6.96	-7.21	-7.99
135	117	-5.25	-4.51	-4.05	-7.16	-7.47	-8.30
135	120	-5.14	-4.43	-3.97	-7.33	-7.72	-8.62
135	123	-5.15	-4.45	-4.00	-7.49	-8.02	-9.04
135	126	-5.18	-4.51	-4.08	-7.65	-8.36	-9.56
135	129	-5.22	-4.60	-4.20	-7.78	-8.68	-10.06
135	132	-5.28	-4.71	-4.35	-7.88	-8.93	-10.45
135	135	-5.35	-4.85	-4.53	-7.92	-9.02	-10.60
135	138	-5.55	-5.09	-4.80	-7.83	-8.96	-10.56
135	141	-5.93	-5.48	-5.22	-7.61	-8.80	-10.44
135	144	-6.44	-5.98	-5.74	-7.31	-8.56	-10.27
135	147	-7.01	-6.53	-6.29	-6.96	-8.28	-10.06
135	150	-7.57	-7.07	-6.84	-6.64	-8.00	-9.82
135	153	-8.27	-7.72	-7.48	-6.28	-7.62	-9.42
135	156	-9.15	-8.51	-8.26	-5.86	-7.12	-8.81
135	159	-10.03	-9.30	-9.01	-5.43	-6.57	-8.10
135	162	-10.73	-9.92	-9.59	-5.05	-6.07	-7.43
135	165	-11.05	-10.21	-9.84	-4.78	-5.68	-6.92
135	168	-11.11	-10.26	-9.87	-4.58	-5.38	-6.51
135	171	-11.16	-10.29	-9.88	-4.40	-5.08	-6.11
135	174	-11.19	-10.32	-9.89	-4.24	-4.83	-5.76
135	177	-11.22	-10.34	-9.90	-4.14	-4.65	-5.52
135	180	-11.25	-10.39	-9.92	-4.10	-4.59	-5.42
135	183	-11.28	-10.45	-9.96	-4.15	-4.61	-5.43

135	186	-11.30	-10.52	-10.03	-4.27	-4.68	-5.46
135	189	-11.32	-10.62	-10.14	-4.44	-4.77	-5.49
135	192	-11.36	-10.75	-10.27	-4.64	-4.89	-5.54
135	195	-11.41	-10.92	-10.44	-4.84	-5.01	-5.60
135	198	-11.59	-11.23	-10.76	-5.05	-5.17	-5.72
135	201	-11.99	-11.76	-11.34	-5.30	-5.38	-5.93
135	204	-12.57	-12.49	-12.16	-5.58	-5.63	-6.19
135	207	-13.27	-13.39	-13.21	-5.86	-5.91	-6.48
135	210	-14.06	-14.43	-14.46	-6.14	-6.18	-6.77
135	213	-15.50	-16.46	-17.42	-6.41	-6.46	-7.07
135	216	-17.77	-19.68	-22.54	-6.69	-6.76	-7.40
135	219	-20.19	-23.17	-28.20	-6.97	-7.08	-7.75
135	222	-22.13	-25.96	-32.78	-7.26	-7.41	-8.12
135	225	-22.92	-27.10	-34.67	-7.56	-7.75	-8.49
135	228	-22.54	-26.08	-32.74	-7.85	-8.08	-8.86
135	231	-21.60	-23.59	-28.05	-8.14	-8.43	-9.24
135	234	-20.36	-20.47	-22.32	-8.44	-8.79	-9.63
135	237	-19.09	-17.59	-17.24	-8.78	-9.18	-10.06
135	240	-18.06	-15.78	-14.49	-9.17	-9.63	-10.53
135	243	-17.26	-14.89	-13.60	-9.61	-10.11	-11.03
135	246	-16.51	-14.19	-12.92	-10.11	-10.64	-11.57
135	249	-15.81	-13.61	-12.39	-10.70	-11.25	-12.17
135	252	-15.12	-13.10	-11.97	-11.40	-11.97	-12.87
135	255	-14.45	-12.62	-11.58	-12.24	-12.82	-13.69
135	258	-13.79	-12.17	-11.24	-13.79	-14.34	-15.06
135	261	-13.17	-11.79	-10.97	-16.16	-16.61	-17.04
135	264	-12.56	-11.42	-10.72	-18.67	-19.00	-19.09
135	267	-11.93	-11.04	-10.46	-20.67	-20.90	-20.70
135	270	-11.27	-10.60	-10.13	-21.49	-21.67	-21.36
135	273	-10.53	-10.04	-9.70	-21.31	-21.45	-21.08
135	276	-9.71	-9.38	-9.18	-20.83	-20.89	-20.37
135	279	-8.89	-8.70	-8.62	-20.13	-20.08	-19.37
135	282	-8.16	-8.08	-8.11	-19.29	-19.13	-18.24
135	285	-7.59	-7.59	-7.71	-18.39	-18.14	-17.15
135	288	-7.11	-7.18	-7.38	-17.11	-16.86	-15.97
135	291	-6.65	-6.78	-7.06	-15.28	-15.16	-14.56
135	294	-6.26	-6.43	-6.77	-13.25	-13.32	-13.10
135	297	-5.98	-6.19	-6.58	-11.37	-11.61	-11.75
135	300	-5.88	-6.10	-6.50	-9.98	-10.32	-10.68
135	303	-5.94	-6.16	-6.58	-9.02	-9.39	-9.85
135	306	-6.10	-6.34	-6.79	-8.17	-8.57	-9.11
135	309	-6.35	-6.61	-7.10	-7.44	-7.85	-8.45
135	312	-6.66	-6.94	-7.50	-6.81	-7.23	-7.88
135	315	-7.03	-7.33	-7.96	-6.28	-6.70	-7.38
135	318	-7.89	-8.21	-8.93	-5.81	-6.22	-6.94
135	321	-9.38	-9.71	-10.57	-5.38	-5.78	-6.53
135	324	-11.03	-11.36	-12.36	-5.01	-5.40	-6.17
135	327	-12.37	-12.69	-13.81	-4.70	-5.07	-5.87
135	330	-12.92	-13.24	-14.41	-4.46	-4.83	-5.63
135	333	-12.86	-13.14	-14.21	-4.28	-4.63	-5.45
135	336	-12.69	-12.84	-13.70	-4.11	-4.45	-5.29
135	339	-12.44	-12.41	-12.98	-3.97	-4.29	-5.15
135	342	-12.13	-11.89	-12.15	-3.87	-4.18	-5.04
135	345	-11.76	-11.33	-11.32	-3.82	-4.11	-4.95
135	348	-11.18	-10.63	-10.44	-3.80	-4.07	-4.89
135	351	-10.25	-9.68	-9.43	-3.79	-4.04	-4.83
135	354	-9.05	-8.53	-8.30	-3.78	-4.01	-4.78
135	357	-7.64	-7.23	-7.06	-3.77	-3.99	-4.75

135	360	-6.09	-5.81	-5.73	-3.77	-3.99	-4.73
138	0	-6.61	-6.32	-6.28	-3.59	-3.81	-4.60
138	3	-6.10	-5.79	-5.77	-3.59	-3.81	-4.55
138	6	-5.69	-5.37	-5.39	-3.58	-3.79	-4.48
138	9	-5.38	-5.07	-5.12	-3.57	-3.76	-4.41
138	12	-5.18	-4.88	-4.96	-3.55	-3.72	-4.33
138	15	-5.11	-4.81	-4.91	-3.53	-3.68	-4.25
138	18	-5.17	-4.89	-5.01	-3.50	-3.62	-4.14
138	21	-5.32	-5.08	-5.27	-3.45	-3.54	-4.01
138	24	-5.55	-5.36	-5.65	-3.38	-3.44	-3.87
138	27	-5.81	-5.69	-6.08	-3.32	-3.35	-3.74
138	30	-6.09	-6.03	-6.53	-3.26	-3.27	-3.62
138	33	-6.40	-6.42	-7.02	-3.21	-3.19	-3.51
138	36	-6.78	-6.91	-7.61	-3.15	-3.12	-3.39
138	39	-7.23	-7.47	-8.28	-3.10	-3.05	-3.29
138	42	-7.73	-8.10	-9.02	-3.07	-3.00	-3.21
138	45	-8.26	-8.75	-9.82	-3.05	-2.98	-3.18
138	48	-8.87	-9.50	-10.77	-3.06	-2.99	-3.20
138	51	-9.57	-10.36	-11.91	-3.09	-3.02	-3.24
138	54	-10.34	-11.28	-13.12	-3.14	-3.06	-3.31
138	57	-11.14	-12.22	-14.26	-3.20	-3.12	-3.39
138	60	-11.95	-13.10	-15.21	-3.26	-3.18	-3.48
138	63	-12.90	-14.06	-16.06	-3.35	-3.29	-3.61
138	66	-14.02	-15.14	-16.92	-3.49	-3.46	-3.81
138	69	-15.10	-16.15	-17.68	-3.66	-3.66	-4.04
138	72	-15.91	-16.89	-18.22	-3.84	-3.89	-4.29
138	75	-16.23	-17.18	-18.42	-4.03	-4.12	-4.54
138	78	-15.84	-16.62	-17.67	-4.24	-4.35	-4.80
138	81	-14.86	-15.20	-15.80	-4.47	-4.61	-5.08
138	84	-13.57	-13.36	-13.41	-4.71	-4.88	-5.37
138	87	-12.23	-11.54	-11.10	-4.96	-5.15	-5.67
138	90	-11.11	-10.15	-9.48	-5.21	-5.41	-5.95
138	93	-10.19	-9.13	-8.44	-5.44	-5.64	-6.21
138	96	-9.27	-8.18	-7.52	-5.68	-5.87	-6.46
138	99	-8.40	-7.33	-6.72	-5.91	-6.10	-6.71
138	102	-7.65	-6.61	-6.07	-6.15	-6.34	-6.97
138	105	-7.06	-6.08	-5.59	-6.39	-6.59	-7.25
138	108	-6.57	-5.66	-5.20	-6.65	-6.86	-7.54
138	111	-6.10	-5.27	-4.84	-6.91	-7.14	-7.85
138	114	-5.70	-4.94	-4.54	-7.18	-7.43	-8.18
138	117	-5.43	-4.72	-4.34	-7.42	-7.73	-8.53
138	120	-5.32	-4.64	-4.26	-7.64	-8.03	-8.91
138	123	-5.35	-4.68	-4.32	-7.85	-8.39	-9.42
138	126	-5.44	-4.81	-4.47	-8.06	-8.81	-10.04
138	129	-5.57	-4.99	-4.69	-8.25	-9.21	-10.66
138	132	-5.73	-5.21	-4.95	-8.39	-9.51	-11.13
138	135	-5.90	-5.45	-5.22	-8.44	-9.63	-11.32
138	138	-6.17	-5.74	-5.55	-8.33	-9.53	-11.24
138	141	-6.57	-6.15	-5.99	-8.05	-9.29	-11.01
138	144	-7.05	-6.61	-6.48	-7.66	-8.94	-10.69
138	147	-7.57	-7.10	-6.98	-7.24	-8.54	-10.31
138	150	-8.07	-7.57	-7.46	-6.84	-8.16	-9.92
138	153	-8.67	-8.10	-7.97	-6.44	-7.71	-9.43
138	156	-9.39	-8.73	-8.55	-5.99	-7.18	-8.77
138	159	-10.08	-9.33	-9.09	-5.54	-6.61	-8.05
138	162	-10.62	-9.79	-9.50	-5.14	-6.10	-7.39
138	165	-10.86	-9.99	-9.66	-4.86	-5.70	-6.87
138	168	-10.89	-10.02	-9.66	-4.66	-5.39	-6.46

138	171	-10.91	-10.04	-9.65	-4.47	-5.09	-6.06
138	174	-10.93	-10.05	-9.65	-4.32	-4.83	-5.72
138	177	-10.94	-10.07	-9.65	-4.21	-4.65	-5.48
138	180	-10.97	-10.09	-9.65	-4.17	-4.58	-5.39
138	183	-11.00	-10.15	-9.68	-4.21	-4.60	-5.40
138	186	-11.04	-10.24	-9.75	-4.32	-4.67	-5.42
138	189	-11.09	-10.36	-9.87	-4.48	-4.76	-5.46
138	192	-11.15	-10.52	-10.03	-4.66	-4.88	-5.52
138	195	-11.24	-10.72	-10.21	-4.84	-5.00	-5.58
138	198	-11.46	-11.05	-10.55	-5.05	-5.17	-5.70
138	201	-11.91	-11.61	-11.16	-5.30	-5.39	-5.92
138	204	-12.54	-12.37	-12.03	-5.58	-5.66	-6.21
138	207	-13.32	-13.32	-13.11	-5.87	-5.95	-6.53
138	210	-14.21	-14.42	-14.40	-6.16	-6.24	-6.85
138	213	-16.02	-16.66	-17.29	-6.46	-6.55	-7.18
138	216	-18.95	-20.31	-22.18	-6.77	-6.89	-7.56
138	219	-22.14	-24.27	-27.56	-7.09	-7.26	-7.96
138	222	-24.69	-27.45	-31.90	-7.42	-7.63	-8.39
138	225	-25.74	-28.75	-33.68	-7.76	-8.02	-8.82
138	228	-25.09	-27.57	-31.84	-8.09	-8.40	-9.25
138	231	-23.50	-24.68	-27.40	-8.41	-8.79	-9.69
138	234	-21.45	-21.07	-21.94	-8.75	-9.20	-10.15
138	237	-19.44	-17.76	-17.07	-9.12	-9.64	-10.65
138	240	-17.97	-15.72	-14.40	-9.54	-10.14	-11.21
138	243	-17.01	-14.78	-13.48	-10.01	-10.67	-11.83
138	246	-16.20	-14.03	-12.78	-10.53	-11.26	-12.52
138	249	-15.47	-13.42	-12.24	-11.13	-11.92	-13.28
138	252	-14.78	-12.89	-11.79	-11.83	-12.68	-14.12
138	255	-14.09	-12.39	-11.37	-12.67	-13.57	-15.03
138	258	-13.42	-11.92	-11.00	-14.16	-15.03	-16.29
138	261	-12.79	-11.52	-10.70	-16.38	-17.10	-17.92
138	264	-12.18	-11.14	-10.42	-18.72	-19.26	-19.55
138	267	-11.55	-10.75	-10.13	-20.57	-20.95	-20.80
138	270	-10.90	-10.29	-9.78	-21.32	-21.63	-21.30
138	273	-10.15	-9.71	-9.32	-21.12	-21.39	-21.00
138	276	-9.33	-9.02	-8.77	-20.60	-20.74	-20.22
138	279	-8.52	-8.32	-8.19	-19.83	-19.83	-19.13
138	282	-7.80	-7.68	-7.68	-18.93	-18.77	-17.92
138	285	-7.25	-7.20	-7.29	-17.97	-17.70	-16.78
138	288	-6.80	-6.83	-7.00	-16.68	-16.40	-15.59
138	291	-6.38	-6.47	-6.72	-14.91	-14.75	-14.22
138	294	-6.02	-6.17	-6.48	-12.97	-12.99	-12.81
138	297	-5.77	-5.96	-6.32	-11.18	-11.37	-11.52
138	300	-5.68	-5.88	-6.26	-9.85	-10.13	-10.49
138	303	-5.74	-5.95	-6.34	-8.91	-9.22	-9.68
138	306	-5.92	-6.14	-6.56	-8.08	-8.42	-8.95
138	309	-6.19	-6.43	-6.90	-7.36	-7.72	-8.31
138	312	-6.54	-6.79	-7.33	-6.75	-7.11	-7.75
138	315	-6.93	-7.21	-7.81	-6.23	-6.59	-7.26
138	318	-7.76	-8.08	-8.78	-5.76	-6.13	-6.84
138	321	-9.16	-9.54	-10.38	-5.34	-5.71	-6.45
138	324	-10.72	-11.14	-12.11	-4.97	-5.34	-6.10
138	327	-12.02	-12.43	-13.51	-4.67	-5.02	-5.81
138	330	-12.66	-12.96	-14.08	-4.43	-4.77	-5.57
138	333	-12.81	-12.95	-14.02	-4.25	-4.57	-5.39
138	336	-12.94	-12.92	-13.85	-4.09	-4.38	-5.22
138	339	-13.03	-12.87	-13.59	-3.96	-4.22	-5.08
138	342	-13.09	-12.80	-13.26	-3.85	-4.10	-4.96

138	345	-13.11	-12.72	-12.87	-3.77	-4.01	-4.87
138	348	-12.76	-12.30	-12.22	-3.72	-3.95	-4.79
138	351	-11.78	-11.31	-11.15	-3.67	-3.90	-4.72
138	354	-10.34	-9.89	-9.74	-3.63	-3.85	-4.66
138	357	-8.57	-8.18	-8.09	-3.60	-3.82	-4.62
138	360	-6.61	-6.32	-6.28	-3.59	-3.81	-4.60
141	0	-7.96	-7.65	-7.70	-3.38	-3.64	-4.47
141	3	-7.28	-6.98	-7.02	-3.36	-3.62	-4.41
141	6	-6.69	-6.40	-6.47	-3.34	-3.59	-4.34
141	9	-6.23	-5.95	-6.05	-3.32	-3.55	-4.27
141	12	-5.93	-5.67	-5.78	-3.29	-3.51	-4.19
141	15	-5.82	-5.56	-5.69	-3.26	-3.47	-4.11
141	18	-5.86	-5.62	-5.77	-3.23	-3.42	-4.02
141	21	-5.97	-5.76	-5.98	-3.18	-3.35	-3.92
141	24	-6.12	-5.97	-6.27	-3.14	-3.27	-3.81
141	27	-6.32	-6.23	-6.62	-3.09	-3.20	-3.71
141	30	-6.52	-6.50	-6.99	-3.06	-3.15	-3.62
141	33	-6.79	-6.84	-7.42	-3.03	-3.11	-3.53
141	36	-7.14	-7.29	-7.96	-3.01	-3.06	-3.43
141	39	-7.57	-7.82	-8.58	-2.99	-3.03	-3.35
141	42	-8.05	-8.41	-9.27	-2.97	-3.00	-3.29
141	45	-8.56	-9.03	-10.00	-2.96	-2.99	-3.26
141	48	-9.15	-9.74	-10.86	-2.98	-3.01	-3.28
141	51	-9.85	-10.58	-11.90	-3.03	-3.04	-3.33
141	54	-10.61	-11.46	-12.98	-3.09	-3.10	-3.41
141	57	-11.37	-12.33	-13.97	-3.17	-3.16	-3.50
141	60	-12.08	-13.09	-14.74	-3.26	-3.24	-3.60
141	63	-12.85	-13.83	-15.38	-3.37	-3.35	-3.73
141	66	-13.70	-14.62	-16.00	-3.51	-3.52	-3.92
141	69	-14.49	-15.33	-16.54	-3.68	-3.73	-4.15
141	72	-15.07	-15.84	-16.91	-3.87	-3.96	-4.39
141	75	-15.30	-16.04	-17.05	-4.07	-4.19	-4.64
141	78	-14.95	-15.57	-16.43	-4.28	-4.43	-4.89
141	81	-14.08	-14.40	-14.91	-4.52	-4.69	-5.17
141	84	-12.94	-12.88	-12.95	-4.78	-4.96	-5.46
141	87	-11.75	-11.35	-11.04	-5.04	-5.24	-5.75
141	90	-10.77	-10.15	-9.66	-5.31	-5.52	-6.04
141	93	-9.96	-9.24	-8.74	-5.57	-5.78	-6.32
141	96	-9.15	-8.37	-7.90	-5.84	-6.03	-6.59
141	99	-8.39	-7.58	-7.17	-6.11	-6.29	-6.86
141	102	-7.73	-6.92	-6.58	-6.39	-6.57	-7.16
141	105	-7.22	-6.44	-6.14	-6.69	-6.88	-7.48
141	108	-6.79	-6.07	-5.81	-7.02	-7.22	-7.85
141	111	-6.39	-5.73	-5.50	-7.39	-7.61	-8.25
141	114	-6.04	-5.45	-5.25	-7.77	-8.02	-8.69
141	117	-5.80	-5.26	-5.08	-8.12	-8.44	-9.17
141	120	-5.72	-5.18	-5.02	-8.44	-8.86	-9.68
141	123	-5.76	-5.25	-5.09	-8.76	-9.36	-10.37
141	126	-5.89	-5.41	-5.28	-9.09	-9.94	-11.24
141	129	-6.07	-5.63	-5.55	-9.39	-10.49	-12.11
141	132	-6.29	-5.90	-5.85	-9.60	-10.91	-12.77
141	135	-6.52	-6.16	-6.15	-9.68	-11.07	-13.04
141	138	-6.81	-6.47	-6.48	-9.51	-10.89	-12.84
141	141	-7.20	-6.85	-6.89	-9.08	-10.43	-12.33
141	144	-7.65	-7.26	-7.32	-8.50	-9.81	-11.63
141	147	-8.11	-7.66	-7.72	-7.88	-9.14	-10.87
141	150	-8.53	-8.02	-8.06	-7.34	-8.54	-10.18
141	153	-8.97	-8.38	-8.36	-6.84	-7.96	-9.50

141	156	-9.47	-8.77	-8.67	-6.31	-7.33	-8.76
141	159	-9.93	-9.12	-8.94	-5.80	-6.72	-8.01
141	162	-10.27	-9.38	-9.14	-5.36	-6.17	-7.35
141	165	-10.40	-9.48	-9.21	-5.05	-5.75	-6.83
141	168	-10.39	-9.47	-9.19	-4.81	-5.42	-6.40
141	171	-10.36	-9.45	-9.14	-4.59	-5.10	-5.99
141	174	-10.34	-9.42	-9.08	-4.41	-4.82	-5.64
141	177	-10.31	-9.40	-9.03	-4.29	-4.64	-5.39
141	180	-10.30	-9.39	-9.01	-4.25	-4.57	-5.30
141	183	-10.33	-9.44	-9.04	-4.28	-4.59	-5.31
141	186	-10.40	-9.56	-9.15	-4.38	-4.65	-5.34
141	189	-10.52	-9.74	-9.30	-4.51	-4.74	-5.39
141	192	-10.67	-9.97	-9.51	-4.68	-4.86	-5.45
141	195	-10.85	-10.24	-9.75	-4.84	-4.98	-5.52
141	198	-11.15	-10.64	-10.15	-5.04	-5.14	-5.66
141	201	-11.67	-11.27	-10.84	-5.29	-5.38	-5.90
141	204	-12.39	-12.11	-11.77	-5.57	-5.66	-6.20
141	207	-13.28	-13.16	-12.92	-5.87	-5.97	-6.55
141	210	-14.33	-14.39	-14.26	-6.18	-6.29	-6.90
141	213	-16.53	-16.87	-16.95	-6.50	-6.63	-7.26
141	216	-20.16	-20.91	-21.29	-6.84	-7.01	-7.68
141	219	-24.11	-25.28	-25.99	-7.19	-7.41	-8.14
141	222	-27.29	-28.78	-29.75	-7.56	-7.83	-8.62
141	225	-28.60	-30.22	-31.30	-7.93	-8.26	-9.12
141	228	-27.67	-28.89	-29.69	-8.30	-8.70	-9.61
141	231	-25.39	-25.64	-25.81	-8.67	-9.14	-10.12
141	234	-22.48	-21.60	-21.01	-9.05	-9.61	-10.67
141	237	-19.69	-17.88	-16.67	-9.46	-10.11	-11.27
141	240	-17.75	-15.59	-14.19	-9.93	-10.67	-11.94
141	243	-16.59	-14.53	-13.21	-10.44	-11.28	-12.76
141	246	-15.61	-13.68	-12.44	-11.01	-11.95	-13.74
141	249	-14.77	-13.00	-11.84	-11.64	-12.70	-14.80
141	252	-14.00	-12.40	-11.34	-12.38	-13.53	-15.86
141	255	-13.25	-11.84	-10.88	-13.23	-14.46	-16.84
141	258	-12.54	-11.32	-10.46	-14.62	-15.83	-17.88
141	261	-11.88	-10.87	-10.11	-16.60	-17.66	-19.02
141	264	-11.25	-10.45	-9.79	-18.65	-19.52	-20.08
141	267	-10.63	-10.02	-9.47	-20.26	-20.95	-20.85
141	270	-10.00	-9.55	-9.11	-20.91	-21.53	-21.16
141	273	-9.31	-8.99	-8.66	-20.67	-21.20	-20.78
141	276	-8.57	-8.36	-8.16	-20.01	-20.35	-19.82
141	279	-7.86	-7.72	-7.65	-19.08	-19.17	-18.52
141	282	-7.24	-7.16	-7.20	-18.02	-17.86	-17.11
141	285	-6.76	-6.75	-6.87	-16.94	-16.61	-15.85
141	288	-6.38	-6.43	-6.62	-15.66	-15.30	-14.66
141	291	-6.03	-6.12	-6.38	-14.04	-13.78	-13.39
141	294	-5.72	-5.86	-6.19	-12.31	-12.22	-12.12
141	297	-5.51	-5.69	-6.05	-10.73	-10.79	-10.97
141	300	-5.44	-5.62	-6.00	-9.52	-9.68	-10.03
141	303	-5.50	-5.69	-6.08	-8.64	-8.83	-9.27
141	306	-5.68	-5.88	-6.29	-7.86	-8.07	-8.58
141	309	-5.95	-6.16	-6.61	-7.18	-7.40	-7.97
141	312	-6.29	-6.51	-7.02	-6.59	-6.83	-7.43
141	315	-6.68	-6.91	-7.47	-6.09	-6.34	-6.98
141	318	-7.35	-7.59	-8.24	-5.65	-5.91	-6.58
141	321	-8.40	-8.67	-9.45	-5.25	-5.52	-6.23
141	324	-9.67	-9.95	-10.86	-4.90	-5.18	-5.91
141	327	-10.94	-11.22	-12.22	-4.60	-4.88	-5.65

141	330	-12.05	-12.28	-13.28	-4.37	-4.65	-5.43
141	333	-13.11	-13.23	-14.17	-4.18	-4.45	-5.26
141	336	-14.25	-14.24	-15.05	-4.01	-4.27	-5.11
141	339	-15.29	-15.13	-15.83	-3.87	-4.11	-4.97
141	342	-16.05	-15.78	-16.37	-3.76	-3.99	-4.86
141	345	-16.34	-16.03	-16.58	-3.66	-3.89	-4.77
141	348	-15.94	-15.62	-16.14	-3.58	-3.82	-4.69
141	351	-14.80	-14.47	-14.89	-3.51	-3.75	-4.61
141	354	-13.03	-12.68	-12.98	-3.45	-3.69	-4.55
141	357	-10.72	-10.37	-10.54	-3.41	-3.66	-4.50
141	360	-7.96	-7.65	-7.70	-3.38	-3.64	-4.47
144	0	-9.83	-9.54	-9.65	-3.19	-3.49	-4.36
144	3	-8.93	-8.66	-8.77	-3.15	-3.45	-4.29
144	6	-8.13	-7.88	-8.00	-3.11	-3.41	-4.21
144	9	-7.47	-7.25	-7.39	-3.07	-3.37	-4.14
144	12	-7.03	-6.83	-7.00	-3.04	-3.32	-4.07
144	15	-6.87	-6.68	-6.85	-3.00	-3.28	-3.99
144	18	-6.88	-6.70	-6.90	-2.97	-3.23	-3.92
144	21	-6.92	-6.78	-7.02	-2.93	-3.17	-3.83
144	24	-6.99	-6.89	-7.21	-2.90	-3.12	-3.75
144	27	-7.07	-7.03	-7.43	-2.87	-3.07	-3.68
144	30	-7.17	-7.19	-7.68	-2.86	-3.05	-3.61
144	33	-7.35	-7.44	-8.01	-2.86	-3.04	-3.55
144	36	-7.66	-7.84	-8.47	-2.87	-3.03	-3.49
144	39	-8.07	-8.32	-9.03	-2.87	-3.02	-3.44
144	42	-8.52	-8.87	-9.65	-2.88	-3.01	-3.40
144	45	-8.99	-9.43	-10.27	-2.89	-3.01	-3.39
144	48	-9.55	-10.09	-11.02	-2.91	-3.03	-3.41
144	51	-10.23	-10.90	-11.92	-2.97	-3.08	-3.47
144	54	-10.95	-11.74	-12.84	-3.06	-3.15	-3.55
144	57	-11.64	-12.50	-13.64	-3.15	-3.23	-3.66
144	60	-12.21	-13.07	-14.18	-3.26	-3.32	-3.77
144	63	-12.73	-13.52	-14.55	-3.38	-3.45	-3.90
144	66	-13.25	-13.95	-14.88	-3.53	-3.63	-4.09
144	69	-13.72	-14.32	-15.16	-3.71	-3.84	-4.31
144	72	-14.05	-14.57	-15.34	-3.91	-4.07	-4.55
144	75	-14.18	-14.67	-15.41	-4.12	-4.31	-4.79
144	78	-13.90	-14.32	-14.96	-4.34	-4.55	-5.04
144	81	-13.20	-13.44	-13.86	-4.60	-4.82	-5.30
144	84	-12.27	-12.29	-12.42	-4.88	-5.10	-5.59
144	87	-11.30	-11.11	-11.00	-5.17	-5.39	-5.88
144	90	-10.49	-10.16	-9.94	-5.47	-5.69	-6.19
144	93	-9.81	-9.39	-9.17	-5.77	-5.98	-6.49
144	96	-9.11	-8.63	-8.44	-6.09	-6.28	-6.79
144	99	-8.46	-7.93	-7.80	-6.42	-6.60	-7.11
144	102	-7.89	-7.35	-7.28	-6.77	-6.94	-7.46
144	105	-7.46	-6.94	-6.92	-7.15	-7.32	-7.85
144	108	-7.11	-6.64	-6.66	-7.59	-7.77	-8.32
144	111	-6.78	-6.37	-6.43	-8.09	-8.29	-8.85
144	114	-6.51	-6.15	-6.23	-8.62	-8.86	-9.45
144	117	-6.32	-6.00	-6.11	-9.12	-9.44	-10.09
144	120	-6.25	-5.94	-6.06	-9.55	-10.01	-10.77
144	123	-6.30	-6.01	-6.14	-9.97	-10.65	-11.66
144	126	-6.45	-6.18	-6.33	-10.40	-11.38	-12.79
144	129	-6.66	-6.41	-6.60	-10.78	-12.08	-13.90
144	132	-6.90	-6.67	-6.90	-11.06	-12.59	-14.75
144	135	-7.15	-6.93	-7.18	-11.17	-12.80	-15.09
144	138	-7.44	-7.21	-7.48	-10.92	-12.51	-14.74



144	141	-7.82	-7.55	-7.84	-10.31	-11.79	-13.86
144	144	-8.23	-7.90	-8.19	-9.49	-10.83	-12.69
144	147	-8.61	-8.21	-8.46	-8.64	-9.83	-11.48
144	150	-8.91	-8.41	-8.59	-7.93	-8.99	-10.47
144	153	-9.16	-8.55	-8.62	-7.32	-8.27	-9.64
144	156	-9.41	-8.67	-8.65	-6.71	-7.55	-8.80
144	159	-9.62	-8.77	-8.67	-6.12	-6.86	-8.01
144	162	-9.77	-8.84	-8.68	-5.63	-6.26	-7.32
144	165	-9.82	-8.86	-8.68	-5.27	-5.81	-6.78
144	168	-9.79	-8.83	-8.63	-4.99	-5.45	-6.33
144	171	-9.71	-8.75	-8.52	-4.73	-5.11	-5.90
144	174	-9.62	-8.66	-8.39	-4.51	-4.82	-5.54
144	177	-9.54	-8.59	-8.28	-4.37	-4.62	-5.29
144	180	-9.51	-8.56	-8.24	-4.31	-4.55	-5.20
144	183	-9.55	-8.62	-8.29	-4.34	-4.57	-5.21
144	186	-9.68	-8.77	-8.43	-4.43	-4.63	-5.24
144	189	-9.86	-9.02	-8.64	-4.55	-4.72	-5.30
144	192	-10.10	-9.32	-8.91	-4.69	-4.83	-5.37
144	195	-10.38	-9.66	-9.22	-4.85	-4.95	-5.46
144	198	-10.77	-10.14	-9.70	-5.03	-5.12	-5.61
144	201	-11.38	-10.86	-10.47	-5.28	-5.36	-5.86
144	204	-12.19	-11.81	-11.49	-5.57	-5.66	-6.19
144	207	-13.20	-12.97	-12.71	-5.88	-5.99	-6.56
144	210	-14.41	-14.35	-14.10	-6.19	-6.33	-6.94
144	213	-16.98	-17.06	-16.52	-6.53	-6.70	-7.34
144	216	-21.23	-21.40	-20.18	-6.89	-7.10	-7.80
144	219	-25.86	-26.09	-24.05	-7.28	-7.55	-8.30
144	222	-29.59	-29.85	-27.13	-7.68	-8.01	-8.84
144	225	-31.12	-31.39	-28.38	-8.09	-8.49	-9.39
144	228	-29.94	-29.94	-27.07	-8.49	-8.97	-9.96
144	231	-27.05	-26.42	-23.86	-8.90	-9.47	-10.55
144	234	-23.38	-22.02	-19.86	-9.33	-10.00	-11.19
144	237	-19.88	-17.95	-16.18	-9.79	-10.57	-11.89
144	240	-17.49	-15.44	-13.93	-10.31	-11.20	-12.70
144	243	-16.11	-14.24	-12.89	-10.89	-11.92	-13.80
144	246	-14.95	-13.28	-12.05	-11.52	-12.72	-15.21
144	249	-13.95	-12.49	-11.38	-12.23	-13.59	-16.70
144	252	-13.07	-11.82	-10.80	-13.01	-14.52	-18.01
144	255	-12.25	-11.19	-10.29	-13.89	-15.50	-18.91
144	258	-11.48	-10.60	-9.82	-15.16	-16.74	-19.51
144	261	-10.78	-10.08	-9.42	-16.85	-18.28	-20.06
144	264	-10.13	-9.60	-9.06	-18.56	-19.79	-20.51
144	267	-9.52	-9.14	-8.71	-19.88	-20.93	-20.82
144	270	-8.93	-8.67	-8.35	-20.41	-21.38	-20.93
144	273	-8.32	-8.16	-7.95	-20.10	-20.94	-20.46
144	276	-7.71	-7.62	-7.52	-19.27	-19.81	-19.27
144	279	-7.14	-7.10	-7.12	-18.13	-18.29	-17.68
144	282	-6.64	-6.65	-6.76	-16.86	-16.67	-16.04
144	285	-6.26	-6.31	-6.50	-15.66	-15.25	-14.66
144	288	-5.96	-6.05	-6.29	-14.42	-13.96	-13.50
144	291	-5.67	-5.79	-6.09	-12.99	-12.61	-12.36
144	294	-5.43	-5.58	-5.93	-11.53	-11.29	-11.27
144	297	-5.26	-5.43	-5.81	-10.19	-10.10	-10.28
144	300	-5.20	-5.38	-5.77	-9.14	-9.13	-9.45
144	303	-5.26	-5.44	-5.84	-8.32	-8.35	-8.75
144	306	-5.44	-5.61	-6.03	-7.60	-7.65	-8.11
144	309	-5.69	-5.86	-6.31	-6.96	-7.03	-7.54
144	312	-6.02	-6.19	-6.66	-6.41	-6.49	-7.04

144	315	-6.39	-6.55	-7.06	-5.93	-6.03	-6.63
144	318	-6.94	-7.10	-7.67	-5.52	-5.64	-6.28
144	321	-7.79	-7.96	-8.58	-5.14	-5.29	-5.96
144	324	-8.86	-9.02	-9.72	-4.81	-4.98	-5.68
144	327	-10.06	-10.22	-11.00	-4.52	-4.72	-5.45
144	330	-11.32	-11.47	-12.32	-4.29	-4.50	-5.26
144	333	-13.05	-13.15	-14.06	-4.09	-4.31	-5.11
144	336	-15.36	-15.36	-16.32	-3.92	-4.14	-4.98
144	339	-17.68	-17.58	-18.58	-3.77	-3.99	-4.86
144	342	-19.47	-19.29	-20.32	-3.64	-3.87	-4.76
144	345	-20.19	-19.98	-21.01	-3.53	-3.77	-4.67
144	348	-19.75	-19.53	-20.51	-3.44	-3.69	-4.60
144	351	-18.46	-18.22	-19.06	-3.35	-3.62	-4.52
144	354	-16.35	-16.08	-16.73	-3.28	-3.56	-4.46
144	357	-13.47	-13.17	-13.57	-3.22	-3.51	-4.40
144	360	-9.83	-9.54	-9.65	-3.19	-3.49	-4.36
147	0	-11.92	-11.68	-11.78	-3.04	-3.38	-4.28
147	3	-10.83	-10.60	-10.73	-2.98	-3.33	-4.20
147	6	-9.82	-9.61	-9.77	-2.93	-3.28	-4.12
147	9	-8.99	-8.79	-8.99	-2.88	-3.23	-4.05
147	12	-8.41	-8.24	-8.47	-2.84	-3.19	-3.98
147	15	-8.15	-8.04	-8.27	-2.81	-3.14	-3.91
147	18	-8.08	-8.04	-8.29	-2.78	-3.10	-3.84
147	21	-8.03	-8.04	-8.32	-2.76	-3.05	-3.77
147	24	-7.99	-8.04	-8.38	-2.73	-3.01	-3.70
147	27	-7.97	-8.04	-8.45	-2.72	-2.98	-3.65
147	30	-7.96	-8.04	-8.54	-2.71	-2.97	-3.61
147	33	-8.06	-8.16	-8.74	-2.72	-2.98	-3.59
147	36	-8.32	-8.48	-9.10	-2.73	-2.98	-3.57
147	39	-8.68	-8.93	-9.58	-2.76	-3.00	-3.56
147	42	-9.10	-9.43	-10.11	-2.79	-3.02	-3.54
147	45	-9.52	-9.93	-10.63	-2.83	-3.04	-3.54
147	48	-10.02	-10.53	-11.25	-2.88	-3.07	-3.57
147	51	-10.67	-11.29	-12.02	-2.95	-3.14	-3.64
147	54	-11.35	-12.07	-12.79	-3.04	-3.22	-3.73
147	57	-11.94	-12.71	-13.40	-3.14	-3.32	-3.85
147	60	-12.34	-13.06	-13.72	-3.26	-3.43	-3.97
147	63	-12.61	-13.21	-13.82	-3.39	-3.57	-4.12
147	66	-12.86	-13.34	-13.91	-3.56	-3.76	-4.30
147	69	-13.06	-13.44	-13.98	-3.75	-3.98	-4.51
147	72	-13.19	-13.50	-14.02	-3.96	-4.22	-4.74
147	75	-13.24	-13.52	-14.03	-4.19	-4.46	-4.98
147	78	-13.02	-13.27	-13.74	-4.43	-4.71	-5.22
147	81	-12.47	-12.63	-12.99	-4.71	-4.98	-5.48
147	84	-11.74	-11.78	-12.02	-5.02	-5.28	-5.76
147	87	-10.97	-10.90	-11.04	-5.34	-5.59	-6.06
147	90	-10.31	-10.18	-10.27	-5.68	-5.91	-6.38
147	93	-9.74	-9.56	-9.66	-6.03	-6.25	-6.71
147	96	-9.14	-8.93	-9.07	-6.41	-6.61	-7.06
147	99	-8.58	-8.34	-8.53	-6.82	-6.99	-7.43
147	102	-8.10	-7.85	-8.09	-7.25	-7.41	-7.85
147	105	-7.75	-7.52	-7.80	-7.72	-7.88	-8.33
147	108	-7.49	-7.30	-7.61	-8.28	-8.45	-8.91
147	111	-7.24	-7.10	-7.45	-8.94	-9.13	-9.60
147	114	-7.04	-6.94	-7.31	-9.63	-9.87	-10.37
147	117	-6.90	-6.83	-7.22	-10.26	-10.61	-11.19
147	120	-6.85	-6.79	-7.19	-10.77	-11.29	-12.02
147	123	-6.91	-6.85	-7.26	-11.22	-12.00	-13.05

147	126	-7.07	-7.01	-7.45	-11.66	-12.79	-14.31
147	129	-7.28	-7.22	-7.69	-12.04	-13.51	-15.52
147	132	-7.52	-7.46	-7.94	-12.31	-14.04	-16.44
147	135	-7.76	-7.67	-8.16	-12.41	-14.24	-16.81
147	138	-8.04	-7.90	-8.36	-12.10	-13.87	-16.33
147	141	-8.39	-8.17	-8.58	-11.33	-12.92	-15.13
147	144	-8.75	-8.43	-8.78	-10.32	-11.67	-13.56
147	147	-9.03	-8.63	-8.93	-9.27	-10.40	-11.98
147	150	-9.18	-8.70	-8.99	-8.42	-9.37	-10.73
147	153	-9.22	-8.68	-8.93	-7.73	-8.54	-9.76
147	156	-9.25	-8.62	-8.79	-7.04	-7.73	-8.84
147	159	-9.28	-8.53	-8.60	-6.40	-6.98	-8.00
147	162	-9.29	-8.43	-8.40	-5.85	-6.34	-7.28
147	165	-9.30	-8.34	-8.23	-5.45	-5.86	-6.72
147	168	-9.25	-8.24	-8.08	-5.13	-5.47	-6.26
147	171	-9.14	-8.11	-7.91	-4.83	-5.11	-5.82
147	174	-9.00	-7.99	-7.75	-4.59	-4.81	-5.46
147	177	-8.89	-7.89	-7.64	-4.42	-4.61	-5.20
147	180	-8.84	-7.86	-7.59	-4.36	-4.53	-5.11
147	183	-8.90	-7.93	-7.65	-4.39	-4.55	-5.12
147	186	-9.07	-8.12	-7.83	-4.46	-4.61	-5.16
147	189	-9.32	-8.41	-8.08	-4.57	-4.70	-5.23
147	192	-9.63	-8.77	-8.41	-4.70	-4.80	-5.31
147	195	-9.98	-9.18	-8.78	-4.85	-4.92	-5.40
147	198	-10.45	-9.73	-9.34	-5.03	-5.10	-5.56
147	201	-11.14	-10.52	-10.19	-5.27	-5.35	-5.84
147	204	-12.03	-11.56	-11.29	-5.56	-5.67	-6.19
147	207	-13.14	-12.82	-12.57	-5.88	-6.01	-6.58
147	210	-14.48	-14.31	-13.97	-6.20	-6.37	-6.98
147	213	-17.32	-17.19	-16.12	-6.55	-6.76	-7.42
147	216	-22.01	-21.74	-19.17	-6.93	-7.20	-7.91
147	219	-27.12	-26.65	-22.33	-7.35	-7.67	-8.46
147	222	-31.22	-30.56	-24.81	-7.78	-8.18	-9.05
147	225	-32.91	-32.16	-25.81	-8.22	-8.70	-9.66
147	228	-31.56	-30.64	-24.74	-8.66	-9.23	-10.30
147	231	-28.22	-26.93	-22.12	-9.12	-9.78	-10.96
147	234	-24.00	-22.29	-18.83	-9.59	-10.37	-11.69
147	237	-19.99	-17.99	-15.74	-10.11	-11.02	-12.51
147	240	-17.27	-15.31	-13.72	-10.68	-11.73	-13.45
147	243	-15.71	-13.99	-12.64	-11.33	-12.57	-14.89
147	246	-14.39	-12.94	-11.74	-12.06	-13.56	-16.85
147	249	-13.27	-12.07	-11.00	-12.86	-14.61	-18.86
147	252	-12.29	-11.33	-10.36	-13.70	-15.67	-20.42
147	255	-11.41	-10.64	-9.79	-14.59	-16.67	-21.04
147	258	-10.59	-9.99	-9.29	-15.73	-17.74	-21.03
147	261	-9.86	-9.41	-8.84	-17.14	-18.94	-20.98
147	264	-9.19	-8.88	-8.44	-18.51	-20.05	-20.90
147	267	-8.58	-8.40	-8.08	-19.55	-20.87	-20.79
147	270	-8.03	-7.93	-7.73	-19.97	-21.19	-20.65
147	273	-7.51	-7.48	-7.38	-19.58	-20.64	-19.99
147	276	-7.01	-7.03	-7.03	-18.58	-19.24	-18.56
147	279	-6.55	-6.62	-6.72	-17.23	-17.41	-16.75
147	282	-6.17	-6.26	-6.44	-15.78	-15.52	-14.93
147	285	-5.87	-5.99	-6.23	-14.50	-13.99	-13.49
147	288	-5.63	-5.76	-6.05	-13.32	-12.77	-12.41
147	291	-5.40	-5.55	-5.89	-12.07	-11.59	-11.39
147	294	-5.20	-5.37	-5.74	-10.85	-10.48	-10.46
147	297	-5.07	-5.24	-5.65	-9.73	-9.49	-9.62

147	300	-5.02	-5.19	-5.61	-8.81	-8.65	-8.90
147	303	-5.08	-5.25	-5.67	-8.06	-7.94	-8.26
147	306	-5.24	-5.40	-5.83	-7.39	-7.29	-7.67
147	309	-5.49	-5.63	-6.07	-6.78	-6.71	-7.14
147	312	-5.80	-5.92	-6.38	-6.25	-6.20	-6.69
147	315	-6.14	-6.25	-6.72	-5.80	-5.78	-6.31
147	318	-6.63	-6.73	-7.22	-5.41	-5.42	-6.00
147	321	-7.36	-7.46	-7.98	-5.05	-5.10	-5.72
147	324	-8.31	-8.40	-8.96	-4.73	-4.82	-5.48
147	327	-9.43	-9.52	-10.14	-4.45	-4.57	-5.28
147	330	-10.71	-10.79	-11.47	-4.22	-4.37	-5.11
147	333	-12.89	-12.94	-13.74	-4.02	-4.19	-4.98
147	336	-16.15	-16.15	-17.14	-3.83	-4.03	-4.86
147	339	-19.59	-19.53	-20.73	-3.67	-3.89	-4.76
147	342	-22.31	-22.20	-23.57	-3.54	-3.78	-4.68
147	345	-23.42	-23.29	-24.72	-3.42	-3.68	-4.59
147	348	-22.98	-22.84	-24.21	-3.32	-3.60	-4.52
147	351	-21.64	-21.47	-22.67	-3.23	-3.53	-4.45
147	354	-19.37	-19.17	-20.09	-3.15	-3.46	-4.38
147	357	-16.14	-15.92	-16.46	-3.09	-3.41	-4.33
147	360	-11.92	-11.68	-11.78	-3.04	-3.38	-4.28
150	0	-13.91	-13.79	-13.76	-2.98	-3.34	-4.25
150	3	-12.71	-12.60	-12.64	-2.92	-3.28	-4.17
150	6	-11.61	-11.50	-11.62	-2.86	-3.23	-4.09
150	9	-10.67	-10.58	-10.76	-2.81	-3.18	-4.01
150	12	-9.96	-9.90	-10.15	-2.77	-3.13	-3.94
150	15	-9.55	-9.53	-9.84	-2.73	-3.09	-3.88
150	18	-9.32	-9.35	-9.72	-2.71	-3.05	-3.81
150	21	-9.12	-9.19	-9.63	-2.69	-3.01	-3.74
150	24	-8.97	-9.08	-9.56	-2.67	-2.98	-3.68
150	27	-8.87	-9.00	-9.51	-2.66	-2.95	-3.63
150	30	-8.83	-8.98	-9.50	-2.65	-2.94	-3.61
150	33	-8.91	-9.07	-9.60	-2.66	-2.95	-3.62
150	36	-9.11	-9.32	-9.86	-2.68	-2.97	-3.63
150	39	-9.40	-9.67	-10.23	-2.72	-2.99	-3.65
150	42	-9.73	-10.07	-10.64	-2.76	-3.03	-3.68
150	45	-10.07	-10.47	-11.05	-2.81	-3.07	-3.71
150	48	-10.52	-10.98	-11.55	-2.86	-3.12	-3.76
150	51	-11.12	-11.65	-12.19	-2.94	-3.20	-3.84
150	54	-11.73	-12.33	-12.83	-3.03	-3.31	-3.95
150	57	-12.24	-12.85	-13.33	-3.14	-3.43	-4.07
150	60	-12.52	-13.05	-13.52	-3.26	-3.56	-4.20
150	63	-12.63	-13.05	-13.52	-3.41	-3.72	-4.36
150	66	-12.72	-13.05	-13.51	-3.59	-3.91	-4.54
150	69	-12.79	-13.05	-13.50	-3.80	-4.14	-4.75
150	72	-12.83	-13.05	-13.48	-4.03	-4.38	-4.97
150	75	-12.85	-13.04	-13.46	-4.27	-4.63	-5.20
150	78	-12.65	-12.82	-13.22	-4.54	-4.90	-5.44
150	81	-12.16	-12.27	-12.67	-4.85	-5.18	-5.70
150	84	-11.50	-11.54	-11.95	-5.18	-5.49	-5.98
150	87	-10.82	-10.80	-11.22	-5.54	-5.82	-6.28
150	90	-10.25	-10.20	-10.63	-5.93	-6.18	-6.61
150	93	-9.75	-9.70	-10.15	-6.34	-6.57	-6.98
150	96	-9.23	-9.20	-9.68	-6.80	-6.99	-7.38
150	99	-8.75	-8.74	-9.24	-7.29	-7.45	-7.83
150	102	-8.35	-8.37	-8.89	-7.82	-7.96	-8.33
150	105	-8.07	-8.12	-8.67	-8.38	-8.52	-8.90
150	108	-7.89	-7.96	-8.53	-9.07	-9.23	-9.60

150	111	-7.72	-7.82	-8.41	-9.90	-10.08	-10.46
150	114	-7.58	-7.70	-8.32	-10.73	-10.98	-11.41
150	117	-7.49	-7.63	-8.25	-11.45	-11.83	-12.38
150	120	-7.46	-7.60	-8.23	-11.92	-12.52	-13.29
150	123	-7.52	-7.66	-8.29	-12.23	-13.14	-14.28
150	126	-7.67	-7.80	-8.45	-12.50	-13.77	-15.40
150	129	-7.88	-7.98	-8.64	-12.73	-14.31	-16.45
150	132	-8.10	-8.17	-8.82	-12.87	-14.70	-17.23
150	135	-8.31	-8.33	-8.95	-12.93	-14.85	-17.53
150	138	-8.53	-8.47	-9.02	-12.60	-14.43	-17.00
150	141	-8.79	-8.62	-9.09	-11.76	-13.39	-15.67
150	144	-9.03	-8.75	-9.14	-10.66	-12.02	-13.93
150	147	-9.22	-8.85	-9.18	-9.54	-10.64	-12.19
150	150	-9.29	-8.89	-9.19	-8.63	-9.53	-10.83
150	153	-9.27	-8.83	-9.10	-7.90	-8.66	-9.81
150	156	-9.22	-8.68	-8.87	-7.18	-7.81	-8.84
150	159	-9.14	-8.49	-8.58	-6.51	-7.03	-7.95
150	162	-9.06	-8.29	-8.28	-5.94	-6.37	-7.21
150	165	-8.98	-8.13	-8.04	-5.52	-5.88	-6.65
150	168	-8.89	-7.99	-7.85	-5.19	-5.49	-6.19
150	171	-8.78	-7.84	-7.66	-4.88	-5.12	-5.76
150	174	-8.67	-7.70	-7.49	-4.62	-4.81	-5.41
150	177	-8.59	-7.60	-7.37	-4.44	-4.60	-5.16
150	180	-8.56	-7.56	-7.32	-4.38	-4.52	-5.07
150	183	-8.63	-7.64	-7.39	-4.41	-4.54	-5.09
150	186	-8.81	-7.85	-7.57	-4.48	-4.60	-5.13
150	189	-9.09	-8.16	-7.85	-4.58	-4.69	-5.20
150	192	-9.43	-8.55	-8.20	-4.71	-4.79	-5.28
150	195	-9.82	-8.98	-8.60	-4.85	-4.91	-5.38
150	198	-10.32	-9.55	-9.19	-5.03	-5.09	-5.55
150	201	-11.04	-10.38	-10.09	-5.27	-5.36	-5.84
150	204	-11.98	-11.46	-11.22	-5.56	-5.68	-6.21
150	207	-13.15	-12.76	-12.52	-5.88	-6.05	-6.62
150	210	-14.55	-14.30	-13.91	-6.21	-6.42	-7.05
150	213	-17.50	-17.24	-15.91	-6.57	-6.83	-7.51
150	216	-22.34	-21.87	-18.64	-6.97	-7.29	-8.04
150	219	-27.62	-26.85	-21.42	-7.41	-7.80	-8.63
150	222	-31.85	-30.82	-23.58	-7.87	-8.33	-9.26
150	225	-33.59	-32.45	-24.45	-8.34	-8.89	-9.93
150	228	-32.17	-30.90	-23.51	-8.82	-9.47	-10.63
150	231	-28.67	-27.12	-21.21	-9.32	-10.07	-11.37
150	234	-24.24	-22.39	-18.29	-9.84	-10.72	-12.18
150	237	-20.03	-18.01	-15.51	-10.40	-11.44	-13.10
150	240	-17.18	-15.25	-13.63	-11.03	-12.23	-14.17
150	243	-15.54	-13.89	-12.55	-11.76	-13.24	-15.83
150	246	-14.16	-12.80	-11.63	-12.60	-14.48	-18.12
150	249	-12.99	-11.90	-10.84	-13.50	-15.79	-20.46
150	252	-11.97	-11.12	-10.17	-14.42	-17.01	-22.30
150	255	-11.06	-10.41	-9.59	-15.31	-17.97	-23.03
150	258	-10.22	-9.74	-9.06	-16.33	-18.79	-22.88
150	261	-9.47	-9.13	-8.60	-17.49	-19.60	-22.46
150	264	-8.79	-8.58	-8.18	-18.58	-20.30	-21.85
150	267	-8.19	-8.08	-7.81	-19.40	-20.79	-21.12
150	270	-7.65	-7.63	-7.47	-19.71	-20.98	-20.32
150	273	-7.17	-7.20	-7.15	-19.28	-20.36	-19.19
150	276	-6.72	-6.79	-6.84	-18.16	-18.80	-17.56
150	279	-6.32	-6.43	-6.56	-16.68	-16.78	-15.74
150	282	-5.97	-6.11	-6.32	-15.12	-14.75	-14.01

150	285	-5.71	-5.86	-6.13	-13.81	-13.18	-12.65
150	288	-5.49	-5.65	-5.96	-12.69	-12.04	-11.63
150	291	-5.29	-5.45	-5.81	-11.57	-10.99	-10.72
150	294	-5.11	-5.28	-5.67	-10.49	-10.03	-9.90
150	297	-5.00	-5.17	-5.58	-9.51	-9.17	-9.17
150	300	-4.95	-5.12	-5.55	-8.68	-8.42	-8.53
150	303	-5.01	-5.17	-5.60	-7.96	-7.75	-7.94
150	306	-5.17	-5.32	-5.75	-7.30	-7.13	-7.39
150	309	-5.41	-5.54	-5.98	-6.71	-6.57	-6.91
150	312	-5.70	-5.81	-6.26	-6.19	-6.08	-6.48
150	315	-6.04	-6.13	-6.58	-5.75	-5.67	-6.14
150	318	-6.51	-6.58	-7.04	-5.36	-5.33	-5.85
150	321	-7.20	-7.26	-7.73	-5.01	-5.02	-5.60
150	324	-8.10	-8.16	-8.63	-4.70	-4.75	-5.38
150	327	-9.19	-9.24	-9.74	-4.42	-4.51	-5.19
150	330	-10.45	-10.50	-11.02	-4.19	-4.32	-5.04
150	333	-12.81	-12.83	-13.49	-3.99	-4.14	-4.91
150	336	-16.46	-16.46	-17.38	-3.80	-3.99	-4.80
150	339	-20.38	-20.33	-21.57	-3.63	-3.85	-4.70
150	342	-23.50	-23.42	-24.91	-3.49	-3.74	-4.62
150	345	-24.77	-24.68	-26.28	-3.37	-3.64	-4.54
150	348	-24.39	-24.30	-25.82	-3.27	-3.56	-4.47
150	351	-23.20	-23.09	-24.41	-3.18	-3.49	-4.40
150	354	-21.11	-21.00	-21.97	-3.10	-3.43	-4.34
150	357	-18.04	-17.92	-18.44	-3.03	-3.38	-4.29
150	360	-13.91	-13.79	-13.76	-2.98	-3.34	-4.25
153	0	-16.27	-16.47	-15.95	-3.01	-3.35	-4.24
153	3	-15.19	-15.36	-15.11	-2.94	-3.29	-4.17
153	6	-14.20	-14.35	-14.34	-2.88	-3.24	-4.09
153	9	-13.32	-13.45	-13.66	-2.83	-3.19	-4.03
153	12	-12.59	-12.71	-13.08	-2.79	-3.15	-3.96
153	15	-12.02	-12.16	-12.64	-2.76	-3.11	-3.90
153	18	-11.55	-11.71	-12.27	-2.74	-3.08	-3.85
153	21	-11.10	-11.30	-11.92	-2.72	-3.04	-3.79
153	24	-10.73	-10.96	-11.63	-2.71	-3.01	-3.73
153	27	-10.48	-10.73	-11.42	-2.70	-2.99	-3.69
153	30	-10.38	-10.64	-11.35	-2.69	-2.99	-3.68
153	33	-10.41	-10.68	-11.39	-2.70	-3.00	-3.69
153	36	-10.48	-10.80	-11.51	-2.73	-3.02	-3.73
153	39	-10.60	-10.96	-11.68	-2.78	-3.07	-3.79
153	42	-10.74	-11.16	-11.88	-2.83	-3.12	-3.86
153	45	-10.90	-11.37	-12.09	-2.88	-3.17	-3.93
153	48	-11.19	-11.69	-12.41	-2.95	-3.25	-4.01
153	51	-11.65	-12.16	-12.86	-3.03	-3.35	-4.12
153	54	-12.15	-12.64	-13.34	-3.14	-3.48	-4.24
153	57	-12.56	-13.03	-13.71	-3.26	-3.63	-4.38
153	60	-12.75	-13.18	-13.86	-3.39	-3.78	-4.52
153	63	-12.78	-13.18	-13.85	-3.56	-3.96	-4.69
153	66	-12.81	-13.17	-13.82	-3.76	-4.18	-4.89
153	69	-12.83	-13.15	-13.78	-4.00	-4.42	-5.10
153	72	-12.84	-13.12	-13.72	-4.26	-4.68	-5.34
153	75	-12.84	-13.08	-13.65	-4.54	-4.96	-5.59
153	78	-12.66	-12.84	-13.41	-4.84	-5.25	-5.85
153	81	-12.19	-12.32	-12.92	-5.19	-5.57	-6.13
153	84	-11.57	-11.65	-12.32	-5.57	-5.91	-6.44
153	87	-10.94	-10.99	-11.72	-5.99	-6.29	-6.78
153	90	-10.43	-10.48	-11.25	-6.45	-6.72	-7.18
153	93	-10.00	-10.10	-10.88	-7.01	-7.25	-7.68

153	96	-9.58	-9.73	-10.52	-7.66	-7.87	-8.28
153	99	-9.18	-9.40	-10.20	-8.38	-8.56	-8.97
153	102	-8.87	-9.14	-9.93	-9.11	-9.29	-9.71
153	105	-8.66	-8.96	-9.76	-9.82	-10.02	-10.46
153	108	-8.53	-8.84	-9.64	-10.61	-10.86	-11.33
153	111	-8.41	-8.72	-9.53	-11.51	-11.84	-12.32
153	114	-8.32	-8.64	-9.44	-12.36	-12.79	-13.34
153	117	-8.26	-8.58	-9.38	-12.99	-13.56	-14.26
153	120	-8.24	-8.55	-9.36	-13.24	-13.99	-14.98
153	123	-8.29	-8.60	-9.38	-13.21	-14.19	-15.57
153	126	-8.41	-8.69	-9.45	-13.15	-14.35	-16.15
153	129	-8.57	-8.81	-9.53	-13.06	-14.48	-16.65
153	132	-8.73	-8.92	-9.59	-12.94	-14.56	-17.00
153	135	-8.87	-8.97	-9.62	-12.78	-14.59	-17.13
153	138	-8.98	-8.98	-9.60	-12.35	-14.18	-16.61
153	141	-9.10	-8.98	-9.55	-11.50	-13.15	-15.31
153	144	-9.21	-8.99	-9.47	-10.44	-11.80	-13.61
153	147	-9.29	-8.99	-9.38	-9.37	-10.43	-11.91
153	150	-9.32	-8.99	-9.27	-8.50	-9.35	-10.59
153	153	-9.28	-8.92	-9.10	-7.78	-8.50	-9.59
153	156	-9.18	-8.75	-8.84	-7.08	-7.68	-8.64
153	159	-9.05	-8.53	-8.54	-6.44	-6.93	-7.78
153	162	-8.92	-8.30	-8.26	-5.89	-6.30	-7.05
153	165	-8.83	-8.13	-8.04	-5.48	-5.82	-6.52
153	168	-8.76	-7.99	-7.85	-5.16	-5.44	-6.09
153	171	-8.69	-7.85	-7.67	-4.86	-5.09	-5.70
153	174	-8.62	-7.72	-7.51	-4.61	-4.79	-5.38
153	177	-8.58	-7.64	-7.40	-4.44	-4.59	-5.15
153	180	-8.56	-7.60	-7.36	-4.37	-4.52	-5.07
153	183	-8.63	-7.68	-7.43	-4.40	-4.54	-5.09
153	186	-8.82	-7.89	-7.61	-4.47	-4.60	-5.14
153	189	-9.09	-8.20	-7.90	-4.58	-4.69	-5.22
153	192	-9.44	-8.59	-8.25	-4.71	-4.81	-5.32
153	195	-9.83	-9.02	-8.65	-4.85	-4.94	-5.43
153	198	-10.34	-9.60	-9.24	-5.02	-5.12	-5.61
153	201	-11.07	-10.43	-10.14	-5.27	-5.40	-5.92
153	204	-12.03	-11.49	-11.26	-5.56	-5.73	-6.30
153	207	-13.21	-12.79	-12.55	-5.88	-6.11	-6.73
153	210	-14.61	-14.31	-13.91	-6.22	-6.50	-7.18
153	213	-17.51	-17.18	-15.86	-6.59	-6.92	-7.66
153	216	-22.22	-21.68	-18.49	-7.02	-7.40	-8.22
153	219	-27.33	-26.50	-21.17	-7.48	-7.93	-8.84
153	222	-31.44	-30.35	-23.25	-7.96	-8.50	-9.52
153	225	-33.12	-31.92	-24.08	-8.47	-9.10	-10.24
153	228	-31.76	-30.47	-23.25	-8.98	-9.72	-11.00
153	231	-28.42	-26.91	-21.18	-9.52	-10.37	-11.81
153	234	-24.17	-22.45	-18.55	-10.09	-11.08	-12.72
153	237	-20.12	-18.27	-15.99	-10.71	-11.87	-13.75
153	240	-17.34	-15.58	-14.18	-11.40	-12.78	-14.95
153	243	-15.69	-14.18	-13.03	-12.24	-14.10	-16.84
153	246	-14.29	-13.03	-12.02	-13.23	-15.88	-19.48
153	249	-13.10	-12.07	-11.14	-14.29	-17.71	-22.19
153	252	-12.06	-11.25	-10.39	-15.32	-19.19	-24.31
153	255	-11.14	-10.51	-9.75	-16.21	-19.92	-25.17
153	258	-10.31	-9.83	-9.20	-17.08	-20.14	-24.80
153	261	-9.56	-9.22	-8.71	-17.99	-20.31	-23.82
153	264	-8.88	-8.67	-8.28	-18.81	-20.44	-22.48
153	267	-8.29	-8.18	-7.90	-19.40	-20.52	-21.00

153	270	-7.77	-7.73	-7.56	-19.63	-20.55	-19.60
153	273	-7.30	-7.31	-7.23	-19.17	-19.92	-18.15
153	276	-6.86	-6.92	-6.92	-17.98	-18.34	-16.50
153	279	-6.47	-6.56	-6.64	-16.42	-16.29	-14.82
153	282	-6.14	-6.26	-6.41	-14.81	-14.27	-13.28
153	285	-5.89	-6.02	-6.22	-13.48	-12.74	-12.06
153	288	-5.68	-5.82	-6.06	-12.41	-11.67	-11.11
153	291	-5.49	-5.63	-5.91	-11.37	-10.71	-10.28
153	294	-5.33	-5.46	-5.78	-10.38	-9.85	-9.54
153	297	-5.22	-5.35	-5.69	-9.48	-9.07	-8.88
153	300	-5.18	-5.31	-5.66	-8.69	-8.37	-8.29
153	303	-5.23	-5.36	-5.71	-7.99	-7.72	-7.75
153	306	-5.39	-5.50	-5.86	-7.34	-7.12	-7.24
153	309	-5.62	-5.72	-6.08	-6.75	-6.57	-6.79
153	312	-5.91	-5.99	-6.36	-6.23	-6.09	-6.39
153	315	-6.24	-6.29	-6.68	-5.79	-5.69	-6.07
153	318	-6.69	-6.73	-7.12	-5.40	-5.35	-5.80
153	321	-7.35	-7.39	-7.78	-5.05	-5.05	-5.57
153	324	-8.21	-8.26	-8.64	-4.74	-4.78	-5.36
153	327	-9.26	-9.31	-9.69	-4.47	-4.54	-5.18
153	330	-10.47	-10.52	-10.91	-4.24	-4.34	-5.03
153	333	-12.70	-12.73	-13.25	-4.03	-4.17	-4.89
153	336	-16.15	-16.17	-16.93	-3.84	-4.01	-4.78
153	339	-19.84	-19.83	-20.89	-3.67	-3.87	-4.67
153	342	-22.78	-22.75	-24.06	-3.53	-3.76	-4.58
153	345	-23.98	-23.94	-25.35	-3.41	-3.66	-4.51
153	348	-23.77	-23.74	-25.05	-3.30	-3.58	-4.44
153	351	-23.03	-23.03	-24.09	-3.21	-3.50	-4.38
153	354	-21.62	-21.68	-22.33	-3.12	-3.44	-4.32
153	357	-19.42	-19.54	-19.66	-3.05	-3.39	-4.28
153	360	-16.27	-16.47	-15.95	-3.01	-3.35	-4.24
156	0	-19.22	-19.97	-18.59	-3.07	-3.38	-4.24
156	3	-18.52	-19.16	-18.35	-3.00	-3.32	-4.17
156	6	-17.83	-18.37	-18.07	-2.94	-3.27	-4.11
156	9	-17.15	-17.62	-17.75	-2.89	-3.22	-4.06
156	12	-16.49	-16.90	-17.39	-2.85	-3.19	-4.01
156	15	-15.84	-16.22	-17.01	-2.83	-3.16	-3.97
156	18	-15.15	-15.51	-16.50	-2.82	-3.14	-3.94
156	21	-14.42	-14.77	-15.85	-2.82	-3.13	-3.91
156	24	-13.72	-14.09	-15.18	-2.81	-3.11	-3.88
156	27	-13.15	-13.54	-14.64	-2.81	-3.10	-3.86
156	30	-12.78	-13.23	-14.34	-2.81	-3.10	-3.86
156	33	-12.56	-13.07	-14.21	-2.82	-3.12	-3.88
156	36	-12.37	-12.93	-14.10	-2.87	-3.17	-3.94
156	39	-12.21	-12.82	-14.02	-2.93	-3.23	-4.03
156	42	-12.11	-12.75	-13.97	-3.01	-3.31	-4.14
156	45	-12.07	-12.72	-13.95	-3.09	-3.40	-4.24
156	48	-12.17	-12.81	-14.02	-3.18	-3.50	-4.36
156	51	-12.41	-13.01	-14.20	-3.29	-3.64	-4.49
156	54	-12.69	-13.24	-14.41	-3.42	-3.79	-4.64
156	57	-12.93	-13.44	-14.59	-3.57	-3.97	-4.81
156	60	-13.02	-13.52	-14.67	-3.74	-4.16	-4.99
156	63	-13.02	-13.50	-14.64	-3.94	-4.38	-5.19
156	66	-12.99	-13.46	-14.55	-4.18	-4.62	-5.41
156	69	-12.95	-13.38	-14.43	-4.45	-4.90	-5.66
156	72	-12.90	-13.28	-14.28	-4.76	-5.20	-5.94
156	75	-12.84	-13.17	-14.11	-5.09	-5.53	-6.23
156	78	-12.64	-12.93	-13.84	-5.45	-5.87	-6.55



156	81	-12.24	-12.50	-13.43	-5.85	-6.24	-6.89
156	84	-11.74	-11.99	-12.97	-6.30	-6.66	-7.28
156	87	-11.25	-11.50	-12.53	-6.81	-7.13	-7.74
156	90	-10.85	-11.14	-12.18	-7.40	-7.69	-8.27
156	93	-10.54	-10.87	-11.93	-8.19	-8.46	-9.03
156	96	-10.23	-10.63	-11.69	-9.23	-9.48	-10.04
156	99	-9.95	-10.42	-11.49	-10.35	-10.60	-11.19
156	102	-9.73	-10.25	-11.31	-11.40	-11.69	-12.33
156	105	-9.58	-10.11	-11.17	-12.24	-12.60	-13.32
156	108	-9.48	-10.01	-11.05	-12.95	-13.44	-14.30
156	111	-9.39	-9.92	-10.95	-13.64	-14.30	-15.34
156	114	-9.32	-9.85	-10.87	-14.25	-15.07	-16.29
156	117	-9.27	-9.79	-10.78	-14.68	-15.62	-16.98
156	120	-9.26	-9.75	-10.70	-14.84	-15.83	-17.25
156	123	-9.28	-9.72	-10.62	-14.69	-15.72	-17.19
156	126	-9.33	-9.70	-10.55	-14.28	-15.43	-17.03
156	129	-9.39	-9.69	-10.48	-13.71	-15.00	-16.78
156	132	-9.44	-9.67	-10.40	-13.05	-14.49	-16.47
156	135	-9.46	-9.64	-10.30	-12.41	-13.94	-16.10
156	138	-9.46	-9.58	-10.16	-11.68	-13.19	-15.37
156	141	-9.44	-9.49	-9.98	-10.79	-12.14	-14.11
156	144	-9.41	-9.36	-9.77	-9.85	-10.97	-12.62
156	147	-9.38	-9.22	-9.55	-8.94	-9.83	-11.15
156	150	-9.34	-9.07	-9.32	-8.17	-8.89	-9.99
156	153	-9.25	-8.90	-9.07	-7.49	-8.11	-9.09
156	156	-9.10	-8.69	-8.78	-6.84	-7.36	-8.22
156	159	-8.93	-8.48	-8.49	-6.25	-6.68	-7.45
156	162	-8.78	-8.28	-8.23	-5.75	-6.11	-6.80
156	165	-8.69	-8.13	-8.03	-5.38	-5.69	-6.33
156	168	-8.65	-8.01	-7.87	-5.08	-5.34	-5.96
156	171	-8.62	-7.90	-7.72	-4.80	-5.03	-5.62
156	174	-8.59	-7.80	-7.59	-4.57	-4.76	-5.33
156	177	-8.57	-7.73	-7.49	-4.42	-4.58	-5.14
156	180	-8.57	-7.71	-7.46	-4.36	-4.51	-5.07
156	183	-8.64	-7.79	-7.53	-4.39	-4.54	-5.10
156	186	-8.83	-8.00	-7.73	-4.46	-4.61	-5.17
156	189	-9.11	-8.32	-8.02	-4.57	-4.72	-5.27
156	192	-9.46	-8.71	-8.39	-4.70	-4.85	-5.40
156	195	-9.86	-9.15	-8.80	-4.84	-5.00	-5.55
156	198	-10.38	-9.73	-9.38	-5.02	-5.19	-5.76
156	201	-11.12	-10.55	-10.26	-5.27	-5.47	-6.08
156	204	-12.09	-11.60	-11.35	-5.56	-5.81	-6.46
156	207	-13.27	-12.87	-12.60	-5.89	-6.19	-6.90
156	210	-14.67	-14.34	-13.93	-6.23	-6.59	-7.37
156	213	-17.42	-17.04	-15.83	-6.62	-7.02	-7.87
156	216	-21.81	-21.19	-18.40	-7.06	-7.53	-8.45
156	219	-26.55	-25.62	-21.01	-7.54	-8.08	-9.10
156	222	-30.34	-29.15	-23.04	-8.06	-8.68	-9.81
156	225	-31.89	-30.58	-23.86	-8.59	-9.32	-10.58
156	228	-30.69	-29.36	-23.19	-9.14	-9.98	-11.40
156	231	-27.74	-26.35	-21.53	-9.72	-10.68	-12.30
156	234	-23.97	-22.53	-19.36	-10.35	-11.45	-13.31
156	237	-20.31	-18.88	-17.18	-11.03	-12.34	-14.47
156	240	-17.71	-16.37	-15.47	-11.80	-13.38	-15.82
156	243	-16.07	-14.88	-14.20	-12.79	-15.06	-17.97
156	246	-14.63	-13.61	-12.98	-14.02	-17.43	-21.01
156	249	-13.38	-12.52	-11.88	-15.31	-19.89	-24.14
156	252	-12.29	-11.58	-10.93	-16.47	-21.81	-26.60

156	255	-11.36	-10.79	-10.16	-17.32	-22.59	-27.59
156	258	-10.54	-10.09	-9.55	-17.97	-22.43	-26.88
156	261	-9.80	-9.47	-9.02	-18.58	-22.01	-25.10
156	264	-9.14	-8.92	-8.56	-19.10	-21.38	-22.74
156	267	-8.56	-8.43	-8.15	-19.45	-20.64	-20.32
156	270	-8.07	-8.01	-7.79	-19.58	-19.83	-18.35
156	273	-7.63	-7.61	-7.46	-19.09	-18.71	-16.78
156	276	-7.22	-7.25	-7.15	-17.84	-17.12	-15.24
156	279	-6.86	-6.92	-6.88	-16.20	-15.34	-13.80
156	282	-6.56	-6.64	-6.65	-14.54	-13.66	-12.52
156	285	-6.34	-6.43	-6.47	-13.20	-12.34	-11.48
156	288	-6.16	-6.24	-6.32	-12.17	-11.35	-10.62
156	291	-6.00	-6.07	-6.18	-11.21	-10.47	-9.87
156	294	-5.87	-5.93	-6.07	-10.30	-9.69	-9.20
156	297	-5.78	-5.83	-5.99	-9.48	-8.98	-8.61
156	300	-5.75	-5.79	-5.96	-8.73	-8.32	-8.07
156	303	-5.80	-5.84	-6.01	-8.06	-7.71	-7.57
156	306	-5.94	-5.97	-6.15	-7.43	-7.13	-7.11
156	309	-6.16	-6.17	-6.37	-6.85	-6.60	-6.68
156	312	-6.42	-6.42	-6.64	-6.33	-6.14	-6.32
156	315	-6.73	-6.71	-6.94	-5.89	-5.74	-6.01
156	318	-7.14	-7.11	-7.36	-5.51	-5.41	-5.76
156	321	-7.74	-7.72	-7.97	-5.17	-5.11	-5.53
156	324	-8.51	-8.51	-8.76	-4.87	-4.85	-5.34
156	327	-9.44	-9.46	-9.72	-4.59	-4.61	-5.16
156	330	-10.51	-10.55	-10.83	-4.36	-4.41	-5.01
156	333	-12.44	-12.49	-12.86	-4.14	-4.23	-4.88
156	336	-15.38	-15.44	-15.98	-3.95	-4.07	-4.75
156	339	-18.52	-18.58	-19.32	-3.77	-3.93	-4.65
156	342	-21.00	-21.08	-21.97	-3.62	-3.80	-4.55
156	345	-22.02	-22.09	-23.05	-3.50	-3.70	-4.48
156	348	-21.99	-22.08	-22.99	-3.38	-3.61	-4.41
156	351	-21.84	-21.96	-22.71	-3.28	-3.54	-4.35
156	354	-21.41	-21.63	-22.00	-3.19	-3.47	-4.30
156	357	-20.58	-21.01	-20.69	-3.12	-3.42	-4.27
156	360	-19.22	-19.97	-18.59	-3.07	-3.38	-4.24
159	0	-22.11	-23.47	-21.14	-3.16	-3.42	-4.24
159	3	-21.85	-23.01	-21.40	-3.09	-3.37	-4.19
159	6	-21.48	-22.49	-21.57	-3.03	-3.31	-4.14
159	9	-21.03	-21.90	-21.65	-2.98	-3.27	-4.10
159	12	-20.50	-21.25	-21.68	-2.95	-3.25	-4.08
159	15	-19.93	-20.56	-21.68	-2.94	-3.24	-4.07
159	18	-19.16	-19.71	-21.33	-2.94	-3.24	-4.07
159	21	-18.16	-18.69	-20.45	-2.94	-3.24	-4.07
159	24	-17.08	-17.63	-19.34	-2.95	-3.25	-4.08
159	27	-16.09	-16.68	-18.29	-2.96	-3.26	-4.09
159	30	-15.35	-16.00	-17.57	-2.97	-3.27	-4.10
159	33	-14.79	-15.50	-17.14	-3.00	-3.30	-4.14
159	36	-14.26	-15.04	-16.76	-3.07	-3.37	-4.23
159	39	-13.80	-14.66	-16.43	-3.16	-3.47	-4.35
159	42	-13.48	-14.38	-16.18	-3.26	-3.59	-4.48
159	45	-13.36	-14.22	-16.02	-3.37	-3.71	-4.62
159	48	-13.35	-14.15	-15.92	-3.50	-3.84	-4.77
159	51	-13.35	-14.11	-15.85	-3.65	-4.01	-4.93
159	54	-13.35	-14.08	-15.80	-3.82	-4.20	-5.12
159	57	-13.34	-14.04	-15.74	-4.01	-4.42	-5.33
159	60	-13.34	-13.98	-15.65	-4.22	-4.65	-5.55
159	63	-13.30	-13.90	-15.52	-4.47	-4.90	-5.80

159	66	-13.23	-13.78	-15.34	-4.75	-5.19	-6.07
159	69	-13.12	-13.64	-15.13	-5.07	-5.51	-6.37
159	72	-12.98	-13.48	-14.90	-5.43	-5.87	-6.71
159	75	-12.84	-13.31	-14.66	-5.81	-6.25	-7.07
159	78	-12.62	-13.07	-14.39	-6.24	-6.67	-7.47
159	81	-12.31	-12.77	-14.06	-6.71	-7.12	-7.90
159	84	-11.96	-12.44	-13.72	-7.25	-7.63	-8.40
159	87	-11.63	-12.14	-13.42	-7.87	-8.23	-8.98
159	90	-11.37	-11.91	-13.19	-8.58	-8.92	-9.67
159	93	-11.17	-11.75	-13.03	-9.66	-9.98	-10.73
159	96	-10.98	-11.62	-12.90	-11.13	-11.45	-12.23
159	99	-10.81	-11.50	-12.79	-12.70	-13.05	-13.88
159	102	-10.67	-11.39	-12.69	-14.06	-14.48	-15.40
159	105	-10.57	-11.29	-12.57	-14.91	-15.46	-16.53
159	108	-10.49	-11.21	-12.46	-15.37	-16.10	-17.38
159	111	-10.43	-11.14	-12.36	-15.78	-16.70	-18.20
159	114	-10.38	-11.07	-12.25	-16.11	-17.19	-18.89
159	117	-10.33	-11.00	-12.13	-16.33	-17.52	-19.37
159	120	-10.28	-10.92	-11.99	-16.41	-17.65	-19.55
159	123	-10.22	-10.81	-11.82	-16.07	-17.32	-19.21
159	126	-10.18	-10.69	-11.62	-15.23	-16.48	-18.35
159	129	-10.13	-10.56	-11.40	-14.10	-15.35	-17.17
159	132	-10.07	-10.41	-11.15	-12.91	-14.14	-15.90
159	135	-10.00	-10.25	-10.90	-11.88	-13.07	-14.74
159	138	-9.91	-10.07	-10.62	-11.00	-12.08	-13.63
159	141	-9.79	-9.84	-10.31	-10.10	-11.05	-12.44
159	144	-9.64	-9.60	-9.98	-9.23	-10.03	-11.24
159	147	-9.49	-9.36	-9.66	-8.43	-9.08	-10.14
159	150	-9.35	-9.14	-9.36	-7.74	-8.29	-9.22
159	153	-9.18	-8.91	-9.06	-7.12	-7.59	-8.43
159	156	-8.98	-8.67	-8.74	-6.54	-6.94	-7.70
159	159	-8.79	-8.44	-8.45	-6.02	-6.36	-7.04
159	162	-8.64	-8.26	-8.20	-5.58	-5.87	-6.50
159	165	-8.58	-8.13	-8.03	-5.25	-5.51	-6.11
159	168	-8.58	-8.05	-7.91	-4.98	-5.22	-5.80
159	171	-8.58	-7.98	-7.79	-4.74	-4.94	-5.52
159	174	-8.58	-7.92	-7.70	-4.53	-4.72	-5.29
159	177	-8.58	-7.88	-7.64	-4.39	-4.57	-5.13
159	180	-8.58	-7.87	-7.62	-4.34	-4.51	-5.07
159	183	-8.65	-7.95	-7.69	-4.37	-4.54	-5.11
159	186	-8.84	-8.17	-7.90	-4.44	-4.63	-5.20
159	189	-9.14	-8.49	-8.21	-4.55	-4.75	-5.34
159	192	-9.50	-8.89	-8.59	-4.69	-4.90	-5.51
159	195	-9.90	-9.34	-9.01	-4.83	-5.07	-5.70
159	198	-10.43	-9.91	-9.60	-5.02	-5.28	-5.93
159	201	-11.19	-10.73	-10.44	-5.26	-5.56	-6.26
159	204	-12.17	-11.76	-11.48	-5.56	-5.89	-6.65
159	207	-13.35	-12.98	-12.67	-5.89	-6.27	-7.09
159	210	-14.72	-14.40	-13.96	-6.24	-6.68	-7.56
159	213	-17.27	-16.85	-15.81	-6.63	-7.12	-8.08
159	216	-21.22	-20.54	-18.32	-7.09	-7.64	-8.68
159	219	-25.45	-24.43	-20.89	-7.60	-8.22	-9.35
159	222	-28.81	-27.52	-22.88	-8.14	-8.85	-10.09
159	225	-30.19	-28.77	-23.68	-8.70	-9.52	-10.90
159	228	-29.21	-27.84	-23.19	-9.29	-10.22	-11.78
159	231	-26.76	-25.51	-21.96	-9.91	-10.96	-12.75
159	234	-23.61	-22.50	-20.30	-10.58	-11.79	-13.86
159	237	-20.49	-19.53	-18.54	-11.32	-12.77	-15.14

159	240	-18.16	-17.31	-17.02	-12.16	-13.93	-16.62
159	243	-16.54	-15.77	-15.66	-13.32	-15.93	-19.02
159	246	-15.07	-14.37	-14.24	-14.82	-18.85	-22.43
159	249	-13.75	-13.12	-12.86	-16.36	-21.92	-25.97
159	252	-12.62	-12.04	-11.66	-17.66	-24.33	-28.74
159	255	-11.66	-11.17	-10.74	-18.41	-25.31	-29.86
159	258	-10.85	-10.45	-10.06	-18.77	-24.87	-28.78
159	261	-10.13	-9.82	-9.47	-19.09	-23.75	-26.11
159	264	-9.50	-9.28	-8.96	-19.33	-22.21	-22.70
159	267	-8.95	-8.80	-8.52	-19.49	-20.55	-19.37
159	270	-8.49	-8.40	-8.14	-19.54	-19.06	-16.99
159	273	-8.08	-8.03	-7.81	-19.02	-17.63	-15.44
159	276	-7.71	-7.70	-7.50	-17.72	-16.09	-14.09
159	279	-7.38	-7.41	-7.23	-16.02	-14.56	-12.90
159	282	-7.12	-7.17	-7.00	-14.31	-13.16	-11.87
159	285	-6.94	-6.98	-6.84	-12.98	-12.01	-10.98
159	288	-6.80	-6.82	-6.70	-11.99	-11.10	-10.21
159	291	-6.68	-6.67	-6.58	-11.09	-10.29	-9.53
159	294	-6.58	-6.55	-6.48	-10.26	-9.56	-8.92
159	297	-6.51	-6.46	-6.41	-9.49	-8.90	-8.38
159	300	-6.49	-6.43	-6.39	-8.80	-8.29	-7.88
159	303	-6.53	-6.48	-6.44	-8.15	-7.71	-7.42
159	306	-6.66	-6.59	-6.57	-7.54	-7.16	-6.99
159	309	-6.85	-6.78	-6.77	-6.98	-6.65	-6.60
159	312	-7.09	-7.00	-7.02	-6.48	-6.20	-6.26
159	315	-7.35	-7.26	-7.30	-6.05	-5.82	-5.97
159	318	-7.71	-7.62	-7.69	-5.67	-5.50	-5.73
159	321	-8.22	-8.15	-8.25	-5.34	-5.21	-5.51
159	324	-8.88	-8.84	-8.96	-5.04	-4.95	-5.32
159	327	-9.67	-9.66	-9.81	-4.77	-4.72	-5.15
159	330	-10.56	-10.59	-10.77	-4.52	-4.51	-5.00
159	333	-11.97	-11.99	-12.33	-4.30	-4.33	-4.87
159	336	-14.00	-13.98	-14.61	-4.10	-4.16	-4.74
159	339	-16.22	-16.19	-17.04	-3.92	-4.00	-4.62
159	342	-18.19	-18.22	-19.06	-3.75	-3.87	-4.53
159	345	-19.49	-19.69	-20.11	-3.62	-3.76	-4.45
159	348	-20.28	-20.73	-20.45	-3.50	-3.67	-4.39
159	351	-21.00	-21.68	-20.74	-3.39	-3.59	-4.34
159	354	-21.58	-22.49	-20.95	-3.30	-3.52	-4.29
159	357	-21.97	-23.10	-21.09	-3.22	-3.46	-4.26
159	360	-22.11	-23.47	-21.14	-3.16	-3.42	-4.24
162	0	-24.32	-26.16	-23.06	-3.26	-3.47	-4.24
162	3	-24.26	-26.00	-24.09	-3.19	-3.42	-4.21
162	6	-24.10	-25.66	-24.77	-3.14	-3.38	-4.19
162	9	-23.85	-25.19	-25.17	-3.10	-3.35	-4.18
162	12	-23.54	-24.63	-25.36	-3.07	-3.33	-4.18
162	15	-23.18	-24.02	-25.41	-3.06	-3.33	-4.18
162	18	-22.45	-23.13	-24.97	-3.06	-3.33	-4.19
162	21	-21.24	-21.87	-23.89	-3.08	-3.35	-4.22
162	24	-19.81	-20.48	-22.49	-3.10	-3.38	-4.26
162	27	-18.43	-19.18	-21.14	-3.13	-3.42	-4.32
162	30	-17.40	-18.20	-20.16	-3.16	-3.47	-4.38
162	33	-16.65	-17.50	-19.53	-3.22	-3.53	-4.46
162	36	-15.95	-16.88	-18.97	-3.31	-3.63	-4.57
162	39	-15.34	-16.34	-18.48	-3.43	-3.76	-4.71
162	42	-14.85	-15.88	-18.06	-3.56	-3.90	-4.87
162	45	-14.50	-15.53	-17.70	-3.70	-4.06	-5.03
162	48	-14.28	-15.26	-17.41	-3.86	-4.23	-5.21

162	51	-14.10	-15.05	-17.17	-4.05	-4.43	-5.42
162	54	-13.96	-14.86	-16.95	-4.26	-4.66	-5.66
162	57	-13.82	-14.68	-16.74	-4.50	-4.92	-5.91
162	60	-13.67	-14.49	-16.50	-4.76	-5.19	-6.19
162	63	-13.51	-14.28	-16.24	-5.05	-5.49	-6.49
162	66	-13.35	-14.07	-15.96	-5.38	-5.83	-6.82
162	69	-13.18	-13.87	-15.68	-5.76	-6.21	-7.18
162	72	-13.01	-13.66	-15.41	-6.17	-6.63	-7.59
162	75	-12.83	-13.47	-15.15	-6.62	-7.08	-8.03
162	78	-12.63	-13.27	-14.89	-7.11	-7.57	-8.52
162	81	-12.40	-13.06	-14.62	-7.66	-8.11	-9.05
162	84	-12.17	-12.86	-14.37	-8.29	-8.73	-9.65
162	87	-11.96	-12.69	-14.16	-9.01	-9.44	-10.36
162	90	-11.80	-12.56	-14.01	-9.84	-10.27	-11.19
162	93	-11.69	-12.47	-13.92	-11.13	-11.55	-12.49
162	96	-11.59	-12.40	-13.85	-12.93	-13.34	-14.32
162	99	-11.50	-12.34	-13.80	-14.80	-15.24	-16.29
162	102	-11.42	-12.28	-13.73	-16.32	-16.85	-18.03
162	105	-11.35	-12.21	-13.65	-17.06	-17.77	-19.15
162	108	-11.29	-12.14	-13.55	-17.24	-18.17	-19.82
162	111	-11.24	-12.07	-13.44	-17.39	-18.52	-20.41
162	114	-11.19	-12.00	-13.30	-17.50	-18.79	-20.89
162	117	-11.13	-11.91	-13.15	-17.57	-18.97	-21.21
162	120	-11.06	-11.81	-12.97	-17.59	-19.03	-21.33
162	123	-10.97	-11.66	-12.73	-17.09	-18.49	-20.69
162	126	-10.85	-11.46	-12.42	-15.85	-17.12	-19.10
162	129	-10.71	-11.22	-12.06	-14.22	-15.34	-17.02
162	132	-10.56	-10.96	-11.69	-12.58	-13.54	-14.93
162	135	-10.40	-10.70	-11.32	-11.30	-12.13	-13.32
162	138	-10.21	-10.42	-10.95	-10.35	-11.08	-12.15
162	141	-10.00	-10.10	-10.54	-9.46	-10.08	-11.05
162	144	-9.78	-9.78	-10.14	-8.65	-9.18	-10.06
162	147	-9.56	-9.47	-9.74	-7.92	-8.37	-9.18
162	150	-9.36	-9.19	-9.40	-7.30	-7.69	-8.44
162	153	-9.15	-8.93	-9.06	-6.75	-7.08	-7.78
162	156	-8.93	-8.65	-8.72	-6.24	-6.53	-7.18
162	159	-8.72	-8.41	-8.41	-5.78	-6.04	-6.65
162	162	-8.57	-8.22	-8.16	-5.40	-5.63	-6.21
162	165	-8.51	-8.14	-8.03	-5.12	-5.33	-5.90
162	168	-8.52	-8.11	-7.96	-4.88	-5.08	-5.65
162	171	-8.53	-8.10	-7.90	-4.67	-4.86	-5.43
162	174	-8.54	-8.08	-7.86	-4.48	-4.68	-5.24
162	177	-8.56	-8.07	-7.83	-4.36	-4.55	-5.12
162	180	-8.59	-8.07	-7.82	-4.31	-4.51	-5.07
162	183	-8.68	-8.15	-7.90	-4.34	-4.54	-5.12
162	186	-8.89	-8.38	-8.12	-4.42	-4.64	-5.23
162	189	-9.19	-8.71	-8.45	-4.54	-4.78	-5.40
162	192	-9.55	-9.12	-8.85	-4.68	-4.95	-5.60
162	195	-9.96	-9.57	-9.29	-4.82	-5.13	-5.82
162	198	-10.51	-10.15	-9.86	-5.01	-5.34	-6.07
162	201	-11.28	-10.95	-10.66	-5.26	-5.63	-6.41
162	204	-12.27	-11.95	-11.64	-5.56	-5.96	-6.80
162	207	-13.44	-13.13	-12.77	-5.89	-6.34	-7.24
162	210	-14.78	-14.46	-13.99	-6.25	-6.74	-7.72
162	213	-17.09	-16.65	-15.78	-6.65	-7.20	-8.25
162	216	-20.56	-19.83	-18.23	-7.12	-7.73	-8.85
162	219	-24.22	-23.16	-20.74	-7.63	-8.32	-9.54
162	222	-27.12	-25.78	-22.69	-8.19	-8.97	-10.29

162	225	-28.30	-26.84	-23.47	-8.78	-9.66	-11.13
162	228	-27.54	-26.17	-23.12	-9.39	-10.39	-12.05
162	231	-25.61	-24.48	-22.23	-10.04	-11.16	-13.08
162	234	-23.10	-22.25	-20.99	-10.75	-12.04	-14.26
162	237	-20.55	-19.97	-19.61	-11.53	-13.08	-15.63
162	240	-18.53	-18.10	-18.32	-12.43	-14.34	-17.21
162	243	-16.98	-16.60	-16.97	-13.73	-16.58	-19.80
162	246	-15.51	-15.12	-15.42	-15.46	-19.94	-23.49
162	249	-14.15	-13.74	-13.84	-17.23	-23.48	-27.32
162	252	-12.97	-12.55	-12.44	-18.62	-26.29	-30.32
162	255	-12.01	-11.62	-11.39	-19.24	-27.43	-31.54
162	258	-11.22	-10.89	-10.65	-19.33	-26.74	-30.16
162	261	-10.52	-10.25	-10.00	-19.40	-24.99	-26.78
162	264	-9.90	-9.70	-9.44	-19.45	-22.70	-22.53
162	267	-9.38	-9.23	-8.97	-19.48	-20.34	-18.52
162	270	-8.96	-8.84	-8.58	-19.49	-18.43	-15.88
162	273	-8.59	-8.51	-8.23	-18.96	-16.91	-14.45
162	276	-8.25	-8.21	-7.92	-17.62	-15.44	-13.26
162	279	-7.96	-7.95	-7.65	-15.89	-14.06	-12.26
162	282	-7.73	-7.74	-7.44	-14.16	-12.83	-11.40
162	285	-7.57	-7.57	-7.28	-12.83	-11.80	-10.63
162	288	-7.47	-7.44	-7.16	-11.88	-10.93	-9.93
162	291	-7.37	-7.31	-7.06	-11.03	-10.16	-9.30
162	294	-7.29	-7.21	-6.97	-10.25	-9.48	-8.73
162	297	-7.24	-7.14	-6.91	-9.54	-8.85	-8.22
162	300	-7.23	-7.11	-6.89	-8.88	-8.27	-7.76
162	303	-7.26	-7.15	-6.94	-8.26	-7.72	-7.32
162	306	-7.37	-7.25	-7.06	-7.67	-7.20	-6.92
162	309	-7.53	-7.40	-7.24	-7.13	-6.72	-6.54
162	312	-7.73	-7.60	-7.46	-6.65	-6.29	-6.22
162	315	-7.95	-7.81	-7.71	-6.22	-5.92	-5.94
162	318	-8.25	-8.12	-8.06	-5.86	-5.61	-5.71
162	321	-8.69	-8.58	-8.56	-5.53	-5.32	-5.50
162	324	-9.24	-9.17	-9.19	-5.23	-5.07	-5.31
162	327	-9.89	-9.86	-9.92	-4.96	-4.84	-5.15
162	330	-10.61	-10.62	-10.72	-4.71	-4.63	-5.00
162	333	-11.54	-11.58	-11.73	-4.48	-4.44	-4.86
162	336	-12.75	-12.81	-13.02	-4.27	-4.26	-4.73
162	339	-14.13	-14.23	-14.47	-4.08	-4.09	-4.61
162	342	-15.59	-15.75	-15.93	-3.90	-3.95	-4.51
162	345	-17.01	-17.29	-17.26	-3.76	-3.83	-4.43
162	348	-18.40	-18.87	-18.48	-3.63	-3.74	-4.38
162	351	-19.82	-20.55	-19.67	-3.51	-3.65	-4.32
162	354	-21.28	-22.33	-20.83	-3.41	-3.57	-4.28
162	357	-22.78	-24.20	-21.96	-3.33	-3.51	-4.25
162	360	-24.32	-26.16	-23.06	-3.26	-3.47	-4.24
165	0	-25.20	-27.24	-23.82	-3.36	-3.53	-4.24
165	3	-25.16	-27.14	-25.11	-3.30	-3.49	-4.24
165	6	-25.07	-26.87	-26.00	-3.25	-3.46	-4.25
165	9	-24.93	-26.47	-26.56	-3.21	-3.44	-4.26
165	12	-24.73	-25.97	-26.85	-3.19	-3.43	-4.27
165	15	-24.50	-25.43	-26.93	-3.19	-3.43	-4.29
165	18	-23.82	-24.53	-26.46	-3.20	-3.44	-4.33
165	21	-22.50	-23.16	-25.29	-3.22	-3.48	-4.38
165	24	-20.90	-21.61	-23.78	-3.26	-3.53	-4.46
165	27	-19.37	-20.16	-22.30	-3.31	-3.60	-4.54
165	30	-18.24	-19.10	-21.22	-3.36	-3.67	-4.64
165	33	-17.47	-18.38	-20.51	-3.44	-3.76	-4.75

165	36	-16.78	-17.75	-19.87	-3.55	-3.89	-4.90
165	39	-16.17	-17.20	-19.31	-3.70	-4.05	-5.06
165	42	-15.66	-16.73	-18.82	-3.86	-4.23	-5.25
165	45	-15.26	-16.33	-18.39	-4.03	-4.41	-5.45
165	48	-14.94	-15.99	-18.04	-4.22	-4.62	-5.67
165	51	-14.68	-15.71	-17.74	-4.44	-4.86	-5.93
165	54	-14.45	-15.46	-17.47	-4.70	-5.13	-6.21
165	57	-14.24	-15.21	-17.20	-4.98	-5.43	-6.51
165	60	-14.01	-14.96	-16.92	-5.28	-5.75	-6.85
165	63	-13.76	-14.68	-16.61	-5.62	-6.10	-7.21
165	66	-13.52	-14.39	-16.29	-6.00	-6.49	-7.61
165	69	-13.27	-14.12	-15.97	-6.42	-6.93	-8.05
165	72	-13.04	-13.86	-15.67	-6.89	-7.41	-8.53
165	75	-12.83	-13.64	-15.40	-7.40	-7.93	-9.05
165	78	-12.64	-13.44	-15.16	-7.96	-8.51	-9.62
165	81	-12.44	-13.25	-14.92	-8.59	-9.14	-10.24
165	84	-12.27	-13.07	-14.70	-9.31	-9.86	-10.93
165	87	-12.11	-12.93	-14.52	-10.10	-10.66	-11.72
165	90	-12.00	-12.83	-14.39	-11.00	-11.57	-12.63
165	93	-11.91	-12.77	-14.32	-12.32	-12.88	-13.95
165	96	-11.85	-12.72	-14.26	-14.10	-14.63	-15.73
165	99	-11.79	-12.68	-14.21	-15.92	-16.44	-17.60
165	102	-11.73	-12.64	-14.16	-17.34	-17.93	-19.22
165	105	-11.67	-12.58	-14.09	-17.94	-18.72	-20.23
165	108	-11.62	-12.52	-13.99	-17.98	-19.00	-20.80
165	111	-11.57	-12.45	-13.87	-18.02	-19.24	-21.29
165	114	-11.51	-12.37	-13.72	-18.04	-19.43	-21.69
165	117	-11.45	-12.28	-13.55	-18.06	-19.54	-21.95
165	120	-11.38	-12.16	-13.35	-18.06	-19.58	-22.05
165	123	-11.26	-11.99	-13.08	-17.46	-18.90	-21.21
165	126	-11.11	-11.75	-12.73	-15.97	-17.19	-19.13
165	129	-10.94	-11.47	-12.32	-14.05	-15.01	-16.49
165	132	-10.74	-11.17	-11.89	-12.16	-12.87	-13.93
165	135	-10.55	-10.87	-11.49	-10.76	-11.30	-12.13
165	138	-10.33	-10.56	-11.08	-9.81	-10.27	-11.01
165	141	-10.09	-10.22	-10.65	-8.95	-9.34	-10.03
165	144	-9.84	-9.87	-10.22	-8.19	-8.52	-9.18
165	147	-9.60	-9.54	-9.82	-7.53	-7.82	-8.45
165	150	-9.38	-9.25	-9.45	-6.96	-7.22	-7.83
165	153	-9.15	-8.96	-9.09	-6.47	-6.69	-7.29
165	156	-8.92	-8.67	-8.71	-6.01	-6.21	-6.78
165	159	-8.70	-8.40	-8.37	-5.61	-5.79	-6.34
165	162	-8.55	-8.21	-8.12	-5.28	-5.44	-5.99
165	165	-8.49	-8.14	-8.03	-5.02	-5.19	-5.73
165	168	-8.49	-8.15	-8.03	-4.81	-4.98	-5.53
165	171	-8.51	-8.17	-8.03	-4.61	-4.80	-5.35
165	174	-8.53	-8.20	-8.04	-4.45	-4.64	-5.21
165	177	-8.57	-8.25	-8.04	-4.33	-4.54	-5.11
165	180	-8.61	-8.30	-8.05	-4.29	-4.50	-5.07
165	183	-8.71	-8.42	-8.15	-4.32	-4.54	-5.12
165	186	-8.93	-8.66	-8.38	-4.40	-4.64	-5.24
165	189	-9.24	-8.99	-8.73	-4.52	-4.79	-5.43
165	192	-9.62	-9.39	-9.14	-4.66	-4.97	-5.64
165	195	-10.04	-9.84	-9.60	-4.81	-5.15	-5.87
165	198	-10.60	-10.42	-10.16	-5.00	-5.37	-6.13
165	201	-11.40	-11.20	-10.91	-5.25	-5.66	-6.47
165	204	-12.39	-12.17	-11.83	-5.55	-5.99	-6.86
165	207	-13.55	-13.29	-12.88	-5.89	-6.37	-7.31

165	210	-14.85	-14.54	-14.03	-6.25	-6.77	-7.78
165	213	-16.93	-16.48	-15.75	-6.66	-7.23	-8.31
165	216	-19.94	-19.21	-18.10	-7.13	-7.76	-8.92
165	219	-23.06	-22.03	-20.51	-7.65	-8.36	-9.61
165	222	-25.52	-24.24	-22.38	-8.22	-9.01	-10.38
165	225	-26.52	-25.14	-23.14	-8.81	-9.72	-11.22
165	228	-25.93	-24.65	-22.86	-9.43	-10.46	-12.15
165	231	-24.44	-23.40	-22.14	-10.09	-11.24	-13.21
165	234	-22.45	-21.73	-21.13	-10.81	-12.14	-14.42
165	237	-20.40	-19.97	-19.99	-11.62	-13.21	-15.82
165	240	-18.69	-18.43	-18.87	-12.53	-14.49	-17.44
165	243	-17.26	-17.06	-17.61	-13.88	-16.83	-20.10
165	246	-15.83	-15.62	-16.10	-15.71	-20.37	-23.90
165	249	-14.47	-14.23	-14.52	-17.56	-24.11	-27.84
165	252	-13.28	-13.01	-13.09	-18.99	-27.07	-30.94
165	255	-12.33	-12.06	-12.02	-19.57	-28.28	-32.20
165	258	-11.57	-11.33	-11.24	-19.56	-27.48	-30.70
165	261	-10.90	-10.69	-10.55	-19.54	-25.48	-27.02
165	264	-10.31	-10.13	-9.96	-19.51	-22.87	-22.43
165	267	-9.81	-9.66	-9.46	-19.46	-20.23	-18.15
165	270	-9.41	-9.29	-9.06	-19.40	-18.17	-15.43
165	273	-9.06	-8.97	-8.71	-18.83	-16.64	-14.05
165	276	-8.75	-8.69	-8.40	-17.49	-15.20	-12.94
165	279	-8.48	-8.45	-8.13	-15.77	-13.88	-12.02
165	282	-8.27	-8.26	-7.91	-14.07	-12.71	-11.23
165	285	-8.13	-8.11	-7.77	-12.78	-11.72	-10.50
165	288	-8.02	-7.99	-7.66	-11.86	-10.87	-9.83
165	291	-7.93	-7.88	-7.56	-11.04	-10.11	-9.22
165	294	-7.86	-7.78	-7.49	-10.29	-9.44	-8.66
165	297	-7.81	-7.72	-7.43	-9.61	-8.83	-8.17
165	300	-7.79	-7.70	-7.41	-8.97	-8.26	-7.71
165	303	-7.83	-7.73	-7.45	-8.38	-7.74	-7.29
165	306	-7.91	-7.81	-7.56	-7.81	-7.25	-6.89
165	309	-8.04	-7.93	-7.71	-7.29	-6.79	-6.52
165	312	-8.20	-8.09	-7.90	-6.82	-6.39	-6.20
165	315	-8.38	-8.26	-8.11	-6.41	-6.04	-5.93
165	318	-8.63	-8.52	-8.41	-6.04	-5.73	-5.70
165	321	-9.01	-8.92	-8.85	-5.71	-5.45	-5.49
165	324	-9.49	-9.43	-9.38	-5.41	-5.20	-5.31
165	327	-10.03	-10.01	-9.99	-5.14	-4.97	-5.14
165	330	-10.63	-10.64	-10.64	-4.89	-4.76	-5.00
165	333	-11.28	-11.32	-11.34	-4.65	-4.56	-4.86
165	336	-12.06	-12.13	-12.15	-4.43	-4.36	-4.72
165	339	-12.97	-13.07	-13.07	-4.23	-4.19	-4.60
165	342	-14.01	-14.16	-14.10	-4.05	-4.04	-4.50
165	345	-15.19	-15.43	-15.24	-3.90	-3.92	-4.43
165	348	-16.62	-17.04	-16.56	-3.76	-3.81	-4.37
165	351	-18.39	-19.10	-18.11	-3.64	-3.72	-4.32
165	354	-20.44	-21.53	-19.85	-3.53	-3.64	-4.28
165	357	-22.73	-24.27	-21.77	-3.44	-3.58	-4.25
165	360	-25.20	-27.24	-23.82	-3.36	-3.53	-4.24
168	0	-24.61	-26.57	-23.33	-3.48	-3.62	-4.27
168	3	-24.59	-26.49	-24.61	-3.42	-3.59	-4.27
168	6	-24.52	-26.26	-25.50	-3.37	-3.57	-4.30
168	9	-24.42	-25.92	-26.08	-3.35	-3.56	-4.33
168	12	-24.28	-25.49	-26.39	-3.33	-3.56	-4.37
168	15	-24.11	-25.01	-26.48	-3.33	-3.56	-4.42
168	18	-23.49	-24.19	-26.03	-3.34	-3.58	-4.47



168	21	-22.24	-22.89	-24.94	-3.38	-3.63	-4.55
168	24	-20.71	-21.41	-23.52	-3.44	-3.71	-4.65
168	27	-19.25	-20.04	-22.13	-3.51	-3.81	-4.76
168	30	-18.21	-19.08	-21.11	-3.59	-3.91	-4.89
168	33	-17.56	-18.46	-20.43	-3.68	-4.03	-5.03
168	36	-17.00	-17.94	-19.81	-3.82	-4.18	-5.21
168	39	-16.52	-17.49	-19.27	-3.98	-4.37	-5.42
168	42	-16.10	-17.10	-18.79	-4.17	-4.57	-5.64
168	45	-15.72	-16.74	-18.39	-4.37	-4.79	-5.89
168	48	-15.40	-16.43	-18.06	-4.59	-5.03	-6.16
168	51	-15.12	-16.16	-17.78	-4.84	-5.31	-6.46
168	54	-14.87	-15.91	-17.53	-5.13	-5.62	-6.79
168	57	-14.62	-15.66	-17.28	-5.45	-5.96	-7.16
168	60	-14.36	-15.39	-17.01	-5.79	-6.33	-7.56
168	63	-14.06	-15.08	-16.71	-6.17	-6.74	-7.99
168	66	-13.75	-14.75	-16.38	-6.60	-7.20	-8.48
168	69	-13.44	-14.42	-16.05	-7.07	-7.70	-9.02
168	72	-13.16	-14.11	-15.75	-7.60	-8.25	-9.59
168	75	-12.91	-13.84	-15.48	-8.16	-8.85	-10.20
168	78	-12.69	-13.59	-15.23	-8.80	-9.51	-10.85
168	81	-12.49	-13.35	-15.00	-9.51	-10.25	-11.54
168	84	-12.30	-13.13	-14.79	-10.30	-11.05	-12.29
168	87	-12.14	-12.95	-14.60	-11.15	-11.92	-13.11
168	90	-12.02	-12.82	-14.47	-12.06	-12.84	-14.00
168	93	-11.92	-12.75	-14.37	-13.26	-14.02	-15.16
168	96	-11.85	-12.69	-14.30	-14.79	-15.48	-16.60
168	99	-11.79	-12.65	-14.23	-16.29	-16.93	-18.07
168	102	-11.72	-12.60	-14.16	-17.44	-18.09	-19.32
168	105	-11.66	-12.54	-14.08	-17.90	-18.66	-20.10
168	108	-11.60	-12.48	-13.97	-17.89	-18.84	-20.54
168	111	-11.54	-12.41	-13.84	-17.88	-18.99	-20.93
168	114	-11.48	-12.33	-13.69	-17.84	-19.10	-21.25
168	117	-11.42	-12.24	-13.52	-17.80	-19.16	-21.45
168	120	-11.33	-12.12	-13.33	-17.75	-19.19	-21.53
168	123	-11.22	-11.95	-13.06	-17.08	-18.46	-20.63
168	126	-11.07	-11.72	-12.70	-15.52	-16.66	-18.41
168	129	-10.90	-11.44	-12.30	-13.54	-14.36	-15.61
168	132	-10.71	-11.14	-11.87	-11.63	-12.15	-12.95
168	135	-10.52	-10.85	-11.47	-10.24	-10.59	-11.17
168	138	-10.31	-10.55	-11.08	-9.33	-9.62	-10.14
168	141	-10.08	-10.22	-10.67	-8.53	-8.77	-9.27
168	144	-9.84	-9.89	-10.27	-7.83	-8.03	-8.54
168	147	-9.60	-9.58	-9.88	-7.22	-7.41	-7.92
168	150	-9.40	-9.30	-9.54	-6.71	-6.88	-7.39
168	153	-9.19	-9.03	-9.19	-6.26	-6.41	-6.92
168	156	-8.97	-8.75	-8.82	-5.85	-5.98	-6.49
168	159	-8.78	-8.49	-8.48	-5.49	-5.61	-6.12
168	162	-8.64	-8.31	-8.25	-5.19	-5.31	-5.82
168	165	-8.58	-8.24	-8.15	-4.96	-5.08	-5.61
168	168	-8.59	-8.26	-8.17	-4.76	-4.90	-5.44
168	171	-8.62	-8.32	-8.21	-4.57	-4.74	-5.29
168	174	-8.66	-8.41	-8.28	-4.41	-4.61	-5.17
168	177	-8.72	-8.52	-8.36	-4.30	-4.52	-5.09
168	180	-8.78	-8.65	-8.46	-4.26	-4.48	-5.06
168	183	-8.91	-8.82	-8.62	-4.29	-4.52	-5.10
168	186	-9.14	-9.08	-8.87	-4.37	-4.62	-5.22
168	189	-9.46	-9.40	-9.21	-4.48	-4.76	-5.40
168	192	-9.84	-9.79	-9.61	-4.62	-4.94	-5.61

168	195	-10.28	-10.24	-10.06	-4.77	-5.12	-5.83
168	198	-10.85	-10.81	-10.60	-4.95	-5.33	-6.09
168	201	-11.64	-11.56	-11.31	-5.20	-5.61	-6.42
168	204	-12.60	-12.48	-12.15	-5.49	-5.94	-6.80
168	207	-13.71	-13.52	-13.11	-5.82	-6.30	-7.23
168	210	-14.93	-14.67	-14.17	-6.18	-6.70	-7.70
168	213	-16.77	-16.36	-15.75	-6.57	-7.14	-8.22
168	216	-19.32	-18.68	-17.92	-7.03	-7.66	-8.81
168	219	-21.94	-21.06	-20.13	-7.54	-8.24	-9.49
168	222	-23.99	-22.91	-21.85	-8.09	-8.88	-10.23
168	225	-24.81	-23.65	-22.55	-8.67	-9.57	-11.06
168	228	-24.36	-23.29	-22.31	-9.28	-10.29	-11.98
168	231	-23.19	-22.34	-21.69	-9.92	-11.06	-13.01
168	234	-21.63	-21.06	-20.82	-10.63	-11.94	-14.19
168	237	-19.99	-19.68	-19.83	-11.42	-12.98	-15.56
168	240	-18.56	-18.42	-18.85	-12.31	-14.24	-17.15
168	243	-17.29	-17.22	-17.74	-13.64	-16.52	-19.73
168	246	-15.97	-15.91	-16.38	-15.42	-19.95	-23.42
168	249	-14.70	-14.62	-14.95	-17.23	-23.58	-27.25
168	252	-13.56	-13.45	-13.64	-18.64	-26.46	-30.26
168	255	-12.65	-12.53	-12.63	-19.20	-27.63	-31.48
168	258	-11.93	-11.81	-11.88	-19.20	-26.89	-30.07
168	261	-11.29	-11.16	-11.21	-19.19	-25.03	-26.61
168	264	-10.73	-10.60	-10.62	-19.19	-22.60	-22.28
168	267	-10.25	-10.12	-10.12	-19.18	-20.13	-18.22
168	270	-9.85	-9.75	-9.71	-19.16	-18.18	-15.61
168	273	-9.52	-9.44	-9.36	-18.64	-16.70	-14.26
168	276	-9.22	-9.16	-9.04	-17.38	-15.30	-13.15
168	279	-8.95	-8.93	-8.76	-15.74	-14.01	-12.23
168	282	-8.74	-8.73	-8.54	-14.11	-12.86	-11.43
168	285	-8.59	-8.59	-8.38	-12.85	-11.87	-10.70
168	288	-8.48	-8.47	-8.27	-11.97	-11.02	-10.01
168	291	-8.37	-8.36	-8.16	-11.16	-10.25	-9.38
168	294	-8.29	-8.27	-8.08	-10.43	-9.57	-8.82
168	297	-8.23	-8.21	-8.02	-9.76	-8.95	-8.30
168	300	-8.21	-8.19	-8.00	-9.14	-8.39	-7.84
168	303	-8.23	-8.21	-8.03	-8.55	-7.87	-7.41
168	306	-8.30	-8.27	-8.10	-8.00	-7.39	-7.00
168	309	-8.39	-8.36	-8.21	-7.49	-6.96	-6.63
168	312	-8.51	-8.48	-8.36	-7.02	-6.56	-6.30
168	315	-8.65	-8.61	-8.51	-6.61	-6.21	-6.02
168	318	-8.86	-8.82	-8.75	-6.25	-5.90	-5.78
168	321	-9.19	-9.16	-9.10	-5.91	-5.62	-5.57
168	324	-9.61	-9.58	-9.54	-5.60	-5.36	-5.38
168	327	-10.08	-10.07	-10.03	-5.32	-5.12	-5.21
168	330	-10.56	-10.58	-10.54	-5.06	-4.90	-5.05
168	333	-11.06	-11.09	-11.05	-4.82	-4.69	-4.91
168	336	-11.61	-11.65	-11.61	-4.59	-4.49	-4.77
168	339	-12.25	-12.30	-12.25	-4.39	-4.31	-4.65
168	342	-13.01	-13.09	-13.01	-4.20	-4.15	-4.55
168	345	-13.93	-14.08	-13.91	-4.04	-4.02	-4.47
168	348	-15.24	-15.53	-15.13	-3.90	-3.91	-4.41
168	351	-17.05	-17.63	-16.75	-3.77	-3.81	-4.36
168	354	-19.28	-20.25	-18.70	-3.65	-3.73	-4.31
168	357	-21.83	-23.27	-20.92	-3.55	-3.66	-4.28
168	360	-24.61	-26.57	-23.33	-3.48	-3.62	-4.27
171	0	-22.89	-24.62	-21.89	-3.61	-3.74	-4.35
171	3	-22.89	-24.57	-23.10	-3.56	-3.74	-4.36

171	6	-22.89	-24.44	-23.99	-3.53	-3.74	-4.40
171	9	-22.89	-24.25	-24.59	-3.51	-3.74	-4.44
171	12	-22.89	-24.00	-24.93	-3.50	-3.74	-4.50
171	15	-22.89	-23.71	-25.04	-3.50	-3.74	-4.56
171	18	-22.47	-23.10	-24.68	-3.52	-3.77	-4.64
171	21	-21.45	-22.05	-23.80	-3.58	-3.84	-4.74
171	24	-20.15	-20.82	-22.65	-3.66	-3.95	-4.86
171	27	-18.91	-19.68	-21.53	-3.76	-4.07	-5.01
171	30	-18.06	-18.89	-20.68	-3.86	-4.20	-5.16
171	33	-17.56	-18.42	-20.11	-3.99	-4.35	-5.34
171	36	-17.15	-18.03	-19.59	-4.14	-4.53	-5.56
171	39	-16.79	-17.70	-19.12	-4.33	-4.74	-5.80
171	42	-16.46	-17.40	-18.71	-4.53	-4.97	-6.07
171	45	-16.14	-17.10	-18.36	-4.76	-5.22	-6.37
171	48	-15.84	-16.83	-18.06	-5.01	-5.50	-6.69
171	51	-15.55	-16.59	-17.81	-5.29	-5.82	-7.05
171	54	-15.28	-16.36	-17.58	-5.61	-6.17	-7.45
171	57	-15.01	-16.12	-17.35	-5.97	-6.56	-7.89
171	60	-14.72	-15.85	-17.09	-6.35	-6.99	-8.36
171	63	-14.40	-15.52	-16.79	-6.77	-7.46	-8.90
171	66	-14.07	-15.16	-16.46	-7.26	-8.00	-9.51
171	69	-13.73	-14.78	-16.13	-7.79	-8.59	-10.18
171	72	-13.41	-14.42	-15.81	-8.37	-9.23	-10.87
171	75	-13.12	-14.09	-15.54	-8.99	-9.91	-11.58
171	78	-12.86	-13.78	-15.30	-9.70	-10.66	-12.30
171	81	-12.61	-13.48	-15.07	-10.50	-11.51	-13.06
171	84	-12.38	-13.19	-14.86	-11.36	-12.41	-13.84
171	87	-12.18	-12.96	-14.68	-12.25	-13.32	-14.64
171	90	-12.03	-12.79	-14.52	-13.13	-14.19	-15.44
171	93	-11.92	-12.68	-14.40	-14.16	-15.18	-16.36
171	96	-11.82	-12.60	-14.30	-15.36	-16.29	-17.41
171	99	-11.74	-12.53	-14.21	-16.49	-17.33	-18.41
171	102	-11.66	-12.46	-14.11	-17.34	-18.10	-19.20
171	105	-11.58	-12.39	-14.00	-17.68	-18.40	-19.60
171	108	-11.50	-12.31	-13.87	-17.64	-18.38	-19.74
171	111	-11.43	-12.23	-13.73	-17.52	-18.34	-19.85
171	114	-11.35	-12.16	-13.58	-17.34	-18.27	-19.94
171	117	-11.27	-12.07	-13.41	-17.11	-18.16	-19.99
171	120	-11.18	-11.95	-13.20	-16.82	-18.04	-20.01
171	123	-11.06	-11.79	-12.93	-16.03	-17.25	-19.15
171	126	-10.91	-11.57	-12.59	-14.51	-15.52	-17.04
171	129	-10.76	-11.31	-12.19	-12.69	-13.36	-14.38
171	132	-10.59	-11.03	-11.79	-10.94	-11.30	-11.87
171	135	-10.41	-10.76	-11.41	-9.68	-9.87	-10.23
171	138	-10.22	-10.48	-11.04	-8.85	-8.99	-9.33
171	141	-10.01	-10.18	-10.66	-8.12	-8.23	-8.58
171	144	-9.79	-9.88	-10.29	-7.49	-7.58	-7.95
171	147	-9.59	-9.60	-9.94	-6.94	-7.03	-7.43
171	150	-9.42	-9.36	-9.64	-6.48	-6.56	-6.98
171	153	-9.27	-9.13	-9.34	-6.07	-6.15	-6.59
171	156	-9.11	-8.90	-9.04	-5.71	-5.78	-6.23
171	159	-8.98	-8.70	-8.77	-5.39	-5.45	-5.92
171	162	-8.88	-8.55	-8.57	-5.12	-5.18	-5.67
171	165	-8.84	-8.49	-8.50	-4.90	-4.99	-5.49
171	168	-8.86	-8.54	-8.53	-4.71	-4.83	-5.35
171	171	-8.92	-8.64	-8.63	-4.53	-4.68	-5.22
171	174	-9.00	-8.80	-8.78	-4.38	-4.56	-5.11
171	177	-9.11	-8.99	-8.95	-4.27	-4.48	-5.04

171	180	-9.23	-9.18	-9.13	-4.23	-4.45	-5.01
171	183	-9.39	-9.40	-9.35	-4.26	-4.48	-5.05
171	186	-9.65	-9.68	-9.62	-4.32	-4.57	-5.17
171	189	-9.97	-10.02	-9.95	-4.42	-4.70	-5.33
171	192	-10.35	-10.40	-10.34	-4.54	-4.86	-5.53
171	195	-10.79	-10.85	-10.77	-4.67	-5.03	-5.73
171	198	-11.34	-11.40	-11.29	-4.84	-5.22	-5.97
171	201	-12.08	-12.10	-11.93	-5.06	-5.48	-6.28
171	204	-12.96	-12.93	-12.68	-5.34	-5.78	-6.63
171	207	-13.96	-13.86	-13.53	-5.65	-6.12	-7.03
171	210	-15.03	-14.87	-14.47	-5.98	-6.49	-7.47
171	213	-16.57	-16.29	-15.84	-6.34	-6.91	-7.95
171	216	-18.63	-18.18	-17.70	-6.77	-7.38	-8.51
171	219	-20.71	-20.09	-19.60	-7.24	-7.92	-9.14
171	222	-22.33	-21.57	-21.07	-7.75	-8.51	-9.84
171	225	-22.98	-22.16	-21.66	-8.28	-9.15	-10.62
171	228	-22.64	-21.91	-21.48	-8.85	-9.82	-11.47
171	231	-21.77	-21.25	-21.00	-9.46	-10.55	-12.44
171	234	-20.59	-20.33	-20.33	-10.13	-11.38	-13.55
171	237	-19.32	-19.32	-19.55	-10.87	-12.35	-14.83
171	240	-18.19	-18.36	-18.76	-11.71	-13.53	-16.31
171	243	-17.12	-17.36	-17.82	-12.93	-15.62	-18.69
171	246	-15.98	-16.21	-16.64	-14.53	-18.76	-22.07
171	249	-14.86	-15.04	-15.38	-16.18	-22.07	-25.57
171	252	-13.83	-13.95	-14.21	-17.51	-24.69	-28.31
171	255	-13.01	-13.08	-13.30	-18.16	-25.76	-29.42
171	258	-12.33	-12.37	-12.63	-18.34	-25.18	-28.27
171	261	-11.73	-11.73	-12.03	-18.49	-23.73	-25.44
171	264	-11.19	-11.15	-11.50	-18.60	-21.82	-21.87
171	267	-10.73	-10.67	-11.04	-18.67	-19.84	-18.46
171	270	-10.34	-10.28	-10.64	-18.69	-18.21	-16.17
171	273	-10.01	-9.96	-10.28	-18.25	-16.89	-14.86
171	276	-9.70	-9.67	-9.95	-17.14	-15.60	-13.76
171	279	-9.44	-9.43	-9.65	-15.69	-14.38	-12.83
171	282	-9.22	-9.23	-9.41	-14.23	-13.27	-12.01
171	285	-9.05	-9.08	-9.22	-13.08	-12.30	-11.24
171	288	-8.92	-8.96	-9.07	-12.23	-11.44	-10.52
171	291	-8.80	-8.85	-8.94	-11.44	-10.66	-9.85
171	294	-8.69	-8.76	-8.82	-10.71	-9.95	-9.25
171	297	-8.62	-8.70	-8.74	-10.04	-9.31	-8.69
171	300	-8.60	-8.68	-8.71	-9.42	-8.73	-8.19
171	303	-8.61	-8.69	-8.73	-8.83	-8.20	-7.74
171	306	-8.66	-8.73	-8.76	-8.27	-7.71	-7.31
171	309	-8.72	-8.78	-8.81	-7.76	-7.26	-6.92
171	312	-8.81	-8.85	-8.88	-7.28	-6.85	-6.57
171	315	-8.90	-8.93	-8.96	-6.86	-6.48	-6.27
171	318	-9.06	-9.08	-9.11	-6.48	-6.15	-6.01
171	321	-9.32	-9.34	-9.37	-6.13	-5.85	-5.77
171	324	-9.65	-9.66	-9.69	-5.81	-5.57	-5.56
171	327	-10.02	-10.03	-10.06	-5.52	-5.32	-5.37
171	330	-10.40	-10.41	-10.42	-5.25	-5.08	-5.20
171	333	-10.76	-10.76	-10.77	-5.01	-4.86	-5.05
171	336	-11.13	-11.13	-11.13	-4.77	-4.65	-4.91
171	339	-11.56	-11.57	-11.54	-4.56	-4.46	-4.78
171	342	-12.10	-12.11	-12.05	-4.36	-4.30	-4.67
171	345	-12.78	-12.82	-12.70	-4.20	-4.16	-4.59
171	348	-13.88	-14.03	-13.72	-4.05	-4.05	-4.52
171	351	-15.56	-15.96	-15.25	-3.92	-3.95	-4.46

171	354	-17.69	-18.47	-17.19	-3.80	-3.86	-4.41
171	357	-20.18	-21.41	-19.43	-3.69	-3.79	-4.37
171	360	-22.89	-24.62	-21.89	-3.61	-3.74	-4.35
174	0	-20.09	-21.42	-19.54	-3.77	-3.90	-4.47
174	3	-20.41	-21.42	-20.60	-3.74	-3.90	-4.49
174	6	-20.60	-21.43	-21.43	-3.72	-3.91	-4.53
174	9	-20.70	-21.43	-22.04	-3.71	-3.92	-4.59
174	12	-20.73	-21.43	-22.40	-3.71	-3.94	-4.65
174	15	-20.74	-21.43	-22.53	-3.71	-3.96	-4.73
174	18	-20.47	-21.16	-22.30	-3.74	-4.01	-4.82
174	21	-19.80	-20.50	-21.75	-3.81	-4.11	-4.95
174	24	-18.96	-19.67	-21.03	-3.92	-4.24	-5.10
174	27	-18.16	-18.89	-20.31	-4.05	-4.39	-5.27
174	30	-17.63	-18.38	-19.78	-4.18	-4.55	-5.45
174	33	-17.33	-18.12	-19.41	-4.33	-4.72	-5.67
174	36	-17.10	-17.92	-19.09	-4.51	-4.93	-5.92
174	39	-16.91	-17.75	-18.80	-4.71	-5.16	-6.21
174	42	-16.71	-17.58	-18.53	-4.94	-5.42	-6.54
174	45	-16.49	-17.39	-18.27	-5.19	-5.71	-6.88
174	48	-16.23	-17.19	-18.03	-5.47	-6.02	-7.26
174	51	-15.97	-17.00	-17.81	-5.78	-6.38	-7.69
174	54	-15.69	-16.80	-17.61	-6.14	-6.79	-8.16
174	57	-15.40	-16.58	-17.39	-6.53	-7.23	-8.68
174	60	-15.11	-16.32	-17.15	-6.95	-7.71	-9.25
174	63	-14.79	-16.00	-16.86	-7.43	-8.26	-9.91
174	66	-14.44	-15.62	-16.53	-7.96	-8.89	-10.67
174	69	-14.09	-15.20	-16.18	-8.56	-9.59	-11.50
174	72	-13.75	-14.78	-15.86	-9.20	-10.33	-12.34
174	75	-13.43	-14.39	-15.58	-9.88	-11.09	-13.14
174	78	-13.12	-14.01	-15.35	-10.67	-11.97	-13.96
174	81	-12.81	-13.62	-15.13	-11.58	-12.97	-14.81
174	84	-12.51	-13.25	-14.93	-12.53	-13.98	-15.64
174	87	-12.25	-12.93	-14.75	-13.43	-14.90	-16.37
174	90	-12.04	-12.70	-14.57	-14.22	-15.63	-16.94
174	93	-11.88	-12.53	-14.40	-14.97	-16.22	-17.41
174	96	-11.74	-12.39	-14.24	-15.75	-16.80	-17.86
174	99	-11.61	-12.27	-14.09	-16.44	-17.30	-18.24
174	102	-11.50	-12.16	-13.94	-16.94	-17.65	-18.50
174	105	-11.38	-12.05	-13.78	-17.13	-17.78	-18.60
174	108	-11.27	-11.96	-13.62	-17.03	-17.69	-18.55
174	111	-11.17	-11.88	-13.46	-16.76	-17.47	-18.41
174	114	-11.07	-11.80	-13.30	-16.36	-17.12	-18.20
174	117	-10.96	-11.71	-13.12	-15.86	-16.68	-17.91
174	120	-10.85	-11.60	-12.90	-15.32	-16.18	-17.57
174	123	-10.73	-11.45	-12.64	-14.43	-15.25	-16.61
174	126	-10.61	-11.26	-12.31	-13.09	-13.72	-14.80
174	129	-10.48	-11.03	-11.96	-11.57	-11.96	-12.64
174	132	-10.35	-10.80	-11.60	-10.15	-10.32	-10.65
174	135	-10.21	-10.58	-11.26	-9.09	-9.14	-9.33
174	138	-10.05	-10.34	-10.94	-8.36	-8.38	-8.58
174	141	-9.87	-10.08	-10.60	-7.72	-7.72	-7.94
174	144	-9.69	-9.82	-10.28	-7.16	-7.16	-7.42
174	147	-9.54	-9.59	-9.99	-6.67	-6.68	-6.98
174	150	-9.44	-9.41	-9.76	-6.26	-6.27	-6.61
174	153	-9.38	-9.26	-9.55	-5.90	-5.91	-6.29
174	156	-9.33	-9.11	-9.35	-5.58	-5.59	-6.00
174	159	-9.28	-8.99	-9.17	-5.29	-5.31	-5.75
174	162	-9.25	-8.90	-9.05	-5.05	-5.08	-5.54

174	165	-9.24	-8.87	-9.01	-4.85	-4.90	-5.39
174	168	-9.28	-8.93	-9.07	-4.67	-4.75	-5.26
174	171	-9.38	-9.10	-9.24	-4.49	-4.62	-5.14
174	174	-9.52	-9.33	-9.49	-4.34	-4.50	-5.04
174	177	-9.69	-9.60	-9.76	-4.24	-4.43	-4.97
174	180	-9.87	-9.87	-10.03	-4.20	-4.40	-4.95
174	183	-10.09	-10.14	-10.29	-4.22	-4.43	-4.98
174	186	-10.36	-10.44	-10.58	-4.27	-4.50	-5.08
174	189	-10.69	-10.79	-10.90	-4.34	-4.61	-5.23
174	192	-11.07	-11.18	-11.26	-4.43	-4.74	-5.40
174	195	-11.50	-11.63	-11.67	-4.53	-4.88	-5.58
174	198	-12.03	-12.15	-12.15	-4.67	-5.06	-5.79
174	201	-12.68	-12.79	-12.72	-4.87	-5.28	-6.05
174	204	-13.43	-13.50	-13.37	-5.12	-5.55	-6.37
174	207	-14.27	-14.29	-14.09	-5.39	-5.86	-6.72
174	210	-15.15	-15.13	-14.88	-5.68	-6.18	-7.10
174	213	-16.34	-16.25	-15.99	-6.00	-6.55	-7.53
174	216	-17.86	-17.70	-17.46	-6.37	-6.96	-8.03
174	219	-19.39	-19.13	-18.94	-6.78	-7.44	-8.60
174	222	-20.56	-20.23	-20.08	-7.23	-7.95	-9.23
174	225	-21.03	-20.67	-20.54	-7.70	-8.52	-9.93
174	228	-20.79	-20.51	-20.42	-8.21	-9.12	-10.70
174	231	-20.18	-20.10	-20.09	-8.76	-9.77	-11.57
174	234	-19.35	-19.52	-19.62	-9.36	-10.51	-12.56
174	237	-18.44	-18.86	-19.08	-10.04	-11.39	-13.69
174	240	-17.60	-18.19	-18.51	-10.80	-12.43	-15.00
174	243	-16.78	-17.42	-17.78	-11.83	-14.22	-17.05
174	246	-15.88	-16.48	-16.81	-13.16	-16.88	-19.94
174	249	-14.96	-15.47	-15.76	-14.55	-19.66	-22.91
174	252	-14.11	-14.50	-14.79	-15.75	-21.86	-25.24
174	255	-13.38	-13.69	-14.03	-16.52	-22.75	-26.18
174	258	-12.78	-13.01	-13.48	-16.99	-22.44	-25.44
174	261	-12.22	-12.37	-12.99	-17.41	-21.65	-23.60
174	264	-11.71	-11.79	-12.57	-17.74	-20.56	-21.22
174	267	-11.26	-11.28	-12.18	-17.96	-19.37	-18.87
174	270	-10.88	-10.87	-11.81	-18.05	-18.29	-17.10
174	273	-10.53	-10.53	-11.44	-17.70	-17.25	-15.88
174	276	-10.22	-10.22	-11.08	-16.81	-16.13	-14.80
174	279	-9.94	-9.96	-10.76	-15.64	-15.00	-13.82
174	282	-9.70	-9.74	-10.47	-14.43	-13.92	-12.93
174	285	-9.51	-9.58	-10.24	-13.43	-12.96	-12.10
174	288	-9.35	-9.46	-10.05	-12.63	-12.11	-11.32
174	291	-9.20	-9.34	-9.87	-11.85	-11.30	-10.59
174	294	-9.07	-9.25	-9.72	-11.12	-10.55	-9.91
174	297	-8.98	-9.18	-9.61	-10.42	-9.86	-9.29
174	300	-8.95	-9.16	-9.54	-9.78	-9.23	-8.74
174	303	-8.96	-9.16	-9.51	-9.18	-8.67	-8.24
174	306	-8.98	-9.17	-9.49	-8.61	-8.15	-7.78
174	309	-9.02	-9.19	-9.47	-8.08	-7.67	-7.36
174	312	-9.06	-9.21	-9.46	-7.59	-7.23	-6.98
174	315	-9.12	-9.24	-9.45	-7.15	-6.83	-6.65
174	318	-9.22	-9.31	-9.51	-6.75	-6.47	-6.35
174	321	-9.40	-9.47	-9.65	-6.38	-6.14	-6.08
174	324	-9.63	-9.68	-9.85	-6.05	-5.83	-5.83
174	327	-9.89	-9.91	-10.08	-5.74	-5.55	-5.61
174	330	-10.15	-10.15	-10.30	-5.46	-5.30	-5.43
174	333	-10.39	-10.37	-10.50	-5.20	-5.06	-5.26
174	336	-10.64	-10.60	-10.71	-4.96	-4.85	-5.11

174	339	-10.93	-10.87	-10.95	-4.74	-4.65	-4.98
174	342	-11.30	-11.21	-11.25	-4.55	-4.48	-4.86
174	345	-11.77	-11.67	-11.66	-4.38	-4.34	-4.77
174	348	-12.61	-12.58	-12.41	-4.23	-4.22	-4.69
174	351	-13.98	-14.15	-13.69	-4.09	-4.11	-4.62
174	354	-15.75	-16.25	-15.38	-3.96	-4.02	-4.55
174	357	-17.82	-18.72	-17.36	-3.85	-3.95	-4.50
174	360	-20.09	-21.42	-19.54	-3.77	-3.90	-4.47
177	0	-16.28	-17.04	-16.30	-3.94	-4.08	-4.62
177	3	-16.71	-17.39	-17.09	-3.94	-4.08	-4.64
177	6	-17.07	-17.67	-17.79	-3.93	-4.10	-4.68
177	9	-17.34	-17.88	-18.34	-3.93	-4.13	-4.75
177	12	-17.51	-18.02	-18.71	-3.93	-4.17	-4.83
177	15	-17.57	-18.06	-18.84	-3.93	-4.21	-4.91
177	18	-17.49	-17.99	-18.78	-3.97	-4.29	-5.02
177	21	-17.31	-17.83	-18.65	-4.07	-4.41	-5.17
177	24	-17.08	-17.63	-18.49	-4.22	-4.57	-5.34
177	27	-16.89	-17.47	-18.34	-4.38	-4.75	-5.54
177	30	-16.79	-17.40	-18.24	-4.54	-4.93	-5.76
177	33	-16.77	-17.42	-18.21	-4.72	-5.13	-6.01
177	36	-16.76	-17.46	-18.18	-4.92	-5.37	-6.31
177	39	-16.75	-17.52	-18.16	-5.14	-5.63	-6.65
177	42	-16.74	-17.56	-18.13	-5.39	-5.92	-7.03
177	45	-16.72	-17.58	-18.09	-5.66	-6.24	-7.43
177	48	-16.62	-17.54	-18.00	-5.97	-6.59	-7.88
177	51	-16.41	-17.42	-17.85	-6.32	-7.00	-8.38
177	54	-16.13	-17.25	-17.65	-6.70	-7.45	-8.93
177	57	-15.81	-17.04	-17.42	-7.13	-7.95	-9.54
177	60	-15.51	-16.82	-17.18	-7.59	-8.50	-10.21
177	63	-15.21	-16.53	-16.91	-8.12	-9.13	-11.01
177	66	-14.87	-16.13	-16.58	-8.72	-9.87	-11.96
177	69	-14.52	-15.66	-16.23	-9.38	-10.67	-12.98
177	72	-14.16	-15.18	-15.89	-10.08	-11.52	-13.98
177	75	-13.81	-14.72	-15.61	-10.82	-12.38	-14.88
177	78	-13.44	-14.26	-15.38	-11.73	-13.42	-15.78
177	81	-13.06	-13.77	-15.18	-12.82	-14.67	-16.74
177	84	-12.69	-13.29	-14.99	-13.91	-15.87	-17.61
177	87	-12.34	-12.85	-14.80	-14.80	-16.77	-18.25
177	90	-12.05	-12.51	-14.59	-15.32	-17.13	-18.50
177	93	-11.80	-12.25	-14.36	-15.57	-17.10	-18.40
177	96	-11.57	-12.01	-14.11	-15.79	-17.04	-18.15
177	99	-11.37	-11.80	-13.85	-15.96	-16.93	-17.79
177	102	-11.18	-11.63	-13.60	-16.07	-16.80	-17.37
177	105	-11.01	-11.48	-13.37	-16.11	-16.64	-16.96
177	108	-10.85	-11.37	-13.16	-15.93	-16.35	-16.55
177	111	-10.70	-11.27	-12.96	-15.45	-15.84	-16.09
177	114	-10.56	-11.19	-12.77	-14.78	-15.18	-15.57
177	117	-10.43	-11.11	-12.57	-14.01	-14.43	-14.97
177	120	-10.32	-11.00	-12.35	-13.26	-13.67	-14.29
177	123	-10.21	-10.88	-12.10	-12.41	-12.74	-13.31
177	126	-10.12	-10.73	-11.82	-11.36	-11.59	-12.01
177	129	-10.04	-10.58	-11.53	-10.27	-10.38	-10.62
177	132	-9.96	-10.41	-11.24	-9.26	-9.27	-9.36
177	135	-9.88	-10.26	-10.98	-8.47	-8.42	-8.46
177	138	-9.78	-10.08	-10.73	-7.86	-7.80	-7.87
177	141	-9.67	-9.88	-10.46	-7.32	-7.25	-7.37
177	144	-9.57	-9.69	-10.22	-6.85	-6.77	-6.94
177	147	-9.49	-9.54	-10.02	-6.43	-6.36	-6.58

177	150	-9.47	-9.45	-9.89	-6.07	-6.01	-6.28
177	153	-9.48	-9.41	-9.81	-5.76	-5.71	-6.02
177	156	-9.52	-9.38	-9.73	-5.47	-5.43	-5.80
177	159	-9.59	-9.35	-9.68	-5.22	-5.19	-5.60
177	162	-9.66	-9.33	-9.64	-4.99	-4.98	-5.44
177	165	-9.75	-9.33	-9.62	-4.81	-4.82	-5.30
177	168	-9.86	-9.42	-9.73	-4.63	-4.68	-5.18
177	171	-10.01	-9.65	-9.99	-4.46	-4.55	-5.06
177	174	-10.21	-9.97	-10.34	-4.31	-4.44	-4.96
177	177	-10.42	-10.32	-10.73	-4.20	-4.37	-4.89
177	180	-10.65	-10.66	-11.08	-4.16	-4.34	-4.87
177	183	-10.92	-10.98	-11.38	-4.17	-4.36	-4.90
177	186	-11.22	-11.33	-11.69	-4.20	-4.41	-4.98
177	189	-11.57	-11.70	-12.00	-4.24	-4.50	-5.09
177	192	-11.95	-12.10	-12.34	-4.30	-4.59	-5.22
177	195	-12.36	-12.53	-12.73	-4.36	-4.70	-5.37
177	198	-12.84	-13.02	-13.16	-4.47	-4.84	-5.54
177	201	-13.38	-13.57	-13.65	-4.63	-5.03	-5.76
177	204	-13.99	-14.16	-14.19	-4.84	-5.26	-6.02
177	207	-14.62	-14.79	-14.77	-5.08	-5.52	-6.31
177	210	-15.27	-15.44	-15.38	-5.32	-5.79	-6.63
177	213	-16.07	-16.24	-16.18	-5.59	-6.09	-7.00
177	216	-17.04	-17.22	-17.19	-5.89	-6.44	-7.43
177	219	-17.98	-18.17	-18.18	-6.22	-6.82	-7.91
177	222	-18.68	-18.88	-18.93	-6.59	-7.25	-8.46
177	225	-18.96	-19.16	-19.23	-6.98	-7.72	-9.05
177	228	-18.82	-19.09	-19.16	-7.41	-8.22	-9.70
177	231	-18.46	-18.89	-18.97	-7.88	-8.78	-10.43
177	234	-17.95	-18.59	-18.70	-8.40	-9.42	-11.27
177	237	-17.38	-18.24	-18.37	-8.98	-10.15	-12.21
177	240	-16.84	-17.86	-18.01	-9.63	-11.00	-13.28
177	243	-16.29	-17.36	-17.52	-10.44	-12.40	-14.91
177	246	-15.66	-16.66	-16.84	-11.45	-14.38	-17.13
177	249	-15.00	-15.87	-16.08	-12.52	-16.44	-19.41
177	252	-14.37	-15.07	-15.36	-13.54	-18.06	-21.19
177	255	-13.79	-14.37	-14.80	-14.38	-18.72	-21.90
177	258	-13.26	-13.73	-14.40	-15.14	-18.71	-21.67
177	261	-12.76	-13.09	-14.07	-15.92	-18.67	-21.07
177	264	-12.28	-12.49	-13.76	-16.60	-18.61	-20.24
177	267	-11.84	-11.96	-13.46	-17.09	-18.54	-19.31
177	270	-11.45	-11.52	-13.14	-17.28	-18.44	-18.41
177	273	-11.09	-11.15	-12.78	-17.04	-18.03	-17.48
177	276	-10.75	-10.81	-12.40	-16.43	-17.15	-16.41
177	279	-10.45	-10.51	-12.03	-15.60	-16.01	-15.28
177	282	-10.18	-10.27	-11.69	-14.70	-14.83	-14.19
177	285	-9.96	-10.09	-11.41	-13.90	-13.82	-13.22
177	288	-9.76	-9.96	-11.17	-13.17	-12.97	-12.36
177	291	-9.57	-9.85	-10.96	-12.40	-12.11	-11.53
177	294	-9.41	-9.76	-10.77	-11.63	-11.30	-10.76
177	297	-9.30	-9.68	-10.61	-10.89	-10.53	-10.05
177	300	-9.26	-9.63	-10.47	-10.21	-9.85	-9.43
177	303	-9.26	-9.60	-10.34	-9.59	-9.25	-8.88
177	306	-9.26	-9.57	-10.20	-9.00	-8.68	-8.37
177	309	-9.27	-9.54	-10.09	-8.44	-8.16	-7.91
177	312	-9.27	-9.52	-10.01	-7.93	-7.68	-7.49
177	315	-9.28	-9.51	-9.98	-7.47	-7.24	-7.11
177	318	-9.32	-9.53	-9.99	-7.05	-6.84	-6.77
177	321	-9.42	-9.58	-10.02	-6.66	-6.47	-6.46



177	324	-9.54	-9.66	-10.06	-6.30	-6.12	-6.17
177	327	-9.69	-9.75	-10.11	-5.97	-5.81	-5.91
177	330	-9.84	-9.84	-10.17	-5.68	-5.54	-5.70
177	333	-9.99	-9.94	-10.24	-5.41	-5.29	-5.52
177	336	-10.16	-10.06	-10.33	-5.17	-5.06	-5.36
177	339	-10.36	-10.21	-10.46	-4.94	-4.86	-5.22
177	342	-10.62	-10.41	-10.62	-4.74	-4.68	-5.09
177	345	-10.94	-10.67	-10.84	-4.57	-4.54	-4.99
177	348	-11.49	-11.23	-11.31	-4.41	-4.41	-4.89
177	351	-12.37	-12.24	-12.18	-4.27	-4.30	-4.81
177	354	-13.50	-13.62	-13.36	-4.14	-4.21	-4.73
177	357	-14.83	-15.26	-14.77	-4.03	-4.13	-4.67
177	360	-16.28	-17.04	-16.30	-3.94	-4.08	-4.62
180	0	-11.51	-11.54	-12.23	-4.12	-4.27	-4.78
180	3	-11.84	-11.91	-12.53	-4.12	-4.29	-4.80
180	6	-12.19	-12.30	-12.84	-4.13	-4.32	-4.85
180	9	-12.55	-12.70	-13.18	-4.14	-4.37	-4.93
180	12	-12.92	-13.10	-13.52	-4.16	-4.42	-5.01
180	15	-13.30	-13.52	-13.88	-4.18	-4.49	-5.11
180	18	-13.71	-13.96	-14.26	-4.24	-4.59	-5.23
180	21	-14.16	-14.42	-14.68	-4.37	-4.74	-5.40
180	24	-14.61	-14.89	-15.10	-4.54	-4.93	-5.60
180	27	-15.03	-15.34	-15.52	-4.74	-5.13	-5.83
180	30	-15.41	-15.77	-15.92	-4.93	-5.35	-6.08
180	33	-15.77	-16.23	-16.37	-5.13	-5.58	-6.37
180	36	-16.14	-16.73	-16.87	-5.35	-5.84	-6.72
180	39	-16.47	-17.19	-17.33	-5.60	-6.13	-7.11
180	42	-16.71	-17.52	-17.67	-5.87	-6.45	-7.55
180	45	-16.80	-17.65	-17.81	-6.17	-6.80	-8.01
180	48	-16.75	-17.64	-17.77	-6.50	-7.20	-8.53
180	51	-16.61	-17.59	-17.68	-6.88	-7.65	-9.11
180	54	-16.40	-17.53	-17.54	-7.30	-8.15	-9.75
180	57	-16.17	-17.44	-17.37	-7.77	-8.71	-10.46
180	60	-15.93	-17.34	-17.20	-8.27	-9.33	-11.23
180	63	-15.66	-17.11	-16.96	-8.85	-10.05	-12.19
180	66	-15.34	-16.71	-16.63	-9.52	-10.91	-13.36
180	69	-14.98	-16.19	-16.27	-10.24	-11.84	-14.59
180	72	-14.60	-15.63	-15.91	-11.02	-12.80	-15.76
180	75	-14.22	-15.09	-15.62	-11.81	-13.76	-16.74
180	78	-13.81	-14.53	-15.40	-12.81	-14.87	-17.63
180	81	-13.36	-13.91	-15.21	-14.02	-16.17	-18.53
180	84	-12.90	-13.28	-15.03	-15.20	-17.41	-19.33
180	87	-12.45	-12.69	-14.84	-16.09	-18.33	-19.90
180	90	-12.05	-12.21	-14.60	-16.44	-18.70	-20.11
180	93	-11.67	-11.81	-14.28	-16.32	-18.43	-19.69
180	96	-11.31	-11.43	-13.88	-15.99	-17.73	-18.63
180	99	-10.97	-11.09	-13.44	-15.53	-16.79	-17.22
180	102	-10.66	-10.81	-13.03	-15.01	-15.77	-15.76
180	105	-10.40	-10.61	-12.68	-14.47	-14.84	-14.56
180	108	-10.17	-10.47	-12.40	-13.85	-13.99	-13.59
180	111	-9.95	-10.36	-12.14	-13.08	-13.07	-12.64
180	114	-9.75	-10.27	-11.90	-12.24	-12.16	-11.75
180	117	-9.60	-10.18	-11.68	-11.41	-11.29	-10.94
180	120	-9.51	-10.10	-11.47	-10.68	-10.54	-10.23
180	123	-9.47	-10.03	-11.26	-10.04	-9.87	-9.61
180	126	-9.44	-9.96	-11.05	-9.42	-9.26	-9.04
180	129	-9.41	-9.89	-10.86	-8.84	-8.69	-8.52
180	132	-9.40	-9.83	-10.69	-8.30	-8.17	-8.05

180	135	-9.39	-9.77	-10.54	-7.81	-7.69	-7.63
180	138	-9.39	-9.70	-10.40	-7.37	-7.24	-7.24
180	141	-9.41	-9.63	-10.27	-6.95	-6.82	-6.87
180	144	-9.43	-9.56	-10.15	-6.56	-6.44	-6.53
180	147	-9.46	-9.51	-10.06	-6.22	-6.09	-6.24
180	150	-9.49	-9.49	-10.03	-5.91	-5.80	-6.00
180	153	-9.57	-9.51	-10.04	-5.64	-5.54	-5.80
180	156	-9.72	-9.55	-10.08	-5.39	-5.30	-5.63
180	159	-9.90	-9.63	-10.14	-5.16	-5.09	-5.48
180	162	-10.11	-9.72	-10.21	-4.95	-4.90	-5.35
180	165	-10.32	-9.82	-10.30	-4.78	-4.75	-5.23
180	168	-10.52	-10.01	-10.50	-4.60	-4.62	-5.11
180	171	-10.74	-10.33	-10.87	-4.42	-4.49	-4.99
180	174	-10.98	-10.72	-11.34	-4.27	-4.38	-4.89
180	177	-11.23	-11.14	-11.81	-4.16	-4.30	-4.81
180	180	-11.51	-11.54	-12.23	-4.12	-4.27	-4.78
180	183	-11.81	-11.91	-12.57	-4.12	-4.29	-4.80
180	186	-12.16	-12.30	-12.89	-4.13	-4.32	-4.85
180	189	-12.53	-12.70	-13.21	-4.14	-4.37	-4.92
180	192	-12.91	-13.10	-13.53	-4.16	-4.42	-5.01
180	195	-13.30	-13.52	-13.88	-4.18	-4.49	-5.11
180	198	-13.71	-13.96	-14.26	-4.24	-4.59	-5.23
180	201	-14.16	-14.42	-14.68	-4.37	-4.74	-5.40
180	204	-14.61	-14.89	-15.10	-4.54	-4.93	-5.60
180	207	-15.03	-15.34	-15.52	-4.74	-5.13	-5.83
180	210	-15.41	-15.77	-15.92	-4.93	-5.35	-6.08
180	213	-15.77	-16.23	-16.37	-5.13	-5.58	-6.37
180	216	-16.14	-16.73	-16.87	-5.35	-5.84	-6.72
180	219	-16.47	-17.19	-17.33	-5.60	-6.13	-7.11
180	222	-16.71	-17.52	-17.67	-5.87	-6.45	-7.55
180	225	-16.80	-17.65	-17.81	-6.17	-6.80	-8.01
180	228	-16.75	-17.64	-17.77	-6.50	-7.20	-8.53
180	231	-16.61	-17.59	-17.68	-6.88	-7.65	-9.11
180	234	-16.40	-17.53	-17.54	-7.30	-8.15	-9.75
180	237	-16.17	-17.44	-17.37	-7.77	-8.71	-10.46
180	240	-15.93	-17.34	-17.20	-8.27	-9.33	-11.23
180	243	-15.66	-17.11	-16.96	-8.85	-10.05	-12.19
180	246	-15.34	-16.71	-16.63	-9.52	-10.91	-13.36
180	249	-14.98	-16.19	-16.27	-10.24	-11.84	-14.59
180	252	-14.60	-15.63	-15.91	-11.02	-12.80	-15.76
180	255	-14.22	-15.09	-15.62	-11.81	-13.76	-16.74
180	258	-13.81	-14.53	-15.40	-12.81	-14.87	-17.63
180	261	-13.36	-13.91	-15.21	-14.02	-16.17	-18.53
180	264	-12.90	-13.28	-15.03	-15.20	-17.41	-19.33
180	267	-12.45	-12.69	-14.84	-16.09	-18.33	-19.90
180	270	-12.05	-12.21	-14.60	-16.44	-18.70	-20.11
180	273	-11.67	-11.81	-14.28	-16.32	-18.43	-19.69
180	276	-11.31	-11.43	-13.88	-15.99	-17.73	-18.63
180	279	-10.97	-11.09	-13.44	-15.53	-16.79	-17.22
180	282	-10.66	-10.81	-13.03	-15.01	-15.77	-15.76
180	285	-10.40	-10.61	-12.68	-14.47	-14.84	-14.56
180	288	-10.17	-10.47	-12.40	-13.85	-13.99	-13.59
180	291	-9.95	-10.36	-12.14	-13.08	-13.07	-12.64
180	294	-9.75	-10.27	-11.90	-12.24	-12.16	-11.75
180	297	-9.60	-10.18	-11.68	-11.41	-11.29	-10.94
180	300	-9.51	-10.10	-11.47	-10.68	-10.54	-10.23
180	303	-9.47	-10.03	-11.26	-10.04	-9.87	-9.61
180	306	-9.44	-9.96	-11.05	-9.42	-9.26	-9.04

180	309	-9.41	-9.89	-10.86	-8.84	-8.69	-8.52
180	312	-9.40	-9.83	-10.69	-8.30	-8.17	-8.05
180	315	-9.39	-9.77	-10.54	-7.81	-7.69	-7.63
180	318	-9.39	-9.70	-10.40	-7.37	-7.24	-7.24
180	321	-9.41	-9.63	-10.27	-6.95	-6.82	-6.87
180	324	-9.43	-9.56	-10.15	-6.56	-6.44	-6.53
180	327	-9.46	-9.51	-10.06	-6.22	-6.09	-6.24
180	330	-9.49	-9.49	-10.03	-5.91	-5.80	-6.00
180	333	-9.57	-9.51	-10.04	-5.64	-5.54	-5.80
180	336	-9.72	-9.55	-10.08	-5.39	-5.30	-5.63
180	339	-9.90	-9.63	-10.14	-5.16	-5.09	-5.48
180	342	-10.11	-9.72	-10.21	-4.95	-4.90	-5.35
180	345	-10.32	-9.82	-10.30	-4.78	-4.75	-5.23
180	348	-10.52	-9.99	-10.47	-4.61	-4.63	-5.12
180	351	-10.75	-10.27	-10.78	-4.46	-4.51	-5.02
180	354	-10.99	-10.64	-11.20	-4.33	-4.41	-4.93
180	357	-11.24	-11.07	-11.69	-4.21	-4.33	-4.85
180	360	-11.51	-11.54	-12.23	-4.12	-4.27	-4.78



Frequency

V-Pol

theta

phi

2G0

2G1

2400MHz

2450MHz

2484MHz

2400MHz

2450MHz

2484MHz

0	0	-14.11	-13.92	-14.20	-19.16	-19.71	-20.57
0	3	-14.11	-13.93	-14.21	-19.17	-19.72	-20.57
0	6	-14.13	-13.94	-14.22	-19.20	-19.73	-20.57
0	9	-14.15	-13.97	-14.24	-19.23	-19.75	-20.58
0	12	-14.17	-13.99	-14.26	-19.27	-19.78	-20.59
0	15	-14.20	-14.02	-14.29	-19.32	-19.81	-20.59
0	18	-14.23	-14.05	-14.32	-19.38	-19.84	-20.60
0	21	-14.28	-14.10	-14.36	-19.46	-19.89	-20.62
0	24	-14.34	-14.16	-14.41	-19.55	-19.95	-20.63
0	27	-14.40	-14.22	-14.47	-19.66	-20.01	-20.65
0	30	-14.47	-14.29	-14.53	-19.76	-20.07	-20.67
0	33	-14.54	-14.36	-14.59	-19.88	-20.14	-20.68
0	36	-14.61	-14.44	-14.65	-20.02	-20.22	-20.71
0	39	-14.70	-14.52	-14.73	-20.16	-20.30	-20.73
0	42	-14.78	-14.60	-14.80	-20.31	-20.38	-20.75
0	45	-14.86	-14.69	-14.87	-20.46	-20.46	-20.77
0	48	-14.95	-14.78	-14.95	-20.62	-20.55	-20.79
0	51	-15.04	-14.87	-15.02	-20.79	-20.64	-20.81
0	54	-15.13	-14.96	-15.10	-20.96	-20.73	-20.83
0	57	-15.22	-15.05	-15.18	-21.13	-20.81	-20.86
0	60	-15.30	-15.13	-15.25	-21.29	-20.90	-20.87
0	63	-15.38	-15.21	-15.32	-21.45	-20.97	-20.89
0	66	-15.46	-15.29	-15.39	-21.62	-21.05	-20.91
0	69	-15.53	-15.37	-15.45	-21.78	-21.13	-20.93
0	72	-15.60	-15.43	-15.51	-21.92	-21.19	-20.94
0	75	-15.65	-15.48	-15.55	-22.02	-21.24	-20.95
0	78	-15.69	-15.52	-15.58	-22.11	-21.28	-20.96
0	81	-15.72	-15.56	-15.61	-22.19	-21.32	-20.97
0	84	-15.75	-15.59	-15.64	-22.26	-21.35	-20.98
0	87	-15.78	-15.61	-15.66	-22.30	-21.37	-20.98
0	90	-15.78	-15.62	-15.66	-22.32	-21.37	-20.98
0	93	-15.78	-15.61	-15.66	-22.30	-21.37	-20.98
0	96	-15.75	-15.59	-15.64	-22.26	-21.35	-20.98
0	99	-15.72	-15.56	-15.61	-22.19	-21.32	-20.97
0	102	-15.69	-15.52	-15.58	-22.11	-21.28	-20.96
0	105	-15.65	-15.48	-15.55	-22.02	-21.24	-20.95
0	108	-15.60	-15.43	-15.51	-21.92	-21.19	-20.94
0	111	-15.53	-15.37	-15.45	-21.78	-21.13	-20.93
0	114	-15.46	-15.29	-15.39	-21.62	-21.05	-20.91
0	117	-15.38	-15.21	-15.32	-21.45	-20.97	-20.89
0	120	-15.30	-15.13	-15.25	-21.29	-20.90	-20.87
0	123	-15.22	-15.05	-15.18	-21.13	-20.81	-20.86
0	126	-15.13	-14.96	-15.10	-20.96	-20.73	-20.83
0	129	-15.04	-14.87	-15.02	-20.79	-20.64	-20.81
0	132	-14.95	-14.78	-14.95	-20.62	-20.55	-20.79
0	135	-14.86	-14.69	-14.87	-20.46	-20.46	-20.77
0	138	-14.78	-14.60	-14.80	-20.31	-20.38	-20.75
0	141	-14.70	-14.52	-14.73	-20.16	-20.30	-20.73
0	144	-14.61	-14.44	-14.65	-20.02	-20.22	-20.71
0	147	-14.54	-14.36	-14.59	-19.88	-20.14	-20.68
0	150	-14.47	-14.29	-14.53	-19.76	-20.07	-20.67
0	153	-14.40	-14.22	-14.47	-19.66	-20.01	-20.65
0	156	-14.34	-14.16	-14.41	-19.55	-19.95	-20.63
0	159	-14.28	-14.10	-14.36	-19.46	-19.89	-20.62
0	162	-14.23	-14.05	-14.32	-19.38	-19.84	-20.60

0	165	-14.20	-14.02	-14.29	-19.32	-19.81	-20.59
0	168	-14.17	-13.99	-14.26	-19.27	-19.78	-20.59
0	171	-14.15	-13.97	-14.24	-19.23	-19.75	-20.58
0	174	-14.12	-13.94	-14.22	-19.20	-19.73	-20.57
0	177	-14.11	-13.93	-14.21	-19.17	-19.72	-20.57
0	180	-14.11	-13.92	-14.20	-19.16	-19.71	-20.57
0	183	-14.11	-13.93	-14.21	-19.17	-19.72	-20.57
0	186	-14.12	-13.94	-14.22	-19.20	-19.73	-20.57
0	189	-14.15	-13.97	-14.24	-19.23	-19.75	-20.58
0	192	-14.17	-13.99	-14.26	-19.27	-19.78	-20.59
0	195	-14.20	-14.02	-14.29	-19.32	-19.81	-20.59
0	198	-14.23	-14.05	-14.32	-19.38	-19.84	-20.60
0	201	-14.28	-14.10	-14.36	-19.46	-19.89	-20.62
0	204	-14.34	-14.16	-14.41	-19.55	-19.95	-20.63
0	207	-14.40	-14.22	-14.47	-19.66	-20.01	-20.65
0	210	-14.47	-14.29	-14.53	-19.76	-20.07	-20.67
0	213	-14.54	-14.36	-14.59	-19.88	-20.14	-20.68
0	216	-14.61	-14.44	-14.65	-20.02	-20.22	-20.71
0	219	-14.70	-14.52	-14.73	-20.16	-20.30	-20.73
0	222	-14.78	-14.60	-14.80	-20.31	-20.38	-20.75
0	225	-14.86	-14.69	-14.87	-20.46	-20.46	-20.77
0	228	-14.95	-14.78	-14.95	-20.62	-20.55	-20.79
0	231	-15.04	-14.87	-15.02	-20.79	-20.64	-20.81
0	234	-15.13	-14.96	-15.10	-20.96	-20.73	-20.83
0	237	-15.22	-15.05	-15.18	-21.13	-20.81	-20.86
0	240	-15.30	-15.13	-15.25	-21.29	-20.90	-20.87
0	243	-15.38	-15.21	-15.32	-21.45	-20.97	-20.89
0	246	-15.46	-15.29	-15.39	-21.62	-21.05	-20.91
0	249	-15.53	-15.37	-15.45	-21.78	-21.13	-20.93
0	252	-15.60	-15.43	-15.51	-21.92	-21.19	-20.94
0	255	-15.65	-15.48	-15.55	-22.02	-21.24	-20.95
0	258	-15.69	-15.52	-15.58	-22.11	-21.28	-20.96
0	261	-15.72	-15.56	-15.61	-22.19	-21.32	-20.97
0	264	-15.75	-15.59	-15.64	-22.26	-21.35	-20.98
0	267	-15.78	-15.61	-15.66	-22.30	-21.37	-20.98
0	270	-15.78	-15.62	-15.66	-22.32	-21.37	-20.98
0	273	-15.78	-15.61	-15.66	-22.30	-21.37	-20.98
0	276	-15.75	-15.59	-15.64	-22.26	-21.35	-20.98
0	279	-15.72	-15.56	-15.61	-22.19	-21.32	-20.97
0	282	-15.69	-15.52	-15.58	-22.11	-21.28	-20.96
0	285	-15.65	-15.48	-15.55	-22.02	-21.24	-20.95
0	288	-15.60	-15.43	-15.51	-21.92	-21.19	-20.94
0	291	-15.53	-15.37	-15.45	-21.78	-21.13	-20.93
0	294	-15.46	-15.29	-15.39	-21.62	-21.05	-20.91
0	297	-15.38	-15.21	-15.32	-21.45	-20.97	-20.89
0	300	-15.30	-15.13	-15.25	-21.29	-20.90	-20.87
0	303	-15.22	-15.05	-15.18	-21.13	-20.81	-20.86
0	306	-15.13	-14.96	-15.10	-20.96	-20.73	-20.83
0	309	-15.04	-14.87	-15.02	-20.79	-20.64	-20.81
0	312	-14.95	-14.78	-14.95	-20.62	-20.55	-20.79
0	315	-14.86	-14.69	-14.87	-20.46	-20.46	-20.77
0	318	-14.78	-14.60	-14.80	-20.31	-20.38	-20.75
0	321	-14.70	-14.52	-14.73	-20.16	-20.30	-20.73
0	324	-14.61	-14.44	-14.65	-20.02	-20.22	-20.71
0	327	-14.54	-14.36	-14.59	-19.88	-20.14	-20.68
0	330	-14.47	-14.29	-14.53	-19.76	-20.07	-20.67
0	333	-14.40	-14.22	-14.47	-19.66	-20.01	-20.65
0	336	-14.34	-14.16	-14.41	-19.55	-19.95	-20.63

0	339	-14.28	-14.10	-14.36	-19.46	-19.89	-20.62
0	342	-14.23	-14.05	-14.32	-19.38	-19.84	-20.60
0	345	-14.20	-14.02	-14.29	-19.32	-19.81	-20.59
0	348	-14.17	-13.99	-14.26	-19.27	-19.78	-20.59
0	351	-14.15	-13.97	-14.24	-19.23	-19.75	-20.58
0	354	-14.13	-13.94	-14.22	-19.20	-19.73	-20.57
0	357	-14.11	-13.93	-14.21	-19.17	-19.72	-20.57
0	360	-14.11	-13.92	-14.20	-19.16	-19.71	-20.57
3	0	-14.03	-13.82	-14.03	-18.43	-18.62	-18.76
3	3	-13.80	-13.54	-13.76	-18.72	-18.92	-19.00
3	6	-13.59	-13.29	-13.52	-18.94	-19.16	-19.20
3	9	-13.39	-13.07	-13.32	-19.09	-19.32	-19.35
3	12	-13.22	-12.90	-13.15	-19.17	-19.42	-19.45
3	15	-13.07	-12.77	-13.04	-19.20	-19.46	-19.48
3	18	-12.93	-12.67	-12.96	-19.14	-19.40	-19.46
3	21	-12.79	-12.58	-12.89	-18.97	-19.26	-19.40
3	24	-12.67	-12.50	-12.83	-18.74	-19.06	-19.31
3	27	-12.58	-12.45	-12.79	-18.50	-18.84	-19.20
3	30	-12.53	-12.43	-12.78	-18.27	-18.63	-19.08
3	33	-12.52	-12.44	-12.78	-18.03	-18.39	-18.90
3	36	-12.51	-12.46	-12.79	-17.74	-18.10	-18.64
3	39	-12.50	-12.47	-12.81	-17.47	-17.81	-18.35
3	42	-12.50	-12.49	-12.82	-17.26	-17.56	-18.07
3	45	-12.48	-12.50	-12.83	-17.18	-17.40	-17.85
3	48	-12.46	-12.48	-12.81	-17.18	-17.29	-17.68
3	51	-12.43	-12.44	-12.75	-17.19	-17.20	-17.53
3	54	-12.39	-12.39	-12.66	-17.20	-17.13	-17.39
3	57	-12.35	-12.33	-12.56	-17.22	-17.08	-17.28
3	60	-12.32	-12.28	-12.47	-17.23	-17.06	-17.21
3	63	-12.28	-12.22	-12.38	-17.28	-17.07	-17.16
3	66	-12.25	-12.16	-12.26	-17.36	-17.08	-17.12
3	69	-12.22	-12.10	-12.14	-17.46	-17.09	-17.09
3	72	-12.20	-12.05	-12.03	-17.57	-17.11	-17.07
3	75	-12.18	-11.99	-11.95	-17.66	-17.13	-17.06
3	78	-12.17	-11.95	-11.89	-17.75	-17.16	-17.07
3	81	-12.16	-11.91	-11.84	-17.84	-17.21	-17.11
3	84	-12.15	-11.87	-11.79	-17.93	-17.27	-17.17
3	87	-12.14	-11.83	-11.75	-18.02	-17.34	-17.25
3	90	-12.13	-11.78	-11.70	-18.11	-17.43	-17.33
3	93	-12.09	-11.72	-11.66	-18.20	-17.53	-17.43
3	96	-12.01	-11.66	-11.62	-18.29	-17.65	-17.59
3	99	-11.91	-11.58	-11.58	-18.38	-17.81	-17.78
3	102	-11.80	-11.50	-11.54	-18.49	-17.98	-18.00
3	105	-11.69	-11.42	-11.49	-18.61	-18.18	-18.24
3	108	-11.59	-11.33	-11.44	-18.78	-18.43	-18.53
3	111	-11.47	-11.24	-11.39	-18.98	-18.74	-18.90
3	114	-11.35	-11.15	-11.33	-19.21	-19.10	-19.29
3	117	-11.23	-11.05	-11.27	-19.47	-19.47	-19.67
3	120	-11.12	-10.96	-11.20	-19.73	-19.82	-19.98
3	123	-11.01	-10.88	-11.14	-20.05	-20.22	-20.25
3	126	-10.90	-10.79	-11.07	-20.46	-20.69	-20.52
3	129	-10.80	-10.71	-11.00	-20.85	-21.13	-20.76
3	132	-10.70	-10.62	-10.93	-21.15	-21.46	-20.94
3	135	-10.61	-10.54	-10.85	-21.27	-21.59	-21.00
3	138	-10.52	-10.46	-10.77	-21.15	-21.47	-20.97
3	141	-10.44	-10.38	-10.69	-20.84	-21.15	-20.90
3	144	-10.36	-10.30	-10.60	-20.45	-20.73	-20.80
3	147	-10.29	-10.22	-10.51	-20.05	-20.32	-20.68

3	150	-10.23	-10.15	-10.43	-19.75	-20.01	-20.57
3	153	-10.17	-10.08	-10.35	-19.55	-19.80	-20.45
3	156	-10.11	-10.01	-10.27	-19.36	-19.61	-20.32
3	159	-10.06	-9.95	-10.19	-19.20	-19.43	-20.18
3	162	-10.02	-9.89	-10.13	-19.04	-19.27	-20.04
3	165	-10.00	-9.86	-10.09	-18.87	-19.12	-19.92
3	168	-9.99	-9.84	-10.07	-18.71	-18.97	-19.82
3	171	-9.99	-9.82	-10.05	-18.56	-18.84	-19.72
3	174	-9.98	-9.80	-10.04	-18.41	-18.71	-19.63
3	177	-9.98	-9.79	-10.03	-18.26	-18.58	-19.54
3	180	-9.97	-9.79	-10.03	-18.10	-18.45	-19.44
3	183	-9.98	-9.80	-10.04	-17.94	-18.32	-19.34
3	186	-10.01	-9.82	-10.08	-17.79	-18.19	-19.23
3	189	-10.05	-9.86	-10.13	-17.63	-18.06	-19.11
3	192	-10.09	-9.90	-10.19	-17.47	-17.93	-18.99
3	195	-10.14	-9.95	-10.25	-17.33	-17.80	-18.86
3	198	-10.21	-10.01	-10.33	-17.18	-17.66	-18.71
3	201	-10.29	-10.10	-10.42	-17.02	-17.51	-18.55
3	204	-10.39	-10.20	-10.52	-16.88	-17.37	-18.38
3	207	-10.50	-10.31	-10.64	-16.75	-17.24	-18.21
3	210	-10.61	-10.43	-10.76	-16.67	-17.12	-18.07
3	213	-10.74	-10.56	-10.90	-16.61	-17.02	-17.93
3	216	-10.90	-10.72	-11.06	-16.56	-16.92	-17.78
3	219	-11.06	-10.89	-11.24	-16.52	-16.83	-17.65
3	222	-11.22	-11.07	-11.41	-16.49	-16.77	-17.55
3	225	-11.38	-11.23	-11.58	-16.48	-16.74	-17.49
3	228	-11.54	-11.40	-11.74	-16.51	-16.75	-17.47
3	231	-11.70	-11.57	-11.91	-16.57	-16.78	-17.44
3	234	-11.86	-11.73	-12.07	-16.66	-16.81	-17.43
3	237	-12.01	-11.89	-12.22	-16.76	-16.86	-17.41
3	240	-12.14	-12.03	-12.35	-16.87	-16.91	-17.41
3	243	-12.27	-12.15	-12.47	-16.99	-16.98	-17.45
3	246	-12.38	-12.27	-12.58	-17.14	-17.09	-17.54
3	249	-12.49	-12.38	-12.68	-17.30	-17.23	-17.67
3	252	-12.60	-12.48	-12.77	-17.48	-17.38	-17.82
3	255	-12.72	-12.59	-12.86	-17.66	-17.54	-17.98
3	258	-12.84	-12.69	-12.94	-17.85	-17.72	-18.16
3	261	-12.96	-12.80	-13.02	-18.07	-17.94	-18.40
3	264	-13.09	-12.90	-13.09	-18.28	-18.17	-18.66
3	267	-13.22	-13.00	-13.16	-18.48	-18.40	-18.92
3	270	-13.34	-13.10	-13.23	-18.63	-18.59	-19.16
3	273	-13.46	-13.19	-13.30	-18.77	-18.78	-19.42
3	276	-13.58	-13.27	-13.35	-18.89	-18.98	-19.70
3	279	-13.69	-13.36	-13.41	-19.00	-19.16	-19.96
3	282	-13.81	-13.44	-13.47	-19.08	-19.28	-20.15
3	285	-13.94	-13.53	-13.55	-19.11	-19.33	-20.23
3	288	-14.08	-13.64	-13.65	-19.07	-19.30	-20.19
3	291	-14.22	-13.76	-13.78	-18.96	-19.21	-20.08
3	294	-14.37	-13.88	-13.92	-18.81	-19.09	-19.93
3	297	-14.53	-14.00	-14.06	-18.64	-18.96	-19.75
3	300	-14.71	-14.12	-14.20	-18.48	-18.82	-19.58
3	303	-14.88	-14.22	-14.31	-18.32	-18.67	-19.39
3	306	-15.05	-14.30	-14.42	-18.13	-18.48	-19.16
3	309	-15.25	-14.40	-14.53	-17.94	-18.28	-18.92
3	312	-15.48	-14.52	-14.67	-17.76	-18.10	-18.71
3	315	-15.77	-14.69	-14.87	-17.62	-17.96	-18.54
3	318	-16.32	-15.26	-15.48	-17.50	-17.84	-18.41
3	321	-17.17	-16.32	-16.62	-17.39	-17.73	-18.28



3	324	-18.07	-17.52	-17.90	-17.29	-17.63	-18.17
3	327	-18.79	-18.51	-18.94	-17.22	-17.57	-18.09
3	330	-19.08	-18.91	-19.37	-17.19	-17.54	-18.06
3	333	-18.90	-18.76	-19.19	-17.20	-17.55	-18.07
3	336	-18.43	-18.36	-18.71	-17.24	-17.59	-18.09
3	339	-17.79	-17.81	-18.06	-17.29	-17.64	-18.12
3	342	-17.12	-17.21	-17.36	-17.35	-17.70	-18.16
3	345	-16.53	-16.65	-16.75	-17.42	-17.78	-18.20
3	348	-16.03	-16.13	-16.21	-17.53	-17.87	-18.27
3	351	-15.52	-15.59	-15.67	-17.70	-18.02	-18.36
3	354	-15.03	-15.02	-15.13	-17.91	-18.19	-18.48
3	357	-14.53	-14.43	-14.58	-18.16	-18.40	-18.61
3	360	-14.03	-13.82	-14.03	-18.43	-18.62	-18.76
6	0	-13.83	-13.52	-13.68	-17.53	-17.43	-17.01
6	3	-13.41	-13.04	-13.22	-18.06	-17.95	-17.44
6	6	-13.02	-12.60	-12.80	-18.44	-18.35	-17.79
6	9	-12.65	-12.21	-12.43	-18.70	-18.63	-18.07
6	12	-12.32	-11.88	-12.12	-18.84	-18.79	-18.24
6	15	-12.02	-11.62	-11.89	-18.89	-18.85	-18.30
6	18	-11.73	-11.39	-11.70	-18.75	-18.75	-18.26
6	21	-11.44	-11.18	-11.53	-18.40	-18.48	-18.16
6	24	-11.19	-11.01	-11.38	-17.92	-18.11	-18.00
6	27	-10.99	-10.88	-11.28	-17.39	-17.69	-17.80
6	30	-10.86	-10.83	-11.24	-16.90	-17.27	-17.59
6	33	-10.80	-10.82	-11.23	-16.37	-16.79	-17.25
6	36	-10.76	-10.82	-11.23	-15.76	-16.20	-16.74
6	39	-10.72	-10.82	-11.23	-15.15	-15.58	-16.16
6	42	-10.69	-10.81	-11.23	-14.62	-15.03	-15.60
6	45	-10.64	-10.80	-11.22	-14.27	-14.62	-15.17
6	48	-10.58	-10.76	-11.16	-14.05	-14.32	-14.83
6	51	-10.50	-10.67	-11.03	-13.85	-14.05	-14.51
6	54	-10.41	-10.54	-10.85	-13.69	-13.83	-14.22
6	57	-10.32	-10.40	-10.65	-13.58	-13.65	-14.00
6	60	-10.23	-10.26	-10.45	-13.54	-13.55	-13.84
6	63	-10.13	-10.12	-10.25	-13.54	-13.49	-13.73
6	66	-10.02	-9.95	-10.00	-13.56	-13.44	-13.64
6	69	-9.91	-9.77	-9.75	-13.59	-13.40	-13.56
6	72	-9.80	-9.60	-9.51	-13.63	-13.37	-13.51
6	75	-9.70	-9.44	-9.31	-13.67	-13.36	-13.49
6	78	-9.60	-9.29	-9.14	-13.73	-13.38	-13.52
6	81	-9.52	-9.14	-8.98	-13.83	-13.45	-13.59
6	84	-9.43	-9.01	-8.83	-13.96	-13.55	-13.70
6	87	-9.34	-8.87	-8.70	-14.10	-13.67	-13.83
6	90	-9.23	-8.73	-8.58	-14.26	-13.81	-13.98
6	93	-9.09	-8.60	-8.48	-14.43	-13.99	-14.19
6	96	-8.94	-8.46	-8.40	-14.64	-14.26	-14.49
6	99	-8.77	-8.33	-8.32	-14.89	-14.59	-14.87
6	102	-8.60	-8.20	-8.24	-15.17	-14.97	-15.30
6	105	-8.43	-8.07	-8.17	-15.49	-15.38	-15.75
6	108	-8.27	-7.94	-8.10	-15.90	-15.90	-16.31
6	111	-8.10	-7.82	-8.03	-16.42	-16.55	-17.00
6	114	-7.94	-7.70	-7.96	-17.01	-17.28	-17.75
6	117	-7.78	-7.59	-7.90	-17.64	-18.04	-18.46
6	120	-7.63	-7.48	-7.83	-18.27	-18.76	-19.06
6	123	-7.50	-7.38	-7.75	-19.03	-19.57	-19.60
6	126	-7.36	-7.29	-7.68	-19.94	-20.50	-20.16
6	129	-7.24	-7.20	-7.61	-20.83	-21.37	-20.65
6	132	-7.12	-7.12	-7.53	-21.49	-22.02	-21.01

6	135	-7.02	-7.03	-7.45	-21.76	-22.28	-21.14
6	138	-6.92	-6.95	-7.36	-21.60	-22.08	-21.08
6	141	-6.83	-6.86	-7.26	-21.20	-21.59	-20.94
6	144	-6.75	-6.78	-7.15	-20.67	-20.96	-20.73
6	147	-6.68	-6.70	-7.04	-20.14	-20.32	-20.51
6	150	-6.61	-6.62	-6.94	-19.72	-19.83	-20.30
6	153	-6.55	-6.54	-6.84	-19.40	-19.49	-20.09
6	156	-6.50	-6.47	-6.73	-19.12	-19.18	-19.86
6	159	-6.45	-6.39	-6.63	-18.85	-18.90	-19.61
6	162	-6.41	-6.33	-6.55	-18.59	-18.63	-19.38
6	165	-6.40	-6.30	-6.50	-18.33	-18.37	-19.17
6	168	-6.40	-6.28	-6.48	-18.07	-18.13	-18.99
6	171	-6.40	-6.26	-6.46	-17.83	-17.91	-18.83
6	174	-6.40	-6.25	-6.45	-17.59	-17.70	-18.68
6	177	-6.41	-6.24	-6.44	-17.34	-17.48	-18.52
6	180	-6.42	-6.23	-6.44	-17.07	-17.25	-18.34
6	183	-6.44	-6.25	-6.46	-16.78	-17.00	-18.15
6	186	-6.48	-6.28	-6.51	-16.47	-16.75	-17.94
6	189	-6.54	-6.34	-6.59	-16.14	-16.49	-17.72
6	192	-6.61	-6.40	-6.69	-15.82	-16.23	-17.49
6	195	-6.68	-6.47	-6.78	-15.49	-15.95	-17.24
6	198	-6.77	-6.56	-6.89	-15.15	-15.65	-16.96
6	201	-6.89	-6.68	-7.02	-14.80	-15.34	-16.64
6	204	-7.03	-6.82	-7.17	-14.44	-15.01	-16.31
6	207	-7.19	-6.97	-7.34	-14.12	-14.71	-15.98
6	210	-7.35	-7.14	-7.52	-13.84	-14.43	-15.69
6	213	-7.53	-7.33	-7.72	-13.58	-14.15	-15.40
6	216	-7.74	-7.54	-7.95	-13.32	-13.86	-15.11
6	219	-7.96	-7.78	-8.20	-13.09	-13.59	-14.84
6	222	-8.19	-8.02	-8.45	-12.93	-13.40	-14.62
6	225	-8.41	-8.25	-8.69	-12.86	-13.33	-14.49
6	228	-8.62	-8.47	-8.92	-12.87	-13.33	-14.42
6	231	-8.83	-8.70	-9.15	-12.88	-13.33	-14.35
6	234	-9.04	-8.93	-9.38	-12.89	-13.33	-14.30
6	237	-9.25	-9.14	-9.60	-12.91	-13.33	-14.27
6	240	-9.44	-9.34	-9.79	-12.94	-13.33	-14.26
6	243	-9.61	-9.51	-9.96	-13.01	-13.38	-14.32
6	246	-9.77	-9.67	-10.12	-13.15	-13.53	-14.48
6	249	-9.92	-9.83	-10.27	-13.34	-13.74	-14.71
6	252	-10.08	-9.98	-10.41	-13.55	-13.98	-14.98
6	255	-10.25	-10.14	-10.55	-13.77	-14.23	-15.27
6	258	-10.44	-10.31	-10.68	-14.02	-14.52	-15.61
6	261	-10.64	-10.47	-10.81	-14.32	-14.88	-16.05
6	264	-10.84	-10.64	-10.93	-14.65	-15.29	-16.54
6	267	-11.05	-10.81	-11.05	-14.97	-15.69	-17.04
6	270	-11.26	-10.98	-11.17	-15.26	-16.05	-17.49
6	273	-11.47	-11.14	-11.28	-15.55	-16.41	-17.95
6	276	-11.68	-11.29	-11.39	-15.86	-16.81	-18.45
6	279	-11.90	-11.44	-11.49	-16.15	-17.17	-18.91
6	282	-12.13	-11.61	-11.61	-16.35	-17.43	-19.25
6	285	-12.38	-11.79	-11.76	-16.43	-17.54	-19.38
6	288	-12.67	-12.02	-11.97	-16.40	-17.49	-19.31
6	291	-12.99	-12.28	-12.24	-16.31	-17.38	-19.12
6	294	-13.34	-12.57	-12.56	-16.18	-17.23	-18.86
6	297	-13.70	-12.87	-12.89	-16.03	-17.05	-18.56
6	300	-14.09	-13.16	-13.20	-15.89	-16.86	-18.27
6	303	-14.46	-13.42	-13.49	-15.72	-16.65	-17.93
6	306	-14.84	-13.66	-13.74	-15.51	-16.37	-17.53

6	309	-15.25	-13.92	-14.03	-15.30	-16.08	-17.11
6	312	-15.73	-14.25	-14.38	-15.12	-15.82	-16.73
6	315	-16.32	-14.68	-14.85	-15.01	-15.63	-16.44
6	318	-17.36	-15.78	-16.02	-14.94	-15.50	-16.22
6	321	-18.90	-17.67	-18.03	-14.89	-15.38	-16.00
6	324	-20.51	-19.76	-20.24	-14.84	-15.28	-15.82
6	327	-21.79	-21.45	-22.03	-14.82	-15.21	-15.69
6	330	-22.31	-22.14	-22.77	-14.80	-15.19	-15.64
6	333	-22.00	-21.88	-22.45	-14.85	-15.22	-15.66
6	336	-21.19	-21.21	-21.63	-14.98	-15.33	-15.71
6	339	-20.12	-20.29	-20.52	-15.16	-15.48	-15.78
6	342	-18.97	-19.28	-19.34	-15.38	-15.65	-15.87
6	345	-17.98	-18.34	-18.30	-15.61	-15.84	-15.96
6	348	-17.14	-17.46	-17.38	-15.87	-16.06	-16.09
6	351	-16.30	-16.54	-16.47	-16.21	-16.34	-16.27
6	354	-15.47	-15.57	-15.54	-16.60	-16.66	-16.48
6	357	-14.65	-14.57	-14.62	-17.05	-17.03	-16.73
6	360	-13.83	-13.52	-13.68	-17.53	-17.43	-17.01
9	0	-13.53	-13.09	-13.21	-16.47	-16.16	-15.31
9	3	-12.96	-12.47	-12.61	-17.22	-16.84	-15.88
9	6	-12.42	-11.89	-12.07	-17.77	-17.37	-16.37
9	9	-11.92	-11.38	-11.58	-18.13	-17.74	-16.74
9	12	-11.47	-10.95	-11.18	-18.34	-17.96	-16.98
9	15	-11.07	-10.60	-10.88	-18.40	-18.04	-17.07
9	18	-10.68	-10.31	-10.63	-18.22	-17.91	-17.02
9	21	-10.30	-10.03	-10.40	-17.74	-17.58	-16.90
9	24	-9.96	-9.80	-10.20	-17.09	-17.11	-16.71
9	27	-9.70	-9.63	-10.07	-16.36	-16.57	-16.48
9	30	-9.55	-9.57	-10.02	-15.67	-16.03	-16.22
9	33	-9.49	-9.58	-10.02	-14.95	-15.39	-15.79
9	36	-9.44	-9.58	-10.03	-14.11	-14.58	-15.11
9	39	-9.41	-9.59	-10.04	-13.26	-13.73	-14.32
9	42	-9.37	-9.60	-10.05	-12.50	-12.95	-13.56
9	45	-9.33	-9.60	-10.05	-11.95	-12.36	-12.96
9	48	-9.26	-9.56	-9.99	-11.54	-11.91	-12.48
9	51	-9.19	-9.46	-9.83	-11.17	-11.49	-12.03
9	54	-9.11	-9.31	-9.61	-10.86	-11.14	-11.62
9	57	-9.01	-9.14	-9.36	-10.63	-10.85	-11.29
9	60	-8.91	-8.96	-9.11	-10.51	-10.66	-11.07
9	63	-8.78	-8.77	-8.84	-10.46	-10.53	-10.90
9	66	-8.62	-8.52	-8.52	-10.42	-10.42	-10.76
9	69	-8.45	-8.25	-8.17	-10.39	-10.32	-10.64
9	72	-8.26	-7.98	-7.83	-10.37	-10.26	-10.56
9	75	-8.08	-7.72	-7.53	-10.36	-10.24	-10.53
9	78	-7.90	-7.47	-7.26	-10.40	-10.27	-10.57
9	81	-7.71	-7.22	-6.99	-10.51	-10.35	-10.66
9	84	-7.52	-6.97	-6.74	-10.66	-10.47	-10.81
9	87	-7.32	-6.73	-6.51	-10.85	-10.63	-10.98
9	90	-7.11	-6.51	-6.32	-11.05	-10.80	-11.18
9	93	-6.89	-6.29	-6.16	-11.29	-11.05	-11.47
9	96	-6.66	-6.09	-6.02	-11.60	-11.42	-11.89
9	99	-6.42	-5.90	-5.90	-11.97	-11.89	-12.41
9	102	-6.19	-5.71	-5.78	-12.40	-12.43	-12.99
9	105	-5.97	-5.54	-5.68	-12.89	-13.02	-13.62
9	108	-5.75	-5.38	-5.58	-13.49	-13.74	-14.37
9	111	-5.54	-5.23	-5.49	-14.25	-14.65	-15.30
9	114	-5.34	-5.08	-5.41	-15.12	-15.66	-16.30
9	117	-5.15	-4.94	-5.33	-16.03	-16.71	-17.28

9	120	-4.97	-4.82	-5.25	-16.95	-17.72	-18.11
9	123	-4.81	-4.71	-5.16	-18.06	-18.84	-18.90
9	126	-4.65	-4.61	-5.08	-19.38	-20.14	-19.73
9	129	-4.51	-4.51	-5.00	-20.66	-21.36	-20.47
9	132	-4.38	-4.42	-4.92	-21.63	-22.27	-21.01
9	135	-4.26	-4.33	-4.83	-22.01	-22.63	-21.21
9	138	-4.15	-4.23	-4.72	-21.83	-22.39	-21.12
9	141	-4.05	-4.14	-4.60	-21.38	-21.78	-20.89
9	144	-3.96	-4.05	-4.48	-20.79	-20.99	-20.56
9	147	-3.88	-3.97	-4.36	-20.17	-20.19	-20.21
9	150	-3.81	-3.89	-4.24	-19.66	-19.56	-19.89
9	153	-3.75	-3.80	-4.12	-19.23	-19.10	-19.59
9	156	-3.69	-3.71	-3.98	-18.82	-18.68	-19.27
9	159	-3.63	-3.63	-3.86	-18.43	-18.28	-18.94
9	162	-3.59	-3.56	-3.76	-18.05	-17.92	-18.63
9	165	-3.58	-3.52	-3.71	-17.69	-17.57	-18.35
9	168	-3.58	-3.50	-3.68	-17.35	-17.26	-18.12
9	171	-3.59	-3.48	-3.66	-17.04	-16.97	-17.91
9	174	-3.60	-3.47	-3.64	-16.74	-16.69	-17.71
9	177	-3.61	-3.46	-3.63	-16.42	-16.41	-17.51
9	180	-3.63	-3.45	-3.63	-16.07	-16.11	-17.27
9	183	-3.66	-3.47	-3.66	-15.67	-15.77	-17.01
9	186	-3.72	-3.52	-3.73	-15.24	-15.42	-16.73
9	189	-3.80	-3.59	-3.83	-14.79	-15.06	-16.43
9	192	-3.89	-3.67	-3.94	-14.32	-14.68	-16.10
9	195	-3.99	-3.76	-4.07	-13.86	-14.29	-15.76
9	198	-4.11	-3.87	-4.20	-13.37	-13.88	-15.37
9	201	-4.26	-4.02	-4.36	-12.86	-13.43	-14.93
9	204	-4.44	-4.19	-4.55	-12.35	-12.97	-14.47
9	207	-4.63	-4.38	-4.75	-11.87	-12.53	-14.03
9	210	-4.84	-4.58	-4.97	-11.46	-12.13	-13.62
9	213	-5.06	-4.81	-5.21	-11.06	-11.73	-13.23
9	216	-5.30	-5.07	-5.49	-10.66	-11.31	-12.83
9	219	-5.57	-5.35	-5.79	-10.30	-10.93	-12.46
9	222	-5.83	-5.63	-6.09	-10.04	-10.64	-12.16
9	225	-6.09	-5.90	-6.38	-9.91	-10.51	-11.99
9	228	-6.34	-6.17	-6.67	-9.87	-10.48	-11.89
9	231	-6.60	-6.45	-6.95	-9.83	-10.46	-11.80
9	234	-6.85	-6.72	-7.23	-9.81	-10.44	-11.74
9	237	-7.10	-6.98	-7.50	-9.79	-10.43	-11.69
9	240	-7.33	-7.22	-7.74	-9.79	-10.43	-11.68
9	243	-7.54	-7.44	-7.96	-9.84	-10.50	-11.76
9	246	-7.74	-7.65	-8.17	-9.98	-10.68	-11.98
9	249	-7.94	-7.85	-8.36	-10.18	-10.93	-12.30
9	252	-8.14	-8.04	-8.55	-10.41	-11.24	-12.67
9	255	-8.36	-8.25	-8.73	-10.65	-11.55	-13.05
9	258	-8.59	-8.47	-8.91	-10.93	-11.92	-13.51
9	261	-8.85	-8.69	-9.08	-11.29	-12.39	-14.10
9	264	-9.11	-8.91	-9.25	-11.68	-12.90	-14.76
9	267	-9.38	-9.14	-9.42	-12.08	-13.42	-15.41
9	270	-9.66	-9.36	-9.58	-12.45	-13.89	-16.00
9	273	-9.92	-9.56	-9.72	-12.84	-14.37	-16.59
9	276	-10.19	-9.75	-9.85	-13.27	-14.90	-17.24
9	279	-10.47	-9.94	-9.98	-13.68	-15.38	-17.83
9	282	-10.77	-10.15	-10.13	-13.98	-15.73	-18.26
9	285	-11.10	-10.39	-10.32	-14.09	-15.87	-18.43
9	288	-11.49	-10.69	-10.59	-14.06	-15.82	-18.33
9	291	-11.93	-11.04	-10.95	-13.98	-15.68	-18.08

9	294	-12.40	-11.44	-11.38	-13.86	-15.49	-17.72
9	297	-12.91	-11.85	-11.83	-13.72	-15.26	-17.32
9	300	-13.44	-12.28	-12.28	-13.59	-15.04	-16.92
9	303	-13.97	-12.67	-12.70	-13.41	-14.77	-16.48
9	306	-14.51	-13.05	-13.10	-13.18	-14.42	-15.94
9	309	-15.10	-13.48	-13.56	-12.95	-14.06	-15.39
9	312	-15.79	-14.00	-14.11	-12.76	-13.74	-14.89
9	315	-16.60	-14.67	-14.82	-12.68	-13.52	-14.51
9	318	-17.99	-16.15	-16.39	-12.67	-13.38	-14.21
9	321	-19.98	-18.57	-18.96	-12.66	-13.25	-13.92
9	324	-22.06	-21.20	-21.76	-12.66	-13.15	-13.68
9	327	-23.70	-23.32	-24.00	-12.65	-13.08	-13.51
9	330	-24.36	-24.18	-24.93	-12.65	-13.05	-13.45
9	333	-23.95	-23.85	-24.51	-12.72	-13.11	-13.48
9	336	-22.91	-22.98	-23.45	-12.92	-13.26	-13.54
9	339	-21.51	-21.80	-22.02	-13.20	-13.48	-13.64
9	342	-20.04	-20.49	-20.49	-13.53	-13.74	-13.77
9	345	-18.76	-19.28	-19.14	-13.87	-14.01	-13.90
9	348	-17.69	-18.16	-17.97	-14.25	-14.31	-14.07
9	351	-16.63	-16.97	-16.78	-14.71	-14.69	-14.31
9	354	-15.58	-15.73	-15.60	-15.24	-15.13	-14.60
9	357	-14.55	-14.43	-14.40	-15.83	-15.62	-14.94
9	360	-13.53	-13.09	-13.21	-16.47	-16.16	-15.31
12	0	-13.14	-12.56	-12.64	-15.29	-14.80	-13.67
12	3	-12.45	-11.85	-11.96	-16.23	-15.61	-14.34
12	6	-11.80	-11.19	-11.34	-16.94	-16.25	-14.92
12	9	-11.21	-10.61	-10.80	-17.43	-16.71	-15.38
12	12	-10.69	-10.13	-10.36	-17.71	-16.98	-15.67
12	15	-10.24	-9.77	-10.04	-17.80	-17.08	-15.78
12	18	-9.83	-9.47	-9.79	-17.58	-16.94	-15.74
12	21	-9.43	-9.20	-9.57	-17.03	-16.58	-15.62
12	24	-9.08	-8.97	-9.38	-16.27	-16.07	-15.45
12	27	-8.82	-8.81	-9.26	-15.42	-15.49	-15.24
12	30	-8.69	-8.75	-9.22	-14.63	-14.90	-14.99
12	33	-8.65	-8.77	-9.23	-13.82	-14.21	-14.55
12	36	-8.62	-8.80	-9.26	-12.88	-13.33	-13.83
12	39	-8.60	-8.84	-9.30	-11.93	-12.40	-12.97
12	42	-8.57	-8.87	-9.33	-11.07	-11.52	-12.13
12	45	-8.54	-8.89	-9.34	-10.41	-10.83	-11.45
12	48	-8.50	-8.85	-9.28	-9.89	-10.29	-10.89
12	51	-8.44	-8.75	-9.12	-9.41	-9.78	-10.35
12	54	-8.38	-8.61	-8.89	-8.99	-9.33	-9.87
12	57	-8.30	-8.45	-8.63	-8.67	-8.97	-9.46
12	60	-8.21	-8.27	-8.36	-8.47	-8.71	-9.18
12	63	-8.08	-8.05	-8.06	-8.34	-8.51	-8.96
12	66	-7.90	-7.76	-7.70	-8.23	-8.34	-8.77
12	69	-7.68	-7.43	-7.30	-8.14	-8.20	-8.61
12	72	-7.44	-7.09	-6.90	-8.09	-8.10	-8.50
12	75	-7.20	-6.76	-6.53	-8.07	-8.06	-8.46
12	78	-6.95	-6.43	-6.18	-8.11	-8.10	-8.50
12	81	-6.68	-6.09	-5.84	-8.22	-8.18	-8.60
12	84	-6.39	-5.76	-5.50	-8.39	-8.32	-8.76
12	87	-6.10	-5.43	-5.20	-8.59	-8.49	-8.95
12	90	-5.81	-5.14	-4.95	-8.81	-8.68	-9.17
12	93	-5.53	-4.87	-4.74	-9.08	-8.96	-9.49
12	96	-5.24	-4.62	-4.56	-9.45	-9.39	-9.97
12	99	-4.95	-4.38	-4.39	-9.91	-9.94	-10.57
12	102	-4.67	-4.15	-4.24	-10.44	-10.57	-11.24

12	105	-4.41	-3.95	-4.11	-11.02	-11.25	-11.96
12	108	-4.16	-3.76	-3.99	-11.73	-12.08	-12.82
12	111	-3.92	-3.58	-3.89	-12.61	-13.12	-13.87
12	114	-3.69	-3.41	-3.79	-13.62	-14.28	-15.01
12	117	-3.47	-3.26	-3.70	-14.70	-15.50	-16.13
12	120	-3.28	-3.12	-3.60	-15.80	-16.69	-17.14
12	123	-3.09	-3.00	-3.51	-17.15	-18.05	-18.15
12	126	-2.92	-2.88	-3.42	-18.80	-19.65	-19.24
12	129	-2.76	-2.78	-3.33	-20.40	-21.17	-20.24
12	132	-2.61	-2.68	-3.24	-21.62	-22.31	-20.96
12	135	-2.48	-2.58	-3.13	-22.10	-22.76	-21.24
12	138	-2.37	-2.48	-3.02	-21.92	-22.48	-21.11
12	141	-2.26	-2.39	-2.89	-21.46	-21.79	-20.77
12	144	-2.16	-2.29	-2.75	-20.83	-20.88	-20.31
12	147	-2.07	-2.20	-2.62	-20.16	-19.95	-19.81
12	150	-2.00	-2.11	-2.49	-19.57	-19.21	-19.38
12	153	-1.93	-2.02	-2.35	-19.04	-18.64	-18.99
12	156	-1.86	-1.92	-2.21	-18.50	-18.10	-18.58
12	159	-1.80	-1.83	-2.07	-17.96	-17.61	-18.18
12	162	-1.76	-1.76	-1.95	-17.44	-17.14	-17.81
12	165	-1.75	-1.72	-1.89	-16.98	-16.72	-17.48
12	168	-1.75	-1.69	-1.86	-16.57	-16.35	-17.20
12	171	-1.76	-1.67	-1.84	-16.21	-16.02	-16.96
12	174	-1.77	-1.66	-1.82	-15.86	-15.70	-16.74
12	177	-1.79	-1.65	-1.80	-15.50	-15.38	-16.50
12	180	-1.81	-1.64	-1.80	-15.10	-15.03	-16.23
12	183	-1.85	-1.67	-1.83	-14.63	-14.63	-15.93
12	186	-1.92	-1.72	-1.91	-14.12	-14.22	-15.59
12	189	-2.02	-1.80	-2.02	-13.58	-13.78	-15.23
12	192	-2.12	-1.90	-2.16	-13.02	-13.33	-14.84
12	195	-2.24	-2.01	-2.29	-12.48	-12.87	-14.43
12	198	-2.38	-2.13	-2.45	-11.91	-12.38	-13.98
12	201	-2.56	-2.30	-2.63	-11.31	-11.86	-13.47
12	204	-2.76	-2.49	-2.84	-10.72	-11.33	-12.94
12	207	-2.99	-2.71	-3.06	-10.17	-10.82	-12.43
12	210	-3.22	-2.93	-3.31	-9.69	-10.37	-11.97
12	213	-3.46	-3.18	-3.57	-9.24	-9.92	-11.53
12	216	-3.73	-3.46	-3.88	-8.79	-9.46	-11.09
12	219	-4.02	-3.76	-4.21	-8.39	-9.04	-10.68
12	222	-4.30	-4.07	-4.54	-8.08	-8.73	-10.36
12	225	-4.59	-4.37	-4.86	-7.92	-8.59	-10.18
12	228	-4.86	-4.66	-5.17	-7.84	-8.56	-10.10
12	231	-5.14	-4.97	-5.49	-7.78	-8.53	-10.04
12	234	-5.42	-5.27	-5.81	-7.73	-8.51	-9.98
12	237	-5.69	-5.56	-6.11	-7.70	-8.49	-9.95
12	240	-5.95	-5.83	-6.38	-7.69	-8.49	-9.94
12	243	-6.20	-6.09	-6.64	-7.74	-8.57	-10.04
12	246	-6.43	-6.33	-6.88	-7.88	-8.77	-10.30
12	249	-6.65	-6.56	-7.11	-8.08	-9.07	-10.68
12	252	-6.89	-6.79	-7.33	-8.32	-9.41	-11.11
12	255	-7.14	-7.03	-7.55	-8.57	-9.75	-11.55
12	258	-7.41	-7.29	-7.76	-8.86	-10.16	-12.07
12	261	-7.70	-7.55	-7.97	-9.24	-10.67	-12.71
12	264	-8.00	-7.81	-8.17	-9.66	-11.23	-13.41
12	267	-8.31	-8.07	-8.36	-10.08	-11.78	-14.11
12	270	-8.62	-8.31	-8.55	-10.47	-12.28	-14.75
12	273	-8.92	-8.54	-8.71	-10.88	-12.79	-15.39
12	276	-9.22	-8.75	-8.85	-11.33	-13.34	-16.09

12	279	-9.53	-8.96	-8.99	-11.75	-13.84	-16.73
12	282	-9.87	-9.19	-9.15	-12.05	-14.20	-17.20
12	285	-10.24	-9.46	-9.36	-12.17	-14.35	-17.39
12	288	-10.66	-9.77	-9.64	-12.14	-14.28	-17.27
12	291	-11.12	-10.13	-10.01	-12.05	-14.12	-16.95
12	294	-11.63	-10.54	-10.45	-11.92	-13.89	-16.51
12	297	-12.18	-10.99	-10.93	-11.78	-13.63	-16.02
12	300	-12.77	-11.46	-11.43	-11.64	-13.37	-15.55
12	303	-13.40	-11.95	-11.95	-11.45	-13.06	-15.03
12	306	-14.08	-12.47	-12.49	-11.21	-12.67	-14.40
12	309	-14.84	-13.06	-13.11	-10.98	-12.26	-13.76
12	312	-15.70	-13.77	-13.86	-10.79	-11.91	-13.18
12	315	-16.71	-14.65	-14.79	-10.72	-11.67	-12.75
12	318	-18.31	-16.38	-16.62	-10.72	-11.52	-12.40
12	321	-20.56	-19.09	-19.50	-10.73	-11.38	-12.08
12	324	-22.88	-21.99	-22.59	-10.74	-11.27	-11.80
12	327	-24.70	-24.31	-25.05	-10.75	-11.20	-11.60
12	330	-25.44	-25.26	-26.06	-10.77	-11.17	-11.53
12	333	-24.97	-24.88	-25.59	-10.87	-11.24	-11.56
12	336	-23.79	-23.90	-24.39	-11.11	-11.41	-11.63
12	339	-22.20	-22.56	-22.77	-11.44	-11.67	-11.75
12	342	-20.53	-21.08	-21.03	-11.83	-11.97	-11.88
12	345	-19.08	-19.70	-19.49	-12.23	-12.28	-12.03
12	348	-17.86	-18.41	-18.14	-12.67	-12.64	-12.23
12	351	-16.66	-17.05	-16.79	-13.22	-13.08	-12.51
12	354	-15.47	-15.62	-15.41	-13.84	-13.60	-12.85
12	357	-14.30	-14.12	-14.03	-14.54	-14.17	-13.24
12	360	-13.14	-12.56	-12.64	-15.29	-14.80	-13.67
15	0	-12.70	-11.99	-12.02	-14.01	-13.37	-12.08
15	3	-11.90	-11.22	-11.30	-15.14	-14.29	-12.81
15	6	-11.16	-10.53	-10.64	-16.00	-15.03	-13.46
15	9	-10.51	-9.92	-10.08	-16.62	-15.57	-13.97
15	12	-9.97	-9.45	-9.66	-16.98	-15.91	-14.31
15	15	-9.55	-9.14	-9.40	-17.10	-16.02	-14.44
15	18	-9.22	-8.93	-9.25	-16.87	-15.89	-14.41
15	21	-8.91	-8.74	-9.12	-16.29	-15.54	-14.34
15	24	-8.66	-8.59	-9.01	-15.49	-15.04	-14.23
15	27	-8.47	-8.50	-8.95	-14.62	-14.48	-14.09
15	30	-8.38	-8.46	-8.92	-13.82	-13.92	-13.92
15	33	-8.35	-8.48	-8.94	-13.03	-13.29	-13.58
15	36	-8.33	-8.53	-8.99	-12.17	-12.52	-12.98
15	39	-8.32	-8.58	-9.04	-11.30	-11.71	-12.25
15	42	-8.30	-8.63	-9.08	-10.50	-10.93	-11.51
15	45	-8.28	-8.65	-9.10	-9.85	-10.28	-10.87
15	48	-8.25	-8.62	-9.04	-9.30	-9.72	-10.32
15	51	-8.20	-8.53	-8.88	-8.79	-9.18	-9.77
15	54	-8.15	-8.39	-8.66	-8.34	-8.70	-9.25
15	57	-8.09	-8.24	-8.40	-7.97	-8.29	-8.80
15	60	-8.01	-8.07	-8.13	-7.72	-7.99	-8.47
15	63	-7.88	-7.84	-7.83	-7.53	-7.74	-8.20
15	66	-7.69	-7.54	-7.45	-7.37	-7.52	-7.96
15	69	-7.45	-7.18	-7.03	-7.24	-7.33	-7.75
15	72	-7.19	-6.81	-6.61	-7.15	-7.20	-7.61
15	75	-6.93	-6.46	-6.22	-7.12	-7.15	-7.56
15	78	-6.66	-6.10	-5.84	-7.16	-7.18	-7.59
15	81	-6.35	-5.73	-5.46	-7.26	-7.26	-7.68
15	84	-6.02	-5.36	-5.09	-7.42	-7.38	-7.82
15	87	-5.69	-5.00	-4.76	-7.60	-7.54	-7.99

15	90	-5.37	-4.68	-4.49	-7.81	-7.71	-8.19
15	93	-5.06	-4.39	-4.26	-8.09	-7.98	-8.49
15	96	-4.75	-4.11	-4.06	-8.48	-8.41	-8.95
15	99	-4.44	-3.85	-3.87	-8.96	-8.95	-9.53
15	102	-4.14	-3.61	-3.71	-9.51	-9.58	-10.19
15	105	-3.87	-3.39	-3.57	-10.11	-10.26	-10.89
15	108	-3.60	-3.19	-3.44	-10.82	-11.07	-11.73
15	111	-3.35	-3.00	-3.33	-11.67	-12.07	-12.76
15	114	-3.11	-2.83	-3.22	-12.64	-13.21	-13.90
15	117	-2.88	-2.66	-3.13	-13.70	-14.43	-15.05
15	120	-2.68	-2.52	-3.03	-14.83	-15.67	-16.15
15	123	-2.49	-2.39	-2.93	-16.32	-17.20	-17.34
15	126	-2.31	-2.28	-2.83	-18.22	-19.06	-18.69
15	129	-2.14	-2.17	-2.74	-20.10	-20.87	-19.95
15	132	-1.99	-2.07	-2.64	-21.54	-22.24	-20.88
15	135	-1.86	-1.97	-2.54	-22.11	-22.78	-21.24
15	138	-1.74	-1.87	-2.41	-21.93	-22.47	-21.07
15	141	-1.62	-1.77	-2.28	-21.46	-21.70	-20.61
15	144	-1.52	-1.67	-2.14	-20.82	-20.68	-20.00
15	147	-1.43	-1.58	-2.00	-20.12	-19.64	-19.35
15	150	-1.35	-1.49	-1.87	-19.47	-18.79	-18.80
15	153	-1.28	-1.39	-1.73	-18.84	-18.12	-18.32
15	156	-1.21	-1.29	-1.57	-18.14	-17.47	-17.83
15	159	-1.15	-1.19	-1.43	-17.43	-16.86	-17.35
15	162	-1.11	-1.12	-1.31	-16.77	-16.31	-16.92
15	165	-1.09	-1.07	-1.25	-16.20	-15.82	-16.54
15	168	-1.09	-1.05	-1.21	-15.75	-15.41	-16.24
15	171	-1.10	-1.03	-1.19	-15.35	-15.06	-15.99
15	174	-1.12	-1.01	-1.16	-14.98	-14.73	-15.75
15	177	-1.14	-1.00	-1.15	-14.59	-14.39	-15.51
15	180	-1.16	-1.00	-1.15	-14.16	-14.02	-15.22
15	183	-1.21	-1.02	-1.18	-13.66	-13.60	-14.89
15	186	-1.28	-1.08	-1.26	-13.11	-13.15	-14.52
15	189	-1.38	-1.17	-1.38	-12.53	-12.68	-14.13
15	192	-1.49	-1.27	-1.52	-11.95	-12.20	-13.72
15	195	-1.62	-1.38	-1.66	-11.39	-11.73	-13.29
15	198	-1.77	-1.51	-1.82	-10.82	-11.23	-12.82
15	201	-1.95	-1.69	-2.01	-10.24	-10.70	-12.29
15	204	-2.17	-1.89	-2.23	-9.67	-10.17	-11.76
15	207	-2.40	-2.11	-2.46	-9.15	-9.69	-11.26
15	210	-2.64	-2.34	-2.71	-8.71	-9.28	-10.83
15	213	-2.89	-2.60	-2.99	-8.32	-8.91	-10.43
15	216	-3.17	-2.89	-3.30	-7.94	-8.54	-10.02
15	219	-3.46	-3.20	-3.64	-7.60	-8.21	-9.66
15	222	-3.76	-3.51	-3.98	-7.34	-7.98	-9.40
15	225	-4.05	-3.82	-4.31	-7.18	-7.87	-9.30
15	228	-4.33	-4.12	-4.64	-7.10	-7.84	-9.30
15	231	-4.62	-4.44	-4.96	-7.03	-7.81	-9.30
15	234	-4.91	-4.75	-5.29	-6.97	-7.79	-9.30
15	237	-5.19	-5.05	-5.60	-6.94	-7.78	-9.30
15	240	-5.47	-5.34	-5.89	-6.92	-7.78	-9.30
15	243	-5.72	-5.60	-6.16	-6.98	-7.86	-9.41
15	246	-5.96	-5.86	-6.41	-7.12	-8.08	-9.70
15	249	-6.20	-6.10	-6.66	-7.33	-8.40	-10.10
15	252	-6.45	-6.35	-6.89	-7.57	-8.75	-10.56
15	255	-6.71	-6.60	-7.12	-7.81	-9.10	-11.00
15	258	-6.99	-6.87	-7.35	-8.10	-9.49	-11.48
15	261	-7.30	-7.14	-7.57	-8.47	-9.95	-12.03



15	264	-7.61	-7.42	-7.78	-8.88	-10.45	-12.62
15	267	-7.93	-7.69	-7.99	-9.26	-10.93	-13.22
15	270	-8.25	-7.95	-8.18	-9.59	-11.36	-13.77
15	273	-8.57	-8.18	-8.35	-9.89	-11.77	-14.37
15	276	-8.89	-8.41	-8.50	-10.21	-12.20	-15.03
15	279	-9.21	-8.63	-8.65	-10.49	-12.59	-15.64
15	282	-9.56	-8.86	-8.81	-10.69	-12.88	-16.09
15	285	-9.92	-9.11	-9.01	-10.77	-12.99	-16.27
15	288	-10.29	-9.38	-9.25	-10.72	-12.91	-16.12
15	291	-10.67	-9.66	-9.53	-10.61	-12.72	-15.76
15	294	-11.08	-9.97	-9.85	-10.45	-12.46	-15.25
15	297	-11.54	-10.32	-10.23	-10.27	-12.16	-14.69
15	300	-12.08	-10.73	-10.67	-10.11	-11.87	-14.15
15	303	-12.75	-11.25	-11.20	-9.91	-11.53	-13.58
15	306	-13.55	-11.88	-11.87	-9.67	-11.13	-12.92
15	309	-14.49	-12.65	-12.67	-9.43	-10.72	-12.25
15	312	-15.55	-13.56	-13.62	-9.25	-10.36	-11.64
15	315	-16.72	-14.63	-14.74	-9.18	-10.12	-11.19
15	318	-18.45	-16.50	-16.72	-9.18	-9.96	-10.83
15	321	-20.78	-19.31	-19.71	-9.19	-9.82	-10.49
15	324	-23.16	-22.27	-22.87	-9.20	-9.70	-10.20
15	327	-25.01	-24.61	-25.37	-9.21	-9.62	-10.00
15	330	-25.75	-25.57	-26.39	-9.22	-9.59	-9.93
15	333	-25.27	-25.18	-25.91	-9.31	-9.65	-9.95
15	336	-24.05	-24.17	-24.68	-9.55	-9.82	-10.02
15	339	-22.41	-22.78	-23.00	-9.88	-10.07	-10.12
15	342	-20.66	-21.24	-21.19	-10.27	-10.37	-10.25
15	345	-19.14	-19.79	-19.56	-10.68	-10.68	-10.39
15	348	-17.84	-18.41	-18.11	-11.15	-11.05	-10.58
15	351	-16.54	-16.94	-16.63	-11.73	-11.52	-10.87
15	354	-15.25	-15.37	-15.12	-12.42	-12.07	-11.22
15	357	-13.97	-13.72	-13.58	-13.18	-12.69	-11.64
15	360	-12.70	-11.99	-12.02	-14.01	-13.37	-12.08
18	0	-11.91	-11.19	-11.21	-12.45	-11.76	-10.56
18	3	-11.11	-10.47	-10.54	-13.62	-12.70	-11.27
18	6	-10.38	-9.80	-9.93	-14.56	-13.48	-11.92
18	9	-9.77	-9.26	-9.43	-15.26	-14.08	-12.46
18	12	-9.30	-8.88	-9.09	-15.70	-14.47	-12.84
18	15	-9.04	-8.73	-8.97	-15.84	-14.60	-12.99
18	18	-8.89	-8.71	-8.98	-15.66	-14.51	-13.01
18	21	-8.77	-8.69	-8.99	-15.20	-14.27	-13.03
18	24	-8.68	-8.68	-9.01	-14.57	-13.92	-13.04
18	27	-8.62	-8.68	-9.04	-13.87	-13.52	-13.05
18	30	-8.60	-8.67	-9.07	-13.24	-13.11	-13.05
18	33	-8.62	-8.74	-9.16	-12.63	-12.66	-12.90
18	36	-8.69	-8.90	-9.30	-11.97	-12.11	-12.50
18	39	-8.79	-9.08	-9.46	-11.30	-11.51	-11.96
18	42	-8.89	-9.24	-9.59	-10.66	-10.91	-11.38
18	45	-8.98	-9.31	-9.64	-10.09	-10.36	-10.85
18	48	-9.06	-9.31	-9.62	-9.54	-9.83	-10.36
18	51	-9.16	-9.31	-9.56	-9.00	-9.30	-9.82
18	54	-9.26	-9.31	-9.46	-8.50	-8.80	-9.29
18	57	-9.32	-9.30	-9.35	-8.08	-8.35	-8.81
18	60	-9.35	-9.30	-9.22	-7.78	-8.01	-8.45
18	63	-9.29	-9.20	-9.02	-7.55	-7.72	-8.15
18	66	-9.14	-8.94	-8.72	-7.33	-7.45	-7.86
18	69	-8.91	-8.57	-8.35	-7.16	-7.22	-7.62
18	72	-8.65	-8.17	-7.96	-7.04	-7.06	-7.45

18	75	-8.38	-7.78	-7.58	-6.99	-7.00	-7.38
18	78	-8.05	-7.39	-7.18	-7.02	-7.03	-7.41
18	81	-7.63	-6.94	-6.74	-7.11	-7.09	-7.47
18	84	-7.17	-6.48	-6.30	-7.25	-7.19	-7.57
18	87	-6.71	-6.04	-5.88	-7.41	-7.32	-7.70
18	90	-6.30	-5.65	-5.54	-7.60	-7.47	-7.85
18	93	-5.93	-5.31	-5.26	-7.86	-7.70	-8.09
18	96	-5.58	-4.99	-5.01	-8.23	-8.08	-8.49
18	99	-5.24	-4.70	-4.78	-8.70	-8.57	-8.99
18	102	-4.92	-4.43	-4.57	-9.23	-9.13	-9.57
18	105	-4.63	-4.18	-4.39	-9.79	-9.74	-10.19
18	108	-4.35	-3.96	-4.23	-10.42	-10.45	-10.93
18	111	-4.09	-3.75	-4.09	-11.15	-11.31	-11.83
18	114	-3.84	-3.56	-3.96	-11.99	-12.31	-12.85
18	117	-3.61	-3.38	-3.84	-12.92	-13.39	-13.91
18	120	-3.40	-3.22	-3.72	-13.93	-14.53	-14.95
18	123	-3.20	-3.08	-3.60	-15.36	-16.01	-16.15
18	126	-3.01	-2.95	-3.48	-17.25	-17.89	-17.56
18	129	-2.83	-2.82	-3.37	-19.15	-19.75	-18.90
18	132	-2.67	-2.71	-3.25	-20.62	-21.16	-19.91
18	135	-2.52	-2.59	-3.13	-21.21	-21.73	-20.31
18	138	-2.37	-2.47	-3.00	-21.04	-21.44	-20.12
18	141	-2.24	-2.36	-2.86	-20.61	-20.69	-19.64
18	144	-2.11	-2.25	-2.72	-20.02	-19.71	-18.99
18	147	-2.00	-2.15	-2.58	-19.35	-18.69	-18.32
18	150	-1.90	-2.04	-2.43	-18.73	-17.86	-17.75
18	153	-1.80	-1.92	-2.28	-18.09	-17.18	-17.26
18	156	-1.71	-1.80	-2.10	-17.35	-16.52	-16.76
18	159	-1.62	-1.68	-1.93	-16.60	-15.90	-16.28
18	162	-1.56	-1.59	-1.80	-15.89	-15.33	-15.85
18	165	-1.54	-1.54	-1.73	-15.30	-14.84	-15.48
18	168	-1.55	-1.53	-1.69	-14.84	-14.43	-15.19
18	171	-1.56	-1.52	-1.66	-14.44	-14.09	-14.95
18	174	-1.59	-1.51	-1.64	-14.07	-13.77	-14.72
18	177	-1.62	-1.50	-1.62	-13.69	-13.44	-14.48
18	180	-1.65	-1.50	-1.62	-13.26	-13.07	-14.20
18	183	-1.71	-1.53	-1.65	-12.74	-12.64	-13.86
18	186	-1.79	-1.59	-1.74	-12.17	-12.17	-13.47
18	189	-1.90	-1.68	-1.86	-11.58	-11.67	-13.05
18	192	-2.02	-1.80	-2.00	-10.99	-11.18	-12.62
18	195	-2.16	-1.91	-2.15	-10.46	-10.72	-12.19
18	198	-2.32	-2.05	-2.30	-9.95	-10.25	-11.74
18	201	-2.52	-2.22	-2.48	-9.45	-9.77	-11.25
18	204	-2.74	-2.43	-2.69	-8.97	-9.30	-10.77
18	207	-2.98	-2.64	-2.91	-8.55	-8.91	-10.33
18	210	-3.22	-2.87	-3.14	-8.22	-8.61	-9.99
18	213	-3.46	-3.11	-3.40	-7.95	-8.39	-9.71
18	216	-3.71	-3.37	-3.68	-7.68	-8.18	-9.44
18	219	-3.97	-3.64	-3.98	-7.45	-8.00	-9.20
18	222	-4.24	-3.93	-4.28	-7.29	-7.88	-9.04
18	225	-4.50	-4.21	-4.58	-7.23	-7.84	-8.98
18	228	-4.77	-4.49	-4.88	-7.22	-7.84	-9.00
18	231	-5.04	-4.79	-5.19	-7.21	-7.86	-9.06
18	234	-5.32	-5.08	-5.50	-7.20	-7.88	-9.14
18	237	-5.59	-5.38	-5.80	-7.20	-7.92	-9.24
18	240	-5.86	-5.66	-6.09	-7.20	-7.95	-9.36
18	243	-6.12	-5.94	-6.37	-7.25	-8.07	-9.55
18	246	-6.38	-6.22	-6.65	-7.40	-8.31	-9.87

18	249	-6.64	-6.49	-6.92	-7.61	-8.62	-10.25
18	252	-6.90	-6.77	-7.18	-7.84	-8.95	-10.66
18	255	-7.17	-7.03	-7.43	-8.07	-9.27	-11.06
18	258	-7.45	-7.31	-7.68	-8.32	-9.60	-11.44
18	261	-7.74	-7.59	-7.92	-8.63	-9.96	-11.85
18	264	-8.03	-7.86	-8.15	-8.95	-10.33	-12.27
18	267	-8.31	-8.12	-8.36	-9.22	-10.66	-12.68
18	270	-8.60	-8.35	-8.53	-9.40	-10.94	-13.09
18	273	-8.87	-8.55	-8.67	-9.52	-11.18	-13.53
18	276	-9.13	-8.72	-8.78	-9.63	-11.41	-14.03
18	279	-9.40	-8.89	-8.88	-9.72	-11.62	-14.49
18	282	-9.66	-9.05	-8.98	-9.78	-11.76	-14.84
18	285	-9.93	-9.22	-9.11	-9.80	-11.81	-14.97
18	288	-10.19	-9.37	-9.24	-9.74	-11.73	-14.81
18	291	-10.42	-9.51	-9.38	-9.59	-11.50	-14.40
18	294	-10.66	-9.66	-9.54	-9.37	-11.19	-13.84
18	297	-10.96	-9.84	-9.73	-9.15	-10.84	-13.23
18	300	-11.33	-10.09	-9.99	-8.95	-10.52	-12.67
18	303	-11.89	-10.49	-10.40	-8.74	-10.19	-12.10
18	306	-12.68	-11.11	-11.05	-8.50	-9.80	-11.46
18	309	-13.64	-11.91	-11.88	-8.28	-9.41	-10.82
18	312	-14.71	-12.86	-12.87	-8.10	-9.08	-10.25
18	315	-15.86	-13.92	-13.98	-8.02	-8.84	-9.82
18	318	-17.44	-15.64	-15.81	-8.00	-8.68	-9.48
18	321	-19.53	-18.16	-18.50	-7.98	-8.52	-9.15
18	324	-21.64	-20.80	-21.33	-7.97	-8.40	-8.87
18	327	-23.27	-22.88	-23.56	-7.96	-8.31	-8.68
18	330	-23.93	-23.73	-24.47	-7.96	-8.28	-8.61
18	333	-23.50	-23.38	-24.05	-8.03	-8.33	-8.63
18	336	-22.42	-22.49	-22.96	-8.23	-8.48	-8.68
18	339	-20.95	-21.26	-21.47	-8.51	-8.68	-8.76
18	342	-19.38	-19.88	-19.86	-8.85	-8.93	-8.86
18	345	-17.99	-18.57	-18.38	-9.21	-9.20	-8.97
18	348	-16.79	-17.29	-17.04	-9.65	-9.53	-9.14
18	351	-15.58	-15.91	-15.65	-10.21	-9.97	-9.40
18	354	-14.36	-14.42	-14.21	-10.87	-10.50	-9.74
18	357	-13.14	-12.85	-12.73	-11.63	-11.10	-10.13
18	360	-11.91	-11.19	-11.21	-12.45	-11.76	-10.56
21	0	-10.63	-10.06	-10.14	-10.53	-9.95	-9.08
21	3	-10.01	-9.53	-9.65	-11.56	-10.77	-9.68
21	6	-9.47	-9.08	-9.25	-12.46	-11.52	-10.23
21	9	-9.03	-8.74	-8.93	-13.17	-12.12	-10.71
21	12	-8.75	-8.51	-8.74	-13.63	-12.53	-11.12
21	15	-8.64	-8.43	-8.67	-13.80	-12.68	-11.43
21	18	-8.67	-8.48	-8.71	-13.74	-12.67	-11.69
21	21	-8.74	-8.60	-8.84	-13.58	-12.64	-11.94
21	24	-8.84	-8.77	-9.02	-13.36	-12.59	-12.15
21	27	-8.97	-8.98	-9.22	-13.09	-12.53	-12.29
21	30	-9.10	-9.19	-9.43	-12.82	-12.46	-12.34
21	33	-9.30	-9.45	-9.68	-12.49	-12.28	-12.24
21	36	-9.58	-9.78	-10.00	-12.09	-11.94	-11.99
21	39	-9.92	-10.16	-10.34	-11.62	-11.50	-11.63
21	42	-10.29	-10.53	-10.67	-11.13	-11.02	-11.23
21	45	-10.64	-10.87	-10.93	-10.64	-10.56	-10.84
21	48	-11.06	-11.21	-11.17	-10.10	-10.07	-10.41
21	51	-11.56	-11.58	-11.40	-9.48	-9.52	-9.88
21	54	-12.04	-11.91	-11.61	-8.87	-8.96	-9.33
21	57	-12.41	-12.16	-11.75	-8.33	-8.45	-8.83

21	60	-12.55	-12.25	-11.81	-7.93	-8.06	-8.44
21	63	-12.51	-12.18	-11.75	-7.64	-7.74	-8.12
21	66	-12.41	-11.97	-11.60	-7.36	-7.43	-7.80
21	69	-12.25	-11.67	-11.38	-7.13	-7.17	-7.53
21	72	-12.05	-11.32	-11.11	-6.97	-6.98	-7.34
21	75	-11.82	-10.95	-10.81	-6.92	-6.91	-7.27
21	78	-11.40	-10.48	-10.41	-6.94	-6.93	-7.29
21	81	-10.73	-9.86	-9.84	-7.02	-6.99	-7.33
21	84	-9.92	-9.18	-9.19	-7.14	-7.07	-7.40
21	87	-9.14	-8.52	-8.57	-7.29	-7.17	-7.49
21	90	-8.51	-7.97	-8.06	-7.46	-7.30	-7.60
21	93	-8.02	-7.52	-7.66	-7.70	-7.50	-7.79
21	96	-7.57	-7.10	-7.28	-8.06	-7.84	-8.12
21	99	-7.15	-6.72	-6.94	-8.51	-8.27	-8.55
21	102	-6.78	-6.37	-6.63	-9.01	-8.77	-9.05
21	105	-6.44	-6.06	-6.36	-9.53	-9.30	-9.58
21	108	-6.13	-5.79	-6.13	-10.09	-9.90	-10.20
21	111	-5.85	-5.54	-5.92	-10.72	-10.61	-10.95
21	114	-5.59	-5.31	-5.73	-11.43	-11.43	-11.79
21	117	-5.35	-5.10	-5.55	-12.20	-12.31	-12.67
21	120	-5.12	-4.90	-5.37	-13.05	-13.24	-13.54
21	123	-4.89	-4.72	-5.20	-14.24	-14.47	-14.55
21	126	-4.68	-4.54	-5.03	-15.78	-16.02	-15.73
21	129	-4.47	-4.38	-4.87	-17.33	-17.54	-16.86
21	132	-4.28	-4.22	-4.71	-18.52	-18.71	-17.71
21	135	-4.09	-4.07	-4.55	-19.00	-19.18	-18.04
21	138	-3.90	-3.92	-4.40	-18.87	-18.95	-17.90
21	141	-3.71	-3.78	-4.25	-18.53	-18.39	-17.52
21	144	-3.54	-3.64	-4.10	-18.07	-17.64	-17.02
21	147	-3.37	-3.51	-3.94	-17.55	-16.85	-16.49
21	150	-3.22	-3.37	-3.78	-17.05	-16.20	-16.05
21	153	-3.07	-3.21	-3.59	-16.53	-15.66	-15.67
21	156	-2.92	-3.03	-3.38	-15.94	-15.14	-15.28
21	159	-2.78	-2.86	-3.17	-15.32	-14.63	-14.92
21	162	-2.68	-2.74	-2.99	-14.73	-14.17	-14.58
21	165	-2.64	-2.69	-2.90	-14.23	-13.75	-14.28
21	168	-2.65	-2.69	-2.85	-13.82	-13.40	-14.03
21	171	-2.68	-2.69	-2.81	-13.47	-13.10	-13.83
21	174	-2.72	-2.69	-2.78	-13.14	-12.82	-13.63
21	177	-2.76	-2.70	-2.76	-12.79	-12.51	-13.42
21	180	-2.82	-2.71	-2.76	-12.38	-12.17	-13.16
21	183	-2.89	-2.74	-2.79	-11.88	-11.73	-12.83
21	186	-3.00	-2.82	-2.88	-11.28	-11.23	-12.41
21	189	-3.13	-2.92	-3.01	-10.66	-10.71	-11.97
21	192	-3.28	-3.05	-3.16	-10.08	-10.20	-11.51
21	195	-3.44	-3.18	-3.30	-9.58	-9.75	-11.10
21	198	-3.63	-3.33	-3.44	-9.14	-9.33	-10.68
21	201	-3.86	-3.51	-3.61	-8.72	-8.90	-10.24
21	204	-4.11	-3.71	-3.79	-8.34	-8.50	-9.83
21	207	-4.35	-3.92	-3.98	-8.03	-8.20	-9.48
21	210	-4.58	-4.12	-4.17	-7.82	-8.04	-9.25
21	213	-4.79	-4.32	-4.37	-7.67	-7.96	-9.09
21	216	-4.99	-4.51	-4.57	-7.54	-7.90	-8.94
21	219	-5.18	-4.71	-4.78	-7.44	-7.86	-8.83
21	222	-5.37	-4.91	-5.00	-7.37	-7.83	-8.75
21	225	-5.59	-5.13	-5.23	-7.35	-7.82	-8.72
21	228	-5.81	-5.37	-5.48	-7.38	-7.85	-8.77
21	231	-6.05	-5.62	-5.74	-7.46	-7.94	-8.89

21	234	-6.29	-5.88	-6.00	-7.58	-8.06	-9.07
21	237	-6.54	-6.16	-6.28	-7.72	-8.21	-9.28
21	240	-6.81	-6.45	-6.57	-7.85	-8.37	-9.50
21	243	-7.09	-6.76	-6.88	-8.00	-8.57	-9.76
21	246	-7.39	-7.09	-7.21	-8.17	-8.83	-10.10
21	249	-7.70	-7.43	-7.55	-8.35	-9.13	-10.47
21	252	-8.00	-7.76	-7.88	-8.53	-9.42	-10.84
21	255	-8.27	-8.07	-8.17	-8.69	-9.68	-11.18
21	258	-8.53	-8.37	-8.47	-8.84	-9.92	-11.48
21	261	-8.79	-8.68	-8.79	-9.00	-10.18	-11.79
21	264	-9.03	-8.97	-9.08	-9.15	-10.41	-12.08
21	267	-9.25	-9.19	-9.29	-9.26	-10.59	-12.35
21	270	-9.42	-9.31	-9.37	-9.30	-10.68	-12.58
21	273	-9.56	-9.36	-9.36	-9.29	-10.71	-12.81
21	276	-9.67	-9.39	-9.36	-9.25	-10.74	-13.05
21	279	-9.77	-9.42	-9.35	-9.21	-10.77	-13.26
21	282	-9.87	-9.44	-9.34	-9.14	-10.78	-13.41
21	285	-9.97	-9.46	-9.34	-9.07	-10.79	-13.46
21	288	-10.07	-9.47	-9.34	-8.94	-10.68	-13.29
21	291	-10.15	-9.48	-9.34	-8.73	-10.41	-12.86
21	294	-10.24	-9.48	-9.35	-8.48	-10.04	-12.28
21	297	-10.36	-9.49	-9.36	-8.23	-9.65	-11.65
21	300	-10.51	-9.51	-9.36	-8.00	-9.30	-11.10
21	303	-10.84	-9.67	-9.53	-7.78	-8.97	-10.57
21	306	-11.38	-10.09	-9.97	-7.56	-8.62	-10.01
21	309	-12.09	-10.69	-10.60	-7.35	-8.27	-9.45
21	312	-12.90	-11.42	-11.36	-7.18	-7.97	-8.96
21	315	-13.73	-12.19	-12.18	-7.07	-7.74	-8.58
21	318	-14.86	-13.42	-13.50	-7.02	-7.58	-8.27
21	321	-16.35	-15.23	-15.45	-6.97	-7.42	-7.98
21	324	-17.86	-17.13	-17.51	-6.93	-7.29	-7.73
21	327	-19.02	-18.63	-19.13	-6.90	-7.20	-7.55
21	330	-19.48	-19.24	-19.79	-6.90	-7.16	-7.49
21	333	-19.18	-19.00	-19.49	-6.95	-7.20	-7.50
21	336	-18.39	-18.36	-18.72	-7.09	-7.29	-7.53
21	339	-17.32	-17.48	-17.67	-7.30	-7.44	-7.58
21	342	-16.18	-16.49	-16.52	-7.55	-7.62	-7.64
21	345	-15.16	-15.54	-15.45	-7.82	-7.81	-7.71
21	348	-14.27	-14.60	-14.47	-8.17	-8.07	-7.84
21	351	-13.37	-13.58	-13.45	-8.63	-8.43	-8.06
21	354	-12.47	-12.48	-12.38	-9.19	-8.88	-8.35
21	357	-11.55	-11.30	-11.28	-9.83	-9.39	-8.70
21	360	-10.63	-10.06	-10.14	-10.53	-9.95	-9.08
24	0	-9.06	-8.73	-8.88	-8.49	-8.08	-7.66
24	3	-8.74	-8.46	-8.65	-9.23	-8.67	-8.12
24	6	-8.51	-8.30	-8.50	-9.90	-9.21	-8.57
24	9	-8.37	-8.22	-8.43	-10.50	-9.71	-9.00
24	12	-8.30	-8.18	-8.40	-11.00	-10.16	-9.42
24	15	-8.28	-8.18	-8.40	-11.38	-10.53	-9.83
24	18	-8.37	-8.28	-8.49	-11.69	-10.89	-10.28
24	21	-8.60	-8.55	-8.73	-11.98	-11.24	-10.77
24	24	-8.93	-8.93	-9.08	-12.21	-11.55	-11.21
24	27	-9.32	-9.36	-9.47	-12.38	-11.76	-11.54
24	30	-9.71	-9.80	-9.86	-12.44	-11.84	-11.67
24	33	-10.16	-10.28	-10.29	-12.37	-11.78	-11.62
24	36	-10.70	-10.85	-10.81	-12.20	-11.62	-11.50
24	39	-11.31	-11.47	-11.37	-11.94	-11.38	-11.31
24	42	-11.97	-12.12	-11.94	-11.64	-11.10	-11.08

24	45	-12.63	-12.74	-12.47	-11.30	-10.80	-10.83
24	48	-13.44	-13.44	-13.05	-10.81	-10.38	-10.48
24	51	-14.42	-14.24	-13.69	-10.11	-9.80	-9.97
24	54	-15.37	-14.99	-14.29	-9.34	-9.16	-9.39
24	57	-16.08	-15.56	-14.73	-8.62	-8.56	-8.85
24	60	-16.37	-15.78	-14.90	-8.12	-8.11	-8.43
24	63	-16.35	-15.72	-14.89	-7.75	-7.76	-8.10
24	66	-16.29	-15.57	-14.87	-7.42	-7.42	-7.76
24	69	-16.20	-15.33	-14.82	-7.13	-7.13	-7.47
24	72	-16.08	-15.05	-14.76	-6.93	-6.93	-7.27
24	75	-15.93	-14.73	-14.68	-6.86	-6.85	-7.19
24	78	-15.44	-14.19	-14.34	-6.89	-6.87	-7.20
24	81	-14.45	-13.37	-13.62	-6.96	-6.91	-7.23
24	84	-13.23	-12.41	-12.71	-7.07	-6.98	-7.28
24	87	-12.04	-11.48	-11.80	-7.20	-7.07	-7.34
24	90	-11.14	-10.73	-11.07	-7.35	-7.17	-7.41
24	93	-10.51	-10.15	-10.52	-7.59	-7.35	-7.56
24	96	-9.95	-9.61	-10.00	-7.94	-7.66	-7.84
24	99	-9.44	-9.12	-9.52	-8.37	-8.06	-8.22
24	102	-9.00	-8.69	-9.09	-8.85	-8.50	-8.65
24	105	-8.60	-8.30	-8.71	-9.33	-8.96	-9.09
24	108	-8.26	-7.97	-8.39	-9.84	-9.46	-9.60
24	111	-7.96	-7.67	-8.10	-10.39	-10.04	-10.20
24	114	-7.68	-7.40	-7.84	-10.99	-10.68	-10.87
24	117	-7.43	-7.15	-7.59	-11.63	-11.36	-11.55
24	120	-7.17	-6.91	-7.35	-12.29	-12.05	-12.20
24	123	-6.91	-6.67	-7.11	-13.13	-12.91	-12.91
24	126	-6.67	-6.45	-6.88	-14.16	-13.95	-13.73
24	129	-6.43	-6.24	-6.66	-15.16	-14.96	-14.49
24	132	-6.20	-6.03	-6.45	-15.92	-15.72	-15.06
24	135	-5.96	-5.84	-6.25	-16.22	-16.02	-15.28
24	138	-5.73	-5.66	-6.07	-16.13	-15.88	-15.19
24	141	-5.49	-5.48	-5.90	-15.90	-15.54	-14.96
24	144	-5.25	-5.31	-5.74	-15.59	-15.09	-14.66
24	147	-5.03	-5.14	-5.57	-15.24	-14.61	-14.35
24	150	-4.83	-4.97	-5.40	-14.90	-14.21	-14.08
24	153	-4.62	-4.77	-5.18	-14.57	-13.87	-13.85
24	156	-4.40	-4.54	-4.93	-14.19	-13.54	-13.63
24	159	-4.21	-4.33	-4.68	-13.80	-13.22	-13.42
24	162	-4.06	-4.17	-4.47	-13.41	-12.91	-13.21
24	165	-4.01	-4.11	-4.35	-13.06	-12.62	-13.02
24	168	-4.02	-4.11	-4.29	-12.75	-12.35	-12.85
24	171	-4.05	-4.11	-4.23	-12.47	-12.11	-12.70
24	174	-4.09	-4.12	-4.18	-12.19	-11.88	-12.55
24	177	-4.15	-4.13	-4.15	-11.89	-11.62	-12.38
24	180	-4.21	-4.14	-4.14	-11.54	-11.31	-12.17
24	183	-4.30	-4.19	-4.18	-11.07	-10.91	-11.86
24	186	-4.43	-4.28	-4.27	-10.48	-10.40	-11.45
24	189	-4.60	-4.40	-4.40	-9.86	-9.86	-10.99
24	192	-4.78	-4.55	-4.54	-9.28	-9.35	-10.53
24	195	-4.97	-4.69	-4.67	-8.84	-8.93	-10.14
24	198	-5.20	-4.85	-4.80	-8.47	-8.57	-9.77
24	201	-5.47	-5.05	-4.95	-8.11	-8.21	-9.38
24	204	-5.75	-5.25	-5.11	-7.80	-7.89	-9.03
24	207	-6.01	-5.45	-5.26	-7.59	-7.67	-8.77
24	210	-6.22	-5.62	-5.40	-7.50	-7.59	-8.64
24	213	-6.37	-5.76	-5.52	-7.51	-7.60	-8.60
24	216	-6.50	-5.87	-5.63	-7.51	-7.63	-8.57

24	219	-6.61	-5.98	-5.74	-7.51	-7.67	-8.54
24	222	-6.73	-6.09	-5.86	-7.52	-7.73	-8.53
24	225	-6.88	-6.23	-6.01	-7.52	-7.80	-8.52
24	228	-7.05	-6.41	-6.18	-7.61	-7.92	-8.60
24	231	-7.24	-6.62	-6.39	-7.83	-8.12	-8.80
24	234	-7.45	-6.85	-6.62	-8.11	-8.36	-9.07
24	237	-7.68	-7.10	-6.87	-8.40	-8.62	-9.38
24	240	-7.93	-7.38	-7.15	-8.63	-8.86	-9.67
24	243	-8.23	-7.72	-7.48	-8.83	-9.13	-9.98
24	246	-8.60	-8.12	-7.87	-9.04	-9.44	-10.34
24	249	-8.97	-8.55	-8.29	-9.23	-9.75	-10.71
24	252	-9.32	-8.96	-8.70	-9.37	-10.00	-11.05
24	255	-9.59	-9.30	-9.05	-9.42	-10.17	-11.32
24	258	-9.81	-9.60	-9.39	-9.41	-10.26	-11.54
24	261	-10.03	-9.91	-9.74	-9.38	-10.35	-11.76
24	264	-10.22	-10.19	-10.05	-9.34	-10.41	-11.95
24	267	-10.36	-10.38	-10.28	-9.28	-10.46	-12.08
24	270	-10.41	-10.46	-10.36	-9.22	-10.47	-12.13
24	273	-10.38	-10.41	-10.31	-9.13	-10.44	-12.12
24	276	-10.30	-10.28	-10.18	-9.00	-10.34	-12.08
24	279	-10.20	-10.11	-9.99	-8.83	-10.19	-12.02
24	282	-10.10	-9.92	-9.80	-8.64	-10.01	-11.95
24	285	-10.01	-9.75	-9.62	-8.45	-9.83	-11.85
24	288	-9.93	-9.58	-9.43	-8.23	-9.59	-11.62
24	291	-9.85	-9.37	-9.21	-7.97	-9.26	-11.17
24	294	-9.77	-9.17	-9.01	-7.69	-8.89	-10.61
24	297	-9.71	-9.02	-8.85	-7.41	-8.51	-10.03
24	300	-9.69	-8.97	-8.79	-7.18	-8.17	-9.53
24	303	-9.77	-9.02	-8.85	-6.96	-7.86	-9.07
24	306	-9.99	-9.17	-9.01	-6.74	-7.54	-8.61
24	309	-10.30	-9.40	-9.26	-6.54	-7.24	-8.16
24	312	-10.67	-9.68	-9.57	-6.37	-6.97	-7.77
24	315	-11.05	-10.00	-9.91	-6.25	-6.76	-7.45
24	318	-11.59	-10.59	-10.56	-6.16	-6.59	-7.18
24	321	-12.34	-11.52	-11.60	-6.08	-6.43	-6.92
24	324	-13.11	-12.53	-12.72	-6.01	-6.29	-6.70
24	327	-13.72	-13.34	-13.62	-5.96	-6.19	-6.54
24	330	-13.96	-13.67	-13.99	-5.95	-6.16	-6.48
24	333	-13.79	-13.54	-13.83	-5.98	-6.18	-6.49
24	336	-13.35	-13.19	-13.43	-6.06	-6.22	-6.50
24	339	-12.75	-12.72	-12.87	-6.18	-6.30	-6.51
24	342	-12.11	-12.19	-12.27	-6.33	-6.39	-6.53
24	345	-11.54	-11.68	-11.71	-6.50	-6.50	-6.55
24	348	-11.05	-11.18	-11.19	-6.73	-6.66	-6.63
24	351	-10.56	-10.63	-10.65	-7.07	-6.92	-6.80
24	354	-10.06	-10.03	-10.08	-7.48	-7.26	-7.04
24	357	-9.56	-9.40	-9.50	-7.96	-7.65	-7.34
24	360	-9.06	-8.73	-8.88	-8.49	-8.08	-7.66
27	0	-7.44	-7.32	-7.56	-6.53	-6.30	-6.28
27	3	-7.46	-7.35	-7.58	-6.99	-6.68	-6.62
27	6	-7.52	-7.43	-7.66	-7.46	-7.08	-6.99
27	9	-7.61	-7.55	-7.77	-7.95	-7.51	-7.39
27	12	-7.73	-7.70	-7.92	-8.47	-7.96	-7.81
27	15	-7.86	-7.87	-8.08	-9.00	-8.43	-8.25
27	18	-8.10	-8.14	-8.32	-9.66	-9.02	-8.82
27	21	-8.51	-8.57	-8.69	-10.44	-9.74	-9.53
27	24	-9.03	-9.10	-9.16	-11.20	-10.43	-10.21
27	27	-9.62	-9.70	-9.68	-11.77	-10.95	-10.73

27	30	-10.22	-10.31	-10.22	-11.99	-11.16	-10.94
27	33	-10.88	-10.98	-10.81	-11.99	-11.15	-10.94
27	36	-11.64	-11.75	-11.50	-11.97	-11.13	-10.92
27	39	-12.48	-12.58	-12.25	-11.94	-11.10	-10.90
27	42	-13.38	-13.45	-13.02	-11.91	-11.05	-10.86
27	45	-14.29	-14.30	-13.77	-11.86	-11.00	-10.82
27	48	-15.43	-15.30	-14.60	-11.52	-10.72	-10.60
27	51	-16.81	-16.47	-15.53	-10.76	-10.13	-10.11
27	54	-18.15	-17.57	-16.42	-9.81	-9.40	-9.49
27	57	-19.17	-18.40	-17.13	-8.90	-8.68	-8.89
27	60	-19.57	-18.73	-17.50	-8.27	-8.16	-8.43
27	63	-19.56	-18.69	-17.64	-7.85	-7.78	-8.07
27	66	-19.54	-18.57	-17.75	-7.45	-7.41	-7.72
27	69	-19.50	-18.39	-17.84	-7.12	-7.09	-7.41
27	72	-19.44	-18.16	-17.90	-6.88	-6.86	-7.19
27	75	-19.37	-17.89	-17.92	-6.80	-6.78	-7.11
27	78	-18.83	-17.32	-17.58	-6.82	-6.79	-7.12
27	81	-17.58	-16.33	-16.73	-6.89	-6.83	-7.14
27	84	-16.01	-15.14	-15.61	-6.99	-6.89	-7.17
27	87	-14.47	-13.97	-14.49	-7.11	-6.97	-7.21
27	90	-13.35	-13.05	-13.59	-7.25	-7.06	-7.26
27	93	-12.61	-12.36	-12.91	-7.48	-7.24	-7.39
27	96	-11.94	-11.72	-12.27	-7.84	-7.53	-7.65
27	99	-11.36	-11.14	-11.68	-8.28	-7.91	-8.00
27	102	-10.85	-10.63	-11.14	-8.75	-8.33	-8.39
27	105	-10.42	-10.18	-10.68	-9.21	-8.74	-8.77
27	108	-10.04	-9.80	-10.28	-9.69	-9.18	-9.20
27	111	-9.72	-9.46	-9.93	-10.22	-9.68	-9.70
27	114	-9.44	-9.15	-9.60	-10.77	-10.20	-10.24
27	117	-9.16	-8.87	-9.30	-11.29	-10.71	-10.75
27	120	-8.88	-8.59	-9.00	-11.76	-11.17	-11.19
27	123	-8.60	-8.31	-8.71	-12.23	-11.66	-11.61
27	126	-8.33	-8.04	-8.42	-12.72	-12.18	-12.05
27	129	-8.06	-7.79	-8.16	-13.16	-12.66	-12.45
27	132	-7.80	-7.55	-7.90	-13.48	-13.01	-12.73
27	135	-7.53	-7.32	-7.67	-13.61	-13.14	-12.84
27	138	-7.27	-7.11	-7.47	-13.54	-13.07	-12.79
27	141	-7.00	-6.91	-7.28	-13.39	-12.91	-12.67
27	144	-6.73	-6.72	-7.11	-13.18	-12.69	-12.51
27	147	-6.48	-6.53	-6.93	-12.95	-12.46	-12.35
27	150	-6.24	-6.34	-6.74	-12.75	-12.26	-12.22
27	153	-6.00	-6.13	-6.52	-12.58	-12.10	-12.12
27	156	-5.74	-5.89	-6.28	-12.41	-11.95	-12.04
27	159	-5.51	-5.66	-6.03	-12.23	-11.80	-11.97
27	162	-5.34	-5.49	-5.83	-12.05	-11.65	-11.89
27	165	-5.27	-5.41	-5.68	-11.86	-11.49	-11.80
27	168	-5.27	-5.38	-5.59	-11.66	-11.32	-11.71
27	171	-5.29	-5.37	-5.50	-11.46	-11.15	-11.63
27	174	-5.31	-5.36	-5.43	-11.24	-10.97	-11.54
27	177	-5.34	-5.35	-5.38	-11.00	-10.76	-11.43
27	180	-5.37	-5.34	-5.36	-10.71	-10.52	-11.29
27	183	-5.46	-5.38	-5.39	-10.31	-10.17	-11.04
27	186	-5.61	-5.49	-5.47	-9.79	-9.71	-10.67
27	189	-5.81	-5.63	-5.59	-9.22	-9.20	-10.24
27	192	-6.04	-5.80	-5.71	-8.71	-8.73	-9.81
27	195	-6.26	-5.96	-5.82	-8.33	-8.36	-9.46
27	198	-6.51	-6.13	-5.94	-8.04	-8.07	-9.15
27	201	-6.82	-6.35	-6.08	-7.76	-7.78	-8.82



27	204	-7.14	-6.56	-6.22	-7.53	-7.53	-8.53
27	207	-7.41	-6.75	-6.34	-7.37	-7.36	-8.32
27	210	-7.59	-6.88	-6.43	-7.31	-7.29	-8.23
27	213	-7.68	-6.95	-6.48	-7.33	-7.32	-8.24
27	216	-7.75	-7.00	-6.52	-7.39	-7.40	-8.26
27	219	-7.81	-7.04	-6.56	-7.49	-7.51	-8.30
27	222	-7.87	-7.09	-6.60	-7.61	-7.65	-8.35
27	225	-7.96	-7.16	-6.66	-7.74	-7.79	-8.40
27	228	-8.08	-7.28	-6.76	-7.95	-8.00	-8.54
27	231	-8.24	-7.44	-6.92	-8.28	-8.29	-8.80
27	234	-8.43	-7.66	-7.13	-8.66	-8.63	-9.13
27	237	-8.64	-7.90	-7.37	-9.02	-8.97	-9.49
27	240	-8.88	-8.17	-7.63	-9.29	-9.28	-9.82
27	243	-9.19	-8.52	-7.97	-9.49	-9.59	-10.17
27	246	-9.61	-8.99	-8.42	-9.69	-9.93	-10.58
27	249	-10.05	-9.49	-8.91	-9.87	-10.25	-10.97
27	252	-10.43	-9.96	-9.39	-9.99	-10.48	-11.28
27	255	-10.69	-10.33	-9.79	-10.03	-10.57	-11.44
27	258	-10.85	-10.63	-10.16	-9.97	-10.56	-11.50
27	261	-11.00	-10.92	-10.53	-9.82	-10.50	-11.55
27	264	-11.12	-11.17	-10.87	-9.60	-10.43	-11.59
27	267	-11.21	-11.35	-11.11	-9.35	-10.33	-11.61
27	270	-11.24	-11.42	-11.20	-9.12	-10.22	-11.62
27	273	-11.15	-11.32	-11.10	-8.89	-10.06	-11.53
27	276	-10.93	-11.06	-10.87	-8.64	-9.81	-11.30
27	279	-10.63	-10.71	-10.54	-8.37	-9.51	-10.98
27	282	-10.32	-10.33	-10.18	-8.09	-9.18	-10.61
27	285	-10.05	-10.00	-9.86	-7.81	-8.86	-10.25
27	288	-9.80	-9.67	-9.52	-7.52	-8.53	-9.87
27	291	-9.54	-9.32	-9.15	-7.22	-8.16	-9.41
27	294	-9.29	-8.97	-8.78	-6.92	-7.79	-8.93
27	297	-9.07	-8.67	-8.46	-6.63	-7.42	-8.46
27	300	-8.91	-8.45	-8.25	-6.39	-7.10	-8.04
27	303	-8.79	-8.29	-8.10	-6.17	-6.81	-7.66
27	306	-8.68	-8.13	-7.96	-5.96	-6.52	-7.30
27	309	-8.59	-8.01	-7.85	-5.77	-6.26	-6.95
27	312	-8.52	-7.92	-7.78	-5.60	-6.03	-6.64
27	315	-8.50	-7.89	-7.75	-5.46	-5.83	-6.39
27	318	-8.54	-7.96	-7.84	-5.35	-5.66	-6.16
27	321	-8.64	-8.13	-8.07	-5.23	-5.49	-5.94
27	324	-8.76	-8.33	-8.35	-5.13	-5.34	-5.74
27	327	-8.86	-8.49	-8.58	-5.06	-5.24	-5.60
27	330	-8.90	-8.56	-8.68	-5.04	-5.20	-5.53
27	333	-8.83	-8.52	-8.63	-5.05	-5.20	-5.50
27	336	-8.67	-8.41	-8.52	-5.08	-5.21	-5.47
27	339	-8.45	-8.26	-8.38	-5.12	-5.22	-5.46
27	342	-8.23	-8.11	-8.22	-5.18	-5.23	-5.45
27	345	-8.05	-7.97	-8.09	-5.25	-5.25	-5.44
27	348	-7.91	-7.84	-7.98	-5.37	-5.32	-5.49
27	351	-7.78	-7.71	-7.87	-5.58	-5.48	-5.61
27	354	-7.65	-7.59	-7.77	-5.85	-5.72	-5.80
27	357	-7.54	-7.46	-7.66	-6.18	-5.99	-6.03
27	360	-7.44	-7.32	-7.56	-6.53	-6.30	-6.28
30	0	-5.96	-5.98	-6.25	-4.90	-4.74	-4.95
30	3	-6.10	-6.15	-6.42	-5.17	-5.00	-5.21
30	6	-6.32	-6.39	-6.65	-5.54	-5.33	-5.53
30	9	-6.60	-6.69	-6.94	-6.00	-5.73	-5.90
30	12	-6.93	-7.04	-7.26	-6.51	-6.17	-6.32

30	15	-7.30	-7.43	-7.62	-7.07	-6.66	-6.77
30	18	-7.74	-7.88	-8.03	-7.85	-7.32	-7.37
30	21	-8.31	-8.45	-8.54	-8.88	-8.18	-8.14
30	24	-8.98	-9.10	-9.11	-9.95	-9.07	-8.93
30	27	-9.69	-9.80	-9.73	-10.85	-9.84	-9.61
30	30	-10.44	-10.52	-10.37	-11.36	-10.30	-10.04
30	33	-11.22	-11.30	-11.06	-11.60	-10.54	-10.27
30	36	-12.08	-12.16	-11.83	-11.80	-10.76	-10.48
30	39	-13.00	-13.07	-12.64	-11.95	-10.93	-10.65
30	42	-13.98	-14.01	-13.48	-12.06	-11.04	-10.76
30	45	-14.99	-14.96	-14.31	-12.09	-11.08	-10.80
30	48	-16.27	-16.08	-15.24	-11.77	-10.84	-10.61
30	51	-17.82	-17.40	-16.29	-10.99	-10.25	-10.13
30	54	-19.32	-18.65	-17.30	-9.98	-9.49	-9.51
30	57	-20.46	-19.59	-18.12	-9.02	-8.74	-8.89
30	60	-20.91	-19.96	-18.58	-8.33	-8.18	-8.41
30	63	-20.91	-19.93	-18.81	-7.87	-7.77	-8.03
30	66	-20.90	-19.83	-19.00	-7.43	-7.36	-7.65
30	69	-20.88	-19.67	-19.15	-7.05	-7.01	-7.31
30	72	-20.85	-19.46	-19.24	-6.79	-6.76	-7.07
30	75	-20.82	-19.22	-19.28	-6.69	-6.67	-6.98
30	78	-20.25	-18.63	-18.91	-6.72	-6.68	-6.99
30	81	-18.89	-17.57	-18.01	-6.78	-6.72	-7.01
30	84	-17.17	-16.28	-16.82	-6.87	-6.78	-7.04
30	87	-15.49	-15.01	-15.61	-6.99	-6.86	-7.08
30	90	-14.28	-14.02	-14.65	-7.12	-6.95	-7.13
30	93	-13.49	-13.28	-13.92	-7.35	-7.12	-7.27
30	96	-12.78	-12.60	-13.22	-7.73	-7.44	-7.54
30	99	-12.17	-11.99	-12.58	-8.20	-7.83	-7.89
30	102	-11.63	-11.44	-12.01	-8.70	-8.26	-8.28
30	105	-11.18	-10.97	-11.51	-9.17	-8.67	-8.66
30	108	-10.79	-10.57	-11.08	-9.68	-9.11	-9.07
30	111	-10.47	-10.21	-10.69	-10.27	-9.61	-9.56
30	114	-10.17	-9.89	-10.34	-10.84	-10.12	-10.05
30	117	-9.89	-9.59	-10.01	-11.30	-10.54	-10.49
30	120	-9.60	-9.29	-9.69	-11.56	-10.83	-10.79
30	123	-9.31	-8.99	-9.38	-11.67	-11.02	-11.01
30	126	-9.02	-8.71	-9.07	-11.77	-11.18	-11.22
30	129	-8.74	-8.44	-8.78	-11.84	-11.32	-11.39
30	132	-8.46	-8.18	-8.51	-11.89	-11.41	-11.50
30	135	-8.19	-7.94	-8.27	-11.90	-11.44	-11.54
30	138	-7.93	-7.73	-8.05	-11.83	-11.38	-11.48
30	141	-7.68	-7.53	-7.85	-11.66	-11.24	-11.32
30	144	-7.43	-7.34	-7.67	-11.44	-11.05	-11.12
30	147	-7.19	-7.15	-7.49	-11.22	-10.87	-10.94
30	150	-6.97	-6.98	-7.31	-11.07	-10.74	-10.84
30	153	-6.75	-6.80	-7.13	-10.99	-10.66	-10.81
30	156	-6.53	-6.62	-6.95	-10.92	-10.60	-10.78
30	159	-6.32	-6.45	-6.78	-10.86	-10.55	-10.76
30	162	-6.15	-6.30	-6.62	-10.79	-10.49	-10.74
30	165	-6.05	-6.19	-6.49	-10.71	-10.41	-10.72
30	168	-5.99	-6.09	-6.35	-10.59	-10.32	-10.70
30	171	-5.94	-6.00	-6.22	-10.46	-10.22	-10.67
30	174	-5.90	-5.92	-6.10	-10.30	-10.10	-10.65
30	177	-5.87	-5.87	-6.02	-10.12	-9.96	-10.62
30	180	-5.86	-5.85	-5.99	-9.91	-9.79	-10.57
30	183	-5.92	-5.89	-6.01	-9.62	-9.54	-10.43
30	186	-6.09	-6.00	-6.06	-9.24	-9.20	-10.17

30	189	-6.31	-6.15	-6.14	-8.83	-8.81	-9.84
30	192	-6.56	-6.32	-6.22	-8.44	-8.44	-9.49
30	195	-6.80	-6.49	-6.31	-8.14	-8.15	-9.20
30	198	-7.07	-6.67	-6.41	-7.89	-7.89	-8.93
30	201	-7.40	-6.90	-6.55	-7.65	-7.63	-8.63
30	204	-7.73	-7.12	-6.68	-7.44	-7.41	-8.36
30	207	-8.00	-7.30	-6.80	-7.29	-7.25	-8.16
30	210	-8.16	-7.41	-6.86	-7.24	-7.19	-8.09
30	213	-8.23	-7.44	-6.88	-7.28	-7.22	-8.10
30	216	-8.27	-7.47	-6.89	-7.40	-7.31	-8.14
30	219	-8.31	-7.49	-6.90	-7.57	-7.45	-8.20
30	222	-8.35	-7.51	-6.91	-7.77	-7.61	-8.27
30	225	-8.41	-7.55	-6.93	-7.97	-7.79	-8.36
30	228	-8.52	-7.63	-7.00	-8.24	-8.03	-8.52
30	231	-8.66	-7.79	-7.14	-8.58	-8.36	-8.81
30	234	-8.84	-7.99	-7.34	-8.95	-8.74	-9.16
30	237	-9.05	-8.23	-7.57	-9.30	-9.12	-9.53
30	240	-9.27	-8.49	-7.83	-9.56	-9.45	-9.88
30	243	-9.60	-8.85	-8.17	-9.76	-9.77	-10.25
30	246	-10.04	-9.35	-8.64	-9.96	-10.12	-10.67
30	249	-10.50	-9.88	-9.17	-10.13	-10.43	-11.07
30	252	-10.90	-10.38	-9.68	-10.25	-10.66	-11.37
30	255	-11.15	-10.76	-10.10	-10.29	-10.75	-11.49
30	258	-11.28	-11.06	-10.48	-10.20	-10.69	-11.46
30	261	-11.40	-11.34	-10.86	-9.97	-10.54	-11.38
30	264	-11.50	-11.59	-11.21	-9.65	-10.33	-11.25
30	267	-11.56	-11.76	-11.45	-9.29	-10.08	-11.09
30	270	-11.58	-11.82	-11.55	-8.94	-9.83	-10.91
30	273	-11.48	-11.70	-11.44	-8.60	-9.52	-10.64
30	276	-11.21	-11.40	-11.16	-8.20	-9.12	-10.23
30	279	-10.83	-10.98	-10.78	-7.80	-8.67	-9.74
30	282	-10.43	-10.52	-10.36	-7.40	-8.23	-9.23
30	285	-10.06	-10.10	-9.95	-7.03	-7.82	-8.77
30	288	-9.71	-9.69	-9.54	-6.70	-7.44	-8.34
30	291	-9.34	-9.24	-9.07	-6.37	-7.06	-7.91
30	294	-8.96	-8.77	-8.59	-6.07	-6.69	-7.48
30	297	-8.59	-8.33	-8.13	-5.78	-6.35	-7.08
30	300	-8.24	-7.94	-7.73	-5.54	-6.05	-6.73
30	303	-7.92	-7.59	-7.38	-5.32	-5.77	-6.41
30	306	-7.61	-7.26	-7.05	-5.12	-5.52	-6.11
30	309	-7.32	-6.94	-6.75	-4.94	-5.29	-5.83
30	312	-7.04	-6.66	-6.48	-4.77	-5.08	-5.58
30	315	-6.80	-6.41	-6.26	-4.63	-4.89	-5.36
30	318	-6.56	-6.17	-6.05	-4.49	-4.72	-5.15
30	321	-6.33	-5.94	-5.84	-4.35	-4.56	-4.96
30	324	-6.12	-5.73	-5.67	-4.23	-4.41	-4.78
30	327	-5.95	-5.57	-5.54	-4.14	-4.29	-4.64
30	330	-5.83	-5.48	-5.49	-4.10	-4.21	-4.54
30	333	-5.75	-5.45	-5.49	-4.08	-4.16	-4.48
30	336	-5.68	-5.42	-5.50	-4.07	-4.12	-4.42
30	339	-5.63	-5.40	-5.51	-4.06	-4.08	-4.37
30	342	-5.59	-5.38	-5.51	-4.05	-4.06	-4.33
30	345	-5.58	-5.38	-5.53	-4.05	-4.05	-4.32
30	348	-5.60	-5.41	-5.57	-4.09	-4.09	-4.35
30	351	-5.65	-5.50	-5.69	-4.22	-4.19	-4.44
30	354	-5.73	-5.63	-5.85	-4.41	-4.34	-4.58
30	357	-5.83	-5.80	-6.04	-4.64	-4.53	-4.75
30	360	-5.96	-5.98	-6.25	-4.90	-4.74	-4.95

33	0	-4.45	-4.48	-4.73	-3.50	-3.35	-3.60
33	3	-4.67	-4.75	-4.99	-3.71	-3.55	-3.81
33	6	-4.97	-5.08	-5.32	-4.04	-3.85	-4.10
33	9	-5.34	-5.48	-5.70	-4.46	-4.22	-4.46
33	12	-5.77	-5.93	-6.13	-4.96	-4.66	-4.86
33	15	-6.23	-6.41	-6.59	-5.50	-5.13	-5.30
33	18	-6.79	-6.98	-7.11	-6.28	-5.77	-5.87
33	21	-7.47	-7.64	-7.73	-7.34	-6.63	-6.62
33	24	-8.24	-8.37	-8.40	-8.47	-7.55	-7.42
33	27	-9.04	-9.15	-9.11	-9.47	-8.38	-8.15
33	30	-9.86	-9.94	-9.84	-10.12	-8.98	-8.71
33	33	-10.68	-10.75	-10.59	-10.51	-9.41	-9.13
33	36	-11.54	-11.62	-11.39	-10.86	-9.82	-9.54
33	39	-12.43	-12.53	-12.22	-11.15	-10.16	-9.89
33	42	-13.35	-13.44	-13.05	-11.34	-10.40	-10.13
33	45	-14.31	-14.33	-13.85	-11.40	-10.49	-10.22
33	48	-15.47	-15.36	-14.73	-11.12	-10.28	-10.06
33	51	-16.85	-16.53	-15.70	-10.43	-9.77	-9.65
33	54	-18.18	-17.63	-16.61	-9.54	-9.10	-9.12
33	57	-19.17	-18.45	-17.30	-8.67	-8.44	-8.58
33	60	-19.57	-18.77	-17.59	-8.05	-7.94	-8.15
33	63	-19.54	-18.71	-17.63	-7.61	-7.55	-7.80
33	66	-19.48	-18.55	-17.66	-7.19	-7.16	-7.44
33	69	-19.38	-18.31	-17.68	-6.82	-6.82	-7.11
33	72	-19.24	-18.00	-17.70	-6.57	-6.57	-6.88
33	75	-19.07	-17.65	-17.70	-6.48	-6.48	-6.79
33	78	-18.45	-17.03	-17.36	-6.50	-6.50	-6.80
33	81	-17.19	-16.03	-16.51	-6.57	-6.55	-6.84
33	84	-15.65	-14.87	-15.40	-6.67	-6.62	-6.89
33	87	-14.18	-13.75	-14.28	-6.80	-6.72	-6.96
33	90	-13.13	-12.89	-13.42	-6.94	-6.83	-7.04
33	93	-12.45	-12.25	-12.78	-7.20	-7.04	-7.21
33	96	-11.85	-11.67	-12.19	-7.62	-7.39	-7.52
33	99	-11.33	-11.15	-11.64	-8.14	-7.84	-7.93
33	102	-10.90	-10.70	-11.17	-8.68	-8.31	-8.36
33	105	-10.53	-10.32	-10.76	-9.19	-8.76	-8.79
33	108	-10.23	-10.00	-10.41	-9.74	-9.25	-9.28
33	111	-9.99	-9.73	-10.12	-10.38	-9.84	-9.87
33	114	-9.77	-9.48	-9.85	-10.99	-10.41	-10.45
33	117	-9.55	-9.25	-9.59	-11.44	-10.83	-10.90
33	120	-9.33	-9.01	-9.34	-11.62	-11.00	-11.09
33	123	-9.08	-8.77	-9.08	-11.58	-10.98	-11.12
33	126	-8.83	-8.52	-8.83	-11.47	-10.93	-11.13
33	129	-8.58	-8.29	-8.58	-11.31	-10.86	-11.15
33	132	-8.35	-8.07	-8.35	-11.13	-10.77	-11.16
33	135	-8.13	-7.87	-8.14	-10.95	-10.67	-11.16
33	138	-7.92	-7.68	-7.95	-10.73	-10.50	-11.03
33	141	-7.72	-7.51	-7.76	-10.45	-10.24	-10.72
33	144	-7.54	-7.35	-7.58	-10.15	-9.94	-10.35
33	147	-7.36	-7.20	-7.42	-9.90	-9.69	-10.02
33	150	-7.19	-7.07	-7.30	-9.74	-9.53	-9.85
33	153	-7.03	-6.95	-7.20	-9.66	-9.46	-9.80
33	156	-6.87	-6.85	-7.12	-9.61	-9.41	-9.76
33	159	-6.72	-6.76	-7.04	-9.56	-9.36	-9.73
33	162	-6.58	-6.67	-6.97	-9.52	-9.32	-9.71
33	165	-6.44	-6.56	-6.87	-9.46	-9.28	-9.70
33	168	-6.29	-6.41	-6.73	-9.38	-9.23	-9.73
33	171	-6.13	-6.22	-6.56	-9.30	-9.19	-9.79

33	174	-5.98	-6.04	-6.38	-9.21	-9.15	-9.86
33	177	-5.87	-5.90	-6.24	-9.12	-9.10	-9.92
33	180	-5.83	-5.84	-6.17	-9.01	-9.04	-9.94
33	183	-5.87	-5.86	-6.16	-8.86	-8.93	-9.92
33	186	-5.96	-5.92	-6.14	-8.68	-8.77	-9.85
33	189	-6.10	-6.00	-6.13	-8.48	-8.59	-9.76
33	192	-6.27	-6.09	-6.13	-8.32	-8.43	-9.66
33	195	-6.43	-6.18	-6.12	-8.21	-8.32	-9.55
33	198	-6.64	-6.32	-6.16	-8.14	-8.26	-9.43
33	201	-6.92	-6.50	-6.26	-8.08	-8.20	-9.28
33	204	-7.22	-6.70	-6.38	-8.03	-8.15	-9.13
33	207	-7.47	-6.87	-6.49	-7.99	-8.12	-8.98
33	210	-7.65	-6.98	-6.55	-7.98	-8.09	-8.85
33	213	-7.74	-7.03	-6.57	-8.01	-8.06	-8.73
33	216	-7.80	-7.07	-6.59	-8.07	-8.04	-8.62
33	219	-7.86	-7.10	-6.60	-8.17	-8.02	-8.51
33	222	-7.92	-7.13	-6.61	-8.28	-8.00	-8.44
33	225	-8.01	-7.18	-6.64	-8.40	-8.00	-8.41
33	228	-8.12	-7.27	-6.70	-8.55	-8.09	-8.49
33	231	-8.26	-7.41	-6.82	-8.76	-8.32	-8.70
33	234	-8.42	-7.59	-6.99	-8.99	-8.63	-8.98
33	237	-8.60	-7.80	-7.19	-9.19	-8.94	-9.28
33	240	-8.81	-8.03	-7.41	-9.34	-9.20	-9.55
33	243	-9.11	-8.36	-7.71	-9.44	-9.43	-9.83
33	246	-9.50	-8.80	-8.14	-9.53	-9.67	-10.16
33	249	-9.92	-9.29	-8.62	-9.61	-9.88	-10.46
33	252	-10.30	-9.76	-9.10	-9.67	-10.04	-10.69
33	255	-10.56	-10.13	-9.51	-9.69	-10.10	-10.78
33	258	-10.73	-10.45	-9.90	-9.58	-10.01	-10.71
33	261	-10.89	-10.76	-10.31	-9.31	-9.79	-10.51
33	264	-11.02	-11.04	-10.68	-8.93	-9.48	-10.23
33	267	-11.11	-11.23	-10.95	-8.50	-9.12	-9.91
33	270	-11.14	-11.31	-11.06	-8.10	-8.77	-9.58
33	273	-11.06	-11.22	-10.98	-7.69	-8.38	-9.20
33	276	-10.86	-10.99	-10.77	-7.22	-7.91	-8.73
33	279	-10.57	-10.67	-10.48	-6.74	-7.41	-8.21
33	282	-10.24	-10.30	-10.13	-6.28	-6.93	-7.70
33	285	-9.90	-9.92	-9.78	-5.90	-6.51	-7.26
33	288	-9.53	-9.50	-9.36	-5.57	-6.14	-6.86
33	291	-9.08	-8.99	-8.84	-5.27	-5.80	-6.49
33	294	-8.58	-8.43	-8.26	-5.00	-5.48	-6.14
33	297	-8.09	-7.88	-7.70	-4.75	-5.19	-5.81
33	300	-7.65	-7.39	-7.20	-4.53	-4.92	-5.51
33	303	-7.24	-6.96	-6.77	-4.33	-4.68	-5.23
33	306	-6.84	-6.54	-6.36	-4.14	-4.45	-4.98
33	309	-6.46	-6.14	-5.97	-3.97	-4.25	-4.74
33	312	-6.09	-5.77	-5.61	-3.82	-4.06	-4.52
33	315	-5.76	-5.42	-5.29	-3.67	-3.88	-4.31
33	318	-5.42	-5.08	-4.96	-3.53	-3.71	-4.12
33	321	-5.09	-4.73	-4.64	-3.38	-3.54	-3.93
33	324	-4.78	-4.41	-4.34	-3.25	-3.39	-3.75
33	327	-4.52	-4.16	-4.11	-3.14	-3.25	-3.60
33	330	-4.34	-3.99	-3.98	-3.06	-3.15	-3.48
33	333	-4.21	-3.89	-3.91	-2.99	-3.06	-3.38
33	336	-4.09	-3.80	-3.85	-2.94	-2.97	-3.29
33	339	-3.99	-3.72	-3.81	-2.89	-2.90	-3.20
33	342	-3.92	-3.67	-3.78	-2.86	-2.85	-3.15
33	345	-3.90	-3.66	-3.77	-2.85	-2.83	-3.13

33	348	-3.92	-3.70	-3.82	-2.88	-2.85	-3.15
33	351	-3.99	-3.81	-3.96	-2.97	-2.92	-3.21
33	354	-4.10	-3.99	-4.17	-3.11	-3.03	-3.31
33	357	-4.26	-4.21	-4.43	-3.29	-3.17	-3.44
33	360	-4.45	-4.48	-4.73	-3.50	-3.35	-3.60
36	0	-2.74	-2.72	-2.91	-2.16	-1.99	-2.23
36	3	-2.98	-3.01	-3.19	-2.35	-2.17	-2.41
36	6	-3.31	-3.37	-3.55	-2.65	-2.45	-2.68
36	9	-3.71	-3.79	-3.97	-3.04	-2.79	-3.00
36	12	-4.16	-4.27	-4.43	-3.50	-3.19	-3.37
36	15	-4.65	-4.78	-4.94	-3.99	-3.63	-3.77
36	18	-5.24	-5.38	-5.52	-4.69	-4.22	-4.30
36	21	-5.97	-6.09	-6.20	-5.63	-4.99	-4.98
36	24	-6.77	-6.87	-6.96	-6.65	-5.82	-5.71
36	27	-7.61	-7.68	-7.74	-7.56	-6.61	-6.41
36	30	-8.43	-8.49	-8.53	-8.21	-7.22	-6.97
36	33	-9.25	-9.33	-9.35	-8.65	-7.72	-7.47
36	36	-10.09	-10.23	-10.25	-9.07	-8.21	-7.97
36	39	-10.95	-11.13	-11.14	-9.41	-8.63	-8.41
36	42	-11.79	-11.99	-11.98	-9.65	-8.92	-8.72
36	45	-12.60	-12.77	-12.68	-9.74	-9.04	-8.84
36	48	-13.49	-13.55	-13.33	-9.54	-8.90	-8.74
36	51	-14.46	-14.37	-13.99	-9.05	-8.56	-8.49
36	54	-15.37	-15.11	-14.58	-8.42	-8.12	-8.16
36	57	-16.03	-15.64	-14.99	-7.81	-7.68	-7.82
36	60	-16.29	-15.85	-15.15	-7.35	-7.33	-7.54
36	63	-16.21	-15.73	-15.08	-7.02	-7.04	-7.30
36	66	-16.00	-15.41	-14.89	-6.69	-6.74	-7.03
36	69	-15.68	-14.95	-14.61	-6.41	-6.48	-6.79
36	72	-15.30	-14.43	-14.28	-6.21	-6.30	-6.62
36	75	-14.88	-13.89	-13.92	-6.13	-6.22	-6.55
36	78	-14.20	-13.24	-13.40	-6.17	-6.25	-6.57
36	81	-13.18	-12.41	-12.65	-6.25	-6.32	-6.63
36	84	-12.05	-11.53	-11.82	-6.39	-6.43	-6.72
36	87	-11.03	-10.73	-11.04	-6.56	-6.57	-6.84
36	90	-10.36	-10.16	-10.47	-6.74	-6.73	-6.97
36	93	-9.95	-9.77	-10.06	-7.05	-6.99	-7.20
36	96	-9.61	-9.42	-9.69	-7.52	-7.41	-7.59
36	99	-9.32	-9.13	-9.37	-8.10	-7.92	-8.07
36	102	-9.10	-8.90	-9.12	-8.69	-8.46	-8.59
36	105	-8.95	-8.73	-8.93	-9.24	-8.97	-9.09
36	108	-8.86	-8.62	-8.80	-9.82	-9.52	-9.68
36	111	-8.79	-8.53	-8.70	-10.49	-10.16	-10.39
36	114	-8.74	-8.46	-8.62	-11.11	-10.76	-11.08
36	117	-8.68	-8.39	-8.54	-11.57	-11.22	-11.60
36	120	-8.61	-8.30	-8.44	-11.75	-11.39	-11.81
36	123	-8.50	-8.18	-8.32	-11.64	-11.30	-11.75
36	126	-8.36	-8.05	-8.19	-11.34	-11.05	-11.60
36	129	-8.21	-7.91	-8.05	-10.93	-10.71	-11.38
36	132	-8.07	-7.77	-7.92	-10.50	-10.34	-11.13
36	135	-7.93	-7.65	-7.80	-10.11	-10.00	-10.87
36	138	-7.81	-7.53	-7.67	-9.74	-9.65	-10.52
36	141	-7.70	-7.42	-7.53	-9.33	-9.25	-10.05
36	144	-7.59	-7.31	-7.40	-8.94	-8.85	-9.55
36	147	-7.48	-7.22	-7.30	-8.61	-8.53	-9.15
36	150	-7.37	-7.14	-7.25	-8.42	-8.34	-8.93
36	153	-7.26	-7.08	-7.24	-8.31	-8.25	-8.85
36	156	-7.15	-7.04	-7.24	-8.22	-8.17	-8.78

36	159	-7.05	-7.00	-7.23	-8.15	-8.11	-8.73
36	162	-6.93	-6.95	-7.22	-8.10	-8.07	-8.69
36	165	-6.79	-6.89	-7.21	-8.07	-8.06	-8.68
36	168	-6.60	-6.74	-7.13	-8.05	-8.07	-8.72
36	171	-6.35	-6.50	-6.96	-8.03	-8.09	-8.83
36	174	-6.09	-6.24	-6.73	-8.02	-8.14	-8.98
36	177	-5.87	-5.99	-6.51	-8.01	-8.19	-9.16
36	180	-5.74	-5.82	-6.32	-8.01	-8.24	-9.33
36	183	-5.68	-5.72	-6.16	-8.03	-8.31	-9.54
36	186	-5.63	-5.62	-5.99	-8.09	-8.40	-9.81
36	189	-5.59	-5.54	-5.83	-8.18	-8.51	-10.08
36	192	-5.56	-5.48	-5.72	-8.29	-8.64	-10.31
36	195	-5.56	-5.46	-5.68	-8.41	-8.79	-10.45
36	198	-5.62	-5.50	-5.69	-8.63	-9.05	-10.52
36	201	-5.79	-5.60	-5.70	-8.98	-9.42	-10.58
36	204	-6.00	-5.72	-5.73	-9.35	-9.80	-10.62
36	207	-6.22	-5.85	-5.76	-9.64	-10.11	-10.65
36	210	-6.40	-5.95	-5.78	-9.76	-10.23	-10.67
36	213	-6.53	-6.02	-5.80	-9.70	-10.05	-10.44
36	216	-6.65	-6.08	-5.82	-9.55	-9.62	-9.91
36	219	-6.76	-6.14	-5.84	-9.37	-9.11	-9.28
36	222	-6.88	-6.20	-5.87	-9.19	-8.68	-8.75
36	225	-7.00	-6.28	-5.90	-9.06	-8.50	-8.53
36	228	-7.12	-6.37	-5.95	-8.98	-8.50	-8.54
36	231	-7.24	-6.47	-6.03	-8.93	-8.51	-8.57
36	234	-7.36	-6.59	-6.13	-8.88	-8.53	-8.62
36	237	-7.50	-6.73	-6.24	-8.82	-8.54	-8.67
36	240	-7.67	-6.90	-6.38	-8.75	-8.55	-8.73
36	243	-7.90	-7.14	-6.60	-8.67	-8.55	-8.79
36	246	-8.21	-7.48	-6.92	-8.58	-8.54	-8.88
36	249	-8.54	-7.87	-7.30	-8.48	-8.54	-8.96
36	252	-8.86	-8.26	-7.70	-8.35	-8.53	-9.02
36	255	-9.13	-8.61	-8.08	-8.20	-8.52	-9.05
36	258	-9.37	-8.97	-8.49	-7.97	-8.40	-8.95
36	261	-9.63	-9.36	-8.97	-7.63	-8.13	-8.71
36	264	-9.85	-9.72	-9.42	-7.24	-7.75	-8.36
36	267	-10.01	-9.98	-9.76	-6.83	-7.35	-7.98
36	270	-10.07	-10.08	-9.89	-6.43	-6.96	-7.62
36	273	-10.05	-10.05	-9.86	-6.03	-6.58	-7.25
36	276	-9.96	-9.96	-9.79	-5.60	-6.16	-6.84
36	279	-9.84	-9.84	-9.67	-5.18	-5.73	-6.41
36	282	-9.69	-9.67	-9.52	-4.79	-5.32	-5.99
36	285	-9.51	-9.49	-9.35	-4.47	-4.98	-5.64
36	288	-9.22	-9.16	-9.03	-4.21	-4.69	-5.33
36	291	-8.75	-8.65	-8.51	-3.98	-4.42	-5.05
36	294	-8.18	-8.02	-7.87	-3.78	-4.18	-4.79
36	297	-7.59	-7.38	-7.22	-3.59	-3.96	-4.54
36	300	-7.07	-6.82	-6.66	-3.41	-3.74	-4.30
36	303	-6.59	-6.32	-6.17	-3.25	-3.54	-4.08
36	306	-6.12	-5.83	-5.68	-3.09	-3.35	-3.86
36	309	-5.65	-5.35	-5.22	-2.94	-3.17	-3.66
36	312	-5.21	-4.90	-4.78	-2.80	-3.00	-3.47
36	315	-4.79	-4.48	-4.37	-2.66	-2.83	-3.27
36	318	-4.38	-4.06	-3.97	-2.51	-2.66	-3.08
36	321	-3.98	-3.64	-3.56	-2.35	-2.49	-2.89
36	324	-3.60	-3.26	-3.19	-2.21	-2.32	-2.70
36	327	-3.27	-2.92	-2.87	-2.08	-2.17	-2.54
36	330	-3.02	-2.68	-2.65	-1.97	-2.04	-2.39

36	333	-2.81	-2.49	-2.48	-1.88	-1.92	-2.26
36	336	-2.61	-2.31	-2.32	-1.79	-1.80	-2.13
36	339	-2.45	-2.16	-2.20	-1.71	-1.70	-2.01
36	342	-2.33	-2.06	-2.11	-1.66	-1.63	-1.92
36	345	-2.29	-2.02	-2.08	-1.64	-1.60	-1.89
36	348	-2.30	-2.05	-2.12	-1.66	-1.61	-1.90
36	351	-2.35	-2.13	-2.23	-1.73	-1.66	-1.94
36	354	-2.43	-2.28	-2.40	-1.84	-1.73	-2.00
36	357	-2.56	-2.47	-2.63	-1.98	-1.84	-2.10
36	360	-2.74	-2.72	-2.91	-2.16	-1.99	-2.23
39	0	-1.14	-1.04	-1.16	-0.95	-0.74	-0.93
39	3	-1.37	-1.30	-1.42	-1.15	-0.93	-1.10
39	6	-1.68	-1.64	-1.76	-1.43	-1.19	-1.35
39	9	-2.06	-2.04	-2.17	-1.78	-1.51	-1.64
39	12	-2.49	-2.49	-2.63	-2.19	-1.87	-1.97
39	15	-2.96	-2.99	-3.14	-2.62	-2.26	-2.34
39	18	-3.54	-3.57	-3.73	-3.20	-2.77	-2.80
39	21	-4.24	-4.28	-4.44	-3.96	-3.42	-3.38
39	24	-5.03	-5.07	-5.24	-4.77	-4.12	-4.01
39	27	-5.84	-5.88	-6.06	-5.51	-4.79	-4.62
39	30	-6.62	-6.67	-6.88	-6.08	-5.34	-5.15
39	33	-7.41	-7.52	-7.78	-6.53	-5.84	-5.65
39	36	-8.25	-8.45	-8.80	-6.96	-6.34	-6.17
39	39	-9.07	-9.36	-9.80	-7.32	-6.79	-6.64
39	42	-9.81	-10.15	-10.62	-7.58	-7.10	-6.98
39	45	-10.40	-10.73	-11.13	-7.68	-7.22	-7.11
39	48	-10.90	-11.15	-11.42	-7.58	-7.17	-7.08
39	51	-11.39	-11.55	-11.67	-7.34	-7.04	-7.02
39	54	-11.81	-11.88	-11.87	-7.03	-6.87	-6.93
39	57	-12.10	-12.11	-12.00	-6.72	-6.69	-6.84
39	60	-12.21	-12.19	-12.05	-6.48	-6.54	-6.75
39	63	-12.05	-11.98	-11.85	-6.28	-6.39	-6.64
39	66	-11.63	-11.45	-11.34	-6.09	-6.23	-6.52
39	69	-11.05	-10.73	-10.67	-5.91	-6.08	-6.40
39	72	-10.42	-9.98	-9.96	-5.79	-5.97	-6.30
39	75	-9.84	-9.35	-9.35	-5.74	-5.92	-6.26
39	78	-9.22	-8.76	-8.78	-5.78	-5.96	-6.30
39	81	-8.49	-8.12	-8.16	-5.90	-6.07	-6.39
39	84	-7.79	-7.53	-7.59	-6.08	-6.22	-6.53
39	87	-7.25	-7.08	-7.14	-6.29	-6.41	-6.71
39	90	-7.03	-6.87	-6.91	-6.54	-6.63	-6.91
39	93	-7.01	-6.82	-6.82	-6.90	-6.96	-7.21
39	96	-6.99	-6.78	-6.75	-7.43	-7.45	-7.68
39	99	-6.98	-6.75	-6.70	-8.06	-8.04	-8.25
39	102	-6.97	-6.73	-6.67	-8.71	-8.65	-8.86
39	105	-6.97	-6.73	-6.66	-9.30	-9.22	-9.46
39	108	-7.03	-6.79	-6.71	-9.92	-9.83	-10.15
39	111	-7.19	-6.93	-6.85	-10.61	-10.53	-10.99
39	114	-7.39	-7.11	-7.02	-11.25	-11.19	-11.81
39	117	-7.55	-7.26	-7.16	-11.73	-11.68	-12.42
39	120	-7.62	-7.32	-7.23	-11.92	-11.87	-12.66
39	123	-7.63	-7.32	-7.25	-11.73	-11.69	-12.52
39	126	-7.63	-7.32	-7.27	-11.26	-11.24	-12.17
39	129	-7.64	-7.32	-7.28	-10.64	-10.64	-11.68
39	132	-7.64	-7.32	-7.29	-9.98	-10.01	-11.15
39	135	-7.64	-7.32	-7.29	-9.42	-9.47	-10.65
39	138	-7.63	-7.31	-7.28	-8.92	-8.97	-10.13
39	141	-7.61	-7.28	-7.26	-8.39	-8.44	-9.51



39	144	-7.58	-7.25	-7.22	-7.89	-7.94	-8.90
39	147	-7.54	-7.21	-7.20	-7.49	-7.53	-8.41
39	150	-7.50	-7.19	-7.18	-7.23	-7.29	-8.13
39	153	-7.45	-7.18	-7.22	-7.08	-7.17	-8.01
39	156	-7.39	-7.17	-7.29	-6.94	-7.06	-7.90
39	159	-7.30	-7.17	-7.38	-6.84	-6.98	-7.82
39	162	-7.20	-7.16	-7.45	-6.77	-6.93	-7.76
39	165	-7.07	-7.15	-7.48	-6.74	-6.91	-7.74
39	168	-6.88	-7.04	-7.41	-6.76	-6.94	-7.80
39	171	-6.58	-6.78	-7.23	-6.81	-7.04	-7.97
39	174	-6.25	-6.44	-6.97	-6.88	-7.18	-8.21
39	177	-5.91	-6.09	-6.69	-6.98	-7.35	-8.49
39	180	-5.62	-5.79	-6.44	-7.09	-7.53	-8.80
39	183	-5.34	-5.50	-6.17	-7.26	-7.78	-9.25
39	186	-5.05	-5.19	-5.85	-7.54	-8.13	-9.88
39	189	-4.78	-4.89	-5.54	-7.90	-8.54	-10.58
39	192	-4.59	-4.68	-5.28	-8.31	-9.01	-11.22
39	195	-4.51	-4.60	-5.12	-8.74	-9.50	-11.68
39	198	-4.53	-4.60	-5.02	-9.34	-10.16	-12.01
39	201	-4.59	-4.61	-4.94	-10.16	-11.01	-12.33
39	204	-4.67	-4.62	-4.87	-10.99	-11.87	-12.59
39	207	-4.77	-4.64	-4.82	-11.63	-12.53	-12.77
39	210	-4.87	-4.66	-4.81	-11.89	-12.80	-12.83
39	213	-5.01	-4.71	-4.82	-11.73	-12.48	-12.46
39	216	-5.18	-4.80	-4.84	-11.33	-11.69	-11.53
39	219	-5.37	-4.91	-4.88	-10.79	-10.69	-10.38
39	222	-5.55	-5.03	-4.91	-10.24	-9.74	-9.32
39	225	-5.70	-5.12	-4.95	-9.77	-9.09	-8.67
39	228	-5.82	-5.19	-4.97	-9.38	-8.71	-8.37
39	231	-5.91	-5.25	-4.99	-9.00	-8.40	-8.14
39	234	-6.00	-5.31	-5.02	-8.64	-8.14	-7.95
39	237	-6.10	-5.38	-5.05	-8.28	-7.89	-7.78
39	240	-6.22	-5.47	-5.09	-7.94	-7.65	-7.62
39	243	-6.39	-5.62	-5.20	-7.60	-7.41	-7.46
39	246	-6.61	-5.85	-5.42	-7.29	-7.19	-7.32
39	249	-6.85	-6.13	-5.70	-6.97	-6.99	-7.19
39	252	-7.10	-6.44	-6.01	-6.66	-6.77	-7.05
39	255	-7.36	-6.75	-6.34	-6.33	-6.52	-6.88
39	258	-7.66	-7.12	-6.75	-5.97	-6.24	-6.66
39	261	-8.01	-7.58	-7.28	-5.59	-5.92	-6.39
39	264	-8.36	-8.03	-7.81	-5.21	-5.59	-6.10
39	267	-8.64	-8.40	-8.26	-4.84	-5.26	-5.80
39	270	-8.79	-8.62	-8.50	-4.50	-4.94	-5.51
39	273	-8.86	-8.72	-8.60	-4.17	-4.63	-5.23
39	276	-8.91	-8.80	-8.68	-3.85	-4.32	-4.93
39	279	-8.96	-8.86	-8.74	-3.54	-4.02	-4.64
39	282	-8.99	-8.91	-8.78	-3.27	-3.74	-4.37
39	285	-9.00	-8.92	-8.79	-3.06	-3.50	-4.13
39	288	-8.82	-8.73	-8.60	-2.88	-3.30	-3.92
39	291	-8.37	-8.24	-8.11	-2.74	-3.13	-3.73
39	294	-7.77	-7.59	-7.46	-2.61	-2.96	-3.56
39	297	-7.12	-6.89	-6.76	-2.49	-2.81	-3.38
39	300	-6.54	-6.28	-6.16	-2.36	-2.65	-3.21
39	303	-6.03	-5.75	-5.63	-2.22	-2.48	-3.02
39	306	-5.50	-5.21	-5.10	-2.09	-2.32	-2.84
39	309	-4.97	-4.67	-4.58	-1.95	-2.16	-2.66
39	312	-4.46	-4.16	-4.08	-1.82	-2.00	-2.48
39	315	-3.99	-3.68	-3.60	-1.68	-1.84	-2.30

39	318	-3.53	-3.22	-3.15	-1.53	-1.67	-2.11
39	321	-3.08	-2.76	-2.69	-1.36	-1.48	-1.90
39	324	-2.66	-2.32	-2.26	-1.20	-1.30	-1.70
39	327	-2.28	-1.94	-1.89	-1.05	-1.14	-1.52
39	330	-1.96	-1.63	-1.58	-0.93	-0.99	-1.35
39	333	-1.68	-1.36	-1.32	-0.81	-0.85	-1.19
39	336	-1.40	-1.09	-1.07	-0.70	-0.70	-1.02
39	339	-1.16	-0.86	-0.85	-0.60	-0.57	-0.87
39	342	-0.99	-0.70	-0.70	-0.53	-0.48	-0.76
39	345	-0.93	-0.64	-0.65	-0.51	-0.44	-0.72
39	348	-0.93	-0.65	-0.66	-0.52	-0.45	-0.72
39	351	-0.94	-0.68	-0.71	-0.58	-0.48	-0.73
39	354	-0.97	-0.74	-0.80	-0.67	-0.53	-0.76
39	357	-1.04	-0.86	-0.95	-0.79	-0.62	-0.82
39	360	-1.14	-1.04	-1.16	-0.95	-0.74	-0.93
42	0	0.04	0.21	0.16	0.07	0.30	0.19
42	3	-0.15	0.00	-0.07	-0.15	0.11	0.01
42	6	-0.43	-0.30	-0.38	-0.43	-0.14	-0.22
42	9	-0.77	-0.65	-0.76	-0.75	-0.44	-0.48
42	12	-1.15	-1.06	-1.19	-1.10	-0.76	-0.79
42	15	-1.58	-1.51	-1.66	-1.49	-1.12	-1.12
42	18	-2.09	-2.05	-2.23	-1.96	-1.55	-1.52
42	21	-2.74	-2.71	-2.92	-2.53	-2.08	-2.00
42	24	-3.46	-3.45	-3.70	-3.14	-2.65	-2.54
42	27	-4.20	-4.21	-4.51	-3.71	-3.20	-3.06
42	30	-4.90	-4.96	-5.32	-4.19	-3.68	-3.53
42	33	-5.66	-5.80	-6.25	-4.62	-4.14	-3.99
42	36	-6.50	-6.77	-7.36	-5.05	-4.61	-4.45
42	39	-7.29	-7.69	-8.42	-5.44	-5.04	-4.89
42	42	-7.91	-8.39	-9.21	-5.71	-5.36	-5.24
42	45	-8.21	-8.69	-9.52	-5.81	-5.54	-5.47
42	48	-8.30	-8.72	-9.50	-5.80	-5.61	-5.62
42	51	-8.38	-8.75	-9.45	-5.78	-5.68	-5.74
42	54	-8.43	-8.77	-9.36	-5.74	-5.72	-5.84
42	57	-8.47	-8.78	-9.25	-5.70	-5.75	-5.91
42	60	-8.48	-8.78	-9.11	-5.66	-5.76	-5.94
42	63	-8.23	-8.50	-8.69	-5.60	-5.75	-5.94
42	66	-7.62	-7.79	-7.90	-5.52	-5.71	-5.94
42	69	-6.84	-6.89	-6.93	-5.44	-5.66	-5.94
42	72	-6.09	-6.02	-6.02	-5.38	-5.62	-5.95
42	75	-5.54	-5.42	-5.38	-5.36	-5.61	-5.95
42	78	-5.16	-5.03	-4.95	-5.41	-5.66	-6.00
42	81	-4.80	-4.65	-4.53	-5.56	-5.79	-6.13
42	84	-4.49	-4.33	-4.19	-5.78	-6.00	-6.33
42	87	-4.27	-4.11	-3.94	-6.04	-6.24	-6.57
42	90	-4.19	-4.03	-3.86	-6.33	-6.52	-6.83
42	93	-4.25	-4.08	-3.90	-6.74	-6.90	-7.21
42	96	-4.40	-4.22	-4.02	-7.33	-7.47	-7.75
42	99	-4.62	-4.41	-4.18	-8.02	-8.13	-8.40
42	102	-4.87	-4.63	-4.37	-8.72	-8.81	-9.09
42	105	-5.11	-4.84	-4.57	-9.35	-9.43	-9.76
42	108	-5.37	-5.09	-4.80	-10.00	-10.10	-10.55
42	111	-5.69	-5.40	-5.11	-10.71	-10.84	-11.50
42	114	-6.02	-5.73	-5.43	-11.38	-11.55	-12.41
42	117	-6.32	-6.03	-5.74	-11.86	-12.06	-13.10
42	120	-6.55	-6.25	-5.97	-12.05	-12.27	-13.38
42	123	-6.74	-6.42	-6.15	-11.82	-12.03	-13.17
42	126	-6.90	-6.58	-6.31	-11.22	-11.43	-12.63

42	129	-7.05	-6.71	-6.46	-10.42	-10.63	-11.91
42	132	-7.17	-6.82	-6.58	-9.60	-9.80	-11.15
42	135	-7.27	-6.91	-6.69	-8.91	-9.11	-10.47
42	138	-7.36	-7.00	-6.78	-8.31	-8.50	-9.82
42	141	-7.45	-7.07	-6.86	-7.69	-7.87	-9.10
42	144	-7.52	-7.13	-6.93	-7.11	-7.28	-8.41
42	147	-7.57	-7.18	-7.01	-6.63	-6.80	-7.85
42	150	-7.59	-7.22	-7.09	-6.33	-6.51	-7.52
42	153	-7.57	-7.25	-7.21	-6.13	-6.35	-7.35
42	156	-7.53	-7.28	-7.36	-5.96	-6.21	-7.20
42	159	-7.46	-7.30	-7.51	-5.82	-6.09	-7.08
42	162	-7.37	-7.31	-7.62	-5.72	-6.02	-7.01
42	165	-7.26	-7.32	-7.66	-5.69	-5.99	-6.98
42	168	-7.06	-7.21	-7.59	-5.73	-6.05	-7.06
42	171	-6.72	-6.93	-7.39	-5.83	-6.21	-7.28
42	174	-6.30	-6.55	-7.12	-5.99	-6.43	-7.60
42	177	-5.87	-6.13	-6.81	-6.19	-6.71	-8.00
42	180	-5.47	-5.75	-6.51	-6.41	-7.02	-8.43
42	183	-5.05	-5.35	-6.16	-6.73	-7.45	-9.12
42	186	-4.58	-4.90	-5.73	-7.21	-8.05	-10.14
42	189	-4.14	-4.45	-5.29	-7.81	-8.78	-11.28
42	192	-3.80	-4.09	-4.89	-8.48	-9.57	-12.32
42	195	-3.64	-3.86	-4.60	-9.16	-10.36	-13.03
42	198	-3.60	-3.74	-4.39	-10.07	-11.33	-13.51
42	201	-3.56	-3.64	-4.19	-11.24	-12.53	-13.95
42	204	-3.54	-3.56	-4.02	-12.41	-13.70	-14.31
42	207	-3.53	-3.51	-3.90	-13.31	-14.59	-14.56
42	210	-3.52	-3.49	-3.86	-13.66	-14.95	-14.65
42	213	-3.60	-3.53	-3.87	-13.42	-14.51	-14.15
42	216	-3.80	-3.64	-3.90	-12.81	-13.42	-12.91
42	219	-4.05	-3.78	-3.94	-11.98	-12.02	-11.34
42	222	-4.29	-3.91	-3.97	-11.10	-10.63	-9.83
42	225	-4.45	-3.99	-3.98	-10.33	-9.59	-8.79
42	228	-4.55	-4.02	-3.97	-9.65	-8.87	-8.18
42	231	-4.62	-4.04	-3.94	-8.96	-8.24	-7.66
42	234	-4.68	-4.06	-3.91	-8.27	-7.66	-7.22
42	237	-4.75	-4.09	-3.88	-7.62	-7.14	-6.82
42	240	-4.84	-4.12	-3.87	-7.02	-6.65	-6.44
42	243	-4.97	-4.21	-3.93	-6.47	-6.19	-6.08
42	246	-5.13	-4.37	-4.07	-5.94	-5.77	-5.74
42	249	-5.31	-4.58	-4.29	-5.45	-5.37	-5.43
42	252	-5.53	-4.83	-4.55	-4.98	-5.00	-5.14
42	255	-5.76	-5.10	-4.82	-4.56	-4.65	-4.87
42	258	-6.09	-5.47	-5.21	-4.16	-4.33	-4.62
42	261	-6.51	-5.97	-5.77	-3.78	-4.02	-4.38
42	264	-6.97	-6.52	-6.39	-3.43	-3.73	-4.16
42	267	-7.38	-7.02	-6.94	-3.12	-3.47	-3.95
42	270	-7.69	-7.39	-7.33	-2.86	-3.23	-3.75
42	273	-7.91	-7.66	-7.60	-2.64	-3.03	-3.57
42	276	-8.13	-7.93	-7.85	-2.44	-2.84	-3.40
42	279	-8.31	-8.15	-8.06	-2.27	-2.66	-3.25
42	282	-8.43	-8.30	-8.20	-2.11	-2.50	-3.09
42	285	-8.48	-8.36	-8.25	-1.98	-2.35	-2.95
42	288	-8.31	-8.18	-8.08	-1.87	-2.22	-2.82
42	291	-7.89	-7.72	-7.62	-1.78	-2.11	-2.69
42	294	-7.31	-7.10	-7.01	-1.70	-2.00	-2.57
42	297	-6.68	-6.44	-6.35	-1.61	-1.89	-2.45
42	300	-6.12	-5.84	-5.76	-1.51	-1.76	-2.31

42	303	-5.59	-5.30	-5.23	-1.39	-1.62	-2.16
42	306	-5.04	-4.74	-4.67	-1.27	-1.47	-1.99
42	309	-4.49	-4.18	-4.12	-1.13	-1.32	-1.82
42	312	-3.95	-3.64	-3.58	-0.99	-1.16	-1.64
42	315	-3.44	-3.13	-3.08	-0.85	-0.99	-1.45
42	318	-2.96	-2.64	-2.59	-0.69	-0.81	-1.26
42	321	-2.48	-2.16	-2.11	-0.51	-0.62	-1.04
42	324	-2.03	-1.70	-1.65	-0.33	-0.42	-0.82
42	327	-1.62	-1.29	-1.24	-0.16	-0.23	-0.61
42	330	-1.26	-0.94	-0.88	-0.02	-0.07	-0.43
42	333	-0.93	-0.60	-0.55	0.11	0.09	-0.24
42	336	-0.58	-0.27	-0.22	0.24	0.26	-0.04
42	339	-0.28	0.03	0.07	0.35	0.41	0.13
42	342	-0.07	0.23	0.27	0.43	0.51	0.26
42	345	0.02	0.31	0.35	0.46	0.55	0.31
42	348	0.03	0.31	0.35	0.45	0.55	0.31
42	351	0.04	0.31	0.34	0.41	0.53	0.30
42	354	0.04	0.29	0.31	0.33	0.49	0.28
42	357	0.04	0.26	0.25	0.22	0.42	0.25
42	360	0.04	0.21	0.16	0.07	0.30	0.19
45	0	0.51	0.71	0.68	0.83	1.08	1.01
45	3	0.33	0.52	0.47	0.59	0.87	0.83
45	6	0.09	0.26	0.19	0.32	0.63	0.61
45	9	-0.20	-0.06	-0.16	0.02	0.35	0.36
45	12	-0.54	-0.41	-0.55	-0.31	0.05	0.07
45	15	-0.90	-0.80	-0.98	-0.66	-0.28	-0.24
45	18	-1.35	-1.27	-1.50	-1.07	-0.68	-0.60
45	21	-1.90	-1.85	-2.12	-1.55	-1.14	-1.04
45	24	-2.51	-2.50	-2.82	-2.06	-1.63	-1.52
45	27	-3.14	-3.17	-3.55	-2.56	-2.13	-1.99
45	30	-3.74	-3.82	-4.28	-2.99	-2.58	-2.44
45	33	-4.39	-4.56	-5.14	-3.41	-3.01	-2.86
45	36	-5.14	-5.43	-6.17	-3.83	-3.45	-3.30
45	39	-5.84	-6.26	-7.15	-4.22	-3.86	-3.72
45	42	-6.36	-6.87	-7.89	-4.53	-4.21	-4.09
45	45	-6.57	-7.11	-8.18	-4.73	-4.48	-4.38
45	48	-6.55	-7.09	-8.12	-4.85	-4.68	-4.62
45	51	-6.50	-7.02	-7.96	-4.96	-4.86	-4.83
45	54	-6.43	-6.92	-7.73	-5.04	-5.01	-5.02
45	57	-6.33	-6.78	-7.44	-5.10	-5.12	-5.17
45	60	-6.22	-6.62	-7.12	-5.12	-5.19	-5.28
45	63	-5.90	-6.23	-6.58	-5.12	-5.22	-5.36
45	66	-5.30	-5.53	-5.74	-5.10	-5.24	-5.42
45	69	-4.60	-4.72	-4.81	-5.08	-5.25	-5.47
45	72	-3.97	-3.99	-3.98	-5.07	-5.27	-5.53
45	75	-3.57	-3.52	-3.44	-5.06	-5.30	-5.61
45	78	-3.36	-3.26	-3.13	-5.12	-5.39	-5.74
45	81	-3.17	-3.02	-2.85	-5.29	-5.56	-5.92
45	84	-3.02	-2.83	-2.63	-5.53	-5.79	-6.14
45	87	-2.92	-2.71	-2.47	-5.83	-6.06	-6.41
45	90	-2.88	-2.66	-2.42	-6.15	-6.37	-6.72
45	93	-2.95	-2.72	-2.47	-6.60	-6.81	-7.15
45	96	-3.12	-2.88	-2.62	-7.23	-7.42	-7.74
45	99	-3.37	-3.11	-2.82	-7.97	-8.13	-8.44
45	102	-3.64	-3.36	-3.06	-8.71	-8.86	-9.17
45	105	-3.91	-3.62	-3.29	-9.37	-9.52	-9.89
45	108	-4.20	-3.90	-3.56	-10.04	-10.21	-10.73
45	111	-4.54	-4.24	-3.89	-10.76	-10.98	-11.72

45	114	-4.90	-4.61	-4.25	-11.43	-11.70	-12.67
45	117	-5.26	-4.97	-4.60	-11.92	-12.23	-13.39
45	120	-5.57	-5.28	-4.90	-12.11	-12.43	-13.67
45	123	-5.86	-5.55	-5.16	-11.85	-12.17	-13.43
45	126	-6.13	-5.80	-5.40	-11.17	-11.51	-12.79
45	129	-6.39	-6.03	-5.63	-10.28	-10.63	-11.95
45	132	-6.63	-6.25	-5.84	-9.36	-9.72	-11.06
45	135	-6.84	-6.45	-6.05	-8.60	-8.96	-10.29
45	138	-7.05	-6.64	-6.25	-7.95	-8.30	-9.58
45	141	-7.25	-6.83	-6.44	-7.29	-7.62	-8.82
45	144	-7.44	-7.01	-6.63	-6.67	-6.98	-8.11
45	147	-7.57	-7.15	-6.80	-6.17	-6.46	-7.52
45	150	-7.62	-7.23	-6.97	-5.83	-6.13	-7.16
45	153	-7.61	-7.28	-7.16	-5.61	-5.93	-6.94
45	156	-7.57	-7.32	-7.36	-5.42	-5.75	-6.76
45	159	-7.50	-7.35	-7.54	-5.26	-5.61	-6.61
45	162	-7.42	-7.37	-7.67	-5.16	-5.52	-6.52
45	165	-7.33	-7.38	-7.73	-5.12	-5.48	-6.48
45	168	-7.12	-7.27	-7.65	-5.18	-5.56	-6.58
45	171	-6.74	-6.97	-7.46	-5.33	-5.76	-6.85
45	174	-6.26	-6.56	-7.18	-5.56	-6.06	-7.26
45	177	-5.76	-6.11	-6.86	-5.84	-6.42	-7.75
45	180	-5.31	-5.70	-6.53	-6.15	-6.82	-8.29
45	183	-4.86	-5.27	-6.15	-6.59	-7.41	-9.21
45	186	-4.37	-4.77	-5.65	-7.23	-8.26	-10.62
45	189	-3.90	-4.28	-5.13	-8.00	-9.27	-12.16
45	192	-3.52	-3.85	-4.64	-8.84	-10.32	-13.50
45	195	-3.27	-3.54	-4.27	-9.67	-11.30	-14.28
45	198	-3.12	-3.32	-3.97	-10.68	-12.35	-14.64
45	201	-2.99	-3.11	-3.68	-11.92	-13.55	-14.95
45	204	-2.88	-2.94	-3.43	-13.13	-14.68	-15.20
45	207	-2.81	-2.82	-3.26	-14.05	-15.52	-15.36
45	210	-2.79	-2.78	-3.19	-14.41	-15.85	-15.41
45	213	-2.86	-2.82	-3.20	-14.14	-15.37	-14.87
45	216	-3.02	-2.91	-3.21	-13.45	-14.18	-13.53
45	219	-3.22	-3.02	-3.22	-12.51	-12.63	-11.80
45	222	-3.42	-3.11	-3.23	-11.49	-11.05	-10.10
45	225	-3.56	-3.17	-3.23	-10.56	-9.79	-8.84
45	228	-3.64	-3.19	-3.22	-9.68	-8.84	-7.99
45	231	-3.70	-3.20	-3.17	-8.73	-7.94	-7.22
45	234	-3.75	-3.21	-3.12	-7.79	-7.11	-6.53
45	237	-3.81	-3.22	-3.08	-6.90	-6.36	-5.93
45	240	-3.90	-3.24	-3.07	-6.14	-5.72	-5.42
45	243	-4.02	-3.31	-3.12	-5.48	-5.15	-4.96
45	246	-4.17	-3.47	-3.27	-4.86	-4.63	-4.55
45	249	-4.37	-3.68	-3.49	-4.29	-4.17	-4.18
45	252	-4.59	-3.94	-3.76	-3.80	-3.76	-3.87
45	255	-4.85	-4.23	-4.05	-3.40	-3.43	-3.62
45	258	-5.22	-4.64	-4.48	-3.06	-3.16	-3.42
45	261	-5.73	-5.22	-5.10	-2.76	-2.92	-3.24
45	264	-6.29	-5.86	-5.78	-2.49	-2.71	-3.09
45	267	-6.80	-6.44	-6.41	-2.27	-2.52	-2.96
45	270	-7.16	-6.87	-6.84	-2.09	-2.37	-2.83
45	273	-7.42	-7.17	-7.14	-1.96	-2.23	-2.72
45	276	-7.67	-7.46	-7.41	-1.84	-2.12	-2.62
45	279	-7.87	-7.71	-7.64	-1.75	-2.02	-2.52
45	282	-8.01	-7.88	-7.80	-1.65	-1.92	-2.43
45	285	-8.06	-7.94	-7.86	-1.55	-1.81	-2.32

45	288	-7.91	-7.77	-7.70	-1.45	-1.70	-2.21
45	291	-7.50	-7.34	-7.28	-1.35	-1.59	-2.10
45	294	-6.96	-6.76	-6.70	-1.26	-1.48	-1.98
45	297	-6.36	-6.13	-6.08	-1.15	-1.36	-1.85
45	300	-5.82	-5.56	-5.52	-1.04	-1.22	-1.71
45	303	-5.32	-5.05	-5.01	-0.90	-1.07	-1.55
45	306	-4.80	-4.51	-4.47	-0.75	-0.91	-1.38
45	309	-4.26	-3.96	-3.92	-0.59	-0.74	-1.19
45	312	-3.74	-3.43	-3.39	-0.42	-0.56	-1.00
45	315	-3.24	-2.92	-2.88	-0.25	-0.37	-0.80
45	318	-2.75	-2.43	-2.39	-0.07	-0.18	-0.59
45	321	-2.27	-1.95	-1.90	0.12	0.04	-0.36
45	324	-1.81	-1.48	-1.43	0.32	0.25	-0.13
45	327	-1.38	-1.06	-1.00	0.50	0.45	0.10
45	330	-1.01	-0.68	-0.63	0.66	0.63	0.30
45	333	-0.66	-0.33	-0.27	0.80	0.80	0.50
45	336	-0.30	0.03	0.09	0.94	0.98	0.71
45	339	0.02	0.35	0.41	1.07	1.14	0.90
45	342	0.25	0.57	0.64	1.16	1.25	1.04
45	345	0.37	0.67	0.72	1.19	1.29	1.09
45	348	0.42	0.68	0.72	1.18	1.29	1.09
45	351	0.46	0.69	0.72	1.14	1.28	1.08
45	354	0.48	0.70	0.71	1.07	1.25	1.07
45	357	0.50	0.70	0.70	0.97	1.18	1.05
45	360	0.51	0.71	0.68	0.83	1.08	1.01
48	0	0.49	0.69	0.67	1.42	1.67	1.64
48	3	0.32	0.51	0.46	1.18	1.47	1.46
48	6	0.11	0.27	0.19	0.91	1.22	1.23
48	9	-0.15	-0.02	-0.14	0.61	0.95	0.98
48	12	-0.44	-0.33	-0.50	0.28	0.64	0.69
48	15	-0.75	-0.68	-0.89	-0.08	0.31	0.38
48	18	-1.13	-1.08	-1.34	-0.48	-0.07	0.02
48	21	-1.58	-1.57	-1.89	-0.95	-0.52	-0.40
48	24	-2.08	-2.11	-2.48	-1.44	-1.00	-0.86
48	27	-2.59	-2.67	-3.11	-1.93	-1.48	-1.33
48	30	-3.07	-3.20	-3.73	-2.38	-1.93	-1.77
48	33	-3.59	-3.81	-4.45	-2.83	-2.38	-2.20
48	36	-4.19	-4.51	-5.29	-3.28	-2.85	-2.65
48	39	-4.75	-5.18	-6.10	-3.72	-3.29	-3.09
48	42	-5.16	-5.67	-6.70	-4.08	-3.68	-3.48
48	45	-5.32	-5.86	-6.94	-4.32	-3.97	-3.79
48	48	-5.31	-5.84	-6.88	-4.48	-4.20	-4.05
48	51	-5.28	-5.78	-6.72	-4.63	-4.41	-4.28
48	54	-5.24	-5.69	-6.48	-4.75	-4.59	-4.48
48	57	-5.18	-5.57	-6.19	-4.83	-4.73	-4.65
48	60	-5.11	-5.43	-5.88	-4.86	-4.82	-4.78
48	63	-4.91	-5.13	-5.43	-4.86	-4.86	-4.87
48	66	-4.52	-4.62	-4.78	-4.86	-4.89	-4.94
48	69	-4.05	-4.03	-4.07	-4.85	-4.92	-5.00
48	72	-3.61	-3.49	-3.43	-4.85	-4.95	-5.08
48	75	-3.32	-3.13	-3.02	-4.85	-5.00	-5.18
48	78	-3.14	-2.91	-2.77	-4.91	-5.10	-5.32
48	81	-2.98	-2.71	-2.54	-5.08	-5.28	-5.52
48	84	-2.84	-2.55	-2.35	-5.33	-5.52	-5.76
48	87	-2.75	-2.43	-2.23	-5.63	-5.80	-6.05
48	90	-2.71	-2.39	-2.18	-5.96	-6.12	-6.38
48	93	-2.75	-2.42	-2.21	-6.42	-6.56	-6.83
48	96	-2.83	-2.51	-2.29	-7.05	-7.18	-7.42

48	99	-2.96	-2.63	-2.40	-7.79	-7.89	-8.11
48	102	-3.11	-2.78	-2.53	-8.53	-8.62	-8.85
48	105	-3.27	-2.93	-2.67	-9.20	-9.29	-9.56
48	108	-3.46	-3.12	-2.85	-9.87	-9.99	-10.40
48	111	-3.71	-3.38	-3.09	-10.60	-10.78	-11.41
48	114	-3.99	-3.68	-3.36	-11.27	-11.51	-12.37
48	117	-4.28	-3.98	-3.64	-11.76	-12.05	-13.09
48	120	-4.56	-4.25	-3.89	-11.95	-12.26	-13.37
48	123	-4.82	-4.50	-4.12	-11.69	-12.02	-13.14
48	126	-5.09	-4.75	-4.35	-11.02	-11.39	-12.54
48	129	-5.36	-5.00	-4.57	-10.13	-10.55	-11.73
48	132	-5.62	-5.23	-4.79	-9.21	-9.67	-10.87
48	135	-5.87	-5.46	-5.02	-8.44	-8.93	-10.12
48	138	-6.12	-5.71	-5.27	-7.78	-8.27	-9.43
48	141	-6.40	-5.96	-5.52	-7.10	-7.57	-8.68
48	144	-6.65	-6.20	-5.77	-6.47	-6.92	-7.96
48	147	-6.84	-6.40	-6.01	-5.95	-6.37	-7.36
48	150	-6.91	-6.53	-6.24	-5.61	-6.01	-6.97
48	153	-6.90	-6.62	-6.47	-5.38	-5.78	-6.72
48	156	-6.89	-6.71	-6.72	-5.18	-5.57	-6.50
48	159	-6.87	-6.78	-6.95	-5.02	-5.40	-6.32
48	162	-6.84	-6.82	-7.12	-4.92	-5.29	-6.20
48	165	-6.80	-6.84	-7.18	-4.88	-5.25	-6.16
48	168	-6.65	-6.75	-7.13	-4.95	-5.33	-6.28
48	171	-6.33	-6.51	-6.99	-5.14	-5.57	-6.60
48	174	-5.91	-6.18	-6.79	-5.43	-5.93	-7.08
48	177	-5.46	-5.82	-6.56	-5.79	-6.37	-7.66
48	180	-5.06	-5.47	-6.30	-6.20	-6.87	-8.31
48	183	-4.69	-5.10	-5.97	-6.89	-7.73	-9.50
48	186	-4.30	-4.68	-5.51	-7.98	-9.09	-11.37
48	189	-3.92	-4.25	-5.00	-9.23	-10.63	-13.39
48	192	-3.58	-3.84	-4.51	-10.42	-12.03	-14.99
48	195	-3.32	-3.52	-4.12	-11.32	-12.97	-15.65
48	198	-3.11	-3.24	-3.78	-12.01	-13.58	-15.60
48	201	-2.91	-2.96	-3.44	-12.69	-14.14	-15.45
48	204	-2.74	-2.72	-3.13	-13.27	-14.60	-15.23
48	207	-2.62	-2.55	-2.91	-13.68	-14.91	-14.95
48	210	-2.58	-2.49	-2.81	-13.83	-15.03	-14.61
48	213	-2.61	-2.50	-2.78	-13.54	-14.56	-13.86
48	216	-2.70	-2.54	-2.76	-12.80	-13.38	-12.53
48	219	-2.82	-2.58	-2.74	-11.79	-11.84	-10.93
48	222	-2.94	-2.63	-2.73	-10.70	-10.25	-9.36
48	225	-3.04	-2.67	-2.71	-9.71	-8.98	-8.14
48	228	-3.10	-2.69	-2.70	-8.77	-7.97	-7.22
48	231	-3.16	-2.71	-2.68	-7.75	-6.99	-6.35
48	234	-3.21	-2.73	-2.67	-6.73	-6.09	-5.57
48	237	-3.28	-2.75	-2.66	-5.81	-5.29	-4.92
48	240	-3.37	-2.79	-2.66	-5.07	-4.67	-4.41
48	243	-3.50	-2.88	-2.73	-4.46	-4.15	-4.01
48	246	-3.69	-3.08	-2.92	-3.90	-3.69	-3.66
48	249	-3.93	-3.34	-3.20	-3.41	-3.28	-3.36
48	252	-4.21	-3.65	-3.53	-3.01	-2.96	-3.12
48	255	-4.52	-3.98	-3.88	-2.72	-2.73	-2.95
48	258	-4.95	-4.45	-4.37	-2.51	-2.57	-2.84
48	261	-5.54	-5.11	-5.06	-2.34	-2.44	-2.76
48	264	-6.18	-5.82	-5.80	-2.19	-2.33	-2.69
48	267	-6.73	-6.45	-6.44	-2.07	-2.23	-2.62
48	270	-7.09	-6.86	-6.85	-1.96	-2.13	-2.55

48	273	-7.30	-7.11	-7.09	-1.87	-2.04	-2.46
48	276	-7.49	-7.33	-7.30	-1.79	-1.96	-2.38
48	279	-7.64	-7.51	-7.47	-1.72	-1.88	-2.29
48	282	-7.74	-7.63	-7.58	-1.65	-1.80	-2.20
48	285	-7.78	-7.67	-7.62	-1.56	-1.70	-2.09
48	288	-7.63	-7.51	-7.47	-1.44	-1.57	-1.97
48	291	-7.24	-7.11	-7.07	-1.31	-1.44	-1.83
48	294	-6.72	-6.55	-6.53	-1.16	-1.28	-1.68
48	297	-6.15	-5.96	-5.94	-1.00	-1.12	-1.52
48	300	-5.65	-5.43	-5.42	-0.84	-0.95	-1.34
48	303	-5.19	-4.95	-4.94	-0.66	-0.76	-1.16
48	306	-4.73	-4.47	-4.45	-0.46	-0.56	-0.95
48	309	-4.25	-3.98	-3.95	-0.24	-0.35	-0.73
48	312	-3.78	-3.49	-3.45	-0.03	-0.13	-0.51
48	315	-3.32	-3.02	-2.97	0.18	0.09	-0.28
48	318	-2.85	-2.54	-2.49	0.39	0.31	-0.04
48	321	-2.37	-2.05	-2.00	0.61	0.54	0.21
48	324	-1.89	-1.58	-1.52	0.83	0.78	0.46
48	327	-1.45	-1.14	-1.08	1.03	0.99	0.69
48	330	-1.07	-0.76	-0.70	1.19	1.18	0.90
48	333	-0.71	-0.39	-0.33	1.35	1.36	1.11
48	336	-0.35	-0.03	0.04	1.50	1.55	1.33
48	339	-0.02	0.30	0.37	1.63	1.72	1.52
48	342	0.22	0.54	0.60	1.73	1.84	1.66
48	345	0.35	0.64	0.69	1.76	1.88	1.72
48	348	0.40	0.66	0.69	1.75	1.88	1.72
48	351	0.44	0.67	0.69	1.72	1.87	1.71
48	354	0.47	0.68	0.69	1.66	1.84	1.70
48	357	0.49	0.69	0.68	1.56	1.78	1.68
48	360	0.49	0.69	0.67	1.42	1.67	1.64
51	0	0.45	0.66	0.64	1.96	2.23	2.23
51	3	0.29	0.47	0.42	1.71	2.01	2.03
51	6	0.09	0.25	0.16	1.43	1.75	1.80
51	9	-0.14	-0.01	-0.14	1.12	1.46	1.53
51	12	-0.38	-0.29	-0.47	0.78	1.15	1.23
51	15	-0.65	-0.60	-0.83	0.42	0.82	0.92
51	18	-0.97	-0.95	-1.24	0.01	0.43	0.55
51	21	-1.34	-1.37	-1.73	-0.46	-0.01	0.13
51	24	-1.75	-1.83	-2.25	-0.95	-0.48	-0.32
51	27	-2.15	-2.28	-2.78	-1.44	-0.96	-0.78
51	30	-2.51	-2.71	-3.29	-1.91	-1.42	-1.22
51	33	-2.89	-3.16	-3.83	-2.38	-1.89	-1.67
51	36	-3.29	-3.66	-4.44	-2.88	-2.38	-2.14
51	39	-3.67	-4.12	-5.01	-3.36	-2.86	-2.59
51	42	-3.95	-4.46	-5.43	-3.76	-3.28	-3.00
51	45	-4.07	-4.59	-5.59	-4.03	-3.60	-3.32
51	48	-4.09	-4.58	-5.54	-4.22	-3.85	-3.58
51	51	-4.11	-4.55	-5.41	-4.40	-4.08	-3.81
51	54	-4.13	-4.50	-5.21	-4.54	-4.27	-4.02
51	57	-4.14	-4.43	-4.97	-4.63	-4.42	-4.18
51	60	-4.14	-4.35	-4.73	-4.67	-4.51	-4.31
51	63	-4.06	-4.17	-4.39	-4.67	-4.55	-4.38
51	66	-3.85	-3.84	-3.93	-4.67	-4.58	-4.44
51	69	-3.58	-3.45	-3.43	-4.67	-4.60	-4.49
51	72	-3.32	-3.08	-2.98	-4.67	-4.63	-4.54
51	75	-3.12	-2.82	-2.68	-4.66	-4.68	-4.63
51	78	-2.98	-2.64	-2.47	-4.73	-4.77	-4.76
51	81	-2.83	-2.46	-2.29	-4.90	-4.94	-4.95



51	84	-2.70	-2.32	-2.14	-5.14	-5.17	-5.19
51	87	-2.61	-2.21	-2.03	-5.44	-5.45	-5.47
51	90	-2.58	-2.18	-1.99	-5.76	-5.75	-5.79
51	93	-2.58	-2.18	-2.00	-6.19	-6.17	-6.21
51	96	-2.60	-2.21	-2.03	-6.78	-6.74	-6.77
51	99	-2.63	-2.24	-2.06	-7.46	-7.40	-7.41
51	102	-2.67	-2.28	-2.10	-8.16	-8.09	-8.10
51	105	-2.72	-2.33	-2.15	-8.79	-8.74	-8.78
51	108	-2.79	-2.41	-2.23	-9.44	-9.45	-9.61
51	111	-2.91	-2.55	-2.35	-10.17	-10.26	-10.61
51	114	-3.06	-2.72	-2.49	-10.85	-11.03	-11.59
51	117	-3.22	-2.89	-2.64	-11.34	-11.60	-12.32
51	120	-3.38	-3.05	-2.79	-11.54	-11.82	-12.61
51	123	-3.53	-3.20	-2.92	-11.30	-11.61	-12.43
51	126	-3.68	-3.34	-3.06	-10.71	-11.08	-11.97
51	129	-3.85	-3.49	-3.20	-9.91	-10.36	-11.33
51	132	-4.02	-3.65	-3.35	-9.07	-9.59	-10.64
51	135	-4.19	-3.82	-3.51	-8.35	-8.91	-10.00
51	138	-4.40	-4.02	-3.71	-7.69	-8.27	-9.35
51	141	-4.63	-4.24	-3.94	-6.99	-7.57	-8.61
51	144	-4.87	-4.46	-4.18	-6.33	-6.90	-7.88
51	147	-5.07	-4.68	-4.43	-5.78	-6.33	-7.26
51	150	-5.21	-4.87	-4.67	-5.42	-5.93	-6.83
51	153	-5.31	-5.04	-4.95	-5.19	-5.67	-6.54
51	156	-5.41	-5.22	-5.27	-4.99	-5.42	-6.28
51	159	-5.48	-5.38	-5.56	-4.82	-5.23	-6.07
51	162	-5.53	-5.50	-5.79	-4.71	-5.09	-5.93
51	165	-5.55	-5.54	-5.87	-4.67	-5.05	-5.88
51	168	-5.50	-5.51	-5.87	-4.76	-5.15	-6.01
51	171	-5.35	-5.43	-5.85	-5.00	-5.43	-6.38
51	174	-5.15	-5.31	-5.83	-5.36	-5.85	-6.93
51	177	-4.93	-5.17	-5.80	-5.82	-6.38	-7.61
51	180	-4.71	-5.01	-5.76	-6.35	-6.99	-8.36
51	183	-4.48	-4.80	-5.60	-7.55	-8.29	-9.79
51	186	-4.22	-4.50	-5.26	-9.61	-10.47	-12.07
51	189	-3.95	-4.16	-4.83	-11.87	-12.86	-14.52
51	192	-3.68	-3.81	-4.38	-13.70	-14.78	-16.49
51	195	-3.44	-3.51	-4.00	-14.45	-15.57	-17.29
51	198	-3.19	-3.21	-3.65	-14.33	-15.42	-16.98
51	201	-2.93	-2.89	-3.28	-14.00	-15.02	-16.16
51	204	-2.68	-2.60	-2.93	-13.53	-14.43	-15.04
51	207	-2.51	-2.38	-2.65	-12.97	-13.74	-13.80
51	210	-2.44	-2.29	-2.50	-12.38	-13.02	-12.63
51	213	-2.45	-2.28	-2.42	-11.66	-12.08	-11.45
51	216	-2.48	-2.27	-2.36	-10.73	-10.83	-10.11
51	219	-2.52	-2.27	-2.31	-9.68	-9.45	-8.74
51	222	-2.57	-2.27	-2.28	-8.63	-8.13	-7.49
51	225	-2.62	-2.27	-2.27	-7.69	-7.04	-6.48
51	228	-2.66	-2.27	-2.27	-6.80	-6.14	-5.65
51	231	-2.72	-2.30	-2.28	-5.89	-5.28	-4.88
51	234	-2.78	-2.34	-2.30	-5.04	-4.50	-4.21
51	237	-2.86	-2.39	-2.32	-4.29	-3.86	-3.66
51	240	-2.96	-2.45	-2.35	-3.72	-3.38	-3.28
51	243	-3.10	-2.57	-2.46	-3.27	-3.00	-3.00
51	246	-3.33	-2.80	-2.69	-2.85	-2.67	-2.76
51	249	-3.61	-3.09	-3.01	-2.50	-2.39	-2.55
51	252	-3.93	-3.44	-3.38	-2.24	-2.19	-2.41
51	255	-4.28	-3.82	-3.77	-2.09	-2.08	-2.36

51	258	-4.77	-4.34	-4.32	-2.02	-2.05	-2.35
51	261	-5.43	-5.06	-5.06	-1.97	-2.02	-2.35
51	264	-6.12	-5.82	-5.84	-1.93	-2.00	-2.35
51	267	-6.70	-6.47	-6.50	-1.90	-1.98	-2.35
51	270	-7.04	-6.85	-6.88	-1.85	-1.95	-2.34
51	273	-7.20	-7.05	-7.06	-1.80	-1.91	-2.31
51	276	-7.34	-7.21	-7.21	-1.76	-1.86	-2.25
51	279	-7.45	-7.34	-7.33	-1.70	-1.79	-2.16
51	282	-7.52	-7.43	-7.41	-1.64	-1.71	-2.05
51	285	-7.55	-7.46	-7.43	-1.56	-1.62	-1.94
51	288	-7.40	-7.31	-7.28	-1.45	-1.50	-1.82
51	291	-7.03	-6.92	-6.90	-1.29	-1.35	-1.66
51	294	-6.53	-6.39	-6.39	-1.11	-1.16	-1.47
51	297	-6.00	-5.83	-5.84	-0.90	-0.95	-1.27
51	300	-5.53	-5.34	-5.35	-0.70	-0.75	-1.06
51	303	-5.13	-4.92	-4.93	-0.47	-0.53	-0.84
51	306	-4.74	-4.51	-4.50	-0.22	-0.28	-0.59
51	309	-4.34	-4.10	-4.07	0.05	-0.02	-0.33
51	312	-3.94	-3.68	-3.64	0.32	0.24	-0.07
51	315	-3.52	-3.25	-3.19	0.57	0.49	0.19
51	318	-3.07	-2.79	-2.72	0.82	0.75	0.46
51	321	-2.58	-2.29	-2.23	1.07	1.01	0.74
51	324	-2.09	-1.81	-1.73	1.30	1.27	1.01
51	327	-1.64	-1.34	-1.27	1.52	1.51	1.27
51	330	-1.23	-0.94	-0.87	1.70	1.71	1.49
51	333	-0.86	-0.56	-0.49	1.86	1.90	1.70
51	336	-0.48	-0.17	-0.09	2.02	2.09	1.92
51	339	-0.14	0.17	0.26	2.17	2.26	2.12
51	342	0.13	0.43	0.51	2.27	2.38	2.26
51	345	0.27	0.55	0.61	2.30	2.43	2.31
51	348	0.33	0.59	0.62	2.29	2.43	2.31
51	351	0.38	0.62	0.63	2.26	2.42	2.30
51	354	0.42	0.64	0.64	2.20	2.39	2.29
51	357	0.44	0.65	0.64	2.10	2.33	2.27
51	360	0.45	0.66	0.64	1.96	2.23	2.23
54	0	0.39	0.60	0.60	2.42	2.68	2.72
54	3	0.23	0.42	0.38	2.16	2.45	2.51
54	6	0.06	0.21	0.13	1.86	2.19	2.26
54	9	-0.14	-0.02	-0.15	1.54	1.90	1.99
54	12	-0.35	-0.27	-0.46	1.20	1.58	1.69
54	15	-0.58	-0.54	-0.78	0.83	1.24	1.36
54	18	-0.84	-0.85	-1.16	0.42	0.85	1.00
54	21	-1.15	-1.21	-1.61	-0.05	0.42	0.58
54	24	-1.47	-1.60	-2.07	-0.54	-0.05	0.13
54	27	-1.78	-1.97	-2.52	-1.04	-0.53	-0.33
54	30	-2.04	-2.28	-2.91	-1.52	-1.00	-0.77
54	33	-2.26	-2.59	-3.28	-2.02	-1.48	-1.22
54	36	-2.48	-2.90	-3.67	-2.55	-2.00	-1.71
54	39	-2.68	-3.19	-4.02	-3.07	-2.50	-2.17
54	42	-2.85	-3.39	-4.27	-3.50	-2.94	-2.59
54	45	-2.98	-3.47	-4.36	-3.80	-3.28	-2.91
54	48	-3.09	-3.47	-4.33	-4.01	-3.54	-3.17
54	51	-3.19	-3.48	-4.23	-4.20	-3.79	-3.41
54	54	-3.28	-3.48	-4.09	-4.36	-3.99	-3.61
54	57	-3.34	-3.48	-3.93	-4.46	-4.15	-3.76
54	60	-3.36	-3.48	-3.77	-4.50	-4.23	-3.86
54	63	-3.34	-3.41	-3.55	-4.50	-4.27	-3.91
54	66	-3.27	-3.23	-3.25	-4.50	-4.28	-3.95

54	69	-3.18	-3.00	-2.93	-4.50	-4.30	-3.97
54	72	-3.07	-2.77	-2.64	-4.50	-4.32	-4.01
54	75	-2.98	-2.58	-2.42	-4.50	-4.35	-4.06
54	78	-2.88	-2.44	-2.27	-4.56	-4.44	-4.17
54	81	-2.77	-2.31	-2.13	-4.73	-4.60	-4.34
54	84	-2.66	-2.19	-2.01	-4.98	-4.82	-4.57
54	87	-2.56	-2.09	-1.92	-5.27	-5.08	-4.84
54	90	-2.48	-2.01	-1.86	-5.58	-5.37	-5.14
54	93	-2.42	-1.96	-1.82	-5.97	-5.75	-5.52
54	96	-2.36	-1.91	-1.78	-6.50	-6.26	-6.01
54	99	-2.32	-1.87	-1.75	-7.10	-6.85	-6.59
54	102	-2.28	-1.84	-1.73	-7.72	-7.47	-7.21
54	105	-2.26	-1.83	-1.73	-8.30	-8.07	-7.85
54	108	-2.25	-1.84	-1.73	-8.92	-8.77	-8.64
54	111	-2.24	-1.85	-1.73	-9.62	-9.60	-9.62
54	114	-2.24	-1.86	-1.74	-10.29	-10.38	-10.58
54	117	-2.23	-1.87	-1.75	-10.78	-10.97	-11.31
54	120	-2.23	-1.89	-1.76	-10.97	-11.21	-11.60
54	123	-2.24	-1.91	-1.78	-10.78	-11.05	-11.49
54	126	-2.25	-1.93	-1.80	-10.29	-10.65	-11.21
54	129	-2.28	-1.95	-1.84	-9.63	-10.09	-10.81
54	132	-2.31	-1.98	-1.88	-8.92	-9.48	-10.35
54	135	-2.35	-2.02	-1.93	-8.27	-8.90	-9.88
54	138	-2.43	-2.11	-2.03	-7.64	-8.30	-9.32
54	141	-2.59	-2.26	-2.18	-6.92	-7.60	-8.60
54	144	-2.79	-2.46	-2.39	-6.23	-6.90	-7.85
54	147	-3.00	-2.67	-2.62	-5.65	-6.30	-7.19
54	150	-3.19	-2.88	-2.85	-5.27	-5.88	-6.72
54	153	-3.38	-3.10	-3.11	-5.04	-5.58	-6.41
54	156	-3.58	-3.34	-3.43	-4.83	-5.32	-6.11
54	159	-3.77	-3.59	-3.76	-4.67	-5.10	-5.87
54	162	-3.94	-3.82	-4.07	-4.56	-4.95	-5.71
54	165	-4.06	-3.99	-4.32	-4.52	-4.89	-5.65
54	168	-4.14	-4.13	-4.53	-4.62	-5.01	-5.80
54	171	-4.22	-4.26	-4.74	-4.91	-5.34	-6.21
54	174	-4.28	-4.37	-4.93	-5.36	-5.84	-6.83
54	177	-4.33	-4.45	-5.06	-5.94	-6.47	-7.59
54	180	-4.34	-4.48	-5.11	-6.60	-7.20	-8.45
54	183	-4.29	-4.42	-5.03	-8.24	-8.85	-10.10
54	186	-4.17	-4.25	-4.82	-11.13	-11.67	-12.76
54	189	-3.99	-4.01	-4.53	-14.33	-14.79	-15.63
54	192	-3.78	-3.75	-4.21	-16.94	-17.31	-17.93
54	195	-3.58	-3.50	-3.90	-18.01	-18.35	-18.88
54	198	-3.34	-3.22	-3.57	-17.43	-17.74	-18.19
54	201	-3.02	-2.89	-3.17	-15.96	-16.21	-16.46
54	204	-2.71	-2.55	-2.77	-14.04	-14.20	-14.21
54	207	-2.45	-2.28	-2.44	-12.08	-12.14	-11.93
54	210	-2.33	-2.12	-2.23	-10.51	-10.47	-10.15
54	213	-2.30	-2.05	-2.11	-9.29	-9.14	-8.78
54	216	-2.28	-1.99	-2.01	-8.13	-7.83	-7.48
54	219	-2.26	-1.94	-1.92	-7.06	-6.62	-6.29
54	222	-2.25	-1.91	-1.87	-6.09	-5.57	-5.27
54	225	-2.24	-1.90	-1.85	-5.27	-4.72	-4.49
54	228	-2.26	-1.92	-1.86	-4.53	-4.02	-3.86
54	231	-2.31	-1.95	-1.89	-3.84	-3.38	-3.28
54	234	-2.39	-2.01	-1.95	-3.23	-2.83	-2.80
54	237	-2.49	-2.08	-2.01	-2.73	-2.40	-2.43
54	240	-2.59	-2.16	-2.09	-2.38	-2.12	-2.23

54	243	-2.76	-2.31	-2.24	-2.14	-1.94	-2.11
54	246	-3.02	-2.56	-2.51	-1.91	-1.79	-2.02
54	249	-3.34	-2.90	-2.86	-1.73	-1.66	-1.94
54	252	-3.71	-3.28	-3.27	-1.61	-1.58	-1.90
54	255	-4.10	-3.69	-3.69	-1.57	-1.55	-1.88
54	258	-4.64	-4.26	-4.28	-1.59	-1.58	-1.91
54	261	-5.36	-5.03	-5.07	-1.64	-1.65	-1.99
54	264	-6.10	-5.83	-5.89	-1.70	-1.73	-2.08
54	267	-6.70	-6.50	-6.56	-1.75	-1.79	-2.15
54	270	-7.01	-6.85	-6.91	-1.77	-1.82	-2.19
54	273	-7.11	-6.99	-7.03	-1.76	-1.81	-2.17
54	276	-7.20	-7.10	-7.12	-1.74	-1.77	-2.11
54	279	-7.27	-7.19	-7.20	-1.69	-1.72	-2.03
54	282	-7.31	-7.24	-7.25	-1.64	-1.65	-1.93
54	285	-7.32	-7.26	-7.26	-1.57	-1.57	-1.83
54	288	-7.18	-7.11	-7.12	-1.47	-1.46	-1.70
54	291	-6.83	-6.74	-6.75	-1.29	-1.28	-1.52
54	294	-6.35	-6.24	-6.26	-1.07	-1.06	-1.30
54	297	-5.85	-5.71	-5.74	-0.83	-0.83	-1.07
54	300	-5.43	-5.26	-5.30	-0.59	-0.59	-0.83
54	303	-5.09	-4.91	-4.93	-0.32	-0.33	-0.58
54	306	-4.77	-4.57	-4.57	-0.02	-0.05	-0.30
54	309	-4.45	-4.24	-4.22	0.30	0.25	0.00
54	312	-4.12	-3.90	-3.85	0.61	0.55	0.30
54	315	-3.76	-3.52	-3.46	0.90	0.84	0.60
54	318	-3.33	-3.09	-3.01	1.17	1.12	0.89
54	321	-2.86	-2.60	-2.52	1.44	1.40	1.19
54	324	-2.36	-2.11	-2.02	1.70	1.68	1.48
54	327	-1.89	-1.63	-1.54	1.93	1.94	1.75
54	330	-1.47	-1.21	-1.12	2.12	2.15	1.99
54	333	-1.07	-0.81	-0.71	2.29	2.35	2.20
54	336	-0.67	-0.39	-0.30	2.46	2.55	2.42
54	339	-0.30	-0.02	0.08	2.61	2.72	2.62
54	342	-0.02	0.27	0.36	2.71	2.84	2.75
54	345	0.14	0.42	0.49	2.75	2.89	2.81
54	348	0.22	0.48	0.53	2.74	2.89	2.81
54	351	0.29	0.53	0.56	2.71	2.88	2.80
54	354	0.35	0.57	0.58	2.65	2.84	2.79
54	357	0.38	0.59	0.59	2.56	2.78	2.76
54	360	0.39	0.60	0.60	2.42	2.68	2.72
57	0	0.31	0.53	0.53	2.73	3.00	3.06
57	3	0.17	0.36	0.32	2.48	2.78	2.85
57	6	0.02	0.17	0.09	2.19	2.52	2.60
57	9	-0.15	-0.03	-0.17	1.87	2.23	2.33
57	12	-0.32	-0.25	-0.44	1.53	1.92	2.04
57	15	-0.51	-0.47	-0.73	1.17	1.58	1.72
57	18	-0.72	-0.74	-1.08	0.76	1.21	1.36
57	21	-0.96	-1.05	-1.47	0.31	0.78	0.95
57	24	-1.20	-1.36	-1.88	-0.18	0.32	0.51
57	27	-1.43	-1.66	-2.26	-0.67	-0.15	0.07
57	30	-1.61	-1.90	-2.55	-1.16	-0.61	-0.37
57	33	-1.76	-2.10	-2.80	-1.67	-1.10	-0.83
57	36	-1.88	-2.28	-3.05	-2.23	-1.63	-1.32
57	39	-1.99	-2.45	-3.26	-2.78	-2.16	-1.80
57	42	-2.10	-2.58	-3.40	-3.24	-2.62	-2.22
57	45	-2.21	-2.67	-3.46	-3.56	-2.97	-2.54
57	48	-2.36	-2.74	-3.44	-3.79	-3.24	-2.79
57	51	-2.52	-2.80	-3.38	-3.99	-3.49	-3.02

57	54	-2.67	-2.85	-3.30	-4.16	-3.71	-3.22
57	57	-2.79	-2.88	-3.21	-4.28	-3.86	-3.36
57	60	-2.85	-2.89	-3.11	-4.32	-3.94	-3.45
57	63	-2.86	-2.86	-2.98	-4.33	-3.97	-3.48
57	66	-2.87	-2.78	-2.80	-4.33	-3.99	-3.50
57	69	-2.88	-2.67	-2.60	-4.33	-4.00	-3.52
57	72	-2.89	-2.55	-2.41	-4.33	-4.02	-3.54
57	75	-2.89	-2.44	-2.26	-4.34	-4.05	-3.57
57	78	-2.86	-2.34	-2.14	-4.40	-4.13	-3.66
57	81	-2.77	-2.23	-2.04	-4.58	-4.30	-3.83
57	84	-2.65	-2.12	-1.94	-4.84	-4.52	-4.05
57	87	-2.53	-2.02	-1.85	-5.14	-4.78	-4.32
57	90	-2.42	-1.91	-1.77	-5.45	-5.07	-4.60
57	93	-2.32	-1.82	-1.69	-5.82	-5.42	-4.95
57	96	-2.22	-1.73	-1.62	-6.29	-5.88	-5.40
57	99	-2.12	-1.64	-1.56	-6.82	-6.40	-5.93
57	102	-2.01	-1.55	-1.49	-7.37	-6.96	-6.49
57	105	-1.90	-1.46	-1.42	-7.88	-7.52	-7.07
57	108	-1.79	-1.36	-1.34	-8.45	-8.18	-7.80
57	111	-1.66	-1.26	-1.25	-9.10	-8.96	-8.71
57	114	-1.54	-1.16	-1.16	-9.71	-9.72	-9.60
57	117	-1.42	-1.07	-1.08	-10.16	-10.30	-10.27
57	120	-1.31	-0.98	-1.00	-10.34	-10.52	-10.54
57	123	-1.19	-0.88	-0.92	-10.19	-10.42	-10.50
57	126	-1.07	-0.77	-0.84	-9.82	-10.15	-10.38
57	129	-0.96	-0.67	-0.76	-9.30	-9.77	-10.20
57	132	-0.88	-0.60	-0.70	-8.72	-9.33	-9.98
57	135	-0.85	-0.57	-0.68	-8.18	-8.88	-9.73
57	138	-0.89	-0.61	-0.72	-7.58	-8.34	-9.29
57	141	-1.00	-0.71	-0.82	-6.88	-7.65	-8.61
57	144	-1.14	-0.86	-0.97	-6.17	-6.91	-7.83
57	147	-1.32	-1.03	-1.14	-5.57	-6.27	-7.11
57	150	-1.49	-1.21	-1.33	-5.18	-5.82	-6.62
57	153	-1.70	-1.44	-1.58	-4.95	-5.51	-6.29
57	156	-1.96	-1.73	-1.90	-4.74	-5.24	-5.99
57	159	-2.24	-2.05	-2.28	-4.57	-5.01	-5.73
57	162	-2.53	-2.39	-2.66	-4.46	-4.85	-5.56
57	165	-2.80	-2.69	-3.01	-4.42	-4.79	-5.50
57	168	-3.10	-3.01	-3.38	-4.55	-4.93	-5.66
57	171	-3.43	-3.37	-3.79	-4.90	-5.31	-6.11
57	174	-3.74	-3.70	-4.17	-5.44	-5.89	-6.79
57	177	-3.97	-3.95	-4.45	-6.14	-6.63	-7.63
57	180	-4.05	-4.04	-4.56	-6.95	-7.48	-8.57
57	183	-4.04	-4.01	-4.52	-8.95	-9.41	-10.39
57	186	-3.99	-3.93	-4.40	-12.48	-12.73	-13.32
57	189	-3.91	-3.80	-4.23	-16.42	-16.38	-16.49
57	192	-3.81	-3.65	-4.02	-19.61	-19.34	-19.03
57	195	-3.70	-3.49	-3.80	-20.93	-20.56	-20.07
57	198	-3.49	-3.25	-3.50	-19.89	-19.50	-19.02
57	201	-3.15	-2.89	-3.07	-17.32	-16.87	-16.44
57	204	-2.76	-2.50	-2.61	-14.05	-13.52	-13.14
57	207	-2.42	-2.16	-2.21	-10.88	-10.30	-9.99
57	210	-2.21	-1.94	-1.94	-8.65	-8.05	-7.81
57	213	-2.10	-1.81	-1.78	-7.21	-6.64	-6.45
57	216	-2.00	-1.70	-1.63	-5.93	-5.37	-5.24
57	219	-1.92	-1.60	-1.52	-4.83	-4.28	-4.21
57	222	-1.87	-1.54	-1.44	-3.92	-3.41	-3.39
57	225	-1.85	-1.52	-1.41	-3.25	-2.78	-2.82

57	228	-1.87	-1.54	-1.43	-2.70	-2.30	-2.40
57	231	-1.92	-1.58	-1.49	-2.21	-1.86	-2.03
57	234	-2.01	-1.66	-1.57	-1.80	-1.50	-1.72
57	237	-2.11	-1.75	-1.68	-1.50	-1.26	-1.52
57	240	-2.23	-1.85	-1.81	-1.36	-1.17	-1.44
57	243	-2.41	-2.03	-2.00	-1.31	-1.17	-1.45
57	246	-2.70	-2.32	-2.31	-1.27	-1.18	-1.47
57	249	-3.06	-2.69	-2.70	-1.24	-1.18	-1.49
57	252	-3.47	-3.11	-3.14	-1.22	-1.19	-1.52
57	255	-3.91	-3.55	-3.60	-1.22	-1.19	-1.56
57	258	-4.50	-4.17	-4.24	-1.27	-1.25	-1.63
57	261	-5.28	-5.00	-5.08	-1.40	-1.38	-1.76
57	264	-6.07	-5.85	-5.95	-1.55	-1.54	-1.89
57	267	-6.70	-6.53	-6.63	-1.67	-1.66	-2.00
57	270	-6.97	-6.85	-6.93	-1.73	-1.72	-2.05
57	273	-7.00	-6.91	-6.98	-1.72	-1.71	-2.03
57	276	-7.03	-6.97	-7.02	-1.70	-1.68	-1.98
57	279	-7.05	-7.01	-7.05	-1.67	-1.63	-1.90
57	282	-7.06	-7.03	-7.07	-1.63	-1.58	-1.81
57	285	-7.06	-7.04	-7.07	-1.58	-1.51	-1.71
57	288	-6.93	-6.90	-6.94	-1.48	-1.39	-1.57
57	291	-6.59	-6.54	-6.59	-1.28	-1.20	-1.37
57	294	-6.14	-6.06	-6.12	-1.03	-0.96	-1.13
57	297	-5.68	-5.57	-5.64	-0.75	-0.70	-0.88
57	300	-5.31	-5.17	-5.23	-0.48	-0.43	-0.62
57	303	-5.02	-4.87	-4.91	-0.19	-0.16	-0.34
57	306	-4.77	-4.61	-4.62	0.14	0.15	-0.04
57	309	-4.53	-4.35	-4.33	0.48	0.47	0.28
57	312	-4.26	-4.07	-4.02	0.81	0.79	0.60
57	315	-3.95	-3.75	-3.68	1.12	1.09	0.91
57	318	-3.57	-3.36	-3.27	1.41	1.38	1.21
57	321	-3.12	-2.90	-2.80	1.70	1.68	1.52
57	324	-2.65	-2.42	-2.31	1.97	1.97	1.82
57	327	-2.17	-1.95	-1.84	2.21	2.23	2.10
57	330	-1.75	-1.52	-1.41	2.41	2.45	2.33
57	333	-1.34	-1.10	-0.99	2.59	2.65	2.55
57	336	-0.91	-0.66	-0.55	2.76	2.86	2.77
57	339	-0.52	-0.25	-0.14	2.91	3.03	2.96
57	342	-0.21	0.07	0.17	3.02	3.16	3.10
57	345	-0.02	0.25	0.33	3.06	3.20	3.15
57	348	0.09	0.34	0.40	3.05	3.20	3.15
57	351	0.18	0.42	0.46	3.02	3.19	3.14
57	354	0.25	0.48	0.50	2.96	3.16	3.13
57	357	0.30	0.51	0.53	2.87	3.10	3.10
57	360	0.31	0.53	0.53	2.73	3.00	3.06
60	0	0.22	0.44	0.46	2.85	3.13	3.18
60	3	0.10	0.30	0.27	2.64	2.94	3.00
60	6	-0.02	0.15	0.06	2.38	2.71	2.79
60	9	-0.14	-0.02	-0.17	2.10	2.46	2.54
60	12	-0.28	-0.20	-0.41	1.79	2.17	2.27
60	15	-0.41	-0.38	-0.66	1.45	1.86	1.98
60	18	-0.56	-0.59	-0.94	1.07	1.52	1.65
60	21	-0.72	-0.82	-1.26	0.64	1.12	1.26
60	24	-0.89	-1.06	-1.59	0.18	0.68	0.85
60	27	-1.06	-1.29	-1.90	-0.30	0.23	0.42
60	30	-1.21	-1.50	-2.16	-0.78	-0.22	0.00
60	33	-1.36	-1.70	-2.41	-1.29	-0.71	-0.45
60	36	-1.50	-1.90	-2.66	-1.86	-1.24	-0.93

60	39	-1.64	-2.09	-2.89	-2.42	-1.77	-1.40
60	42	-1.78	-2.25	-3.05	-2.90	-2.23	-1.82
60	45	-1.92	-2.37	-3.11	-3.24	-2.59	-2.14
60	48	-2.08	-2.46	-3.10	-3.49	-2.87	-2.39
60	51	-2.26	-2.54	-3.06	-3.71	-3.13	-2.62
60	54	-2.42	-2.61	-3.00	-3.89	-3.35	-2.81
60	57	-2.57	-2.66	-2.93	-4.02	-3.52	-2.96
60	60	-2.66	-2.68	-2.86	-4.09	-3.61	-3.05
60	63	-2.72	-2.66	-2.77	-4.11	-3.66	-3.11
60	66	-2.77	-2.61	-2.63	-4.12	-3.69	-3.14
60	69	-2.82	-2.54	-2.48	-4.13	-3.71	-3.17
60	72	-2.85	-2.47	-2.33	-4.14	-3.74	-3.20
60	75	-2.86	-2.39	-2.21	-4.17	-3.78	-3.26
60	78	-2.83	-2.31	-2.10	-4.26	-3.89	-3.37
60	81	-2.75	-2.21	-2.01	-4.47	-4.09	-3.56
60	84	-2.64	-2.11	-1.92	-4.75	-4.34	-3.80
60	87	-2.52	-2.00	-1.83	-5.07	-4.64	-4.08
60	90	-2.40	-1.88	-1.74	-5.40	-4.94	-4.38
60	93	-2.27	-1.76	-1.64	-5.77	-5.31	-4.74
60	96	-2.12	-1.63	-1.54	-6.23	-5.75	-5.18
60	99	-1.96	-1.49	-1.44	-6.74	-6.25	-5.68
60	102	-1.80	-1.35	-1.34	-7.25	-6.77	-6.21
60	105	-1.63	-1.21	-1.23	-7.71	-7.28	-6.74
60	108	-1.47	-1.07	-1.13	-8.20	-7.86	-7.38
60	111	-1.29	-0.93	-1.01	-8.74	-8.55	-8.14
60	114	-1.11	-0.79	-0.90	-9.23	-9.20	-8.88
60	117	-0.94	-0.65	-0.79	-9.60	-9.68	-9.43
60	120	-0.79	-0.52	-0.68	-9.74	-9.87	-9.65
60	123	-0.65	-0.39	-0.56	-9.63	-9.82	-9.65
60	126	-0.50	-0.24	-0.42	-9.34	-9.66	-9.63
60	129	-0.37	-0.11	-0.30	-8.94	-9.43	-9.60
60	132	-0.27	-0.01	-0.21	-8.48	-9.16	-9.56
60	135	-0.24	0.03	-0.17	-8.02	-8.85	-9.51
60	138	-0.27	0.00	-0.20	-7.49	-8.38	-9.21
60	141	-0.35	-0.09	-0.28	-6.82	-7.68	-8.55
60	144	-0.48	-0.21	-0.40	-6.13	-6.91	-7.75
60	147	-0.62	-0.35	-0.54	-5.53	-6.21	-6.99
60	150	-0.78	-0.51	-0.70	-5.15	-5.74	-6.49
60	153	-0.99	-0.73	-0.93	-4.91	-5.45	-6.18
60	156	-1.27	-1.05	-1.26	-4.70	-5.18	-5.90
60	159	-1.60	-1.41	-1.66	-4.54	-4.96	-5.66
60	162	-1.95	-1.79	-2.07	-4.43	-4.81	-5.50
60	165	-2.28	-2.15	-2.46	-4.38	-4.76	-5.44
60	168	-2.65	-2.54	-2.89	-4.54	-4.92	-5.62
60	171	-3.09	-2.99	-3.38	-4.96	-5.36	-6.10
60	174	-3.50	-3.42	-3.85	-5.61	-6.03	-6.83
60	177	-3.82	-3.74	-4.20	-6.43	-6.87	-7.72
60	180	-3.94	-3.86	-4.33	-7.37	-7.83	-8.72
60	183	-3.93	-3.84	-4.30	-9.55	-9.89	-10.61
60	186	-3.90	-3.79	-4.20	-13.29	-13.35	-13.62
60	189	-3.87	-3.70	-4.06	-17.42	-17.15	-16.88
60	192	-3.81	-3.60	-3.88	-20.76	-20.20	-19.48
60	195	-3.75	-3.47	-3.69	-22.13	-21.46	-20.55
60	198	-3.56	-3.24	-3.38	-20.82	-20.12	-19.27
60	201	-3.18	-2.84	-2.91	-17.59	-16.83	-16.14
60	204	-2.73	-2.39	-2.38	-13.53	-12.71	-12.22
60	207	-2.31	-1.97	-1.91	-9.72	-8.87	-8.57
60	210	-2.02	-1.69	-1.59	-7.24	-6.43	-6.27

60	213	-1.83	-1.50	-1.38	-5.87	-5.14	-5.06
60	216	-1.66	-1.33	-1.20	-4.70	-4.04	-4.04
60	219	-1.51	-1.19	-1.04	-3.72	-3.14	-3.19
60	222	-1.41	-1.09	-0.94	-2.95	-2.45	-2.55
60	225	-1.38	-1.06	-0.90	-2.40	-1.97	-2.12
60	228	-1.40	-1.08	-0.93	-1.96	-1.61	-1.82
60	231	-1.46	-1.14	-1.01	-1.57	-1.29	-1.55
60	234	-1.55	-1.22	-1.13	-1.25	-1.03	-1.33
60	237	-1.66	-1.34	-1.27	-1.03	-0.86	-1.19
60	240	-1.79	-1.47	-1.44	-0.96	-0.80	-1.14
60	243	-1.99	-1.67	-1.67	-0.96	-0.81	-1.16
60	246	-2.32	-1.99	-2.02	-0.98	-0.86	-1.21
60	249	-2.72	-2.40	-2.45	-1.01	-0.92	-1.28
60	252	-3.18	-2.86	-2.94	-1.05	-0.99	-1.36
60	255	-3.65	-3.35	-3.44	-1.09	-1.06	-1.44
60	258	-4.29	-4.03	-4.14	-1.18	-1.17	-1.53
60	261	-5.14	-4.93	-5.04	-1.34	-1.31	-1.65
60	264	-5.98	-5.85	-5.96	-1.51	-1.47	-1.77
60	267	-6.63	-6.56	-6.66	-1.65	-1.58	-1.86
60	270	-6.90	-6.84	-6.95	-1.71	-1.63	-1.89
60	273	-6.89	-6.84	-6.94	-1.70	-1.62	-1.87
60	276	-6.87	-6.83	-6.93	-1.69	-1.59	-1.82
60	279	-6.83	-6.81	-6.90	-1.66	-1.54	-1.74
60	282	-6.79	-6.78	-6.87	-1.63	-1.48	-1.64
60	285	-6.73	-6.75	-6.84	-1.58	-1.41	-1.53
60	288	-6.57	-6.59	-6.68	-1.47	-1.29	-1.38
60	291	-6.25	-6.26	-6.35	-1.25	-1.08	-1.17
60	294	-5.85	-5.82	-5.92	-0.96	-0.81	-0.92
60	297	-5.45	-5.39	-5.49	-0.65	-0.53	-0.64
60	300	-5.13	-5.03	-5.12	-0.35	-0.25	-0.38
60	303	-4.89	-4.78	-4.84	-0.06	0.02	-0.10
60	306	-4.69	-4.56	-4.59	0.26	0.32	0.20
60	309	-4.50	-4.34	-4.34	0.59	0.63	0.51
60	312	-4.29	-4.12	-4.07	0.91	0.94	0.81
60	315	-4.04	-3.85	-3.77	1.21	1.23	1.10
60	318	-3.71	-3.51	-3.41	1.50	1.52	1.39
60	321	-3.32	-3.11	-2.99	1.79	1.81	1.69
60	324	-2.89	-2.68	-2.56	2.07	2.09	1.97
60	327	-2.45	-2.24	-2.12	2.32	2.35	2.23
60	330	-2.05	-1.83	-1.71	2.52	2.57	2.46
60	333	-1.63	-1.41	-1.28	2.70	2.77	2.68
60	336	-1.19	-0.95	-0.82	2.88	2.97	2.90
60	339	-0.77	-0.52	-0.39	3.03	3.15	3.09
60	342	-0.42	-0.17	-0.05	3.13	3.27	3.23
60	345	-0.21	0.05	0.15	3.17	3.32	3.28
60	348	-0.07	0.17	0.25	3.17	3.32	3.28
60	351	0.04	0.28	0.34	3.14	3.31	3.27
60	354	0.14	0.37	0.40	3.08	3.28	3.26
60	357	0.20	0.42	0.45	2.99	3.22	3.23
60	360	0.22	0.44	0.46	2.85	3.13	3.18
63	0	-0.03	0.22	0.25	2.87	3.16	3.18
63	3	-0.07	0.15	0.13	2.70	3.02	3.04
63	6	-0.11	0.07	-0.01	2.50	2.83	2.87
63	9	-0.17	-0.02	-0.17	2.26	2.62	2.67
63	12	-0.23	-0.13	-0.33	1.99	2.38	2.44
63	15	-0.29	-0.24	-0.51	1.70	2.12	2.19
63	18	-0.37	-0.37	-0.70	1.36	1.81	1.89
63	21	-0.45	-0.51	-0.92	0.97	1.44	1.55



63	24	-0.55	-0.67	-1.16	0.54	1.04	1.16
63	27	-0.66	-0.85	-1.41	0.09	0.61	0.76
63	30	-0.78	-1.05	-1.66	-0.36	0.18	0.36
63	33	-0.95	-1.28	-1.96	-0.86	-0.28	-0.07
63	36	-1.17	-1.56	-2.30	-1.41	-0.79	-0.53
63	39	-1.42	-1.85	-2.64	-1.96	-1.30	-0.99
63	42	-1.68	-2.14	-2.93	-2.44	-1.76	-1.40
63	45	-1.93	-2.38	-3.12	-2.80	-2.13	-1.72
63	48	-2.21	-2.62	-3.25	-3.06	-2.41	-1.98
63	51	-2.53	-2.87	-3.37	-3.29	-2.68	-2.20
63	54	-2.84	-3.09	-3.46	-3.49	-2.90	-2.40
63	57	-3.07	-3.25	-3.53	-3.65	-3.09	-2.56
63	60	-3.19	-3.31	-3.55	-3.75	-3.22	-2.69
63	63	-3.23	-3.28	-3.48	-3.82	-3.31	-2.79
63	66	-3.26	-3.19	-3.29	-3.86	-3.37	-2.86
63	69	-3.28	-3.07	-3.05	-3.89	-3.42	-2.92
63	72	-3.29	-2.93	-2.80	-3.94	-3.48	-2.99
63	75	-3.30	-2.80	-2.59	-4.01	-3.57	-3.10
63	78	-3.24	-2.65	-2.42	-4.15	-3.73	-3.26
63	81	-3.09	-2.48	-2.26	-4.40	-3.97	-3.49
63	84	-2.88	-2.30	-2.10	-4.72	-4.27	-3.78
63	87	-2.66	-2.12	-1.95	-5.08	-4.61	-4.10
63	90	-2.46	-1.94	-1.81	-5.44	-4.96	-4.43
63	93	-2.26	-1.77	-1.67	-5.85	-5.36	-4.82
63	96	-2.06	-1.59	-1.53	-6.34	-5.83	-5.28
63	99	-1.85	-1.41	-1.39	-6.86	-6.33	-5.78
63	102	-1.64	-1.24	-1.26	-7.34	-6.82	-6.29
63	105	-1.45	-1.08	-1.14	-7.74	-7.27	-6.75
63	108	-1.26	-0.93	-1.03	-8.09	-7.72	-7.24
63	111	-1.06	-0.78	-0.93	-8.44	-8.21	-7.78
63	114	-0.88	-0.64	-0.83	-8.75	-8.66	-8.28
63	117	-0.72	-0.51	-0.74	-8.97	-8.98	-8.66
63	120	-0.60	-0.40	-0.65	-9.06	-9.11	-8.83
63	123	-0.50	-0.30	-0.56	-8.96	-9.07	-8.86
63	126	-0.40	-0.20	-0.46	-8.71	-8.97	-8.88
63	129	-0.32	-0.11	-0.37	-8.35	-8.83	-8.90
63	132	-0.27	-0.05	-0.31	-7.95	-8.64	-8.91
63	135	-0.25	-0.03	-0.28	-7.56	-8.43	-8.91
63	138	-0.28	-0.07	-0.32	-7.08	-8.02	-8.66
63	141	-0.38	-0.17	-0.42	-6.48	-7.36	-8.07
63	144	-0.53	-0.32	-0.58	-5.88	-6.63	-7.34
63	147	-0.70	-0.50	-0.76	-5.39	-6.00	-6.69
63	150	-0.89	-0.69	-0.96	-5.14	-5.65	-6.33
63	153	-1.12	-0.94	-1.22	-5.07	-5.52	-6.20
63	156	-1.44	-1.28	-1.59	-5.00	-5.41	-6.09
63	159	-1.79	-1.68	-2.02	-4.95	-5.32	-6.00
63	162	-2.16	-2.08	-2.45	-4.92	-5.27	-5.95
63	165	-2.51	-2.45	-2.85	-4.91	-5.25	-5.93
63	168	-2.88	-2.83	-3.26	-5.24	-5.59	-6.27
63	171	-3.30	-3.26	-3.72	-6.11	-6.49	-7.18
63	174	-3.70	-3.66	-4.15	-7.35	-7.75	-8.45
63	177	-3.99	-3.95	-4.46	-8.78	-9.20	-9.87
63	180	-4.10	-4.07	-4.59	-10.25	-10.64	-11.25
63	183	-4.08	-4.03	-4.52	-12.25	-12.51	-12.92
63	186	-4.02	-3.93	-4.36	-14.98	-14.99	-15.04
63	189	-3.92	-3.78	-4.12	-17.76	-17.47	-17.14
63	192	-3.81	-3.59	-3.83	-19.92	-19.40	-18.74
63	195	-3.67	-3.39	-3.54	-20.79	-20.17	-19.38

63	198	-3.40	-3.07	-3.13	-19.46	-18.81	-18.09
63	201	-2.96	-2.59	-2.58	-16.21	-15.51	-14.95
63	204	-2.44	-2.06	-1.98	-12.17	-11.41	-11.05
63	207	-1.95	-1.57	-1.44	-8.45	-7.66	-7.49
63	210	-1.60	-1.22	-1.06	-6.16	-5.42	-5.36
63	213	-1.34	-0.97	-0.80	-5.06	-4.39	-4.40
63	216	-1.09	-0.74	-0.56	-4.15	-3.55	-3.60
63	219	-0.88	-0.55	-0.36	-3.41	-2.87	-2.96
63	222	-0.73	-0.41	-0.22	-2.83	-2.35	-2.47
63	225	-0.68	-0.36	-0.17	-2.40	-1.98	-2.14
63	228	-0.70	-0.39	-0.21	-2.04	-1.68	-1.88
63	231	-0.77	-0.46	-0.30	-1.71	-1.41	-1.65
63	234	-0.88	-0.57	-0.44	-1.44	-1.20	-1.47
63	237	-1.01	-0.71	-0.62	-1.25	-1.05	-1.35
63	240	-1.17	-0.86	-0.81	-1.18	-1.00	-1.30
63	243	-1.40	-1.10	-1.08	-1.19	-1.01	-1.32
63	246	-1.77	-1.46	-1.47	-1.21	-1.05	-1.36
63	249	-2.22	-1.92	-1.95	-1.23	-1.10	-1.42
63	252	-2.73	-2.44	-2.49	-1.27	-1.16	-1.49
63	255	-3.25	-2.97	-3.05	-1.30	-1.22	-1.54
63	258	-3.94	-3.70	-3.79	-1.37	-1.29	-1.59
63	261	-4.82	-4.66	-4.76	-1.48	-1.38	-1.64
63	264	-5.70	-5.62	-5.72	-1.60	-1.47	-1.68
63	267	-6.37	-6.36	-6.47	-1.70	-1.54	-1.72
63	270	-6.64	-6.66	-6.77	-1.73	-1.57	-1.73
63	273	-6.62	-6.64	-6.75	-1.72	-1.55	-1.70
63	276	-6.55	-6.60	-6.72	-1.69	-1.50	-1.63
63	279	-6.46	-6.52	-6.67	-1.65	-1.43	-1.52
63	282	-6.34	-6.43	-6.60	-1.58	-1.33	-1.39
63	285	-6.21	-6.32	-6.52	-1.51	-1.23	-1.26
63	288	-6.01	-6.12	-6.34	-1.37	-1.08	-1.08
63	291	-5.70	-5.79	-6.02	-1.12	-0.85	-0.86
63	294	-5.36	-5.41	-5.62	-0.80	-0.57	-0.60
63	297	-5.03	-5.03	-5.22	-0.48	-0.28	-0.33
63	300	-4.77	-4.73	-4.89	-0.17	-0.01	-0.07
63	303	-4.59	-4.52	-4.64	0.10	0.25	0.19
63	306	-4.44	-4.34	-4.41	0.39	0.51	0.45
63	309	-4.31	-4.17	-4.20	0.67	0.78	0.71
63	312	-4.16	-3.99	-3.97	0.95	1.05	0.98
63	315	-3.98	-3.78	-3.72	1.22	1.31	1.23
63	318	-3.75	-3.53	-3.44	1.49	1.57	1.49
63	321	-3.47	-3.23	-3.12	1.77	1.84	1.74
63	324	-3.16	-2.91	-2.80	2.04	2.10	2.00
63	327	-2.83	-2.58	-2.46	2.28	2.33	2.23
63	330	-2.50	-2.25	-2.12	2.48	2.54	2.44
63	333	-2.14	-1.88	-1.75	2.66	2.74	2.65
63	336	-1.74	-1.47	-1.33	2.84	2.94	2.86
63	339	-1.34	-1.06	-0.93	2.99	3.12	3.06
63	342	-0.99	-0.71	-0.58	3.10	3.24	3.19
63	345	-0.73	-0.45	-0.34	3.14	3.29	3.25
63	348	-0.53	-0.26	-0.17	3.14	3.29	3.25
63	351	-0.35	-0.08	-0.01	3.12	3.28	3.24
63	354	-0.20	0.06	0.13	3.07	3.26	3.23
63	357	-0.09	0.17	0.21	2.99	3.22	3.21
63	360	-0.03	0.22	0.25	2.87	3.16	3.18
66	0	-0.48	-0.18	-0.16	2.88	3.18	3.17
66	3	-0.38	-0.12	-0.16	2.76	3.08	3.08
66	6	-0.29	-0.09	-0.18	2.59	2.94	2.94

66	9	-0.22	-0.07	-0.21	2.39	2.77	2.78
66	12	-0.18	-0.06	-0.25	2.17	2.57	2.59
66	15	-0.16	-0.06	-0.29	1.92	2.35	2.38
66	18	-0.17	-0.09	-0.36	1.63	2.09	2.12
66	21	-0.19	-0.16	-0.49	1.28	1.76	1.81
66	24	-0.23	-0.27	-0.67	0.88	1.38	1.45
66	27	-0.28	-0.40	-0.87	0.47	0.98	1.08
66	30	-0.34	-0.55	-1.10	0.05	0.59	0.70
66	33	-0.49	-0.78	-1.40	-0.41	0.16	0.31
66	36	-0.77	-1.12	-1.80	-0.92	-0.32	-0.13
66	39	-1.13	-1.54	-2.25	-1.43	-0.80	-0.58
66	42	-1.55	-1.98	-2.72	-1.89	-1.25	-0.98
66	45	-1.96	-2.42	-3.16	-2.26	-1.61	-1.31
66	48	-2.47	-2.94	-3.63	-2.54	-1.90	-1.57
66	51	-3.12	-3.57	-4.17	-2.78	-2.17	-1.80
66	54	-3.77	-4.17	-4.67	-3.00	-2.41	-2.01
66	57	-4.26	-4.63	-5.04	-3.18	-2.61	-2.20
66	60	-4.46	-4.82	-5.19	-3.34	-2.79	-2.36
66	63	-4.45	-4.75	-5.06	-3.46	-2.92	-2.50
66	66	-4.44	-4.57	-4.74	-3.55	-3.03	-2.61
66	69	-4.41	-4.32	-4.32	-3.63	-3.13	-2.71
66	72	-4.38	-4.04	-3.87	-3.72	-3.24	-2.83
66	75	-4.34	-3.76	-3.49	-3.86	-3.38	-2.99
66	78	-4.18	-3.47	-3.17	-4.07	-3.60	-3.20
66	81	-3.83	-3.12	-2.83	-4.38	-3.90	-3.49
66	84	-3.40	-2.75	-2.52	-4.76	-4.24	-3.82
66	87	-2.96	-2.39	-2.22	-5.16	-4.62	-4.18
66	90	-2.60	-2.09	-1.97	-5.56	-5.00	-4.55
66	93	-2.31	-1.83	-1.76	-6.02	-5.44	-4.97
66	96	-2.03	-1.59	-1.56	-6.56	-5.95	-5.46
66	99	-1.78	-1.37	-1.38	-7.10	-6.47	-5.96
66	102	-1.54	-1.17	-1.22	-7.55	-6.93	-6.42
66	105	-1.32	-0.99	-1.09	-7.81	-7.27	-6.79
66	108	-1.11	-0.82	-0.97	-7.94	-7.52	-7.10
66	111	-0.90	-0.66	-0.85	-8.05	-7.76	-7.40
66	114	-0.71	-0.52	-0.76	-8.14	-7.97	-7.67
66	117	-0.56	-0.40	-0.68	-8.20	-8.11	-7.85
66	120	-0.46	-0.33	-0.63	-8.22	-8.16	-7.93
66	123	-0.40	-0.28	-0.61	-8.12	-8.12	-7.92
66	126	-0.35	-0.23	-0.58	-7.85	-8.01	-7.91
66	129	-0.31	-0.20	-0.56	-7.48	-7.85	-7.90
66	132	-0.28	-0.17	-0.55	-7.08	-7.66	-7.88
66	135	-0.27	-0.16	-0.55	-6.73	-7.46	-7.85
66	138	-0.32	-0.22	-0.61	-6.37	-7.13	-7.66
66	141	-0.46	-0.37	-0.77	-5.95	-6.64	-7.24
66	144	-0.66	-0.58	-1.01	-5.55	-6.13	-6.75
66	147	-0.90	-0.84	-1.28	-5.26	-5.72	-6.34
66	150	-1.14	-1.10	-1.57	-5.14	-5.56	-6.17
66	153	-1.44	-1.43	-1.92	-5.19	-5.60	-6.21
66	156	-1.83	-1.85	-2.38	-5.32	-5.71	-6.33
66	159	-2.26	-2.32	-2.88	-5.54	-5.89	-6.52
66	162	-2.68	-2.77	-3.37	-5.82	-6.13	-6.77
66	165	-3.05	-3.16	-3.77	-6.17	-6.42	-7.08
66	168	-3.41	-3.52	-4.14	-7.41	-7.69	-8.33
66	171	-3.80	-3.89	-4.52	-9.85	-10.25	-10.82
66	174	-4.14	-4.23	-4.86	-12.70	-13.22	-13.68
66	177	-4.40	-4.47	-5.10	-15.15	-15.70	-16.04
66	180	-4.49	-4.56	-5.19	-16.42	-16.79	-17.02

66	183	-4.43	-4.48	-5.07	-16.79	-16.87	-17.00
66	186	-4.27	-4.26	-4.76	-17.10	-16.93	-16.95
66	189	-4.04	-3.95	-4.33	-17.33	-16.98	-16.85
66	192	-3.76	-3.59	-3.83	-17.48	-17.01	-16.72
66	195	-3.47	-3.22	-3.35	-17.53	-17.02	-16.56
66	198	-3.07	-2.76	-2.80	-16.37	-15.84	-15.32
66	201	-2.52	-2.17	-2.13	-13.57	-13.00	-12.57
66	204	-1.92	-1.54	-1.44	-10.09	-9.48	-9.24
66	207	-1.36	-0.97	-0.82	-6.93	-6.31	-6.26
66	210	-0.94	-0.55	-0.38	-5.08	-4.47	-4.53
66	213	-0.62	-0.24	-0.05	-4.27	-3.72	-3.80
66	216	-0.31	0.05	0.25	-3.60	-3.10	-3.21
66	219	-0.04	0.30	0.51	-3.08	-2.61	-2.74
66	222	0.15	0.47	0.68	-2.68	-2.25	-2.39
66	225	0.21	0.53	0.74	-2.40	-2.01	-2.17
66	228	0.18	0.50	0.71	-2.19	-1.84	-2.02
66	231	0.09	0.42	0.60	-2.01	-1.70	-1.89
66	234	-0.04	0.28	0.45	-1.86	-1.58	-1.78
66	237	-0.21	0.12	0.26	-1.77	-1.51	-1.72
66	240	-0.39	-0.07	0.05	-1.73	-1.48	-1.69
66	243	-0.67	-0.34	-0.25	-1.74	-1.49	-1.70
66	246	-1.09	-0.76	-0.68	-1.76	-1.52	-1.72
66	249	-1.60	-1.27	-1.20	-1.79	-1.56	-1.74
66	252	-2.17	-1.84	-1.78	-1.81	-1.59	-1.76
66	255	-2.73	-2.43	-2.39	-1.82	-1.60	-1.77
66	258	-3.45	-3.20	-3.18	-1.82	-1.60	-1.76
66	261	-4.34	-4.19	-4.20	-1.81	-1.59	-1.74
66	264	-5.21	-5.17	-5.22	-1.81	-1.57	-1.70
66	267	-5.88	-5.93	-6.00	-1.80	-1.55	-1.65
66	270	-6.15	-6.23	-6.31	-1.80	-1.53	-1.59
66	273	-6.11	-6.20	-6.31	-1.77	-1.47	-1.51
66	276	-6.00	-6.13	-6.28	-1.69	-1.38	-1.39
66	279	-5.85	-6.02	-6.24	-1.59	-1.26	-1.24
66	282	-5.67	-5.89	-6.20	-1.46	-1.11	-1.07
66	285	-5.49	-5.74	-6.14	-1.32	-0.96	-0.89
66	288	-5.26	-5.52	-5.96	-1.13	-0.77	-0.69
66	291	-4.97	-5.19	-5.63	-0.87	-0.52	-0.46
66	294	-4.66	-4.82	-5.22	-0.56	-0.25	-0.21
66	297	-4.39	-4.48	-4.81	-0.25	0.02	0.04
66	300	-4.21	-4.23	-4.50	0.04	0.27	0.28
66	303	-4.11	-4.08	-4.29	0.29	0.50	0.50
66	306	-4.04	-3.95	-4.10	0.53	0.72	0.71
66	309	-3.98	-3.85	-3.93	0.76	0.94	0.93
66	312	-3.91	-3.74	-3.77	0.99	1.16	1.14
66	315	-3.83	-3.61	-3.59	1.23	1.38	1.35
66	318	-3.73	-3.47	-3.42	1.47	1.60	1.56
66	321	-3.61	-3.33	-3.25	1.72	1.84	1.78
66	324	-3.48	-3.18	-3.08	1.97	2.06	1.99
66	327	-3.34	-3.01	-2.89	2.20	2.28	2.19
66	330	-3.17	-2.81	-2.68	2.39	2.47	2.38
66	333	-2.94	-2.57	-2.43	2.57	2.66	2.58
66	336	-2.64	-2.27	-2.13	2.75	2.86	2.79
66	339	-2.30	-1.94	-1.81	2.90	3.04	2.97
66	342	-1.97	-1.62	-1.50	3.01	3.17	3.11
66	345	-1.67	-1.33	-1.22	3.05	3.22	3.17
66	348	-1.41	-1.08	-0.98	3.05	3.22	3.17
66	351	-1.16	-0.83	-0.75	3.04	3.22	3.17
66	354	-0.92	-0.60	-0.54	3.02	3.21	3.17

66	357	-0.70	-0.38	-0.34	2.97	3.20	3.17
66	360	-0.48	-0.18	-0.16	2.88	3.18	3.17
69	0	-0.98	-0.63	-0.61	2.89	3.19	3.15
69	3	-0.71	-0.39	-0.41	2.80	3.13	3.09
69	6	-0.46	-0.18	-0.25	2.67	3.03	2.99
69	9	-0.25	-0.01	-0.14	2.51	2.89	2.86
69	12	-0.10	0.10	-0.07	2.32	2.73	2.70
69	15	-0.02	0.14	-0.04	2.11	2.56	2.53
69	18	0.00	0.13	-0.07	1.86	2.33	2.31
69	21	0.03	0.10	-0.14	1.55	2.04	2.03
69	24	0.04	0.05	-0.26	1.20	1.69	1.71
69	27	0.05	-0.02	-0.40	0.82	1.33	1.36
69	30	0.06	-0.10	-0.57	0.44	0.96	1.01
69	33	-0.07	-0.31	-0.85	0.03	0.57	0.64
69	36	-0.41	-0.71	-1.32	-0.42	0.13	0.23
69	39	-0.88	-1.25	-1.91	-0.89	-0.31	-0.19
69	42	-1.43	-1.86	-2.56	-1.32	-0.73	-0.58
69	45	-1.99	-2.48	-3.22	-1.67	-1.08	-0.91
69	48	-2.75	-3.30	-4.03	-1.96	-1.38	-1.18
69	51	-3.78	-4.37	-5.05	-2.22	-1.65	-1.42
69	54	-4.83	-5.45	-6.06	-2.45	-1.89	-1.64
69	57	-5.65	-6.28	-6.83	-2.67	-2.12	-1.85
69	60	-5.97	-6.61	-7.14	-2.87	-2.34	-2.05
69	63	-5.96	-6.50	-6.95	-3.05	-2.52	-2.22
69	66	-5.90	-6.22	-6.48	-3.19	-2.68	-2.38
69	69	-5.82	-5.81	-5.84	-3.34	-2.83	-2.52
69	72	-5.71	-5.36	-5.16	-3.50	-3.00	-2.69
69	75	-5.58	-4.92	-4.58	-3.71	-3.21	-2.89
69	78	-5.27	-4.44	-4.06	-4.00	-3.49	-3.17
69	81	-4.69	-3.86	-3.52	-4.37	-3.83	-3.51
69	84	-3.98	-3.26	-3.00	-4.81	-4.23	-3.89
69	87	-3.29	-2.70	-2.54	-5.26	-4.64	-4.29
69	90	-2.77	-2.26	-2.17	-5.69	-5.05	-4.69
69	93	-2.38	-1.92	-1.88	-6.19	-5.54	-5.15
69	96	-2.04	-1.62	-1.61	-6.77	-6.12	-5.69
69	99	-1.72	-1.35	-1.38	-7.33	-6.68	-6.21
69	102	-1.45	-1.11	-1.19	-7.74	-7.10	-6.62
69	105	-1.21	-0.92	-1.04	-7.91	-7.26	-6.84
69	108	-0.98	-0.74	-0.92	-7.88	-7.26	-6.92
69	111	-0.76	-0.57	-0.81	-7.80	-7.26	-7.00
69	114	-0.57	-0.42	-0.71	-7.69	-7.25	-7.05
69	117	-0.43	-0.31	-0.65	-7.56	-7.24	-7.08
69	120	-0.36	-0.27	-0.62	-7.41	-7.22	-7.10
69	123	-0.34	-0.27	-0.63	-7.17	-7.15	-7.06
69	126	-0.32	-0.28	-0.67	-6.82	-6.97	-6.98
69	129	-0.31	-0.29	-0.72	-6.43	-6.73	-6.87
69	132	-0.30	-0.30	-0.78	-6.06	-6.49	-6.75
69	135	-0.30	-0.32	-0.86	-5.80	-6.28	-6.63
69	138	-0.37	-0.41	-1.00	-5.61	-6.08	-6.49
69	141	-0.56	-0.62	-1.25	-5.43	-5.87	-6.33
69	144	-0.82	-0.92	-1.57	-5.28	-5.66	-6.17
69	147	-1.13	-1.25	-1.93	-5.18	-5.52	-6.05
69	150	-1.44	-1.59	-2.30	-5.14	-5.46	-6.00
69	153	-1.82	-2.01	-2.76	-5.26	-5.57	-6.12
69	156	-2.30	-2.54	-3.33	-5.61	-5.89	-6.46
69	159	-2.82	-3.10	-3.93	-6.15	-6.40	-6.98
69	162	-3.31	-3.62	-4.48	-6.85	-7.05	-7.66
69	165	-3.71	-4.01	-4.88	-7.67	-7.82	-8.46

69	168	-4.04	-4.33	-5.17	-9.88	-10.03	-10.60
69	171	-4.38	-4.64	-5.45	-13.91	-14.10	-14.49
69	174	-4.68	-4.90	-5.69	-18.43	-18.69	-18.85
69	177	-4.88	-5.08	-5.85	-22.11	-22.44	-22.40
69	180	-4.96	-5.15	-5.91	-23.63	-23.99	-23.86
69	183	-4.85	-5.01	-5.73	-22.88	-23.18	-23.06
69	186	-4.57	-4.65	-5.24	-21.00	-21.13	-21.01
69	189	-4.16	-4.14	-4.58	-18.46	-18.41	-18.28
69	192	-3.70	-3.57	-3.85	-15.80	-15.55	-15.44
69	195	-3.24	-3.02	-3.17	-13.50	-13.13	-13.04
69	198	-2.70	-2.43	-2.48	-11.37	-10.95	-10.90
69	201	-2.04	-1.72	-1.69	-9.08	-8.62	-8.64
69	204	-1.35	-0.99	-0.90	-6.91	-6.45	-6.53
69	207	-0.71	-0.34	-0.20	-5.17	-4.71	-4.84
69	210	-0.23	0.14	0.31	-4.13	-3.69	-3.84
69	213	0.14	0.51	0.70	-3.58	-3.16	-3.32
69	216	0.50	0.86	1.06	-3.11	-2.71	-2.88
69	219	0.81	1.15	1.36	-2.74	-2.36	-2.53
69	222	1.02	1.35	1.57	-2.50	-2.13	-2.30
69	225	1.10	1.43	1.65	-2.41	-2.05	-2.21
69	228	1.06	1.39	1.61	-2.40	-2.05	-2.19
69	231	0.95	1.29	1.50	-2.39	-2.05	-2.18
69	234	0.79	1.14	1.34	-2.39	-2.05	-2.17
69	237	0.59	0.95	1.15	-2.38	-2.06	-2.17
69	240	0.37	0.73	0.93	-2.38	-2.06	-2.16
69	243	0.05	0.42	0.61	-2.39	-2.06	-2.14
69	246	-0.42	-0.04	0.16	-2.40	-2.06	-2.13
69	249	-0.99	-0.61	-0.40	-2.41	-2.06	-2.11
69	252	-1.61	-1.23	-1.02	-2.42	-2.06	-2.08
69	255	-2.21	-1.85	-1.65	-2.43	-2.06	-2.05
69	258	-2.93	-2.65	-2.48	-2.39	-2.02	-1.99
69	261	-3.81	-3.64	-3.54	-2.30	-1.92	-1.89
69	264	-4.65	-4.62	-4.59	-2.16	-1.79	-1.75
69	267	-5.30	-5.37	-5.40	-2.01	-1.63	-1.60
69	270	-5.55	-5.66	-5.72	-1.87	-1.49	-1.45
69	273	-5.49	-5.63	-5.72	-1.74	-1.34	-1.29
69	276	-5.34	-5.54	-5.72	-1.59	-1.18	-1.11
69	279	-5.14	-5.42	-5.72	-1.43	-1.01	-0.91
69	282	-4.91	-5.27	-5.71	-1.26	-0.83	-0.70
69	285	-4.69	-5.10	-5.70	-1.07	-0.64	-0.50
69	288	-4.45	-4.86	-5.55	-0.84	-0.42	-0.28
69	291	-4.15	-4.51	-5.19	-0.57	-0.18	-0.05
69	294	-3.86	-4.13	-4.73	-0.29	0.08	0.18
69	297	-3.64	-3.81	-4.30	-0.01	0.32	0.40
69	300	-3.55	-3.62	-4.01	0.24	0.54	0.60
69	303	-3.55	-3.54	-3.84	0.46	0.73	0.78
69	306	-3.56	-3.46	-3.69	0.65	0.91	0.95
69	309	-3.57	-3.41	-3.56	0.84	1.08	1.11
69	312	-3.58	-3.37	-3.46	1.03	1.25	1.27
69	315	-3.60	-3.36	-3.40	1.23	1.43	1.43
69	318	-3.64	-3.36	-3.36	1.44	1.62	1.61
69	321	-3.70	-3.37	-3.34	1.66	1.81	1.78
69	324	-3.77	-3.38	-3.32	1.88	2.01	1.96
69	327	-3.83	-3.38	-3.30	2.08	2.20	2.13
69	330	-3.86	-3.39	-3.26	2.26	2.38	2.30
69	333	-3.78	-3.32	-3.16	2.43	2.56	2.47
69	336	-3.59	-3.13	-2.98	2.61	2.75	2.66
69	339	-3.33	-2.88	-2.74	2.78	2.92	2.84

69	342	-3.03	-2.59	-2.47	2.89	3.06	2.98
69	345	-2.74	-2.31	-2.21	2.94	3.12	3.05
69	348	-2.45	-2.03	-1.94	2.93	3.15	3.09
69	351	-2.12	-1.72	-1.64	2.93	3.16	3.11
69	354	-1.77	-1.38	-1.32	2.93	3.18	3.14
69	357	-1.39	-1.01	-0.98	2.91	3.19	3.15
69	360	-0.98	-0.63	-0.61	2.89	3.19	3.15
72	0	-1.39	-0.99	-0.98	2.90	3.20	3.13
72	3	-0.97	-0.60	-0.62	2.83	3.16	3.10
72	6	-0.59	-0.24	-0.30	2.73	3.08	3.02
72	9	-0.27	0.05	-0.05	2.59	2.97	2.91
72	12	-0.02	0.25	0.12	2.44	2.84	2.78
72	15	0.12	0.32	0.18	2.27	2.69	2.64
72	18	0.19	0.32	0.16	2.06	2.50	2.45
72	21	0.25	0.31	0.12	1.79	2.25	2.20
72	24	0.30	0.29	0.04	1.48	1.94	1.90
72	27	0.33	0.26	-0.06	1.14	1.61	1.59
72	30	0.34	0.23	-0.17	0.81	1.29	1.27
72	33	0.20	0.04	-0.45	0.45	0.94	0.93
72	36	-0.18	-0.42	-0.98	0.05	0.55	0.55
72	39	-0.73	-1.06	-1.68	-0.36	0.15	0.16
72	42	-1.37	-1.79	-2.48	-0.75	-0.24	-0.21
72	45	-2.04	-2.55	-3.29	-1.10	-0.58	-0.53
72	48	-3.00	-3.61	-4.37	-1.39	-0.87	-0.80
72	51	-4.34	-5.05	-5.80	-1.65	-1.14	-1.05
72	54	-5.72	-6.52	-7.23	-1.90	-1.39	-1.29
72	57	-6.81	-7.66	-8.34	-2.14	-1.64	-1.51
72	60	-7.24	-8.12	-8.78	-2.38	-1.88	-1.73
72	63	-7.21	-7.98	-8.54	-2.60	-2.11	-1.94
72	66	-7.13	-7.60	-7.93	-2.81	-2.32	-2.13
72	69	-7.00	-7.07	-7.11	-3.02	-2.52	-2.33
72	72	-6.83	-6.47	-6.24	-3.25	-2.75	-2.54
72	75	-6.63	-5.89	-5.48	-3.53	-3.02	-2.79
72	78	-6.18	-5.25	-4.80	-3.89	-3.36	-3.11
72	81	-5.40	-4.48	-4.09	-4.34	-3.76	-3.50
72	84	-4.47	-3.69	-3.40	-4.83	-4.20	-3.94
72	87	-3.57	-2.96	-2.80	-5.33	-4.65	-4.38
72	90	-2.91	-2.41	-2.33	-5.81	-5.09	-4.81
72	93	-2.44	-2.00	-1.97	-6.33	-5.59	-5.29
72	96	-2.02	-1.63	-1.64	-6.91	-6.16	-5.85
72	99	-1.65	-1.31	-1.36	-7.46	-6.70	-6.37
72	102	-1.34	-1.04	-1.14	-7.87	-7.10	-6.75
72	105	-1.08	-0.83	-0.98	-8.03	-7.26	-6.91
72	108	-0.85	-0.65	-0.87	-7.94	-7.21	-6.88
72	111	-0.62	-0.48	-0.77	-7.73	-7.09	-6.81
72	114	-0.43	-0.34	-0.68	-7.43	-6.91	-6.72
72	117	-0.30	-0.24	-0.63	-7.10	-6.71	-6.60
72	120	-0.25	-0.21	-0.60	-6.79	-6.51	-6.49
72	123	-0.25	-0.22	-0.63	-6.42	-6.26	-6.32
72	126	-0.26	-0.25	-0.71	-5.96	-5.93	-6.07
72	129	-0.28	-0.31	-0.83	-5.50	-5.60	-5.82
72	132	-0.30	-0.37	-0.97	-5.16	-5.34	-5.63
72	135	-0.32	-0.46	-1.13	-5.02	-5.24	-5.55
72	138	-0.43	-0.61	-1.34	-5.03	-5.24	-5.56
72	141	-0.66	-0.87	-1.66	-5.04	-5.26	-5.59
72	144	-0.97	-1.22	-2.04	-5.07	-5.28	-5.65
72	147	-1.33	-1.61	-2.47	-5.10	-5.31	-5.72
72	150	-1.69	-2.01	-2.91	-5.14	-5.34	-5.81

72	153	-2.14	-2.50	-3.46	-5.36	-5.55	-6.06
72	156	-2.70	-3.12	-4.14	-5.89	-6.06	-6.60
72	159	-3.30	-3.76	-4.83	-6.69	-6.83	-7.40
72	162	-3.85	-4.33	-5.42	-7.72	-7.82	-8.41
72	165	-4.25	-4.73	-5.80	-8.92	-8.99	-9.61
72	168	-4.56	-5.00	-6.02	-11.89	-11.97	-12.50
72	171	-4.86	-5.25	-6.22	-17.13	-17.27	-17.56
72	174	-5.11	-5.45	-6.37	-22.94	-23.19	-23.16
72	177	-5.29	-5.59	-6.48	-27.66	-27.99	-27.70
72	180	-5.35	-5.65	-6.52	-29.61	-29.97	-29.57
72	183	-5.20	-5.46	-6.27	-27.87	-28.17	-27.83
72	186	-4.80	-4.97	-5.64	-23.59	-23.75	-23.55
72	189	-4.25	-4.29	-4.79	-18.20	-18.20	-18.17
72	192	-3.63	-3.55	-3.87	-13.15	-12.99	-13.11
72	195	-3.04	-2.86	-3.04	-9.86	-9.62	-9.82
72	198	-2.40	-2.16	-2.24	-8.01	-7.75	-7.97
72	201	-1.65	-1.36	-1.36	-6.39	-6.11	-6.34
72	204	-0.88	-0.56	-0.49	-5.04	-4.75	-4.99
72	207	-0.19	0.15	0.27	-4.05	-3.75	-3.98
72	210	0.33	0.68	0.83	-3.46	-3.16	-3.38
72	213	0.74	1.09	1.27	-3.12	-2.81	-3.01
72	216	1.13	1.48	1.68	-2.84	-2.52	-2.70
72	219	1.47	1.81	2.02	-2.61	-2.29	-2.46
72	222	1.69	2.03	2.26	-2.47	-2.14	-2.30
72	225	1.78	2.11	2.34	-2.42	-2.09	-2.24
72	228	1.73	2.07	2.30	-2.47	-2.14	-2.27
72	231	1.61	1.96	2.20	-2.60	-2.25	-2.35
72	234	1.42	1.79	2.03	-2.75	-2.38	-2.44
72	237	1.20	1.58	1.83	-2.87	-2.49	-2.51
72	240	0.95	1.35	1.61	-2.93	-2.54	-2.55
72	243	0.59	1.01	1.29	-2.93	-2.54	-2.53
72	246	0.08	0.52	0.82	-2.94	-2.52	-2.49
72	249	-0.53	-0.08	0.24	-2.94	-2.50	-2.44
72	252	-1.17	-0.73	-0.39	-2.94	-2.47	-2.36
72	255	-1.79	-1.38	-1.04	-2.94	-2.44	-2.28
72	258	-2.50	-2.16	-1.87	-2.87	-2.35	-2.16
72	261	-3.34	-3.14	-2.92	-2.69	-2.16	-1.98
72	264	-4.14	-4.08	-3.97	-2.44	-1.92	-1.75
72	267	-4.74	-4.80	-4.78	-2.18	-1.67	-1.52
72	270	-4.97	-5.09	-5.13	-1.94	-1.44	-1.29
72	273	-4.90	-5.05	-5.17	-1.72	-1.22	-1.07
72	276	-4.71	-4.96	-5.20	-1.49	-0.99	-0.83
72	279	-4.46	-4.82	-5.23	-1.26	-0.77	-0.59
72	282	-4.19	-4.65	-5.24	-1.02	-0.54	-0.36
72	285	-3.96	-4.47	-5.24	-0.79	-0.32	-0.14
72	288	-3.71	-4.20	-5.08	-0.55	-0.09	0.08
72	291	-3.43	-3.82	-4.67	-0.30	0.13	0.29
72	294	-3.16	-3.42	-4.17	-0.05	0.35	0.49
72	297	-2.96	-3.11	-3.72	0.19	0.56	0.68
72	300	-2.88	-2.98	-3.47	0.40	0.74	0.85
72	303	-2.90	-2.99	-3.37	0.58	0.90	0.99
72	306	-2.97	-2.99	-3.28	0.75	1.05	1.12
72	309	-3.07	-3.01	-3.21	0.91	1.18	1.24
72	312	-3.19	-3.02	-3.17	1.07	1.32	1.36
72	315	-3.32	-3.05	-3.15	1.23	1.46	1.49
72	318	-3.51	-3.14	-3.21	1.41	1.62	1.63
72	321	-3.79	-3.34	-3.35	1.59	1.78	1.77
72	324	-4.08	-3.57	-3.51	1.78	1.94	1.91



72	327	-4.31	-3.75	-3.65	1.95	2.11	2.06
72	330	-4.40	-3.83	-3.71	2.12	2.27	2.20
72	333	-4.35	-3.79	-3.67	2.28	2.43	2.36
72	336	-4.23	-3.68	-3.57	2.45	2.61	2.53
72	339	-4.05	-3.52	-3.41	2.61	2.78	2.69
72	342	-3.84	-3.32	-3.22	2.73	2.92	2.83
72	345	-3.61	-3.11	-3.01	2.80	3.01	2.92
72	348	-3.32	-2.84	-2.75	2.83	3.07	2.99
72	351	-2.94	-2.47	-2.40	2.86	3.12	3.04
72	354	-2.48	-2.04	-1.98	2.88	3.16	3.09
72	357	-1.96	-1.54	-1.50	2.89	3.19	3.12
72	360	-1.39	-0.99	-0.98	2.90	3.20	3.13
75	0	-1.56	-1.14	-1.14	2.90	3.20	3.11
75	3	-1.05	-0.66	-0.68	2.85	3.16	3.08
75	6	-0.58	-0.22	-0.28	2.76	3.09	3.01
75	9	-0.19	0.14	0.04	2.65	2.99	2.92
75	12	0.10	0.38	0.26	2.52	2.88	2.80
75	15	0.25	0.47	0.33	2.37	2.75	2.67
75	18	0.32	0.46	0.32	2.20	2.58	2.51
75	21	0.37	0.45	0.27	1.97	2.36	2.29
75	24	0.41	0.43	0.20	1.70	2.10	2.02
75	27	0.44	0.40	0.10	1.42	1.83	1.74
75	30	0.45	0.36	-0.02	1.13	1.54	1.45
75	33	0.30	0.15	-0.31	0.82	1.24	1.15
75	36	-0.11	-0.34	-0.88	0.47	0.89	0.81
75	39	-0.69	-1.02	-1.63	0.10	0.53	0.45
75	42	-1.38	-1.82	-2.49	-0.25	0.18	0.11
75	45	-2.09	-2.63	-3.38	-0.57	-0.14	-0.19
75	48	-3.13	-3.79	-4.57	-0.86	-0.42	-0.46
75	51	-4.60	-5.37	-6.14	-1.12	-0.68	-0.71
75	54	-6.11	-6.98	-7.74	-1.38	-0.94	-0.94
75	57	-7.30	-8.25	-8.97	-1.63	-1.19	-1.17
75	60	-7.77	-8.75	-9.47	-1.89	-1.45	-1.41
75	63	-7.74	-8.59	-9.20	-2.16	-1.70	-1.64
75	66	-7.64	-8.18	-8.54	-2.42	-1.95	-1.87
75	69	-7.49	-7.59	-7.64	-2.68	-2.20	-2.10
75	72	-7.29	-6.93	-6.69	-2.98	-2.48	-2.35
75	75	-7.07	-6.30	-5.86	-3.31	-2.79	-2.65
75	78	-6.57	-5.59	-5.12	-3.73	-3.18	-3.01
75	81	-5.71	-4.75	-4.34	-4.24	-3.64	-3.45
75	84	-4.69	-3.88	-3.58	-4.79	-4.13	-3.92
75	87	-3.70	-3.08	-2.92	-5.34	-4.64	-4.41
75	90	-2.96	-2.47	-2.40	-5.86	-5.11	-4.86
75	93	-2.43	-2.01	-1.99	-6.40	-5.62	-5.36
75	96	-1.95	-1.58	-1.62	-7.01	-6.18	-5.92
75	99	-1.53	-1.22	-1.29	-7.58	-6.71	-6.45
75	102	-1.17	-0.92	-1.05	-7.99	-7.11	-6.83
75	105	-0.90	-0.70	-0.89	-8.15	-7.26	-6.98
75	108	-0.67	-0.52	-0.79	-8.04	-7.19	-6.94
75	111	-0.45	-0.36	-0.70	-7.75	-7.02	-6.82
75	114	-0.27	-0.23	-0.64	-7.36	-6.77	-6.65
75	117	-0.14	-0.14	-0.59	-6.93	-6.50	-6.45
75	120	-0.10	-0.11	-0.58	-6.54	-6.23	-6.25
75	123	-0.11	-0.13	-0.61	-6.12	-5.91	-5.99
75	126	-0.14	-0.19	-0.71	-5.63	-5.50	-5.64
75	129	-0.19	-0.27	-0.86	-5.15	-5.10	-5.29
75	132	-0.26	-0.39	-1.04	-4.80	-4.79	-5.02
75	135	-0.33	-0.51	-1.24	-4.65	-4.66	-4.91

75	138	-0.48	-0.70	-1.49	-4.68	-4.69	-4.95
75	141	-0.73	-0.99	-1.83	-4.74	-4.76	-5.04
75	144	-1.05	-1.35	-2.24	-4.84	-4.88	-5.19
75	147	-1.42	-1.76	-2.70	-4.98	-5.03	-5.38
75	150	-1.80	-2.18	-3.17	-5.14	-5.21	-5.60
75	153	-2.27	-2.70	-3.75	-5.46	-5.55	-5.98
75	156	-2.87	-3.36	-4.48	-6.08	-6.16	-6.64
75	159	-3.50	-4.04	-5.21	-6.97	-7.03	-7.55
75	162	-4.07	-4.63	-5.82	-8.10	-8.15	-8.71
75	165	-4.48	-5.02	-6.19	-9.45	-9.48	-10.10
75	168	-4.78	-5.27	-6.37	-12.73	-12.80	-13.32
75	171	-5.06	-5.50	-6.53	-18.47	-18.61	-18.87
75	174	-5.30	-5.68	-6.66	-24.83	-25.07	-24.98
75	177	-5.46	-5.81	-6.74	-29.98	-30.31	-29.93
75	180	-5.52	-5.85	-6.77	-32.11	-32.47	-31.96
75	183	-5.35	-5.64	-6.50	-29.82	-30.14	-29.71
75	186	-4.90	-5.10	-5.81	-24.27	-24.46	-24.23
75	189	-4.29	-4.35	-4.88	-17.43	-17.47	-17.47
75	192	-3.60	-3.54	-3.88	-11.27	-11.18	-11.37
75	195	-2.96	-2.80	-2.99	-7.76	-7.59	-7.86
75	198	-2.28	-2.05	-2.14	-6.35	-6.15	-6.43
75	201	-1.49	-1.22	-1.22	-5.18	-4.97	-5.25
75	204	-0.69	-0.38	-0.33	-4.26	-4.04	-4.32
75	207	0.03	0.35	0.46	-3.61	-3.37	-3.64
75	210	0.56	0.90	1.04	-3.21	-2.96	-3.21
75	213	0.99	1.33	1.50	-2.96	-2.69	-2.91
75	216	1.39	1.73	1.92	-2.74	-2.46	-2.64
75	219	1.73	2.07	2.28	-2.57	-2.28	-2.44
75	222	1.96	2.30	2.53	-2.47	-2.16	-2.30
75	225	2.05	2.39	2.62	-2.43	-2.12	-2.25
75	228	2.00	2.35	2.58	-2.50	-2.19	-2.30
75	231	1.87	2.23	2.47	-2.69	-2.34	-2.41
75	234	1.68	2.05	2.31	-2.90	-2.52	-2.55
75	237	1.44	1.84	2.11	-3.08	-2.68	-2.66
75	240	1.18	1.60	1.89	-3.16	-2.74	-2.71
75	243	0.81	1.25	1.57	-3.16	-2.74	-2.69
75	246	0.28	0.76	1.09	-3.16	-2.72	-2.64
75	249	-0.34	0.16	0.52	-3.16	-2.69	-2.57
75	252	-0.99	-0.49	-0.11	-3.16	-2.65	-2.48
75	255	-1.60	-1.12	-0.76	-3.16	-2.60	-2.38
75	258	-2.27	-1.88	-1.56	-3.07	-2.48	-2.22
75	261	-3.05	-2.80	-2.56	-2.86	-2.25	-1.97
75	264	-3.78	-3.69	-3.56	-2.57	-1.95	-1.67
75	267	-4.33	-4.37	-4.33	-2.25	-1.64	-1.36
75	270	-4.54	-4.63	-4.66	-1.96	-1.36	-1.08
75	273	-4.46	-4.59	-4.70	-1.68	-1.09	-0.82
75	276	-4.25	-4.48	-4.74	-1.38	-0.81	-0.57
75	279	-3.97	-4.31	-4.76	-1.08	-0.53	-0.32
75	282	-3.67	-4.12	-4.77	-0.79	-0.27	-0.08
75	285	-3.41	-3.93	-4.78	-0.53	-0.04	0.13
75	288	-3.15	-3.64	-4.59	-0.30	0.16	0.32
75	291	-2.85	-3.25	-4.14	-0.09	0.34	0.49
75	294	-2.58	-2.85	-3.60	0.11	0.51	0.65
75	297	-2.38	-2.53	-3.14	0.30	0.67	0.80
75	300	-2.30	-2.40	-2.93	0.47	0.82	0.94
75	303	-2.34	-2.42	-2.91	0.64	0.96	1.07
75	306	-2.45	-2.46	-2.89	0.79	1.09	1.18
75	309	-2.61	-2.53	-2.88	0.94	1.22	1.29

75	312	-2.81	-2.61	-2.87	1.09	1.34	1.40
75	315	-3.01	-2.70	-2.87	1.23	1.47	1.51
75	318	-3.30	-2.90	-2.98	1.39	1.61	1.63
75	321	-3.72	-3.23	-3.23	1.54	1.74	1.74
75	324	-4.15	-3.60	-3.53	1.69	1.88	1.86
75	327	-4.48	-3.89	-3.79	1.84	2.02	1.98
75	330	-4.62	-4.01	-3.89	1.98	2.16	2.10
75	333	-4.58	-3.98	-3.86	2.13	2.31	2.24
75	336	-4.49	-3.90	-3.78	2.30	2.48	2.40
75	339	-4.34	-3.77	-3.66	2.45	2.64	2.55
75	342	-4.17	-3.61	-3.51	2.58	2.79	2.69
75	345	-3.97	-3.43	-3.34	2.67	2.90	2.79
75	348	-3.69	-3.18	-3.10	2.74	2.98	2.88
75	351	-3.29	-2.80	-2.73	2.80	3.06	2.95
75	354	-2.78	-2.31	-2.26	2.85	3.12	3.02
75	357	-2.20	-1.75	-1.72	2.89	3.17	3.07
75	360	-1.56	-1.14	-1.14	2.90	3.20	3.11
78	0	-1.47	-1.07	-1.06	2.87	3.17	3.05
78	3	-0.92	-0.56	-0.59	2.83	3.12	3.02
78	6	-0.42	-0.11	-0.18	2.77	3.06	2.96
78	9	-0.01	0.26	0.15	2.68	2.97	2.88
78	12	0.28	0.50	0.36	2.57	2.86	2.78
78	15	0.40	0.59	0.43	2.46	2.75	2.66
78	18	0.42	0.58	0.41	2.31	2.61	2.52
78	21	0.43	0.55	0.35	2.13	2.43	2.32
78	24	0.44	0.49	0.25	1.92	2.22	2.09
78	27	0.44	0.43	0.11	1.68	2.00	1.84
78	30	0.45	0.34	-0.04	1.44	1.76	1.59
78	33	0.29	0.09	-0.38	1.18	1.50	1.33
78	36	-0.14	-0.43	-0.99	0.88	1.20	1.03
78	39	-0.74	-1.14	-1.79	0.56	0.89	0.72
78	42	-1.44	-1.94	-2.67	0.25	0.58	0.42
78	45	-2.16	-2.75	-3.55	-0.05	0.29	0.14
78	48	-3.14	-3.83	-4.65	-0.31	0.03	-0.10
78	51	-4.47	-5.25	-6.04	-0.56	-0.22	-0.33
78	54	-5.83	-6.68	-7.42	-0.80	-0.46	-0.55
78	57	-6.89	-7.78	-8.47	-1.06	-0.71	-0.77
78	60	-7.31	-8.23	-8.89	-1.33	-0.97	-1.01
78	63	-7.26	-8.05	-8.62	-1.61	-1.23	-1.26
78	66	-7.12	-7.60	-7.94	-1.90	-1.50	-1.51
78	69	-6.92	-6.98	-7.02	-2.21	-1.79	-1.76
78	72	-6.66	-6.29	-6.05	-2.55	-2.10	-2.05
78	75	-6.36	-5.64	-5.23	-2.93	-2.45	-2.37
78	78	-5.85	-4.95	-4.51	-3.39	-2.88	-2.77
78	81	-5.04	-4.16	-3.77	-3.95	-3.39	-3.25
78	84	-4.11	-3.35	-3.06	-4.54	-3.94	-3.76
78	87	-3.21	-2.62	-2.44	-5.15	-4.50	-4.29
78	90	-2.52	-2.04	-1.96	-5.72	-5.02	-4.79
78	93	-2.01	-1.59	-1.56	-6.34	-5.58	-5.35
78	96	-1.53	-1.17	-1.19	-7.03	-6.21	-5.98
78	99	-1.10	-0.81	-0.87	-7.68	-6.79	-6.57
78	102	-0.75	-0.52	-0.64	-8.16	-7.22	-7.01
78	105	-0.50	-0.33	-0.51	-8.34	-7.39	-7.18
78	108	-0.31	-0.19	-0.46	-8.22	-7.32	-7.12
78	111	-0.13	-0.07	-0.42	-7.92	-7.13	-6.98
78	114	0.02	0.03	-0.39	-7.50	-6.87	-6.77
78	117	0.12	0.10	-0.37	-7.04	-6.57	-6.53
78	120	0.16	0.12	-0.36	-6.62	-6.28	-6.29

78	123	0.14	0.09	-0.40	-6.17	-5.91	-5.97
78	126	0.08	0.00	-0.53	-5.64	-5.43	-5.53
78	129	-0.02	-0.12	-0.70	-5.12	-4.96	-5.09
78	132	-0.13	-0.28	-0.91	-4.74	-4.60	-4.75
78	135	-0.26	-0.45	-1.13	-4.59	-4.45	-4.61
78	138	-0.44	-0.67	-1.41	-4.61	-4.48	-4.65
78	141	-0.70	-0.97	-1.77	-4.67	-4.55	-4.74
78	144	-1.03	-1.34	-2.19	-4.77	-4.67	-4.89
78	147	-1.40	-1.75	-2.66	-4.90	-4.82	-5.08
78	150	-1.78	-2.17	-3.13	-5.06	-5.00	-5.31
78	153	-2.26	-2.69	-3.70	-5.39	-5.35	-5.70
78	156	-2.85	-3.34	-4.39	-5.99	-5.97	-6.38
78	159	-3.47	-3.99	-5.09	-6.86	-6.85	-7.33
78	162	-4.02	-4.57	-5.67	-7.95	-7.97	-8.50
78	165	-4.42	-4.95	-6.02	-9.25	-9.29	-9.90
78	168	-4.72	-5.20	-6.20	-12.25	-12.35	-12.90
78	171	-5.00	-5.42	-6.36	-17.40	-17.59	-17.91
78	174	-5.24	-5.61	-6.49	-23.08	-23.37	-23.39
78	177	-5.40	-5.73	-6.57	-27.67	-28.04	-27.80
78	180	-5.46	-5.78	-6.60	-29.56	-29.97	-29.62
78	183	-5.31	-5.59	-6.36	-27.40	-27.76	-27.47
78	186	-4.92	-5.10	-5.74	-22.17	-22.41	-22.26
78	189	-4.36	-4.43	-4.91	-15.75	-15.85	-15.86
78	192	-3.75	-3.70	-4.00	-10.02	-9.99	-10.14
78	195	-3.15	-3.00	-3.17	-6.88	-6.75	-6.96
78	198	-2.50	-2.29	-2.36	-5.77	-5.59	-5.80
78	201	-1.73	-1.47	-1.47	-4.87	-4.66	-4.87
78	204	-0.94	-0.64	-0.59	-4.18	-3.94	-4.14
78	207	-0.22	0.11	0.20	-3.67	-3.41	-3.60
78	210	0.34	0.68	0.80	-3.33	-3.04	-3.22
78	213	0.79	1.14	1.29	-3.06	-2.76	-2.92
78	216	1.22	1.58	1.76	-2.83	-2.52	-2.65
78	219	1.60	1.96	2.16	-2.65	-2.32	-2.43
78	222	1.86	2.22	2.43	-2.53	-2.19	-2.29
78	225	1.95	2.31	2.53	-2.48	-2.15	-2.23
78	228	1.91	2.27	2.50	-2.53	-2.18	-2.26
78	231	1.79	2.16	2.40	-2.64	-2.27	-2.31
78	234	1.61	2.00	2.25	-2.77	-2.38	-2.38
78	237	1.38	1.80	2.07	-2.88	-2.47	-2.43
78	240	1.14	1.57	1.86	-2.93	-2.50	-2.45
78	243	0.78	1.24	1.55	-2.92	-2.49	-2.43
78	246	0.27	0.76	1.09	-2.90	-2.45	-2.37
78	249	-0.34	0.18	0.53	-2.86	-2.38	-2.27
78	252	-0.97	-0.44	-0.08	-2.80	-2.31	-2.15
78	255	-1.56	-1.04	-0.70	-2.74	-2.22	-2.02
78	258	-2.18	-1.74	-1.45	-2.63	-2.07	-1.84
78	261	-2.88	-2.58	-2.39	-2.43	-1.84	-1.57
78	264	-3.54	-3.39	-3.31	-2.18	-1.57	-1.26
78	267	-4.02	-4.01	-4.01	-1.91	-1.28	-0.96
78	270	-4.22	-4.25	-4.28	-1.65	-1.01	-0.69
78	273	-4.13	-4.20	-4.28	-1.37	-0.76	-0.46
78	276	-3.90	-4.06	-4.27	-1.07	-0.48	-0.24
78	279	-3.60	-3.86	-4.26	-0.76	-0.22	-0.03
78	282	-3.27	-3.63	-4.24	-0.48	0.03	0.17
78	285	-2.98	-3.40	-4.21	-0.25	0.22	0.33
78	288	-2.70	-3.10	-4.00	-0.07	0.36	0.47
78	291	-2.37	-2.68	-3.52	0.08	0.49	0.59
78	294	-2.06	-2.26	-2.97	0.22	0.60	0.70

78	297	-1.84	-1.94	-2.50	0.35	0.70	0.81
78	300	-1.75	-1.81	-2.30	0.49	0.82	0.92
78	303	-1.79	-1.82	-2.29	0.64	0.94	1.03
78	306	-1.90	-1.87	-2.29	0.78	1.07	1.14
78	309	-2.06	-1.93	-2.28	0.92	1.19	1.25
78	312	-2.26	-2.02	-2.28	1.07	1.32	1.35
78	315	-2.46	-2.12	-2.28	1.20	1.44	1.46
78	318	-2.77	-2.33	-2.40	1.34	1.56	1.56
78	321	-3.22	-2.71	-2.69	1.47	1.68	1.66
78	324	-3.68	-3.12	-3.04	1.60	1.80	1.77
78	327	-4.05	-3.45	-3.33	1.72	1.92	1.87
78	330	-4.20	-3.58	-3.45	1.86	2.05	1.98
78	333	-4.17	-3.57	-3.43	2.00	2.20	2.11
78	336	-4.11	-3.51	-3.38	2.16	2.35	2.26
78	339	-4.01	-3.43	-3.30	2.31	2.51	2.41
78	342	-3.88	-3.32	-3.20	2.45	2.66	2.55
78	345	-3.73	-3.19	-3.08	2.55	2.78	2.66
78	348	-3.49	-2.98	-2.89	2.64	2.88	2.76
78	351	-3.12	-2.64	-2.56	2.72	2.97	2.85
78	354	-2.64	-2.18	-2.12	2.78	3.05	2.93
78	357	-2.08	-1.65	-1.62	2.84	3.11	3.00
78	360	-1.47	-1.07	-1.06	2.87	3.17	3.05
81	0	-1.26	-0.89	-0.88	2.81	3.08	2.94
81	3	-0.71	-0.39	-0.42	2.79	3.04	2.92
81	6	-0.21	0.05	-0.04	2.75	2.99	2.87
81	9	0.20	0.39	0.27	2.68	2.92	2.81
81	12	0.47	0.62	0.46	2.61	2.83	2.72
81	15	0.57	0.71	0.53	2.53	2.74	2.63
81	18	0.56	0.69	0.50	2.43	2.63	2.51
81	21	0.55	0.63	0.41	2.29	2.50	2.34
81	24	0.52	0.55	0.27	2.13	2.33	2.15
81	27	0.48	0.44	0.09	1.95	2.16	1.93
81	30	0.44	0.30	-0.12	1.76	1.97	1.72
81	33	0.23	-0.01	-0.53	1.55	1.76	1.49
81	36	-0.24	-0.59	-1.24	1.31	1.51	1.25
81	39	-0.87	-1.34	-2.12	1.05	1.25	0.99
81	42	-1.57	-2.15	-3.03	0.78	0.98	0.73
81	45	-2.25	-2.93	-3.86	0.53	0.73	0.49
81	48	-3.07	-3.81	-4.72	0.29	0.50	0.28
81	51	-4.10	-4.87	-5.69	0.07	0.28	0.07
81	54	-5.12	-5.89	-6.59	-0.16	0.06	-0.12
81	57	-5.90	-6.66	-7.27	-0.40	-0.18	-0.33
81	60	-6.21	-6.97	-7.53	-0.66	-0.43	-0.56
81	63	-6.12	-6.76	-7.24	-0.95	-0.70	-0.80
81	66	-5.87	-6.23	-6.50	-1.26	-0.98	-1.06
81	69	-5.52	-5.52	-5.52	-1.59	-1.28	-1.33
81	72	-5.11	-4.75	-4.52	-1.96	-1.62	-1.64
81	75	-4.68	-4.07	-3.71	-2.37	-2.00	-1.98
81	78	-4.15	-3.43	-3.05	-2.87	-2.46	-2.41
81	81	-3.45	-2.74	-2.40	-3.45	-3.00	-2.91
81	84	-2.71	-2.07	-1.80	-4.10	-3.60	-3.47
81	87	-2.01	-1.48	-1.28	-4.76	-4.21	-4.05
81	90	-1.47	-1.02	-0.89	-5.40	-4.81	-4.62
81	93	-1.05	-0.65	-0.58	-6.13	-5.47	-5.27
81	96	-0.67	-0.32	-0.28	-6.98	-6.24	-6.04
81	99	-0.33	-0.03	-0.03	-7.78	-6.96	-6.76
81	102	-0.07	0.19	0.14	-8.38	-7.49	-7.31
81	105	0.11	0.31	0.20	-8.62	-7.70	-7.52

81	108	0.23	0.36	0.20	-8.49	-7.62	-7.45
81	111	0.34	0.41	0.18	-8.18	-7.40	-7.26
81	114	0.43	0.45	0.16	-7.74	-7.09	-7.00
81	117	0.49	0.47	0.13	-7.27	-6.74	-6.70
81	120	0.51	0.48	0.10	-6.82	-6.39	-6.39
81	123	0.47	0.44	0.02	-6.33	-5.97	-5.99
81	126	0.38	0.31	-0.15	-5.72	-5.41	-5.47
81	129	0.25	0.14	-0.37	-5.14	-4.86	-4.93
81	132	0.10	-0.08	-0.62	-4.70	-4.44	-4.52
81	135	-0.08	-0.30	-0.89	-4.53	-4.27	-4.35
81	138	-0.30	-0.56	-1.21	-4.55	-4.29	-4.38
81	141	-0.59	-0.90	-1.61	-4.59	-4.35	-4.46
81	144	-0.95	-1.29	-2.07	-4.67	-4.44	-4.58
81	147	-1.34	-1.72	-2.55	-4.77	-4.57	-4.74
81	150	-1.74	-2.16	-3.03	-4.89	-4.72	-4.93
81	153	-2.21	-2.66	-3.56	-5.18	-5.04	-5.31
81	156	-2.78	-3.26	-4.18	-5.76	-5.66	-6.00
81	159	-3.36	-3.86	-4.78	-6.58	-6.52	-6.95
81	162	-3.88	-4.39	-5.28	-7.59	-7.58	-8.10
81	165	-4.26	-4.75	-5.59	-8.75	-8.81	-9.41
81	168	-4.56	-4.99	-5.76	-11.06	-11.21	-11.80
81	171	-4.84	-5.21	-5.91	-14.81	-15.06	-15.52
81	174	-5.08	-5.40	-6.03	-18.87	-19.24	-19.50
81	177	-5.25	-5.52	-6.11	-22.13	-22.58	-22.68
81	180	-5.31	-5.57	-6.14	-23.46	-23.95	-23.97
81	183	-5.20	-5.43	-5.97	-21.80	-22.25	-22.29
81	186	-4.93	-5.09	-5.54	-17.79	-18.13	-18.21
81	189	-4.53	-4.60	-4.94	-12.87	-13.07	-13.20
81	192	-4.07	-4.05	-4.26	-8.50	-8.56	-8.72
81	195	-3.60	-3.49	-3.60	-6.14	-6.07	-6.22
81	198	-3.04	-2.86	-2.90	-5.35	-5.20	-5.31
81	201	-2.32	-2.07	-2.08	-4.75	-4.52	-4.59
81	204	-1.54	-1.24	-1.22	-4.28	-3.99	-4.03
81	207	-0.80	-0.46	-0.43	-3.91	-3.57	-3.59
81	210	-0.21	0.16	0.22	-3.61	-3.24	-3.24
81	213	0.31	0.69	0.79	-3.33	-2.94	-2.95
81	216	0.82	1.22	1.35	-3.08	-2.68	-2.69
81	219	1.26	1.67	1.84	-2.86	-2.46	-2.47
81	222	1.58	1.99	2.18	-2.70	-2.29	-2.30
81	225	1.70	2.12	2.31	-2.59	-2.17	-2.17
81	228	1.66	2.08	2.29	-2.54	-2.11	-2.09
81	231	1.57	1.99	2.21	-2.49	-2.06	-2.03
81	234	1.42	1.86	2.10	-2.46	-2.02	-1.97
81	237	1.24	1.69	1.95	-2.42	-1.98	-1.92
81	240	1.03	1.50	1.78	-2.37	-1.93	-1.84
81	243	0.71	1.20	1.51	-2.29	-1.84	-1.74
81	246	0.22	0.75	1.07	-2.18	-1.73	-1.62
81	249	-0.37	0.19	0.52	-2.05	-1.59	-1.48
81	252	-0.98	-0.40	-0.07	-1.90	-1.45	-1.33
81	255	-1.52	-0.97	-0.65	-1.76	-1.30	-1.17
81	258	-2.09	-1.61	-1.35	-1.61	-1.13	-0.98
81	261	-2.71	-2.36	-2.19	-1.44	-0.94	-0.76
81	264	-3.30	-3.09	-3.02	-1.26	-0.74	-0.52
81	267	-3.73	-3.63	-3.65	-1.08	-0.53	-0.29
81	270	-3.90	-3.85	-3.89	-0.89	-0.34	-0.11
81	273	-3.80	-3.78	-3.88	-0.69	-0.16	0.05
81	276	-3.56	-3.62	-3.83	-0.47	0.04	0.19
81	279	-3.24	-3.38	-3.75	-0.25	0.22	0.31

81	282	-2.89	-3.12	-3.65	-0.05	0.38	0.43
81	285	-2.58	-2.85	-3.53	0.09	0.50	0.52
81	288	-2.26	-2.51	-3.26	0.19	0.57	0.60
81	291	-1.88	-2.07	-2.78	0.27	0.63	0.67
81	294	-1.53	-1.62	-2.24	0.34	0.68	0.73
81	297	-1.27	-1.28	-1.77	0.42	0.74	0.79
81	300	-1.16	-1.14	-1.53	0.50	0.81	0.86
81	303	-1.19	-1.14	-1.45	0.61	0.90	0.94
81	306	-1.25	-1.15	-1.39	0.73	1.00	1.03
81	309	-1.35	-1.17	-1.34	0.86	1.12	1.13
81	312	-1.47	-1.19	-1.31	1.00	1.24	1.23
81	315	-1.61	-1.21	-1.29	1.12	1.36	1.33
81	318	-1.86	-1.37	-1.40	1.24	1.47	1.42
81	321	-2.27	-1.70	-1.67	1.36	1.58	1.52
81	324	-2.70	-2.09	-1.99	1.48	1.69	1.62
81	327	-3.05	-2.42	-2.26	1.60	1.81	1.72
81	330	-3.19	-2.57	-2.39	1.73	1.93	1.84
81	333	-3.19	-2.59	-2.42	1.87	2.07	1.96
81	336	-3.19	-2.60	-2.44	2.02	2.22	2.11
81	339	-3.18	-2.61	-2.46	2.17	2.37	2.25
81	342	-3.17	-2.62	-2.47	2.31	2.52	2.39
81	345	-3.16	-2.62	-2.47	2.43	2.64	2.51
81	348	-3.04	-2.53	-2.38	2.52	2.74	2.61
81	351	-2.75	-2.26	-2.15	2.61	2.84	2.71
81	354	-2.33	-1.88	-1.79	2.69	2.93	2.80
81	357	-1.81	-1.41	-1.36	2.76	3.01	2.87
81	360	-1.26	-0.89	-0.88	2.81	3.08	2.94
84	0	-1.00	-0.68	-0.67	2.71	2.94	2.79
84	3	-0.47	-0.20	-0.24	2.71	2.93	2.78
84	6	0.00	0.21	0.11	2.69	2.90	2.75
84	9	0.38	0.53	0.38	2.66	2.86	2.70
84	12	0.64	0.74	0.55	2.63	2.80	2.64
84	15	0.73	0.81	0.61	2.59	2.74	2.58
84	18	0.71	0.78	0.56	2.53	2.67	2.49
84	21	0.67	0.70	0.44	2.44	2.56	2.35
84	24	0.61	0.58	0.26	2.32	2.44	2.19
84	27	0.52	0.43	0.04	2.18	2.29	2.00
84	30	0.42	0.25	-0.23	2.04	2.15	1.83
84	33	0.15	-0.14	-0.75	1.88	1.98	1.64
84	36	-0.38	-0.82	-1.62	1.69	1.78	1.43
84	39	-1.05	-1.64	-2.63	1.48	1.56	1.22
84	42	-1.75	-2.46	-3.57	1.26	1.34	1.01
84	45	-2.36	-3.14	-4.24	1.05	1.12	0.80
84	48	-2.96	-3.73	-4.72	0.85	0.92	0.62
84	51	-3.64	-4.35	-5.17	0.65	0.73	0.44
84	54	-4.26	-4.91	-5.54	0.45	0.53	0.27
84	57	-4.72	-5.31	-5.81	0.23	0.31	0.08
84	60	-4.90	-5.47	-5.90	-0.03	0.07	-0.13
84	63	-4.74	-5.21	-5.58	-0.31	-0.19	-0.36
84	66	-4.34	-4.58	-4.77	-0.62	-0.48	-0.62
84	69	-3.79	-3.75	-3.73	-0.97	-0.79	-0.90
84	72	-3.20	-2.89	-2.69	-1.36	-1.15	-1.21
84	75	-2.67	-2.20	-1.90	-1.79	-1.54	-1.57
84	78	-2.16	-1.63	-1.32	-2.30	-2.02	-2.01
84	81	-1.61	-1.07	-0.78	-2.92	-2.59	-2.55
84	84	-1.06	-0.55	-0.29	-3.59	-3.23	-3.14
84	87	-0.57	-0.11	0.11	-4.30	-3.89	-3.78
84	90	-0.21	0.20	0.38	-5.02	-4.56	-4.41

84	93	0.06	0.44	0.57	-5.87	-5.34	-5.17
84	96	0.32	0.66	0.74	-6.89	-6.26	-6.09
84	99	0.53	0.84	0.88	-7.87	-7.15	-6.98
84	102	0.69	0.96	0.98	-8.61	-7.81	-7.64
84	105	0.77	1.00	1.01	-8.90	-8.07	-7.90
84	108	0.80	1.00	0.99	-8.78	-7.98	-7.82
84	111	0.82	0.98	0.93	-8.47	-7.72	-7.59
84	114	0.84	0.95	0.85	-8.03	-7.36	-7.27
84	117	0.85	0.91	0.74	-7.54	-6.95	-6.90
84	120	0.86	0.87	0.63	-7.08	-6.56	-6.54
84	123	0.82	0.77	0.48	-6.54	-6.07	-6.07
84	126	0.71	0.61	0.27	-5.86	-5.43	-5.45
84	129	0.54	0.40	0.01	-5.19	-4.80	-4.82
84	132	0.35	0.15	-0.29	-4.69	-4.32	-4.34
84	135	0.14	-0.12	-0.60	-4.49	-4.13	-4.15
84	138	-0.11	-0.42	-0.97	-4.50	-4.14	-4.17
84	141	-0.45	-0.81	-1.42	-4.52	-4.18	-4.22
84	144	-0.84	-1.23	-1.91	-4.56	-4.24	-4.31
84	147	-1.26	-1.68	-2.41	-4.62	-4.33	-4.42
84	150	-1.67	-2.13	-2.88	-4.69	-4.43	-4.56
84	153	-2.13	-2.61	-3.35	-4.94	-4.72	-4.92
84	156	-2.66	-3.14	-3.85	-5.49	-5.33	-5.62
84	159	-3.19	-3.67	-4.33	-6.25	-6.17	-6.57
84	162	-3.66	-4.12	-4.73	-7.15	-7.16	-7.66
84	165	-4.02	-4.45	-4.99	-8.11	-8.20	-8.79
84	168	-4.32	-4.68	-5.14	-9.56	-9.75	-10.38
84	171	-4.60	-4.90	-5.28	-11.62	-11.94	-12.54
84	174	-4.84	-5.08	-5.39	-13.75	-14.20	-14.73
84	177	-5.00	-5.20	-5.47	-15.43	-15.97	-16.44
84	180	-5.07	-5.25	-5.49	-16.11	-16.68	-17.12
84	183	-5.02	-5.18	-5.42	-15.10	-15.63	-16.05
84	186	-4.88	-5.01	-5.20	-12.66	-13.09	-13.45
84	189	-4.68	-4.75	-4.89	-9.67	-9.96	-10.23
84	192	-4.43	-4.43	-4.52	-7.01	-7.14	-7.32
84	195	-4.15	-4.08	-4.12	-5.55	-5.53	-5.62
84	198	-3.71	-3.57	-3.58	-5.07	-4.92	-4.93
84	201	-3.04	-2.82	-2.83	-4.72	-4.46	-4.39
84	204	-2.26	-1.97	-1.99	-4.44	-4.09	-3.95
84	207	-1.49	-1.14	-1.16	-4.20	-3.78	-3.60
84	210	-0.85	-0.46	-0.47	-3.94	-3.47	-3.27
84	213	-0.29	0.14	0.17	-3.67	-3.18	-2.98
84	216	0.31	0.76	0.83	-3.42	-2.90	-2.73
84	219	0.83	1.30	1.42	-3.18	-2.65	-2.51
84	222	1.21	1.69	1.84	-2.95	-2.42	-2.30
84	225	1.36	1.84	2.01	-2.73	-2.20	-2.09
84	228	1.33	1.82	1.99	-2.51	-1.98	-1.88
84	231	1.27	1.76	1.94	-2.30	-1.78	-1.67
84	234	1.16	1.66	1.87	-2.09	-1.59	-1.48
84	237	1.03	1.54	1.78	-1.88	-1.41	-1.28
84	240	0.88	1.39	1.67	-1.67	-1.21	-1.09
84	243	0.60	1.14	1.44	-1.45	-1.00	-0.89
84	246	0.14	0.71	1.03	-1.21	-0.79	-0.70
84	249	-0.42	0.18	0.50	-0.97	-0.57	-0.50
84	252	-0.99	-0.39	-0.07	-0.76	-0.38	-0.32
84	255	-1.50	-0.91	-0.62	-0.58	-0.20	-0.15
84	258	-2.01	-1.49	-1.25	-0.44	-0.05	0.01
84	261	-2.57	-2.17	-2.02	-0.31	0.09	0.16
84	264	-3.09	-2.81	-2.76	-0.20	0.21	0.31



84	267	-3.47	-3.30	-3.33	-0.09	0.33	0.43
84	270	-3.62	-3.49	-3.55	0.01	0.42	0.51
84	273	-3.53	-3.41	-3.51	0.11	0.51	0.56
84	276	-3.28	-3.22	-3.41	0.21	0.59	0.60
84	279	-2.94	-2.96	-3.26	0.30	0.66	0.63
84	282	-2.57	-2.65	-3.07	0.37	0.72	0.66
84	285	-2.23	-2.36	-2.87	0.42	0.75	0.68
84	288	-1.88	-2.00	-2.55	0.44	0.76	0.70
84	291	-1.45	-1.55	-2.07	0.46	0.77	0.72
84	294	-1.05	-1.09	-1.54	0.47	0.77	0.73
84	297	-0.74	-0.72	-1.07	0.49	0.78	0.75
84	300	-0.62	-0.51	-0.77	0.51	0.79	0.77
84	303	-0.63	-0.42	-0.59	0.57	0.83	0.81
84	306	-0.63	-0.34	-0.44	0.66	0.91	0.88
84	309	-0.65	-0.29	-0.32	0.77	1.02	0.96
84	312	-0.66	-0.25	-0.24	0.89	1.13	1.05
84	315	-0.68	-0.24	-0.21	1.01	1.24	1.14
84	318	-0.81	-0.33	-0.28	1.11	1.34	1.23
84	321	-1.09	-0.55	-0.46	1.23	1.45	1.33
84	324	-1.43	-0.85	-0.70	1.34	1.56	1.44
84	327	-1.76	-1.13	-0.94	1.46	1.67	1.55
84	330	-1.98	-1.35	-1.13	1.59	1.80	1.67
84	333	-2.13	-1.51	-1.29	1.72	1.93	1.80
84	336	-2.26	-1.67	-1.45	1.87	2.07	1.94
84	339	-2.37	-1.81	-1.60	2.02	2.22	2.09
84	342	-2.45	-1.90	-1.70	2.16	2.36	2.23
84	345	-2.48	-1.94	-1.74	2.28	2.48	2.35
84	348	-2.40	-1.88	-1.69	2.39	2.59	2.45
84	351	-2.19	-1.71	-1.55	2.48	2.69	2.55
84	354	-1.87	-1.44	-1.32	2.57	2.79	2.64
84	357	-1.47	-1.09	-1.03	2.65	2.87	2.72
84	360	-1.00	-0.68	-0.67	2.71	2.94	2.79
87	0	-0.78	-0.51	-0.50	2.59	2.78	2.61
87	3	-0.27	-0.05	-0.09	2.61	2.78	2.61
87	6	0.17	0.33	0.23	2.62	2.78	2.59
87	9	0.53	0.63	0.47	2.63	2.77	2.57
87	12	0.76	0.82	0.61	2.63	2.75	2.55
87	15	0.84	0.88	0.66	2.63	2.74	2.52
87	18	0.82	0.85	0.61	2.61	2.70	2.45
87	21	0.76	0.75	0.46	2.54	2.62	2.34
87	24	0.67	0.59	0.23	2.46	2.51	2.20
87	27	0.55	0.40	-0.05	2.35	2.39	2.05
87	30	0.40	0.17	-0.36	2.24	2.27	1.90
87	33	0.06	-0.31	-1.02	2.12	2.13	1.74
87	36	-0.56	-1.12	-2.11	1.97	1.96	1.57
87	39	-1.29	-2.05	-3.30	1.80	1.78	1.38
87	42	-1.98	-2.87	-4.26	1.61	1.59	1.20
87	45	-2.49	-3.37	-4.65	1.43	1.40	1.03
87	48	-2.86	-3.63	-4.65	1.26	1.23	0.86
87	51	-3.21	-3.86	-4.63	1.08	1.05	0.71
87	54	-3.51	-4.04	-4.61	0.89	0.87	0.56
87	57	-3.72	-4.16	-4.58	0.69	0.67	0.39
87	60	-3.80	-4.21	-4.54	0.45	0.44	0.19
87	63	-3.58	-3.91	-4.16	0.18	0.19	-0.03
87	66	-3.02	-3.18	-3.29	-0.13	-0.10	-0.28
87	69	-2.30	-2.24	-2.19	-0.49	-0.42	-0.57
87	72	-1.57	-1.31	-1.14	-0.89	-0.78	-0.89
87	75	-0.99	-0.63	-0.39	-1.33	-1.19	-1.25

87	78	-0.54	-0.14	0.12	-1.86	-1.68	-1.70
87	81	-0.10	0.32	0.58	-2.48	-2.27	-2.26
87	84	0.31	0.73	0.98	-3.19	-2.93	-2.88
87	87	0.63	1.04	1.28	-3.93	-3.63	-3.55
87	90	0.84	1.23	1.44	-4.70	-4.34	-4.24
87	93	0.98	1.34	1.52	-5.65	-5.22	-5.09
87	96	1.10	1.43	1.59	-6.81	-6.28	-6.13
87	99	1.20	1.50	1.63	-7.93	-7.30	-7.14
87	102	1.26	1.55	1.67	-8.79	-8.08	-7.91
87	105	1.29	1.57	1.68	-9.13	-8.39	-8.22
87	108	1.28	1.54	1.64	-9.01	-8.28	-8.12
87	111	1.26	1.48	1.55	-8.71	-8.00	-7.87
87	114	1.22	1.39	1.41	-8.28	-7.62	-7.52
87	117	1.18	1.29	1.24	-7.80	-7.18	-7.11
87	120	1.13	1.17	1.07	-7.33	-6.74	-6.71
87	123	1.05	1.03	0.87	-6.75	-6.20	-6.18
87	126	0.92	0.83	0.62	-6.01	-5.50	-5.48
87	129	0.75	0.59	0.32	-5.26	-4.79	-4.78
87	132	0.55	0.33	-0.01	-4.69	-4.25	-4.23
87	135	0.32	0.04	-0.36	-4.46	-4.04	-4.01
87	138	0.04	-0.31	-0.77	-4.46	-4.05	-4.03
87	141	-0.32	-0.73	-1.26	-4.47	-4.07	-4.06
87	144	-0.73	-1.19	-1.77	-4.48	-4.10	-4.11
87	147	-1.17	-1.65	-2.27	-4.50	-4.14	-4.18
87	150	-1.59	-2.09	-2.70	-4.52	-4.20	-4.27
87	153	-2.02	-2.52	-3.09	-4.77	-4.50	-4.64
87	156	-2.50	-2.98	-3.47	-5.34	-5.15	-5.41
87	159	-2.96	-3.41	-3.82	-6.09	-6.00	-6.39
87	162	-3.39	-3.79	-4.11	-6.86	-6.88	-7.40
87	165	-3.72	-4.08	-4.30	-7.49	-7.62	-8.22
87	168	-4.01	-4.30	-4.44	-8.07	-8.30	-8.96
87	171	-4.29	-4.51	-4.56	-8.68	-9.05	-9.74
87	174	-4.53	-4.68	-4.66	-9.24	-9.73	-10.45
87	177	-4.70	-4.80	-4.72	-9.65	-10.22	-10.97
87	180	-4.76	-4.85	-4.75	-9.81	-10.41	-11.16
87	183	-4.75	-4.84	-4.74	-9.37	-9.94	-10.63
87	186	-4.73	-4.80	-4.72	-8.32	-8.77	-9.32
87	189	-4.70	-4.74	-4.68	-7.01	-7.32	-7.68
87	192	-4.66	-4.67	-4.62	-5.83	-5.97	-6.14
87	195	-4.60	-4.57	-4.56	-5.15	-5.13	-5.16
87	198	-4.32	-4.23	-4.24	-4.89	-4.73	-4.65
87	201	-3.69	-3.52	-3.56	-4.71	-4.43	-4.24
87	204	-2.89	-2.62	-2.69	-4.56	-4.18	-3.90
87	207	-2.07	-1.71	-1.79	-4.41	-3.94	-3.60
87	210	-1.40	-0.98	-1.05	-4.22	-3.67	-3.30
87	213	-0.80	-0.34	-0.38	-3.99	-3.38	-3.01
87	216	-0.16	0.33	0.35	-3.73	-3.10	-2.75
87	219	0.41	0.93	1.00	-3.44	-2.81	-2.50
87	222	0.83	1.37	1.48	-3.14	-2.52	-2.25
87	225	0.99	1.53	1.66	-2.83	-2.21	-1.98
87	228	0.97	1.52	1.65	-2.50	-1.89	-1.68
87	231	0.93	1.48	1.64	-2.12	-1.55	-1.36
87	234	0.87	1.42	1.61	-1.74	-1.20	-1.03
87	237	0.78	1.35	1.57	-1.37	-0.87	-0.72
87	240	0.68	1.25	1.52	-1.02	-0.57	-0.43
87	243	0.45	1.04	1.34	-0.69	-0.27	-0.16
87	246	0.04	0.65	0.96	-0.35	0.04	0.11
87	249	-0.48	0.15	0.46	-0.03	0.32	0.36

87	252	-1.01	-0.39	-0.08	0.24	0.56	0.56
87	255	-1.48	-0.88	-0.60	0.41	0.71	0.70
87	258	-1.95	-1.41	-1.18	0.52	0.82	0.79
87	261	-2.46	-2.03	-1.89	0.61	0.91	0.87
87	264	-2.94	-2.62	-2.58	0.69	0.98	0.94
87	267	-3.29	-3.06	-3.10	0.74	1.03	0.98
87	270	-3.43	-3.23	-3.30	0.76	1.05	0.99
87	273	-3.33	-3.15	-3.25	0.76	1.04	0.98
87	276	-3.08	-2.94	-3.10	0.74	1.02	0.94
87	279	-2.73	-2.65	-2.88	0.72	0.99	0.89
87	282	-2.35	-2.32	-2.63	0.69	0.96	0.84
87	285	-1.99	-2.00	-2.36	0.67	0.93	0.80
87	288	-1.62	-1.62	-2.00	0.64	0.89	0.76
87	291	-1.19	-1.17	-1.51	0.60	0.85	0.73
87	294	-0.77	-0.70	-0.98	0.56	0.81	0.69
87	297	-0.42	-0.29	-0.49	0.53	0.78	0.67
87	300	-0.22	-0.01	-0.15	0.52	0.77	0.66
87	303	-0.12	0.16	0.10	0.54	0.79	0.68
87	306	-0.04	0.32	0.33	0.60	0.85	0.73
87	309	0.03	0.45	0.52	0.68	0.92	0.79
87	312	0.07	0.54	0.65	0.78	1.01	0.87
87	315	0.08	0.57	0.70	0.87	1.10	0.95
87	318	0.01	0.51	0.65	0.96	1.19	1.03
87	321	-0.19	0.35	0.51	1.07	1.30	1.13
87	324	-0.45	0.13	0.33	1.19	1.41	1.25
87	327	-0.73	-0.11	0.12	1.31	1.53	1.37
87	330	-0.96	-0.33	-0.07	1.44	1.65	1.49
87	333	-1.19	-0.56	-0.30	1.57	1.78	1.62
87	336	-1.44	-0.83	-0.57	1.72	1.92	1.76
87	339	-1.67	-1.09	-0.84	1.86	2.06	1.91
87	342	-1.84	-1.29	-1.05	2.00	2.19	2.05
87	345	-1.91	-1.37	-1.13	2.12	2.31	2.17
87	348	-1.86	-1.34	-1.11	2.23	2.42	2.27
87	351	-1.72	-1.24	-1.05	2.33	2.52	2.37
87	354	-1.49	-1.07	-0.93	2.43	2.61	2.46
87	357	-1.18	-0.83	-0.75	2.51	2.70	2.54
87	360	-0.78	-0.51	-0.50	2.59	2.78	2.61
90	0	-0.69	-0.43	-0.42	2.45	2.61	2.42
90	3	-0.19	0.02	-0.02	2.53	2.67	2.43
90	6	0.24	0.39	0.29	2.58	2.71	2.43
90	9	0.59	0.67	0.51	2.62	2.73	2.44
90	12	0.81	0.85	0.64	2.64	2.73	2.44
90	15	0.89	0.91	0.68	2.64	2.73	2.44
90	18	0.87	0.87	0.61	2.63	2.71	2.40
90	21	0.79	0.75	0.44	2.57	2.64	2.32
90	24	0.68	0.57	0.18	2.50	2.54	2.19
90	27	0.54	0.34	-0.15	2.41	2.43	2.06
90	30	0.38	0.09	-0.51	2.32	2.31	1.92
90	33	-0.01	-0.47	-1.22	2.21	2.19	1.78
90	36	-0.70	-1.40	-2.37	2.08	2.04	1.62
90	39	-1.49	-2.42	-3.62	1.92	1.87	1.45
90	42	-2.20	-3.26	-4.62	1.75	1.69	1.28
90	45	-2.63	-3.61	-5.03	1.58	1.51	1.11
90	48	-2.85	-3.64	-4.97	1.42	1.34	0.96
90	51	-3.04	-3.66	-4.82	1.25	1.18	0.81
90	54	-3.20	-3.67	-4.59	1.07	1.00	0.67
90	57	-3.30	-3.68	-4.29	0.87	0.81	0.50
90	60	-3.33	-3.68	-3.97	0.64	0.59	0.32

90	63	-3.08	-3.37	-3.39	0.37	0.34	0.10
90	66	-2.46	-2.59	-2.46	0.06	0.05	-0.15
90	69	-1.66	-1.60	-1.41	-0.30	-0.28	-0.43
90	72	-0.87	-0.65	-0.44	-0.70	-0.64	-0.75
90	75	-0.29	0.03	0.25	-1.14	-1.05	-1.12
90	78	0.13	0.48	0.72	-1.67	-1.54	-1.57
90	81	0.53	0.90	1.16	-2.31	-2.14	-2.14
90	84	0.88	1.27	1.52	-3.02	-2.81	-2.77
90	87	1.14	1.53	1.78	-3.78	-3.52	-3.46
90	90	1.28	1.66	1.89	-4.56	-4.26	-4.16
90	93	1.36	1.71	1.91	-5.55	-5.17	-5.05
90	96	1.41	1.74	1.93	-6.77	-6.28	-6.14
90	99	1.46	1.77	1.94	-7.96	-7.37	-7.21
90	102	1.49	1.79	1.95	-8.86	-8.19	-8.02
90	105	1.50	1.80	1.95	-9.22	-8.52	-8.34
90	108	1.49	1.77	1.91	-9.11	-8.42	-8.25
90	111	1.45	1.69	1.80	-8.83	-8.15	-8.02
90	114	1.39	1.57	1.64	-8.43	-7.78	-7.68
90	117	1.32	1.44	1.45	-7.98	-7.35	-7.28
90	120	1.24	1.30	1.26	-7.52	-6.92	-6.88
90	123	1.14	1.13	1.03	-6.92	-6.35	-6.33
90	126	1.00	0.92	0.76	-6.13	-5.60	-5.58
90	129	0.83	0.67	0.44	-5.32	-4.83	-4.81
90	132	0.62	0.40	0.10	-4.70	-4.24	-4.21
90	135	0.40	0.10	-0.26	-4.45	-4.01	-3.97
90	138	0.12	-0.26	-0.68	-4.45	-4.01	-3.97
90	141	-0.25	-0.70	-1.17	-4.45	-4.02	-4.00
90	144	-0.66	-1.17	-1.68	-4.45	-4.04	-4.04
90	147	-1.09	-1.63	-2.14	-4.45	-4.07	-4.09
90	150	-1.49	-2.04	-2.51	-4.45	-4.11	-4.16
90	153	-1.88	-2.41	-2.81	-4.72	-4.45	-4.57
90	156	-2.30	-2.78	-3.07	-5.37	-5.21	-5.45
90	159	-2.70	-3.13	-3.31	-6.14	-6.11	-6.50
90	162	-3.07	-3.43	-3.50	-6.79	-6.87	-7.41
90	165	-3.38	-3.67	-3.64	-7.06	-7.23	-7.86
90	168	-3.64	-3.86	-3.73	-7.05	-7.29	-7.97
90	171	-3.87	-4.02	-3.80	-7.02	-7.34	-8.06
90	174	-4.09	-4.16	-3.85	-6.98	-7.38	-8.13
90	177	-4.26	-4.29	-3.92	-6.93	-7.40	-8.17
90	180	-4.40	-4.40	-4.00	-6.86	-7.40	-8.19
90	183	-4.51	-4.50	-4.14	-6.64	-7.19	-7.90
90	186	-4.62	-4.60	-4.33	-6.22	-6.65	-7.19
90	189	-4.71	-4.69	-4.52	-5.71	-5.97	-6.29
90	192	-4.77	-4.75	-4.68	-5.24	-5.31	-5.41
90	195	-4.79	-4.78	-4.74	-4.94	-4.85	-4.80
90	198	-4.55	-4.50	-4.48	-4.79	-4.58	-4.42
90	201	-3.93	-3.80	-3.81	-4.68	-4.37	-4.12
90	204	-3.12	-2.87	-2.93	-4.59	-4.18	-3.85
90	207	-2.29	-1.94	-2.03	-4.48	-3.98	-3.59
90	210	-1.62	-1.20	-1.29	-4.34	-3.76	-3.31
90	213	-1.05	-0.57	-0.64	-4.14	-3.49	-3.02
90	216	-0.44	0.08	0.06	-3.88	-3.20	-2.74
90	219	0.11	0.66	0.69	-3.57	-2.89	-2.46
90	222	0.51	1.08	1.15	-3.23	-2.56	-2.17
90	225	0.66	1.24	1.33	-2.88	-2.22	-1.86
90	228	0.65	1.23	1.34	-2.47	-1.83	-1.52
90	231	0.62	1.21	1.34	-2.00	-1.41	-1.14
90	234	0.58	1.18	1.34	-1.50	-0.97	-0.76

90	237	0.52	1.14	1.34	-1.02	-0.55	-0.40
90	240	0.46	1.09	1.34	-0.62	-0.20	-0.09
90	243	0.27	0.92	1.21	-0.26	0.13	0.20
90	246	-0.10	0.57	0.88	0.10	0.45	0.49
90	249	-0.56	0.10	0.41	0.42	0.74	0.75
90	252	-1.04	-0.40	-0.10	0.67	0.97	0.95
90	255	-1.48	-0.87	-0.59	0.82	1.10	1.06
90	258	-1.92	-1.37	-1.15	0.90	1.17	1.10
90	261	-2.41	-1.97	-1.83	0.97	1.23	1.14
90	264	-2.88	-2.53	-2.50	1.03	1.27	1.17
90	267	-3.22	-2.96	-3.01	1.07	1.30	1.19
90	270	-3.36	-3.13	-3.21	1.08	1.31	1.19
90	273	-3.26	-3.05	-3.14	1.06	1.29	1.17
90	276	-3.00	-2.83	-2.97	0.99	1.23	1.10
90	279	-2.65	-2.53	-2.72	0.91	1.15	1.01
90	282	-2.27	-2.19	-2.43	0.83	1.07	0.92
90	285	-1.91	-1.86	-2.14	0.76	1.00	0.84
90	288	-1.52	-1.47	-1.75	0.70	0.94	0.77
90	291	-1.08	-1.00	-1.24	0.64	0.87	0.69
90	294	-0.64	-0.50	-0.69	0.58	0.80	0.62
90	297	-0.27	-0.07	-0.19	0.54	0.76	0.56
90	300	-0.03	0.24	0.18	0.52	0.74	0.54
90	303	0.12	0.45	0.45	0.54	0.75	0.56
90	306	0.26	0.65	0.70	0.57	0.79	0.59
90	309	0.37	0.81	0.92	0.61	0.84	0.64
90	312	0.44	0.92	1.07	0.67	0.90	0.70
90	315	0.46	0.96	1.12	0.73	0.96	0.77
90	318	0.40	0.91	1.07	0.80	1.04	0.85
90	321	0.22	0.76	0.95	0.91	1.14	0.95
90	324	-0.02	0.55	0.77	1.02	1.26	1.07
90	327	-0.27	0.32	0.57	1.15	1.38	1.20
90	330	-0.51	0.10	0.37	1.27	1.50	1.32
90	333	-0.77	-0.16	0.12	1.40	1.62	1.45
90	336	-1.07	-0.48	-0.20	1.54	1.74	1.59
90	339	-1.36	-0.79	-0.53	1.68	1.87	1.72
90	342	-1.58	-1.03	-0.77	1.81	2.00	1.85
90	345	-1.67	-1.13	-0.87	1.94	2.12	1.97
90	348	-1.63	-1.11	-0.87	2.05	2.22	2.07
90	351	-1.52	-1.04	-0.84	2.16	2.33	2.17
90	354	-1.33	-0.92	-0.77	2.26	2.43	2.26
90	357	-1.06	-0.72	-0.63	2.36	2.52	2.34
90	360	-0.69	-0.43	-0.42	2.45	2.61	2.42
93	0	-0.76	-0.52	-0.54	2.24	2.39	2.19
93	3	-0.25	-0.06	-0.12	2.34	2.48	2.23
93	6	0.19	0.32	0.20	2.42	2.55	2.26
93	9	0.54	0.61	0.42	2.48	2.59	2.27
93	12	0.76	0.79	0.55	2.51	2.61	2.28
93	15	0.84	0.85	0.59	2.52	2.62	2.28
93	18	0.82	0.80	0.52	2.50	2.59	2.25
93	21	0.74	0.68	0.34	2.45	2.53	2.18
93	24	0.63	0.48	0.06	2.38	2.43	2.07
93	27	0.49	0.24	-0.29	2.30	2.32	1.95
93	30	0.32	-0.03	-0.68	2.21	2.21	1.83
93	33	-0.08	-0.60	-1.42	2.11	2.09	1.70
93	36	-0.78	-1.55	-2.61	1.97	1.94	1.54
93	39	-1.59	-2.59	-3.89	1.82	1.78	1.37
93	42	-2.32	-3.44	-4.92	1.66	1.60	1.20
93	45	-2.77	-3.84	-5.34	1.49	1.43	1.03

93	48	-3.01	-3.90	-5.29	1.33	1.27	0.88
93	51	-3.22	-3.95	-5.17	1.17	1.10	0.74
93	54	-3.38	-3.98	-4.98	1.00	0.93	0.59
93	57	-3.50	-4.00	-4.74	0.80	0.74	0.43
93	60	-3.54	-4.01	-4.46	0.57	0.52	0.24
93	63	-3.30	-3.71	-3.90	0.31	0.27	0.02
93	66	-2.73	-2.95	-2.97	0.00	-0.02	-0.23
93	69	-1.98	-1.98	-1.89	-0.36	-0.34	-0.51
93	72	-1.23	-1.04	-0.88	-0.76	-0.71	-0.83
93	75	-0.67	-0.36	-0.16	-1.20	-1.11	-1.20
93	78	-0.25	0.10	0.33	-1.73	-1.60	-1.65
93	81	0.15	0.54	0.78	-2.36	-2.20	-2.20
93	84	0.50	0.91	1.16	-3.06	-2.86	-2.83
93	87	0.77	1.19	1.44	-3.81	-3.57	-3.51
93	90	0.94	1.34	1.57	-4.59	-4.29	-4.21
93	93	1.05	1.42	1.61	-5.56	-5.19	-5.08
93	96	1.13	1.48	1.65	-6.75	-6.29	-6.16
93	99	1.20	1.52	1.67	-7.91	-7.37	-7.21
93	102	1.25	1.55	1.69	-8.79	-8.18	-8.01
93	105	1.26	1.56	1.69	-9.14	-8.50	-8.32
93	108	1.25	1.54	1.66	-9.05	-8.41	-8.25
93	111	1.23	1.47	1.55	-8.81	-8.18	-8.05
93	114	1.19	1.37	1.40	-8.46	-7.86	-7.76
93	117	1.15	1.25	1.22	-8.05	-7.47	-7.42
93	120	1.09	1.12	1.04	-7.63	-7.08	-7.06
93	123	1.01	0.97	0.83	-7.05	-6.53	-6.52
93	126	0.89	0.78	0.56	-6.26	-5.76	-5.76
93	129	0.73	0.55	0.26	-5.44	-4.98	-4.97
93	132	0.55	0.30	-0.06	-4.81	-4.37	-4.35
93	135	0.35	0.03	-0.39	-4.54	-4.12	-4.10
93	138	0.11	-0.30	-0.76	-4.54	-4.12	-4.11
93	141	-0.20	-0.69	-1.19	-4.53	-4.13	-4.13
93	144	-0.55	-1.10	-1.61	-4.53	-4.15	-4.17
93	147	-0.90	-1.49	-1.98	-4.53	-4.18	-4.21
93	150	-1.22	-1.81	-2.24	-4.53	-4.21	-4.28
93	153	-1.53	-2.08	-2.40	-4.76	-4.52	-4.67
93	156	-1.84	-2.33	-2.55	-5.32	-5.22	-5.52
93	159	-2.14	-2.55	-2.66	-5.98	-6.04	-6.51
93	162	-2.42	-2.75	-2.76	-6.53	-6.73	-7.33
93	165	-2.66	-2.92	-2.82	-6.77	-7.01	-7.68
93	168	-2.86	-3.05	-2.86	-6.75	-7.01	-7.67
93	171	-3.04	-3.16	-2.89	-6.71	-6.99	-7.65
93	174	-3.20	-3.26	-2.91	-6.64	-6.97	-7.62
93	177	-3.36	-3.36	-2.94	-6.55	-6.93	-7.58
93	180	-3.51	-3.47	-2.99	-6.45	-6.89	-7.53
93	183	-3.68	-3.62	-3.15	-6.24	-6.68	-7.24
93	186	-3.85	-3.81	-3.45	-5.90	-6.21	-6.61
93	189	-4.02	-3.99	-3.78	-5.50	-5.64	-5.83
93	192	-4.13	-4.12	-4.05	-5.12	-5.08	-5.07
93	195	-4.18	-4.18	-4.16	-4.86	-4.67	-4.53
93	198	-3.96	-3.93	-3.93	-4.70	-4.42	-4.20
93	201	-3.42	-3.30	-3.34	-4.58	-4.22	-3.92
93	204	-2.71	-2.49	-2.57	-4.48	-4.03	-3.68
93	207	-2.00	-1.68	-1.79	-4.36	-3.84	-3.43
93	210	-1.43	-1.04	-1.16	-4.21	-3.62	-3.17
93	213	-0.97	-0.54	-0.63	-4.00	-3.35	-2.88
93	216	-0.50	-0.02	-0.07	-3.72	-3.05	-2.57
93	219	-0.08	0.44	0.44	-3.40	-2.74	-2.27

93	222	0.22	0.77	0.80	-3.05	-2.40	-1.96
93	225	0.34	0.89	0.94	-2.69	-2.05	-1.64
93	228	0.32	0.88	0.94	-2.27	-1.66	-1.30
93	231	0.27	0.86	0.93	-1.77	-1.22	-0.95
93	234	0.20	0.81	0.92	-1.25	-0.78	-0.60
93	237	0.11	0.75	0.91	-0.78	-0.37	-0.27
93	240	0.00	0.68	0.90	-0.40	-0.04	0.01
93	243	-0.20	0.50	0.77	-0.09	0.25	0.27
93	246	-0.56	0.16	0.45	0.21	0.52	0.52
93	249	-0.99	-0.28	0.01	0.47	0.76	0.75
93	252	-1.44	-0.75	-0.47	0.67	0.95	0.91
93	255	-1.84	-1.19	-0.93	0.78	1.04	0.99
93	258	-2.24	-1.66	-1.44	0.83	1.08	1.00
93	261	-2.69	-2.21	-2.07	0.88	1.11	1.01
93	264	-3.11	-2.73	-2.69	0.91	1.14	1.02
93	267	-3.41	-3.12	-3.15	0.93	1.15	1.03
93	270	-3.53	-3.27	-3.34	0.94	1.16	1.03
93	273	-3.42	-3.18	-3.26	0.91	1.13	1.00
93	276	-3.14	-2.94	-3.06	0.84	1.07	0.93
93	279	-2.74	-2.61	-2.77	0.75	0.98	0.84
93	282	-2.32	-2.23	-2.44	0.67	0.89	0.74
93	285	-1.92	-1.86	-2.10	0.60	0.83	0.66
93	288	-1.52	-1.45	-1.69	0.55	0.77	0.58
93	291	-1.07	-0.95	-1.15	0.50	0.71	0.50
93	294	-0.61	-0.44	-0.58	0.45	0.66	0.42
93	297	-0.23	0.01	-0.06	0.42	0.62	0.37
93	300	0.02	0.33	0.30	0.41	0.61	0.35
93	303	0.19	0.54	0.56	0.42	0.62	0.36
93	306	0.34	0.74	0.81	0.44	0.65	0.41
93	309	0.45	0.91	1.01	0.48	0.70	0.47
93	312	0.53	1.02	1.15	0.53	0.76	0.54
93	315	0.56	1.06	1.20	0.57	0.82	0.62
93	318	0.49	1.00	1.15	0.64	0.89	0.70
93	321	0.31	0.83	1.00	0.74	0.99	0.81
93	324	0.05	0.60	0.80	0.85	1.10	0.93
93	327	-0.22	0.34	0.58	0.97	1.22	1.05
93	330	-0.48	0.10	0.36	1.09	1.33	1.17
93	333	-0.75	-0.18	0.08	1.21	1.44	1.28
93	336	-1.08	-0.52	-0.27	1.33	1.56	1.41
93	339	-1.39	-0.85	-0.61	1.46	1.67	1.53
93	342	-1.62	-1.10	-0.88	1.59	1.78	1.64
93	345	-1.72	-1.20	-0.98	1.71	1.89	1.75
93	348	-1.68	-1.18	-0.98	1.82	2.00	1.85
93	351	-1.58	-1.12	-0.95	1.93	2.10	1.94
93	354	-1.39	-1.00	-0.89	2.04	2.20	2.03
93	357	-1.12	-0.80	-0.76	2.14	2.29	2.11
93	360	-0.76	-0.52	-0.54	2.24	2.39	2.19
96	0	-0.94	-0.75	-0.87	1.91	2.08	1.90
96	3	-0.42	-0.27	-0.43	2.01	2.18	1.95
96	6	0.03	0.12	-0.08	2.09	2.25	1.97
96	9	0.39	0.42	0.16	2.15	2.29	1.99
96	12	0.63	0.61	0.31	2.19	2.32	1.99
96	15	0.71	0.67	0.35	2.20	2.32	2.00
96	18	0.68	0.63	0.29	2.18	2.30	1.97
96	21	0.61	0.50	0.10	2.14	2.24	1.90
96	24	0.50	0.31	-0.18	2.08	2.15	1.80
96	27	0.36	0.06	-0.52	2.00	2.05	1.69
96	30	0.19	-0.21	-0.91	1.92	1.95	1.58

96	33	-0.19	-0.75	-1.65	1.83	1.84	1.45
96	36	-0.87	-1.65	-2.85	1.71	1.70	1.31
96	39	-1.67	-2.66	-4.15	1.57	1.55	1.15
96	42	-2.41	-3.54	-5.19	1.42	1.39	0.98
96	45	-2.92	-4.06	-5.62	1.27	1.22	0.82
96	48	-3.26	-4.31	-5.63	1.12	1.07	0.67
96	51	-3.57	-4.52	-5.63	0.97	0.91	0.53
96	54	-3.83	-4.69	-5.63	0.80	0.74	0.38
96	57	-4.01	-4.80	-5.63	0.62	0.55	0.22
96	60	-4.08	-4.84	-5.63	0.40	0.34	0.04
96	63	-3.89	-4.55	-5.25	0.14	0.09	-0.18
96	66	-3.40	-3.83	-4.31	-0.16	-0.19	-0.43
96	69	-2.77	-2.90	-3.11	-0.52	-0.51	-0.71
96	72	-2.12	-1.99	-1.96	-0.91	-0.88	-1.03
96	75	-1.60	-1.30	-1.14	-1.35	-1.28	-1.39
96	78	-1.19	-0.81	-0.61	-1.87	-1.77	-1.84
96	81	-0.78	-0.35	-0.12	-2.49	-2.35	-2.38
96	84	-0.41	0.06	0.31	-3.18	-3.00	-2.99
96	87	-0.10	0.38	0.62	-3.91	-3.69	-3.65
96	90	0.13	0.59	0.80	-4.66	-4.40	-4.32
96	93	0.29	0.72	0.89	-5.59	-5.27	-5.16
96	96	0.44	0.84	0.97	-6.71	-6.33	-6.20
96	99	0.56	0.93	1.03	-7.81	-7.36	-7.21
96	102	0.65	0.99	1.06	-8.64	-8.14	-7.98
96	105	0.69	1.01	1.08	-8.97	-8.45	-8.28
96	108	0.71	0.99	1.04	-8.89	-8.38	-8.22
96	111	0.72	0.94	0.95	-8.69	-8.19	-8.06
96	114	0.72	0.88	0.82	-8.41	-7.91	-7.83
96	117	0.73	0.80	0.67	-8.07	-7.58	-7.55
96	120	0.73	0.71	0.51	-7.71	-7.24	-7.25
96	123	0.70	0.59	0.33	-7.19	-6.73	-6.77
96	126	0.62	0.44	0.09	-6.45	-6.01	-6.05
96	129	0.50	0.25	-0.17	-5.67	-5.25	-5.29
96	132	0.37	0.05	-0.44	-5.06	-4.66	-4.70
96	135	0.24	-0.16	-0.70	-4.80	-4.43	-4.46
96	138	0.08	-0.39	-0.97	-4.77	-4.43	-4.46
96	141	-0.13	-0.66	-1.27	-4.75	-4.43	-4.48
96	144	-0.34	-0.94	-1.56	-4.73	-4.44	-4.51
96	147	-0.56	-1.18	-1.77	-4.73	-4.45	-4.55
96	150	-0.74	-1.34	-1.85	-4.72	-4.46	-4.59
96	153	-0.90	-1.45	-1.84	-4.91	-4.72	-4.93
96	156	-1.06	-1.54	-1.83	-5.35	-5.31	-5.67
96	159	-1.20	-1.61	-1.81	-5.87	-6.00	-6.53
96	162	-1.33	-1.67	-1.79	-6.31	-6.59	-7.24
96	165	-1.45	-1.73	-1.77	-6.49	-6.83	-7.54
96	168	-1.56	-1.78	-1.75	-6.48	-6.82	-7.52
96	171	-1.65	-1.81	-1.71	-6.43	-6.78	-7.45
96	174	-1.74	-1.85	-1.68	-6.36	-6.72	-7.35
96	177	-1.83	-1.89	-1.65	-6.28	-6.64	-7.23
96	180	-1.94	-1.95	-1.64	-6.18	-6.55	-7.08
96	183	-2.10	-2.07	-1.76	-6.00	-6.33	-6.76
96	186	-2.29	-2.27	-2.04	-5.72	-5.92	-6.18
96	189	-2.49	-2.49	-2.38	-5.40	-5.43	-5.50
96	192	-2.65	-2.66	-2.66	-5.07	-4.94	-4.84
96	195	-2.71	-2.73	-2.78	-4.81	-4.55	-4.33
96	198	-2.57	-2.57	-2.63	-4.61	-4.27	-3.97
96	201	-2.22	-2.15	-2.25	-4.44	-4.02	-3.67
96	204	-1.76	-1.62	-1.75	-4.28	-3.79	-3.39



96	207	-1.32	-1.08	-1.24	-4.11	-3.55	-3.12
96	210	-0.98	-0.68	-0.84	-3.90	-3.29	-2.83
96	213	-0.72	-0.37	-0.51	-3.64	-2.99	-2.52
96	216	-0.47	-0.06	-0.17	-3.32	-2.67	-2.21
96	219	-0.25	0.21	0.14	-2.97	-2.34	-1.89
96	222	-0.09	0.40	0.36	-2.61	-2.00	-1.59
96	225	-0.03	0.47	0.44	-2.24	-1.66	-1.29
96	228	-0.07	0.44	0.43	-1.83	-1.29	-0.99
96	231	-0.18	0.37	0.38	-1.37	-0.90	-0.68
96	234	-0.34	0.25	0.31	-0.92	-0.51	-0.39
96	237	-0.54	0.11	0.22	-0.51	-0.17	-0.13
96	240	-0.74	-0.05	0.11	-0.21	0.10	0.09
96	243	-1.03	-0.29	-0.09	0.04	0.32	0.29
96	246	-1.44	-0.67	-0.44	0.27	0.53	0.48
96	249	-1.89	-1.11	-0.86	0.47	0.72	0.64
96	252	-2.34	-1.56	-1.31	0.61	0.84	0.76
96	255	-2.71	-1.96	-1.73	0.66	0.89	0.80
96	258	-3.04	-2.37	-2.17	0.66	0.88	0.79
96	261	-3.37	-2.81	-2.68	0.65	0.87	0.76
96	264	-3.68	-3.22	-3.16	0.64	0.84	0.72
96	267	-3.89	-3.52	-3.52	0.62	0.81	0.67
96	270	-3.97	-3.64	-3.66	0.60	0.78	0.62
96	273	-3.83	-3.52	-3.56	0.55	0.72	0.55
96	276	-3.47	-3.21	-3.29	0.45	0.63	0.46
96	279	-2.97	-2.79	-2.92	0.34	0.53	0.37
96	282	-2.45	-2.32	-2.49	0.24	0.45	0.28
96	285	-1.98	-1.89	-2.08	0.19	0.40	0.21
96	288	-1.54	-1.43	-1.61	0.17	0.37	0.17
96	291	-1.06	-0.90	-1.05	0.15	0.35	0.12
96	294	-0.59	-0.38	-0.47	0.13	0.33	0.09
96	297	-0.20	0.08	0.04	0.12	0.32	0.06
96	300	0.07	0.40	0.40	0.12	0.31	0.05
96	303	0.24	0.62	0.66	0.14	0.34	0.08
96	306	0.40	0.82	0.89	0.18	0.39	0.15
96	309	0.53	0.99	1.09	0.24	0.47	0.25
96	312	0.61	1.10	1.22	0.32	0.56	0.36
96	315	0.64	1.14	1.27	0.39	0.64	0.46
96	318	0.57	1.07	1.20	0.47	0.73	0.56
96	321	0.38	0.89	1.04	0.57	0.84	0.67
96	324	0.11	0.64	0.82	0.68	0.94	0.79
96	327	-0.18	0.35	0.56	0.79	1.05	0.90
96	330	-0.45	0.09	0.31	0.90	1.16	1.01
96	333	-0.75	-0.23	-0.01	1.00	1.25	1.12
96	336	-1.12	-0.62	-0.42	1.11	1.35	1.22
96	339	-1.48	-1.00	-0.84	1.21	1.44	1.32
96	342	-1.75	-1.29	-1.15	1.32	1.54	1.41
96	345	-1.85	-1.40	-1.28	1.42	1.63	1.50
96	348	-1.82	-1.39	-1.28	1.52	1.72	1.59
96	351	-1.73	-1.34	-1.26	1.62	1.81	1.67
96	354	-1.56	-1.23	-1.19	1.72	1.90	1.75
96	357	-1.30	-1.04	-1.07	1.81	1.99	1.83
96	360	-0.94	-0.75	-0.87	1.91	2.08	1.90
99	0	-1.24	-1.13	-1.39	1.50	1.72	1.56
99	3	-0.70	-0.63	-0.91	1.59	1.80	1.59
99	6	-0.22	-0.20	-0.52	1.66	1.85	1.61
99	9	0.16	0.12	-0.24	1.71	1.89	1.62
99	12	0.41	0.32	-0.07	1.74	1.91	1.62
99	15	0.50	0.39	-0.02	1.75	1.91	1.62

99	18	0.47	0.35	-0.08	1.74	1.89	1.60
99	21	0.41	0.23	-0.25	1.70	1.84	1.53
99	24	0.30	0.05	-0.51	1.65	1.76	1.44
99	27	0.17	-0.19	-0.84	1.59	1.68	1.33
99	30	0.00	-0.46	-1.21	1.53	1.59	1.23
99	33	-0.36	-0.96	-1.88	1.45	1.49	1.11
99	36	-1.00	-1.80	-2.97	1.35	1.36	0.98
99	39	-1.77	-2.77	-4.19	1.23	1.23	0.83
99	42	-2.52	-3.67	-5.26	1.10	1.08	0.67
99	45	-3.11	-4.32	-5.92	0.97	0.93	0.52
99	48	-3.58	-4.78	-6.27	0.84	0.79	0.38
99	51	-4.05	-5.21	-6.58	0.70	0.64	0.24
99	54	-4.46	-5.58	-6.82	0.54	0.48	0.10
99	57	-4.75	-5.83	-6.98	0.36	0.30	-0.06
99	60	-4.86	-5.93	-7.04	0.16	0.09	-0.25
99	63	-4.71	-5.65	-6.64	-0.09	-0.15	-0.46
99	66	-4.32	-4.96	-5.66	-0.39	-0.43	-0.71
99	69	-3.79	-4.06	-4.41	-0.74	-0.76	-1.00
99	72	-3.24	-3.16	-3.19	-1.13	-1.12	-1.32
99	75	-2.77	-2.46	-2.31	-1.56	-1.52	-1.68
99	78	-2.35	-1.93	-1.73	-2.07	-2.00	-2.11
99	81	-1.92	-1.42	-1.19	-2.67	-2.57	-2.63
99	84	-1.51	-0.96	-0.72	-3.34	-3.20	-3.22
99	87	-1.15	-0.59	-0.35	-4.05	-3.87	-3.85
99	90	-0.86	-0.32	-0.12	-4.77	-4.55	-4.49
99	93	-0.64	-0.13	0.02	-5.64	-5.38	-5.29
99	96	-0.43	0.05	0.15	-6.68	-6.39	-6.27
99	99	-0.25	0.20	0.25	-7.69	-7.37	-7.22
99	102	-0.11	0.29	0.31	-8.46	-8.10	-7.94
99	105	0.00	0.33	0.34	-8.76	-8.40	-8.23
99	108	0.08	0.32	0.31	-8.70	-8.34	-8.18
99	111	0.16	0.30	0.24	-8.55	-8.19	-8.07
99	114	0.22	0.28	0.13	-8.33	-7.97	-7.91
99	117	0.26	0.24	0.01	-8.07	-7.71	-7.71
99	120	0.28	0.20	-0.12	-7.79	-7.43	-7.48
99	123	0.26	0.13	-0.28	-7.34	-6.99	-7.08
99	126	0.23	0.01	-0.49	-6.69	-6.34	-6.44
99	129	0.18	-0.13	-0.71	-6.00	-5.66	-5.75
99	132	0.13	-0.27	-0.92	-5.43	-5.11	-5.20
99	135	0.08	-0.39	-1.06	-5.17	-4.88	-4.98
99	138	0.02	-0.49	-1.17	-5.11	-4.86	-4.98
99	141	-0.06	-0.60	-1.28	-5.07	-4.85	-4.99
99	144	-0.13	-0.70	-1.36	-5.04	-4.84	-5.01
99	147	-0.19	-0.78	-1.42	-5.02	-4.83	-5.02
99	150	-0.21	-0.80	-1.45	-5.01	-4.83	-5.05
99	153	-0.20	-0.78	-1.39	-5.14	-5.02	-5.31
99	156	-0.18	-0.70	-1.25	-5.45	-5.48	-5.90
99	159	-0.16	-0.61	-1.06	-5.82	-6.03	-6.60
99	162	-0.14	-0.52	-0.87	-6.13	-6.48	-7.18
99	165	-0.13	-0.46	-0.73	-6.26	-6.68	-7.42
99	168	-0.13	-0.41	-0.61	-6.25	-6.66	-7.39
99	171	-0.14	-0.36	-0.49	-6.21	-6.60	-7.29
99	174	-0.15	-0.32	-0.38	-6.14	-6.52	-7.14
99	177	-0.17	-0.29	-0.30	-6.07	-6.42	-6.95
99	180	-0.19	-0.28	-0.28	-5.98	-6.30	-6.74
99	183	-0.28	-0.36	-0.37	-5.83	-6.08	-6.40
99	186	-0.47	-0.53	-0.58	-5.60	-5.72	-5.88
99	189	-0.68	-0.75	-0.84	-5.33	-5.28	-5.26

99	192	-0.86	-0.93	-1.05	-5.04	-4.83	-4.66
99	195	-0.94	-1.00	-1.14	-4.77	-4.45	-4.16
99	198	-0.89	-0.93	-1.08	-4.53	-4.12	-3.76
99	201	-0.77	-0.77	-0.95	-4.30	-3.81	-3.40
99	204	-0.63	-0.57	-0.76	-4.06	-3.51	-3.06
99	207	-0.50	-0.37	-0.59	-3.81	-3.21	-2.74
99	210	-0.44	-0.24	-0.45	-3.53	-2.89	-2.42
99	213	-0.42	-0.16	-0.34	-3.21	-2.56	-2.10
99	216	-0.40	-0.08	-0.23	-2.84	-2.21	-1.78
99	219	-0.39	-0.02	-0.14	-2.45	-1.85	-1.47
99	222	-0.38	0.03	-0.07	-2.06	-1.51	-1.18
99	225	-0.38	0.05	-0.04	-1.70	-1.19	-0.91
99	228	-0.45	-0.01	-0.09	-1.33	-0.87	-0.66
99	231	-0.65	-0.16	-0.20	-0.94	-0.54	-0.41
99	234	-0.93	-0.37	-0.36	-0.58	-0.24	-0.19
99	237	-1.25	-0.62	-0.56	-0.27	0.02	0.01
99	240	-1.57	-0.87	-0.77	-0.05	0.21	0.15
99	243	-1.95	-1.20	-1.05	0.11	0.35	0.27
99	246	-2.44	-1.62	-1.44	0.26	0.47	0.38
99	249	-2.96	-2.09	-1.88	0.38	0.58	0.47
99	252	-3.42	-2.54	-2.31	0.46	0.65	0.53
99	255	-3.74	-2.90	-2.68	0.49	0.68	0.56
99	258	-3.98	-3.22	-3.04	0.47	0.65	0.52
99	261	-4.19	-3.55	-3.41	0.41	0.58	0.44
99	264	-4.37	-3.84	-3.75	0.33	0.48	0.33
99	267	-4.50	-4.04	-4.00	0.24	0.38	0.21
99	270	-4.54	-4.12	-4.10	0.15	0.28	0.10
99	273	-4.36	-3.96	-3.96	0.05	0.18	0.00
99	276	-3.89	-3.56	-3.60	-0.08	0.07	-0.12
99	279	-3.27	-3.02	-3.10	-0.21	-0.04	-0.23
99	282	-2.62	-2.44	-2.56	-0.31	-0.12	-0.31
99	285	-2.07	-1.92	-2.06	-0.34	-0.16	-0.35
99	288	-1.58	-1.42	-1.55	-0.34	-0.15	-0.34
99	291	-1.06	-0.87	-0.96	-0.33	-0.14	-0.33
99	294	-0.58	-0.33	-0.38	-0.31	-0.12	-0.32
99	297	-0.18	0.13	0.13	-0.29	-0.09	-0.31
99	300	0.10	0.45	0.48	-0.27	-0.06	-0.29
99	303	0.28	0.68	0.73	-0.22	-0.01	-0.23
99	306	0.45	0.88	0.96	-0.14	0.09	-0.12
99	309	0.58	1.05	1.14	-0.04	0.21	0.03
99	312	0.67	1.16	1.27	0.07	0.34	0.17
99	315	0.70	1.20	1.31	0.17	0.45	0.31
99	318	0.63	1.13	1.25	0.27	0.55	0.42
99	321	0.43	0.94	1.07	0.37	0.66	0.54
99	324	0.16	0.67	0.81	0.48	0.77	0.65
99	327	-0.14	0.37	0.52	0.58	0.87	0.76
99	330	-0.43	0.07	0.23	0.68	0.96	0.85
99	333	-0.77	-0.29	-0.15	0.77	1.04	0.94
99	336	-1.20	-0.75	-0.65	0.85	1.12	1.02
99	339	-1.62	-1.21	-1.16	0.93	1.19	1.09
99	342	-1.94	-1.56	-1.56	1.01	1.26	1.16
99	345	-2.07	-1.70	-1.72	1.09	1.33	1.23
99	348	-2.05	-1.70	-1.72	1.17	1.41	1.30
99	351	-1.97	-1.67	-1.70	1.25	1.48	1.37
99	354	-1.83	-1.58	-1.65	1.33	1.56	1.43
99	357	-1.59	-1.41	-1.55	1.42	1.64	1.50
99	360	-1.24	-1.13	-1.39	1.50	1.72	1.56
102	0	-1.64	-1.64	-2.07	1.04	1.31	1.19

102	3	-1.06	-1.09	-1.53	1.11	1.36	1.20
102	6	-0.55	-0.63	-1.09	1.17	1.40	1.20
102	9	-0.15	-0.28	-0.77	1.21	1.43	1.20
102	12	0.12	-0.05	-0.56	1.24	1.44	1.21
102	15	0.22	0.03	-0.49	1.25	1.44	1.21
102	18	0.20	-0.01	-0.55	1.24	1.42	1.18
102	21	0.14	-0.12	-0.71	1.22	1.38	1.12
102	24	0.04	-0.30	-0.95	1.18	1.32	1.03
102	27	-0.09	-0.52	-1.25	1.14	1.25	0.93
102	30	-0.24	-0.77	-1.59	1.09	1.17	0.83
102	33	-0.58	-1.25	-2.22	1.04	1.09	0.73
102	36	-1.19	-2.05	-3.24	0.96	0.99	0.60
102	39	-1.94	-2.99	-4.42	0.86	0.87	0.47
102	42	-2.71	-3.92	-5.52	0.75	0.74	0.33
102	45	-3.35	-4.66	-6.30	0.64	0.61	0.19
102	48	-3.96	-5.28	-6.85	0.53	0.48	0.05
102	51	-4.61	-5.92	-7.37	0.40	0.34	-0.08
102	54	-5.20	-6.48	-7.80	0.25	0.18	-0.23
102	57	-5.63	-6.89	-8.10	0.08	0.01	-0.39
102	60	-5.79	-7.04	-8.21	-0.11	-0.19	-0.57
102	63	-5.66	-6.76	-7.80	-0.35	-0.43	-0.79
102	66	-5.31	-6.06	-6.79	-0.65	-0.71	-1.04
102	69	-4.83	-5.14	-5.49	-0.99	-1.04	-1.33
102	72	-4.32	-4.21	-4.22	-1.38	-1.40	-1.65
102	75	-3.86	-3.48	-3.29	-1.80	-1.80	-2.00
102	78	-3.43	-2.91	-2.67	-2.30	-2.27	-2.43
102	81	-2.96	-2.35	-2.08	-2.89	-2.82	-2.93
102	84	-2.50	-1.85	-1.58	-3.54	-3.44	-3.50
102	87	-2.07	-1.43	-1.17	-4.22	-4.09	-4.10
102	90	-1.73	-1.11	-0.90	-4.90	-4.74	-4.71
102	93	-1.44	-0.86	-0.71	-5.71	-5.53	-5.46
102	96	-1.18	-0.63	-0.55	-6.68	-6.48	-6.37
102	99	-0.95	-0.44	-0.41	-7.61	-7.39	-7.25
102	102	-0.76	-0.31	-0.32	-8.31	-8.08	-7.92
102	105	-0.60	-0.26	-0.29	-8.58	-8.35	-8.18
102	108	-0.48	-0.26	-0.31	-8.54	-8.31	-8.16
102	111	-0.36	-0.26	-0.37	-8.44	-8.21	-8.10
102	114	-0.26	-0.26	-0.46	-8.28	-8.06	-8.02
102	117	-0.19	-0.26	-0.55	-8.09	-7.87	-7.91
102	120	-0.15	-0.26	-0.65	-7.89	-7.67	-7.78
102	123	-0.13	-0.29	-0.79	-7.53	-7.32	-7.47
102	126	-0.12	-0.38	-0.98	-6.98	-6.76	-6.93
102	129	-0.11	-0.48	-1.17	-6.39	-6.16	-6.33
102	132	-0.10	-0.56	-1.31	-5.89	-5.67	-5.83
102	135	-0.09	-0.60	-1.37	-5.62	-5.43	-5.62
102	138	-0.06	-0.59	-1.36	-5.53	-5.37	-5.60
102	141	-0.01	-0.55	-1.33	-5.46	-5.33	-5.59
102	144	0.06	-0.50	-1.27	-5.40	-5.29	-5.58
102	147	0.14	-0.43	-1.21	-5.36	-5.27	-5.57
102	150	0.22	-0.36	-1.13	-5.35	-5.27	-5.57
102	153	0.34	-0.24	-0.98	-5.43	-5.40	-5.75
102	156	0.50	-0.04	-0.73	-5.61	-5.71	-6.18
102	159	0.67	0.18	-0.44	-5.83	-6.09	-6.70
102	162	0.82	0.40	-0.16	-6.01	-6.41	-7.13
102	165	0.94	0.56	0.07	-6.09	-6.54	-7.31
102	168	1.02	0.70	0.26	-6.08	-6.51	-7.26
102	171	1.10	0.83	0.45	-6.03	-6.44	-7.12
102	174	1.17	0.95	0.62	-5.96	-6.33	-6.92

102	177	1.22	1.03	0.74	-5.88	-6.20	-6.68
102	180	1.24	1.06	0.79	-5.79	-6.05	-6.42
102	183	1.19	1.01	0.74	-5.65	-5.83	-6.07
102	186	1.06	0.89	0.63	-5.46	-5.51	-5.58
102	189	0.89	0.74	0.49	-5.23	-5.12	-5.02
102	192	0.72	0.59	0.35	-4.98	-4.71	-4.47
102	195	0.57	0.48	0.24	-4.72	-4.33	-3.98
102	198	0.45	0.40	0.16	-4.46	-3.98	-3.56
102	201	0.35	0.33	0.09	-4.18	-3.62	-3.16
102	204	0.24	0.28	0.03	-3.87	-3.27	-2.78
102	207	0.14	0.21	-0.04	-3.55	-2.91	-2.42
102	210	0.02	0.14	-0.10	-3.22	-2.55	-2.08
102	213	-0.10	0.07	-0.16	-2.84	-2.19	-1.75
102	216	-0.22	0.00	-0.21	-2.43	-1.81	-1.42
102	219	-0.34	-0.08	-0.26	-2.00	-1.43	-1.12
102	222	-0.49	-0.18	-0.33	-1.59	-1.09	-0.84
102	225	-0.66	-0.30	-0.41	-1.24	-0.79	-0.61
102	228	-0.89	-0.46	-0.54	-0.92	-0.52	-0.40
102	231	-1.18	-0.69	-0.73	-0.60	-0.25	-0.19
102	234	-1.51	-0.96	-0.96	-0.31	-0.01	-0.01
102	237	-1.87	-1.26	-1.21	-0.08	0.17	0.12
102	240	-2.25	-1.58	-1.49	0.06	0.28	0.19
102	243	-2.72	-1.96	-1.83	0.14	0.33	0.22
102	246	-3.28	-2.44	-2.26	0.20	0.37	0.25
102	249	-3.85	-2.94	-2.72	0.25	0.41	0.27
102	252	-4.33	-3.38	-3.14	0.29	0.43	0.28
102	255	-4.62	-3.72	-3.48	0.30	0.44	0.28
102	258	-4.77	-3.97	-3.77	0.26	0.39	0.23
102	261	-4.91	-4.21	-4.06	0.14	0.27	0.10
102	264	-5.01	-4.42	-4.30	-0.01	0.10	-0.07
102	267	-5.08	-4.56	-4.48	-0.17	-0.07	-0.25
102	270	-5.11	-4.61	-4.54	-0.31	-0.20	-0.39
102	273	-4.89	-4.42	-4.36	-0.44	-0.33	-0.51
102	276	-4.32	-3.93	-3.91	-0.59	-0.46	-0.64
102	279	-3.58	-3.27	-3.29	-0.73	-0.58	-0.75
102	282	-2.81	-2.57	-2.63	-0.84	-0.66	-0.84
102	285	-2.18	-1.97	-2.05	-0.88	-0.70	-0.87
102	288	-1.64	-1.43	-1.50	-0.87	-0.68	-0.85
102	291	-1.10	-0.85	-0.89	-0.84	-0.65	-0.81
102	294	-0.59	-0.30	-0.31	-0.79	-0.59	-0.75
102	297	-0.17	0.17	0.19	-0.74	-0.53	-0.68
102	300	0.11	0.49	0.53	-0.68	-0.46	-0.61
102	303	0.31	0.71	0.77	-0.60	-0.36	-0.50
102	306	0.48	0.92	1.00	-0.48	-0.22	-0.35
102	309	0.62	1.09	1.18	-0.34	-0.06	-0.18
102	312	0.71	1.20	1.30	-0.20	0.10	-0.01
102	315	0.74	1.24	1.34	-0.07	0.23	0.14
102	318	0.67	1.17	1.27	0.04	0.35	0.26
102	321	0.47	0.97	1.07	0.15	0.46	0.38
102	324	0.20	0.69	0.79	0.26	0.57	0.50
102	327	-0.11	0.37	0.47	0.35	0.67	0.60
102	330	-0.42	0.05	0.14	0.44	0.75	0.68
102	333	-0.80	-0.37	-0.32	0.50	0.81	0.74
102	336	-1.31	-0.92	-0.93	0.56	0.86	0.80
102	339	-1.81	-1.48	-1.56	0.62	0.91	0.85
102	342	-2.19	-1.92	-2.05	0.67	0.95	0.89
102	345	-2.34	-2.09	-2.24	0.73	1.01	0.94
102	348	-2.34	-2.08	-2.24	0.79	1.06	0.99

102	351	-2.29	-2.06	-2.23	0.85	1.12	1.04
102	354	-2.18	-1.99	-2.21	0.91	1.18	1.09
102	357	-1.97	-1.86	-2.15	0.97	1.24	1.14
102	360	-1.64	-1.64	-2.07	1.04	1.31	1.19
105	0	-2.14	-2.27	-2.88	0.56	0.87	0.80
105	3	-1.51	-1.66	-2.27	0.62	0.92	0.80
105	6	-0.96	-1.15	-1.77	0.68	0.95	0.79
105	9	-0.51	-0.75	-1.38	0.72	0.96	0.79
105	12	-0.22	-0.49	-1.14	0.75	0.97	0.79
105	15	-0.11	-0.40	-1.05	0.76	0.98	0.78
105	18	-0.13	-0.43	-1.10	0.75	0.96	0.75
105	21	-0.19	-0.54	-1.25	0.74	0.93	0.70
105	24	-0.28	-0.71	-1.47	0.73	0.89	0.62
105	27	-0.40	-0.92	-1.75	0.71	0.83	0.53
105	30	-0.54	-1.16	-2.07	0.69	0.77	0.44
105	33	-0.86	-1.63	-2.69	0.65	0.71	0.35
105	36	-1.46	-2.42	-3.72	0.59	0.62	0.24
105	39	-2.20	-3.37	-4.92	0.52	0.53	0.12
105	42	-2.99	-4.32	-6.03	0.43	0.42	0.00
105	45	-3.69	-5.12	-6.82	0.34	0.30	-0.13
105	48	-4.41	-5.83	-7.36	0.24	0.18	-0.26
105	51	-5.22	-6.58	-7.87	0.12	0.05	-0.40
105	54	-5.98	-7.25	-8.30	-0.02	-0.10	-0.54
105	57	-6.54	-7.74	-8.60	-0.18	-0.27	-0.71
105	60	-6.76	-7.93	-8.71	-0.36	-0.47	-0.89
105	63	-6.61	-7.62	-8.29	-0.60	-0.70	-1.11
105	66	-6.21	-6.85	-7.26	-0.89	-0.99	-1.37
105	69	-5.67	-5.84	-5.94	-1.24	-1.32	-1.66
105	72	-5.09	-4.82	-4.65	-1.63	-1.69	-1.98
105	75	-4.57	-4.02	-3.71	-2.05	-2.09	-2.34
105	78	-4.08	-3.41	-3.06	-2.53	-2.55	-2.76
105	81	-3.55	-2.82	-2.47	-3.11	-3.10	-3.25
105	84	-3.02	-2.29	-1.95	-3.74	-3.70	-3.79
105	87	-2.55	-1.84	-1.53	-4.40	-4.32	-4.37
105	90	-2.16	-1.50	-1.24	-5.05	-4.95	-4.95
105	93	-1.84	-1.22	-1.04	-5.82	-5.70	-5.65
105	96	-1.55	-0.97	-0.85	-6.73	-6.59	-6.49
105	99	-1.29	-0.76	-0.70	-7.60	-7.44	-7.30
105	102	-1.07	-0.61	-0.61	-8.25	-8.08	-7.92
105	105	-0.90	-0.55	-0.57	-8.51	-8.33	-8.16
105	108	-0.77	-0.53	-0.59	-8.48	-8.31	-8.16
105	111	-0.65	-0.52	-0.64	-8.41	-8.27	-8.17
105	114	-0.55	-0.52	-0.72	-8.31	-8.19	-8.17
105	117	-0.47	-0.51	-0.81	-8.19	-8.10	-8.17
105	120	-0.41	-0.51	-0.90	-8.04	-7.99	-8.17
105	123	-0.37	-0.53	-1.02	-7.77	-7.73	-7.99
105	126	-0.34	-0.59	-1.17	-7.33	-7.27	-7.55
105	129	-0.31	-0.65	-1.33	-6.83	-6.75	-7.01
105	132	-0.28	-0.70	-1.45	-6.39	-6.29	-6.54
105	135	-0.23	-0.73	-1.50	-6.13	-6.04	-6.31
105	138	-0.15	-0.69	-1.47	-6.00	-5.93	-6.24
105	141	-0.04	-0.60	-1.40	-5.88	-5.85	-6.19
105	144	0.10	-0.48	-1.28	-5.79	-5.78	-6.15
105	147	0.25	-0.33	-1.15	-5.73	-5.73	-6.12
105	150	0.40	-0.18	-1.00	-5.71	-5.72	-6.11
105	153	0.58	0.02	-0.79	-5.74	-5.79	-6.22
105	156	0.79	0.26	-0.50	-5.82	-5.96	-6.49
105	159	1.01	0.53	-0.18	-5.90	-6.17	-6.81

105	162	1.22	0.78	0.14	-5.98	-6.34	-7.07
105	165	1.37	0.98	0.39	-6.01	-6.41	-7.18
105	168	1.50	1.15	0.61	-5.98	-6.37	-7.11
105	171	1.63	1.32	0.83	-5.90	-6.27	-6.92
105	174	1.73	1.47	1.02	-5.79	-6.11	-6.66
105	177	1.81	1.57	1.16	-5.66	-5.93	-6.35
105	180	1.84	1.61	1.21	-5.54	-5.73	-6.03
105	183	1.80	1.58	1.19	-5.40	-5.50	-5.67
105	186	1.70	1.50	1.12	-5.24	-5.21	-5.21
105	189	1.56	1.39	1.03	-5.07	-4.87	-4.71
105	192	1.41	1.27	0.92	-4.87	-4.52	-4.21
105	195	1.25	1.14	0.82	-4.65	-4.17	-3.77
105	198	1.08	1.01	0.70	-4.40	-3.83	-3.37
105	201	0.88	0.85	0.55	-4.11	-3.48	-2.99
105	204	0.66	0.68	0.40	-3.78	-3.12	-2.62
105	207	0.44	0.51	0.24	-3.44	-2.76	-2.26
105	210	0.22	0.34	0.09	-3.09	-2.40	-1.93
105	213	0.02	0.19	-0.04	-2.70	-2.02	-1.60
105	216	-0.17	0.04	-0.16	-2.26	-1.63	-1.28
105	219	-0.37	-0.12	-0.28	-1.81	-1.25	-0.98
105	222	-0.59	-0.28	-0.41	-1.40	-0.91	-0.71
105	225	-0.84	-0.47	-0.56	-1.05	-0.63	-0.49
105	228	-1.12	-0.70	-0.75	-0.75	-0.37	-0.30
105	231	-1.45	-0.97	-0.97	-0.44	-0.12	-0.11
105	234	-1.80	-1.26	-1.22	-0.17	0.09	0.05
105	237	-2.18	-1.59	-1.49	0.02	0.25	0.17
105	240	-2.58	-1.93	-1.78	0.10	0.30	0.21
105	243	-3.06	-2.34	-2.15	0.10	0.30	0.20
105	246	-3.64	-2.83	-2.59	0.10	0.29	0.17
105	249	-4.22	-3.34	-3.05	0.10	0.27	0.14
105	252	-4.70	-3.79	-3.48	0.10	0.24	0.09
105	255	-5.00	-4.13	-3.82	0.10	0.21	0.03
105	258	-5.17	-4.38	-4.12	0.04	0.13	-0.07
105	261	-5.32	-4.62	-4.41	-0.10	-0.03	-0.22
105	264	-5.43	-4.82	-4.66	-0.30	-0.22	-0.41
105	267	-5.51	-4.96	-4.84	-0.50	-0.41	-0.59
105	270	-5.54	-5.01	-4.91	-0.67	-0.56	-0.73
105	273	-5.29	-4.79	-4.70	-0.82	-0.70	-0.86
105	276	-4.67	-4.23	-4.16	-0.98	-0.84	-0.98
105	279	-3.85	-3.47	-3.44	-1.13	-0.97	-1.09
105	282	-3.00	-2.69	-2.69	-1.25	-1.06	-1.17
105	285	-2.31	-2.03	-2.05	-1.29	-1.09	-1.20
105	288	-1.74	-1.45	-1.47	-1.27	-1.08	-1.18
105	291	-1.15	-0.86	-0.86	-1.24	-1.03	-1.13
105	294	-0.61	-0.30	-0.28	-1.18	-0.96	-1.05
105	297	-0.17	0.17	0.21	-1.12	-0.87	-0.95
105	300	0.12	0.50	0.55	-1.04	-0.79	-0.85
105	303	0.32	0.73	0.79	-0.94	-0.67	-0.73
105	306	0.49	0.93	1.01	-0.80	-0.51	-0.56
105	309	0.63	1.10	1.19	-0.63	-0.33	-0.38
105	312	0.72	1.21	1.31	-0.47	-0.15	-0.20
105	315	0.76	1.26	1.35	-0.34	-0.01	-0.05
105	318	0.68	1.18	1.27	-0.22	0.12	0.08
105	321	0.49	0.98	1.06	-0.10	0.24	0.21
105	324	0.22	0.70	0.75	0.00	0.34	0.32
105	327	-0.10	0.36	0.39	0.09	0.43	0.41
105	330	-0.42	0.02	0.02	0.16	0.50	0.48
105	333	-0.85	-0.46	-0.50	0.21	0.54	0.52

105	336	-1.43	-1.12	-1.23	0.24	0.57	0.55
105	339	-2.03	-1.79	-1.97	0.28	0.60	0.58
105	342	-2.49	-2.31	-2.56	0.31	0.63	0.61
105	345	-2.67	-2.53	-2.81	0.34	0.66	0.63
105	348	-2.67	-2.52	-2.83	0.38	0.70	0.67
105	351	-2.64	-2.51	-2.85	0.43	0.74	0.70
105	354	-2.56	-2.47	-2.87	0.47	0.78	0.73
105	357	-2.40	-2.39	-2.87	0.52	0.82	0.76
105	360	-2.14	-2.27	-2.88	0.56	0.87	0.80
108	0	-4.43	-5.15	-5.26	0.02	0.35	0.33
108	3	-3.45	-4.08	-4.38	0.08	0.39	0.33
108	6	-2.57	-3.12	-3.63	0.14	0.42	0.33
108	9	-1.85	-2.35	-3.03	0.19	0.44	0.32
108	12	-1.37	-1.83	-2.64	0.22	0.45	0.31
108	15	-1.19	-1.65	-2.50	0.25	0.46	0.29
108	18	-1.21	-1.68	-2.54	0.26	0.45	0.27
108	21	-1.25	-1.77	-2.66	0.28	0.44	0.22
108	24	-1.31	-1.90	-2.84	0.29	0.42	0.16
108	27	-1.40	-2.08	-3.08	0.30	0.39	0.09
108	30	-1.50	-2.29	-3.35	0.30	0.36	0.02
108	33	-1.83	-2.78	-4.00	0.29	0.32	-0.05
108	36	-2.51	-3.69	-5.14	0.25	0.26	-0.14
108	39	-3.37	-4.77	-6.43	0.20	0.18	-0.24
108	42	-4.27	-5.81	-7.54	0.14	0.10	-0.35
108	45	-5.05	-6.59	-8.12	0.07	0.00	-0.47
108	48	-5.81	-7.17	-8.32	-0.01	-0.11	-0.59
108	51	-6.64	-7.73	-8.48	-0.12	-0.24	-0.73
108	54	-7.42	-8.22	-8.60	-0.26	-0.39	-0.88
108	57	-7.99	-8.56	-8.68	-0.42	-0.56	-1.05
108	60	-8.21	-8.69	-8.70	-0.60	-0.76	-1.24
108	63	-7.97	-8.33	-8.29	-0.84	-1.00	-1.47
108	66	-7.35	-7.42	-7.26	-1.14	-1.30	-1.74
108	69	-6.54	-6.25	-5.94	-1.49	-1.64	-2.05
108	72	-5.69	-5.09	-4.64	-1.89	-2.03	-2.40
108	75	-4.97	-4.19	-3.70	-2.32	-2.44	-2.78
108	78	-4.37	-3.54	-3.06	-2.82	-2.92	-3.21
108	81	-3.76	-2.93	-2.47	-3.40	-3.48	-3.71
108	84	-3.17	-2.38	-1.96	-4.03	-4.09	-4.27
108	87	-2.66	-1.91	-1.54	-4.70	-4.72	-4.85
108	90	-2.25	-1.57	-1.26	-5.36	-5.36	-5.43
108	93	-1.91	-1.29	-1.06	-6.15	-6.10	-6.11
108	96	-1.61	-1.03	-0.87	-7.07	-6.97	-6.89
108	99	-1.34	-0.81	-0.72	-7.96	-7.80	-7.66
108	102	-1.12	-0.66	-0.63	-8.62	-8.45	-8.28
108	105	-0.96	-0.60	-0.59	-8.89	-8.75	-8.65
108	108	-0.85	-0.60	-0.61	-8.88	-8.82	-8.83
108	111	-0.75	-0.60	-0.67	-8.87	-8.88	-8.98
108	114	-0.67	-0.60	-0.75	-8.86	-8.92	-9.11
108	117	-0.60	-0.60	-0.84	-8.83	-8.94	-9.18
108	120	-0.54	-0.60	-0.93	-8.81	-8.95	-9.21
108	123	-0.50	-0.62	-1.05	-8.64	-8.79	-9.06
108	126	-0.47	-0.67	-1.19	-8.27	-8.40	-8.68
108	129	-0.44	-0.73	-1.34	-7.81	-7.90	-8.20
108	132	-0.41	-0.77	-1.45	-7.36	-7.42	-7.75
108	135	-0.36	-0.79	-1.50	-7.05	-7.09	-7.45
108	138	-0.27	-0.76	-1.47	-6.84	-6.88	-7.27
108	141	-0.14	-0.66	-1.40	-6.65	-6.69	-7.10
108	144	0.03	-0.52	-1.28	-6.48	-6.52	-6.96



108	147	0.20	-0.36	-1.15	-6.35	-6.41	-6.87
108	150	0.38	-0.19	-1.01	-6.25	-6.35	-6.84
108	153	0.57	0.01	-0.80	-6.18	-6.33	-6.85
108	156	0.78	0.25	-0.52	-6.13	-6.32	-6.90
108	159	1.00	0.52	-0.20	-6.09	-6.31	-6.95
108	162	1.21	0.77	0.11	-6.04	-6.30	-7.00
108	165	1.37	0.97	0.36	-5.97	-6.28	-7.02
108	168	1.50	1.14	0.58	-5.86	-6.20	-6.91
108	171	1.63	1.31	0.80	-5.70	-6.02	-6.64
108	174	1.74	1.46	0.99	-5.52	-5.77	-6.27
108	177	1.82	1.56	1.13	-5.33	-5.51	-5.87
108	180	1.85	1.60	1.18	-5.16	-5.25	-5.48
108	183	1.82	1.58	1.16	-5.02	-5.01	-5.10
108	186	1.73	1.52	1.10	-4.89	-4.74	-4.69
108	189	1.61	1.43	1.01	-4.76	-4.46	-4.26
108	192	1.47	1.33	0.91	-4.61	-4.17	-3.84
108	195	1.32	1.22	0.81	-4.44	-3.88	-3.46
108	198	1.15	1.09	0.71	-4.23	-3.59	-3.12
108	201	0.95	0.94	0.58	-3.98	-3.30	-2.81
108	204	0.71	0.76	0.44	-3.71	-2.99	-2.51
108	207	0.47	0.57	0.30	-3.41	-2.69	-2.22
108	210	0.24	0.39	0.16	-3.09	-2.37	-1.93
108	213	0.02	0.22	0.03	-2.73	-2.03	-1.63
108	216	-0.20	0.05	-0.10	-2.32	-1.67	-1.32
108	219	-0.42	-0.12	-0.24	-1.89	-1.31	-1.03
108	222	-0.65	-0.31	-0.39	-1.49	-0.98	-0.77
108	225	-0.91	-0.53	-0.55	-1.16	-0.70	-0.55
108	228	-1.21	-0.77	-0.75	-0.86	-0.46	-0.37
108	231	-1.53	-1.04	-0.97	-0.55	-0.22	-0.19
108	234	-1.87	-1.34	-1.21	-0.29	-0.01	-0.03
108	237	-2.25	-1.66	-1.49	-0.10	0.14	0.08
108	240	-2.64	-2.01	-1.78	-0.02	0.20	0.12
108	243	-3.10	-2.42	-2.14	-0.03	0.19	0.10
108	246	-3.65	-2.89	-2.56	-0.04	0.15	0.05
108	249	-4.19	-3.39	-3.01	-0.06	0.11	-0.02
108	252	-4.68	-3.85	-3.45	-0.09	0.05	-0.10
108	255	-5.02	-4.21	-3.83	-0.13	-0.02	-0.19
108	258	-5.27	-4.53	-4.19	-0.21	-0.12	-0.30
108	261	-5.50	-4.84	-4.56	-0.36	-0.28	-0.46
108	264	-5.69	-5.11	-4.90	-0.55	-0.46	-0.63
108	267	-5.82	-5.30	-5.14	-0.75	-0.64	-0.79
108	270	-5.86	-5.37	-5.23	-0.92	-0.79	-0.92
108	273	-5.63	-5.15	-5.03	-1.08	-0.93	-1.04
108	276	-5.03	-4.60	-4.51	-1.25	-1.08	-1.16
108	279	-4.23	-3.87	-3.81	-1.41	-1.21	-1.26
108	282	-3.41	-3.10	-3.08	-1.53	-1.30	-1.34
108	285	-2.73	-2.44	-2.44	-1.57	-1.34	-1.37
108	288	-2.14	-1.86	-1.87	-1.56	-1.32	-1.35
108	291	-1.53	-1.25	-1.26	-1.52	-1.28	-1.29
108	294	-0.96	-0.68	-0.68	-1.47	-1.21	-1.21
108	297	-0.50	-0.20	-0.18	-1.41	-1.13	-1.12
108	300	-0.19	0.14	0.17	-1.34	-1.05	-1.02
108	303	0.00	0.37	0.42	-1.24	-0.93	-0.90
108	306	0.18	0.58	0.64	-1.10	-0.77	-0.74
108	309	0.32	0.76	0.83	-0.94	-0.60	-0.56
108	312	0.41	0.87	0.96	-0.78	-0.43	-0.39
108	315	0.44	0.92	1.00	-0.65	-0.29	-0.25
108	318	0.37	0.84	0.92	-0.53	-0.17	-0.13

108	321	0.18	0.65	0.70	-0.41	-0.05	-0.01
108	324	-0.09	0.36	0.38	-0.31	0.06	0.10
108	327	-0.41	0.02	0.00	-0.23	0.14	0.19
108	330	-0.75	-0.34	-0.40	-0.18	0.19	0.23
108	333	-1.22	-0.82	-0.94	-0.16	0.21	0.25
108	336	-1.88	-1.48	-1.66	-0.14	0.22	0.27
108	339	-2.58	-2.22	-2.46	-0.13	0.23	0.28
108	342	-3.20	-2.91	-3.19	-0.11	0.24	0.29
108	345	-3.61	-3.46	-3.74	-0.10	0.25	0.30
108	348	-3.86	-3.88	-4.15	-0.08	0.27	0.30
108	351	-4.08	-4.28	-4.52	-0.06	0.29	0.31
108	354	-4.27	-4.63	-4.84	-0.03	0.31	0.32
108	357	-4.39	-4.92	-5.09	-0.01	0.33	0.33
108	360	-4.43	-5.15	-5.26	0.02	0.35	0.33
111	0	-9.13	-11.05	-9.69	-0.62	-0.29	-0.22
111	3	-7.39	-8.93	-8.29	-0.56	-0.26	-0.23
111	6	-5.79	-7.00	-7.04	-0.50	-0.23	-0.24
111	9	-4.48	-5.43	-6.02	-0.45	-0.21	-0.25
111	12	-3.59	-4.36	-5.34	-0.39	-0.18	-0.27
111	15	-3.26	-3.97	-5.09	-0.34	-0.16	-0.29
111	18	-3.26	-3.99	-5.12	-0.29	-0.15	-0.32
111	21	-3.27	-4.04	-5.19	-0.23	-0.13	-0.35
111	24	-3.28	-4.11	-5.31	-0.17	-0.12	-0.38
111	27	-3.30	-4.21	-5.46	-0.13	-0.11	-0.42
111	30	-3.33	-4.34	-5.65	-0.12	-0.11	-0.47
111	33	-3.70	-4.94	-6.27	-0.12	-0.12	-0.52
111	36	-4.59	-6.16	-7.46	-0.13	-0.15	-0.59
111	39	-5.74	-7.59	-8.81	-0.15	-0.20	-0.67
111	42	-6.87	-8.79	-9.91	-0.17	-0.26	-0.75
111	45	-7.74	-9.33	-10.37	-0.20	-0.33	-0.85
111	48	-8.41	-9.38	-10.28	-0.25	-0.42	-0.96
111	51	-9.09	-9.42	-10.02	-0.36	-0.54	-1.10
111	54	-9.69	-9.46	-9.65	-0.50	-0.70	-1.26
111	57	-10.11	-9.48	-9.19	-0.67	-0.88	-1.44
111	60	-10.27	-9.48	-8.70	-0.86	-1.09	-1.65
111	63	-9.88	-9.06	-7.96	-1.10	-1.34	-1.89
111	66	-8.90	-8.01	-6.89	-1.41	-1.66	-2.20
111	69	-7.62	-6.66	-5.68	-1.79	-2.04	-2.54
111	72	-6.33	-5.33	-4.55	-2.21	-2.46	-2.93
111	75	-5.34	-4.34	-3.69	-2.66	-2.90	-3.35
111	78	-4.60	-3.65	-3.05	-3.18	-3.41	-3.82
111	81	-3.91	-3.00	-2.47	-3.79	-4.00	-4.36
111	84	-3.27	-2.44	-1.96	-4.46	-4.65	-4.96
111	87	-2.73	-1.96	-1.55	-5.17	-5.33	-5.59
111	90	-2.30	-1.61	-1.27	-5.88	-6.02	-6.23
111	93	-1.95	-1.33	-1.07	-6.71	-6.79	-6.95
111	96	-1.64	-1.06	-0.88	-7.67	-7.68	-7.77
111	99	-1.37	-0.84	-0.74	-8.61	-8.55	-8.58
111	102	-1.15	-0.69	-0.64	-9.37	-9.29	-9.29
111	105	-1.00	-0.64	-0.60	-9.79	-9.76	-9.80
111	108	-0.90	-0.64	-0.62	-9.98	-10.05	-10.17
111	111	-0.82	-0.65	-0.69	-10.13	-10.30	-10.52
111	114	-0.75	-0.66	-0.77	-10.25	-10.51	-10.80
111	117	-0.70	-0.67	-0.87	-10.33	-10.65	-11.00
111	120	-0.65	-0.68	-0.96	-10.35	-10.69	-11.07
111	123	-0.62	-0.71	-1.07	-10.21	-10.54	-10.92
111	126	-0.59	-0.75	-1.21	-9.85	-10.16	-10.56
111	129	-0.57	-0.80	-1.35	-9.38	-9.65	-10.07

111	132	-0.54	-0.84	-1.45	-8.89	-9.13	-9.58
111	135	-0.50	-0.85	-1.49	-8.48	-8.71	-9.18
111	138	-0.41	-0.81	-1.47	-8.16	-8.38	-8.87
111	141	-0.27	-0.71	-1.39	-7.85	-8.06	-8.58
111	144	-0.09	-0.57	-1.29	-7.55	-7.76	-8.31
111	147	0.11	-0.40	-1.16	-7.28	-7.48	-8.05
111	150	0.30	-0.23	-1.02	-7.02	-7.22	-7.81
111	153	0.51	-0.03	-0.83	-6.78	-6.99	-7.60
111	156	0.73	0.22	-0.56	-6.57	-6.78	-7.43
111	159	0.97	0.49	-0.25	-6.37	-6.59	-7.25
111	162	1.18	0.74	0.04	-6.17	-6.38	-7.06
111	165	1.35	0.94	0.29	-5.95	-6.15	-6.83
111	168	1.49	1.12	0.50	-5.70	-5.88	-6.51
111	171	1.63	1.29	0.72	-5.43	-5.57	-6.12
111	174	1.75	1.44	0.92	-5.16	-5.26	-5.68
111	177	1.83	1.55	1.06	-4.91	-4.95	-5.24
111	180	1.86	1.59	1.11	-4.71	-4.66	-4.84
111	183	1.83	1.57	1.09	-4.56	-4.40	-4.46
111	186	1.76	1.53	1.04	-4.44	-4.16	-4.08
111	189	1.65	1.45	0.97	-4.33	-3.92	-3.72
111	192	1.52	1.37	0.89	-4.21	-3.69	-3.38
111	195	1.38	1.28	0.81	-4.08	-3.46	-3.08
111	198	1.21	1.16	0.72	-3.92	-3.24	-2.82
111	201	1.00	1.00	0.60	-3.74	-3.02	-2.58
111	204	0.75	0.82	0.48	-3.55	-2.81	-2.37
111	207	0.49	0.63	0.35	-3.34	-2.59	-2.15
111	210	0.25	0.44	0.21	-3.11	-2.35	-1.92
111	213	0.02	0.25	0.08	-2.82	-2.08	-1.68
111	216	-0.21	0.07	-0.05	-2.46	-1.77	-1.41
111	219	-0.44	-0.12	-0.20	-2.09	-1.45	-1.15
111	222	-0.69	-0.33	-0.36	-1.73	-1.15	-0.92
111	225	-0.96	-0.55	-0.53	-1.42	-0.91	-0.73
111	228	-1.26	-0.81	-0.73	-1.14	-0.69	-0.57
111	231	-1.58	-1.08	-0.95	-0.85	-0.46	-0.40
111	234	-1.92	-1.38	-1.20	-0.59	-0.27	-0.26
111	237	-2.28	-1.71	-1.47	-0.41	-0.13	-0.16
111	240	-2.67	-2.05	-1.77	-0.34	-0.07	-0.13
111	243	-3.12	-2.46	-2.12	-0.34	-0.08	-0.15
111	246	-3.64	-2.92	-2.54	-0.35	-0.11	-0.19
111	249	-4.17	-3.41	-2.98	-0.36	-0.16	-0.26
111	252	-4.65	-3.87	-3.42	-0.38	-0.21	-0.34
111	255	-5.03	-4.27	-3.83	-0.41	-0.27	-0.42
111	258	-5.35	-4.65	-4.25	-0.48	-0.37	-0.52
111	261	-5.66	-5.05	-4.72	-0.62	-0.51	-0.65
111	264	-5.93	-5.40	-5.14	-0.80	-0.67	-0.80
111	267	-6.12	-5.65	-5.46	-0.98	-0.83	-0.94
111	270	-6.19	-5.75	-5.58	-1.14	-0.98	-1.06
111	273	-6.00	-5.58	-5.43	-1.30	-1.11	-1.17
111	276	-5.50	-5.14	-5.04	-1.48	-1.26	-1.28
111	279	-4.83	-4.54	-4.51	-1.64	-1.40	-1.38
111	282	-4.12	-3.90	-3.93	-1.77	-1.50	-1.45
111	285	-3.51	-3.33	-3.40	-1.81	-1.54	-1.48
111	288	-2.94	-2.78	-2.86	-1.80	-1.52	-1.46
111	291	-2.33	-2.17	-2.25	-1.78	-1.48	-1.41
111	294	-1.75	-1.58	-1.65	-1.74	-1.43	-1.33
111	297	-1.26	-1.08	-1.12	-1.69	-1.36	-1.24
111	300	-0.95	-0.72	-0.75	-1.63	-1.28	-1.15
111	303	-0.75	-0.48	-0.48	-1.55	-1.18	-1.04

111	306	-0.58	-0.25	-0.23	-1.42	-1.05	-0.90
111	309	-0.44	-0.07	-0.02	-1.27	-0.90	-0.74
111	312	-0.34	0.06	0.12	-1.13	-0.75	-0.60
111	315	-0.31	0.11	0.17	-1.01	-0.62	-0.48
111	318	-0.38	0.04	0.09	-0.90	-0.51	-0.37
111	321	-0.57	-0.16	-0.12	-0.79	-0.40	-0.25
111	324	-0.85	-0.44	-0.44	-0.69	-0.30	-0.15
111	327	-1.19	-0.78	-0.81	-0.61	-0.22	-0.08
111	330	-1.56	-1.15	-1.22	-0.59	-0.19	-0.06
111	333	-2.07	-1.65	-1.75	-0.59	-0.20	-0.06
111	336	-2.79	-2.34	-2.49	-0.59	-0.20	-0.06
111	339	-3.63	-3.16	-3.35	-0.60	-0.21	-0.07
111	342	-4.51	-4.08	-4.25	-0.60	-0.22	-0.08
111	345	-5.33	-5.02	-5.13	-0.61	-0.22	-0.09
111	348	-6.09	-6.03	-5.99	-0.61	-0.23	-0.10
111	351	-6.85	-7.14	-6.87	-0.61	-0.25	-0.12
111	354	-7.61	-8.36	-7.79	-0.61	-0.26	-0.15
111	357	-8.37	-9.67	-8.72	-0.62	-0.28	-0.18
111	360	-9.13	-11.05	-9.69	-0.62	-0.29	-0.22
114	0	-14.57	-17.86	-14.68	-1.30	-0.97	-0.80
114	3	-11.94	-14.52	-12.69	-1.24	-0.95	-0.82
114	6	-9.52	-11.46	-10.87	-1.18	-0.92	-0.85
114	9	-7.53	-8.93	-9.37	-1.11	-0.89	-0.87
114	12	-6.15	-7.22	-8.36	-1.04	-0.86	-0.90
114	15	-5.60	-6.59	-7.99	-0.97	-0.83	-0.92
114	18	-5.53	-6.59	-8.00	-0.88	-0.78	-0.93
114	21	-5.48	-6.60	-8.03	-0.78	-0.73	-0.95
114	24	-5.44	-6.61	-8.07	-0.68	-0.67	-0.96
114	27	-5.42	-6.63	-8.13	-0.60	-0.63	-0.98
114	30	-5.41	-6.64	-8.21	-0.56	-0.61	-1.00
114	33	-5.89	-7.26	-8.75	-0.53	-0.61	-1.03
114	36	-7.08	-8.69	-9.91	-0.51	-0.62	-1.07
114	39	-8.56	-10.40	-11.27	-0.50	-0.64	-1.12
114	42	-9.94	-11.82	-12.39	-0.49	-0.66	-1.19
114	45	-10.82	-12.42	-12.86	-0.48	-0.68	-1.26
114	48	-11.30	-12.29	-12.57	-0.52	-0.74	-1.36
114	51	-11.73	-11.95	-11.83	-0.62	-0.86	-1.50
114	54	-12.08	-11.44	-10.81	-0.76	-1.03	-1.67
114	57	-12.32	-10.84	-9.70	-0.94	-1.23	-1.87
114	60	-12.41	-10.19	-8.69	-1.13	-1.45	-2.09
114	63	-11.85	-9.31	-7.68	-1.37	-1.71	-2.35
114	66	-10.45	-8.07	-6.58	-1.70	-2.05	-2.69
114	69	-8.66	-6.71	-5.47	-2.10	-2.46	-3.07
114	72	-6.91	-5.43	-4.46	-2.55	-2.91	-3.50
114	75	-5.64	-4.45	-3.67	-3.02	-3.40	-3.95
114	78	-4.79	-3.72	-3.04	-3.57	-3.94	-4.47
114	81	-4.02	-3.06	-2.46	-4.21	-4.57	-5.06
114	84	-3.35	-2.48	-1.96	-4.92	-5.26	-5.71
114	87	-2.79	-2.00	-1.55	-5.68	-5.98	-6.40
114	90	-2.35	-1.64	-1.28	-6.45	-6.73	-7.10
114	93	-1.98	-1.35	-1.07	-7.34	-7.57	-7.90
114	96	-1.66	-1.09	-0.89	-8.37	-8.53	-8.79
114	99	-1.38	-0.87	-0.74	-9.40	-9.48	-9.70
114	102	-1.17	-0.72	-0.65	-10.28	-10.33	-10.53
114	105	-1.03	-0.66	-0.61	-10.87	-10.96	-11.18
114	108	-0.95	-0.67	-0.63	-11.25	-11.45	-11.72
114	111	-0.88	-0.68	-0.70	-11.60	-11.91	-12.25
114	114	-0.82	-0.70	-0.79	-11.88	-12.29	-12.70

114	117	-0.78	-0.72	-0.89	-12.07	-12.55	-13.02
114	120	-0.74	-0.74	-0.98	-12.14	-12.65	-13.14
114	123	-0.72	-0.77	-1.09	-11.99	-12.49	-12.99
114	126	-0.70	-0.81	-1.22	-11.60	-12.09	-12.60
114	129	-0.68	-0.85	-1.35	-11.08	-11.54	-12.07
114	132	-0.66	-0.89	-1.45	-10.52	-10.95	-11.51
114	135	-0.63	-0.90	-1.48	-10.03	-10.44	-11.01
114	138	-0.55	-0.86	-1.46	-9.59	-9.98	-10.58
114	141	-0.40	-0.76	-1.39	-9.14	-9.51	-10.14
114	144	-0.20	-0.61	-1.29	-8.70	-9.04	-9.70
114	147	0.01	-0.44	-1.17	-8.26	-8.58	-9.26
114	150	0.21	-0.27	-1.04	-7.84	-8.14	-8.83
114	153	0.42	-0.07	-0.86	-7.44	-7.70	-8.39
114	156	0.67	0.18	-0.61	-7.04	-7.27	-7.96
114	159	0.91	0.44	-0.33	-6.66	-6.85	-7.53
114	162	1.14	0.69	-0.05	-6.29	-6.44	-7.10
114	165	1.32	0.90	0.18	-5.93	-6.03	-6.65
114	168	1.47	1.08	0.39	-5.55	-5.61	-6.16
114	171	1.62	1.26	0.61	-5.17	-5.19	-5.64
114	174	1.74	1.42	0.80	-4.81	-4.77	-5.12
114	177	1.83	1.53	0.94	-4.50	-4.40	-4.64
114	180	1.87	1.57	1.00	-4.27	-4.08	-4.22
114	183	1.84	1.56	0.99	-4.11	-3.82	-3.85
114	186	1.77	1.52	0.96	-3.99	-3.59	-3.51
114	189	1.67	1.47	0.91	-3.89	-3.38	-3.20
114	192	1.55	1.40	0.86	-3.79	-3.19	-2.93
114	195	1.42	1.32	0.80	-3.68	-3.02	-2.70
114	198	1.26	1.21	0.72	-3.57	-2.87	-2.51
114	201	1.04	1.06	0.63	-3.48	-2.74	-2.36
114	204	0.78	0.87	0.51	-3.38	-2.62	-2.22
114	207	0.51	0.66	0.39	-3.27	-2.49	-2.08
114	210	0.25	0.47	0.26	-3.13	-2.34	-1.92
114	213	0.01	0.28	0.13	-2.93	-2.14	-1.74
114	216	-0.22	0.08	-0.01	-2.66	-1.90	-1.54
114	219	-0.47	-0.12	-0.16	-2.36	-1.65	-1.33
114	222	-0.72	-0.34	-0.32	-2.06	-1.41	-1.14
114	225	-1.00	-0.58	-0.50	-1.79	-1.20	-0.99
114	228	-1.30	-0.83	-0.71	-1.54	-1.01	-0.85
114	231	-1.61	-1.11	-0.93	-1.27	-0.80	-0.71
114	234	-1.95	-1.42	-1.18	-1.02	-0.63	-0.59
114	237	-2.31	-1.74	-1.46	-0.84	-0.50	-0.50
114	240	-2.69	-2.09	-1.76	-0.76	-0.45	-0.47
114	243	-3.13	-2.49	-2.11	-0.75	-0.45	-0.48
114	246	-3.63	-2.94	-2.52	-0.74	-0.47	-0.51
114	249	-4.15	-3.42	-2.95	-0.73	-0.49	-0.55
114	252	-4.63	-3.89	-3.40	-0.72	-0.52	-0.60
114	255	-5.04	-4.32	-3.83	-0.72	-0.55	-0.66
114	258	-5.42	-4.75	-4.31	-0.77	-0.61	-0.74
114	261	-5.80	-5.22	-4.85	-0.88	-0.73	-0.84
114	264	-6.14	-5.66	-5.36	-1.04	-0.87	-0.96
114	267	-6.39	-5.97	-5.74	-1.20	-1.01	-1.08
114	270	-6.48	-6.09	-5.89	-1.35	-1.15	-1.18
114	273	-6.33	-5.98	-5.81	-1.51	-1.28	-1.28
114	276	-5.96	-5.68	-5.59	-1.69	-1.43	-1.39
114	279	-5.46	-5.27	-5.27	-1.86	-1.57	-1.48
114	282	-4.90	-4.81	-4.91	-1.99	-1.68	-1.55
114	285	-4.39	-4.36	-4.53	-2.04	-1.72	-1.58
114	288	-3.87	-3.87	-4.07	-2.03	-1.71	-1.56

114	291	-3.27	-3.27	-3.47	-2.02	-1.68	-1.51
114	294	-2.68	-2.66	-2.82	-1.99	-1.63	-1.43
114	297	-2.18	-2.13	-2.25	-1.96	-1.58	-1.35
114	300	-1.86	-1.75	-1.84	-1.92	-1.52	-1.27
114	303	-1.66	-1.49	-1.54	-1.86	-1.44	-1.17
114	306	-1.48	-1.25	-1.27	-1.76	-1.33	-1.06
114	309	-1.34	-1.05	-1.04	-1.64	-1.21	-0.93
114	312	-1.24	-0.91	-0.88	-1.52	-1.09	-0.82
114	315	-1.21	-0.86	-0.83	-1.42	-0.99	-0.72
114	318	-1.28	-0.93	-0.90	-1.32	-0.90	-0.63
114	321	-1.47	-1.11	-1.10	-1.22	-0.80	-0.54
114	324	-1.76	-1.39	-1.39	-1.13	-0.71	-0.45
114	327	-2.12	-1.73	-1.75	-1.07	-0.64	-0.39
114	330	-2.52	-2.11	-2.15	-1.04	-0.62	-0.37
114	333	-3.09	-2.64	-2.69	-1.05	-0.62	-0.38
114	336	-3.93	-3.40	-3.46	-1.07	-0.64	-0.39
114	339	-4.96	-4.36	-4.41	-1.10	-0.67	-0.42
114	342	-6.10	-5.49	-5.47	-1.12	-0.70	-0.45
114	345	-7.27	-6.74	-6.60	-1.15	-0.73	-0.48
114	348	-8.49	-8.27	-7.86	-1.18	-0.76	-0.52
114	351	-9.84	-10.22	-9.32	-1.20	-0.81	-0.58
114	354	-11.31	-12.50	-10.97	-1.23	-0.86	-0.64
114	357	-12.89	-15.07	-12.76	-1.27	-0.91	-0.72
114	360	-14.57	-17.86	-14.68	-1.30	-0.97	-0.80
117	0	-19.05	-23.48	-18.77	-1.96	-1.62	-1.35
117	3	-15.69	-19.14	-16.28	-1.90	-1.60	-1.39
117	6	-12.60	-15.16	-14.00	-1.83	-1.58	-1.44
117	9	-10.04	-11.87	-12.12	-1.76	-1.55	-1.47
117	12	-8.27	-9.62	-10.83	-1.68	-1.51	-1.50
117	15	-7.52	-8.73	-10.35	-1.59	-1.47	-1.51
117	18	-7.39	-8.66	-10.33	-1.48	-1.41	-1.51
117	21	-7.28	-8.60	-10.32	-1.35	-1.33	-1.51
117	24	-7.20	-8.56	-10.31	-1.22	-1.24	-1.51
117	27	-7.15	-8.53	-10.30	-1.10	-1.16	-1.52
117	30	-7.14	-8.52	-10.30	-1.01	-1.12	-1.52
117	33	-7.74	-9.19	-10.77	-0.95	-1.10	-1.53
117	36	-9.20	-10.79	-11.91	-0.89	-1.08	-1.55
117	39	-10.98	-12.69	-13.26	-0.84	-1.06	-1.59
117	42	-12.54	-14.28	-14.40	-0.80	-1.05	-1.63
117	45	-13.35	-14.95	-14.87	-0.79	-1.05	-1.68
117	48	-13.60	-14.67	-14.41	-0.83	-1.09	-1.76
117	51	-13.80	-13.94	-13.22	-0.92	-1.21	-1.90
117	54	-13.95	-12.93	-11.65	-1.06	-1.39	-2.08
117	57	-14.05	-11.79	-10.03	-1.24	-1.59	-2.29
117	60	-14.09	-10.71	-8.67	-1.42	-1.81	-2.52
117	63	-13.38	-9.55	-7.54	-1.67	-2.08	-2.80
117	66	-11.65	-8.18	-6.41	-2.00	-2.44	-3.15
117	69	-9.45	-6.78	-5.35	-2.41	-2.87	-3.56
117	72	-7.33	-5.51	-4.41	-2.87	-3.34	-4.02
117	75	-5.85	-4.53	-3.65	-3.36	-3.84	-4.50
117	78	-4.93	-3.78	-3.03	-3.92	-4.40	-5.04
117	81	-4.11	-3.10	-2.45	-4.58	-5.05	-5.65
117	84	-3.42	-2.52	-1.96	-5.31	-5.76	-6.33
117	87	-2.84	-2.04	-1.56	-6.09	-6.51	-7.05
117	90	-2.39	-1.68	-1.28	-6.91	-7.30	-7.80
117	93	-2.02	-1.39	-1.08	-7.85	-8.20	-8.66
117	96	-1.69	-1.12	-0.90	-8.96	-9.22	-9.64
117	99	-1.41	-0.90	-0.75	-10.07	-10.27	-10.64

117	102	-1.20	-0.75	-0.66	-11.06	-11.22	-11.57
117	105	-1.06	-0.69	-0.62	-11.78	-11.97	-12.33
117	108	-0.99	-0.70	-0.65	-12.31	-12.60	-13.00
117	111	-0.93	-0.71	-0.71	-12.81	-13.21	-13.67
117	114	-0.88	-0.73	-0.80	-13.22	-13.74	-14.26
117	117	-0.85	-0.76	-0.90	-13.51	-14.11	-14.67
117	120	-0.82	-0.78	-0.99	-13.61	-14.25	-14.82
117	123	-0.80	-0.81	-1.09	-13.45	-14.08	-14.66
117	126	-0.78	-0.85	-1.22	-13.02	-13.65	-14.24
117	129	-0.77	-0.89	-1.34	-12.45	-13.05	-13.66
117	132	-0.75	-0.92	-1.43	-11.82	-12.40	-13.04
117	135	-0.72	-0.93	-1.47	-11.26	-11.81	-12.46
117	138	-0.65	-0.89	-1.45	-10.74	-11.26	-11.94
117	141	-0.50	-0.79	-1.38	-10.20	-10.68	-11.40
117	144	-0.30	-0.65	-1.29	-9.65	-10.09	-10.83
117	147	-0.09	-0.48	-1.17	-9.09	-9.49	-10.25
117	150	0.12	-0.31	-1.05	-8.55	-8.90	-9.67
117	153	0.34	-0.12	-0.89	-8.01	-8.30	-9.05
117	156	0.59	0.13	-0.66	-7.46	-7.69	-8.41
117	159	0.85	0.39	-0.40	-6.91	-7.08	-7.76
117	162	1.09	0.64	-0.15	-6.39	-6.49	-7.12
117	165	1.28	0.84	0.06	-5.91	-5.95	-6.51
117	168	1.44	1.03	0.26	-5.45	-5.42	-5.91
117	171	1.60	1.21	0.48	-4.98	-4.90	-5.29
117	174	1.74	1.38	0.67	-4.54	-4.41	-4.70
117	177	1.84	1.50	0.80	-4.18	-3.98	-4.18
117	180	1.87	1.54	0.86	-3.94	-3.65	-3.76
117	183	1.85	1.53	0.85	-3.77	-3.39	-3.41
117	186	1.78	1.50	0.84	-3.63	-3.16	-3.09
117	189	1.69	1.46	0.83	-3.52	-2.96	-2.81
117	192	1.57	1.41	0.81	-3.43	-2.80	-2.58
117	195	1.45	1.35	0.78	-3.36	-2.68	-2.41
117	198	1.29	1.25	0.73	-3.31	-2.59	-2.28
117	201	1.06	1.09	0.65	-3.28	-2.53	-2.19
117	204	0.80	0.90	0.54	-3.25	-2.47	-2.10
117	207	0.52	0.69	0.41	-3.21	-2.41	-2.02
117	210	0.26	0.49	0.29	-3.16	-2.33	-1.92
117	213	0.01	0.29	0.16	-3.05	-2.21	-1.80
117	216	-0.24	0.09	0.02	-2.87	-2.05	-1.67
117	219	-0.50	-0.13	-0.13	-2.65	-1.88	-1.54
117	222	-0.76	-0.36	-0.30	-2.42	-1.70	-1.41
117	225	-1.05	-0.61	-0.48	-2.21	-1.54	-1.29
117	228	-1.35	-0.87	-0.68	-1.99	-1.38	-1.18
117	231	-1.66	-1.15	-0.91	-1.75	-1.20	-1.06
117	234	-2.00	-1.46	-1.17	-1.52	-1.04	-0.96
117	237	-2.35	-1.78	-1.45	-1.33	-0.92	-0.88
117	240	-2.73	-2.13	-1.75	-1.22	-0.86	-0.86
117	243	-3.15	-2.53	-2.10	-1.17	-0.86	-0.86
117	246	-3.64	-2.98	-2.50	-1.12	-0.85	-0.87
117	249	-4.14	-3.45	-2.94	-1.09	-0.85	-0.88
117	252	-4.62	-3.92	-3.39	-1.06	-0.84	-0.90
117	255	-5.05	-4.36	-3.83	-1.05	-0.84	-0.92
117	258	-5.46	-4.83	-4.35	-1.09	-0.88	-0.97
117	261	-5.90	-5.36	-4.95	-1.18	-0.96	-1.04
117	264	-6.29	-5.84	-5.52	-1.30	-1.08	-1.14
117	267	-6.57	-6.20	-5.95	-1.44	-1.21	-1.24
117	270	-6.68	-6.34	-6.12	-1.57	-1.33	-1.32
117	273	-6.58	-6.27	-6.09	-1.72	-1.45	-1.41

117	276	-6.31	-6.10	-6.00	-1.90	-1.61	-1.51
117	279	-5.94	-5.84	-5.86	-2.08	-1.76	-1.60
117	282	-5.53	-5.54	-5.68	-2.22	-1.87	-1.67
117	285	-5.12	-5.22	-5.49	-2.27	-1.91	-1.69
117	288	-4.65	-4.80	-5.12	-2.27	-1.90	-1.67
117	291	-4.07	-4.21	-4.52	-2.27	-1.88	-1.62
117	294	-3.49	-3.58	-3.84	-2.26	-1.85	-1.55
117	297	-2.98	-3.01	-3.20	-2.25	-1.81	-1.48
117	300	-2.64	-2.61	-2.75	-2.23	-1.77	-1.40
117	303	-2.44	-2.34	-2.44	-2.20	-1.71	-1.32
117	306	-2.25	-2.08	-2.14	-2.12	-1.63	-1.23
117	309	-2.10	-1.87	-1.89	-2.03	-1.54	-1.14
117	312	-2.00	-1.72	-1.72	-1.93	-1.46	-1.05
117	315	-1.96	-1.67	-1.66	-1.85	-1.38	-0.98
117	318	-2.03	-1.74	-1.73	-1.77	-1.30	-0.90
117	321	-2.23	-1.92	-1.91	-1.68	-1.21	-0.83
117	324	-2.53	-2.19	-2.19	-1.60	-1.13	-0.76
117	327	-2.90	-2.53	-2.53	-1.54	-1.07	-0.72
117	330	-3.32	-2.91	-2.92	-1.52	-1.05	-0.70
117	333	-3.94	-3.46	-3.46	-1.53	-1.06	-0.71
117	336	-4.89	-4.29	-4.27	-1.56	-1.09	-0.73
117	339	-6.08	-5.36	-5.28	-1.61	-1.13	-0.77
117	342	-7.43	-6.65	-6.46	-1.65	-1.17	-0.82
117	345	-8.85	-8.12	-7.77	-1.70	-1.22	-0.87
117	348	-10.43	-10.06	-9.32	-1.74	-1.28	-0.93
117	351	-12.27	-12.69	-11.26	-1.79	-1.35	-1.01
117	354	-14.34	-15.88	-13.51	-1.84	-1.43	-1.11
117	357	-16.62	-19.52	-16.04	-1.90	-1.52	-1.22
117	360	-19.05	-23.48	-18.77	-1.96	-1.62	-1.35
120	0	-20.92	-25.83	-20.46	-2.54	-2.15	-1.80
120	3	-17.24	-21.07	-17.78	-2.49	-2.14	-1.86
120	6	-13.87	-16.70	-15.31	-2.43	-2.12	-1.92
120	9	-11.07	-13.10	-13.28	-2.35	-2.10	-1.97
120	12	-9.13	-10.61	-11.88	-2.26	-2.07	-2.00
120	15	-8.32	-9.62	-11.32	-2.17	-2.03	-2.01
120	18	-8.17	-9.51	-11.26	-2.05	-1.97	-2.01
120	21	-8.05	-9.42	-11.22	-1.90	-1.88	-2.01
120	24	-7.97	-9.35	-11.18	-1.74	-1.77	-2.00
120	27	-7.92	-9.32	-11.16	-1.59	-1.67	-1.99
120	30	-7.90	-9.30	-11.16	-1.47	-1.60	-1.99
120	33	-8.55	-10.00	-11.63	-1.38	-1.56	-2.00
120	36	-10.12	-11.66	-12.76	-1.29	-1.51	-2.01
120	39	-12.02	-13.64	-14.10	-1.21	-1.47	-2.03
120	42	-13.64	-15.30	-15.23	-1.16	-1.45	-2.05
120	45	-14.41	-16.00	-15.70	-1.13	-1.44	-2.09
120	48	-14.53	-15.65	-15.16	-1.17	-1.48	-2.16
120	51	-14.63	-14.75	-13.78	-1.26	-1.59	-2.29
120	54	-14.70	-13.51	-11.98	-1.39	-1.76	-2.47
120	57	-14.75	-12.16	-10.13	-1.55	-1.96	-2.69
120	60	-14.76	-10.91	-8.65	-1.73	-2.17	-2.92
120	63	-14.00	-9.65	-7.48	-1.96	-2.44	-3.20
120	66	-12.13	-8.23	-6.34	-2.29	-2.79	-3.55
120	69	-9.75	-6.81	-5.29	-2.69	-3.21	-3.95
120	72	-7.48	-5.53	-4.37	-3.15	-3.67	-4.40
120	75	-5.92	-4.55	-3.62	-3.63	-4.17	-4.88
120	78	-4.99	-3.81	-3.01	-4.17	-4.71	-5.40
120	81	-4.17	-3.14	-2.45	-4.81	-5.33	-5.99
120	84	-3.48	-2.56	-1.96	-5.52	-6.02	-6.64



120	87	-2.91	-2.09	-1.57	-6.29	-6.76	-7.34
120	90	-2.46	-1.73	-1.30	-7.10	-7.54	-8.09
120	93	-2.09	-1.44	-1.10	-8.06	-8.44	-8.96
120	96	-1.75	-1.17	-0.92	-9.19	-9.50	-9.97
120	99	-1.46	-0.95	-0.77	-10.35	-10.59	-11.02
120	102	-1.25	-0.80	-0.67	-11.38	-11.59	-12.01
120	105	-1.12	-0.74	-0.64	-12.15	-12.39	-12.82
120	108	-1.05	-0.75	-0.66	-12.75	-13.08	-13.54
120	111	-0.99	-0.75	-0.72	-13.31	-13.76	-14.26
120	114	-0.95	-0.77	-0.81	-13.78	-14.34	-14.90
120	117	-0.91	-0.78	-0.91	-14.10	-14.75	-15.35
120	120	-0.88	-0.79	-1.00	-14.22	-14.91	-15.52
120	123	-0.85	-0.82	-1.09	-14.05	-14.73	-15.35
120	126	-0.83	-0.86	-1.22	-13.61	-14.28	-14.91
120	129	-0.82	-0.90	-1.33	-13.00	-13.66	-14.31
120	132	-0.79	-0.93	-1.42	-12.35	-12.99	-13.65
120	135	-0.76	-0.94	-1.46	-11.76	-12.37	-13.06
120	138	-0.68	-0.90	-1.43	-11.23	-11.80	-12.51
120	141	-0.54	-0.80	-1.37	-10.68	-11.21	-11.95
120	144	-0.36	-0.66	-1.28	-10.12	-10.59	-11.36
120	147	-0.16	-0.49	-1.17	-9.55	-9.96	-10.75
120	150	0.04	-0.33	-1.06	-8.97	-9.32	-10.11
120	153	0.26	-0.14	-0.91	-8.36	-8.64	-9.42
120	156	0.52	0.09	-0.71	-7.71	-7.93	-8.67
120	159	0.78	0.34	-0.48	-7.07	-7.21	-7.89
120	162	1.03	0.58	-0.25	-6.45	-6.53	-7.15
120	165	1.23	0.78	-0.06	-5.91	-5.92	-6.46
120	168	1.40	0.97	0.13	-5.40	-5.34	-5.80
120	171	1.58	1.16	0.32	-4.90	-4.78	-5.15
120	174	1.73	1.33	0.49	-4.44	-4.26	-4.53
120	177	1.83	1.46	0.63	-4.06	-3.81	-4.00
120	180	1.87	1.51	0.70	-3.80	-3.47	-3.57
120	183	1.85	1.50	0.72	-3.63	-3.21	-3.23
120	186	1.79	1.48	0.74	-3.47	-2.98	-2.92
120	189	1.69	1.45	0.75	-3.35	-2.78	-2.66
120	192	1.58	1.41	0.76	-3.26	-2.63	-2.45
120	195	1.46	1.36	0.77	-3.22	-2.54	-2.30
120	198	1.30	1.27	0.73	-3.22	-2.48	-2.19
120	201	1.07	1.11	0.66	-3.21	-2.44	-2.11
120	204	0.81	0.92	0.54	-3.21	-2.41	-2.05
120	207	0.53	0.70	0.42	-3.20	-2.38	-1.98
120	210	0.26	0.50	0.30	-3.20	-2.33	-1.92
120	213	0.00	0.29	0.17	-3.15	-2.26	-1.86
120	216	-0.27	0.07	0.03	-3.05	-2.18	-1.80
120	219	-0.55	-0.16	-0.12	-2.91	-2.09	-1.74
120	222	-0.84	-0.40	-0.29	-2.75	-1.99	-1.68
120	225	-1.13	-0.66	-0.47	-2.60	-1.88	-1.61
120	228	-1.44	-0.93	-0.68	-2.42	-1.76	-1.53
120	231	-1.75	-1.22	-0.91	-2.20	-1.61	-1.44
120	234	-2.07	-1.53	-1.16	-1.97	-1.46	-1.34
120	237	-2.41	-1.86	-1.44	-1.77	-1.33	-1.27
120	240	-2.78	-2.21	-1.75	-1.64	-1.26	-1.24
120	243	-3.20	-2.61	-2.10	-1.56	-1.22	-1.23
120	246	-3.67	-3.05	-2.50	-1.49	-1.20	-1.23
120	249	-4.17	-3.51	-2.93	-1.44	-1.17	-1.22
120	252	-4.64	-3.98	-3.39	-1.40	-1.16	-1.22
120	255	-5.07	-4.42	-3.84	-1.38	-1.15	-1.22
120	258	-5.49	-4.90	-4.37	-1.41	-1.18	-1.24

120	261	-5.94	-5.43	-4.99	-1.48	-1.25	-1.29
120	264	-6.35	-5.93	-5.59	-1.58	-1.34	-1.36
120	267	-6.64	-6.29	-6.03	-1.70	-1.44	-1.44
120	270	-6.76	-6.44	-6.21	-1.81	-1.55	-1.51
120	273	-6.67	-6.39	-6.19	-1.95	-1.67	-1.58
120	276	-6.45	-6.26	-6.15	-2.14	-1.82	-1.67
120	279	-6.14	-6.07	-6.08	-2.32	-1.98	-1.76
120	282	-5.78	-5.84	-5.99	-2.47	-2.09	-1.82
120	285	-5.42	-5.58	-5.88	-2.53	-2.14	-1.85
120	288	-4.99	-5.19	-5.58	-2.55	-2.13	-1.83
120	291	-4.44	-4.62	-4.99	-2.56	-2.12	-1.78
120	294	-3.86	-3.97	-4.28	-2.57	-2.10	-1.71
120	297	-3.36	-3.39	-3.61	-2.57	-2.08	-1.64
120	300	-3.02	-2.98	-3.13	-2.58	-2.05	-1.58
120	303	-2.80	-2.70	-2.81	-2.56	-2.01	-1.51
120	306	-2.59	-2.43	-2.51	-2.50	-1.96	-1.45
120	309	-2.43	-2.21	-2.25	-2.43	-1.89	-1.38
120	312	-2.32	-2.07	-2.07	-2.36	-1.82	-1.31
120	315	-2.27	-2.01	-2.01	-2.29	-1.76	-1.25
120	318	-2.35	-2.07	-2.07	-2.22	-1.69	-1.19
120	321	-2.55	-2.25	-2.25	-2.15	-1.61	-1.13
120	324	-2.85	-2.52	-2.52	-2.08	-1.54	-1.07
120	327	-3.23	-2.86	-2.86	-2.02	-1.48	-1.03
120	330	-3.66	-3.25	-3.24	-2.00	-1.46	-1.02
120	333	-4.30	-3.81	-3.78	-2.01	-1.47	-1.03
120	336	-5.29	-4.66	-4.60	-2.05	-1.51	-1.06
120	339	-6.55	-5.78	-5.64	-2.10	-1.55	-1.11
120	342	-7.98	-7.13	-6.87	-2.16	-1.61	-1.17
120	345	-9.50	-8.69	-8.24	-2.21	-1.67	-1.23
120	348	-11.23	-10.80	-9.91	-2.27	-1.73	-1.30
120	351	-13.27	-13.71	-12.04	-2.33	-1.82	-1.40
120	354	-15.60	-17.28	-14.56	-2.40	-1.92	-1.52
120	357	-18.16	-21.37	-17.39	-2.47	-2.03	-1.65
120	360	-20.92	-25.83	-20.46	-2.54	-2.15	-1.80
123	0	-19.14	-23.46	-18.59	-3.06	-2.57	-2.16
123	3	-15.91	-19.26	-16.25	-3.02	-2.57	-2.24
123	6	-12.94	-15.41	-14.11	-2.96	-2.56	-2.31
123	9	-10.49	-12.23	-12.34	-2.88	-2.54	-2.37
123	12	-8.81	-10.06	-11.14	-2.80	-2.53	-2.41
123	15	-8.14	-9.24	-10.70	-2.71	-2.51	-2.43
123	18	-8.08	-9.20	-10.70	-2.59	-2.46	-2.43
123	21	-8.03	-9.17	-10.71	-2.43	-2.37	-2.42
123	24	-7.99	-9.15	-10.72	-2.26	-2.26	-2.42
123	27	-7.97	-9.14	-10.73	-2.09	-2.15	-2.42
123	30	-7.96	-9.14	-10.75	-1.96	-2.07	-2.42
123	33	-8.58	-9.78	-11.19	-1.85	-2.01	-2.42
123	36	-10.07	-11.29	-12.21	-1.73	-1.95	-2.43
123	39	-11.84	-13.11	-13.42	-1.63	-1.89	-2.44
123	42	-13.34	-14.63	-14.44	-1.56	-1.86	-2.46
123	45	-14.00	-15.26	-14.87	-1.53	-1.84	-2.48
123	48	-14.04	-14.94	-14.36	-1.56	-1.88	-2.54
123	51	-14.07	-14.09	-13.08	-1.64	-1.99	-2.67
123	54	-14.10	-12.93	-11.40	-1.76	-2.14	-2.85
123	57	-14.11	-11.66	-9.69	-1.90	-2.32	-3.06
123	60	-14.12	-10.48	-8.30	-2.06	-2.52	-3.28
123	63	-13.41	-9.30	-7.20	-2.27	-2.77	-3.54
123	66	-11.65	-7.96	-6.13	-2.58	-3.09	-3.87
123	69	-9.43	-6.63	-5.14	-2.96	-3.49	-4.26

123	72	-7.30	-5.43	-4.27	-3.38	-3.92	-4.68
123	75	-5.84	-4.50	-3.57	-3.83	-4.38	-5.13
123	78	-4.97	-3.80	-2.98	-4.33	-4.88	-5.61
123	81	-4.20	-3.17	-2.45	-4.91	-5.45	-6.14
123	84	-3.55	-2.63	-1.98	-5.57	-6.08	-6.73
123	87	-3.01	-2.18	-1.61	-6.28	-6.76	-7.37
123	90	-2.58	-1.83	-1.34	-7.03	-7.48	-8.06
123	93	-2.21	-1.55	-1.14	-7.93	-8.34	-8.88
123	96	-1.88	-1.29	-0.96	-9.00	-9.35	-9.85
123	99	-1.60	-1.07	-0.81	-10.11	-10.39	-10.87
123	102	-1.38	-0.92	-0.71	-11.11	-11.36	-11.82
123	105	-1.24	-0.85	-0.68	-11.86	-12.14	-12.61
123	108	-1.15	-0.83	-0.69	-12.45	-12.81	-13.32
123	111	-1.08	-0.81	-0.74	-13.01	-13.48	-14.03
123	114	-1.03	-0.80	-0.81	-13.48	-14.06	-14.66
123	117	-0.98	-0.80	-0.89	-13.81	-14.47	-15.10
123	120	-0.93	-0.79	-0.96	-13.94	-14.62	-15.27
123	123	-0.89	-0.81	-1.04	-13.78	-14.46	-15.11
123	126	-0.86	-0.84	-1.15	-13.38	-14.05	-14.71
123	129	-0.83	-0.87	-1.25	-12.84	-13.49	-14.17
123	132	-0.80	-0.90	-1.33	-12.25	-12.88	-13.57
123	135	-0.75	-0.91	-1.36	-11.71	-12.32	-13.02
123	138	-0.67	-0.87	-1.34	-11.24	-11.80	-12.52
123	141	-0.54	-0.77	-1.28	-10.75	-11.25	-12.00
123	144	-0.38	-0.64	-1.20	-10.25	-10.69	-11.46
123	147	-0.20	-0.48	-1.11	-9.72	-10.10	-10.89
123	150	-0.02	-0.33	-1.01	-9.18	-9.49	-10.28
123	153	0.19	-0.16	-0.88	-8.56	-8.82	-9.59
123	156	0.43	0.05	-0.71	-7.89	-8.09	-8.83
123	159	0.68	0.26	-0.53	-7.20	-7.34	-8.03
123	162	0.91	0.47	-0.34	-6.55	-6.63	-7.26
123	165	1.10	0.65	-0.19	-5.99	-6.00	-6.56
123	168	1.26	0.81	-0.04	-5.47	-5.43	-5.91
123	171	1.43	0.99	0.11	-4.97	-4.87	-5.26
123	174	1.57	1.15	0.25	-4.52	-4.36	-4.65
123	177	1.67	1.26	0.36	-4.15	-3.92	-4.12
123	180	1.71	1.30	0.41	-3.90	-3.59	-3.71
123	183	1.68	1.29	0.44	-3.73	-3.33	-3.37
123	186	1.61	1.27	0.46	-3.57	-3.10	-3.07
123	189	1.51	1.23	0.48	-3.45	-2.91	-2.81
123	192	1.38	1.18	0.49	-3.36	-2.77	-2.60
123	195	1.25	1.12	0.49	-3.33	-2.67	-2.45
123	198	1.07	1.02	0.46	-3.34	-2.62	-2.35
123	201	0.84	0.85	0.37	-3.34	-2.58	-2.26
123	204	0.57	0.65	0.25	-3.34	-2.55	-2.19
123	207	0.28	0.43	0.11	-3.35	-2.52	-2.14
123	210	0.00	0.21	-0.02	-3.35	-2.48	-2.09
123	213	-0.28	-0.01	-0.15	-3.32	-2.44	-2.07
123	216	-0.57	-0.24	-0.28	-3.26	-2.40	-2.05
123	219	-0.87	-0.48	-0.43	-3.17	-2.36	-2.03
123	222	-1.18	-0.73	-0.59	-3.07	-2.30	-2.01
123	225	-1.48	-0.99	-0.77	-2.95	-2.24	-1.98
123	228	-1.78	-1.25	-0.96	-2.80	-2.14	-1.92
123	231	-2.07	-1.53	-1.17	-2.58	-1.99	-1.83
123	234	-2.37	-1.82	-1.40	-2.35	-1.84	-1.74
123	237	-2.68	-2.12	-1.66	-2.14	-1.70	-1.65
123	240	-3.02	-2.45	-1.94	-1.99	-1.61	-1.61
123	243	-3.41	-2.82	-2.26	-1.90	-1.57	-1.58

123	246	-3.85	-3.23	-2.63	-1.82	-1.52	-1.57
123	249	-4.30	-3.66	-3.04	-1.75	-1.49	-1.55
123	252	-4.74	-4.08	-3.46	-1.70	-1.47	-1.54
123	255	-5.14	-4.49	-3.88	-1.69	-1.46	-1.54
123	258	-5.53	-4.93	-4.37	-1.71	-1.48	-1.55
123	261	-5.96	-5.41	-4.94	-1.77	-1.54	-1.59
123	264	-6.34	-5.86	-5.49	-1.86	-1.61	-1.63
123	267	-6.62	-6.20	-5.90	-1.96	-1.70	-1.69
123	270	-6.73	-6.33	-6.07	-2.06	-1.79	-1.74
123	273	-6.65	-6.28	-6.05	-2.19	-1.91	-1.80
123	276	-6.43	-6.15	-6.00	-2.37	-2.07	-1.89
123	279	-6.12	-5.97	-5.93	-2.56	-2.22	-1.97
123	282	-5.77	-5.74	-5.83	-2.71	-2.34	-2.03
123	285	-5.42	-5.49	-5.72	-2.81	-2.39	-2.05
123	288	-5.00	-5.11	-5.41	-2.85	-2.39	-2.03
123	291	-4.48	-4.56	-4.85	-2.89	-2.39	-1.99
123	294	-3.93	-3.93	-4.16	-2.92	-2.38	-1.93
123	297	-3.44	-3.36	-3.52	-2.94	-2.37	-1.86
123	300	-3.08	-2.94	-3.05	-2.94	-2.36	-1.80
123	303	-2.82	-2.64	-2.71	-2.93	-2.33	-1.75
123	306	-2.57	-2.35	-2.39	-2.90	-2.29	-1.69
123	309	-2.37	-2.11	-2.11	-2.85	-2.24	-1.63
123	312	-2.23	-1.95	-1.92	-2.80	-2.18	-1.58
123	315	-2.18	-1.89	-1.85	-2.75	-2.12	-1.53
123	318	-2.24	-1.94	-1.91	-2.69	-2.06	-1.47
123	321	-2.40	-2.09	-2.05	-2.62	-1.98	-1.41
123	324	-2.65	-2.31	-2.27	-2.55	-1.91	-1.36
123	327	-2.97	-2.59	-2.55	-2.50	-1.86	-1.32
123	330	-3.33	-2.92	-2.87	-2.47	-1.84	-1.31
123	333	-3.90	-3.41	-3.35	-2.49	-1.85	-1.32
123	336	-4.80	-4.18	-4.09	-2.52	-1.88	-1.36
123	339	-5.95	-5.20	-5.04	-2.58	-1.93	-1.41
123	342	-7.26	-6.44	-6.16	-2.63	-1.99	-1.47
123	345	-8.65	-7.86	-7.41	-2.69	-2.05	-1.54
123	348	-10.23	-9.78	-8.93	-2.75	-2.12	-1.62
123	351	-12.10	-12.42	-10.88	-2.82	-2.21	-1.73
123	354	-14.24	-15.68	-13.18	-2.89	-2.32	-1.86
123	357	-16.60	-19.40	-15.78	-2.97	-2.44	-2.00
123	360	-19.14	-23.46	-18.59	-3.06	-2.57	-2.16
126	0	-14.87	-17.78	-14.11	-3.54	-2.94	-2.48
126	3	-12.73	-14.94	-12.62	-3.52	-2.95	-2.57
126	6	-10.77	-12.36	-11.28	-3.47	-2.95	-2.66
126	9	-9.17	-10.24	-10.19	-3.40	-2.95	-2.73
126	12	-8.09	-8.81	-9.46	-3.33	-2.95	-2.79
126	15	-7.70	-8.29	-9.19	-3.24	-2.95	-2.81
126	18	-7.71	-8.31	-9.21	-3.12	-2.92	-2.81
126	21	-7.75	-8.36	-9.29	-2.96	-2.83	-2.81
126	24	-7.82	-8.45	-9.41	-2.79	-2.73	-2.82
126	27	-7.91	-8.57	-9.55	-2.61	-2.62	-2.82
126	30	-8.02	-8.72	-9.73	-2.47	-2.53	-2.82
126	33	-8.61	-9.31	-10.17	-2.35	-2.47	-2.83
126	36	-9.85	-10.50	-10.95	-2.22	-2.40	-2.83
126	39	-11.28	-11.86	-11.83	-2.10	-2.34	-2.84
126	42	-12.47	-12.99	-12.54	-2.02	-2.29	-2.86
126	45	-12.97	-13.46	-12.83	-1.99	-2.28	-2.88
126	48	-12.95	-13.18	-12.42	-2.01	-2.31	-2.94
126	51	-12.90	-12.47	-11.39	-2.07	-2.40	-3.06
126	54	-12.81	-11.50	-10.03	-2.17	-2.53	-3.22

126	57	-12.68	-10.43	-8.63	-2.29	-2.70	-3.41
126	60	-12.53	-9.44	-7.49	-2.42	-2.87	-3.62
126	63	-11.84	-8.44	-6.57	-2.60	-3.09	-3.87
126	66	-10.39	-7.33	-5.67	-2.88	-3.39	-4.18
126	69	-8.59	-6.20	-4.83	-3.21	-3.75	-4.54
126	72	-6.88	-5.19	-4.08	-3.60	-4.15	-4.94
126	75	-5.66	-4.39	-3.47	-4.00	-4.57	-5.35
126	78	-4.89	-3.76	-2.94	-4.45	-5.02	-5.79
126	81	-4.21	-3.20	-2.46	-4.97	-5.53	-6.27
126	84	-3.63	-2.71	-2.03	-5.55	-6.09	-6.79
126	87	-3.14	-2.30	-1.68	-6.18	-6.70	-7.36
126	90	-2.74	-1.97	-1.42	-6.85	-7.35	-7.98
126	93	-2.39	-1.71	-1.22	-7.64	-8.11	-8.71
126	96	-2.09	-1.47	-1.03	-8.57	-8.99	-9.58
126	99	-1.82	-1.27	-0.88	-9.54	-9.91	-10.50
126	102	-1.60	-1.12	-0.78	-10.42	-10.77	-11.36
126	105	-1.44	-1.02	-0.74	-11.11	-11.48	-12.09
126	108	-1.32	-0.95	-0.75	-11.69	-12.12	-12.75
126	111	-1.22	-0.88	-0.77	-12.25	-12.76	-13.43
126	114	-1.13	-0.84	-0.80	-12.73	-13.32	-14.03
126	117	-1.05	-0.80	-0.83	-13.07	-13.72	-14.46
126	120	-0.99	-0.79	-0.87	-13.19	-13.87	-14.62
126	123	-0.93	-0.80	-0.92	-13.08	-13.76	-14.51
126	126	-0.88	-0.80	-0.99	-12.81	-13.47	-14.21
126	129	-0.84	-0.81	-1.07	-12.42	-13.06	-13.80
126	132	-0.79	-0.82	-1.12	-11.99	-12.60	-13.35
126	135	-0.72	-0.83	-1.15	-11.58	-12.16	-12.91
126	138	-0.63	-0.79	-1.13	-11.20	-11.73	-12.49
126	141	-0.51	-0.71	-1.09	-10.78	-11.26	-12.02
126	144	-0.38	-0.59	-1.03	-10.33	-10.74	-11.53
126	147	-0.23	-0.45	-0.96	-9.86	-10.20	-10.99
126	150	-0.08	-0.32	-0.89	-9.35	-9.63	-10.42
126	153	0.09	-0.19	-0.80	-8.77	-8.99	-9.77
126	156	0.30	-0.03	-0.68	-8.10	-8.28	-9.03
126	159	0.51	0.13	-0.56	-7.41	-7.55	-8.26
126	162	0.70	0.29	-0.44	-6.76	-6.86	-7.50
126	165	0.85	0.41	-0.34	-6.20	-6.24	-6.82
126	168	0.97	0.53	-0.26	-5.70	-5.68	-6.19
126	171	1.09	0.65	-0.18	-5.20	-5.14	-5.56
126	174	1.19	0.75	-0.10	-4.76	-4.64	-4.98
126	177	1.26	0.82	-0.05	-4.40	-4.22	-4.47
126	180	1.28	0.85	-0.03	-4.16	-3.90	-4.07
126	183	1.25	0.83	-0.04	-4.00	-3.66	-3.75
126	186	1.16	0.78	-0.06	-3.86	-3.45	-3.46
126	189	1.02	0.71	-0.09	-3.74	-3.27	-3.22
126	192	0.87	0.61	-0.12	-3.67	-3.13	-3.02
126	195	0.70	0.51	-0.16	-3.64	-3.05	-2.89
126	198	0.50	0.38	-0.23	-3.65	-3.01	-2.79
126	201	0.25	0.18	-0.35	-3.66	-2.97	-2.71
126	204	-0.05	-0.04	-0.50	-3.67	-2.95	-2.65
126	207	-0.36	-0.28	-0.66	-3.68	-2.93	-2.60
126	210	-0.66	-0.52	-0.81	-3.69	-2.89	-2.56
126	213	-0.95	-0.74	-0.94	-3.67	-2.85	-2.53
126	216	-1.26	-0.98	-1.07	-3.61	-2.81	-2.51
126	219	-1.57	-1.22	-1.21	-3.52	-2.77	-2.49
126	222	-1.88	-1.46	-1.35	-3.42	-2.72	-2.47
126	225	-2.17	-1.70	-1.50	-3.31	-2.65	-2.43
126	228	-2.45	-1.93	-1.66	-3.16	-2.54	-2.37

126	231	-2.70	-2.16	-1.83	-2.94	-2.39	-2.27
126	234	-2.96	-2.39	-2.01	-2.70	-2.22	-2.16
126	237	-3.22	-2.63	-2.20	-2.48	-2.07	-2.07
126	240	-3.51	-2.90	-2.42	-2.33	-1.97	-2.00
126	243	-3.84	-3.20	-2.67	-2.22	-1.91	-1.97
126	246	-4.20	-3.53	-2.97	-2.13	-1.86	-1.93
126	249	-4.58	-3.88	-3.30	-2.05	-1.81	-1.90
126	252	-4.94	-4.23	-3.64	-1.99	-1.78	-1.89
126	255	-5.28	-4.56	-3.98	-1.97	-1.77	-1.88
126	258	-5.62	-4.92	-4.37	-1.99	-1.79	-1.89
126	261	-5.99	-5.32	-4.83	-2.04	-1.83	-1.91
126	264	-6.32	-5.69	-5.27	-2.12	-1.90	-1.94
126	267	-6.57	-5.96	-5.60	-2.21	-1.98	-1.98
126	270	-6.66	-6.07	-5.73	-2.30	-2.06	-2.02
126	273	-6.59	-6.02	-5.71	-2.43	-2.17	-2.08
126	276	-6.38	-5.90	-5.65	-2.60	-2.32	-2.15
126	279	-6.09	-5.72	-5.56	-2.79	-2.48	-2.23
126	282	-5.75	-5.51	-5.45	-2.96	-2.60	-2.29
126	285	-5.42	-5.27	-5.31	-3.07	-2.66	-2.31
126	288	-5.02	-4.92	-5.02	-3.15	-2.67	-2.29
126	291	-4.53	-4.41	-4.51	-3.22	-2.67	-2.25
126	294	-4.00	-3.83	-3.89	-3.28	-2.68	-2.19
126	297	-3.50	-3.28	-3.30	-3.32	-2.68	-2.13
126	300	-3.12	-2.86	-2.84	-3.33	-2.68	-2.08
126	303	-2.80	-2.51	-2.47	-3.33	-2.67	-2.03
126	306	-2.48	-2.17	-2.11	-3.31	-2.63	-1.97
126	309	-2.21	-1.88	-1.79	-3.29	-2.58	-1.92
126	312	-2.01	-1.67	-1.57	-3.26	-2.53	-1.86
126	315	-1.94	-1.59	-1.48	-3.22	-2.48	-1.81
126	318	-1.97	-1.62	-1.51	-3.18	-2.42	-1.76
126	321	-2.06	-1.69	-1.58	-3.11	-2.34	-1.70
126	324	-2.19	-1.80	-1.69	-3.04	-2.27	-1.64
126	327	-2.36	-1.95	-1.84	-2.99	-2.22	-1.60
126	330	-2.57	-2.12	-2.01	-2.96	-2.19	-1.59
126	333	-2.95	-2.45	-2.32	-2.98	-2.21	-1.60
126	336	-3.63	-3.03	-2.87	-3.01	-2.24	-1.64
126	339	-4.51	-3.82	-3.60	-3.05	-2.28	-1.69
126	342	-5.53	-4.79	-4.47	-3.10	-2.34	-1.76
126	345	-6.61	-5.88	-5.42	-3.15	-2.40	-1.83
126	348	-7.83	-7.33	-6.59	-3.21	-2.47	-1.91
126	351	-9.30	-9.36	-8.10	-3.28	-2.56	-2.02
126	354	-10.99	-11.84	-9.89	-3.36	-2.68	-2.16
126	357	-12.86	-14.68	-11.92	-3.45	-2.80	-2.31
126	360	-14.87	-17.78	-14.11	-3.54	-2.94	-2.48
129	0	-9.70	-10.94	-8.72	-4.00	-3.28	-2.77
129	3	-8.87	-9.72	-8.22	-3.99	-3.32	-2.88
129	6	-8.15	-8.66	-7.82	-3.95	-3.35	-2.98
129	9	-7.59	-7.82	-7.53	-3.90	-3.36	-3.06
129	12	-7.22	-7.26	-7.35	-3.83	-3.37	-3.12
129	15	-7.09	-7.06	-7.29	-3.75	-3.37	-3.16
129	18	-7.14	-7.12	-7.36	-3.65	-3.34	-3.17
129	21	-7.29	-7.29	-7.55	-3.49	-3.27	-3.18
129	24	-7.50	-7.53	-7.81	-3.32	-3.17	-3.19
129	27	-7.76	-7.82	-8.12	-3.14	-3.07	-3.20
129	30	-8.05	-8.14	-8.41	-3.00	-2.99	-3.21
129	33	-8.62	-8.66	-8.79	-2.87	-2.93	-3.22
129	36	-9.53	-9.44	-9.28	-2.73	-2.86	-3.23
129	39	-10.52	-10.26	-9.77	-2.60	-2.79	-3.24

129	42	-11.31	-10.92	-10.15	-2.52	-2.75	-3.26
129	45	-11.63	-11.18	-10.30	-2.48	-2.73	-3.28
129	48	-11.57	-10.97	-10.02	-2.50	-2.76	-3.33
129	51	-11.42	-10.44	-9.30	-2.54	-2.83	-3.44
129	54	-11.19	-9.70	-8.34	-2.61	-2.94	-3.59
129	57	-10.90	-8.89	-7.34	-2.70	-3.08	-3.76
129	60	-10.56	-8.14	-6.51	-2.79	-3.22	-3.95
129	63	-9.91	-7.38	-5.81	-2.94	-3.42	-4.18
129	66	-8.83	-6.54	-5.12	-3.18	-3.68	-4.46
129	69	-7.56	-5.68	-4.47	-3.47	-4.00	-4.80
129	72	-6.35	-4.89	-3.87	-3.81	-4.35	-5.16
129	75	-5.44	-4.25	-3.36	-4.16	-4.72	-5.53
129	78	-4.80	-3.72	-2.90	-4.54	-5.12	-5.93
129	81	-4.22	-3.23	-2.48	-5.00	-5.57	-6.35
129	84	-3.72	-2.80	-2.10	-5.50	-6.07	-6.82
129	87	-3.28	-2.43	-1.78	-6.04	-6.60	-7.32
129	90	-2.91	-2.13	-1.53	-6.61	-7.16	-7.85
129	93	-2.59	-1.89	-1.33	-7.26	-7.80	-8.49
129	96	-2.31	-1.67	-1.14	-8.01	-8.52	-9.22
129	99	-2.06	-1.48	-0.99	-8.78	-9.27	-9.99
129	102	-1.84	-1.33	-0.87	-9.51	-9.98	-10.72
129	105	-1.66	-1.20	-0.82	-10.11	-10.59	-11.35
129	108	-1.50	-1.09	-0.80	-10.66	-11.17	-11.96
129	111	-1.36	-0.98	-0.78	-11.21	-11.77	-12.59
129	114	-1.23	-0.90	-0.76	-11.70	-12.31	-13.15
129	117	-1.13	-0.83	-0.76	-12.04	-12.69	-13.55
129	120	-1.03	-0.79	-0.75	-12.17	-12.84	-13.71
129	123	-0.95	-0.77	-0.77	-12.13	-12.78	-13.65
129	126	-0.88	-0.76	-0.80	-12.00	-12.64	-13.49
129	129	-0.82	-0.74	-0.84	-11.82	-12.43	-13.27
129	132	-0.76	-0.73	-0.87	-11.61	-12.19	-13.01
129	135	-0.68	-0.71	-0.88	-11.39	-11.93	-12.74
129	138	-0.59	-0.67	-0.87	-11.12	-11.62	-12.42
129	141	-0.48	-0.60	-0.85	-10.78	-11.22	-12.02
129	144	-0.37	-0.50	-0.81	-10.39	-10.76	-11.56
129	147	-0.26	-0.41	-0.77	-9.95	-10.26	-11.06
129	150	-0.14	-0.32	-0.74	-9.49	-9.74	-10.53
129	153	0.00	-0.22	-0.69	-8.96	-9.16	-9.93
129	156	0.16	-0.12	-0.63	-8.33	-8.50	-9.25
129	159	0.32	-0.01	-0.57	-7.67	-7.82	-8.53
129	162	0.45	0.08	-0.53	-7.05	-7.16	-7.82
129	165	0.54	0.14	-0.51	-6.51	-6.58	-7.19
129	168	0.59	0.17	-0.51	-6.03	-6.05	-6.59
129	171	0.64	0.21	-0.52	-5.56	-5.54	-6.00
129	174	0.68	0.24	-0.53	-5.14	-5.06	-5.45
129	177	0.70	0.26	-0.55	-4.80	-4.67	-4.97
129	180	0.71	0.27	-0.57	-4.57	-4.37	-4.60
129	183	0.67	0.23	-0.61	-4.43	-4.16	-4.30
129	186	0.55	0.14	-0.68	-4.30	-3.96	-4.04
129	189	0.38	0.01	-0.78	-4.20	-3.80	-3.81
129	192	0.18	-0.14	-0.89	-4.13	-3.68	-3.64
129	195	-0.03	-0.29	-1.01	-4.10	-3.61	-3.52
129	198	-0.26	-0.47	-1.14	-4.11	-3.58	-3.44
129	201	-0.55	-0.70	-1.31	-4.13	-3.56	-3.38
129	204	-0.87	-0.96	-1.49	-4.15	-3.54	-3.33
129	207	-1.20	-1.22	-1.67	-4.17	-3.53	-3.28
129	210	-1.51	-1.47	-1.83	-4.18	-3.50	-3.23
129	213	-1.82	-1.70	-1.97	-4.15	-3.45	-3.18

129	216	-2.14	-1.94	-2.10	-4.08	-3.39	-3.14
129	219	-2.46	-2.17	-2.23	-3.97	-3.32	-3.09
129	222	-2.76	-2.39	-2.35	-3.85	-3.23	-3.04
129	225	-3.03	-2.60	-2.48	-3.72	-3.13	-2.98
129	228	-3.26	-2.78	-2.59	-3.55	-3.00	-2.89
129	231	-3.47	-2.94	-2.70	-3.32	-2.83	-2.78
129	234	-3.67	-3.10	-2.81	-3.07	-2.65	-2.65
129	237	-3.88	-3.27	-2.92	-2.85	-2.48	-2.54
129	240	-4.10	-3.45	-3.06	-2.69	-2.37	-2.46
129	243	-4.36	-3.66	-3.23	-2.57	-2.30	-2.41
129	246	-4.63	-3.90	-3.44	-2.46	-2.23	-2.36
129	249	-4.91	-4.15	-3.66	-2.37	-2.17	-2.31
129	252	-5.18	-4.41	-3.90	-2.31	-2.13	-2.28
129	255	-5.44	-4.65	-4.13	-2.28	-2.12	-2.27
129	258	-5.72	-4.91	-4.40	-2.30	-2.13	-2.28
129	261	-6.01	-5.20	-4.71	-2.34	-2.17	-2.29
129	264	-6.29	-5.48	-5.01	-2.41	-2.23	-2.31
129	267	-6.49	-5.68	-5.24	-2.48	-2.30	-2.34
129	270	-6.57	-5.76	-5.32	-2.57	-2.37	-2.37
129	273	-6.50	-5.71	-5.30	-2.69	-2.48	-2.41
129	276	-6.31	-5.60	-5.23	-2.86	-2.62	-2.48
129	279	-6.04	-5.44	-5.12	-3.05	-2.77	-2.55
129	282	-5.73	-5.23	-4.99	-3.23	-2.90	-2.61
129	285	-5.42	-5.01	-4.83	-3.37	-2.96	-2.63
129	288	-5.04	-4.70	-4.56	-3.48	-2.99	-2.62
129	291	-4.57	-4.23	-4.10	-3.59	-3.01	-2.58
129	294	-4.06	-3.71	-3.57	-3.68	-3.03	-2.53
129	297	-3.56	-3.19	-3.03	-3.74	-3.04	-2.47
129	300	-3.15	-2.76	-2.59	-3.76	-3.04	-2.41
129	303	-2.76	-2.37	-2.20	-3.76	-3.03	-2.36
129	306	-2.37	-1.97	-1.79	-3.76	-3.00	-2.30
129	309	-2.01	-1.61	-1.43	-3.75	-2.95	-2.24
129	312	-1.76	-1.35	-1.16	-3.74	-2.90	-2.18
129	315	-1.66	-1.24	-1.04	-3.73	-2.85	-2.12
129	318	-1.66	-1.22	-1.02	-3.70	-2.79	-2.06
129	321	-1.66	-1.20	-1.00	-3.64	-2.72	-2.00
129	324	-1.66	-1.19	-0.98	-3.56	-2.64	-1.94
129	327	-1.65	-1.18	-0.97	-3.50	-2.58	-1.90
129	330	-1.65	-1.18	-0.97	-3.47	-2.56	-1.88
129	333	-1.80	-1.31	-1.09	-3.48	-2.57	-1.89
129	336	-2.20	-1.66	-1.41	-3.50	-2.60	-1.93
129	339	-2.78	-2.17	-1.88	-3.53	-2.64	-1.98
129	342	-3.46	-2.80	-2.45	-3.57	-2.68	-2.04
129	345	-4.16	-3.49	-3.06	-3.61	-2.74	-2.11
129	348	-4.95	-4.40	-3.80	-3.66	-2.80	-2.19
129	351	-5.93	-5.66	-4.77	-3.73	-2.90	-2.30
129	354	-7.06	-7.22	-5.94	-3.81	-3.01	-2.44
129	357	-8.33	-9.00	-7.27	-3.90	-3.14	-2.60
129	360	-9.70	-10.94	-8.72	-4.00	-3.28	-2.77
132	0	-5.23	-5.09	-4.10	-4.43	-3.61	-3.05
132	3	-5.44	-5.17	-4.37	-4.42	-3.68	-3.17
132	6	-5.67	-5.30	-4.64	-4.39	-3.72	-3.28
132	9	-5.91	-5.46	-4.93	-4.35	-3.75	-3.37
132	12	-6.17	-5.65	-5.22	-4.30	-3.76	-3.44
132	15	-6.44	-5.85	-5.52	-4.24	-3.76	-3.49
132	18	-6.73	-6.11	-5.84	-4.14	-3.74	-3.52
132	21	-7.04	-6.43	-6.19	-4.00	-3.68	-3.54
132	24	-7.36	-6.79	-6.54	-3.83	-3.60	-3.56



132	27	-7.71	-7.16	-6.86	-3.66	-3.52	-3.57
132	30	-8.08	-7.50	-7.12	-3.52	-3.45	-3.59
132	33	-8.54	-7.86	-7.36	-3.39	-3.39	-3.61
132	36	-9.12	-8.27	-7.60	-3.25	-3.32	-3.62
132	39	-9.68	-8.65	-7.80	-3.12	-3.26	-3.63
132	42	-10.10	-8.93	-7.95	-3.03	-3.21	-3.65
132	45	-10.27	-9.04	-8.00	-3.00	-3.20	-3.68
132	48	-10.18	-8.89	-7.83	-3.01	-3.22	-3.73
132	51	-9.94	-8.53	-7.40	-3.03	-3.28	-3.83
132	54	-9.59	-8.02	-6.82	-3.07	-3.36	-3.96
132	57	-9.18	-7.47	-6.20	-3.13	-3.47	-4.11
132	60	-8.75	-6.94	-5.65	-3.19	-3.59	-4.27
132	63	-8.20	-6.41	-5.16	-3.30	-3.74	-4.47
132	66	-7.47	-5.82	-4.66	-3.49	-3.97	-4.73
132	69	-6.66	-5.21	-4.16	-3.74	-4.24	-5.02
132	72	-5.88	-4.63	-3.69	-4.02	-4.55	-5.34
132	75	-5.24	-4.13	-3.27	-4.31	-4.86	-5.67
132	78	-4.72	-3.70	-2.89	-4.63	-5.21	-6.02
132	81	-4.24	-3.28	-2.52	-5.01	-5.60	-6.40
132	84	-3.80	-2.91	-2.19	-5.44	-6.02	-6.81
132	87	-3.41	-2.57	-1.90	-5.89	-6.48	-7.24
132	90	-3.07	-2.29	-1.66	-6.35	-6.94	-7.70
132	93	-2.77	-2.05	-1.46	-6.86	-7.45	-8.22
132	96	-2.49	-1.84	-1.28	-7.42	-8.00	-8.81
132	99	-2.25	-1.66	-1.12	-8.01	-8.58	-9.42
132	102	-2.03	-1.49	-1.00	-8.57	-9.13	-10.01
132	105	-1.83	-1.34	-0.90	-9.07	-9.64	-10.54
132	108	-1.64	-1.20	-0.83	-9.56	-10.15	-11.07
132	111	-1.47	-1.07	-0.76	-10.08	-10.70	-11.64
132	114	-1.32	-0.95	-0.70	-10.55	-11.19	-12.15
132	117	-1.18	-0.86	-0.66	-10.90	-11.55	-12.53
132	120	-1.06	-0.78	-0.65	-11.05	-11.69	-12.67
132	123	-0.96	-0.73	-0.64	-11.08	-11.69	-12.66
132	126	-0.87	-0.69	-0.64	-11.10	-11.68	-12.64
132	129	-0.79	-0.66	-0.64	-11.12	-11.67	-12.61
132	132	-0.71	-0.63	-0.63	-11.13	-11.65	-12.57
132	135	-0.63	-0.59	-0.63	-11.13	-11.63	-12.52
132	138	-0.54	-0.53	-0.63	-11.03	-11.50	-12.36
132	141	-0.44	-0.48	-0.62	-10.77	-11.19	-12.03
132	144	-0.35	-0.42	-0.61	-10.41	-10.76	-11.59
132	147	-0.26	-0.36	-0.60	-10.00	-10.28	-11.09
132	150	-0.17	-0.31	-0.60	-9.58	-9.81	-10.60
132	153	-0.08	-0.27	-0.60	-9.12	-9.30	-10.07
132	156	0.03	-0.22	-0.61	-8.56	-8.72	-9.45
132	159	0.13	-0.18	-0.63	-7.96	-8.10	-8.80
132	162	0.20	-0.15	-0.65	-7.38	-7.50	-8.16
132	165	0.23	-0.14	-0.67	-6.89	-6.98	-7.58
132	168	0.22	-0.15	-0.71	-6.45	-6.50	-7.04
132	171	0.21	-0.18	-0.79	-6.02	-6.02	-6.50
132	174	0.18	-0.22	-0.88	-5.62	-5.59	-6.00
132	177	0.15	-0.28	-0.98	-5.30	-5.22	-5.56
132	180	0.11	-0.34	-1.09	-5.10	-4.96	-5.23
132	183	0.03	-0.43	-1.22	-4.97	-4.77	-4.97
132	186	-0.13	-0.57	-1.36	-4.86	-4.60	-4.74
132	189	-0.33	-0.74	-1.52	-4.77	-4.46	-4.54
132	192	-0.56	-0.93	-1.70	-4.71	-4.36	-4.38
132	195	-0.80	-1.13	-1.87	-4.69	-4.31	-4.28
132	198	-1.06	-1.36	-2.06	-4.70	-4.29	-4.21

132	201	-1.38	-1.62	-2.27	-4.72	-4.27	-4.16
132	204	-1.72	-1.90	-2.49	-4.74	-4.26	-4.13
132	207	-2.07	-2.18	-2.70	-4.77	-4.25	-4.09
132	210	-2.39	-2.44	-2.87	-4.78	-4.23	-4.04
132	213	-2.70	-2.67	-3.01	-4.74	-4.18	-3.97
132	216	-3.02	-2.91	-3.15	-4.64	-4.09	-3.90
132	219	-3.33	-3.14	-3.27	-4.51	-3.97	-3.81
132	222	-3.61	-3.33	-3.38	-4.35	-3.84	-3.72
132	225	-3.85	-3.50	-3.47	-4.20	-3.71	-3.63
132	228	-4.04	-3.62	-3.53	-4.01	-3.55	-3.51
132	231	-4.20	-3.72	-3.58	-3.77	-3.36	-3.37
132	234	-4.35	-3.81	-3.63	-3.52	-3.16	-3.23
132	237	-4.50	-3.90	-3.68	-3.29	-2.98	-3.10
132	240	-4.67	-4.01	-3.75	-3.12	-2.85	-3.01
132	243	-4.84	-4.14	-3.83	-2.99	-2.76	-2.93
132	246	-5.03	-4.29	-3.94	-2.87	-2.67	-2.87
132	249	-5.22	-4.44	-4.06	-2.76	-2.60	-2.81
132	252	-5.41	-4.59	-4.18	-2.69	-2.55	-2.77
132	255	-5.59	-4.74	-4.31	-2.66	-2.54	-2.75
132	258	-5.80	-4.92	-4.46	-2.67	-2.55	-2.75
132	261	-6.03	-5.11	-4.63	-2.71	-2.58	-2.76
132	264	-6.24	-5.30	-4.80	-2.76	-2.63	-2.77
132	267	-6.40	-5.44	-4.93	-2.83	-2.69	-2.78
132	270	-6.46	-5.49	-4.98	-2.90	-2.75	-2.79
132	273	-6.40	-5.46	-4.95	-3.01	-2.85	-2.82
132	276	-6.23	-5.35	-4.87	-3.18	-2.98	-2.88
132	279	-5.99	-5.19	-4.75	-3.38	-3.13	-2.95
132	282	-5.71	-5.00	-4.60	-3.57	-3.26	-3.00
132	285	-5.42	-4.80	-4.43	-3.73	-3.34	-3.03
132	288	-5.06	-4.50	-4.17	-3.86	-3.38	-3.01
132	291	-4.61	-4.08	-3.76	-4.00	-3.42	-2.98
132	294	-4.11	-3.60	-3.29	-4.12	-3.45	-2.93
132	297	-3.61	-3.11	-2.80	-4.21	-3.47	-2.87
132	300	-3.18	-2.67	-2.38	-4.25	-3.47	-2.82
132	303	-2.77	-2.28	-1.99	-4.26	-3.46	-2.76
132	306	-2.36	-1.87	-1.59	-4.27	-3.43	-2.70
132	309	-1.97	-1.49	-1.21	-4.28	-3.38	-2.63
132	312	-1.65	-1.17	-0.90	-4.28	-3.33	-2.55
132	315	-1.43	-0.94	-0.67	-4.29	-3.28	-2.49
132	318	-1.27	-0.78	-0.50	-4.26	-3.21	-2.42
132	321	-1.12	-0.63	-0.35	-4.19	-3.13	-2.35
132	324	-1.00	-0.50	-0.22	-4.11	-3.05	-2.28
132	327	-0.92	-0.42	-0.14	-4.04	-2.99	-2.23
132	330	-0.89	-0.39	-0.11	-4.01	-2.96	-2.21
132	333	-0.96	-0.45	-0.16	-4.01	-2.97	-2.22
132	336	-1.14	-0.61	-0.30	-4.02	-2.99	-2.25
132	339	-1.41	-0.85	-0.52	-4.03	-3.02	-2.29
132	342	-1.73	-1.15	-0.78	-4.05	-3.05	-2.35
132	345	-2.07	-1.47	-1.07	-4.07	-3.09	-2.41
132	348	-2.49	-1.91	-1.44	-4.11	-3.15	-2.49
132	351	-3.03	-2.52	-1.96	-4.17	-3.23	-2.59
132	354	-3.69	-3.27	-2.59	-4.24	-3.34	-2.73
132	357	-4.43	-4.14	-3.31	-4.33	-3.47	-2.88
132	360	-5.23	-5.09	-4.10	-4.43	-3.61	-3.05
135	0	-3.06	-2.36	-1.95	-4.83	-3.95	-3.35
135	3	-3.67	-2.93	-2.49	-4.82	-4.02	-3.47
135	6	-4.25	-3.48	-3.00	-4.80	-4.07	-3.58
135	9	-4.81	-4.00	-3.49	-4.77	-4.11	-3.67

135	12	-5.35	-4.49	-3.95	-4.72	-4.13	-3.75
135	15	-5.86	-4.95	-4.38	-4.68	-4.14	-3.81
135	18	-6.36	-5.41	-4.81	-4.60	-4.12	-3.85
135	21	-6.86	-5.86	-5.24	-4.47	-4.08	-3.89
135	24	-7.32	-6.28	-5.63	-4.32	-4.02	-3.92
135	27	-7.74	-6.64	-5.96	-4.17	-3.95	-3.94
135	30	-8.08	-6.90	-6.17	-4.03	-3.90	-3.97
135	33	-8.39	-7.11	-6.31	-3.91	-3.84	-3.99
135	36	-8.69	-7.31	-6.44	-3.77	-3.78	-4.01
135	39	-8.95	-7.47	-6.54	-3.64	-3.73	-4.03
135	42	-9.13	-7.58	-6.61	-3.55	-3.68	-4.05
135	45	-9.20	-7.62	-6.63	-3.52	-3.67	-4.08
135	48	-9.10	-7.53	-6.54	-3.52	-3.68	-4.14
135	51	-8.84	-7.28	-6.29	-3.53	-3.73	-4.22
135	54	-8.47	-6.94	-5.95	-3.55	-3.79	-4.33
135	57	-8.06	-6.57	-5.57	-3.57	-3.87	-4.46
135	60	-7.65	-6.20	-5.21	-3.60	-3.96	-4.59
135	63	-7.21	-5.82	-4.85	-3.67	-4.08	-4.76
135	66	-6.70	-5.39	-4.44	-3.82	-4.26	-4.97
135	69	-6.15	-4.93	-4.01	-4.02	-4.49	-5.22
135	72	-5.62	-4.49	-3.60	-4.25	-4.74	-5.48
135	75	-5.13	-4.08	-3.23	-4.48	-5.00	-5.76
135	78	-4.70	-3.71	-2.90	-4.74	-5.28	-6.07
135	81	-4.28	-3.35	-2.58	-5.05	-5.61	-6.40
135	84	-3.88	-3.01	-2.29	-5.39	-5.97	-6.77
135	87	-3.51	-2.69	-2.02	-5.75	-6.34	-7.15
135	90	-3.18	-2.42	-1.79	-6.12	-6.72	-7.54
135	93	-2.88	-2.18	-1.59	-6.50	-7.11	-7.96
135	96	-2.60	-1.96	-1.41	-6.92	-7.53	-8.41
135	99	-2.35	-1.75	-1.25	-7.35	-7.95	-8.87
135	102	-2.11	-1.57	-1.10	-7.77	-8.37	-9.33
135	105	-1.90	-1.41	-0.98	-8.18	-8.78	-9.76
135	108	-1.70	-1.26	-0.88	-8.58	-9.18	-10.19
135	111	-1.52	-1.11	-0.78	-9.00	-9.60	-10.63
135	114	-1.36	-0.98	-0.69	-9.39	-10.01	-11.05
135	117	-1.21	-0.87	-0.62	-9.74	-10.35	-11.40
135	120	-1.07	-0.78	-0.57	-10.02	-10.61	-11.65
135	123	-0.95	-0.70	-0.54	-10.25	-10.81	-11.83
135	126	-0.85	-0.63	-0.51	-10.47	-10.99	-12.00
135	129	-0.75	-0.57	-0.48	-10.65	-11.14	-12.13
135	132	-0.66	-0.51	-0.46	-10.78	-11.25	-12.22
135	135	-0.57	-0.47	-0.46	-10.83	-11.29	-12.25
135	138	-0.48	-0.42	-0.46	-10.76	-11.19	-12.15
135	141	-0.39	-0.38	-0.47	-10.56	-10.95	-11.87
135	144	-0.31	-0.34	-0.48	-10.27	-10.61	-11.49
135	147	-0.24	-0.31	-0.49	-9.95	-10.22	-11.05
135	150	-0.19	-0.30	-0.51	-9.62	-9.83	-10.62
135	153	-0.14	-0.31	-0.54	-9.23	-9.41	-10.16
135	156	-0.10	-0.31	-0.59	-8.76	-8.90	-9.61
135	159	-0.07	-0.33	-0.65	-8.24	-8.36	-9.02
135	162	-0.04	-0.34	-0.73	-7.74	-7.84	-8.45
135	165	-0.03	-0.36	-0.82	-7.31	-7.38	-7.94
135	168	-0.05	-0.41	-0.92	-6.93	-6.96	-7.47
135	171	-0.11	-0.49	-1.05	-6.54	-6.55	-7.01
135	174	-0.19	-0.59	-1.20	-6.18	-6.17	-6.57
135	177	-0.29	-0.72	-1.37	-5.90	-5.85	-6.20
135	180	-0.40	-0.85	-1.54	-5.71	-5.63	-5.91
135	183	-0.54	-1.00	-1.72	-5.60	-5.47	-5.69

135	186	-0.73	-1.18	-1.92	-5.50	-5.33	-5.49
135	189	-0.96	-1.39	-2.13	-5.42	-5.21	-5.32
135	192	-1.21	-1.61	-2.35	-5.37	-5.12	-5.18
135	195	-1.46	-1.84	-2.56	-5.35	-5.08	-5.09
135	198	-1.75	-2.09	-2.79	-5.36	-5.06	-5.04
135	201	-2.08	-2.38	-3.04	-5.38	-5.05	-5.00
135	204	-2.43	-2.68	-3.28	-5.41	-5.05	-4.97
135	207	-2.78	-2.96	-3.50	-5.43	-5.04	-4.93
135	210	-3.10	-3.22	-3.68	-5.44	-5.02	-4.89
135	213	-3.40	-3.45	-3.83	-5.40	-4.96	-4.81
135	216	-3.71	-3.68	-3.98	-5.29	-4.85	-4.72
135	219	-3.99	-3.90	-4.11	-5.14	-4.71	-4.61
135	222	-4.25	-4.07	-4.21	-4.96	-4.55	-4.49
135	225	-4.45	-4.20	-4.26	-4.79	-4.39	-4.38
135	228	-4.60	-4.27	-4.28	-4.59	-4.21	-4.24
135	231	-4.72	-4.33	-4.30	-4.34	-4.00	-4.09
135	234	-4.83	-4.38	-4.31	-4.09	-3.79	-3.93
135	237	-4.94	-4.43	-4.32	-3.85	-3.59	-3.78
135	240	-5.06	-4.48	-4.34	-3.67	-3.45	-3.67
135	243	-5.18	-4.55	-4.36	-3.52	-3.34	-3.58
135	246	-5.31	-4.62	-4.39	-3.38	-3.24	-3.50
135	249	-5.43	-4.69	-4.42	-3.26	-3.15	-3.42
135	252	-5.56	-4.77	-4.46	-3.17	-3.09	-3.37
135	255	-5.69	-4.85	-4.50	-3.14	-3.07	-3.34
135	258	-5.84	-4.97	-4.56	-3.15	-3.08	-3.33
135	261	-6.02	-5.10	-4.65	-3.18	-3.10	-3.32
135	264	-6.19	-5.24	-4.74	-3.22	-3.14	-3.32
135	267	-6.31	-5.34	-4.81	-3.27	-3.18	-3.31
135	270	-6.36	-5.39	-4.84	-3.32	-3.23	-3.31
135	273	-6.30	-5.35	-4.81	-3.43	-3.32	-3.33
135	276	-6.15	-5.24	-4.72	-3.60	-3.44	-3.38
135	279	-5.94	-5.09	-4.60	-3.80	-3.59	-3.44
135	282	-5.68	-4.91	-4.44	-4.00	-3.72	-3.49
135	285	-5.42	-4.71	-4.26	-4.18	-3.81	-3.51
135	288	-5.08	-4.42	-4.00	-4.33	-3.86	-3.50
135	291	-4.65	-4.02	-3.62	-4.50	-3.91	-3.46
135	294	-4.16	-3.55	-3.17	-4.64	-3.95	-3.42
135	297	-3.67	-3.07	-2.71	-4.76	-3.98	-3.36
135	300	-3.22	-2.64	-2.29	-4.82	-3.99	-3.31
135	303	-2.80	-2.24	-1.90	-4.84	-3.98	-3.25
135	306	-2.37	-1.82	-1.50	-4.86	-3.94	-3.17
135	309	-1.96	-1.43	-1.12	-4.87	-3.90	-3.09
135	312	-1.60	-1.08	-0.78	-4.88	-3.84	-3.01
135	315	-1.33	-0.82	-0.51	-4.89	-3.78	-2.93
135	318	-1.11	-0.60	-0.30	-4.86	-3.71	-2.85
135	321	-0.90	-0.39	-0.09	-4.78	-3.62	-2.76
135	324	-0.73	-0.22	0.09	-4.69	-3.53	-2.68
135	327	-0.61	-0.10	0.21	-4.61	-3.45	-2.62
135	330	-0.57	-0.06	0.26	-4.57	-3.43	-2.60
135	333	-0.60	-0.08	0.23	-4.56	-3.43	-2.61
135	336	-0.68	-0.16	0.16	-4.55	-3.44	-2.63
135	339	-0.80	-0.27	0.05	-4.55	-3.45	-2.66
135	342	-0.95	-0.41	-0.09	-4.55	-3.47	-2.71
135	345	-1.12	-0.57	-0.24	-4.54	-3.49	-2.75
135	348	-1.35	-0.78	-0.44	-4.56	-3.53	-2.82
135	351	-1.67	-1.08	-0.73	-4.60	-3.60	-2.92
135	354	-2.08	-1.45	-1.08	-4.66	-3.70	-3.04
135	357	-2.55	-1.89	-1.50	-4.74	-3.82	-3.19

135	360	-3.06	-2.36	-1.95	-4.83	-3.95	-3.35
138	0	-2.60	-1.95	-1.62	-5.16	-4.25	-3.63
138	3	-3.15	-2.44	-2.08	-5.15	-4.33	-3.74
138	6	-3.68	-2.93	-2.53	-5.14	-4.39	-3.85
138	9	-4.21	-3.39	-2.95	-5.11	-4.43	-3.94
138	12	-4.74	-3.84	-3.36	-5.08	-4.46	-4.03
138	15	-5.25	-4.28	-3.75	-5.04	-4.47	-4.10
138	18	-5.81	-4.73	-4.15	-4.98	-4.46	-4.16
138	21	-6.41	-5.19	-4.56	-4.88	-4.44	-4.21
138	24	-6.97	-5.63	-4.94	-4.76	-4.40	-4.25
138	27	-7.44	-5.99	-5.25	-4.63	-4.37	-4.30
138	30	-7.73	-6.24	-5.47	-4.52	-4.33	-4.34
138	33	-7.91	-6.40	-5.63	-4.41	-4.30	-4.38
138	36	-8.07	-6.55	-5.77	-4.29	-4.26	-4.41
138	39	-8.20	-6.67	-5.89	-4.19	-4.22	-4.44
138	42	-8.28	-6.75	-5.97	-4.11	-4.19	-4.48
138	45	-8.31	-6.78	-5.99	-4.08	-4.18	-4.52
138	48	-8.24	-6.72	-5.94	-4.08	-4.19	-4.58
138	51	-8.03	-6.56	-5.79	-4.08	-4.23	-4.66
138	54	-7.75	-6.34	-5.58	-4.08	-4.27	-4.74
138	57	-7.42	-6.08	-5.33	-4.09	-4.33	-4.84
138	60	-7.10	-5.82	-5.09	-4.09	-4.40	-4.96
138	63	-6.76	-5.54	-4.79	-4.13	-4.49	-5.08
138	66	-6.37	-5.19	-4.43	-4.23	-4.62	-5.24
138	69	-5.94	-4.82	-4.03	-4.37	-4.78	-5.42
138	72	-5.51	-4.44	-3.64	-4.53	-4.96	-5.61
138	75	-5.10	-4.09	-3.29	-4.70	-5.15	-5.82
138	78	-4.71	-3.76	-2.99	-4.89	-5.36	-6.07
138	81	-4.32	-3.42	-2.69	-5.11	-5.61	-6.35
138	84	-3.94	-3.09	-2.42	-5.37	-5.89	-6.66
138	87	-3.58	-2.79	-2.17	-5.64	-6.18	-6.98
138	90	-3.25	-2.51	-1.94	-5.91	-6.46	-7.29
138	93	-2.94	-2.26	-1.73	-6.18	-6.75	-7.61
138	96	-2.65	-2.02	-1.54	-6.48	-7.04	-7.94
138	99	-2.38	-1.80	-1.36	-6.78	-7.34	-8.27
138	102	-2.12	-1.59	-1.20	-7.09	-7.65	-8.60
138	105	-1.90	-1.41	-1.06	-7.39	-7.94	-8.92
138	108	-1.69	-1.25	-0.93	-7.70	-8.25	-9.24
138	111	-1.50	-1.10	-0.80	-8.02	-8.56	-9.57
138	114	-1.33	-0.96	-0.69	-8.34	-8.87	-9.89
138	117	-1.17	-0.83	-0.60	-8.65	-9.16	-10.18
138	120	-1.03	-0.72	-0.53	-8.93	-9.43	-10.45
138	123	-0.89	-0.62	-0.48	-9.23	-9.70	-10.71
138	126	-0.77	-0.53	-0.42	-9.56	-9.98	-10.97
138	129	-0.66	-0.44	-0.38	-9.86	-10.24	-11.21
138	132	-0.56	-0.37	-0.35	-10.07	-10.42	-11.38
138	135	-0.47	-0.34	-0.34	-10.15	-10.49	-11.45
138	138	-0.39	-0.32	-0.35	-10.11	-10.44	-11.38
138	141	-0.32	-0.30	-0.37	-10.01	-10.29	-11.18
138	144	-0.25	-0.29	-0.39	-9.85	-10.08	-10.91
138	147	-0.20	-0.28	-0.43	-9.67	-9.84	-10.61
138	150	-0.18	-0.28	-0.46	-9.49	-9.60	-10.30
138	153	-0.18	-0.29	-0.51	-9.26	-9.32	-9.96
138	156	-0.19	-0.33	-0.59	-8.96	-8.98	-9.56
138	159	-0.19	-0.38	-0.69	-8.63	-8.60	-9.12
138	162	-0.21	-0.45	-0.81	-8.33	-8.25	-8.70
138	165	-0.22	-0.52	-0.93	-8.08	-7.95	-8.33
138	168	-0.27	-0.61	-1.08	-7.89	-7.70	-8.00

138	171	-0.36	-0.74	-1.25	-7.73	-7.48	-7.68
138	174	-0.50	-0.89	-1.45	-7.58	-7.27	-7.38
138	177	-0.66	-1.07	-1.66	-7.43	-7.08	-7.11
138	180	-0.82	-1.25	-1.87	-7.27	-6.89	-6.89
138	183	-1.01	-1.44	-2.10	-7.07	-6.70	-6.68
138	186	-1.23	-1.67	-2.34	-6.84	-6.50	-6.48
138	189	-1.49	-1.92	-2.59	-6.63	-6.31	-6.31
138	192	-1.76	-2.17	-2.84	-6.46	-6.17	-6.18
138	195	-2.04	-2.43	-3.09	-6.40	-6.12	-6.10
138	198	-2.34	-2.71	-3.35	-6.41	-6.12	-6.07
138	201	-2.68	-3.01	-3.61	-6.42	-6.12	-6.05
138	204	-3.02	-3.32	-3.87	-6.43	-6.12	-6.03
138	207	-3.36	-3.60	-4.11	-6.44	-6.12	-6.02
138	210	-3.66	-3.85	-4.30	-6.44	-6.11	-5.99
138	213	-3.94	-4.07	-4.46	-6.41	-6.07	-5.94
138	216	-4.21	-4.29	-4.62	-6.30	-5.98	-5.86
138	219	-4.47	-4.49	-4.76	-6.16	-5.84	-5.77
138	222	-4.69	-4.65	-4.85	-6.00	-5.68	-5.67
138	225	-4.85	-4.73	-4.89	-5.83	-5.53	-5.57
138	228	-4.97	-4.78	-4.89	-5.64	-5.36	-5.45
138	231	-5.06	-4.81	-4.88	-5.41	-5.16	-5.31
138	234	-5.14	-4.83	-4.88	-5.16	-4.95	-5.17
138	237	-5.21	-4.85	-4.87	-4.93	-4.76	-5.03
138	240	-5.29	-4.88	-4.86	-4.74	-4.61	-4.92
138	243	-5.38	-4.90	-4.85	-4.58	-4.48	-4.82
138	246	-5.46	-4.92	-4.82	-4.42	-4.36	-4.73
138	249	-5.55	-4.94	-4.79	-4.28	-4.25	-4.64
138	252	-5.64	-4.96	-4.76	-4.18	-4.18	-4.58
138	255	-5.73	-5.00	-4.75	-4.14	-4.15	-4.53
138	258	-5.84	-5.06	-4.77	-4.15	-4.16	-4.49
138	261	-5.98	-5.16	-4.80	-4.16	-4.17	-4.46
138	264	-6.11	-5.27	-4.85	-4.19	-4.19	-4.44
138	267	-6.20	-5.36	-4.88	-4.22	-4.22	-4.42
138	270	-6.24	-5.39	-4.90	-4.25	-4.25	-4.41
138	273	-6.19	-5.36	-4.86	-4.34	-4.32	-4.42
138	276	-6.06	-5.25	-4.77	-4.50	-4.44	-4.45
138	279	-5.87	-5.10	-4.64	-4.69	-4.58	-4.48
138	282	-5.64	-4.91	-4.47	-4.89	-4.70	-4.50
138	285	-5.40	-4.71	-4.29	-5.06	-4.78	-4.51
138	288	-5.09	-4.43	-4.03	-5.22	-4.82	-4.49
138	291	-4.67	-4.03	-3.65	-5.39	-4.87	-4.42
138	294	-4.21	-3.57	-3.21	-5.55	-4.90	-4.33
138	297	-3.73	-3.10	-2.75	-5.66	-4.92	-4.23
138	300	-3.29	-2.68	-2.34	-5.71	-4.93	-4.13
138	303	-2.87	-2.27	-1.95	-5.70	-4.90	-4.02
138	306	-2.43	-1.86	-1.55	-5.70	-4.82	-3.90
138	309	-2.01	-1.47	-1.17	-5.69	-4.71	-3.78
138	312	-1.64	-1.12	-0.83	-5.68	-4.59	-3.65
138	315	-1.36	-0.85	-0.56	-5.67	-4.48	-3.54
138	318	-1.14	-0.63	-0.34	-5.62	-4.37	-3.43
138	321	-0.93	-0.42	-0.12	-5.51	-4.25	-3.30
138	324	-0.75	-0.24	0.06	-5.39	-4.13	-3.19
138	327	-0.63	-0.12	0.19	-5.27	-4.03	-3.11
138	330	-0.58	-0.07	0.23	-5.19	-3.98	-3.08
138	333	-0.61	-0.09	0.21	-5.13	-3.95	-3.09
138	336	-0.67	-0.15	0.14	-5.08	-3.93	-3.09
138	339	-0.76	-0.24	0.03	-5.04	-3.92	-3.10
138	342	-0.88	-0.36	-0.09	-5.01	-3.91	-3.11

138	345	-1.01	-0.48	-0.23	-5.00	-3.90	-3.13
138	348	-1.19	-0.65	-0.41	-5.01	-3.92	-3.17
138	351	-1.46	-0.90	-0.64	-5.03	-3.97	-3.25
138	354	-1.79	-1.21	-0.93	-5.06	-4.05	-3.36
138	357	-2.18	-1.56	-1.26	-5.10	-4.14	-3.49
138	360	-2.60	-1.95	-1.62	-5.16	-4.25	-3.63
141	0	-2.23	-1.62	-1.37	-5.43	-4.52	-3.88
141	3	-2.69	-2.03	-1.75	-5.43	-4.59	-3.98
141	6	-3.16	-2.44	-2.12	-5.41	-4.65	-4.08
141	9	-3.62	-2.83	-2.48	-5.40	-4.70	-4.17
141	12	-4.08	-3.22	-2.83	-5.37	-4.74	-4.26
141	15	-4.55	-3.61	-3.18	-5.35	-4.75	-4.34
141	18	-5.07	-4.01	-3.53	-5.31	-4.75	-4.42
141	21	-5.63	-4.44	-3.90	-5.24	-4.76	-4.49
141	24	-6.18	-4.84	-4.25	-5.15	-4.76	-4.56
141	27	-6.63	-5.19	-4.56	-5.07	-4.76	-4.63
141	30	-6.90	-5.43	-4.79	-4.99	-4.76	-4.69
141	33	-7.06	-5.60	-4.97	-4.92	-4.76	-4.75
141	36	-7.19	-5.76	-5.15	-4.84	-4.75	-4.81
141	39	-7.30	-5.89	-5.30	-4.77	-4.75	-4.87
141	42	-7.37	-5.97	-5.40	-4.72	-4.74	-4.93
141	45	-7.40	-6.01	-5.44	-4.69	-4.74	-4.99
141	48	-7.35	-5.98	-5.41	-4.69	-4.75	-5.06
141	51	-7.22	-5.89	-5.34	-4.68	-4.78	-5.13
141	54	-7.04	-5.78	-5.24	-4.68	-4.82	-5.20
141	57	-6.83	-5.64	-5.12	-4.68	-4.87	-5.28
141	60	-6.62	-5.49	-4.98	-4.68	-4.92	-5.36
141	63	-6.38	-5.29	-4.78	-4.70	-4.97	-5.44
141	66	-6.09	-5.03	-4.48	-4.74	-5.04	-5.53
141	69	-5.76	-4.73	-4.13	-4.80	-5.11	-5.63
141	72	-5.41	-4.42	-3.77	-4.88	-5.20	-5.74
141	75	-5.07	-4.11	-3.45	-4.96	-5.30	-5.87
141	78	-4.72	-3.81	-3.16	-5.06	-5.43	-6.04
141	81	-4.35	-3.49	-2.88	-5.20	-5.59	-6.25
141	84	-3.98	-3.17	-2.61	-5.35	-5.78	-6.48
141	87	-3.62	-2.86	-2.35	-5.52	-5.97	-6.72
141	90	-3.29	-2.58	-2.11	-5.69	-6.15	-6.93
141	93	-2.98	-2.32	-1.89	-5.85	-6.32	-7.14
141	96	-2.69	-2.07	-1.68	-6.03	-6.50	-7.34
141	99	-2.40	-1.84	-1.48	-6.21	-6.67	-7.53
141	102	-2.14	-1.62	-1.29	-6.39	-6.85	-7.73
141	105	-1.90	-1.42	-1.13	-6.59	-7.03	-7.93
141	108	-1.67	-1.23	-0.97	-6.79	-7.22	-8.13
141	111	-1.46	-1.05	-0.83	-7.00	-7.42	-8.33
141	114	-1.26	-0.88	-0.69	-7.21	-7.61	-8.53
141	117	-1.07	-0.73	-0.58	-7.44	-7.82	-8.74
141	120	-0.92	-0.61	-0.49	-7.67	-8.02	-8.94
141	123	-0.77	-0.49	-0.42	-7.95	-8.27	-9.17
141	126	-0.63	-0.37	-0.35	-8.27	-8.56	-9.43
141	129	-0.50	-0.27	-0.29	-8.58	-8.83	-9.67
141	132	-0.40	-0.20	-0.25	-8.83	-9.03	-9.85
141	135	-0.33	-0.18	-0.23	-8.97	-9.11	-9.92
141	138	-0.28	-0.18	-0.24	-9.02	-9.11	-9.90
141	141	-0.23	-0.19	-0.27	-9.07	-9.10	-9.83
141	144	-0.19	-0.20	-0.31	-9.10	-9.08	-9.74
141	147	-0.17	-0.21	-0.36	-9.12	-9.06	-9.63
141	150	-0.16	-0.23	-0.42	-9.15	-9.04	-9.52
141	153	-0.17	-0.27	-0.49	-9.18	-8.99	-9.40

141	156	-0.20	-0.34	-0.60	-9.20	-8.91	-9.25
141	159	-0.25	-0.42	-0.73	-9.21	-8.82	-9.08
141	162	-0.31	-0.53	-0.87	-9.24	-8.75	-8.93
141	165	-0.37	-0.64	-1.03	-9.27	-8.72	-8.79
141	168	-0.47	-0.78	-1.21	-9.38	-8.75	-8.68
141	171	-0.62	-0.96	-1.42	-9.57	-8.80	-8.58
141	174	-0.80	-1.16	-1.66	-9.79	-8.87	-8.49
141	177	-1.01	-1.39	-1.91	-9.97	-8.92	-8.38
141	180	-1.22	-1.62	-2.16	-10.04	-8.95	-8.27
141	183	-1.46	-1.86	-2.43	-9.84	-8.81	-8.10
141	186	-1.73	-2.14	-2.71	-9.36	-8.48	-7.89
141	189	-2.02	-2.43	-3.01	-8.78	-8.08	-7.67
141	192	-2.32	-2.73	-3.30	-8.28	-7.75	-7.51
141	195	-2.63	-3.02	-3.58	-8.04	-7.61	-7.45
141	198	-2.94	-3.33	-3.86	-8.00	-7.61	-7.45
141	201	-3.28	-3.64	-4.15	-7.98	-7.63	-7.45
141	204	-3.61	-3.95	-4.43	-7.97	-7.64	-7.46
141	207	-3.93	-4.24	-4.68	-7.95	-7.65	-7.47
141	210	-4.20	-4.47	-4.88	-7.92	-7.65	-7.47
141	213	-4.45	-4.68	-5.05	-7.86	-7.63	-7.46
141	216	-4.69	-4.89	-5.22	-7.77	-7.55	-7.43
141	219	-4.91	-5.07	-5.36	-7.66	-7.45	-7.38
141	222	-5.09	-5.20	-5.47	-7.54	-7.33	-7.33
141	225	-5.21	-5.25	-5.50	-7.40	-7.21	-7.28
141	228	-5.29	-5.25	-5.50	-7.24	-7.08	-7.21
141	231	-5.34	-5.25	-5.48	-7.03	-6.91	-7.13
141	234	-5.39	-5.26	-5.46	-6.81	-6.73	-7.03
141	237	-5.44	-5.26	-5.43	-6.59	-6.55	-6.92
141	240	-5.49	-5.26	-5.40	-6.41	-6.41	-6.83
141	243	-5.54	-5.25	-5.35	-6.24	-6.27	-6.74
141	246	-5.59	-5.23	-5.28	-6.06	-6.12	-6.64
141	249	-5.65	-5.20	-5.20	-5.90	-6.00	-6.55
141	252	-5.70	-5.19	-5.13	-5.78	-5.91	-6.46
141	255	-5.76	-5.18	-5.09	-5.74	-5.87	-6.40
141	258	-5.83	-5.20	-5.08	-5.74	-5.87	-6.35
141	261	-5.92	-5.26	-5.07	-5.75	-5.88	-6.31
141	264	-6.00	-5.33	-5.07	-5.75	-5.89	-6.27
141	267	-6.06	-5.39	-5.06	-5.76	-5.90	-6.24
141	270	-6.09	-5.42	-5.05	-5.78	-5.91	-6.21
141	273	-6.05	-5.38	-5.00	-5.84	-5.97	-6.20
141	276	-5.93	-5.27	-4.89	-5.97	-6.08	-6.19
141	279	-5.76	-5.11	-4.74	-6.13	-6.20	-6.18
141	282	-5.56	-4.92	-4.56	-6.30	-6.30	-6.16
141	285	-5.35	-4.72	-4.36	-6.44	-6.34	-6.14
141	288	-5.07	-4.44	-4.10	-6.56	-6.34	-6.07
141	291	-4.69	-4.07	-3.73	-6.70	-6.34	-5.93
141	294	-4.25	-3.63	-3.31	-6.82	-6.34	-5.75
141	297	-3.80	-3.19	-2.88	-6.90	-6.34	-5.55
141	300	-3.38	-2.78	-2.49	-6.94	-6.34	-5.36
141	303	-2.97	-2.38	-2.10	-6.92	-6.26	-5.17
141	306	-2.53	-1.98	-1.70	-6.87	-6.08	-4.96
141	309	-2.11	-1.58	-1.31	-6.80	-5.84	-4.74
141	312	-1.74	-1.23	-0.96	-6.72	-5.60	-4.53
141	315	-1.46	-0.96	-0.69	-6.63	-5.39	-4.35
141	318	-1.22	-0.72	-0.45	-6.51	-5.21	-4.18
141	321	-1.00	-0.50	-0.22	-6.35	-5.03	-4.01
141	324	-0.81	-0.30	-0.03	-6.16	-4.86	-3.86
141	327	-0.68	-0.17	0.11	-5.99	-4.72	-3.74



141	330	-0.63	-0.12	0.16	-5.86	-4.61	-3.66
141	333	-0.64	-0.13	0.14	-5.75	-4.53	-3.62
141	336	-0.69	-0.18	0.08	-5.64	-4.45	-3.59
141	339	-0.75	-0.24	-0.01	-5.54	-4.39	-3.56
141	342	-0.83	-0.32	-0.11	-5.47	-4.35	-3.54
141	345	-0.92	-0.41	-0.23	-5.44	-4.33	-3.54
141	348	-1.06	-0.54	-0.37	-5.44	-4.34	-3.55
141	351	-1.28	-0.75	-0.57	-5.43	-4.36	-3.60
141	354	-1.56	-1.00	-0.80	-5.43	-4.39	-3.68
141	357	-1.88	-1.30	-1.07	-5.43	-4.45	-3.77
141	360	-2.23	-1.62	-1.37	-5.43	-4.52	-3.88
144	0	-1.96	-1.38	-1.18	-5.70	-4.80	-4.14
144	3	-2.33	-1.71	-1.49	-5.70	-4.85	-4.23
144	6	-2.71	-2.04	-1.80	-5.69	-4.90	-4.32
144	9	-3.10	-2.37	-2.11	-5.68	-4.95	-4.41
144	12	-3.49	-2.70	-2.41	-5.66	-4.99	-4.50
144	15	-3.88	-3.03	-2.71	-5.65	-5.03	-4.59
144	18	-4.31	-3.37	-3.03	-5.62	-5.07	-4.68
144	21	-4.78	-3.73	-3.35	-5.59	-5.10	-4.77
144	24	-5.24	-4.09	-3.67	-5.54	-5.13	-4.86
144	27	-5.63	-4.40	-3.95	-5.50	-5.15	-4.95
144	30	-5.91	-4.64	-4.19	-5.46	-5.18	-5.04
144	33	-6.11	-4.85	-4.41	-5.43	-5.21	-5.13
144	36	-6.29	-5.04	-4.63	-5.39	-5.23	-5.22
144	39	-6.44	-5.21	-4.81	-5.36	-5.25	-5.30
144	42	-6.54	-5.32	-4.94	-5.33	-5.27	-5.38
144	45	-6.58	-5.37	-4.99	-5.31	-5.30	-5.45
144	48	-6.56	-5.36	-4.99	-5.29	-5.32	-5.52
144	51	-6.51	-5.34	-4.98	-5.28	-5.35	-5.58
144	54	-6.43	-5.31	-4.96	-5.27	-5.38	-5.63
144	57	-6.34	-5.26	-4.93	-5.26	-5.40	-5.68
144	60	-6.23	-5.21	-4.90	-5.25	-5.41	-5.73
144	63	-6.09	-5.11	-4.79	-5.24	-5.42	-5.77
144	66	-5.87	-4.92	-4.57	-5.23	-5.42	-5.80
144	69	-5.62	-4.68	-4.27	-5.22	-5.43	-5.83
144	72	-5.33	-4.41	-3.96	-5.21	-5.43	-5.87
144	75	-5.05	-4.15	-3.67	-5.21	-5.43	-5.91
144	78	-4.74	-3.88	-3.40	-5.22	-5.47	-6.00
144	81	-4.39	-3.58	-3.12	-5.27	-5.54	-6.12
144	84	-4.03	-3.26	-2.85	-5.33	-5.63	-6.26
144	87	-3.67	-2.94	-2.58	-5.40	-5.72	-6.40
144	90	-3.33	-2.65	-2.32	-5.47	-5.81	-6.51
144	93	-3.02	-2.38	-2.08	-5.53	-5.87	-6.60
144	96	-2.72	-2.13	-1.84	-5.59	-5.94	-6.68
144	99	-2.43	-1.88	-1.61	-5.66	-6.00	-6.76
144	102	-2.16	-1.64	-1.40	-5.73	-6.06	-6.84
144	105	-1.90	-1.42	-1.21	-5.82	-6.14	-6.92
144	108	-1.65	-1.20	-1.03	-5.91	-6.22	-7.01
144	111	-1.40	-0.99	-0.86	-6.02	-6.30	-7.09
144	114	-1.17	-0.79	-0.70	-6.14	-6.40	-7.18
144	117	-0.96	-0.61	-0.56	-6.28	-6.50	-7.28
144	120	-0.78	-0.47	-0.46	-6.43	-6.62	-7.39
144	123	-0.62	-0.34	-0.37	-6.62	-6.77	-7.53
144	126	-0.46	-0.22	-0.28	-6.85	-6.95	-7.69
144	129	-0.32	-0.12	-0.21	-7.10	-7.15	-7.86
144	132	-0.22	-0.05	-0.16	-7.36	-7.35	-8.02
144	135	-0.17	-0.02	-0.14	-7.60	-7.54	-8.15
144	138	-0.16	-0.03	-0.16	-7.81	-7.70	-8.24

144	141	-0.15	-0.05	-0.19	-8.02	-7.84	-8.32
144	144	-0.14	-0.09	-0.25	-8.22	-7.99	-8.39
144	147	-0.13	-0.13	-0.31	-8.45	-8.14	-8.46
144	150	-0.13	-0.18	-0.38	-8.70	-8.32	-8.55
144	153	-0.16	-0.25	-0.48	-9.00	-8.52	-8.67
144	156	-0.22	-0.35	-0.61	-9.35	-8.74	-8.81
144	159	-0.30	-0.47	-0.76	-9.73	-8.98	-8.95
144	162	-0.41	-0.61	-0.94	-10.13	-9.24	-9.10
144	165	-0.52	-0.76	-1.12	-10.56	-9.52	-9.23
144	168	-0.67	-0.94	-1.33	-11.10	-9.88	-9.37
144	171	-0.87	-1.17	-1.58	-11.77	-10.32	-9.53
144	174	-1.10	-1.42	-1.86	-12.43	-10.75	-9.67
144	177	-1.36	-1.70	-2.15	-12.93	-11.08	-9.77
144	180	-1.62	-1.98	-2.44	-13.13	-11.21	-9.81
144	183	-1.90	-2.27	-2.75	-12.84	-11.03	-9.73
144	186	-2.21	-2.60	-3.07	-12.14	-10.61	-9.55
144	189	-2.54	-2.94	-3.41	-11.28	-10.11	-9.33
144	192	-2.88	-3.27	-3.73	-10.51	-9.68	-9.14
144	195	-3.20	-3.59	-4.04	-10.09	-9.48	-9.06
144	198	-3.52	-3.91	-4.35	-9.95	-9.46	-9.07
144	201	-3.85	-4.23	-4.65	-9.85	-9.45	-9.09
144	204	-4.17	-4.55	-4.94	-9.77	-9.45	-9.11
144	207	-4.46	-4.83	-5.20	-9.70	-9.44	-9.13
144	210	-4.70	-5.05	-5.41	-9.61	-9.42	-9.14
144	213	-4.92	-5.23	-5.60	-9.52	-9.38	-9.14
144	216	-5.13	-5.41	-5.77	-9.43	-9.32	-9.13
144	219	-5.31	-5.57	-5.92	-9.34	-9.24	-9.13
144	222	-5.45	-5.68	-6.03	-9.23	-9.14	-9.13
144	225	-5.53	-5.72	-6.07	-9.12	-9.05	-9.12
144	228	-5.56	-5.71	-6.06	-8.96	-8.93	-9.11
144	231	-5.59	-5.69	-6.04	-8.77	-8.79	-9.06
144	234	-5.61	-5.67	-6.01	-8.57	-8.63	-9.00
144	237	-5.63	-5.64	-5.97	-8.37	-8.47	-8.93
144	240	-5.66	-5.61	-5.93	-8.19	-8.33	-8.86
144	243	-5.68	-5.57	-5.86	-8.01	-8.18	-8.79
144	246	-5.71	-5.51	-5.77	-7.82	-8.02	-8.69
144	249	-5.73	-5.45	-5.67	-7.64	-7.88	-8.59
144	252	-5.76	-5.41	-5.57	-7.52	-7.77	-8.49
144	255	-5.78	-5.39	-5.49	-7.46	-7.72	-8.41
144	258	-5.82	-5.39	-5.44	-7.45	-7.72	-8.36
144	261	-5.86	-5.41	-5.41	-7.44	-7.72	-8.31
144	264	-5.90	-5.43	-5.37	-7.44	-7.72	-8.26
144	267	-5.93	-5.45	-5.33	-7.43	-7.71	-8.21
144	270	-5.94	-5.46	-5.27	-7.43	-7.71	-8.17
144	273	-5.90	-5.41	-5.18	-7.47	-7.75	-8.12
144	276	-5.80	-5.30	-5.05	-7.57	-7.83	-8.09
144	279	-5.66	-5.14	-4.88	-7.69	-7.92	-8.05
144	282	-5.48	-4.94	-4.69	-7.82	-8.00	-8.00
144	285	-5.29	-4.73	-4.48	-7.91	-8.04	-7.93
144	288	-5.04	-4.47	-4.21	-7.99	-8.03	-7.79
144	291	-4.70	-4.13	-3.87	-8.07	-8.00	-7.58
144	294	-4.30	-3.73	-3.48	-8.14	-7.95	-7.32
144	297	-3.88	-3.32	-3.09	-8.19	-7.90	-7.03
144	300	-3.49	-2.94	-2.71	-8.20	-7.83	-6.76
144	303	-3.10	-2.56	-2.33	-8.17	-7.67	-6.47
144	306	-2.68	-2.15	-1.93	-8.07	-7.39	-6.16
144	309	-2.27	-1.76	-1.53	-7.93	-7.03	-5.85
144	312	-1.90	-1.40	-1.18	-7.76	-6.68	-5.55

144	315	-1.61	-1.12	-0.89	-7.60	-6.38	-5.29
144	318	-1.36	-0.86	-0.63	-7.42	-6.14	-5.06
144	321	-1.11	-0.61	-0.38	-7.20	-5.90	-4.84
144	324	-0.90	-0.40	-0.17	-6.96	-5.68	-4.64
144	327	-0.76	-0.25	-0.02	-6.74	-5.48	-4.47
144	330	-0.70	-0.19	0.04	-6.55	-5.32	-4.34
144	333	-0.71	-0.20	0.03	-6.39	-5.18	-4.24
144	336	-0.73	-0.22	-0.01	-6.24	-5.04	-4.15
144	339	-0.76	-0.26	-0.07	-6.10	-4.92	-4.07
144	342	-0.81	-0.31	-0.14	-5.98	-4.84	-4.02
144	345	-0.86	-0.36	-0.22	-5.90	-4.80	-4.00
144	348	-0.96	-0.46	-0.34	-5.84	-4.80	-4.00
144	351	-1.14	-0.62	-0.50	-5.79	-4.80	-4.01
144	354	-1.37	-0.84	-0.70	-5.74	-4.80	-4.04
144	357	-1.65	-1.10	-0.93	-5.71	-4.80	-4.08
144	360	-1.96	-1.38	-1.18	-5.70	-4.80	-4.14
147	0	-1.79	-1.23	-1.06	-6.02	-5.13	-4.47
147	3	-2.10	-1.51	-1.33	-6.02	-5.18	-4.54
147	6	-2.41	-1.78	-1.59	-6.01	-5.22	-4.62
147	9	-2.73	-2.06	-1.86	-6.01	-5.27	-4.70
147	12	-3.05	-2.34	-2.13	-6.00	-5.32	-4.79
147	15	-3.38	-2.62	-2.40	-5.99	-5.36	-4.88
147	18	-3.73	-2.91	-2.68	-5.99	-5.41	-4.98
147	21	-4.10	-3.22	-2.97	-5.98	-5.47	-5.09
147	24	-4.46	-3.52	-3.26	-5.97	-5.52	-5.20
147	27	-4.80	-3.80	-3.53	-5.96	-5.57	-5.31
147	30	-5.07	-4.05	-3.78	-5.95	-5.62	-5.41
147	33	-5.32	-4.27	-4.01	-5.94	-5.66	-5.51
147	36	-5.57	-4.50	-4.24	-5.93	-5.71	-5.61
147	39	-5.78	-4.70	-4.45	-5.91	-5.75	-5.71
147	42	-5.93	-4.85	-4.61	-5.89	-5.78	-5.79
147	45	-5.99	-4.93	-4.70	-5.87	-5.79	-5.85
147	48	-5.99	-4.97	-4.75	-5.84	-5.79	-5.90
147	51	-5.99	-4.99	-4.79	-5.81	-5.79	-5.94
147	54	-5.99	-5.02	-4.83	-5.77	-5.79	-5.97
147	57	-5.98	-5.03	-4.85	-5.73	-5.79	-6.00
147	60	-5.98	-5.03	-4.85	-5.69	-5.78	-6.01
147	63	-5.92	-4.98	-4.79	-5.64	-5.76	-6.00
147	66	-5.76	-4.84	-4.63	-5.57	-5.70	-5.98
147	69	-5.54	-4.65	-4.41	-5.50	-5.64	-5.96
147	72	-5.28	-4.43	-4.16	-5.44	-5.57	-5.95
147	75	-5.03	-4.20	-3.92	-5.39	-5.53	-5.94
147	78	-4.76	-3.96	-3.68	-5.35	-5.51	-5.96
147	81	-4.43	-3.67	-3.40	-5.32	-5.50	-5.99
147	84	-4.08	-3.35	-3.11	-5.29	-5.49	-6.03
147	87	-3.72	-3.04	-2.82	-5.26	-5.48	-6.07
147	90	-3.39	-2.74	-2.55	-5.24	-5.46	-6.08
147	93	-3.07	-2.46	-2.29	-5.22	-5.44	-6.08
147	96	-2.77	-2.19	-2.02	-5.20	-5.42	-6.06
147	99	-2.46	-1.92	-1.77	-5.18	-5.39	-6.05
147	102	-2.17	-1.66	-1.53	-5.16	-5.37	-6.03
147	105	-1.90	-1.42	-1.31	-5.16	-5.36	-6.03
147	108	-1.62	-1.18	-1.10	-5.17	-5.37	-6.03
147	111	-1.35	-0.94	-0.90	-5.20	-5.38	-6.04
147	114	-1.09	-0.71	-0.71	-5.25	-5.40	-6.05
147	117	-0.86	-0.51	-0.56	-5.32	-5.42	-6.07
147	120	-0.67	-0.36	-0.43	-5.39	-5.45	-6.09
147	123	-0.50	-0.23	-0.33	-5.50	-5.52	-6.13

147	126	-0.33	-0.10	-0.24	-5.66	-5.63	-6.22
147	129	-0.19	0.00	-0.16	-5.88	-5.79	-6.33
147	132	-0.09	0.07	-0.10	-6.12	-5.97	-6.46
147	135	-0.05	0.10	-0.08	-6.37	-6.16	-6.60
147	138	-0.05	0.09	-0.10	-6.65	-6.37	-6.76
147	141	-0.06	0.05	-0.14	-6.98	-6.63	-6.95
147	144	-0.07	0.00	-0.20	-7.35	-6.93	-7.17
147	147	-0.09	-0.07	-0.28	-7.77	-7.26	-7.41
147	150	-0.11	-0.14	-0.36	-8.22	-7.62	-7.68
147	153	-0.16	-0.23	-0.47	-8.76	-8.03	-7.99
147	156	-0.26	-0.37	-0.63	-9.39	-8.51	-8.37
147	159	-0.39	-0.53	-0.81	-10.10	-9.04	-8.78
147	162	-0.54	-0.71	-1.02	-10.84	-9.59	-9.18
147	165	-0.71	-0.90	-1.24	-11.58	-10.14	-9.57
147	168	-0.90	-1.13	-1.49	-12.47	-10.80	-9.97
147	171	-1.15	-1.40	-1.78	-13.54	-11.58	-10.42
147	174	-1.43	-1.71	-2.09	-14.56	-12.33	-10.84
147	177	-1.73	-2.03	-2.42	-15.33	-12.90	-11.15
147	180	-2.03	-2.35	-2.75	-15.64	-13.12	-11.27
147	183	-2.35	-2.68	-3.08	-15.35	-12.99	-11.23
147	186	-2.70	-3.04	-3.44	-14.63	-12.68	-11.15
147	189	-3.06	-3.41	-3.80	-13.74	-12.29	-11.04
147	192	-3.41	-3.77	-4.15	-12.90	-11.92	-10.95
147	195	-3.73	-4.10	-4.48	-12.35	-11.67	-10.89
147	198	-4.05	-4.42	-4.79	-12.06	-11.55	-10.86
147	201	-4.37	-4.75	-5.10	-11.82	-11.45	-10.84
147	204	-4.67	-5.05	-5.40	-11.63	-11.37	-10.82
147	207	-4.93	-5.32	-5.66	-11.45	-11.29	-10.81
147	210	-5.14	-5.52	-5.88	-11.28	-11.20	-10.79
147	213	-5.32	-5.69	-6.06	-11.13	-11.09	-10.78
147	216	-5.50	-5.84	-6.25	-10.99	-10.99	-10.76
147	219	-5.64	-5.97	-6.40	-10.87	-10.88	-10.75
147	222	-5.75	-6.06	-6.51	-10.74	-10.76	-10.73
147	225	-5.79	-6.10	-6.55	-10.59	-10.64	-10.71
147	228	-5.80	-6.09	-6.55	-10.41	-10.50	-10.68
147	231	-5.80	-6.06	-6.52	-10.21	-10.34	-10.64
147	234	-5.81	-6.02	-6.49	-10.00	-10.17	-10.59
147	237	-5.81	-5.98	-6.45	-9.79	-10.01	-10.54
147	240	-5.81	-5.94	-6.41	-9.61	-9.86	-10.48
147	243	-5.81	-5.88	-6.34	-9.42	-9.70	-10.41
147	246	-5.81	-5.81	-6.25	-9.22	-9.54	-10.31
147	249	-5.81	-5.74	-6.14	-9.04	-9.38	-10.21
147	252	-5.81	-5.67	-6.02	-8.90	-9.26	-10.11
147	255	-5.81	-5.62	-5.93	-8.83	-9.20	-10.02
147	258	-5.81	-5.59	-5.85	-8.81	-9.19	-9.96
147	261	-5.82	-5.58	-5.79	-8.79	-9.18	-9.90
147	264	-5.82	-5.56	-5.72	-8.78	-9.17	-9.85
147	267	-5.83	-5.54	-5.65	-8.77	-9.16	-9.80
147	270	-5.83	-5.51	-5.55	-8.76	-9.16	-9.74
147	273	-5.79	-5.44	-5.43	-8.79	-9.18	-9.68
147	276	-5.70	-5.31	-5.27	-8.86	-9.24	-9.62
147	279	-5.57	-5.15	-5.07	-8.95	-9.31	-9.56
147	282	-5.41	-4.96	-4.86	-9.03	-9.37	-9.49
147	285	-5.24	-4.76	-4.63	-9.09	-9.39	-9.39
147	288	-5.02	-4.51	-4.37	-9.12	-9.37	-9.23
147	291	-4.72	-4.20	-4.05	-9.15	-9.32	-8.99
147	294	-4.37	-3.86	-3.71	-9.17	-9.24	-8.70
147	297	-4.00	-3.50	-3.35	-9.19	-9.14	-8.38

147	300	-3.64	-3.15	-2.99	-9.19	-9.02	-8.06
147	303	-3.27	-2.78	-2.62	-9.14	-8.82	-7.73
147	306	-2.87	-2.38	-2.22	-9.01	-8.48	-7.36
147	309	-2.47	-1.99	-1.82	-8.82	-8.09	-6.99
147	312	-2.10	-1.63	-1.45	-8.62	-7.69	-6.63
147	315	-1.80	-1.32	-1.14	-8.41	-7.35	-6.31
147	318	-1.53	-1.05	-0.87	-8.20	-7.07	-6.03
147	321	-1.26	-0.77	-0.59	-7.96	-6.79	-5.76
147	324	-1.03	-0.53	-0.35	-7.70	-6.53	-5.51
147	327	-0.86	-0.36	-0.18	-7.46	-6.30	-5.30
147	330	-0.80	-0.29	-0.12	-7.24	-6.09	-5.12
147	333	-0.80	-0.29	-0.12	-7.05	-5.91	-4.96
147	336	-0.80	-0.30	-0.13	-6.86	-5.73	-4.82
147	339	-0.81	-0.31	-0.16	-6.69	-5.57	-4.69
147	342	-0.81	-0.32	-0.19	-6.54	-5.45	-4.59
147	345	-0.82	-0.33	-0.22	-6.42	-5.36	-4.54
147	348	-0.88	-0.39	-0.30	-6.31	-5.29	-4.52
147	351	-1.03	-0.53	-0.43	-6.22	-5.23	-4.50
147	354	-1.24	-0.73	-0.61	-6.13	-5.18	-4.48
147	357	-1.50	-0.97	-0.83	-6.07	-5.15	-4.47
147	360	-1.79	-1.23	-1.06	-6.02	-5.13	-4.47
150	0	-1.73	-1.18	-1.02	-6.45	-5.58	-4.89
150	3	-2.01	-1.43	-1.27	-6.45	-5.61	-4.95
150	6	-2.30	-1.69	-1.52	-6.45	-5.65	-5.01
150	9	-2.59	-1.94	-1.77	-6.45	-5.70	-5.09
150	12	-2.89	-2.20	-2.02	-6.45	-5.74	-5.17
150	15	-3.18	-2.46	-2.28	-6.45	-5.79	-5.26
150	18	-3.50	-2.74	-2.55	-6.45	-5.85	-5.36
150	21	-3.82	-3.02	-2.83	-6.46	-5.92	-5.47
150	24	-4.15	-3.30	-3.11	-6.47	-5.99	-5.59
150	27	-4.45	-3.57	-3.38	-6.48	-6.05	-5.70
150	30	-4.72	-3.81	-3.62	-6.48	-6.09	-5.80
150	33	-4.98	-4.05	-3.85	-6.47	-6.12	-5.89
150	36	-5.25	-4.28	-4.09	-6.44	-6.14	-5.99
150	39	-5.49	-4.50	-4.31	-6.41	-6.16	-6.07
150	42	-5.67	-4.67	-4.48	-6.36	-6.17	-6.13
150	45	-5.77	-4.77	-4.60	-6.31	-6.17	-6.15
150	48	-5.81	-4.83	-4.67	-6.25	-6.16	-6.15
150	51	-5.84	-4.89	-4.74	-6.17	-6.12	-6.14
150	54	-5.86	-4.93	-4.79	-6.08	-6.06	-6.14
150	57	-5.88	-4.96	-4.82	-5.98	-5.99	-6.13
150	60	-5.89	-4.97	-4.84	-5.89	-5.93	-6.11
150	63	-5.83	-4.93	-4.80	-5.81	-5.87	-6.09
150	66	-5.69	-4.81	-4.69	-5.72	-5.80	-6.07
150	69	-5.49	-4.65	-4.53	-5.64	-5.72	-6.03
150	72	-5.26	-4.46	-4.35	-5.55	-5.65	-5.99
150	75	-5.03	-4.27	-4.17	-5.46	-5.57	-5.95
150	78	-4.77	-4.05	-3.96	-5.37	-5.49	-5.91
150	81	-4.47	-3.77	-3.69	-5.28	-5.41	-5.86
150	84	-4.14	-3.47	-3.40	-5.19	-5.32	-5.81
150	87	-3.80	-3.16	-3.09	-5.10	-5.23	-5.75
150	90	-3.47	-2.86	-2.81	-5.02	-5.15	-5.70
150	93	-3.15	-2.57	-2.53	-4.93	-5.07	-5.63
150	96	-2.83	-2.27	-2.24	-4.84	-4.99	-5.56
150	99	-2.50	-1.98	-1.96	-4.76	-4.91	-5.49
150	102	-2.19	-1.69	-1.69	-4.70	-4.85	-5.43
150	105	-1.90	-1.43	-1.44	-4.68	-4.81	-5.39
150	108	-1.61	-1.17	-1.20	-4.68	-4.79	-5.36

150	111	-1.33	-0.91	-0.97	-4.69	-4.77	-5.34
150	114	-1.06	-0.67	-0.75	-4.70	-4.76	-5.32
150	117	-0.82	-0.47	-0.56	-4.72	-4.75	-5.31
150	120	-0.63	-0.31	-0.42	-4.74	-4.75	-5.30
150	123	-0.45	-0.18	-0.32	-4.81	-4.78	-5.33
150	126	-0.28	-0.06	-0.22	-4.95	-4.88	-5.39
150	129	-0.14	0.05	-0.14	-5.14	-5.01	-5.49
150	132	-0.04	0.12	-0.08	-5.36	-5.18	-5.62
150	135	0.00	0.15	-0.06	-5.61	-5.36	-5.75
150	138	0.00	0.13	-0.07	-5.90	-5.59	-5.93
150	141	-0.02	0.09	-0.12	-6.28	-5.89	-6.17
150	144	-0.04	0.03	-0.18	-6.73	-6.26	-6.47
150	147	-0.07	-0.04	-0.26	-7.24	-6.68	-6.81
150	150	-0.10	-0.12	-0.35	-7.80	-7.12	-7.17
150	153	-0.18	-0.24	-0.48	-8.46	-7.64	-7.58
150	156	-0.32	-0.41	-0.67	-9.27	-8.27	-8.07
150	159	-0.51	-0.62	-0.90	-10.16	-8.96	-8.61
150	162	-0.73	-0.86	-1.15	-11.09	-9.68	-9.16
150	165	-0.95	-1.10	-1.41	-12.00	-10.39	-9.70
150	168	-1.20	-1.37	-1.70	-13.05	-11.22	-10.29
150	171	-1.49	-1.69	-2.03	-14.28	-12.20	-10.95
150	174	-1.81	-2.04	-2.38	-15.45	-13.13	-11.58
150	177	-2.15	-2.40	-2.75	-16.33	-13.83	-12.10
150	180	-2.48	-2.75	-3.11	-16.67	-14.11	-12.40
150	183	-2.82	-3.11	-3.46	-16.52	-14.11	-12.55
150	186	-3.18	-3.48	-3.84	-16.15	-14.12	-12.68
150	189	-3.55	-3.85	-4.21	-15.64	-14.12	-12.77
150	192	-3.89	-4.21	-4.56	-15.11	-14.12	-12.84
150	195	-4.21	-4.53	-4.89	-14.64	-14.12	-12.86
150	198	-4.51	-4.84	-5.20	-14.23	-14.02	-12.82
150	201	-4.81	-5.14	-5.50	-13.82	-13.76	-12.70
150	204	-5.08	-5.43	-5.79	-13.41	-13.42	-12.55
150	207	-5.32	-5.67	-6.04	-13.02	-13.07	-12.39
150	210	-5.50	-5.85	-6.25	-12.69	-12.76	-12.24
150	213	-5.64	-6.00	-6.43	-12.40	-12.52	-12.12
150	216	-5.78	-6.14	-6.61	-12.14	-12.29	-12.00
150	219	-5.90	-6.25	-6.77	-11.91	-12.06	-11.88
150	222	-5.98	-6.33	-6.88	-11.67	-11.83	-11.76
150	225	-6.01	-6.36	-6.92	-11.43	-11.60	-11.65
150	228	-6.00	-6.35	-6.91	-11.17	-11.37	-11.54
150	231	-6.00	-6.33	-6.90	-10.90	-11.13	-11.44
150	234	-5.99	-6.29	-6.88	-10.64	-10.89	-11.34
150	237	-5.98	-6.25	-6.85	-10.40	-10.67	-11.24
150	240	-5.96	-6.21	-6.82	-10.18	-10.48	-11.14
150	243	-5.95	-6.16	-6.76	-9.98	-10.31	-11.04
150	246	-5.93	-6.09	-6.68	-9.78	-10.14	-10.94
150	249	-5.90	-6.02	-6.57	-9.60	-9.98	-10.85
150	252	-5.88	-5.94	-6.47	-9.47	-9.87	-10.76
150	255	-5.86	-5.87	-6.36	-9.40	-9.81	-10.68
150	258	-5.85	-5.82	-6.27	-9.37	-9.79	-10.61
150	261	-5.83	-5.77	-6.19	-9.34	-9.77	-10.55
150	264	-5.82	-5.71	-6.10	-9.32	-9.76	-10.50
150	267	-5.80	-5.65	-5.99	-9.31	-9.75	-10.44
150	270	-5.78	-5.57	-5.87	-9.31	-9.75	-10.38
150	273	-5.73	-5.47	-5.72	-9.33	-9.77	-10.32
150	276	-5.64	-5.33	-5.52	-9.40	-9.82	-10.27
150	279	-5.52	-5.17	-5.30	-9.47	-9.88	-10.22
150	282	-5.38	-4.98	-5.07	-9.53	-9.92	-10.15

150	285	-5.22	-4.78	-4.82	-9.57	-9.94	-10.07
150	288	-5.02	-4.56	-4.56	-9.58	-9.92	-9.94
150	291	-4.77	-4.30	-4.28	-9.58	-9.86	-9.76
150	294	-4.47	-4.01	-3.97	-9.59	-9.77	-9.54
150	297	-4.15	-3.71	-3.66	-9.59	-9.66	-9.29
150	300	-3.83	-3.39	-3.33	-9.59	-9.53	-9.04
150	303	-3.48	-3.05	-2.96	-9.55	-9.35	-8.74
150	306	-3.10	-2.66	-2.56	-9.42	-9.09	-8.40
150	309	-2.71	-2.26	-2.15	-9.25	-8.78	-8.02
150	312	-2.34	-1.89	-1.77	-9.07	-8.46	-7.66
150	315	-2.02	-1.57	-1.45	-8.89	-8.17	-7.33
150	318	-1.74	-1.27	-1.15	-8.71	-7.91	-7.03
150	321	-1.46	-0.98	-0.85	-8.51	-7.64	-6.74
150	324	-1.21	-0.71	-0.59	-8.30	-7.39	-6.47
150	327	-1.02	-0.51	-0.40	-8.09	-7.14	-6.22
150	330	-0.92	-0.42	-0.30	-7.90	-6.92	-6.00
150	333	-0.88	-0.38	-0.28	-7.71	-6.71	-5.80
150	336	-0.85	-0.36	-0.25	-7.52	-6.51	-5.61
150	339	-0.83	-0.34	-0.24	-7.34	-6.32	-5.45
150	342	-0.81	-0.33	-0.23	-7.17	-6.16	-5.31
150	345	-0.81	-0.32	-0.22	-7.02	-6.02	-5.20
150	348	-0.86	-0.37	-0.27	-6.89	-5.91	-5.11
150	351	-0.99	-0.50	-0.39	-6.76	-5.80	-5.03
150	354	-1.20	-0.69	-0.56	-6.64	-5.71	-4.96
150	357	-1.45	-0.92	-0.78	-6.54	-5.63	-4.91
150	360	-1.73	-1.18	-1.02	-6.45	-5.58	-4.89
153	0	-1.94	-1.44	-1.28	-7.20	-6.33	-5.55
153	3	-2.21	-1.67	-1.51	-7.20	-6.35	-5.59
153	6	-2.48	-1.91	-1.74	-7.20	-6.38	-5.64
153	9	-2.76	-2.15	-1.98	-7.19	-6.40	-5.70
153	12	-3.04	-2.40	-2.22	-7.19	-6.43	-5.76
153	15	-3.33	-2.65	-2.47	-7.18	-6.46	-5.82
153	18	-3.63	-2.91	-2.73	-7.17	-6.50	-5.90
153	21	-3.95	-3.19	-3.00	-7.16	-6.54	-6.00
153	24	-4.27	-3.46	-3.27	-7.15	-6.58	-6.10
153	27	-4.57	-3.73	-3.53	-7.13	-6.62	-6.19
153	30	-4.84	-3.96	-3.77	-7.11	-6.63	-6.24
153	33	-5.10	-4.19	-4.00	-7.07	-6.62	-6.28
153	36	-5.36	-4.42	-4.23	-7.00	-6.60	-6.31
153	39	-5.60	-4.63	-4.44	-6.90	-6.56	-6.34
153	42	-5.78	-4.80	-4.62	-6.80	-6.52	-6.35
153	45	-5.89	-4.91	-4.73	-6.69	-6.47	-6.36
153	48	-5.94	-4.97	-4.80	-6.56	-6.40	-6.34
153	51	-5.98	-5.02	-4.86	-6.41	-6.29	-6.29
153	54	-6.02	-5.06	-4.90	-6.24	-6.16	-6.22
153	57	-6.04	-5.09	-4.93	-6.07	-6.03	-6.14
153	60	-6.04	-5.10	-4.95	-5.93	-5.92	-6.08
153	63	-5.99	-5.06	-4.92	-5.82	-5.83	-6.03
153	66	-5.85	-4.95	-4.83	-5.71	-5.75	-5.98
153	69	-5.65	-4.80	-4.71	-5.61	-5.67	-5.94
153	72	-5.43	-4.62	-4.57	-5.51	-5.58	-5.89
153	75	-5.20	-4.43	-4.42	-5.40	-5.48	-5.83
153	78	-4.96	-4.22	-4.23	-5.28	-5.37	-5.74
153	81	-4.67	-3.96	-3.97	-5.14	-5.23	-5.64
153	84	-4.36	-3.67	-3.68	-5.01	-5.09	-5.52
153	87	-4.03	-3.37	-3.37	-4.88	-4.95	-5.40
153	90	-3.71	-3.08	-3.08	-4.76	-4.84	-5.30
153	93	-3.38	-2.78	-2.80	-4.65	-4.73	-5.21

153	96	-3.04	-2.46	-2.50	-4.53	-4.61	-5.11
153	99	-2.69	-2.14	-2.21	-4.42	-4.51	-5.01
153	102	-2.36	-1.83	-1.93	-4.34	-4.44	-4.95
153	105	-2.05	-1.56	-1.67	-4.31	-4.40	-4.91
153	108	-1.76	-1.30	-1.41	-4.32	-4.39	-4.90
153	111	-1.48	-1.04	-1.15	-4.32	-4.38	-4.89
153	114	-1.21	-0.81	-0.92	-4.34	-4.37	-4.89
153	117	-0.98	-0.61	-0.71	-4.35	-4.37	-4.88
153	120	-0.78	-0.45	-0.57	-4.37	-4.37	-4.88
153	123	-0.61	-0.32	-0.47	-4.43	-4.40	-4.91
153	126	-0.45	-0.20	-0.37	-4.57	-4.50	-5.00
153	129	-0.30	-0.10	-0.29	-4.75	-4.65	-5.12
153	132	-0.20	-0.03	-0.24	-4.97	-4.82	-5.27
153	135	-0.16	-0.01	-0.22	-5.20	-5.01	-5.42
153	138	-0.17	-0.02	-0.23	-5.49	-5.24	-5.62
153	141	-0.18	-0.06	-0.28	-5.86	-5.55	-5.89
153	144	-0.21	-0.12	-0.35	-6.31	-5.91	-6.21
153	147	-0.23	-0.19	-0.43	-6.82	-6.33	-6.57
153	150	-0.27	-0.27	-0.52	-7.38	-6.79	-6.95
153	153	-0.36	-0.40	-0.66	-8.05	-7.33	-7.39
153	156	-0.54	-0.60	-0.87	-8.88	-7.98	-7.90
153	159	-0.78	-0.85	-1.13	-9.80	-8.71	-8.47
153	162	-1.04	-1.12	-1.42	-10.76	-9.48	-9.08
153	165	-1.30	-1.40	-1.71	-11.70	-10.25	-9.69
153	168	-1.58	-1.71	-2.02	-12.73	-11.04	-10.35
153	171	-1.91	-2.06	-2.38	-13.90	-11.88	-11.08
153	174	-2.25	-2.43	-2.76	-15.03	-12.73	-11.83
153	177	-2.60	-2.80	-3.14	-15.96	-13.58	-12.55
153	180	-2.94	-3.16	-3.51	-16.54	-14.38	-13.19
153	183	-3.28	-3.52	-3.87	-16.86	-15.25	-13.82
153	186	-3.64	-3.88	-4.23	-17.14	-16.21	-14.48
153	189	-3.98	-4.23	-4.59	-17.36	-17.09	-15.08
153	192	-4.31	-4.56	-4.93	-17.50	-17.74	-15.52
153	195	-4.60	-4.86	-5.25	-17.56	-18.00	-15.68
153	198	-4.88	-5.14	-5.54	-17.27	-17.70	-15.53
153	201	-5.15	-5.42	-5.82	-16.55	-16.96	-15.14
153	204	-5.39	-5.67	-6.09	-15.62	-16.00	-14.62
153	207	-5.60	-5.88	-6.32	-14.69	-15.05	-14.09
153	210	-5.76	-6.05	-6.52	-13.97	-14.31	-13.66
153	213	-5.88	-6.19	-6.70	-13.46	-13.79	-13.31
153	216	-5.99	-6.31	-6.87	-13.00	-13.31	-12.97
153	219	-6.08	-6.42	-7.03	-12.58	-12.88	-12.66
153	222	-6.14	-6.50	-7.13	-12.19	-12.48	-12.37
153	225	-6.17	-6.52	-7.17	-11.81	-12.10	-12.11
153	228	-6.16	-6.52	-7.17	-11.44	-11.73	-11.87
153	231	-6.15	-6.50	-7.17	-11.07	-11.36	-11.65
153	234	-6.14	-6.48	-7.16	-10.72	-11.01	-11.45
153	237	-6.12	-6.45	-7.16	-10.42	-10.71	-11.27
153	240	-6.10	-6.42	-7.15	-10.17	-10.48	-11.13
153	243	-6.08	-6.39	-7.12	-9.95	-10.29	-11.01
153	246	-6.05	-6.34	-7.07	-9.74	-10.11	-10.90
153	249	-6.02	-6.28	-7.00	-9.56	-9.95	-10.81
153	252	-5.99	-6.23	-6.92	-9.43	-9.84	-10.72
153	255	-5.97	-6.17	-6.85	-9.35	-9.78	-10.65
153	258	-5.96	-6.12	-6.78	-9.31	-9.75	-10.58
153	261	-5.96	-6.06	-6.71	-9.28	-9.73	-10.52
153	264	-5.95	-6.00	-6.63	-9.25	-9.72	-10.46
153	267	-5.94	-5.94	-6.54	-9.24	-9.71	-10.41



153	270	-5.93	-5.86	-6.43	-9.23	-9.70	-10.36
153	273	-5.89	-5.76	-6.30	-9.25	-9.72	-10.32
153	276	-5.82	-5.65	-6.13	-9.30	-9.76	-10.29
153	279	-5.72	-5.51	-5.94	-9.35	-9.81	-10.26
153	282	-5.61	-5.35	-5.73	-9.41	-9.86	-10.22
153	285	-5.48	-5.18	-5.50	-9.45	-9.88	-10.18
153	288	-5.31	-4.99	-5.26	-9.47	-9.86	-10.12
153	291	-5.08	-4.75	-4.98	-9.49	-9.81	-10.06
153	294	-4.82	-4.49	-4.68	-9.50	-9.74	-9.98
153	297	-4.53	-4.21	-4.35	-9.52	-9.65	-9.89
153	300	-4.24	-3.91	-4.02	-9.52	-9.57	-9.78
153	303	-3.91	-3.57	-3.64	-9.49	-9.47	-9.61
153	306	-3.53	-3.18	-3.22	-9.42	-9.36	-9.38
153	309	-3.14	-2.78	-2.79	-9.33	-9.22	-9.12
153	312	-2.77	-2.39	-2.38	-9.22	-9.08	-8.84
153	315	-2.45	-2.05	-2.03	-9.12	-8.93	-8.58
153	318	-2.15	-1.74	-1.72	-9.03	-8.77	-8.34
153	321	-1.86	-1.43	-1.41	-8.93	-8.59	-8.09
153	324	-1.60	-1.15	-1.13	-8.83	-8.41	-7.84
153	327	-1.40	-0.93	-0.91	-8.72	-8.21	-7.60
153	330	-1.27	-0.80	-0.77	-8.61	-8.03	-7.36
153	333	-1.21	-0.74	-0.70	-8.49	-7.84	-7.11
153	336	-1.15	-0.69	-0.63	-8.37	-7.66	-6.86
153	339	-1.11	-0.65	-0.58	-8.24	-7.47	-6.61
153	342	-1.08	-0.62	-0.54	-8.10	-7.29	-6.39
153	345	-1.07	-0.61	-0.53	-7.96	-7.12	-6.20
153	348	-1.11	-0.65	-0.57	-7.82	-6.95	-6.04
153	351	-1.24	-0.77	-0.67	-7.67	-6.79	-5.89
153	354	-1.43	-0.95	-0.84	-7.52	-6.63	-5.76
153	357	-1.67	-1.18	-1.04	-7.36	-6.48	-5.64
153	360	-1.94	-1.44	-1.28	-7.20	-6.33	-5.55
156	0	-2.51	-2.11	-1.96	-8.32	-7.46	-6.53
156	3	-2.73	-2.31	-2.15	-8.31	-7.45	-6.54
156	6	-2.97	-2.51	-2.34	-8.30	-7.44	-6.56
156	9	-3.21	-2.71	-2.55	-8.28	-7.43	-6.57
156	12	-3.46	-2.93	-2.76	-8.25	-7.42	-6.59
156	15	-3.71	-3.15	-2.97	-8.23	-7.40	-6.61
156	18	-3.99	-3.38	-3.20	-8.18	-7.38	-6.63
156	21	-4.29	-3.63	-3.45	-8.12	-7.35	-6.66
156	24	-4.60	-3.89	-3.71	-8.03	-7.32	-6.69
156	27	-4.89	-4.13	-3.95	-7.93	-7.28	-6.72
156	30	-5.15	-4.35	-4.17	-7.83	-7.23	-6.73
156	33	-5.40	-4.57	-4.39	-7.71	-7.17	-6.72
156	36	-5.65	-4.79	-4.61	-7.57	-7.08	-6.69
156	39	-5.88	-4.99	-4.81	-7.41	-6.98	-6.64
156	42	-6.07	-5.15	-4.97	-7.23	-6.86	-6.59
156	45	-6.19	-5.25	-5.07	-7.05	-6.74	-6.53
156	48	-6.27	-5.31	-5.12	-6.85	-6.59	-6.46
156	51	-6.34	-5.37	-5.17	-6.62	-6.42	-6.35
156	54	-6.39	-5.41	-5.20	-6.39	-6.24	-6.22
156	57	-6.43	-5.44	-5.23	-6.16	-6.07	-6.10
156	60	-6.44	-5.45	-5.23	-5.97	-5.91	-5.99
156	63	-6.40	-5.41	-5.20	-5.81	-5.77	-5.89
156	66	-6.27	-5.29	-5.12	-5.66	-5.65	-5.81
156	69	-6.08	-5.13	-4.99	-5.53	-5.53	-5.72
156	72	-5.87	-4.95	-4.85	-5.40	-5.40	-5.64
156	75	-5.65	-4.76	-4.69	-5.25	-5.27	-5.53
156	78	-5.41	-4.55	-4.50	-5.10	-5.12	-5.41

156	81	-5.13	-4.29	-4.25	-4.93	-4.95	-5.27
156	84	-4.81	-4.00	-3.96	-4.76	-4.78	-5.12
156	87	-4.48	-3.71	-3.67	-4.60	-4.62	-4.99
156	90	-4.16	-3.41	-3.38	-4.47	-4.49	-4.87
156	93	-3.83	-3.11	-3.11	-4.34	-4.37	-4.76
156	96	-3.48	-2.80	-2.83	-4.21	-4.24	-4.66
156	99	-3.12	-2.48	-2.54	-4.09	-4.13	-4.56
156	102	-2.78	-2.18	-2.27	-4.01	-4.05	-4.50
156	105	-2.47	-1.91	-2.02	-3.97	-4.02	-4.47
156	108	-2.19	-1.66	-1.78	-3.98	-4.02	-4.47
156	111	-1.90	-1.41	-1.53	-3.99	-4.02	-4.48
156	114	-1.64	-1.18	-1.30	-4.00	-4.03	-4.49
156	117	-1.41	-0.99	-1.11	-4.02	-4.03	-4.50
156	120	-1.22	-0.84	-0.98	-4.05	-4.04	-4.52
156	123	-1.05	-0.72	-0.89	-4.11	-4.08	-4.57
156	126	-0.89	-0.61	-0.80	-4.24	-4.18	-4.67
156	129	-0.75	-0.51	-0.73	-4.41	-4.34	-4.81
156	132	-0.66	-0.45	-0.68	-4.62	-4.52	-4.97
156	135	-0.62	-0.42	-0.67	-4.84	-4.71	-5.15
156	138	-0.63	-0.44	-0.68	-5.11	-4.94	-5.37
156	141	-0.64	-0.48	-0.73	-5.47	-5.24	-5.65
156	144	-0.67	-0.53	-0.80	-5.89	-5.60	-5.98
156	147	-0.70	-0.61	-0.89	-6.37	-6.01	-6.35
156	150	-0.73	-0.69	-0.98	-6.90	-6.46	-6.76
156	153	-0.83	-0.82	-1.13	-7.53	-6.99	-7.22
156	156	-1.01	-1.03	-1.34	-8.29	-7.63	-7.75
156	159	-1.26	-1.28	-1.61	-9.15	-8.35	-8.35
156	162	-1.53	-1.56	-1.90	-10.07	-9.12	-9.00
156	165	-1.80	-1.84	-2.19	-10.99	-9.92	-9.68
156	168	-2.08	-2.15	-2.50	-11.96	-10.71	-10.40
156	171	-2.40	-2.49	-2.85	-13.00	-11.53	-11.18
156	174	-2.74	-2.86	-3.22	-14.08	-12.41	-12.01
156	177	-3.08	-3.23	-3.60	-15.16	-13.41	-12.90
156	180	-3.41	-3.57	-3.95	-16.21	-14.54	-13.84
156	183	-3.73	-3.90	-4.28	-17.39	-16.26	-15.04
156	186	-4.06	-4.23	-4.62	-18.73	-18.60	-16.51
156	189	-4.37	-4.55	-4.95	-19.97	-20.97	-17.95
156	192	-4.67	-4.85	-5.26	-20.89	-22.81	-19.04
156	195	-4.94	-5.12	-5.55	-21.25	-23.56	-19.47
156	198	-5.18	-5.37	-5.82	-20.77	-22.92	-19.13
156	201	-5.42	-5.61	-6.08	-19.56	-21.34	-18.27
156	204	-5.64	-5.84	-6.32	-18.00	-19.33	-17.16
156	207	-5.82	-6.03	-6.54	-16.46	-17.37	-16.04
156	210	-5.95	-6.18	-6.72	-15.32	-15.98	-15.17
156	213	-6.05	-6.31	-6.89	-14.54	-15.10	-14.53
156	216	-6.14	-6.43	-7.05	-13.84	-14.34	-13.94
156	219	-6.21	-6.54	-7.20	-13.21	-13.67	-13.40
156	222	-6.26	-6.61	-7.30	-12.65	-13.08	-12.92
156	225	-6.28	-6.63	-7.36	-12.14	-12.54	-12.51
156	228	-6.28	-6.63	-7.39	-11.65	-12.03	-12.15
156	231	-6.27	-6.63	-7.41	-11.19	-11.55	-11.81
156	234	-6.25	-6.62	-7.42	-10.78	-11.11	-11.52
156	237	-6.23	-6.60	-7.43	-10.41	-10.74	-11.27
156	240	-6.22	-6.59	-7.44	-10.12	-10.47	-11.08
156	243	-6.21	-6.58	-7.43	-9.88	-10.25	-10.94
156	246	-6.20	-6.57	-7.43	-9.66	-10.05	-10.81
156	249	-6.18	-6.55	-7.42	-9.46	-9.89	-10.71
156	252	-6.18	-6.53	-7.41	-9.32	-9.77	-10.62

156	255	-6.17	-6.52	-7.40	-9.22	-9.69	-10.55
156	258	-6.19	-6.51	-7.39	-9.16	-9.65	-10.49
156	261	-6.22	-6.50	-7.38	-9.11	-9.62	-10.43
156	264	-6.27	-6.49	-7.37	-9.07	-9.59	-10.38
156	267	-6.30	-6.49	-7.35	-9.04	-9.57	-10.34
156	270	-6.32	-6.47	-7.33	-9.03	-9.56	-10.32
156	273	-6.31	-6.44	-7.29	-9.03	-9.58	-10.30
156	276	-6.28	-6.40	-7.22	-9.05	-9.61	-10.29
156	279	-6.24	-6.33	-7.13	-9.07	-9.65	-10.28
156	282	-6.19	-6.24	-7.01	-9.10	-9.68	-10.27
156	285	-6.13	-6.14	-6.88	-9.13	-9.69	-10.27
156	288	-6.02	-5.99	-6.68	-9.16	-9.68	-10.29
156	291	-5.81	-5.76	-6.37	-9.22	-9.66	-10.34
156	294	-5.55	-5.47	-6.01	-9.27	-9.63	-10.41
156	297	-5.26	-5.16	-5.62	-9.31	-9.61	-10.46
156	300	-4.97	-4.84	-5.23	-9.33	-9.60	-10.49
156	303	-4.65	-4.49	-4.81	-9.33	-9.61	-10.47
156	306	-4.27	-4.09	-4.35	-9.32	-9.64	-10.40
156	309	-3.88	-3.66	-3.88	-9.32	-9.68	-10.32
156	312	-3.51	-3.26	-3.43	-9.32	-9.71	-10.21
156	315	-3.18	-2.91	-3.05	-9.32	-9.72	-10.11
156	318	-2.89	-2.59	-2.71	-9.33	-9.71	-9.99
156	321	-2.60	-2.28	-2.38	-9.35	-9.66	-9.84
156	324	-2.34	-1.99	-2.09	-9.38	-9.60	-9.66
156	327	-2.14	-1.76	-1.85	-9.40	-9.52	-9.47
156	330	-2.01	-1.62	-1.69	-9.41	-9.44	-9.25
156	333	-1.93	-1.54	-1.58	-9.40	-9.34	-8.98
156	336	-1.86	-1.48	-1.49	-9.38	-9.21	-8.64
156	339	-1.80	-1.42	-1.41	-9.34	-9.05	-8.28
156	342	-1.77	-1.39	-1.36	-9.30	-8.87	-7.93
156	345	-1.75	-1.38	-1.34	-9.25	-8.69	-7.63
156	348	-1.79	-1.41	-1.37	-9.16	-8.49	-7.37
156	351	-1.90	-1.52	-1.45	-9.01	-8.26	-7.13
156	354	-2.06	-1.68	-1.58	-8.81	-8.01	-6.91
156	357	-2.27	-1.88	-1.76	-8.58	-7.74	-6.71
156	360	-2.51	-2.11	-1.96	-8.32	-7.46	-6.53
159	0	-3.32	-3.06	-2.94	-9.62	-8.81	-7.74
159	3	-3.48	-3.20	-3.07	-9.61	-8.77	-7.70
159	6	-3.65	-3.34	-3.21	-9.58	-8.71	-7.67
159	9	-3.84	-3.50	-3.36	-9.53	-8.65	-7.62
159	12	-4.05	-3.67	-3.52	-9.47	-8.57	-7.58
159	15	-4.26	-3.84	-3.69	-9.40	-8.48	-7.53
159	18	-4.50	-4.04	-3.89	-9.30	-8.39	-7.48
159	21	-4.77	-4.26	-4.10	-9.15	-8.27	-7.43
159	24	-5.06	-4.48	-4.33	-8.96	-8.13	-7.37
159	27	-5.33	-4.70	-4.54	-8.76	-7.99	-7.30
159	30	-5.58	-4.90	-4.74	-8.55	-7.84	-7.23
159	33	-5.82	-5.09	-4.94	-8.34	-7.69	-7.14
159	36	-6.05	-5.29	-5.14	-8.11	-7.52	-7.04
159	39	-6.28	-5.48	-5.33	-7.87	-7.34	-6.93
159	42	-6.47	-5.63	-5.47	-7.62	-7.16	-6.81
159	45	-6.60	-5.73	-5.55	-7.37	-6.97	-6.68
159	48	-6.71	-5.79	-5.58	-7.09	-6.76	-6.54
159	51	-6.81	-5.84	-5.61	-6.80	-6.54	-6.38
159	54	-6.89	-5.89	-5.63	-6.51	-6.31	-6.21
159	57	-6.95	-5.91	-5.64	-6.23	-6.09	-6.04
159	60	-6.97	-5.92	-5.64	-5.99	-5.89	-5.88
159	63	-6.92	-5.88	-5.60	-5.78	-5.70	-5.74