

FCC 47 CFR PART 15 SUBPART C

RF Test Report

Applicant : Ocean Star Electronics Limited

Product Type : Bluetooth/Wi-Fi Wireless Stereo Smart Speaker

Trade Name : JENSEN, SOLIS, Ocean

Model Number : JSB-1000, JSB-1000XXXXX, SO-3000, SO-3000XXXXX,
SO-6000, SO-6000XXXXX,
iStation 20GC, iStation 4GC, iStation 8GC

Test Specification : FCC 47 CFR PART 15 SUBPART C
ANSI C63.10:2013

Receive Date : Dec. 10, 2016

Test Period : Nov. 16 ~ Dec 12, 2016

Issue Date : Jan. 20, 2017

Issue by

A Test Lab Techno Corp.
No. 140-1, Changan Street, Bade District,
Taoyuan City 33465, Taiwan (R.O.C)
Tel : +886-3-2710188 / Fax : +886-3-2710190



Taiwan Accreditation Foundation accreditation number: 1330

Note: This report shall not be reproduced except in full, without the written approval of A Test Lab Techno Corp. This document may be altered or revised by A Test Lab Techno Corp. personnel only, and shall be noted in the revision section of the document. The client should not use it to claim product endorsement by TAF, or any government agencies. The test results in the report only apply to the tested sample.



Revision History

Rev.	Issue Date	Revisions	Revised By
00	Jan. 20, 2017	Initial Issue	Snow Wang



Verification of Compliance

Issued Date: Jan. 20, 2017

Applicant : Ocean Star Electronics Limited

Product Type : Bluetooth/Wi-Fi Wireless Stereo Smart Speaker

Trade Name : JENSEN, SOLIS, Ocean

Model Number : JSB-1000, JSB-1000XXXXX, SO-3000, SO-3000XXXXX, SO-6000, SO-6000XXXXX, iStation 20GC, iStation 4GC, iStation 8GC

FCC ID : LMZ-250737476GC

EUT Rated Voltage : DC 18V, 1.5A

Test Voltage : 120 Vac / 60 Hz

Applicable Standard : FCC 47 CFR PART 15 SUBPART C
ANSI C63.10:2013

Test Result : Complied

Performing Lab. : A Test Lab Techno Corp.

No. 140-1, Changan Street, Bade District,
Taoyuan City 33465, Taiwan (R.O.C)
Tel : +886-3-2710188 / Fax : +886-3-2710190



Taiwan Accreditation Foundation accreditation number: 1330

<http://www.atl-lab.com.tw/e-index.htm>

A Test Lab Techno Corp. tested the above equipment in accordance with the requirements set forth in the above standards. All indications of Pass/Fail in this report are opinions expressed by A Test Lab Techno Corp. based on interpretations and/or observations of test results. Measurement Uncertainties were not taken into account and are published for informational purposes only. The test results show that the equipment tested is capable of demonstrating compliance with the requirements as documented in this report.

Approved By

: Fly Lu

(Manager)

Reviewed By

: Eric Ou Yang

(Testing Engineer)

(Eric Ou Yang)



TABLE OF CONTENTS

1	General Information	5
	1.1. Summary of Test Result	5
	1.2. Measurement Uncertainty	5
2	EUT Description	6
3	Test Methodology	8
	3.1. Mode of Operation.....	8
	3.2. EUT Exercise Software	8
	3.3. Configuration of Test System Details.....	9
	3.4. Test Site Environment	9
4	Maximum Conducted Output Power Measurement	10
5	AC Power Line Conducted Emission Measurement.....	12
6	Radiated Interference Measurement	16
7	20dB RF Bandwidth Measurement	45
8	Carrier Frequency Separation Measurement	49
9	Number of Hopping Measurement	53
10	Time of Occupancy (Dwell Time) Measurement.....	57
11	Out of Band Conducted Emissions Measurement.....	62
12	Antenna Measurement.....	67



1 General Information

1.1. Summary of Test Result

FCC Standard	Item	Result	Remark
15.207	AC Power Conducted Emission	PASS	-----
15.203	Antenna Requirement	PASS	-----
15.247(b)(1)	Max. Output Power	PASS	-----
15.247(d)	Transmitter Radiated Emissions	PASS	-----
15.247(a)(1)	20dB RF Bandwidth	PASS	-----
15.247(a)(1)	Carrier Frequency Separation	PASS	-----
15.247(a)(1)(iii)	Number of Hopping	PASS	-----
15.247(a)(1)(iii)	Time of Occupancy (Dwell Time)	PASS	-----
15.247(d)	Out of Band Conducted Spurious Emission	PASS	-----

The test results of this report relate only to the tested sample(s) identified in this report. Manufacturer or whom it may concern should recognize the pass or fail of the test result.

1.2. Measurement Uncertainty

Test Item	Frequency Range	Uncertainty (dB)
Conducted Emission	9kHz ~ 150KHz	2.7
	150kHz ~ 30MHz	2.7
Radiated Emission	9kHz ~ 30MHz	1.7
	30MHz ~ 1000MHz	5.7
	1000MHz ~ 18000MHz	5.5
	18000MHz ~ 26500MHz	4.8
	26500MHz ~ 40000MHz	4.8
Conducted Output Power	+0.27 dB / -0.28 dB	
RF Bandwidth	4.96%	
Power Spectral Density	+0.71 dB / -0.77 dB	



2 EUT Description

Applicant	Ocean Star Electronics Limited Unit 15, 8/F., Wah Wai Centre, 38-40 Au Pui Wan Street, Fo Tan, Hong Kong			
Manufacturer	Ocean Star Electronics Limited Unit 15, 8/F., Wah Wai Centre, 38-40 Au Pui Wan Street, Fo Tan, Hong Kong			
Product	Bluetooth/Wi-Fi Wireless Stereo Smart Speaker			
Trade Name	JENSEN, SOLIS, Ocean			
Model Number	JSB-1000, JSB-1000XXXXX, SO-3000, SO-3000XXXXX, SO-6000, SO-6000XXXXX, iStation 20GC, iStation 4GC, iStation 8GC			
FCC ID	LMZ-250737476GC			
Frequency Range	2402 ~ 2480 MHz			
Modulation Type	GFSK for 1Mbps			
	$\pi/4$ -DQPSK for 2Mbps			
	8DPSK for 3Mbps			
Antenna Information	Antenna Model	Antenna Type	Antenna Gain	
	GY 9000	PCB Antenna	2dBi	
RF Output Power (Conducted)	GFSK for 1Mbps	9.72 dBm /	0.00938 W	
	$\pi/4$ -DQPSK for 2Mbps	7.29 dBm /	0.00536 W	
	8DPSK for 3Mbps	7.49 dBm /	0.00561 W	
Component List				
Power adapter(1)	Trade Name	JIEDONG DLECFRON FACTORY	Model Number	JDA0301800150WUS
	I/P: 100-240VAC, 50-60Hz, 0.8A			
	O/P: 18VDC, 1.5A Cable out: Shielded, 1.5m, Non-Detachable at Power Adapter			
Power adapter(2)	Trade Name	KINGWALL	Model Number	AS360-180.AA150
	I/P: 100-240VAC, 50-60Hz, 1.2A			
	O/P: 18VDC, 1.5A Cable out: Shielded, 1.5m with one core, Non-Detachable at Power Adapter			

Trade name / model number and model different description :

Model Group	Trade Name	Model Number	Description
1	JENSEN	JSB-1000	JSB-1000XXXXX (where XXXXX denote any printable characters in the ASCII Standard Character Table to represent variances in cosmetics or buyers)
		JSB-1000XXXXX	
	Ocean	iStation 20GC	JSB-1000 and iStation 20GC differ is the model number only.
2	SOLIS	SO-3000	SO-3000XXXXX (where XXXXX denote any printable characters in the ASCII Standard Character Table to represent variances in cosmetics or buyers)
		SO-3000XXXXX	
	Ocean	iStation 4GC	SO-3000 and iStation 4GC differ is the model number only.
	SOLIS	SO-6000	SO-6000XXXXX (where XXXXX denote any printable characters in the ASCII Standard Character Table to represent variances in cosmetics or buyers)
SO-6000XXXXX			
	Ocean	iStation 8GC	SO-6000 and iStation 8GC differ is the model number only.
The model group 1 and group 2 differ is the appearance and button.			

3 Test Methodology

3.1. Mode of Operation

In the test report use EUT model: JSB-1000 to operate testing.

Decision of Test ATL has verified the construction and function in typical operation. All the test modes were carried out with the EUT in normal operation, which was shown in this test report and defined as:

Pre-Test Mode
Mode 1: Continuous TX mode
Mode 2: GFSK Link Mode
Mode 3: $\pi/4$ -DQPSK Link Mode
Mode 4: 8DPSK Link Mode

By preliminary testing and verifying three axis (X, Y and Z) position of EUT transmitted status, it was found that "X axis" position was the worst, then the final test was executed the worst condition and test data were recorded in this report.

Final-Test Mode
Mode 1: Continuous TX mode
Mode 2: GFSK Link Mode
Mode 4: 8DPSK Link Mode

Description of Test Modes

Preliminary tests were performed in different modulation to find the worst case. The modulation has shown the worst-case in section 4.5. Investigation has been done on all the possible configurations for searching the worst cases.

Note: The device used two models of adapter, adapter number: JDA0301800150WUS is worst case to perform testing.

Tested System Details

The types for all equipments, plus descriptions of all cables used in the tested system (including inserted cards) are:

	Product	Manufacturer	Model Number	Serial Number	Power Cord
1.	Bluetooth Tester	R & S	CBT	100350	NA

3.2. EUT Exercise Software

1	Setup the EUT and Bluetooth Tester (CBT) as shown on 3.3.
2	Turn on the power of all equipment.
3	Turn on Bluetooth function and link to Bluetooth tester
4	EUT run test program.

Measurement Software	
1	EZ-EMC Ver. ATL-03A1-1
2	EZ-EMC Ver ATL-ITC-3A1-1

3.3. Configuration of Test System Details

AC Power Conducted Emission

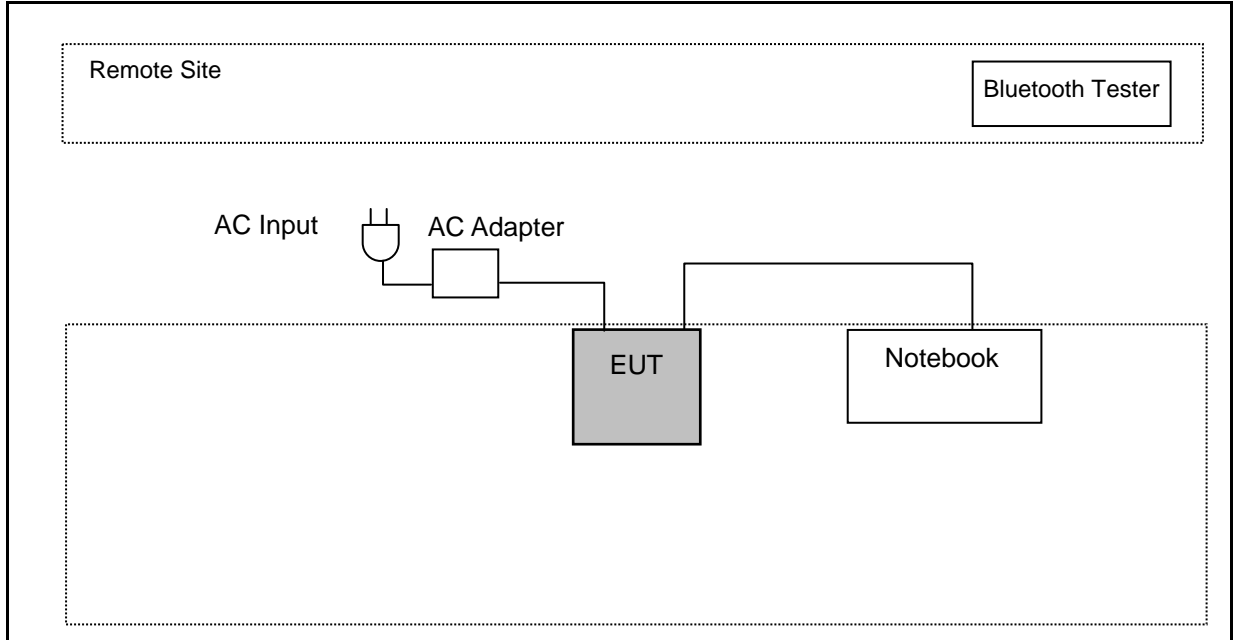

Radiated Emissions

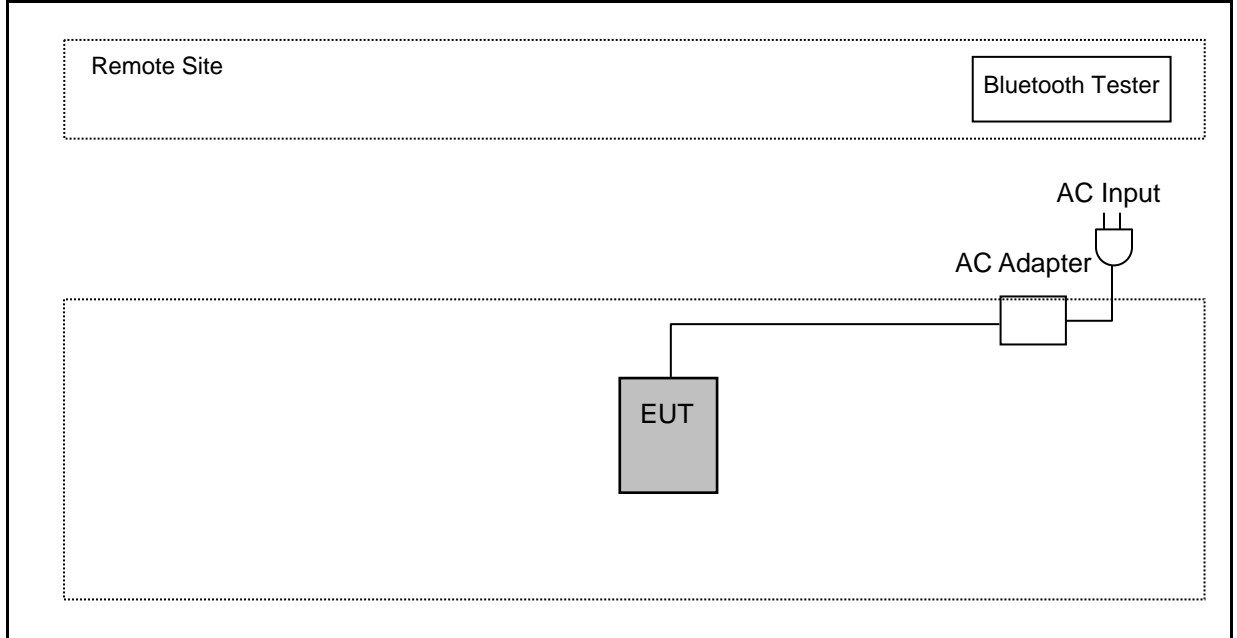

3.4. Test Site Environment

Items	Required (IEC 60068-1)	Actual
Temperature (°C)	15-35	26
Humidity (%RH)	25-75	60
Barometric pressure (mbar)	860-1060	950

4 Maximum Conducted Output Power Measurement

■ Limit

For frequency hopping systems operating in the 2400–2483.5 MHz band employing at least 75 non-overlapping hopping channels < 0.125 watt.

■ Test Setup

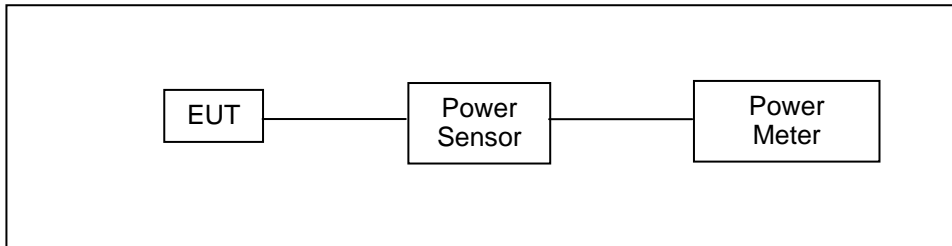

■ Test Instruments

Equipment	Manufacturer	Model Number	Serial Number	Cal. Date	Remark
Power Sensor	Anritsu	MA2411B	1126022	08/29/2016	1 year
Power Meter	Anritsu	ML2495A	1135009	08/29/2016	1 year
Microwave Cable	EMCI	EMC104-SM-SM-1 500	140303	02/23/2016	1 year
Test Site	ATL	TE05	TE05	N.C.R.	-----

NOTE: N.C.R. = No Calibration Request.

■ Test Procedure

Testing must be done according to this procedure, FCC Public Notice DA 00-705 - Filing and Measurement Guidelines for Frequency Hopping Spread Spectrum Systems. This is the only method recognized by the FCC. The tests below are run with the EUT's transmitter set at high power in TX mode. The EUT is needed to force selection of output power level and channel number. While testing, EUT was set to transmit continuously. Remove the Subjective device's antenna and connect the RF output port to power sensor. The maximum peak output power shall not exceed 1 watt.

Use a direct connection between the antenna port of transmitter and the power sensor, for prevent the power sensor input attenuation 40-50 dB. Set the RBW Bandwidth of the emission or use a channel power meter mode.

For antennas with gains of 6 dBi or less, maximum allowed transmitter output is 1 watt (+30 dBm). For antennas with gains greater than 6 dBi, transmitter output level must be decreased by an amount equal to (GAIN - 6)/3 dBm.

The antenna port of the EUT was connected to the input of a power sensor. Power was read directly and cable loss correction was added to the reading to obtain power at the EUT antenna terminals.



■ Test Result

Test Mode	Frequency (MHz)	Packet Type	Average Power		Peak Power		Limit (W)
			(dBm)	(W)	(dBm)	(W)	
Mode 2	2402	DH1	9.56	0.00904	9.68	0.00929	< 0.125
		DH3	9.59	0.00910	9.69	0.00931	< 0.125
		DH5	9.61	0.00914	9.72	0.00938	< 0.125
	2441	DH1	9.00	0.00794	9.12	0.00817	< 0.125
		DH3	9.03	0.00800	9.14	0.00820	< 0.125
		DH5	9.07	0.00807	9.17	0.00826	< 0.125
	2480	DH1	8.53	0.00713	8.66	0.00735	< 0.125
		DH3	8.56	0.00718	8.69	0.00740	< 0.125
		DH5	8.58	0.00721	8.72	0.00745	< 0.125
Mode 3	2402	2DH1	7.09	0.00512	7.23	0.00528	< 0.125
		2DH3	7.12	0.00515	7.26	0.00532	< 0.125
		2DH5	7.14	0.00518	7.29	0.00536	< 0.125
	2441	2DH1	6.52	0.00449	6.66	0.00463	< 0.125
		2DH3	6.56	0.00453	6.69	0.00467	< 0.125
		2DH5	6.59	0.00456	6.73	0.00471	< 0.125
	2480	2DH1	6.01	0.00399	6.15	0.00412	< 0.125
		2DH3	6.05	0.00403	6.18	0.00415	< 0.125
		2DH5	6.07	0.00405	6.21	0.00418	< 0.125
Mode 4	2402	3DH1	7.29	0.00536	7.44	0.00555	< 0.125
		3DH3	7.32	0.00540	7.46	0.00557	< 0.125
		3DH5	7.35	0.00543	7.49	0.00561	< 0.125
	2441	3DH1	6.74	0.00472	6.89	0.00489	< 0.125
		3DH3	6.77	0.00475	6.92	0.00492	< 0.125
		3DH5	6.89	0.00489	6.95	0.00495	< 0.125
	2480	3DH1	6.24	0.00421	6.38	0.00435	< 0.125
		3DH3	6.27	0.00424	6.41	0.00438	< 0.125
		3DH5	6.29	0.00426	6.43	0.00440	< 0.125

Note: The relevant measured result has the offset with cable loss already.

5 AC Power Line Conducted Emission Measurement

■ Limit

Frequency (MHz)	Quasi-peak	Average
0.15 - 0.5	66 to 56	56 to 46
0.50 - 5.0	56	46
5.0 - 30.0	60	50

■ Test Instruments

Describe	Manufacturer	Model Number	Serial Number	Cal. Date	Remark
Test Receiver	R&S	ESCI	100367	05/31/2016	1 year
LISN	R&S	ENV216	101040	03/15/2016	1 year
LISN	R&S	ENV216	101041	03/07/2016	1 year
RF Cable	Woken	00100D1380194M	TE-02-02	05/31/2016	1 year
Test Site	ATL	TE02	TE02	N.C.R.	-----

NOTE: N.C.R. = No Calibration Request.

■ Test Setup

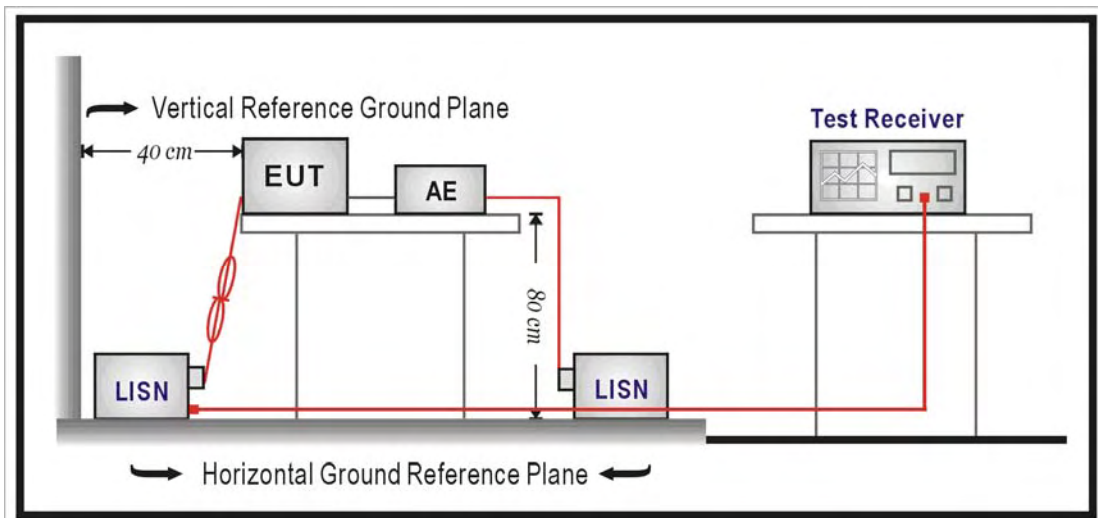

■ Test Procedure

The EUT and simulators are connected to the main power through a line impedance stabilization network (L.I.S.N.). This provides a $50\Omega//50\mu\text{H}$ coupling impedance for the measuring equipment. The peripheral devices are also connected to the main power through a LISN that provides a $50\Omega//50\mu\text{H}$ coupling impedance with 50ohm termination.

Tabletop device shall be placed on a non-conducting platform, of nominal size 1 m by 1.5 m, raised 80 cm above the reference ground plane. The wall of screened room shall be located 40cm to the rear of the EUT. Other surfaces of tabletop or floor standing EUT shall be at least 80cm from any other ground conducting surface including one or more LISNs. For floor-standing device shall be placed under the EUT with a 12mm insulating material.

Conducted emissions were investigated over the frequency range from 0.15 MHz to 30 MHz using a resolution bandwidth of 9 kHz. The equipment under test (EUT) shall be meet the limits in section 4.1, as applicable, including the average limit and the quasi-peak limit when using respectively, an average detector and quasi-peak detector measured in accordance with the methods described of related standard. When all of peak value were complied with quasi-peak and average limit from 150kHz to 30MHz then quasi-peak and average measurement was unnecessary.

The AMN shall be placed 0,8 m from the boundary of the unit under test and bonded to a ground reference plane for AMNs mounted on top of the ground reference plane. This distance is between the closest points of the AMN and the EUT. All other units of the EUT and associated equipment shall be at least 0,8 m from the AMN. If the mains power cable is longer than 1m then the cable shall be folded back and forth at the centre of the lead to form a bundle no longer than 0.4m. All of interconnecting cables that hang closer than 40cm to the ground plane shall be folded back and forth in the center forming a bundle 30 cm to 40 cm long. All of EUT and AE shall be separate place more than 0.1m. All 50Ω ports of the LISN shall be resistively terminated into 50Ω loads when not connected to the measuring instrument.

If the reading of the measuring receiver shows fluctuations close to the limit, the reading shall be observed for at least 15 s at each measurement frequency; the higher reading shall be recorded with the exception of any brief isolated high reading which shall be ignored.



■ Test Result

Standard:	FCC Part 15C	Line:	L1
Test item:	Conducted Emission	Power:	AC 120V/60Hz
Test Mode:	Mode 1	Temp.(°C)/Hum.(%RH):	26(°C)/60%RH
		Date:	11/16/2016
		Test By:	Eric Ou Yang
Description:			

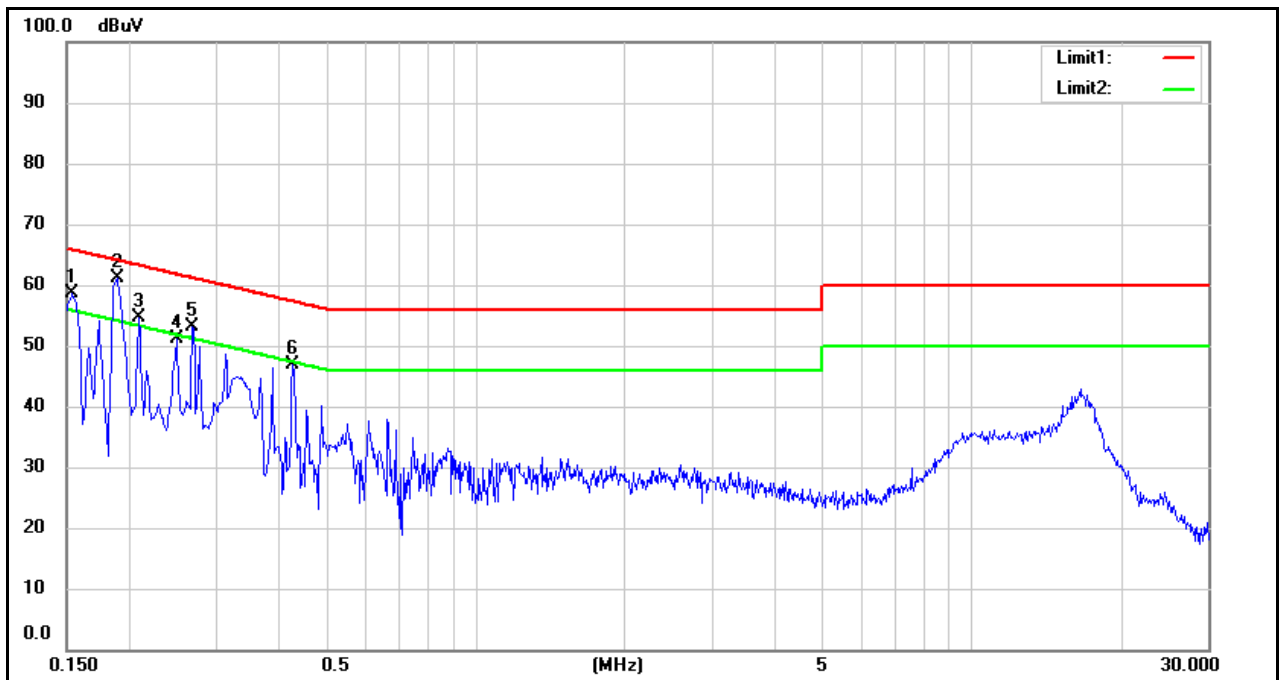

No.	Frequency (MHz)	QP reading (dBuV)	AVG reading (dBuV)	Correction factor (dB)	QP result (dBuV)	AVG result (dBuV)	QP limit (dBuV)	AVG limit (dBuV)	QP margin (dB)	AVG margin (dB)	Remark
1	0.1540	41.45	17.21	9.64	51.09	26.85	65.78	55.78	-14.69	-28.93	Pass
2	0.1900	37.04	13.68	9.64	46.68	23.32	64.04	54.04	-17.36	-30.72	Pass
3	0.2100	35.83	9.14	9.64	45.47	18.78	63.21	53.21	-17.74	-34.43	Pass
4	0.2500	31.19	15.83	9.64	40.83	25.47	61.76	51.76	-20.93	-26.29	Pass
5	0.2700	32.18	12.34	9.65	41.83	21.99	61.12	51.12	-19.29	-29.13	Pass
6	0.4300	22.13	8.51	9.66	31.79	18.17	57.25	47.25	-25.46	-29.08	Pass

Note: 1. Result (dBuV/m) = Correct Factor (dB/m) + Reading(dBuV).

2. Correction factor (dB) = Cable loss (dB) + L.I.S.N. factor (dB).



Standard:	FCC Part 15C	Line:	N
Test item:	Conducted Emission	Power:	AC 120V/60Hz
Test Mode:	Mode 1	Temp.(°C)/Hum.(%RH):	26(°C)/60%RH
		Date:	11/16/2016
		Test By:	Eric Ou Yang
Description:			

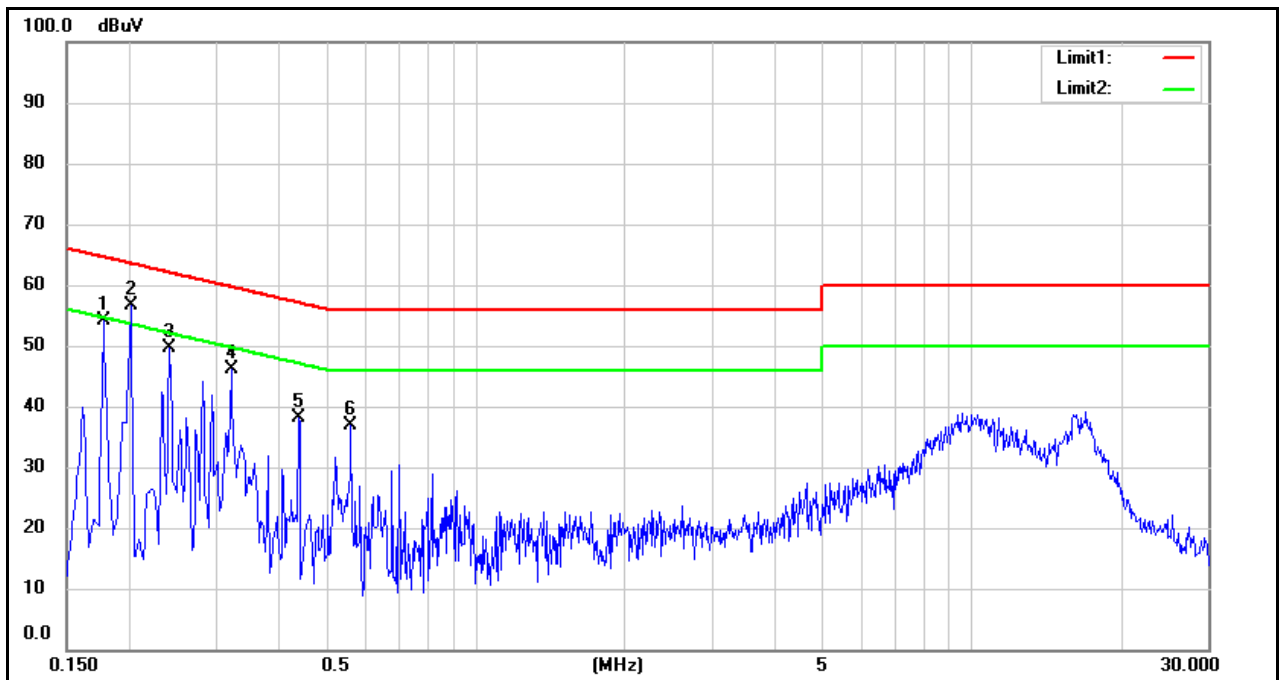

No.	Frequency (MHz)	QP reading (dBuV)	AVG reading (dBuV)	Correction factor (dB)	QP result (dBuV)	AVG result (dBuV)	QP limit (dBuV)	AVG limit (dBuV)	QP margin (dB)	AVG margin (dB)	Remark
1	0.1780	38.09	6.21	9.64	47.73	15.85	64.58	54.58	-16.85	-38.73	Pass
2	0.2020	37.31	10.12	9.64	46.95	19.76	63.53	53.53	-16.58	-33.77	Pass
3	0.2420	31.39	7.88	9.64	41.03	17.52	62.03	52.03	-21.00	-34.51	Pass
4	0.3220	28.10	14.53	9.65	37.75	24.18	59.66	49.66	-21.91	-25.48	Pass
5	0.4420	19.26	-0.46	9.66	28.92	9.20	57.02	47.02	-28.10	-37.82	Pass
6	0.5620	19.32	5.38	9.67	28.99	15.05	56.00	46.00	-27.01	-30.95	Pass

Note: 1. Result (dBuV/m) = Correct Factor (dB/m) + Reading(dBuV).

2. Correction factor (dB) = Cable loss (dB) + L.I.S.N. factor (dB).



6 Radiated Interference Measurement

■ Limit

According to §15.209(a), except as provided elsewhere in this subpart, the emissions from an intentional radiator shall not exceed the field strength levels specified in the following table:

Frequency (MHz)	Field Strength ($\mu\text{V}/\text{m}$ at meter)	Measurement Distance (meters)
0.009 – 0.490	2400 / F (kHz)	300
0.490 – 1.705	24000 / F (kHz)	30
1.705 – 30.0	30	30
30 - 88	100**	3
88-216	150**	3
216-960	200**	3
Above 960	500	3

** Except as provided in paragraph (g), fundamental emissions from intentional radiators operating under this Section shall not be located in the frequency bands 54-72 MHz, 76-88 MHz, 174-216 MHz or 470-806 MHz. However, operation within these frequency bands is permitted under other sections of this Part, e.g., Sections 15.231 and 15.241.

■ Test Instruments

3 Meter Chamber					
Equipment	Manufacturer	Model Number	Serial Number	Cal. Date	Cal. Period
RF Pre-selector	Agilent	N9039A	MY46520256	01/08/2016	1 year
Spectrum Analyzer	Agilent	E4446A	MY46180578	01/08/2016	1 year
Pre Amplifier	Agilent	8449B	3008A02237	10/11/2016	1 year
Pre Amplifier	Agilent	8447D	2944A11119	01/11/2016	1 year
Broadband Antenna	Schwarzbeck	VULB9168	416	10/13/2016	1 year
Horn Antenna (1~18GHz)	SCHWARZBECK MESS-ELEKTRONIK	BBHA9120D	9120D-550	06/06/2016	1 year
Horn Antenna (18~40GHz)	ETS	3116	86467	09/05/2016	1 year
Loop Antenna	COM-POWER CORPORATION	AL-130	121014	02/01/2016	1 year
Microwave Cable	EMCI	EMC102-KM-KM-14000	151001	02/23/2016	1 year
Microwave Cable	EMCI	EMC-104-SM-SM-14000	140202	02/23/2016	1 year
Microwave Cable	EMCI	EMC104-SM-SM-600	140301	02/23/2016	1 year
Test Site	ATL	TE01	888001	08/29/2016	1 year

Note: N.C.R. = No Calibration Request.

■ **Setup**

9kHz ~ 30MHz

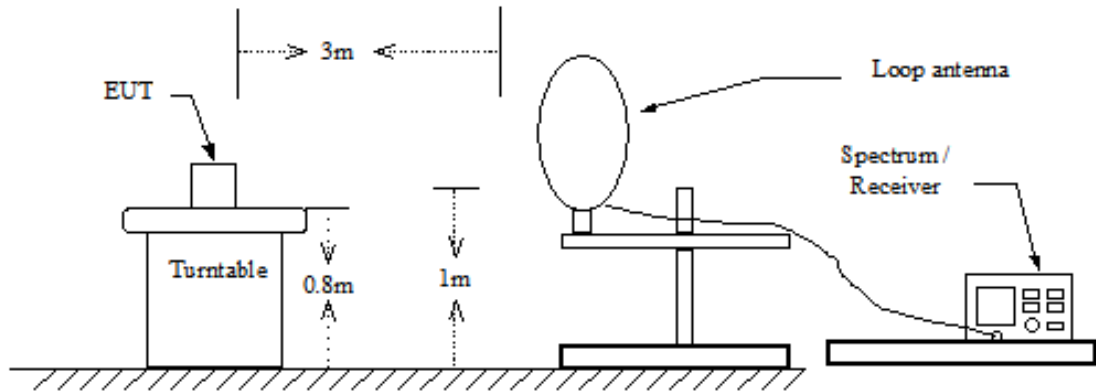

Below 1GHz

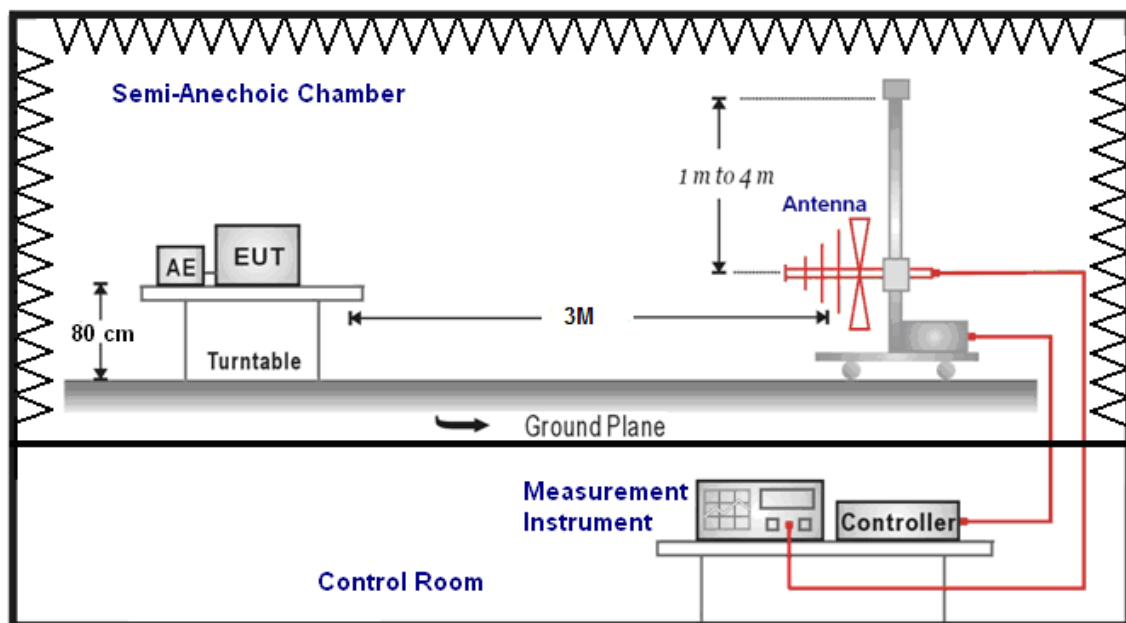

Above 1GHz

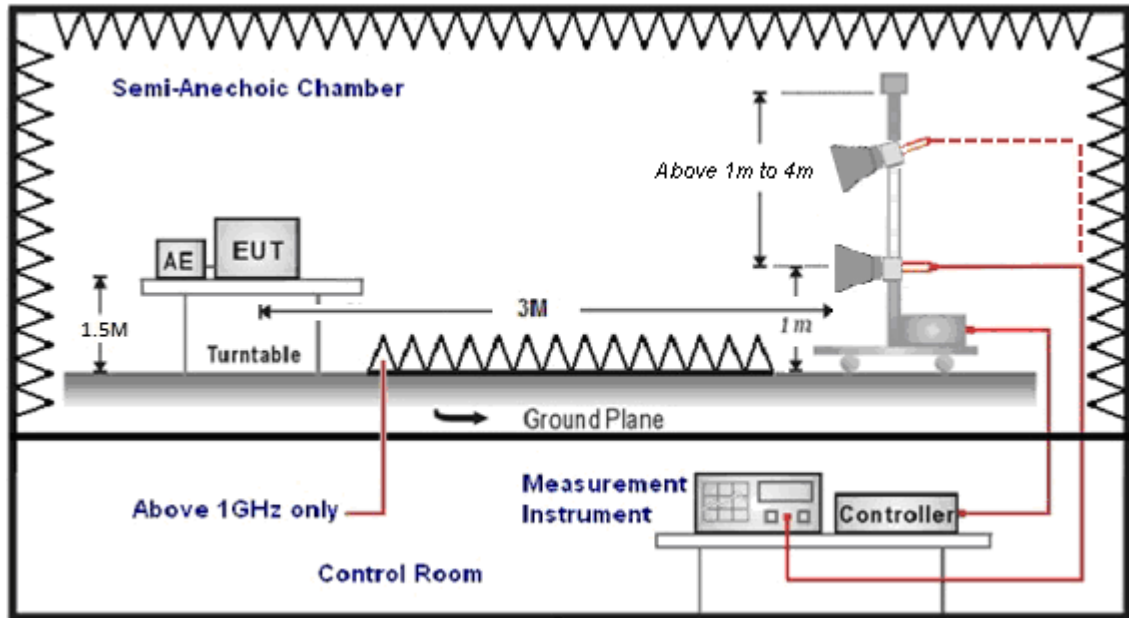



■ Test Procedure

Final radiation measurements were made on a three-meter, Semi Anechoic Chamber. The EUT system was placed on a nonconductive turntable which is 0.8 or 1.5 meters height (below 1GHz use 0.8m turntable / above 1GHz use 1.5m turntable), top surface 1.0 x 1.5 meter. The spectrum was examined from 250 MHz to 2.5 GHz in order to cover the whole spectrum below 10th harmonic which could generate from the EUT. During the test, EUT was set to transmit continuously & Measurements spectrum range from 9 kHz to 26.5 GHz is investigated.

For measurements below 1 GHz the resolution bandwidth is set to 100 kHz for peak detection measurements or 120 kHz for quasi-peak detection measurements. Peak detection is used unless otherwise noted as quasi-peak.

For measurements above 1 GHz the resolution bandwidth is set to 1 MHz, and then the video bandwidth is set to 1 MHz for peak measurements and 10 Hz for average measurements.

A nonconductive material surrounded the EUT to supporting the EUT for standing on three orthogonal planes. At each condition, the EUT was rotated 360 degrees, and the antenna was raised and lowered from one to four meters to find the maximum emission levels. Measurements were taken using both horizontal and vertical antenna polarization.

SCHWARZBECK MESS-ELEKTRONIK Biconilog Antenna at 3 Meter and the SCHWARZBECK Double Ridged Guide Antenna was used in frequencies 1 – 26.5 GHz at a distance of 1 meter. All test results were extrapolated to equivalent signal at 3 meters utilizing an inverse linear distance extrapolation Factor (20dB/decade).

For testing above 1GHz, the emission level of the EUT in peak mode was 20dB lower than average limit (that means the emission level in peak mode also complies with the limit in average mode), then testing will be stopped and peak values of EUT will be reported, otherwise, the emissions will be measured in average mode again and reported.

Appropriate preamplifiers were used for improving sensitivity and precautions were taken to avoid overloading or desensitizing the spectrum analyzer. No post – detector video filters were used in the test.

The spectrum analyzer's 6 dB bandwidth was set to 1 MHz, and the analyzer was operated in the peak detection mode, for frequencies both below and up 1 GHz. The average levels were obtained by subtracting the duty cycle correction factor from the peak readings.

The following procedures were used to convert the emission levels measured in decibels referenced to 1 microvolt (dBuV) into field intensity in micro volts per meter (uV/m).

The actual field intensity in decibels referenced to 1 microvolt in to field intensity in micro volts per meter (dBuV/m).

The actual field intensity in decibels referenced to 1 microvolt per meter (dBuV/m) is determined by algebraically adding the measured reading in dBuV, the antenna factor (dB), and cable loss (dB) and Subtracting the gain of preamplifier (dB) is auto calculate in spectrum analyzer.

$$(1) \text{ Amplitude (dBuV/m) = FI (dBuV) + AF (dBuV) + CL (dBuV) - Gain (dB)}$$

FI= Reading of the field intensity.

AF= Antenna factor.

CL= Cable loss.

P.S Amplitude is auto calculate in spectrum analyzer.

$$(2) \text{ Actual Amplitude (dBuV/m) = Amplitude (dBuV) - Dis(dB)}$$

The FCC specified emission limits were calculated according the EUT operating frequency and by following linear interpolation equations:

(a) For fundamental frequency : Transmitter Output < +30dBm

(b) For spurious frequency : Spurious emission limits = fundamental emission limit /10

Data of measurement within this frequency range without mark in the table above means the reading of emissions are attenuated more than 20dB below the permissible limits or the field strength is too small to be measured.



■ Test Result

Below 1GHz

Standard:		FCC Part 15C		Test Distance:		3m	
Test item:		Radiated Emission		Power:		AC 120V/60Hz	
Test Mode:		Mode 1		Temp.(°C)/Hum.(%RH):		26(°C)/60%RH	
				Date:		12/12/2016	
Frequency (MHz)	Reading (dBuV)	Correct Factor (dB/m)	Result (dBuV/m)	Limit (dBuV/m)	Margin (dB)	Remark	Ant.Polar. H / V
221.0000	39.01	-7.35	31.66	46.00	-14.34	QP	H
270.5000	37.92	-4.43	33.49	46.00	-12.51	QP	H
319.5000	39.30	-3.10	36.20	46.00	-9.80	QP	H
344.0000	31.31	-2.77	28.54	46.00	-17.46	QP	H
497.5000	26.78	0.70	27.48	46.00	-18.52	QP	H
737.5000	26.45	5.69	32.14	46.00	-13.86	QP	H
196.5000	36.79	-7.67	29.12	43.50	-14.38	QP	V
270.5000	30.46	-4.43	26.03	46.00	-19.97	QP	V
476.5000	27.60	0.31	27.91	46.00	-18.09	QP	V
551.5000	27.98	1.50	29.48	46.00	-16.52	QP	V
757.0000	27.10	6.12	33.22	46.00	-12.78	QP	V
893.0000	26.27	8.45	34.72	46.00	-11.28	QP	V

Note:1.Result (dBuV/m) = Correct Factor (dB/m) + Reading(dBuV).

2.Correction factor (dB/m) = Antenna Factor (dB/m) + Cable loss (dB) – Pre-Amplifier gain (dB).

3.No emission found between lowest internal used/generated frequencies to 30MHz (9 kHz~30MHz).



Above 1GHz

Standard:	FCC Part 15.247	Test Distance:	3m
Test item:	Harmonic	Power:	AC 120V/60Hz
Frequency:	2402MHz	Temp.(°C)/Hum. (%RH):	26(°C)/60%RH
Mode:	Mode 2	Date:	12/09/2016
Ant.Polar.:	Horizontal		

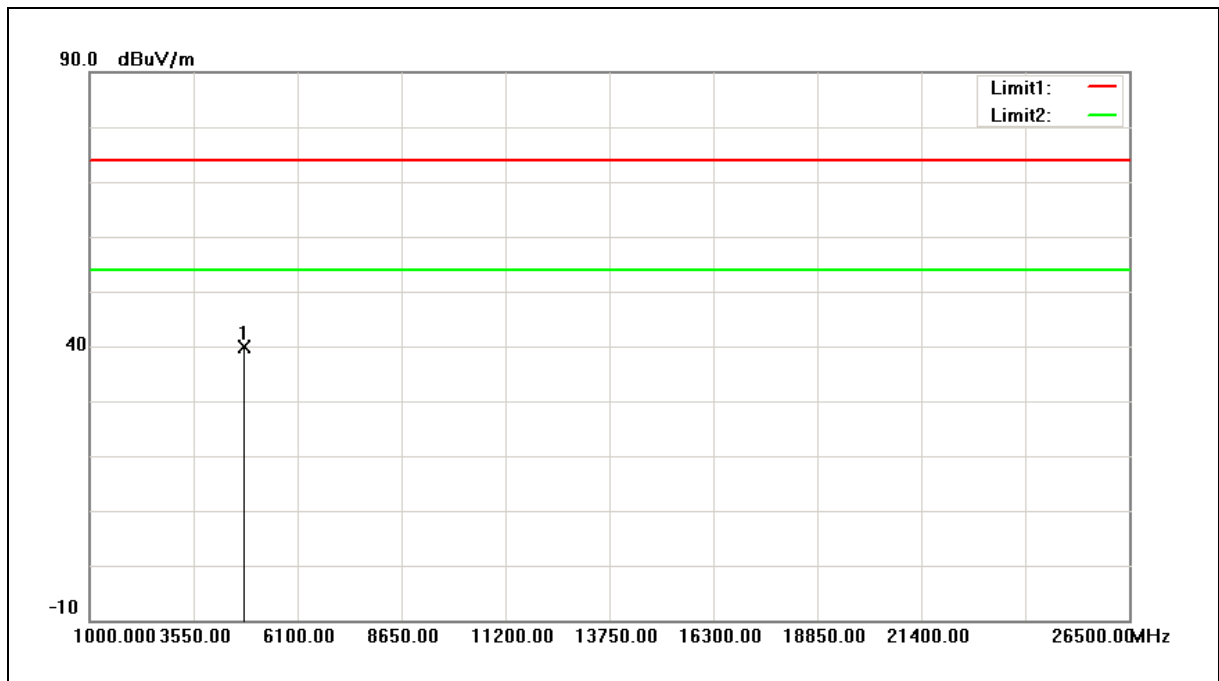

No.	Frequency (MHz)	Reading (dBuV)	Correct Factor (dB/m)	Result (dBuV/m)	Limit (dBuV/m)	Margin (dB)	Remark
1	4804.000	47.98	-8.01	39.97	74.00	-34.03	peak

- Note:1.Result (dBuV/m) = Correct Factor (dB/m) + Reading(dBuV).
 2.Correction factor (dB/m) = Antenna Factor (dB/m) + Cable loss (dB) – Pre-Amplifier gain (dB).
 3. When the peak results are less than average limit, so not need to evaluate the average.



Standard:	FCC Part 15.247	Test Distance:	3m
Test item:	Harmonic	Power:	AC 120V/60Hz
Frequency:	2402MHz	Temp.(°C)/Hum.(%RH):	26(°C)/60%RH
Mode:	Mode 2	Date:	12/09/2016
Ant.Polar.:	Vertical		

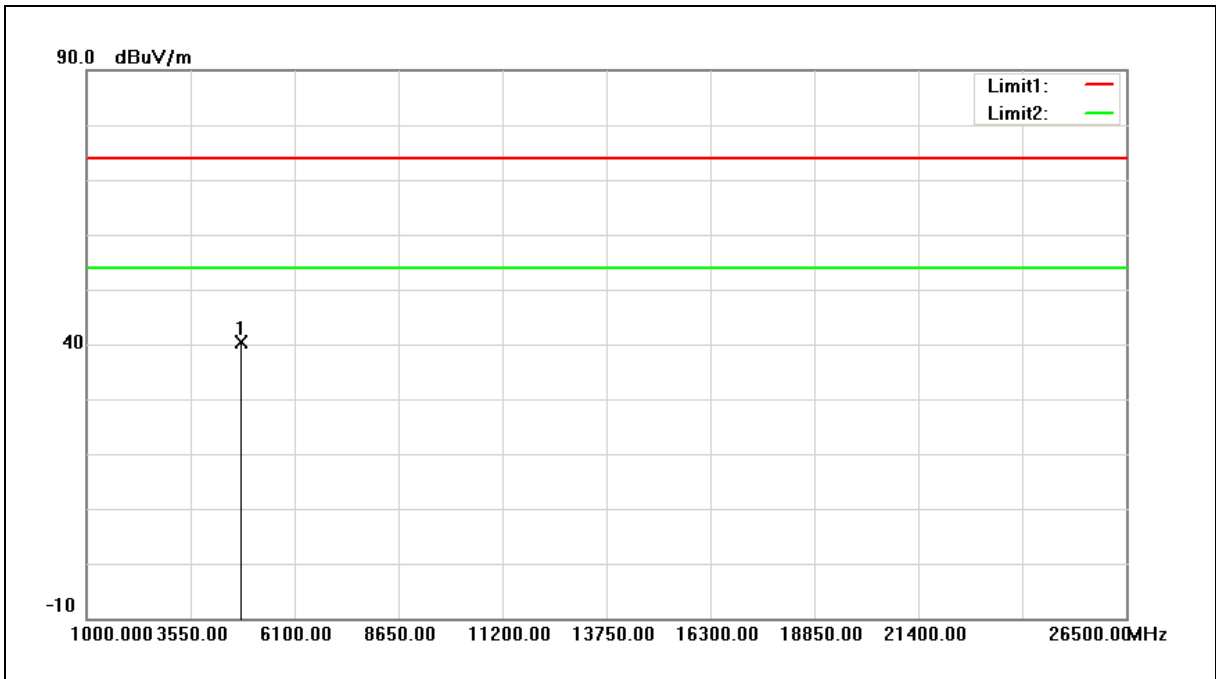

No.	Frequency (MHz)	Reading (dBuV)	Correct Factor (dB/m)	Result (dBuV/m)	Limit (dBuV/m)	Margin (dB)	Remark
1	4804.000	48.48	-8.01	40.47	74.00	-33.53	peak

- Note:1.Result (dBuV/m) = Correct Factor (dB/m) + Reading(dBuV).
 2.Correction factor (dB/m) = Antenna Factor (dB/m) + Cable loss (dB) – Pre-Amplifier gain (dB).
 3. When the peak results are less than average limit, so not need to evaluate the average.



Standard:	FCC Part 15.247	Test Distance:	3m
Test item:	Harmonic	Power:	AC 120V/60Hz
Frequency:	2441MHz	Temp.(°C)/Hum.(%RH):	26(°C)/60%RH
Mode:	Mode 2	Date:	12/09/2016
Ant.Polar.:	Horizontal		

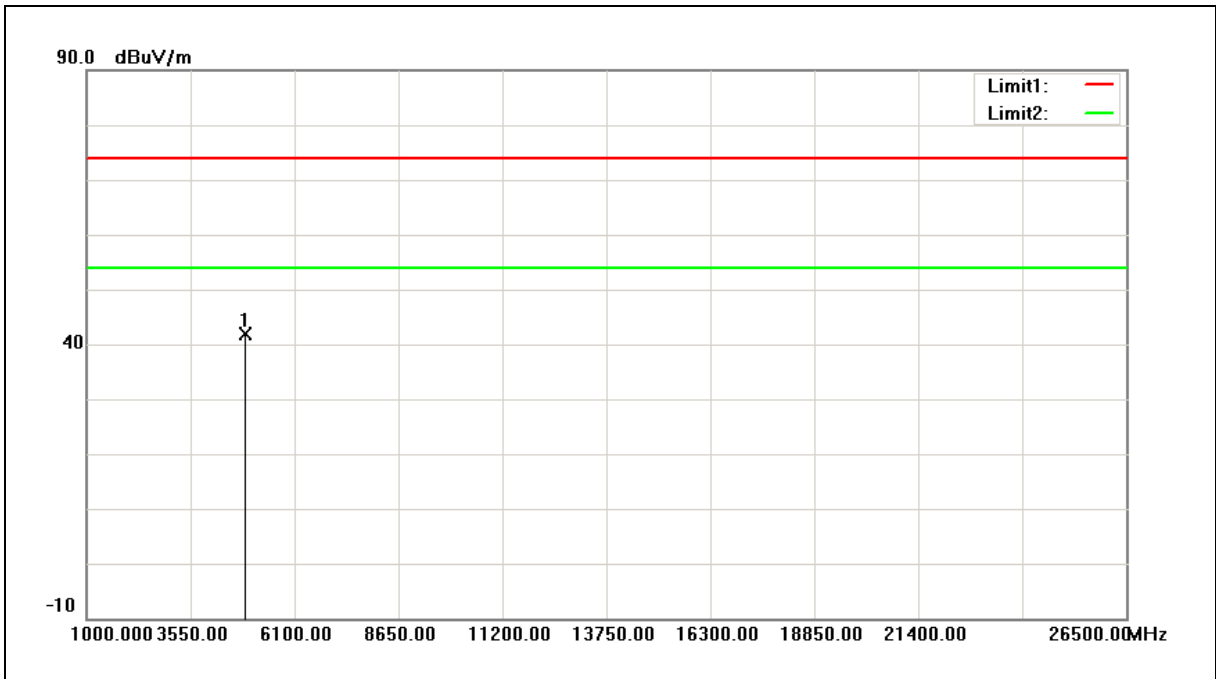

No.	Frequency (MHz)	Reading (dBuV)	Correct Factor (dB/m)	Result (dBuV/m)	Limit (dBuV/m)	Margin (dB)	Remark
1	4882.000	49.60	-7.77	41.83	74.00	-32.17	peak

- Note:1.Result (dBuV/m) = Correct Factor (dB/m) + Reading(dBuV).
 2.Correction factor (dB/m) = Antenna Factor (dB/m) + Cable loss (dB) – Pre-Amplifier gain (dB).
 3. When the peak results are less than average limit, so not need to evaluate the average.



Standard:	FCC Part 15.247	Test Distance:	3m
Test item:	Harmonic	Power:	AC 120V/60Hz
Frequency:	2441MHz	Temp.(°C)/Hum. (%RH):	26(°C)/60%RH
Mode:	Mode 2	Date:	12/09/2016
Ant.Polar.:	Vertical		

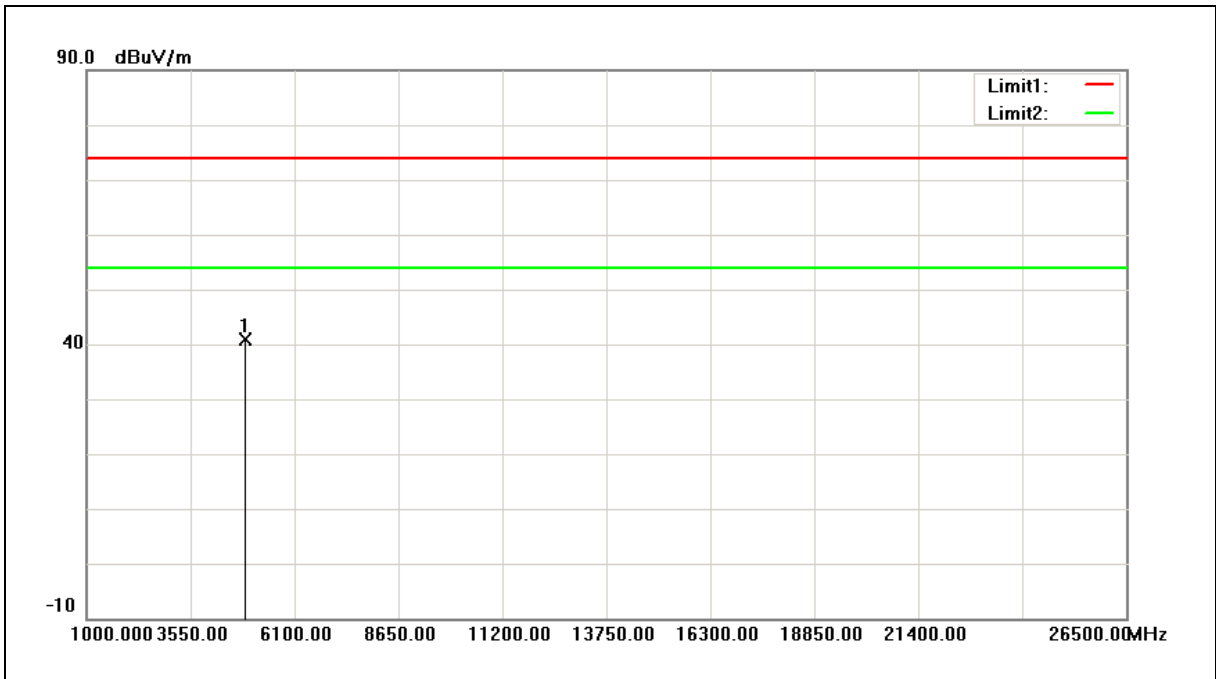

No.	Frequency (MHz)	Reading (dBuV)	Correct Factor (dB/m)	Result (dBuV/m)	Limit (dBuV/m)	Margin (dB)	Remark
1	4882.000	48.64	-7.77	40.87	74.00	-33.13	peak

- Note:1.Result (dBuV/m) = Correct Factor (dB/m) + Reading(dBuV).
- 2.Correction factor (dB/m) = Antenna Factor (dB/m) + Cable loss (dB) – Pre-Amplifier gain (dB).
3. When the peak results are less than average limit, so not need to evaluate the average.



Standard:	FCC Part 15.247	Test Distance:	3m
Test item:	Harmonic	Power:	AC 120V/60Hz
Frequency:	2480MHz	Temp.(°C)/Hum.(%RH):	26(°C)/60%RH
Mode:	Mode 2	Date:	12/09/2016
Ant.Polar.:	Horizontal		

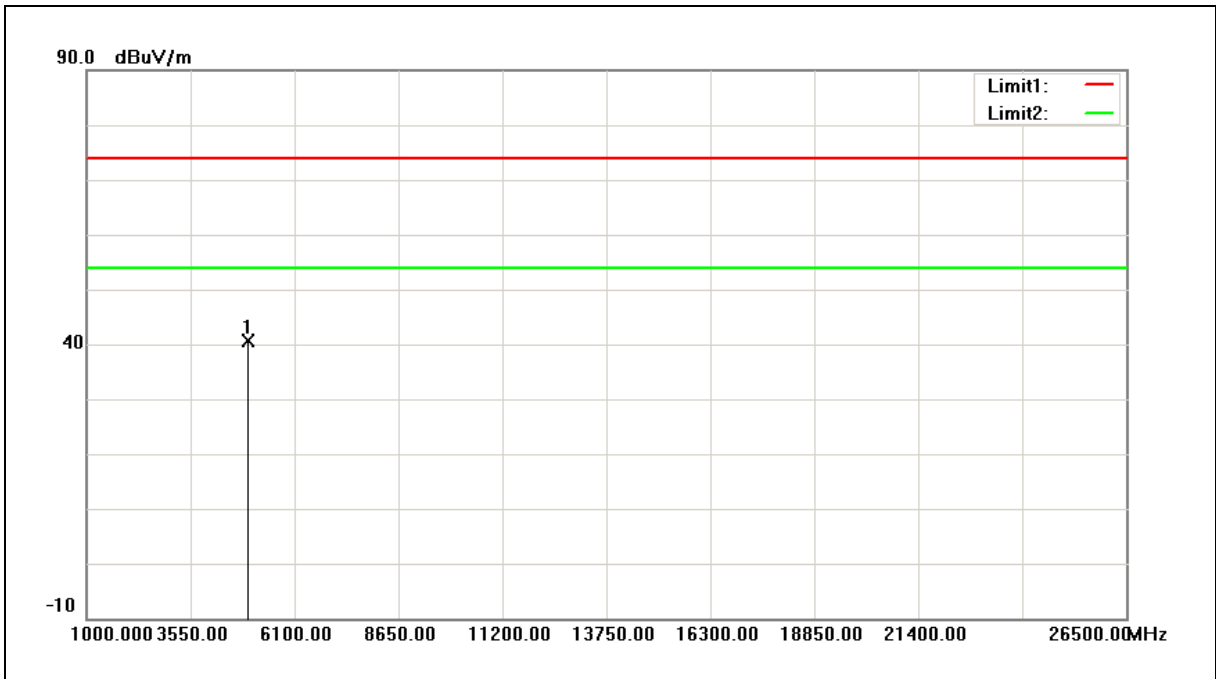

No.	Frequency (MHz)	Reading (dBuV)	Correct Factor (dB/m)	Result (dBuV/m)	Limit (dBuV/m)	Margin (dB)	Remark
1	4960.000	48.11	-7.52	40.59	74.00	-33.41	peak

- Note:1.Result (dBuV/m) = Correct Factor (dB/m) + Reading(dBuV).
 2.Correction factor (dB/m) = Antenna Factor (dB/m) + Cable loss (dB) – Pre-Amplifier gain (dB).
 3. When the peak results are less than average limit, so not need to evaluate the average.



Standard:	FCC Part 15.247	Test Distance:	3m
Test item:	Harmonic	Power:	AC 120V/60Hz
Frequency:	2480MHz	Temp.(°C)/Hum.(%RH):	26(°C)/60%RH
Mode:	Mode 2	Date:	12/09/2016
Ant.Polar.:	Vertical		

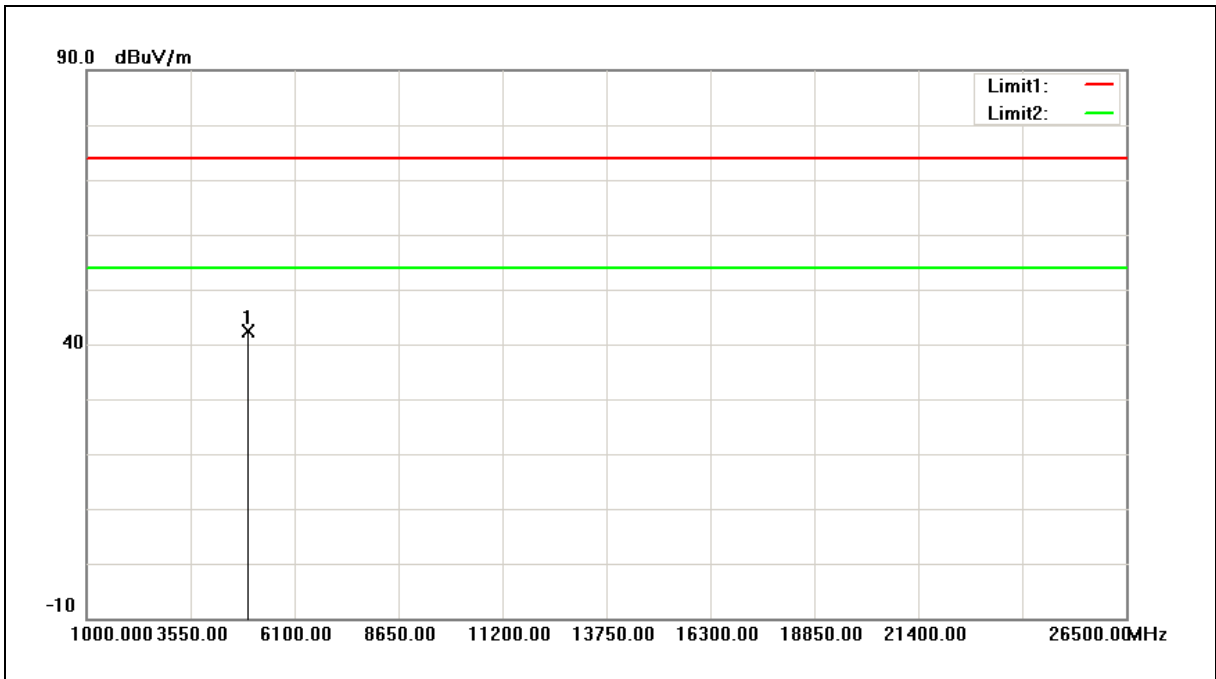

No.	Frequency (MHz)	Reading (dBuV)	Correct Factor (dB/m)	Result (dBuV/m)	Limit (dBuV/m)	Margin (dB)	Remark
1	4960.000	49.99	-7.52	42.47	74.00	-31.53	peak

- Note:1.Result (dBuV/m) = Correct Factor (dB/m) + Reading(dBuV).
- 2.Correction factor (dB/m) = Antenna Factor (dB/m) + Cable loss (dB) – Pre-Amplifier gain (dB).
3. When the peak results are less than average limit, so not need to evaluate the average.



Standard:	FCC Part 15.247	Test Distance:	3m
Test item:	Harmonic	Power:	AC 120V/60Hz
Frequency:	2402MHz	Temp.(°C)/Hum.(%RH):	26(°C)/60%RH
Mode:	Mode 4	Date:	12/09/2016
Ant.Polar.:	Horizontal		

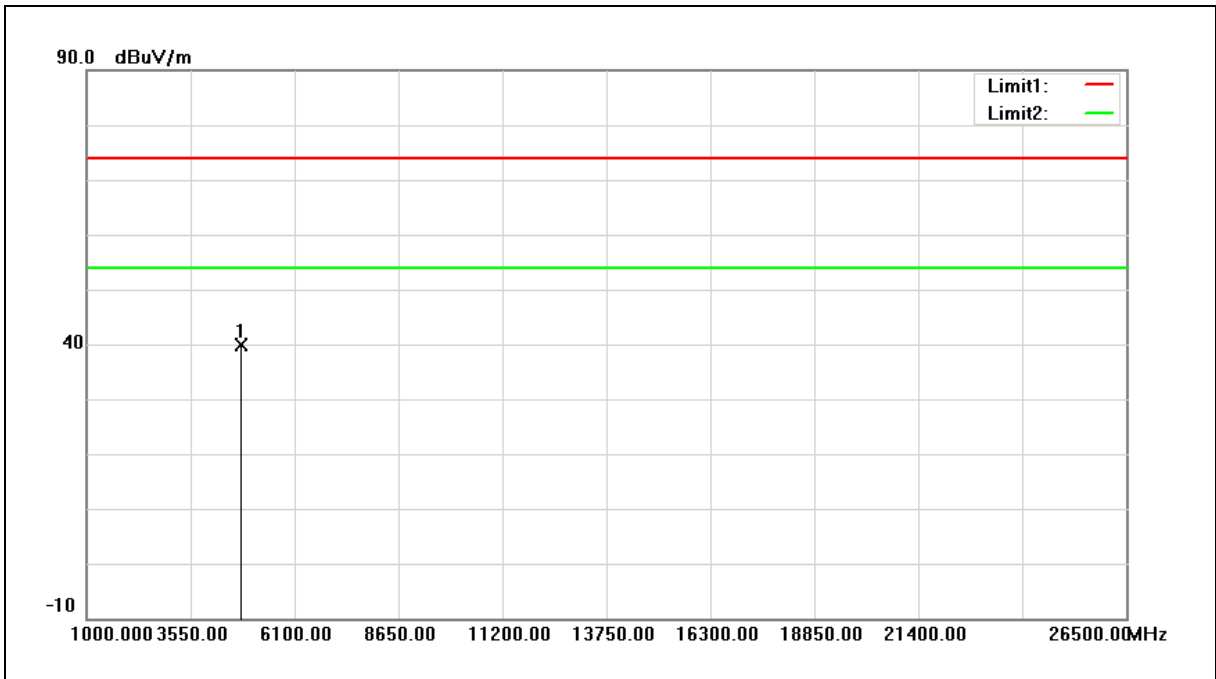

No.	Frequency (MHz)	Reading (dBuV)	Correct Factor (dB/m)	Result (dBuV/m)	Limit (dBuV/m)	Margin (dB)	Remark
1	4804.000	47.98	-8.01	39.97	74.00	-34.03	peak

- Note:1.Result (dBuV/m) = Correct Factor (dB/m) + Reading(dBuV).
 2.Correction factor (dB/m) = Antenna Factor (dB/m) + Cable loss (dB) – Pre-Amplifier gain (dB).
 3. When the peak results are less than average limit, so not need to evaluate the average.



Standard:	FCC Part 15.247	Test Distance:	3m
Test item:	Harmonic	Power:	AC 120V/60Hz
Frequency:	2402MHz	Temp.(°C)/Hum.(%RH):	26(°C)/60%RH
Mode:	Mode 4	Date:	12/09/2016
Ant.Polar.:	Vertical		

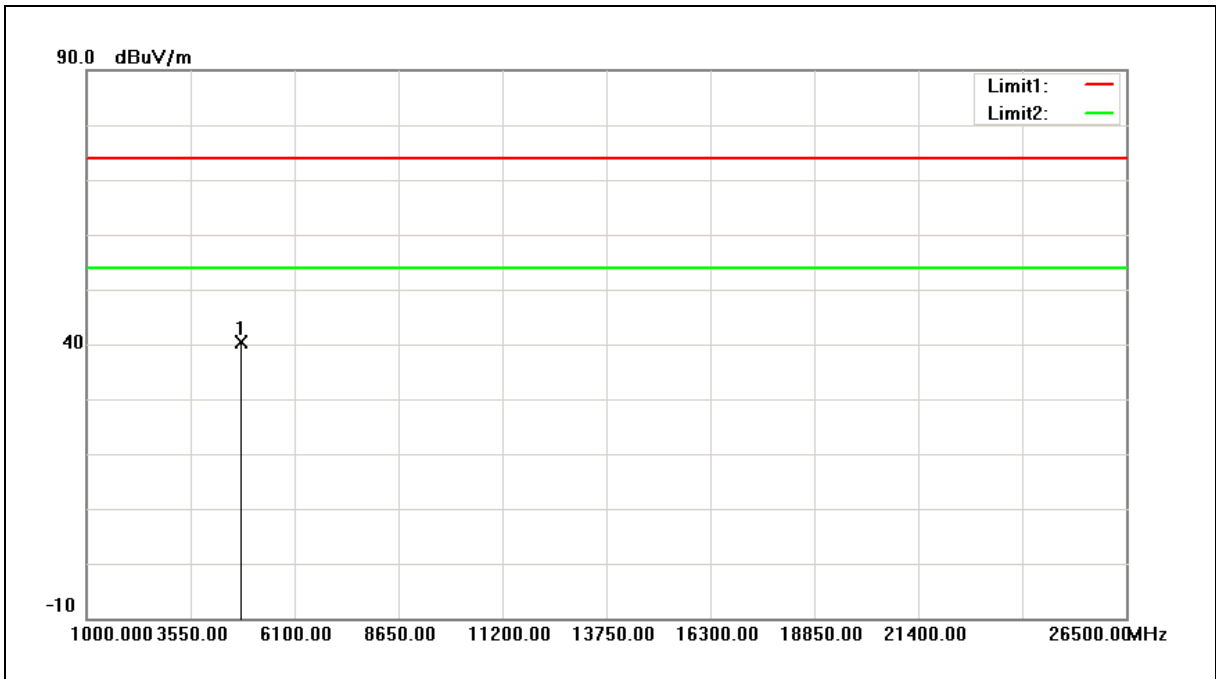

No.	Frequency (MHz)	Reading (dBuV)	Correct Factor (dB/m)	Result (dBuV/m)	Limit (dBuV/m)	Margin (dB)	Remark
1	4804.000	48.48	-8.01	40.47	74.00	-33.53	peak

- Note:1.Result (dBuV/m) = Correct Factor (dB/m) + Reading(dBuV).
 2.Correction factor (dB/m) = Antenna Factor (dB/m) + Cable loss (dB) – Pre-Amplifier gain (dB).
 3. When the peak results are less than average limit, so not need to evaluate the average.



Standard:	FCC Part 15.247	Test Distance:	3m
Test item:	Harmonic	Power:	AC 120V/60Hz
Frequency:	2441MHz	Temp.(°C)/Hum.(%RH):	26(°C)/60%RH
Mode:	Mode 4	Date:	12/09/2016
Ant.Polar.:	Horizontal		

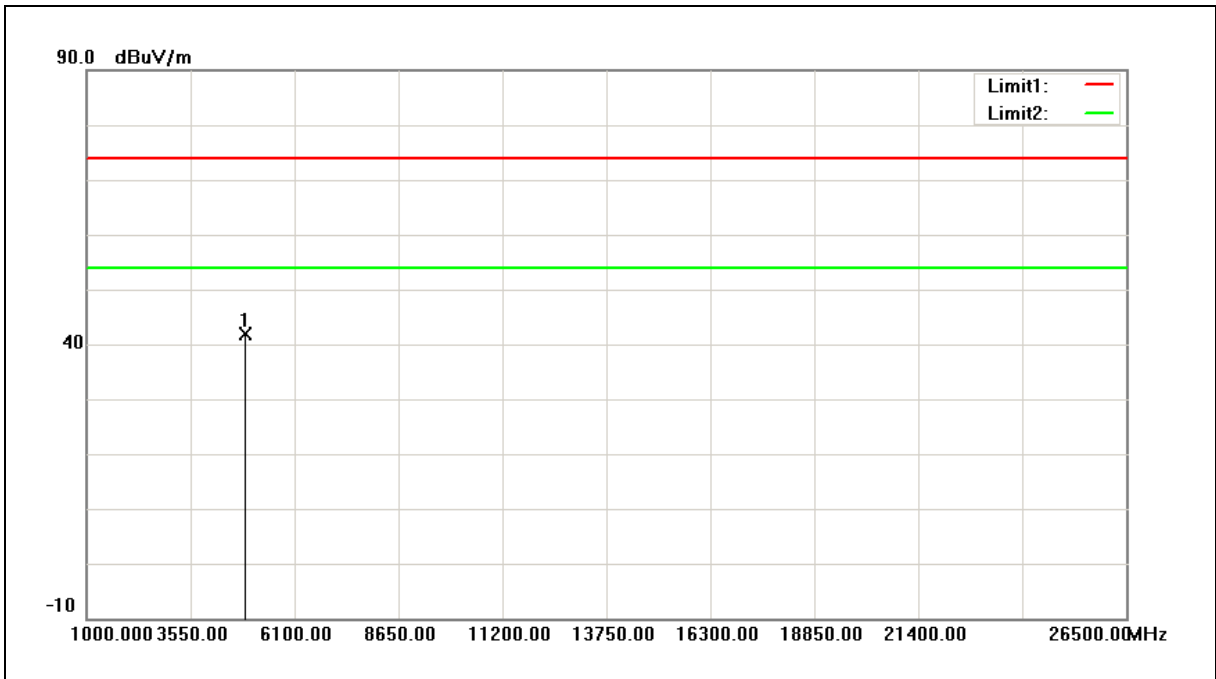

No.	Frequency (MHz)	Reading (dBuV)	Correct Factor (dB/m)	Result (dBuV/m)	Limit (dBuV/m)	Margin (dB)	Remark
1	4882.000	49.60	-7.77	41.83	74.00	-32.17	peak

- Note:1.Result (dBuV/m) = Correct Factor (dB/m) + Reading(dBuV).
 2.Correction factor (dB/m) = Antenna Factor (dB/m) + Cable loss (dB) – Pre-Amplifier gain (dB).
 3. When the peak results are less than average limit, so not need to evaluate the average.



Standard:	FCC Part 15.247	Test Distance:	3m
Test item:	Harmonic	Power:	AC 120V/60Hz
Frequency:	2441MHz	Temp.(°C)/Hum.(%RH):	26(°C)/60%RH
Mode:	Mode 4	Date:	12/09/2016
Ant.Polar.:	Vertical		

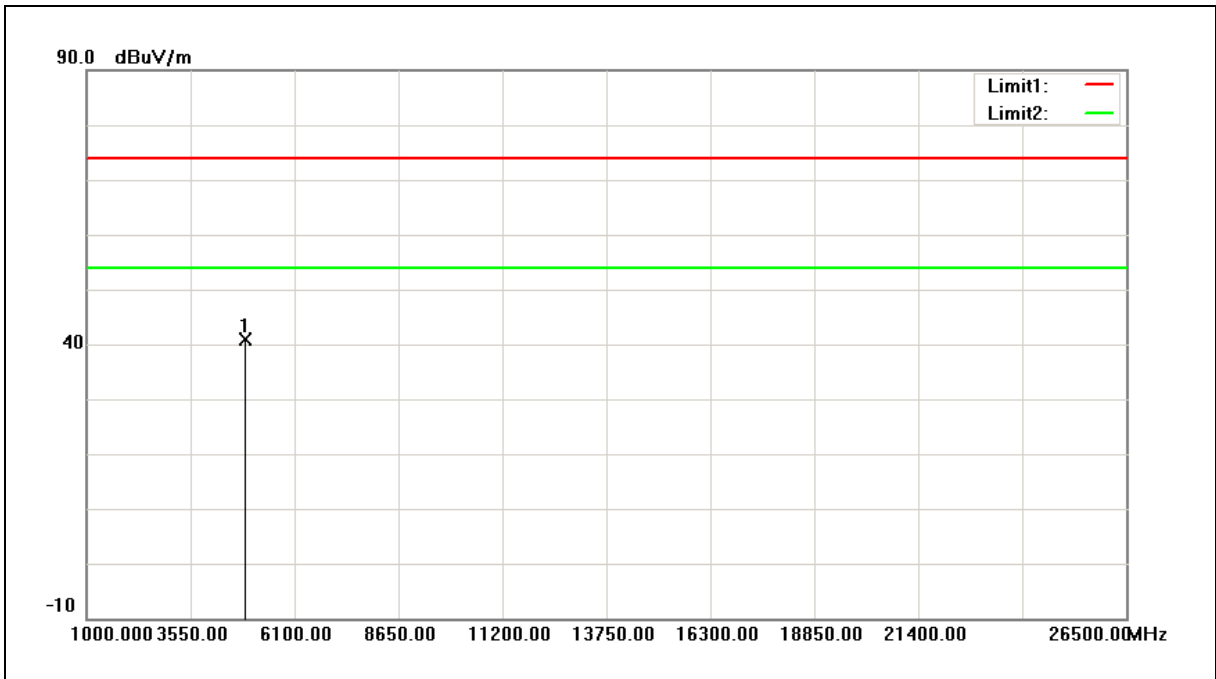

No.	Frequency (MHz)	Reading (dBuV)	Correct Factor (dB/m)	Result (dBuV/m)	Limit (dBuV/m)	Margin (dB)	Remark
1	4882.000	48.64	-7.77	40.87	74.00	-33.13	peak

- Note:1.Result (dBuV/m) = Correct Factor (dB/m) + Reading(dBuV).
- 2.Correction factor (dB/m) = Antenna Factor (dB/m) + Cable loss (dB) – Pre-Amplifier gain (dB).
3. When the peak results are less than average limit, so not need to evaluate the average.



Standard:	FCC Part 15.247	Test Distance:	3m
Test item:	Harmonic	Power:	AC 120V/60Hz
Frequency:	2480MHz	Temp.(°C)/Hum.(%RH):	26(°C)/60%RH
Mode:	Mode 4	Date:	12/09/2016
Ant.Polar.:	Horizontal		

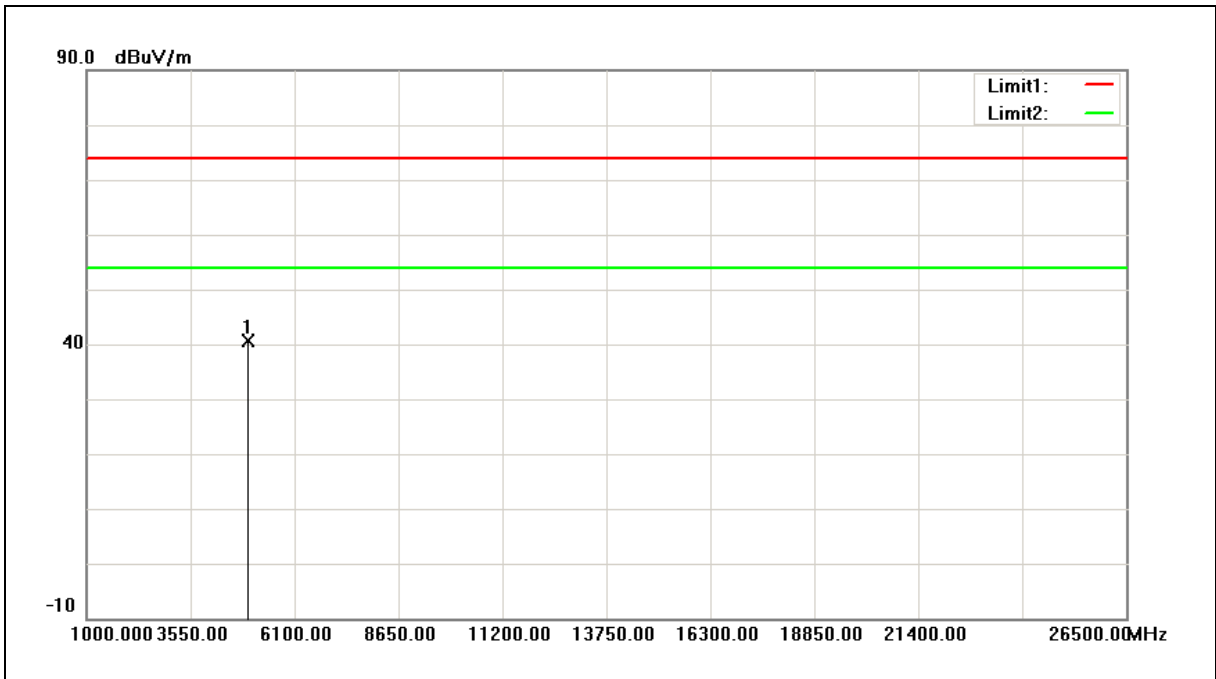

No.	Frequency (MHz)	Reading (dBuV)	Correct Factor (dB/m)	Result (dBuV/m)	Limit (dBuV/m)	Margin (dB)	Remark
1	4960.000	48.11	-7.52	40.59	74.00	-33.41	peak

- Note:1.Result (dBuV/m) = Correct Factor (dB/m) + Reading(dBuV).
 2.Correction factor (dB/m) = Antenna Factor (dB/m) + Cable loss (dB) – Pre-Amplifier gain (dB).
 3. When the peak results are less than average limit, so not need to evaluate the average.



Standard:	FCC Part 15.247	Test Distance:	3m
Test item:	Harmonic	Power:	AC 120V/60Hz
Frequency:	2480MHz	Temp.(°C)/Hum.(%RH):	26(°C)/60%RH
Mode:	Mode 4	Date:	12/09/2016
Ant.Polar.:	Vertical		

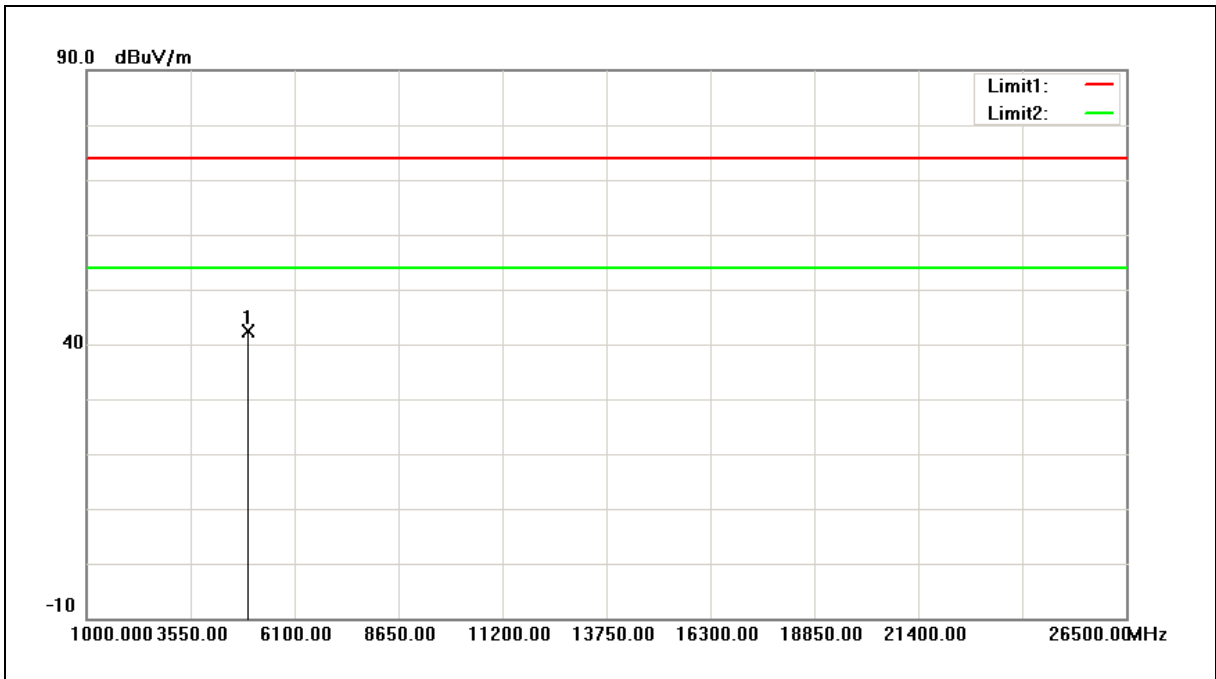

No.	Frequency (MHz)	Reading (dBuV)	Correct Factor (dB/m)	Result (dBuV/m)	Limit (dBuV/m)	Margin (dB)	Remark
1	4960.000	49.99	-7.52	42.47	74.00	-31.53	peak

- Note:1.Result (dBuV/m) = Correct Factor (dB/m) + Reading(dBuV).
- 2.Correction factor (dB/m) = Antenna Factor (dB/m) + Cable loss (dB) – Pre-Amplifier gain (dB).
3. When the peak results are less than average limit, so not need to evaluate the average.



Band Edge

Standard:	FCC Part 15.247	Test Distance:	3m
Test item:	Band edge	Power:	AC 120V/60Hz
Frequency:	2402MHz	Temp.(°C)/Hum. (%RH):	26(°C)/60%RH
Mode:	Mode 2	Date:	12/09/2016
Ant.Polar.:	Horizontal		

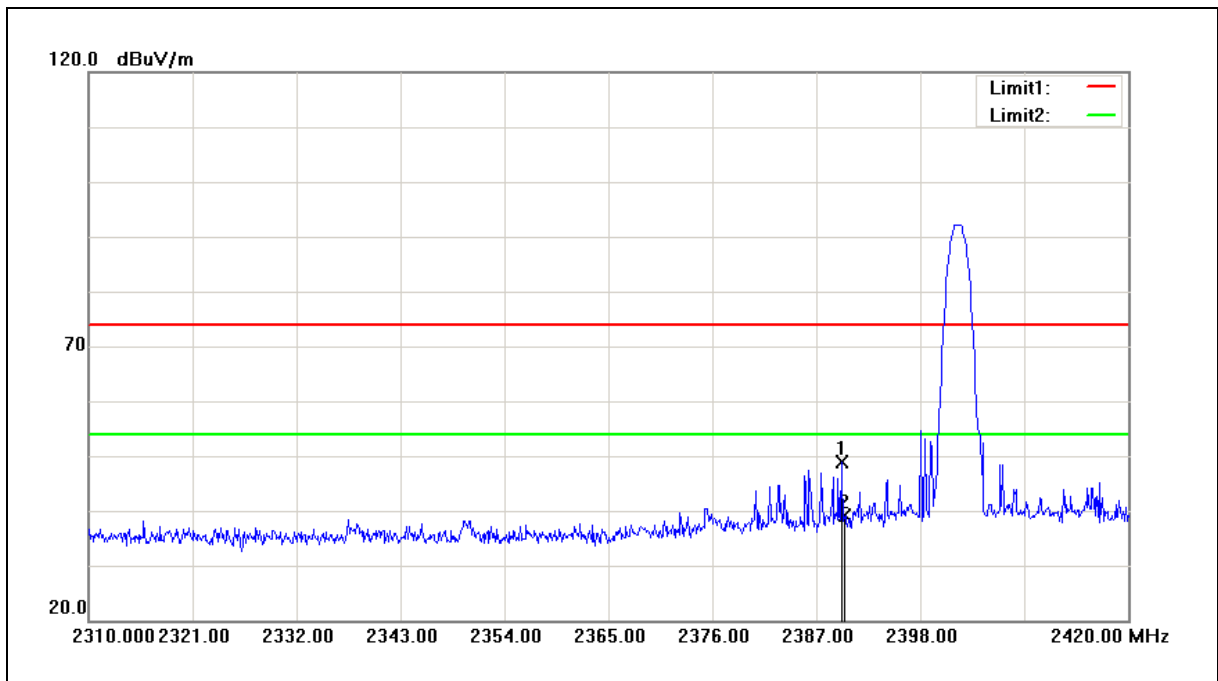

No.	Frequency (MHz)	Reading (dBuV)	Correct Factor (dB/m)	Result (dBuV/m)	Limit (dBuV/m)	Margin (dB)	Remark
1	2389.640	49.23	-0.26	48.97	74.00	-25.03	peak
2	2390.000	39.31	-0.26	39.05	74.00	-34.95	peak

Note:1.Result (dBuV/m) = Correct Factor (dB/m) + Reading(dBuV).

2.Correction factor (dB/m) = Antenna Factor (dB/m) + Cable loss (dB) – Pre-Amplifier gain (dB).

3. When the peak results are less than average limit, so not need to evaluate the average.



Standard:	FCC Part 15.247	Test Distance:	3m
Test item:	Band edge	Power:	AC 120V/60Hz
Frequency:	2402MHz	Temp.(°C)/Hum.(%RH):	26(°C)/60%RH
Mode:	Mode 2	Date:	12/09/2016
Ant.Polar.:	Vertical		

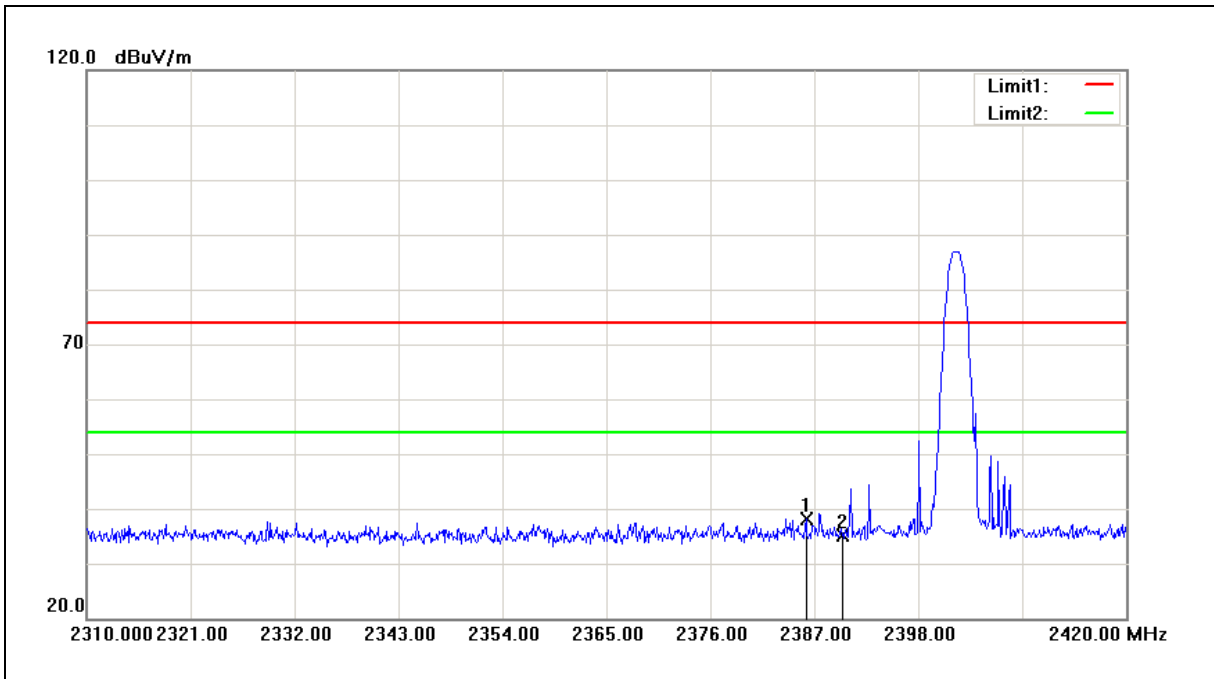

No.	Frequency (MHz)	Reading (dBuV)	Correct Factor (dB/m)	Result (dBuV/m)	Limit (dBuV/m)	Margin (dB)	Remark
1	2386.120	38.48	-0.28	38.20	74.00	-35.80	peak
2	2390.000	35.42	-0.26	35.16	74.00	-38.84	peak

Note:1.Result (dBuV/m) = Correct Factor (dB/m) + Reading(dBuV).

2.Correction factor (dB/m) = Antenna Factor (dB/m) + Cable loss (dB) – Pre-Amplifier gain (dB).

3. When the peak results are less than average limit, so not need to evaluate the average.



Standard:	FCC Part 15.247	Test Distance:	3m
Test item:	Band edge	Power:	AC 120V/60Hz
Frequency:	2480MHz	Temp.(°C)/Hum.(%RH):	26(°C)/60%RH
Mode:	Mode 2	Date:	12/09/2016
Ant.Polar.:	Horizontal		

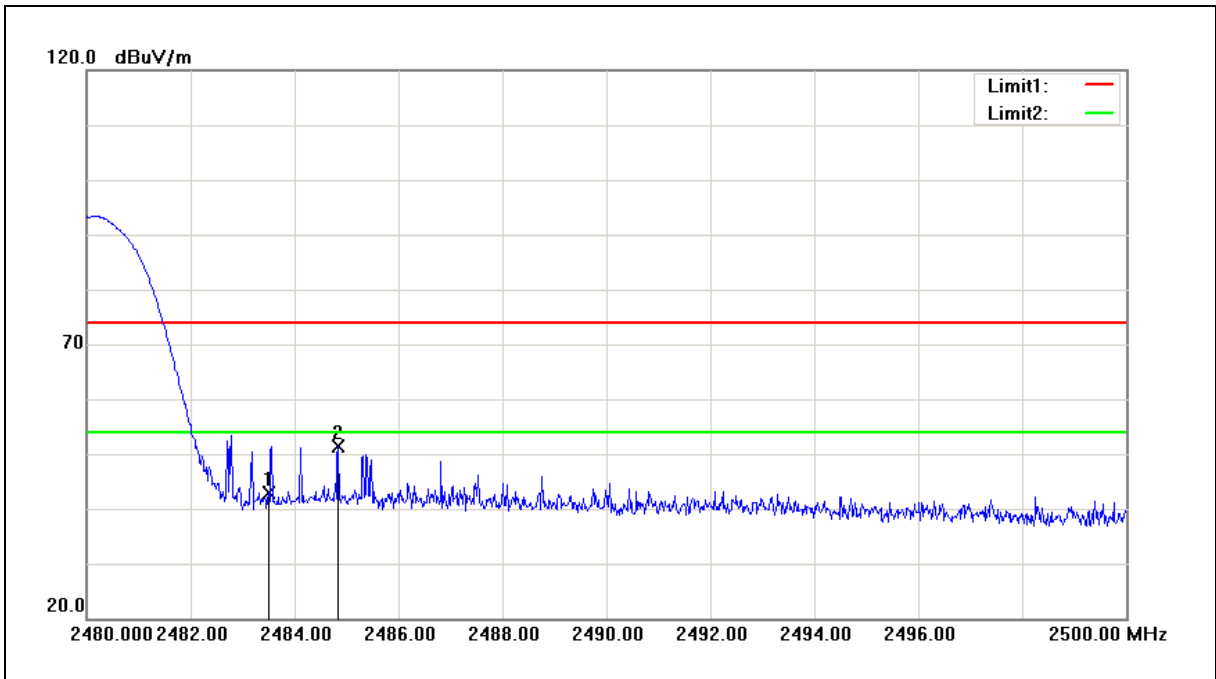

No.	Frequency (MHz)	Reading (dBuV)	Correct Factor (dB/m)	Result (dBuV/m)	Limit (dBuV/m)	Margin (dB)	Remark
1	2483.500	42.65	0.11	42.76	74.00	-31.24	peak
2	2484.840	51.38	0.12	51.50	74.00	-22.50	peak

- Note:1.Result (dBuV/m) = Correct Factor (dB/m) + Reading(dBuV).
- 2.Correction factor (dB/m) = Antenna Factor (dB/m) + Cable loss (dB) – Pre-Amplifier gain (dB).
3. When the peak results are less than average limit, so not need to evaluate the average.



Standard:	FCC Part 15.247	Test Distance:	3m
Test item:	Band edge	Power:	AC 120V/60Hz
Frequency:	2480MHz	Temp.(°C)/Hum.(%RH):	26(°C)/60%RH
Mode:	Mode 2	Date:	12/09/2016
Ant.Polar.:	Vertical		

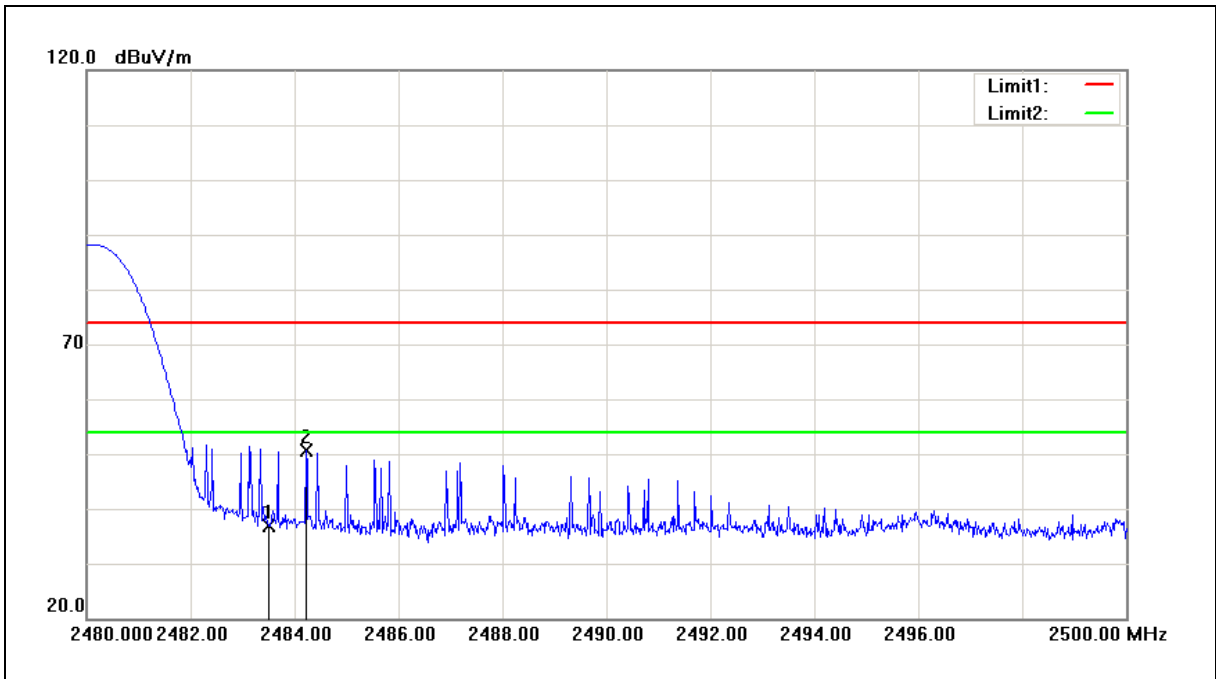

No.	Frequency (MHz)	Reading (dBuV)	Correct Factor (dB/m)	Result (dBuV/m)	Limit (dBuV/m)	Margin (dB)	Remark
1	2483.500	36.89	0.11	37.00	74.00	-37.00	peak
2	2484.220	50.48	0.12	50.60	74.00	-23.40	peak

- Note:1.Result (dBuV/m) = Correct Factor (dB/m) + Reading(dBuV).
 2.Correction factor (dB/m) = Antenna Factor (dB/m) + Cable loss (dB) – Pre-Amplifier gain (dB).
 3. When the peak results are less than average limit, so not need to evaluate the average.



Standard:	FCC Part 15.247	Test Distance:	3m
Test item:	Band edge	Power:	AC 120V/60Hz
Frequency:	Hopping	Temp.(°C)/Hum.(%RH):	26(°C)/60%RH
Mode:	Mode 2	Date:	12/09/2016
Ant.Polar.:	Horizontal		

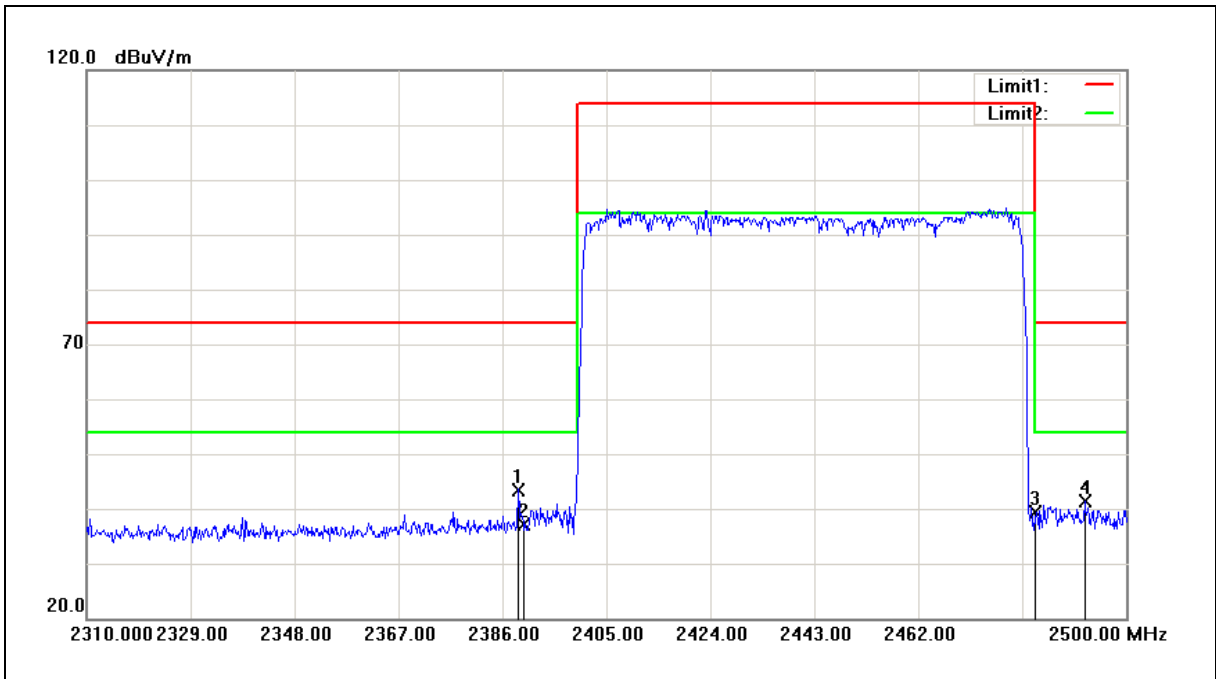

No.	Frequency (MHz)	Reading (dBuV)	Correct Factor (dB/m)	Result (dBuV/m)	Limit (dBuV/m)	Margin (dB)	Remark
1	2388.850	43.76	-0.26	43.50	74.00	-30.50	peak
2	2390.000	37.41	-0.26	37.15	74.00	-36.85	peak
3	2483.500	39.29	0.11	39.40	74.00	-34.60	peak
4	2492.400	41.26	0.15	41.41	74.00	-32.59	peak

Note:1.Result (dBuV/m) = Correct Factor (dB/m) + Reading(dBuV).

2.Correction factor (dB/m) = Antenna Factor (dB/m) + Cable loss (dB) – Pre-Amplifier gain (dB).

3. When the peak results are less than average limit, so not need to evaluate the average.



Standard:	FCC Part 15.247	Test Distance:	3m
Test item:	Band edge	Power:	AC 120V/60Hz
Frequency:	Hopping	Temp.(°C)/Hum.(%RH):	26(°C)/60%RH
Mode:	Mode 2	Date:	12/09/2016
Ant.Polar.:	Vertical		

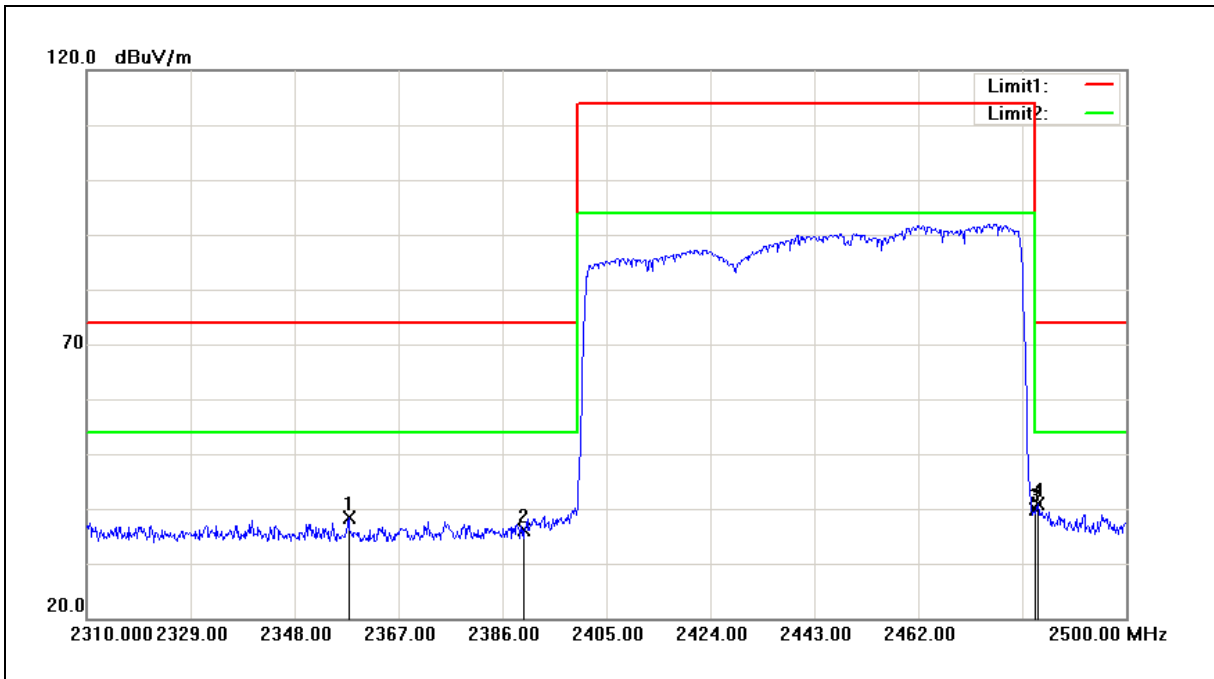

No.	Frequency (MHz)	Reading (dBuV)	Correct Factor (dB/m)	Result (dBuV/m)	Limit (dBuV/m)	Margin (dB)	Remark
1	2357.880	38.66	-0.39	38.27	74.00	-35.73	peak
2	2390.000	36.35	-0.26	36.09	74.00	-37.91	peak
3	2483.500	39.81	0.11	39.92	74.00	-34.08	peak
4	2483.850	40.77	0.11	40.88	74.00	-33.12	peak

Note:1.Result (dBuV/m) = Correct Factor (dB/m) + Reading(dBuV).

2.Correction factor (dB/m) = Antenna Factor (dB/m) + Cable loss (dB) – Pre-Amplifier gain (dB).

3. When the peak results are less than average limit, so not need to evaluate the average.



Standard:	FCC Part 15.247	Test Distance:	3m
Test item:	Band edge	Power:	AC 120V/60Hz
Frequency:	2402MHz	Temp.(°C)/Hum.(%RH):	26(°C)/60%RH
Mode:	Mode 4	Date:	12/09/2016
Ant.Polar.:	Horizontal		

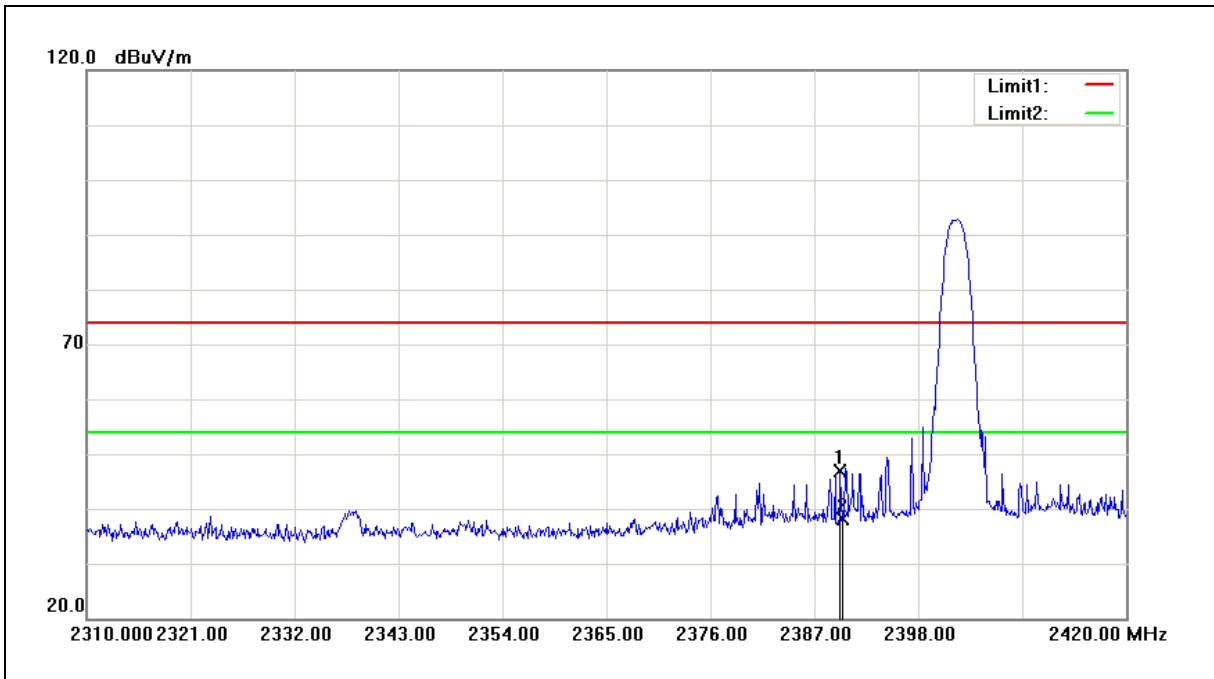

No.	Frequency (MHz)	Reading (dBuV)	Correct Factor (dB/m)	Result (dBuV/m)	Limit (dBuV/m)	Margin (dB)	Remark
1	2389.750	47.25	-0.26	46.99	74.00	-27.01	peak
2	2390.000	38.46	-0.26	38.20	74.00	-35.80	peak

Note:1.Result (dBuV/m) = Correct Factor (dB/m) + Reading(dBuV).

2.Correction factor (dB/m) = Antenna Factor (dB/m) + Cable loss (dB) – Pre-Amplifier gain (dB).

3. When the peak results are less than average limit, so not need to evaluate the average.



Standard:	FCC Part 15.247	Test Distance:	3m
Test item:	Band edge	Power:	AC 120V/60Hz
Frequency:	2402MHz	Temp.(°C)/Hum.(%RH):	26(°C)/60%RH
Mode:	Mode 4	Date:	12/09/2016
Ant.Polar.:	Vertical		

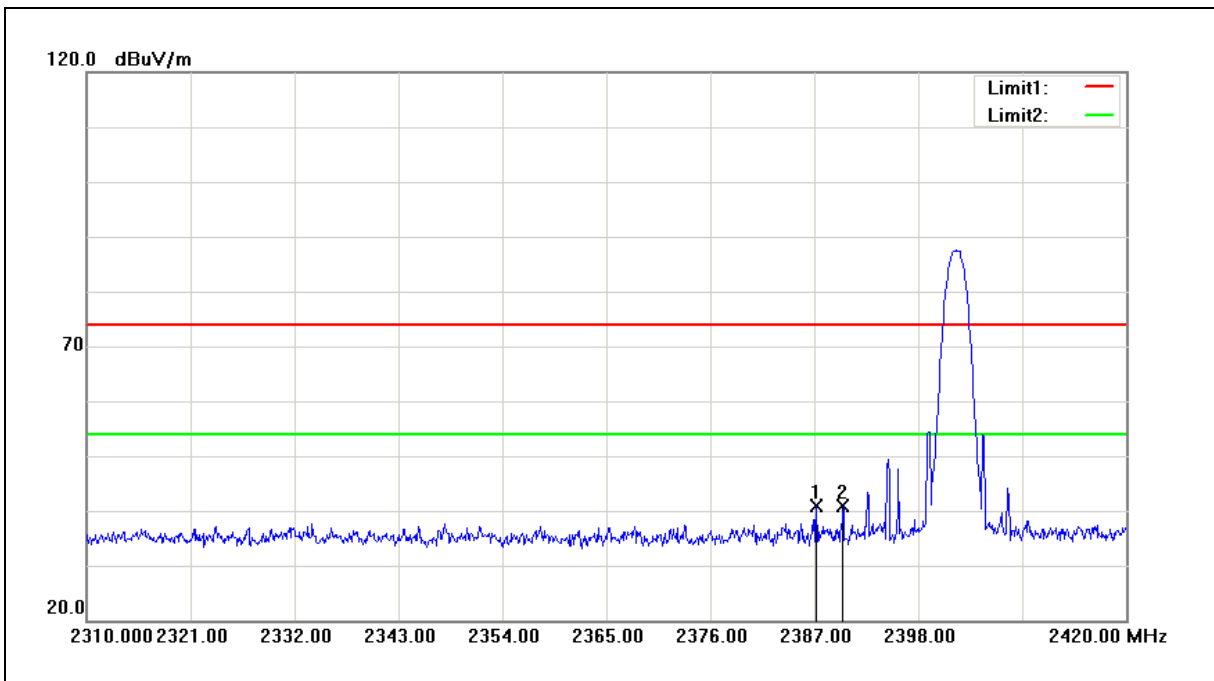

No.	Frequency (MHz)	Reading (dBuV)	Correct Factor (dB/m)	Result (dBuV/m)	Limit (dBuV/m)	Margin (dB)	Remark
1	2387.220	41.13	-0.27	40.86	74.00	-33.14	peak
2	2390.000	41.24	-0.26	40.98	74.00	-33.02	peak

Note:1.Result (dBuV/m) = Correct Factor (dB/m) + Reading(dBuV).

2.Correction factor (dB/m) = Antenna Factor (dB/m) + Cable loss (dB) – Pre-Amplifier gain (dB).

3. When the peak results are less than average limit, so not need to evaluate the average.



Standard:	FCC Part 15.247	Test Distance:	3m
Test item:	Band edge	Power:	AC 120V/60Hz
Frequency:	2480MHz	Temp.(°C)/Hum.(%RH):	26(°C)/60%RH
Mode:	Mode 4	Date:	12/09/2016
Ant.Polar.:	Horizontal		

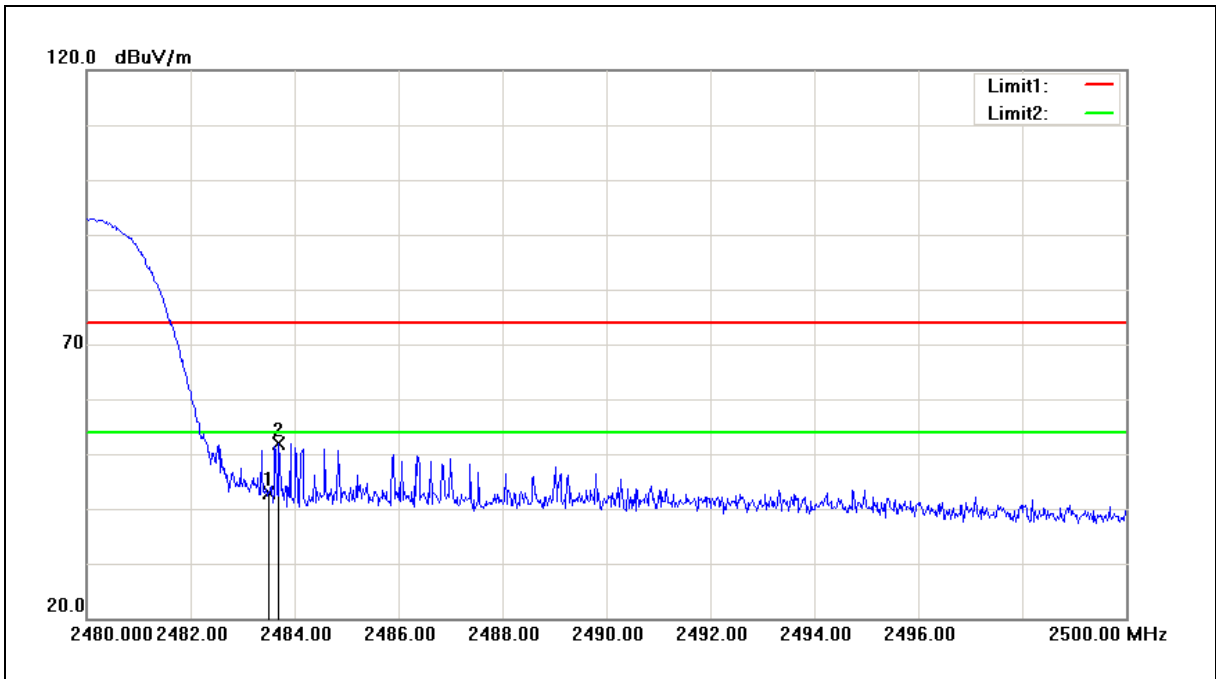

No.	Frequency (MHz)	Reading (dBuV)	Correct Factor (dB/m)	Result (dBuV/m)	Limit (dBuV/m)	Margin (dB)	Remark
1	2483.500	42.88	0.11	42.99	74.00	-31.01	peak
2	2483.700	51.72	0.11	51.83	74.00	-22.17	peak

Note:1.Result (dBuV/m) = Correct Factor (dB/m) + Reading(dBuV).

2.Correction factor (dB/m) = Antenna Factor (dB/m) + Cable loss (dB) – Pre-Amplifier gain (dB).

3. When the peak results are less than average limit, so not need to evaluate the average.



Standard:	FCC Part 15.247	Test Distance:	3m
Test item:	Band edge	Power:	AC 120V/60Hz
Frequency:	2480MHz	Temp.(°C)/Hum.(%RH):	26(°C)/60%RH
Mode:	Mode 4	Date:	12/09/2016
Ant.Polar.:	Vertical		

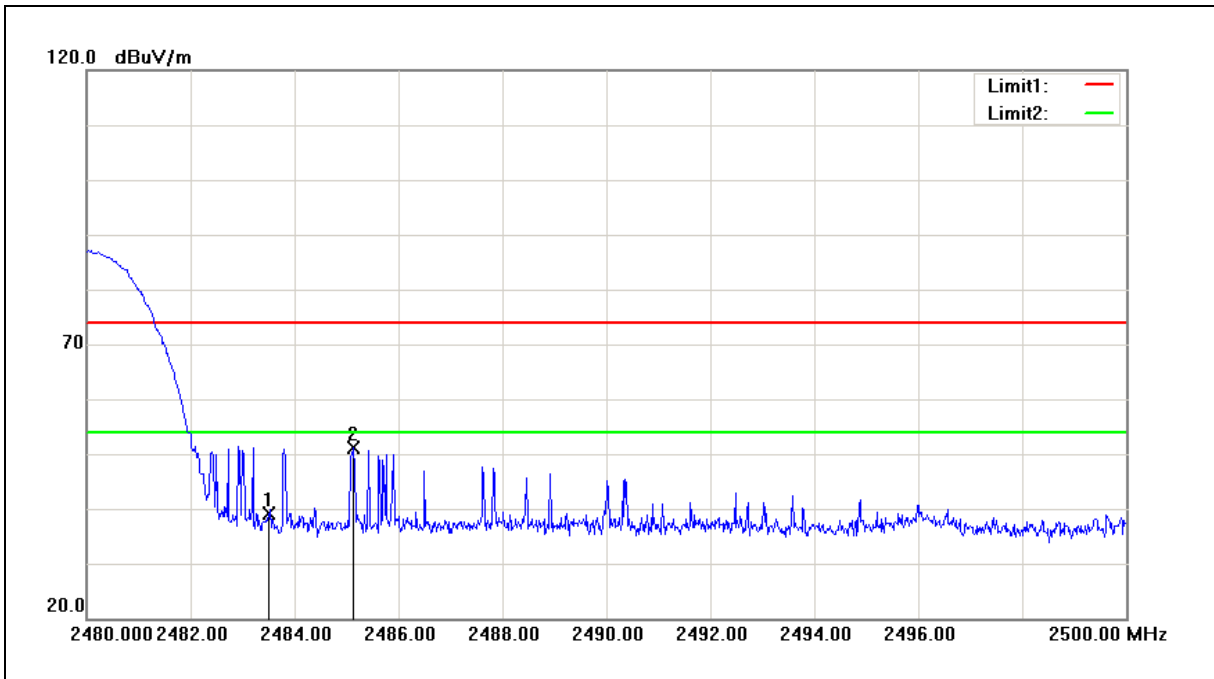

No.	Frequency (MHz)	Reading (dBuV)	Correct Factor (dB/m)	Result (dBuV/m)	Limit (dBuV/m)	Margin (dB)	Remark
1	2483.500	38.98	0.11	39.09	74.00	-34.91	peak
2	2485.120	51.04	0.12	51.16	74.00	-22.84	peak

Note:1.Result (dBuV/m) = Correct Factor (dB/m) + Reading(dBuV).

2.Correction factor (dB/m) = Antenna Factor (dB/m) + Cable loss (dB) – Pre-Amplifier gain (dB).

3. When the peak results are less than average limit, so not need to evaluate the average.



Standard:	FCC Part 15.247	Test Distance:	3m
Test item:	Band edge	Power:	AC 120V/60Hz
Frequency:	Hopping	Temp.(°C)/Hum. (%RH):	26(°C)/60%RH
Mode:	Mode 4	Date:	12/09/2016
Ant.Polar.:	Horizontal		

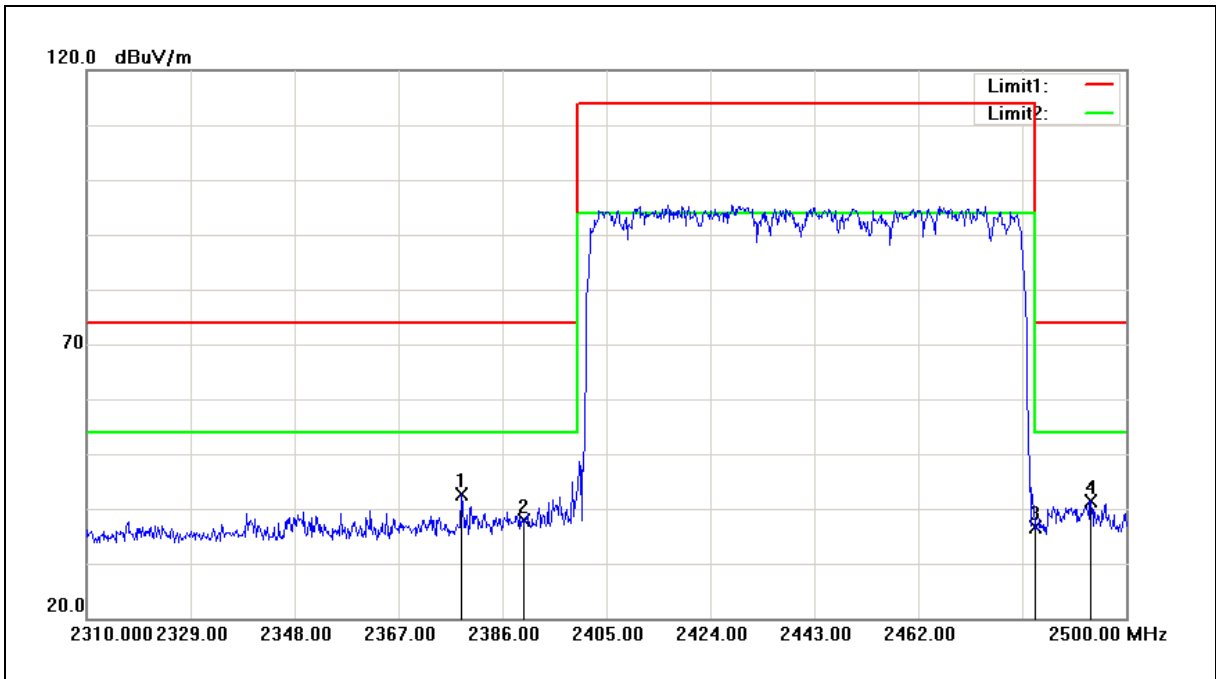

No.	Frequency (MHz)	Reading (dBuV)	Correct Factor (dB/m)	Result (dBuV/m)	Limit (dBuV/m)	Margin (dB)	Remark
1	2378.400	42.97	-0.31	42.66	74.00	-31.34	peak
2	2390.000	38.14	-0.26	37.88	74.00	-36.12	peak
3	2483.500	36.59	0.11	36.70	74.00	-37.30	peak
4	2493.540	41.30	0.15	41.45	74.00	-32.55	peak

Note:1.Result (dBuV/m) = Correct Factor (dB/m) + Reading(dBuV).

2.Correction factor (dB/m) = Antenna Factor (dB/m) + Cable loss (dB) – Pre-Amplifier gain (dB).

3. When the peak results are less than average limit, so not need to evaluate the average.



Standard:	FCC Part 15.247	Test Distance:	3m
Test item:	Band edge	Power:	AC 120V/60Hz
Frequency:	Hopping	Temp.(°C)/Hum.(%RH):	26(°C)/60%RH
Mode:	Mode 4	Date:	12/09/2016
Ant.Polar.:	Vertical		

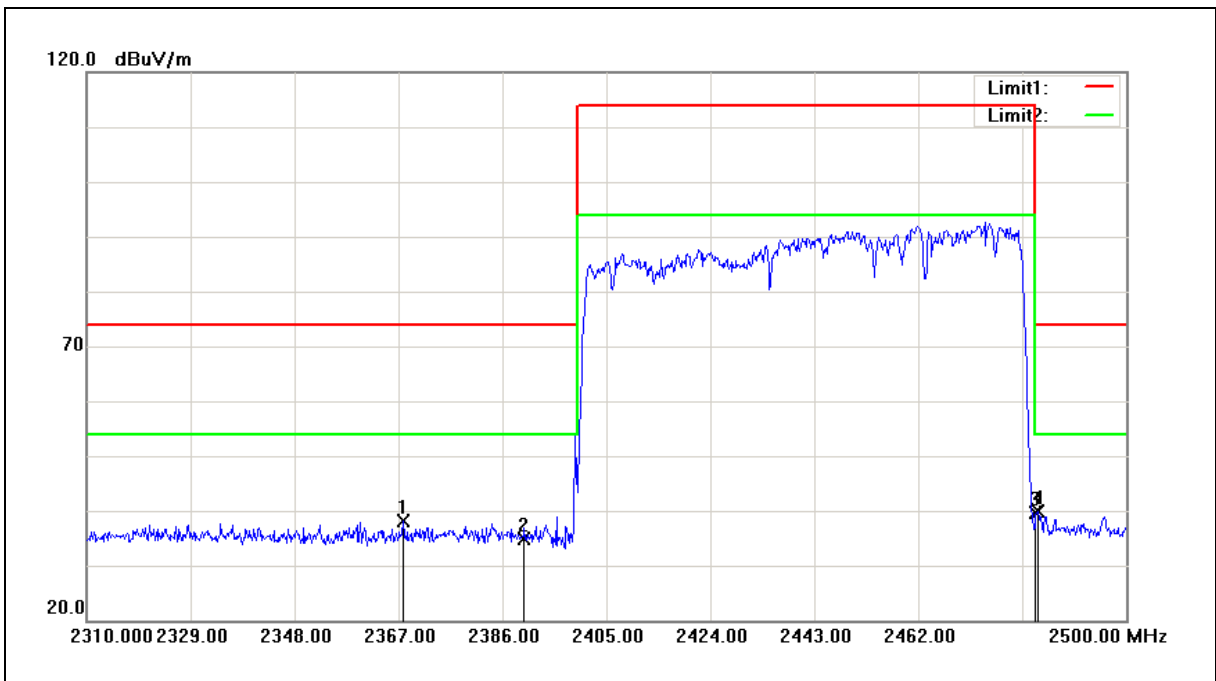

No.	Frequency (MHz)	Reading (dBuV)	Correct Factor (dB/m)	Result (dBuV/m)	Limit (dBuV/m)	Margin (dB)	Remark
1	2367.760	38.40	-0.35	38.05	74.00	-35.95	peak
2	2390.000	35.05	-0.26	34.79	74.00	-39.21	peak
3	2483.500	39.51	0.11	39.62	74.00	-34.38	peak
4	2483.850	39.79	0.11	39.90	74.00	-34.10	peak

- Note:1.Result (dBuV/m) = Correct Factor (dB/m) + Reading(dBuV).
- 2.Correction factor (dB/m) = Antenna Factor (dB/m) + Cable loss (dB) – Pre-Amplifier gain (dB).
3. When the peak results are less than average limit, so not need to evaluate the average.

7 20dB RF Bandwidth Measurement

- Limit

N/A

- Test Setup

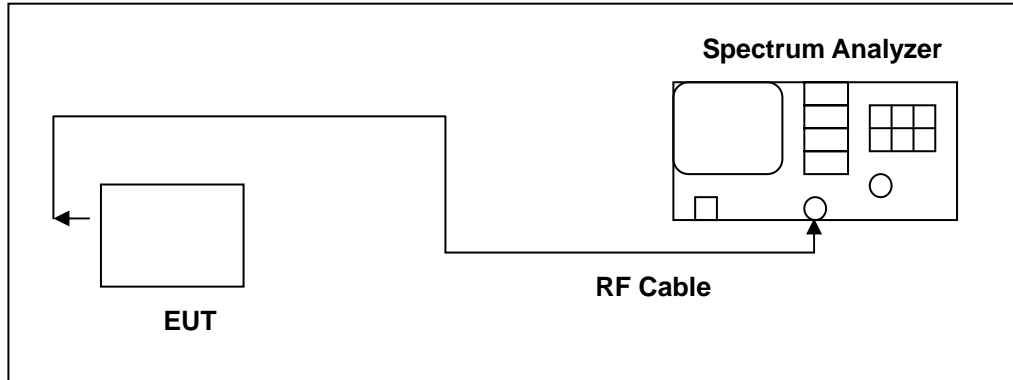

- Test Instruments

Equipment	Manufacturer	Model Number	Serial Number	Cal. Date	Remark
Spectrum Analyzer	Agilent	E4445A	MY45300744	12/15/2015	1 year
Microwave Cable	EMCI	EMC104-SM-SM-1 500	140303	02/23/2016	1 year
Test Site	ATL	TE05	TE05	N.C.R.	-----

NOTE: N.C.R. = No Calibration Request.



■ **Test Procedure**

20dB RF Bandwidth

Testing must be done according to this procedure, FCC Public Notice DA 00-705 - Filing and Measurement Guidelines for Frequency Hopping Spread Spectrum Systems. This is the only method recognized by the FCC. The RF output port of the Equipment-Under-Test is directly coupled to the input of the EMC analyzer through a specialized RF connector and a 10dB passive attenuator. A fully charged battery was used for the supply voltage. The Bluetooth frequency hopping function of the EUT was enabled. The spectrum analyzer used the following settings:

1. Span = approx. 2 to 3 times the 20dB bandwidth, centered on a hopping frequency
2. RBW \geq 1% of the 20dB span
3. VBW \geq RBW
4. Sweep = auto
5. Detector function = peak
6. Trace = max hold

The trace was allowed to stabilize. The EUT was transmitting at its maximum data rate. The marker-to-peak function was used to set the marker to the peak of the emission. The marker-delta function was used to measure 20dB down one side of the emission. The marker-delta function and marker was moved to the other side of the emission until it was even with the reference marker. The marker-delta reading at this point was the 20dB bandwidth of the emission.

■ **Test Result**

Test Mode	Frequency (MHz)	Measurement Results (MHz)
Mode 2	2402	0.926
	2441	0.926
	2480	0.947
Mode 4	2402	1.283
	2441	1.285
	2480	1.296



■ Test Graphs

Mode 2: GFSK Link Mode	
2402 MHz	<p>Agilent R T Freq/Channel</p> <p>Ch Freq 2.402 GHz Trig Free</p> <p>Center Freq 2.40200000 GHz</p> <p>Start Freq 2.40050000 GHz</p> <p>Stop Freq 2.40350000 GHz</p> <p>CF Step 300.000000 kHz Auto Man</p> <p>Freq Offset 0.00000000 Hz</p> <p>Signal Track On Off</p> <p>Ref 20 dBm #Atten 30 dB</p> <p>#Peak</p> <p>Log</p> <p>10 dB/Offst 1.5 dB</p> <p>Center 2.402 000 GHz Span 3 MHz</p> <p>#Res BW 30 kHz #VBW 100 kHz Sweep 3.2 ms (601 pts)</p> <p>Occupied Bandwidth 860.7969 kHz</p> <p>Occ BW % Pwr 99.00 %</p> <p>x dB -20.00 dB</p> <p>Transmit Freq Error -50.778 Hz</p> <p>x dB Bandwidth 925.803 kHz</p> <p>Copyright 2000-2006 Agilent Technologies</p>
2441 MHz	<p>Agilent R T Freq/Channel</p> <p>Ch Freq 2.441 GHz Trig Free</p> <p>Center Freq 2.44100000 GHz</p> <p>Start Freq 2.43950000 GHz</p> <p>Stop Freq 2.44250000 GHz</p> <p>CF Step 300.000000 kHz Auto Man</p> <p>Freq Offset 0.00000000 Hz</p> <p>Signal Track On Off</p> <p>Ref 20 dBm #Atten 30 dB</p> <p>#Peak</p> <p>Log</p> <p>10 dB/Offst 1.5 dB</p> <p>Center 2.441 000 GHz Span 3 MHz</p> <p>#Res BW 30 kHz #VBW 100 kHz Sweep 3.2 ms (601 pts)</p> <p>Occupied Bandwidth 849.2496 kHz</p> <p>Occ BW % Pwr 99.00 %</p> <p>x dB -20.00 dB</p> <p>Transmit Freq Error 2.201 kHz</p> <p>x dB Bandwidth 926.117 kHz</p> <p>Copyright 2000-2006 Agilent Technologies</p>
2480 MHz	<p>Agilent R T Freq/Channel</p> <p>Ch Freq 2.48 GHz Trig Free</p> <p>Center Freq 2.48000000 GHz</p> <p>Start Freq 2.47850000 GHz</p> <p>Stop Freq 2.48150000 GHz</p> <p>CF Step 300.000000 kHz Auto Man</p> <p>Freq Offset 0.00000000 Hz</p> <p>Signal Track On Off</p> <p>Ref 20 dBm #Atten 30 dB</p> <p>#Peak</p> <p>Log</p> <p>10 dB/Offst 1.5 dB</p> <p>Center 2.480 000 GHz Span 3 MHz</p> <p>#Res BW 30 kHz #VBW 100 kHz Sweep 3.2 ms (601 pts)</p> <p>Occupied Bandwidth 866.3029 kHz</p> <p>Occ BW % Pwr 99.00 %</p> <p>x dB -20.00 dB</p> <p>Transmit Freq Error 3.489 kHz</p> <p>x dB Bandwidth 946.681 kHz</p> <p>Copyright 2000-2006 Agilent Technologies</p>



Mode 4: 8DPSK Link Mode	
2402 MHz	<div style="border: 1px solid black; padding: 5px;"> <p style="text-align: right;">Agilent R T</p> <p style="text-align: center;">Ch Freq 2.402 GHz Trig Free</p> <p>Occupied Bandwidth █</p> <hr/> <p>Ref 20 dBm #Atten 30 dB</p> <p>#Peak</p> <p>Log</p> <p>10</p> <p>dB/</p> <p>Offst</p> <p>1.5</p> <p>dB</p> <p style="text-align: center;">Center 2.402 000 GHz Span 3 MHz</p> <p>#Res BW 30 kHz #VBW 100 kHz Sweep 3.2 ms (601 pts)</p> <div style="border: 1px solid green; padding: 2px; margin-top: 5px;"> <p>Occupied Bandwidth Occ BW % Pwr 99.00 %</p> <p style="text-align: center;">1.1621 MHz x dB -20.00 dB</p> <p>Transmit Freq Error -185.838 Hz</p> <p>x dB Bandwidth 1.283 MHz</p> </div> <p style="font-size: small; color: yellow;">Copyright 2000-2006 Agilent Technologies</p> </div> <div style="border: 1px solid gray; padding: 5px; margin-top: 5px;"> <p style="text-align: right;">Freq/Channel</p> <p>Center Freq 2.40200000 GHz</p> <p>Start Freq 2.40050000 GHz</p> <p>Stop Freq 2.40350000 GHz</p> <p>CF Step 300.000000 kHz Auto Man</p> <p>Freq Offset 0.00000000 Hz</p> <p>Signal Track On Off</p> </div>
2441 MHz	<div style="border: 1px solid black; padding: 5px;"> <p style="text-align: right;">Agilent R T</p> <p style="text-align: center;">Ch Freq 2.441 GHz Trig Free</p> <p>Occupied Bandwidth █</p> <hr/> <p>Ref 20 dBm #Atten 30 dB</p> <p>#Peak</p> <p>Log</p> <p>10</p> <p>dB/</p> <p>Offst</p> <p>1.5</p> <p>dB</p> <p style="text-align: center;">Center 2.441 000 GHz Span 3 MHz</p> <p>#Res BW 30 kHz #VBW 100 kHz Sweep 3.2 ms (601 pts)</p> <div style="border: 1px solid green; padding: 2px; margin-top: 5px;"> <p>Occupied Bandwidth Occ BW % Pwr 99.00 %</p> <p style="text-align: center;">1.1661 MHz x dB -20.00 dB</p> <p>Transmit Freq Error 940.950 Hz</p> <p>x dB Bandwidth 1.285 MHz</p> </div> <p style="font-size: small; color: yellow;">Copyright 2000-2006 Agilent Technologies</p> </div> <div style="border: 1px solid gray; padding: 5px; margin-top: 5px;"> <p style="text-align: right;">Freq/Channel</p> <p>Center Freq 2.44100000 GHz</p> <p>Start Freq 2.43950000 GHz</p> <p>Stop Freq 2.44250000 GHz</p> <p>CF Step 300.000000 kHz Auto Man</p> <p>Freq Offset 0.00000000 Hz</p> <p>Signal Track On Off</p> </div>
2480 MHz	<div style="border: 1px solid black; padding: 5px;"> <p style="text-align: right;">Agilent R T</p> <p style="text-align: center;">Ch Freq 2.48 GHz Trig Free</p> <p>Occupied Bandwidth █</p> <hr/> <p>Ref 20 dBm #Atten 30 dB</p> <p>#Peak</p> <p>Log</p> <p>10</p> <p>dB/</p> <p>Offst</p> <p>1.5</p> <p>dB</p> <p style="text-align: center;">Center 2.480 000 GHz Span 3 MHz</p> <p>#Res BW 30 kHz #VBW 100 kHz Sweep 3.2 ms (601 pts)</p> <div style="border: 1px solid green; padding: 2px; margin-top: 5px;"> <p>Occupied Bandwidth Occ BW % Pwr 99.00 %</p> <p style="text-align: center;">1.1760 MHz x dB -20.00 dB</p> <p>Transmit Freq Error 2.620 kHz</p> <p>x dB Bandwidth 1.296 MHz</p> </div> <p style="font-size: small; color: yellow;">Copyright 2000-2006 Agilent Technologies</p> </div> <div style="border: 1px solid gray; padding: 5px; margin-top: 5px;"> <p style="text-align: right;">Freq/Channel</p> <p>Center Freq 2.48000000 GHz</p> <p>Start Freq 2.47850000 GHz</p> <p>Stop Freq 2.48150000 GHz</p> <p>CF Step 300.000000 kHz Auto Man</p> <p>Freq Offset 0.00000000 Hz</p> <p>Signal Track On Off</p> </div>

8 Carrier Frequency Separation Measurement

■ Limit

Title 47 of the CFR, Part 15 Subpart (c) 15.247(a)(1) requires the measurement of the bandwidth of the transmission between the -20 dB points on the transmitted spectrum. The results of this test determine the limits for channel spacing. The channel spacing shall be a minimum of 25 kHz or the 20 dB bandwidth, whichever is greater. Alternatively, frequency hopping systems operating in the 2400-2483.5 MHz band may have hopping channel carrier frequencies that are separated by 25 kHz or two-thirds of the 20 dB bandwidth of the hopping channel.

■ Test Setup

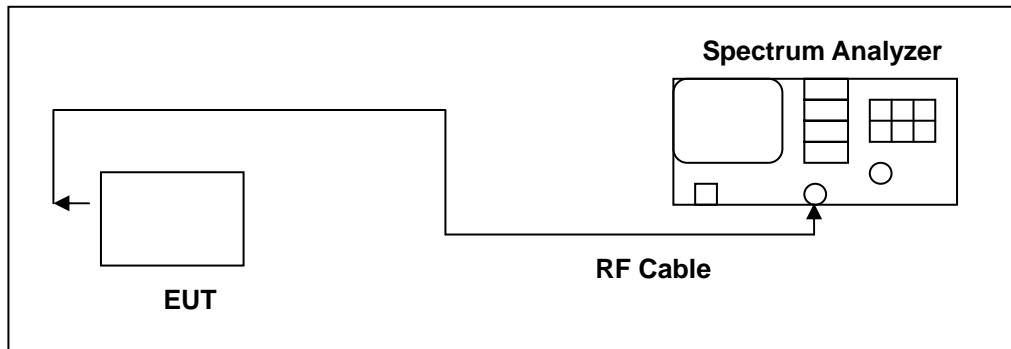

■ Test Instruments

Equipment	Manufacturer	Model Number	Serial Number	Cal. Date	Remark
Spectrum Analyzer	Agilent	E4445A	MY45300744	12/15/2015	1 year
Microwave Cable	EMCI	EMC104-SM-SM-1 500	140303	02/23/2016	1 year
Test Site	ATL	TE05	TE05	N.C.R.	-----

NOTE: N.C.R. = No Calibration Request.



■ **Test Procedure**

Testing must be done according to this procedure, FCC Public Notice DA 00-705 - Filing and Measurement Guidelines for Frequency Hopping Spread Spectrum Systems. This is the only method recognized by the FCC. The RF output port of the Equipment-Under-Test is directly coupled to the input of the EMC analyzer through a specialized RF connector and a 10dB passive attenuator. A fully charged battery was used for the supply voltage. The Bluetooth frequency hopping function of the EUT was enabled. The following spectrum analyzer settings were used:

1. Span = wide enough to capture the peaks of two adjacent channels
2. Resolution (or IF) Bandwidth (RBW) \geq 1% of the span
3. Video (or Average) Bandwidth (VBW) \geq RBW
4. Sweep = auto
5. Detector function = peak
6. Trace = max hold

The trace was allowed to stabilize. The marker-delta function was used to determine the separation between the peaks of the adjacent channels.

■ **Test Result**

Test Mode	Frequency (MHz)	Measurement Results (MHz)	Limit (MHz)
Mode 2	2402	1.000	> 0.617
	2441	1.000	> 0.617
	2480	1.000	> 0.631
Mode 4	2402	1.000	> 0.855
	2441	1.000	> 0.857
	2480	1.000	> 0.864



■ Test Graphs

Mode 2: GFSK Link Mode	
2402 MHz	<p>Copyright 2000-2006 Agilent Technologies</p>
2441 MHz	<p>Copyright 2000-2006 Agilent Technologies</p>
2480 MHz	<p>Copyright 2000-2006 Agilent Technologies</p>



Mode 4: 8DPSK Link Mode	
2402 MHz	<p>Copyright 2000-2006 Agilent Technologies</p>
2441 MHz	<p>Copyright 2000-2006 Agilent Technologies</p>
2480 MHz	<p>Copyright 2000-2006 Agilent Technologies</p>

9 Number of Hopping Measurement

■ Limit

Frequency hopping systems in the 2400–2483.5 MHz band shall use at least 15 channels.

■ Test Setup

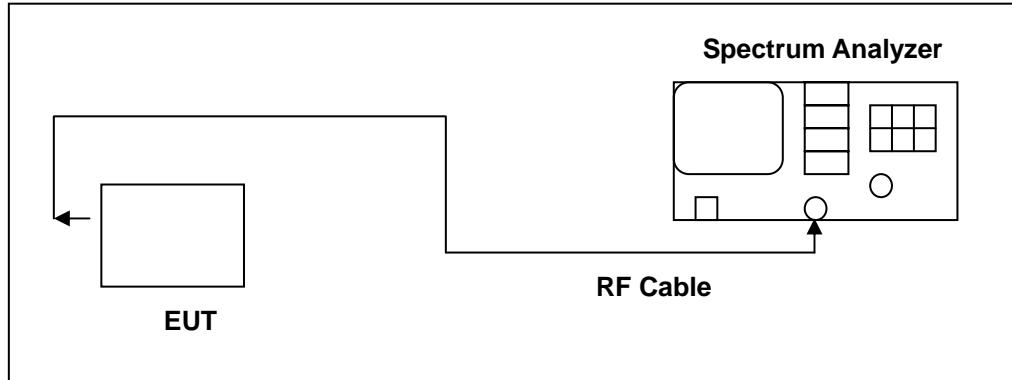

■ Test Instruments

Equipment	Manufacturer	Model Number	Serial Number	Cal. Date	Remark
Spectrum Analyzer	Agilent	E4445A	MY45300744	12/15/2015	1 year
Microwave Cable	EMCI	EMC104-SM-SM-1500	140303	02/23/2016	1 year
Test Site	ATL	TE05	TE05	N.C.R.	-----

NOTE: N.C.R. = No Calibration Request.

■ Test Procedure

Testing must be done according to this procedure, FCC Public Notice DA 00-705 - Filing and Measurement Guidelines for Frequency Hopping Spread Spectrum Systems. This is the only method recognized by the FCC. The RF output port of the Equipment-Under-Test is directly coupled to the input of the EMC analyzer through a specialized RF connector and a 10dB passive attenuator. A fully charged battery was used for the supply voltage. The Bluetooth frequency hopping function of the EUT was enabled. The spectrum analyzer used the following settings:

1. Span = the frequency band of operation
2. RBW \geq 1% of the span
3. VBW \geq RBW
4. Sweep = auto
5. Detector function = peak
6. Trace = max hold

The trace was allowed to stabilize.



■ **Test Result**

Test Mode	Frequency Range (MHz)	Measurement Results (Ch)	Limit (ch)
Mode 2	2402 - 2480	79	> 15
Mode 4	2402 - 2480	79	> 15



■ Test Graphs

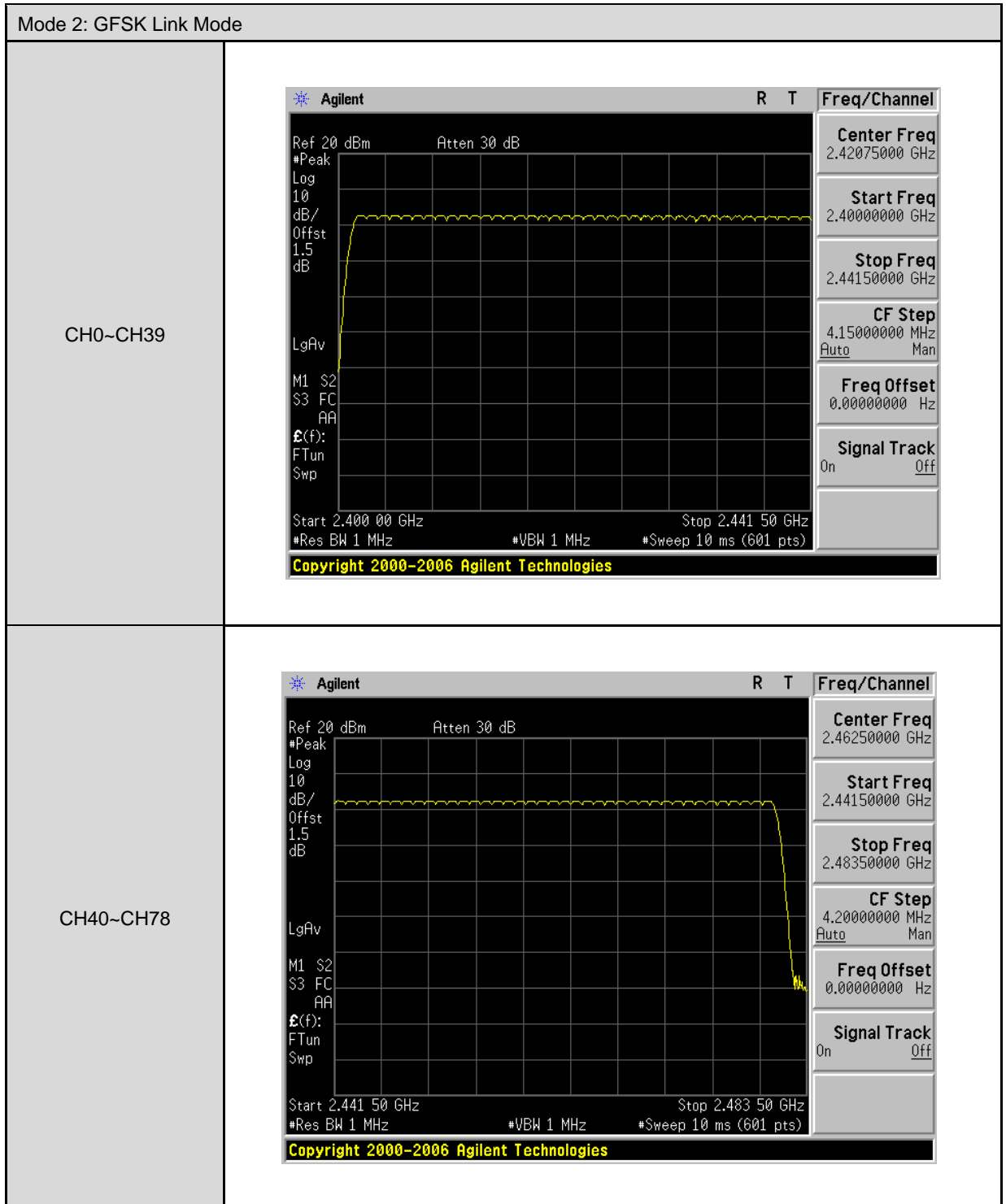

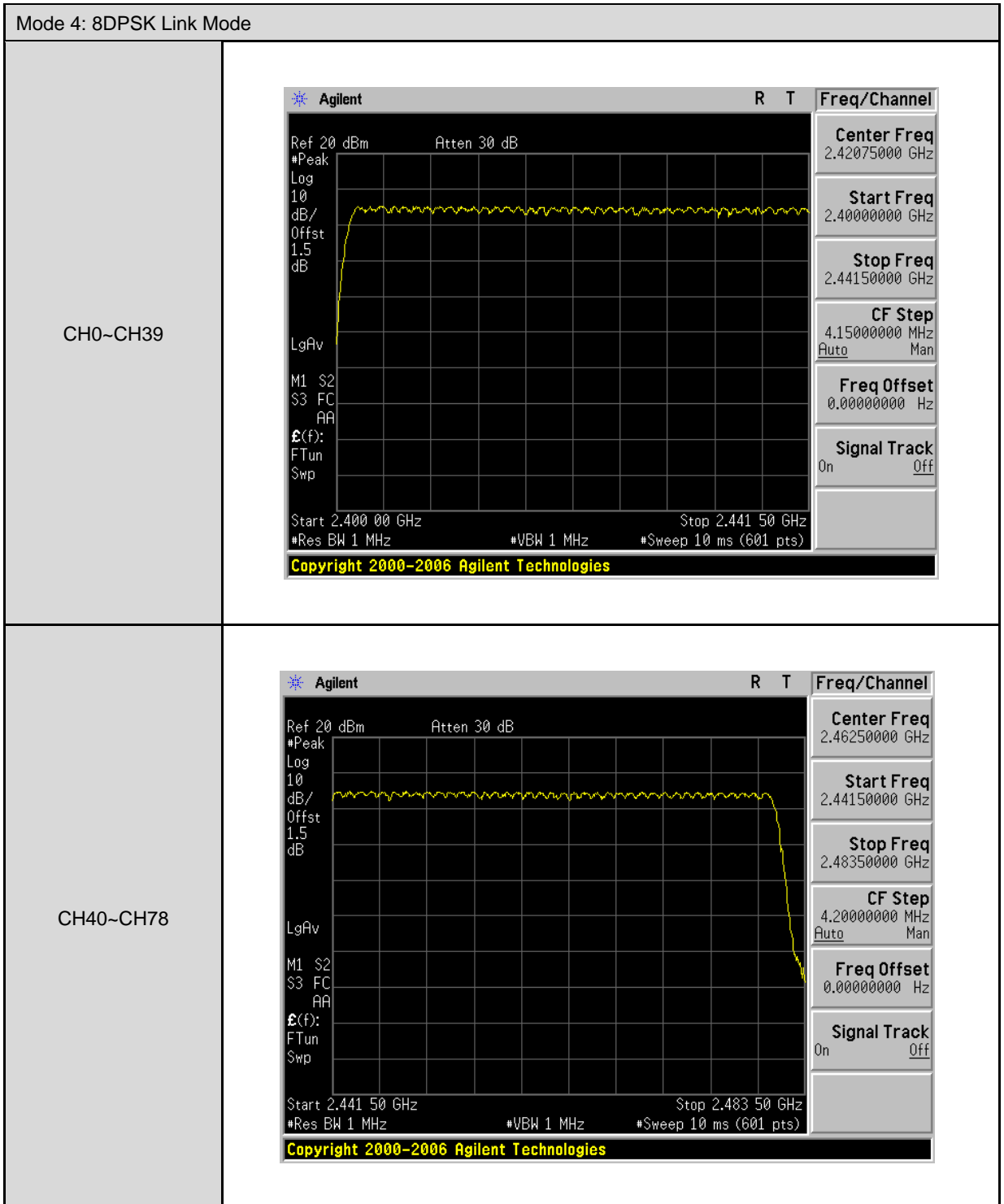

10 Time of Occupancy (Dwell Time) Measurement

■ Limit

The average time of occupancy on any channel shall not be greater than 0.4 seconds within a period of 0.4 seconds multiplied by the number of hopping channels employed.

■ Test Setup

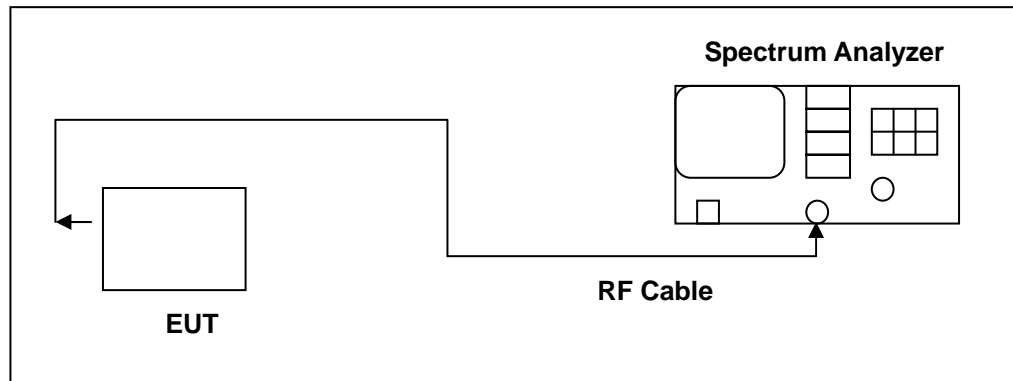

■ Test Instruments

Equipment	Manufacturer	Model Number	Serial Number	Cal. Date	Remark
Spectrum Analyzer	Agilent	E4445A	MY45300744	12/15/2015	1 year
Microwave Cable	EMCI	EMC104-SM-SM-1500	140303	02/23/2016	1 year
Test Site	ATL	TE05	TE05	N.C.R.	-----

NOTE: N.C.R. = No Calibration Request.

■ Test Procedure

Testing must be done according to this procedure, FCC Public Notice DA 00-705 - Filing and Measurement Guidelines for Frequency Hopping Spread Spectrum Systems. This is the only method recognized by the FCC. The RF output port of the Equipment-Under-Test is directly coupled to the input of the spectrum through a specialized RF connector and a 10dB passive attenuator. A fully charged battery was used for the supply voltage. The Bluetooth hopping function of the EUT was enabled. The following spectrum analyzer settings were used:

1. Span = zero span, centered on a hopping channel
2. RBW = 1 MHz
3. VBW \geq RBW
4. Sweep = as necessary to capture the entire dwell time per hopping channel
5. Detector function = peak
6. Trace = max hold

The marker-delta function was used to determine the dwell time.



■ Test Result

Mode 2: GFSK Link Mode	
DH1	
Cycle Calculate	$79CH * 0.4 = 31.6 \text{ (sec)}$
The EUT Hopping Number per Sec	1600 times/sec
Each Channel Dwell Times per Sec	$800/79CH = 10.13(\text{times/sec})$
Each Channel Dwell Times on Cycle(1)	$31.6 * 10.13 = 320.108(\text{times})$
Each Channel Dwell Times (2)	0.467 ms (sec)
Dwell Times on Cycle (1) * (2)	149.394 ms (sec)
LIMIT(msec)	$< = 400$
DH3	
Cycle Calculate	$79CH * 0.4 = 31.6 \text{ (sec)}$
The EUT Hopping Number per Sec	1600 times/sec
Each Channel Dwell Times per Sec	$400/79CH = 5.1(\text{times/sec})$
Each Channel Dwell Times on Cycle(1)	$31.6 * 5.1 = 161.16(\text{times})$
Each Channel Dwell Times (2)	1.733 ms (sec)
Dwell Times on Cycle (1) * (2)	277.100 ms (sec)
LIMIT(msec)	$< = 400$
DH5	
Cycle Calculate	$79CH * 0.4 = 31.6 \text{ (sec)}$
The EUT Hopping Number per Sec	1600 times/sec
Each Channel Dwell Times per Sec	$266.7/79CH = 3.37(\text{times/sec})$
Each Channel Dwell Times on Cycle(1)	$31.6 * 3.37 = 106.492(\text{times})$
Each Channel Dwell Times (2)	2.950 ms (sec)
Dwell Times on Cycle (1) * (2)	315.084 ms (sec)
LIMIT(msec)	$< = 400$



Mode 4: 8DPSK Link Mode	
3DH1	
Cycle Calculate	$79CH * 0.4 = 31.6 \text{ (sec)}$
The EUT Hopping Number per Sec	1600 times/sec
Each Channel Dwell Times per Sec	$800/79CH = 10.13(\text{times/sec})$
Each Channel Dwell Times on Cycle(1)	$31.6 * 10.13 = 320.108(\text{times})$
Each Channel Dwell Times (2)	0.467 ms (sec)
Dwell Times on Cycle (1) * (2)	149.394 ms (sec)
LIMIT(msec)	$< = 400$
3DH3	
Cycle Calculate	$79CH * 0.4 = 31.6 \text{ (sec)}$
The EUT Hopping Number per Sec	1600 times/sec
Each Channel Dwell Times per Sec	$400/79CH = 5.1(\text{times/sec})$
Each Channel Dwell Times on Cycle(1)	$31.6 * 5.1 = 161.16(\text{times})$
Each Channel Dwell Times (2)	1.733 ms (sec)
Dwell Times on Cycle (1) * (2)	277.100 ms (sec)
LIMIT(msec)	$< = 400$
3DH5	
Cycle Calculate	$79CH * 0.4 = 31.6 \text{ (sec)}$
The EUT Hopping Number per Sec	1600 times/sec
Each Channel Dwell Times per Sec	$266.7/79CH = 3.37(\text{times/sec})$
Each Channel Dwell Times on Cycle(1)	$31.6 * 3.37 = 106.492(\text{times})$
Each Channel Dwell Times (2)	2.950 ms (sec)
Dwell Times on Cycle (1) * (2)	315.084 ms (sec)
LIMIT(msec)	$< = 400$



■ Test Graphs

Mode 2: GFSK Link Mode	
DH1	<p>Agilent R T Freq/Channel Ref 20 dBm Atten 30 dB Δ Mkr1 466.7 μs #Peak -0.29 dB Log 10 dB/ Offst 1.5 dB LgAv W1 S2 S3 FS AA E(f): FTun Center 2.402 000 GHz Span 0 Hz Res BW 1 MHz VBW 1 MHz Sweep 10 ms (601 pts) Copyright 2000-2006 Agilent Technologies</p> <p>Center Freq 2.40200000 GHz Start Freq 2.40200000 GHz Stop Freq 2.40200000 GHz CF Step 1.00000000 MHz Auto Man Freq Offset 0.00000000 Hz Signal Track On Off</p>
DH3	<p>Agilent R T Freq/Channel Ref 20 dBm Atten 30 dB Δ Mkr1 1.733 ms #Peak -1.75 dB Log 10 dB/ Offst 1.5 dB LgAv W1 S2 S3 FS AA E(f): FTun Center 2.402 000 GHz Span 0 Hz Res BW 1 MHz VBW 1 MHz Sweep 10 ms (601 pts) Copyright 2000-2006 Agilent Technologies</p> <p>Center Freq 2.40200000 GHz Start Freq 2.40200000 GHz Stop Freq 2.40200000 GHz CF Step 1.00000000 MHz Auto Man Freq Offset 0.00000000 Hz Signal Track On Off</p>
DH5	<p>Agilent R T Freq/Channel Ref 20 dBm Atten 30 dB Δ Mkr1 2.95 ms #Peak -1.21 dB Log 10 dB/ Offst 1.5 dB LgAv W1 S2 S3 FS AA E(f): FTun Center 2.402 000 GHz Span 0 Hz Res BW 1 MHz VBW 1 MHz Sweep 10 ms (601 pts) Copyright 2000-2006 Agilent Technologies</p> <p>Center Freq 2.40200000 GHz Start Freq 2.40200000 GHz Stop Freq 2.40200000 GHz CF Step 1.00000000 MHz Auto Man Freq Offset 0.00000000 Hz Signal Track On Off</p>



Mode 4: 8DPSK Link Mode	
3DH1	<p>Agilent R T Freq/Channel Ref 20 dBm Atten 30 dB Mkr1 466.7 μs #Peak -0.89 dB Log 10 dB/ Offst 1.5 dB LgAv W1 S2 S3 FS AA E(f): FTun Center 2.402 000 GHz Span 0 Hz Res BW 1 MHz VBW 1 MHz Sweep 10 ms (601 pts) Copyright 2000-2006 Agilent Technologies</p> <p>Center Freq 2.40200000 GHz Start Freq 2.40200000 GHz Stop Freq 2.40200000 GHz CF Step 1.00000000 MHz Auto Man Freq Offset 0.00000000 Hz Signal Track On Off</p>
3DH3	<p>Agilent R T Freq/Channel Ref 20 dBm Atten 30 dB Mkr1 1.733 ms #Peak -0.21 dB Log 10 dB/ Offst 1.5 dB LgAv W1 S2 S3 FS AA E(f): FTun Center 2.402 000 GHz Span 0 Hz Res BW 1 MHz VBW 1 MHz Sweep 10 ms (601 pts) Copyright 2000-2006 Agilent Technologies</p> <p>Center Freq 2.40200000 GHz Start Freq 2.40200000 GHz Stop Freq 2.40200000 GHz CF Step 1.00000000 MHz Auto Man Freq Offset 0.00000000 Hz Signal Track On Off</p>
3DH5	<p>Agilent R T Freq/Channel Ref 20 dBm Atten 30 dB Mkr1 2.95 ms #Peak 1.20 dB Log 10 dB/ Offst 1.5 dB LgAv W1 S2 S3 FS AA E(f): FTun Center 2.402 000 GHz Span 0 Hz Res BW 1 MHz VBW 1 MHz Sweep 10 ms (601 pts) Copyright 2000-2006 Agilent Technologies</p> <p>Center Freq 2.40200000 GHz Start Freq 2.40200000 GHz Stop Freq 2.40200000 GHz CF Step 1.00000000 MHz Auto Man Freq Offset 0.00000000 Hz Signal Track On Off</p>

11 Out of Band Conducted Emissions Measurement

■ Limit

In any 100 kHz bandwidth outside the frequency band in which the spread spectrum or digitally modulated intentional radiator is operating, the radio frequency power that is produced by the intentional radiator shall be at least 20 dB below that in the 100 kHz bandwidth within the band that contains the highest level of the desired power

■ Test Setup

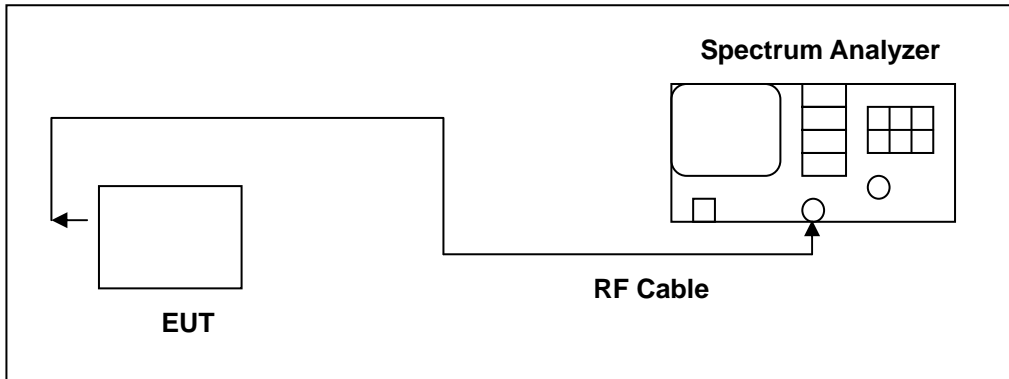

■ Test Instruments

Equipment	Manufacturer	Model Number	Serial Number	Cal. Date	Remark
Spectrum Analyzer	Agilent	E4445A	MY45300744	12/15/2015	1 year
Spectrum Analyzer	Agilent	E4408B	MY45107753	08/08/2016	1 year
Microwave Cable	EMCI	EMC104-SM-SM-1500	140303	02/23/2016	1 year
Test Site	ATL	TE05	TE05	N.C.R.	-----

NOTE: N.C.R. = No Calibration Request.

■ Test Procedure

Testing must be done according to this procedure, FCC Public Notice DA 00-705 - Filing and Measurement Guidelines for Frequency Hopping Spread Spectrum Systems. This is the only method recognized by the FCC. In any 100 kHz bandwidth outside the EUT pass band, the RF power produced by the modulation products of the spreading sequence, the information sequence, and the carrier frequency shall be at least 20 dB below that of the maximum in-band 100 kHz emission, antenna output of the EUT was coupled directly to spectrum analyzer; if an external attenuator and/or cable was used, these losses are compensated for with the analyzer OFFSET function. All other types of emissions from the EUT shall meet the general limits for radiated frequencies outside the pass band. The test was performed at 3 channels (Channel 0, 39, 78)



■ Test Graphs

Mode 2: GFSK Link Mode	
2402 MHz	
2441 MHz	
2480 MHz	

Mode 2: GFSK Link Mode _ Un-hopping

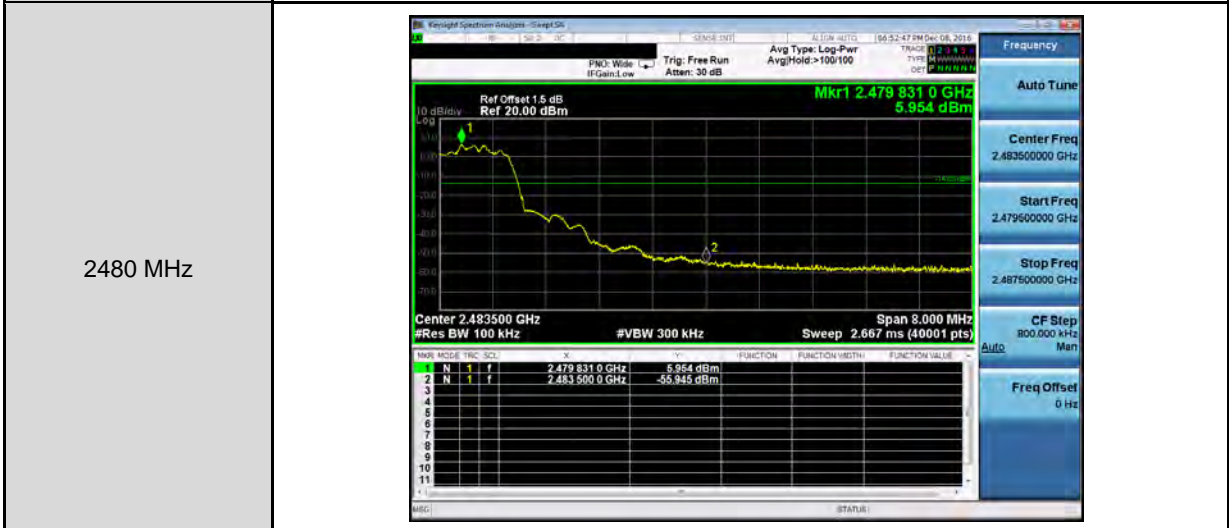
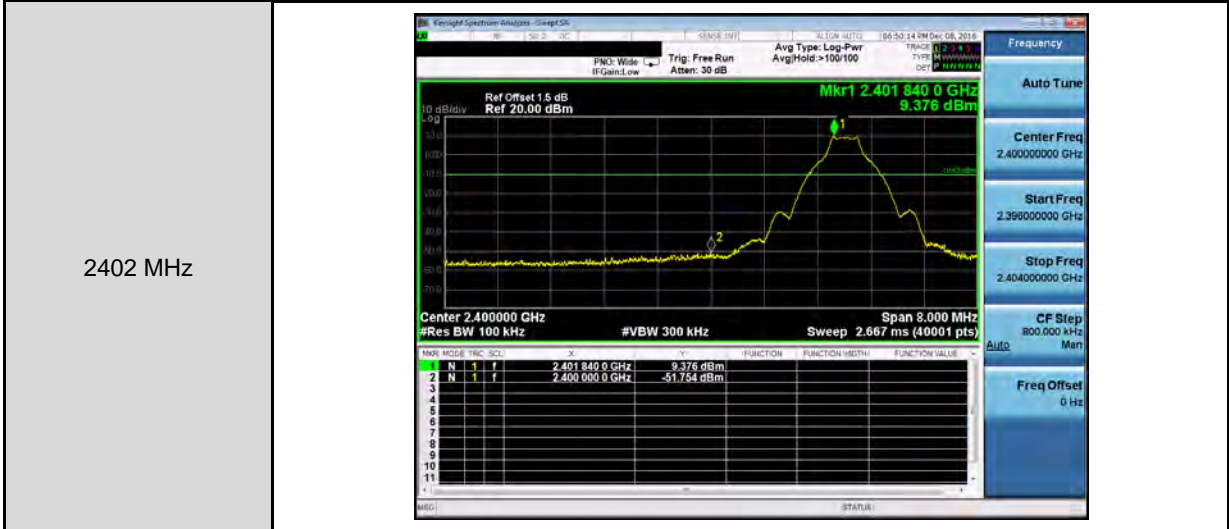

Mode 2: GFSK Link Mode _ Hopping

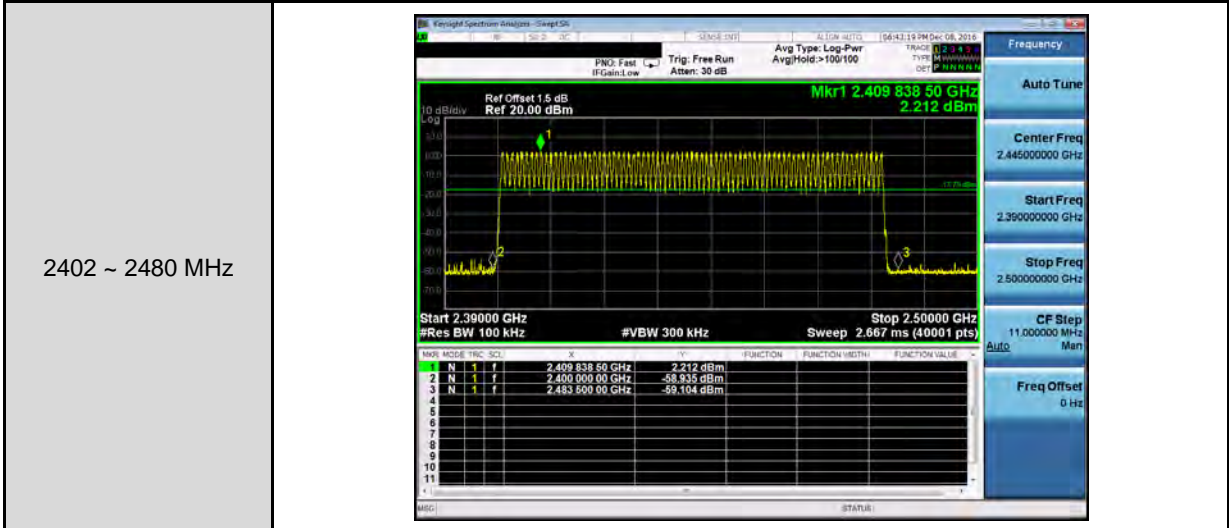



Mode 4: 8DPSK Link Mode																			
2402 MHz	<p>Key parameters from screenshot: Mkr1 2.402 0 GHz 6.900 dBm Start 30 MHz Stop 26.50 GHz Res BW 100 kHz VBW 300 kHz Sweep 88.00 ms (40001 pts)</p> <table border="1"><thead><tr><th>MKR</th><th>MODE</th><th>TRC</th><th>SCN</th><th>X</th><th>Y</th><th>FUNCTION</th><th>FUNCTION METH</th><th>FUNCTION VALUE</th></tr></thead><tbody><tr><td>1</td><td>N</td><td>1</td><td>f</td><td>2.402 0 GHz</td><td>6.900 dBm</td><td></td><td></td><td></td></tr></tbody></table>	MKR	MODE	TRC	SCN	X	Y	FUNCTION	FUNCTION METH	FUNCTION VALUE	1	N	1	f	2.402 0 GHz	6.900 dBm			
MKR	MODE	TRC	SCN	X	Y	FUNCTION	FUNCTION METH	FUNCTION VALUE											
1	N	1	f	2.402 0 GHz	6.900 dBm														
2441 MHz	<p>Key parameters from screenshot: Mkr1 2.441 0 GHz 5.304 dBm Start 30 MHz Stop 26.50 GHz Res BW 100 kHz VBW 300 kHz Sweep 88.00 ms (40001 pts)</p> <table border="1"><thead><tr><th>MKR</th><th>MODE</th><th>TRC</th><th>SCN</th><th>X</th><th>Y</th><th>FUNCTION</th><th>FUNCTION METH</th><th>FUNCTION VALUE</th></tr></thead><tbody><tr><td>1</td><td>N</td><td>1</td><td>f</td><td>2.441 0 GHz</td><td>5.304 dBm</td><td></td><td></td><td></td></tr></tbody></table>	MKR	MODE	TRC	SCN	X	Y	FUNCTION	FUNCTION METH	FUNCTION VALUE	1	N	1	f	2.441 0 GHz	5.304 dBm			
MKR	MODE	TRC	SCN	X	Y	FUNCTION	FUNCTION METH	FUNCTION VALUE											
1	N	1	f	2.441 0 GHz	5.304 dBm														
2480 MHz	<p>Key parameters from screenshot: Mkr1 2.480 0 GHz 6.000 dBm Start 30 MHz Stop 26.50 GHz Res BW 100 kHz VBW 300 kHz Sweep 88.00 ms (40001 pts)</p> <table border="1"><thead><tr><th>MKR</th><th>MODE</th><th>TRC</th><th>SCN</th><th>X</th><th>Y</th><th>FUNCTION</th><th>FUNCTION METH</th><th>FUNCTION VALUE</th></tr></thead><tbody><tr><td>1</td><td>N</td><td>1</td><td>f</td><td>2.480 0 GHz</td><td>6.000 dBm</td><td></td><td></td><td></td></tr></tbody></table>	MKR	MODE	TRC	SCN	X	Y	FUNCTION	FUNCTION METH	FUNCTION VALUE	1	N	1	f	2.480 0 GHz	6.000 dBm			
MKR	MODE	TRC	SCN	X	Y	FUNCTION	FUNCTION METH	FUNCTION VALUE											
1	N	1	f	2.480 0 GHz	6.000 dBm														

Mode 4: 8DPSK Link Mode _ Un-hopping

2402 MHz



2480 MHz

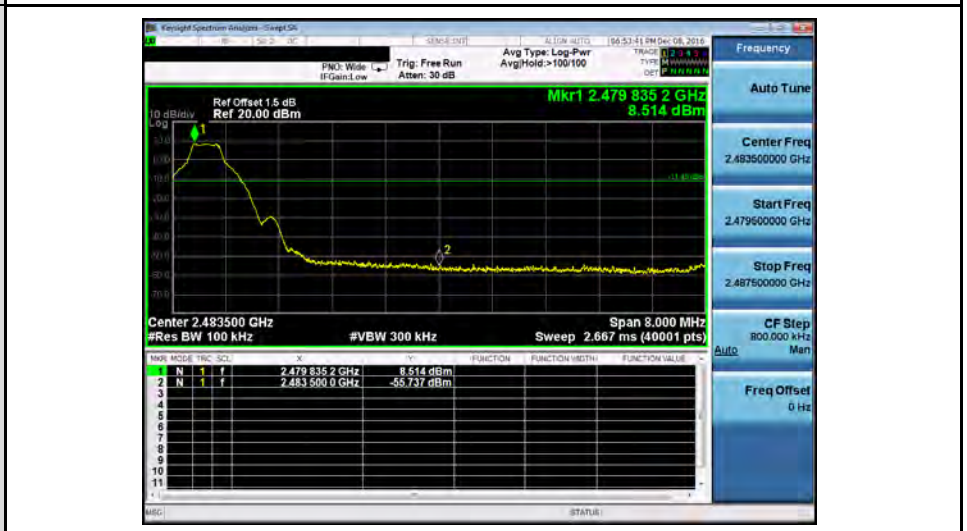

Mode 4: 8DPSK Link Mode _ Hopping

2402 ~ 2480 MHz

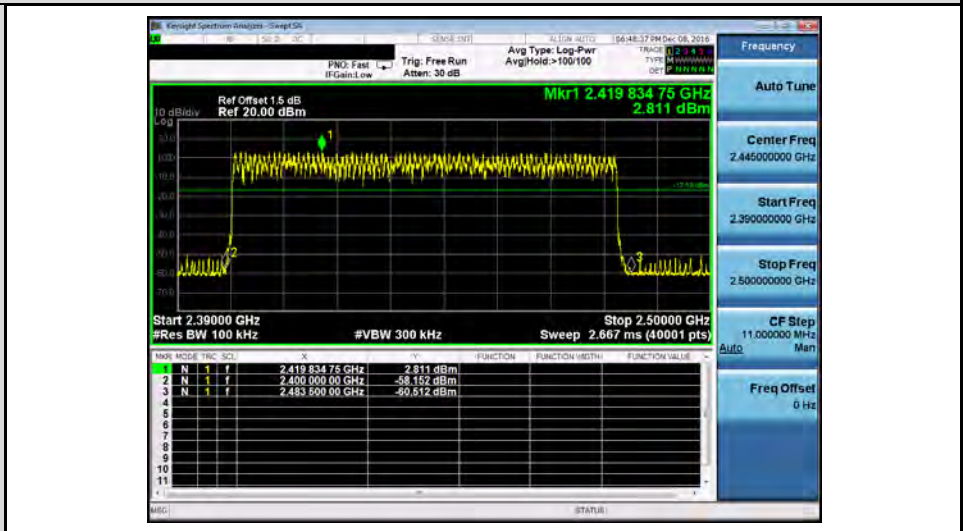



12 Antenna Measurement

■ Limit

For intentional device, according to 15.203, an intentional radiator shall be designed to ensure that no antenna other than that furnished by the responsible party shall be used with the device.

And According to 15.247 (b)(4), if transmitting antennas of directional gain greater than 6 dBi are used, the power shall be reduced by the amount in dB that the directional gain of the antenna exceeds 6dBi.

■ Antenna Connector Construction

See section 2 – antenna information.