

Label of Model: XW-BTS3-K

Pioneer
WIRELESS SPEAKER SYSTEM
ENCEINTE SANS FIL
MODEL / MODELE : XW-BTS3-K
18 V $\overline{\text{~}}$ 1.5 A 27 W
FCC ID : LMZ-20133BT
IC : 10306A-20133BT

CONFORMS TO
ANSI/UL STD. 60065
CERTIFIED TO
CAN/CSA STD. C22.2
No. 60065



 C  US
Intertek
4005405

This device complies with Part 15 of the FCC Rules.
Operation is subject to the following two conditions : (1) This device
may not cause harmful interference, and (2) this device must accept any
interference received, including interference that may cause undesired operation.
This Class B digital apparatus complies with Canadian ICES-003.
Cet appareil numérique de la Classe B est
conforme à la norme NMB-003 du Canada.

PIONEER CORPORATION
MADE IN CHINA
FABRIQUE EN CHINE

Serial No.

Label of Model: XW-BTS3-W

<p>Pioneer WIRELESS SPEAKER SYSTEM ENCEINTE SANS FIL MODEL / MODELE : XW-BTS3-W 18 V \Rightarrow 1.5 A 27 W FCC ID : LMZ-20133BT IC : 10306A-20133BT</p>	<p>CONFORMS TO ANSI/UL STD. 60065 CERTIFIED TO CAN/CSA STD. C22.2 No. 60065</p>	
<p>This device complies with Part 15 of the FCC Rules. Operation is subject to the following two conditions : (1) This device may not cause harmful interference, and (2) this device must accept any interference received, including interference that may cause undesired operation.</p>		
<p>This Class B digital apparatus complies with Canadian ICES-003. Cet appareil numérique de la Classe B est conforme à la norme NMB-003 du Canada.</p>		
<p>PIONEER CORPORATION MADE IN CHINA FABRIQUE EN CHINE</p>	<p>Serial No. <input type="text"/></p>	<p>  4005405</p>

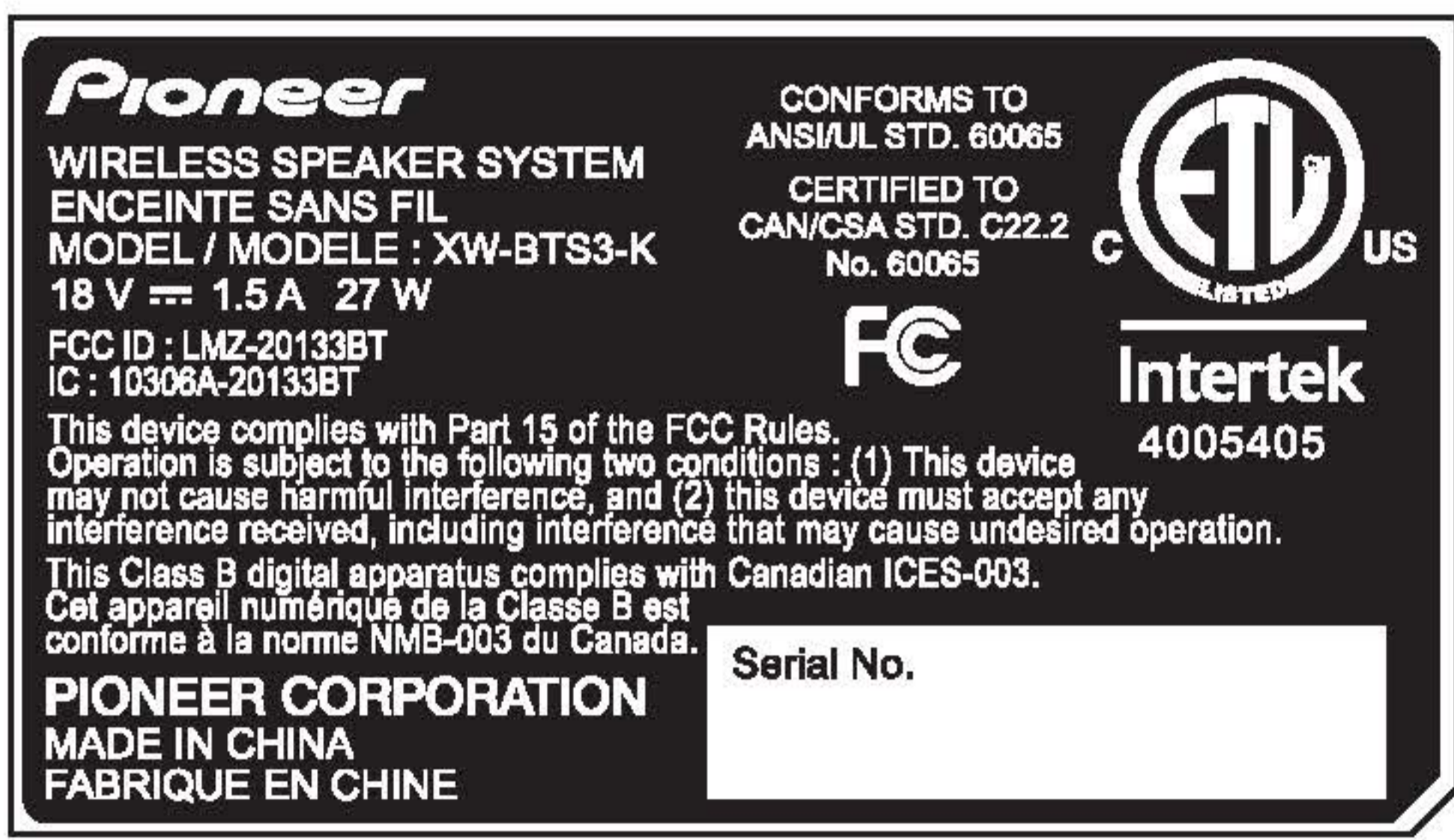
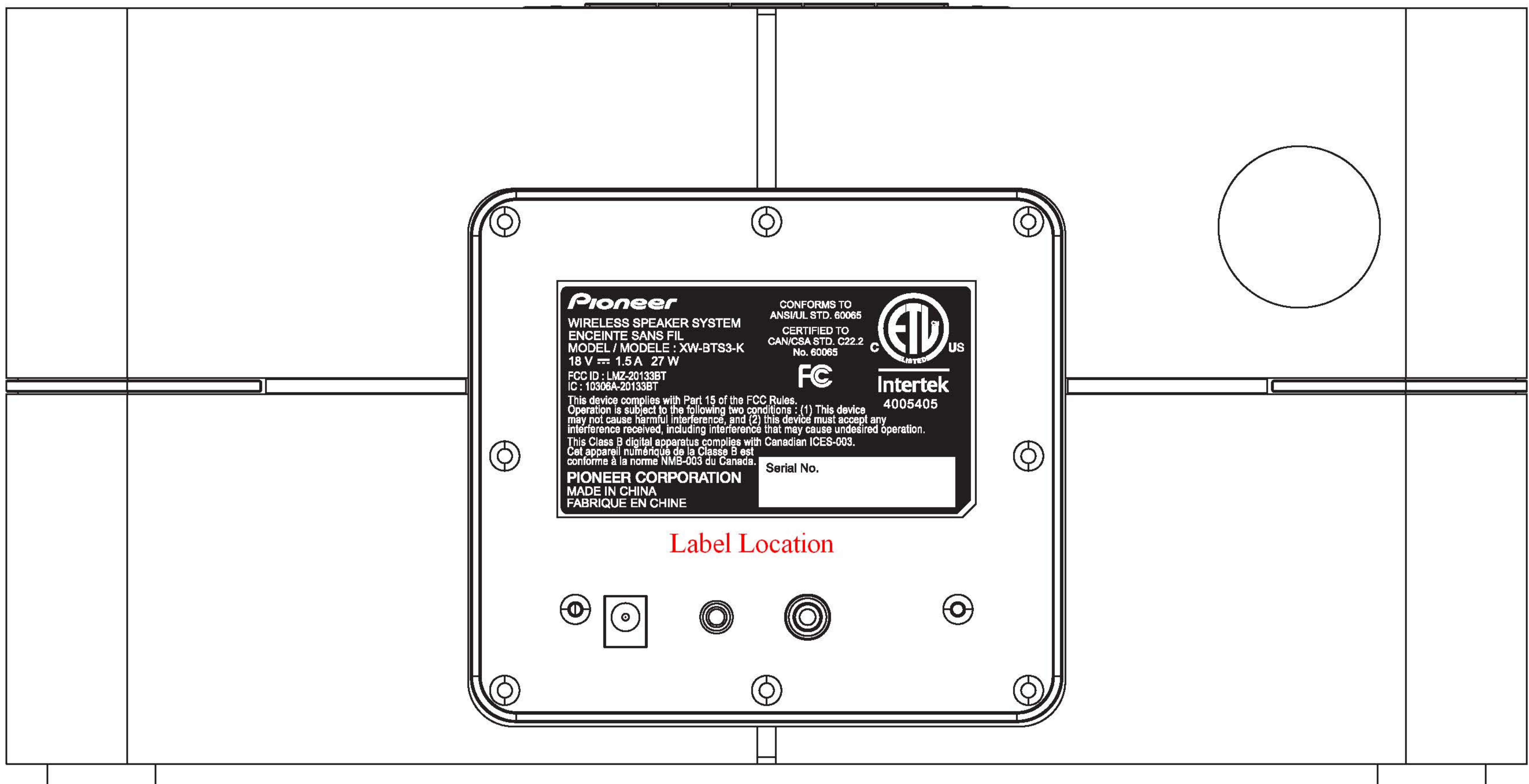
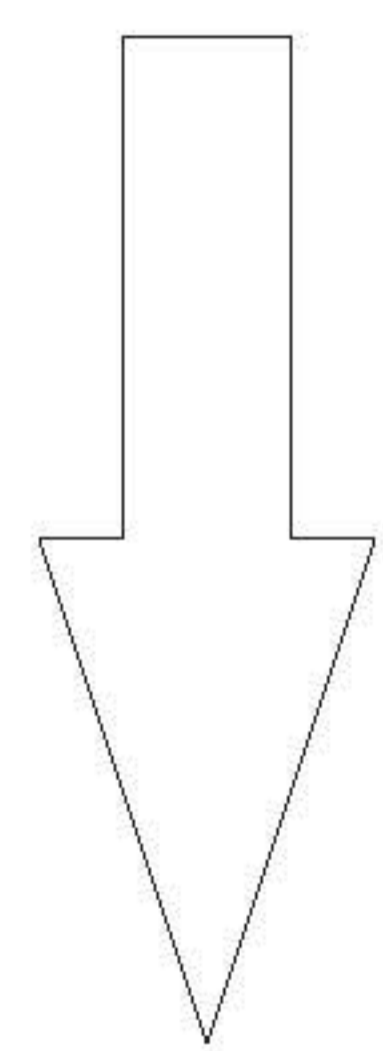
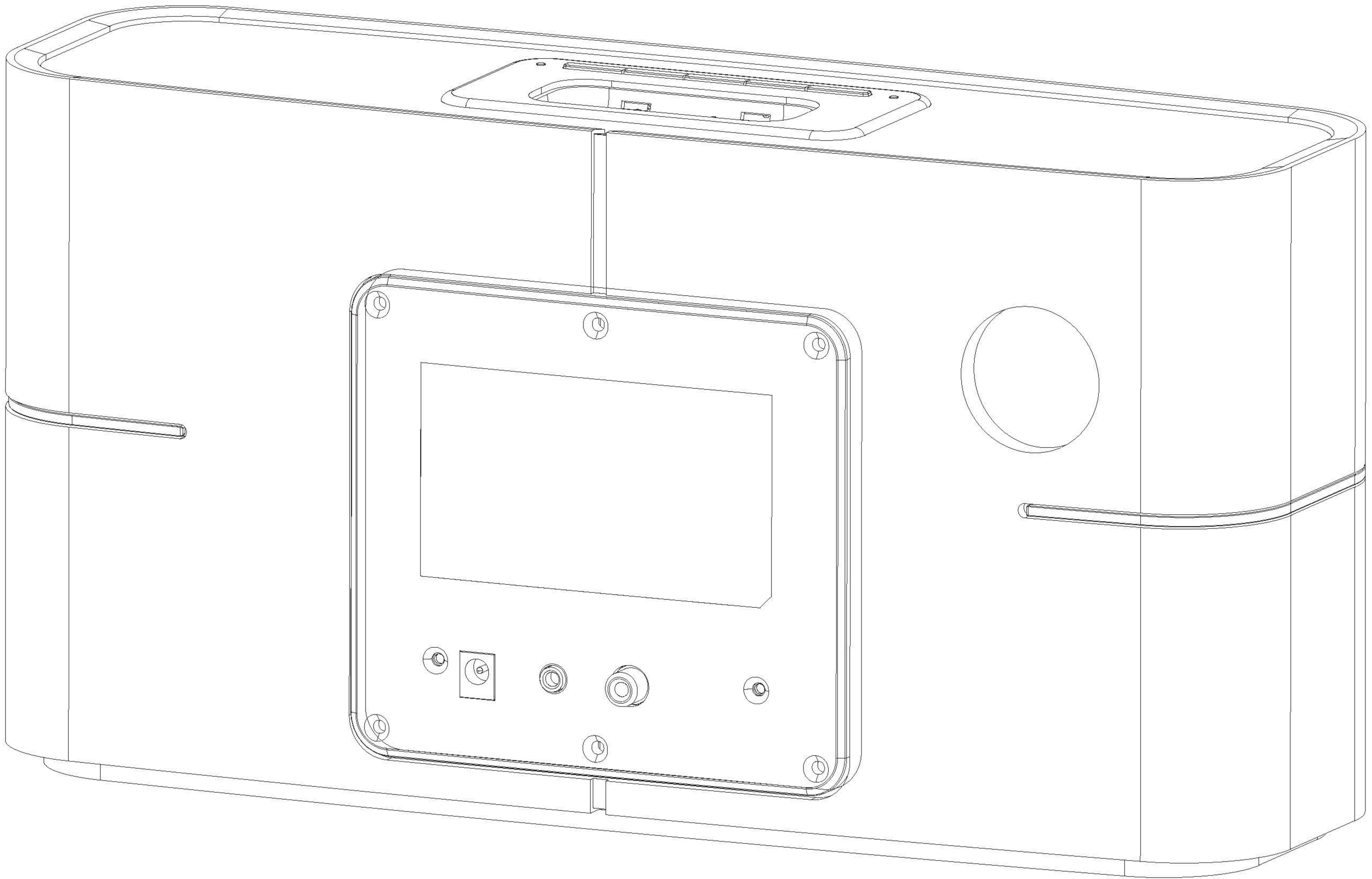

Label Location

Label Size

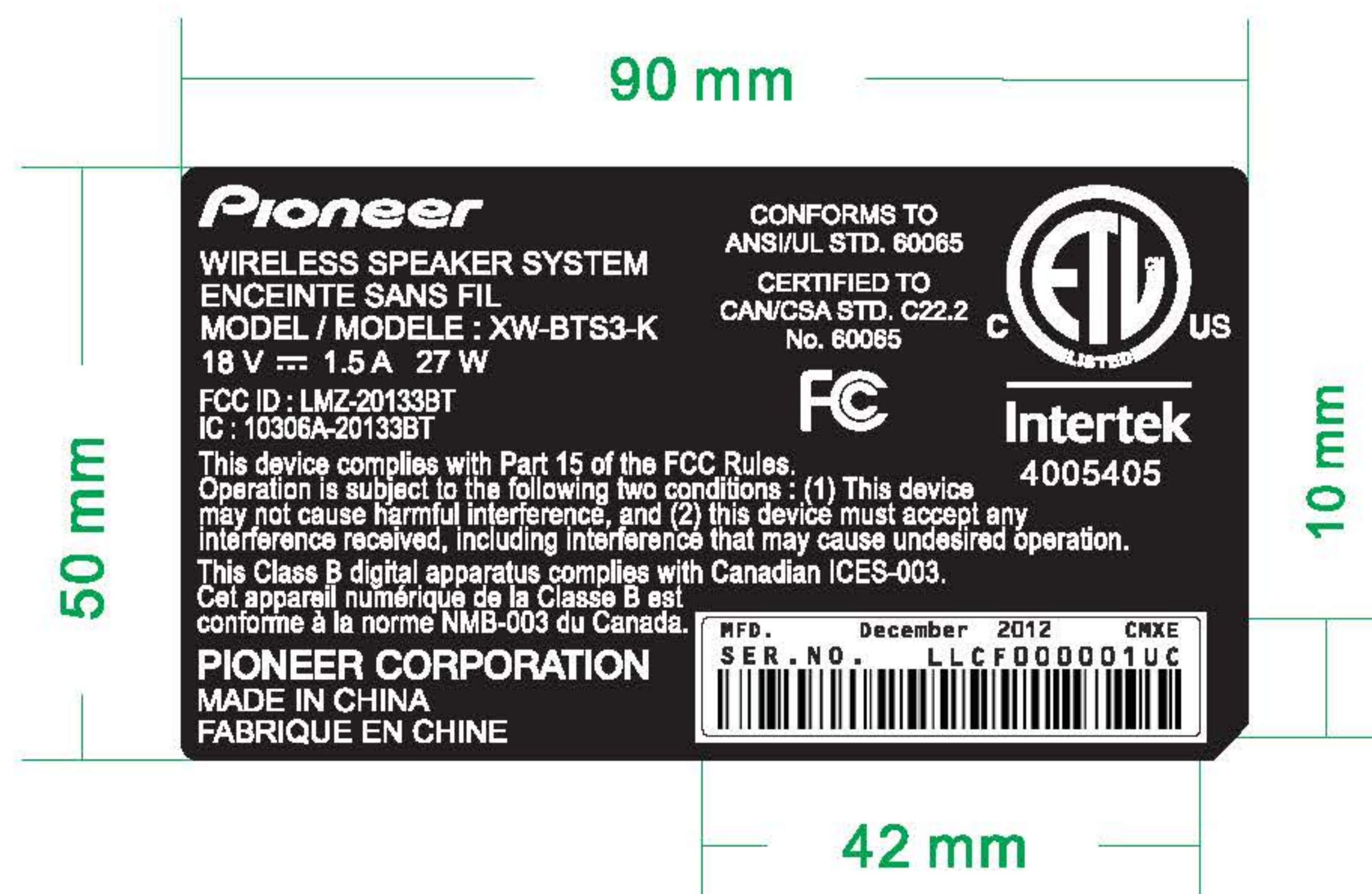

The white label is also the same location and size as the black label.