



Electromagnetic Compatibility Test Report

Tests Performed on an Aclara Technologies, LLC

Aclara Core Module, Model: 101-2020-001

Radiometrics Document RP-9571A



<i>Product Detail:</i>			
FCC ID: LLB2020001			
IC: 4546A-2020001			
Equipment type: 450-470 MHz Transceiver			
<i>Test Standards:</i>			
US CFR Title 47, Chapter I, FCC Part 2 and 90			
FCC Parts 2, 15, and 90 CFR Title 47: 2022			
IC RSS-119 Issue 12: 2015			
IC RSS-GEN Issue 5: 2018			
<i>Tests Performed For:</i>		<i>Test Facility:</i>	
Aclara Technologies, LLC		Radiometrics Midwest Corporation	
77 Westport Plaza Drive, Suite 500		12 Devonwood Avenue	
Saint Louis, MO 63146		Romeoville, IL 60446	
		Phone: (815) 293-0772	
<i>Test Dates:</i>			
January 12 to February 16, 2022			
Document RP-9571A Revisions:			
Rev.	Issue Date	Affected Sections	Revised By
0	March 17, 2022		
1	March 30, 2022	Cover	Joseph Strzelecki
2	April 1, 2022	Cover	Joseph Strzelecki



Table of Contents

1 ADMINISTRATIVE DATA	3
2 TEST SUMMARY AND RESULTS	3
3 EQUIPMENT UNDER TEST (EUT) DETAILS.....	4
3.1 EUT Description	4
4 TESTED SYSTEM DETAILS	4
4.1 Tested System Configuration	4
4.2 Special Accessories	4
4.3 Equipment Modifications	4
5 TEST SPECIFICATIONS AND RELATED DOCUMENTS	5
6 RADIOMETRICS' TEST FACILITIES.....	5
7 DEVIATIONS AND EXCLUSIONS FROM THE TEST SPECIFICATIONS	5
8 CERTIFICATION	6
9 TEST EQUIPMENT TABLE	6
10 TEST SECTIONS	6
10.1 Peak Output Power	10
10.2 Occupied Bandwidth; Emissions Masks	10
10.2.1 Conducted Spurious Emissions	17
10.3 Occupied Bandwidth	18
10.4 Field Strength of Unwanted Spurious Radiation	20
10.4.1 Test Procedures	20
Figure 1. Drawing of Radiated Emissions Setup	21
10.4.2 Spurious Radiated Emissions Test Results.....	22
10.5 Frequency Stability.....	24
10.5.1 Frequency Stability Vs Temperature	24
10.5.2 Frequency Stability Vs Supply Voltage.....	24
10.5.3 Test Results for Frequency Stability.....	24
10.6 Transient Frequency Behavior.....	25
10.6.1 Test method.....	25
10.6.2 Limits of transient frequency	25
10.6.3 Test Results.....	26
10.6.4 Results for Time Periods t1 and t2	26
10.6.5 Results for Time Period between t2 and t3.....	28
10.6.6 Results for Time Period t3.....	30
10.7 Radiated Emissions (Receive Mode).....	32
10.7.1 Radiated Emissions Field Strength Sample Calculation	32
10.7.2 Spurious Radiated Emissions Test Results (Receive Mode)	32
11 MEASUREMENT INSTRUMENTATION UNCERTAINTY	35

Notice: This report must not be reproduced (except in full) without the written approval of Radiometrics Midwest Corporation.

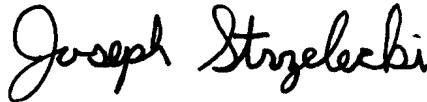

1.0 ADMINISTRATIVE DATA

<i>Equipment Under Test:</i>	
An Aclara Technologies LLC., Aclara Core Module Model: 101-2020-001; Serial Numbers: RMC-1, RMC-2 These will be referred to as the EUT in this Report	
<i>Date EUT Received at Radiometrics:</i>	<i>Test Dates:</i>
January 3, 2022	January 12 to February 16, 2022
<i>Test Report Written and Authorized By:</i>	<i>Test Witnessed By:</i>
Joseph Strzelecki Senior EMC Engineer	The tests were not witnessed by personnel from Aclara Technologies, LLC
<i>Radiometrics' Personnel Responsible for Test:</i>	
 <div style="display: flex; justify-content: space-between; align-items: center;"> 03/17/2022 Date </div> <p>Joseph Strzelecki Senior EMC Engineer NARTE EMC-000877-NE</p> <p>Jeffrey E. Tomes Senior EMC Technician</p> <p>Chris E. Dalessio EMC Technician</p>	

2.0 TEST SUMMARY AND RESULTS

The EUT (Equipment Under Test) is an Aclara Core Module, Model 101-2020-001, manufactured by Aclara Technologies, LLC. The detailed test results are presented in a separate section. The following is a summary of the test results.

Transmitter Requirements

Environmental Phenomena	Frequency Range	FCC Sections	RSS 119 Section	Test Result
RF Power Output	450-470 MHz	2.1046 & 90.205	5.4	Pass
Occupied Bandwidth Test; Emissions Masks	450-470 MHz	2.1049 & 90.209	5.5	Pass
Spurious RF Conducted Emissions	1-4700 MHz	2.1051 & 90.210	5.8	Pass
Conducted Emissions, AC Mains	0.15 - 30 MHz	15.249 & 15.207	RSS-GEN 8.8	Pass
Field Strength of Spurious Radiation	30-4700 MHz	2.1053	5.3	Pass
Frequency Vs. Temperature	450-470 MHz	2.1055 & 90.213	5.3	Pass
Frequency Vs. Voltage	450-470 MHz	2.1055 & 90.213	5.3	Pass
Transient Frequency Behavior	450-470 MHz	90.214	5.9	Pass



3.0 EQUIPMENT UNDER TEST (EUT) DETAILS

3.1 EUT Description

The EUT is an Aclara Core Module (ACM). The EUT is a 450-470 MHz transceiver, manufactured by Aclara Technologies, LLC. The ACM is a module that can be used with other Aclara products. The ACM sends data over a narrow-band RF transmission link. The RF communications link is encrypted in both directions. The EUT was in good working condition during the tests, with no known defects.

4.0 TESTED SYSTEM DETAILS

4.1 Tested System Configuration

The system was configured for testing in a typical fashion. The testing was performed in conditions as close as possible to installed conditions. Wiring was consistent with manufacturer's recommendations. The identification for all equipment, used in the tested system, is:

Tested System Configuration List

Item	Description	Type*	Manufacturer	Model Number	Serial Number
1	Aclara Core Module	E	Aclara Technologies, LLC	101-2020-001	RMC-1
2	Aclara Core Module	E	Aclara Technologies, LLC	101-2020-001	RMC-2

* Type: E = EUT

4.2 Operating Conditions of EUT

The EUT was in a normal operating mode during the tests. All circuits were activated during the tests. Power was supplied with a new battery.

Type of modulation including the bit rate and symbol rate	7232 Baud NRZ 2GFSK with +/-2.0KHz Dev. Typ.
Name and version of the test software used to exercise the device	RF Test Mode App ACM version 1.0.15
Power settings used for the purpose of exercising the device	30 dBm
Firmware number of the transmitter	Ver1.0.17

The EUT was set to 2GFSK modulation.

4.3 Special Accessories

No special accessories were used during the tests in order to achieve compliance.

4.4 Equipment Modifications

No modifications were made to the EUT at Radiometrics' test facility in order to comply with the standards listed in this report.



5.0 TEST SPECIFICATIONS AND RELATED DOCUMENTS

Document	Date	Title
FCC CFR Title 47	2022	Code of Federal Regulations Title 47, Chapter 1, Federal Communications Commission, Part 15 & 90 - Radio Frequency Devices
ANSI C63.4-2014	2014	Methods of Measurement of Radio Noise Emissions from Low-Voltage Electrical and Electronic Equipment in the Range of 9 kHz to 40 GHz
TIA-603-E	2016	Land Mobile FM or PM Communications Equipment – Measurement and Performance Standards
IC RSS-Gen Issue 5	2018	General Requirements and Information for the Certification of Radiocommunication Equipment (RSS-Gen)
IC RSS-119 Issue 12	2015	Radio Transmitters and Receivers Operating in the Land Mobile and Fixed Services in the Frequency Range 27.41-960 MHz

RSS-Gen & RSS-119 are not currently in Radiometrics’ Scope of Accreditation, however it uses the procedures from TIA-603-D and ANSI C63.4 that are in Radiometrics Scope of Accreditation

6.0 RADIOMETRICS’ TEST FACILITIES

The results of these tests were obtained at Radiometrics Midwest Corp. in Romeoville, Illinois, USA. Radiometrics is accredited by A2LA (American Association for Laboratory Accreditation) to conform to ISO/IEC 17025: 2017 "General Requirements for the Competence of Calibration and Testing Laboratories". Radiometrics’ Lab Code is 121191 and Certification Number is 1495.01. A copy of the accreditation can be accessed on our web site (www.radiomet.com). Radiometrics accreditation status can be verified at A2LA’s web site (www.a2la2.org).

The following is a list of shielded enclosures located in Romeoville, Illinois used during the tests:

Chamber A: Is an anechoic chamber that measures 24’ L X 12’ W X 12’ H. The walls and ceiling are fully lined with ferrite absorber tiles. The floor has a 10’ x 10’ section of ferrite absorber tiles located in the center. Panashield of Rowayton, Connecticut manufactured the chamber. The enclosure is NAMAS certified.

Chamber B: Is a shielded enclosure that measures 20’ L X 12’ W X 8’ H. Erik A. Lindgren & Associates of Chicago, Illinois manufactured the enclosure.

Chamber E: Is a custom-made anechoic chamber that measures 52’ L X 30’ W X 18’ H. The walls and ceiling are fully lined with RF absorber. Pro-shield of Collinsville, Oklahoma manufactured the chamber.

Test Station F: Is an area that measures approximately 10’ D X 12’ W X 10’ H. The floor and back wall are metal shielded. This area is used for conducted emissions measurements.

A separate ten-foot long, brass plated, steel ground rod attached via a 6-inch copper braid grounds each of the above chambers. Each enclosure is also equipped with low-pass power line filters.

The FCC has accepted these sites as test site number US1065. The FCC test site Registration Number is 732175. Details of the site characteristics are on file with the Industry Canada as site number IC3124A.

7.0 DEVIATIONS AND EXCLUSIONS FROM THE TEST SPECIFICATIONS

There were no deviations or exclusions from the test specifications.



8.0 CERTIFICATION

Radiometrics Midwest Corporation certifies that the data contained herein was taken under conditions that meet or exceed the requirements of the test specification. The results relate only to the EUT listed herein. Any modifications made to the EUT subsequent to the indicated test date will invalidate the data and void this certification.

9.0 TEST EQUIPMENT TABLE

RMC ID	Manufacturer	Description	Model No.	Serial No.	Frequency Range	Cal Period	Cal Date
AMP-05	RMC/Celeritek	Pre-amplifier	MW110G	1001	1.0-12GHz	12 Mo.	01/04/22
ANT-06	EMCO	Log-Periodic Ant.	3146	1248	200-1000MHz	24 Mo.	01/18/22
ANT-07	RMC	Log-Periodic Ant.	LP1000	1001	200-1000MHz	24 Mo.	08/11/21
ANT-13	EMCO	Horn Antenna	3115	2502	1.0-18GHz	24 Mo.	01/29/21
ANT-66	ETS-Lindgren	Horn Antenna	3115	62580	1.0-18GHz	24 Mo.	03/11/21
ANT-79	AH Systems	Bicon Antenna	SAS-540	793	20-330MHz	24 Mo.	01/05/21
ANT-80	AH Systems	Bicon Antenna	SAS-540	294	20-330MHz	24 Mo.	01/05/21
ATT-53	Weinschel	Attenuator (20 dB)	23-20-34	CG7857	DC-18 GHz	12 Mo	12/17/21
CDT-01	Wiltron	Crystal RF Detector	75N50	CDT-01	DC-18GHz	N/A	NCR
COM-01	Anaren	Coupler	10023-3	COM-01	250-1000MHz	N/A	NCR
DIR-19	Narda	Directional Coupler	3000-10	01174	200-500MHz	N/A	NCR
DMM-09	Fluke	DMM	15B	12220951	DC-500 Hz	24 Mo.	01/22/21
HPF-01	Solar	High Pass Filter	7930-100	HPF-1	0.15-30MHz	24 Mo.	03/02/20
LSN-01	Electrometrics	50 uH LISN	FCC/VDE 50/2	1001	0.01-30MHz	24 Mo.	08/23/21
PWM-01	Boonton	Power Meter	4230	22503	50kHz-18GHz	24 Mo.	01/15/20 02/12/22
REC-11	HP / Agilent	Spectrum Analyzer	E7405A	US39110103	9Hz-26.5GHz	24 Mo.	04/16/20
REC-20	HP / Agilent	Spectrum Analyzer	85460A/84562A	33330A00135 3410A00178	30Hz-6GHz	24 Mo.	08/18/21
REC-44	Agilent	Spectrum Analyzer	E4440A	US40420673	3Hz-26.5GHz	24 Mo.	02/25/20
SCP-02	Tektronix	Oscilloscope	TDS784A	B040258	DC-1GHz	24 Mo.	01/22/21
SIG-31	Rohde Schwarz	Vector Signal Generator	SMJ 100A	101395	100kHz-6GHz	36 Mo.	09/08/20
TC-01	GS Blue M Electric	Temperature Chamber	ETC-04S-E	0003-ETC-201	-40 to 100 Deg C	24 Mo.	10/16/20
THM-02	Fluke	Temp/Humid Meter	971	93490471	N/A	24 Mo.	11/13/20

Note: All calibrated equipment is subject to periodic checks.

NCR – No Calibration Required. Device monitored by calibrated equipment. N/A: Not Applicable.

10.0 TEST SECTIONS

10.1 AC Conducted Emissions

The tests and limits are in accordance with FCC section 15.207 and RSS Gen section 8.8.

A computer-controlled analyzer was used to perform the conducted emissions measurements. The frequency range was divided into 500 subranges equally spaced on a logarithmic scale. The computer recorded the peak of each subrange. This data was then plotted on a semi-log graph generated by the computer. Adjusting the positions of the cables and orientation of the test system then maximizes the highest emissions.



Mains Conducted emission measurements were performed using a 50 Ohm/50 uH Line Impedance Stabilization Network (LISN) as the pick-up device. Measurements were repeated on both leads within the power cord. If the EUT power cord exceeded 80 cm in length, the excess length of the power cord was made into a 30 to 40 cm bundle near the center of the cord. The LISN was placed on the floor at the base of the test platform and electrically bonded to the ground plane.

FCC Limits of Conducted Emissions at the AC Mains Ports

Frequency Range (MHz)	Class B Limits (dBuV)	
	Quasi-Peak	Average
0.150 - 0.50*	66 - 56	56 - 46
0.5 - 5.0	56	46
5.0 - 30	60	50

* The limit decreases linearly with the logarithm of the frequency in this range.

The initial step in collecting conducted data is a peak detector scan and the plotting of the measurement range. Significant peaks are then marked as shown on the following table, and these signals are then measured with the quasi-peak detector. The following represents the worst case emissions from the EUT power supply, after testing all modes of operation.

Model	101-2020-001	Specification	FCC part 15 RSS-GEN
Serial Number	RMC-2	Test Date	January 24, 2022
Test Personnel	Jeffrey Tomes	Test Location	Chamber B
Test Equipment	Spectrum Analyzer (REC-20); LISN (LSN-01)		

The Amplitude is the final corrected value with cable and LISN Loss.

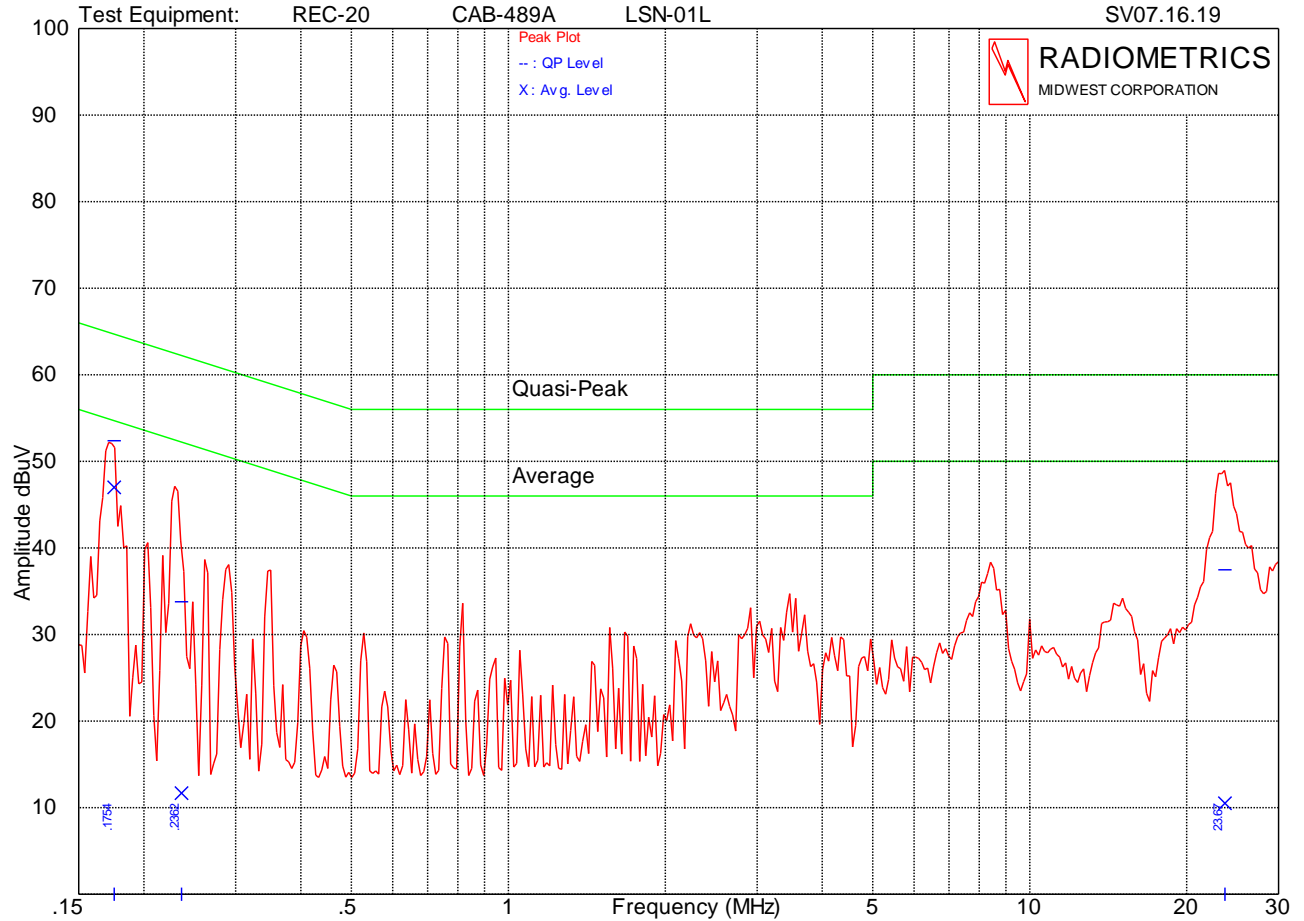

Company: Aclara
 Lead Tested: AC Hot 120 VAC
 Notes: UpBright AC Adaptor Model 335000
 FCC/ICES/EN; Class B Conducted Emissions; Mains Port

Model: ACM 101-2020-001 Rev B
 S/N : RMC-2

Date :01-24-2022
 Time:14:19
 Tested By: JET
 RP-9571A | CE-HOT

Frequency (MHz)	QP Amp. (dBuV)	QP Limit (dBuV)	Average Amp. (dBuV)	Average Limit (dBuV)	Margin Under Limit (dB)
0.175	52.4	64.7	47.0	54.7	7.7
0.236	33.8	62.2	11.7	52.2	28.4
23.678	37.5	60.0	10.5	50.0	22.5

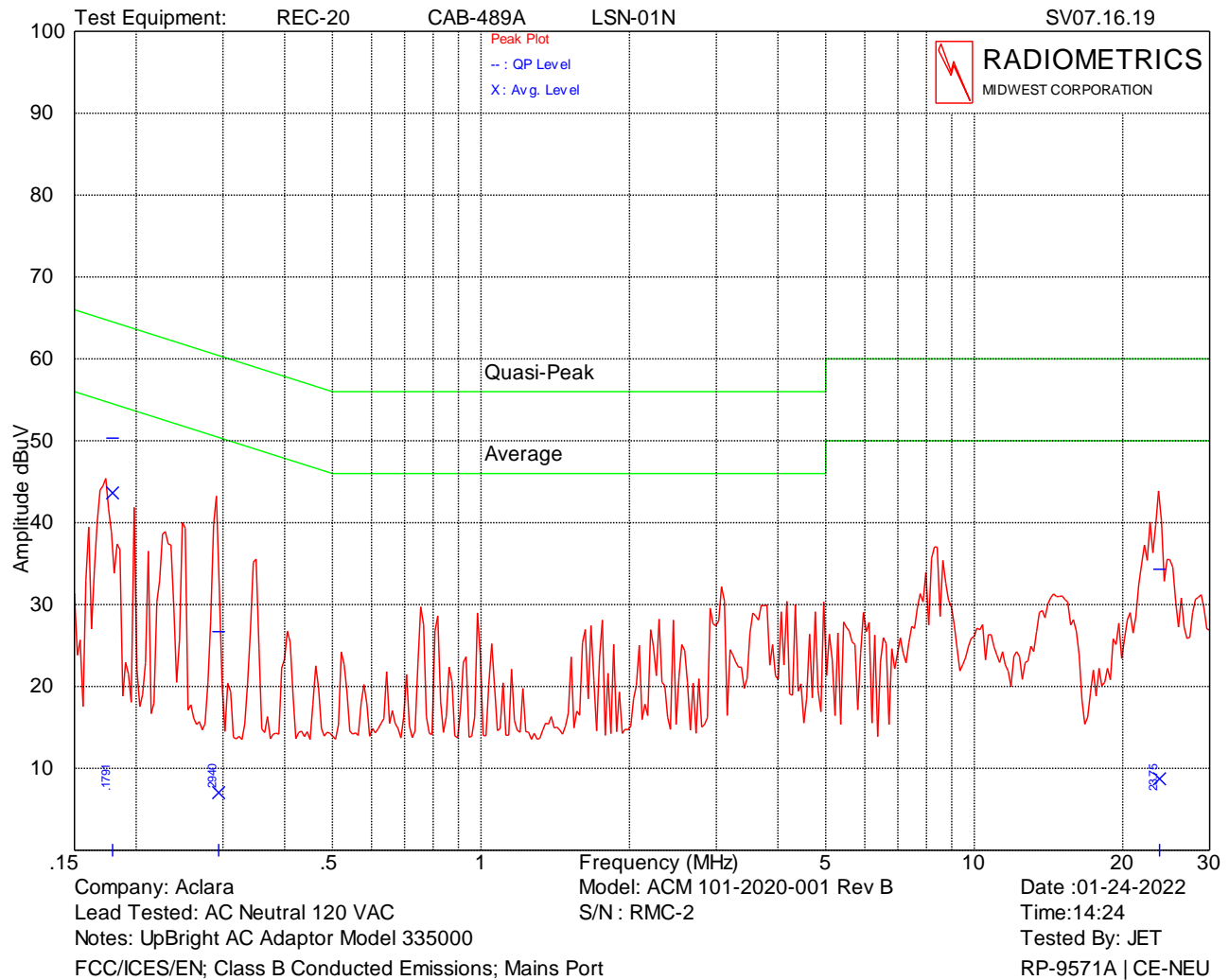

Frequency (MHz)	QP Amp. (dBuV)	QP Limit (dBuV)	Average Amp. (dBuV)	Average Limit (dBuV)	Margin Under Limit (dB)
0.179	50.3	64.5	43.6	54.5	10.9
0.294	26.7	60.4	7.0	50.4	33.7
23.751	34.3	60.0	8.7	50.0	25.7

Judgement: Pass by at least 8 dB.



10.2 Peak Output Power

The peak power was measured by connecting the EUT antenna port to the spectrum analyzer via a low loss coaxial cable and an appropriate power attenuator.

Model	101-2020-001	Specification	FCC part 90.205 RSS-119 Section 5.4
Serial Number	RMC-2	Test Date	January 20, 2022
Test Personnel	Jeffrey Tomes	Test Location	Chamber B
Test Equipment	Power meter (PWM-01); Attenuator (ATT-53)		

Standard Power

TX Freq MHz	Reading dBm	Atten & Cable	Total dBm	Peak Power Watts	Antenna Gain dBi	ERP Watts
450.0250	9.30	20.4	29.7	0.933	5.0	1.799
460.0000	9.10	20.4	29.5	0.891	5.0	1.718
469.9750	8.50	20.4	28.9	0.776	5.0	1.496

Judgement: Pass

The fundamental emission ERP limit is 100 watts (50 dBm) for an 8 km service area radius.

Note that in decibel units:

$$ERP = EIRP - 2.15 = P+G-2.15$$

where:

P = transmitter output power in dB(W)

G = Gain of the transmitting antenna in dBi

3 dBi is the maximum gain allowed by the product specification.

10.3 Occupied Bandwidth; Emissions Masks

Model	101-2020-001	Specification	FCC Part 90.209 & 90.210 RSS-119 Section 5.5
Serial Number	RMC-2	Test Date	01/12/2022
Test Personnel	Joseph Strzelecki	Test Location	Chamber B
Test Equipment	Spectrum Analyzer (REC-44); Attenuator (ATT-53)		

The spectrum analyzer was set to the MAX HOLD mode to record the worst case of the modulation. The EUT was transmitting at its maximum data rate. The trace was allowed to stabilize. All Channels are 12.5 kHz. The emissions Mask D is from FCC part 90.210.

- (1) On any frequency from the center of the authorized bandwidth f0 to 5.625 kHz removed from f0: Zero dB.
- (2) On any frequency removed from the center of the authorized bandwidth by a displacement frequency (fd in kHz) of more than 5.625 kHz but no more than 12.5 kHz: At least 7.27(fd - 2.88 kHz) dB.
- (3) On any frequency removed from the center of the authorized bandwidth by a displacement frequency (fd in kHz) of more than 12.5 kHz: At least 50 + 10 log (P) dB.

For all Frequencies beyond 25 kHz from the center of the transmit frequency, the worst-case limit was used. The red line is a 50-dB reduction from carrier based on 1 watt.

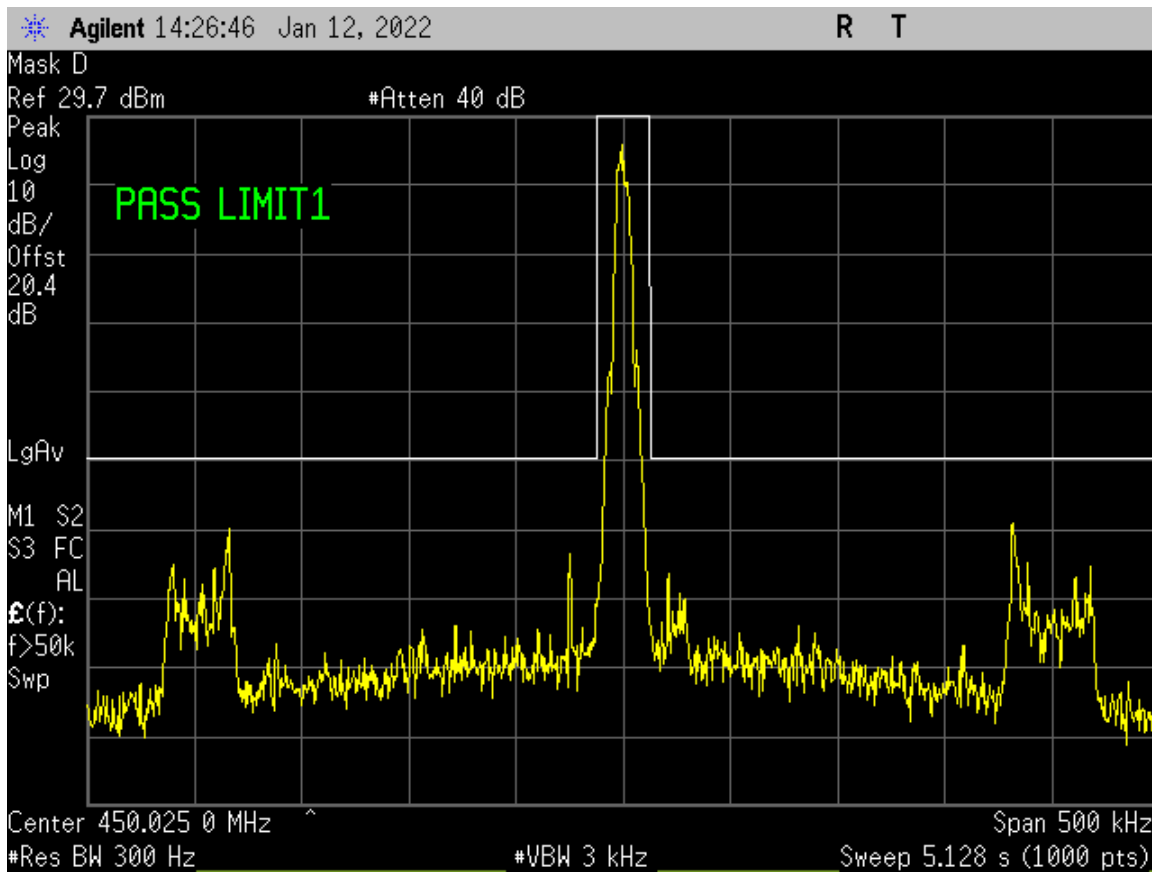
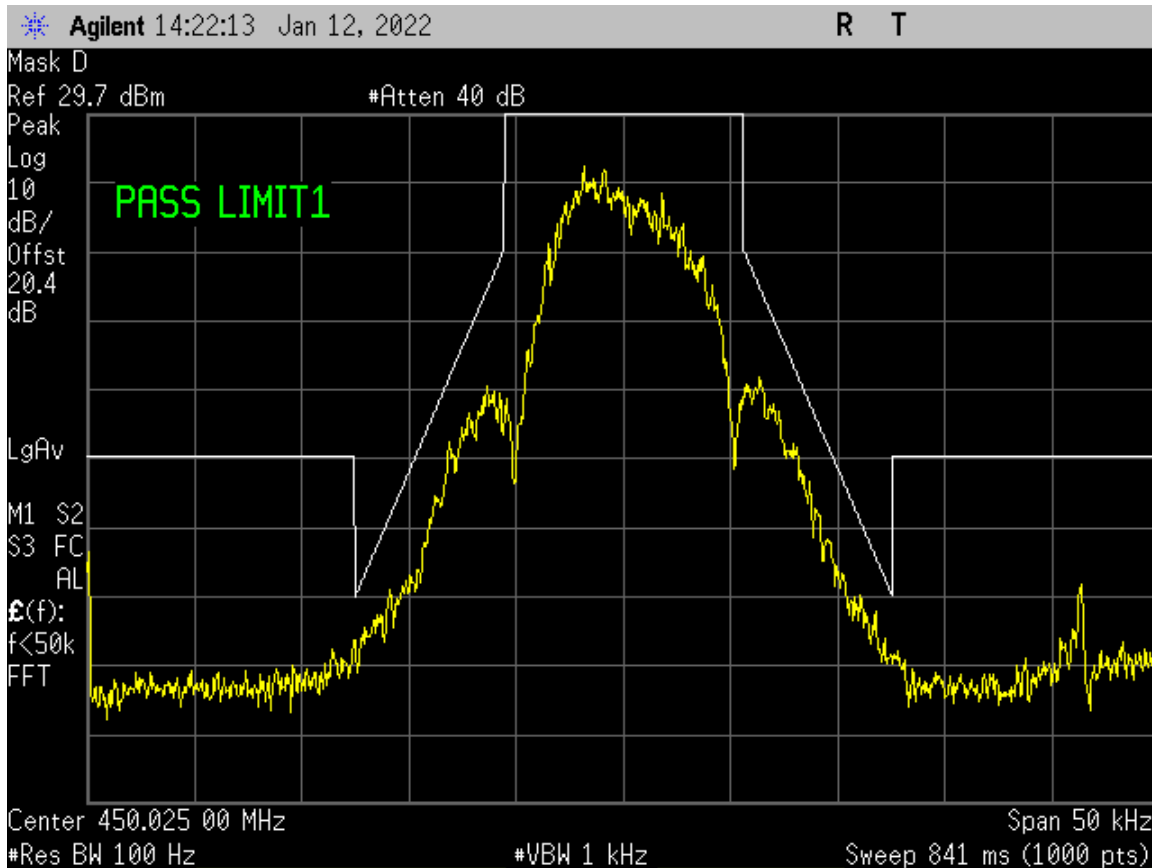

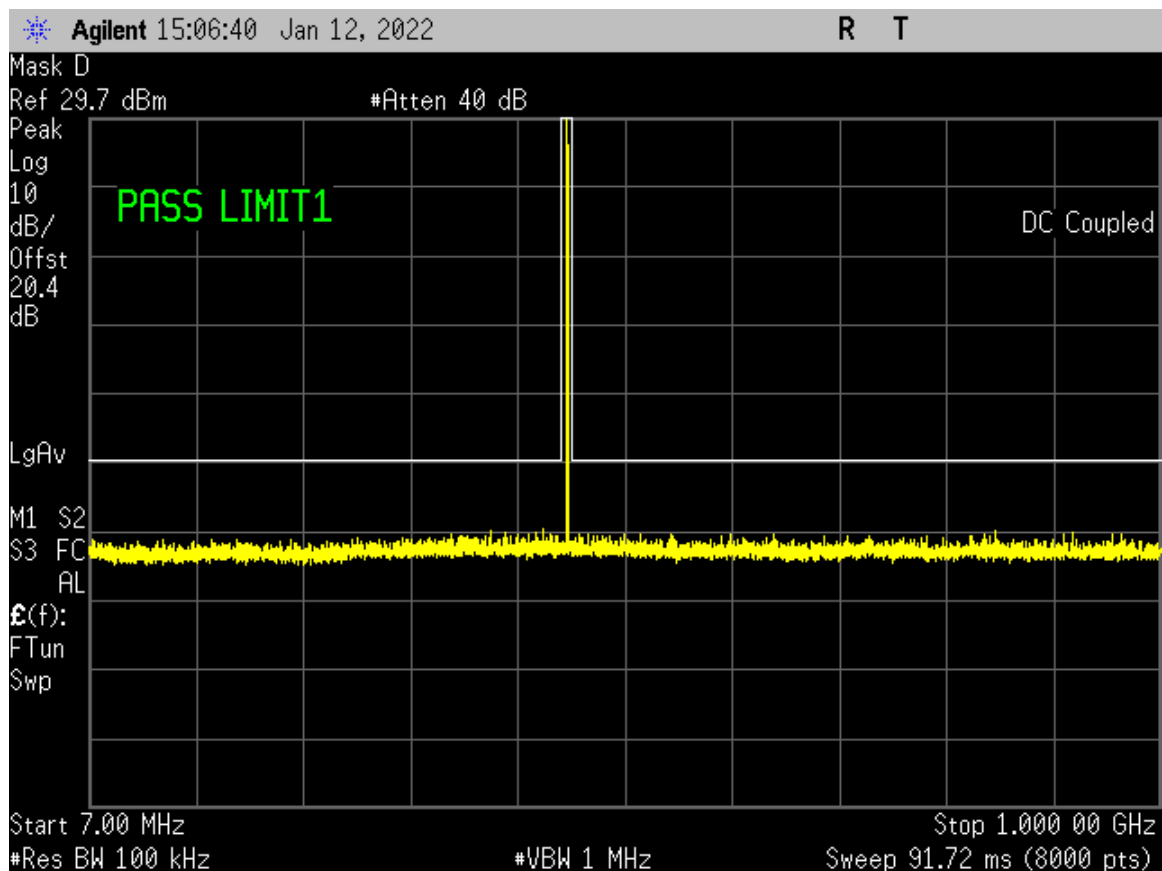
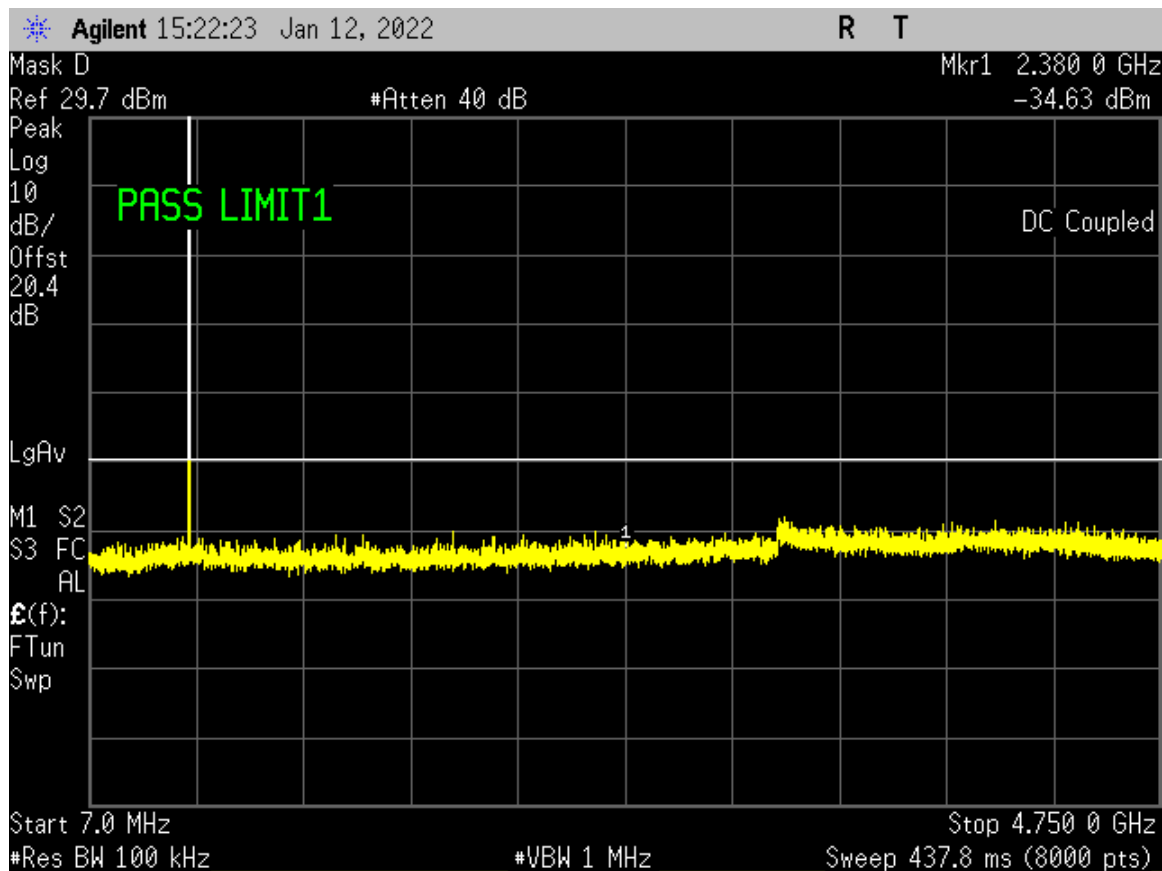

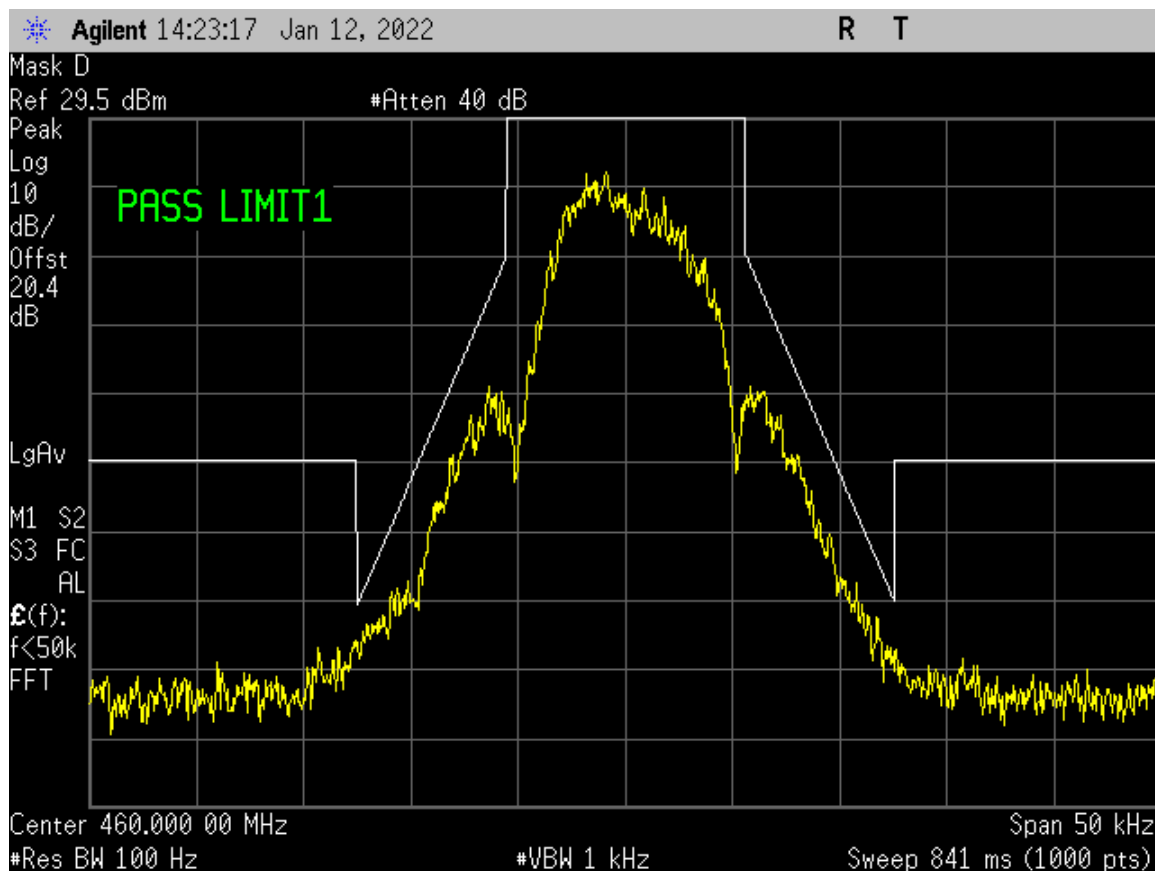
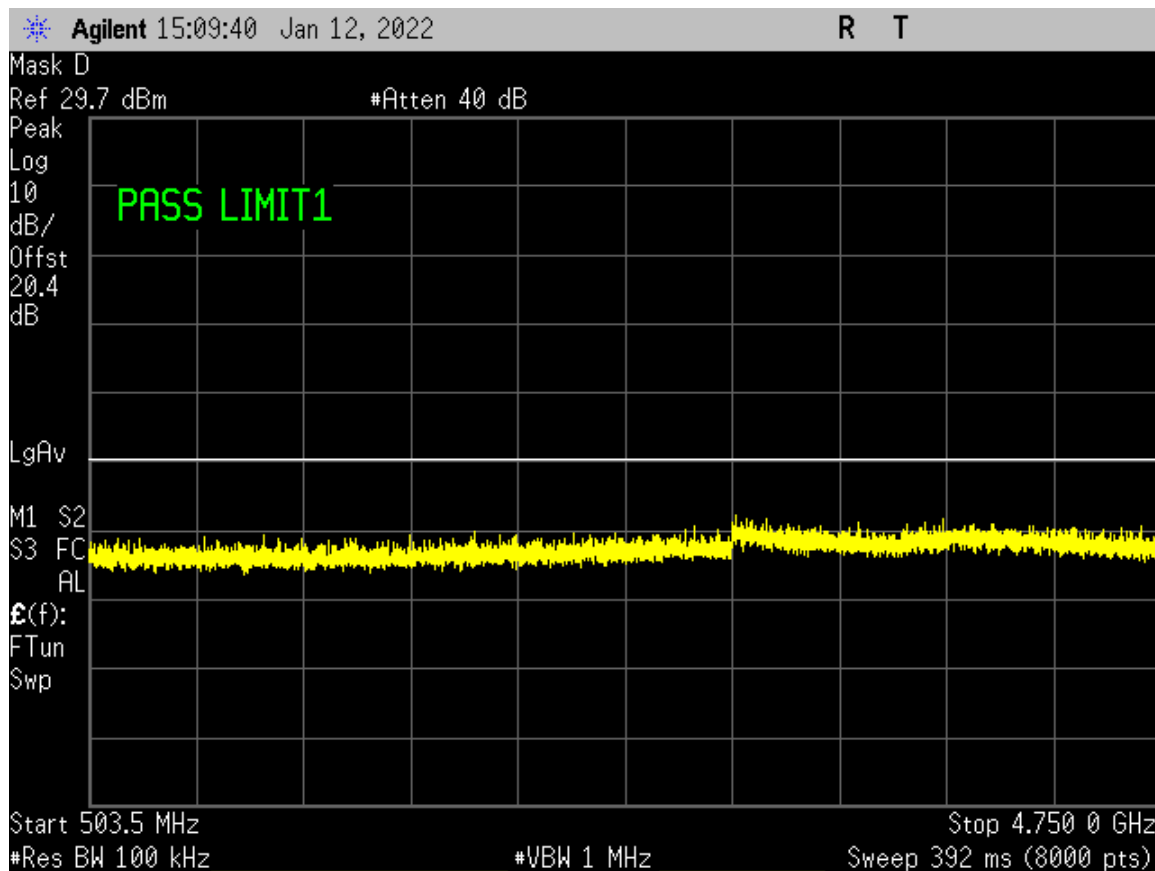

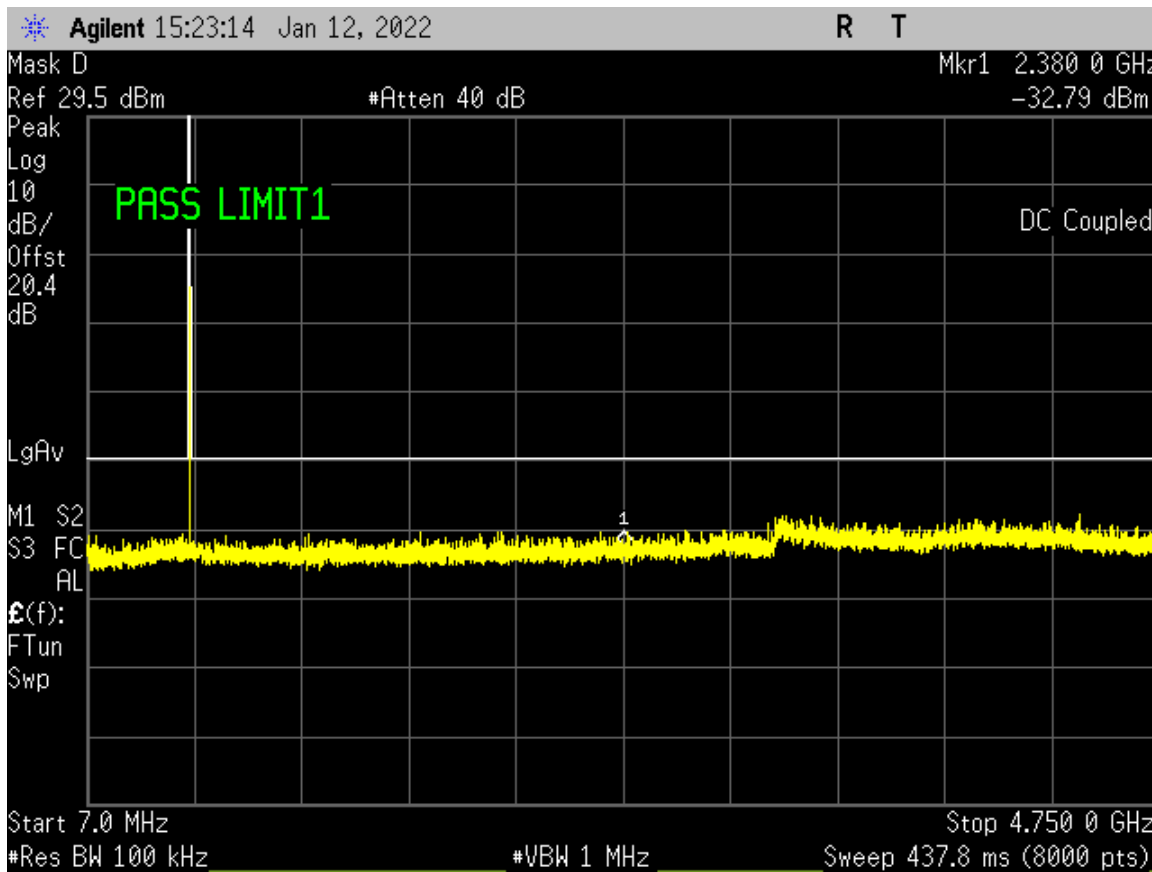
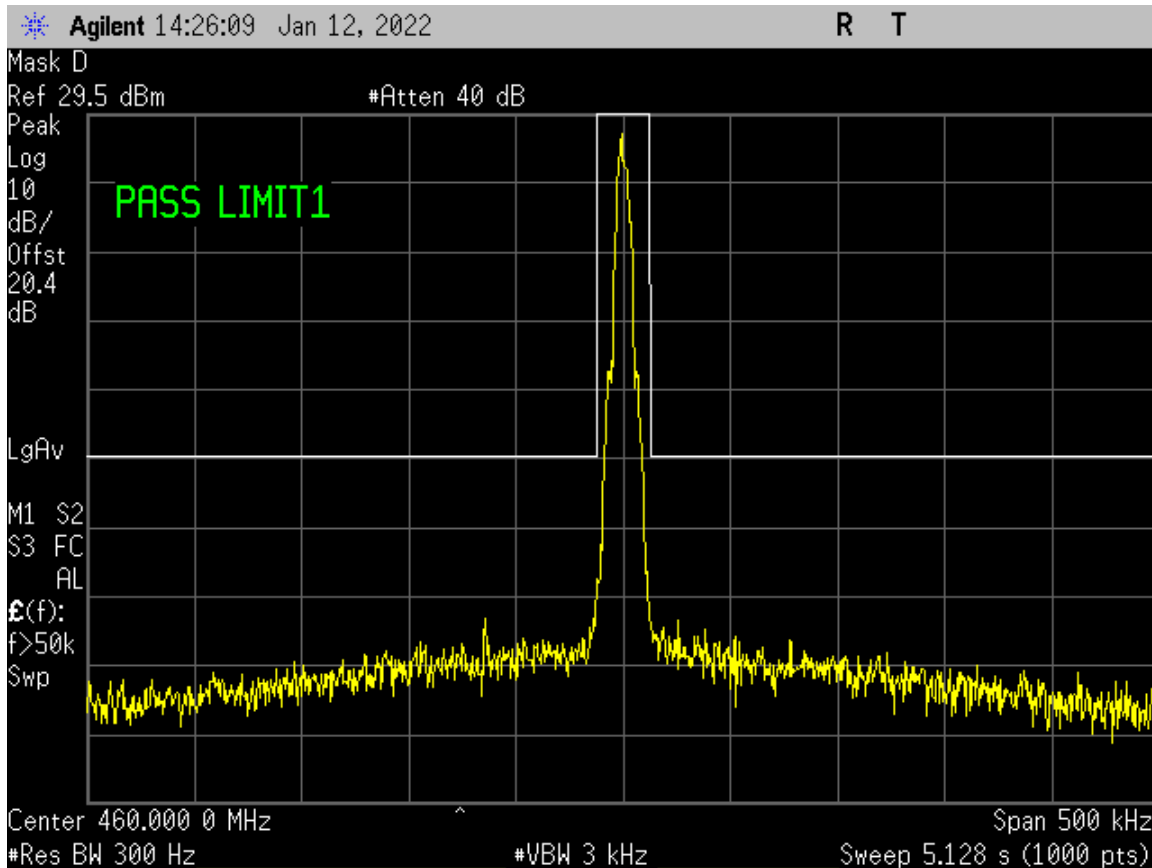

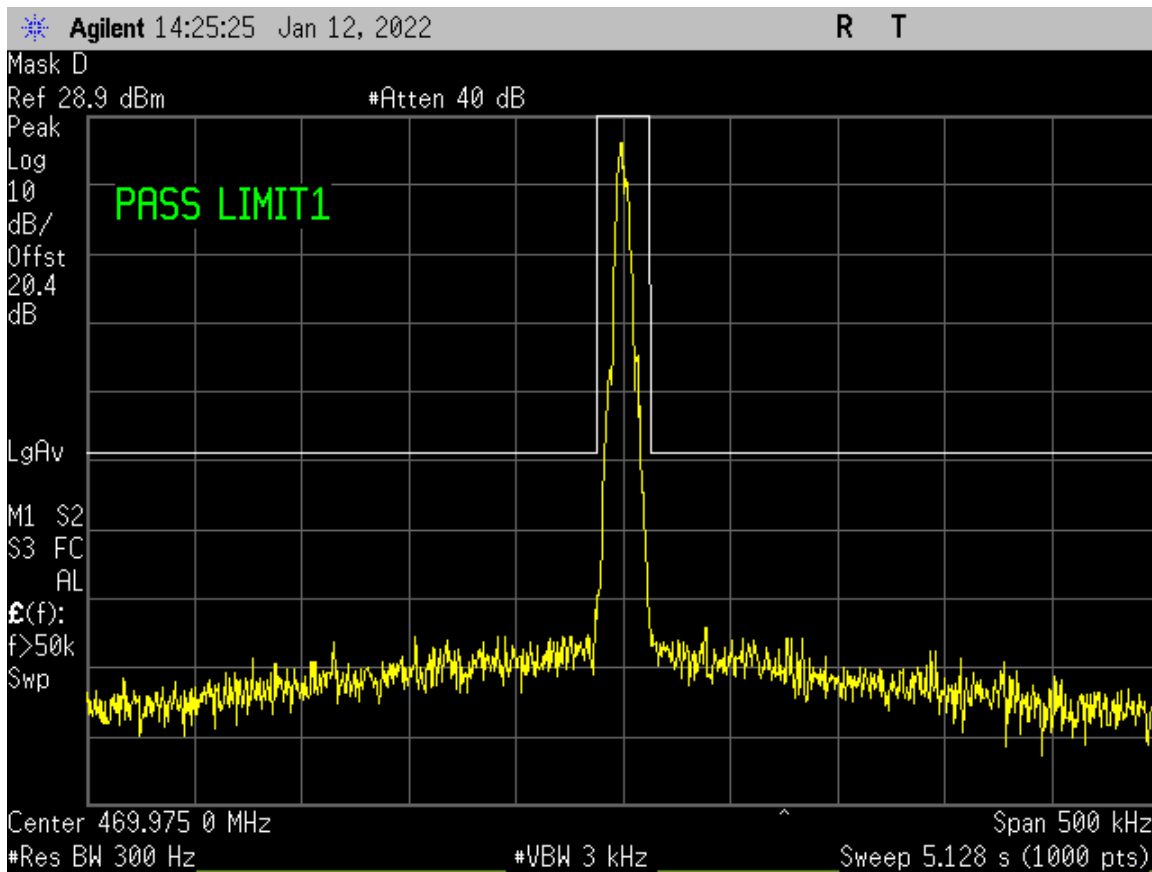
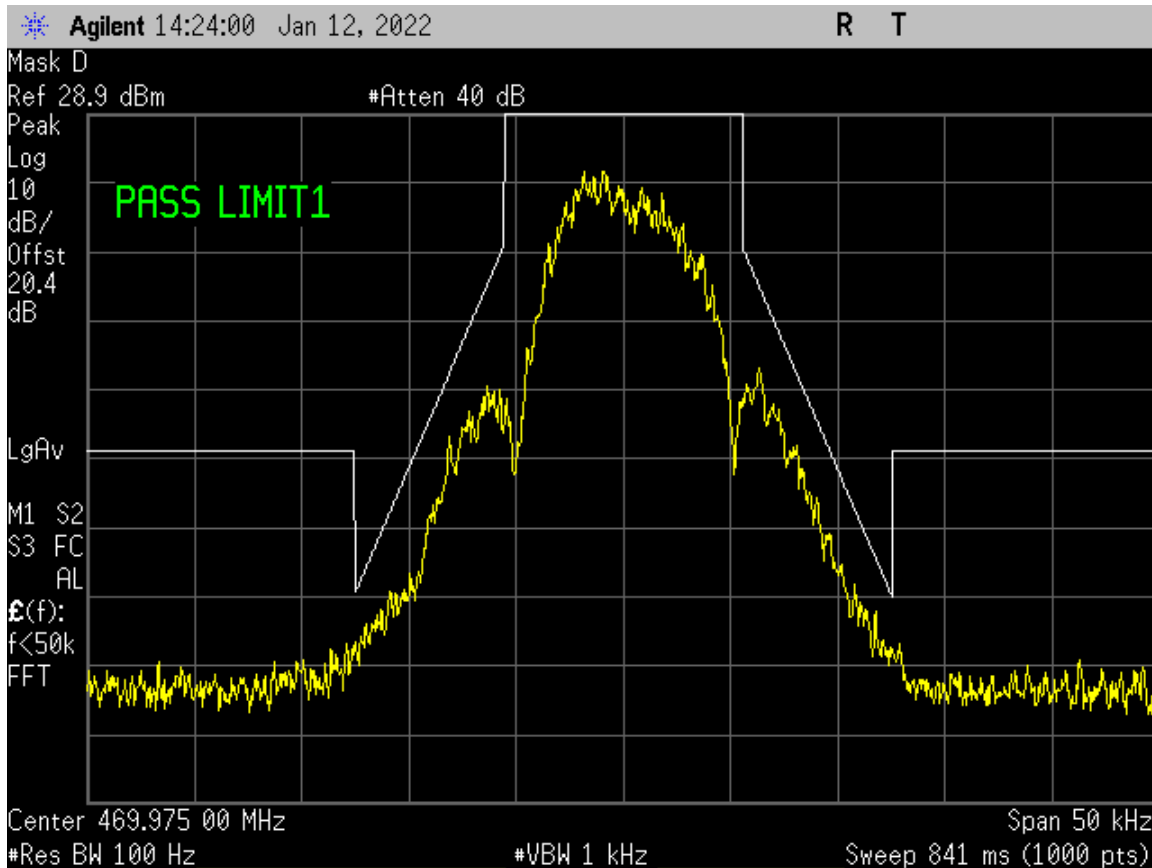

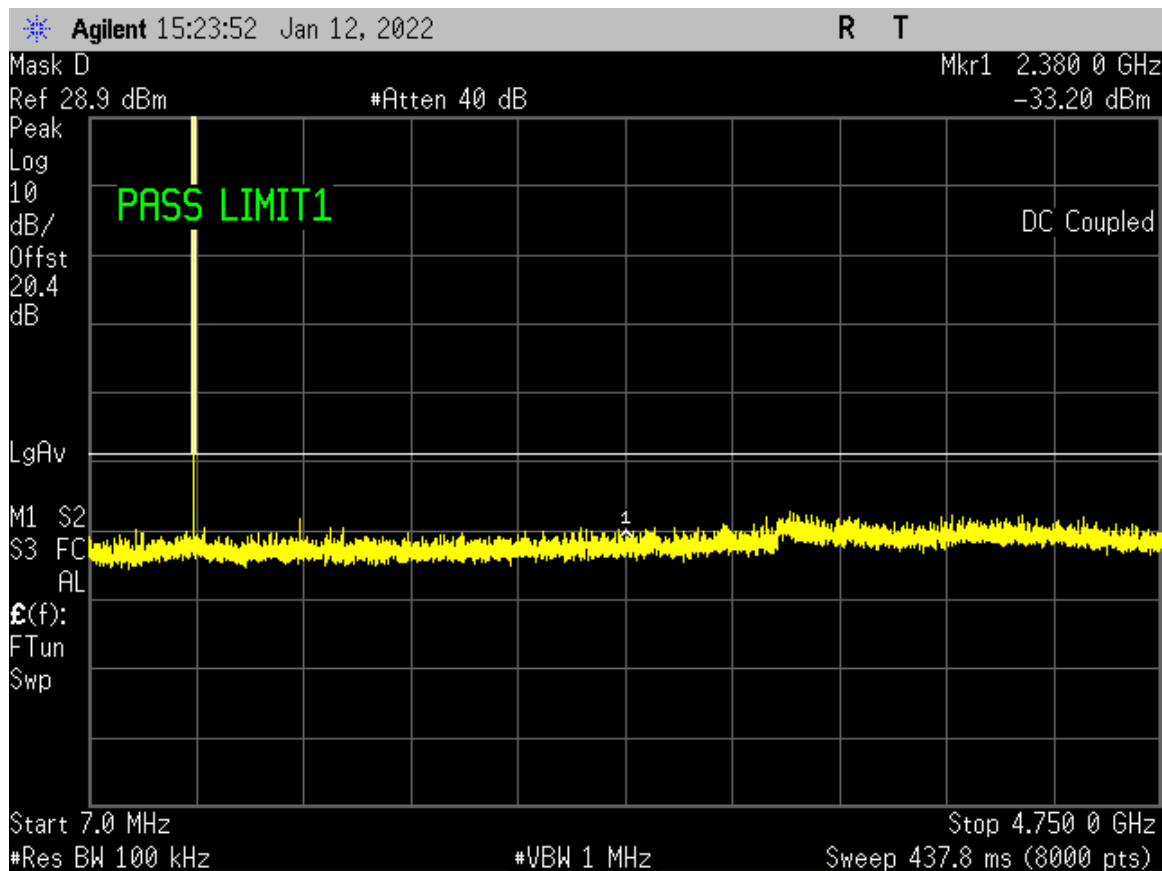

Judgement: Pass



10.3.1 Conducted Spurious Emissions

Model	101-2020-001	Specification	FCC Part 90.210 RSS-119 Section 5.5
Serial Number	RMC-2	Test Date	01/22/2022
Test Personnel	Jeffrey Tomes	Test Location	Chamber B
Test Equipment	EMI Receiver (REC-44); Attenuator (ATT-53)		

This is a direct measurement from the Antenna port to the EMI Receiver

Power 7

Freq. Tx MHz	Harm #	Tested Freq. MHz	Rec Reading dBm	HPF-09 Attn. Factor dB	Ext. Atten. Factor dB	Cable Loss dB	Total Power dBm	Power Limit dBm	Margin Under Limit dB
450.0250	1	450.0250	9.3	0.0	19.9	0.5	29.7	37.0	7.3
450.0250	2	900.0500	-49.6	0.4	6.1	0.5	-42.6	-20.0	22.6
450.0250	3	1350.0750	-62.9	0.4	6.1	0.6	-55.8	-20.0	35.8
450.0250	4	1800.1000	-51.0	0.4	6.1	0.7	-43.8	-20.0	23.8
450.0250	5	2250.1250	-40.4	0.5	6.1	0.7	-33.1	-20.0	13.1
450.0250	6	2700.1500	-73.0	0.6	6.1	0.8	-65.5	-20.0	45.5
450.0250	7	3150.1750	-70.6	0.5	6.1	0.9	-63.1	-20.0	43.1
450.0250	8	3600.2000	-62.4	0.8	6.1	0.9	-54.6	-20.0	34.6
450.0250	9	4050.2250	-55.6	1.0	6.1	1.0	-47.5	-20.0	27.5
450.0250	10	4500.2500	-60.6	1.0	6.1	1.0	-52.5	-20.0	32.5
460.0000	1	460.0000	9.1	0.0	19.9	0.5	29.5	37.0	7.5
460.0000	2	920.0000	-50.8	0.4	6.1	0.5	-43.8	-20.0	23.8
460.0000	3	1380.0000	-61.0	0.4	6.1	0.6	-53.9	-20.0	33.9
460.0000	4	1840.0000	-49.2	0.4	6.1	0.7	-42.0	-20.0	22.0
460.0000	5	2300.0000	-44.1	0.5	6.1	0.7	-36.8	-20.0	16.8
460.0000	6	2760.0000	-69.3	0.6	6.1	0.8	-61.8	-20.0	41.8
460.0000	7	3220.0000	-74.6	0.5	6.1	0.9	-67.1	-20.0	47.1
460.0000	8	3680.0000	-57.4	0.8	6.1	0.9	-49.6	-20.0	29.6
460.0000	9	4140.0000	-53.0	1.0	6.1	1.0	-44.9	-20.0	24.9
460.0000	10	4600.0000	-75.1	1.0	6.1	1.0	-67.0	-20.0	47.0
469.9750	1	469.9750	8.5	0.0	19.9	0.5	28.9	37.0	8.1
469.9750	2	939.9500	-47.5	0.4	6.1	0.5	-40.5	-20.0	20.5
469.9750	3	1409.9250	-61.2	0.4	6.1	0.6	-54.1	-20.0	34.1
469.9750	4	1879.9000	-48.4	0.4	6.1	0.7	-41.2	-20.0	21.2
469.9750	5	2349.8750	-48.6	0.5	6.1	0.7	-41.3	-20.0	21.3
469.9750	6	2819.8500	-71.9	0.6	6.1	0.8	-64.4	-20.0	44.4
469.9750	7	3289.8250	-68.2	0.5	6.1	0.9	-60.7	-20.0	40.7
469.9750	8	3759.8000	-63.2	0.8	6.1	0.9	-55.4	-20.0	35.4
469.9750	9	4229.7750	-55.8	1.0	6.1	1.0	-47.7	-20.0	27.7
469.9750	10	4699.7500	-65.5	1.0	6.1	1.0	-57.4	-20.0	37.4

The fundamental emission ERP limit is 100 watts (50 dBm) for an 8 km service area radius.

Judgment: Passed by at least 7.3 dB.



10.4 Occupied Bandwidth

Channel	99% EBW kHz
450.0250	7.494
460.0000	7.486
469.9875	7.506

99% OBW: 450.025 MHz





99% OBW 460 MHz

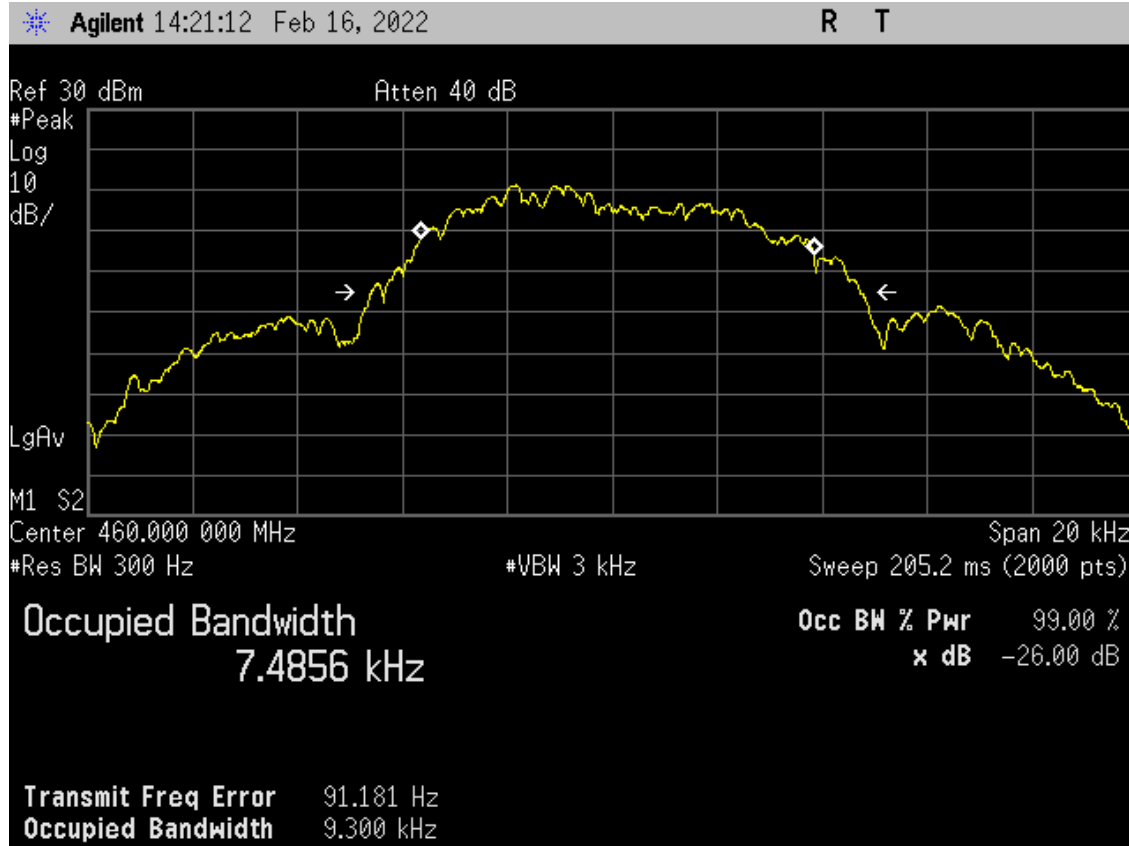

99% OBW 470 MHz

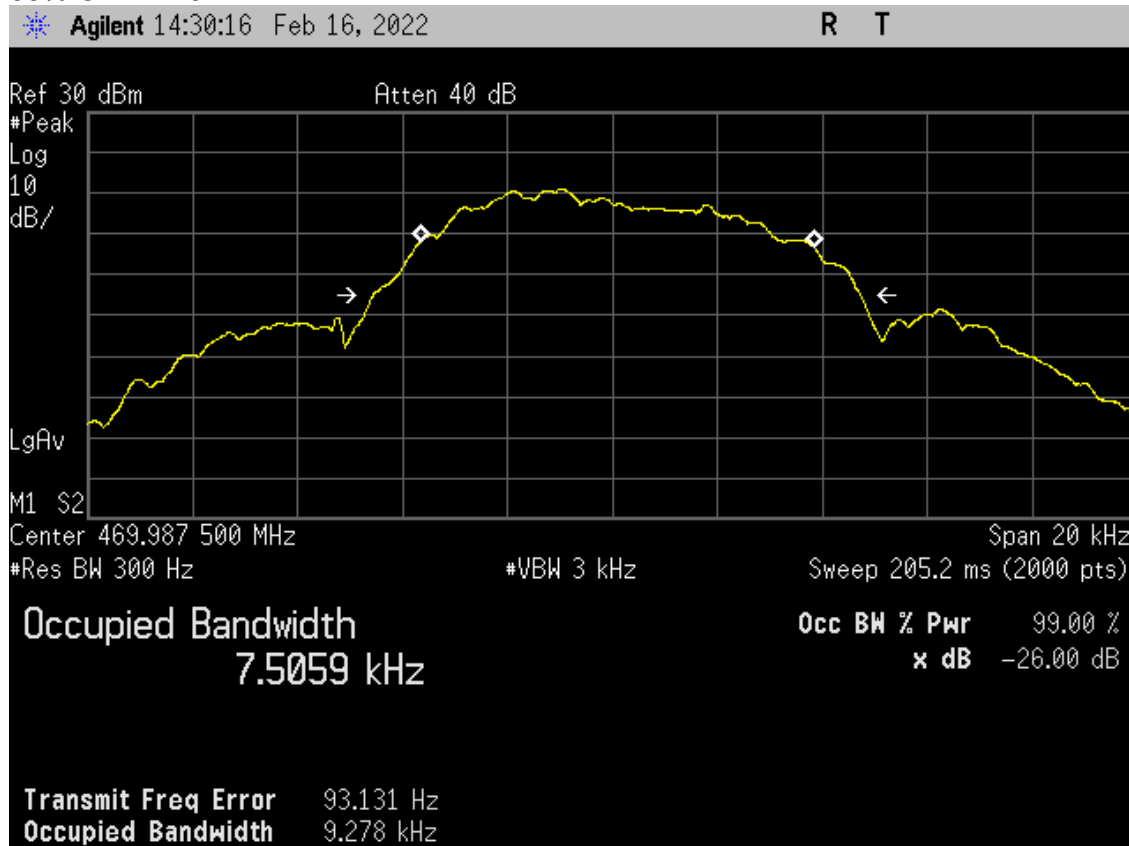



10.5 Field Strength of Unwanted Spurious Radiation

10.5.1 Test Procedures

Radiated emission measurements in the Restricted bands were performed with linearly polarized broadband antennas. The results obtained with these antennas can be correlated with results obtained with a tuned dipole antenna. A 10 dB linearity check is performed prior to start of testing in order to determine if an overload condition exists. From 30 to 4700 MHz, a spectrum analyzer with a preselector was used for measurement. Radiated emissions measurements were performed at the anechoic chamber at a test distance of 3 meters. The entire frequency range from 30 to 4700 MHz was slowly scanned and the emissions in the restricted frequency bands were recorded. Measurements were performed using the peak detector function.

The spectrum analyzer was adjusted for the following settings:

- 1) Resolution Bandwidth = 100 kHz for spurious emissions below 1 GHz, and 1 MHz for spurious emissions above 1 GHz.
- 2) Video Bandwidth = 300 kHz for spurious emissions below 1 GHz, and 3 MHz for spurious emissions above 1 GHz.
- 3) Sweep Speed slow enough to maintain measurement calibration.
- 4) Detector Mode = Positive Peak.

The transmitter to be tested was placed on the turntable in the standard test site, or an FCC listed site compliant with ANSI C63.4. The transmitter is transmitting into a non-radiating load that is placed on the turntable. Measurements were made from the lowest radio frequency generated in the equipment to the tenth harmonic of the carrier. The transmitter was keyed during the tests.

For each spurious frequency, the test antenna was raised and lowered from 1 m to 4m to obtain a maximum reading on the spectrum analyzer with the test antenna at horizontal polarity. Then the turntable was rotated 360° to determine the maximum reading. This procedure was repeated to obtain the highest possible reading. This maximum reading was recorded.

Each measurement was repeated for each spurious frequency with the test antenna polarized vertically.



Figure 1. Drawing of Radiated Emissions Setup

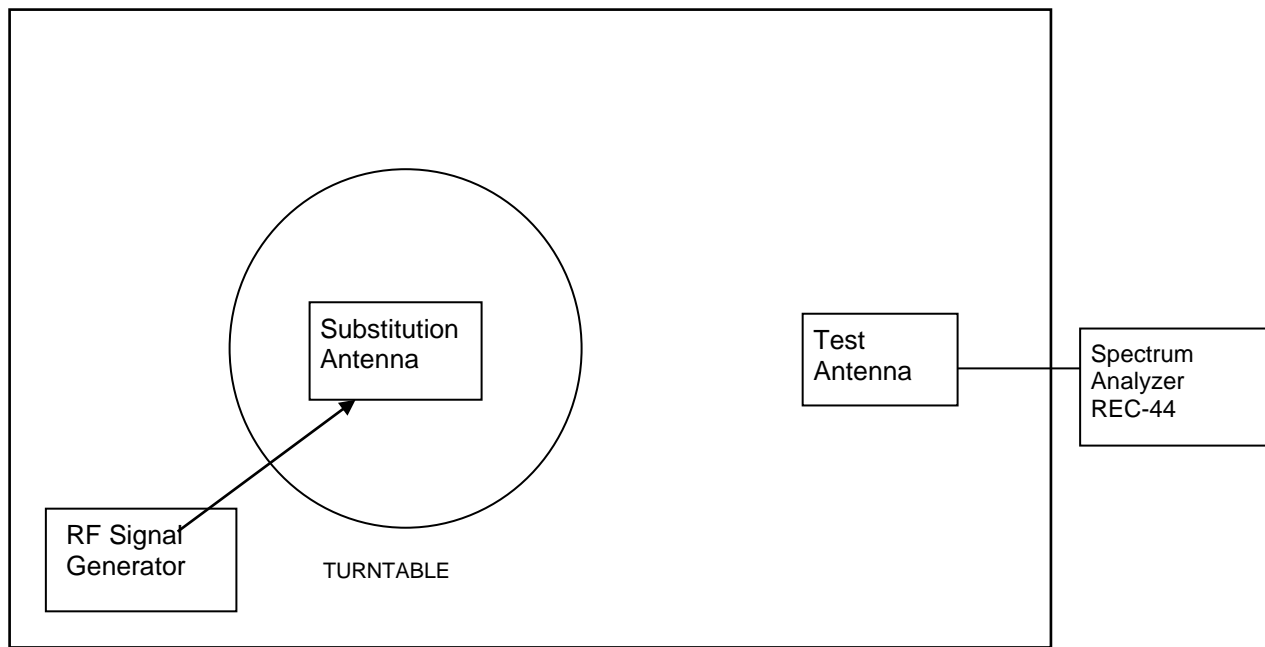

ANSI C63.4 Listed Test Site

Notes:

- Test Antenna height varied from 1 to 4 meters
- Distance from antenna to tested system is 3 meters
- Not to Scale

Frequency MHz	Test Antenna	Substitution Antenna	Receiver to Coupler	Signal Generator
30 - 200	ANT-80	ANT-79	REC-44	SIG-31
200 - 1000	ANT-07	ANT-06	REC-44	SIG-31
1000-5000	ANT-66	ANT-13	REC-44	SIG-31

The transmitter was removed and replaced with a broadband substitution antenna. The substitution antenna is calibrated so that the gain relative to a dipole is known. The center of the substitution antenna was approximately at the same location as the center of the transmitter.

The substitution antenna was fed at the transmitter end with a signal generator connected to the antenna by means of a non-radiating cable. With the antennas at both ends horizontally polarized, and with the signal generator tuned to a particular spurious frequency, the test antenna was raised and lowered to obtain a maximum reading at the spectrum analyzer. The level of the signal generator output was adjusted until the previously recorded maximum reading for this set of conditions was obtained.

The measurements were repeated with both antennas horizontally and vertically polarized for each spurious frequency.

The power in dBm into a was calculated by reducing the substitution readings obtained above by the loss in the cable between the generator and the antenna, and further corrected for the gain of the substitution antenna used relative to an ideal half-wave dipole antenna by the following formula:



$Pd(dBm) = Pg(dBm) - \text{cable loss (dB)} + \text{antenna gain (dB)}$

where:

Pd is the dipole equivalent power and

Pg is the generator output power into the substitution antenna.

10.5.2 Test Limits

Any emission must be attenuated below the power (P) of the highest emission contained within the authorized bandwidth as follows:

On any frequency removed from the center of the authorized bandwidth by a displacement frequency (fd in kHz) of more than 12.5 kHz: At least 50 + 10 log (P) dB.

Since by mathematical definition, $P(dBm) - (50+10 \times \text{LOG}(P(W))) = -20 \text{ dBm}$, the limit for spurious emissions was set to -20 dBm equivalent radiated power. $P(W)$ = Power in watts.

10.5.3 Spurious Radiated Emissions Test Results

Model	101-2020-001	Specification	FCC Part 90.210 RSS-119 Section 5.8
Serial Number	RMC-1	Test Date	02/04/2022
Test Distance	3 Meters	Notes	Transmit Mode
Test Personnel	Chris Dalessio		

Harmonic #	Tx Freq MHz	Measured Freq MHz	Equivalent Radiated power into Dipole		Limit dBm	Margin Under Limit	
			Vertical dBm	Horizontal dBm		Vertical dB	Horizontal dB
2	450.0250	900.05	-34.6	-38.0	-20.0	14.6	18.0
3	450.0250	1350.08	-28.7	-29.7	-20.0	8.7	9.7
4	450.0250	1800.10	-32.7	-32.2	-20.0	12.7	12.2
5	450.0250	2250.13	-34.4	-34.9	-20.0	14.4	14.9
6	450.0250	2700.15	-41.9	-41.5	-20.0	21.9	21.5
7	450.0250	3150.18	-45.2	-44.2	-20.0	25.2	24.2
8	450.0250	3600.20	-43.6	-41.9	-20.0	23.6	21.9
9	450.0250	4050.23	-46.1	-45.9	-20.0	26.1	25.9
10	450.0250	4500.25	-38.0	-35.9	-20.0	18.0	15.9
2	460.0000	920.00	-37.9	-36.9	-20.0	17.9	16.9
3	460.0000	1380.00	-29.5	-31.3	-20.0	9.5	11.3
4	460.0000	1840.00	-32.5	-31.4	-20.0	12.5	11.4
5	460.0000	2300.00	-37.8	-34.0	-20.0	17.8	14.0
6	460.0000	2760.00	-48.4	-44.2	-20.0	28.4	24.2
7	460.0000	3220.00	-43.4	-38.8	-20.0	23.4	18.8
8	460.0000	3680.00	-44.5	-40.3	-20.0	24.5	20.3
9	460.0000	4140.00	-45.3	-47.2	-20.0	25.3	27.2
10	460.0000	4600.00	-40.9	-39.0	-20.0	20.9	19.0
2	469.9750	939.95	-37.4	-36.4	-20.0	17.4	16.4
3	469.9750	1409.93	-29.3	-28.8	-20.0	9.3	8.8
4	469.9750	1879.90	-30.4	-31.9	-20.0	10.4	11.9
5	469.9750	2349.88	-34.5	-35.2	-20.0	14.5	15.2
6	469.9750	2819.85	-44.3	-44.1	-20.0	24.3	24.1
7	469.9750	3289.83	-45.6	-44.1	-20.0	25.6	24.1
8	469.9750	3759.80	-44.8	-41.5	-20.0	24.8	21.5



Harmonic #	Tx	Measured	Equivalent Radiated power into Dipole		Limit dBm	Margin Under Limit	
	Freq	Freq	Vertical	Horizontal		Vertical	Horizontal
	MHz	MHz	dBm	dBm		dB	dB
9	469.9750	4229.78	-45.8	-44.8	-20.0	25.8	24.8
10	469.9750	4699.75	-44.2	-42.2	-20.0	24.2	22.2

Note: Tx Extended mode
Non-Harmonic frequencies

Freq MHz	Detector	Ant Pol	EUT dBm	Limit dBm	Margin dB
32.9	P	H	-61.3	-20.0	41.3
198.7	P	H	-64.3	-20.0	44.3
253.7	P	H	-58.4	-20.0	38.4
435.6	P	H	-59.5	-20.0	39.5
650.0	P	H	-59.5	-20.0	39.5
750.8	P	H	-58.7	-20.0	38.7
849.2	P	H	-56.2	-20.0	36.2
957.5	P	H	-55.4	-20.0	35.4
1328.3	P	H	-49.5	-20.0	29.5
1921.7	P	H	-44.7	-20.0	24.7
2835.0	P	H	-43.4	-20.0	23.4
3160.0	P	H	-44.2	-20.0	24.2
3950.0	P	H	-41.6	-20.0	21.6
4635.0	P	H	-41.9	-20.0	21.9
33.7	P	V	-58.8	-20.0	38.8
98.1	P	V	-64.7	-20.0	44.7
105.1	P	V	-63.4	-20.0	43.4
205.7	P	V	-63.5	-20.0	43.5
260.8	P	V	-60.4	-20.0	40.4
363.7	P	V	-59.0	-20.0	39.0
415.8	P	V	-52.5	-20.0	32.5
684.2	P	V	-59.6	-20.0	39.6
770.8	P	V	-58.7	-20.0	38.7
844.2	P	V	-56.3	-20.0	36.3
898.3	P	V	-55.6	-20.0	35.6
1383.3	P	V	-50.4	-20.0	30.4
1505.0	P	V	-49.6	-20.0	29.6
1921.7	P	V	-46.1	-20.0	26.1
2520.0	P	V	-44.3	-20.0	24.3
3098.3	P	V	-44.1	-20.0	24.1
3948.3	P	V	-41.6	-20.0	21.6
4658.3	P	V	-40.9	-20.0	20.9

No other radiated emissions were detected within 15 dB of the limits from 30 MHz to 4.7 GHz.

Judgment: Passed by at least 20.0 dB.



10.6 Frequency Stability

10.6.1 Frequency Stability Vs Temperature

The chamber was then set to the lowest temperature. The transmitter was in the chamber and allowed to stabilize for 15 minutes. The transmitter was then keyed, and the frequency was recorded. The chamber was then incremented in 10°C steps with a minimum of 15-minute stabilization period for each temperature measurement. The transmitter was off during the temperature transitions.

10.6.2 Frequency Stability Vs Supply Voltage

The EUT was allowed to stabilize with the nominal primary power supply voltage applied. The primary input voltage was varied from the lowest to the highest rated levels specified by the manufacturer. Frequency readings were taken at increments of 0.2 VDC, tested to Battery End point.

10.6.3 Test Results for Frequency Stability

Model	101-2020-001	Specification	FCC Part 90.213 RSS-119 Section 5.3
Serial Number	RMC-2	Test Date	1/25/2022
Test Personnel	Jeffrey Tomes	Test Location	Station F
Test Equipment	Spectrum Analyzer (REC-44); Temperature Chamber TC-01; Digital Multimeter (DMM-09)		
Notes	15 minutes at each Temperature; 1 min at each voltage		
Nominal Frequency	460.000 MHz		

Volts	Freq.	Nominal Freq:	Deviation	
VDC	(MHz)	at 3.6 VDC	Hz	PPM
3.8	460.000049	460.000043	6	0.013
3.6	460.000043	460.000043	0	0.000
3.4	460.000043	460.000043	0	0.000
3.2	460.000042	460.000043	-1	-0.002
3.0	460.000043	460.000043	0	0.000
2.8	460.000053	460.000043	10	0.022

Temp	Measured Freq	Nominal Freq:	Deviation	
Deg C	(MHz)	at 20 Deg C	Hz	PPM
50	460.000008	460.000026	-18	-0.04
40	459.999981	460.000026	-45	-0.10
30	460.000005	460.000026	-21	-0.05
20	460.000026	460.000026	0	0.00
10	459.999984	460.000026	-42	-0.09
0	459.999947	460.000026	-79	-0.17
-10	459.999982	460.000026	-44	-0.10
-20	460.000011	460.000026	-15	-0.03

Test Requirements: Limit is 2.5 ppm
Judgement: Pass



10.7 Transient Frequency Behavior

10.7.1 Test method

The test was performed in accordance to TIA-603-D Section 2.2.19.3 Alternate Method of Measurement (Using a Test Receiver). The equipment was connected as shown below.

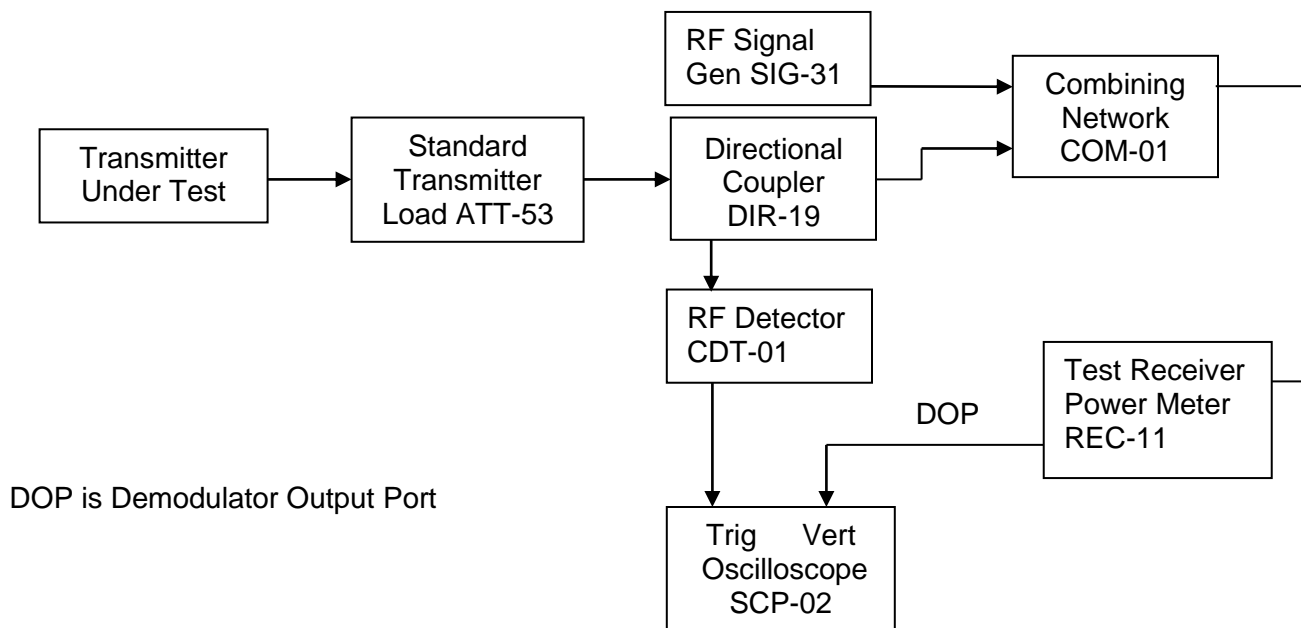

10.7.2 Limits of transient frequency

Time intervals ^{1,2}	Maximum Frequency Difference ³	421 to 512 MHz Equipment Operating on 12.5 kHz Channels
t_1 ⁴	±12.5 kHz	10.0 mSec
t_2	±6.25 kHz	25.0 mSec
t_3 ⁴	±12.5 kHz	10.0 mSec

¹_{on} is the instant when a 1 kHz test signal is completely suppressed, including any capture time due to phasing.

t_1 is the time period immediately following t_{on} .

t_2 is the time period immediately following t_1 .

t_3 is the time period from the instant when the transmitter is turned off until t_{off} .

t_{off} is the instant when the 1 kHz test signal starts to rise.

² During the time from the end of t_2 to the beginning of t_3 , the frequency difference must not exceed the limits specified in § 90.213.

³ Difference between the actual transmitter frequency and the assigned transmitter frequency.

⁴ If the transmitter carrier output power rating is 6 watts or less, the frequency difference during this time period may exceed the maximum frequency difference for this time period.



10.7.3 Test Results

Model	101-2020-001	Specification	FCC part 90.214 RSS-119 Section 5.9
Serial Number	RMC-2	Test Date	02/16/2022
Test Personnel	Joseph Strzelecki	Test Location	Chamber C

Freq MHz	Channel BW	Limits for Time interval/Freq difference						Test Result
		t ₁		t ₂		t ₃		
		mSec	kHz	mSec	kHz	mSec	kHz	
450.025	12.5	10	12.5	25	6.25	10	12.5*	Pass
460.000	12.5	10	12.5	25	6.25	10	12.5*	Pass
469.975	12.5	10	12.5	25	6.25	10	12.5*	Pass

Judgement: Pass

*Since the transmitter carrier output power is less than 6 watts, the frequency difference during the t3 time period may exceed the maximum frequency difference for this time period.

10.7.4 Results for Time Periods t1, t2, and t3

The EUT passed the 6.25 kHz limit so the 12.5 limit is not shown.

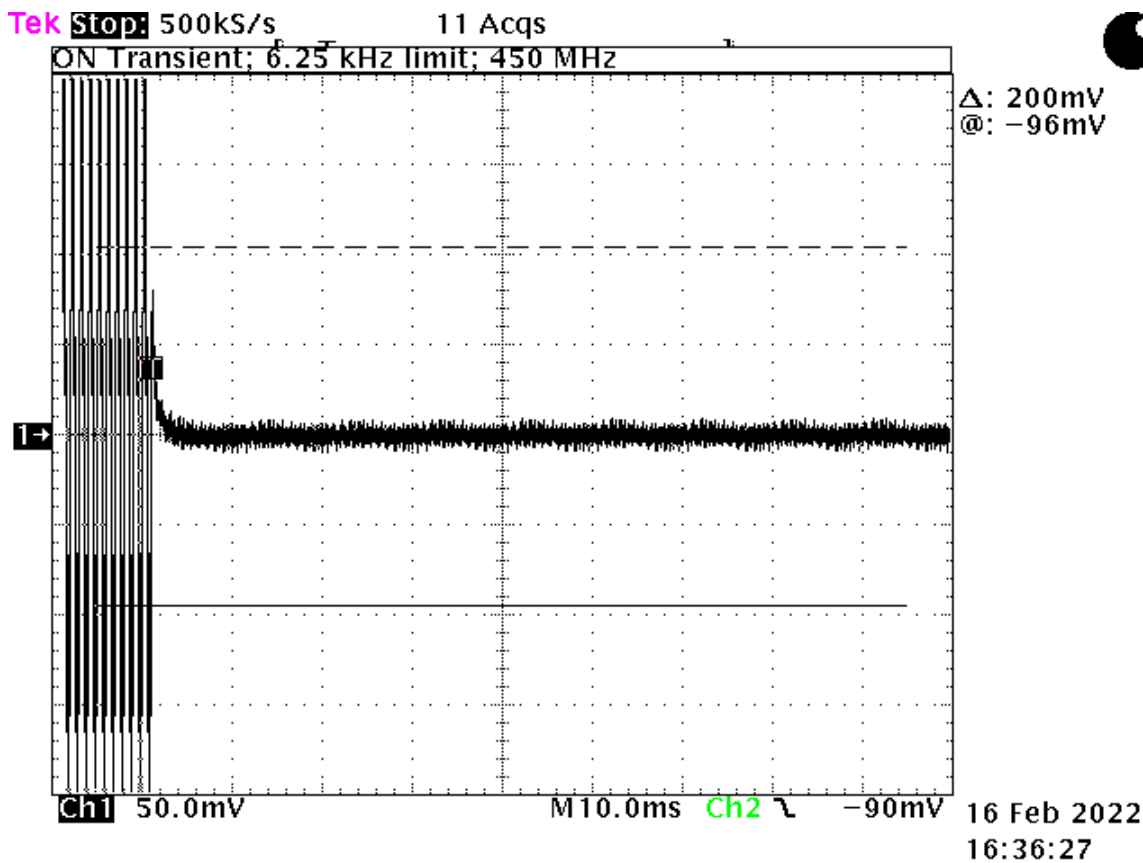

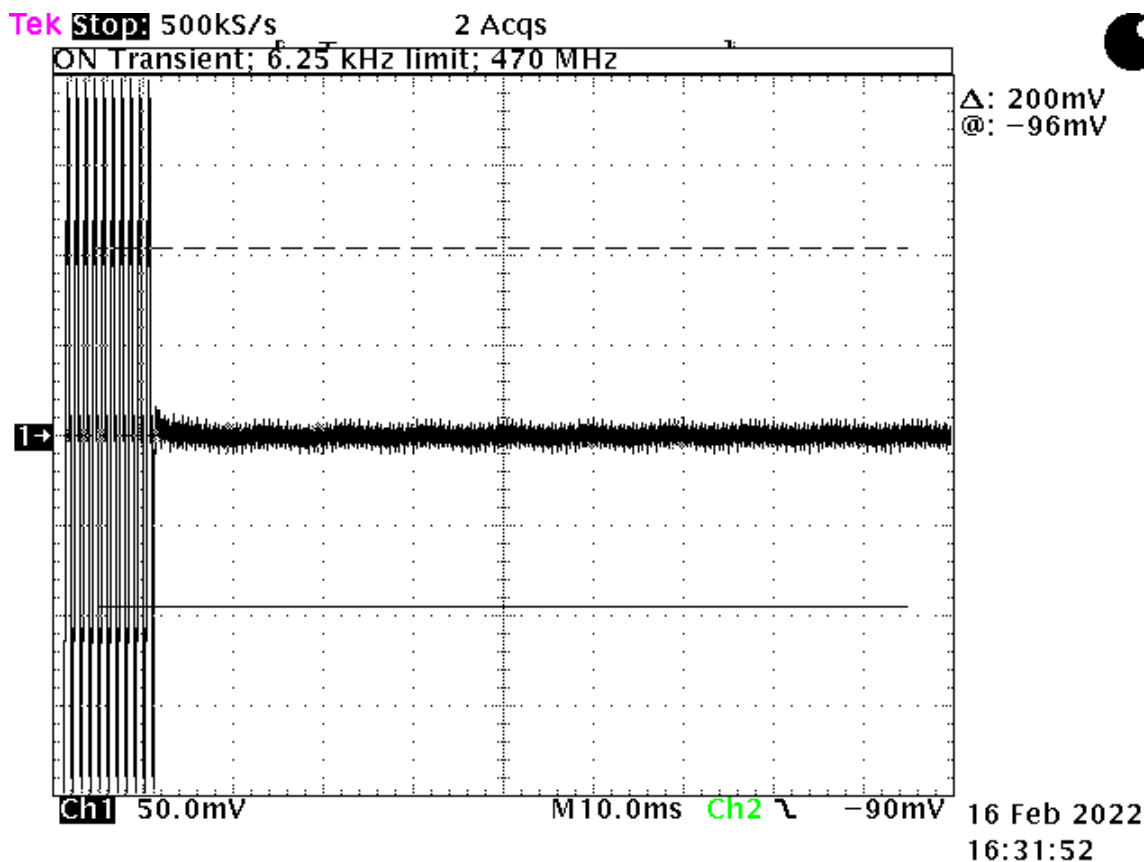
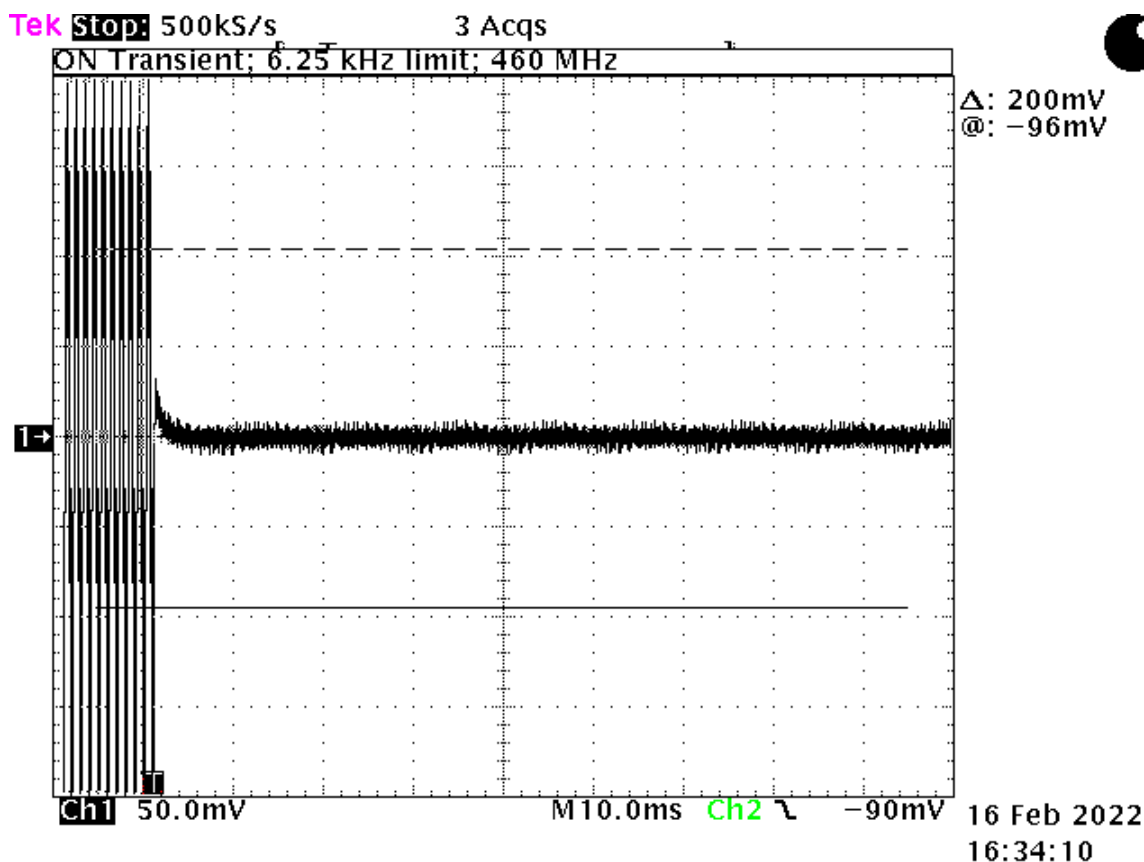



10.7.5 Results for Time Period between t2 and t3

The limit between t2 and t3 on all the scope traces are calculated for the 450 MHz Channel since this is the lowest limit. This limit is $450 \text{ MHz} * 2.5 \text{ ppm}$ or 1125 Hz.

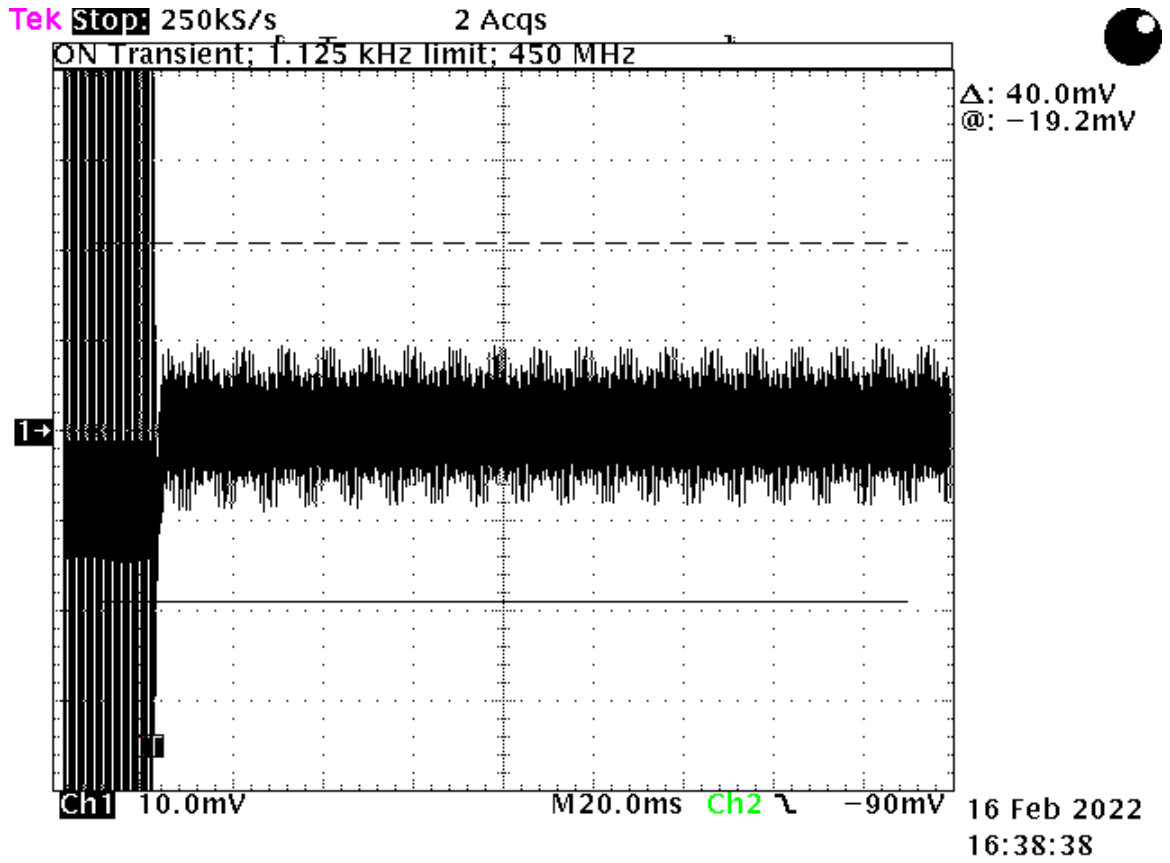

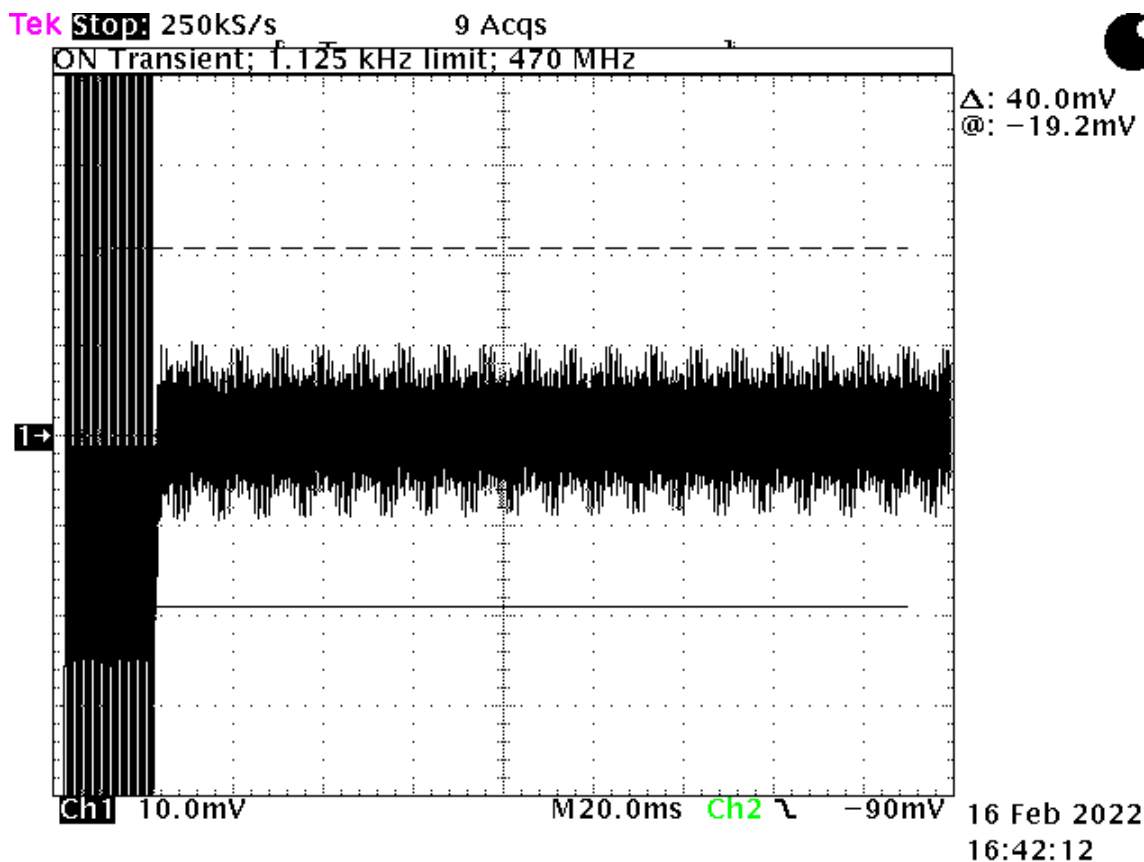
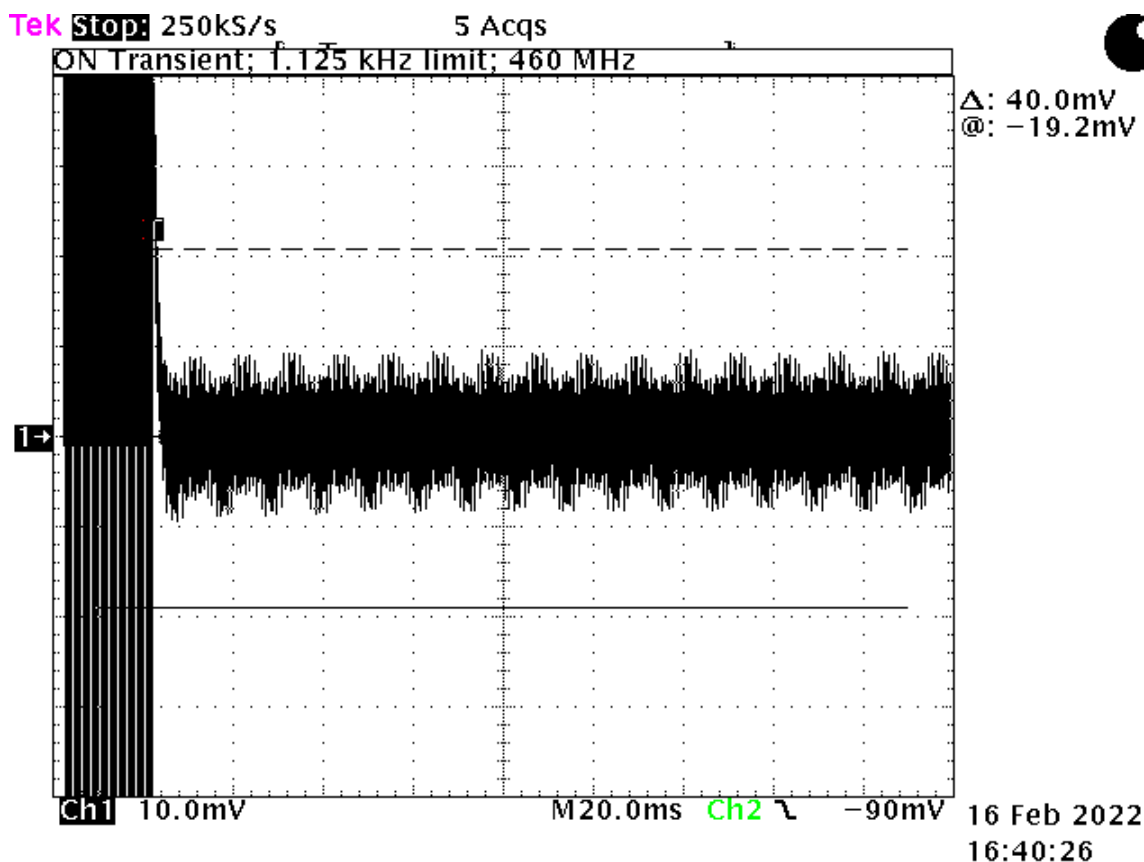



10.7.6 Results for Time Period t3

Since the transmitter carrier output power is less than 6 watts, the frequency difference during the t3 time period may exceed the maximum frequency difference for this time period.

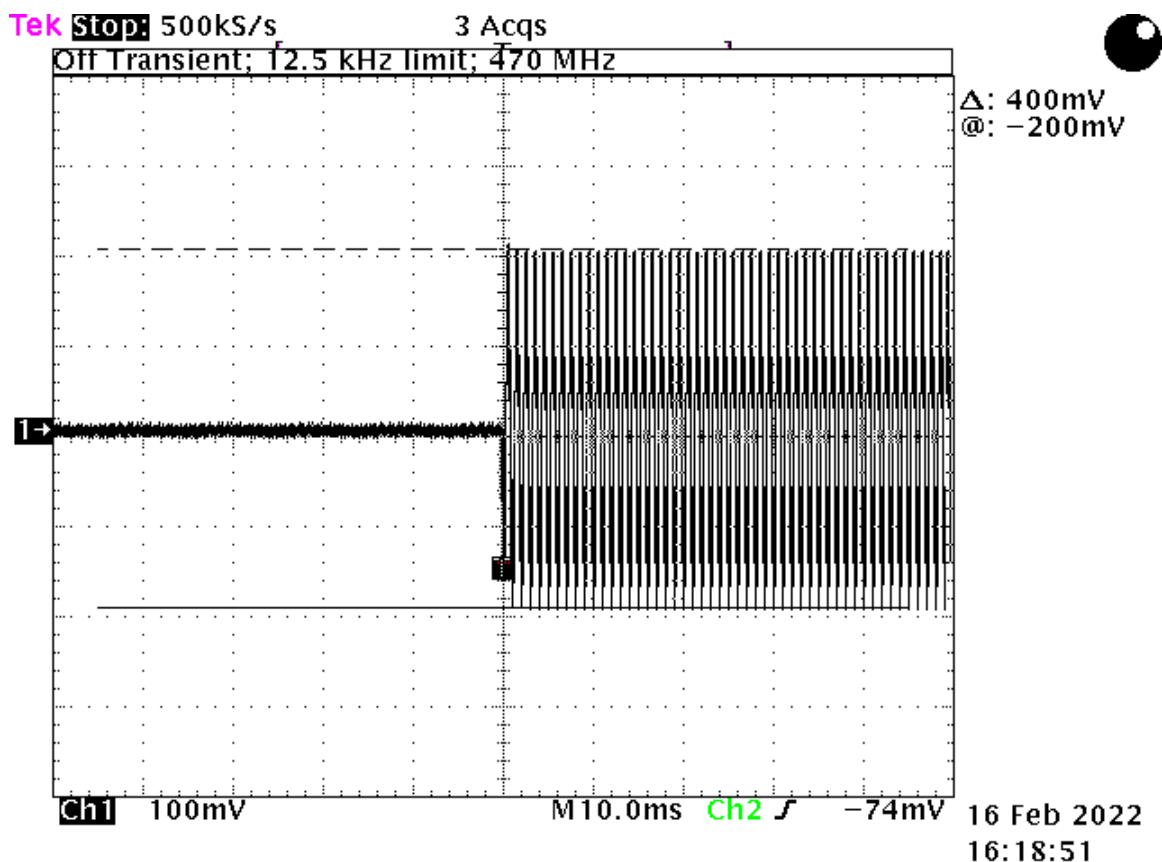

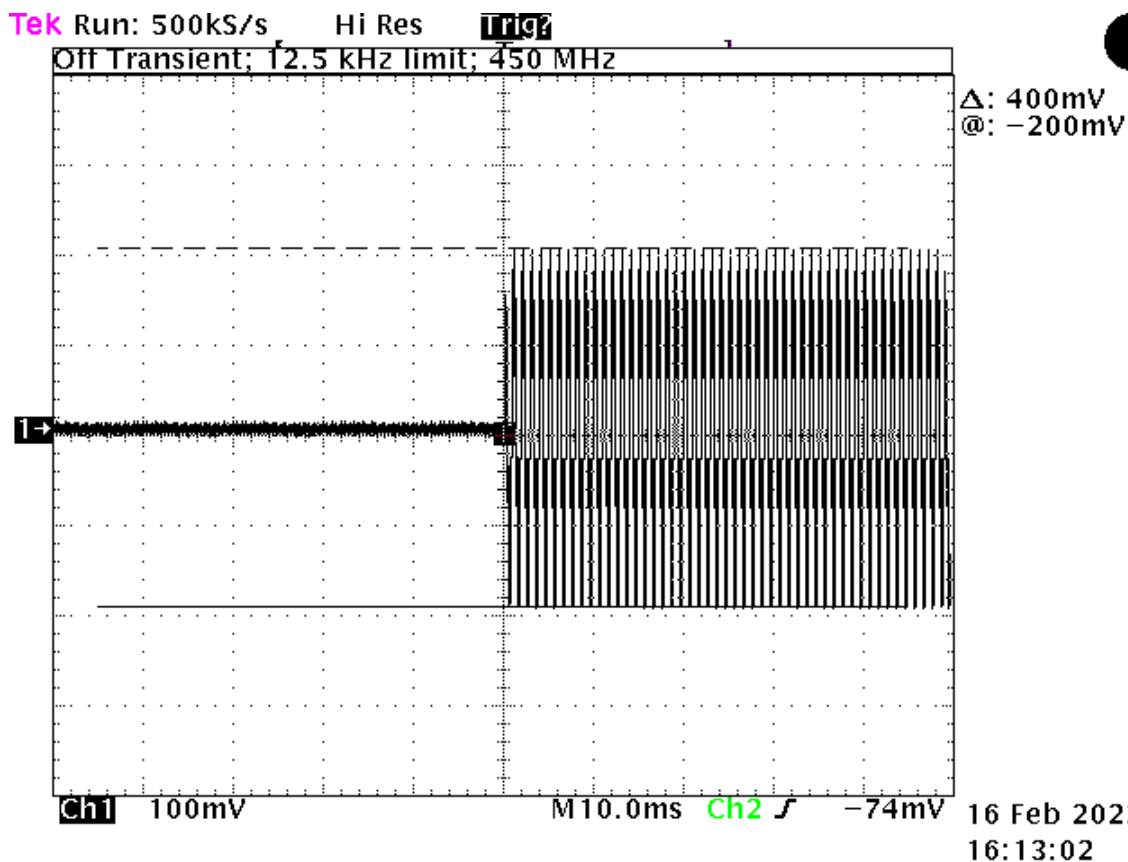
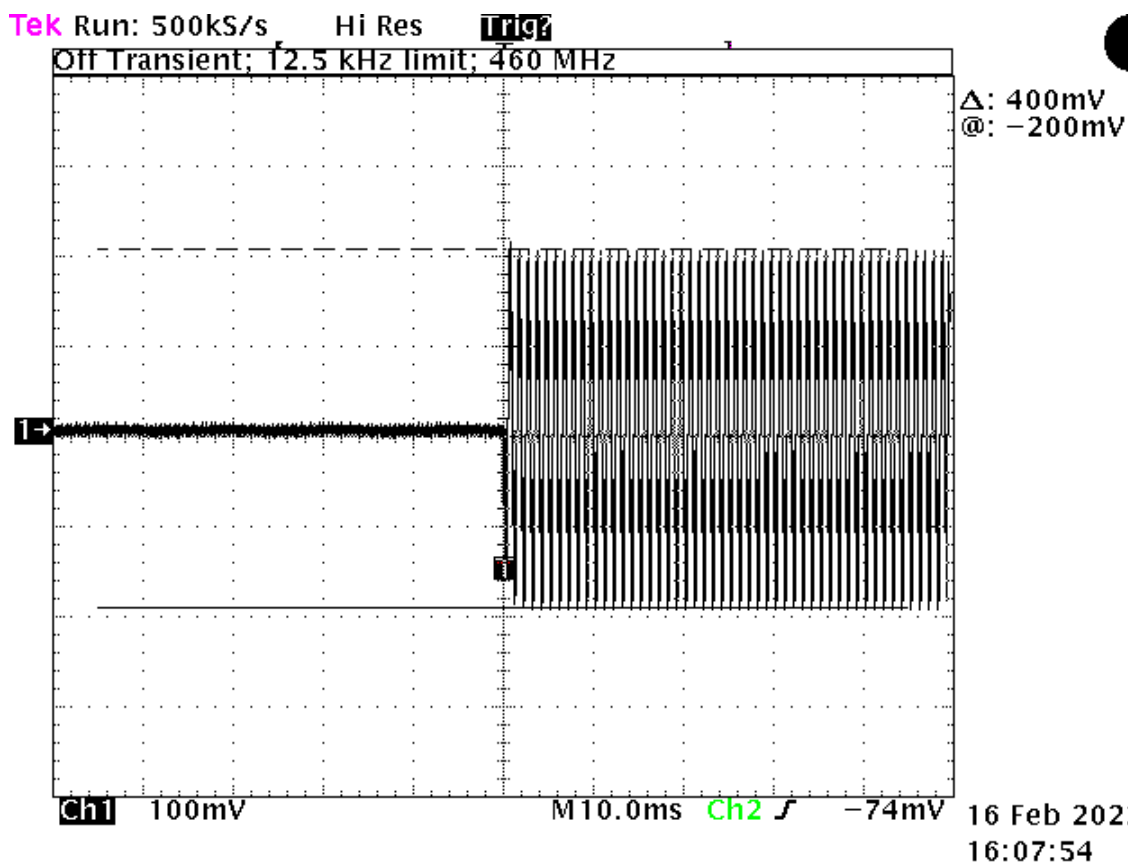



10.8 Radiated Emissions (Receive Mode)

Radiated emission measurements were performed with linearly polarized broadband antennas. The results obtained with these antennas can be correlated with results obtained with a tuned dipole antenna. The radiated emission measurements were performed with a spectrum analyzer. The bandwidth used from 30 MHz to 1000 MHz is 120 kHz. Above 1 GHz, a 1 MHz bandwidth is used. A 10-dB linearity check is performed prior to start of testing in order to determine if an overload condition exists.

From 30 to 2000 MHz, an Anritsu spectrum analyzer was used. Final radiated emissions measurements were performed inside of an anechoic chamber at a test distance of 3 meters. The anechoic chamber is designated as Chamber E. This Chamber meets the Site Attenuation requirements of ANSI C63.4 and CISPR 16-1. Chamber E is located at 12 Devonwood Ave. Romeoville, Illinois EMI test lab.

The entire frequency range from 30 to 2000 MHz was slowly scanned with attention paid to those frequency ranges which appeared high. Measurements were performed using two antenna polarizations, (vertical and horizontal). The worst-case emissions were recorded. All measurements may be performed using either the peak, average or quasi-peak detector functions. If the peak detector data exceeds or is marginally close to the limits, the measurements are repeated using a quasi-peak detector or average function as required by the specification for final determination of compliance.

The detected emission levels were maximized by rotating the EUT, adjusting the positions of all cables, and by scanning the measurement antenna from 1 to 4 meters above the ground.

10.8.1 Radiated Emissions Field Strength Sample Calculation

The field strength is calculated by adding the Antenna Factor and Cable Loss, and by subtracting the Amplifier Gain from the measured reading. The basic equation is as follows:

$$FS = RA + AF + CF - AG$$

Where: FS = Field Strength

RA = Receiver Amplitude

AF = Antenna Factor

CF = Cable Attenuation Factor

AG = Amplifier Gain

10.8.2 Spurious Radiated Emissions Test Results (Receive Mode)

Model	101-2020-001	Specification	FCC Part 15 Subpart B & RSS-Gen
Serial Number	RMC-1	Test Date	02/04/2022
Tested by	Chris D'Alessio	Test Distance	3 Meters
Abbreviations	Pol = Antenna Polarization; V = Vertical; H = Horizontal; P = peak; Q = QP		
Notes	Corr. Factors = Cable Loss – Preamp Gain		
Configuration	Receive Mode		
Test Equipment	Spectrum Analyzer (REC-44); Antennas ANT-06; ANT-80, ANT-66		

Freq. MHz	Meter Reading dBuV	Dect.	Ant. Pol.	Ant Factor	Cable & Amp Factors	Dist. Fact dB	EUT dBuV/m	Limit dBuV/m	Margin Under Limit dB	Note
33.7	11.9	P	H	12.8	0.6	0.0	25.3	40.0	14.7	
50.6	7.8	P	H	9.7	0.7	0.0	18.2	40.0	21.8	
63.9	8.4	P	H	9.2	0.8	0.0	18.4	40.0	21.6	
75.7	8.3	P	H	9.3	0.9	0.0	18.5	40.0	21.5	
87.5	7.7	P	H	9.6	1.0	0.0	18.3	40.0	21.7	
103.7	9.2	P	H	10.5	1.1	0.0	20.8	43.5	22.7	



Freq. MHz	Meter Reading dBuV	Decet.	Ant. Pol.	Ant Factor	Cable & Amp Factors	Dist. Fact dB	EUT dBuV/m	Limit dBuV/m	Margin Under Limit dB	Note
119.9	9.8	P	H	11.6	1.2	0.0	22.6	43.5	20.9	
135.7	8.2	P	H	12.4	1.3	0.0	21.9	43.5	21.6	
149.3	8.2	P	H	12.7	1.3	0.0	22.2	43.5	21.3	
164.1	8.4	P	H	13.1	1.4	0.0	22.9	43.5	20.6	
174.0	9.2	P	H	13.4	1.4	0.0	24.0	43.5	19.5	
183.6	14.6	P	H	13.7	1.5	0.0	29.8	43.5	13.7	
194.3	9.7	P	H	14.1	1.5	0.0	25.3	43.5	18.2	
209.0	8.7	P	H	14.6	1.6	0.0	24.9	43.5	18.6	
224.8	8.8	P	H	14.9	1.6	0.0	25.3	46.0	20.7	
266.3	9.0	P	H	12.1	1.8	0.0	22.9	46.0	23.1	
287.7	8.2	P	H	13.3	1.8	0.0	23.3	46.0	22.7	
315.0	8.1	P	H	14.9	1.9	0.0	24.9	46.0	21.1	
338.1	7.8	P	H	14.2	2.0	0.0	24.0	46.0	22.0	
356.6	8.8	P	H	14.2	2.1	0.0	25.1	46.0	20.9	
378.4	8.7	P	H	14.7	2.1	0.0	25.5	46.0	20.5	
401.5	8.5	P	H	15.4	2.2	0.0	26.1	46.0	19.9	
422.1	14.0	P	H	15.7	2.2	0.0	31.9	46.0	14.1	
452.4	8.9	P	H	16.5	2.3	0.0	27.7	46.0	18.3	
560.8	7.1	P	H	18.2	2.6	0.0	27.9	46.0	18.1	
633.3	6.5	P	H	19.2	2.8	0.0	28.5	46.0	17.5	
701.7	11.4	P	H	20.8	2.9	0.0	35.1	46.0	10.9	
780.0	9.2	P	H	20.9	3.1	0.0	33.2	46.0	12.8	
877.5	9.5	P	H	22.8	3.3	0.0	35.6	46.0	10.4	
961.7	7.6	P	H	23.1	3.5	0.0	34.2	54.0	19.8	
1105.0	35.3	P	H	24.6	-31.7	0.0	28.2	74.0	45.8	1
1271.7	34.9	P	H	25.3	-31.9	0.0	28.3	74.0	45.7	1
1486.7	36.0	P	H	24.8	-31.7	0.0	29.1	74.0	44.9	1
1655.0	36.6	P	H	25.3	-31.3	0.0	30.6	74.0	43.4	1
1801.7	36.5	P	H	26.7	-31.2	0.0	32.0	74.0	42.0	1
1923.3	35.9	P	H	27.6	-30.9	0.0	32.6	74.0	41.4	1
36.3	11.6	P	V	12.0	0.6	0.0	24.2	40.0	15.8	
43.6	10.1	P	V	10.5	0.7	0.0	21.3	40.0	18.7	
54.3	10.8	P	V	9.4	0.8	0.0	21.0	40.0	19.0	
61.7	10.1	P	V	9.3	0.8	0.0	20.2	40.0	19.8	
67.9	8.3	P	V	9.2	0.9	0.0	18.4	40.0	21.6	
76.4	8.5	P	V	9.2	0.9	0.0	18.6	40.0	21.4	
83.8	9.3	P	V	9.5	1.0	0.0	19.8	40.0	20.2	
90.0	9.1	P	V	9.7	1.0	0.0	19.8	43.5	23.7	
98.1	8.8	P	V	10.2	1.1	0.0	20.1	43.5	23.4	
105.1	8.2	P	V	10.6	1.1	0.0	19.9	43.5	23.6	
117.7	8.8	P	V	11.5	1.2	0.0	21.5	43.5	22.0	
126.5	8.9	P	V	12.0	1.2	0.0	22.1	43.5	21.4	
136.4	9.9	P	V	12.4	1.3	0.0	23.6	43.5	19.9	
147.1	9.2	P	V	12.7	1.3	0.0	23.2	43.5	20.3	
159.3	9.1	P	V	12.9	1.4	0.0	23.4	43.5	20.1	
168.9	8.9	P	V	13.2	1.4	0.0	23.5	43.5	20.0	
181.4	8.4	P	V	13.6	1.5	0.0	23.5	43.5	20.0	
192.8	9.0	P	V	14.0	1.5	0.0	24.5	43.5	19.0	
201.6	8.8	P	V	14.4	1.5	0.0	24.7	43.5	18.8	
214.5	8.9	P	V	14.8	1.6	0.0	25.3	43.5	18.2	
234.1	8.9	P	V	15.0	1.7	0.0	25.6	46.0	20.4	
255.8	14.4	P	V	12.0	1.7	0.0	28.1	46.0	17.9	
261.3	11.4	P	V	12.0	1.7	0.0	25.1	46.0	20.9	



Freq. MHz	Meter Reading dBuV	Decet.	Ant. Pol.	Ant Factor	Cable & Amp Factors	Dist. Fact dB	EUT dBuV/m	Limit dBuV/m	Margin Under Limit dB	Note
297.0	8.2	P	V	13.9	1.9	0.0	24.0	46.0	22.0	
326.4	9.3	P	V	14.2	2.0	0.0	25.5	46.0	20.5	
352.0	9.1	P	V	14.2	2.0	0.0	25.3	46.0	20.7	
374.2	8.7	P	V	14.6	2.1	0.0	25.4	46.0	20.6	
400.3	8.2	P	V	15.4	2.2	0.0	25.8	46.0	20.2	
439.8	12.1	P	V	16.1	2.3	0.0	30.5	46.0	15.5	
467.1	10.9	P	V	16.9	2.4	0.0	30.2	46.0	15.8	
548.3	6.6	P	V	18.1	2.6	0.0	27.3	46.0	18.7	
598.3	7.0	P	V	18.7	2.7	0.0	28.4	46.0	17.6	
659.2	9.4	P	V	20.2	2.9	0.0	32.5	46.0	13.5	
687.5	11.1	P	V	20.8	2.9	0.0	34.8	46.0	11.2	
701.7	15.1	P	V	20.8	2.9	0.0	38.8	46.0	7.2	
813.3	10.4	P	V	21.4	3.2	0.0	35.0	46.0	11.0	
895.0	8.5	P	V	22.5	3.3	0.0	34.3	46.0	11.7	
962.5	7.8	P	V	23.2	3.5	0.0	34.5	54.0	19.5	
1118.3	34.8	P	V	24.6	-31.7	0.0	27.7	74.0	46.3	1
1258.3	34.7	P	V	25.3	-31.8	0.0	28.2	74.0	45.8	1
1398.3	35.2	P	V	25.4	-31.6	0.0	29.0	74.0	45.0	1
1508.3	34.9	P	V	24.9	-31.5	0.0	28.3	74.0	45.7	1
1635.0	36.6	P	V	25.3	-31.4	0.0	30.5	74.0	43.5	1
1805.0	35.1	P	V	26.7	-31.2	0.0	30.6	74.0	43.4	1

Note 1; Peak reading meeting the average limit, so the average reading is not required.

Judgment: Pass by at least 10 dB

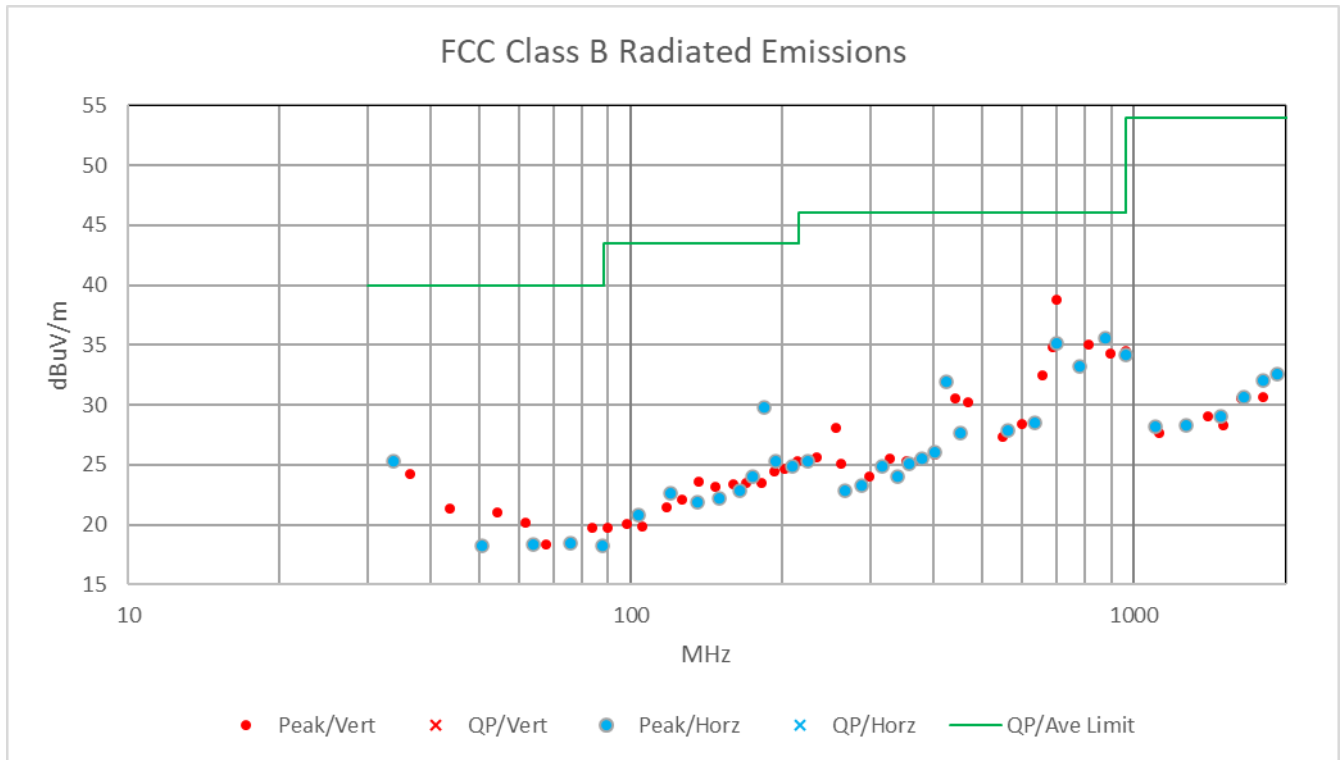

Radiated emissions in a graphical format. The above chart is the same data as the previous table. The peak limit is not shown, since the peak readings meet the lower average limit.



11.0 MEASUREMENT INSTRUMENTATION UNCERTAINTY

Measurement	Uncertainty
Radiated Emissions, E-field, 3 meters, 30 to 200 MHz	4.7 dB
Radiated Emissions, E-field, 3 meters, 200 to 1000 MHz	6.2 dB
Radiated Emissions, E-field, 3 meters, 1 to 6 GHz	5.0 dB
99% Occupied Bandwidth	1% of frequency span
Conducted power PWM-01 at 450-470 MHz	0.14 dB
Amplitude measurement 1-5000 MHz	1.5 dB
Temperature	0.6 Deg. C

The uncertainties represent expanded uncertainties expressed at approximately the 95% confidence level using a coverage factor of k=2 in accordance with CISPR 16-4-2.