



Electromagnetic Compatibility Test Report

Tests Performed on an Aclara Technologies, LLC

Series 4000 Meter Transmitting Unit (MTU), Model 4291-065-MBS2W

Radiometrics Document RP-8231A

<i>Product Detail:</i>			
FCC ID: LLB2015001 Equipment type: 450-470 MHz Transceiver			
<i>Test Standards:</i>			
US CFR Title 47, Chapter I, FCC Part 2 and 90 FCC Parts 2, 15, and 90 CFR Title 47: 2015			
<i>Tests Performed For:</i>		<i>Test Facility:</i>	
Aclara Technologies, LLC 30400 Solon Rd Solon, OH 44139		Radiometrics Midwest Corporation 12 East Devonwood Romeoville, IL 60446 Phone: (815) 293-0772	
<i>Test Date(s): (Month-Day-Year)</i>			
November 5 thru 18, 2015			
Document RP-8231A Revisions:			
Rev.	Issue Date	Affected Sections	Revised By
0	December 1, 2015		
1	December 2, 2015	Cover, 1, 2, 3, 4, 10	Joseph Strzelecki
2	December 10, 2015	2, 10.2.1, 10.3.2	Joseph Strzelecki

Table of Contents

1 ADMINISTRATIVE DATA.....	3
2 TEST SUMMARY AND RESULTS.....	3
3 EQUIPMENT UNDER TEST (EUT) DETAILS.....	4
3.1 EUT Description.....	4
4 TESTED SYSTEM DETAILS	4
4.1 Tested System Configuration	4
4.2 Special Accessories.....	4
4.3 Equipment Modifications.....	4
5 TEST SPECIFICATIONS AND RELATED DOCUMENTS	4
6 RADIOMETRICS' TEST FACILITIES.....	5
7 DEVIATIONS AND EXCLUSIONS FROM THE TEST SPECIFICATIONS	5
8 CERTIFICATION.....	5
9 TEST EQUIPMENT TABLE	5
10 TEST SECTIONS.....	6
10.1 Peak Output Power.....	6
10.2 Occupied Bandwidth; Emissions Masks	6
10.3 Field Strength of Unwanted Spurious Radiation.....	19
10.3.1 Test Procedures.....	19
Figure 1. Drawing of Radiated Emissions Setup.....	20
10.3.2 Spurious Radiated Emissions Test Results	21
10.4 Frequency Stability	22
10.4.1 Frequency Stability Vs Temperature	22
10.4.2 Frequency Stability Vs Supply Voltage	22
10.4.3 Test Results for Frequency Stability.....	22
10.5 Transient Frequency Behavior.....	23
10.5.1 Test method	23
10.5.2 Limits of transient frequency	23
10.5.3 Test Results	24
10.5.4 Results for Time Periods t1 and t2.....	24
10.5.5 Results for Time Period between t2 and t3	26
10.5.6 Results for Time Period t3.....	28
10.6 Radiated Emissions (Receive Mode).....	29
10.6.1 Radiated Emissions Field Strength Sample Calculation	29
10.6.2 Spurious Radiated Emissions Test Results (Receive Mode).....	31

Notice: This report must not be reproduced (except in full) without the written approval of Radiometrics Midwest Corporation.

Test Report for the Aclara, Series 4000 MTU, Model 4291-065-MBS2W

1 ADMINISTRATIVE DATA

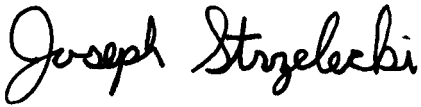
<i>Equipment Under Test:</i> An Aclara Technologies LLC. Meter Transmitting Unit (MTU) Model: 4291-065-MBS2W; Serial Numbers: 80010783, 80010757 This will be referred to as the EUT in this Report	
<i>Date EUT Received at Radiometrics: (Month-Day-Year)</i> November 4, 2015	<i>Test Date(s): (Month-Day-Year)</i> November 5 thru 18, 2015
<i>Test Report Written By:</i> Joseph Strzelecki Senior EMC Engineer	<i>Test Witnessed By:</i> The tests were not witnessed by personnel from Aclara Technologies, LLC
<i>Radiometrics' Personnel Responsible for Test:</i>  12/01/2015 Date Joseph Strzelecki Senior EMC Engineer NARTE EMC-000877-NE Richard L. Tichgelaar EMC Technician	<i>Test Report Approved By</i> Chris W. Carlson Director of Engineering NARTE EMC-000921-NE

2 TEST SUMMARY AND RESULTS

The EUT (Equipment Under Test) is a Meter Transmitting Unit (MTU), Model 4291-065-MBS2W, manufactured by Aclara Technologies, LLC. The detailed test results are presented in a separate section. The following is a summary of the test results.

Transmitter Requirements

Environmental Phenomena	Frequency Range	FCC Section	Test Result
RF Power Output	450-470 MHz	2.1046 90.205	Pass
Occupied Bandwidth Test; Emissions Masks	450-470 MHz	2.1049 90.209	Pass
Spurious RF Conducted Emissions	1-4700 MHz	2.1051 90.210	Pass
Field Strength of Spurious Radiation	30-4700 MHz	2.1053	Pass
Frequency Vs. Temperature	450-470 MHz	2.1055 90.213	Pass
Frequency Vs. Voltage	450-470 MHz	2.1055 90.213	Pass
Transient Frequency Behavior	450-470 MHz	90.214	Pass
Radiated Emissions Receive Mode	30-2000 MHz	15	Pass

3 EQUIPMENT UNDER TEST (EUT) DETAILS

3.1 EUT Description

The EUT is a Meter Transmitting Unit (MTU), Model 4291-065-MBS2W, manufactured by Aclara Technologies, LLC. The RF communications link is encrypted in both directions. The EUT was in good working condition during the tests, with no known defects.

4 TESTED SYSTEM DETAILS

4.1 Tested System Configuration

The system was configured for testing in a typical fashion. The testing was performed in conditions as close as possible to installed conditions. Wiring was consistent with manufacturer's recommendations. The Transponder was tested as a stand alone device. The TX/RX Module was used to terminate the receiver ports only. The identification for all equipment used in the tested system, is:

Tested System Configuration List

Item	Description	Type*	Manufacturer	Model Number	Serial Numbers
1	Meter Transmitting Unit (MTU)	E	Aclara Technologies, LLC	4291-065-MBS2W	80010783; 80010757

* Type: E = EUT,

4.2 Special Accessories

No special accessories were used during the tests in order to achieve compliance.

4.3 Equipment Modifications

No modifications were made to the EUT at Radiometrics' test facility in order to comply with the standards listed in this report.

5 TEST SPECIFICATIONS AND RELATED DOCUMENTS

Document	Date	Title
FCC CFR Title 47	2015	Code of Federal Regulations Title 47, Chapter 1, Federal Communications Commission, Part 15 & 90 - Radio Frequency Devices
ANSI C63.4-2009	2009	Methods of Measurement of Radio Noise Emissions from Low-Voltage Electrical and Electronic Equipment in the Range of 9 kHz to 40 GHz
TIA-603-C	2004	Land Mobile FM or PM Communications Equipment – Measurement and Performance Standards

6 RADIOMETRICS' TEST FACILITIES

The results of these tests were obtained at Radiometrics Midwest Corp. in Romeoville, Illinois, USA. Radiometrics is accredited by A2LA (American Association for Laboratory Accreditation) to conform to ISO/IEC 17025: 2005 "General Requirements for the Competence of Calibration and Testing Laboratories". Radiometrics' Lab Code is 121191 and Certification Number is 1495.01. A copy of the accreditation can be accessed on our web site (www.radiomet.com). Radiometrics accreditation status can be verified at A2LA's web site (www.a2la2.org).

The following is a list of shielded enclosures located in Romeoville, Illinois used during the tests:

Chamber A: Is an anechoic chamber that measures 24' L X 12' W X 12' H. The walls and ceiling are fully lined with ferrite absorber tiles. The floor has a 10' x 10' section of ferrite absorber tiles located in the center. Panashield of Rowayton, Connecticut manufactured the chamber. The enclosure is NAMAS certified.

Chamber B: Is a shielded enclosure that measures 20' L X 12' W X 8' H. Erik A. Lindgren & Associates of Chicago, Illinois manufactured the enclosure.

Chamber C: Is a shielded enclosure that measures 17' L X 10' W X 8' H. Lindgren RF Enclosures Inc. of Addison, Illinois manufactured the enclosure.

Chamber E: Is a custom made anechoic chamber that measures 52' L X 30' W X 18' H. The walls and ceiling are fully lined with RF absorber. Pro-shield of Collinsville, Oklahoma manufactured the chamber.

A separate ten-foot long, brass plated, steel ground rod attached via a 6 inch copper braid grounds each of the above chambers. Each enclosure is also equipped with low-pass power line filters.

The FCC has accepted these sites as test site number US1065. The FCC test site Registration Number is 732175. Details of the site characteristics are on file with the Industry Canada as site number IC3124A-1.

7 DEVIATIONS AND EXCLUSIONS FROM THE TEST SPECIFICATIONS

There were no deviations or exclusions from the test specifications.

8 CERTIFICATION

Radiometrics Midwest Corporation certifies that the data contained herein was taken under conditions that meet or exceed the requirements of the test specification. The results relate only to the EUT listed herein. Any modifications made to the EUT subsequent to the indicated test date will invalidate the data and void this certification.

9 TEST EQUIPMENT TABLE

RMC ID	Manufacturer	Description	Model No.	Serial No.	Frequency Range	Cal Period	Cal Date
ANT-03	Tensor	Biconical Antenna	4104	2231	20-250MHz	24 Mo.	11/26/13
ANT-06	EMCO	Log-Periodic Ant.	3146	1248	200-1000MHz	24 Mo.	11/26/13
ANT-13	EMCO	Horn Antenna	3115	2502	1.0-18GHz	24 Mo.	12/01/14
ANT-36	Ailtech (Eaton)	Horn Antenna	96001	2013	1.0-18GHz	24 Mo.	10/20/14

Test Report for the Aclara, Series 4000 MTU, Model 4291-065-MBS2W

RMC ID	Manufacturer	Description	Model No.	Serial No.	Frequency Range	Cal Period	Cal Date
ANT-44	Impossible Machine	Super Log Antenna	SL-20M2G	1002	20-2000MHz	24 Mo.	12/10/13
ATT-28	Narda	Attenuator(20dB)	757B-20	3131	DC - 6 GHz	24 Mo.	09/24/14
CDT-01	Wiltron	Crystal RF Detector	75N50	CDT-01	DC-18GHz	N/A	NCR
COM-01	Anaren	Coupler	10023-3	COM-01	250-1000MHz	N/A	NCR
DIR-07	Werlatone	Directional Coupler	C3908	6929	80-1000MHz	24 Mo.	06/10/15
DIR-19	Narda	Directional Coupler	3000-10	01174	200-500MHz	N/A	NCR
DMM-08	Fluke	DMM	8840A/AF	AF4005032	DC-100kHz	24 Mo	05/26/14
REC-11	HP / Agilent	Spectrum Analyzer	E7405A	US39110103	9Hz-26.5GHz	12 Mo.	06/23/15
SCP-02	Tektronix	Oscilloscope	TDS784A	B040258	DC-1GHz	24 Mo.	11/15/14
SIG-30	Rohde & Schwarz	Signal Generator	SMC100A	102914	9k-3.2GHz	24 Mo.	10/07/15
THM-02	Fluke	Temp/Humid Meter	971	93490471	N/A	12 Mo.	08/03/15

Note: All calibrated equipment is subject to periodic checks.

NCR – No Calibration Required. Device monitored by calibrated equipment. N/A: Not Applicable.

10 TEST SECTIONS

10.1 Peak Output Power

The peak power was measured by connecting the EUT antenna port to the spectrum analyzer via a low loss coaxial cable and an appropriate power attenuator.

Model	4291-065-MBS2W	Specification	FCC part 90.205
Serial Number	80010783	Test Date	November , 2015
Test Personnel	Joseph Strzelecki	Test Location	Chamber B
Test Equipment	EMI Receiver (REC-11)		

TX freq MHz	Reading dBm	Atten & Cable	Total dBm	Peak Power Watts
450.0250	9.5	20.2	29.7	0.933
460.0000	9.5	20.3	29.8	0.955
469.9875	9.5	20.3	29.8	0.955

Judgement: Pass

The limit is 33 dBm for this product.

10.2 Occupied Bandwidth; Emissions Masks

Model	4291-065-MBS2W	Specification	FCC Part 90.209
Serial Number	80010783	Test Date	08/03/2015
Test Personnel	Richard Tichelaar	Test Location	Chamber B
Test Equipment	Spectrum Analyzer (REC-11)		

The spectrum analyzer was set to the MAX HOLD mode to record the worst case of the modulation. The EUT was transmitting at its maximum data rate. The trace was allowed to stabilize. All Channels are 12.5 kHz

Test Report for the Aclara, Series 4000 MTU, Model 4291-065-MBS2W

The emissions Masks D is from FCC part 90.210.

- (1) On any frequency from the center of the authorized bandwidth f_0 to 5.625 kHz removed from f_0 : Zero dB.
- (2) On any frequency removed from the center of the authorized bandwidth by a displacement frequency (f_d in kHz) of more than 5.625 kHz but no more than 12.5 kHz: At least $7.27(f_d - 2.88 \text{ kHz})$ dB.
- (3) On any frequency removed from the center of the authorized bandwidth by a displacement frequency (f_d in kHz) of more than 12.5 kHz: At least $50 + 10 \log(P)$ dB.

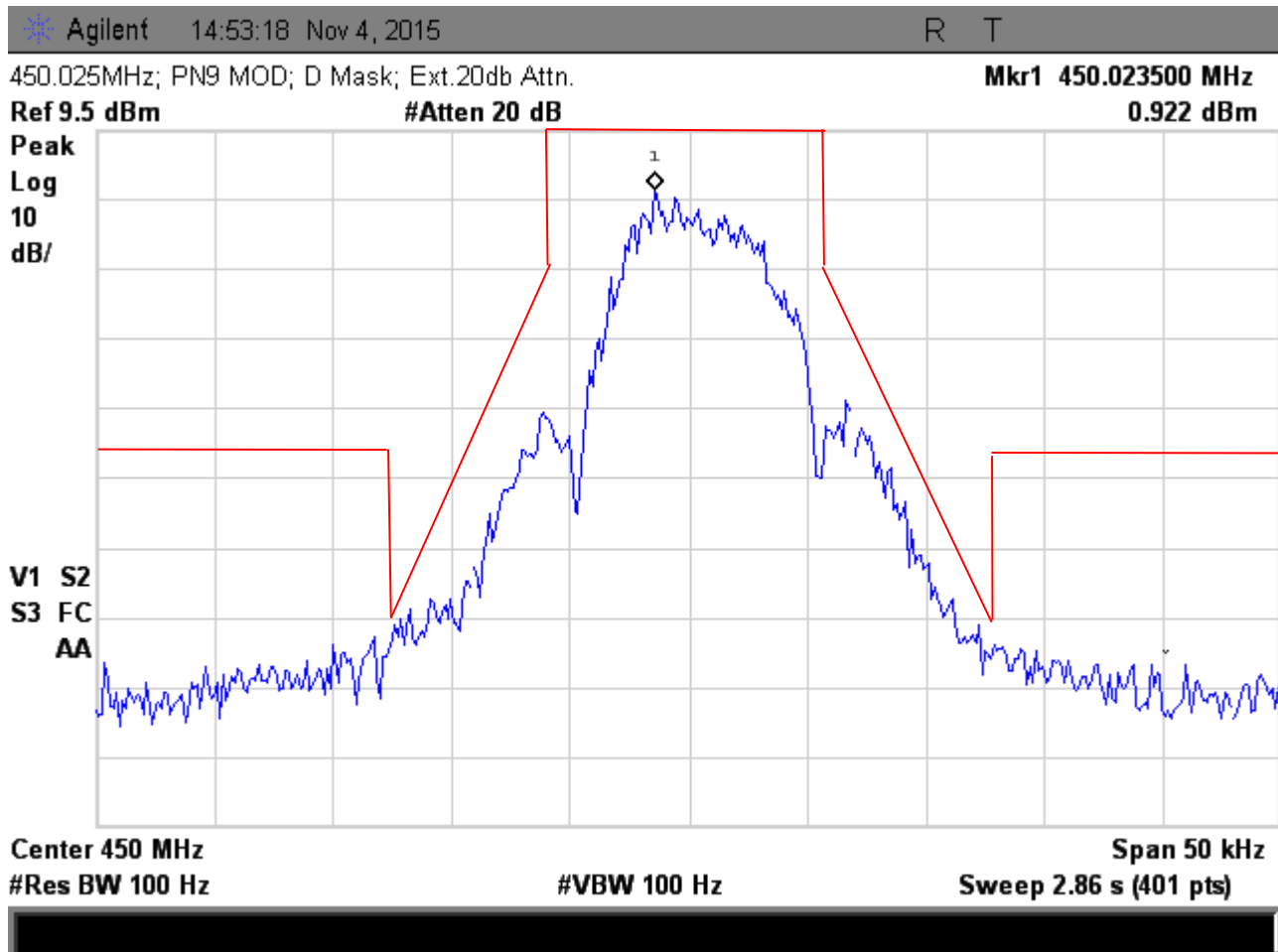

Test Report for the Aclara, Series 4000 MTU, Model 4291-065-MBS2W

Agilent 14:43:23 Nov 4, 2015

R T

460.000MHz; PN9 MOD; D Mask; Ext.20db Attn.

Mkr1 459.999375 MHz

Ref 9.5 dBm

#Atten 20 dB

-0.41 dBm

Peak
Log
10
dB/

V1 S2
S3 FC
AA



Center 460 MHz
#Res BW 100 Hz

#VBW 100 Hz

Span 50 kHz
Sweep 2.86 s (401 pts)

Test Report for the Aclara, Series 4000 MTU, Model 4291-065-MBS2W

Agilent 14:18:36 Nov 4, 2015

R T

469.9875MHz; PN9 MOD; D Mask w 20db Atten.

Mkr1 469.987000 MHz

Ref 9.5 dBm

#Atten 20 dB

0.121 dBm

Peak
Log
10
dB/

V1 S2
S3 FC
AA

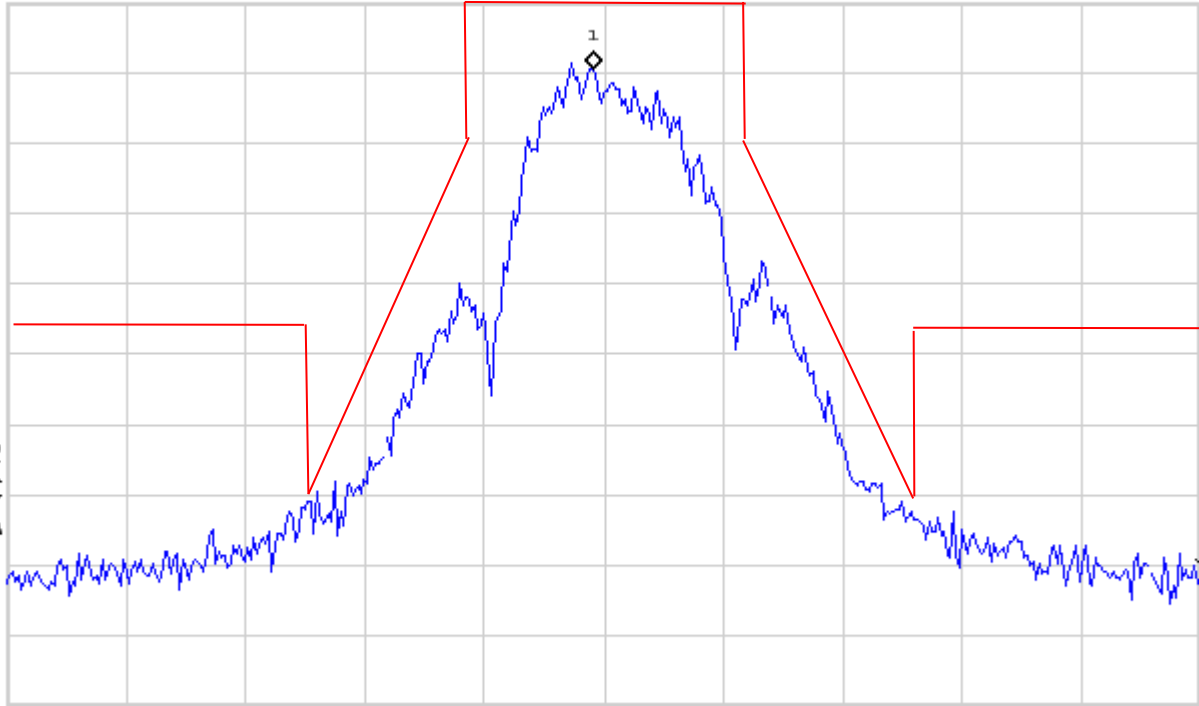

Center 470 MHz
#Res BW 100 Hz

#VBW 100 Hz

Span 50 kHz
Sweep 2.86 s (401 pts)

Test Report for the Aclara, Series 4000 MTU, Model 4291-065-MBS2W

Agilent 15:19:11 Nov 4, 2015

R T

450.025MHz; PN9 MOD; D Mask; Ext.20db Attn.

Mkr1 450.02500 MHz

Ref 9.5 dBm

#Atten 20 dB

3.822 dBm

Peak
Log
10
dB/

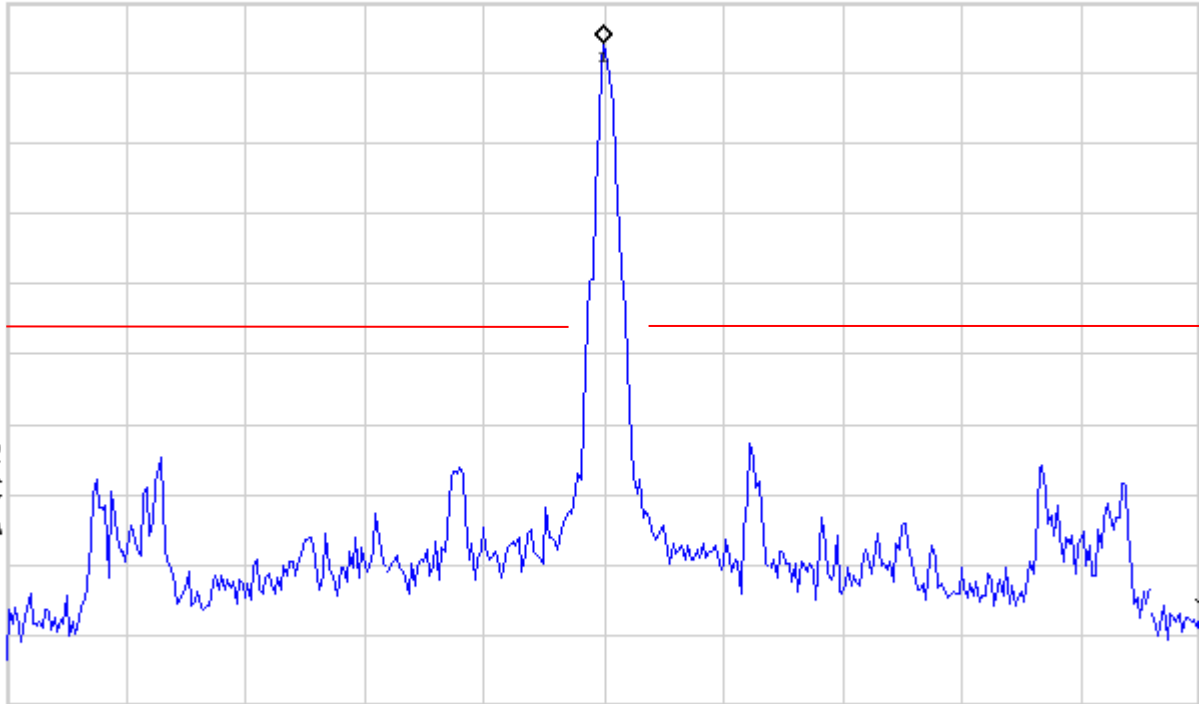

Center 450 MHz
#Res BW 300 Hz

#VBW 1 kHz

Span 500 kHz
Sweep 22.26 s (401 pts)

Test Report for the Aclara, Series 4000 MTU, Model 4291-065-MBS2W

Agilent 15:12:39 Nov 4, 2015

R T

460.000MHz; PN9 MOD; D Mask; Ext.20db Attn.

Mkr1 459.99875 MHz

Ref 9.5 dBm

#Atten 20 dB

5.823 dBm

Peak
Log
10
dB/

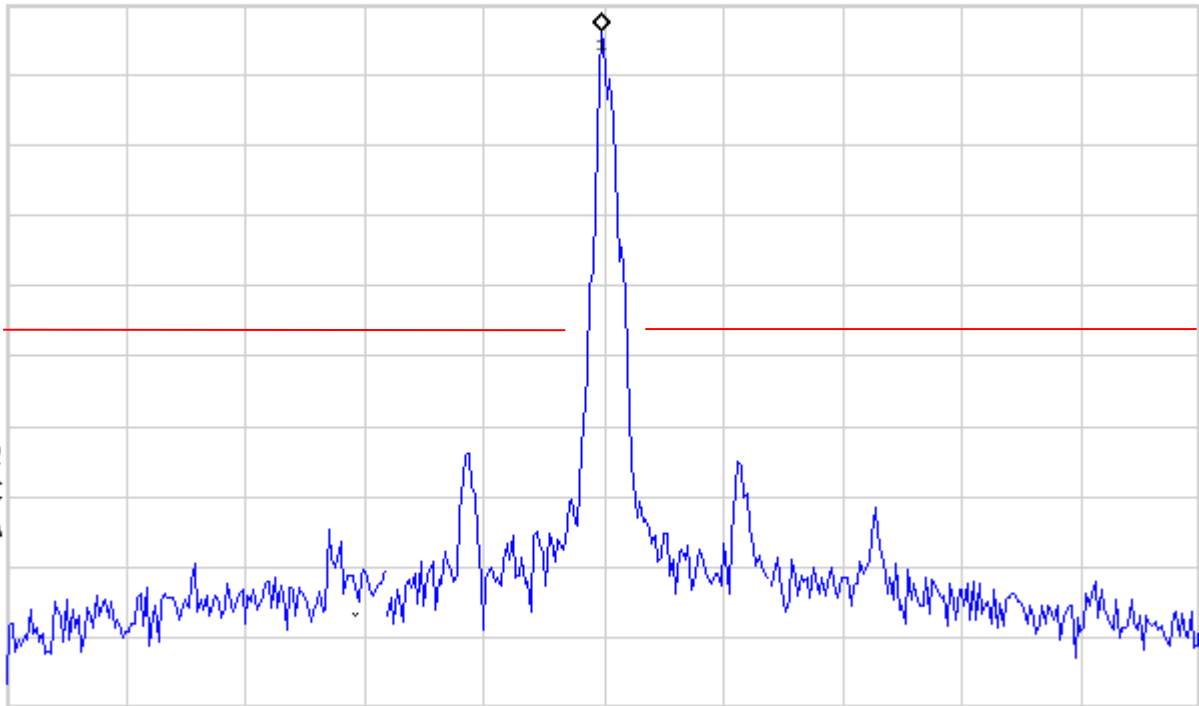

V1 S2
S3 FC
AA

Center 460 MHz
#Res BW 300 Hz

#VBW 1 kHz

Span 500 kHz
Sweep 22.26 s (401 pts)

Test Report for the Aclara, Series 4000 MTU, Model 4291-065-MBS2W

Agilent 15:23:34 Nov 4, 2015

R T

469.9875MHz; PN9 MOD; D Mask; Ext.20db Attn.

Mkr1 469.98875 MHz

Ref 9.5 dBm

#Atten 20 dB

2.841 dBm

Peak
Log
10
dB/

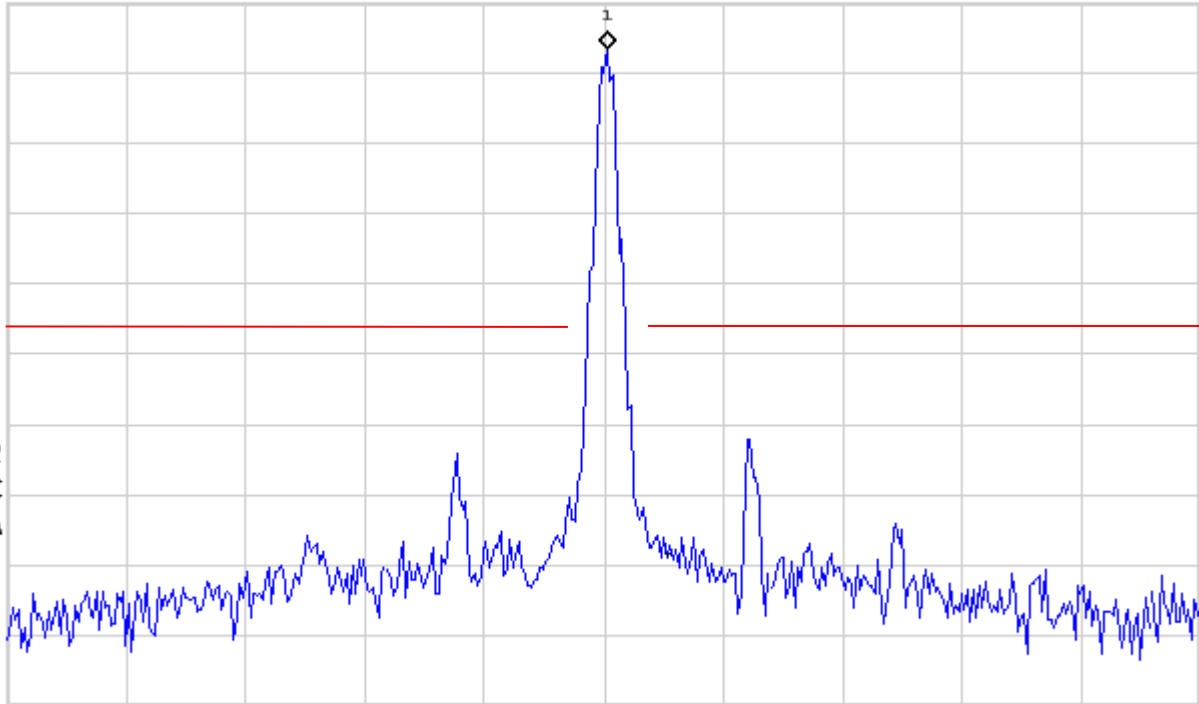

Center 470 MHz

Span 500 kHz

#Res BW 300 Hz

#VBW 1 kHz

Sweep 22.26 s (401 pts)



Test Report for the Aclara, Series 4000 MTU, Model 4291-065-MBS2W

Agilent 15:44:18 Nov 4, 2015

R T

450.0250MHz; PN9 MOD; D Mask; 20db Ext Attn.

Mkr1 446 MHz

Ref 9.5 dBm

#Atten 20 dB

9.338 dBm

Peak
Log
10
dB/

M1 S2
S3 FC
AA

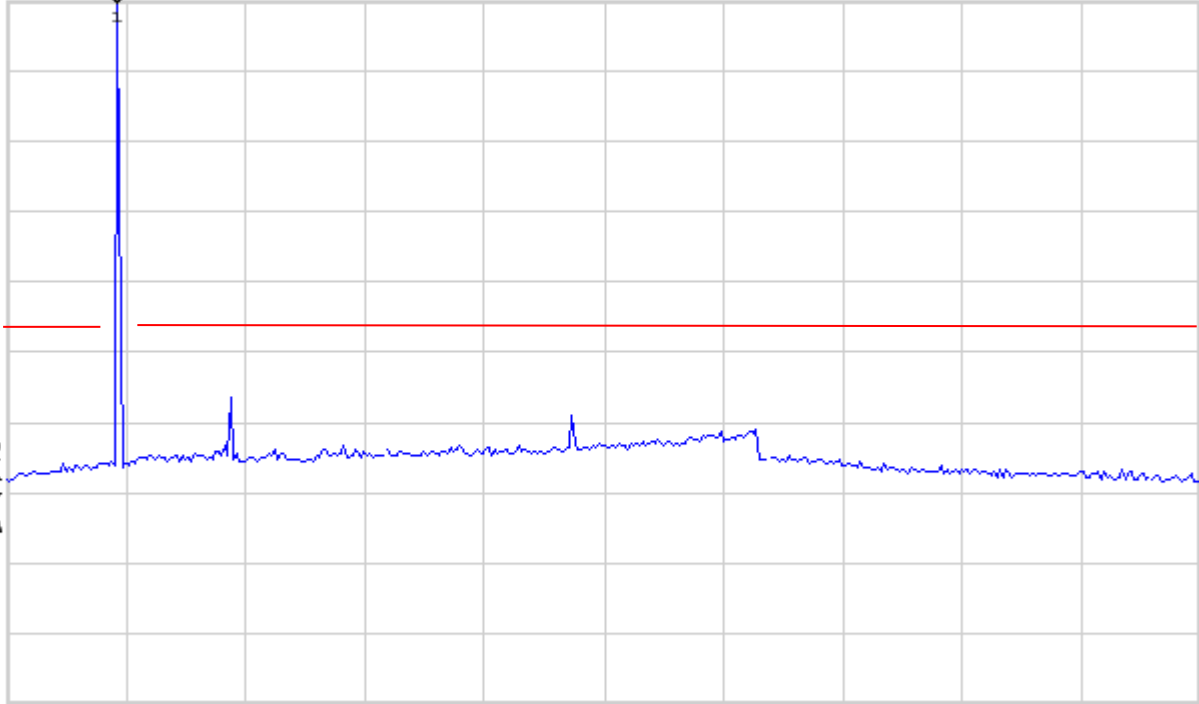

Start 7 MHz

Stop 4.75 GHz

#Res BW 100 kHz

#VBW 300 kHz

Sweep 491.4 ms (401 pts)

Test Report for the Aclara, Series 4000 MTU, Model 4291-065-MBS2W

Agilent 15:40:17 Nov 4, 2015

R T

460.0000MHz; PN9 MOD; D Mask; 20db Ext Attn.

Mkr1 458 MHz

Ref 9.5 dBm

#Atten 20 dB

9.269 dBm

Peak
Log
10
dB/

V1 S2
S3 FC
AA

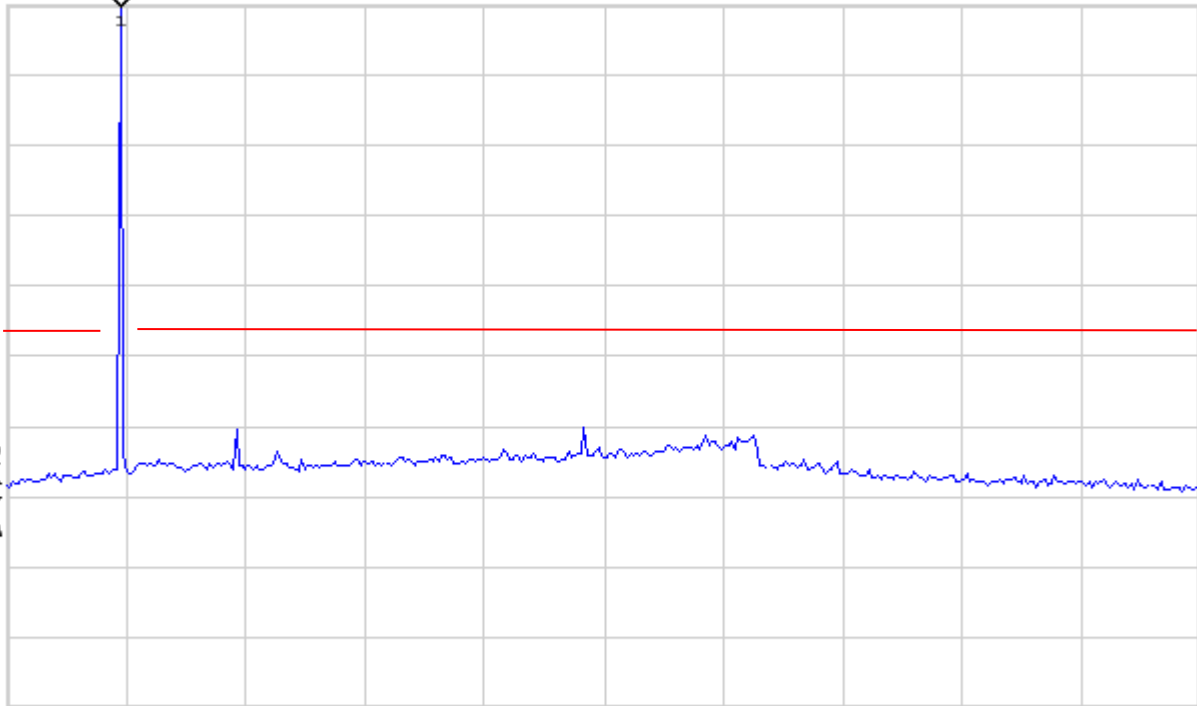

Start 7 MHz

Stop 4.75 GHz

#Res BW 100 kHz

#VBW 300 kHz

Sweep 491.4 ms (401 pts)

Test Report for the Aclara, Series 4000 MTU, Model 4291-065-MBS2W

Agilent 15:37:19 Nov 4, 2015

R T

469.9875MHz; PN9 MOD; D Mask; 20db Ext Attn.

Mkr1 469 MHz

Ref 9.5 dBm

#Atten 20 dB

9.37 dBm

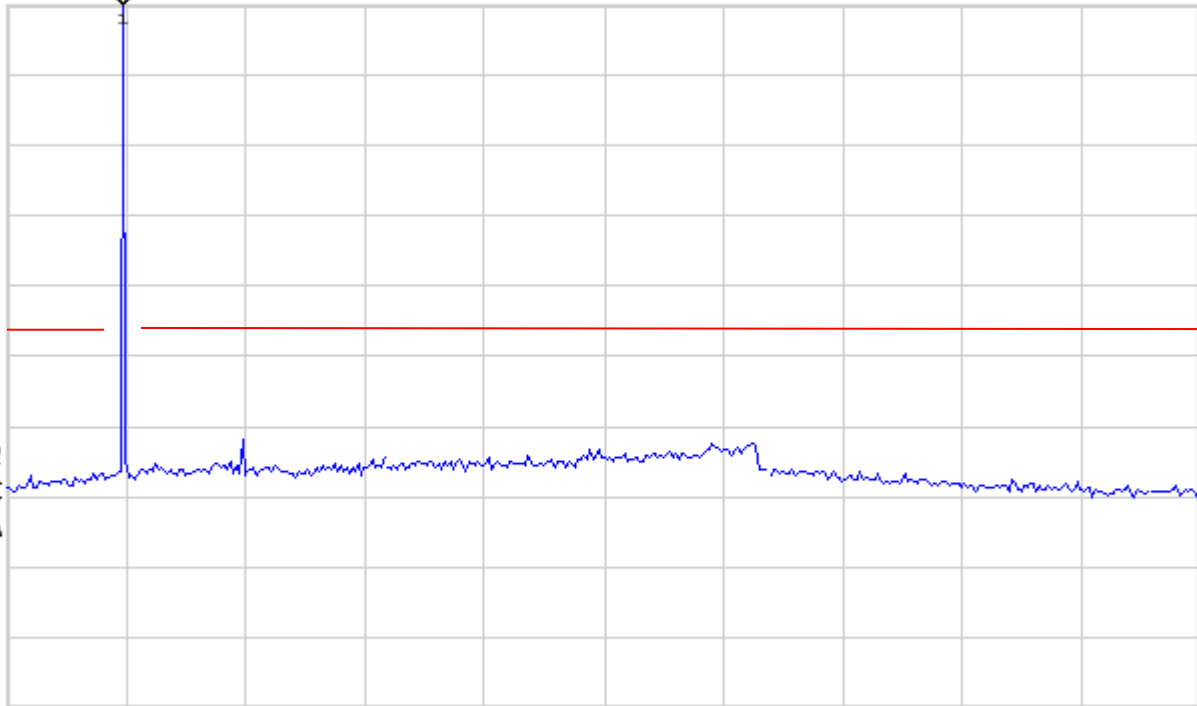
Peak
Log
10
dB/V1 S2
S3 FC
AA

Start 7 MHz

Stop 4.75 GHz

#Res BW 100 kHz

#VBW 300 kHz

Sweep 491.4 ms (401 pts)

Judgement: Pass

10.2.1 Occupied bandwidth 99%

Channel	20 dB OBW kHz
450.0250	8.25
460.0000	8.10
469.9875	8.65

Test Report for the Aclara, Series 4000 MTU, Model 4291-065-MBS2W

MKR Delta 8.25 kHz 0.80 dB

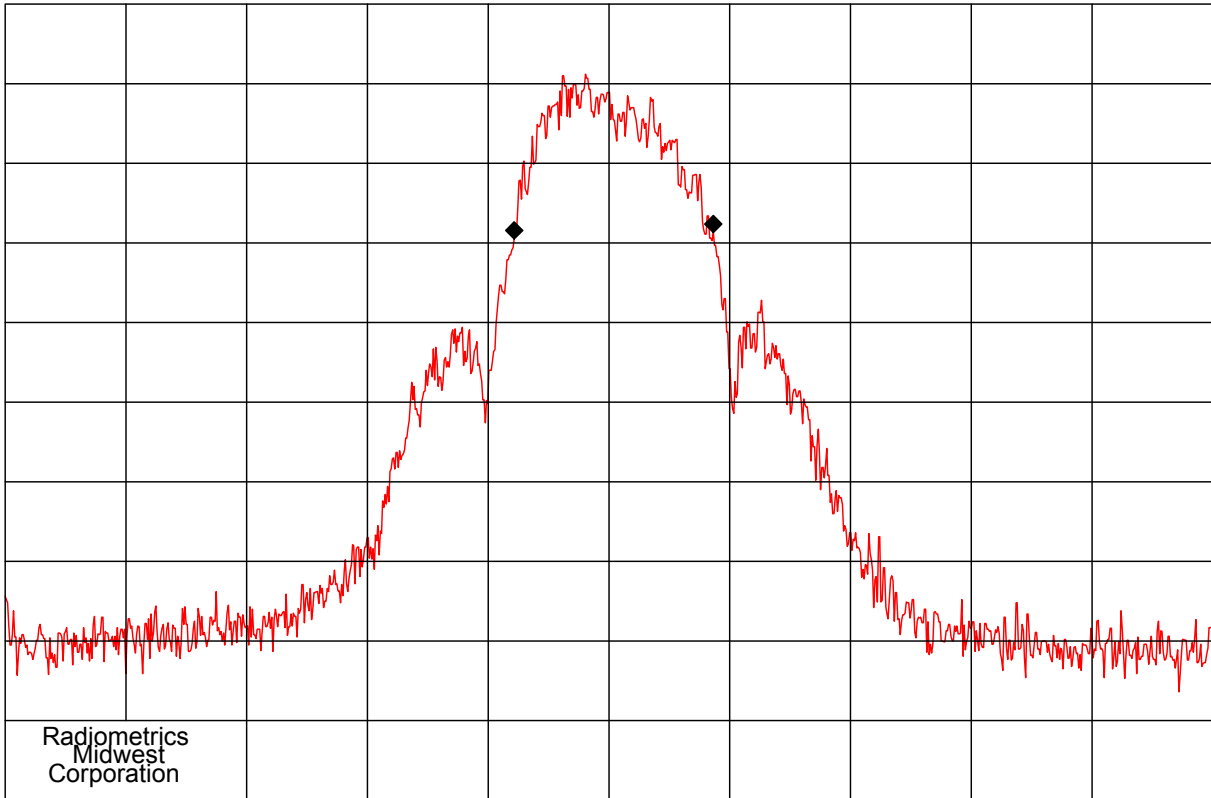

Radiometrics
Midwest
Corporation

Company: Aclara Technologies
CENTER 450.025 0 MHz
RES BW 100 Hz
10 dB/
Notes: 450.025 MHz PN9 Mod Occupied Bandwidth Test.,

ITEM : Series 4000
REF 10.8 dBm
VBW 100 Hz
Time: 14:55

Date : 11-23-2015
SPAN 50.0 kHz
ATTEN 30 dB
SWP 15.0 sec
File: 450M-OBW

Test Report for the Aclara, Series 4000 MTU, Model 4291-065-MBS2W

MKR Delta 8.10 kHz -0.10 dB

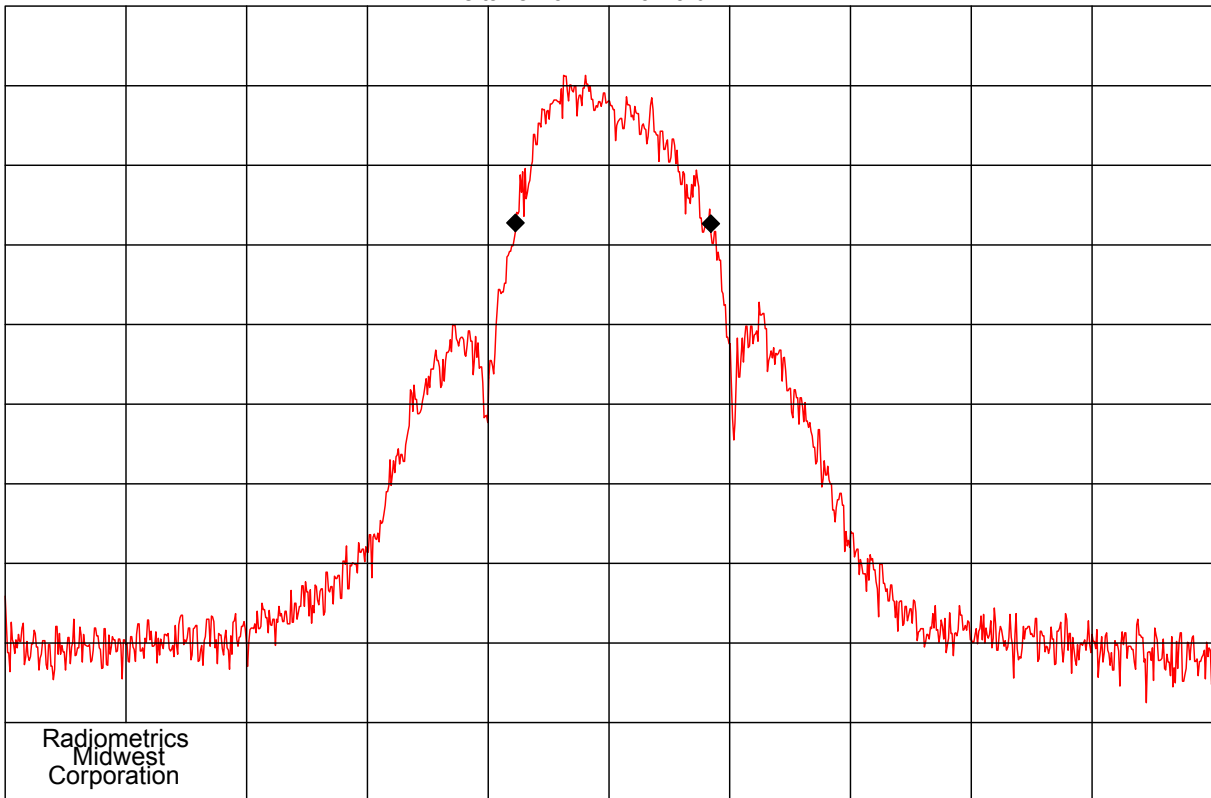
Radiometrics
Midwest
CorporationCompany: Aclara Technologies
CENTER 460.000 0 MHz
RES BW 100 Hz
10 dB/

Notes: 460.000 MHz PN9 Mod Occupied Bandwidth Test.,

ITEM : Series 4000
REF 10.5 dBm
VBW 100 Hz
Time: 14:43Date : 11-23-2015
SPAN 50.0 kHz
ATTEN 30 dB
SWP 15.0 sec
File: 460M-OBW

Test Report for the Aclara, Series 4000 MTU, Model 4291-065-MBS2W

MKR Delta 8.65 kHz -0.50 dB

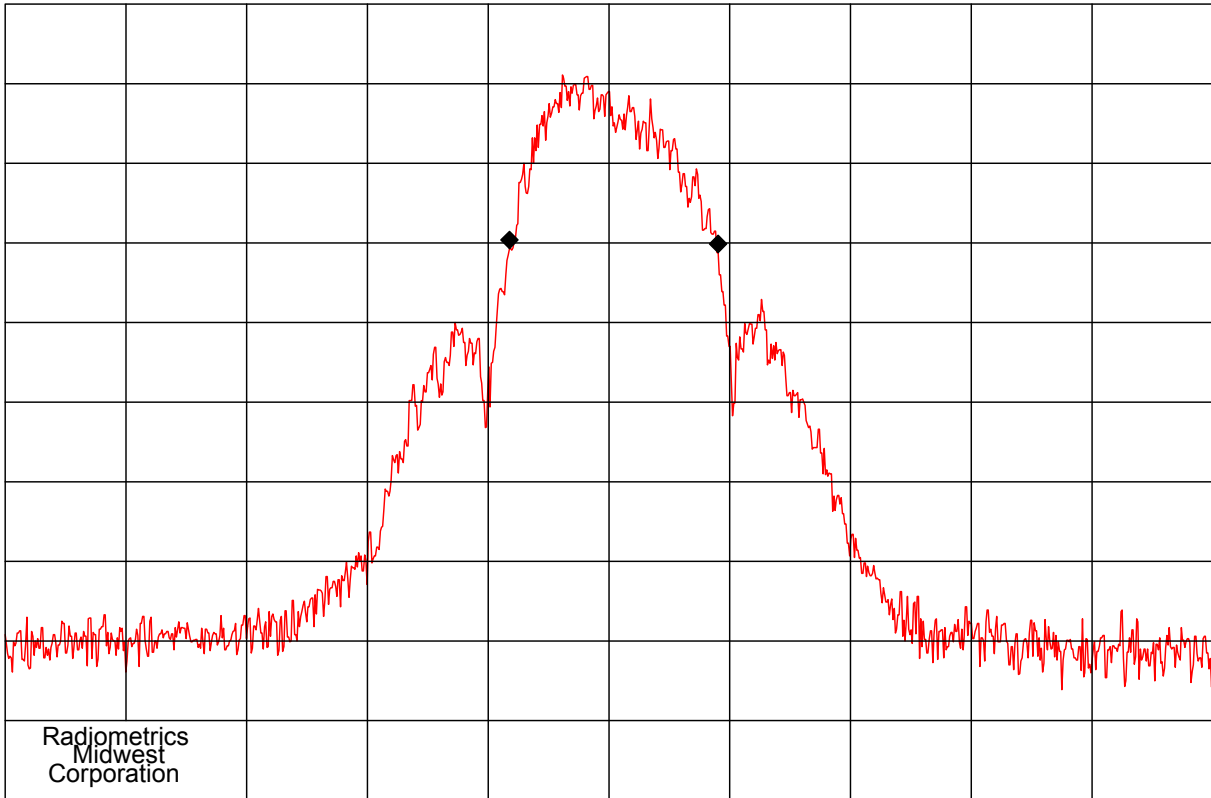

Radiometrics
Midwest
Corporation

Company: Aclara Technologies
CENTER 469.987 5 MHz
RES BW 100 Hz
10 dB/
Notes: 469.9875 MHz PN9 Mod Occupied Bandwidth Test.,

ITEM : Series 4000
REF 10.8 dBm
VBW 100 Hz
Time: 15:06

Date : 11-23-2015
SPAN 50.0 kHz
ATTEN 30 dB
SWP 15.0 sec
File: 469M-OBW

10.3 Field Strength of Unwanted Spurious Radiation

10.3.1 Test Procedures

Radiated emission measurements in the Restricted bands were performed with linearly polarized broadband antennas. The results obtained with these antennas can be correlated with results obtained with a tuned dipole antenna. A 10 dB linearity check is performed prior to start of testing in order to determine if an overload condition exists. From 30 to 4700 MHz, a spectrum analyzer with a preselector was used for measurement. Radiated emissions measurements were performed at the anechoic chamber at a test distance of 3 meters. The entire frequency range from 30 to 4700 MHz was slowly scanned and the emissions in the restricted frequency bands were recorded. Measurements were performed using the peak detector function.

The spectrum analyzer was adjusted for the following settings:

- 1) Resolution Bandwidth = 100 kHz for spurious emissions below 1 GHz, and 1 MHz for spurious emissions above 1GHz.
- 2) Video Bandwidth = 300 kHz for spurious emissions below 1 GHz, and 3 MHz for spurious emissions above 1 GHz.
- 3) Sweep Speed slow enough to maintain measurement calibration.
- 4) Detector Mode = Positive Peak.

The transmitter to be tested was placed on the turntable in the standard test site, or an FCC listed site compliant with ANSI C63.4. The transmitter is transmitting into a non-radiating load that is placed on the turntable (except for the fundamental reading which had an antenna). Since the transmitter has an integral antenna, the tests are to be run with the unit operating into the integral antenna. Measurements were made from the lowest radio frequency generated in the equipment to the tenth harmonic of the carrier. The transmitter was keyed during the tests.

For each spurious frequency, the test antenna was raised and lowered from 1 m to 4m to obtain a maximum reading on the spectrum analyzer with the test antenna at horizontal polarity. Then the turntable was rotated 360° to determine the maximum reading. This procedure was repeated to obtain the highest possible reading. This maximum reading was recorded.

Each measurement was repeated for each spurious frequency with the test antenna polarized vertically.

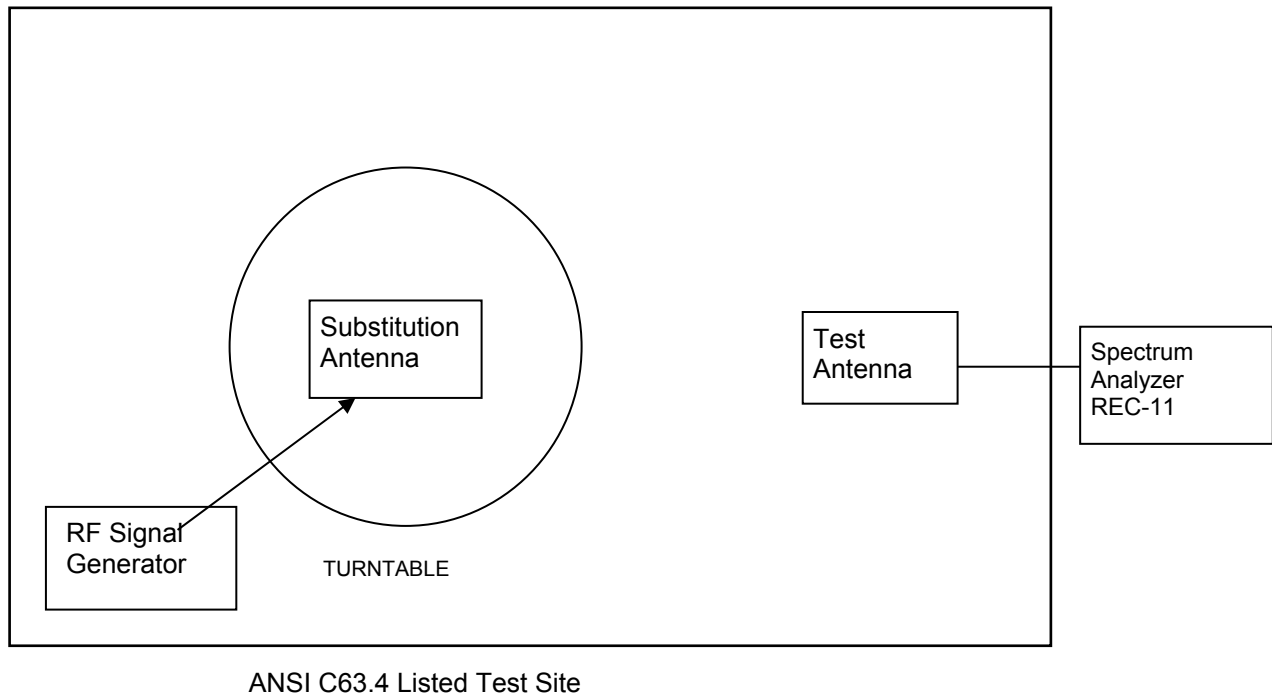
Figure 1. Drawing of Radiated Emissions Setup**Notes:**

- Test Antenna height varied from 1 to 4 meters
- Distance from antenna to tested system is 3 meters
- Not to Scale

Frequency MHz	Test Antenna	Substitution Antenna	Receiver to Coupler	Signal Generator
30 - 200	ANT-44	ANT-03	REC-11	SIG-30
200 - 1000	ANT-44	ANT-06	REC-11	SIG-30
1000-5000	ANT-13	ANT-36	REC-11	SIG-30

The transmitter was removed and replaced with a broadband substitution antenna. The substitution antenna is calibrated so that the gain relative to a dipole is known. The center of the substitution antenna was approximately at the same location as the center of the transmitter.

The substitution antenna was fed at the transmitter end with a signal generator connected to the antenna by means of a non-radiating cable. With the antennas at both ends horizontally polarized, and with the signal generator tuned to a particular spurious frequency, the test antenna was raised and lowered to obtain a maximum reading at the spectrum analyzer. The level of the signal generator output was adjusted until the previously recorded maximum reading for this set of conditions was obtained.

The measurements were repeated with both antennas horizontally and vertically polarized for each spurious frequency.

Test Report for the Aclara, Series 4000 MTU, Model 4291-065-MBS2W

The power in dBm into a reference ideal half-wave dipole antenna was calculated by reducing the readings obtained in steps k) and l) by the power loss in the cable between the generator and the antenna, and further corrected for the gain of the substitution antenna used relative to an ideal half-wave dipole antenna by the following formula:

$$Pd(\text{dBm}) = Pg(\text{dBm}) - \text{cable loss (dB)} + \text{antenna gain (dB)}$$

where:

Pd is the dipole equivalent power and

Pg is the generator output power into the substitution antenna.

The Pd levels record in step m) are the absolute levels of radiated spurious emissions in dBm.

Any emission must be attenuated below the power (P) of the highest emission contained within the authorized bandwidth as follows:

On any frequency removed from the center of the authorized bandwidth by a displacement frequency (fd in kHz) of more than 12.5 kHz: At least $50 + 10 \log (P)$ dB.

Since by mathematical definition, $P(\text{dBm}) - (50 + 10 \times \text{LOG } P(\text{W})) = -20 \text{ dBm}$, the limit for spurious emissions was set to -20 dBm equivalent radiated power.

10.3.2 Spurious Radiated Emissions Test Results

Model	4291-065-MBS2W	Specification	FCC Part 90.210
Serial Number	80010783	Test Date	November 9, 10 & 11, 2015
Test Distance	3 Meters	Notes	Transmit Mode

Harmonic #	Tx	Measured	Equivalent Radiated power into Dipole		Limit dBm	Margin Under Limit	
	Freq MHz	Freq MHz	Vertical dBm	Horizontal dBm		Vertical dB	Horizontal dB
1	450.0250	450.03	28.9	20.8	33.0	4.1	12.3
2	450.0250	900.05	-28.6	-33.9	-20.0	8.6	13.9
3	450.0250	1350.08	-48.5	-51.4	-20.0	28.5	31.4
4	450.0250	1800.10	-52.0	-56.8	-20.0	32.0	36.8
5	450.0250	2250.13	-42.4	-45.0	-20.0	22.4	25.0
6	450.0250	2700.15	-58.0	-58.3	-20.0	38.0	38.3
7	450.0250	3150.18	-40.1	-40.8	-20.0	20.1	20.8
8	450.0250	3600.20	-39.5	-41.3	-20.0	19.5	21.3
9	450.0250	4050.23	-39.4	-40.1	-20.0	19.4	20.1
10	450.0250	4500.25	-39.8	-39.9	-20.0	19.8	19.9
1	460.0000	460.00	29.6	21.4	33.0	3.4	11.6
2	460.0000	920.00	-28.0	-33.7	-20.0	8.0	13.7
3	460.0000	1380.00	-52.2	-51.6	-20.0	32.2	31.6
4	460.0000	1840.00	-51.8	-54.5	-20.0	31.8	34.5
5	460.0000	2300.00	-48.7	-51.4	-20.0	28.7	31.4
6	460.0000	2760.00	-57.5	-57.5	-20.0	37.5	37.5
7	460.0000	3220.00	-40.6	-40.6	-20.0	20.6	20.6
8	460.0000	3680.00	-40.7	-38.6	-20.0	20.7	18.6
9	460.0000	4140.00	-40.6	-39.0	-20.0	20.6	19.0
10	460.0000	4600.00	-38.7	-40.0	-20.0	18.7	20.0
1	469.9875	469.99	30.6	20.0	33.0	2.4	13.0
2	469.9875	939.98	-28.1	-33.9	-20.0	8.1	13.9
3	469.9875	1409.96	-46.1	-52.1	-20.0	26.1	32.1

Test Report for the Aclara, Series 4000 MTU, Model 4291-065-MBS2W

Harmonic #	Tx Freq	Measured Freq	Equivalent Radiated power into Dipole		Limit dBm	Margin Under Limit	
	MHz	MHz	Vertical dBm	Horizontal dBm		Vertical dB	Horizontal dB
4	469.9875	1879.95	-50.9	-53.2	-20.0	30.9	33.2
5	469.9875	2349.94	-52.4	-52.1	-20.0	32.4	32.1
6	469.9875	2819.93	-55.6	-57.0	-20.0	35.6	37.0
7	469.9875	3289.91	-41.8	-39.7	-20.0	21.8	19.7
8	469.9875	3759.90	-40.4	-38.4	-20.0	20.4	18.4
9	469.9875	4229.89	-39.7	-39.2	-20.0	19.7	19.2
10	469.9875	4699.88	-40.0	-39.4	-20.0	20.0	19.4

The fundamental emission limit is 2 watts.

Judgment: Spurious emissions passed by 8 dB.

10.4 Frequency Stability

10.4.1 Frequency Stability Vs Temperature

The chamber was then set to the lowest temperature. The transmitter was in the chamber and allowed to stabilize for 15 minutes. The transmitter was then keyed and the frequency was recorded. The chamber was then incremented in 10°C steps with a minimum of 15 minute stabilization period for each temperature measurement. The transmitter was off during the temperature transitions.

10.4.2 Frequency Stability Vs Supply Voltage

The EUT was allowed to stabilize with the nominal primary power supply voltage applied. The primary input voltage was varied from the lowest to the highest rated levels specified by the manufacturer. Frequency readings were taken at increments of 0.5 VDC.

10.4.3 Test Results for Frequency Stability

Model	4291-065-MBS2W	Specification	FCC Part 90.213
Serial Number	80010783	Test Date	11/11/2015
Test Personnel	Rich Tichgelaar	Test Location	Chamber B
Test Equipment	Spectrum Analyzer (REC-11); Temperature Chamber TC-01 Digital Multimeter (DMM-08)		
Notes	15 minutes at each Temperature; 1 min at each voltage		
Nominal Frequency	460.0000 MHz		

Volts	Freq.	Deviation	
VAC	(MHz)	Hz	PPM
3.8	460.000011	11	0.02
3.6	460.000012	12	0.03
3.4	460.000011	11	0.02
3.2	460.000012	12	0.03
3.0	460.000009	9	0.02
2.8	460.000008	8	0.02

Temp	Freq.	Deviation	
Deg C	(MHz)	Hz	PPM
50	460.000079	79	0.17

Test Report for the Aclara, Series 4000 MTU, Model 4291-065-MBS2W

40	460.000019	19	0.04
30	459.999997	-3	-0.01
20	460.000018	18	0.04
10	459.999949	-51	-0.11
0	459.999900	-100	-0.22
-10	459.999898	-102	-0.22
-20	459.999918	-82	-0.18
-30	459.999911	-89	-0.19

Test Requirements: Limit is 2.5 ppm
Judgement: Pass

10.5 Transient Frequency Behavior

10.5.1 Test method

The test was performed in accordance to TIA-603-C Section 2.2.19.3 Alternate Method of Measurement (Using a Test Receiver). The equipment was connected as shown below.

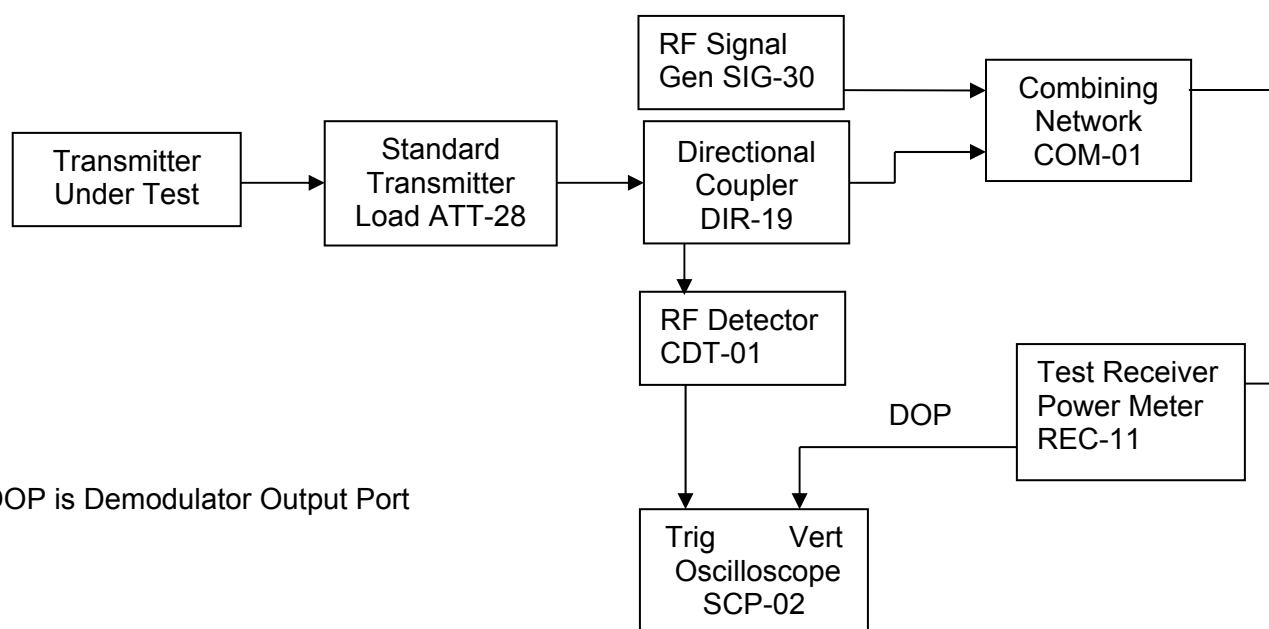

DOP is Demodulator Output Port

10.5.2 Limits of transient frequency

Time intervals ^{1,2}	Maximum Frequency Difference ³	421 to 512 MHz Equipment Operating on 12.5 kHz Channels
t_1^4	± 12.5 kHz	10.0 ms
t_2	± 6.25 kHz	25.0 ms
t_3^4	± 12.5 kHz	10.0 ms

¹_{on} is the instant when a 1 kHz test signal is completely suppressed, including any capture time due to phasing.

t_1 is the time period immediately following t_{on} .

t_2 is the time period immediately following t_1 .

Test Report for the Aclara, Series 4000 MTU, Model 4291-065-MBS2W

t_3 is the time period from the instant when the transmitter is turned off until t_{off} .

t_{off} is the instant when the 1 kHz test signal starts to rise.

²During the time from the end of t_2 to the beginning of t_3 , the frequency difference must not exceed the limits specified in § 90.213.

³Difference between the actual transmitter frequency and the assigned transmitter frequency.

⁴If the transmitter carrier output power rating is 6 watts or less, the frequency difference during this time period may exceed the maximum frequency difference for this time period.

10.5.3 Test Results

Model	4291-065-MBS2W	Specification	FCC part 90.213
Serial Number	80010783	Test Date	November 18, 2015
Test Personnel	Joseph Strzelecki Rich Tichgelaar	Test Location	Chamber B
Notes			

Freq MHz	Channel BW	Limits for Time interval/Freq difference						Test Result
		t_1		t_2		t_3		
		mSec	kHz	mSec	kHz	mSec	kHz	
450.0250	12.5	10	12.5	25	6.25	10	12.5*	Pass
460.000	12.5	10	12.5	25	6.25	10	12.5*	Pass
469.9875	12.5	10	12.5	25	6.25	10	12.5*	Pass

Judgement: Pass

*Since the transmitter carrier output power is less than 6 watts, the frequency difference during the t_3 time period may exceed the maximum frequency difference for this time period.

10.5.4 Results for Time Periods t_1 and t_2

The EUT passed the 6.25 kHz limit so the 12.5 limit is not shown.

Test Report for the Aclara, Series 4000 MTU, Model 4291-065-MBS2W

Tek Run: 500kS/s Hi Res **1792**

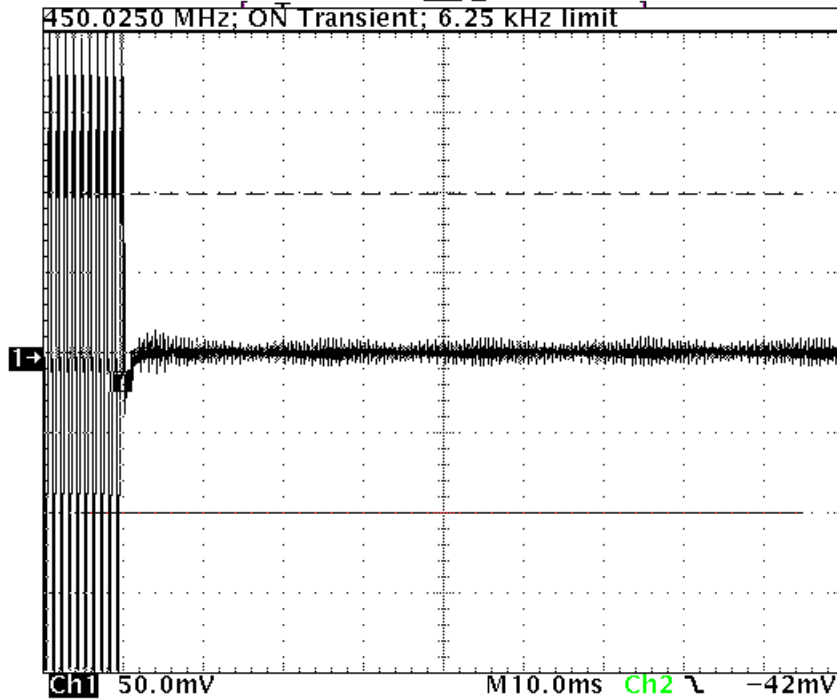

Δ: 200mV
@: -98mV

C1 Pk-Pk
399mV

18 Nov 2015
09:50:04

Tek Run: 500kS/s Hi Res **1793**

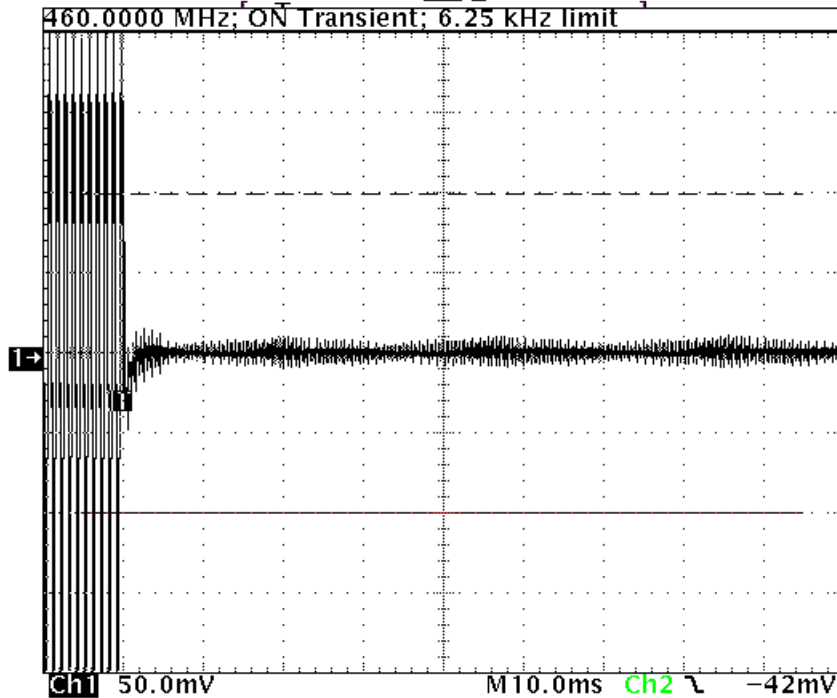

Δ: 200mV
@: -98mV

C1 Pk-Pk
400mV

18 Nov 2015
09:55:54

Test Report for the Aclara, Series 4000 MTU, Model 4291-065-MBS2W

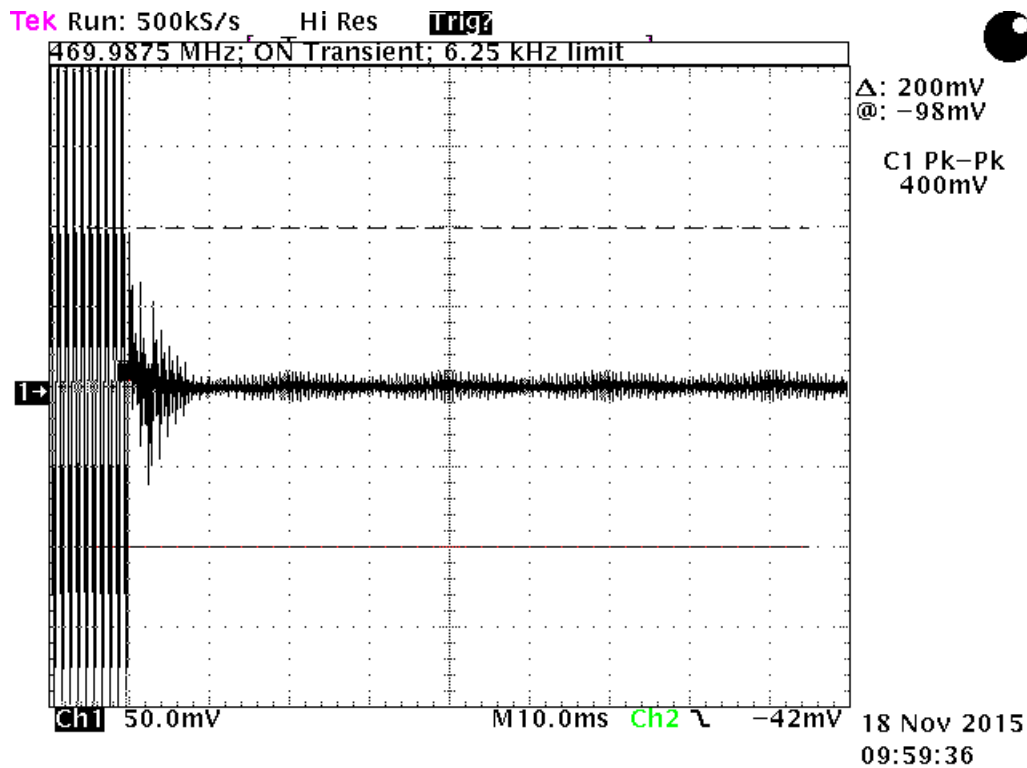

10.5.5 Results for Time Period between t2 and t3

The limit between t2 and t3 on all of the scope traces are calculated for the 450 MHz Channel since this is the lowest limit. This limit is $450 \text{ MHz} * 2.5 \text{ ppm}$ or 1125 Hz.

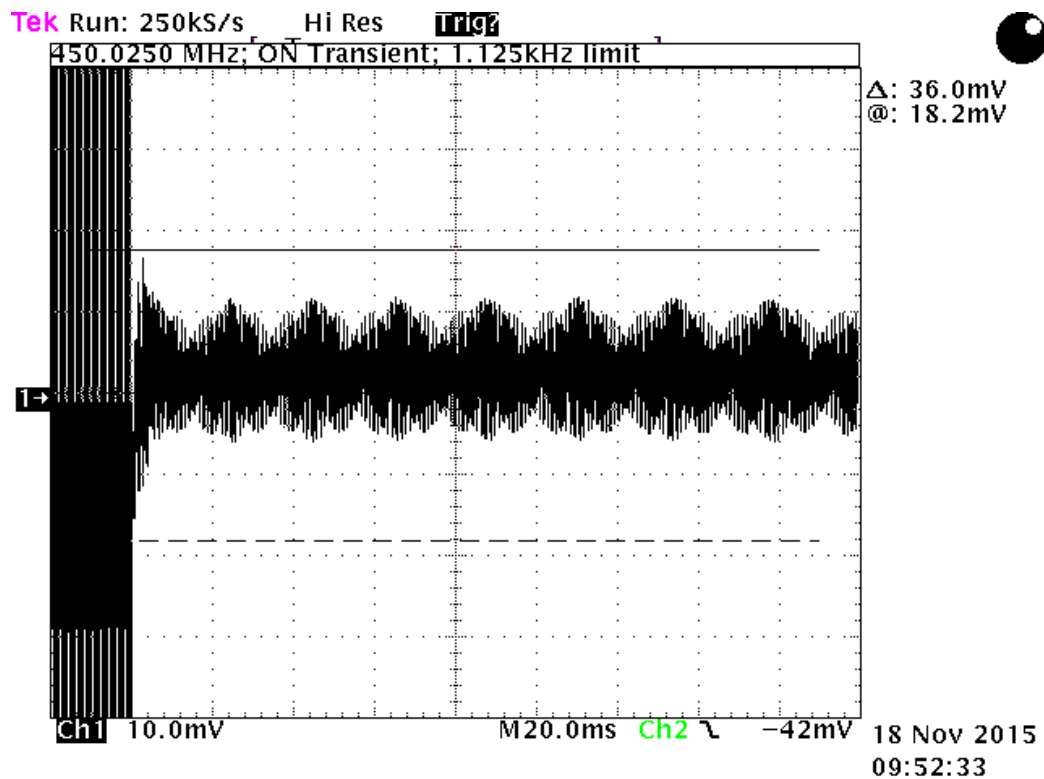

Test Report for the Aclara, Series 4000 MTU, Model 4291-065-MBS2W

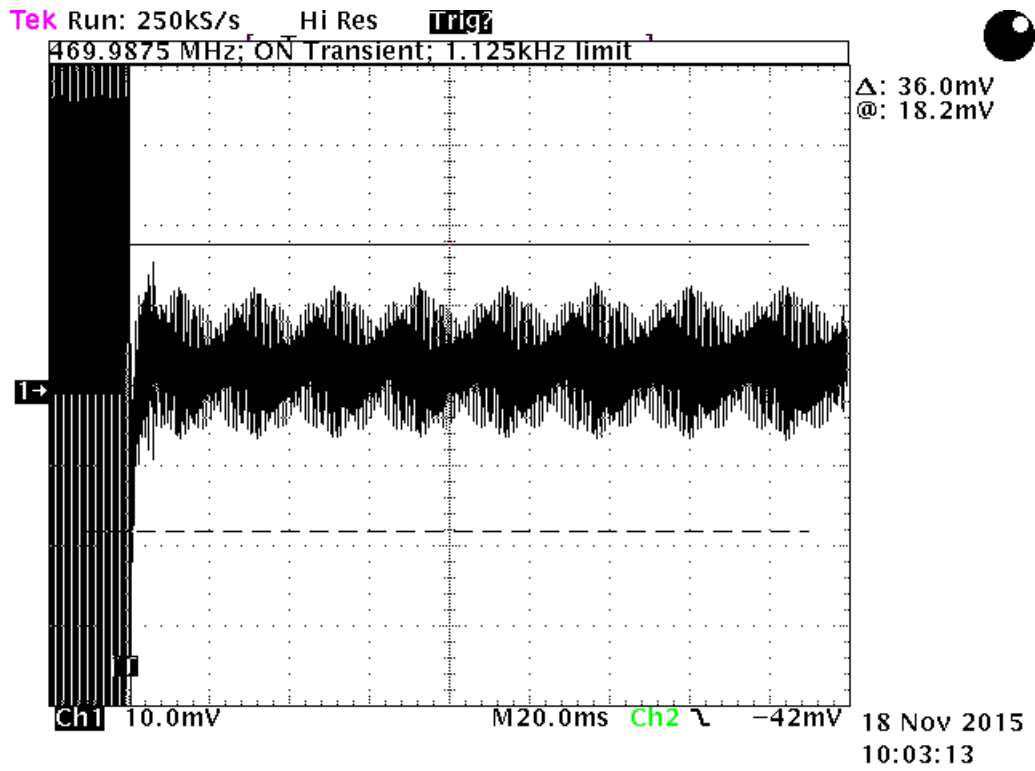
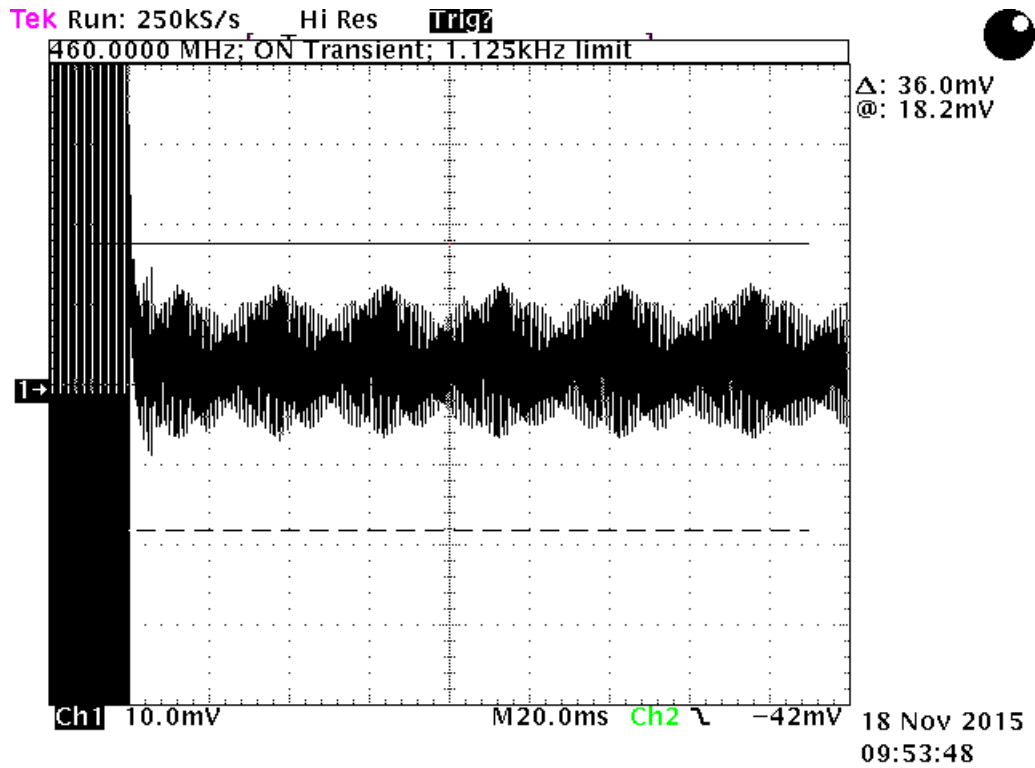

Test Report for the Aclara, Series 4000 MTU, Model 4291-065-MBS2W

10.5.6 Results for Time Period t3

Since the transmitter carrier output power is less than 6 watts, the frequency difference during the t3 time period may exceed the maximum frequency difference for this time period.

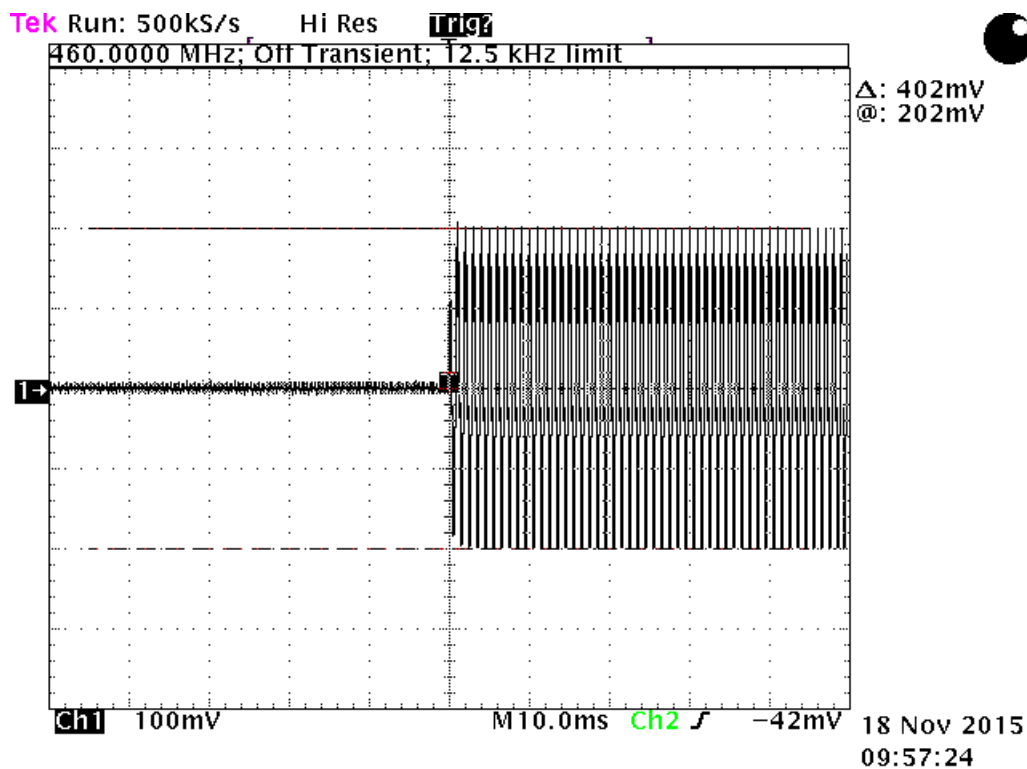
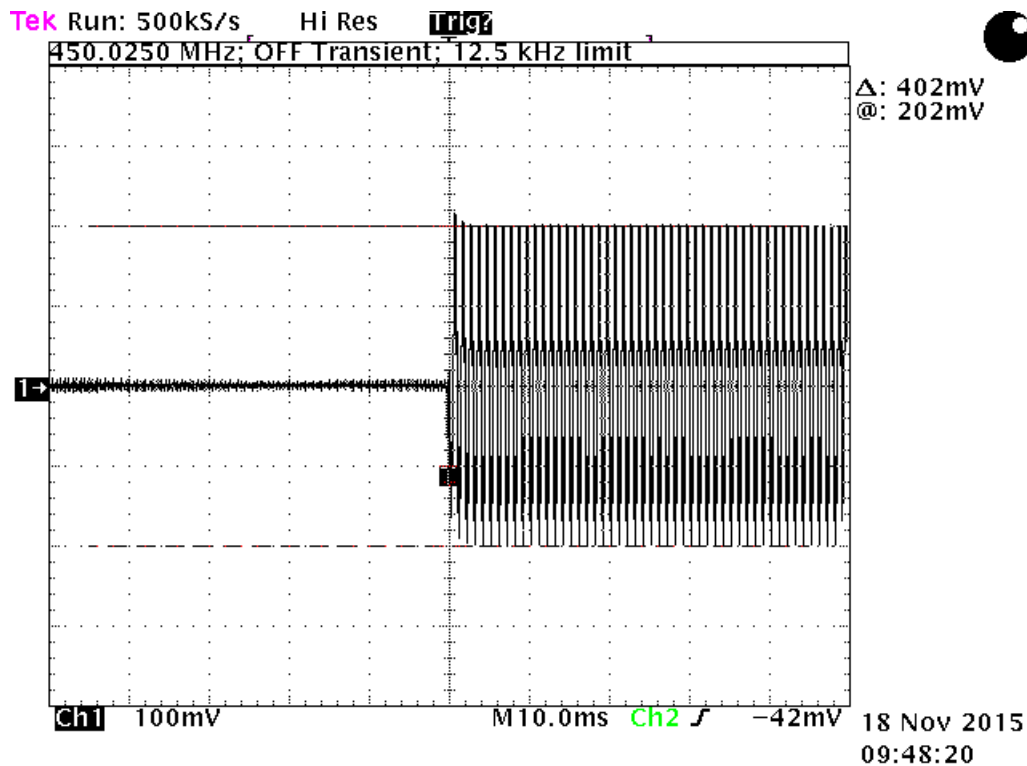

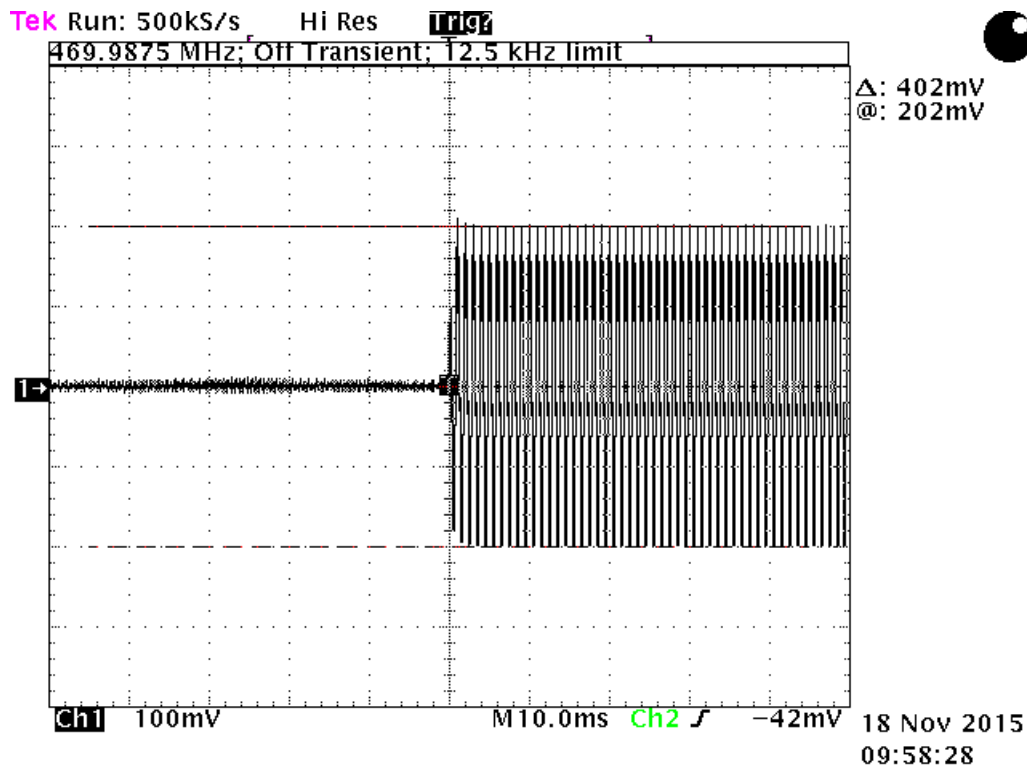

10.6 Radiated Emissions (Receive Mode)

Radiated emission measurements were performed with linearly polarized broadband antennas. The results obtained with these antennas can be correlated with results obtained with a tuned dipole antenna. The radiated emission measurements were performed with a spectrum analyzer. The bandwidth used from 150 kHz to 30 MHz is 9 or 10 kHz and the bandwidth from 30 MHz to 1000 MHz is 100 or 120 kHz. Above 1 GHz, a 1 MHz bandwidth is used. A 10 dB linearity check is performed prior to start of testing in order to determine if an overload condition exists.

From 30 to 2000 MHz, an Anritsu spectrum analyzer was used. Final radiated emissions measurements were performed inside of an anechoic chamber at a test distance of 3 meters. The anechoic chamber is designated as Chamber E. This Chamber meets the Site Attenuation requirements of ANSI C63.4 and CISPR 16-1. Chamber E is located at 12 East Devonwood Ave. Romeoville, Illinois EMI test lab.

The entire frequency range from 30 to 2000 MHz was slowly scanned with particular attention paid to those frequency ranges which appeared high. Measurements were performed using two antenna polarizations, (vertical and horizontal). The worst case emissions were recorded. All measurements may be performed using either the peak, average or quasi-peak detector functions. If the peak detector data exceeds or is marginally close to the limits, the measurements are repeated using a quasi-peak detector or average function as required by the specification for final determination of compliance.

The detected emission levels were maximized by rotating the EUT, adjusting the positions of all cables, and by scanning the measurement antenna from 1 to 4 meters above the ground.

10.6.1 Radiated Emissions Field Strength Sample Calculation

The field strength is calculated by adding the Antenna Factor and Cable Loss, and by subtracting the Amplifier Gain from the measured reading. The basic equation is as follows:

Test Report for the Aclara, Series 4000 MTU, Model 4291-065-MBS2W

$$FS = RA + AF + CF - AG$$

Where: FS = Field Strength

RA = Receiver Amplitude

AF = Antenna Factor

CF = Cable Attenuation Factor

AG = Amplifier Gain

Test Report for the Aclara, Series 4000 MTU, Model 4291-065-MBS2W

10.6.2 Spurious Radiated Emissions Test Results (Receive Mode)

Model	4291-065-MBS2W-1	Specification	FCC Part 15 Subpart B
Serial Number	80010757	Test Date	11/09/2015
Tested by	Richard Tichelaar	Test Distance	3 Meters
Abbreviations	Pol = Antenna Polarization; V = Vertical; H = Horizontal; P = peak; Q = QP		
Notes	Corr. Factors = Cable Loss – Preamp Gain		
Configuration	Receive Mode		

Freq. MHz	Meter Reading dBuV	Dect.	Ant. Pol.	Ant Factor	Cable & Amp Factors	Dist Fact dB	EUT dBuV/m	Limit dBuV/m	Margin Under Limit dB	Note
30.0	33.5	P	H	16.9	-28.3	0.0	22.0	40.0	18.0	
35.0	38.1	P	H	16.6	-28.2	0.0	26.4	40.0	13.6	
132.3	34.3	P	H	13.6	-27.7	0.0	20.3	43.5	23.2	
204.9	34.6	P	H	10.3	-27.5	0.0	17.4	43.5	26.1	
250.0	34.3	P	H	12.4	-27.3	0.0	19.5	46.0	26.5	
258.1	33.4	P	H	12.9	-27.3	0.0	19.0	46.0	27.0	
343.8	35.1	P	H	15.3	-27.2	0.0	23.2	46.0	22.8	
420.0	35.7	P	H	17.0	-27.0	0.0	25.7	46.0	20.3	
493.1	34.6	P	H	17.6	-26.9	0.0	25.4	46.0	20.6	
522.5	33.6	P	H	19.1	-26.7	0.0	26.0	46.0	20.0	
668.8	35.5	P	H	20.2	-26.2	0.0	29.5	46.0	16.5	
863.8	34.2	P	H	21.1	-25.4	0.0	29.9	46.0	16.1	
987.5	34.8	P	H	22.3	-24.5	0.0	32.7	54.0	21.3	
1025.0	40.4	P	H	23.9	-32.8	0.0	31.5	74.0	42.5	Note 1
1677.5	40.1	P	H	26.1	-32.2	0.0	34.0	74.0	40.0	Note 1
1932.5	42.2	P	H	27.6	-31.8	0.0	38.0	74.0	36.0	Note 1
1992.5	39.9	P	H	27.6	-31.6	0.0	35.9	74.0	38.1	Note 1
30.0	34.1	P	V	16.9	-28.3	0.0	22.7	40.0	17.3	
35.0	39.9	P	V	16.6	-28.2	0.0	28.3	40.0	11.7	
49.8	39.2	P	V	14.3	-28.1	0.0	25.4	40.0	14.6	
75.7	34.1	P	V	7.1	-27.9	0.0	13.2	40.0	26.8	
185.6	34.6	P	V	9.4	-27.5	0.0	16.5	43.5	27.0	
245.1	34.5	P	V	12.5	-27.3	0.0	19.7	46.0	26.3	
255.0	34.5	P	V	12.9	-27.3	0.0	20.1	46.0	25.9	
298.8	33.9	P	V	13.2	-27.2	0.0	20.0	46.0	26.0	
425.6	34.2	P	V	17.2	-27.0	0.0	24.4	46.0	21.6	
500.0	33.6	P	V	17.3	-27.0	0.0	24.0	46.0	22.0	
518.8	34.5	P	V	19.0	-26.8	0.0	26.7	46.0	19.3	
618.8	35.9	P	V	19.4	-26.6	0.0	28.8	46.0	17.2	
805.0	36.0	P	V	20.1	-25.8	0.0	30.3	46.0	15.7	
993.8	35.6	P	V	22.6	-24.4	0.0	33.8	54.0	20.2	
1002.5	39.0	P	V	23.7	-32.7	0.0	29.9	74.0	44.1	Note 1
1475.0	40.6	P	V	25.5	-32.5	0.0	33.6	74.0	40.4	Note 1
1695.0	41.0	P	V	26.2	-32.1	0.0	35.1	74.0	38.9	Note 1
1902.5	40.1	P	V	27.6	-31.9	0.0	35.9	74.0	38.1	Note 1
1990.0	39.8	P	V	27.6	-31.6	0.0	35.8	74.0	38.2	Note 1

Note 1; Peak reading meeting the average limit so the average reading is not required.

Judgment: Pass by at least 10 dB