



**DFS PORTION OF
FCC CFR47 PART 15 SUBPART E
CERTIFICATION TEST REPORT
FOR**

BROADBAND WIRELESS ACCESS, POINT TO MUTIPOINT SYSTEM

MODEL NUMBER: AU-E-SA-5.X-VL

FCC ID: LKT-VL-53C

REPORT NUMBER: 07U10917-1

ISSUE DATE: APRIL 13, 2007

Prepared for
**ALVARION
21A HABARAEEL STREET
TEL AVIV
69710 ISRAEL**

Prepared by
**COMPLIANCE CERTIFICATION SERVICES
47173 BENICIA STREET
FREMONT, CA 94538, U.S.A.
TEL: (510) 771-1000
FAX: (510) 661-0888**



NVLAP LAB CODE 200065-0

Revision History

<u>Rev.</u>	<u>Issue Date</u>	<u>Revisions</u>	<u>Revised By</u>
--	4/13/2007	Initial Issue	M. Heckrotte

TABLE OF CONTENTS

1. ATTESTATION OF TEST RESULTS.....	5
2. TEST METHODOLOGY	6
3. FACILITIES AND ACCREDITATION	6
4. CALIBRATION AND UNCERTAINTY.....	6
4.1. MEASURING INSTRUMENT CALIBRATION.....	6
4.2. MEASUREMENT UNCERTAINTY.....	6
5. DYNAMIC FREQUENCY SELECTION	7
5.1. DFS OVERVIEW	7
5.1.1. LIMITS	7
5.1.2. TEST AND MEASUREMENT SYSTEM	10
5.1.3. TEST AND MEASUREMENT EQUIPMENT	13
5.1.4. DESCRIPTION OF EUT	14
5.1.5. SETUP OF EUT.....	15
5.2. MASTER CONFIGURATION IN 10 MHz BANDWIDTH.....	16
5.2.1. PLOTS OF RADAR WAVEFORM, AND WLAN TRAFFIC	16
5.2.2. TEST CHANNEL AND METHOD	23
5.2.3. CHANNEL AVAILABILITY CHECK TIME.....	23
5.2.4. CHANNEL MOVE TIME AND CHANNEL CLOSING TRANSMISSION TIME.....	28
5.2.5. NON-OCCUPANCY PERIOD.....	34
5.2.6. DETECTION BANDWIDTH.....	35
5.2.7. IN-SERVICE MONITORING.....	37
5.3. SLAVE CONFIGURATION IN 10 MHz BANDWIDTH.....	44
5.3.1. PLOTS OF RADAR WAVEFORM AND WLAN TRAFFIC	44
5.3.2. TEST CHANNEL AND METHOD	46
5.3.3. CHANNEL MOVE TIME AND CHANNEL CLOSING TRANSMISSION TIME.....	46
5.4. MASTER CONFIGURATION IN 20 MHz BANDWIDTH.....	51
5.4.1. PLOTS OF RADAR WAVEFORM, AND WLAN TRAFFIC	51
5.4.2. TEST CHANNEL AND METHOD	58
5.4.3. CHANNEL AVAILABILITY CHECK TIME.....	58
5.4.4. CHANNEL MOVE TIME AND CHANNEL CLOSING TRANSMISSION TIME.....	63
5.4.5. NON-OCCUPANCY PERIOD.....	69
5.4.6. DETECTION BANDWIDTH.....	70
5.4.7. IN-SERVICE MONITORING.....	72
5.5. SLAVE CONFIGURATION IN 20 MHz BANDWIDTH.....	79
5.5.1. PLOTS OF RADAR WAVEFORM AND WLAN TRAFFIC	79
5.5.2. TEST CHANNEL AND METHOD	81
5.5.3. CHANNEL MOVE TIME AND CHANNEL CLOSING TRANSMISSION TIME.....	81
5.6. MASTER CONFIGURATION IN 40 MHz BANDWIDTH.....	86
5.6.1. PLOTS OF RADAR WAVEFORM, AND WLAN TRAFFIC	86
5.6.2. TEST CHANNEL AND METHOD	93

5.6.3. CHANNEL AVAILABILITY CHECK TIME..... 93
5.6.4. CHANNEL MOVE TIME AND CHANNEL CLOSING TRANSMISSION TIME..... 98
5.6.5. NON-OCCUPANCY PERIOD..... 104
5.6.6. DETECTION BANDWIDTH..... 105
5.6.7. IN-SERVICE MONITORING..... 107
5.7. SLAVE CONFIGURATION IN 40 MHz BANDWIDTH..... 114
5.7.1. PLOTS OF RADAR WAVEFORM AND WLAN TRAFFIC 114
5.7.2. TEST CHANNEL AND METHOD 116
5.7.3. CHANNEL MOVE TIME AND CHANNEL CLOSING TRANSMISSION TIME..... 116
6. SETUP PHOTOS 121

1. ATTESTATION OF TEST RESULTS

COMPANY NAME: ALVARION
21A HABARZEL STREET
TEL AVI 69710 ISRAEL

EUT DESCRIPTION: BROADBAND WIRELESS ACCESS

MODEL: AU-E-SA-5.X-VL

SERIAL NUMBER: 00-10-E7-C4-00-81

DATE TESTED: MARCH 21-31, 2007

APPLICABLE STANDARDS	
STANDARD	TEST RESULTS
DFS PORTION OF FCC PART 15 SUBPART E	NO NON-COMPLIANCE NOTED

Compliance Certification Services, Inc. tested the above equipment in accordance with the requirements set forth in the above standards. The test results show that the equipment tested is capable of demonstrating compliance with the requirements as documented in this report.

Note: The results documented in this report apply only to the tested sample, under the conditions and modes of operation as described herein. This document may not be altered or revised in any way unless done so by Compliance Certification Services and all revisions are duly noted in the revisions section. Any alteration of this document not carried out by Compliance Certification Services will constitute fraud and shall nullify the document. No part of this report may be used to claim product certification, approval, or endorsement by NVLAP, NIST, or any government agency.

Approved & Released For CCS By:

Tested By:



MICHAEL HECKROTTE
ENGINEERING MANAGER
COMPLIANCE CERTIFICATION SERVICES

CAN MING CHUNG
EMC ENGINEER
COMPLIANCE CERTIFICATION SERVICES

2. TEST METHODOLOGY

The tests documented in this report were performed in accordance with FCC CFR 47 Part 15 and FCC 06-96 APPENDIX "COMPLIANCE MEASUREMENT PROCEDURES FOR UNLICENSED-NATIONAL INFORMATION INFRASTRUCTURE DEVICES OPERATING IN THE 5250-5350 MHz AND 5470-5725 MHz BANDS INCORPORATING DYNAMIC FREQUENCY SELECTION".

3. FACILITIES AND ACCREDITATION

The test sites and measurement facilities used to collect data are located at 47173 Benicia Street, Fremont, California, USA. The sites are constructed in conformance with the requirements of ANSI C63.4, ANSI C63.7 and CISPR Publication 22. All receiving equipment conforms to CISPR Publication 16-1, "Radio Interference Measuring Apparatus and Measurement Methods."

CCS is accredited by NVLAP, Laboratory Code 200065-0. The full scope of accreditation can be viewed at <http://www.ccsemc.com>.

4. CALIBRATION AND UNCERTAINTY

4.1. MEASURING INSTRUMENT CALIBRATION

The measuring equipment utilized to perform the tests documented in this report has been calibrated in accordance with the manufacturer's recommendations, and is traceable to recognized national standards.

4.2. MEASUREMENT UNCERTAINTY

Where relevant, the following measurement uncertainty levels have been estimated for tests performed on the apparatus:

PARAMETER	UNCERTAINTY
Radiated Emission, 30 to 200 MHz	+/- 3.3 dB
Radiated Emission, 200 to 1000 MHz	+4.5 / -2.9 dB
Radiated Emission, 1000 to 2000 MHz	+4.5 / -2.9 dB
Power Line Conducted Emission	+/- 2.9 dB

Uncertainty figures are valid to a confidence level of 95%.

5. DYNAMIC FREQUENCY SELECTION

5.1. DFS OVERVIEW

5.1.1. LIMITS

§15.407 (h) and FCC 06-96 APPENDIX “COMPLIANCE MEASUREMENT PROCEDURES FOR UNLICENSED-NATIONAL INFORMATION INFRASTRUCTURE DEVCIES OPERATING IN THE 5250-5350 MHz AND 5470-5725 MHz BANDS INCORPORATING DYNAMIC FREQUENCY SELECTION”.

Table 1: Applicability of DFS requirements prior to use of a channel

Requirement	Operational Mode		
	Master	Client (without radar detection)	Client (with radar detection)
<i>Non-Occupancy Period</i>	Yes	Not required	Yes
<i>DFS Detection Threshold</i>	Yes	Not required	Yes
<i>Channel Availability Check Time</i>	Yes	Not required	Not required
<i>Uniform Spreading</i>	Yes	Not required	Not required

Table 2: Applicability of DFS requirements during normal operation

Requirement	Operational Mode		
	Master	Client (without DFS)	Client (with DFS)
<i>DFS Detection Threshold</i>	Yes	Not required	Yes
<i>Channel Closing Transmission Time</i>	Yes	Yes	Yes
<i>Channel Move Time</i>	Yes	Yes	Yes

Table 3: Interference Threshold values, Master or Client incorporating In-Service Monitoring

Maximum Transmit Power	Value (see note)
≥ 200 milliwatt	-64 dBm
< 200 milliwatt	-62 dBm
Note 1: This is the level at the input of the receiver assuming a 0 dBi receive antenna Note 2: Throughout these test procedures an additional 1 dB has been added to the amplitude of the test transmission waveforms to account for variations in measurement equipment. This will ensure that the test signal is at or above the detection threshold level to trigger a DFS response.	

Table 4: DFS Response requirement values

Parameter	Value
<i>Non-occupancy period</i>	30 minutes
<i>Channel Availability Check Time</i>	60 seconds
<i>Channel Move Time</i>	10 seconds
<i>Channel Closing Transmission Time</i>	200 milliseconds + approx. 60 milliseconds over remaining 10 second period
The instant that the <i>Channel Move Time</i> and the <i>Channel Closing Transmission Time</i> begins is as follows: <ul style="list-style-type: none"> • For the Short pulse radar Test Signals this instant is the end of the <i>Burst</i>. • For the Frequency Hopping radar Test Signal, this instant is the end of the last radar burst generated. • For the Long Pulse radar Test Signal this instant is the end of the 12 second period defining the radar transmission. The Channel Closing Transmission Time is comprised of 200 milliseconds starting at the beginning of the Channel Move Time plus any additional intermittent control signals required to facilitate channel changes (an aggregate of approximately 60 milliseconds) during the remainder of the 10 second period. The aggregate duration of control signals will not count quiet periods in between transmissions.	

Table 5 – Short Pulse Radar Test Waveforms

Radar Type	Pulse Width (Microseconds)	PRI (Microseconds)	Pulses	Minimum Percentage of Successful Detection	Minimum Trials
1	1	1428	18	60%	30
2	1-5	150-230	23-29	60%	30
3	6-10	200-500	16-18	60%	30
4	11-20	200-500	12-16	60%	30
Aggregate (Radar Types 1-4)				80%	120

Table 6 – Long Pulse Radar Test Signal

Radar Waveform	Bursts	Pulses per Burst	Pulse Width (µsec)	Chirp Width (MHz)	PRI (µsec)	Minimum Percentage of Successful Detection	Minimum Trials
5	8-20	1-3	50-100	5-20	1000-2000	80%	30

Table 7 – Frequency Hopping Radar Test Signal

Radar Waveform	Pulse Width (µsec)	PRI (µsec)	Burst Length (ms)	Pulses per Hop	Hopping Rate (kHz)	Minimum Percentage of Successful Detection	Minimum Trials
6	1	333	300	9	.333	70%	30

5.1.2. TEST AND MEASUREMENT SYSTEM

SYSTEM OVERVIEW

The measurement system is based on a conducted test method.

The short pulse and long pulse signal generating system utilizes the NTIA software. The Vector Signal Generator has been validated by the NTIA. The hopping signal generating system utilizes the CCS simulated hopping method and system, which has been validated by the DoD, FCC and NTIA. The software selects waveform parameters from within the bounds of the signal type on a random basis using uniform distribution.

The short pulse types 2, 3 and 4, and the long pulse type 5 parameters are randomized at run-time.

The hopping type 6 pulse parameters are fixed while the hopping sequence is based on the August 2005 NTIA Hopping Frequency List. The initial starting point randomized at run-time and each subsequent starting point is incremented by 475. Each frequency in the 100-length segment is compared to the boundaries of the EUT Detection Bandwidth and the software creates a hopping burst pattern in accordance with Section 7.4.1.3 Method #2 Simulated Frequency Hopping Radar Waveform Generating Subsystem of FCC 06-96 APPENDIX. The frequency of the signal generator is incremented in 1 MHz steps from F_L to F_H for each successive trial. This incremental sequence is repeated as required to generate a minimum of 30 total trials and to maintain a uniform frequency distribution over the entire Detection Bandwidth.

The signal monitoring equipment consists of a spectrum analyzer set to display 8001 bins on the horizontal axis. The time-domain resolution is 2 msec / bin with a 16 second sweep time, meeting the 10 second short pulse reporting criteria. The aggregate ON time is calculated by multiplying the number of bins above a threshold during a particular observation period by the dwell time per bin, with the analyzer set to peak detection and max hold. The time-domain resolution is 3 msec / bin with a 24 second sweep time, meeting the 22 second long pulse reporting criteria and allowing a minimum of 10 seconds after the end of the long pulse waveform.

Should multiple RF ports be utilized for the Master and/or Slave devices (for example, for diversity or MIMO implementations), additional combiner/dividers are inserted between the Master Combiner/Divider and the 10 dB pad connected to the Master Device (and/or between the Slave Combiner/Divider and the 10 dB pad connected to the Slave Device). Additional 10 dB pads are connected as needed, such that there is one pad at each RF port on each EUT.

CONDUCTED METHOD SYSTEM BLOCK DIAGRAM

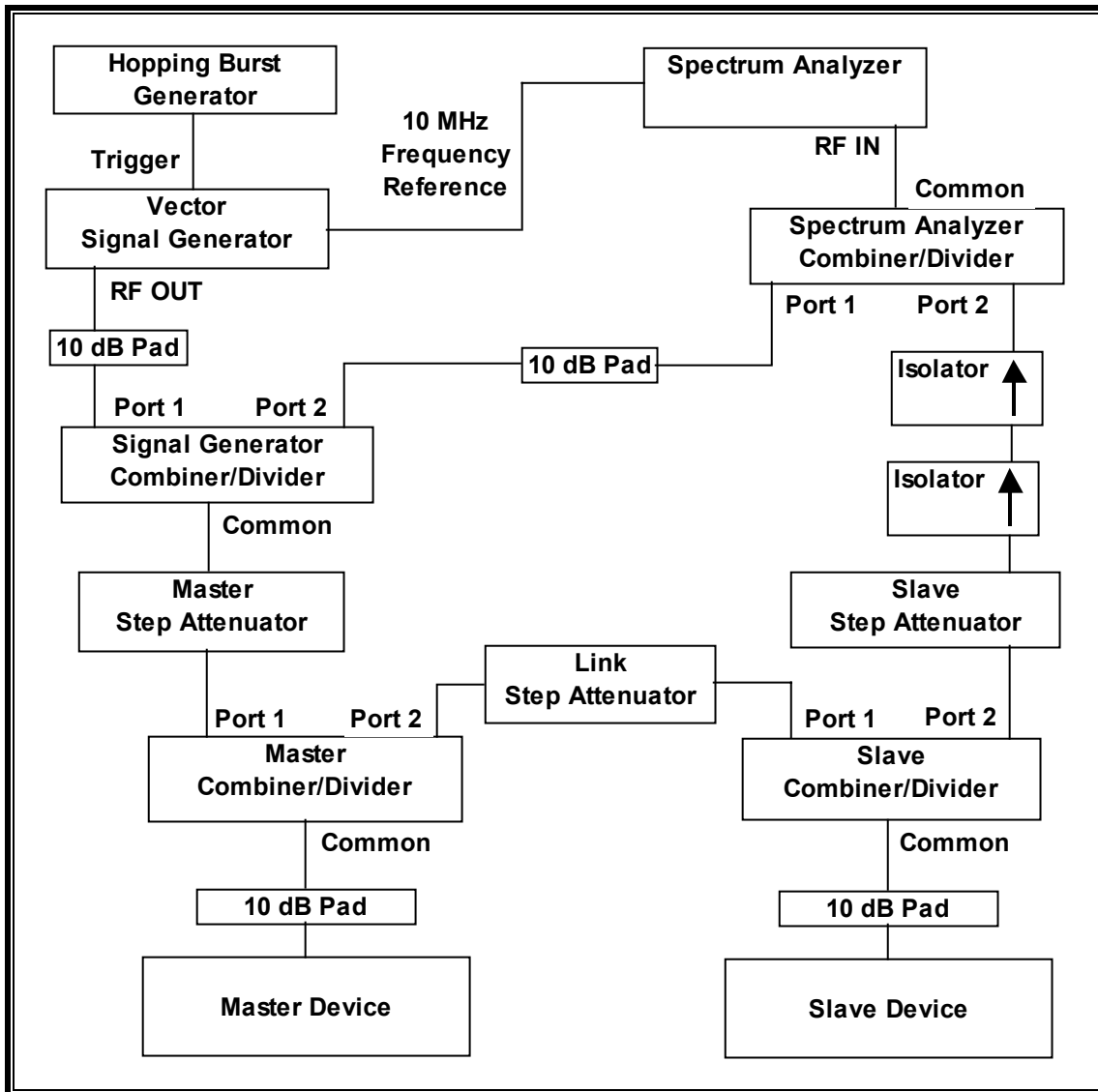

SYSTEM CALIBRATION

Connect the spectrum analyzer to the test system in place of the master device. Set the signal generator to CW mode. Adjust the amplitude of the signal generator to yield a measured level of -64 dBm on the spectrum analyzer.

Without changing any of the instrument settings, reconnect the spectrum analyzer to the Common port of the Spectrum Analyzer Combiner/Divider and connect a 50 ohm load to the Master Device port of the test system.

Measure the amplitude and calculate the difference from -64 dBm. Adjust the Reference Level Offset of the spectrum analyzer to this difference. Confirm that the signal is displayed at -64 dBm. Readjust the RBW and VBW to 3 MHz, set the span to 10 MHz, and confirm that the signal is still displayed at -64 dBm.

The spectrum analyzer displays the level of the signal generator as received at the antenna ports of the Master Device. The interference detection threshold may be varied from the calibrated value of -64 dBm and the spectrum analyzer will still indicate the level as received by the Master Device.

Set the signal generator to produce a radar waveform, trigger a burst manually and measure the level on the spectrum analyzer. Readjust the amplitude of the signal generator as required so that the peak level of the waveform is at a displayed level equal to the required or desired interference detection threshold. Separate signal generator amplitude settings are determined as required for each radar type.

ADJUSTMENT OF DISPLAYED TRAFFIC LEVEL

Establish a link between the Master and Slave, adjusting the Link Step Attenuator as needed to provide a suitable received level at the Master and Slave devices. Stream the video test file to generate WLAN traffic. Confirm that the WLAN traffic level, as displayed on the spectrum analyzer, is at lower amplitude than the radar detection threshold. Confirm that the displayed traffic is from the Master Device. Confirm that the displayed traffic does not include Slave Device traffic.

If a different setting of the Master Step Attenuator is required to meet the above conditions, perform a new System Calibration for the new Master Step Attenuator setting.

5.1.3. TEST AND MEASUREMENT EQUIPMENT

The following test and measurement equipment was utilized for the tests documented in this report:

TEST EQUIPMENT LIST				
Description	Manufacturer	Model	Serial Number	Cal Due
Spectrum Analyzer 3 Hz ~ 44 GHz	Agilent / HP	E4446A	US42070220	7/26/2007
Vector Signal Generator 250kHz-20GHz	Agilent / HP	E8267C	US43320336	11/2/2007
High Speed Digital I/O Card	National Instruments	PCI-6534	HA1612845	1/16/2008

5.1.4. DESCRIPTION OF EUT

The EUT operates over the 5250-5350 MHz and 5470-5725 MHz ranges.

The EUT can be configured as a Master Device, or as a Slave Device without radar detection.

The highest power level within these bands is 27 dBm in 10 MHz bandwidth and 30 dBm EIRP in 20 and 40 MHz bandwidths.

The highest gain antenna assembly utilized with the EUT has a gain of 23 dBi. The lowest gain antenna assembly utilized with the EUT has a gain of 15 dBi.

The rated output power of the Master unit is $> 23\text{dBm}$ (EIRP). Therefore the required interference threshold level is -64 dBm . After correction for antenna gain and procedural adjustments, the required conducted threshold at the antenna port is $-64 + 15 + 1 = -48\text{ dBm}$.

The calibrated conducted DFS Detection Threshold level is set to -48 dBm .

The EUT uses one transmitter connected to a 50-ohm coaxial antenna to perform conducted tests.

WLAN traffic is generated by streaming the video file TestFile.mp2 "6 ½ Magic Hours" from the Master to the Slave in full motion video mode using the media player with the V2.61 Codec package.

TPC is required since the maximum EIRP is less than 500 mW (27 dBm).

The EUT utilizes the 802.11a architecture. Three nominal channel bandwidths are implemented: 10 MHz, 20 MHz and 40 MHz.

The software installed in the access point is A4_5xx.bz revision C.

INFORMATION REGARDING TPC

The TPC power levels and EIRP calculations are in a separate document.

MANUFACTURER'S STATEMENT REGARDING UNIFORM CHANNEL SPREADING

This statement is in a separate document.

5.1.5. SETUP OF EUT

SUPPORT EQUIPMENT

PERIPHERAL SUPPORT EQUIPMENT LIST				
Description	Manufacturer	Model	Serial Number	FCC ID
AC Adapter	Compaq	PPP012L	3300371601	DoC
Laptop	Compaq	Presario 3000	CNU327025L	DoC
AC Adapter	Compaq	PPP012L	N/A	DoC
Laptop	Compaq	Presario 3000	N/A	DoC

TEST SETUP

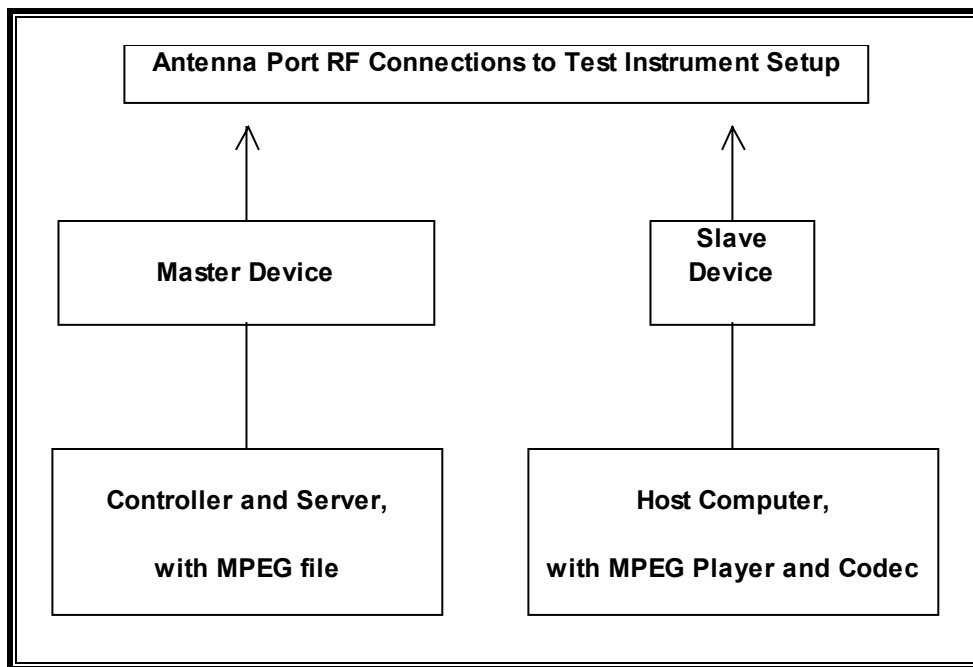

5.2. MASTER CONFIGURATION IN 10 MHz BANDWIDTH

5.2.1. PLOTS OF RADAR WAVEFORM, AND WLAN TRAFFIC

PLOTS OF RADAR WAVEFORMS

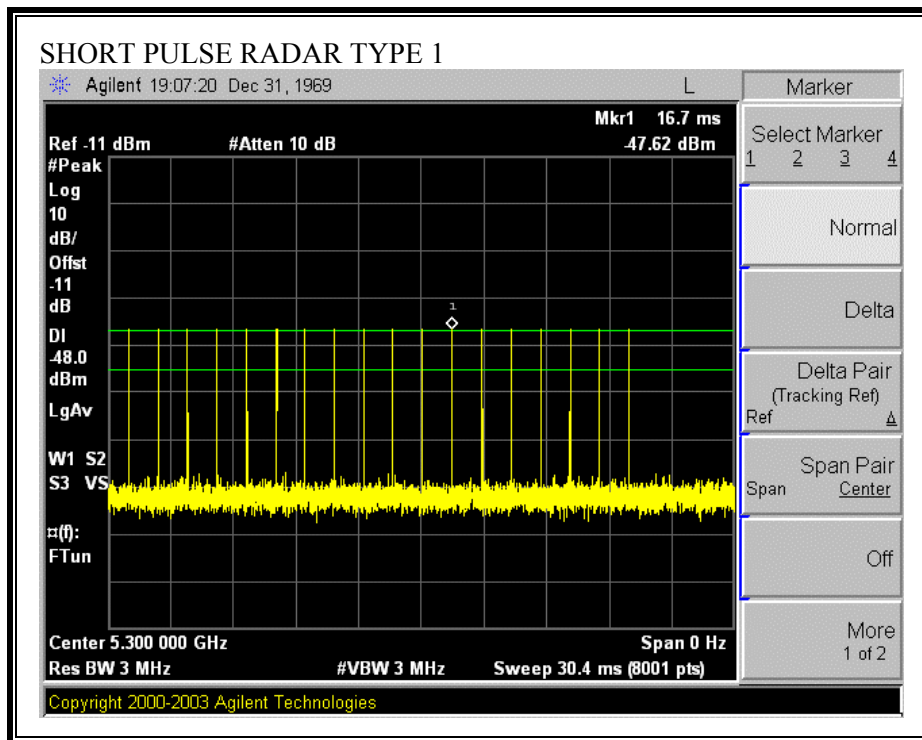

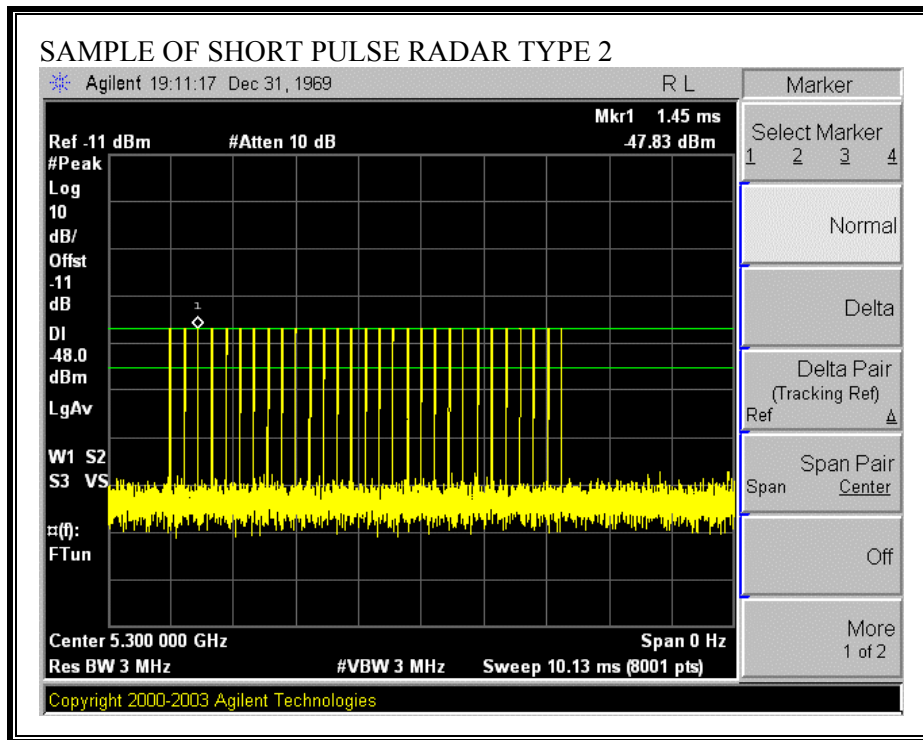

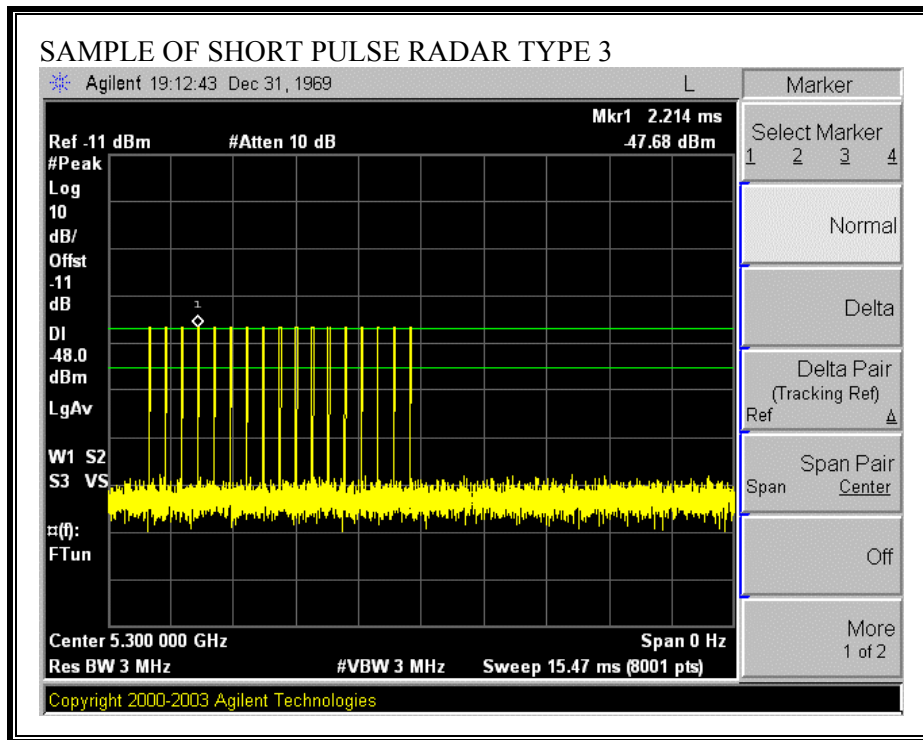

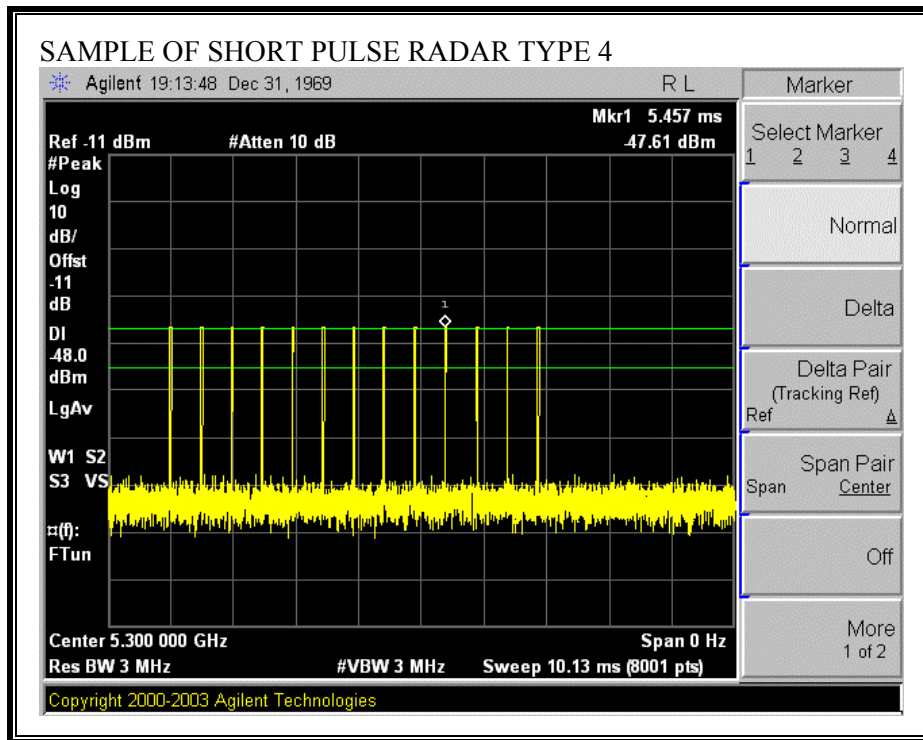

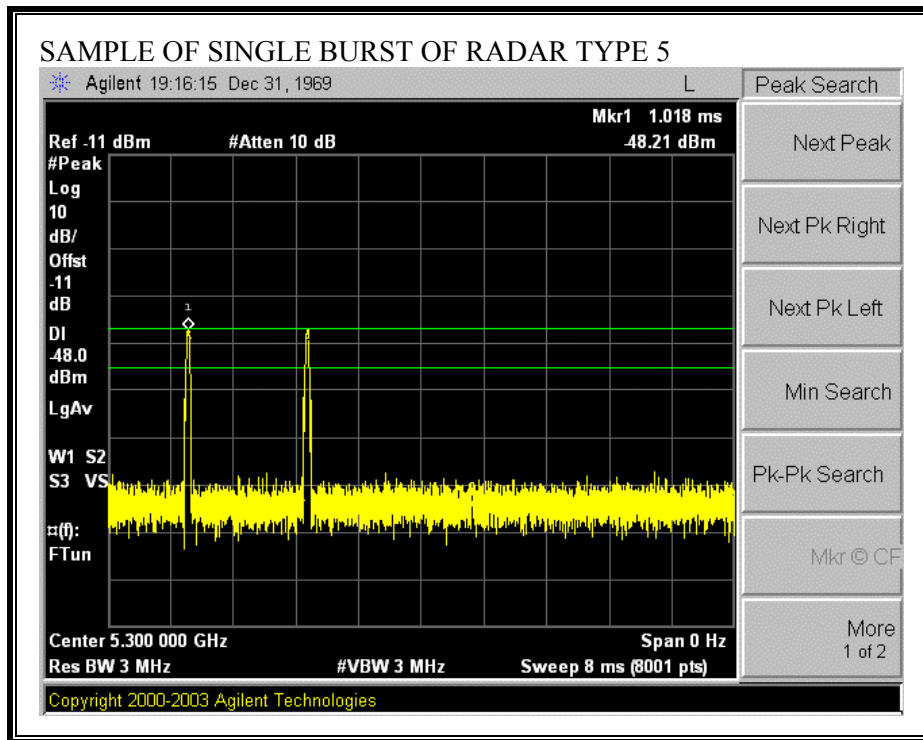

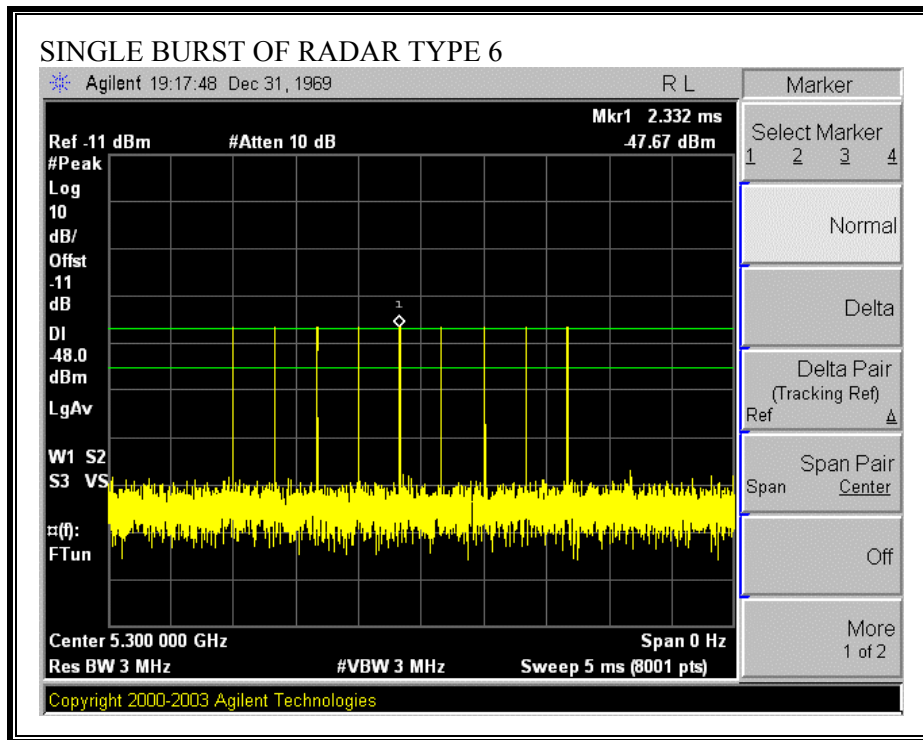

PLOT OF WLAN TRAFFIC FROM MASTER

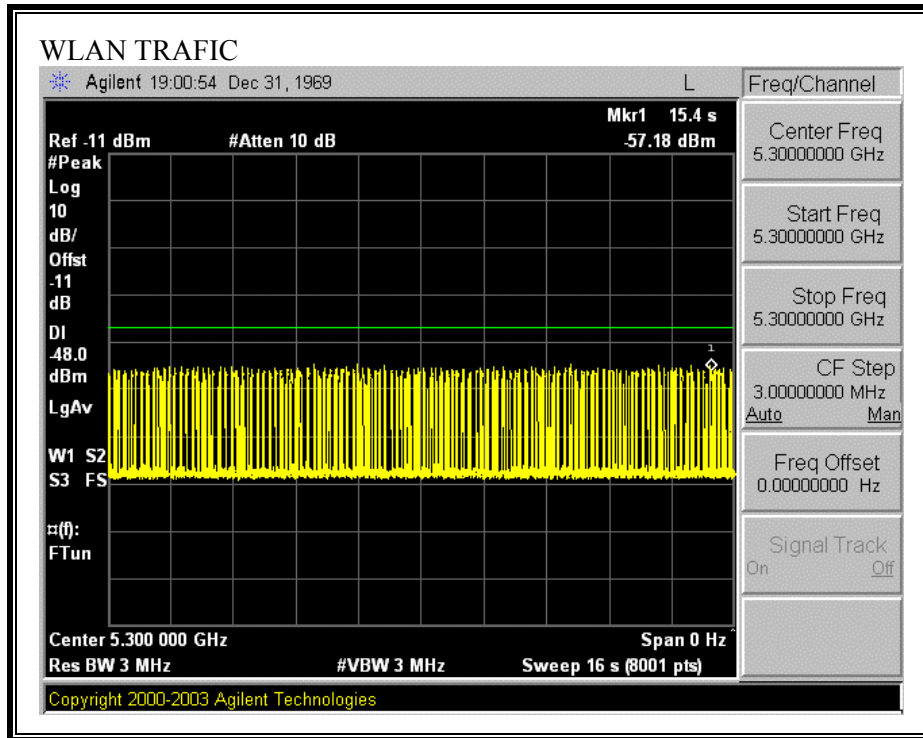

5.2.2. TEST CHANNEL AND METHOD

All tests were performed at a channel center frequency of 5300 MHz utilizing a conducted test method.

5.2.3. CHANNEL AVAILABILITY CHECK TIME

TEST PROCEDURE TO DETERMINE INITIAL POWER-UP CYCLE TIME

A link was established on channel, then the EUT was rebooted. The time from the cessation of traffic to the re-initialization of traffic was measured as the time required for the EUT to complete the total power-up cycle. The time to complete the initial power-up period is 60 seconds less than this total power-up time.

TEST PROCEDURE FOR TIMING OF RADAR BURST

With a link established on channel, the EUT was rebooted. A radar signal was triggered within 0 to 6 seconds after the initial power-up period, and transmissions on the channel were monitored on the spectrum analyzer.

The Non-Occupancy list was cleared. With a link established on channel, the EUT was rebooted. A radar signal was triggered within 54 to 60 seconds after the initial power-up period, and transmissions on the channel were monitored on the spectrum analyzer.

CHANNEL AVAILABILITY CHECK TIME RESULTS

No non-compliance noted:

Time required for EUT to complete the initial power-up cycle (sec)
23.58

If a radar signal is detected during the channel availability check then the PC controlling the EUT displays a message stating that radar was detected.

Timing of Radar Burst	Display on EUT / PC Control Computer	Spectrum Analyzer Display
No Radar Triggered	EUT Initiates Transmissions	Transmissions begin on channel after completion of the initial power-up cycle and the 60 second CAC
Within 0 to 6 second window	EUT indicates radar detected	No transmissions on channel
Within 54 to 60 second window	EUT indicates radar detected	No transmissions on channel

TIMING PLOT WITHOUT RADAR DURING CAC

AP is rebooted
Traffic ceases
Start of Initial Power-up cycle

End of Initial Power-up cycle
Start of CAC

End of CAC
Traffic is Initiated

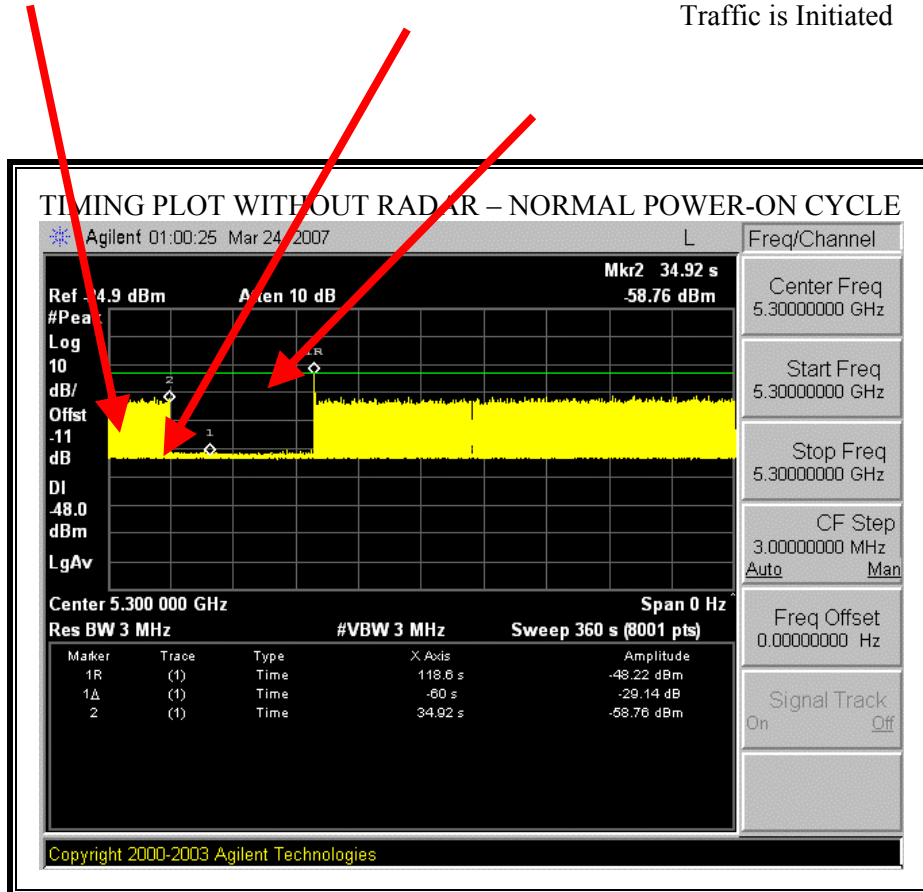

Note: The initial power-up cycle requires $(118.6 - 34.92 - 60) = 23.58$ seconds.

TIMING PLOT WITH RADAR NEAR BEGINNING OF CAC

AP is rebooted
Traffic ceases
Start of Initial Power-up cycle

End of Initial Power-up cycle
Start of CAC

Radar Signal Applied

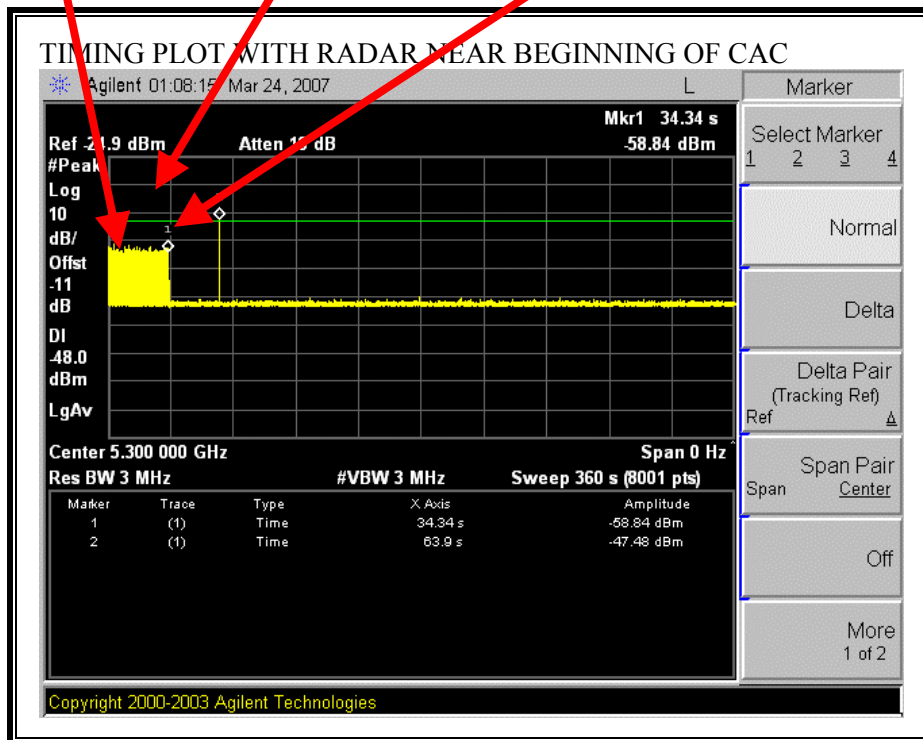

The radar signal is applied $(63.9 - 34.34) = 29.56$ seconds after reboot, which is $(29.56 - 23.58) = 5.98$ seconds after the completion of the initial power-up cycle / start of the CAC period.

No EUT transmissions were observed after the radar signal.

TIMING PLOT WITH RADAR NEAR END OF CAC

AP is rebooted
Traffic ceases
Start of Initial Power-up cycle

End of Initial Power-up cycle
Start of CAC

Radar Signal Applied

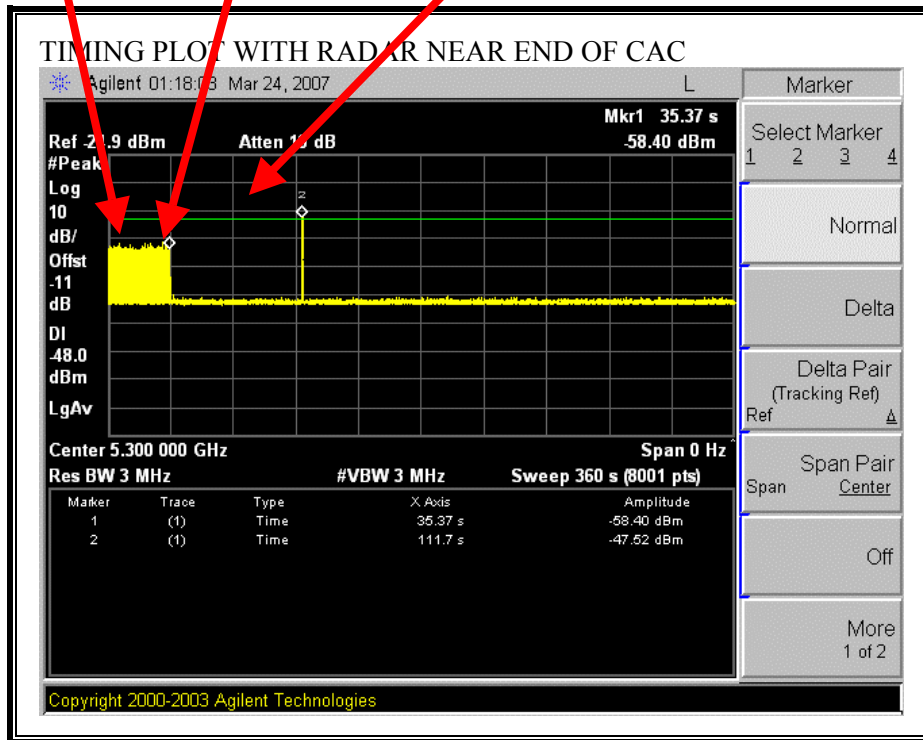

The radar signal is applied $(111.7 - 35.37) = 76.33$ seconds after reboot, which is $(76.33 - 23.58) = 52.75$ seconds after the completion of the initial power-up cycle / start of the CAC period.

No EUT transmissions were observed after the radar signal.

5.2.4. CHANNEL MOVE TIME AND CHANNEL CLOSING TRANSMISSION TIME

GENERAL REPORTING NOTES

The reference marker is set at the end of last radar pulse.

SHORT PULSE RADAR REPORTING NOTES

The delta marker is set at the end of the last WLAN transmission following the radar pulse. This delta is the channel move time.

The aggregate channel closing transmission time is calculated as follows:

Aggregate Transmission Time =
(Number of analyzer bins showing transmission) * (dwell time per bin)

The observation period over which the aggregate time is calculated for the FCC version
Begins at (Reference Marker + 200 msec)
and
Ends no earlier than (Reference Marker + 10 sec).

The observation period over which the aggregate time is calculated for the IC version
Begins at (Reference Marker)
and
Ends no earlier than (Reference Marker + 10 sec).

LONG PULSE RADAR REPORTING NOTES

The delta marker is set to 10 seconds after the end of the radar pulse.

CHANNEL MOVE TIME RESULTS

No non-compliance noted:

Channel Move Time (s)	Limit (s)
0.000	10

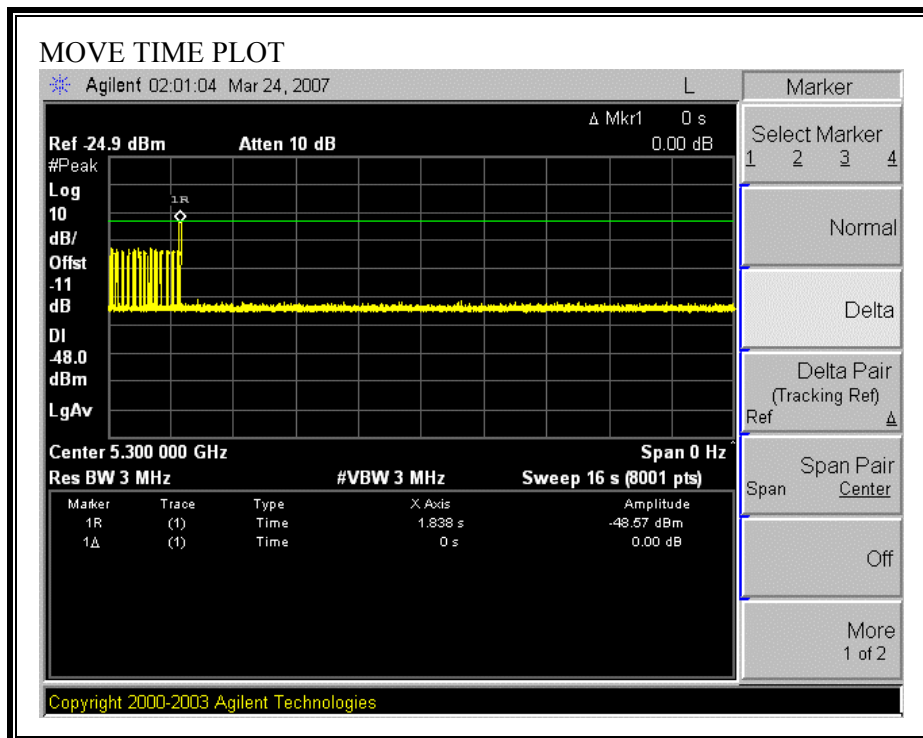

CHANNEL CLOSING TIME RESULTS

No non-compliance noted:

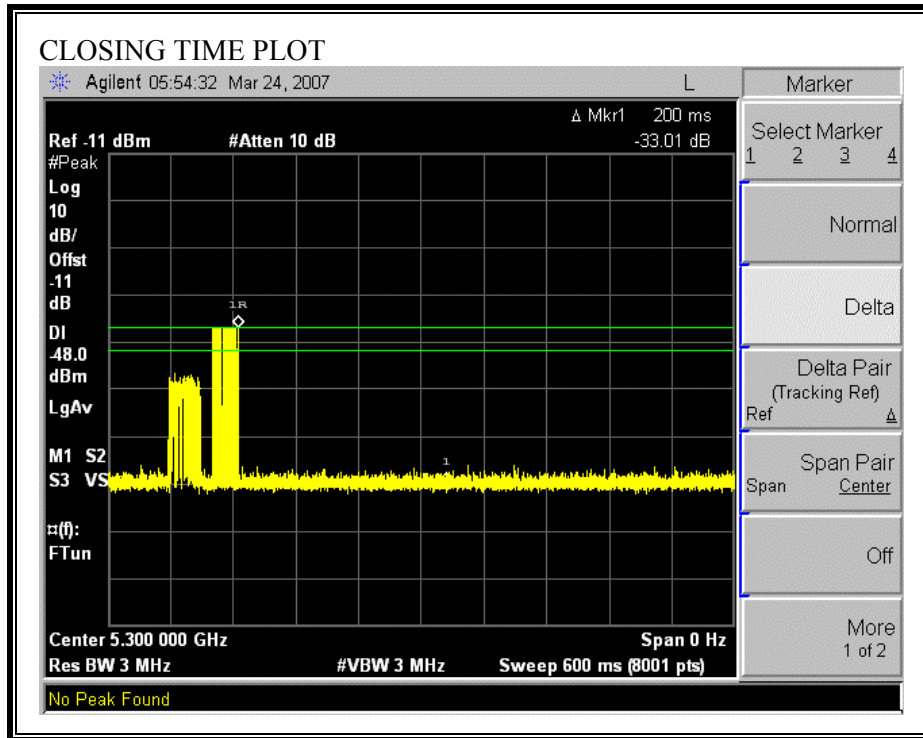

FCC AGGREGATE CHANNEL CLOSING TRANSMISSION TIME RESULTS

No non-compliance noted:

Aggregate Transmission Time (ms)	Limit (ms)	Margin (ms)
0.00	60	60.00

No transmissions are observed during the aggregate monitoring period.

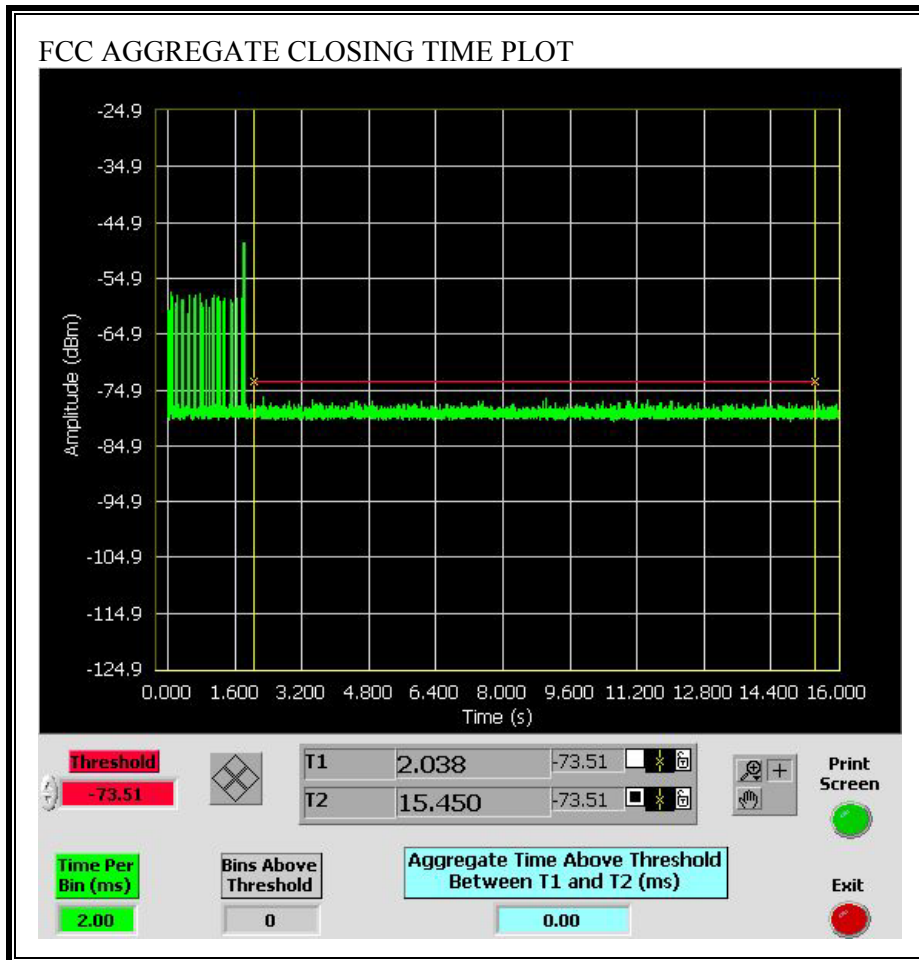

IC AGGREGATE CHANNEL CLOSING TRANSMISSION TIME RESULTS

No non-compliance noted:

Aggregate Transmission Time (ms)	Limit (ms)	Margin (ms)
0.00	260	260.00

No transmissions are observed during the aggregate monitoring period.

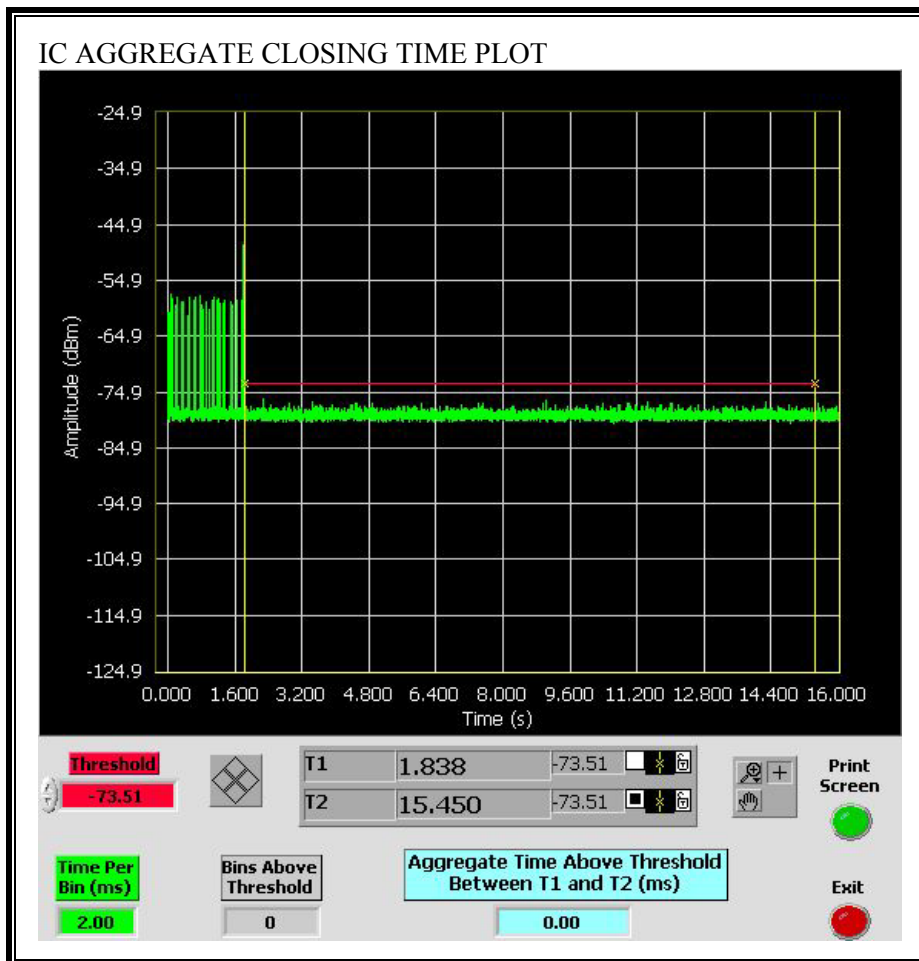

LONG PULSE CHANNEL MOVE TIME RESULTS

No non-compliance noted: The traffic ceases prior to the end of the radar waveform, therefore it also ceases prior to 10 seconds after the end of the radar waveform.

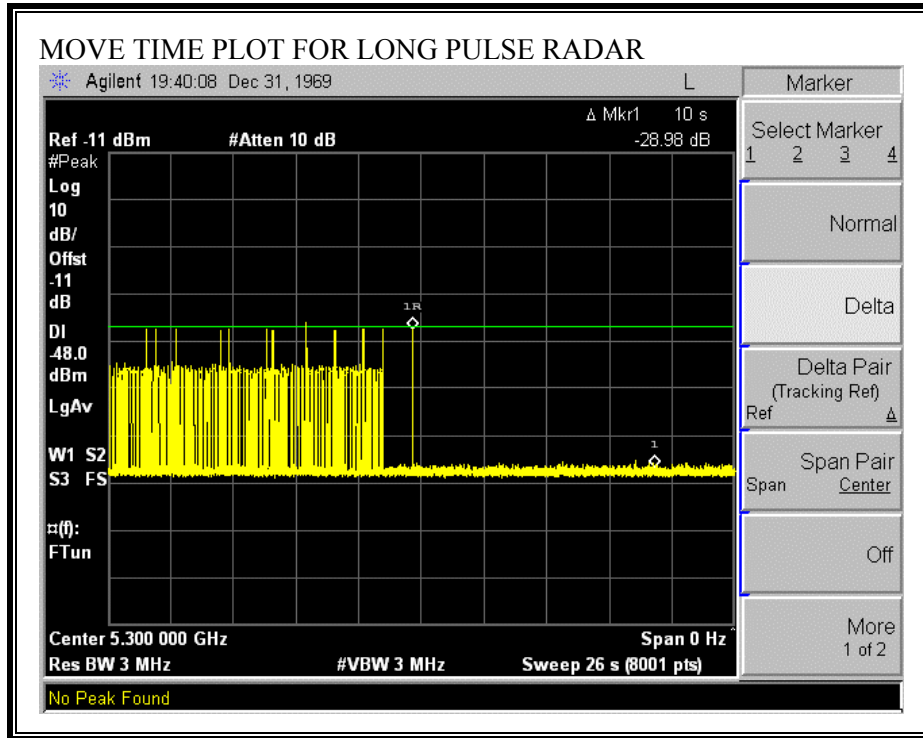

5.2.5. NON-OCCUPANCY PERIOD

RESULTS

No non-compliance noted: No EUT transmissions were observed on the test channel during the 30 minute observation time.

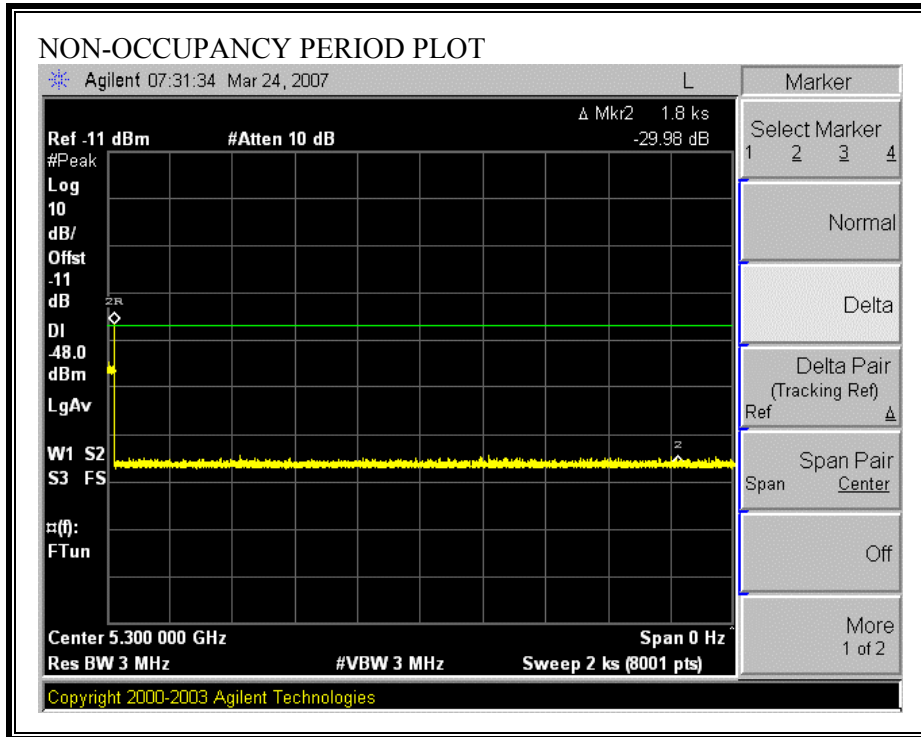

5.2.6. DETECTION BANDWIDTH

REFERENCE PLOT OF 99% BANDWIDTH

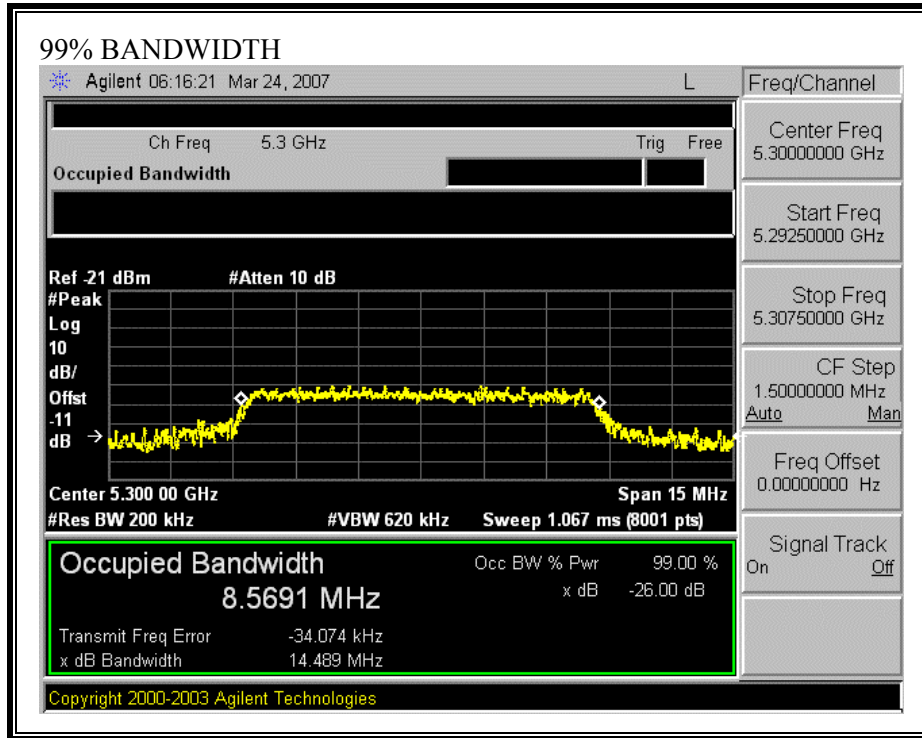

RESULTS

No non-compliance noted:

FL	FH	Detection Bandwidth	99% Power Bandwidth	Ratio of Detection BW to 99% Power BW	Minimum Limit
(MHz)	(MHz)	(MHz)	(MHz)	(%)	(%)
5296	5304	8	8.569	93.4	80

DETECTION BANDWIDTH PROBABILITY

DETECTION BANDWIDTH PROBABILITY RESULTS				
Detection Bandwidth Test Results:			Waveform: TYPE 1	
Frequency (MHz)	Number of Trials	Number Detected	Detection (%)	Mark
5295	10	0	0.00	
5296	10	10	100.00	FL
5297	10	10	100.00	
5298	10	10	100.00	
5299	10	10	100.00	
5300	10	10	100.00	
5301	10	10	100.00	
5302	10	10	100.00	
5303	10	10	100.00	
5304	10	10	100.00	FH
5305	10	0	0.00	

5.2.7. IN-SERVICE MONITORING

RESULTS

No non-compliance noted:

Radar Test Summary:				
Signal Type	Waveform/Trial No.	Detection (%)	Limit (%)	Pas/Fail
FCC TYPE 1	30	80.00	60.00	Pass
FCC TYPE 2	30	90.00	60.00	Pass
FCC TYPE 3	30	83.33	60.00	Pass
FCC TYPE 4	30	86.67	60.00	Pass
Aggregate		85.00	80.00	Pass
FCC TYPE 5	30	80.00	80.00	Pass
FCC TYPE 6	36	86.11	70.00	Pass

TYPE 1 DETECTION PROBABILITY

Data Sheet for Short Pulse Radar Type 1	
Trial No.	Successful Detection (Yes/No)
1	Yes
2	Yes
3	Yes
4	Yes
5	Yes
6	No
7	Yes
8	Yes
9	Yes
10	Yes
11	Yes
12	Yes
13	Yes
14	Yes
15	Yes
16	No
17	Yes
18	Yes
19	No
20	No
21	Yes
22	Yes
23	Yes
24	Yes
25	Yes
26	Yes
27	No
28	Yes
29	No
30	Yes

TYPE 2 DETECTION PROBABILITY

Data Sheet for Short Pulse Radar Type 2				
Waveform No.	# Pulses per burst	Pulse Width (us)	Pulse repetition Interval (us)	Successful Detection (Yes/No)
2001	29	1.60	226	Yes
2002	25	4.30	227	Yes
2003	28	1.30	184	Yes
2004	23	4.40	187	Yes
2005	26	1.90	198	Yes
2006	25	1.20	172	Yes
2007	29	2.40	158	Yes
2008	24	1.40	182	No
2009	26	4.10	151	Yes
2010	28	3.60	202	Yes
2011	25	4.10	173	Yes
2012	29	1.10	164	Yes
2013	27	1.60	208	Yes
2014	26	4.50	199	Yes
2015	28	4.00	167	Yes
2016	28	4.30	156	Yes
2017	26	1.40	166	Yes
2018	29	4.70	215	No
2019	24	3.90	170	Yes
2020	25	3.90	215	Yes
2021	28	1.20	151	Yes
2022	29	3.90	166	No
2023	27	1.00	203	Yes
2024	28	2.00	208	Yes
2025	23	2.90	217	Yes
2026	26	3.00	198	Yes
2027	24	2.10	203	Yes
2028	25	3.50	165	Yes
2029	28	2.20	165	Yes
2030	24	2.40	224	Yes

TYPE 3 DETECTION PROBABILITY

Data Sheet for Short Pulse Radar Type 3				
Waveform No.	# Pulses per burst	Pulse Width (us)	Pulse repetition Interval (us)	Successful Detection (Yes/No)
3001	17	9.30	404	No
3002	18	9.30	396	Yes
3003	16	5.10	434	No
3004	17	7.70	262	Yes
3005	16	6.60	442	Yes
3006	16	7.00	480	Yes
3007	18	7.10	403	Yes
3008	18	8.50	468	Yes
3009	18	7.50	441	No
3010	18	9.30	350	Yes
3011	16	8.30	400	Yes
3012	18	7.40	273	Yes
3013	16	9.70	438	Yes
3014	18	7.40	464	Yes
3015	18	6.10	256	Yes
3016	16	6.00	387	Yes
3017	17	7.10	490	No
3018	16	7.20	293	Yes
3019	18	8.20	467	Yes
3020	18	8.20	413	Yes
3021	17	8.60	407	Yes
3022	17	7.00	435	No
3023	17	5.90	455	Yes
3024	16	6.40	381	Yes
3025	17	9.60	266	Yes
3026	16	5.20	401	Yes
3027	18	7.70	446	Yes
3028	16	9.30	470	Yes
3029	17	7.20	354	Yes
3030	18	5.30	359	Yes

TYPE 4 DETECTION PROBABILITY

Data Sheet for Short Pulse Radar Type 4				
Waveform No.	# Pulses per burst	Pulse Width (us)	Pulse repetition Interval (us)	Successful Detection (Yes/No)
4001	13	13.70	495	Yes
4002	14	17.20	289	Yes
4003	13	10.20	497	Yes
4004	12	12.40	365	No
4005	12	13.70	425	Yes
4006	16	18.70	495	No
4007	15	14.20	448	Yes
4008	16	17.20	441	Yes
4009	14	11.40	487	Yes
4010	16	13.90	500	Yes
4011	16	16.60	472	Yes
4012	15	18.40	421	No
4013	14	19.30	300	No
4014	14	11.10	399	Yes
4015	16	10.90	309	Yes
4016	16	18.90	274	Yes
4017	14	10.30	354	Yes
4018	14	17.00	365	Yes
4019	12	18.90	393	Yes
4020	13	16.90	342	Yes
4021	16	12.50	340	Yes
4022	14	19.30	268	Yes
4023	14	19.20	482	Yes
4024	14	15.60	262	Yes
4025	12	18.50	350	Yes
4026	13	19.20	450	Yes
4027	16	18.20	371	Yes
4028	13	10.90	355	Yes
4029	16	17.70	256	Yes
4030	14	18.00	322	Yes

TYPE 5 DETECTION PROBABILITY

Data Sheet for Long Pulse Radar Type 5	
Waveform No.	Successful Detection (Yes/No)
5001	Yes
5002	Yes
5003	Yes
5004	Yes
5005	Yes
5006	No
5007	No
5008	No
5009	Yes
5010	Yes
5011	Yes
5012	Yes
5013	Yes
5014	Yes
5015	No
5016	Yes
5017	Yes
5018	Yes
5019	Yes
5020	Yes
5021	Yes
5022	No
5023	Yes
5024	Yes
5025	Yes
5026	Yes
5027	Yes
5028	Yes
5029	No
5030	Yes

Type 5 randomized parameters are in a separate document.

TYPE 6 DETECTION PROBABILITY

Data Sheet for Hopping Signal				
Trial No.	Starting Index within NTIA August 2005 Sequence	Signal Generator Frequency (MHz)	Hops within Detection BW	Successful Detection (Yes/No)
1	161	5296	1	Yes
2	636	5297	1	No
3	1111	5298	3	Yes
4	1586	5299	5	Yes
5	2061	5300	3	Yes
6	3011	5301	2	Yes
7	3486	5302	1	Yes
8	3961	5303	1	No
9	4436	5304	1	Yes
10	4911	5296	2	Yes
11	5386	5297	1	Yes
12	5861	5298	1	Yes
13	6336	5299	1	Yes
14	6811	5300	1	No
15	7286	5301	1	Yes
16	7761	5302	1	Yes
17	8236	5303	5	Yes
18	8711	5304	3	Yes
19	9186	5296	2	No
20	9661	5297	1	Yes
21	10136	5298	1	Yes
22	10611	5299	2	Yes
23	11086	5300	3	Yes
24	11561	5301	2	Yes
25	12036	5302	2	Yes
26	12511	5303	1	No
27	12986	5304	3	Yes
28	13461	5296	3	Yes
29	13936	5297	4	Yes
30	14411	5298	3	Yes
31	14886	5299	2	Yes
32	15361	5300	2	Yes
33	15836	5301	4	Yes
34	16311	5302	3	Yes
35	17261	5303	3	Yes
36	17736	5304	3	Yes

5.3. SLAVE CONFIGURATION IN 10 MHz BANDWIDTH

5.3.1. PLOTS OF RADAR WAVEFORM AND WLAN TRAFFIC

PLOT OF RADAR WAVEFORM

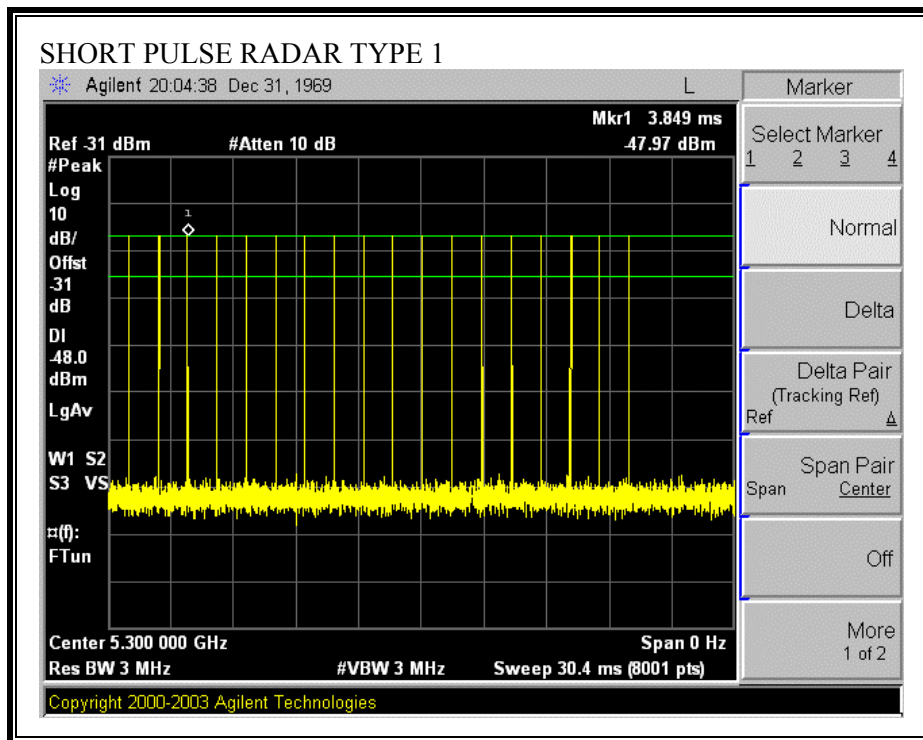

PLOT OF WLAN TRAFFIC FROM SLAVE

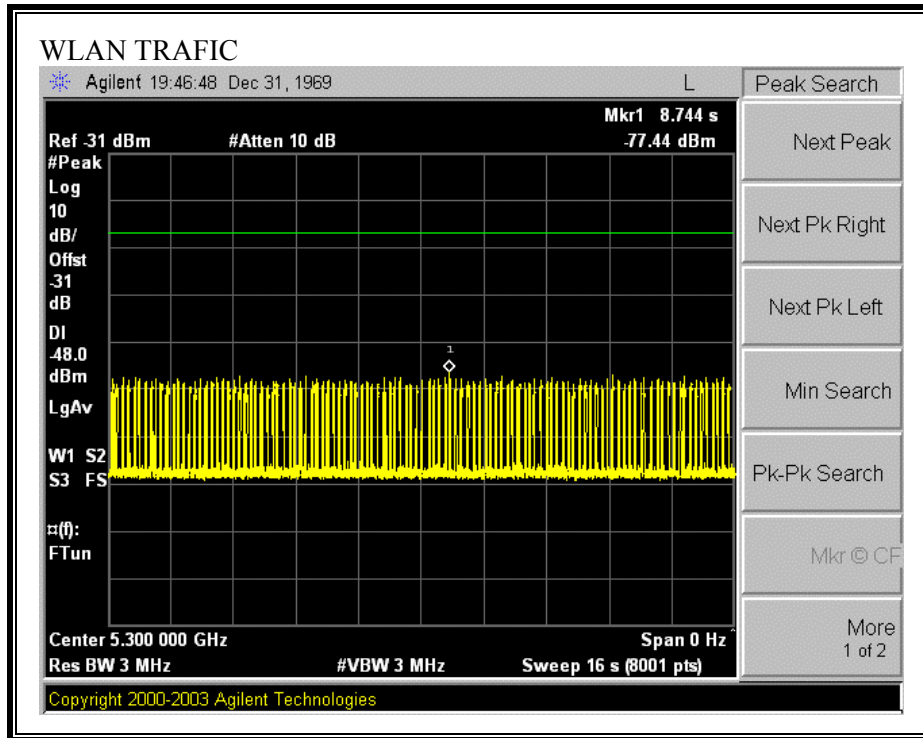

5.3.2. TEST CHANNEL AND METHOD

All tests were performed at a channel center frequency of 5300 MHz utilizing a conducted test method.

5.3.3. CHANNEL MOVE TIME AND CHANNEL CLOSING TRANSMISSION TIME

REPORTING NOTES

The reference marker is set at the end of last radar pulse.

The delta marker is set at the end of the last WLAN transmission following the radar pulse. This delta is the channel move time.

The aggregate channel closing transmission time is calculated as follows:

Aggregate Transmission Time =
(Number of analyzer bins showing transmission) * (dwell time per bin)

The observation period over which the aggregate time is calculated for the FCC version
Begins at (Reference Marker + 200 msec)
and
Ends no earlier than (Reference Marker + 10 sec).

The observation period over which the aggregate time is calculated for the IC version
Begins at (Reference Marker)
and
Ends no earlier than (Reference Marker + 10 sec).

CHANNEL MOVE TIME RESULTS

No non-compliance noted:

Channel Move Time (s)	Limit (s)
0.000	10

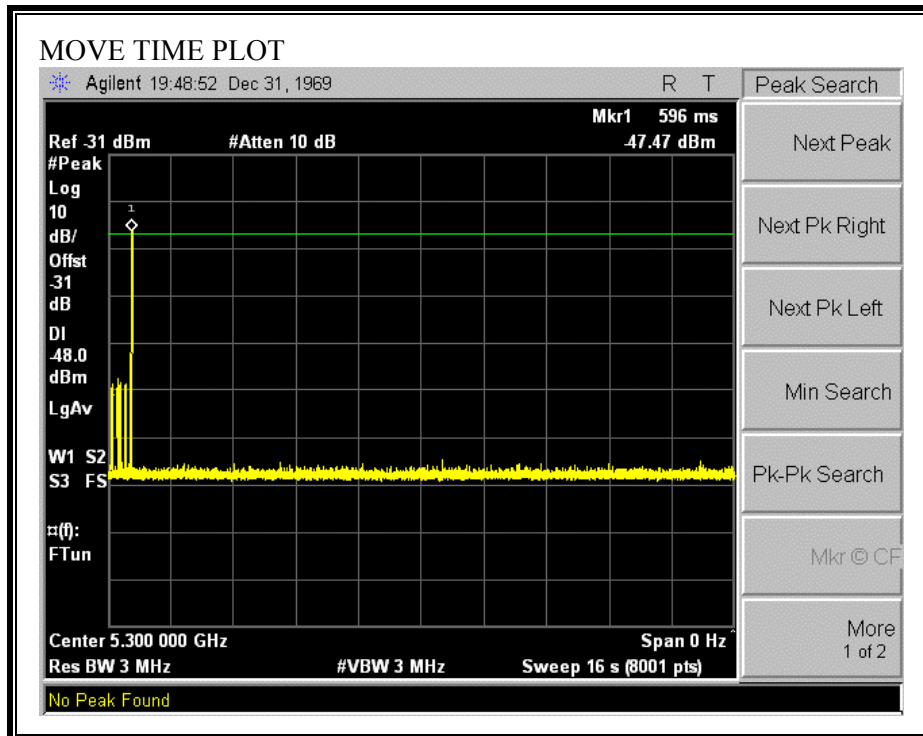

CHANNEL CLOSING TIME RESULTS

No non-compliance noted:

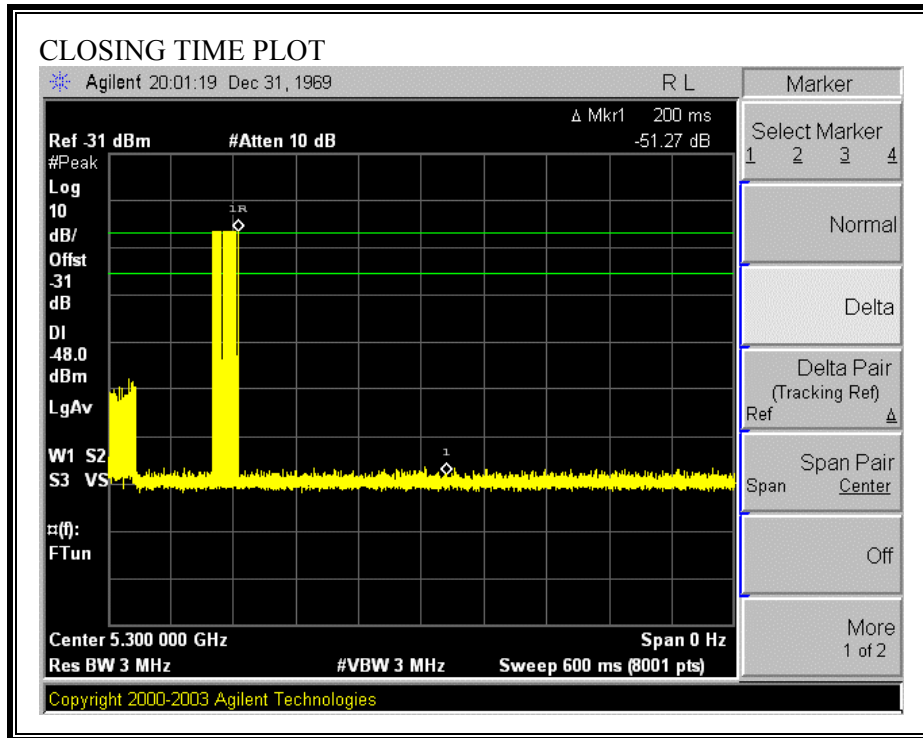

FCC AGGREGATE CHANNEL CLOSING TRANSMISSION TIME RESULTS

No non-compliance noted:

Aggregate Transmission Time (ms)	Limit (ms)	Margin (ms)
0.00	60	60.00

No transmissions are observed during the aggregate monitoring period.

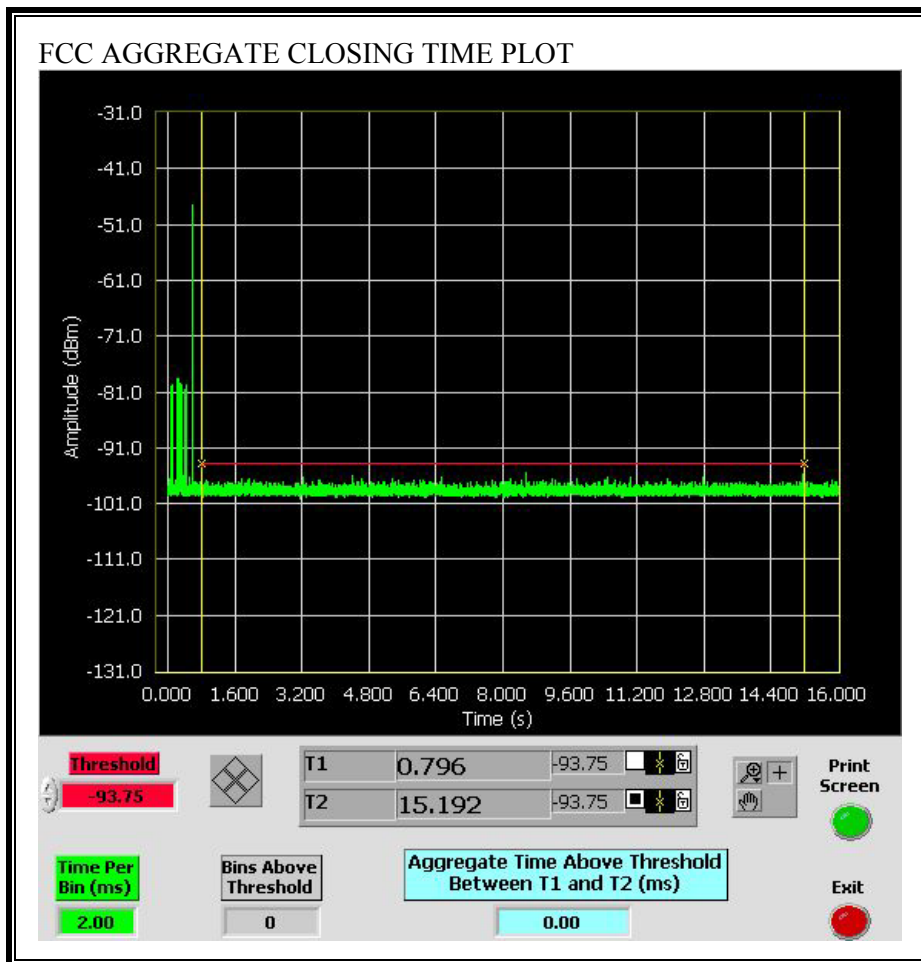

IC AGGREGATE CHANNEL CLOSING TRANSMISSION TIME RESULTS

No non-compliance noted:

Aggregate Transmission Time (ms)	Limit (ms)	Margin (ms)
0.00	260	260.00

No transmissions are observed during the aggregate monitoring period.

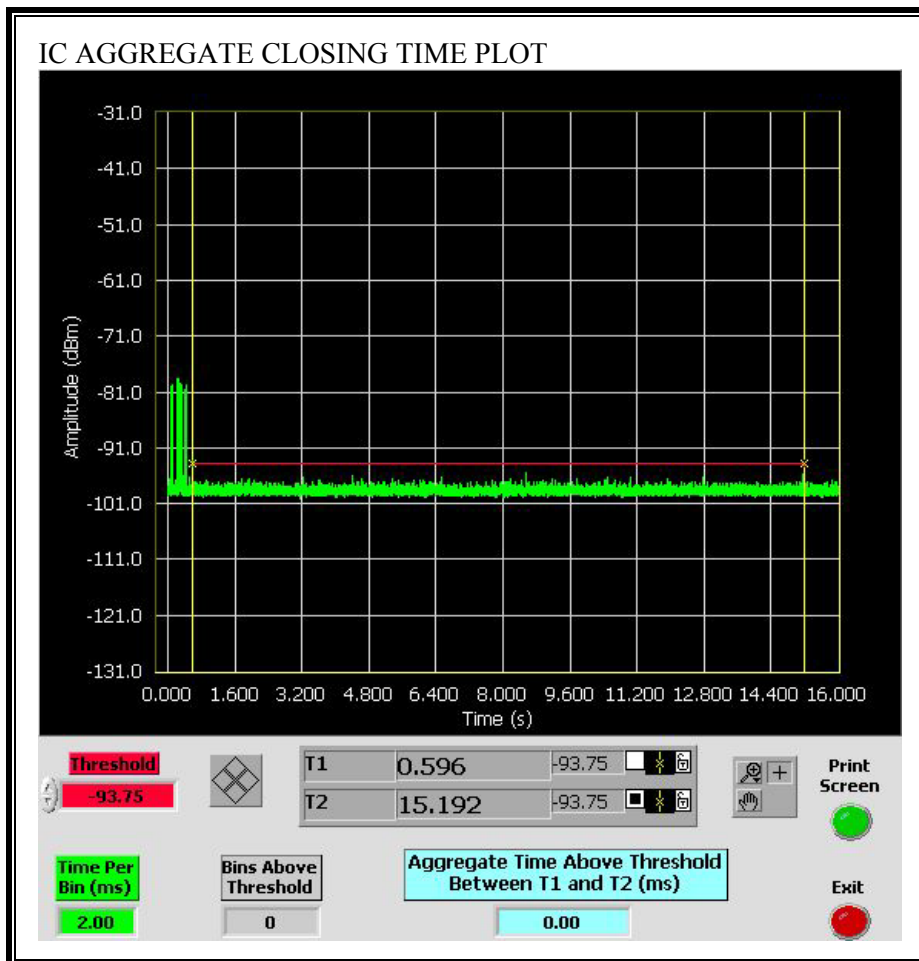

5.4. MASTER CONFIGURATION IN 20 MHz BANDWIDTH

5.4.1. PLOTS OF RADAR WAVEFORM, AND WLAN TRAFFIC

PLOTS OF RADAR WAVEFORMS

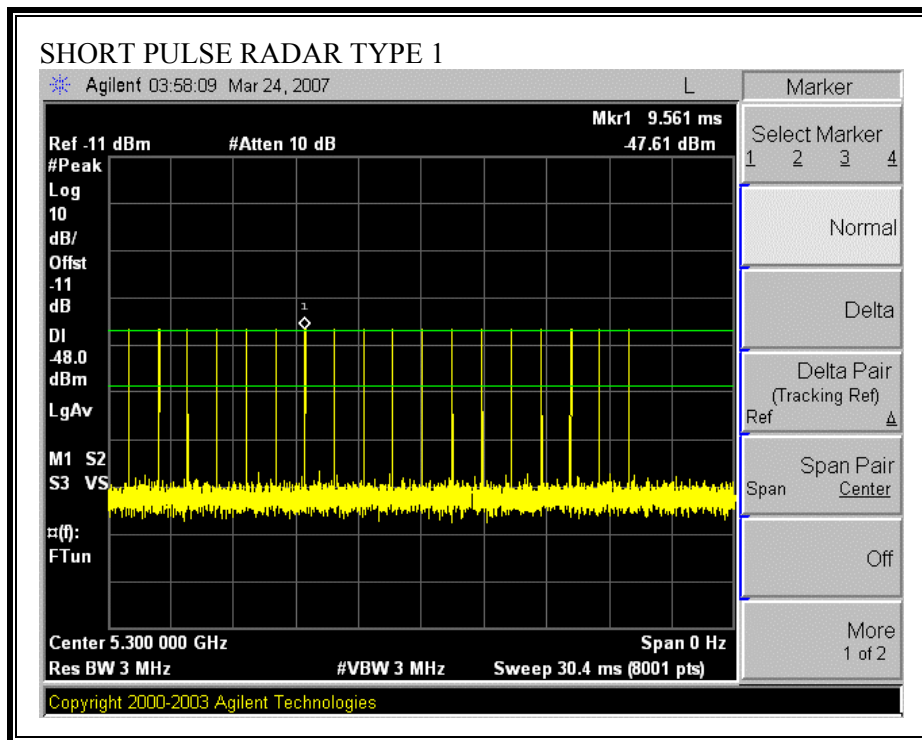

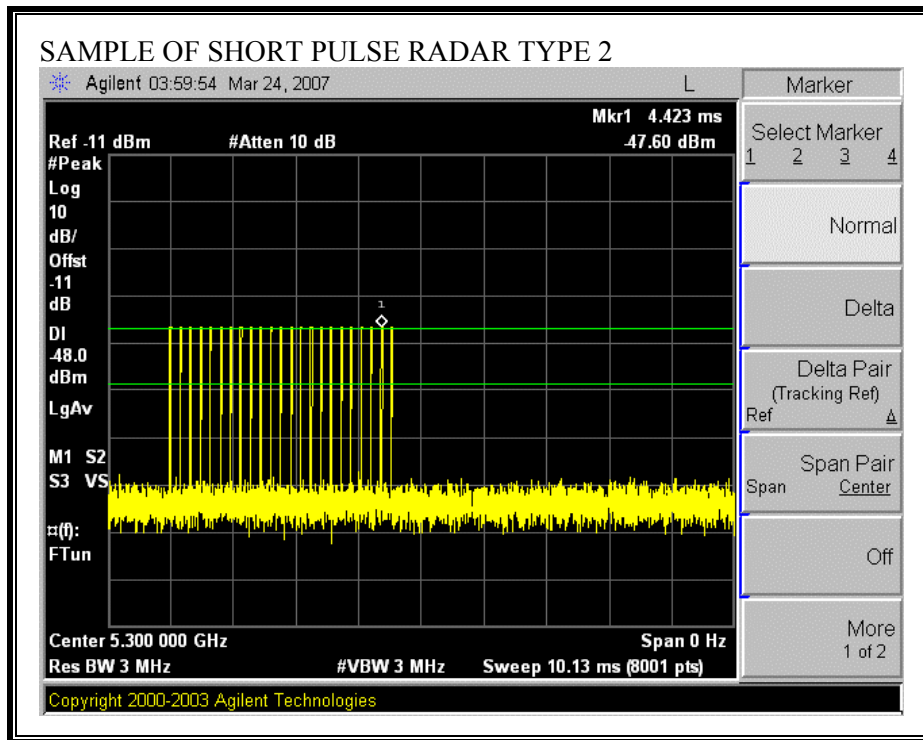

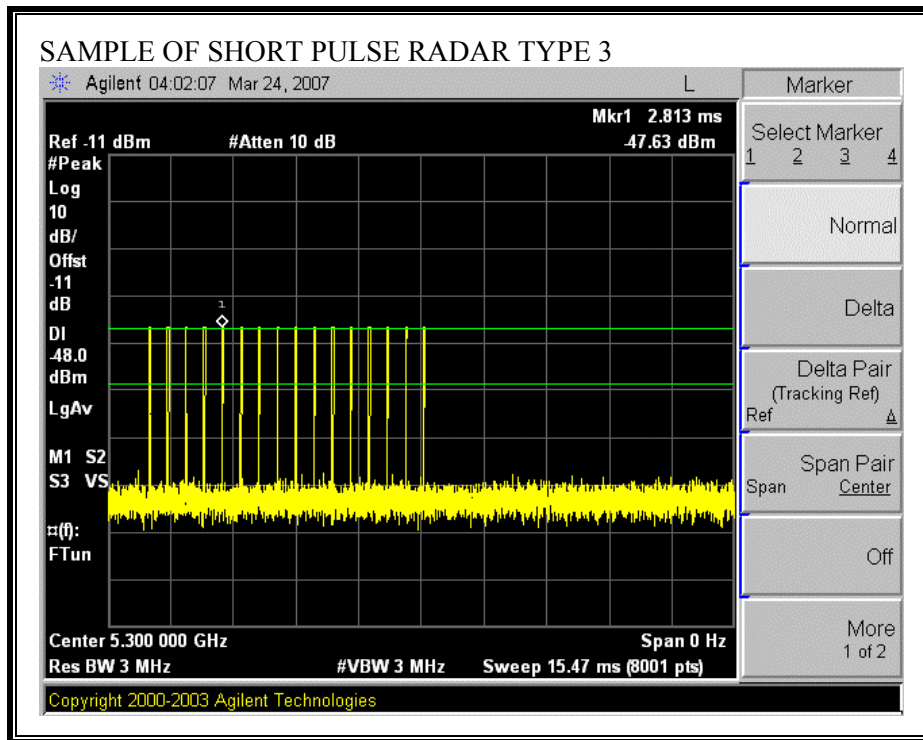

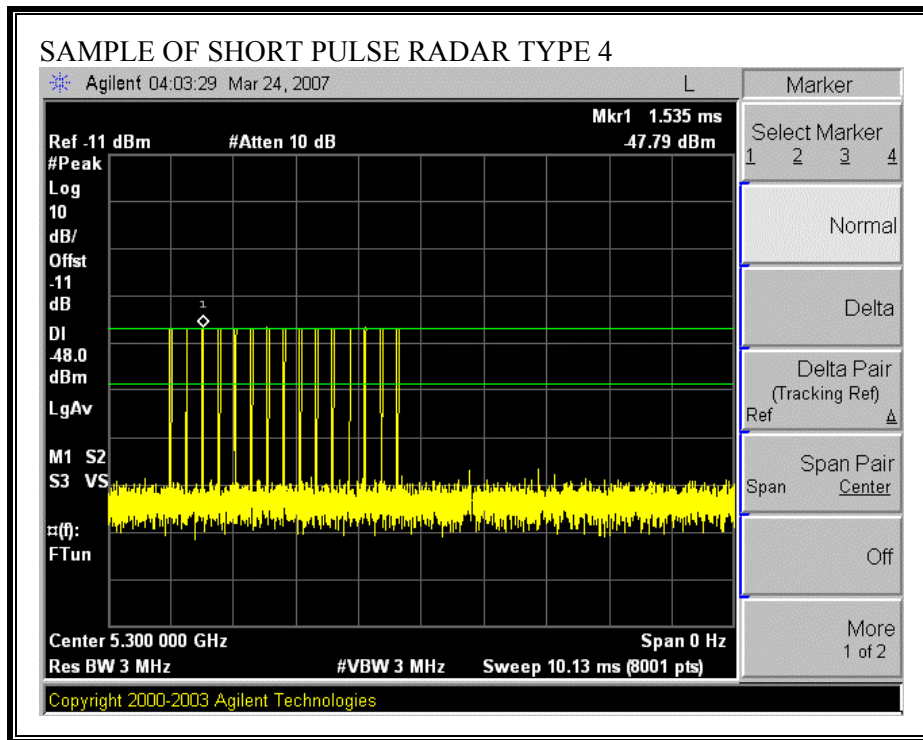

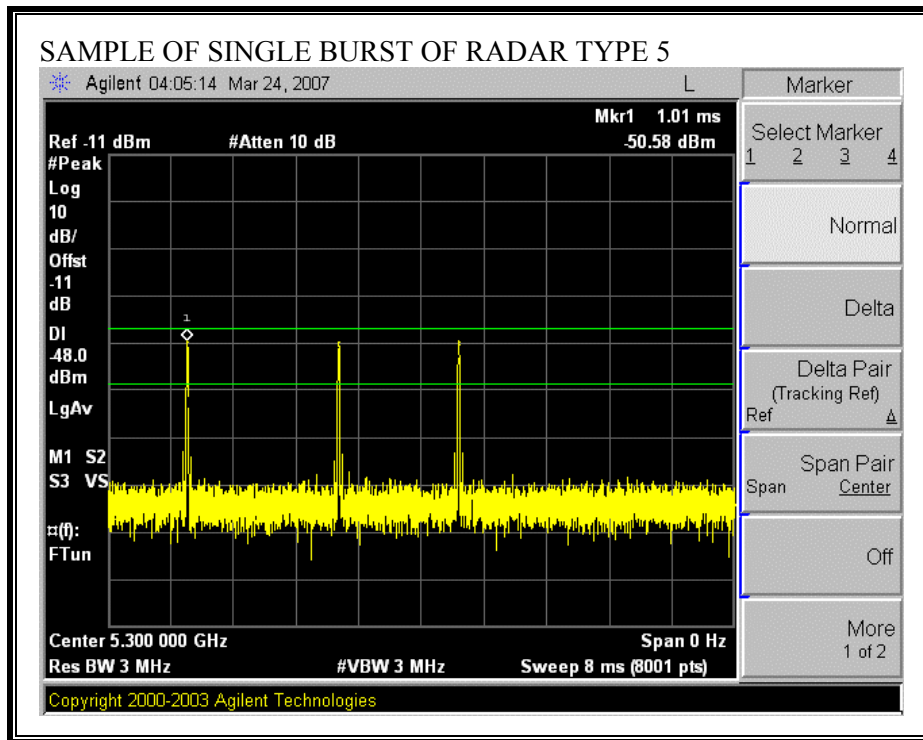

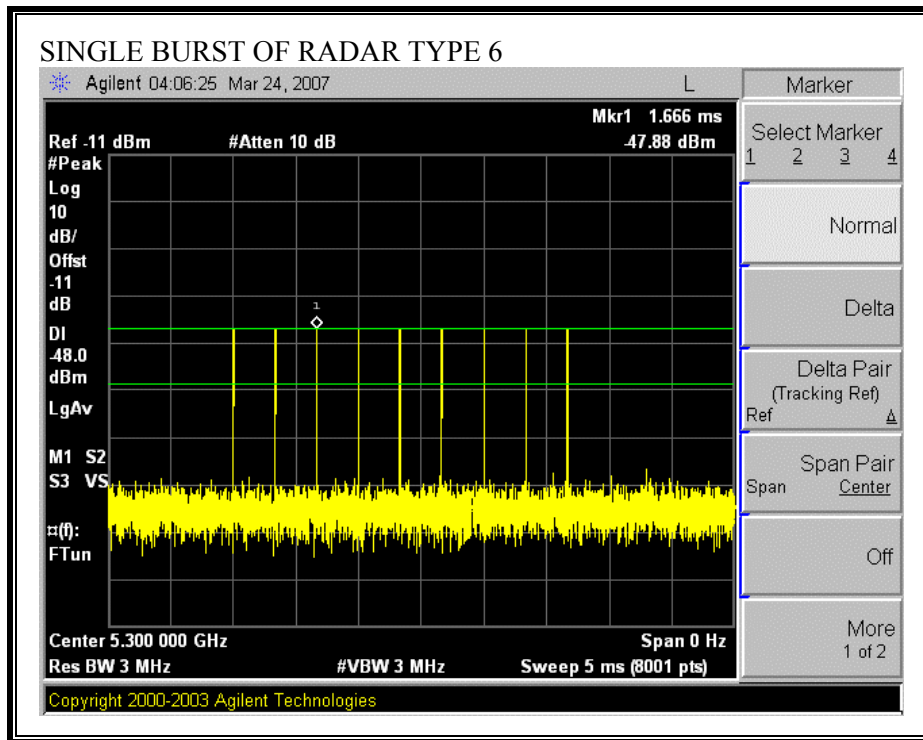

PLOT OF WLAN TRAFFIC FROM MASTER

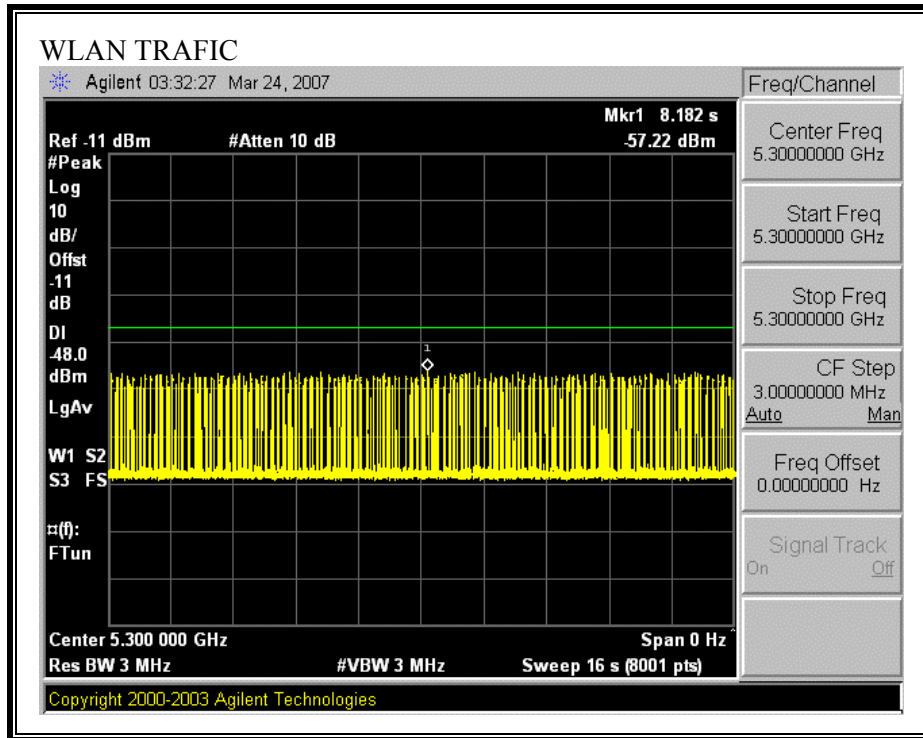

5.4.2. TEST CHANNEL AND METHOD

All tests were performed at a channel center frequency of 5300 MHz utilizing a conducted test method.

5.4.3. CHANNEL AVAILABILITY CHECK TIME

TEST PROCEDURE TO DETERMINE INITIAL POWER-UP CYCLE TIME

A link was established on channel, then the EUT was rebooted. The time from the cessation of traffic to the re-initialization of traffic was measured as the time required for the EUT to complete the total power-up cycle. The time to complete the initial power-up period is 60 seconds less than this total power-up time.

TEST PROCEDURE FOR TIMING OF RADAR BURST

With a link established on channel, the EUT was rebooted. A radar signal was triggered within 0 to 6 seconds after the initial power-up period, and transmissions on the channel were monitored on the spectrum analyzer.

The Non-Occupancy list was cleared. With a link established on channel, the EUT was rebooted. A radar signal was triggered within 54 to 60 seconds after the initial power-up period, and transmissions on the channel were monitored on the spectrum analyzer.

CHANNEL AVAILABILITY CHECK TIME RESULTS

No non-compliance noted:

Time required for EUT to complete the initial power-up cycle (sec)
23.36

If a radar signal is detected during the channel availability check then the PC controlling the EUT displays a message stating that radar was detected.

Timing of Radar Burst	Display on EUT / PC Control Computer	Spectrum Analyzer Display
No Radar Triggered	EUT Initiates Transmissions	Transmissions begin on channel after completion of the initial power-up cycle and the 60 second CAC
Within 0 to 6 second window	EUT does not display any radar parameter values	No transmissions on channel
Within 54 to 60 second window	EUT does not display any radar parameter values	No transmissions on channel

TIMING PLOT WITHOUT RADAR DURING CAC

AP is rebooted
 Traffic ceases
 Start of Initial Power-up cycle

End of Initial Power-up cycle
 Start of CAC

End of CAC
 Traffic is Initiated

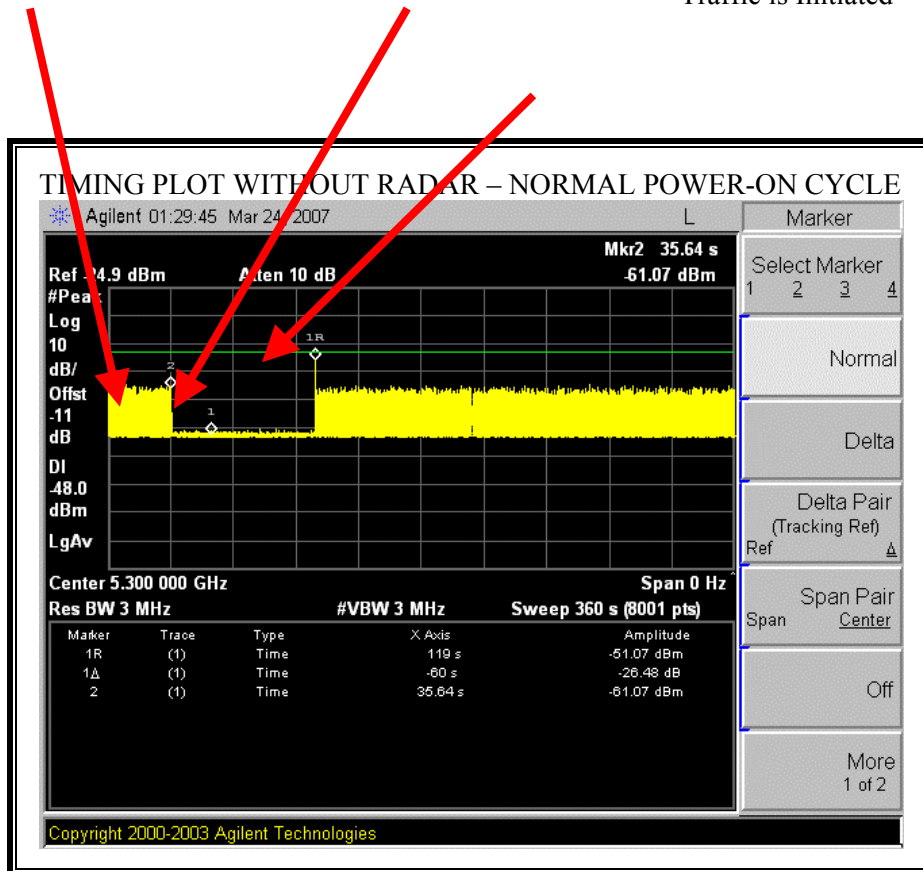

Note: The initial power-up cycle requires $(119 - 35.64 - 60) = 23.36$ seconds.

TIMING PLOT WITH RADAR NEAR BEGINNING OF CAC

AP is rebooted
Traffic ceases
Start of Initial Power-up cycle

End of Initial Power-up cycle
Start of CAC

Radar Signal Applied

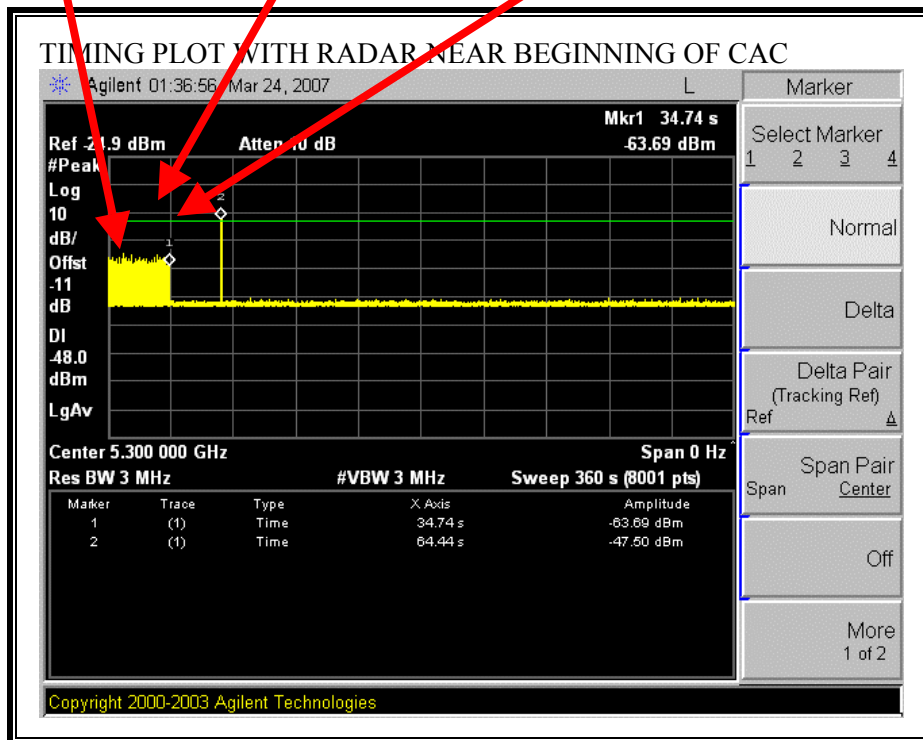

The radar signal is applied $(64.44 - 34.74) = 29.7$ seconds after reboot, which is $(29.7 - 23.36) = 3.9$ seconds after the completion of the initial power-up cycle / start of the CAC period.

No EUT transmissions were observed after the radar signal.

TIMING PLOT WITH RADAR NEAR END OF CAC

AP is rebooted
Traffic ceases
Start of Initial Power-up cycle

End of Initial Power-up cycle
Start of CAC

Radar Signal Applied

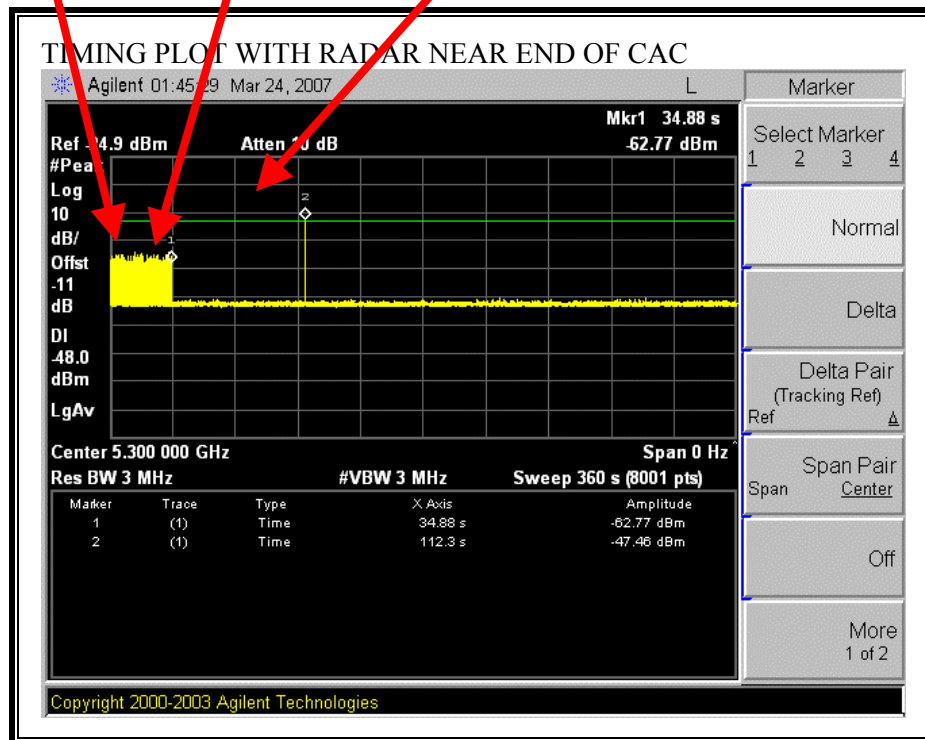

The radar signal is applied $(112.3 - 34.88) = 77.5$ seconds after reboot, which is $(77.5 - 23.36) = 54.14$ seconds after the completion of the initial power-up cycle / start of the CAC period.

No EUT transmissions were observed after the radar signal.

5.4.4. CHANNEL MOVE TIME AND CHANNEL CLOSING TRANSMISSION TIME

GENERAL REPORTING NOTES

The reference marker is set at the end of last radar pulse.

SHORT PULSE RADAR REPORTING NOTES

The delta marker is set at the end of the last WLAN transmission following the radar pulse. This delta is the channel move time.

The aggregate channel closing transmission time is calculated as follows:

Aggregate Transmission Time =
(Number of analyzer bins showing transmission) * (dwell time per bin)

The observation period over which the aggregate time is calculated for the FCC version
Begins at (Reference Marker + 200 msec)
and
Ends no earlier than (Reference Marker + 10 sec).

The observation period over which the aggregate time is calculated for the IC version
Begins at (Reference Marker)
and
Ends no earlier than (Reference Marker + 10 sec).

LONG PULSE RADAR REPORTING NOTES

The delta marker is set to 10 seconds after the end of the radar pulse.

CHANNEL MOVE TIME RESULTS

No non-compliance noted:

Channel Move Time (s)	Limit (s)
0.000	10

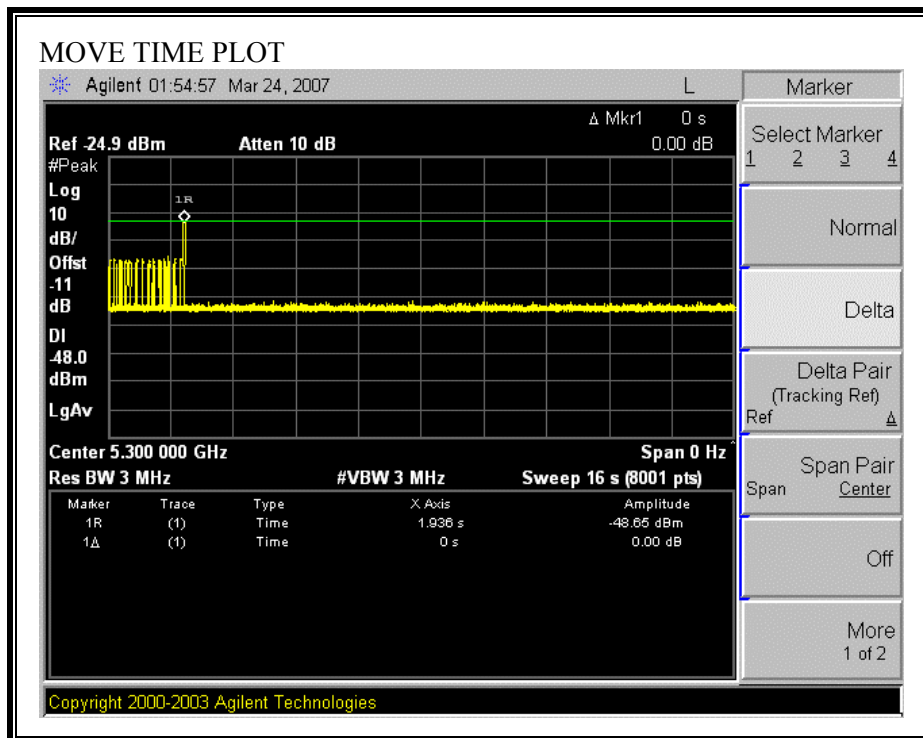

CHANNEL CLOSING TIME RESULTS

No non-compliance noted:

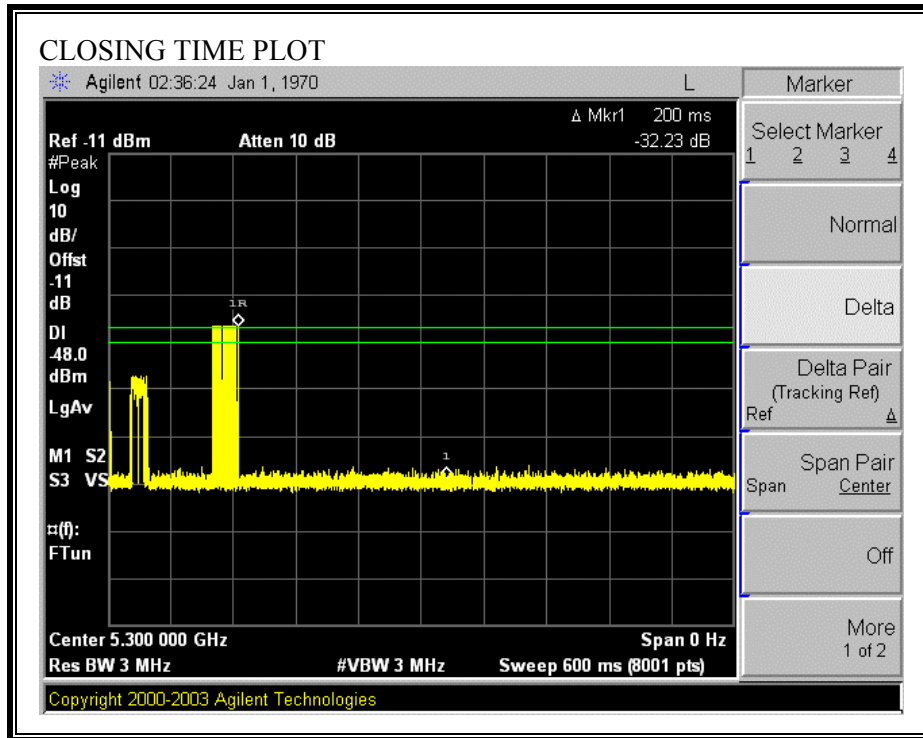

FCC AGGREGATE CHANNEL CLOSING TRANSMISSION TIME RESULTS

No non-compliance noted:

Aggregate Transmission Time (ms)	Limit (ms)	Margin (ms)
0.00	60	60.00

No transmissions are observed during the aggregate monitoring period.

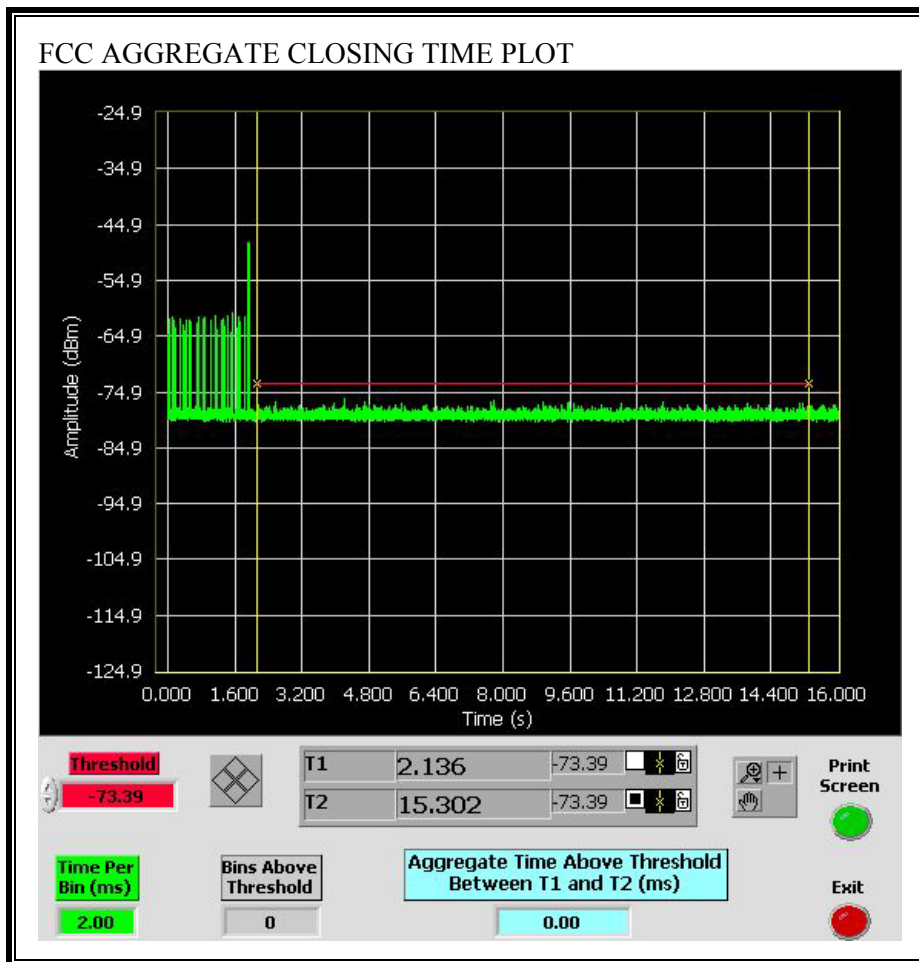

IC AGGREGATE CHANNEL CLOSING TRANSMISSION TIME RESULTS

No non-compliance noted:

Aggregate Transmission Time (ms)	Limit (ms)	Margin (ms)
0.00	260	260.00

No transmissions are observed during the aggregate monitoring period.

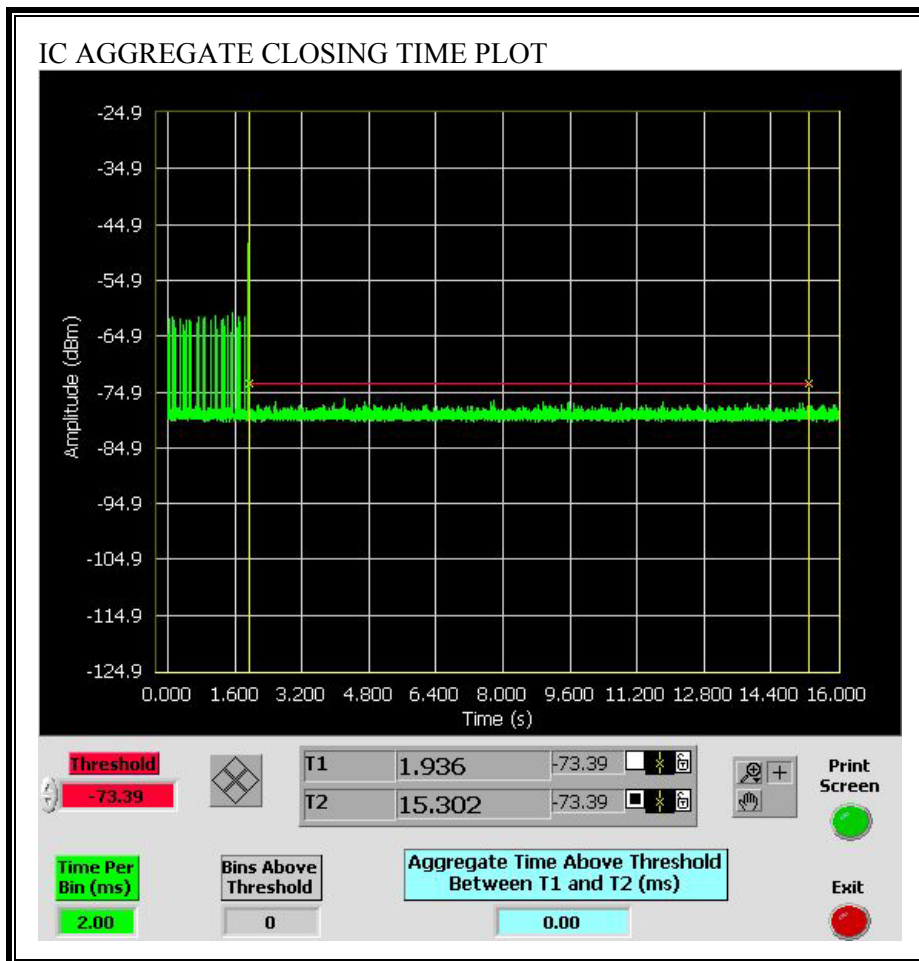

LONG PULSE CHANNEL MOVE TIME RESULTS

No non-compliance noted: The traffic ceases prior to the end of the radar waveform, therefore it also ceases prior to 10 seconds after the end of the radar waveform.

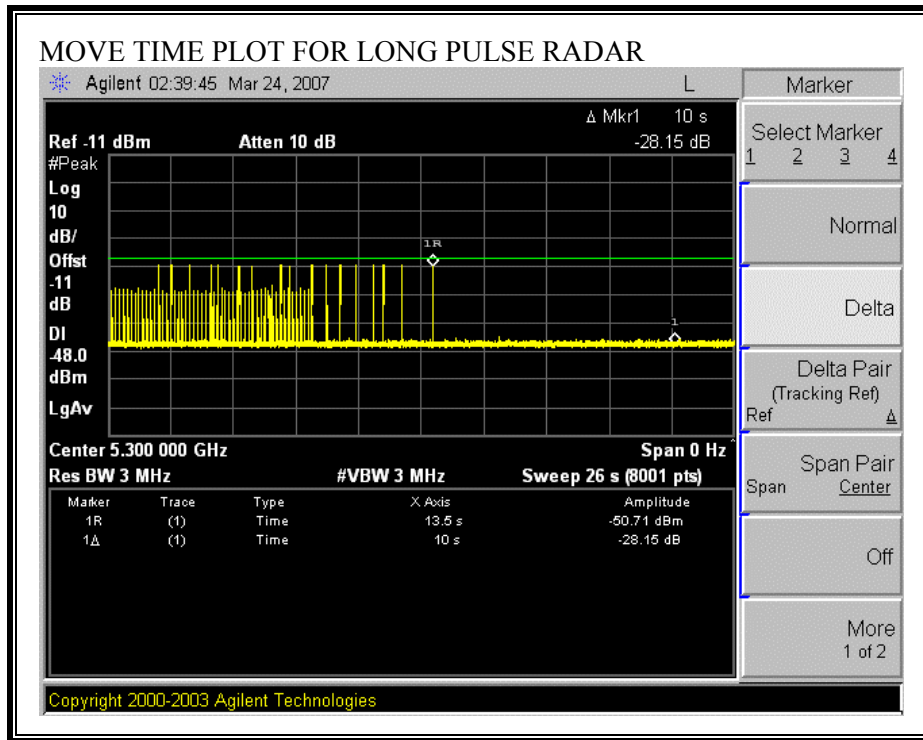

5.4.5. NON-OCCUPANCY PERIOD

RESULTS

No non-compliance noted: No EUT transmissions were observed on the test channel during the 30 minute observation time.

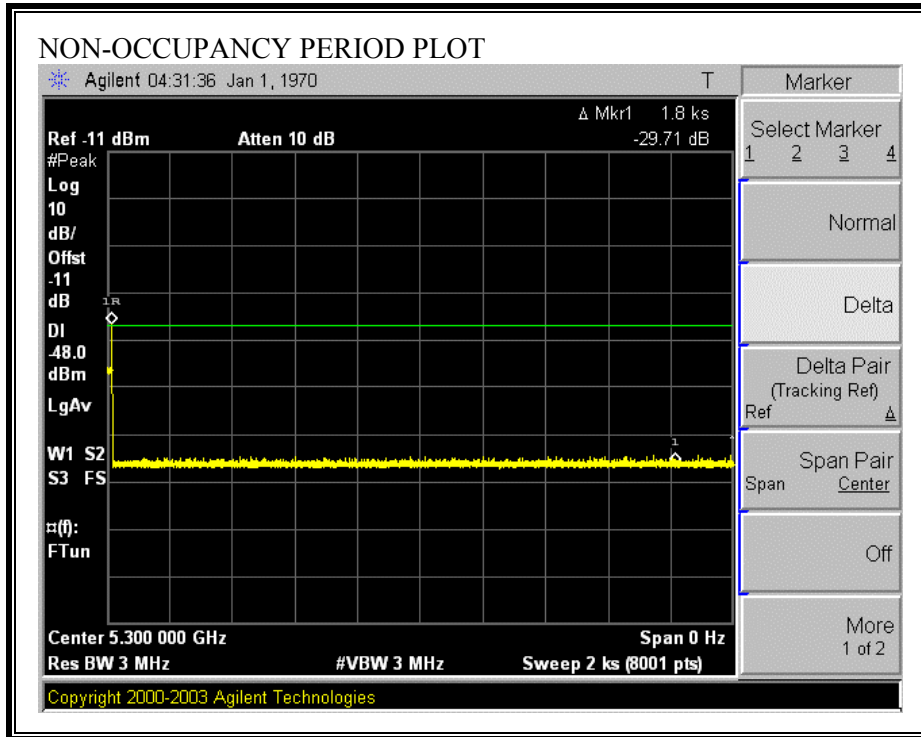

5.4.6. DETECTION BANDWIDTH

REFERENCE PLOT FOR 99% BANDWIDTH

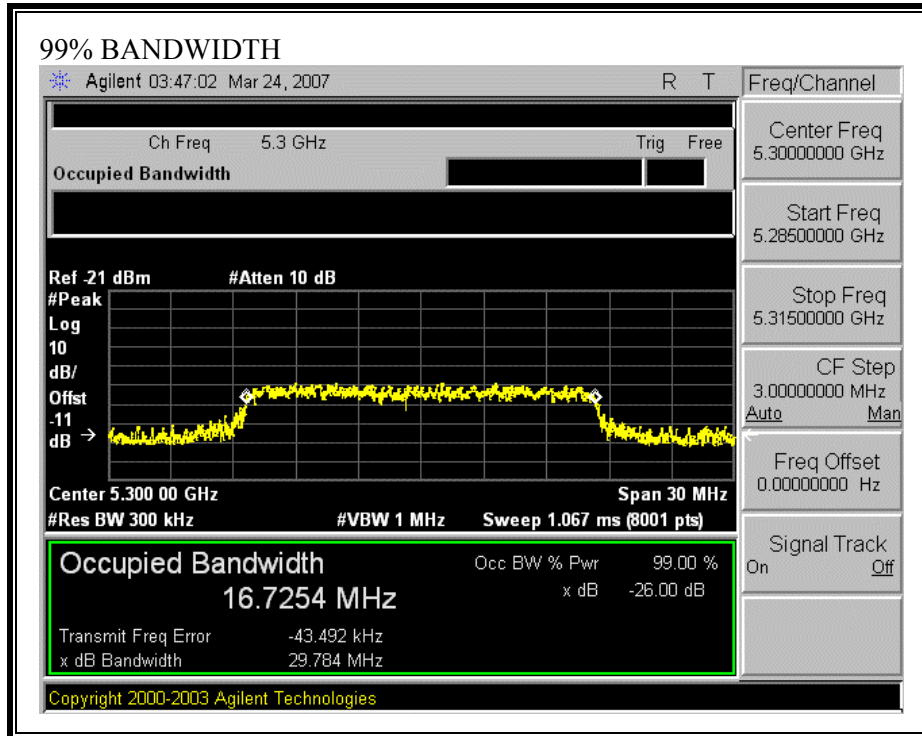

RESULTS

No non-compliance noted:

FL	FH	Detection Bandwidth	99% Power Bandwidth	Ratio of Detection BW to 99% Power BW	Minimum Limit
(MHz)	(MHz)	(MHz)	(MHz)	(%)	(%)
5290	5310	20	16.725	119.6	80

DETECTION BANDWIDTH PROBABILITY

DETECTION BANDWIDTH PROBABILITY RESULTS				
Detection Bandwidth Test Results:			Waveform: TYPE 1	
Frequency (MHz)	Number of Trials	Number Detected	Detection (%)	Mark
5289	10	6	60.00	
5290	10	10	100.00	FL
5291	10	10	100.00	
5292	10	10	100.00	
5293	10	10	100.00	
5294	10	10	100.00	
5295	10	10	100.00	
5296	10	10	100.00	
5297	10	10	100.00	
5298	10	10	100.00	
5299	10	9	90.00	
5300	10	10	100.00	
5301	10	10	100.00	
5302	10	9	90.00	
5303	10	9	90.00	
5304	10	10	100.00	
5305	10	9	90.00	
5306	10	10	100.00	
5307	10	10	100.00	
5308	10	10	100.00	
5309	10	10	100.00	
5310	10	10	100.00	FH
5311	10	3	30.00	

5.4.7. IN-SERVICE MONITORING

RESULTS

No non-compliance noted:

Radar Test Summary:				
Signal Type	Waveform/Trial No.	Detection (%)	Limit (%)	Pas/Fail
FCC TYPE 1	30	93.33	60.00	Pass
FCC TYPE 2	30	96.67	60.00	Pass
FCC TYPE 3	30	90.00	60.00	Pass
FCC TYPE 4	30	100.00	60.00	Pass
Aggregate		95.00	80.00	Pass
FCC TYPE 5	30	100.00	80.00	Pass
FCC TYPE 6	42	100.00	70.00	Pass

TYPE 1 DETECTION PROBABILITY

Data Sheet for Short Pulse Radar Type 1	
Trial No.	Successful Detection (Yes/No)
1	Yes
2	Yes
3	Yes
4	Yes
5	Yes
6	Yes
7	Yes
8	Yes
9	Yes
10	Yes
11	Yes
12	Yes
13	Yes
14	Yes
15	Yes
16	Yes
17	Yes
18	Yes
19	Yes
20	Yes
21	Yes
22	Yes
23	No
24	Yes
25	Yes
26	No
27	Yes
28	Yes
29	Yes
30	Yes

TYPE 2 DETECTION PROBABILITY

Data Sheet for Short Pulse Radar Type 2				
Waveform No.	# Pulses per burst	Pulse Width (us)	Pulse repetition Interval (us)	Successful Detection (Yes/No)
2001	23	4.50	163	Yes
2002	27	4.70	215	Yes
2003	25	2.90	173	Yes
2004	29	3.70	182	Yes
2005	24	1.70	184	Yes
2006	24	2.90	206	Yes
2007	28	2.60	162	Yes
2008	25	2.90	167	Yes
2009	25	1.50	173	Yes
2010	25	4.40	192	Yes
2011	24	4.80	174	Yes
2012	23	1.50	199	Yes
2013	27	2.50	221	Yes
2014	24	3.90	186	Yes
2015	29	3.70	196	Yes
2016	24	3.00	225	Yes
2017	25	3.30	191	Yes
2018	27	2.30	205	Yes
2019	25	3.10	219	Yes
2020	27	4.70	163	Yes
2021	25	4.20	219	Yes
2022	23	4.10	209	Yes
2023	25	2.40	205	Yes
2024	24	2.00	226	Yes
2025	23	1.20	178	Yes
2026	26	1.00	157	Yes
2027	25	3.10	200	Yes
2028	26	2.00	200	No
2029	23	1.70	161	Yes
2030	26	1.80	156	Yes

TYPE 3 DETECTION PROBABILITY

Data Sheet for Short Pulse Radar Type 3				
Waveform No.	# Pulses per burst	Pulse Width (us)	Pulse repetition Interval (us)	Successful Detection (Yes/No)
3001	16	9.20	454	Yes
3002	16	6.00	282	Yes
3003	18	8.40	401	Yes
3004	16	5.80	389	Yes
3005	17	9.90	495	No
3006	16	6.60	359	No
3007	16	6.60	452	Yes
3008	16	8.30	333	Yes
3009	16	9.10	400	Yes
3010	17	6.70	447	Yes
3011	18	6.10	458	Yes
3012	16	5.40	442	Yes
3013	16	7.20	393	Yes
3014	18	9.40	397	No
3015	17	7.80	344	Yes
3016	18	9.60	418	Yes
3017	16	6.90	364	Yes
3018	17	8.60	349	Yes
3019	16	6.80	407	Yes
3020	16	9.40	270	Yes
3021	18	6.30	455	Yes
3022	16	6.30	326	Yes
3023	17	8.70	396	Yes
3024	17	9.60	421	Yes
3025	18	8.50	449	Yes
3026	16	5.00	420	Yes
3027	18	9.50	372	Yes
3028	17	6.10	273	Yes
3029	18	6.20	464	Yes
3030	17	8.90	361	Yes

TYPE 4 DETECTION PROBABILITY

Data Sheet for Short Pulse Radar Type 4				
Waveform No.	# Pulses per burst	Pulse Width (us)	Pulse repetition Interval (us)	Successful Detection (Yes/No)
4001	15	12.70	263	Yes
4002	15	14.60	336	Yes
4003	12	13.60	439	Yes
4004	13	15.90	475	Yes
4005	16	13.50	300	Yes
4006	16	15.00	394	Yes
4007	14	13.10	381	Yes
4008	16	17.30	462	Yes
4009	14	16.10	471	Yes
4010	12	12.50	479	Yes
4011	12	18.70	348	Yes
4012	16	14.20	273	Yes
4013	15	15.40	362	Yes
4014	15	15.40	403	Yes
4015	12	13.80	358	Yes
4016	16	12.20	347	Yes
4017	13	18.50	371	Yes
4018	13	10.50	455	Yes
4019	16	12.30	312	Yes
4020	15	13.60	500	Yes
4021	14	12.60	360	Yes
4022	12	14.80	420	Yes
4023	13	12.80	430	Yes
4024	14	18.00	468	Yes
4025	16	13.30	409	Yes
4026	12	12.80	328	Yes
4027	12	14.90	386	Yes
4028	14	16.30	284	Yes
4029	13	10.50	469	Yes
4030	13	15.20	276	Yes

TYPE 5 DETECTION PROBABILITY

Data Sheet for Long Pulse Radar Type 5	
Waveform No.	Successful Detection (Yes/No)
5001	Yes
5002	Yes
5003	Yes
5004	Yes
5005	Yes
5006	Yes
5007	Yes
5008	Yes
5009	Yes
5010	Yes
5011	Yes
5012	Yes
5013	Yes
5014	Yes
5015	Yes
5016	Yes
5017	Yes
5018	Yes
5019	Yes
5020	Yes
5021	Yes
5022	Yes
5023	Yes
5024	Yes
5025	Yes
5026	Yes
5027	Yes
5028	Yes
5029	Yes
5030	Yes

Type 5 randomized parameters are in a separate document.

TYPE 6 DETECTION PROBABILITY

Data Sheet for Hopping Signal				
Trial No.	Starting Index within NTIA August 2005 Sequence	Signal Generator Frequency (MHz)	Hops within Detection BW	Successful Detection (Yes/No)
1	259	5290	6	Yes
2	734	5291	3	Yes
3	1209	5292	4	Yes
4	1684	5293	4	Yes
5	2159	5294	6	Yes
6	2634	5295	3	Yes
7	3109	5296	4	Yes
8	3584	5297	2	Yes
9	4059	5298	9	Yes
10	4534	5299	6	Yes
11	5009	5300	5	Yes
12	5484	5301	4	Yes
13	5959	5302	5	Yes
14	6434	5303	4	Yes
15	6909	5304	4	Yes
16	7384	5305	6	Yes
17	7859	5306	6	Yes
18	8334	5307	5	Yes
19	8809	5308	4	Yes
20	9284	5309	7	Yes
21	9759	5310	3	Yes
22	10234	5290	4	Yes
23	10709	5291	3	Yes
24	11184	5292	3	Yes
25	11659	5293	5	Yes
26	12134	5294	3	Yes
27	12609	5295	8	Yes
28	13084	5296	4	Yes
29	13559	5297	2	Yes
30	14034	5298	1	Yes
31	14509	5299	4	Yes
32	14984	5300	1	Yes
33	15459	5301	4	Yes
34	15934	5302	3	Yes
35	16409	5303	3	Yes
36	16884	5304	6	Yes
37	17359	5305	5	Yes
38	17834	5306	3	Yes
39	18309	5307	6	Yes
40	18784	5308	6	Yes
41	19259	5309	7	Yes
42	19734	5310	4	Yes

5.5. SLAVE CONFIGURATION IN 20 MHz BANDWIDTH

5.5.1. PLOTS OF RADAR WAVEFORM AND WLAN TRAFFIC

PLOT OF RADAR WAVEFORM

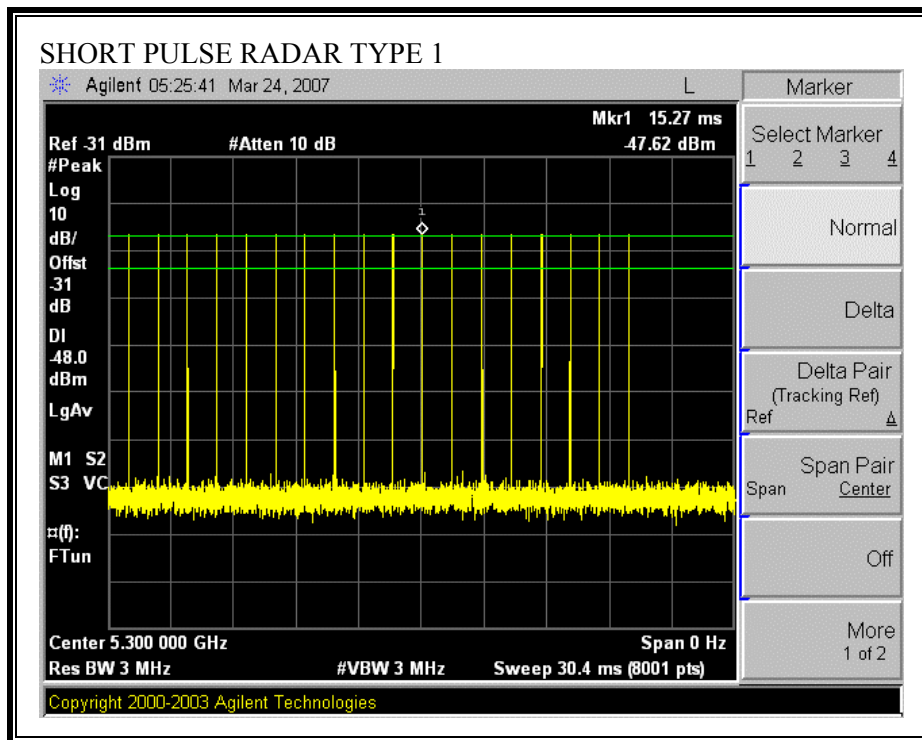

PLOT OF WLAN TRAFFIC FROM SLAVE

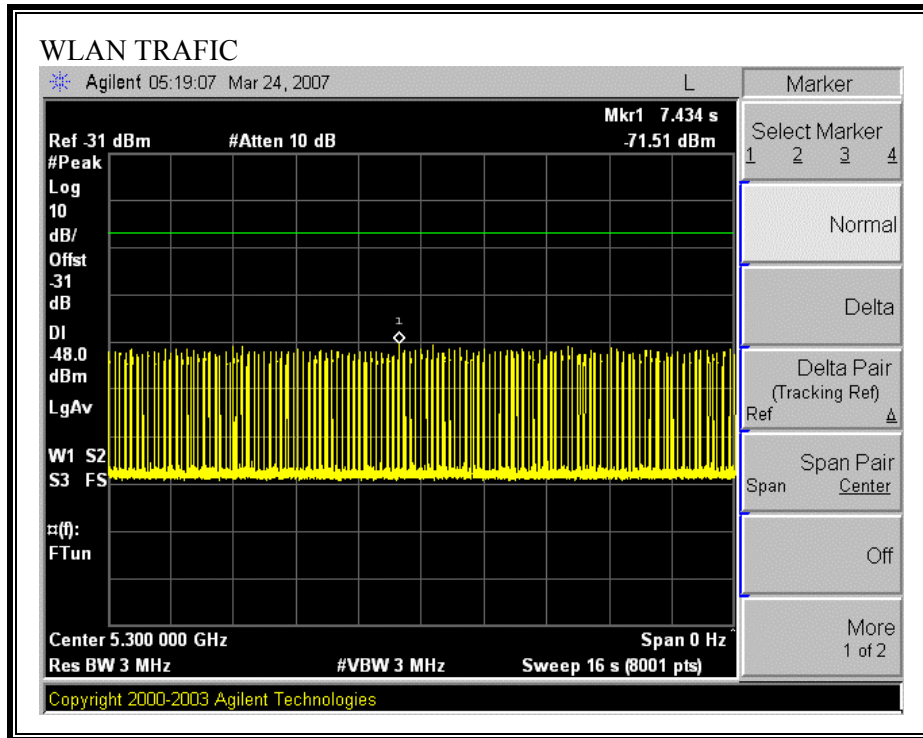

5.5.2. TEST CHANNEL AND METHOD

All tests were performed at a channel center frequency of 5300 MHz utilizing a conducted test method.

5.5.3. CHANNEL MOVE TIME AND CHANNEL CLOSING TRANSMISSION TIME

REPORTING NOTES

The reference marker is set at the end of last radar pulse.

The delta marker is set at the end of the last WLAN transmission following the radar pulse. This delta is the channel move time.

The aggregate channel closing transmission time is calculated as follows:

Aggregate Transmission Time =
(Number of analyzer bins showing transmission) * (dwell time per bin)

The observation period over which the aggregate time is calculated for the FCC version
Begins at (Reference Marker + 200 msec)
and
Ends no earlier than (Reference Marker + 10 sec).

The observation period over which the aggregate time is calculated for the IC version
Begins at (Reference Marker)
and
Ends no earlier than (Reference Marker + 10 sec).

CHANNEL MOVE TIME RESULTS

No non-compliance noted:

Channel Move Time (s)	Limit (s)
0.000	10

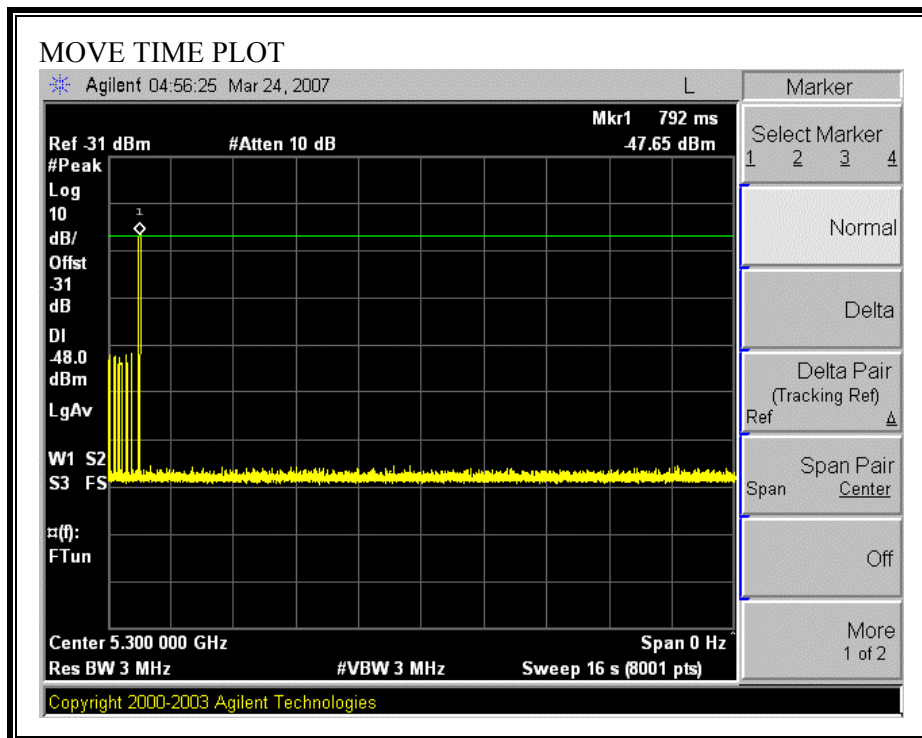

CHANNEL CLOSING TIME RESULTS

No non-compliance noted:

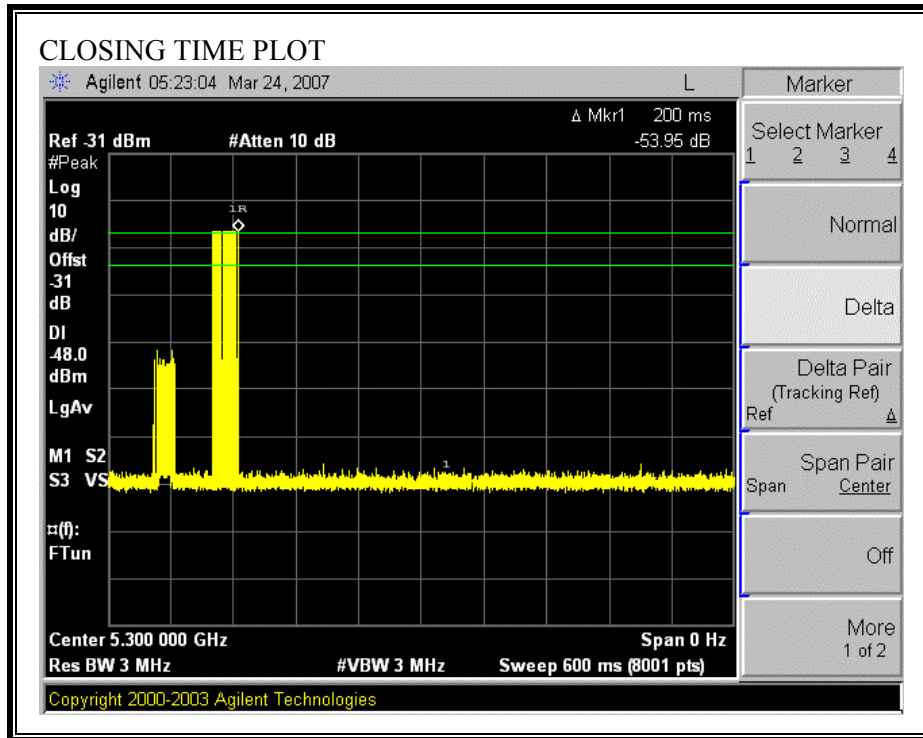

FCC AGGREGATE CHANNEL CLOSING TRANSMISSION TIME RESULTS

No non-compliance noted:

Aggregate Transmission Time (ms)	Limit (ms)	Margin (ms)
0.00	60	60.00

Only intermittent transmissions are observed during the aggregate monitoring period.

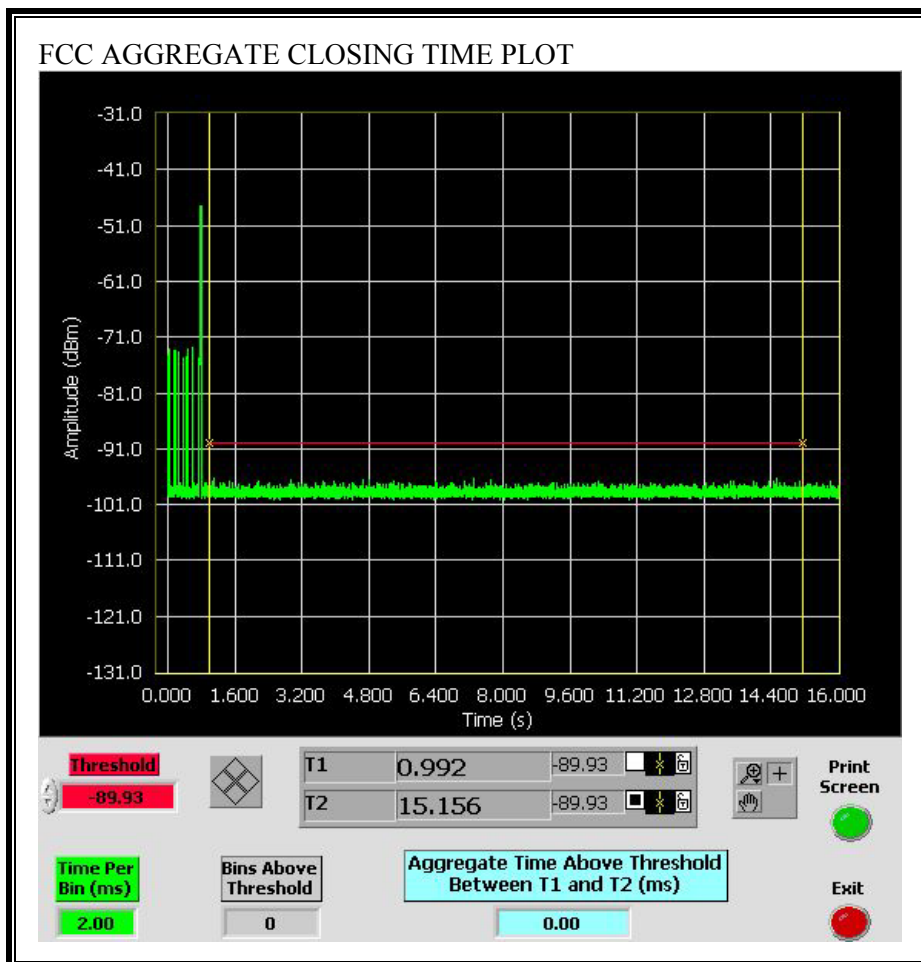

IC AGGREGATE CHANNEL CLOSING TRANSMISSION TIME RESULTS

No non-compliance noted:

Aggregate Transmission Time (ms)	Limit (ms)	Margin (ms)
0.00	260	260.00

No transmissions are observed during the aggregate monitoring period.

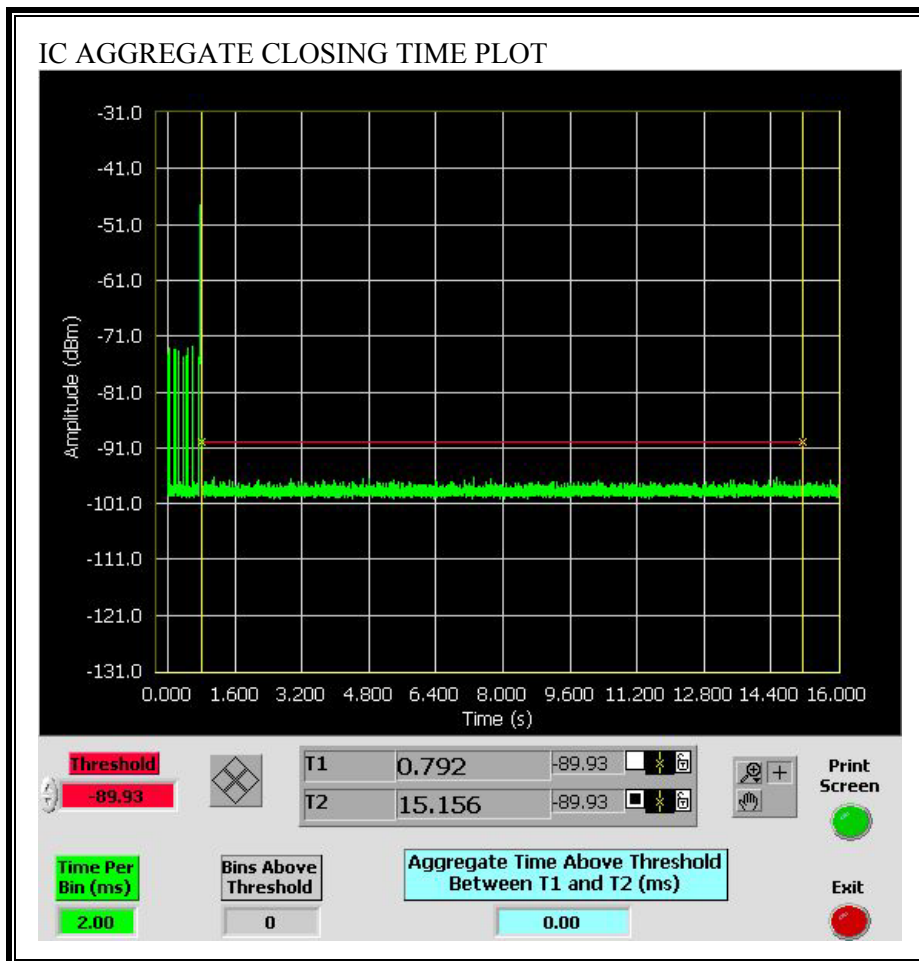

5.6. MASTER CONFIGURATION IN 40 MHz BANDWIDTH

5.6.1. PLOTS OF RADAR WAVEFORM, AND WLAN TRAFFIC

PLOTS OF RADAR WAVEFORMS

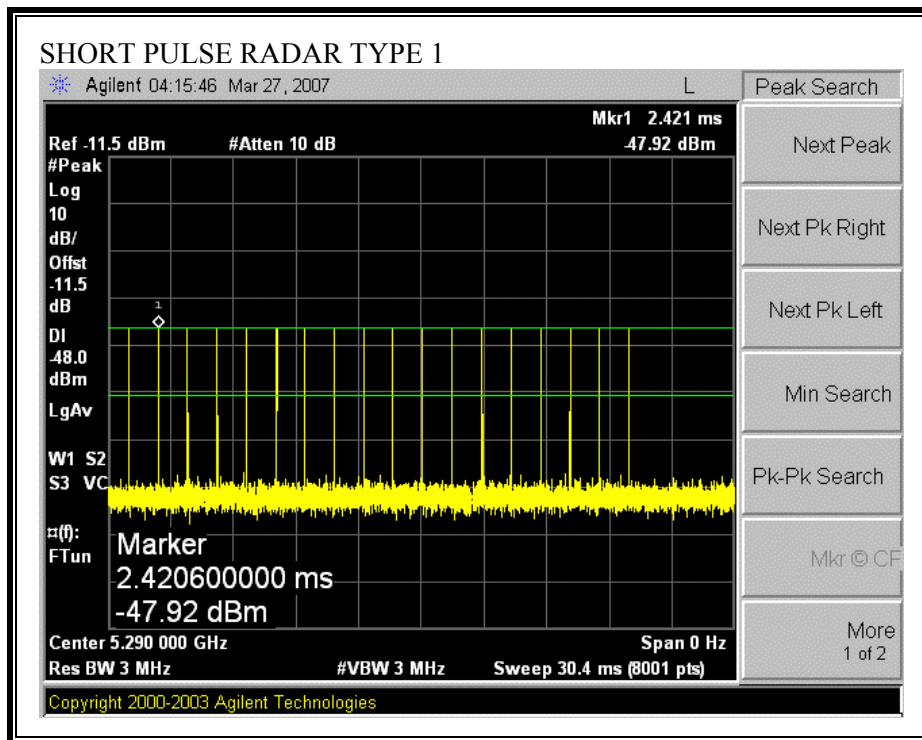

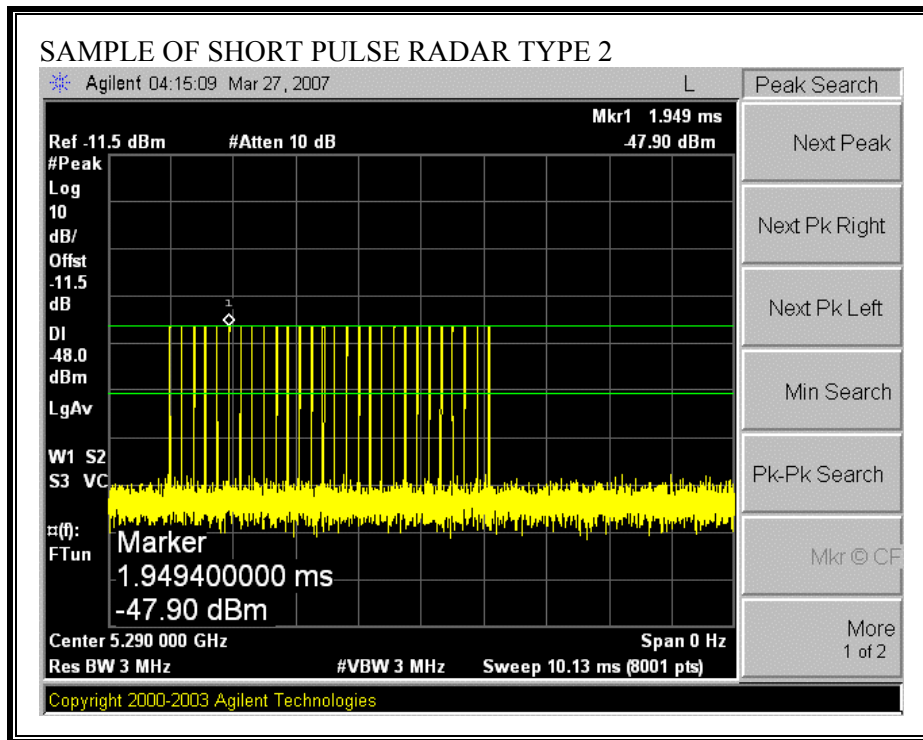

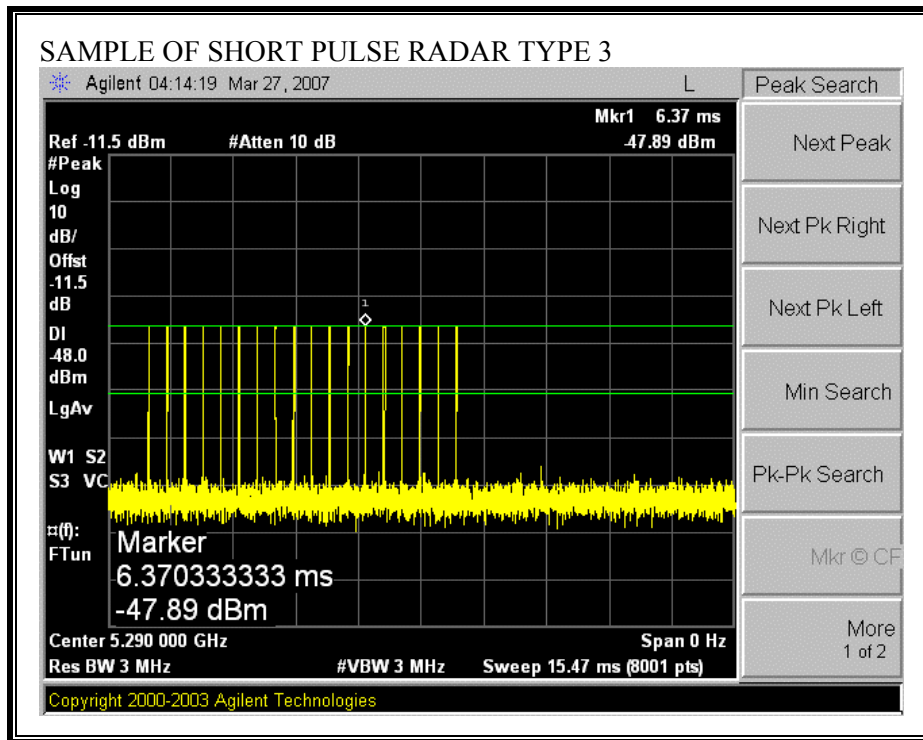

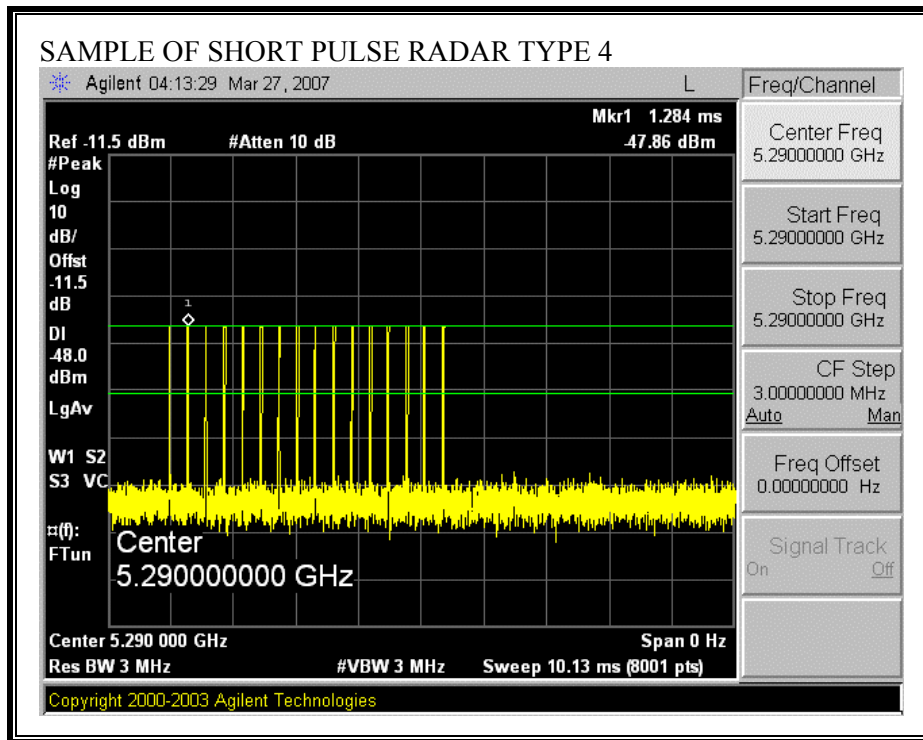

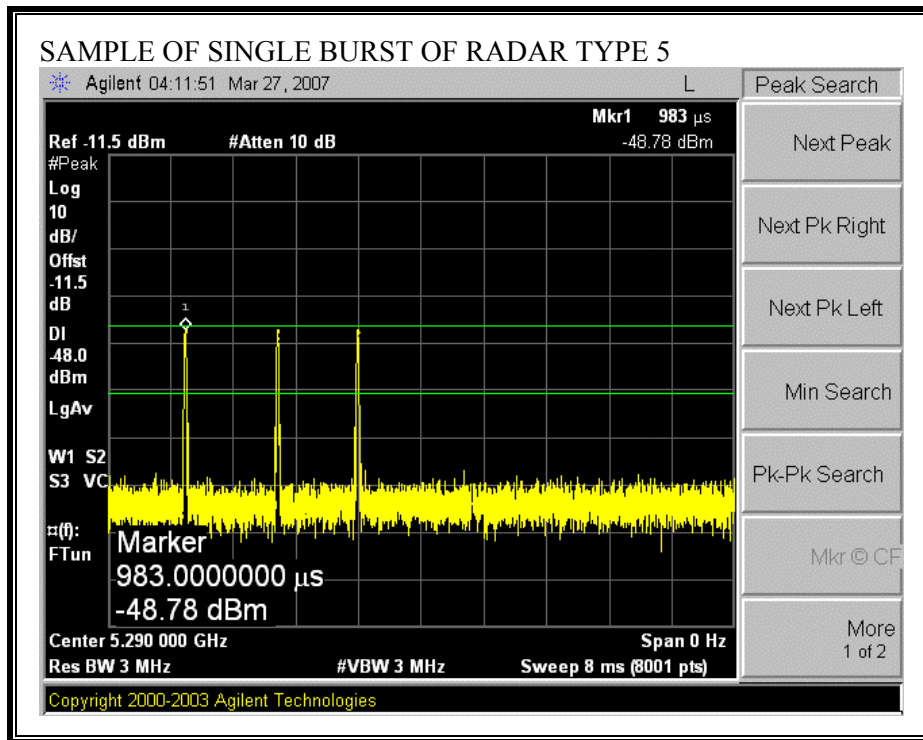

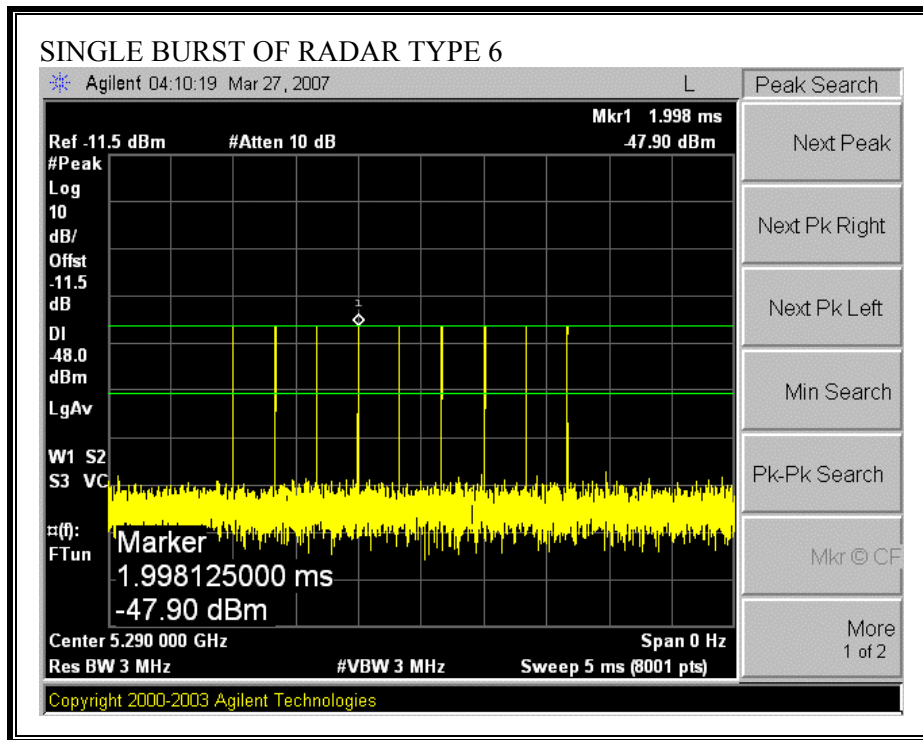

PLOT OF WLAN TRAFFIC FROM MASTER

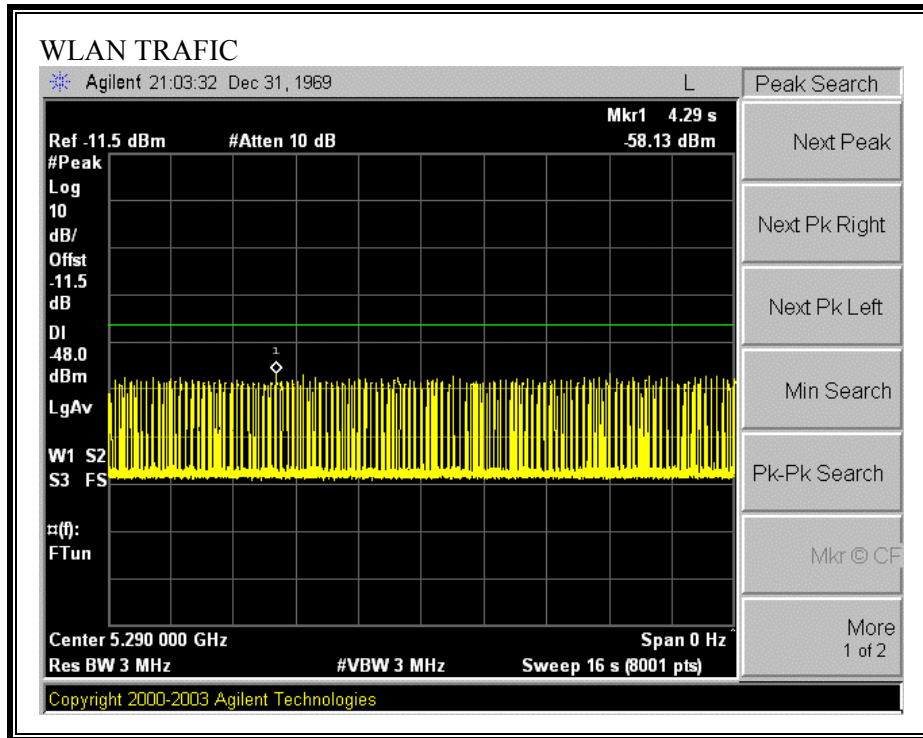

5.6.2. TEST CHANNEL AND METHOD

All tests were performed at a channel center frequency of 5290 MHz utilizing a conducted test method.

5.6.3. CHANNEL AVAILABILITY CHECK TIME

TEST PROCEDURE TO DETERMINE INITIAL POWER-UP CYCLE TIME

A link was established on channel, then the EUT was rebooted. The time from the cessation of traffic to the re-initialization of traffic was measured as the time required for the EUT to complete the total power-up cycle. The time to complete the initial power-up period is 60 seconds less than this total power-up time.

TEST PROCEDURE FOR TIMING OF RADAR BURST

With a link established on channel, the EUT was rebooted. A radar signal was triggered within 0 to 6 seconds after the initial power-up period, and transmissions on the channel were monitored on the spectrum analyzer.

The Non-Occupancy list was cleared. With a link established on channel, the EUT was rebooted. A radar signal was triggered within 54 to 60 seconds after the initial power-up period, and transmissions on the channel were monitored on the spectrum analyzer.

CHANNEL AVAILABILITY CHECK TIME RESULTS

No non-compliance noted:

Time required for EUT to complete the initial power-up cycle (sec)
21.30

If a radar signal is detected during the channel availability check then the PC controlling the EUT displays a message stating that radar was detected.

Timing of Radar Burst	Display on EUT / PC Control Computer	Spectrum Analyzer Display
No Radar Triggered	EUT Initiates Transmissions	Transmissions begin on channel after completion of the initial power-up cycle and the 60 second CAC
Within 0 to 6 second window	EUT does not display any radar parameter values	No transmissions on channel
Within 54 to 60 second window	EUT does not display any radar parameter values	No transmissions on channel

TIMING PLOT WITHOUT RADAR DURING CAC

AP is rebooted
 Traffic ceases
 Start of Initial Power-up cycle

End of Initial Power-up cycle
 Start of CAC

End of CAC
 Traffic is Initiated

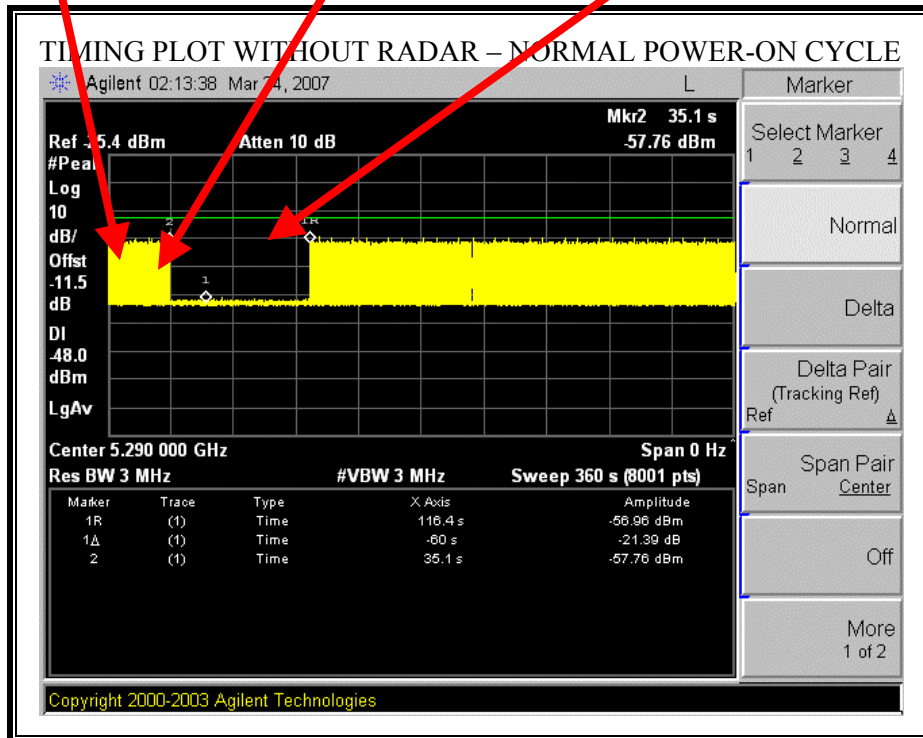

Note: The initial power-up cycle requires $(116.4 - 35.1 - 60) = 21.3$ seconds.

TIMING PLOT WITH RADAR NEAR BEGINNING OF CAC

AP is rebooted
Traffic ceases
Start of Initial Power-up cycle

End of Initial Power-up cycle
Start of CAC

Radar Signal Applied

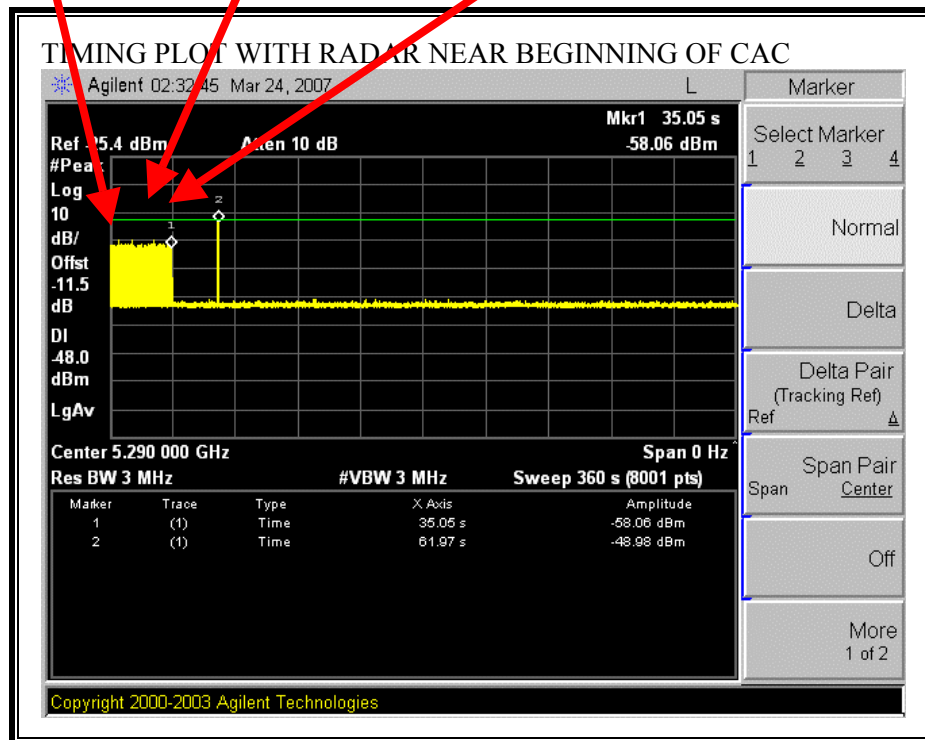

The radar signal is applied $(61.97 - 35.05) = 26.69$ seconds after reboot, which is $(26.69 - 21.3) = 5.39$ seconds after the completion of the initial power-up cycle / start of the CAC period.

No EUT transmissions were observed after the radar signal.

TIMING PLOT WITH RADAR NEAR END OF CAC

AP is rebooted
Traffic ceases
Start of Initial Power-up cycle

End of Initial Power-up cycle
Start of CAC

Radar Signal Applied

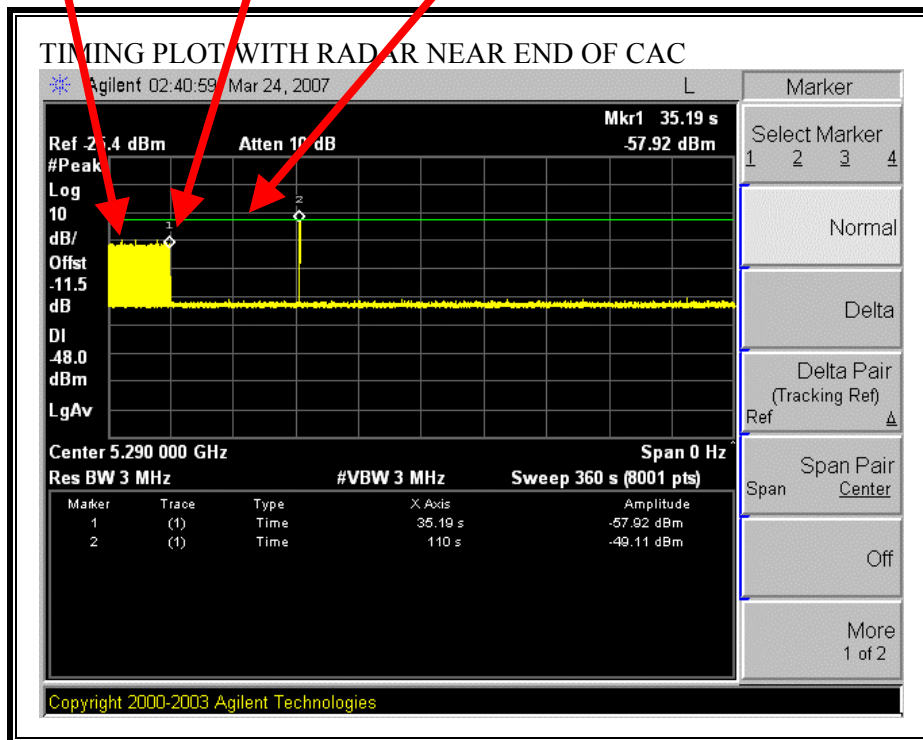

The radar signal is applied $(110 - 35.19) = 74.81$ seconds after reboot, which is $(78.41 - 21.3) = 53.51$ seconds after the completion of the initial power-up cycle / start of the CAC period.

No EUT transmissions were observed after the radar signal.

5.6.4. CHANNEL MOVE TIME AND CHANNEL CLOSING TRANSMISSION TIME

GENERAL REPORTING NOTES

The reference marker is set at the end of last radar pulse.

SHORT PULSE RADAR REPORTING NOTES

The delta marker is set at the end of the last WLAN transmission following the radar pulse. This delta is the channel move time.

The aggregate channel closing transmission time is calculated as follows:

Aggregate Transmission Time =
(Number of analyzer bins showing transmission) * (dwell time per bin)

The observation period over which the aggregate time is calculated for the FCC version
Begins at (Reference Marker + 200 msec)
and
Ends no earlier than (Reference Marker + 10 sec).

The observation period over which the aggregate time is calculated for the IC version
Begins at (Reference Marker)
and
Ends no earlier than (Reference Marker + 10 sec).

LONG PULSE RADAR REPORTING NOTES

The delta marker is set to 10 seconds after the end of the radar pulse.

CHANNEL MOVE TIME RESULTS

No non-compliance noted:

Channel Move Time (s)	Limit (s)
0.000	10

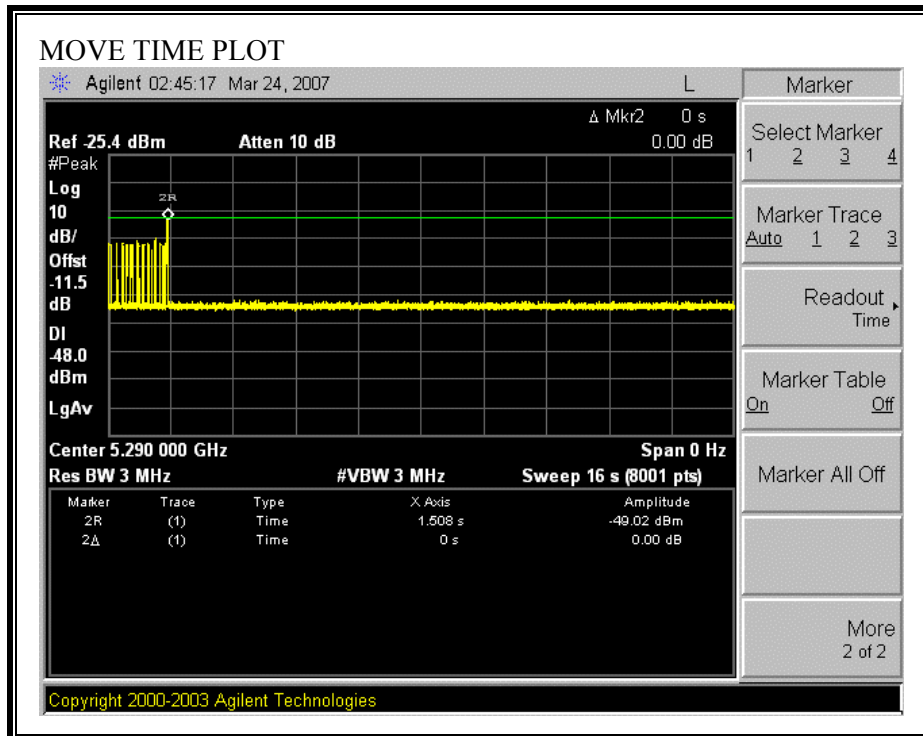

CHANNEL CLOSING TIME RESULTS

No non-compliance noted:

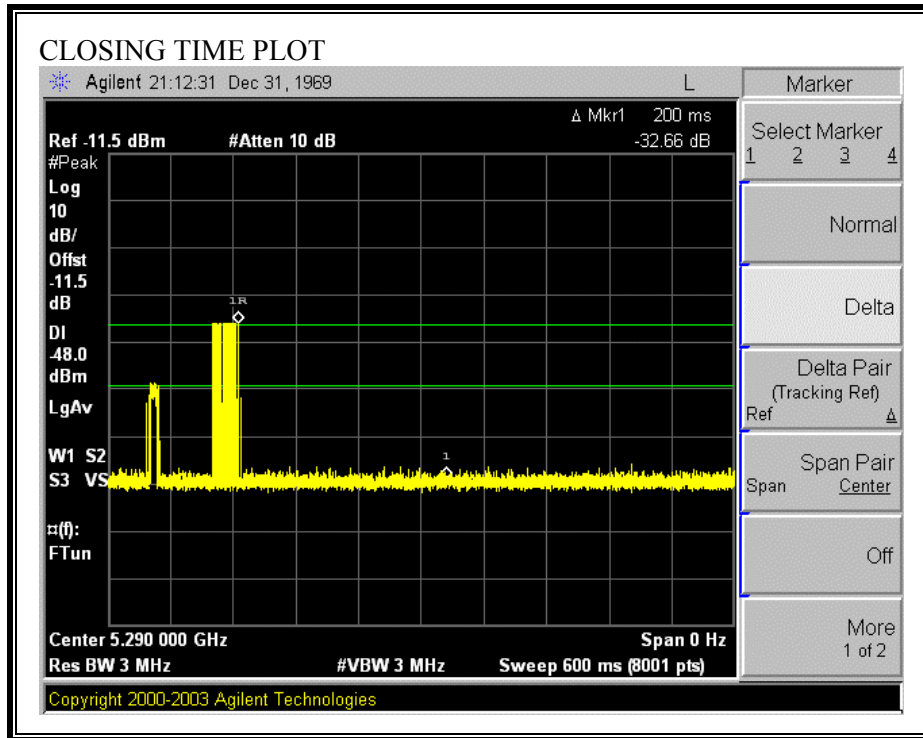

FCC AGGREGATE CHANNEL CLOSING TRANSMISSION TIME RESULTS

No non-compliance noted:

Aggregate Transmission Time (ms)	Limit (ms)	Margin (ms)
0.00	60	60.00

No transmissions are observed during the aggregate monitoring period.

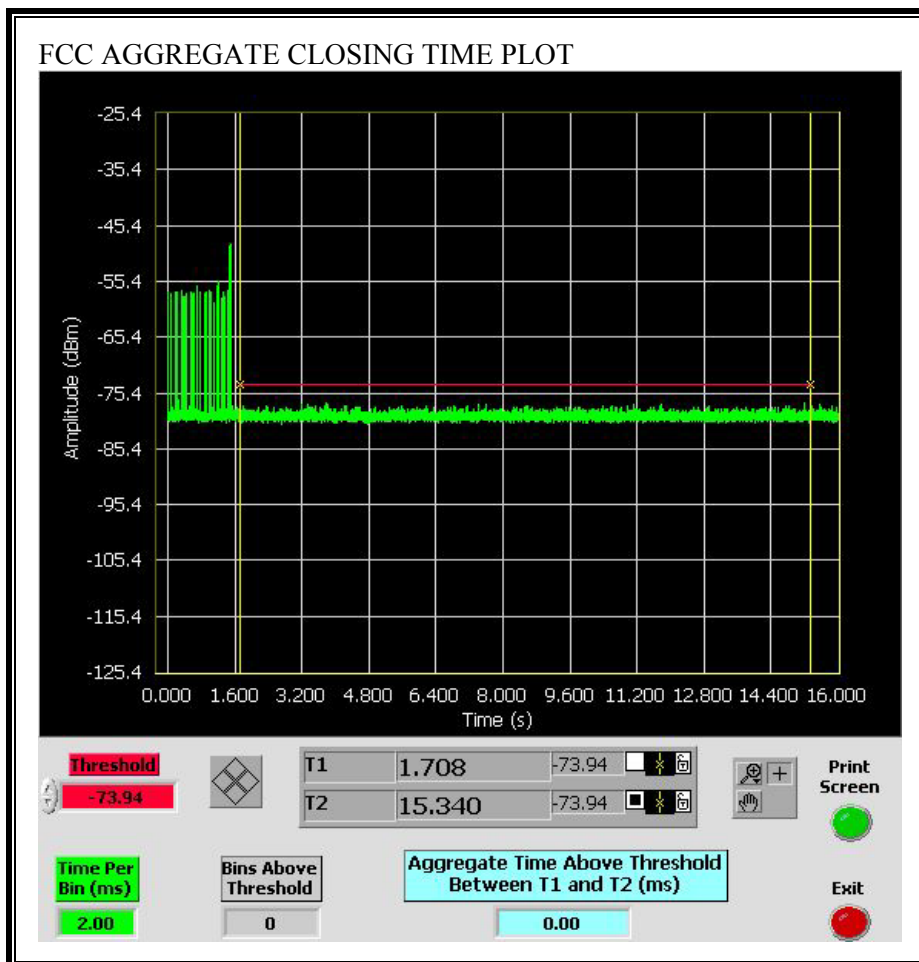

IC AGGREGATE CHANNEL CLOSING TRANSMISSION TIME RESULTS

No non-compliance noted:

Aggregate Transmission Time (ms)	Limit (ms)	Margin (ms)
0.00	260	260.00

No transmissions are observed during the aggregate monitoring period.

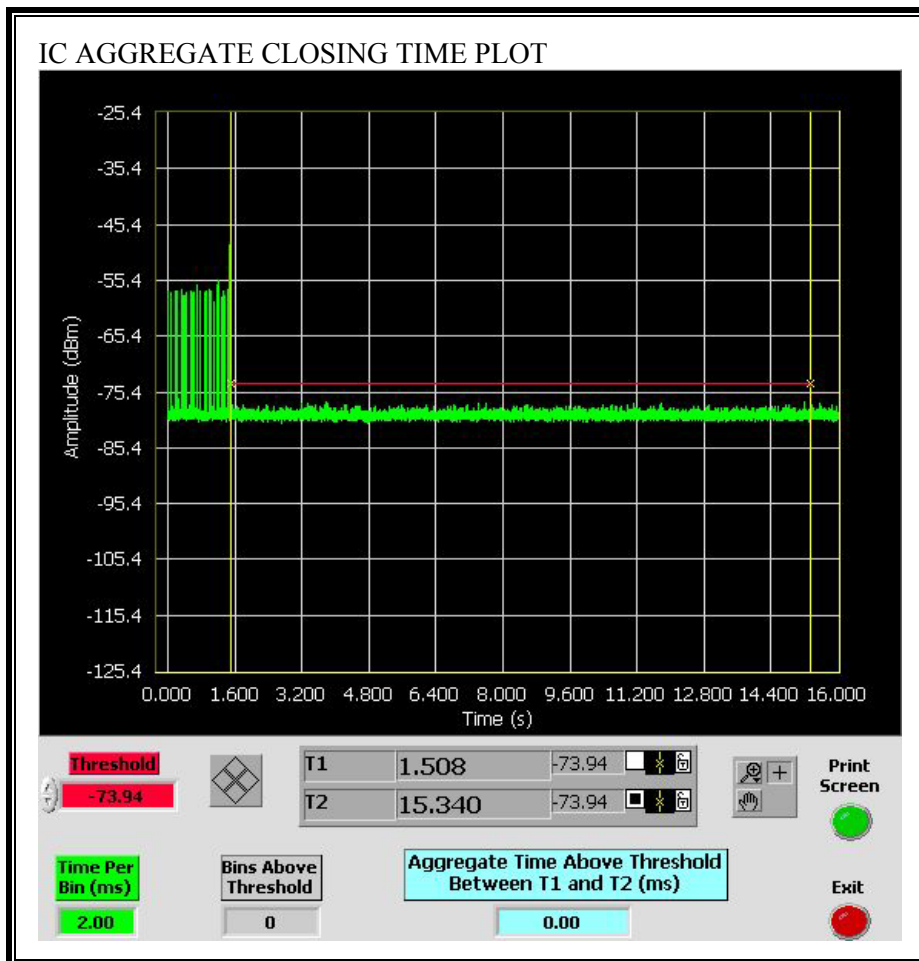

LONG PULSE CHANNEL MOVE TIME RESULTS

No non-compliance noted: The traffic ceases prior to the end of the radar waveform, therefore it also ceases prior to 10 seconds after the end of the radar waveform.

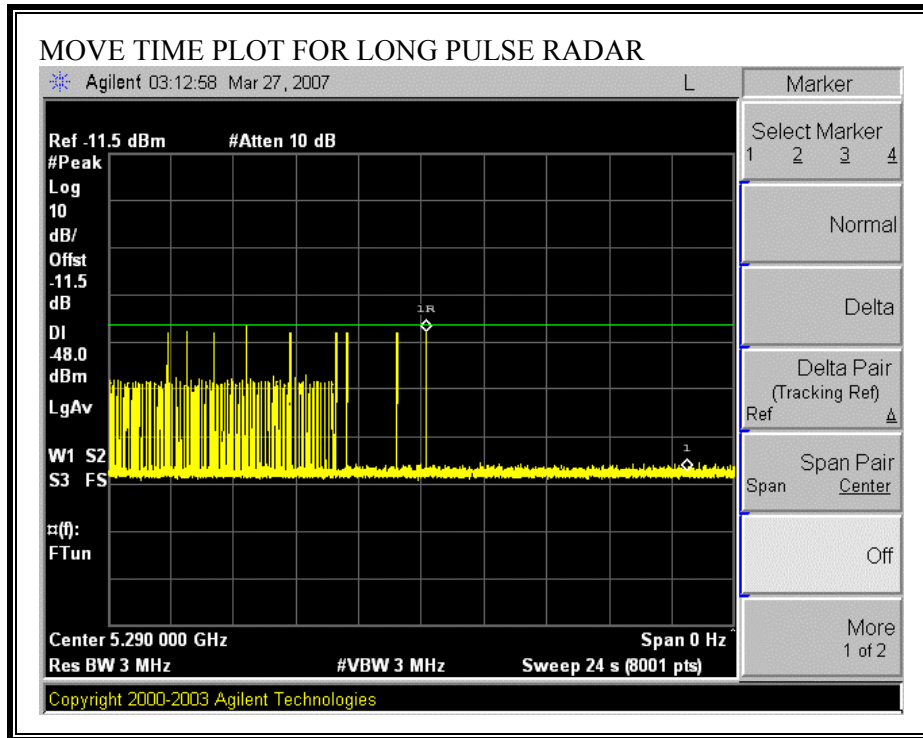

5.6.5. NON-OCCUPANCY PERIOD

RESULTS

No non-compliance noted: No EUT transmissions were observed on the test channel during the 30 minute observation time.

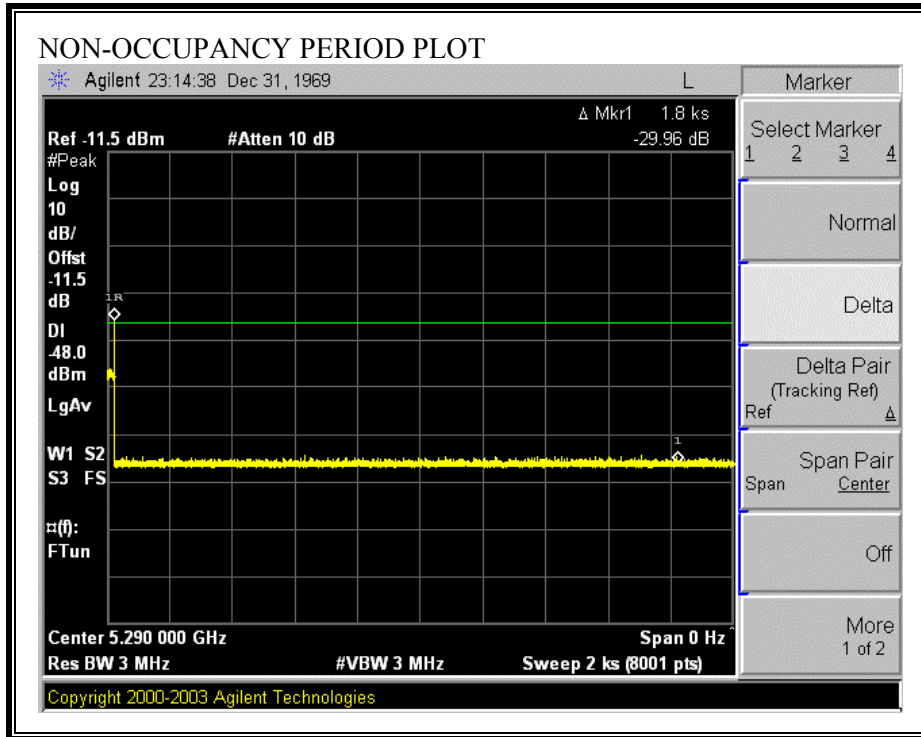

5.6.6. DETECTION BANDWIDTH

REFERENCE PLOT FOR 99% BANDWIDTH

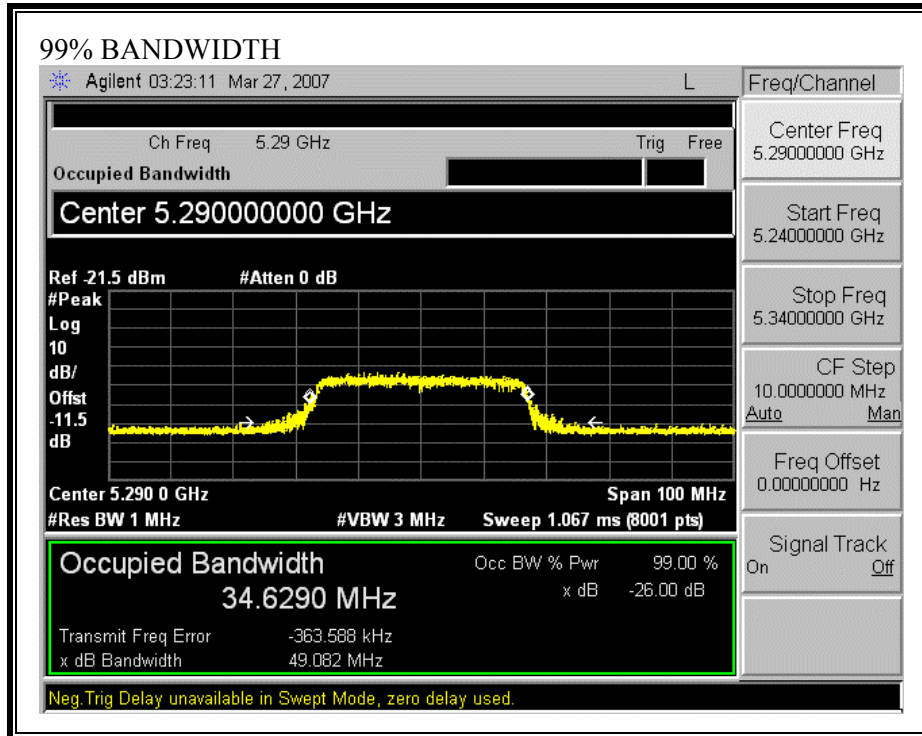

RESULTS

No non-compliance noted:

FL	FH	Detection Bandwidth	99% Power Bandwidth	Ratio of Detection BW to 99% Power BW	Minimum Limit
(MHz)	(MHz)	(MHz)	(MHz)	(%)	(%)
5271	5309	38	34.629	109.7	80

DETECTION BANDWIDTH PROBABILITY

DETECTION BANDWIDTH PROBABILITY RESULTS				
Detection Bandwidth Test Results:			Waveform: TYPE 1	
Frequency (MHz)	Number of Trials	Number Detected	Detection (%)	Mark
5270	10	7	70.00	
5271	10	10	100.00	FL
5272	10	10	100.00	
5273	10	10	100.00	
5274	10	10	100.00	
5275	10	10	100.00	
5276	10	10	100.00	
5277	10	10	100.00	
5278	10	10	100.00	
5279	10	10	100.00	
5280	10	10	100.00	
5281	10	10	100.00	
5282	10	10	100.00	
5283	10	10	100.00	
5284	10	10	100.00	
5285	10	10	100.00	
5286	10	10	100.00	
5287	10	10	100.00	
5288	10	10	100.00	
5289	10	10	100.00	
5290	10	10	100.00	
5291	10	10	100.00	
5292	10	10	100.00	
5293	10	10	100.00	
5294	10	10	100.00	
5295	10	10	100.00	
5296	10	10	100.00	
5297	10	10	100.00	
5298	10	10	100.00	
5299	10	10	100.00	
5300	10	10	100.00	
5301	10	10	100.00	
5302	10	10	100.00	
5303	10	10	100.00	
5304	10	10	100.00	
5305	10	10	100.00	
5306	10	10	100.00	
5307	10	10	100.00	
5308	10	10	100.00	
5309	10	10	100.00	FH
5310	10	5	50.00	

5.6.7. IN-SERVICE MONITORING

RESULTS

No non-compliance noted:

Radar Test Summary:				
Signal Type	Waveform/Trial No.	Detection (%)	Limit (%)	Pas/Fail
FCC TYPE 1	30	100.00	60.00	Pass
FCC TYPE 2	30	93.33	60.00	Pass
FCC TYPE 3	30	100.00	60.00	Pass
FCC TYPE 4	30	96.67	60.00	Pass
Aggregate		97.50	80.00	Pass
FCC TYPE 5	30	100.00	80.00	Pass
FCC TYPE 6	39	100.00	70.00	Pass

TYPE 1 DETECTION PROBABILITY

Data Sheet for Short Pulse Radar Type 1	
Trial No.	Successful Detection (Yes/No)
1	Yes
2	Yes
3	Yes
4	Yes
5	Yes
6	Yes
7	Yes
8	Yes
9	Yes
10	Yes
11	Yes
12	Yes
13	Yes
14	Yes
15	Yes
16	Yes
17	Yes
18	Yes
19	Yes
20	Yes
21	Yes
22	Yes
23	Yes
24	Yes
25	Yes
26	Yes
27	Yes
28	Yes
29	Yes
30	Yes

TYPE 2 DETECTION PROBABILITY

Data Sheet for Short Pulse Radar Type 2				
Waveform No.	# Pulses per burst	Pulse Width (us)	Pulse repetition Interval (us)	Successful Detection (Yes/No)
2001	28	4.40	191	Yes
2002	28	2.70	167	Yes
2003	23	3.80	218	Yes
2004	25	1.20	153	Yes
2005	27	4.70	159	Yes
2006	26	5.00	200	Yes
2007	27	2.80	229	Yes
2008	24	4.90	192	No
2009	27	1.90	189	Yes
2010	24	3.40	155	Yes
2011	23	1.40	228	Yes
2012	23	3.20	154	Yes
2013	25	1.30	184	Yes
2014	26	1.60	150	Yes
2015	28	4.60	222	Yes
2016	24	2.20	167	Yes
2017	24	1.70	222	Yes
2018	28	1.00	224	Yes
2019	25	3.90	228	No
2020	23	2.70	178	Yes
2021	23	1.70	203	Yes
2022	25	3.90	164	Yes
2023	27	2.40	190	Yes
2024	26	3.60	185	Yes
2025	27	4.30	204	Yes
2026	24	4.20	187	Yes
2027	23	2.40	167	Yes
2028	27	1.70	211	Yes
2029	29	2.90	182	Yes
2030	24	5.00	205	Yes

TYPE 3 DETECTION PROBABILITY

Data Sheet for Short Pulse Radar Type 3				
Waveform No.	# Pulses per burst	Pulse Width (us)	Pulse repetition Interval (us)	Successful Detection (Yes/No)
3001	18	8.10	448	Yes
3002	18	9.10	412	Yes
3003	18	8.10	433	Yes
3004	17	8.40	260	Yes
3005	16	8.00	398	Yes
3006	18	6.10	388	Yes
3007	18	6.80	271	Yes
3008	16	8.40	454	Yes
3009	17	7.10	429	Yes
3010	16	8.50	408	Yes
3011	17	7.60	331	Yes
3012	18	5.00	375	Yes
3013	16	7.30	492	Yes
3014	17	8.70	270	Yes
3015	16	8.50	394	Yes
3016	16	9.90	382	Yes
3017	18	9.40	261	Yes
3018	17	7.60	361	Yes
3019	18	9.00	396	Yes
3020	17	9.00	480	Yes
3021	18	9.60	259	Yes
3022	16	6.00	324	Yes
3023	16	6.20	495	Yes
3024	17	6.60	396	Yes
3025	18	5.90	285	Yes
3026	18	7.30	328	Yes
3027	16	8.00	413	Yes
3028	17	6.90	254	Yes
3029	16	6.70	456	Yes
3030	17	7.10	363	Yes

TYPE 4 DETECTION PROBABILITY

Data Sheet for Short Pulse Radar Type 4				
Waveform No.	# Pulses per burst	Pulse Width (us)	Pulse repetition Interval (us)	Successful Detection (Yes/No)
4001	16	19.40	296	Yes
4002	12	12.70	293	Yes
4003	16	15.20	461	Yes
4004	13	12.10	285	Yes
4005	13	11.70	486	Yes
4006	12	15.20	400	Yes
4007	14	16.70	376	Yes
4008	12	17.90	499	Yes
4009	13	18.90	338	Yes
4010	13	10.90	353	Yes
4011	15	13.80	326	Yes
4012	12	18.90	487	Yes
4013	12	18.70	345	Yes
4014	12	16.30	456	Yes
4015	16	17.80	392	Yes
4016	13	12.90	354	Yes
4017	16	16.00	409	Yes
4018	14	10.00	286	Yes
4019	13	16.80	360	Yes
4020	15	12.10	387	Yes
4021	15	17.90	380	Yes
4022	16	13.60	488	Yes
4023	14	19.70	483	Yes
4024	13	16.90	306	Yes
4025	13	12.70	332	Yes
4026	14	16.20	476	Yes
4027	16	19.00	499	Yes
4028	14	19.20	435	Yes
4029	15	11.40	390	Yes
4030	15	15.40	304	No

TYPE 5 DETECTION PROBABILITY

Data Sheet for Long Pulse Radar Type 5	
Waveform No.	Successful Detection (Yes/No)
5001	Yes
5002	Yes
5003	Yes
5004	Yes
5005	Yes
5006	Yes
5007	Yes
5008	Yes
5009	Yes
5010	Yes
5011	Yes
5012	Yes
5013	Yes
5014	Yes
5015	Yes
5016	Yes
5017	Yes
5018	Yes
5019	Yes
5020	Yes
5021	Yes
5022	Yes
5023	Yes
5024	Yes
5025	Yes
5026	Yes
5027	Yes
5028	Yes
5029	Yes

Type 5 randomized parameters are in a separate document.

TYPE 6 DETECTION PROBABILITY

Data Sheet for Hopping Signal				
Trial No.	Starting Index within NTIA August 2005 Sequence	Signal Generator Frequency (MHz)	Hops within Detection BW	Successful Detection (Yes/No)
1	288	5271	8	Yes
2	763	5272	12	Yes
3	1238	5273	9	Yes
4	1713	5274	7	Yes
5	2188	5275	10	Yes
6	2663	5276	9	Yes
7	3138	5277	7	Yes
8	3613	5278	7	Yes
9	4088	5279	8	Yes
10	4563	5280	8	Yes
11	5038	5281	7	Yes
12	5513	5282	8	Yes
13	5988	5283	8	Yes
14	6463	5284	9	Yes
15	6938	5285	8	Yes
16	7413	5286	12	Yes
17	7888	5287	9	Yes
18	8363	5288	7	Yes
19	8838	5289	10	Yes
20	9313	5290	13	Yes
21	9788	5291	11	Yes
22	10263	5292	9	Yes
23	10738	5293	4	Yes
24	11213	5294	3	Yes
25	11688	5295	9	Yes
26	12163	5296	9	Yes
27	12638	5297	8	Yes
28	13113	5298	7	Yes
29	13588	5299	5	Yes
30	14063	5300	5	Yes
31	14538	5301	11	Yes
32	15013	5302	6	Yes
33	15488	5303	9	Yes
34	15963	5304	9	Yes
35	16438	5305	11	Yes
36	16913	5306	10	Yes
37	17388	5307	8	Yes
38	17863	5308	6	Yes
39	18338	5309	7	Yes

5.7. SLAVE CONFIGURATION IN 40 MHz BANDWIDTH

5.7.1. PLOTS OF RADAR WAVEFORM AND WLAN TRAFFIC

PLOT OF RADAR WAVEFORM

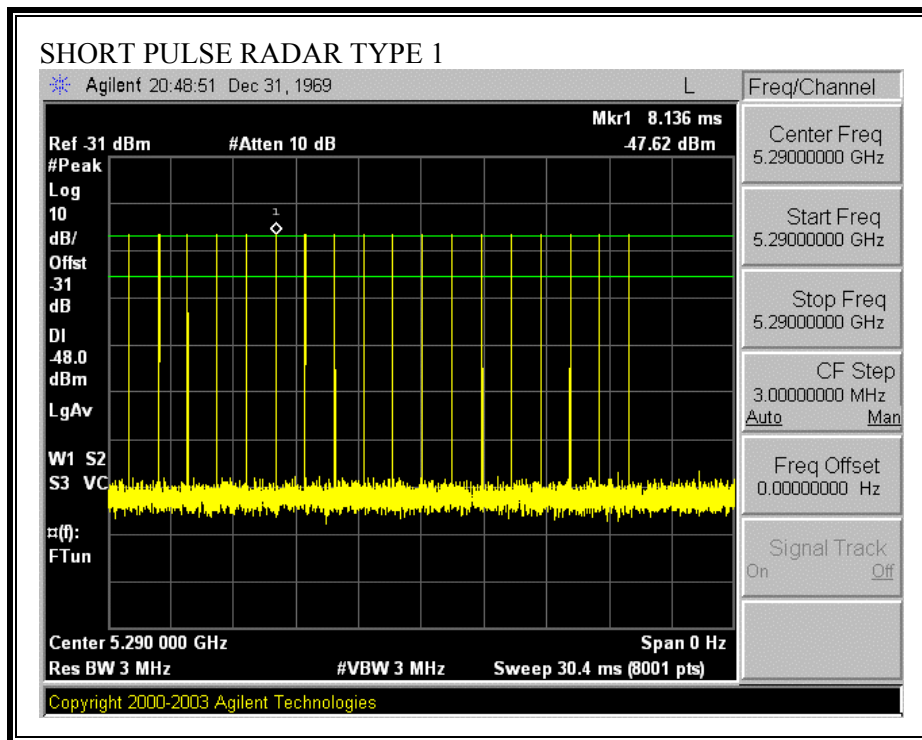

PLOT OF WLAN TRAFFIC FROM SLAVE

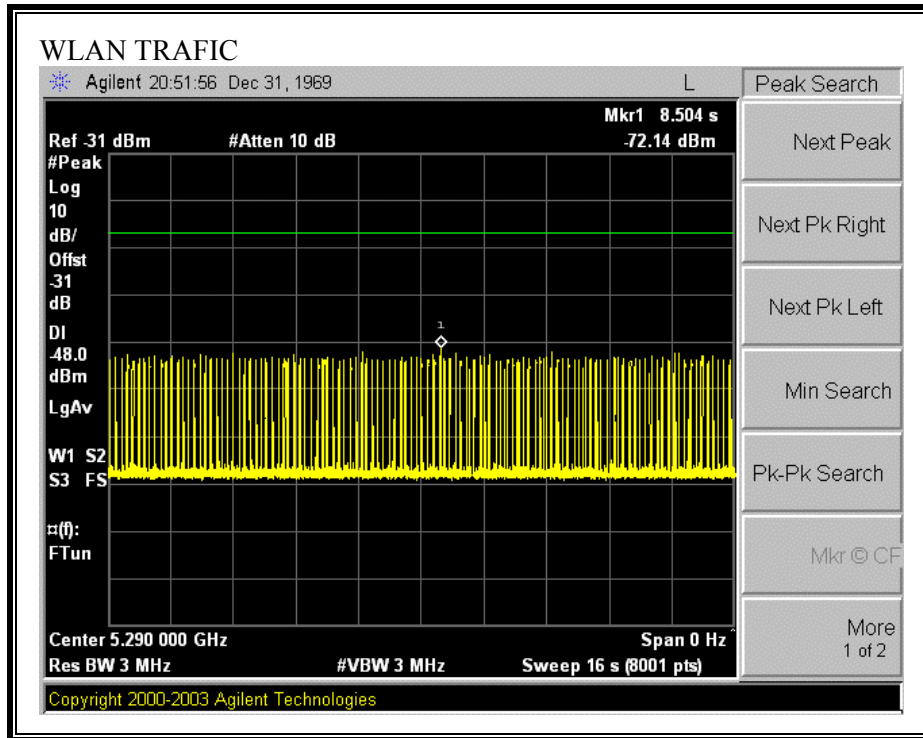

5.7.2. TEST CHANNEL AND METHOD

All tests were performed at a channel center frequency of 5290 MHz utilizing a conducted test method.

5.7.3. CHANNEL MOVE TIME AND CHANNEL CLOSING TRANSMISSION TIME

REPORTING NOTES

The reference marker is set at the end of last radar pulse.

The delta marker is set at the end of the last WLAN transmission following the radar pulse. This delta is the channel move time.

The aggregate channel closing transmission time is calculated as follows:

Aggregate Transmission Time =
(Number of analyzer bins showing transmission) * (dwell time per bin)

The observation period over which the aggregate time is calculated for the FCC version
Begins at (Reference Marker + 200 msec)
and
Ends no earlier than (Reference Marker + 10 sec).

The observation period over which the aggregate time is calculated for the IC version
Begins at (Reference Marker)
and
Ends no earlier than (Reference Marker + 10 sec).

CHANNEL MOVE TIME RESULTS

No non-compliance noted:

Channel Move Time (s)	Limit (s)
0.000	10

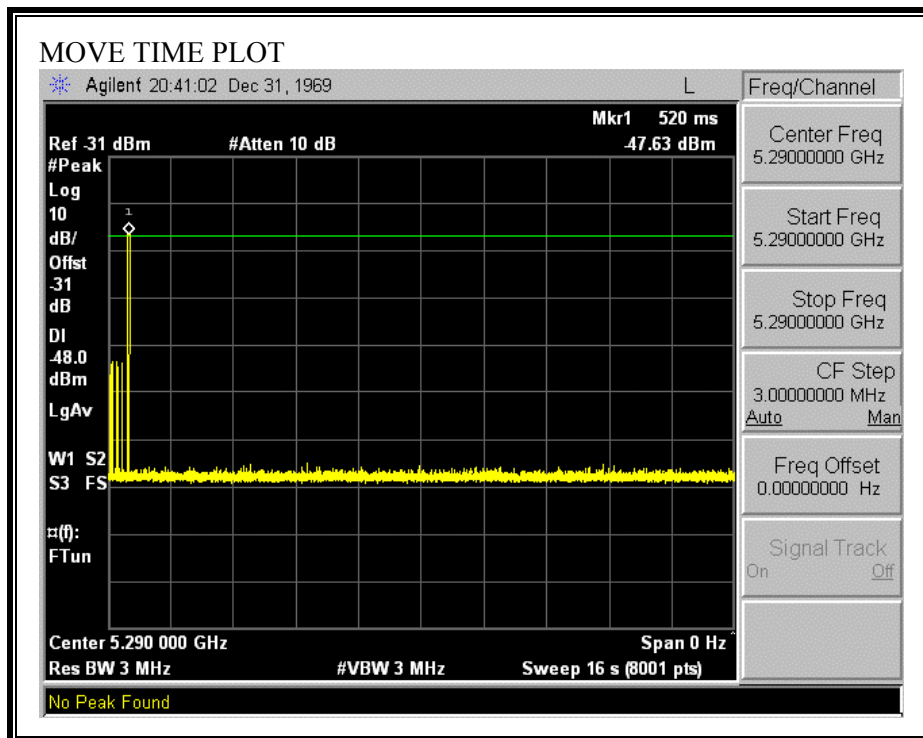

CHANNEL CLOSING TIME RESULTS

No non-compliance noted:

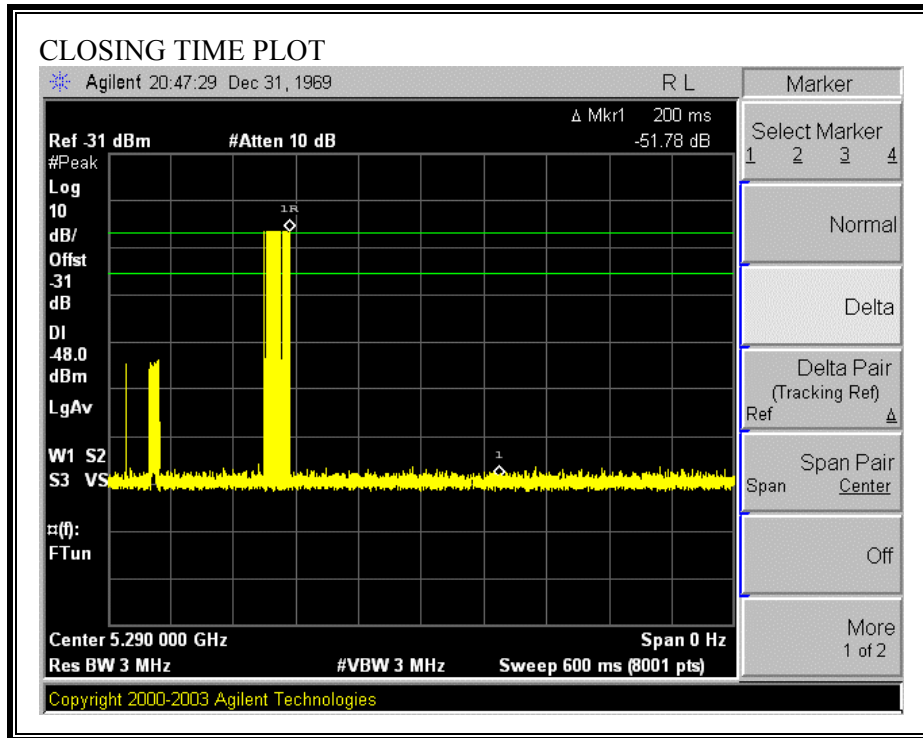

FCC AGGREGATE CHANNEL CLOSING TRANSMISSION TIME RESULTS

No non-compliance noted:

Aggregate Transmission Time (ms)	Limit (ms)	Margin (ms)
0.00	60	60.00

No transmissions are observed during the aggregate monitoring period.

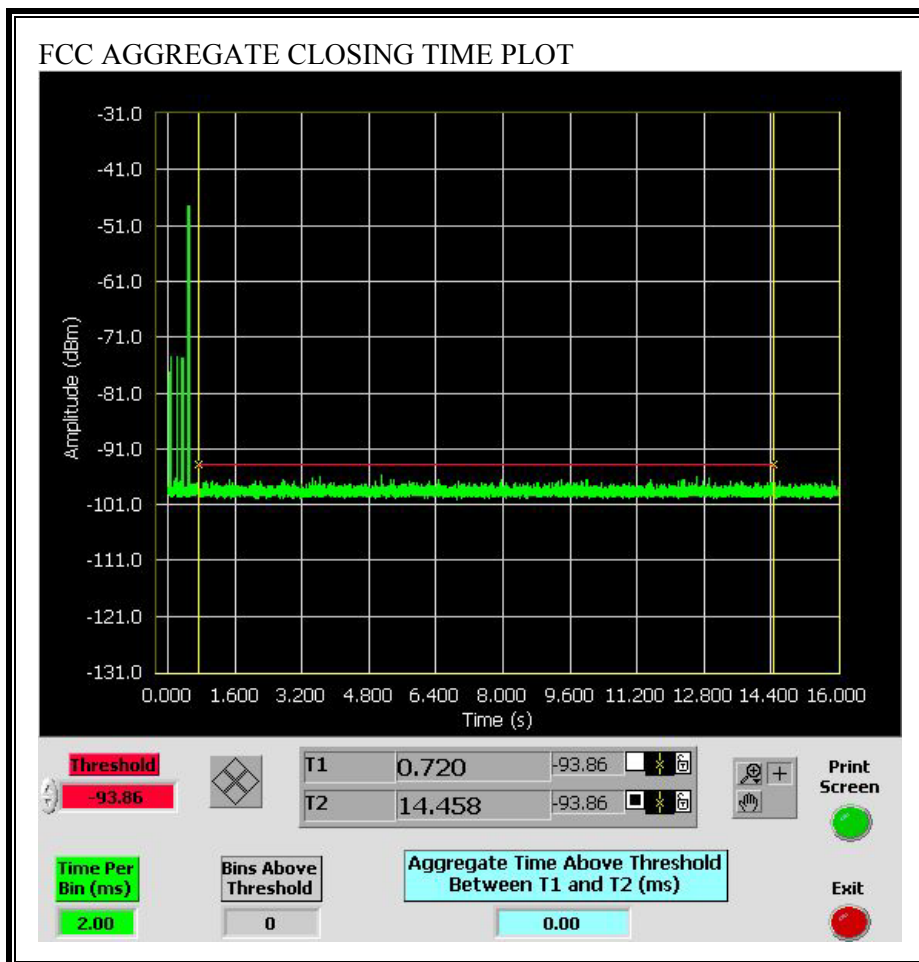

IC AGGREGATE CHANNEL CLOSING TRANSMISSION TIME RESULTS

No non-compliance noted:

Aggregate Transmission Time (ms)	Limit (ms)	Margin (ms)
0.00	260	260.00

No transmissions are observed during the aggregate monitoring period.

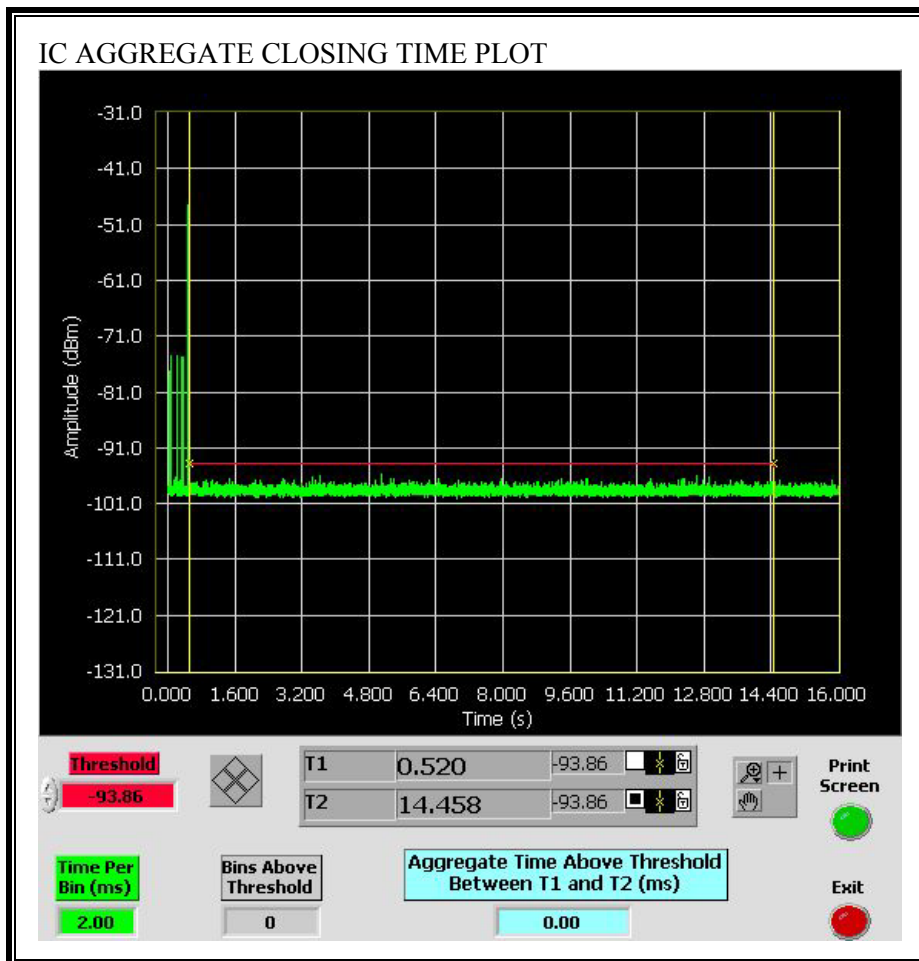

6. SETUP PHOTOS

DFS MEASUREMENT SETUP

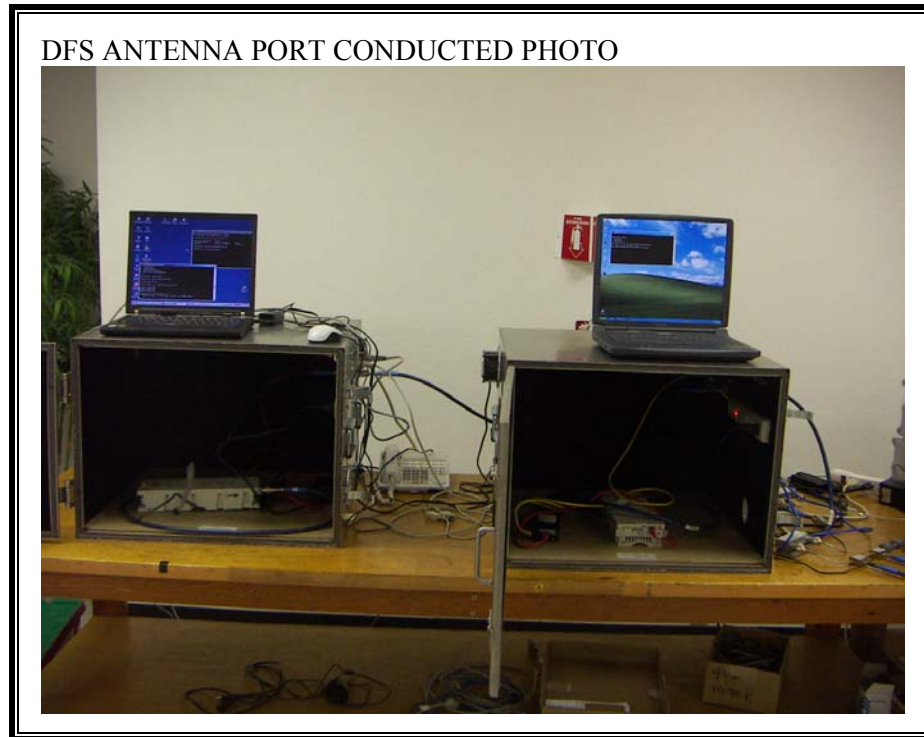

END OF REPORT