



Test Report No. 8912311553/1

For ALVARION Ltd.

Equipment Under Test:

BreezeMAX Extreme 5.4 Base station

Model: XTRM-BS-2SIS-5.4-Ext

**From The Standards Institution
Of Israel
Industry Division
Electronics & Telematics Laboratory
EMC Section**



ACCLASS Accreditation Services

Certificate Number: AT-1359



Test report No: 8912311553/1

Page 1 of 72 Pages

Title: BreezeMAX Extreme 5.4 Base station

Model: XTRM-BS-2SIS-5.4-Ext

FCC ID: LKT-EXTR-50

Table of Contents

1.	Applicant information.....	2
2.	Test performance.....	2
3.	Summary of test:.....	3
4.	Equipment under test description.....	4
4.1	General description	4
4.2	EUT configuration.....	5
5.	Test results.....	6
5.1	Transmitter characteristics	6
5.1.1	Peak output power test.....	6
5.1.2	Peak power density test § 15.407(a) (2)	16
5.1.3	Spurious emissions at antenna terminal § 15.407(b)(3)	22
5.1.4	Radiated spurious emissions test § 15.407(b)(3)	28
5.1.5	Peak excursion test	53
5.2	Radiated emissions test according to § 15.209.....	59
5.3	Conducted emissions test according to § 15.207	61
APPENDIX A	Photographs.....	65
APPENDIX B	Test equipment used	68
APPENDIX C	General information.....	72



Test report No: 8912311553/1

Page 2 of 72 Pages

Title: BreezeMAX Extreme 5.4 Base station

Model: XTRM-BS-2SIS-5.4-Ext

FCC ID: LKT-EXTR-50

1. Applicant information

Applicant:	Alvarion Ltd
Address:	21A Habarzel str, Tel-Aviv, 69710, Israel
Sample for test selected by:	The customer
The date of test:	February - March 2009; January 2011

Equipment under test information

Description of Equipment Under Test (EUT):	BreezeMAX Extreme 5.4 Base station
Model:	XTRM-BS-2SIS-5.4-Ext
Serial Number:	NA
Manufactured by:	Alvarion Ltd

2. Test performance

Location:	SII EMC Section
Purpose of test:	Apparatus compliance verification in accordance with emission requirements
Test specifications:	47CFR part 15.407, part 1 §1.1310

Reference Documents:

CFR 47 FCC:	Rules and Regulations; Part 15. "Radio frequency devices"; Subpart C: "Intentional radiators", Subpart E: "UNII devices"
--------------------	--

This Test Report contains 72 pages and may be used only in full.

This Test Report applies only to the specimen tested and may not be applied to other specimens of the same product.



Test report No: 8912311553/1

Page 3 of 72 Pages

Title: BreezeMAX Extreme 5.4 Base station

Model: XTRM-BS-2SIS-5.4-Ext

FCC ID: LKT-EXTR-50

3. Summary of test:

The EUT was found to be in compliance with requirements of: 47CFR Part 15 section 15.407

Transmitter characteristics	Subclasses
Peak output power	15.407(a)(2)
Peak power spectral density	15.407(a)(2)
Spurious emissions at antenna terminal	15.407(b)(3)
Out of band spurious emissions radiated	15.205, 15.407(b)(3)
Peak excursion test	15.407(a)(6)
Conducted emissions on AC power line	15.407(b)(6)
Unwanted radiated emissions below 1 GHz	15.407(b)(6)

Test performed by: Mr. Michael Feldman test technician

Test report prepared by: Mr. Michael Feldman test technician

Test report approved by: Mr. Yuri Rozenberg. Head of EMC Branch

Measurement uncertainty.

Were relevant, the following measurement uncertainty level have been estimated for tests performed on the EUT as specified in CISPR 16-4-2:

This uncertainty represents an expanded uncertainty expressed at approximately the 95% confidence level using a coverage factor of k=2.

Test description	Expanded uncertainty
<u>Radiated emissions</u> in the open field test site at 3 m measuring distance: 30 MHz – 1.0 GHz 1.0 GHz – 18 GHz	2 Uc (E) = ± 4.32 dB 2 Uc (E) = ± 4.47 dB

**Test report No:** 8912311553/1

Page 4 of 72 Pages

Title: BreezeMAX Extreme 5.4 Base station**Model:** XTRM-BS-2SIS-5.4-Ext

FCC ID: LKT-EXTR-50

4. Equipment under test description.

*The customer provided description.

4.1 General description

The BreezeMAX Extreme 5.4 Base station product is high-capacity WiMAX communication system. It shall be compatible with IEEE802.16e standard and support set of Alvarion's enhancements.

BreezeMAX Extreme 5.4 is digital modulated TDD system which covers 5470 MHz up to 5950 MHz range. The system contains a base station unit and a subscriber unit. The basic base station system configuration is all outdoor-box configurations.

The BTS Extreme is a low cost 16e mobile WiMAX solution. It should provide high performance and advanced feature set and complement Alvarion's macro-BTS solutions. This product family comes to provide wireless access solutions for the following deployment scenarios:

- Low cost Point to Multi Point wireless access mass deployments in emerging markets for licensed and un-licensed solutions to provide dual play services (Primary VoIP & Data).
- Vertical markets for video surveillance, security and municipalities markets solutions using products licensed and un-licensed portfolio.

Base station Extreme consists of the following main components: One or two 16e WiMax SoCs (System on Chip) with one or two Radio channels using integrated antenna or external antennas. In two Radio channels applications, one antenna is connected to each radio output port.

EUT technical characteristics

Transmitter technical characteristics.		Note	
Stand-alone/fixed use			
Assigned frequency range	5.470 GHz – 5.725 GHz		
Operating frequency range	5.475 GHz – 5.720 GHz	5 MHz EBW	
	5.480 GHz – 5.715 GHz	10 MHz EBW	
RF channel spacing	5 MHz, 10 MHz		
Maximum rated output power	22 dBm		
Antenna connection	N-type for external antenna	Professional installation	
Type of modulation	4QAM, 16QAM, 64QAM		
Type of multiplexing	OFDM		
Modulating test signal (baseband)	PRBS		
Maximum transmitter duty cycle in normal use	60 %		
Transmitter duty cycle supplied for test	100%		
Antenna information			
Type	Manufacturer	Model	Gain
External, sector	MTI	AN1353	17 dBi
External, Omni	MTI	AN1299	8 dBi
Internal dual slant	MTI	AN1427-01	15.5 dBi

Test report No: 8912311553/1

Page 5 of 72 Pages

Title: BreezeMAX Extreme 5.4 Base station

Model: XTRM-BS-2SIS-5.4-Ext

FCC ID: LKT-EXTR-50

4.1.1 Environmental evaluation and exposure limit according to FCC CFR 47 part 1, §1.1307, §1.1310

Limit for power density for general population/uncontrolled exposure is 1(mW/cm²) or 10 (W/m²).

The power density calculation is $S = (Pt / 4\pi r^2)$.

Where

Pt - The transmitted power (EIRP) (mW)

r - The distance from the unit. (cm)

The limit 1(mW/cm²) can be calculated from the above based on the following data:

Pt- the transmitted power which is equal to the maximum output power 20.7 dBm plus external antenna gain 8 dBi. The maximum EIRP = 28.7 dBm = 741.3 mW.

Maximum allowed distance “r”, where RF exposure limits may not be exceeded, = SQRT(741.3/4π) and is more than 8 cm from the antenna main lobe.

4.2 EUT configuration

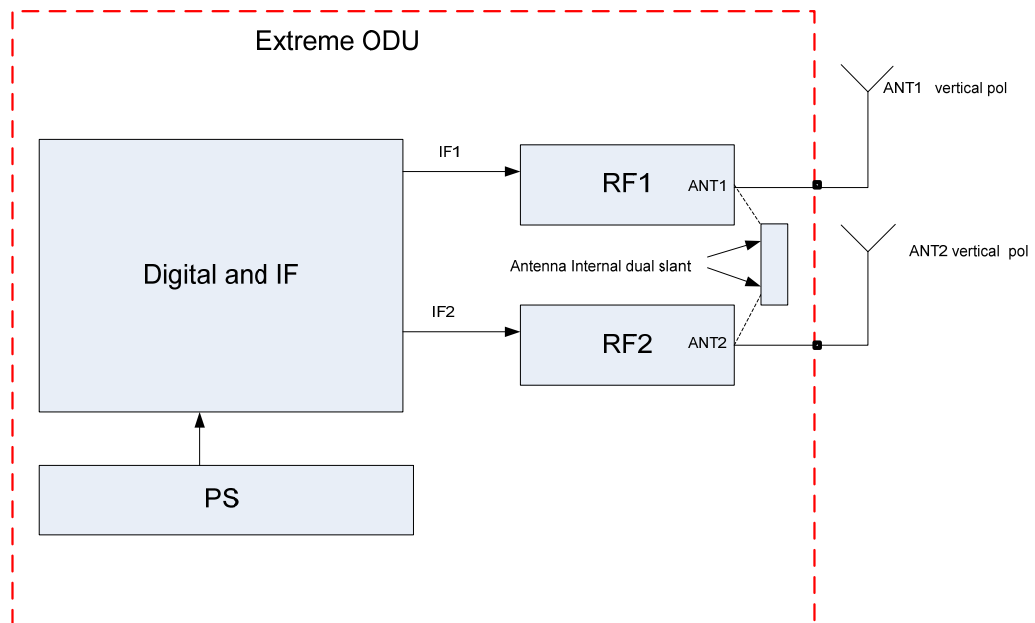

Fig. 1 BreezeMax Exteme block diagram.



Test report No: 8912311553/1

Page 6 of 72 Pages

Title: BreezeMAX Extreme 5.4 Base station

Model: XTRM-BS-2SIS-5.4-Ext

FCC ID: LKT-EXTR-50

5. Test results

5.1 Transmitter characteristics

5.1.1 Peak output power test

Method of measurement DA 02-2138
 Operating Frequency Range 5.475 – 5.720 GHz
 Ambient Temperature 23⁰ C Relative Humidity 49% Air Pressure 1009 hPa

The peak transmit power shall not exceed the lesser of 250mW or 11dBm + 10 log B, where B is the 26 dB emission bandwidth in MHz. as required in sec. 15.407 (a)(2).

Calculated limit for 5 MHz EBW is 11 + 10 log 5.33 MHz = 18.3 dBm

Calculated limit for 10 MHz EBW is 11 + 10 log 10.5 MHz = 21.2 dBm

RF channel 1

5 MHz emission bandwidth

Carrier frequency MHz	Measured 26 dB bandwidth, MHz	Measured Peak output power, dBm	Reference to plot #
5475	5.30	16.9	1, 4
5580	4.91	17.5	2, 5
5720	5.33	16.9	3, 6

10 MHz emission bandwidth

Carrier frequency MHz	Measured 26 dB bandwidth, MHz	Measured Peak output power, dBm	Reference to plot #
5480	10.2	20.2	7, 10
5580	9.54	20.3	8, 11
5715	10.2	20.3	9, 12

RF channel 2

5 MHz emission bandwidth

Carrier frequency MHz	Measured 26 dB bandwidth, MHz	Measured Peak output power, dBm	Reference to plot #
5475	5.32	17.2	13, 16
5580	4.91	17.3	14, 17
5720	5.32	17.6	15, 18



Test report No: 8912311553/1 **Page 7 of 72 Pages**
Title: BreezeMAX Extreme 5.4 Base station
Model: XTRM-BS-2SIS-5.4-Ext **FCC ID:** LKT-EXTR-50

10 MHz emission bandwidth

Carrier frequency MHz	Measured 26 dB bandwidth, MHz	Measured Peak output power, dBm	Reference to plot #
5480	10.5	20.7	19, 22
5580	9.5	19.7	20, 23
5715	10.4	20.3	21, 24

TEST PROCEDURE

Test was performed at worse case output power without correlation to antenna gain. The measurements were performed at three transmitted carrier (channel) frequencies at bottom, middle and top of the 5.470 – 5.725 GHz frequency band under maximum data transfer bit rate. The EUT RF output was connected to the Spectrum Analyzer through appropriate attenuator and accounted with cable loss in SA settings.

TEST EQUIPMENT USED:

2	3	4	5			
---	---	---	---	--	--	--



Test report No: 8912311553/1
Title: BreezeMAX Extreme 5.4 Base station
Model: XTRM-BS-2SIS-5.4-Ext

Page 8 of 72 Pages
FCC ID: LKT-EXTR-50

RF channel 1

5 MHz BW option. 26 dB EBW results.

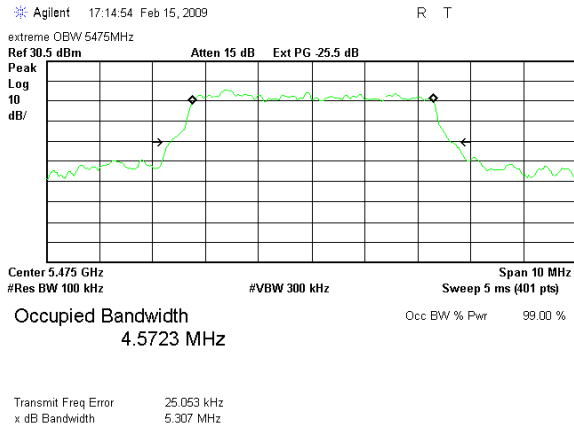

Plot # 1. Carrier Frequency 5475 MHz

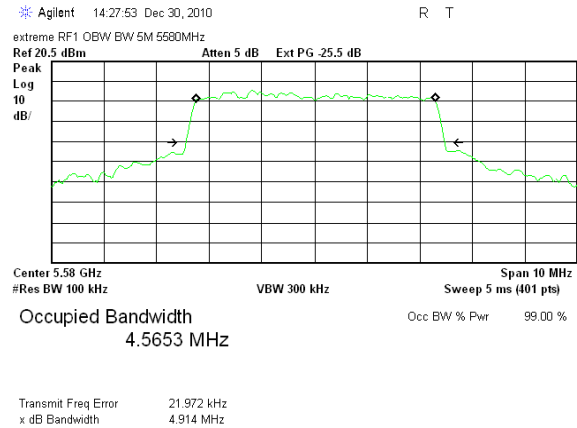

Plot # 2. Carrier Frequency 5580 MHz

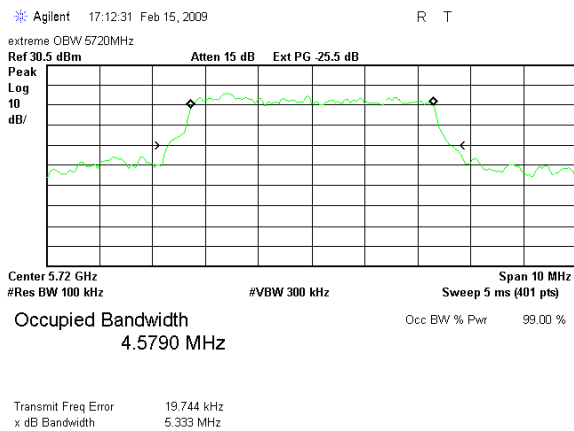

Plot # 3. Carrier Frequency 5720 MHz

Insertion loss of external attenuator, directional coupler and cable = 25.5 dB



Test report No: 8912311553/1
Title: BreezeMAX Extreme 5.4 Base station
Model: XTRM-BS-2SIS-5.4-Ext

Page 9 of 72 Pages
FCC ID: LKT-EXTR-50

5 MHz BW option. Peak output power results

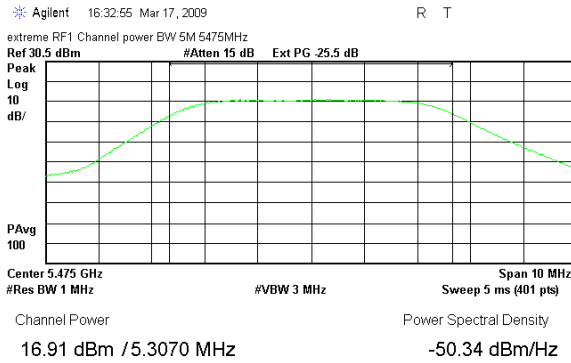

Plot # 4. Carrier Frequency 5475 MHz

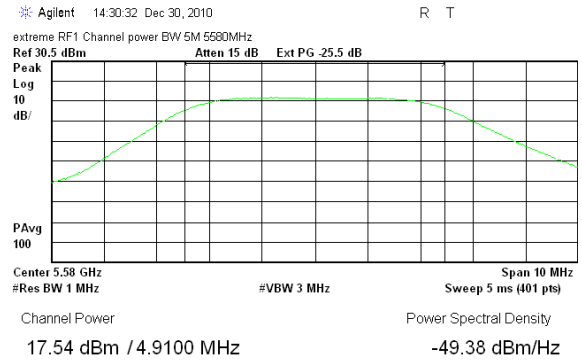

Plot # 5. Carrier Frequency 5580 MHz

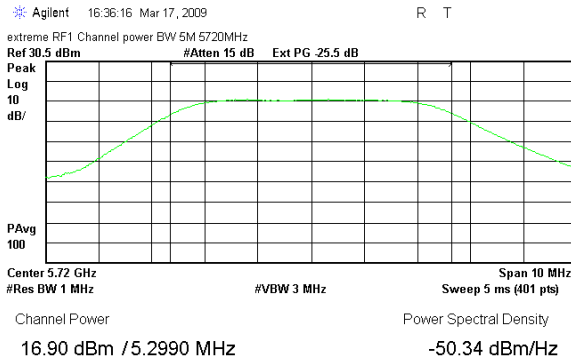

Plot # 6. Carrier Frequency 5720 MHz



Test report No: 8912311553/1
Title: BreezeMAX Extreme 5.4 Base station
Model: XTRM-BS-2SIS-5.4-Ext

Page 10 of 72 Pages
FCC ID: LKT-EXTR-50

10 MHz BW option. 26 dB EBW results.

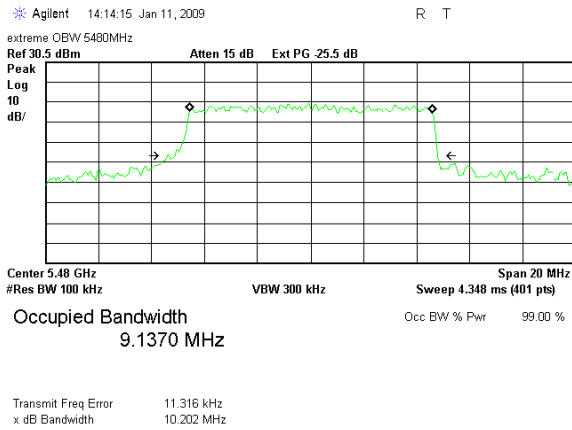

Plot # 7. Carrier Frequency 5480 MHz

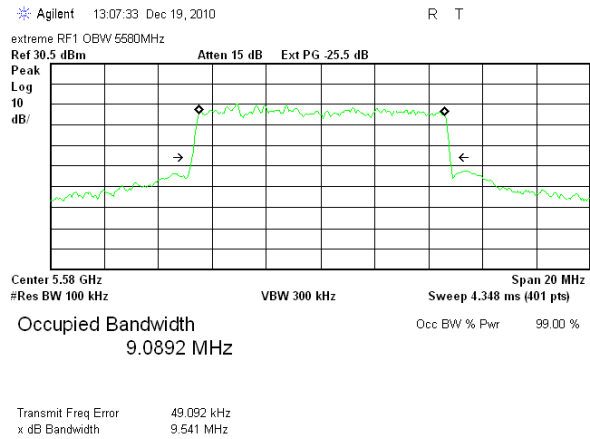

Plot # 8. Carrier Frequency 5580 MHz

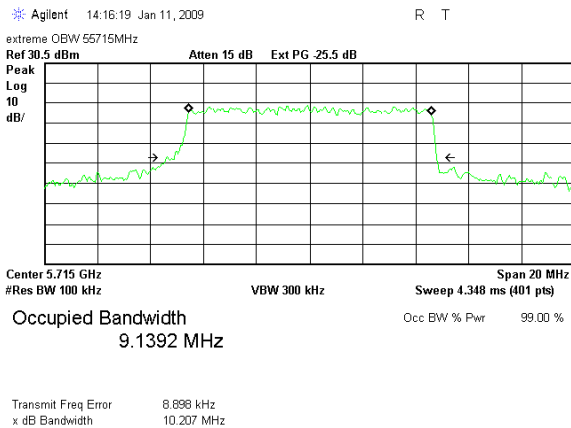

Plot # 9. Carrier Frequency 5715 MHz



Test report No: 8912311553/1
Title: BreezeMAX Extreme 5.4 Base station
Model: XTRM-BS-2SIS-5.4-Ext

Page 11 of 72 Pages
FCC ID: LKT-EXTR-50

10 MHz BW option. Peak output power results

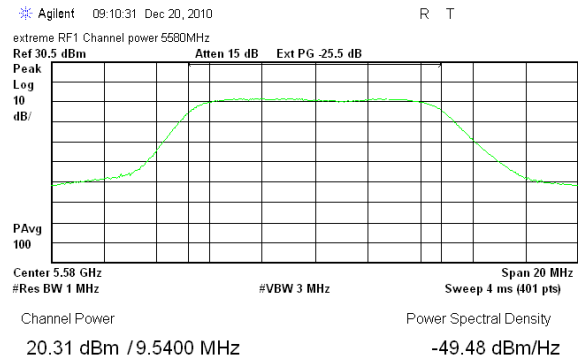
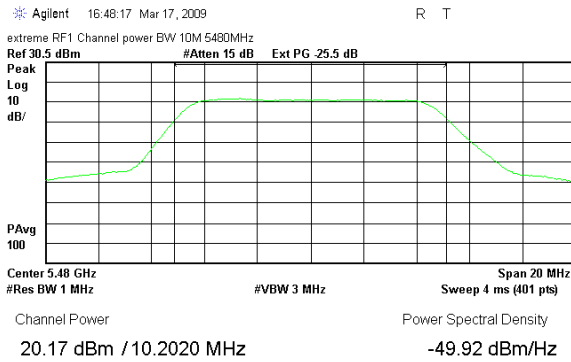

Plot # 10. Carrier Frequency 5480 MHz

Plot # 11. Carrier Frequency 5580 MHz

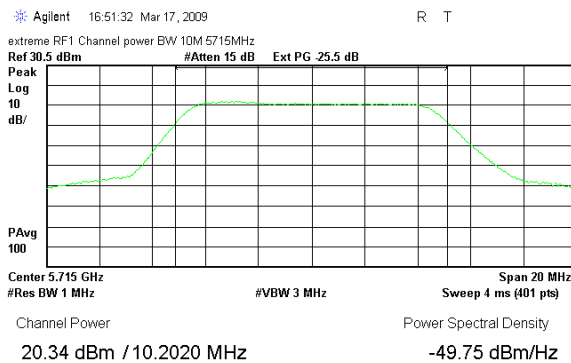

Plot # 12. Carrier Frequency 5715 MHz

Insertion loss of external attenuator, directional coupler and cable = 25.5 dB



Test report No: 8912311553/1
Title: BreezeMAX Extreme 5.4 Base station
Model: XTRM-BS-2SIS-5.4-Ext

Page 12 of 72 Pages
FCC ID: LKT-EXTR-50

RF channel 2

5 MHz BW option. 26 dB EBW results.

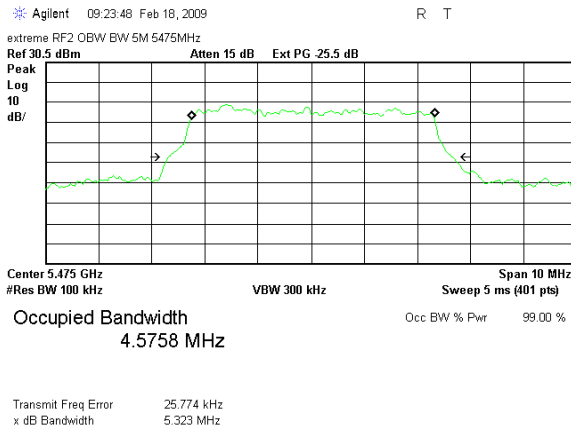

Plot # 13. Carrier Frequency 5475 MHz

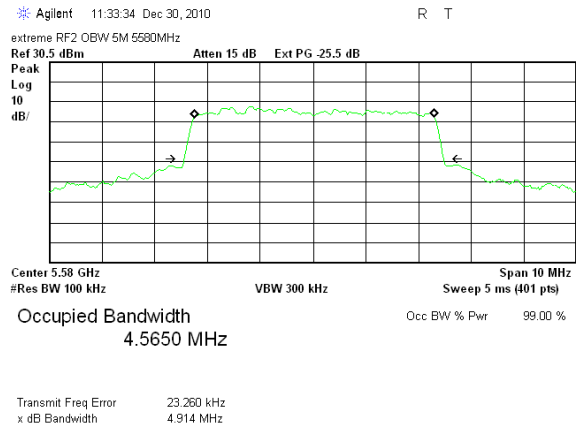

Plot # 14. Carrier Frequency 5580 MHz

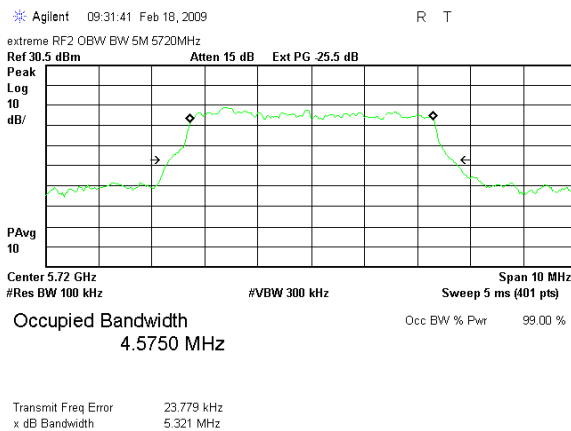

Plot # 15. Carrier Frequency 5720 MHz



Test report No: 8912311553/1
Title: BreezeMAX Extreme 5.4 Base station
Model: XTRM-BS-2SIS-5.4-Ext

Page 13 of 72 Pages
FCC ID: LKT-EXTR-50

5 MHz BW option. Peak output power results

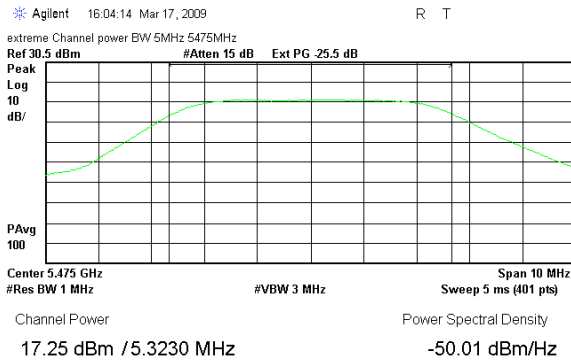

Plot # 16. Carrier Frequency 5475 MHz

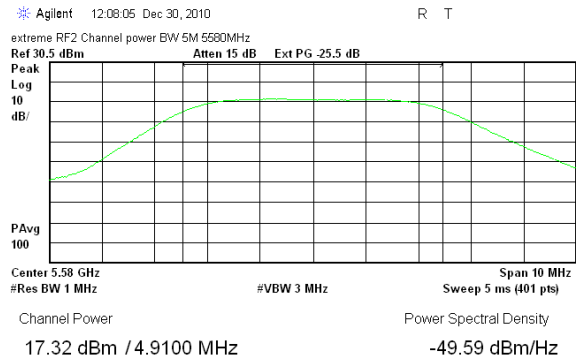

Plot # 17. Carrier Frequency 5580 MHz

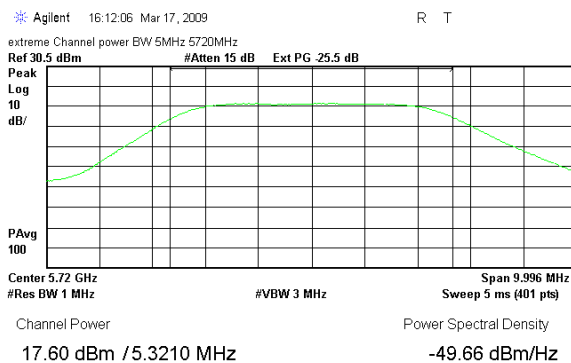

Plot # 18. Carrier Frequency 5720 MHz



Test report No: 8912311553/1
Title: BreezeMAX Extreme 5.4 Base station
Model: XTRM-BS-2SIS-5.4-Ext

Page 14 of 72 Pages
FCC ID: LKT-EXTR-50

10 MHz BW option. 26 dB EBW results.

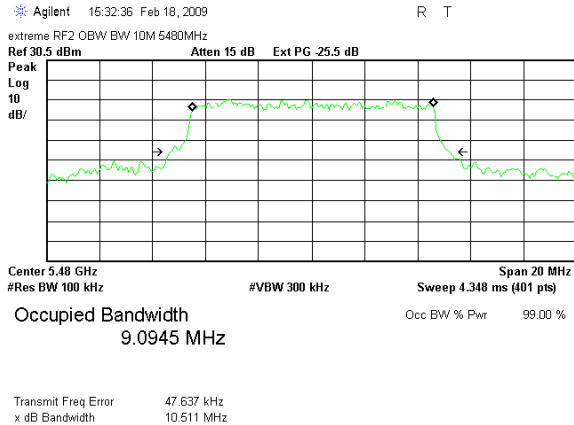

Plot # 19. Carrier Frequency 5480 MHz

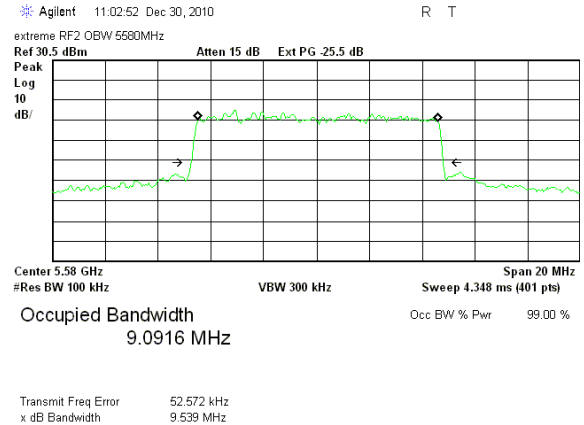

Plot # 20. Carrier Frequency 5580 MHz

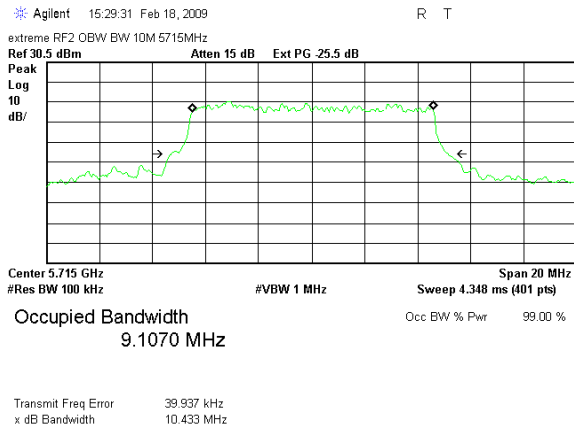

Plot # 21. Carrier Frequency 5715 MHz



Test report No: 8912311553/1
Title: BreezeMAX Extreme 5.4 Base station
Model: XTRM-BS-2SIS-5.4-Ext

Page 15 of 72 Pages
FCC ID: LKT-EXTR-50

10 MHz BW option. Peak output power results

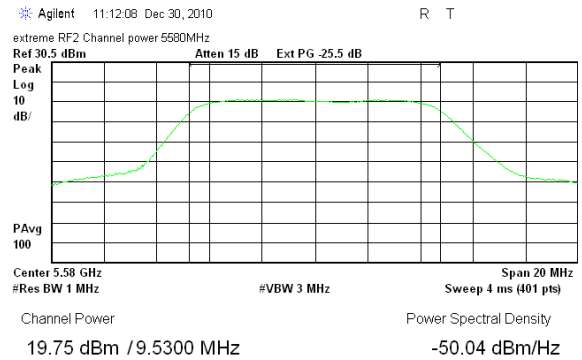
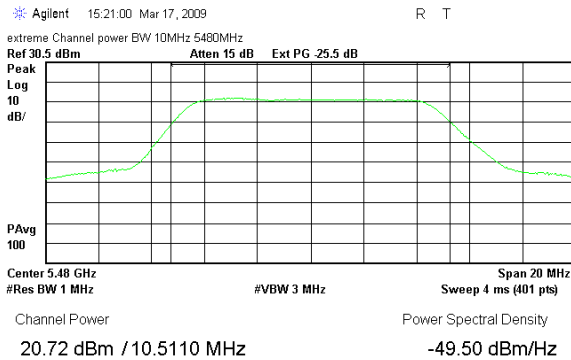

Plot # 22. Carrier Frequency 5480 MHz

Plot # 23. Carrier Frequency 5580 MHz

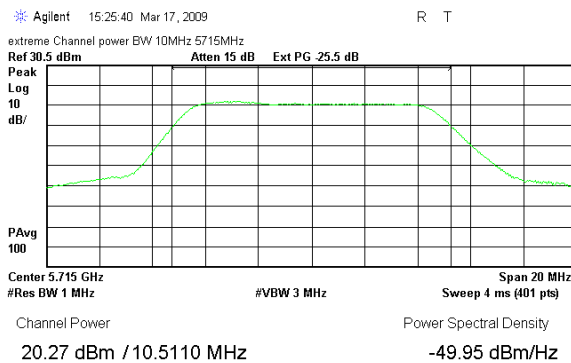

Plot # 24. Carrier Frequency 5715 MHz



Test report No: 8912311553/1

Page 16 of 72 Pages

Title: BreezeMAX Extreme 5.4 Base station

Model: XTRM-BS-2SIS-5.4-Ext

FCC ID: LKT-EXTR-50

5.1.2 Peak power density test § 15.407(a) (2)

Method of measurement DA 02-2138
 Operating Frequency Range 5.480 – 5.715 GHz
 Ambient Temperature 21⁰ C Relative Humidity 54% Air Pressure 1011 hPa

The peak power spectral density shall not exceed 11 dBm in any 1 MHz band.

RF channel 1

5 MHz emission bandwidth

Carrier frequency MHz	Peak power density. dBm	PSD Limit dBm	Reference to plot #
5475	5.30	11.0	25
5580	6.00	11.0	26
5720	4.93	11.0	27

10 MHz emission bandwidth

Carrier frequency MHz	Peak power density. dBm	PSD Limit dBm	Reference to plot #
5480	6.15	11.0	28
5580	5.38	11.0	29
5715	6.32	11.0	30

RF channel 2

5 MHz emission bandwidth

Carrier frequency MHz	Peak power density. dBm	PSD Limit dBm	Reference to plot #
5475	5.93	11.0	31
5580	5.09	11.0	32
5720	5.82	11.0	33

10 MHz emission bandwidth

Carrier frequency MHz	Peak power density. dBm	PSD Limit dBm	Reference to plot #
5480	6.86	11.0	34
5580	5.34	11.0	35
5715	6.34	11.0	36



Test report No: 8912311553/1

Page 17 of 72 Pages

Title: BreezeMAX Extreme 5.4 Base station

Model: XTRM-BS-2SIS-5.4-Ext

FCC ID: LKT-EXTR-50

TEST PROCEDURE

Test was performed at worse case output power without correlation to antenna gain. The measurements were performed according to procedure DA 02-2138 August 2002 at three transmitted carrier (channel) frequencies at bottom, middle and top of the 5.470 GHz – 5.725 GHz frequency band under maximum data transfer bit rate. The EUT RF output was connected to the Spectrum Analyzer through appropriate attenuator and accounted with cable loss in SA settings.

TEST EQUIPMENT USED:

2	3	4	5			
---	---	---	---	--	--	--



Test report No: 8912311553/1
Title: BreezeMAX Extreme 5.4 Base station
Model: XTRM-BS-2SIS-5.4-Ext

Page 18 of 72 Pages
FCC ID: LKT-EXTR-50

RF channel 1

5 MHz EBW. Peak power spectral density test results.

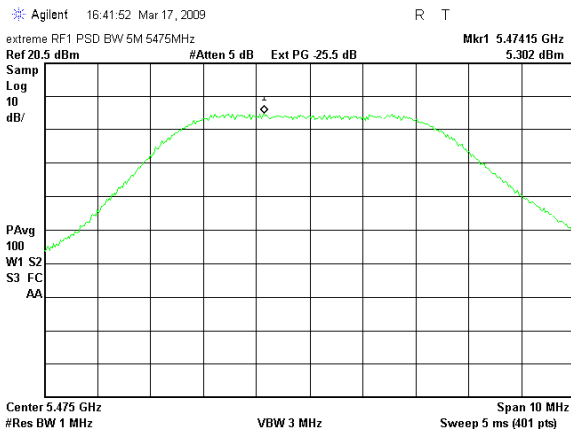

Plot # 25. Carrier Frequency 5475 MHz

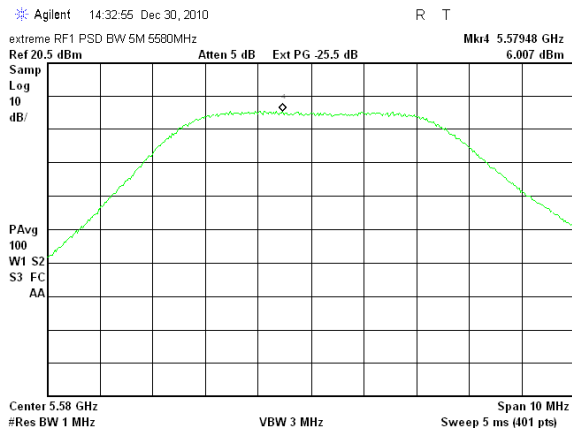

Plot # 26. Carrier Frequency 5580 MHz

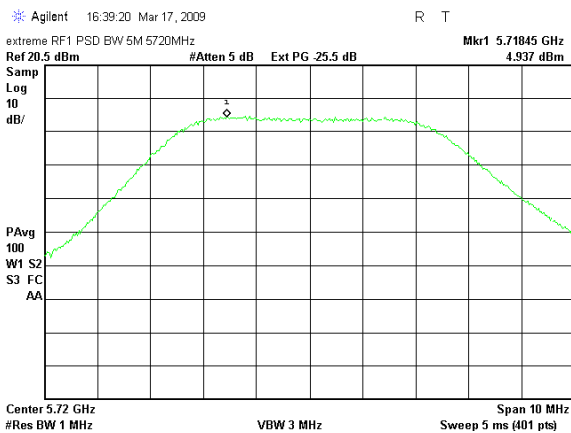

Plot # 27. Carrier Frequency 5720 MHz

Insertion loss of external attenuator, directional coupler and cable = 25.5 dB



Test report No: 8912311553/1
Title: BreezeMAX Extreme 5.4 Base station
Model: XTRM-BS-2SIS-5.4-Ext

Page 19 of 72 Pages
FCC ID: LKT-EXTR-50

10 MHz EBW. Peak power spectral density test results.

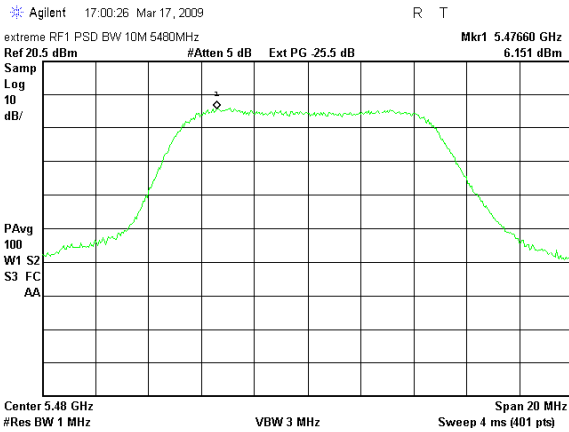

Plot # 28. Carrier Frequency 5480 MHz

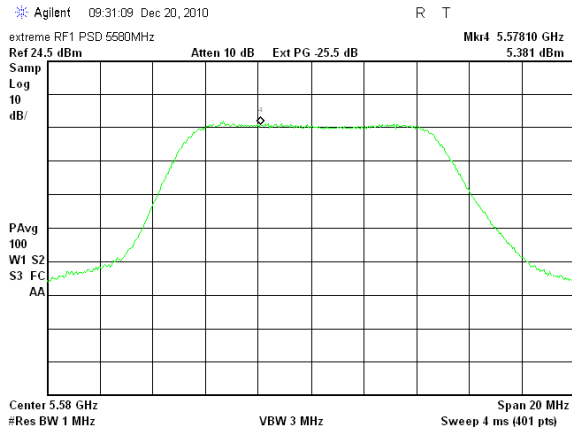

Plot # 29. Carrier Frequency 5580 MHz

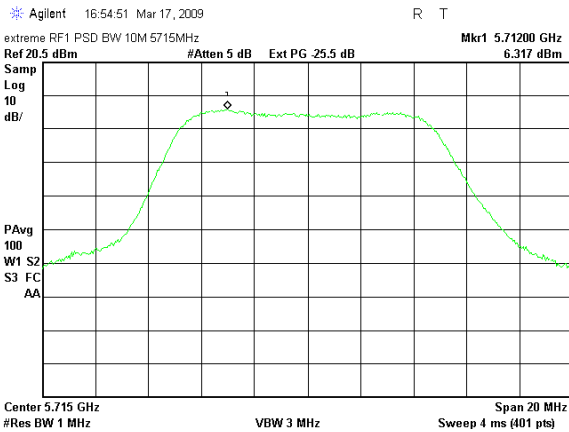

Plot # 30. Carrier Frequency 5715 MHz



Test report No: 8912311553/1
Title: BreezeMAX Extreme 5.4 Base station
Model: XTRM-BS-2SIS-5.4-Ext

Page 20 of 72 Pages
FCC ID: LKT-EXTR-50

RF channel 2

5 MHz EBW. Peak power spectral density test results.

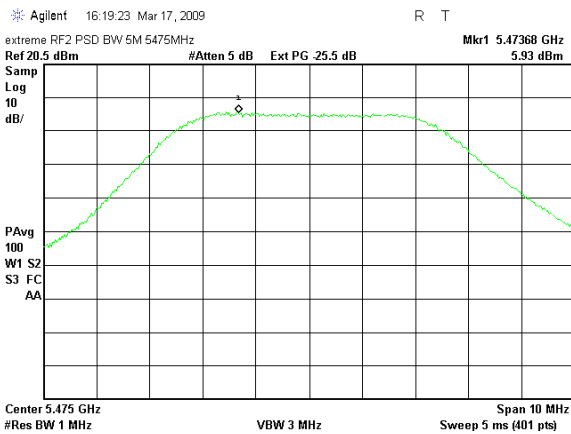

Plot # 31. Carrier Frequency 5475 MHz

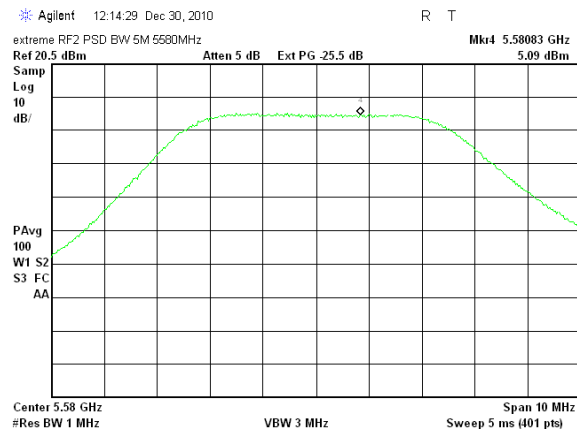

Plot # 32. Carrier Frequency 5580 MHz

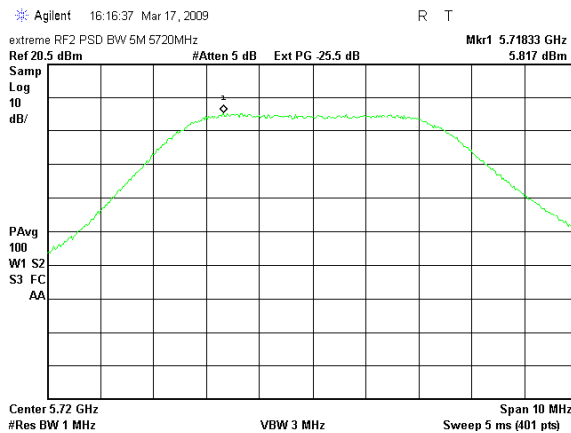

Plot # 33. Carrier Frequency 5720 MHz



Test report No: 8912311553/1
Title: BreezeMAX Extreme 5.4 Base station
Model: XTRM-BS-2SIS-5.4-Ext

Page 21 of 72 Pages
FCC ID: LKT-EXTR-50

10 MHz EBW. Peak power spectral density test results.

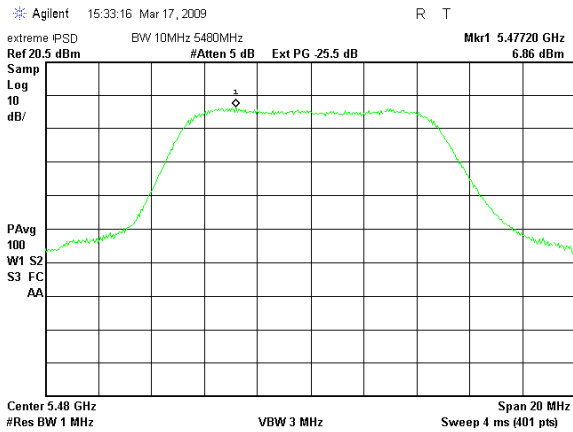

Plot # 34. Carrier Frequency 5480 MHz

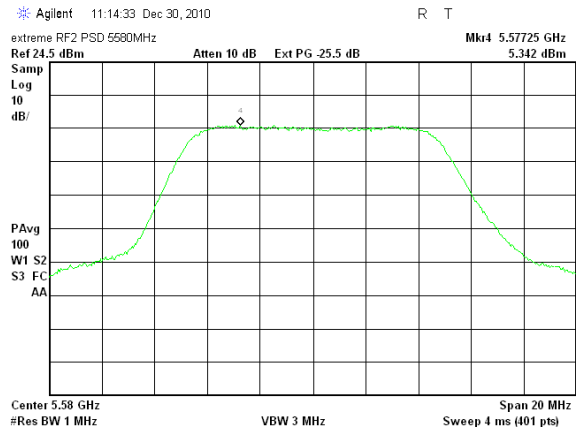

Plot # 35. Carrier Frequency 5580 MHz

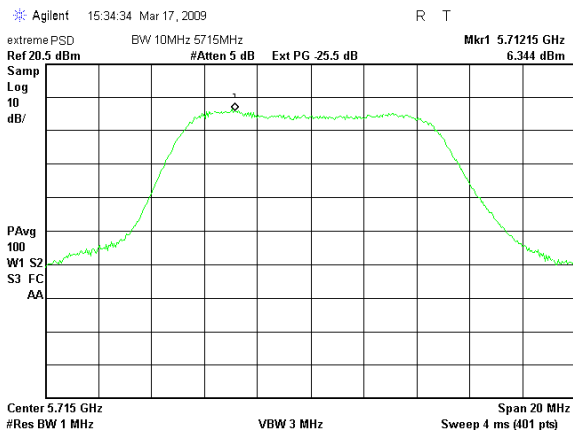

Plot # 36. Carrier Frequency 5715 MHz



Test report No: 8912311553/1	Page 22 of 72 Pages
Title: BreezeMAX Extreme 5.4 Base station	
Model: XTRM-BS-2SIS-5.4-Ext	FCC ID: LKT-EXTR-50

5.1.3 Spurious emissions at antenna terminal § 15.407(b)(3)

Operating Frequency Range 5.475 – 5.720 GHz
Ambient Temperature 21° C Relative Humidity 49% Air Pressure 1009 hPa

The frequency spectrum was investigated from the lowest radio frequency signal generated in the equipment up to 40 GHz. The emission levels 20 dB lower than specified limit were not recorded in the tables. No emissions closer to limit except band-edge point were found.

5 MHz emission bandwidth

Frequency, MHz	Spurious emission level, dBm	EIRP limit, dBm/MHz	Margin dB	Reference to plot #
5470	-32.8	-27	5.8	38
5725	-30.5	-27	3.5	41

10 MHz emission bandwidth

Frequency, MHz	Spurious emission level, dBm	EIRP limit, dBm/MHz	Margin dB	Reference to plot #
5470	-32.2	-27	5.2	44
5725	-34.8	-27	7.8	48

LIMIT

For operation in the band 5470 - 5725 MHz all emissions outside of the band shall not exceed an EIRP of -27dBm/MHz. At 5600 – 5650 MHz frequency band any emissions shall be at least 20 dB below the carrier.

TEST PROCEDURE

The test was performed at worse case mode at maximum allowed output power at three transmitted carrier (channel) frequencies at bottom, middle and top of the 5.470 GHz – 5.725 GHz frequency band under maximum data transfer bit rate. Additional test was performed at 5600 – 5650 MHz frequency band to approve that any emissions inside this band is 20 dB below the carrier frequency. The EUT RF output was connected to the Spectrum Analyzer through appropriate attenuator and accounted with cable loss in SA settings.

TEST EQUIPMENT USED:

1	2	3	5			
---	---	---	---	--	--	--



Test report No: 8912311553/1
Title: BreezeMAX Extreme 5.4 Base station
Model: XTRM-BS-2SIS-5.4-Ext

Page 23 of 72 Pages

FCC ID: LKT-EXTR-50

5 MHz emission bandwidth

Frequency carrier 5475 MHz.

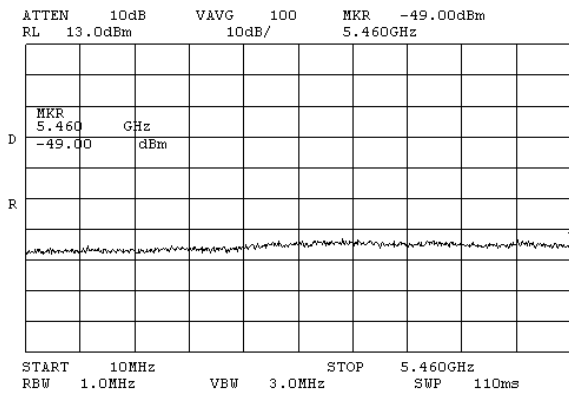

Plot # 37

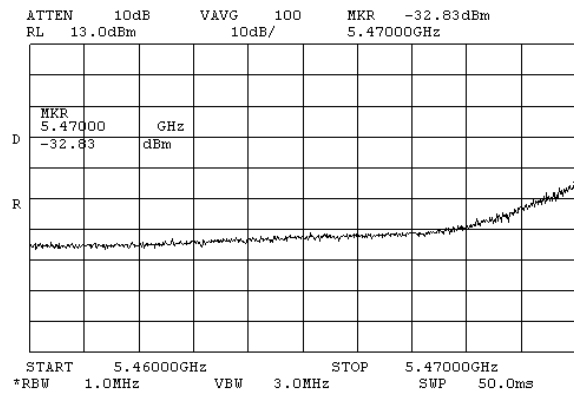

Plot # 38

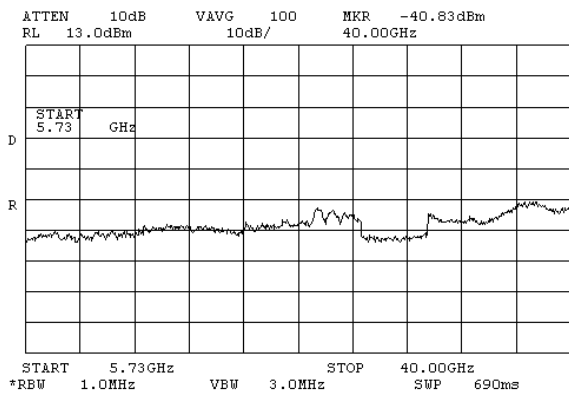

Plot # 39

Insertion loss of external attenuator and cable = 25.5 dB



Test report No: 8912311553/1
Title: BreezeMAX Extreme 5.4 Base station
Model: XTRM-BS-2SIS-5.4-Ext

Page 24 of 72 Pages
FCC ID: LKT-EXTR-50

Frequency carrier 5720 MHz.

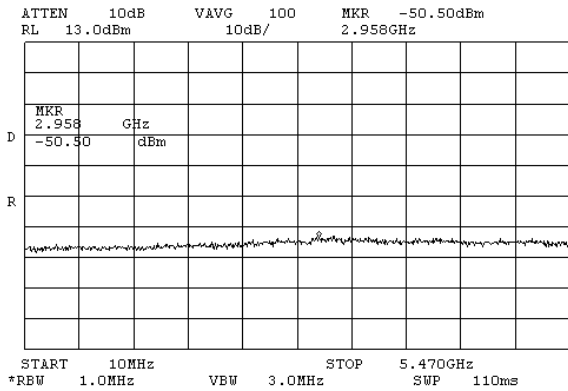

Plot # 40

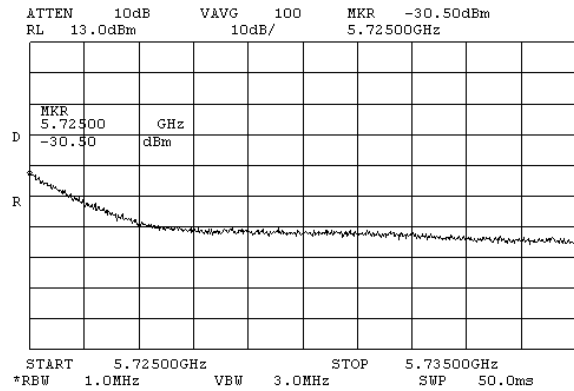

Plot # 41

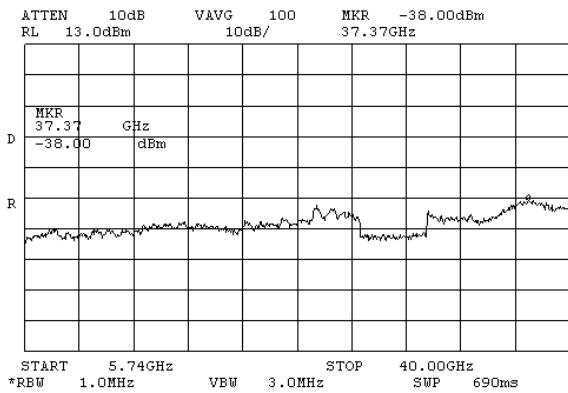

Plot # 42



Test report No: 8912311553/1
Title: BreezeMAX Extreme 5.4 Base station
Model: XTRM-BS-2SIS-5.4-Ext

Page 25 of 72 Pages
FCC ID: LKT-EXTR-50

10 MHz emission bandwidth

Frequency carrier 5480 MHz

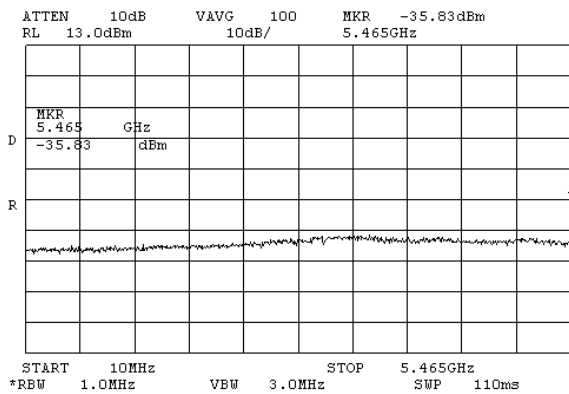

Plot # 43

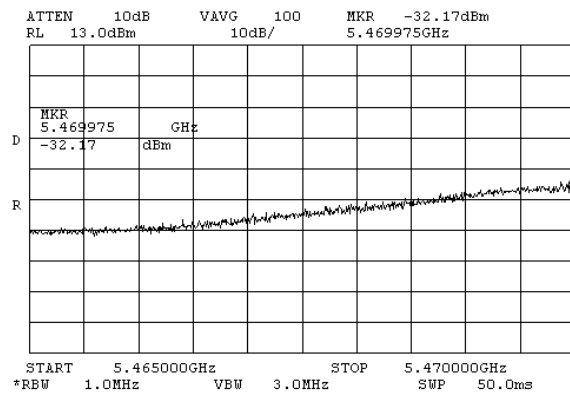

Plot # 44

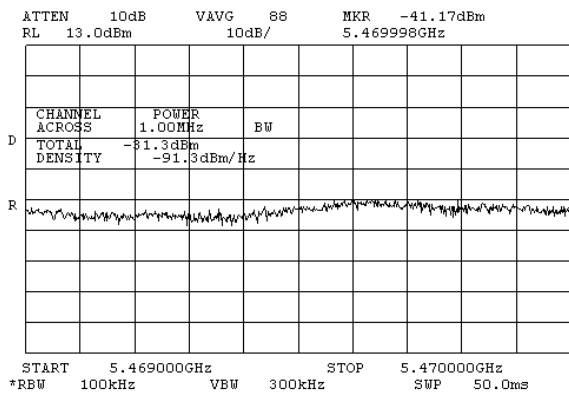

Plot # 45

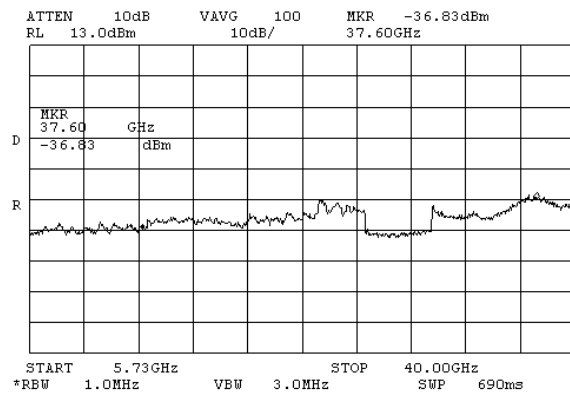

Plot # 46



Test report No: 8912311553/1

Title: BreezeMAX Extreme 5.4 Base station

Model: XTRM-BS-2SIS-5.4-Ext

Page 26 of 72 Pages

FCC ID: LKT-EXTR-50

Frequency carrier 5715 MHz.

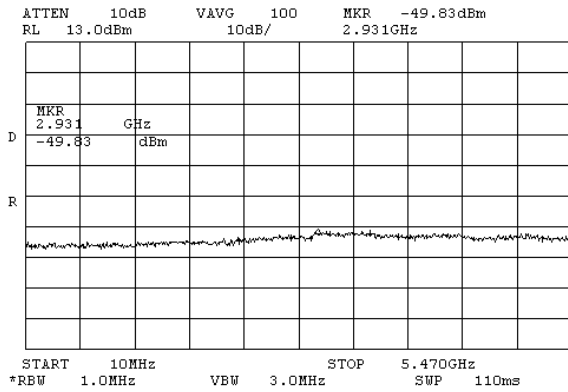

Plot # 47

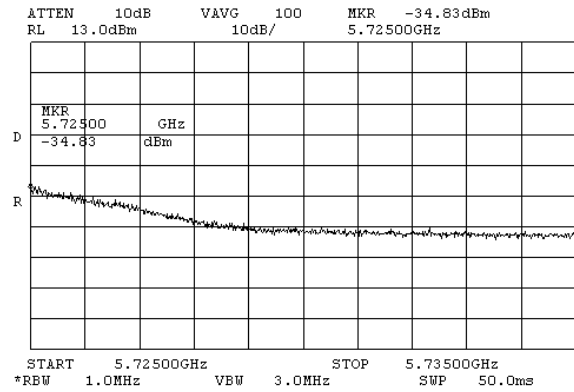

Plot # 48

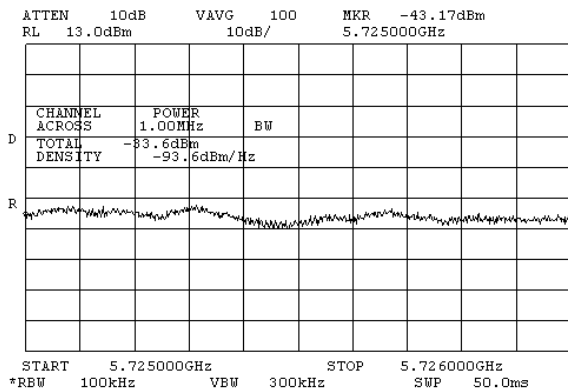

Plot # 49

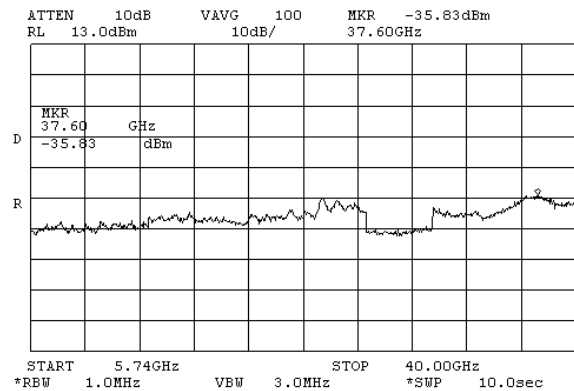

Plot # 50



Test report No: 8912311553/1
Title: BreezeMAX Extreme 5.4 Base station
Model: XTRM-BS-2SIS-5.4-Ext

Page 27 of 72 Pages
FCC ID: LKT-EXTR-50

5 MHz emission bandwidth

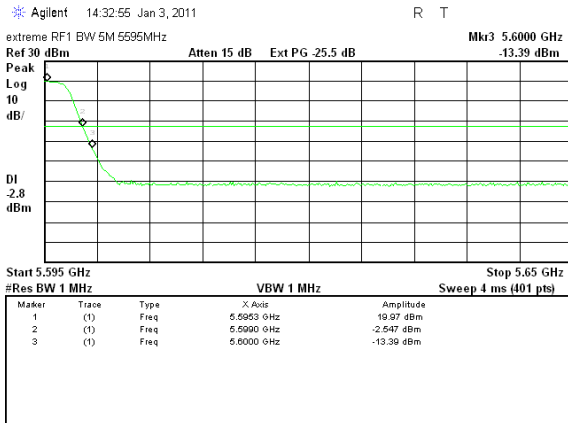

Plot # 51. Fc - 5595 MHz

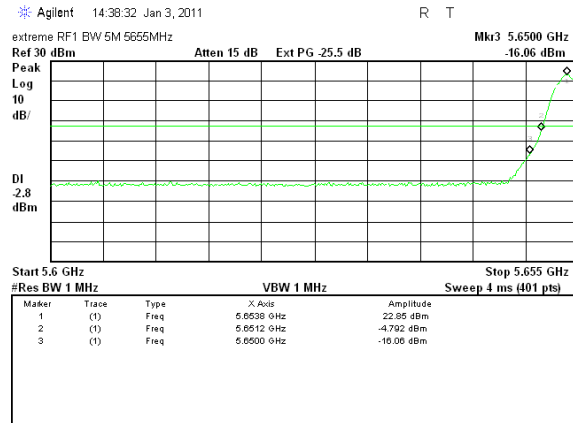

Plot # 52. Fc - 5655 MHz

10 MHz emission bandwidth

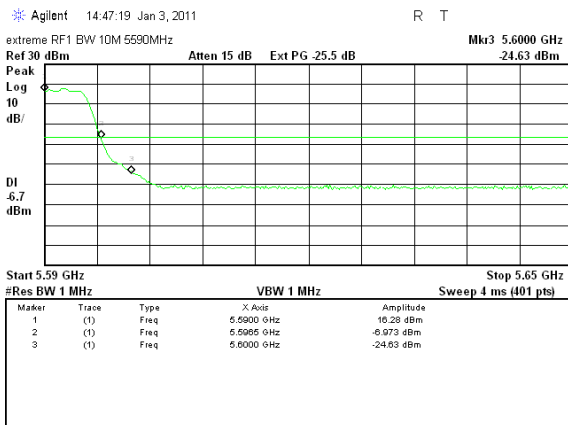

Plot # 53. Fc- 5590 MHz

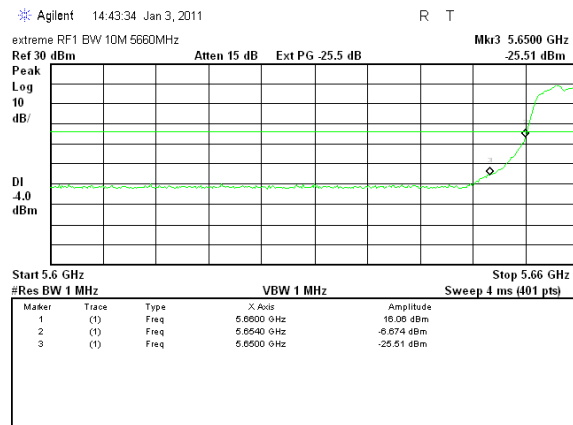

Plot # 54. Fc - 5660 MHz



Test report No: 8912311553/1

Page 28 of 72 Pages

Title: BreezeMAX Extreme 5.4 Base station

Model: XTRM-BS-2SIS-5.4-Ext

FCC ID: LKT-EXTR-50

5.1.4 Radiated spurious emissions test § 15.407(b)(3)

Operating Frequency Range 5.475 – 5.720 GHz
 Ambient Temperature 23⁰ C Relative Humidity 49% Air Pressure 1009 hPa

The frequency spectrum was investigated from the lowest radio frequency signal generated in the equipment up to 40 GHz. The emission levels of the EUT more than 20 dB lower than the specified limit were not recorded in the tables. For the test results refer to the tables and plots in this section.

Antenna integral 15.5 dBi gain

5 MHz emission bandwidth

Carrier frequency = 5475 MHz

Frequency, MHz	Radiated emissions, dBm	Limit, dBm	Margin, dB	Note	Reference to plot #
5469.9	-30.5	-27.0	3.5		57
6152	-36.9	-27.0	9.9	Noise floor	58

Carrier frequency = 5580 MHz

Frequency, MHz	Radiated emissions, dBm	Limit, dBm	Margin, dB	Note	Reference to plot #
5358	-37.6	-27.0	10.6	Noise floor	61
6370	-36.8	-27.0	9.7	Noise floor	63

Carrier frequency = 5720 MHz

Frequency, MHz	Radiated emissions, dBm	Limit, dBm	Margin, dB	Note	Reference to plot #
5436	-41.8	-27.0	14.8	Noise floor	66
5725	-29.6	-27.0	2.6		68



Test report No: 8912311553/1

Page 29 of 72 Pages

Title: BreezeMAX Extreme 5.4 Base station

Model: XTRM-BS-2SIS-5.4-Ext

FCC ID: LKT-EXTR-50

10 MHz emission bandwidth

Carrier frequency = 5480 MHz

Frequency, MHz	Radiated emissions, dBm	Limit, dBm	Margin, dB	Note	Reference to plot #
5469.6	-31.5	-27.0	4.5		74
6472	-38.3	-27.0	11.3	Noise floor	75

Carrier frequency = 5580 MHz

Frequency, MHz	Radiated emissions, dBm	Limit, dBm	Margin, dB	Note	Reference to plot #
5381	-38.2	-27.0	11.2	Noise floor	78
6364	-36.8	-27.0	9.8	Noise floor	80

Carrier frequency = 5715 MHz

Frequency, MHz	Radiated emissions, dBm	Limit, dBm	Margin, dB	Note	Reference to plot #
5336	-37.6	-27.0	10.6	Noise floor	83
5725	-29.2	-27.0	2.2		85



Test report No: 8912311553/1

Page 30 of 72 Pages

Title: BreezeMAX Extreme 5.4 Base station

Model: XTRM-BS-2SIS-5.4-Ext

FCC ID: LKT-EXTR-50

Antenna 8 dBi gain

5 MHz emission bandwidth

Carrier frequency = 5475 MHz

Frequency, MHz	Radiated emissions, dBm	Limit, dBm	Margin, dB	Note	Reference to plot #
5469.8	-27.7	-27.0	0.7		90
6089	-41.1	-27.0	14.1	Noise floor	91

Carrier frequency = 5580 MHz

Frequency, MHz	Radiated emissions, dBm	Limit, dBm	Margin, dB	Note	Reference to plot #
5403	-39.3	-27.0	12.3	Noise floor	94
6079	-36.9	-27.0	9.9	Noise floor	96

Carrier frequency = 5720 MHz

Frequency, MHz	Radiated emissions, dBm	Limit, dBm	Margin, dB	Note	Reference to plot #
5438	-38.0	-27.0	11.0	Noise floor	99
5725	-29.2	-27.0	2.2		101

**Test report No:** 8912311553/1

Page 31 of 72 Pages

Title: BreezeMAX Extreme 5.4 Base station**Model:** XTRM-BS-2SIS-5.4-Ext

FCC ID: LKT-EXTR-50

10 MHz emission bandwidth

Carrier frequency = 5480 MHz

Frequency, MHz	Radiated emissions, dBm	Limit, dBm	Margin, dB	Note	Reference to plot #
5469.7	-40.2	-27.0	13.2		106
5982	-37.9	-27.0	10.9	Noise floor	107

Carrier frequency = 5580 MHz

Frequency, MHz	Radiated emissions, dBm	Limit, dBm	Margin, dB	Note	Reference to plot #
5388	-38.1	-27.0	11.1	Noise floor	110
6036	-38.2	-27.0	11.2	Noise floor	112

Carrier frequency = 5715 MHz

Frequency, MHz	Radiated emissions, dBm	Limit, dBm	Margin, dB	Note	Reference to plot #
5403	-38.5	-27.0	11.5	Noise floor	115
5725	-36.4	-27.0	9.4		118

**Test report No:** 8912311553/1

Page 32 of 72 Pages

Title: BreezeMAX Extreme 5.4 Base station**Model:** XTRM-BS-2SIS-5.4-Ext

FCC ID: LKT-EXTR-50

Antenna 17 dBi gain**5 MHz emission bandwidth****Carrier frequency = 5475 MHz**

Frequency, MHz	Radiated emissions, dBm	Limit, dBm	Margin, dB	Note	Reference to plot #
5469.8	-28.4	-27.0	1.4		122
6364	-37.2	-27.0	10.2	Noise floor	123

Carrier frequency = 5580 MHz

Frequency, MHz	Radiated emissions, dBm	Limit, dBm	Margin, dB	Note	Reference to plot #
5436	-37.6	-27.0	10.6	Noise floor	126
6112	-37.9	-27.0	10.3	Noise floor	128

Carrier frequency = 5720 MHz

Frequency, MHz	Radiated emissions, dBm	Limit, dBm	Margin, dB	Note	Reference to plot #
4546	-42.7	-27.0	15.7	Noise floor	131
5725	-30.4	-27.0	3.42		134

**Test report No:** 8912311553/1

Page 33 of 72 Pages

Title: BreezeMAX Extreme 5.4 Base station**Model:** XTRM-BS-2SIS-5.4-Ext

FCC ID: LKT-EXTR-50

10 MHz emission bandwidth

Carrier frequency = 5480 MHz

Frequency, MHz	Radiated emissions, dBm	Limit, dBm	Margin, dB	Note	Reference to plot #
5469.8	-31.6	-27.0	4.6		138
6186	-40.2	-27.0	13.2	Noise floor	139

Carrier frequency = 5580 MHz

Frequency, MHz	Radiated emissions, dBm	Limit, dBm	Margin, dB	Note	Reference to plot #
5448	-38.2	-27.0	11.2	Noise floor	141
6439	-38.2	-27.0	10.5	Noise floor	143

Carrier frequency = 5715 MHz

Frequency, MHz	Radiated emissions, dBm	Limit, dBm	Margin, dB	Note	Reference to plot #
5204	-38.5	-27.0	12.2	Noise floor	146
5726	-38.1	-27.0	11.1		149



Test report No: 8912311553/1

Page 34 of 72 Pages

Title: BreezeMAX Extreme 5.4 Base station

Model: XTRM-BS-2SIS-5.4-Ext

FCC ID: LKT-EXTR-50

TEST PROCEDURE

The test was conducted with three antenna configurations: internal slant, external Omni and external sector. In order to find a worse case result preliminary testing for each configuration were performed in single chain (SISO) and in spatial multiplexing (SM-MIMO) modes.

The worse case result was found for internal antenna in SM-MIMO mode, for external Omni antenna in SISO mode and for external sector antenna in SM-MIMO mode.

Transmitter output power was changed according to antenna configuration and standard requirements as shown in table below:

Antenna configuration	Output power dBm	
	5 MHz EBW	10 MHz EBW
Internal antenna 15.5 dBi	8.5 dBm	11.5 dBm
Antenna Omni 8 dBi	*16.7 dBm	*19.7 dBm
Antenna sector 17 dBi	*4.7 dBm	*7.7 dBm

* Calculation includes loss of cable to external antenna - 0.7 dB.

Substitution method.

The measurements were performed according to ANSI/TIA-603-C-2004 section 2.2.12 test method. Investigation of transmitter spurious emissions was performed. EUT was replaced by generator and substitution antenna. Result calculated from generator output level, substitution antenna gain and loss of connected cable was compared with the limit. Transmitter was operated at bottom, middle and top of the 5.470 GHz – 5.725 GHz frequency band.

LIMIT

For transmitters operating in the 5.47 – 5.725 GHz band: all emissions outside of the 5.47 – 5.725 GHz band shall not exceed an EIRP of -27 dBm/MHz.

TEST EQUIPMENT USED:

1	5	6	7	8	12	13	14
---	---	---	---	---	----	----	----



Test report No: 8912311553/1
Title: BreezeMAX Extreme 5.4 Base station
Model: XTRM-BS-2SIS-5.4-Ext

Page 35 of 72 Pages
FCC ID: LKT-EXTR-50

Antenna internal 15.5 dBi. Frequency carrier 5475 MHz. 5 MHz EBW.

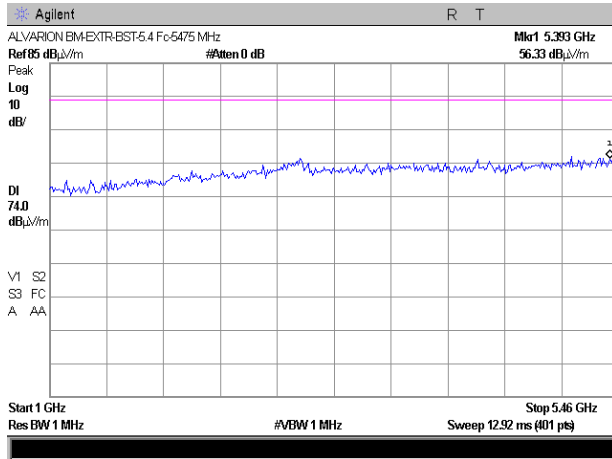

Plot # 55

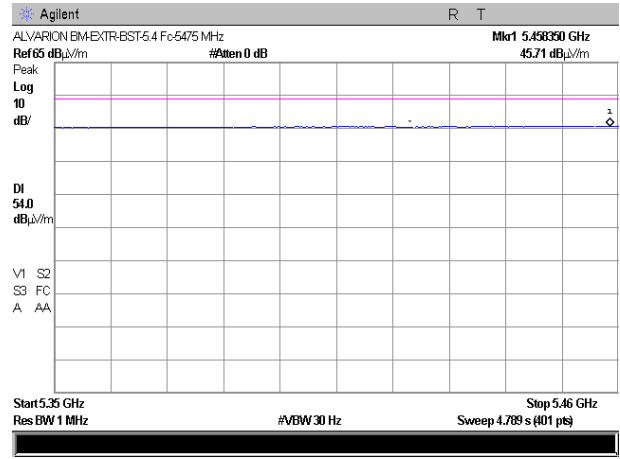

Plot # 56

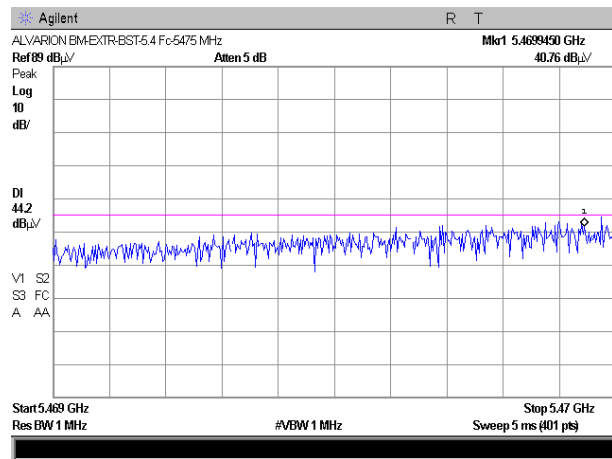

Plot # 57

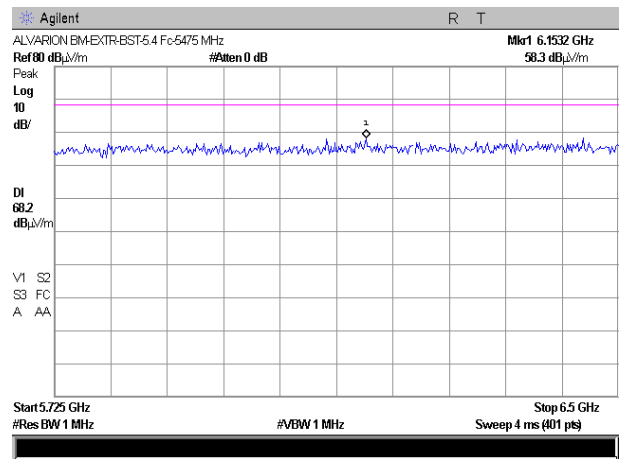

Plot # 58

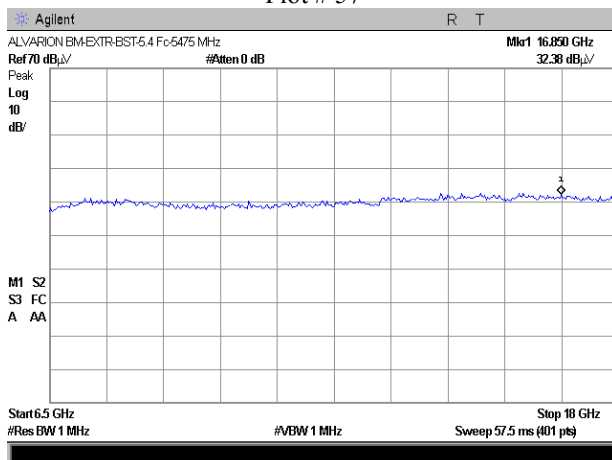

Plot # 59

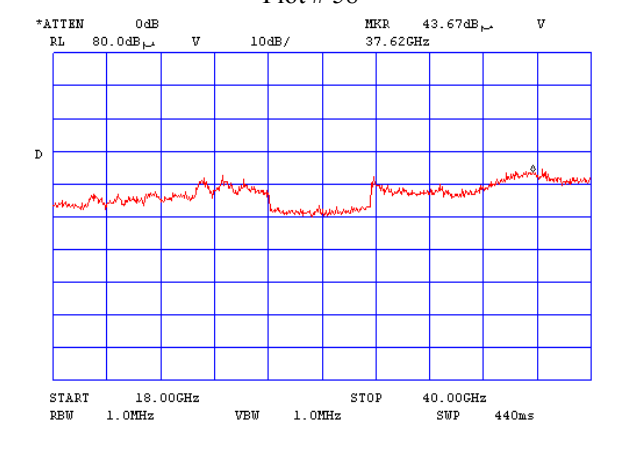

Plot # 60



Test report No: 8912311553/1
Title: BreezeMAX Extreme 5.4 Base station
Model: XTRM-BS-2SIS-5.4-Ext

Page 36 of 72 Pages
FCC ID: LKT-EXTR-50

Frequency carrier 5580 MHz.

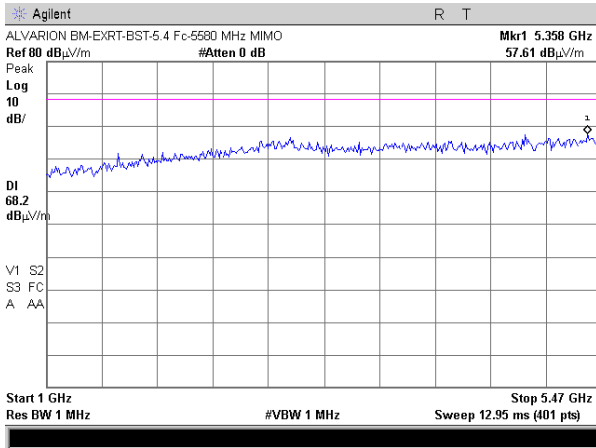

Plot # 61

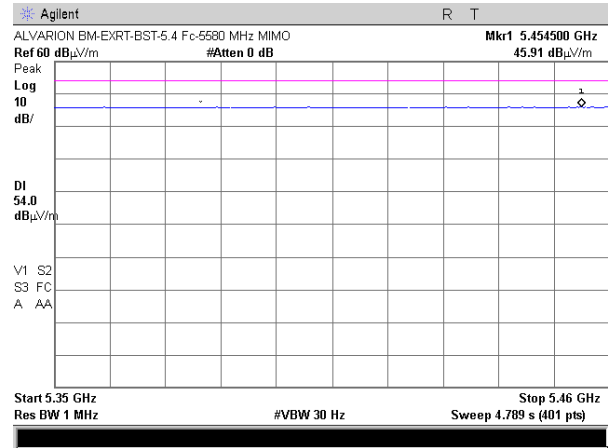

Plot # 62

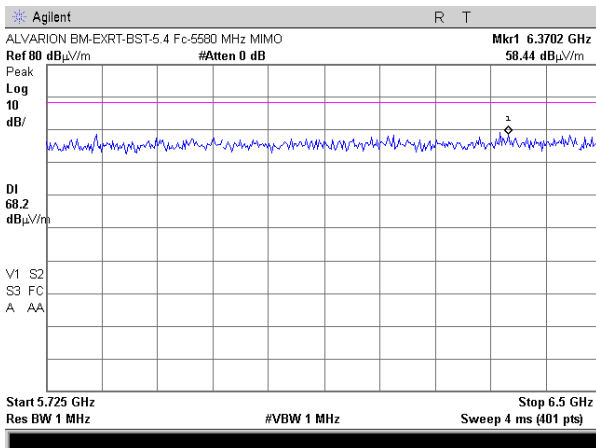

Plot # 63

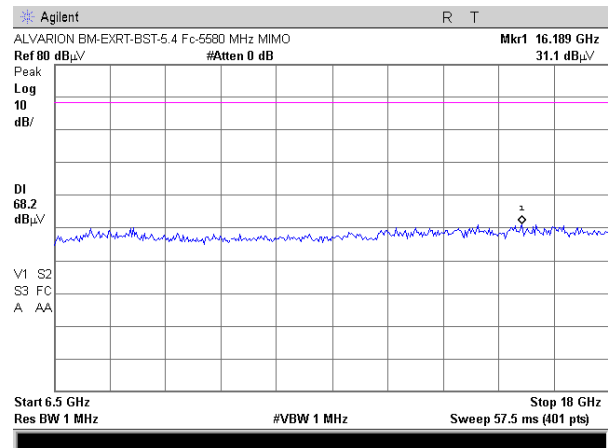

Plot # 64

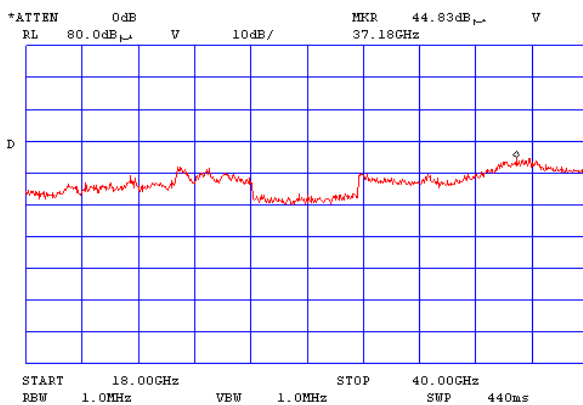

Plot # 65



Test report No: 8912311553/1
Title: BreezeMAX Extreme 5.4 Base station
Model: XTRM-BS-2SIS-5.4-Ext

Page 37 of 72 Pages
FCC ID: LKT-EXTR-50

Frequency carrier 5720 MHz.

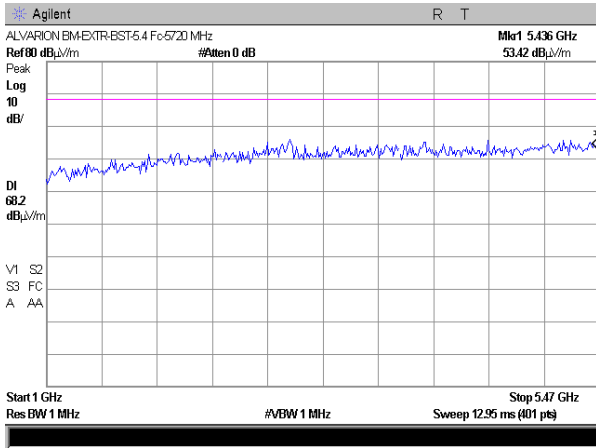

Plot # 66

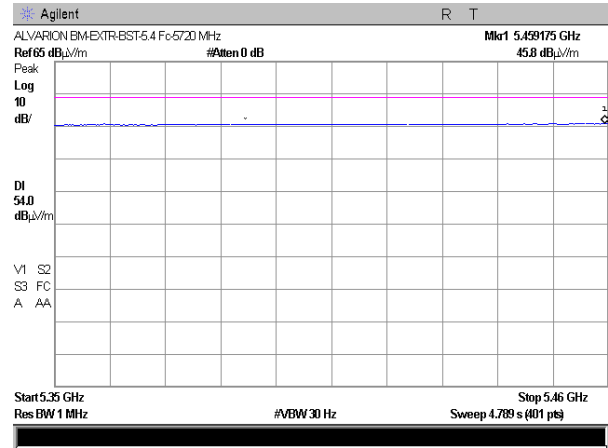

Plot # 67

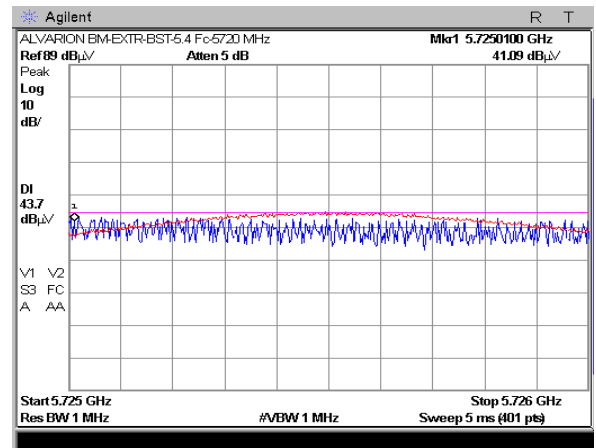

Plot # 68

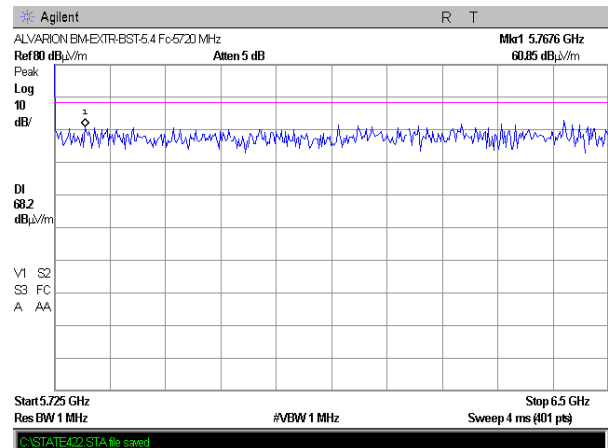

Plot # 69

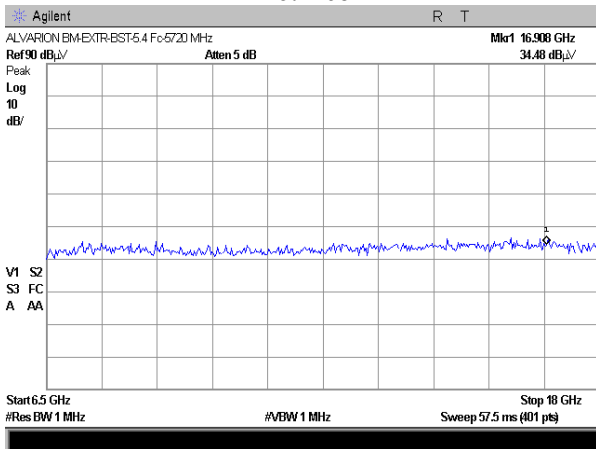

Plot # 70

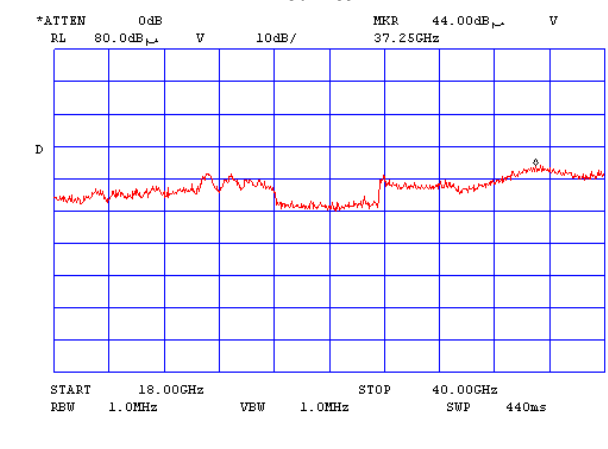

Plot # 71



Test report No: 8912311553/1
Title: BreezeMAX Extreme 5.4 Base station
Model: XTRM-BS-2SIS-5.4-Ext

Page 38 of 72 Pages
FCC ID: LKT-EXTR-50

Antenna internal 15.5 dBi. Frequency carrier 5480 MHz. 10 MHz EBW

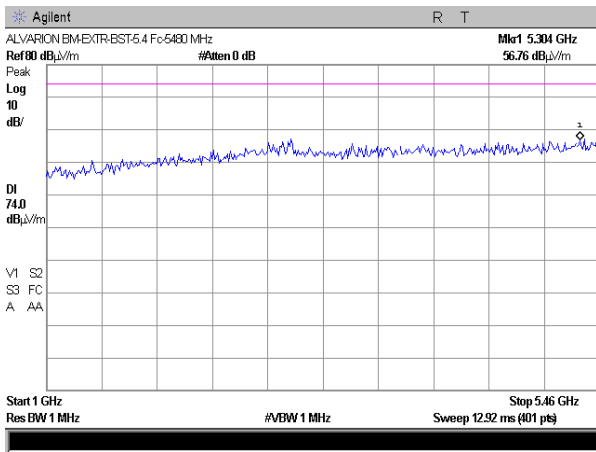

Plot # 72

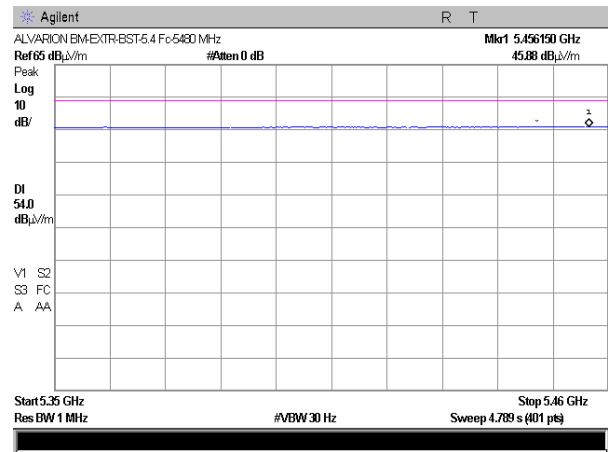

Plot # 73

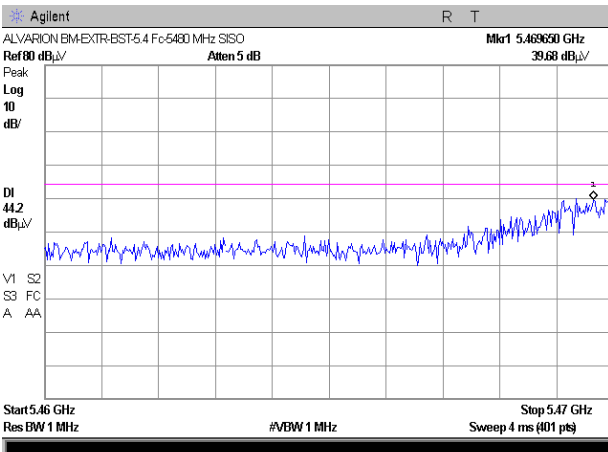

Plot # 74

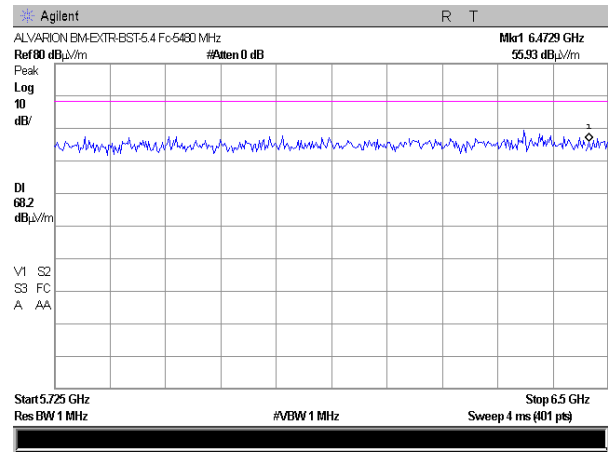

Plot # 75

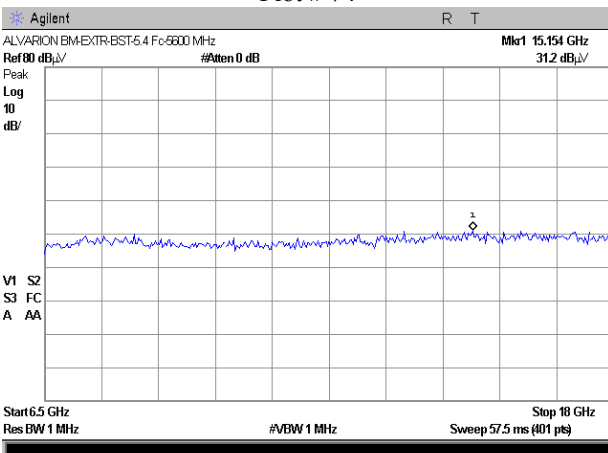

Plot # 76

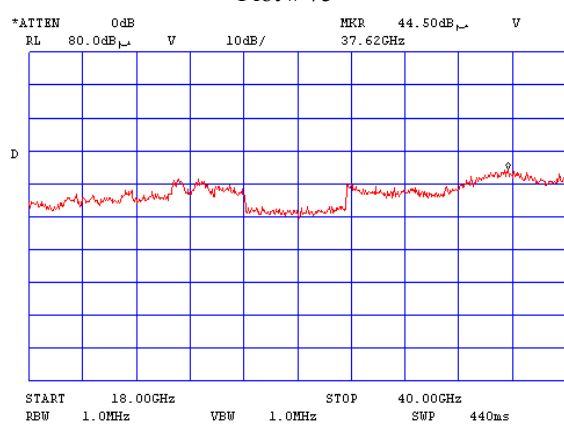

Plot # 77



Test report No: 8912311553/1
Title: BreezeMAX Extreme 5.4 Base station
Model: XTRM-BS-2SIS-5.4-Ext

Page 39 of 72 Pages
FCC ID: LKT-EXTR-50

Frequency carrier 5580 MHz.

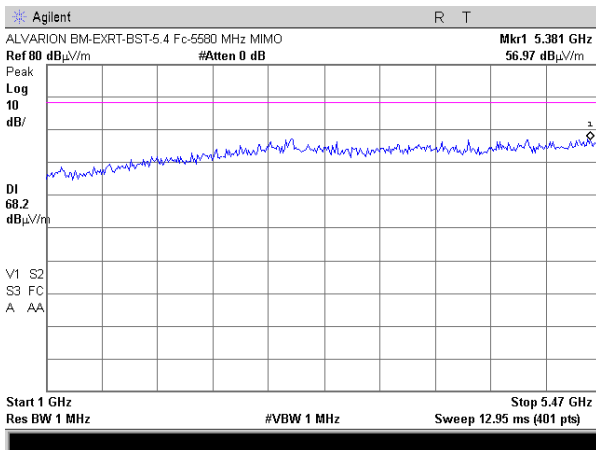

Plot # 78

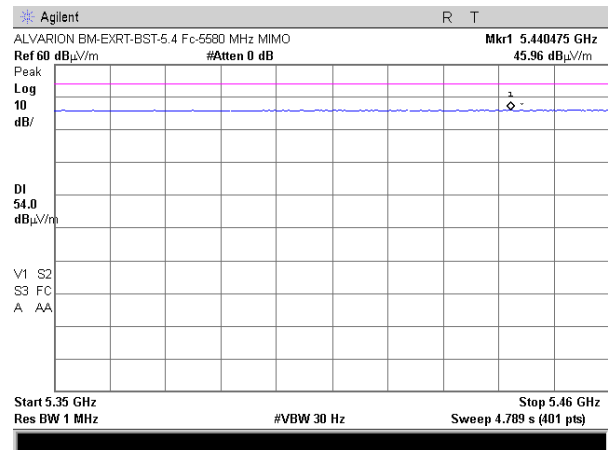

Plot # 79

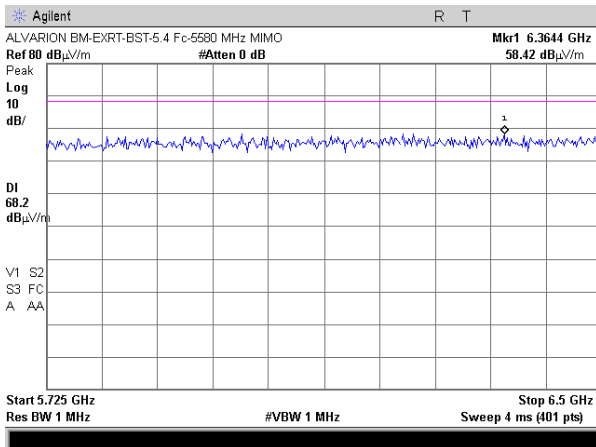

Plot # 80

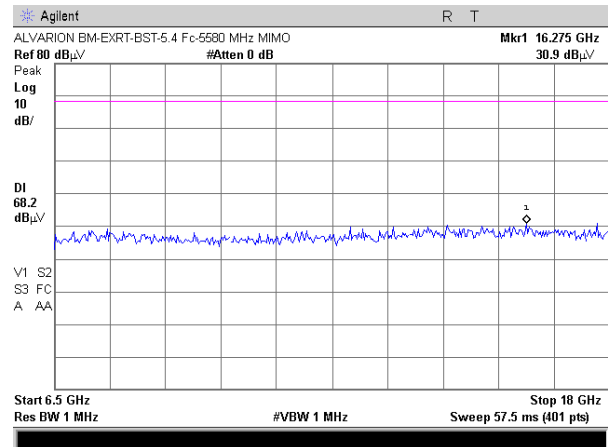

Plot # 81

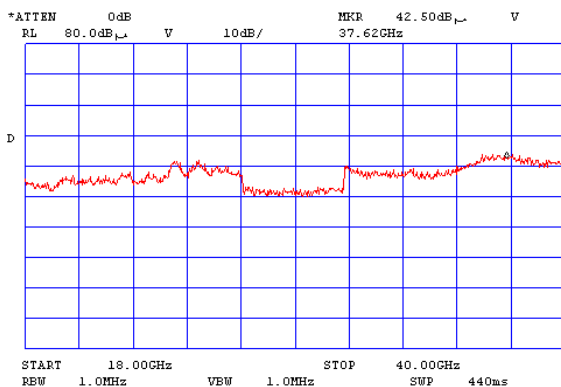

Plot # 82



Test report No: 8912311553/1
Title: BreezeMAX Extreme 5.4 Base station
Model: XTRM-BS-2SIS-5.4-Ext

Page 40 of 72 Pages
FCC ID: LKT-EXTR-50

Frequency carrier 5715 MHz.

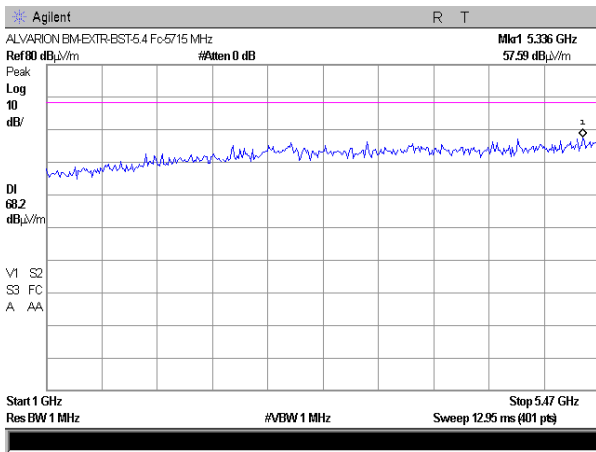

Plot # 83

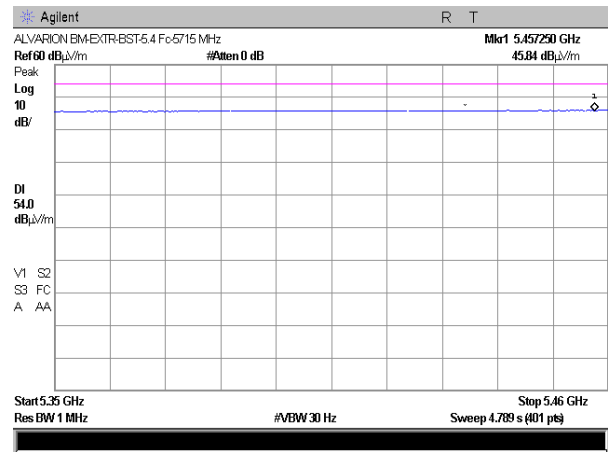

Plot # 84

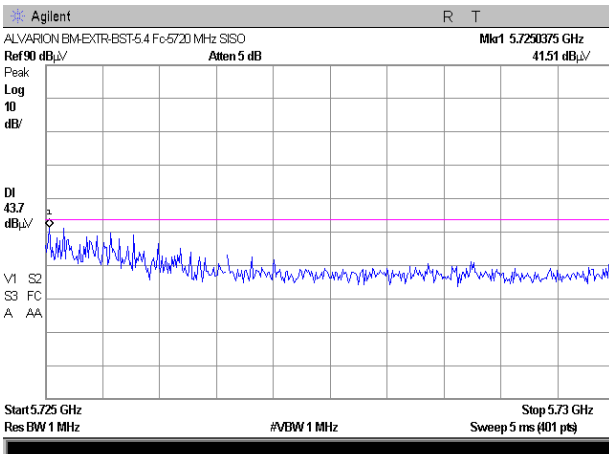

Plot # 85

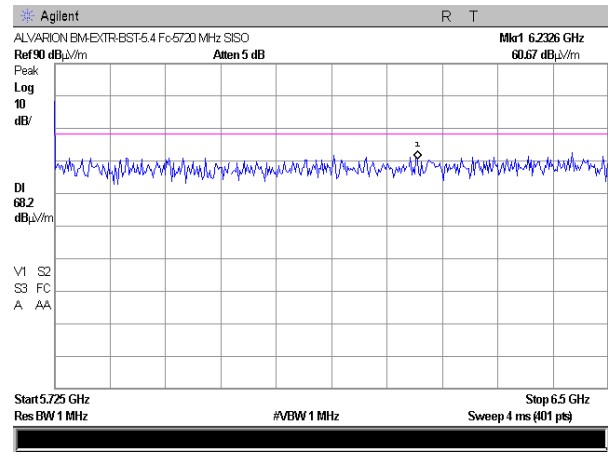

Plot # 86

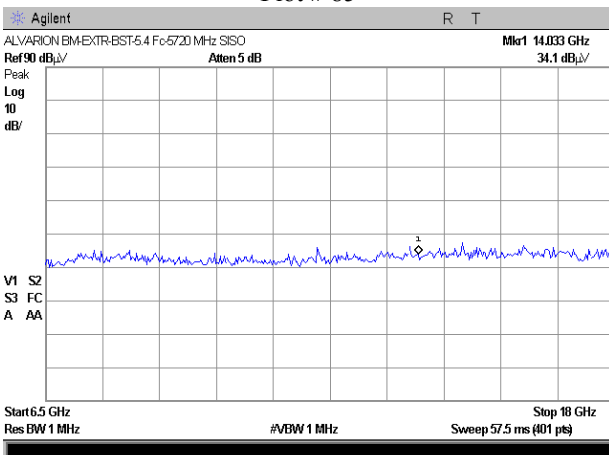

Plot # 87

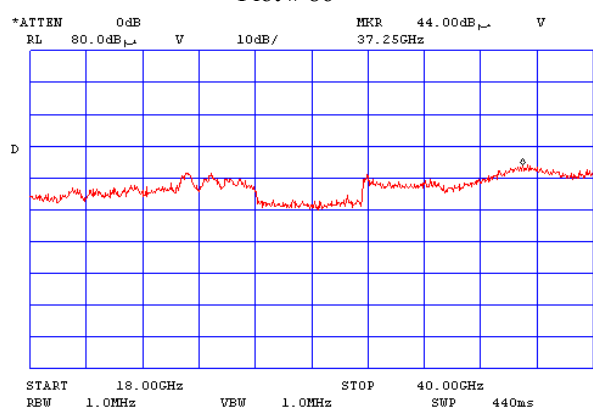



Test report No: 8912311553/1
Title: BreezeMAX Extreme 5.4 Base station
Model: XTRM-BS-2SIS-5.4-Ext

Page 41 of 72 Pages
FCC ID: LKT-EXTR-50

Antenna Omni 8 dBi. Frequency carrier 5475 MHz. 5 MHz EBW.

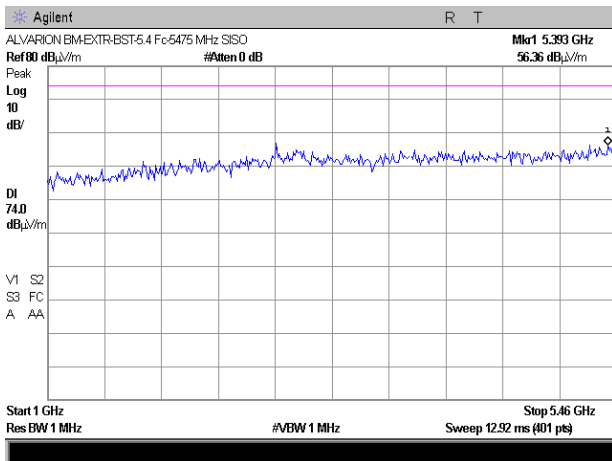

Plot # 88

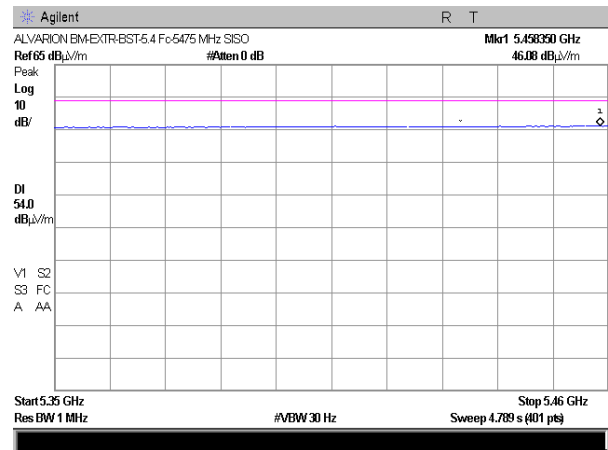

Plot # 89

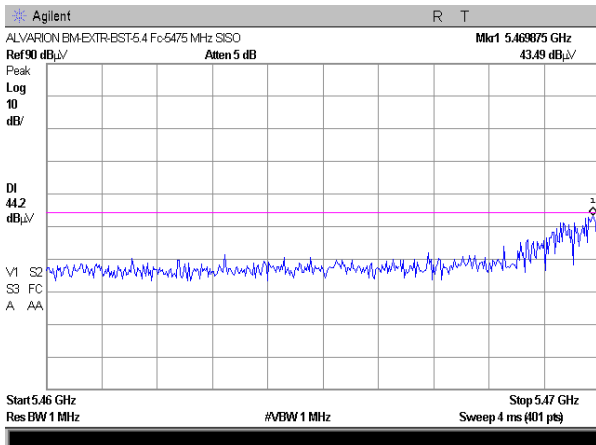

Plot # 90

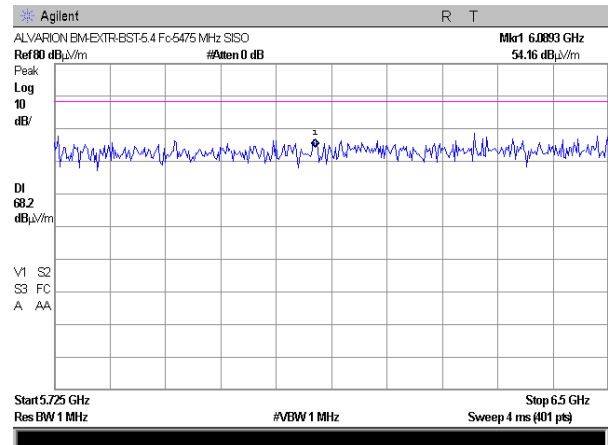

Plot # 91

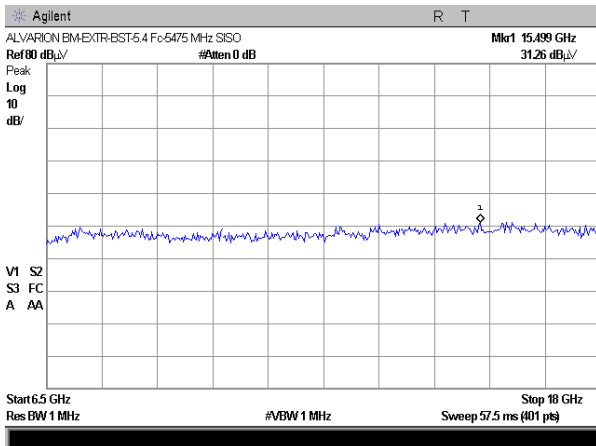

Plot # 92

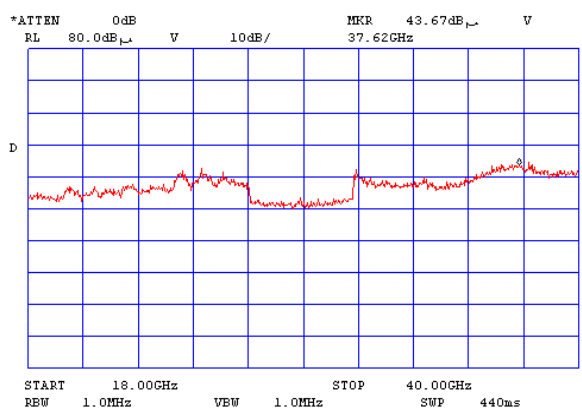

Plot # 93



Test report No: 8912311553/1
Title: BreezeMAX Extreme 5.4 Base station
Model: XTRM-BS-2SIS-5.4-Ext

Page 42 of 72 Pages
FCC ID: LKT-EXTR-50

Frequency carrier 5580 MHz.

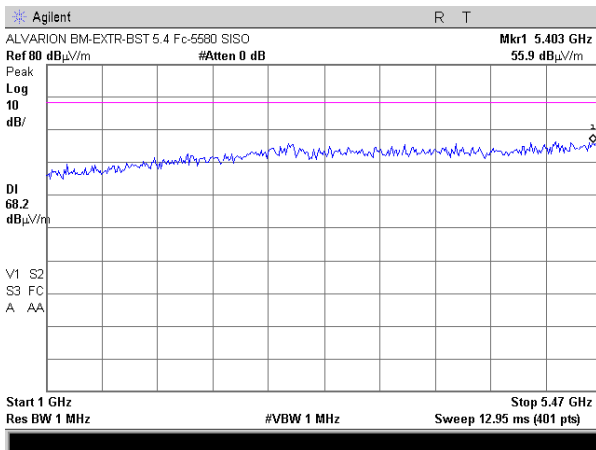

Plot # 94

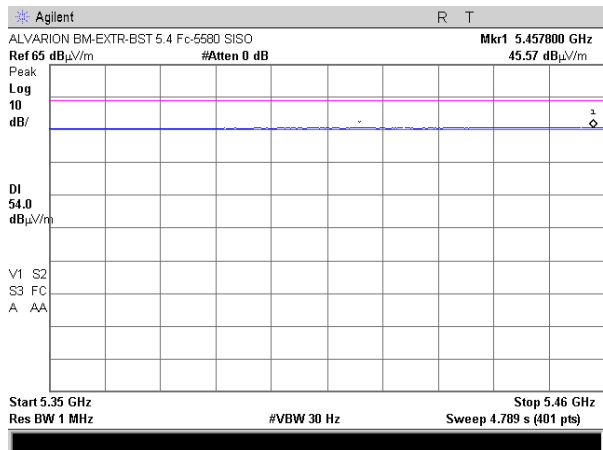

Plot # 95

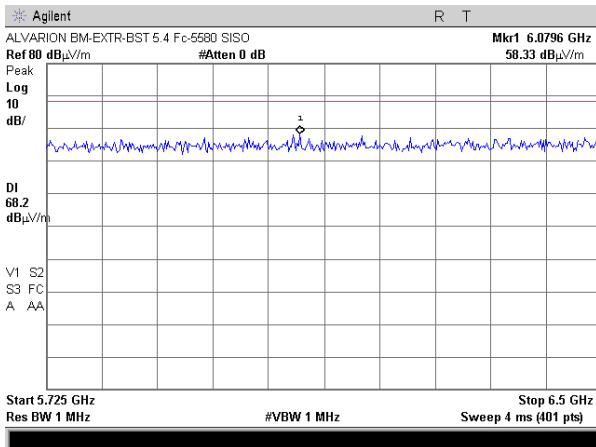

Plot # 96

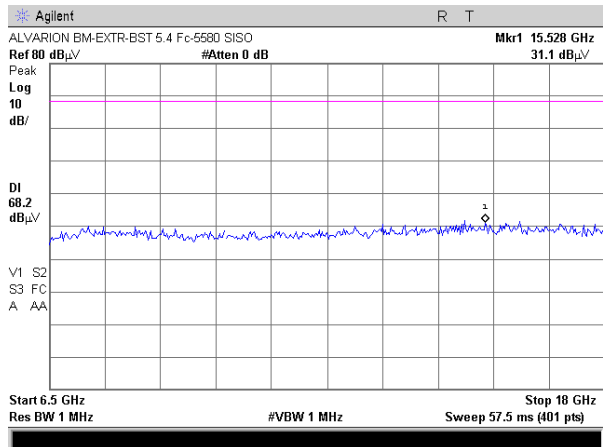

Plot # 97

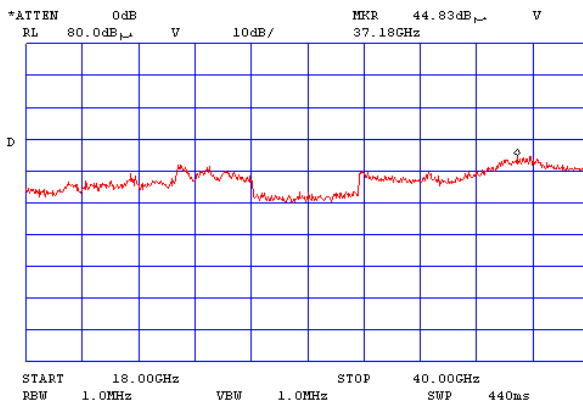

Plot # 98



Test report No: 8912311553/1
Title: BreezeMAX Extreme 5.4 Base station
Model: XTRM-BS-2SIS-5.4-Ext

Page 43 of 72 Pages
FCC ID: LKT-EXTR-50

Frequency carrier 5720 MHz.

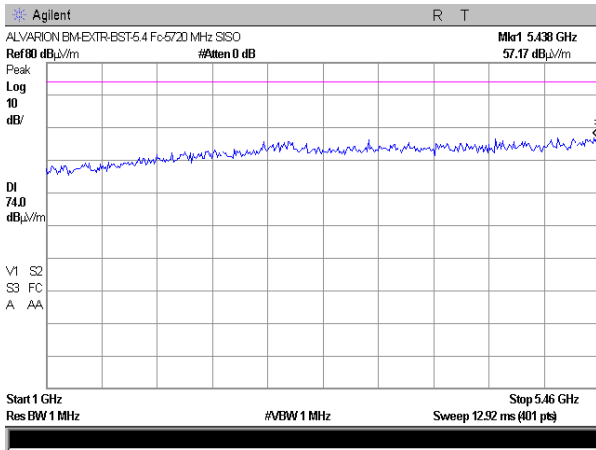

Plot # 99

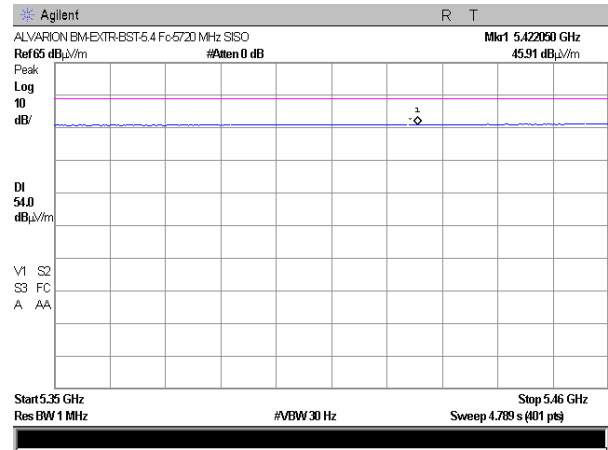

Plot # 100

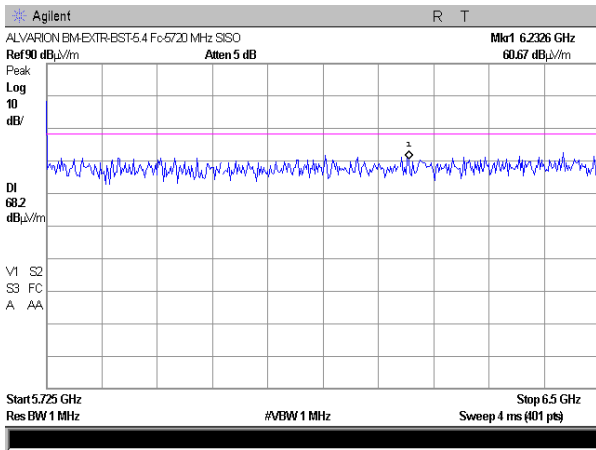

Plot # 101

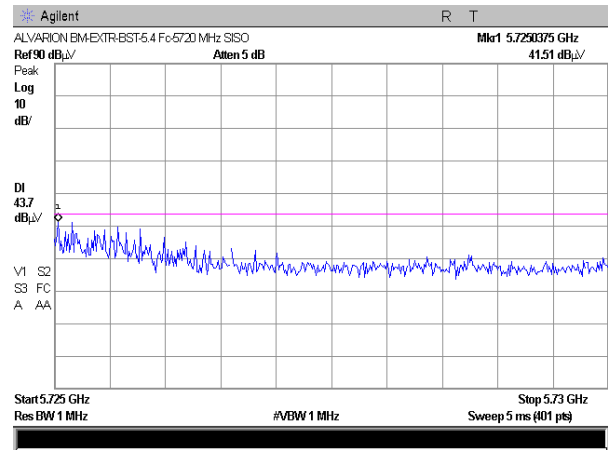

Plot # 102

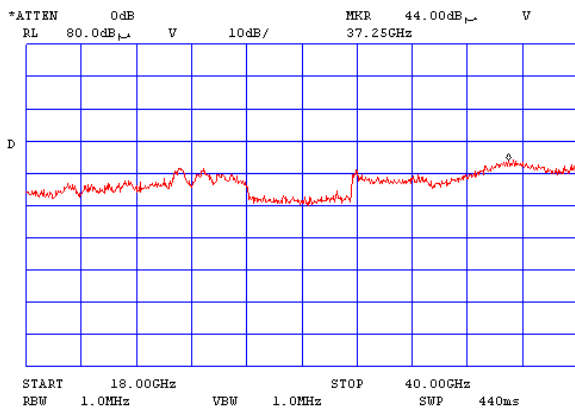

Plot # 103



Test report No: 8912311553/1
Title: BreezeMAX Extreme 5.4 Base station
Model: XTRM-BS-2SIS-5.4-Ext

Page 45 of 72 Pages
FCC ID: LKT-EXTR-50

Frequency carrier 5580 MHz

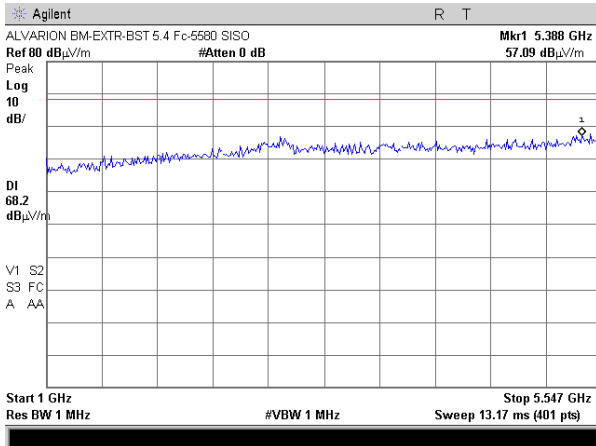

Plot # 110

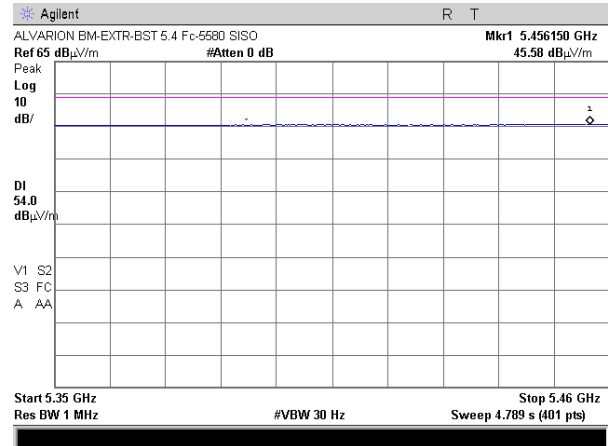

Plot # 111

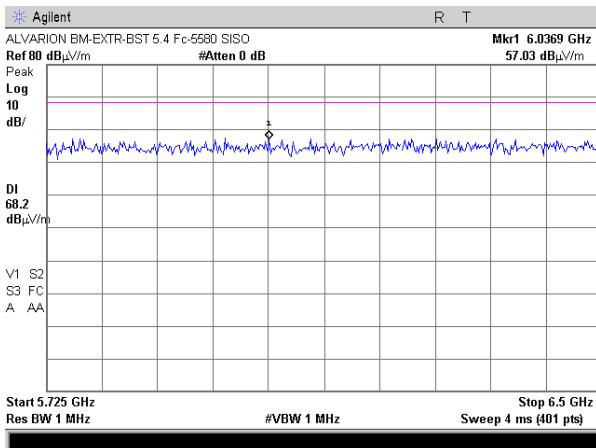

Plot # 112

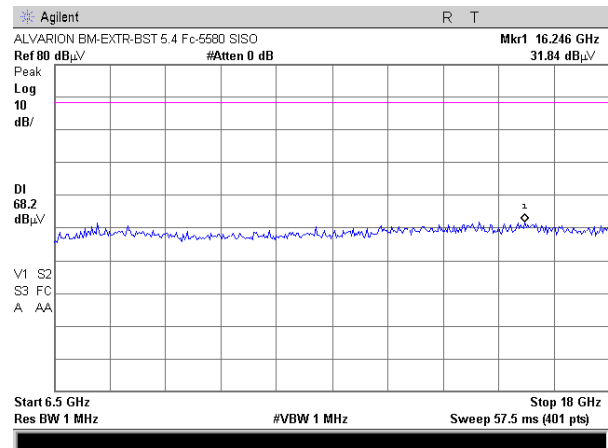

Plot # 113

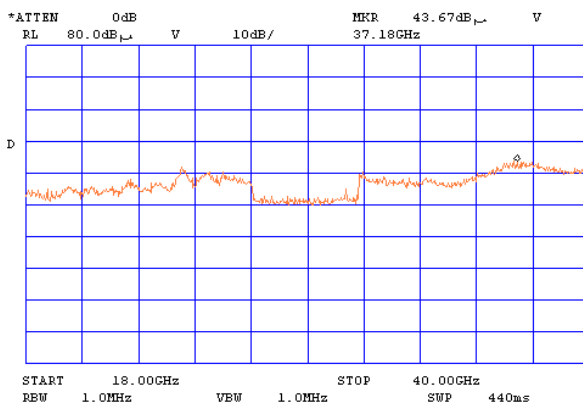

Plot # 114



Test report No: 8912311553/1
Title: BreezeMAX Extreme 5.4 Base station
Model: XTRM-BS-2SIS-5.4-Ext

Page 46 of 72 Pages
FCC ID: LKT-EXTR-50

Frequency carrier 5715 MHz.

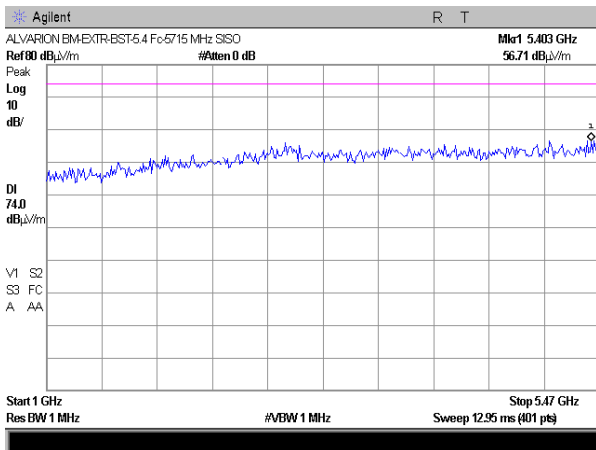

Plot # 115

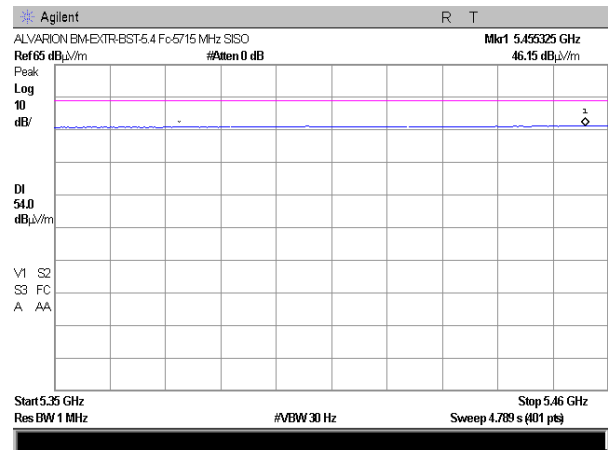

Plot # 116

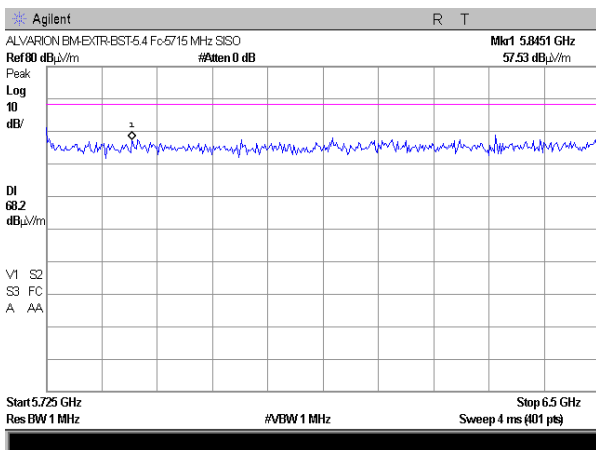

Plot # 117

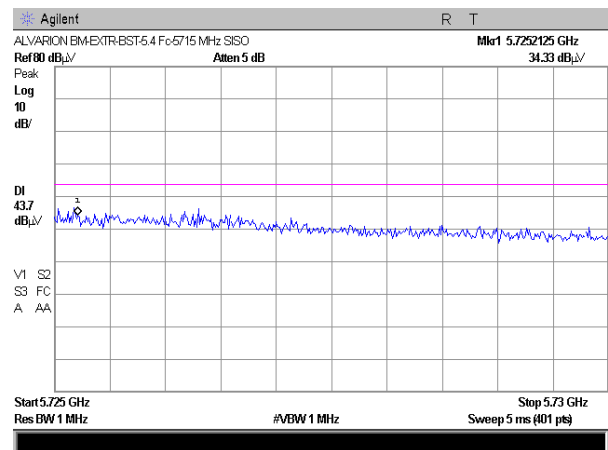

Plot # 118

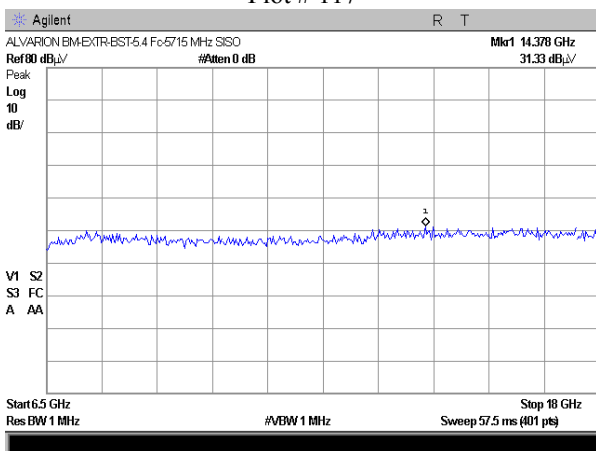

Plot # 119

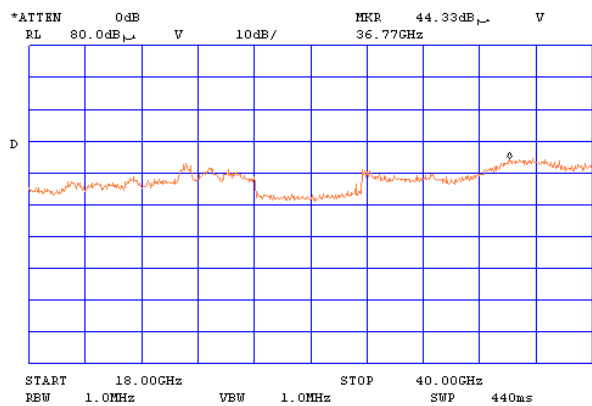



Test report No: 8912311553/1
Title: BreezeMAX Extreme 5.4 Base station
Model: XTRM-BS-2SIS-5.4-Ext

Page 47 of 72 Pages
FCC ID: LKT-EXTR-50

Antenna sector 17 dBi. Frequency carrier 5475 MHz. 5 MHz EBW.

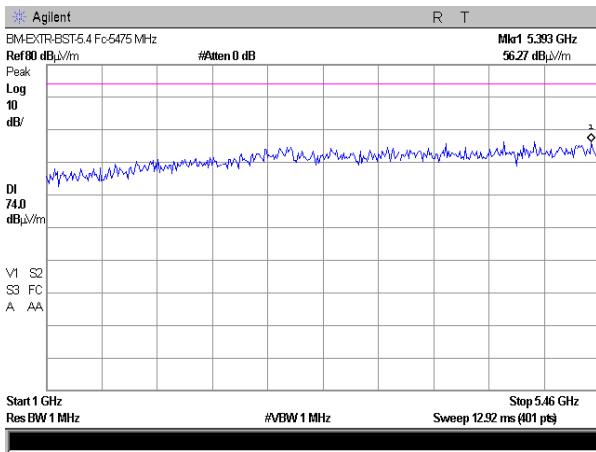

Plot # 120

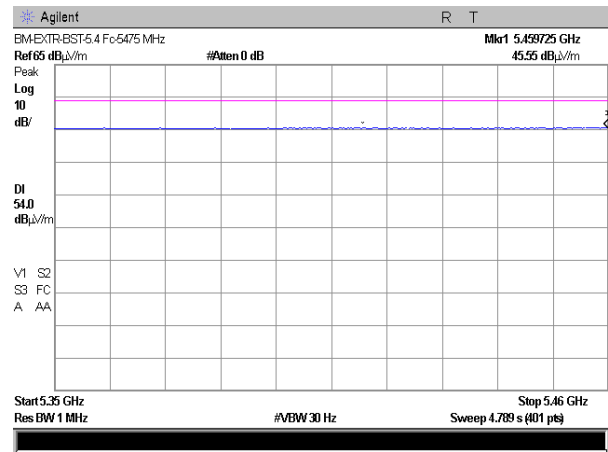

Plot # 121

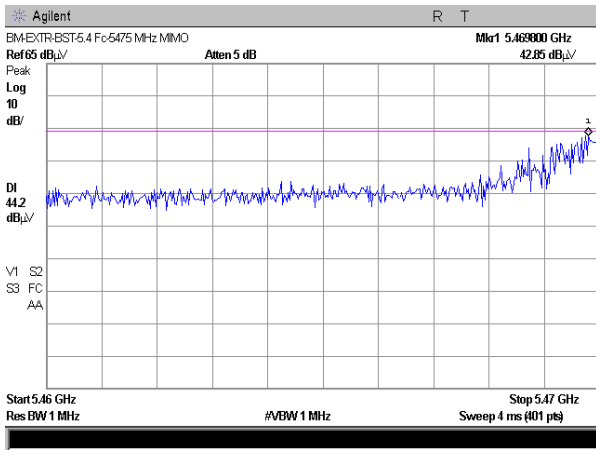

Plot # 122

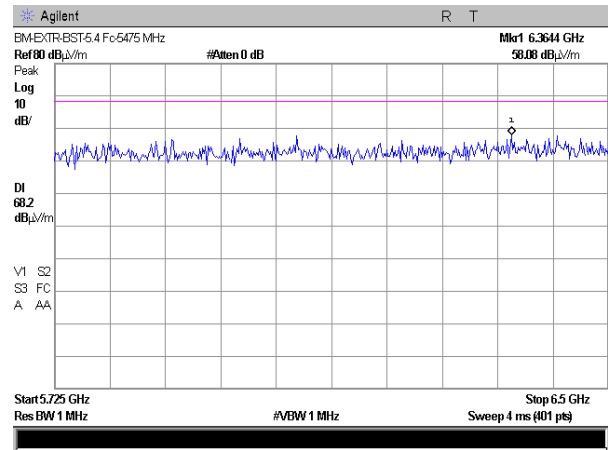

Plot # 123

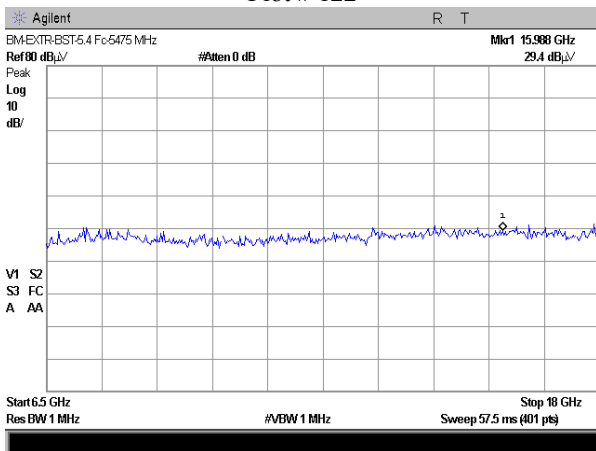

Plot # 124

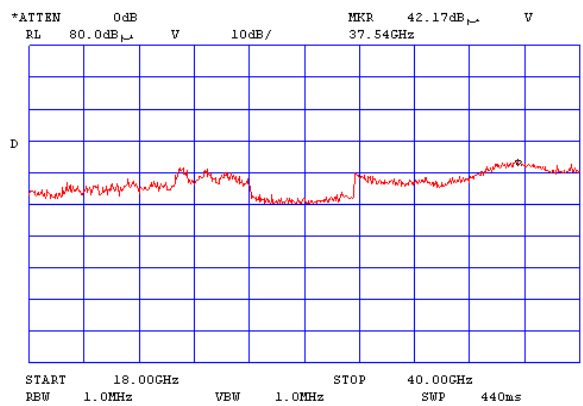

Plot # 125



Test report No: 8912311553/1
Title: BreezeMAX Extreme 5.4 Base station
Model: XTRM-BS-2SIS-5.4-Ext

Page 48 of 72 Pages
FCC ID: LKT-EXTR-50

Frequency carrier 5580 MHz

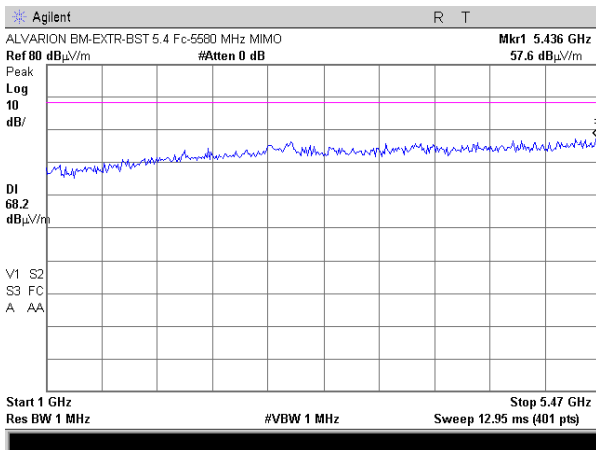

Plot # 126

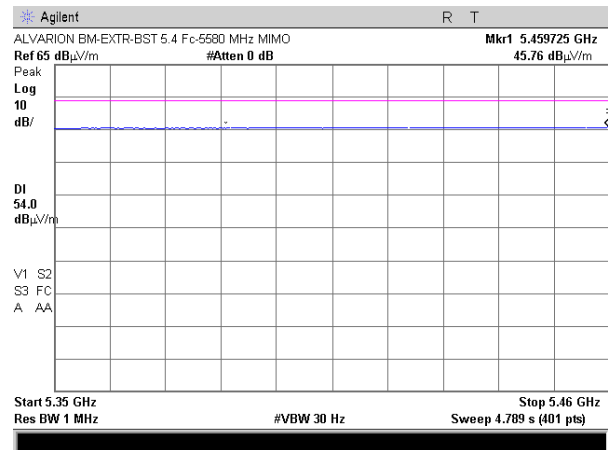

Plot # 127

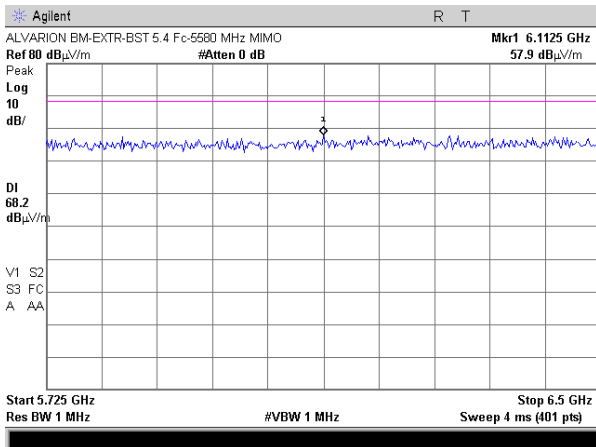

Plot # 128

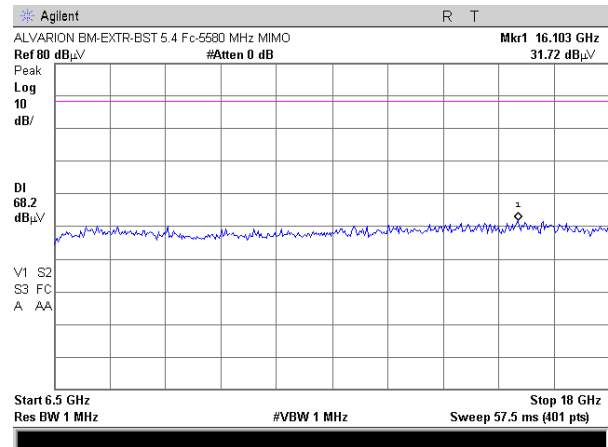

Plot # 129

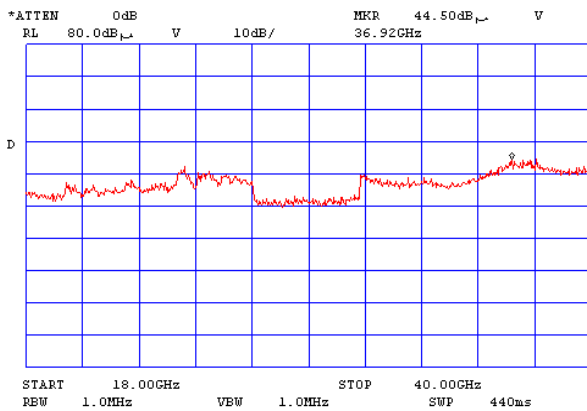

Plot # 130



Test report No: 8912311553/1
Title: BreezeMAX Extreme 5.4 Base station
Model: XTRM-BS-2SIS-5.4-Ext

Page 49 of 72 Pages
FCC ID: LKT-EXTR-50

Frequency carrier 5720 MHz.

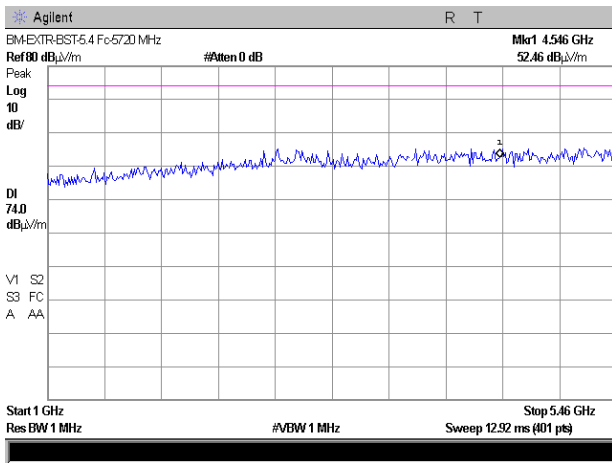

Plot # 131

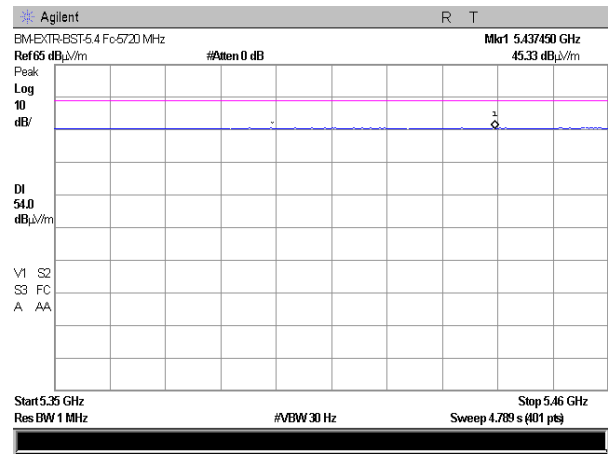

Plot # 132

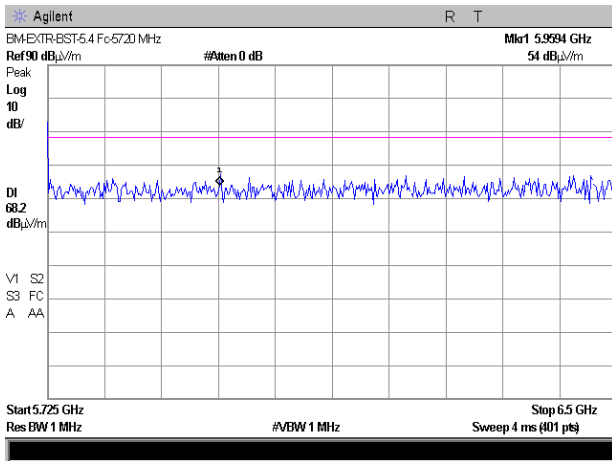

Plot # 133

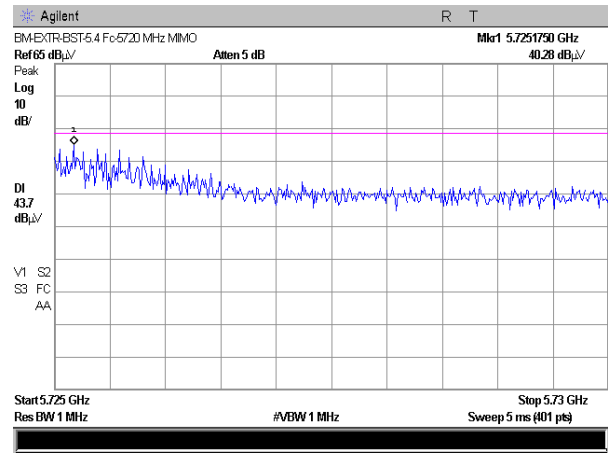

Plot # 134

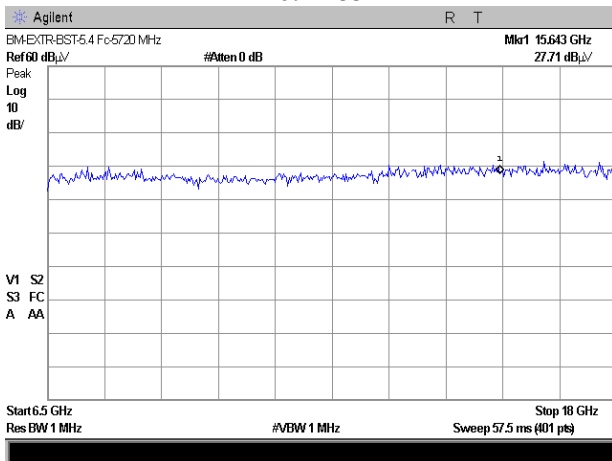

Plot # 135

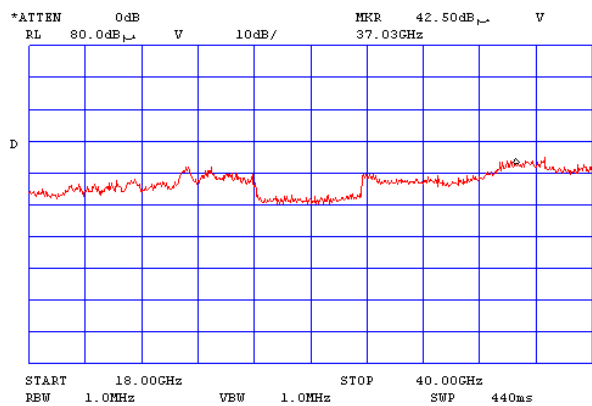



Test report No: 8912311553/1
Title: BreezeMAX Extreme 5.4 Base station
Model: XTRM-BS-2SIS-5.4-Ext

Page 50 of 72 Pages
FCC ID: LKT-EXTR-50

Antenna sector 17 dBi. Frequency carrier 5480 MHz. 10 MHz EBW.

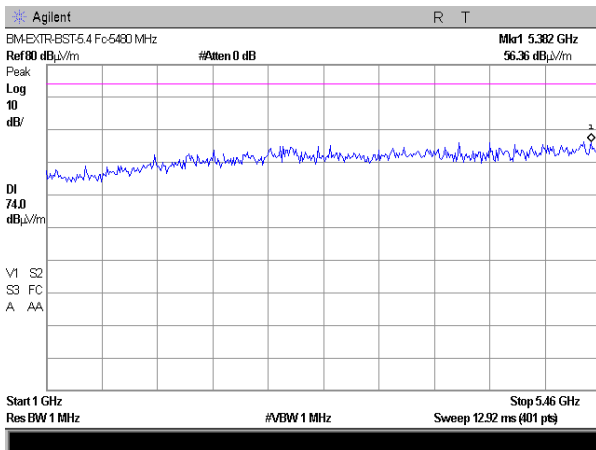

Plot # 136

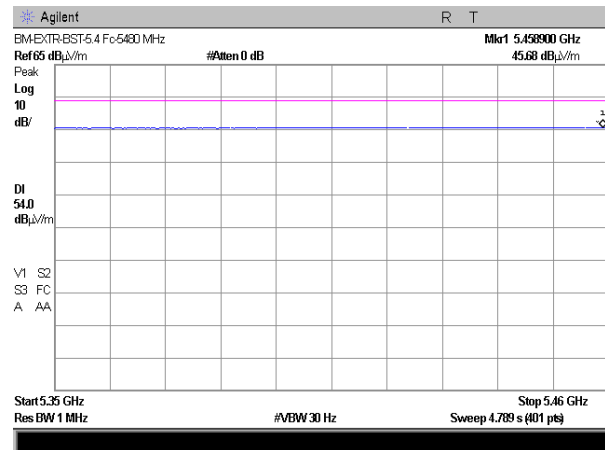

Plot # 137

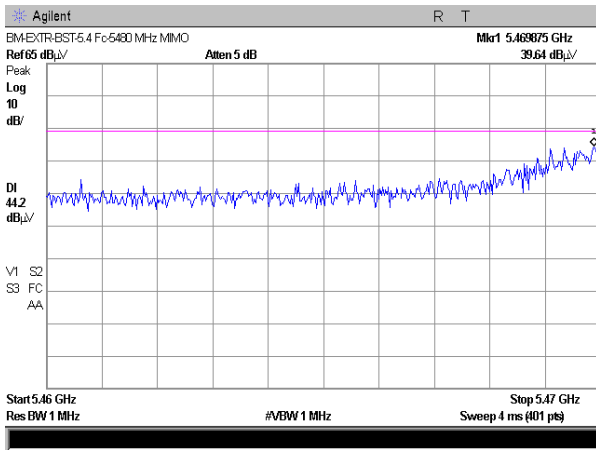

Plot # 138

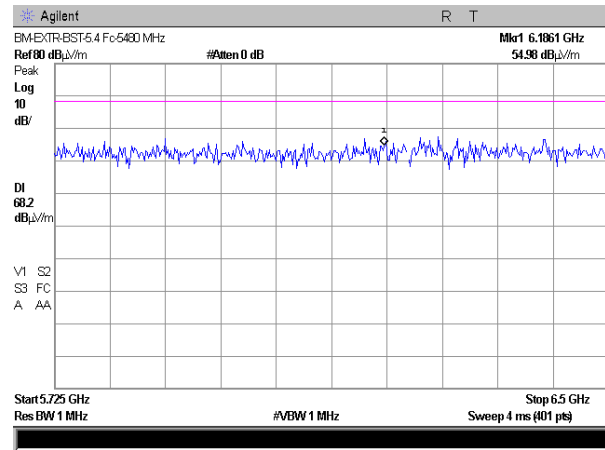

Plot # 139

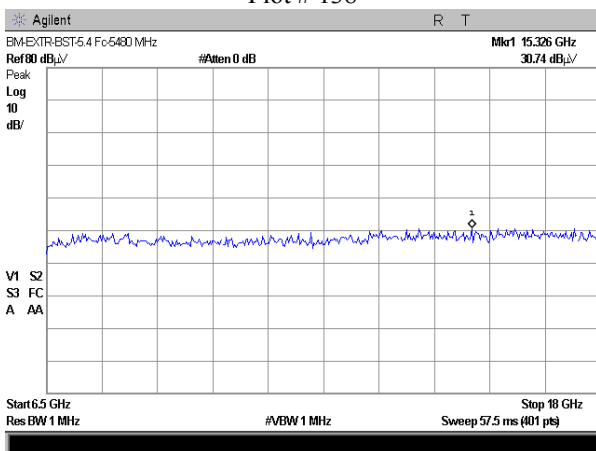

Plot # 140

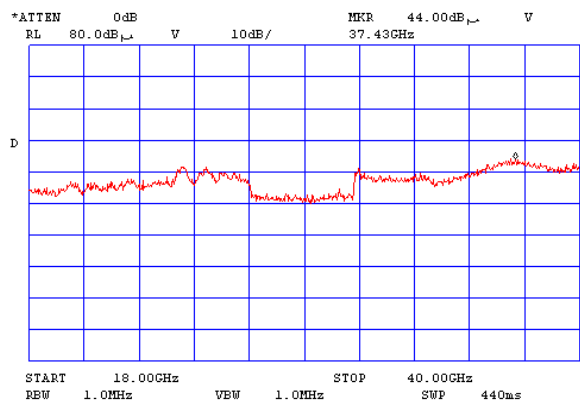



Test report No: 8912311553/1
Title: BreezeMAX Extreme 5.4 Base station
Model: XTRM-BS-2SIS-5.4-Ext

Page 51 of 72 Pages
FCC ID: LKT-EXTR-50

Frequency carrier 5580 MHz

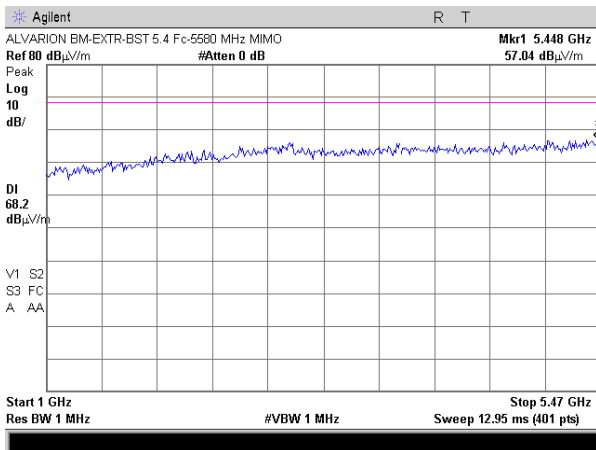

Plot # 141

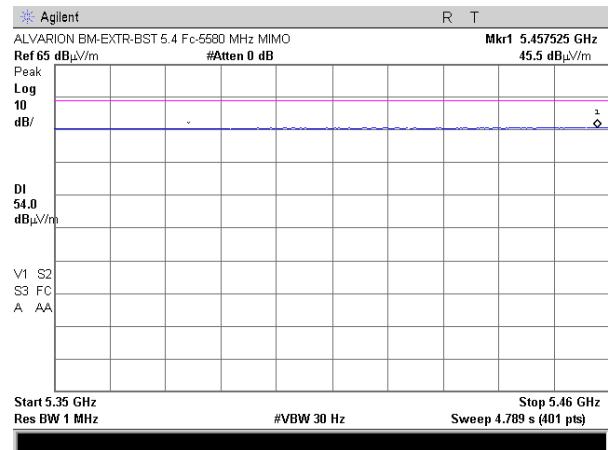

Plot # 142

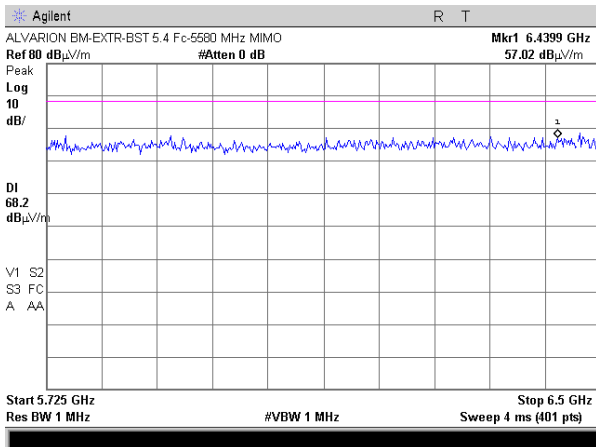

Plot # 143

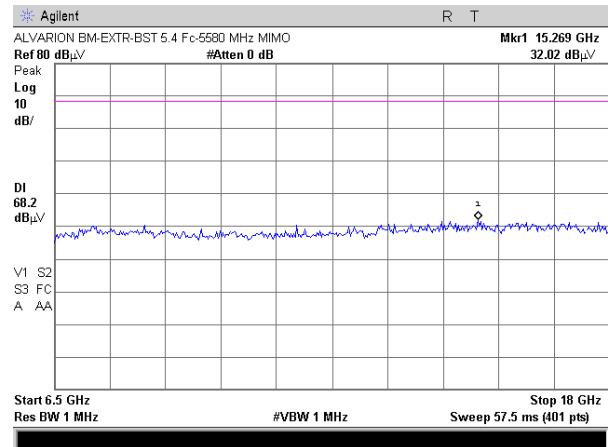

Plot # 144

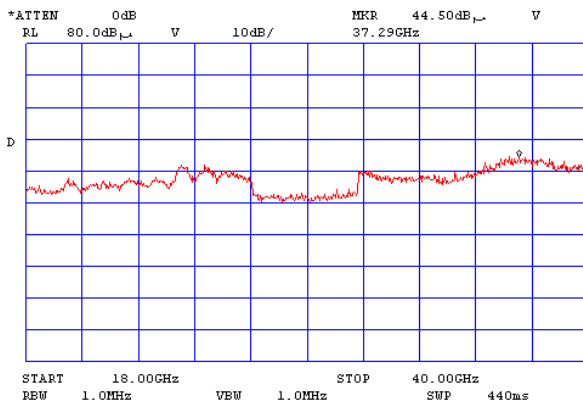

Plot # 145



Test report No: 8912311553/1
Title: BreezeMAX Extreme 5.4 Base station
Model: XTRM-BS-2SIS-5.4-Ext

Page 52 of 72 Pages
FCC ID: LKT-EXTR-50

Frequency carrier 5715 MHz.

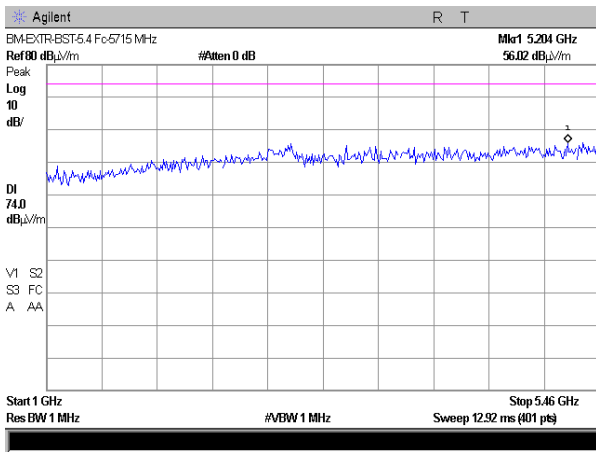

Plot # 146

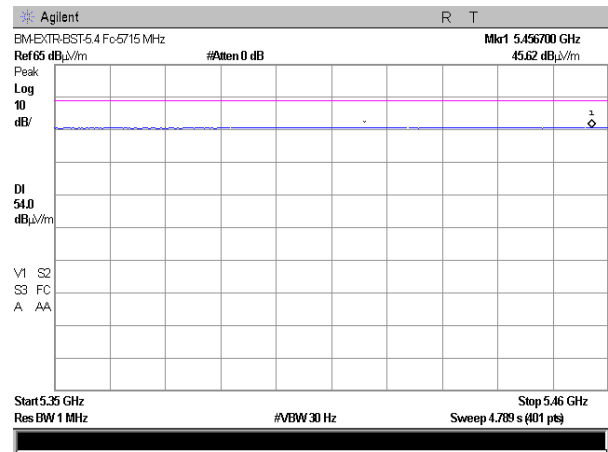

Plot # 147

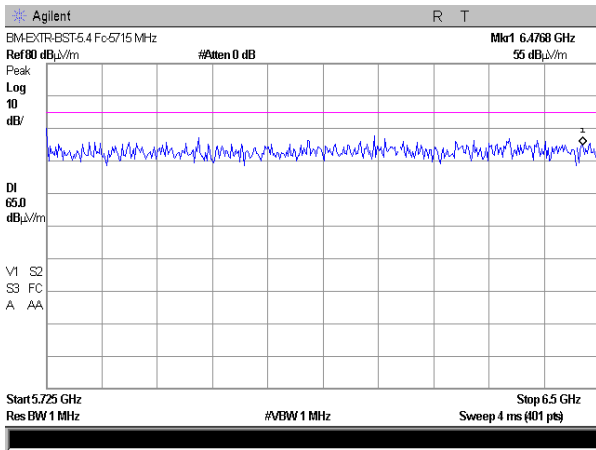

Plot # 148

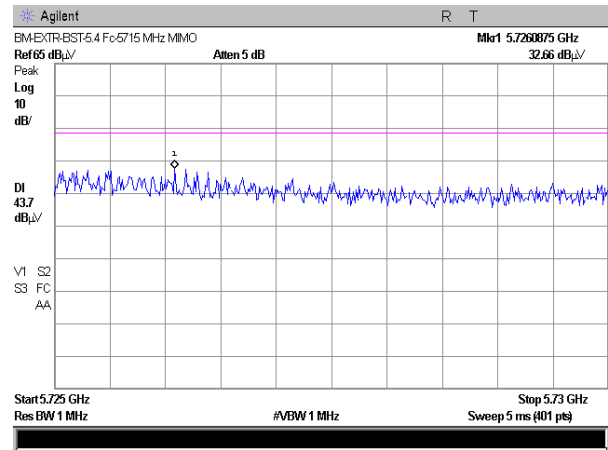

Plot # 149

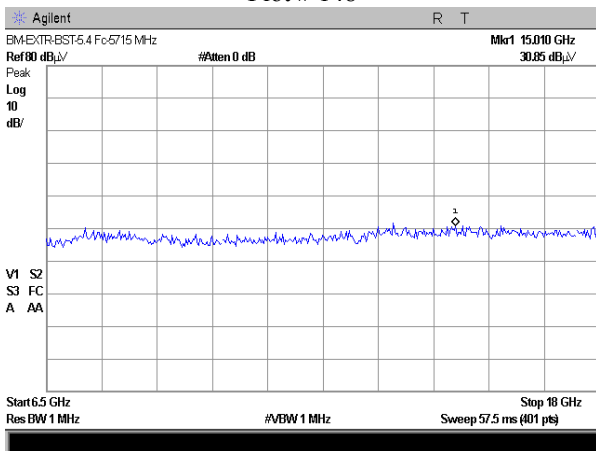

Plot # 150

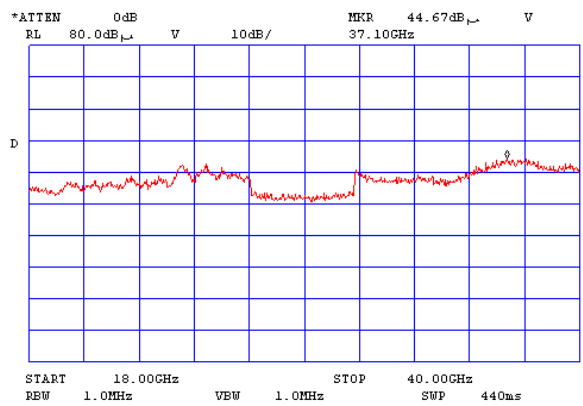

**Test report No:** 8912311553/1

Page 53 of 72 Pages

Title: BreezeMAX Extreme 5.4 Base station**Model:** XTRM-BS-2SIS-5.4-Ext

FCC ID: LKT-EXTR-50

5.1.5 Peak excursion test

Method of measurement DA 02-2138
 Operating Frequency Range 5.475 – 5.720 GHz
 Ambient Temperature 23⁰ C Relative Humidity 49% Air Pressure 1009 hPa

The measurements were performed at three transmitted carrier (channel) frequencies at bottom, middle and top of the 5.470 GHz – 5.725 GHz frequency band under maximum data transfer bit rate.

RF channel 15 MHz emission bandwidth

Carrier frequency MHz	Measured ratio of the PEME dB	The limit of PEME ratio dB	Reference to plot #
5475	10.1	13.0	151
5580	9.9	13.0	152
5720	9.7	13.0	153

10 MHz emission bandwidth

Carrier frequency MHz	Measured ratio of the PEME dB	The limit of PEME ratio dB	Reference to plot #
5480	9.9	13.0	154
5580	10.4	13.0	155
5715	10.0	13.0	156

RF channel 25 MHz emission bandwidth

Carrier frequency MHz	Measured ratio of the PEME dB	The limit of PEME ratio dB	Reference to plot #
5475	8.7	13.0	157
5580	9.4	13.0	158
5720	9.9	13.0	159

10 MHz emission bandwidth

Carrier frequency MHz	Measured ratio of the PEME dB	The limit of PEME ratio dB	Reference to plot #
5480	9.5	13.0	160
5580	10.0	13.0	161
5715	10.2	13.0	162



Test report No: 8912311553/1

Page 54 of 72 Pages

Title: BreezeMAX Extreme 5.4 Base station

Model: XTRM-BS-2SIS-5.4-Ext

FCC ID: LKT-EXTR-50

REQUIREMENT

The ratio of the peak excursion of the modulation envelope (PEME) to the peak transmit power shall not exceed 13 dB across any 1 MHz bandwidth or the emission bandwidth whichever is less as required in sec. 15.407 (a) (6).

TEST PROCEDURE

The test was performed at worse case mode at maximum allowed output power.

The measurements were performed at three transmitted carrier (channel) frequencies at bottom, middle and top of the 5.470 GHz – 5.725 GHz frequency band under maximum data transfer bit rate.

Test was conducted with the follow SA settings:

Trace #1 – RBW = 1 MHz VBW = 3 MHz Max hold mode.

Trace #2 – RBW = 1 MHz VBW = 3 MHz in power averaging mode.

TEST SAMMARY

Transmitter meets standard requirement.

TEST EQUIPMENT USED:

2	3	4	5			
---	---	---	---	--	--	--



Test report No: 8912311553/1
Title: BreezeMAX Extreme 5.4 Base station
Model: XTRM-BS-2SIS-5.4-Ext

Page 55 of 72 Pages
FCC ID: LKT-EXTR-50

RF channel 1

5 MHz emission bandwidth

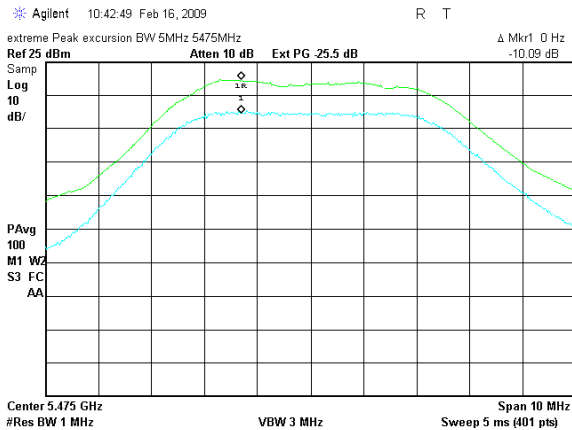

Plot # 151. Carrier Frequency 5475 MHz

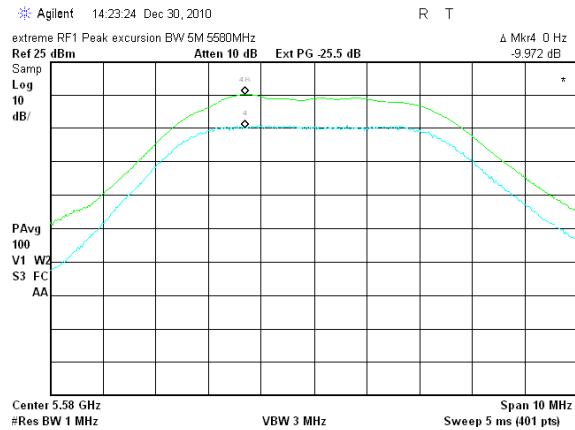

Plot # 152. Carrier Frequency 5580MHz

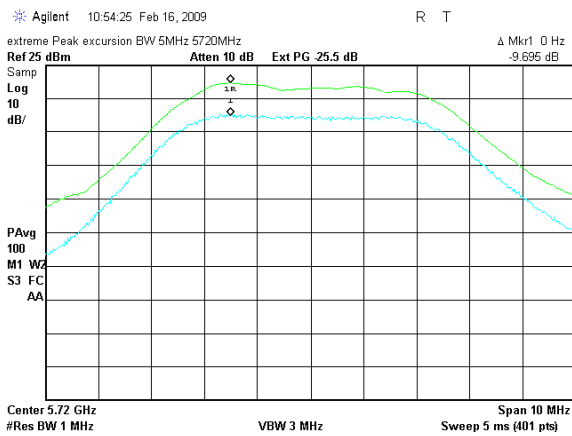

Plot # 153. Carrier Frequency 5720 MHz



Test report No: 8912311553/1
Title: BreezeMAX Extreme 5.4 Base station
Model: XTRM-BS-2SIS-5.4-Ext

Page 56 of 72 Pages
FCC ID: LKT-EXTR-50

10 MHz emission bandwidth

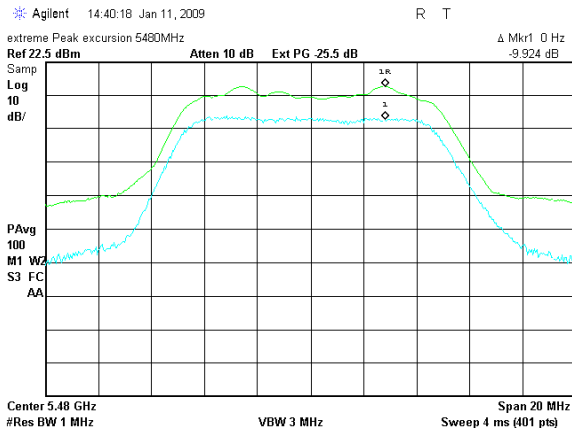

Plot # 154. Carrier Frequency 5480 MHz

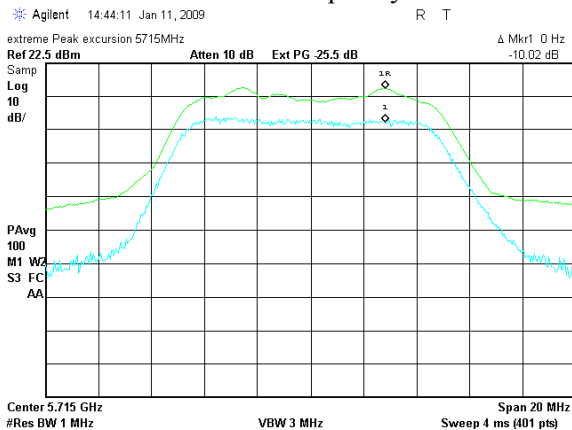

Plot # 156. Carrier Frequency 5715 MHz

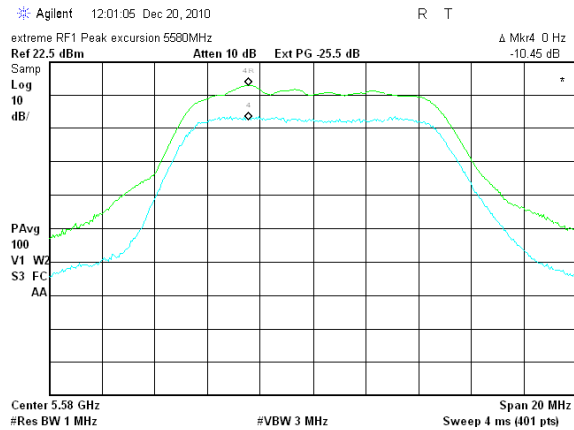

Plot # 155. Carrier Frequency 5580 MHz



Test report No: 8912311553/1
Title: BreezeMAX Extreme 5.4 Base station
Model: XTRM-BS-2SIS-5.4-Ext

Page 57 of 72 Pages
FCC ID: LKT-EXTR-50

RF channel 2

5 MHz emission bandwidth

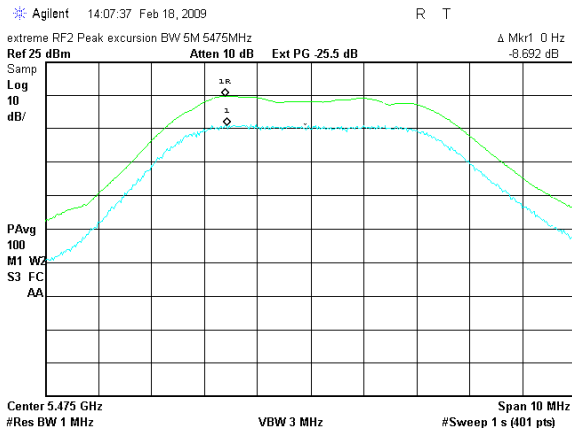

Plot # 157. Carrier Frequency 5475 MHz

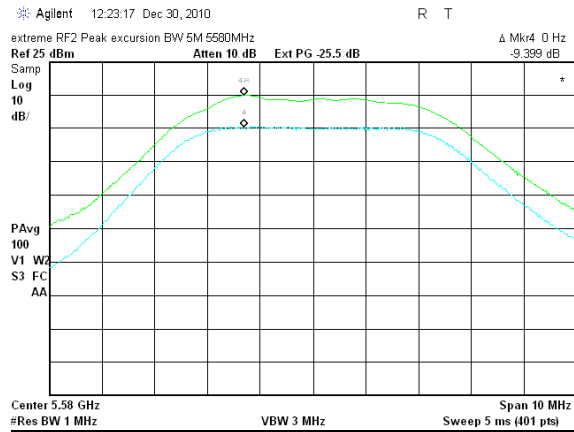

Plot # 158. Carrier Frequency 5580 MHz

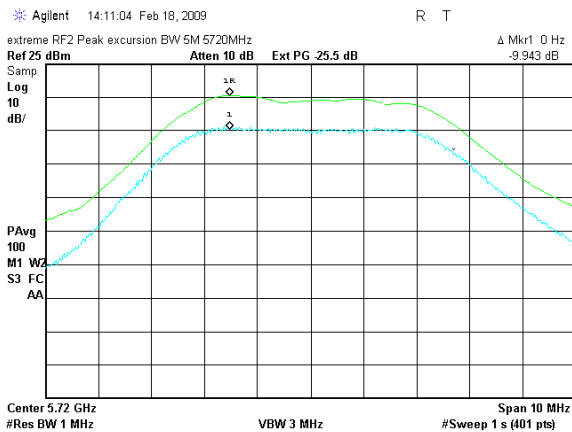

Plot # 159. Carrier Frequency 5720 MHz



Test report No: 8912311553/1
Title: BreezeMAX Extreme 5.4 Base station
Model: XTRM-BS-2SIS-5.4-Ext

Page 58 of 72 Pages
FCC ID: LKT-EXTR-50

10 MHz emission bandwidth

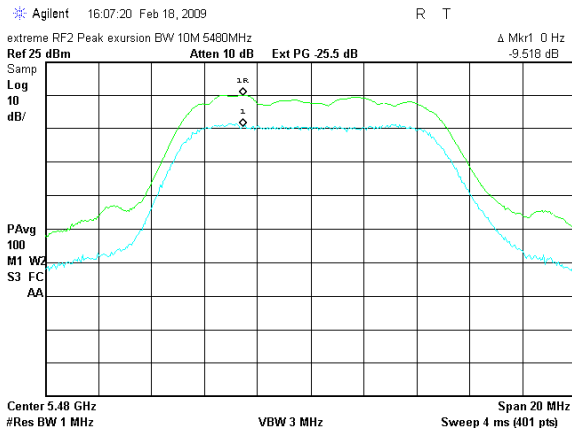

Plot # 160. Carrier Frequency 5480 MHz

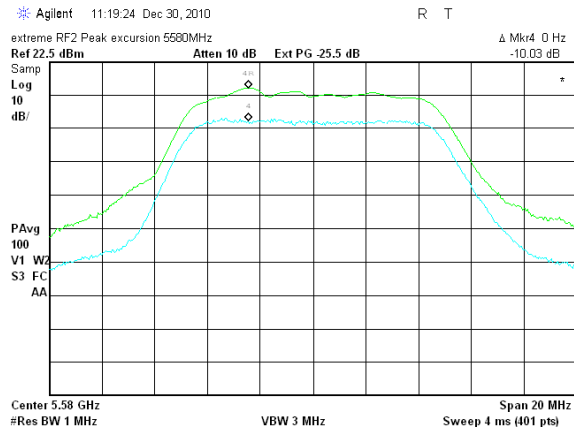

Plot # 161. Carrier Frequency 5580 MHz

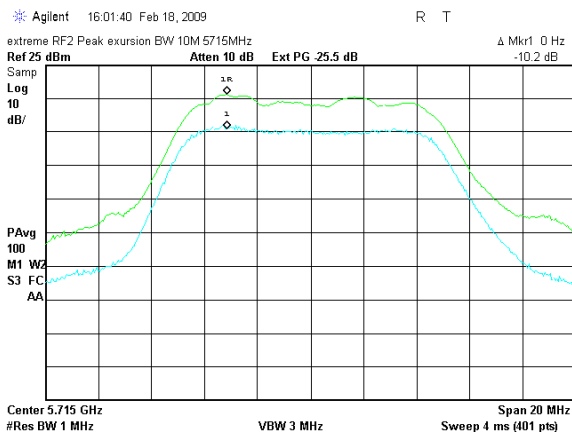

Plot # 162. Carrier Frequency 5715 MHz



Test report No: 8912311553/1	Page 59 of 72 Pages
Title: BreezeMAX Extreme 5.4 Base station	
Model: XTRM-BS-2SIS-5.4-Ext	FCC ID: LKT-EXTR-50

5.2 Radiated emissions test according to § 15.209

Method of measurement ANSI 63.4 §13.1.4
Ambient Temperature 24⁰ C Relative Humidity 55% Air Pressure 1012 hPa

TEST DESCRIPTION:

The measurements were performed at the Open Area Test Site. The test configuration is shown in Fig.1. The EUT was arranged on a wooden table 0.8 m placed on the turn - table. The measurements were performed at a 10 m measurement distance. The Biconilog antenna 30 MHz-2 GHz frequency range was used. The frequency range was investigated from 30 MHz to 1.0 GHz. The measurements were performed at each frequency at which the signal was 10 dB below the limit or less. The level was maximized by initially rotating turntable through 360°, varying the antenna height between 1 m and 4 m, rerouting EUT cables and changing antenna polarization from vertical to horizontal.

REQUIREMENTS:

EUT radiated emission shall not exceed value required in section 15.209

TEST RESULT:

Test results are presented in Tables 1 and 2.
Results more than 20 dB under the limit were not inserted in the table.

TEST EQUIPMENT USED:

8	9	13				
---	---	----	--	--	--	--

**Test report No:** 8912311553/1

Page 60 of 72 Pages

Title: BreezeMAX Extreme 5.4 Base station**Model:** XTRM-BS-2SIS-5.4-Ext

FCC ID: LKT-EXTR-50

Table 1. Radiated emission test results. AC option.

Frequency (MHz)	Antenna Polariz V/H	Turn- table Angle (°)	Antenna Height (m)	Emission Level Note 1 (dB μ V/m)	Limit @ 3m (dB μ V/m)	Margin Note 2 (dB)	Results
59.4	V	303	1.0	27.3	40.0	12.7	Pass
112.2	V	286	1.0	28.6	43.5	14.9	Pass
136.0	V	231	1.0	24.2	43.5	19.3	Pass

Table 2. Radiated emission test results. DC option.

Frequency (MHz)	Antenna Polariz V/H	Turn- table Angle (°)	Antenna Height (m)	Emission Level Note 1 (dB μ V/m)	Limit @ 3m (dB μ V/m)	Margin Note 2 (dB)	Results
66.7	V	104	1.0	23.9	40.0	16.1	Pass
69.6	V	104	1.0	24.2	40.0	15.8	Pass
112.2	V	231	1.0	28.6	43.5	14.9	Pass
136.0	V	236	1.0	24.2	43.5	19.3	Pass

Note 1: Emission level = E Reading (dB μ V) + Cable loss (dB) + Antenna Factor (dB/m) + 10 dB

Where 10 dB is an extrapolation distance factor.

For Cable Loss and Antenna Factor refer to Appendix 2.

Note 2: Margin (dB) = Limit (dB μ V/m) – Emission level (dB μ V/m)



Test report No: 8912311553/1	Page 61 of 72 Pages
Title: BreezeMAX Extreme 5.4 Base station	
Model: XTRM-BS-2SIS-5.4-Ext	FCC ID: LKT-EXTR-50

5.3 Conducted emissions test according to § 15.207

Method of measurement ANSI 63.4 §13.1.3
Ambient Temperature 23⁰ C Relative Humidity 52% Air Pressure 1008 hPa

Frequency, MHz	dB (µV)	
	QP	AVRG
0.15 - 0.5	66 - 56*	56 - 46*
0.5 - 5	56	46
5 - 30	60	50

* Decreases with the logarithm of the frequency.

TEST PROCEDURE

EUT was placed on a wooden table in a shielded chamber at a height of 80 cm from the floor and 40 cm from the vertical reference plane. The measurements were performed at mains terminals by means of LISN, connected to spectrum analyzer in the frequency range as referred to in the table above. The measurements were made with quasi-peak (CISPR) and average detectors. The position of the EUT cables was varied to determine maximum emission level. Test was conducted twice on EUT AC main input and on AC power line to AC/DC auxiliary power supply in 48VDC power option.

TEST RESULT:

Test results for EUT AC main option present at plots # 163 for line Phase and # 164 for line Neutral.

Test result for AC/DC auxiliary power supply option present at plots # 165 for line Phase and # 166 for line Neutral.

TEST EQUIPMENT USED:

9	10	11				
---	----	----	--	--	--	--



Test report No: 8912311553/1
Title: BreezeMAX Extreme 5.4 Base station
Model: XTRM-BS-2SIS-5.4-Ext

Page 62 of 72 Pages

FCC ID: LKT-EXTR-50

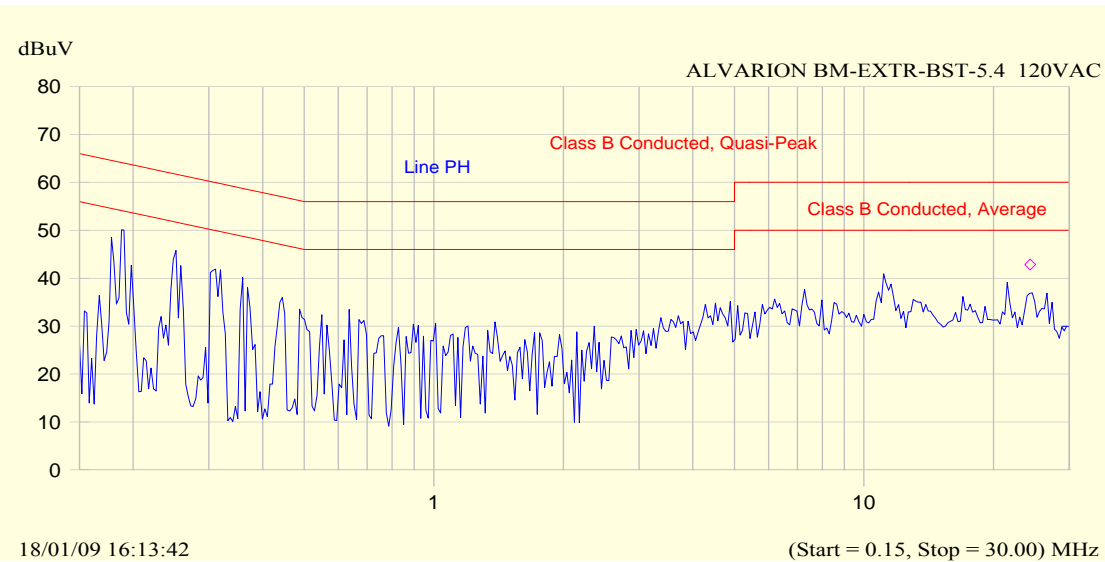

Frequency MHz	Peak dB μ V	QP dB μ V	QP Limit dB	QP-QP Limit dB	Avg dB μ V	Avg Limit dB	Avg-Avg Limit dB
0.184	54.0	53.0	64.3	-11.3	39.9	54.3	-14.4
0.257	50.1	49.2	61.5	-12.3	39.8	51.5	-11.7
0.371	44.7	42.8	58.5	-15.6	33.3	48.5	-15.2
0.494	36.3	35.3	56.1	-20.8	26.2	46.1	-19.9
24.046	41.8	38.4	60.0	-21.6	34.3	50.0	-15.7
24.352	42.8	39.7	60.0	-20.3	33.7	50.0	-16.3

Plot # 163. Conducted emissions test. Line Phase

Test report No: 8912311553/1
Title: BreezeMAX Extreme 5.4 Base station
Model: XTRM-BS-2SIS-5.4-Ext

Page 63 of 72 Pages

FCC ID: LKT-EXTR-50

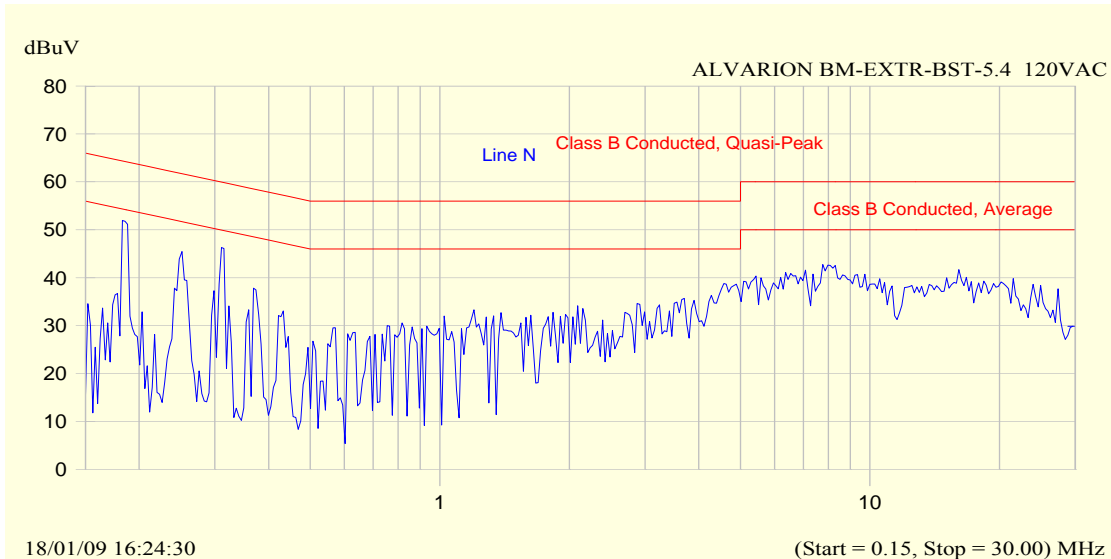

Frequency MHz	Peak dB μ V	QP dB μ V	QP Limit dB	QP-QP Limit dB	Avg dB μ V	Avg Limit dB	Avg-Avg Limit dB
0.184	51.4	43.4	64.3	-20.9	35.7	54.3	-18.6
0.257	48.9	48.1	61.5	-13.4	39.2	51.5	-12.3
0.370	43.1	41.7	58.5	-16.8	31.6	48.5	-16.9
0.960	31.9	30.6	56.0	-25.4	23.8	46.0	-22.2
24.046	41.7	38.4	60.0	-21.6	34.2	50.0	-15.8
24.351	42.9	39.5	60.0	-20.5	33.6	50.0	-16.4

Plot # 164. Conducted emissions test. Line Neutral



Test report No: 8912311553/1
Title: BreezeMAX Extreme 5.4 Base station
Model: XTRM-BS-2SIS-5.4-Ext

Page 64 of 72 Pages
FCC ID: LKT-EXTR-50

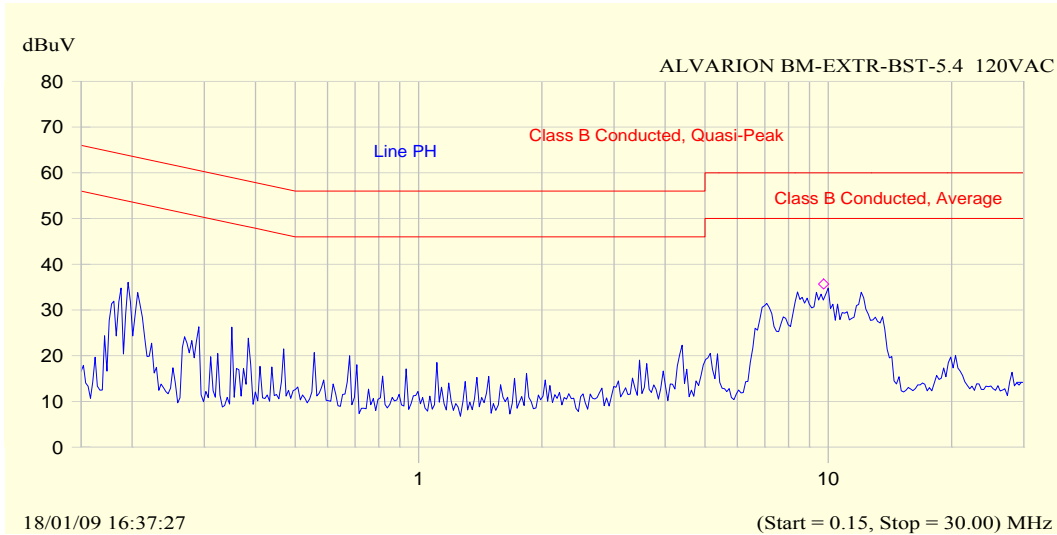

Frequency MHz	Peak dB μ V	QP dB μ V	QP Limit dB	QP-QP Limit dB	Avg dB μ V	Avg Limit dB	Avg-Avg Limit dB
8.602	36.7	30.6	60.0	-29.4	20.9	50.0	-29.1
9.736	35.7	30.1	60.0	-29.9	21.1	50.0	-28.9

Plot # 165. CE test on auxiliary AC/DC P.S. Line Phase.

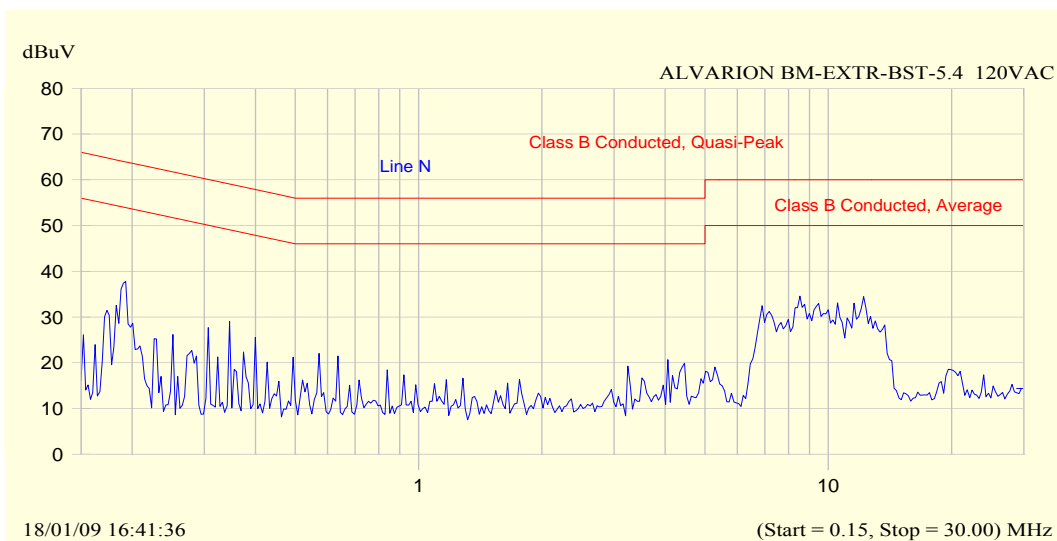

Plot # 166. CE test on auxiliary AC/DC P.S. Line Neutral.



Test report No: 8912311553/1

Title: BreezeMAX Extreme 5.4 Base station

Model: XTRM-BS-2SIS-5.4-Ext

Page 65 of 72 Pages

FCC ID: LKT-EXTR-50

APPENDIX A Photographs

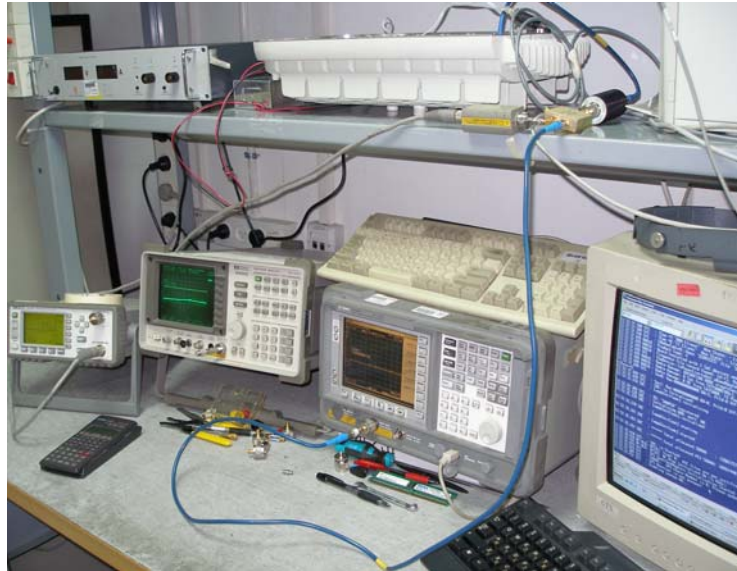

Photo 1. Conducted measurements. Test setup.



Photo 2. Test setup on OATS.

Test report No: 8912311553/1

Title: BreezeMAX Extreme 5.4 Base station

Model: XTRM-BS-2SIS-5.4-Ext

Page 66 of 72 Pages

FCC ID: LKT-EXTR-50



Photo 3. Investigation test setup with internal antenna.

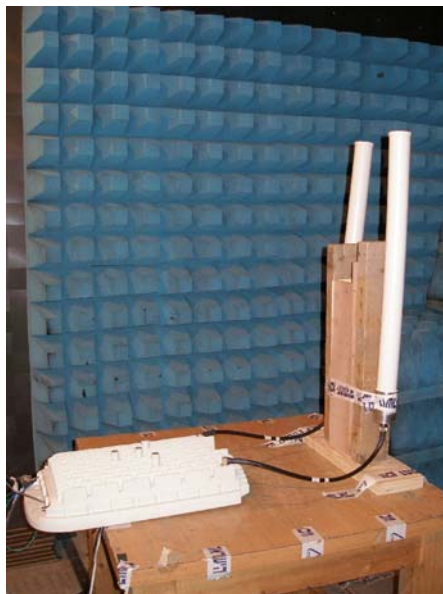

Photo 4. Investigation test setup with external Omni antenna.

Test report No: 8912311553/1

Title: BreezeMAX Extreme 5.4 Base station

Model: XTRM-BS-2SIS-5.4-Ext

Page 67 of 72 Pages

FCC ID: LKT-EXTR-50



Photo 5. Investigation test setup with external sector antenna.



Photo 6. EUT's internal view.

**Test report No:** 8912311553/1**Page 68 of 72 Pages****Title:** BreezeMAX Extreme 5.4 Base station**Model:** XTRM-BS-2SIS-5.4-Ext**FCC ID:** LKT-EXTR-50**APPENDIX B Test equipment used****Test equipment used**

No	Description	Manufacturer information			Due Calibration date
		Name	Model No	Serial No	
1	Spectrum Analyzer 9 kHz - 40 GHz	HP	8565E	3835A01359	June 2011
2	Spectrum Analyzer 9 kHz - 26.5 GHz	Adjilent	4407B	US40241729	June 2011
3	Attenuators 20 dB DC – 8.5 GHz	Aeroflex/ Weinshel	33-30-34	A3451	June 2011
4	Power splitter 1.7 – 9 GHz	Mini-Circuits	ZN2PD-9G	0142	June 2011
5	Cable RF 1m	Huber-Suhner	Sucoflex 104	21324/4PE	December 2011
6	Double Ridged Guide Antenna 1 – 18 GHz	EMCO	3115	5802	October 2011
7	Broadband Horn antenna 15 – 40 GHz	Schwarzbeck Mess-Electronik	BBHA 9170	9170-341	October 2011
8	Antenna Biconilog 30 – 2000 MHz	Schaffner-Chase	CBL6112B	S/N 23181	Aug 2009
9	EMI Receiver 9 kHz-6.5 GHz	HP	8546A+8546 0A	SII 4068	April 2009
10	LISN 9 kHz – 30 MHz	FCC	LISN 250- 32-4-16	SII5023	October 2009
11	Transient limiter 0.009-200 MHz	HP	11947A	3107105	October 2009
12	Spectrum analyzer 10 KHz-26.5 GHz	HP	E7405A	SII 4944	April 2011
13	Cable RF 4m	Huber-Suhner	Sucoflex 104PE	21328/4PE	December 2011
14	Active Loop antenna 10 kHz – 30 MHz	EMCO	6502	SII 4874	October 2009



Test report No: 8912311553/1

Title: BreezeMAX Extreme 5.4 Base station

Model: XTRM-BS-2SIS-5.4-Ext

Page 69 of 72 Pages

FCC ID: LKT-EXTR-50

Cable Loss (10m cable + Mast)

Point	Frequency (MHz)	Cable Loss (dB)	Point	Frequency (MHz)	Cable Loss (dB)
1	30	0.53	21	1000	3.68
2	50	0.75	22	1100	3.82
3	100	1.08	23	1200	4.07
4	150	1.39	24	1300	4.24
5	200	1.61	25	1400	4.43
6	250	1.752	26	1500	4.6
7	300	2.00	27	1600	4.7
8	350	2.15	28	1700	4.85
9	400	2.26	29	1800	4.98
10	450	2.383	30	1900	5.19
11	500	2.52	31	2000	5.34
12	550	2.606	32	2100	5.51
13	600	2.75	33	2200	5.69
14	650	2.856	34	2300	5.89
15	700	3.06	35	2400	6.07
16	750	3.201	36	2500	6.22
17	800	3.27	37	2600	6.28
18	850	3.38	38	2700	6.41
19	900	3.46	39	2800	6.53
20	950	3.55	40	2900	6.84



Test report No: 8912311553/1

Page 70 of 72 Pages

Title: BreezeMAX Extreme 5.4 Base station

Model: XTRM-BS-2SIS-5.4-Ext

FCC ID: LKT-EXTR-50

Biconilog Antenna, Model Number: CBL-6112D, S/N: 23181.

No.	f / MHz)	AF / dB/m	f / MHz)	AF / dB/m	f / MHz)	AF / dB/m	f / MHz)	AF / dB/m
1	30	17.90	170	9.40	530	17.70	1040	22.20
2	32	16.70	175	9.00	540	18.25	1060	22.50
3	34	15.55	180	8.50	550	18.60	1080	22.50
4	36	14.35	185	8.45	560	14.45	1100	22.40
5	38	13.30	190	8.60	570	18.40	1120	22.60
6	40	12.20	195	8.85	580	18.50	1140	22.45
7	42	11.05	200	8.95	590	18.60	1160	22.50
8	44	9.95	205	8.80	600	18.60	1180	22.40
9	46	8.90	210	8.50	610	18.80	1200	22.80
10	48	8.05	215	8.20	620	18.99	1220	22.95
11	50	7.30	220	8.50	630	19.05	1240	23.10
12	52	6.80	225	9.00	640	19.23	1260	23.40
13	54	6.45	230	9.65	650	19.10	1280	23.35
14	56	6.00	235	10.30	660	19.13	1300	23.62
15	58	5.70	240	11.00	670	19.04	1320	23.64
16	60	5.45	245	11.60	680	19.00	1340	23.86
17	62	5.30	250	12.00	690	19.17	1360	23.95
18	64	5.20	255	12.45	700	19.28	1380	23.90
19	66	5.30	260	12.85	710	19.25	1400	24.45
20	68	5.30	265	12.50	720	19.45	1420	24.74
21	70	5.35	270	12.45	730	19.75	1440	24.93
22	72	5.50	275	12.40	740	19.95	1460	25.03
23	74	5.80	280	12.55	750	20.07	1480	25.45
24	76	6.00	285	12.65	760	19.85	1500	25.30
25	78	6.60	290	12.75	770	19.80	1520	25.25
26	80	6.70	295	12.95	780	19.85	1540	25.36
27	82	7.15	300	13.00	790	19.95	1560	25.58
28	84	7.60	310	13.35	800	20.05	1580	25.50
29	86	8.10	320	13.75	810	20.10	1600	25.65
30	88	8.50	330	13.85	820	20.35	1620	25.60
31	90	8.90	340	14.10	830	20.40	1640	25.70
32	92	9.20	350	14.50	840	20.35	1660	25.83
33	94	9.75	360	14.70	850	20.46	1680	25.97
34	96	9.95	370	14.90	860	20.39	1700	26.10
35	98	10.20	380	15.10	870	20.29	1720	26.25
36	100	10.50	390	15.45	880	20.24	1740	26.04
37	105	11.25	400	16.00	890	20.35	1760	26.14
38	110	11.70	410	16.40	900	20.55	1780	26.20
39	115	11.70	420	16.70	910	20.45	1800	26.40
40	120	11.80	430	16.35	920	20.60	1820	26.64
41	125	11.80	440	16.30	930	20.60	1840	26.86
42	130	11.70	450	16.30	940	20.66	1860	27.12
43	135	11.35	460	16.70	950	20.88	1880	27.00
44	140	10.95	470	17.05	960	21.11	1900	27.25
45	145	10.35	480	17.20	970	20.93	1920	27.36
46	150	10.05	490	17.30	980	21.03	1940	27.68
47	155	9.70	500	17.40	990	21.05	1960	27.10
48	160	9.70	510	17.50	1000	21.10	1980	27.06
49	165	9.45	520	17.60	1020	21.40	2000	27.25



Test report No: 8912311553/1

Page 71 of 72 Pages

Title: BreezeMAX Extreme 5.4 Base station

Model: XTRM-BS-2SIS-5.4-Ext

FCC ID: LKT-EXTR-50

Antenna Factor

Double Ridged Guide Antenna mfr EMCO model 3115 1m calibration

Point	Frequency (MHz)	Antenna Factor (dB/m)
1	1000	23.9
2	2000	28.3
3	3000	31.0
4	4000	33.1
5	4500	32.5
6	5000	32.4
7	6000	53.7
8	6500	35.6
9	7000	36.4
10	7500	36.9
11	8000	37.0
12	8500	38.0
13	9000	38.6
14	9500	38.4
15	10000	38.4
16	10500	38.4
17	11000	38.9
18	11500	39.6
19	12000	39.4
20	12500	39.2
21	13000	40.3
22	13500	41.0
23	14000	41.2
24	14500	41.3
25	15000	40.0
26	15500	38.0
27	16000	38.1
28	16500	40.3
29	17000	42.2
30	17500	44.6
31	18000	46.2

Cable Loss

Type: Sucoflex 104PE; Ser.No.21328/4PE; 4 m length

Point	Frequency (GHz)	Cable Loss (dB)
1	0.0-1.0	1.7
2	1.0- 3.5	3.2
3	3.5- 5.5	4.0
4	5.5 - 7.5	4.7
5	7.5 - 9.5	5.3
6	9.5 - 10.5	5.6
7	10.5 - 12.5	6.2
8	12.5 - 14.5	6.8
9	14.5 - 16.5	7.5
10	16.5 - 18.0	8.1

**Test report No:** 8912311553/1**Title:** BreezeMAX Extreme 5.4 Base station**Model:** XTRM-BS-2SIS-5.4-Ext

Page 72 of 72 Pages

FCC ID: LKT-EXTR-50

APPENDIX C General information.

Abbreviations and acronyms

The following abbreviations and acronyms are applicable to this test report:

AC	alternating current
cm	centimeter
dB	decibel
dBm	decibel referred to one milliwatt
dB(μ V)	decibel referred to one microvolt
dB(μ V/m)	decibel referred to one microvolt per meter
EMC	electromagnetic compatibility
EUT	equipment under test
GHz	gigahertz
H	height
Hz	hertz
kHz	kilohertz
L	length
LNA	low noise amplifier
m	meter
Mbps	megabit per second
MHz	megahertz
NA	not applicable
OFDM	Orthogonal Frequency Division Multiple Access
PRBS	pseudo random binary sequence
QP	quasi-peak
RF	radio frequency
RE	radiated emission
rms	root mean square

Specification references

47 CFR part 15: 2009	Radio Frequency Devices
ANSI C63.4: 2003	American National Standard for Method of Measurements of Radio-Noise Emissions from Low-Voltage Electrical and Electronic Equipment in the Range of 9 kHz to 40 GHz
ANSI/TIA-603-C: 2004	Land Mobile FM or PM Communication Equipment Measurement and Performance.