

BreezeCOMPACT

PRELIMINARY

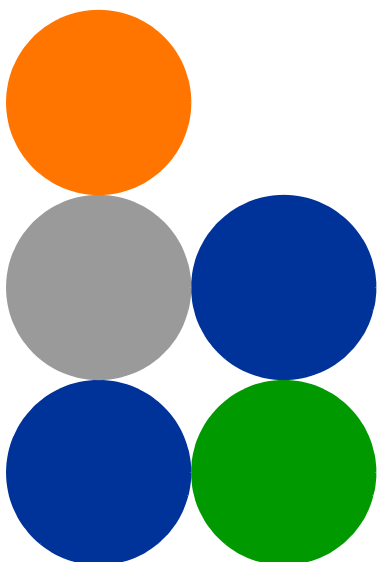

System Manual

Release Version: 1.0
December 2011
P/N

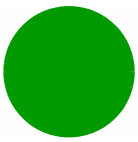

Document History

Topic	Description	Date Issued
BreezeCOMPACT System Manual	First publication of a System Manual for a new product	March 2012



Legal Rights

© Copyright 2012 Alvarion Ltd. All rights reserved.

The material contained herein is proprietary, privileged, and confidential and owned by Alvarion or its third party licensors. No disclosure thereof shall be made to third parties without the express written permission of Alvarion Ltd.

Alvarion Ltd. reserves the right to alter the equipment specifications and descriptions in this publication without prior notice. No part of this publication shall be deemed to be part of any contract or warranty unless specifically incorporated by reference into such contract or warranty.

Trade Names

Alvarion[®], BreezeCOM[®], WALKair[®], WALKnet[®], BreezeNET[®], BreezeACCESS[®], BreezeLINK[®], BreezeMAX[®], BreezeLITE[®], BreezePHONE[®], 4Motion[®], and/or other products and/or services referenced here in are either registered trademarks, trademarks or service marks of Alvarion Ltd.

All other names are or may be the trademarks of their respective owners.

"WiMAX Forum" is a registered trademark of the WiMAX Forum. "WiMAX," the WiMAX Forum logo, "WiMAX Forum Certified", and the WiMAX Forum Certified logo are trademarks of the WiMAX Forum.

Statement of Conditions

The information contained in this manual is subject to change without notice. Alvarion Ltd. shall not be liable for errors contained herein or for incidental or consequential damages in connection with the furnishing, performance, or use of this manual or equipment supplied with it.

Warranties and Disclaimers

All Alvarion Ltd. ("Alvarion") products purchased from Alvarion or through any of Alvarion's authorized resellers are subject to the following warranty and product liability terms and conditions.

Exclusive Warranty

(a) Alvarion warrants that the Product hardware it supplies and the tangible media on which any software is installed, under normal use and conditions, will be free from significant defects in materials and workmanship for a period of fourteen (14) months from the date of shipment of a given Product to Purchaser (the "Warranty Period"). Alvarion will, at its sole option and as Purchaser's sole remedy, repair or replace any defective Product in accordance with Alvarion' standard R&R procedure.

(b) With respect to the Firmware, Alvarion warrants the correct functionality according to the attached documentation, for a period of fourteen (14) month from invoice date (the "Warranty Period)". During the Warranty Period, Alvarion may release to its Customers firmware updates, which include additional performance improvements and/or bug fixes, upon availability (the "Warranty"). Bug fixes, temporary patches and/or workarounds may be supplied as Firmware updates.

Additional hardware, if required, to install or use Firmware updates must be purchased by the Customer. Alvarion will be obligated to support solely the two (2) most recent Software major releases.

ALVARION SHALL NOT BE LIABLE UNDER THIS WARRANTY IF ITS TESTING AND EXAMINATION DISCLOSE THAT THE ALLEGED DEFECT IN THE PRODUCT DOES NOT EXIST OR WAS CAUSED BY PURCHASER'S OR ANY THIRD PERSON'S MISUSE, NEGLIGENCE, IMPROPER INSTALLATION OR IMPROPER TESTING, UNAUTHORIZED ATTEMPTS TO REPAIR, OR ANY OTHER CAUSE BEYOND THE RANGE OF THE INTENDED USE, OR BY ACCIDENT, FIRE, LIGHTNING OR OTHER HAZARD.

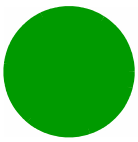

Disclaimer

(a) The Software is sold on an "AS IS" basis. Alvarion, its affiliates or its licensors MAKE NO WARRANTIES, WHATSOEVER, WHETHER EXPRESS OR IMPLIED, WITH RESPECT TO THE SOFTWARE AND THE ACCOMPANYING DOCUMENTATION. ALVARION SPECIFICALLY DISCLAIMS ALL IMPLIED WARRANTIES OF MERCHANTABILITY AND FITNESS FOR A PARTICULAR PURPOSE AND NON-INFRINGEMENT WITH RESPECT TO THE SOFTWARE. UNITS OF PRODUCT (INCLUDING ALL THE SOFTWARE) DELIVERED TO PURCHASER HEREUNDER ARE NOT FAULT-TOLERANT AND ARE NOT DESIGNED, MANUFACTURED OR INTENDED FOR USE OR RESALE IN APPLICATIONS WHERE THE FAILURE, MALFUNCTION OR INACCURACY OF PRODUCTS CARRIES A RISK OF DEATH OR BODILY INJURY OR SEVERE PHYSICAL OR ENVIRONMENTAL DAMAGE ("HIGH RISK ACTIVITIES"). HIGH RISK ACTIVITIES MAY INCLUDE, BUT ARE NOT LIMITED TO, USE AS PART OF ON-LINE CONTROL SYSTEMS IN HAZARDOUS ENVIRONMENTS REQUIRING FAIL-SAFE PERFORMANCE, SUCH AS IN THE OPERATION OF NUCLEAR FACILITIES, AIRCRAFT NAVIGATION OR COMMUNICATION SYSTEMS, AIR TRAFFIC CONTROL, LIFE SUPPORT MACHINES, WEAPONS SYSTEMS OR OTHER APPLICATIONS REPRESENTING A SIMILAR DEGREE OF POTENTIAL HAZARD. ALVARION SPECIFICALLY DISCLAIMS ANY EXPRESS OR IMPLIED WARRANTY OF FITNESS FOR HIGH RISK ACTIVITIES.

(b) PURCHASER'S SOLE REMEDY FOR BREACH OF THE EXPRESS WARRANTIES ABOVE SHALL BE REPLACEMENT OR REFUND OF THE PURCHASE PRICE AS SPECIFIED ABOVE, AT ALVARION'S OPTION. TO THE FULLEST EXTENT ALLOWED BY LAW, THE WARRANTIES AND REMEDIES SET FORTH IN THIS AGREEMENT ARE EXCLUSIVE AND IN LIEU OF ALL OTHER WARRANTIES OR CONDITIONS, EXPRESS OR IMPLIED, EITHER IN FACT OR BY OPERATION OF LAW, STATUTORY OR OTHERWISE, INCLUDING BUT NOT LIMITED TO WARRANTIES, TERMS OR CONDITIONS OF MERCHANTABILITY, FITNESS FOR A PARTICULAR PURPOSE, SATISFACTORY QUALITY, CORRESPONDENCE WITH DESCRIPTION, NON-INFRINGEMENT, AND ACCURACY OF INFORMATION GENERATED. ALL OF WHICH ARE EXPRESSLY DISCLAIMED. ALVARION' WARRANTIES HEREIN RUN ONLY TO PURCHASER, AND ARE NOT EXTENDED TO ANY THIRD PARTIES. ALVARION NEITHER ASSUMES NOR AUTHORIZES ANY OTHER PERSON TO ASSUME FOR IT ANY OTHER LIABILITY IN CONNECTION WITH THE SALE, INSTALLATION, MAINTENANCE OR USE OF ITS PRODUCTS.

Limitation of Liability

(a) ALVARION SHALL NOT BE LIABLE TO THE PURCHASER OR TO ANY THIRD PARTY, FOR ANY LOSS OF PROFITS, LOSS OF USE, INTERRUPTION OF BUSINESS OR FOR ANY INDIRECT, SPECIAL, INCIDENTAL, PUNITIVE OR CONSEQUENTIAL DAMAGES OF ANY KIND, WHETHER ARISING UNDER BREACH OF CONTRACT, TORT (INCLUDING NEGLIGENCE), STRICT LIABILITY OR OTHERWISE AND WHETHER BASED ON THIS AGREEMENT OR OTHERWISE, EVEN IF ADVISED OF THE POSSIBILITY OF SUCH DAMAGES.

(b) TO THE EXTENT PERMITTED BY APPLICABLE LAW, IN NO EVENT SHALL THE LIABILITY FOR DAMAGES HEREUNDER OF ALVARION OR ITS EMPLOYEES OR AGENTS EXCEED THE PURCHASE PRICE PAID FOR THE PRODUCT BY PURCHASER, NOR SHALL THE AGGREGATE LIABILITY FOR DAMAGES TO ALL PARTIES REGARDING ANY PRODUCT EXCEED THE PURCHASE PRICE PAID FOR THAT PRODUCT BY THAT PARTY (EXCEPT IN THE CASE OF A BREACH OF A PARTY'S CONFIDENTIALITY OBLIGATIONS).

Radio Frequency Interference Statement

The Base Transceiver Station (BTS) equipment has been tested and found to comply with the limits for a class A digital device, pursuant to ETSI EN 301 489-1 rules and Part 15 of the FCC Rules. These limits are designed to provide reasonable protection against harmful interference when the equipment is operated in commercial, business and industrial environments. This equipment generates, uses, and can radiate radio frequency energy and, if not installed and used in accordance with the instruction manual, may cause harmful interference to radio communications. Operation of this equipment in a residential area is likely to cause harmful interference in which case the user will be required to correct the interference at the user's own expense.

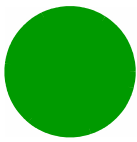

FCC and Industry Canada Radiation Hazard Warning

To comply with Industry Canada exposure requirements, and FCC RF exposure requirements in Section 1.1307 and 2.1091 of FCC Rules, the antenna used for this transmitter must be fixed-mounted on outdoor permanent structures with a separation distance of at least 2 meters from all persons.

Industry Canada Statement

Users can obtain Canadian information on RF exposure and compliance from the Canadian Representative:

Nick Dewar

Nick.Dewar@alvarion.com

Canadian Radio Standards Specifications (RSS) Compliance Statement

This device has been designed to operate with the antennas listed in [Section 1.4.8](#) of this manual, and having a maximum gain of 18 dBi. Antennas not included in this list or having a gain greater than 18 dBi are strictly prohibited for use with this device. The required antenna impedance is 50 ohms.

To reduce potential radio interference to other users, the antenna type and its gain should be so chosen that the Equivalent Isotropically Radiated Power (EIRP) is not more than that permitted for successful communication.

R&TTE Compliance Statement

This equipment complies with the appropriate essential requirements of Article 3 of the R&TTE Directive 1999/5/EC.

Safety Considerations - General

For the following safety considerations, "Instrument" means the BreezeCOMPACT units' components and their cables.

Grounding

BTS chassis is required to be bonded to protective grounding using the bonding stud or screw provided with each unit.

Safety Considerations - DC Powered Equipment



CAUTION

Risk of electric shock and energy hazard.

ATTENTION

Risque de décharge électrique et d'électrocution.

Restricted Access Area: The DC powered equipment should only be installed in a Restricted Access Area.

Installation Codes: The equipment must be installed according to the latest edition of the country national electrical codes. For North America, equipment must be installed in accordance with the US National Electrical Code and the Canadian Electrical Code.

Overcurrent Protection: A readily accessible Listed branch circuit overcurrent protective device, rated 10A must be incorporated in the building wiring.

CAUTION: This equipment is designed to permit connection between the earthed conductor of the DC supply circuit and the grounding conductor at the equipment. See installation instructions.

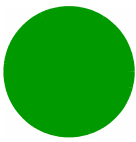

Important Notice

This user manual is delivered subject to the following conditions and restrictions:

- This manual contains proprietary information belonging to Alvarion Ltd. Such information is supplied solely for the purpose of assisting properly authorized users of the respective Alvarion products.
- No part of its contents may be used for any other purpose, disclosed to any person or firm or reproduced by any means, electronic and mechanical, without the express prior written permission of Alvarion Ltd.
- The text and graphics are for the purpose of illustration and reference only. The specifications on which they are based are subject to change without notice.
- The software described in this document is furnished under a license. The software may be used or copied only in accordance with the terms of that license.
- Information in this document is subject to change without notice. Corporate and individual names and data used in examples herein are fictitious unless otherwise noted.
- Alvarion reserves the right to alter the equipment specifications and descriptions in this publication without prior notice. No part of this publication shall be deemed to be part of any contract or warranty unless specifically incorporated by reference into such contract or warranty.
- The information contained herein is merely descriptive in nature, and does not constitute an offer for the sale of the product described herein.
- Any changes or modifications of equipment, including opening of the equipment not expressly approved by Alvarion Ltd. will void equipment warranty and any repair thereafter shall be charged for. It could also void the user's authority to operate the equipment.

Some of the equipment provided by Alvarion and specified in this manual, is manufactured and warranted by third parties. All such equipment must be installed and handled in full compliance with the instructions provided by such manufacturers as attached to this manual or provided thereafter by Alvarion or the manufacturers. Non-compliance with such instructions may result in serious damage and/or bodily harm and/or void the user's authority to operate the equipment and/or revoke the warranty provided by such manufacturer.

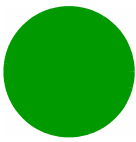

About This Manual

This manual describes the BreezeCOMPACT solution, and details how to install, operate and manage the BTS equipment.

This manual is intended for technicians responsible for installing, setting and operating the BreezeCOMPACT BTS equipment, and for system administrators responsible for managing the system.

This manual contains the following chapters and appendices:

- **Chapter 1 - System description:** Describes the BreezeCOMPACT system.
- **Chapter 2 - Installation:** Describes how to install the BTS equipment.
- **Chapter 3 - Commissioning:** Describes how to configure basic parameters and validate units' operation.
- **Chapter 4 - Operation and Administration:** Describes how to use the Monitor program for configuring parameters, checking system status and monitoring performance.

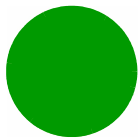

Contents

- Chapter 1 - System Description 1**
- 1.1 About WiMAX.....2**
 - 1.1.1 Introduction to WiMAX 2
 - 1.1.2 WiMAX Network Reference Model..... 2
- 1.2 The Breeze Compact Solution 9**
 - 1.2.1 Breeze Compact Highlights..... 9
 - 1.2.2 Network Architectures 9
 - 1.2.3 System Topologies 10
 - 1.2.4 Antennas 12
 - 1.2.5 GPS 12
- 1.3 Element Management Systems 14**
 - 1.3.1 AlvariSTAR 14
- 1.4 Specifications 15**
 - 1.4.1 Modem & Radio 15
 - 1.4.2 Sensitivity (per channel)* 15
 - 1.4.3 ODUs 16
 - 1.4.4 Micro Outdoor BTS 25
 - 1.4.5 AU - ODU Communication (Macro BTS)..... 26
 - 1.4.6 Data Communication (Ethernet Interfaces)..... 27
 - 1.4.7 Configuration and Management 27
 - 1.4.8 Standards Compliance, General..... 28
 - 1.4.9 Environmental 28
 - 1.4.10 Mechanical and Electrical..... 28
 - 1.4.11 BMAX-4M-GPS Receiver Specifications 32
 - 1.4.12 Antennas 33
- Chapter 2 - Commissioning 40**
- 2.1 Introduction.....41**
- 2.2 Configuring Parameters Required for Management Connectivity.....42**
 - 2.2.1 Configuring the BTS Number 42
 - 2.2.2 Configuring the Management Interface Connectivity Mode Parameter..... 42

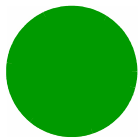

- 2.2.3 Configuring the IP Interfaces Parameters..... 42
- 2.2.4 Configuring the L1 & L2 Parameters (if necessary)..... 43
- 2.2.5 Configuring the SNMP Authorized Manager and Traps Manager 44
- 2.2.6 Applying the Configuration..... 45
- 2.3 Activating the Unit 46**
 - 2.3.1 Creating the BS..... 46
 - 2.3.2 Defining the Antenna(s)..... 48
 - 2.3.3 Configuring Radio Cluster Parameters..... 48
 - 2.3.4 Configuring Antenna Associations..... 49
 - 2.3.5 Applying the Configuration..... 49
- Chapter 3 - Operation and Administration 50**
 - 3.1 BTS System Management 51**
 - 3.2 The Monitor Program..... 52**
 - 3.2.1 Accessing the Monitor Program..... 52
 - 3.2.2 Using the Monitor Program 53
 - 3.3 IP Addresses Configuration..... 55**
 - 3.3.1 IP Address Configuration Restrictions 55
 - 3.3.2 IP Subnets..... 55
 - 3.4 The Main Menu..... 56**
 - 3.5 BTS Menu..... 57**
 - 3.5.1 General 57
 - 3.5.2 Connectivity..... 58
 - 3.5.3 Unit Control 64
 - 3.5.4 Management..... 68
 - 3.6 Sector Menu 72**
 - 3.6.1 Sector Definition 72
 - 3.6.2 Radio Cluster 72
 - 3.6.3 Antenna Association 73
 - 3.7 BS Menu 75**
 - 3.7.1 Add 75
 - 3.7.2 Select..... 77
 - 3.8 Chassis (AU) Menu 99**
 - 3.8.1 General 99
 - 3.8.2 Ports Control 100

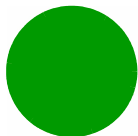

- 3.8.3 RadioHead 101
- 3.9 Antenna Menu 103**
 - 3.9.1 Antenna Number 103
 - 3.9.2 Antenna Product Type..... 103
 - 3.9.3 Mechanical Down Tilt..... 103
 - 3.9.4 Electrical Down Tilt 103
 - 3.9.5 Longitude 104
 - 3.9.6 Latitude 104
 - 3.9.7 Tower Height 104
 - 3.9.8 Heading 104
 - 3.9.9 Cable Loss..... 104
- 3.10 GPS Menu 105**
 - 3.10.1 General Configuration 105
 - 3.10.2 Inventory & Statuses..... 108

A vertical decorative line on the left side of the page, consisting of a thin blue line with five circles of varying colors and sizes: a light blue circle at the top, an orange circle, a large dark blue circle in the middle, a green circle, and a light blue circle at the bottom.

Chapter 1 - System Description

In This Chapter:

- "About WiMAX" on page 2
- "The BreezeCOMPACT Solution" on page 9
- "Element Management Systems" on page 14
- "Specifications" on page 15

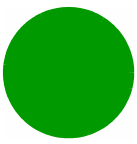

1.1 About WiMAX

1.1.1 Introduction to WiMAX

Emanating from the broadband world and using all-IP architecture, mobile WiMAX is the leading technology for implementing personal broadband services. With huge market potential and affordable deployment costs, mobile WiMAX is on the verge of a major breakthrough. No other technology offers a full set of chargeable and differentiated voice, data, and premium video services in a variety of wireless fashions - fixed, portable and mobile - that increase revenue and reduce subscriber churn.

WiMAX technology is the solution for many types of high-bandwidth applications at the same time across long distances and will enable service carriers to converge the all-IP-based network for triple-play services data, voice, and video.

WiMAX with its QoS support, longer reach, and high data capacity is positioned for fixed broadband access applications in rural areas, particularly when distance is too large for DSL and cable, as well as in urban/suburban areas of developing countries. Among applications for residential are high speed Internet, Voice Over IP telephony and streaming video/online gaming with additional applications for enterprise such as Video conferencing, Video surveillance and secured Virtual Private Network (with need for high security). WiMAX technology allows covering applications with media content requesting more bandwidth.

WiMAX allows portable and mobile access applications, with incorporation in notebook computers and PDAs, allowing for urban areas and cities to become "metro zones" for portable and mobile outdoor broadband wireless access. As such WiMAX is the natural complement to 3G networks by offering higher bandwidth and to Wi-Fi networks by offering broadband connectivity in larger areas.

The WiMAX Forum is an organization of leading operators and communications component and equipment companies. The WiMAX Forum's charter is to promote and certify the compatibility and interoperability of broadband wireless access equipment that conforms to the Institute for Electrical and Electronics Engineers (IEEE) 802.16 and ETSI HiperMAN standards. The ultimate goal of the WiMAX Forum is to accelerate the introduction of cost-effective broadband wireless access services into the marketplace. Standards-based, interoperable solutions enable economies of scale that, in turn, drive price and performance levels unachievable by proprietary approaches, making WiMAX Forum Certified products.

1.1.2 WiMAX Network Reference Model

Figure 1-1 and Figure 1-2 show the basic mobile WiMAX network architecture, with a single ASN-GW and with multiple ASN-GWs, as defined by the WiMAX Forum NWG

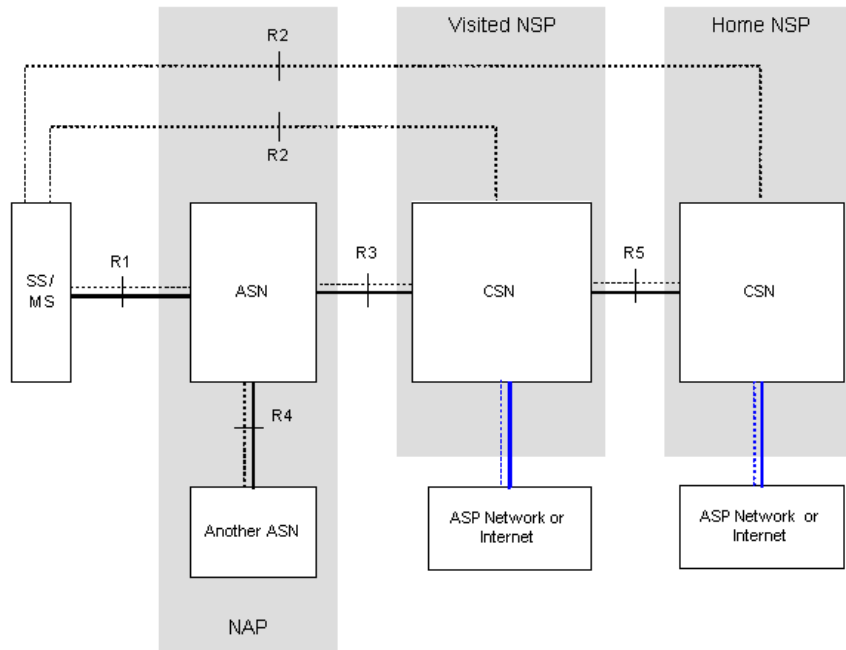
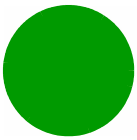

Figure 1-1: Mobile WiMAX Network Reference Model

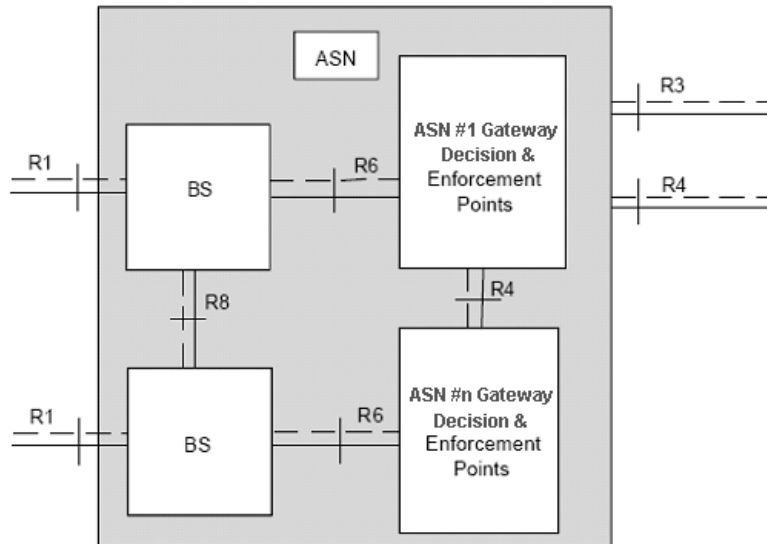
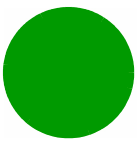

Figure 1-2: ASN Reference Model containing Multiple ASN-GWs

The various components and entities involved in the networking architecture are:

1.1.2.1 Access Service Network (ASN)

An ASN is defined as a complete set of network functions needed to provide radio access to a WiMAX subscriber. The ASN provides the following mandatory functions:



- WiMAX Layer-2 (L2) connectivity with WiMAX mobile station (MS)
- Transfer of AAA messages to the WiMAX subscriber's home network service provider (H-NSP) for authentication, authorization and session accounting for subscriber sessions
- Network discovery and selection of the WiMAX subscriber's preferred NSP
- Relay functionality for establishing Layer-3 (L3) connectivity with a WiMAX MS (i.e. IP address allocation)
- Radio resource management
- ASN-CSN tunneling
- ASN anchored mobility

An ASN is comprised of network elements such as one or more base transceiver stations and one or more ASN gateways. An ASN may be shared by more than one connectivity service network (CSN).

1.1.2.2 Connectivity Service Network (CSN)

A CSN is defined as a set of network functions that provide IP connectivity services to WiMAX subscribers. A CSN may offer the following functions:

- MS IP address and endpoint parameter allocation for user sessions
- Internet access
- AAA proxy or server
- Policy and admission control based on user subscription profiles
- ASN-CSN tunneling support
- WiMAX subscriber billing and inter-operator settlement
- WiMAX services such as location-based services, connectivity for peer-to-peer services, provisioning, authorization and/or connectivity to IP multimedia services, and facilities to support lawful intercept services such as those compliant with Communications Assistance Law Enforcement Act (CALEA) procedures

A CSN is comprised of network elements such as routers, proxy/servers, user databases, and inter-working gateway devices.

1.1.2.3 Network Access Provider (NAP)

An NAP is a business entity that provides WiMAX radio access infrastructure to one or more WiMAX network service providers (NSPs). A NAP implements this infrastructure using one or more ASNs.

1.1.2.4 Network Service Provider (NSP)

An NSP is a business entity that provides IP connectivity and WiMAX services to WiMAX subscribers compliant with the established service level agreement. The NSP concept is an extension of the Internet service provider (ISP) concept, providing network services beyond Internet access. To provide these

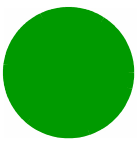

services, an NSP establishes contractual agreements with one or more NAPs. An NSP may also establish roaming agreements with other NSPs and contractual agreements with third-party application providers (e.g. ASP, ISP) for the delivery of WiMAX services to subscribers. From a WiMAX subscriber standpoint, an NSP may be classified as a home or visited NSP.

1.1.2.5 Base Station (BS)

The WiMAX BS is an entity that implements the WiMAX MAC and PHY in compliance with the IEEE 802.16e standard. A BS operates on one frequency assignment, and incorporates scheduler functions for uplink and downlink resources.

The basic functionality of the BS includes:

- IEEE 802.16e OFDMA PHY/MAC entity
- R6 and R8 functionality according to NWG definitions
- Extensible Authentication Protocol (EAP) relay
- Control message authentication
- User traffic authentication and encryption
- Handover management
- QoS service flow management entity

1.1.2.6 ASN Gateway (ASN-GW)

The ASN-GW is a network entity that acts as a gateway between the ASN and CSN. The ASN functions hosted in an ASN-GW may be viewed as consisting of two groups - the decision point (DP) and enforcement point (EP). The EP includes bearer plane functions, and the DP includes non-bearer plane functions.

The basic DP functionality of the ASN-GW includes:

- Implementation of EAP Authenticator and AAA client
- Termination of RADIUS protocol against the selected CSN AAA server (home or visited AAA server) for MS authentication and per-MS policy profile retrieval
- Storage of the MS policy profile
- Generation of authentication key material
- QoS service flow authorization entity
- AAA accounting client

The basic EP functionality of the ASN-GW includes:

- Classification of downlink data into generic routing encapsulation (GRE) tunnels
- Packet header suppression functionality

- DHCP functionality
- Handover functionality

The WiMAX Forum NWG has adopted two different approaches for ASN architecture - centralized and distributed: In the centralized approach there is at least one central ASN-GW, and the BTS operates in transparent mode, as shown in [Figure 1-3](#).

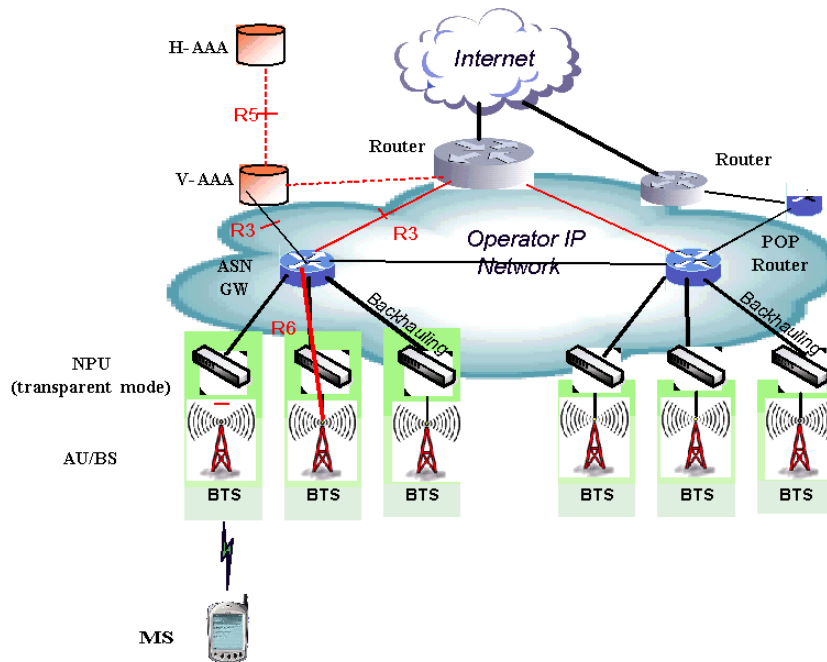
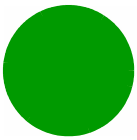

Figure 1-3: Centralized Network Reference Model



In the distributed approach, the BTS operates in ASN-GW mode, as shown in Figure 1-4.

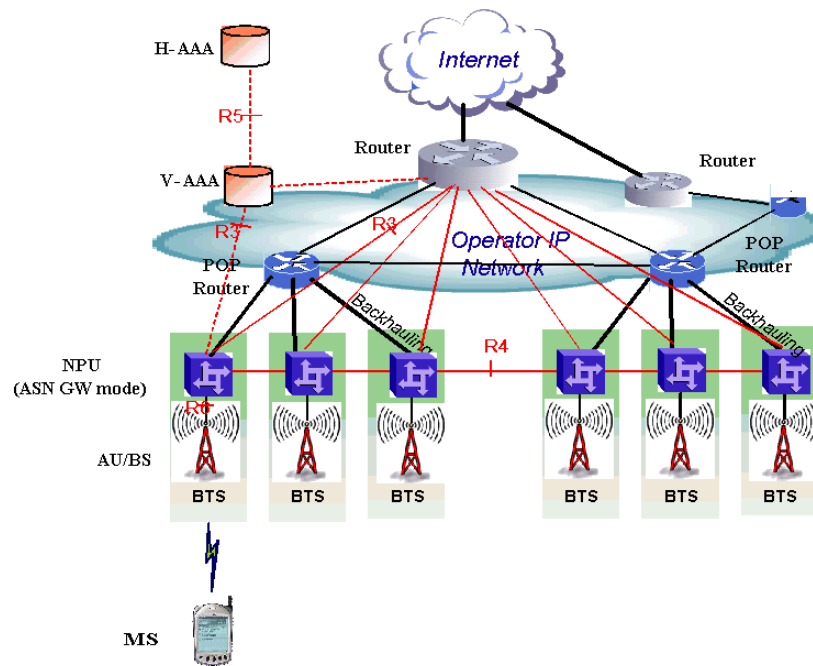
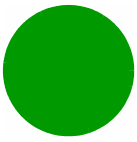

Figure 1-4: Distributed Network Reference Model

Alvarion believes in providing operators with the flexibility to select the mobile WiMAX network topology that best suits their needs and existing network architecture. Therefore, 4Motion is designed to support both distributed and centralized topology approaches according to WiMAX Forum NWG profile C.

1.1.2.7 Reference Points

- **Reference point R1** consists of the protocols and procedures between the MS and ASN as per the air-interface (PHY and MAC) specifications (IEEE 802.16e).
- **Reference point R2** consists of protocols and procedures between the MS and CSN associated with authentication, services authorization and IP host configuration management. This reference point is logical in that it does not reflect a direct protocol interface between the MS and CSN. The authentication part of reference point R2 runs between the MS and CSN operated by the home NSP, however, the ASN and CSN operated by the visited NSP may partially process the aforementioned procedures and mechanisms. Reference point R2 might support IP host configuration management running between the MS and CSN (operated by either the home NSP or visited NSP).
- **Reference point R3** consists of the set of control plane protocols between the ASN and CSN to support AAA, policy enforcement and mobility management capabilities. It also encompasses the bearer plane methods (e.g. tunneling) to transfer user data between the ASN and CSN.
- **Reference point R4** consists of the set of control and bearer plane protocols originating/terminating in various functional entities of an ASN that coordinate MS mobility between ASNs and ASN-GWs. R4 is the only interoperable reference point between similar or heterogeneous ASNs.



- **Reference point R5** consists of the set of control plane and bearer plane protocols for internetworking between the CSN operated by the home NSP and that operated by a visited NSP.
- **Reference point R6** consists of the set of control and bearer plane protocols for communication between the BS and ASN-GW. The bearer plane consists of an intra-ASN data path between the BS and ASN gateway. The control plane includes protocols for data path establishment, modification and release control in accordance with the MS mobility events.
- **Reference point R8** consists of the set of control plane message flows and optional bearer plane data flows between the base stations to ensure a fast and seamless handover. The bearer plane consists of protocols that allow data transfer between base stations involved in the handover of a certain MS.

It is important to note that all reference points are logical and do not necessarily imply a physical or even direct connection. For instance, the R4 reference point between ASN-GWs might be implemented across the NAP internal transport IP network, in which case R4 traffic might traverse several routers from the source to the destination ASN-GW.

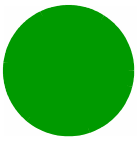

1.2 The BreezeCOMPACT Solution

1.2.1 BreezeCOMPACT Highlights

BreezeCOMPACT is a small, lightweight, all-outdoor single box base transceiver station enabling easy installation and maintenance and reduced Total Cost of Ownership (TCO).

BreezeCOMPACT enhances Alvarion's 4Motion product portfolio of BreezeMAX Macro and Micro BTS systems with a compact all-outdoor 4x4 platform enabling extended and flexible installation capabilities while sustaining 4Motion leading technological advantages and ecosystem.

BreezeCOMPACT is a weatherized carrier-class WiMAX 802.16e platform, based on Software Defined Radio (SDR) that is SW upgradable for new technologies such as Time-Division Long-Term Evolution (TD-LTE) and IEEE 802.16m. It is an integral part of 4Motion end-to-end solution. BreezeCOMPACT BTS complements Alvarion's Macro BTS products for coverage and capacity extension as well as rural deployment scenarios.

BreezeCOMPACT is a reliable platform utilizing the mature field-proven 4Motion modules and ecosystem elements (e.g. ASN-GW, AAA, and WiMAX™ devices), hence delivering high product availability.

Portable and mobile subscribers can connect to BreezeCOMPACT base station through various end-user terminals such as USB dongles, Self Installed (SI) Residential Gateways (RGW), and Outdoor CPEs.

Alvarion's Compact, Micro and Macro solutions share similar functionality with same ecosystem, allowing flexible mix & match approach to address various operator deployment needs.

Alvarion believes that compliance with standard-driven open architecture protects the infrastructure investment, and opens the system to a variety of fully interoperable end-user devices. As such, 4Motion is designed with open architecture and interfaces according to the WiMAX Forum networking working group (NWG) profile C, which supports openness and enables flat as well as hierarchical topologies. In addition, by keeping the radio resource management functionality in the Base Transceiver Station only, Profile C delivers a faster, optimized handover mechanism.

1.2.2 Network Architectures

BreezeCOMPACT supports different network architectures:

- External ASN-GW
- Embedded ASN-GW Local Authentication
- Embedded ASN-GW Centralized Authentication

INFORMATION



In the current release only External ASN-GW network architecture is supported.

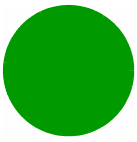

Following is a description of each of these working modes:

1.2.2.1 External ASN-GW

The ASN-GW is a separate entity (centralized architecture) that communicates with the BTS over R6 interface. Service components (Service Profiles and Service Flows) are configured in the external ASN-GW. MS authentication and services provisioning are managed by a centralized AAA server, based on user credentials (user name and password).

1.2.2.2 Embedded ASN-GW Local Authentication

The ASN-GW functionality resides in the BTS (distributed architecture). Service components (Service Profiles and Service Flows) are configured in the internal ASN-GW of each BTS. MSs list and services provisioning including authentication are managed locally by the internal ASN-GW (AAA server not needed), based on the SU MAC address.

1.2.2.3 Embedded ASN-GW Centralized Authentication

The ASN-GW functionality resides in the BTS (distributed architecture). Service components (Service Profiles and Service Flows) are configured locally in the BTS. MS authentication and service provisioning are managed centrally by an external AAA server, based on user credentials (user name and password).

1.2.3 System Topologies

BreezeCOMPACT supports different system topologies:

- One Sector, One Carrier
- One Sector, Dual Carrier
- Two Sector, Two Carriers (One Carrier per Sector)

INFORMATION



In the current release only One Sector, One Carrier topology with a 10 MHz bandwidth is supported.

Following is a description of each of these topologies:

1.2.3.1 One Sector, One Carrier

This is the basic configuration based on a single BS, supporting a single 4x4 sector with a bandwidth of 5, 7, or 10 MHz.

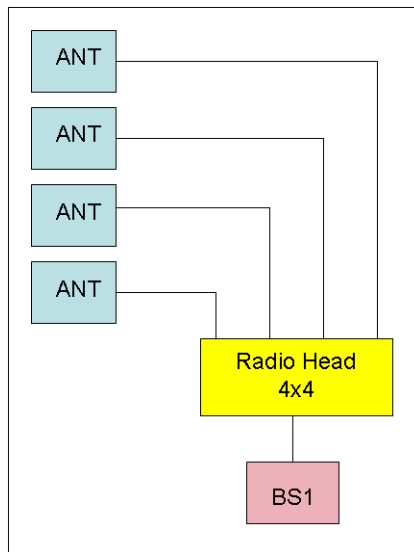
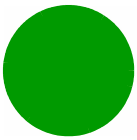

Figure 1-5: One Sector, One Carrier

1.2.3.2 One Sector, Dual Carrier

Two BSs support a single 4x4 sector with a total bandwidth of 20 (10+10) or 14 (7+7) MHz.

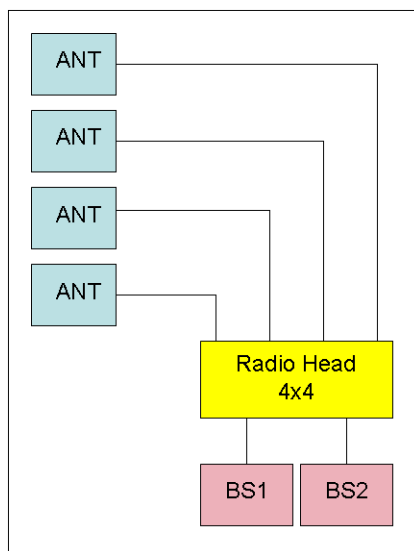

Figure 1-6: One Sector, Dual Carrier

1.2.3.3 Two Sector, Two Carriers (One Carrier per Sector)

Two BSs support two 2x2 sectors, each with a bandwidth of 10 or 7 MHz.

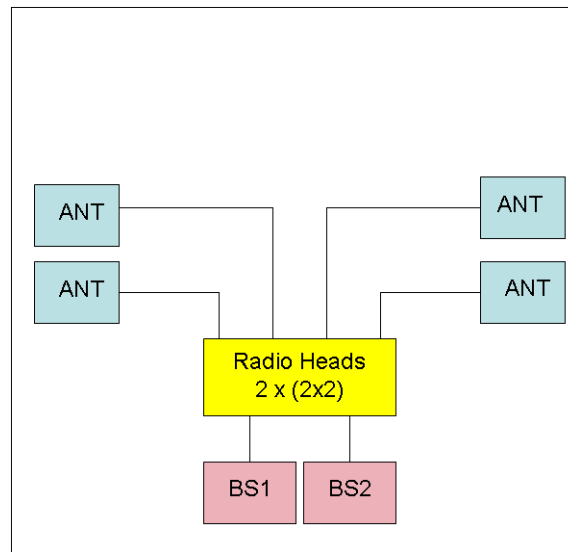
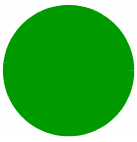

Figure 1-7: Two Sectors, Two Carriers (One Carrier per Sector)

1.2.4 Antennas

In the 4Motion architecture, the antenna is approached as an independent element. This provides the operator with the flexibility to select the antennas source according to its supplier policy. To ensure the availability of antennas that complement the 4Motion solution, Alvarion works closely with several antenna suppliers to ensure availability of antennas that comply with its requirements.

In cases where the operator prefers other antenna vendors, Alvarion can provide a recommended antenna specification based on the required antennas types.

Antennas may support one or several different downtilt options:

- Mechanical Down-Tilt (MDT) using a suitable mounting kit.
- Electrical Down-Tilt (EDT) that may be either fixed or adjustable using a special adjustment screw.
- Remote Electrical Tilt (RET) through a special interface.

Alvarion offers also AISG (Antenna Interface Standards Group) compliant electrical downtilt control kit enabling remote tilt control for antennas that support RET.

In addition to a range of standard commercial antennas, Alvarion offers also a special attached antenna design for convenient installation on top of the BreezeCOMPACT unit.

For details on antennas offered by Alvarion refer to [“Antennas” on page 19](#).

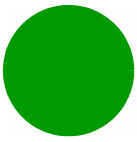

1.2.5 GPS

GPS is used to synchronize the air link frames of Intra-site and Inter-site located Base Transceiver Stations to ensure that in all Base Stations the air frame will start at the same time, and that all Base Stations will switch from transmit (downlink) to receive (uplink) at the same time. This synchronization is necessary to prevent Intra-site and Inter-site interference and Base Stations saturation (assuming that all Base Stations are operating with the same frame size and with the same DL/UL ratio).

In order for the system to be synchronized, the GPS have to first acquire at least 4 satellites. After that the GPS reception can be reduced to 1 satellite. If no satellite is received the BTS will go to holdover state where internal clock is provided to synchronize the BTS for up to two hours. Following a pre-configured time in holdover state the unit will stop transmissions to avoid interfering with the operation of neighboring units.

The all-outdoor GPS Receiver is a pole mountable GPS receiver and antenna in a single environmentally protected enclosure. The receiver is powered from the unit, and it can be installed at a distance of up to 100m from the unit. GPS signals chaining (not supported in current release) enables using a single GPS receiver for several colocated units.

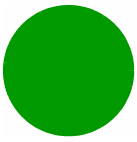

1.3 Element Management Systems

The end-to-end IP-based architecture of the system enables full management of all components, using standard management tools. An SNMP agent in the NPU implements proprietary MIBs for remote setting of operational modes and parameters of the Base Transceiver Station equipment. Security features incorporated in the equipment restrict the access for management purposes.

Alvarion offers the following management tool:

1.3.1 AlvariSTAR

AlvariSTAR is a comprehensive carrier-class Element Management System (EMS) for Alvarion's Broadband Wireless Access systems. AlvariSTAR is designed for today's most advanced Network Operation Centers (NOCs), providing the network Operation, Administration and Maintenance (OA&M) staff and managers with all the network surveillance, monitoring and configuration and service provisioning capabilities required to effectively manage the network while keeping the resources and expenses at a minimum.

AlvariSTAR offers the network's OA&M staff with a unified, scalable and distributable management system. Utilizing distributed client-server architecture, the user is provided with a robust, scalable and fully redundant management system in which all single points of failure can be avoided.

AlvariSTAR provides the following management functionality:

- Device Discovery
- Device Inventory
- Topology
- Fault Management
- Configuration Management
- Service Management
- Data Collection
- Performance Monitoring
- Device embedded software upgrade
- Template-based configuration modification of multiple BTS simultaneously.
- Preparation of offline configuration files for mass configuration of new BTSs.
- Security Management
- Event Forwarding to other Network Management Systems.

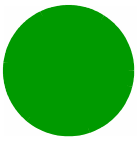

1.4 Specifications

1.4.1 Modem & Radio

Table 1-1: General Modem & Radio Specifications

Item	Description
Frequency Band	3400-3675
Central Frequency Resolution	0.125 MHz
Operation Mode	TDD
Channel Bandwidth	<ul style="list-style-type: none">■ 5 MHz■ 7 MHz■ 10 MHz
Bandwidth Support	Up to 20 MHz
Ports Configuration	4x4
Maximum Tx Power	27 dBm per channel
Tx Power Control Range	10 dB, in 1 dB steps
Tx Power Accuracy	+/- 1 dB
Maximum Input Power @ antenna port	-45 dBm before saturation, -35 dBm before damage
Noise Figure	5 dB typical, 6 dB maximum
Modulation	OFDM modulation, 1024/512 FFT points; QPSK, QAM16, QAM64
Access Method	OFDMA
FEC	Convolutional Turbo Coding: 1/2, 3/4 for QPSK and QAM16. 1/2, 2/3, 3/4, 5/6 for QAM64

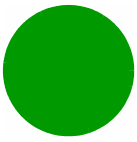

1.4.2 Sensitivity (per channel)*

Table 1-2: Per Channel Sensitivity, AWGN @ PER=1%

Modulation & Coding	Sensitivity (dBm), 5 MHz Bandwidth	Sensitivity (dBm), 7 MHz Bandwidth	Sensitivity (dBm), 10 MHz Bandwidth
QPSK 1/2 Repetition 6	-102	-100	-99
QPSK 1/2 Repletion 4	-101	-99	-98
QPSK 1/2 Repletion 2	-99	-97	-96
QPSK 1/2	-96	-94	-93
QPSK 3/4	-93	-91	-90
16QAM 1/2	-90	-88	-87
16QAM 3/4	-85	-83	-82
64QAM1/2	-84	-82	-81
64QAM2/3	-82	-79	-78
64QAM3/4	-80	-78	-77
64QAM5/6	-78	-76	-75

* For second order receive diversity configurations sensitivity is improved by 3 dB. For fourth order receive diversity configurations sensitivity is improved by 6 dB.

1.4.3 Data Communication (Ethernet Interfaces)

Table 1-3: Data Communication (Ethernet Interfaces)

Item	Description
Standard Compliance	IEEE 802.3 CSMA/CD
DAT 1 (optional, if an SFP is installed)	100/1000 Mbps Base-X optical fiber interface, Full Duplex with Auto Negotiation.
DAT 2	100/1000 Mbps Base-T twisted-pair electrical interface, Half/Full Duplex with Auto Negotiation.
DAT 3	10/100 Mbps Base-T twisted-pair electrical interface, Half/Full Duplex with Auto Negotiation.

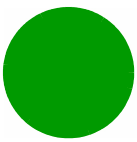

1.4.4 Configuration and Management

Table 1-4: Configuration and Management

Item	Description
Management (Out Of Band, In Band)	<ul style="list-style-type: none">■ SNMP■ Telnet
SNMP Agents	SNMP Ver. 2 client MIB II (RFC 1213), Private MIBs
Software Upgrade	Using TFTP
Configuration Upload/Download	Using TFTP

1.4.5 Standards Compliance, General

Table 1-5: Standards Compliance, General

Type	Standard
EMC	<ul style="list-style-type: none">■ ETSI EN 301 489-1/4■ FCC Part 15
Safety	<ul style="list-style-type: none">■ EN60950-1 (CE)■ UL 60950-1 (US/C)
Environmental	ETS 300 019: <ul style="list-style-type: none">■ Part 2-1 T 1.2 & part 2-2 T 2.3 for indoor & outdoor■ Part 2-3 T 3.2 for indoor■ Part 2-4 T 4.1E for outdoor
Radio	<ul style="list-style-type: none">■ ETSI EN 302 326■ FCC Part 90 Subpart Z■ IC RSS-192 issue1■ IC RSS-197 issue 3

1.4.6 Environmental

Table 1-6: Environmental Specifications

Type	Details
Operating Temperature	-40°C to 55°C
Operating Humidity	5%-95%, weather protected

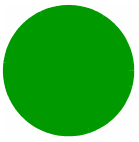

1.4.7 Mechanical and Electrical

Table 1-7: Mechanical & Electrical Specifications

Item	Description
Dimensions	242.7 x 343 x 166.9 mm
Weight	9 Kg
Power Source	-40 to -60 VDC
Power Consumption	125 W peak
PoE Out (DAT 3)	1 A @ -40 to -60 VDC

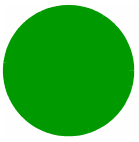

1.4.8 Antennas

1.4.8.1 Attached, 3.3-3.8 GHz, 4 Ports 65° Double Dual Slant (xx)

Table 1-8: Attached Antenna 3.3-3.8 DDS 65° (P.N. 300726) Specifications

Item	Description
Frequency Band (MHz)	3300-3800
Number of Elements	4
Polarization	Linear, +/-45°
Gain (dB)	18
Azimuth Beamwidth (degrees)	65
Elevation Beamwidth (degrees)	6.5
Maximum Power (W)	150
Cross-polarization Discrimination (dB)	>15
Front-to-Back Ratio (dB)	>30
Electrical Downtilt Range (degrees)	0
Isolation Between Ports (dB)	>30
Return Loss (dB)	>15
RF Interface Impedance (Ohm)	50
RF Connectors	4 x N-Type jacks with RF cable tails
Dimensions (mm)	720x 266 x 52
Weight (Kg)	4
Regulatory Compliance	RoHS Compliance

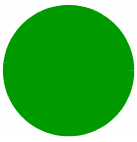

1.4.8.2 3.3 -3.8 GHz, 4 Ports 65° Double Dual Slant (xx), with EDT

Table 1-9: ANT BS-EDT-DDP-65°-3.3-3.8GHz (P.N. 323109) Specifications

Item	Description
Frequency Band (MHz)	3300-3800
Number of Elements	4
Polarization	Linear, 2 x +/-45°
Gain (dB)	18
Azimuth Beamwidth (degrees)	65
Elevation Beamwidth (degrees)	6.5° with nullfill
Elevation Side Lobe Level (dB)	<-18
Maximum Power (W)	150
Front-to-Back Ratio (dB)	>30
Electrical Downtilt Range	0° - 10° independently continuously adjustable
Isolation Between Ports (dB)	>30
Return Loss (dB)	>15
RF Interface Impedance (Ohm)	50
RF Connectors	4 x N-Type jack
Mounting	F-042-GL-E: Fixed clamps for 50-115 mm diameter pipe, 5Kg T-045-GL-E: Adjustable clamps for 50-115 mm diameter pipe, 0-10° down tilt, 6Kg
Dimensions (mm)	750 x 300 x 115
Weight (Kg)	10

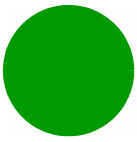

1.4.8.3 3.3 -3.8 GHz, 2 Ports 65° Dual Slant (x)

Table 1-10: ANT,BS,3.3-3.8GHz, DS,Sec.65°,16.5dBi min (P.N. 300644) Specifications

Item	Description
Frequency Band (MHz)	3300-3800
Number of Elements	2
Polarization	Linear, +/-45°
Gain	16.5dBi +/- 0.5dB
VSWR	1.5:1 (max)
Azimuth Beamwidth (degrees)	65 +/-5
Elevation Beamwidth (degrees)	6 +/-1
Maximum Power (W)	50
Cross-polarization Discrimination (dB)	-15
Front-to-Back Ratio (dB)	>25
Isolation Between Ports (dB)	>25
RF Interface Impedance (Ohm)	50
Lightning Protection	DC grounded
RF Connectors	2 x N-Type jacks
Mounting	Fully adjustable pipe mount (1.63" to 4.5" pipe) with 0-15° down tilt
Dimensions (mm)	711 x 171 x 90
Weight (Kg)	2.6 (excluding mounting kit)
Regulatory Compliance	RoHS Compliance

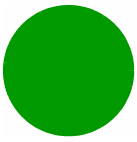

1.4.8.4 3.3 -3.8 GHz, 2 Ports 90° Dual Slant (x)

Table 1-11: ANT,BS,3.3-3.8GHz, DS,Sec.90°,15.5dBi min (P.N. 300645) Specifications

Item	Description
Frequency Band (MHz)	3300-3800
Number of Elements	2
Polarization	Linear, +/-45°
Gain	15.5dBi +/- 0.5dB
VSWR	1.5:1 (max)
Azimuth Beamwidth (degrees)	85 +/-5
Elevation Beamwidth (degrees)	6 +/-1
Maximum Power (W)	50
Cross-polarization Discrimination (dB)	-17
Front-to-Back Ratio (dB)	>25
Isolation Between Ports (dB)	>25
RF Interface Impedance (Ohm)	50
Lightning Protection	DC grounded
RF Connectors	2 x N-Type jacks
Mounting	Fully adjustable pipe mount (1.63" to 4.5" pipe) with 0-15° down tilt
Dimensions (mm)	711 x 171 x 90
Weight (Kg)	2.6 (excluding mounting kit)
Regulatory Compliance	RoHS Compliance

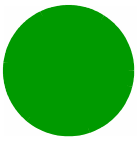

1.4.8.5 3.3 -3.8 GHz, 4 Ports 65° Double Dual Slant (xx)

Table 1-12: ANT-DDP-65°-3.3-3.8GHz (P.N. 300720) Specifications

Item	Description
Frequency Band (MHz)	3300-3800
Number of Elements	4
Polarization	Linear, 2 x +/-45°
Gain	18dBi
Azimuth Beamwidth (degrees)	65
Elevation Beamwidth (degrees)	7
Maximum Power (W)	150
Cross-polarization Discrimination (dB)	>15
Front-to-Back Ratio (dB)	>30
Isolation Between Ports (dB)	>30
Return Loss (dB)	>15
Upper Sidelobe Suppression (dB)	>18
RF Interface Impedance (Ohm)	50
Lightning Protection	DC grounded
RF Connectors	4 x N-Type jack
Electrical Downtilt	4° (fixed)
Mounting	Adjustable mounting kit (optional) for 50-115mm pole, with +2° to -10° tilt range
Dimensions (mm)	720 x 260 x 55
Weight (Kg)	7 (excluding mounting kit)

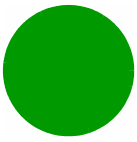

1.4.8.6 3.3 -3.8 GHz, 4 Ports 90° Double Dual Slant (xx)

Table 1-13: ANT-DDP-90°-3.3-3.8GHz (P.N. 300719) Specifications

Item	Description
Frequency Band (MHz)	3300-3800
Number of Elements	4
Polarization	Linear, 2 x +/-45°
Gain	17dBi
Azimuth Beamwidth (degrees)	90
Elevation Beamwidth (degrees)	7
Maximum Power (W)	150
Cross-polarization Discrimination (dB)	>15
Front-to-Back Ratio (dB)	>30
Isolation Between Ports (dB)	>30
Return Loss (dB)	>15
Upper Sidelobe Suppression (dB)	>18
RF Interface Impedance (Ohm)	50
Lightning Protection	DC grounded
RF Connectors	4 x N-Type jack
Electrical Downtilt	4° (fixed)
Mounting	Adjustable mounting kit (optional) for 50-115mm pole, with +2° to -10° tilt range
Dimensions (mm)	720 x 260 x 55
Weight (Kg)	7 (excluding mounting kit)

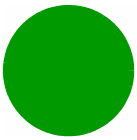

1.4.8.7 3.3 -3.8 GHz, 90° Vertical

Table 1-14: ANT BS 3.3-3.8GHz, 90° V (P.N. 300616) Specifications

Item	Description
Frequency Band (MHz)	3300-3800
Number of Elements	1
Polarization	Vertical
Gain	14.5dBi (min)
VSWR	1.8:1 (max)
Azimuth Beamwidth (degrees)	90
Elevation Beamwidth (degrees)	7
Maximum Power (W)	10
RF Interface Impedance (Ohm)	50
Lightning Protection	DC grounded
RF Connectors	2 x N-Type jacks
Mounting	Tilt Mounting Kit for 2" to 4.5" Dia pole
Dimensions (mm)	766 x 150 x 86
Weight (Kg)	2.2 (excluding mounting kit)
Regulatory Compliance	ESTI EN 302 085 V.1.1.2 (2001-02) CS3 RoHS Compliance

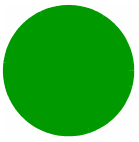

1.4.9 BMAX-4M-GPS Receiver Specifications

Table 1-15: BMAX-4M-GPS Receiver, Mechanical & Electrical Specifications

Item	Description
Dimensions	8.8 x 10.4 x 16 cm
Weight	0.38 Kg
Power Source	12 VDC from the NPU
Power Consumption	2W maximum
Connector	RJ-45

A vertical line on the left side of the page, featuring five circles of varying sizes and colors: a small light blue circle at the top, an orange circle, a large dark blue circle in the middle, a green circle, and a small light blue circle at the bottom.

Chapter 2 - BreezeCOMPACT Installation

In this Chapter:

- "Introduction" on page 28
- "Unpacking and Inspecting" on page 29
- "BreezeCOMPACT Installation" on page 35
- "Connecting the BreezeCOMPACT Cables" on page 53
- "System Initial Verification" on page 68
- "GPS Installation" on page 47

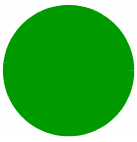

2.1 Introduction

BreezeCOMPACT is a small, lightweight, optimized single box, all-outdoor base station system enabling easy installation and maintenance, thus reducing the operator's Total Cost of Ownership (TCO).

BreezeCOMPACT allows flexible mounting options including rooftops, walls, poles and top towers installation, thus providing an effective solution for installation-constrained areas.

CAUTION



ONLY experienced installation professionals who are familiar with local building and safety codes and, wherever applicable, are licensed by the appropriate government regulatory authorities should install outdoor units and antennas.

Failure to do so may void the product warranty and may expose the end user or Service Provider to legal and financial liabilities. Alvarion and its resellers or distributors are not liable for injury, damage or regulation violations associated with the installation of Outdoor Units or antennas.

Français

SEULS les installateurs professionnels expérimentés qui sont familiers avec les codes locaux des bâtiments et de la sécurité et, lorsque cela s'applique, qui sont autorisés par les autorités gouvernementales de régulation, doivent installer les unités extérieures et les antennes. Le non-respect de cette clause peut invalider la garantie du produit et exposer l'utilisateur final ou le prestataire de services à des responsabilités légales et financières. Le fabricant et ses revendeurs ou distributeurs ne sont pas responsables pour toute blessure, dommage ou violation de la réglementation associée à l'installation d'unités extérieures ou d'antennes.

Italiano

ATTENZIONE: SOLO professionisti esperti che hanno familiarità con le norme di costruzione locali e coi codici di sicurezza e, ove applicabile, sono autorizzati dalle autorità governative competenti possono installare unità esterne ed antenne. Assicurarsi che le unità esterne, antenne e strutture di supporto siano installate correttamente per eliminare ogni pericolo fisico a persone o cose. In caso contrario, ciò può invalidare la garanzia del prodotto e può esporre l'utente finale o il fornitore di servizi a responsabilità legali ed economiche. Anche quando la messa a terra non è obbligatoria in base alla normativa regolatoria applicabile e ai codici nazionali, è obbligatorio garantire che l'unità esterna e il palo dell'antenna siano messi a terra e idonei dispositivi di protezione contro i fulmini siano utilizzati in modo da fornire protezione contro le sovratensioni e le scariche statiche. In ogni caso, il Fornitore e i suoi rivenditori non sono responsabili per eventuali danni fisici, danni ad oggetti o violazioni del regolamento associati con o causati dall'installazione, la messa a terra o di protezione contro i fulmini.

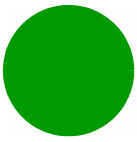

2.2 Unpacking and Inspecting

- 1** Examine the shipping container for damage. If you notice any damage, notify the carrier that delivered the unit immediately [and enter a service call in Alvarion's SSM \(www.alvarion.com > Customer Service area\)](http://www.alvarion.com).
- 2** Check the items against this manual. If any items are missing, notify your agent immediately.
- 3** Remove the packing material without damaging it.
- 4** Components susceptible to damage from static electricity are packed in static resistant bags. Unpack these items in a static-free environment to avoid damage.



2.2.1 Package Content

- BTS (weight: 9 kg)
- Mounting kit (for 1''-4'' poles) including:
 - » 4 x heavy duty metal clamps
 - » 4 x M8 threaded rods
 - » 4 x M8x22 Hex screws
 - » 8 x M8 nuts
 - » 8 x M8 flat washers
 - » 8 x M8 spring washers
- Sealing gland wrench
- For poles up to 6'' - an additional kit containing 4 metal bands (ordered separately)
- For poles larger than 6'' and for wall mount - two large heavy duty metal clamps (ordered separately)

2.2.2 Additional Installation Requirements

The following items are also required to install the BTS:

INFORMATION



Items marked with an asterisk (*) are available from Alvarion.

- Power Supply: High power AC/DC Power Supply unit and DC power cable* (available in various lengths)
- Power cable*: a 250m power cable drum. 6-pin mini-fit (manufactured by Samtek), DC in -40 to -60VDC at connector input.
- Ethernet cable*: a 250m CAT5e cable drum (connectors not included)
- Optical fiber cable*: 10/100/1000BASE-T Optic SFP (small form-factor pluggable) shielded
- Antenna(s)* and RF cable(s)* for connecting the antenna(s) to the BTS. (applicable for units without integral antennas). External antennas are connected via LMR-400 1m / 0.5m cables.
- Grounding 10 AWG cable with an appropriate termination
- GPS Antenna kit including mounting kit, 3m cable, and one lightning arrester
- Hook for carrying the assembly up the pole
- Installation tools and materials