

**TEST RESULTS (Cont):**

LTE QPSK MODULATION. BW = 15 MHz  
 Lowest Channel 99% Occupied Bandwidth

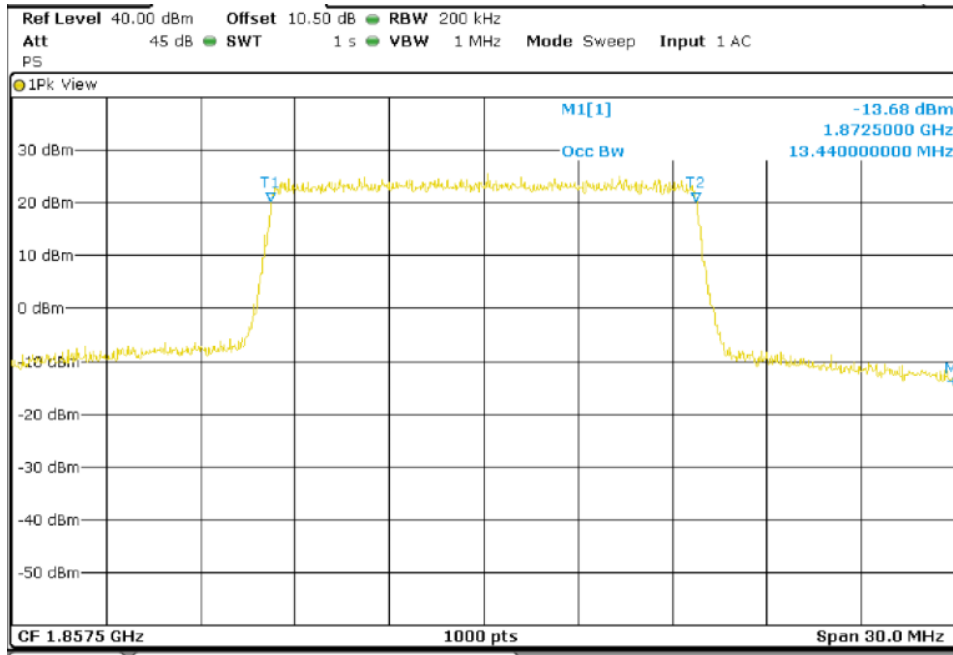

Lowest Channel -26dBc Bandwidth kHz

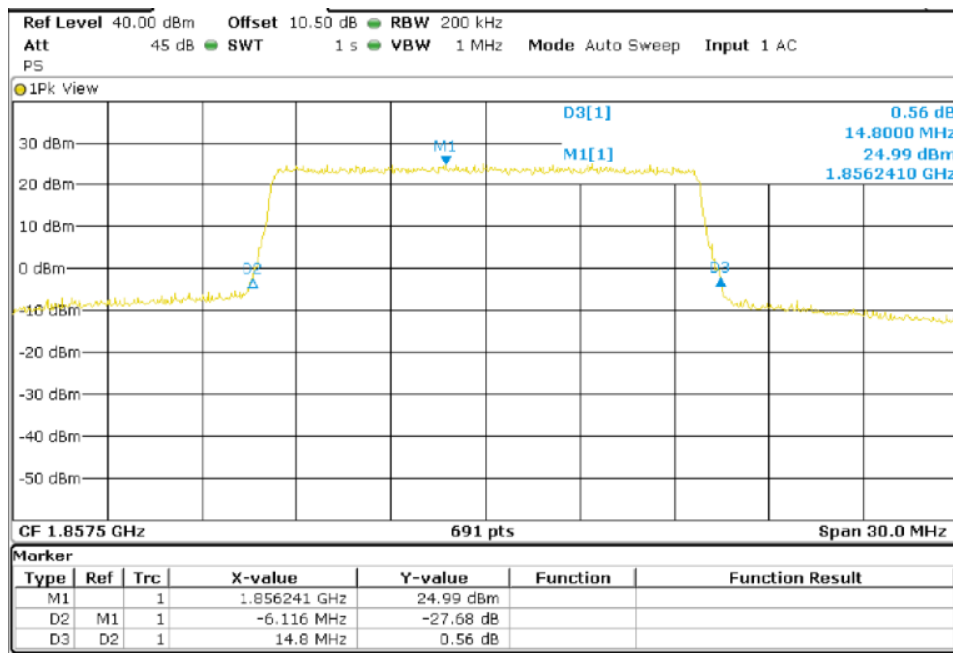

**TEST RESULTS (Cont):**

Middle Channel 99% Occupied Bandwidth

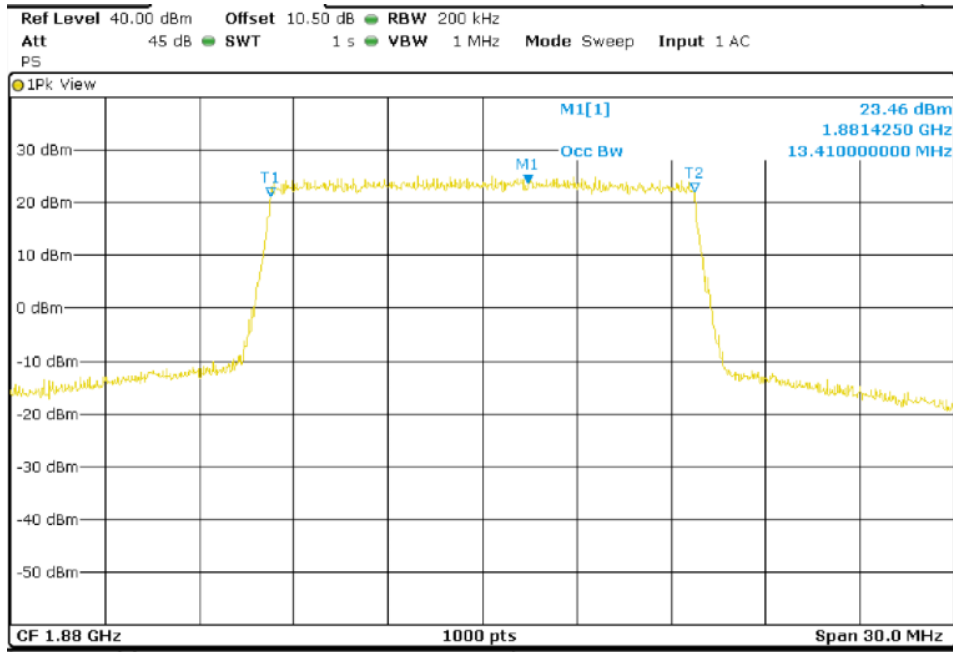

Middle Channel -26dBc Bandwidth kHz

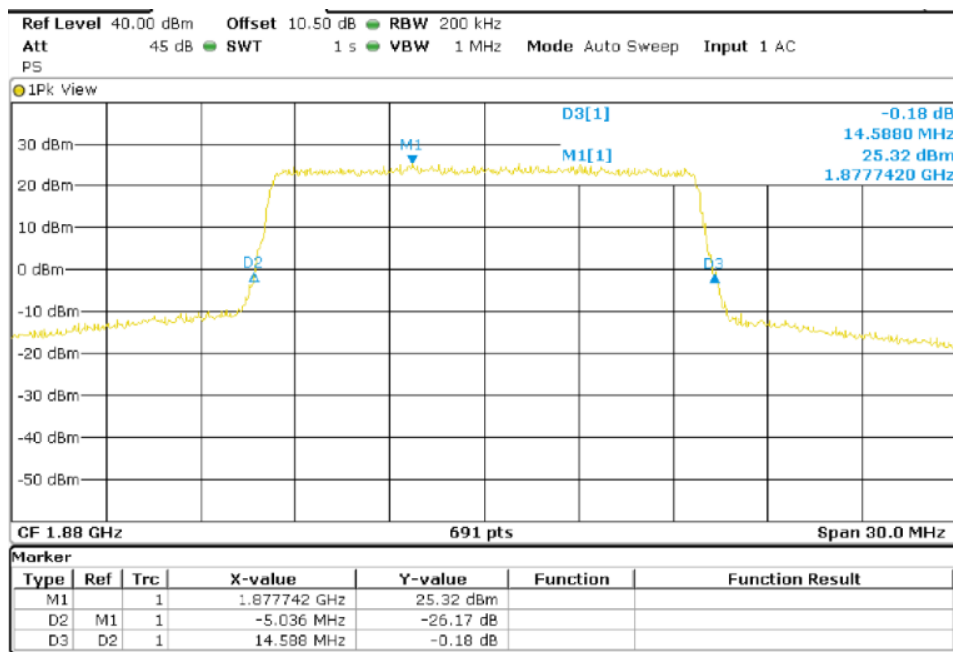

**TEST RESULTS (Cont):**

Highest Channel 99% Occupied Bandwidth

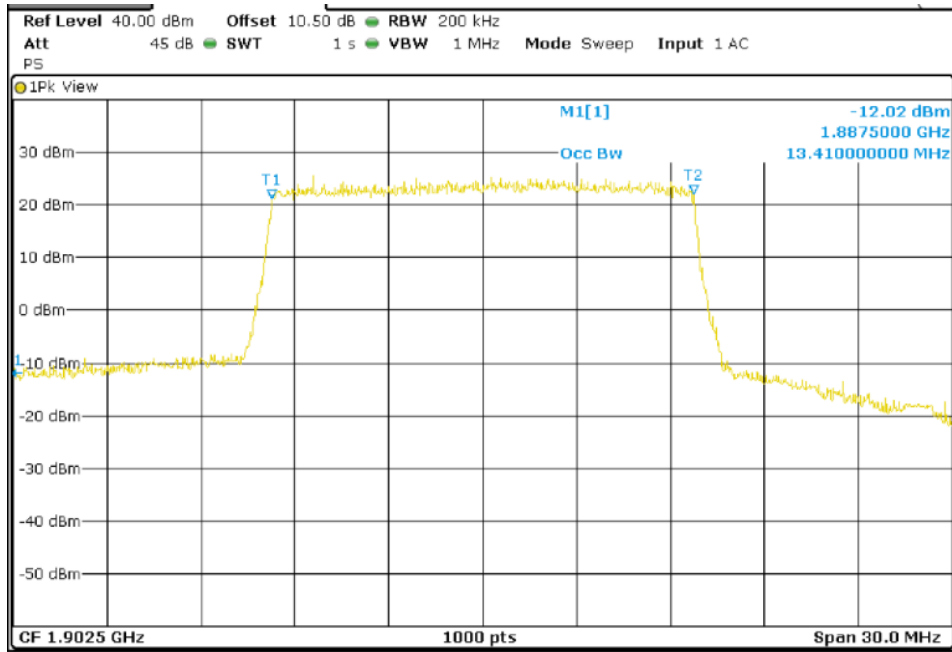

Highest Channel -26dBc Bandwidth kHz

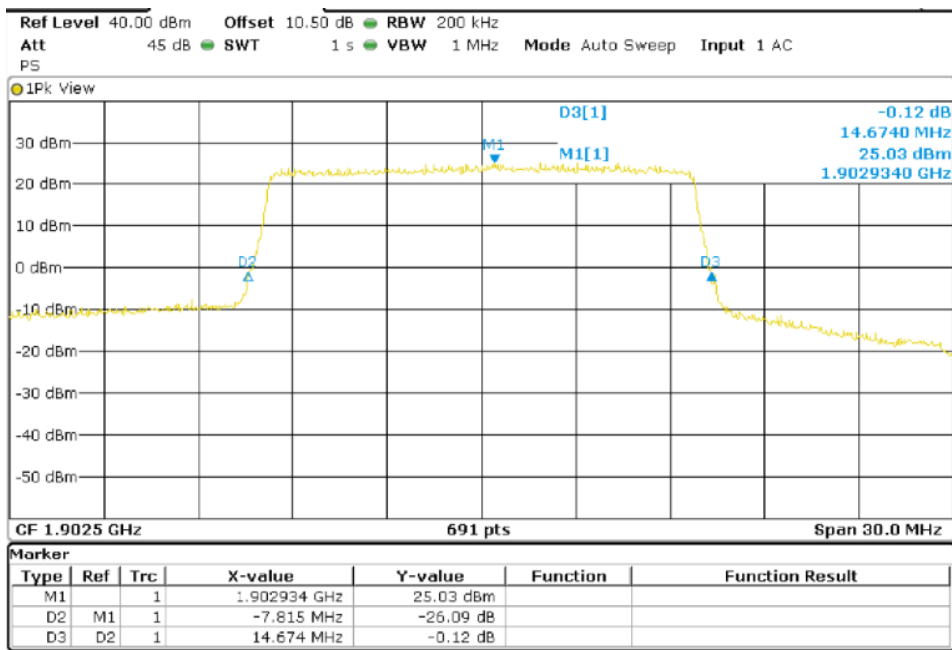

**TEST RESULTS (Cont):**

LTE 16QAM MODULATION. BW = 15 MHz

Lowest Channel 99% Occupied Bandwidth

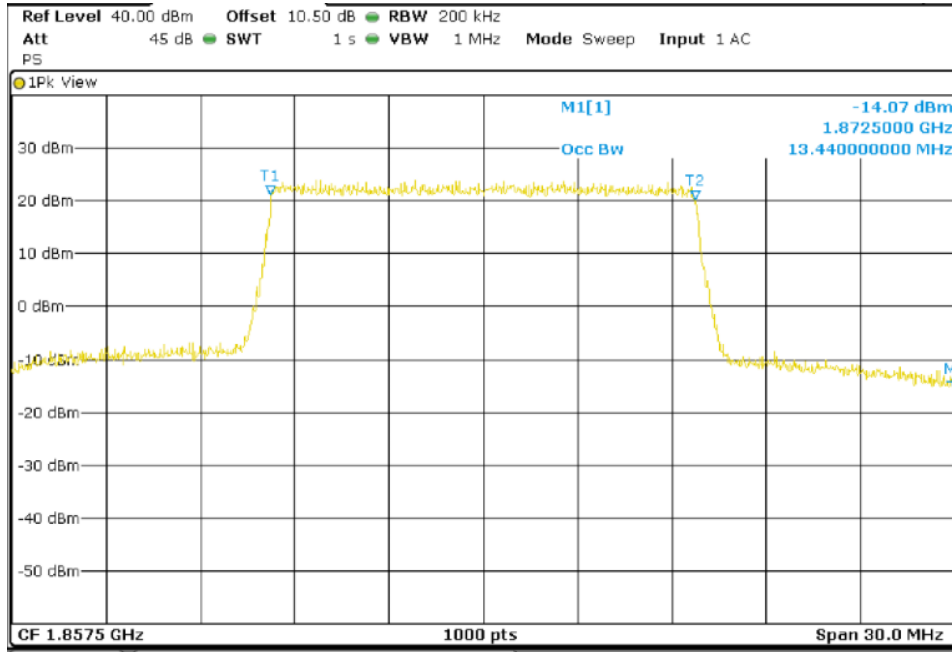

Lowest Channel -26dBc Bandwidth kHz

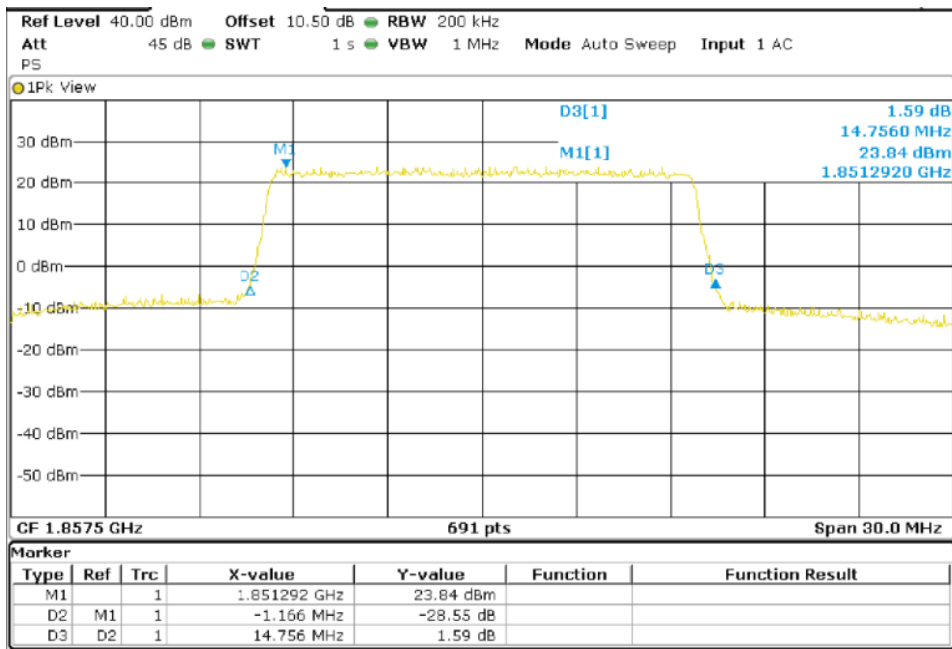

**TEST RESULTS (Cont):**

Middle Channel 99% Occupied Bandwidth

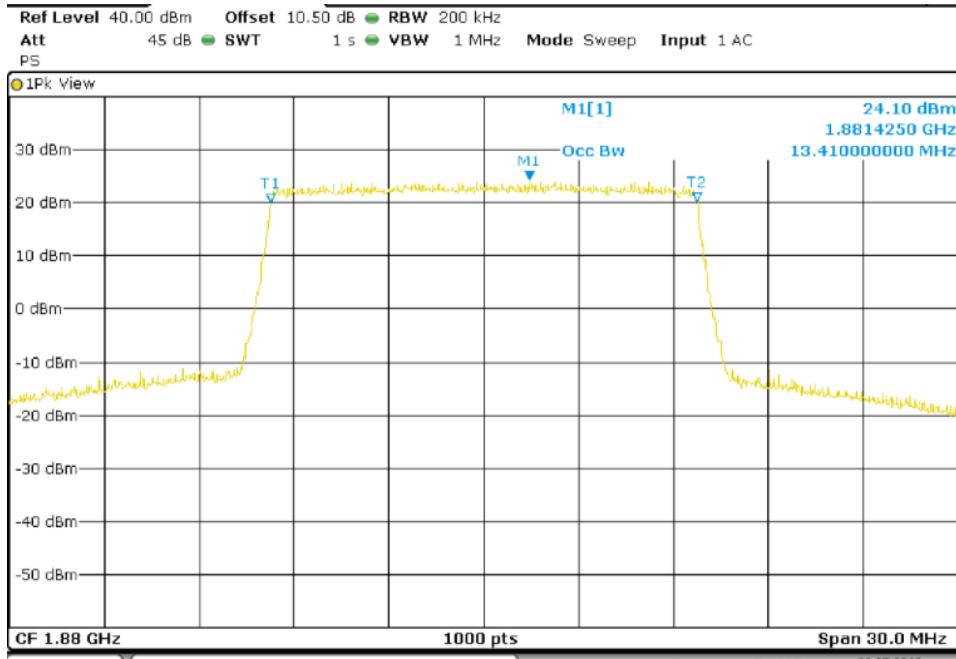

Middle Channel -26dBc Bandwidth kHz

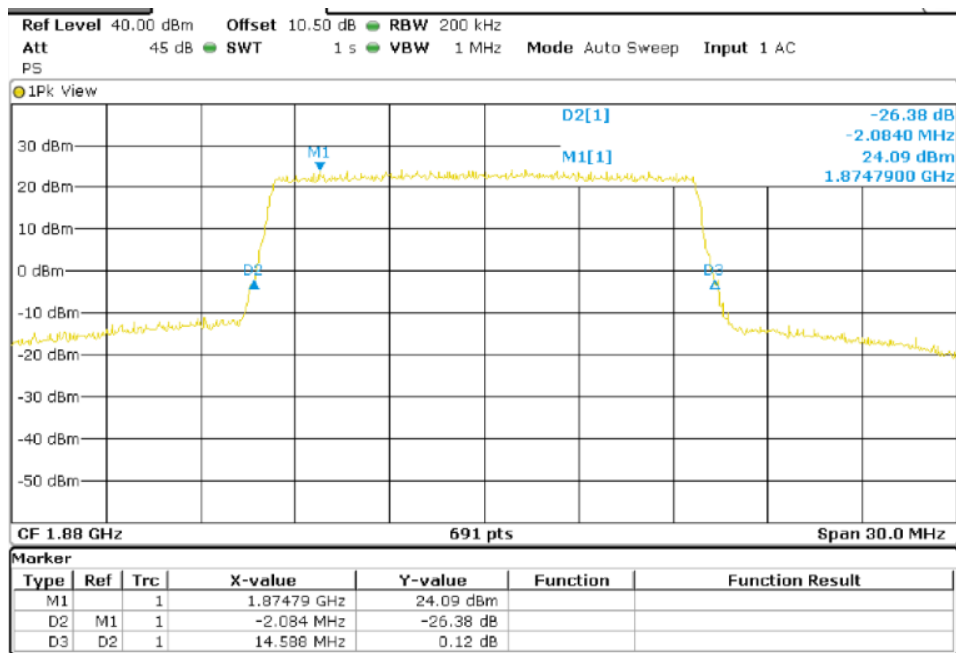

**TEST RESULTS (Cont):**

Highest Channel 99% Occupied Bandwidth

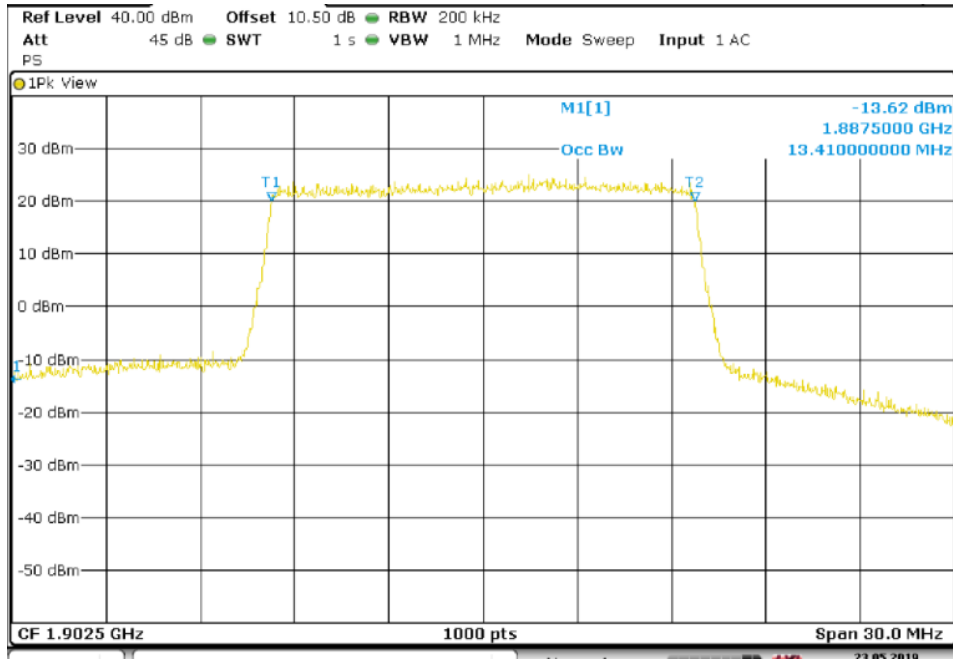

Highest Channel -26dBc Bandwidth kHz

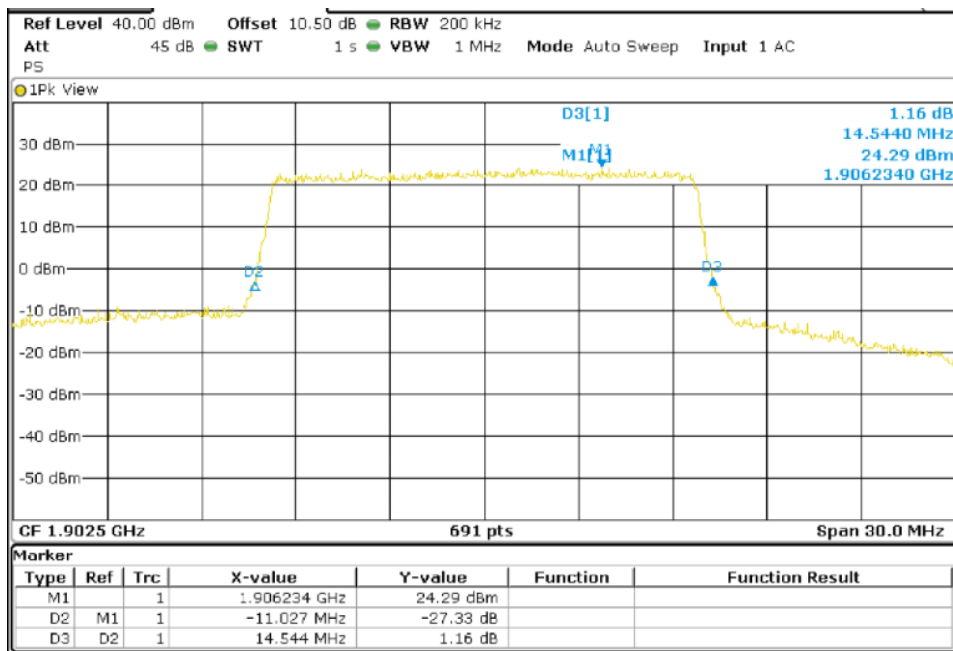

**TEST RESULTS (Cont):**

LTE QPSK MODULATION. BW = 20 MHz  
 Lowest Channel 99% Occupied Bandwidth

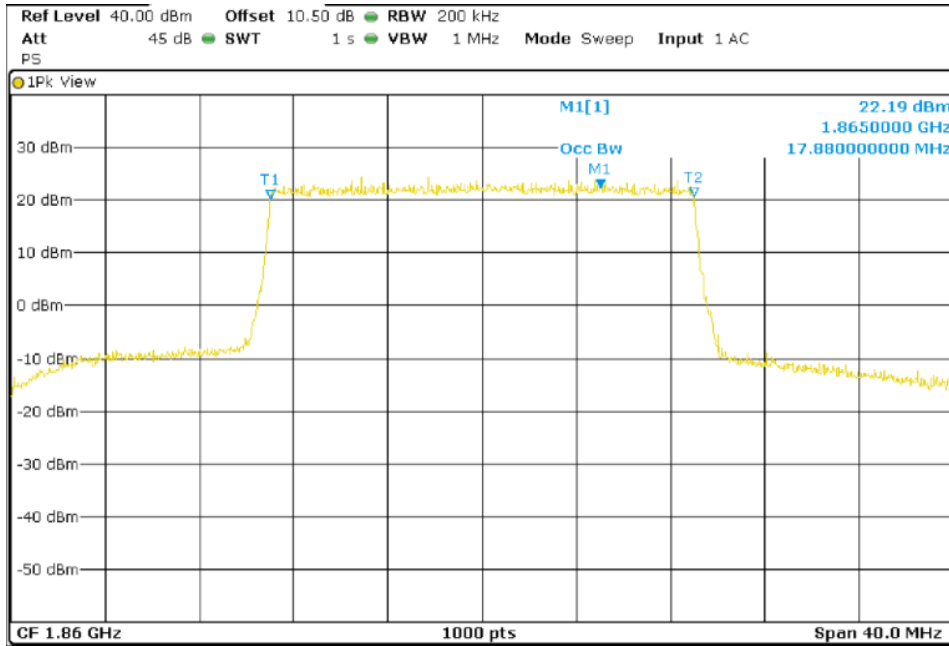

Lowest Channel -26dBc Bandwidth kHz

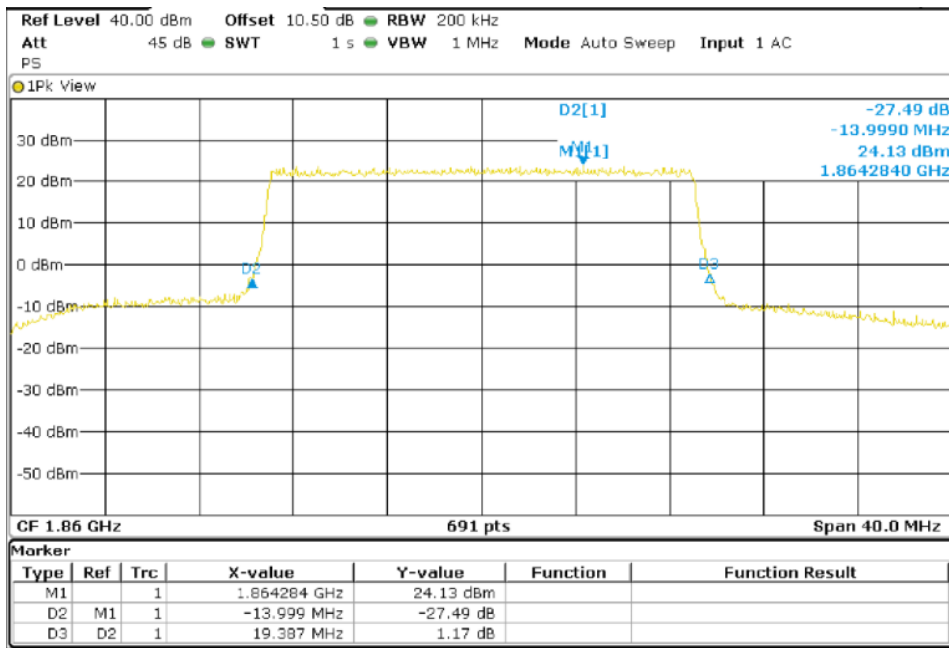

**TEST RESULTS (Cont):**

Middle Channel 99% Occupied Bandwidth

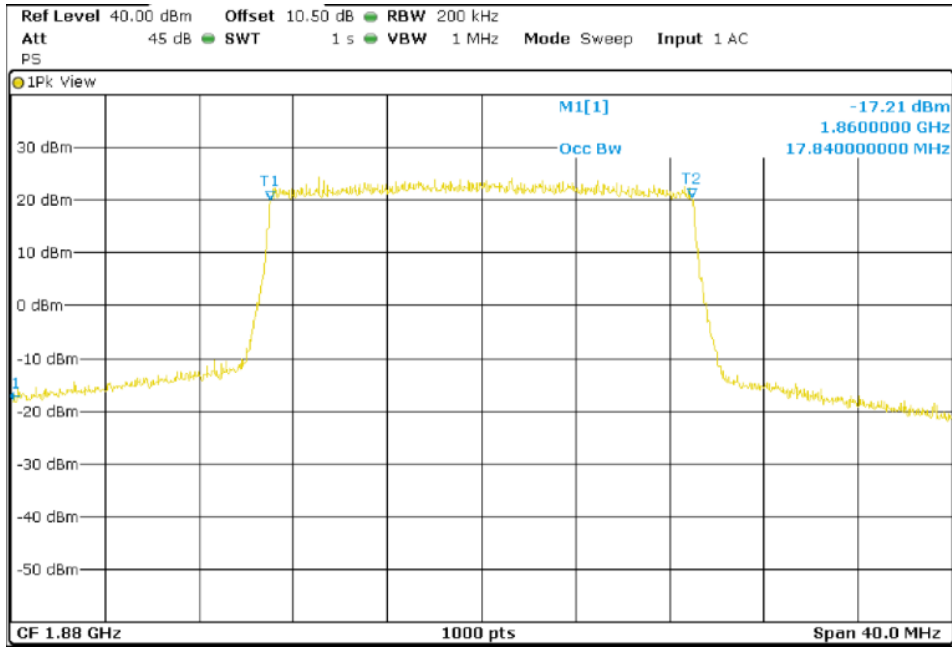

Middle Channel -26dBc Bandwidth kHz

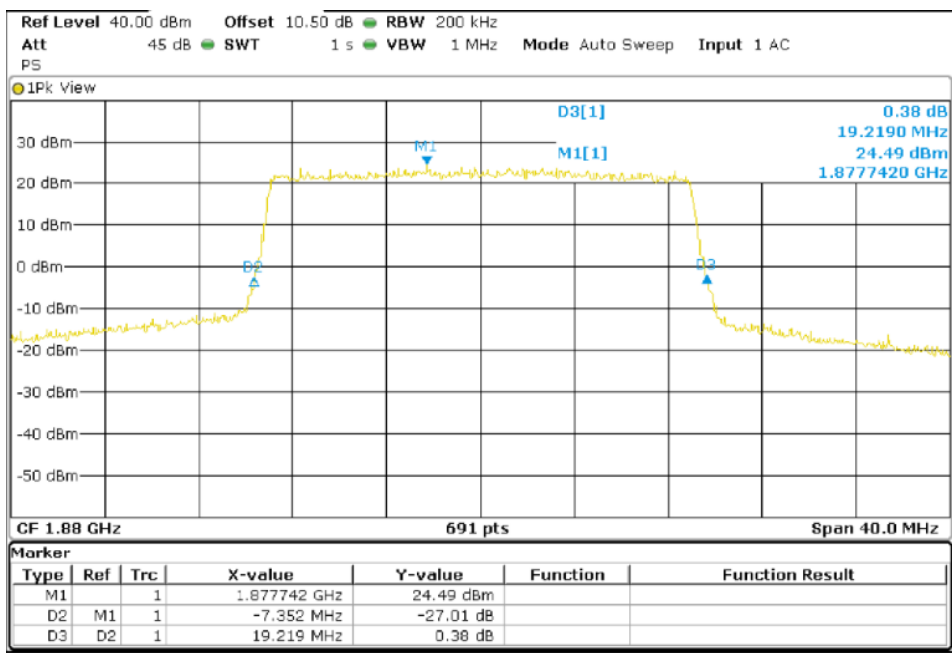



**TEST RESULTS (Cont):**

Highest Channel 99% Occupied Bandwidth

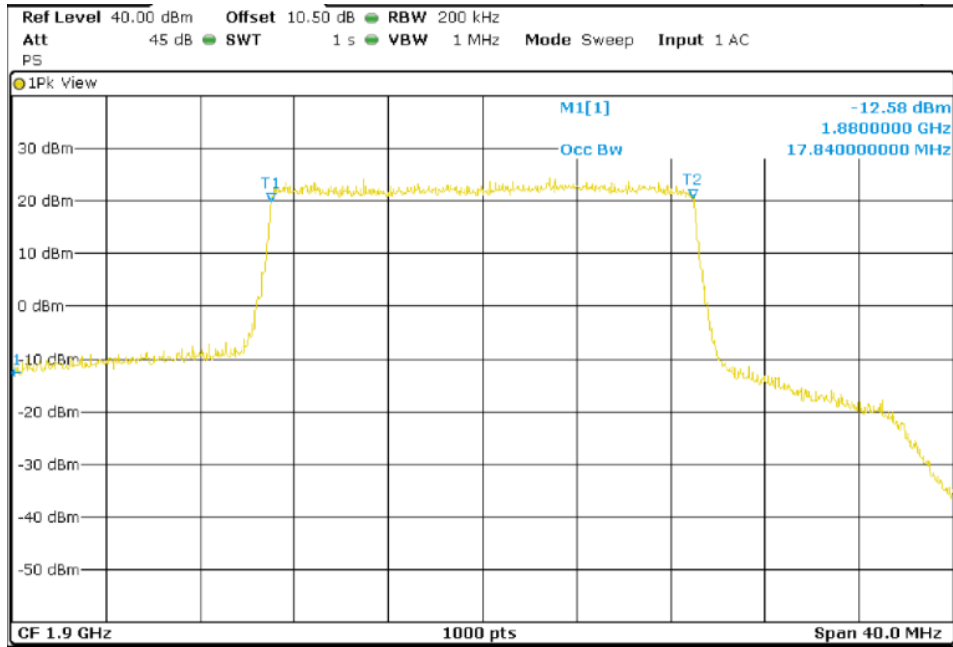

Highest Channel -26dBc Bandwidth kHz

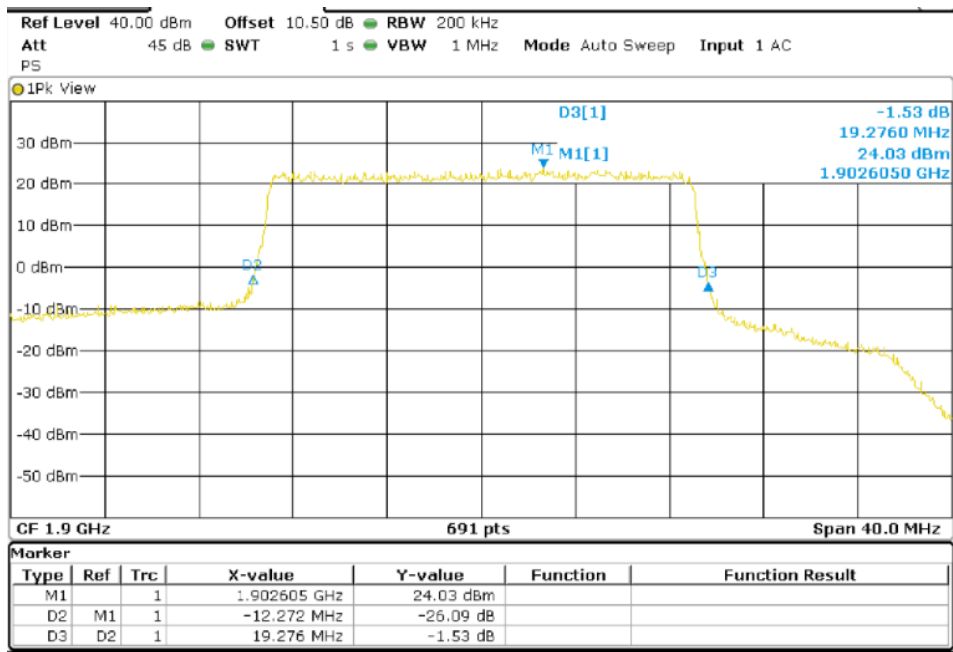

**TEST RESULTS (Cont):**

LTE 16QAM MODULATION. BW = 20 MHz

Lowest Channel 99% Occupied Bandwidth

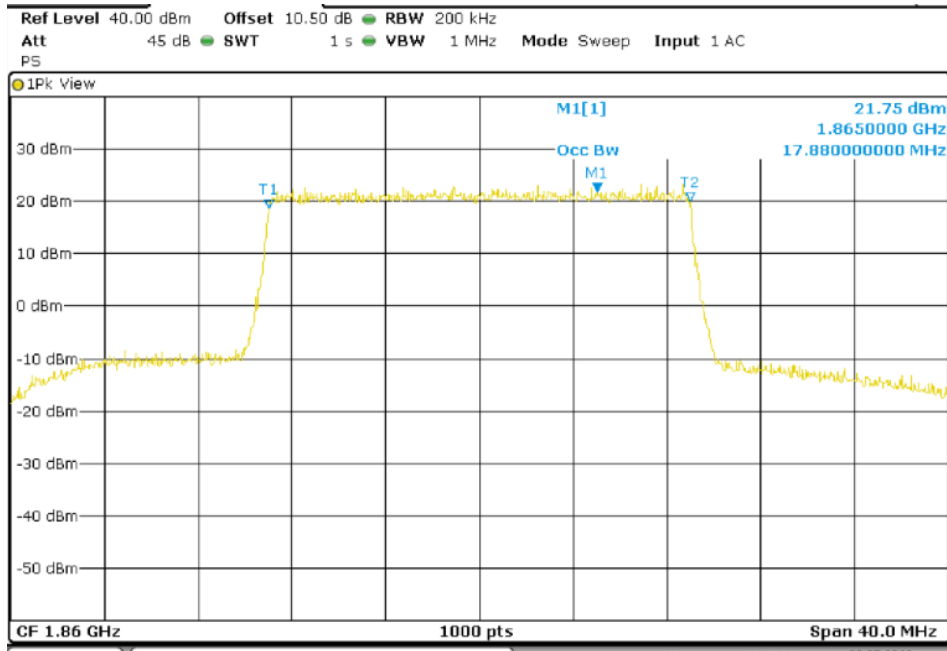

Lowest Channel -26dBc Bandwidth kHz

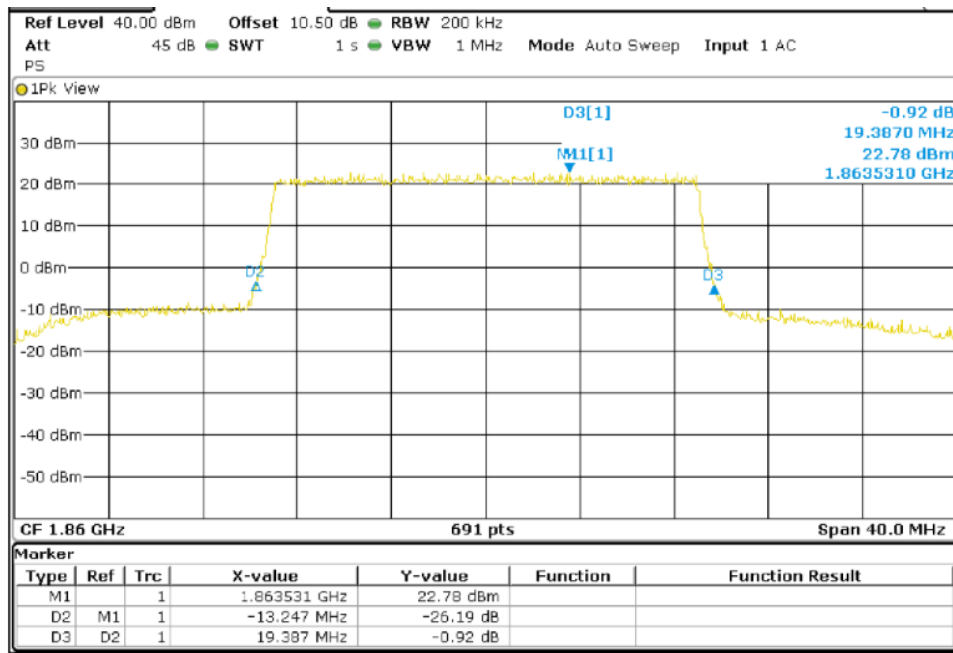

**TEST RESULTS (Cont):**

Middle Channel 99% Occupied Bandwidth

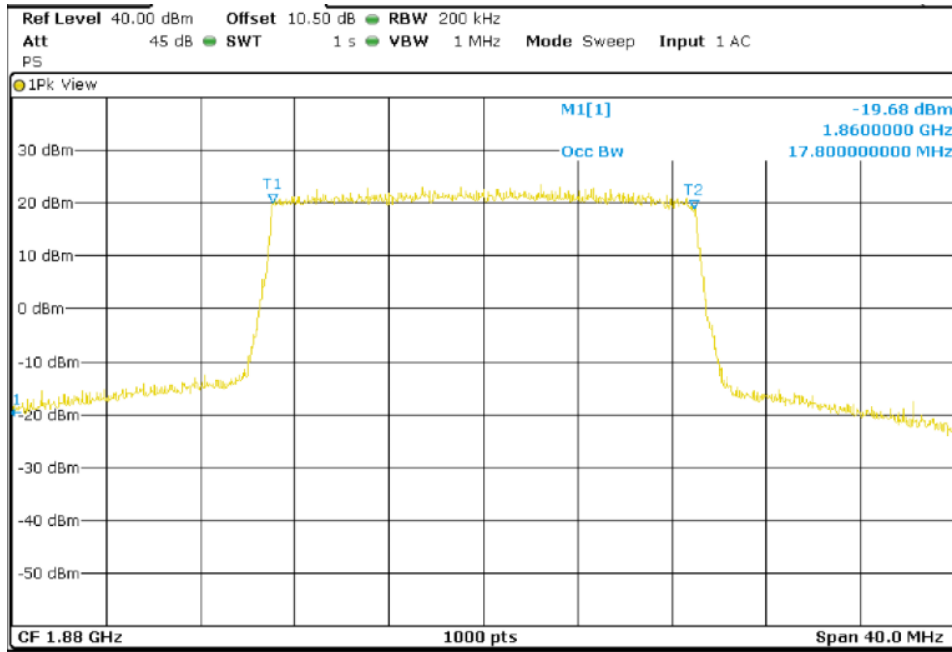

Middle Channel -26dBc Bandwidth kHz

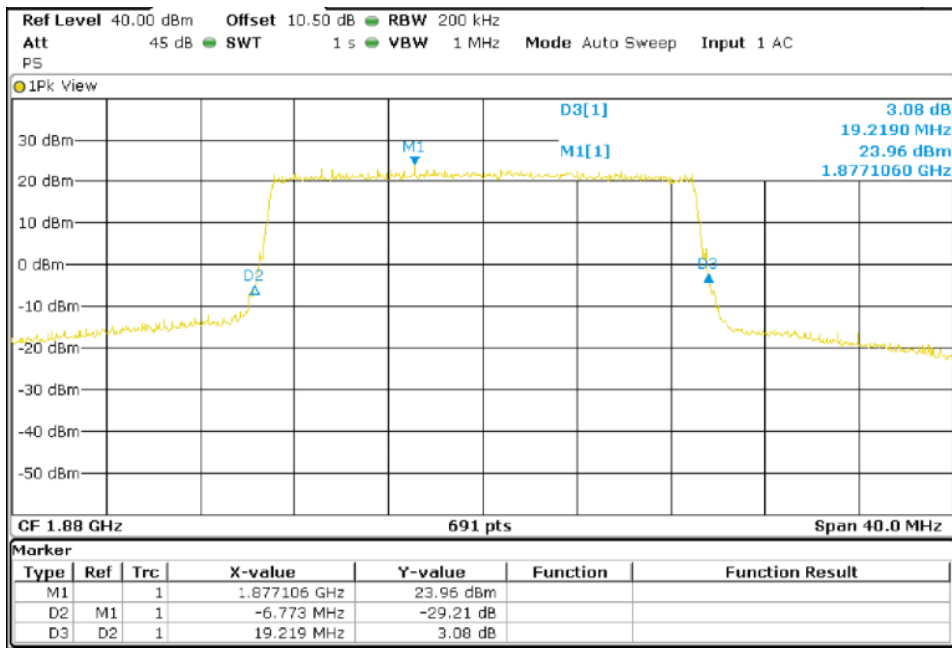

**TEST RESULTS (Cont):**

Highest Channel 99% Occupied Bandwidth

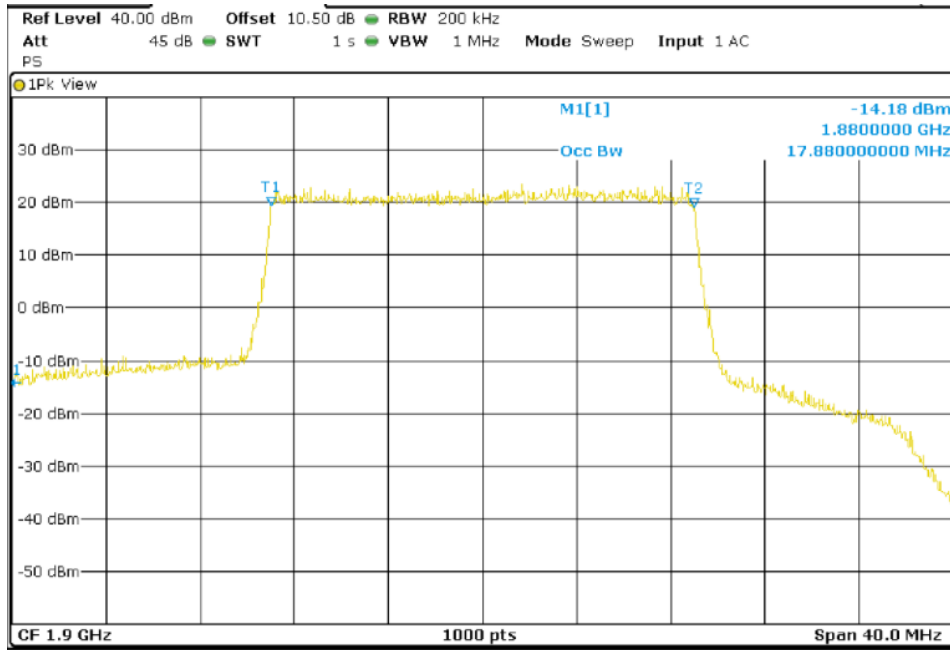

Highest Channel -26dBc Bandwidth kHz

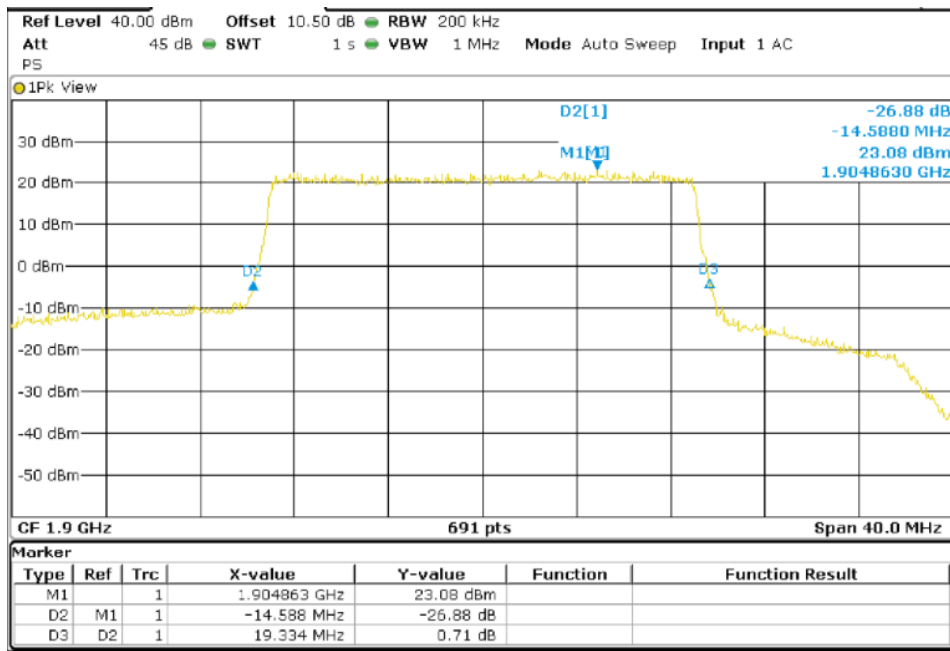

## TEST C.5: SPURIOUS EMISSIONS AT ANTENNA TERMINALS

<b>LIMITS:</b>	Product standard:	FCC Part 24 / IC RSS-133
	Test standard:	FCC §2.1051 and § 24.238/ RSS-133 Clause 6.5

### LIMITS

According to specification, the power of emissions shall be attenuated below the transmitter power (P) by a factor of at least  $43 + 10 \log (P)$  dB. P in watts.

At  $P_o$  transmitting power of 2 watts (33 dBm), the specified minimum attenuation becomes  $43+10\log (P_o)$ . and the level in dBm relative to  $P_o$  becomes:

$$P_o \text{ (dBm)} - [43 + 10 \log (P_o \text{ in watts})] = -13 \text{ dBm}$$

### TEST SETUP

The EUT RF output connector was connected to a spectrum analyzer and to the Universal Radio Communication Tester R&S CMW500 (selecting maximum transmission power of the EUT and different modes of modulation) using a 50-ohm attenuator and a power splitter.

The spectrum was investigated from 9 kHz to 26 GHz for LTE Band 25.

The reading of the spectrum analyzer is corrected with the attenuation loss of connection between output terminal of EUT and input of the spectrum analyzer.

For LTE mode the configuration of Resource Blocks and modulation which is the worst case for conducted power was used.

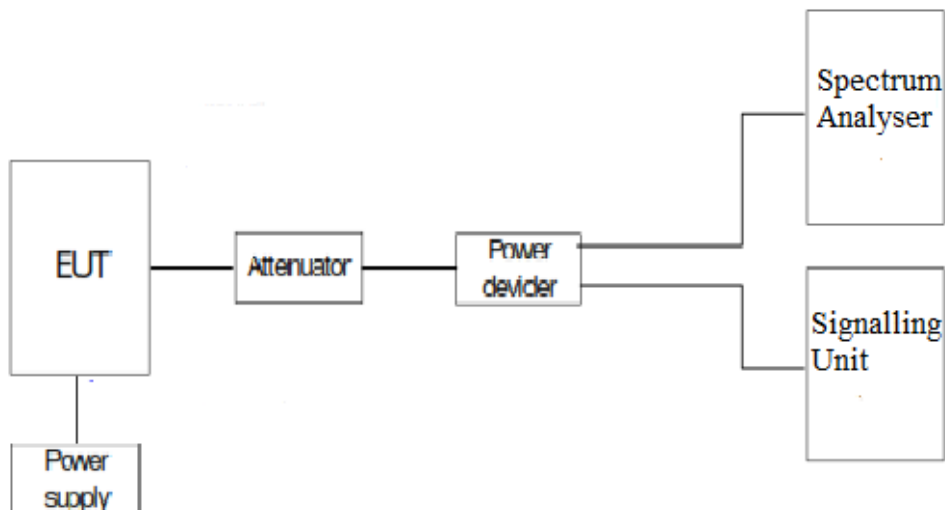

<b>TESTED SAMPLES:</b>	S/01
<b>TESTED CONDITIONS MODES:</b>	TC#01
<b>TEST RESULTS:</b>	PASS

Frequency range 9 kHz – 20 GHz

LTE QPSK MODULATION. BW = 1.4 MHz

Lowest Channel

Spurious frequency (MHz)	Level (dBm)	Measurement uncertainty (dB)
1930.949	-21.91	< ± 1.20

Middle Channel

Spurious frequency (MHz)	Level (dBm)	Measurement uncertainty (dB)
1959.699	-21.78	< ± 1.20

Highest Channel

Spurious frequency (MHz)	Level (dBm)	Measurement uncertainty (dB)
1982.819	-21.99	< ± 1.20

LTE QPSK MODULATION. BW = 3 MHz

Lowest Channel

Spurious frequency (MHz)	Level (dBm)	Measurement uncertainty (dB)
1931.569	-20.26	< ± 1.20

Middle Channel

Spurious frequency (MHz)	Level (dBm)	Measurement uncertainty (dB)
1960.319	-20.2	< ± 1.20

Highest Channel

Spurious frequency (MHz)	Level (dBm)	Measurement uncertainty (dB)
1988.449	-20.1	< ± 1.20

LTE QPSK MODULATION. BW = 5 MHz

Lowest Channel

Spurious frequency (MHz)	Level (dBm)	Measurement uncertainty (dB)
1932.819	-20.29	< ± 1.20

Middle Channel

Spurious frequency (MHz)	Level (dBm)	Measurement uncertainty (dB)
1960.949	-20.33	< ± 1.20

Highest Channel

Spurious frequency (MHz)	Level (dBm)	Measurement uncertainty (dB)
1982.819	-20.1	< ± 1.20

TEST RESULTS (Cont):		
LTE QPSK MODULATION. BW = 10 MHz		
Lowest Channel		
Spurious frequency (MHz)	Level (dBm)	Measurement uncertainty (dB)
1937.199	-22.67	< ± 1.20
Middle Channel		
Spurious frequency (MHz)	Level (dBm)	Measurement uncertainty (dB)
1962.819	-22.71	< ± 1.20
Highest Channel		
Spurious frequency (MHz)	Level (dBm)	Measurement uncertainty (dB)
1986.569	-22.92	< ± 1.20
LTE QPSK MODULATION. BW = 15 MHz		
Lowest Channel		
Spurious frequency (MHz)	Level (dBm)	Measurement uncertainty (dB)
1934.069	-24.51	< ± 1.20
Middle Channel		
Spurious frequency (MHz)	Level (dBm)	Measurement uncertainty (dB)
1962.819	-24.31	< ± 1.20
Highest Channel		
Spurious frequency (MHz)	Level (dBm)	Measurement uncertainty (dB)
1985.319	-24.58	< ± 1.20
LTE QPSK MODULATION. BW = 20 MHz		
Lowest Channel		
Spurious frequency (MHz)	Level (dBm)	Measurement uncertainty (dB)
1948.449	-25.92	< ± 1.20
Middle Channel		
Spurious frequency (MHz)	Level (dBm)	Measurement uncertainty (dB)
1952.819	-25.28	< ± 1.20
Highest Channel		
Spurious frequency (MHz)	Level (dBm)	Measurement uncertainty (dB)
1980.319	-25.35	< ± 1.20

**TEST RESULTS (Cont):**

LTE QPSK MODULATION. BW = 1.4MHz

Lowest Channel

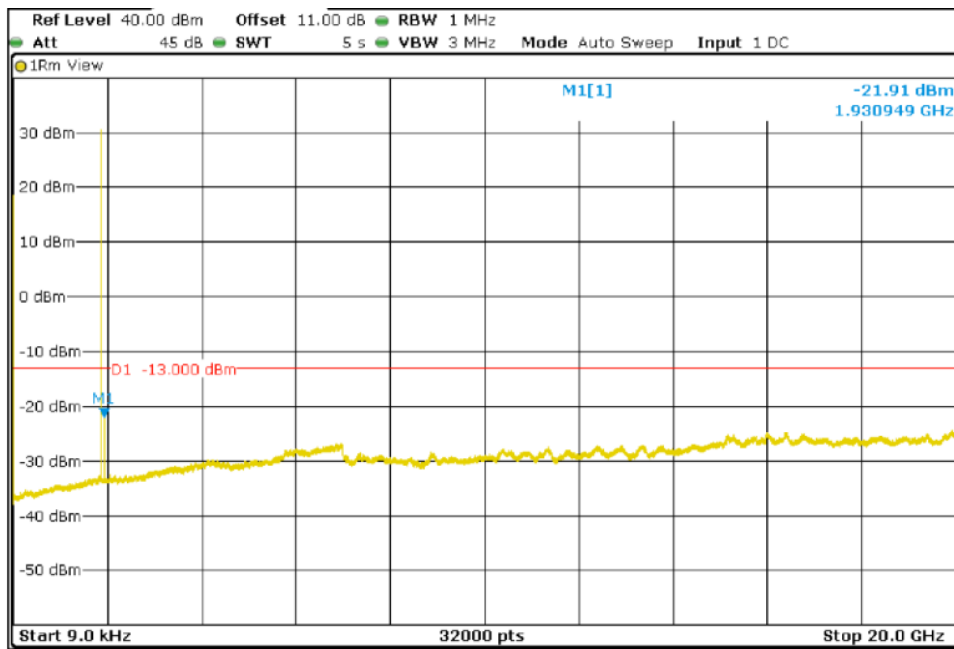

Middle Channel

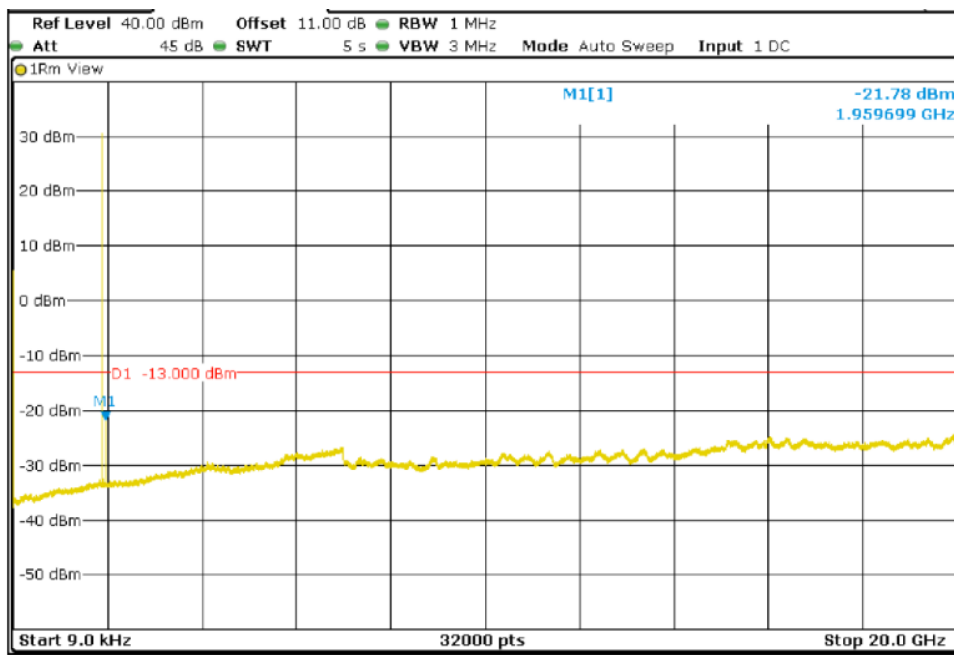



TEST RESULTS (Cont):

Highest Channel

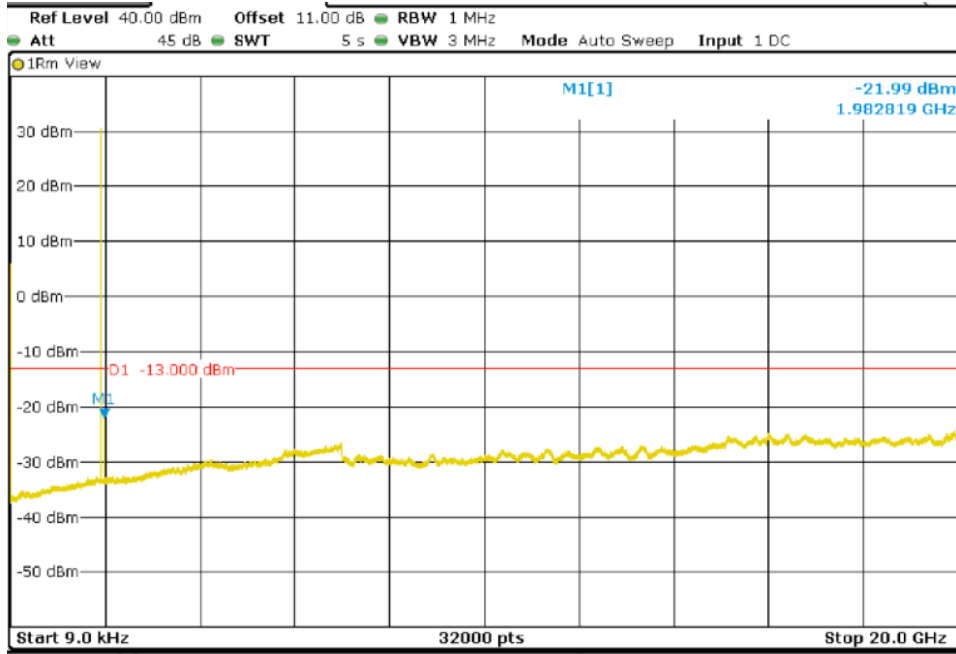

LTE QPSK MODULATION. BW = 3 MHz

Lowest Channel

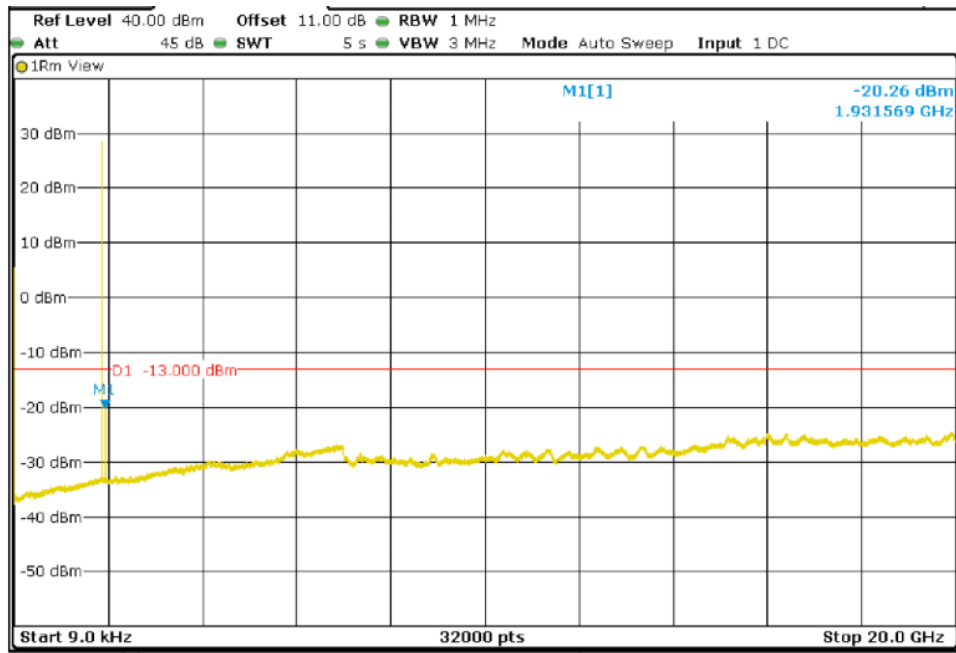

TEST RESULTS (Cont):

Middle Channel

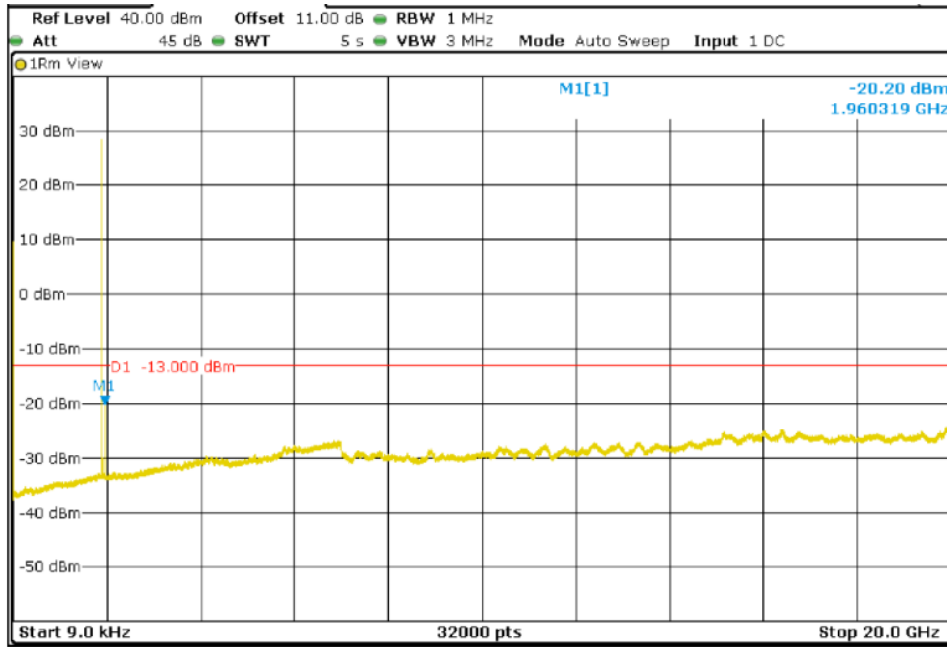

Highest Channel

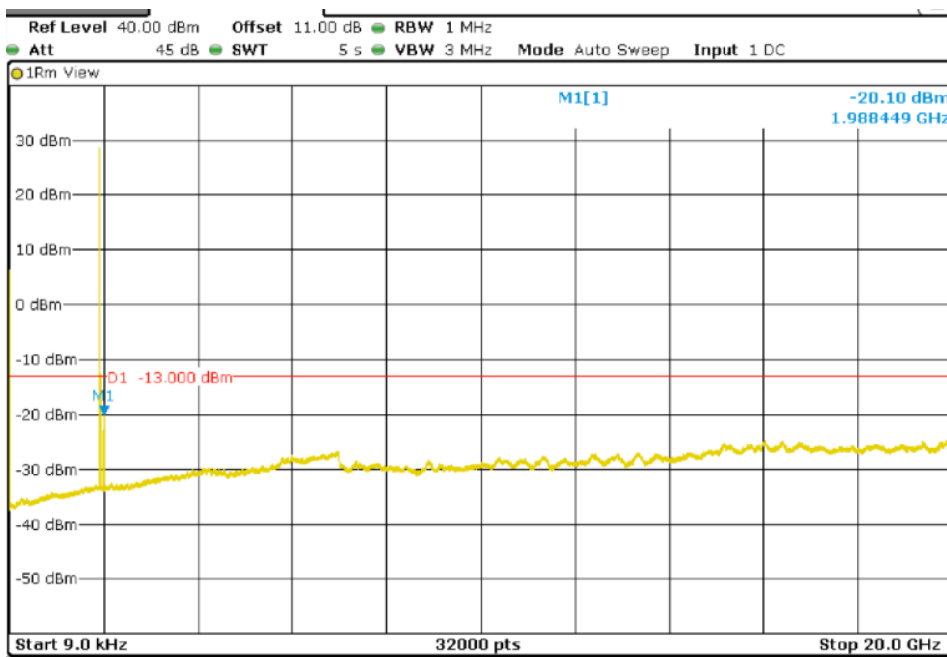

**TEST RESULTS (Cont):**

LTE QPSK MODULATION. BW = 5 MHz

Lowest Channel

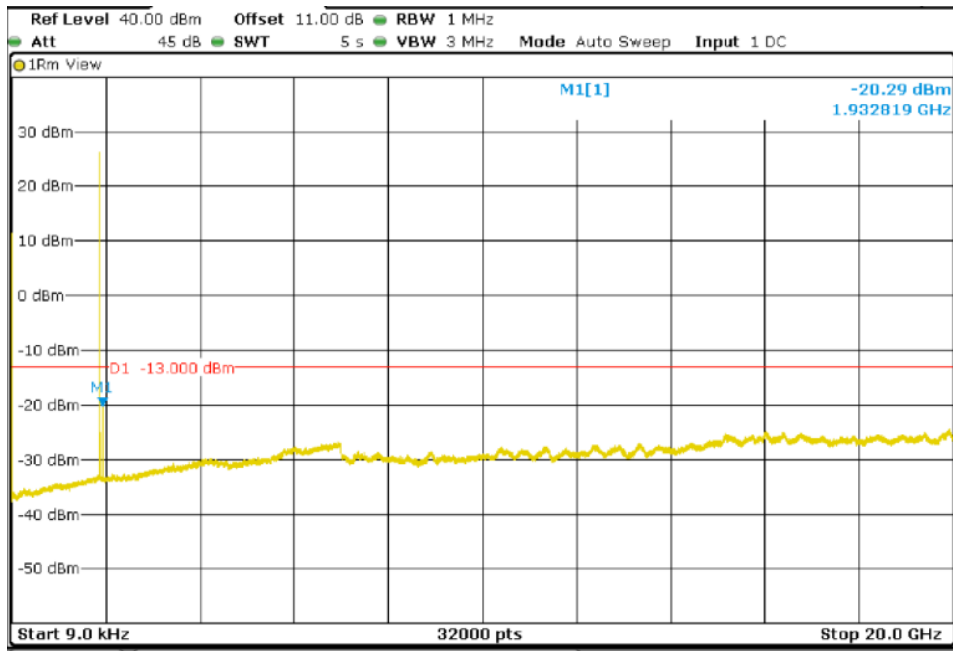

Middle Channel

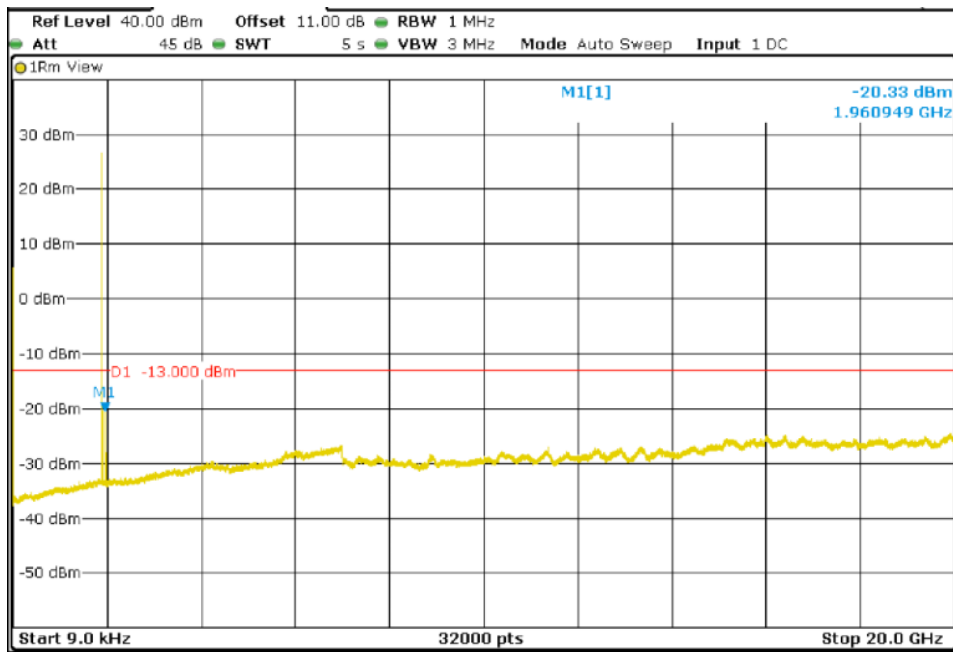

**TEST RESULTS (Cont):**

Highest Channel

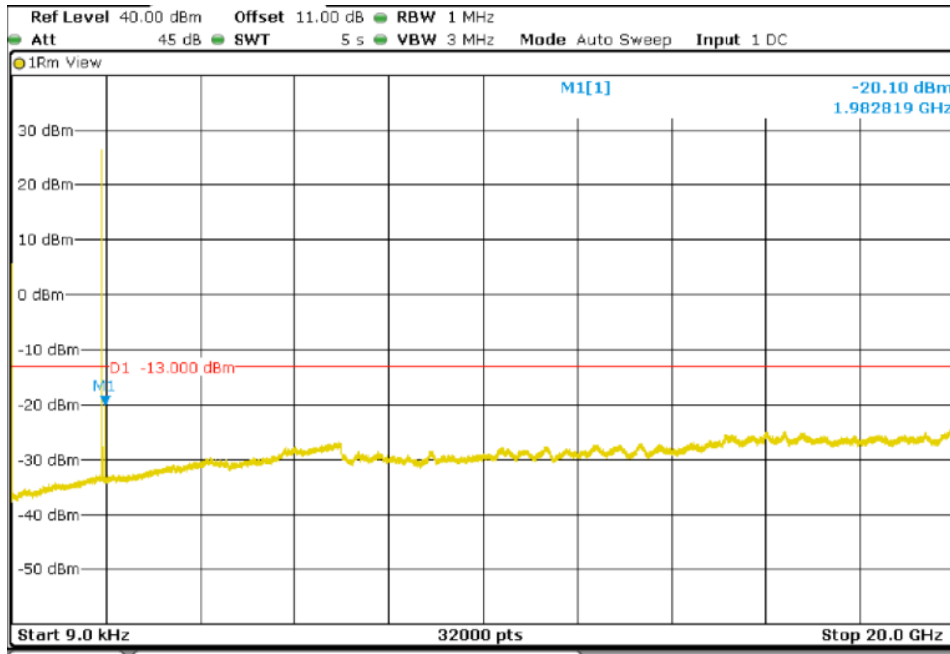

LTE QPSK MODULATION. BW = 10 MHz

Lowest Channel

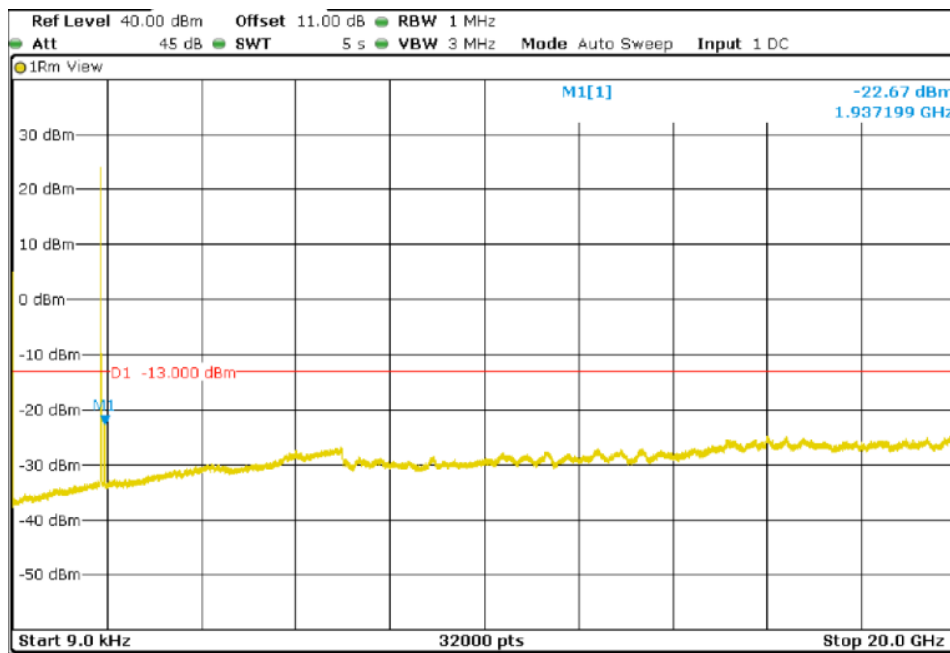

TEST RESULTS (Cont):

Middle Channel

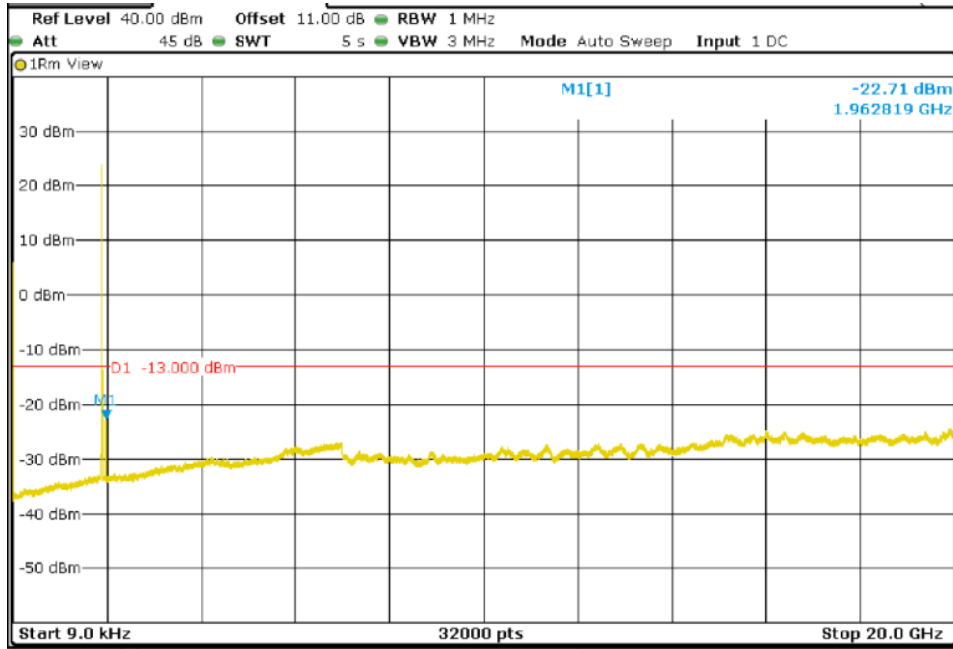

Highest Channel

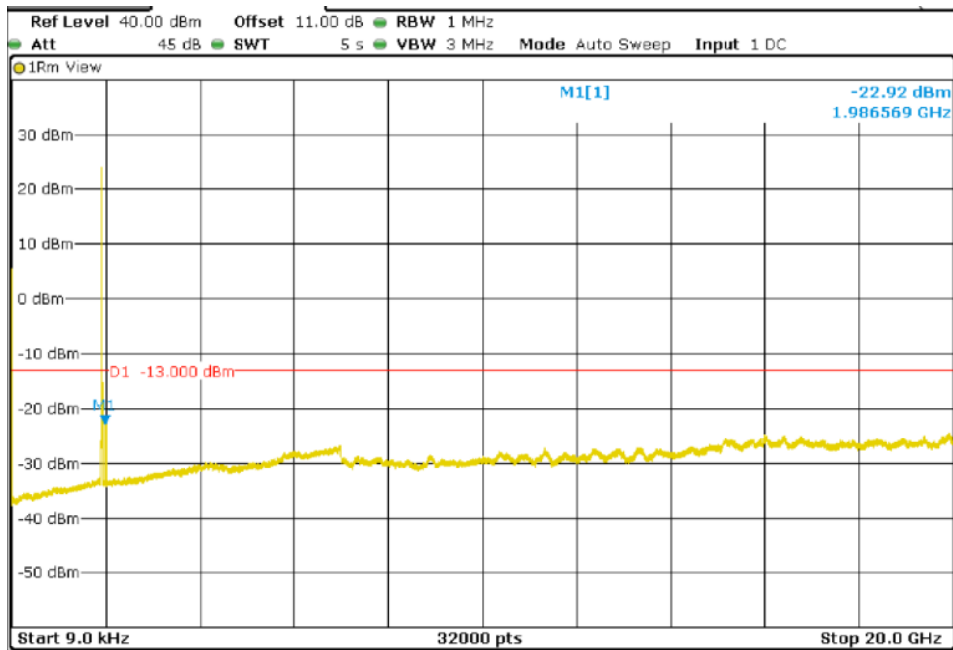

**TEST RESULTS (Cont):**

LTE QPSK MODULATION. BW = 15 MHz

Lowest Channel

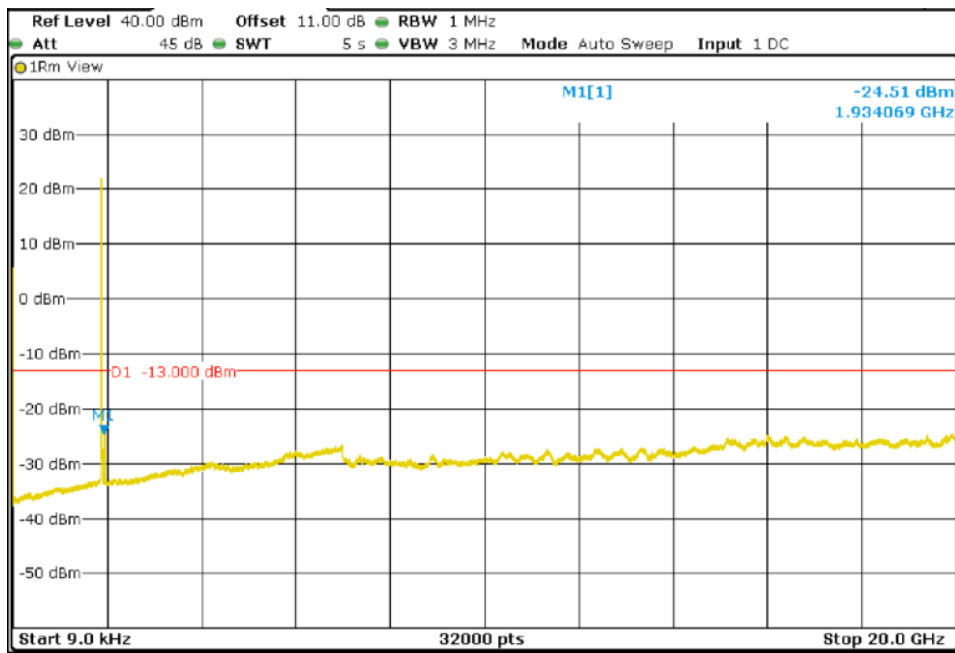

Middle Channel

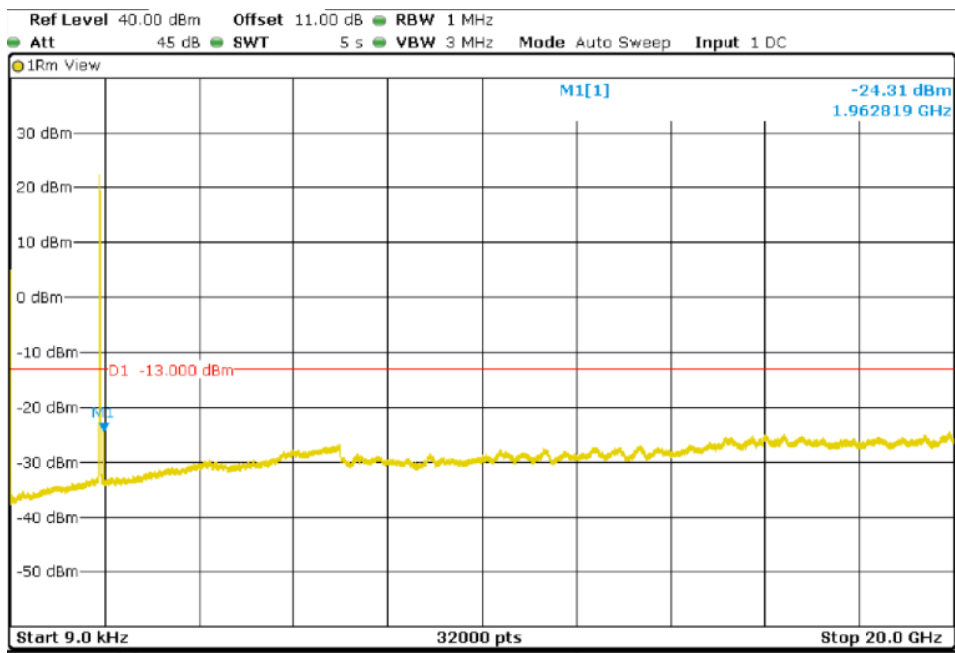

**TEST RESULTS (Cont):**

Highest Channel

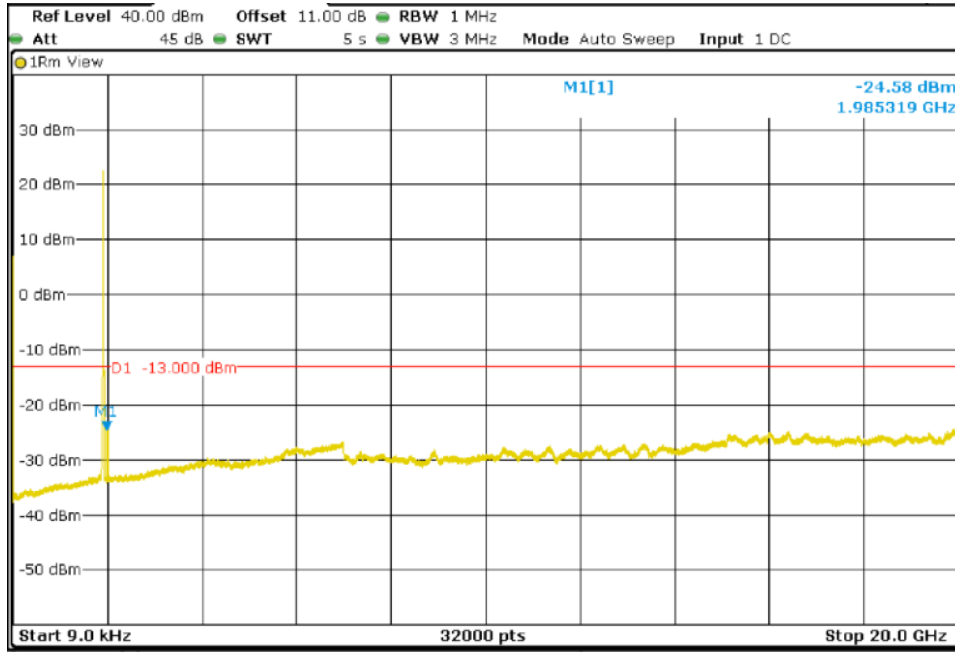

LTE QPSK MODULATION. BW = 20 MHz

Lowest Channel

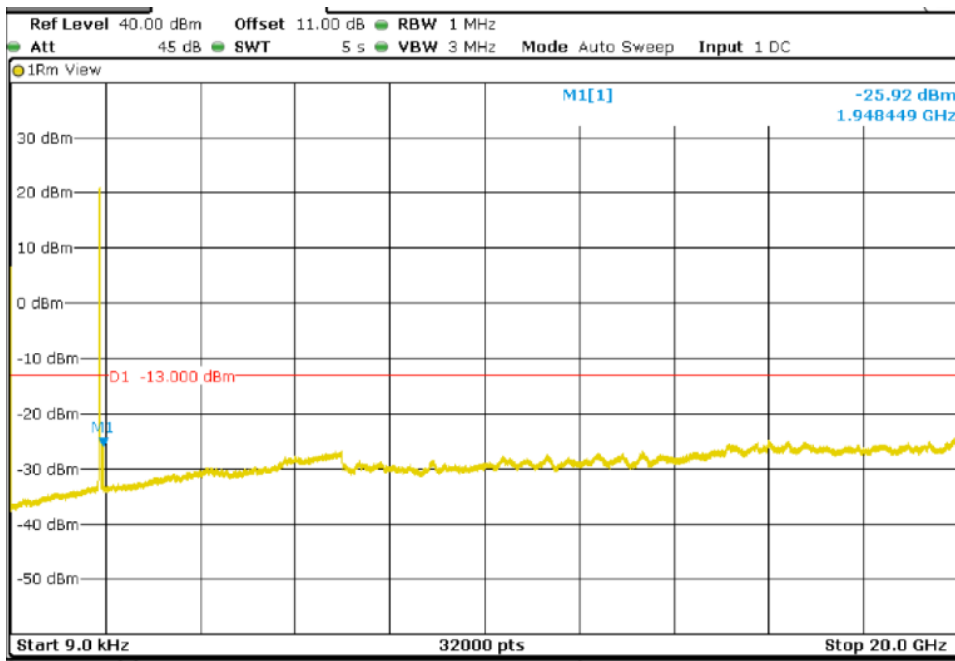

TEST RESULTS (Cont):

Middle Channel

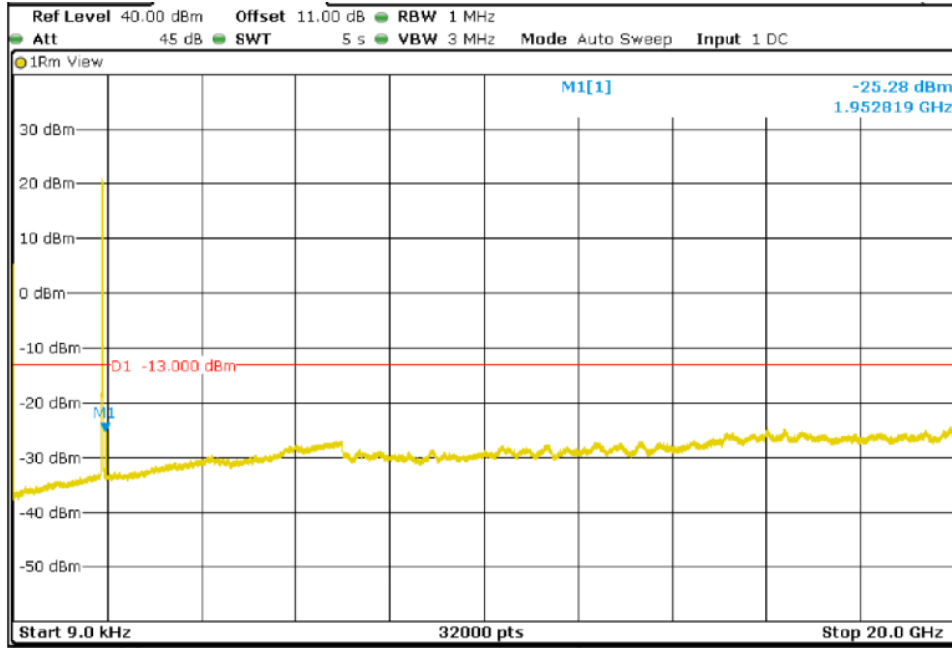

Highest Channel

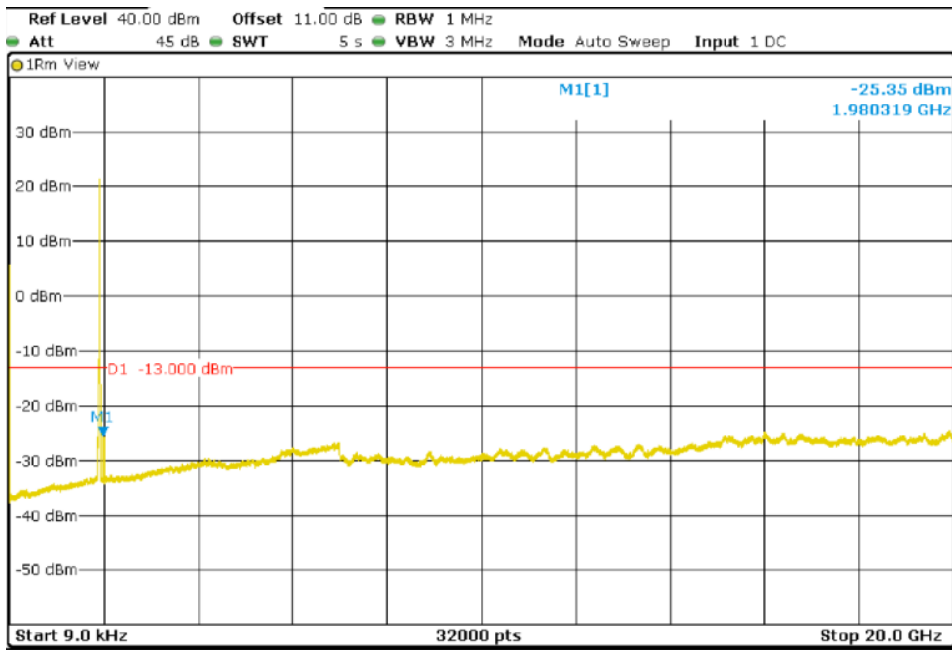



## TEST C.6: SPURIOUS EMISSIONS AT ANTENNA TERMINALS AT BLOCK EDGES

<b>LIMITS:</b>	Product standard:	FCC Part 24 / IC RSS-133
	Test standard:	FCC § 24.238 and FCC §2.1051 / RSS 133- Clause 6.6

### LIMITS

According to specification, the power of emissions shall be attenuated below the transmitter power (P) by a factor of at least  $43 + 10 \log (P)$  dB. P in watts.

At  $P_o$  transmitting power of 2 watts (33 dBm), the specified minimum attenuation becomes  $43 + 10 \log (P_o)$ . and the level in dBm relative to  $P_o$  becomes:

$$P_o \text{ (dBm)} - [43 + 10 \log (P_o \text{ in watts})] = -13 \text{ dBm}$$

### **TEST SETUP**

The EUT RF output connector was connected to a spectrum analyzer and to the Universal Radio Communication Tester R&S CMW500 (selecting maximum transmission power of the EUT and different modes of modulation) using a 50-ohm attenuator and a power splitter.

The reading of the spectrum analyzer is corrected with the attenuation loss of connection between output terminal of EUT and input of the spectrum analyzer.

For LTE mode the configuration of modulation which is the worst case for conducted power was used.

As indicated in FCC part 24, in the 1 MHz bands immediately outside and adjacent to the licensee's frequency block or band, a resolution bandwidth of at least one percent of the emission bandwidth of the fundamental emission of the transmitter may be employed.

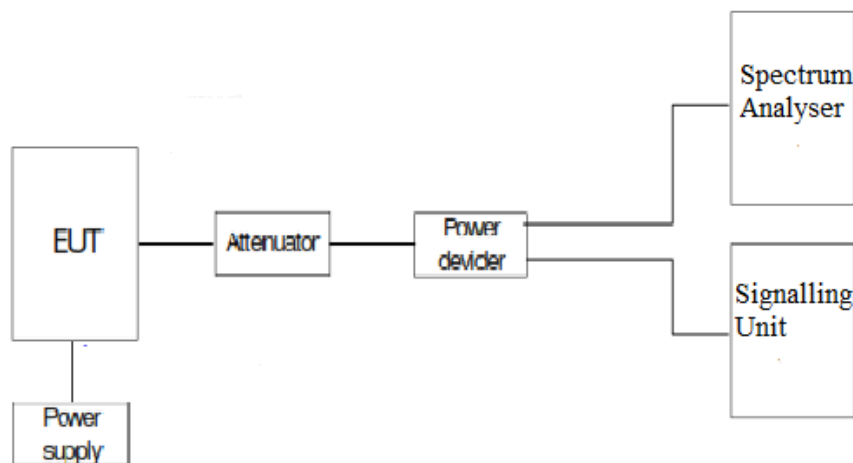

<b>TESTED SAMPLES:</b>		S/01				
<b>TESTED CONDITIONS MODES:</b>		TC#01				
<b>TEST RESULTS:</b>		PASS				
LTE QPSK MODULATION	RB=1.  Offset=0.  BW=1.4 MHz	RB=1.  Offset =0.  BW = 3 MHz	RB=1.  Offset =0.  BW = 5 MHz	RB=1.  Offset =0.  BW = 10 MHz	RB=1.  Offset =0.  BW = 15 MHz	RB=1.  Offset =0.  BW = 20 MHz
Maximum measured level at lowest Block Edge at antenna port (dBm)	-15.94	-18.91	-19	-20.87	-16.28	-19.04
LTE QPSK MODULATION:	RB= All.  Offset=0.  BW=1.4 MHz	RB= All.  Offset =0.  BW = 3 MHz	RB= All.  Offset =0.  BW = 5 MHz	RB= All.  Offset =0.  BW = 10 MHz	RB= All.  Offset =0.  BW = 15 MHz	RB= All.  Offset =0.  BW = 20 MHz
Maximum measured level at lowest Block Edge at antenna port (dBm)	-22.59	-15.73	-13.94	-15.56	-13.83	-16.62
LTE QPSK MODULATION:	RB= 1.  Offset=Max.  BW=1.4 MHz	RB= 1.  Offset=Max.  BW = 3 MHz	RB= 1.  Offset=Max.  BW = 5 MHz	RB= 1.  Offset=Max.  BW = 10 MHz	RB= 1.  Offset=Max.  BW = 15 MHz	RB= 1.  Offset=Max.  BW = 20 MHz
Maximum measured level at highest Block Edge at antenna port (dBm)	-19.75	-20.12	-17.88	-20.25	-19.66	-20.69
LTE QPSK MODULATION:	RB= All.  Offset=0.  BW=1.4 MHz	RB= All.  Offset =0.  BW = 3 MHz	RB= All.  Offset =0.  BW = 5 MHz	RB= All.  Offset =0.  BW = 10 MHz	RB= All.  Offset =0.  BW = 15 MHz	RB= All.  Offset =0.  BW = 20 MHz
Maximum measured level at highest Block Edge at antenna port (dBm)	-17.33	-16.08	-15.92	-19.36	-18.09	-19.71

**TEST RESULTS (Cont):**

LTE QPSK MODULATION. RB = 1. Offset = 0. BW = 1.4 MHz

Lowest Channel

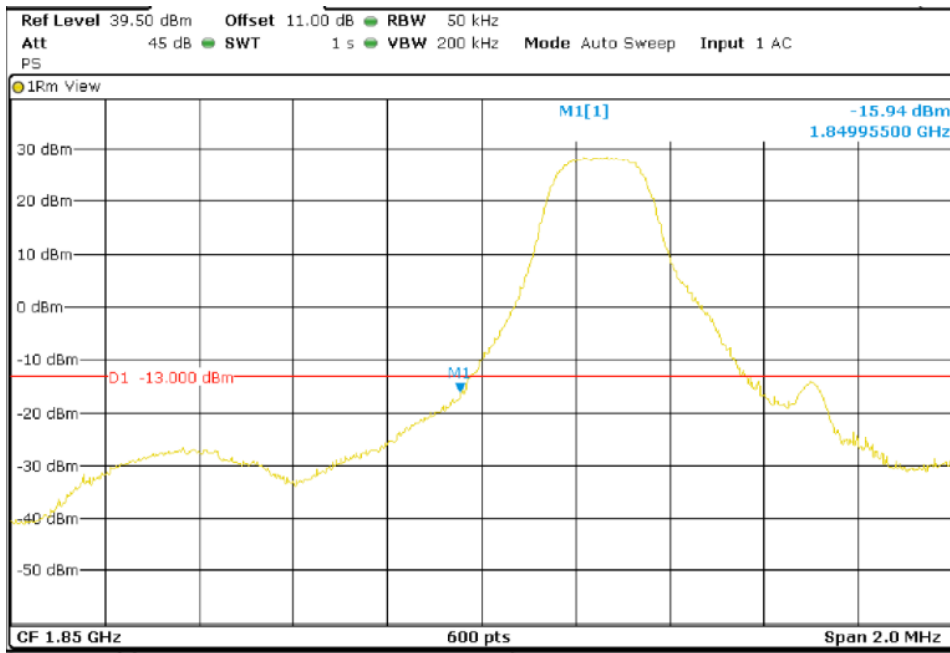

Highest Channel

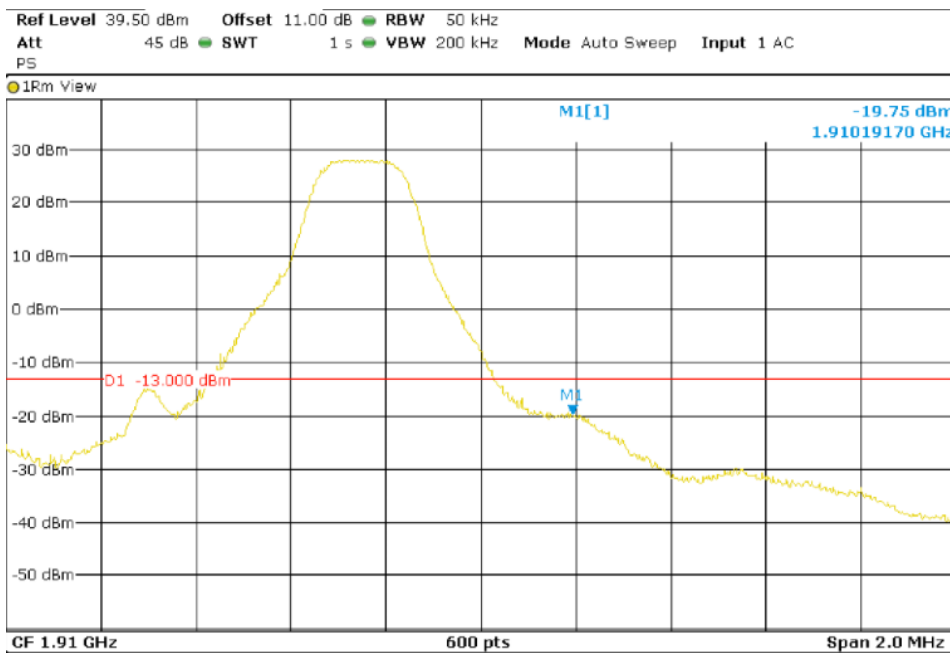

**TEST RESULTS (Cont):**

LTE QPSK MODULATION. RB = 6. Offset = 0. BW = 1.4 MHz

Lowest Channel

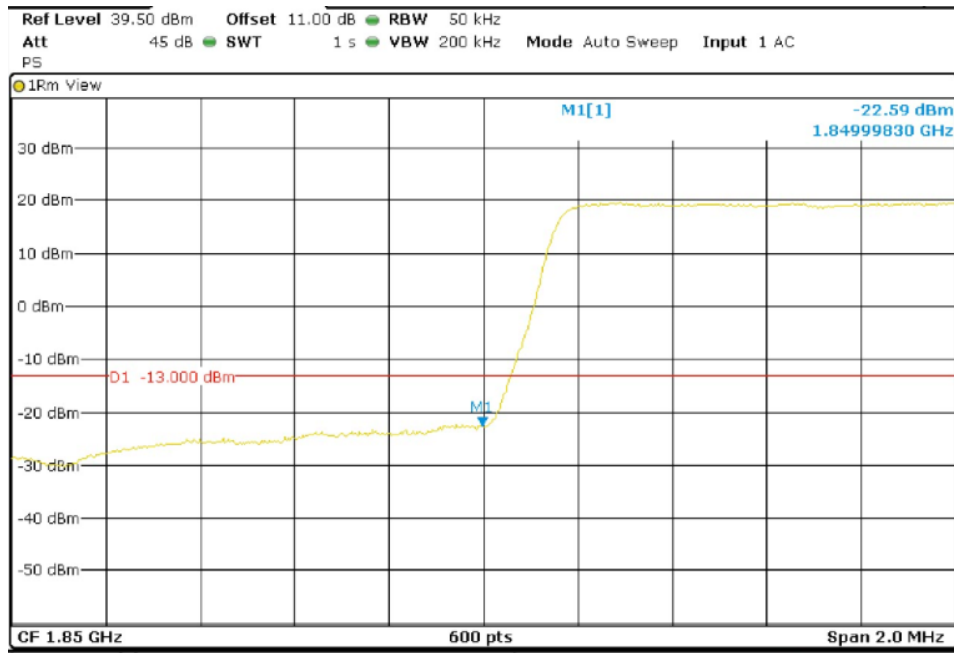

Highest Channel

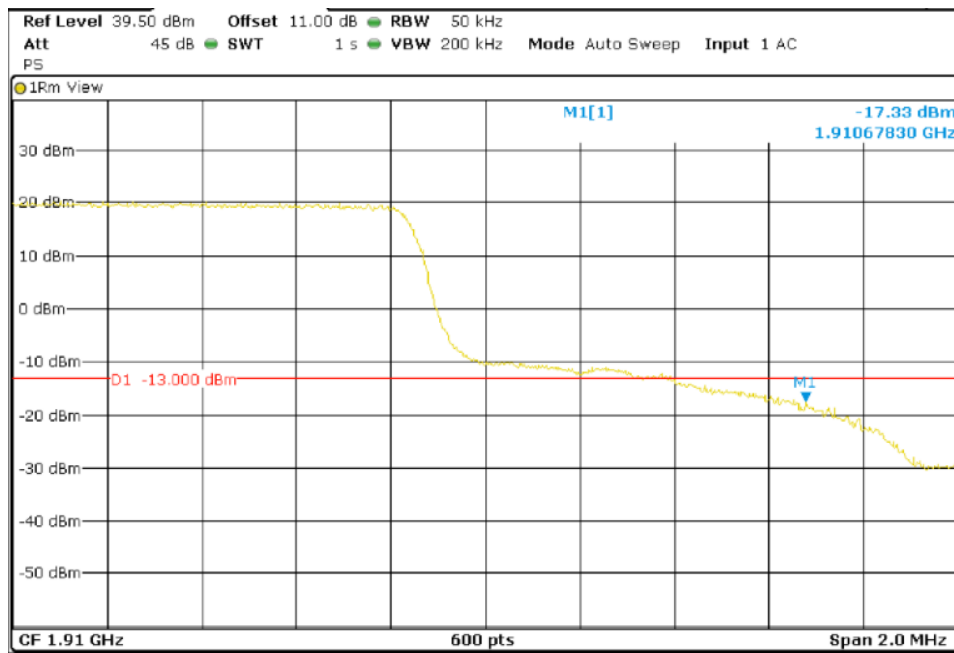

**TEST RESULTS (Cont):**

LTE QPSK MODULATION. RB = 1. Offset = 0. BW = 3 MHz

Lowest Channel

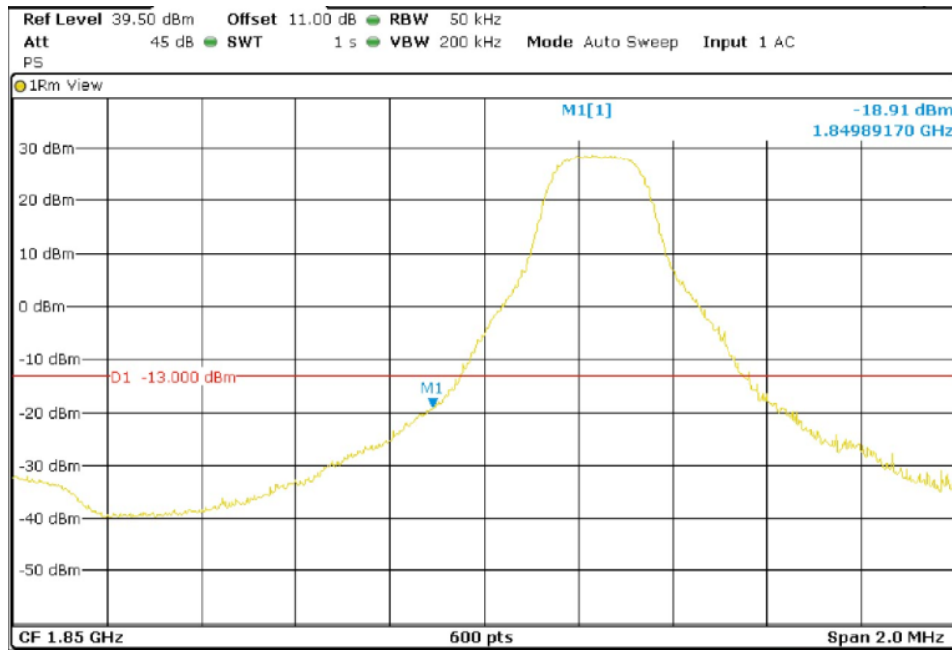

Highest Channel

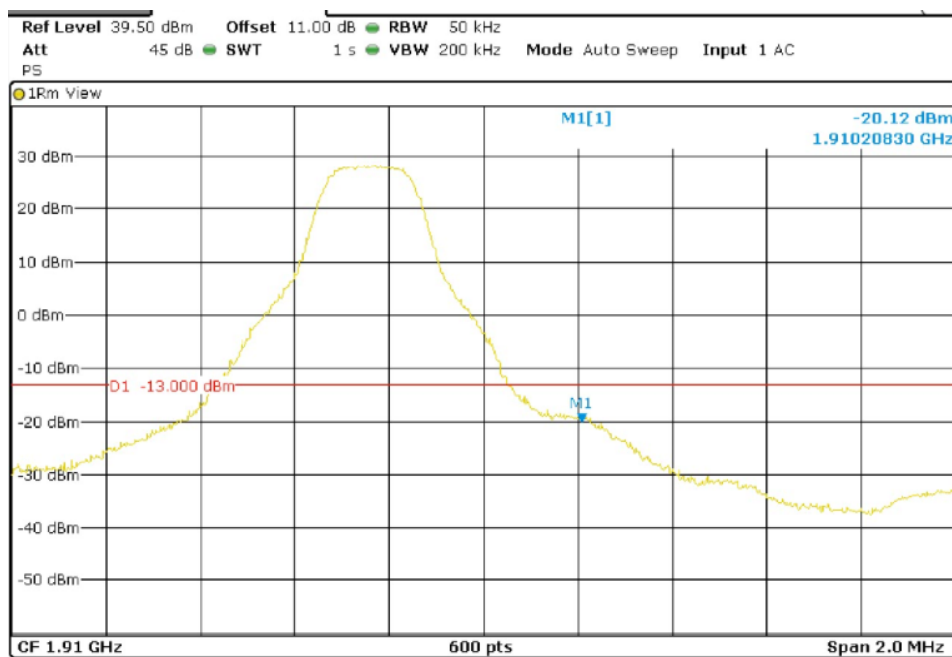

**TEST RESULTS (Cont):**

LTE QPSK MODULATION. RB = 15. Offset = 0. BW = 3 MHz

Lowest Channel

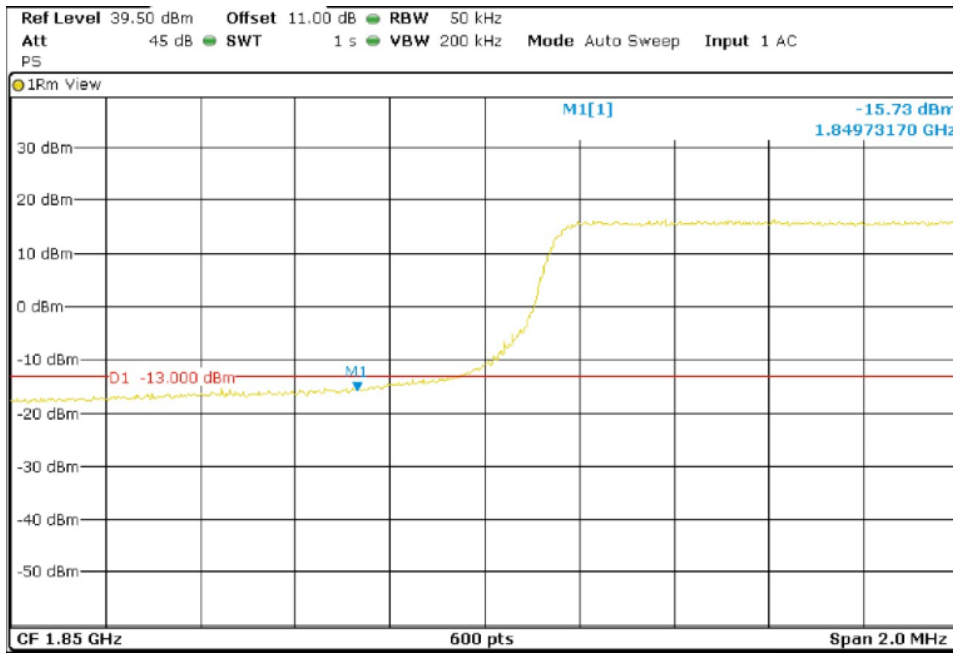

Highest Channel

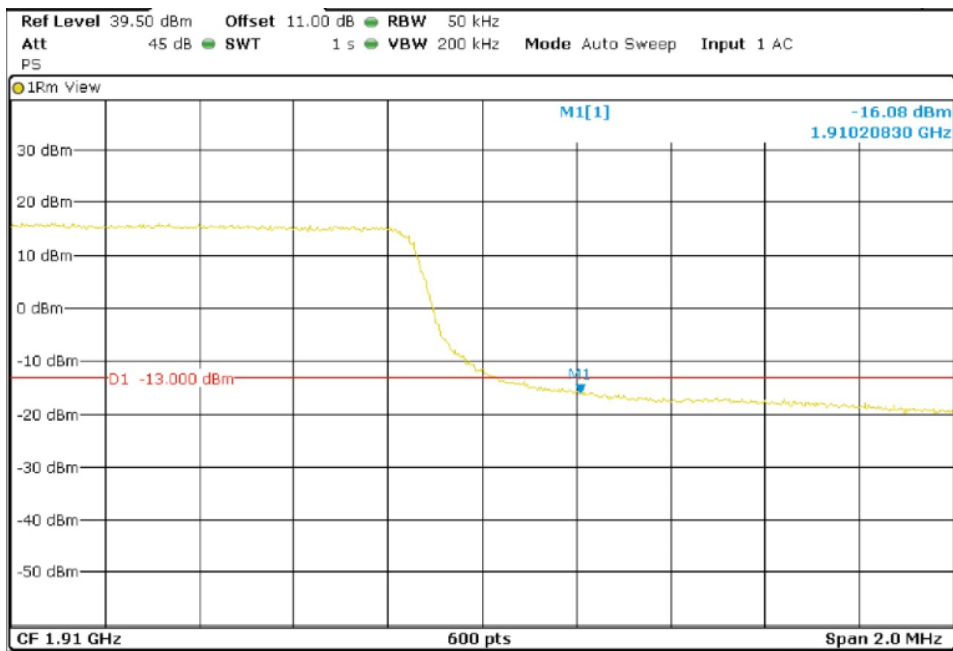

**TEST RESULTS (Cont):**

LTE QPSK MODULATION. RB = 1. Offset = 0. BW = 5 MHz

Lowest Channel

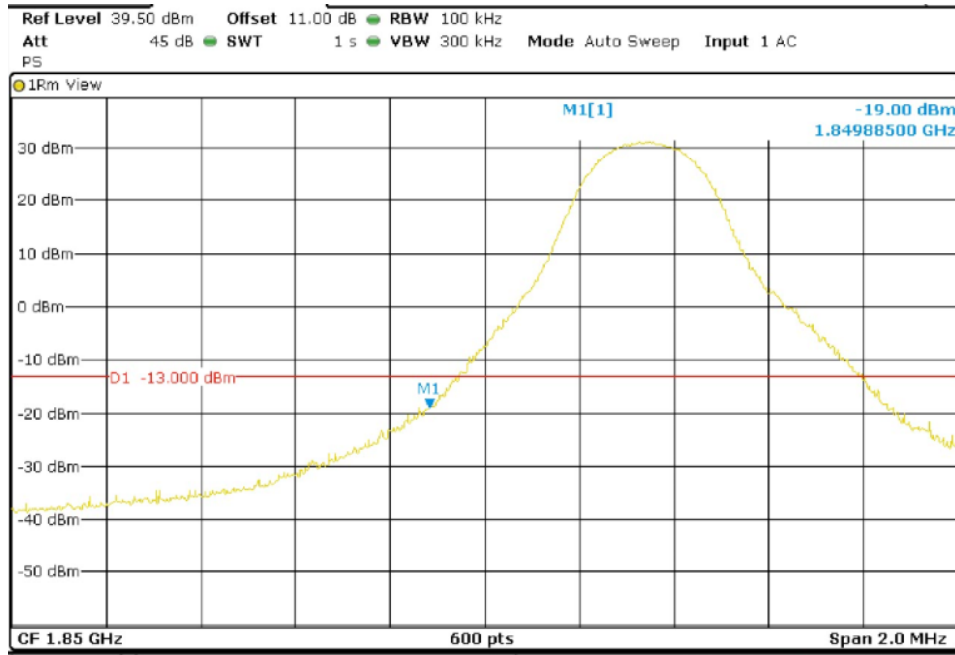

Highest Channel

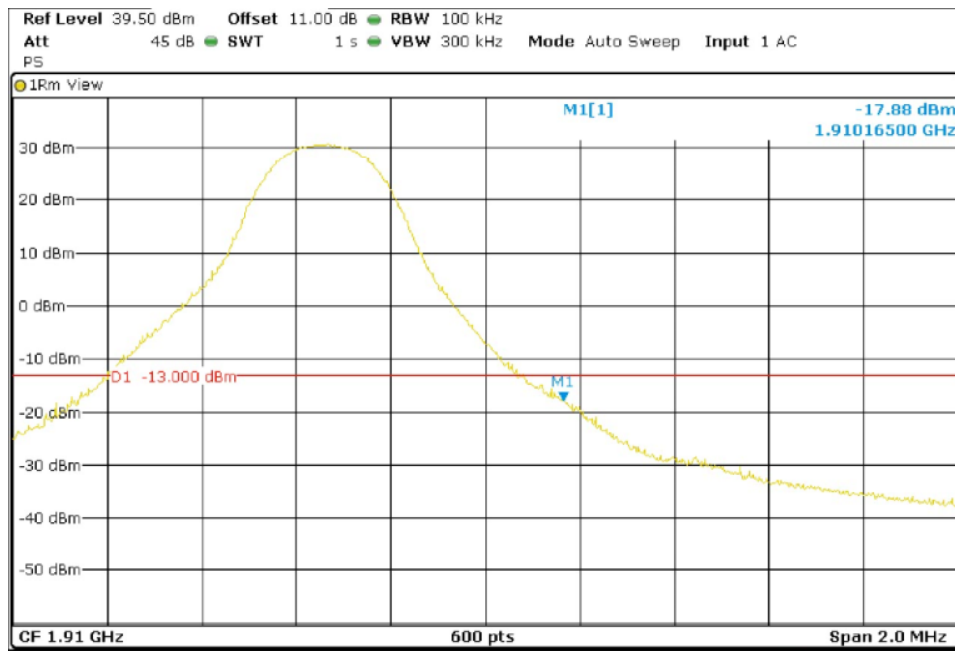

**TEST RESULTS (Cont):**

LTE QPSK MODULATION. RB = 25. Offset = 0. BW = 5 MHz

Lowest Channel

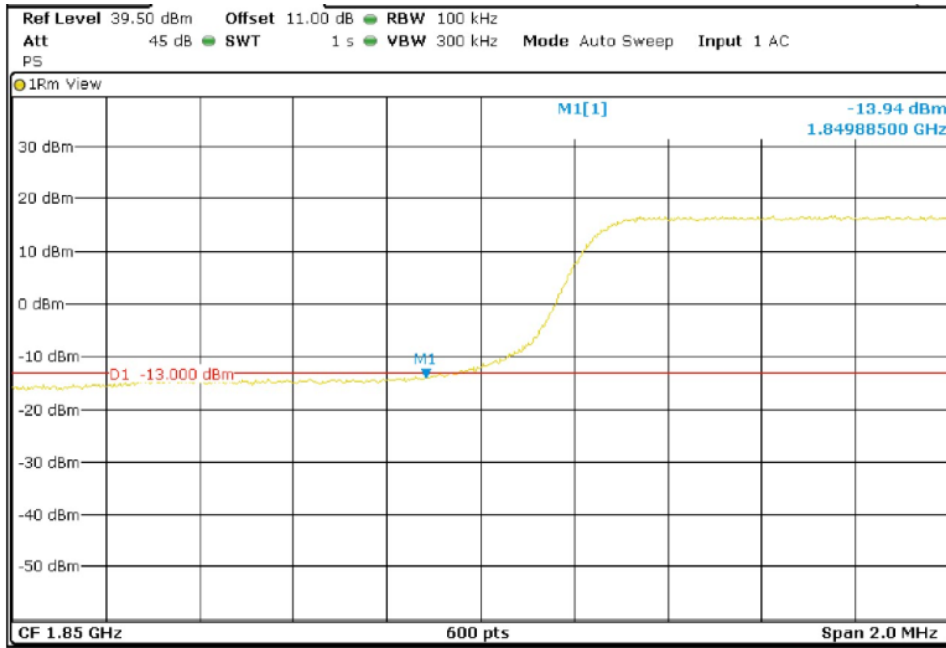

Highest Channel

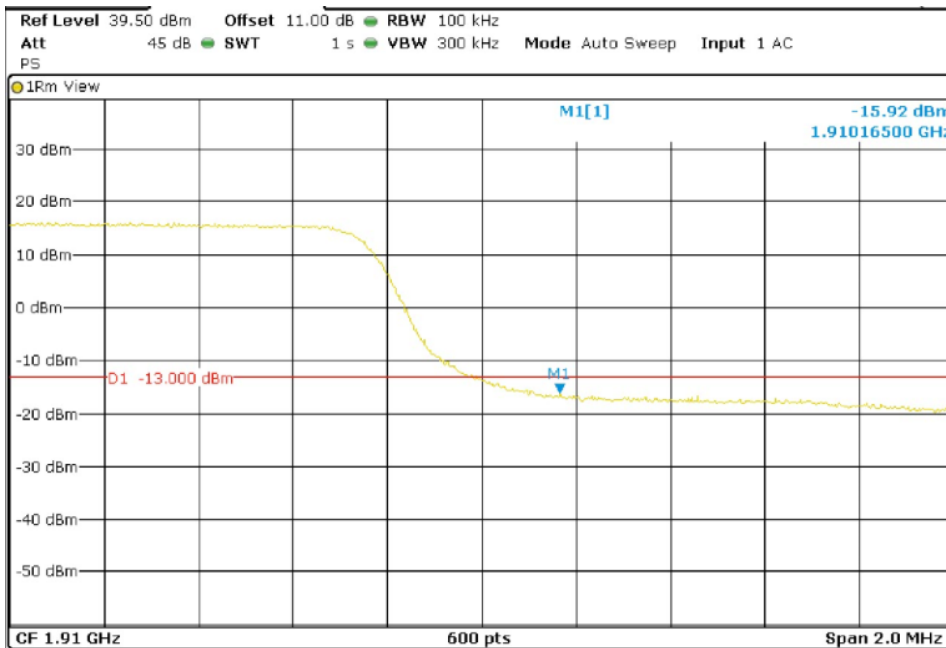



**TEST RESULTS (Cont):**

LTE QPSK MODULATION. RB = 1. Offset = 0. BW = 10 MHz

Lowest Channel

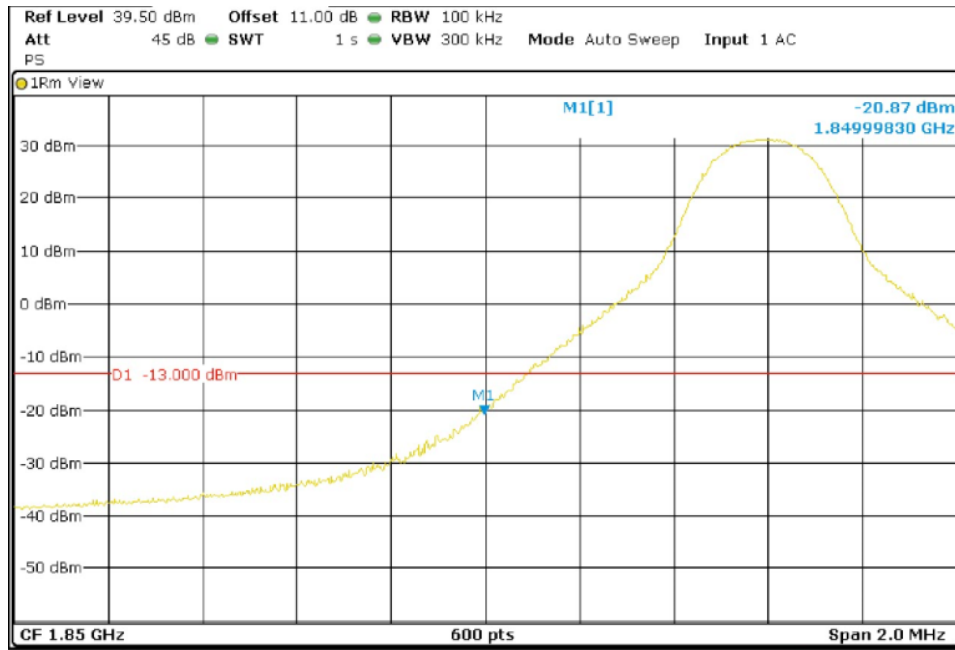

Highest Channel

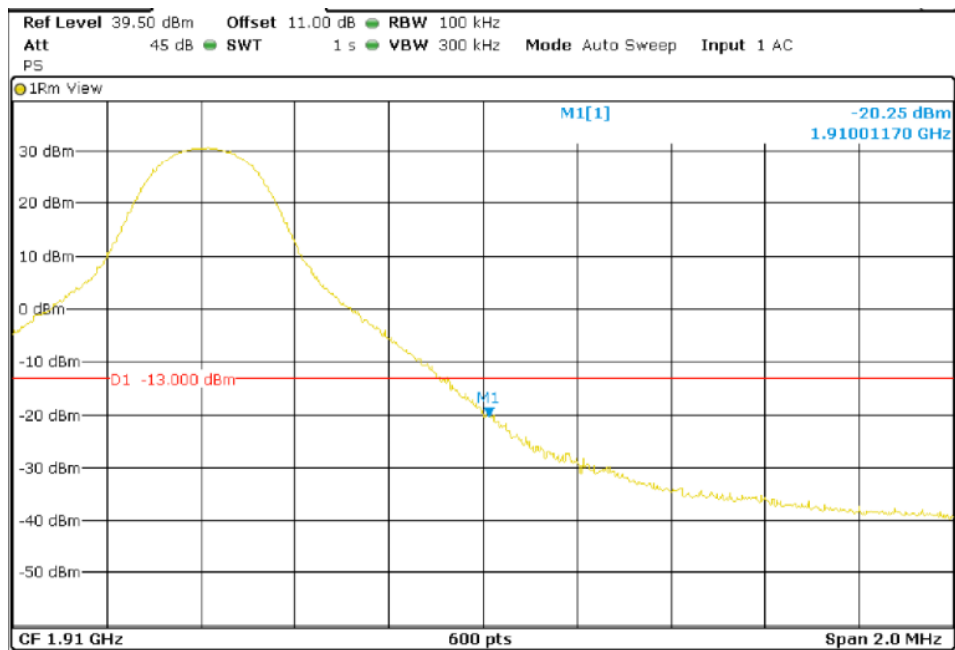

**TEST RESULTS (Cont):**

LTE QPSK MODULATION. RB = 50. Offset = 0. BW = 10 MHz

Lowest Channel

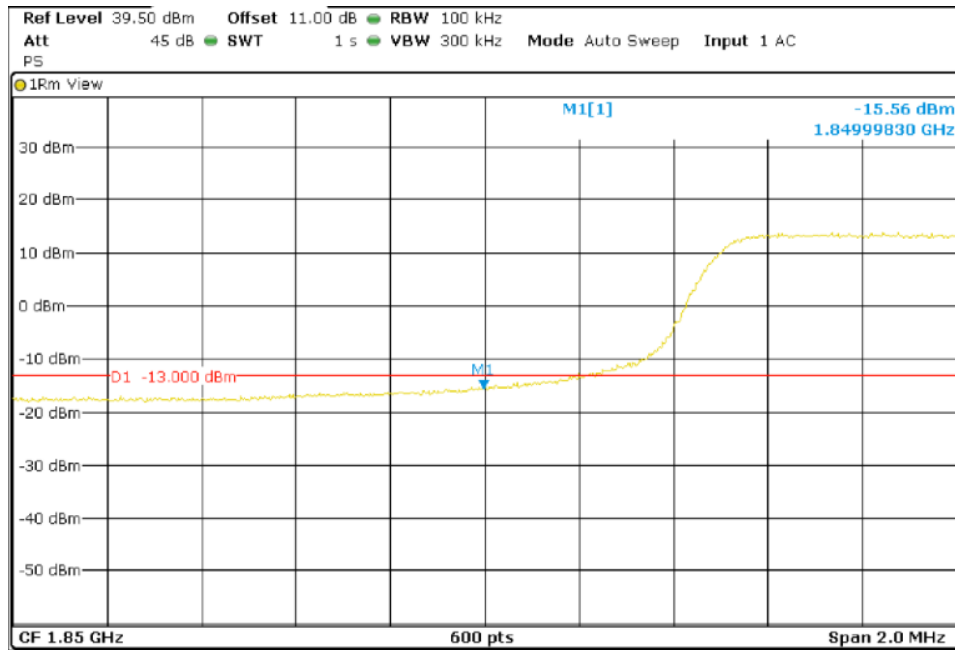

Highest Channel

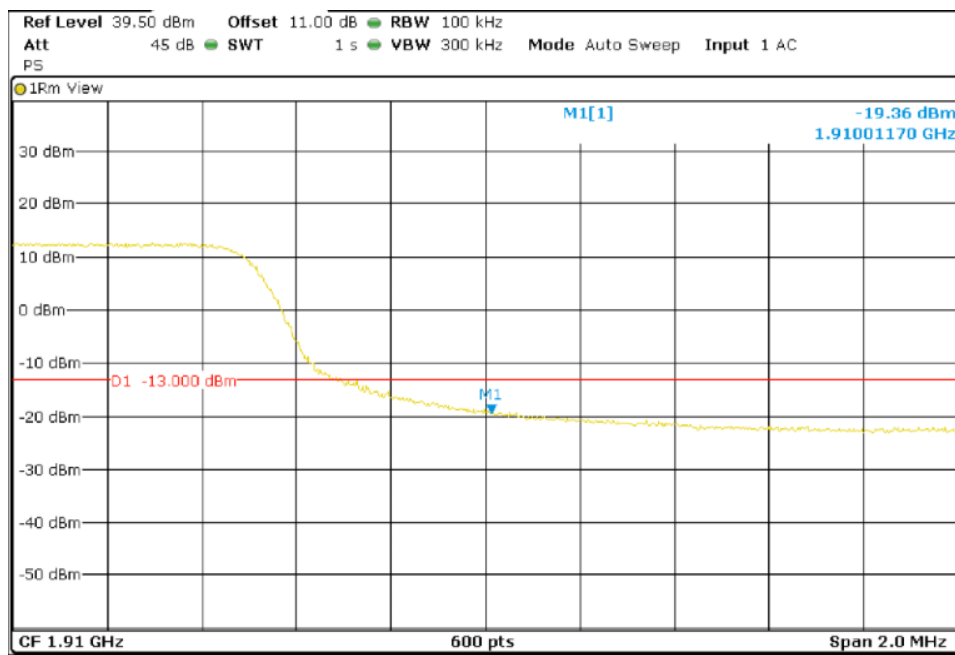

**TEST RESULTS (Cont):**

LTE QPSK MODULATION. RB = 1. Offset = 0. BW = 15 MHz

Lowest Channel

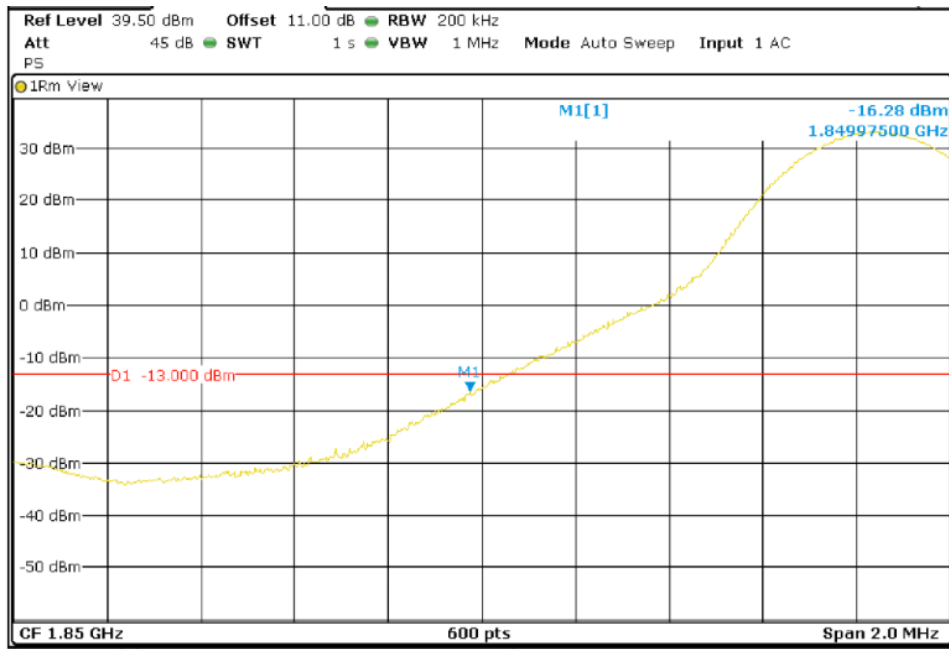

Highest Channel

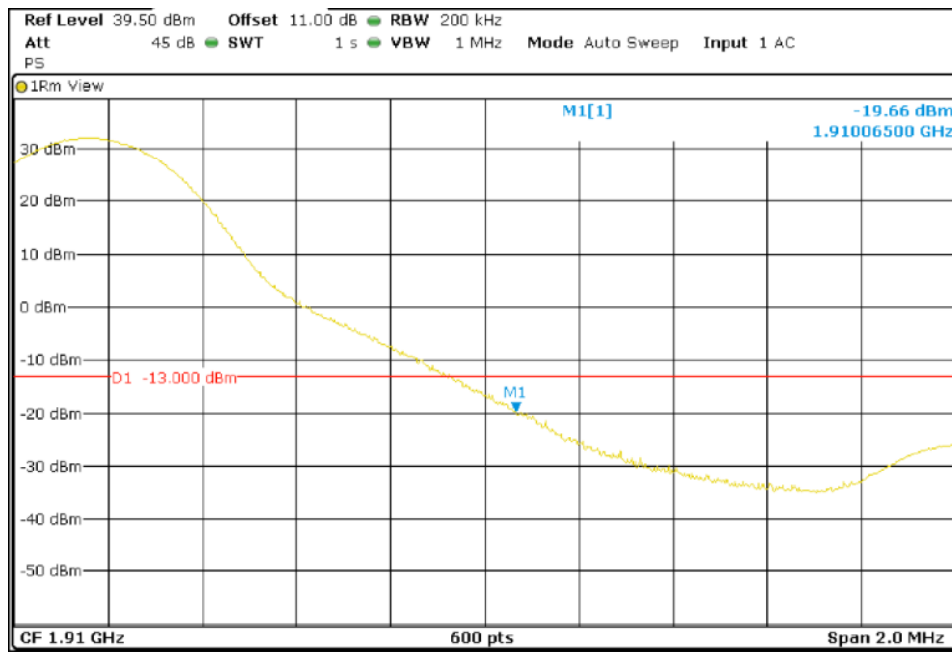

**TEST RESULTS (Cont):**

LTE QPSK MODULATION. RB = 75. Offset = 0. BW = 15 MHz

Lowest Channel

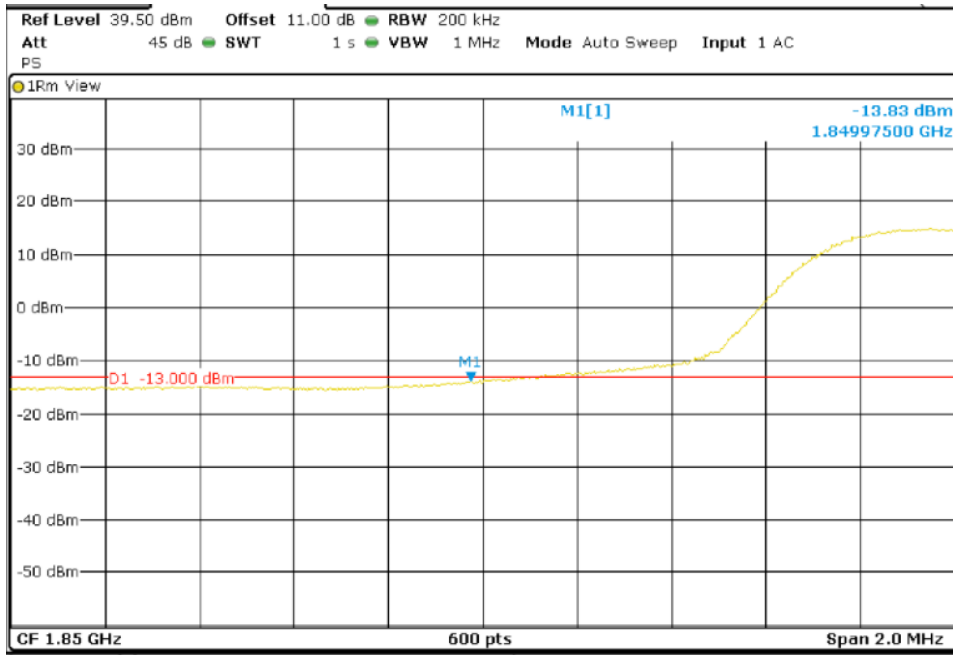

Highest Channel

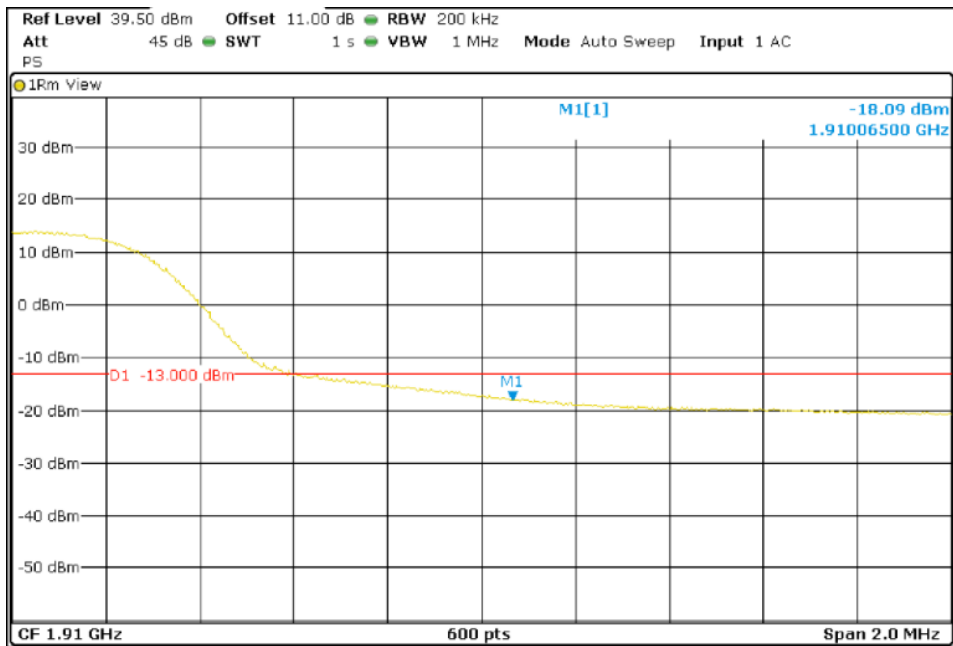

**TEST RESULTS (Cont):**

LTE QPSK MODULATION. RB = 1. Offset = 0. BW = 20 MHz

Lowest Channel

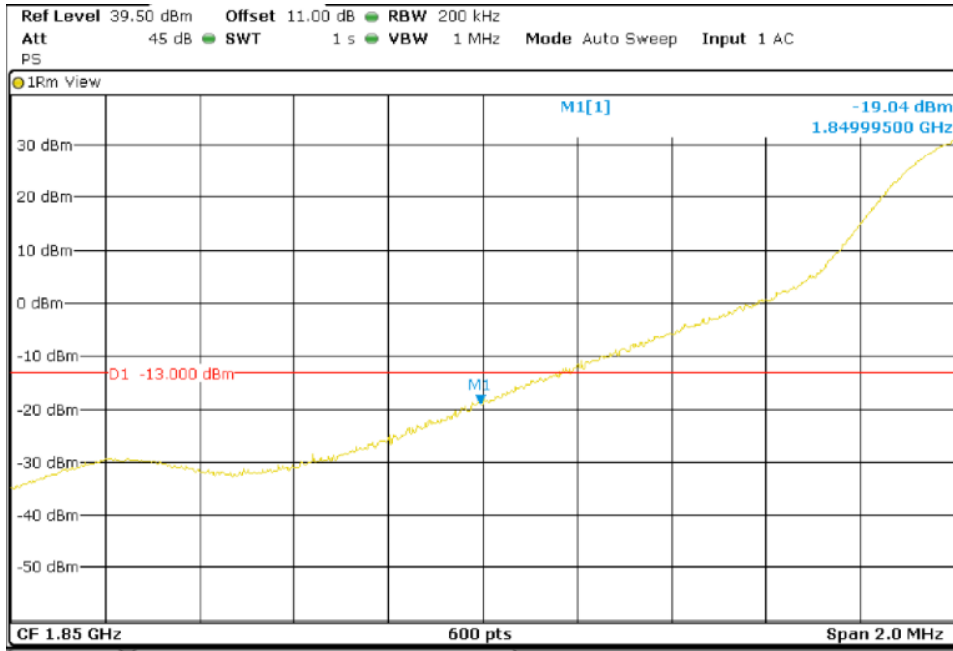

Highest Channel

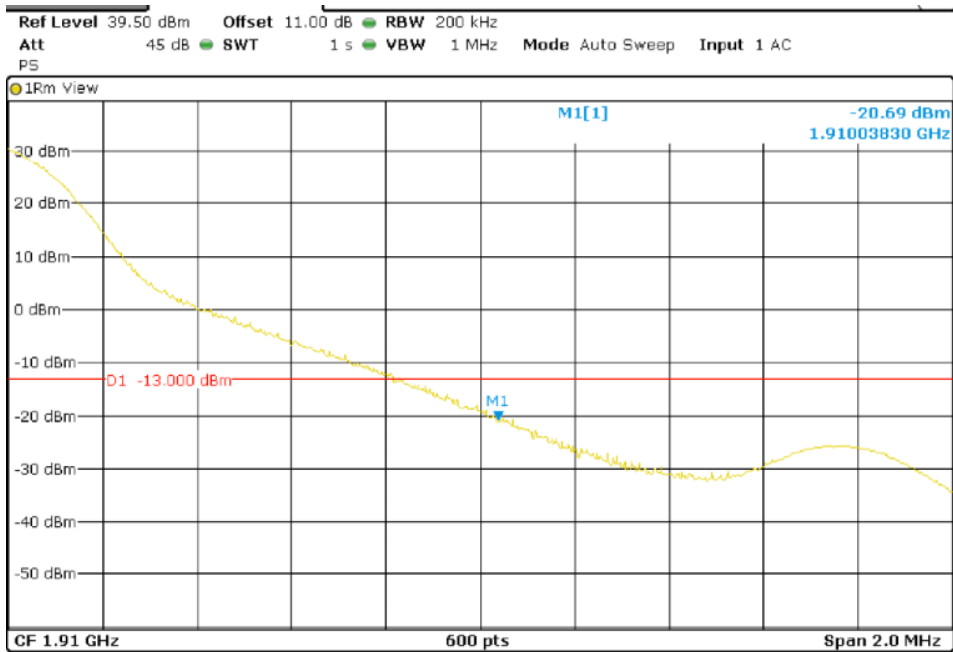

**TEST RESULTS (Cont):**

LTE QPSK MODULATION. RB = 100. Offset = 0. BW = 20 MHz

Lowest Channel

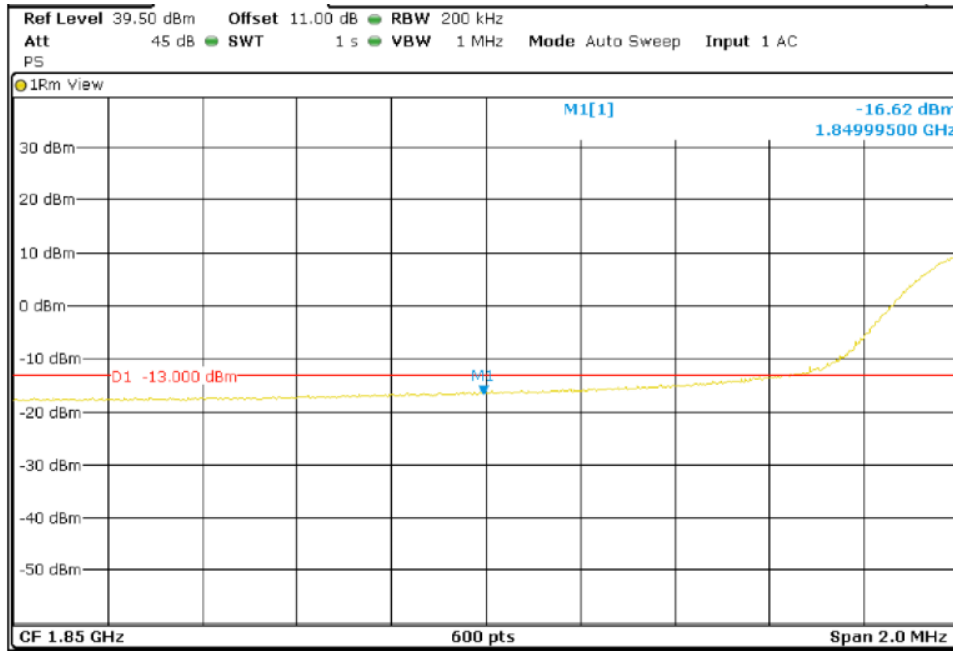

Highest Channel

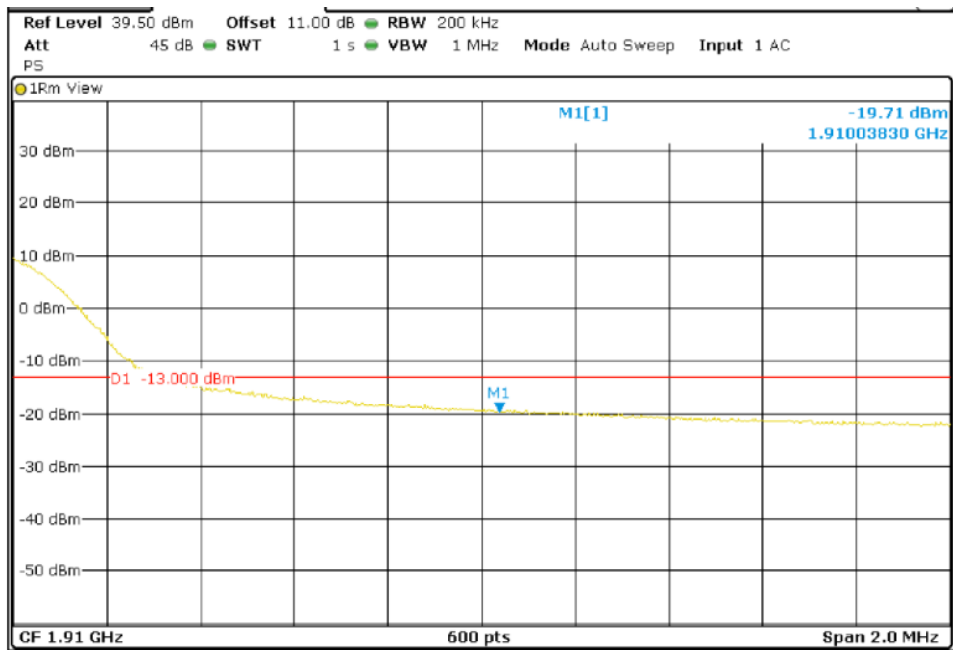

## TEST C.7: RADIATED EMISSIONS

<b>LIMITS:</b>	Product standard:	FCC Part 24 / IC RSS-133
	Test standard:	FCC §2.1053 and §24.238 /RSS-133 Clause 6.6

### LIMITS

According to specification, the power of emissions shall be attenuated below the transmitter power (P) by a factor of at least  $43 + 10 \log (P)$  dB. P in watts.

At  $P_o$  transmitting power of 2 watts (33 dBm), the specified minimum attenuation becomes  $43+10\log (P_o)$ . and the level in dBm relative to  $P_o$  becomes:

$$P_o \text{ (dBm)} - [43 + 10 \log (P_o \text{ in watts})] = -13 \text{ dBm}$$

### TEST SETUP

The measurement was performed with the EUT inside an anechoic chamber. The spectrum was scanned from 30 MHz to at least the 10th harmonic of the highest frequency generated within the equipment.

The EUT was placed on a non-conductive stand at a 3-meter distance from the measuring antenna for measurements below 1 GHz and at 1-meter distance for measurements above 1 GHz.

Detected emissions were maximized at each frequency by rotating the EUT and adjusting the measuring antenna height and polarization. The maximum reading was recorded.

#### Radiated measurements < 1GHz

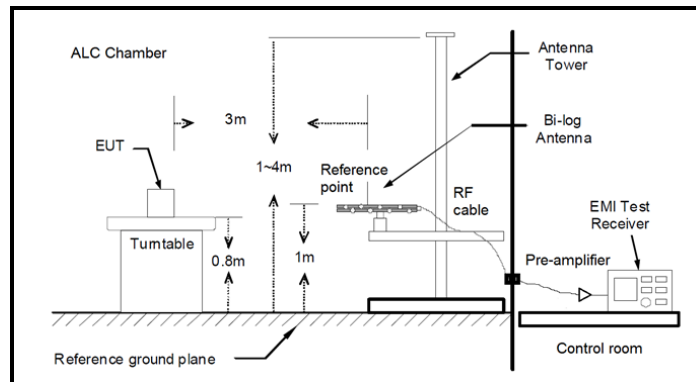

#### Radiated measurements > 1GHz

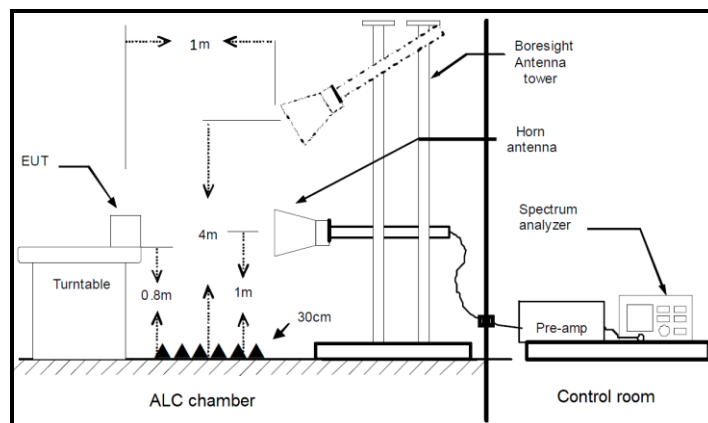

<b>TESTED SAMPLES:</b>	S/01
<b>TESTED CONDITIONS MODES:</b>	TC#01
<b>TEST RESULTS:</b>	PASS

**RESULTS**

A preliminary scan determined the QPSK 20 MHz bandwidth as the worst case. The configuration of Resource Blocks which is the worst case for conducted power was used.

The following plots show the results for this configuration.

No spurious signal was found at less than 20dB respect to the limit in all the frequency ranges.

LTE QPSK MODULATION. RB = 1. Offset = 0. BW = 20 MHz

<b>TEST RESULTS (Cont):</b>	Low Channel
-----------------------------	-------------

FREQUENCY RANGE: 30-1000 MHz

Frequency (MHz)	PK+_CLRWR (dBm)	PK+_MAXH (dBm)	Comment
82.347667	-57.94	-57.10	
184.359333	-59.93	-49.84	
202.821667	-54.51	-50.91	
222.415667	-60.67	-51.17	

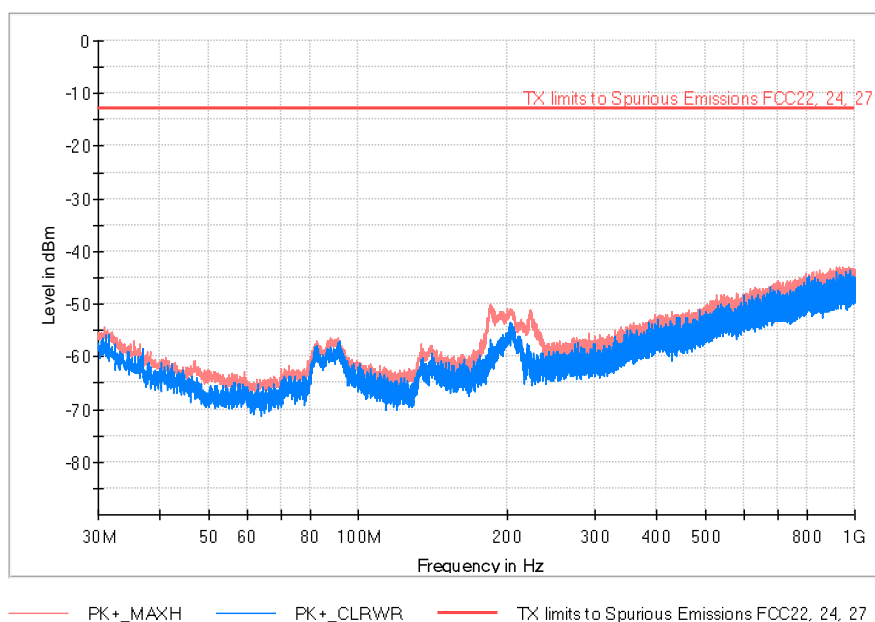



<b>TEST RESULTS (Cont):</b>	Low Channel
-----------------------------	-------------

FREQUENCY RANGE: 1-18 GHz

Frequency (MHz)	PK+ _CLRWR (dBm)	PK+ _MAXH (dBm)	Comment
1851.000000	12.5	26.9	
1932.500000	-35.3	-33.2	Fundamental
12958.000000	-47.6	-39.9	

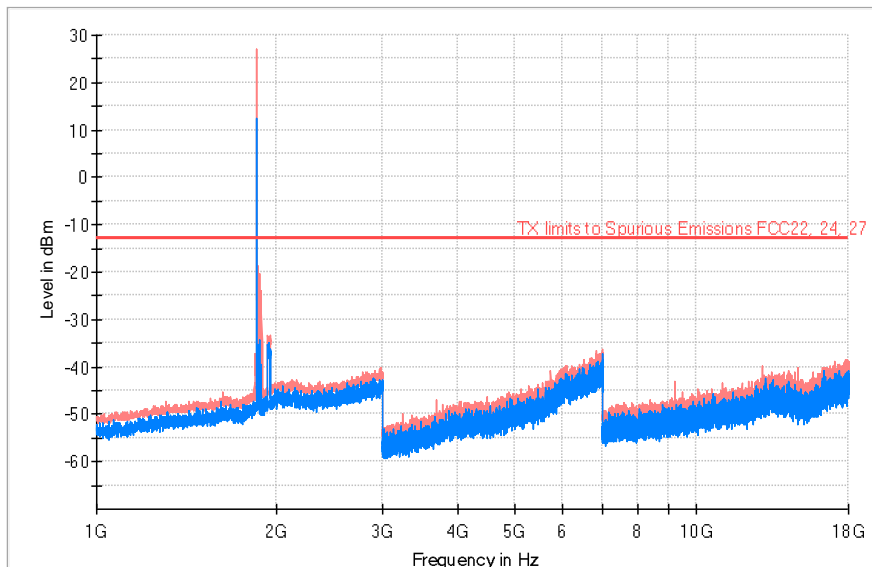

— PK+\_MAXH    — PK+\_CLRWR    — TX limits to Spurious Emissions FCC22, 24, 27

TEST RESULTS (Cont):

Low Channel

FREQUENCY RANGE: 18-20 GHz

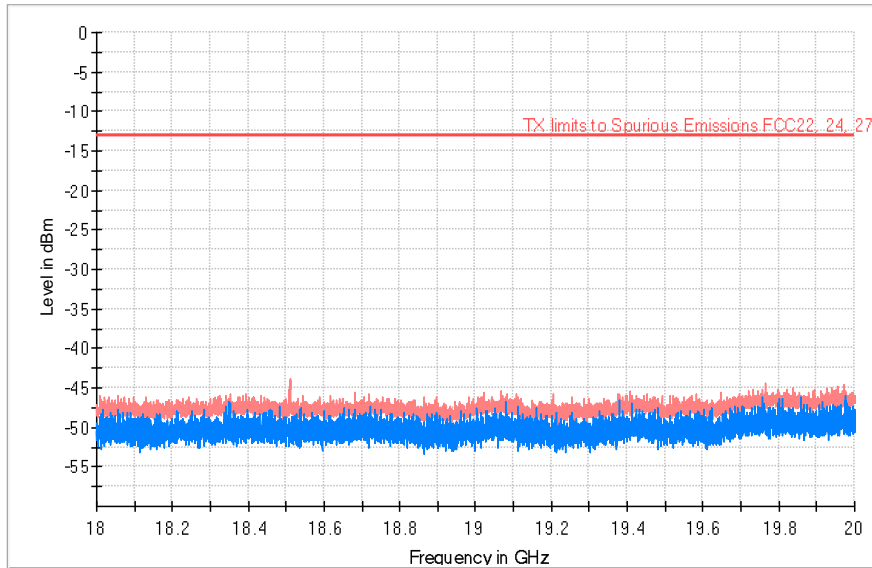

PK+\_MAXH PK+\_CLRWR TX limits to Spurious Emissions FCC22, 24, 27

**TEST RESULTS(Cont.):**

Middle Channel

FREQUENCY RANGE: 30-1000 MHz

Frequency (MHz)	PK+_CLRWR (dBm)	PK+_MAXH (dBm)	Comment
88.426333	-67.32	-55.78	
184.327000	-55.96	-49.51	
222.609667	-52.55	-49.47	

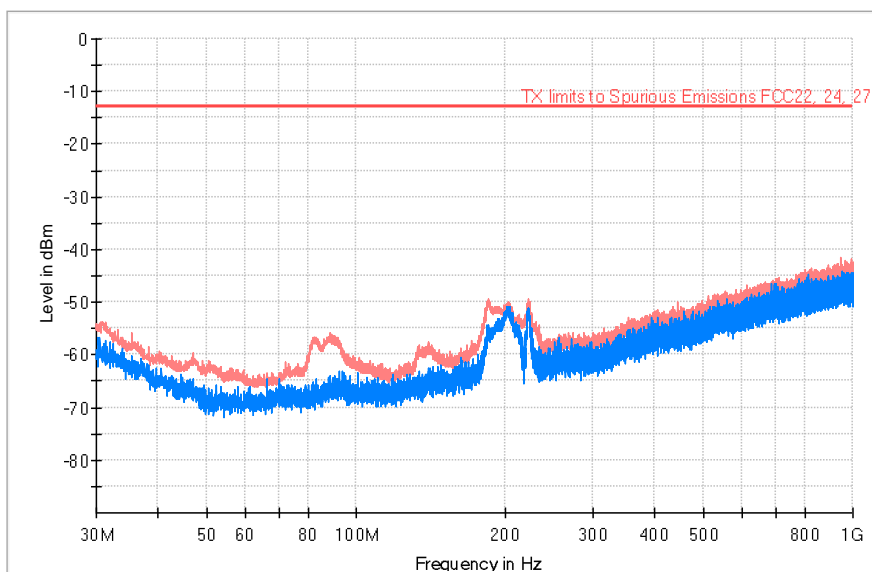

PK+\_MAXH    PK+\_CLRWR    TX limits to Spurious Emissions FCC22, 24, 27

<b>TEST RESULTS (Cont):</b>	Middle Channel
-----------------------------	----------------

FREQUENCY RANGE: 1-18 GHz

Frequency (MHz)	PK+ _CLRWR (dBm)	PK+ _MAXH (dBm)	Comment
1871.000000	11.9	25.8	Fundamental
1957.500000	-36.2	-31.8	Fundamental
3742.000000	-52.4	-46.3	
9356.000000	-52.9	-40.8	
11227.000000	-48.2	-42.7	
13098.000000	-46.9	-35.9	

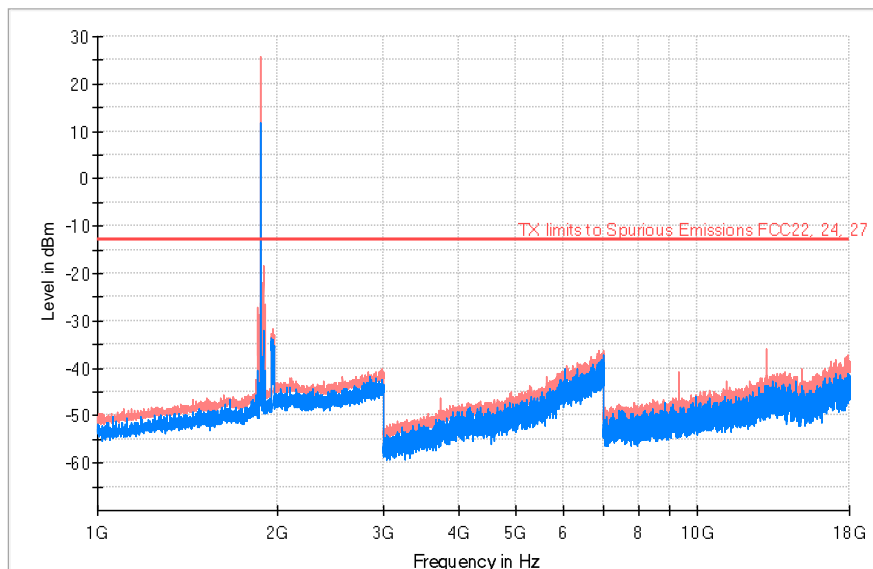

— PK+\_MAXH    — PK+\_CLRWR    — TX limits to Spurious Emissions FCC22, 24, 27

TEST RESULTS (Cont):

Middle Channel

FREQUENCY RANGE: 18-20 GHz

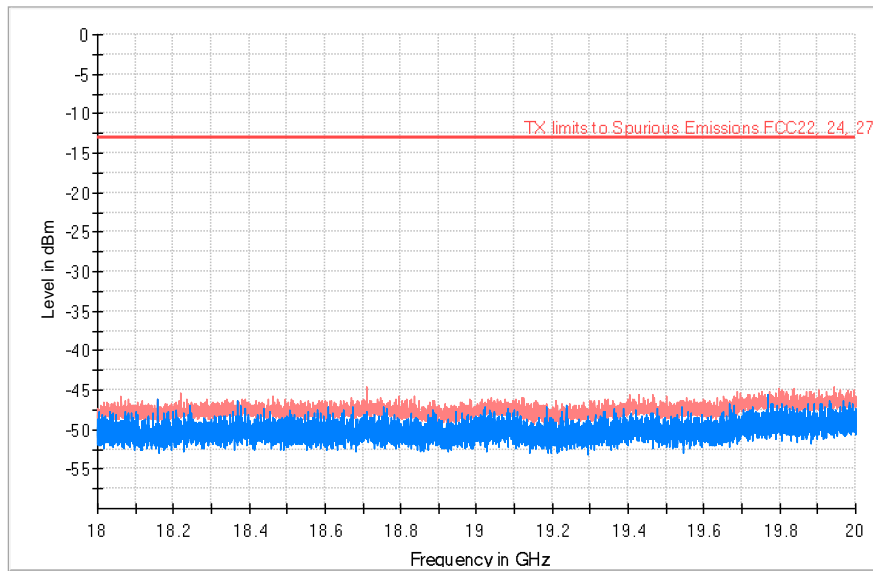

PK+\_MAXH    PK+\_CLRWR    TX limits to Spurious Emissions FCC22, 24, 27

