



Test Report No.: W7L-221220W001RF01



# FCC TEST REPORT (PART 22)

Applicant:	Continental Automotive Systems, Inc.
Address:	21440 W Lake Cook Rd., Deer Park, IL 60010, USA

Manufacturer or Supplier:	Continental Automotive Systems, Inc.
Address:	21440 W Lake Cook Rd., Deer Park, IL 60010, USA
Product:	HM28NA-001
Brand Name:	Continental Automotive Systems, Inc.
Model Name:	HM28NA-001
FCC ID:	LHJ-HM28NA001
Date of tests:	Dec. 20, 2022 ~ Apr. 10, 2023

The tests have been carried out according to the requirements of the following standard:

- FCC PART 22, Subpart H     FCC Part 2
- ANSI/TIA/EIA-603-D     ANSI C63.26-2015
- ANSI/TIA/EIA-603-E

CONCLUSION: The submitted sample was found to COMPLY with the test requirement

Prepared by Simon Wang Engineer / Mobile Department	Approved by Luke Lu Manager / Mobile Department
Date: Apr. 10, 2023	Date: Apr. 10, 2023

This report is governed by, and incorporates by reference, the Conditions of Testing as posted at the date of issuance of this report at <http://www.bureauveritas.com/home/about-us/our-business/cps/about-us/terms-conditions/> and is intended for your exclusive use. Any copying or replication of this report to or for any other person or entity, or use of our name or trademark, is permitted only with our prior written permission. This report sets forth our findings solely with respect to the test samples identified herein. The results set forth in this report are not indicative or representative of the quality or characteristics of the lot from which a test sample was taken or any similar or identical product unless specifically and expressly noted. Our report includes all of the tests requested by you and the results thereof based upon the information that you provided to us. Measurement uncertainty is only provided upon request for accredited tests. Statements of conformity are based on simple acceptance criteria without taking measurement uncertainty into account, unless otherwise requested in writing. You have 60 days from date of issuance of this report to notify us of any material error or omission caused by our negligence or if you require measurement uncertainty; provided, however, that such notice shall be in writing and shall specifically address the issue you wish to raise. A failure to raise such issue within the prescribed time shall constitute your unqualified acceptance of the completeness of this report, the tests conducted and the correctness of the report contents.



# TABLE OF CONTENTS

**RELEASE CONTROL RECORD .....4**

**1 SUMMARY OF TEST RESULTS.....5**

1.1 MEASUREMENT UNCERTAINTY .....6

1.2 TEST SITE AND INSTRUMENTS .....7

**2 GENERAL INFORMATION .....8**

2.1 GENERAL DESCRIPTION OF EUT .....8

2.2 CONFIGURATION OF SYSTEM UNDER TEST ..... 10

2.3 DESCRIPTION OF SUPPORT UNITS ..... 11

2.4 TEST ITEM AND TEST CONFIGURATION..... 11

2.5 EUT OPERATING CONDITIONS ..... 14

2.6 GENERAL DESCRIPTION OF APPLIED STANDARDS ..... 15

**3 TEST TYPES AND RESULTS..... 16**

3.1 OUTPUT POWER MEASUREMENT ..... 16

3.1.1 LIMITS OF OUTPUT POWER MEASUREMENT ..... 16

3.1.2 TEST PROCEDURES ..... 16

3.1.3 TEST SETUP ..... 17

3.1.4 TEST RESULTS ..... 17

3.2 FREQUENCY STABILITY MEASUREMENT ..... 23

3.2.1 LIMITS OF FREQUENCY STABILITY MEASUREMENT ..... 23

3.2.2 TEST PROCEDURE ..... 23

3.2.3 TEST SETUP ..... 23

3.2.4 TEST RESULTS ..... 24

3.3 OCCUPIED BANDWIDTH MEASUREMENT ..... 25

3.3.1 LIMITS OF OCCUPIED BANDWIDTH MEASUREMENT ..... 25

3.3.2 TEST SETUP ..... 25

3.3.3 TEST PROCEDURES ..... 25

3.3.4 TEST RESULTS ..... 26

3.4 BAND EDGE MEASUREMENT ..... 27

3.4.1 LIMITS OF BAND EDGE MEASUREMENT ..... 27

3.4.2 TEST SETUP ..... 27

3.4.3 TEST PROCEDURES ..... 28

3.4.4 TEST RESULTS ..... 29

3.5 CONDUCTED SPURIOUS EMISSIONS..... 30

3.5.1 LIMITS OF CONDUCTED SPURIOUS EMISSIONS MEASUREMENT ..... 30

3.5.2 TEST PROCEDURE ..... 30

3.5.3 TEST SETUP ..... 30

3.5.4 TEST RESULTS ..... 31

3.6 RADIATED EMISSION MEASUREMENT ..... 32

3.6.1 LIMITS OF RADIATED EMISSION MEASUREMENT ..... 32

3.6.2 TEST PROCEDURES ..... 32

3.6.3 DEVIATION FROM TEST STANDARD ..... 32

3.6.4 TEST SETUP ..... 33



**BUREAU  
VERITAS**

**Test Report No.: W7L-221220W001RF01**

3.6.5	TEST RESULTS .....	35
3.7	PEAK TO AVERAGE RATIO .....	67
3.7.1	LIMITS OF PEAK TO AVERAGE RATIO MEASUREMENT .....	67
3.7.2	TEST SETUP .....	67
3.7.3	TEST PROCEDURES .....	67
3.7.4	TEST RESULTS .....	68
<b>4</b>	<b>PHOTOGRAPHS OF THE TEST CONFIGURATION .....</b>	<b>69</b>
<b>5</b>	<b>INFORMATION ON THE TESTING LABORATORIES .....</b>	<b>70</b>
<b>6</b>	<b>MODIFICATIONS RECORDERS FOR ENGINEERING CHANGES TO THE EUT BY THE LAB .....</b>	<b>71</b>
<b>7</b>	<b>APPENDIX.....</b>	<b>72</b>
	GSM 850 .....	72
	WCDMA V .....	90
	LTE BAND 5 .....	104



**BUREAU**  
**VERITAS**

Test Report No.: W7L-221220W001RF01

## RELEASE CONTROL RECORD

ISSUE NO.	REASON FOR CHANGE	DATE ISSUED
W7L-221220W001RF01	Original release	Apr. 10, 2023



# 1 SUMMARY OF TEST RESULTS

The EUT has been tested according to the following specifications:

<b>APPLIED STANDARD: FCC Part 22 &amp; Part 2</b>			
<b>STANDARD SECTION</b>	<b>TEST TYPE</b>	<b>RESULT</b>	<b>TEST LAB*</b>
§2.1046	Conducted Output Power	Compliance	A
§22.913 (a)(5)	Effective Radiated Power	Compliance	A
§2.1055 §22.355	Frequency Stability	Compliance	A
§2.1049	Occupied Bandwidth	Compliance	A
§22.913 (d)	Peak to average ratio*	Compliance	A
§22.917(a)	Band Edge Measurements	Compliance	A
§2.1051 §22.917(a)	Conducted Spurious Emissions	Compliance	A
§2.1053 §22.917(a)	Radiated Spurious Emissions	Compliance	A

\* Refer to KDB 971168 D01 Power Meas License Digital Systems v03r01.

### **\*Test Lab Information Reference**

#### **Lab A:**

BV 7Layers Communications Technology (Shenzhen) Co., Ltd

#### **Lab Address:**

No.B102, Dazu Chuangxin Mansion, North of Beihuan Avenue, North Area, Hi-Tech Industrial Park, Nanshan District, Shenzhen, Guangdong, China

**Accredited Test Lab Cert 3939.01**

**The FCC Site Registration No. : 525120; Designation No. : CN1171;**



### 1.1 MEASUREMENT UNCERTAINTY

Where relevant, the following measurement uncertainty levels have been estimated for tests performed on the EUT as specified in CISPR 16-4-2:

MEASUREMENT	UNCERTAINTY
Maximum Peak Output Power	±2.06dB
Frequency Stability	±76.97Hz
Radiated emissions (9KHz~30MHz)	±2.68dB
Radiated emissions (30MHz~1GHz)	±4.98dB
Radiated emissions (1GHz ~6GHz)	±4.70dB
Radiated emissions (6GHz ~18GHz)	±4.60dB
Radiated emissions (18GHz ~40GHz)	±4.12dB
Conducted emissions	±4.01dB
Occupied Channel Bandwidth	±43.58KHz
Band Edge Measurements	±4.70dB
Peak to average ratio	±0.76dB

This uncertainty represents an expanded uncertainty expressed at approximately the 95% confidence level using a coverage factor of k=2.



## 1.2 TEST SITE AND INSTRUMENTS

Equipment	Manufacturer	Model No.	Serial No.	Last Cal.	Next Cal.
MXE EMI Receiver	KEYSIGHT	N9038A-544	MY54450026	Feb. 18,22	Feb. 17,23
MXE EMI Receiver	KEYSIGHT	N9038A-544	MY54450026	Feb. 17,23	Feb. 16,24
EXA Signal Analyzer	KEYSIGHT	N9010A-544	MY54510355	May.14,22	May.13,23
Loop Antenna	Schwarzbeck	FMZB 1519B	00173	Sep.03,22	Sep.02,23
Bilog Antenna	ETS-LINDGREN	3143B	00161965	Mar. 06,22	Mar. 05,23
Bilog Antenna	ETS-LINDGREN	3143B	00161965	Mar. 05,23	Mar. 04,24
Horn Antenna	ETS-LINDGREN	3117	00168692	Mar. 06,22	Mar. 05,23
Horn Antenna	ETS-LINDGREN	3117	00168692	Mar. 05,23	Mar. 04,24
Horn Antenna (18GHz-40GHz)	N/A	QWH-SL-18-40- K-SG/QMS-003 61	15433	Sep.04, 22	Sep.03, 23
Radio Communication Analyzer	ANRITSU	MT8820C	6201465426	Feb. 15,22	Feb. 14,23
Radio Communication Analyzer	ANRITSU	MT8820C	6201465426	Feb. 14,23	Feb. 13,24
Signal Pre-Amplifier	EMSI	EMC 9135	980249	May.12,22	May.11,23
Signal Pre-Amplifier	EMSI	EMC 012645B	980257	May.12,22	May.11,23
Signal Pre-Amplifier	EMSI	EMC 184045B	980259	Feb. 18,22	Feb.17,23
Signal Pre-Amplifier	EMSI	EMC 184045B	980259	Feb. 17,23	Feb.16,24
3m Semi-anechoic Chamber	ETS-LINDGREN	9m*6m*6m	Euroshieldpn- CT0001143-121 6	May. 19,20	May.18,23
Test Software	E3	V 9.160323	N/A	N/A	N/A
Test Software	JS1120	3.1.36	N/A	N/A	N/A
10dB Attenuator	JFW/USA	50HF-010-SMA	N/A	May. 12,22	May. 11,23
Power Meter	Anritsu	ML2495A	1506002	Feb. 15,22	Feb. 14,23
Power Meter	Anritsu	ML2495A	1506002	Feb. 14,23	Feb. 13,24
Power Sensor	Anritsu	MA2411B	1339352	Feb. 15,22	Feb. 14,23
Power Sensor	Anritsu	MA2411B	1339352	Feb. 14,23	Feb. 13,24
Temperature Chamber	ESPEC	SH-242	93000855	May. 12,22	May. 11,23
MXG Analog Microwave Signal Generator	KEYSIGHT	N5183A	MY50143024	Feb. 15,22	Feb. 14,23
MXG Analog Microwave Signal Generator	KEYSIGHT	N5183A	MY50143024	Feb. 14,23	Feb. 13,24
Base station R&S CMW500	Rohde&Schwarz	CMW500	153085	May.12,22	May.11,23
DC Source	Kikusui/JP	PMX18-5A	N/A	Aug. 12,22	Aug. 11,23

- NOTE:**
1. The calibration interval of the above test instruments is 12 months or 36 months and the calibrations are traceable to CEPREI/CHINA, GRGT/CHINA and NIM/CHINA.
  2. The test was performed in 3m Semi-anechoic Chamber and RF Oven Room.
  3. The horn antenna is used only for the measurement of emission frequency above 1GHz if tested.
  4. The FCC Site Registration No. is 525120; The Designation No. is CN1171.



## 2 GENERAL INFORMATION

### 2.1 GENERAL DESCRIPTION OF EUT

<b>PRODUCT</b>	HM28NA-001	
<b>BRAND NAME</b>	Continental Automotive Systems, Inc.	
<b>MODEL NAME</b>	HM28NA-001	
<b>NOMINAL VOLTAGE</b>	EUT 4.0V	
<b>MODULATION TYPE</b>	<b>GSM/GPRS/EDGE</b>	GMSK, 8PSK
	<b>WCDMA</b>	BPSK, QPSK
	<b>LTE</b>	QPSK, 16QAM
<b>FREQUENCY RANGE</b>	<b>GSM/GPRS/EDGE</b>	824.2MHz ~ 848.8MHz
	<b>WCDMA</b>	826.4MHz ~ 846.6MHz
	<b>LTE Band 5 (Channel Bandwidth: 1.4MHz)</b>	824.7MHz ~ 848.3MHz
	<b>LTE Band 5 (Channel Bandwidth: 3MHz)</b>	825.5MHz ~ 847.5MHz
	<b>LTE Band 5 (Channel Bandwidth: 5MHz)</b>	826.5MHz ~ 846.5MHz
	<b>LTE Band 5 (Channel Bandwidth: 10MHz)</b>	829MHz ~ 844MHz
<b>MAX. ERP POWER</b>	<b>GSM/GPRS</b>	1276.44mW
	<b>EDGE</b>	334.2mW
	<b>WCDMA</b>	162.93mW
	<b>LTE Band 5 (Channel Bandwidth: 1.4MHz)</b>	152.05mW
	<b>LTE Band 5 (Channel Bandwidth: 3MHz)</b>	150.31mW
	<b>LTE Band 5 (Channel Bandwidth: 5MHz)</b>	151.01mW
	<b>LTE Band 5 (Channel Bandwidth: 10MHz)</b>	152.41mW
<b>EMISSION DESIGNATOR GOGN</b>	<b>GSM/GPRS</b>	248KGXW
	<b>EDGE</b>	250KG7W
	<b>WCDMA</b>	4M15F9W
	<b>LTE Band 5 (Channel Bandwidth: 1.4MHz)</b>	QPSK: 1M09G7D
		16QAM: 1M09W7D
	<b>LTE Band 5 (Channel Bandwidth: 3MHz)</b>	QPSK: 2M70G7D
		16QAM: 2M70W7D
<b>LTE Band 5</b>	QPSK: 4M50G7D	





	(Channel Bandwidth: 5MHz)	16QAM: 4M51W7D
	LTE Band 5 (Channel Bandwidth: 10MHz)	QPSK: 9M97G7D
		16QAM: 8M96W7D
<b>ANTENNA TYPE</b>	Dipole Antenna with 0.82dBi gain for GSM850/WCDMA V/LTE B5	
<b>HW VERSION</b>	P4	
<b>SW VERSION</b>	MODEM9x28_64.01.20	
<b>I/O PORTS</b>	Refer to user's manual	
<b>CABLE SUPPLIED</b>	N/A	
<b>EXTREME TEMPERATURE</b>	-30 - 75 °C	
<b>EXTREME VOLTAGE</b>	3.8V – 4.2V	

**NOTE:**

1. For a more detailed features description, please refer to the manufacturer's specifications or the user's manual.
2. The EUT incorporates a SISO function. Physically, the EUT provides one transmitter and one receiver.

MODULATION MODE	TX FUNCTION
GSM/GPRS/EDGE	1TX/1RX
WCDMA	1TX/1RX
LTE	1TX/1RX

3. For the test results, the EUT had been tested with all conditions. But only the worst case was shown in test report.



## 2.2 CONFIGURATION OF SYSTEM UNDER TEST FOR RADIATION EMISSION

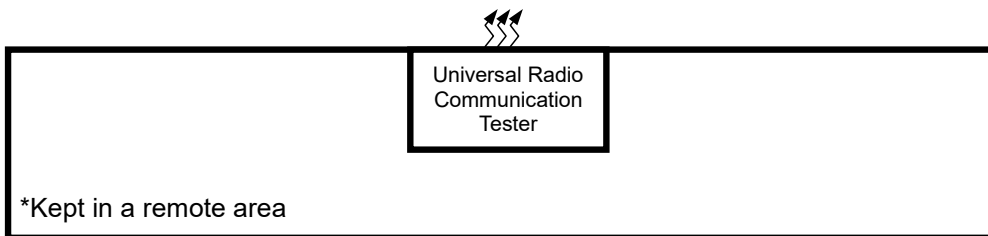
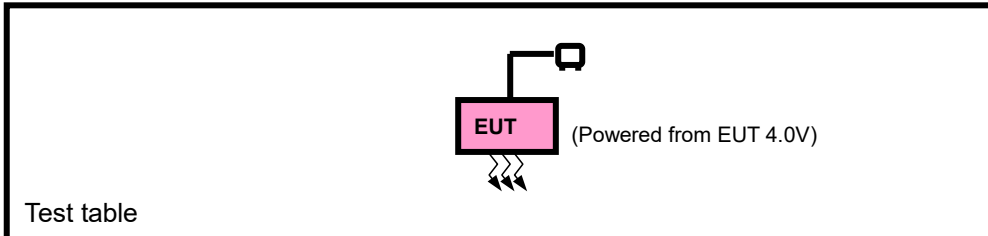

## FOR CONDUCTED TEST

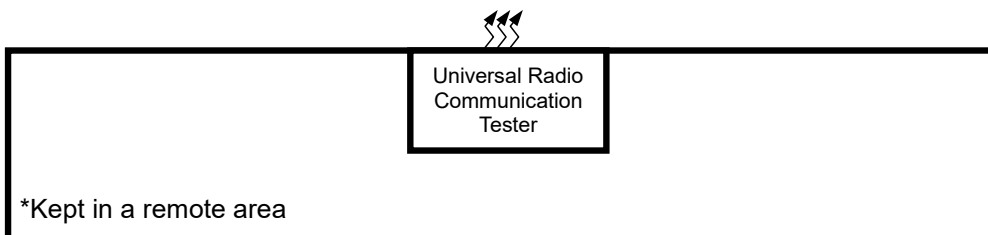
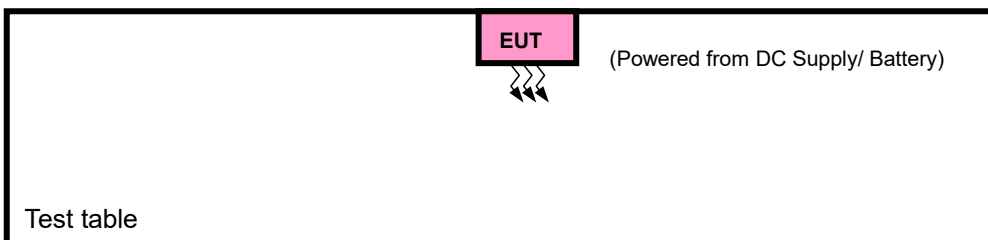



### 2.3 DESCRIPTION OF SUPPORT UNITS

The EUT has been tested as an independent unit together with other necessary accessories or support units. The following support units or accessories were used to form a representative test configuration during the tests.

NO.	PRODUCT	BRAND	MODEL NO.	SERIAL NO.	FCC ID
1	DC source	Kikusui/JP	PMX18-5A	0000001	N/A

NO.	SIGNAL CABLE DESCRIPTION OF THE ABOVE SUPPORT UNITS
1	DC Line: Unshielded, Detachable 1.0m

### 2.4 TEST ITEM AND TEST CONFIGURATION

Pre-Scan has been conducted to determine the worst-case mode from all possible combinations between available modulations, data rates, XYZ axis and antenna ports. The worst case in ERP and radiated emission was found when positioned on X-plane for GSM /EDGE/WCDMA/LTE. Following channel(s) was (were) selected for the final test as listed below:

EUT CONFIGURE MODE	DESCRIPTION
A	EUT + DC source with GSM or WCDMA or LTE link



**GSM MODE**

EUT CONFIGURE MODE	TEST ITEM	AVAILABLE CHANNEL	TESTED CHANNEL	MODE
A	ERP	128 to 251	128, 189, 251	GPRS,EDGE
A	FREQUENCY STABILITY	128 to 251	128, 189, 251	GPRS,EDGE
A	OCCUPIED BANDWIDTH	128 to 251	128, 189, 251	GPRS,EDGE
A	BAND EDGE	128 to 251	128, 251	GPRS,EDGE
A	CONDCUDETED EMISSION	128 to 251	128, 189, 251	GPRS,EDGE
A	RADIATED EMISSION	128 to 251	128, 189, 251	GPRS,EDGE
A	PEAK TO AVERAGE RATIO	128 to 251	128, 189, 251	GPRS,EDGE

**WCDMA MODE**

EUT CONFIGURE MODE	TEST ITEM	AVAILABLE CHANNEL	TESTED CHANNEL	MODE
A	ERP	4132 to 4233	4132, 4182, 4233	WCDMA
A	FREQUENCY STABILITY	4132 to 4233	4132, 4182, 4233	WCDMA
A	OCCUPIED BANDWIDTH	4132 to 4233	4132, 4182, 4233	WCDMA
A	BAND EDGE	4132 to 4233	4132, 4233	WCDMA
A	CONDCUDETED EMISSION	4132 to 4233	4132, 4182, 4233	WCDMA
A	RADIATED EMISSION	4132 to 4233	4132, 4182, 4233	WCDMA
A	PEAK TO AVERAGE RATIO	4132 to 4233	4132, 4182, 4233	WCDMA



**LTE BAND 5 MODE**

EUT CONFIGURE MODE	TEST ITEM	Available Channel	Tested Channel	Channel bandwidth	modulation	mode
A	ERP	20407 to 20643	20407, 20525, 20643	1.4MHz	QPSK,16QAM	1 RB / 0 RB Offset
		20415 to 20635	20415, 20525, 20635	3MHz	QPSK,16QAM	1 RB / 0 RB Offset
		20425 to 20625	20425, 20525, 20625	5MHz	QPSK,16QAM	1 RB / 0 RB Offset
		20450 to 20600	20450, 20525, 20600	10MHz	QPSK,16QAM	1 RB / 0 RB Offset
A	FREQUENCY STABILITY	20450 to 20600	20450, 20525, 20600	10MHz	QPSK	50 RB / 0 RB Offset
A	OCCUPIED BANDWIDTH	20407 to 20643	20407, 20525, 20643	1.4MHz	QPSK,16QAM	6 RB / 0 RB Offset
		20415 to 20635	20415, 20525, 20635	3MHz	QPSK,16QAM	15 RB / 0 RB Offset
		20425 to 20625	20425, 20525, 20625	5MHz	QPSK,16QAM	25 RB / 0 RB Offset
		20450 to 20600	20450, 20525, 20600	10MHz	QPSK,16QAM	50 RB / 0 RB Offset
A	BAND EDGE	20407 to 20643	20407	1.4 MHz	QPSK,16QAM	1 RB / 0 RB Offset
						6 RB / 0 RB Offset
		20407 to 20643	20643	1.4 MHz	QPSK,16QAM	1 RB / 5 RB Offset
						6 RB / 0 RB Offset
		20415 to 20635	20415	3 MHz	QPSK,16QAM	1 RB / 0 RB Offset
						15 RB / 0 RB Offset
		20415 to 20635	20635	3 MHz	QPSK,16QAM	1 RB / 14 RB Offset
						15 RB / 0 RB Offset
		20425 to 20625	20425	5MHz	QPSK,16QAM	1 RB / 0 RB Offset
						25 RB / 0 RB Offset
		20425 to 20625	20625	5MHz	QPSK,16QAM	1 RB / 24 RB Offset
						25 RB / 0 RB Offset
		20450 to 20600	20450	10MHz	QPSK,16QAM	1 RB / 0 RB Offset
						50 RB / 0 RB Offset
		20450 to 20600	20600	10MHz	QPSK,16QAM	1 RB / 49 RB Offset
						50 RB / 0 RB Offset



A	CONDCUDED EMISSION	20407 to 20643	20407, 20525, 20643	1.4MHz	QPSK	1 RB / 0 RB Offset
		20415 to 20635	20415, 20525, 20635	3MHz	QPSK	1 RB / 0 RB Offset
		20425 to 20625	20425, 20525, 20625	5MHz	QPSK	1 RB / 0 RB Offset
		20450 to 20600	20450, 20525, 20600	10MHz	QPSK	1 RB / 0 RB Offset
A	RADIATED EMISSION	20407 to 20643	20525	1.4MHz	QPSK	1 RB / 0 RB Offset
		20415 to 20635	20525	3MHz	QPSK	1 RB / 0 RB Offset
		20425 to 20625	20525	5MHz	QPSK	1 RB / 0 RB Offset
		20450 to 20600	20450, 20525, 20600	10MHz	QPSK	1 RB / 0 RB Offset
A	PEAK TO AVERAGE RATIO	20450 to 20600	20450, 20525, 20600	10MHz	QPSK, 16QAM	1 RB / 0 RB Offset 50 RB / 0 RB Offset

**Note:** This device was tested under all bandwidths, RB configurations and modulations. The worst case was found in QPSK modulation.

**TEST CONDITION:**

TEST ITEM	ENVIRONMENTAL CONDITIONS	INPUT POWER	TESTED BY
ERP	23deg. C, 70%RH	EUT 4.0V	Jace Hu
FREQUENCY STABILITY	23deg. C, 70%RH	DC 3.8/4.0/4.2 V By DC Source	James Fu
OCCUPIED BANDWIDTH	23deg. C, 70%RH	EUT 4.0V	James Fu
BAND EDGE	23deg. C, 70%RH	EUT 4.0V	James Fu
CONDCUDED EMISSION	23deg. C, 70%RH	EUT 4.0V	James Fu
RADIATED EMISSION	23deg. C, 70%RH	EUT 4.0V	Jace Hu
PEAK TO AVERAGE RATIO	23deg. C, 70%RH	EUT 4.0V	James Fu

**2.5 EUT OPERATING CONDITIONS**

The EUT makes a call to the communication simulator. The communication simulator station system controlled a EUT to export maximum output power under transmission mode and specific channel frequency



**BUREAU  
VERITAS**

Test Report No.: W7L-221220W001RF01

## 2.6 GENERAL DESCRIPTION OF APPLIED STANDARDS

The EUT is a RF product. According to the specifications of the manufacturer, it must comply with the requirements of the following standards:

**FCC 47 CFR Part 2**

**FCC 47 CFR Part 22**

**KDB 971168 D01 Power Meas License Digital Systems v03r01**

**ANSI/TIA/EIA-603-D**

**ANSI/TIA/EIA-603-E**

**ANSI C63.26-2015**

**NOTE:** All test items have been performed and recorded as per the above standards.

### 3 TEST TYPES AND RESULTS

#### 3.1 OUTPUT POWER MEASUREMENT

##### 3.1.1 LIMITS OF OUTPUT POWER MEASUREMENT

Mobile / Portable station are limited to 7 watts e.r.p.

##### 3.1.2 TEST PROCEDURES

###### **EIRP / ERP MEASUREMENT:**

Per KDB 971168 D01 Power Meas License Digital Systems v03r01 or subclause 5.2.5.5 of ANSI C63.26-2015, the relevant equation for determining the ERP or EIRP from the conducted RF output power measured using the guidance provided above is:

$$\text{ERP or EIRP} = P_{\text{Meas}} + G_{\text{T}} - L_{\text{C}}$$

Where:

ERP or EIRP = effective radiated power or equivalent isotropically radiated power, respectively

(expressed in the same units as  $P_{\text{Meas}}$ , typically dBW or dBm);

$P_{\text{Meas}}$  = measured transmitter output power or PSD, in dBm or dBW;

$G_{\text{T}}$  = gain of the transmitting antenna, in dBd (ERP) or dBi (EIRP);

$L_{\text{C}}$  = signal attenuation in the connecting cable between the transmitter and antenna, in dB.

###### **CONDUCTED POWER MEASUREMENT:**

The EUT was set up for the maximum power with WCDMA link data modulation and link up with simulator. Set the EUT to transmit under low, middle and high channel and record the power level shown on simulator.





### 3.1.3 TEST SETUP

**EIRP / ERP Measurement:**

**CONDUCTED POWER MEASUREMENT:**

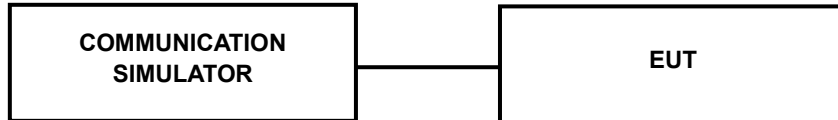

### 3.1.4 TEST RESULTS

**CONDUCTED OUTPUT POWER (dBm)**

Band	GSM850		
Channel	128	189	251
Frequency	824.2	836.4	848.8
GPRS (GMSK, 1Tx-slot)	<b>32.39</b>	32.27	32.25
GPRS (GMSK, 2Tx-slot)	31.27	31.19	31.17
GPRS (GMSK, 3Tx-slot)	29.68	29.61	29.59
GPRS (GMSK, 4Tx-slot)	28.46	28.37	28.35
EDGE (8PSK, 1Tx-slot)	26.57	26.51	26.27
EDGE (8PSK, 2Tx-slot)	25.52	25.24	25.37
EDGE (8PSK, 3Tx-slot)	23.87	23.64	23.69
EDGE (8PSK, 4Tx-slot)	22.82	22.44	22.49

Band	WCDMA V		
Channel	4132	4182	4233
Frequency	826.4	836.4	846.6
RMC 12.2K	<b>23.45</b>	23.38	23.22
HSDPA Subtest-1	22.43	22.30	22.21
HSDPA Subtest-2	22.37	22.34	22.17
HSDPA Subtest-3	21.93	21.80	21.71
HSDPA Subtest-4	21.87	21.84	21.67
DC-HSDPA Subtest-1	22.42	22.32	22.20
DC-HSDPA Subtest-2	22.43	22.31	22.17
DC-HSDPA Subtest-3	21.89	21.80	21.70
DC-HSDPA Subtest-4	21.94	21.86	21.64
HSUPA Subtest-1	22.40	22.30	22.16
HSUPA Subtest-2	20.44	20.32	20.20
HSUPA Subtest-3	21.45	21.38	21.22
HSUPA Subtest-4	20.43	20.30	20.21
HSUPA Subtest-5	22.37	22.34	22.17



**LTE Band 5**

Band/BW	Modulation	RB Size	RB Offset	Low CH 20407	Mid CH 20525	High CH 20643
				Frequency 824.7 MHz	Frequency 836.5 MHz	Frequency 848.3 MHz
5/ 1.4	QPSK	1	0	23.15	22.90	23.11
		1	2	23.05	22.91	23.06
		1	5	22.87	22.61	22.88
		3	0	22.97	22.79	23.00
		3	1	22.89	22.71	22.91
		3	3	22.78	22.72	22.82
		6	0	21.96	21.70	21.97
	16QAM	1	0	21.71	21.58	21.70
		1	2	21.78	21.65	21.81
		1	5	21.55	21.44	21.61
		3	0	21.89	21.63	21.88
		3	1	21.85	21.70	21.88
		3	3	21.79	21.70	21.79
		6	0	20.89	20.74	20.97

Band/BW	Modulation	RB Size	RB Offset	Low CH 20415	Mid CH 20525	High CH 20635
				Frequency 825.5 MHz	Frequency 836.5 MHz	Frequency 847.5 MHz
5/ 3	QPSK	1	0	23.10	22.89	23.08
		1	7	23.03	22.93	23.09
		1	14	22.81	22.67	22.84
		8	0	21.94	21.86	21.99
		8	3	21.89	21.71	21.88
		8	7	21.78	21.72	21.85
		15	0	21.95	21.70	21.94
	16QAM	1	0	21.75	21.52	21.74
		1	7	21.77	21.66	21.78
		1	14	21.60	21.40	21.64
		8	0	20.89	20.64	20.85
		8	3	20.87	20.68	20.94
		8	7	20.84	20.70	20.77
		15	0	20.89	20.74	20.92



Band/BW	Modulation	RB Size	RB Offset	Low CH 20425	Mid CH 20525	High CH 20625
				Frequency 826.5 MHz	Frequency 836.5 MHz	Frequency 846.5 MHz
5/ 5	QPSK	1	0	23.12	22.91	23.08
		1	12	23.02	22.97	23.06
		1	24	22.85	22.64	22.89
		12	0	21.96	21.85	21.96
		12	6	21.86	21.71	21.94
		12	13	21.78	21.71	21.82
		25	0	21.98	21.67	21.96
	16QAM	1	0	21.69	21.54	21.67
		1	12	21.79	21.68	21.77
		1	24	21.56	21.41	21.64
		12	0	20.85	20.64	20.85
		12	6	20.86	20.71	20.94
		12	13	20.77	20.70	20.79
		25	0	20.86	20.81	20.96

Band/BW	Modulation	RB Size	RB Offset	Low CH 20450	Mid CH 20525	High CH 20600
				Frequency 829 MHz	Frequency 836.5 MHz	Frequency 844 MHz
5/ 10	QPSK	1	0	<b>23.16</b>	22.96	23.13
		1	24	23.10	22.98	23.11
		1	49	22.89	22.69	22.90
		25	0	22.02	21.87	22.01
		25	12	21.93	21.76	21.96
		25	25	21.86	21.73	21.87
		50	0	22.00	21.75	21.98
	16QAM	1	0	21.77	21.60	21.75
		1	24	21.85	21.70	21.83
		1	49	21.63	21.46	21.66
		25	0	20.91	20.71	20.90
		25	12	20.93	20.76	20.96
		25	25	20.85	20.72	20.85
		50	0	20.94	20.82	20.98



**ERP POWER (dBm)**

**GSM**

Channel	Frequency (MHz)	Conducted Power (dBm)	G <sub>T</sub> -L <sub>c</sub> (dB)	ERP (dBm)	ERP (mW)	Limit (W)
128	824.2	32.39	0.82	31.06	1276.44	7
189	836.4	32.27	0.82	30.94	1241.65	7
251	848.8	32.25	0.82	30.92	1235.95	7

**REMARKS:** ERP Output Power (dBm) = EIRP (dBm) -2.15(dB).

**EDGE**

Channel	Frequency (MHz)	Conducted Power (dBm)	G <sub>T</sub> -L <sub>c</sub> (dB)	ERP (dBm)	ERP (mW)	Limit (W)
128	824.2	26.57	0.82	25.24	334.2	7
189	836.4	26.51	0.82	25.18	329.61	7
251	848.8	26.27	0.82	24.94	311.89	7

**REMARKS:** ERP Output Power (dBm) = EIRP (dBm) -2.15(dB).

**WCDMA**

Channel	Frequency (MHz)	Conducted Power (dBm)	G <sub>T</sub> -L <sub>c</sub> (dB)	ERP (dBm)	ERP (mW)	Limit (W)
4132	826.4	23.45	0.82	22.12	162.93	7
4182	836.4	23.38	0.82	22.05	160.32	7
4233	846.6	23.22	0.82	21.89	154.53	7

**REMARKS:** ERP Output Power (dBm) = EIRP (dBm) -2.15(dB).



**LTE BAND 5**

**CHANNEL BANDWIDTH: 1.4MHz QPSK**

Channel	Frequency (MHz)	Conducted Power (dBm)	G <sub>T</sub> -L <sub>c</sub> (dB)	ERP (dBm)	ERP (mW)	Limit (W)
20407	824.7	23.15	0.82	21.82	152.05	7
20525	836.5	22.91	0.82	21.58	143.88	7
20643	848.3	23.11	0.82	21.78	150.66	7

**CHANNEL BANDWIDTH: 1.4MHz 16QAM**

Channel	Frequency (MHz)	Conducted Power (dBm)	G <sub>T</sub> -L <sub>c</sub> (dB)	ERP (dBm)	ERP (mW)	Limit (W)
20407	824.7	21.89	0.82	20.56	113.76	7
20525	836.5	21.7	0.82	20.37	108.89	7
20643	848.3	21.88	0.82	20.55	113.5	7

**CHANNEL BANDWIDTH: 3MHz QPSK**

Channel	Frequency (MHz)	Conducted Power (dBm)	G <sub>T</sub> -L <sub>c</sub> (dB)	ERP (dBm)	ERP (mW)	Limit (W)
20415	825.5	23.1	0.82	21.77	150.31	7
20525	836.5	22.93	0.82	21.6	144.54	7
20635	847.5	23.09	0.82	21.76	149.97	7

**CHANNEL BANDWIDTH: 3MHz 16QAM**

Channel	Frequency (MHz)	Conducted Power (dBm)	G <sub>T</sub> -L <sub>c</sub> (dB)	ERP (dBm)	ERP (mW)	Limit (W)
20415	825.5	21.77	0.82	20.44	110.66	7
20525	836.5	21.66	0.82	20.33	107.89	7
20635	847.5	21.78	0.82	20.45	110.92	7



**CHANNEL BANDWIDTH: 5MHz QPSK**

Channel	Frequency (MHz)	Conducted Power (dBm)	G <sub>T</sub> -L <sub>C</sub> (dB)	ERP (dBm)	ERP (mW)	Limit (W)
20425	826.5	23.12	0.82	21.79	151.01	7
20525	836.5	22.97	0.82	21.64	145.88	7
20625	846.5	23.08	0.82	21.75	149.62	7

**CHANNEL BANDWIDTH: 5MHz 16QAM**

Channel	Frequency (MHz)	Conducted Power (dBm)	G <sub>T</sub> -L <sub>C</sub> (dB)	ERP (dBm)	ERP (mW)	Limit (W)
20425	826.5	21.79	0.82	20.46	111.17	7
20525	836.5	21.68	0.82	20.35	108.39	7
20625	846.5	21.77	0.82	20.44	110.66	7

**CHANNEL BANDWIDTH: 10MHz QPSK**

Channel	Frequency (MHz)	Conducted Power (dBm)	G <sub>T</sub> -L <sub>C</sub> (dB)	ERP (dBm)	ERP (mW)	Limit (W)
20450	829.0	23.16	0.82	21.83	152.41	7
20525	836.5	22.98	0.82	21.65	146.22	7
20600	844.0	23.13	0.82	21.8	151.36	7

**CHANNEL BANDWIDTH: 10MHz 16QAM**

Channel	Frequency (MHz)	Conducted Power (dBm)	G <sub>T</sub> -L <sub>C</sub> (dB)	ERP (dBm)	ERP (mW)	Limit (W)
20450	829.0	21.85	0.82	20.52	112.72	7
20525	836.5	21.7	0.82	20.37	108.89	7
20600	844.0	21.83	0.82	20.5	112.2	7

**REMARKS:** ERP Output Power (dBm) = EIRP (dBm) -2.15(dB).



### 3.2 FREQUENCY STABILITY MEASUREMENT

#### 3.2.1 LIMITS OF FREQUENCY STABILITY MEASUREMENT

1.5 ppm is for base and fixed station. 2.5 ppm is for mobile station.

#### 3.2.2 TEST PROCEDURE

- a. Device is placed at the oven room. The oven room could control the temperatures and humidity. Power warm up is at least 15 min and power applied should perform before recording frequency error.
- b. EUT is connected the external power supply to control the DC input power. The test voltage range is from minimum to maximum working voltage. Each step shall be record the frequency error rate.
- c. The temperature range step is 10 degrees in this test items. All temperature levels shall be hold the  $\pm 0.5^{\circ}\text{C}$  during the measurement testing. The each temperature step shall be at least 0.5 hours, consider the EUT could be test under the stability condition.

NOTE: The frequency error was recorded frequency error from the communication simulator.

#### 3.2.3 TEST SETUP

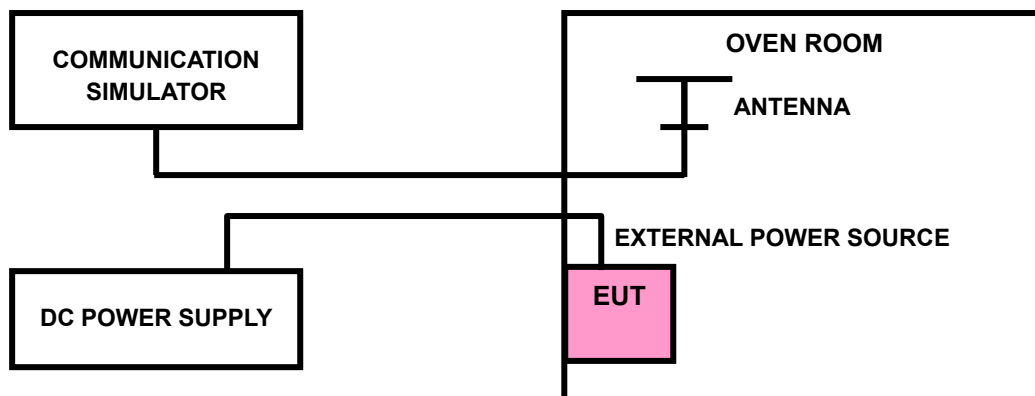



**BUREAU  
VERITAS**

**Test Report No.: W7L-221220W001RF01**

### 3.2.4 TEST RESULTS

Please Refer to Appendix Of this test report.

Note: VL = Low voltage (3.8V); VN/NV = Normal voltage(4V); VH = High voltage(4.2V);

NT = Normal temperature (25°C)





### 3.3 OCCUPIED BANDWIDTH MEASUREMENT

#### 3.3.1 LIMITS OF OCCUPIED BANDWIDTH MEASUREMENT

The width of a frequency band such that, below the lower and above the upper frequency limits, the mean powers emitted are each equal to a specified percentage 0.5 % of the total mean power of a given emission.

#### 3.3.2 TEST SETUP

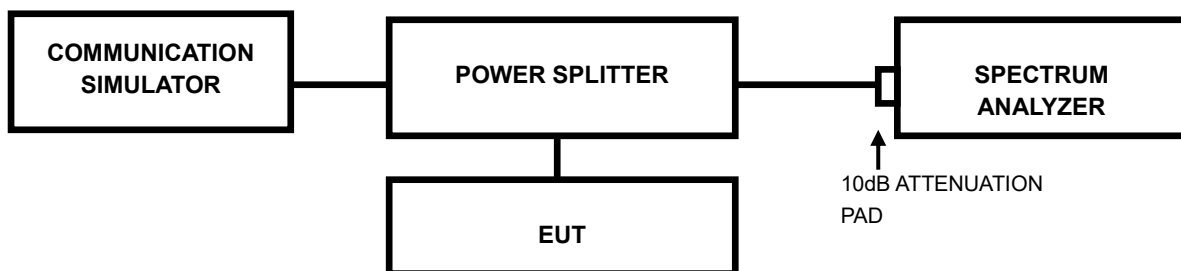

#### 3.3.3 TEST PROCEDURES

- The conducted occupied bandwidth used the power splitter via EUT RF power connector between simulation base station and spectrum analyzer.
- Use OBW measurement function of Spectrum analyzer to measure 99 % occupied bandwidth.



**BUREAU  
VERITAS**

**Test Report No.: W7L-221220W001RF01**

### 3.3.4 TEST RESULTS

Please Refer to Appendix Of this test report.

### 3.4 BAND EDGE MEASUREMENT

#### 3.4.1 LIMITS OF BAND EDGE MEASUREMENT

Power of any emission outside of the authorized operating frequency ranges must be attenuated below the transmitting power (P) by a factor of at least  $43 + 10 \log(P)$  dB. In the 1 MHz bands immediately outside and adjacent to the frequency block a resolution bandwidth of at least one percent of the emission bandwidth of the fundamental emission of the transmitter may be employed.

#### 3.4.2 TEST SETUP

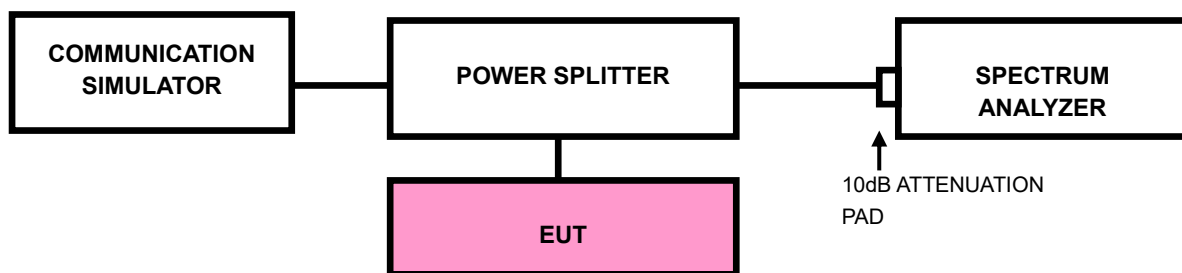



### 3.4.3 TEST PROCEDURES

- a) All measurements were done at low and high operational frequency range
- b) Connect the transmitter to the spectrum analyzer via coaxial cable while ensuring proper impedance matching.
- c) Tune the analyzer to the nominal center frequency of the emission bandwidth (EBW)
- d) .Set the resolution bandwidth (RBW)  $\geq$  1% EBW in the 1MHz band immediately outside and adjacent to the band edge.
- e) Beyond the 1MHz band from the band edge, RBW=1MHz was used.
- f) Set the video bandwidth (VBW) to  $\geq$  3 x RBW.
- g) Select the average power (RMS) display detector.
- h) Set the number of measurement points to  $\geq$  1001.
- i) Use auto-coupled sweep time.
- j) Perform the measurement over an interval of time when the transmission is continuous and at its maximum power level.
- k) The RF fundamental frequency should be excluded against the limit line in the operating frequency band and use RBW is 5KHz or 10KHz or 100KHz.
- l) Record the max trace plot into the test report.



**BUREAU  
VERITAS**

**Test Report No.: W7L-221220W001RF01**

### 3.4.4 TEST RESULTS

Please Refer to Appendix Of this test report.



### 3.5 CONDUCTED SPURIOUS EMISSIONS

#### 3.5.1 LIMITS OF CONDUCTED SPURIOUS EMISSIONS MEASUREMENT

The power of any emission outside of the authorized operating frequency ranges must be attenuated below the transmitting power (P) by a factor of at least  $43 + 10 \log(P)$  dB. The emission limit equal to  $-13\text{dBm}$ .

#### 3.5.2 TEST PROCEDURE

- a. The EUT makes a phone call to the communication simulator. All measurements were done at low, middle and high operational frequency range.
- b. Measuring frequency range is from 9kHz up to a frequency including its 10<sup>th</sup> harmonic. 10dB attenuation pad is connected with spectrum. RBW=1MHz and VBW=3MHz is used for conducted emission measurement.

#### 3.5.3 TEST SETUP

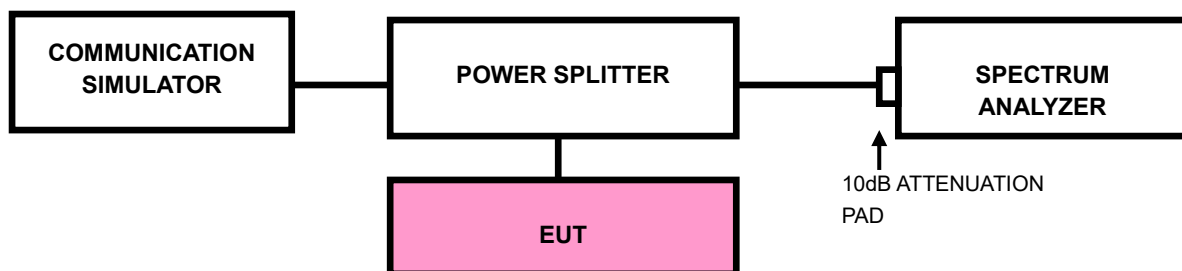



**BUREAU  
VERITAS**

**Test Report No.: W7L-221220W001RF01**

### 3.5.4 TEST RESULTS

NOTE : The 9K~30MHz amplitude of spurious emissions attenuated more than 20 dB below the permissible value is not required in the report.

Please Refer to Appendix Of this test report.



### 3.6 RADIATED EMISSION MEASUREMENT

#### 3.6.1 LIMITS OF RADIATED EMISSION MEASUREMENT

The power of any emission outside of the authorized operating frequency ranges must be attenuated below the transmitting power (P) by a factor of at least  $43 + 10 \log(P)$  dB. The emission limit equal to  $-13\text{dBm}$ .

#### 3.6.2 TEST PROCEDURES

- a. Substitution method is used for E.I.R.P measurement. In the semi-anechoic chamber, EUT placed on the 0.8m height of Turn Table, rotated the table around 360 degrees to search the maximum radiation power and receiver antenna shall be rotated vertical and horizontal polarization and moved height from 1m to 4m to find the maximum polar radiated power. The "Read Value" is the spectrum reading the maximum power value.
- b. The substitution horn antenna is substituted for EUT at the same position and signals generator export the CW signal to the substitution antenna via a TX cable. Rotated the Turn Table and moved receiving antenna to find the maximum radiation power. Adjust output power level of S.G to get a Value of spectrum reading equal to "Read Value " of step a. Record the power level of S.G
- c.  $\text{EIRP} = \text{Output power level of S.G} - \text{TX cable loss} + \text{Antenna gain of substitution horn.}$
- d. E.R.P power can be calculated form E.I.R.P power by subtracting the gain of dipole,  
 $\text{E.R.P power} = \text{E.I.P.R power} - 2.15\text{dBi.}$

**NOTE:** The resolution bandwidth and video bandwidth of test receiver/spectrum analyzer is 1MHz/3MHz.

#### 3.6.3 DEVIATION FROM TEST STANDARD

No deviation





### 3.6.4 TEST SETUP

#### < Frequency Range below 30MHz >

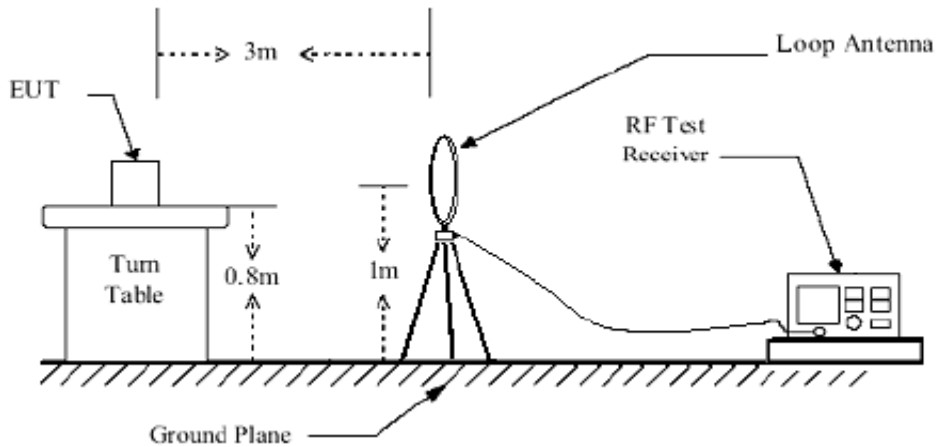

#### < Frequency Range 30MHz~1GHz >

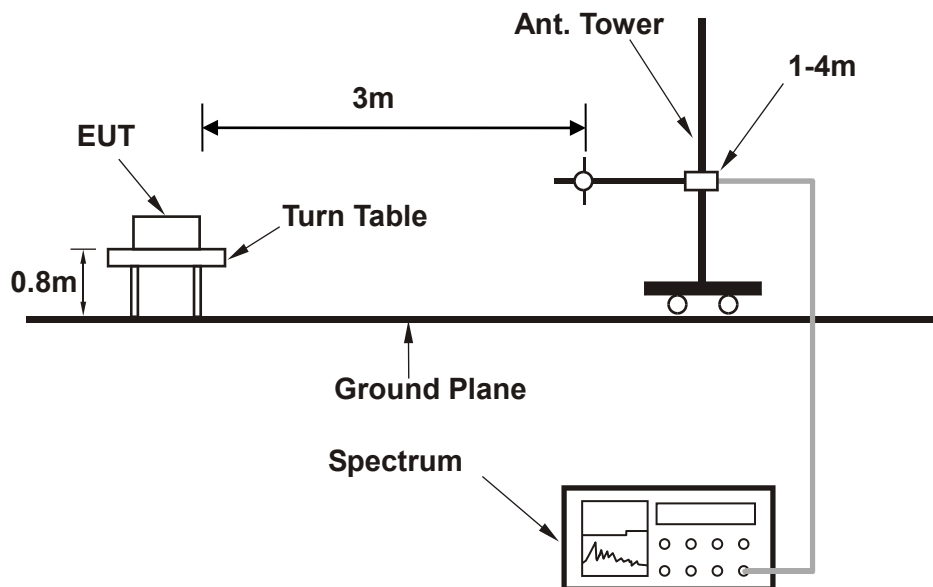



<Frequency Range above 1GHz>

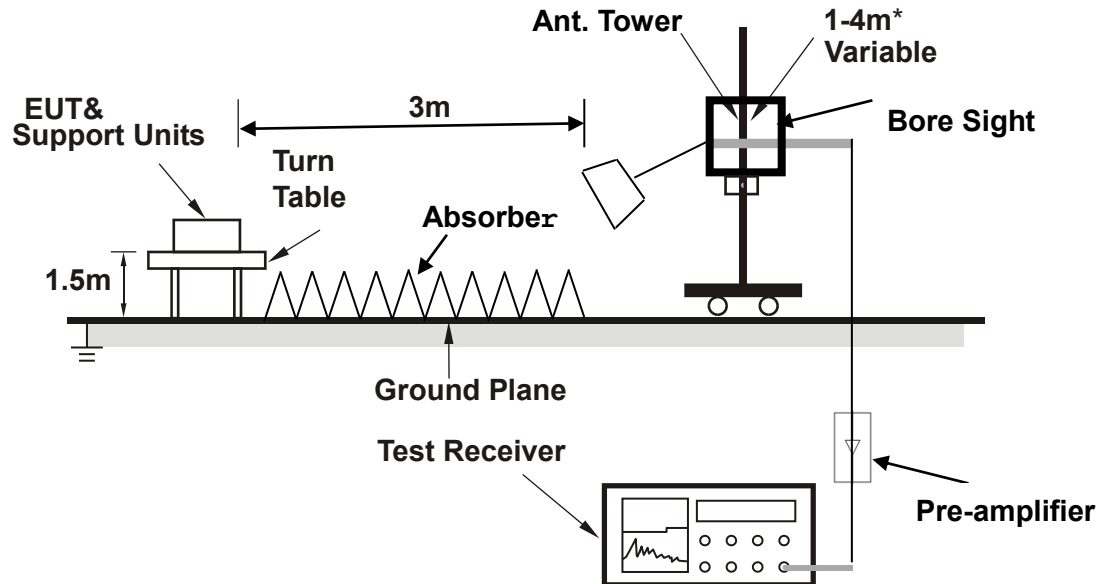

**Note:** Above 1G is a directional antenna

Depends on the EUT height and the antenna 3dB beamwidth both, refer to section 7.3 of CISPR 16-2-3.

For the actual test configuration, please refer to the attached file (Test Setup Photo).



### 3.6.5 TEST RESULTS

NOTE : The 9K~30MHz amplitude of spurious emissions attenuated more than 20 dB below the permissible value is not required in the report.

#### BELOW 1GHz WORST-CASE DATA

30 MHz – 1GHz data:

LTE Band 5

CHANNEL BANDWIDTH: 1.4MHz / QPSK

MODE	TX channel 20525	FREQUENCY RANGE	Below 1000MHz
ENVIRONMENTAL CONDITIONS	23deg. C, 70%RH	INPUT POWER	EUT 4.0V
TESTED BY	Jace Hu		
<b>ANTENNA POLARITY &amp; TEST DISTANCE: HORIZONTAL AT 3 M</b>			

	Freq	Level	Read Level	Limit Line	Over Limit	Factor	Remark	Pol/Phase
	MHz	dBm/m	dBm	dBm/m	dB	dB/m		
1	52.310	-66.54	-49.17	-13.00	-53.54	-17.37	Peak	Horizontal
2	157.070	-58.68	-41.88	-13.00	-45.68	-16.80	Peak	Horizontal
3	217.210	-59.80	-44.43	-13.00	-46.80	-15.37	Peak	Horizontal
4 PP	275.410	-54.65	-42.68	-13.00	-41.65	-11.97	Peak	Horizontal
5	377.260	-58.55	-47.97	-13.00	-45.55	-10.58	Peak	Horizontal
6	485.900	-60.36	-51.86	-13.00	-47.36	-8.50	Peak	Horizontal

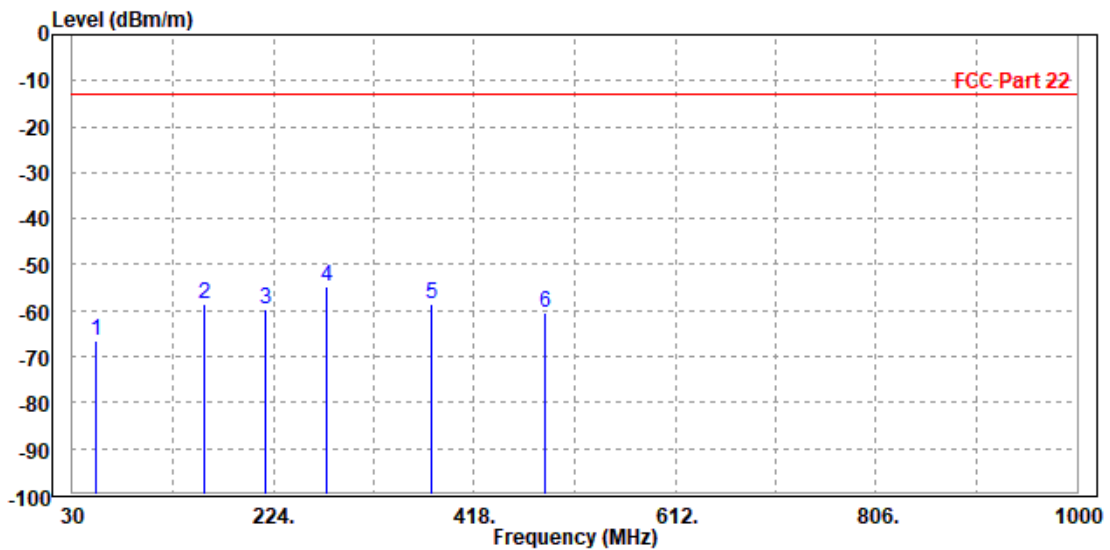



**BUREAU  
VERITAS**

Test Report No.: W7L-221220W001RF01

<b>MODE</b>	TX channel 20525	<b>FREQUENCY RANGE</b>	Below 1000MHz
<b>ENVIRONMENTAL CONDITIONS</b>	23deg. C, 70%RH	<b>INPUT POWER</b>	EUT 4.0V
<b>TESTED BY</b>	Jace Hu		
<b>ANTENNA POLARITY &amp; TEST DISTANCE: VERTICAL AT 3 M</b>			

	Freq	Level	Read Level	Limit Line	Over Limit	Factor	Remark	Pol/Phase
	MHz	dBm/m	dBm	dBm/m	dB	dB/m		
1	96.930	-59.47	-50.22	-13.00	-46.47	-9.25	Peak	Vertical
2	159.010	-61.55	-44.61	-13.00	-48.55	-16.94	Peak	Vertical
3	216.240	-65.98	-49.39	-13.00	-52.98	-16.59	Peak	Vertical
4	279.290	-61.46	-49.49	-13.00	-48.46	-11.97	Peak	Vertical
5	377.260	-62.15	-52.74	-13.00	-49.15	-9.41	Peak	Vertical
6	486.870	-59.81	-51.61	-13.00	-46.81	-8.20	Peak	Vertical

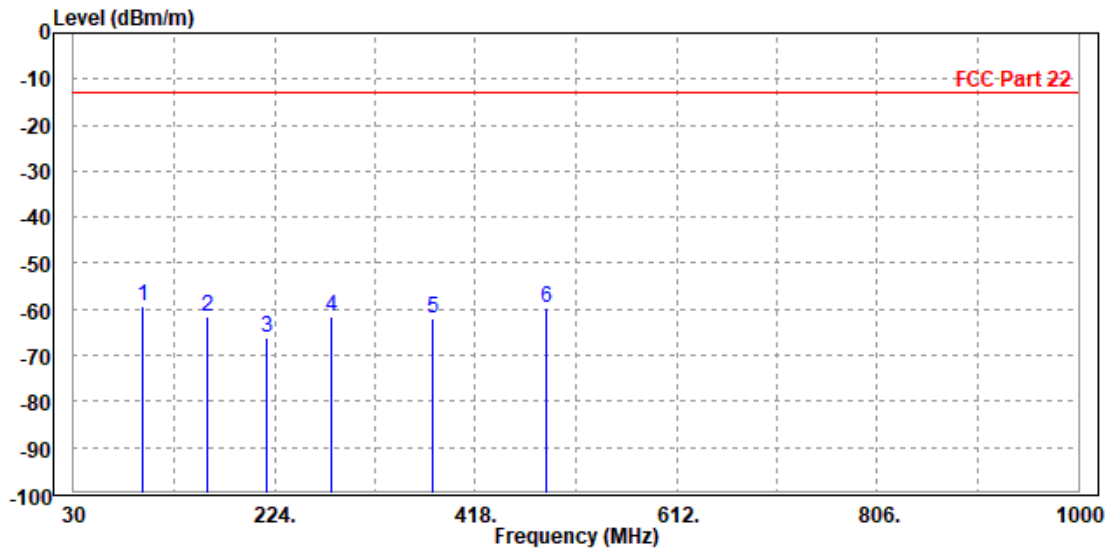



ABOVE 1GHz DATA

Note: For higher frequency, the emission is too low to be detected.

GPRS 850

CH 128:

MODE	TX channel 128	FREQUENCY RANGE	Above 1000MHz
ENVIRONMENTAL CONDITIONS	23deg. C, 70%RH	INPUT POWER	EUT 4.0V
TESTED BY	Jace Hu		
<b>ANTENNA POLARITY &amp; TEST DISTANCE: HORIZONTAL AT 3 M</b>			

	Freq	Level	Read Level	Limit Line	Over Limit	Factor	Remark	Pol/Phase
	MHz	dBm/m	dBm	dBm/m	dB	dB/m		
1	1648.000	-55.90	-56.67	-13.00	-42.90	0.77	Peak	Horizontal
2 PP	2472.600	-52.19	-57.53	-13.00	-39.19	5.34	Peak	Horizontal

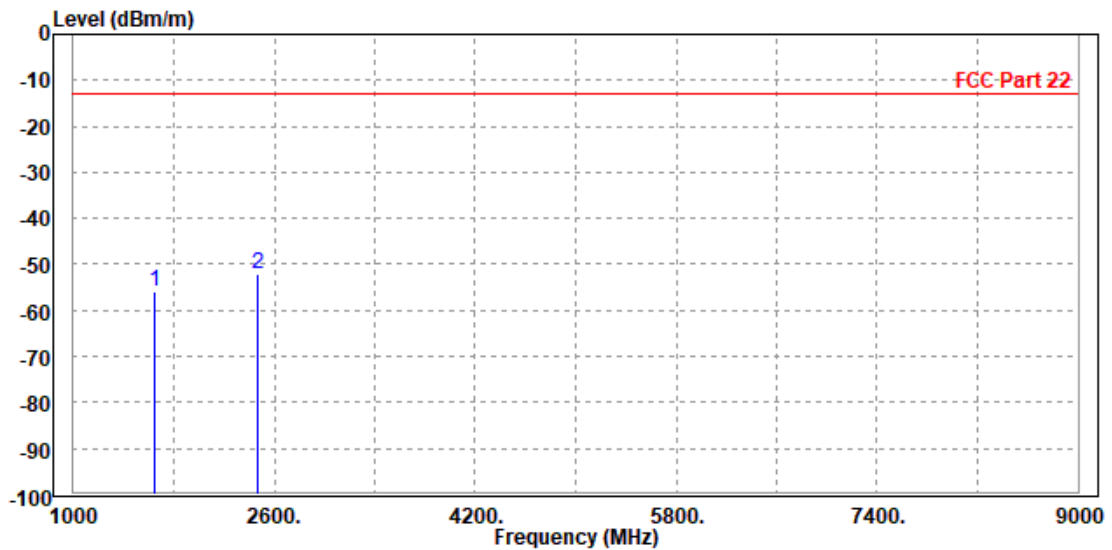



**BUREAU  
VERITAS**

**Test Report No.: W7L-221220W001RF01**

<b>MODE</b>	TX channel 128	<b>FREQUENCY RANGE</b>	Above 1000MHz
<b>ENVIRONMENTAL CONDITIONS</b>	23deg. C, 70%RH	<b>INPUT POWER</b>	EUT 4.0V
<b>TESTED BY</b>	Jace Hu		
<b>ANTENNA POLARITY &amp; TEST DISTANCE: VERTICAL AT 3 M</b>			

	Freq	Level	Read Level	Limit Line	Over Limit	Factor	Remark	Pol/Phase
	MHz	dBm/m	dBm	dBm/m	dB	dB/m		
1	1648.400	-55.95	-56.99	-13.00	-42.95	1.04	Peak	Vertical
2 PP	2472.000	-53.39	-58.25	-13.00	-40.39	4.86	Peak	Vertical

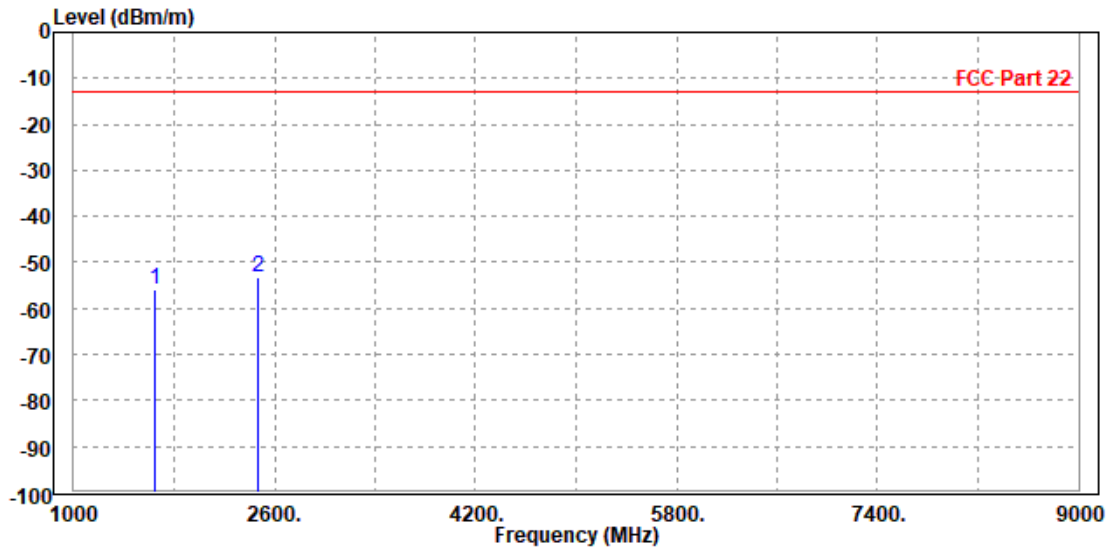



**BUREAU  
VERITAS**

**Test Report No.: W7L-221220W001RF01**

**CH 189:**

<b>MODE</b>	TX channel 189	<b>FREQUENCY RANGE</b>	Above 1000MHz
<b>ENVIRONMENTAL CONDITIONS</b>	23deg. C, 70%RH	<b>INPUT POWER</b>	EUT 4.0V
<b>TESTED BY</b>	Jace Hu		
<b>ANTENNA POLARITY &amp; TEST DISTANCE: HORIZONTAL AT 3 M</b>			

	Freq	Level	Read Level	Limit Line	Over Limit	Factor	Remark	Pol/Phase
	MHz	dBm/m	dBm	dBm/m	dB	dB/m		
1	1672.800	-55.13	-56.10	-13.00	-42.13	0.97	Peak	Horizontal
2 PP	2512.000	-50.49	-55.96	-13.00	-37.49	5.47	Peak	Horizontal

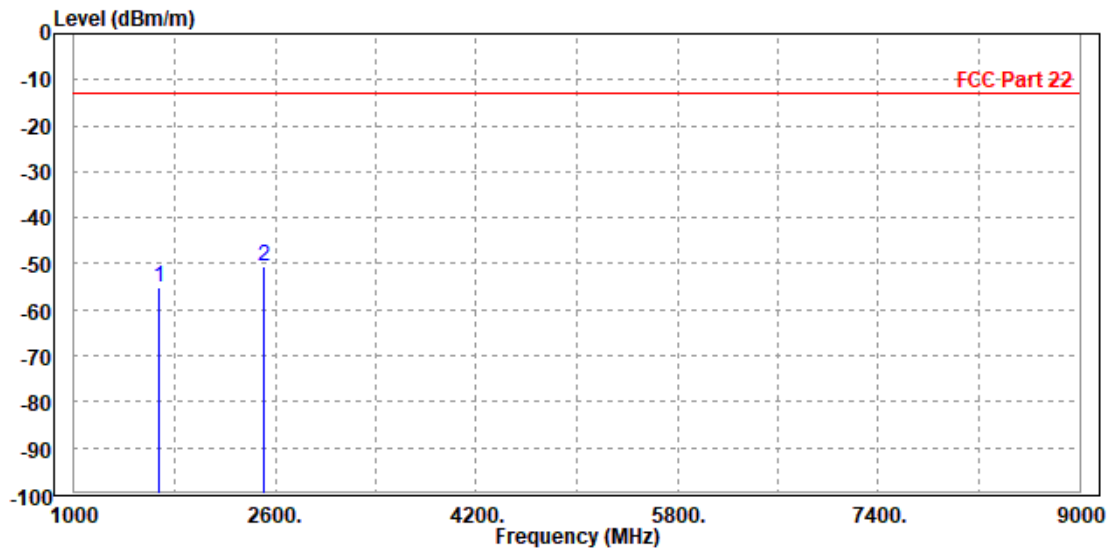



**BUREAU  
VERITAS**

**Test Report No.: W7L-221220W001RF01**

<b>MODE</b>	TX channel 189	<b>FREQUENCY RANGE</b>	Above 1000MHz
<b>ENVIRONMENTAL CONDITIONS</b>	23deg. C, 70%RH	<b>INPUT POWER</b>	EUT 4.0V
<b>TESTED BY</b>	Jace Hu		
<b>ANTENNA POLARITY &amp; TEST DISTANCE: VERTICAL AT 3 M</b>			

	Freq	Level	Read Level	Limit Line	Over Limit	Factor	Remark	Pol/Phase
	MHz	dBm/m	dBm	dBm/m	dB	dB/m		
1	1672.000	-54.68	-55.89	-13.00	-41.68	1.21	Peak	Vertical
2	PP 2509.200	-48.67	-53.64	-13.00	-35.67	4.97	Peak	Vertical

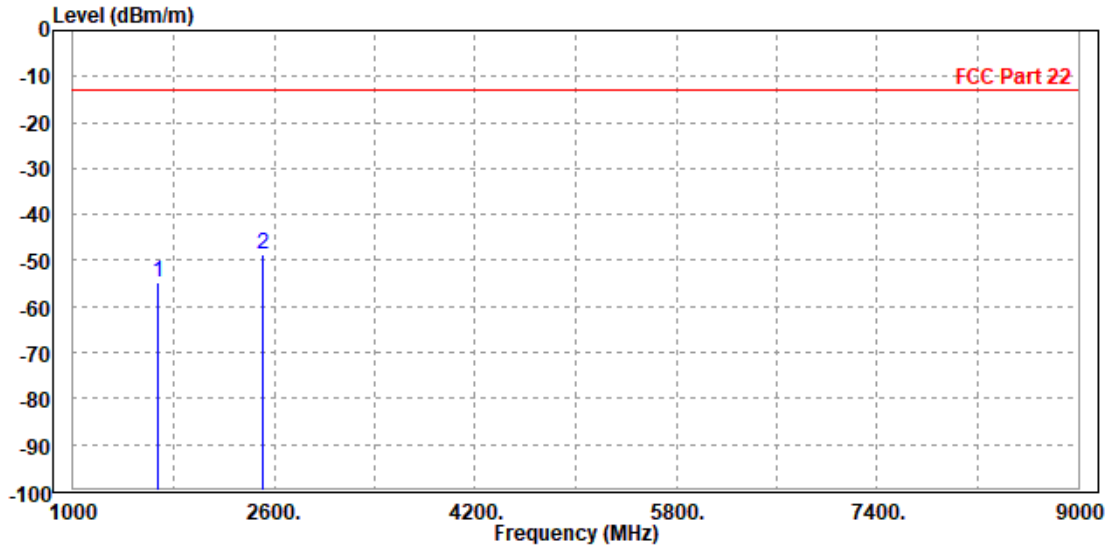





**CH 251:**

<b>MODE</b>	TX channel 251	<b>FREQUENCY RANGE</b>	Above 1000MHz
<b>ENVIRONMENTAL CONDITIONS</b>	23deg. C, 70%RH	<b>INPUT POWER</b>	EUT 4.0V
<b>TESTED BY</b>	Jace Hu		
<b>ANTENNA POLARITY &amp; TEST DISTANCE: HORIZONTAL AT 3 M</b>			

	Freq	Level	Read Level	Limit Line	Over Limit	Factor	Remark	Pol/Phase
	MHz	dBm/m	dBm	dBm/m	dB	dB/m		
1	1697.600	-55.76	-56.94	-13.00	-42.76	1.18	Peak	Horizontal
2 PP	2544.000	-49.52	-55.06	-13.00	-36.52	5.54	Peak	Horizontal

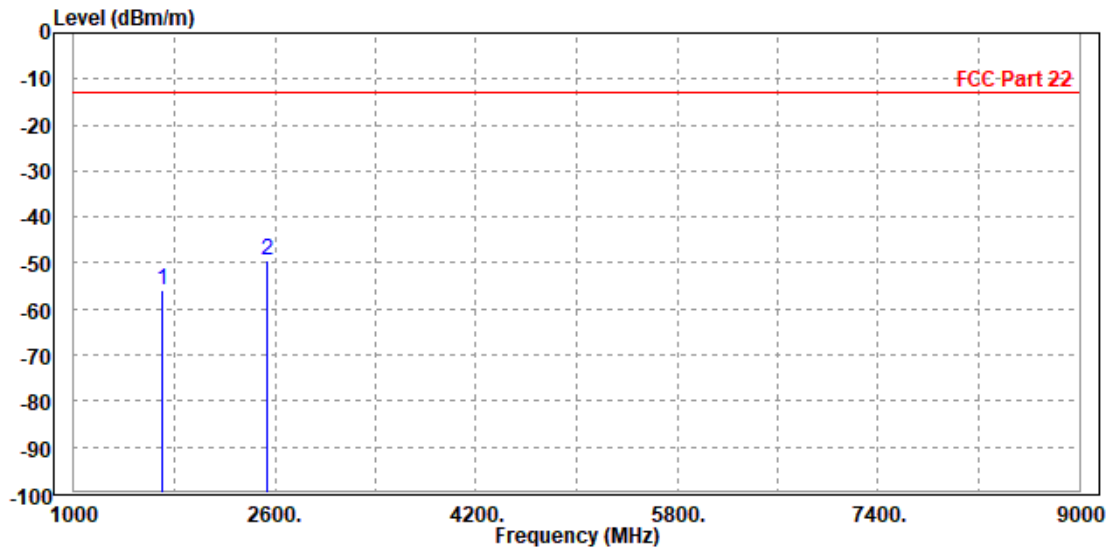



**BUREAU  
VERITAS**

**Test Report No.: W7L-221220W001RF01**

<b>MODE</b>	TX channel 251	<b>FREQUENCY RANGE</b>	Above 1000MHz
<b>ENVIRONMENTAL CONDITIONS</b>	23deg. C, 70%RH	<b>INPUT POWER</b>	EUT 4.0V
<b>TESTED BY</b>	Jace Hu		
<b>ANTENNA POLARITY &amp; TEST DISTANCE: VERTICAL AT 3 M</b>			

	Freq	Level	Read Level	Limit Line	Over Limit	Factor	Remark	Pol/Phase
	MHz	dBm/m	dBm	dBm/m	dB	dB/m		
1	1696.000	-55.82	-57.20	-13.00	-42.82	1.38	Peak	Vertical
2 PP	2546.400	-52.25	-57.34	-13.00	-39.25	5.09	Peak	Vertical

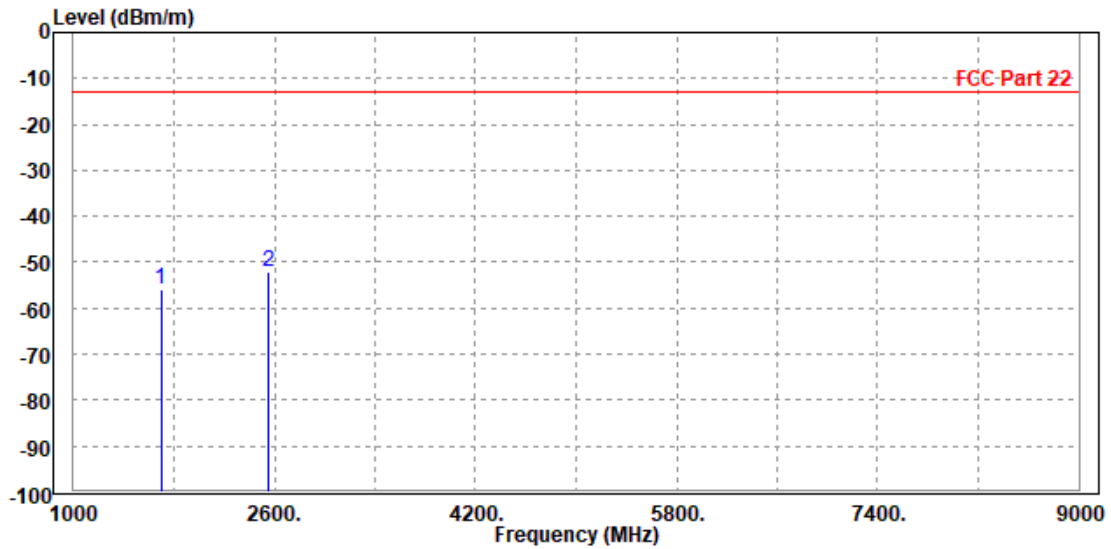



**EDGE 850:**

**CH 128:**

<b>MODE</b>	TX channel 128	<b>FREQUENCY RANGE</b>	Above 1000MHz
<b>ENVIRONMENTAL CONDITIONS</b>	23deg. C, 70%RH	<b>INPUT POWER</b>	EUT 4.0V
<b>TESTED BY</b>	Jace Hu		
<b>ANTENNA POLARITY &amp; TEST DISTANCE: HORIZONTAL AT 3 M</b>			

	Freq	Level	Read Level	Limit Line	Over Limit	Factor	Remark	Pol/Phase
	MHz	dBm/m	dBm	dBm/m	dB	dB/m		
1	1648.400	-56.92	-57.70	-13.00	-43.92	0.78	Peak	Horizontal
2 PP	2472.000	-53.18	-58.52	-13.00	-40.18	5.34	Peak	Horizontal

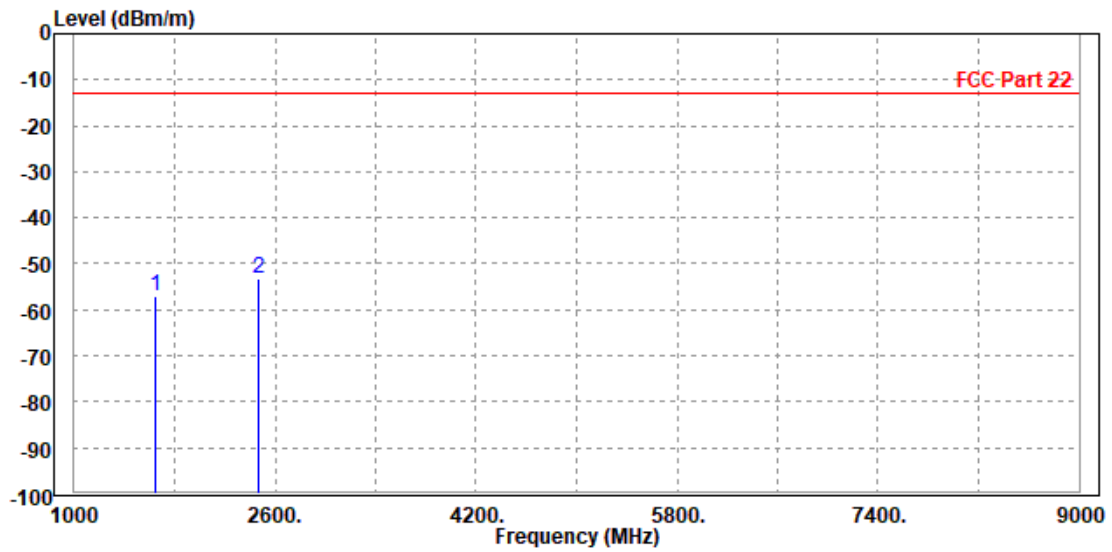



**BUREAU  
VERITAS**

**Test Report No.: W7L-221220W001RF01**

<b>MODE</b>	TX channel 128	<b>FREQUENCY RANGE</b>	Above 1000MHz
<b>ENVIRONMENTAL CONDITIONS</b>	23deg. C, 70%RH	<b>INPUT POWER</b>	EUT 4.0V
<b>TESTED BY</b>	Jace Hu		
<b>ANTENNA POLARITY &amp; TEST DISTANCE: VERTICAL AT 3 M</b>			

	Freq	Level	Read Level	Limit Line	Over Limit	Factor	Remark	Pol/Phase
	MHz	dBm/m	dBm	dBm/m	dB	dB/m		
1	1648.000	-52.43	-53.47	-13.00	-39.43	1.04	Peak	Vertical
2 PP	2472.600	-47.96	-52.82	-13.00	-34.96	4.86	Peak	Vertical

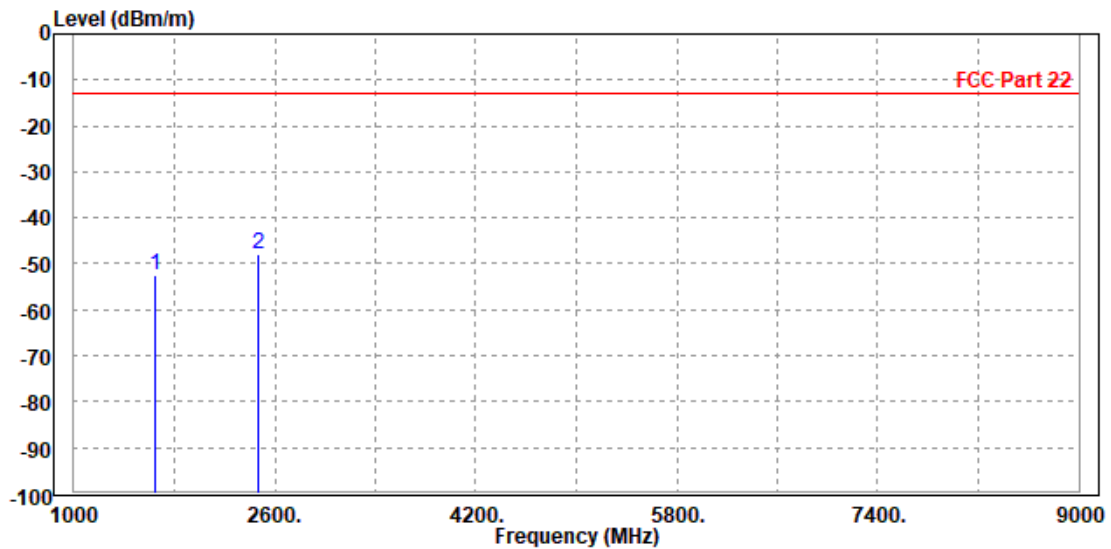



**BUREAU  
VERITAS**

Test Report No.: W7L-221220W001RF01

CH 189:

<b>MODE</b>	TX channel 189	<b>FREQUENCY RANGE</b>	Above 1000MHz
<b>ENVIRONMENTAL CONDITIONS</b>	23deg. C, 70%RH	<b>INPUT POWER</b>	EUT 4.0V
<b>TESTED BY</b>	Jace Hu		
<b>ANTENNA POLARITY &amp; TEST DISTANCE: HORIZONTAL AT 3 M</b>			

	Freq	Level	Read Level	Limit Line	Over Limit	Factor	Remark	Pol/Phase
	MHz	dBm/m	dBm	dBm/m	dB	dB/m		
1	1672.000	-56.03	-57.00	-13.00	-43.03	0.97	Peak	Horizontal
2 PP	2509.200	-49.93	-55.39	-13.00	-36.93	5.46	Peak	Horizontal

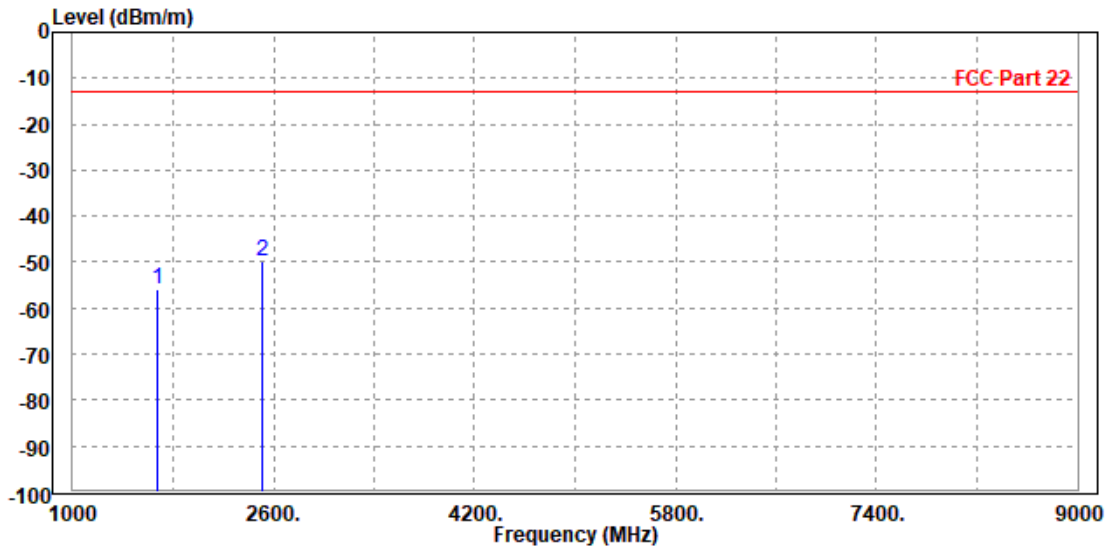



**BUREAU  
VERITAS**

Test Report No.: W7L-221220W001RF01

<b>MODE</b>	TX channel 189	<b>FREQUENCY RANGE</b>	Above 1000MHz
<b>ENVIRONMENTAL CONDITIONS</b>	23deg. C, 70%RH	<b>INPUT POWER</b>	EUT 4.0V
<b>TESTED BY</b>	Jace Hu		
<b>ANTENNA POLARITY &amp; TEST DISTANCE: VERTICAL AT 3 M</b>			

	Freq	Read Level	Limit Level	Over Limit	Factor	Remark	Pol/Phase
	MHz	dBm/m	dBm	dBm/m	dB	dB/m	
1	1672.800	-54.84	-56.06	-13.00	-41.84	1.22 Peak	Vertical
2 PP	2512.000	-48.35	-53.33	-13.00	-35.35	4.98 Peak	Vertical

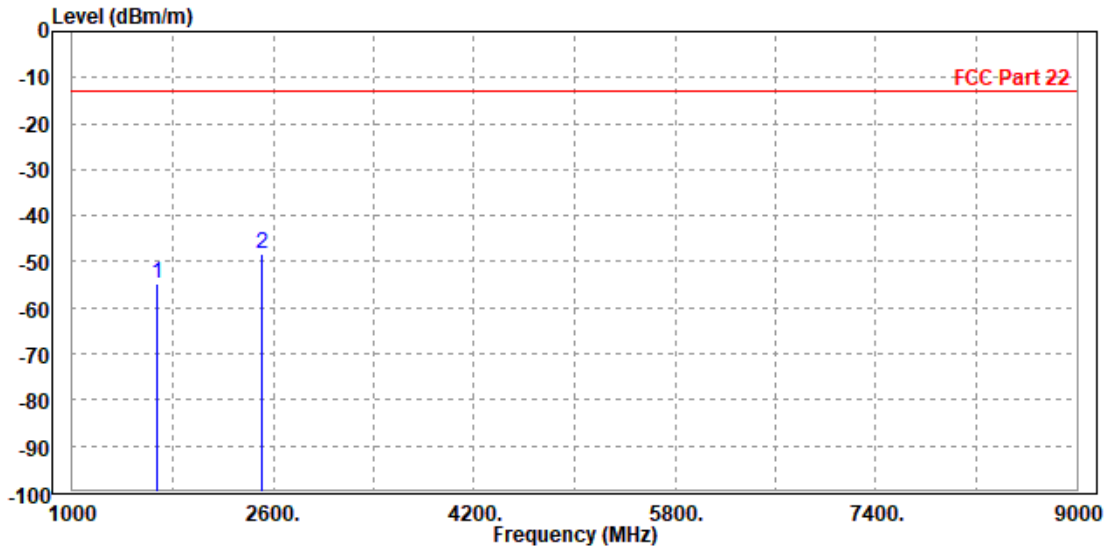



**CH 251:**

<b>MODE</b>	TX channel 251	<b>FREQUENCY RANGE</b>	Above 1000MHz
<b>ENVIRONMENTAL CONDITIONS</b>	23deg. C, 70%RH	<b>INPUT POWER</b>	EUT 4.0V
<b>TESTED BY</b>	Jace Hu		
<b>ANTENNA POLARITY &amp; TEST DISTANCE: HORIZONTAL AT 3 M</b>			

	Freq	Level	Read Level	Limit Line	Over Limit	Factor	Remark	Pol/Phase
	MHz	dBm/m	dBm	dBm/m	dB	dB/m		
1	1696.000	-56.12	-57.28	-13.00	-43.12	1.16	Peak	Horizontal
2 PP	2546.400	-51.25	-56.80	-13.00	-38.25	5.55	Peak	Horizontal

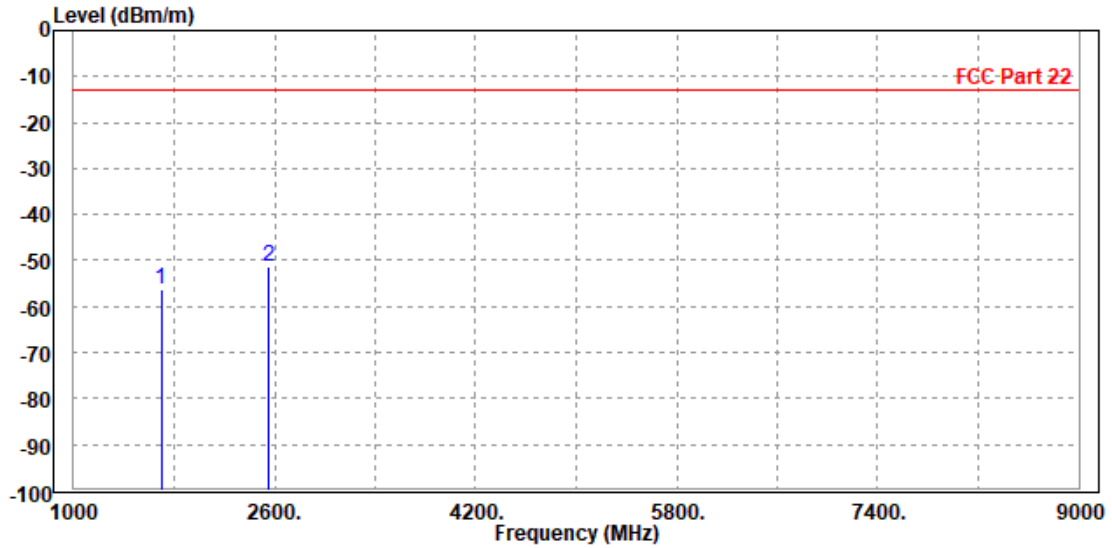



**BUREAU  
VERITAS**

**Test Report No.: W7L-221220W001RF01**

<b>MODE</b>	TX channel 251	<b>FREQUENCY RANGE</b>	Above 1000MHz
<b>ENVIRONMENTAL CONDITIONS</b>	23deg. C, 70%RH	<b>INPUT POWER</b>	EUT 4.0V
<b>TESTED BY</b>	Jace Hu		
<b>ANTENNA POLARITY &amp; TEST DISTANCE: VERTICAL AT 3 M</b>			

	Freq	Level	Read Level	Limit Line	Over Limit	Factor	Remark	Pol/Phase
	MHz	dBm/m	dBm	dBm/m	dB	dB/m		
1	1697.600	-55.81	-57.21	-13.00	-42.81	1.40	Peak	Vertical
2 PP	2544.000	-52.50	-57.58	-13.00	-39.50	5.08	Peak	Vertical

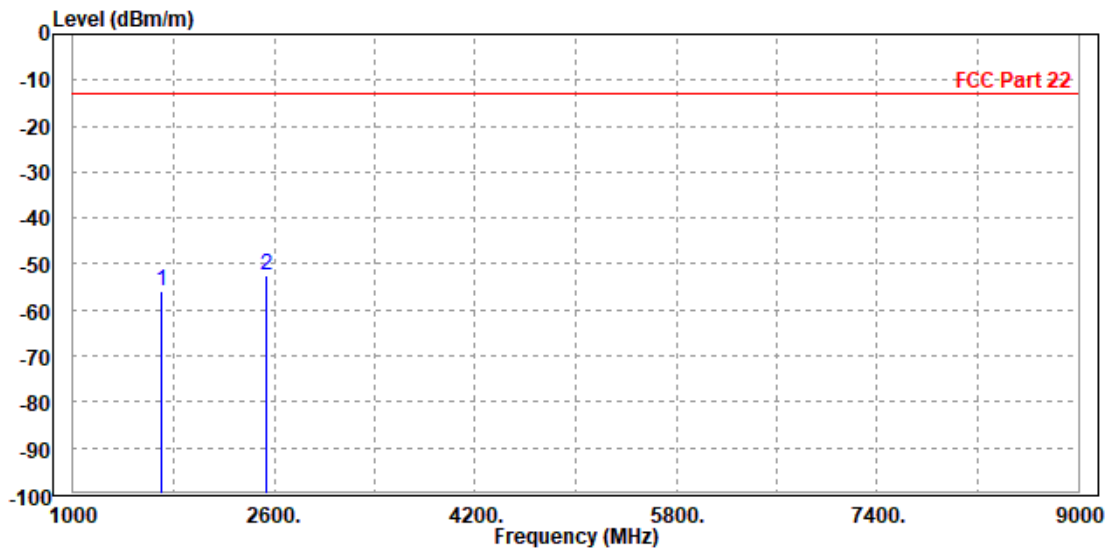





**WCDMA Band V:**

**CH 4132:**

<b>MODE</b>	TX channel 4132	<b>FREQUENCY RANGE</b>	Above 1000MHz
<b>ENVIRONMENTAL CONDITIONS</b>	23deg. C, 70%RH	<b>INPUT POWER</b>	EUT 4.0V
<b>TESTED BY</b>	Jace Hu		
<b>ANTENNA POLARITY &amp; TEST DISTANCE: HORIZONTAL AT 3 M</b>			

	Freq	Level	Read Level	Limit Line	Over Limit	Factor	Remark	Pol/Phase
	MHz	dBm/m	dBm	dBm/m	dB	dB/m		
1	1652.800	-57.57	-58.38	-13.00	-44.57	0.81	Peak	Horizontal
2 PP	2480.000	-51.98	-57.35	-13.00	-38.98	5.37	Peak	Horizontal

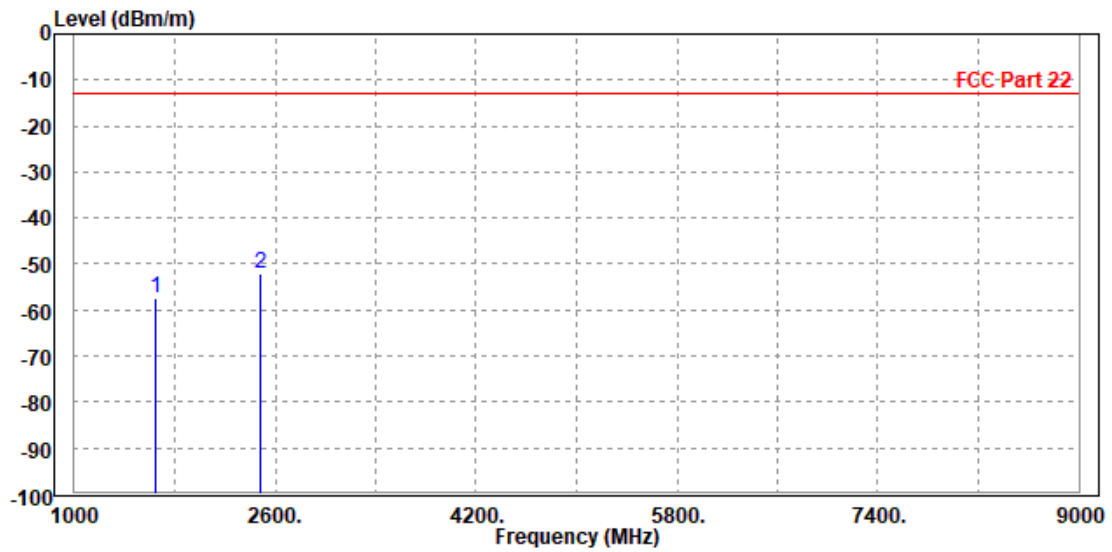



**BUREAU  
VERITAS**

**Test Report No.: W7L-221220W001RF01**

<b>MODE</b>	TX channel 4132	<b>FREQUENCY RANGE</b>	Above 1000MHz
<b>ENVIRONMENTAL CONDITIONS</b>	23deg. C, 70%RH	<b>INPUT POWER</b>	EUT 4.0V
<b>TESTED BY</b>	Jace Hu		
<b>ANTENNA POLARITY &amp; TEST DISTANCE: VERTICAL AT 3 M</b>			

	Freq	Level	Read Level	Limit Line	Over Limit	Factor	Remark	Pol/Phase
	MHz	dBm/m	dBm	dBm/m	dB	dB/m		
1	1656.000	-55.89	-56.98	-13.00	-42.89	1.09	Peak	Vertical
2 PP	2480.000	-51.73	-56.61	-13.00	-38.73	4.88	Peak	Vertical

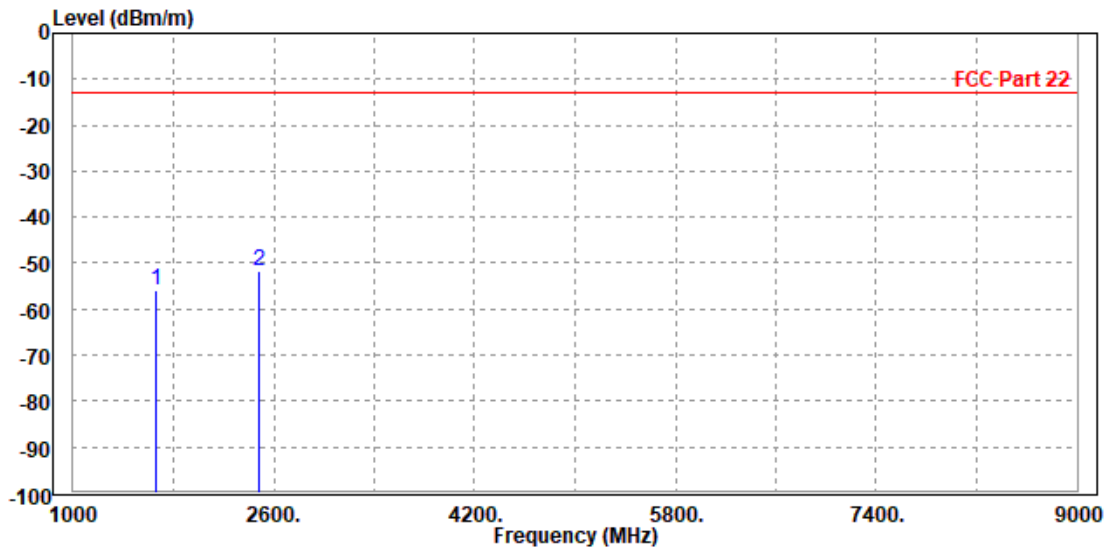



CH 4182:

<b>MODE</b>	TX channel 4182	<b>FREQUENCY RANGE</b>	Above 1000MHz
<b>ENVIRONMENTAL CONDITIONS</b>	23deg. C, 70%RH	<b>INPUT POWER</b>	EUT 4.0V
<b>TESTED BY</b>	Jace Hu		
<b>ANTENNA POLARITY &amp; TEST DISTANCE: HORIZONTAL AT 3 M</b>			

	Freq	Level	Read Level	Limit Line	Over Limit	Factor	Remark	Pol/Phase
	MHz	dBm/m	dBm	dBm/m	dB	dB/m		
1	1672.800	-56.66	-57.63	-13.00	-43.66	0.97	Peak	Horizontal
2 PP	2512.000	-52.14	-57.61	-13.00	-39.14	5.47	Peak	Horizontal

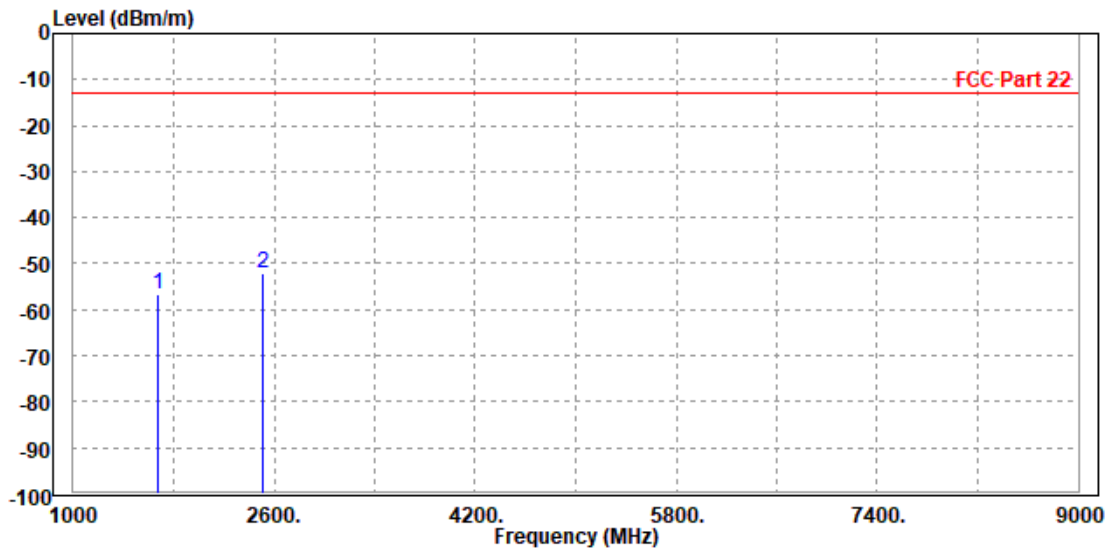



**BUREAU  
VERITAS**

**Test Report No.: W7L-221220W001RF01**

<b>MODE</b>	TX channel 4182	<b>FREQUENCY RANGE</b>	Above 1000MHz
<b>ENVIRONMENTAL CONDITIONS</b>	23deg. C, 70%RH	<b>INPUT POWER</b>	EUT 4.0V
<b>TESTED BY</b>	Jace Hu		
<b>ANTENNA POLARITY &amp; TEST DISTANCE: VERTICAL AT 3 M</b>			

	Freq	Level	Read Level	Limit Line	Over Limit	Factor	Remark	Pol/Phase
	MHz	dBm/m	dBm	dBm/m	dB	dB/m		
1	1672.000	-56.24	-57.45	-13.00	-43.24	1.21	Peak	Vertical
2 PP	2509.200	-48.24	-53.21	-13.00	-35.24	4.97	Peak	Vertical

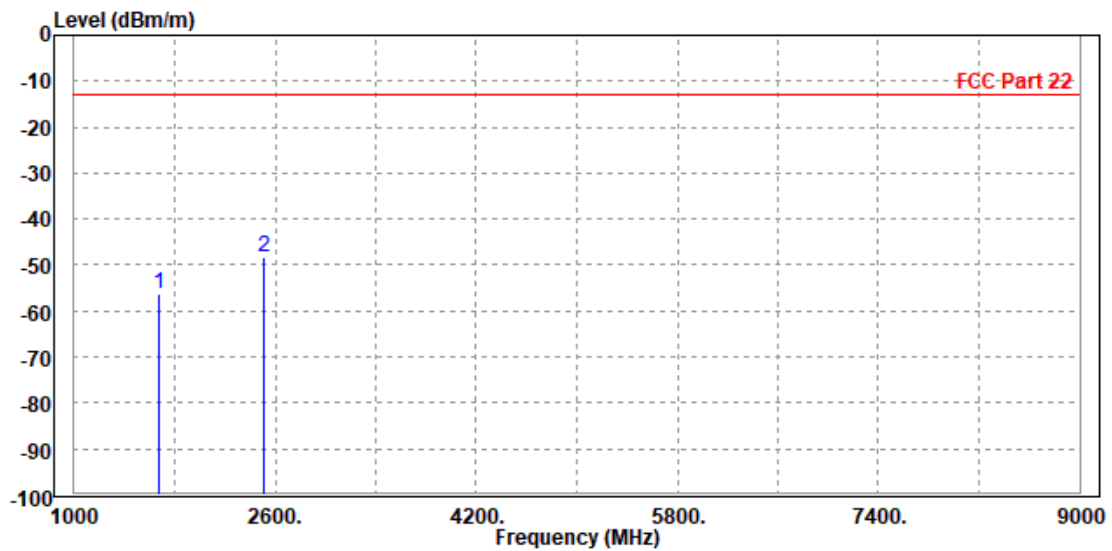



CH 4233:

<b>MODE</b>	TX channel 4233	<b>FREQUENCY RANGE</b>	Above 1000MHz
<b>ENVIRONMENTAL CONDITIONS</b>	23deg. C, 70%RH	<b>INPUT POWER</b>	EUT 4.0V
<b>TESTED BY</b>	Jace Hu		
<b>ANTENNA POLARITY &amp; TEST DISTANCE: HORIZONTAL AT 3 M</b>			

	Freq	Level	Read Level	Limit Line	Over Limit	Factor	Remark	Pol/Phase
	MHz	dBm/m	dBm	dBm/m	dB	dB/m		
1	1696.000	-56.19	-57.35	-13.00	-43.19	1.16	Peak	Horizontal
2 PP	2539.800	-52.61	-58.14	-13.00	-39.61	5.53	Peak	Horizontal

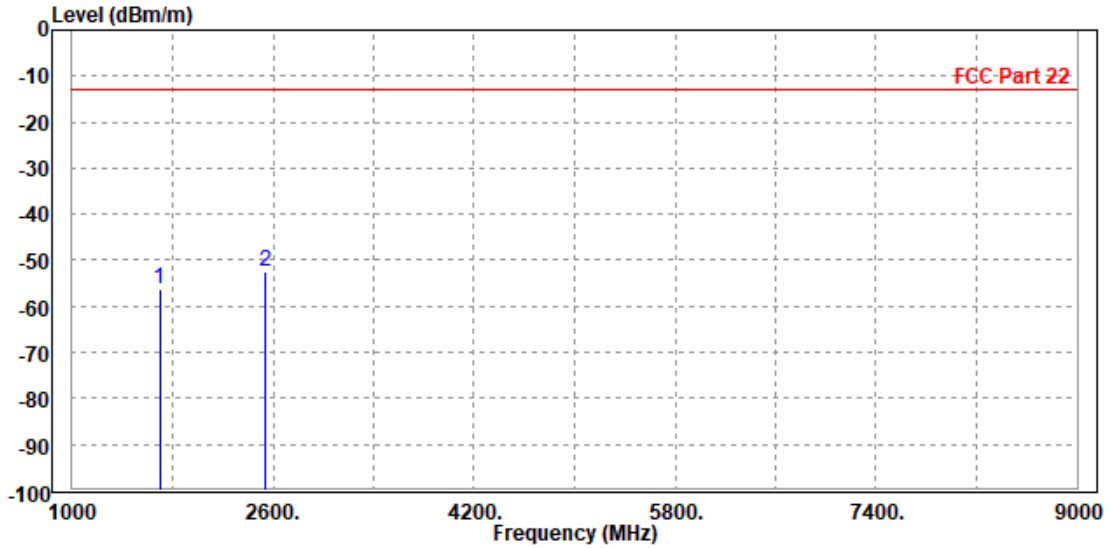



**BUREAU  
VERITAS**

**Test Report No.: W7L-221220W001RF01**

<b>MODE</b>	TX channel 4233	<b>FREQUENCY RANGE</b>	Above 1000MHz
<b>ENVIRONMENTAL CONDITIONS</b>	23deg. C, 70%RH	<b>INPUT POWER</b>	EUT 4.0V
<b>TESTED BY</b>	Jace Hu		
<b>ANTENNA POLARITY &amp; TEST DISTANCE: VERTICAL AT 3 M</b>			

	Freq	Level	Read Level	Limit Line	Over Limit	Factor	Remark	Pol/Phase
	MHz	dBm/m	dBm	dBm/m	dB	dB/m		
1	1693.200	-56.42	-57.78	-13.00	-43.42	1.36	Peak	Vertical
2 PP	2536.000	-53.13	-58.18	-13.00	-40.13	5.05	Peak	Vertical

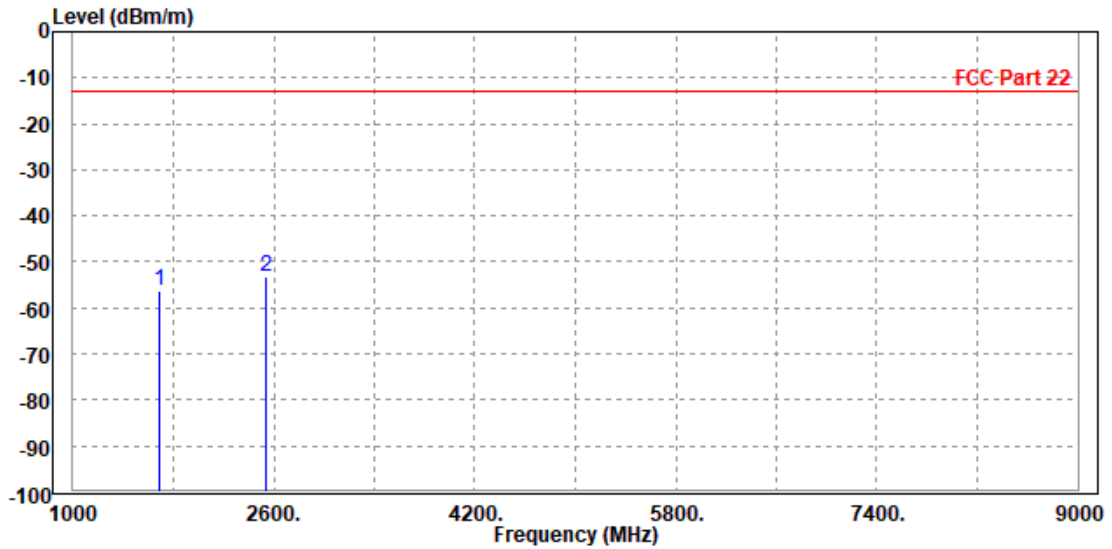



LTE Band 5

CHANNEL BANDWIDTH: 1.4MHz / QPSK

MODE	TX channel 20525	FREQUENCY RANGE	Above 1000MHz
ENVIRONMENTAL CONDITIONS	23deg. C, 70%RH	INPUT POWER	EUT 4.0V
TESTED BY	Jace Hu		
<b>ANTENNA POLARITY &amp; TEST DISTANCE: HORIZONTAL AT 3 M</b>			

	Freq	Level	Read Level	Limit Line	Over Limit	Factor	Remark	Pol/Phase
	MHz	dBm/m	dBm	dBm/m	dB	dB/m		
1	1673.000	-56.55	-57.53	-13.00	-43.55	0.98	Peak	Horizontal
2 PP	2512.000	-52.03	-57.50	-13.00	-39.03	5.47	Peak	Horizontal

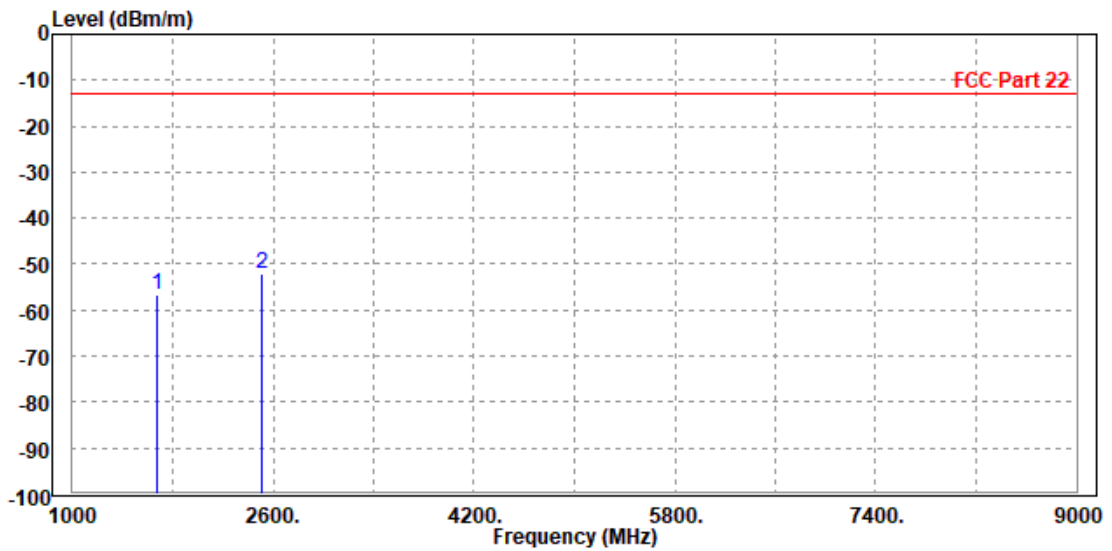



**BUREAU  
VERITAS**

Test Report No.: W7L-221220W001RF01

<b>MODE</b>	TX channel 20525	<b>FREQUENCY RANGE</b>	Above 1000MHz
<b>ENVIRONMENTAL CONDITIONS</b>	23deg. C, 70%RH	<b>INPUT POWER</b>	EUT 4.0V
<b>TESTED BY</b>	Jace Hu		
<b>ANTENNA POLARITY &amp; TEST DISTANCE: VERTICAL AT 3 M</b>			

	Freq	Level	Read Level	Limit Line	Over Limit	Factor	Remark	Pol/Phase
	MHz	dBm/m	dBm	dBm/m	dB	dB/m		
1	1672.000	-56.85	-58.06	-13.00	-43.85	1.21	Peak	Vertical
2 PP	2509.500	-54.00	-58.97	-13.00	-41.00	4.97	Peak	Vertical

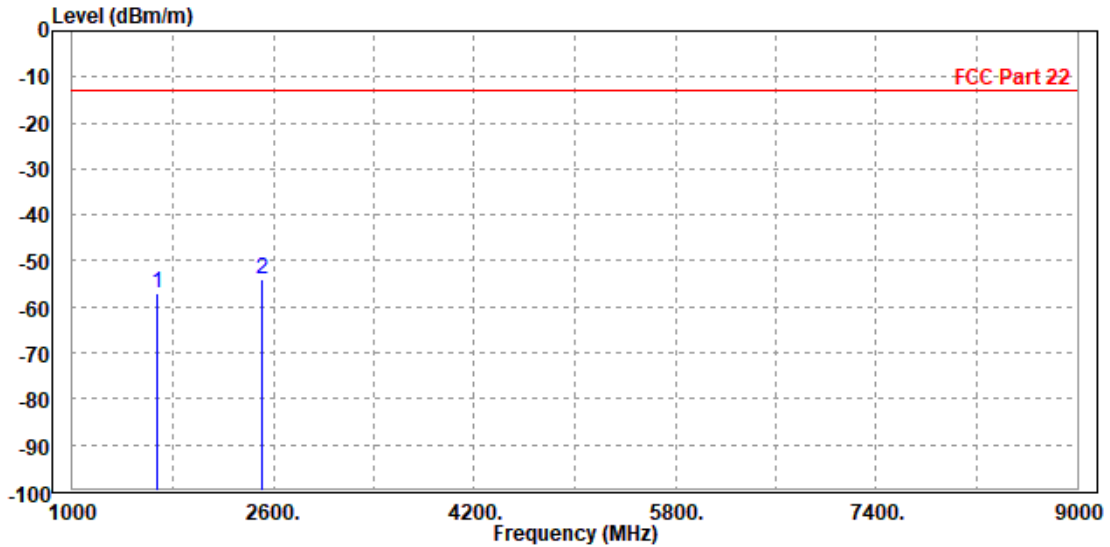





CHANNEL BANDWIDTH: 3MHz / QPSK

MODE	TX channel 20525	FREQUENCY RANGE	Above 1000MHz
ENVIRONMENTAL CONDITIONS	23deg. C, 70%RH	INPUT POWER	EUT 4.0V
TESTED BY	Jace Hu		
<b>ANTENNA POLARITY &amp; TEST DISTANCE: HORIZONTAL AT 3 M</b>			

	Freq	Level	Read Level	Limit Line	Over Limit	Factor	Remark	Pol/Phase
	MHz	dBm/m	dBm	dBm/m	dB	dB/m		
1	1672.000	-55.73	-56.70	-13.00	-42.73	0.97	Peak	Horizontal
2 PP	2509.500	-52.04	-57.50	-13.00	-39.04	5.46	Peak	Horizontal

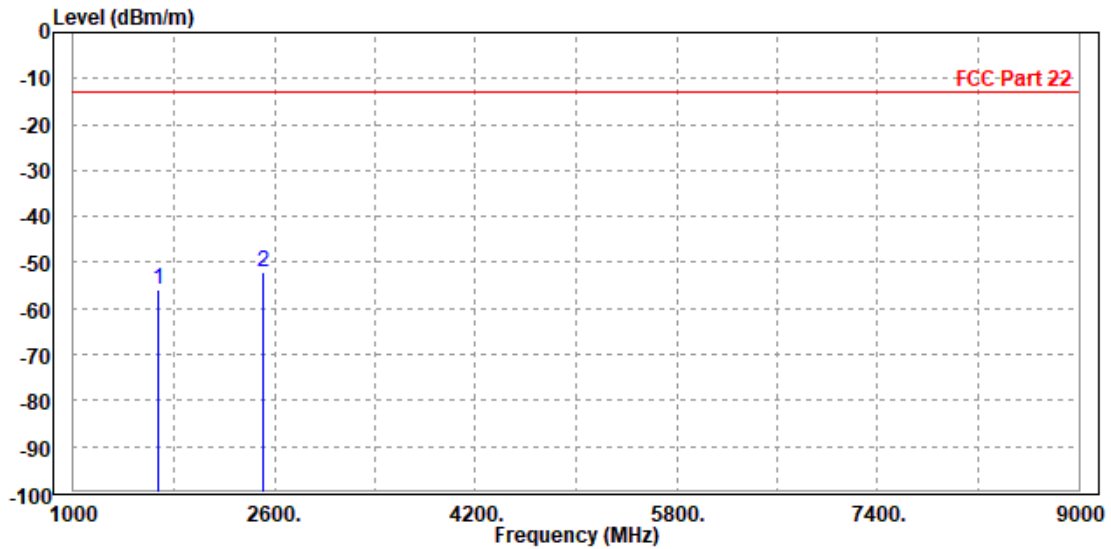



**BUREAU  
VERITAS**

**Test Report No.: W7L-221220W001RF01**

<b>MODE</b>	TX channel 20525	<b>FREQUENCY RANGE</b>	Above 1000MHz
<b>ENVIRONMENTAL CONDITIONS</b>	23deg. C, 70%RH	<b>INPUT POWER</b>	EUT 4.0V
<b>TESTED BY</b>	Jace Hu		
<b>ANTENNA POLARITY &amp; TEST DISTANCE: VERTICAL AT 3 M</b>			

	Freq	Level	Read Level	Limit Line	Over Limit	Factor	Remark	Pol/Phase
	MHz	dBm/m	dBm	dBm/m	dB	dB/m		
1	1673.000	-56.81	-58.03	-13.00	-43.81	1.22	Peak	Vertical
2	PP 2512.000	-53.52	-58.50	-13.00	-40.52	4.98	Peak	Vertical

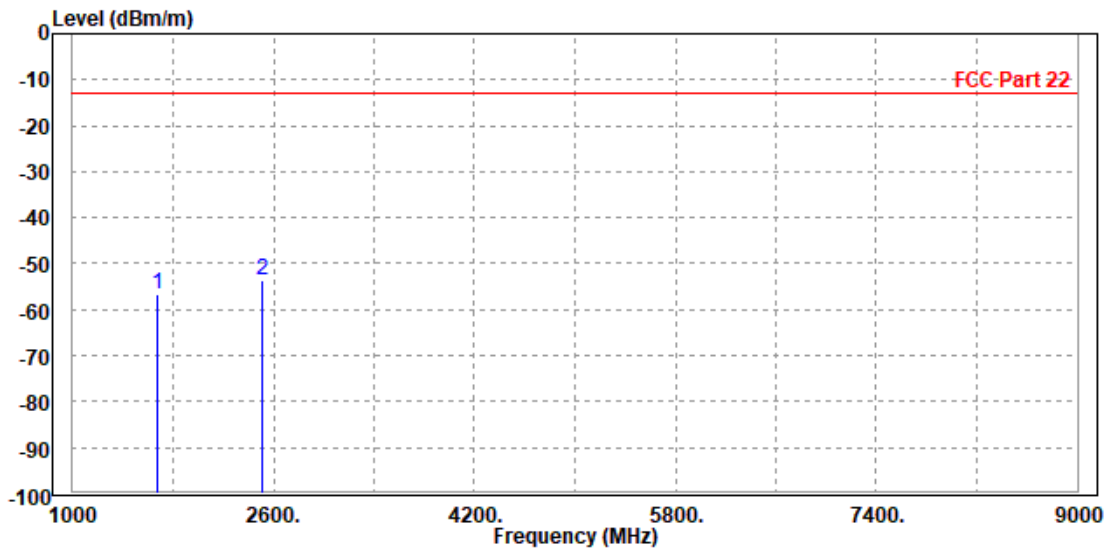



CHANNEL BANDWIDTH: 5MHz / QPSK

MODE	TX channel 20525	FREQUENCY RANGE	Above 1000MHz
ENVIRONMENTAL CONDITIONS	23deg. C, 70%RH	INPUT POWER	EUT 4.0V
TESTED BY	Jace Hu		
<b>ANTENNA POLARITY &amp; TEST DISTANCE: HORIZONTAL AT 3 M</b>			

	Freq	Level	Read Level	Limit Line	Over Limit	Factor	Remark	Pol/Phase
	MHz	dBm/m	dBm	dBm/m	dB	dB/m		
1	1673.000	-57.10	-58.08	-13.00	-44.10	0.98	Peak	Horizontal
2 PP	2512.000	-52.18	-57.65	-13.00	-39.18	5.47	Peak	Horizontal

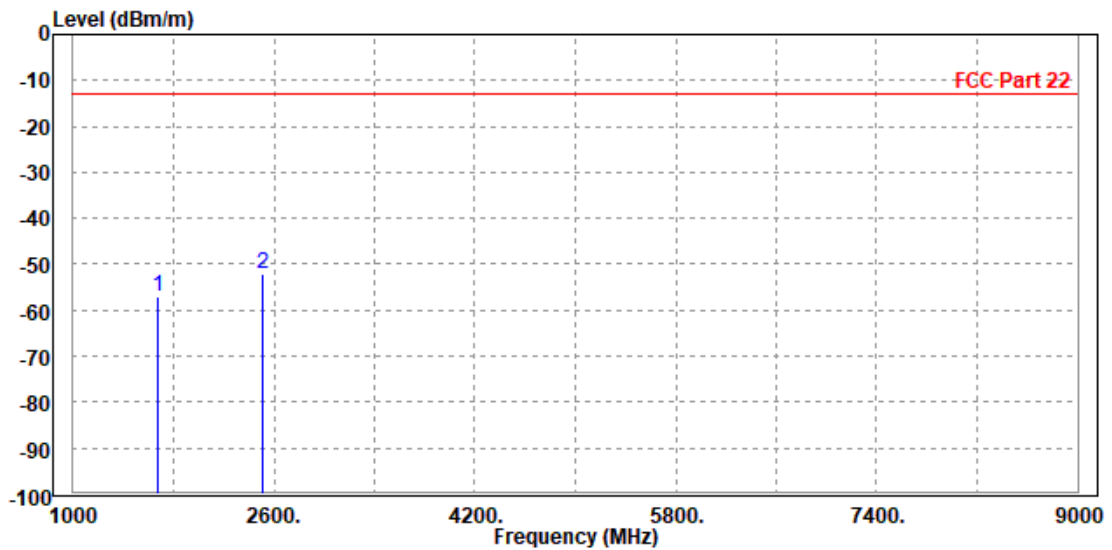



**BUREAU  
VERITAS**

**Test Report No.: W7L-221220W001RF01**

<b>MODE</b>	TX channel 20525	<b>FREQUENCY RANGE</b>	Above 1000MHz
<b>ENVIRONMENTAL CONDITIONS</b>	23deg. C, 70%RH	<b>INPUT POWER</b>	EUT 4.0V
<b>TESTED BY</b>	Jace Hu		
<b>ANTENNA POLARITY &amp; TEST DISTANCE: VERTICAL AT 3 M</b>			

	Freq	Level	Read Level	Limit Line	Over Limit	Factor	Remark	Pol/Phase
	MHz	dBm/m	dBm	dBm/m	dB	dB/m		
1	1672.000	-57.04	-58.25	-13.00	-44.04	1.21	Peak	Vertical
2 PP	2509.500	-52.73	-57.70	-13.00	-39.73	4.97	Peak	Vertical

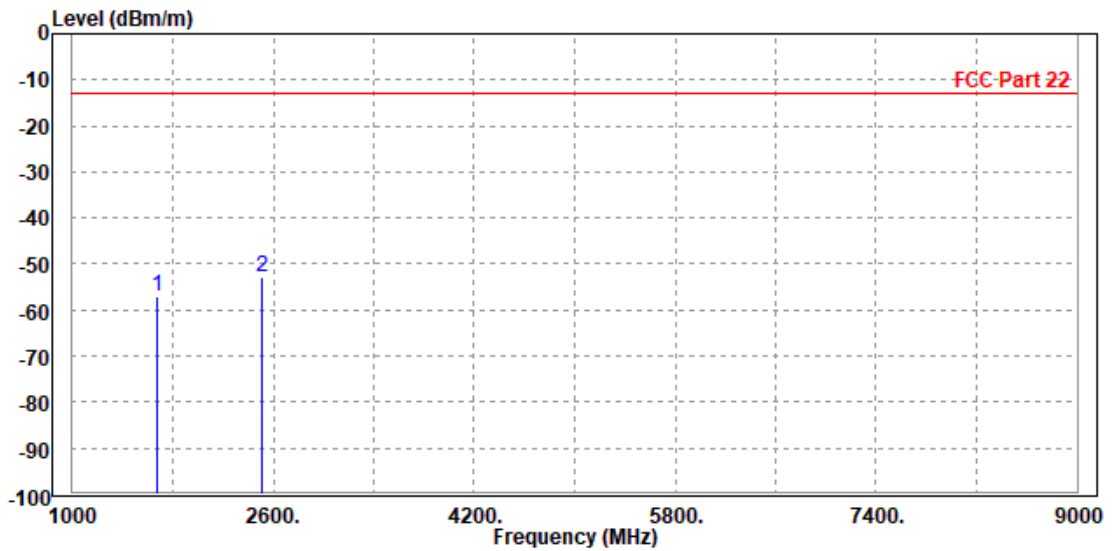



**BUREAU  
VERITAS**

**Test Report No.: W7L-221220W001RF01**

**CHANNEL BANDWIDTH: 10MHz / QPSK**

**CH 20450**

<b>MODE</b>	TX channel 20450	<b>FREQUENCY RANGE</b>	Above 1000MHz
<b>ENVIRONMENTAL CONDITIONS</b>	23deg. C, 70%RH	<b>INPUT POWER</b>	EUT 4.0V
<b>TESTED BY</b>	Jace Hu		
<b>ANTENNA POLARITY &amp; TEST DISTANCE: HORIZONTAL AT 3 M</b>			

	Freq	Level	Read Level	Limit Line	Over Limit	Factor	Remark	Pol/Phase
	MHz	dBm/m	dBm	dBm/m	dB	dB/m		
1	1656.000	-57.07	-57.91	-13.00	-44.07	0.84	Peak	Horizontal
2 PP	2487.000	-53.05	-58.44	-13.00	-40.05	5.39	Peak	Horizontal

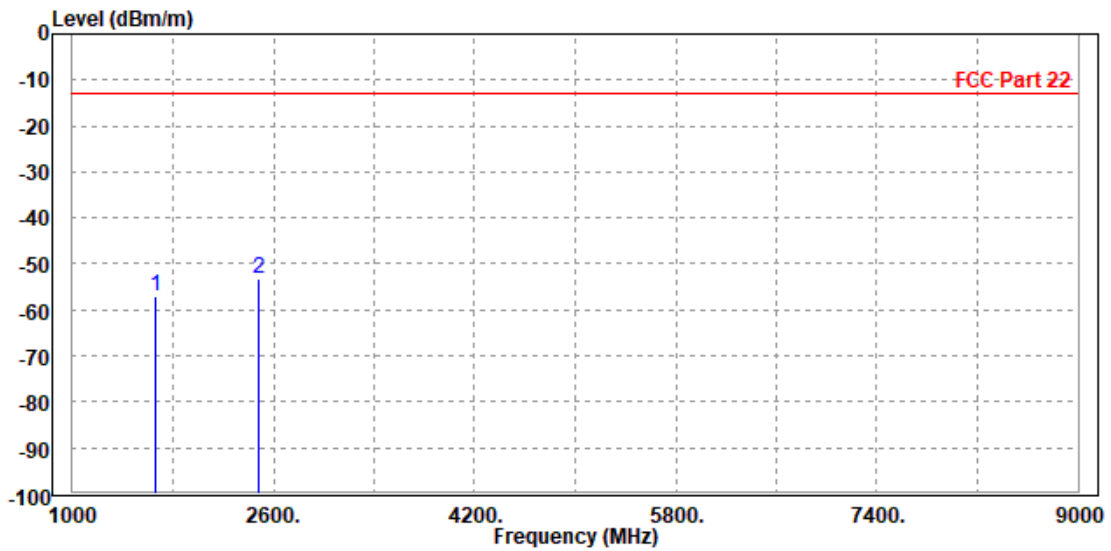



<b>MODE</b>	TX channel 20450	<b>FREQUENCY RANGE</b>	Above 1000MHz
<b>ENVIRONMENTAL CONDITIONS</b>	23deg. C, 70%RH	<b>INPUT POWER</b>	EUT 4.0V
<b>TESTED BY</b>	Jace Hu		
<b>ANTENNA POLARITY &amp; TEST DISTANCE: VERTICAL AT 3 M</b>			

	Freq	Level	Read Level	Limit Line	Over Limit	Factor	Remark	Pol/Phase
	MHz	dBm/m	dBm	dBm/m	dB	dB/m		
1	1658.000	-56.76	-57.87	-13.00	-43.76	1.11	Peak	Vertical
2 PP	2488.000	-51.50	-56.41	-13.00	-38.50	4.91	Peak	Vertical

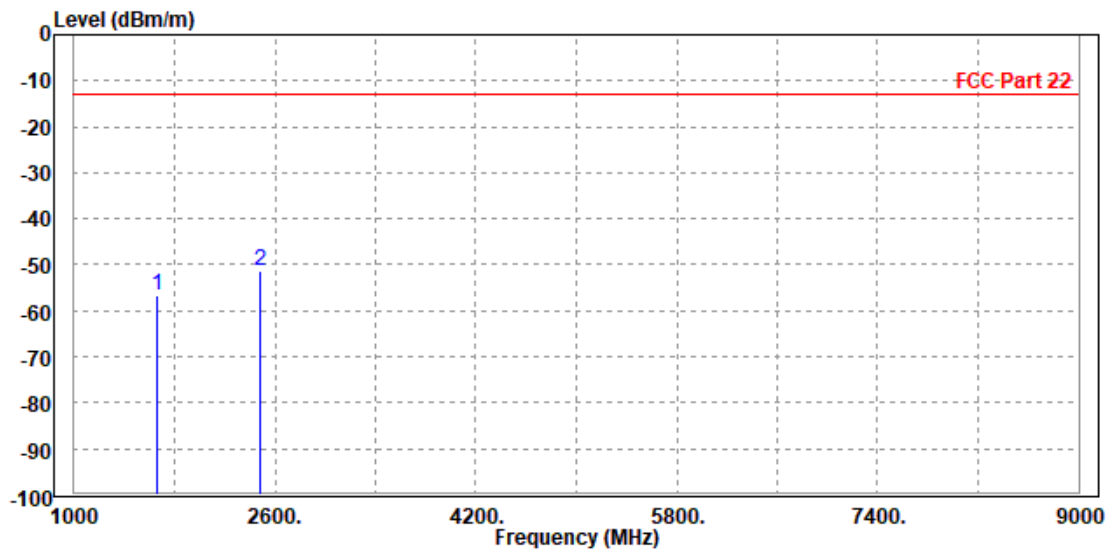



CH 20525

MODE	TX channel 20525	FREQUENCY RANGE	Above 1000MHz
ENVIRONMENTAL CONDITIONS	23deg. C, 70%RH	INPUT POWER	EUT 4.0V
TESTED BY	Jace Hu		
<b>ANTENNA POLARITY &amp; TEST DISTANCE: HORIZONTAL AT 3 M</b>			

	Freq	Level	Read Level	Limit Line	Over Limit	Factor	Remark	Pol/Phase
	MHz	dBm/m	dBm	dBm/m	dB	dB/m		
1	1673.000	-56.79	-57.77	-13.00	-43.79	0.98	Peak	Horizontal
2 PP	2512.000	-46.16	-51.63	-13.00	-33.16	5.47	Peak	Horizontal

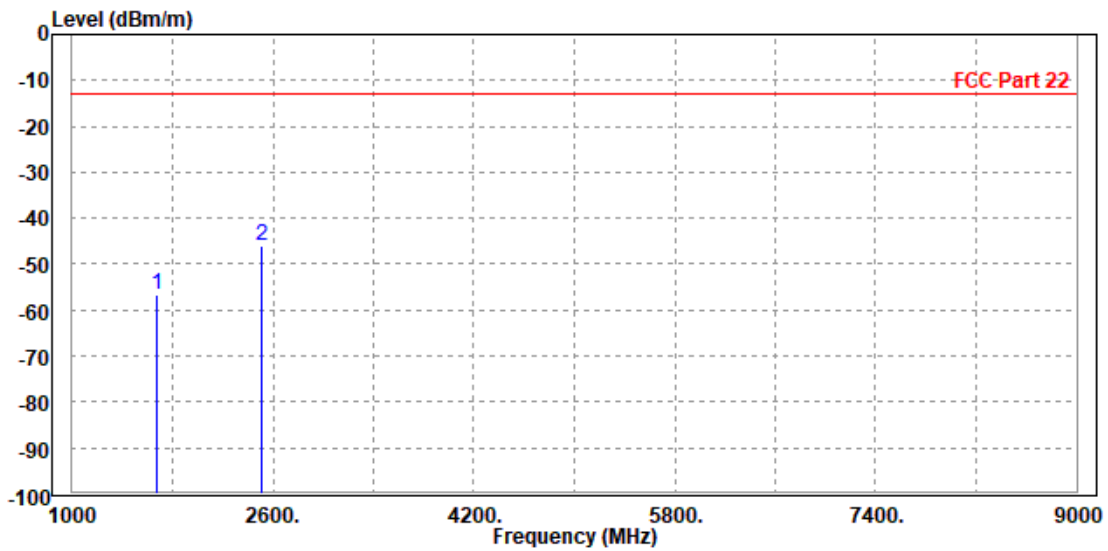



**BUREAU  
VERITAS**

**Test Report No.: W7L-221220W001RF01**

<b>MODE</b>	TX channel 20525	<b>FREQUENCY RANGE</b>	Above 1000MHz
<b>ENVIRONMENTAL CONDITIONS</b>	23deg. C, 70%RH	<b>INPUT POWER</b>	EUT 4.0V
<b>TESTED BY</b>	Jace Hu		
<b>ANTENNA POLARITY &amp; TEST DISTANCE: VERTICAL AT 3 M</b>			

	Freq	Level	Read Level	Limit Line	Over Limit	Factor	Remark	Pol/Phase
	MHz	dBm/m	dBm	dBm/m	dB	dB/m		
1	1672.000	-56.21	-57.42	-13.00	-43.21	1.21	Peak	Vertical
2 PP	2509.500	-48.66	-53.63	-13.00	-35.66	4.97	Peak	Vertical

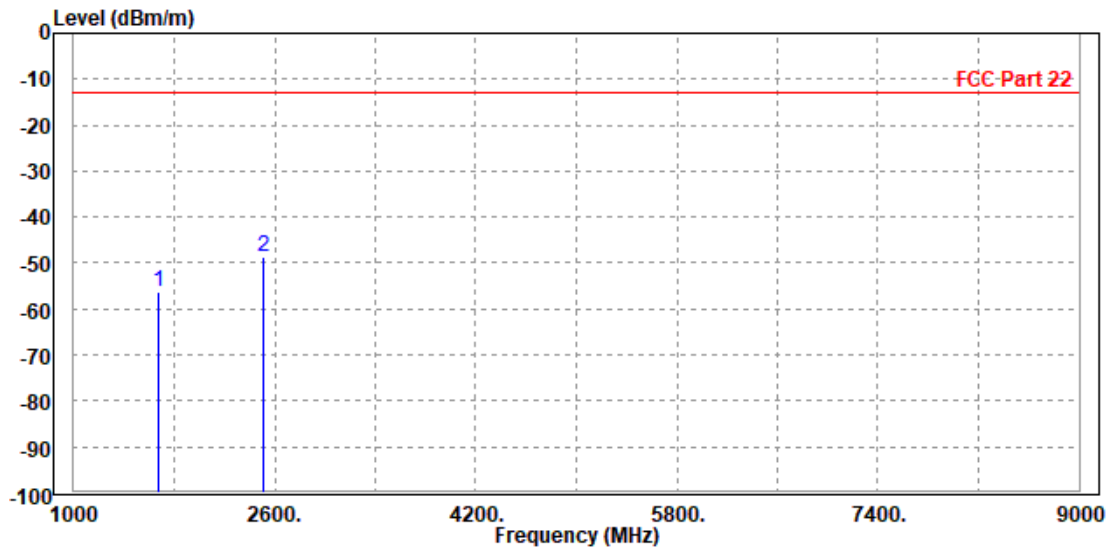





**BUREAU  
VERITAS**

**Test Report No.: W7L-221220W001RF01**

**CH 20600**

<b>MODE</b>	TX channel 20600	<b>FREQUENCY RANGE</b>	Above 1000MHz
<b>ENVIRONMENTAL CONDITIONS</b>	23deg. C, 70%RH	<b>INPUT POWER</b>	EUT 4.0V
<b>TESTED BY</b>	Jace Hu		
<b>ANTENNA POLARITY &amp; TEST DISTANCE: HORIZONTAL AT 3 M</b>			

	Freq	Level	Read Level	Limit Line	Over Limit	Factor	Remark	Pol/Phase
	MHz	dBm/m	dBm	dBm/m	dB	dB/m		
1	1688.000	-56.34	-57.44	-13.00	-43.34	1.10	Peak	Horizontal
2 PP	2536.000	-52.88	-58.41	-13.00	-39.88	5.53	Peak	Horizontal

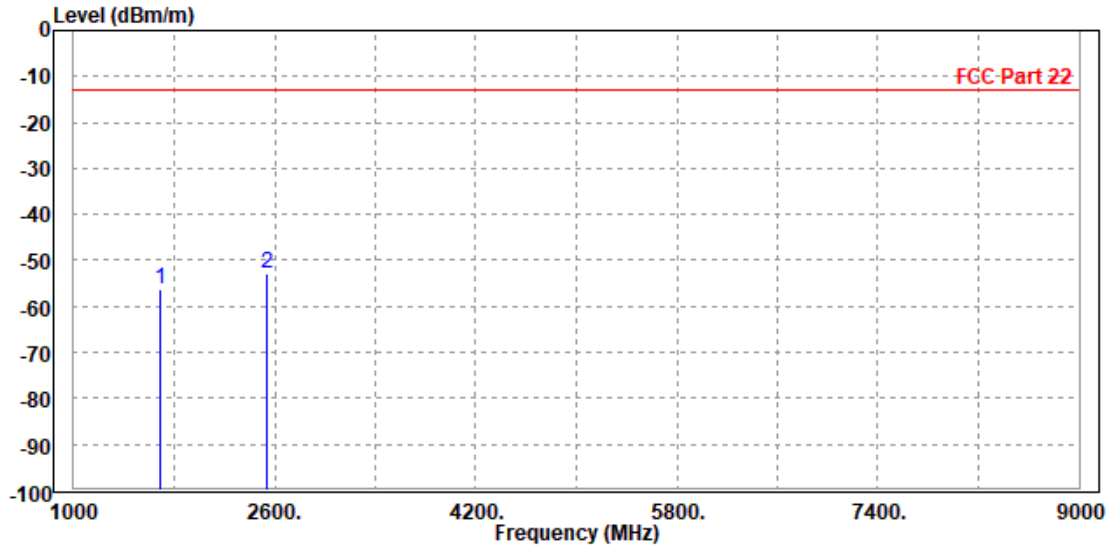



**BUREAU  
VERITAS**

**Test Report No.: W7L-221220W001RF01**

<b>MODE</b>	TX channel 20600	<b>FREQUENCY RANGE</b>	Above 1000MHz
<b>ENVIRONMENTAL CONDITIONS</b>	23deg. C, 70%RH	<b>INPUT POWER</b>	EUT 4.0V
<b>TESTED BY</b>	Jace Hu		
<b>ANTENNA POLARITY &amp; TEST DISTANCE: VERTICAL AT 3 M</b>			

	Freq	Level	Read Level	Limit Line	Over Limit	Factor	Remark	Pol/Phase
	MHz	dBm/m	dBm	dBm/m	dB	dB/m		
1	1688.000	-55.73	-57.06	-13.00	-42.73	1.33	Peak	Vertical
2 PP	2532.000	-52.51	-57.55	-13.00	-39.51	5.04	Peak	Vertical

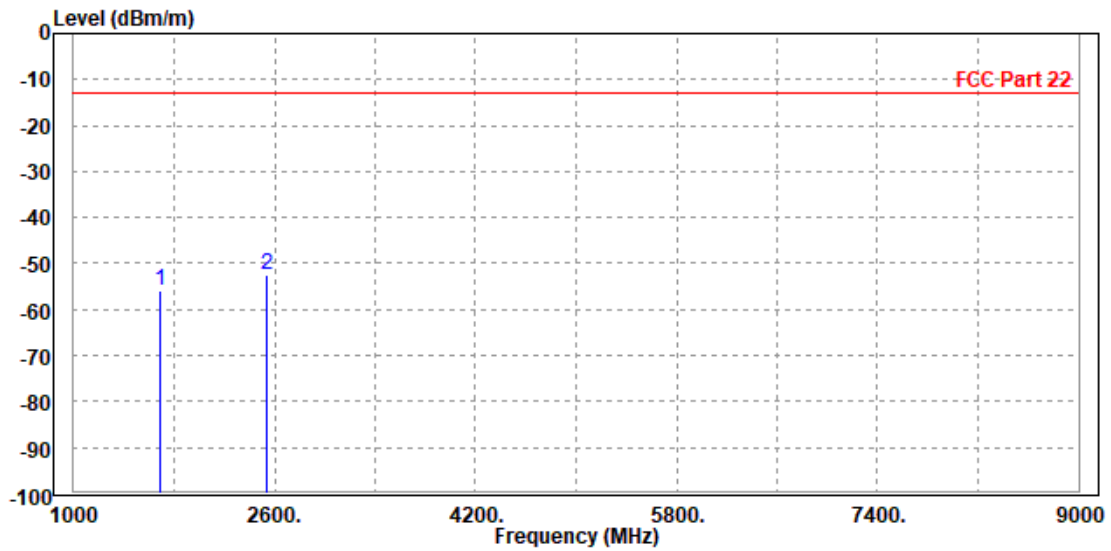

### 3.7 PEAK TO AVERAGE RATIO

#### 3.7.1 LIMITS OF PEAK TO AVERAGE RATIO MEASUREMENT

In measuring transmissions in this band using an average power technique, the peak to-average ratio (PAR) of the transmission may not exceed 13 dB

#### 3.7.2 TEST SETUP

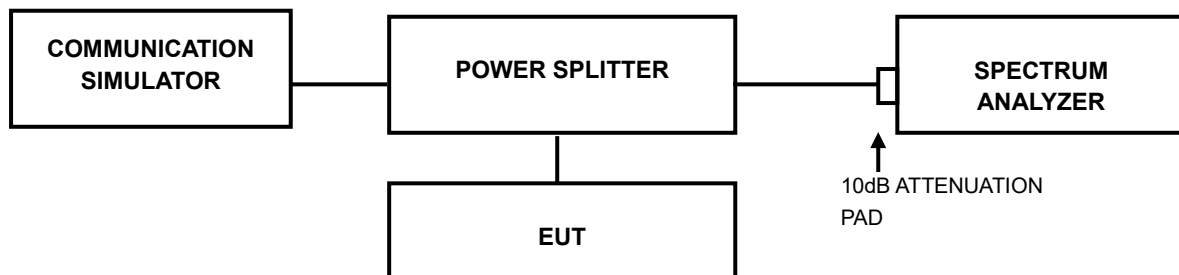

#### 3.7.3 TEST PROCEDURES

1. Set resolution/measurement bandwidth  $\geq$  signal's occupied bandwidth;
2. Set the number of counts to a value that stabilizes the measured CCDF curve;
3. Record the maximum PAPR level associated with a probability of 0.1%.



**BUREAU  
VERITAS**

**Test Report No.: W7L-221220W001RF01**

### 3.7.4 TEST RESULTS

Please Refer to Appendix Of this test report.



**BUREAU  
VERITAS**

Test Report No.: W7L-221220W001RF01

## 4 PHOTOGRAPHS OF THE TEST CONFIGURATION

Please refer to the attached file (Test Setup Photo).



**BUREAU  
VERITAS**

Test Report No.: W7L-221220W001RF01

## 5 INFORMATION ON THE TESTING LABORATORIES

We, BV 7LAYERS COMMUNICATIONS TECHNOLOGY (SHENZHEN) CO. LTD., were founded in 2015 to provide our best service in EMC, Radio, Telecom and Safety consultation. Our laboratories are accredited and approved according to ISO/IEC 17025.

If you have any comments, please feel free to contact us at the following:

**Shenzhen EMC/RF Lab:**

Tel: +86-755-88696566

Fax: +86-755-88696577

**Email:** [customerservice.sw@bureauveritas.com](mailto:customerservice.sw@bureauveritas.com)

**Web Site:** [www.adt.com.tw](http://www.adt.com.tw)

The address and road map of all our labs can be found in our web site also.



**BUREAU  
VERITAS**

Test Report No.: W7L-221220W001RF01

## **6 MODIFICATIONS RECORDERS FOR ENGINEERING CHANGES TO THE EUT BY THE LAB**

No any modifications are made to the EUT by the lab during the test.



## 7 APPENDIX

### GSM 850

#### PEAK-TO-AVERAGE RATIO

##### Test Result

Band	Channel	Result(dB)	Limit(dB)	Verdict
GPRS850	189	2.78	13	PASS
GPRS850	128	2.78	13	PASS
GPRS850	251	2.78	13	PASS
EGPRS850	189	5.82	13	PASS
EGPRS850	128	5.75	13	PASS
EGPRS850	251	5.75	13	PASS





### Test Graphs

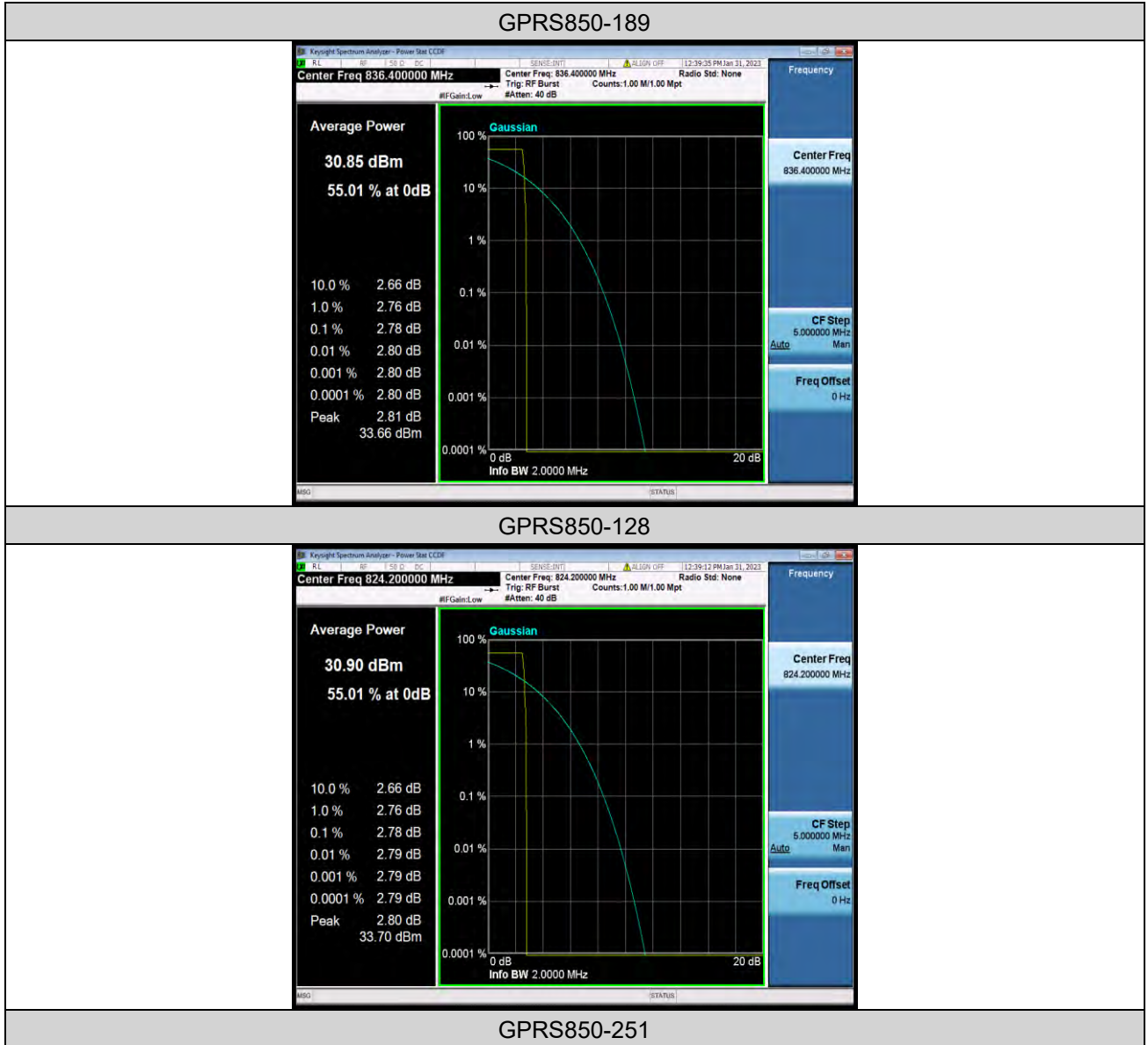

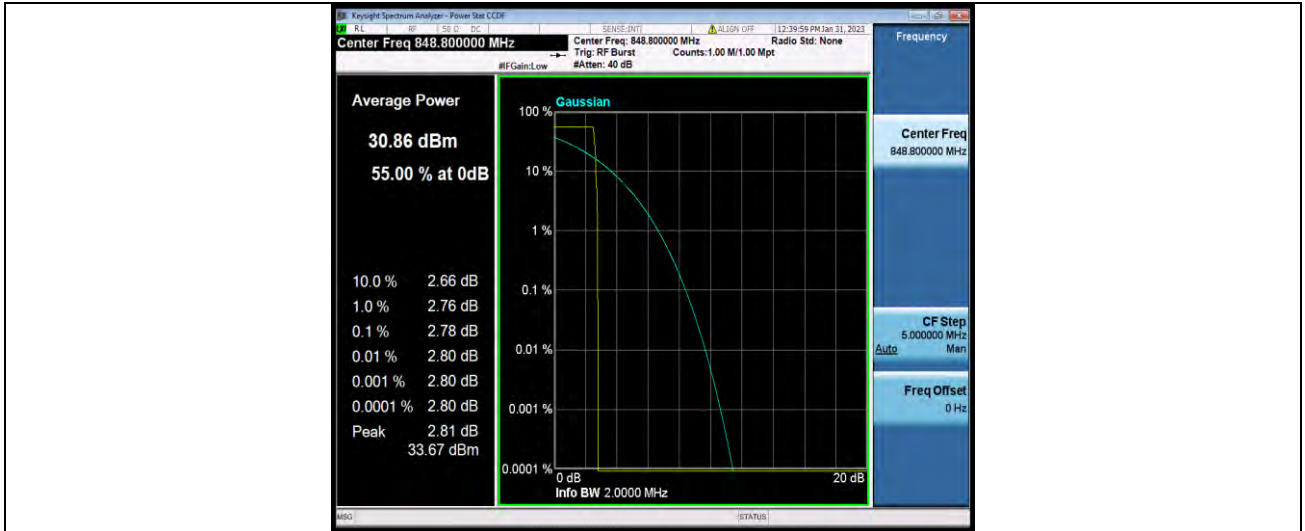

EGPRS850-189

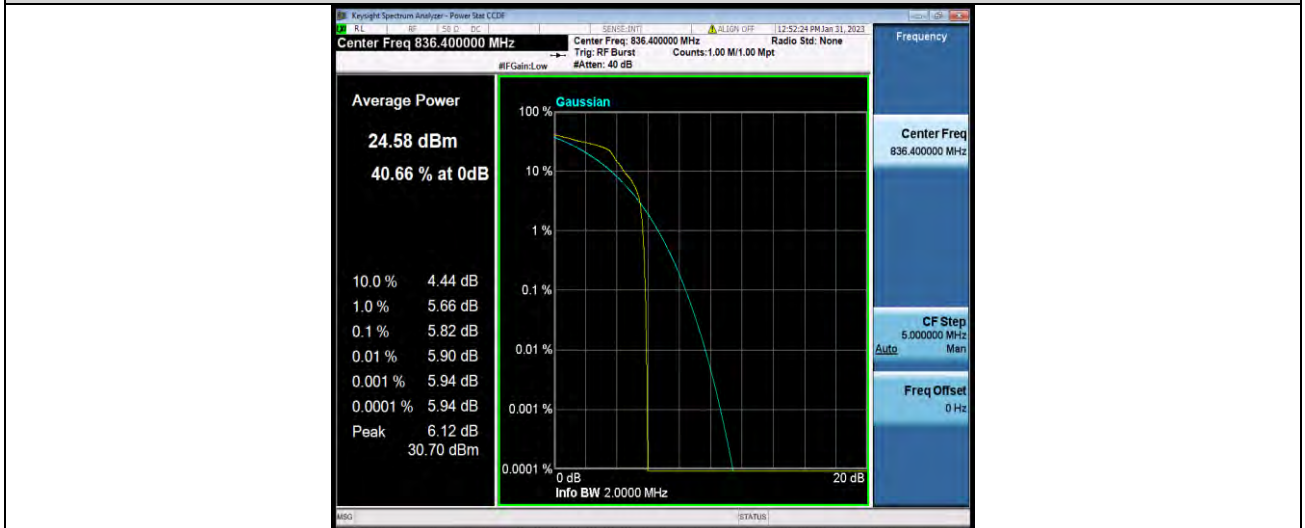

EGPRS850-128

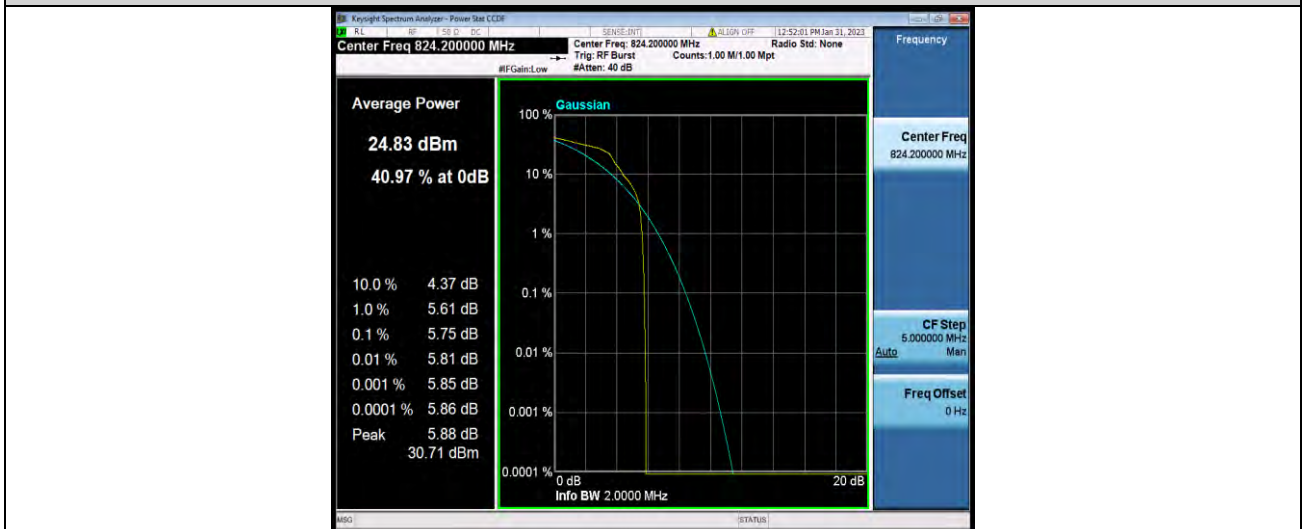

EGPRS850-251



**BUREAU  
VERITAS**

**Test Report No.: W7L-221220W001RF01**

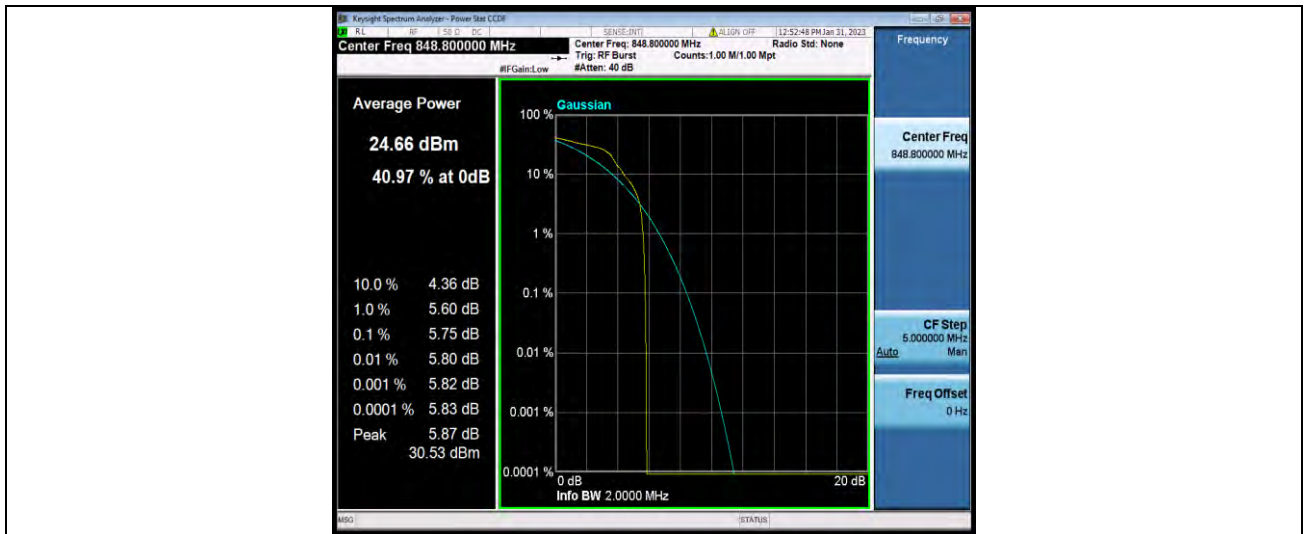



## 26DB BANDWIDTH AND OCCUPIED BANDWIDTH

### Test Result

Band	Channel	Occupied Bandwidth (MHz)	26dB Bandwidth (MHz)	Limit (MHz)	Verdict
GPRS850	189	0.24824	0.3113	---	PASS
GPRS850	128	0.24562	0.3166	---	PASS
GPRS850	251	0.24438	0.3154	---	PASS
EGPRS850	189	0.24478	0.3073	---	PASS
EGPRS850	128	0.24246	0.3123	---	PASS
EGPRS850	251	0.24985	0.3059	---	PASS



### Test Graphs

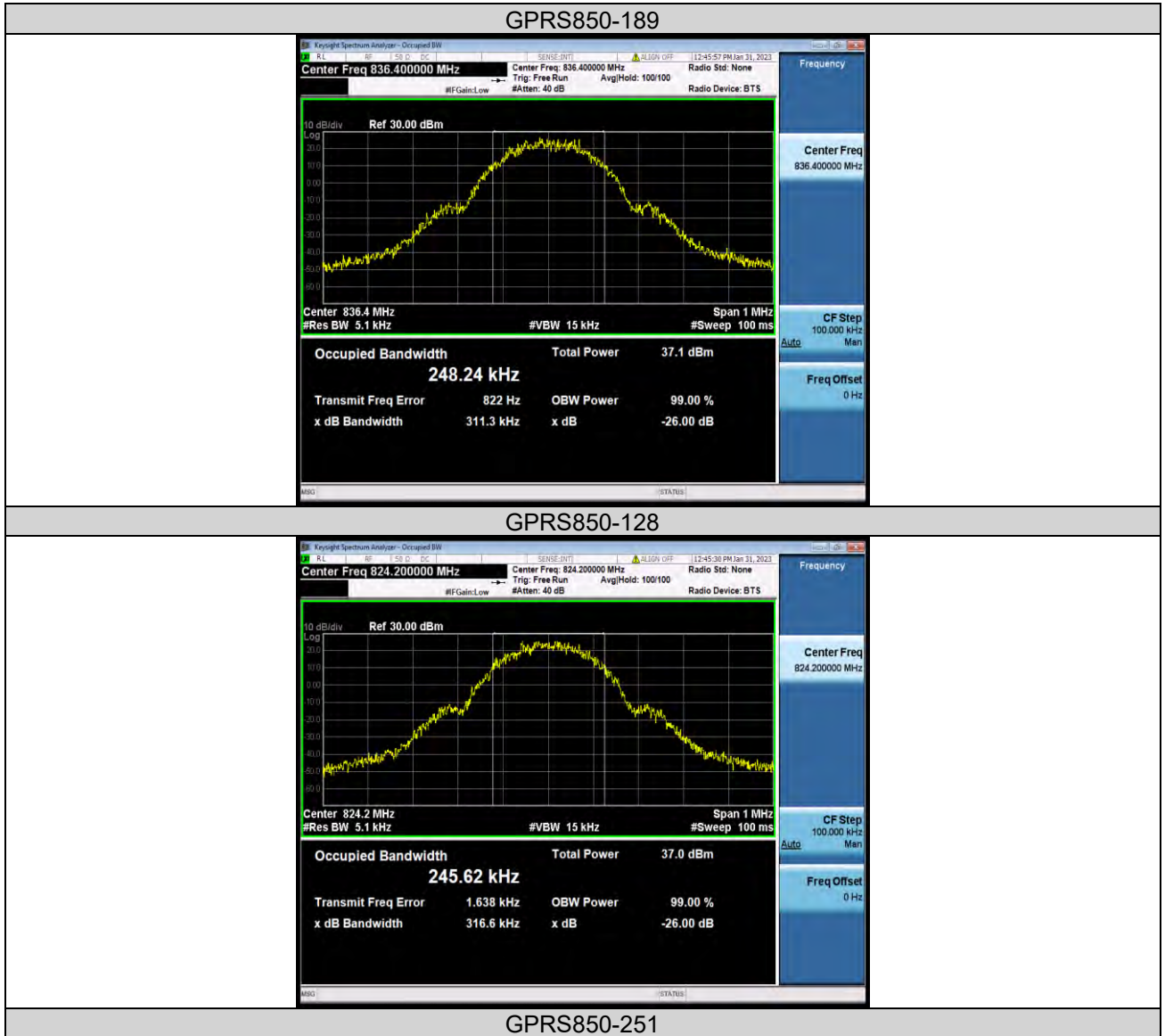





BUREAU VERITAS

Test Report No.: W7L-221220W001RF01

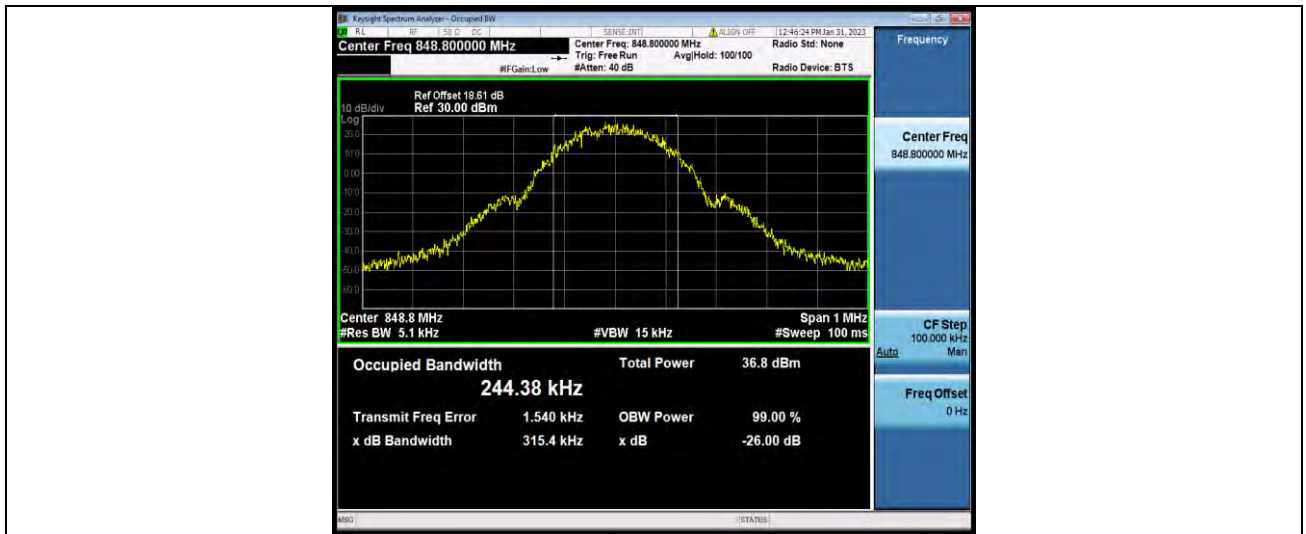

EGPRS850-189

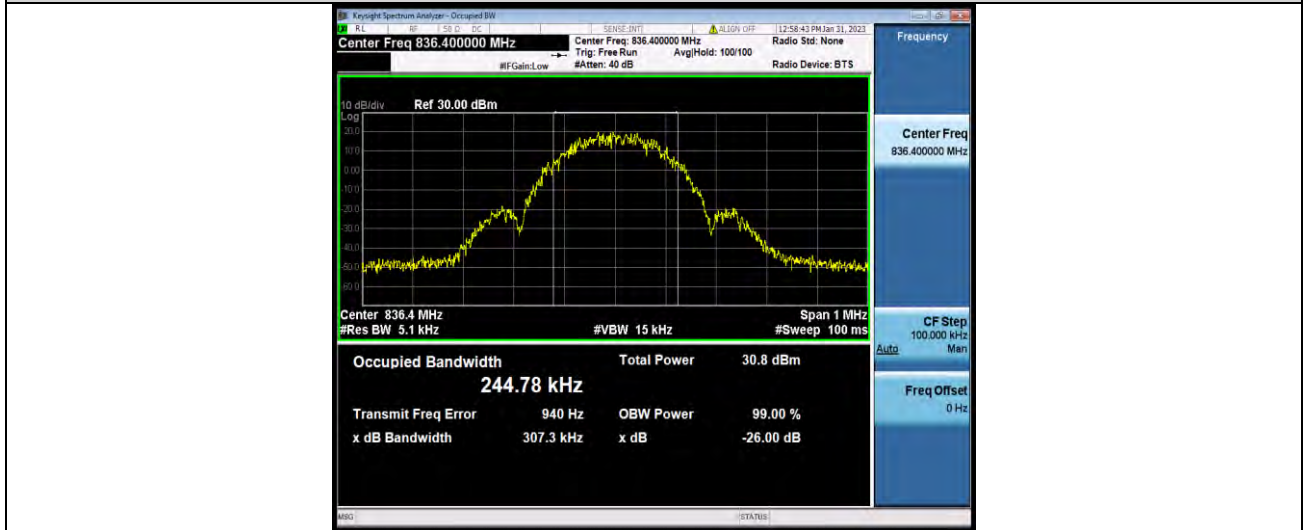

EGPRS850-128

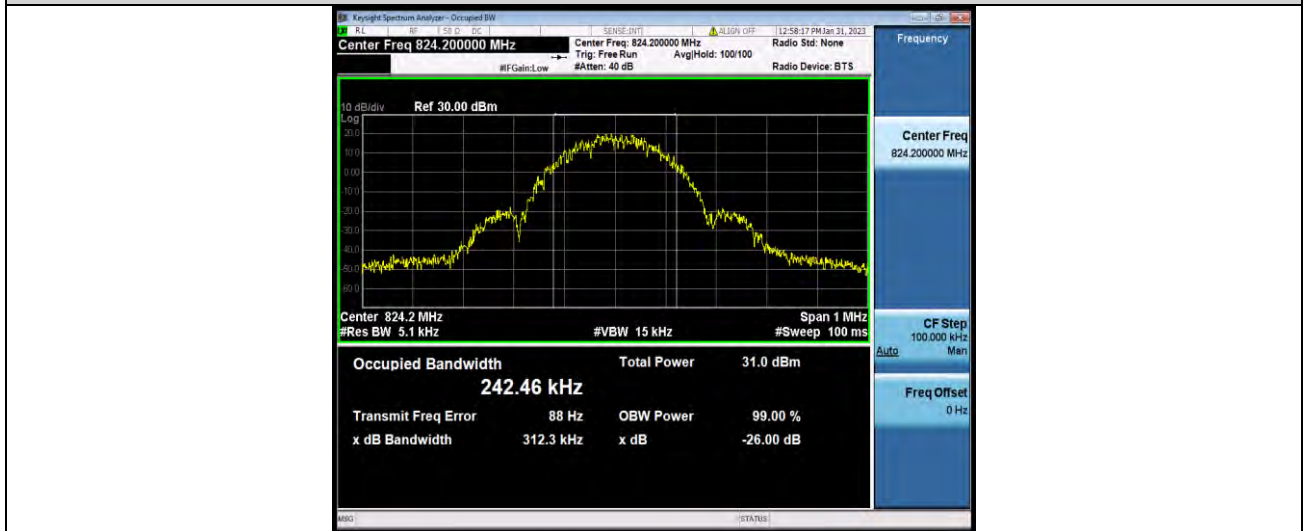

EGPRS850-251



**BUREAU  
VERITAS**

**Test Report No.: W7L-221220W001RF01**

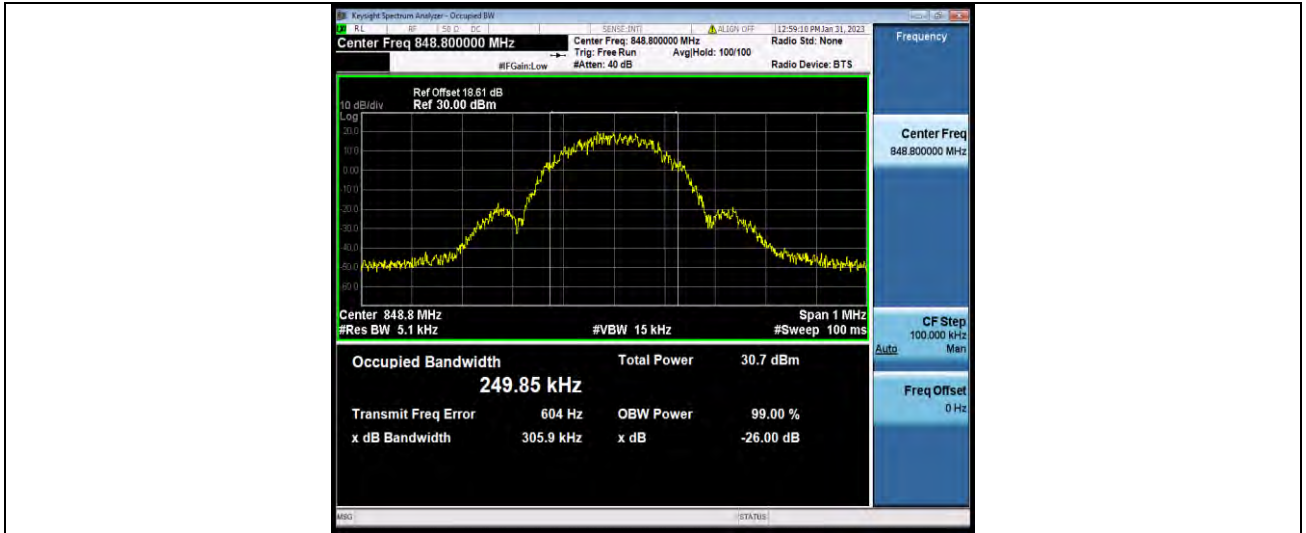



**BUREAU**  
**VERITAS**

Test Report No.: W7L-221220W001RF01

## BAND EDGE

### Test Result

Band	Channel	Freq (MHz)	Result (dBm)	Limit(dBm)	Verdict
GPRS850	128	823.99	-23.73	-13	PASS
GPRS850	251	849.01	-22.39	-13	PASS
EGPRS850	128	824.00	-21.95	-13	PASS
EGPRS850	251	849.04	-19.53	-13	PASS





BUREAU VERITAS

Test Report No.: W7L-221220W001RF01

### Test Graphs

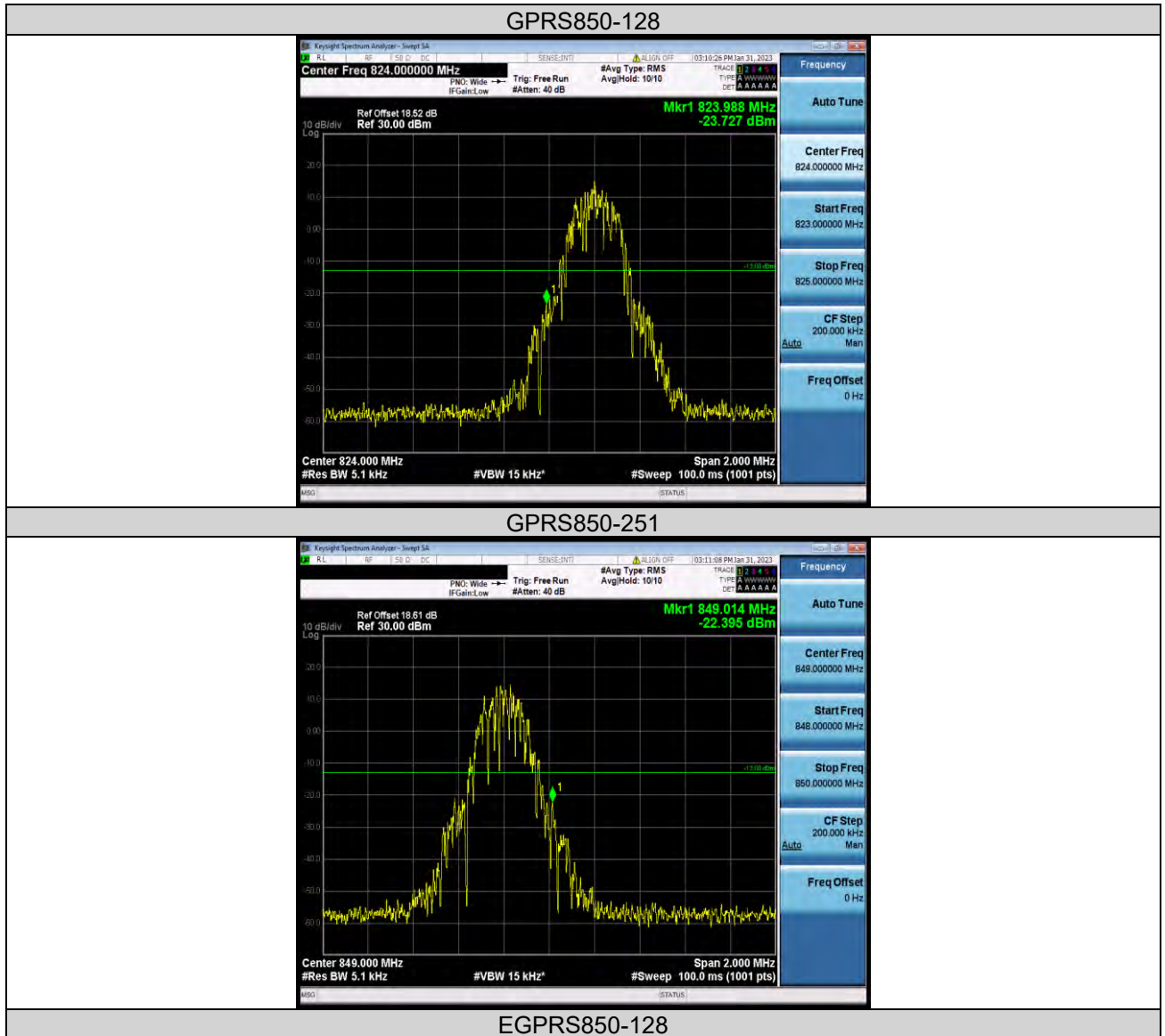

EGPRS850-128



BUREAU VERITAS

Test Report No.: W7L-221220W001RF01

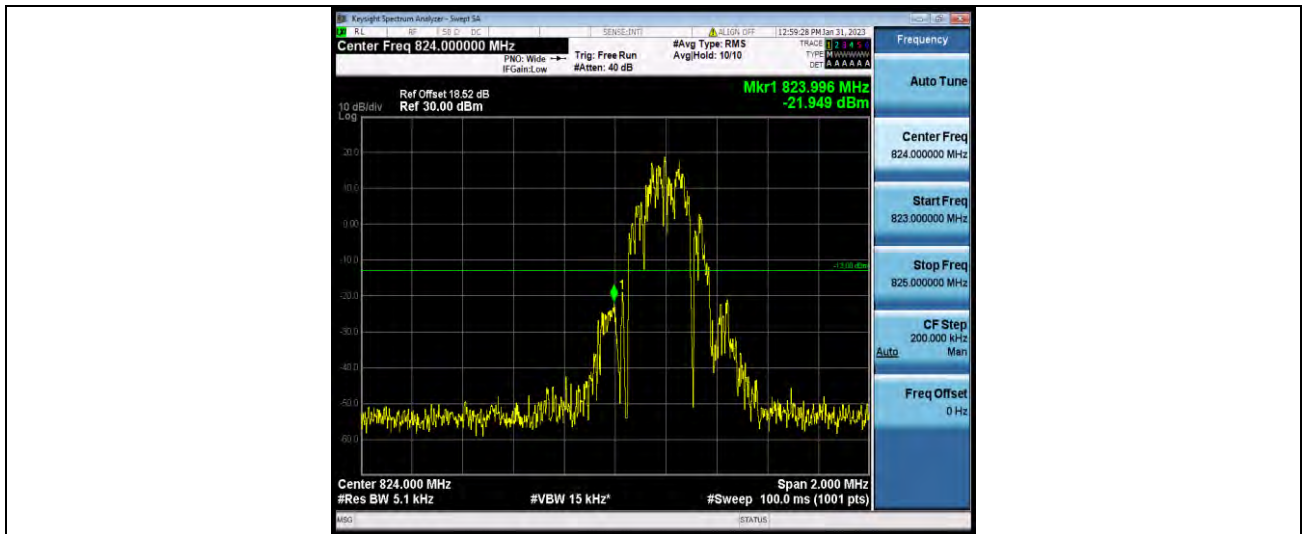

EGPRS850-251

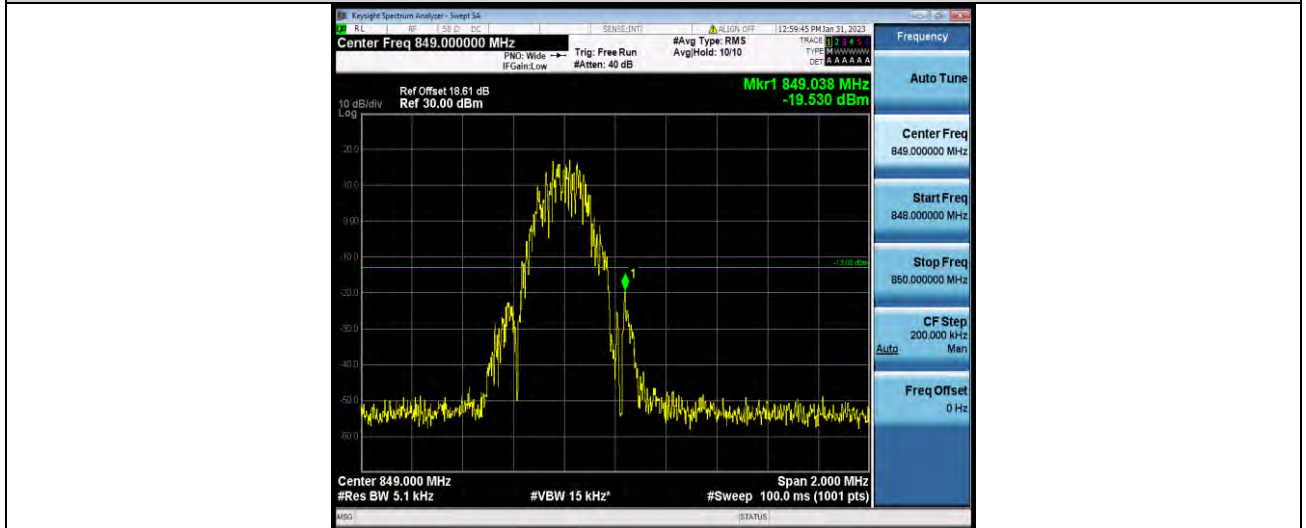



## CONDUCTED SPURIOUS EMISSION

### Test Result

Band	Channel	Frequency Range(MHz)	Max.Freq. (MHz)	Result (dBm)	Limit (dBm)	Verdict
GPRS850	189	30~1000MHz	973.23	-44.08	-13	PASS
GPRS850	189	1000~10000MHz	3793.3	-26.64	-13	PASS
GPRS850	128	30~1000MHz	723.03	-44.39	-13	PASS
GPRS850	128	1000~10000MHz	3820.6	-26.53	-13	PASS
GPRS850	251	30~1000MHz	991.24	-44.1	-13	PASS
GPRS850	251	1000~10000MHz	3769	-26.73	-13	PASS
EGPRS850	189	30~1000MHz	962.95	-44.45	-13	PASS
EGPRS850	189	1000~10000MHz	3769.3	-26.49	-13	PASS
EGPRS850	128	30~1000MHz	676.57	-44.35	-13	PASS
EGPRS850	128	1000~10000MHz	3845.5	-25.8	-13	PASS
EGPRS850	251	30~1000MHz	591.27	-44.17	-13	PASS
EGPRS850	251	1000~10000MHz	3679.9	-25.4	-13	PASS



BUREAU VERITAS

Test Report No.: W7L-221220W001RF01

### Test Graphs

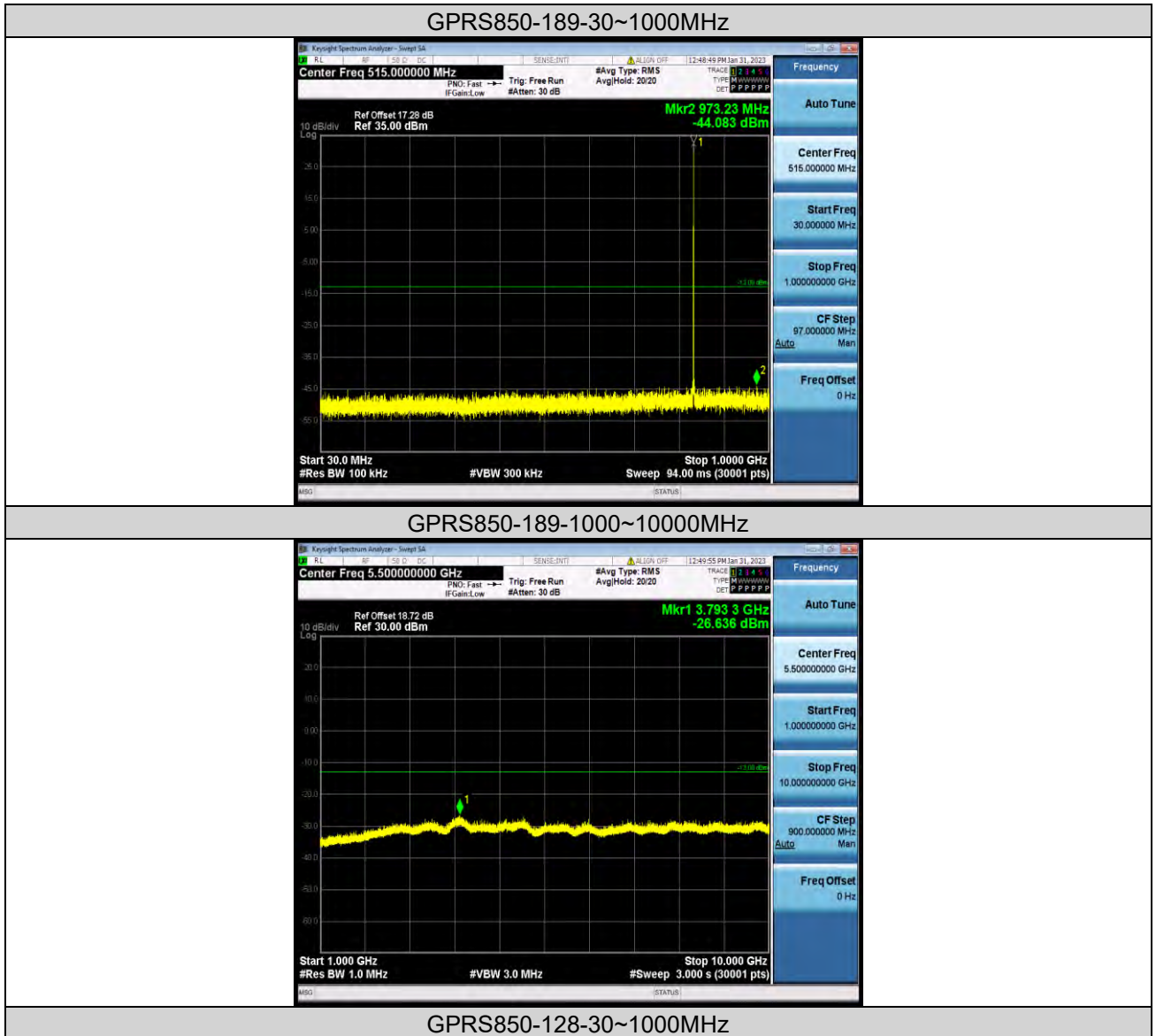



BUREAU VERITAS

Test Report No.: W7L-221220W001RF01

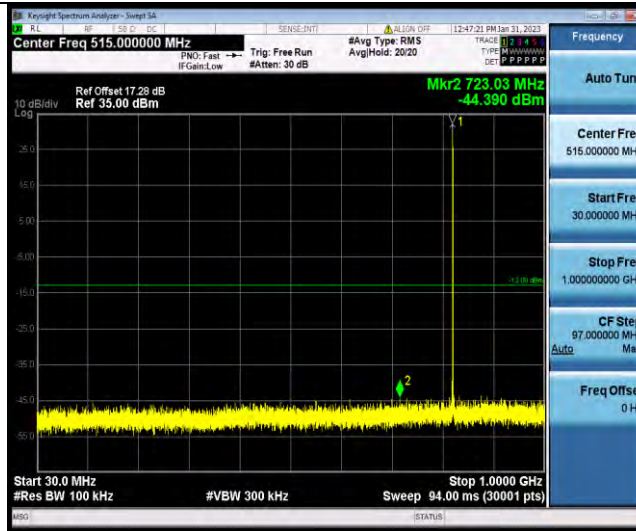

GPRS850-128-1000~10000MHz



GPRS850-251-30~1000MHz

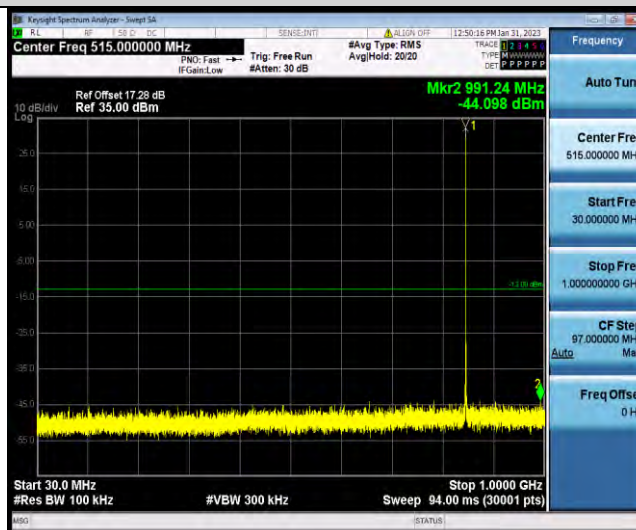

GPRS850-251-1000~10000MHz





BUREAU VERITAS

Test Report No.: W7L-221220W001RF01



EGPRS850-189-30~1000MHz

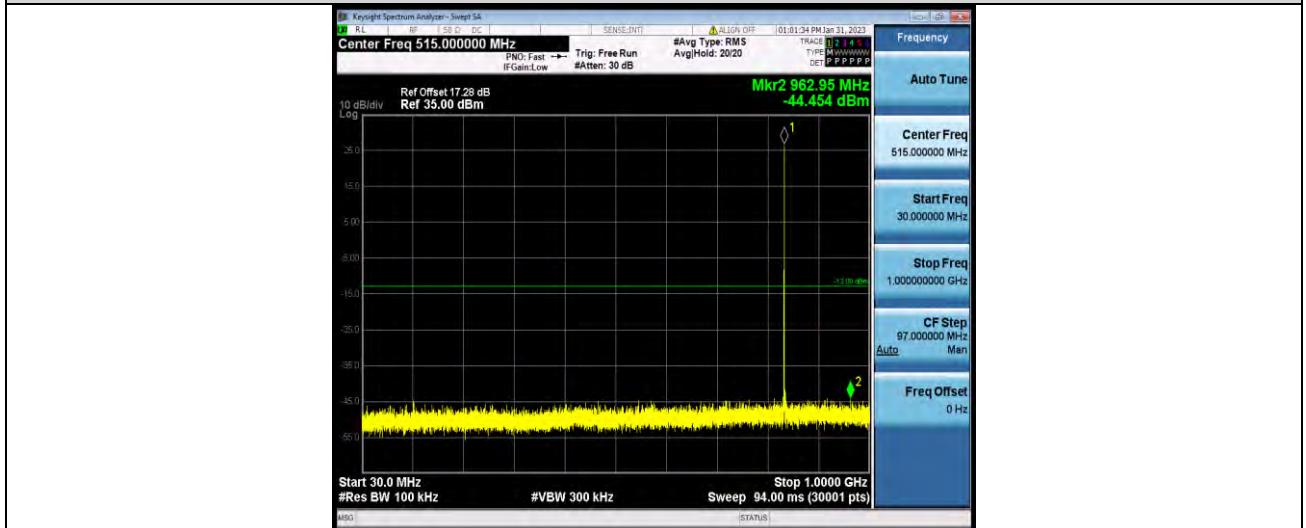

EGPRS850-189-1000~10000MHz

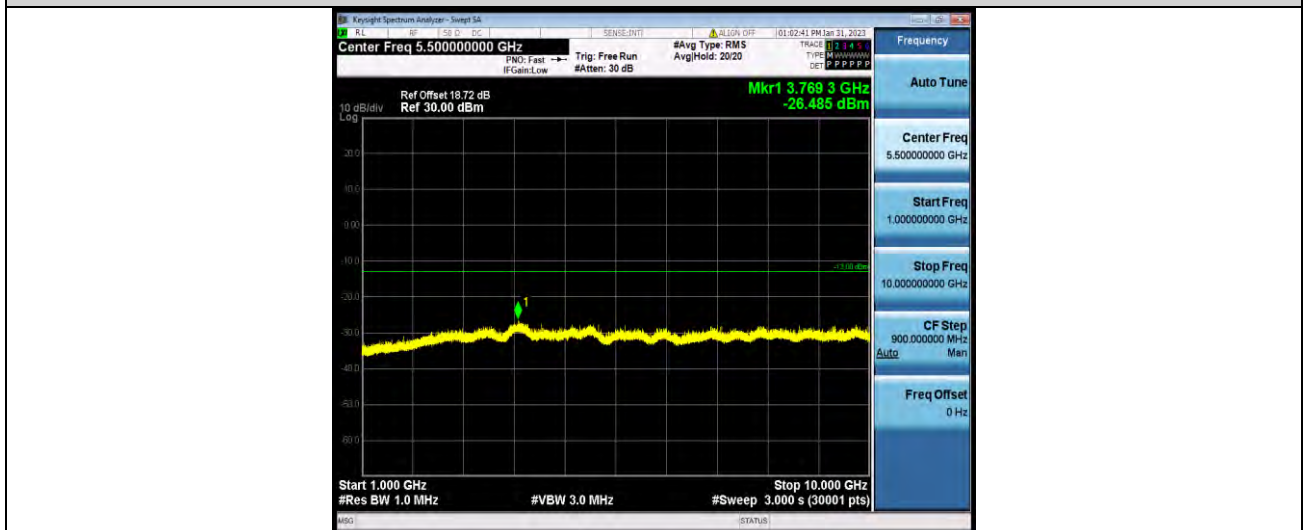

EGPRS850-128-30~1000MHz



BUREAU VERITAS

Test Report No.: W7L-221220W001RF01

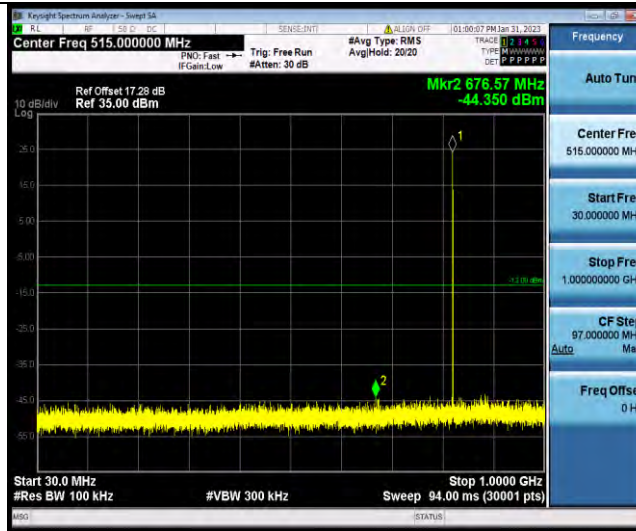

EGPRS850-128-1000~10000MHz



EGPRS850-251-30~1000MHz



EGPRS850-251-1000~10000MHz



**BUREAU  
VERITAS**

**Test Report No.: W7L-221220W001RF01**







### FREQUENCY STABILITY

#### Test Result

Voltage							
Band	Channel	Voltage [Vdc]	Temperature (°C)	Deviation (Hz)	Deviation (ppm)	Limit (ppm)	Verdict
GPRS850	189	VL	NT	29.19	0.034900	±2.5	PASS
GPRS850	189	VN	NT	29.64	0.035438	±2.5	PASS
GPRS850	189	VH	NT	30.61	0.036597	±2.5	PASS
GPRS850	128	VL	NT	29.48	0.035768	±2.5	PASS
GPRS850	128	VN	NT	27.89	0.033839	±2.5	PASS
GPRS850	128	VH	NT	29.25	0.035489	±2.5	PASS
GPRS850	251	VL	NT	28.25	0.033282	±2.5	PASS
GPRS850	251	VN	NT	29.51	0.034767	±2.5	PASS
GPRS850	251	VH	NT	29.09	0.034272	±2.5	PASS

Temperature							
Band	Channel	Voltage [Vdc]	Temperature (°C)	Deviation (Hz)	Deviation (ppm)	Limit (ppm)	Verdict
GPRS850	189	NV	-30	28.83	0.034469	±2.5	PASS
GPRS850	189	NV	-20	28.61	0.034206	±2.5	PASS
GPRS850	189	NV	-10	28.83	0.034469	±2.5	PASS
GPRS850	189	NV	0	29.19	0.034900	±2.5	PASS
GPRS850	189	NV	10	28.90	0.034553	±2.5	PASS
GPRS850	189	NV	20	28.61	0.034206	±2.5	PASS
GPRS850	189	NV	30	28.57	0.034158	±2.5	PASS
GPRS850	189	NV	40	28.93	0.034589	±2.5	PASS
GPRS850	189	NV	50	27.83	0.033274	±2.5	PASS
GPRS850	128	NV	-30	30.12	0.036545	±2.5	PASS
GPRS850	128	NV	-20	27.93	0.033887	±2.5	PASS
GPRS850	128	NV	-10	27.06	0.032832	±2.5	PASS
GPRS850	128	NV	0	28.54	0.034628	±2.5	PASS
GPRS850	128	NV	10	29.57	0.035877	±2.5	PASS
GPRS850	128	NV	20	28.57	0.034664	±2.5	PASS
GPRS850	128	NV	30	28.02	0.033997	±2.5	PASS
GPRS850	128	NV	40	28.77	0.034907	±2.5	PASS
GPRS850	128	NV	50	28.90	0.035064	±2.5	PASS
GPRS850	251	NV	-30	30.19	0.035568	±2.5	PASS
GPRS850	251	NV	-20	30.35	0.035756	±2.5	PASS
GPRS850	251	NV	-10	28.44	0.033506	±2.5	PASS
GPRS850	251	NV	0	29.57	0.034837	±2.5	PASS
GPRS850	251	NV	10	28.48	0.033553	±2.5	PASS
GPRS850	251	NV	20	29.41	0.034649	±2.5	PASS
GPRS850	251	NV	30	29.32	0.034543	±2.5	PASS
GPRS850	251	NV	40	27.96	0.032941	±2.5	PASS
GPRS850	251	NV	50	29.38	0.034614	±2.5	PASS



**BUREAU  
VERITAS**

Test Report No.: W7L-221220W001RF01

## WCDMA V

### PEAK-TO-AVERAGE RATIO

#### Test Result

Band	Channel	Peak-to-Average Ratio(dB)	Limit(dBm)	Verdict
Band5	4132	4.1	13	PASS
Band5	4182	3	13	PASS
Band5	4233	2.8	13	PASS



### Test Graphs





**BUREAU  
VERITAS**

**Test Report No.: W7L-221220W001RF01**

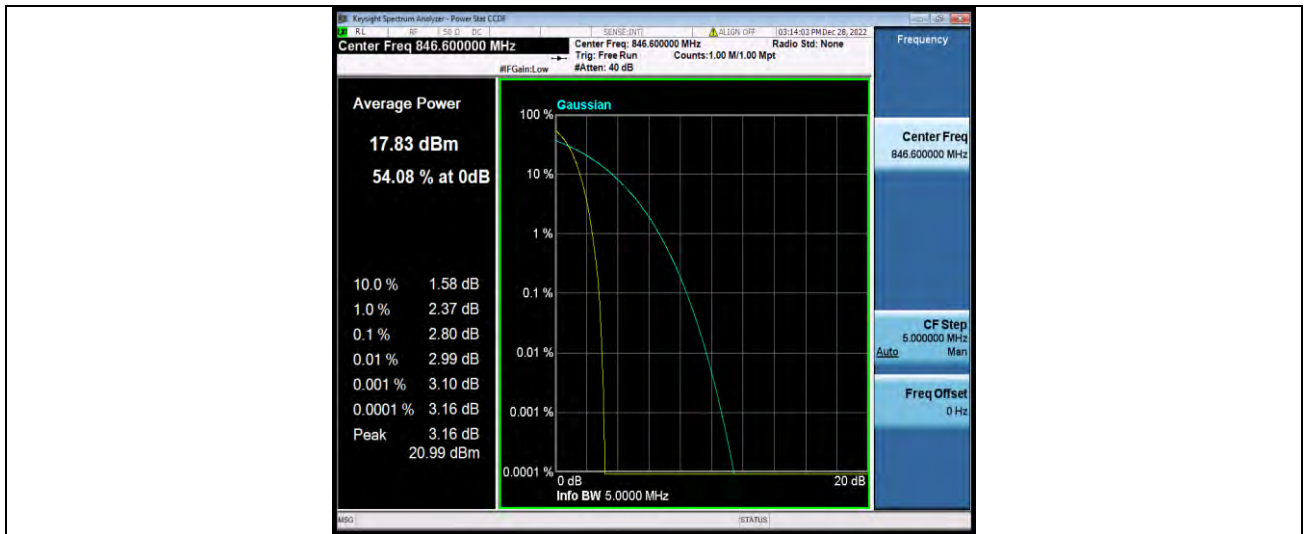



**BUREAU**  
**VERITAS**

Test Report No.: W7L-221220W001RF01

## 26DB BANDWIDTH AND OCCUPIED BANDWIDTH

### Test Result

Band	Channel	Occupied Bandwidth (kHz)	26dB Bandwidth (kHz)	Limit(kHz)	Verdict
Band5	4132	4.1381	4.720	---	PASS
Band5	4182	4.1408	4.727	---	PASS
Band5	4233	4.1475	4.745	---	PASS



BUREAU VERITAS

Test Report No.: W7L-221220W001RF01

### Test Graphs

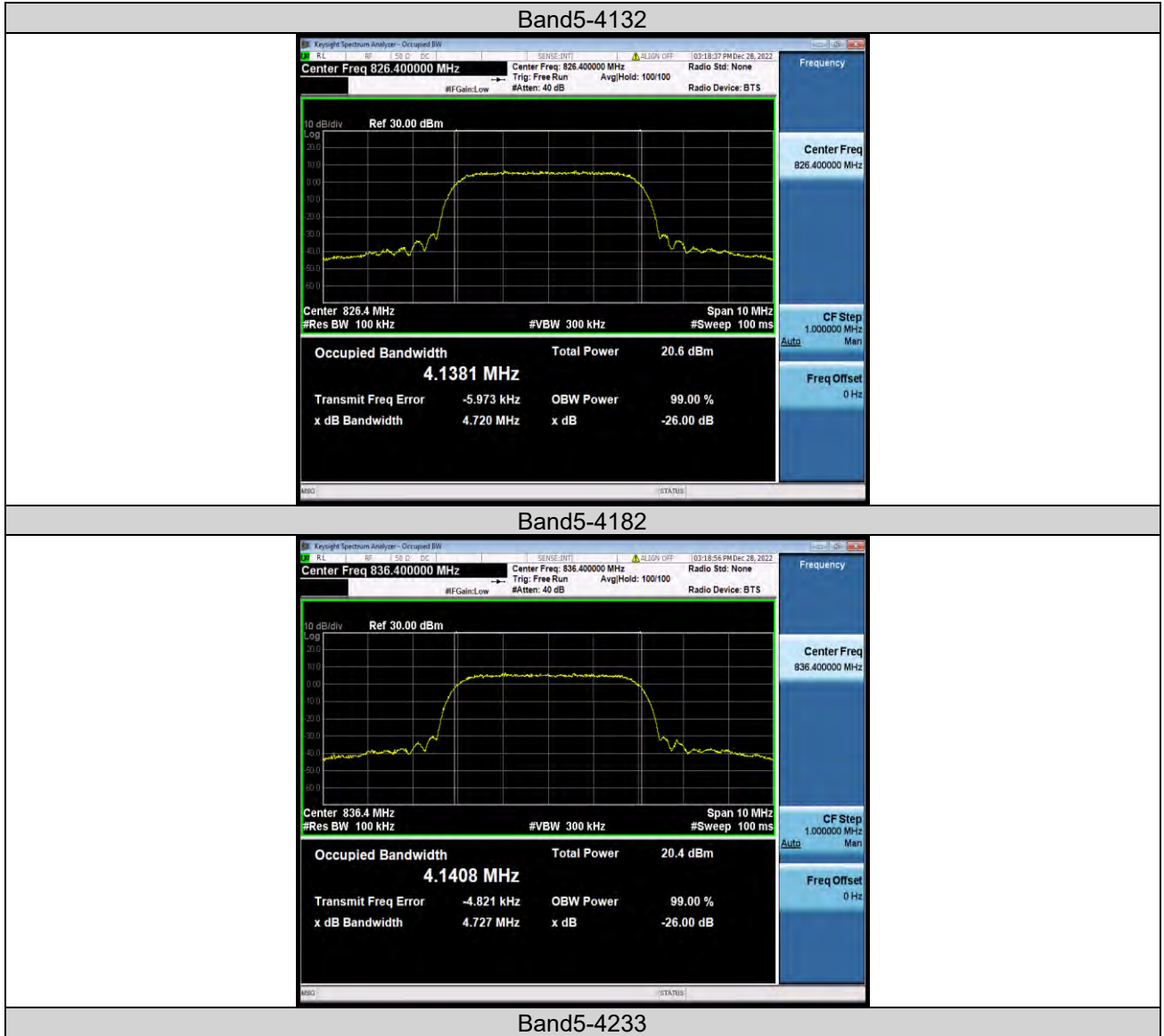



**BUREAU  
VERITAS**

**Test Report No.: W7L-221220W001RF01**

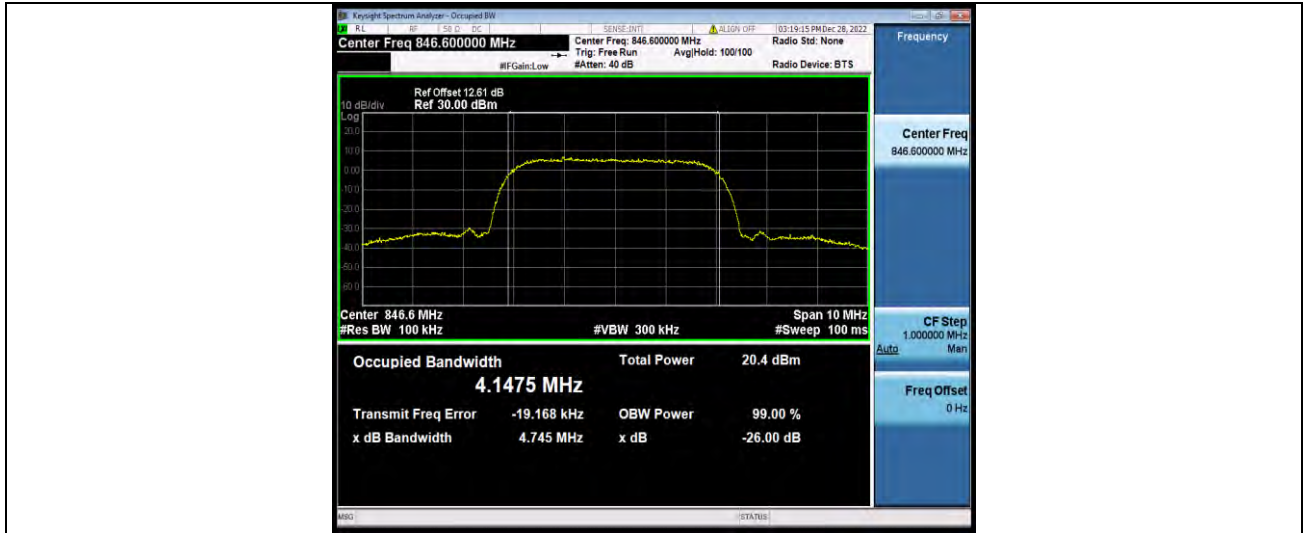



**BUREAU  
VERITAS**

**Test Report No.: W7L-221220W001RF01**

## **BAND EDGE**

### **Test Result**

Band	Channel	Frequency (MHz)	Result (dBm)	Limit(dBm)	Verdict
Band5	4132	824.00	-28.67	-13	PASS
Band5	4233	849.01	-27.82	-13	PASS





BUREAU VERITAS

Test Report No.: W7L-221220W001RF01

### Test Graphs





## CONDUCTED SPURIOUS EMISSION

### Test Result

Band	Channel	Frequency Range (Mhz)	Frequency (dBm)	Result (dBm)	Limit (dBm)	Verdict
Band5	4132	30~1000MHz	450.43	-50.76	-13	PASS
Band5	4132	1000~10000MHz	3735.1	-32.99	-13	PASS
Band5	4182	30~1000MHz	951.63	-49.22	-13	PASS
Band5	4182	1000~10000MHz	3734.2	-32.01	-13	PASS
Band5	4233	30~1000MHz	993.89	-50.41	-13	PASS
Band5	4233	1000~10000MHz	3814.6	-32.65	-13	PASS



BUREAU VERITAS

Test Report No.: W7L-221220W001RF01

### Test Graphs

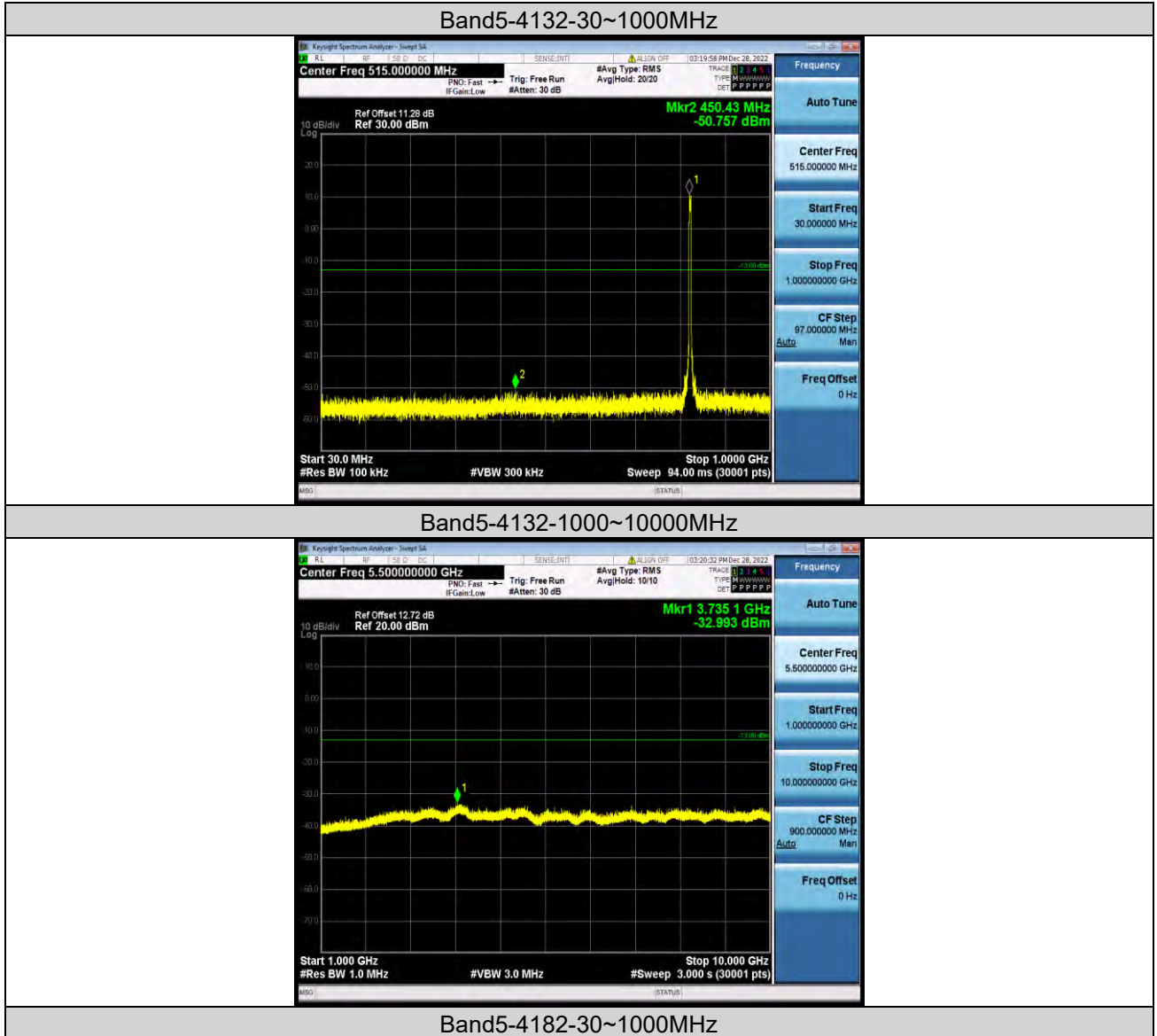



BUREAU VERITAS

Test Report No.: W7L-221220W001RF01

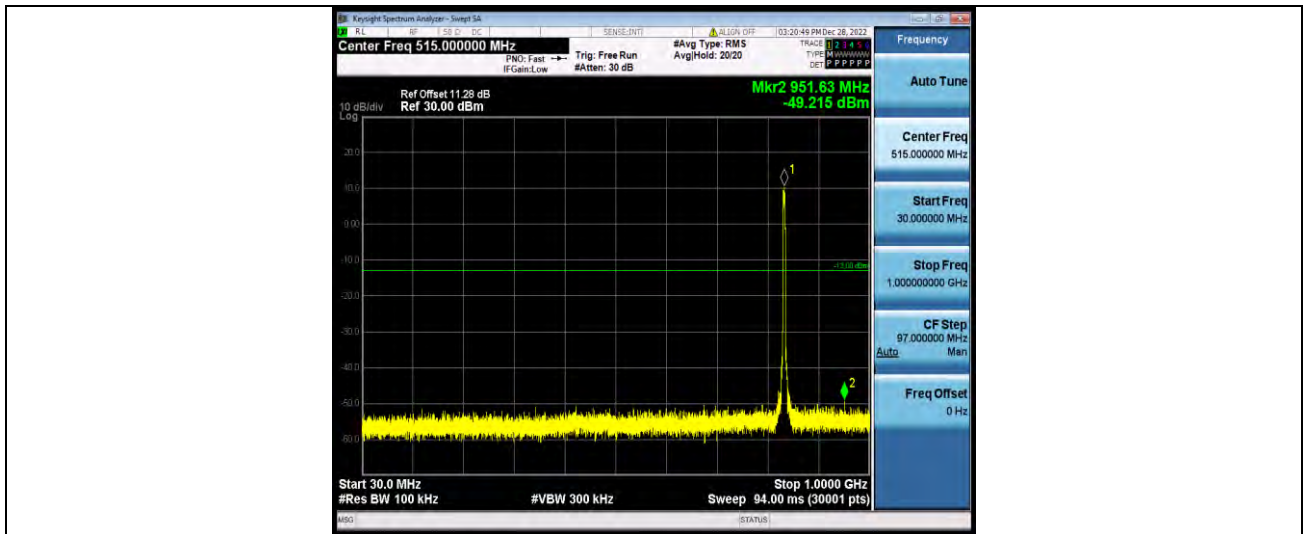

Band5-4182-1000~10000MHz



Band5-4233-30~1000MHz

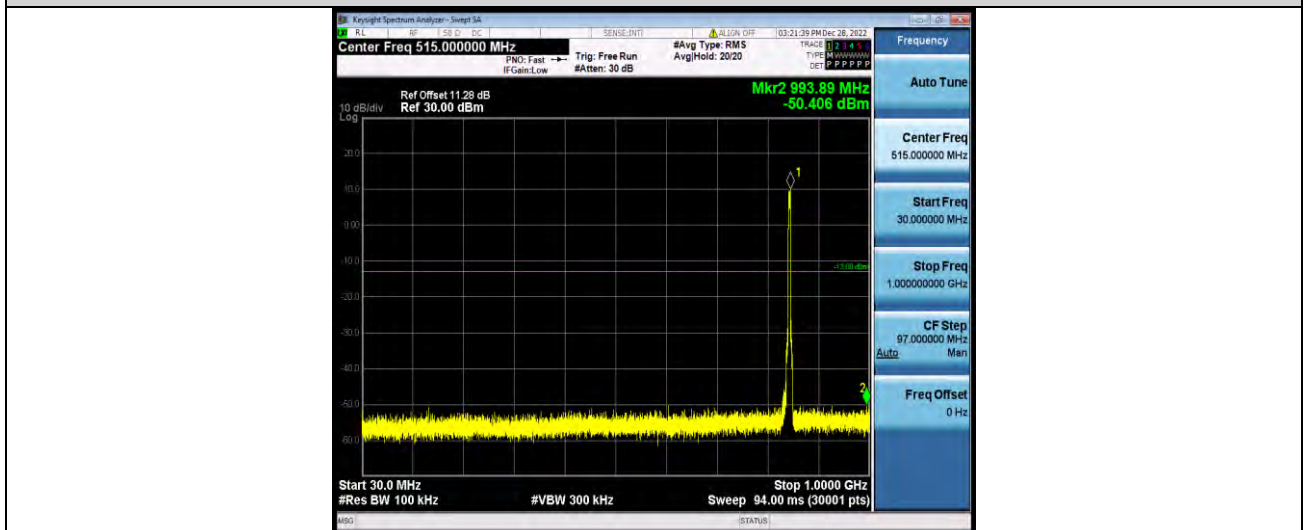

Band5-4233-1000~10000MHz



**BUREAU  
VERITAS**

**Test Report No.: W7L-221220W001RF01**

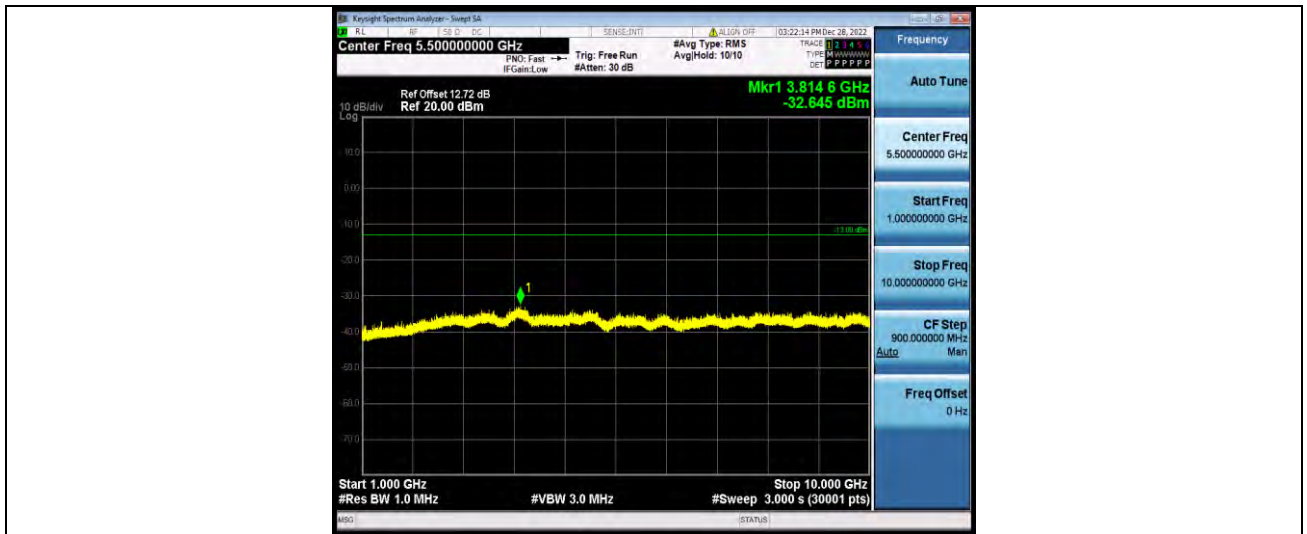



### FREQUENCY STABILITY

#### Test Result

Voltage							
Band	Channel	Voltage (Vdc)	Temperature (°C)	Deviation (Hz)	Deviation (ppm)	Limit (ppm)	Verdict
Band5	4132	VL	NT	-0.22	-0.000266	±2.5	PASS
Band5	4132	VN	NT	-0.34	-0.000411	±2.5	PASS
Band5	4132	VH	NT	-0.13	-0.000157	±2.5	PASS
Band5	4182	VL	NT	0.21	0.000251	±2.5	PASS
Band5	4182	VN	NT	-0.01	-0.000012	±2.5	PASS
Band5	4182	VH	NT	0.11	0.000132	±2.5	PASS
Band5	4233	VL	NT	0.04	0.000047	±2.5	PASS
Band5	4233	VN	NT	0.36	0.000425	±2.5	PASS
Band5	4233	VH	NT	0.41	0.000484	±2.5	PASS

Temperature							
Band	Channel	Voltage (Vdc)	Temperature (°C)	Deviation (Hz)	Deviation (ppm)	Limit (ppm)	Verdict
Band5	4132	NV	-30	-0.99	-0.001198	±2.5	PASS
Band5	4132	NV	-20	-1.03	-0.001246	±2.5	PASS
Band5	4132	NV	-10	-1.52	-0.001839	±2.5	PASS
Band5	4132	NV	0	-1.54	-0.001864	±2.5	PASS
Band5	4132	NV	10	-2.48	-0.003001	±2.5	PASS
Band5	4132	NV	20	-1.24	-0.001500	±2.5	PASS
Band5	4132	NV	30	-1.04	-0.001258	±2.5	PASS
Band5	4132	NV	40	-2.22	-0.002686	±2.5	PASS
Band5	4132	NV	50	-2.44	-0.002953	±2.5	PASS
Band5	4182	NV	-30	1.73	0.002068	±2.5	PASS
Band5	4182	NV	-20	2.15	0.002571	±2.5	PASS
Band5	4182	NV	-10	2.37	0.002834	±2.5	PASS
Band5	4182	NV	0	2.23	0.002666	±2.5	PASS
Band5	4182	NV	10	2.19	0.002618	±2.5	PASS
Band5	4182	NV	20	0.93	0.001112	±2.5	PASS
Band5	4182	NV	30	-0.67	-0.000801	±2.5	PASS
Band5	4182	NV	40	-0.69	-0.000825	±2.5	PASS
Band5	4182	NV	50	-0.02	-0.000024	±2.5	PASS
Band5	4233	NV	-30	1.07	0.001264	±2.5	PASS
Band5	4233	NV	-20	1.36	0.001606	±2.5	PASS
Band5	4233	NV	-10	0.69	0.000815	±2.5	PASS
Band5	4233	NV	0	0.21	0.000248	±2.5	PASS
Band5	4233	NV	10	-0.60	-0.000709	±2.5	PASS
Band5	4233	NV	20	-1.60	-0.001890	±2.5	PASS
Band5	4233	NV	30	-1.75	-0.002067	±2.5	PASS



**BUREAU**  
**VERITAS**

**Test Report No.: W7L-221220W001RF01**

Band5	4233	NV	40	-1.29	-0.001524	±2.5	PASS
Band5	4233	NV	50	-1.24	-0.001465	±2.5	PASS





## LTE BAND 5

### PEAK-TO-AVERAGE RATIO(CCDF)

#### Test Result

Band	Bandwidth	Modulation	Channel	RB Configuration	Result(dB)	Limit(dB)	Verdict
Band5	10MHz	QPSK	20450	1RB#0	4.68	13	PASS
Band5	10MHz	QPSK	20450	50RB#0	5.20	13	PASS
Band5	10MHz	QPSK	20525	1RB#0	4.73	13	PASS
Band5	10MHz	QPSK	20525	50RB#0	5.17	13	PASS
Band5	10MHz	QPSK	20600	1RB#0	4.53	13	PASS
Band5	10MHz	QPSK	20600	50RB#0	4.80	13	PASS
Band5	10MHz	16QAM	20450	1RB#0	5.54	13	PASS
Band5	10MHz	16QAM	20450	50RB#0	6.04	13	PASS
Band5	10MHz	16QAM	20525	1RB#0	5.65	13	PASS
Band5	10MHz	16QAM	20525	50RB#0	5.97	13	PASS
Band5	10MHz	16QAM	20600	1RB#0	5.22	13	PASS
Band5	10MHz	16QAM	20600	50RB#0	5.66	13	PASS





### Test Graphs

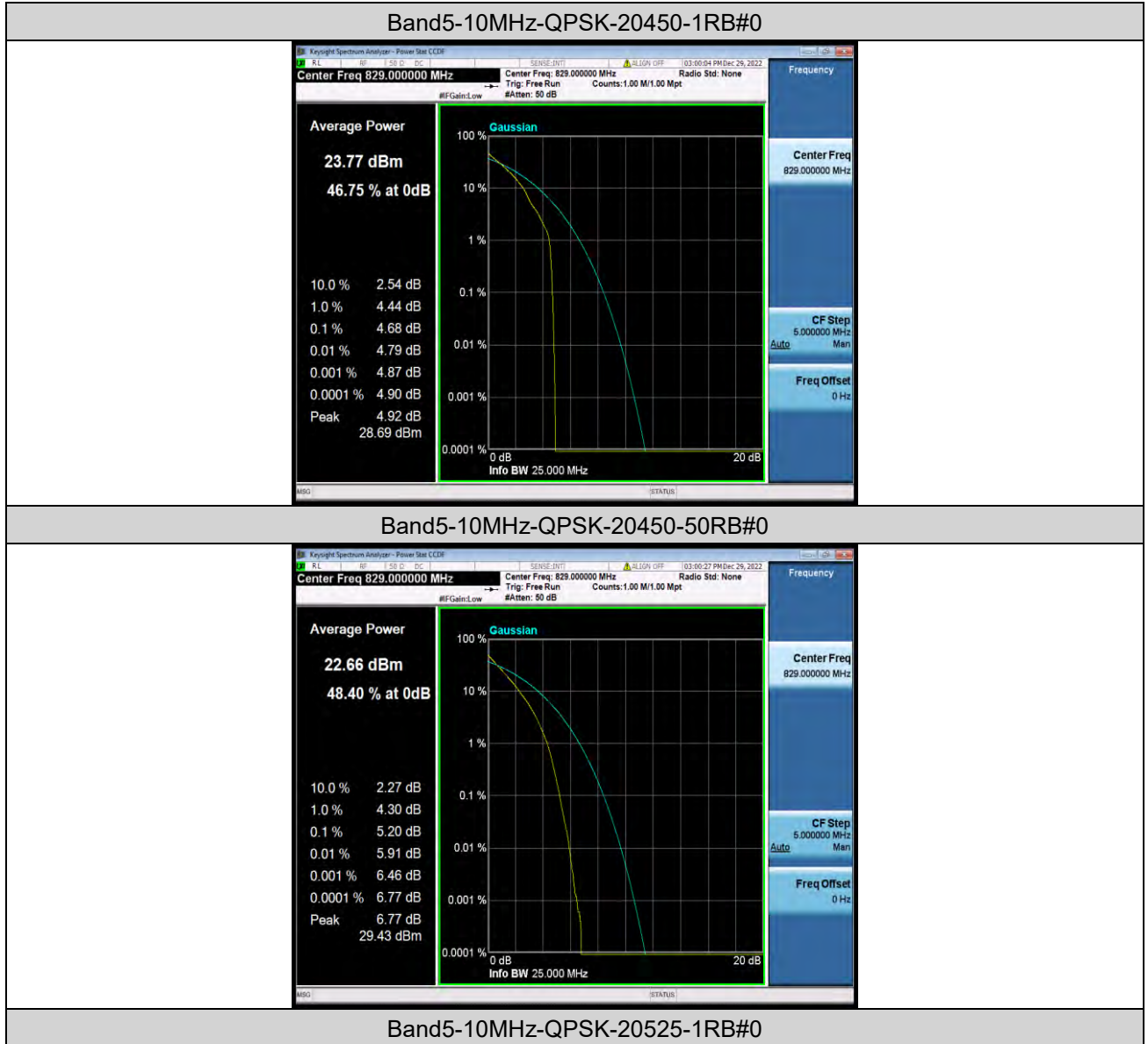



BUREAU VERITAS

Test Report No.: W7L-221220W001RF01



Band5-10MHz-QPSK-20525-50RB#0

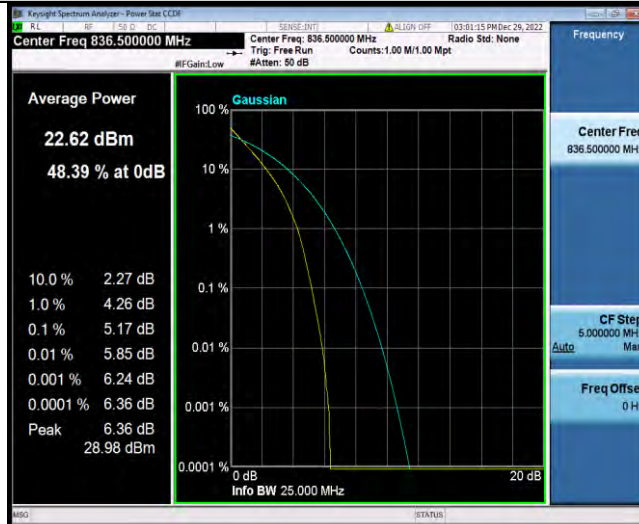

Band5-10MHz-QPSK-20600-1RB#0

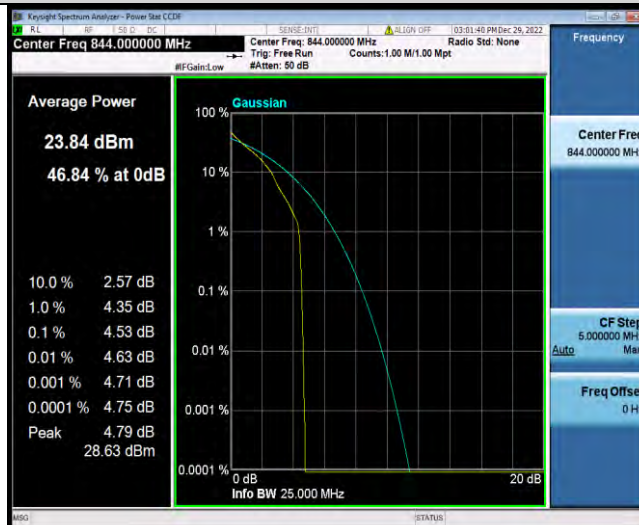

Band5-10MHz-QPSK-20600-50RB#0



BUREAU VERITAS

Test Report No.: W7L-221220W001RF01

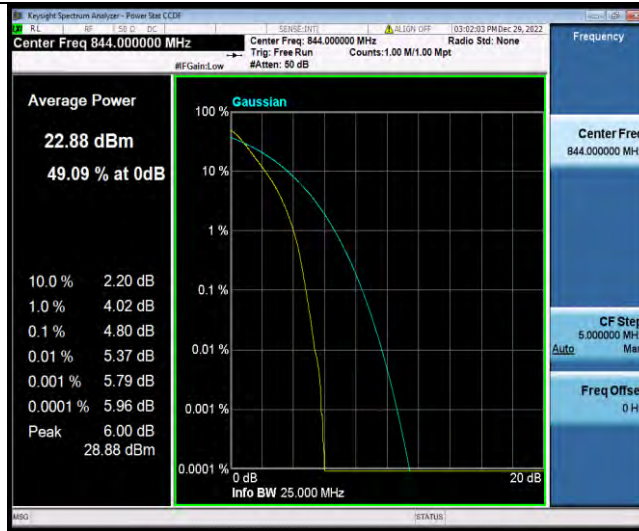

Band5-10MHz-16QAM-20450-1RB#0



Band5-10MHz-16QAM-20450-50RB#0



Band5-10MHz-16QAM-20525-1RB#0



BUREAU VERITAS

Test Report No.: W7L-221220W001RF01

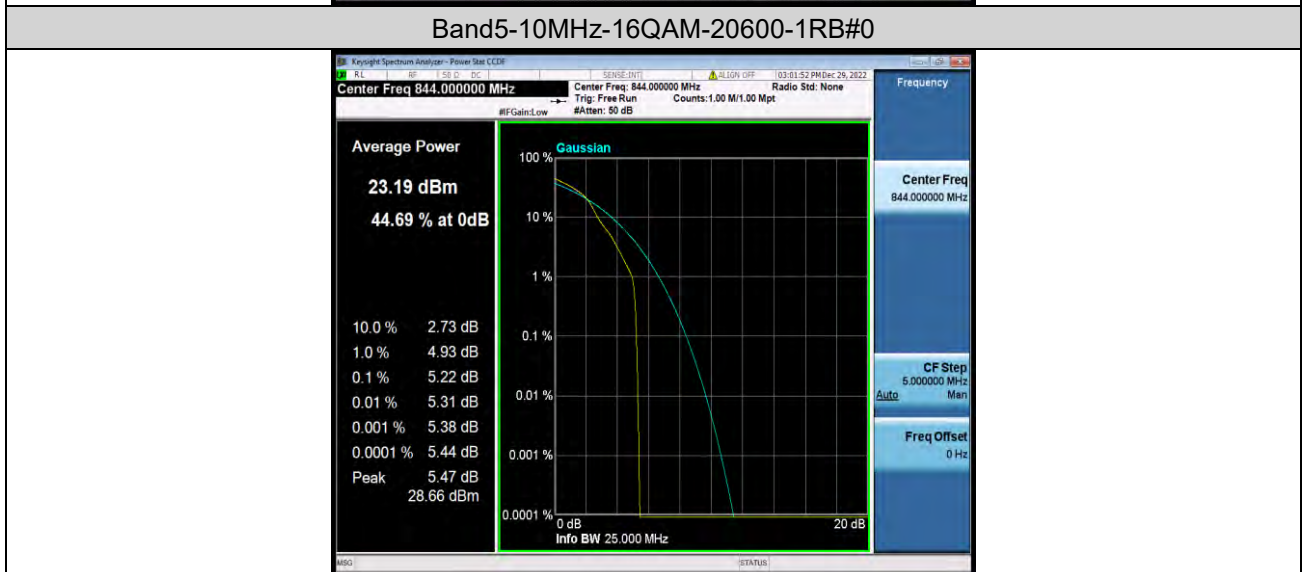
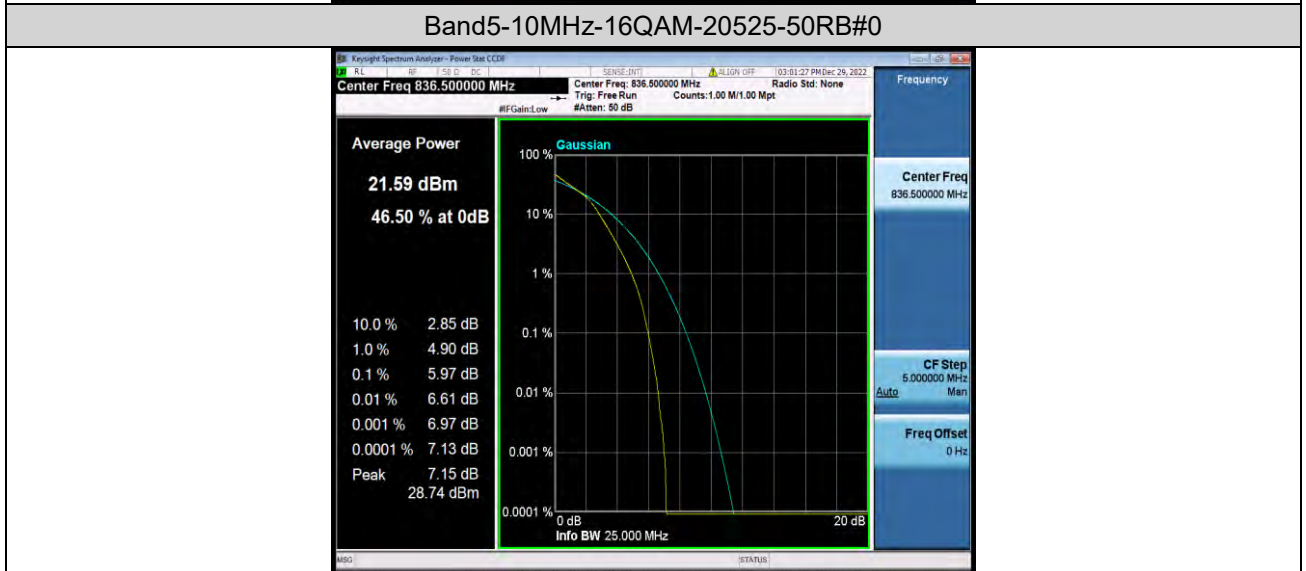
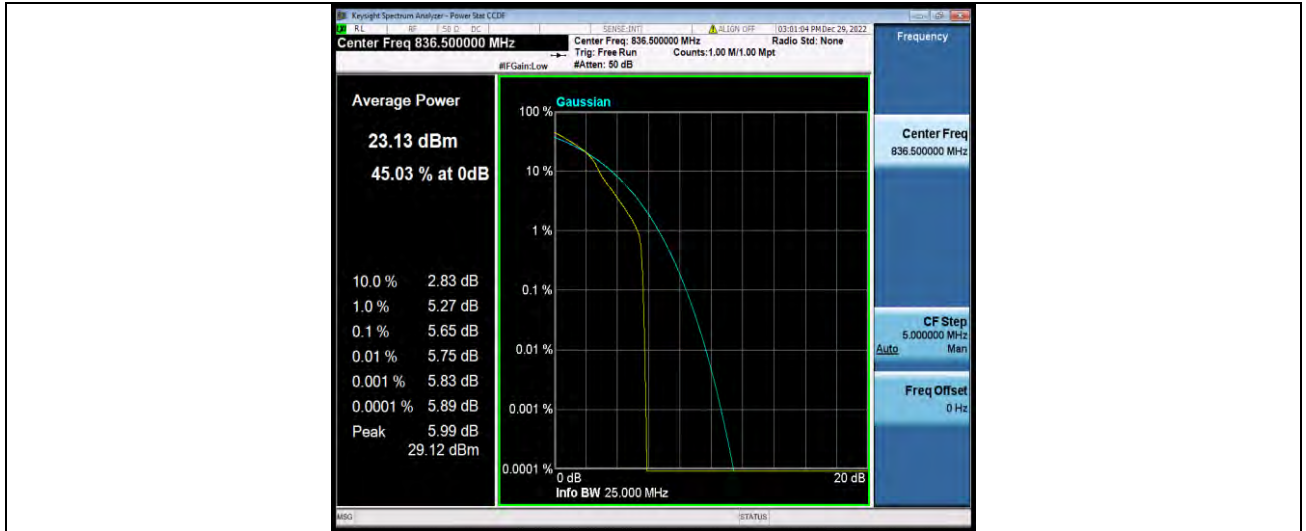





**BUREAU  
VERITAS**

**Test Report No.: W7L-221220W001RF01**

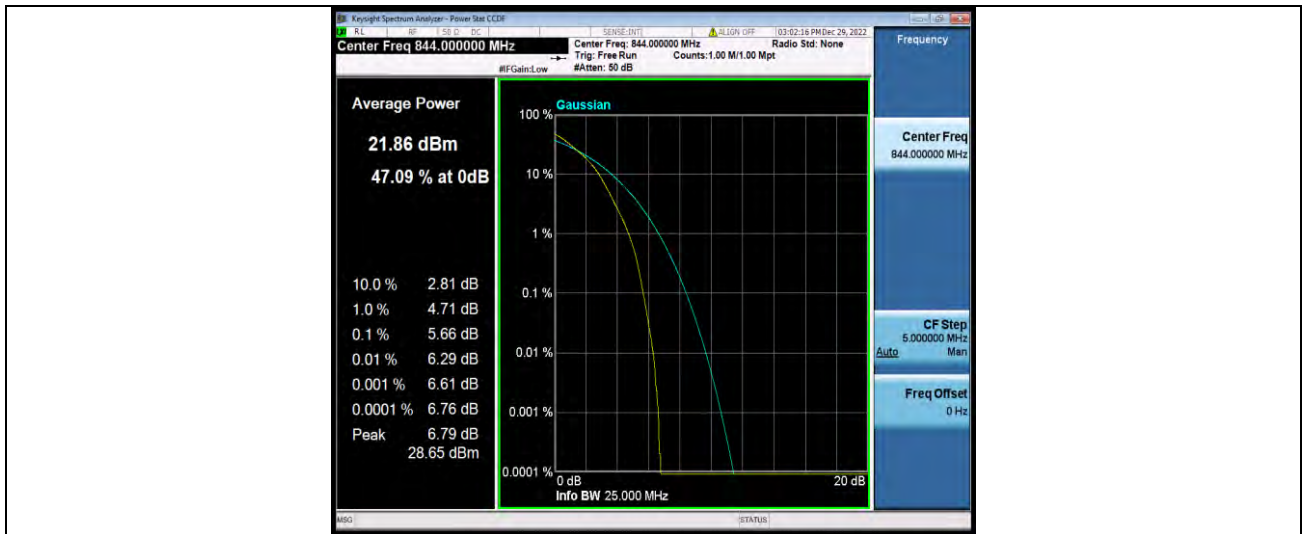



### 26DB BANDWIDTH AND OCCUPIED BANDWIDTH

#### Test Result

Band	Bandwidth	Modulation	Channel	RB Configuration	Occupied Bandwidth (MHz)	26dB Bandwidth (MHz)	Verdict
Band5	1.4MHz	QPSK	20407	6RB#0	1.0922	1.245	PASS
Band5	1.4MHz	QPSK	20525	6RB#0	1.0934	1.253	PASS
Band5	1.4MHz	QPSK	20643	6RB#0	1.0906	1.266	PASS
Band5	1.4MHz	16QAM	20407	6RB#0	1.0886	1.263	PASS
Band5	1.4MHz	16QAM	20525	6RB#0	1.0912	1.262	PASS
Band5	1.4MHz	16QAM	20643	6RB#0	1.0893	1.233	PASS
Band5	3MHz	QPSK	20415	15RB#0	2.6983	2.926	PASS
Band5	3MHz	QPSK	20525	15RB#0	2.6959	2.923	PASS
Band5	3MHz	QPSK	20635	15RB#0	2.6950	2.920	PASS
Band5	3MHz	16QAM	20415	15RB#0	2.6939	2.907	PASS
Band5	3MHz	16QAM	20525	15RB#0	2.6897	2.915	PASS
Band5	3MHz	16QAM	20635	15RB#0	2.6958	2.901	PASS
Band5	5MHz	QPSK	20425	25RB#0	4.4995	4.878	PASS
Band5	5MHz	QPSK	20525	25RB#0	4.4953	4.851	PASS
Band5	5MHz	QPSK	20625	25RB#0	4.5034	4.845	PASS
Band5	5MHz	16QAM	20425	25RB#0	4.4999	4.844	PASS
Band5	5MHz	16QAM	20525	25RB#0	4.5036	4.901	PASS
Band5	5MHz	16QAM	20625	25RB#0	4.5057	4.861	PASS
Band5	10MHz	QPSK	20450	50RB#0	8.9618	9.542	PASS
Band5	10MHz	QPSK	20525	50RB#0	8.9684	9.537	PASS
Band5	10MHz	QPSK	20600	50RB#0	8.9439	9.532	PASS
Band5	10MHz	16QAM	20450	50RB#0	8.9569	9.545	PASS
Band5	10MHz	16QAM	20525	50RB#0	8.9560	9.518	PASS
Band5	10MHz	16QAM	20600	50RB#0	8.9387	9.542	PASS



BUREAU VERITAS

Test Report No.: W7L-221220W001RF01

### Test Graphs

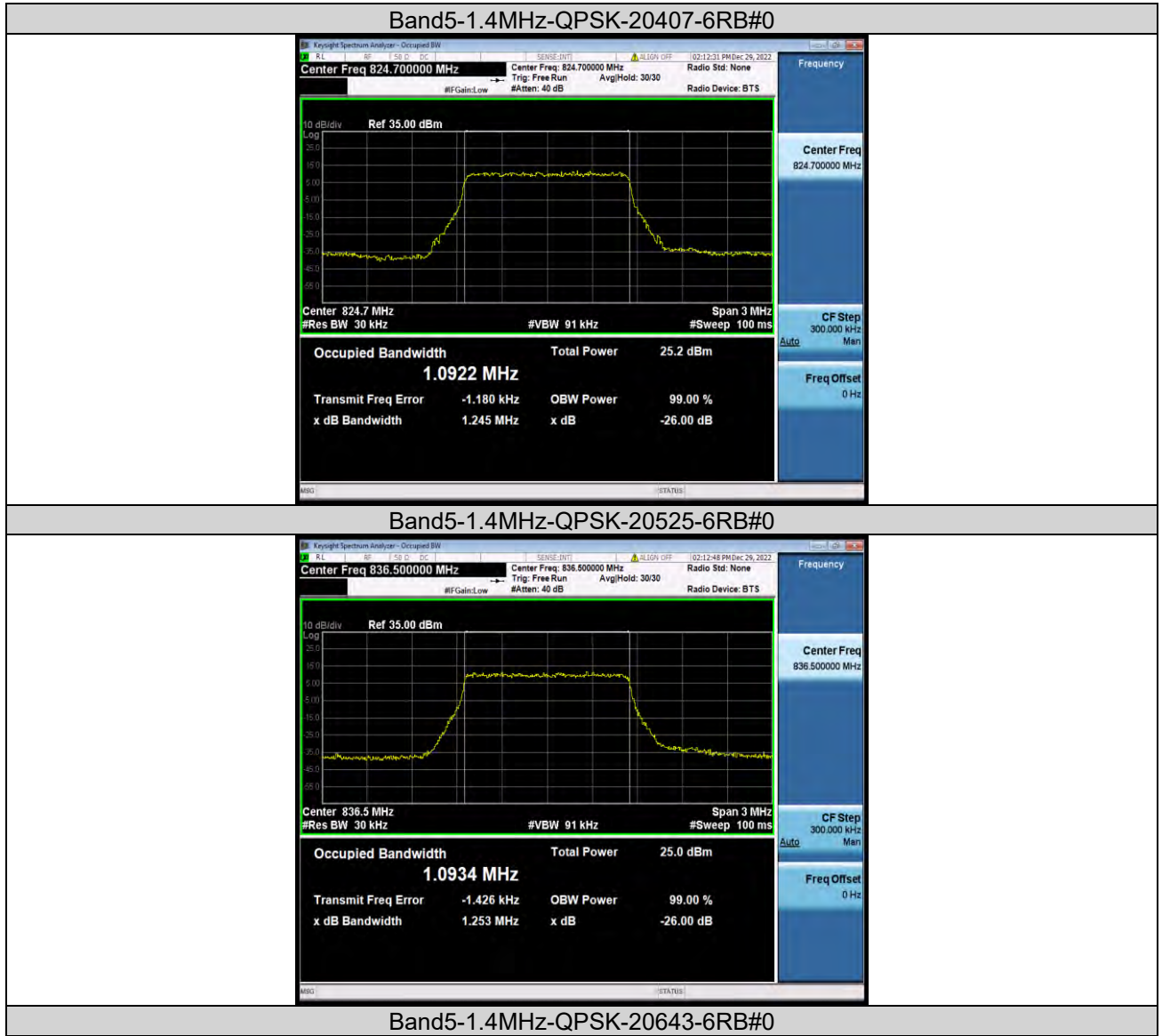



BUREAU VERITAS

Test Report No.: W7L-221220W001RF01

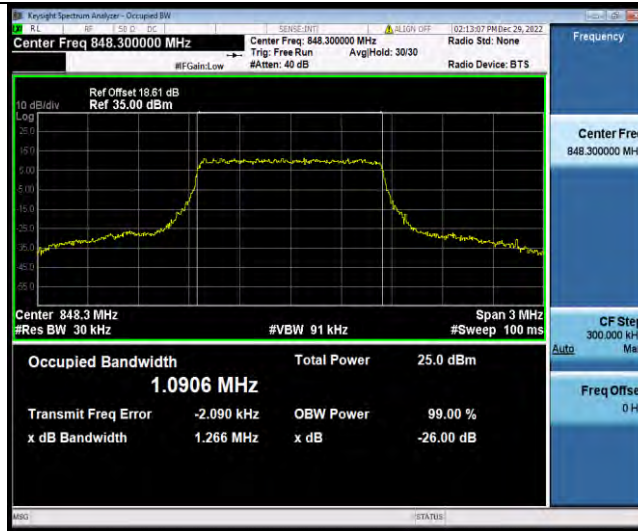

Band5-1.4MHz-16QAM-20407-6RB#0



Band5-1.4MHz-16QAM-20525-6RB#0



Band5-1.4MHz-16QAM-20643-6RB#0





BUREAU VERITAS

Test Report No.: W7L-221220W001RF01



Band5-3MHz-QPSK-20415-15RB#0



Band5-3MHz-QPSK-20525-15RB#0



Band5-3MHz-QPSK-20635-15RB#0



BUREAU VERITAS

Test Report No.: W7L-221220W001RF01



Band5-3MHz-16QAM-20415-15RB#0

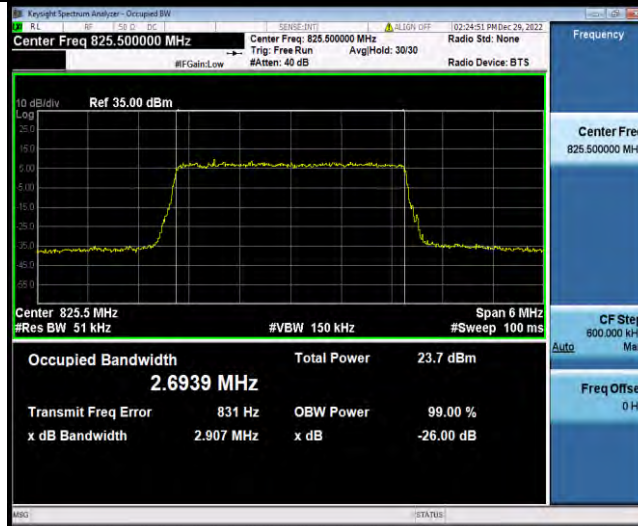

Band5-3MHz-16QAM-20525-15RB#0

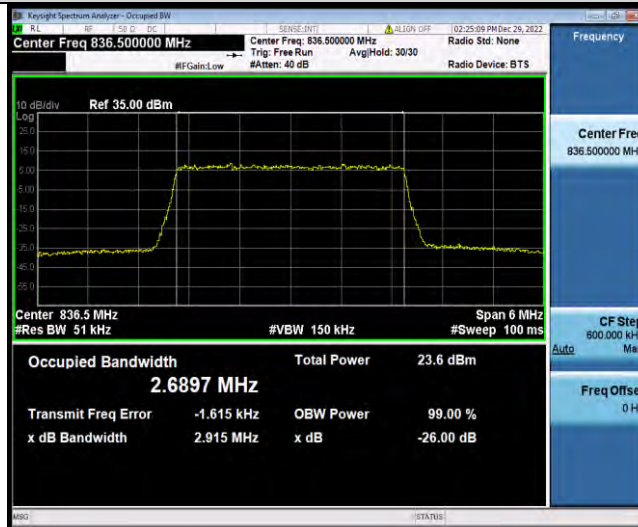

Band5-3MHz-16QAM-20635-15RB#0



BUREAU VERITAS

Test Report No.: W7L-221220W001RF01

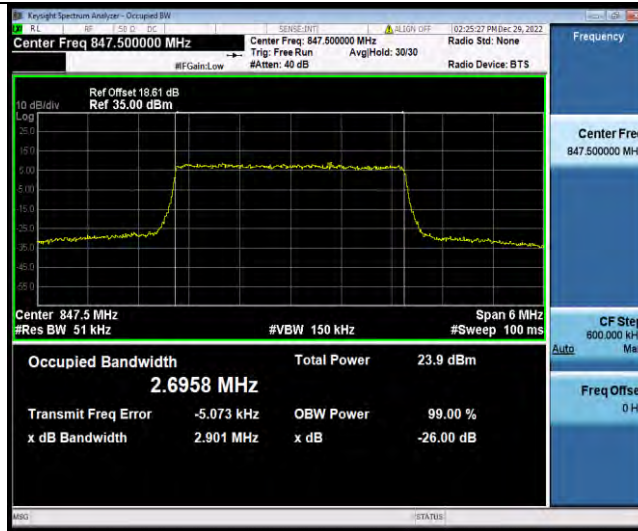

Band5-5MHz-QPSK-20425-25RB#0



Band5-5MHz-QPSK-20525-25RB#0



Band5-5MHz-QPSK-20625-25RB#0





BUREAU VERITAS

Test Report No.: W7L-221220W001RF01



Band5-5MHz-16QAM-20425-25RB#0



Band5-5MHz-16QAM-20525-25RB#0



Band5-5MHz-16QAM-20625-25RB#0



BUREAU VERITAS

Test Report No.: W7L-221220W001RF01



Band5-10MHz-QPSK-20450-50RB#0



Band5-10MHz-QPSK-20525-50RB#0



Band5-10MHz-QPSK-20600-50RB#0



BUREAU VERITAS

Test Report No.: W7L-221220W001RF01



Band5-10MHz-16QAM-20450-50RB#0



Band5-10MHz-16QAM-20525-50RB#0



Band5-10MHz-16QAM-20600-50RB#0



**BUREAU  
VERITAS**

**Test Report No.: W7L-221220W001RF01**







### BAND EDGE

### Test Result

Band	Bandwidth	Modulation	Channel	RB Configuration	Result(dBm)	Verdict
Band5	1.4MHz	QPSK	20407	1RB#0	-48.92,-29.48	PASS
Band5	1.4MHz	QPSK	20407	6RB#0	-37.91,-31.45	PASS
Band5	1.4MHz	QPSK	20643	1RB#5	-28.45,-49.35	PASS
Band5	1.4MHz	QPSK	20643	6RB#0	-27.13,-43.87	PASS
Band5	1.4MHz	16QAM	20407	1RB#0	-49.91,-28.07	PASS
Band5	1.4MHz	16QAM	20407	6RB#0	-38.23,-32.28	PASS
Band5	1.4MHz	16QAM	20643	1RB#5	-30.66,-49.52	PASS
Band5	1.4MHz	16QAM	20643	6RB#0	-29.77,-43.55	PASS
Band5	3MHz	QPSK	20415	1RB#0	-48.67,-25.09	PASS
Band5	3MHz	QPSK	20415	15RB#0	-40.70,-29.70	PASS
Band5	3MHz	QPSK	20635	1RB#14	-28.18,-47.38	PASS
Band5	3MHz	QPSK	20635	15RB#0	-25.75,-32.65	PASS
Band5	3MHz	16QAM	20415	1RB#0	-49.29,-31.27	PASS
Band5	3MHz	16QAM	20415	15RB#0	-38.75,-30.93	PASS
Band5	3MHz	16QAM	20635	1RB#14	-34.12,-48.61	PASS
Band5	3MHz	16QAM	20635	15RB#0	-27.45,-34.36	PASS
Band5	5MHz	QPSK	20425	1RB#0	-49.65,-28.76	PASS
Band5	5MHz	QPSK	20425	25RB#0	-42.55,-33.57	PASS
Band5	5MHz	QPSK	20625	1RB#24	-30.52,-48.65	PASS
Band5	5MHz	QPSK	20625	25RB#0	-28.49,-34.49	PASS
Band5	5MHz	16QAM	20425	1RB#0	-50.22,-31.07	PASS
Band5	5MHz	16QAM	20425	25RB#0	-40.05,-33.63	PASS
Band5	5MHz	16QAM	20625	1RB#24	-31.49,-50.27	PASS
Band5	5MHz	16QAM	20625	25RB#0	-30.56,-36.23	PASS
Band5	10MHz	QPSK	20450	1RB#0	-49.80,-42.33	PASS
Band5	10MHz	QPSK	20450	50RB#0	-44.46,-33.78	PASS
Band5	10MHz	QPSK	20600	1RB#49	-43.27,-50.55	PASS
Band5	10MHz	QPSK	20600	50RB#0	-28.60,-38.54	PASS
Band5	10MHz	16QAM	20450	1RB#0	-50.72,-42.35	PASS
Band5	10MHz	16QAM	20450	50RB#0	-42.08,-34.41	PASS
Band5	10MHz	16QAM	20600	1RB#49	-41.95,-51.25	PASS
Band5	10MHz	16QAM	20600	50RB#0	-32.12,-40.89	PASS





BUREAU  
VERITAS

Test Report No.: W7L-221220W001RF01

## Test Graphs





BUREAU VERITAS

Test Report No.: W7L-221220W001RF01



Band5-1.4MHz-QPSK-20643-6RB#0



Band5-1.4MHz-16QAM-20407-1RB#0

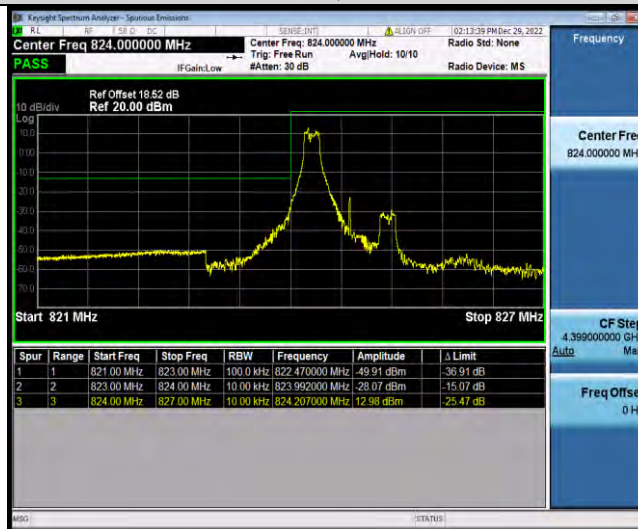

Band5-1.4MHz-16QAM-20407-6RB#0



BUREAU VERITAS

Test Report No.: W7L-221220W001RF01

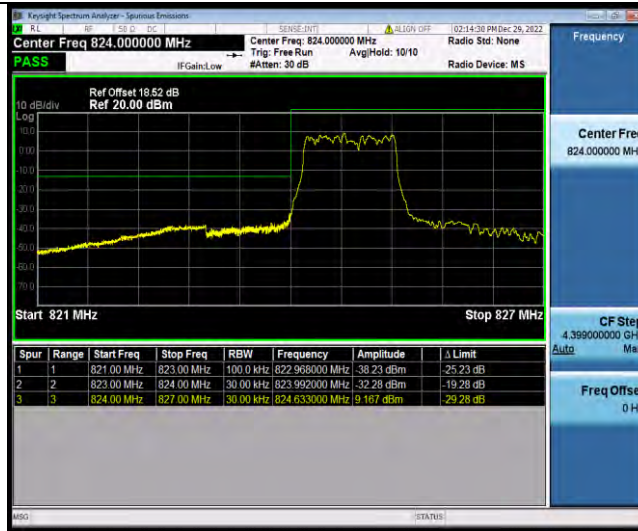

Band5-1.4MHz-16QAM-20643-1RB#5



Band5-1.4MHz-16QAM-20643-6RB#0



Band5-3MHz-QPSK-20415-1RB#0





BUREAU VERITAS

Test Report No.: W7L-221220W001RF01

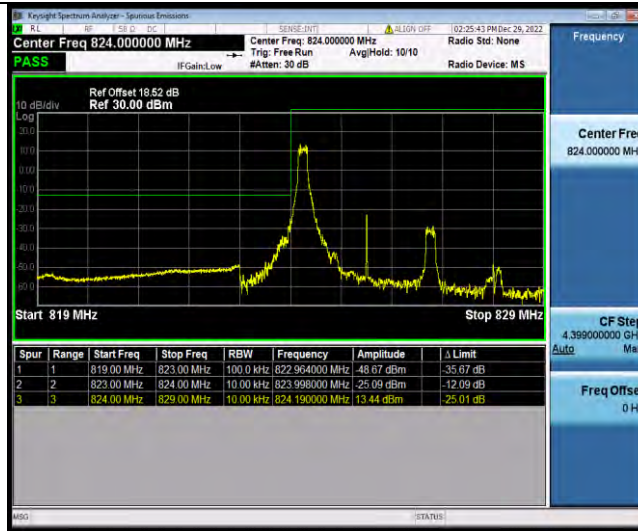

Band5-3MHz-QPSK-20415-15RB#0

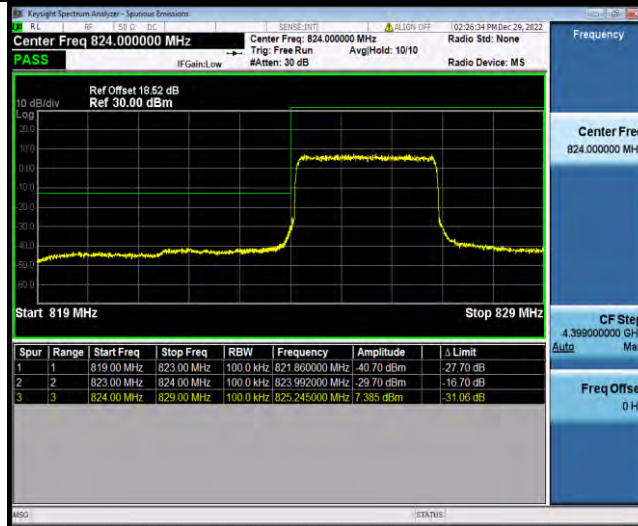

Band5-3MHz-QPSK-20635-1RB#14

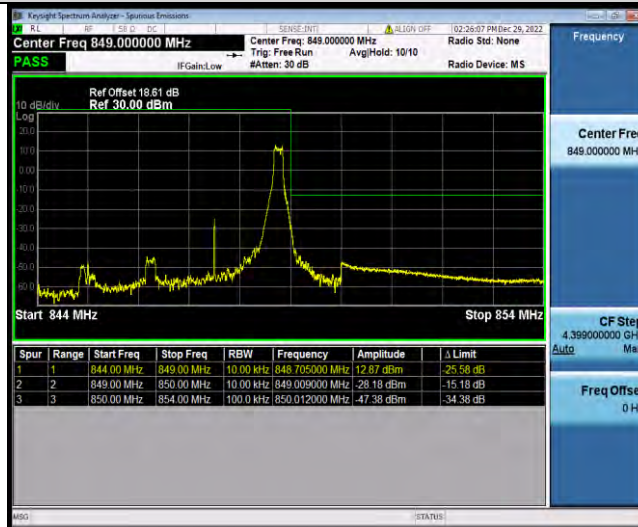

Band5-3MHz-QPSK-20635-15RB#0



BUREAU VERITAS

Test Report No.: W7L-221220W001RF01



Band5-3MHz-16QAM-20415-1RB#0

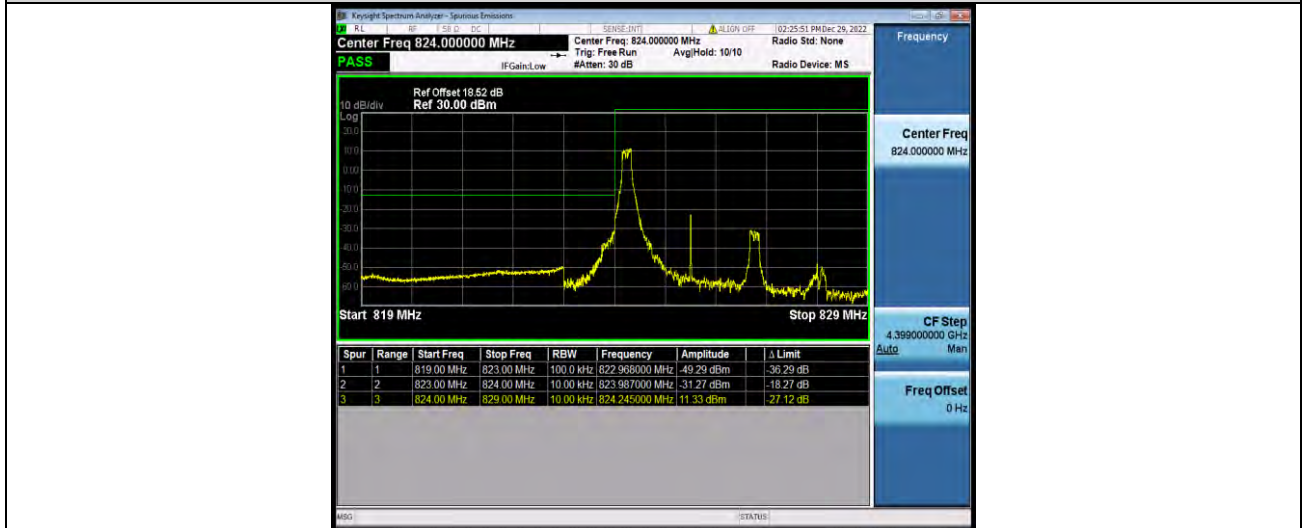

Band5-3MHz-16QAM-20415-15RB#0



Band5-3MHz-16QAM-20635-1RB#14



BUREAU VERITAS

Test Report No.: W7L-221220W001RF01

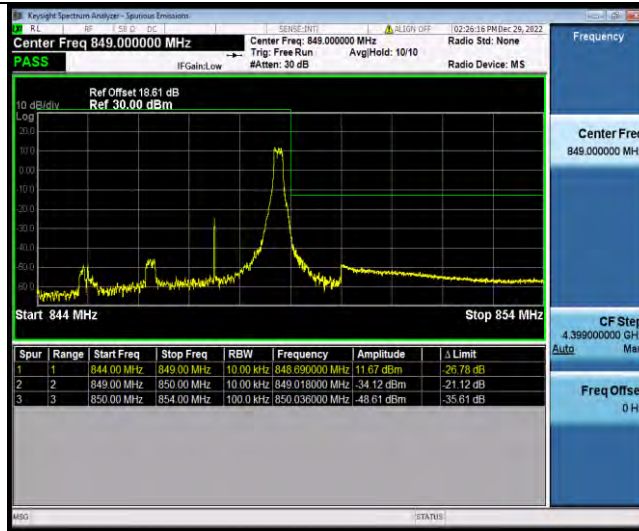

Band5-3MHz-16QAM-20635-15RB#0



Band5-5MHz-QPSK-20425-1RB#0

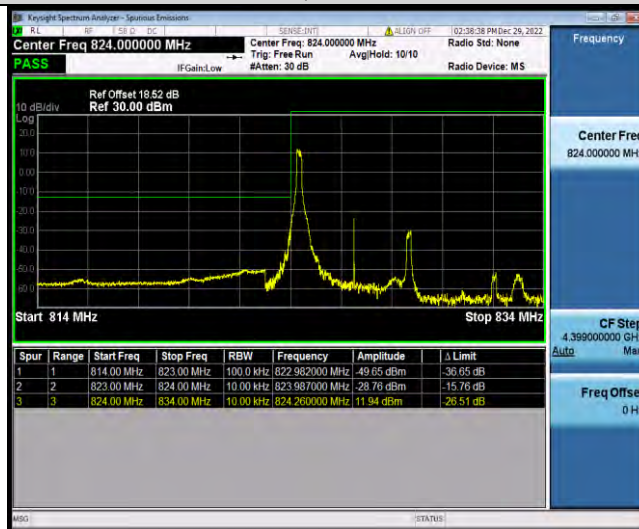

Band5-5MHz-QPSK-20425-25RB#0





BUREAU VERITAS

Test Report No.: W7L-221220W001RF01

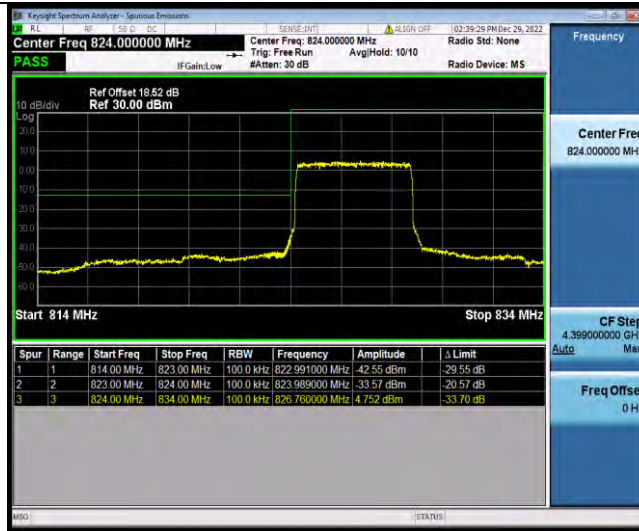

Band5-5MHz-QPSK-20625-1RB#24

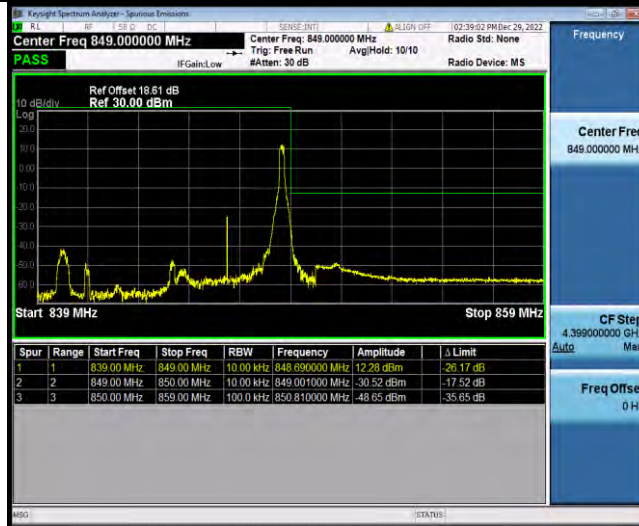

Band5-5MHz-QPSK-20625-25RB#0



Band5-5MHz-16QAM-20425-1RB#0



BUREAU VERITAS

Test Report No.: W7L-221220W001RF01

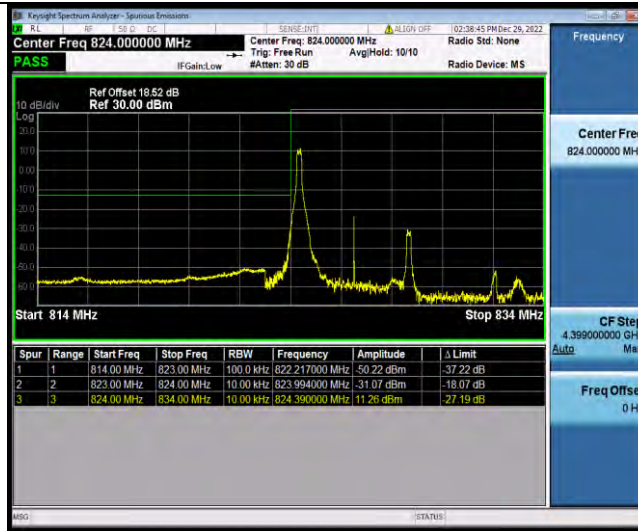

Band5-5MHz-16QAM-20425-25RB#0

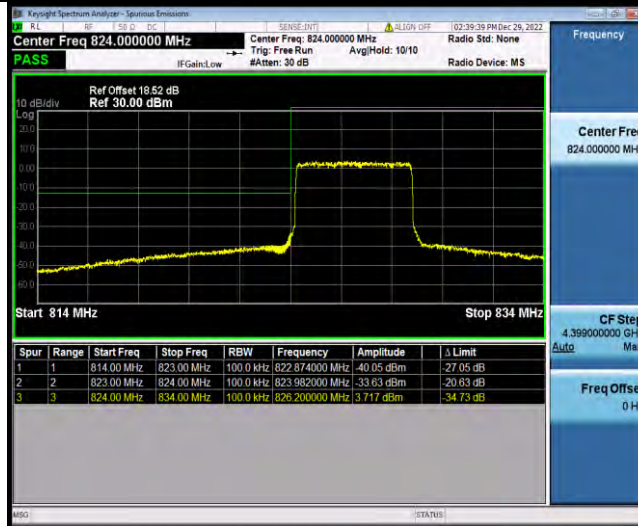

Band5-5MHz-16QAM-20625-1RB#24

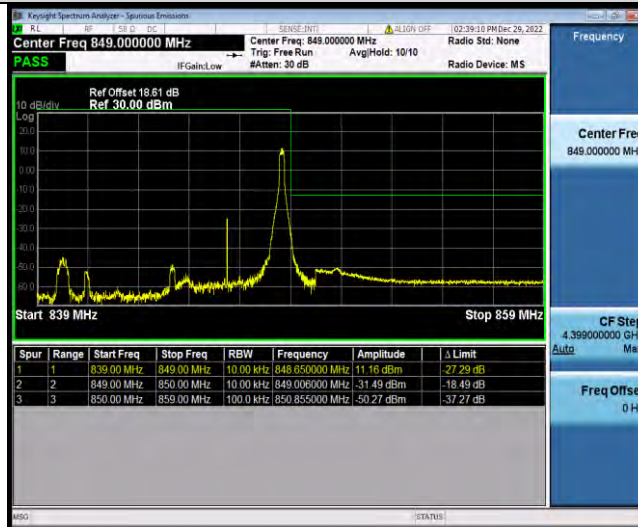

Band5-5MHz-16QAM-20625-25RB#0





BUREAU VERITAS

Test Report No.: W7L-221220W001RF01



Band5-10MHz-QPSK-20450-1RB#0

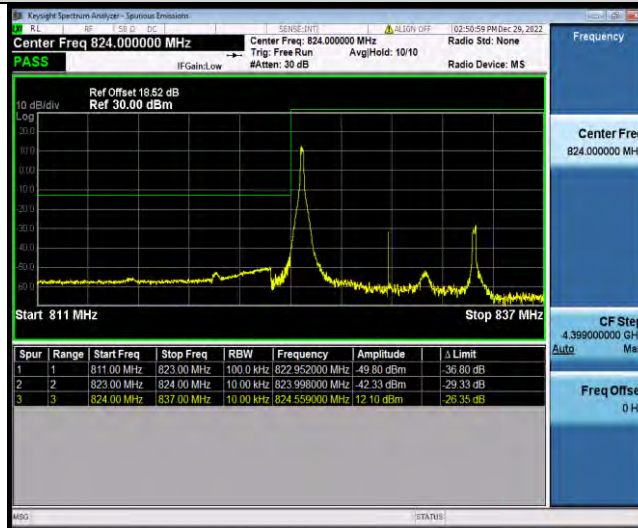

Band5-10MHz-QPSK-20450-50RB#0



Band5-10MHz-QPSK-20600-1RB#49



**BUREAU  
VERITAS**

Test Report No.: W7L-221220W001RF01

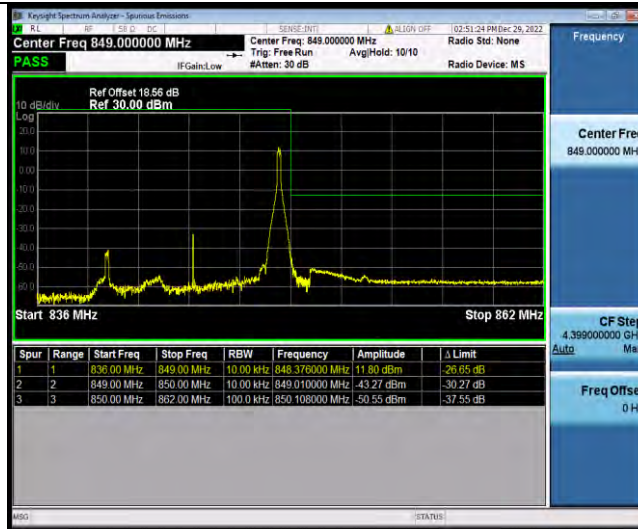

Band5-10MHz-QPSK-20600-50RB#0

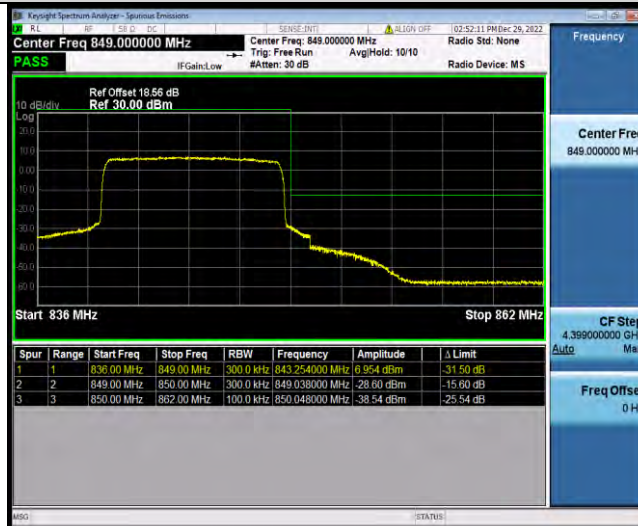

Band5-10MHz-16QAM-20450-1RB#0

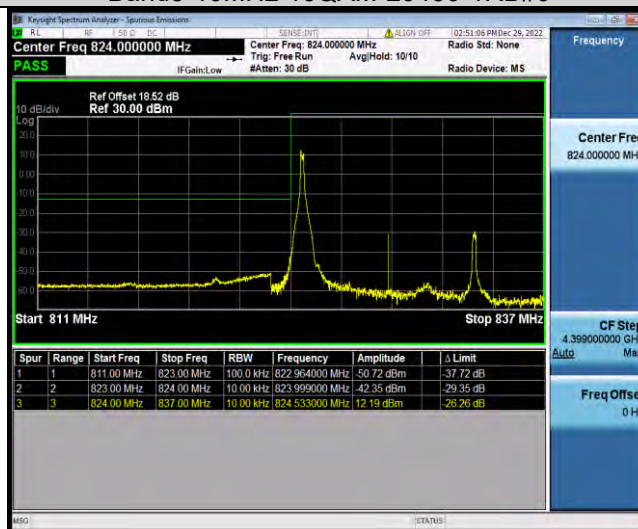

Band5-10MHz-16QAM-20450-50RB#0



BUREAU VERITAS

Test Report No.: W7L-221220W001RF01

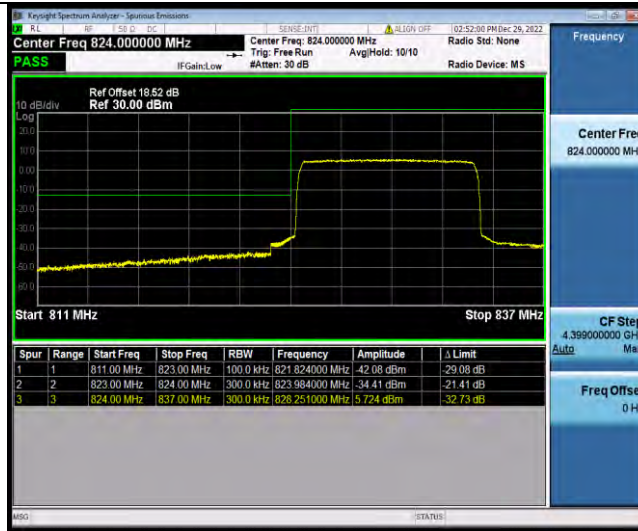

Band5-10MHz-16QAM-20600-1RB#49

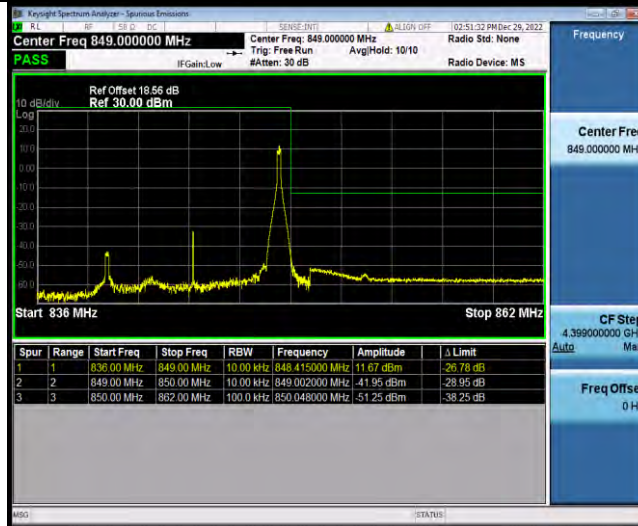

Band5-10MHz-16QAM-20600-50RB#0





### CONDUCTED SPURIOUS EMISSION

#### Test Result

Band	Bandwidth	Modulation	Channel	RB Configuration	Frequency Range	Result (dBm)	Verdict
Band5	1.4MHz	QPSK	20407	1RB#0	Range1:30~1000MHz	-33.38	PASS
Band5	1.4MHz	QPSK	20407	1RB#0	Range2:1000~10000MHz	-27.62	PASS
Band5	1.4MHz	QPSK	20525	1RB#0	Range1:30~1000MHz	-34.24	PASS
Band5	1.4MHz	QPSK	20525	1RB#0	Range2:1000~10000MHz	-26.46	PASS
Band5	1.4MHz	QPSK	20643	1RB#0	Range1:30~1000MHz	-33.91	PASS
Band5	1.4MHz	QPSK	20643	1RB#0	Range2:1000~10000MHz	-28.2	PASS
Band5	3MHz	QPSK	20415	1RB#0	Range1:30~1000MHz	-34.37	PASS
Band5	3MHz	QPSK	20415	1RB#0	Range2:1000~10000MHz	-28.94	PASS
Band5	3MHz	QPSK	20525	1RB#0	Range1:30~1000MHz	-34.4	PASS
Band5	3MHz	QPSK	20525	1RB#0	Range2:1000~10000MHz	-27.36	PASS
Band5	3MHz	QPSK	20635	1RB#0	Range1:30~1000MHz	-34.36	PASS
Band5	3MHz	QPSK	20635	1RB#0	Range2:1000~10000MHz	-27.89	PASS
Band5	5MHz	QPSK	20425	1RB#0	Range1:30~1000MHz	-34.01	PASS
Band5	5MHz	QPSK	20425	1RB#0	Range2:1000~10000MHz	-28.59	PASS
Band5	5MHz	QPSK	20525	1RB#0	Range1:30~1000MHz	-33.83	PASS
Band5	5MHz	QPSK	20525	1RB#0	Range2:1000~10000MHz	-28.06	PASS
Band5	5MHz	QPSK	20625	1RB#0	Range1:30~1000MHz	-34.31	PASS
Band5	5MHz	QPSK	20625	1RB#0	Range2:1000~10000MHz	-28.46	PASS
Band5	10MHz	QPSK	20450	1RB#0	Range1:30~1000MHz	-34.39	PASS
Band5	10MHz	QPSK	20450	1RB#0	Range2:1000~10000MHz	-28.06	PASS
Band5	10MHz	QPSK	20525	1RB#0	Range1:30~1000MHz	-34.03	PASS
Band5	10MHz	QPSK	20525	1RB#0	Range2:1000~10000MHz	-28.44	PASS
Band5	10MHz	QPSK	20600	1RB#0	Range1:30~1000MHz	-34.3	PASS
Band5	10MHz	QPSK	20600	1RB#0	Range2:1000~10000MHz	-27.92	PASS





BUREAU VERITAS

Test Report No.: W7L-221220W001RF01

### Test Graphs

Band5-1.4MHz-QPSK-20407-1RB#0-Range1:30~1000MHz

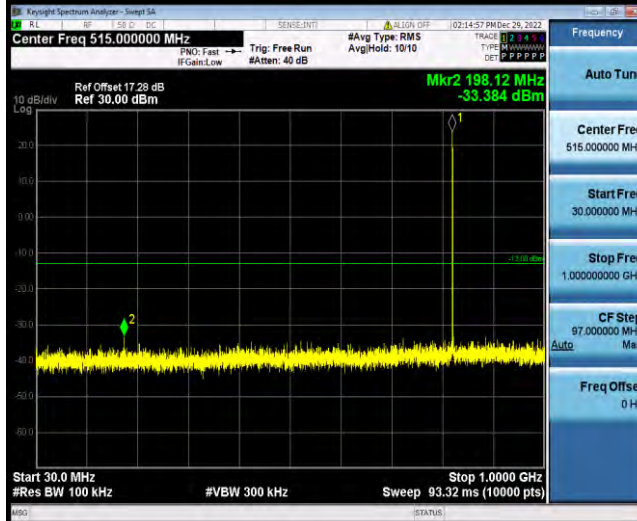

Band5-1.4MHz-QPSK-20407-1RB#0-Range2:1000~10000MHz

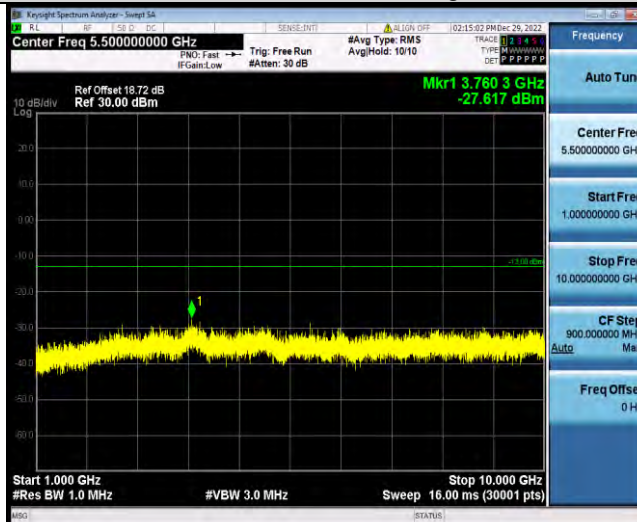

Band5-1.4MHz-QPSK-20525-1RB#0-Range1:30~1000MHz



BUREAU VERITAS

Test Report No.: W7L-221220W001RF01

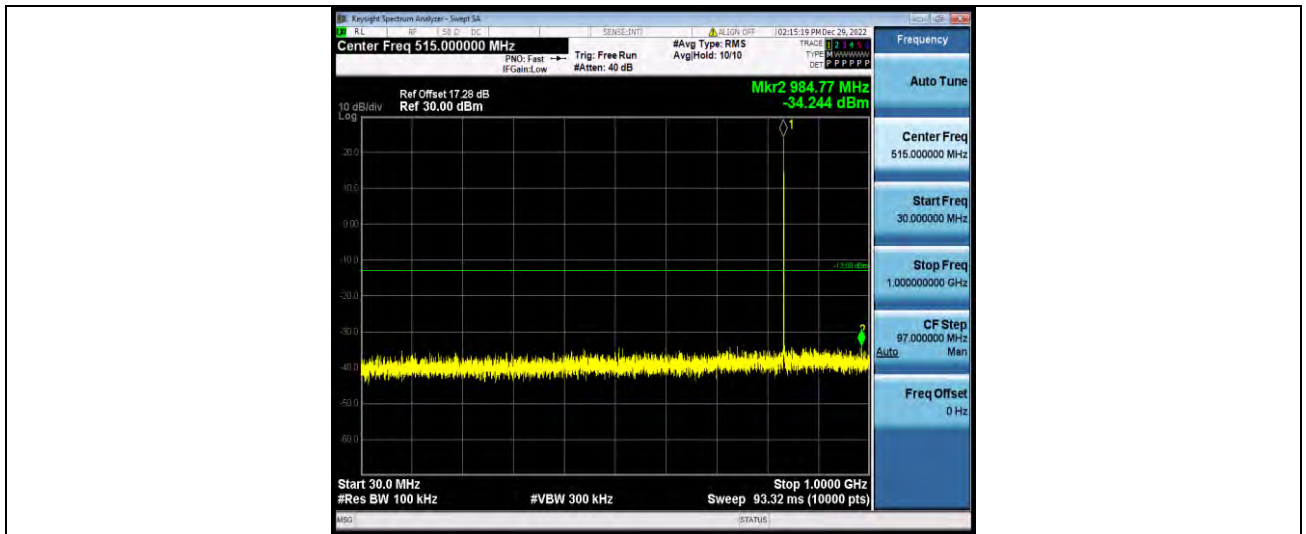

Band5-1.4MHz-QPSK-20525-1RB#0-Range2:1000~10000MHz

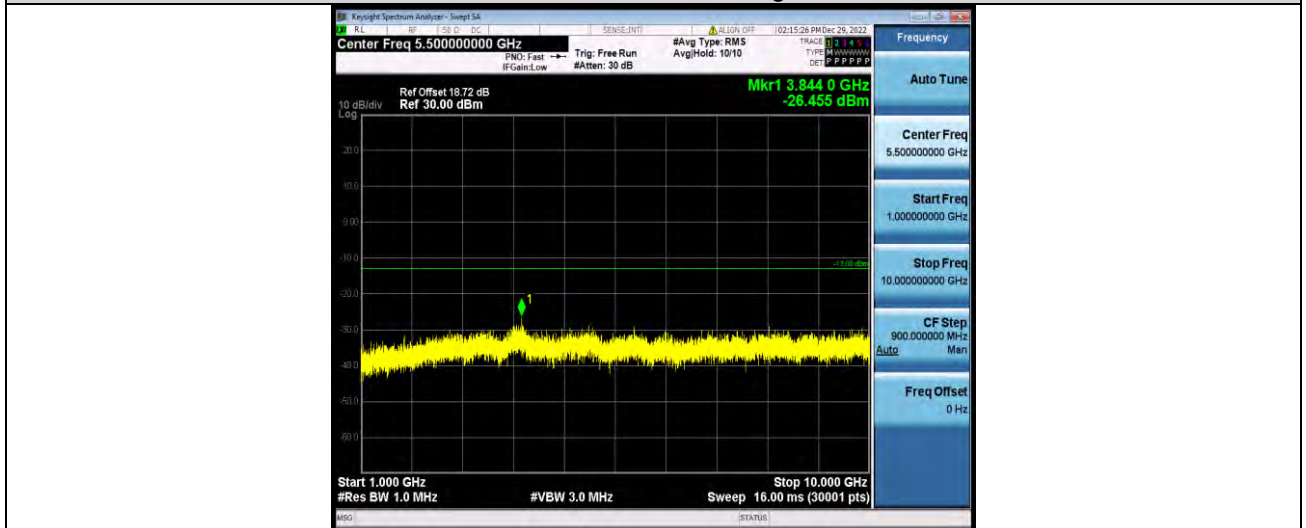

Band5-1.4MHz-QPSK-20643-1RB#0-Range1:30~1000MHz

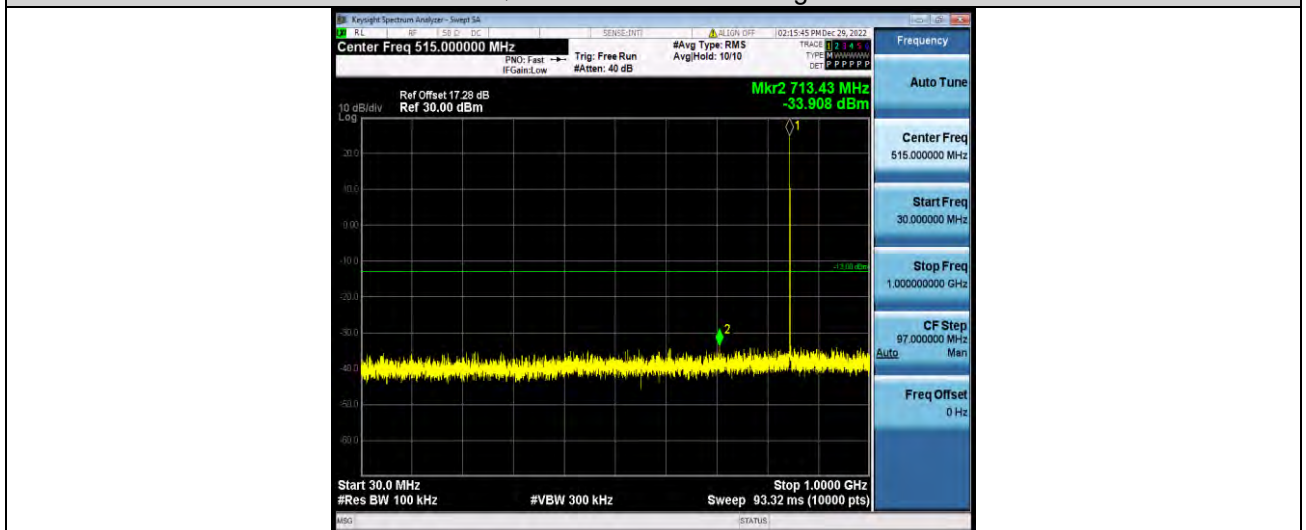

Band5-1.4MHz-QPSK-20643-1RB#0-Range2:1000~10000MHz



BUREAU VERITAS

Test Report No.: W7L-221220W001RF01



Band5-3MHz-QPSK-20415-1RB#0-Range1:30~1000MHz

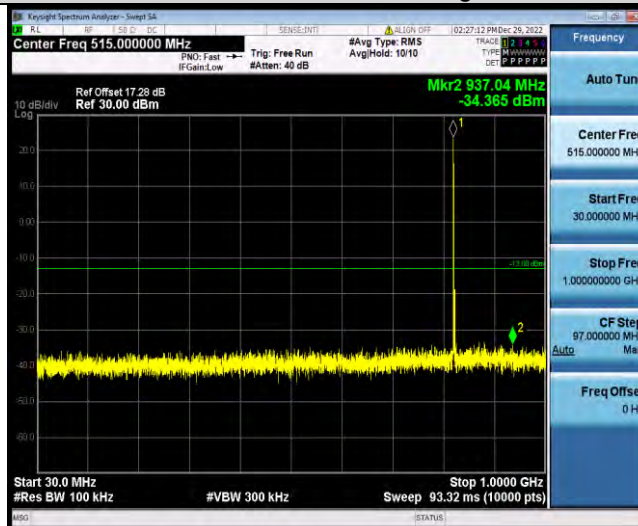

Band5-3MHz-QPSK-20415-1RB#0-Range2:1000~10000MHz

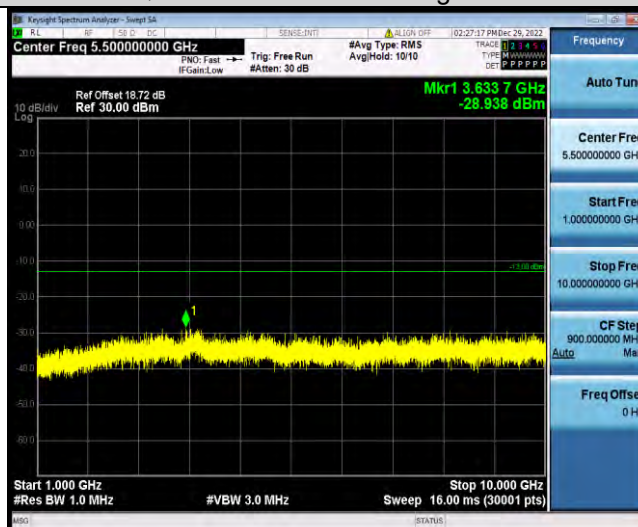

Band5-3MHz-QPSK-20525-1RB#0-Range1:30~1000MHz





BUREAU VERITAS

Test Report No.: W7L-221220W001RF01

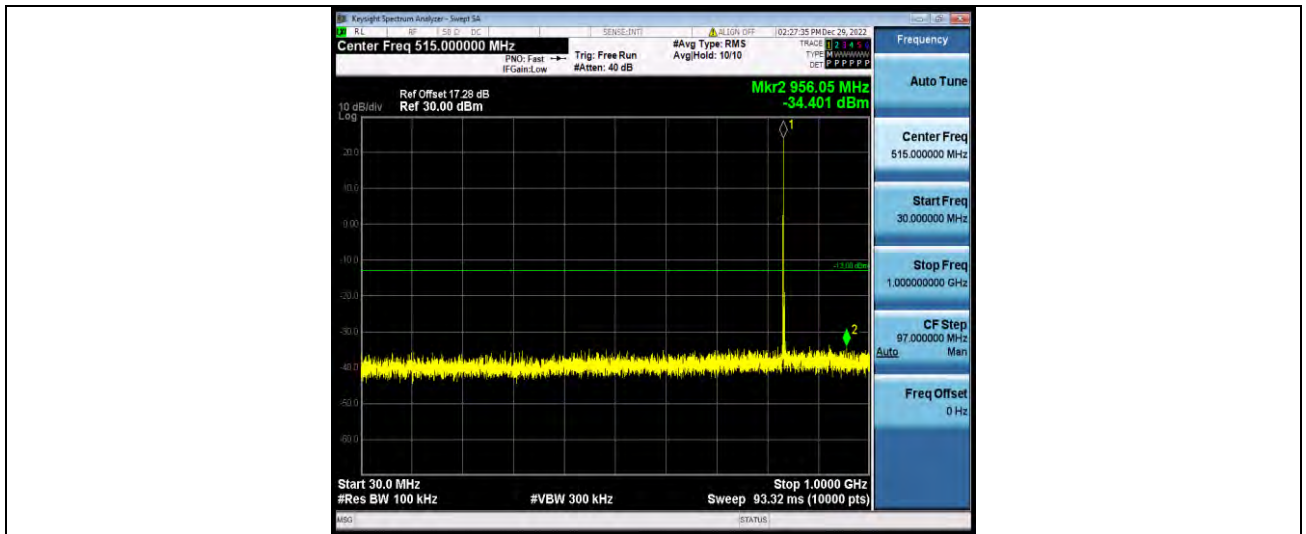

Band5-3MHz-QPSK-20525-1RB#0-Range2:1000~10000MHz

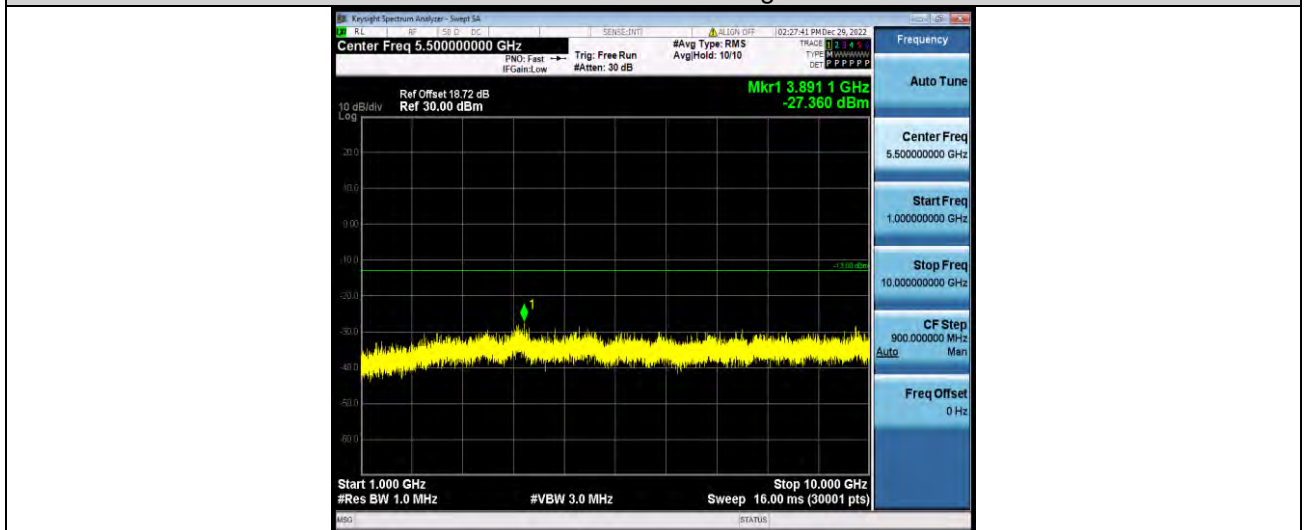

Band5-3MHz-QPSK-20635-1RB#0-Range1:30~1000MHz



Band5-3MHz-QPSK-20635-1RB#0-Range2:1000~10000MHz





BUREAU VERITAS

Test Report No.: W7L-221220W001RF01

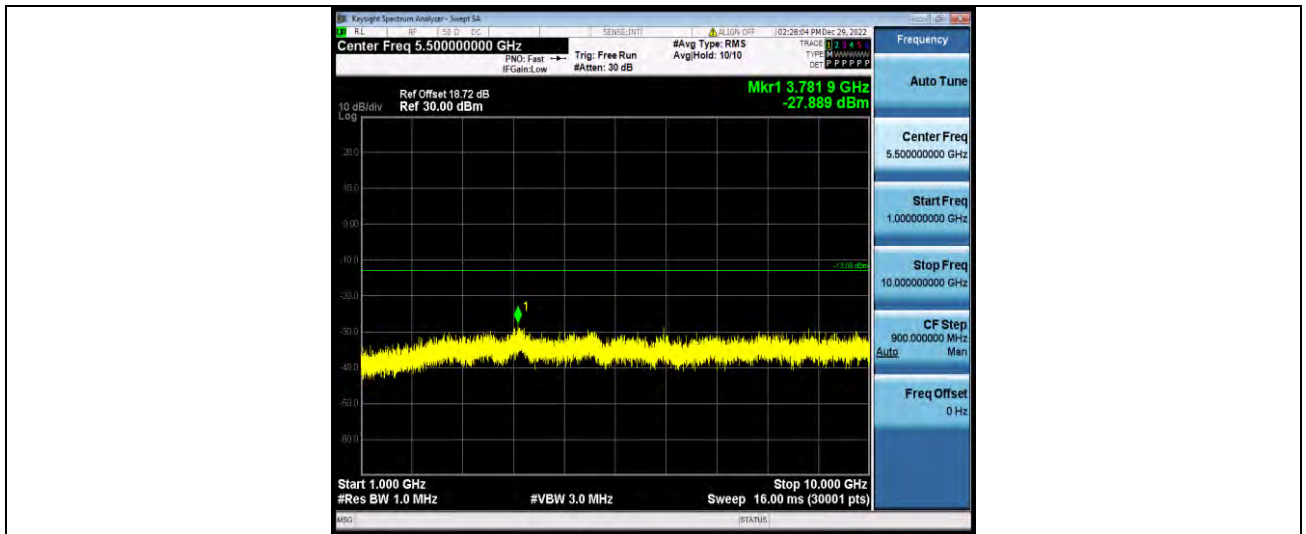

Band5-5MHz-QPSK-20425-1RB#0-Range1:30~1000MHz

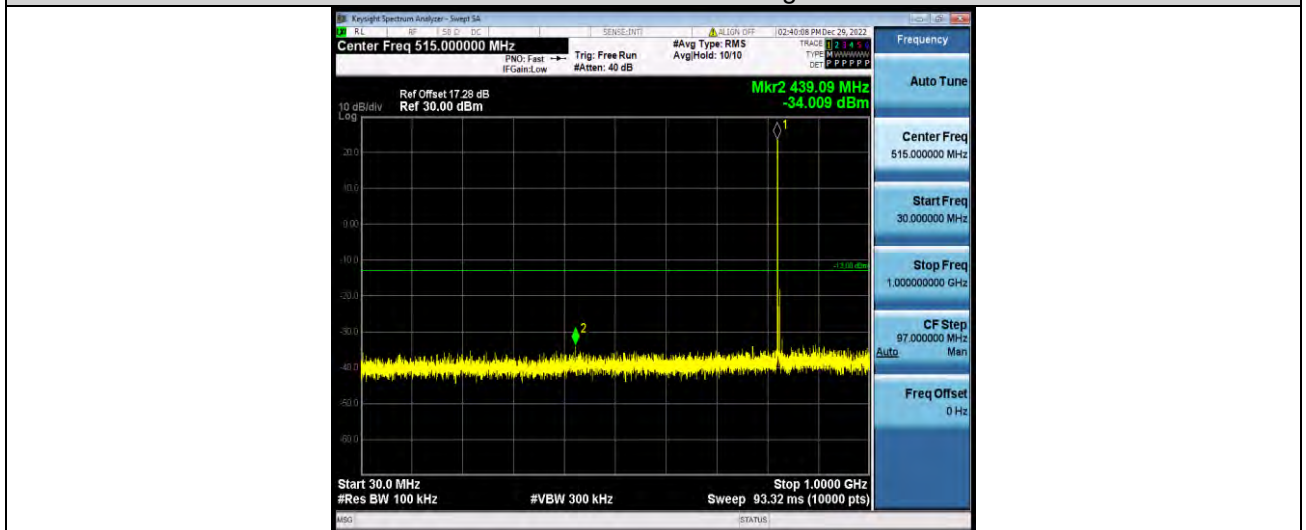

Band5-5MHz-QPSK-20425-1RB#0-Range2:1000~10000MHz

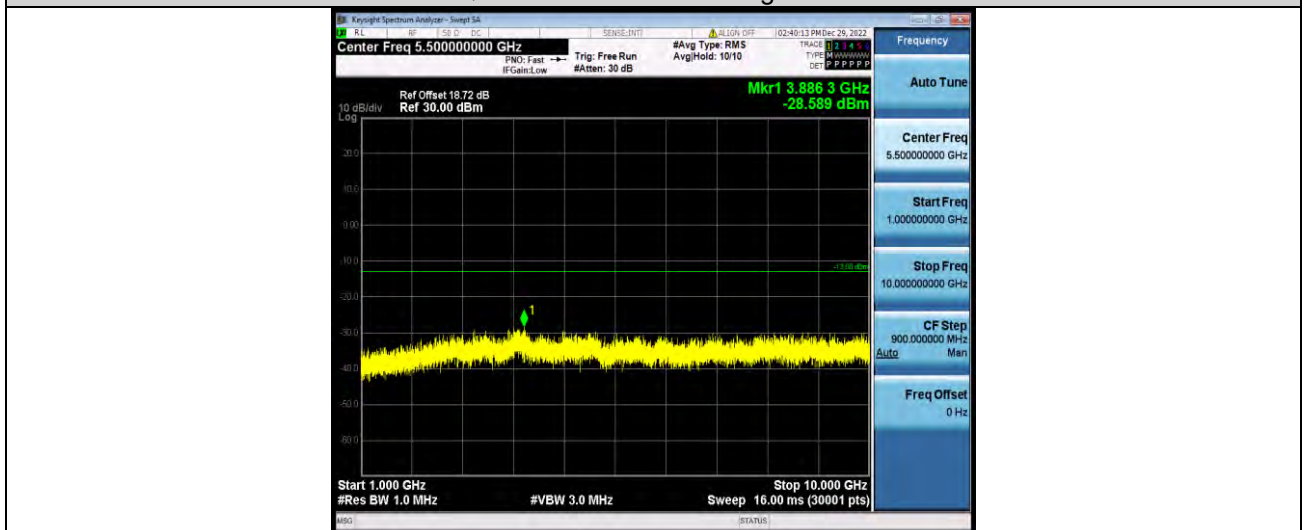

Band5-5MHz-QPSK-20525-1RB#0-Range1:30~1000MHz



BUREAU VERITAS

Test Report No.: W7L-221220W001RF01

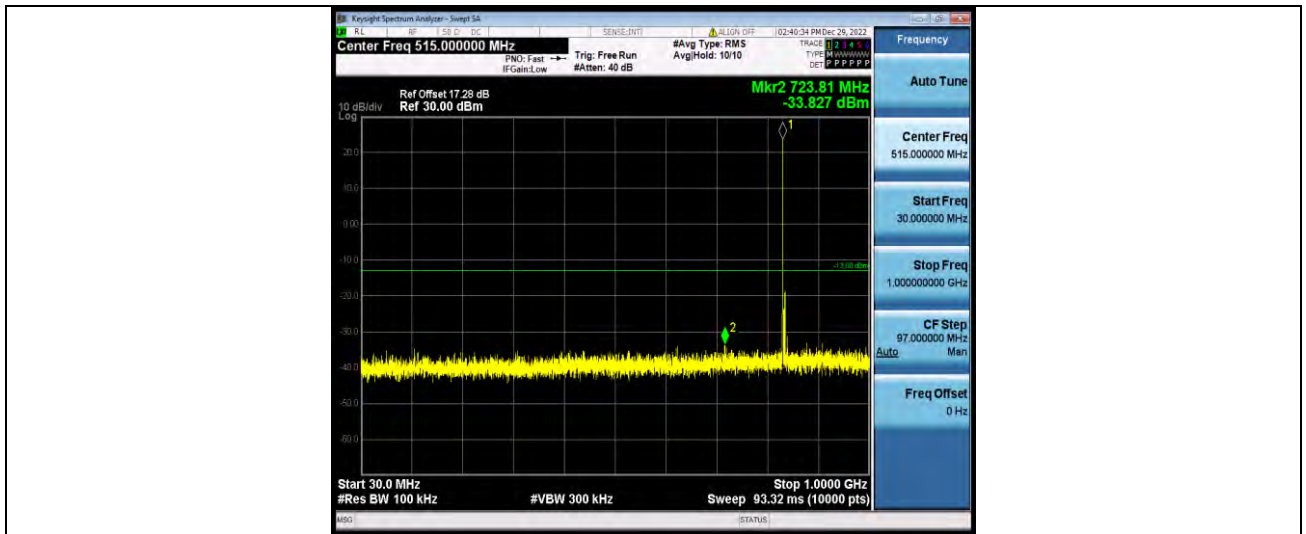

Band5-5MHz-QPSK-20525-1RB#0-Range2:1000~10000MHz

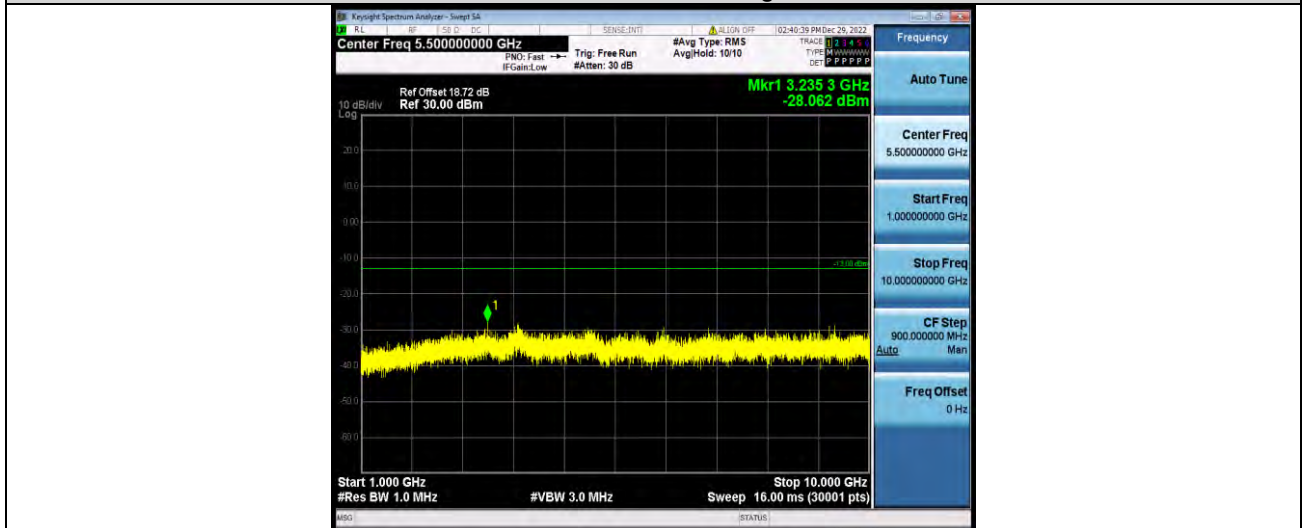

Band5-5MHz-QPSK-20625-1RB#0-Range1:30~1000MHz

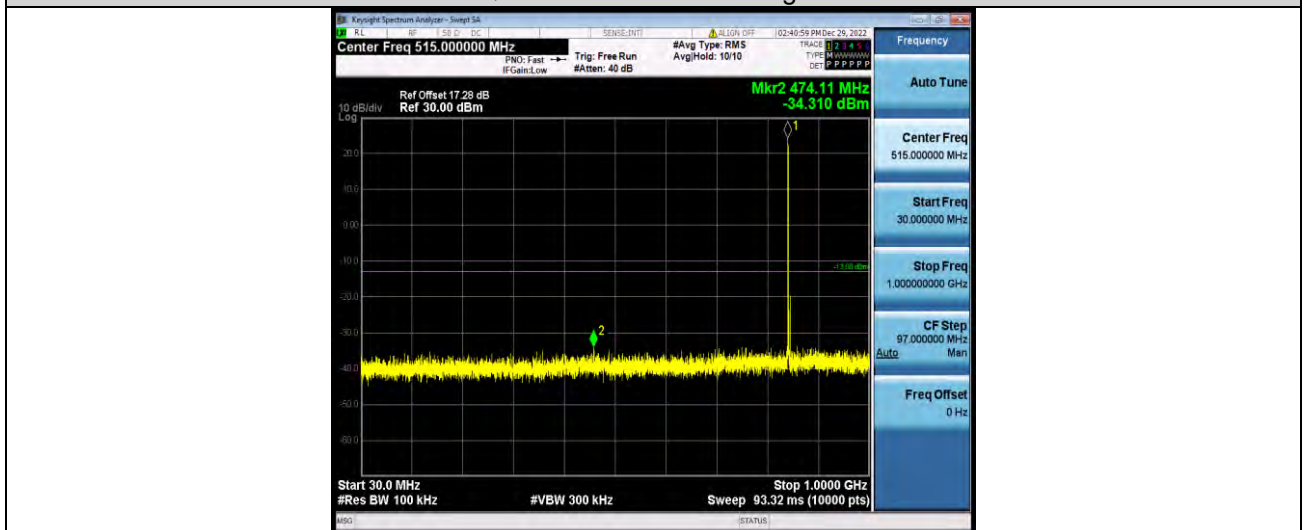

Band5-5MHz-QPSK-20625-1RB#0-Range2:1000~10000MHz



BUREAU VERITAS

Test Report No.: W7L-221220W001RF01

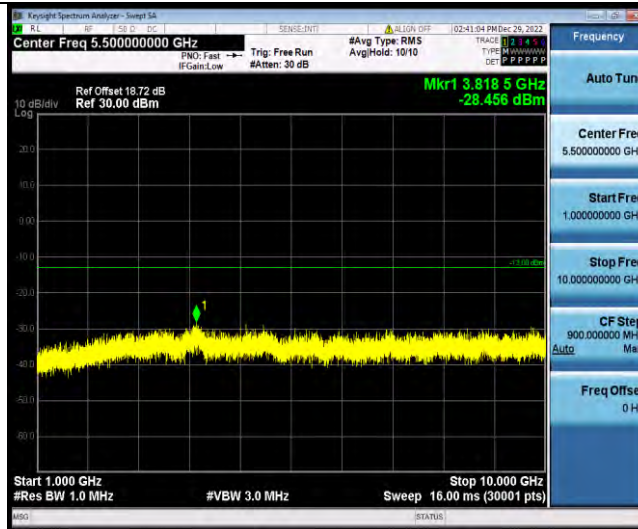

Band5-10MHz-QPSK-20450-1RB#0-Range1:30~1000MHz

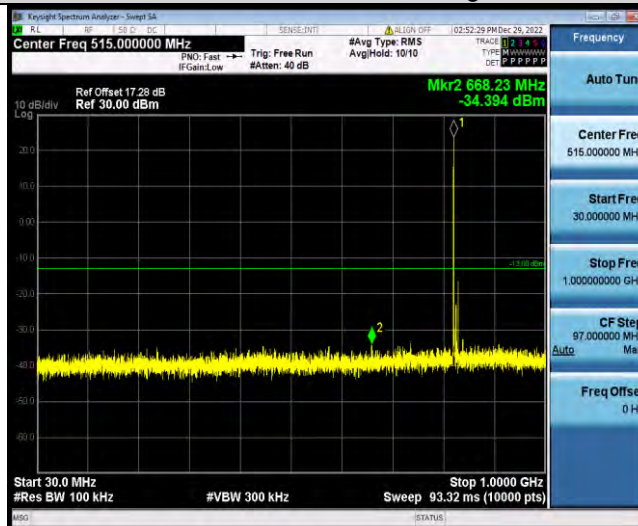

Band5-10MHz-QPSK-20450-1RB#0-Range2:1000~10000MHz

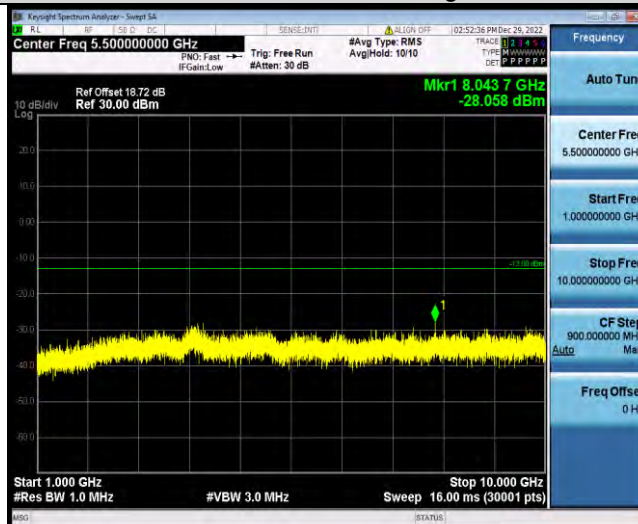

Band5-10MHz-QPSK-20525-1RB#0-Range1:30~1000MHz





BUREAU VERITAS

Test Report No.: W7L-221220W001RF01

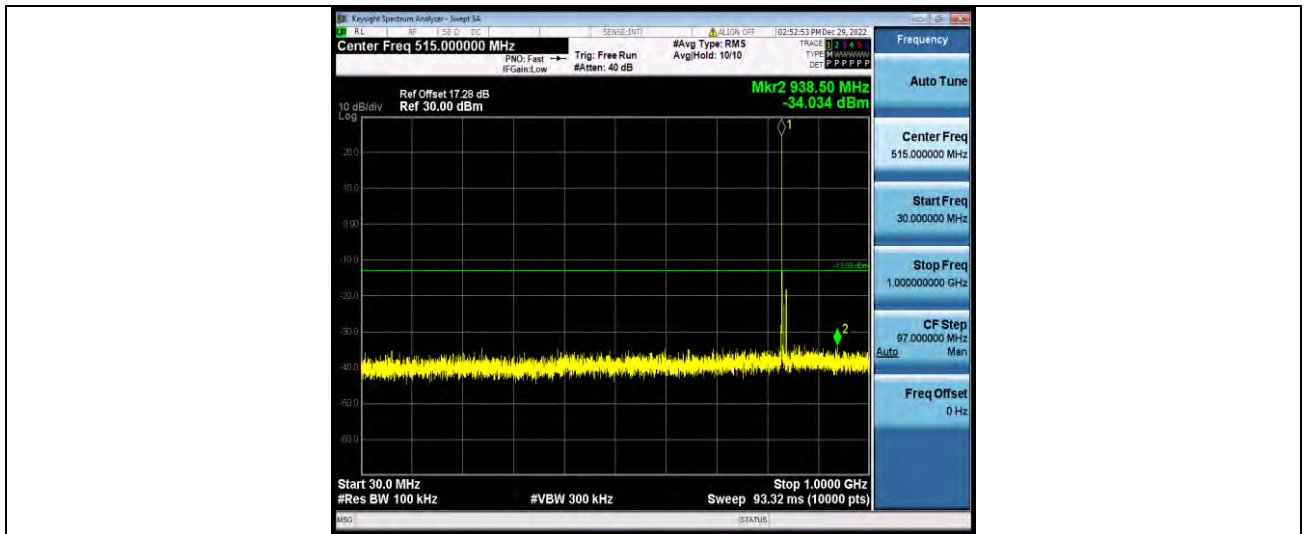

Band5-10MHz-QPSK-20525-1RB#0-Range2:1000~10000MHz

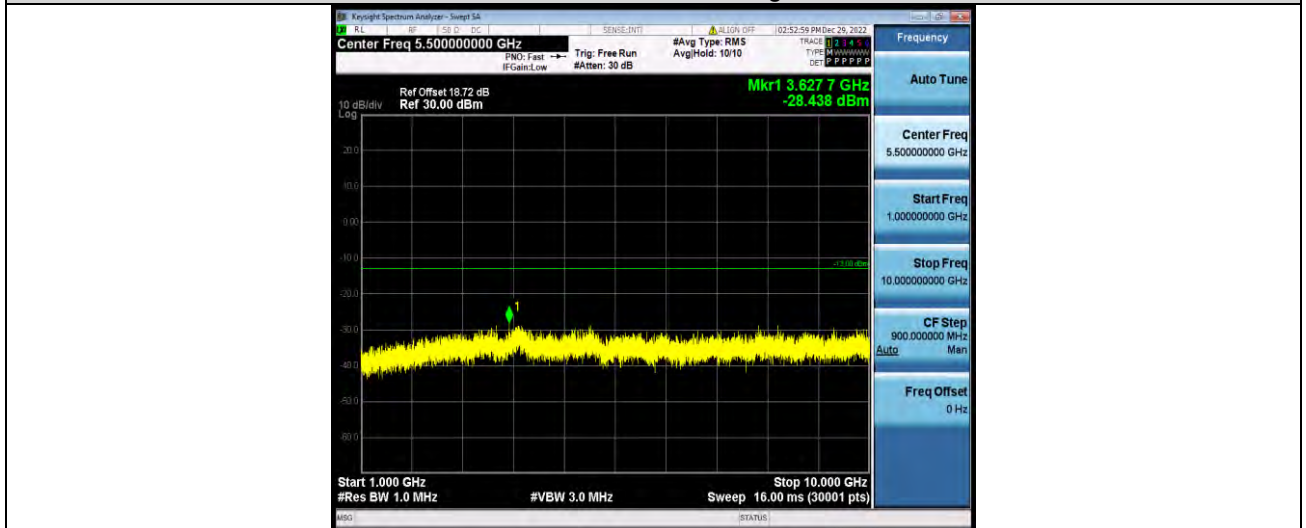

Band5-10MHz-QPSK-20600-1RB#0-Range1:30~1000MHz

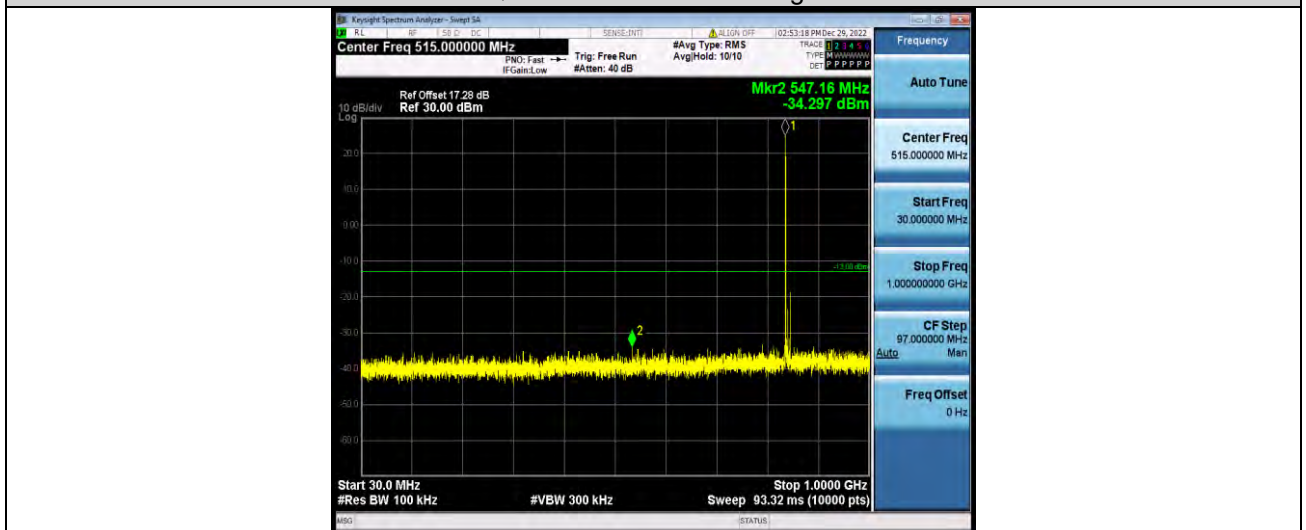

Band5-10MHz-QPSK-20600-1RB#0-Range2:1000~10000MHz



BUREAU  
VERITAS

Test Report No.: W7L-221220W001RF01

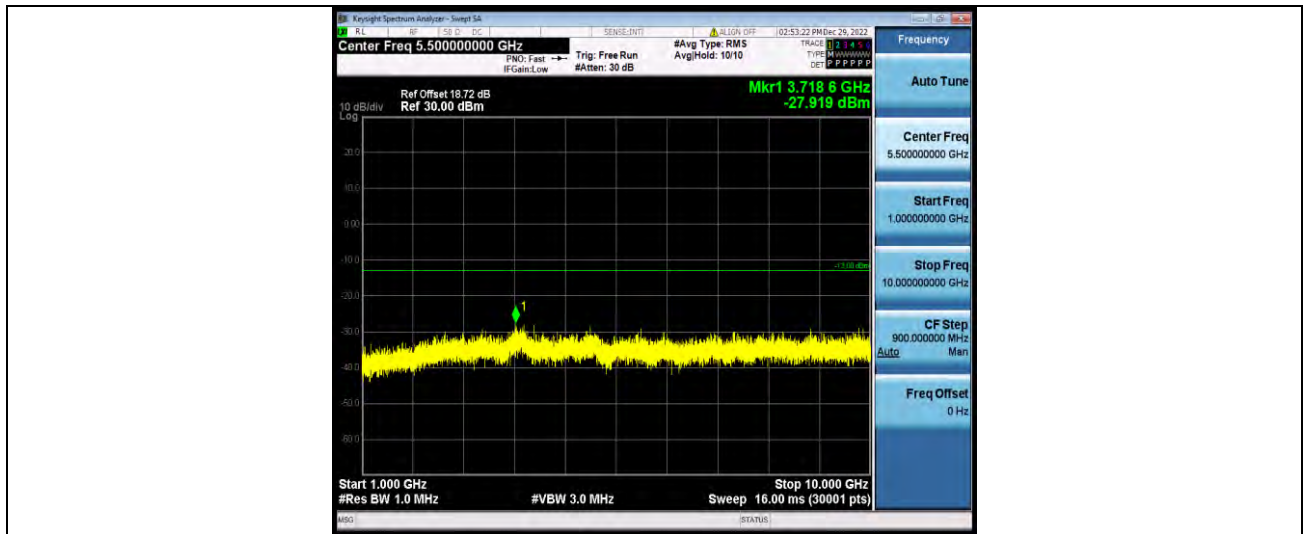



### FREQUENCY STABILITY

#### Test Result

Voltage										
Band	Bandwidth	Modulation	Channel	RB Configure	Voltage [Vdc]	Temperature (°C)	Deviation (Hz)	Deviation (ppm)	Limit (ppm)	Verdict
Band5	10MHz	QPSK	20450	50RB#0	VL	NT	2.07	0.002497	±2.5	PASS
Band5	10MHz	QPSK	20450	50RB#0	VN	NT	1.27	0.001532	±2.5	PASS
Band5	10MHz	QPSK	20450	50RB#0	VH	NT	1.95	0.002352	±2.5	PASS
Band5	10MHz	QPSK	20525	50RB#0	VL	NT	3.43	0.004100	±2.5	PASS
Band5	10MHz	QPSK	20525	50RB#0	VN	NT	2.40	0.002869	±2.5	PASS
Band5	10MHz	QPSK	20525	50RB#0	VH	NT	2.42	0.002893	±2.5	PASS
Band5	10MHz	QPSK	20600	50RB#0	VL	NT	-2.52	-0.002986	±2.5	PASS
Band5	10MHz	QPSK	20600	50RB#0	VN	NT	-3.55	-0.004206	±2.5	PASS
Band5	10MHz	QPSK	20600	50RB#0	VH	NT	1.59	0.001884	±2.5	PASS

Temperature										
Band	Bandwidth	Modulation	Channel	RB Configure	Voltage [Vdc]	Temperature (°C)	Deviation (Hz)	Deviation (ppm)	Limit (ppm)	Verdict
Band5	10MHz	QPSK	20450	50RB#0	NV	-30	-3.73	-0.004499	±2.5	PASS
Band5	10MHz	QPSK	20450	50RB#0	NV	-20	-1.80	-0.002171	±2.5	PASS
Band5	10MHz	QPSK	20450	50RB#0	NV	-10	-1.90	-0.002292	±2.5	PASS
Band5	10MHz	QPSK	20450	50RB#0	NV	0	-3.15	-0.003800	±2.5	PASS
Band5	10MHz	QPSK	20450	50RB#0	NV	10	-1.50	-0.001809	±2.5	PASS
Band5	10MHz	QPSK	20450	50RB#0	NV	20	-2.92	-0.003522	±2.5	PASS
Band5	10MHz	QPSK	20450	50RB#0	NV	30	-2.00	-0.002413	±2.5	PASS
Band5	10MHz	QPSK	20450	50RB#0	NV	40	-3.00	-0.003619	±2.5	PASS
Band5	10MHz	QPSK	20450	50RB#0	NV	50	2.76	0.003329	±2.5	PASS
Band5	10MHz	QPSK	20525	50RB#0	NV	-30	-2.73	-0.003264	±2.5	PASS
Band5	10MHz	QPSK	20525	50RB#0	NV	-20	-1.76	-0.002104	±2.5	PASS
Band5	10MHz	QPSK	20525	50RB#0	NV	-10	-3.00	-0.003586	±2.5	PASS
Band5	10MHz	QPSK	20525	50RB#0	NV	0	-1.77	-0.002116	±2.5	PASS
Band5	10MHz	QPSK	20525	50RB#0	NV	10	2.05	0.002451	±2.5	PASS
Band5	10MHz	QPSK	20525	50RB#0	NV	20	-1.60	-0.001913	±2.5	PASS
Band5	10MHz	QPSK	20525	50RB#0	NV	30	-3.06	-0.003658	±2.5	PASS
Band5	10MHz	QPSK	20525	50RB#0	NV	40	-1.63	-0.001949	±2.5	PASS
Band5	10MHz	QPSK	20525	50RB#0	NV	50	-3.20	-0.003825	±2.5	PASS
Band5	10MHz	QPSK	20600	50RB#0	NV	-30	-3.66	-0.004336	±2.5	PASS
Band5	10MHz	QPSK	20600	50RB#0	NV	-20	-4.66	-0.005521	±2.5	PASS
Band5	10MHz	QPSK	20600	50RB#0	NV	-10	-2.96	-0.003507	±2.5	PASS
Band5	10MHz	QPSK	20600	50RB#0	NV	0	-3.05	-0.003614	±2.5	PASS
Band5	10MHz	QPSK	20600	50RB#0	NV	10	-4.92	-0.005829	±2.5	PASS
Band5	10MHz	QPSK	20600	50RB#0	NV	20	-2.92	-0.003460	±2.5	PASS
Band5	10MHz	QPSK	20600	50RB#0	NV	30	-3.40	-0.004028	±2.5	PASS



**BUREAU  
VERITAS**

**Test Report No.: W7L-221220W001RF01**

Band5	10MHz	QPSK	20600	50RB#0	NV	40	-3.23	-0.003827	±2.5	PASS
Band5	10MHz	QPSK	20600	50RB#0	NV	50	-3.93	-0.004656	±2.5	PASS

**--END--**