

2595MHz

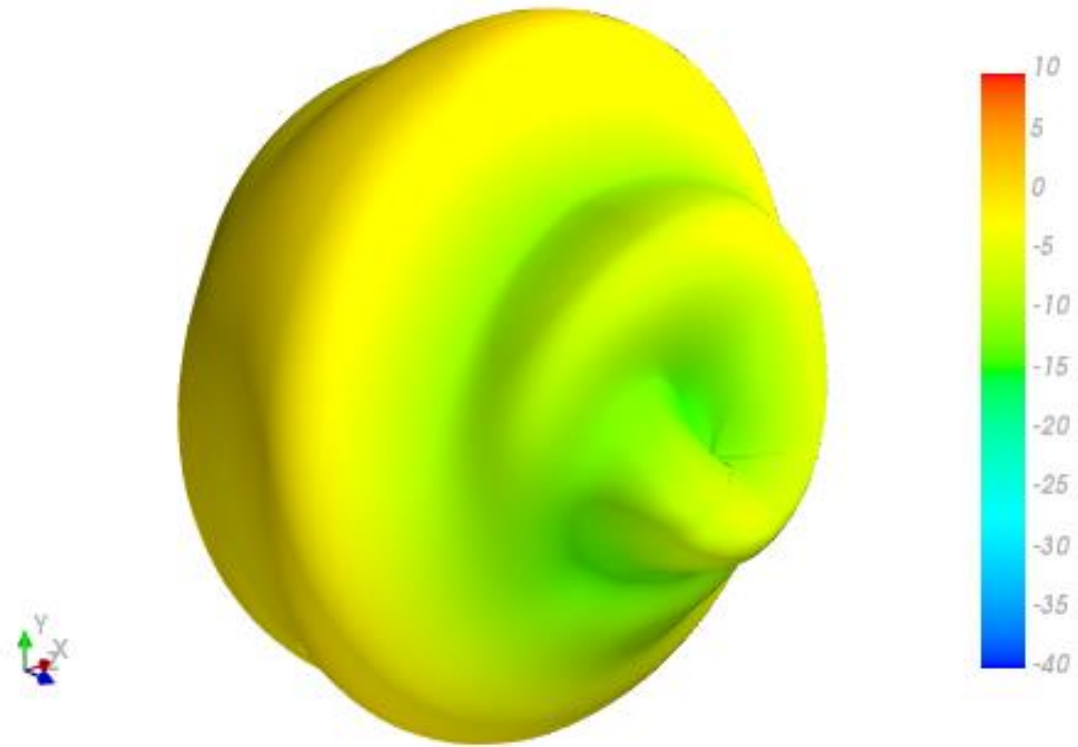

XY Plane

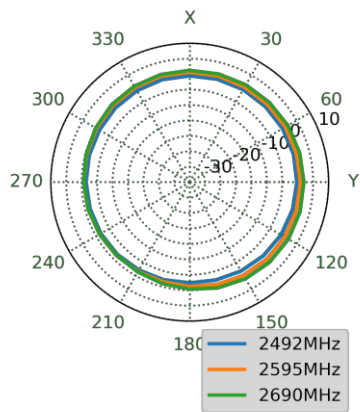

XZ Plane

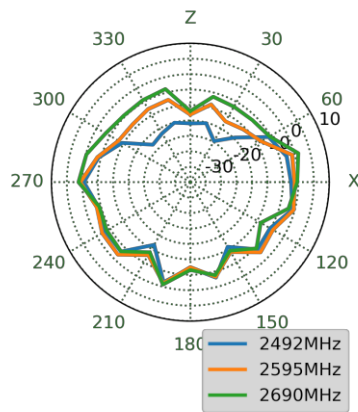

YZ Plane

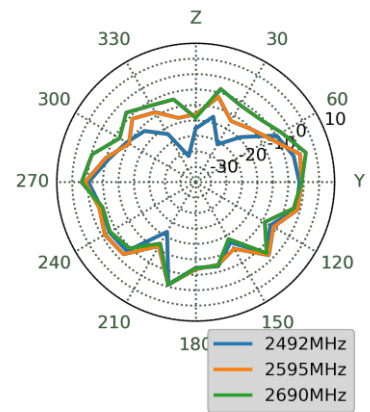

3550MHz

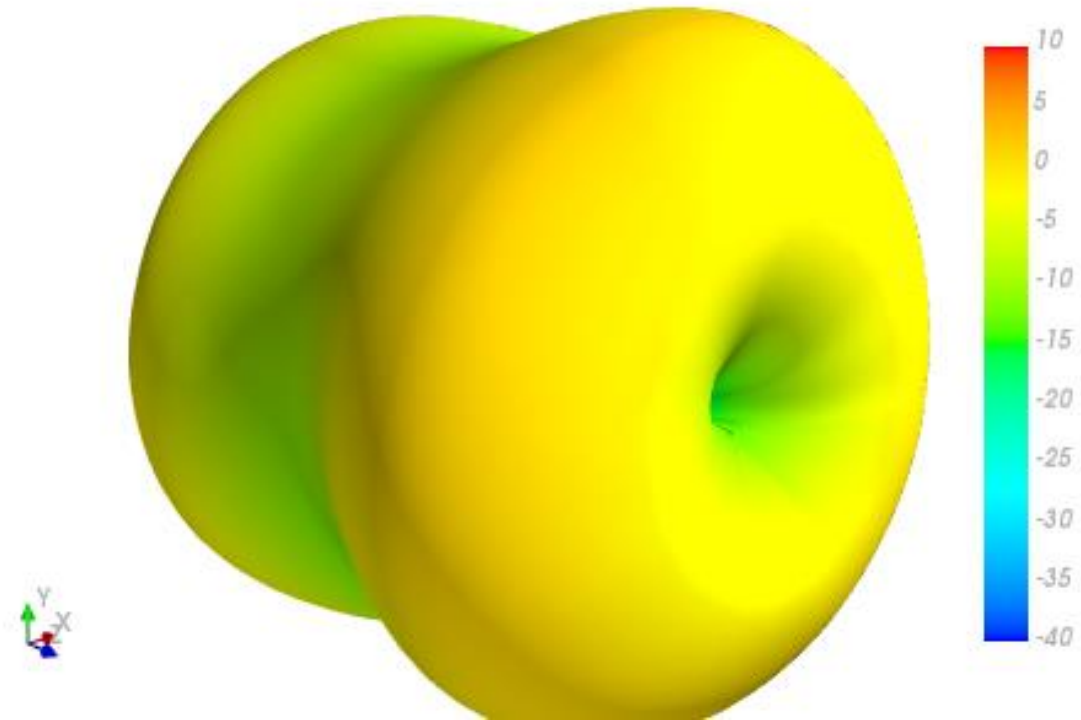

XY Plane

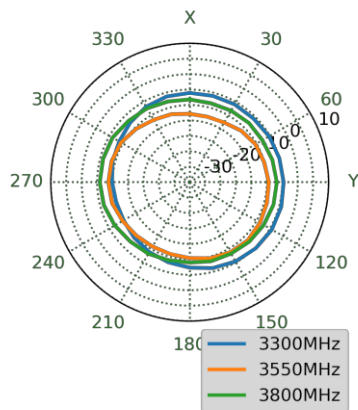

XZ Plane

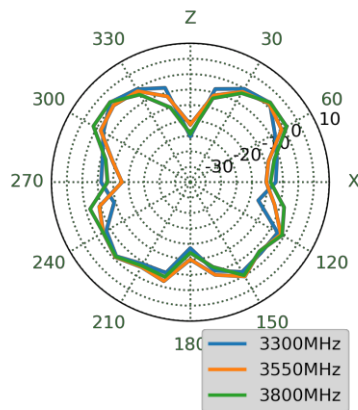

YZ Plane

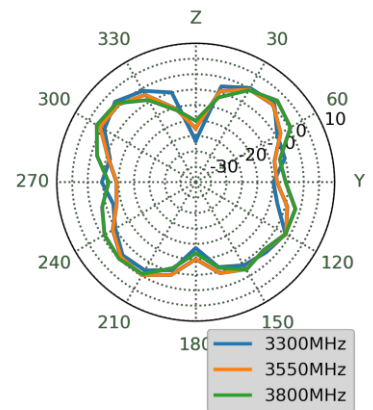

5530MHz

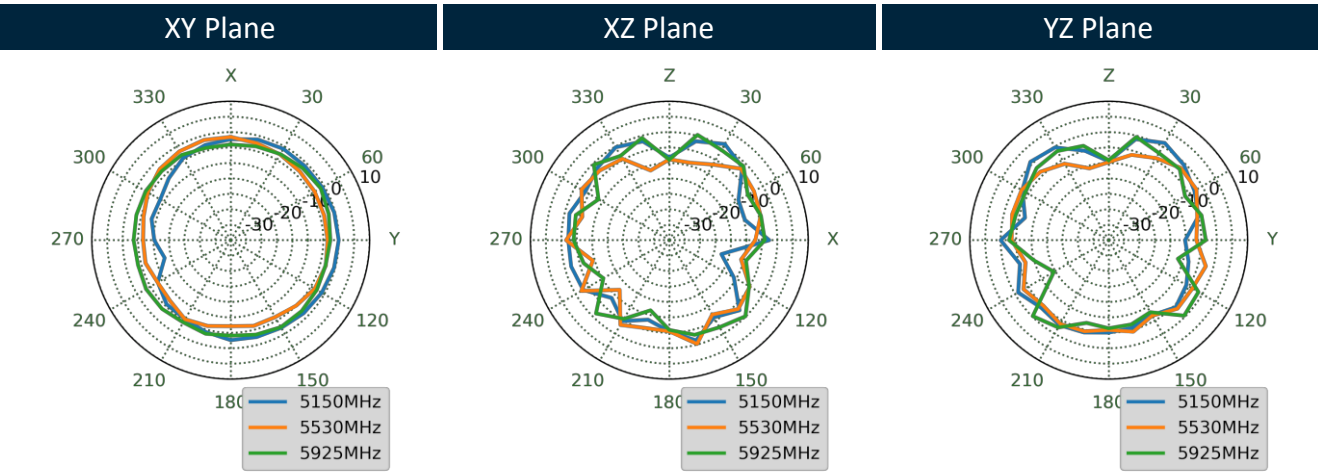
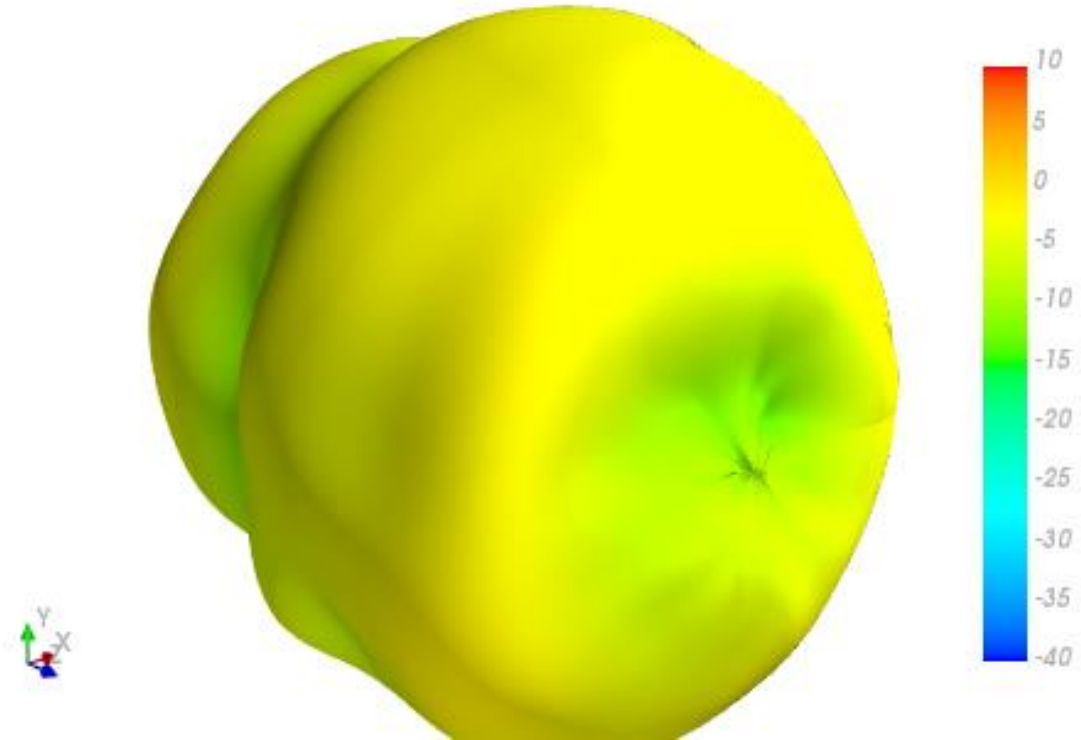

### 4.3 Test Setup

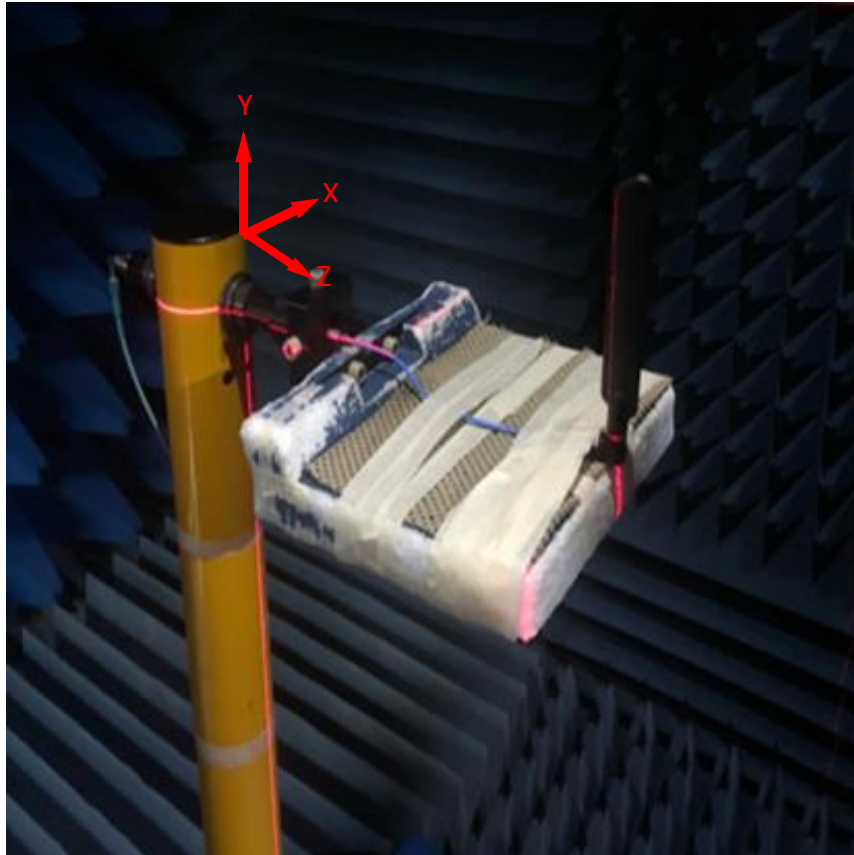

Bent Free Space

4.4 Bent Free Space 2D & 3D Radiation Patterns

652MHz

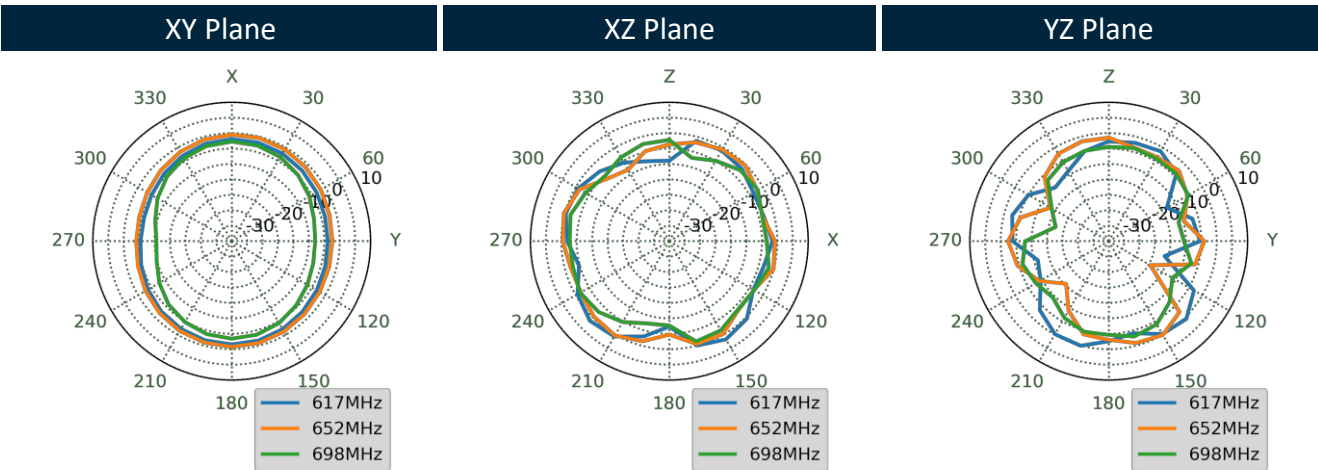
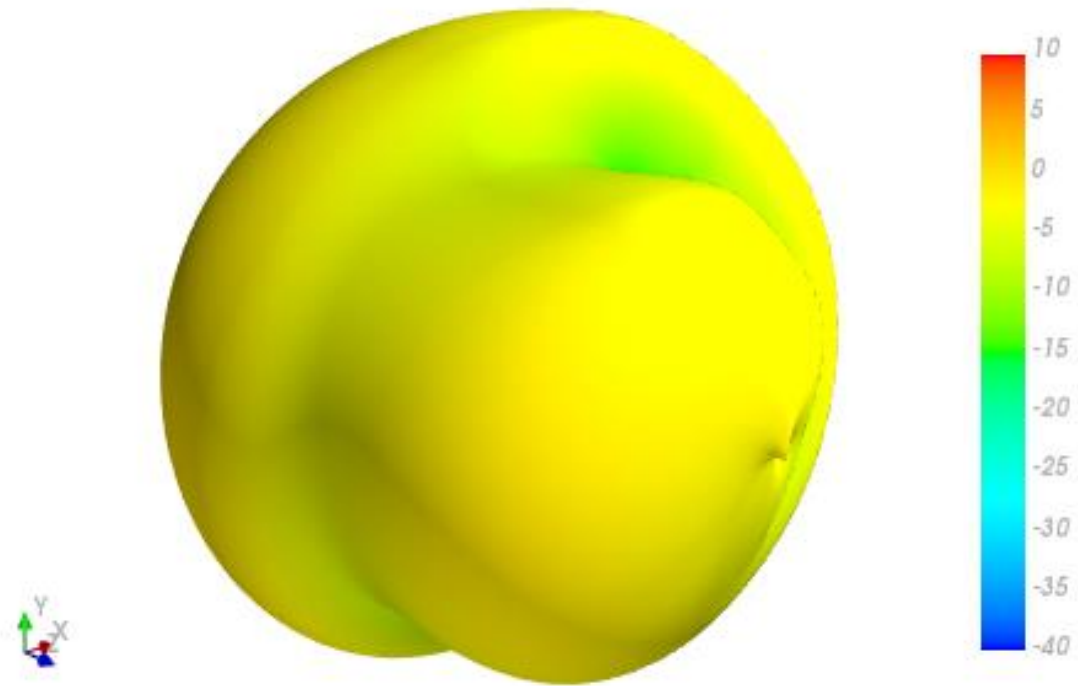

751MHz

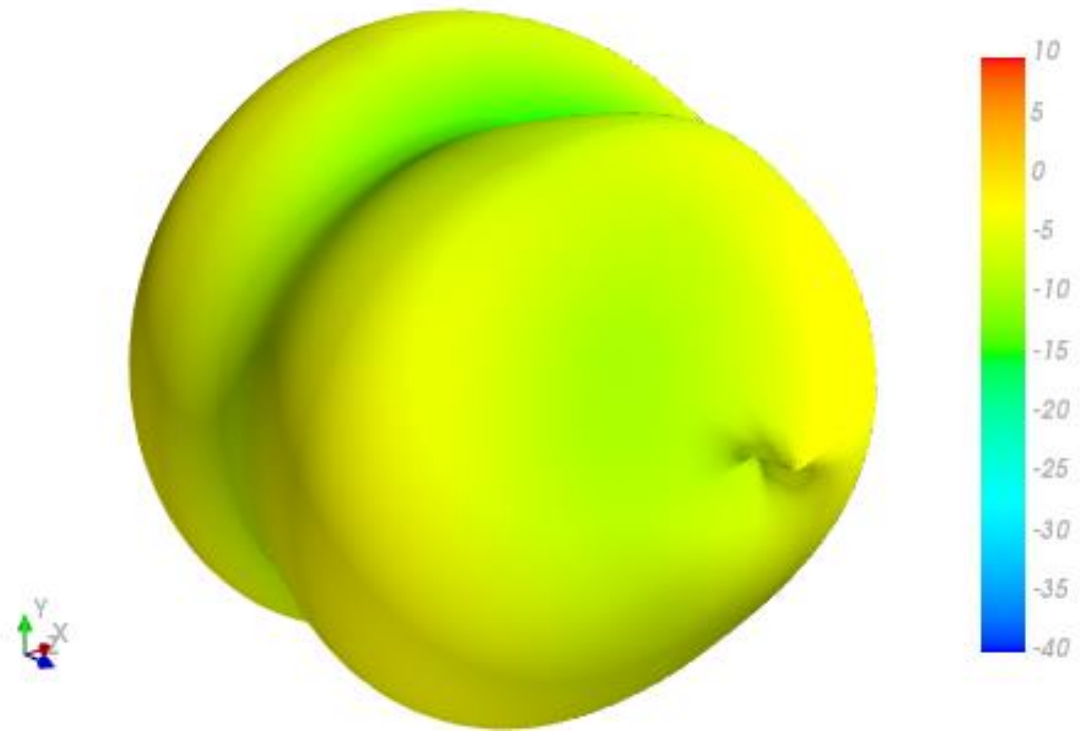

XY Plane      XZ Plane      YZ Plane

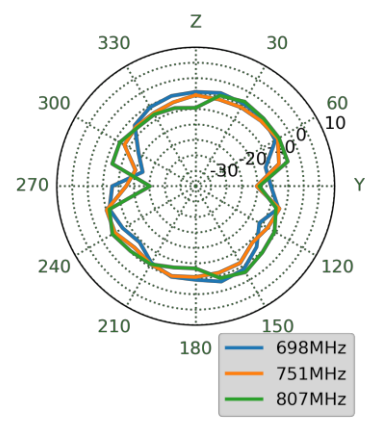
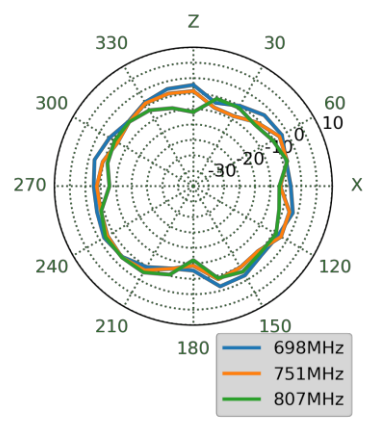
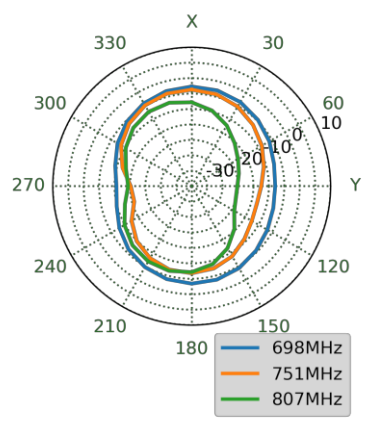

890MHz

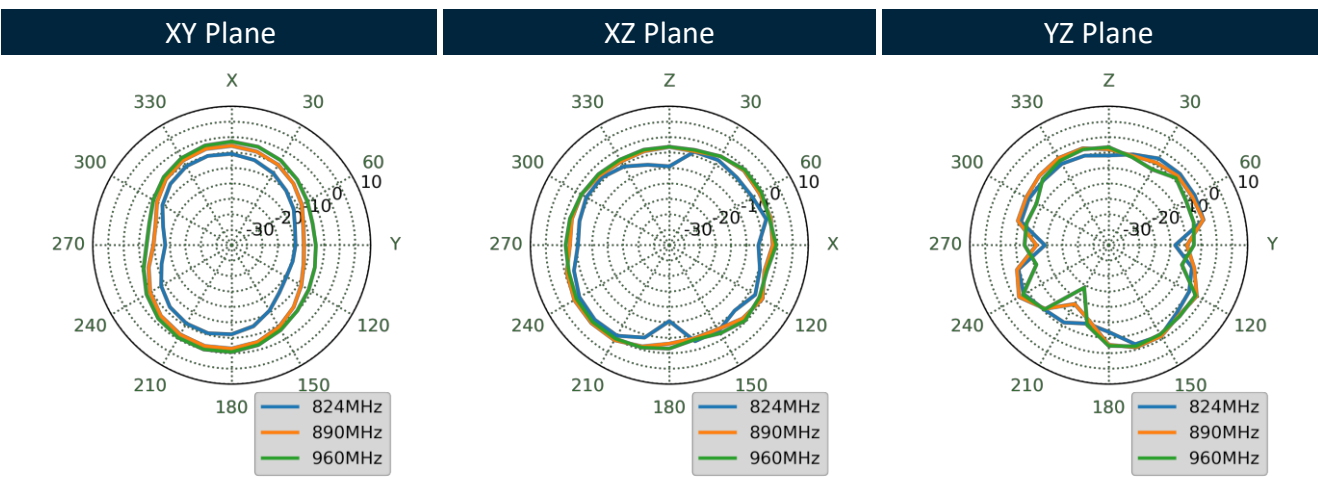
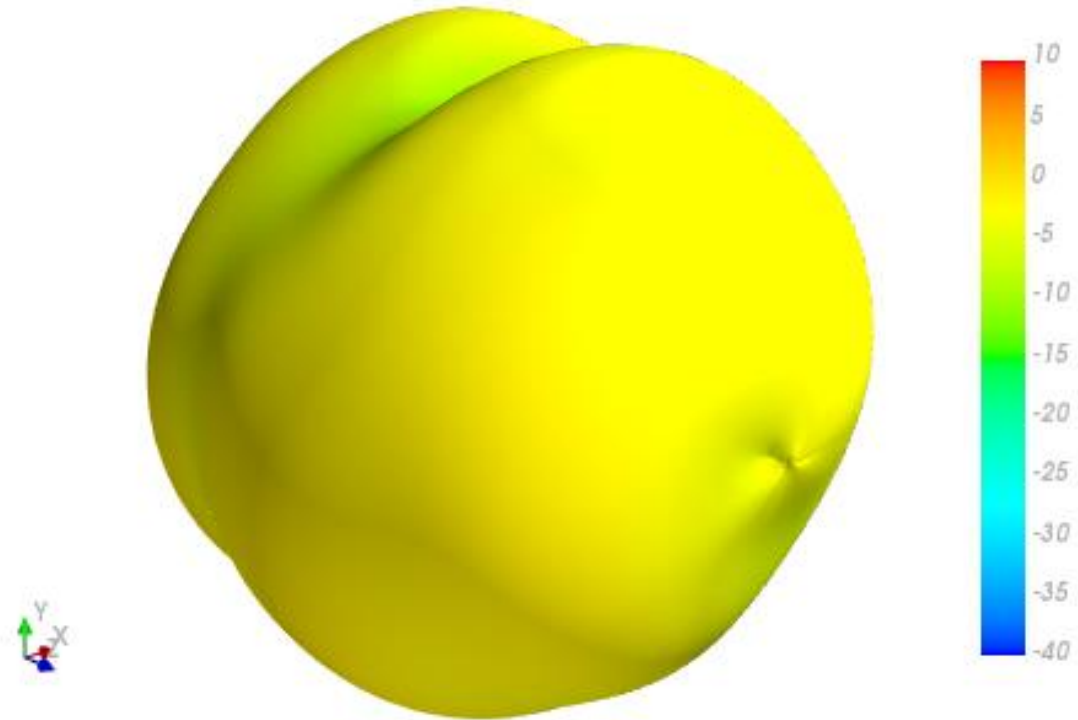

1470MHz

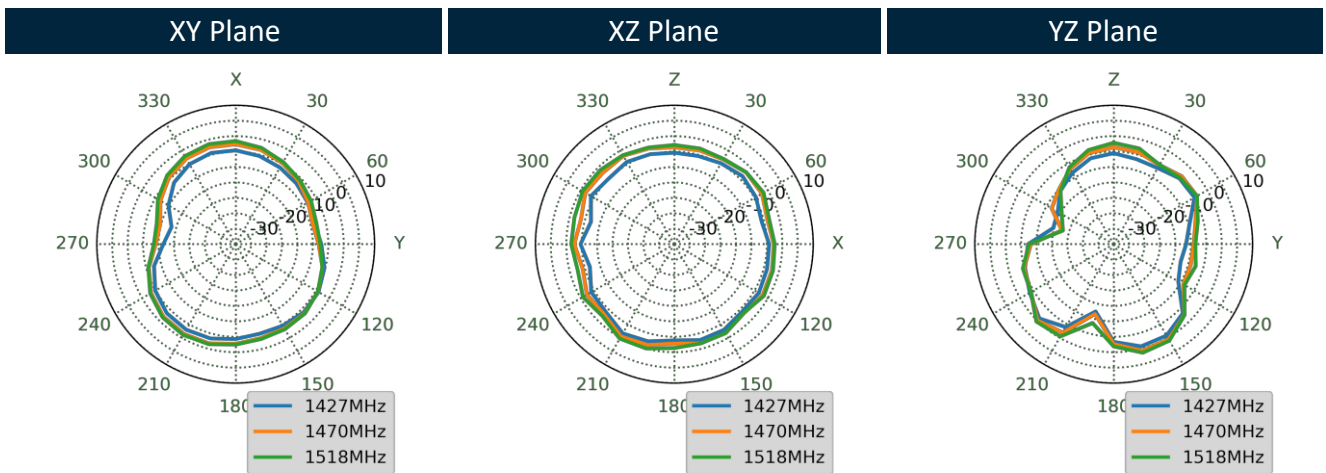
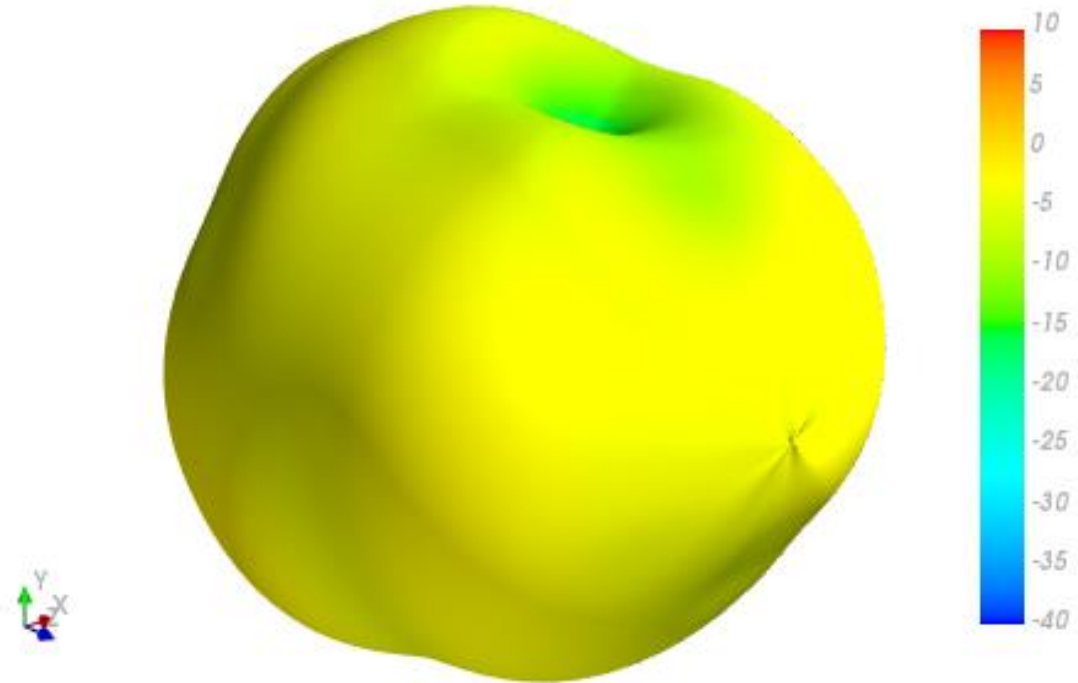



1805MHz

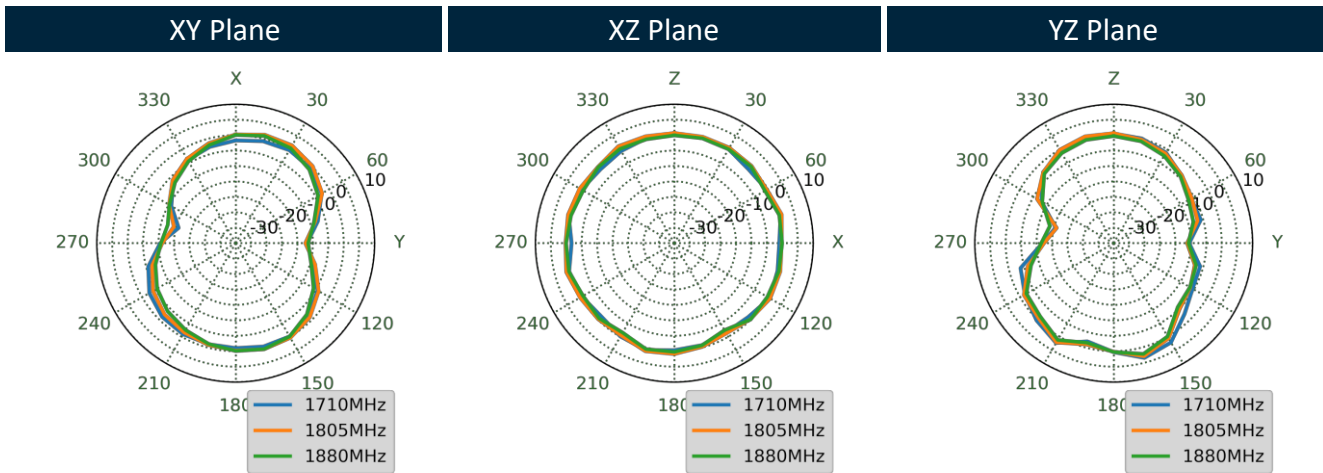
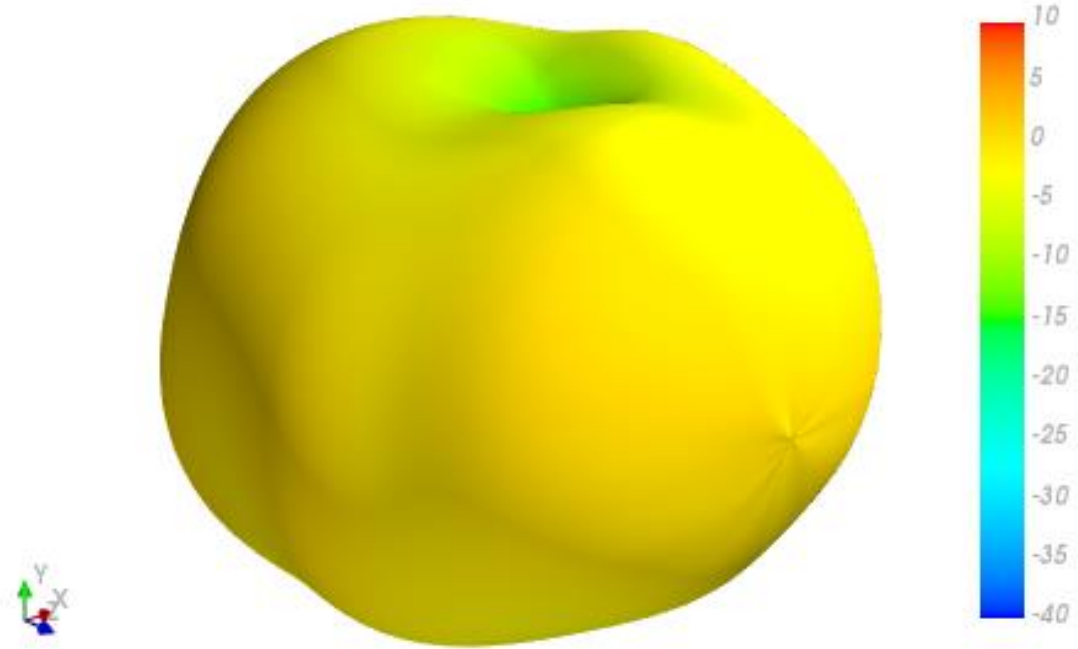

1920MHz

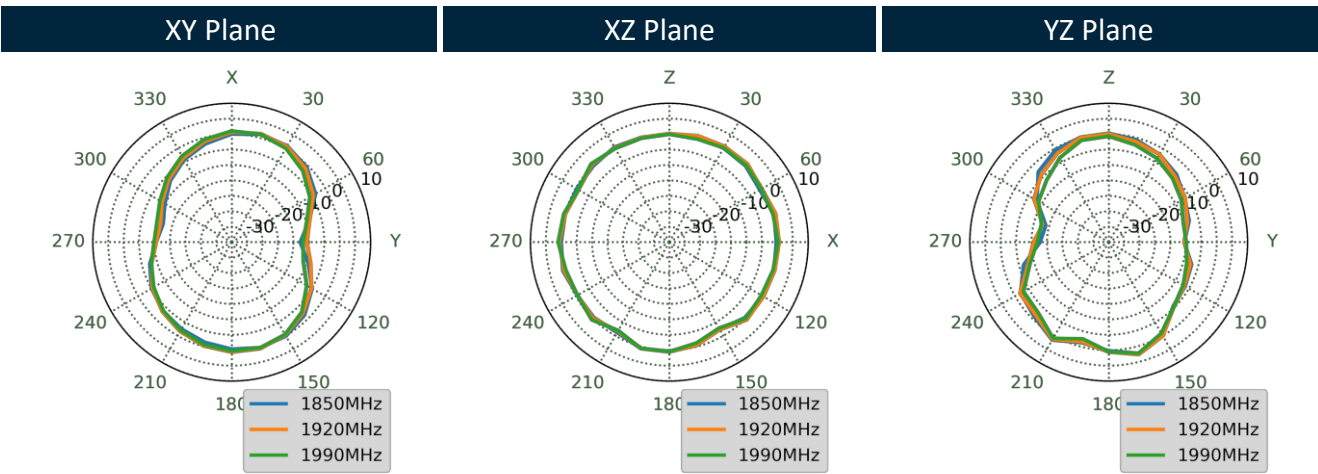
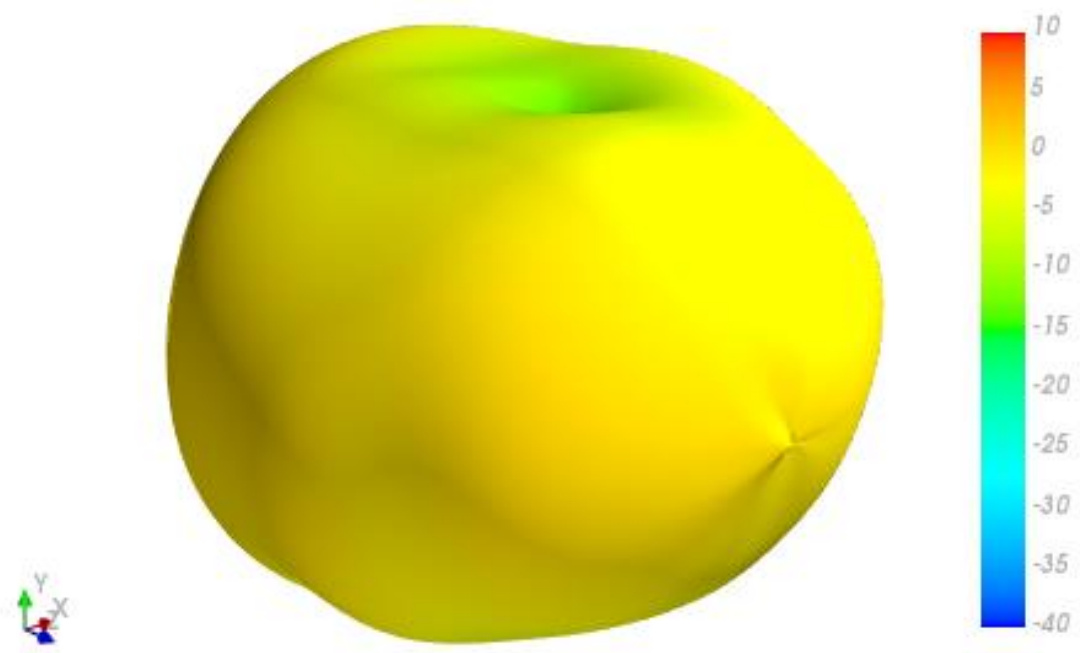

1990MHz

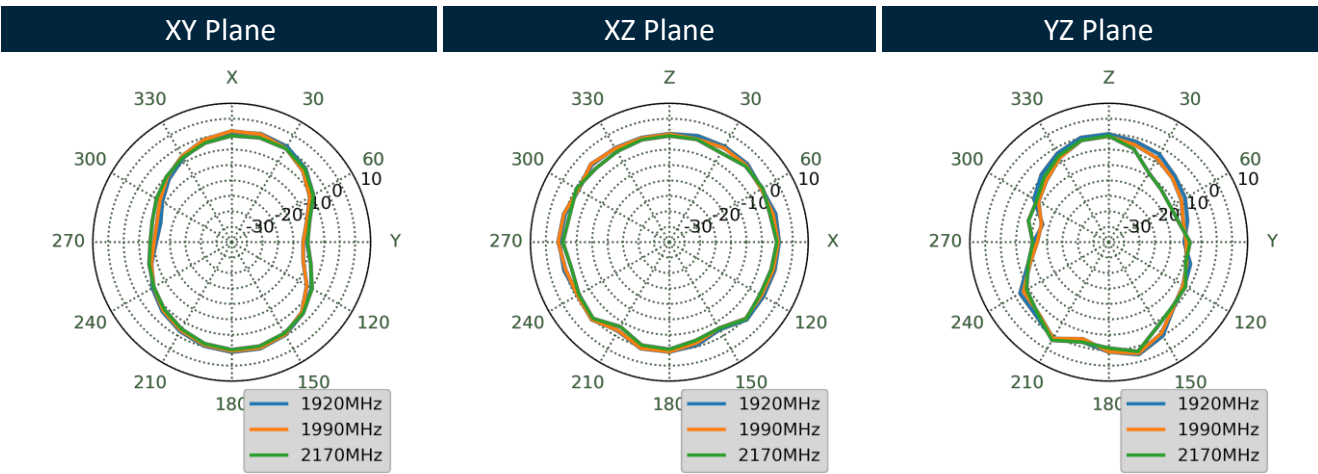
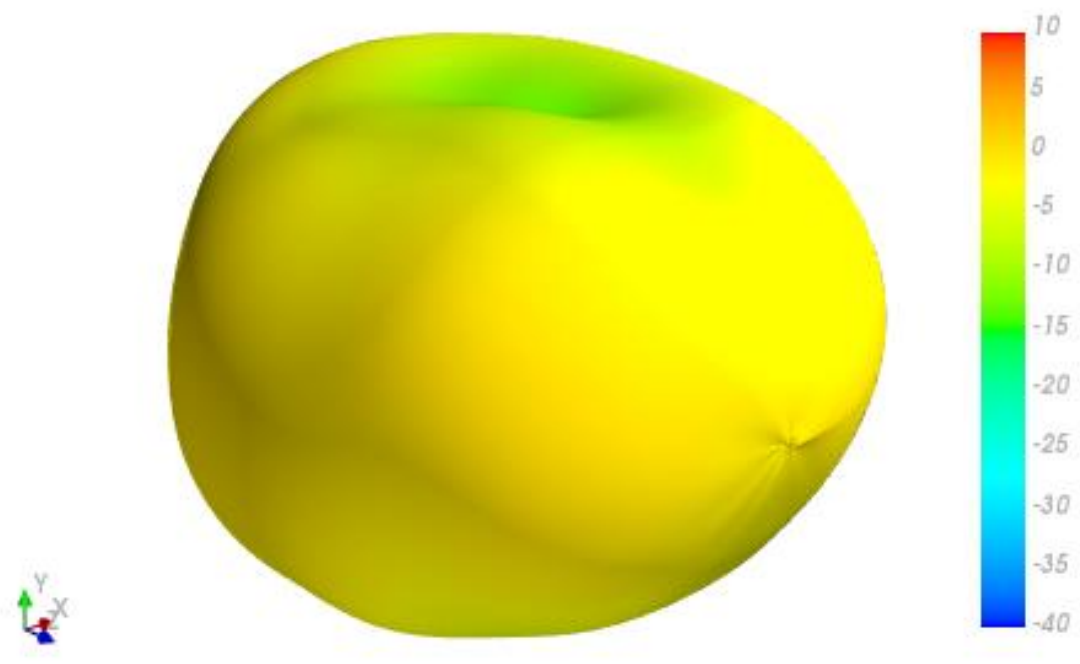

2595MHz

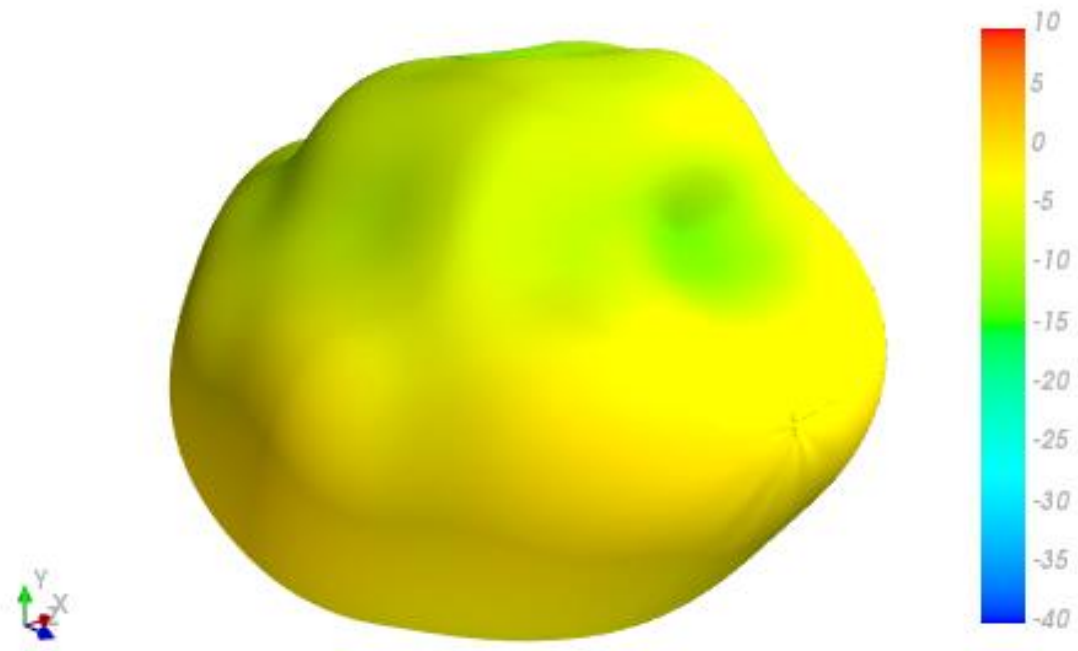

XY Plane

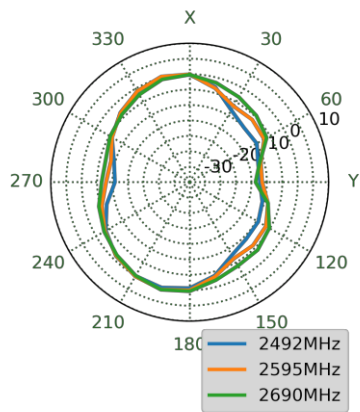

XZ Plane

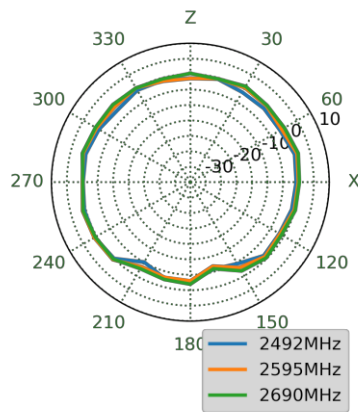

YZ Plane

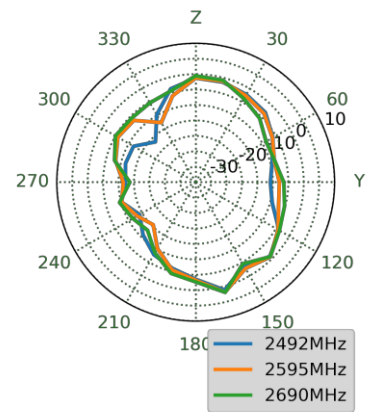

3550MHz

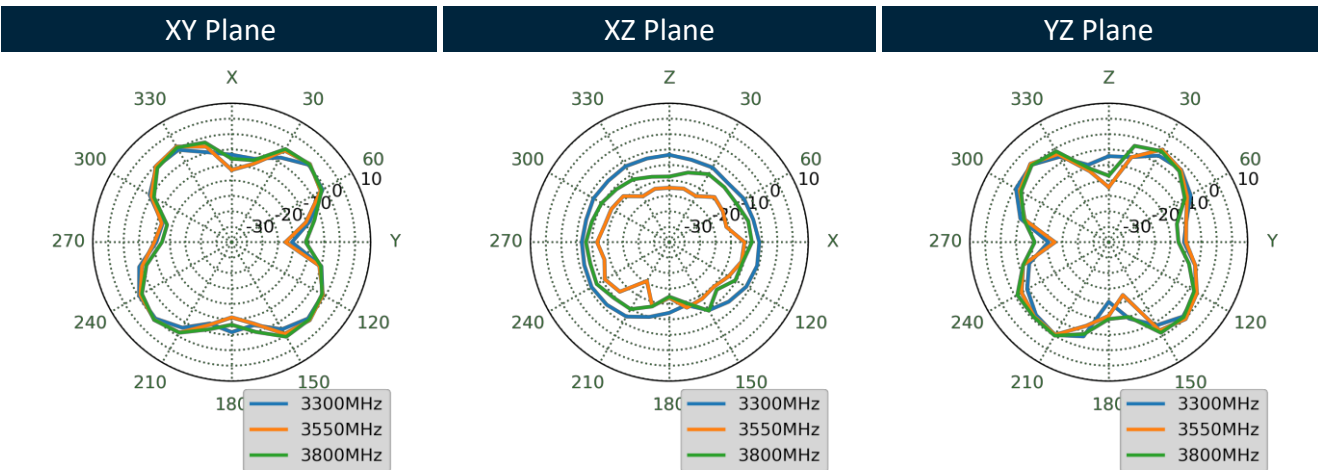
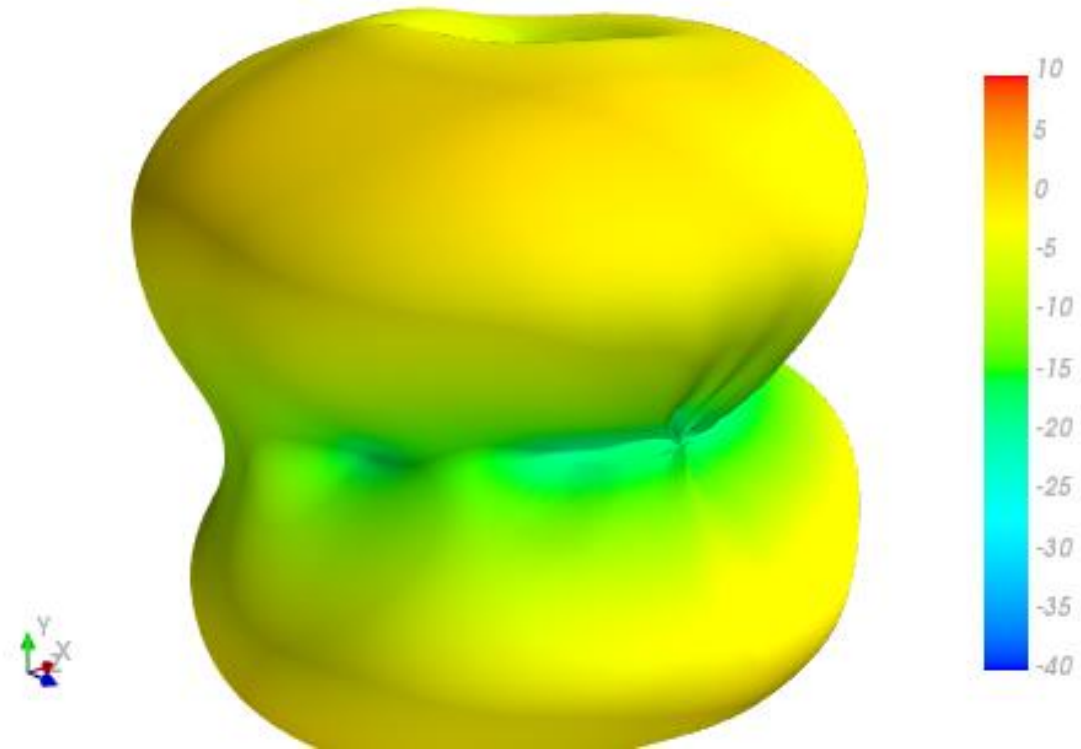

5530MHz

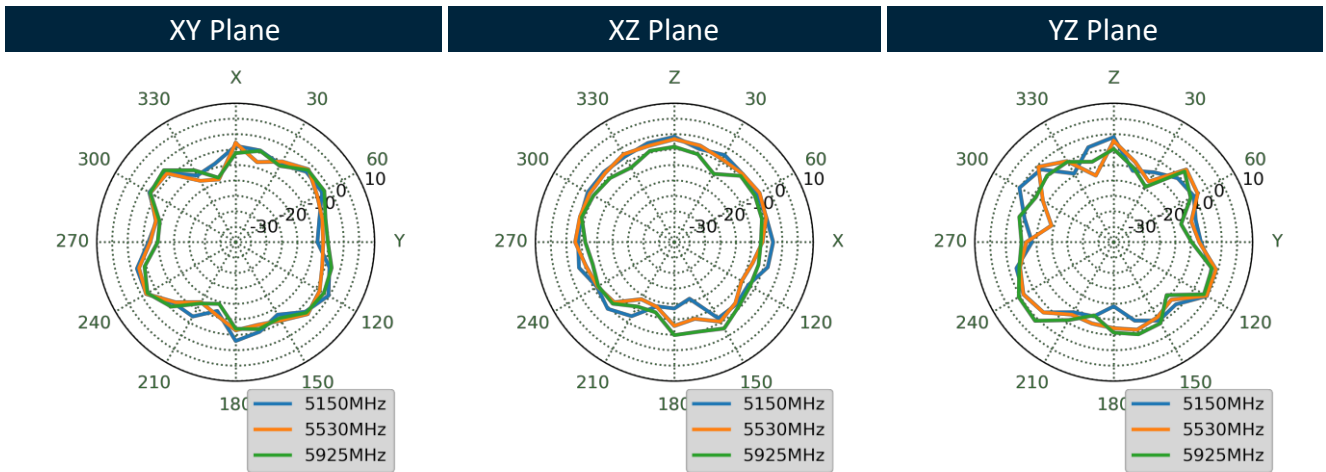
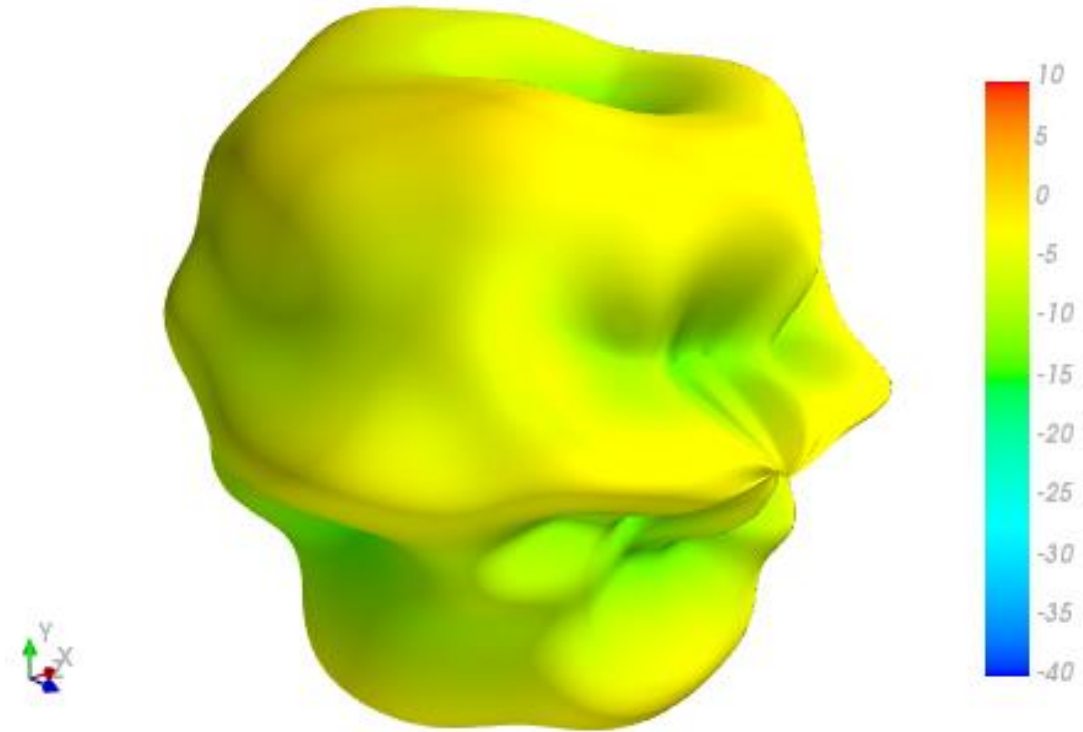

## 4.5 Test Setup

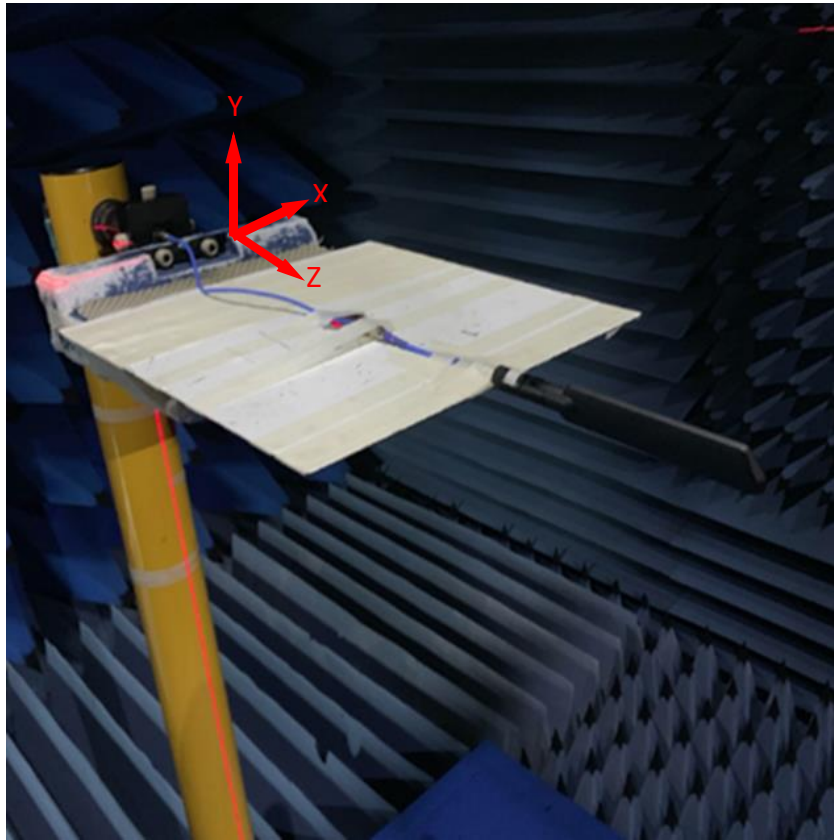

Straight 30x30cm Ground Plane Edge

4.6 Straight 30x30cm Ground Plane Edge 2D & 3D Radiation Patterns

652MHz

