



FCC RADIO TEST REPORT

FCC ID : LHJ-FE4RW0110
Equipment : FE4RW0110
Brand Name : Continental
Model Name : FE4RW0110
Applicant : Continental Automotive Systems, Inc.
21440 W Lake Cook Rd.
Manufacturer : Continental Automotive Systems, Inc.
21440 W Lake Cook Rd.
Standard : FCC 47 CFR Part 2, 22(H), 24(E), 27

The product was received on May 06, 2021 and testing was started from May 16, 2021 and completed on May 19, 2021. We, Sporton International Inc. EMC & Wireless Communications Laboratory, would like to declare that the tested sample has been evaluated in accordance with the test procedures given in ANSI / TIA-603-E and has been in compliance with the applicable technical standards.

The test results in this report apply exclusively to the tested model / sample. Without written approval of Sporton International Inc. EMC & Wireless Communications Laboratory, the test report shall not be reproduced except in full.

Louis Wu

Approved by: Louis Wu

Sporton International Inc. EMC & Wireless Communications Laboratory

No. 52, Huaya 1st Rd., Guishan Dist., Taoyuan City 333, Taiwan (R.O.C.)



Table of Contents

History of this test report.....	3
Summary of Test Result.....	4
1 General Description	6
1.1 Product Feature of Equipment Under Test.....	6
1.2 Product Specification of Equipment Under Test.....	6
1.3 Modification of EUT	7
1.4 Testing Location	7
1.5 Applicable Standards.....	8
2 Test Configuration of Equipment Under Test	9
2.1 Test Mode.....	9
2.2 Connection Diagram of Test System.....	11
2.3 Support Unit used in test configuration and system	11
2.4 Measurement Results Explanation Example.....	11
2.5 Frequency List of Low/Middle/High Channels	12
3 Conducted Test Items.....	15
3.1 Measuring Instruments	15
3.2 Conducted Output Power and ERP/EIRP	16
3.3 Peak-to-Average Ratio	17
3.4 Occupied Bandwidth.....	18
3.5 Conducted Band Edge	19
3.6 Conducted Spurious Emission	21
3.7 Frequency Stability	22
4 Radiated Test Items	23
4.1 Measuring Instruments	23
4.2 Radiated Spurious Emission Measurement	25
5 List of Measuring Equipment.....	26
6 Uncertainty of Evaluation.....	28
Appendix A. Test Results of Conducted Test	
Appendix B. Test Results of ERP/EIRP and Radiated Test	
Appendix C. Test Setup Photographs	



History of this test report

Report No.	Version	Description	Issued Date
FG150634-01B	01	Initial issue of report	Jun. 04, 2021



Summary of Test Result

Report Clause	Ref Std. Clause	Test Items	Result (PASS/FAIL)	Remark
3.2	§2.1046	Conducted Output Power	Reporting only	-
	§22.913 (a)(5)	Effective Radiated Power (Band 5)	Pass	
	§24.232 (c) §27.50 (h)(2)	Equivalent Isotropic Radiated Power (Band 2) (Band 7) (Band 38) (Band 41)		
	§27.50 (d)(4)	Equivalent Isotropic Radiated Power (Band 4)		
3.3	§24.232 (d) §27.50 (d)(5)	Peak-to-Average Ratio	Pass	-
3.4	§2.1049	Occupied Bandwidth	Reporting only	-
3.5	§2.1051 §22.917 (a) §24.238 (a) §27.53 (h)	Conducted Band Edge Measurement (Band 2) (Band 4) (Band 5)	Pass	-
	§2.1051 §27.53 (m)(4)	Conducted Band Edge Measurement (Band 7) (Band 38) (Band 41)		
3.6	§2.1051 §22.917 (a) §24.238 (a) §27.53 (h)	Conducted Spurious Emission (Band 2) (Band 4) (Band 5)	Pass	-
	§2.1051 §27.53 (m)(4)	Conducted Spurious Emission (Band 7) (Band 38) (Band 41)		
3.7	§2.1055 §22.355 §24.235 §27.54	Frequency Stability Temperature & Voltage	Pass	-



Report Clause	Ref Std. Clause	Test Items	Result (PASS/FAIL)	Remark
4.2	§2.1053 §22.917 (a) §24.238 (a) §27.53 (h)	Radiated Spurious Emission (Band 2) (Band 4) (Band 5)	Pass	Under limit 9.24 dB at 15516.000 MHz
	§2.1051 §27.53 (m)(4)	Radiated Spurious Emission (Band 7) (Band 38) (Band 41)		

Declaration of Conformity:

The test results with all measurement uncertainty excluded are presented in accordance with the regulation limits or requirements declared by manufacturers.

Comments and Explanations:

The declared of product specification for EUT presented in the report are provided by the manufacturer, and the manufacturer takes all the responsibilities for the accuracy of product specification.

Reviewed by: Yun Huang

Report Producer: Celery Wei



1 General Description

1.1 Product Feature of Equipment Under Test

Product Feature	
Equipment	FE4RW0110
Brand Name	Continental
Model Name	FE4RW0110
FCC ID	LHJ-FE4RW0110
EUT supports Radios application	GPRS/EGPRS/WCDMA/HSPA/LTE/GNSS
HW Version	P4
EUT Stage	Identical Prototype

Remark: The above EUT's information was declared by manufacturer.

1.2 Product Specification of Equipment Under Test

Product Specification subjective to this standard	
Tx Frequency	LTE Band 2 : 1850.7 MHz ~ 1909.3 MHz LTE Band 4 : 1710.7 MHz ~ 1754.3 MHz LTE Band 5 : 824.7 MHz ~ 848.3 MHz LTE Band 7 : 2502.5 MHz ~ 2567.5 MHz LTE Band 38 : 2572.5 MHz ~ 2617.5 MHz LTE Band 41 : 2498.5 MHz ~ 2687.5 MHz
Rx Frequency	LTE Band 2 : 1930.7 MHz ~ 1989.3 MHz LTE Band 4 : 2110.7 MHz ~ 2154.3 MHz LTE Band 5 : 869.7 MHz ~ 893.3 MHz LTE Band 7 : 2622.5 MHz ~ 2687.5 MHz LTE Band 38 : 2572.5 MHz ~ 2617.5 MHz LTE Band 41 : 2498.5 MHz ~ 2687.5 MHz
Maximum Output Power to Antenna	LTE Band 2 : 22.71 dBm LTE Band 4 : 22.60 dBm LTE Band 5 : 22.70 dBm LTE Band 7 : 22.35 dBm LTE Band 38 : 22.16 dBm LTE Band 41 : 22.32 dBm
Antenna Type	Fixed External Antenna Antenna Model name: SPDA24700/2700 Antenna Manufactory: Pulse electronics
Antenna Gain	LTE Band 2: 2 dBi LTE Band 4: 2 dBi LTE Band 5: 2 dBi LTE Band 7: 2 dBi LTE Band 38: 2 dBi LTE Band 41: 2 dBi
Type of Modulation	LTE: QPSK / 16QAM / 64QAM

Remark: The above EUT's information was declared by manufacturer. Please refer to Comments and Explanations in report summary.



1.3 Modification of EUT

No modifications are made to the EUT during all test items.

1.4 Testing Location

Test Site	Sporton International Inc. EMC & Wireless Communications Laboratory
Test Site Location	No.52, Huaya 1st Rd., Guishan Dist., Taoyuan City 333, Taiwan (R.O.C.) TEL: +886-3-327-3456 FAX: +886-3-328-4978
Test Site No.	Sporton Site No.
	TH03-HY
Test Engineer	Benjamin Lin
Temperature	24.5~25.3°C
Relative Humidity	48.4~50.9%

Test Site	Sporton International Inc. Wensan Laboratory.
Test Site Location	No.58, Aly. 75, Ln. 564, Wenhua 3rd, Rd., Guishan Dist., Taoyuan City 333010, Taiwan (R.O.C.) TEL: +886-3-327-0868 FAX: +886-3-327-0855
Test Site No.	Sporton Site No.
	03CH12-HY (TAF Code: 3786)
Test Engineer	Jack Cheng, Lance Chiang and Chuan Chu
Temperature	23.8~26.2°C
Relative Humidity	56.5~68.6%
Remark	The Radiated Spurious Emission test item subcontracted to Sporton International Inc. Wensan Laboratory.

Note: The test site complies with ANSI C63.4 2014 requirement.

FCC Designation No.: TW1190 and TW3786



1.5 Applicable Standards

According to the specifications of the manufacturer, the EUT must comply with the requirements of the following standards:

- ♦ ANSI C63.26-2015
- ♦ ANSI / TIA-603-E
- ♦ FCC 47 CFR Part 2, 22(H), 24(E), 27
- ♦ FCC KDB 971168 D01 Power Meas. License Digital Systems v03r01
- ♦ FCC KDB 412172 D01 Determining ERP and EIRP v01r01
- ♦ FCC KDB 414788 D01 Radiated Test Site v01r01.

Remark:

1. All test items were verified and recorded according to the standards and without any deviation during the test.
2. This EUT has also been tested and complied with the requirements of FCC Part 15, Subpart B, recorded in a separate test report.
3. The TAF code is not including all the FCC KDB listed without accreditation.



2 Test Configuration of Equipment Under Test

2.1 Test Mode

Antenna port conducted and radiated test items listed below are performed according to KDB 971168 D01 Power Meas. License Digital Systems v03r01 with maximum output power.

For radiated measurement, pre-scanned in two test degrees (Ant. Degree 0 and Ant. Degree 90). The worst cases (Ant. Degree 0 for LTE Band 4, 5, and 7; Ant. Degree 90 for LTE Band 2, 38 and 41) were recorded in this report.

Test Items	Band	Bandwidth (MHz)						Modulation			RB #			Test Channel		
		1.4	3	5	10	15	20	QPSK	16QAM	64QAM	1	Half	Full	L	M	H
Max. Output Power	2	v	v	v	v	v	v	v	v	v	v	v	v	v	v	v
	4	v	v	v	v	v	v	v	v	v	v	v	v	v	v	v
	5	v	v	v	v	-	-	v	v	v	v	v	v	v	v	v
	7	-	-	v	v	v	v	v	v	v	v	v	v	v	v	v
	38	-	-	v	v	v	v	v	v	v	v	v	v	v	v	v
	41	-	-	v	v	v	v	v	v	v	v	v	v	v	v	v
Peak-to-Average Ratio	2						v	v	v	v			v		v	
	4						v	v	v	v			v		v	
	5				v	-	-	v	v	v			v		v	
	7	-	-				v	v	v	v			v		v	
	38	-	-				v	v	v	v			v		v	
	41	-	-				v	v	v	v			v		v	
26dB and 99% Bandwidth	2	v	v	v	v	v	v	v	v	v			v		v	
	4	v	v	v	v	v	v	v	v	v			v		v	
	5	v	v	v	v	-	-	v	v	v			v		v	
	7	-	-	v	v	v	v	v	v	v			v		v	
	38	-	-	v	v	v	v	v	v	v			v		v	
	41	-	-	v	v	v	v	v	v	v			v		v	
Conducted Band Edge	2	v	v	v	v	v	v	v	v	v	v		v		v	
	4	v	v	v	v	v	v	v	v	v	v		v		v	
	5	v	v	v	v	-	-	v	v	v	v		v		v	
	7	-	-	v	v	v	v	v	v	v	v		v		v	
	38	-	-	v	v	v	v	v	v	v	v		v		v	
	41	-	-	v	v	v	v	v	v	v	v		v		v	



Test Items	Band	Bandwidth (MHz)						Modulation			RB #			Test Channel		
		1.4	3	5	10	15	20	QPSK	16QAM	64QAM	1	Half	Full	L	M	H
Conducted Spurious Emission	2	v	v	v	v	v	v	v			v			v	v	v
	4	v	v	v	v	v	v	v			v			v	v	v
	5	v	v	v	v	-	-	v			v			v	v	v
	7	-	-	v	v	v	v	v			v			v	v	v
	38	-	-	v	v	v	v	v			v			v	v	v
	41	-	-	v	v	v	v	v			v			v	v	v
Frequency Stability	2				v			v					v		v	
	4				v			v					v		v	
	5				v	-	-	v					v		v	
	7	-	-		v			v					v		v	
	38	-	-		v			v					v		v	
	41	-	-		v			v					v		v	
E.R.P / E.I.R.P	2	v	v	v	v	v	v	v	v	v	Max. Power					
	4	v	v	v	v	v	v	v	v	v						
	5	v	v	v	v	-	-	v	v	v						
	7	-	-	v	v	v	v	v	v	v						
	38	-	-	v	v	v	v	v	v	v						
	41	-	-	v	v	v	v	v	v	v						
Radiated Spurious Emission	2	Worst Case											v	v	v	
	4	Worst Case											v	v	v	
	5	Worst Case											v	v	v	
	7	Worst Case											v	v	v	
	38	Worst Case											v	v	v	
	41	Worst Case											v	v	v	
Remark	<ol style="list-style-type: none"> The mark "v" means that this configuration is chosen for testing The mark "-" means that this bandwidth is not supported. The device is investigated from 30MHz to 10 times of fundamental signal for radiated spurious emission test under different RB size/offset and modulations in exploratory test. Subsequently, only the worst case emissions are reported. 															

2.2 Connection Diagram of Test System

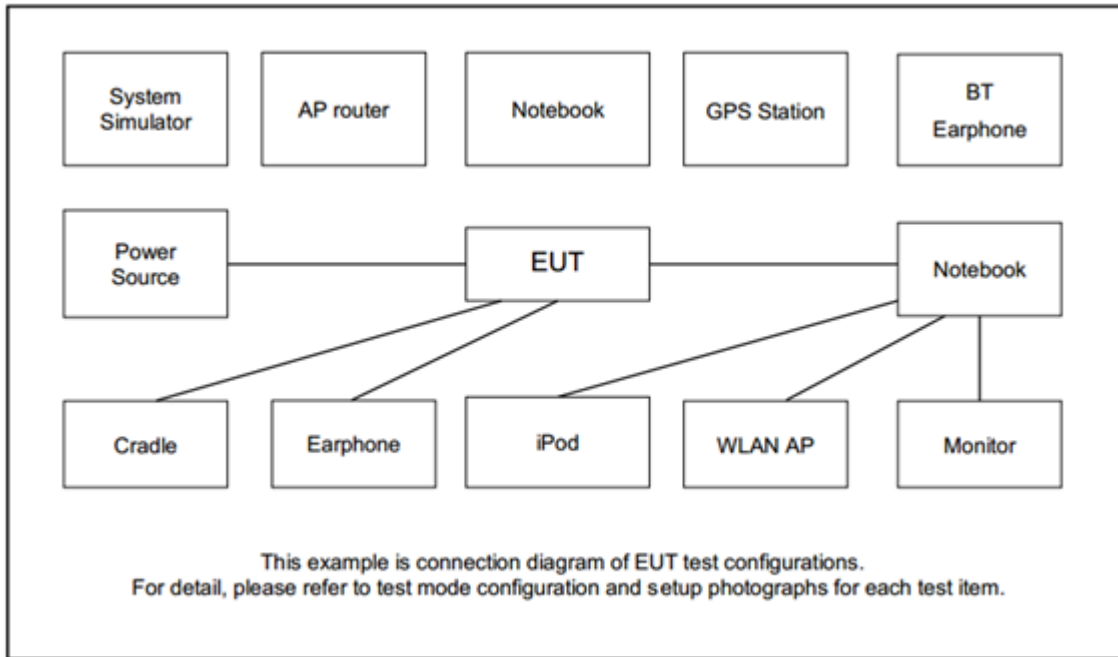

2.3 Support Unit used in test configuration and system

Item	Equipment	Brand Name	Model No.	FCC ID	Data Cable	Power Cord
1.	System Simulator	Anritsu	MT8821C	N/A	N/A	Unshielded, 1.8 m
2.	Dipole Antenna	Larsen	SPDA24700/2700	N/A	N/A	N/A
3.	Adapter	Qualtek	ATS018T-W120U	N/A	N/A	N/A

2.4 Measurement Results Explanation Example

For all conducted test items:

The offset level is set in the spectrum analyzer to compensate the RF cable loss and attenuator factor between EUT conducted output port and spectrum analyzer. With the offset compensation, the spectrum analyzer reading level is exactly the EUT RF output level.

The spectrum analyzer offset is derived from RF cable loss and attenuator factor.

Offset = RF cable loss + attenuator factor.

Following shows an offset computation example with cable loss 4.2 dB and 10dB attenuator.

Example :

$$\begin{aligned} \text{Offset(dB)} &= \text{RF cable loss(dB)} + \text{attenuator factor(dB)} \\ &= 4.2 + 10 = 14.2 \text{ (dB)} \end{aligned}$$



2.5 Frequency List of Low/Middle/High Channels

LTE Band 2 Channel and Frequency List				
BW [MHz]	Channel/Frequency(MHz)	Lowest	Middle	Highest
20	Channel	18700	18900	19100
	Frequency	1860	1880	1900
15	Channel	18675	18900	19125
	Frequency	1857.5	1880	1902.5
10	Channel	18650	18900	19150
	Frequency	1855	1880	1905
5	Channel	18625	18900	19175
	Frequency	1852.5	1880	1907.5
3	Channel	18615	18900	19185
	Frequency	1851.5	1880	1908.5
1.4	Channel	18607	18900	19193
	Frequency	1850.7	1880	1909.3

LTE Band 4 Channel and Frequency List				
BW [MHz]	Channel/Frequency(MHz)	Lowest	Middle	Highest
20	Channel	20050	20175	20300
	Frequency	1720	1732.5	1745
15	Channel	20025	20175	20325
	Frequency	1717.5	1732.5	1747.5
10	Channel	20000	20175	20350
	Frequency	1715	1732.5	1750
5	Channel	19975	20175	20375
	Frequency	1712.5	1732.5	1752.5
3	Channel	19965	20175	20385
	Frequency	1711.5	1732.5	1753.5
1.4	Channel	19957	20175	20393
	Frequency	1710.7	1732.5	1754.3



LTE Band 5 Channel and Frequency List				
BW [MHz]	Channel/Frequency(MHz)	Lowest	Middle	Highest
10	Channel	20450	20525	20600
	Frequency	829	836.5	844
5	Channel	20425	20525	20625
	Frequency	826.5	836.5	846.5
3	Channel	20415	20525	20635
	Frequency	825.5	836.5	847.5
1.4	Channel	20407	20525	20643
	Frequency	824.7	836.5	848.3

LTE Band 7 Channel and Frequency List				
BW [MHz]	Channel/Frequency(MHz)	Lowest	Middle	Highest
20	Channel	20850	21100	21350
	Frequency	2510	2535	2560
15	Channel	20825	21100	21375
	Frequency	2507.5	2535	2562.5
10	Channel	20800	21100	21400
	Frequency	2505	2535	2565
5	Channel	20775	21100	21425
	Frequency	2502.5	2535	2567.5

LTE Band 38 Channel and Frequency List				
BW [MHz]	Channel/Frequency(MHz)	Lowest	Middle	Highest
20	Channel	37850	38000	38150
	Frequency	2580.0	2595.0	2610.0
15	Channel	37825	38000	38175
	Frequency	2577.5	2595.0	2612.5
10	Channel	37800	38000	38200
	Frequency	2575.0	2595.0	2615.0
5	Channel	37775	38000	38225
	Frequency	2572.5	2595.0	2617.5



LTE Band 41 Channel and Frequency List				
BW [MHz]	Channel/Frequency(MHz)	Lowest	Middle	Highest
20	Channel	39750	40620	41490
	Frequency	2506.0	2593.0	2680.0
15	Channel	39725	40620	41515
	Frequency	2503.5	2593.0	2682.5
10	Channel	39700	40620	41540
	Frequency	2501.0	2593.0	2685.0
5	Channel	39675	40620	41565
	Frequency	2498.5	2593.0	2687.5

3 Conducted Test Items

3.1 Measuring Instruments

See list of measuring instruments of this test report.

3.1.1 Test Setup

3.1.2 Conducted Output Power

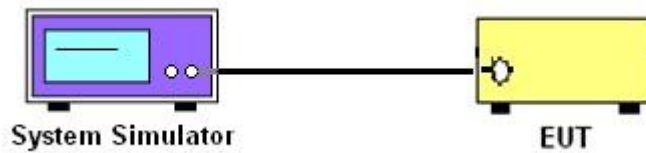

3.1.3 Peak-to-Average Ratio, Occupied Bandwidth ,Conducted Band-Edge and Conducted Spurious Emission

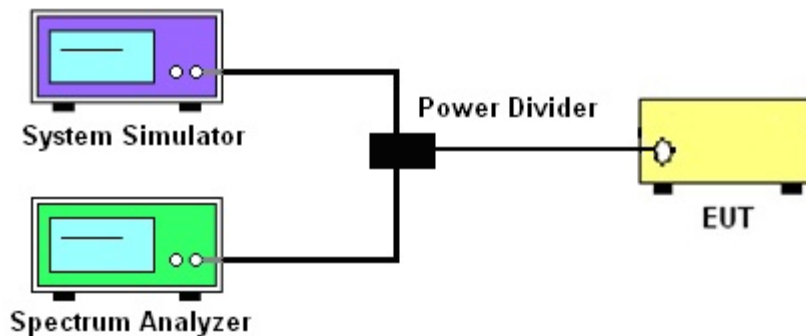

3.1.4 Frequency Stability

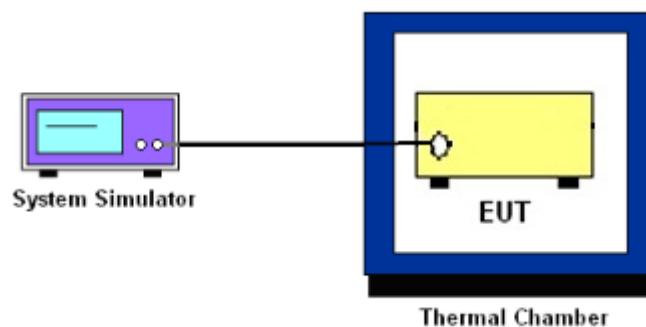

3.1.5 Test Result of Conducted Test

Please refer to Appendix A.



3.2 Conducted Output Power and ERP/EIRP

3.2.1 Description of the Conducted Output Power Measurement and ERP/EIRP Measurement

A system simulator was used to establish communication with the EUT. Its parameters were set to force the EUT transmitting at maximum output power. The measured power in the radio frequency on the transmitter output terminals shall be reported.

The ERP of mobile transmitters must not exceed 7 Watts for LTE Band 5

The EIRP of mobile transmitters must not exceed 2 Watts for LTE Band 2 and Band 7 and Band 38 and Band 41

The EIRP of mobile transmitters must not exceed 1 Watts for LTE Band 4

According to KDB 412172 D01 Power Approach,

$EIRP = P_T + G_T - L_C$, $ERP = EIRP - 2.15$, where

P_T = transmitter output power in dBm

G_T = gain of the transmitting antenna in dBi

L_C = signal attenuation in the connecting cable between the transmitter and antenna in dB

3.2.2 Test Procedures

1. The transmitter output port was connected to the system simulator.
2. Set EUT at maximum power through the system simulator.
3. Select lowest, middle, and highest channels for each band and different modulation.
4. Measure and record the power level from the system simulator.



3.3 Peak-to-Average Ratio

3.3.1 Description of the PAR Measurement

Power Complementary Cumulative Distribution Function (CCDF) curves provide a means for characterizing the power peaks of a digitally modulated signal on a statistical basis. A CCDF curve depicts the probability of the peak signal amplitude exceeding the average power level. Most contemporary measurement instrumentation include the capability to produce CCDF curves for an input signal provided that the instrument's resolution bandwidth can be set wide enough to accommodate the entire input signal bandwidth. In measuring transmissions in this band using an average power technique, the peak-to-average ratio (PAR) of the transmission may not exceed 13 dB.

3.3.2 Test Procedures

The testing follows ANSI C63.26-2015 Section 5.2.6

1. The EUT was connected to spectrum and system simulator via a power divider.
2. Set the CCDF (Complementary Cumulative Distribution Function) option in spectrum analyzer.
3. The highest RF powers were measured and recorded the maximum PAPR level associated with a probability of 0.1 %.
4. Record the deviation as Peak to Average Ratio.



3.4 Occupied Bandwidth

3.4.1 Description of Occupied Bandwidth Measurement

The occupied bandwidth is the width of a frequency band such that, below the lower and above the upper frequency limits, the mean powers emitted are each equal to a specified percentage 0.5% of the total mean transmitted power.

The 26 dB emission bandwidth is defined as the frequency range between two points, one above and one below the carrier frequency, at which the spectral density of the emission is attenuated 26 dB below the maximum in-band spectral density of the modulated signal. Spectral density (power per unit bandwidth) is to be measured with a detector of resolution bandwidth equal to approximately 1.0% of the emission bandwidth.

3.4.2 Test Procedures

The testing follows ANSI C63.26-2015 Section 5.4.3 (26dB) and Section 5.4.4 (99OB)

1. The EUT was connected to spectrum analyzer and system simulator via a power divider.
2. The spectrum analyzer center frequency is set to the nominal EUT channel center frequency. The span range for the spectrum analyzer shall be between two and five times the anticipated OBW.
3. The nominal resolution bandwidth (RBW) shall be in the range of 1 to 5 % of the anticipated OBW, and the VBW shall be at least 3 times the RBW.
4. Set the detection mode to peak, and the trace mode to max hold.
5. Determine the reference value: Set the EUT to transmit a modulated signal. Allow the trace to stabilize. Set the spectrum analyzer marker to the highest level of the displayed trace.
(this is the reference value)
6. Determine the “-26 dB down amplitude” as equal to (Reference Value – X).
7. Place two markers, one at the lowest and the other at the highest frequency of the envelope of the spectral display such that each marker is at or slightly below the “-X dB down amplitude” determined in step 6. If a marker is below this “-X dB down amplitude” value it shall be placed as close as possible to this value. The OBW is the positive frequency difference between the two markers.
8. Use the 99 % power bandwidth function of the spectrum analyzer and report the measured bandwidth.



3.5 Conducted Band Edge

3.5.1 Description of Conducted Band Edge Measurement

22.917(a)

For operations in the 824 – 849 MHz band, the FCC limit is $43 + 10\log_{10}(P[\text{Watts}])$ dB below the transmitter power $P(\text{Watts})$ in a 100kHz bandwidth. However, in the 1MHz bands immediately outside and adjacent to the licensee's frequency block, a resolution bandwidth of at least one percent of the emission bandwidth of the fundamental emission of the transmitter may be employed.

24.238 (a)

For operations in the 1850-1910 and 1930-1990 MHz band, the FCC limit is $43 + 10\log_{10}(P[\text{Watts}])$ dB below the transmitter power $P(\text{Watts})$ in a 1MHz bandwidth. However, in the 1 MHz bands immediately outside and adjacent to the frequency block a resolution bandwidth of at least one percent of the emission bandwidth of the fundamental emission of the transmitter may be employed.

27.53 (h)

For operations in the 1710 – 1755 MHz band, 1755-1780 MHz, the FCC limit is $43 + 10\log_{10}(P[\text{Watts}])$ dB below the transmitter power $P(\text{Watts})$ in a 1 MHz bandwidth. However, in the 1MHz bands immediately outside and adjacent to the licensee's frequency block, a resolution bandwidth of at least one percent of the emission bandwidth of the fundamental emission of the transmitter may be employed.

**27.53(m)(4)**

For mobile digital stations, the attenuation factor shall be not less than $40 + 10 \log (P)$ dB on all frequencies between the channel edge and 5 megahertz from the channel edge, $43 + 10 \log (P)$ dB on all frequencies between 5 megahertz and X megahertz from the channel edge, and $55 + 10 \log (P)$ dB on all frequencies more than X megahertz from the channel edge, where X is the greater of 6 megahertz or the actual emission bandwidth as defined in paragraph (m)(6) of this section. In addition, the attenuation factor shall not be less that $43 + 10 \log (P)$ dB on all frequencies between 2490.5 MHz and 2496 MHz and $55 + 10 \log (P)$ dB at or below 2490.5 MHz. Mobile Satellite Service licensees operating on frequencies below 2495 MHz may also submit a documented interference complaint against BRS licensees operating on channel BRS Channel 1 on the same terms and conditions as adjacent channel BRS or EBS licensees.

3.5.2 Test Procedures

The testing follows FCC KDB 971168 D01 v03r01 Section 6.1.

1. The EUT was connected to spectrum analyzer and system simulator via a power divider.
2. The band edges of low and high channels for the highest RF powers were measured.
3. Set RBW \geq 1% EBW in the 1MHz band immediately outside and adjacent to the band edge.
4. Beyond the 1 MHz band from the band edge, RBW=1MHz was used.
5. Set spectrum analyzer with RMS detector.
6. The RF fundamental frequency should be excluded against the limit line in the operating frequency band.
7. Checked that all the results comply with the emission limit line.

The limit line is derived from $43 + 10\log(P)$ dB below the transmitter power P(Watts)

For LTE Band 7, 38, 41

The other 40 dB, and 55 dB have additionally applied same calculation above.



3.6 Conducted Spurious Emission

3.6.1 Description of Conducted Spurious Emission Measurement

The power of any emission outside of the authorized operating frequency ranges must be lower than the transmitter power (P) by a factor of at least $43 + 10 \log (P)$ dB.

For LTE Band 7, 38, 41

The power of any emission outside of the authorized operating frequency ranges must be lower than the transmitter power (P) by a factor of at least $55 + 10 \log (P)$ dB.

It is measured by means of a calibrated spectrum analyzer and scanned from 30 MHz up to a frequency including its 10th harmonic.

3.6.2 Test Procedures

The testing follows FCC KDB 971168 D01 v03r01 Section 6.1.

1. The EUT was connected to spectrum analyzer and system simulator via a power divider.
2. The RF output of EUT was connected to the spectrum analyzer by RF cable and attenuator.
The path loss was compensated to the results for each measurement.
3. The middle channel for the highest RF power within the transmitting frequency was measured.
4. The conducted spurious emission for the whole frequency range was taken.
5. Make the measurement with the spectrum analyzer's RBW = 1MHz, VBW = 3MHz.
6. Set spectrum analyzer with RMS detector.
7. Taking the record of maximum spurious emission.
8. The RF fundamental frequency should be excluded against the limit line in the operating frequency band.
9. The limit line is derived from $43 + 10\log(P)$ dB below the transmitter power P(Watts)
For LTE Band 7, 38, 41
The limit line is derived from $55 + 10\log(P)$ dB below the transmitter power P(Watts)



3.7 Frequency Stability

3.7.1 Description of Frequency Stability Measurement

22.355

The frequency stability shall be measured by variation of ambient temperature and variation of primary supply voltage to ensure that the fundamental emission stays within the authorized frequency block. The frequency stability of the transmitter shall be maintained within $\pm 0.00025\%$ ($\pm 2.5\text{ppm}$) of the center frequency.

24.235 & 27.54

The frequency stability shall be sufficient to ensure that the fundamental emission stays within the authorized frequency block.

3.7.2 Test Procedures for Temperature Variation

The testing follows FCC KDB 971168 D01 v03r01 Section 9.0.

1. The EUT was set up in the thermal chamber and connected with the system simulator.
2. With power OFF, the temperature was decreased to -30°C and the EUT was stabilized before testing. Power was applied and the maximum change in frequency was recorded within one minute.
3. With power OFF, the temperature was raised in 10°C step up to 50°C . The EUT was stabilized at each step for at least half an hour. Power was applied and the maximum frequency change was recorded within one minute.

3.7.3 Test Procedures for Voltage Variation

The testing follows FCC KDB 971168 D01 v03r01 Section 9.0.

1. The EUT was placed in a temperature chamber at $20\pm 5^{\circ}\text{C}$ and connected with the system simulator.
2. The power supply voltage to the EUT was varied from 85% to 115% of the nominal value measured at the input to the EUT.
3. The variation in frequency was measured for the worst case.

4 Radiated Test Items

4.1 Measuring Instruments

See list of measuring instruments of this test report.

4.1.1 Test Setup

For radiated test below 30MHz

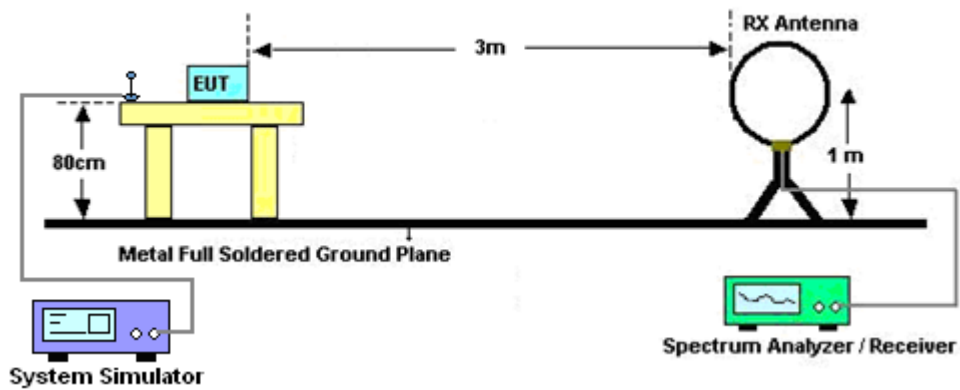

For radiated test from 30MHz to 1GHz

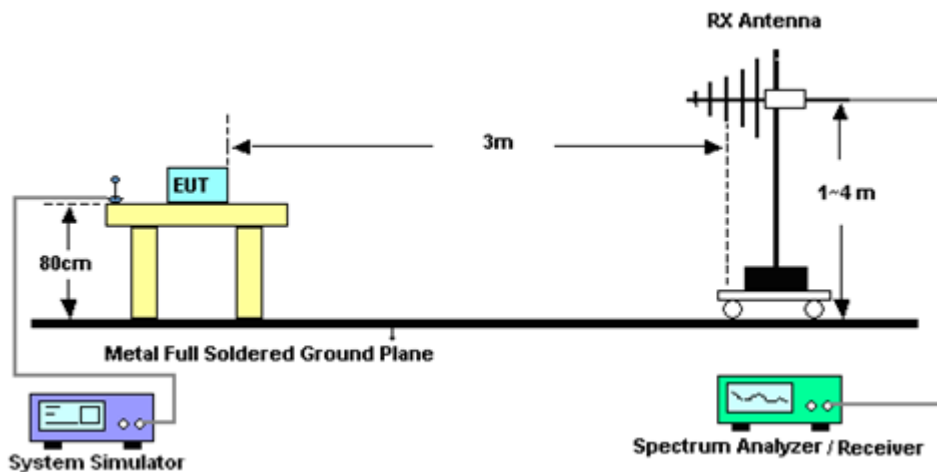

For radiated test from 1GHz to 18GHz

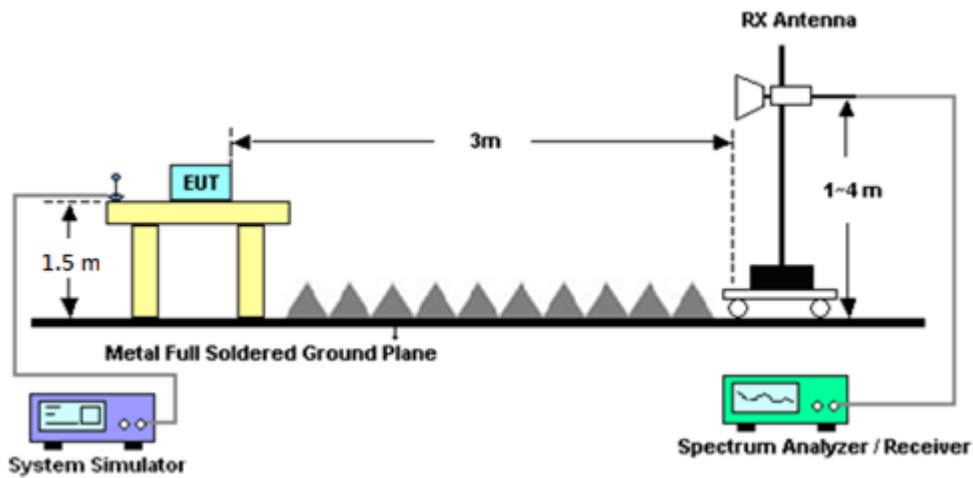

For radiated test above 18GHz

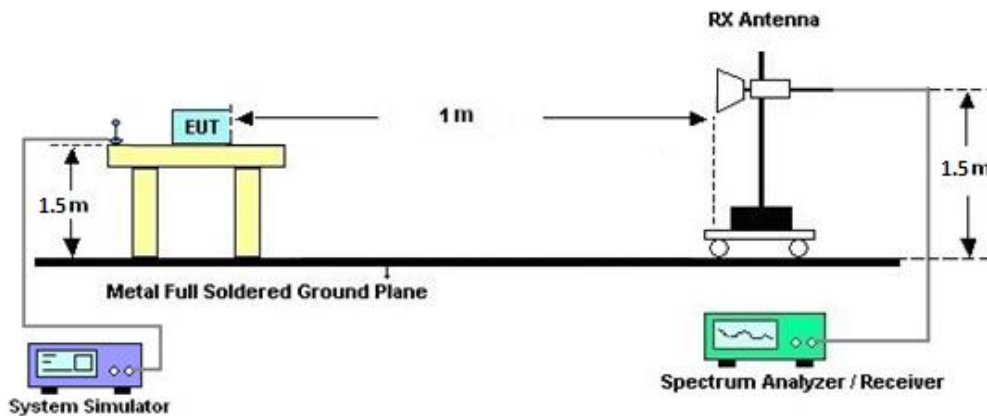

4.1.2 Test Result of Radiated Test

Please refer to Appendix B.

Note:

The low frequency, which started from 9 kHz to 30MHz, was pre-scanned and the result which was 20dB lower than the limit line was not reported.

There is a comparison data of both open-field test site and alternative test site - semi-Anechoic chamber according to 414788 D01 Radiated Test Site v01r01, and the result came out very similar.



4.2 Radiated Spurious Emission Measurement

4.2.1 Description of Radiated Spurious Emission Measurement

The radiated spurious emission was measured by substitution method according to ANSI / TIA-603-E. The power of any emission outside of the authorized operating frequency ranges must be attenuated below the transmitter power (P) by a factor of at least $43 + 10 \log (P)$ dB.

For LTE Band 7, 38, 41

The power of any emission outside of the authorized operating frequency ranges must be attenuated below the transmitter power (P) by a factor of at least $55 + 10 \log (P)$ dB.

The spectrum is scanned from 30 MHz up to a frequency including its 10th harmonic.

4.2.2 Test Procedures

The testing follows FCC KDB 971168 D01 v03r01 Section 7 and ANSI / TIA-603-E Section 2.2.12.

1. The EUT was placed on a turntable with 0.8 meter for frequency below 1GHz and 1.5 meter for frequency above 1GHz respectively above ground.
2. The EUT was set 3 meters from the receiving antenna, which was mounted on the antenna tower.
3. The table was rotated 360 degrees to determine the position of the highest spurious emission.
4. The height of the receiving antenna is varied between one meter and four meters to search the maximum spurious emission for both horizontal and vertical polarizations.
5. Make the measurement with the spectrum analyzer's RBW = 1MHz, VBW = 3MHz, taking the record of maximum spurious emission.
6. A horn antenna was substituted in place of the EUT and was driven by a signal generator.
7. Tune the output power of signal generator to the same emission level with EUT maximum spurious emission.
8. Taking the record of output power at antenna port.
9. Repeat step 7 to step 8 for another polarization.
10. The RF fundamental frequency should be excluded against the limit line in the operating frequency band.

The limit line is derived from $43 + 10\log(P)$ dB below the transmitter power P(Watts)

For LTE Band 7, 38, 41

The limit line is derived from $55 + 10\log(P)$ dB below the transmitter power P(Watts)

EIRP (dBm) = S.G. Power – Tx Cable Loss + Tx Antenna Gain

ERP (dBm) = EIRP - 2.15



5 List of Measuring Equipment

Instrument	Brand Name	Model No.	Serial No.	Characteristics	Calibration Date	Test Date	Due Date	Remark
Loop Antenna	Rohde & Schwarz	HFH2-Z2	100488	9 kHz~30 MHz	Jul. 14, 2020	May 16, 2021~ May 18, 2021	Jul. 13, 2021	Radiation (03CH12-HY)
Bilog Antenna	TESEQ	CBL 6111D & 00800N1D01N -06	37059 & 01	30MHz~1GHz	Oct. 11, 2020	May 16, 2021~ May 18, 2021	Oct. 10, 2021	Radiation (03CH12-HY)
Bilog Antenna	TESEQ	CBL 6111D & N-6-06	35414 & AT-N0602	30MHz~1GHz	Oct. 11, 2020	May 16, 2021~ May 18, 2021	Oct. 10, 2021	Radiation (03CH12-HY)
Horn Antenna	SCHWARZBE CK	BBHA 9120 D	9120D-1328	1GHz~18GHz	Nov. 23, 2020	May 16, 2021~ May 18, 2021	Nov. 22, 2021	Radiation (03CH12-HY)
Horn Antenna	SCHWARZBE CK	BBHA 9120 D	9120D-1212	1GHz~18GHz	May 20, 2020	May 16, 2021~ May 18, 2021	May 19, 2021	Radiation (03CH12-HY)
SHF-EHF Horn Antenna	SCHWARZBE CK	BBHA 9170	00993	18GHz~40GHz	Dec. 19, 2020	May 16, 2021~ May 18, 2021	Dec. 18, 2021	Radiation (03CH12-HY)
SHF-EHF Horn Antenna	SCHWARZBE CK	BBHA 9170	BBHA917057 6	18GHz~40GHz	May 22, 2020	May 16, 2021~ May 18, 2021	May 21, 2021	Radiation (03CH12-HY)
Preamplifier	COM-POWER	PA-103	161075	10MHz~1GHz	Mar. 24, 2021	May 16, 2021~ May 18, 2021	Mar. 23, 2022	Radiation (03CH12-HY)
Preamplifier	Keysight	83017A	MY57280120	1GHz~26.5GHz	Jul. 20, 2020	May 16, 2021~ May 18, 2021	Jul. 19, 2021	Radiation (03CH12-HY)
Preamplifier	E-INSTRUME NT TECH LTD.	ERA-100M-18 G-56-01-A70	EC1900249	1GHz~18GHz	Dec. 05, 2020	May 16, 2021~ May 18, 2021	Dec. 04, 2021	Radiation (03CH12-HY)
Preamplifier	EMEC	EM18G40G	060801	18GHz~40GHz	Jun. 15, 2020	May 16, 2021~ May 18, 2021	Jun. 14, 2021	Radiation (03CH12-HY)
Preamplifier	EMEC	EM18G40G	060715	18GHz~40GHz	Dec. 11, 2020	May 16, 2021~ May 18, 2021	Dec. 10, 2021	Radiation (03CH12-HY)
Spectrum Analyzer	Agilent	N9010A	MY53470118	10Hz~44GHz	Sep. 14, 2020	May 16, 2021~ May 18, 2021	Sep. 13, 2021	Radiation (03CH12-HY)
Signal Generator	Rohde & Schwarz	SMB100A	101107	100kHz~40GHz	Dec. 04, 2020	May 16, 2021~ May 18, 2021	Dec. 03, 2021	Radiation (03CH12-HY)
RF Cable	HUBER + SUHNER	SUCOFLEX 126E	0058/126E	30MHz~18GHz	Dec. 11, 2020	May 16, 2021~ May 18, 2021	Dec. 10, 2021	Radiation (03CH12-HY)
RF Cable	HUBER + SUHNER	SUCOFLEX 102	505134/2	30MHz~40GHz	Feb. 22, 2021	May 16, 2021~ May 18, 2021	Feb. 21, 2022	Radiation (03CH12-HY)
RF Cable	HUBER + SUHNER	SUCOFLEX 102	800740/2	30MHz~40GHz	Feb. 22, 2021	May 16, 2021~ May 18, 2021	Feb. 21, 2022	Radiation (03CH12-HY)
Filter	Wainwright	WLKS1200-12 SS	SN2	1.2GHz Low Pass Filter	Mar. 17, 2021	May 16, 2021~ May 18, 2021	Mar. 16, 2022	Radiation (03CH12-HY)
Filter	Wainwright	WHKX12-1080 -1200-15000-6 0SS	SN1	1.2GHz High Pass Filter	Mar. 17, 2021	May 16, 2021~ May 18, 2021	Mar. 16, 2022	Radiation (03CH12-HY)
Filter	Wainwright	WHKX12-2700 -3000-18000-6 0ST	SN2	3GHz High Pass Filter	Jul. 14, 2020	May 16, 2021~ May 18, 2021	Jul. 13, 2021	Radiation (03CH12-HY)
Hygrometer	TECPEL	DTM-303B	TP140349	N/A	Oct. 02, 2020	May 16, 2021~ May 18, 2021	Oct. 01, 2021	Radiation (03CH12-HY)
Controller	EMEC	EM1000	N/A	Control Turn table & Ant Mast	N/A	May 16, 2021~ May 18, 2021	N/A	Radiation (03CH12-HY)
Antenna Mast	EMEC	AM-BS-4500-B	N/A	1m~4m	N/A	May 16, 2021~ May 18, 2021	N/A	Radiation (03CH12-HY)
Turn Table	EMEC	TT2000	N/A	0~360 Degree	N/A	May 16, 2021~ May 18, 2021	N/A	Radiation (03CH12-HY)
Software	Audix	E3 6.2009-8-24	RK-000989	N/A	N/A	May 16, 2021~ May 18, 2021	N/A	Radiation (03CH12-HY)



Instrument	Brand Name	Model No.	Serial No.	Characteristics	Calibration Date	Test Date	Due Date	Remark
Base Station (Measure)	Anritsu	MT8821C	6262002534 1	N/A	Oct. 05, 2020	May 18, 2021~ May 19, 2021	Oct. 04, 2021	Conducted (TH03-HY)
Spectrum Analyzer	Rohde & Schwarz	FSV40	101397	10Hz~40GHz	Nov. 27, 2020	May 18, 2021~ May 19, 2021	Nov. 26, 2021	Conducted (TH03-HY)
Thermal Chamber	Ten Billion	TTH-D3SP	TBN-930701	N/A	Aug. 05, 2020	May 18, 2021~ May 19, 2021	Aug. 04, 2021	Conducted (TH03-HY)
Programmable Power Supply	GW Instek	PSS-2005	EL890094	1V~20V 0.5A~5A	Oct. 05, 2020	May 18, 2021~ May 19, 2021	Oct. 04, 2021	Conducted (TH03-HY)
Coupler	Warison	20dB 25W SMA Directional Coupler	#B	1-18GHz	Jan. 09, 2021	May 18, 2021~ May 19, 2021	Jan. 08, 2022	Conducted (TH03-HY)



6 Uncertainty of Evaluation

Uncertainty of Radiated Emission Measurement (30 MHz ~ 1000 MHz)

Measuring Uncertainty for a Level of Confidence of 95% ($U = 2Uc(y)$)	3.07
---	------

Uncertainty of Radiated Emission Measurement (1 GHz ~ 18 GHz)

Measuring Uncertainty for a Level of Confidence of 95% ($U = 2Uc(y)$)	3.21
---	------

Uncertainty of Radiated Emission Measurement (18 GHz ~ 40 GHz)

Measuring Uncertainty for a Level of Confidence of 95% ($U = 2Uc(y)$)	3.80
---	------



Appendix A. Test Results of Conducted Test

Conducted Output Power(Average power & ERP/EIRP)

LTE Band 2 Maximum Average Power [dBm] (GT - LC = 2 dB)								
BW [MHz]	RB Size	RB Offset	Mod	Lowest	Middle	Highest	EIRP (dBm)	EIRP (W)
20	1	0	QPSK	22.71	22.53	22.38	24.71	0.2958
20	1	49		22.56	22.45	22.25		
20	1	99		22.52	22.40	22.21		
20	50	0		21.72	21.58	21.35		
20	50	24		21.68	21.60	21.41		
20	50	50		21.77	21.59	21.40		
20	100	0		21.77	21.59	21.41		
20	1	0	16-QAM	21.92	21.81	21.66	23.92	0.2466
20	1	49		21.84	21.67	21.48		
20	1	99		21.79	21.63	21.48		
20	50	0		20.79	20.64	20.39		
20	50	24		20.11	20.13	20.11		
20	50	50		20.76	20.64	20.48		
20	100	0		20.68	20.60	20.37		
20	1	0	64-QAM	20.86	20.80	20.66	22.86	0.1932
20	1	49		20.76	20.65	20.44		
20	1	99		20.72	20.58	20.38		
20	50	0		19.74	19.60	19.37		
20	50	24		19.06	19.05	19.08		
20	50	50		19.71	19.58	19.41		
20	100	0		19.63	19.55	19.33		
Limit	EIRP < 2W			Result			Pass	



LTE Band 2 Maximum Average Power [dBm] (GT - LC = 2 dB)								
BW [MHz]	RB Size	RB Offset	Mod	Lowest	Middle	Highest	EIRP (dBm)	EIRP (W)
15	1	0	QPSK	22.65	22.50	22.37	24.65	0.2917
15	1	37		22.55	22.36	22.22		
15	1	74		22.43	22.33	22.20		
15	36	0		21.63	21.52	21.35		
15	36	20		21.64	21.55	21.32		
15	36	39		21.73	21.58	21.34		
15	75	0		21.75	21.52	21.38		
15	1	0	16-QAM	21.90	21.76	21.66	23.9	0.2455
15	1	37		21.79	21.67	21.45		
15	1	74		21.79	21.57	21.39		
15	36	0		20.76	20.60	20.29		
15	36	20		20.03	20.10	20.11		
15	36	39		20.71	20.58	20.45		
15	75	0		20.58	20.56	20.36		
15	1	0	64-QAM	20.81	20.74	20.61	22.81	0.1910
15	1	37		20.75	20.57	20.35		
15	1	74		20.68	20.55	20.36		
15	36	0		19.69	19.50	19.32		
15	36	20		19.05	19.05	19.04		
15	36	39		19.69	19.53	19.41		
15	75	0		19.57	19.48	19.27		
Limit	EIRP < 2W			Result			Pass	



LTE Band 2 Maximum Average Power [dBm] (GT - LC = 2 dB)								
BW [MHz]	RB Size	RB Offset	Mod	Lowest	Middle	Highest	EIRP (dBm)	EIRP (W)
10	1	0	QPSK	22.64	22.44	22.28	24.64	0.2911
10	1	25		22.54	22.36	22.21		
10	1	49		22.47	22.39	22.14		
10	25	0		21.69	21.56	21.29		
10	25	12		21.67	21.60	21.38		
10	25	25		21.74	21.50	21.35		
10	50	0		21.74	21.53	21.39		
10	1	0	16-QAM	21.84	21.81	21.56	23.84	0.2421
10	1	25		21.80	21.66	21.47		
10	1	49		21.76	21.57	21.46		
10	25	0		20.69	20.62	20.33		
10	25	12		20.04	20.06	20.08		
10	25	25		20.75	20.64	20.39		
10	50	0		20.62	20.51	20.34		
10	1	0	64-QAM	20.82	20.77	20.59	22.82	0.1914
10	1	25		20.68	20.60	20.35		
10	1	49		20.65	20.50	20.38		
10	25	0		19.73	19.60	19.31		
10	25	12		19.05	19.02	19.00		
10	25	25		19.69	19.51	19.31		
10	50	0		19.63	19.45	19.31		
Limit	EIRP < 2W			Result			Pass	



LTE Band 2 Maximum Average Power [dBm] (GT - LC = 2 dB)								
BW [MHz]	RB Size	RB Offset	Mod	Lowest	Middle	Highest	EIRP (dBm)	EIRP (W)
5	1	0	QPSK	22.64	22.44	22.34	24.64	0.2911
5	1	12		22.52	22.39	22.15		
5	1	24		22.46	22.36	22.21		
5	12	0		21.65	21.50	21.35		
5	12	7		21.66	21.51	21.39		
5	12	13		21.71	21.51	21.36		
5	25	0		21.76	21.59	21.41		
5	1	0	16-QAM	21.92	21.78	21.58	23.92	0.2466
5	1	12		21.82	21.61	21.42		
5	1	24		21.74	21.59	21.47		
5	12	0		20.73	20.56	20.39		
5	12	7		20.04	20.05	20.10		
5	12	13		20.71	20.59	20.39		
5	25	0		20.66	20.57	20.28		
5	1	0	64-QAM	20.78	20.72	20.59	22.78	0.1897
5	1	12		20.74	20.60	20.38		
5	1	24		20.62	20.49	20.37		
5	12	0		19.72	19.51	19.31		
5	12	7		19.03	19.00	19.02		
5	12	13		19.63	19.51	19.35		
5	25	0		19.60	19.53	19.28		
Limit	EIRP < 2W			Result			Pass	



LTE Band 2 Maximum Average Power [dBm] (GT - LC = 2 dB)								
BW [MHz]	RB Size	RB Offset	Mod	Lowest	Middle	Highest	EIRP (dBm)	EIRP (W)
3	1	0	QPSK	22.62	22.44	22.38	24.62	0.2897
3	1	8		22.47	22.41	22.16		
3	1	14		22.48	22.30	22.13		
3	8	0		21.70	21.51	21.30		
3	8	4		21.63	21.50	21.34		
3	8	7		21.74	21.58	21.36		
3	15	0		21.72	21.57	21.31		
3	1	0	16-QAM	21.85	21.71	21.60	23.85	0.2427
3	1	8		21.75	21.58	21.48		
3	1	14		21.73	21.62	21.45		
3	8	0		20.77	20.63	20.35		
3	8	4		20.01	20.08	20.08		
3	8	7		20.71	20.63	20.43		
3	15	0		20.62	20.52	20.37		
3	1	0	64-QAM	20.82	20.75	20.65	22.82	0.1914
3	1	8		20.73	20.55	20.38		
3	1	14		20.63	20.57	20.37		
3	8	0		19.69	19.58	19.34		
3	8	4		19.03	19.05	19.00		
3	8	7		19.66	19.54	19.41		
3	15	0		19.62	19.53	19.29		
Limit	EIRP < 2W			Result			Pass	



LTE Band 2 Maximum Average Power [dBm] (GT - LC = 2 dB)								
BW [MHz]	RB Size	RB Offset	Mod	Lowest	Middle	Highest	EIRP (dBm)	EIRP (W)
1.4	1	0	QPSK	22.69	22.50	22.28	24.69	0.2944
1.4	1	3		22.46	22.45	22.16		
1.4	1	5		22.48	22.36	22.15		
1.4	3	0		22.64	22.47	22.30		
1.4	3	1		22.51	22.42	22.19		
1.4	3	3		22.43	22.35	22.12		
1.4	6	0		21.75	21.58	21.31		
1.4	1	0	16-QAM	21.91	21.71	21.61	23.91	0.2460
1.4	1	3		21.78	21.65	21.39		
1.4	1	5		21.75	21.62	21.45		
1.4	3	0		21.84	21.72	21.62		
1.4	3	1		21.76	21.60	21.42		
1.4	3	3		21.74	21.53	21.41		
1.4	6	0		20.66	20.50	20.29		
1.4	1	0	64-QAM	20.80	20.77	20.64	22.86	0.1932
1.4	1	3		20.75	20.63	20.43		
1.4	1	5		20.69	20.48	20.35		
1.4	3	0		20.86	20.74	20.61		
1.4	3	1		20.74	20.57	20.44		
1.4	3	3		20.65	20.51	20.28		
1.4	6	0		19.61	19.48	19.24		
Limit	EIRP < 2W			Result			Pass	



LTE Band 4 Maximum Average Power [dBm] (GT - LC = 2 dB)								
BW [MHz]	RB Size	RB Offset	Mod	Lowest	Middle	Highest	EIRP (dBm)	EIRP (W)
20	1	0	QPSK	22.43	22.45	22.60	24.60	0.2884
20	1	49		22.31	22.42	22.41		
20	1	99		22.35	22.44	22.48		
20	50	0		21.53	21.60	21.64		
20	50	24		21.52	21.59	21.54		
20	50	50		21.55	21.57	21.51		
20	100	0		21.57	21.59	21.56		
20	1	0	16-QAM	21.58	21.66	21.66	23.66	0.2323
20	1	49		21.56	21.66	21.66		
20	1	99		21.60	21.63	21.66		
20	50	0		20.52	20.59	20.63		
20	50	24		20.56	20.60	20.61		
20	50	50		20.48	20.58	20.55		
20	100	0		20.49	20.56	20.58		
20	1	0	64-QAM	20.50	20.59	20.64	22.64	0.1837
20	1	49		20.48	20.63	20.64		
20	1	99		20.53	20.54	20.60		
20	50	0		19.48	19.57	19.57		
20	50	24		19.48	19.53	19.56		
20	50	50		19.45	19.52	19.52		
20	100	0		19.49	19.51	19.58		
Limit	EIRP < 1W			Result			Pass	



LTE Band 4 Maximum Average Power [dBm] (GT - LC = 2 dB)								
BW [MHz]	RB Size	RB Offset	Mod	Lowest	Middle	Highest	EIRP (dBm)	EIRP (W)
15	1	0	QPSK	22.42	22.52	22.54	24.60	0.2884
15	1	37		22.35	22.49	22.59		
15	1	74		22.28	22.50	22.50		
15	36	0		22.45	22.59	22.60		
15	36	20		22.31	22.54	22.55		
15	36	39		22.28	22.49	22.49		
15	75	0		21.47	21.61	21.74		
15	1	0	16-QAM	21.67	21.73	21.76	23.90	0.2455
15	1	37		21.54	21.74	21.78		
15	1	74		21.71	21.90	21.88		
15	36	0		21.65	21.72	21.75		
15	36	20		21.47	21.69	21.78		
15	36	39		21.62	21.81	21.83		
15	75	0		20.39	20.65	20.75		
15	1	0	64-QAM	20.59	20.69	20.75	22.82	0.1914
15	1	37		20.40	20.65	20.66		
15	1	74		20.68	20.82	20.76		
15	36	0		20.50	20.73	20.76		
15	36	20		20.40	20.60	20.75		
15	36	39		20.67	20.76	20.76		
15	75	0		19.32	19.61	19.57		
Limit	EIRP < 1W			Result			Pass	



LTE Band 4 Maximum Average Power [dBm] (GT - LC = 2 dB)								
BW [MHz]	RB Size	RB Offset	Mod	Lowest	Middle	Highest	EIRP (dBm)	EIRP (W)
10	1	0	QPSK	22.43	22.41	22.45	24.45	0.2786
10	1	25		22.24	22.42	22.31		
10	1	49		22.28	22.38	22.40		
10	25	0		21.52	21.51	21.56		
10	25	12		21.43	21.59	21.44		
10	25	25		21.49	21.49	21.48		
10	50	0		21.54	21.59	21.54		
10	1	0	16-QAM	21.49	21.64	21.66	23.66	0.2323
10	1	25		21.46	21.64	21.63		
10	1	49		21.50	21.56	21.57		
10	25	0		20.51	20.56	20.58		
10	25	12		20.48	20.58	20.55		
10	25	25		20.45	20.58	20.50		
10	50	0		20.49	20.49	20.51		
10	1	0	64-QAM	20.40	20.55	20.63	22.63	0.1832
10	1	25		20.43	20.53	20.55		
10	1	49		20.48	20.44	20.59		
10	25	0		19.47	19.53	19.57		
10	25	12		19.48	19.46	19.56		
10	25	25		19.43	19.49	19.52		
10	50	0		19.44	19.41	19.56		
Limit	EIRP < 1W			Result			Pass	



LTE Band 4 Maximum Average Power [dBm] (GT - LC = 2 dB)								
BW [MHz]	RB Size	RB Offset	Mod	Lowest	Middle	Highest	EIRP (dBm)	EIRP (W)
5	1	0	QPSK	22.42	22.36	22.48	24.48	0.2805
5	1	12		22.28	22.38	22.39		
5	1	24		22.32	22.34	22.41		
5	12	0		21.43	21.52	21.56		
5	12	7		21.52	21.58	21.52		
5	12	13		21.52	21.57	21.50		
5	25	0		21.51	21.59	21.47		
5	1	0	16-QAM	21.50	21.62	21.58	23.64	0.2312
5	1	12		21.52	21.57	21.64		
5	1	24		21.50	21.59	21.61		
5	12	0		20.45	20.54	20.59		
5	12	7		20.51	20.53	20.58		
5	12	13		20.45	20.57	20.53		
5	25	0		20.48	20.49	20.49		
5	1	0	64-QAM	20.47	20.58	20.64	22.64	0.1837
5	1	12		20.44	20.60	20.61		
5	1	24		20.50	20.50	20.52		
5	12	0		19.39	19.53	19.56		
5	12	7		19.40	19.44	19.48		
5	12	13		19.36	19.45	19.50		
5	25	0		19.39	19.47	19.53		
Limit	EIRP < 1W			Result			Pass	



LTE Band 4 Maximum Average Power [dBm] (GT - LC = 2 dB)								
BW [MHz]	RB Size	RB Offset	Mod	Lowest	Middle	Highest	EIRP (dBm)	EIRP (W)
3	1	0	QPSK	22.34	22.39	22.45	24.47	0.2799
3	1	8		22.21	22.39	22.39		
3	1	14		22.35	22.41	22.47		
3	8	0		21.47	21.53	21.60		
3	8	4		21.47	21.50	21.52		
3	8	7		21.47	21.57	21.43		
3	15	0		21.50	21.52	21.49		
3	1	0	16-QAM	21.51	21.65	21.57	23.65	0.2317
3	1	8		21.49	21.58	21.65		
3	1	14		21.55	21.57	21.61		
3	8	0		20.43	20.56	20.58		
3	8	4		20.50	20.54	20.61		
3	8	7		20.43	20.51	20.55		
3	15	0		20.45	20.56	20.50		
3	1	0	64-QAM	20.45	20.51	20.56	22.60	0.1820
3	1	8		20.48	20.60	20.56		
3	1	14		20.48	20.48	20.54		
3	8	0		19.40	19.49	19.52		
3	8	4		19.41	19.50	19.48		
3	8	7		19.37	19.47	19.51		
3	15	0		19.48	19.51	19.54		
Limit	EIRP < 1W			Result			Pass	



LTE Band 4 Maximum Average Power [dBm] (GT - LC = 2 dB)								
BW [MHz]	RB Size	RB Offset	Mod	Lowest	Middle	Highest	EIRP (dBm)	EIRP (W)
1.4	1	0	QPSK	22.41	22.43	22.49	24.49	0.2812
1.4	1	3		22.21	22.39	22.31		
1.4	1	5		22.32	22.41	22.42		
1.4	3	0		22.40	22.36	22.48		
1.4	3	1		22.31	22.40	22.37		
1.4	3	3		22.29	22.41	22.41		
1.4	6	0		21.53	21.57	21.54		
1.4	1	0	16-QAM	21.48	21.56	21.57	23.65	0.2317
1.4	1	3		21.56	21.57	21.63		
1.4	1	5		21.60	21.63	21.58		
1.4	3	0		21.52	21.58	21.65		
1.4	3	1		21.46	21.64	21.61		
1.4	3	3		21.52	21.61	21.63		
1.4	6	0		20.44	20.54	20.55		
1.4	1	0	64-QAM	20.43	20.59	20.55	22.63	0.1832
1.4	1	3		20.38	20.61	20.63		
1.4	1	5		20.53	20.44	20.53		
1.4	3	0		20.47	20.49	20.56		
1.4	3	1		20.48	20.56	20.63		
1.4	3	3		20.46	20.51	20.54		
1.4	6	0		19.43	19.49	19.52		
Limit	EIRP < 1W			Result			Pass	



LTE Band 5 Maximum Average Power [dBm] (GT - LC = 2 dB)								
BW [MHz]	RB Size	RB Offset	Mod	Lowest	Middle	Highest	ERP (dBm)	ERP (W)
10	1	0	QPSK	22.47	22.61	22.70	22.55	0.1799
10	1	25		22.39	22.57	22.63		
10	1	49		22.29	22.53	22.59		
10	25	0		21.55	21.71	21.73		
10	25	12		21.50	21.70	21.72		
10	25	25		21.55	21.73	21.80		
10	50	0		21.52	21.69	21.77		
10	1	0	16-QAM	21.67	21.81	21.84	21.75	0.1496
10	1	25		21.55	21.79	21.83		
10	1	49		21.71	21.90	21.89		
10	25	0		20.48	20.71	20.78		
10	25	12		20.50	20.70	20.74		
10	25	25		20.56	20.72	20.75		
10	50	0		20.46	20.69	20.77		
10	1	0	64-QAM	20.60	20.76	20.80	20.68	0.1169
10	1	25		20.50	20.69	20.75		
10	1	49		20.68	20.83	20.82		
10	25	0		19.39	19.71	19.71		
10	25	12		19.49	19.60	19.70		
10	25	25		19.51	19.72	19.65		
10	50	0		19.36	19.66	19.67		
Limit	ERP < 7W			Result			Pass	



LTE Band 5 Maximum Average Power [dBm] (GT - LC = 2 dB)								
BW [MHz]	RB Size	RB Offset	Mod	Lowest	Middle	Highest	ERP (dBm)	ERP (W)
5	1	0	QPSK	22.40	22.57	22.68	22.53	0.1791
5	1	12		22.36	22.57	22.55		
5	1	24		22.24	22.52	22.49		
5	12	0		21.46	21.65	21.63		
5	12	7		21.48	21.69	21.71		
5	12	13		21.55	21.67	21.72		
5	25	0		21.42	21.69	21.67		
5	1	0	16-QAM	21.57	21.72	21.81	21.71	0.1483
5	1	12		21.45	21.77	21.81		
5	1	24		21.62	21.86	21.82		
5	12	0		20.44	20.69	20.75		
5	12	7		20.42	20.60	20.65		
5	12	13		20.46	20.62	20.67		
5	25	0		20.42	20.63	20.76		
5	1	0	64-QAM	20.53	20.67	20.77	20.62	0.1153
5	1	12		20.46	20.59	20.72		
5	1	24		20.63	20.77	20.76		
5	12	0		19.35	19.68	19.70		
5	12	7		19.46	19.58	19.66		
5	12	13		19.46	19.69	19.64		
5	25	0		19.30	19.61	19.66		
Limit	ERP < 7W			Result			Pass	



LTE Band 5 Maximum Average Power [dBm] (GT - LC = 2 dB)								
BW [MHz]	RB Size	RB Offset	Mod	Lowest	Middle	Highest	ERP (dBm)	ERP (W)
3	1	0	QPSK	22.41	22.52	22.65	22.5	0.1778
3	1	8		22.37	22.52	22.53		
3	1	14		22.23	22.50	22.56		
3	8	0		21.48	21.66	21.66		
3	8	4		21.44	21.62	21.71		
3	8	7		21.54	21.71	21.76		
3	15	0		21.51	21.59	21.68		
3	1	0	16-QAM	21.65	21.71	21.76	21.7	0.1479
3	1	8		21.47	21.77	21.80		
3	1	14		21.61	21.80	21.85		
3	8	0		20.44	20.67	20.78		
3	8	4		20.40	20.60	20.73		
3	8	7		20.46	20.71	20.71		
3	15	0		20.45	20.62	20.69		
3	1	0	64-QAM	20.59	20.69	20.73	20.63	0.1156
3	1	8		20.44	20.69	20.65		
3	1	14		20.61	20.73	20.78		
3	8	0		19.35	19.67	19.66		
3	8	4		19.44	19.51	19.67		
3	8	7		19.47	19.62	19.63		
3	15	0		19.32	19.65	19.64		
Limit	ERP < 7W			Result			Pass	



LTE Band 5 Maximum Average Power [dBm] (GT - LC = 2 dB)								
BW [MHz]	RB Size	RB Offset	Mod	Lowest	Middle	Highest	ERP (dBm)	ERP (W)
1.4	1	0	QPSK	22.46	22.57	22.63	22.49	0.1774
1.4	1	3		22.29	22.51	22.63		
1.4	1	5		22.22	22.46	22.53		
1.4	3	0		22.43	22.54	22.64		
1.4	3	1		22.32	22.56	22.63		
1.4	3	3		22.28	22.53	22.58		
1.4	6	0		21.42	21.67	21.74		
1.4	1	0	16-QAM	21.65	21.71	21.76	21.74	0.1493
1.4	1	3		21.48	21.74	21.76		
1.4	1	5		21.62	21.89	21.84		
1.4	3	0		21.67	21.71	21.84		
1.4	3	1		21.53	21.70	21.77		
1.4	3	3		21.62	21.80	21.84		
1.4	6	0		20.37	20.60	20.70		
1.4	1	0	64-QAM	20.60	20.68	20.77	20.66	0.1164
1.4	1	3		20.48	20.59	20.66		
1.4	1	5		20.64	20.77	20.74		
1.4	3	0		20.58	20.71	20.71		
1.4	3	1		20.41	20.63	20.69		
1.4	3	3		20.68	20.81	20.73		
1.4	6	0		19.35	19.57	19.66		
Limit	ERP < 7W			Result			Pass	



LTE Band 7 Maximum Average Power [dBm] (GT - LC = 2 dB)								
BW [MHz]	RB Size	RB Offset	Mod	Lowest	Middle	Highest	EIRP (dBm)	EIRP (W)
20	1	0	QPSK	22.35	22.31	22.24	24.35	0.2723
20	1	49		22.11	22.17	22.02		
20	1	99		22.09	22.12	22.05		
20	50	0		21.40	21.40	21.29		
20	50	24		21.38	21.35	21.27		
20	50	50		21.32	21.29	21.20		
20	100	0		21.35	21.34	21.23		
20	1	0	16-QAM	21.61	21.62	21.55	23.62	0.2301
20	1	49		21.46	21.46	21.34		
20	1	99		21.39	21.43	21.32		
20	50	0		20.45	20.42	20.27		
20	50	24		20.33	20.39	20.25		
20	50	50		20.27	20.31	20.21		
20	100	0		20.34	20.36	20.23		
20	1	0	64-QAM	20.55	20.59	20.49	22.59	0.1816
20	1	49		20.38	20.37	20.33		
20	1	99		20.39	20.38	20.27		
20	50	0		19.41	19.33	19.22		
20	50	24		19.26	19.29	19.25		
20	50	50		19.25	19.21	19.15		
20	100	0		19.31	19.34	19.17		
Limit	EIRP < 2W			Result			Pass	



LTE Band 7 Maximum Average Power [dBm] (GT - LC = 2 dB)								
BW [MHz]	RB Size	RB Offset	Mod	Lowest	Middle	Highest	EIRP (dBm)	EIRP (W)
15	1	0	QPSK	22.30	22.25	22.22	24.30	0.2692
15	1	37		22.04	22.11	22.05		
15	1	74		22.03	22.10	22.04		
15	36	0		21.30	21.40	21.20		
15	36	20		21.34	21.26	21.25		
15	36	39		21.29	21.20	21.20		
15	75	0		21.31	21.31	21.22		
15	1	0	16-QAM	21.53	21.54	21.55	23.55	0.2265
15	1	37		21.45	21.46	21.28		
15	1	74		21.34	21.36	21.32		
15	36	0		20.35	20.34	20.23		
15	36	20		20.27	20.37	20.15		
15	36	39		20.21	20.30	20.15		
15	75	0		20.33	20.31	20.19		
15	1	0	64-QAM	20.55	20.59	20.48	22.59	0.1816
15	1	37		20.29	20.36	20.29		
15	1	74		20.32	20.30	20.18		
15	36	0		19.36	19.33	19.20		
15	36	20		19.26	19.22	19.16		
15	36	39		19.21	19.16	19.15		
15	75	0		19.28	19.30	19.15		
Limit	EIRP < 2W			Result			Pass	



LTE Band 7 Maximum Average Power [dBm] (GT - LC = 2 dB)								
BW [MHz]	RB Size	RB Offset	Mod	Lowest	Middle	Highest	EIRP (dBm)	EIRP (W)
10	1	0	QPSK	22.32	22.30	22.14	24.32	0.2704
10	1	25		22.11	22.16	22.04		
10	1	49		22.03	22.10	22.03		
10	25	0		21.34	21.30	21.24		
10	25	12		21.35	21.28	21.20		
10	25	25		21.22	21.23	21.20		
10	50	0		21.27	21.25	21.19		
10	1	0	16-QAM	21.51	21.52	21.48	23.52	0.2249
10	1	25		21.46	21.39	21.30		
10	1	49		21.31	21.42	21.29		
10	25	0		20.35	20.38	20.20		
10	25	12		20.31	20.34	20.18		
10	25	25		20.20	20.28	20.13		
10	50	0		20.24	20.30	20.15		
10	1	0	64-QAM	20.52	20.54	20.43	22.54	0.1795
10	1	25		20.34	20.34	20.29		
10	1	49		20.31	20.28	20.18		
10	25	0		19.37	19.32	19.16		
10	25	12		19.17	19.29	19.15		
10	25	25		19.18	19.14	19.05		
10	50	0		19.29	19.32	19.17		
Limit	EIRP < 2W			Result			Pass	



LTE Band 7 Maximum Average Power [dBm] (GT - LC = 2 dB)								
BW [MHz]	RB Size	RB Offset	Mod	Lowest	Middle	Highest	EIRP (dBm)	EIRP (W)
5	1	0	QPSK	22.34	22.22	22.19	24.34	0.2716
5	1	12		22.06	22.16	22.00		
5	1	24		22.04	22.06	22.03		
5	12	0		21.38	21.32	21.22		
5	12	7		21.36	21.25	21.22		
5	12	13		21.29	21.20	21.15		
5	25	0		21.31	21.25	21.19		
5	1	0	16-QAM	21.57	21.56	21.51	23.57	0.2275
5	1	12		21.39	21.43	21.30		
5	1	24		21.38	21.40	21.27		
5	12	0		20.41	20.34	20.25		
5	12	7		20.31	20.38	20.15		
5	12	13		20.21	20.26	20.21		
5	25	0		20.29	20.26	20.22		
5	1	0	64-QAM	20.50	20.54	20.41	22.54	0.1795
5	1	12		20.37	20.37	20.29		
5	1	24		20.33	20.31	20.19		
5	12	0		19.31	19.26	19.13		
5	12	7		19.16	19.19	19.17		
5	12	13		19.16	19.19	19.13		
5	25	0		19.29	19.31	19.11		
Limit	EIRP < 2W			Result			Pass	



LTE Band 38 Maximum Average Power [dBm] (GT - LC = 2 dB)								
BW [MHz]	RB Size	RB Offset	Mod	Lowest	Middle	Highest	EIRP (dBm)	EIRP (W)
20	1	0	QPSK	22.15	22.16	22.12	24.16	0.2606
20	1	49		22.14	22.13	22.08		
20	1	99		22.13	22.14	22.11		
20	50	0		21.23	21.25	21.28		
20	50	24		21.34	21.32	21.30		
20	50	50		21.20	21.32	21.23		
20	100	0		21.18	21.19	21.33		
20	1	0	16-QAM	21.20	21.22	21.14	23.24	0.2109
20	1	49		21.11	21.24	21.22		
20	1	99		21.01	21.11	21.24		
20	50	0		20.23	20.26	20.37		
20	50	24		20.29	20.29	20.38		
20	50	50		20.22	20.27	20.26		
20	100	0		20.12	20.29	20.27		
20	1	0	64-QAM	21.01	20.10	20.01	23.01	0.2000
20	1	49		20.94	20.89	20.93		
20	1	99		20.78	20.83	20.69		
20	50	0		20.18	19.27	19.30		
20	50	24		20.23	19.21	19.33		
20	50	50		20.20	19.28	19.25		
20	100	0		20.27	19.18	19.35		
Limit	EIRP < 2W			Result			Pass	



LTE Band 38 Maximum Average Power [dBm] (GT - LC = 2 dB)								
BW [MHz]	RB Size	RB Offset	Mod	Lowest	Middle	Highest	EIRP (dBm)	EIRP (W)
15	1	0	QPSK	22.11	22.10	22.11	24.11	0.2576
15	1	37		22.06	22.07	22.08		
15	1	74		22.09	22.09	22.08		
15	36	0		21.16	21.24	21.23		
15	36	20		21.29	21.25	21.24		
15	36	39		21.12	21.29	21.16		
15	75	0		21.15	21.09	21.26		
15	1	0	16-QAM	21.14	21.16	21.10	23.22	0.2099
15	1	37		21.10	21.20	21.18		
15	1	74		20.98	21.04	21.22		
15	36	0		20.20	20.26	20.34		
15	36	20		20.27	20.25	20.30		
15	36	39		20.14	20.19	20.16		
15	75	0		20.11	20.26	20.24		
15	1	0	64-QAM	20.97	20.07	20.01	22.97	0.1982
15	1	37		20.85	20.80	20.90		
15	1	74		20.78	20.78	20.60		
15	36	0		20.15	19.25	19.21		
15	36	20		20.16	19.18	19.32		
15	36	39		20.12	19.21	19.21		
15	75	0		20.18	19.10	19.31		
Limit	EIRP < 2W			Result			Pass	



LTE Band 38 Maximum Average Power [dBm] (GT - LC = 2 dB)								
BW [MHz]	RB Size	RB Offset	Mod	Lowest	Middle	Highest	EIRP (dBm)	EIRP (W)
10	1	0	QPSK	22.07	22.12	22.12	24.14	0.2594
10	1	25		22.14	22.10	22.07		
10	1	49		22.04	22.14	22.08		
10	25	0		21.17	21.19	21.27		
10	25	12		21.31	21.29	21.24		
10	25	25		21.18	21.23	21.15		
10	50	0		21.15	21.17	21.28		
10	1	0	16-QAM	21.11	21.18	21.04	23.24	0.2109
10	1	25		21.09	21.24	21.21		
10	1	49		21.12	21.10	21.16		
10	25	0		20.16	20.17	20.31		
10	25	12		20.26	20.27	20.28		
10	25	25		20.21	20.23	20.17		
10	50	0		20.04	20.22	20.20		
10	1	0	64-QAM	21.01	20.04	20.11	23.01	0.2000
10	1	25		20.87	20.88	20.84		
10	1	49		20.74	20.82	20.67		
10	25	0		20.10	19.23	19.25		
10	25	12		20.18	19.18	19.31		
10	25	25		20.14	19.28	19.17		
10	50	0		20.25	19.13	19.27		
Limit	EIRP < 2W			Result			Pass	



LTE Band 38 Maximum Average Power [dBm] (GT - LC = 2 dB)								
BW [MHz]	RB Size	RB Offset	Mod	Lowest	Middle	Highest	EIRP (dBm)	EIRP (W)
5	1	0	QPSK	22.07	22.09	22.11	24.13	0.2588
5	1	12		22.10	22.04	22.01		
5	1	24		22.13	22.09	22.11		
5	12	0		21.17	21.21	21.21		
5	12	7		21.32	21.25	21.20		
5	12	13		21.12	21.30	21.15		
5	25	0		21.17	21.11	21.28		
5	1	0	16-QAM	21.18	21.19	21.13	23.21	0.2094
5	1	12		21.04	21.18	21.21		
5	1	24		21.15	21.04	21.16		
5	12	0		20.18	20.19	20.31		
5	12	7		20.23	20.20	20.28		
5	12	13		20.21	20.19	20.16		
5	25	0		20.05	20.29	20.17		
5	1	0	64-QAM	20.95	20.00	20.21	22.95	0.1972
5	1	12		20.85	20.83	20.93		
5	1	24		20.73	20.82	20.60		
5	12	0		20.16	19.18	19.25		
5	12	7		20.16	19.12	19.27		
5	12	13		20.13	19.26	19.16		
5	25	0		20.22	19.11	19.26		
Limit	EIRP < 2W			Result			Pass	



LTE Band 41 Maximum Average Power [dBm] (GT - LC = 2 dB)								
BW [MHz]	RB Size	RB Offset	Mod	Lowest	Middle	Highest	EIRP (dBm)	EIRP (W)
20	1	0	QPSK	22.25	22.23	22.06	24.32	0.2704
20	1	49		22.24	22.32	22.25		
20	1	99		22.26	22.17	22.28		
20	50	0		21.56	21.50	21.47		
20	50	24		21.50	21.47	21.47		
20	50	50		21.62	21.50	21.41		
20	100	0		21.53	21.42	21.37		
20	1	0	16-QAM	21.42	21.41	21.09	23.44	0.2208
20	1	49		21.34	21.37	21.27		
20	1	99		21.42	21.44	21.33		
20	50	0		20.51	20.38	20.43		
20	50	24		20.44	20.43	20.46		
20	50	50		20.55	20.39	20.42		
20	100	0		20.49	20.49	20.40		
20	1	0	64-QAM	20.20	20.14	20.04	22.20	0.1660
20	1	49		20.07	20.09	20.08		
20	1	99		20.09	20.19	20.20		
20	50	0		19.52	19.41	19.36		
20	50	24		19.47	19.45	19.36		
20	50	50		19.52	19.43	19.45		
20	100	0		19.54	19.47	19.32		
Limit	EIRP < 2W			Result			Pass	



LTE Band 41 Maximum Average Power [dBm] (GT - LC = 2 dB)								
BW [MHz]	RB Size	RB Offset	Mod	Lowest	Middle	Highest	EIRP (dBm)	EIRP (W)
15	1	0	QPSK	22.18	22.22	22.16	24.30	0.2692
15	1	37		22.18	22.30	22.24		
15	1	74		22.20	22.07	22.20		
15	36	0		21.48	21.46	21.40		
15	36	20		21.41	21.39	21.42		
15	36	39		21.62	21.45	21.37		
15	75	0		21.51	21.39	21.37		
15	1	0	16-QAM	21.36	21.38	21.06	23.41	0.2193
15	1	37		21.31	21.27	21.26		
15	1	74		21.34	21.41	21.30		
15	36	0		20.50	20.33	20.36		
15	36	20		20.42	20.40	20.36		
15	36	39		20.48	20.36	20.42		
15	75	0		20.43	20.49	20.34		
15	1	0	64-QAM	20.16	20.10	20.00	22.19	0.1656
15	1	37		20.01	20.05	19.97		
15	1	74		20.04	20.09	20.19		
15	36	0		19.52	19.37	19.31		
15	36	20		19.41	19.35	19.29		
15	36	39		19.48	19.42	19.40		
15	75	0		19.48	19.41	19.22		
Limit	EIRP < 2W			Result			Pass	



LTE Band 41 Maximum Average Power [dBm] (GT - LC = 2 dB)								
BW [MHz]	RB Size	RB Offset	Mod	Lowest	Middle	Highest	EIRP (dBm)	EIRP (W)
10	1	0	QPSK	22.17	22.21	22.14	24.32	0.2704
10	1	25		22.18	22.32	22.18		
10	1	49		22.21	22.09	22.18		
10	25	0		21.51	21.40	21.39		
10	25	12		21.41	21.37	21.45		
10	25	25		21.59	21.41	21.40		
10	50	0		21.43	21.32	21.36		
10	1	0	16-QAM	21.39	21.36	21.04	23.39	0.2183
10	1	25		21.33	21.35	21.19		
10	1	49		21.32	21.35	21.27		
10	25	0		20.48	20.28	20.34		
10	25	12		20.38	20.34	20.39		
10	25	25		20.48	20.30	20.41		
10	50	0		20.46	20.46	20.32		
10	1	0	64-QAM	20.19	20.14	20.04	22.19	0.1656
10	1	25		20.04	20.08	20.05		
10	1	49		20.01	20.09	20.16		
10	25	0		19.46	19.40	19.30		
10	25	12		19.39	19.37	19.28		
10	25	25		19.50	19.43	19.39		
10	50	0		19.48	19.37	19.23		
Limit	EIRP < 2W			Result			Pass	



LTE Band 41 Maximum Average Power [dBm] (GT - LC = 2 dB)								
BW [MHz]	RB Size	RB Offset	Mod	Lowest	Middle	Highest	EIRP (dBm)	EIRP (W)
5	1	0	QPSK	22.25	22.22	22.06	24.28	0.2679
5	1	12		22.16	22.28	22.24		
5	1	24		22.23	22.15	22.25		
5	12	0		21.48	21.49	21.46		
5	12	7		21.41	21.44	21.45		
5	12	13		21.62	21.46	21.35		
5	25	0		21.45	21.40	21.37		
5	1	0	16-QAM	21.38	21.36	21.00	23.41	0.2193
5	1	12		21.32	21.33	21.24		
5	1	24		21.41	21.39	21.28		
5	12	0		20.45	20.28	20.37		
5	12	7		20.38	20.37	20.37		
5	12	13		20.48	20.38	20.36		
5	25	0		20.44	20.48	20.31		
5	1	0	64-QAM	20.12	20.06	20.04	22.17	0.1648
5	1	12		20.04	20.00	20.15		
5	1	24		20.06	20.16	20.17		
5	12	0		19.46	19.31	19.26		
5	12	7		19.47	19.40	19.31		
5	12	13		19.42	19.35	19.41		
5	25	0		19.53	19.42	19.29		
Limit	EIRP < 2W			Result			Pass	



LTE Band 2

Peak-to-Average Ratio

Mode	LTE Band 2 / 20MHz				
Mod.	QPSK	16QAM	64QAM	256QAM	Limit: 13dB
RB Size	Full RB	Full RB	Full RB	Full RB	Result
Middle CH	4.90	5.86	6.41	-	PASS

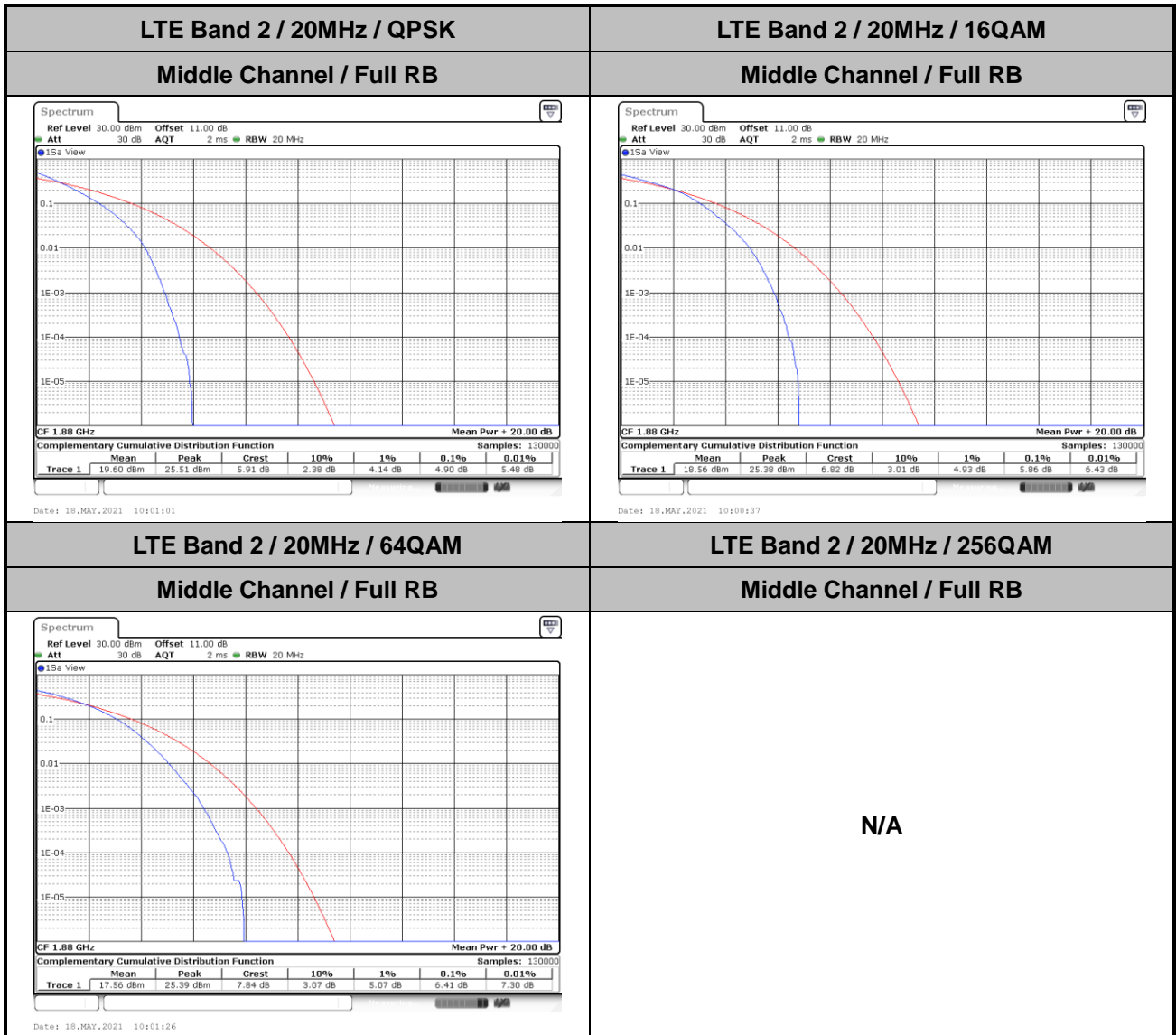



26dB Bandwidth

Mode	LTE Band 2 : 26dB BW(MHz)											
BW	1.4MHz		3MHz		5MHz		10MHz		15MHz		20MHz	
Mod.	QPSK	16QAM	QPSK	16QAM	QPSK	16QAM	QPSK	16QAM	QPSK	16QAM	QPSK	16QAM
Middle CH	1.23	1.24	3.04	3.07	4.91	4.89	9.87	9.81	14.36	14.15	19.02	19.30
Mode	LTE Band 2 : 26dB BW(MHz)											
BW	1.4MHz		3MHz		5MHz		10MHz		15MHz		20MHz	
Mod.	64QAM	256 QAM	64QAM	256 QAM	64QAM	256 QAM	64QAM	256 QAM	64QAM	256 QAM	64QAM	256 QAM
Middle CH	1.22	-	3.03	-	4.96	-	9.91	-	14.36	-	18.98	-



LTE Band 2

Middle Channel / 1.4MHz / QPSK

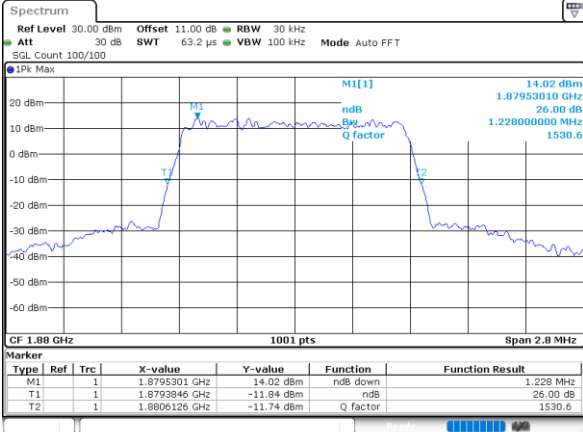

Date: 18.MAY.2021 09:05:27

Middle Channel / 1.4MHz / 16QAM

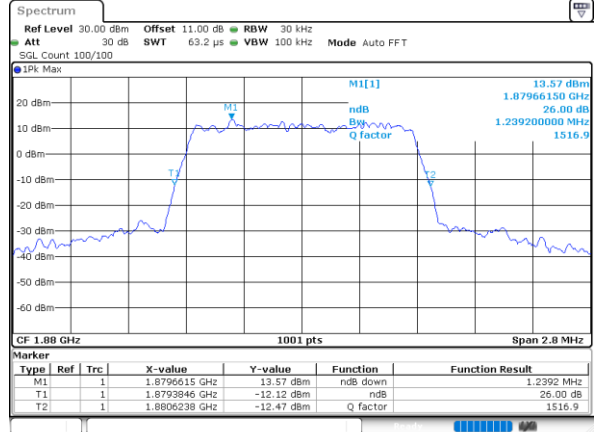

Date: 18.MAY.2021 09:05:47

Middle Channel / 3MHz / QPSK

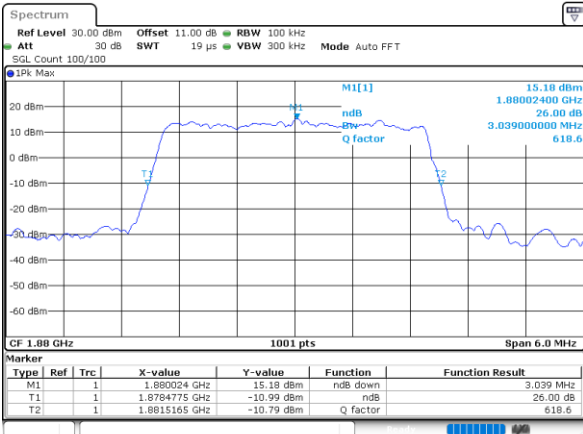

Date: 18.MAY.2021 09:13:10

Middle Channel / 3MHz / 16QAM

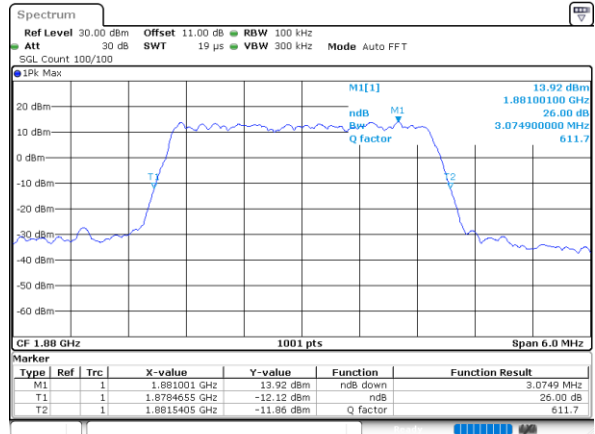

Date: 18.MAY.2021 09:13:30

Middle Channel / 5MHz / QPSK

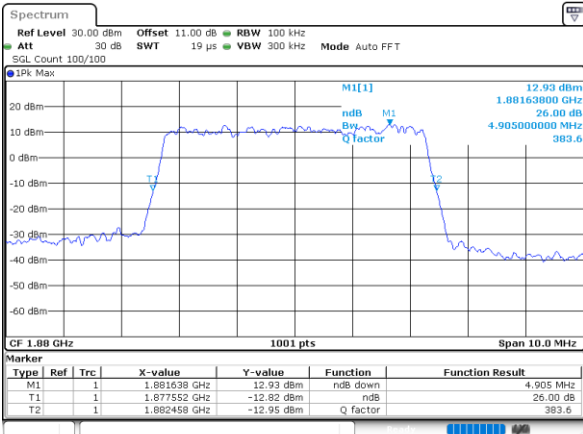

Date: 18.MAY.2021 09:20:52

Middle Channel / 5MHz / 16QAM

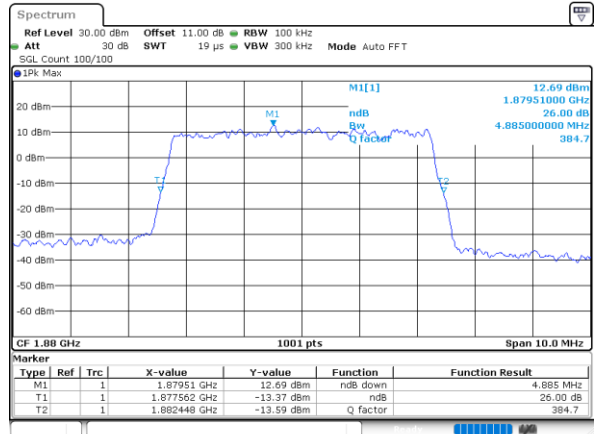

Date: 18.MAY.2021 09:21:13



LTE Band 2

Middle Channel / 10MHz / QPSK

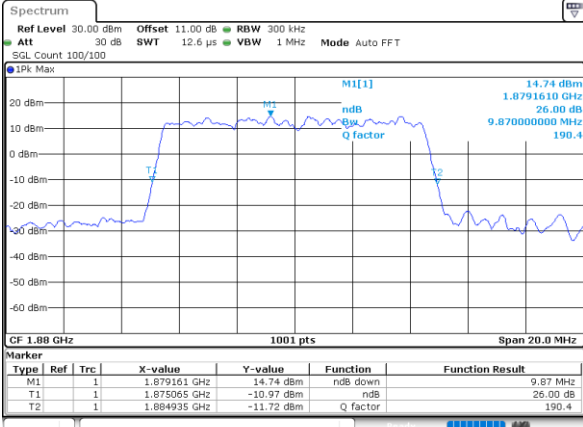

Date: 18.MAY.2021 09:28:36

Middle Channel / 10MHz / 16QAM

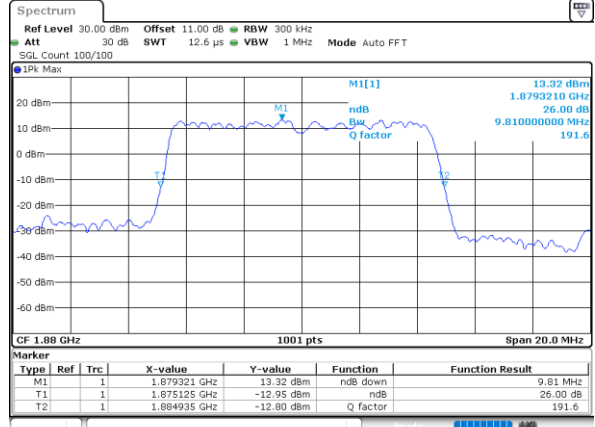

Date: 18.MAY.2021 09:28:57

Middle Channel / 15MHz / QPSK

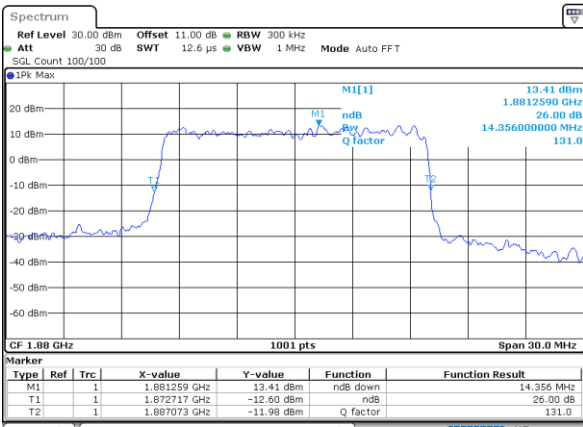

Date: 18.MAY.2021 09:36:23

Middle Channel / 15MHz / 16QAM

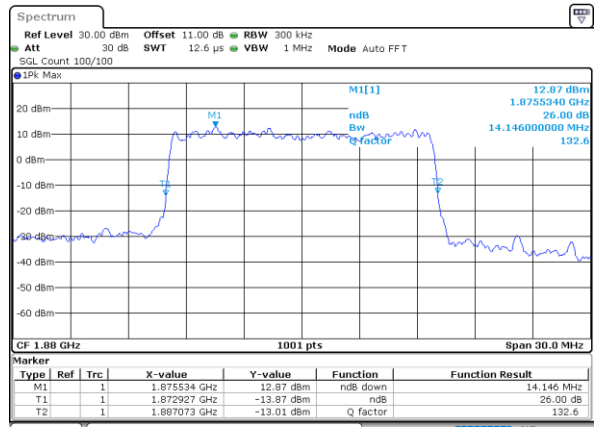

Date: 18.MAY.2021 09:36:44

Middle Channel / 20MHz / QPSK

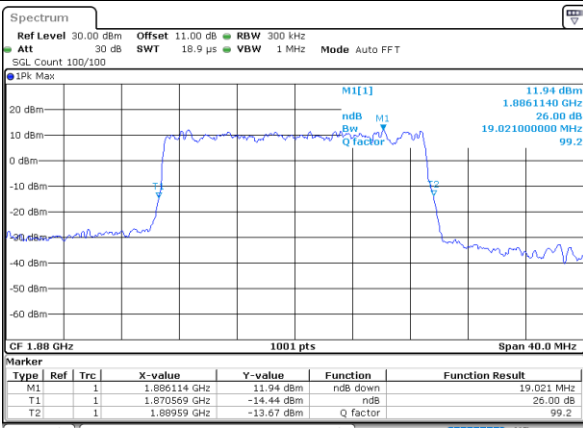

Date: 18.MAY.2021 09:44:07

Middle Channel / 20MHz / 16QAM

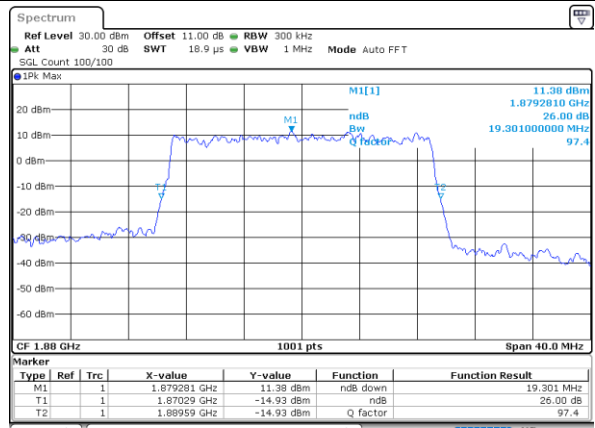

Date: 18.MAY.2021 09:44:28



LTE Band 2

Middle Channel / 1.4MHz / 64QAM

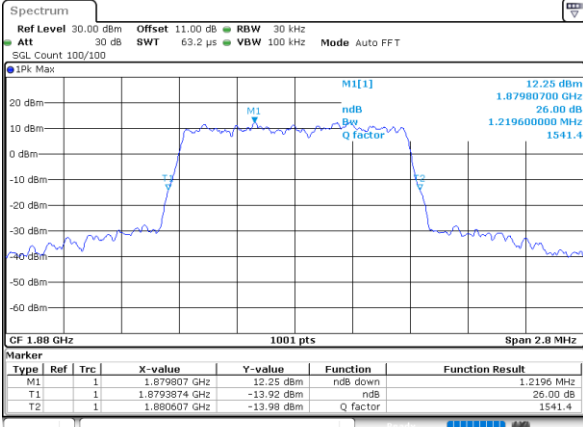

Date: 18.MAY.2021 09:00:49

Middle Channel / 3MHz / 64QAM

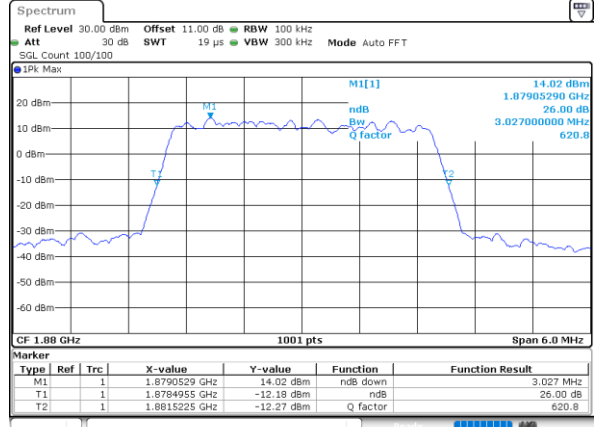

Date: 18.MAY.2021 09:49:37

Middle Channel / 5MHz / 64QAM

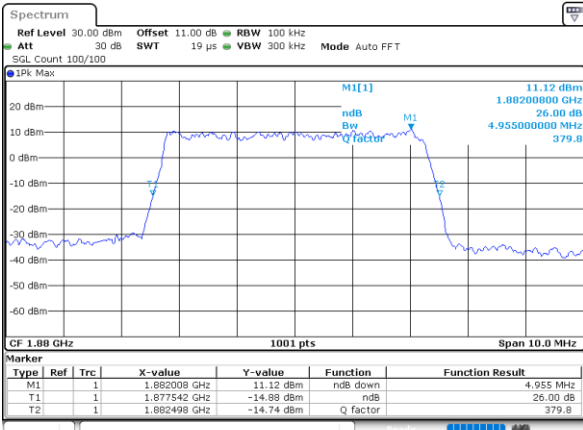

Date: 18.MAY.2021 09:52:04

Middle Channel / 10MHz / 64QAM

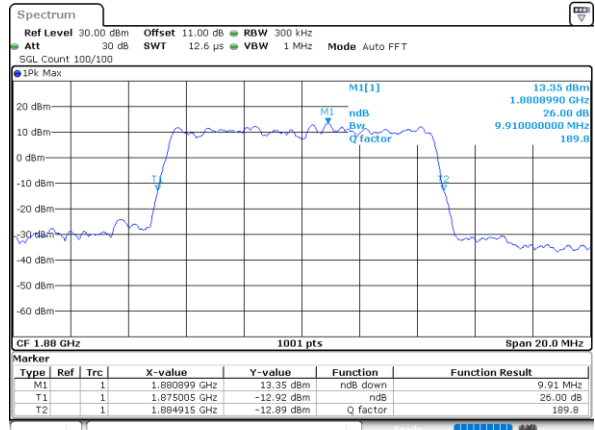

Date: 18.MAY.2021 09:54:31

Middle Channel / 15MHz / 64QAM

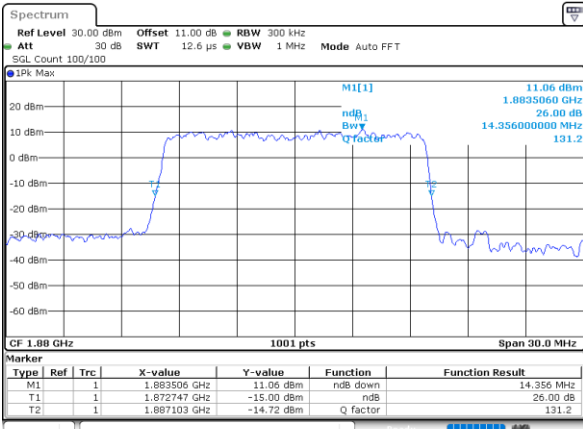

Date: 18.MAY.2021 09:56:57

Middle Channel / 20MHz / 64QAM

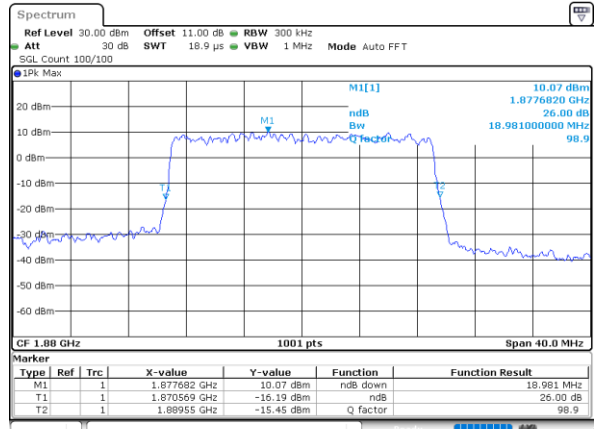

Date: 18.MAY.2021 09:59:24



Occupied Bandwidth

Mode	LTE Band 2 : 99%OBW(MHz)											
BW	1.4MHz		3MHz		5MHz		10MHz		15MHz		20MHz	
Mod.	QPSK	16QAM	QPSK	16QAM	QPSK	16QAM	QPSK	16QAM	QPSK	16QAM	QPSK	16QAM
Middle CH	1.09	1.09	2.73	2.70	4.50	4.47	9.01	9.03	13.40	13.46	17.82	17.90
Mode	LTE Band 2 : 99%OBW(MHz)											
BW	1.4MHz		3MHz		5MHz		10MHz		15MHz		20MHz	
Mod.	64QAM	256 QAM	64QAM	256 QAM	64QAM	256 QAM	64QAM	256 QAM	64QAM	256 QAM	64QAM	256 QAM
Middle CH	1.09	-	2.74	-	4.51	-	8.97	-	13.43	-	17.82	-



LTE Band 2

Middle Channel / 1.4MHz / QPSK

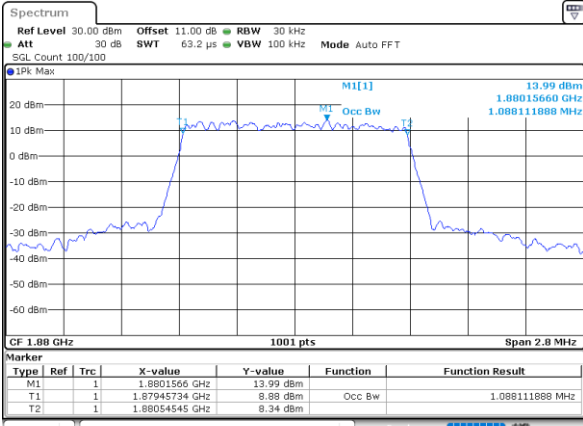

Date: 18.MAY.2021 09:04:42

Middle Channel / 1.4MHz / 16QAM

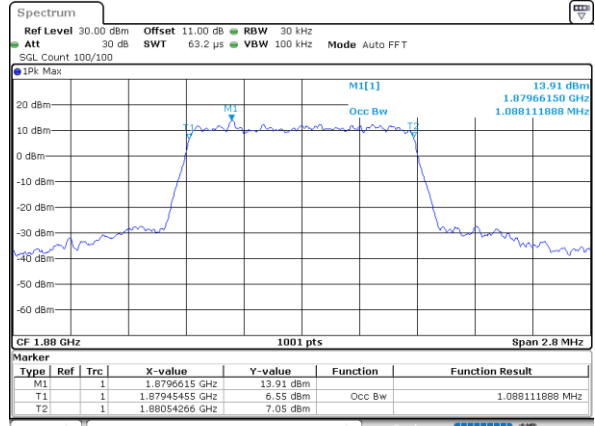

Date: 18.MAY.2021 09:05:04

Middle Channel / 3MHz / QPSK

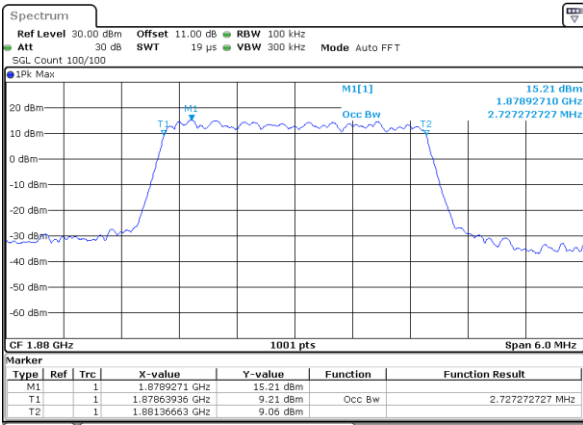

Date: 18.MAY.2021 09:12:05

Middle Channel / 3MHz / 16QAM

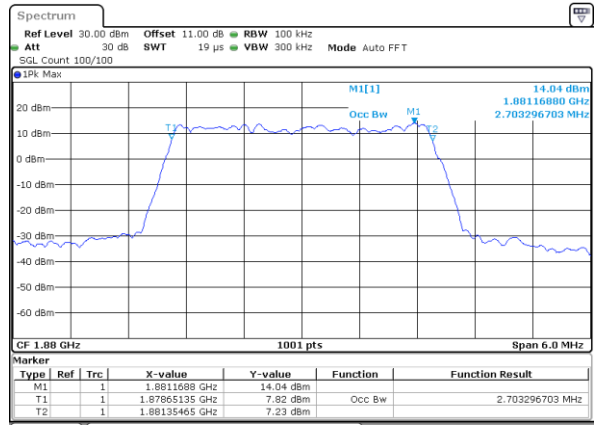

Date: 18.MAY.2021 09:12:47

Middle Channel / 5MHz / QPSK

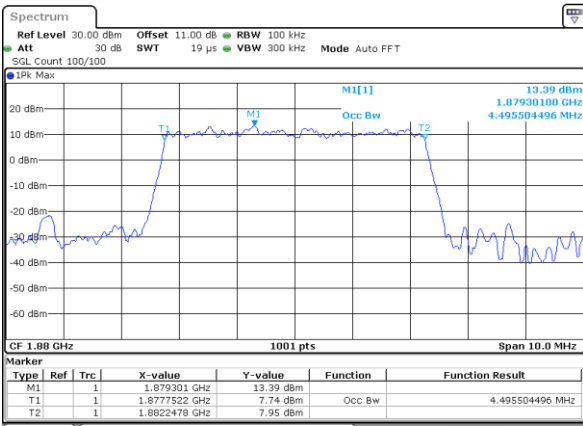

Date: 18.MAY.2021 09:20:07

Middle Channel / 5MHz / 16QAM

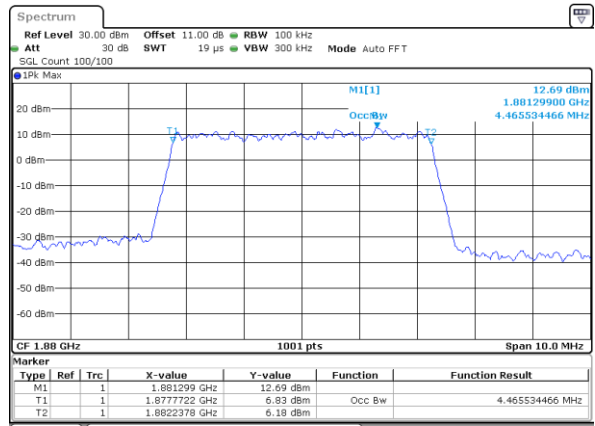

Date: 18.MAY.2021 09:20:30



LTE Band 2

Middle Channel / 10MHz / QPSK

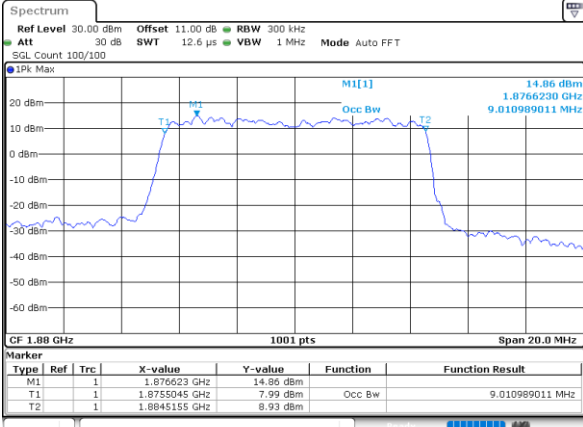

Date: 18_MAY.2021 09:27:51

Middle Channel / 10MHz / 16QAM

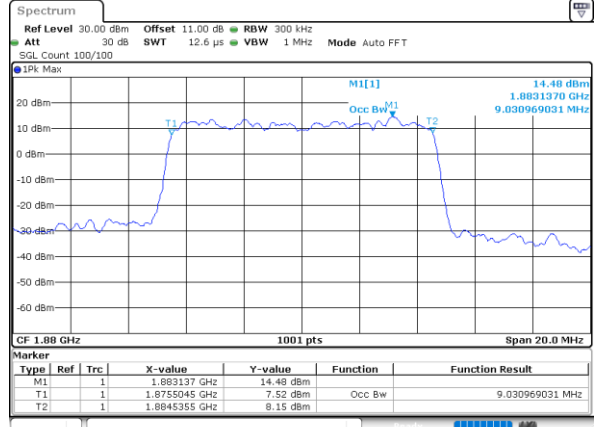

Date: 18_MAY.2021 09:28:14

Middle Channel / 15MHz / QPSK

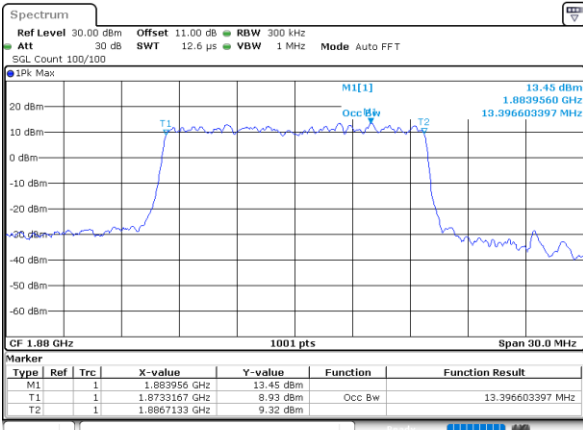

Date: 18_MAY.2021 09:35:08

Middle Channel / 15MHz / 16QAM

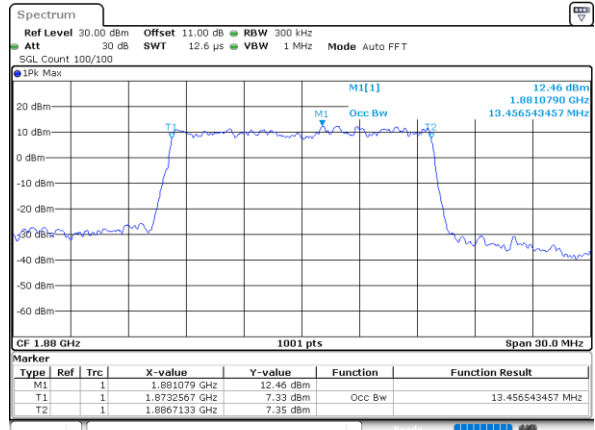

Date: 18_MAY.2021 09:36:00

Middle Channel / 20MHz / QPSK

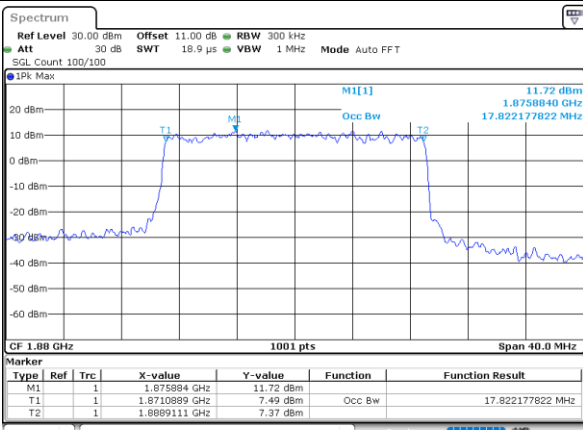

Date: 18_MAY.2021 09:43:22

Middle Channel / 20MHz / 16QAM

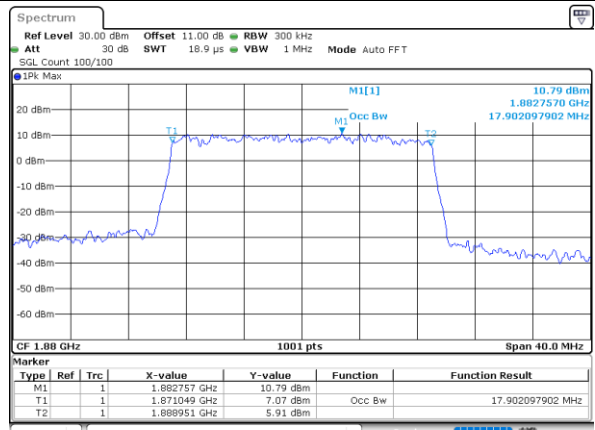

Date: 18_MAY.2021 09:43:44



LTE Band 2

Middle Channel / 1.4MHz / 64QAM

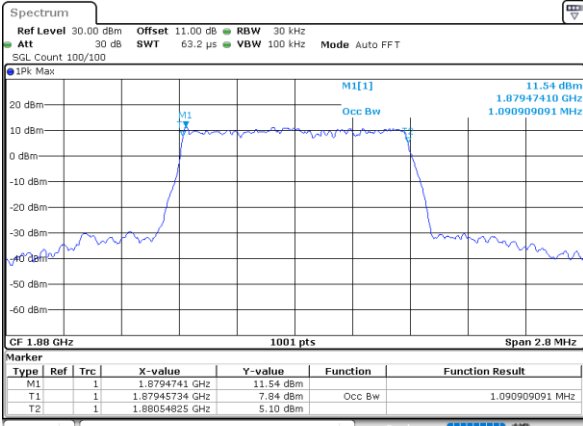

Middle Channel / 3MHz / 64QAM

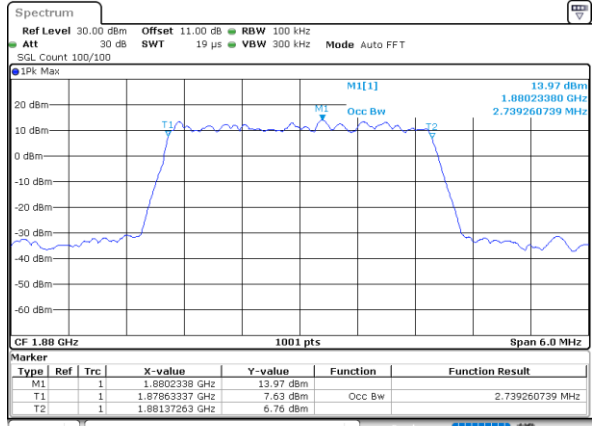

Middle Channel / 5MHz / 64QAM

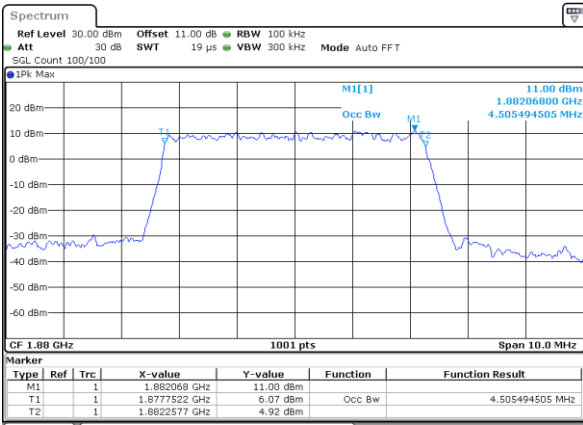

Middle Channel / 10MHz / 64QAM

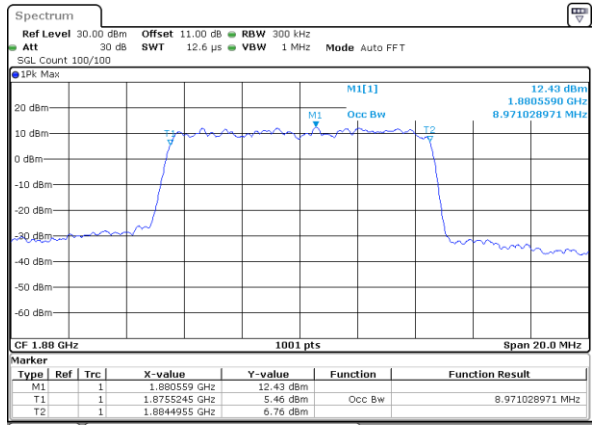

Middle Channel / 15MHz / 64QAM

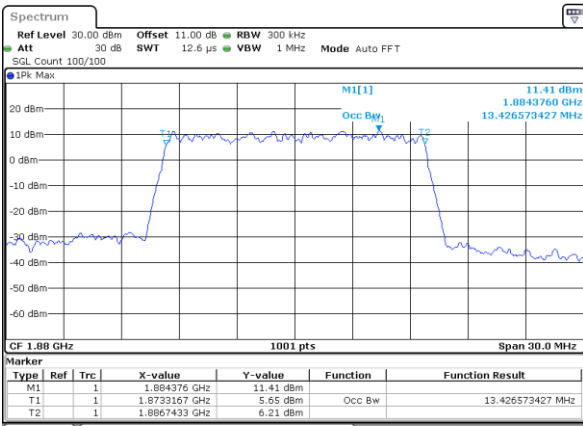

Middle Channel / 20MHz / 64QAM

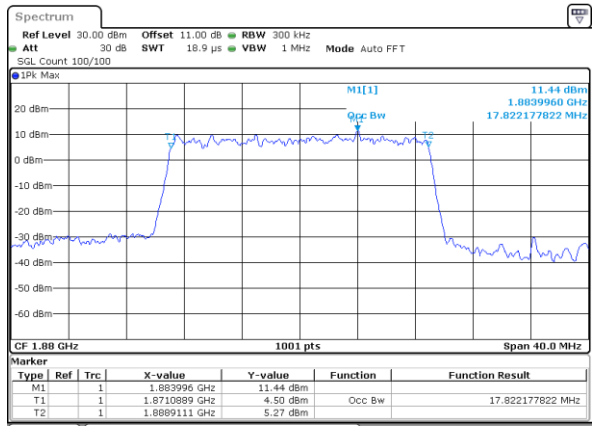



Conducted Band Edge

LTE Band 2 / 1.4MHz / QPSK

Lowest Band Edge / 1RB

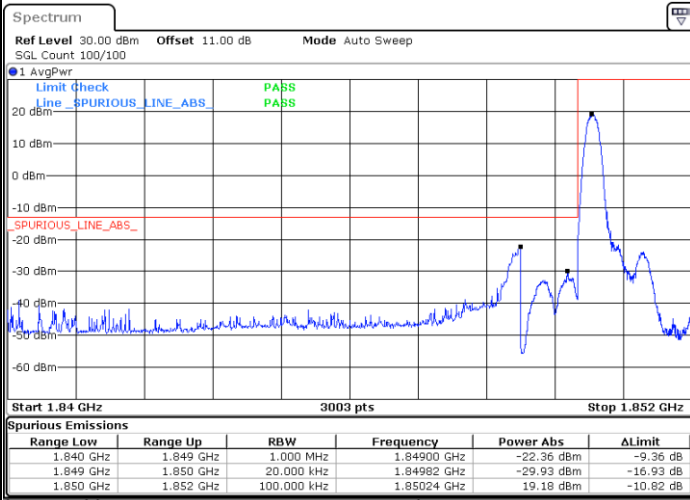

Date: 18.MAY.2021 09:02:06

Highest Band Edge / 1RB

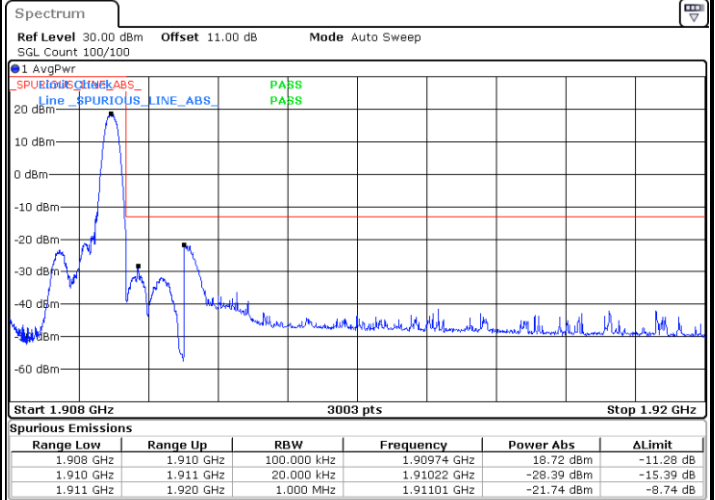

Date: 18.MAY.2021 09:07:08

Lowest Band Edge / Full RB

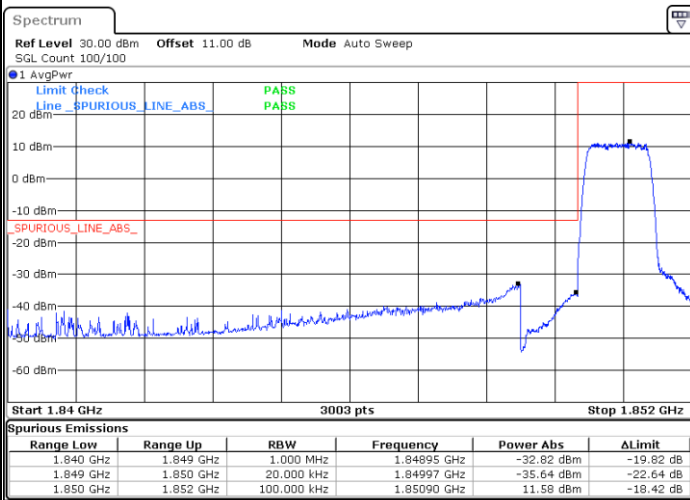

Date: 18.MAY.2021 09:02:58

Highest Band Edge / Full RB



Date: 18.MAY.2021 09:07:59



LTE Band 2 / 1.4MHz / 16QAM

Lowest Band Edge / 1 RB

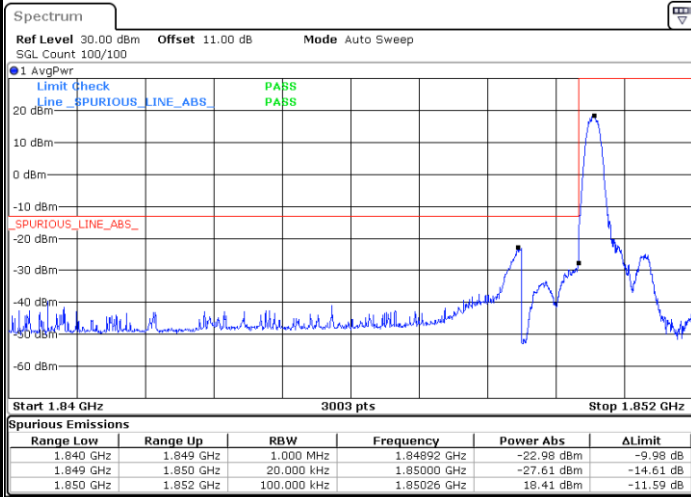

Date: 18.MAY.2021 09:02:33

Highest Band Edge / 1 RB

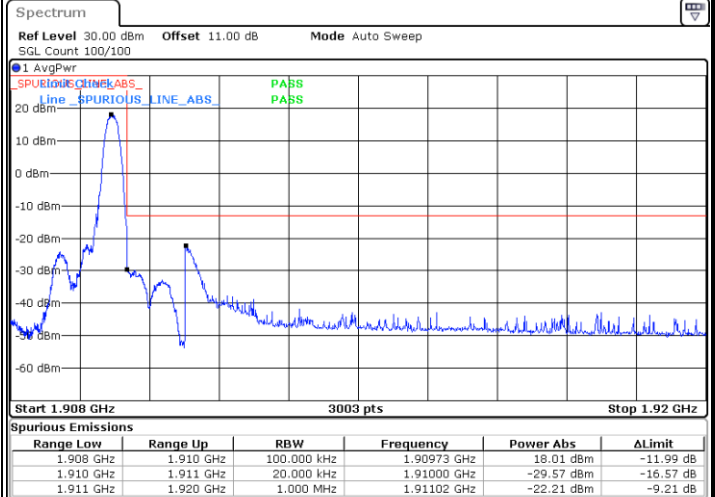

Date: 18.MAY.2021 09:07:33

Lowest Band Edge / Full RB

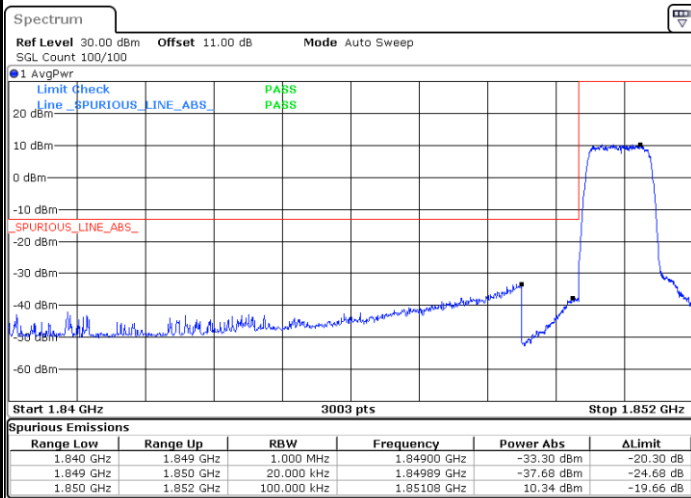

Date: 18.MAY.2021 09:03:24

Highest Band Edge / Full RB

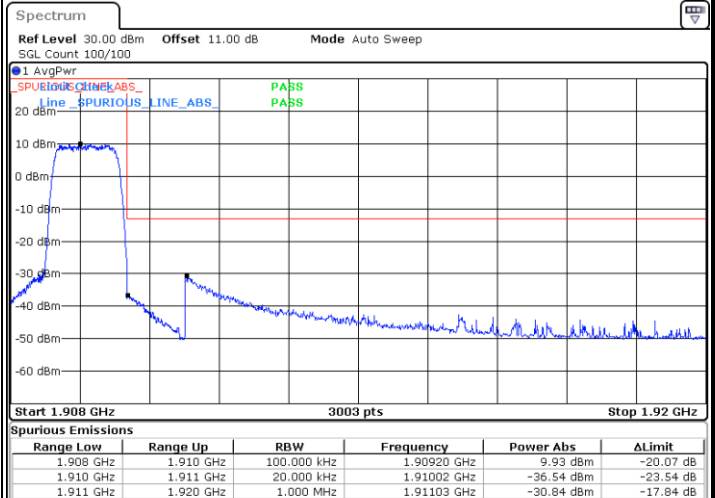

Date: 18.MAY.2021 09:08:26



LTE Band 2 / 1.4MHz / 64QAM

Lowest Band Edge / 1 RB

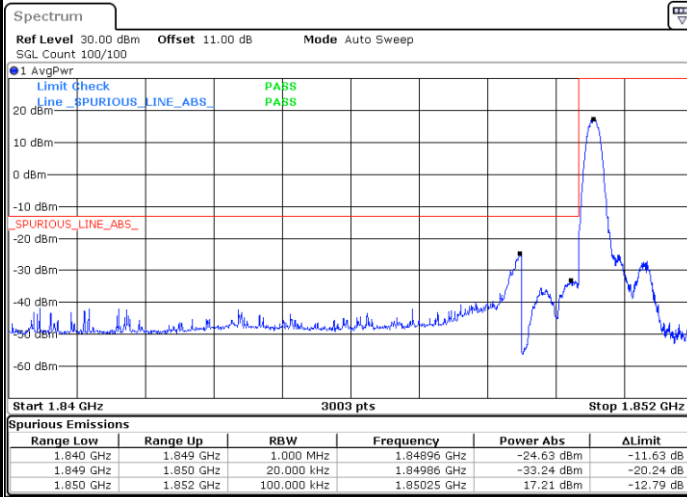

Date: 18.MAY.2021 08:59:38

Highest Band Edge / 1 RB

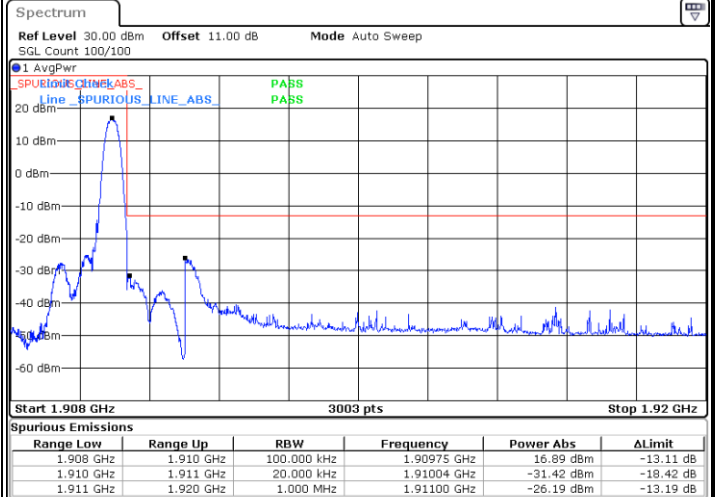

Date: 18.MAY.2021 09:01:14

Lowest Band Edge / Full RB

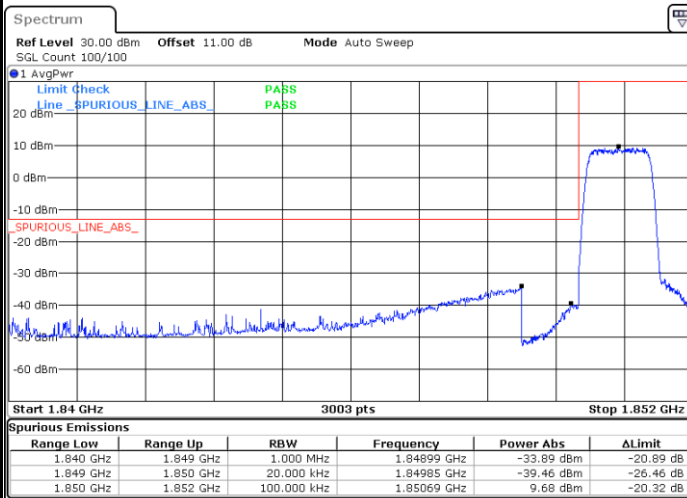

Date: 18.MAY.2021 09:00:05

Highest Band Edge / Full RB

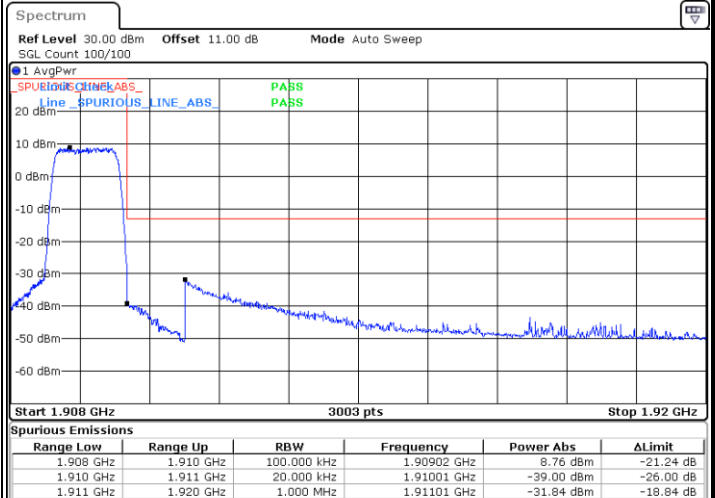

Date: 18.MAY.2021 09:01:40



LTE Band 2 / 3MHz / QPSK

Lowest Band Edge / 1RB

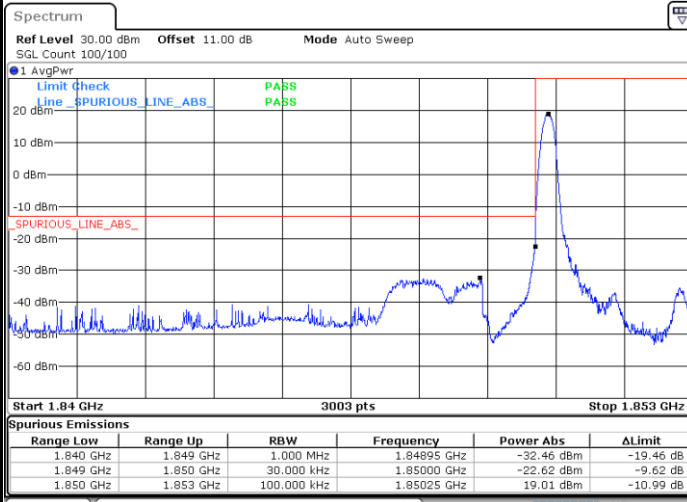

Date: 18.MAY.2021 09:09:49

Highest Band Edge / 1 RB

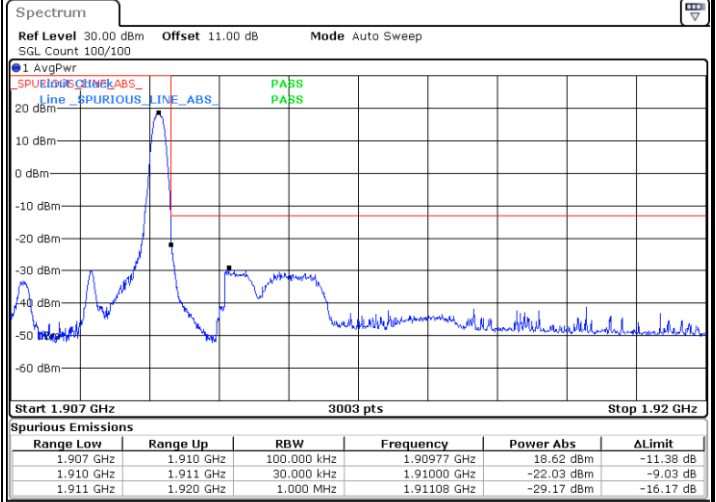

Date: 18.MAY.2021 09:14:51

Lowest Band Edge / Full RB

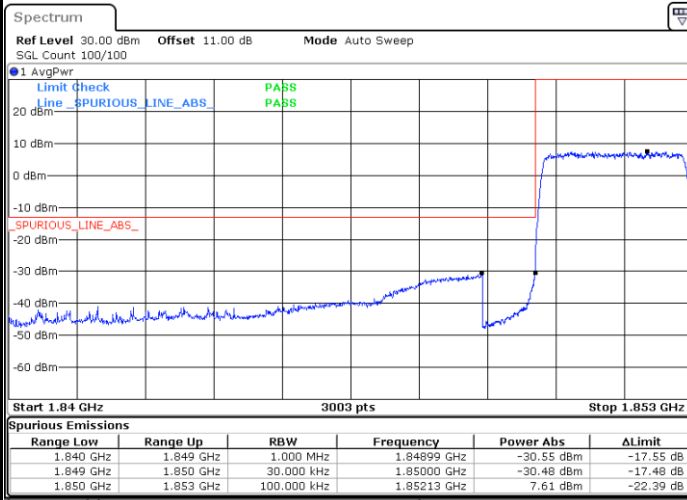

Date: 18.MAY.2021 09:10:42

Highest Band Edge / Full RB

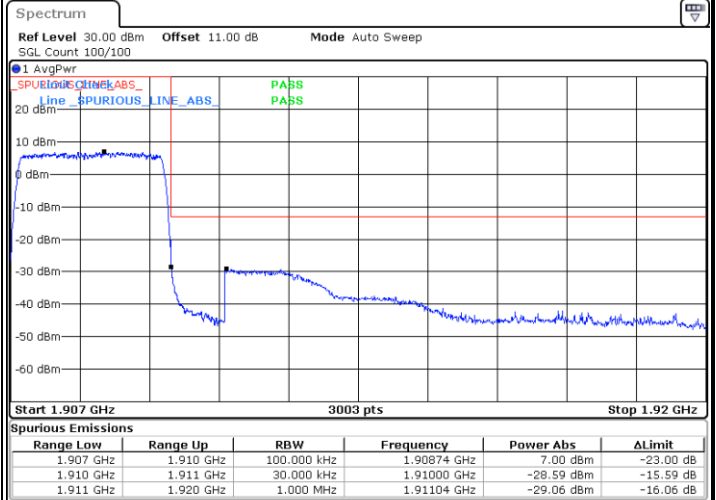

Date: 18.MAY.2021 09:15:43



LTE Band 2 / 3MHz / 16QAM

Lowest Band Edge / 1 RB

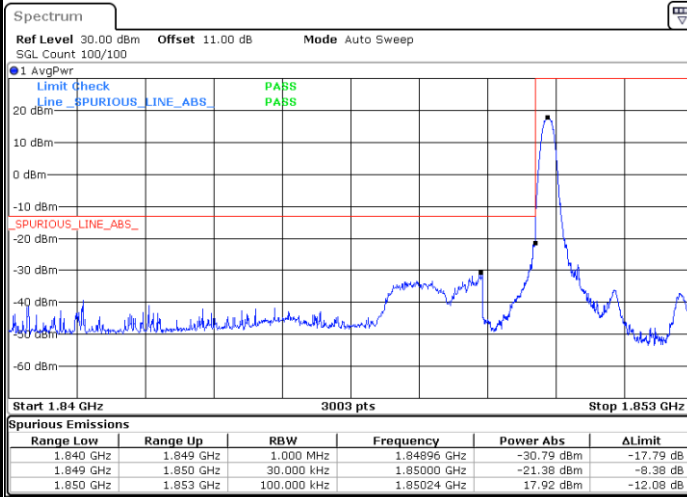

Date: 18.MAY.2021 09:10:15

Highest Band Edge / 1 RB

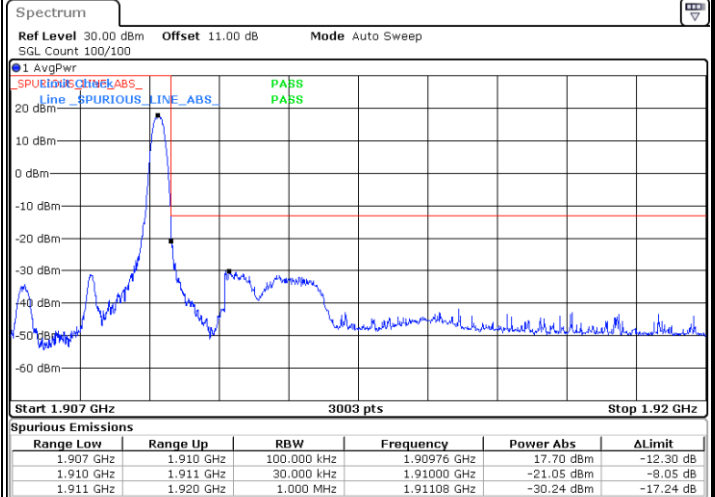

Date: 18.MAY.2021 09:15:17

Lowest Band Edge / Full RB

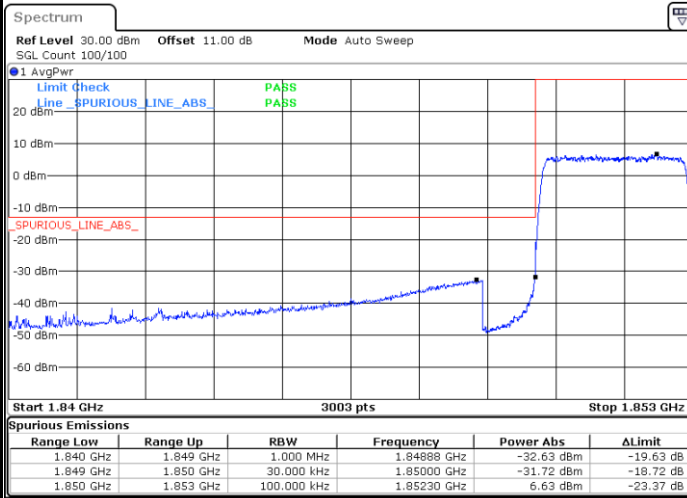

Date: 18.MAY.2021 09:11:07

Highest Band Edge / Full RB

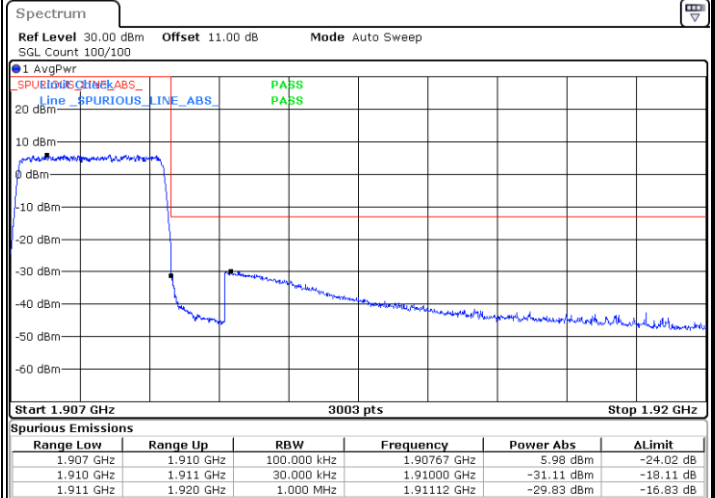

Date: 18.MAY.2021 09:16:10



LTE Band 2 / 3MHz / 64QAM

Lowest Band Edge / 1 RB

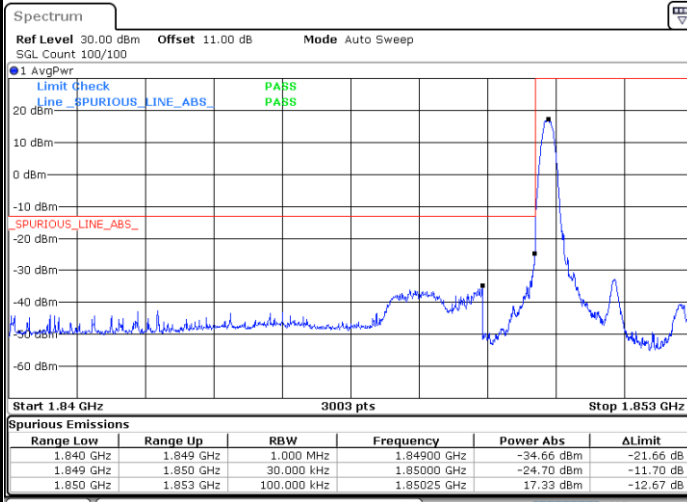

Date: 18.MAY.2021 09:48:28

Highest Band Edge / 1 RB

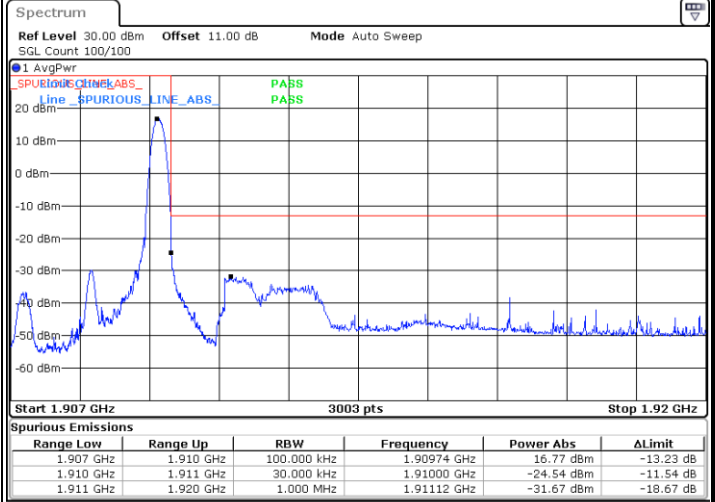

Date: 18.MAY.2021 09:50:03

Lowest Band Edge / Full RB

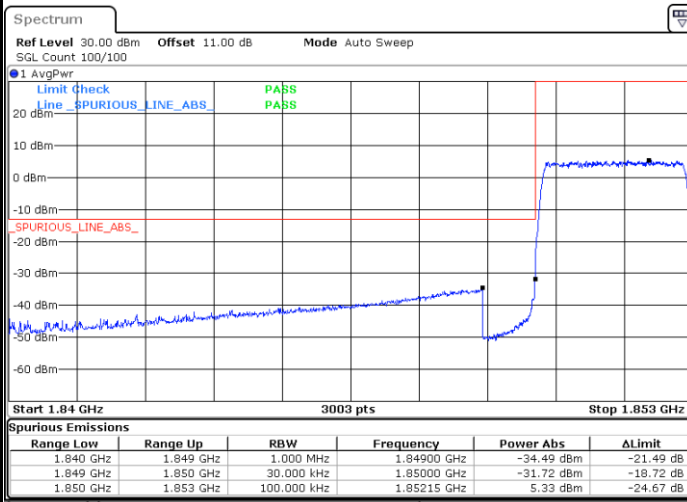

Date: 18.MAY.2021 09:48:54

Highest Band Edge / Full RB

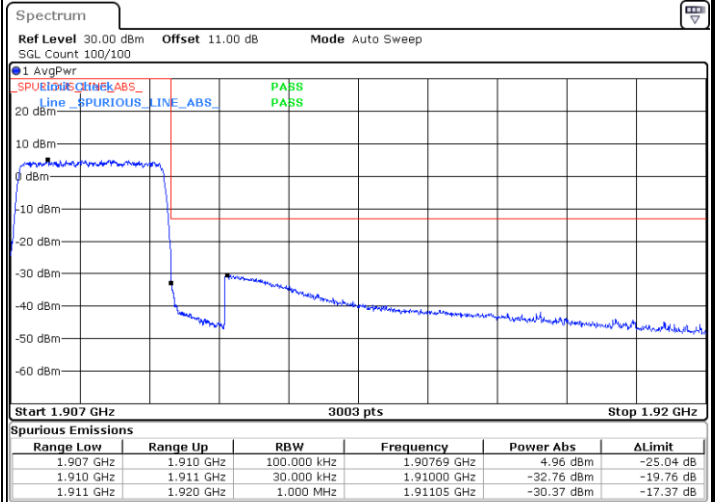

Date: 18.MAY.2021 09:50:29



LTE Band 2 / 5MHz / QPSK

Lowest Band Edge / 1 RB

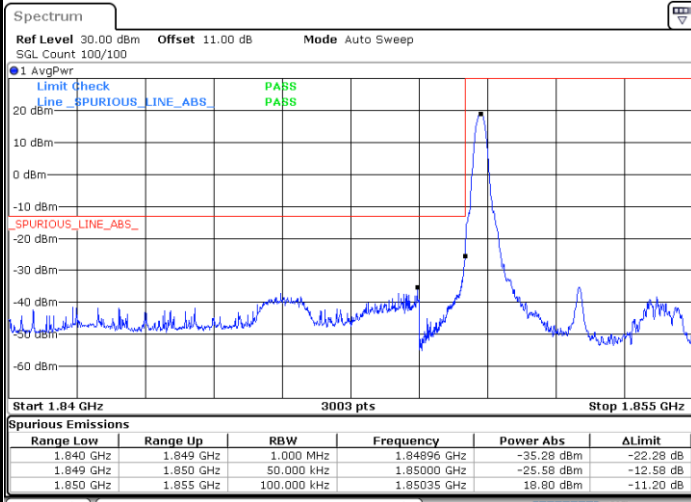

Date: 18.MAY.2021 09:17:32

Highest Band Edge / 1 RB

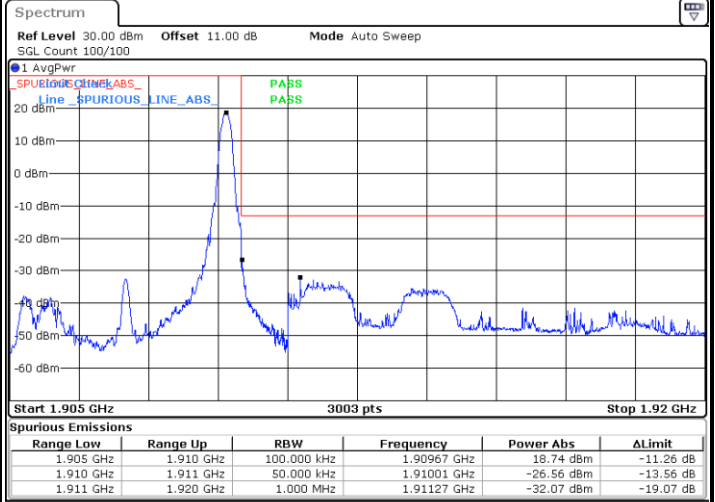

Date: 18.MAY.2021 09:22:34

Lowest Band Edge / Full RB

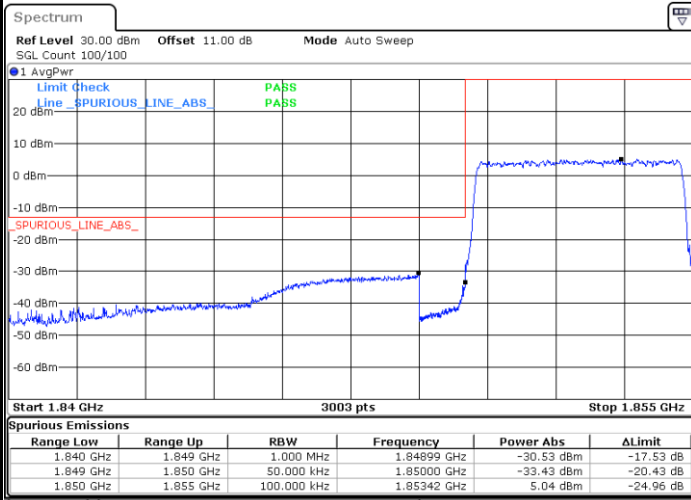

Date: 18.MAY.2021 09:18:23

Highest Band Edge / Full RB

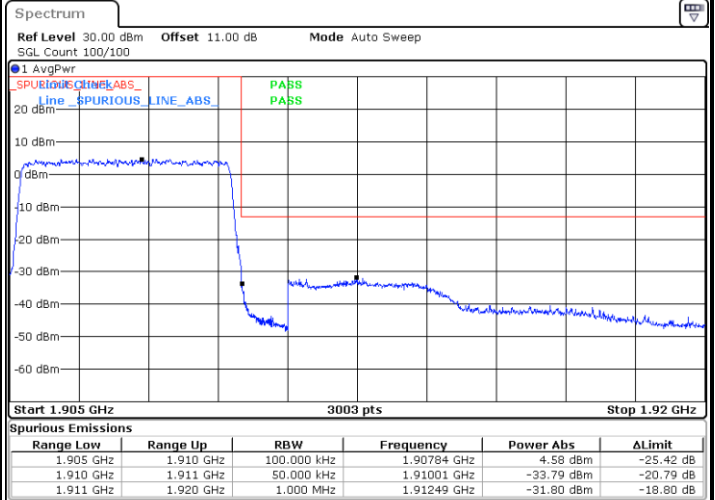

Date: 18.MAY.2021 09:23:26



LTE Band 2 / 5MHz / 16QAM

Lowest Band Edge / 1RB

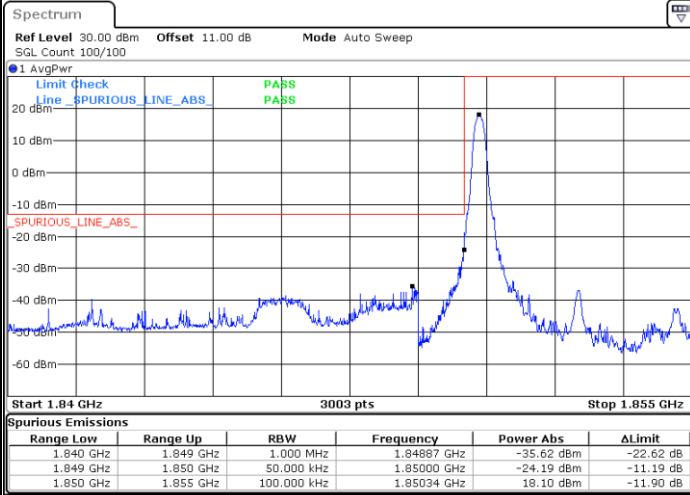

Date: 18.MAY.2021 09:17:58

Highest Band Edge / 1 RB

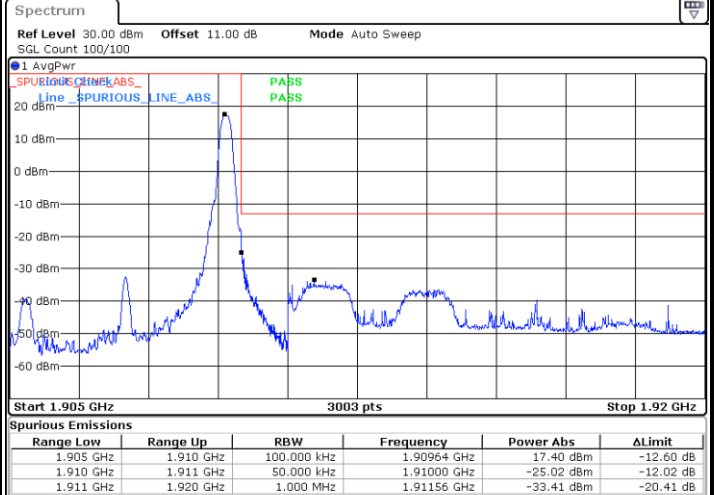

Date: 18.MAY.2021 09:23:00

Lowest Band Edge / Full RB

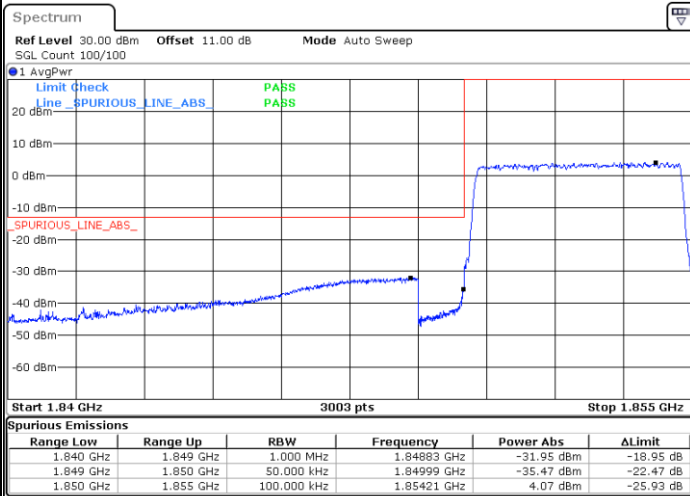

Date: 18.MAY.2021 09:18:50

Highest Band Edge / Full RB

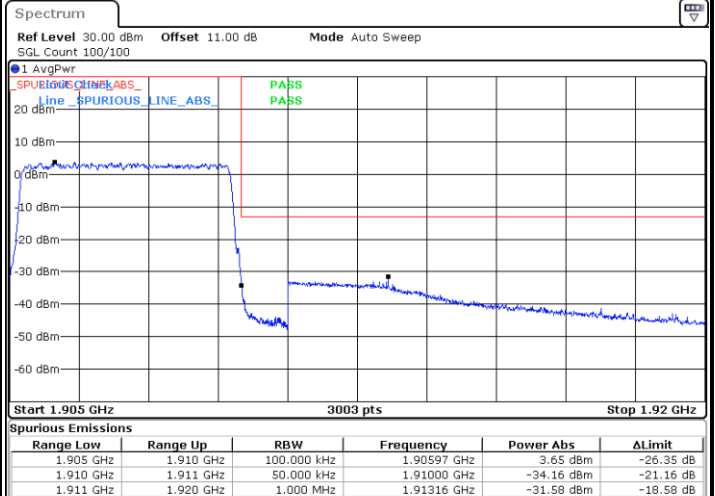

Date: 18.MAY.2021 09:23:52



LTE Band 2 / 5MHz / 64QAM

Lowest Band Edge / 1RB

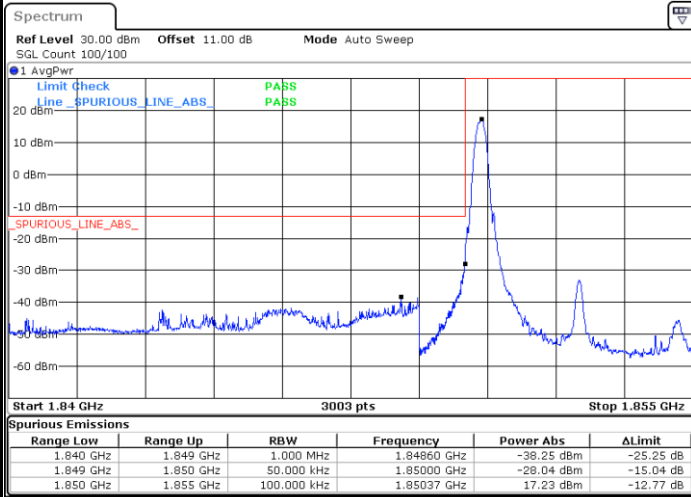

Date: 18.MAY.2021 09:50:55

Highest Band Edge / 1 RB

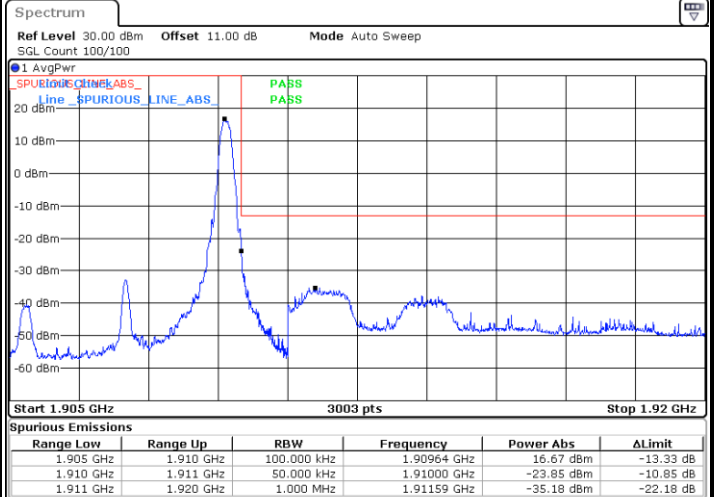

Date: 18.MAY.2021 09:52:29

Lowest Band Edge / Full RB

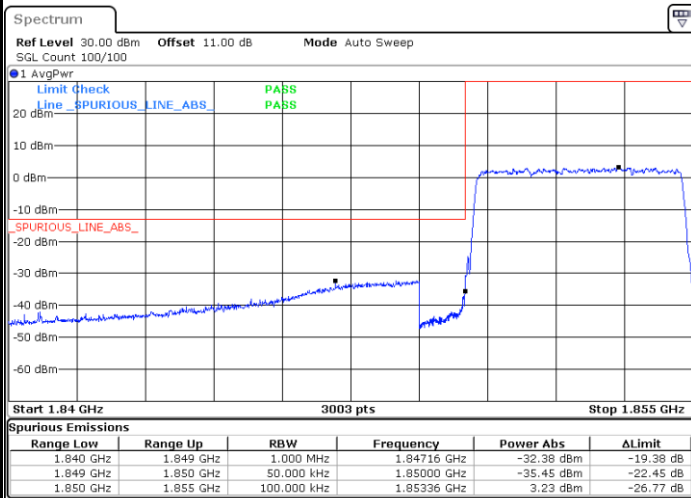

Date: 18.MAY.2021 09:51:20

Highest Band Edge / Full RB

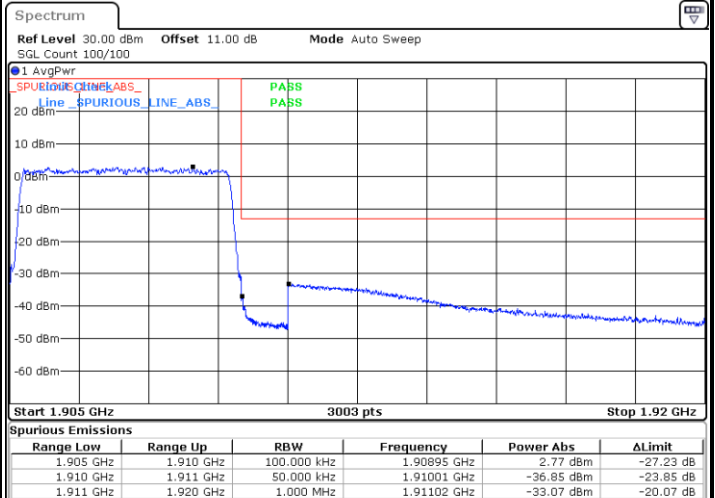

Date: 18.MAY.2021 09:52:55



LTE Band 2 / 10MHz / QPSK

Lowest Band Edge / 1 RB

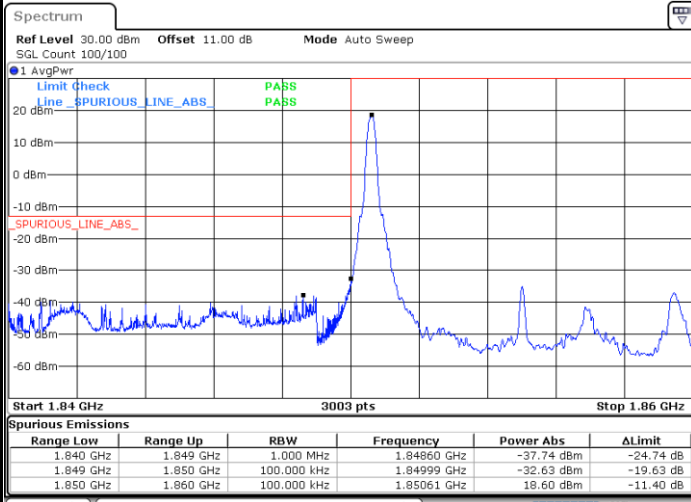

Date: 18.MAY.2021 09:25:14

Highest Band Edge / 1 RB

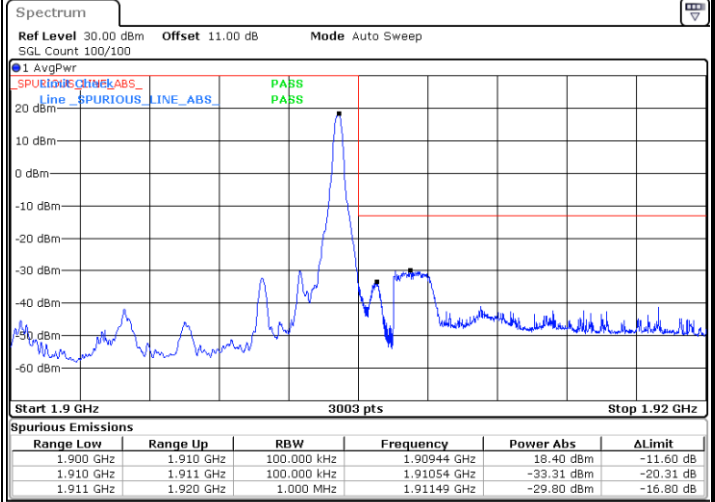

Date: 18.MAY.2021 09:30:18

Lowest Band Edge / Full RB

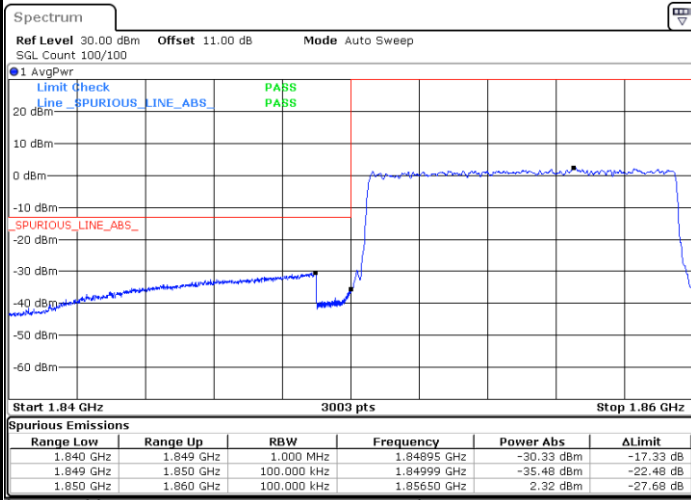

Date: 18.MAY.2021 09:26:06

Highest Band Edge / Full RB

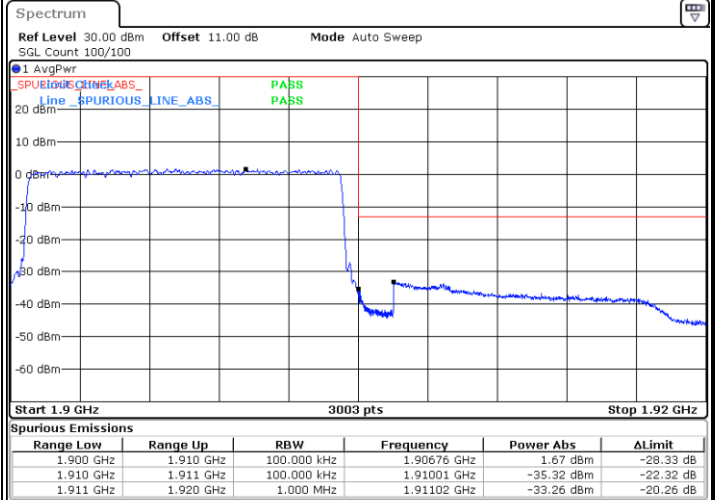

Date: 18.MAY.2021 09:31:11



LTE Band 2 / 10MHz / 16QAM

Lowest Band Edge / 1 RB

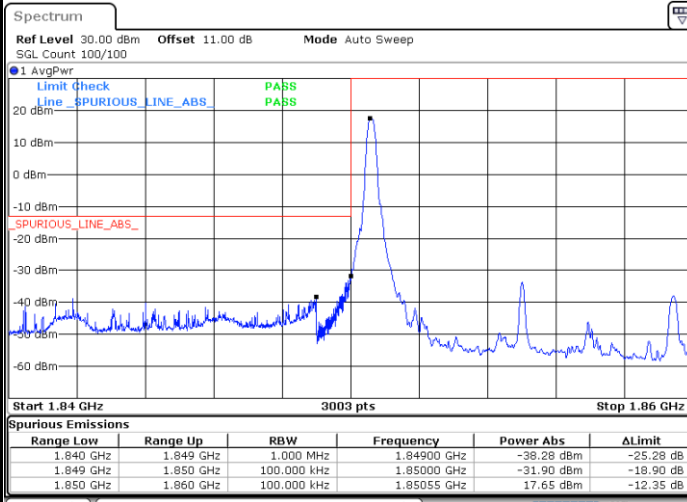

Date: 18.MAY.2021 09:25:40

Highest Band Edge / 1 RB

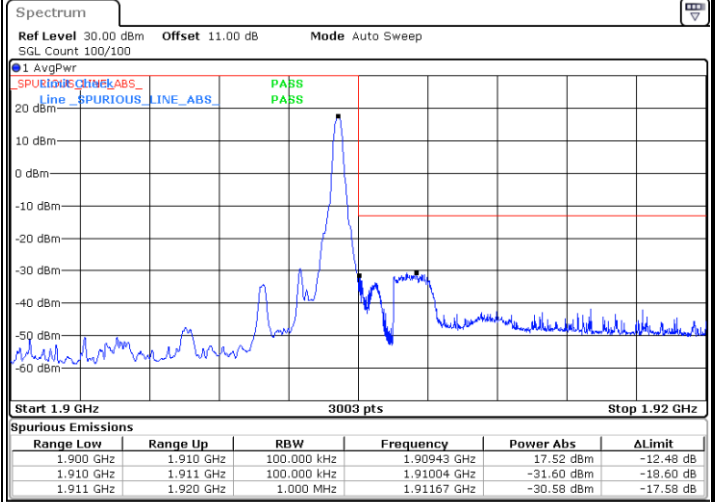

Date: 18.MAY.2021 09:30:44

Lowest Band Edge / Full RB

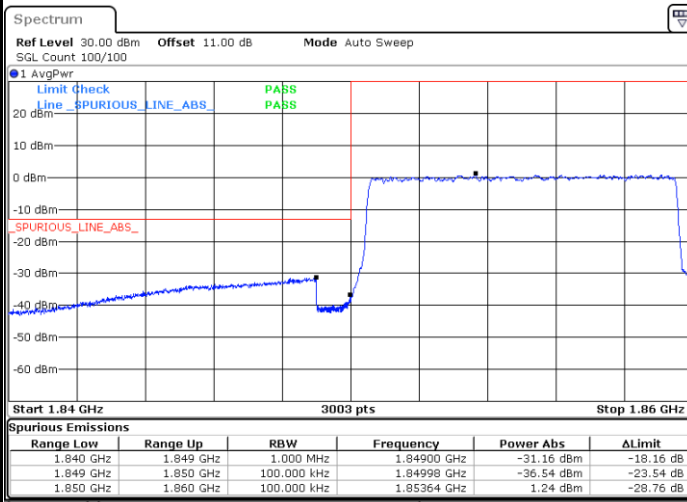

Date: 18.MAY.2021 09:26:33

Highest Band Edge / Full RB

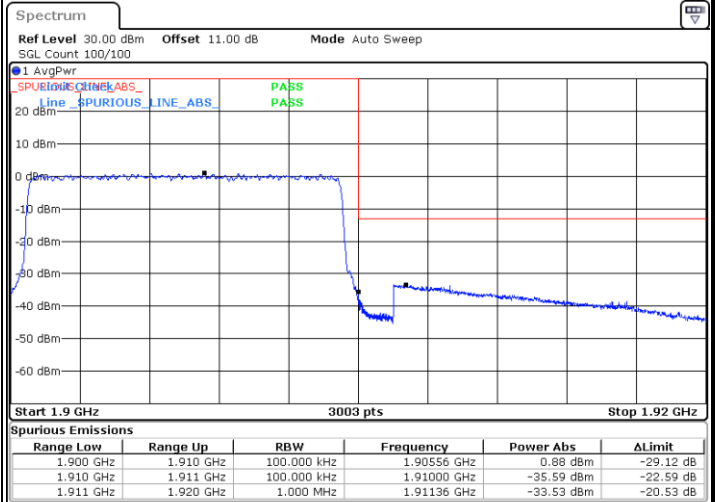

Date: 18.MAY.2021 09:31:36



LTE Band 2 / 10MHz / 64QAM

Lowest Band Edge / 1 RB

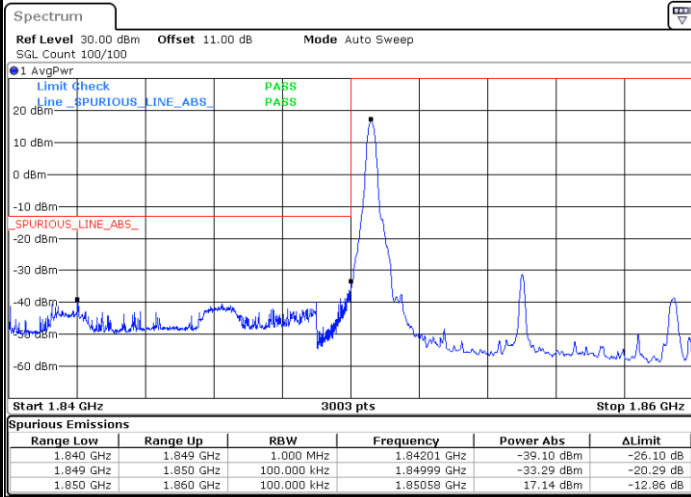

Date: 18.MAY.2021 09:53:21

Highest Band Edge / 1 RB

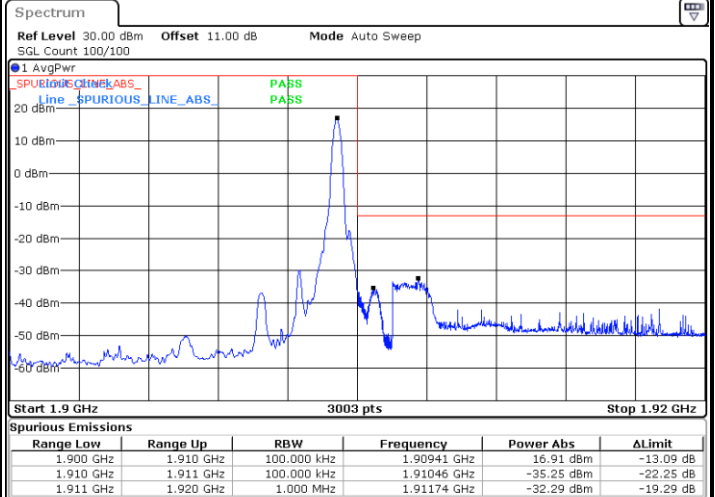

Date: 18.MAY.2021 09:54:56

Lowest Band Edge / Full RB

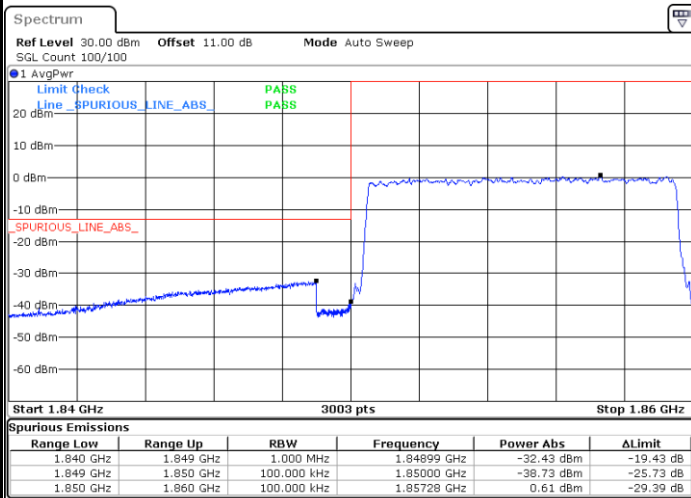

Date: 18.MAY.2021 09:53:47

Highest Band Edge / Full RB

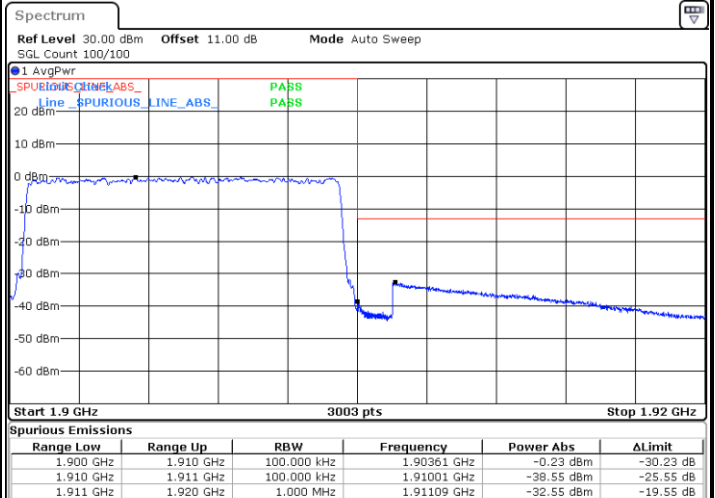

Date: 18.MAY.2021 09:55:22



LTE Band 2 / 15MHz / QPSK

Lowest Band Edge / 1 RB

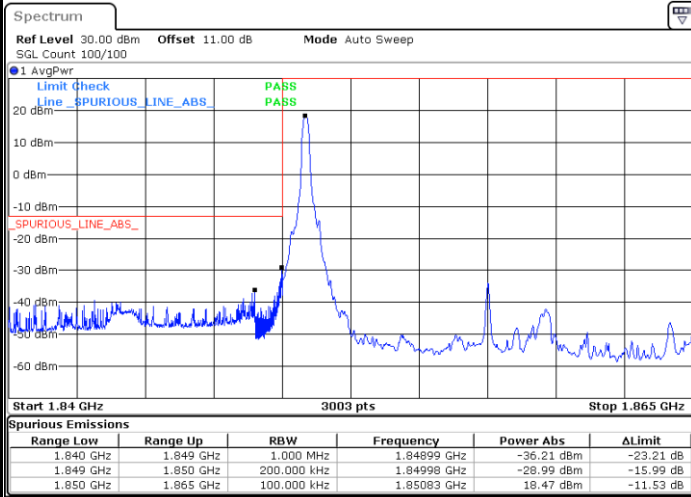

Date: 18.MAY.2021 09:32:59

Highest Band Edge / 1 RB



Date: 18.MAY.2021 09:38:04

Lowest Band Edge / Full RB

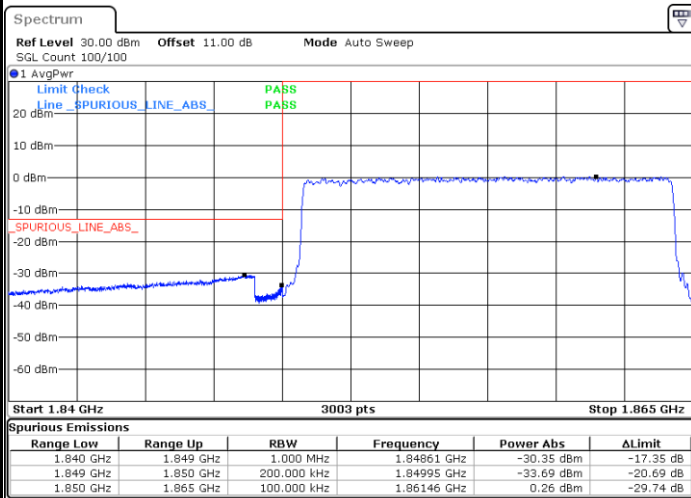

Date: 18.MAY.2021 09:33:53

Highest Band Edge / Full RB

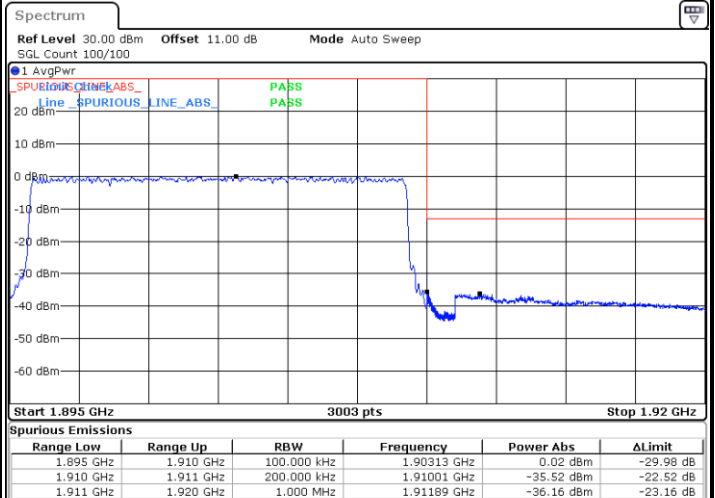

Date: 18.MAY.2021 09:38:57



LTE Band 2 / 15MHz / 16QAM

Lowest Band Edge / 1 RB

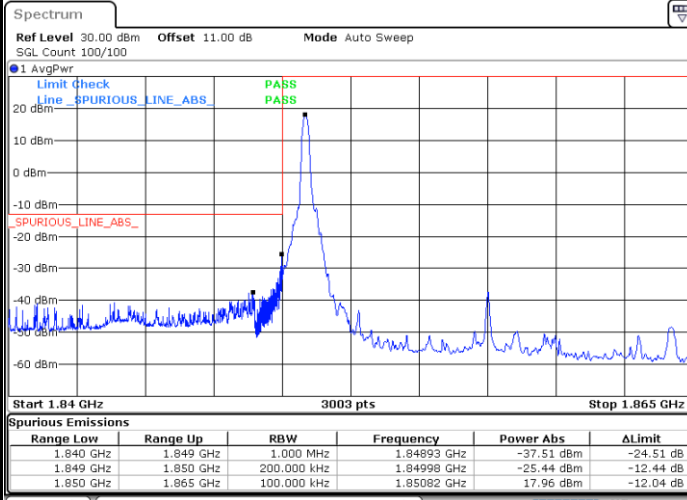

Date: 18.MAY.2021 09:33:26

Highest Band Edge / 1 RB

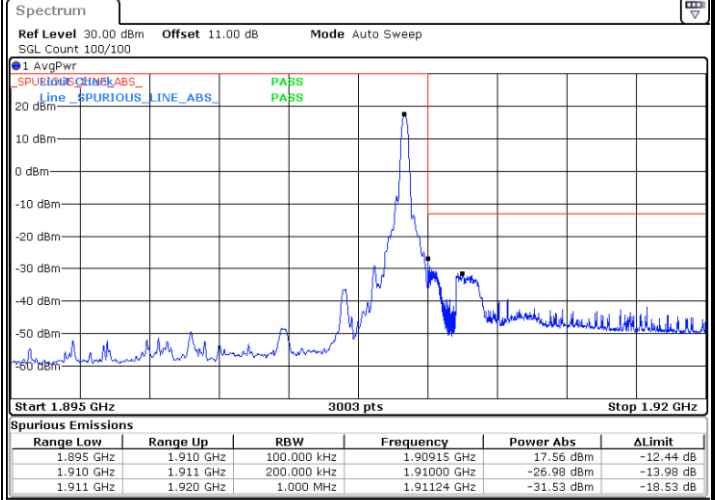

Date: 18.MAY.2021 09:38:30

Lowest Band Edge / Full RB

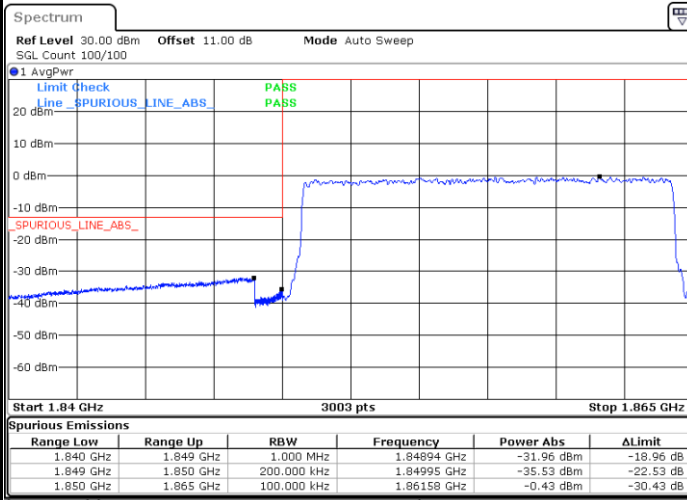

Date: 18.MAY.2021 09:34:20

Highest Band Edge / Full RB

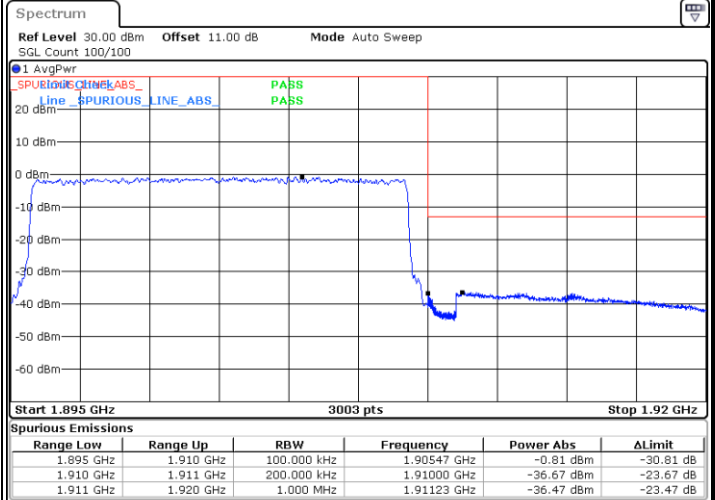

Date: 18.MAY.2021 09:39:23