



Test Report No.: W7L-221021W001RF04

FCC TEST REPORT (PART 90)



| | |
|------------|---|
| Applicant: | Continental Automotive Systems, Inc. |
| Address: | 21440 W Lake Cook Rd., Deer Park, IL 60010, USA |

| | |
|--------------------------|---|
| Manufacturer or Supplier | Continental Automotive Systems, Inc. |
| Address | 21440 W Lake Cook Rd., Deer Park, IL 60010, USA |
| Product | FE3RW0051 |
| Brand Name | Continental |
| Model Name | FE3RW0051 |
| FCC ID | LHJ-FE3RW0051 |
| Date of tests | Oct. 21, 2022 ~ Nov. 11, 2022 |

The tests have been carried out according to the requirements of the following standard:

- FCC Part 90, Subpart R, S ANSI/TIA/EIA-603- D
- FCC Part 2 ANSI/TIA/EIA-603-E ANSI C63.26-2015

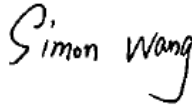
CONCLUSION: The submitted sample was found to COMPLY with the test requirement

| | |
|--|--|
| Prepared by Simon Wang Engineer / Mobile Department | Approved by Luke Lu Manager / Mobile Department |
|  Date: Nov. 11, 2022 |  Date: Nov. 11, 2022 |

This report is governed by, and incorporates by reference, the Conditions of Testing as posted at the date of issuance of this report at <http://www.bureauveritas.com/home/about-us/our-business/cps/about-us/terms-conditions> and is intended for your exclusive use. Any copying or replication of this report to or for any other person or entity, or use of our name or trademark, is permitted only with our prior written permission. This report sets forth our findings solely with respect to the test samples identified herein. The results set forth in this report are not indicative or representative of the quality or characteristics of the lot from which a test sample was taken or any similar or identical product unless specifically and expressly noted. Our report includes all of the tests requested by you and the results thereof based upon the information that you provided to us. Measurement uncertainty is only provided upon request for accredited tests. Statements of conformity are based on simple acceptance criteria without taking measurement uncertainty into account, unless otherwise requested in writing. You have 60 days from date of issuance of this report to notify us of any material error or omission caused by our negligence or if you require measurement uncertainty; provided, however, that such notice shall be in writing and shall specifically address the issue you wish to raise. A failure to raise such issue within the prescribed time shall constitute your unqualified acceptance of the completeness of this report, the tests conducted and the correctness of the report contents.



TABLE OF CONTENTS

RELEASE CONTROL RECORD 4

1 SUMMARY OF TEST RESULTS 5

1.1 MEASUREMENT UNCERTAINTY 5

1.2 TEST SITE AND INSTRUMENTS 6

2 GENERAL INFORMATION 7

2.1 GENERAL DESCRIPTION OF EUT 7

2.2 CONFIGURATION OF SYSTEM UNDER TEST 9

2.3 DESCRIPTION OF SUPPORT UNITS 10

2.4 DESCRIPTION OF TEST MODES 10

2.5 GENERAL DESCRIPTION OF APPLIED STANDARDS 12

3 TEST TYPES AND RESULTS 13

3.1 OUTPUT POWER MEASUREMENT 13

3.1.1 LIMITS OF OUTPUT POWER MEASUREMENT 13

3.1.2 TEST PROCEDURES 13

3.1.3 TEST SETUP 14

3.1.4 TEST RESULTS 14

3.2 FREQUENCY STABILITY MEASUREMENT 21

3.2.1 LIMITS OF FREQUENCY STABILITY MEASUREMENT 21

3.2.2 TEST PROCEDURE 21

3.2.3 TEST SETUP 21

3.2.4 TEST RESULTS 22

3.3 OCCUPIED BANDWIDTH MEASUREMENT 23

3.3.1 LIMITS OF OCCUPIED BANDWIDTH MEASUREMENT 23

3.3.2 TEST SETUP 23

3.3.3 TEST PROCEDURES 23

3.3.4 TEST RESULTS 24

3.4 EMISSION MASK MEASUREMENT 25

3.4.1 LIMITS OF EMISSION MASK MEASUREMENT 25

3.4.2 TEST SETUP 25

3.4.3 TEST PROCEDURES 26

3.4.4 TEST RESULTS 27

3.5 CONDUCTED SPURIOUS EMISSIONS 28

3.5.1 LIMITS OF CONDUCTED SPURIOUS EMISSIONS MEASUREMENT 28

3.5.2 TEST PROCEDURE 28

3.5.3 TEST SETUP 28

3.5.4 TEST RESULTS 29

3.6 RADIATED EMISSION MEASUREMENT 30

3.6.1 LIMITS OF RADIATED EMISSION MEASUREMENT 30

3.6.2 TEST PROCEDURES 30

3.6.3 DEVIATION FROM TEST STANDARD 30

3.6.4 TEST SETUP 31

3.6.5 TEST RESULTS 33

3.7 PEAK TO AVERAGE RATIO 47

3.7.1 LIMITS OF PEAK TO AVERAGE RATIO MEASUREMENT 47

3.7.2 TEST SETUP 47

3.7.3 TEST PROCEDURES 47

3.7.4 TEST RESULTS 48



**BUREAU
VERITAS**

Test Report No.: W7L-221021W001RF04

| | | |
|----------|--|-----------|
| 4 | INFORMATION ON THE TESTING LABORATORIES | 49 |
| 5 | MODIFICATIONS RECORDERS FOR ENGINEERING CHANGES TO THE EUT BY THE LAB | 50 |
| | APPENDIX D: | 51 |



Test Report No.: W7L-221021W001RF04

RELEASE CONTROL RECORD

| ISSUE NO. | REASON FOR CHANGE | DATE ISSUED |
|--------------------|-------------------|---------------|
| W7L-221021W001RF04 | Original release | Nov. 11, 2022 |

1 SUMMARY OF TEST RESULTS

The EUT has been tested according to the following specifications:

| APPLIED STANDARD: FCC Part 90 & Part 2 | | |
|--|------------------------------|--------|
| STANDARD SECTION | TEST TYPE AND LIMIT | RESULT |
| §2.1046 §90.635(b) | Conducted Output Power | PASS |
| §2.1055 §90.213 | Frequency Stability | PASS |
| §2.1049 §90.209 | Occupied Bandwidth | PASS |
| §2.1051 §90.691 | Emission Masks | PASS |
| §2.1051 §90.691 | Conducted Spurious Emissions | PASS |
| §2.1053 §90.691 | Radiated Spurious Emissions | PASS |

1.1 MEASUREMENT UNCERTAINTY

Where relevant, the following measurement uncertainty levels have been estimated for tests performed on the EUT as specified in CISPR 16-4-2:

| MEASUREMENT | FREQUENCY | UNCERTAINTY |
|---------------------|---------------|-------------|
| Conducted emissions | 9kHz~30MHz | 2.66dB |
| Radiated emissions | 9KHz ~ 30MHz | 2.68dB |
| | 30MHz ~ 1GMHz | 3.26dB |
| | 1GHz ~ 18GHz | 4.48dB |
| | 18GHz ~ 40GHz | 4.12dB |

This uncertainty represents an expanded uncertainty expressed at approximately the 95% confidence level using a coverage factor of k=2.

1.2 TEST SITE AND INSTRUMENTS

| Equipment | Manufacturer | Model No. | Serial No. | Last Cal. | Next Cal. |
|---|-------------------|---------------------------------|-------------------------------------|-------------|-------------|
| MXE EMI Receiver | KEYSIGHT | N9038A-544 | MY54450026 | Feb. 18,22 | Feb. 17,23 |
| EXA Signal Analyzer | KEYSIGHT | N9010A-544 | MY54510355 | May.15,22 | May.14,23 |
| Loop Antenna | Schwarzbeck | FMZB 1519B | 00173 | Sep.04,22 | Sep.03,23 |
| Bilog Antenna | ETS-LINDGRE N | 3143B | 00161965 | Mar. 06,22 | Mar. 05,23 |
| Horn Antenna | ETS-LINDGRE N | 3117 | 00168692 | Mar. 06,22 | Mar. 05,23 |
| Horn Antenna (18GHz-40GHz) | N/A | QWH-SL-18-40-K- SG/QMS-00361 | 15433 | Aug. 24, 22 | Aug. 23, 23 |
| Radio Communication Analyzer | ANRITSU | MT8820C | 6201465426 | Feb. 15,22 | Feb. 14,23 |
| Signal Pre-Amplifier | EMSI | EMC 9135 | 980249 | May.12,22 | May.11,23 |
| Signal Pre-Amplifier | EMSI | EMC 012645B | 980257 | May.12,22 | May.11,23 |
| Signal Pre-Amplifier | EMSI | EMC 184045B | 980259 | Feb. 21,22 | Feb.20,23 |
| 3m Semi-anechoic Chamber | ETS-LINDGRE N | 9m*6m*6m | Euroshieldpn- CT0001143-121 6 | May. 19,20 | May. 18,23 |
| Test Software | E3 | V 9.160323 | N/A | N/A | N/A |
| Test Software | JS1120 | 3.1.36 | N/A | N/A | N/A |
| 10dB Attenuator | JFW/USA | 50HF-010-SMA | 1505 | May. 07,22 | May. 06,23 |
| Power Meter | Anritsu | ML2495A | 1506002 | Feb. 22,22 | Feb. 21,23 |
| Power Sensor | Anritsu | MA2411B | 1339352 | May. 07,22 | May. 06,23 |
| Temperature Chamber | ESPEC | SH-242 | 93000855 | May. 12,22 | May. 11,23 |
| MXG Analog Microwave Signal Generator | KEYSIGHT | N5183A | MY50143024 | Feb. 18,22 | Feb. 17,23 |
| Base station R&S CMW500 | Rohde&Schwa rz | CMW500 | 153085 | May.12,22 | May.11,23 |
| DC Source | Kikusui/JP | PMX18-5A | 0000001 | Aug. 24,22 | Aug. 23,23 |

- NOTE:**
1. The calibration interval of the above test instruments is 12 months or 36 months and the calibrations are traceable to CEPREI/CHINA, GRGT/CHINA and NIM/CHINA.
 2. The test was performed in 3m Semi-anechoic Chamber and RF Oven Room.
 3. The horn antenna is used only for the measurement of emission frequency above 1GHz if tested.
 4. The FCC Site Registration No. is 525120.

2 GENERAL INFORMATION

2.1 GENERAL DESCRIPTION OF EUT

| | | |
|------------------------------|--|---------------------------------|
| PRODUCT | FE3RW0051 | |
| BRAND NAME | Continental | |
| MODEL NAME | FE3RW0051 | |
| POWER SUPPLY | EUT 4.0V | |
| MODULATION TECHNOLOGY | LTE | QPSK, 16QAM |
| FREQUENCY RANGE | LTE Band 26 (Channel Bandwidth: 1.4MHz) | 814.7MHz ~ 823.3MHz |
| | LTE Band 26 (Channel Bandwidth: 3MHz) | 815.5MHz ~ 822.5MHz |
| | LTE Band 26 (Channel Bandwidth: 5MHz) | 816.5MHz ~ 821.5MHz |
| | LTE Band 26 (Channel Bandwidth: 10MHz) | 819MHz |
| MISSION DESIGNATOR | LTE Band 26 (Channel Bandwidth: 1.4MHz) | QPSK: 1M09G7D 16QAM: 1M09W7D |
| | LTE Band 26 (Channel Bandwidth: 3MHz) | QPSK: 2M70G7D 16QAM: 2M69W7D |
| | LTE Band 26 (Channel Bandwidth: 5MHz) | QPSK: 4M50G7D 16QAM: 4M50W7D |
| | LTE Band 26 (Channel Bandwidth: 10MHz) | QPSK: 8M99G7D 16QAM: 8M97W7D |
| MAX. EIRP POWER | LTE Band 26 (Channel Bandwidth: 1.4MHz) | 139.96mW |
| | LTE Band 26 (Channel Bandwidth: 3MHz) | 139.00mW |
| | LTE Band 26 (Channel Bandwidth: 5MHz) | 140.28mW |
| | LTE Band 26 (Channel Bandwidth: 10MHz) | 140.60mW |
| ANTENNA TYPE | Monopole Antenna | |
| ANTENNA GAIN | 0.82 dBi for LTE Band 26 | |
| HW VERSION | P2 | |
| SW VERSION | MODEMSA415M_01.13.65 | |
| I/O PORTS | Refer to user's manual | |
| DATA CABLE | N/A | |



**BUREAU
VERITAS**

Test Report No.: W7L-P20210616-3RF04

| | |
|----------------------------|---------------------|
| EXTREME TEMPERATURE | -30-75 °C |
| EXTREME VOLTAGE | EUT 3.8V - EUT 4.2V |

NOTE:

1. For a more detailed features description, please refer to the manufacturer's specifications or the user's manual.
2. The EUT incorporates a SISO function. Physically, the EUT provides one completed transmitter and one receiver.

| MODE | TX FUNCTION |
|-------------|--------------------|
| LTE | 1TX/4RX |

3. For the test results, the EUT had been tested with all conditions. But only the worst case was shown in test report.

2.2 CONFIGURATION OF SYSTEM UNDER TEST

FOR RADIATION EMISSION TEST

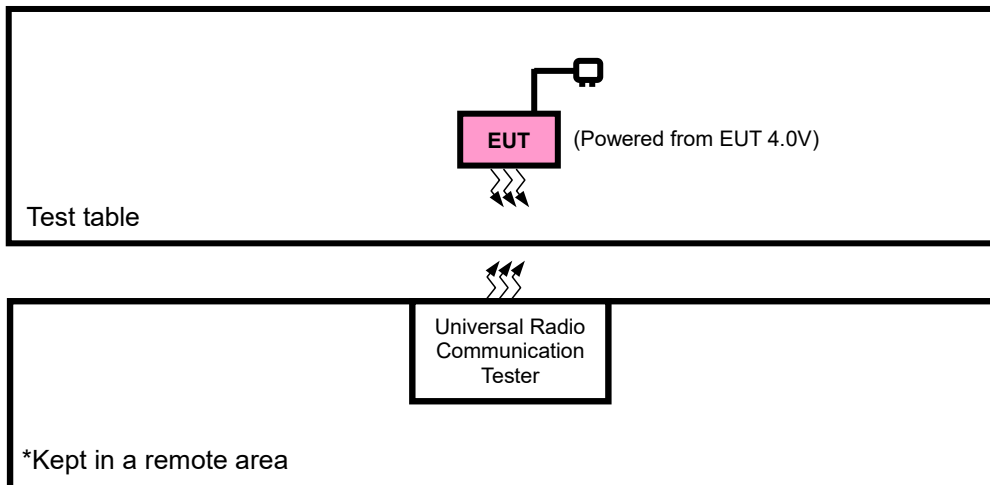

FOR CONDUCTED & E.R.P./E.I.R.P TEST

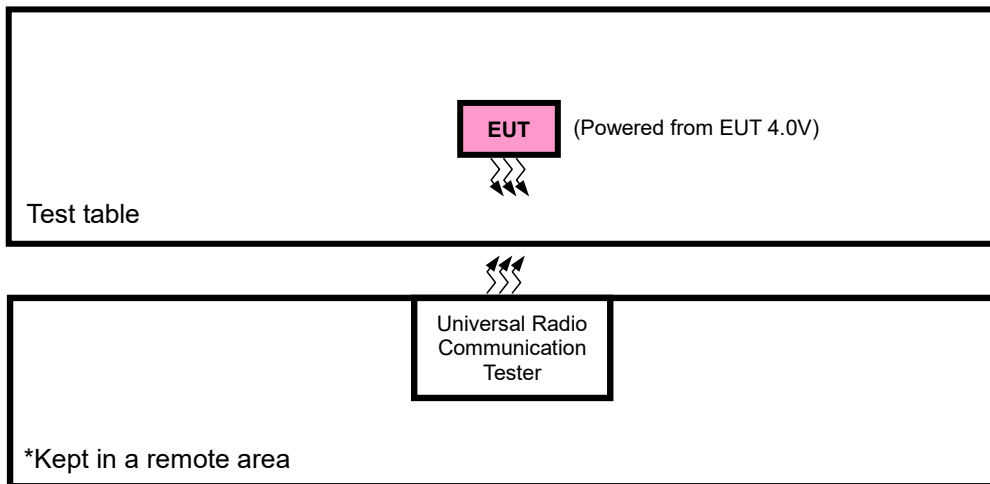



2.3 DESCRIPTION OF SUPPORT UNITS

The EUT has been tested as an independent unit together with other necessary accessories or support units. The following support units or accessories were used to form a representative test configuration during the tests.

| NO. | PRODUCT | BRAND | MODEL NO. | SERIAL NO. | FCC ID |
|-----|-----------|----------|-----------|------------|--------|
| 1 | DC source | LONG WEI | PS-6403D | 010934269 | N/A |

| NO. | SIGNAL CABLE DESCRIPTION OF THE ABOVE SUPPORT UNITS |
|-----|---|
| 1 | DC Line: Unshielded, Detachable 1.0m |

2.4 DESCRIPTION OF TEST MODES

Pre-Scan has been conducted to determine the worst-case mode from all possible combinations between available modulations, data rates, XYZ axis and antenna ports. The worst case in ERP/EIRP and radiated emission was found when positioned on X-plane for LTE. Following channel(s) was (were) selected for the final test as listed below:

| EUT CONFIGURE MODE | DESCRIPTION |
|--------------------|-------------------------------|
| A | EUT + DC Source with LTE link |

LTE BAND 26 MODE

| EUT CONFIGURE MODE | TEST ITEM | AVAILABLE CHANNEL | TESTED CHANNEL | CHANNEL BANDWIDTH | MODULATION | MODE | | |
|--------------------|---------------------|-------------------|---------------------|-------------------|---------------------|--|-------------|--------------------|
| A | ERP | 26697 to 26783 | 26697, 26740, 26783 | 1.4MHz | QPSK, 16QAM | 1 RB / 0 RB Offset | | |
| | | 26705 to 26775 | 26705, 26740, 26775 | 3MHz | QPSK, 16QAM | 1 RB / 0 RB Offset | | |
| | | 26715 to 26765 | 26715, 26740, 26765 | 5MHz | QPSK, 16QAM | 1 RB / 0 RB Offset | | |
| | | 26740 | 26740 | 10MHz | QPSK, 16QAM | 1 RB / 0 RB Offset | | |
| A | FREQUENCY STABILITY | 26697 to 26783 | 26697, 26740, 26783 | 1.4MHz | QPSK, 16QAM | 6 RB / 0 RB Offset | | |
| | | 26705 to 26775 | 26705, 26740, 26775 | 3MHz | QPSK, 16QAM | 15 RB / 0 RB Offset | | |
| | | 26715 to 26765 | 26715, 26740, 26765 | 5MHz | QPSK, 16QAM | 25 RB / 0 RB Offset | | |
| | | 26740 | 26740 | 10MHz | QPSK, 16QAM | 50 RB / 0 RB Offset | | |
| A | OCCUPIED BANDWIDTH | 26697 to 26783 | 26697, 26740, 26783 | 1.4MHz | QPSK, 16QAM | 6 RB / 0 RB Offset | | |
| | | 26705 to 26775 | 26705, 26740, 26775 | 3MHz | QPSK, 16QAM | 15 RB / 0 RB Offset | | |
| | | 26715 to 26765 | 26715, 26740, 26765 | 5MHz | QPSK, 16QAM | 25 RB / 0 RB Offset | | |
| | | 26740 | 26740 | 10MHz | QPSK, 16QAM | 50 RB / 0 RB Offset | | |
| A | BAND EDGE | 26697 to 26783 | 26697 | 1.4MHz | QPSK, 16QAM | 1 RB / 0 RB Offset 6 RB / 0 RB Offset | | |
| | | | 26783 | 1.4MHz | QPSK, 16QAM | 1 RB / 5 RB Offset 6 RB / 0 RB Offset | | |
| | | 26705 to 26775 | 26705 | 3MHz | QPSK, 16QAM | 1 RB / 0 RB Offset 15 RB / 0 RB Offset | | |
| | | | 26775 | 3MHz | QPSK, 16QAM | 1 RB / 14 RB Offset 15 RB / 0 RB Offset | | |
| | | 26715 to 26765 | 26715 | 5MHz | QPSK, 16QAM | 1 RB / 0 RB Offset 25 RB / 0 RB Offset | | |
| | | | 26765 | 5MHz | QPSK, 16QAM | 1 RB / 24 RB Offset 25 RB / 0 RB Offset | | |
| | | 26740 | 26740 | 10MHz | QPSK, 16QAM | 1 RB / 0 RB Offset 50 RB / 0 RB Offset | | |
| | | | 26740 | 10MHz | QPSK, 16QAM | 1 RB / 49 RB Offset 50 RB / 0 RB Offset | | |
| | | A | CONDUCTED EMISSION | 26697 to 26783 | 26697, 26740, 26783 | 1.4MHz | QPSK, 16QAM | 1 RB / 0 RB Offset |
| | | | | 26705 to 26775 | 26705, 26740, 26775 | 3MHz | QPSK, 16QAM | 1 RB / 0 RB Offset |
| | | | | 26715 to 26765 | 26715, 26740, 26765 | 5MHz | QPSK, 16QAM | 1 RB / 0 RB Offset |
| | | | | 26740 | 26740 | 10MHz | QPSK, 16QAM | 1 RB / 0 RB Offset |
| A | RADIATED EMISSION | 26697 to 26783 | 26740 | 1.4MHz | QPSK | 1 RB / 0 RB Offset | | |
| | | 26705 to 26775 | 26740 | 3MHz | QPSK | 1 RB / 0 RB Offset | | |
| | | 26715 to 26765 | 26715, 26740, 26765 | 5MHz | QPSK | 1 RB / 0 RB Offset | | |
| | | 26740 | 26740 | 10MHz | QPSK | 1 RB / 0 RB Offset | | |

Note: This device was tested under all bandwidths, RB configurations and modulations. The worst case was found in QPSK modulation.



Test Report No.: W7L-P20210616-3RF04

TEST CONDITION:

| TEST ITEM | ENVIRONMENTAL CONDITIONS | INPUT POWER | TESTED BY |
|---------------------|--------------------------|-------------|-----------|
| EIRP(ERP) | 24deg. C, 60%RH | EUT 4.0V | Jace Hu |
| FREQUENCY STABILITY | 24deg. C, 61%RH | EUT 4.0V | James Fu |
| OCCUPIED BANDWIDTH | 24deg. C, 61%RH | EUT 4.0V | James Fu |
| BAND EDGE | 24deg. C, 61%RH | EUT 4.0V | James Fu |
| CONDUCTED EMISSION | 24deg. C, 61%RH | EUT 4.0V | James Fu |
| RADIATED EMISSION | 23deg. C, 70%RH | EUT 4.0V | Jace Hu |

2.5 GENERAL DESCRIPTION OF APPLIED STANDARDS

The EUT is a RF product. According to the specifications of the manufacturer, it must comply with the requirements of the following standards:

FCC 47 CFR Part 2

FCC 47 CFR Part 90

ANSI/TIA/EIA-603-D

ANSI/TIA/EIA-603-E

ANSI C63.26-2015

NOTE: All test items have been performed and recorded as per the above standards.



3 TEST TYPES AND RESULTS

3.1 OUTPUT POWER MEASUREMENT

3.1.1 LIMITS OF OUTPUT POWER MEASUREMENT

Per FCC Part 90.635(a)(b)

The maximum output power of the transmitter for mobile stations is 100 watts (20 dBw).

3.1.2 TEST PROCEDURES

EIRP / ERP MEASUREMENT:

Per KDB 971168 D01 Power Meas License Digital Systems v03r01 or subclause 5.2.5.5 of ANSI C63.26-2015, the relevant equation for determining the ERP or EIRP from the conducted RF output power measured using the guidance provided above is:

$$\text{ERP or EIRP} = P_{\text{Meas}} + G_{\text{T}} - L_{\text{C}}$$

Where:

ERP or EIRP = effective radiated power or equivalent isotropically radiated power, respectively
(expressed in the same units as P_{Meas} , typically dBW or dBm);

P_{Meas} = measured transmitter output power or PSD, in dBm or dBW;

G_{T} = gain of the transmitting antenna, in dBd (ERP) or dBi (EIRP);

L_{C} = signal attenuation in the connecting cable between the transmitter and antenna, in dB

CONDUCTED POWER MEASUREMENT:

- a. The EUT was set up for the maximum power with LTE link data modulation and link up with simulator.
- b. Set the EUT to transmit under low, middle and high channel and record the power level shown on simulator.

3.1.3 TEST SETUP

For the actual test configuration, please refer to the attached file (Test Setup Photo).

CONDUCTED POWER MEASUREMENT:

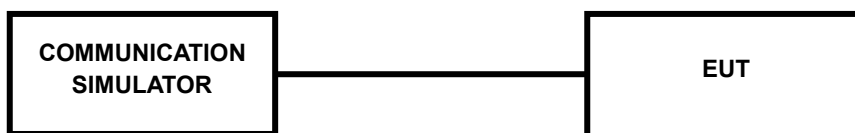

For the actual test configuration, please refer to the attached file (Test Setup Photo).

3.1.4 TEST RESULTS

AVERAGE CONDUCTED OUTPUT POWER (dBm)

LTE Band 26

| Band/BW | Modulation | RB Size | RB Offset | Low CH 26697 | Mid CH 26740 | High CH 26783 |
|---------|------------|---------|-----------|------------------------|----------------------|------------------------|
| | | | | Frequency 814.7 MHz | Frequency 819 MHz | Frequency 823.3 MHz |
| 26/ 1.4 | QPSK | 1 | 0 | 22.79 | 22.74 | 22.76 |
| | | 1 | 2 | 22.65 | 22.59 | 22.66 |
| | | 1 | 5 | 22.48 | 22.52 | 22.51 |
| | | 3 | 0 | 22.66 | 22.63 | 22.67 |
| | | 3 | 1 | 22.57 | 22.52 | 22.54 |
| | | 3 | 3 | 22.54 | 22.52 | 22.58 |
| | | 6 | 0 | 21.83 | 21.82 | 21.76 |
| | 16QAM | 1 | 0 | 22.11 | 22.10 | 22.12 |
| | | 1 | 2 | 22.06 | 22.03 | 22.07 |
| | | 1 | 5 | 21.94 | 21.89 | 21.91 |
| | | 3 | 0 | 21.78 | 21.76 | 21.82 |
| | | 3 | 1 | 21.73 | 21.67 | 21.74 |
| | | 3 | 3 | 21.70 | 21.74 | 21.73 |
| | | 6 | 0 | 20.86 | 20.80 | 20.87 |

| Band/BW | Modulation | RB Size | RB Offset | Low CH 26705 | Mid CH 26740 | High CH 26775 |
|---------|------------|---------|-----------|------------------------|----------------------|------------------------|
| | | | | Frequency 815.5 MHz | Frequency 819 MHz | Frequency 822.5 MHz |
| 26/ 3 | QPSK | 1 | 0 | 22.75 | 22.74 | 22.76 |
| | | 1 | 7 | 22.60 | 22.62 | 22.65 |
| | | 1 | 14 | 22.48 | 22.54 | 22.50 |
| | | 8 | 0 | 21.81 | 21.88 | 21.87 |
| | | 8 | 3 | 21.75 | 21.74 | 21.71 |
| | | 8 | 7 | 21.72 | 21.79 | 21.78 |
| | | 15 | 0 | 21.79 | 21.79 | 21.80 |
| | 16QAM | 1 | 0 | 22.16 | 22.10 | 22.17 |
| | | 1 | 7 | 22.01 | 22.05 | 22.04 |
| | | 1 | 14 | 21.93 | 21.90 | 21.94 |
| | | 8 | 0 | 20.82 | 20.77 | 20.79 |
| | | 8 | 3 | 20.69 | 20.67 | 20.73 |
| | | 8 | 7 | 20.77 | 20.76 | 20.70 |
| | | 15 | 0 | 20.83 | 20.80 | 20.82 |

| Band/BW | Modulation | RB Size | RB Offset | Low CH 26715 | Mid CH 26740 | High CH 26765 |
|---------|------------|---------|-----------|------------------------|----------------------|------------------------|
| | | | | Frequency 816.5 MHz | Frequency 819 MHz | Frequency 821.5 MHz |
| 26/ 5 | QPSK | 1 | 0 | 22.80 | 22.75 | 22.79 |
| | | 1 | 12 | 22.62 | 22.60 | 22.62 |
| | | 1 | 24 | 22.54 | 22.48 | 22.54 |
| | | 12 | 0 | 21.84 | 21.81 | 21.88 |
| | | 12 | 6 | 21.75 | 21.74 | 21.74 |
| | | 12 | 13 | 21.72 | 21.79 | 21.75 |
| | | 25 | 0 | 21.80 | 21.79 | 21.83 |
| | 16QAM | 1 | 0 | 22.12 | 22.16 | 22.13 |
| | | 1 | 12 | 22.02 | 22.04 | 22.07 |
| | | 1 | 24 | 21.88 | 21.94 | 21.91 |
| | | 12 | 0 | 20.82 | 20.76 | 20.82 |
| | | 12 | 6 | 20.67 | 20.69 | 20.67 |
| | | 12 | 13 | 20.72 | 20.76 | 20.72 |
| | | 25 | 0 | 20.83 | 20.80 | 20.87 |



**BUREAU
VERITAS**

Test Report No.: W7L-P20210616-3RF04

| Band/BW | Modulation | RB Size | RB Offset | / | Mid CH 26740 | / |
|---------|------------|---------|-----------|---|----------------------|---|
| | | | | / | Frequency 819 MHz | / |
| 26/ 10 | QPSK | 1 | 0 | / | 22.81 | / |
| | | 1 | 24 | / | 22.67 | / |
| | | 1 | 49 | / | 22.56 | / |
| | | 25 | 0 | / | 21.89 | / |
| | | 25 | 12 | / | 21.79 | / |
| | | 25 | 25 | / | 21.80 | / |
| | | 50 | 0 | / | 21.84 | / |
| | 16QAM | 1 | 0 | / | 22.18 | / |
| | | 1 | 24 | / | 22.09 | / |
| | | 1 | 49 | / | 21.96 | / |
| | | 25 | 0 | / | 20.84 | / |
| | | 25 | 12 | / | 20.75 | / |
| | | 25 | 25 | / | 20.78 | / |
| | | 50 | 0 | / | 20.88 | / |



ERP

LTE BAND 26

CHANNEL BANDWIDTH: 1.4MHz QPSK

| Channel | Frequency (MHz) | Conducted Power (dBm) | G _T -L _c (dB) | ERP (dBm) | ERP (mW) | Limit (W) |
|---------|-----------------|-----------------------|-------------------------------------|-----------|----------|-----------|
| 26697 | 814.7 | 22.79 | 0.82 | 21.46 | 139.96 | 100 |
| 26740 | 819 | 22.74 | 0.82 | 21.41 | 138.36 | 100 |
| 26783 | 823.3 | 22.76 | 0.82 | 21.43 | 139 | 100 |

REMARKS: ERP Output Power (dBm) = EIRP (dBm) -2.15(dB).

CHANNEL BANDWIDTH: 1.4MHz 16QAM

| Channel | Frequency (MHz) | Conducted Power (dBm) | G _T -L _c (dB) | ERP (dBm) | ERP (mW) | Limit (W) |
|---------|-----------------|-----------------------|-------------------------------------|-----------|----------|-----------|
| 26697 | 814.7 | 22.11 | 0.82 | 20.78 | 119.67 | 100 |
| 26740 | 819 | 22.1 | 0.82 | 20.77 | 119.4 | 100 |
| 26783 | 823.3 | 22.12 | 0.82 | 20.79 | 119.95 | 100 |

REMARKS: ERP Output Power (dBm) = EIRP (dBm) -2.15(dB).



Test Report No.: W7L-P20210616-3RF04

LTE BAND 26

CHANNEL BANDWIDTH: 3MHz QPSK

| Channel | Frequency (MHz) | Conducted Power (dBm) | G _T -L _c (dB) | ERP (dBm) | ERP (mW) | Limit (W) |
|---------|-----------------|-----------------------|-------------------------------------|-----------|----------|-----------|
| 26705 | 815.5 | 22.75 | 0.82 | 21.42 | 138.68 | 100 |
| 26740 | 819 | 22.74 | 0.82 | 21.41 | 138.36 | 100 |
| 26775 | 822.5 | 22.76 | 0.82 | 21.43 | 139.00 | 100 |

REMARKS: ERP Output Power (dBm) = EIRP (dBm) -2.15(dB).

CHANNEL BANDWIDTH: 3MHz 16QAM

| Channel | Frequency (MHz) | Conducted Power (dBm) | G _T -L _c (dB) | ERP (dBm) | ERP (mW) | Limit (W) |
|---------|-----------------|-----------------------|-------------------------------------|-----------|----------|-----------|
| 26705 | 815.5 | 22.16 | 0.82 | 20.83 | 121.06 | 100 |
| 26740 | 819 | 22.1 | 0.82 | 20.77 | 119.4 | 100 |
| 26775 | 822.5 | 22.17 | 0.82 | 20.84 | 121.34 | 100 |

REMARKS: ERP Output Power (dBm) = EIRP (dBm) -2.15(dB).



Test Report No.: W7L-P20210616-3RF04

LTE BAND 26

CHANNEL BANDWIDTH: 5MHz QPSK

| Channel | Frequency (MHz) | Conducted Power (dBm) | G _T -L _C (dB) | ERP (dBm) | ERP (mW) | Limit (W) |
|---------|-----------------|-----------------------|-------------------------------------|-----------|----------|-----------|
| 26715 | 816.5 | 22.8 | 0.82 | 21.47 | 140.28 | 100 |
| 26740 | 819 | 22.75 | 0.82 | 21.42 | 138.68 | 100 |
| 26765 | 821.5 | 22.79 | 0.82 | 21.46 | 139.96 | 100 |

REMARKS: ERP Output Power (dBm) = EIRP (dBm) -2.15(dB).

CHANNEL BANDWIDTH: 5MHz 16QAM

| Channel | Frequency (MHz) | Conducted Power (dBm) | G _T -L _C (dB) | ERP (dBm) | ERP (mW) | Limit (W) |
|---------|-----------------|-----------------------|-------------------------------------|-----------|----------|-----------|
| 26715 | 816.5 | 22.12 | 0.82 | 20.79 | 119.95 | 100 |
| 26740 | 819 | 22.16 | 0.82 | 20.83 | 121.06 | 100 |
| 26765 | 821.5 | 22.13 | 0.82 | 20.8 | 120.23 | 100 |

REMARKS: ERP Output Power (dBm) = EIRP (dBm) -2.15(dB).



LTE BAND 26

CHANNEL BANDWIDTH: 10MHz QPSK

| Channel | Frequency (MHz) | Conducted Power (dBm) | G _T -L _C (dB) | ERP (dBm) | ERP (mW) | Limit (W) |
|---------|-----------------|-----------------------|-------------------------------------|-----------|----------|-----------|
| - | - | - | - | - | - | - |
| 26740 | 819 | 22.81 | 0.82 | 21.48 | 140.60 | 100 |
| - | - | - | - | - | - | - |

REMARKS: ERP Output Power (dBm) = EIRP (dBm) -2.15(dB).

CHANNEL BANDWIDTH: 10MHz 16QAM

| Channel | Frequency (MHz) | Conducted Power (dBm) | G _T -L _C (dB) | ERP (dBm) | ERP (mW) | Limit (W) |
|---------|-----------------|-----------------------|-------------------------------------|-----------|----------|-----------|
| - | - | - | - | - | - | - |
| 26740 | 819 | 22.18 | 0.82 | 20.85 | 121.62 | 100 |
| - | - | - | - | - | - | - |

REMARKS: ERP Output Power (dBm) = EIRP (dBm) -2.15(dB).

3.2 FREQUENCY STABILITY MEASUREMENT

3.2.1 LIMITS OF FREQUENCY STABILITY MEASUREMENT

The frequency stability of mobile, portable and control transmitters operating in the wideband segment must be 1.25 parts per million or better when AFC is locked to a base station, and 5 parts per million or better when AFC is not locked

3.2.2 TEST PROCEDURE

- a. Device is placed at the oven room. The oven room could control the temperatures and humidity. Power warm up is at least 15 min and power applied should perform before recording frequency error.
- b. EUT is connected the external power supply to control the DC input power. The test voltage range is from minimum to maximum working voltage. Each step shall be record the frequency error rate.
- c. The temperature range step is 10 degrees in this test items. All temperature levels shall be hold the $\pm 0.5^{\circ}\text{C}$ during the measurement testing. The each temperature step shall be at least 0.5 hours, consider the EUT could be test under the stability condition.

NOTE: The frequency error was recorded frequency error from the communication simulator.

3.2.3 TEST SETUP

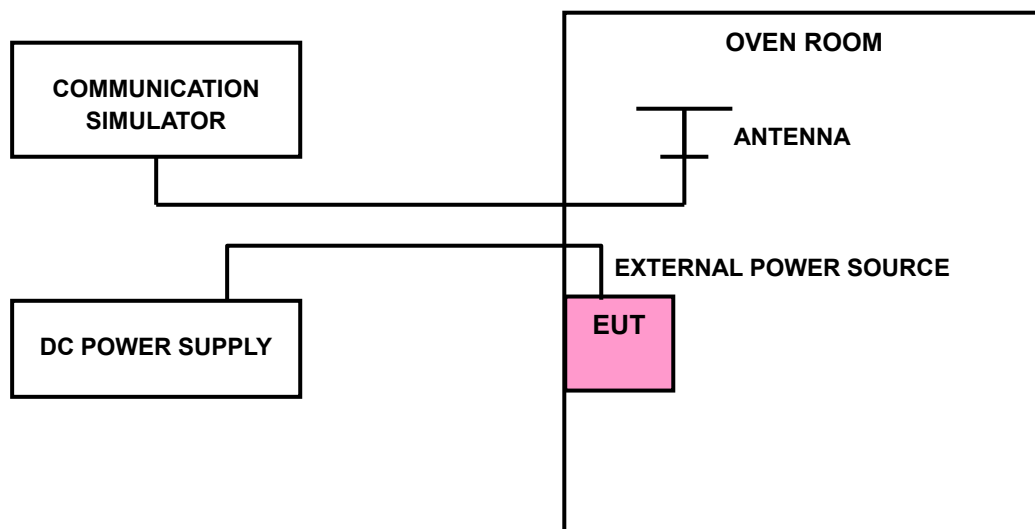



Test Report No.: W7L-P20210616-3RF04

3.2.4 TEST RESULTS

Please Refer to Appendix D Of this test report.

3.3 OCCUPIED BANDWIDTH MEASUREMENT

3.3.1 LIMITS OF OCCUPIED BANDWIDTH MEASUREMENT

The width of a frequency band such that, below the lower and above the upper frequency limits, the mean powers emitted are each equal to a specified percentage 0.5 % of the total mean power of a given emission.

3.3.2 TEST SETUP

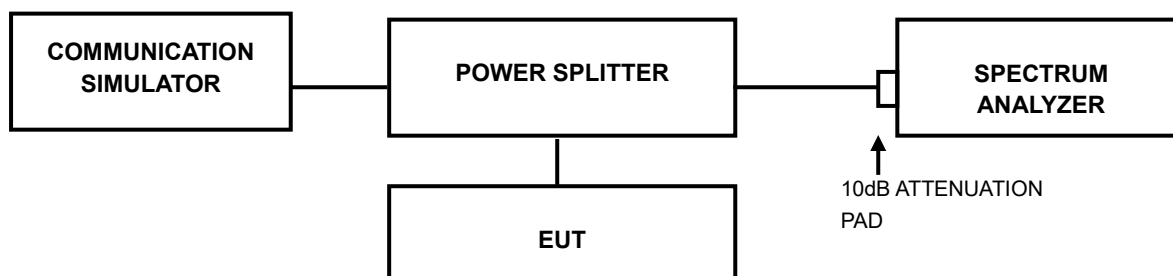

3.3.3 TEST PROCEDURES

- a. The conducted occupied bandwidth used the power splitter via EUT RF power connector between simulation base station and spectrum analyzer.
- b. Use OBW measurement function of Spectrum analyzer to measure 99 % occupied bandwidth.



Test Report No.: W7L-P20210616-3RF04

3.3.4 TEST RESULTS

Please Refer to Appendix D Of this test report.

3.4 EMISSION MASK MEASUREMENT

3.4.1 LIMITS OF EMISSION MASK MEASUREMENT

According to FCC part 90.691 shall be tested the emission mask. For any frequency removed from the EA licensee's frequency block by up to and including 37.5 kHz, the power of any emission shall be attenuated below the transmitter power (P) in watts by at least $116 \log_{10}(f/6.1)$ decibels or $50 + 10 \log_{10}(P)$ decibels or 80 decibels, whichever is the lesser attenuation, where f is the frequency removed from the center of the outer channel in the block in kilohertz and where f is greater than 12.5 kHz.

3.4.2 TEST SETUP

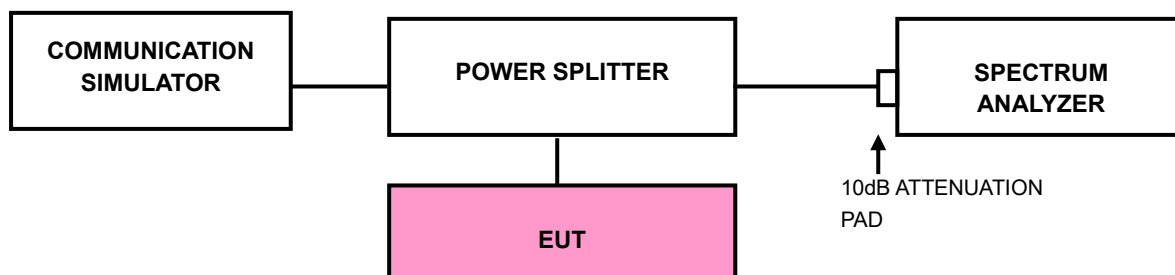



Test Report No.: W7L-P20210616-3RF04

3.4.3 TEST PROCEDURES

- a. The EUT was set up for the maximum peak power with LTE link data modulation. The power was measured with R&S Spectrum Analyzer. All measurements were done at 2 channels (low and high operational frequency range.).
- b. The band edge measurement used the power splitter via EUT RF power connector between simulation base station and spectrum analyzer.
- c. The center frequency of spectrum is the band edge frequency and span is 1~5 MHz. RBW of the spectrum is 20kHz and VBW of the spectrum is 100 kHz. (LTE bandwidth 1.4MHz)
- d. The center frequency of spectrum is the band edge frequency and span is 1~5 MHz. RBW of the spectrum is 30kHz and VBW of the spectrum is 100kHz. (LTE bandwidth 3MHz)
- e. The center frequency of spectrum is the band edge frequency and span is 1~5 MHz. RBW of the spectrum is 50kHz and VBW of the spectrum is 200kHz. (LTE bandwidth 5MHz)
- f. The center frequency of spectrum is the band edge frequency and span is 1~5 MHz. RBW of the spectrum is 100kHz and VBW of the spectrum is 300kHz. (LTE bandwidth 10MHz)
- g. Record the max trace plot into the test report.



Test Report No.: W7L-P20210616-3RF04

3.4.4 TEST RESULTS

Please Refer to Appendix D Of this test report.

3.5 CONDUCTED SPURIOUS EMISSIONS

3.5.1 LIMITS OF CONDUCTED SPURIOUS EMISSIONS MEASUREMENT

The power of any emission outside a licensee's frequency block shall be attenuated below the transmitter power (P) by at least $43 + 10 \log_{10}(P)$ dB. The limit of emission equal to -13dBm

3.5.2 TEST PROCEDURE

- a. The EUT makes a phone call to the communication simulator. All measurements were done at middle operational frequency range.
- b. Measuring frequency range is from 9kHz up to a frequency including its 10th harmonic. 10dB attenuation pad is connected with spectrum. RBW=1MHz and VBW=3MHz is used for conducted emission measurement.

3.5.3 TEST SETUP

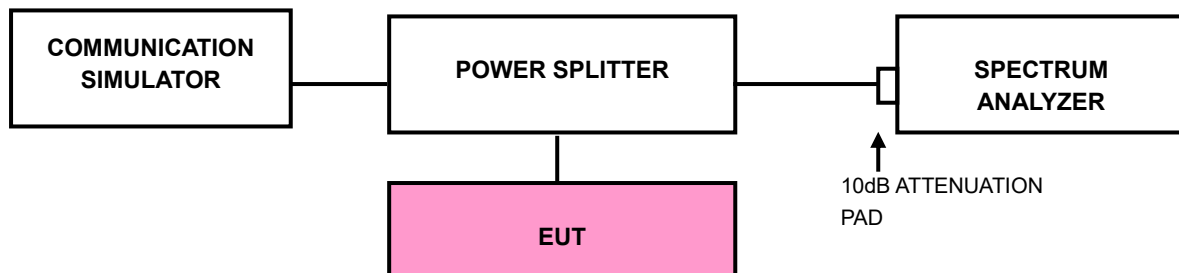



Test Report No.: W7L-P20210616-3RF04

3.5.4 TEST RESULTS

NOTE : The 9K~30MHz amplitude of spurious emissions attenuated more than 20 dB below the permissible value is not required in the report.

Please Refer to Appendix D Of this test report.



3.6 RADIATED EMISSION MEASUREMENT

3.6.1 LIMITS OF RADIATED EMISSION MEASUREMENT

The power of any emission outside a licensee's frequency block shall be attenuated below the transmitter power (P) by at least $43 + 10 \log_{10}(P)$ dB. The limit of emission equal to -13dBm

3.6.2 TEST PROCEDURES

- a. Substitution method is used for E.I.R.P measurement. In the semi-anechoic chamber, EUT placed on the 0.8m height of Turn Table, rotated the table around 360 degrees to search the maximum radiation power and receiver antenna shall be rotated vertical and horizontal polarization and moved height from 1m to 4m to find the maximum polar radiated power. The "Read Value" is the spectrum reading the maximum power value.
- b. The substitution horn antenna is substituted for EUT at the same position and signals generator export the CW signal to the substitution antenna via a TX cable. Rotated the Turn Table and moved receiving antenna to find the maximum radiation power. Adjust output power level of S.G to get a Value of spectrum reading equal to "Read Value" of step a. Record the power level of S.G
- c. $\text{EIRP} = \text{Output power level of S.G} - \text{TX cable loss} + \text{Antenna gain of substitution horn}$.
- d. E.R.P power can be calculated form E.I.R.P power by subtracting the gain of dipole, $\text{E.R.P power} = \text{E.I.P.R power} - 2.15\text{dBi}$.

NOTE: The resolution bandwidth of spectrum analyzer is 1 MHz and the video bandwidth is 3 MHz.

3.6.3 DEVIATION FROM TEST STANDARD

No deviation

3.6.4 TEST SETUP

<Below 30MHz>

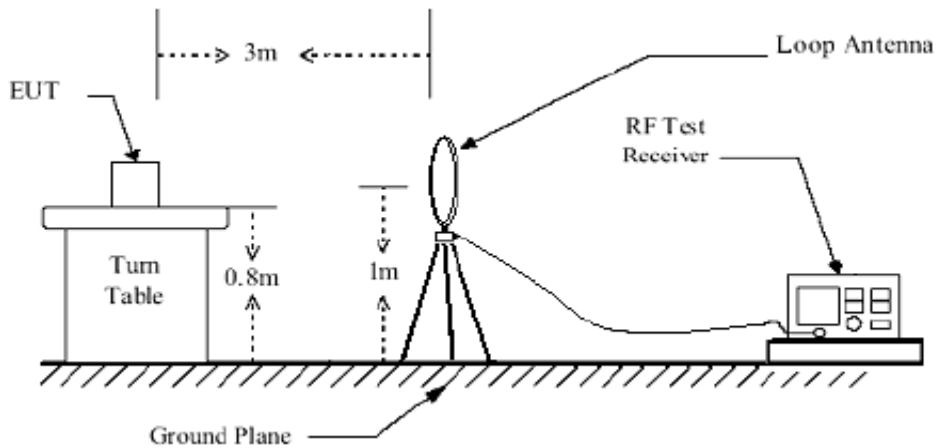

< Frequency Range 30MHz~1GHz >

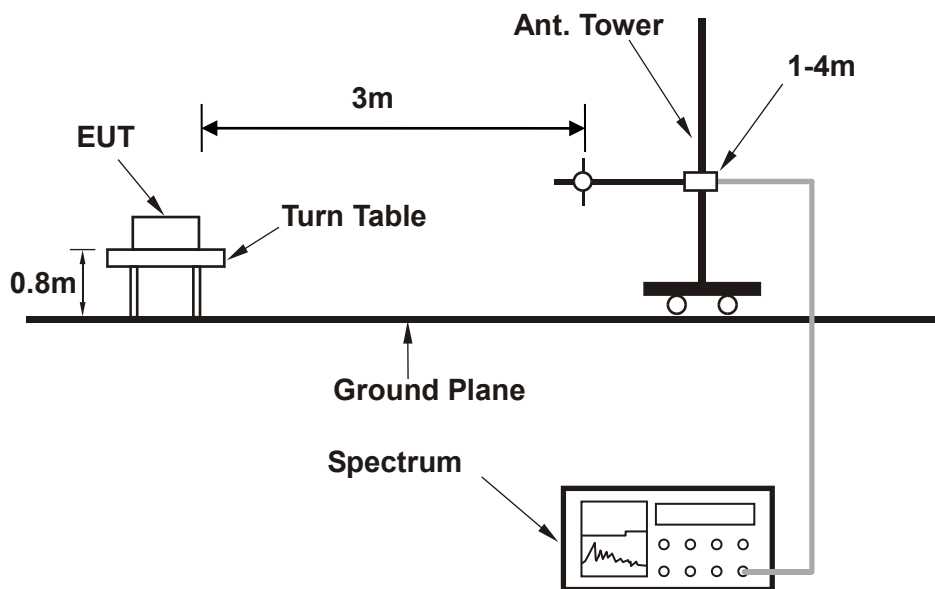

< Frequency Range above 1GHz >

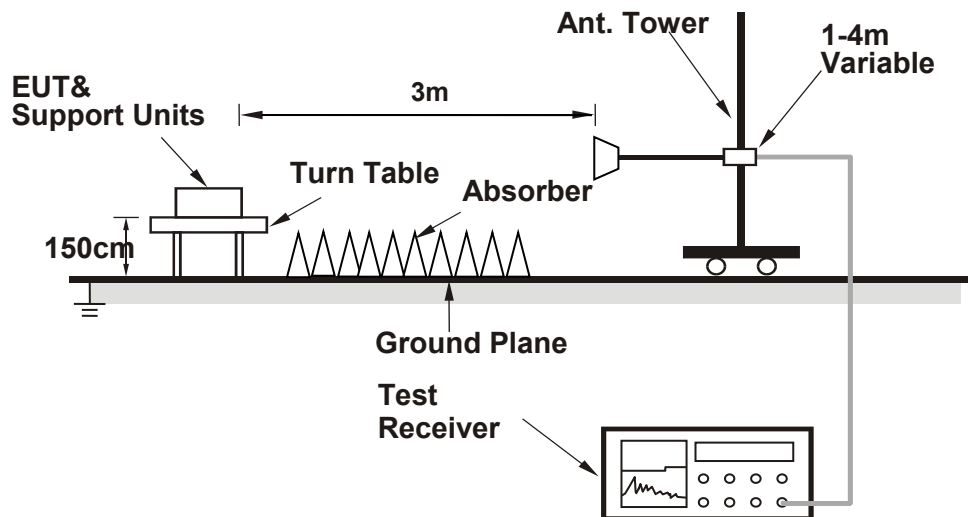

For the actual test configuration, please refer to the attached file (Test Setup Photo).



3.6.5 TEST RESULTS

NOTE : The 9K~30MHz amplitude of spurious emissions attenuated more than 20 dB below the permissible value is not required in the report.

BELOW 1GHz WORST-CASE DATA

30 MHz – 1GHz data:

LTE Band 26:

CHANNEL BANDWIDTH: 5MHz / QPSK

| | | | |
|--|------------------|-----------------|---------------|
| MODE | TX channel 26740 | FREQUENCY RANGE | Below 1000MHz |
| ENVIRONMENTAL CONDITIONS | 23deg. C, 70%RH | INPUT POWER | EUT 4.0V |
| TESTED BY | Jace HU | | |
| ANTENNA POLARITY & TEST DISTANCE: HORIZONTAL AT 3 M | | | |

| | Freq | Level | Read Level | Limit Line | Over Limit | Factor | Remark | Pol/Phase |
|------|---------|--------|------------|------------|------------|--------|--------|------------|
| | MHz | dBm/m | dBm | dBm/m | dB | dB/m | | |
| 1 | 55.220 | -61.68 | -43.78 | -13.00 | -48.68 | -17.90 | Peak | Horizontal |
| 2 | 88.200 | -73.20 | -52.15 | -13.00 | -60.20 | -21.05 | Peak | Horizontal |
| 3 | 163.860 | -64.06 | -47.99 | -13.00 | -51.06 | -16.07 | Peak | Horizontal |
| 4 | 251.160 | -57.58 | -46.10 | -13.00 | -44.58 | -11.48 | Peak | Horizontal |
| 5 PP | 320.030 | -56.30 | -44.32 | -13.00 | -43.30 | -11.98 | Peak | Horizontal |
| 6 | 495.600 | -61.80 | -53.47 | -13.00 | -48.80 | -8.33 | Peak | Horizontal |

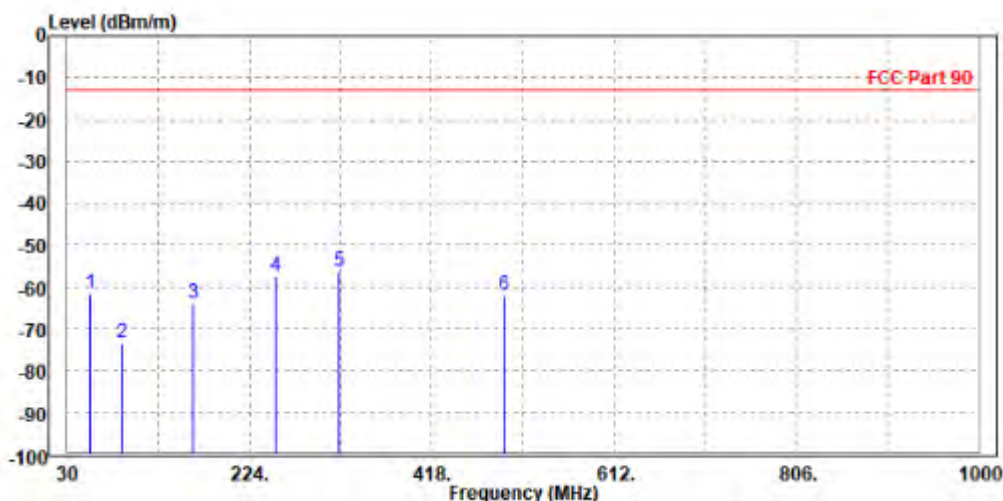



Test Report No.: W7L-P20210616-3RF04

| | | | |
|--|------------------|------------------------|---------------|
| MODE | TX channel 26740 | FREQUENCY RANGE | Below 1000MHz |
| ENVIRONMENTAL CONDITIONS | 23deg. C, 70%RH | INPUT POWER | EUT 4.0V |
| TESTED BY | Jace HU | | |
| ANTENNA POLARITY & TEST DISTANCE: VERTICAL AT 3 M | | | |

| | Freq | Level | Read Level | Limit Line | Over Limit | Factor | Remark | Pol/Phase | |
|---|------|---------|------------|------------|------------|--------|--------|-----------|----------|
| | MHz | dBm/m | dBm | dBm/m | dB | dB/m | | | |
| 1 | PP | 53.280 | -57.45 | -32.61 | -13.00 | -44.45 | -24.84 | Peak | Vertical |
| 2 | | 88.200 | -61.89 | -45.52 | -13.00 | -48.89 | -16.37 | Peak | Vertical |
| 3 | | 251.160 | -68.28 | -54.75 | -13.00 | -55.28 | -13.53 | Peak | Vertical |
| 4 | | 306.450 | -64.65 | -53.95 | -13.00 | -51.65 | -10.70 | Peak | Vertical |
| 5 | | 388.900 | -63.33 | -54.13 | -13.00 | -50.33 | -9.20 | Peak | Vertical |
| 6 | | 495.600 | -61.51 | -53.39 | -13.00 | -48.51 | -8.12 | Peak | Vertical |

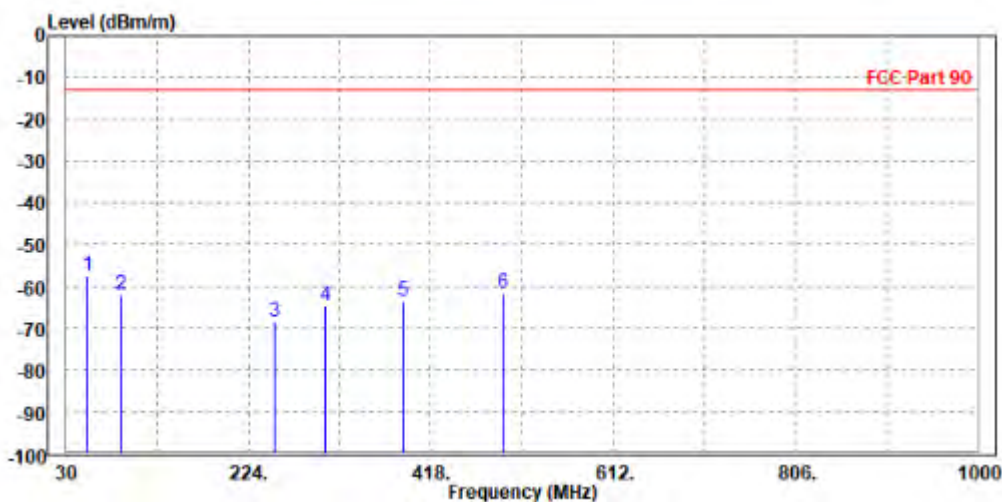



Test Report No.: W7L-P20210616-3RF04

ABOVE 1GHz

Note: For higher frequency, the emission is too low to be detected.

LTE BAND 26

CHANNEL BANDWIDTH: 1.4MHz / QPSK

| | | | |
|--|------------------|------------------------|---------------|
| MODE | TX channel 26740 | FREQUENCY RANGE | Above 1000MHz |
| ENVIRONMENTAL CONDITIONS | 23deg. C, 70%RH | INPUT POWER | EUT 4.0V |
| TESTED BY | Jace Hu | | |
| ANTENNA POLARITY & TEST DISTANCE: HORIZONTAL AT 3 M | | | |

| | Freq | Level | Read Level | Limit Line | Over Limit | Factor | Remark | PoI/Phase |
|------|----------|--------|------------|------------|------------|--------|--------|------------|
| | MHz | dBm/m | dBm | dBm/m | dB | dB/m | | |
| 1 | 1646.000 | -57.92 | -58.68 | -13.00 | -44.92 | 0.76 | Peak | Horizontal |
| 2 PP | 2457.000 | -53.18 | -58.46 | -13.00 | -40.18 | 5.28 | Peak | Horizontal |

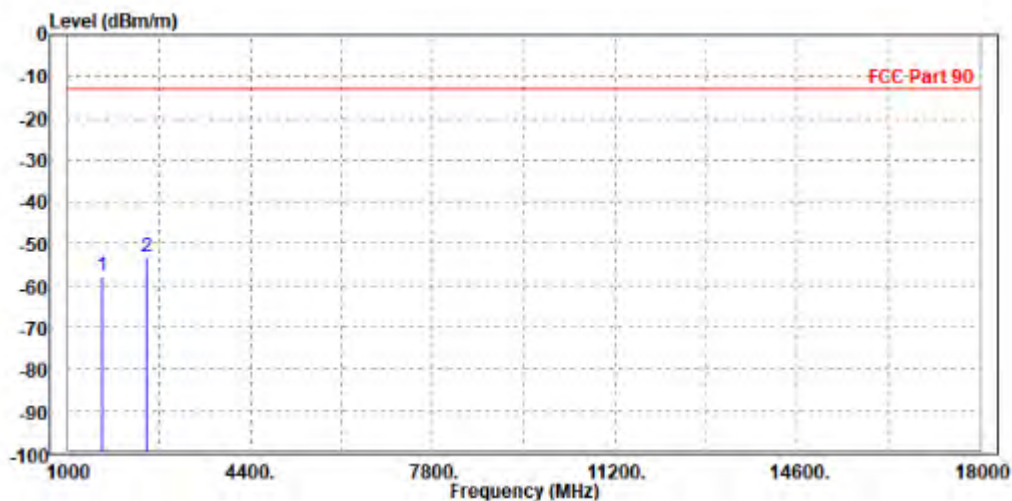

c



Test Report No.: W7L-P20210616-3RF04

| | | | |
|--|------------------|------------------------|---------------|
| MODE | TX channel 26740 | FREQUENCY RANGE | Above 1000MHz |
| ENVIRONMENTAL CONDITIONS | 23deg. C, 70%RH | INPUT POWER | EUT 4.0V |
| TESTED BY | Jace Hu | | |
| ANTENNA POLARITY & TEST DISTANCE: VERTICAL AT 3 M | | | |

| | Freq | Level | Read Level | Limit Line | Over Limit | Factor | Remark | Pol/Phase |
|------|----------|--------|------------|------------|------------|--------|--------|-----------|
| | MHz | dBm/m | dBm | dBm/m | dB | dB/m | | |
| 1 | 1638.000 | -56.45 | -57.41 | -13.00 | -43.45 | 0.96 | Peak | Vertical |
| 2 PP | 2462.000 | -51.73 | -56.57 | -13.00 | -38.73 | 4.84 | Peak | Vertical |

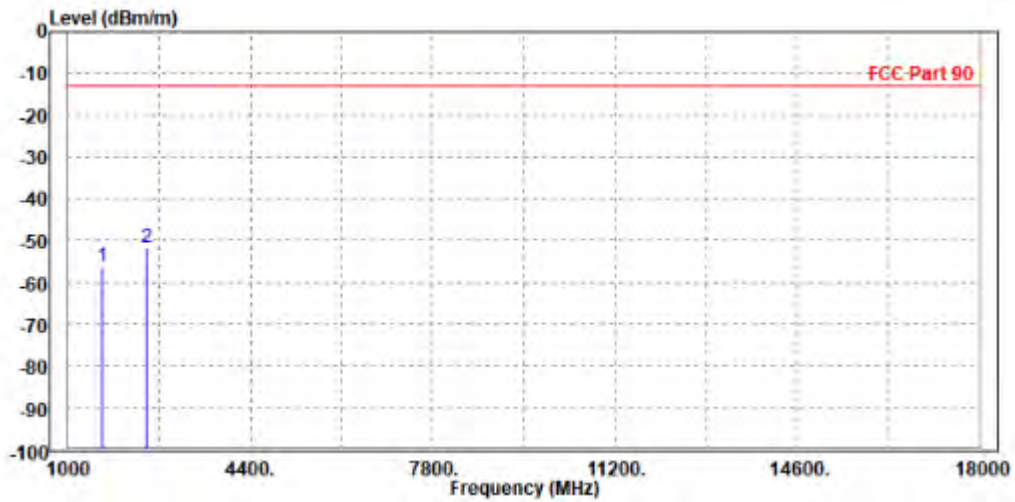



**BUREAU
VERITAS**

Test Report No.: W7L-P20210616-3RF04

CHANNEL BANDWIDTH: 3MHz / QPSK

| | | | |
|--|------------------|------------------------|---------------|
| MODE | TX channel 26740 | FREQUENCY RANGE | Above 1000MHz |
| ENVIRONMENTAL CONDITIONS | 23deg. C, 70%RH | INPUT POWER | EUT 4.0V |
| TESTED BY | Jace Hu | | |
| ANTENNA POLARITY & TEST DISTANCE: HORIZONTAL AT 3 M | | | |

| | Freq | Level | Read Level | Limit | Over | Factor | Remark | Pol/Phase |
|------|----------|--------|------------|--------|--------|--------|--------|------------|
| | MHz | dBm/m | dBm | dBm/m | dB | dB/m | | |
| 1 | 1638.000 | -57.74 | -58.43 | -13.00 | -44.74 | 0.69 | Peak | Horizontal |
| 2 PP | 2462.000 | -53.58 | -58.88 | -13.00 | -40.58 | 5.30 | Peak | Horizontal |

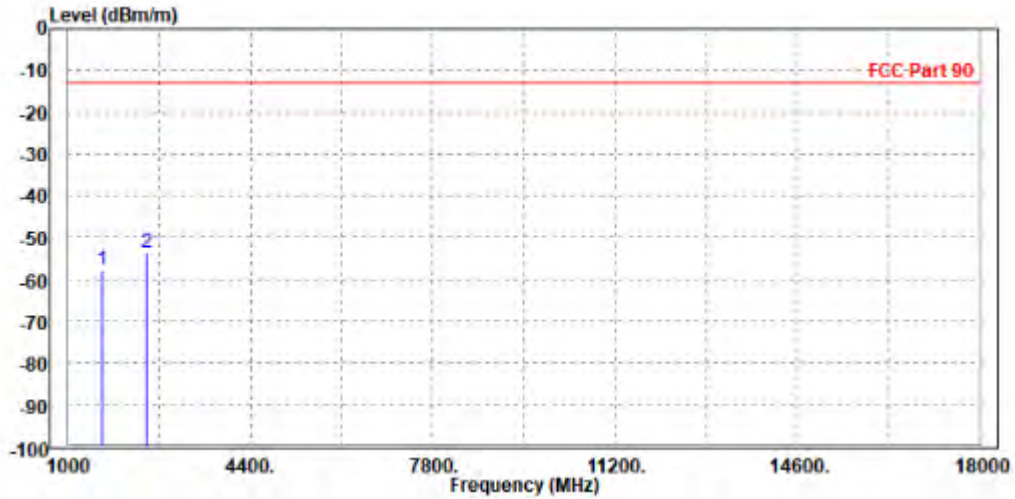



Test Report No.: W7L-P20210616-3RF04

| | | | |
|--|------------------|-----------------|---------------|
| MODE | TX channel 26740 | FREQUENCY RANGE | Above 1000MHz |
| ENVIRONMENTAL CONDITIONS | 23deg. C, 70%RH | INPUT POWER | EUT 4.0V |
| TESTED BY | Jace Hu | | |
| ANTENNA POLARITY & TEST DISTANCE: VERTICAL AT 3 M | | | |

| | Freq | Level | Read Level | Limit Line | Over Limit | Factor | Remark | Pol/Phase |
|---|-------------|--------|------------|------------|------------|--------|--------|-----------|
| | MHz | dBm/m | dBm | dBm/m | dB | dB/m | | |
| 1 | 1646.000 | -56.62 | -57.64 | -13.00 | -43.62 | 1.02 | Peak | Vertical |
| 2 | PP 2457.000 | -52.93 | -57.75 | -13.00 | -39.93 | 4.82 | Peak | Vertical |

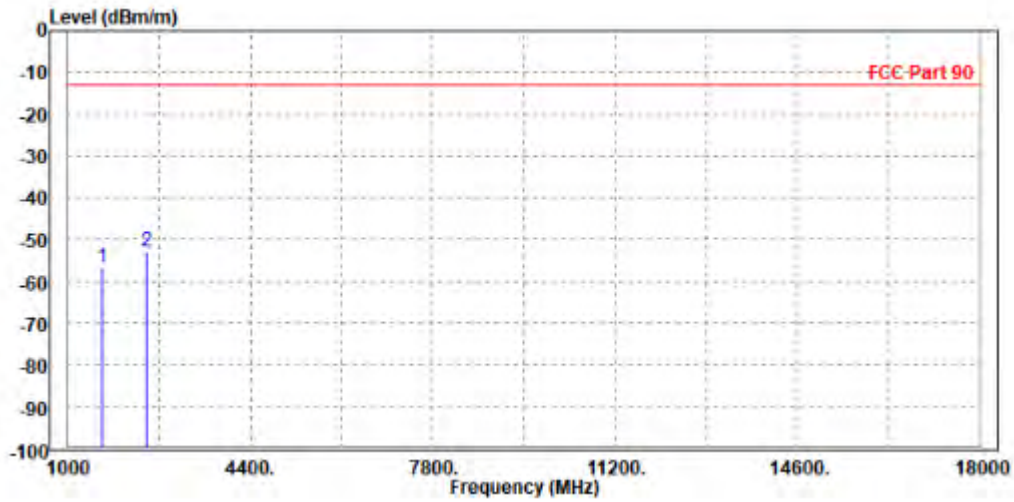



**BUREAU
VERITAS**

Test Report No.: W7L-P20210616-3RF04

CHANNEL BANDWIDTH: 5MHz / QPSK

CH26715

| | | | |
|--|------------------|------------------------|---------------|
| MODE | TX channel 26715 | FREQUENCY RANGE | Above 1000MHz |
| ENVIRONMENTAL CONDITIONS | 23deg. C, 70%RH | INPUT POWER | EUT 4.0V |
| TESTED BY | Jace Hu | | |
| ANTENNA POLARITY & TEST DISTANCE: HORIZONTAL AT 3 M | | | |

| | Freq | Level | Read Level | Limit Line | Over Limit | Factor | Remark | Pol/Phase |
|---|-------------|--------|------------|------------|------------|--------|--------|------------|
| | MHz | dBm/m | dBm | dBm/m | dB | dB/m | | |
| 1 | 1633.000 | -58.13 | -58.78 | -13.00 | -45.13 | 0.65 | Peak | Horizontal |
| 2 | PP 2445.000 | -53.14 | -58.38 | -13.00 | -40.14 | 5.24 | Peak | Horizontal |

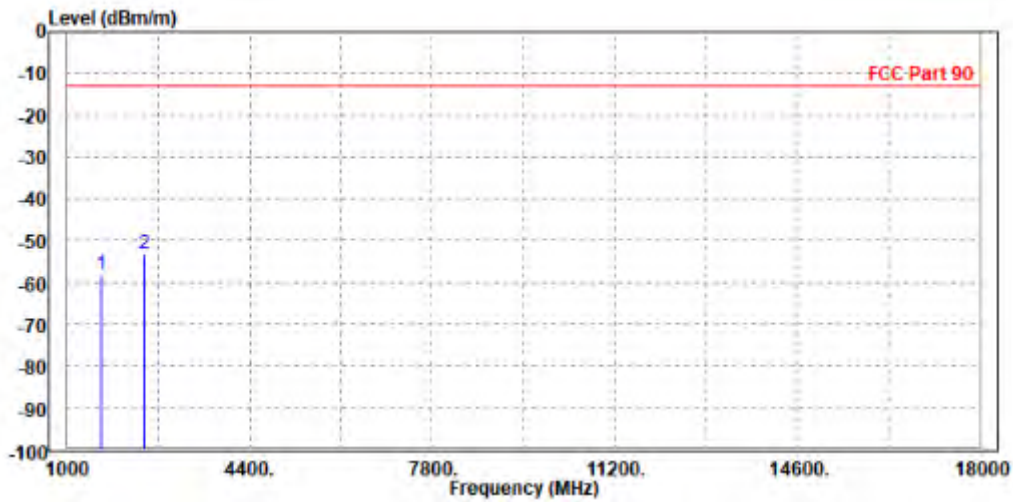



Test Report No.: W7L-P20210616-3RF04

| | | | |
|--|------------------|-----------------|---------------|
| MODE | TX channel 26715 | FREQUENCY RANGE | Above 1000MHz |
| ENVIRONMENTAL CONDITIONS | 23deg. C, 70%RH | INPUT POWER | EUT 4.0V |
| TESTED BY | Jace Hu | | |
| ANTENNA POLARITY & TEST DISTANCE: VERTICAL AT 3 M | | | |

| | Freq | Level | Read Level | Limit Line | Over Limit | Factor | Remark | Pol/Phase |
|------|----------|--------|------------|------------|------------|--------|--------|-----------|
| | MHz | dBm/m | dBm | dBm/m | dB | dB/m | | |
| 1 | 1629.000 | -57.95 | -58.85 | -13.00 | -44.95 | 0.90 | Peak | Vertical |
| 2 PP | 2449.500 | -52.41 | -57.21 | -13.00 | -39.41 | 4.80 | Peak | Vertical |

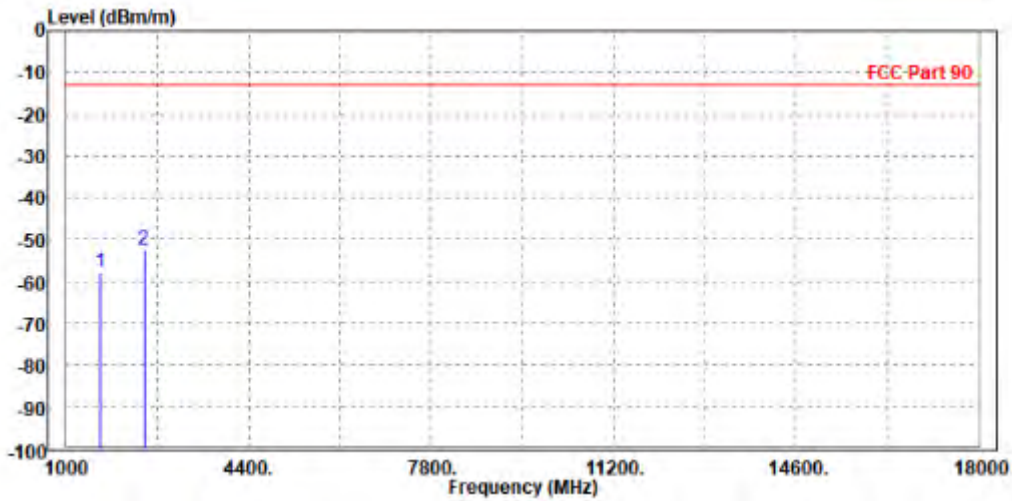



**BUREAU
VERITAS**

Test Report No.: W7L-P20210616-3RF04

CH26740

| | | | |
|--|------------------|------------------------|---------------|
| MODE | TX channel 26740 | FREQUENCY RANGE | Above 1000MHz |
| ENVIRONMENTAL CONDITIONS | 23deg. C, 70%RH | INPUT POWER | EUT 4.0V |
| TESTED BY | Jace Hu | | |
| ANTENNA POLARITY & TEST DISTANCE: HORIZONTAL AT 3 M | | | |

| | Freq | Level | Read Level | Limit Line | Over Limit | Factor | Remark | Pol/Phase |
|------|----------|--------|------------|------------|------------|--------|--------|------------|
| | MHz | dBm/m | dBm | dBm/m | dB | dB/m | | |
| 1 | 1646.000 | -57.76 | -58.52 | -13.00 | -44.76 | 0.76 | Peak | Horizontal |
| 2 PP | 2457.000 | -51.03 | -56.31 | -13.00 | -38.03 | 5.28 | Peak | Horizontal |

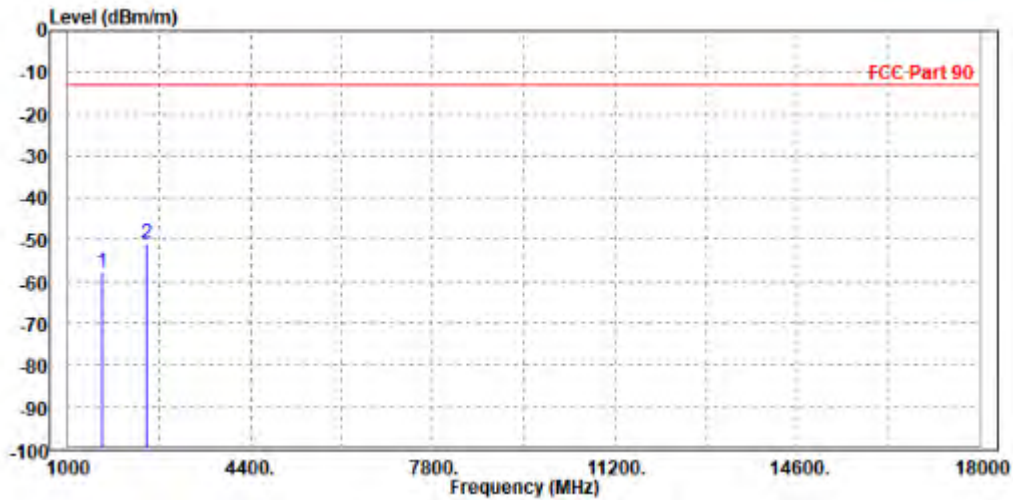



Test Report No.: W7L-P20210616-3RF04

| | | | |
|--|------------------|-----------------|---------------|
| MODE | TX channel 26740 | FREQUENCY RANGE | Above 1000MHz |
| ENVIRONMENTAL CONDITIONS | 23deg. C, 70%RH | INPUT POWER | EUT 4.0V |
| TESTED BY | Jace Hu | | |
| ANTENNA POLARITY & TEST DISTANCE: VERTICAL AT 3 M | | | |

| | Freq | Level | Read Level | Limit Line | Over Limit | Factor | Remark | Pol/Phase |
|------|----------|--------|------------|------------|------------|--------|--------|-----------|
| | MHz | dBm/m | dBm | dBm/m | dB | dB/m | | |
| 1 | 1638.000 | -57.07 | -58.03 | -13.00 | -44.07 | 0.96 | Peak | Vertical |
| 2 PP | 2462.000 | -53.63 | -58.47 | -13.00 | -40.63 | 4.84 | Peak | Vertical |

