

*FCC PART 15, SUBPART B and C
TEST REPORT**for***BLUETOOTH MODULE****MODEL: BT260146**

Prepared for

O'NEIL PRODUCT DEVELOPMENT
8 MASON
IRVINE, CALIFORNIA 92618-2705

Prepared by: _____

KYLE FUJIMOTO

Approved by: _____

MICHAEL CHRISTENSEN**COMPATIBLE ELECTRONICS INC.**
114 OLINDA DRIVE
BREA, CALIFORNIA 92823
(714) 579-0500

DATE: MARCH 22, 2004

	REPORT BODY	APPENDICES					TOTAL
		<i>A</i>	<i>B</i>	<i>C</i>	<i>D</i>	<i>E</i>	
PAGES	24	2	2	2	17	53	100

This report shall not be reproduced except in full, without the written approval of Compatible Electronics.

TABLE OF CONTENTS

Section / Title	PAGE
GENERAL REPORT SUMMARY	4
SUMMARY OF TEST RESULTS	5
1. PURPOSE	6
2. ADMINISTRATIVE DATA	7
2.1 Location of Testing	7
2.2 Traceability Statement	7
2.3 Cognizant Personnel	7
2.4 Date Test Sample was Received	7
2.5 Disposition of the Test Sample	7
2.6 Abbreviations and Acronyms	7
3. APPLICABLE DOCUMENTS	8
4. DESCRIPTION OF TEST CONFIGURATION	9
4.1 Description of Test Configuration - EMI	9
4.1.1 Cable Construction and Termination	10
5. LISTS OF EUT, ACCESSORIES AND TEST EQUIPMENT	11
5.1 EUT and Accessory List	11
5.2 EMI Test Equipment	12
6. TEST SITE DESCRIPTION	14
6.1 Test Facility Description	14
6.2 EUT Mounting, Bonding and Grounding	14
7. CHARACTERISTICS OF THE TRANSMITTER	15
7.1 Transmitter Power	15
7.2 Channel Number and Frequencies	15
7.3 Antenna Gain	15
8. TEST PROCEDURES	16
8.1 RF Emissions	16
8.1.1 Conducted Emissions Test	16
8.1.2 Radiated Emissions (Spurious and Harmonics) Test	17
8.3 20 dB Bandwidth	19
8.4 Peak Output Power	20
8.5 RF Antenna Conducted Test	20
8.6 RF Band Edges	21
8.7 Carrier Frequency Separation	21
8.8 Number of Hopping Frequencies	21
8.8 Average Time of Occupancy Test	22
8.9 Spectral Density Test	23
9. CONCLUSIONS	24

LIST OF APPENDICES

APPENDIX	TITLE
A	Laboratory Recognitions
B	Modifications to the EUT
C	Additional Models Covered Under This Report
D	Diagrams, Charts, and Photos <ul style="list-style-type: none">• Test Setup Diagrams• Radiated Emissions Photos• Antenna and Effective Gain Factors
E	Data Sheets

LIST OF FIGURES

FIGURE	TITLE
1	Conducted Emissions Test Setup
2	Plot Map And Layout of Test Site

GENERAL REPORT SUMMARY

This electromagnetic emission test report is generated by Compatible Electronics Inc., which is an independent testing and consulting firm. The test report is based on testing performed by Compatible Electronics personnel according to the measurement procedures described in the test specifications given below and in the "Test Procedures" section of this report.

The measurement data and conclusions appearing herein relate only to the sample tested and this report may not be reproduced without the written permission of Compatible Electronics, unless done so in full.

This report must not be used to claim product endorsement by NVLAP or any other agency of the U.S. Government.

Device Tested: Bluetooth Module
Model: BT260146
S/N: N/A

Product Description: See Expository Statement.

Modifications: The EUT was not modified during the testing.

Manufacturer: O'Neil Product Development
8 Mason
Irvine, California 92618-2705

Test Dates: March 1, 2, and 4, 2004

Test Specifications: EMI requirements
CFR Title 47, Part 15, Subpart B; and Subpart C, sections 15.205, 15.207, 15.209, and 15.247

Test Procedure: ANSI C63.4: 2001

Test Deviations: The test procedure was not deviated from during the testing.

SUMMARY OF TEST RESULTS

<i>TEST</i>	DESCRIPTION	RESULTS
1	Conducted RF Emissions, 150 kHz – 30 MHz	Complies with the Class B limits of CFR Title 47, Part 15 Subpart B; and the limits of CFR Title 47, Part 15, Subpart C, section 15.207
2	Spurious Radiated RF Emissions, 30 MHz – 1000 MHz	Complies with the Class B limits of CFR Title 47, Part 15 Subpart B; and the limits of CFR Title 47, Part 15, Subpart C, section 15.209
3	Spurious Radiated RF Emissions, 10 kHz – 30 MHz and 1000 MHz – 25000 MHz	Complies with the Class B limits of CFR Title 47, Part 15, Subpart B; and CFR Title 47, Part 15, Subpart C, section 15.247(c)
4	Fundamental and Emissions produced by the intentional radiator in non-restricted bands, 10 kHz – 25 GHz	Complies with the relevant requirements of CFR Title 47, Part 15, Subpart C, section 15.247(c)
5	Emissions produced by the intentional radiator in restricted bands, 10 kHz – 25 GHz	Complies with the relevant requirements of CFR Title 47, Part 15, Subpart C, section 15.205, 15.209(a), and section 15.247 (c)
6	20 dB Bandwidth	Complies with the relevant requirements of FCC Title 47, Part 15, Subpart C, section 15.247 (a)(1)
7	Peak Power Output	Complies with the relevant requirements of FCC Title 47, Part 15, Subpart C, section 15.247 (b)(1)
8	RF Conducted Antenna Test	Complies with the relevant requirements of FCC Title 47, Part 15, Subpart C, section 15.247 (c)
9	Channel Hopping Separation	Complies with the relevant requirements of CFR Title 47, Part 15, Subpart C, section 15.247 (a)(1) and 15.247 (a)(1)(iii)
10	Average Time of Occupancy	Complies with the relevant requirements of CFR Title 47, Part 15, Subpart C, section 15.247 (a)(1)(iii)
11	Peak Power Spectral Density from the Intentional Radiator to the Antenna	Complies with the relevant requirements of CFR Title 47, Part 15, Subpart C, section 15.247 (f)

1. PURPOSE

This document is a qualification test report based on the Electromagnetic Interference (EMI) tests performed on the Bluetooth Module Model: BT260146. The EMI measurements were performed according to the measurement procedure described in ANSI C63.4: 1992. The tests were performed in order to determine whether the electromagnetic emissions from the equipment under test, referred to as EUT hereafter, are within the Class B specification limits defined by CFR Title 47, Part 15, Subpart B; and Subpart C, sections 15.205, 15.207, 15.209, and 15.247.

Note: For the unintentional radiator portion of the test, the EUT was within the **Class B** specification limits defined by CFR Title 47, Part 15, Subpart B.

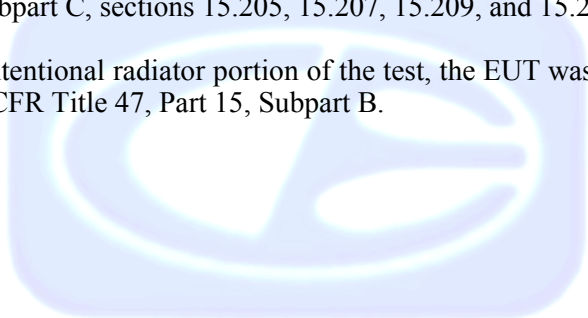

2. ADMINISTRATIVE DATA

2.1 Location of Testing

The EMI tests described herein were performed at the test facility of Compatible Electronics, 114 Olinda Drive, Brea, California 92823.

2.2 Traceability Statement

The calibration certificates of all test equipment used during the test are on file at the location of the test. The calibration is traceable to the National Institute of Standards and Technology (NIST).

2.3 Cognizant Personnel

O'Neil Product Development

Ken Carlson Director of Electrical Engineering

Compatible Electronics, Inc.

Kyle Fujimoto Test Engineer
Michael Christensen Senior Test Engineer

2.4 Date Test Sample was Received

The test sample was received on March 1, 2004.

2.5 Disposition of the Test Sample

The sample has not been returned to O'Neil Product Development as of March 22, 2004.

2.6 Abbreviations and Acronyms

The following abbreviations and acronyms may be used in this document.

RF	Radio Frequency
EMI	Electromagnetic Interference
EUT	Equipment Under Test
P/N	Part Number
S/N	Serial Number
HP	Hewlett Packard
ITE	Information Technology Equipment
CML	Corrected Meter Limit
LISN	Line Impedance Stabilization Network

3. APPLICABLE DOCUMENTS

The following documents are referenced or used in the preparation of this EMI Test Report.

SPEC	TITLE
FCC Title 47, Part 15 Subpart C	FCC Rules - Radio frequency devices (including digital devices) – Intentional Radiators
ANSI C63.4 2001	Methods of measurement of radio-noise emissions from low-voltage electrical and electronic equipment in the range of 9 kHz to 40 GHz
FCC Title 47, Part 15 Subpart B	FCC Rules - Radio frequency devices (including digital devices) – Unintentional Radiators

4. DESCRIPTION OF TEST CONFIGURATION

4.1 Description of Test Configuration - EMI

Setup and operation of the equipment under test.

Specifics of the EUT and Peripherals Tested

The Bluetooth Module Model: BT260146 (EUT) was directly connected to the modular board PCB. The modular board PCB was connected to an AC Adapter via its power port.

Operation of the EUT during the testing

For the intentional radiator portion of the test - The EUT used a program that locked one channel at a time so that the low, middle, and high channels could be tested. This allowed the EUT to be in a no hopping mode. The EUT was testing in three orthogonal axis. The carrier was modulated in the same way it would be when the EUT was in its normal frequency hopping mode. The EUT was investigated during the preliminary scans in DH1, DH3, and DH5 modes. The DH5 mode was found to be worst case.

For the unintentional radiator and conducted emission portion of the test - The EUT used a program that allowed the EUT to function as normal (the channels frequency hopping) on a continuous basis.

Note: The D-9 port on the modular board is a diagnostic port only. It was only connected whenever the channel needed to be changed and/or change modes on the EUT.

The final radiated as well as the conducted data was taken in the mode above. Please see Appendix E for the data sheets.

4.1.1 Cable Construction and Termination

Cable 1 This is a 6 foot unshielded cable connecting the modular board PCB to the AC Adapter. It has a 1/8 inch power connector at the modular board PCB end and is hard wired into the AC Adapter.

Cable 2 **(Only connected when changing channels, not during the actual test)** This is a 6 foot braid and foil shielded cable connecting the modular board PCB to the laptop. It has a D-25 pin metallic connector at each end. The shield of the cable was grounded to the chassis via the connectors.

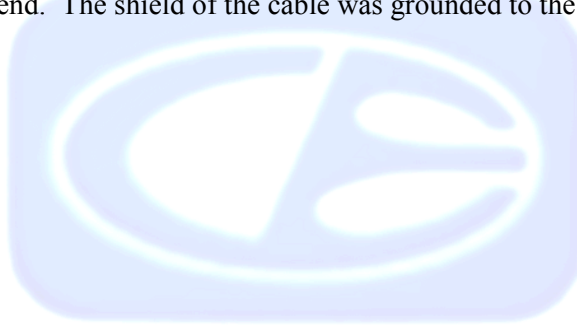

5. LISTS OF EUT, ACCESSORIES AND TEST EQUIPMENT**5.1 EUT and Accessory List**

EQUIPMENT	MANUFACTURER	MODEL NUMBER	SERIAL NUMBER	FCC ID
BLUETOOTH MODULE (EUT)	O'NEIL PRODUCT DEVELOPMENT	BT260146	N/A	LGYBT260146
AC ADAPTER	CUI STACK	DSA-0151F-05	N/A	N/A
POWER SUPPLY PCB	O'NEIL PRODUCT DEVELOPMENT	200-0054A	B160210022	N/A
LAPTOP	COMPAQ COMPUTER CORPORATION	1456VQL1N	1V98CLS9A1J1	DoC

5.2 EMI Test Equipment

EQUIPMENT TYPE	MANUFACTURER	MODEL NUMBER	SERIAL NUMBER	CAL. DATE	CAL. DUE DATE
Radiated Emissions Manual Test – Radiated	Compatible Electronics	N/A	N/A	N/A	N/A
Conducted Emissions Test Program	Compatible Electronics	N/A	N/A	N/A	N/A
Spectrum Analyzer – Main Section	Hewlett Packard	8566B	3638A08767	June 25, 2003	June 25, 2004
Spectrum Analyzer – Display Section	Hewlett Packard	85662A	3701A22262	June 25, 2003	June 25, 2004
Spectrum Analyzer – Quasi-Peak Adapter	Hewlett Packard	85650A	2811A01363	June 24, 2003	June 24, 2004
EMI Test Receiver	Rohde & Schwarz	ESIB40	100172	July 22, 2003	July 22, 2004
Preamplifier	Com Power	PA-103	1582	March 6, 2003	March 6, 2004
Biconical Antenna	Com Power	AB-900	15226	April 21, 2003	April 21, 2004
Log Periodic Antenna	Com Power	AL-100	16202	Feb. 18, 2004	Feb. 18, 2005
Computer	Hewlett Packard	D5251A 888	US74458128	N/A	N/A
Printer	Hewlett Packard	C5886A	SG7CM1P090	N/A	N/A
Monitor	Hewlett Packard	D5258A	DK74889705	N/A	N/A
Loop Antenna	Com-Power	AL-130	25310	June 4, 2003	June 4, 2004
Horn Antenna	Com Power	AH-118	71005	April 8, 2002	April 8, 2004
Microwave Preamplifier	Com-Power	PA-122	25196	March 4, 2004	March 4, 2005
Microwave Preamplifier	Com-Power	PA-840	711013	Mar. 6, 2002	Mar. 6, 2004
Horn Antenna	Com-Power	AH826	0071957	Nov. 5, 2003	Nov. 5, 2004

5.3 EMI Test Equipment (continued)

EQUIPMENT TYPE	MANU-FACTURER	MODEL NUMBER	SERIAL NUMBER	CAL. DATE	CAL. DUE DATE
Power Meter	Gigatronics	8541C	1836248	Jan. 13, 2003	Jan. 13, 2005
Power Sensor	Gigatronics	80401A	1830892	Jan. 13, 2003	Jan. 13, 2005
LISN	Com Power	LI-215	12090	Nov. 22, 2003	Nov. 22, 2004
LISN	Com Power	LI-215	12076	Nov. 22, 2003	Nov. 22, 2004
RF Attenuator	Weinschel Corp.	2	BJ6394	Aug. 7, 2003	Aug. 7, 2004

6. TEST SITE DESCRIPTION**6.1 Test Facility Description**

Please refer to section 2.1 and 7.1 of this report for EMI test location.

6.2 EUT Mounting, Bonding and Grounding

The EUT was mounted on a 1.0 by 1.5 meter non-conductive table 0.8 meters above the ground plane.

The EUT was not grounded.

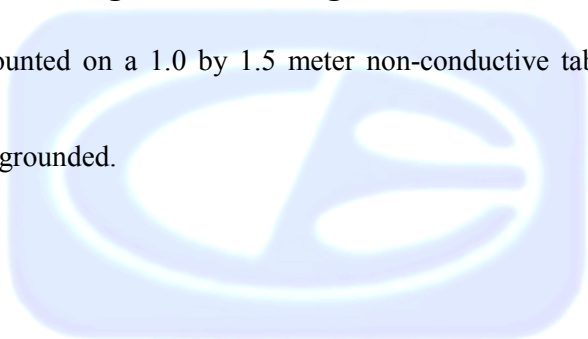

7. CHARACTERISTICS OF THE TRANSMITTER

7.1 Transmitter Power

Transmit power is herein defined as the power delivered to a 50 ohm load at the RF output of the EUT.

Power	Channel	Accuracy
1.7 dBm	LOW	+2/-2 dB
3.0 dBm	MIDDLE	+2/-2 dB
1.5 dBm	HIGH	+2/-2 dB

7.2 Channel Number and Frequencies

There are a total of 79 channels. The low channel is at 2402.0 MHz and the high channel is at 2480.0 MHz. There is a 1 MHz separation between channels.

Channel 1: 2402 MHz
Channel 2: 2403 MHz
(Etc.)

7.3 Antenna Gain

The antenna had a worst gain of -4.7 dBd in the YZ-plane. Thus, the antenna gain is -2.55 dBi. (Antenna gain in dBi = Antenna gain in dBd + 2.15)

8. TEST PROCEDURES

The following sections describe the test methods and the specifications for the tests. Test results are also included in this section.

8.1 RF Emissions

8.1.1 Conducted Emissions Test

The spectrum analyzer was used as a measuring meter. The data was collected with the spectrum analyzer in the peak detect mode with the "Max Hold" feature activated. The quasi-peak was used only where indicated in the data sheets. A 10 dB attenuation pad was used for the protection of the spectrum analyzer input stage, and the offset was adjusted accordingly to read the actual data measured. The LISN output was measured using the spectrum analyzer. The output of the second LISN was terminated by a 50 ohm termination. The effective measurement bandwidth used for this test was 9 kHz.

Please see section 6.2 of this report for mounting, bonding and grounding of the EUT. The EUT was powered through the LISN, which was bonded to the ground plane. The LISN power was filtered and the filter was bonded to the ground plane. The EUT was set up with the minimum distances from any conductive surfaces as specified in ANSI C63.4: 2001. The excess power cord was wrapped in a figure eight pattern to form a bundle not exceeding 0.4 meters in length.

The conducted emissions from the EUT were maximized for operating mode as well as cable placement. The final data was collected under program control by the Compatible Electronics conducted emissions software in several overlapping sweeps by running the spectrum analyzer at a minimum scan rate of 10 seconds per octave. The final qualification data is located in Appendix E.

Test Results:

The EUT complies with the **Class B** limits of CFR Title 47, Part 15, Subpart B; and the limits of CFR Title 47, Part 15, Subpart C, Section 15.207 for conducted emissions.

8.1.2 Radiated Emissions (Spurious and Harmonics) Test

The spectrum analyzer and EMI Receiver were used as a measuring meter along with the quasi-peak adapter. Amplifiers were used to increase the sensitivity of the instrument. The Com Power Preamplifier Model: PA-103 was used for frequencies from 30 MHz to 1 GHz, the Com Power Microwave Preamplifier Model: PA-122 was used for frequencies above 1 GHz, and the Com Power Microwave Preamplifier Model: PA-840 was used for frequencies above 18 GHz. The spectrum analyzer was used in the peak detect mode with the "Max Hold" feature activated. In this mode, the spectrum analyzer records the highest measured reading over all the sweeps.

The quasi-peak adapter was used only for those readings which are marked accordingly on the data sheets.

The frequencies above 1 GHz were averaged manually by narrowing the video filter down to 10 Hz and putting the sweep time on AUTO on the spectrum analyzer to keep the amplitude reading calibrated.

After the readings above 1 GHz were average manually, the reading was further adjusted by a "duty cycle correction factor", derived from $20 \log(\text{dwell time} / 100 \text{ ms})$. Since the duty cycle was below 10%, the maximum allowed 20 dB was subtracted from the peak reading. The duty cycle correction factor is explained in Appendix E.

The measurement bandwidths and transducers used for the radiated emissions test were:

FREQUENCY RANGE	EFFECTIVE MEASUREMENT BANDWIDTH	TRANSDUCER
10 kHz to 150 kHz	200 Hz	Active Loop Antenna
150 kHz to 30 MHz	9 kHz	Active Loop Antenna
30 MHz to 300 MHz	120 kHz	Biconical Antenna
300 MHz to 1 GHz	120 kHz	Log Periodic Antenna
1 GHz to 25 GHz	1 MHz	Horn Antenna

The open field test site of Compatible Electronics, Inc. was used for radiated emission testing. This test site is set up according to ANSI C63.4: 2001. Please see section 6.2 of this report for mounting, bonding and grounding of the EUT. The turntable supporting the EUT is remote controlled using a motor. The turntable permits EUT rotation of 360 degrees in order to maximize emissions. Also, the antenna mast allows height variation of the antenna from 1 meter to 4 meters. Data was collected in the worst case (highest emission) configuration of the EUT by the Radiated Emission Manual Test software. At each reading, the EUT was rotated 360 degrees and the antenna height was varied from 1 to 4 meters (for E field radiated field strength). The gunsight method was used when measuring with the horn antenna in order to ensure accurate results.

Radiated Emissions (Spurious and Harmonics) Test (con't)

The presence of ambient signals was verified by turning the EUT off. In case an ambient signal was detected, the measurement bandwidth was reduced temporarily and verification was made that an additional adjacent peak did not exist. This ensures that the ambient signal does not hide any emissions from the EUT. The EUT was tested at a 3 meter test distance from 10 kHz to 25 GHz to obtain the final test data.

Test Results:

The EUT complies with the **Class B** limits of CFR Title 47, Part 15, Subpart B; and the limits of CFR Title 47, Part 15, Subpart C, Sections 15.209 and 15.247 for radiated emissions.

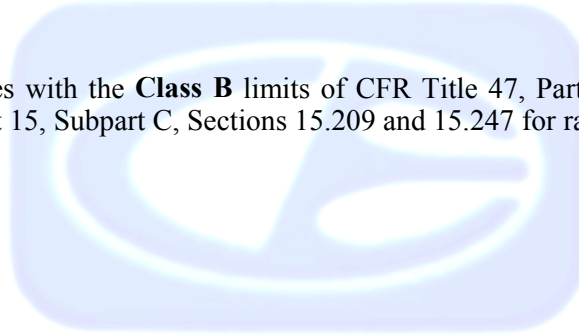

8.3 20 dB Bandwidth

The 20 dB Bandwidth was measured using the EMI Receiver. The bandwidth was measured using a direct connection from the RF output of the EUT. The resolution bandwidth was 100 kHz and the video bandwidth was 300 kHz.

Test Results:

The EUT complies with the relevant requirements of FCC Title 47, Part 15, Subpart C section 15.247 (a)(1). The 20 dB bandwidth is less than the separation between channels. Please see the data sheets located in Appendix E.

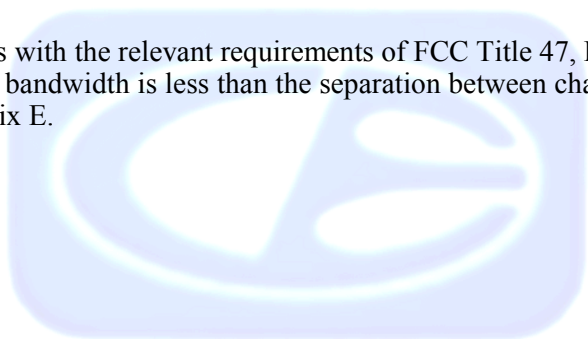

8.4 Peak Output Power

The Peak Output Power was measured using the power meter and power sensor. The EUT was directly connected to the power sensor, which was directly connected to the power meter. The Peak Output Power was then measured.

Test Results:

The EUT complies with the relevant requirements of FCC Title 47, Part 15, Subpart C section 15.247 (b)(1). The maximum peak output power is less than 1 watt. Please see the results in section 7.1 of this test report.

8.5 RF Antenna Conducted Test

The RF antenna conducted test was performed using the EMI Receiver. The RF antenna conducted test measured using a direct connection from the RF out on the EUT into the input of the EMI Receiver. The resolution bandwidth was 100 kHz, and the video bandwidth was 300 kHz. The spans were wide enough to include all the harmonics and emissions that were produced by the intentional radiator.

Test Results:

The EUT complies with the relevant requirements of FCC Title 47, Part 15, Subpart C section 15.247 (c). The RF power that is produced by the intentional radiator is at least 20 dB below that in the 100 kHz bandwidth within the band that contains the highest level of desired power. Please see the radiated emission data sheets located in Appendix E.

8.6 RF Band Edges

The RF band edges were taken at the edges of the ISM spectrum (2400 MHz when the EUT was on the low channel and 2483.5 MHz when the EUT was on the high channel) using the spectrum analyzer. A preamplifier was used to boost the signal level, with the plots being taken at a 3 meter test distance. The frequencies below 2390 MHz were also averaged manually by narrowing the video filter down to 10 Hz and putting the sweep time on AUTO on the spectrum analyzer to keep the amplitude reading calibrated. A data sheet is also included, which compares the reading from the spectrum analyzer to the spec limit. The EUT was tested in DH5 mode, which is the worst case.

Test Results:

The EUT complies with the relevant requirements of FCC Title 47, Part 15, Subpart C section 15.247 (c). The RF power at the band edges at 2400 MHz and 2483.5 MHz meet the limits of section 15.209. Please see the data sheets located in Appendix E.

8.7 Carrier Frequency Separation

The Channel Hopping Separation Test was measured using the spectrum analyzer. The EUT was operating in its normal operating mode. The resolution bandwidth was 100 kHz, and the video bandwidth 100 kHz. The frequency span was wide enough to include the peaks of two adjacent channels.

Test Results:

The EUT complies with the relevant requirements of FCC Title 47, Part 15, Subpart C section 15.247 (a)(1) and 15.247 (a)(1)(iii). The Channel Hopping Separation is greater than the 20 dB bandwidth. Please see the data sheets located in Appendix D.

8.8 Number of Hopping Frequencies

The Channel Hopping Separation Test was measured using the spectrum analyzer. The EUT was operating in its normal operating mode. The resolution bandwidth was 1 MHz, and the video bandwidth 1 MHz. The frequency span was wide enough to include all of the peaks in the frequency band of operation.

Test Results:

The EUT complies with the relevant requirements of FCC Title 47, Part 15, Subpart C section 15.247 (a)(1) and 15.247 (a)(1)(iii). The number of hopping frequencies is 79. Please see the data sheets located in Appendix E.

8.8 Average Time of Occupancy Test

The Average Time of Occupancy Test was measured using the EMI Receiver. The EUT was operating in normal operating mode. The frequency span was taken to 0 Hz with a sweep time of 20 msec to determine the time for each transmission. The EUT was tested in DH1, DH3, and DH5 modes.

The average time of occupancy on any channel shall not be greater than 0.4 seconds within a period of 0.4 seconds multiplied by the number of hopping channels employed. This means the time of occupancy of any one channel cannot be greater than 0.4 seconds in a 31.6 second period (0.4 seconds * 79 channels).

For DH1 mode, the sweep time was then changed to 11 seconds and the number of pulses taken. The number of pulses was multiplied by 2.8727 to determine the number of pulses in a 31.6 second period. The number of pulses was then multiplied by the time for each pulse to determine the average time of occupancy.

For DH3 mode, the sweep time was then changed to 11 seconds and the number of pulses taken. The number of pulses was then multiplied by 2.8727 to determine the number of pulses in a 31.6 second period. The number of pulses was then multiplied by the time for each pulse to determine the average time of occupancy.

For DH5 mode, the sweep time was then changed to 11 seconds and the number of pulses taken. The number of pulses was then multiplied by 2.8727 to determine the number of pulses in a 31.6 second period. The number of pulses was then multiplied by the time for each pulse to determine the average time of occupancy.

Test Results:

The EUT complies with the relevant requirements of FCC Title 47, Part 15, Subpart C section 15.247 (a)(1)(iii). The EUT does not transmit for more than 400 msec in a 31.6 second period on any frequency. Please see the data sheets located in Appendix E.

9. CONCLUSIONS

The Bluetooth Module meets all of the specification limits defined in FCC Title 47, Part 15, Subpart C, sections 15.205, 15.207, 15.209, and 15.247.

Note: For the unintentional radiator portion of the test, the EUT was within the **Class B** specification limits defined by CFR Title 47, Part 15, Subpart B.



APPENDIX A

LABORATORY RECOGNITIONS

Brea Division
114 Olinda Drive
Brea, CA 92823
(714) 579-0500

Agoura Division
2337 Troutdale Drive
Agoura, CA 91301
(818) 597-0600

Silverado Division
19121 El Toro Road
Silverado, CA 92676
(949) 589-0700

Lake Forest Division
20621 Pascal Way
Lake Forest, CA 92630
(949) 587-0400

LABORATORY RECOGNITIONS

Compatible Electronics has the following agency accreditations:

National Voluntary Laboratory Accreditation Program - Lab Code: 200528-0

Voluntary Control Council for Interference - Registration Numbers: R-983, C-1026, R-984 and C-1027

Bureau of Standards and Metrology Inspection - Reference Number: SL2-IN-E-1031

Conformity Assessment Body for the EMC Directive Under the US/EU MRA Appointed by NIST

Compatible Electronics is recognized or on file with the following agencies:

Federal Communications Commission

Industry Canada

Radio-Frequency Technologies (Competent Body)



APPENDIX B

MODIFICATIONS TO THE EUT

MODIFICATIONS TO THE EUT

The modifications listed below were made to the EUT to pass FCC 15.247 specifications.

All the rework described below was implemented during the test in a method that could be reproduced in all the units by the manufacturer.

No modifications were made to the EUT during the testing.

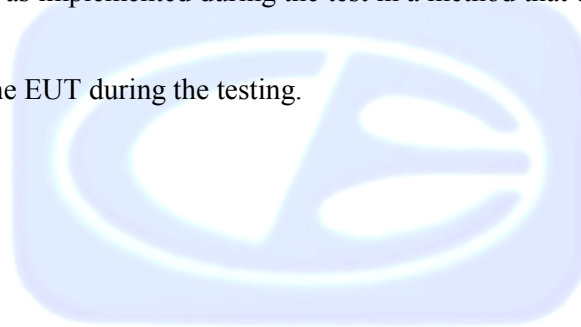



APPENDIX C

***ADDITIONAL MODELS COVERED
UNDER THIS REPORT***

Brea Division
114 Olinda Drive
Brea, CA 92823
(714) 579-0500

Agoura Division
2337 Troutdale Drive
Agoura, CA 91301
(818) 597-0600

Silverado Division
19121 El Toro Road
Silverado, CA 92676
(949) 589-0700

Lake Forest Division
20621 Pascal Way
Lake Forest, CA 92630
(949) 587-0400

ADDITIONAL MODELS COVERED UNDER THIS REPORT

USED FOR THE PRIMARY TEST

Bluetooth Module
Model: BT260146
S/N: N/A

There were no additional models covered under this report.



APPENDIX D

DIAGRAMS, CHARTS, AND PHOTOS

FIGURE 1: CONDUCTED EMISSIONS TEST SETUP

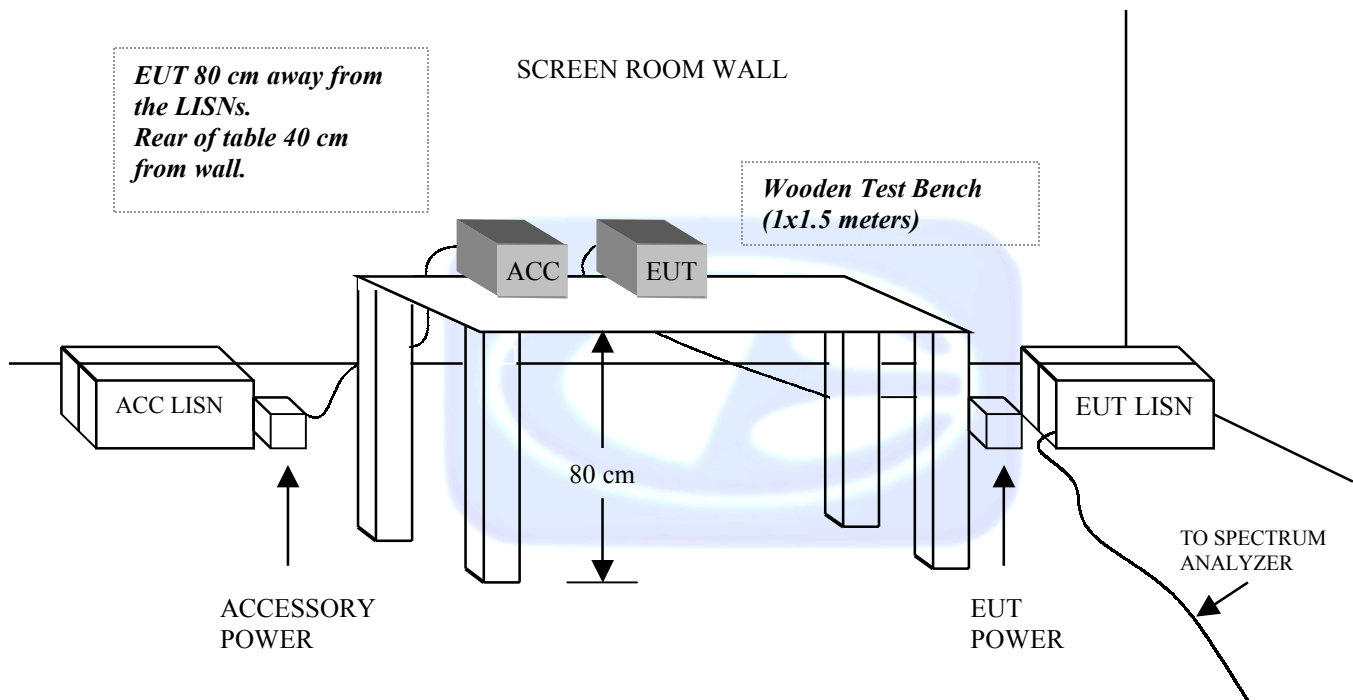
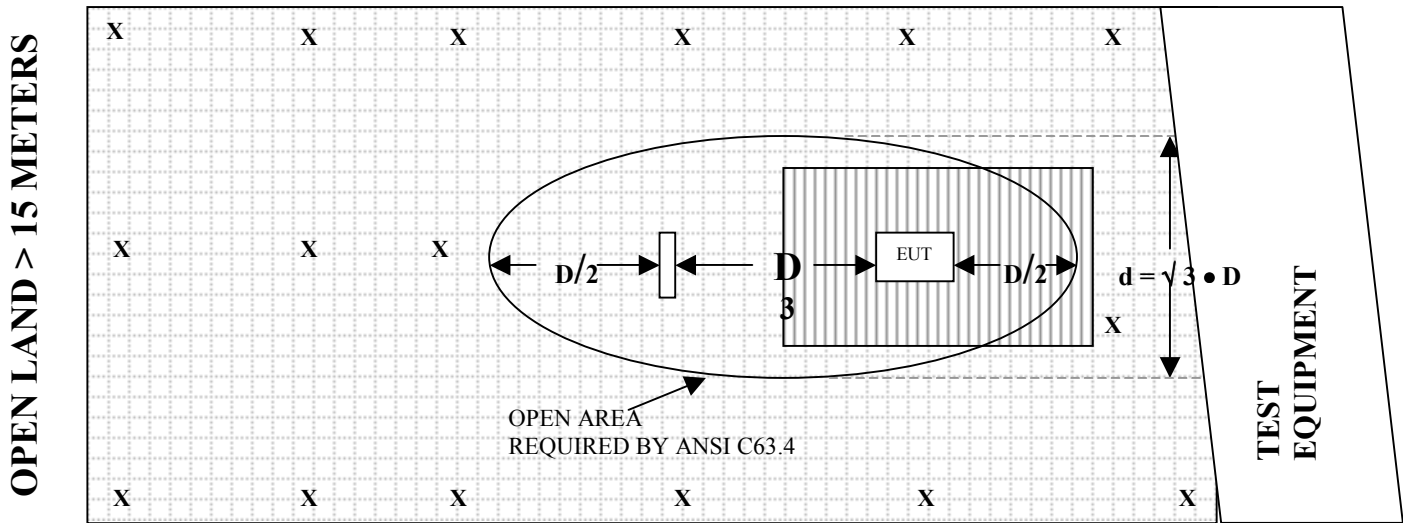

FIGURE 2: PLOT MAP AND LAYOUT OF RADIATED SITE

OPEN LAND > 15 METERS



OPEN LAND > 15 METERS

- | | | | |
|----------|--------------------------|--|-----------------|
| X | = GROUND RODS | | = GROUND SCREEN |
| D | = TEST DISTANCE (meters) | | = WOOD COVER |

COM-POWER AB-900**BICONICAL ANTENNA**

S/N: 15226

CALIBRATION DATE: APRIL 21, 2003

FREQUENCY (MHz)	FACTOR (dB)	FREQUENCY (MHz)	FACTOR (dB)
30	11.20	120	13.80
35	10.40	125	12.50
40	10.20	140	12.50
45	11.00	150	10.90
50	11.30	160	11.50
60	9.60	175	14.90
70	7.40	180	15.50
80	6.10	200	16.90
90	7.70	250	15.50
100	10.50	300	23.80

COM-POWER AL-100**LOG PERIODIC ANTENNA**

S/N: 16202

CALIBRATION DATE: FEBRUARY 18, 2004

FREQUENCY (MHz)	FACTOR (dB)	FREQUENCY (MHz)	FACTOR (dB)
300	12.90	700	19.60
400	14.40	800	21.80
500	17.40	900	20.50
600	18.90	1000	22.70

COM-POWER PA-103**PREAMPLIFIER**

S/N: 1582

CALIBRATION DATE: MARCH 6, 2003

FREQUENCY (MHz)	FACTOR (dB)	FREQUENCY (MHz)	FACTOR (dB)
30	33.6	300	33.3
40	33.6	350	33.3
50	33.6	400	33.1
60	33.6	450	33.0
70	33.5	500	32.9
80	33.5	550	33.0
90	33.5	600	32.8
100	33.6	650	32.6
125	33.6	700	32.7
150	33.4	750	32.4
175	33.5	800	32.4
200	33.4	850	32.7
225	33.3	900	31.9
250	33.2	950	31.8
275	33.3	1000	32.5

COM-POWER PA-122**MICROWAVE PREAMPLIFIER**

S/N: 25196

CALIBRATION DATE: MARCH 4, 2004

FREQUENCY (GHz)	FACTOR (dB)	FREQUENCY (GHz)	FACTOR (dB)
1.0	32.1	9.5	29.9
1.1	32.0	10.0	29.3
1.2	31.8	11.0	28.5
1.3	31.6	12.0	30.5
1.4	31.5	13.0	31.1
1.5	31.4	14.0	29.9
1.6	31.2	15.0	29.8
1.7	31.0	16.0	29.1
1.8	30.8	17.0	28.0
1.9	30.7	18.0	26.0
2.0	30.5		
2.5	30.0		
3.0	29.7		
3.5	29.2		
4.0	28.6		
4.5	28.4		
5.0	28.3		
5.5	28.5		
6.0	28.9		
6.5	29.3		
7.0	29.7		
7.5	29.8		
8.0	29.9		
8.5	30.2		
9.0	30.3		

COM POWER AH-118**HORN ANTENNA**

S/N: 71005

CALIBRATION DATE: JANUARY 16, 2004

FREQUENCY (GHz)	FACTOR (dB)	FREQUENCY (GHz)	FACTOR (dB)
1.0	25.4	9.5	38.8
1.5	28.2	10.0	39.8
2.0	31.0	10.5	41.2
2.5	31.6	11.0	39.7
3.0	32.2	11.5	44.7
3.5	32.6	12.0	45.5
4.0	33.6	12.5	42.6
4.5	35.2	13.0	40.1
5.0	35.5	13.5	40.0
5.5	36.7	14.0	41.1
6.0	35.8	14.5	13.3
6.5	36.5	15.0	47.0
7.0	38.7	15.5	45.7
7.5	40.9	16.0	44.2
8.0	40.3	16.5	47.0
8.5	40.4	17.0	45.4
9.0	40.0	17.5	48.0
		18.0	44.0

COM-POWER AL-130**LOOP ANTENNA**

S/N: 25310

CALIBRATION DATE: JUNE 4, 2003

FREQUENCY (MHz)	MAGNETIC (dB/m)	ELECTRIC (dB/m)
0.009	-41.2	10.3
0.01	-41.3	10.2
0.02	-42.3	9.2
0.05	-42.5	9.0
0.07	-42.3	9.2
0.1	-42.5	9.0
0.2	-44.6	6.9
0.3	-42.1	9.4
0.5	-42.4	9.1
0.7	-42.1	9.4
1	-41.5	10.0
2	-41.0	10.5
3	-41.3	10.2
4	-41.3	10.2
5	-40.9	10.6
10	-41.6	9.9
15	-42.1	9.4
20	-42.2	9.3
25	-42.7	8.8
30	-44.3	7.2

COM-POWER AH826**HORN ANTENNA**

S/N: 0071957

CALIBRATION DATE: NOVEMBER 05, 2003

FREQUENCY (GHz)	FACTOR (dB)	FREQUENCY (GHz)	FACTOR (dB)
18.0	33.3	22.5	32.9
18.5	32.9	23.0	33.0
19.0	32.7	23.5	33.6
19.5	32.6	24.0	33.6
20.0	32.7	24.5	33.5
20.5	33.0	25.0	33.5
21.0	33.0	25.5	33.7
21.5	33.2	26.0	34.1
22.0	32.9	26.5	34.5

COM-POWER PA-840**MICROWAVE PREAMPLIFIER**

S/N: 711013

CALIBRATION DATE: MARCH 06, 2002

FREQUENCY (GHz)	FACTOR (dB)	FREQUENCY (GHz)	FACTOR (dB)
18.0	26.4	30.0	27.6
19.0	25.4	31.0	27.3
20.0	24.5	32.0	26.9
21.0	23.9	33.0	26.7
22.0	24.0	34.0	27.0
23.0	24.4	35.0	25.9
24.0	25.2	36.0	25.5
25.0	26.1	37.0	26.2
26.0	26.6	38.0	25.6
27.0	27.2	39.0	23.4
28.0	27.4	40.0	24.3
29.0	27.5		



FRONT VIEW

O'NEIL PRODUCT DEVELOPMENT
BLUETOOTH MODULE
MODEL: BT260146

FCC SUBPART B AND C - RADIATED EMISSIONS – 03-01-04

**PHOTOGRAPH SHOWING THE EUT CONFIGURATION
FOR MAXIMUM EMISSIONS**

Brea Division
114 Olinda Drive
Brea, CA 92823
(714) 579-0500

Agoura Division
2337 Troutdale Drive
Agoura, CA 91301
(818) 597-0600

Silverado Division
19121 El Toro Road
Silverado, CA 92676
(949) 589-0700

Lake Forest Division
20621 Pascal Way
Lake Forest, CA 92630
(949) 587-0400



REAR VIEW

O'NEIL PRODUCT DEVELOPMENT
BLUETOOTH MODULE
MODEL: BT260146

FCC SUBPART B AND C - RADIATED EMISSIONS – 03-01-04

**PHOTOGRAPH SHOWING THE EUT CONFIGURATION
FOR MAXIMUM EMISSIONS**

Brea Division
114 Olinda Drive
Brea, CA 92823
(714) 579-0500

Agoura Division
2337 Troutdale Drive
Agoura, CA 91301
(818) 597-0600

Silverado Division
19121 El Toro Road
Silverado, CA 92676
(949) 589-0700

Lake Forest Division
20621 Pascal Way
Lake Forest, CA 92630
(949) 587-0400



FRONT VIEW

O'NEIL PRODUCT DEVELOPMENT
BLUETOOTH MODULE
MODEL: BT260146

FCC SUBPART B AND C - RADIATED EMISSIONS – 03-04-04

**PHOTOGRAPH SHOWING THE EUT CONFIGURATION
FOR MAXIMUM EMISSIONS**

Brea Division
114 Olinda Drive
Brea, CA 92823
(714) 579-0500

Agoura Division
2337 Troutdale Drive
Agoura, CA 91301
(818) 597-0600

Silverado Division
19121 El Toro Road
Silverado, CA 92676
(949) 589-0700

Lake Forest Division
20621 Pascal Way
Lake Forest, CA 92630
(949) 587-0400

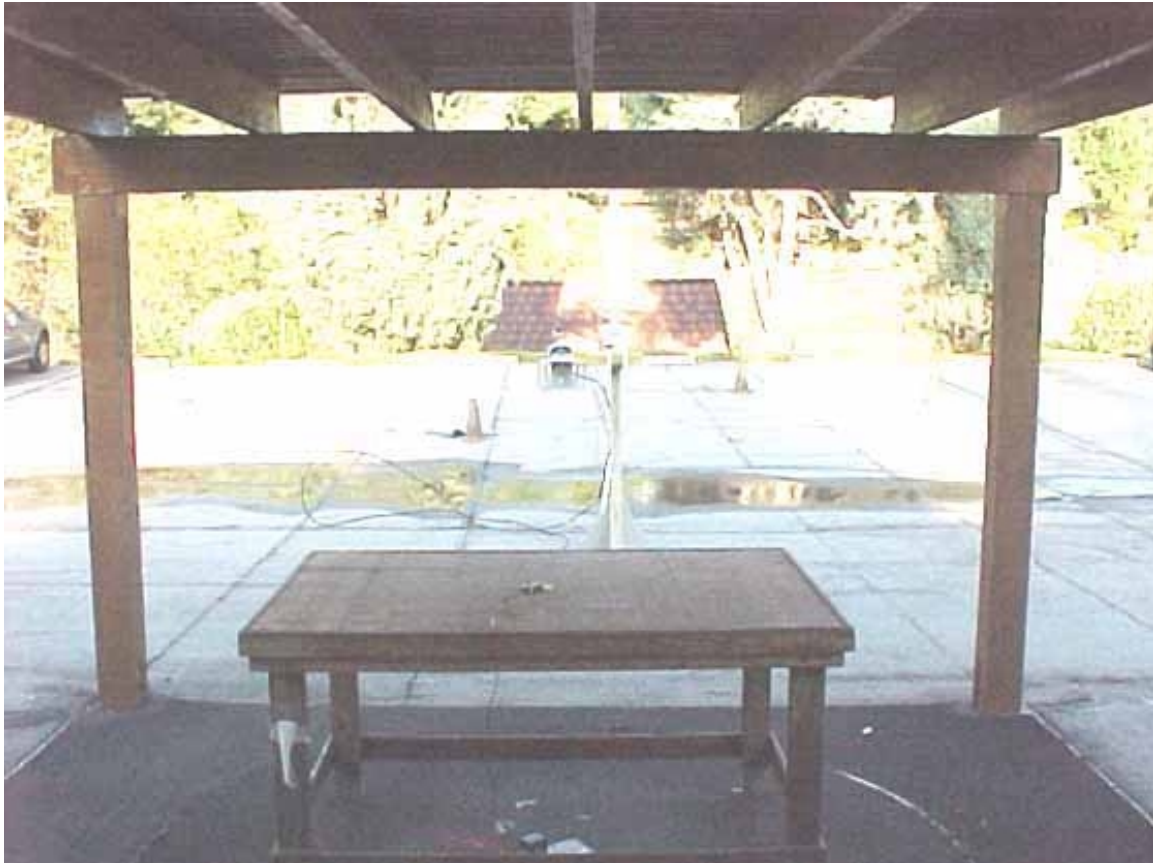

REAR VIEW

O'NEIL PRODUCT DEVELOPMENT
BLUETOOTH MODULE
MODEL: BT260146

FCC SUBPART B AND C - RADIATED EMISSIONS – 03-04-04

**PHOTOGRAPH SHOWING THE EUT CONFIGURATION
FOR MAXIMUM EMISSIONS**



FRONT VIEW

O'NEIL PRODUCT DEVELOPMENT
BLUETOOTH MODULE
MODEL: BT260146

FCC SUBPART B AND C - RADIATED EMISSIONS – 03-04-04

**PHOTOGRAPH SHOWING THE EUT CONFIGURATION
FOR MAXIMUM EMISSIONS**

Brea Division
114 Olinda Drive
Brea, CA 92823
(714) 579-0500

Agoura Division
2337 Troutdale Drive
Agoura, CA 91301
(818) 597-0600

Silverado Division
19121 El Toro Road
Silverado, CA 92676
(949) 589-0700

Lake Forest Division
20621 Pascal Way
Lake Forest, CA 92630
(949) 587-0400



REAR VIEW

O'NEIL PRODUCT DEVELOPMENT
BLUETOOTH MODULE
MODEL: BT260146

FCC SUBPART B AND C - CONDUCTED EMISSIONS – 03-01-04

**PHOTOGRAPH SHOWING THE EUT CONFIGURATION
FOR MAXIMUM EMISSIONS**