

EXHIBIT 3

Report Of Measurement

Includes sample calculations, block diagrams, photographs of test configurations and properly signed and dated report.

TEST RESULT SUMMARY

EUROPEAN STANDARD EN 55011: 1991

Group 1 Class B Limit

FCC PART 15, SUBPART C, SECTION 15.209

MANUFACTURER'S NAME	Medtronic - Neurological Division
NAME OF EQUIPMENT	Patient Programmer with Internal Antenna - Patient Programmer with 7440 External Antenna tested for FCC 15.209 only
MODEL NUMBER	7435 & 7436
MANUFACTURER'S ADDRESS	800 53rd Avenue NE Minneapolis MN 55421-9811
TEST REPORT NUMBER	W8147
TEST DATE	01 April 1998

According to testing performed at TÜV Product Service Inc, the above-mentioned unit with internal antenna is in compliance with the electromagnetic compatibility requirements defined in European Standard EN 55011. The above-mentioned unit meets the requirements of FCC Part 15, Section 15.209 with internal or external antenna.

It is the manufacturer's responsibility to assure that additional production units of this model are manufactured with identical electrical and mechanical characteristics. Any modifications necessary for compliance made during testing on the above mentioned date(s) must be implemented in all production units for compliance to be maintained.

TÜV Product Service Inc, as an independent testing laboratory, declares that the equipment tested as specified above conforms to the requirements of European Standard EN 55011: "Limits and Methods of Measurement of Radio Interference Characteristics of Industrial, Scientific and Medical (ISM) Equipment" and FCC Part 15, Section 15.209.

Date: 15 May 1998

Location: Taylors Falls MN
USA

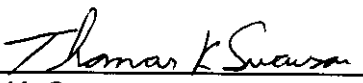
 T. K. Swanson
 Test Technician

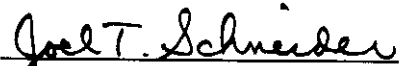
 J.T. Schneider
 Site Manager

EMC EMISSION - TEST REPORT

Test Report File No. : **W371814701** Date of issue: 15 May 1998

Model / Serial No. : 7435 & 7436 / QUL0000P

Product Type : Patient Programmer with Internal Antenna - Patient Programmer with 7440 External Antenna tested for FCC 15.209 only

Applicant : Medtronic - Neurological Division

Manufacturer : Medtronic - Neurological Division

License holder : Medtronic - Neurological Division

Address : 800 53rd Avenue NE
 : Minneapolis MN 55421-9811

Test Result : **Positive** **Negative**

Test Project Number Reference(s) : W8147

Total pages including Appendices : 35

TÜV Product Service Inc is a subcontractor to TÜV Product Service, GmbH according to the principles outlined in ISO/IEC Guide 25 and EN 45001.

TÜV Product Service Inc reports apply only to the specific samples tested under stated test conditions. It is the manufacturer's responsibility to assure that additional production units of this model are manufactured with identical electrical and mechanical components. TÜV Product Service Inc shall have no liability for any deductions, inferences or generalizations drawn by the client or others from TÜV Product Service Inc issued reports.

This report is the confidential property of the client. As a mutual protection to our clients, the public and ourselves, extracts from the test report shall not be reproduced except in full without our written approval. This report shall not be used by the client to claim product endorsement by NVLAP or any agency of the US government.

TÜV Product Service Inc and its professional staff hold government and professional organization certifications and are members of AAMI, ACIL, AEA, ANSI, IEEE, NVLAP, and VCCI

DIRECTORY - EMISSIONS

		Page(s)
A) Documentation		
Test report		<u>1 - 10</u>
Directory		<u>2</u>
Test Regulations		<u>3</u>
Deviations from standard / Summary		<u>10</u>
Test-setups (Photos)		<u>11 - 12</u>
Test-setup (drawing)		<u>Appendix A</u>
B) Test data		
Conducted emissions	10/150 kHz - 30 MHz	<u>5, 9</u>
Radiated emissions	10 kHz - 30 MHz	<u>5, 9</u>
Radiated emissions	30 MHz - 1000 MHz	<u>6, 9</u>
Interference power	30 MHz - 300 MHz	<u>6, 9</u>
Equivalent Radiated emissions	1 GHz - 18 GHz	<u>7, 9</u>
C) Appendix A		
Test Data Sheets and Test Setup Drawing(s)		<u>A2 - A11</u>
D) Appendix B		
Constructional Data Form		<u>B2</u>
Product Information Form		<u>B3 - B10</u>
E) Appendix C		
Measurement Protocol		<u>C1 - C2</u>

EMISSIONS TEST REGULATIONS :

The emissions tests were performed according to following regulations:

- | | | |
|------------------------------------------------------------------|-------------------------------------------------------------|-----------------------------------------------|
| <input type="checkbox"/> - EN 50081-1 / 1992 | <input checked="" type="checkbox"/> - Group 1 | <input type="checkbox"/> - Group 2 |
| <input checked="" type="checkbox"/> - EN 55011 / 1991 | <input type="checkbox"/> - Class A | <input checked="" type="checkbox"/> - Class B |
| <input type="checkbox"/> - EN 55013 / 1990 | <input type="checkbox"/> - Household appliances and similar | |
| <input type="checkbox"/> - EN 55014 / 1987 | <input type="checkbox"/> - Portable tools | |
| | <input type="checkbox"/> - Semiconductor devices | |
| <input type="checkbox"/> - EN 55014 / A2:1990 | <input type="checkbox"/> - Household appliances and similar | |
| <input type="checkbox"/> - EN 55014 / 1993 | <input type="checkbox"/> - Portable tools | |
| | <input type="checkbox"/> - Semiconductor devices | |
| <input type="checkbox"/> - EN 55015 / 1987 | | |
| <input type="checkbox"/> - EN 55015 / A1:1990 | | |
| <input type="checkbox"/> - EN 55015 / 1993 | | |
| <input type="checkbox"/> - EN 55022 / 1987 | <input type="checkbox"/> - Class A | <input type="checkbox"/> - Class B |
| <input checked="" type="checkbox"/> - EN 55022 / 1994 | <input type="checkbox"/> - Class A | <input checked="" type="checkbox"/> - Class B |
| <input type="checkbox"/> - BS | | |
| <input type="checkbox"/> - VCCI | <input type="checkbox"/> - Class A | <input type="checkbox"/> - Class B |
| <input checked="" type="checkbox"/> - FCC Part 15 Section 15.209 | | |
| <input type="checkbox"/> - AS 3548 (1992) | <input type="checkbox"/> - Class A | <input type="checkbox"/> - Class B |
| <input checked="" type="checkbox"/> - CISPR 11 (1990) | <input checked="" type="checkbox"/> - Group 1 | <input type="checkbox"/> - Group 2 |
| | <input type="checkbox"/> - Class A | <input checked="" type="checkbox"/> - Class B |
| <input checked="" type="checkbox"/> - CISPR 22 (1993) | <input type="checkbox"/> - Class A | <input checked="" type="checkbox"/> - Class B |

Environmental conditions in the lab:

	<u>Actual</u>
Temperature	: 23 °C
Relative Humidity	: 36 %
Atmospheric pressure	: 99.3 kPa
Power supply system	: battery

Sign Explanations:

- not applicable
- applicable

Emissions Test Conditions: CONDUCTED EMISSIONS (Interference Voltage)

The **CONDUCTED EMISSIONS (INTERFERENCE VOLTAGE)** measurements were performed at the following test location:

- Test not applicable

- Wild River Lab Large Test Site (Open Area Test Site)
- Wild River Lab Small Test Site (Open Area Test Site)
- Oakwood Lab (Open Area Test Site)
- Wild River Lab Screen Room
- New Brighton Lab Shielded Room

Test equipment used :

Model Number	Manufacturer	Description	Serial Number	Cal Date
--------------	--------------	-------------	---------------	----------

Emissions Test Conditions: RADIATED EMISSIONS (9 kHz - 30 MHz)

The **RADIATED EMISSIONS** measurements were performed at the following test location:

- Wild River Lab Large Test Site (Open Area Test Site)
- Wild River Lab Small Test Site (Open Area Test Site)
- Oakwood Lab (Open Area Test Site)

at a test distance of :

- 3 meters
- 10 meters

- Test not applicable

Test equipment used :

Model Number	Manufacturer	Description	Serial Number	Cal Date
<input checked="" type="checkbox"/> - HFH2-Z2	Polarad	Loop Antenna	879285/036	6-97
<input checked="" type="checkbox"/> - ESH-3	Rohde & Schwarz	EMI Receiver	892473/004	4-97

Use of the calibrated equipment on this list ensures traceability to national and international standards.

Emissions Test Conditions: RADIATED EMISSIONS (Electric Field)

The *RADIATED EMISSIONS (ELECTRIC FIELD)* measurements, in the frequency range of 30 MHz-1000 MHz, were tested in a horizontal and vertical polarization at the following test location :

- Test not applicable

- Wild River Lab Large Test Site (Open Area Test Site)
- Wild River Lab Small Test Site (Open Area Test Site)
- Oakwood Lab (Open Area Test Site)

at a test distance of :

- 3 meters
- 10 meters
- 30 meters

Test equipment used :

Model Number	Manufacturer	Description	Serial Number	Cal Date
■ - 3146	Electro-Mechanics (EMCO)	Log Periodic Antenna	9103-3075	7-97
■ - 3108	Electro-Mechanics (EMCO)	Biconical Antenna	2118	7-97
■ - 8566B	Hewlett-Packard	Spectrum Analyzer	2430A00930	4-98
■ - 85662A	Hewlett-Packard	Analyzer Display	2403A08134	4-98
■ - 85650A	Hewlett-Packard	Quasi-Peak Adapter	2521A01006	4-98
■ - ZHL-1042J	Mini-Circuits	Preamplifier	H081396-16	4-97

Use of the calibrated equipment on this list ensures traceability to national and international standards.

Emissions Test Conditions: INTERFERENCE POWER

The *INTERFERENCE POWER* measurements were performed by using the absorbing clamp on the mains and interface cables in the frequency range 30 MHz - 300 MHz at the following test location :

- Test not applicable

- Wild River Lab Large Test Site (Open Area Test Site)
- Wild River Lab Small Test Site (Open Area Test Site)
- Oakwood Lab (Open Area Test Site)
- Wild River Lab Screen Room
- New Brighton Lab Shielded Room

Test equipment used :

Model Number	Manufacturer	Description	Serial Number	Cal Date
--------------	--------------	-------------	---------------	----------

Emissions Test Conditions: RADIATED EMISSIONS (Electric Field)

The *EQUIVALENT RADIATED EMISSIONS* measurements in the frequency range 1 GHz - 18 GHz were performed in a horizontal and vertical polarization at the following test location :

- Wild River Lab Large Test Site (Open Area Test Site)
- Wild River Lab Small Test Site (Open Area Test Site)
- Oakwood Lab (Open Area Test Site)
- Wild River Lab Screen Room

at a test distance of:

- 1 meters
- 3 meters
- 10 meters

 - Test not applicable

Test equipment used :

	Model Number	Manufacturer	Description	Serial Number	Cal Date
■ -	3115	Electro-Mechanics (EMCO)	Horn Antenna	9001-3275	6-97
■ -	8566B	Hewlett-Packard	Spectrum Analyzer	2430A00930	4-98
■ -	85662A	Hewlett-Packard	Analyzer Display	2403A08134	4-98
■ -	85650A	Hewlett-Packard	Quasi-Peak Adapter	2521A01006	4-98
■ -	AWT-18037	Avantek	Preamplifier	1001-9226	4-97

Use of the calibrated equipment on this list ensures traceability to national and international standards.

Equipment Under Test (EUT) Test Operation Mode - Emission tests :

The device under test was operated under the following conditions during emissions testing:

- Standby
- Test program (H - Pattern)
- Test program (color bar)
- Test program (customer specific)
- Practice operation
- Normal Operating Mode
- Single command programming - one downlink transmission per key press. Scroll mode - one downlink transmission per 0.5 seconds.

Configuration of the device under test:

- See Constructional Data Form in Appendix B - Page B2
- See Product Information Form in Appendix B - beginning on Page B3

The following peripheral devices and interface cables were connected during the measurement:

- | | |
|----------------------------------|--------------|
| <input type="checkbox"/> - _____ | Type : _____ |
| <input type="checkbox"/> - _____ | Type : _____ |
| <input type="checkbox"/> - _____ | Type : _____ |
| <input type="checkbox"/> - _____ | Type : _____ |
| <input type="checkbox"/> - _____ | Type : _____ |
| <input type="checkbox"/> - _____ | Type : _____ |
| <input type="checkbox"/> - _____ | Type : _____ |
| <input type="checkbox"/> - _____ | Type : _____ |

- unshielded power cable

- unshielded cables

- shielded cables

MPS.No.: _____

- customer specific cables

- _____

- _____

Emission Test Results:

Conducted emissions 10/150 kHz - 30 MHz

The requirements are - MET - NOT MET
 Minimum limit margin _____ dB at _____ kHz
 Maximum limit exceeding _____ dB at _____ MHz
 Remarks: _____

Radiated emissions 10 kHz - 30 MHz (FCC Section 15.209)

The requirements are - MET - NOT MET
 Minimum limit margin _____ 7 dB at _____ 525.0 kHz
 Maximum limit exceeding _____ dB at _____ MHz
 Remarks: _____

Radiated emissions (electric field) 30 MHz - 1000 MHz

The requirements are - MET - NOT MET
 Minimum limit margin _____ >10 dB at _____ MHz
 Maximum limit exceeding _____ dB at _____ MHz
 Remarks: _____

Interference Power at the mains and interface cables 30 MHz - 300 MHz

The requirements are - MET - NOT MET
 Minimum limit margin _____ dB at _____ MHz
 Maximum limit exceeding _____ dB at _____ MHz
 Remarks: _____

Equivalent Radiated emissions 1 GHz - 18 GHz

The requirements are - MET - NOT MET
 Minimum limit margin _____ >10 dB at _____ MHz
 Maximum limit exceeding _____ dB at _____ MHz
 Remarks: No signals detected above the noise level in the 11.7-12.7 GHz range.

DEVIATIONS FROM STANDARD:

None.

GENERAL REMARKS:

The programmer with internal antenna was tested for conformance to CISPR 11 Group 1 Class B and FCC Part 15 Section 15.209. The programmer with external antenna was tested for conformance to FCC Part 15 Section 15.209 only at this time. The Model 7436 is identical to the Model 7435 in all aspects except for the model number itself and the manufacturer's brand names for the two different models.

SUMMARY:

The requirements according to the technical regulations are

- met

- not met.

The device under test does

- fulfill the general approval requirements mentioned on page 3.

- not fulfill the general approval requirements mentioned on page 3.

Testing Start Date: 01 April 1998

Testing End Date: 01 April 1998

- TÜV PRODUCT SERVICE INC -

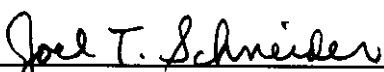

J. T. Schneider
Site Manager



Tested By:
T. K. Swanson

Test-setup photo(s):

Conducted emission 10/150 kHz - 30 MHz

The pictures of the test setups were erroneously labelled W8157. They are in actuality the test setup photographs for the equipment tested as W8147.

Not Applicable

FCC ID: LF57434



PRODUCT SERVICE

Appendix A

Test Data Sheets

and

Test Setup Drawing(s)

TEST SETUP FOR EMISSIONS TESTING

WILD RIVER LAB
 Large Test Site

Notes:

1. Items shown in dotted lines are located on the floor below the test area. It is 5 meters vertically from the ground floor to the test area.
2. 50 Hz, 60 Hz, and 400 Hz are power panels for alternating current.
3. The antenna may be positioned horizontally 3, 10 or 30 meters from the center of the turntable.
4. The circle is a 6.7 meter diameter turntable.
5. A ground plane is in the plane of this sheet.
6. The test sample is shown in the azimuthal position representing zero degrees.

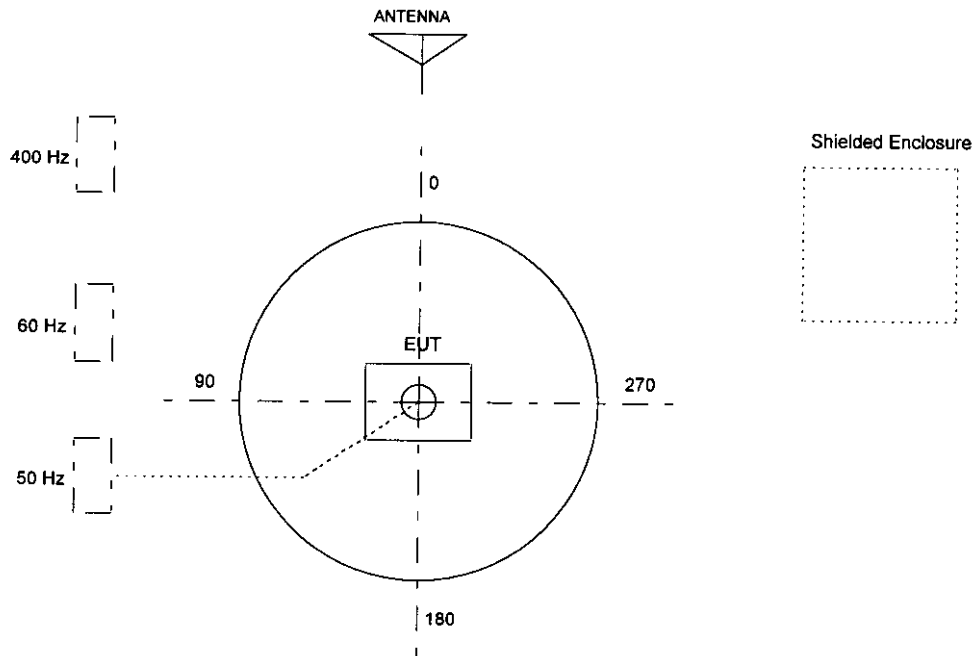

REPORT #W8147
RUN 3

TUV PRODUCT SERVICE
RADIATED EMISSIONS AT 10 METERS
MEDTRONIC NEUROLOGICAL MODEL 7435 PATIENT PROGRAMMER
INTERNAL ANTENNA CONFIGURATION

04-01-98

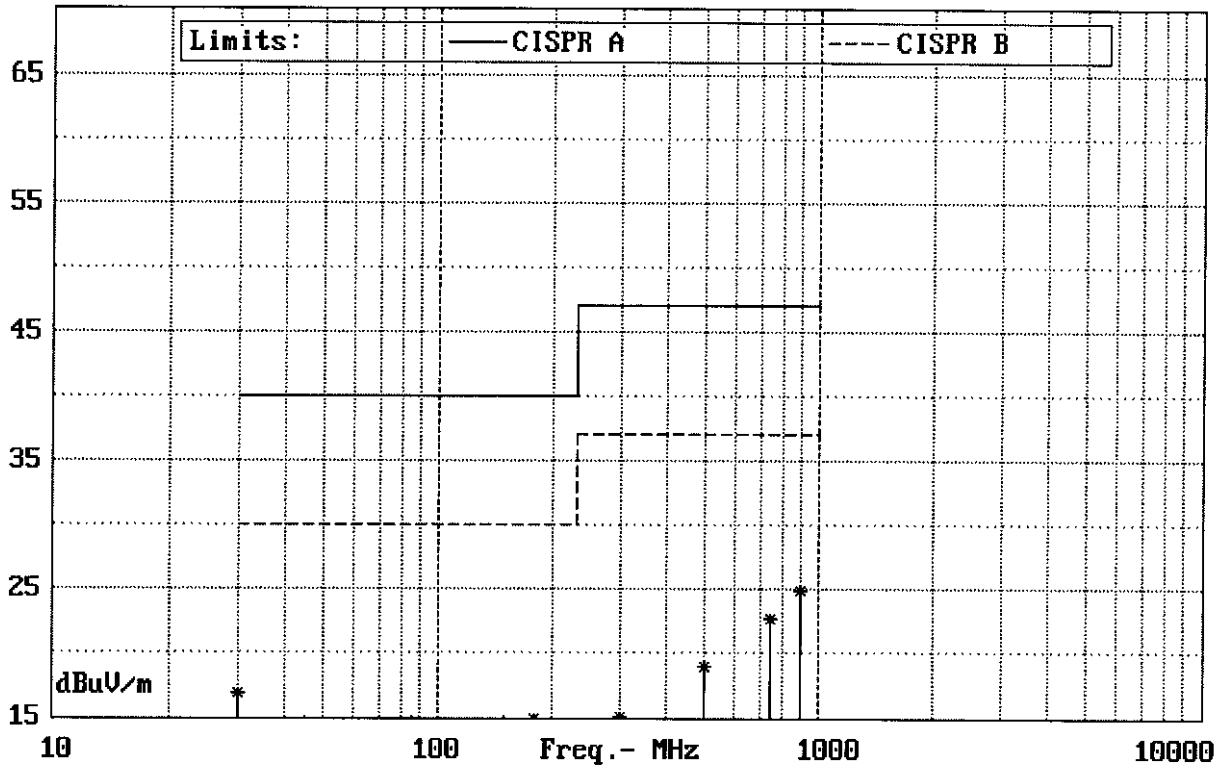

T U V P R O D U C T S E R V I C E

RADIATED EMISSIONS

Large Test Site
 10 Meter Antenna Distance
 Equipment Under Test:
 MEDTRONIC NEUROLOGICAL
 MODEL 7435 PATIENT PROGRAMMER
 Notes: INTERNAL ANTENNA CONFIGURATION

Report W8147 Run 3
 Date 04-01-98 Page 1
 Engineer _____
 Tech: TKS TKS
 Requester _____

Frequency MHz	Level dBuV	Factor dB	Cable dB	Final dBuV/m	Az deg	Polar\ Height	Delta CISPR B	Delta CISPR A
------------------	---------------	--------------	-------------	-----------------	-----------	------------------	------------------	------------------

0 DEGREES - ANTENNA 1 METER HIGH

NO SIGNIFICANT EMISSIONS DETECTED 30 TO 200 MHZ

NOISE FLOOR MEASUREMENTS

30	2.35	13.6	.9	16.9	--	V --	-13.1	-23.1
45	1.05	11.9	.8	13.8	--	V --	-16.2	-26.2
85	1.2	7.7	1.2	10.1	--	V --	-19.9	-29.9
150	-1.23	12.6	1.7	13	--	V --	-17	-27
180	0	12.9	1.9	14.8	--	V --	-15.2	-25.2
300	-1.32	14.3	2.1	15	--	V --	-22	-32
500	-1.84	18.4	2.3	18.9	--	V --	-18.1	-28.1
750	-2.06	21.1	3.6	22.7	--	V --	-14.3	-24.3
900	-2.18	23	4	24.8	--	V --	-12.2	-22.2

NO SIGNIFICANT EMISSIONS DETECTED 30 TO 1000 MHZ - VERTICAL OR HORIZONTAL
 END OF SCAN 30 TO 1000 MHZ

T U V P R O D U C T S E R V I C E

RADIATED EMISSIONS

Large Test Site
 10 Meter Antenna Distance
 Equipment Under Test:
 MEDTRONIC NEUROLOGICAL
 MODEL 7435 PATIENT PROGRAMMER
 Notes: INTERNAL ANTENNA CONFIGURATION

Figure _____

Report W8147 Run 3
 Date 04-01-98 Page 2
 Engineer _____
 Tech: TKS _____
 Requester _____

 Measurement Summary

Frequency MHz	----- Final dBuV/m	----- uV/m	Azimuth deg	Polar\ Height	Delta CISPR B	Delta CISPR A
30	16.9	6.9984	--	V --	-13.1	-23.1
45	13.8	4.8977	--	V --	-16.2	-26.2
85	10.1	3.1988	--	V --	-19.9	-29.9
150	13	4.4668	--	V --	-17	-27
180	14.8	5.4954	--	V --	-15.2	-25.2
300	15	5.6234	--	V --	-22	-32
500	18.9	8.8104	--	V --	-18.1	-28.1
750	22.7	13.645	--	V --	-14.3	-24.3
900	24.8	17.378	--	V --	-12.2	-22.2

Minimum Passing Margin for CISPR B is 12.2 dB at 900 MHz
 Minimum Passing Margin for CISPR A is 22.2 dB at 900 MHz

File W8147 Run 3

REPORT #W8147

RUN 2

TUV PS

FIGURE _____

RADIATED EMISSIONS AT 10 METERS DATE 04-01-98

MEDTRONIC NEUROLOGICAL MODEL 7435 PATIENT PROGRAMMER

internal antenna configuration - transmitting

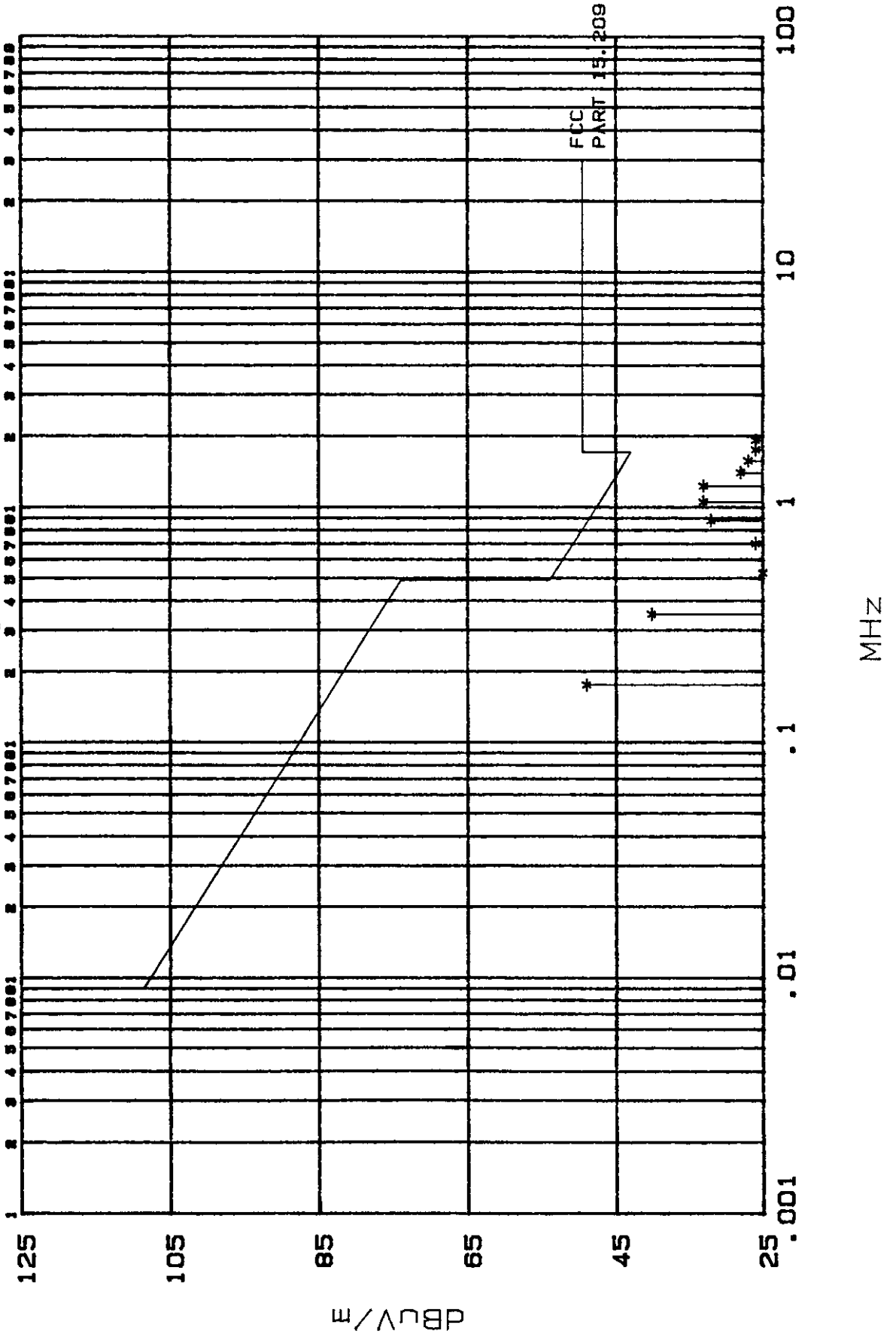

A

TUV PS

Figure _____

RADIATED EMISSIONS AT 10 METERS
 MEDTRONIC NEUROLOGICAL MODEL 7435 PATIENT PROGRAMMER
 internal antenna configuration - transmitting

Report W8147 Run 2
 Date: 04-01-98 Page 1
 Engineer _____
 Tech _____

Measurement Summary

DELTA
 FCC
 PART 15.209

Frequency (MHz)	Amplitude (dBuV/m)	DELTA FCC PART 15.209
0.1750	49	-33
0.3500	40	-36
0.5250	25	-28
0.7000	26	-24
0.8750	32	-16
1.0500	33	-14
1.2250	33	-12
1.4000	28	-16
1.5700	27	-16
1.7500	26	-23
1.9200	26	-23

Minimum Passing Margin for FCC PART 15.209 is 12 dB at 1.2 MHz

File W8147 Run 2

Form



~~Radiated Power~~ Mag Field

TEST REPORT # W8197

REQUIREMENT FCC Pt 15

DATE ~~3~~ 4-1-98

RECEIVER ESH 3

PRODUCT ID: Model 7435 Patient Programmer
with internal antenna

~~ABSORBING~~ Polarad
~~CLAMP~~ Loop

SHEET _____ OF _____

TEST FREQ (MHz)			Condition 1		Condition 2		Condition 3		REMARKS
	Distance	Factor *	dBuV	dBpW	dBuV	dBpW	dBuV	dBpW	
			<u>3 m</u>		<u>10 m</u>				
<u>.175</u>	<u>3m</u>		<u>57</u>		<u>49</u>				<u>Average</u>
<u>.35</u>	<u>↓</u>		<u>38</u>		<u>40</u>				<u>↓</u>
<u>.535</u>	<u>↓</u>		<u>55</u>		<u>25</u>				<u>Quasi-Peak</u>
<u>.7</u>	<u>↓</u>		<u>35</u>		<u>26</u>				<u>↓</u>
<u>.875</u>	<u>↓</u>		<u>46</u>		<u>32</u>				<u>↓</u>
<u>1.05</u>	<u>↓</u>		<u>32</u>		<u>33</u>				<u>↓</u>
<u>1.225</u>	<u>↓</u>		<u>33</u>		<u>33</u>				<u>↓</u>
<u>1.40</u>	<u>↓</u>		<u>33</u>		<u>28</u>				<u>↓</u>
<u>1.57</u>	<u>↓</u>		<u>28</u>		<u>27</u>				<u>↓</u>
<u>1.75</u>	<u>↓</u>		<u>26</u>		<u>26</u>				<u>↓</u>
<u>1.92</u>	<u>↓</u>		<u>26</u>						<u>↓</u>
			<u>J. K. Swanson</u>						

* Factor: Absorbing Clamp and Cable Loss

Condition1 3 Meter antenna

Condition2 10 Meter antenna

Condition3 _____

Tested By TKS Results (Pass / Fail)

TUV Product Service
1775 Old Hwy 8
New Brighton, MN 55112
Telephone: (612)-631-2487

EMRADPOW.DOC
Author: D.S. Carlson
Released:
Page 1 of 1

REPORT #W8147
RUN 3

TUV PS

FIGURE _____

RADIATED EMISSIONS AT 10 METERS DATE 04-01-98

MEDTRONIC NEUROLOGICAL MODEL 7435 PATIENT PROGRAMMER

external antenna configuration - transmitting

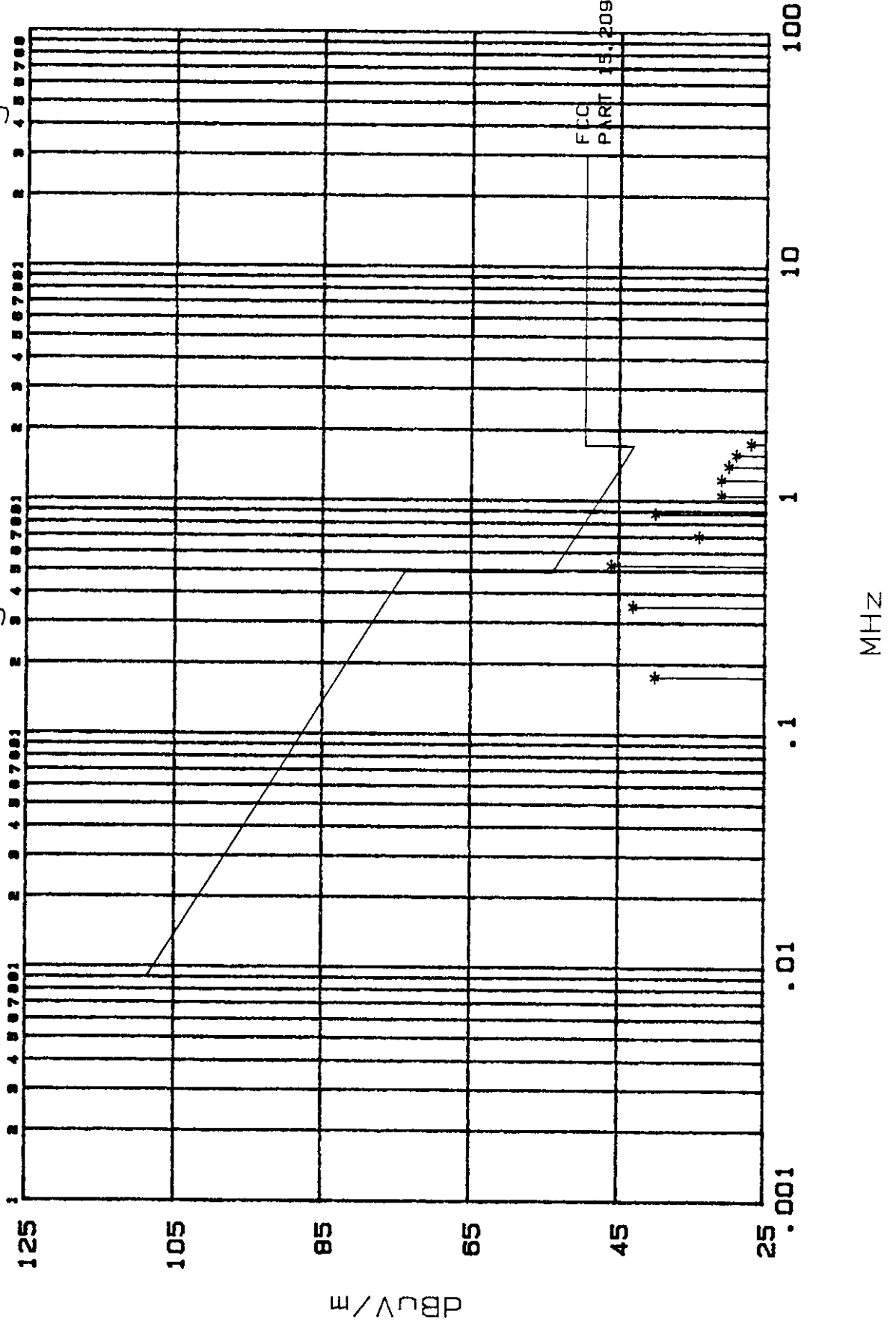

A

TUV PS

Figure _____

RADIATED EMISSIONS AT 10 METERS
 MEDTRONIC NEUROLOGICAL MODEL 7435 PATIENT PROGRAMMER
 external antenna configuration - transmitting

Report W8147 Run 3
 Date: 04-01-98 Page 1
 Engineer _____
 Tech _____

Measurement Summary

Frequency (MHz)	Amplitude (dBuV/m)	DELTA FCC PART 15.209
0.1750	40	-42
0.3500	43	-33
0.5250	46	-7
0.7000	34	-16
0.8750	40	-8
1.0500	31	-16
1.2250	31	-14
1.4000	30	-14
1.5700	29	-14
1.7500	27	-22

Minimum Passing Margin for FCC PART 15.209 is 7 dB at .525 MHz

File W8147 Run 3

Form



Radiated Power

TEST REPORT # W8197

REQUIREMENT FCC Pt 15

DATE 4-1-98

RECEIVER ESH3

PRODUCT ID: Model 7435 Patient Programmer
with external 7440 Antenna

ABSORBING CLAMP Polarad Loop

SHEET OF

TEST FREQ (MHz)			Condition 1		Condition 2		Condition 3		REMARKS
	Distance	Factor *	dBuV	dBpW	dBuV	dBpW	dBuV	dBpW	
.175	<u>3</u>		50		40				Average ↓ Quasi-Peak ↓ ↓
.35			36		43				
.525			71		46				
.7			34		34				
.875			60		40				
1.05			31		31				
1.225			40		31				
1.4			35		30				
1.57			31		29				
1.75			26		27				
<i>J.K. Swanson</i>									

* Factor: Absorbing Clamp and Cable Loss

Condition1 3 Meter antenna

Condition2 10 " "

Condition3

Tested By JKS Results (Pass / Fail)

TUV Product Service
1775 Old Hwy 8
New Brighton, MN 55112
Telephone: (612)-631-2487

EMRADPOW.DOC
Author: D.S. Carlson
Released:
Page 1 of 1

FCC ID: LF57434



PRODUCT SERVICE

Appendix B

Constructional Data Form

and

Product Information Form(s)

FCC ID: LF57434



PRODUCT SERVICE

Constructional Data Form

Not Applicable



PRODUCT INFORMATION FORM

NOTE: It is required to complete both 1) a Product Information Form for each unit under test and 2) a Constructional Data Form for each system tested as outlined in the enclosed instructions.

*** Please show the exact spelling [including spacing, capitalization, etc] as you want shown on the After Test Documentation.**

*Company Name Medtronic

*Company Address 800 53rd Ave N.E.
Minneapolis, MN 55421-9811
USA

Customer Representatives John Grevious

*Equipment Description Patient Programmer

*Model Number 7435 *Serial Number QUL0000 P

- Type of Test
- Development
 - Initial Design Verification
 - Design Change (Please describe exact changes below)
 - Production Sample (Audit Test)
 -

Changes Made none

Oscillator Frequencies : 20MHz ; 32kHz

Power Interface	<u>A</u>	Power Supply	<u>NA</u>
Frequency	_____	Description	_____
Voltage	_____	Manufacturer	_____
# of Phases	_____	Model Number	_____
Current	_____	Switching Freq	_____

- Power Cable NA
- Hardwired
 - Shielded
 - Attached
 - Flexible
 - Unshielded
 - Removable

Power Line Filter NA
Manufacturer _____ Model Number _____

Cabinet Shielding Provision

Partial sprayed nickel shield on lower case half.

Software and/or Operating Modes

*Single Command Programming - one downlink transmission per Key Press.
 Scroll Mode - one downlink transmission per 0.5 second.*

Interfacing Equipment or Simulators

Description	Model Number	Serial Number	FCC ID#
<i>none</i>			

I/O Cables

Function	Length (meters)	Shielded	Analog/Digital	Active During Test
<i>External Antenna (7440)</i>	<i>1.22</i>	<i>Y (N)</i>	<i>(A) D</i>	<i>(Y) N</i>
		<i>Y N</i>	<i>A D</i>	<i>Y N</i>
		<i>Y N</i>	<i>A D</i>	<i>Y N</i>
		<i>Y N</i>	<i>A D</i>	<i>Y N</i>
		<i>Y N</i>	<i>A D</i>	<i>Y N</i>
		<i>Y N</i>	<i>A D</i>	<i>Y N</i>

Block Diagram

Internal Antenna Conf.

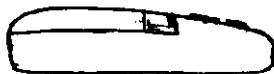

External Antenna Conf.

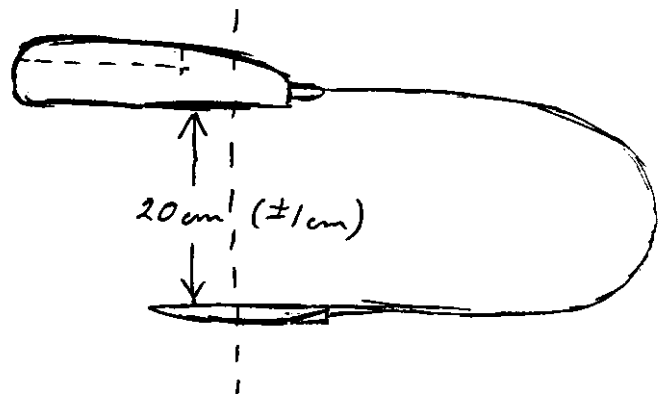

** For these drawings the Horizontal Plane is represented by the surface of this page.*

TEST PLAN**Medtronic**  **NEUROLOGICAL DIVISION**Medtronic Confidential
Declassification Review Date PermanentPREPARED BY: RITA PATRIAS
DATE: MARCH 19, 1998
DOCUMENT/FILE NO.: 1111-98-66
PAGE 1 OF DRAFT7**TITLE: MODEL 7435 EMC TEST PLAN DRAFT**

AUTHOR, Reliability

APPROVAL, Dave Lee, Mechanical
DesignAPPROVAL, John Grevious,
Electrical DesignAPPROVAL, Kevin Kelly, Project
manager

DISTRIBUTION: STEVE AHCAN, N240 LISA PRITCHARD, N245 LYNN SWITZER, N240

1.0 PURPOSE

This document describes the testing to be performed by a certified testing authority (e.g.: TUV Product Services) to demonstrate model 7435 Patient Programmer Electromagnetic Compatibility (EMC) compliance for Europe and compliance to FCC Part 15 (intentional radiators) for U.S. The model 7435 Patient Programmer is part of the Dual Channel Itrel (DCI) system.

2.0 SCOPE

This test plan covers EMC testing of the completed 7435 device as the DUT (Device Under Test) configured for operation using the internal antenna, and as a DUT configured with the external model 7440 antenna. The model 7440 antenna is available in several lengths. Testing will be performed with the longest length offered (48 cm) which is generally the worst case for EMC.

3.0 SAMPLE SIZE

A minimum of one 7435 Patient Programmer and one model 7440 external antenna is required for this testing. All samples will be built per documented manufacturing procedures and serialized or marked in a manner such that each can be distinguished from one another.

TEST PLAN

Medtronic  NEUROLOGICAL DIVISION

 FILE NO.: 1111-98-66
 PAGE 2 OF DRAFT7

Medtronic Confidential

Declassification Review Date Permanent

4.0 APPLICABLE DOCUMENTS

The following documents are referenced to the extent listed within this plan.

TITLE	NUMBER	Applicable To:
Product Specification - DCI Patient Programmer, 7435	083710, Rev E	DUT functional requirements
Active Implantable Medical Devices	EN 45502-1:1997	European EMC safety requirements
Medical electrical equipment Part 1: General requirements for safety 2. Collateral standard: Electromagnetic compatibility - requirements and tests (EU adaptation of IEC 601-1-2)	EN 60601-1-2	referenced by EN 45502-1:1997
Electromagnetic compatibility for industrial-process measurement and control equipment, part 2: Electrostatic discharge requirements	EN 60801-2	referenced by EN 45502-1:1997 for ESD testing
Electromagnetic Compatibility Radiated Susceptibility	IEC 801-3	EMC radiated susceptibility
Limits and Methods of Measurement of Electromagnetic Disturbance Characteristics of ISM Radio Frequency Equipment	EN 55011(CISPR11)	emissions testing: Europe
	IEC 601-1-2, tbd	-referenced by CISPR11 for Class B -apply to internal antenna operation.
	IEC 601-1-2, 36.201.1.8	-referenced by CISPR11 for Class A. -apply to external antenna operation.
FCC Radio Frequency Devices Emissions	FCC Part 15 (Intentional radiator)	emissions testing: U.S. -apply to Internal and External antenna operation.

5.0 TEST PROCEDURE

Any deviations from this test plan are to be discussed with Medtronic design or reliability engineer prior to implementation.

5.1 EMC SUSCEPTIBLY

Objective: To demonstrate compliance of the 7435 to the EMC susceptibility requirements of EN 45502-1 (IEC 801-3) when configured with and without the external antenna.

Sample: One 7435. One 48 inch 7440 antenna. One IPG (7427 or 7428), programmed per Table 1.

Procedure: Test per IEC 801-3. Test the 7435 in both configurations:

Internal Antenna Configuration -- 7435 alone, without the 7440

External Antenna Configuration -- with the 7440 connected

TEST PLAN

Medtronic  NEUROLOGICAL DIVISION

Medtronic Confidential

Declassification Review Date Permanent
 FILE NO.: 1111-98-66
 PAGE 3 OF DRAFT7

For all test conditions, place the graphics surface of the IPG parallel to the applicable programmer antenna surface (flat surface of 7440; label surface of 7435) and separated by 5.0 cm (+1.0 cm/ -0.0 cm). Orient the devices such that the IPG antenna axis and the programmer antenna axis are coaxial within 1 cm. The orientation of the DUT/IPG system configuration under evaluation to the radiation fields is determined and documented by the certified testing authority. As the DUT is exposed to the electromagnetic radiation signals, alternately press the ON and OFF keys using pneumatic actuators or other non-conductive connection. Verify DUT functionality by monitoring the IPG output using an oscilloscope and observing the 7435 LED's. Record any deviation from the following DUT responses:

When the OFF button is pushed, verify the following:

- a) IPG output switches off.
- b) the IPG OFF LED of the 7435 is lit.
- c) the IPG ON LED is not lit.

When the ON button is pushed, verify the following:

- a) IPG output switches on.
- b) the IPG ON LED of the 7435 is lit .
- c) the IPG OFF LED is not lit.

Requirement: The programmer, utilizing either antenna, can turn the IPG OFF when subjected to the radiation test. Reference product specification section 7.9.

Table 1 - IPG Test Parameters

PARAMETER	VALUE	PARAMETER	VALUE
Rate	85 pps	CH1 Amplitude Lower Limit	0 V
Rate Upper Limit	+ 30 pps tracking	CH2 Amplitude Lower Limit	0 V
Rate Lower Limit	1.0 pps	Output	On
CH1 Pulse Width	210 μ sec	Mode	Sequence By Pulse, Continuous
CH2 Pulse Width	210 μ sec	Softstart/Stop	Off
CH1 & CH2 Pulse Width Upper Limit	+ 30 μ sec tracking	Reed Switch (7428 only)	Enabled (7428 only)
CH1 Pulse Width Lower Limit	60 μ sec		
CH2 Pulse Width Lower Limit	60 μ sec	CH1 Electrodes	#0 Negative, #3 Positive, all others Open
CH1 Amplitude	3.0 V	CH1 Case	Open

TEST PLAN

Medtronic  NEUROLOGICAL DIVISION

Medtronic Confidential

Declassification Review Date Permanent

FILE NO.: 1111-98-66

PAGE 4 OF

DRAFT7

PARAMETER	VALUE	PARAMETER	VALUE
CH2 Amplitude	3.0 V	CH2 Electrodes	#4 Negative, #7 Positive, all others Open
CH1 & CH2 Amplitude Upper Limit	+ 3 V tracking	CH2 Case	Open

5.2 EMISSIONS

Objective: Demonstrate conformance to FCC Part 15 (intentional radiator) Class B requirements. Demonstrate conformance to emissions requirements of EN 45502-1 (CISPR11 Class B Group 1) for internal antenna configuration. Demonstrate conformance to emissions requirements of EN 45502-1 (CISPR11 Class A Group 1) for external antenna configuration. (Reference 601-1-2, section 36.201.1.7 for class A rationale.)

Sample: One 7435. One 7440 antenna (cable length: 48 cm).

Procedure: Test per FCC Part 15, Class B requirements and per CISPR11. Test the 7435 in both configurations:

Internal Antenna Configuration -- 7435 alone, without the 7440

External Antenna Configuration -- with the 7440 connected

For the external antenna configuration, position the antenna 25 ± 5 cm away from and parallel to the 7435 label (note: cable positioned in a U-shape). This orientation approximates the most typical orientation during usage. Operate the programmer keypad using pneumatic actuators or other non-conductive connection. Worst case condition for emissions is to operate the programmer in scroll mode. This is accomplished by pressing and holding one key on the keypad. (Note that the device has a 30 second timeout if no valid uplinks are received while scrolling. Release the key and then press and hold to begin downlink transmission again.)

Requirement: Must meet FCC Part 15 (intentional radiator), Class B requirements. Must meet CISPR11 Class B Group 1 requirements for internal antenna configuration and CISPR11 Class A Group 1 requirements for external antenna configuration. All requirements to be met when operating for the worst case emissions condition (i.e.: programming in scroll mode). Reference product specification section 7.10.

5.3 ELECTROSTATIC DISCHARGE (ESD)

TEST PLAN	
Medtronic  NEUROLOGICAL DIVISION <small>Medtronic Confidential</small>	FILE NO.: 1111-98-66 PAGE 5 OF DRAFT7
<small>Declassification Review Date <u>Permanent</u></small>	

Objective: To demonstrate compliance of the 7435 to EN 45502-1 for ESD exposure when configured with and without the external antenna.

Sample: One 7435. One 7440 antenna (cable length: 48 cm).

Procedure: Test per EN 45502-1, 1997 Section 24.1. ESD Discharge sites on the DUT are to be determined and documented by the certified testing authority for each DUT configuration tested. Test the 7435 in both configurations:

Internal Antenna Configuration – 7435 alone, without the 7440 antenna. Test with the antenna jack plug left unplugged (most sensitive condition).

External Antenna Configuration – with the 7440 connected

After completion of ESD exposure, verify functionality of the 7435 by the following Functional Test:

Post ESD Functional Test:

- a) *Place the beeper switch in the right (High) position.*
- b) *Initiate a power-on self test by removing the battery, pressing any key once and then replacing the battery. Verify successful completion of the Power ON Self Test (Successful self test is indicated by all four LED's turning on and then off coincident with a single beep).*
- c) *Remove the battery once again, press any key once, then replace the battery with the reverse polarity from Step b. Verify successful Self-Test.*
- d) *Plug in the 7440 antenna and place the 7440 antenna surface parallel to a DCI IPG graphics surface with a separation no less than 5 cm. With the beeper switch in the center position (Low), press the "ON" button and confirm that the programmer beeps once, the LED for IPG ON turns on and the LED for IPG battery turns on.*
- e) *Disconnect the external antenna and set the beeper switch to the right (High) position. Place the programmer bottom surface parallel to the IPG graphics surface with a separation of no less than 5 cm. Press the "OFF" button and confirm that the programmer beeps once, louder than that of Step d above, and the LED for IPG OFF turns on.*

Note: (If the programmer does not provide a confirmation beep, observe and record the Telemetry Diagnostic Click indication that is required to occur when the LED indication times out and record result.)

After completion of all testing, return the DUT device to Medtronic to be tested per the manufacturing final device test.

Requirement: After exposure to ESD, the Beeper and LED's must operate as described in the functional test above. Additionally, the device shall pass the manufacturing final device test. Reference product specification section 7.8.

TEST PLAN**Medtronic**  **NEUROLOGICAL DIVISION**

Medtronic Confidential

Declassification Review Date Permanent

FILE NO.:

1111-98-66

PAGE 6 OF

DRAFT7**6.0 TEST REPORTING**

The certified testing authority is to report results of all testing performed and any deviations to this plan. This report will also indicate the status of any related certifications that accompany the test results and clearly indicate directives to submit for certifications that must be applied for following completion of this test plan. A summary report will then be written which includes the results reported by the certified testing authority and the results of post EMC testing using the manufacturing final device test. Any deviations from this test plan are to be addressed in the summary report.

7.0 COMPLETION

This paragraph completes this plan.

Appendix C

MEASUREMENT PROTOCOL

GENERAL INFORMATION

Test Methodology

Conducted and radiated emission testing is performed according to the procedures in International Special Committee on Radio Interference (CISPR) Publication 11 and FCC Part 15.

Measurement Uncertainty

The test system for conducted emissions is defined as the LISN, tuned receiver or spectrum analyzer, and coaxial cable. The test system for radiated emissions is defined as the antenna, the pre-amplifier, the spectrum analyzer and the coaxial cable. These test systems have a measurement uncertainty of ±4.5 dB. The equipment comprising the test systems are calibrated on an annual basis.

Justification

The Equipment Under Test (EUT) is configured in a typical user arrangement in accordance with the manufacturer's instructions. A cable is connected to each available port and either terminated with a peripheral into it's characteristic impedance or left unterminated. When appropriate, the cables are manually manipulated with respect to each other to obtain maximum emissions from the unit.

CONDUCTED EMISSIONS

The final level, expressed in dBµV, is arrived at by taking the reading directly from the EMI receiver. This level is compared directly to the CISPR limit.

To convert between dBµV and µV, the following conversions apply:

$$dB\mu V = 20(\log \mu V)$$

$$\mu V = \text{Inverse log}(dB\mu V/20)$$

RADIATED EMISSIONS

The final level, expressed in dBµV/m, is arrived at by taking the reading from the spectrum analyzer (Level dBµV) and adding the antenna correction factor and cable loss factor (Factor dB) to it. This result then has the CISPR limit subtracted from it to provide the Delta which gives the tabular data as shown in the data sheets in Attachment B. The amplifier gain is automatically accounted for by using an analyzer offset.

Example:

Frequency (MHz)	Level (dBµV)	+	Factor (dB)	=	Final (dBµV/m)	-	CISPR B Limit (dBµV/m)	=	Delta CISPR B (dB)
37.19	10.2	+	12.0	=	22.2	-	30.0	=	-7.8

DETAILS OF TEST PROCEDURES**General Standard Information**

The test methods used comply with ANSI C63.4-1992 - "Methods of Measurement of Radio-Noise Emissions from Low-Voltage Electrical and Electronic Equipment in the Range of 9 kHz to 40 GHz."

Conducted Emissions

Conducted emissions on the 50 Hz and/or 60 Hz power interface of the EUT are measured in the frequency range of 150 kHz to 30 MHz. The measurements are performed using a receiver, which has CISPR characteristic bandwidth and quasi-peak detection, and a Line Impedance Stabilization Network (LISN), with 50 Ω /50 μ H (CISPR 16) characteristics. Table top equipment is placed on a non-conducting table 80 centimeters above the floor and is positioned 40 centimeters from the vertical ground plane (wall) of the screen room. In some cases, a pre-scan using a spectrum analyzer is initially performed on the units comprising the system under test to locate the highest emissions. If the minimum passing margin appears to be less than 20 dB with a peak mode measurement, the emissions are re-measured using a tuned receiver or spectrum analyzer with quasi-peak and average detection and recorded on the data sheets.

Radiated Emissions

Radiated emissions from the EUT are measured in the frequency range of 30 to 1000 MHz using a spectrum analyzer and appropriate broadband linearly polarized antennas. Measurements between 30 MHz and 1000 MHz are made with 120 kHz/6 dB bandwidth and quasi-peak detection and measurements above 1000 MHz are made with a 1 MHz/6 dB bandwidth and peak detection. Table top equipment is placed on a 1.0 X 1.5 meter non-conducting table 80 centimeters above the ground plane. Floor standing equipment is placed directly on the turntable/ground plane. Interface cables that are closer than 40 centimeters to the ground plane are bundled in the center in a serpentine fashion so they are at least 40 centimeters from the ground plane. Cables to simulators/testers (if used in this test) are routed through the center of the table and to a screen room located outside the test area. The antenna is positioned 3, 10 or 30 meters horizontally from the EUT. To locate maximum emissions from the test sample the antenna is varied in height from 1 to 4 meters, measurement scans are made with both horizontal and vertical antenna polarizations and the EUT are rotated 360 degrees.

Radiated emissions from the EUT are measured in the frequency range of 9 kHz to 30 MHz using a receiver and shielded loop antenna. Measurements between 110 and 490 kHz were made using average detection, otherwise quasi-peak detection was used. The loop antenna was placed 3 and 10 meters horizontally from the EUT. Intentional radiators are rotated through three orthogonal axes to determine the attitude that maximizes the emissions.