 Medtronic	<i>Neurological</i> <i>Medtronic Confidential</i>	
	Title Model 7439 Patient Programmer User Manual - Global	
Medtronic Confidential This Document is the Property of Medtronic, Inc. and must be accounted for. Information hereon is confidential. DO NOT reproduce it, reveal it to unauthorized persons or send it outside Medtronic without proper authorization.	Writer Theresa King-Hunter	Date 11/03/04
Part No.	Part No. Rev	Comments
221244001	D	Release for translation

DO NOT PRINT THIS FORM WHEN PRINTING THE LITERATURE PIECE.
DO NOT COUNT THIS FORM IN THE LITERATURE PIECE PAGE COUNT.
REVISION HISTORY: SEE PDM WEBSITE FOR INFORMATION.

1. **Materials:**

Covers

- **Grade #1, 80 lb. white gloss coated cover stock, minimum brightness level: 89**

Text

- **60 lb. white smooth opaque text stock**

Labels

- **N/A**

2. **Colors: To confirm all colors, graphics and text, refer to electronic file**

Front Cover

- **4-color cover and solid gloss varnish**

Back Cover

- **Black text and graphics; solid gloss varnish**

Body

- **2-color text and graphics (PMS 301, black, percentages of PMS 301 or percentages of black)**

Labels

- **N/A**

3. **Size: 4.6" ± 0.2 (w) x 6.0" ± 0.2 (h)**

4. **Type of Binding: Clear plastic coil, MWE lay-flat, or perfect bound**

5. **Other:**

- **Cover and text whiteness must match visually.**

6. **Literature Piece Page Count (Including covers, excluding this form): 136**

7. **Note to print supplier:** *Supplier may add up to three blank pages at the end of the document before the back cover sheet as needed. If more are required, contact the purchasing agent.*

8. **Vendor-supplied information may appear at an appropriate location on the literature piece (eg, part number, bar code, etc.).**

9. **Graphics Content and Layout to be as shown and per Medtronic electronic file that is supplied (stored) by Medtronic Neuro.**



Medtronic

PATIENT PROGRAMMER
Pain therapy user manual

7439



USA Rx only



The following are trademarks of Medtronic, Inc.: Medtronic[®], MyStim[™], SoftStart[™], Synergy Plus⁺[™], Synergy Compact⁺[™], and Synergy[®].

USA **FCC Information**

The following is communications regulation information on the Model 7439 Patient Programmer.

FCC ID: LF537741

This device complies with Part 15 Rules. Operation is subject to the following two conditions: (1) this device may not cause harmful interference and (2) this device must accept any interference received, including interference that may cause undesired operation.

IMPORTANT: Changes or modifications to this product not authorized by Medtronic, Inc., could void the FCC Certification and negate your authority to operate this product.

Contents

Label symbols 7

1 Introduction 9

A company dedicated to patients 10

How to use this manual 11

Patient guides 13

Patient identification card 14

2 Important therapy information 15

Purpose of the neurostimulation system
(indications) 16

Therapies that may not be used with the
neurostimulation system
(contraindications) 16

Risks and benefits 17

Risks of surgery 17

Possible adverse effects 18

Changes in therapy 18

Possible system complications 18

Warnings 19

Precautions 26

System and therapy 26

Patient activities 29

Individualization of treatment 31

3 Introduction to stimulation 33

How stimulation works 34

Parts of your system 36

Understanding your therapy 38

Controlling your stimulation 40

 What your clinician controls 40

 What you control 40

Recovery and care 41

 Recovering from surgery 41

 Activities 41

 When to call your clinician 43

 Care schedule 44

4 Using your patient programmer 45

How the patient programmer works 46

Synchronizing and displaying the THERAPY
screen 48

Guidelines for adjusting your stimulation 53

Turning your neurostimulator ON or
OFF 55

Adjusting stimulation settings 57

Using the NAVIGATOR key 58

Changing a group 59

Increasing or decreasing a parameter
(amplitude, pulse width, or rate) 62

Patient programmer batteries 66

Checking patient programmer
batteries 66

Replacing patient programmer
batteries 68

Summary of keys 69

Preferences: Changing the audio, contrast,
and number format 72

Using the carrying case and labeling the
patient programmer 75

Optional detachable antenna 76

Connecting the antenna 76

Using the antenna 78

5 Troubleshooting 79

Programmer screens 80

Warning screens 80

Communication screen 82

Information screens 83
Possible problems and solutions 88
User assistance 95

6 Maintenance 97

Cleaning and care 98
Safety and technical checks 100
Battery and programmer disposal 101
Neurostimulator disposal 101
Declaration of conformity 102
Specifications 103

7 Appendix A: Electromagnetic interference (EMI) 105

Contraindication 106
Warnings 108
Precautions 116
Notes 120

Glossary 123

Index 129

Label symbols

Explanation of symbols on products and packaging. Refer to the appropriate product to see symbols that apply.



CE Conformité Européenne (European Conformity). This symbol means that the device fully complies with AIMD Directive 90/385/EEC (NB 0123) and R&TTE Directive 1999/5/EC.



The use of this device might be subject to individual country licensing regimes in Europe.



System meets the applicable Canadian [C22.2-601.1-M90 (R2001)] and US (UL 60601-1:2003) electrical safety standard requirements.



Caution, consult accompanying documents



Serial number

Label symbols



Storage temperature



Relative humidity



Atmospheric pressure



IEC 60601-1/EN60601-1, Type BF
Equipment



Non-ionizing electromagnetic radiation



Screen light



Antenna jack



For USA audience only

Label symbols

The Medtronic Model 7439 Patient Programmer is designed to program the adjustable settings of the Medtronic Model 7479 Synergy Plus⁺ and Model 7479B Synergy Compact⁺ neurostimulators.

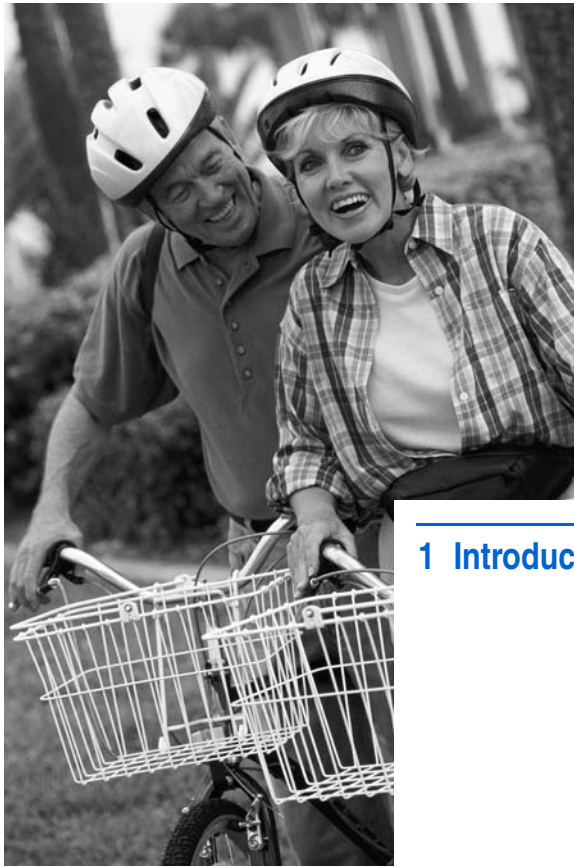

1 Introduction

A company dedicated to patients

Medtronic was founded in 1949 by Earl Bakken, a graduate student in electrical engineering, and his brother-in-law, Palmer J. Hermundslie. Today Medtronic is the world leader in medical technology, pioneering therapies that restore health, extend life and alleviate pain.



From its modest beginnings in a 55-square meter (600-square-foot) Minneapolis garage, we have transformed Medtronic into a worldwide company that serves customers in more than 120 countries. Each year, millions of patients are treated with Medtronic products and therapies. We invest almost \$500 million each year in research and development, working closely with the world's leading physicians and scientists to enhance our current products and therapies, and to

develop new ones. Although we are a large company, individual patients and their needs are still the driving force behind what we do and how we do it.

Our goal is to improve the quality of your life. This booklet, which provides information about your neurostimulation system, is one small way we try to help.

Welcome to the Medtronic family. We wish you well.

How to use this manual

Use this manual after receiving an implanted neurostimulator. Ask your clinician to explain anything that is unclear.

- Chapter 1, "Introduction," describes the patient documents your clinician should have provided to you.
- Chapter 2, "Important therapy information," describes when you should and should not use a neurostimulation

system, and the risks, benefits, warnings, precautions, and patient activities related to your neurostimulation system.

- Chapter 3, "Introduction to stimulation," describes the therapy, neurostimulation system components, and recovery and care information.
- Chapter 4, "Using your patient programmer," describes the patient programmer and how to perform specific tasks.
- Chapter 5, "Troubleshooting," describes patient programmer warning and information screens, how to solve possible problems, and who to contact if your device is lost or broken.
- Chapter 6, "Maintenance," describes how to care for your patient programmer and system specifications.
- Appendix A provides more information about electromagnetic interference.
- A glossary is included at the end of this manual.

Patient guides

You should receive the following documents after a neurostimulator is implanted.

- *Medtronic Model 7439 Patient Programmer Quick Reference Guide*: provides instructions for common patient programmer tasks.
- The *Patient Identification Card*: provides information about you, your neurostimulator, and your doctor.
- *Medtronic Model 7439 Patient Programmer Pain Therapy User Manual*.

Patient identification card

When you leave the hospital, your doctor will give you a patient identification card. This card supplies information about you, your implanted device, and your doctor. Your identification card may allow you to bypass security devices. Carry this card with you at all times. If you move, change doctors, or lose your card, contact Medtronic for a replacement card. Refer to the Medtronic contacts at the end of this manual.

■ A temporary identification card will be provided at the hospital. After Medtronic receives your implant registration from the hospital, you will receive a permanent identification card.



2 Important therapy information

Purpose of the neurostimulation system (indications)

Refer to the indications sheet that is packaged with the patient programmer for the purpose of the neurostimulation system and related information.



Therapies that may not be used with the neurostimulation system (contraindications)

Diathermy – Inform anyone treating you that you CANNOT have any shortwave diathermy, microwave diathermy or therapeutic ultrasound diathermy (all now referred to as diathermy) anywhere on your body because you have an implanted neurostimulation system. Energy from diathermy can be transferred through your implanted system,

Important therapy information 2

and can cause tissue damage, resulting in severe injury or death. Refer to "Appendix A: Electromagnetic interference (EMI)" on page 105 for more information.

Risks and benefits

Stimulation has helped thousands of patients manage their pain and improve their quality of life. Your neurostimulation system may be used with other pain treatments. Stimulation will not cure your pain. It can, however, reduce your pain to a tolerable level and allow you to resume many of your daily activities.

Risks of surgery

Implanting a neurostimulation system has risks similar to spinal procedures, including spinal fluid leak, headaches, swelling, bruising, bleeding, infection, or paralysis.

If you are on anticoagulation therapy you might be at greater risk for postoperative

complications such as hematomas that could result in paralysis.

Possible adverse effects

Adverse effects of stimulation are usually mild and go away when stimulation is turned OFF. These adverse effects could include radicular chest wall stimulation, uncomfortable stimulation, a jolting or shocking sensation, or persistent pain at the neurostimulator site.

Changes in therapy

Over time there could be changes in the level of your symptom control. In most cases your doctor can correct these changes without surgery.

Possible system complications

The lead, extension, or neurostimulator could migrate within the body or erode through the skin. There could be undesirable changes in stimulation, possibly related to cellular changes around the electrode(s), changes in

the position of the electrode(s), loose electrical connections, or lead or extension fractures. It is also possible that the implanted materials could cause an allergic or immune system response.

Your neurostimulation system might unexpectedly cease to function due to battery depletion or other causes. These events, which can include electrical shorts or open circuits, conductor (wire) fractures, and insulation breaches, cannot be predicted.

Warnings

Electromagnetic interference (EMI) – Electromagnetic interference is a field of energy generated by equipment found in the home, work, medical or public environments that is strong enough to interfere with neurostimulator function. Neurostimulators include features that provide protection from EMI. Most electrical devices and magnets encountered in a normal day are unlikely to affect the operation of a neurostimulator.

Important therapy information 2

However, strong sources of EMI can result in the following:

- Serious patient injury or death, resulting from heating of the implanted components of the neurostimulation system and damage to surrounding tissue.
- System damage, resulting in a loss of or change in symptom control and requiring additional surgery.
- Operational changes to the neurostimulator that can cause it to turn ON or OFF (particularly in a neurostimulator enabled for magnet use) or to reset to the power-on-reset (POR) values, resulting in loss of stimulation, return of underlying symptoms, and in the case of POR, requiring your health care provider to reprogram your neurostimulator.
- Unexpected changes in stimulation, causing a momentary increase in stimulation or intermittent stimulation, which some patients have described as a

Important therapy information 2

jolting or shocking sensation. Although the unexpected change in stimulation could feel uncomfortable, it does not damage the device or injure a patient directly. In rare cases, as a result of the unexpected changes in stimulation, patients have fallen down and been injured.

Refer to Table 2.1, on page 22, and “Appendix A: Electromagnetic interference (EMI)” on page 105 for information on the sources of EMI, the effect of EMI on you and your neurostimulation system, and instructions on how to reduce the risk from EMI.

Important therapy information 2

Table 2.1 Potential effects of EMI from devices or procedures

Device/procedure	Serious patient injury	Device damage	Momentary increase in stimulation	Device turns OFF or ON	Intermittent stimulation	See guidelines
Bone growth stimulators		✓	✓		✓	page 116
Defibrillation/ cardioversion	✓	✓	✓		✓	page 108
Dental drills and probes		✓				page 116
Diathermy, therapeutic	✓	✓			✓	page 106
Electrocautery	✓	✓				page 109
Electrolysis	✓	✓				page 116
Electromagnetic field devices (eg, arc welding, power stations)			✓	✓	✓	page 117
High-output ultrasonics /lithotripsy		✓				page 111
Household items			✓	✓		page 120

Table 2.1 Potential effects of EMI from devices or procedures (continued)

Device/procedure	Serious patient injury	Device damage	Momentary increase in stimulation	Device turns OFF or ON	Intermittent stimulation	See guidelines
Laser procedures		✓				page 118
Magnetic resonance imaging (MRI)	✓	✓	✓	✓	✓	page 111
Psychotherapeutic procedures		✓	✓	✓	✓	page 119
Radiation therapy		✓				page 119
Radiofrequency (RF)/microwave ablation	✓	✓			✓	page 113
Therapeutic magnets				✓		page 122
Theft detectors/security devices			✓	✓	✓	page 114

Important therapy information 2

Important therapy information 2

Table 2.1 Potential effects of EMI from devices or procedures (continued)

Device/procedure	Serious patient injury	Device damage	Momentary increase in stimulation	Device turns OFF or ON	Intermittent stimulation	See guidelines
Therapeutic ultrasound	✓	✓			✓	page 106
Transcutaneous electrical nerve stimulation (TENS)			✓	✓		page 119

Case damage – If the neurostimulator case is ruptured or pierced due to outside forces, severe burns could result from exposure to the battery chemicals.

Neurostimulator interaction with cardiac implantable devices – When a neurostimulator and an implanted cardiac device (eg, pacemaker, defibrillator) are required, the doctors involved with both devices (neurologist, neurosurgeon, cardiologist, cardiac surgeon) should discuss the possible interaction between the devices before surgery. To minimize or prevent device damage or interactions, your doctors should place the devices on the opposite side of the body from one another.

- Defibrillation therapy from the implanted defibrillator can damage the neurostimulator.
- The electrical pulses from the neurostimulation system could affect the sensing operation of the cardiac device and result in inappropriate responses from the cardiac device. Your doctor

should reprogram your neurostimulator to a bipolar configuration and a minimum rate of 60 Hz. The cardiac device should be programmed to bipolar sensing.

Precautions

System and therapy

Clinician programmer interaction with a cochlear implant – If you have a cochlear implant, the external portion of the cochlear system should be kept as far away as possible from the clinician programmer or the cochlear implant should be turned OFF during programming to prevent unintended audible clicks.

Clinician programmer interaction with other active implanted devices – If you have a neurostimulator and another active implanted device, the radio-frequency signal used to program either device can reset or reprogram the other device, or the magnet in a cardiac programmer can activate magnetically controlled functions in the

Important therapy information 2

neurostimulator. To verify that inadvertent programming did not occur, clinicians familiar with each device should check the programmed settings before you are sent home from the hospital and after either device is programmed (or as soon as possible after these times).

Contact your doctor immediately if you notice symptoms that could be related to either device or to the medical condition treated by that device.

Component compatibility – For proper therapy, only components that are compatible with the appropriate indication (eg, spinal cord stimulation) should be used. For a list of Medtronic-compatible components, ask your doctor. No claims of safety or efficacy are made about the compatibility of non-Medtronic components with Medtronic components.

Patient control devices – Do not place patient control devices (eg, patient programmer) over another device (eg,

pacemaker, defibrillator, another neurostimulator). The patient control device could accidentally change the operation of another device.

Patient device handling – To avoid damaging the device, do not immerse it in liquid; do not clean it with bleach, nail polish remover, mineral oil, or similar substances; and do not drop it or mishandle it in a way that may damage it.

Patient device use – When operating an external neurostimulator, patient programmer, or charging system use special care near flammable or explosive atmospheres. An interaction between the flammable or explosive atmospheres and the battery in the device could occur. The consequences of using a battery-powered device near flammable or explosive atmospheres are unknown.

Important therapy information 2

Patient activities

Activities requiring excessive twisting or stretching – Avoid activities that put undue stress on the implanted components of your neurostimulation system. Activities that include sudden, excessive, or repetitive bending, twisting, bouncing, or stretching can cause parts of your neurostimulation system to fracture or migrate. This can result in a loss of stimulation, intermittent stimulation, stimulation at the fracture site, and additional surgery. Spinal cord stimulation patients in particular should avoid excessive bending of the torso.

Component manipulation – Do not manipulate or rub your neurostimulation system through the skin, sometimes called “Twiddler’s Syndrome.” Manipulation can cause damage to your system, skin erosion, or stimulation at the implant site.

Important therapy information 2

Scuba diving or hyperbaric chambers –

Do not dive below 10 meters (33 feet) of water or enter hyperbaric chambers above 2.0 atmospheres absolute (ATA). Pressures below 10 meters (33 feet) of water or above 2.0 ATA can damage the neurostimulation system. Before diving or using a hyperbaric chamber, discuss the effects of high pressure with your doctor.

Skydiving, skiing, or hiking in the mountains –

High altitudes should not affect the neurostimulator; however, you should consider the movements involved in any planned activity and take care to not put undue stress on your implanted neurostimulation system. During skydiving, the sudden jerking that occurs when the parachute opens can dislodge or fracture the lead, requiring additional surgery to repair or replace the lead.

Unexpected changes in stimulation –

Electromagnetic interference, changes in posture, and other activities can cause a perceived increase in stimulation, which

some patients have described as uncomfortable stimulation (a jolting or shocking sensation). You should reduce your amplitude to the lowest setting and turn OFF your neurostimulator before engaging in activities that could become unsafe for you or others if you received an unexpected jolt or shock (eg, driving, operating power tools). Discuss these activities with your doctor.

Individualization of treatment

Patient management – Best results are achieved when you are fully informed about the therapy risks and benefits, surgical procedure, follow-up requirements, and self-care responsibilities. Maximum benefits from the neurostimulation system require long-term postsurgical management.

Patient selection – The neurostimulation system should not be implanted if:

- your symptoms are not of physiological origin.

- you are not an appropriate candidate for surgery.
- you cannot properly operate the system.
- you do not receive satisfactory results from test stimulation.

Use in specific populations – The safety and effectiveness of this therapy has not been established for the following:

- Pregnancy, unborn fetus, or delivery
- Pediatric use (patients under the age of 18)

Important therapy information 2



3 Introduction to stimulation

How stimulation works

Nerve signals from all over your body travel to your spinal cord and then to your brain. Your brain translates the signals into sensations such as pain.

Stimulation delivers electrical pulses to the area where your pain signals will be blocked as they move to the brain (Figure 3.1).

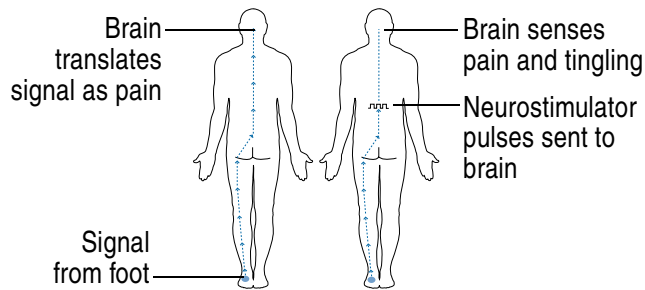

Figure 3.1 Stimulation blocks some of the pain signals as they move to the brain.

Note: Stimulation will not cure your pain, nor will it block sharp pain caused by a recent injury.

To most patients, the pulses feel like a steady, tingling sensation in the painful area (Figure 3.2).

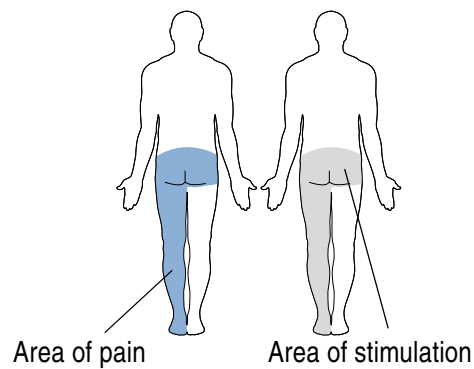

Figure 3.2 Stimulation feels like tingling in the area of pain.

Generally, people experience a fairly constant sensation of stimulation. However, you may feel changes when you suddenly move or change position.

Parts of your system

A typical neurostimulation system has implanted parts that deliver the electrical pulses to the area where your pain signals are blocked. Typically the implanted parts are: a neurostimulator, one or two leads, and one or two extensions (optional) (Figure 3.3).

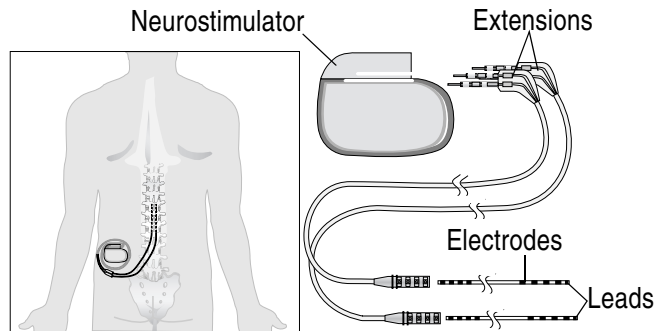

Figure 3.3 Implanted parts of a typical neurostimulation system.

A typical neurostimulation system also includes a patient programmer that allows you to control some stimulation settings.(Figure 3.4).

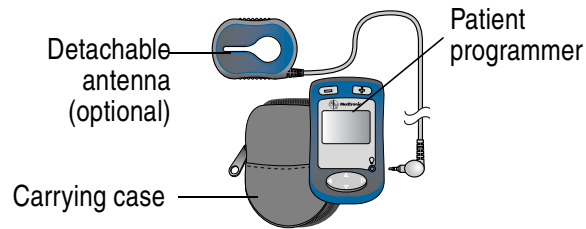

Figure 3.4 Patient programmer with accessories.

Neurostimulator – The neurostimulator is the power source for your neurostimulation system. It contains electronics that generate the electrical pulses.

Lead(s) – A lead is a thin wire covered with a protective coating. A lead has small metal electrodes near the tip. The electrodes transmit electrical pulses to the area where your pain signals are blocked.

Extension(s) – An extension is a thin wire, covered with a protective coating, that connects the neurostimulator to a lead.

Patient programmer – A patient programmer is a hand-held device that you use to select and adjust your stimulation. A

detachable antenna is also available if you have difficulty reaching the neurostimulator implant site.

Understanding your therapy

Stimulation delivers electrical pulses to the area where your pain signals will be blocked as they travel to the brain. The electrical pulses are made up of parameters called amplitude, pulse width, and rate.

- Amplitude is the strength of the pulse. It affects the stimulation strength or coverage required to manage your pain.
- Pulse width is the duration of the pulse. It affects the stimulation strength or coverage required to manage your pain.
- Rate is the number of pulses delivered per second. Rate feels like “tapping.”

A program delivers electrical pulses to a specified pain site. Programs are combined into “groups” to provide stimulation to more than one pain site.

A menu of groups can be designed to meet a patient's specific needs. Typically, each group is designed for particular activities, symptoms, or time of day.

For example, Alex has pain in his low back. Typically, Alex's pain doesn't vary; however, sometimes Alex has additional pain in his right thigh. Alex's clinician designed two groups for Alex to choose from. Group A is for Alex's typical pain; group B is for the additional thigh pain (Figure 3.5). Alex chooses whichever group he requires.

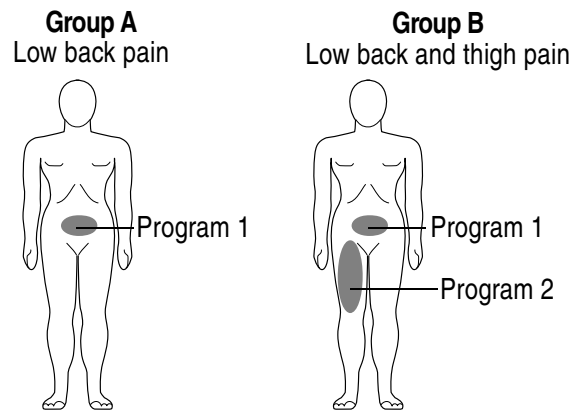

Figure 3.5 Example of programs and groups.

Controlling your stimulation

Your neurostimulator only accepts programming from the clinician programmer or patient programmer; other devices are not able to program your neurostimulator.

What your clinician controls

Your clinician uses a clinician programmer to communicate with your neurostimulator and your patient programmer. Your clinician designs programs and groups according to your needs. Your clinician can also specify the settings that you will be able to adjust with your patient programmer. Discuss this with your clinician.

What you control

As your activities vary throughout the day, your therapy needs may change. The patient programmer allows you to turn stimulation ON and OFF, switch from one group to another and adjust the amplitude, pulse width, or rate for each program in the active

group. Talk to your clinician about the settings that apply to your therapy.

Recovery and care

Recovering from surgery

It takes several weeks to heal from surgery. It is normal to feel some discomfort from the incision(s) and to have some pain at the implant site for 2 to 6 weeks.

Your doctor may also prescribe physical therapy or medication to help manage your pain. Always follow your doctor's instructions.

Activities

Some movements can cause changes in stimulation. For example, leaning back may cause the lead to move closer to your spinal cord; this can increase the sensation of stimulation. Other movements may cause the lead to move further away from your spinal cord and decrease the stimulation sensation. Sudden changes in stimulation are most common during recovery.

- Avoid activities where you must bend, stretch, or twist your body; these movements can move your leads which affects your stimulation.
- Avoid lying on your stomach.
- Avoid reaching over your head.
- Avoid turning from side to side.
- Avoid bending forward, backward, or from side to side.
- Avoid lifting more than 2.3 kilograms (5 pounds).

As you begin to feel better, you should be able to perform activities such as:

- Bathing or showering
- Sexual activity
- Working at home or at your business
- Hobbies or activities, such as walking, gardening, cycling, or swimming
- Traveling

Remember, returning to your daily activities should make you feel better, not worse.

Note: As you adjust to life with better pain management, you may want to try activities that you could not perform before your surgery. Discuss your activity level with your doctor.

When to call your clinician

Contact your clinician if any of the following events occur:

- You have pain, redness, or swelling at the incision(s) later than 6 weeks after surgery.
- You feel discomfort or pain during stimulation. Turn your neurostimulator OFF and call your doctor.
- Your system is not working properly.
- You cannot turn the neurostimulator ON or OFF.
- You cannot adjust stimulation using your patient programmer.

Care schedule

Your clinician will schedule follow-up visits to make sure you are receiving the most appropriate therapy.

Note: Bring your patient programmer to all appointments with your clinician. When groups are programmed, some settings are stored in your neurostimulator and some settings are stored in your patient programmer. To most effectively evaluate your therapy, the clinician needs your patient programmer.



4 Using your patient programmer

How the patient programmer works

The patient programmer communicates with your neurostimulator by sending signals to and receiving signals from the neurostimulator. To send and receive the signals, the internal antenna of the programmer, or the detachable antenna, must be placed over the neurostimulator (Figure 4.1).



Notes:

- The internal antenna is on the back of the programmer.
- The programmer screen must face outward.
- The detachable antenna plugs into the patient programmer.

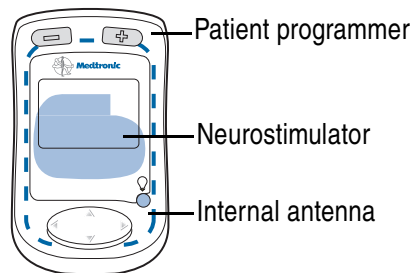

Figure 4.1 Place the patient programmer over the neurostimulator.

The patient programmer is used to:

- turn the neurostimulator ON or OFF.
- change stimulation settings.

Synchronizing and displaying the THERAPY screen

Synchronizing sends the settings from your neurostimulator to the patient programmer. All communication with the neurostimulator begins with synchronization.

- To synchronize your neurostimulator and the patient programmer, hold the programmer over your neurostimulator and press one of the three keys shown in Figure 4.2.

Note: Using the NEUROSTIMULATOR ON key to synchronize, also turns ON the neurostimulator. Using the NEUROSTIMULATOR OFF key to synchronize, also turns OFF the neurostimulator.



Figure 4.2 Synchronizing your neurostimulator and patient programmer.

After synchronizing, the THERAPY screen appears (Figure 4.3).

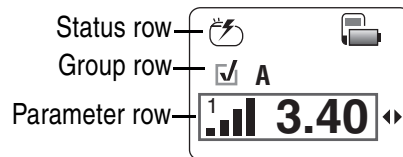

Figure 4.3 THERAPY screen.

Icons on the THERAPY screen indicate your neurostimulator settings and the patient programmer battery level (Table 4.1).

Table 4.1 THERAPY screen icons











Row	Icons	Description
Status		Neurostimulator is ON
		Neurostimulator is OFF
		Day Cycling is ON
		Neurostimulator battery level is low
		Patient programmer battery level
	Group	<input checked="" type="checkbox"/>
<input type="checkbox"/>		Not active
A, B, C, ...		Group name
???		Unknown group

Table 4.1 THERAPY screen icons (continued)

Row	Icons	Description
Parameter^a		Amplitude
		Amplitude
		Pulse width
		Pulse width
		Rate

^a If you cannot change any parameters, this row is blank.

If your clinician scheduled a time when stimulation is OFF (eg, when you sleep), the DAY CYCLING (☑) icon is displayed in the Status row (Figure 4.4).

Note: Whether DAY CYCLING IS ON or OFF, you can turn stimulation ON or OFF at any time.

An example of Day Cycling is shown in Figure 4.4. The screens and timetable show the following:

- When stimulation is ON, the NEUROSTIMULATOR ON icon is displayed. Stimulation is ON for most of the day.
- When stimulation is OFF, the NEUROSTIMULATOR OFF icon is displayed. Stimulation is OFF during the time you would be asleep.

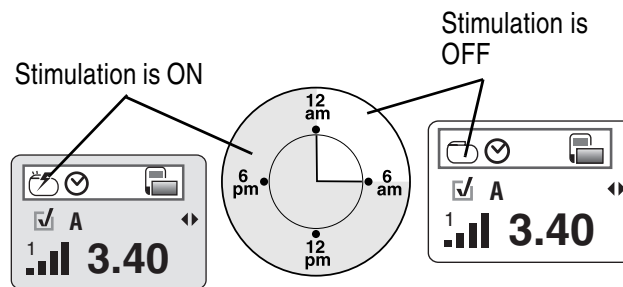

Figure 4.4 Example of Day Cycling.

Guidelines for adjusting your stimulation

To receive the most effective therapy, some days you may need to adjust your stimulation several times; other days you may not need to adjust it at all. Your clinician will provide complete guidelines about when you may want to adjust your stimulation. Table 4.2 provides general guidelines for adjusting your stimulation.

Table 4.2 Stimulation adjustment guidelines

Situation	Action
Stimulation is too strong	Decrease amplitude(s) or pulse width(s)
Stimulation is not strong enough	Increase amplitude(s) or pulse width(s)
Stimulation covers too much area	Decrease amplitude(s) or pulse width(s) or change to a different group
Stimulation does not cover painful area	Increase amplitude(s) or pulse width(s) or change to a different group



Table 4.2 Stimulation adjustment guidelines (continued)

Situation	Action
The pulses (tapping sensations) feel too slow	Increase rate
The pulses (tapping sensations) feel too fast	Decrease rate
You have unexpected changes in stimulation	<ol style="list-style-type: none">1. Turn OFF the neurostimulator.2. Decrease amplitude(s), turn ON the neurostimulator, adjust parameters, and slowly increase amplitude(s) to the desired level. <p>or</p> <p>Change to a different group and turn ON the neurostimulator.</p>
You have tried adjusting stimulation but are unable to find an effective setting.	Contact your clinician.

Table 4.2 Stimulation adjustment guidelines (continued)

Situation	Action
You will be passing through a theft detector or security device	Before engaging in these activities, consult
You will be using potentially dangerous equipment	"Appendix A: Electromagnetic Interference (EMI)," for details.
You will be having a medical procedure	

Turning your neurostimulator ON or OFF

1. Hold the programmer over your neurostimulator with the programmer screen facing outward and press the NEUROSTIMULATOR ON  or NEUROSTIMULATOR OFF  key (Figure 4.5). The THERAPY screen appears.
2. Verify that the appropriate ON or OFF icon is displayed on the THERAPY screen (Figure 4.5).

Using your patient programmer 4

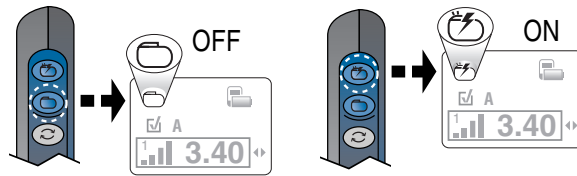

Figure 4.5 Turning your neurostimulator ON or OFF.

△ Caution: To prevent possible uncomfortable or unexpected stimulation (jolting or shocking sensation) when stimulation is turned ON, decrease all amplitudes to the lowest setting before adjusting the pulse width or rate and after turning OFF the neurostimulator.

3. If you have turned the neurostimulator OFF, decrease the program amplitudes to the lowest setting. For instructions, see “Increasing or decreasing a parameter (amplitude, pulse width, or rate)” on page 62.

Note: When you turn your neurostimulator ON or OFF, the patient programmer and neurostimulator are synchronized.

Adjusting stimulation settings

There is often more than one way to change stimulation settings. These instructions describe the most common ways.

Notes:

- Ask your clinician to print a report with your programmed settings.
- When a stimulation setting is changed, you will see the change on the THERAPY screen.
- If the audio is ON, the following tones mean:
 - One tone means the stimulation setting was successfully changed.
 - Three rapid tones mean the stimulation setting change did not occur.
 - Up to ten short tones means the patient programmer is unsuccessfully trying to establish communication with the neurostimulator.

Using the NAVIGATOR key

The NAVIGATOR key arrows move the selection box on the THERAPY screen (Figure 4.6).

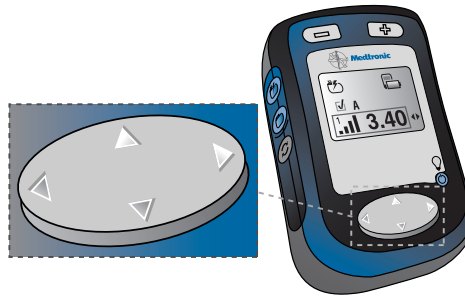



Figure 4.6 NAVIGATOR key.

- To move the selection box between rows press the up ▲ and down ▼ arrows on the NAVIGATOR key.
- To move the selection box across a row that continues, press the left ◀ and right ▶ arrows on the NAVIGATOR key.
- When moving the selection box with the NAVIGATOR key, you do not need to hold your programmer over your

neurostimulator. However, you must hold your programmer over your neurostimulator when pressing all other keys except the POWER key.

A row continues when the OPTIONS  icon is displayed at the end of a row (Figure 4.7).

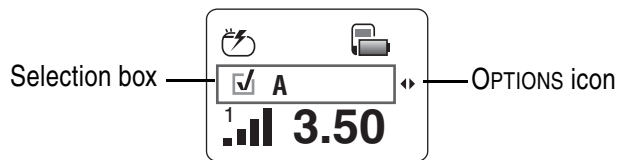



Figure 4.7 The OPTIONS icon and selection box.

Changing a group

1. Hold the patient programmer over your neurostimulator with the screen facing outward and press the SYNC  key. The THERAPY screen appears.

Note: Changing a group may take up to 8 seconds.

2. Press the up  arrow on the NAVIGATOR key to move the selection box to the Group row (Figure 4.8).

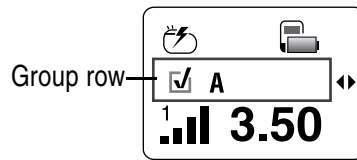

Figure 4.8 Group row.

3. Press the left ◀ or right ▶ arrows on the NAVIGATOR key to move the selection box to the desired group □ (Figure 4.9).

⚠ **Caution:** Select the group that your clinician has recommended for the current activity or posture. Use of another group may result in uncomfortable or unexpected stimulation (jolting or shocking sensation) when stimulation is turned ON.

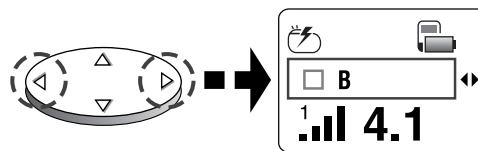



Figure 4.9 Move to a new group.

4. Hold the programmer over your neurostimulator and press the SYNC  key to send the change to your neurostimulator (Figure 4.10).

Note: If an UNKNOWN GROUP ??? icon is displayed, there is a conflict between the group settings stored in the programmer and the group settings stored in the neurostimulator. Select a different group.

5. Verify that the new group is active on the THERAPY screen (Figure 4.10).

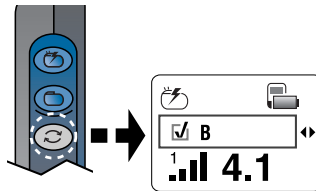





Figure 4.10 Active group.

Increasing or decreasing a parameter (amplitude, pulse width, or rate)

Notes:

- To increase a parameter, the neurostimulator must be ON.
 - To decrease a parameter, the neurostimulator may be ON or OFF.
1. Hold the patient programmer over your neurostimulator with the screen facing outward and press the NEUROSTIMULATOR ON , NEUROSTIMULATOR OFF , or SYNC  key. The THERAPY screen appears.

 **Caution:** To prevent possible uncomfortable or unexpected stimulation (jolting or shocking sensation) when stimulation is turned ON, decrease all amplitudes to the lowest setting before adjusting the pulse width or rate and after turning OFF the neurostimulator.

Notes:

- To change a parameter, it must be in a group that is active .
 - Changing a parameter takes one to two seconds.
2. Use the left ◀ or right ▶ arrow on the NAVIGATOR key to move the selection box to the desired parameter (Figure 4.11).

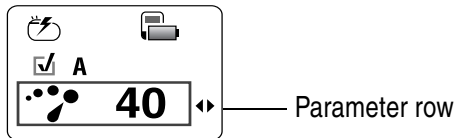



Figure 4.11 Move to parameter row.

Notes:

- If there is more than one program, scroll to the right to display the amplitude () for each program, followed by the pulse width () for each program, and then the rate (). (Scrolling to the left reverses the order.)
- The rate is the same for all programs within a group.

3. Hold the programmer over your neurostimulator and press the INCREASE  or DECREASE  key as needed (Figure 4.12). The increase or decrease occurs immediately and is saved in the neurostimulator.

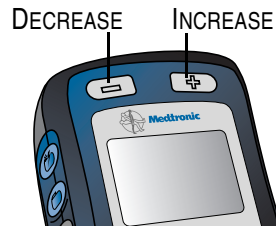

Figure 4.12 DECREASE and INCREASE keys.

Notes:



- Pressing and holding the INCREASE  or DECREASE  key, changes the value approximately every half-second.
- If one of the information screens in Table 4.3 appears, you tried to increase or decrease the value beyond the available limits programmed by your clinician.

Table 4.3 Parameter limit screens

Lower limit

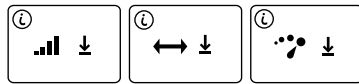

You tried to decrease a parameter (amplitude, pulse width, or rate) below the lowest value allowed.

Press any arrow on the NAVIGATOR key to clear the screen.

Upper limit

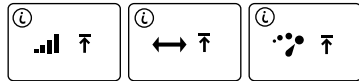

You tried to increase a parameter (amplitude, pulse width, or rate) above the highest value allowed.

Press any arrow on the NAVIGATOR key to clear the screen.

Patient programmer batteries

Always keep two new AAA alkaline batteries available for replacement. New batteries provide about two months use, depending upon how often the programmer is used.

△ **Caution:** If the device will not be used for several weeks, remove the batteries from the device. A battery left in the device may corrode, causing damage to the electronic components.

Checking patient programmer batteries

The patient programmer battery level is displayed on the THERAPY screen (Figure 4.13).

- To check the programmer battery level, hold the patient programmer over your neurostimulator and press the SYNC  key. The THERAPY screen appears displaying the programmer battery level (Figure 4.13).

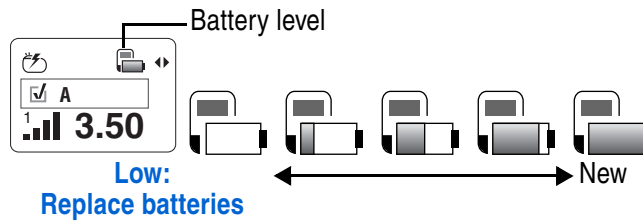
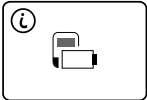
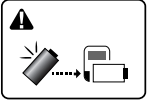

Figure 4.13 Patient programmer battery level.

If the programmer batteries need immediate replacement, one of the screens in Table 4.4 appears.

Table 4.4 Patient programmer battery replacement screens

	<p>The patient programmer batteries are low. You can finish programming.</p> <p>Press any arrow on the NAVIGATOR key to clear the screen; then continue programming. Replace the programmer batteries before the batteries become depleted.</p>
	<p>The patient programmer batteries are depleted. Programming is not possible.</p> <p>Replace the patient programmer batteries now.</p>

Using your patient programmer 4

Replacing patient programmer batteries

1. Open the battery compartment cover (Figure 4.14).

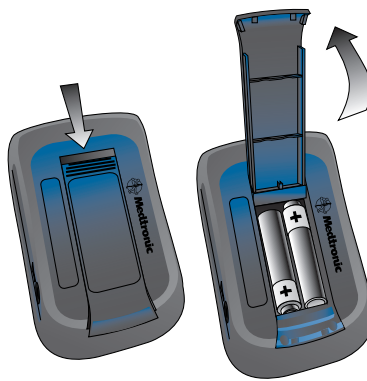

Figure 4.14 Opening the battery cover.

2. Remove the depleted batteries. (For disposal information, see “Battery and programmer disposal” on page 101.
3. Insert the new batteries as shown on the battery compartment label.
4. Close the battery compartment cover.

Summary of keys



Figure 4.15 Patient programmer keys.

Table 4.5 Summary of keys



















Key	Function
 ON	Turns the neurostimulator ON  or OFF . <ul style="list-style-type: none">• The programmer must be held over the neurostimulator while pressing the NEUROSTIMULATOR ON  or OFF  key.• Pressing either of these keys also automatically synchronizes the neurostimulator and programmer and displays the THERAPY screen.
 OFF	
	Synchronizes the neurostimulator and programmer. Activates a selected group. <p>The programmer must be held over the neurostimulator while pressing the SYNC  key.</p>

Table 4.5 Summary of keys (continued)



Key	Function
 Decrease	Decreases  or increases  a parameter. <ul style="list-style-type: none">The programmer must be held over the neurostimulator while pressing the INCREASE  or DECREASE  key.Pressing and holding the INCREASE  or DECREASE  key changes the parameter approximately every half-second.
 Increase	
	Moves the selection box on the THERAPY screen. <p>The OPTION  icon at the end of a row on the THERAPY screen indicates that the row continues.</p>
	Turns the patient programmer power ON and OFF. <p>Pressing and holding this key also turns the backlight ON and OFF. The backlight provides light to the display.</p>



Preferences: Changing the audio, contrast, and number format

Programmer preferences are accessed from the Status row of the THERAPY screen.

Table 4.6 lists the preference icons.

Table 4.6 Preference icons

Icons	Preference
	Audio
	Contrast
	Number format

1. Hold the patient programmer over your neurostimulator with the screen facing outward and press the SYNC  key. The THERAPY screen appears.
2. Press the up  arrow on the NAVIGATOR key to move the selection box to the Status row (Figure 4.16).

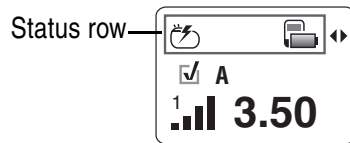

Figure 4.16 Preferences are accessed from the Status row.

3. Press the left ◀ or right ▶ arrow on the NAVIGATOR key to move the selection box to the desired preference (Figure 4.17).

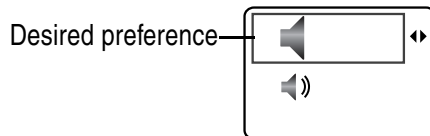

Figure 4.17 Move to desired preference.

4. Press the down ▼ arrow to move the selection box to the Change row (Figure 4.18).

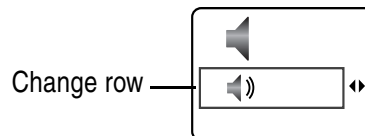
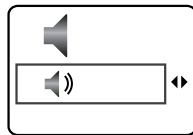



Figure 4.18 Move to Change row.

5. Follow the steps in Table 4.7 to change the selected preference.

Table 4.7 Changing preferences



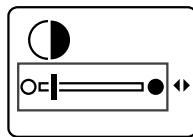

Audio

1. Press the left ◀ or right ▶ arrow on the NAVIGATOR key to move the selection box to audio ON  or OFF .
2. Go to step 6.



Contrast

1. Press the left ◀ or right ▶ arrow on the NAVIGATOR key to make the contrast lighter  or darker .
2. Go to step 6.

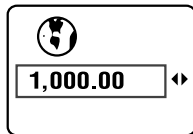

Number format

1. Press the left ◀ or right ▶ arrow on the NAVIGATOR key to change from the comma to the decimal point format.
2. Go to step 6.

6. When the change is displayed on the screen, move the selection box to the Status (top) row and scroll back to the

THERAPY screen. Scrolling to the THERAPY screen saves the change in the patient programmer.

7. Press the left ◀ or right ▶ arrow on the NAVIGATOR key to move to another preference or return to the THERAPY screen.

Using the carrying case and labeling the patient programmer

The carrying case has a pouch to hold the patient programmer and the quick reference guide (Figure 4.19).

The case also has a loop on the back that attaches to a belt.

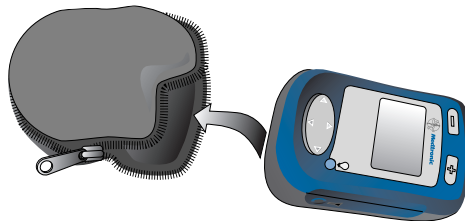

Figure 4.19 Insert the programmer into the case.

Place an identification label on the back of your patient programmer in case the programmer is lost (Figure 4.20).

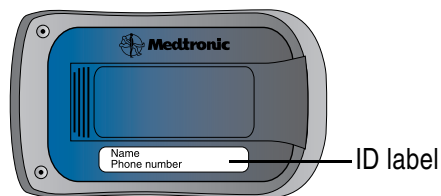

Figure 4.20 Place the adhesive label on the back of the programmer.

Optional detachable antenna

The detachable antenna is available if you have difficulty reaching the neurostimulator. It is also useful for viewing the patient programmer screen while you are adjusting stimulation.

Connecting the antenna

1. Place the antenna over your neurostimulator (Figure 4.21).

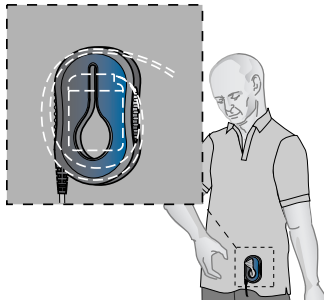

Figure 4.21 Place the antenna over your neurostimulator.

2. Pull the fabric of your clothing through the large opening in the antenna. Then, wedge the fabric in the narrow slit to secure the antenna in place (Figure 4.22).

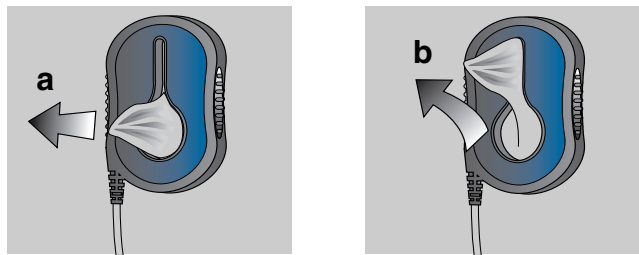

Figure 4.22 Pull the fabric through the slit (a) and wedge in place (b).

3. Push the antenna plug firmly into the antenna jack (Ψ) on the patient programmer (Figure 4.23).



Figure 4.23 Insert the antenna plug into the antenna jack.

Using the antenna

After the antenna is connected, follow the instructions for using the patient programmer.

When you have finished using the patient programmer, grasp the antenna plug and pull it out.

Caution: Do not pull directly on the antenna cable to disconnect the cable from the programmer because this may damage the antenna cable.

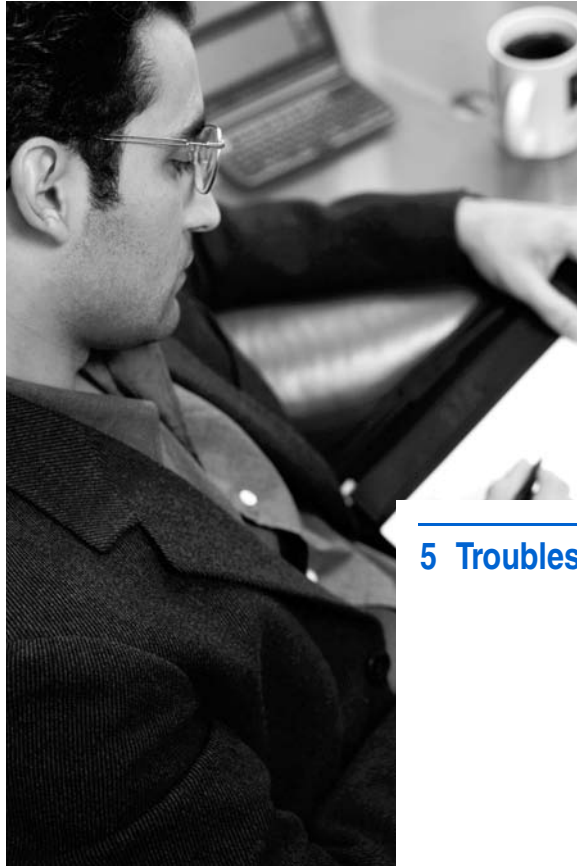

5 Troubleshooting

This chapter will help you solve problems with your programmer. It also provides information on when to call your clinician.

Note: If you cannot solve a problem or if your problem is not described here, contact your clinician.



Programmer screens

The programmer displays warning (▲), communication (Σ), and information (i) screens to alert you to a problem with your system or guide you during programmer use. If the audio is ON, a series of tones alerts you to some messages.

Warning screens

Warning screens indicate a problem with the programmer, antenna, or neurostimulator. Table 5.1 describes warning screens and

provides instructions ([see blue text](#)) on how to resolve the problem and clear the screen.

Table 5.1 Warning screens

Screen	Cause and action
Synchronize programmer and neurostimulator 	The programmer and the neurostimulator are not synchronized. Synchronize the programmer and neurostimulator.
Replace programmer batteries 	The programmer batteries are depleted. Programming is not possible. Replace the programmer batteries now.

Table 5.1 Warning screens (continued)

Screen	Cause and action
Call doctor 	EOS: Your neurostimulator battery is depleted. Stimulation is not available. Other code: The system is not working correctly. Stimulation might have stopped. Write down the code shown on the screen. Call your doctor.

Communication screen

A communication screen shows you that a process is in progress. Table 5.2 describes the communication screen for your neurostimulation system.

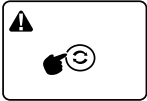
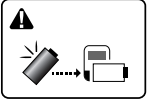
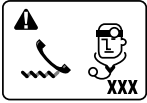
The communication screen automatically clears when the neurostimulation system finishes the process.

Table 5.2 Communication screen

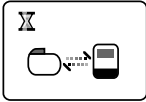
Screen	Description and action
Communication 	The programmer is communicating or attempting to communicate with the neurostimulator.

Information screens

The information screens show the programming status and the battery level for your programmer and neurostimulator. Table 5.3 describes information screens and instructions on how to proceed ([see blue text](#)).

Note: Press any arrow on the NAVIGATOR key to clear an information screen.

Table 5.3 Information screens

Screen	Description and action
Poor communication 	The programmer attempted to communicate with the neurostimulator, but communication was unsuccessful. Reposition the programmer over the neurostimulator with the screen facing outward and try communication again. If using the detachable antenna, check that the antenna is connected properly, reposition the antenna, and try communication again.
Press NEUROSTIMULATOR ON key 	You tried increasing a parameter value with the neurostimulator OFF. Turn your neurostimulator ON and try communication again.

Table 5.3 Information screens (continued)



Screen	Description and action
Upper limit (amplitude shown) 	You tried increasing a parameter (amplitude, pulse width, or rate) above the highest value allowed.
Lower limit (amplitude shown) 	You tried decreasing a parameter (amplitude, pulse width, or rate) below the lowest value allowed.
Programmer batteries are low 	The patient programmer batteries are low. You can finish programming. Replace the programmer batteries before the batteries become depleted.
Neurostimulator battery is low 	The neurostimulator battery is low. Stimulation will not be available soon. Write down the code shown on the screen. Call your clinician.

Table 5.3 Information screens (continued)

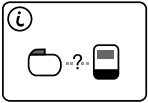
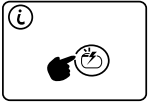
Screen	Description and action
Sync up 	<p>You tried to unsuccessfully change to a different group, then tried to turn the neurostimulator ON.</p> <p>Synchronize the programmer and neurostimulator.</p> <p>You tried increasing or decreasing a parameter for an inactive group.</p> <p>Synchronize the programmer and neurostimulator.</p>
Incorrect patient programmer 	<p>You have more than one neurostimulator of the same type, and you are trying to use the patient programmer to communicate with the wrong neurostimulator.</p> <p>Use the correct patient programmer.</p>

Table 5.3 Information screens (continued)

Screen	Description and action
--------	------------------------

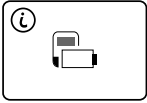
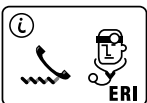
Patient programmer information

These screens provide information to your clinician or Medtronic during troubleshooting.

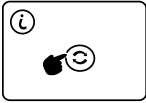
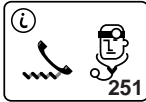
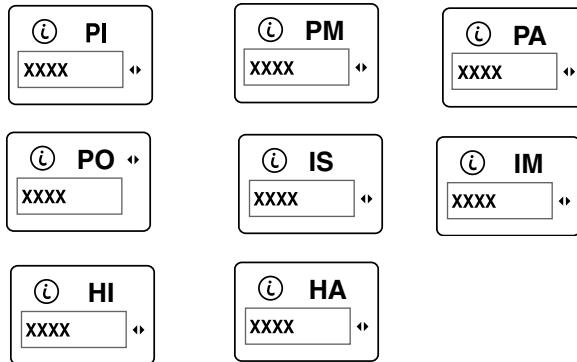

Possible problems and solutions

Table 5.4 will help you solve problems or identify when to call your clinician. Problems are described in the left column (**bold black text**). The right column lists possible causes of the problem (plain text) and how to correct the problem (**bold blue text**).

Note: If a problem is not solved after several attempts, or if a problem is not described here, contact your clinician.

Table 5.4 Troubleshooting problems

Problems	Causes and actions
Uncomfortable stimulation: You are too uncomfortable with the current stimulation to think about how to change it.	The selected group or stimulation settings are not suitable for your current activity or posture. <ol style="list-style-type: none">1. Turn the neurostimulator OFF.2. Change one or more of the following:<ul style="list-style-type: none">• Reduce the amplitude and pulse width for each program in the active group.• Reduce the rate for the active group.• Change the group if the active group is not one that is recommended by your clinician for your current activity or posture; or adjust the amplitude, pulse width, and rate to values that provide adequate pain relief.3. Turn the neurostimulator ON.

Troubleshooting 5

Table 5.4 Troubleshooting problems (continued)

Problems	Causes and actions
Delayed stimulation changes: You do not feel stimulation right away after turning ON the neurostimulator or you feel stimulation after turning OFF the neurostimulator.	Your clinician programmed SoftStart/Stop so that stimulation starts and stops gradually: Allow about 8 seconds for your neurostimulator to turn ON and OFF. You may feel a residual effect after the neurostimulator is turned OFF.
Intermittent stimulation: You feel stimulation only some of the time.	Your clinician may have programmed your neurostimulator to turn ON and OFF at regular intervals. However, if you are not receiving adequate pain relief, contact your clinician.

Table 5.4 Troubleshooting problems (continued)



Problems	Causes and actions
No stimulation: You do not feel stimulation but you think stimulation should be ON.	Stimulation is OFF. Use your patient programmer to turn your neurostimulator ON. Your clinician has programmed Day Cycling and stimulation is scheduled to be OFF at this time. If stimulation is desired, turn stimulation ON. The amplitudes for each program in the active group are set too low to feel. Use your patient programmer to increase the amplitude(s).

Troubleshooting 5

Table 5.4 Troubleshooting problems (continued)

Problems	Causes and actions
Patient programmer is unresponsive: The display screen is blank when you press a key.	<p>You are pressing two or more patient programmer keys at the same time.</p> <p>Make sure you are pressing only one key at a time.</p> <p>The programmer batteries are depleted.</p> <p>Replace the programmer batteries.</p> <p>The programmer batteries are in backwards.</p> <p>Check the battery polarity and reinstall the patient programmer batteries.</p>
Dropped programmer: Your patient programmer falls off a cabinet or table.	<p>The patient programmer is designed to withstand a short drop to a hard surface and still operate normally, even if the case is chipped or nicked.</p> <p>Try the patient programmer; it should work.</p>

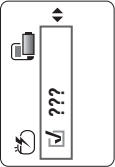
Table 5.4 Troubleshooting problems (continued)

Problems	Causes and actions
Fluid on the programmer: Fluid was spilled onto the programmer or the programmer was dropped into water.	The patient programmer is not waterproof, and water can damage the device. Immediately remove the programmer from the water, then dry the programmer with a towel dampened with clean tap water. Remove the batteries, then allow the battery compartment to air dry at room temperature for 24 hours.
Cannot access or use group. 	There is a conflict between the group stored in the programmer and neurostimulator. Choose a new group. (See Page 59). Press the Sync  key.

Troubleshooting 5

Table 5.4 Troubleshooting problems (continued)

Problems	Causes and actions
Cannot use group. 	No group is selected. Choose a new group. (See Page 59). Press the Sync  key.

User assistance

The patient programmer has been designed and tested to provide trouble-free service. If repair or service is needed, contact your clinician or a Medtronic sales office. Refer to the list of Medtronic contacts at the end of this manual.

The serial number is located in the battery compartment. This number identifies each patient programmer. If you contact Medtronic about your patient programmer, refer to the serial number.

If your programmer stops working – First try the steps in Table 5.4. Otherwise, contact your clinician.

If you lose your programmer – Contact your clinician to order a new programmer.

■ To register the programmer for service covered by the warranty, complete and mail the warranty registration.

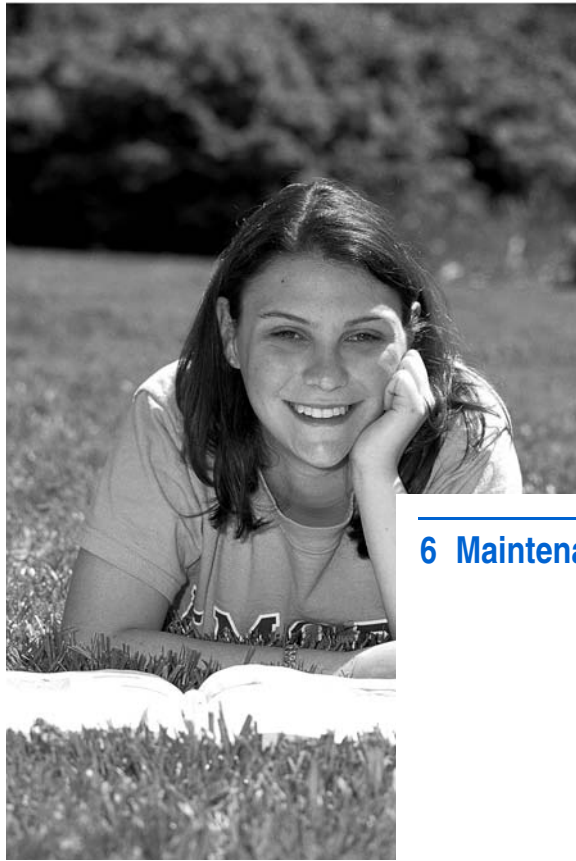

6 Maintenance

This section describes how to care for and dispose of your patient programmer and accessories.

Cleaning and care

Follow these guidelines to ensure that the patient programmer and accessories function properly.

△ Caution: If the device will not be used for several weeks, remove the batteries from the device. A battery left in the device may corrode, causing damage to the electronic components.

- Keep the device out of the reach of children.
- Use the device only as explained to you by your clinician or as discussed in this manual.



- Follow all warnings and precautions in Chapter 2 “Important therapy information” and “Appendix A: Electromagnetic interference (EMI)”.
- Handle the device with care. Do not drop, strike, or step on the device.
- Do not dismantle or tamper with the device.
- Clean the outside of the device with a damp cloth when necessary. Mild household cleaners will not damage the device or labels.
- The device is not waterproof. Do not allow moisture to get inside the device.
- Keep fresh batteries available.
- Replace low or depleted batteries.

Safety and technical checks

Periodic safety and technical checks or periodic maintenance of the patient programmer are not required. If the patient programmer requires repair or is nonfunctional, send it to the address listed below. The patient programmer contains no user-serviceable parts.

USA

Medtronic, Inc.
Neurological Division
MSN600
PO Box 1250
Minneapolis, MN 55440-9087

Europe, Africa, Middle East, and Asia-Pacific countries

Medtronic EOC
Medical Equipment Service Europe
Earl Bakkenstraat 10
6422 PJ Heerlen
The Netherlands
Tel. 31-45566-4880
Fax 31-45566-8028

Battery and programmer disposal

Dispose of depleted batteries and worn out devices according to local requirements. If you no longer need your programmer and would like to donate it, contact your clinician.

Neurostimulator disposal

The implanted device should be removed before burial or cremation. In some countries, removal of battery-powered implantable devices is required before burial because of environmental concerns. Also, the device should be removed before cremation. The cremation process causes the battery to explode. Explanted devices should not be resterilized or reimplanted.

Declaration of conformity

Medtronic declares that this product is in conformity with the essential requirements of AIMD Directive 90/385/EEC and R&TTE Directive 1999/5/EC.

For additional information, contact Medtronic at the telephone numbers and addresses provided on the back cover.

Specifications

Table 6.1 Patient programmer specifications

Item	Specification
Power source	2 AAA alkaline batteries (non-rechargeable, LR03)
Operating temperature	+9 to +43°C (+49 to +110°F)
Storage temperature	-40 to +65°C (-40 to +150°F)
Operating/storage relative humidity	30% to 95%
Operating/storage atmospheric pressure	700 hPa to 1060 hPa (20.7 in. Hg to 31.3 in. Hg)
Size	Approximately 9.4 x 5.6 x 2.8 cm (3.7 x 2.2 x 1.1 inches)
Weight, including batteries	Approximately 111 g (3.9 oz.)
Battery life	2 months (average) for alkaline batteries
Mode of operation	Continuous

Table 6.2 Neurostimulation system specifications

Description	Specifications
Typical materials in contact with human tissue ^a	
Neurostimulator	
Case	Titanium
Connector block	Polyurethane
Recharge coil	Polysulfone
Grommets, seals	Silicone rubber
Setscrews	Titanium
Insulation	Fluoropolymer
Adhesive	Silicone adhesive
Lead	Polyurethane Platinum iridium
Extension	Polyurethane

^a For a complete list of materials in contact with human tissue, contact your clinician.



7 Appendix A: Electromagnetic interference (EMI)

Please review
“Electromagnetic interference
(EMI)” on page 19 and
Table 2.1 on page 22 for
additional information.

Before any medical procedure
is begun, always inform any
health care personnel that you
have an implanted
neurostimulation system. The
potential for the following
effects results from an
interaction of the neurostimulation system
and equipment — even when both are
working properly.



Contraindication

Diathermy – Inform anyone treating you that
you **CANNOT** have any shortwave
diathermy, microwave diathermy or
therapeutic ultrasound diathermy (all now
referred to as diathermy) anywhere on your
body because you have an implanted
neurostimulation system. Energy from

diathermy can be transferred through your implanted system, can cause tissue damage, and can result in severe injury or death.

Diathermy can also damage parts of your neurostimulation system. This can result in loss of therapy from your neurostimulation system, and can require additional surgery to remove or replace parts of your implanted system.

Personal injury or device damage can occur during diathermy treatment when:

- the neurostimulation system is turned ON or OFF.
- diathermy is used anywhere on your body (not just where your neurostimulation system is located).
- diathermy is used to deliver heat or no heat.
- any component of your neurostimulation system (lead, extension, neurostimulator) remains in your body.

Warnings

EMI from the following medical procedures or equipment can damage the device, interfere with device operation, or cause you harm. If these procedures or equipment are required, the guidelines below must be followed:

Defibrillation / cardioversion – When you are in ventricular or atrial fibrillation, the first consideration is your survival. External defibrillation or cardioversion can damage a neurostimulation system and cause induced electrical currents through the lead and extension. These induced electrical currents could injure you. The current flowing through the neurostimulation system should be minimized as follows:

- Paddles should be positioned as far from the neurostimulator as possible.
- Paddles should be positioned perpendicular to the neurostimulation system.

- The lowest clinically appropriate energy output (watt seconds) should be used.

After external defibrillation, your doctor should confirm that the neurostimulation system is working as intended.

Electrocautery – If electrocautery tools are used near an implanted device or contacts a device, the following effects can occur:

- The insulation on the lead or extension can be damaged, causing the lead or extension to fail or causing induced currents that can damage tissue or stimulate or shock you.
- The neurostimulator can be damaged, stimulation can be temporarily decreased or increased, or the neurostimulator can be turned OFF because the neurostimulator was reset to power-on-reset values (requiring your health care provider to reprogram your neurostimulator).

When electrocautery is necessary, these precautions must be followed:

- The neurostimulator should be turned OFF before using electrocautery.
- Bipolar cautery should be used.
- If unipolar cautery is necessary:
 - only low-voltage modes should be used.
 - the lowest possible power setting should be used.
 - the current path (ground plate) should be kept as far away as possible from the neurostimulator, extension, and lead.
 - full-length operating-room-table grounding pads should not be used.
- After electrocautery, your doctor should confirm that the neurostimulator is working as intended.

High-output ultrasonics / lithotripsy –

Use of high-output ultrasonics or lithotripsy is not recommended if you have an implanted neurostimulation system. If lithotripsy must be used, the beam should not be focused within 15 cm (6 in) of the neurostimulator.

Magnetic resonance imaging (MRI) –

Medtronic recommends that an MRI should not be prescribed for you if you have any part of an implanted neurostimulation system. Exposing you to an MRI can potentially injure you or damage your neurostimulator. The known potential risks are as follows:

- Induced electrical currents from the MRI to the neurostimulation system can cause heating, especially at the lead electrode site, resulting in tissue damage. Induced electrical currents can also stimulate or shock you.

Note: This warning applies even if only a lead or an extension is implanted in your body.

Factors that increase the risks of heating and injury include, but are not limited to, the following:

- High MRI Specific Absorption Rate (SAR) Radio Frequency (RF) power levels
- Lower impedance leads or extensions (Medtronic product names or model numbers designated with a “Z”, an “LZ”, or “Low Impedance”)
- MRI RF transmit coil that is near or extends over the implanted lead
- Implanted leads with small surface area electrodes
- Short distances between lead electrodes and tissue that is sensitive to heat

- An MRI can permanently damage the neurostimulator, requiring it be removed or replaced.
- An MRI can affect neurostimulator operation. The MRI can also reset the neurostimulator to power-on-reset values requiring your health care provider to reprogram your neurostimulator.
- The neurostimulator can move within the implant pocket and align with the MRI field, resulting in discomfort or reopening of a recent implant incision.

In addition, the MRI image can be degraded, distorted, or blocked from view by your implanted neurostimulation system.

Radiofrequency (RF) / microwave ablation – Safety has not been established for radiofrequency (RF) or microwave ablation in patients with an implanted neurostimulation system. Induced electrical currents can cause heating, especially at the lead electrode site, resulting in tissue damage.

Theft detectors and security devices –

Use care when approaching theft detector and security devices (such as those found in airports, libraries, and some department stores). When approaching these devices, do the following:

1. Show the security personnel your patient identification card for the neurostimulator and ask for a manual search. Security personnel may use a handheld security wand but ask them not to hold the security wand near the neurostimulator any longer than is needed.
2. If you must pass through the theft detector or security screening device, turn your neurostimulator OFF, approach the center of the device and walk through normally.
 - a. If two security gates are present, walk through the middle, keeping as far away as possible from each gate.
 - b. If one gate is present, walk as far away as possible from it.

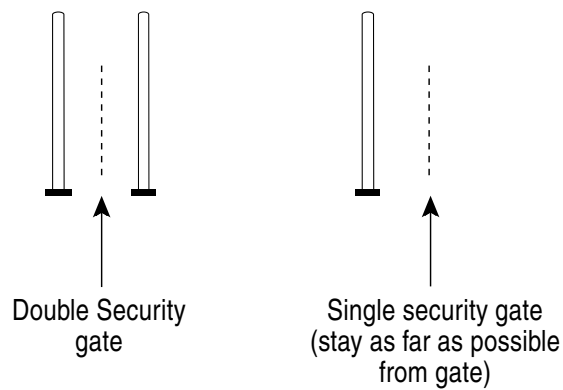

Figure 7.1 Approaching security gates.

Note: Some theft detectors might not be visible.

3. Proceed through the security device. Do not linger near or lean on the security device.
4. After you pass through the security device, turn your neurostimulator ON again.

Precautions

EMI from the following equipment is unlikely to affect your neurostimulation system if the guidelines below are followed:

Bone growth stimulators – The coils of an external magnetic field bone growth stimulator should be kept 45 cm (18 in) away from the neurostimulation system. When a bone growth stimulator is used, your doctor should ensure that both the bone growth stimulator and neurostimulator are working as intended.

Dental drills and ultrasonic probes – The neurostimulator should be turned OFF and the drill or probe should be kept at least 15 cm (6 in) away from the neurostimulator.

Electrolysis – The neurostimulator should be turned OFF, and the electrolysis wand should be kept at least 15 cm (6 in) away from the neurostimulator.

Electromagnetic field devices – The following equipment or environments should be avoided:

- Antennas of citizen band (CB) or ham radios
- Electric arc welding equipment
- Electric induction heaters
- Electric steel furnaces
- High-power amateur transmitters
- High-voltage areas (safe if outside the fenced area)
- Linear power amplifiers
- Magnetic degaussing equipment
- Magnets and other equipment that generate strong magnetic fields
- Microwave communication transmitters (safe if outside the fenced area)
- Perfusion systems
- Resistance welders

- Television and radio transmitting towers (safe if outside the fenced area)

If you suspect that equipment is interfering with the neurostimulation system, do the following:

1. Move away from the equipment or object.
2. If possible, turn off the equipment or object.
3. Then, if necessary, use the patient programmer to return the neurostimulator to the desired ON or OFF state.
4. Inform the equipment owner or operator about the interference.

If the above actions do not resolve the effects of the interference, or you suspect that your therapy is not the same after exposure to EMI, contact your doctor.

Laser procedures – The neurostimulator should be turned OFF, and the laser should be directed away from the neurostimulation system.

Psychotherapeutic procedures – Safety
has not been established for psychotherapeutic procedures using equipment that generates electromagnetic interference (eg, electroconvulsive therapy, transcranial magnetic stimulation) in patients who have an implanted neurostimulation system. Induced electrical currents may cause heating, especially at the lead electrode site, resulting in tissue damage.

Radiation therapy – High radiation sources such as cobalt 60 or gamma radiation should not be directed at the neurostimulation system. If radiation therapy is required near the neurostimulation system, lead shielding should be placed over the device to help prevent damage.

Transcutaneous electrical nerve stimulation (TENS) – TENS electrodes should not be placed so that current passes over any part of the neurostimulation system. If you feel that the TENS unit might be interfering with your neurostimulator,

discontinue using the TENS until you talk with your doctor.

Notes

Household items – Most household appliances and equipment that work properly and are properly grounded will not interfere with the neurostimulation system. The following equipment is safe if you follow these guidelines:

- Computer disk drives: Keep the neurostimulator away from disk drives.
- Induction range: Keep the neurostimulator away from the burners while the burners are turned on.
- Freezer, refrigerator, or storm doors: Do not lean against the magnetic strip that holds the door closed.
- Power tools: Keep the motor away from the neurostimulator, lead, and extension.

- Radio frequency sources: Keep AM/FM radios, and cellular, cordless, and conventional telephones at least 10 cm (4 in) away from the implanted neurostimulator.
- Sewing machines or salon hair dryers: Keep the neurostimulator away from the motors.
- Stereo speakers and radios for the home or car: Do not lift or carry them close to or touching the part of your body where the neurostimulator is located.

Other medical procedures – EMI from the following medical procedures is unlikely to affect your neurostimulation system:

- Computerized axial tomography (CT or CAT) scans
- Diagnostic ultrasound (eg, carotid scan, doppler studies)

Note: To minimize potential image distortion, the neurostimulator should be turned OFF and the transducer kept

15 cm (6 in) away from the neurostimulation system.

- Diagnostic X-rays or fluoroscopy

Note: Tight pressure in the area of your neurostimulator, such as used during mammography, can damage the neurostimulator or disconnect components of your neurostimulation system. This will require surgery to replace or repair the neurostimulation system. X-ray equipment should be adjusted so it does not squeeze the neurostimulator too tightly.

- Magnetoencephalography (MEG)
- Positron Emission Tomography (PET) scans

Therapeutic magnets (eg, magnetic mattresses, blankets, wrist wraps, elbow wraps) – Keep the magnet at least 25 cm (10 in) away from your neurostimulator. Magnetic fields of 10 gauss or less will generally not affect the neurostimulator.

Glossary

Amplitude – The strength or intensity of an electrical pulse.

Caution – A statement describing actions that could result in damage to or improper functioning of a device.

Clinician – A healthcare professional such as a doctor or nurse.

Clinician programmer – A device used by a clinician to send instructions to the neurostimulator and the patient programmer.

Contraindication – A condition or circumstance when a person should not have a neurostimulation system.

Diathermy – A medical treatment applied to the outside of the body that delivers energy into the body. Three types of energy that can be used are shortwave, microwave, and ultrasound. Depending on the power level used, diathermy devices may or may not produce heat within the body. This treatment is typically used to relieve pain, stiffness and

muscle spasms, reduce joint contractures, reduce swelling and pain after surgery, and promote wound healing.

Electrode – A metal piece near the tip of the lead. Electrodes deliver electrical pulses to the area where your pain signals will be blocked.

Electromagnetic interference (EMI) – A strong field of energy near electrical or magnetic devices that could prevent the neurostimulator from functioning properly.

Extension – A thin wire covered with a protective coating that connects the neurostimulator to a lead.

Group – Combined programs that provide stimulation to one or more pain sites. Each group may be defined for a different activity, symptom, or time of day.

Group row – The middle row on the THERAPY screen. This row includes groups that a patient can change.

Indication – The purpose of the neurostimulation system and the medical condition for which it may be implanted.

Information screen – A screen displayed on the patient programmer that alerts you to a problem with the programmer, antenna, or neurostimulator.

Lead – A thin wire with protective coating that has metal electrodes on one end and a connector on the other.

Neurostimulation system – Components that deliver electrical pulses to block pain signals as they move to the brain.

Neurostimulator – The power source of a neurostimulation system. It contains the battery and electronics that control the stimulation you feel.

Parameter – One of three stimulation settings that adjust the electrical pulse: amplitude, pulse width, and rate.

Parameter row – The bottom row on the THERAPY screen. Icons indicate the parameters that a patient can adjust.

Patient programmer – A hand-held device that allows you to turn your neurostimulator ON and OFF. It is also used to adjust some stimulation settings.

Program – Stimulation directed to a specific pain site.

Programming – Using a clinician or patient programmer to communicate stimulation settings to a neurostimulator.

Precaution – See Caution.

Pulse width – The length or duration of an electrical pulse.

Rate – The number of electrical pulses delivered each second.

Settings – See Stimulation settings.

SoftStart/Stop – This feature, programmed by your clinician, starts and stops stimulation gradually by slowly increasing or decreasing to the programmed amplitude or OFF.

Spinal cord – This is your body's information center. Nerve signals from the entire body travel to your spinal cord, and then to your brain.

Status row – The top row on the THERAPY screen. Icons represent information about the neurostimulator and the patient programmer.

Stimulation – The delivery of electrical pulses to the area where pain signals are blocked as they move to the brain. Stimulation blocks some pain signals from reaching the brain.

Stimulation settings – Refers to all the features assembled to define the stimulation you feel. The clinician programs all stimulation settings. You can adjust some stimulation settings.

Synchronize – The process of sending and receiving information between the patient programmer and neurostimulator.

Therapy – Treatment of a disease or condition. When neurostimulation therapy is prescribed, a neurostimulation system is used to deliver stimulation to one or more sites.

Therapy screen – The main screen displayed on the patient programmer.

Warning – A statement describing an action or situation that could harm the patient.

Warning screen – A screen displayed on the patient programmer that alerts you to a problem with the programmer, antenna, or neurostimulator.

Index

Activities 29, 30, 41
Adjusting stimulation guidelines 53–55
Adjusting stimulation settings 57–65
Adverse effects 18
Amplitude
 description 38
 increasing or decreasing 62–65
 reduce to lowest setting 31
Antenna, detachable 76–78
Antenna, internal (patient programmer) 46
Audio
 changing preference 72–75
 tones 57, 80
Backlight (Power/Backlight) key 71
Batteries (patient programmer)
 about 66
 caution 66
 checking 66–67
 disposing of 101
 replacing 68
Bone growth stimulators 116
Cardioversion 108
Carrying case 75
CAT scans 121
Cell phones 121
Change row 73
Changes in stimulation, unexpected 30, 54
Changing a group 59–61

Checking batteries
 patient programmer 66–67
Clinician programmer 40
Communication screens 82
Complications, system 18
Computerized axial tomography 121
Contraindications 16
Contrast preference 72–75
Cremation 101
CT scans 121
Day cycling
 example 52
 icon 51
Decrease key 64, 71
Decreasing a parameter 62–65
Defibrillation 108
Dental drills 116
Diathermy 16
Disposing of
 neurostimulator 101
 patient programmer 101
 patient programmer batteries 101
Driving 31
Electrocautery 109
Electrolysis 116
Electromagnetic field devices 117
Electromagnetic interference (EMI) 19–24, 106–122
Error codes 82
Extensions 37
Fluoroscopy 122

Index

Group row 49, 60
Group row icons 50
Group, changing 59–61
Groups 38–39
Hiking 30
Household items 120
Hyperbaric chambers 30
Identification label 76
Increase key 64, 71
Increasing a parameter 62–65
Indications 16
Information screens 83–87
Interference
 See Electromagnetic interference (EMI)
Keys (patient programmer) 69–71
Laser procedures 118
Leads 37
Lithotripsy 111
Lower limit screens 65
Magnetic resonance imaging (MRI) 111
Magnetoencephalography (MEG) 122
Magnets, therapeutic 122
Mammography 122
Microwave ablation 113
Navigator key 58, 69
Neurostimulation system parts 36

Neurostimulator
description 37
disposing of 101
low battery screen 85
turning ON or OFF 55
when to turn OFF 31
Neurostimulator OFF key 49, 70
Neurostimulator ON key 49, 70
Number format preference 72–75
Options icon 59
Parameter limit screens 65
Parameter row 49
Parameter row icons 51
Parameter, increasing or decreasing 62–65
Patient identification card 14
Patient programmer
batteries 66–68
cleaning and care 28, 98
description 37, 40, 46, 47
disposing of 101
keys 69–71
preferences 72–75
screens 80
troubleshooting 92–94
Positron Emission Tomography (PET) scans 122
Power tools 31
Power/Backlight key 69, 71
Precautions 26–31
Preference icons 72
Preferences, changing 72–75

Index

Pregnancy 32
Programmer
 See Patient programmer
Programs
 description 38–39
 navigating 63
Psychotherapeutic procedures 119
Pulse width
 description 38
 increasing or decreasing 62–65
Radiation therapy 119
Radiofrequency (RF) ablation 113
Rate
 description 38
 in programs and group 63
 increasing or decreasing 62–65
Scuba diving 30
Security devices 114
Serial number 95
Settings, adjusting stimulation 57–65
Skiing 30
Skydiving 30
SoftStart/Stop 90
Specifications 103
Status row 49, 72
Status row icons 50

Stimulation

- adjusting settings 57–65
- description 34
- guidelines for adjusting 53–55
- troubleshooting 89–91
- uncomfortable 56, 89
- unexpected 56
- unexpected changes 30, 54
- Sync key 49, 70
- Synchronizing 48
- Theft detectors 114
- Therapy screen 48, 49
- Therapy screen icons 49
- Tones, audio 57, 80
- Transcutaneous electrical nerve stimulation (TENS) 119
- Turning neurostimulator ON or OFF 55
- Twiddler's Syndrome 29
- Ultrasonic probes 116
- Ultrasonics, high-output 111
- Ultrasound 121
- Uncomfortable stimulation
 - preventing 56
 - troubleshooting 89
- Unexpected changes in stimulation 30, 54
- Unexpected stimulation, preventing 56
- Upper limit screens 65
- Warning screens 80–82
- Warnings 19–26
- X-rays 122

Contacts:

Asia: Medtronic International Ltd.
Suite 1602 16/F, Manulife Plaza,
The Lee Gardens, 33 Hysan Avenue,
Causeway Bay, Hong Kong
Tel. 852-2891-4068 Fax 852-2591-0313

Medtronic Asia Ltd.
3 Floor Peter Building,
570-6 Shinsa-Dong Kangnam-ku,
Seoul 135-120, South Korea
Tel. 82-2-548-1148 Fax 82-2-518-4786

Australia: Medtronic Australasia Pty. Ltd.
Unit 4/446 Victoria Road, Gladesville NSW 2111
Tel. 02-9879-5999 Fax 02-9879-5100

Austria: Medtronic Österreich G.m.b.H.
Millennium Tower, Handelskaj 94-96, 1200 Vienna
Tel. 01-24044 Fax 01-24044-100

Belgium: Medtronic Belgium S.A.
Boechoutlaan 55, 1853 Strombeek-Bever
Tel. 02-456-0900 Fax 02-460-2667

Canada: Medtronic of Canada Ltd.
6733 Kitimat Road, Mississauga,
Ontario L5N 1W3
Tel. 905-826-6020 Fax 905-826-6620

Denmark: Medtronic-ViCare A/S
Birkerød Kongevej 150B, DK-3460 Birkerød
Tel. 45-823366 Fax 45-823365

Finland: Medtronic Finland OY/LTD
Sahaajankatu 24, P.O. Box 230
FIN-00810 Helsinki
Tel. 9-755-2500 Fax 9-755-25018

France: Medtronic France S.A.S.
122, avenue du Général Leclerc,
92514 Boulogne-Billancourt Cedex
Tel. 01-5538-1700 Fax 01-5538-1800

Germany: Medtronic GmbH
Emanuel-Leutze-Straße 20, 40547 Düsseldorf,
P.O. Box 110738
Tel. 0211-52930 Fax 0211-5293100

Greece: Medtronic Hellas S.A.
Agias Varvaras 5, 15231 Halandri, Athens
Tel. +30 2 10-677 90 99 Fax 30 2 10-677 93 99

Italy: Medtronic Italia SpA
P.zza Indro Montanelli 30,20099 Sesto
San Giovanni (MI).
Tel. 02-241371. Fax 02-241381.
Via Lucrezio Caro, 63, 00193 Roma
Tel. 06-328141 Fax 06-3215812

Japan: Medtronic Japan
Solid Square West Tower 6F,
580 Horikawa-cho, Saiwai-ku,
Kawasaki, Kanagawa 210-0913.
Tel. 044-540-6112 Fax 044-540-6200

Latin America Headquarters: Medtronic, Inc.
710 Medtronic Parkway,
Minneapolis, MN 55432-5604 USA
Tel. 763-514-4000 Fax 763-514-4879

The Netherlands: Medtronic B.V.
Earl Bakkenstraat 10, P.O.Box 2542,
6401 DA Heerlen
Tel. 045-5668000 Fax 045-5668668

Norway: Medtronic Vingmed AS
Fjordveien 1, Postboks 366, 1323 Høvik
Tel. 67 58 06 80 Fax 67 10 12 12

Portugal: Medtronic Portugal, Lda.
Rua Tomás da Fonseca,
Torre E 8, andar A,B,
1600 - 209 Lisboa
Tel.21-724-5100 Fax 21-724-5199

Spain: Medtronic Ibérica, S.A.
Centro Empresarial Miniparc III, Edificio K,
Calle Caléndula, 93, El Soto de la Moraleja,
28109 Alcobendas - Madrid
Tel. 91-625-0400 Fax 91-650-7410

Sweden: Medtronic AB
Dackevägen 33, Box 265
S-177 25 Järfälla
Tel. 08-5222-0000 Fax 08-5222-0050
Internet: www.medtronic.se

Switzerland: Medtronic (Schweiz) AG
Route du Molliau 31
Case Postale 84
CH-1131 Tolochenaz
Tel. 021-803-8000 Fax 021-803-8099

U.K. and Ireland: Medtronic U.K. Ltd.
Suite 1, Sherbourne House,
Croxley Business Center, Watford,
Herts WD1 8YE, United Kingdom
Tel. 1923-212213 Fax 1923-241004

USA: Medtronic, Inc.
710 Medtronic Parkway
Minneapolis, MN 55432-5604 USA
Tel. 763-505-0606
Toll-free: 1-800-707-0933
Fax 763-505-0130

7439_bcv.fm 10/13/04 9:31 am
Size 4.625" x 6.0" (117 mm x 152 mm)
UC200xxxxx EN

Medtronic Confidential
NeuroPatntR00



Medtronic
When Life Depends on Medical Technology

Manufacturer

Medtronic, Inc.
710 Medtronic Parkway
Minneapolis, MN 55432-5604
USA
Internet: www.medtronic.com
Tel. 1-763-505-5000
Fax 1-763-505-1000

**Medtronic E.C. Authorized
Representative/Distributed by**

Medtronic B.V.
Earl Bakkenstraat 10
6422 PJ Heerlen
The Netherlands
Tel. 31-45-566-8000
Fax 31-45-566-8668

**Europe/Africa/Middle East
Headquarters**

Medtronic Europe Sàrl
Route du Molliiau 31
Case Postale
CH-1131 Tolochenaz
Switzerland
Internet: www.medtronic.co.uk
Tel. 41-21-802-7000
Fax 41-21-802-7900

Asia-Pacific

Medtronic International Ltd.
Suite 1602 16/F, Manulife Plaza
The Lee Gardens, 33 Hysan Avenue
Causeway Bay
Hong Kong
Tel. 852-2891-4068
Fax 852-2591-0313

Contacts for specific countries are listed
inside this cover.



* 2 2 1 2 4 4 0 0 1 *

© Medtronic, Inc. 2004
All Rights Reserved
221244001

221244001 Rev X

Printing instructions: