



Medtronic

vitatron

CARELINK ENCORE™ 29901

Programmer for Medtronic and Vitatron Devices

DRAFT VERSION
May 22, 2012

Reference Manual

29901/SW028:  0123
2012 VSH02:  0344
2012

CARELINK ENCORE™ 29901

Reference Manual

A guide for setting up and using the CareLink Encore 29901 Programmer.

The following list includes trademarks or registered trademarks of Medtronic in the United States and possibly in other countries. All other trademarks are the property of their respective owners.

CareLink, CareLink Encore, Marker Channel, Medtronic, Paceart, SessionSync, Vitatron

Contents

- 1 Introduction to the programmer 8**
- 1.1 Explanation of packaging and product symbols 8
- 1.2 About this guide 11
- 1.3 Description 11
- 1.4 Intended use 12
- 1.5 Warnings 12
- 1.6 Precautions 15
- 1.7 Declaration of Conformity 17
- 1.8 Regulatory compliance 17
- 1.9 Programmer functions 18
- 1.10 Security features of the programmer 19
- 1.11 Software requirements 20
- 1.12 Compatible components 20
- 1.13 Obtain technical manuals 21
- 2 Set up the programmer 22**
- 2.1 System components 22
- 2.2 Programmer button panel 25
- 2.3 Basic setup 26
- 2.4 Charge the battery 32
- 2.5 Use external printers 35
- 3 Configure the programmer 40**
- 3.1 Display screen features 40
- 3.2 About the Between Patient Sessions tool palette 43
- 3.3 Change the language setting 44
- 3.4 Use the on-screen keyboard 45
- 3.5 View and update programmer location and hardware information 45
- 3.6 Adjust programmer time and date 46
- 3.7 Select audible tones 47
- 3.8 Check the software version 48
- 3.9 Select other software 49

Medtronic

CARELINK ENCORE™ 29901

- 3.10 Remove other software applications 49
- 3.11 Improve the detection of pacing artifacts 50
- 3.12 Start the Demonstrations option 50
- 3.13 Configure network using the Network Configuration window 51
- 4 Update programmer software using the Software Distribution Network 54**
- 4.1 The Software Distribution Network 54
- 4.2 Connect to the SDN using a wired network connection 54
- 4.3 Connect to the SDN using a wireless network connection 59
- 5 Conduct a patient session 62**
- 5.1 Prepare for a patient session 62
- 5.2 Initiate a patient session 69
- 5.3 Electronic Strip Chart (eStrip) recorder 73
- 5.4 Emergency VVI button 76
- 5.5 End a patient session 77
- 5.6 Store components 78
- 6 Manage session data and reports 79**
- 6.1 Session data 79
- 6.2 Reports 79
- 6.3 Save to a PDF file 79
- 6.4 Save to USB 80
- 6.5 View reports that are saved to media 81
- 6.6 View reports on the programmer using PDF Viewer 82
- 6.7 Viewing and printing PDF files on a computer 82
- 6.8 Manage patient data privacy 83
- 6.9 Set the interval for report deletion 86
- 7 SessionSync (Optional) 88**
- 7.1 About SessionSync 88
- 7.2 Enable and disable SessionSync 88
- 7.3 SessionSync Status icon 89
- 7.4 Use Automatic SessionSync 90
- 7.5 Use Manual SessionSync for supported devices 91
- 7.6 SessionSync error message descriptions 91

Medtronic

CARELINK ENCORE™ 29901

7.7 View SessionSync Status screen 92

7.8 Update SessionSync status 92

8 Service the programmer 94

8.1 Clean the system components 94

8.2 Sterilize the programming head, ECG cable, and lead wires 94

8.3 Programmer specifications 96

8.4 Special notice 98

8.5 Medtronic limited warranty 99

A End-user license agreement 100

A.1 End-user license agreement (EULA) terms 100

Index 105











Medtronic

CARELINK ENCORE™ 29901

1 Introduction to the programmer









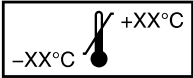

1.1 Explanation of packaging and product symbols

Refer to the package label and product to see which symbols apply to this product.

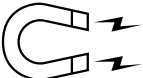
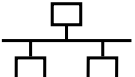
	Caution
	Consult instructions for use
	The product complies with both Canadian and U.S. requirements for meeting UL safety standards.
	System meets the applicable Canadian [C22.2-601.1-M90 (R2001) CAN/CSA C22.2 No. 60601-1-08] and US (UL 60601-1:2003) electrical safety standard requirements.
	Conformité Européenne (European Conformity). This symbol means that the device fully complies with European Directive AIMD 90/385/EEC (NB 0123). (Applies to Medtronic hardware and software only.)
	Conformité Européenne (European Conformity). This symbol means that the device fully complies with European Directive AIMD 90/385/EEC (NB 0344). (Applies to Vitatron desktop software only.)
	Conformité Européenne (European Conformity). This symbol means that the device fully complies with the essential requirements of R&TTE Directive 1999/5/EC (NB 0984). (Applies to Bluetooth only.)
	This product conforms to IP21. There are no openings that allow the user to insert a finger or similar sized objects. The product is resistant to dripping water or vertically falling drops.
	Use only with specified power supply.
	Class II ME Equipment
	Type BF applied part



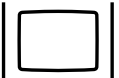









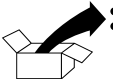

Medtronic

CARELINK ENCORE™ 29901

	<p>Temperature limitation</p>
	<p>Humidity limitation</p>
	<p>RF transmitter</p>
	<p>Notice of proper disposal.</p>
	<p>Do not dispose of this product in the unsorted municipal waste stream. Dispose of this product according to local regulations. See http://recycling.Medtronic.com for instructions on proper disposal of this product.</p>
	<p>Caution: Strong magnet</p>
	<p>Network connection port</p>
	<p>USB port</p>
<p>19V </p>	<p>DC input</p>
<p>PCe</p>	<p>ExpressCard</p>
	<p>Battery</p>
	<p>VGA monitor</p>
	<p>Manufacturer/Date of Manufacture</p>
	<p>Authorized representative in the European community</p>







Medtronic

CARELINK ENCORE™ 29901

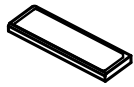
	Reorder number
	Serial number
	Lot number
	Humidity limitation
	Package contents
	Programmer, software installed
	Power cord
	Product documentation
	Accessories
	Programmer
	Stylus / tether
	Programming head
	Power supply
	Power cord

Medtronic

CARELINK ENCORE™ 29901

	Battery
	China RoHS
	This product contains lead (Pb). Do not dispose of this product in the unsorted municipal waste stream. Dispose of this product according to local regulations. See http://recycling.Medtronic.com for instructions on proper disposal of this product.
	Turn the page
	Store programming head
	Do not wrap cord behind head
	Do not wrap cord around head

1.2 About this guide

This guide describes the features and functions of the CareLink Encore 29901 Programmer (referred to as the “programmer”).

Note: Screen images in this guide are for reference only. The content and presentation may vary depending on user selections, desktop, and device being interrogated.

1.3 Description

The CareLink Encore 29901 Programmer is a portable, line-powered (AC) or battery-powered microprocessor-based system with software to interrogate and program Medtronic and Vitatron implantable devices. Other features include:

- Automated software updates using a wireless or local area network (LAN) connection. This connection allows the programmer to program new devices and to provide new features as they become available.
- A large, bright screen that is adjustable for viewing when sitting or standing.

Medtronic

CARELINK ENCORE™ 29901

1.4 Intended use

The programmer is intended to be used to interrogate and program Medtronic and Vitatron implantable devices.

1.5 Warnings

These warnings apply in general to using the programmer for programming implantable device parameter settings. For more information related to specific implantable device models, see the reference guides for the implantable device and the programmer software.

Battery charging – Use the programmer for charging batteries by installing the battery and connecting the power supply. Unapproved charging equipment may damage the battery or cause excessive heating, battery case rupture, or ignition of the battery cells. Use of a damaged battery may damage equipment or cause user or patient injury.

Battery disposal – Do not dispose of batteries in fire, in order to avoid the risk of explosion.

Battery exposure – Exposing the battery to cold temperatures may result in a loss of performance and shortened battery service life. Use of a damaged battery may cause injury, damage equipment, or impact user or patient safety.

Battery handling – Do not puncture batteries. Do not disassemble batteries as this can generate a gas that may irritate the throat and lungs. If the battery is opened, lithium in the battery may react with moisture and generate heat or fire, which could result in injury.

Battery overheating – Do not store the programmer battery in direct sunlight, inside a car, or in an enclosed space in extremely hot weather. Overheating the battery may result in a loss of performance and shortened battery service life. The battery contains built-in thermal protection circuitry that prevents the battery from charging when hot. Excessive heating of the battery may cause battery case rupture or ignition of the battery cells.

Battery replacement – If you receive a message on the programmer to replace the battery, you need to replace the battery with a new battery. Use of a failed battery will reduce programmer operating time and may cause user or patient injury. For more information, see Section 2.4.

Connection of external devices – Additional equipment connected to medical electrical equipment must comply with the respective IEC or ISO standards (for example, IEC 60950 for data processing equipment). All configurations must comply with the requirements for medical electrical systems (see IEC 60601-1-1 or clause 16 of the 3rd edition of IEC 60601-1, respectively). Anyone connecting additional equipment to medical electrical equipment configures a medical system and is therefore responsible that the system complies with the requirements for medical electrical systems. Local laws take priority over the above mentioned requirements. If in doubt, consult your local Medtronic representative or the technical service department.

Medtronic

CARELINK ENCORE™ 29901

Damage due to impact – Do not use the programmer if it has sustained impact damage. Internal components may be damaged or exposed. Use of damaged equipment may impact user or patient safety.

Defective equipment – If technical and safety inspection reveals a defect that could harm the patient, clinicians, or third parties, the programmer should not be used until it has been properly repaired. The operator must immediately notify Medtronic or Vitatron of these defects.

Diagnostic ECG – Do not use the programmer ECG display for recording or diagnosis. Use a separate ECG device if recording or diagnostic ECG capabilities are required.

Electric shock risk – Do not simultaneously touch the patient and any metal parts of the programmer, such as the USB port or the power connector, as voltage may be present. Application of voltage to the patient may impact user or patient safety.

Equipment compatibility – The programmer must be used only for interrogating and programming compatible Medtronic or Vitatron implantable devices. If the programmer is used on other implanted devices, direct stimulation through energy coupling may occur. The programmer is not compatible with programmable devices of other manufacturers.

Flammable anesthetic mixture – The programmer is not suited for use in the presence of a flammable anesthetic mixture.

High sound pressure levels – The programmer speaker may emit alert tones at high sound pressure levels. Consider speaker position when setting up the programmer, and dismiss alerts as soon as possible, in order to avoid hearing damage. Exposure to high sound pressure levels may damage hearing and impact patient health.

Importance of reference documentation – Implantable device programming should be done only after careful study of the reference guide for the implantable device and after careful determination of appropriate parameter values based on the patient's condition and pacing system used. The implantable device reference guide contains a complete description of implantable device operation and important information, such as indications for use, contraindications, warnings, and precautions. The instructions contained in this reference guide and the reference guide supplied with the programmer software are limited to the mechanics of setting up the programmer and selecting the correct options for the desired programming function. Improper use of the programmer could result in erroneous or inadvertent programming and improper operation of telemetry and measurement functions.

Internal electrodes – Do not connect the programmer to wires or electrodes internal to the body. The programmer is designed to be medically safe only when attached to **surface** electrodes.

Internal RTC battery replacement – The real-time clock (RTC) battery, located inside the programmer on a circuit board, is not replaceable by the user. The battery needs

Reference Manual

13

Medtronic

CARELINK ENCORE™ 29901

replacement if the time-of-day clock cannot keep time. Return the programmer to Medtronic for replacement. Use of damaged equipment may impact user or patient safety.

Light-emitting diode (LED) radiation – This device contains Class 1M LEDs. To avoid eye injury, do not view LEDs directly with optical instruments or magnifiers.

Magnetic Resonance (MR) Unsafe – The programmer is MR Unsafe. Do not bring the programmer into Zone 4 (magnet room), as defined by the American College of Radiology.

Measurement function – The programmer is also designed to detect and measure pulse rate, AV interval and pulse width, and implantable device artifacts. The device takes these digital measurements with the assistance of optional skin electrodes. Medtronic and Vitatron make no claims or warranties as to the effectiveness of the programmer as a diagnostic tool to the physician.

Modification of equipment – Do not modify this equipment. Modifications may reduce system effectiveness and impact user or patient safety.

Programmer ventilation – Ensure that the fan is running and programmer ventilation openings are not blocked, in order to prevent overheating. Overheating may cause equipment damage or user or patient safety.

Supply mains with protective earth – To avoid the risk of electric shock, connect the power supply only to a hospital-grade supply mains receptacle which has a protective earth. If the integrity of the supply mains protective earth is in doubt, operate the device using the charged internal battery only.

Use of approved components – Use the specified, Medtronic-supplied power cord, power supply, battery, and components only. The battery is a custom component designed to be used solely in the programmer; replace with and use only the battery supplied by Medtronic. Use of unapproved components may reduce device effectiveness or impact user or patient safety.

Use of unapproved ports and connections – Do not connect unapproved or unsupported equipment or components, such as a docking station, to the programmer. Use of unapproved components may damage equipment or impact user or patient safety.

Use of unapproved power supply – Use only the Medtronic-supplied power supply model 26907 (APS100EM-190530) with the programmer. Use of an unapproved power supply may damage equipment or impact user or patient safety.

Use of wireless devices – The programmer incorporates radio-frequency (RF) communications components which may affect other devices and equipment in the medical environment. The use of wireless devices in the medical environment must be evaluated and authorized by the responsible organization. RF interference may affect device performance.

Medtronic

CARELINK ENCORE™ 29901

1.6 Precautions

Care in handling ECG cable wire – Do not pull on the insulated cable wire to disconnect the cable. Tension on the insulated cable wire may result in damage to the cable.

Electrocautery/external defibrillation – Do not position the programming head over an implanted device during electrocautery or external defibrillation procedures.

Do not immerse – Take care to prevent liquid from entering the programmer and programming head. Do not immerse the programmer or any accessories in any liquid or clean them with aromatic or chlorinated hydrocarbons.

Autoclaving – Do not autoclave the programming head or ECG cable and lead wires.

Electromagnetic interference (EMI) – The programming head has been tested for compliance with industrial and medical EMI regulations. Any use outside the patient environment may result in the programming head malfunctioning.

Radio-frequency (RF) interference – Portable and mobile RF communications equipment can interfere with the operation of the programmer. Although this system has been approved, there is no guarantee that it will not receive interference or that any particular transmission from this system will be free from interference.

Damaged equipment – If the case of the programmer is cracked or if any of the connectors are damaged, contact your Medtronic or Vitatron representative. If there is insulation damage to the power cord or accessory cables or if any of the wall or equipment plugs are damaged, replace the part and dispose of it according to local regulations or return the part to Medtronic.

Electrode quality – Use of high-quality silver/silver chloride (Ag/AgCl) electrodes can minimize the occurrence of small DC voltages that can block the ECG signal. Use electrodes that are fresh and from the same box. Prepare the patient's skin according to the directions provided with the electrodes.

Avoid damage from programming head – Keep the programming head away from any device or material that will be damaged by the magnetic field, including magnetic media, watches, and other electronic devices.

Finger injury – Do not place fingers in the hinge area when opening or closing the stand. Do not place fingers near the storage doors when opening or closing the storage doors. A painful pinch may result.

Programmer and power cord positioning – Position the programmer and power cord so that the power cord can be easily accessed and disconnected. If it is necessary to remove the programmer from the AC mains, the power cord is the power disconnect at the mains outlet.

Medtronic

CARELINK ENCORE™ 29901

Connection or disconnection of programming head – Do not connect or disconnect the programming head while the programmer power is on. Disconnecting the programming head causes an error that requires the programmer to be shut down and restarted.

Product and packaging labels and information – If labels or information appear to be missing from the product or packaging, contact your local Medtronic representative at the address and telephone number located on the back cover of this document.

1.6.1 Environmental precautions

To ensure safe and effective operation, use the device with care to avoid damage to the programmer from environmental factors that may impair its function. Care is exercised in design and manufacturing to minimize damage to devices under normal use. However, electronic devices are susceptible to many environmental stresses including, but not limited to, the following examples.

- The unit is designed to be used indoors in a clinic or hospital.
- The unit should not be dropped or mishandled in such a manner as to cause physical damage to the unit. This may impair device function. Even if the unit works immediately after being dropped, operational damage may have occurred that may not be observed until some future time.
- Fluid should not be spilled on the unit. Even though care is exercised in design and manufacture of the unit to minimize leakage, fluid incursion may occur, which could impair functioning of the unit.
- The programmer may be affected by electrostatic discharge (ESD). In an environment likely to cause ESD, such as a carpeted floor, discharge any charge collected on your body before touching the device.
- The programmer should be placed on a table or other hard surface and positioned to avoid contact with the physician or patient; it is not intended to be used while supported by or in contact with the physician or patient.
- The programmer should maintain a distance of at least 20 cm away from patients and clinicians when the programmer is using Wi-Fi or Bluetooth radios.
- Printers and other connected office equipment should be placed at least 1.5 m from the patient environment.
- Electrically-operated medical devices, such as the programmer require special care (in terms of electromagnetic compatibility) when being installed. Refer to the accompanying insert: Electromagnetic Compatibility Declaration.
- Do not open the device. The programmer is constructed to minimize risk from environmental factors. Opening the unit may make the unit susceptible to environmental factors and may expose the patient or user to hazardous voltage or current.

Medtronic

CARELINK ENCORE™ 29901

- Rapid temperature changes may affect proper operation. Always allow the temperature to stabilize in the environment in which the device is used before using the device.
- Prolonged storage or operation of the device in high humidity may affect proper operation.

If there is any concern that damage has occurred, the unit should be returned to Medtronic or Vitatron for inspection and any needed repair.

Besides these listed examples, various other environmental factors may impair proper performance of the unit in the hospital setting. Always use good health management practices to prevent environmental damage to the unit.

1.7 Declaration of Conformity

Medtronic declares that this product is in conformity with the essential requirements of Directive 1999/5/EC on Radio and Telecommunications Terminal Equipment and Directive 90/385/EEC on Active Implantable Medical Devices (AIMD).

For additional information, contact Medtronic or Vitatron at the telephone numbers and addresses provided on the back cover.

1.8 Regulatory compliance

1.8.1 US Federal Communications Commission (FCC)

FCC ID:LF529901 (for programmer and programming head)

1.8.2 The following provision applies to the low frequency communications system in the device:

This device complies with Part 15 of the FCC Rules. Operation is subject to the following two conditions: (1) this device may not cause harmful interference, and (2) this device must accept any interference received, including interference that may cause undesired operation. The user is cautioned that changes or modifications not expressly approved by the party responsible for compliance could void the user's authority to operate the equipment.

Medtronic

CARELINK ENCORE™ 29901

1.9 Programmer functions

The following list summarizes some of the programmer functions. Specific functions depend on the implantable device model being programmed or monitored and the software installed.

1.9.1 Programming functions:

- Permanent and temporary adjustment of parameter values.
- Selection of nominal parameter values established by Medtronic, Vitatron or by the user.
- Emergency button for VVI pacing.

1.9.2 Telemetry functions:

- Automatic detection of the device model, and automatic application start-up, if the programming head is in proper position when the programmer is turned on.
- Automatic confirmation of a programmed change.
- Reporting of currently programmed parameter values in effect, battery status of the implanted device, saved implantable system information, and patient status information.
- Display and save as a PDF file an atrial and/or ventricular intracardiac electrogram (EGM) taken from the electrodes of the implantable device lead system or Marker Channel telemetry.

1.9.3 ECG functions:

- Live Rhythm Monitor window on programming and telemetry data screens provides a continuous view of the patient's ECG.
- Full-window Live Rhythm display including a freeze option and an amplitude adjustment feature; Live Rhythm display includes Marker Channel telemetry, EGM waveforms, or both when available.
- Continuous multi-channel storage.
- Stimulation threshold test functions.
- Direct measurement of pulse rate, AV interval, and pulse width from the desktop.

Warning: Do not use the programmer ECG display for recording or diagnosis. Use a separate ECG device if recording or diagnostic ECG capabilities are required.

Medtronic

CARELINK ENCORE™ 29901

1.9.4 Software update function:

- Automated software updates using a wireless or local area network (LAN) connection. This connection allows the programmer to program new devices and to provide new features as they become available.
- Updates available from Medtronic personnel.
- Clinical software applications that have Uninstall Software capability may be removed using the programmer desktop.

1.10 Security features of the programmer

Good security practices are needed to protect patient data and the integrity of any network-connected product. The programmer incorporates features that facilitate management of security. These features work in conjunction with the security practices of hospitals and clinics to provide safe and secure operation of the programmer and protect the attached network.

1.10.1 How the programmer promotes security

All installed software has been approved by Medtronic. It is not possible to install general purpose software on the programmer. Controlling installed software minimizes the potential for vulnerabilities. Internal software that runs the programmer is locked from change. Every time the programmer is started, a clean version of the installed software is used.

Patient data is encrypted. The length of time that patient data can be stored on the programmer is limited. The programmer limits patient data stored on the programmer by deleting it after at most 14 days. When patient data is removed from the programmer, it is completely erased so that it is no longer recoverable.

The programmer limits how it communicates on a network. When communicating on a network, the programmer uses industry-accepted protocols for authenticating servers and encrypting transmitted data. Only required network connections are open. Network communications are originated by the programmer. Unauthorized software is not permitted to originate communications with the programmer.

Unsupported hardware, including unsupported USB devices, is ignored by the programmer and is not accessed.

Medtronic continues to work with its partners to analyze emerging threats and evaluate potential impact on the programmer.

Medtronic

CARELINK ENCORE™ 29901

1.10.2 What hospitals and clinics can do to promote the security of programmers

Maintain good physical controls over the programmer. Having a secure physical environment prevents access to the internals of the programmer.

Only connect the programmer to managed, secure networks.

Update the software on the programmer when Medtronic updates are available.

1.10.3 What to do if you suspect the programmer has been compromised

If you believe that the programmer has been compromised by a security threat, turn off the programmer, disconnect it from the network, then restart the system. Discontinue use of the programmer if it does not behave as expected. Contact your Medtronic or Vitatron representative for further assistance.

1.11 Software requirements

The programmer requires software from Medtronic and Vitatron to operate. Once installed, the software remains on the programmer.

Medtronic and Vitatron periodically update the software to add functions to the programmer.

The programmer will not operate properly without the appropriate software installed. If the programmer does not operate properly, check the version of software that is loaded on the programmer, and update it if necessary.

1.12 Compatible components

The following compatible components are available for the programmer:

- Battery 26902
- EC 2090 ECG Cables, Electrode Lead Wires, and Plug
- EC ECL 2090 ECG Cables, Electrode Lead Wires, and Plug
- Power Cord 26906
- Power Supply 26907 (APS100EM-190530)
- Programming Head 26901
- Stylus and Tether 26905

Contact your local Medtronic representative to order them.

Medtronic

CARELINK ENCORE™ 29901

The following components are available as repair parts during authorized service only:

- Articulating Stand 26909
- Storage Doors 26908

1.13 Obtain technical manuals

Medtronic technical manuals, including the manual you are reading, are available in a number of different formats from the Medtronic eManuals website listed on the back cover of this manual. The website offers real-time access to the latest version of manuals 24 hours per day, seven days per week. Manuals can be viewed online, downloaded for viewing or printing, or ordered from the website.

All manuals are available online in English. Most manuals are also available in additional languages in online, CD-ROM, or paper format. New manuals are added to this site regularly. If you do not find the manual you want, contact your Medtronic or Vitatron representative.

Your order for CD-ROM or printed versions of manuals ships from our facility within 24 hours and should reach you within 3 business days. If you need a copy before the shipment arrives, download the manual and print it, or contact your Medtronic or Vitatron representative.

1.13.1 Access the eManuals website

1. Point your browser to the address listed on the back cover of this manual.
2. Select location and language, and click [Continue].
3. Select one or more manual languages, and click [Continue].

To see lists of CRDM manuals, click the desired category on the left of the screen. You can also search for manuals using a product name or model number.

Medtronic

CARELINK ENCORE™ 29901

2 Set up the programmer

2.1 System components

Figure 1. Programmer components - front view

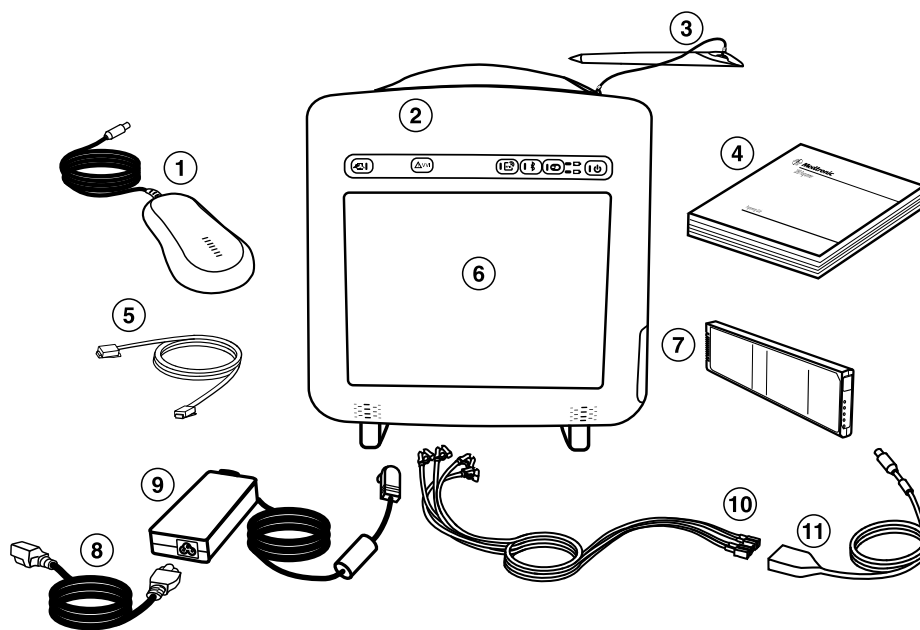

- | | |
|---------------------------------|---------------------------------------|
| 1 Programming head | 7 Battery |
| 2 Button panel | 8 Power cord |
| 3 Stylus and Tether | 9 Power supply |
| 4 Product documentation | 10 Electrode leads (not supplied) |
| 5 Ethernet cable (not supplied) | 11 ECG cable with plug (not supplied) |
| 6 Display screen | |

Warning: Use only the specified, Medtronic-supplied power cord, power supply, and components. Use of unapproved components may reduce device effectiveness or impact patient health.

Programming head – Provides the communication link between the programmer and the patient’s implantable device. The programming head contains a strong permanent magnet, radio-frequency (RF) transmitter and receiver, and light array. It must be held over the implantable device during a program or interrogate operation.

Medtronic

CARELINK ENCORE™ 29901

Display screen – Display can be positioned horizontally, vertically, or at an angle. Programming options are selected on the screen with the stylus.

Stylus – Used to select options on the display screen. Predetermined options are selected by applying the stylus to the screen.

Ethernet cable – Used to connect the programmer to the clinic's network. The Ethernet cable must be Category 5 or better. (Not supplied by Medtronic.)

Power cord – Connects the power supply to an AC power outlet.

Power supply – Connects the programmer to the power cord.

Electrode leads/ECG cable – Connects the programmer to skin electrodes on the patient for ECG and measurement functions requiring surface detection of cardiac and implantable device signals. Four color-coded lead wires connect the cable to standard, disposable skin electrodes applied to the patient. (The electrode leads/ECG cables are optional.)

Figure 2. Right view

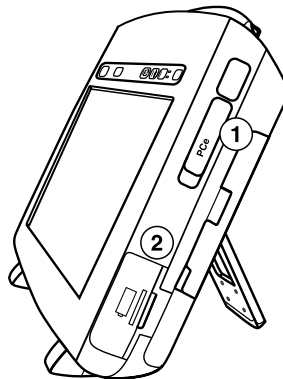

- 1 ExpressCard slot
- 2 Battery cover

ExpressCard slot – Intended for future use.

Battery cover – Covers the battery compartment. Push the cover forward and slide it out to insert or remove the battery.

Medtronic

CARELINK ENCORE™ 29901

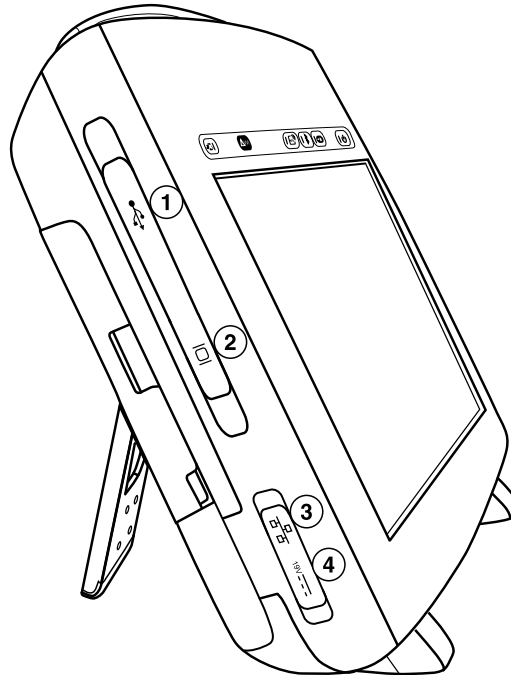
Figure 3. Left view

1 USB ports

2 VGA output port

3 Integrated Ethernet

4 Power input

USB port(s) – Allows installation of software, software updates, and future device application installations. The USB port can also be used to connect to a USB printer or a USB flash drive.

VGA output port – Allows porting the screen image of the programmer to an external VGA monitor or for conversion of the output signal to NTSC/PAL format for presentation on a television monitor.

Integrated Ethernet – Allows the programmer to connect to the Software Distribution Network and the Paceart data management system using an Ethernet connection.

Power input – Used to connect the programmer to an AC power outlet using the power supply and power cord.

Medtronic

CARELINK ENCORE™ 29901

Figure 4. Back view (doors open)

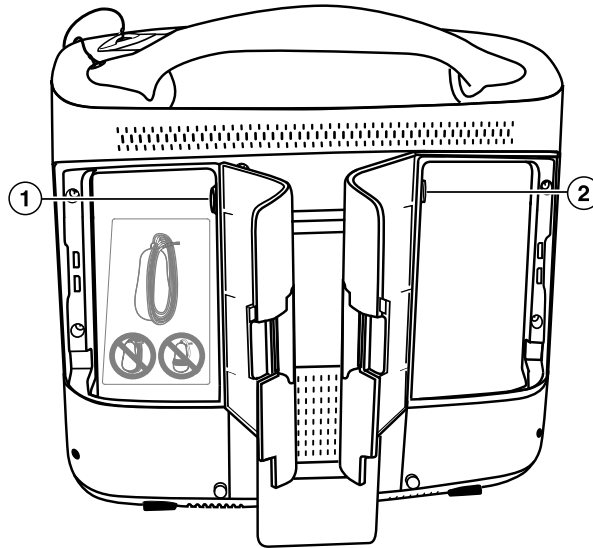

- 1 Programming head connector
- 2 ECG cable connector

2.2 Programmer button panel

Figure 5. Programmer button panel











The programmer button panel contains these buttons and indicators:

Medtronic

CARELINK ENCORE™ 29901

Table 1. Buttons and indicators on the programmer button panel

Button or indicator	Name	Function
	Electronic Strip Chart (eStrip) button	Used to insert a highlight into the recorded Electronic Strip Chart (eStrip) waveform data.
	Emergency VVI button	Provides immediate access for emergency VVI pacing during a session.
	RFID button	Intended for future use.
	Bluetooth button	Used to enable or disable Bluetooth power.
	Wi-Fi button	Used to enable or disable Wi-Fi power.
	Battery Status indicator	Provides information about the status of the battery.
	Battery Charge indicator	Provides information about the charge of the battery.
	Power button	Turns on and turns off the programmer.

2.3 Basic setup

Before setting up the programmer, select a sturdy location for it without blocking the air vents on the back. The programmer uses an AC power supply and has a backup battery. To use the power supply, the location of the programmer must be near a hospital-grade supply mains receptacle which has a protective earth.

This section describes how to:

- Position the programmer
- Connect the power supply
- Install the battery
- Connect the programming head

Medtronic

CARELINK ENCORE™ 29901

- Connect the ECG cable
- Turn on the programmer
- Troubleshoot potential interference

2.3.1 Position the programmer

The programmer can be positioned horizontally or at an angle.

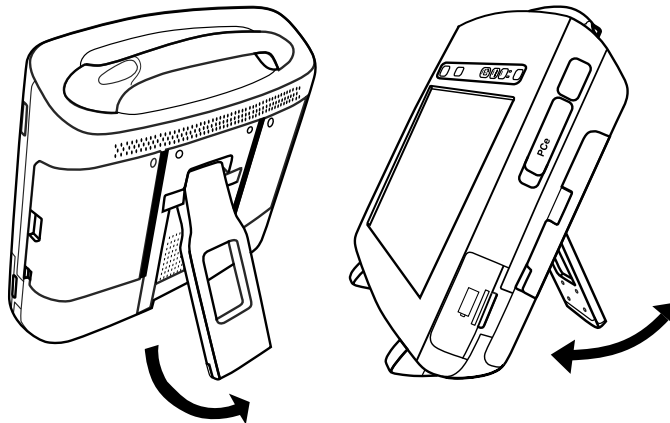

1. To position the programmer at an angle, pull out the stand on the rear of the programmer.
2. Place it at a comfortable viewing angle.

Caution: Do not place fingers in the hinge area when opening or closing the stand. A painful pinch may result.

Medtronic

CARELINK ENCORE™ 29901

2.3.2 Connect the power supply

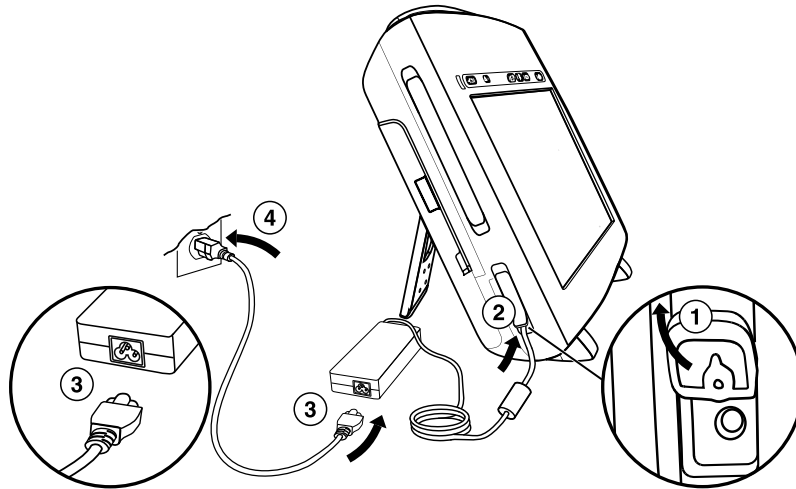

1. Open the power input cover on the lower left side of the programmer.
2. Plug the power supply into the programmer.
3. Plug the power cord into the power supply.
4. Position the programmer and power cord so that the power cord can be easily accessed and disconnected.
5. Plug the power cord into the AC power outlet (AC mains).

Note: If it is necessary to remove the programmer from the AC power outlet (AC mains), the power cord is the power disconnect at the mains outlet.

Warnings:

- To avoid the risk of electric shock, connect the power supply only to a hospital-grade supply mains receptacle that has a protective earth. If the integrity of the supply mains protective earth is in doubt, operate the device using the charged internal battery only.
- Use only the specified, Medtronic-supplied power cord, power supply, and components. Use of unapproved components may reduce device effectiveness or impact patient health.

Medtronic

CARELINK ENCORE™ 29901

2.3.3 Install the battery

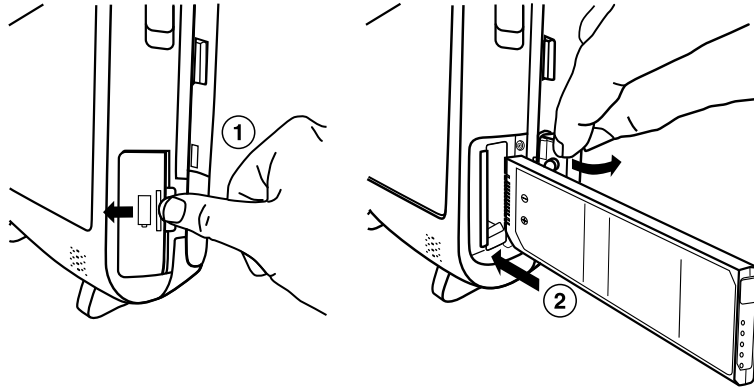

1. Open the battery door on the lower right side of the programmer by pressing forward on the battery door recess and flipping the door to the left.
2. Slide the battery in until you hear it click into position. The battery is kept in position by a hook located on the bottom of the opening.
3. Close the battery door.

Notes:

- The battery is supplied partially charged. After installing a new or replacement battery, connect the power supply and charge the battery for 2 hours before operating the programmer on battery power.
- If the programmer is on, turn the programmer off before installing or removing the battery.

Medtronic

CARELINK ENCORE™ 29901

2.3.4 Connect the programming head

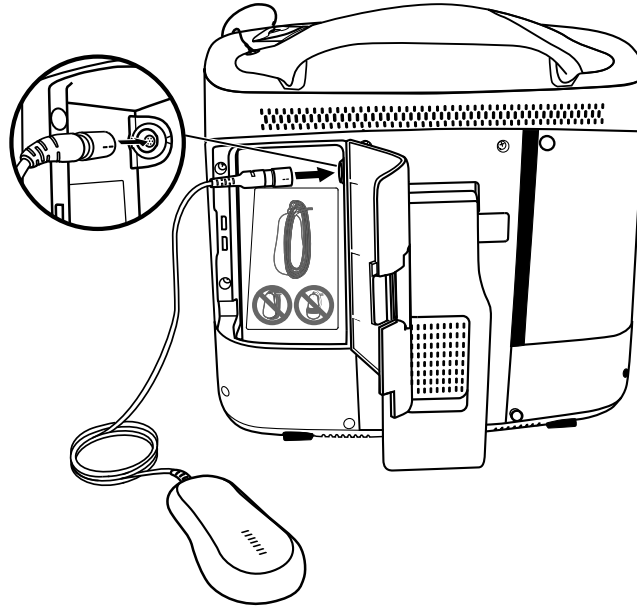

1. Open the door on the left rear of the programmer.
2. Line up the black arrows on the programming head cable and the programming head connector.
3. Plug the cable into the programming head connector with the yellow marker.
4. Close the door, making sure the cable passes through the notch on the bottom of the door.

Warning: Do not connect or disconnect the programming head while the programmer power is on. Disconnecting the programming head causes an error that requires the programmer to be shut down and restarted.

Medtronic

CARELINK ENCORE™ 29901

2.3.5 Connect the ECG cable

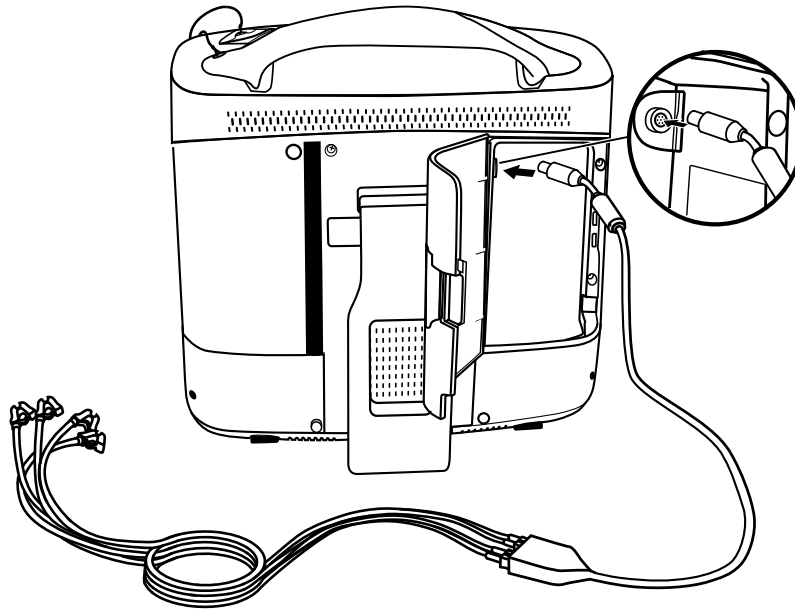

1. Open the right rear door.
2. Line up the ECG cable with the arrow next to the ECG connector.
3. Plug the cable into the connector.
4. Close the door, making sure that the cable passes through the notch on the lower left side.

Note: Improper insertion of the ECG cable plug may damage the connector pins.

Medtronic

CARELINK ENCORE™ 29901

2.3.6 Turn on the programmer

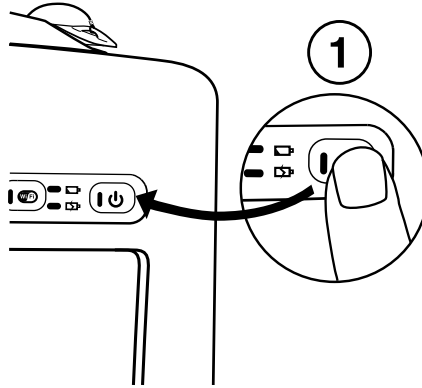

1. Locate the Power button on the front right corner of the programmer button panel.
2. Press and release the Power button.

2.3.7 Troubleshoot potential interference

To address possible harmful interference between the programmer and other devices, you are encouraged to take one or more of the following measures to address the situation:

- Reorient or relocate the devices.
- Increase the separation between the devices.
- Connect the equipment to an outlet on a different circuit.
- Consult Medtronic or Vitatron for help.

2.4 Charge the battery

2.4.1 About battery charge

When the programmer is connected to AC power, the battery automatically charges until it reaches a full charge. Charging occurs when the unit is turned on, turned off or hibernating. Typically an empty battery can be fully charged in two hours. A new, fully charged battery operates for two hours (typical).

Medtronic

CARELINK ENCORE™ 29901

Warning: Use the programmer for charging batteries, by installing the battery and connecting the power supply. Unapproved charging equipment may damage the battery or cause excessive heating, battery case rupture, or ignition of the battery cells. Use of a damaged battery may damage equipment or cause user or patient injury.

2.4.2 Battery status indicators

There are two battery indicators on the programmer button panel that indicate the battery status and the charging status, when active, as shown in Figure 6. The indication varies depending on the operating condition (power state) of the programmer.

Figure 6. Battery indicators

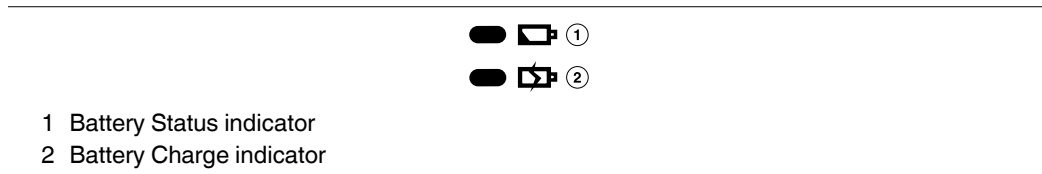

Table 2. Indicator color and indication

Indicator	Indication
Battery Status indicator is solid amber	The programmer is running on battery power, battery power is 20% or less than the full charge, and the programmer should be plugged into AC power to be recharged.
Battery Status indicator is flashing amber	The programmer is running on battery power, battery power is critically low, and the programmer needs to be plugged in to AC power immediately to prevent shutdown.
Battery Charge indicator is solid green	The programmer is running on AC power and the battery has more than 90% of the full charge.
Battery Charge indicator is flashing green	The programmer is running on AC power and the battery has less than 90% of the full charge.

If the programmer is running on battery power and the battery power is getting low, the Battery Power icon displays the power as yellow and a message displays a caution: “Programmer battery is low. Connect the programmer to outlet power or continue at risk of losing power. Estimating 20% or less programmer battery power remaining.”

Medtronic

CARELINK ENCORE™ 29901

If the programmer is running on battery power and battery power is critically low, the Battery Power icon changed to a caution symbol and displays a warning: "Critically low programmer battery. Programmer will shut down. Plug in the programmer immediately to prevent shut down.". The programmer beeps once every 30 seconds and the Battery Power icon bounces every 30 seconds for 9 seconds until it is replaced by another icon or you select the warning.

Warning: If you receive a message on the programmer to replace the battery, you need to replace the battery with a new battery. Use of a failed battery will reduce programmer operating time and may cause user or patient injury.

2.4.3 Battery pack indicators

In addition to the battery status indicators, the battery pack itself provides information about the remaining charge and the charge capacity. By pressing the button on the front side of the battery pack for less than 2 seconds, the indicator lights are lit displaying the remaining charge:

- The first 4 lights each represent 20% of the total charge.
- The fifth light represents a minimum of 15% of the total charge

For example, if all 5 lights are lit, the remaining charge is more than 95% of the original/new charge capacity. If only 2 lights are lit, the remaining charge is more than 40% but less than 60% of the original/new charge capacity.

By holding the button for more than 5 seconds until the lights start to flash, the indicator lights display the indication of how the charge capacity has degraded with respect to the original design capacity after an amount of time or number of charge cycles.

Figure 7. 80-100% of the original/new charge capacity

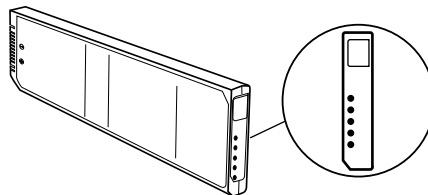

Medtronic

CARELINK ENCORE™ 29901

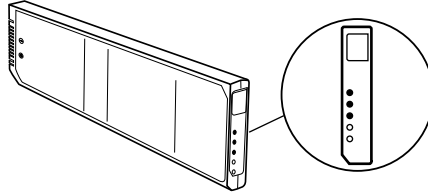
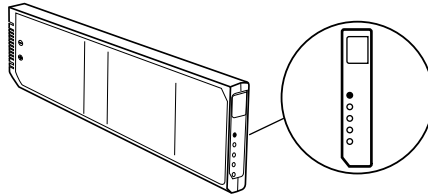
Figure 8. 60-79% of the original/new charge capacity**Figure 9.** Less than 40% of the original/new charge capacity

Check the battery charge capacity periodically with the built-in indicator. Replace the battery pack when the battery charge capacity is less than 60% of the original/new charge capacity, and/or when the battery charge time increases significantly.

2.5 Use external printers

Connecting a compatible printer to the programmer allows you to print full, page-size reports of session data when available. For more information, see the reference guide for the implanted device. This section describes how to connect a printer to your programmer.

All printers listed by this software are certified to IEC 60950-1, UL 60950-1 or equivalent. Only printers listed by this software may be connected to the programmer.

2.5.1 Printer compatibility

The programmer is compatible with many printers. A list of compatible printers can be accessed from the Print Queue screen.

Note: When programming a Vitatron device, refer to the applicable Vitatron reference guide for information about printing.

Medtronic

CARELINK ENCORE™ 29901

2.5.2 View a list of supported printers

1. If you are conducting a patient session, press the **Reports** icon, and then select **Print Queue**.

If you are not conducting a patient session, press the **Print Queue** icon.

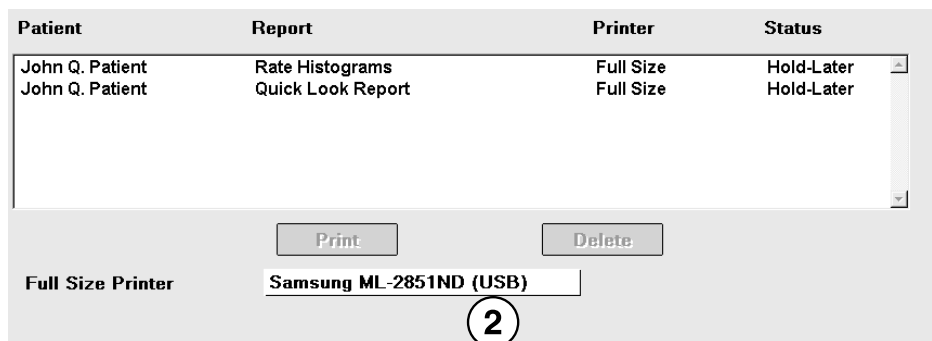

2. On the Print Queue screen, select the Printer field to open the list of supported printers.

2.5.3 Materials you need

To connect the programmer to a printer, you need either a Bluetooth printer or a USB printer cable. One end of the USB cable must be a USB Type A connector. The other end of the cable must fit the USB port on your printer.

2.5.4 Connect the printer

Note: The connection method you use depends on your printer.

Medtronic

CARELINK ENCORE™ 29901

2.5.4.1 Connect to a printer with a USB cable

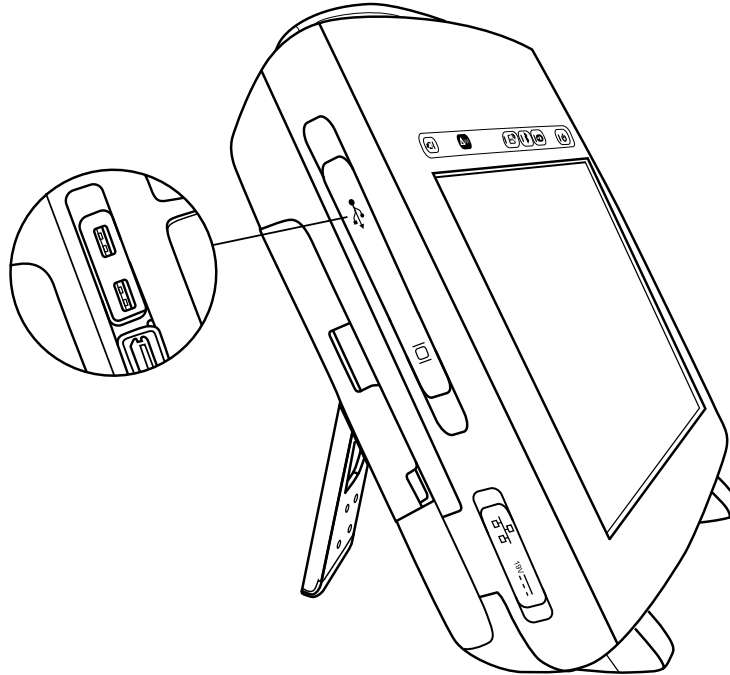

1. To connect to a printer with a USB cable, locate a USB port. There are two USB ports located on the left front side of the programmer.
2. Open the input cover on the upper left side of the programmer.
3. Connect the printer cable to a USB port on the programmer.
4. Connect the other end of the cable to the printer. Connect the printer power cord to an outlet and turn on the printer. Make sure that the printer has paper.
5. Turn on the programmer and select the Print Queue icon.
6. If not previously done, select the correct printer driver from the options listed when you select the Printer field on the Print Queue window. You are now ready to use your programmer with the connected printer.

Medtronic

CARELINK ENCORE™ 29901

2.5.4.2 Connect to a printer with Bluetooth

1. To connect to a printer with Bluetooth, turn on the programmer and turn the Bluetooth radio on for the programmer by pressing the Bluetooth button on the programmer button panel.



2. Connect the printer power cord to an outlet and turn on the printer. Turn Bluetooth on for the printer.

Note: For more information on turning on Bluetooth for the printer, refer to the printer manual.

3. Launch the Bluetooth configuration application by pressing the Bluetooth icon on the programmer taskbar.



4. Press [Search] to search for available Bluetooth printers. If the Bluetooth radio is disabled on the programmer, a message is displayed that you need to enable the Bluetooth radio on the programmer by pressing the Bluetooth button on the programmer button panel.
5. The **Pair Bluetooth Printer** window is displayed listing the available Bluetooth printers. Select the printer you would like to pair with the programmer.

Note: Only one printer can be paired with the programmer. To pair a new printer with the programmer, you must unpair the currently paired printer.
6. Press [Pair]. Depending on your printer configuration, you will use one of the following methods to pair to the printer:

- Enter the printer PIN on the programmer
- Enter the Passkey (PIN) on the printer
- Confirmation code sent to the printer

The programmer will automatically identify which method is needed to pair with a specific printer.

- a. To pair using a PIN, enter the PIN code found on the printer or in the printer manual. The PIN can be between 1 and 16 characters. When you tap the PIN text field the on-screen keyboard is displayed. Enter the PIN with the on-screen keyboard in the **Pair Bluetooth Printer** window. After the PIN has been entered, press [OK].

Medtronic

CARELINK ENCORE™ 29901

- b. To pair using a passkey, enter the PIN from the **Pair Bluetooth Printer** window on your printer. The dialog automatically closes if the passkey is entered correctly.
Note: The passkey is referred to as a “PIN”, but it is different from the PIN supplied by the printer and entered on the programmer.
- c. To pair using a confirmation code, the programmer generates a code and sends it to the printer. The **Pair Bluetooth Printer** window displays the confirmation code. Confirm that the correct code was sent to the printer and press [Yes].
7. The **Pair Bluetooth Printer** window shows a pairing activity indicator. When pairing has completed successfully, the **Configure Bluetooth** window confirms that the printer you selected is currently paired.
8. Select the Print Queue icon.
Note: Be sure to select the correct printer driver from the options listed when you select the Printer field on the Print Queue window. Make sure that the printer has paper. You are now ready to use your programmer with the paired printer.

Medtronic

CARELINK ENCORE™ 29901

3 Configure the programmer

3.1 Display screen features

The programmer display screen is a touch-sensitive interface that displays text and graphics. It is also a control panel that displays buttons and menu options that you can select.

3.1.1 Features and conventions of the display screen

This section provides an overview of the features of the display screen. For more information, see the reference guide for the implanted device. The main elements of a typical display screen before you select a model, when you turn the programmer on, and when you end a patient session, are shown in Figure 10.

Figure 10. Main elements of the display screen

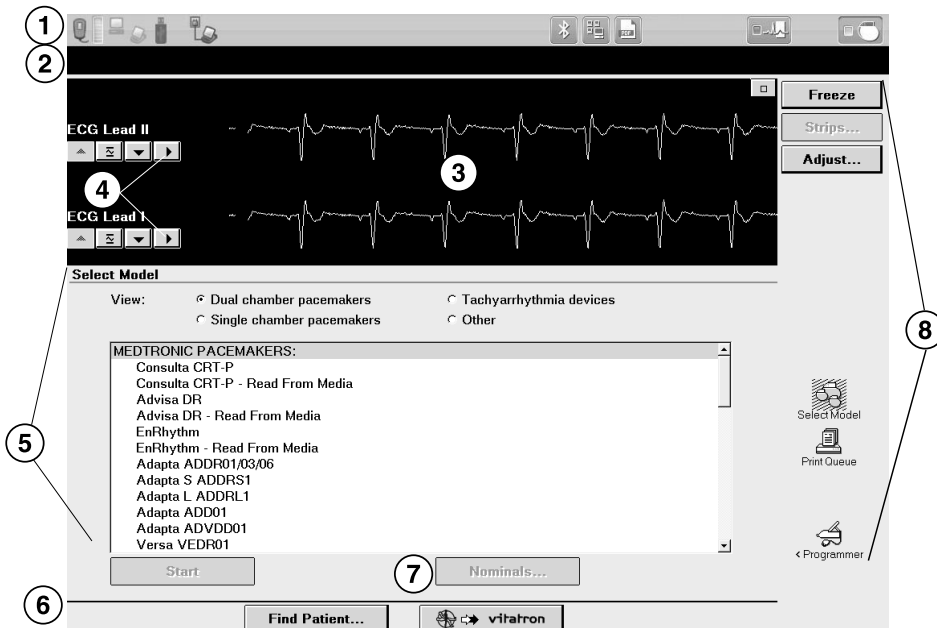

- | | |
|------------------------------|----------------|
| 1 Task bar | 5 Task area |
| 2 Status bar | 6 Command bar |
| 3 Live Rhythm Monitor window | 7 Buttons |
| 4 Waveform adjustment bars | 8 Tool palette |

Medtronic









CARELINK ENCORE™ 29901

Vitatron display screens may be different. For more information, see the reference guide for the implanted device. If you see a Medtronic/Vitatron switch button, press it to display the Vitatron Select Model screen.

3.1.1.1 Task bar

The task bar can contain these icons/indicators:



Table 3. Task bar icons/indicators

Icon	Name	Function
	Telemetry strength	Turns green to indicate successful communication between the programming head and the device. More green bars on the array indicates better communication. A minimum of two green bars should be lit. An amber light means the device is out of range.
	SessionSync	Provides information about the connection and data transfer status between the Programmer and the data management system. SessionSync is an optional feature.
	External USB drive	Turns green to indicate a USB flash drive or other external storage media are available for saving PDF reports and patient data. When inserting a USB flash drive, you may experience a slight delay before the device is available for use.
	AC Power	Appears in the taskbar to indicate that the programmer is connected to AC power.
	Battery Power	Provides information about the status of the battery power when the programmer is not connected to AC power.
	Bluetooth configuration	Opens the Configure Bluetooth window for connecting a Bluetooth-enabled printer to the programmer.
	Network Configuration	Opens the Network Configuration window for configuring network preferences.
	PDF Viewer	Used to view PDFs from a USB flash drive. PDFs can be viewed while in a device application or on the programmer desktop.

Medtronic

CARELINK ENCORE™ 29901

Table 3. Task bar icons/indicators (continued)

Icon	Name	Function
	Electronic Strip Chart (eStrip) selector	Used to go to the Electronic Strip Chart (eStrip) recorder screen.
	Device Application selector	Used to go to the Select Model screen on the programmer desktop. During a patient session, the indicator box turns blue to indicate that the programmer is on a device application screen.

3.1.1.2 Status bar

Before selecting a model, the status bar has no information. For specific information about the status bar, refer to the reference guide for the implanted device. After model selection, the status bar may include:

- The present pacing mode.
- Test condition status.
- The device model.

3.1.1.3 Live Rhythm Monitor window

This window is a partial view of the full-screen display of the ECG, and contains a Waveform adjustment bar that allows you to change the size of the waveform. You can expand this window to full size by selecting the small square button in the upper-right corner of the window or by pressing [Adjust...].

After model selection, Marker Channel and telemetered EGM waveform traces may be available.

3.1.1.4 Task area

The portion of the screen between the Live Rhythm Monitor window near the top of the screen and the command bar at the bottom of the screen changes according to the task or function you select.

3.1.1.5 Command bar

The bar at the bottom of the screen shows the command buttons for automatically launching the proper software application and displaying the Vitatron Select Model screen. For information on what command buttons are available after selecting a model, see the reference guide for the implanted device.

Medtronic

CARELINK ENCORE™ 29901

3.1.1.6 Buttons

Buttons allow you to operate the programmer. You can “press” a button by touching it with the tip of the stylus or your finger.

Buttons may directly execute a command, such as [Freeze], or they may open a window that prompts another action. Buttons that open a window usually have a label ending with an ellipsis, such as [Strips...] or [Adjust...].

A procedure may instruct you to “press and hold” a button. Press the button and maintain pressure until it is time to “release” the button.

When a button is inactive, it appears a lighter color and does not execute a command when you press it.

3.1.1.7 Tool palette

The collection of buttons and icons along the edge of the screen is referred to as the “tool palette”. These buttons and icons are the controls you use to choose the task or function screen you want to display. Each of the icons acts like a button. Touch the icon to select it. For more information, see Section 3.2. For information about the session tool palette, see the reference guide for the implanted device.



3.2 About the Between Patient Sessions tool palette

The Between Patient Sessions tool palette is on the Select Model screen. The Select Model screen appears before you select a model, when you turn the programmer on, and when you end a patient session.

The tools that are available between patient sessions are described in Table 4.

Note: When programming a Vitatron device, refer to the applicable reference guide for information about the tool palette.



Table 4. Between Patient Sessions tool palette

Tool	Selecting the tool (button or icon)...
	Freezes a segment of the live rhythm display. Note: A frozen strip can be viewed, printed, or saved to PDF between patient sessions. Markers and EGM traces are not present between patient sessions.
	The [Strips...] button is not available between patient sessions. Saved rhythm strips can only be accessed during a patient session.
	Opens a window of options for adjusting the live rhythm display. Note: Additional adjustment options are present during a patient session.

Medtronic

CARELINK ENCORE™ 29901

Table 4. Between Patient Sessions tool palette (continued)

Tool	Selecting the tool (button or icon)...
 Select Model	Displays the screen for selecting a model and starting a patient session.
 Print Queue	Displays a queue of print requests from previous sessions as well as frozen waveform reports requested between sessions. Refer to the reference guide for the implanted device to determine if these features are available.
 < Programmer	Displays the programmer setup options. Preferences Time and Date Artifact Detection Software Demonstrations Programmer Profile SessionSync Status SessionSync Network Configuration... Other Software Tools Licensing

Note: When some functions are active on the display, pressing a tool button or icon has no effect. Closing the active window restores operation of the tool palette.

3.3 Change the language setting

The software is translated into several languages. Use the following procedure to determine which languages are available. For Vitatron devices, see the applicable reference guide.

3.3.1 Choose a language

1. Press the **Programmer** icon, and then select **Preferences**.
2. From the Preferences screen, select the Language field to display the options.

Note: The programmer screen goes blank for about 2 minutes after selecting a language. The programmer then resumes operation in the selected language.

Medtronic

CARELINK ENCORE™ 29901

3.4 Use the on-screen keyboard

The on-screen keyboard is used for entering text into an editable field. When you tap in an editable field, the on-screen keyboard displays. When you tap outside the editable field, the on-screen keyboard stops displaying. For fields that have frequently re-used names, terms or medical terminology, a selectable library displays when the field is selected. The library provides you with the ability to add or reuse words when entering text.

3.5 View and update programmer location and hardware information

Information about the location of the programmer and its hardware is on the Programmer Profile screens.

The Programmer Profile location screen has the following information:

- Clinic's name, address, telephone number, contact person, and customer account number
- Service representative's name, telephone number, fax number, and e-mail address

The Programmer Profile hardware screen has the model and serial numbers for the programmer. You can also enter the model and serial numbers for the programming head.

Information on the screen may be updated by selecting the appropriate field and then using the keyboard.

3.5.1 Verify Programmer Profile information

Each programmer has a profile screen that contains identifying information about the installed hardware, the programmer location, and contact information for the Medtronic service representative.

Typically, the profile is completed when the programmer is first installed, and then updated only when necessary.

1. Press the **Programmer** icon, and then select **Programmer Profile**. Location Information appears by default.
2. Complete the location information or verify that the information shown is correct.
3. To view hardware information, select **Hardware Information**.

Medtronic

CARELINK ENCORE™ 29901

Figure 11. Programmer Profile screen

Programmer Profile			
View:	<input checked="" type="radio"/> Location Information	<input type="radio"/> Hardware Information	
Programmer Location		Service Representative	
*Clinic	<input type="text"/>	Last Name	<input type="text"/>
Address	<input type="text"/>	First Name	<input type="text"/>
*City	<input type="text"/>	Phone Number	<input type="text"/>
State/Province	<input type="text"/>	Fax Number	<input type="text"/>
*Country	<input type="text"/>	Email	<input type="text"/>
Postal Code	<input type="text"/>		
Phone Number	<input type="text"/>		
Clinic Contact Person	<input type="text"/>		
*Account Number	<input type="text"/>		
		* Important: Information from these fields is automatically used to determine the dial up sequence for remote software download.	

3.6 Adjust programmer time and date

If the time or date displayed and printed by the programmer is incorrect, use the following procedure to enter the correct settings. For Vitatron devices, see the applicable reference guide.

3.6.1 Set the time and date

1. Press the **Programmer** icon then **Time and Date**.
2. From the Programmer Time and Date screen, press the up or down button to increase or decrease the value for the unit of time you want to change. Press and release the button for single unit changes or press and hold the button to effect greater changes.
3. When all fields show the correct time and date, press [Apply]. Select another tool palette icon to close the Programmer Time and Date window

Medtronic

CARELINK ENCORE™ 29901

Figure 12. Programmer Time and Date screen

Programmer Time and Date

Current: 13:39 04/27/11

Adjust:

Hours: 13 Minutes: 39

Month: 04 Day: 27 Year: 11

Apply

Note: Time must be entered based on a 24-hour clock, with 00:00 being midnight, and 12:00 being noon.

3.7 Select audible tones

Certain events in the operation of the programmer result in an audible signal. The following tones alert you to the success or failure of an action.

- A two-tone beep (low-to-high) indicates confirmation of an Interrogate or a Program command.
- A double low-tone beep indicates that an Interrogate, Program, or Emergency command was **not** confirmed. It can also indicate that the selected command cannot be executed.

Note: For some devices, the tones may not be turned off. For more information, see the reference guide for the implanted device. For Vitatron devices, see the applicable reference guide.

3.7.1 Turn tones on or off

1. Press the **Programmer** icon, and then select **Preferences**.
2. From the Preferences screen, select [Audio ON] or [Audio OFF] as desired.

Medtronic

CARELINK ENCORE™ 29901

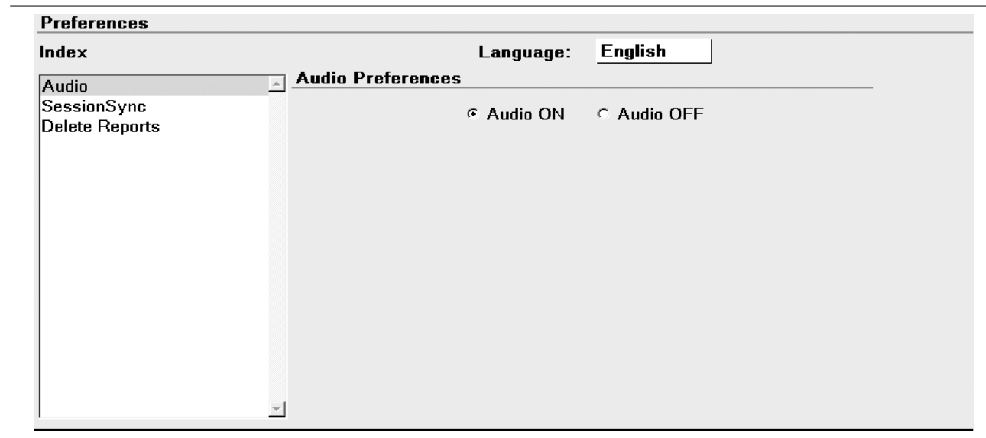
Figure 13. Audio Preferences screen

3.8 Check the software version

This section describes how to determine the version of software that is loaded on the programmer.

If you need to know what version of software is currently loaded on the programmer for any of the device models, use the following procedure.

For Vitatron devices, see the applicable reference guide.

3.8.1 To check the software version number

1. Select **Programmer**, and then select **Software**.
2. For each device model with software loaded on the programmer, the screen displays the software version number next to the model number.

Medtronic

CARELINK ENCORE™ 29901

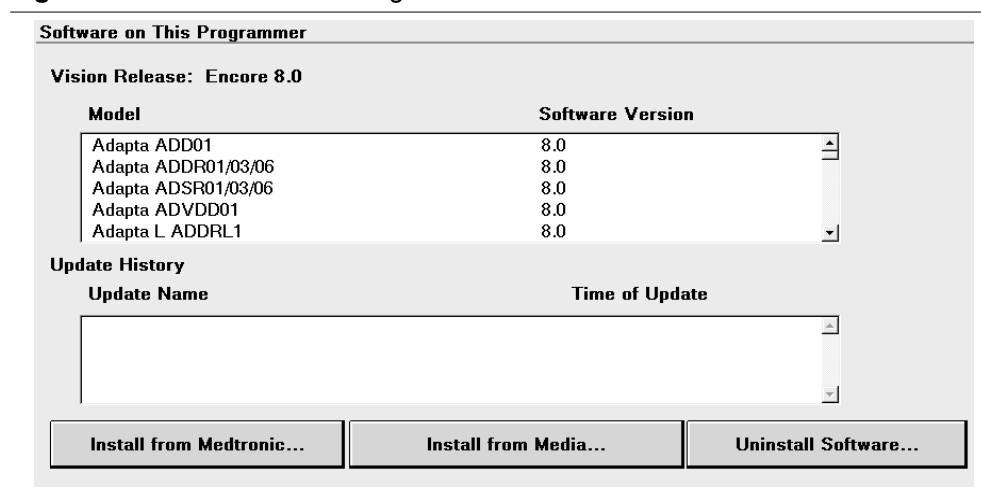
Figure 14. Software on This Programmer screen

Note: If the model that you require is not displayed, the software to support that model is not currently loaded on the programmer. Contact your Medtronic or Vitatron representative.

3.9 Select other software

In addition to the standard application software, there are some programmers that have other applications installed. These applications may include supplemental software or software used in clinical studies for research. If you have other software installed, you may access the software, using the following procedure.

1. Press the **Programmer** icon, and then select **Other Software**.
2. When the programmer displays the list of available software, select the application and press [Start].

3.10 Remove other software applications

Programmers with other software installed, such as supplemental software or those used in clinical studies for research, may allow the applications to be removed from the programmer desktop. If you have software installed that permits removal, you may remove it using the following procedure.

1. Press the **Programmer** icon, and then select **Software**.
2. Press [Uninstall Software...].

Medtronic

CARELINK ENCORE™ 29901

3. When the programmer displays the list of removable software, select the application to be removed, and then press [Uninstall].
4. Select the check box next to the acknowledgment statement, and then press [Continue].
5. The software is removed, and the programmer reboots.
6. Verify that the software has been removed.

3.11 Improve the detection of pacing artifacts

The Artifact Detection function allows you to improve the detection of pacing artifacts when interference causes either false artifacts or no artifacts to appear on the patient's ECG. Pacing artifacts are displayed on the patient's ECG when the artifact detection option (Show Artifacts) has been enabled.

To determine if this feature is applicable, see the reference guide for the implanted device.

3.11.1 Enable artifact detection

1. Press the **Programmer** icon, and then select **Artifact Detection**.
2. Make sure the current settings include ARTIFACT DISPLAY IS ON.
3. Make sure the current settings include MV FILTER IS ON.

3.12 Start the Demonstrations option

The demonstrations option allows you to run a demonstration program on the programmer.

For Vitatron devices, see the applicable reference guide.

Note: Device applications and reference manuals may still refer to using the “demonstration disk” or “demonstration diskette” to run a demonstration program. The need for a demonstration diskette to access demonstration mode is no longer required. All references to a demonstration diskette can be ignored. All demonstration mode features are accessible with or without a demonstration diskette.

Medtronic

CARELINK ENCORE™ 29901

3.12.1 Access demonstrations

1. Press the **Programmer** icon, and then select **Demonstrations**.
2. From the Demonstration Model Selection screen, select the desired **View** option to list the available demonstration programs.
3. Select the desired demonstration program and press [Start] followed by [Continue].

3.13 Configure network using the Network Configuration window

3.13.1 About the Network Configuration window

Figure 15. Network Configuration window

The Network Configuration window is used to set up connections to the Software Distribution Network (SDN) and SessionSync using wireless and Ethernet connections. The first time the Network Configuration window is accessed the Clinic Name field is empty. For SessionSync, the SessionSync Gateway Address field also needs to be filled in. Until the Clinic Name and SessionSync Gateway Address fields are filled in, the [OK] is disabled. After you click [OK], the values are saved and the dialog closes. The next time the dialog is opened, the fields will be populated with the previously saved values and the [OK] will be enabled. If you manually clear one or more fields, the [OK] is disabled and the “Some fields empty...” message is displayed in the entry error text box.

Medtronic

CARELINK ENCORE™ 29901

3.13.2 Configure network connection

1. Press the Network Configuration icon on the task bar. The programmer displays the Network Configuration window.
2. Select the radio button for SDN or SessionSync.

Note: If you selected SessionSync, you also need to enter the SessionSync Gateway Address. The field is visible only after selecting SessionSync.

3. Enter the Clinic Name.
4. Enter the Network Name (SSID). To select the Network Name from the Available Networks, see Section 3.13.3.
5. Select Network Authentication from the drop-down list.
6. Enter Network Key.
7. Re-enter the Network Key in the Confirm Network Key field.
8. Press [OK].

3.13.3 View available networks

Note: Wi-Fi must be enabled to view available networks. Press the Wi-Fi button to enable Wi-Fi. If there is an Ethernet connection when the Network Configuration window is launched, a Wi-Fi connection cannot be established.

1. Press [View Available Networks]. The View Available Networks dialog displays with no network selected and the [OK] button disabled. When you select a network, the [OK] button is enabled.

Note: If there are no available networks, the View Available Networks dialog will not have any networks listed. If there are more than 3 available networks, the first three are visible and a vertical scroll bar is displayed.

2. After you select the network and press the [OK] button, the Network Name (SSID) field displays the network you selected in the Network Configuration dialog.

3.13.4 Test the network connection

After connecting to the network, you can test the connection to make sure the programmer is connected properly. From the Network Configuration window, press [Test Network Connection]. The Test Output: field displays the results of the test and is scrollable using the up and down arrows on the right.

Medtronic

CARELINK ENCORE™ 29901

Use the Test Network Connection feature if your programmer is having difficulty connecting to your clinic's network. Contact Medtronic Technical Support if you need assistance in interpreting results.

3.13.5 Save network connection test results to media

1. Connect a USB flash drive to the programmer.
2. Press [Save To Media].

Note: This button is available only if the Test Network Connection tests have been run. The programmer displays the Save to Media dialog.

3. Press [Save].

A text file (NtwkTestOutput.log) containing the test results is saved to the USB flash drive. Download the file to a compatible computer for viewing and/or transfer to Medtronic personnel.

Medtronic

CARELINK ENCORE™ 29901

4 Update programmer software using the Software Distribution Network

4.1 The Software Distribution Network

Programmer software can be updated by Medtronic customers or Medtronic personnel by accessing the Medtronic Software Distribution Network (SDN) and downloading the software. The SDN uses a world-wide network to connect to servers in the United States. These servers are able to download software to many programmers simultaneously through secure connections.

The SDN is available 24 hours per day, 7 days per week and always contains the most current software. For this reason, it is recommended that you download the software from the SDN rather than from the flash drive. You can connect to the SDN using a wired or wireless network connection.

Notes:

- It is recommended that the SDN be checked on a regular basis. Checking regularly reduces the size of the download and the time it takes to receive the software.
- If the download was interrupted, the download will resume the next time the programmer attempts to access the SDN.
- Normal programmer functions are unavailable during software installation.

4.2 Connect to the SDN using a wired network connection

You can connect to the SDN using the Integrated Ethernet connection and your clinic's network. By connecting through your network, software download time can be reduced.

Before you begin, make sure that the Ethernet cable is correctly connected to the Integrated Ethernet connection.

Medtronic

CARELINK ENCORE™ 29901

4.2.1 Connect the Ethernet cable

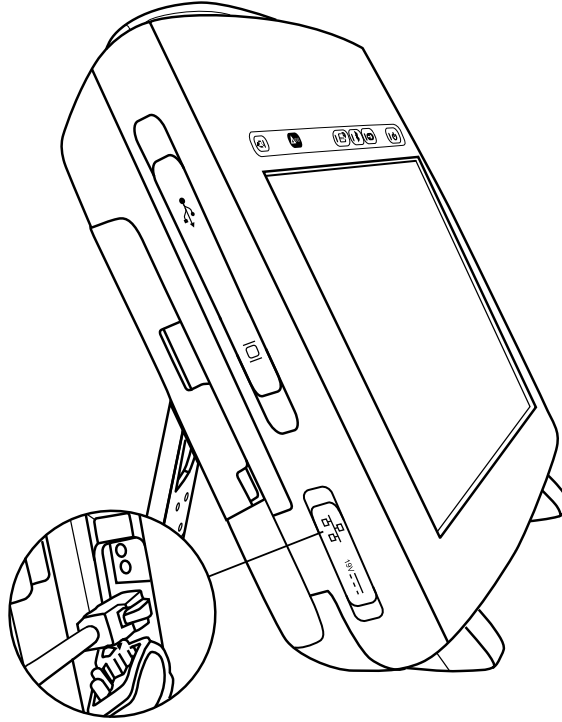

1. Open the input cover on the lower left side of the programmer.
2. Connect the Ethernet cable to the Integrated Ethernet connection.
3. Connect the opposite end of the Ethernet cable to a network jack.

Medtronic

CARELINK ENCORE™ 29901

4.2.2 How to connect to the SDN using a wired network connection

1. Press the **Programmer** icon, and then select **Software**.

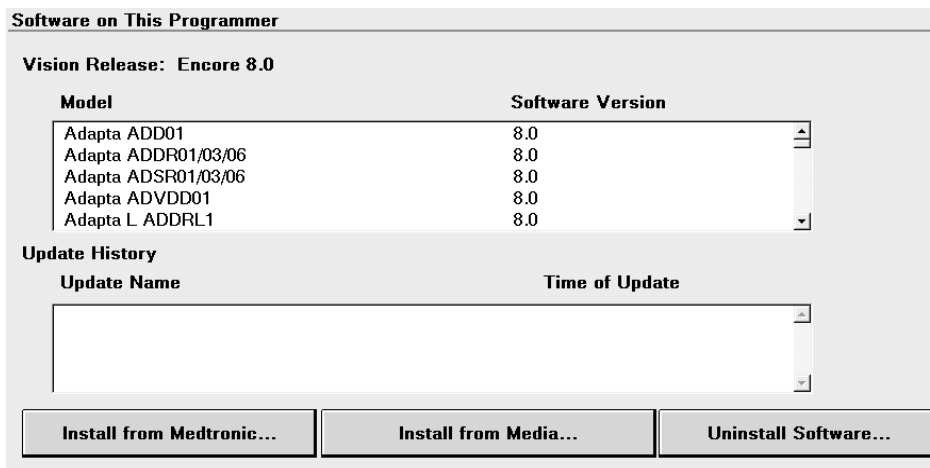

The programmer displays the Software on This Programmer screen and lists the software already installed on the programmer. For each model, the screen displays the software version.

Note: The SDN cannot be accessed from Vitatron screens. Change to the Medtronic Select Model screen.

2. Press [Install from Medtronic...].
3. Follow the prompts that are displayed to start the download.
or
Press [Cancel]. The download process is canceled and the programmer redisplay the Software on This Programmer screen.

Medtronic

CARELINK ENCORE™ 29901

- The programmer displays the Scheduled Software Update screen.
Choose to either start the download at a particular time by selecting a time from the Scheduled Update Time pull-down menu, or begin the download as soon as possible by pressing [Start].

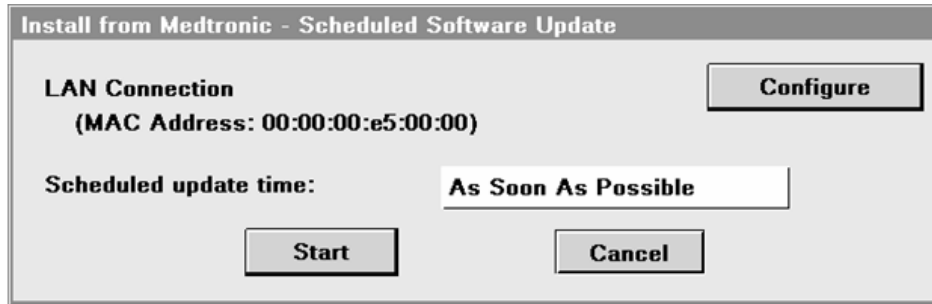

Medtronic

CARELINK ENCORE™ 29901

- The Scheduled Software Update window displays a countdown window showing how much time remains until the countdown begins. Press [Start Now] to override the countdown or press [Cancel] to interrupt the countdown and the download request and return to the Software on This Programmer screen.

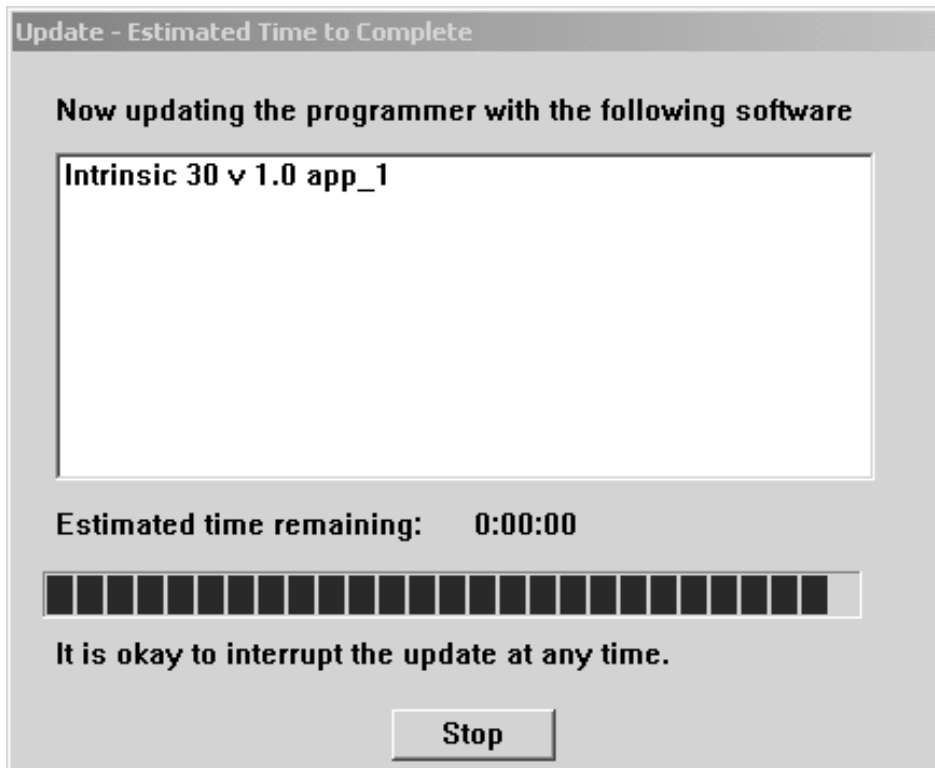

- The programmer displays a list of software that will download and install.

Note: Individual software cannot be selected or rejected.
You may press [Stop] at anytime and resume the download at a future time.
- When the download is complete, the programmer disconnects from the SDN, automatically reboots, and displays a screen listing the software that was downloaded.
- To obtain technical manuals for the new software, see Section 1.13.
- Press the **Select Model** icon. The programmer is then available for patient use.

Note: The first time the newly downloaded software is accessed, some additional installation steps may be completed but these steps are automatic and no user intervention is required

Medtronic

CARELINK ENCORE™ 29901

4.3 Connect to the SDN using a wireless network connection

Note: Before you begin, make sure that the wireless connection is correctly configured. For more information, see Section 3.13.

4.3.1 How to connect to the SDN using a wireless network connection

1. Press the **Programmer** icon, and then select **Software**.

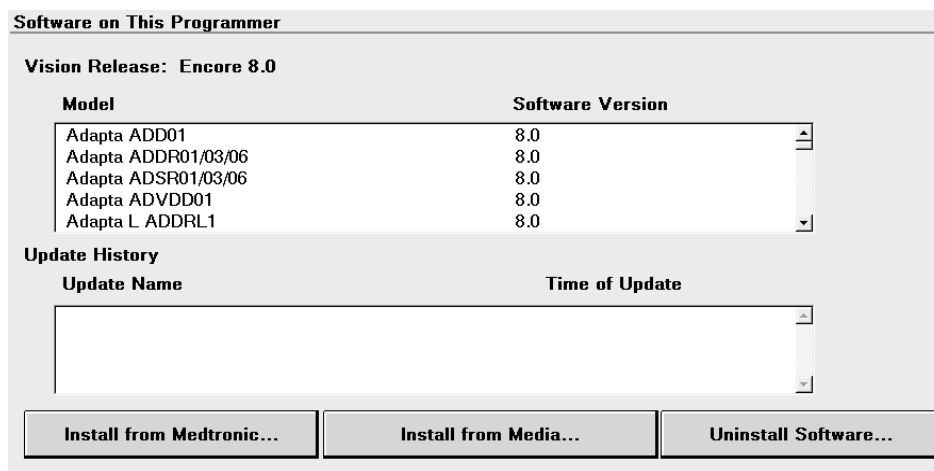

The programmer displays the Software on This Programmer screen and lists the software already installed on the programmer. For each model, the screen displays the software version.

Note: The SDN cannot be accessed from Vitatron screens. Change to the Medtronic Select Model screen.

2. Press [Install from Medtronic...].
3. Follow the prompts that are displayed to start the download.
or
Press [Cancel] if you do not agree to the terms. The download process is canceled and the programmer redisplay the Software on This Programmer screen.

Medtronic

CARELINK ENCORE™ 29901

- The programmer displays the Scheduled Software Update screen. Press [Configure].

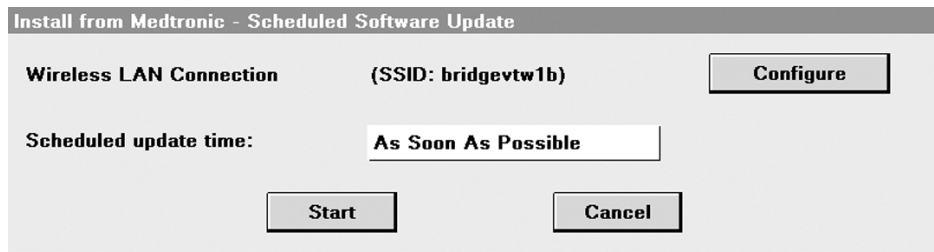

- On the Scheduled Software Update screen, either choose to start the download at a particular time by selecting a time from the pull-down menu, or begin the download as soon as possible by pressing [Start]. The programmer shuts down and displays a window telling you to please wait.

6. The Scheduled Software Update window displays a countdown window showing how much time remains until the countdown begins. Press [Start Now] to override the countdown or press [Cancel] to interrupt the countdown and the download request and return to the Software on This Programmer screen.

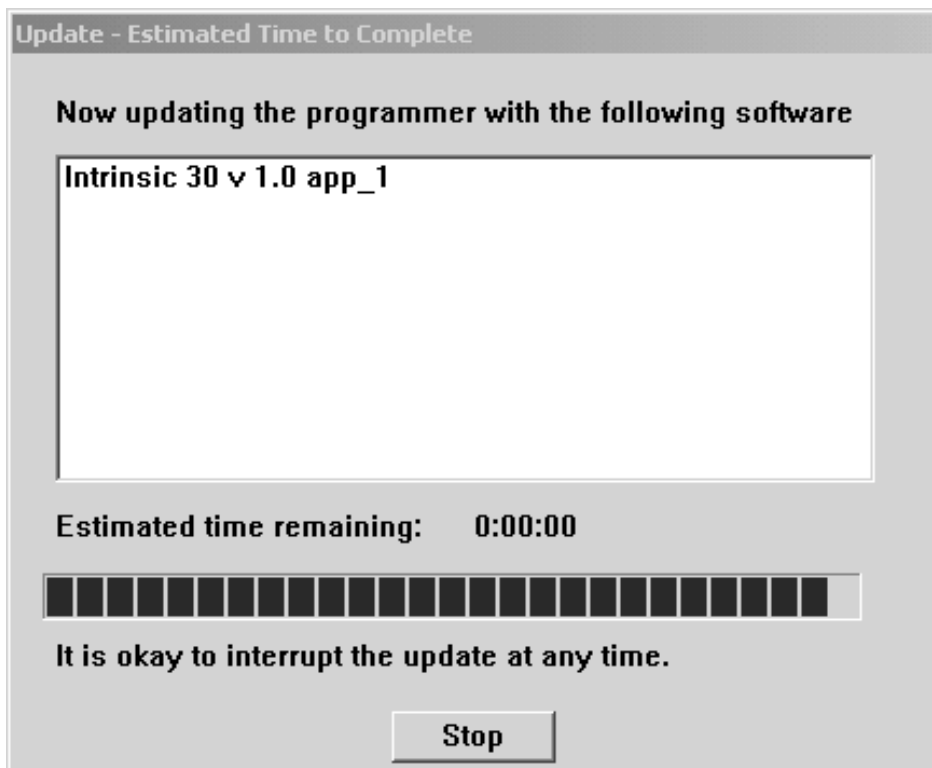

7. The programmer displays a list of software that will download and install.
Note: Individual software cannot be selected or rejected.
 You may press [Stop] at anytime and resume the download at a future time.
8. When the download is complete, the programmer disconnects from the SDN, automatically reboots, and displays a screen listing the software that was downloaded.
9. To obtain technical manuals for the new software, see Section 1.13.
10. Press the **Select Model** icon. The programmer is then available for patient use.

Note: The first time the newly downloaded software is accessed, some additional installation steps may be completed but these steps are automatic and no user intervention is required.

Medtronic

CARELINK ENCORE™ 29901

5 Conduct a patient session

5.1 Prepare for a patient session

Familiarize yourself with the information in this section before beginning a patient session.

5.1.1 Connect the programmer to skin electrodes

At the start of each patient session, ECG cable leads must be connected to the patient to detect cardiac and pulse artifact signals.

Note: The quality of disposable skin electrodes used with the programmer is important to the performance of the programmer signal sensing functions. Chemical reactions occur at the electrode/paste interface and produce small DC voltages that can block the ECG signal. Using high quality silver/silver chloride (Ag/AgCl) electrodes can minimize this problem. Electrodes should be fresh and from the same box. The patient's skin should be prepared according to the directions provided with the electrodes.

Protocols covering attachment of leads to disposable skin electrodes may vary. Leads may be attached to the electrodes either before or after the electrodes are applied to the patient. The order of the following procedure is arbitrary.

Warning: Do not connect the programmer to wires or electrodes internal to the body. The programmer is designed to be medically safe only when attached to surface electrodes.

5.1.2 Attach electrodes

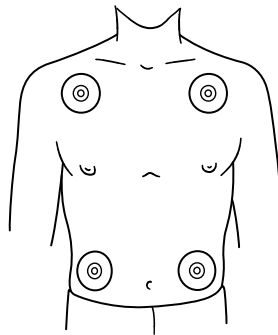

Attach four standard, disposable electrodes to the patient in the positions shown.

Note: Electrodes are intended for one-time use and should not be reused.

Medtronic

CARELINK ENCORE™ 29901

5.1.3 Connect the ECG cable

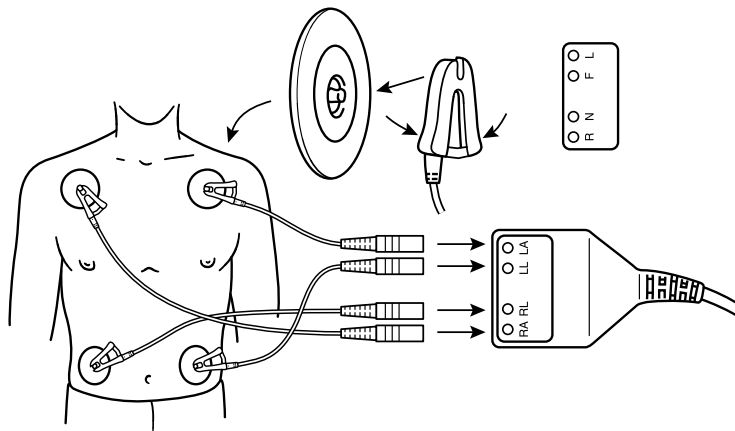

1. As shown, attach a color-coded lead wire to each of the four electrodes. Match a color to each electrode as in Table 5.

Note: The chest lead is not used. The middle cable port of the ECG cable is sealed off with the chest ECG plug.

2. Connect each lead wire to the ECG cable as in Table 6. Match each lead connector to the proper cable port.

Table 5. Electrode lead wire color coding

AHA Coding ^a	IEC Coding ^b	Body Area
Black	Yellow	to left arm
Red	Green	to left leg
Green	Black	to right leg
White	Red	to right arm

^aAmerican Hospital Association

^bInternational Electrotechnical Commission

Table 6. ECG cable color coding

AHA Coding		IEC Coding	
Black	to LA	Yellow	to L
Red	to LL	Green	to F
Green	to RL	Black	to N
White	to RA	Red	to R

Medtronic

CARELINK ENCORE™ 29901

Note: Occasionally, mutual interference occurs between the programmer skin electrode signals and signals from an external ECG recorder or monitor attached directly to the patient. This interference may cause erratic operation of the programmer functions that depend on surface signal detection. If interference occurs, temporarily disconnect the leads from the attached ECG recorder or monitor. This interference does not affect the programming functions of the programmer.

5.1.4 Use the stylus

The stylus is used to select programming functions provided by the software. Proper use of the stylus is described in Figure 16 and in Section 5.1.5.

You can also use your finger to make selections on the screen. However, for accuracy a stylus is recommended. Because the screen is responsive to touch, avoid resting your hand on the screen or touching multiple screen locations while using the programmer. Avoid pointing and touching the screen while others are using the programmer. You should also avoid touching the screen with sharp objects.

Figure 16. Hold the stylus

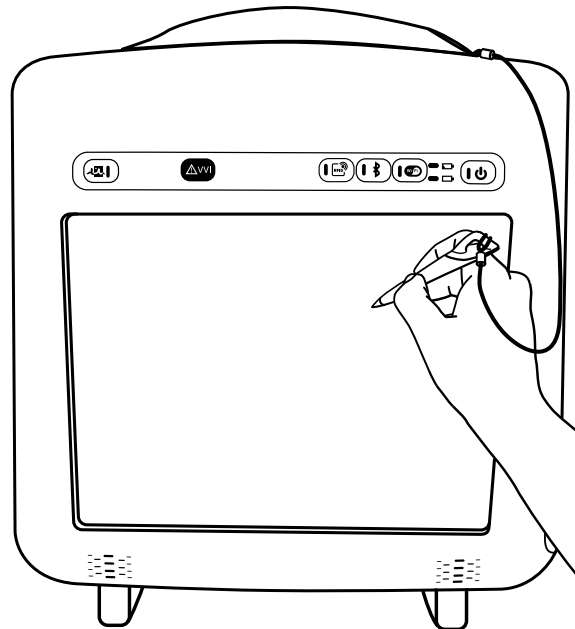

Medtronic

CARELINK ENCORE™ 29901

5.1.5 Select an option on the screen

Figure 17. Position the stylus

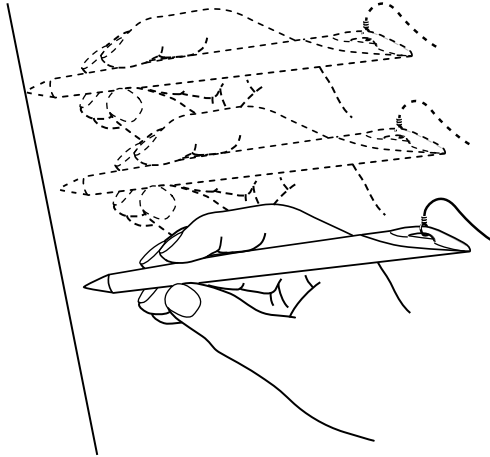

1. Move the tip of the stylus to a position directly over the desired option. If the desired option is a displayed key or button, position the stylus tip within the rectangular outline. If the desired option is a name or number, such as a parameter or parameter value, position the stylus directly over the letters or numbers forming the option.
2. Touch the stylus to the screen to select an option.

Medtronic

CARELINK ENCORE™ 29901

5.1.6 Attach and store the stylus

Figure 18 shows how to attach and store the stylus

Figure 18. Attach and store the stylus

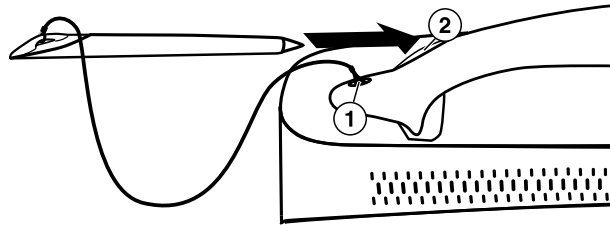

- 1 Attach one end of the tether to the stylus and the other end to the programmer.
- 2 Store the stylus in the handle of the programmer by inserting it into the hollow end of the handle, tip first.

5.1.7 Position the programming head

At some point during most applications of the programmer, the programming head must be positioned over the implantable device. Positioning the programming head is required for any interaction between the programmer and the implantable device.

5.1.8 When to position the programming head

Caution: Do not position the programming head over an implanted device during electrocautery or external defibrillation procedures.

During a patient session, properly position the programming head over the implanted device before any of the following actions:

- Selection of any command that initiates a programming transmission. The programming head must be held in position until completion of the transmission, which usually is indicated by a confirmation message.
- Selection of any command that initiates data transmission from the implantable device. The programming head should be held steady until data reception is complete, which usually is indicated by a confirmation message.
- Selection of a measurement function that requires the implantable device to be operating asynchronously as a result of the programming head magnet.

Medtronic

CARELINK ENCORE™ 29901

For any temporarily programmed state or function or for reception of continuous data such as Marker Channel telemetry or EGM waveforms, the programming head must be held in place over the implantable device for the duration of the function or until termination is desired. Lifting the programming head cancels a temporary program and terminates continuous telemetry. The implantable device reverts to permanently programmed values.

5.1.9 Determine the correct position

For an implantable device, the programming head should be held directly against the patient's skin. The face of the programming head must be parallel to and typically within 5 cm of the implantable device. Optimum position of the programming head may not be directly centered over the implantable device. The distal end of the programming head should be placed over the device with the device under the antenna. For best telemetry performance, do not use the programming head close to the programmer or other sources of electrical noise.

Figure 19. Position the programming head

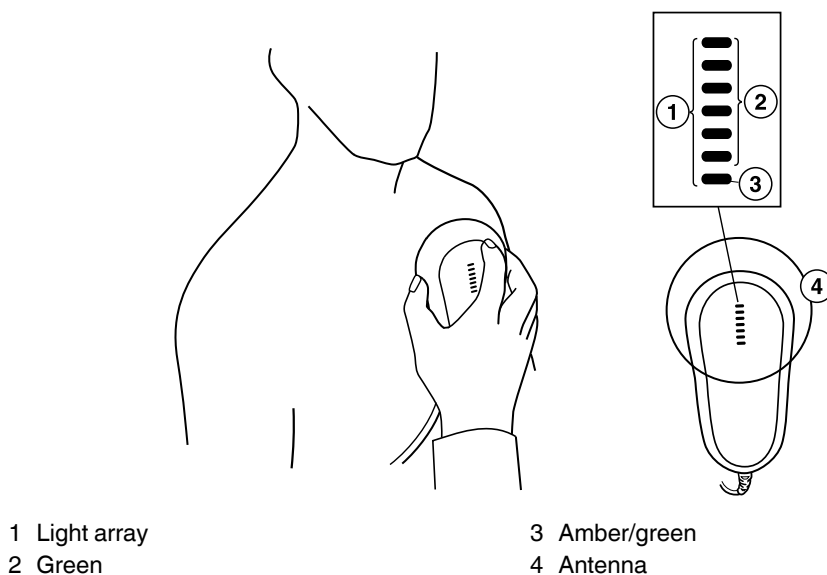

1 Light array
2 Green

3 Amber/green
4 Antenna

Correct placement of the programming head is indicated in two places: the position head array in the top left corner of the screen and the array of seven lights on the programming head (see Figure 19).

Programming and Interrogation are not recommended when fewer than three green lights are lit.

Medtronic

CARELINK ENCORE™ 29901

Note: The number of lights used on the light array may vary for some devices. For more information, see the *Carelink Encore Programmer Software Application Supplement*.

5.1.10 Program and interrogate the implanted device

1. Select the appropriate software parameters according to the reference guide for the implanted device.
2. Position the programming head near the implanted device.

Programming and Interrogation can begin when the LED lights on the position head array indicate satisfactory positioning and telemetry strength.

Notes:

- The programming head array shows the signal strength of the communication link. Medtronic recommends moving the programming head to maximize the number of green lights. All lights may not illuminate for all models. For more information, see the reference guide for the implanted device.
- Misalignment of the programming head could result in failure of a programming transmission and/or failure to receive data from the implantable device. Medtronic recommends that you interrogate the device after programming to confirm that any setting changes were successful.

5.1.11 The programming head magnet

The programming head contains a strong magnet. For more information about the effects of a magnet, see the reference guide for the implanted device.

The programming head may attract metal instruments or may be attracted to metal surfaces. The magnet is susceptible to partial demagnetization when it is subjected to opposing magnetic fields, such as those present when forcing the programming head against another magnet. The programming head should be stored as shown in Figure 22 when not in use.

Caution: Keep the programming head away from any device or material that will be damaged by the magnetic field, including magnetic media, watches, and other electronic devices.

Medtronic

CARELINK ENCORE™ 29901

5.2 Initiate a patient session

A patient session involves the application of the various programmer functions to such procedures as programming implantable device parameters, analyzing or assessing implantable device operation, troubleshooting, and routine follow-up. The instructions for using each programmer function are covered in the reference guide for the implanted device.

Note: Before proceeding, ensure that all preparations covered in Section 2.3 and Section 5.1 have been completed.

5.2.1 Programmer checklist

1. Is the programmer set up according to the procedures in Section 2.3?
2. Are the ECG cable, stylus, and programming head connected to the programmer?
3. Is the battery installed and charged?
4. If you are charging the battery or are using AC power instead of the battery, does the power supply cord connect the programmer to a hospital-grade outlet?
5. Has the appropriate software been installed? Refer to Section 3.8 for a description of how to verify the software version.
6. Are the programmer ECG cable leads connected to electrodes on the patient as described in Section 5.1.1?

Specific information related to each implantable device model or family of models is included in the reference guide for the device.

Before beginning a patient session, see the reference guide for the implanted device.

5.2.2 Model identification

Because the programmer collects and stores data on a session-by-session basis, it is important to start and end each session correctly.

The programmer supports both a Medtronic and Vitatron desktop. Whichever desktop is in use when the programmer is powered down, that same desktop appears when the programmer is powered on. To switch from the Vitatron desktop to the Medtronic desktop and vice versa, press the Vitatron/Medtronic switch button that appears on the bottom of the screen.

Medtronic

CARELINK ENCORE™ 29901

There are two ways to begin a patient session:

- Before turning on the programmer, position the programming head over the patient's device. When you turn on the programmer, the programmer attempts to interrogate the device. Depending on the device, either the software application is launched automatically or a message appears with further instructions.
- After turning on the programmer, position the programming head over the patient's device. During the first 5 minutes, the Medtronic desktop displays the Find Patient screen. Afterward, it displays the Select Model screen. The Vitatron desktop displays the Select Model screen immediately. A patient session can begin at either the Find Patient screen or the Select Model screen. Follow the instructions on the screen that is displayed.

5.2.2.1 Find Patient screen

When the programmer is first turned on, the Medtronic desktop displays the Find Patient screen. If it does not detect a device within about 5 minutes, the programmer removes the Find Patient screen to reveal the Select Model screen.

When the Find Patient screen is displayed, you may begin a patient session.

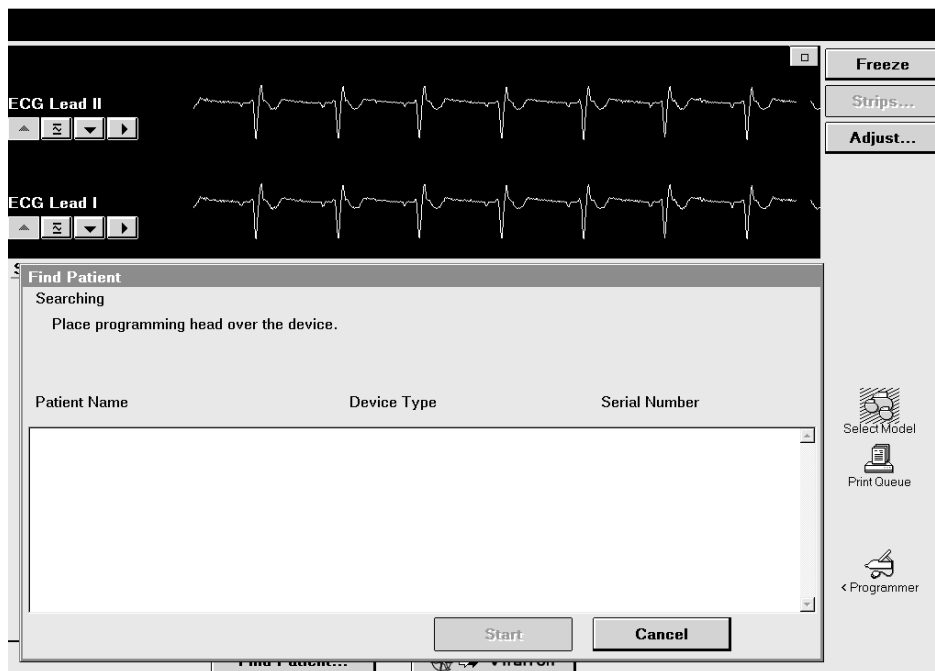

Medtronic

CARELINK ENCORE™ 29901

Place the programming head over the patient's device and hold it steady. For most devices, the programmer identifies the device model and automatically starts up the proper software application. If a device cannot be automatically identified, the programmer displays a message at the top of the Find Patient screen. Perform one of the following steps, depending on the message instructions:

- Press [Cancel] and manually select the software application from the Select Model screen.
- Press [Cancel] and then press the Vitatron/Medtronic switch button to go to the Vitatron desktop.
- If the message indicates that the needed software application has not been installed, contact your Medtronic or Vitatron representative.

5.2.2.2 Select Model screen

A patient session may also begin from the Select Model screen. The Select Model screen appears after one of the following actions:

- Shortly after the programmer has been turned on
- After you end a patient session

If the Select Model screen is not displayed, use the stylus to press the Select Model icon. If the Select Model icon is not displayed, a patient session is in progress. You must end that session before starting a new session.

If you are between patient sessions, you can access other screens by using the icons and buttons described in Section 3.2.

Medtronic

CARELINK ENCORE™ 29901

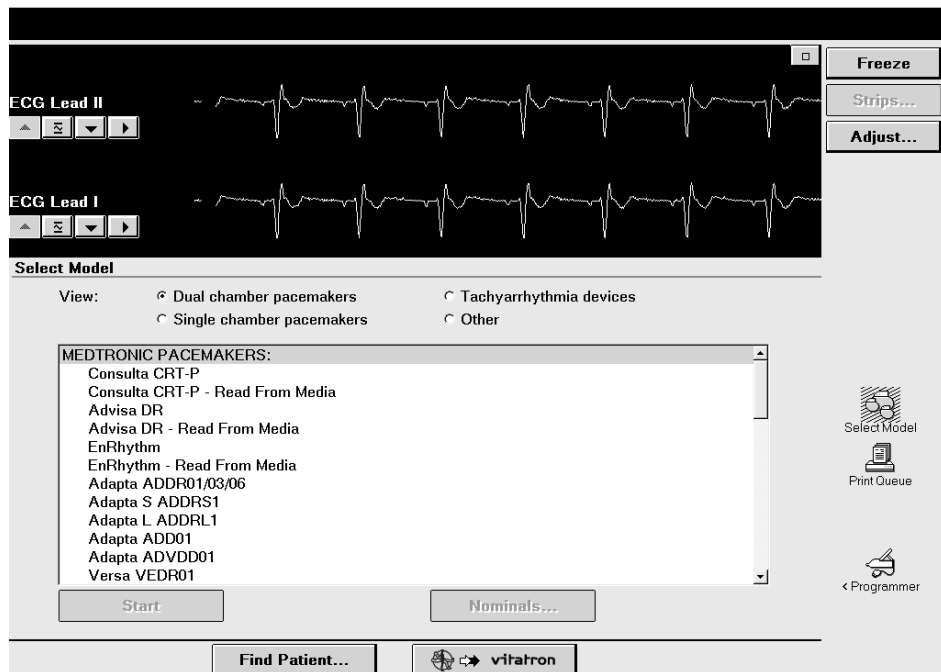

If the Select Model screen does not look like this example and you see a different button in the command bar, press the Vitatron/Medtronic switch button to display this screen.

If the device is a Vitatron device and it is not listed on the Select Model screen, see the *Vitatron Software Programming Guide*.

Position the programming head over the patient's device and hold it steady. Press [Find Patient] shown on the Medtronic desktop or manually select the device from the displayed list of devices and press [Start].

When a device is manually selected from the list of devices, the programmer starts up the application that corresponds to your selection, not the device that is under the programming head. The Find Patient screen is displayed briefly as the programmer starts up the proper software application. If the software application has not been installed, the programmer displays a message indicating that the software must be installed before proceeding.

The programmer may automatically interrogate the patient's implanted device to retrieve most of the data that might be needed during the session. To take advantage of this automatic interrogation, position the programming head over the implanted device and continue to hold it in place until the interrogation is complete.

For more information about determining the model, see the reference guide for the implanted device.

Medtronic

CARELINK ENCORE™ 29901

5.3 Electronic Strip Chart (eStrip) recorder

The Electronic Strip Chart (eStrip) recorder retains continuous rhythm information collected during a session. Patient ECG and EGM are recorded without interrupting the device application. Live rhythm is viewable in both the device application and the eStrip recorder.

The last 30 minutes of strip information is available. By highlighting areas of interest, strip reports can be generated using the highlighted information. Highlighted strips can be viewed using the eStrip recorder and the scale, length and other strip information can be changed. The grid on the screen is the same size and ratio as printed strip chart paper.

5.3.1 eStrip recorder screen features

Figure 20. eStrip recorder screen

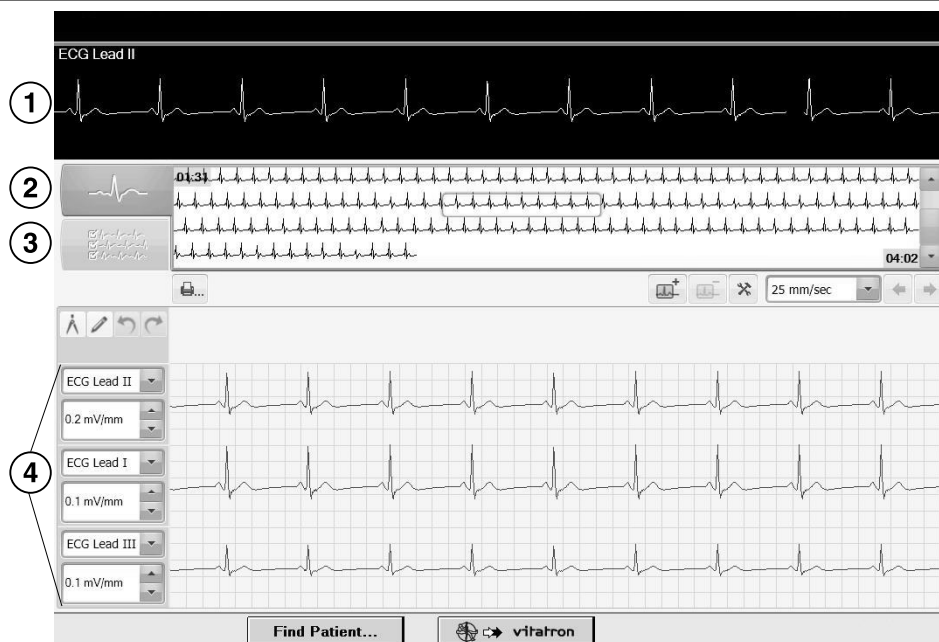

- 1 Real-time waveform viewer—shows real-time waveforms.
- 2 Holter view selector—shows overview of waveforms.
- 3 List view selector—shows available strips.
- 4 Expanded view—shows expanded view of a segment of a waveform.











Medtronic

CARELINK ENCORE™ 29901

5.3.2 eStrip recorder screen icons/selectors

The eStrip recorder screen contains these icons/selectors:

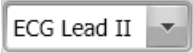

Table 7. Icons/selectors on the eStrip recorder screen

Icon	Name	Function
	Caliper	Initiates interval caliper tool.
	Markup tool	Provides ability to draw notes on a waveform.
	Undo	Erase the most recent caliper or markup.
	Redo	Replaces the most recently erased caliper or markup.
	Print	Opens the print screen.
	Add highlight	Add highlight to previously unhighlighted waveform.
	Remove highlight	Removes existing highlight from a waveform.
	Strip preferences	Opens preferences screen.
	Chart speed adjust	Presents chart speed choices. Selecting a new chart speed changes data presentation in expanded view based on new chart speed.
	Previous highlight	Navigates to previous highlight.
	Next highlight	Navigates to next highlight.

Medtronic

CARELINK ENCORE™ 29901

Table 7. Icons/selectors on the eStrip recorder screen (continued)

Icon	Name	Function
	Lead/vector selector	Changes the lead/vector in the expanded view. Selecting None removes the lead/vector from the expanded view.
	Gain adjust	Changes trace gain.

5.3.3 Highlight an area of interest during a session

1. Press the Electronic Strip Chart (eStrip) button on the button panel to highlight an area of interest.
2. Open the eStrip recorder from the Task bar to view the highlight.

5.3.4 Change the length of a strip

1. Select a strip.
2. Press and hold the border of the strip.
3. Drag the border of the strip to make it longer or shorter.

5.3.5 Measure intervals using calipers

1. Select a strip.
2. Press the Caliper icon.
3. Press the arrow icon on the bottom right corner of the strip to walk the calipers.
4. To save caliper measurement to strip, press the tack icon.

5.3.6 Change the name of a strip

1. Press the List View button to display available strips.
2. Press the name of the strip in the expanded view on the bottom half of the screen.
3. Change the name of the selected strip by either typing a new name when the keyboard displays or selecting a name from the library by clicking the down arrows next to the name field.
4. Press [OK].

Medtronic

CARELINK ENCORE™ 29901

5.3.7 Create test strip report from the eStrip recorder

1. Run a test in the device application.
2. Open the eStrip recorder from the Task bar.
3. Press the List View button to display available strips.
4. Select the strip or strips you want to use to create a report.
5. Press the Print icon.
6. From the Reports – Strip Chart window, press [Print Now] to print the report or [Save to PDF File] to save the report to PDF. You can select the number of copies to print or press Select Strips to change which strips will be included in the report.

Note: To save a report to PDF, you must have a USB flash drive connected to the programmer where the PDF will be saved to.

5.4 Emergency VVI button

The red emergency VVI button on the programmer button panel provides immediate access for emergency VVI pacing during a patient session. Pressing the red emergency VVI button displays the emergency screen options and delivers VVI pacing.

Figure 21. Programmer button panel

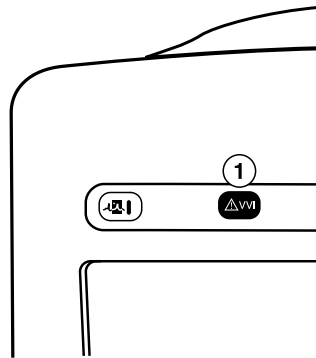

1 Red emergency VVI button

Specific parameter values for emergency VVI pacing are determined by each device application. The red emergency VVI button may be available after a system error.

Medtronic

CARELINK ENCORE™ 29901

Note: For all ICD applications, the [Emergency] button is also implemented in the software and is available from the display screen. For more information on the [Emergency] button available from the display screen, see the reference guide for the implanted device.

5.4.1 Deliver emergency bradycardia pacing

To initiate emergency pacing, correctly position the programming head over the implanted device and press the red emergency VVI button. A message confirms programming, and emergency VVI operation begins.

5.4.2 Deliver emergency tachyarrhythmia therapy

To deliver therapy, press the red emergency VVI button to display the emergency screen on the programmer and press the on-screen [Deliver] button.

For complete instructions regarding the use of the [Deliver] button for specific applications, see the appropriate device *Reference Guide*, *System Reference Guide*, or *Clinician Manual*.

5.5 End a patient session

When you want to end a patient session, you may save data to a supported storage device or end the session without saving.

Refer to the reference guide for the implanted device for specific information on saving device data.

Medtronic

CARELINK ENCORE™ 29901

5.6 Store components

Figure 22 shows the proper way to store components.

Figure 22. Store components

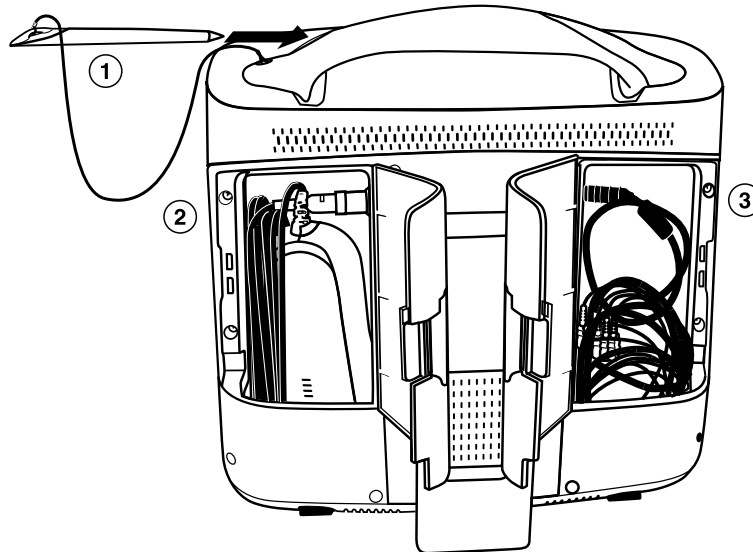

- 1 Store the stylus in the handle of the programmer.
 - 2 Store the programming head in the left rear door.
 - 3 Store the ECG cable in the right rear door.
-

Medtronic

CARELINK ENCORE™ 29901

6 Manage session data and reports

6.1 Session data

Patient session data may be saved to a USB flash drive.

6.2 Reports

Depending on the implanted device model, various types of reports can be created. Refer to the reference guide for the implanted device for specific information on report types and contents. During an active session, reports may be printed, or saved as PDF files on a USB flash drive. Reports held for later printing may be printed while at the desktop or when returning to a session. Reports might not be available for later printing from the desktop, depending on the device application and on the current print queue deletion schedule. For more information, see Section 6.9.

6.3 Save to a PDF file

Printable reports, frozen strips, and other data may be saved to a PDF file. A PDF file is an electronic version of a printed document; therefore, the feature is accessible under the printing commands.

To save to a PDF file, perform the following steps:

1. Open or create the report or file.
2. Press [Print...] or [Print Options...] to display the **Print – Options** dialog box.

Note: If the **Print – Options** dialog box does not display, open **Preferences**, and then select the **Printing: Pop up these options when any print button is selected** check box.

3. From the list of supported printers, select the **Save to PDF File** option. The report is saved to an attached USB flash drive. For more information on saving to USB, see Section 6.4.

Medtronic

CARELINK ENCORE™ 29901

6.4 Save to USB

Many device applications support the use of USB flash drives for saving and loading session data.

Note: Device applications and reference manuals may still use the terms “disk” or “diskette” in the context of saving and retrieving device data. When a USB flash drive is connected to the programmer and available for use as described below, the terms *disk* or *diskette* should be interpreted as applying to the USB flash drive, rather than the diskette.

6.4.1 Supported USB storage devices

In order to ensure the integrity and security of patient health information, it is recommended that you use USB flash drives that are dedicated to storing programmer data only.

6.4.2 Operation

A USB flash drive should be connected or disconnected while at the desktop or in a session. Connect a writable USB flash drive to the programmer using any available USB port. A slight delay may occur while the USB flash drive is authorized. The USB indicator on the task bar turns green to indicate that the USB flash drive is available for use.

Note: The USB ports on the programmer are USB 2.0.

Figure 23. USB indicator status

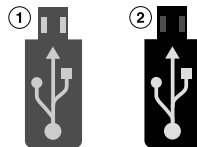

- 1 No USB connected
- 2 USB connected

USB flash drives should not be connected or disconnected while the following actions are in progress:

- Programming a device
- Performing a Save to Media
- Performing a Read from Media
- Saving a report as a PDF file

Medtronic

CARELINK ENCORE™ 29901

Notes:

- While a Save to Media action is in progress, the progress indicator and the message “Saving...” display. The progress indicator displays the completion percentage. Before removing the USB flash drive, wait a few seconds after the progress indicator shows 100%.
- After a report is saved as a PDF file, the message “PDF report(s) saved to media” is displayed for about 5 seconds. Wait a few seconds after the message goes away before removing the USB flash drive.
- If an active session is ended while reports are currently printing or pending, the reports are canceled and may not be available from the desktop print queue.

Any action to read or write data (such as Save to Media, Read from Media, save reports to a PDF file) will use the USB flash drive after it is connected. Refer to the reference guide for the implanted device for specific information on saving device data. For more information on saving reports to PDF file, see Section 6.3.

Connect only one writable USB flash drive at a time. Connecting two or more USB flash drives results in an error during data-saving operations. This condition is indicated by the USB disabled icon.

6.5 View reports that are saved to media

Saved report PDFs may be viewed on the programmer or on a computer.

All reports from one patient's session are contained in one PDF file. File names are automatically assigned according to a naming convention that ensures uniqueness on the storage media:

- Patient's name (if previously provided in Patient Information)
- Device serial number
- “Session Report”
- Clinic visit date in MM_DD_YY format
- Version number (the first PDF saved to this storage media gets “1”)

For example: John Q Patient_aaannnnna_Session Report_06_25_10_1.PDF

Medtronic

CARELINK ENCORE™ 29901

6.6 View reports on the programmer using PDF Viewer

The PDF Viewer allows you to view and print PDF reports previously saved on a USB flash drive.

1. Connect a USB flash drive with saved PDF reports.
2. Select the PDF Viewer in the taskbar. The list of the available PDF files on the USB flash drive is displayed in the left panel.
3. Click the file name to open a preview of the PDF. To open the PDF, press [Open document] or double-click the PDF file name

PDF files on the USB flash drive other than previously-saved PDF reports are also viewable with the PDF Viewer.

- You can use the toolbar at the top of the PDF to go to a specific page, increase or decrease the size of the document, or search within the PDF.
- To hide the list of PDFs to provide a larger viewing area for the PDF, press [Hide] in the lower left corner of the PDF viewer. To restore the list, press [Show].
- To print a PDF, with a report open in the PDF Viewer, press the **Print** icon.

6.7 Viewing and printing PDF files on a computer

Insert the USB flash drive containing the reports into a computer equipped to display files that are in PDF format.

Due to computer and software variations, some PDF files may not be displayed properly when viewed on a computer monitor.

The use of Adobe Reader 9 or later is recommended. Adjusting the following settings may reduce or eliminate display imperfections:

- Replace document colors with white page background and black text (in Adobe Reader 9, select: Edit > Preferences > Accessibility > Replace Document Colors > Custom Color)
- Deselect the option to enhance thin lines (in Adobe Reader 9, select: Edit > Preferences > Page Display)

Imperfections that may be seen on screen:

- On graphs that contain rectangles drawn with thin lines, e.g., bar graphs, the thin lines may not be displayed at various zoom levels.
- On Pacing and Tachy Trigger Episode reports, unfilled circles may be displayed as filled circles.

Medtronic

CARELINK ENCORE™ 29901

PDF reports print properly at a resolution of 300 dpi or greater.

6.8 Manage patient data privacy

You can immediately remove from the programmer all Protected Health Information (PHI). This feature deletes all of the following files:

- Contents of the Print Queue (unless files are currently being printed or copied)
- Temporary files residing on the programmer
- Memory dumps (applies to Vitatron devices only)

You cannot delete any PHI data if a session is in progress or while files are being printed or copied to media. If deletion is interrupted manually, some PHI remains on the programmer.

Note: The user of the programmer is responsible for the use of this feature, as well as for management of patient data that has already been removed from the programmer (for example on paper or a USB flash drive).

6.8.1 Delete Protected Health Information

1. Press the **Programmer** icon, and then select **Tools**. The programmer displays the Tools screen as shown in Figure 24.

Figure 24. Tools screen with Patient Data Privacy index item selected

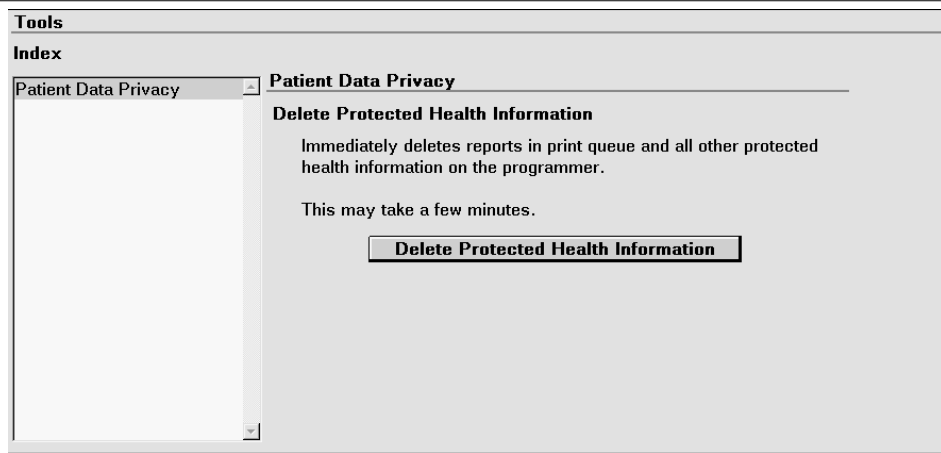

2. Press [Delete Protected Health Information]. The programmer displays the dialog box as shown in Figure 25.

Figure 25. Delete Protected Health Information confirmation dialog box

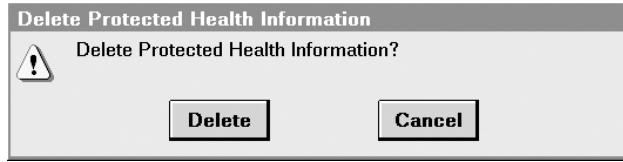

3. Press [Delete] to continue.
 One of the following events may occur:
 The programmer displays an “In progress...” dialog box as shown in Figure 26. Deletion may last several minutes, depending on the amount of data to delete.

Figure 26. In progress dialog box



If there are SessionSync files on the programmer that have not been transferred yet, the programmer displays a message indicating that there are SessionSync files waiting to be transferred, as shown in Figure 27. Press [Delete] to delete the SessionSync files or [Cancel] to wait until the SessionSync files have transferred.

Figure 27. SessionSync files waiting dialog box



If there are reports currently printing, the programmer displays a message directing you to wait until printing is complete, as shown in Figure 28. Press [Close].

Figure 28. Printing in progress dialog box

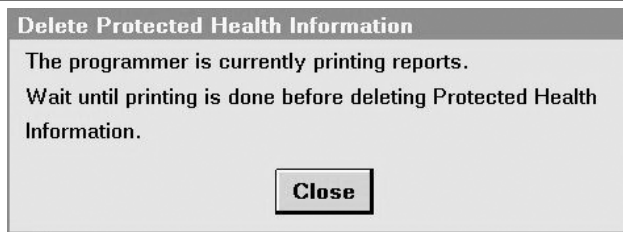

4. If pressing [Delete] in Step 3 resulted in protected health information deletion, the programmer displays a message stating that deletion was successful, as shown in Figure 29. Press [Close].

Figure 29. Deletion successful dialog box

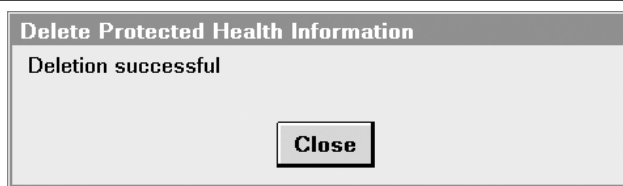

Or,

If the programmer is unable to complete deletion of files, it displays a message stating that there was an error and that some data may remain on the programmer, as shown in Figure 30. Press [Close]. Contact Medtronic Technical Support if the message recurs.

Figure 30. Error deleting files dialog box

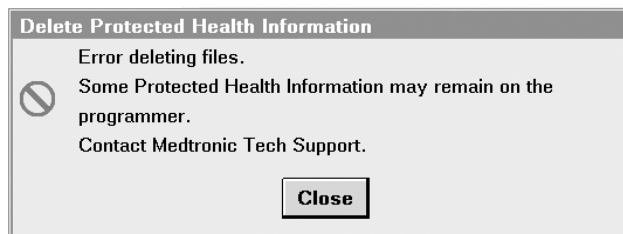

Medtronic

CARELINK ENCORE™ 29901

6.9 Set the interval for report deletion

For patient data security, the programmer permanently deletes reports automatically from the Medtronic desktop print queue at the time when the programmer is powered up. You can control how long reports are retained in the print queue before automatic deletion.

6.9.1 Select a report deletion interval

1. Press the **Programmer** icon, and then select **Preferences**.
2. From the Preferences screen, select **Delete Reports**. The programmer displays the Delete Reports screen as shown in Figure 31.

Figure 31. Delete Reports screen

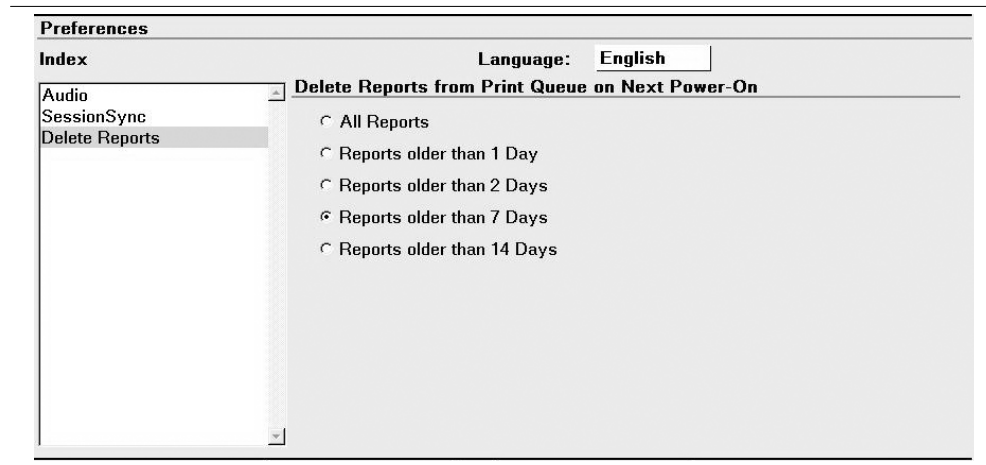

3. Select a radio button to specify which reports the programmer deletes:
 - All Reports
 - Reports older than 1 Day
 - Reports older than 2 Days
 - Reports older than 7 Days (Default)
 - Reports older than 14 Days

The age of a report is determined by the date and time it was created. When the programmer is powered on, reports that meet the deletion criteria are permanently deleted.

Medtronic

CARELINK ENCORE™ 29901

6.9.2 Delete a report immediately

To delete a report immediately, directly access it from the print queue and press [Delete].

Medtronic

CARELINK ENCORE™ 29901

7 SessionSync (Optional)

7.1 About SessionSync

SessionSync is an optionally installed feature that provides network connectivity between the programmer and the Medtronic Paceart data management system. Using your clinic's network, the programmer can send downloaded device data through SessionSync to the data management system.

The SessionSync status icon and the SessionSync status screen provide information on the connection status of the programmer to the data management system.

You must configure the programmer network settings to allow for this data transfer.

7.2 Enable and disable SessionSync

1. Select Programmer > Preferences.
2. Select SessionSync from the Index menu.
3. Select [Enabled] to enable SessionSync or Select [Disabled] to disable SessionSync.

Note: The SessionSync icon in the task bar will be grayed out when the feature is disabled. SessionSync functions are not available within a patient session unless you have enabled this feature prior to starting a patient session.

Figure 32. Preferences screen with Session Sync selected

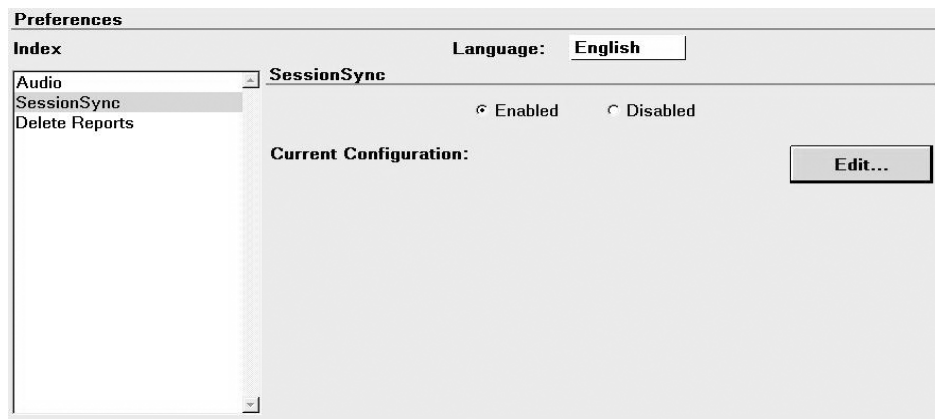

7.3 SessionSync Status icon

The SessionSync status icon provides information on the network connection between the programmer and the data management system.

Figure 33. The task bar with the SessionSync Status icon



- 1 The SessionSync Status icon

If SessionSync is not installed on the programmer, the icon is not visible in the task bar.

Figure 34. Parts of the SessionSync Status icon

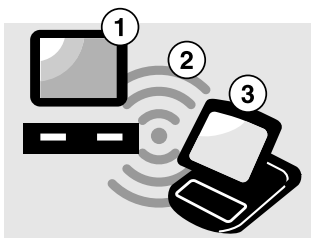

- 1 The data management system status
- 2 The connection status between the programmer and the data management system
- 3 The programmer status

The sections of the SessionSync Status icon change colors to indicate data ready for transfer, a valid connection between the programmer and the data management system, and successful data transfer to the data management system.

Note: When the whole icon is grayed out, SessionSync has been disabled under the programmer preferences.

Table 8. SessionSync Status icon states

Part of SessionSync Status Icon	Color	What the color indicates
Programmer	Gray	No session data files are in the Transfer Queue. Note: The transfer queue is the list of session data files that have been saved to the programmer hard disk but are waiting for transfer.
	Blue	Session data files exist in the Transfer Queue

Medtronic

CARELINK ENCORE™ 29901

Table 8. SessionSync Status icon states (continued)

Part of SessionSync Status Icon	Color	What the color indicates
Connection	Not visible	No valid connection exists between the programmer and the data management system
	Green	Valid connection exists between the programmer and the data management system
	Red circle with a line through it	Device application in use does not support SessionSync
Data Management System	Gray	No session data has been transferred to the data management system
	Blue	All session data has been successfully transferred to the data management system

7.4 Use Automatic SessionSync

Automatic SessionSync allows you to perform a SessionSync automatically at the end of a patient session. This feature is available for all SessionSync enabled devices.

7.4.1 Save the patient session with Manual SessionSync

1. Press the **Session** icon.
2. Select **SessionSync**....
3. The SessionSync - Saving Session Data On Programmer window is opened and for some devices an interrogation is automatically started. The SessionSync - Saving Session Data On Programmer window shows the progress of the save. The Programmer side of the SessionSync Status icon turns blue after the data has been saved on the Programmer hard disk. If the subsequent transfer is successful, the data management system side of the SessionSync Status icon turns blue.

7.4.2 End a patient session with Automatic SessionSync enabled

1. Press [End Session...]. If an interrogation is required before the SessionSync data transfer, the Interrogation Required window is displayed.
2. Verify that the Automatic SessionSync box is checked, and then press [End Now].

Medtronic

CARELINK ENCORE™ 29901

3. The SessionSync - Saving Session Data On Programmer window is opened. For some devices, an interrogation is automatically started. The SessionSync - Saving Session Data On Programmer window shows the progress of the save. The programmer side of the SessionSync Status icon turns blue after the data has been saved on the programmer hard disk. If the subsequent transfer is successful, the data management system side of the SessionSync Status icon turns blue.

7.5 Use Manual SessionSync for supported devices

Manual SessionSync allows you to send interrogated data to the Paceart data management system without ending the patient session on the Programmer.

Manual SessionSync is not available for all SessionSync supported devices. If manual SessionSync is available for a device, the **SessionSync...** option appears in the **Session** menu.

7.6 SessionSync error message descriptions

You may receive error or information messages at different times in the SessionSync process. For a list of error messages, see Table 9. If you have any issues with the programmer contact Medtronic Technical Support at the telephone number on the back cover of this manual.

Table 9. SessionSync error messages

Error Message	What it means
Data Transfer Failed	A device communication error has occurred during the interrogation and you have cancelled out of the interrogation window. The session data has not been saved on the programmer hard disk. Do one of the following: Press [Retry] to retry the operation. Press [Cancel] to close the window.
Ending a Session without Automatic SessionSync	You have cleared the Automatic SessionSync check box on the End Session window before pressing the [End Now] button.
Interrogation Required	You must conduct an interrogation before starting a SessionSync data transfer for this device. Press [OK] to close the window.

Medtronic

CARELINK ENCORE™ 29901

Table 9. SessionSync error messages (continued)

Error Message	What it means
Interrogate - Unsuccessful	The programmer cannot interrogate the device. You must reposition the programming head. Do one of the following: Press [Retry] or [Continue] after repositioning the programming head. Press [Cancel] to close the window.
Unable to Save Session Data	The session data cannot be saved on the programmer hard disk. Do one of the following: Press [Save to Disk] or [Save Session] to save the session data on a floppy disk. Press [End Now] to end the session without saving the device data. Press [Cancel] to close the window without saving the device data.

7.7 View SessionSync Status screen

The SessionSync Status screen displays information on the data files being transferred to the data management system using SessionSync. Each message includes the date, time, and event information for the associated SessionSync event.

7.8 Update SessionSync status

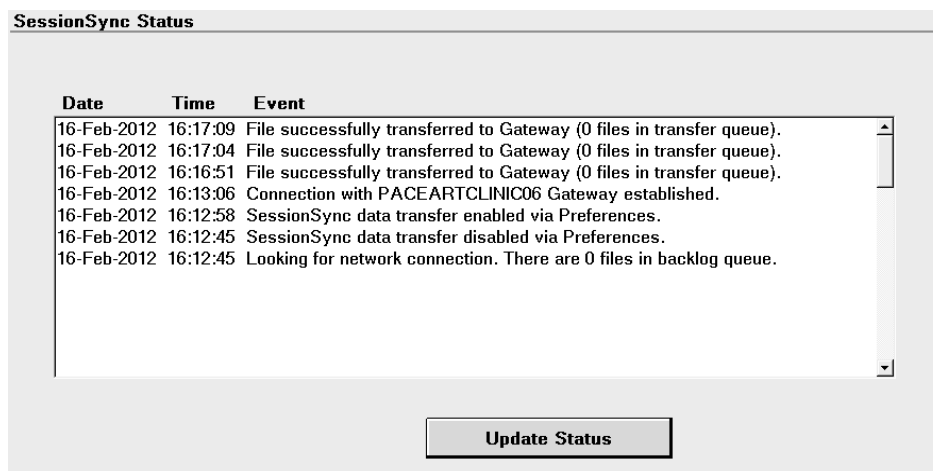

Medtronic

CARELINK ENCORE™ 29901

1. Press the **Programmer** icon, and then select **SessionSync Status**.
2. Press [Update Status].

Note: SessionSync status does not dynamically update when the window is open. To update, press [Update Status].

Medtronic

CARELINK ENCORE™ 29901

8 Service the programmer

8.1 Clean the system components

The exterior surfaces of the programmer and its accessories may be cleaned with a sponge or soft cloth moistened with water, mild detergent, hydrogen peroxide, or alcohol.

Thoroughly clean the surfaces of the programmer wires; the bottom surface of the programming head; and the wire connecting the programming head to the programmer.

Caution: Take care to prevent liquid from entering the programmer and programming head. Do not immerse the programmer or any accessories in any liquid or clean them with aromatic or chlorinated hydrocarbons.

The lead wires may be cleaned by wiping each lead wire with a sponge or soft cloth moistened with the cleaning material, then wiped with a sponge or soft cloth moistened with clean water, and then wiped dry.

The exterior surfaces of the lead wires can be cleaned up to 15 times with each of the following materials without functional degradation:

- Green soap, green soap tincture, or alcohol-free hand soap
- 2% gluteraldehyde solution (such as Cidex)
- Sodium hypochlorite (bleach solution 10% in water)

8.2 Sterilize the programming head, ECG cable, and lead wires

Except for the programming head or ECG cable and lead wires, the programmer and its accessories cannot be sterilized.

Caution: Do not autoclave the programming head or ECG cable and lead wires.

Visually inspect the cable and connections of the programming head after sterilizing. Do not use the programming head if it appears damaged. Damage includes, but is not limited to, deterioration of the cable insulation (brittleness, cracking, thinning, or bare spots). Do not use the programming head if the conductive wires are exposed.

Medtronic

CARELINK ENCORE™ 29901

8.2.1 Ethylene oxide

Note: The programming head or ECG cable and lead wires must be completely dry before being ethylene-oxide sterilized.

1. Wrap the programming head or ECG cable and lead wires in packaging permeable to ethylene oxide.
2. Medtronic recommends normal gas concentration of 725 mg/L ethylene oxide followed by a minimum of 12 hours of aeration. The worst case cycle will consist of no more than 3 hours exposure to EO.
3. Do not exceed 55 °C, 50% RH.
4. Do not resterilize the programming head more than 20 EO cycles. Do not resterilize the ECG cable and lead wires more than 10 EO cycles.

Biological indicators should be used to ensure that proper sterilization standards have been met. A previously validated sterilization cycle should be used.

Due to the variability in sterilization systems, precise sterilization instructions cannot be provided. Contact the manufacturer of your sterilization system for more information regarding procedures.

8.2.2 Gas plasma (programming head only STERRAD 100S gas plasma system)

1. Place the programming head in packing material appropriate for gas plasma sterilization.
2. Sterilize by procedures validated for effectiveness using suitable biological controls.
 - a. Do not exceed 55 °C.
 - b. Do not use an H₂O₂ concentration below 1 mg/L (nominal 1.8 mg/L).
 - c. Do not expose the programming head to a sterilizer cycle longer than 72 min (nominal 55 min).
 - d. Do not resterilize the programming head more than 20 cycles.

Medtronic

CARELINK ENCORE™ 29901

8.3 Programmer specifications

Table 10. Programmer specifications

Standards (The programmer complies with the following:)	
Radio frequency wireless specifications and applicable standards	
EMC	EN / IEC 60601-1-2 EN 301 489 EN 302 195 EN 55022 Class B/CISPR 22 EN 55024 Class B/CISPR 24
Radio	FCC CFR 47 P.15 RSS-210
Patient safety	UL/CUL 60601-1, Class I, Type BF ordinary EN 60601-1, Class I, Type BF, continuous operation
AC power requirement	
Voltage	100 to 125 VAC nominal or 200 to 240 VAC nominal
Frequency	50/60 Hz nominal
Power	100 W
Battery	
Type	Li-ion, rechargeable
Capacity	3900 mAh
Charge duration	Standby: 15 days Operating: 2 hours (typical)
Voltage	11.1 V
Power cord	
AC/DC adapter in	100-240 VAC 1.5 A @ 50/60 Hz
AC/DC adapter out	19 VDC 5.3 A
Electrical safety requirements per IEC 60601-1:1988, Clause 19	
Enclosure leakage current	≤ 0.1 mA
Earth leakage current	≤ 0.5 mA
Patient leakage current A.C.	≤ 0.1 mA
Patient auxiliary current D.C.	≤ 0.01 mA
Patient auxiliary current A.C.	≤ 0.1 mA
Electrical safety requirements per IEC 60601-1:2005, Clause 8.7	
Touch leakage current	≤0.1 mA
Earth leakage current	≤0.1 mA
Patient leakage current A.C.	≤0.1 mA
Patient auxiliary current D.C.	≤ 0.01 mA
Patient auxiliary current A.C.	≤0.1 mA

Medtronic

CARELINK ENCORE™ 29901

Table 10. Programmer specifications (continued)

Standards (The programmer complies with the following:)	
Physical dimension and weight	
Height	35.5 cm
Width	35.5 cm
Depth	10.2 cm
Weight	4.94 kg
Temperature limits	
Operating	5 °C to 40 °C
Storage	- 20 °C to 60 °C
Humidity limits	
Operating	80%
Storage	95% at 35 °C
Altitude	
Maximum	3000 m
Connectivity and controls	
Onboard LAN	
Data Interface	RJ-45 Ethernet connector
Data Modulation	IEEE 802.3 10 Mbps full-duplex and half-duplex on 10Base-T IEEE 802.3u 100 Mbps full-duplex and half-duplex on 100Base-Tx
Wireless LAN	
Frequency range	2.4 GHz, 5 GHz
Modulation	802.11 a/b/g/n
Output power	17 dBm (typical)
Bluetooth 2.1	
Frequency range	2.4 GHz
Output power	+4 dBm (maximum)

8.3.1 Functional test, maintenance, and safety checks

8.3.1.1 Functional test at installation

Before putting the programmer into service for the first time, the device and its accessories should be visually inspected and tested for operability by a designated Medtronic person. Visual inspection requires examining the programmer case for cracks, verifying that all connectors are properly fastened, checking for insulation damage to the power cord and other accessory cables, and inspecting for wall plug and equipment plug damage.

Verify operation by turning on the programmer and checking monitor functionality.

Medtronic

CARELINK ENCORE™ 29901

8.3.1.2 Maintenance

Medtronic recommends that you should test the programmer for operability and also visually inspect the programmer and its accessories (e.g., power cord, cables) before each use as outlined in the previous section.

Caution: If the case of the programmer is cracked or if any of the connectors are damaged, contact your Medtronic or Vitatron representative. If there is insulation damage to the power cord or accessory cables or if any of the wall or equipment plugs are damaged, replace the part and dispose of it according to local regulations or return the part to Medtronic.

8.3.1.3 Safety checks

Safety checks require a functional test and electrical safety tests once every two years or as directed by local requirements. It is not necessary that technical and safety inspections are performed by Medtronic or Vitatron personnel; however, technical and safety inspections of the programmer and its accessories must be performed by persons, who, based on their training, knowledge, and practical experience, are capable of adequately performing such inspections and who do not require instructions with regard to the technical and safety inspection.

Warning: If technical and safety inspection reveals a defect which could harm the patient, clinicians, or third parties, the device should not be used until it has been properly repaired. The operator must immediately notify Medtronic or Vitatron of these defects.

8.3.2 Disposal of the programmer

Return the programmer to Medtronic or Vitatron for proper disposal.

8.4 Special notice

The CareLink Encore 29901 Programmer (the “programmer”) is designed to program the adjustable parameters of the Medtronic or Vitatron programmable implantable devices included in the applications of the software used with the programmer. Refer to the appropriate reference guides for a list of the implantable device models applicable to the software. The programming and telemetry functions of the programmer are not compatible with any other implantable device models.

The programmer also functions as a digital measuring device intended for measurement of the pulse rate, AV interval, and pulse width of implantable device artifacts as detected by skin electrodes. Medtronic and Vitatron make no claims or warranties as to the effectiveness of the programmer as a diagnostic tool to the physician.

Medtronic

CARELINK ENCORE™ 29901

For information regarding difficulties, which may be encountered using the programmer, consult other portions of this reference guide.

8.5 Medtronic limited warranty

For complete warranty information, see the accompanying card enclosed in the package.

Medtronic

CARELINK ENCORE™ 29901

A End-user license agreement

A.1 End-user license agreement (EULA) terms

You have acquired a device (“DEVICE”) that includes software licensed by Medtronic from an affiliate of Microsoft Corporation (“MS”). Those installed software products of MS origin, as well as associated media, printed materials, and “online” or electronic documentation (“SOFTWARE”) are protected by international intellectual property laws and treaties. Manufacturer, MS and its suppliers (including Microsoft Corporation) own the title, copyright, and other intellectual property rights in the SOFTWARE. The SOFTWARE is licensed, not sold. All rights reserved.

This EULA is valid and grants the end-user rights ONLY if the SOFTWARE is genuine and a genuine Certificate of Authenticity for the SOFTWARE is included. For more information on identifying whether your software is genuine, please see <http://www.microsoft.com/piracy/howtotell>.

IF YOU DO NOT AGREE TO THIS END USER LICENSE AGREEMENT (“EULA”), DO NOT USE THE DEVICE OR COPY THE SOFTWARE. INSTEAD, PROMPTLY CONTACT MEDTRONIC FOR INSTRUCTIONS ON RETURN OF THE UNUSED DEVICE(S) FOR A REFUND. ANY USE OF THE SOFTWARE, INCLUDING BUT NOT LIMITED TO USE ON THE DEVICE, WILL CONSTITUTE YOUR AGREEMENT TO THIS EULA (OR RATIFICATION OF ANY PREVIOUS CONSENT).

GRANT OF SOFTWARE LICENSE – This EULA grants you the following license:

You may use the SOFTWARE only on the DEVICE.

Restricted Functionality – You are licensed to use the SOFTWARE to provide only the limited functionality (specific tasks or processes) for which the DEVICE has been designed and marketed by Medtronic. This license specifically prohibits any other use of the software programs or functions, or inclusion of additional software programs or functions that do not directly support the limited functionality on the DEVICE. Notwithstanding the foregoing, you may install or enable on a DEVICE, systems utilities, resource management or similar software solely for the purpose of administration, performance enhancement and/or preventive maintenance of the DEVICE.

If you use the DEVICE to access or utilize the services or functionality of Microsoft Windows Server products (such as Microsoft Windows Server 2003), or use the DEVICE to permit workstation or computing devices to access or utilize the services or functionality of Microsoft Windows Server products, you may be required to obtain a Client Access License for the DEVICE and/or each such workstation or computing device. Please refer to the end user license agreement for your Microsoft Windows Server product for additional information.

Medtronic

CARELINK ENCORE™ 29901

NOT FAULT TOLERANT – THE SOFTWARE IS NOT FAULT TOLERANT. MEDTRONIC HAS INDEPENDENTLY DETERMINED HOW TO USE THE SOFTWARE IN THE DEVICE, AND MS HAS RELIED UPON MEDTRONIC TO CONDUCT SUFFICIENT TESTING TO DETERMINE THAT THE SOFTWARE IS SUITABLE FOR SUCH USE.

NO WARRANTIES FOR THE SOFTWARE – THE SOFTWARE is provided “AS IS” and with all faults. THE ENTIRE RISK AS TO SATISFACTORY QUALITY, PERFORMANCE, ACCURACY, AND EFFORT (INCLUDING LACK OF NEGLIGENCE) IS WITH YOU. ALSO, THERE IS NO WARRANTY AGAINST INTERFERENCE WITH YOUR ENJOYMENT OF THE SOFTWARE OR AGAINST INFRINGEMENT. IF YOU HAVE RECEIVED ANY WARRANTIES REGARDING THE DEVICE OR THE SOFTWARE, THOSE WARRANTIES DO NOT ORIGINATE FROM, AND ARE NOT BINDING ON, MS.

No Liability for Certain Damages – EXCEPT AS PROHIBITED BY LAW, MS SHALL HAVE NO LIABILITY FOR ANY INDIRECT, SPECIAL, CONSEQUENTIAL OR INCIDENTAL DAMAGES ARISING FROM OR IN CONNECTION WITH THE USE OR PERFORMANCE OF THE SOFTWARE. THIS LIMITATION SHALL APPLY EVEN IF ANY REMEDY FAILS OF ITS ESSENTIAL PURPOSE. IN NO EVENT SHALL MS BE LIABLE FOR ANY AMOUNT IN EXCESS OF U.S. TWO HUNDRED FIFTY DOLLARS (U.S. \$250.00).

Restricted Uses – The SOFTWARE is not designed or intended for use or resale in hazardous environments requiring fail-safe performance, such as in the operation of nuclear facilities, aircraft navigation or communication systems, air traffic control, or other devices or systems in which a malfunction of the SOFTWARE would result in foreseeable risk of injury or death to the operator of the device or system, or to others.

Limitations on Reverse Engineering, Decompilation, and Disassembly – You may not reverse engineer, decompile, or disassemble the SOFTWARE, except and only to the extent that such activity is expressly permitted by applicable law notwithstanding this limitation.

SOFTWARE as a Component of the DEVICE - Transfer – This license may not be shared, transferred to or used concurrently on different computers. The SOFTWARE is licensed with the DEVICE as a single integrated product and may only be used with the DEVICE. If the SOFTWARE is not accompanied by a DEVICE, you may not use the SOFTWARE. You may permanently transfer all of your rights under this EULA only as part of a permanent sale or transfer of the DEVICE, provided you retain no copies of the SOFTWARE. If the SOFTWARE is an upgrade, any transfer must also include all prior versions of the SOFTWARE. This transfer must also include the Certificate of Authenticity label. The transfer may not be an indirect transfer, such as a consignment. Prior to the transfer, the end user receiving the SOFTWARE must agree to all the EULA terms.

Consent to Use of Data – You agree that MS, Microsoft Corporation and their affiliates may collect and use technical information gathered in any manner as part of product support

Medtronic

CARELINK ENCORE™ 29901

services related to the SOFTWARE. MS, Microsoft Corporation and their affiliates may use this information solely to improve their products or to provide customized services or technologies to you. MS, Microsoft Corporation and their affiliates may disclose this information to others, but not in a form that personally identifies you.

Internet Gaming/Update Features – If the SOFTWARE provides, and you choose to utilize, the Internet gaming or update features within the SOFTWARE, it is necessary to use certain computer system, hardware, and software information to implement the features. By using these features, you explicitly authorize MS, Microsoft Corporation and/or their designated agent to use this information solely to improve their products or to provide customized services or technologies to you. MS or Microsoft Corporation may disclose this information to others, but not in a form that personally identifies you.

Internet-Based Services Components – The SOFTWARE may contain components that enable and facilitate the use of certain Internet-based services. You acknowledge and agree that MS, Microsoft Corporation or their affiliates may automatically check the version of the SOFTWARE and/or its components that you are utilizing and may provide upgrades or supplements to the SOFTWARE that may be automatically downloaded to your DEVICE. Microsoft Corporation or their affiliates do not use these features to collect any information that will be used to identify you or contact you. For more information about these features, please see the privacy statement at <http://go.microsoft.com/fwlink/?LinkId=25243>.

Links to Third Party Sites – You may link to third party sites through the use of the SOFTWARE. The third party sites are not under the control of MS or Microsoft Corporation, and MS or Microsoft are not responsible for the contents of any third party sites, any links contained in third party sites, or any changes or updates to third party sites. MS or Microsoft Corporation is not responsible for webcasting or any other form of transmission received from any third party sites. MS or Microsoft Corporation are providing these links to third party sites to you only as a convenience, and the inclusion of any link does not imply an endorsement by MS or Microsoft Corporation of the third party site.

Notice Regarding Security – To help protect against breaches of security and malicious software, periodically back up your data and system information, use security features such as firewalls, and install and use security updates.

No Rental/Commercial Hosting – You may not rent, lease, lend or provide commercial hosting services with the SOFTWARE to others.

Separation of Components – The SOFTWARE is licensed as a single product. Its component parts may not be separated for use on more than one computer.

Additional Software/Services – This EULA applies to updates, supplements, add-on components, product support services, or Internet-based services components (“Supplemental Components”), of the SOFTWARE that you may obtain from Medtronic, MS, Microsoft Corporation or their subsidiaries after the date you obtain your initial copy of the SOFTWARE, unless you accept updated terms or another agreement governs. If other

Medtronic

CARELINK ENCORE™ 29901

terms are not provided along with such Supplemental Components and the Supplemental Components are provided to you by MS, Microsoft Corporation or their subsidiaries then you will be licensed by such entity under the same terms and conditions of this EULA, except that (i) MS, Microsoft Corporation or their subsidiaries providing the Supplemental Components will be the licensor with respect to such Supplemental Components in lieu of Medtronic for the purposes of the EULA, and (ii) TO THE MAXIMUM EXTENT PERMITTED BY APPLICABLE LAW, THE SUPPLEMENTAL COMPONENTS AND ANY (IF ANY) SUPPORT SERVICES RELATED TO THE SUPPLEMENTAL COMPONENTS ARE PROVIDED AS IS AND WITH ALL FAULTS. ALL OTHER DISCLAIMERS, LIMITATION OF DAMAGES, AND SPECIAL PROVISIONS PROVIDED BELOW AND/OR OTHERWISE WITH THE SOFTWARE SHALL APPLY TO SUCH SUPPLEMENTAL COMPONENTS. MS, Microsoft Corporation or their subsidiaries reserve the right to discontinue any Internet-based services provided to you or made available to you through the use of the SOFTWARE.

Recovery Media – If SOFTWARE is provided by Medtronic on separate media and labeled “Recovery Media” you may use the Recovery Media solely to restore or reinstall the SOFTWARE originally installed on the DEVICE.

Backup Copy – You may make one (1) backup copy of the SOFTWARE. You may use this backup copy solely for your archival purposes and to reinstall the SOFTWARE on the DEVICE. Except as expressly provided in this EULA or by local law, you may not otherwise make copies of the SOFTWARE, including the printed materials accompanying the SOFTWARE. You may not loan, rent, lend or otherwise transfer the backup copy to another user.

End User Proof of License – If you acquired the SOFTWARE on a DEVICE, or on a compact disc or other media, a genuine Microsoft “Proof of License”/Certificate of Authenticity label with a genuine copy of the SOFTWARE identifies a licensed copy of the SOFTWARE. To be valid, the label must be affixed to the DEVICE, or appear on Medtronic’s software packaging. If you receive the label separately other than from Medtronic, it is invalid. You should keep the label on the DEVICE or packaging to prove that you are licensed to use the SOFTWARE.

Product Support – Product support for the SOFTWARE is not provided by MS, Microsoft Corporation, or their affiliates or subsidiaries. For product support, please refer to Medtronic support number provided in the documentation for the DEVICE. Should you have any questions concerning this EULA, or if you desire to contact Medtronic for any other reason, please refer to the address provided in the documentation for the DEVICE.

Termination – Without prejudice to any other rights, Medtronic may terminate this EULA if you fail to comply with the terms and conditions of this EULA. In such event, you must destroy all copies of the SOFTWARE and all of its component parts.

Reference Manual

103

Medtronic

CARELINK ENCORE™ 29901

EXPORT RESTRICTIONS – You acknowledge that SOFTWARE is subject to U.S. and European Union export jurisdiction. You agree to comply with all applicable international and national laws that apply to the SOFTWARE, including the U.S. Export Administration Regulations, as well as end-user, end-use and destination restrictions issued by U.S. and other governments. For additional information see <http://www.microsoft.com/exporting/>.

Medtronic

CARELINK ENCORE™ 29901

Index

A

AC power input	23
Adjust button	43
[Adjust...] button	43
Adobe settings	82
AHA coding	
electrodes	63
annotations	
Marker Channel	42
parameter programming	42
artifact detection	50
Auto Identify	72
<i>see also</i> Find Patient	

B

battery	23, 29
charge	32
status	33
Bluetooth	38, 41
buttons	
Adjust	43
[Adjust...]	43
Auto Identify	72
Bluetooth	26
[Deliver]	77
description	43
Electronic Strip Chart (eStrip)	26
[Emergency]	76
Emergency VVI	26
Find Patient	42, 72
[Freeze]	43
inactive	44
Power	26, 32
RFID	26
Strips	43
[Strips...]	43
Vitatron/Medtronic switch	72
VVI	76
Wi-Fi	26
<i>see also</i> Find Patient	
<i>see also</i> icons	

C

command bar, programmer	42
components	
storing	77, 78

connector	
ECG cable	25
programming head	25

D

date and time	
setting	46
Declaration of Conformity	17
[Deliver] button	77
demonstrations option	50
dimensions, programmer	97
display screen	
features of screen	40

E

ECG	18
cable	23
cable connections	31
functions on the programmer	18
electrodes	
AHA coding	63
attaching	62, 63
IEC coding	63
[Emergency] button	76
Emergency VVI button	26
environmental precautions	
disposal of programmer	9, 11
while using programmer	16
Ethernet cable	23
connecting	55

F

features	
programmer	11
Federal Communications Commission (FCC)	17
Find Patient button	72
Find Patient screen	70
[Freeze] button	43

H

hardware information	
programmer	45
humidity limits	
programmer	97

I

icons	
AC power indicator	41
battery indicator	26

Medtronic

CARELINK ENCORE™ 29901

battery power indicator 41

Bluetooth configuration 41

device application indicator/selector 42

Electronic Strip Chart (eStrip) indicator/selector 42

inactive 44

network configuration 41

PDF Viewer 41

Print Queue 44

programmer 44

Select Model 44

SessionSync 41

SessionSync status 89

telemetry strength 41

USB indicator 41

IEC coding

 electrodes 63

interference 15

 troubleshooting 32

L

Live Rhythm Monitor 42

 switching views 42

location

 programmer 45

M

manuals

 obtaining from website 21

model (device)

 selection screen 71

model numbers 45

modes, pacing

 display of active mode 42

N

Network configuration 41

O

operating humidity

 programmer 97

operating preferences 47

operating temperature

 programmer 97

other software

 option 49

P

patient session

 conducting 69

PDF

 viewing 82

PDF, saving to 79

PDF Viewer 82

power supply 23

precautions

 environmental 16

 programmer 15

 programmer modification 15

printer

 compatibility 35

 connecting 36

 specifications 96

print queue settings 86

profile

 programmer 45

programmer

 components 19

 device status 42

 dimensions 97

 display screen 40

 functions 18

 hardware information 45

 location 45

 preferences 47

 profile 45

 setting time and date 46

 specifications 96

 task area 42

 tool palette 43

 view or update serial numbers 45

 waveform traces 42

 weight 97

see also buttons

see also icons

see also Live Rhythm Monitor

programming head

 determining the correct position 67

 magnet 68

 positioning 66, 67

 sterilizing 94

 when to position 66

R

regulatory compliance 17

reports

 deleting 86

 saving to PDF 79

 saving to USB 80

 viewing 81

RFID button 26

RTTE Directive

 device conformance 17

Medtronic

CARELINK ENCORE™ 29901

S

screen

- Find Patient 70
- Select Model 71
- selecting the device model 71
- serial numbers 45
- SessionSync 41, 88
 - automatic 90
 - color indicators 89
 - components of status icon 89
 - enabling and disabling 88
 - error messages 91
 - manual 91
 - status icon 89
 - viewing status of 92
- skin electrodes 62, 63
 - see also* electrodes
- software requirements 20
- specifications
 - printer 96
 - programmer 96
- standards, compliance 96
- status bar, programmer 42
- storage humidity
 - programmer 97
- storage temperature
 - programmer 97
- Strips button 43
- [Strips...] button 43
- stylus
 - storing 66
 - using 64

- system preferences 47

T

- task bar, programmer 41
- telemetry
 - functions 18
- temperature limits
 - programmer 97
- time and date
 - setting 46
- traces, waveform 42

U

USB

- saving to 80
- storage devices 80

V

- Vitatron/Medtronic switch button 72
- VVI button 76

W

- warnings
 - programmer 12
- warranty information
 - programmer 99
- waveform traces 42
- website
 - accessing technical manuals 21
- weight, programmer 97
- Wi-Fi 26
- wireless 59



Medtronic

Medtronic

Manufacturer

Medtronic, Inc.
710 Medtronic Parkway
Minneapolis, MN 55432-5604
USA
www.medtronic.com
Tel. +1-763-514-4000
Fax +1-763-514-4879

Medtronic E.C. Authorized Representative

Medtronic B.V.
Earl Bakkenstraat 10
6422 PJ Heerlen
The Netherlands
Tel. +31-45-566-8000
Fax +31-45-566-8668

Europe/Africa/Middle East Headquarters

Medtronic International Trading Sàrl
Route du Molliau 31
Case Postale 84
CH-1131 Tolochenaz
Switzerland
www.medtronic.com
Tel. +41-21-802-7000
Fax +41-21-802-7900

Australia

Medtronic Australasia Pty Ltd
97 Waterloo Road
North Ryde, NSW 2113
Australia

Technical manuals:
www.medtronic.com/manuals

vitatron

Vitatron

Manufacturer

Vitatron Holding B.V.
Endepolsdomein 5
6229 GW Maastricht
The Netherlands
Tel. +31-43-356-6551

© Medtronic, Inc. 2012
M945141A001B
2012-04-26



M945141A001