

The purpose of this document is to record the antenna information for the products identified below.

Products
MyCarelink Patient Monitor Model 24950 (Radio Ref Model 24950B)

1. General antenna information

Table 1: General antenna information

Telemetry: MEDradio	Antenna Type: 1: Helical coil, 2: Serpentine PCB trace Manufacturer: 1: Precision Inc. 2: N/A Model number: 1: 101049-322 2: N/A Connection with transmitter: Electrically controllable switch Antenna Gain: 1: -5.9 dBi 2: -5.2 dBi
Telemetry: Bluetooth + Low Energy	Antenna Type: Custom BT Coil Manufacturer: Plexus Manufacturing Model number: 501443-01 Connection with transmitter: Soldered directly to PCB Antenna Gain: 2.8 dBi

2. Antenna assembly drawing

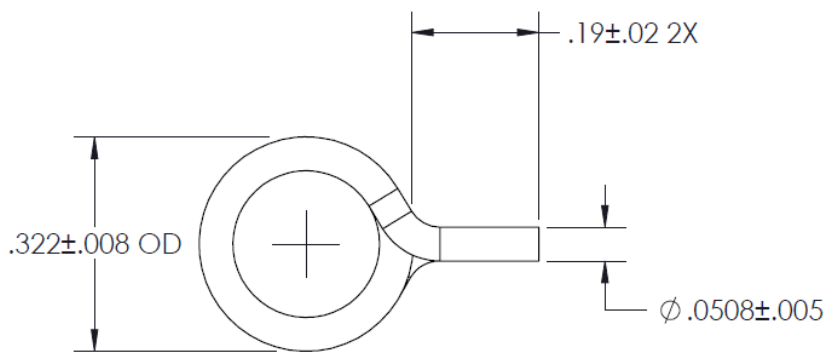
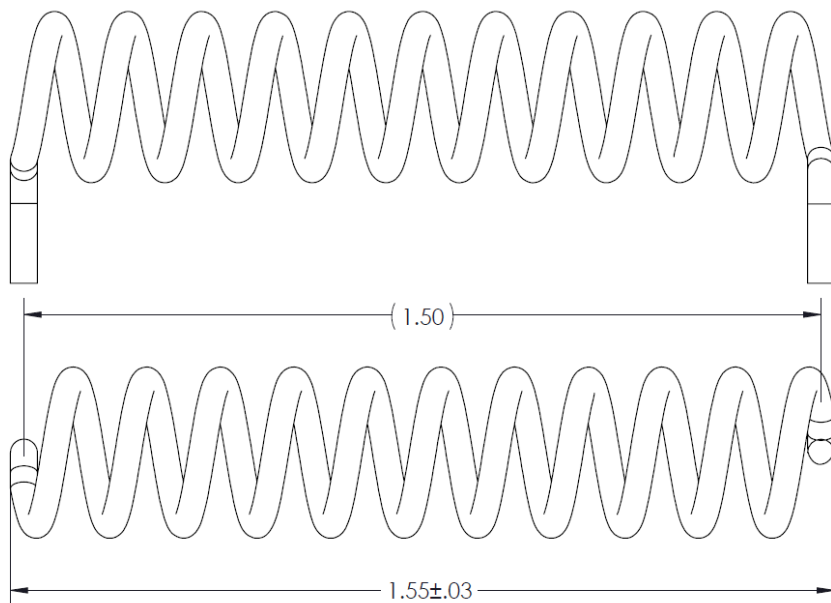

MedRadio

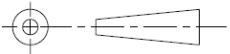

 Medtronic MEDTRONIC, INC. MINNEAPOLIS, MINNESOTA USA	TITLE ANTENNA, HELICAL 11 TURN			
	SCALE NONE	DO NOT SCALE PRINT	UNLESS OTHERWISE SPECIFIED ALL DIMENSIONS ARE IN INCHES	
	DRAFTING RICK BERG	DATE 11JUL12	THE CAD DATA FOR THIS PART NUMBER CAN BE MADE AVAILABLE UPON REQUEST	
	ENGINEERING RICK BERG			
UNLESS OTHERWISE SPECIFIED: DIMENSIONING & TOLERANCING IN ACCORDANCE WITH ASME Y14.5M-1994	X.X ± .1 X.XX ± .01 X.XXX ± .005 ANGLES ± 1.0°	DIMENSIONS UNLESS OTHERWISE SPECIFIED	TYPE --	FIRST DESIGNED FOR MODEL NEXT ASSY -- --
THIRD ANGLE PROJECTION 	SIZE B		DOCUMENT NUMBER 101049-322	REV C

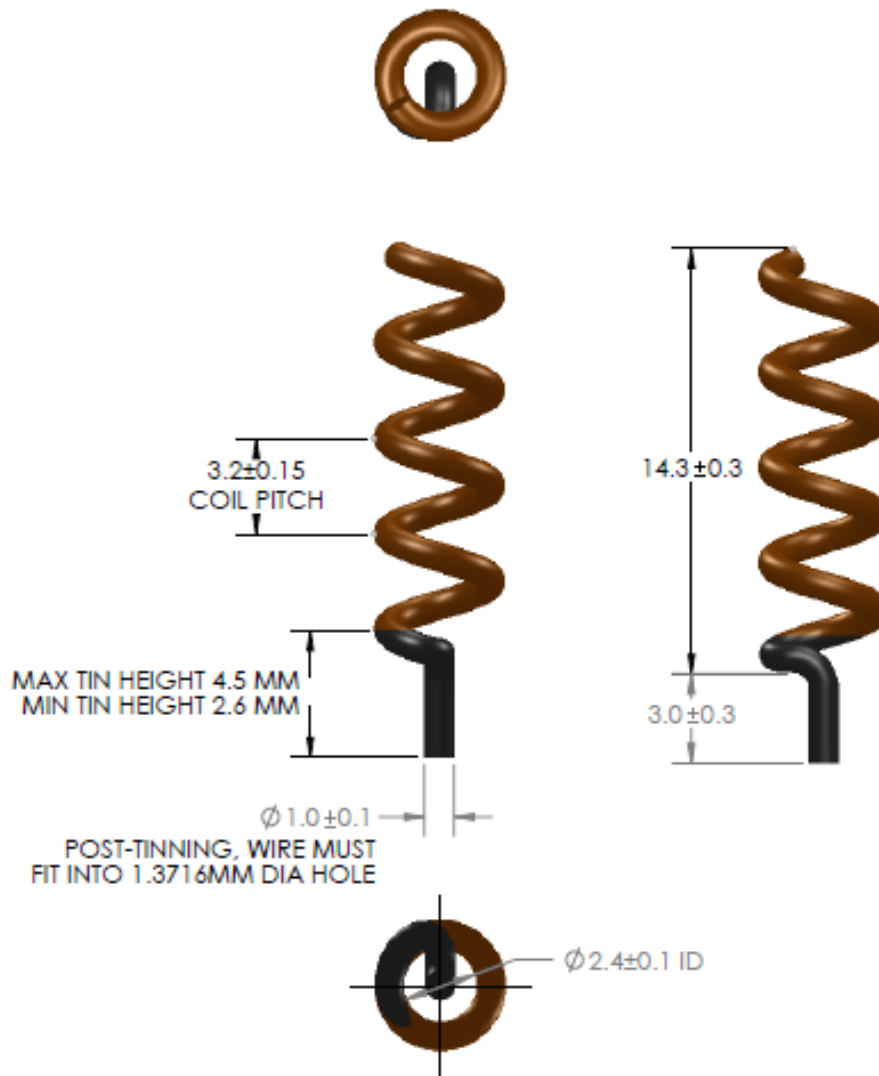
Bluetooth module



DESCRIPTION			ANTENNA, BLUETOOTH, MCL-X		
TOLERANCES UNLESS OTHERWISE NOTED LINEAR X.X ± 0.1 X.XX ± 0.01 X.XXX ± 0.005 ANGLES ± 0.5°	PART NUMBER	UNITS		MM	
	501443-01	DRAWING LAST MODIFIED BY		SCALE	
paige.bostrom		501443		11/18/2015	
 <i>The Product Realization Company</i>		PROJECT	DRAWING ITERATION		
		D445	C.2		
CONFIDENTIAL <small>ALL INFORMATION CONTAINED IN THIS DRAWING MAY NOT BE USED WITHOUT THE WRITTEN CONSENT OF PLEXUS ENGINEERING SOLUTIONS</small>		INTERPRET GEOMETRIC DIMENSIONS AND TOLERANCES ACCORDING TO ASME Y14.5-2009	 THIRD ANGLE PROJECTION	REV	
		DO NOT SCALE DRAWING		C	
SHEET SIZE B		SHEET 1 of 1			

3. Antenna plots

MedRadio

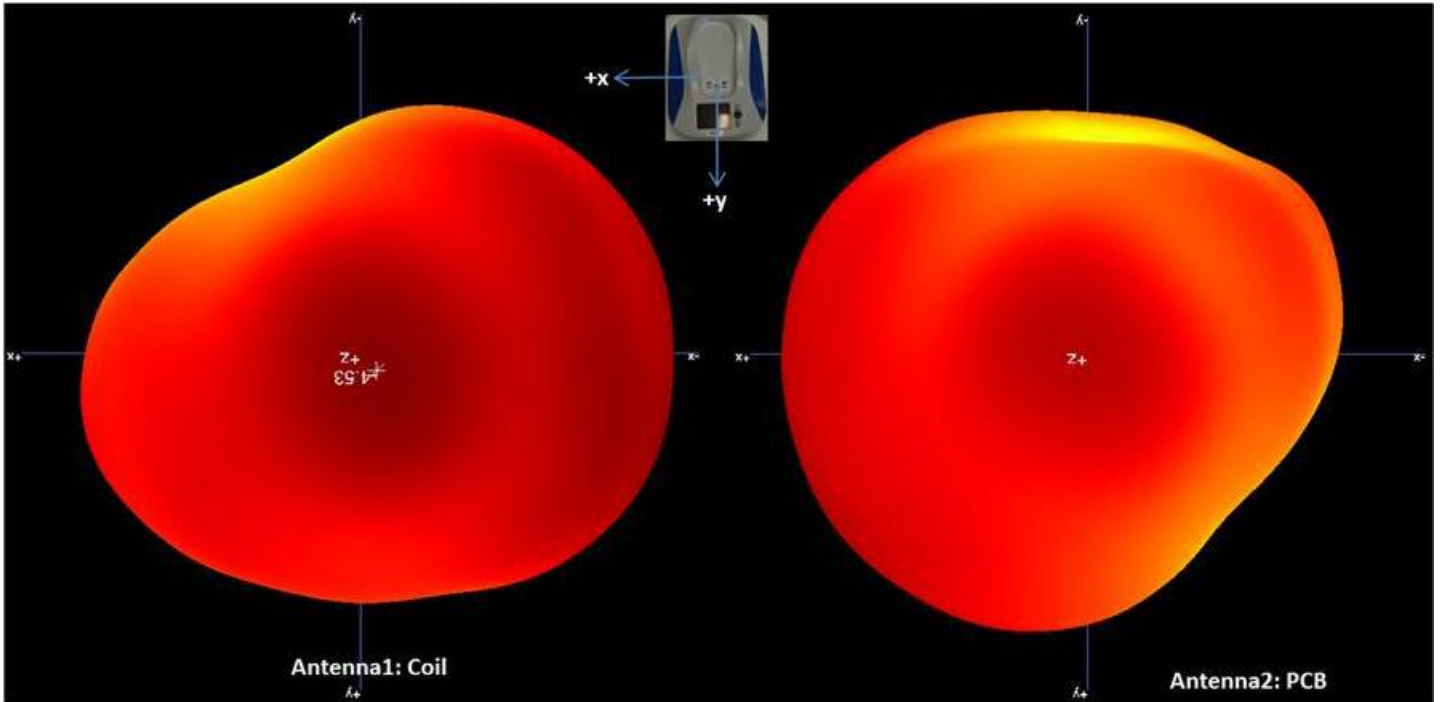

Bluetooth module

