

Vital Sync™

Wearable SpO₂ Patient Monitoring System

Exhibit #8

Medtronic, the Medtronic logo, and Further, Together are trademarks of Medtronic. Other brands are trademarks of a Medtronic company.

This manual © 2015, 2016 Medtronic. All rights reserved.

Table of Contents

| | | |
|------------|--|------------|
| 1 | Introduction | |
| 1.1 | Overview | 1-1 |
| 1.2 | Intended Audience | 1-1 |
| 1.3 | Safety Information | 1-2 |
| 1.3.1 | Safety Symbols | 1-2 |
| 1.3.2 | Warnings | 1-2 |
| 1.3.3 | Cautions | 1-5 |
| 1.3.4 | Notes | 1-5 |
| 1.4 | Obtaining Technical Assistance | 1-6 |
| 1.4.1 | Technical Services | 1-6 |
| 1.4.2 | Related Documents | 1-7 |
| 1.5 | Revision History | 1-7 |
| 1.6 | Warranty Information | 1-7 |
| 1.7 | Licensing Information | 1-8 |
| 1.8 | HIPAA Disclaimer | 1-8 |
| 2 | Product Overview | |
| 2.1 | Overview | 2-1 |
| 2.2 | Product Description | 2-1 |
| 2.3 | Indications for Use | 2-2 |
| 2.4 | Components and Accessories | 2-2 |
| 2.5 | Views | 2-3 |
| 2.5.1 | Module | 2-3 |
| 2.5.2 | Module with Connected Sensor | 2-3 |
| 2.5.3 | Docking Station | 2-4 |
| 2.6 | Symbols and Descriptions | 2-4 |
| 2.6.1 | Monitoring System Module | 2-4 |
| 2.6.2 | Packaging and Labeling | 2-5 |
| 3 | Docking Station Setup and Operation | |
| 3.1 | Overview | 3-1 |
| 3.2 | Safety Reminders | 3-1 |
| 3.3 | Setup | 3-1 |
| 3.4 | Operation | 3-2 |
| 3.4.1 | Power On and Power Off | 3-2 |
| 3.4.2 | Module Battery Recharge | 3-2 |
| 3.5 | Cleaning and Disinfection | 3-3 |
| 3.6 | Troubleshooting | 3-3 |

| | | |
|------------|--|------------|
| 4 | Module and Sensor Setup and Operation | |
| 4.1 | Overview | 4-1 |
| 4.2 | Safety Reminders | 4-1 |
| 4.3 | Setup | 4-2 |
| 4.4 | Operation | 4-2 |
| 4.4.1 | Power On and Power Off | 4-2 |
| 4.4.2 | Monitor a Patient | 4-3 |
| 4.4.3 | Change Alarm Thresholds | 4-5 |
| 4.4.4 | Battery Recharge | 4-6 |
| 4.5 | Alarm Thresholds | 4-6 |
| 4.6 | Troubleshooting | 4-7 |
| 5 | Performance Considerations | |
| 5.1 | Overview | 5-1 |
| 5.2 | Oximetry Considerations | 5-1 |
| 5.2.1 | Monitoring System Constraints | 5-1 |
| 5.2.2 | Sensor Performance Considerations | 5-1 |
| 5.3 | Patient Conditions | 5-3 |
| 5.4 | Reducing Electromagnetic Interference (EMI) | 5-4 |
| 6 | Product Maintenance | |
| 6.1 | Overview | 6-1 |
| 6.2 | Cleaning and Disinfection | 6-1 |
| 6.2.1 | Cleaning and Disinfecting Agents | 6-1 |
| 6.2.2 | Clean the Module | 6-2 |
| 6.2.3 | Disinfect the Module | 6-3 |
| 6.2.4 | Clean or Disinfect the Docking Station | 6-5 |
| 6.3 | Module Battery Recharge | 6-5 |
| 6.4 | Service | 6-6 |
| 7 | Troubleshooting | |
| 7.1 | Overview | 7-1 |
| 7.2 | Monitoring System Troubleshooting | 7-1 |
| 7.3 | Docking Station Troubleshooting | 7-3 |

Table of Contents

| | | |
|------------|--|------------|
| 8 | Product Specifications | |
| 8.1 | Physical Characteristics | 8-1 |
| 8.2 | Battery | 8-1 |
| 8.3 | Environmental Conditions | 8-2 |
| 8.3.1 | Operating | 8-2 |
| 8.3.2 | Transport and Storage | 8-2 |
| 8.4 | Product Compliance | 8-3 |
| 8.5 | Manufacturer’s Declaration and Guidance | 8-3 |
| 8.5.1 | Electromagnetic Compatibility (EMC) | 8-3 |
| 8.5.2 | FCC Compliance | 8-7 |
| 8.6 | Sensor Accuracy and Ranges | 8-8 |
| 8.7 | Essential Performance | 8-9 |
| A | Clinical Studies | |
| A.1 | Overview | A-1 |
| A.2 | Methods | A-1 |
| A.3 | Study Population | A-1 |
| A.4 | Study Results | A-1 |
| A.5 | Adverse Events or Deviations | A-1 |
| A.6 | Conclusion | A-1 |

Page Left Intentionally Blank

1 Introduction

1.1 Overview

This manual describes the features, setup, and operation of the patient components of the Vital Sync™ Wearable SpO₂ Patient Monitoring System, along with the docking station used with the device.

This manual applies to the following products:

REF OS1E

REF OS1ACC

1.2 Intended Audience

This manual provides information to health-care professionals acting as caregivers in low-acuity hospital or hospital-type settings for operation and maintenance of the monitoring system.

Consult facility requirements and protocols for any additional training or skill requirements beyond those identified here for operation and maintenance of the monitoring system.

Before using the monitoring system or the docking station, thoroughly read this manual, as well as the user documentation for the monitoring application used as part of the monitoring system.



1.3 Safety Information

This section contains important information regarding the safe and correct use of the Vital Sync Wearable SpO₂ Patient Monitoring System.

Other important safety information appears in various locations in this manual.

1.3.1 Safety Symbols

Table 1-1. Safety Symbol Definitions

| Symbol | Definition |
|---|---|
|  | WARNING Warnings alert users to potential serious outcomes (death, injury, or adverse events) to the patient, user, or environment. |
|  | Caution Cautions alert users to exercise appropriate care for safe and effective use of the product. |
|  | Note Notes provide additional guidelines or information. |

1.3.2 Warnings

The following warnings apply when using the monitoring system.

||new warnings and draft warnings possibly to be added are in blue text||

Hazard Warnings



WARNING:

Electrical shock hazard — Do not soak the monitoring system module or submerge it into any liquids.



WARNING:

Always disconnect and remove the monitoring system module and sensor during magnetic resonance imaging (MRI) scanning. Attempting to use the monitoring system during an MRI procedure could cause burns or adversely affect the MRI image or the monitoring system's accuracy.

Patient and Device Safety Warnings



WARNING:

Do not use the monitoring system if the module or sensor appears or is suspected to be damaged.



WARNING:

Using different alarm limits for the same or similar equipment within a single area of care may compromise patient safety.

General Usage Warnings



WARNING:

The monitoring system is intended only as an adjunct in patient assessment. It must be used in conjunction with clinical signs and symptoms and periodic patient observations.



WARNING:

The monitoring system module does not have an on-device screen or display. Users must view monitored data and alarms in an appropriate application on an external host system that is communicating with the module and sensor.



WARNING:

The monitoring system module and sensor communicate with the external host system via the facility's data network. This may result in delays in reporting of device data and alarms, depending on network bandwidth and loading and on networking hardware used.



WARNING:

The monitoring system module reports data periodically, not continuously. The data reporting interval, as well as delays due to network bandwidth, loading, or hardware issues, will create a lag between when a patient event happens and when it is reported in the external application.



WARNING:

Due to the monitoring system's periodic data reporting, as well as the potential for network delays, the monitoring system is not suitable for use as a pulse oximeter for transient events.

System Performance and Accuracy Warnings



WARNING:

Verify that accessories and sensors used are compatible with the monitoring system module. Only use accessories and sensors specified by Medtronic for use with this monitoring system.



WARNING:

The use of accessories and sensors other than those specified may result in inaccurate readings of the monitoring system and increased emission and/or decreased electromagnetic immunity of the monitoring system module and sensor.



WARNING:

For best product performance and measurement accuracy, use only accessories supplied or specified by Medtronic. Use accessories according to the manufacturer's directions for use and institutional standards.



WARNING:

Portable and mobile radio frequency (RF) communications equipment can affect medical electrical equipment.



WARNING:

Interference from electrosurgical generators can degrade the performance or accuracy of the module and sensor.



WARNING:

The presence of dysfunctional hemoglobin may result in inaccurate SpO₂ measurements.



WARNING:

Excessive motion may cause deterioration of SpO₂ and pulse rate accuracy.



WARNING:

While the monitoring system is in use, the patient should avoid gripping with the hand to which the sensor is attached, or inaccurate measurements may result.

1.3.3 Cautions

||new draft cautions possibly to be added are in blue text||



Caution:

Failure to charge the monitoring system module promptly after a low battery indication may result in the module shutting down.



Caution:

Do not use any constricting instrument, such as a noninvasive blood pressure (NIBP) cuff, on the same appendage as the monitoring system sensor, or inaccurate measurements may result.



Caution:

Follow local government ordinances and recycling instructions regarding disposal or recycling of the monitoring system and its components, including batteries and accessories.

1.3.4 Notes



Note:

Failure of any cable or connector, or failure of the wireless connection to the external host system, will interrupt the transfer of data from the monitoring system module to the external host system.



Note:

If the module is out of range of the external host system, it will not report monitored data or alarms to the host system.



Note:

If the module loses connection with the external host system, it will continue to monitor data from the patient. The module will record alarm conditions that occur while it is disconnected or out of range, and will report them to the monitoring application once it reestablishes connection with the host system.



Note:

Failure to cover the pulse oximetry sensor site with opaque material in high ambient light conditions may result in inaccurate measurements. Pulse oximetry readings and pulse signals can be affected by certain environmental conditions, pulse oximetry sensor application errors,

and certain patient conditions. Refer to the appropriate sections of this manual for specific safety information.



Note:

Do not lift or carry the module by the pulse oximetry sensor or sensor cable. The cable is not designed to be weight-bearing. It can be damaged if used to lift or carry the module, or can disconnect, potentially damaging the module if the module falls on a hard surface.



Note:

A functional tester cannot be used to assess the accuracy of the monitoring system module or sensor.



Note:

Use and store the monitoring system module in environmental conditions that are within specifications. Refer to *Environmental Conditions* on page 8-2.



Note:

Before using this device, carefully review this manual, the associated accessory *Instructions for Use*, and all precautionary information and specifications.



Note:

The module contains WEEE materials. Do not discard the module as unsorted municipal waste.

1.4 Obtaining Technical Assistance

1.4.1 Technical Services

For technical information and assistance, if unable to correct a problem while using the device, contact Medtronic or a local Medtronic representative.

Medtronic Technical Services (Patient Monitoring & Recovery)

15 Hampshire Street

Mansfield, MA 02048 USA

1.800.635.5267, or 1.925.463.4635,

or contact a local Medtronic representative

www.medtronic.com

When calling Medtronic or a local Medtronic representative, provide the serial number from the label on the bottom of the monitoring system module.

1.4.2 Related Documents

Before using the device, review both this manual and the user documentation for the monitoring application on the external host system. This information is essential for understanding the data posted to the external host system and appearing in the monitoring application, as well as the device's own visual indicators. In addition, review the instructions for use for the wrist strap and cradle and the sensor.

Also read all precautionary information and specifications both for the device and its associated accessories, and for the monitoring application in which the device data is being viewed.

Table 1-2. Related Documents

| Document | Description |
|--|---|
| Vital Sync™ Wearable SpO ₂ Patient Monitoring System Operator's Manual | Provides information on device operation and on troubleshooting errors or malfunctions. |
| Vital Sync™ Wearable SpO ₂ Patient Monitoring System Wrist Strap Instructions for Use | Provides information on use of the wrist strap and cradle with the module. |
| Nellcor™ Adult SpO ₂ Sensor Instructions for Use (MAXNW) | Provides information on positioning and use of the connected sensor. |

1.5 Revision History

The part number, revision level and date on the documentation indicate its version. The revision level and date change when a new edition is printed in accordance with the revision history of the documentation. Minor corrections and updates incorporated at reprint do not cause the revision number to change. The document part number may change when extensive technical changes are incorporated into the document.

1.6 Warranty Information

The information contained in this document is subject to change without notice. Medtronic makes no warranty of any kind with regard to this material, including, but not limited to, the implied warranties or merchantability and fitness for a particular purpose. Medtronic shall not be liable for errors contained herein or for incidental or consequential damages in connection with the furnishing, performance, or use of this material.

1.7 Licensing Information

Users of the external host system and associated software applications to which the Vital Sync Wearable Patient Monitoring System is connected must obtain licenses for the host system and associated applications separately.

1.8 HIPAA Disclaimer

The Vital Sync Wearable SpO₂ Patient Monitoring System interfaces with an external host system and software applications used in conjunction with electronic medical devices within the customer's secure health information system.

Healthcare providers using such systems and software are expected to take appropriate security measures to protect the confidentiality of all data created, stored or transmitted on their systems, including data received from the Vital Sync Wearable SpO₂ Patient Monitoring System.

Although the external host system and software applications used in conjunction with the monitoring system (such as the Vital Sync Virtual Patient Monitoring Platform and Informatics Manager) contain certain features to assist users in the users' steps to protect their data, Medtronic cannot provide any assurance that the user's use of said applications in conjunction with the Vital Sync Wearable SpO₂ Patient Monitoring System will comply with HIPAA regulations or be otherwise in compliance with the customer's obligations as a covered entity.

2 Product Overview

2.1 Overview

This chapter provides general descriptive information for the Vital Sync™ Wearable SpO₂ Patient Monitoring System.

2.2 Product Description

The Vital Sync™ Wearable SpO₂ Patient Monitoring System is a noninvasive wearable, wireless automated spot check device that measures functional oxygen saturation of arterial hemoglobin (SpO₂).

The monitoring system consists of a module and a pulse oximetry sensor. The sensor collects signals usable for determining SpO₂ and pulse rate values and sends them to the module. The module then wirelessly transmits the measured parameter data to an external host system.

The monitoring system module has four colored LEDs to indicate system status. The monitoring system module does not include a dedicated on-unit data display. Users view monitored data and see associated alarm indications in an appropriate application (e.g., the Vital Sync™ Virtual Patient Monitoring Platform and Informatics Manager) residing on the host system.

The monitoring system is powered by an internal battery, and is able to operate for a minimum of 12 hours before requiring recharging.



Note:

For purposes of using the monitoring system, “hospital use” refers to low-acuity areas within a hospital and in hospital-type facilities.

“Hospital-type facilities” are medical care facilities external to a hospital; examples include skilled nursing facilities, long term acute care centers, and step-down units. “Low-acuity areas” are patient care locations where patients are not at risk of rapid desaturation. Patients using the monitoring system are spot-checked periodically, and may be ambulatory and under minimal supervision.

2.3 Indications for Use



WARNING:

The monitoring system is intended only as an adjunct in patient assessment. It must be used in conjunction with clinical signs and symptoms and periodic patient observations.

The Vital Sync™ Wearable SpO₂ Patient Monitoring System is a wireless pulse oximeter indicated for prescription use only as an automated spot check of functional oxygen saturation of arterial hemoglobin (SpO₂) and pulse rate of adult patients in motion and no motion conditions who are well or poorly perfused. It is intended for use in hospitals and hospital-type facilities with a transceiver.

The Nellcor™ Adult SpO₂ Sensor, model MAXNW, is indicated for single patient use when spot-check, non-invasive arterial oxygen saturation and pulse rate monitoring are required for adults weighing more than 40 kg.

2.4 Components and Accessories

The patient components of the monitoring system include the following:

- The module, which interprets signal data from the connected sensor and transmits measured parameter data to an external host system.
- The OxiMax™ MAXNW sensor for collecting the patient's SpO₂ level and pulse rate signal information. This connects to the module.

In addition, the following accessories are available:

- The hook and loop wrist strap and attached cradle, used to secure the module to the patient.
- An additional hook and loop strap (if included with the sensor), usable as needed to further secure the sensor cable.
- The docking station, which recharges up to five modules simultaneously.

Table 2-1. Monitoring System Patient Components and Accessories

| Item Number | Description |
|-------------|---|
| GR107997 | Module, Vital Sync Wearable Patient SpO ₂ Monitoring System |
| MAXNW | Adult SpO ₂ Sensor |
| OS1ACWS | Wearable SpO ₂ Strap and Cradle |
| OS1ACC | Docking Station, Vital Sync Wearable SpO ₂ Patient Monitoring System |

2.5 Views

2.5.1 Module

Figure 2-1. Monitoring System Module (top view)

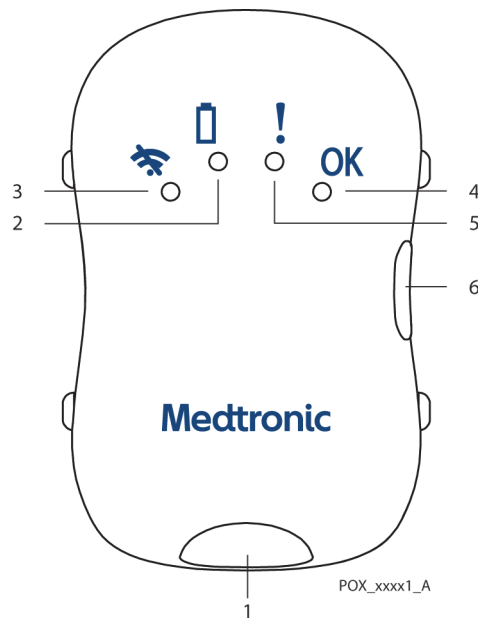

| | | | |
|---|--------------------------------|---|---------------------------------|
| 1 | Sensor Connector Socket | 4 | Nominal Condition LED (green) |
| 2 | Low Battery LED (orange) | 5 | Patient Data Error LED (orange) |
| 3 | Wireless Connection LED (blue) | 6 | Power Button |



Note:

The visible indicators on the module do not relate to the patient's physiological condition; they only show the status of the module and connected sensor.

2.5.2 Module with Connected Sensor

Figure 2-2. ||Module with Connected Sensor – graphic pending||

Amg2019a

2.5.3 Docking Station

Figure 2-3. Docking Station

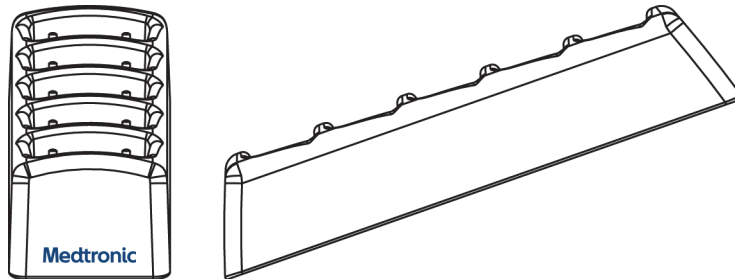

POX_xxxx3_A

2.6 Symbols and Descriptions

This section lists and defines the symbols on the monitoring system module and the packaging labeling.

2.6.1 Monitoring System Module

Table 2-1 defines the symbols that appear on the monitoring system module.

Table 2-2. Symbols on Module

















| Symbol | Description | Symbol | Description |
|---|--|---|---|
|  | Connection error (monitoring system not connected to external host). |  | US federal law restricts this device to sale by or on the order of a physician. |
|  | Module battery charge low (if module is not docked), or module battery recharging (if docked). |  | Follow instructions for use (appears in blue on the device). |
|  | Sensor error or sensor disconnect. |  | Not safe in any magnetic resonance (MR) environment. |
|  | Nominal condition (monitoring system is operating normally). |  | Defibrillator-proof type BF applied part. |
|  | Power on / power off. |  | Protection against fluid ingress. |
|  | Part number. |  | Serial number. |

Table 2-2. Symbols on Module (Continued)

| Symbol | Description | Symbol | Description |
|---|-------------------------------------|---|---|
|  | Manufacturer. |  | Date of manufacture. |
|  | Canadian and US certification mark. |  | WEEE (Waste from Electrical and Electronic Equipment) |

2.6.2 Packaging and Labeling

Table 2-2 defines the symbols that appear on the packaging and package labeling for the patient components of the monitoring system.

Table 2-3. Symbols on Labeling













| Symbol | Definition |
|---|---|
|  | Part number |
|  | Serial number |
|  | Manufacturer |
|  | Date of manufacture |
|  | US federal law restricts this device to sale by or on the order of a physician |
|  | Follow instructions for use (appears in blue on the device) |
|  | Not safe in any magnetic resonance (MR) environment |
|  | Atmospheric pressure limitation. For upper and lower limits, refer to <i>Environmental Conditions</i> on page 8-2. |
|  | Humidity limitation. For upper and lower limits, refer to <i>Environmental Conditions</i> on page 8-2. |

Table 2-3. Symbols on Labeling (Continued)

| Symbol | Definition |
|---|--|
|  | Temperature limitation. For upper and lower limits, refer to <i>Environmental Conditions</i> on page 8-2. |
|  | Keep dry. |
|  | Canadian and U.S. certification mark. Products bearing this mark have been tested and certified in accordance with applicable U.S. and Canadian electrical safety and performance standards. |

3 Docking Station Setup and Operation

3.1 Overview

This chapter describes how to set up and operate the docking station used with the Vital Sync™ Wearable SpO₂ Patient Monitoring System.

3.2 Safety Reminders



WARNING:

Electrical shock hazard — Do not soak the docking station or submerge the docking station into any liquids.



Caution:

To avoid damaging the docking station, do not spray, pour, or spill any liquid directly onto the docking station, or into any of the sockets.

3.3 Setup



WARNING:

Use only the power cord supplied with the docking station. Do not use any other cord.

To set up the docking station:

1. Plug the cord from the power supply into the round socket on the docking station.
2. Plug the power supply into an appropriate AC mains power outlet. If the docking station is receiving sufficient power for recharging modules, the green LED on the side of the docking station will light steadily.

Consult with Medtronic Professional Services for more information on configuration and firmware update procedures; these are beyond the scope of this manual. The USB port on the docking station is for authorized service use only.

3.4 Operation

This section details how to use the docking station, including powering the station on and off and recharging Vital Sync Wearable SpO₂ Patient Monitoring System modules.

3.4.1 Power On and Power Off

The docking station automatically powers on when its power supply is connected and is plugged into AC power.

The docking station automatically powers off when its power supply is disconnected or is unplugged from AC power.

The docking station is suitable for continuous AC power operation. Once connected to AC power, it does not need to be disconnected, except for cleaning and disinfection.

3.4.2 Module Battery Recharge

Use the docking station to recharge the internal batteries in the Vital Sync Wearable SpO₂ Patient Monitoring System modules.

To prepare the monitoring system for module recharging:

1. Remove the module and sensor from the patient.
2. Disconnect the wrist strap and cradle from the module, reversing the procedure used to attach it. Refer to the wrist strap *Instructions for Use* for details.
3. Ensure that the module is turned off, then grip the sensor connector (not the connector cable) and pull straight out to unplug the sensor from the module.
4. Clean and disinfect the module before recharging. Refer to *Cleaning and Disinfection* on page 6-1.

To recharge the module:

1. Fit the module into an empty socket on the docking station, so that the recharging plug connects into the module's sensor connector socket. The socket is shaped to fit the module casing; do not force the module into the socket.
2. Check to see that the module's orange battery LED (which normally indicates a low battery) starts blinking, which indicates the module is charging. (If this does not happen, consult *Monitoring System Troubleshooting* on page 7-1.)

3. When the orange battery LED stops blinking and is lighted steadily, the battery is recharged, and the module is ready to be returned to patient use. Remove the module from the docking station by pulling it out from the socket at the same angle as it is inserted.

**Note:**

While the module is recharging, it will communicate with the external application to indicate that it is being recharged, showing the battery's current charging level. This allows the device to be viewable in the external application even while charging (it will show as present, but currently unavailable for patient use).

If the module cannot communicate with the external host, the blue LED will flash to indicate a connection error; resolve this error as normal (refer to *Monitoring System Troubleshooting* on page 7-1). However, the module will recharge whether it is able to communicate with the external host or not.

**Note:**

Avoid completely discharging the module battery, as this can shorten battery life.

**Note:**

For best results, allow the battery to recharge completely before reusing the module.

3.5 Cleaning and Disinfection

For details on cleaning and disinfection, refer to Chapter 6.

3.6 Troubleshooting

If encountering problems with the docking station, refer to *Docking Station Troubleshooting* on page 7-3 for possible causes and solutions.

Page Left Intentionally Blank

4 Module and Sensor Setup and Operation

4.1 Overview

This chapter describes how to set up and operate the Vital Sync™ Wearable SpO₂ Patient Monitoring System module and sensor.



Note:

The setup and operation procedures in this chapter only apply to the monitoring system module and sensor, not to the monitoring application on the external host system. See the user documentation for the monitoring application for details on how to set up the device in the application, associate it with a patient, and view device data.

4.2 Safety Reminders

||new draft warning possibly to be added is in blue text||



WARNING:

The monitoring system is intended only as an adjunct in patient assessment. It must be used in conjunction with clinical signs and symptoms and periodic patient observations.



WARNING:

Tissue damage can be caused by incorrect application or use of a pulse oximetry sensor. Do not wrap the pulse oximetry sensor too tightly, apply supplemental tape, or leave it too long on one place. Inspect the pulse oximetry sensor site as directed in the sensor's instructions for use to ensure skin integrity, correct positioning, and adhesion.



WARNING:

Discontinue use and dispose of the wrist strap and cradle if the strap or cradle appears to be stained or becomes excessively moist, to minimize risk of skin irritation.



WARNING:

If skin irritation occurs beneath the wrist strap, discontinue use of the strap.



WARNING:

Do not overtighten the wrist strap, as this can cause patient discomfort, edema, or pressure injury, or lead to inaccurate sensor readings.



WARNING:

For best product performance and measurement accuracy, use only accessories supplied or specified by Medtronic. Use accessories according to the manufacturer's directions for use and institutional standards.

4.3 Setup



Note:

This procedure is only for placing the module and sensor on the patient. To view monitoring system data, additional setup is necessary in the monitoring application on the external host system. Refer to the user documentation for the monitoring application for details.

To set up the monitoring system module and sensor for use on a patient:

1. Ensure that the module battery is charged. Refer to [Module Battery Recharge](#) on page 3-2.
2. Attach the module to the cradle, which should already be secured to the patient's wrist with the wrist strap. Refer to the wrist strap/cradle instructions for use for details.
3. Plug the sensor connector straight into the connector socket.
4. Place the sensor on the patient. Refer to the sensor instructions for use for details.



Note:

If the patient is to wear the module and sensor for an extended period, periodically inspect the patient's skin for irritation at the sensor site or underneath the wrist strap. If irritation develops, inspect the strap to determine if it should be replaced, and move the module to a different site.

4.4 Operation

This section details how to use the module and sensor, including powering on and off, interpreting the device display, and viewing patient data. It also details alarm threshold functionality.

4.4.1 Power On and Power Off

To turn the monitoring system module on, press and hold the on/off button on the side of the module until all four LEDs flash briefly. The LEDs will then change to indicate the module's current status.

If the module's condition is nominal, the blue LED will blink for a short period until the module connects with the external host; after this, the green LED will turn on to indicate normal operation.

If any LED or LEDs other than the green LED are lighted, there is a problem. Refer to *Monitoring System Troubleshooting* on page 7-1 for more information.

To turn the monitoring system module off, press and hold the on/off button until all four LEDs flash briefly, then all turn off.

4.4.2 Monitor a Patient

Once the module is attached to the patient and is powered on, use the LEDs on the module to view the current status of the module and sensor, and use the monitoring application to view patient data and alarms.



Note:

The LEDs on the module do not relate to the patient's physiological condition; they only show the status of the module and connected sensor.



Note:

The LEDs on the module do not indicate SpO₂, pulse rate, or SatSeconds alarms. Those alarms are only visible in the monitoring application.

Device Display

The LEDs on the monitoring system module indicate its current status. See *Table 4-1*.

Table 4-1. Module LEDs and System Status



| Symbol | LED Color | Description / Normal Functioning |
|---|-----------|---|
|  | Blue | Indicates the status of the connection between the module and the external host system (connected or trying to connect). If the monitoring system is functioning normally, this LED flashes briefly on module power up, then blinks while the module establishes a connection with the external host, then turns off once the connection is established. |
|  | Orange | Indicates the module battery charge status (nominal, low, or charging). When the module is in use on a patient, if the monitoring system is functioning normally, this LED flashes briefly on module power up, then turns off. When the module is being recharged, if the docking station is functioning normally, this LED blinks during charging, then lights steadily when charging is complete. |

Table 4-1. Module LEDs and System Status (Continued)

| Symbol | LED Color | Description / Normal Functioning |
|--------|-----------|---|
| ! | Orange | Indicates the status of the sensor (operating normally or not). During normal functioning, this LED flashes briefly on module power up, then turns off. |
| OK | Green | Indicates normal module operation. During normal functioning, this LED flashes briefly on module power up, then lights steadily once the module establishes connection with the external host. |

Any LED state other than those described in Table 3-1 indicates a problem. Refer to *Monitoring System Troubleshooting* on page 7-1 for details on potential problem causes and solutions.

**Note:**

LEDs that are lighted will dim slightly after a short period of time. This is a power-saving feature, and part of the module's normal operation.

Procedure**To monitor data from a patient:**

1. After completing setup on the patient (as described in *Setup* on page 4-2), turn the monitoring system module on.
2. Wait briefly for the module to communicate with and connect to the external host system. If it does not successfully connect, the blue LED will blink; refer to *Monitoring System Troubleshooting* on page 7-1 for further steps.
3. Once the module is communicating with the host system, the blue LED will turn off, and the green LED will light steadily. This indicates that the sensor is receiving useful data, and that the module is transferring the data successfully to the host system. (If this does not happen, refer to *Monitoring System Troubleshooting* on page 7-1 for further steps.)
4. Ensure that the monitoring application on the external host system shows that the module is connected, and is showing SpO₂ and pulse rate data for this patient. Refer to the monitoring application user documentation for details on identifying specific devices in the application, and for properly associating devices with specific patients.
5. Continue to monitor the patient according to clinical needs and facility protocols.

Data Transmission

The module transmits SpO₂ and pulse rate data to the external host system once every minute. Data values for both parameters are averaged across the one-minute interval.

If SpO₂ or pulse rate is outside alarm limits, or if certain other conditions exist, the module will transmit an alarm indication to the external host within 15 to 30 seconds

of the onset of the alarm condition. If needed, the module will transmit the alarm indication again once every 15 to 30 seconds, until the host system acknowledges it. In this case, the module will transmit the exact value for any parameter in an alarm state when the alarm was detected, rather than averaging it across the data interval as normal.

**Note:**

The speed at which an alarm indication from the module appears in the monitoring application on the external host can be affected by network loading.

**Note:**

The monitoring application may allow users to set annunciation delays for SpO₂ and pulse rate alarms. This will directly affect when alarm indications appear in the monitoring application. Refer to the application's user documentation for more information.

**Note:**

If the module is out of range of the external host system, it will not report monitored data or alarms to the host system.

**Note:**

If the module loses connection with the external host, it will continue to monitor data from the patient. The module will record alarm conditions that occur while it is disconnected or out of range, and will report them to the monitoring application once it reestablishes connection with the host system.

4.4.3 Change Alarm Thresholds

The monitoring system module has default thresholds for alarms that are preset on the device (see [Alarm Thresholds](#) on page 4-6). Users may adjust these thresholds in the monitoring application on the external host system; see the user documentation for the monitoring application for details.

Once thresholds are adjusted in the application, the application will communicate the changes to affected modules wirelessly, at the same time that the affected modules transmit their monitored data to the external host.

Any changes to alarm thresholds will persist on the affected module until changed again in the application.

4.4.4 Battery Recharge

The module's internal battery requires periodic recharging using the docking station. The battery LED indicates whether the module's battery is low (25% or less of maximum charge remaining.)

Refer to *Module Battery Recharge* on page 3-2 for recharging steps.



Note:

Avoid completely discharging the module battery, as this can shorten battery life.



Note:

While the module is recharging, it will communicate with the external application to indicate that it is being recharged, showing the battery's current charging level. This allows the device to be viewable in the external application even while charging (it will show as present, but currently unavailable for patient use).

If the module cannot communicate with the external host, the blue LED will flash to indicate a connection error; resolve this error as normal (refer to *Monitoring System Troubleshooting* on page 7-1). However, the module will recharge whether it is able to communicate with the external host or not.



Note:

For best results, allow the battery to recharge completely before reusing the module.

4.5 Alarm Thresholds

The default alarm thresholds for measured parameters are in *Table 4-2*.

||to be confirmed vs. project documentation||

Table 4-2. Alarm Threshold Defaults for Vital Sync Wearable Monitoring System

| Configurable Parameter | Manufacturer Default |
|----------------------------------|----------------------|
| Low SpO ₂ Threshold | 85% |
| High SpO ₂ Threshold | 100% |
| Low Pulse Rate Threshold | 40 bpm |
| High Pulse Rate Threshold | 170 bpm |
| SatSeconds Threshold | 100 |
| Pulse Rate Alarm Delay Threshold | 10 s |

If measured values are less than the low threshold values set for SpO₂ or pulse rate, the monitoring application will indicate an alarm condition.

If measured values are greater than the high threshold values set for SpO₂ or pulse rate, the monitoring application will indicate an alarm condition.

If measured values exceed the thresholds set for SatSeconds or pulse rate alarm delay, the monitoring application will indicate an alarm condition.

4.6 Troubleshooting

The module indicates the presence of problems via its LEDs. Depending on which LEDs are lighted or blinking, more than one problem may be indicated.

Refer to *Monitoring System Troubleshooting* on page 7-1 for possible problem causes and solutions.

Page Left Intentionally Blank

5 Performance Considerations

5.1 Overview

This chapter contains information to assist users in optimizing the performance of the Vital Sync™ Wearable SpO₂ Patient Monitoring System.

5.2 Oximetry Considerations

5.2.1 Monitoring System Constraints

||to be confirmed vs. project documentation & testing reports||

- **Pulse Rate**—The monitoring system only reports pulse rates between 20 and 250 bpm. Detected pulse rates above 250 bpm appear as 250. Detected pulse rates below 20 appear as a zero (0).
- **Saturation**—The monitoring system reports saturation levels between 1% and 100%.



Note:

The monitoring application on the external host system displays pulse rate and saturation data.

5.2.2 Sensor Performance Considerations

||draft warning possibly to be added is in blue text||



WARNING:

Do not use the monitoring system if the module or sensor appears or is suspected to be damaged.



WARNING:

Use only the provided MAXNW sensor with the monitoring system. Connecting any other sensor influences the accuracy of sensor data, which may lead to inaccurate readings.



Note:

Failure to cover the pulse oximetry sensor site with opaque material in high ambient light conditions may result in inaccurate measurements. Pulse oximetry readings and pulse signals can be affected by certain environmental conditions, pulse oximetry sensor application errors, and certain patient conditions. Refer to the appropriate sections of this manual for specific safety information.

Inaccurate Sensor Measurement Conditions

A variety of conditions can cause inaccurate sensor measurements.

- Incorrect application of the sensor
- Placement of the sensor on an extremity with a blood pressure cuff, arterial catheter, or intravascular line
- Ambient light
- Failure to cover the sensor site with opaque material when operating under high ambient light conditions
- Excessive patient movement
- Dark skin pigment
- Intravascular dyes or externally applied coloring, such as nail polish or pigmented cream

Signal Loss

Loss-of-pulse signal can occur for several reasons.

- Sensor applied too tightly
- Inflation of a blood pressure cuff on the same extremity as the attached sensor
- Arterial occlusion proximal to the sensor
- Poor peripheral perfusion

Recommended Usage

Apply the provided MAXNW sensor as directed, and observe all warnings and cautions presented in the *Directions for Use* accompanying the sensor. Clean and remove any substances such as nail polish from the application site. Periodically check to ensure that the sensor remains properly positioned on the patient.

High ambient light sources such as bilirubin lamps, fluorescent lights, infrared heating lamps, and direct sunlight can interfere with the performance of a sensor. To prevent interference from ambient light, ensure the sensor is properly applied, and cover the sensor with opaque material.

If patient movement presents a problem, try one or more of the following remedies to correct the problem.

- Verify the sensor is properly and securely applied.
- Move the sensor to a less active site.
- Use a new sensor with fresh adhesive backing.
- Keep the patient still, if possible.

5.3 Patient Conditions

Application issues and certain patient conditions can affect the measurements of the monitoring system and cause the loss of the pulse signal.

- Anemia — Anemia causes decreased arterial oxygen content. Although SpO₂ readings may appear normal, an anemic patient may be hypoxic. Correcting anemia can improve arterial oxygen content. The monitoring system may fail to provide an SpO₂ reading if hemoglobin levels fall below 5 gm/dl.
- Dysfunctional hemoglobins — Dysfunctional hemoglobins such as carboxyhemoglobin, methemoglobin, and sulfhemoglobin are unable to carry oxygen. SpO₂ readings may appear normal; however, a patient may be hypoxic because less hemoglobin is available to carry oxygen. Further assessment beyond pulse oximetry is recommended.
- Additional possible patient conditions may also influence measurements.
 - Poor peripheral perfusion
 - Excessive patient movement
 - Dark skin pigment
 - Intravascular dyes, such as indocyanine green or methylene blue
 - Externally applied coloring agents (nail polish, dye, pigmented cream)
 - Defibrillation

5.4 Reducing Electromagnetic Interference (EMI)



WARNING:

Interference from electrosurgical generators can degrade the performance or accuracy of the module and sensor.



WARNING:

This monitoring system is intended for use by healthcare professionals only. This equipment may cause radio interference or may disrupt the operation of nearby equipment. It may be necessary to take mitigation measures, such as re-orienting or relocating the monitoring system module or shielding the location.

Because of the proliferation of radio frequency transmitting equipment and other sources of electrical noise in health care environments (for example, electrosurgical units, cellular phones, mobile two-way radios, electrical appliances, and high-definition television), it is possible that high levels of such interference due to close proximity or strength of a source might result in disruption of monitoring system performance. Refer to *Electromagnetic Emissions* on page 8-4.

The monitoring system is designed for use in environments in which electromagnetic interference might obscure the client's pulse. During such interference, measurements may seem inappropriate or the monitoring system may not seem to operate correctly. EMI disruption can cause erratic readings, cessation of operation, or other incorrect functioning. If this occurs, survey the site of use to determine the source of this disruption, and take the listed actions to eliminate the source.

- Turn equipment in the vicinity off and on to isolate the interfering equipment.
- Reorient or relocate the interfering equipment.
- Increase the separation between the interfering equipment and the monitoring system.

The monitoring system module generates, uses, and can radiate radio frequency energy and, if not installed and used in accordance with these instructions, may itself cause harmful interference with other susceptible devices in the vicinity.

6 Product Maintenance

6.1 Overview

This chapter describes how to clean, disinfect, and (if necessary) obtain service for the Vital Sync™ Wearable SpO₂ Patient Monitoring System module and docking station.

6.2 Cleaning and Disinfection

After use on a patient, the module is reusable on the same patient or a different patient. However, it must be cleaned and disinfected before recharging, and then cleaned again after recharging, before the next patient use.



WARNING:

The sensor and the wrist strap and cradle are intended for single use only. Do not clean or disinfect the sensor or the wrist strap and cradle.

6.2.1 Cleaning and Disinfecting Agents

||to be confirmed vs. project documentation & testing reports||

Use any of the following agents for cleaning and disinfection:

- Ethyl or isopropyl alcohol (70%–90%)
- Quaternary ammonium germicidal detergent solution (e.g., SaniWipe or PDI Sani-cloth Plus)¹
- CaviCide disinfectant (CaviWipes)¹
- Sodium hypochlorite (8.25% bleach, diluted to 1:10 to 1:100)
- Phenolic germicidal detergent solution (e.g., Lysol or Reckitte Benckiser)¹
- Hydrogen peroxide (3% solution)

1. Follow product label for disinfection use dilution.

6.2.2 Clean the Module



WARNING:

Electrical shock hazard — Do not soak the monitoring system module or submerge it into any liquids.



Caution:

To avoid damaging the monitoring system module, do not spray, pour, or spill any liquid directly onto the module, or into the sensor connector socket.



Note:

Do not clean the monitoring system module while it is turned on and attached to a patient.

Cleaning Materials

||to be confirmed vs. project documentation & testing reports||

For best results, use the following when cleaning the module:

- Spray bottle containing warm water (tap water is suitable)
- Cleaning agent (refer to *Cleaning and Disinfecting Agents* on page 6-1).
- Paper towels

Cleaning Procedure

||to be confirmed vs. project documentation & testing reports||

To clean the module:

1. Make sure the module is powered off (no LEDs are lighted).
2. If the sensor is still connected, unplug it from its socket. Dispose of the sensor according to facility procedures for disposal of single-patient-use devices.
3. If the wrist strap and cradle are still in place, disengage them from the module and dispose of them following facility procedures for single-use devices.



Caution:

Do not spray prepared water or cleaning agents directly onto the module or into the sensor connector socket during cleaning, as this can damage the module or render it inoperative.

4. Moisten (but do not saturate) a paper towel with warm water from the prepared spray bottle. Remove excess water, as required.
5. Use the moistened paper towel to soften and loosen any bulky soils on the exterior of the module, then wipe them off, using back and forth overlapping strokes until the soils are removed.
6. Moisten (but do not saturate) another paper towel with prepared cleaning agent. If the cleaning agent is in a pre-moistened wipe (e.g., CaviWipe), use the wipe as dispensed.
7. Wipe down all external surfaces of the module, removing all visible soil. Begin at the edges of the connector socket and work toward the opposite end of the module using back and forth overlapping strokes, to avoid leaving residual soils in or near the socket.

**Note:**

Ensure at least 30 seconds of contact time between the prepared cleaning agent and all surfaces being cleaned.

8. Moisten (but do not saturate) another paper towel with warm water from the prepared spray bottle. Remove excess water, as required.
9. Beginning at the edges of the socket as in step 7 above, wipe down all external surfaces of the module to remove residual detergent.
10. Using a dry paper towel, wipe all external surfaces of the module until they are free of moisture.
11. Inspect the module for any remaining residual soil. If any residual soil is visible, repeat the cleaning process.

6.2.3 Disinfect the Module

**WARNING:**

Electrical shock hazard — Do not soak the monitoring system module or submerge it into any liquids.

**Caution:**

To avoid damaging the monitoring system module, do not spray, pour, or spill any liquid directly onto the module, or into the connector socket.



Caution:
Do not sterilize the monitoring system module.



Note:
The module should already have been cleaned before disinfecting. For cleaning instructions, refer to *Clean the Module* on page 6-2.



Note:
Do not disinfect the monitoring system module while it is turned on and attached to a patient.

Disinfection Materials

||to be confirmed vs. project documentation & testing reports||

Use the following when disinfecting the module:

- Disinfecting agent (refer to *Cleaning and Disinfecting Agents* on page 6-1)
- Sterile lint-free cloths
- Purified water

Disinfection Procedure

||to be confirmed vs. project documentation & testing reports||

To disinfect the module:

1. Make sure the module is powered off (no LEDs are lighted).



Caution:
Do not spray disinfecting agents directly onto the module or into the sensor connector socket during disinfection, as this can damage the module or render it inoperative.

2. Moisten (but do not saturate) two sterile lint-free cloths with disinfecting agent. If the disinfecting agent is in a pre-moistened wipe (e.g., CaviWipe), have two new wipes ready for use.



Note:
Ensure at least four minutes of contact time between the disinfecting agent and the surfaces being disinfected.

3. Use one prepared cloth or disinfecting wipe to wipe all exterior surfaces of the module, using back and forth overlapping strokes. Begin wiping at the edges of the connector socket and work toward the opposite end of the device.
4. Use a second prepared cloth or disinfecting wipe to re-wipe all external surfaces of the module, using back and forth overlapping strokes. Begin wiping at the edges of the connector socket and work toward the opposite end of the device.
5. Moisten (but do not saturate) a sterile lint-free cloth with purified water. Remove excess water, as required.
6. Making sure no liquid enters the connector socket, wipe down all external surfaces, beginning at the edges of the connector socket as in step 4 above, to remove residual disinfectant. Ensure at least 30 seconds of wipe-down time.
7. Inspect the module for any remaining residual disinfectant. If any residual disinfectant is visible, repeat steps 5 and 6 of this procedure, using a new sterile lint-free cloth.
8. Allow the device to dry completely before returning it to patient use.

6.2.4 Clean or Disinfect the Docking Station



WARNING:

Electrical shock hazard — Do not soak the docking station or submerge the docking station into any liquids.

If the docking station requires cleaning or disinfection, use an appropriate cleaning/disinfecting agent (refer to *Cleaning and Disinfecting Agents* on page 6-1).

Clean or disinfect only the plastic exterior casing of the docking station.

6.3 Module Battery Recharge

The module's internal battery requires periodic recharging. The battery LED indicates whether the module's battery is low (25% or less of maximum charge remaining.)

Refer to *Module Battery Recharge* on page 3-2 for the recharging procedure.



Note:

Avoid completely discharging the module battery, as this can shorten battery life.



Note:

While the module is recharging, it will communicate with the external application to indicate that it is being recharged, showing the battery's current charging level. This allows the device to be viewable in the external application even while charging (it will show as present, but currently unavailable for patient use).

If the module cannot communicate with the external host, the blue LED will flash to indicate a connection error; resolve this error as normal (refer to [Troubleshooting](#) on page 3-3). However, the module will recharge whether it is able to communicate with the external host or not.



Note:

For best results, allow the battery to recharge completely before reusing the module.



Note:

All batteries lose capacity with age. The amount of run time for the monitoring system module in a low battery condition will vary depending on the age of the battery.

6.4 Service

Neither the Vital Sync Wearable SpO₂ Patient Monitoring System nor the docking station has any user-serviceable components or accessories.

Do not attempt to open or make any repairs to the module or docking station.

If encountering problems that indicate removal of the module or docking station from patient use, consult with Medtronic for details on returning the module or docking station for repair or replacement. Refer to [Obtaining Technical Assistance](#) on page 1-6 for details.

7 Troubleshooting

7.1 Overview

This chapter provides troubleshooting information both for the Vital Sync™ Wearable SpO₂ Patient Monitoring System and for the docking station.

7.2 Monitoring System Troubleshooting

This section lists common problems users may encounter when using the monitoring system, along with possible causes and solutions.

The monitoring system indicates the presence of problems via its LEDs. If more than one LED is lighted or blinking, more than one problem may be indicated.

Table 7-1. Monitoring System Troubleshooting





| Visual Indicator | Problem Indicated | Potential Cause | Solution |
|---|--|---|---|
| Blue LED blinking.  | Module has not made a connection to the external host. | Module is in the process of establishing connection (e.g., right after it is powered up). | Wait several seconds to see if the module establishes a connection. If the blue LED continues to blink after several seconds, check for and eliminate other possible causes for this problem. |
| | | External host system is unavailable. | Check the external host system to see that it is powered on and operational. |
| | | Module is out of range of the external host. | Bring the module back within range of the external host. |
| | | | Check for interfering equipment in the patient care area; if possible, reorient or move any such equipment to reduce the interference. |
| Possible module fault. | Replace the module with a different module, and see if the new module is able to establish a connection. If the new module successfully connects with the external host, remove the defective module from patient use. | | |

Table 7-1. Monitoring System Troubleshooting (Continued)

| Visual Indicator | Problem Indicated | Potential Cause | Solution |
|--|---|---|---|
| Orange battery LED blinking.  | Battery charge is low. | Battery has less than 25% of full charge (less than 3 hours remaining). | Remove the module from the patient and recharge it. Refer to Module Battery Recharge on page 3-2. |
| | | | If the module is recharging, this behavior is normal; no action is required. |
| Orange battery LED not lighted when module is charging.  | Battery is not charging. | Module is not fully plugged into docking station. | Unplug the module from the docking station, then plug it back in. Ensure that the orange battery LED lights. |
| | | Module or module battery has a fault. | Unplug the module from the socket, then plug it into a different socket. If the orange battery LED is not lighted when plugged into any socket, but the same LED on a different module is lighted when plugged into the docking station, remove this module from patient use. |
| Orange sensor error LED lighted steadily.  | Module is not receiving useful sensor data. | Sensor is disconnected from module. | Check to see that the sensor is fully plugged into the socket on the module. |
| | | Sensor is not attached to patient. | Check the sensor site and ensure the sensor is properly placed. |
| | | Sensor is connected and properly placed, but is not receiving usable data. | Disconnect the sensor from the module, then reconnect it. If disconnecting and reconnecting the sensor does not resolve this issue, check the sensor site for any factors that might interfere with the sensor, including ambient light. Refer to Patient Conditions on page 5-3. If any such factors exist, relocate the sensor. |
| All LEDs are lighted steadily at the same time after module is powered on. | Power-on self-test error. | Fault in module, causing one or more of the module's internal self-tests to fail. | Remove the module from the patient and replace it with a different module. Remove the defective module from patient use. |
| One or more LEDs does not light when module is powered on or off. | LED fault. | The LED that is not lighting is faulty. | Remove the module from the patient and replace it with a different module. |
| | Module fault. | The module has a fault causing the affected LED or LEDs not to light. | Remove the defective module from patient use. |

7.3 Docking Station Troubleshooting

This section lists common problems users may encounter when using the docking station, along with possible causes and solutions.

Refer to Table 7-2 for more information.

Table 7-2. Docking Station Troubleshooting

| Visual Indicator | Problem Indicated | Potential Cause | Solution |
|--|---|---|---|
| Green LED next to power cord socket does not light. | Docking station is not receiving power, or is not receiving sufficient power to recharge modules. | Docking station power supply is not plugged into AC mains power. | Check to ensure the power supply is plugged into an appropriate AC power outlet. If plugging in the power supply does not resolve the problem, and another power outlet is available, plug the docking station power cord into it. |
| | | Power supply is not plugged into the docking station. | Check to ensure that the cord from the power supply is completely and securely plugged into the docking station. |
| | | Docking station is connected to a PC via USB cable. | The green LED is designed to not light when connected to USB. |
| | | LED fault. | The green LED is faulty. |
| | Docking station fault. | The docking station has a fault causing the green LED not to light. | |
| Orange battery LED on module not lighted when module is charging.  | Battery is not charging. | Docking station is not generating power. | Ensure that docking station is plugged into AC power. |
| | | Docking station socket is faulty. | Unplug the module from the socket, then plug it into a different socket. If the orange battery LED lights when plugged into a different socket, recharge the module, but remove and replace the docking station as soon as possible. |



Note:

If a module or docking station needs to be removed from use, consult with Medtronic for details on returning the item in question for replacement. Refer to *Obtaining Technical Assistance* on page 1-6.

Page Left Intentionally Blank

8 Product Specifications



Note:

Unless otherwise noted, the specifications listed in this chapter are for the Vital Sync™ Wearable SpO₂ Patient Monitoring System module only.

8.1 Physical Characteristics

||all information in this section to be updated per project documentation & reports||

| | |
|----------------------------|-----------------------------|
| Module weight | 72.6 g (2.56 oz) |
| Module dimensions | 3.06 in x 1.81 in x 1.00 in |
| Docking station dimensions | pending |

8.2 Battery

||all information in this section to be updated per project documentation & reports||

| | |
|------------------------|--|
| Type | Lithium ion |
| Voltage | 3.7V TYP, 900mAh |
| Minimum operating time | On first use: 33 hours After 1 year: 28 hours After 3 years: 15 hours |
| Recharge time | 3–4 hours to fully recharge from low battery condition |
| Shelf life | Four (4) months for new, fully-charged battery After four (4) months of storage, module runs 33% of stated battery life |
| Compliance | IEC 62133 |

8.3 Environmental Conditions

||all information in this section to be updated per project documentation & reports||

8.3.1 Operating

Module

| | |
|----------------------|---|
| Temperature | 5 °C to 40 °C (41 °F to 104 °F), inclusive |
| Altitude | -500 m to 4,000 m (-1,640 ft to 13,123 ft), inclusive |
| Atmospheric Pressure | 107.5 kPa to 61.6 kPa (31.7 inHg to 18.2 inHg), inclusive |
| Relative Humidity | 15% to 75% (inclusive), non-condensing |

Docking Station

| | |
|-------------------|---|
| Temperature | 5 °C to 40 °C (41 °F to 104 °F), inclusive |
| Altitude | -500 m to 4,000 m (-1,640 ft to 13,123 ft), inclusive |
| Relative Humidity | 15% to 95% (inclusive), non-condensing |

8.3.2 Transport and Storage

| | |
|----------------------|---|
| Temperature | -10 °C to 45 °C (14 °F to 113 °F), inclusive |
| Altitude | -500 m to 5,572 m (-1,640 ft. to 18,281 ft.), inclusive |
| Atmospheric Pressure | 107.5 kPa to 50 kPa (31.7 in. Hg to 14.8 in. Hg), inclusive |
| Relative Humidity | 15% to 95% non-condensing |

8.4 Product Compliance

||all information in this section to be updated per project documentation & reports||

| | |
|-------------------------------|--|
| Equipment Classification | IEC/EN 80601-2-61:2011 IEC/EN 60601-1:2005 CAN/CSA C22.2 No. 60601-1:08 ANSI AAMI ES 60601-1:2005 |
| Protection Type | Class I (Internally powered) |
| Degree of Protection | Type BF (defibrillator-proof) - Applied part |
| Mode of Operation | Continuous ¹ |
| Electromagnetic Compatibility | IEC 60601-1-2:2007 IEC 60601-1-2:2014 |
| Liquid Ingress | IPX2: Protected against harmful effects of dripping water |
| Degree of Safety | Not suitable for use in the presence of flammable anesthetics |

1. The sensor continuously collects data and reports it to the module. The module reports data to the external host system once every minute, unless an alarm condition exists, in which case it will report to the external host system within 15 to 30 seconds of alarm condition detection.

8.5 Manufacturer's Declaration and Guidance

||all information in this section to be updated per project documentation & reports||

8.5.1 Electromagnetic Compatibility (EMC)



WARNING:

This monitoring system is intended for use by healthcare professionals only. This equipment may cause radio interference or may disrupt the operation of nearby equipment. It may be necessary to take mitigation measures, such as re-orienting or relocating the monitoring system module or shielding the location.



WARNING:

The use of accessories and sensors other than those specified may result in inaccurate readings of the monitoring system and increased emission and/or decreased electromagnetic immunity of the monitoring system.

The monitoring system is suitable for prescription use only in the specified electromagnetic environments, in accordance with the IEC 60601-1-2:2014 standard. The monitoring system requires special precautions during installation and operation for electromagnetic compatibility. In particular, the use of nearby mobile or portable communications equipment may influence monitoring system performance.

Frequency and Bandwidth for Wireless Connection

Table 8-1. Frequency Band, Output Power, and Modulation Type

| Frequency Band (MHz) | Output Power (Watts) | Modulation Type |
|----------------------|----------------------|-----------------|
| 2412 - 2462 | 0.088 | BPSK, CCK, OFDM |
| 5180 - 5240 | 0.018 | OFDM |
| 5260 - 5320 | 0.018 | OFDM |
| 5500 - 5700 | 0.028 | OFDM |
| 5745 - 5825 | 0.026 | OFDM |

Electromagnetic Emissions

Table 8-2. Electromagnetic Emissions Guidelines and Compliance

| Guidance and Manufacturer's Declaration—Electromagnetic Emissions (IEC/EN 60601-1-2:2014, Table 1) | | |
|--|------------|--|
| The monitoring system is intended for use in the electromagnetic environment specified below. The customer or the user of the monitoring system should assure that it is used in such an environment. | | |
| Emissions Test | Compliance | Electromagnetic Environment Guidance |
| RF emission CISPR 11 EN 55011 | Class B | Not intended for use in a residential environment. If used in a domestic environment, may not offer adequate protection to radio-frequency communication services. The user may be required to take mitigation measures, such as relocating or re-orienting the equipment. |

Electromagnetic Immunity

Table 8-3. Electromagnetic Immunity Guidelines and Compliance

| Guidance and Manufacturer's Declaration—Electromagnetic Immunity (IEC/EN 60601-1-2:2014, Table 2) | | | |
|--|--------------------------------|------------------------------|---|
| The monitoring system is intended for use in the electromagnetic environment specified below. The customer or the user of the monitoring system should assure that it is used in such an environment. | | | |
| Immunity Test | IEC/EN 60601-1-2 Test Level | Compliance Level | Electromagnetic Environment Guidance |
| Electrostatic discharge (ESD) IEC/EN 61000-4-2 | ± 6 kV contact ± 8 kV air | ± 6 kV contact ± 8 kV air | Floor should be wood, concrete, or ceramic tile. If floors are covered with synthetic material, the relative humidity should be at least 30%. |
| Power frequency (50/60 Hz) magnetic field IEC/EN 61000-4-8 | 3 A/m | 3 A/m | It may be necessary to position further from the sources of power frequency magnetic fields or to install magnetic shielding. |

Table 8-4. Recommended Separation Distance Calculations

| Guidance and Manufacturer's Declaration—Electromagnetic Immunity (IEC/EN 60601-1-2:2014, Table 4) | | | |
|---|--|--|--|
| The monitoring system is intended for use in the electromagnetic environment specified below. The customer or the user of the monitoring system should assure that it is used in such an environment. | | | |
| Immunity Test | IEC/EN 60601-1-2 Test Level | Compliance Level | Electromagnetic Environment Guidance |
| Conducted RF IEC/EN 61000-4-6 Radiated RF IEC/EN 61000-4-3 | 3 Vrms 150 kHz to 80 MHz 3 V/m 80 MHz to 2.5 GHz 10 V/m 80 MHz to 2.5 GHz | 3 Vrms 150 kHz to 80 MHz 3 V/m 80 MHz to 2.5 GHz 10 V/m 80 MHz to 2.5 GHz | Portable and mobile RF communications equipment should be used no closer to any part of the monitoring system, including cables, than the recommended separation distance calculated from the equation applicable to the frequency of the transmitter. Recommended Separation Distance $d = 1.2\sqrt{P}$ 80 MHz to 800 MHz $d = 2.3\sqrt{P}$ 800 MHz to 2.5 GHz where P is the maximum output power rating of the transmitter in watts (W) according to the transmitter manufacturer and d is the recommended separation distance in meters (m). Field strengths from fixed RF transmitters, as determined by an electromagnetic site survey ^a , should be less than the compliance level in each frequency range ^b . Interference may occur in the vicinity of equipment marked with the following symbol:  |
| NOTE 1: At 80 MHz and 800 MHz, the higher frequency range applies. NOTE 2: These guidelines may not apply in all situations. Electromagnetic propagation is affected by absorption and reflection from structures, objects, and people. | | | |
| ^a Field strengths from fixed transmitters, such as base stations for radio (cellular/cordless) telephones and land mobile radios, amateur radio, AM and FM radio broadcast and TV broadcast cannot be predicted theoretically with accuracy. To assess the electromagnetic environment due to fixed RF transmitters, an electromagnetic site survey should be considered. If the measured field strength in the location in which the monitoring system is used exceeds the applicable RF compliance level above, the monitoring system should be observed to verify normal operation. If abnormal performance is observed, additional measures may be necessary, such as re-orienting or relocating the monitoring system. ^b Over the frequency range 150 kHz to 80 MHz, field strengths should be less than 3 V/m. | | | |

Table 8-5. Recommended Separation Distances

| Recommended Separation Distances Between Portable and Mobile RF Communications Equipment and the Monitoring System (IEC/EN 60601-1-2:2014, Table 6) | | | |
|--|---|--|---|
| The monitoring system is intended for use in an electromagnetic environment in which radiated RF disturbances are controlled. The customer or the user of the monitoring system can help prevent electromagnetic interference by maintaining a minimum distance between portable and mobile RF communications equipment (transmitters) and the monitoring system as recommended below, according to the maximum output power of the communications equipment. | | | |
| Rated Maximum Output Power (<i>P</i>) of Transmitter in Watts | Separation Distance According to Frequency of Transmitter in Meters | | |
| | $d = 1.2\sqrt{P}$ 150 kHz to 80 MHz | $d = 1.2\sqrt{P}$ 80 MHz to 800 MHz | $d = 2.3\sqrt{P}$ 800 MHz to 2.5 GHz |
| 0.01 | 0.12 | 0.12 | 0.23 |
| 0.10 | 0.38 | 0.38 | 0.73 |
| 1.00 | 1.20 | 1.20 | 2.30 |
| 10.00 | 3.80 | 3.80 | 7.30 |
| 100.00 | 12.00 | 12.00 | 23.00 |
| For transmitters rated at a maximum output power not listed above, the recommended separation distance (<i>d</i>) in meters (<i>m</i>) can be estimated using the equation applicable to the frequency of the transmitter, where <i>P</i> is the maximum output power rating of the transmitter in watts (<i>W</i>) according to the transmitter manufacturer. NOTE 1: At 80 MHz and 800 MHz, the separation distance for the higher frequency range applies. NOTE 2: These guidelines may not apply in all situations. Electromagnetic propagation is affected by absorption and reflection from structures, objects, and people. | | | |

8.5.2 FCC Compliance

This device complies with part 15 of the FCC Rules. Operation is subject to the following two conditions: (1) This device may not cause harmful interference, and (2) this device must accept any interference received, including interference that may cause undesired operation.



Caution:

Changes or modifications not expressly approved by the party responsible for compliance could void the user's authority to operate this equipment.

8.6 Sensor Accuracy and Ranges

||all information in this section to be updated per project documentation & reports||

This monitoring system has the capability to detect physiological alarm conditions using SpO₂ accuracy, pulse rate accuracy and alarm limit conditions.

Table 8-6. Nellcor™ Sensor Accuracy and Ranges

| Measurement Range | |
|----------------------------------|----------------------------------|
| SpO ₂ | 1% to 100% |
| Pulse Rate | 20 to 250 beats per minute (bpm) |
| Accuracy¹ | |
| Saturation | |
| Adult ^{2,3} | 70 to 100% ±3 digits |
| Low Perfusion ⁴ | 70 to 100% ±3 digits |
| Adult with Motion ^{2,5} | 70 to 100% ±3 digits |
| Pulse Rate | |
| Adult ^{2,3} | 20 to 250 bpm ±5 digits |
| Low Perfusion ⁴ | 20 to 250 bpm ±5 digits |
| Adult with Motion ^{2,5} | 48 to 127 bpm ±5 digits |

1. Saturation accuracy varies by sensor type. Refer to the Sensor Accuracy Grid at www.covidien.com/rms.
2. Accuracy specifications were validated using measurements of healthy non-smoking adult volunteers during controlled hypoxia studies spanning the specified saturation ranges. Subjects were recruited from the local population and comprised both men and women ranging in age from 18-50 years old, and spanned a range of skin pigmentations. Pulse oximeter SpO₂ readings were compared to SaO₂ values of drawn blood samples measured by hemoximetry. All accuracies are expressed as ±1 SD. Because pulse oximeter equipment measurements are statistically distributed, about two-thirds of the measurements can be expected to fall in this accuracy (A_{RM}) range (refer to the Sensor Accuracy Grid for more details).
3. Adult specifications are shown for OXIMAX MAXNW sensors with the Vital Sync Wearable Patient Monitoring System.
4. Specification applies to Vital Sync Wearable Patient Monitoring System oximeter performance. Reading accuracy in the presence of low perfusion (detected IR pulse modulation amplitude 0.1% to 1.5%) was validated using signals supplied by a patient simulator. SpO₂ and pulse rate values were varied across the monitoring range over a range of weak signal conditions and compared to the known true saturation and pulse rate of the input signals.
5. Motion performance was validated during a controlled hypoxia blood study. Subjects performed rubbing and tapping movements 1-2 cm in amplitude with aperiodic intervals (randomly changing) with a random variation in frequency between 1-4 Hz. Applicability: OXIMAX MAXNW sensor.



Note:

A functional tester cannot be used to assess the accuracy of the monitoring system or sensor.

Table 8-7. Nellcor™ Sensor Operating Range and Power Dissipation

| Operating Range and Dissipation | |
|---------------------------------|----------------------|
| Red Light Wavelength | Approximately 660 nm |
| Infrared Light Wavelength | Approximately 900 nm |
| Optical Output Power | Less than 15 mW |
| Power Dissipation | 52.5 mW |

8.7 Essential Performance

||all information in this section to be updated per project documentation||

Per IEC 60601-1-2:2007 and ISO 80601-2-61:2011, the monitoring system's essential performance attributes include:

- **SpO₂ and pulse rate accuracy** — Refer to *Sensor Accuracy and Ranges* on page 8-8.
- **Visual indicator of power source** — Refer to *Module* on page 2-3 and *Device Display* on page 4-3.
- **Sensor disconnect/off notification** — Refer to *Device Display* on page 4-3 and Table 7-1 on page 7-1. This information is also sent to the external host system.
- **Motion, interference, or signal degradation indicator** — Refer to Table 7-1 on page 7-1. This information is **not** indicated on the device, but only in the monitoring application on the external host system.

Page Left Intentionally Blank

A Clinical Studies

A.1 Overview

||This appendix will contain clinical study data relevant to the Vital Sync™ Wearable SpO₂ Patient Monitoring System, once that data is available. Headings below are representative.||

A.2 Methods

A.3 Study Population

A.4 Study Results

A.5 Adverse Events or Deviations

A.6 Conclusion

Page Left Intentionally Blank

Rx
ONLY

Part No. PT00015629 Rev X05 2016-04

© 2015 Covidien.

 Covidien Inc
15 Hampshire Street, Mansfield, MA 02048 USA

www.covidien.com

[T] 1.800.635.5267

 **COVIDIEN**