

### Test Report

# C9120AXP-x & C9120AXP-EWC-x (x=B)

## Cisco Catalyst C9120AX Series 802.11ax Access Point

### XOR 5GHz Radio + 13dBi Antenna

FCC ID: LDKROFSN2177

**5470-5725 MHz**

Against the following Specifications:

CFR47 Part 15.407



Cisco Systems

170 West Tasman Drive

San Jose, CA 95134

	
<b>Author:</b> Chris Blair <b>Tested By:</b> Chris Blair	<b>Approved By:</b> Gez Thorpe <b>Title:</b> Radio Compliance Manager <b>Revision:</b> See EDCS

This report replaces any previously entered test report under EDCS – **18362182**. This test report has been electronically authorized and archived using the CISCO Engineering Document Control system. Test Report Template EDCS# 11644124.

This test report has been electronically authorized and archived using the CISCO Engineering Document Control system.

<b>SECTION 1: OVERVIEW .....</b>	<b>3</b>
<b>SECTION2: ASSESSMENT INFORMATION .....</b>	<b>4</b>
2.1 GENERAL .....	4
2.2 DATE OF TESTING.....	6
2.3 REPORT ISSUE DATE .....	6
2.4 TESTING FACILITIES .....	6
2.5 EQUIPMENT ASSESSED (EUT).....	6
2.6 EUT DESCRIPTION.....	7
<b>SECTION 3: RESULT SUMMARY .....</b>	<b>12</b>
3.1 RESULTS SUMMARY TABLE .....	12
<b>SECTION 4: SAMPLE DETAILS.....</b>	<b>13</b>
4.1 SAMPLE DETAILS .....	13
4.2 SYSTEM DETAILS .....	13
4.3 MODE OF OPERATION DETAILS.....	13
<b>APPENDIX A: EMISSION TEST RESULTS .....</b>	<b>14</b>
CONDUCTED TEST SETUP DIAGRAM.....	14
TARGET MAXIMUM CHANNEL POWER .....	14
A.1 DUTY CYCLE .....	16
A.2 99% AND 26DB BANDWIDTH.....	20
A.3 MAXIMUM CONDUCTED OUTPUT POWER .....	25
A.4 POWER SPECTRAL DENSITY .....	42
A.5 CONDUCTED SPURIOUS EMISSIONS.....	60
A.6 CONDUCTED BANDEDGE.....	93
A.7 CONDUCTED RECEIVER SPURIOUS EMISSIONS.....	109
<b>APPENDIX B: RADIATED &amp; AC CONDUCTED EMISSIONS TEST RESULTS .....</b>	<b>116</b>
<b>APPENDIX C: LIST OF TEST EQUIPMENT USED TO PERFORM THE TEST .....</b>	<b>117</b>
<b>APPENDIX D: ABBREVIATION KEY AND DEFINITIONS.....</b>	<b>118</b>
<b>APPENDIX E: PHOTOGRAPHS OF TEST SETUPS .....</b>	<b>119</b>
<b>APPENDIX F: SOFTWARE USED TO PERFORM TESTING .....</b>	<b>120</b>
<b>APPENDIX G: TEST PROCEDURES.....</b>	<b>120</b>
<b>APPENDIX H: SCOPE OF ACCREDITATION (A2LA CERTIFICATE NUMBER 1178-01).....</b>	<b>120</b>
<b>APPENDIX I: TEST ASSESSMENT PLAN .....</b>	<b>120</b>



**Section 1: Overview**

The samples were assessed against the tests detailed in section 3 under the requirements of the following specifications:

<b>Specifications:</b>
CFR47 Part 15.407

## Section2: Assessment Information

### 2.1 General

This report contains an assessment of an apparatus against Electromagnetic Compatibility Standards based upon tests carried out on the samples submitted. The testing was performed by and for the use of Cisco systems Inc:

With regard to this assessment, the following points should be noted:

- a) The results contained in this report relate only to the items tested and were obtained in the period between the date of the initial assessment and the date of issue of the report. Manufactured products will not necessarily give identical results due to production and measurement tolerances.
- b) The apparatus was set up and exercised using the configuration and modes of operation defined in this report only.
- c) Where relevant, the apparatus was only assessed using the susceptibility criteria defined in this report and the Test Assessment Plan (TAP).
- d) All testing was performed under the following environmental conditions:

Temperature	15°C to 35°C (54°F to 95°F)
Atmospheric Pressure	860mbar to 1060mbar (25.4" to 31.3")
Humidity	10% to 75*%

### Units of Measurement

The units of measurements defined in the appendices are reported in specific terms, which are test dependent. Where radiated measurements are concerned these are defined at a particular distance. Basic voltage measurements are defined in units of [dBuV]

As an example, the basic calculation for all measurements is as follows:

$$\text{Emission level [dBuV]} = \text{Indicated voltage level [dBuV]} + \text{Cable Loss [dB]} + \text{Other correction factors [dB]}$$

The combinations of correction factors are dependent upon the exact test configurations [see test equipment lists for further details] and may include:-

Antenna Factors, Pre Amplifier Gain, LISN Loss, Pulse Limiter Loss and Filter Insertion Loss

Note: to convert the results from dBuV/m to uV/m use the following formula:-

$$\text{Level in uV/m} = \text{Common Antilogarithm } [(X \text{ dBuV/m})/20] = Y \text{ uV/m}$$

## Measurement Uncertainty Values

voltage and power measurements	± 2 dB
conducted EIRP measurements	± 1.4 dB
radiated measurements	± 3.2 dB
frequency measurements	± 2.4 10 <sup>-7</sup>
temperature measurements	± 0.54°
humidity measurements	± 2.3%
DC and low frequency measurements	± 2.5%

Where relevant measurement uncertainty levels have been estimated for tests performed on the apparatus. This uncertainty represents an expanded uncertainty expressed at approximately the 95% confidence level using a coverage factor of k=2.

## Radiated emissions (expanded uncertainty, confidence interval 95%)

30 MHz - 300 MHz	+/- 3.8 dB
300 MHz - 1000 MHz	+/- 4.3 dB
1 GHz - 10 GHz	+/- 4.0 dB
10 GHz - 18GHz	+/- 8.2 dB
18GHz - 26.5GHz	+/- 4.1 dB
26.5GHz - 40GHz	+/- 3.9 dB

## Conducted emissions (expanded uncertainty, confidence interval 95%)

30 MHz – 40GHz	+/- 0.38 dB
----------------	-------------

A product is considered to comply with a requirement if the nominal measured value is below the limit line. The product is considered to not be in compliance in case the nominal measured value is above the limit line.

**This report must not be reproduced except in full, without written approval of Cisco Systems.**

**2.2 Date of testing**

20-Aug-19 - 10-Sep-19

**2.3 Report Issue Date**

22-Oct-19

Cisco uses an electronic system to issue, store and control the revision of test reports. This system is called the Engineering Document Control System. The actual report issue date is embedded into the original file on EDCS. Any copies of this report, either electronic or paper, that are not on EDCS must be considered uncontrolled.

**2.4 Testing facilities**

This assessment was performed by: Chris Blair &amp; Julian Land

**Testing Laboratory**

Cisco Systems, Inc.  
125 West Tasman Drive (Building P)  
San Jose, CA 95134  
USA

**Headquarters**

Cisco Systems, Inc.,  
170 West Tasman Drive  
San Jose, CA 95134,  
USA

**Registration Numbers for Industry Canada**

<b>Cisco System Site</b>	<b>Address</b>	<b>Site Identifier</b>
Building P, 10m Chamber	125 West Tasman Dr San Jose, CA 95134	Company #: 2461N-2
Building P, 5m Chamber	125 West Tasman Dr San Jose, CA 95134	Company #: 2461N-1
Building I, 5m Chamber	285 W. Tasman Drive San Jose, California 95134	Company #: 2461M-1
Building 7, 5m Chamber	425 E. Tasman Drive San Jose, California 95134	Company #: 2461N-3

**Test Engineers**

Chris Blair

**2.5 Equipment Assessed (EUT)**

C9120AXP-B

## 2.6 EUT Description

The radio supports the following modes of operation. The modes are further defined in the radio Theory of Operation. The modes included in this report represent the worst case data for all modes.

802.11a - Non HT20, One Antenna, 6 to 54 Mbps, 1ss  
802.11a - Non HT20, Two Antennas, 6 to 54 Mbps, 1ss  
802.11a - Non HT20, Three Antennas, 6 to 54 Mbps, 1ss  
802.11a - Non HT20, Four Antennas, 6 to 54 Mbps, 1ss

802.11a - Non HT20 Beam Forming, Two Antennas, 6 to 54 Mbps, 1ss  
802.11a - Non HT20 Beam Forming, Three Antennas, 6 to 54 Mbps, 1ss  
802.11a - Non HT20 Beam Forming, Four Antennas, 6 to 54 Mbps, 1ss

802.11n/ac - HT/VHT20, One Antenna, M0 to M7, 1ss  
802.11n/ac - HT/VHT20, Two Antennas, M0 to M7, 1ss  
802.11n/ac - HT/VHT20, Two Antennas, M8 to M15, 2ss  
802.11n/ac - HT/VHT20, Three Antennas, M0 to M7, 1ss  
802.11n/ac - HT/VHT20, Three Antennas, M8 to M15, 2ss  
802.11n/ac - HT/VHT20, Three Antennas, M16 to M23, 3ss  
802.11n/ac - HT/VHT20, Four Antennas, M0 to M7, 1ss  
802.11n/ac - HT/VHT20, Four Antennas, M8 to M15, 2ss  
802.11n/ac - HT/VHT20, Four Antennas, M16 to M23, 3ss  
802.11n/ac - HT/VHT20, Four Antennas, M24 to M31, 4ss

802.11n/ac - HT/VHT20 Beam Forming, Two Antennas, M0 to M7, 1ss  
802.11n/ac - HT/VHT20 Beam Forming, Two Antennas, M8 to M15, 2ss  
802.11n/ac - HT/VHT20 Beam Forming, Three Antennas, M0 to M7, 1ss  
802.11n/ac - HT/VHT20 Beam Forming, Three Antennas, M8 to M15, 2ss  
802.11n/ac - HT/VHT20 Beam Forming, Three Antennas, M16 to M23, 3ss  
802.11n/ac - HT/VHT20 Beam Forming, Four Antennas, M0 to M7, 1ss  
802.11n/ac - HT/VHT20 Beam Forming, Four Antennas, M8 to M15, 2ss  
802.11n/ac - HT/VHT20 Beam Forming, Four Antennas, M16 to M23, 3ss  
802.11n/ac - HT/VHT20 Beam Forming, Four Antennas, M24 to M31, 4ss

802.11n/ac - HT/VHT20 STBC, Two Antennas, M0 to M7, 2ss  
802.11n/ac - HT/VHT20 STBC, Three Antennas, M0 to M7, 2ss  
802.11n/ac - HT/VHT20 STBC, Four Antennas, M0 to M7, 2ss

802.11ax - HE20, One Antenna, M0 to M9 1ss  
802.11ax - HE20, Two Antennas, M0 to M9 1ss  
802.11ax - HE20, Two Antennas, M0 to M9 2ss  
802.11ax - HE20, Three Antennas, M0 to M9 1ss  
802.11ax - HE20, Three Antennas, M0 to M9 2ss  
802.11ax - HE20, Three Antennas, M0 to M9 3ss  
802.11ax - HE20, Four Antennas, M0 to M9 1ss  
802.11ax - HE20, Four Antennas, M0 to M9 2ss  
802.11ax - HE20, Four Antennas, M0 to M9 3ss  
802.11ax - HE20, Four Antennas, M0 to M9 4ss

802.11ax - HE20 Beam Forming, Two Antennas, M0 to M9 1ss  
802.11ax - HE20 Beam Forming, Two Antennas, M0 to M9 2ss  
802.11ax - HE20 Beam Forming, Three Antennas, M0 to M9 1ss  
802.11ax - HE20 Beam Forming, Three Antennas, M0 to M9 2ss  
802.11ax - HE20 Beam Forming, Three Antennas, M0 to M9 3ss  
802.11ax - HE20 Beam Forming, Four Antennas, M0 to M9 1ss  
802.11ax - HE20 Beam Forming, Four Antennas, M0 to M9 2ss  
802.11ax - HE20 Beam Forming, Four Antennas, M0 to M9 3ss  
802.11ax - HE20 Beam Forming, Four Antennas, M0 to M9 4ss

802.11ax - HE20 STBC, Two Antennas, M0 to M9 2ss  
802.11ax - HE20 STBC, Three Antennas, M0 to M9 2ss  
802.11ax - HE20 STBC, Four Antennas, M0 to M9 2ss

802.11a - Non HT40, One Antenna, 6 to 54 Mbps, 1ss  
802.11a - Non HT40, Two Antennas, 6 to 54 Mbps, 1ss  
802.11a - Non HT40, Three Antennas, 6 to 54 Mbps, 1ss  
802.11a - Non HT40, Four Antennas, 6 to 54 Mbps, 1ss

802.11n/ac - HT/VHT40, One Antenna, M0 to M7, 1ss  
802.11n/ac - HT/VHT40, Two Antennas, M0 to M7, 1ss  
802.11n/ac - HT/VHT40, Two Antennas, M8 to M15, 2ss  
802.11n/ac - HT/VHT40, Three Antennas, M0 to M7, 1ss  
802.11n/ac - HT/VHT40, Three Antennas, M8 to M15, 2ss  
802.11n/ac - HT/VHT40, Three Antennas, M16 to M23, 3ss  
802.11n/ac - HT/VHT40, Four Antennas, M0 to M7, 1ss  
802.11n/ac - HT/VHT40, Four Antennas, M8 to M15, 2ss  
802.11n/ac - HT/VHT40, Four Antennas, M16 to M23, 3ss  
802.11n/ac - HT/VHT40, Four Antennas, M24 to M31, 4ss

802.11n/ac - HT/VHT40 Beam Forming, Two Antennas, M0 to M7, 1ss  
802.11n/ac - HT/VHT40 Beam Forming, Two Antennas, M8 to M15, 2ss  
802.11n/ac - HT/VHT40 Beam Forming, Three Antennas, M0 to M7, 1ss  
802.11n/ac - HT/VHT40 Beam Forming, Three Antennas, M8 to M15, 2ss  
802.11n/ac - HT/VHT40 Beam Forming, Three Antennas, M16 to M23, 3ss  
802.11n/ac - HT/VHT40 Beam Forming, Four Antennas, M0 to M7, 1ss  
802.11n/ac - HT/VHT40 Beam Forming, Four Antennas, M8 to M15, 2ss  
802.11n/ac - HT/VHT40 Beam Forming, Four Antennas, M16 to M23, 3ss  
802.11n/ac - HT/VHT40 Beam Forming, Four Antennas, M24 to M31, 4ss

802.11n/ac - HT/VHT40 STBC, Two Antennas, M0 to M7, 2ss  
802.11n/ac - HT/VHT40 STBC, Three Antennas, M0 to M7, 2ss  
802.11n/ac - HT/VHT40 STBC, Four Antennas, M0 to M7, 2ss



802.11ax - HE40, One Antenna, M0 to M9 1ss  
802.11ax - HE40, Two Antennas, M0 to M9 1ss  
802.11ax - HE40, Two Antennas, M0 to M9 2ss  
802.11ax - HE40, Three Antennas, M0 to M9 1ss  
802.11ax - HE40, Three Antennas, M0 to M9 2ss  
802.11ax - HE40, Three Antennas, M0 to M9 3ss  
802.11ax - HE40, Four Antennas, M0 to M9 1ss  
802.11ax - HE40, Four Antennas, M0 to M9 2ss  
802.11ax - HE40, Four Antennas, M0 to M9 3ss  
802.11ax - HE40, Four Antennas, M0 to M9 4ss

802.11ax - HE40 Beam Forming, Two Antennas, M0 to M9 1ss  
802.11ax - HE40 Beam Forming, Two Antennas, M0 to M9 2ss  
802.11ax - HE40 Beam Forming, Three Antennas, M0 to M9 1ss  
802.11ax - HE40 Beam Forming, Three Antennas, M0 to M9 2ss  
802.11ax - HE40 Beam Forming, Three Antennas, M0 to M9 3ss  
802.11ax - HE40 Beam Forming, Four Antennas, M0 to M9 1ss  
802.11ax - HE40 Beam Forming, Four Antennas, M0 to M9 2ss  
802.11ax - HE40 Beam Forming, Four Antennas, M0 to M9 3ss  
802.11ax - HE40 Beam Forming, Four Antennas, M0 to M9 4ss

802.11ax - HE40 STBC, Two Antennas, M0 to M9 2ss  
802.11ax - HE40 STBC, Three Antennas, M0 to M9 2ss  
802.11ax - HE40 STBC, Four Antennas, M0 to M9 2ss

802.11a - Non HT80, One Antenna, 6 to 54 Mbps, 1ss  
802.11a - Non HT80, Two Antennas, 6 to 54 Mbps, 1ss  
802.11a - Non HT80, Three Antennas, 6 to 54 Mbps, 1ss  
802.11a - Non HT80, Four Antennas, 6 to 54 Mbps, 1ss

802.11ac - VHT80, One Antenna, M0 to M9 1ss  
802.11ac - VHT80, Two Antennas, M0 to M9 1ss  
802.11ac - VHT80, Two Antennas, M0 to M9 2ss  
802.11ac - VHT80, Three Antennas, M0 to M9 1ss  
802.11ac - VHT80, Three Antennas, M0 to M9 2ss  
802.11ac - VHT80, Three Antennas, M0 to M9 3ss  
802.11ac - VHT80, Four Antennas, M0 to M9 1ss  
802.11ac - VHT80, Four Antennas, M0 to M9 2ss  
802.11ac - VHT80, Four Antennas, M0 to M9 3ss  
802.11ac - VHT80, Four Antennas, M0 to M9 4ss

802.11ac - VHT80 Beam Forming, Two Antennas, M0 to M9 1ss  
802.11ac - VHT80 Beam Forming, Two Antennas, M0 to M9 2ss  
802.11ac - VHT80 Beam Forming, Three Antennas, M0 to M9 1ss  
802.11ac - VHT80 Beam Forming, Three Antennas, M0 to M9 2ss  
802.11ac - VHT80 Beam Forming, Three Antennas, M0 to M9 3ss  
802.11ac - VHT80 Beam Forming, Four Antennas, M0 to M9 1ss  
802.11ac - VHT80 Beam Forming, Four Antennas, M0 to M9 2ss

802.11ac - VHT80 Beam Forming, Four Antennas, M0 to M9 3ss  
802.11ac - VHT80 Beam Forming, Four Antennas, M0 to M9 4ss

802.11ac - VHT80 STBC, Two Antennas, M0 to M9 2ss  
802.11ac - VHT80 STBC, Three Antennas, M0 to M9 2ss  
802.11ac - VHT80 STBC, Four Antennas, M0 to M9 2ss

802.11ax - HE80, One Antenna, M0 to M9 1ss  
802.11ax - HE80, Two Antennas, M0 to M9 1ss  
802.11ax - HE80, Two Antennas, M0 to M9 2ss  
802.11ax - HE80, Three Antennas, M0 to M9 1ss  
802.11ax - HE80, Three Antennas, M0 to M9 2ss  
802.11ax - HE80, Three Antennas, M0 to M9 3ss  
802.11ax - HE80, Four Antennas, M0 to M9 1ss  
802.11ax - HE80, Four Antennas, M0 to M9 2ss  
802.11ax - HE80, Four Antennas, M0 to M9 3ss  
802.11ax - HE80, Four Antennas, M0 to M9 4ss

802.11ax - HE80 Beam Forming, Two Antennas, M0 to M9 1ss  
802.11ax - HE80 Beam Forming, Two Antennas, M0 to M9 2ss  
802.11ax - HE80 Beam Forming, Three Antennas, M0 to M9 1ss  
802.11ax - HE80 Beam Forming, Three Antennas, M0 to M9 2ss  
802.11ax - HE80 Beam Forming, Three Antennas, M0 to M9 3ss  
802.11ax - HE80 Beam Forming, Four Antennas, M0 to M9 1ss  
802.11ax - HE80 Beam Forming, Four Antennas, M0 to M9 2ss  
802.11ax - HE80 Beam Forming, Four Antennas, M0 to M9 3ss  
802.11ax - HE80 Beam Forming, Four Antennas, M0 to M9 4ss

802.11ax - HE80 STBC, Two Antennas, M0 to M9 2ss  
802.11ax - HE80 STBC, Three Antennas, M0 to M9 2ss  
802.11ax - HE80 STBC, Four Antennas, M0 to M9 2ss

802.11a - Non HT160, One Antenna, 6 to 54 Mbps, 1ss  
802.11a - Non HT160, Two Antennas, 6 to 54 Mbps, 1ss  
802.11a - Non HT160, Three Antennas, 6 to 54 Mbps, 1ss  
802.11a - Non HT160, Four Antennas, 6 to 54 Mbps, 1ss

802.11ac - VHT160, One Antenna, M0 to M9 1ss  
802.11ac - VHT160, Two Antennas, M0 to M9 1ss  
802.11ac - VHT160, Two Antennas, M0 to M9 2ss  
802.11ac - VHT160, Three Antennas, M0 to M9 1ss  
802.11ac - VHT160, Three Antennas, M0 to M9 2ss  
802.11ac - VHT160, Three Antennas, M0 to M9 3ss  
802.11ac - VHT160, Four Antennas, M0 to M9 1ss  
802.11ac - VHT160, Four Antennas, M0 to M9 2ss  
802.11ac - VHT160, Four Antennas, M0 to M9 3ss  
802.11ac - VHT160, Four Antennas, M0 to M9 4ss

802.11ac - VHT160 Beam Forming, Two Antennas, M0 to M9 1ss  
 802.11ac - VHT160 Beam Forming, Two Antennas, M0 to M9 2ss  
 802.11ac - VHT160 Beam Forming, Three Antennas, M0 to M9 1ss  
 802.11ac - VHT160 Beam Forming, Three Antennas, M0 to M9 2ss  
 802.11ac - VHT160 Beam Forming, Three Antennas, M0 to M9 3ss  
 802.11ac - VHT160 Beam Forming, Four Antennas, M0 to M9 1ss  
 802.11ac - VHT160 Beam Forming, Four Antennas, M0 to M9 2ss  
 802.11ac - VHT160 Beam Forming, Four Antennas, M0 to M9 3ss  
 802.11ac - VHT160 Beam Forming, Four Antennas, M0 to M9 4ss

802.11ac - VHT160 STBC, Two Antennas, M0 to M9 2ss  
 802.11ac - VHT160 STBC, Three Antennas, M0 to M9 2ss  
 802.11ac - VHT160 STBC, Four Antennas, M0 to M9 2ss

802.11ax - HE160, One Antenna, M0 to M9 1ss  
 802.11ax - HE160, Two Antennas, M0 to M9 1ss  
 802.11ax - HE160, Two Antennas, M0 to M9 2ss  
 802.11ax - HE160, Three Antennas, M0 to M9 1ss  
 802.11ax - HE160, Three Antennas, M0 to M9 2ss  
 802.11ax - HE160, Three Antennas, M0 to M9 3ss  
 802.11ax - HE160, Four Antennas, M0 to M9 1ss  
 802.11ax - HE160, Four Antennas, M0 to M9 2ss  
 802.11ax - HE160, Four Antennas, M0 to M9 3ss  
 802.11ax - HE160, Four Antennas, M0 to M9 4ss

802.11ax - HE160 Beam Forming, Two Antennas, M0 to M9 1ss  
 802.11ax - HE160 Beam Forming, Two Antennas, M0 to M9 2ss  
 802.11ax - HE160 Beam Forming, Three Antennas, M0 to M9 1ss  
 802.11ax - HE160 Beam Forming, Three Antennas, M0 to M9 2ss  
 802.11ax - HE160 Beam Forming, Three Antennas, M0 to M9 3ss  
 802.11ax - HE160 Beam Forming, Four Antennas, M0 to M9 1ss  
 802.11ax - HE160 Beam Forming, Four Antennas, M0 to M9 2ss  
 802.11ax - HE160 Beam Forming, Four Antennas, M0 to M9 3ss  
 802.11ax - HE160 Beam Forming, Four Antennas, M0 to M9 4ss

802.11ax - HE160 STBC, Two Antennas, M0 to M9 2ss  
 802.11ax - HE160 STBC, Three Antennas, M0 to M9 2ss  
 802.11ax - HE160 STBC, Four Antennas, M0 to M9 2ss

The following antennas are supported by this product series.

The data included in this report represent the worst case data for all antennas.

Frequency	Part Number	Antenna Type	Antenna Gain (dBi)
2.4GHz&5GHz	AIR-ANT2513P4M-N=	2.4 GHz 13 dBi/5 GHz 13 dBi Patch Ant., 4-port, N Type	13dBi@2.4GHz 13dBi@5GHz

### Section 3: Result Summary

#### 3.1 Results Summary Table

##### Conducted emissions

Basic Standard	Technical Requirements / Details	Result
FCC 15.407	<p><b>99% &amp; 26 dB Bandwidth:</b> The 99% occupied bandwidth is the frequency bandwidth such that, below its lower and above its upper frequency limits, the mean powers are each equal to 0.5% of the total mean power of the given emission. There is no limit for 99% OBW.</p> <p>The 26 dB emission is the width of the emission that is constrained by the frequencies associated with the two outermost amplitude points (upper and lower frequencies) that are attenuated by 26 dB relative to the maximum level measured in the fundamental emission.</p>	Pass
FCC 15.407	<p><b>Output Power:</b> <b>15.407</b> (2) For the 5.25-5.35 GHz and 5.47-5.725 GHz bands, the maximum conducted output power over the frequency bands of operation shall not exceed the lesser of 250 mW or 11 dBm + 10 log B, where B is the 26 dB emission bandwidth in megahertz. In addition, the maximum power spectral density shall not exceed 11 dBm in any 1 megahertz band. If transmitting antennas of directional gain greater than 6 dBi are used, both the maximum conducted output power and the maximum power spectral density shall be reduced by the amount in dB that the directional gain of the antenna exceeds 6 dBi.</p>	Pass
FCC 15.407	<p><b>Power Spectral Density:</b> <b>15.407</b> (2) For the 5.25-5.35 GHz and 5.47-5.725 GHz bands...the maximum power spectral density shall not exceed 11 dBm in any 1 megahertz band. If transmitting antennas of directional gain greater than 6 dBi are used, both the maximum conducted output power and the maximum power spectral density shall be reduced by the amount in dB that the directional gain of the antenna exceeds 6 dBi.</p>	Pass
FCC 15.407	<p><b>Conducted Spurious Emissions / Band-Edge:</b> <b>15.407</b> (3) For transmitters operating in the 5.47-5.725 GHz band: All emissions outside of the 5.47-5.725 GHz band shall not exceed an e.i.r.p. of -27 dBm/MHz.</p>	Pass
FCC 15.407 FCC 15.209 FCC 15.205	<p><b>Restricted band:</b> Unwanted emissions falling within the restricted bands, as defined in FCC 15.205 (a) must also comply with the radiated emission limits specified in FCC 15.209 (a).</p>	Pass

##### Radiated Emissions (General requirements)

Basic Standard	Technical Requirements / Details	Result
FCC 15.209 FCC 15.205	<p><b>TX Spurious Emissions:</b> Except as provided elsewhere in this subpart, the emissions from an intentional radiator shall not exceed the field strength levels specified in the filed strength limits table in this section.</p>	Not Tested
FCC 15.207	<p><b>AC conducted Emissions:</b> Except when the requirements applicable to a given device state otherwise, for any radio apparatus equipped to operate from the public utility AC power supply, either directly or indirectly (such as with a battery charger), the radio frequency voltage of emissions conducted back onto the AC power lines in the frequency range of 0.15 MHz to 30 MHz shall not exceed the limits shown in the table in these sections. The more stringent limit applies at the frequency range boundaries.</p>	Not Tested

## Section 4: Sample Details

Note: Each sample was evaluated to ensure that its condition was suitable to be used as a test sample prior to the commencement of testing.

### 4.1 Sample Details

Sample No.	Equipment Details	Manufacturer	Hardware Rev.	Firmware Rev.	Software Rev.	Serial Number
S01	C9120AXP-B	Foxconn	P2-2	1268.14948.r1 46 146	Cisco AP Software, (ap1g7), [cheetah-build6:/san2/BUILD/worksapce/Nightly-Cheetah-axel-bcm-mfg-c8_10_throttle] Compiled Tue Aug 6 08:07:11 PDT 2019	FOC23302F3B
S02	DART cable 37-100909-01	Amphenol	NA	NA	NA	NA

### 4.2 System Details

System #	Description	Samples
1	C9120AXP-B and DART cable	S01+S02

### 4.3 Mode of Operation Details

Mode#	Description	Comments
1	Continuously Transmitting	Constant duty cycle

**Appendix A: Emission Test Results**

**Conducted Test Setup Diagram**

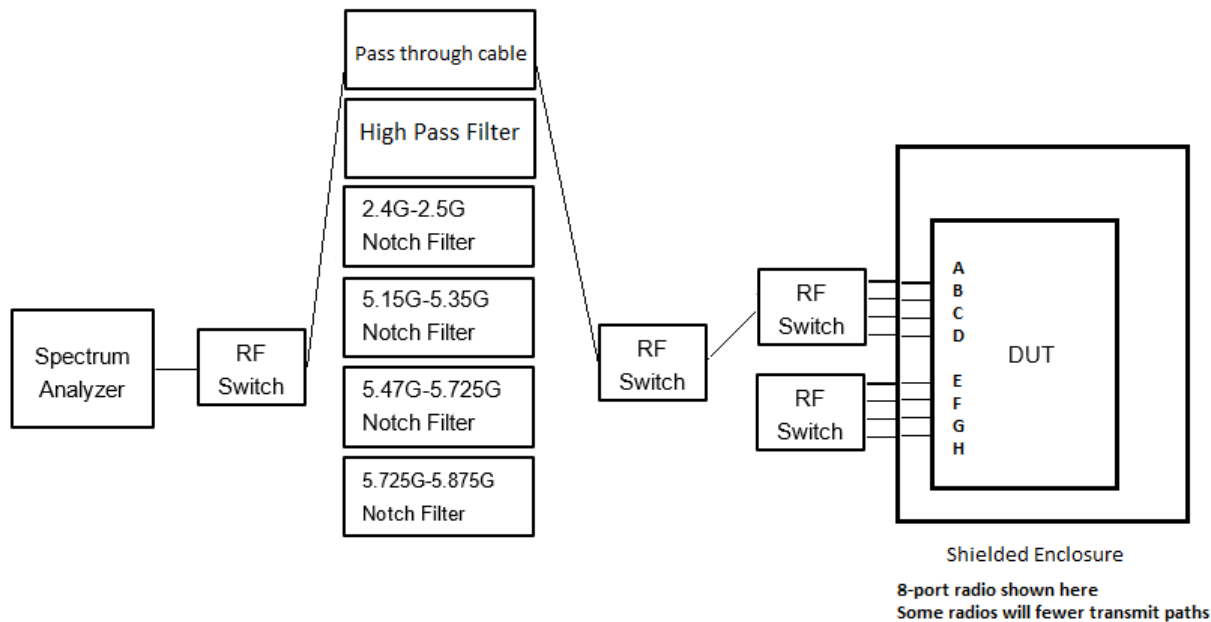

**Target Maximum Channel Power**

The following table details the maximum supported Total Channel Power for all operating modes.

Operating Mode	Maximum Channel Power (dBm)		
	Frequency (MHz)		
	5570		
Non HT160, 6 to 54 Mbps	11		
VHT160, M0 to M9, M0 to M9 1-2ss	12		
VHT160 Beam Forming, M0 to M9, M0 to M9 1-2ss	12		
VHT160 STBC, M0 to M9 1ss	12		
HE160, M0 to M9, M0 to M9 1-2ss	13		
HE160 Beam Forming, M0 to M9, M0 to M9 1-2ss	13		
HE160 STBC, M0 to M9 1ss	13		
	5500	5560	5700
Non HT20, 6 to 54 Mbps	14	15	14
Non HT20 Beam Forming, 6 to 54 Mbps	12	13	13
HT/VHT20, M0 to M31	15	15	15
HT/VHT20 Beam Forming, M0 to M31	15	15	15
HT/VHT20 STBC, M0 to M7	13	15	14
HE20, M0 to M9, M0 to M9 1-2ss	15	15	14

HE20 Beam Forming, M0 to M9, M0 to M9 1-2ss	15	15	14
HE20 STBC, M0 to M9 2ss	13	15	13
	5510	5550	5710
Non HT40, 6 to 54 Mbps	12	15	16
HT/VHT40, M0 to M31	13	15	16
HT/VHT40 Beam Forming, M0 to M31	13	15	16
HT/VHT40 STBC, M0 to M7	12	15	16
HE40, M0 to M9, M0 to M9 1-2ss	13	16	17
HE40 Beam Forming, M0 to M9, M0 to M9 1-2ss	13	16	17
HE40 STBC, M0 to M9 2ss	13	16	16
	5530	5610	5690
Non HT80, 6 to 54 Mbps	12	16	16
VHT80, M0 to M9, M0 to M9 1-2ss	13	16	16
VHT80 Beam Forming, M0 to M9, M0 to M9 1-2ss	13	16	16
VHT80 STBC, M0 to M9 1ss	13	16	16
HE80, M0 to M9, M0 to M9 1-2ss	13	17	16
HE80 Beam Forming, M0 to M9, M0 to M9 1-2ss	13	17	16
HE80 STBC, M0 to M9 1ss	13	16	16



## A.1 Duty Cycle

### Duty Cycle Test Requirement

From KDB 789033 D02 General UNII Test Procedures New Rules v02r01

#### B. Duty Cycle (x), Transmission Duration (T), and Maximum Power Control Level

1. All measurements are to be performed with the EUT transmitting at 100 percent duty cycle at its maximum power control level; however, if 100 percent duty cycle cannot be achieved, measurements of duty cycle, x, and maximum-power transmission duration, T, are required for each tested mode of operation.

### Duty Cycle Test Method

From KDB 789033 D02 General UNII Test Procedures New Rules v02r01:

#### B. Duty Cycle (x), Transmission Duration (T), and Maximum Power Control Level

The zero-span mode on a spectrum analyzer or EMI receiver, if the response time and spacing between bins on the sweep are sufficient to permit accurate measurements of the on and off times of the transmitted signal. Set the center frequency of the instrument to the center frequency of the transmission. Set RBW ≥ EBW if possible; otherwise, set RBW to the largest available value. Set VBW ≥ RBW. Set detector = peak or average. The zero-span measurement method shall not be used unless both RBW and VBW are > 50/T, where T is defined in section II.B.1.a), and the number of sweep points across duration T exceeds 100. (For example, if VBW and/or RBW are limited to 3 MHz, then the zero-span method of measuring duty cycle shall not be used if T ≤ 16.7 microseconds.)

### Duty Cycle Test Information

<b>Tested By :</b> Chris Blair	<b>Date of testing:</b> 20-Aug-19 - 10-Sep-19
<b>Test Result : PASS</b>	

#### Test Equipment

See Appendix C for list of test equipment

#### Samples, Systems, and Modes

System Number	Description	Samples	System under test	Support equipment
1	EUT	S01+S02	<input checked="" type="checkbox"/>	<input type="checkbox"/>
	Support		<input type="checkbox"/>	<input checked="" type="checkbox"/>



## Duty Cycle Data Table

Duty Cycle table and screen captures are shown below for power/psd modes.

Frequency	Mode	Data Rate	Duty Cycle correction (dB)
5500	Non HT20, 6 to 54 Mbps	6	0.1
	HT/VHT20, M0 to M31	m0	0.1
	HE20, M0 to M9, M0 to M9 1-2ss	m0h1	0.1
5510	Non HT40, 6 to 54 Mbps	6	0.0
	HT/VHT40, M0 to M31	m0	0.1
	HE40, M0 to M9, M0 to M9 1-2ss	m0h1	0.1
5530	Non HT80, 6 to 54 Mbps	6	0.1
	VHT80, M0 to M9, M0 to M9 1-2ss	m0x1	0.2
	HE80, M0 to M9, M0 to M9 1-2ss	m0h1	0.3
5550	Non HT40, 6 to 54 Mbps	6	0.0
	HT/VHT40, M0 to M31	m0	0.1
	HE40, M0 to M9, M0 to M9 1-2ss	m0h1	0.1
5560	Non HT20, 6 to 54 Mbps	6	0.1
	HT/VHT20, M0 to M31	m0	0.1
	HE20, M0 to M9, M0 to M9 1-2ss	m0h1	0.1
5570	Non HT160, 6 to 54 Mbps	6	0.0
	VHT160, M0 to M9, M0 to M9 1-2ss	m0x1	0.4
	<b>HE160, M0 to M9, M0 to M9 1-2ss</b>	<b>m0h1</b>	<b>0.4</b>
5610	Non HT80, 6 to 54 Mbps	6	0.1
	VHT80, M0 to M9, M0 to M9 1-2ss	m0x1	0.2
	HE80, M0 to M9, M0 to M9 1-2ss	m0h1	0.3
5690	Non HT80, 6 to 54 Mbps	6	0.1
	VHT80, M0 to M9, M0 to M9 1-2ss	m0x1	0.2
	HE80, M0 to M9, M0 to M9 1-2ss	m0h1	0.3
5700	Non HT20, 6 to 54 Mbps	6	0.1
	HT/VHT20, M0 to M31	m0	0.1

	HE20, M0 to M9, M0 to M9 1-2ss	m0h1	0.1
5710	Non HT40, 6 to 54 Mbps	6	0.0
	HT/VHT40, M0 to M31	m0	0.1
	HE40, M0 to M9, M0 to M9 1-2ss	m0h1	0.1
5720	Non HT20, 6 to 54 Mbps	6	0.1
	HT/VHT20, M0 to M31	m0	0.1
	HE20, M0 to M9, M0 to M9 1-2ss	m0h1	0.1



Duty Cycle, 5570 MHz, HE160, M0 to M9, M0 to M9 1-2ss

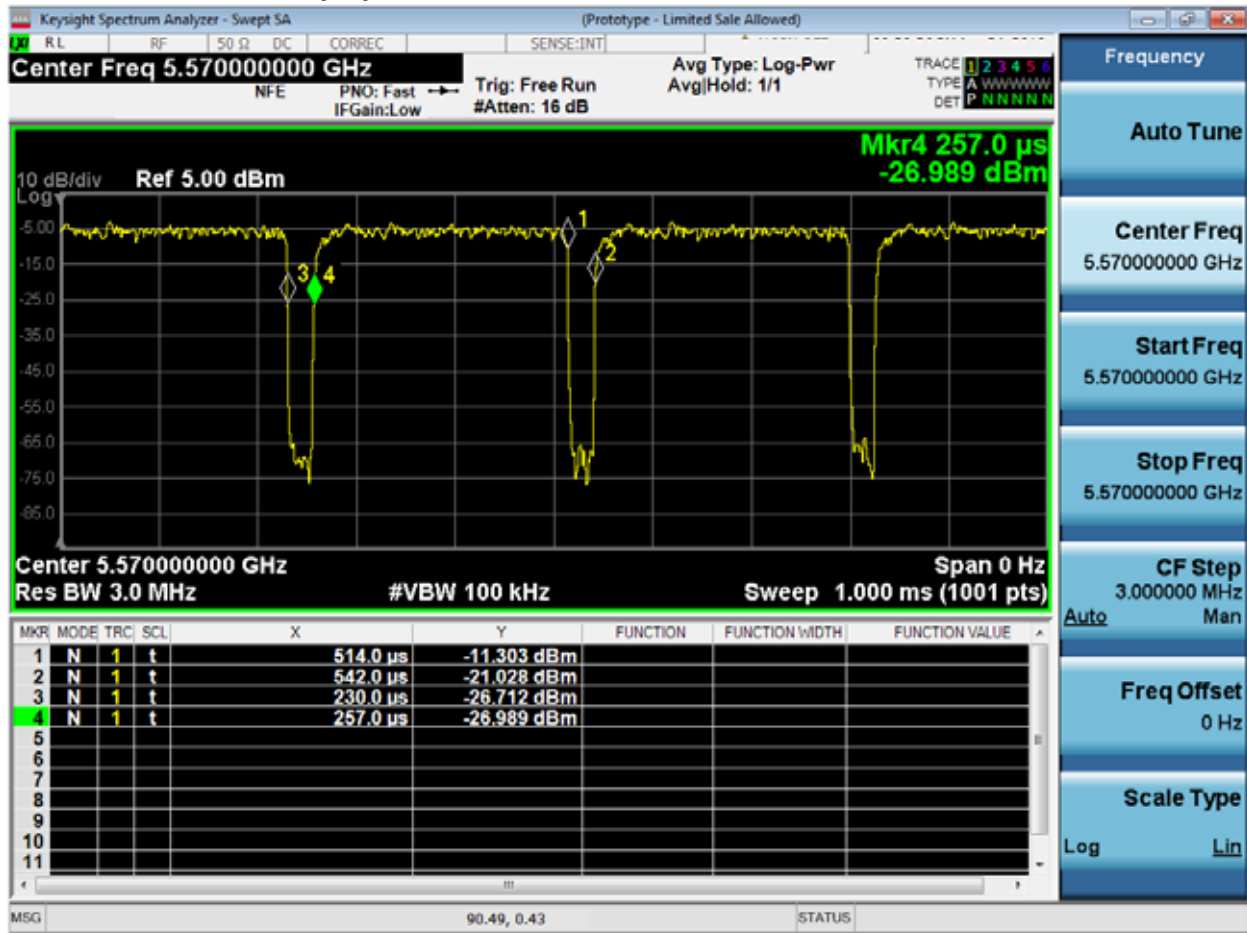

## A.2 99% and 26dB Bandwidth

### 99% and 26dB Bandwidth Test Requirement

There is no requirement for the value of bandwidth. However, the 26dB BW (EBW) is used to calculate the power limits in 15.407 (a) (2). Power measurements are made using the 99% Bandwidth as the integration bandwidth.

**Band-crossing emissions:** For an emission that crosses the boundary between two adjacent U-NII bands, the boundary frequency between the bands serves as one edge for defining the portion of the EBW that falls within a particular U-NII band. However, the -26 dB points are measured relative to the highest point on the contiguous segment—regardless of which band contains that highest point (Figure4).

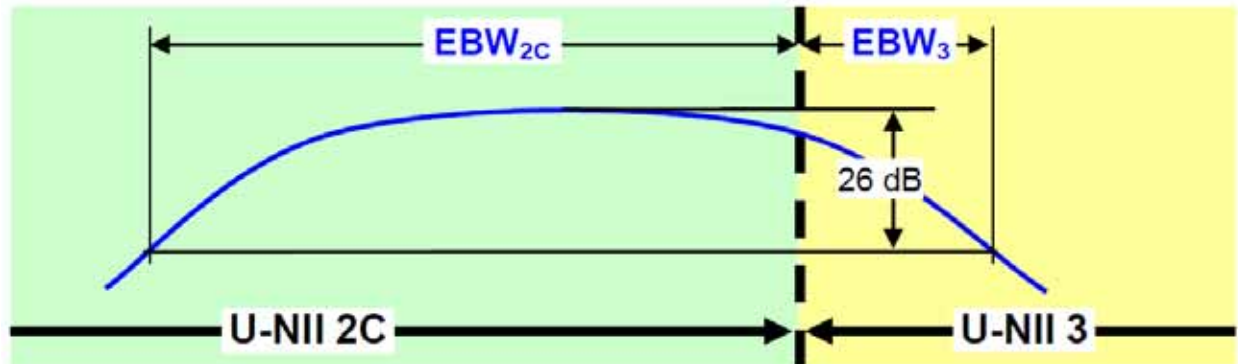

Figure 3. Emission Bandwidth (EBW) within a Band for Band-Crossing Signals

### 99% and 26dB Bandwidth Test Procedure

Ref. KDB 789033 Section D. 99 Percent Occupied Bandwidth  
ANSI C63.10: 2013 Section 6.9.3  
KDB 662911

#### 99% BW

##### Test Parameters

1. Set center frequency to the nominal EUT channel center frequency.
2. Set span = 1.5 times to 5.0 times the OBW.
3. Set RBW = 1 % to 5 % of the OBW
4. Set VBW  $\geq 3 \cdot$  RBW
5. Video averaging is not permitted. Where practical, a sample detection and single sweep mode shall be used. Otherwise, peak detection and max hold mode (until the trace stabilizes) shall be used.
6. Use the 99 % power bandwidth function of the instrument (if available).

#### Ref KDB 789033 in Section C. Measurement Bandwidth, Section 1

#### 26 BW

##### Test parameters

X dB BW = -26dB (using the OBW function of the spectrum analyzer)

##### Emission Bandwidth (EBW)

- a) Set RBW = approximately 1% of the emission bandwidth.
- b) Set the VBW  $>$  RBW.
- c) Detector = Peak.
- d) Trace mode = max hold.
- e) Measure the maximum width of the emission that is 26 dB down from the maximum of the emission.

Compare this with the RBW setting of the analyzer. Readjust RBW and repeat measurement as needed until the RBW/EBW ratio is approximately 1%.

**Samples, Systems, and Modes**

System Number	Description	Samples	System under test	Support equipment
1	EUT	S01+S02	<input checked="" type="checkbox"/>	<input type="checkbox"/>
	Support		<input type="checkbox"/>	<input checked="" type="checkbox"/>

<b>Tested By :</b> Chris Blair	<b>Date of testing:</b> 20-Aug-19 - 10-Sep-19
<b>Test Result : PASS</b>	

**Test Equipment**

See Appendix C for list of test equipment

## 99% and 26dB Bandwidth Table

Frequency (MHz)	Mode	Data Rate (Mbps)	26dB BW (MHz)	99% BW (MHz)
5500	Non HT20, 6 to 54 Mbps	6	21.2	16.779
	HT/VHT20, M0 to M31	m0	21.8	18.043
	HE20, M0 to M9, M0 to M9 1-2ss	m0h1	21.5	19.139
5510	Non HT40, 6 to 54 Mbps	6	39.8	36.363
	HT/VHT40, M0 to M31	m0	40.1	36.418
	HE40, M0 to M9, M0 to M9 1-2ss	m0h1	39.8	37.572
5530	Non HT80, 6 to 54 Mbps	6	82.0	76.250
	VHT80, M0 to M9, M0 to M9 1-2ss	m0x1	82.5	76.095
	HE80, M0 to M9, M0 to M9 1-2ss	m0h1	82.2	77.113
5550	Non HT40, 6 to 54 Mbps	6	39.7	36.305
	HT/VHT40, M0 to M31	m0	40.0	36.423
	HE40, M0 to M9, M0 to M9 1-2ss	m0h1	39.9	37.553
5560	<b>Non HT20, 6 to 54 Mbps</b>	<b>6</b>	<b>21.2</b>	<b>16.778</b>
	HT/VHT20, M0 to M31	m0	21.8	18.040
	HE20, M0 to M9, M0 to M9 1-2ss	m0h1	21.4	19.123
5570	Non HT160, 6 to 54 Mbps	6	163.6	154.158
	VHT160, M0 to M9, M0 to M9 1-2ss	m0x1	165.2	154.851
	HE160, M0 to M9, M0 to M9 1-2ss	m0h1	163.7	155.193
5610	Non HT80, 6 to 54 Mbps	6	81.9	76.176
	VHT80, M0 to M9, M0 to M9 1-2ss	m0x1	82.4	76.051
	HE80, M0 to M9, M0 to M9 1-2ss	m0h1	82.1	77.057
5690	Non HT80, 6 to 54 Mbps	6	81.9	76.213
	VHT80, M0 to M9, M0 to M9 1-2ss	m0x1	82.4	76.045
	HE80, M0 to M9, M0 to M9 1-2ss	m0h1	82.2	77.080
5700	Non HT20, 6 to 54 Mbps	6	21.2	16.784
	HT/VHT20, M0 to M31	m0	21.8	18.033
	HE20, M0 to M9, M0 to M9 1-2ss	m0h1	21.4	19.100

5710	Non HT40, 6 to 54 Mbps	6	39.8	36.379
	HT/VHT40, M0 to M31	m0	40.1	36.405
	HE40, M0 to M9, M0 to M9 1-2ss	m0h1	39.9	37.574
5720	<b>Non HT20, 6 to 54 Mbps</b>	<b>6</b>	<b>15.6</b>	<b>13.483</b>
	HT/VHT20, M0 to M31	m0	16.0	14.142
	HE20, M0 to M9, M0 to M9 1-2ss	m0h1	15.8	14.575

**26dB / 99% Bandwidth, 5720 MHz, Non HT20 Beam Forming, 6 to 54 Mbps**



**26dB / 99% Bandwidth, 5560 MHz, Non HT20 Beam Forming, 6 to 54 Mbps**

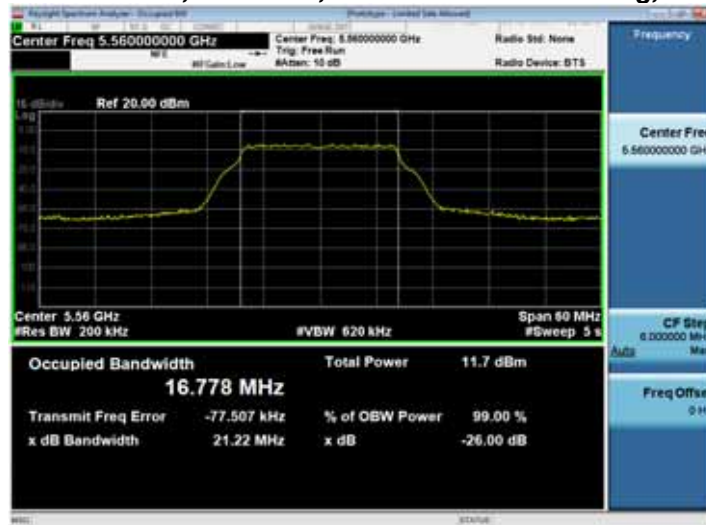



## A.3 Maximum Conducted Output Power

### Maximum Conducted Output Power Test Requirement

**15.407 (2)** For the 5.25-5.35 GHz and 5.47-5.725 GHz bands, the maximum conducted output power over the frequency bands of operation shall not exceed the lesser of 250 mW or  $11 \text{ dBm} + 10 \log B$ , where B is the 26 dB emission bandwidth in megahertz. ... If transmitting antennas of directional gain greater than 6 dBi are used, both the maximum conducted output power and the maximum power spectral density shall be reduced by the amount in dB that the directional gain of the antenna exceeds 6 dBi.

**Band-Crossing Signals** When measuring the portion of the maximum conducted output power within a single U-NII band, the power shall be integrated across only the portion of the EBW that falls within that band. That is, if an EBW extends across the boundary between two adjacent bands, the boundary frequency between the bands serves as one edge of the frequency range to be integrated. Integration across an entire U-NII band without regard to 26 dB points is also acceptable for determining conducted output power within that band.

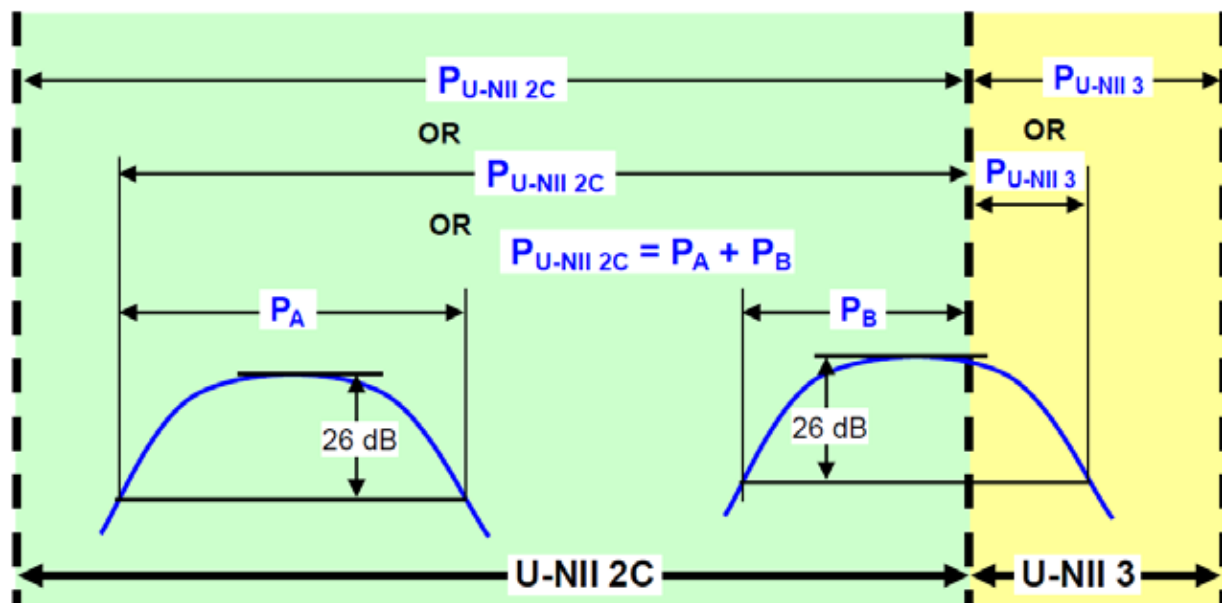

**Conducted output power within a U-NII band:** Integrate over the band or integrate over a span including the 26 dB EBWs of transmission segments within the band or integrate over 26 dB EBW of each transmission segment in the band and sum.

**Figure 4. Conducted Output Power Measurement Examples**

### Maximum Conducted Output Power Test Procedure

Ref. KDB 789033 D02 General UNII Test Procedures New Rules v02r01  
ANSI C63.10: 2013

#### Maximum Conducted Output Power

##### Test Procedure

1. Set the radio in the continuous transmitting mode at full power
2. Compute power by integrating the spectrum across the EBW (or alternatively entire 99% OBW) of the signal using the instrument's band power measurement function. The integration shall be performed using the spectrum analyzer band-power measurement function with band limits set equal to the EBW or the OBW band edges.

3. Capture graphs and record pertinent measurement data.
--

**Ref. KDB 789033 D02 General UNII Test Procedures New Rules v02r01**

**2. Measurement using a Spectrum Analyzer or EMI Receiver (SA), (d) Method SA-2**

**Maximum Conducted Output Power**

Test parameters

Method SA-2 (trace averaging across on and off times of the EUT transmissions, followed by duty cycle correction).

(i) Measure the duty cycle,  $x$ , of the transmitter output signal as described in section II.B.

(ii) Set span to encompass the EBW (or, alternatively, the entire 99% occupied bandwidth) of the signal.

(iii) Set RBW = 1 MHz.

(iv) Set VBW  $\geq$  3 MHz.

(v) Number of points in sweep  $\geq$  2 Span / RBW. (This ensures that bin-to-bin spacing is  $\leq$  RBW/2, so that narrowband signals are not lost between frequency bins.)

(vi) Sweep time = auto.

(vii) Detector = RMS (i.e., power averaging), if available. Otherwise, use sample detector mode.

(viii) Do not use sweep triggering. Allow the sweep to “free run”.

(ix) Trace average at least 100 traces in power averaging (i.e., RMS) mode; however, the number of traces to be averaged shall be increased above 100 as needed to ensure that the average accurately represents the true average over the on and off periods of the transmitter.

(x) Compute power by integrating the spectrum across the EBW (or, alternatively, the entire 99% occupied bandwidth) of the signal using the instrument’s band power measurement function with band limits set equal to the EBW (or occupied bandwidth)

The “measure-and-sum technique” is used for measuring in-band transmit power of a device. In the measure-and-sum approach, the conducted emission level is measured at each antenna port. The measured results at the various antenna ports are then summed mathematically to determine the total emission level from the device. Summing is performed in linear power units. ANSI C63.10 section 14.3.2.2

**Samples, Systems, and Modes**

System Number	Description	Samples	System under test	Support equipment
1	EUT	S01+S02	<input checked="" type="checkbox"/>	<input type="checkbox"/>
	Support		<input type="checkbox"/>	<input checked="" type="checkbox"/>

<b>Tested By :</b> Chris Blair	<b>Date of testing:</b> 20-Aug-19 - 10-Sep-19
<b>Test Result : PASS</b>	

**Test Equipment**

See Appendix C for list of test equipment

## Maximum Output Power

Frequency (MHz)	Mode	Tx Paths	Correlated Antenna Gain (dBi)	Tx 1 Max Power (dBm)	Tx 2 Max Power (dBm)	Tx 3 Max Power (dBm)	Tx 4 Max Power (dBm)	Duty Cycle Correction (dB)	Total Tx Channel Power (dBm)	Limit (dBm) EIRP	Margin (dB)
5500	Non HT20, 6 to 54 Mbps	1	13	10.2				0.1	10.3	17.0	6.75
	Non HT20, 6 to 54 Mbps	2	13	10.2	9.7			0.1	13.0	17.0	3.98
	Non HT20, 6 to 54 Mbps	3	13	9.1	8.4	9.5		0.1	13.8	17.0	3.15
	Non HT20, 6 to 54 Mbps	4	13	8.1	7.7	8.5	8.3	0.1	14.2	17.0	2.77
	Non HT20 Beam Forming, 6 to 54 Mbps	2	13	9.1	8.4			0.1	11.8	17.0	5.17
	Non HT20 Beam Forming, 6 to 54 Mbps	3	15	5.2	4.8	5.4		0.1	10.0	15.0	5.04
	Non HT20 Beam Forming, 6 to 54 Mbps	4	16	3.2	2.6	3.5	3.4	0.1	9.3	14.0	4.74
	HT/VHT20, M0 to M7	1	13	10.1				0.1	10.2	17.0	6.85
	HT/VHT20, M0 to M7	2	13	10.1	9.8			0.1	13.0	17.0	3.98
	HT/VHT20, M8 to M15	2	13	10.1	9.8			0.1	13.0	17.0	3.98
	HT/VHT20, M0 to M7	3	13	9.0	8.6	9.7		0.1	13.9	17.0	3.05
	HT/VHT20, M8 to M15	3	13	9.0	8.6	9.7		0.1	13.9	17.0	3.05
	HT/VHT20, M16 to M23	3	13	9.0	8.6	9.7		0.1	13.9	17.0	3.05
	HT/VHT20, M0 to M7	4	13	9.0	8.6	9.7	9.3	0.1	15.2	17.0	1.76
	HT/VHT20, M8 to M15	4	13	9.0	8.6	9.7	9.3	0.1	15.2	17.0	1.76
	HT/VHT20, M16 to M23	4	13	9.0	8.6	9.7	9.3	0.1	15.2	17.0	1.76
	HT/VHT20, M24 to M31	4	13	9.0	8.6	9.7	9.3	0.1	15.2	17.0	1.76
	HT/VHT20 Beam Forming, M0 to M7	2	13	9.0	8.6			0.1	11.9	17.0	5.13
	HT/VHT20 Beam Forming, M8 to M15	2	13	10.1	9.8			0.1	13.0	17.0	3.98
	HT/VHT20 Beam Forming, M0 to M7	3	15	5.0	4.7	5.4		0.1	9.9	15.0	5.13
	HT/VHT20 Beam Forming, M8 to M15	3	13	8.1	7.6	8.4		0.1	12.9	17.0	4.13
	HT/VHT20 Beam Forming, M16 to M23	3	13	9.0	8.6	9.7		0.1	13.9	17.0	3.05
	HT/VHT20 Beam Forming, M0 to M7	4	16	3.2	2.5	3.5	3.2	0.1	9.2	14.0	4.81
	HT/VHT20 Beam Forming, M8 to M15	4	13	6.3	5.5	6.4	6.3	0.1	12.2	17.0	4.79
	HT/VHT20 Beam Forming, M16 to M23	4	13	8.1	7.6	8.4	8.3	0.1	14.2	17.0	2.82
	HT/VHT20 Beam Forming, M24 to M31	4	13	9.0	8.6	9.7	9.3	0.1	15.2	17.0	1.76
	HT/VHT20 STBC, M0 to M7	2	13	10.1	9.8			0.1	13.0	17.0	3.98
	HT/VHT20 STBC, M0 to M7	3	13	8.1	7.6	8.4		0.1	12.9	17.0	4.13
	HT/VHT20 STBC, M0 to M7	4	13	6.3	5.5	6.4	6.3	0.1	12.2	17.0	4.79
	HE20, M0 to M9 1ss	1	13	9.4				0.1	9.5	17.0	7.53
	HE20, M0 to M9 1ss	2	13	9.4	8.9			0.1	12.2	17.0	4.77

	HE20, M0 to M9 2ss	2	13	9.4	8.9			0.1	12.2	17.0	4.77
	HE20, M0 to M9 1ss	3	13	9.4	8.9	10.0		0.1	14.3	17.0	2.71
	HE20, M0 to M9 2ss	3	13	9.4	8.9	10.0		0.1	14.3	17.0	2.71
	HE20, M0 to M9 3ss	3	13	9.4	8.9	10.0		0.1	14.3	17.0	2.71
	HE20, M0 to M9 1ss	4	13	8.4	8.0	8.7	8.6	0.1	14.5	17.0	2.48
	HE20, M0 to M9 2ss	4	13	8.4	8.0	8.7	8.6	0.1	14.5	17.0	2.48
	HE20, M0 to M9 3ss	4	13	8.4	8.0	8.7	8.6	0.1	14.5	17.0	2.48
	HE20, M0 to M9 4ss	4	13	8.4	8.0	8.7	8.6	0.1	14.5	17.0	2.48
	HE20 Beam Forming, M0 to M9 1ss	2	13	9.4	8.9			0.1	12.2	17.0	4.77
	HE20 Beam Forming, M0 to M9 2ss	2	13	9.4	8.9			0.1	12.2	17.0	4.77
	HE20 Beam Forming, M0 to M9 1ss	3	15	5.3	5.0	5.7		0.1	10.2	15.0	4.82
	HE20 Beam Forming, M0 to M9 2ss	3	13	8.4	8.0	8.7		0.1	13.2	17.0	3.79
	HE20 Beam Forming, M0 to M9 3ss	3	13	9.4	8.9	10.0		0.1	14.3	17.0	2.71
	HE20 Beam Forming, M0 to M9 1ss	4	16	3.5	3.0	3.7	3.6	0.1	9.5	14.0	4.46
	HE20 Beam Forming, M0 to M9 2ss	4	13	6.5	5.8	6.8	6.5	0.1	12.5	17.0	4.50
	HE20 Beam Forming, M0 to M9 3ss	4	13	8.4	8.0	8.7	8.6	0.1	14.5	17.0	2.48
	HE20 Beam Forming, M0 to M9 4ss	4	13	8.4	8.0	8.7	8.6	0.1	14.5	17.0	2.48
	HE20 STBC, M0 to M9 2ss	2	13	9.4	8.9			0.1	12.2	17.0	4.77
	HE20 STBC, M0 to M9 2ss	3	13	8.4	8.0	8.7		0.1	13.2	17.0	3.79
	HE20 STBC, M0 to M9 2ss	4	13	6.5	5.8	6.8	6.5	0.1	12.5	17.0	4.50
5510	Non HT40, 6 to 54 Mbps	1	13	7.2				0.0	7.2	17.0	9.75
	Non HT40, 6 to 54 Mbps	2	13	7.2	7.0			0.0	10.2	17.0	6.84
	Non HT40, 6 to 54 Mbps	3	13	7.2	7.0	7.0		0.0	11.9	17.0	5.11
	Non HT40, 6 to 54 Mbps	4	13	6.2	6.0	6.0	6.2	0.0	12.2	17.0	4.83
	HT/VHT40, M0 to M7	1	13	8.1				0.1	8.2	17.0	8.79
	HT/VHT40, M0 to M7	2	13	8.1	8.1			0.1	11.2	17.0	5.78
	HT/VHT40, M8 to M15	2	13	8.1	8.1			0.1	11.2	17.0	5.78
	HT/VHT40, M0 to M7	3	13	7.1	7.0	6.8		0.1	11.8	17.0	5.15
	HT/VHT40, M8 to M15	3	13	7.1	7.0	6.8		0.1	11.8	17.0	5.15
	HT/VHT40, M16 to M23	3	13	7.1	7.0	6.8		0.1	11.8	17.0	5.15
	HT/VHT40, M0 to M7	4	13	7.1	7.0	6.8	7.3	0.1	13.2	17.0	3.82
	HT/VHT40, M8 to M15	4	13	7.1	7.0	6.8	7.3	0.1	13.2	17.0	3.82
	HT/VHT40, M16 to M23	4	13	7.1	7.0	6.8	7.3	0.1	13.2	17.0	3.82
	HT/VHT40, M24 to M31	4	13	7.1	7.0	6.8	7.3	0.1	13.2	17.0	3.82
	HT/VHT40 Beam Forming, M0 to M7	2	13	8.1	8.1			0.1	11.2	17.0	5.78
	HT/VHT40 Beam Forming, M8 to M15	2	13	8.1	8.1			0.1	11.2	17.0	5.78
	HT/VHT40 Beam Forming, M0 to M7	3	15	5.3	5.0	4.9		0.1	10.0	15.0	5.05
	HT/VHT40 Beam Forming, M8 to M15	3	13	7.1	7.0	6.8		0.1	11.8	17.0	5.15
	HT/VHT40 Beam Forming, M16 to M23	3	13	7.1	7.0	6.8		0.1	11.8	17.0	5.15
	HT/VHT40 Beam Forming, M0 to M7	4	16	3.2	3.1	2.8	3.3	0.1	9.2	14.0	4.77
HT/VHT40 Beam Forming, M8 to M15	4	13	6.1	5.9	5.8	6.1	0.1	12.1	17.0	4.89	
HT/VHT40 Beam Forming, M16 to M23	4	13	7.1	7.0	6.8	7.3	0.1	13.2	17.0	3.82	

	HT/VHT40 Beam Forming, M24 to M31	4	13	7.1	7.0	6.8	7.3	0.1	13.2	17.0	3.82
	HT/VHT40 STBC, M0 to M7	2	13	8.1	8.1			0.1	11.2	17.0	5.78
	HT/VHT40 STBC, M0 to M7	3	13	7.1	7.0	6.8		0.1	11.8	17.0	5.15
	HT/VHT40 STBC, M0 to M7	4	13	6.1	5.9	5.8	6.1	0.1	12.1	17.0	4.89
	HE40, M0 to M9 1ss	1	13	8.0				0.1	8.1	17.0	8.87
	HE40, M0 to M9 1ss	2	13	8.0	7.9			0.1	11.1	17.0	5.90
	HE40, M0 to M9 2ss	2	13	8.0	7.9			0.1	11.1	17.0	5.90
	HE40, M0 to M9 1ss	3	13	8.0	7.9	7.8		0.1	12.8	17.0	4.19
	HE40, M0 to M9 2ss	3	13	8.0	7.9	7.8		0.1	12.8	17.0	4.19
	HE40, M0 to M9 3ss	3	13	8.0	7.9	7.8		0.1	12.8	17.0	4.19
	HE40, M0 to M9 1ss	4	13	7.0	6.8	6.7	7.0	0.1	13.0	17.0	3.97
	HE40, M0 to M9 2ss	4	13	7.0	6.8	6.7	7.0	0.1	13.0	17.0	3.97
	HE40, M0 to M9 3ss	4	13	7.0	6.8	6.7	7.0	0.1	13.0	17.0	3.97
	HE40, M0 to M9 4ss	4	13	7.0	6.8	6.7	7.0	0.1	13.0	17.0	3.97
	HE40 Beam Forming, M0 to M9 1ss	2	13	8.0	7.9			0.1	11.1	17.0	5.90
	HE40 Beam Forming, M0 to M9 2ss	2	13	8.0	7.9			0.1	11.1	17.0	5.90
	HE40 Beam Forming, M0 to M9 1ss	3	15	6.1	6.0	4.9		0.1	10.6	15.0	4.39
	HE40 Beam Forming, M0 to M9 2ss	3	13	8.0	7.9	7.8		0.1	12.8	17.0	4.19
	HE40 Beam Forming, M0 to M9 3ss	3	13	8.0	7.9	7.8		0.1	12.8	17.0	4.19
	HE40 Beam Forming, M0 to M9 1ss	4	16	3.6	3.1	3.0	3.3	0.1	9.4	14.0	4.59
	HE40 Beam Forming, M0 to M9 2ss	4	13	7.0	6.8	6.7	7.0	0.1	13.0	17.0	3.97
	HE40 Beam Forming, M0 to M9 3ss	4	13	7.0	6.8	6.7	7.0	0.1	13.0	17.0	3.97
	HE40 Beam Forming, M0 to M9 4ss	4	13	7.0	6.8	6.7	7.0	0.1	13.0	17.0	3.97
	HE40 STBC, M0 to M9 2ss	2	13	8.0	7.9			0.1	11.1	17.0	5.90
	HE40 STBC, M0 to M9 2ss	3	13	8.0	7.9	7.8		0.1	12.8	17.0	4.19
	HE40 STBC, M0 to M9 2ss	4	13	7.0	6.8	6.7	7.0	0.1	13.0	17.0	3.97
5530	Non HT80, 6 to 54 Mbps	1	13	6.8				0.1	6.9	17.0	10.15
	Non HT80, 6 to 54 Mbps	2	13	6.8	7.3			0.1	10.1	17.0	6.88
	Non HT80, 6 to 54 Mbps	3	13	6.8	7.3	6.5		0.1	11.7	17.0	5.30
	Non HT80, 6 to 54 Mbps	4	13	5.9	6.1	5.5	5.5	0.1	11.8	17.0	5.17
	VHT80, M0 to M9 1ss	1	13	7.6				0.2	7.8	17.0	9.18
	VHT80, M0 to M9 1ss	2	13	7.6	7.9			0.2	11.0	17.0	6.02
	VHT80, M0 to M9 2ss	2	13	7.6	7.9			0.2	11.0	17.0	6.02
	VHT80, M0 to M9 1ss	3	13	6.5	6.9	6.4		0.2	11.6	17.0	5.41
	VHT80, M0 to M9 2ss	3	13	6.5	6.9	6.4		0.2	11.6	17.0	5.41
	VHT80, M0 to M9 3ss	3	13	6.5	6.9	6.4		0.2	11.6	17.0	5.41
	VHT80, M0 to M9 1ss	4	13	6.5	6.9	6.4	6.5	0.2	12.8	17.0	4.18
	VHT80, M0 to M9 2ss	4	13	6.5	6.9	6.4	6.5	0.2	12.8	17.0	4.18
	VHT80, M0 to M9 3ss	4	13	6.5	6.9	6.4	6.5	0.2	12.8	17.0	4.18
	VHT80, M0 to M9 4ss	4	13	6.5	6.9	6.4	6.5	0.2	12.8	17.0	4.18
	VHT80 Beam Forming, M0 to M9 1ss	2	13	7.6	7.9			0.2	11.0	17.0	6.02
	VHT80 Beam Forming, M0 to M9 2ss	2	13	7.6	7.9			0.2	11.0	17.0	6.02

VHT80 Beam Forming, M0 to M9 1ss	3	15	5.5	5.9	5.2			0.2	10.5	15.0	4.47
VHT80 Beam Forming, M0 to M9 2ss	3	13	6.5	6.9	6.4			0.2	11.6	17.0	5.41
VHT80 Beam Forming, M0 to M9 3ss	3	13	6.5	6.9	6.4			0.2	11.6	17.0	5.41
VHT80 Beam Forming, M0 to M9 1ss	4	16	3.8	3.8	3.1	3.2		0.2	9.7	14.0	4.28
VHT80 Beam Forming, M0 to M9 2ss	4	13	6.5	6.9	6.4	6.5		0.2	12.8	17.0	4.18
VHT80 Beam Forming, M0 to M9 3ss	4	13	6.5	6.9	6.4	6.5		0.2	12.8	17.0	4.18
VHT80 Beam Forming, M0 to M9 4ss	4	13	6.5	6.9	6.4	6.5		0.2	12.8	17.0	4.18
VHT80 STBC, M0 to M9 1ss	2	13	7.6	7.9				0.2	11.0	17.0	6.02
VHT80 STBC, M0 to M9 1ss	3	13	6.5	6.9	6.4			0.2	11.6	17.0	5.41
VHT80 STBC, M0 to M9 1ss	4	13	6.5	6.9	6.4	6.5		0.2	12.8	17.0	4.18
HE80, M0 to M9 1ss	1	13	8.1					0.3	8.4	17.0	8.65
HE80, M0 to M9 1ss	2	13	8.1	8.3				0.3	11.5	17.0	5.54
HE80, M0 to M9 2ss	2	13	8.1	8.3				0.3	11.5	17.0	5.54
HE80, M0 to M9 1ss	3	13	7.0	7.3	6.6			0.3	12.0	17.0	5.00
HE80, M0 to M9 2ss	3	13	7.0	7.3	6.6			0.3	12.0	17.0	5.00
HE80, M0 to M9 3ss	3	13	7.0	7.3	6.6			0.3	12.0	17.0	5.00
HE80, M0 to M9 1ss	4	13	7.0	7.3	6.6	6.8		0.3	13.2	17.0	3.80
HE80, M0 to M9 2ss	4	13	7.0	7.3	6.6	6.8		0.3	13.2	17.0	3.80
HE80, M0 to M9 3ss	4	13	7.0	7.3	6.6	6.8		0.3	13.2	17.0	3.80
HE80, M0 to M9 4ss	4	13	7.0	7.3	6.6	6.8		0.3	13.2	17.0	3.80
HE80 Beam Forming, M0 to M9 1ss	2	13	8.1	8.3				0.3	11.5	17.0	5.54
HE80 Beam Forming, M0 to M9 2ss	2	13	8.1	8.3				0.3	11.5	17.0	5.54
HE80 Beam Forming, M0 to M9 1ss	3	15	6.1	6.2	5.6			0.3	11.0	15.0	4.00
HE80 Beam Forming, M0 to M9 2ss	3	13	7.0	7.3	6.6			0.3	12.0	17.0	5.00
HE80 Beam Forming, M0 to M9 3ss	3	13	7.0	7.3	6.6			0.3	12.0	17.0	5.00
HE80 Beam Forming, M0 to M9 1ss	4	16	4.1	4.1	3.5	3.7		0.3	10.1	14.0	3.87
HE80 Beam Forming, M0 to M9 2ss	4	13	7.0	7.3	6.6	6.8		0.3	13.2	17.0	3.80
HE80 Beam Forming, M0 to M9 3ss	4	13	7.0	7.3	6.6	6.8		0.3	13.2	17.0	3.80
HE80 Beam Forming, M0 to M9 4ss	4	13	7.0	7.3	6.6	6.8		0.3	13.2	17.0	3.80
HE80 STBC, M0 to M9 1ss	2	13	8.1	8.3				0.3	11.5	17.0	5.54
HE80 STBC, M0 to M9 1ss	3	13	7.0	7.3	6.6			0.3	12.0	17.0	5.00
HE80 STBC, M0 to M9 1ss	4	13	7.0	7.3	6.6	6.8		0.3	13.2	17.0	3.80

5550	Non HT40, 6 to 54 Mbps	1	13	11.4				0.0	11.4	17.0	5.55
	Non HT40, 6 to 54 Mbps	2	13	11.4	12.4			0.0	15.0	17.0	2.01
	Non HT40, 6 to 54 Mbps	3	13	10.4	10.1	10.2		0.0	15.1	17.0	1.94
	Non HT40, 6 to 54 Mbps	4	13	9.4	9.1	9.0	9.8	0.0	15.4	17.0	1.59
	HT/VHT40, M0 to M7	1	13	11.3				0.1	11.4	17.0	5.59
	HT/VHT40, M0 to M7	2	13	11.3	12.4			0.1	15.0	17.0	2.00
	HT/VHT40, M8 to M15	2	13	11.3	12.4			0.1	15.0	17.0	2.00
	HT/VHT40, M0 to M7	3	13	10.4	10.3	10.2		0.1	15.2	17.0	1.82
	HT/VHT40, M8 to M15	3	13	10.4	10.3	10.2		0.1	15.2	17.0	1.82
	HT/VHT40, M16 to M23	3	13	10.4	10.3	10.2		0.1	15.2	17.0	1.82

	HT/VHT40, M0 to M7	4	13	9.5	8.9	8.9	9.6	0.1	15.4	17.0	1.63
	HT/VHT40, M8 to M15	4	13	9.5	8.9	8.9	9.6	0.1	15.4	17.0	1.63
	HT/VHT40, M16 to M23	4	13	9.5	8.9	8.9	9.6	0.1	15.4	17.0	1.63
	HT/VHT40, M24 to M31	4	13	9.5	8.9	8.9	9.6	0.1	15.4	17.0	1.63
	HT/VHT40 Beam Forming, M0 to M7	2	13	9.5	8.9			0.1	12.3	17.0	4.67
	HT/VHT40 Beam Forming, M8 to M15	2	13	11.3	12.4			0.1	15.0	17.0	2.00
	HT/VHT40 Beam Forming, M0 to M7	3	15	5.6	5.2	5.0		0.1	10.2	15.0	4.84
	HT/VHT40 Beam Forming, M8 to M15	3	13	8.5	8.1	8.1		0.1	13.1	17.0	3.88
	HT/VHT40 Beam Forming, M16 to M23	3	13	10.4	10.3	10.2		0.1	15.2	17.0	1.82
	HT/VHT40 Beam Forming, M0 to M7	4	16	3.6	3.2	2.9	3.8	0.1	9.5	14.0	4.48
	HT/VHT40 Beam Forming, M8 to M15	4	13	6.4	6.0	5.9	6.7	0.1	12.4	17.0	4.61
	HT/VHT40 Beam Forming, M16 to M23	4	13	8.5	8.1	8.1	8.6	0.1	14.5	17.0	2.54
	HT/VHT40 Beam Forming, M24 to M31	4	13	9.5	8.9	8.9	9.6	0.1	15.4	17.0	1.63
	HT/VHT40 STBC, M0 to M7	2	13	11.3	12.4			0.1	15.0	17.0	2.00
	HT/VHT40 STBC, M0 to M7	3	13	8.5	8.1	8.1		0.1	13.1	17.0	3.88
	HT/VHT40 STBC, M0 to M7	4	13	6.4	6.0	5.9	6.7	0.1	12.4	17.0	4.61
	HE40, M0 to M9 1ss	1	13	11.8				0.1	11.9	17.0	5.07
	HE40, M0 to M9 1ss	2	13	11.8	13.0			0.1	15.6	17.0	1.41
	HE40, M0 to M9 2ss	2	13	11.8	13.0			0.1	15.6	17.0	1.41
	HE40, M0 to M9 1ss	3	13	11.0	11.0	10.8		0.1	15.8	17.0	1.16
	HE40, M0 to M9 2ss	3	13	11.0	11.0	10.8		0.1	15.8	17.0	1.16
	HE40, M0 to M9 3ss	3	13	11.0	11.0	10.8		0.1	15.8	17.0	1.16
	HE40, M0 to M9 1ss	4	13	10.1	9.7	9.6	10.4	0.1	16.1	17.0	0.88
	HE40, M0 to M9 2ss	4	13	10.1	9.7	9.6	10.4	0.1	16.1	17.0	0.88
	HE40, M0 to M9 3ss	4	13	10.1	9.7	9.6	10.4	0.1	16.1	17.0	0.88
	HE40, M0 to M9 4ss	4	13	10.1	9.7	9.6	10.4	0.1	16.1	17.0	0.88
	HE40 Beam Forming, M0 to M9 1ss	2	13	10.1	9.7			0.1	13.0	17.0	3.95
	HE40 Beam Forming, M0 to M9 2ss	2	13	11.8	13.0			0.1	15.6	17.0	1.41
	HE40 Beam Forming, M0 to M9 1ss	3	15	6.5	6.1	5.9		0.1	11.1	15.0	3.92
	HE40 Beam Forming, M0 to M9 2ss	3	13	9.1	8.7	8.7		0.1	13.7	17.0	3.26
	HE40 Beam Forming, M0 to M9 3ss	3	13	11.0	11.0	10.8		0.1	15.8	17.0	1.16
	HE40 Beam Forming, M0 to M9 1ss	4	16	4.6	3.8	3.7	4.3	0.1	10.3	14.0	3.73
	HE40 Beam Forming, M0 to M9 2ss	4	13	7.3	7.0	6.9	7.6	0.1	13.4	17.0	3.64
	HE40 Beam Forming, M0 to M9 3ss	4	13	9.1	8.7	8.7	9.3	0.1	15.1	17.0	1.89
	HE40 Beam Forming, M0 to M9 4ss	4	13	10.1	9.7	9.6	10.4	0.1	16.1	17.0	0.88
	HE40 STBC, M0 to M9 2ss	2	13	11.8	13.0			0.1	15.6	17.0	1.41
	HE40 STBC, M0 to M9 2ss	3	13	9.1	8.7	8.7		0.1	13.7	17.0	3.26
	HE40 STBC, M0 to M9 2ss	4	13	7.3	7.0	6.9	7.6	0.1	13.4	17.0	3.64
5560	Non HT20, 6 to 54 Mbps	1	13	12.1				0.1	12.2	17.0	4.85
	Non HT20, 6 to 54 Mbps	2	13	12.1	11.5			0.1	14.9	17.0	2.13
	Non HT20, 6 to 54 Mbps	3	13	10.1	9.3	10.3		0.1	14.7	17.0	2.26
	Non HT20, 6 to 54 Mbps	4	13	8.3	7.5	8.1	8.7	0.1	14.2	17.0	2.76

Non HT20 Beam Forming, 6 to 54 Mbps	2	13	10.1	9.3			0.1	12.8	17.0	4.22
Non HT20 Beam Forming, 6 to 54 Mbps	3	15	6.2	5.4	6.1		0.1	10.7	15.0	4.26
Non HT20 Beam Forming, 6 to 54 Mbps	4	16	4.3	3.5	4.1	4.6	0.1	10.2	14.0	3.79
HT/VHT20, M0 to M7	1	13	12.1				0.1	12.2	17.0	4.85
HT/VHT20, M0 to M7	2	13	12.1	11.7			0.1	15.0	17.0	2.03
HT/VHT20, M8 to M15	2	13	12.1	11.7			0.1	15.0	17.0	2.03
HT/VHT20, M0 to M7	3	13	10.2	9.4	10.5		0.1	14.9	17.0	2.12
HT/VHT20, M8 to M15	3	13	10.2	9.4	10.5		0.1	14.9	17.0	2.12
HT/VHT20, M16 to M23	3	13	10.2	9.4	10.5		0.1	14.9	17.0	2.12
HT/VHT20, M0 to M7	4	13	9.2	8.5	9.2	9.5	0.1	15.2	17.0	1.81
HT/VHT20, M8 to M15	4	13	9.2	8.5	9.2	9.5	0.1	15.2	17.0	1.81
HT/VHT20, M16 to M23	4	13	9.2	8.5	9.2	9.5	0.1	15.2	17.0	1.81
HT/VHT20, M24 to M31	4	13	9.2	8.5	9.2	9.5	0.1	15.2	17.0	1.81
HT/VHT20 Beam Forming, M0 to M7	2	13	10.2	9.4			0.1	12.9	17.0	4.12
HT/VHT20 Beam Forming, M8 to M15	2	13	12.1	11.7			0.1	15.0	17.0	2.03
HT/VHT20 Beam Forming, M0 to M7	3	15	6.2	5.6	6.2		0.1	10.8	15.0	4.17
HT/VHT20 Beam Forming, M8 to M15	3	13	9.2	8.5	9.2		0.1	13.8	17.0	3.20
HT/VHT20 Beam Forming, M16 to M23	3	13	10.2	9.4	10.5		0.1	14.9	17.0	2.12
HT/VHT20 Beam Forming, M0 to M7	4	16	4.4	3.4	4.3	4.5	0.1	10.2	14.0	3.76
HT/VHT20 Beam Forming, M8 to M15	4	13	7.3	6.4	7.3	7.4	0.1	13.2	17.0	3.81
HT/VHT20 Beam Forming, M16 to M23	4	13	9.2	8.5	9.2	9.5	0.1	15.2	17.0	1.81
HT/VHT20 Beam Forming, M24 to M31	4	13	9.2	8.5	9.2	9.5	0.1	15.2	17.0	1.81
HT/VHT20 STBC, M0 to M7	2	13	12.1	11.7			0.1	15.0	17.0	2.03
HT/VHT20 STBC, M0 to M7	3	13	9.2	8.5	9.2		0.1	13.8	17.0	3.20
HT/VHT20 STBC, M0 to M7	4	13	7.3	6.4	7.3	7.4	0.1	13.2	17.0	3.81
HE20, M0 to M9 1ss	1	13	12.1				0.1	12.2	17.0	4.83
HE20, M0 to M9 1ss	2	13	12.1	12.4			0.1	15.3	17.0	1.67
HE20, M0 to M9 2ss	2	13	12.1	12.4			0.1	15.3	17.0	1.67
HE20, M0 to M9 1ss	3	13	10.2	9.7	10.7		0.1	15.1	17.0	1.94
HE20, M0 to M9 2ss	3	13	10.2	9.7	10.7		0.1	15.1	17.0	1.94
HE20, M0 to M9 3ss	3	13	10.2	9.7	10.7		0.1	15.1	17.0	1.94
HE20, M0 to M9 1ss	4	13	8.5	7.6	8.6	8.9	0.1	14.5	17.0	2.49
HE20, M0 to M9 2ss	4	13	8.5	7.6	8.6	8.9	0.1	14.5	17.0	2.49
HE20, M0 to M9 3ss	4	13	8.5	7.6	8.6	8.9	0.1	14.5	17.0	2.49
HE20, M0 to M9 4ss	4	13	8.5	7.6	8.6	8.9	0.1	14.5	17.0	2.49
HE20 Beam Forming, M0 to M9 1ss	2	13	10.2	9.7			0.1	13.0	17.0	3.97
HE20 Beam Forming, M0 to M9 2ss	2	13	12.1	12.4			0.1	15.3	17.0	1.67
HE20 Beam Forming, M0 to M9 1ss	3	15	6.4	5.7	6.3		0.1	11.0	15.0	4.02
HE20 Beam Forming, M0 to M9 2ss	3	13	9.5	8.7	9.4		0.1	14.1	17.0	2.95
HE20 Beam Forming, M0 to M9 3ss	3	13	10.2	9.7	10.7		0.1	15.1	17.0	1.94
HE20 Beam Forming, M0 to M9 1ss	4	16	4.6	3.6	4.5	4.8	0.1	10.5	14.0	3.52
HE20 Beam Forming, M0 to M9 2ss	4	13	7.5	6.7	7.4	7.7	0.1	13.4	17.0	3.57
HE20 Beam Forming, M0 to M9 3ss	4	13	8.5	7.6	8.6	8.9	0.1	14.5	17.0	2.49



	HE20 Beam Forming, M0 to M9 4ss	4	13	8.5	7.6	8.6	8.9	0.1	14.5	17.0	2.49
	HE20 STBC, M0 to M9 2ss	2	13	12.1	12.4			0.1	15.3	17.0	1.67
	HE20 STBC, M0 to M9 2ss	3	13	9.5	8.7	9.4		0.1	14.1	17.0	2.95
	HE20 STBC, M0 to M9 2ss	4	13	7.5	6.7	7.4	7.7	0.1	13.4	17.0	3.57
5570	Non HT160, 6 to 54 Mbps	1	13	5.2				0.0	5.2	17.0	11.75
	Non HT160, 6 to 54 Mbps	2	13	5.2	5.4			0.0	8.4	17.0	8.64
	Non HT160, 6 to 54 Mbps	3	13	5.2	5.4	5.4		0.0	10.2	17.0	6.85
	Non HT160, 6 to 54 Mbps	4	13	4.4	4.7	4.2	4.5	0.0	10.5	17.0	6.48
	VHT160, M0 to M9 1ss	1	13	6.2				0.4	6.6	17.0	10.39
	VHT160, M0 to M9 1ss	2	13	6.2	6.4			0.4	9.7	17.0	7.28
	VHT160, M0 to M9 2ss	2	13	6.2	6.4			0.4	9.7	17.0	7.28
	VHT160, M0 to M9 1ss	3	13	5.0	5.3	5.0		0.4	10.3	17.0	6.72
	VHT160, M0 to M9 2ss	3	13	5.0	5.3	5.0		0.4	10.3	17.0	6.72
	VHT160, M0 to M9 3ss	3	13	5.0	5.3	5.0		0.4	10.3	17.0	6.72
	VHT160, M0 to M9 1ss	4	13	5.0	5.3	5.0	5.3	0.4	11.6	17.0	5.42
	VHT160, M0 to M9 2ss	4	13	5.0	5.3	5.0	5.3	0.4	11.6	17.0	5.42
	VHT160, M0 to M9 3ss	4	13	5.0	5.3	5.0	5.3	0.4	11.6	17.0	5.42
	VHT160, M0 to M9 4ss	4	13	5.0	5.3	5.0	5.3	0.4	11.6	17.0	5.42
	VHT160 Beam Forming, M0 to M9 1ss	2	13	6.2	6.4			0.4	9.7	17.0	7.28
	VHT160 Beam Forming, M0 to M9 2ss	2	13	6.2	6.4			0.4	9.7	17.0	7.28
	VHT160 Beam Forming, M0 to M9 1ss	3	15	5.0	5.3	5.0		0.4	10.3	15.0	4.72
	VHT160 Beam Forming, M0 to M9 2ss	3	13	5.0	5.3	5.0		0.4	10.3	17.0	6.72
	VHT160 Beam Forming, M0 to M9 3ss	3	13	5.0	5.3	5.0		0.4	10.3	17.0	6.72
	VHT160 Beam Forming, M0 to M9 1ss	4	16	3.3	3.3	3.2	3.3	0.4	9.7	14.0	4.30
	VHT160 Beam Forming, M0 to M9 2ss	4	13	5.0	5.3	5.0	5.3	0.4	11.6	17.0	5.42
	VHT160 Beam Forming, M0 to M9 3ss	4	13	5.0	5.3	5.0	5.3	0.4	11.6	17.0	5.42
	VHT160 Beam Forming, M0 to M9 4ss	4	13	5.0	5.3	5.0	5.3	0.4	11.6	17.0	5.42
	VHT160 STBC, M0 to M9 1ss	2	13	6.2	6.4			0.4	9.7	17.0	7.28
	VHT160 STBC, M0 to M9 1ss	3	13	5.0	5.3	5.0		0.4	10.3	17.0	6.72
	VHT160 STBC, M0 to M9 1ss	4	13	5.0	5.3	5.0	5.3	0.4	11.6	17.0	5.42
	HE160, M0 to M9 1ss	1	13	7.4				0.4	7.8	17.0	9.17
	HE160, M0 to M9 1ss	2	13	7.4	7.8			0.4	11.0	17.0	5.95
	HE160, M0 to M9 2ss	2	13	7.4	7.8			0.4	11.0	17.0	5.95
	HE160, M0 to M9 1ss	3	13	7.4	7.8	7.5		0.4	12.8	17.0	4.22
	HE160, M0 to M9 2ss	3	13	7.4	7.8	7.5		0.4	12.8	17.0	4.22
	HE160, M0 to M9 3ss	3	13	7.4	7.8	7.5		0.4	12.8	17.0	4.22
	HE160, M0 to M9 1ss	4	13	6.7	6.7	6.6	6.7	0.4	13.1	17.0	3.87
	HE160, M0 to M9 2ss	4	13	6.7	6.7	6.6	6.7	0.4	13.1	17.0	3.87
HE160, M0 to M9 3ss	4	13	6.7	6.7	6.6	6.7	0.4	13.1	17.0	3.87	
HE160, M0 to M9 4ss	4	13	6.7	6.7	6.6	6.7	0.4	13.1	17.0	3.87	
HE160 Beam Forming, M0 to M9 1ss	2	13	7.4	7.8			0.4	11.0	17.0	5.95	
HE160 Beam Forming, M0 to M9 2ss	2	13	7.4	7.8			0.4	11.0	17.0	5.95	

	HE160 Beam Forming, M0 to M9 1ss	3	15	5.6	5.8	5.5		0.4	10.8	15.0	4.16
	HE160 Beam Forming, M0 to M9 2ss	3	13	7.4	7.8	7.5		0.4	12.8	17.0	4.22
	HE160 Beam Forming, M0 to M9 3ss	3	13	7.4	7.8	7.5		0.4	12.8	17.0	4.22
	HE160 Beam Forming, M0 to M9 1ss	4	16	3.5	3.5	3.4	3.6	0.4	10.0	14.0	4.04
	HE160 Beam Forming, M0 to M9 2ss	4	13	6.7	6.7	6.6	6.7	0.4	13.1	17.0	3.87
	HE160 Beam Forming, M0 to M9 3ss	4	13	6.7	6.7	6.6	6.7	0.4	13.1	17.0	3.87
	HE160 Beam Forming, M0 to M9 4ss	4	13	6.7	6.7	6.6	6.7	0.4	13.1	17.0	3.87
	HE160 STBC, M0 to M9 1ss	2	13	7.4	7.8			0.4	11.0	17.0	5.95
	HE160 STBC, M0 to M9 1ss	3	13	7.4	7.8	7.5		0.4	12.8	17.0	4.22
	HE160 STBC, M0 to M9 1ss	4	13	6.7	6.7	6.6	6.7	0.4	13.1	17.0	3.87
5610	Non HT80, 6 to 54 Mbps	1	13	11.9				0.1	12.0	17.0	5.05
	Non HT80, 6 to 54 Mbps	2	13	11.9	13.6			0.1	15.9	17.0	1.11
	Non HT80, 6 to 54 Mbps	3	13	11.1	11.5	11.7		0.1	16.3	17.0	0.74
	Non HT80, 6 to 54 Mbps	4	13	10.3	10.4	10.4	9.7	0.1	16.3	17.0	0.72
	VHT80, M0 to M9 1ss	1	13	11.9				0.2	12.1	17.0	4.88
	VHT80, M0 to M9 1ss	2	13	11.9	13.5			0.2	16.0	17.0	1.00
	VHT80, M0 to M9 2ss	2	13	11.9	13.5			0.2	16.0	17.0	1.00
	VHT80, M0 to M9 1ss	3	13	11.1	11.2	11.4		0.2	16.2	17.0	0.78
	VHT80, M0 to M9 2ss	3	13	11.1	11.2	11.4		0.2	16.2	17.0	0.78
	VHT80, M0 to M9 3ss	3	13	11.1	11.2	11.4		0.2	16.2	17.0	0.78
	VHT80, M0 to M9 1ss	4	13	10.0	10.3	10.2	9.6	0.2	16.3	17.0	0.73
	VHT80, M0 to M9 2ss	4	13	10.0	10.3	10.2	9.6	0.2	16.3	17.0	0.73
	VHT80, M0 to M9 3ss	4	13	10.0	10.3	10.2	9.6	0.2	16.3	17.0	0.73
	VHT80, M0 to M9 4ss	4	13	10.0	10.3	10.2	9.6	0.2	16.3	17.0	0.73
	VHT80 Beam Forming, M0 to M9 1ss	2	13	10.0	10.3			0.2	13.4	17.0	3.62
	VHT80 Beam Forming, M0 to M9 2ss	2	13	11.9	13.5			0.2	16.0	17.0	1.00
	VHT80 Beam Forming, M0 to M9 1ss	3	15	5.9	6.2	6.0		0.2	11.0	15.0	3.98
	VHT80 Beam Forming, M0 to M9 2ss	3	13	9.2	9.3	9.3		0.2	14.3	17.0	2.75
	VHT80 Beam Forming, M0 to M9 3ss	3	13	11.1	11.2	11.4		0.2	16.2	17.0	0.78
	VHT80 Beam Forming, M0 to M9 1ss	4	16	4.1	4.0	4.0	3.5	0.2	10.1	14.0	3.86
	VHT80 Beam Forming, M0 to M9 2ss	4	13	7.1	7.2	7.3	6.5	0.2	13.3	17.0	3.73
	VHT80 Beam Forming, M0 to M9 3ss	4	13	9.2	9.3	9.3	8.7	0.2	15.4	17.0	1.63
	VHT80 Beam Forming, M0 to M9 4ss	4	13	10.0	10.3	10.2	9.6	0.2	16.3	17.0	0.73
	VHT80 STBC, M0 to M9 1ss	2	13	11.9	13.5			0.2	16.0	17.0	1.00
	VHT80 STBC, M0 to M9 1ss	3	13	9.2	9.3	9.3		0.2	14.3	17.0	2.75
	VHT80 STBC, M0 to M9 1ss	4	13	7.1	7.2	7.3	6.5	0.2	13.3	17.0	3.73
	HE80, M0 to M9 1ss	1	13	12.3				0.3	12.6	17.0	4.45
	HE80, M0 to M9 1ss	2	13	12.3	13.6			0.3	16.3	17.0	0.74
	HE80, M0 to M9 2ss	2	13	12.3	13.6			0.3	16.3	17.0	0.74
	HE80, M0 to M9 1ss	3	13	11.2	11.6	11.4		0.3	16.4	17.0	0.58
	HE80, M0 to M9 2ss	3	13	11.2	11.6	11.4		0.3	16.4	17.0	0.58
	HE80, M0 to M9 3ss	3	13	11.2	11.6	11.4		0.3	16.4	17.0	0.58

	<b>HE80, M0 to M9 1ss</b>	<b>4</b>	<b>13</b>	<b>10.4</b>	<b>10.7</b>	<b>10.5</b>	<b>9.8</b>	<b>0.3</b>	<b>16.6</b>	<b>17.0</b>	<b>0.37</b>
	HE80, M0 to M9 2ss	4	13	10.4	10.7	10.5	9.8	0.3	16.6	17.0	0.37
	HE80, M0 to M9 3ss	4	13	10.4	10.7	10.5	9.8	0.3	16.6	17.0	0.37
	HE80, M0 to M9 4ss	4	13	10.4	10.7	10.5	9.8	0.3	16.6	17.0	0.37
	HE80 Beam Forming, M0 to M9 1ss	2	13	10.4	10.7			0.3	13.8	17.0	3.19
	HE80 Beam Forming, M0 to M9 2ss	2	13	12.3	13.6			0.3	16.3	17.0	0.74
	HE80 Beam Forming, M0 to M9 1ss	3	15	6.2	6.4	6.3		0.3	11.3	15.0	3.68
	HE80 Beam Forming, M0 to M9 2ss	3	13	9.3	9.4	9.6		0.3	14.5	17.0	2.54
	HE80 Beam Forming, M0 to M9 3ss	3	13	11.2	11.6	11.4		0.3	16.4	17.0	0.58
	HE80 Beam Forming, M0 to M9 1ss	4	16	4.4	4.3	4.4	3.9	0.3	10.5	14.0	3.47
	HE80 Beam Forming, M0 to M9 2ss	4	13	7.3	7.5	7.5	6.9	0.3	13.6	17.0	3.42
	HE80 Beam Forming, M0 to M9 3ss	4	13	9.3	9.4	9.6	8.9	0.3	15.6	17.0	1.42
	HE80 Beam Forming, M0 to M9 4ss	4	13	10.4	10.7	10.5	9.8	0.3	16.6	17.0	0.37
	HE80 STBC, M0 to M9 1ss	2	13	12.3	13.6			0.3	16.3	17.0	0.74
	HE80 STBC, M0 to M9 1ss	3	13	9.3	9.4	9.6		0.3	14.5	17.0	2.54
	HE80 STBC, M0 to M9 1ss	4	13	7.3	7.5	7.5	6.9	0.3	13.6	17.0	3.42
5690	Non HT80, 6 to 54 Mbps	1	13	11.1				0.1	11.2	17.0	5.85
	Non HT80, 6 to 54 Mbps	2	13	11.1	10.7			0.1	14.0	17.0	3.03
	Non HT80, 6 to 54 Mbps	3	13	11.1	10.7	11.0		0.1	15.8	17.0	1.24
	Non HT80, 6 to 54 Mbps	4	13	10.3	9.8	9.8	9.9	0.1	16.0	17.0	0.97
	VHT80, M0 to M9 1ss	1	13	12.0				0.2	12.2	17.0	4.78
	VHT80, M0 to M9 1ss	2	13	12.0	12.8			0.2	15.6	17.0	1.36
	VHT80, M0 to M9 2ss	2	13	12.0	12.8			0.2	15.6	17.0	1.36
	VHT80, M0 to M9 1ss	3	13	11.1	10.7	10.7		0.2	15.8	17.0	1.18
	VHT80, M0 to M9 2ss	3	13	11.1	10.7	10.7		0.2	15.8	17.0	1.18
	VHT80, M0 to M9 3ss	3	13	11.1	10.7	10.7		0.2	15.8	17.0	1.18
	VHT80, M0 to M9 1ss	4	13	10.4	9.8	9.6	9.6	0.2	16.1	17.0	0.90
	VHT80, M0 to M9 2ss	4	13	10.4	9.8	9.6	9.6	0.2	16.1	17.0	0.90
	VHT80, M0 to M9 3ss	4	13	10.4	9.8	9.6	9.6	0.2	16.1	17.0	0.90
	VHT80, M0 to M9 4ss	4	13	10.4	9.8	9.6	9.6	0.2	16.1	17.0	0.90
	VHT80 Beam Forming, M0 to M9 1ss	2	13	10.4	9.8			0.2	13.3	17.0	3.66
	VHT80 Beam Forming, M0 to M9 2ss	2	13	12.0	12.8			0.2	15.6	17.0	1.36
	VHT80 Beam Forming, M0 to M9 1ss	3	15	6.1	5.7	5.5		0.2	10.8	15.0	4.24
	VHT80 Beam Forming, M0 to M9 2ss	3	13	9.1	8.5	8.8		0.2	13.8	17.0	3.21
	VHT80 Beam Forming, M0 to M9 3ss	3	13	11.1	10.7	10.7		0.2	15.8	17.0	1.18
	VHT80 Beam Forming, M0 to M9 1ss	4	16	4.1	3.3	3.3	3.4	0.2	9.8	14.0	4.23
	VHT80 Beam Forming, M0 to M9 2ss	4	13	7.0	6.5	6.6	6.8	0.2	13.0	17.0	4.03
	VHT80 Beam Forming, M0 to M9 3ss	4	13	9.1	8.5	8.8	8.8	0.2	15.0	17.0	1.96
	VHT80 Beam Forming, M0 to M9 4ss	4	13	10.4	9.8	9.6	9.6	0.2	16.1	17.0	0.90
VHT80 STBC, M0 to M9 1ss	2	13	12.0	12.8			0.2	15.6	17.0	1.36	
VHT80 STBC, M0 to M9 1ss	3	13	9.1	8.5	8.8		0.2	13.8	17.0	3.21	
VHT80 STBC, M0 to M9 1ss	4	13	7.0	6.5	6.6	6.8	0.2	13.0	17.0	4.03	

	HE80, M0 to M9 1ss	1	13	12.3				0.3	12.6	17.0	4.45
	HE80, M0 to M9 1ss	2	13	12.3	13.0			0.3	15.9	17.0	1.08
	HE80, M0 to M9 2ss	2	13	12.3	13.0			0.3	15.9	17.0	1.08
	HE80, M0 to M9 1ss	3	13	11.3	10.7	11.0		0.3	16.0	17.0	0.97
	HE80, M0 to M9 2ss	3	13	11.3	10.7	11.0		0.3	16.0	17.0	0.97
	HE80, M0 to M9 3ss	3	13	11.3	10.7	11.0		0.3	16.0	17.0	0.97
	HE80, M0 to M9 1ss	4	13	10.5	10.0	9.9	10.0	0.3	16.4	17.0	0.62
	HE80, M0 to M9 2ss	4	13	10.5	10.0	9.9	10.0	0.3	16.4	17.0	0.62
	HE80, M0 to M9 3ss	4	13	10.5	10.0	9.9	10.0	0.3	16.4	17.0	0.62
	HE80, M0 to M9 4ss	4	13	10.5	10.0	9.9	10.0	0.3	16.4	17.0	0.62
	HE80 Beam Forming, M0 to M9 1ss	2	13	10.5	10.0			0.3	13.5	17.0	3.48
	HE80 Beam Forming, M0 to M9 2ss	2	13	12.3	13.0			0.3	15.9	17.0	1.08
	HE80 Beam Forming, M0 to M9 1ss	3	15	6.3	5.9	5.8		0.3	11.0	15.0	3.97
	HE80 Beam Forming, M0 to M9 2ss	3	13	9.3	8.8	9.0		0.3	14.1	17.0	2.94
	HE80 Beam Forming, M0 to M9 3ss	3	13	11.3	10.7	11.0		0.3	16.0	17.0	0.97
	HE80 Beam Forming, M0 to M9 1ss	4	16	4.5	3.6	3.8	3.8	0.3	10.2	14.0	3.79
	HE80 Beam Forming, M0 to M9 2ss	4	13	7.4	6.7	7.0	6.6	0.3	13.2	17.0	3.79
	HE80 Beam Forming, M0 to M9 3ss	4	13	9.3	8.8	9.0	8.9	0.3	15.3	17.0	1.73
	HE80 Beam Forming, M0 to M9 4ss	4	13	10.5	10.0	9.9	10.0	0.3	16.4	17.0	0.62
	HE80 STBC, M0 to M9 1ss	2	13	12.3	13.0			0.3	15.9	17.0	1.08
	HE80 STBC, M0 to M9 1ss	3	13	9.3	8.8	9.0		0.3	14.1	17.0	2.94
	HE80 STBC, M0 to M9 1ss	4	13	7.4	6.7	7.0	6.6	0.3	13.2	17.0	3.79

5700	Non HT20, 6 to 54 Mbps	1	13	10.6				0.1	10.7	17.0	6.35
	Non HT20, 6 to 54 Mbps	2	13	10.6	9.5			0.1	13.1	17.0	3.85
	Non HT20, 6 to 54 Mbps	3	13	9.6	8.6	8.8		0.1	13.8	17.0	3.16
	Non HT20, 6 to 54 Mbps	4	13	8.6	7.6	7.7	7.9	0.1	14.0	17.0	2.96
	Non HT20 Beam Forming, 6 to 54 Mbps	2	13	10.6	9.5			0.1	13.1	17.0	3.85
	Non HT20 Beam Forming, 6 to 54 Mbps	3	15	6.7	5.8	5.7		0.1	10.9	15.0	4.09
	Non HT20 Beam Forming, 6 to 54 Mbps	4	16	4.6	3.7	3.8	3.9	0.1	10.1	14.0	3.91
	HT/VHT20, M0 to M7	1	13	9.6				0.1	9.7	17.0	7.35
	HT/VHT20, M0 to M7	2	13	9.6	8.7			0.1	12.2	17.0	4.76
	HT/VHT20, M8 to M15	2	13	9.6	8.7			0.1	12.2	17.0	4.76
	HT/VHT20, M0 to M7	3	13	9.6	8.7	8.7		0.1	13.8	17.0	3.16
	HT/VHT20, M8 to M15	3	13	9.6	8.7	8.7		0.1	13.8	17.0	3.16
	HT/VHT20, M16 to M23	3	13	9.6	8.7	8.7		0.1	13.8	17.0	3.16
	HT/VHT20, M0 to M7	4	13	9.6	8.7	8.7	8.7	0.1	15.0	17.0	1.98
	HT/VHT20, M8 to M15	4	13	9.6	8.7	8.7	8.7	0.1	15.0	17.0	1.98
	HT/VHT20, M16 to M23	4	13	9.6	8.7	8.7	8.7	0.1	15.0	17.0	1.98
	HT/VHT20, M24 to M31	4	13	9.6	8.7	8.7	8.7	0.1	15.0	17.0	1.98
	HT/VHT20 Beam Forming, M0 to M7	2	13	9.6	8.7			0.1	12.2	17.0	4.76
	HT/VHT20 Beam Forming, M8 to M15	2	13	9.6	8.7			0.1	12.2	17.0	4.76
	HT/VHT20 Beam Forming, M0 to M7	3	15	6.7	5.7	5.6		0.1	10.9	15.0	4.15

	HT/VHT20 Beam Forming, M8 to M15	3	13	9.6	8.7	8.7		0.1	13.8	17.0	3.16
	HT/VHT20 Beam Forming, M16 to M23	3	13	9.6	8.7	8.7		0.1	13.8	17.0	3.16
	HT/VHT20 Beam Forming, M0 to M7	4	16	4.7	3.7	3.6	3.7	0.1	10.0	14.0	3.98
	HT/VHT20 Beam Forming, M8 to M15	4	13	7.6	6.6	6.7	7.0	0.1	13.1	17.0	3.93
	HT/VHT20 Beam Forming, M16 to M23	4	13	9.6	8.7	8.7	8.7	0.1	15.0	17.0	1.98
	HT/VHT20 Beam Forming, M24 to M31	4	13	9.6	8.7	8.7	8.7	0.1	15.0	17.0	1.98
	HT/VHT20 STBC, M0 to M7	2	13	9.6	8.7			0.1	12.2	17.0	4.76
	HT/VHT20 STBC, M0 to M7	3	13	9.6	8.7	8.7		0.1	13.8	17.0	3.16
	HT/VHT20 STBC, M0 to M7	4	13	7.6	6.6	6.7	7.0	0.1	13.1	17.0	3.93
	HE20, M0 to M9 1ss	1	13	8.9				0.1	9.0	17.0	8.03
	HE20, M0 to M9 1ss	2	13	8.9	7.8			0.1	11.5	17.0	5.54
	HE20, M0 to M9 2ss	2	13	8.9	7.8			0.1	11.5	17.0	5.54
	HE20, M0 to M9 1ss	3	13	8.9	7.8	7.9		0.1	13.1	17.0	3.93
	HE20, M0 to M9 2ss	3	13	8.9	7.8	7.9		0.1	13.1	17.0	3.93
	HE20, M0 to M9 3ss	3	13	8.9	7.8	7.9		0.1	13.1	17.0	3.93
	HE20, M0 to M9 1ss	4	13	8.9	7.8	7.9	8.2	0.1	14.3	17.0	2.69
	HE20, M0 to M9 2ss	4	13	8.9	7.8	7.9	8.2	0.1	14.3	17.0	2.69
	HE20, M0 to M9 3ss	4	13	8.9	7.8	7.9	8.2	0.1	14.3	17.0	2.69
	HE20, M0 to M9 4ss	4	13	8.9	7.8	7.9	8.2	0.1	14.3	17.0	2.69
	HE20 Beam Forming, M0 to M9 1ss	2	13	8.9	7.8			0.1	11.5	17.0	5.54
	HE20 Beam Forming, M0 to M9 2ss	2	13	8.9	7.8			0.1	11.5	17.0	5.54
	HE20 Beam Forming, M0 to M9 1ss	3	15	7.0	6.0	5.9		0.1	11.2	15.0	3.83
	HE20 Beam Forming, M0 to M9 2ss	3	13	8.9	7.8	7.9		0.1	13.1	17.0	3.93
	HE20 Beam Forming, M0 to M9 3ss	3	13	8.9	7.8	7.9		0.1	13.1	17.0	3.93
	HE20 Beam Forming, M0 to M9 1ss	4	16	5.0	4.0	3.9	4.1	0.1	10.4	14.0	3.64
	HE20 Beam Forming, M0 to M9 2ss	4	13	8.0	6.9	7.0	7.3	0.1	13.4	17.0	3.59
	HE20 Beam Forming, M0 to M9 3ss	4	13	8.9	7.8	7.9	8.2	0.1	14.3	17.0	2.69
	HE20 Beam Forming, M0 to M9 4ss	4	13	8.9	7.8	7.9	8.2	0.1	14.3	17.0	2.69
	HE20 STBC, M0 to M9 2ss	2	13	8.9	7.8			0.1	11.5	17.0	5.54
	HE20 STBC, M0 to M9 2ss	3	13	8.9	7.8	7.9		0.1	13.1	17.0	3.93
	HE20 STBC, M0 to M9 2ss	4	13	8.0	6.9	7.0	7.3	0.1	13.4	17.0	3.59
5710	Non HT40, 6 to 54 Mbps	1	13	12.3				0.0	12.3	17.0	4.65
	Non HT40, 6 to 54 Mbps	2	13	12.3	12.9			0.0	15.7	17.0	1.33
	Non HT40, 6 to 54 Mbps	3	13	11.3	10.8	11.1		0.0	15.9	17.0	1.11
	Non HT40, 6 to 54 Mbps	4	13	10.6	9.5	10.3	10.3	0.0	16.3	17.0	0.74
	HT/VHT40, M0 to M7	1	13	12.3				0.1	12.4	17.0	4.59
	HT/VHT40, M0 to M7	2	13	12.3	12.7			0.1	15.6	17.0	1.38
	HT/VHT40, M8 to M15	2	13	12.3	12.7			0.1	15.6	17.0	1.38
	HT/VHT40, M0 to M7	3	13	11.2	10.6	10.9		0.1	15.8	17.0	1.21
	HT/VHT40, M8 to M15	3	13	11.2	10.6	10.9		0.1	15.8	17.0	1.21
	HT/VHT40, M16 to M23	3	13	11.2	10.6	10.9		0.1	15.8	17.0	1.21
	HT/VHT40, M0 to M7	4	13	10.6	9.4	10.2	10.0	0.1	16.2	17.0	0.80

	HT/VHT40, M8 to M15	4	13	10.6	9.4	10.2	10.0	0.1	16.2	17.0	0.80
	HT/VHT40, M16 to M23	4	13	10.6	9.4	10.2	10.0	0.1	16.2	17.0	0.80
	HT/VHT40, M24 to M31	4	13	10.6	9.4	10.2	10.0	0.1	16.2	17.0	0.80
	HT/VHT40 Beam Forming, M0 to M7	2	13	10.6	9.4			0.1	13.2	17.0	3.84
	HT/VHT40 Beam Forming, M8 to M15	2	13	12.3	12.7			0.1	15.6	17.0	1.38
	HT/VHT40 Beam Forming, M0 to M7	3	15	6.7	5.6	6.1		0.1	11.0	15.0	3.96
	HT/VHT40 Beam Forming, M8 to M15	3	13	9.3	8.7	9.0		0.1	13.9	17.0	3.11
	HT/VHT40 Beam Forming, M16 to M23	3	13	11.2	10.6	10.9		0.1	15.8	17.0	1.21
	HT/VHT40 Beam Forming, M0 to M7	4	16	4.8	3.7	4.0	4.2	0.1	10.3	14.0	3.68
	HT/VHT40 Beam Forming, M8 to M15	4	13	7.5	6.6	6.9	7.0	0.1	13.1	17.0	3.86
	HT/VHT40 Beam Forming, M16 to M23	4	13	9.3	8.7	9.0	9.2	0.1	15.2	17.0	1.81
	HT/VHT40 Beam Forming, M24 to M31	4	13	10.6	9.4	10.2	10.0	0.1	16.2	17.0	0.80
	HT/VHT40 STBC, M0 to M7	2	13	12.3	12.7			0.1	15.6	17.0	1.38
	HT/VHT40 STBC, M0 to M7	3	13	9.3	8.7	9.0		0.1	13.9	17.0	3.11
	HT/VHT40 STBC, M0 to M7	4	13	7.5	6.6	6.9	7.0	0.1	13.1	17.0	3.86
	HE40, M0 to M9 1ss	1	13	12.5				0.1	12.6	17.0	4.37
	HE40, M0 to M9 1ss	2	13	12.5	13.2			0.1	16.0	17.0	0.99
	HE40, M0 to M9 2ss	2	13	12.5	13.2			0.1	16.0	17.0	0.99
	HE40, M0 to M9 1ss	3	13	11.6	10.8	11.5		0.1	16.2	17.0	0.78
	HE40, M0 to M9 2ss	3	13	11.6	10.8	11.5		0.1	16.2	17.0	0.78
	HE40, M0 to M9 3ss	3	13	11.6	10.8	11.5		0.1	16.2	17.0	0.78
	HE40, M0 to M9 1ss	4	13	10.8	9.7	10.6	10.2	0.1	16.5	17.0	0.50
	HE40, M0 to M9 2ss	4	13	10.8	9.7	10.6	10.2	0.1	16.5	17.0	0.50
	HE40, M0 to M9 3ss	4	13	10.8	9.7	10.6	10.2	0.1	16.5	17.0	0.50
	HE40, M0 to M9 4ss	4	13	10.8	9.7	10.6	10.2	0.1	16.5	17.0	0.50
	HE40 Beam Forming, M0 to M9 1ss	2	13	10.8	9.7			0.1	13.4	17.0	3.57
	HE40 Beam Forming, M0 to M9 2ss	2	13	12.5	13.2			0.1	16.0	17.0	0.99
	HE40 Beam Forming, M0 to M9 1ss	3	15	6.9	5.9	6.3		0.1	11.3	15.0	3.71
	HE40 Beam Forming, M0 to M9 2ss	3	13	9.5	9.0	9.3		0.1	14.2	17.0	2.82
	HE40 Beam Forming, M0 to M9 3ss	3	13	11.6	10.8	11.5		0.1	16.2	17.0	0.78
	HE40 Beam Forming, M0 to M9 1ss	4	16	5.1	3.9	4.3	4.3	0.1	10.6	14.0	3.42
	HE40 Beam Forming, M0 to M9 2ss	4	13	7.7	6.8	7.1	7.4	0.1	13.4	17.0	3.58
	HE40 Beam Forming, M0 to M9 3ss	4	13	9.5	9.0	9.3	9.4	0.1	15.5	17.0	1.54
	HE40 Beam Forming, M0 to M9 4ss	4	13	10.8	9.7	10.6	10.2	0.1	16.5	17.0	0.50
	HE40 STBC, M0 to M9 2ss	2	13	12.5	13.2			0.1	16.0	17.0	0.99
	HE40 STBC, M0 to M9 2ss	3	13	9.5	9.0	9.3		0.1	14.2	17.0	2.82
	HE40 STBC, M0 to M9 2ss	4	13	7.7	6.8	7.1	7.4	0.1	13.4	17.0	3.58
5720	Non HT20, 6 to 54 Mbps	1	13	11.7				0.1	11.8	17.0	5.25
	Non HT20, 6 to 54 Mbps	2	13	10.8	9.7			0.1	13.3	17.0	3.65
	Non HT20, 6 to 54 Mbps	3	13	8.8	7.6	7.6		0.1	12.9	17.0	4.14
	Non HT20, 6 to 54 Mbps	4	13	7.9	6.6	6.7	6.8	0.1	13.1	17.0	3.90
	Non HT20 Beam Forming, 6 to 54 Mbps	2	13	9.8	8.5			0.1	12.3	17.0	4.74

Non HT20 Beam Forming, 6 to 54 Mbps	3	15	6.1	4.8	4.6		0.1	10.0	15.0	4.96
Non HT20 Beam Forming, 6 to 54 Mbps	4	16	3.9	2.8	2.6	2.7	0.1	9.1	14.0	4.90
HT/VHT20, M0 to M7	1	13	11.5				0.1	11.6	17.0	5.45
HT/VHT20, M0 to M7	2	13	10.6	9.5			0.1	13.1	17.0	3.85
HT/VHT20, M8 to M15	2	13	10.6	9.5			0.1	13.1	17.0	3.85
HT/VHT20, M0 to M7	3	13	9.8	8.5	8.7		0.1	13.9	17.0	3.14
HT/VHT20, M8 to M15	3	13	9.8	8.5	8.7		0.1	13.9	17.0	3.14
HT/VHT20, M16 to M23	3	13	9.8	8.5	8.7		0.1	13.9	17.0	3.14
HT/VHT20, M0 to M7	4	13	8.8	7.6	7.5	7.6	0.1	14.0	17.0	3.02
HT/VHT20, M8 to M15	4	13	8.8	7.6	7.5	7.6	0.1	14.0	17.0	3.02
HT/VHT20, M16 to M23	4	13	8.8	7.6	7.5	7.6	0.1	14.0	17.0	3.02
HT/VHT20, M24 to M31	4	13	8.8	7.6	7.5	7.6	0.1	14.0	17.0	3.02
HT/VHT20 Beam Forming, M0 to M7	2	13	9.8	8.5			0.1	12.3	17.0	4.74
HT/VHT20 Beam Forming, M8 to M15	2	13	10.6	9.5			0.1	13.1	17.0	3.85
HT/VHT20 Beam Forming, M0 to M7	3	15	5.8	4.7	4.4		0.1	9.8	15.0	5.17
HT/VHT20 Beam Forming, M8 to M15	3	13	8.8	7.6	7.5		0.1	12.8	17.0	4.17
HT/VHT20 Beam Forming, M16 to M23	3	13	9.8	8.5	8.7		0.1	13.9	17.0	3.14
HT/VHT20 Beam Forming, M0 to M7	4	16	3.8	2.7	2.5	2.7	0.1	9.0	14.0	4.97
HT/VHT20 Beam Forming, M8 to M15	4	13	6.8	5.6	5.6	5.6	0.1	12.0	17.0	4.99
HT/VHT20 Beam Forming, M16 to M23	4	13	8.8	7.6	7.5	7.6	0.1	14.0	17.0	3.02
HT/VHT20 Beam Forming, M24 to M31	4	13	8.8	7.6	7.5	7.6	0.1	14.0	17.0	3.02
HT/VHT20 STBC, M0 to M7	2	13	10.6	9.5			0.1	13.1	17.0	3.85
HT/VHT20 STBC, M0 to M7	3	13	8.8	7.6	7.5		0.1	12.8	17.0	4.17
HT/VHT20 STBC, M0 to M7	4	13	6.8	5.6	5.6	5.6	0.1	12.0	17.0	4.99
HE20, M0 to M9 1ss	1	13	11.6				0.1	11.7	17.0	5.33
HE20, M0 to M9 1ss	2	13	10.8	9.6			0.1	13.3	17.0	3.68
HE20, M0 to M9 2ss	2	13	10.8	9.6			0.1	13.3	17.0	3.68
HE20, M0 to M9 1ss	3	13	9.8	8.6	8.9		0.1	14.0	17.0	3.03
HE20, M0 to M9 2ss	3	13	9.8	8.6	8.9		0.1	14.0	17.0	3.03
HE20, M0 to M9 3ss	3	13	9.8	8.6	8.9		0.1	14.0	17.0	3.03
HE20, M0 to M9 1ss	4	13	8.9	7.8	7.7	7.7	0.1	14.1	17.0	2.86
HE20, M0 to M9 2ss	4	13	8.9	7.8	7.7	7.7	0.1	14.1	17.0	2.86
HE20, M0 to M9 3ss	4	13	8.9	7.8	7.7	7.7	0.1	14.1	17.0	2.86
HE20, M0 to M9 4ss	4	13	8.9	7.8	7.7	7.7	0.1	14.1	17.0	2.86
HE20 Beam Forming, M0 to M9 1ss	2	13	9.8	8.6			0.1	12.3	17.0	4.68
HE20 Beam Forming, M0 to M9 2ss	2	13	10.8	9.6			0.1	13.3	17.0	3.68
HE20 Beam Forming, M0 to M9 1ss	3	15	6.0	4.9	4.6		0.1	10.0	15.0	4.95
HE20 Beam Forming, M0 to M9 2ss	3	13	8.9	7.8	7.7		0.1	13.0	17.0	3.99
HE20 Beam Forming, M0 to M9 3ss	3	13	9.8	8.6	8.9		0.1	14.0	17.0	3.03
HE20 Beam Forming, M0 to M9 1ss	4	16	4.0	2.8	2.6	2.9	0.1	9.2	14.0	4.80
HE20 Beam Forming, M0 to M9 2ss	4	13	6.9	5.7	5.7	5.8	0.1	12.1	17.0	4.86
HE20 Beam Forming, M0 to M9 3ss	4	13	8.9	7.8	7.7	7.7	0.1	14.1	17.0	2.86
HE20 Beam Forming, M0 to M9 4ss	4	13	8.9	7.8	7.7	7.7	0.1	14.1	17.0	2.86



HE20 STBC, M0 to M9 2ss	2	13	10.8	9.6			0.1	13.3	17.0	3.68
HE20 STBC, M0 to M9 2ss	3	13	8.9	7.8	7.7		0.1	13.0	17.0	3.99
HE20 STBC, M0 to M9 2ss	4	13	6.9	5.7	5.7	5.8	0.1	12.1	17.0	4.86



**Maximum Transmit Output Power, 5610 MHz, HE80, M0 to M9 1ss**



**Antenna A**



**Antenna B**



**Antenna C**



**Antenna D**

## A.4 Power Spectral Density

### Power Spectral Density Test Requirement

**15.407 (2)** For the 5.25-5.35 GHz and 5.47-5.725 GHz bands, the maximum conducted output power over the frequency bands of operation shall not exceed the lesser of 250 mW or 11 dBm + 10 log B, where B is the 26 dB emission bandwidth in megahertz. In addition, the maximum power spectral density shall not exceed 11 dBm in any 1 megahertz band. If transmitting antennas of directional gain greater than 6 dBi are used, both the maximum conducted output power and the maximum power spectral density shall be reduced by the amount in dB that the directional gain of the antenna exceeds 6 dBi.

#### Band-Crossing Signals

When measuring the portion of the maximum conducted output power within a single U-NII band, the power shall be integrated across only the portion of the EBW that falls within that band. That is, if an EBW extends across the boundary between two adjacent bands, the boundary frequency between the bands serves as one edge of the frequency range to be integrated. Integration across an entire U-NII band without regard to 26 dB points is also acceptable for determining conducted output power within that band.

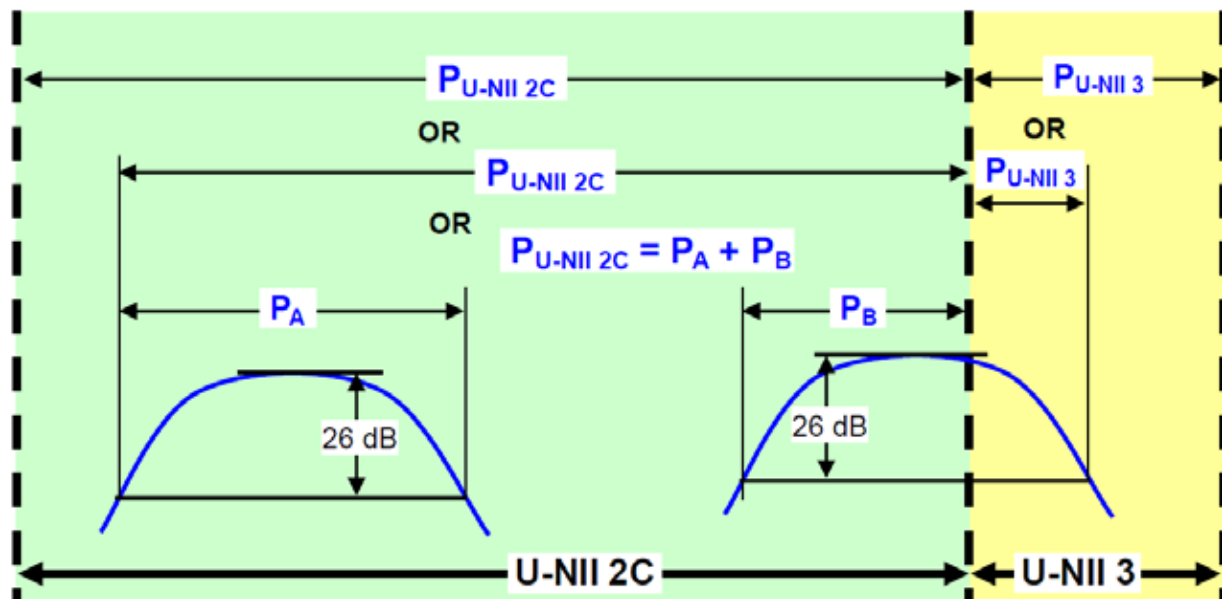

**Conducted output power within a U-NII band:** Integrate over the band or integrate over a span including the 26 dB EBWs of transmission segments within the band or integrate over 26 dB EBW of each transmission segment in the band and sum.

Figure 4. Conducted Output Power Measurement Examples

### Power Spectral Density Test Procedure

Ref. KDB 789033 D02 General UNII Test Procedures New Rules v02r01, F. Maximum Power Spectral Density  
ANSI C63.10: 2013 Peak Power Spectral Density 12.5, 12.3.2.4 Method SA-2

#### Power Spectral Density

##### Test Procedure

The rules requires “maximum power spectral density” measurements where the intent is to measure the maximum value of the time average of the power spectral density measured during a period of continuous transmission.

1. Create an average power spectrum for the EUT operating mode being tested by following the instructions in section II.E.2. for measuring maximum conducted output power using a spectrum analyzer or EMI receiver: select the

appropriate test method (SA-1, SA-2, SA-3, or alternatives to each) and apply it up to, but not including, the step labeled, “Compute power...”. (This procedure is required even if the maximum conducted output power measurement was performed using a power meter, method PM.)

2. Use the peak search function on the instrument to find the peak of the spectrum and record its value.
3. Make the following adjustments to the peak value of the spectrum, if applicable: a) If Method SA-2 or SA-2 Alternative was used, add  $10 \log(1/x)$ , where  $x$  is the duty cycle, to the peak of the spectrum.  
b) If Method SA-3 Alternative was used and the linear mode was used in step II.E.2.g)(viii), add 1 dB to the final result to compensate for the difference between linear averaging and power averaging.
4. The result is the Maximum PSD over 1 MHz reference bandwidth.

**Ref. KDB 789033 D02 General UNII Test Procedures New Rules v02r01, F. Maximum Power Spectral Density ANSI C63.10: 2013 Peak Power Spectral Density 12.5, 12.3.2.4 Method SA-2**

**Power Spectral Density**

Test parameters

Method SA-2 (trace averaging across on and off times of the EUT transmissions, followed by duty cycle correction).

- (i) Measure the duty cycle,  $x$ , of the transmitter output signal as described in section II.B.
- (ii) Set span to encompass the EBW (or, alternatively, the entire 99% occupied bandwidth) of the signal.
- (iii) Set RBW = 1 MHz.
- (iv) Set VBW  $\geq$  3 MHz.
- (v) Number of points in sweep  $\geq$  2 Span / RBW. (This ensures that bin-to-bin spacing is  $\leq$  RBW/2, so that narrowband signals are not lost between frequency bins.)
- (vi) Sweep time = auto.
- (vii) Detector = RMS (i.e., power averaging), if available. Otherwise, use sample detector mode.
- (viii) Do not use sweep triggering. Allow the sweep to “free run”.
- (ix) Trace average at least 100 traces in power averaging (i.e., RMS) mode; however, the number of traces to be averaged shall be increased above 100 as needed to ensure that the average accurately represents the true average over the on and off periods of the transmitter.
- (x) Compute power by integrating the spectrum across the EBW (or, alternatively, the entire 99% occupied bandwidth) of the signal using the instrument’s band power measurement function with band limits set equal to the EBW (or occupied bandwidth)

**F. Maximum Power Spectral Density (PSD)**

2. Use the peak search function on the instrument to find the peak of the spectrum and record its value.
3. Make the following adjustments to the peak value of the spectrum, if applicable: a) If Method SA-2 or SA-2 Alternative was used, add  $10 \log(1/x)$ , where  $x$  is the duty cycle, to the peak of the spectrum.

The “measure-and-sum technique” is used for measuring in-band transmit power of a device. In the measure-and-sum approach, the conducted emission level is measured at each antenna port. The measured results at the various antenna ports are then summed mathematically to determine the total emission level from the device. Summing is performed in linear power units. ANSI C63.10 section 14.3.2.2

**Samples, Systems, and Modes**

System Number	Description	Samples	System under test	Support equipment
1	EUT	S01+S02	<input checked="" type="checkbox"/>	<input type="checkbox"/>
	Support		<input type="checkbox"/>	<input checked="" type="checkbox"/>



<b>Tested By :</b> Chris Blair	<b>Date of testing:</b> 20-Aug-19 - 10-Sep-19
<b>Test Result : PASS</b>	

**Test Equipment**

See Appendix C for list of test equipment

**Power Spectral Density**



Frequency (MHz)	Mode	Tx Paths	Correlated Antenna Gain (dBi)	Tx 1 PSD (dBm/MHz)	Tx 2 PSD (dBm/MHz)	Tx 3 PSD (dBm/MHz)	Tx 4 PSD (dBm/MHz)	Duty Cycle Correction (dB)	Total PSD (dBm/MHz)	Limit (dBm/MHz) EIRP	Margin (dB)
5500	Non HT20, 6 to 54 Mbps	1	13	-0.7				0.1	-0.6	4.0	4.65
	Non HT20, 6 to 54 Mbps	2	13	-0.7	-1.3			0.1	2.1	4.0	1.93
	Non HT20, 6 to 54 Mbps	3	13	-1.8	-2.6	-0.9		0.1	3.1	4.0	0.89
	Non HT20, 6 to 54 Mbps	4	13	-2.7	-3.2	-2.3	-2.6	0.1	3.4	4.0	0.62
	Non HT20 Beam Forming, 6 to 54 Mbps	2	13	-1.8	-2.6			0.1	0.9	4.0	3.12
	Non HT20 Beam Forming, 6 to 54 Mbps	3	15	-5.8	-6.1	-5.3		0.1	-0.9	2.0	2.90
	Non HT20 Beam Forming, 6 to 54 Mbps	4	16	-7.7	-8.2	-7.6	-7.4	0.1	-1.6	1.0	2.64
	HT/VHT20, M0 to M7	1	13	-1.2				0.1	-1.1	4.0	5.15
	HT/VHT20, M0 to M7	2	13	-1.2	-1.4			0.1	1.8	4.0	2.24
	HT/VHT20, M8 to M15	2	13	-1.2	-1.4			0.1	1.8	4.0	2.24
	HT/VHT20, M0 to M7	3	13	-2.1	-2.7	-1.7		0.1	2.7	4.0	1.32
	HT/VHT20, M8 to M15	3	13	-2.1	-2.7	-1.7		0.1	2.7	4.0	1.32
	HT/VHT20, M16 to M23	3	13	-2.1	-2.7	-1.7		0.1	2.7	4.0	1.32
	<b>HT/VHT20, M0 to M7</b>	<b>4</b>	<b>13</b>	<b>-2.1</b>	<b>-2.7</b>	<b>-1.7</b>	<b>-2.0</b>	<b>0.1</b>	<b>4.0</b>	<b>4.0</b>	<b>0.04</b>
	HT/VHT20, M8 to M15	4	13	-2.1	-2.7	-1.7	-2.0	0.1	4.0	4.0	0.04
	HT/VHT20, M16 to M23	4	13	-2.1	-2.7	-1.7	-2.0	0.1	4.0	4.0	0.04
	HT/VHT20, M24 to M31	4	13	-2.1	-2.7	-1.7	-2.0	0.1	4.0	4.0	0.04
	HT/VHT20 Beam Forming, M0 to M7	2	13	-2.1	-2.7			0.1	0.7	4.0	3.33
	HT/VHT20 Beam Forming, M8 to M15	2	13	-1.2	-1.4			0.1	1.8	4.0	2.24
	HT/VHT20 Beam Forming, M0 to M7	3	15	-6.0	-6.1	-5.9		0.1	-1.2	2.0	3.18
	HT/VHT20 Beam Forming, M8 to M15	3	13	-3.1	-3.5	-2.8		0.1	1.7	4.0	2.30
	HT/VHT20 Beam Forming, M16 to M23	3	13	-2.1	-2.7	-1.7		0.1	2.7	4.0	1.32
	HT/VHT20 Beam Forming, M0 to M7	4	16	-7.8	-8.8	-7.7	-8.3	0.1	-2.1	1.0	3.06
	HT/VHT20 Beam Forming, M8 to M15	4	13	-4.8	-5.8	-4.8	-5.1	0.1	1.0	4.0	3.03
	HT/VHT20 Beam Forming, M16 to M23	4	13	-3.1	-3.5	-2.8	-3.0	0.1	3.0	4.0	1.02
	HT/VHT20 Beam Forming, M24 to M31	4	13	-2.1	-2.7	-1.7	-2.0	0.1	4.0	4.0	0.04
	HT/VHT20 STBC, M0 to M7	2	13	-1.2	-1.4			0.1	1.8	4.0	2.24
	HT/VHT20 STBC, M0 to M7	3	13	-3.1	-3.5	-2.8		0.1	1.7	4.0	2.30
	HT/VHT20 STBC, M0 to M7	4	13	-4.8	-5.8	-4.8	-5.1	0.1	1.0	4.0	3.03
	HE20, M0 to M9 1ss	1	13	-1.9				0.1	-1.8	4.0	5.83
	HE20, M0 to M9 1ss	2	13	-1.9	-2.5			0.1	0.9	4.0	3.11
	HE20, M0 to M9 2ss	2	13	-1.9	-2.5			0.1	0.9	4.0	3.11

	HE20, M0 to M9 1ss	3	13	-1.9	-2.5	-1.3		0.1	3.0	4.0	1.04
	HE20, M0 to M9 2ss	3	13	-1.9	-2.5	-1.3		0.1	3.0	4.0	1.04
	HE20, M0 to M9 3ss	3	13	-1.9	-2.5	-1.3		0.1	3.0	4.0	1.04
	HE20, M0 to M9 1ss	4	13	-2.5	-3.5	-2.7	-2.8	0.1	3.2	4.0	0.77
	HE20, M0 to M9 2ss	4	13	-2.5	-3.5	-2.7	-2.8	0.1	3.2	4.0	0.77
	HE20, M0 to M9 3ss	4	13	-2.5	-3.5	-2.7	-2.8	0.1	3.2	4.0	0.77
	HE20, M0 to M9 4ss	4	13	-2.5	-3.5	-2.7	-2.8	0.1	3.2	4.0	0.77
	HE20 Beam Forming, M0 to M9 1ss	2	13	-1.9	-2.5			0.1	0.9	4.0	3.11
	HE20 Beam Forming, M0 to M9 2ss	2	13	-1.9	-2.5			0.1	0.9	4.0	3.11
	HE20 Beam Forming, M0 to M9 1ss	3	15	-6.1	-6.7	-5.7		0.1	-1.3	2.0	3.31
	HE20 Beam Forming, M0 to M9 2ss	3	13	-2.5	-3.5	-2.7		0.1	2.0	4.0	2.04
	HE20 Beam Forming, M0 to M9 3ss	3	13	-1.9	-2.5	-1.3		0.1	3.0	4.0	1.04
	HE20 Beam Forming, M0 to M9 1ss	4	16	-7.7	-8.3	-7.7	-8.0	0.1	-1.8	1.0	2.83
	HE20 Beam Forming, M0 to M9 2ss	4	13	-5.1	-5.5	-4.5	-4.9	0.1	1.1	4.0	2.90
	HE20 Beam Forming, M0 to M9 3ss	4	13	-2.5	-3.5	-2.7	-2.8	0.1	3.2	4.0	0.77
	HE20 Beam Forming, M0 to M9 4ss	4	13	-2.5	-3.5	-2.7	-2.8	0.1	3.2	4.0	0.77
	HE20 STBC, M0 to M9 2ss	2	13	-1.9	-2.5			0.1	0.9	4.0	3.11
	HE20 STBC, M0 to M9 2ss	3	13	-2.5	-3.5	-2.7		0.1	2.0	4.0	2.04
	HE20 STBC, M0 to M9 2ss	4	13	-5.1	-5.5	-4.5	-4.9	0.1	1.1	4.0	2.90
5510	Non HT40, 6 to 54 Mbps	1	13	-6.6				0.0	-6.6	4.0	10.55
	Non HT40, 6 to 54 Mbps	2	13	-6.6	-6.8			0.0	-3.6	4.0	7.64
	Non HT40, 6 to 54 Mbps	3	13	-6.6	-6.8	-6.4		0.0	-1.8	4.0	5.78
	Non HT40, 6 to 54 Mbps	4	13	-7.5	-8.0	-7.6	-7.6	0.0	-1.6	4.0	5.60
	HT/VHT40, M0 to M7	1	13	-6.1				0.1	-6.0	4.0	9.99
	HT/VHT40, M0 to M7	2	13	-6.1	-6.2			0.1	-3.0	4.0	7.03
	HT/VHT40, M8 to M15	2	13	-6.1	-6.2			0.1	-3.0	4.0	7.03
	HT/VHT40, M0 to M7	3	13	-7.0	-7.4	-7.5		0.1	-2.4	4.0	6.41
	HT/VHT40, M8 to M15	3	13	-7.0	-7.4	-7.5		0.1	-2.4	4.0	6.41
	HT/VHT40, M16 to M23	3	13	-7.0	-7.4	-7.5		0.1	-2.4	4.0	6.41
	HT/VHT40, M0 to M7	4	13	-7.0	-7.4	-7.5	-6.7	0.1	-1.0	4.0	5.01
	HT/VHT40, M8 to M15	4	13	-7.0	-7.4	-7.5	-6.7	0.1	-1.0	4.0	5.01
	HT/VHT40, M16 to M23	4	13	-7.0	-7.4	-7.5	-6.7	0.1	-1.0	4.0	5.01
	HT/VHT40, M24 to M31	4	13	-7.0	-7.4	-7.5	-6.7	0.1	-1.0	4.0	5.01
	HT/VHT40 Beam Forming, M0 to M7	2	13	-6.1	-6.2			0.1	-3.0	4.0	7.03
	HT/VHT40 Beam Forming, M8 to M15	2	13	-6.1	-6.2			0.1	-3.0	4.0	7.03
	HT/VHT40 Beam Forming, M0 to M7	3	15	-8.5	-9.3	-9.3		0.1	-4.1	2.0	6.14
	HT/VHT40 Beam Forming, M8 to M15	3	13	-7.0	-7.4	-7.5		0.1	-2.4	4.0	6.41
	HT/VHT40 Beam Forming, M16 to M23	3	13	-7.0	-7.4	-7.5		0.1	-2.4	4.0	6.41
	HT/VHT40 Beam Forming, M0 to M7	4	16	-10.7	-10.9	-11.4	-10.7	0.1	-4.8	1.0	5.79
HT/VHT40 Beam Forming, M8 to M15	4	13	-8.0	-8.4	-8.4	-8.0	0.1	-2.1	4.0	6.06	
HT/VHT40 Beam Forming, M16 to M23	4	13	-7.0	-7.4	-7.5	-6.7	0.1	-1.0	4.0	5.01	
HT/VHT40 Beam Forming, M24 to M31	4	13	-7.0	-7.4	-7.5	-6.7	0.1	-1.0	4.0	5.01	

	HT/VHT40 STBC, M0 to M7	2	13	-6.1	-6.2			0.1	-3.0	4.0	7.03
	HT/VHT40 STBC, M0 to M7	3	13	-7.0	-7.4	-7.5		0.1	-2.4	4.0	6.41
	HT/VHT40 STBC, M0 to M7	4	13	-8.0	-8.4	-8.4	-8.0	0.1	-2.1	4.0	6.06
	HE40, M0 to M9 1ss	1	13	-6.2				0.1	-6.1	4.0	10.07
	HE40, M0 to M9 1ss	2	13	-6.2	-6.5			0.1	-3.2	4.0	7.20
	HE40, M0 to M9 2ss	2	13	-6.2	-6.5			0.1	-3.2	4.0	7.20
	HE40, M0 to M9 1ss	3	13	-6.2	-6.5	-6.6		0.1	-1.5	4.0	5.52
	HE40, M0 to M9 2ss	3	13	-6.2	-6.5	-6.6		0.1	-1.5	4.0	5.52
	HE40, M0 to M9 3ss	3	13	-6.2	-6.5	-6.6		0.1	-1.5	4.0	5.52
	HE40, M0 to M9 1ss	4	13	-7.4	-7.7	-7.5	-7.3	0.1	-1.3	4.0	5.32
	HE40, M0 to M9 2ss	4	13	-7.4	-7.7	-7.5	-7.3	0.1	-1.3	4.0	5.32
	HE40, M0 to M9 3ss	4	13	-7.4	-7.7	-7.5	-7.3	0.1	-1.3	4.0	5.32
	HE40, M0 to M9 4ss	4	13	-7.4	-7.7	-7.5	-7.3	0.1	-1.3	4.0	5.32
	HE40 Beam Forming, M0 to M9 1ss	2	13	-6.2	-6.5			0.1	-3.2	4.0	7.20
	HE40 Beam Forming, M0 to M9 2ss	2	13	-6.2	-6.5			0.1	-3.2	4.0	7.20
	HE40 Beam Forming, M0 to M9 1ss	3	15	-8.3	-8.4	-9.3		0.1	-3.7	2.0	5.74
	HE40 Beam Forming, M0 to M9 2ss	3	13	-6.2	-6.5	-6.6		0.1	-1.5	4.0	5.52
	HE40 Beam Forming, M0 to M9 3ss	3	13	-6.2	-6.5	-6.6		0.1	-1.5	4.0	5.52
	HE40 Beam Forming, M0 to M9 1ss	4	16	-10.5	-11.0	-11.5	-10.9	0.1	-4.8	1.0	5.80
	HE40 Beam Forming, M0 to M9 2ss	4	13	-7.4	-7.7	-7.5	-7.3	0.1	-1.3	4.0	5.32
	HE40 Beam Forming, M0 to M9 3ss	4	13	-7.4	-7.7	-7.5	-7.3	0.1	-1.3	4.0	5.32
	HE40 Beam Forming, M0 to M9 4ss	4	13	-7.4	-7.7	-7.5	-7.3	0.1	-1.3	4.0	5.32
	HE40 STBC, M0 to M9 2ss	2	13	-6.2	-6.5			0.1	-3.2	4.0	7.20
	HE40 STBC, M0 to M9 2ss	3	13	-6.2	-6.5	-6.6		0.1	-1.5	4.0	5.52
	HE40 STBC, M0 to M9 2ss	4	13	-7.4	-7.7	-7.5	-7.3	0.1	-1.3	4.0	5.32
5530	Non HT80, 6 to 54 Mbps	1	13	-9.8				0.1	-9.7	4.0	13.75
	Non HT80, 6 to 54 Mbps	2	13	-9.8	-9.7			0.1	-6.7	4.0	10.69
	Non HT80, 6 to 54 Mbps	3	13	-9.8	-9.7	-10.1		0.1	-5.0	4.0	9.04
	Non HT80, 6 to 54 Mbps	4	13	-10.8	-10.2	-10.9	-11.2	0.1	-4.7	4.0	8.69
	VHT80, M0 to M9 1ss	1	13	-9.3				0.2	-9.1	4.0	13.08
	VHT80, M0 to M9 1ss	2	13	-9.3	-9.1			0.2	-6.0	4.0	9.97
	VHT80, M0 to M9 2ss	2	13	-9.3	-9.1			0.2	-6.0	4.0	9.97
	VHT80, M0 to M9 1ss	3	13	-10.7	-10.2	-10.9		0.2	-5.6	4.0	9.60
	VHT80, M0 to M9 2ss	3	13	-10.7	-10.2	-10.9		0.2	-5.6	4.0	9.60
	VHT80, M0 to M9 3ss	3	13	-10.7	-10.2	-10.9		0.2	-5.6	4.0	9.60
	VHT80, M0 to M9 1ss	4	13	-10.7	-10.2	-10.9	-10.9	0.2	-4.4	4.0	8.43
	VHT80, M0 to M9 2ss	4	13	-10.7	-10.2	-10.9	-10.9	0.2	-4.4	4.0	8.43
	VHT80, M0 to M9 3ss	4	13	-10.7	-10.2	-10.9	-10.9	0.2	-4.4	4.0	8.43
	VHT80, M0 to M9 4ss	4	13	-10.7	-10.2	-10.9	-10.9	0.2	-4.4	4.0	8.43
	VHT80 Beam Forming, M0 to M9 1ss	2	13	-9.3	-9.1			0.2	-6.0	4.0	9.97
	VHT80 Beam Forming, M0 to M9 2ss	2	13	-9.3	-9.1			0.2	-6.0	4.0	9.97
	VHT80 Beam Forming, M0 to M9 1ss	3	15	-11.5	-10.8	-12.0		0.2	-6.4	2.0	8.42

VHT80 Beam Forming, M0 to M9 2ss	3	13	-10.7	-10.2	-10.9		0.2	-5.6	4.0	9.60	
VHT80 Beam Forming, M0 to M9 3ss	3	13	-10.7	-10.2	-10.9		0.2	-5.6	4.0	9.60	
VHT80 Beam Forming, M0 to M9 1ss	4	16	-13.2	-13.3	-14.3	-13.7	0.2	-7.4	1.0	8.37	
VHT80 Beam Forming, M0 to M9 2ss	4	13	-10.7	-10.2	-10.9	-10.9	0.2	-4.4	4.0	8.43	
VHT80 Beam Forming, M0 to M9 3ss	4	13	-10.7	-10.2	-10.9	-10.9	0.2	-4.4	4.0	8.43	
VHT80 Beam Forming, M0 to M9 4ss	4	13	-10.7	-10.2	-10.9	-10.9	0.2	-4.4	4.0	8.43	
VHT80 STBC, M0 to M9 1ss	2	13	-9.3	-9.1			0.2	-6.0	4.0	9.97	
VHT80 STBC, M0 to M9 1ss	3	13	-10.7	-10.2	-10.9		0.2	-5.6	4.0	9.60	
VHT80 STBC, M0 to M9 1ss	4	13	-10.7	-10.2	-10.9	-10.9	0.2	-4.4	4.0	8.43	
HE80, M0 to M9 1ss	1	13	-8.9				0.3	-8.6	4.0	12.65	
HE80, M0 to M9 1ss	2	13	-8.9	-8.9			0.3	-5.6	4.0	9.64	
HE80, M0 to M9 2ss	2	13	-8.9	-8.9			0.3	-5.6	4.0	9.64	
HE80, M0 to M9 1ss	3	13	-10.5	-10.1	-10.6		0.3	-5.4	4.0	9.37	
HE80, M0 to M9 2ss	3	13	-10.5	-10.1	-10.6		0.3	-5.4	4.0	9.37	
HE80, M0 to M9 3ss	3	13	-10.5	-10.1	-10.6		0.3	-5.4	4.0	9.37	
HE80, M0 to M9 1ss	4	13	-10.5	-10.1	-10.6	-10.4	0.3	-4.1	4.0	8.13	
HE80, M0 to M9 2ss	4	13	-10.5	-10.1	-10.6	-10.4	0.3	-4.1	4.0	8.13	
HE80, M0 to M9 3ss	4	13	-10.5	-10.1	-10.6	-10.4	0.3	-4.1	4.0	8.13	
HE80, M0 to M9 4ss	4	13	-10.5	-10.1	-10.6	-10.4	0.3	-4.1	4.0	8.13	
HE80 Beam Forming, M0 to M9 1ss	2	13	-8.9	-8.9			0.3	-5.6	4.0	9.64	
HE80 Beam Forming, M0 to M9 2ss	2	13	-8.9	-8.9			0.3	-5.6	4.0	9.64	
HE80 Beam Forming, M0 to M9 1ss	3	15	-11.0	-11.2	-11.6		0.3	-6.2	2.0	8.24	
HE80 Beam Forming, M0 to M9 2ss	3	13	-10.5	-10.1	-10.6		0.3	-5.4	4.0	9.37	
HE80 Beam Forming, M0 to M9 3ss	3	13	-10.5	-10.1	-10.6		0.3	-5.4	4.0	9.37	
HE80 Beam Forming, M0 to M9 1ss	4	16	-13.1	-13.3	-13.7	-13.3	0.3	-7.1	1.0	8.07	
HE80 Beam Forming, M0 to M9 2ss	4	13	-10.5	-10.1	-10.6	-10.4	0.3	-4.1	4.0	8.13	
HE80 Beam Forming, M0 to M9 3ss	4	13	-10.5	-10.1	-10.6	-10.4	0.3	-4.1	4.0	8.13	
HE80 Beam Forming, M0 to M9 4ss	4	13	-10.5	-10.1	-10.6	-10.4	0.3	-4.1	4.0	8.13	
HE80 STBC, M0 to M9 1ss	2	13	-8.9	-8.9			0.3	-5.6	4.0	9.64	
HE80 STBC, M0 to M9 1ss	3	13	-10.5	-10.1	-10.6		0.3	-5.4	4.0	9.37	
HE80 STBC, M0 to M9 1ss	4	13	-10.5	-10.1	-10.6	-10.4	0.3	-4.1	4.0	8.13	
5550	Non HT40, 6 to 54 Mbps	1	13	-2.1				0.0	-2.1	4.0	6.05
	Non HT40, 6 to 54 Mbps	2	13	-2.1	-1.3			0.0	1.4	4.0	2.62
	Non HT40, 6 to 54 Mbps	3	13	-3.4	-3.8	-3.4		0.0	1.3	4.0	2.71
	Non HT40, 6 to 54 Mbps	4	13	-4.5	-5.0	-4.7	-4.0	0.0	1.5	4.0	2.47
	HT/VHT40, M0 to M7	1	13	-2.6				0.1	-2.5	4.0	6.49
	HT/VHT40, M0 to M7	2	13	-2.6	-1.9			0.1	0.9	4.0	3.12
	HT/VHT40, M8 to M15	2	13	-2.6	-1.9			0.1	0.9	4.0	3.12
	HT/VHT40, M0 to M7	3	13	-3.5	-3.9	-3.9		0.1	1.1	4.0	2.88
	HT/VHT40, M8 to M15	3	13	-3.5	-3.9	-3.9		0.1	1.1	4.0	2.88
	HT/VHT40, M16 to M23	3	13	-3.5	-3.9	-3.9		0.1	1.1	4.0	2.88
HT/VHT40, M0 to M7	4	13	-4.7	-5.3	-5.0	-4.5	0.1	1.3	4.0	2.73	



HT/VHT40, M8 to M15	4	13	-4.7	-5.3	-5.0	-4.5	0.1	1.3	4.0	2.73
HT/VHT40, M16 to M23	4	13	-4.7	-5.3	-5.0	-4.5	0.1	1.3	4.0	2.73
HT/VHT40, M24 to M31	4	13	-4.7	-5.3	-5.0	-4.5	0.1	1.3	4.0	2.73
HT/VHT40 Beam Forming, M0 to M7	2	13	-4.7	-5.3			0.1	-1.9	4.0	5.87
HT/VHT40 Beam Forming, M8 to M15	2	13	-2.6	-1.9			0.1	0.9	4.0	3.12
HT/VHT40 Beam Forming, M0 to M7	3	15	-8.7	-8.9	-8.8		0.1	-3.9	2.0	5.92
HT/VHT40 Beam Forming, M8 to M15	3	13	-5.5	-5.6	-6.2		0.1	-0.9	4.0	4.87
HT/VHT40 Beam Forming, M16 to M23	3	13	-3.5	-3.9	-3.9		0.1	1.1	4.0	2.88
HT/VHT40 Beam Forming, M0 to M7	4	16	-10.6	-10.8	-11.2	-10.2	0.1	-4.6	1.0	5.55
HT/VHT40 Beam Forming, M8 to M15	4	13	-7.8	-8.3	-8.3	-7.4	0.1	-1.8	4.0	5.80
HT/VHT40 Beam Forming, M16 to M23	4	13	-5.5	-5.6	-6.2	-5.4	0.1	0.5	4.0	3.53
HT/VHT40 Beam Forming, M24 to M31	4	13	-4.7	-5.3	-5.0	-4.5	0.1	1.3	4.0	2.73
HT/VHT40 STBC, M0 to M7	2	13	-2.6	-1.9			0.1	0.9	4.0	3.12
HT/VHT40 STBC, M0 to M7	3	13	-5.5	-5.6	-6.2		0.1	-0.9	4.0	4.87
HT/VHT40 STBC, M0 to M7	4	13	-7.8	-8.3	-8.3	-7.4	0.1	-1.8	4.0	5.80
HE40, M0 to M9 1ss	1	13	-2.2				0.1	-2.1	4.0	6.07
HE40, M0 to M9 1ss	2	13	-2.2	-1.3			0.1	1.4	4.0	2.58
HE40, M0 to M9 2ss	2	13	-2.2	-1.3			0.1	1.4	4.0	2.58
HE40, M0 to M9 1ss	3	13	-3.2	-3.0	-3.3		0.1	1.7	4.0	2.26
HE40, M0 to M9 2ss	3	13	-3.2	-3.0	-3.3		0.1	1.7	4.0	2.26
HE40, M0 to M9 3ss	3	13	-3.2	-3.0	-3.3		0.1	1.7	4.0	2.26
HE40, M0 to M9 1ss	4	13	-4.0	-4.6	-4.6	-3.7	0.1	1.9	4.0	2.05
HE40, M0 to M9 2ss	4	13	-4.0	-4.6	-4.6	-3.7	0.1	1.9	4.0	2.05
HE40, M0 to M9 3ss	4	13	-4.0	-4.6	-4.6	-3.7	0.1	1.9	4.0	2.05
HE40, M0 to M9 4ss	4	13	-4.0	-4.6	-4.6	-3.7	0.1	1.9	4.0	2.05
HE40 Beam Forming, M0 to M9 1ss	2	13	-4.0	-4.6			0.1	-1.1	4.0	5.14
HE40 Beam Forming, M0 to M9 2ss	2	13	-2.2	-1.3			0.1	1.4	4.0	2.58
HE40 Beam Forming, M0 to M9 1ss	3	15	-7.9	-8.0	-8.4		0.1	-3.2	2.0	5.19
HE40 Beam Forming, M0 to M9 2ss	3	13	-5.1	-5.5	-5.5		0.1	-0.5	4.0	4.46
HE40 Beam Forming, M0 to M9 3ss	3	13	-3.2	-3.0	-3.3		0.1	1.7	4.0	2.26
HE40 Beam Forming, M0 to M9 1ss	4	16	-9.7	-10.5	-10.5	-9.4	0.1	-3.8	1.0	4.84
HE40 Beam Forming, M0 to M9 2ss	4	13	-7.0	-7.3	-7.3	-6.6	0.1	-0.9	4.0	4.88
HE40 Beam Forming, M0 to M9 3ss	4	13	-5.1	-5.5	-5.5	-5.1	0.1	0.9	4.0	3.14
HE40 Beam Forming, M0 to M9 4ss	4	13	-4.0	-4.6	-4.6	-3.7	0.1	1.9	4.0	2.05
HE40 STBC, M0 to M9 2ss	2	13	-2.2	-1.3			0.1	1.4	4.0	2.58
HE40 STBC, M0 to M9 2ss	3	13	-5.1	-5.5	-5.5		0.1	-0.5	4.0	4.46
HE40 STBC, M0 to M9 2ss	4	13	-7.0	-7.3	-7.3	-6.6	0.1	-0.9	4.0	4.88

5 6 Non HT20, 6 to 54 Mbps	1	13	1.4				0.1	1.5	4.0	2.55
----------------------------	---	----	-----	--	--	--	-----	-----	-----	------

Non HT20, 6 to 54 Mbps	2	13	1.4	0.3			0.1	3.9	4.0	0.05
Non HT20, 6 to 54 Mbps	3	13	-0.5	-1.6	-0.6		0.1	3.9	4.0	0.05
Non HT20, 6 to 54 Mbps	4	13	-2.4	-3.7	-3.1	-1.9	0.1	3.3	4.0	0.65
Non HT20 Beam Forming, 6 to 54 Mbps	2	13	-0.5	-1.6			0.1	2.0	4.0	1.95
Non HT20 Beam Forming, 6 to 54 Mbps	3	15	-4.8	-5.4	-4.8		0.1	-0.2	2.0	2.17
Non HT20 Beam Forming, 6 to 54 Mbps	4	16	-6.7	-6.9	-6.6	-6.0	0.1	-0.5	1.0	1.47
HT/VHT20, M0 to M7	1	13	0.8				0.1	0.9	4.0	3.15
HT/VHT20, M0 to M7	2	13	0.8	0.2			0.1	3.6	4.0	0.43
HT/VHT20, M8 to M15	2	13	0.8	0.2			0.1	3.6	4.0	0.43
HT/VHT20, M0 to M7	3	13	-1.1	-1.6	-0.8		0.1	3.7	4.0	0.33
HT/VHT20, M8 to M15	3	13	-1.1	-1.6	-0.8		0.1	3.7	4.0	0.33
HT/VHT20, M16 to M23	3	13	-1.1	-1.6	-0.8		0.1	3.7	4.0	0.33
HT/VHT20, M0 to M7	4	13	-2.2	-2.8	-1.8	-1.8	0.1	3.9	4.0	0.06
HT/VHT20, M8 to M15	4	13	-2.2	-2.8	-1.8	-1.8	0.1	3.9	4.0	0.06
HT/VHT20, M16 to M23	4	13	-2.2	-2.8	-1.8	-1.8	0.1	3.9	4.0	0.06
HT/VHT20, M24 to M31	4	13	-2.2	-2.8	-1.8	-1.8	0.1	3.9	4.0	0.06
HT/VHT20 Beam Forming, M0 to M7	2	13	-1.1	-1.6			0.1	1.7	4.0	2.28
HT/VHT20 Beam Forming, M8 to M15	2	13	0.8	0.2			0.1	3.6	4.0	0.43
HT/VHT20 Beam Forming, M0 to M7	3	15	-4.9	-5.4	-4.9		0.1	-0.2	2.0	2.24
HT/VHT20 Beam Forming, M8 to M15	3	13	-2.2	-2.8	-1.8		0.1	2.6	4.0	1.42
HT/VHT20 Beam Forming, M16 to M23	3	13	-1.1	-1.6	-0.8		0.1	3.7	4.0	0.33
HT/VHT20 Beam Forming, M0 to M7	4	16	-6.9	-7.6	-6.8	-6.9	0.1	-1.0	1.0	1.97
HT/VHT20 Beam Forming, M8 to M15	4	13	-3.7	-4.9	-3.8	-3.7	0.1	2.1	4.0	1.92
HT/VHT20 Beam Forming, M16 to M23	4	13	-2.2	-2.8	-1.8	-1.8	0.1	3.9	4.0	0.06
HT/VHT20 Beam Forming, M24 to M31	4	13	-2.2	-2.8	-1.8	-1.8	0.1	3.9	4.0	0.06
HT/VHT20 STBC, M0 to M7	2	13	0.8	0.2			0.1	3.6	4.0	0.43
HT/VHT20 STBC, M0 to M7	3	13	-2.2	-2.8	-1.8		0.1	2.6	4.0	1.42
HT/VHT20 STBC, M0 to M7	4	13	-3.7	-4.9	-3.8	-3.7	0.1	2.1	4.0	1.92
HE20, M0 to M9 1ss	1	13	0.8				0.1	0.9	4.0	3.13
HE20, M0 to M9 1ss	2	13	0.8	0.9			0.1	3.9	4.0	0.07
HE20, M0 to M9 2ss	2	13	0.8	0.9			0.1	3.9	4.0	0.07
HE20, M0 to M9 1ss	3	13	-1.2	-1.6	-0.8		0.1	3.6	4.0	0.35
HE20, M0 to M9 2ss	3	13	-1.2	-1.6	-0.8		0.1	3.6	4.0	0.35
HE20, M0 to M9 3ss	3	13	-1.2	-1.6	-0.8		0.1	3.6	4.0	0.35
HE20, M0 to M9 1ss	4	13	-2.9	-4.1	-2.9	-2.2	0.1	3.1	4.0	0.89
HE20, M0 to M9 2ss	4	13	-2.9	-4.1	-2.9	-2.2	0.1	3.1	4.0	0.89
HE20, M0 to M9 3ss	4	13	-2.9	-4.1	-2.9	-2.2	0.1	3.1	4.0	0.89
HE20, M0 to M9 4ss	4	13	-2.9	-4.1	-2.9	-2.2	0.1	3.1	4.0	0.89
HE20 Beam Forming, M0 to M9 1ss	2	13	-1.2	-1.6			0.1	1.7	4.0	2.32
HE20 Beam Forming, M0 to M9 2ss	2	13	0.8	0.9			0.1	3.9	4.0	0.07
HE20 Beam Forming, M0 to M9 1ss	3	15	-5.1	-5.7	-4.8		0.1	-0.3	2.0	2.35
HE20 Beam Forming, M0 to M9 2ss	3	13	-2.0	-2.7	-1.5		0.1	2.8	4.0	1.20
HE20 Beam Forming, M0 to M9 3ss	3	13	-1.2	-1.6	-0.8		0.1	3.6	4.0	0.35

	HE20 Beam Forming, M0 to M9 1ss	4	16	-6.9	-7.8	-6.8	-6.6	0.1	-0.9	1.0	1.92
	HE20 Beam Forming, M0 to M9 2ss	4	13	-3.7	-4.5	-3.9	-3.6	0.1	2.2	4.0	1.83
	HE20 Beam Forming, M0 to M9 3ss	4	13	-2.9	-4.1	-2.9	-2.2	0.1	3.1	4.0	0.89
	HE20 Beam Forming, M0 to M9 4ss	4	13	-2.9	-4.1	-2.9	-2.2	0.1	3.1	4.0	0.89
	HE20 STBC, M0 to M9 2ss	2	13	0.8	0.9			0.1	3.9	4.0	0.07
	HE20 STBC, M0 to M9 2ss	3	13	-2.0	-2.7	-1.5		0.1	2.8	4.0	1.20
	HE20 STBC, M0 to M9 2ss	4	13	-3.7	-4.5	-3.9	-3.6	0.1	2.2	4.0	1.83
5570	Non HT160, 6 to 54 Mbps	1	13	-13.8				0.0	-13.8	4.0	17.75
	Non HT160, 6 to 54 Mbps	2	13	-13.8	-12.4			0.0	-10.0	4.0	13.99
	Non HT160, 6 to 54 Mbps	3	13	-13.8	-12.4	-13.6		0.0	-8.4	4.0	12.40
	Non HT160, 6 to 54 Mbps	4	13	-14.4	-12.6	-15.1	-14.4	0.0	-8.0	4.0	11.96
	VHT160, M0 to M9 1ss	1	13	-13.5				0.4	-13.1	4.0	17.09
	VHT160, M0 to M9 1ss	2	13	-13.5	-13.1			0.4	-9.9	4.0	13.88
	VHT160, M0 to M9 2ss	2	13	-13.5	-13.1			0.4	-9.9	4.0	13.88
	VHT160, M0 to M9 1ss	3	13	-14.7	-14.2	-14.9		0.4	-9.4	4.0	13.41
	VHT160, M0 to M9 2ss	3	13	-14.7	-14.2	-14.9		0.4	-9.4	4.0	13.41
	VHT160, M0 to M9 3ss	3	13	-14.7	-14.2	-14.9		0.4	-9.4	4.0	13.41
	VHT160, M0 to M9 1ss	4	13	-14.7	-14.2	-14.9	-14.4	0.4	-8.1	4.0	12.12
	VHT160, M0 to M9 2ss	4	13	-14.7	-14.2	-14.9	-14.4	0.4	-8.1	4.0	12.12
	VHT160, M0 to M9 3ss	4	13	-14.7	-14.2	-14.9	-14.4	0.4	-8.1	4.0	12.12
	VHT160, M0 to M9 4ss	4	13	-14.7	-14.2	-14.9	-14.4	0.4	-8.1	4.0	12.12
	VHT160 Beam Forming, M0 to M9 1ss	2	13	-13.5	-13.1			0.4	-9.9	4.0	13.88
	VHT160 Beam Forming, M0 to M9 2ss	2	13	-13.5	-13.1			0.4	-9.9	4.0	13.88
	VHT160 Beam Forming, M0 to M9 1ss	3	15	-14.7	-14.2	-14.9		0.4	-9.4	2.0	11.41
	VHT160 Beam Forming, M0 to M9 2ss	3	13	-14.7	-14.2	-14.9		0.4	-9.4	4.0	13.41
	VHT160 Beam Forming, M0 to M9 3ss	3	13	-14.7	-14.2	-14.9		0.4	-9.4	4.0	13.41
	VHT160 Beam Forming, M0 to M9 1ss	4	16	-16.0	-15.6	-16.7	-16.2	0.4	-9.7	1.0	10.68
	VHT160 Beam Forming, M0 to M9 2ss	4	13	-14.7	-14.2	-14.9	-14.4	0.4	-8.1	4.0	12.12
	VHT160 Beam Forming, M0 to M9 3ss	4	13	-14.7	-14.2	-14.9	-14.4	0.4	-8.1	4.0	12.12
	VHT160 Beam Forming, M0 to M9 4ss	4	13	-14.7	-14.2	-14.9	-14.4	0.4	-8.1	4.0	12.12
	VHT160 STBC, M0 to M9 1ss	2	13	-13.5	-13.1			0.4	-9.9	4.0	13.88
	VHT160 STBC, M0 to M9 1ss	3	13	-14.7	-14.2	-14.9		0.4	-9.4	4.0	13.41
	VHT160 STBC, M0 to M9 1ss	4	13	-14.7	-14.2	-14.9	-14.4	0.4	-8.1	4.0	12.12
	HE160, M0 to M9 1ss	1	13	-12.5				0.4	-12.1	4.0	16.07
	HE160, M0 to M9 1ss	2	13	-12.5	-12.0			0.4	-8.8	4.0	12.80
	HE160, M0 to M9 2ss	2	13	-12.5	-12.0			0.4	-8.8	4.0	12.80
	HE160, M0 to M9 1ss	3	13	-12.5	-12.0	-12.3		0.4	-7.1	4.0	11.06
	HE160, M0 to M9 2ss	3	13	-12.5	-12.0	-12.3		0.4	-7.1	4.0	11.06
	HE160, M0 to M9 3ss	3	13	-12.5	-12.0	-12.3		0.4	-7.1	4.0	11.06
	HE160, M0 to M9 1ss	4	13	-13.0	-13.1	-13.2	-13.0	0.4	-6.6	4.0	10.62
HE160, M0 to M9 2ss	4	13	-13.0	-13.1	-13.2	-13.0	0.4	-6.6	4.0	10.62	
HE160, M0 to M9 3ss	4	13	-13.0	-13.1	-13.2	-13.0	0.4	-6.6	4.0	10.62	

	HE160, M0 to M9 4ss	4	13	-13.0	-13.1	-13.2	-13.0	0.4	-6.6	4.0	10.62
	HE160 Beam Forming, M0 to M9 1ss	2	13	-12.5	-12.0			0.4	-8.8	4.0	12.80
	HE160 Beam Forming, M0 to M9 2ss	2	13	-12.5	-12.0			0.4	-8.8	4.0	12.80
	HE160 Beam Forming, M0 to M9 1ss	3	15	-14.3	-14.1	-14.4		0.4	-9.1	2.0	11.06
	HE160 Beam Forming, M0 to M9 2ss	3	13	-12.5	-12.0	-12.3		0.4	-7.1	4.0	11.06
	HE160 Beam Forming, M0 to M9 3ss	3	13	-12.5	-12.0	-12.3		0.4	-7.1	4.0	11.06
	HE160 Beam Forming, M0 to M9 1ss	4	16	-16.3	-15.3	-15.8	-16.2	0.4	-9.4	1.0	10.43
	HE160 Beam Forming, M0 to M9 2ss	4	13	-13.0	-13.1	-13.2	-13.0	0.4	-6.6	4.0	10.62
	HE160 Beam Forming, M0 to M9 3ss	4	13	-13.0	-13.1	-13.2	-13.0	0.4	-6.6	4.0	10.62
	HE160 Beam Forming, M0 to M9 4ss	4	13	-13.0	-13.1	-13.2	-13.0	0.4	-6.6	4.0	10.62
	HE160 STBC, M0 to M9 1ss	2	13	-12.5	-12.0			0.4	-8.8	4.0	12.80
	HE160 STBC, M0 to M9 1ss	3	13	-12.5	-12.0	-12.3		0.4	-7.1	4.0	11.06
	HE160 STBC, M0 to M9 1ss	4	13	-13.0	-13.1	-13.2	-13.0	0.4	-6.6	4.0	10.62
5610	Non HT80, 6 to 54 Mbps	1	13	-4.5				0.1	-4.4	4.0	8.45
	Non HT80, 6 to 54 Mbps	2	13	-4.5	-2.8			0.1	-0.5	4.0	4.51
	Non HT80, 6 to 54 Mbps	3	13	-5.3	-5.2	-4.7		0.1	-0.2	4.0	4.24
	Non HT80, 6 to 54 Mbps	4	13	-6.3	-6.3	-6.2	-7.0	0.1	-0.4	4.0	4.37
	VHT80, M0 to M9 1ss	1	13	-5.1				0.2	-4.9	4.0	8.88
	VHT80, M0 to M9 1ss	2	13	-5.1	-3.8			0.2	-1.2	4.0	5.18
	VHT80, M0 to M9 2ss	2	13	-5.1	-3.8			0.2	-1.2	4.0	5.18
	VHT80, M0 to M9 1ss	3	13	-6.2	-5.9	-5.6		0.2	-0.9	4.0	4.91
	VHT80, M0 to M9 2ss	3	13	-6.2	-5.9	-5.6		0.2	-0.9	4.0	4.91
	VHT80, M0 to M9 3ss	3	13	-6.2	-5.9	-5.6		0.2	-0.9	4.0	4.91
	VHT80, M0 to M9 1ss	4	13	-7.0	-6.9	-6.8	-7.5	0.2	-0.8	4.0	4.81
	VHT80, M0 to M9 2ss	4	13	-7.0	-6.9	-6.8	-7.5	0.2	-0.8	4.0	4.81
	VHT80, M0 to M9 3ss	4	13	-7.0	-6.9	-6.8	-7.5	0.2	-0.8	4.0	4.81
	VHT80, M0 to M9 4ss	4	13	-7.0	-6.9	-6.8	-7.5	0.2	-0.8	4.0	4.81
	VHT80 Beam Forming, M0 to M9 1ss	2	13	-7.0	-6.9			0.2	-3.7	4.0	7.72
	VHT80 Beam Forming, M0 to M9 2ss	2	13	-5.1	-3.8			0.2	-1.2	4.0	5.18
	VHT80 Beam Forming, M0 to M9 1ss	3	15	-11.2	-10.9	-11.2		0.2	-6.1	2.0	8.11
	VHT80 Beam Forming, M0 to M9 2ss	3	13	-7.8	-8.0	-7.8		0.2	-2.9	4.0	6.88
	VHT80 Beam Forming, M0 to M9 3ss	3	13	-6.2	-5.9	-5.6		0.2	-0.9	4.0	4.91
	VHT80 Beam Forming, M0 to M9 1ss	4	16	-12.8	-13.2	-12.9	-13.5	0.2	-6.9	1.0	7.85
	VHT80 Beam Forming, M0 to M9 2ss	4	13	-10.0	-9.9	-9.7	-10.5	0.2	-3.8	4.0	7.78
	VHT80 Beam Forming, M0 to M9 3ss	4	13	-7.8	-8.0	-7.8	-8.3	0.2	-1.7	4.0	5.73
	VHT80 Beam Forming, M0 to M9 4ss	4	13	-7.0	-6.9	-6.8	-7.5	0.2	-0.8	4.0	4.81
	VHT80 STBC, M0 to M9 1ss	2	13	-5.1	-3.8			0.2	-1.2	4.0	5.18
	VHT80 STBC, M0 to M9 1ss	3	13	-7.8	-8.0	-7.8		0.2	-2.9	4.0	6.88
	VHT80 STBC, M0 to M9 1ss	4	13	-10.0	-9.9	-9.7	-10.5	0.2	-3.8	4.0	7.78
	HE80, M0 to M9 1ss	1	13	-4.9				0.3	-4.6	4.0	8.65
	HE80, M0 to M9 1ss	2	13	-4.9	-3.3			0.3	-0.8	4.0	4.77
	HE80, M0 to M9 2ss	2	13	-4.9	-3.3			0.3	-0.8	4.0	4.77

	HE80, M0 to M9 1ss	3	13	-5.8	-5.2	-5.5		0.3	-0.5	4.0	4.47
	HE80, M0 to M9 2ss	3	13	-5.8	-5.2	-5.5		0.3	-0.5	4.0	4.47
	HE80, M0 to M9 3ss	3	13	-5.8	-5.2	-5.5		0.3	-0.5	4.0	4.47
	HE80, M0 to M9 1ss	4	13	-6.5	-6.3	-6.6	-7.3	0.3	-0.4	4.0	4.39
	HE80, M0 to M9 2ss	4	13	-6.5	-6.3	-6.6	-7.3	0.3	-0.4	4.0	4.39
	HE80, M0 to M9 3ss	4	13	-6.5	-6.3	-6.6	-7.3	0.3	-0.4	4.0	4.39
	HE80, M0 to M9 4ss	4	13	-6.5	-6.3	-6.6	-7.3	0.3	-0.4	4.0	4.39
	HE80 Beam Forming, M0 to M9 1ss	2	13	-6.5	-6.3			0.3	-3.1	4.0	7.14
	HE80 Beam Forming, M0 to M9 2ss	2	13	-4.9	-3.3			0.3	-0.8	4.0	4.77
	HE80 Beam Forming, M0 to M9 1ss	3	15	-11.0	-10.7	-10.3		0.3	-5.6	2.0	7.64
	HE80 Beam Forming, M0 to M9 2ss	3	13	-7.9	-8.0	-7.5		0.3	-2.8	4.0	6.77
	HE80 Beam Forming, M0 to M9 3ss	3	13	-5.8	-5.2	-5.5		0.3	-0.5	4.0	4.47
	HE80 Beam Forming, M0 to M9 1ss	4	16	-12.7	-12.9	-12.5	-13.2	0.3	-6.5	1.0	7.55
	HE80 Beam Forming, M0 to M9 2ss	4	13	-9.7	-9.8	-9.8	-10.1	0.3	-3.6	4.0	7.58
	HE80 Beam Forming, M0 to M9 3ss	4	13	-7.9	-8.0	-7.5	-8.2	0.3	-1.6	4.0	5.62
	HE80 Beam Forming, M0 to M9 4ss	4	13	-6.5	-6.3	-6.6	-7.3	0.3	-0.4	4.0	4.39
	HE80 STBC, M0 to M9 1ss	2	13	-4.9	-3.3			0.3	-0.8	4.0	4.77
	HE80 STBC, M0 to M9 1ss	3	13	-7.9	-8.0	-7.5		0.3	-2.8	4.0	6.77
	HE80 STBC, M0 to M9 1ss	4	13	-9.7	-9.8	-9.8	-10.1	0.3	-3.6	4.0	7.58
5690	Non HT80, 6 to 54 Mbps	1	13	-5.8				0.1	-5.7	4.0	9.75
	Non HT80, 6 to 54 Mbps	2	13	-5.8	-5.8			0.1	-2.7	4.0	6.74
	Non HT80, 6 to 54 Mbps	3	13	-5.8	-5.8	-5.3		0.1	-0.8	4.0	4.80
	Non HT80, 6 to 54 Mbps	4	13	-6.3	-6.8	-6.7	-6.6	0.1	-0.5	4.0	4.52
	VHT80, M0 to M9 1ss	1	13	-5.3				0.2	-5.1	4.0	9.08
	VHT80, M0 to M9 1ss	2	13	-5.3	-4.3			0.2	-1.5	4.0	5.55
	VHT80, M0 to M9 2ss	2	13	-5.3	-4.3			0.2	-1.5	4.0	5.55
	VHT80, M0 to M9 1ss	3	13	-6.1	-6.7	-6.4		0.2	-1.4	4.0	5.41
	VHT80, M0 to M9 2ss	3	13	-6.1	-6.7	-6.4		0.2	-1.4	4.0	5.41
	VHT80, M0 to M9 3ss	3	13	-6.1	-6.7	-6.4		0.2	-1.4	4.0	5.41
	VHT80, M0 to M9 1ss	4	13	-6.6	-7.4	-7.2	-7.5	0.2	-0.9	4.0	4.92
	VHT80, M0 to M9 2ss	4	13	-6.6	-7.4	-7.2	-7.5	0.2	-0.9	4.0	4.92
	VHT80, M0 to M9 3ss	4	13	-6.6	-7.4	-7.2	-7.5	0.2	-0.9	4.0	4.92
	VHT80, M0 to M9 4ss	4	13	-6.6	-7.4	-7.2	-7.5	0.2	-0.9	4.0	4.92
	VHT80 Beam Forming, M0 to M9 1ss	2	13	-6.6	-7.4			0.2	-3.8	4.0	7.76
	VHT80 Beam Forming, M0 to M9 2ss	2	13	-5.3	-4.3			0.2	-1.5	4.0	5.55
	VHT80 Beam Forming, M0 to M9 1ss	3	15	-11.2	-11.5	-11.6		0.2	-6.4	2.0	8.44
	VHT80 Beam Forming, M0 to M9 2ss	3	13	-7.9	-8.4	-8.3		0.2	-3.2	4.0	7.21
	VHT80 Beam Forming, M0 to M9 3ss	3	13	-6.1	-6.7	-6.4		0.2	-1.4	4.0	5.41
	VHT80 Beam Forming, M0 to M9 1ss	4	16	-12.6	-13.7	-13.7	-13.6	0.2	-7.1	1.0	8.14
VHT80 Beam Forming, M0 to M9 2ss	4	13	-10.0	-10.7	-10.4	-10.1	0.2	-4.1	4.0	8.05	
VHT80 Beam Forming, M0 to M9 3ss	4	13	-7.9	-8.4	-8.3	-8.4	0.2	-2.0	4.0	6.01	
VHT80 Beam Forming, M0 to M9 4ss	4	13	-6.6	-7.4	-7.2	-7.5	0.2	-0.9	4.0	4.92	



	VHT80 STBC, M0 to M9 1ss	2	13	-5.3	-4.3			0.2	-1.5	4.0	5.55
	VHT80 STBC, M0 to M9 1ss	3	13	-7.9	-8.4	-8.3		0.2	-3.2	4.0	7.21
	VHT80 STBC, M0 to M9 1ss	4	13	-10.0	-10.7	-10.4	-10.1	0.2	-4.1	4.0	8.05
	HE80, M0 to M9 1ss	1	13	-5.0				0.3	-4.7	4.0	8.75
	HE80, M0 to M9 1ss	2	13	-5.0	-3.9			0.3	-1.2	4.0	5.15
	HE80, M0 to M9 2ss	2	13	-5.0	-3.9			0.3	-1.2	4.0	5.15
	HE80, M0 to M9 1ss	3	13	-5.9	-6.3	-6.3		0.3	-1.1	4.0	5.14
	HE80, M0 to M9 2ss	3	13	-5.9	-6.3	-6.3		0.3	-1.1	4.0	5.14
	HE80, M0 to M9 3ss	3	13	-5.9	-6.3	-6.3		0.3	-1.1	4.0	5.14
	HE80, M0 to M9 1ss	4	13	-6.6	-7.3	-7.0	-7.1	0.3	-0.7	4.0	4.72
	HE80, M0 to M9 2ss	4	13	-6.6	-7.3	-7.0	-7.1	0.3	-0.7	4.0	4.72
	HE80, M0 to M9 3ss	4	13	-6.6	-7.3	-7.0	-7.1	0.3	-0.7	4.0	4.72
	HE80, M0 to M9 4ss	4	13	-6.6	-7.3	-7.0	-7.1	0.3	-0.7	4.0	4.72
	HE80 Beam Forming, M0 to M9 1ss	2	13	-6.6	-7.3			0.3	-3.7	4.0	7.68
	HE80 Beam Forming, M0 to M9 2ss	2	13	-5.0	-3.9			0.3	-1.2	4.0	5.15
	HE80 Beam Forming, M0 to M9 1ss	3	15	-11.0	-11.3	-11.3		0.3	-6.2	2.0	8.18
	HE80 Beam Forming, M0 to M9 2ss	3	13	-8.0	-8.2	-8.0		0.3	-3.0	4.0	7.04
	HE80 Beam Forming, M0 to M9 3ss	3	13	-5.9	-6.3	-6.3		0.3	-1.1	4.0	5.14
	HE80 Beam Forming, M0 to M9 1ss	4	16	-12.4	-13.7	-13.4	-13.0	0.3	-6.8	1.0	7.83
	HE80 Beam Forming, M0 to M9 2ss	4	13	-9.9	-10.1	-10.3	-10.4	0.3	-3.9	4.0	7.90
	HE80 Beam Forming, M0 to M9 3ss	4	13	-8.0	-8.2	-8.0	-8.0	0.3	-1.8	4.0	5.78
	HE80 Beam Forming, M0 to M9 4ss	4	13	-6.6	-7.3	-7.0	-7.1	0.3	-0.7	4.0	4.72
	HE80 STBC, M0 to M9 1ss	2	13	-5.0	-3.9			0.3	-1.2	4.0	5.15
	HE80 STBC, M0 to M9 1ss	3	13	-8.0	-8.2	-8.0		0.3	-3.0	4.0	7.04
	HE80 STBC, M0 to M9 1ss	4	13	-9.9	-10.1	-10.3	-10.4	0.3	-3.9	4.0	7.90
5700	Non HT20, 6 to 54 Mbps	1	13	-0.2				0.1	-0.1	4.0	4.15
	Non HT20, 6 to 54 Mbps	2	13	-0.2	-1.5			0.1	2.3	4.0	1.74
	Non HT20, 6 to 54 Mbps	3	13	-1.2	-2.5	-2.2		0.1	2.9	4.0	1.11
	Non HT20, 6 to 54 Mbps	4	13	-2.2	-3.4	-3.3	-2.7	0.1	3.2	4.0	0.80
	Non HT20 Beam Forming, 6 to 54 Mbps	2	13	-0.2	-1.5			0.1	2.3	4.0	1.74
	Non HT20 Beam Forming, 6 to 54 Mbps	3	15	-4.3	-5.1	-5.0		0.1	0.0	2.0	1.96
	Non HT20 Beam Forming, 6 to 54 Mbps	4	16	-6.2	-7.3	-7.2	-7.1	0.1	-0.9	1.0	1.86
	HT/VHT20, M0 to M7	1	13	-1.6				0.1	-1.5	4.0	5.55
	HT/VHT20, M0 to M7	2	13	-1.6	-2.3			0.1	1.1	4.0	2.87
	HT/VHT20, M8 to M15	2	13	-1.6	-2.3			0.1	1.1	4.0	2.87
	HT/VHT20, M0 to M7	3	13	-1.6	-2.3	-2.6		0.1	2.7	4.0	1.32
	HT/VHT20, M8 to M15	3	13	-1.6	-2.3	-2.6		0.1	2.7	4.0	1.32
	HT/VHT20, M16 to M23	3	13	-1.6	-2.3	-2.6		0.1	2.7	4.0	1.32
	HT/VHT20, M0 to M7	4	13	-1.6	-2.3	-2.6	-2.5	0.1	3.8	4.0	0.16
	HT/VHT20, M8 to M15	4	13	-1.6	-2.3	-2.6	-2.5	0.1	3.8	4.0	0.16
	HT/VHT20, M16 to M23	4	13	-1.6	-2.3	-2.6	-2.5	0.1	3.8	4.0	0.16
	HT/VHT20, M24 to M31	4	13	-1.6	-2.3	-2.6	-2.5	0.1	3.8	4.0	0.16

	HT/VHT20 Beam Forming, M0 to M7	2	13	-1.6	-2.3			0.1	1.1	4.0	2.87
	HT/VHT20 Beam Forming, M8 to M15	2	13	-1.6	-2.3			0.1	1.1	4.0	2.87
	HT/VHT20 Beam Forming, M0 to M7	3	15	-4.7	-5.5	-5.8		0.1	-0.5	2.0	2.48
	HT/VHT20 Beam Forming, M8 to M15	3	13	-1.6	-2.3	-2.6		0.1	2.7	4.0	1.32
	HT/VHT20 Beam Forming, M16 to M23	3	13	-1.6	-2.3	-2.6		0.1	2.7	4.0	1.32
	HT/VHT20 Beam Forming, M0 to M7	4	16	-6.3	-7.3	-7.6	-7.5	0.1	-1.1	1.0	2.07
	HT/VHT20 Beam Forming, M8 to M15	4	13	-3.6	-4.5	-4.5	-4.1	0.1	1.9	4.0	2.09
	HT/VHT20 Beam Forming, M16 to M23	4	13	-1.6	-2.3	-2.6	-2.5	0.1	3.8	4.0	0.16
	HT/VHT20 Beam Forming, M24 to M31	4	13	-1.6	-2.3	-2.6	-2.5	0.1	3.8	4.0	0.16
	HT/VHT20 STBC, M0 to M7	2	13	-1.6	-2.3			0.1	1.1	4.0	2.87
	HT/VHT20 STBC, M0 to M7	3	13	-1.6	-2.3	-2.6		0.1	2.7	4.0	1.32
	HT/VHT20 STBC, M0 to M7	4	13	-3.6	-4.5	-4.5	-4.1	0.1	1.9	4.0	2.09
	HE20, M0 to M9 1ss	1	13	-2.6				0.1	-2.5	4.0	6.53
	HE20, M0 to M9 1ss	2	13	-2.6	-3.5			0.1	0.0	4.0	3.95
	HE20, M0 to M9 2ss	2	13	-2.6	-3.5			0.1	0.0	4.0	3.95
	HE20, M0 to M9 1ss	3	13	-2.6	-3.5	-3.5		0.1	1.7	4.0	2.34
	HE20, M0 to M9 2ss	3	13	-2.6	-3.5	-3.5		0.1	1.7	4.0	2.34
	HE20, M0 to M9 3ss	3	13	-2.6	-3.5	-3.5		0.1	1.7	4.0	2.34
	HE20, M0 to M9 1ss	4	13	-2.6	-3.5	-3.5	-3.1	0.1	2.9	4.0	1.07
	HE20, M0 to M9 2ss	4	13	-2.6	-3.5	-3.5	-3.1	0.1	2.9	4.0	1.07
	HE20, M0 to M9 3ss	4	13	-2.6	-3.5	-3.5	-3.1	0.1	2.9	4.0	1.07
	HE20, M0 to M9 4ss	4	13	-2.6	-3.5	-3.5	-3.1	0.1	2.9	4.0	1.07
	HE20 Beam Forming, M0 to M9 1ss	2	13	-2.6	-3.5			0.1	0.0	4.0	3.95
	HE20 Beam Forming, M0 to M9 2ss	2	13	-2.6	-3.5			0.1	0.0	4.0	3.95
	HE20 Beam Forming, M0 to M9 1ss	3	15	-4.3	-5.5	-5.4		0.1	-0.2	2.0	2.19
	HE20 Beam Forming, M0 to M9 2ss	3	13	-2.6	-3.5	-3.5		0.1	1.7	4.0	2.34
	HE20 Beam Forming, M0 to M9 3ss	3	13	-2.6	-3.5	-3.5		0.1	1.7	4.0	2.34
	HE20 Beam Forming, M0 to M9 1ss	4	16	-6.5	-7.2	-7.6	-7.2	0.1	-1.0	1.0	2.02
	HE20 Beam Forming, M0 to M9 2ss	4	13	-3.3	-4.6	-4.6	-4.2	0.1	1.9	4.0	2.06
	HE20 Beam Forming, M0 to M9 3ss	4	13	-2.6	-3.5	-3.5	-3.1	0.1	2.9	4.0	1.07
	HE20 Beam Forming, M0 to M9 4ss	4	13	-2.6	-3.5	-3.5	-3.1	0.1	2.9	4.0	1.07
	HE20 STBC, M0 to M9 2ss	2	13	-2.6	-3.5			0.1	0.0	4.0	3.95
	HE20 STBC, M0 to M9 2ss	3	13	-2.6	-3.5	-3.5		0.1	1.7	4.0	2.34
	HE20 STBC, M0 to M9 2ss	4	13	-3.3	-4.6	-4.6	-4.2	0.1	1.9	4.0	2.06
5710	Non HT40, 6 to 54 Mbps	1	13	-1.4				0.0	-1.4	4.0	5.35
	Non HT40, 6 to 54 Mbps	2	13	-1.4	-1.1			0.0	1.8	4.0	2.19
	Non HT40, 6 to 54 Mbps	3	13	-2.4	-3.0	-2.8		0.0	2.1	4.0	1.91
	Non HT40, 6 to 54 Mbps	4	13	-3.3	-4.2	-3.4	-3.3	0.0	2.5	4.0	1.46
	HT/VHT40, M0 to M7	1	13	-1.9				0.1	-1.8	4.0	5.79
	HT/VHT40, M0 to M7	2	13	-1.9	-1.3			0.1	1.5	4.0	2.47
	HT/VHT40, M8 to M15	2	13	-1.9	-1.3			0.1	1.5	4.0	2.47
	HT/VHT40, M0 to M7	3	13	-3.0	-3.7	-2.9		0.1	1.7	4.0	2.30



HT/VHT40, M8 to M15	3	13	-3.0	-3.7	-2.9		0.1	1.7	4.0	2.30
HT/VHT40, M16 to M23	3	13	-3.0	-3.7	-2.9		0.1	1.7	4.0	2.30
HT/VHT40, M0 to M7	4	13	-3.6	-4.4	-4.0	-4.2	0.1	2.1	4.0	1.91
HT/VHT40, M8 to M15	4	13	-3.6	-4.4	-4.0	-4.2	0.1	2.1	4.0	1.91
HT/VHT40, M16 to M23	4	13	-3.6	-4.4	-4.0	-4.2	0.1	2.1	4.0	1.91
HT/VHT40, M24 to M31	4	13	-3.6	-4.4	-4.0	-4.2	0.1	2.1	4.0	1.91
HT/VHT40 Beam Forming, M0 to M7	2	13	-3.6	-4.4			0.1	-0.9	4.0	4.86
HT/VHT40 Beam Forming, M8 to M15	2	13	-1.9	-1.3			0.1	1.5	4.0	2.47
HT/VHT40 Beam Forming, M0 to M7	3	15	-7.3	-8.6	-7.8		0.1	-3.0	2.0	4.99
HT/VHT40 Beam Forming, M8 to M15	3	13	-5.0	-5.4	-4.9		0.1	-0.2	4.0	4.21
HT/VHT40 Beam Forming, M16 to M23	3	13	-3.0	-3.7	-2.9		0.1	1.7	4.0	2.30
HT/VHT40 Beam Forming, M0 to M7	4	16	-9.2	-10.5	-10.3	-9.7	0.1	-3.8	1.0	4.76
HT/VHT40 Beam Forming, M8 to M15	4	13	-6.6	-7.6	-7.0	-7.1	0.1	-0.9	4.0	4.93
HT/VHT40 Beam Forming, M16 to M23	4	13	-5.0	-5.4	-4.9	-4.9	0.1	1.1	4.0	2.91
HT/VHT40 Beam Forming, M24 to M31	4	13	-3.6	-4.4	-4.0	-4.2	0.1	2.1	4.0	1.91
HT/VHT40 STBC, M0 to M7	2	13	-1.9	-1.3			0.1	1.5	4.0	2.47
HT/VHT40 STBC, M0 to M7	3	13	-5.0	-5.4	-4.9		0.1	-0.2	4.0	4.21
HT/VHT40 STBC, M0 to M7	4	13	-6.6	-7.6	-7.0	-7.1	0.1	-0.9	4.0	4.93
HE40, M0 to M9 1ss	1	13	-1.8				0.1	-1.7	4.0	5.67
HE40, M0 to M9 1ss	2	13	-1.8	-0.9			0.1	1.8	4.0	2.18
HE40, M0 to M9 2ss	2	13	-1.8	-0.9			0.1	1.8	4.0	2.18
HE40, M0 to M9 1ss	3	13	-2.5	-3.0	-2.6		0.1	2.2	4.0	1.79
HE40, M0 to M9 2ss	3	13	-2.5	-3.0	-2.6		0.1	2.2	4.0	1.79
HE40, M0 to M9 3ss	3	13	-2.5	-3.0	-2.6		0.1	2.2	4.0	1.79
HE40, M0 to M9 1ss	4	13	-3.3	-4.8	-3.7	-3.9	0.1	2.3	4.0	1.74
HE40, M0 to M9 2ss	4	13	-3.3	-4.8	-3.7	-3.9	0.1	2.3	4.0	1.74
HE40, M0 to M9 3ss	4	13	-3.3	-4.8	-3.7	-3.9	0.1	2.3	4.0	1.74
HE40, M0 to M9 4ss	4	13	-3.3	-4.8	-3.7	-3.9	0.1	2.3	4.0	1.74
HE40 Beam Forming, M0 to M9 1ss	2	13	-3.3	-4.8			0.1	-0.8	4.0	4.84
HE40 Beam Forming, M0 to M9 2ss	2	13	-1.8	-0.9			0.1	1.8	4.0	2.18
HE40 Beam Forming, M0 to M9 1ss	3	15	-7.2	-8.1	-7.9		0.1	-2.8	2.0	4.81
HE40 Beam Forming, M0 to M9 2ss	3	13	-4.5	-5.4	-4.8		0.1	0.0	4.0	3.98
HE40 Beam Forming, M0 to M9 3ss	3	13	-2.5	-3.0	-2.6		0.1	2.2	4.0	1.79
HE40 Beam Forming, M0 to M9 1ss	4	16	-9.1	-10.5	-9.7	-9.5	0.1	-3.5	1.0	4.52
HE40 Beam Forming, M0 to M9 2ss	4	13	-6.6	-7.4	-7.2	-6.7	0.1	-0.8	4.0	4.81
HE40 Beam Forming, M0 to M9 3ss	4	13	-4.5	-5.4	-4.8	-4.7	0.1	1.3	4.0	2.68
HE40 Beam Forming, M0 to M9 4ss	4	13	-3.3	-4.8	-3.7	-3.9	0.1	2.3	4.0	1.74
HE40 STBC, M0 to M9 2ss	2	13	-1.8	-0.9			0.1	1.8	4.0	2.18
HE40 STBC, M0 to M9 2ss	3	13	-4.5	-5.4	-4.8		0.1	0.0	4.0	3.98
HE40 STBC, M0 to M9 2ss	4	13	-6.6	-7.4	-7.2	-6.7	0.1	-0.8	4.0	4.81

7 2 Non HT20, 6 to 54 Mbps	1	13	1.7				0.1	1.8	4.0	2.25
----------------------------	---	----	-----	--	--	--	-----	-----	-----	------



Non HT20, 6 to 54 Mbps	2	13	1.1	-0.3			0.1	3.5	4.0	0.48
Non HT20, 6 to 54 Mbps	3	13	-1.0	-2.4	-2.4		0.1	2.9	4.0	1.06
Non HT20, 6 to 54 Mbps	4	13	-2.2	-3.6	-3.3	-3.2	0.1	3.0	4.0	0.97
Non HT20 Beam Forming, 6 to 54 Mbps	2	13	0.2	-1.5			0.1	2.5	4.0	1.51
Non HT20 Beam Forming, 6 to 54 Mbps	3	15	-3.8	-5.3	-5.5		0.1	0.0	2.0	1.98
Non HT20 Beam Forming, 6 to 54 Mbps	4	16	-5.6	-7.2	-7.4	-7.5	0.1	-0.8	1.0	1.78
HT/VHT20, M0 to M7	1	13	1.3				0.1	1.4	4.0	2.65
HT/VHT20, M0 to M7	2	13	0.5	-0.9			0.1	2.9	4.0	1.08
HT/VHT20, M8 to M15	2	13	0.5	-0.9			0.1	2.9	4.0	1.08
HT/VHT20, M0 to M7	3	13	-0.3	-1.6	-1.4		0.1	3.8	4.0	0.24
HT/VHT20, M8 to M15	3	13	-0.3	-1.6	-1.4		0.1	3.8	4.0	0.24
HT/VHT20, M16 to M23	3	13	-0.3	-1.6	-1.4		0.1	3.8	4.0	0.24
HT/VHT20, M0 to M7	4	13	-1.6	-2.3	-2.7	-2.4	0.1	3.8	4.0	0.16
HT/VHT20, M8 to M15	4	13	-1.6	-2.3	-2.7	-2.4	0.1	3.8	4.0	0.16
HT/VHT20, M16 to M23	4	13	-1.6	-2.3	-2.7	-2.4	0.1	3.8	4.0	0.16
HT/VHT20, M24 to M31	4	13	-1.6	-2.3	-2.7	-2.4	0.1	3.8	4.0	0.16
HT/VHT20 Beam Forming, M0 to M7	2	13	-0.3	-1.6			0.1	2.2	4.0	1.84
HT/VHT20 Beam Forming, M8 to M15	2	13	0.5	-0.9			0.1	2.9	4.0	1.08
HT/VHT20 Beam Forming, M0 to M7	3	15	-4.3	-5.6	-6.0		0.1	-0.4	2.0	2.41
HT/VHT20 Beam Forming, M8 to M15	3	13	-1.6	-2.3	-2.7		0.1	2.6	4.0	1.35
HT/VHT20 Beam Forming, M16 to M23	3	13	-0.3	-1.6	-1.4		0.1	3.8	4.0	0.24
HT/VHT20 Beam Forming, M0 to M7	4	16	-6.3	-7.5	-7.3	-7.5	0.1	-1.0	1.0	2.05
HT/VHT20 Beam Forming, M8 to M15	4	13	-3.4	-4.6	-4.6	-4.4	0.1	1.9	4.0	2.15
HT/VHT20 Beam Forming, M16 to M23	4	13	-1.6	-2.3	-2.7	-2.4	0.1	3.8	4.0	0.16
HT/VHT20 Beam Forming, M24 to M31	4	13	-1.6	-2.3	-2.7	-2.4	0.1	3.8	4.0	0.16
HT/VHT20 STBC, M0 to M7	2	13	0.5	-0.9			0.1	2.9	4.0	1.08
HT/VHT20 STBC, M0 to M7	3	13	-1.6	-2.3	-2.7		0.1	2.6	4.0	1.35
HT/VHT20 STBC, M0 to M7	4	13	-3.4	-4.6	-4.6	-4.4	0.1	1.9	4.0	2.15
HE20, M0 to M9 1ss	1	13	1.4				0.1	1.5	4.0	2.53
HE20, M0 to M9 1ss	2	13	0.3	-0.8			0.1	2.9	4.0	1.14
HE20, M0 to M9 2ss	2	13	0.3	-0.8			0.1	2.9	4.0	1.14
HE20, M0 to M9 1ss	3	13	-0.5	-1.5	-1.3		0.1	3.8	4.0	0.24
HE20, M0 to M9 2ss	3	13	-0.5	-1.5	-1.3		0.1	3.8	4.0	0.24
HE20, M0 to M9 3ss	3	13	-0.5	-1.5	-1.3		0.1	3.8	4.0	0.24
HE20, M0 to M9 1ss	4	13	-1.3	-2.6	-2.2	-2.7	0.1	3.9	4.0	0.08
HE20, M0 to M9 2ss	4	13	-1.3	-2.6	-2.2	-2.7	0.1	3.9	4.0	0.08
HE20, M0 to M9 3ss	4	13	-1.3	-2.6	-2.2	-2.7	0.1	3.9	4.0	0.08
HE20, M0 to M9 4ss	4	13	-1.3	-2.6	-2.2	-2.7	0.1	3.9	4.0	0.08
HE20 Beam Forming, M0 to M9 1ss	2	13	-0.5	-1.5			0.1	2.1	4.0	1.90
HE20 Beam Forming, M0 to M9 2ss	2	13	0.3	-0.8			0.1	2.9	4.0	1.14
HE20 Beam Forming, M0 to M9 1ss	3	15	-4.4	-5.4	-5.8		0.1	-0.3	2.0	2.32
HE20 Beam Forming, M0 to M9 2ss	3	13	-1.3	-2.6	-2.2		0.1	2.8	4.0	1.16
HE20 Beam Forming, M0 to M9 3ss	3	13	-0.5	-1.5	-1.3		0.1	3.8	4.0	0.24



HE20 Beam Forming, M0 to M9 1ss	4	16	-6.1	-7.6	-7.6	-7.5	0.1	-1.1	1.0	2.06
HE20 Beam Forming, M0 to M9 2ss	4	13	-3.4	-4.5	-4.3	-4.1	0.1	2.0	4.0	1.97
HE20 Beam Forming, M0 to M9 3ss	4	13	-1.3	-2.6	-2.2	-2.7	0.1	3.9	4.0	0.08
HE20 Beam Forming, M0 to M9 4ss	4	13	-1.3	-2.6	-2.2	-2.7	0.1	3.9	4.0	0.08
HE20 STBC, M0 to M9 2ss	2	13	0.3	-0.8			0.1	2.9	4.0	1.14
HE20 STBC, M0 to M9 2ss	3	13	-1.3	-2.6	-2.2		0.1	2.8	4.0	1.16
HE20 STBC, M0 to M9 2ss	4	13	-3.4	-4.5	-4.3	-4.1	0.1	2.0	4.0	1.97

***Power Spectral Density, 5500 MHz, HT/VHT20, M0 to M7***

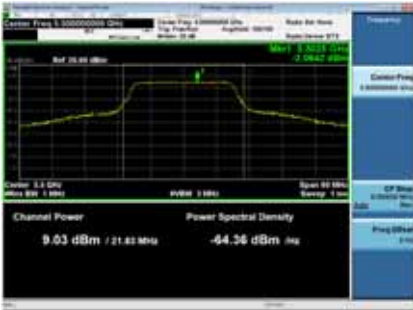

Antenna A

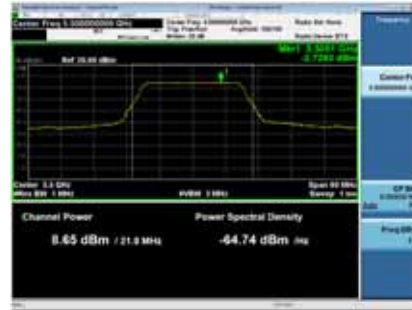

Antenna B

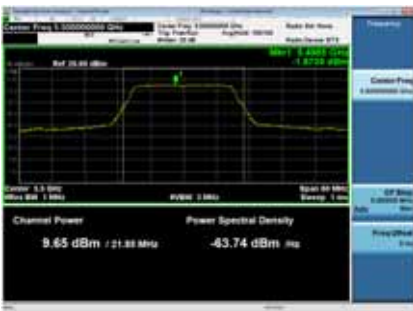

Antenna C

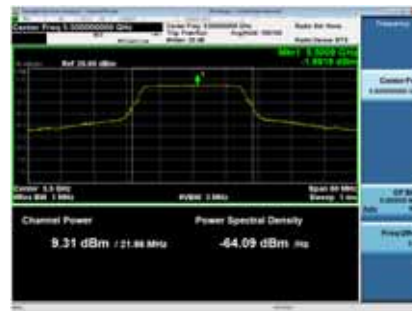

Antenna D

## A.5 Conducted Spurious Emissions

### Conducted Spurious Emissions Test Requirement

**15.407(b) Undesirable emission limits.** Except as shown in paragraph (b)(7) of this section, the maximum emissions outside of the frequency bands of operation shall be attenuated in accordance with the following limits:

- (3) For transmitters operating in the 5.47-5.725 GHz band: All emissions outside of the 5.47-5.725 GHz band shall not exceed an e.i.r.p. of -27 dBm/MHz..
- (6) Unwanted emissions below 1 GHz must comply with the general field strength limits set forth in §15.209.
- (7) The provisions of §15.205 apply to intentional radiators operating under this section.
- (8) When measuring the emission limits, the nominal carrier frequency shall be adjusted as close to the upper and lower frequency band edges as the design of the equipment permits

**15.205 / 15.209** - Radiated emissions which fall in the restricted bands, as defined in Section 15.205(a), must also comply with the radiated emission limits specified in Section 15.209(a) (see Section 15.205(c)).

Use formula below to substitute conducted measurements in place of radiated measurements

$$E[\text{dB}\mu\text{V}/\text{m}] = \text{EIRP}[\text{dBm}] - 20 \log(d[\text{meters}]) + 104.77, \text{ where } E = \text{field strength and } d = 3 \text{ meter}$$

- 1) Average Plot, Limit= -41.25 dBm eirp
- 2) Peak plot, Limit = -21.25 dBm eirp

### KDB 789033 D02 General UNII Test Procedures New Rules v02r01

#### 2. Unwanted Emissions that fall Outside of the Restricted Bands

- a) For all measurements, follow the requirements in II.G.3. “*General Requirements for Unwanted Emissions Measurements.*”
- b) At frequencies below 1000 MHz, use the procedure described in II.G.4. “*Procedure for Unwanted Emissions Measurements Below 1000 MHz.*”
- c) At frequencies above 1000 MHz, use the procedure for maximum emissions described in II.G.5., “*Procedure for Unwanted Emissions Measurements Above 1000 MHz.*”
- (i) Sections 15.407(b)(1-3) specifies the unwanted emissions limit for the U-NII-1 and U-NII-2 bands. As specified, emissions above 1000 MHz that are outside of the restricted bands are subject to a peak emission limit of -27 dBm/MHz.<sup>3</sup>

### Conducted Spurious Emissions Test Procedure

#### KDB 789033 D02 General UNII Test Procedures New Rules v02r01

Ref. ANSI C63.10: 2013

#### Conducted Spurious Emissions

##### Test Procedure

1. Connect the antenna port(s) to the spectrum analyzer input.
2. Place the radio in continuous transmit mode
3. Configure Spectrum analyzer as per test parameters below (be sure to enter all losses between the transmitter output and the spectrum analyzer).
4. Use the peak marker function to determine the maximum spurs amplitude level.
5. The “measure-and-sum technique” is used for measuring in-band transmit power of a device. In the measure-and-sum approach, the conducted emission level is measured at each antenna port. The measured results at the various antenna ports are then summed mathematically to determine the total emission level from the device. Summing is performed in linear power units. The worst case output is recorded. (see ANSI C63.10:2013 section 14.3.2.2)

6. Capture graphs and record pertinent measurement data.
--

**Ref. ANSI C63.10: 2013 section 12.7.6 (Peak) and 12.7.7.2 (Average)**

**KDB 789033 D02 General UNII Test Procedures New Rules v02r01, Sec. 5 (Peak), Sec. 6 (Average Method AD)**

**Conducted Spurious Emissions**

Test parameters

**Peak**

RBW = 1 MHz

VBW  $\geq$  3 MHz

Sweep = Auto

Detector = Peak

Trace = Max Hold.

**Average**

RBW = 1 MHz

VBW  $\geq$  3 MHz

Sweep = Auto

Detector = RMS

Power Averaging

Add the max antenna gain + ground reflection factor (4.7 dB for frequencies between 30 MHz and 1000 MHz, and 0 dB for frequencies > 1000 MHz).

**Samples, Systems, and Modes**

System Number	Description	Samples	System under test	Support equipment
1	EUT	S01+S02	<input checked="" type="checkbox"/>	<input type="checkbox"/>
	Support		<input type="checkbox"/>	<input checked="" type="checkbox"/>

**Tested By :**

Chris Blair

**Date of testing:**

20-Aug-19 - 10-Sep-19

**Test Result : PASS**

**Test Equipment**

See Appendix C for list of test equipment

**Conducted Spurs Average Upper, 5500 MHz, Non HT20, 6 to 54 Mbps**



**Conducted Spurs Peak Upper, 5500 MHz, Non HT20, 6 to 54 Mbps**



## Conducted Spurious Average Table

Frequency (MHz)	Mode	Tx Paths	Correlated Antenna Gain (dBi)	Tx 1 Spur Power (dBm)	Tx 2 Spur Power (dBm)	Tx 3 Spur Power (dBm)	Tx 4 Spur Power (dBm)	Duty Cycle Correction (dB)	Total Conducted Spur (dBm)	Limit (dBm)	Margin (dB)
5500	Non HT20, 6 to 54 Mbps	1	13	-64.1				0.1	-51.0	-41.25	9.80
	Non HT20, 6 to 54 Mbps	2	13	-64.1	-64.1			0.1	-48.0	-41.25	6.79
	Non HT20, 6 to 54 Mbps	3	13	-65.3	-65.3	-66.8		0.1	-47.9	-41.25	6.67
	Non HT20, 6 to 54 Mbps	4	13	-66.0	-65.9	-67.3	-68.2	0.1	-47.7	-41.25	6.43
	Non HT20 Beam Forming, 6 to 54 Mbps	2	13	-65.3	-65.3			0.1	-49.2	-41.25	7.99
	Non HT20 Beam Forming, 6 to 54 Mbps	3	15	-68.0	-67.0	-68.4		0.1	-47.9	-41.25	6.69
	Non HT20 Beam Forming, 6 to 54 Mbps	4	16	-70.1	-69.6	-71.2	-71.8	0.1	-48.5	-41.25	7.27
	HT/VHT20, M0 to M7	1	13	-64.3				0.1	-51.2	-41.25	10.00
	HT/VHT20, M0 to M7	2	13	-64.3	-64.8			0.1	-48.5	-41.25	7.23
	HT/VHT20, M8 to M15	2	13	-64.3	-64.8			0.1	-48.5	-41.25	7.23
	HT/VHT20, M0 to M7	3	13	-65.2	-65.6	-66.7		0.1	-48.0	-41.25	6.71
	HT/VHT20, M8 to M15	3	13	-65.2	-65.6	-66.7		0.1	-48.0	-41.25	6.71
	HT/VHT20, M16 to M23	3	13	-65.2	-65.6	-66.7		0.1	-48.0	-41.25	6.71
	HT/VHT20, M0 to M7	4	13	-65.2	-65.6	-66.7	-67.7	0.1	-47.1	-41.25	5.87
	HT/VHT20, M8 to M15	4	13	-65.2	-65.6	-66.7	-67.7	0.1	-47.1	-41.25	5.87
	HT/VHT20, M16 to M23	4	13	-65.2	-65.6	-66.7	-67.7	0.1	-47.1	-41.25	5.87
	HT/VHT20, M24 to M31	4	13	-65.2	-65.6	-66.7	-67.7	0.1	-47.1	-41.25	5.87
	HT/VHT20 Beam Forming, M0 to M7	2	13	-65.2	-65.6			0.1	-49.3	-41.25	8.08
	HT/VHT20 Beam Forming, M8 to M15	2	13	-64.3	-64.8			0.1	-48.5	-41.25	7.23
	HT/VHT20 Beam Forming, M0 to M7	3	15	-68.0	-67.0	-68.5		0.1	-48.0	-41.25	6.71
	HT/VHT20 Beam Forming, M8 to M15	3	13	-66.0	-65.8	-67.4		0.1	-48.5	-41.25	7.27
	HT/VHT20 Beam Forming, M16 to M23	3	13	-65.2	-65.6	-66.7		0.1	-48.0	-41.25	6.71
	HT/VHT20 Beam Forming, M0 to M7	4	16	-70.1	-69.7	-71.2	-73.0	0.1	-48.8	-41.25	7.50
	HT/VHT20 Beam Forming, M8 to M15	4	13	-67.3	-66.8	-68.2	-69.8	0.1	-48.8	-41.25	7.56
	HT/VHT20 Beam Forming, M16 to M23	4	13	-66.0	-65.8	-67.4	-68.5	0.1	-47.7	-41.25	6.47
	HT/VHT20 Beam Forming, M24 to M31	4	13	-65.2	-65.6	-66.7	-67.7	0.1	-47.1	-41.25	5.87
	HT/VHT20 STBC, M0 to M7	2	13	-64.3	-64.8			0.1	-48.5	-41.25	7.23
	HT/VHT20 STBC, M0 to M7	3	13	-66.0	-65.8	-67.4		0.1	-48.5	-41.25	7.27
	HT/VHT20 STBC, M0 to M7	4	13	-67.3	-66.8	-68.2	-69.8	0.1	-48.8	-41.25	7.56
	HE20, M0 to M9 1ss	1	13	-65.2				0.1	-52.1	-41.25	10.88



	HE20, M0 to M9 1ss	2	13	-65.2	-65.4			0.1	-49.2	-41.25	7.97
	HE20, M0 to M9 2ss	2	13	-65.2	-65.4			0.1	-49.2	-41.25	7.97
	HE20, M0 to M9 1ss	3	13	-65.2	-65.4	-66.7		0.1	-47.9	-41.25	6.63
	HE20, M0 to M9 2ss	3	13	-65.2	-65.4	-66.7		0.1	-47.9	-41.25	6.63
	HE20, M0 to M9 3ss	3	13	-65.2	-65.4	-66.7		0.1	-47.9	-41.25	6.63
	HE20, M0 to M9 1ss	4	13	-66.0	-65.8	-67.4	-68.3	0.1	-47.7	-41.25	6.42
	HE20, M0 to M9 2ss	4	13	-66.0	-65.8	-67.4	-68.3	0.1	-47.7	-41.25	6.42
	HE20, M0 to M9 3ss	4	13	-66.0	-65.8	-67.4	-68.3	0.1	-47.7	-41.25	6.42
	HE20, M0 to M9 4ss	4	13	-66.0	-65.8	-67.4	-68.3	0.1	-47.7	-41.25	6.42
	HE20 Beam Forming, M0 to M9 1ss	2	13	-65.2	-65.4			0.1	-49.2	-41.25	7.97
	HE20 Beam Forming, M0 to M9 2ss	2	13	-65.2	-65.4			0.1	-49.2	-41.25	7.97
	HE20 Beam Forming, M0 to M9 1ss	3	15	-68.0	-67.2	-68.5		0.1	-48.0	-41.25	6.78
	HE20 Beam Forming, M0 to M9 2ss	3	13	-66.0	-65.8	-67.4		0.1	-48.5	-41.25	7.26
	HE20 Beam Forming, M0 to M9 3ss	3	13	-65.2	-65.4	-66.7		0.1	-47.9	-41.25	6.63
	HE20 Beam Forming, M0 to M9 1ss	4	16	-70.2	-70.0	-71.4	-71.9	0.1	-48.7	-41.25	7.47
	HE20 Beam Forming, M0 to M9 2ss	4	13	-67.3	-66.6	-68.3	-69.8	0.1	-48.8	-41.25	7.50
	HE20 Beam Forming, M0 to M9 3ss	4	13	-66.0	-65.8	-67.4	-68.3	0.1	-47.7	-41.25	6.42
	HE20 Beam Forming, M0 to M9 4ss	4	13	-66.0	-65.8	-67.4	-68.3	0.1	-47.7	-41.25	6.42
	HE20 STBC, M0 to M9 2ss	2	13	-65.2	-65.4			0.1	-49.2	-41.25	7.97
	HE20 STBC, M0 to M9 2ss	3	13	-66.0	-65.8	-67.4		0.1	-48.5	-41.25	7.26
	HE20 STBC, M0 to M9 2ss	4	13	-67.3	-66.6	-68.3	-69.8	0.1	-48.8	-41.25	7.50
5510	Non HT40, 6 to 54 Mbps	1	13	-66.1				0.0	-53.1	-41.25	11.80
	Non HT40, 6 to 54 Mbps	2	13	-66.1	-65.9			0.0	-49.9	-41.25	8.69
	Non HT40, 6 to 54 Mbps	3	13	-66.1	-65.9	-67.9		0.0	-48.7	-41.25	7.47
	Non HT40, 6 to 54 Mbps	4	13	-67.0	-66.3	-68.3	-69.4	0.0	-48.5	-41.25	7.27
	HT/VHT40, M0 to M7	1	13	-65.8				0.1	-52.7	-41.25	11.44
	HT/VHT40, M0 to M7	2	13	-65.8	-65.6			0.1	-49.6	-41.25	8.33
	HT/VHT40, M8 to M15	2	13	-65.8	-65.6			0.1	-49.6	-41.25	8.33
	HT/VHT40, M0 to M7	3	13	-66.5	-66.1	-67.8		0.1	-48.9	-41.25	7.61
	HT/VHT40, M8 to M15	3	13	-66.5	-66.1	-67.8		0.1	-48.9	-41.25	7.61
	HT/VHT40, M16 to M23	3	13	-66.5	-66.1	-67.8		0.1	-48.9	-41.25	7.61
	HT/VHT40, M0 to M7	4	13	-66.5	-66.1	-67.8	-68.9	0.1	-48.1	-41.25	6.81
	HT/VHT40, M8 to M15	4	13	-66.5	-66.1	-67.8	-68.9	0.1	-48.1	-41.25	6.81
	HT/VHT40, M16 to M23	4	13	-66.5	-66.1	-67.8	-68.9	0.1	-48.1	-41.25	6.81
	HT/VHT40, M24 to M31	4	13	-66.5	-66.1	-67.8	-68.9	0.1	-48.1	-41.25	6.81
	HT/VHT40 Beam Forming, M0 to M7	2	13	-65.8	-65.6			0.1	-49.6	-41.25	8.33
	HT/VHT40 Beam Forming, M8 to M15	2	13	-65.8	-65.6			0.1	-49.6	-41.25	8.33
	HT/VHT40 Beam Forming, M0 to M7	3	15	-67.8	-66.7	-69.6		0.1	-48.0	-41.25	6.74
	HT/VHT40 Beam Forming, M8 to M15	3	13	-66.5	-66.1	-67.8		0.1	-48.9	-41.25	7.61
	HT/VHT40 Beam Forming, M16 to M23	3	13	-66.5	-66.1	-67.8		0.1	-48.9	-41.25	7.61
	HT/VHT40 Beam Forming, M0 to M7	4	16	-70.0	-69.5	-71.5	-72.8	0.1	-48.6	-41.25	7.38
HT/VHT40 Beam Forming, M8 to M15	4	13	-67.3	-66.5	-68.3	-69.7	0.1	-48.7	-41.25	7.41	





	HT/VHT40 Beam Forming, M16 to M23	4	13	-66.5	-66.1	-67.8	-68.9	0.1	-48.1	-41.25	6.81
	HT/VHT40 Beam Forming, M24 to M31	4	13	-66.5	-66.1	-67.8	-68.9	0.1	-48.1	-41.25	6.81
	HT/VHT40 STBC, M0 to M7	2	13	-65.8	-65.6			0.1	-49.6	-41.25	8.33
	HT/VHT40 STBC, M0 to M7	3	13	-66.5	-66.1	-67.8		0.1	-48.9	-41.25	7.61
	HT/VHT40 STBC, M0 to M7	4	13	-67.3	-66.5	-68.3	-69.7	0.1	-48.7	-41.25	7.41
	HE40, M0 to M9 1ss	1	13	-65.9				0.1	-52.8	-41.25	11.52
	HE40, M0 to M9 1ss	2	13	-65.9	-65.7			0.1	-49.7	-41.25	8.40
	HE40, M0 to M9 2ss	2	13	-65.9	-65.7			0.1	-49.7	-41.25	8.40
	HE40, M0 to M9 1ss	3	13	-65.9	-65.7	-67.2		0.1	-48.3	-41.25	7.06
	HE40, M0 to M9 2ss	3	13	-65.9	-65.7	-67.2		0.1	-48.3	-41.25	7.06
	HE40, M0 to M9 3ss	3	13	-65.9	-65.7	-67.2		0.1	-48.3	-41.25	7.06
	HE40, M0 to M9 1ss	4	13	-66.5	-66.1	-67.7	-68.9	0.1	-48.0	-41.25	6.76
	HE40, M0 to M9 2ss	4	13	-66.5	-66.1	-67.7	-68.9	0.1	-48.0	-41.25	6.76
	HE40, M0 to M9 3ss	4	13	-66.5	-66.1	-67.7	-68.9	0.1	-48.0	-41.25	6.76
	HE40, M0 to M9 4ss	4	13	-66.5	-66.1	-67.7	-68.9	0.1	-48.0	-41.25	6.76
	HE40 Beam Forming, M0 to M9 1ss	2	13	-65.9	-65.7			0.1	-49.7	-41.25	8.40
	HE40 Beam Forming, M0 to M9 2ss	2	13	-65.9	-65.7			0.1	-49.7	-41.25	8.40
	HE40 Beam Forming, M0 to M9 1ss	3	15	-67.2	-66.8	-69.8		0.1	-47.8	-41.25	6.59
	HE40 Beam Forming, M0 to M9 2ss	3	13	-65.9	-65.7	-67.2		0.1	-48.3	-41.25	7.06
	HE40 Beam Forming, M0 to M9 3ss	3	13	-65.9	-65.7	-67.2		0.1	-48.3	-41.25	7.06
	HE40 Beam Forming, M0 to M9 1ss	4	16	-69.8	-69.8	-71.7	-72.8	0.1	-48.7	-41.25	7.44
	HE40 Beam Forming, M0 to M9 2ss	4	13	-66.5	-66.1	-67.7	-68.9	0.1	-48.0	-41.25	6.76
	HE40 Beam Forming, M0 to M9 3ss	4	13	-66.5	-66.1	-67.7	-68.9	0.1	-48.0	-41.25	6.76
	HE40 Beam Forming, M0 to M9 4ss	4	13	-66.5	-66.1	-67.7	-68.9	0.1	-48.0	-41.25	6.76
	HE40 STBC, M0 to M9 2ss	2	13	-65.9	-65.7			0.1	-49.7	-41.25	8.40
	HE40 STBC, M0 to M9 2ss	3	13	-65.9	-65.7	-67.2		0.1	-48.3	-41.25	7.06
	HE40 STBC, M0 to M9 2ss	4	13	-66.5	-66.1	-67.7	-68.9	0.1	-48.0	-41.25	6.76
5530	Non HT80, 6 to 54 Mbps	1	13	-67.0				0.1	-53.9	-41.25	12.70
	Non HT80, 6 to 54 Mbps	2	13	-67.0	-66.6			0.1	-50.7	-41.25	9.48
	Non HT80, 6 to 54 Mbps	3	13	-67.0	-66.6	-68.6		0.1	-49.5	-41.25	8.25
	Non HT80, 6 to 54 Mbps	4	13	-67.7	-66.9	-68.9	-70.2	0.1	-49.2	-41.25	7.93
	VHT80, M0 to M9 1ss	1	13	-66.8				0.2	-53.6	-41.25	12.33
	VHT80, M0 to M9 1ss	2	13	-66.8	-66.7			0.2	-50.5	-41.25	9.27
	VHT80, M0 to M9 2ss	2	13	-66.8	-66.7			0.2	-50.5	-41.25	9.27
	VHT80, M0 to M9 1ss	3	13	-67.6	-67.1	-68.8		0.2	-49.8	-41.25	8.54
	VHT80, M0 to M9 2ss	3	13	-67.6	-67.1	-68.8		0.2	-49.8	-41.25	8.54
	VHT80, M0 to M9 3ss	3	13	-67.6	-67.1	-68.8		0.2	-49.8	-41.25	8.54
	VHT80, M0 to M9 1ss	4	13	-67.6	-67.1	-68.8	-69.9	0.2	-49.0	-41.25	7.73
	VHT80, M0 to M9 2ss	4	13	-67.6	-67.1	-68.8	-69.9	0.2	-49.0	-41.25	7.73
	VHT80, M0 to M9 3ss	4	13	-67.6	-67.1	-68.8	-69.9	0.2	-49.0	-41.25	7.73
	VHT80, M0 to M9 4ss	4	13	-67.6	-67.1	-68.8	-69.9	0.2	-49.0	-41.25	7.73
	VHT80 Beam Forming, M0 to M9 1ss	2	13	-66.8	-66.7			0.2	-50.5	-41.25	9.27



	VHT80 Beam Forming, M0 to M9 2ss	2	13	-66.8	-66.7			0.2	-50.5	-41.25	9.27
	VHT80 Beam Forming, M0 to M9 1ss	3	15	-68.3	-67.4	-69.3		0.2	-48.3	-41.25	7.03
	VHT80 Beam Forming, M0 to M9 2ss	3	13	-67.6	-67.1	-68.8		0.2	-49.8	-41.25	8.54
	VHT80 Beam Forming, M0 to M9 3ss	3	13	-67.6	-67.1	-68.8		0.2	-49.8	-41.25	8.54
	VHT80 Beam Forming, M0 to M9 1ss	4	16	-70.3	-67.8	-72.1	-73.3	0.2	-48.1	-41.25	6.88
	VHT80 Beam Forming, M0 to M9 2ss	4	13	-67.6	-67.1	-68.8	-69.9	0.2	-49.0	-41.25	7.73
	VHT80 Beam Forming, M0 to M9 3ss	4	13	-67.6	-67.1	-68.8	-69.9	0.2	-49.0	-41.25	7.73
	VHT80 Beam Forming, M0 to M9 4ss	4	13	-67.6	-67.1	-68.8	-69.9	0.2	-49.0	-41.25	7.73
	VHT80 STBC, M0 to M9 1ss	2	13	-66.8	-66.7			0.2	-50.5	-41.25	9.27
	VHT80 STBC, M0 to M9 1ss	3	13	-67.6	-67.1	-68.8		0.2	-49.8	-41.25	8.54
	VHT80 STBC, M0 to M9 1ss	4	13	-67.6	-67.1	-68.8	-69.9	0.2	-49.0	-41.25	7.73
	HE80, M0 to M9 1ss	1	13	-66.6				0.3	-53.3	-41.25	12.10
	HE80, M0 to M9 1ss	2	13	-66.6	-66.4			0.3	-50.2	-41.25	8.99
	HE80, M0 to M9 2ss	2	13	-66.6	-66.4			0.3	-50.2	-41.25	8.99
	HE80, M0 to M9 1ss	3	13	-67.4	-66.9	-68.8		0.3	-49.6	-41.25	8.36
	HE80, M0 to M9 2ss	3	13	-67.4	-66.9	-68.8		0.3	-49.6	-41.25	8.36
	HE80, M0 to M9 3ss	3	13	-67.4	-66.9	-68.8		0.3	-49.6	-41.25	8.36
	HE80, M0 to M9 1ss	4	13	-67.4	-66.9	-68.8	-69.8	0.3	-48.8	-41.25	7.56
	HE80, M0 to M9 2ss	4	13	-67.4	-66.9	-68.8	-69.8	0.3	-48.8	-41.25	7.56
	HE80, M0 to M9 3ss	4	13	-67.4	-66.9	-68.8	-69.8	0.3	-48.8	-41.25	7.56
	HE80, M0 to M9 4ss	4	13	-67.4	-66.9	-68.8	-69.8	0.3	-48.8	-41.25	7.56
	HE80 Beam Forming, M0 to M9 1ss	2	13	-66.6	-66.4			0.3	-50.2	-41.25	8.99
	HE80 Beam Forming, M0 to M9 2ss	2	13	-66.6	-66.4			0.3	-50.2	-41.25	8.99
	HE80 Beam Forming, M0 to M9 1ss	3	15	-68.1	-67.0	-69.1		0.3	-48.0	-41.25	6.71
	HE80 Beam Forming, M0 to M9 2ss	3	13	-67.4	-66.9	-68.8		0.3	-49.6	-41.25	8.36
	HE80 Beam Forming, M0 to M9 3ss	3	13	-67.4	-66.9	-68.8		0.3	-49.6	-41.25	8.36
	HE80 Beam Forming, M0 to M9 1ss	4	16	-70.0	-67.9	-71.9	-72.1	0.3	-47.9	-41.25	6.61
	HE80 Beam Forming, M0 to M9 2ss	4	13	-67.4	-66.9	-68.8	-69.8	0.3	-48.8	-41.25	7.56
	HE80 Beam Forming, M0 to M9 3ss	4	13	-67.4	-66.9	-68.8	-69.8	0.3	-48.8	-41.25	7.56
	HE80 Beam Forming, M0 to M9 4ss	4	13	-67.4	-66.9	-68.8	-69.8	0.3	-48.8	-41.25	7.56
	HE80 STBC, M0 to M9 1ss	2	13	-66.6	-66.4			0.3	-50.2	-41.25	8.99
	HE80 STBC, M0 to M9 1ss	3	13	-67.4	-66.9	-68.8		0.3	-49.6	-41.25	8.36
	HE80 STBC, M0 to M9 1ss	4	13	-67.4	-66.9	-68.8	-69.8	0.3	-48.8	-41.25	7.56
5550	Non HT40, 6 to 54 Mbps	1	13	-63.6				0.0	-50.6	-41.25	9.30
	Non HT40, 6 to 54 Mbps	2	13	-63.6	-63.0			0.0	-47.2	-41.25	5.98
	Non HT40, 6 to 54 Mbps	3	13	-64.6	-64.1	-67.0		0.0	-47.2	-41.25	5.99
	Non HT40, 6 to 54 Mbps	4	13	-65.2	-65.6	-67.7	-67.4	0.0	-47.3	-41.25	6.02
	HT/VHT40, M0 to M7	1	13	-63.9				0.1	-50.8	-41.25	9.54
	HT/VHT40, M0 to M7	2	13	-63.9	-63.0			0.1	-47.3	-41.25	6.06
	HT/VHT40, M8 to M15	2	13	-63.9	-63.0			0.1	-47.3	-41.25	6.06
	HT/VHT40, M0 to M7	3	13	-64.6	-64.3	-67.6		0.1	-47.4	-41.25	6.14
	HT/VHT40, M8 to M15	3	13	-64.6	-64.3	-67.6		0.1	-47.4	-41.25	6.14

HT/VHT40, M16 to M23	3	13	-64.6	-64.3	-67.6		0.1	-47.4	-41.25	6.14
HT/VHT40, M0 to M7	4	13	-65.5	-65.8	-67.9	-68.0	0.1	-47.5	-41.25	6.27
HT/VHT40, M8 to M15	4	13	-65.5	-65.8	-67.9	-68.0	0.1	-47.5	-41.25	6.27
HT/VHT40, M16 to M23	4	13	-65.5	-65.8	-67.9	-68.0	0.1	-47.5	-41.25	6.27
HT/VHT40, M24 to M31	4	13	-65.5	-65.8	-67.9	-68.0	0.1	-47.5	-41.25	6.27
HT/VHT40 Beam Forming, M0 to M7	2	13	-65.5	-65.8			0.1	-49.5	-41.25	8.28
HT/VHT40 Beam Forming, M8 to M15	2	13	-63.9	-63.0			0.1	-47.3	-41.25	6.06
HT/VHT40 Beam Forming, M0 to M7	3	15	-68.3	-67.3	-71.2		0.1	-48.8	-41.25	7.51
HT/VHT40 Beam Forming, M8 to M15	3	13	-66.3	-66.2	-68.1		0.1	-48.9	-41.25	7.65
HT/VHT40 Beam Forming, M16 to M23	3	13	-64.6	-64.3	-67.6		0.1	-47.4	-41.25	6.14
HT/VHT40 Beam Forming, M0 to M7	4	16	-70.5	-70.1	-71.9	-73.1	0.1	-49.1	-41.25	7.86
HT/VHT40 Beam Forming, M8 to M15	4	13	-67.8	-67.1	-68.9	-70.0	0.1	-49.2	-41.25	7.93
HT/VHT40 Beam Forming, M16 to M23	4	13	-66.3	-66.2	-68.1	-68.6	0.1	-48.0	-41.25	6.79
HT/VHT40 Beam Forming, M24 to M31	4	13	-65.5	-65.8	-67.9	-68.0	0.1	-47.5	-41.25	6.27
HT/VHT40 STBC, M0 to M7	2	13	-63.9	-63.0			0.1	-47.3	-41.25	6.06
HT/VHT40 STBC, M0 to M7	3	13	-66.3	-66.2	-68.1		0.1	-48.9	-41.25	7.65
HT/VHT40 STBC, M0 to M7	4	13	-67.8	-67.1	-68.9	-70.0	0.1	-49.2	-41.25	7.93
HE40, M0 to M9 1ss	1	13	-63.5				0.1	-50.4	-41.25	9.12
HE40, M0 to M9 1ss	2	13	-63.5	-62.4			0.1	-46.8	-41.25	5.52
HE40, M0 to M9 2ss	2	13	-63.5	-62.4			0.1	-46.8	-41.25	5.52
HE40, M0 to M9 1ss	3	13	-63.9	-63.4	-66.4		0.1	-46.5	-41.25	5.23
HE40, M0 to M9 2ss	3	13	-63.9	-63.4	-66.4		0.1	-46.5	-41.25	5.23
HE40, M0 to M9 3ss	3	13	-63.9	-63.4	-66.4		0.1	-46.5	-41.25	5.23
HE40, M0 to M9 1ss	4	13	-64.9	-65.0	-67.0	-67.3	0.1	-46.8	-41.25	5.51
HE40, M0 to M9 2ss	4	13	-64.9	-65.0	-67.0	-67.3	0.1	-46.8	-41.25	5.51
HE40, M0 to M9 3ss	4	13	-64.9	-65.0	-67.0	-67.3	0.1	-46.8	-41.25	5.51
HE40, M0 to M9 4ss	4	13	-64.9	-65.0	-67.0	-67.3	0.1	-46.8	-41.25	5.51
HE40 Beam Forming, M0 to M9 1ss	2	13	-64.9	-65.0			0.1	-48.8	-41.25	7.55
HE40 Beam Forming, M0 to M9 2ss	2	13	-63.5	-62.4			0.1	-46.8	-41.25	5.52
HE40 Beam Forming, M0 to M9 1ss	3	15	-67.8	-67.0	-70.7		0.1	-48.3	-41.25	7.08
HE40 Beam Forming, M0 to M9 2ss	3	13	-65.5	-65.4	-67.3		0.1	-48.1	-41.25	6.83
HE40 Beam Forming, M0 to M9 3ss	3	13	-63.9	-63.4	-66.4		0.1	-46.5	-41.25	5.23
HE40 Beam Forming, M0 to M9 1ss	4	16	-69.9	-69.1	-70.8	-72.3	0.1	-48.2	-41.25	6.96
HE40 Beam Forming, M0 to M9 2ss	4	13	-67.4	-66.7	-68.4	-69.5	0.1	-48.7	-41.25	7.47
HE40 Beam Forming, M0 to M9 3ss	4	13	-65.5	-65.4	-67.3	-68.0	0.1	-47.3	-41.25	6.00
HE40 Beam Forming, M0 to M9 4ss	4	13	-64.9	-65.0	-67.0	-67.3	0.1	-46.8	-41.25	5.51
HE40 STBC, M0 to M9 2ss	2	13	-63.5	-62.4			0.1	-46.8	-41.25	5.52
HE40 STBC, M0 to M9 2ss	3	13	-65.5	-65.4	-67.3		0.1	-48.1	-41.25	6.83
HE40 STBC, M0 to M9 2ss	4	13	-67.4	-66.7	-68.4	-69.5	0.1	-48.7	-41.25	7.47

5560	Non HT20, 6 to 54 Mbps	1	13	-63.5				0.1	-50.4	-41.25	9.20
	Non HT20, 6 to 54 Mbps	2	13	-63.5	-63.4			0.1	-47.4	-41.25	6.14
	Non HT20, 6 to 54 Mbps	3	13	-65.0	-65.4	-66.9		0.1	-47.9	-41.25	6.62
	Non HT20, 6 to 54 Mbps	4	13	-66.5	-66.2	-67.7	-68.8	0.1	-48.1	-41.25	6.86
	Non HT20 Beam Forming, 6 to 54 Mbps	2	13	-65.0	-65.4			0.1	-49.1	-41.25	7.88
	Non HT20 Beam Forming, 6 to 54 Mbps	3	15	-68.1	-66.7	-68.3		0.1	-47.8	-41.25	6.57
	Non HT20 Beam Forming, 6 to 54 Mbps	4	16	-70.1	-69.6	-71.0	-71.6	0.1	-48.4	-41.25	7.18
	HT/VHT20, M0 to M7	1	13	-63.8				0.1	-50.7	-41.25	9.50
	HT/VHT20, M0 to M7	2	13	-63.8	-63.5			0.1	-47.6	-41.25	6.33
	HT/VHT20, M8 to M15	2	13	-63.8	-63.5			0.1	-47.6	-41.25	6.33
	HT/VHT20, M0 to M7	3	13	-65.4	-65.7	-67.2		0.1	-48.2	-41.25	6.96
	HT/VHT20, M8 to M15	3	13	-65.4	-65.7	-67.2		0.1	-48.2	-41.25	6.96
	HT/VHT20, M16 to M23	3	13	-65.4	-65.7	-67.2		0.1	-48.2	-41.25	6.96
	HT/VHT20, M0 to M7	4	13	-66.1	-66.0	-67.7	-68.5	0.1	-47.9	-41.25	6.62
	HT/VHT20, M8 to M15	4	13	-66.1	-66.0	-67.7	-68.5	0.1	-47.9	-41.25	6.62
	HT/VHT20, M16 to M23	4	13	-66.1	-66.0	-67.7	-68.5	0.1	-47.9	-41.25	6.62
	HT/VHT20, M24 to M31	4	13	-66.1	-66.0	-67.7	-68.5	0.1	-47.9	-41.25	6.62
	HT/VHT20 Beam Forming, M0 to M7	2	13	-65.4	-65.7			0.1	-49.5	-41.25	8.23
	HT/VHT20 Beam Forming, M8 to M15	2	13	-63.8	-63.5			0.1	-47.6	-41.25	6.33
	HT/VHT20 Beam Forming, M0 to M7	3	15	-68.0	-67.1	-70.7		0.1	-48.5	-41.25	7.28
	HT/VHT20 Beam Forming, M8 to M15	3	13	-66.1	-66.0	-67.7		0.1	-48.7	-41.25	7.46
	HT/VHT20 Beam Forming, M16 to M23	3	13	-65.4	-65.7	-67.2		0.1	-48.2	-41.25	6.96
	HT/VHT20 Beam Forming, M0 to M7	4	16	-70.2	-69.8	-71.3	-72.9	0.1	-48.8	-41.25	7.57
	HT/VHT20 Beam Forming, M8 to M15	4	13	-67.3	-66.7	-68.2	-69.7	0.1	-48.8	-41.25	7.51
	HT/VHT20 Beam Forming, M16 to M23	4	13	-66.1	-66.0	-67.7	-68.5	0.1	-47.9	-41.25	6.62
	HT/VHT20 Beam Forming, M24 to M31	4	13	-66.1	-66.0	-67.7	-68.5	0.1	-47.9	-41.25	6.62
	HT/VHT20 STBC, M0 to M7	2	13	-63.8	-63.5			0.1	-47.6	-41.25	6.33
	HT/VHT20 STBC, M0 to M7	3	13	-66.1	-66.0	-67.7		0.1	-48.7	-41.25	7.46
	HT/VHT20 STBC, M0 to M7	4	13	-67.3	-66.7	-68.2	-69.7	0.1	-48.8	-41.25	7.51
	HE20, M0 to M9 1ss	1	13	-63.6				0.1	-50.5	-41.25	9.28
	HE20, M0 to M9 1ss	2	13	-63.6	-62.7			0.1	-47.1	-41.25	5.80
	HE20, M0 to M9 2ss	2	13	-63.6	-62.7			0.1	-47.1	-41.25	5.80
	HE20, M0 to M9 1ss	3	13	-65.2	-65.5	-67.0		0.1	-48.0	-41.25	6.74
	HE20, M0 to M9 2ss	3	13	-65.2	-65.5	-67.0		0.1	-48.0	-41.25	6.74
	HE20, M0 to M9 3ss	3	13	-65.2	-65.5	-67.0		0.1	-48.0	-41.25	6.74
	HE20, M0 to M9 1ss	4	13	-66.7	-66.2	-67.9	-68.9	0.1	-48.2	-41.25	6.96
	HE20, M0 to M9 2ss	4	13	-66.7	-66.2	-67.9	-68.9	0.1	-48.2	-41.25	6.96
	HE20, M0 to M9 3ss	4	13	-66.7	-66.2	-67.9	-68.9	0.1	-48.2	-41.25	6.96
	HE20, M0 to M9 4ss	4	13	-66.7	-66.2	-67.9	-68.9	0.1	-48.2	-41.25	6.96
	HE20 Beam Forming, M0 to M9 1ss	2	13	-65.2	-65.5			0.1	-49.3	-41.25	8.02
HE20 Beam Forming, M0 to M9 2ss	2	13	-63.6	-62.7			0.1	-47.1	-41.25	5.80	
HE20 Beam Forming, M0 to M9 1ss	3	15	-68.1	-66.9	-70.5		0.1	-48.4	-41.25	7.17	



	HE20 Beam Forming, M0 to M9 2ss	3	13	-65.9	-65.8	-67.5		0.1	-48.5	-41.25	7.25
	HE20 Beam Forming, M0 to M9 3ss	3	13	-65.2	-65.5	-67.0		0.1	-48.0	-41.25	6.74
	HE20 Beam Forming, M0 to M9 1ss	4	16	-70.1	-69.6	-71.1	-72.6	0.1	-48.6	-41.25	7.37
	HE20 Beam Forming, M0 to M9 2ss	4	13	-67.2	-66.5	-68.1	-69.5	0.1	-48.6	-41.25	7.35
	HE20 Beam Forming, M0 to M9 3ss	4	13	-66.7	-66.2	-67.9	-68.9	0.1	-48.2	-41.25	6.96
	HE20 Beam Forming, M0 to M9 4ss	4	13	-66.7	-66.2	-67.9	-68.9	0.1	-48.2	-41.25	6.96
	HE20 STBC, M0 to M9 2ss	2	13	-63.6	-62.7			0.1	-47.1	-41.25	5.80
	HE20 STBC, M0 to M9 2ss	3	13	-65.9	-65.8	-67.5		0.1	-48.5	-41.25	7.25
	HE20 STBC, M0 to M9 2ss	4	13	-67.2	-66.5	-68.1	-69.5	0.1	-48.6	-41.25	7.35
5570	Non HT160, 6 to 54 Mbps	1	13	-65.2				0.0	-52.2	-41.25	10.90
	Non HT160, 6 to 54 Mbps	2	13	-65.2	-66.2			0.0	-49.6	-41.25	8.37
	Non HT160, 6 to 54 Mbps	3	13	-65.2	-66.2	-67.6		0.0	-48.4	-41.25	7.16
	Non HT160, 6 to 54 Mbps	4	13	-65.8	-66.5	-68.4	-68.3	0.0	-48.0	-41.25	6.79
	VHT160, M0 to M9 1ss	1	13	-65.9				0.4	-52.5	-41.25	11.24
	VHT160, M0 to M9 1ss	2	13	-65.9	-66.8			0.4	-49.9	-41.25	8.66
	VHT160, M0 to M9 2ss	2	13	-65.9	-66.8			0.4	-49.9	-41.25	8.66
	VHT160, M0 to M9 1ss	3	13	-66.8	-67.5	-69.2		0.4	-49.5	-41.25	8.29
	VHT160, M0 to M9 2ss	3	13	-66.8	-67.5	-69.2		0.4	-49.5	-41.25	8.29
	VHT160, M0 to M9 3ss	3	13	-66.8	-67.5	-69.2		0.4	-49.5	-41.25	8.29
	VHT160, M0 to M9 1ss	4	13	-66.8	-67.5	-69.2	-69.0	0.4	-48.6	-41.25	7.33
	VHT160, M0 to M9 2ss	4	13	-66.8	-67.5	-69.2	-69.0	0.4	-48.6	-41.25	7.33
	VHT160, M0 to M9 3ss	4	13	-66.8	-67.5	-69.2	-69.0	0.4	-48.6	-41.25	7.33
	VHT160, M0 to M9 4ss	4	13	-66.8	-67.5	-69.2	-69.0	0.4	-48.6	-41.25	7.33
	VHT160 Beam Forming, M0 to M9 1ss	2	13	-65.9	-66.8			0.4	-49.9	-41.25	8.66
	VHT160 Beam Forming, M0 to M9 2ss	2	13	-65.9	-66.8			0.4	-49.9	-41.25	8.66
	VHT160 Beam Forming, M0 to M9 1ss	3	15	-66.8	-67.5	-69.2		0.4	-47.5	-41.25	6.29
	VHT160 Beam Forming, M0 to M9 2ss	3	13	-66.8	-67.5	-69.2		0.4	-49.5	-41.25	8.29
	VHT160 Beam Forming, M0 to M9 3ss	3	13	-66.8	-67.5	-69.2		0.4	-49.5	-41.25	8.29
	VHT160 Beam Forming, M0 to M9 1ss	4	16	-68.4	-67.9	-71.7	-70.5	0.4	-46.9	-41.25	5.68
	VHT160 Beam Forming, M0 to M9 2ss	4	13	-66.8	-67.5	-69.2	-69.0	0.4	-48.6	-41.25	7.33
	VHT160 Beam Forming, M0 to M9 3ss	4	13	-66.8	-67.5	-69.2	-69.0	0.4	-48.6	-41.25	7.33
	VHT160 Beam Forming, M0 to M9 4ss	4	13	-66.8	-67.5	-69.2	-69.0	0.4	-48.6	-41.25	7.33
	VHT160 STBC, M0 to M9 1ss	2	13	-65.9	-66.8			0.4	-49.9	-41.25	8.66
	VHT160 STBC, M0 to M9 1ss	3	13	-66.8	-67.5	-69.2		0.4	-49.5	-41.25	8.29
	VHT160 STBC, M0 to M9 1ss	4	13	-66.8	-67.5	-69.2	-69.0	0.4	-48.6	-41.25	7.33
	HE160, M0 to M9 1ss	1	13	-65.0				0.4	-51.6	-41.25	10.32
	HE160, M0 to M9 1ss	2	13	-65.0	-65.8			0.4	-48.9	-41.25	7.69
	HE160, M0 to M9 2ss	2	13	-65.0	-65.8			0.4	-48.9	-41.25	7.69
	HE160, M0 to M9 1ss	3	13	-65.0	-65.8	-67.7		0.4	-47.8	-41.25	6.57
	HE160, M0 to M9 2ss	3	13	-65.0	-65.8	-67.7		0.4	-47.8	-41.25	6.57
	HE160, M0 to M9 3ss	3	13	-65.0	-65.8	-67.7		0.4	-47.8	-41.25	6.57
HE160, M0 to M9 1ss	4	13	-65.6	-66.7	-68.1	-68.1	0.4	-47.5	-41.25	6.29	



	HE160, M0 to M9 2ss	4	13	-65.6	-66.7	-68.1	-68.1	0.4	-47.5	-41.25	6.29
	HE160, M0 to M9 3ss	4	13	-65.6	-66.7	-68.1	-68.1	0.4	-47.5	-41.25	6.29
	HE160, M0 to M9 4ss	4	13	-65.6	-66.7	-68.1	-68.1	0.4	-47.5	-41.25	6.29
	HE160 Beam Forming, M0 to M9 1ss	2	13	-65.0	-65.8			0.4	-48.9	-41.25	7.69
	HE160 Beam Forming, M0 to M9 2ss	2	13	-65.0	-65.8			0.4	-48.9	-41.25	7.69
	HE160 Beam Forming, M0 to M9 1ss	3	15	-66.3	-67.1	-69.0		0.4	-47.1	-41.25	5.87
	HE160 Beam Forming, M0 to M9 2ss	3	13	-65.0	-65.8	-67.7		0.4	-47.8	-41.25	6.57
	HE160 Beam Forming, M0 to M9 3ss	3	13	-65.0	-65.8	-67.7		0.4	-47.8	-41.25	6.57
	HE160 Beam Forming, M0 to M9 1ss	4	16	-68.2	-68.0	-71.6	-70.2	0.4	-46.8	-41.25	5.55
	HE160 Beam Forming, M0 to M9 2ss	4	13	-65.6	-66.7	-68.1	-68.1	0.4	-47.5	-41.25	6.29
	HE160 Beam Forming, M0 to M9 3ss	4	13	-65.6	-66.7	-68.1	-68.1	0.4	-47.5	-41.25	6.29
	HE160 Beam Forming, M0 to M9 4ss	4	13	-65.6	-66.7	-68.1	-68.1	0.4	-47.5	-41.25	6.29
	HE160 STBC, M0 to M9 1ss	2	13	-65.0	-65.8			0.4	-48.9	-41.25	7.69
	HE160 STBC, M0 to M9 1ss	3	13	-65.0	-65.8	-67.7		0.4	-47.8	-41.25	6.57
	HE160 STBC, M0 to M9 1ss	4	13	-65.6	-66.7	-68.1	-68.1	0.4	-47.5	-41.25	6.29
	Non HT80, 6 to 54 Mbps	1	13	-63.2				0.1	-50.1	-41.25	8.90
	Non HT80, 6 to 54 Mbps	2	13	-63.2	-62.4			0.1	-46.7	-41.25	5.47
	Non HT80, 6 to 54 Mbps	3	13	-63.8	-63.3	-65.1		0.1	-46.2	-41.25	4.93
	Non HT80, 6 to 54 Mbps	4	13	-64.4	-63.8	-66.8	-67.3	0.1	-46.2	-41.25	5.00
	VHT80, M0 to M9 1ss	1	13	-63.8				0.2	-50.6	-41.25	9.33
	VHT80, M0 to M9 1ss	2	13	-63.8	-62.7			0.2	-47.0	-41.25	5.74
	VHT80, M0 to M9 2ss	2	13	-63.8	-62.7			0.2	-47.0	-41.25	5.74
	VHT80, M0 to M9 1ss	3	13	-64.1	-63.6	-66.8		0.2	-46.6	-41.25	5.39
	VHT80, M0 to M9 2ss	3	13	-64.1	-63.6	-66.8		0.2	-46.6	-41.25	5.39
	VHT80, M0 to M9 3ss	3	13	-64.1	-63.6	-66.8		0.2	-46.6	-41.25	5.39
	VHT80, M0 to M9 1ss	4	13	-65.1	-64.9	-67.3	-67.7	0.2	-46.8	-41.25	5.58
	VHT80, M0 to M9 2ss	4	13	-65.1	-64.9	-67.3	-67.7	0.2	-46.8	-41.25	5.58
	VHT80, M0 to M9 3ss	4	13	-65.1	-64.9	-67.3	-67.7	0.2	-46.8	-41.25	5.58
	VHT80, M0 to M9 4ss	4	13	-65.1	-64.9	-67.3	-67.7	0.2	-46.8	-41.25	5.58
	VHT80 Beam Forming, M0 to M9 1ss	2	13	-65.1	-64.9			0.2	-48.8	-41.25	7.52
	VHT80 Beam Forming, M0 to M9 2ss	2	13	-63.8	-62.7			0.2	-47.0	-41.25	5.74
	VHT80 Beam Forming, M0 to M9 1ss	3	15	-68.1	-66.7	-68.4		0.2	-47.7	-41.25	6.43
	VHT80 Beam Forming, M0 to M9 2ss	3	13	-65.9	-65.8	-67.6		0.2	-48.4	-41.25	7.12
	VHT80 Beam Forming, M0 to M9 3ss	3	13	-64.1	-63.6	-66.8		0.2	-46.6	-41.25	5.39
	VHT80 Beam Forming, M0 to M9 1ss	4	16	-69.8	-69.6	-71.1	-72.7	0.2	-48.4	-41.25	7.15
	VHT80 Beam Forming, M0 to M9 2ss	4	13	-67.3	-66.6	-68.1	-69.8	0.2	-48.6	-41.25	7.31
	VHT80 Beam Forming, M0 to M9 3ss	4	13	-65.9	-65.8	-67.6	-68.6	0.2	-47.6	-41.25	6.33
	VHT80 Beam Forming, M0 to M9 4ss	4	13	-65.1	-64.9	-67.3	-67.7	0.2	-46.8	-41.25	5.58
	VHT80 STBC, M0 to M9 1ss	2	13	-63.8	-62.7			0.2	-47.0	-41.25	5.74
	VHT80 STBC, M0 to M9 1ss	3	13	-65.9	-65.8	-67.6		0.2	-48.4	-41.25	7.12
	VHT80 STBC, M0 to M9 1ss	4	13	-67.3	-66.6	-68.1	-69.8	0.2	-48.6	-41.25	7.31
	HE80, M0 to M9 1ss	1	13	-63.5				0.3	-50.2	-41.25	9.00



	HE80, M0 to M9 1ss	2	13	-63.5	-62.6			0.3	-46.8	-41.25	5.52
	HE80, M0 to M9 2ss	2	13	-63.5	-62.6			0.3	-46.8	-41.25	5.52
	HE80, M0 to M9 1ss	3	13	-64.2	-63.9	-66.8		0.3	-46.8	-41.25	5.51
	HE80, M0 to M9 2ss	3	13	-64.2	-63.9	-66.8		0.3	-46.8	-41.25	5.51
	HE80, M0 to M9 3ss	3	13	-64.2	-63.9	-66.8		0.3	-46.8	-41.25	5.51
	HE80, M0 to M9 1ss	4	13	-64.9	-64.1	-67.1	-67.7	0.3	-46.4	-41.25	5.18
	HE80, M0 to M9 2ss	4	13	-64.9	-64.1	-67.1	-67.7	0.3	-46.4	-41.25	5.18
	HE80, M0 to M9 3ss	4	13	-64.9	-64.1	-67.1	-67.7	0.3	-46.4	-41.25	5.18
	HE80, M0 to M9 4ss	4	13	-64.9	-64.1	-67.1	-67.7	0.3	-46.4	-41.25	5.18
	HE80 Beam Forming, M0 to M9 1ss	2	13	-64.9	-64.1			0.3	-48.2	-41.25	6.97
	HE80 Beam Forming, M0 to M9 2ss	2	13	-63.5	-62.6			0.3	-46.8	-41.25	5.52
	HE80 Beam Forming, M0 to M9 1ss	3	15	-67.9	-66.9	-68.5		0.3	-47.7	-41.25	6.44
	HE80 Beam Forming, M0 to M9 2ss	3	13	-65.6	-65.9	-67.5		0.3	-48.2	-41.25	6.99
	HE80 Beam Forming, M0 to M9 3ss	3	13	-64.2	-63.9	-66.8		0.3	-46.8	-41.25	5.51
	HE80 Beam Forming, M0 to M9 1ss	4	16	-69.8	-69.5	-71.1	-72.8	0.3	-48.3	-41.25	7.10
	HE80 Beam Forming, M0 to M9 2ss	4	13	-67.3	-66.5	-68.1	-69.8	0.3	-48.5	-41.25	7.24
	HE80 Beam Forming, M0 to M9 3ss	4	13	-65.6	-65.9	-67.5	-68.6	0.3	-47.5	-41.25	6.21
	HE80 Beam Forming, M0 to M9 4ss	4	13	-64.9	-64.1	-67.1	-67.7	0.3	-46.4	-41.25	5.18
	HE80 STBC, M0 to M9 1ss	2	13	-63.5	-62.6			0.3	-46.8	-41.25	5.52
	HE80 STBC, M0 to M9 1ss	3	13	-65.6	-65.9	-67.5		0.3	-48.2	-41.25	6.99
	HE80 STBC, M0 to M9 1ss	4	13	-67.3	-66.5	-68.1	-69.8	0.3	-48.5	-41.25	7.24
5690	Non HT80, 6 to 54 Mbps	1	13	-55.9				0.1	-42.8	-41.25	1.60
	Non HT80, 6 to 54 Mbps	2	13	-55.9	-63.3			0.1	-42.1	-41.25	0.87
	<b>Non HT80, 6 to 54 Mbps</b>	<b>3</b>	<b>13</b>	<b>-55.9</b>	<b>-63.3</b>	<b>-63.9</b>		<b>0.1</b>	<b>-41.6</b>	<b>-41.25</b>	<b>0.33</b>
	Non HT80, 6 to 54 Mbps	4	13	-59.4	-65.2	-64.9	-64.1	0.1	-43.6	-41.25	2.35
	VHT80, M0 to M9 1ss	1	13	-57.4				0.2	-44.2	-41.25	2.93
	VHT80, M0 to M9 1ss	2	13	-57.4	-62.0			0.2	-42.9	-41.25	1.64
	VHT80, M0 to M9 2ss	2	13	-57.4	-62.0			0.2	-42.9	-41.25	1.64
	VHT80, M0 to M9 1ss	3	13	-60.1	-64.4	-64.1		0.2	-44.4	-41.25	3.16
	VHT80, M0 to M9 2ss	3	13	-60.1	-64.4	-64.1		0.2	-44.4	-41.25	3.16
	VHT80, M0 to M9 3ss	3	13	-60.1	-64.4	-64.1		0.2	-44.4	-41.25	3.16
	VHT80, M0 to M9 1ss	4	13	-63.0	-65.7	-65.5	-65.3	0.2	-45.5	-41.25	4.24
	VHT80, M0 to M9 2ss	4	13	-63.0	-65.7	-65.5	-65.3	0.2	-45.5	-41.25	4.24
	VHT80, M0 to M9 3ss	4	13	-63.0	-65.7	-65.5	-65.3	0.2	-45.5	-41.25	4.24
	VHT80, M0 to M9 4ss	4	13	-63.0	-65.7	-65.5	-65.3	0.2	-45.5	-41.25	4.24
	VHT80 Beam Forming, M0 to M9 1ss	2	13	-63.0	-65.7			0.2	-47.9	-41.25	6.67
	VHT80 Beam Forming, M0 to M9 2ss	2	13	-57.4	-62.0			0.2	-42.9	-41.25	1.64
	VHT80 Beam Forming, M0 to M9 1ss	3	15	-67.3	-67.8	-70.1		0.2	-48.3	-41.25	7.00
	VHT80 Beam Forming, M0 to M9 2ss	3	13	-64.6	-66.4	-66.5		0.2	-47.8	-41.25	6.50
	VHT80 Beam Forming, M0 to M9 3ss	3	13	-60.1	-64.4	-64.1		0.2	-44.4	-41.25	3.16
	VHT80 Beam Forming, M0 to M9 1ss	4	16	-69.5	-70.6	-71.7	-71.9	0.2	-48.6	-41.25	7.33
VHT80 Beam Forming, M0 to M9 2ss	4	13	-66.5	-67.7	-68.1	-68.5	0.2	-48.4	-41.25	7.15	



	VHT80 Beam Forming, M0 to M9 3ss	4	13	-64.6	-66.4	-66.5	-66.5	0.2	-46.7	-41.25	5.43
	VHT80 Beam Forming, M0 to M9 4ss	4	13	-63.0	-65.7	-65.5	-65.3	0.2	-45.5	-41.25	4.24
	VHT80 STBC, M0 to M9 1ss	2	13	-57.4	-62.0			0.2	-42.9	-41.25	1.64
	VHT80 STBC, M0 to M9 1ss	3	13	-64.6	-66.4	-66.5		0.2	-47.8	-41.25	6.50
	VHT80 STBC, M0 to M9 1ss	4	13	-66.5	-67.7	-68.1	-68.5	0.2	-48.4	-41.25	7.15
	HE80, M0 to M9 1ss	1	13	-55.9				0.3	-42.6	-41.25	1.40
	HE80, M0 to M9 1ss	2	13	-55.9	-62.0			0.3	-41.7	-41.25	0.45
	HE80, M0 to M9 2ss	2	13	-55.9	-62.0			0.3	-41.7	-41.25	0.45
	HE80, M0 to M9 1ss	3	13	-59.3	-64.0	-64.0		0.3	-43.8	-41.25	2.55
	HE80, M0 to M9 2ss	3	13	-59.3	-64.0	-64.0		0.3	-43.8	-41.25	2.55
	HE80, M0 to M9 3ss	3	13	-59.3	-64.0	-64.0		0.3	-43.8	-41.25	2.55
	HE80, M0 to M9 1ss	4	13	-61.9	-65.2	-65.1	-65.4	0.3	-44.9	-41.25	3.61
	HE80, M0 to M9 2ss	4	13	-61.9	-65.2	-65.1	-65.4	0.3	-44.9	-41.25	3.61
	HE80, M0 to M9 3ss	4	13	-61.9	-65.2	-65.1	-65.4	0.3	-44.9	-41.25	3.61
	HE80, M0 to M9 4ss	4	13	-61.9	-65.2	-65.1	-65.4	0.3	-44.9	-41.25	3.61
	HE80 Beam Forming, M0 to M9 1ss	2	13	-61.9	-65.2			0.3	-47.0	-41.25	5.73
	HE80 Beam Forming, M0 to M9 2ss	2	13	-55.9	-62.0			0.3	-41.7	-41.25	0.45
	HE80 Beam Forming, M0 to M9 1ss	3	15	-67.3	-67.8	-69.5		0.3	-48.1	-41.25	6.83
	HE80 Beam Forming, M0 to M9 2ss	3	13	-64.6	-66.6	-66.1		0.3	-47.7	-41.25	6.41
	HE80 Beam Forming, M0 to M9 3ss	3	13	-59.3	-64.0	-64.0		0.3	-43.8	-41.25	2.55
	HE80 Beam Forming, M0 to M9 1ss	4	16	-69.7	-70.6	-71.7	-71.4	0.3	-48.5	-41.25	7.26
	HE80 Beam Forming, M0 to M9 2ss	4	13	-66.4	-67.7	-67.7	-68.1	0.3	-48.2	-41.25	6.90
	HE80 Beam Forming, M0 to M9 3ss	4	13	-64.6	-66.6	-66.1	-66.2	0.3	-46.5	-41.25	5.28
	HE80 Beam Forming, M0 to M9 4ss	4	13	-61.9	-65.2	-65.1	-65.4	0.3	-44.9	-41.25	3.61
	HE80 STBC, M0 to M9 1ss	2	13	-55.9	-62.0			0.3	-41.7	-41.25	0.45
	HE80 STBC, M0 to M9 1ss	3	13	-64.6	-66.6	-66.1		0.3	-47.7	-41.25	6.41
	HE80 STBC, M0 to M9 1ss	4	13	-66.4	-67.7	-67.7	-68.1	0.3	-48.2	-41.25	6.90
5700	Non HT20, 6 to 54 Mbps	1	13	-65.6				0.1	-52.5	-41.25	11.30
	Non HT20, 6 to 54 Mbps	2	13	-65.6	-67.0			0.1	-50.2	-41.25	8.93
	Non HT20, 6 to 54 Mbps	3	13	-67.0	-67.3	-68.8		0.1	-49.8	-41.25	8.56
	Non HT20, 6 to 54 Mbps	4	13	-67.7	-67.4	-69.1	-70.3	0.1	-49.4	-41.25	8.15
	Non HT20 Beam Forming, 6 to 54 Mbps	2	13	-65.6	-67.0			0.1	-50.2	-41.25	8.93
	Non HT20 Beam Forming, 6 to 54 Mbps	3	15	-69.2	-67.9	-71.3		0.1	-49.4	-41.25	8.18
	Non HT20 Beam Forming, 6 to 54 Mbps	4	16	-71.4	-70.5	-71.9	-73.6	0.1	-49.6	-41.25	8.39
	HT/VHT20, M0 to M7	1	13	-66.9				0.1	-53.8	-41.25	12.60
	HT/VHT20, M0 to M7	2	13	-66.9	-67.3			0.1	-51.0	-41.25	9.78
	HT/VHT20, M8 to M15	2	13	-66.9	-67.3			0.1	-51.0	-41.25	9.78
	HT/VHT20, M0 to M7	3	13	-66.9	-67.3	-68.9		0.1	-49.8	-41.25	8.54
	HT/VHT20, M8 to M15	3	13	-66.9	-67.3	-68.9		0.1	-49.8	-41.25	8.54
	HT/VHT20, M16 to M23	3	13	-66.9	-67.3	-68.9		0.1	-49.8	-41.25	8.54
	HT/VHT20, M0 to M7	4	13	-66.9	-67.3	-68.9	-69.5	0.1	-48.9	-41.25	7.69
	HT/VHT20, M8 to M15	4	13	-66.9	-67.3	-68.9	-69.5	0.1	-48.9	-41.25	7.69



	HT/VHT20, M16 to M23	4	13	-66.9	-67.3	-68.9	-69.5	0.1	-48.9	-41.25	7.69
	HT/VHT20, M24 to M31	4	13	-66.9	-67.3	-68.9	-69.5	0.1	-48.9	-41.25	7.69
	HT/VHT20 Beam Forming, M0 to M7	2	13	-66.9	-67.3			0.1	-51.0	-41.25	9.78
	HT/VHT20 Beam Forming, M8 to M15	2	13	-66.9	-67.3			0.1	-51.0	-41.25	9.78
	HT/VHT20 Beam Forming, M0 to M7	3	15	-69.1	-68.1	-71.7		0.1	-49.6	-41.25	8.31
	HT/VHT20 Beam Forming, M8 to M15	3	13	-66.9	-67.3	-68.9		0.1	-49.8	-41.25	8.54
	HT/VHT20 Beam Forming, M16 to M23	3	13	-66.9	-67.3	-68.9		0.1	-49.8	-41.25	8.54
	HT/VHT20 Beam Forming, M0 to M7	4	16	-71.4	-70.6	-71.9	-73.7	0.1	-49.7	-41.25	8.44
	HT/VHT20 Beam Forming, M8 to M15	4	13	-68.5	-67.8	-69.2	-71.0	0.1	-49.9	-41.25	8.65
	HT/VHT20 Beam Forming, M16 to M23	4	13	-66.9	-67.3	-68.9	-69.5	0.1	-48.9	-41.25	7.69
	HT/VHT20 Beam Forming, M24 to M31	4	13	-66.9	-67.3	-68.9	-69.5	0.1	-48.9	-41.25	7.69
	HT/VHT20 STBC, M0 to M7	2	13	-66.9	-67.3			0.1	-51.0	-41.25	9.78
	HT/VHT20 STBC, M0 to M7	3	13	-66.9	-67.3	-68.9		0.1	-49.8	-41.25	8.54
	HT/VHT20 STBC, M0 to M7	4	13	-68.5	-67.8	-69.2	-71.0	0.1	-49.9	-41.25	8.65
	HE20, M0 to M9 1ss	1	13	-67.8				0.1	-54.7	-41.25	13.48
	HE20, M0 to M9 1ss	2	13	-67.8	-67.5			0.1	-51.6	-41.25	10.32
	HE20, M0 to M9 2ss	2	13	-67.8	-67.5			0.1	-51.6	-41.25	10.32
	HE20, M0 to M9 1ss	3	13	-67.8	-67.5	-69.2		0.1	-50.3	-41.25	9.02
	HE20, M0 to M9 2ss	3	13	-67.8	-67.5	-69.2		0.1	-50.3	-41.25	9.02
	HE20, M0 to M9 3ss	3	13	-67.8	-67.5	-69.2		0.1	-50.3	-41.25	9.02
	HE20, M0 to M9 1ss	4	13	-67.8	-67.5	-69.2	-70.3	0.1	-49.5	-41.25	8.22
	HE20, M0 to M9 2ss	4	13	-67.8	-67.5	-69.2	-70.3	0.1	-49.5	-41.25	8.22
	HE20, M0 to M9 3ss	4	13	-67.8	-67.5	-69.2	-70.3	0.1	-49.5	-41.25	8.22
	HE20, M0 to M9 4ss	4	13	-67.8	-67.5	-69.2	-70.3	0.1	-49.5	-41.25	8.22
	HE20 Beam Forming, M0 to M9 1ss	2	13	-67.8	-67.5			0.1	-51.6	-41.25	10.32
	HE20 Beam Forming, M0 to M9 2ss	2	13	-67.8	-67.5			0.1	-51.6	-41.25	10.32
	HE20 Beam Forming, M0 to M9 1ss	3	15	-69.0	-68.0	-71.6		0.1	-49.4	-41.25	8.20
	HE20 Beam Forming, M0 to M9 2ss	3	13	-67.8	-67.5	-69.2		0.1	-50.3	-41.25	9.02
	HE20 Beam Forming, M0 to M9 3ss	3	13	-67.8	-67.5	-69.2		0.1	-50.3	-41.25	9.02
	HE20 Beam Forming, M0 to M9 1ss	4	16	-71.5	-70.4	-71.9	-73.6	0.1	-49.6	-41.25	8.37
	HE20 Beam Forming, M0 to M9 2ss	4	13	-68.5	-67.8	-69.3	-70.8	0.1	-49.9	-41.25	8.63
	HE20 Beam Forming, M0 to M9 3ss	4	13	-67.8	-67.5	-69.2	-70.3	0.1	-49.5	-41.25	8.22
	HE20 Beam Forming, M0 to M9 4ss	4	13	-67.8	-67.5	-69.2	-70.3	0.1	-49.5	-41.25	8.22
	HE20 STBC, M0 to M9 2ss	2	13	-67.8	-67.5			0.1	-51.6	-41.25	10.32
	HE20 STBC, M0 to M9 2ss	3	13	-67.8	-67.5	-69.2		0.1	-50.3	-41.25	9.02
	HE20 STBC, M0 to M9 2ss	4	13	-68.5	-67.8	-69.3	-70.8	0.1	-49.9	-41.25	8.63
5710	Non HT40, 6 to 54 Mbps	1	13	-63.4				0.0	-50.4	-41.25	9.10
	Non HT40, 6 to 54 Mbps	2	13	-63.4	-64.3			0.0	-47.8	-41.25	6.52
	Non HT40, 6 to 54 Mbps	3	13	-64.2	-65.1	-65.8		0.0	-47.2	-41.25	5.91
	Non HT40, 6 to 54 Mbps	4	13	-65.0	-66.8	-66.6	-66.3	0.0	-47.0	-41.25	5.80
	HT/VHT40, M0 to M7	1	13	-63.8				0.1	-50.7	-41.25	9.44
	HT/VHT40, M0 to M7	2	13	-63.8	-64.4			0.1	-48.0	-41.25	6.72

HT/VHT40, M8 to M15	2	13	-63.8	-64.4			0.1	-48.0	-41.25	6.72
HT/VHT40, M0 to M7	3	13	-64.7	-66.1	-66.3		0.1	-47.8	-41.25	6.51
HT/VHT40, M8 to M15	3	13	-64.7	-66.1	-66.3		0.1	-47.8	-41.25	6.51
HT/VHT40, M16 to M23	3	13	-64.7	-66.1	-66.3		0.1	-47.8	-41.25	6.51
HT/VHT40, M0 to M7	4	13	-65.7	-67.0	-67.0	-67.2	0.1	-47.6	-41.25	6.30
HT/VHT40, M8 to M15	4	13	-65.7	-67.0	-67.0	-67.2	0.1	-47.6	-41.25	6.30
HT/VHT40, M16 to M23	4	13	-65.7	-67.0	-67.0	-67.2	0.1	-47.6	-41.25	6.30
HT/VHT40, M24 to M31	4	13	-65.7	-67.0	-67.0	-67.2	0.1	-47.6	-41.25	6.30
HT/VHT40 Beam Forming, M0 to M7	2	13	-65.7	-67.0			0.1	-50.2	-41.25	8.93
HT/VHT40 Beam Forming, M8 to M15	2	13	-63.8	-64.4			0.1	-48.0	-41.25	6.72
HT/VHT40 Beam Forming, M0 to M7	3	15	-68.7	-68.0	-69.4		0.1	-48.8	-41.25	7.53
HT/VHT40 Beam Forming, M8 to M15	3	13	-66.6	-67.5	-68.3		0.1	-49.5	-41.25	8.28
HT/VHT40 Beam Forming, M16 to M23	3	13	-64.7	-66.1	-66.3		0.1	-47.8	-41.25	6.51
HT/VHT40 Beam Forming, M0 to M7	4	16	-71.0	-70.7	-71.9	-72.5	0.1	-49.3	-41.25	8.09
HT/VHT40 Beam Forming, M8 to M15	4	13	-67.9	-67.8	-69.2	-69.6	0.1	-49.4	-41.25	8.17
HT/VHT40 Beam Forming, M16 to M23	4	13	-66.6	-67.5	-68.3	-68.1	0.1	-48.4	-41.25	7.19
HT/VHT40 Beam Forming, M24 to M31	4	13	-65.7	-67.0	-67.0	-67.2	0.1	-47.6	-41.25	6.30
HT/VHT40 STBC, M0 to M7	2	13	-63.8	-64.4			0.1	-48.0	-41.25	6.72
HT/VHT40 STBC, M0 to M7	3	13	-66.6	-67.5	-68.3		0.1	-49.5	-41.25	8.28
HT/VHT40 STBC, M0 to M7	4	13	-67.9	-67.8	-69.2	-69.6	0.1	-49.4	-41.25	8.17
HE40, M0 to M9 1ss	1	13	-63.6				0.1	-50.5	-41.25	9.22
HE40, M0 to M9 1ss	2	13	-63.6	-64.0			0.1	-47.7	-41.25	6.40
HE40, M0 to M9 2ss	2	13	-63.6	-64.0			0.1	-47.7	-41.25	6.40
HE40, M0 to M9 1ss	3	13	-64.5	-66.1	-66.2		0.1	-47.6	-41.25	6.37
HE40, M0 to M9 2ss	3	13	-64.5	-66.1	-66.2		0.1	-47.6	-41.25	6.37
HE40, M0 to M9 3ss	3	13	-64.5	-66.1	-66.2		0.1	-47.6	-41.25	6.37
HE40, M0 to M9 1ss	4	13	-65.6	-67.2	-67.0	-67.3	0.1	-47.6	-41.25	6.31
HE40, M0 to M9 2ss	4	13	-65.6	-67.2	-67.0	-67.3	0.1	-47.6	-41.25	6.31
HE40, M0 to M9 3ss	4	13	-65.6	-67.2	-67.0	-67.3	0.1	-47.6	-41.25	6.31
HE40, M0 to M9 4ss	4	13	-65.6	-67.2	-67.0	-67.3	0.1	-47.6	-41.25	6.31
HE40 Beam Forming, M0 to M9 1ss	2	13	-65.6	-67.2			0.1	-50.2	-41.25	8.93
HE40 Beam Forming, M0 to M9 2ss	2	13	-63.6	-64.0			0.1	-47.7	-41.25	6.40
HE40 Beam Forming, M0 to M9 1ss	3	15	-68.5	-67.9	-69.4		0.1	-48.7	-41.25	7.40
HE40 Beam Forming, M0 to M9 2ss	3	13	-66.3	-67.3	-67.9		0.1	-49.2	-41.25	7.96
HE40 Beam Forming, M0 to M9 3ss	3	13	-64.5	-66.1	-66.2		0.1	-47.6	-41.25	6.37
HE40 Beam Forming, M0 to M9 1ss	4	16	-70.8	-70.8	-72.1	-71.9	0.1	-49.2	-41.25	7.95
HE40 Beam Forming, M0 to M9 2ss	4	13	-67.8	-67.7	-69.3	-69.4	0.1	-49.3	-41.25	8.07
HE40 Beam Forming, M0 to M9 3ss	4	13	-66.3	-67.3	-67.9	-68.0	0.1	-48.2	-41.25	6.92
HE40 Beam Forming, M0 to M9 4ss	4	13	-65.6	-67.2	-67.0	-67.3	0.1	-47.6	-41.25	6.31
HE40 STBC, M0 to M9 2ss	2	13	-63.6	-64.0			0.1	-47.7	-41.25	6.40
HE40 STBC, M0 to M9 2ss	3	13	-66.3	-67.3	-67.9		0.1	-49.2	-41.25	7.96
HE40 STBC, M0 to M9 2ss	4	13	-67.8	-67.7	-69.3	-69.4	0.1	-49.3	-41.25	8.07

5720	Non HT20, 6 to 54 Mbps	1	13	-64.3				0.1	-51.2	-41.25	10.00
	Non HT20, 6 to 54 Mbps	2	13	-65.1	-66.1			0.1	-49.5	-41.25	8.26
	Non HT20, 6 to 54 Mbps	3	13	-67.0	-67.3	-68.8		0.1	-49.8	-41.25	8.56
	Non HT20, 6 to 54 Mbps	4	13	-67.8	-67.6	-69.0	-69.6	0.1	-49.4	-41.25	8.10
	Non HT20 Beam Forming, 6 to 54 Mbps	2	13	-65.7	-66.8			0.1	-50.2	-41.25	8.90
	Non HT20 Beam Forming, 6 to 54 Mbps	3	15	-69.0	-67.9	-71.5		0.1	-49.4	-41.25	8.15
	Non HT20 Beam Forming, 6 to 54 Mbps	4	16	-70.9	-70.6	-71.8	-73.5	0.1	-49.5	-41.25	8.24
	HT/VHT20, M0 to M7	1	13	-64.4				0.1	-51.3	-41.25	10.10
	HT/VHT20, M0 to M7	2	13	-65.1	-66.3			0.1	-49.6	-41.25	8.35
	HT/VHT20, M8 to M15	2	13	-65.1	-66.3			0.1	-49.6	-41.25	8.35
	HT/VHT20, M0 to M7	3	13	-66.4	-66.9	-68.1		0.1	-49.3	-41.25	8.00
	HT/VHT20, M8 to M15	3	13	-66.4	-66.9	-68.1		0.1	-49.3	-41.25	8.00
	HT/VHT20, M16 to M23	3	13	-66.4	-66.9	-68.1		0.1	-49.3	-41.25	8.00
	HT/VHT20, M0 to M7	4	13	-67.0	-67.4	-69.1	-69.0	0.1	-49.0	-41.25	7.70
	HT/VHT20, M8 to M15	4	13	-67.0	-67.4	-69.1	-69.0	0.1	-49.0	-41.25	7.70
	HT/VHT20, M16 to M23	4	13	-67.0	-67.4	-69.1	-69.0	0.1	-49.0	-41.25	7.70
	HT/VHT20, M24 to M31	4	13	-67.0	-67.4	-69.1	-69.0	0.1	-49.0	-41.25	7.70
	HT/VHT20 Beam Forming, M0 to M7	2	13	-66.4	-66.9			0.1	-50.6	-41.25	9.33
	HT/VHT20 Beam Forming, M8 to M15	2	13	-65.1	-66.3			0.1	-49.6	-41.25	8.35
	HT/VHT20 Beam Forming, M0 to M7	3	15	-68.9	-68.0	-71.6		0.1	-49.4	-41.25	8.18
	HT/VHT20 Beam Forming, M8 to M15	3	13	-67.0	-67.4	-69.1		0.1	-49.9	-41.25	8.67
	HT/VHT20 Beam Forming, M16 to M23	3	13	-66.4	-66.9	-68.1		0.1	-49.3	-41.25	8.00
	HT/VHT20 Beam Forming, M0 to M7	4	16	-71.2	-70.6	-71.8	-73.5	0.1	-49.6	-41.25	8.32
	HT/VHT20 Beam Forming, M8 to M15	4	13	-68.4	-67.7	-69.3	-70.2	0.1	-49.7	-41.25	8.48
	HT/VHT20 Beam Forming, M16 to M23	4	13	-67.0	-67.4	-69.1	-69.0	0.1	-49.0	-41.25	7.70
	HT/VHT20 Beam Forming, M24 to M31	4	13	-67.0	-67.4	-69.1	-69.0	0.1	-49.0	-41.25	7.70
	HT/VHT20 STBC, M0 to M7	2	13	-65.1	-66.3			0.1	-49.6	-41.25	8.35
	HT/VHT20 STBC, M0 to M7	3	13	-67.0	-67.4	-69.1		0.1	-49.9	-41.25	8.67
	HT/VHT20 STBC, M0 to M7	4	13	-68.4	-67.7	-69.3	-70.2	0.1	-49.7	-41.25	8.48
	HE20, M0 to M9 1ss	1	13	-64.4				0.1	-51.3	-41.25	10.08
	HE20, M0 to M9 1ss	2	13	-65.1	-66.2			0.1	-49.5	-41.25	8.29
	HE20, M0 to M9 2ss	2	13	-65.1	-66.2			0.1	-49.5	-41.25	8.29
	HE20, M0 to M9 1ss	3	13	-66.2	-66.8	-68.0		0.1	-49.1	-41.25	7.85
	HE20, M0 to M9 2ss	3	13	-66.2	-66.8	-68.0		0.1	-49.1	-41.25	7.85
	HE20, M0 to M9 3ss	3	13	-66.2	-66.8	-68.0		0.1	-49.1	-41.25	7.85
	HE20, M0 to M9 1ss	4	13	-67.0	-67.5	-68.8	-69.1	0.1	-48.9	-41.25	7.68
HE20, M0 to M9 2ss	4	13	-67.0	-67.5	-68.8	-69.1	0.1	-48.9	-41.25	7.68	
HE20, M0 to M9 3ss	4	13	-67.0	-67.5	-68.8	-69.1	0.1	-48.9	-41.25	7.68	
HE20, M0 to M9 4ss	4	13	-67.0	-67.5	-68.8	-69.1	0.1	-48.9	-41.25	7.68	
HE20 Beam Forming, M0 to M9 1ss	2	13	-66.2	-66.8			0.1	-50.4	-41.25	9.16	
HE20 Beam Forming, M0 to M9 2ss	2	13	-65.1	-66.2			0.1	-49.5	-41.25	8.29	
HE20 Beam Forming, M0 to M9 1ss	3	15	-68.8	-68.0	-71.7		0.1	-49.4	-41.25	8.15	



HE20 Beam Forming, M0 to M9 2ss	3	13	-67.0	-67.5	-68.8		0.1	-49.9	-41.25	8.62
HE20 Beam Forming, M0 to M9 3ss	3	13	-66.2	-66.8	-68.0		0.1	-49.1	-41.25	7.85
HE20 Beam Forming, M0 to M9 1ss	4	16	-70.9	-70.6	-72.0	-73.6	0.1	-49.5	-41.25	8.29
HE20 Beam Forming, M0 to M9 2ss	4	13	-68.3	-67.8	-69.1	-70.3	0.1	-49.7	-41.25	8.44
HE20 Beam Forming, M0 to M9 3ss	4	13	-67.0	-67.5	-68.8	-69.1	0.1	-48.9	-41.25	7.68
HE20 Beam Forming, M0 to M9 4ss	4	13	-67.0	-67.5	-68.8	-69.1	0.1	-48.9	-41.25	7.68
HE20 STBC, M0 to M9 2ss	2	13	-65.1	-66.2			0.1	-49.5	-41.25	8.29
HE20 STBC, M0 to M9 2ss	3	13	-67.0	-67.5	-68.8		0.1	-49.9	-41.25	8.62
HE20 STBC, M0 to M9 2ss	4	13	-68.3	-67.8	-69.1	-70.3	0.1	-49.7	-41.25	8.44

**Conducted Spurs Average, 5690 MHz, Non HT80, 6 to 54 Mbps**

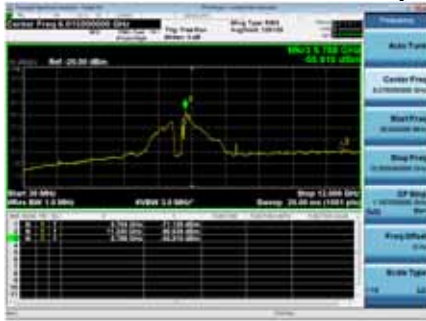

**Antenna A**

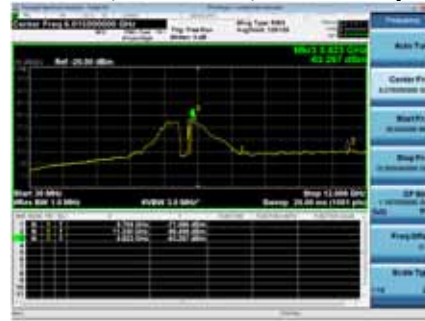

**Antenna B**

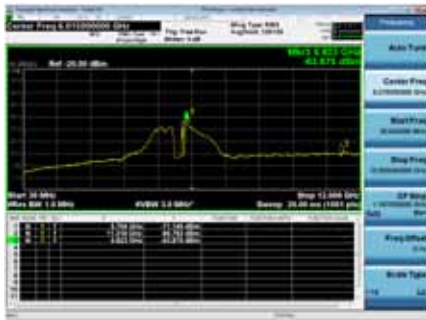

**Antenna C**

## Conducted Spurious Emissions Peak Table

Frequency (MHz)	Mode	Tx Paths	Correlated Antenna Gain (dBi)	Tx 1 Spur Power (dBm)	Tx 2 Spur Power (dBm)	Tx 3 Spur Power (dBm)	Tx 4 Spur Power (dBm)	Tx 5 Spur Power (dBm)	Total Conducted Spur (dBm)	Limit (dBm)	Margin (dB)
5500	Non HT20, 6 to 54 Mbps	1	13	-56.8				0.1	-43.7	-21.25	22.50
	Non HT20, 6 to 54 Mbps	2	13	-56.8	-53.0			0.1	-38.4	-21.25	17.19
	Non HT20, 6 to 54 Mbps	3	13	-57.7	-54.5	-56.0		0.1	-38.1	-21.25	16.80
	Non HT20, 6 to 54 Mbps	4	13	-59.0	-55.7	-57.0	-57.9	0.1	-38.2	-21.25	16.91
	Non HT20 Beam Forming, 6 to 54 Mbps	2	13	-57.7	-54.5			0.1	-39.8	-21.25	18.50
	Non HT20 Beam Forming, 6 to 54 Mbps	3	15	-60.2	-56.0	-58.4		0.1	-38.0	-21.25	16.79
	Non HT20 Beam Forming, 6 to 54 Mbps	4	16	-61.8	-59.1	-59.6	-60.9	0.1	-38.2	-21.25	16.90
	HT/VHT20, M0 to M7	1	13	-56.8				0.1	-43.7	-21.25	22.50
	HT/VHT20, M0 to M7	2	13	-56.8	-54.4			0.1	-39.4	-21.25	18.12
	HT/VHT20, M8 to M15	2	13	-56.8	-54.4			0.1	-39.4	-21.25	18.12
	HT/VHT20, M0 to M7	3	13	-57.4	-54.8	-56.3		0.1	-38.2	-21.25	16.96
	HT/VHT20, M8 to M15	3	13	-57.4	-54.8	-56.3		0.1	-38.2	-21.25	16.96
	HT/VHT20, M16 to M23	3	13	-57.4	-54.8	-56.3		0.1	-38.2	-21.25	16.96
	HT/VHT20, M0 to M7	4	13	-57.4	-54.8	-56.3	-58.9	0.1	-37.5	-21.25	16.27
	HT/VHT20, M8 to M15	4	13	-57.4	-54.8	-56.3	-58.9	0.1	-37.5	-21.25	16.27
	HT/VHT20, M16 to M23	4	13	-57.4	-54.8	-56.3	-58.9	0.1	-37.5	-21.25	16.27
	HT/VHT20, M24 to M31	4	13	-57.4	-54.8	-56.3	-58.9	0.1	-37.5	-21.25	16.27
	HT/VHT20 Beam Forming, M0 to M7	2	13	-57.4	-54.8			0.1	-39.8	-21.25	18.60
	HT/VHT20 Beam Forming, M8 to M15	2	13	-56.8	-54.4			0.1	-39.4	-21.25	18.12
	HT/VHT20 Beam Forming, M0 to M7	3	15	-60.2	-56.5	-58.0		0.1	-38.2	-21.25	16.90
	HT/VHT20 Beam Forming, M8 to M15	3	13	-59.1	-55.4	-57.0		0.1	-39.1	-21.25	17.84
	HT/VHT20 Beam Forming, M16 to M23	3	13	-57.4	-54.8	-56.3		0.1	-38.2	-21.25	16.96
	HT/VHT20 Beam Forming, M0 to M7	4	16	-61.5	-59.2	-60.2	-63.3	0.1	-38.7	-21.25	17.47
	HT/VHT20 Beam Forming, M8 to M15	4	13	-60.2	-56.5	-57.4	-59.7	0.1	-39.1	-21.25	17.86
	HT/VHT20 Beam Forming, M16 to M23	4	13	-59.1	-55.4	-57.0	-58.7	0.1	-38.2	-21.25	16.97
	HT/VHT20 Beam Forming, M24 to M31	4	13	-57.4	-54.8	-56.3	-58.9	0.1	-37.5	-21.25	16.27
	HT/VHT20 STBC, M0 to M7	2	13	-56.8	-54.4			0.1	-39.4	-21.25	18.12
	HT/VHT20 STBC, M0 to M7	3	13	-59.1	-55.4	-57.0		0.1	-39.1	-21.25	17.84
	HT/VHT20 STBC, M0 to M7	4	13	-60.2	-56.5	-57.4	-59.7	0.1	-39.1	-21.25	17.86
	HE20, M0 to M9 1ss	1	13	-58.2				0.1	-45.1	-21.25	23.88



HE20, M0 to M9 1ss	2	13	-58.2	-55.3			0.1	-40.4	-21.25	19.19
HE20, M0 to M9 2ss	2	13	-58.2	-55.3			0.1	-40.4	-21.25	19.19
HE20, M0 to M9 1ss	3	13	-58.2	-55.3	-55.9		0.1	-38.5	-21.25	17.21
HE20, M0 to M9 2ss	3	13	-58.2	-55.3	-55.9		0.1	-38.5	-21.25	17.21
HE20, M0 to M9 3ss	3	13	-58.2	-55.3	-55.9		0.1	-38.5	-21.25	17.21
HE20, M0 to M9 1ss	4	13	-57.8	-56.0	-56.4	-59.5	0.1	-38.1	-21.25	16.89
HE20, M0 to M9 2ss	4	13	-57.8	-56.0	-56.4	-59.5	0.1	-38.1	-21.25	16.89
HE20, M0 to M9 3ss	4	13	-57.8	-56.0	-56.4	-59.5	0.1	-38.1	-21.25	16.89
HE20, M0 to M9 4ss	4	13	-57.8	-56.0	-56.4	-59.5	0.1	-38.1	-21.25	16.89
HE20 Beam Forming, M0 to M9 1ss	2	13	-58.2	-55.3			0.1	-40.4	-21.25	19.19
HE20 Beam Forming, M0 to M9 2ss	2	13	-58.2	-55.3			0.1	-40.4	-21.25	19.19
HE20 Beam Forming, M0 to M9 1ss	3	15	-61.0	-56.6	-56.7		0.1	-37.8	-21.25	16.59
HE20 Beam Forming, M0 to M9 2ss	3	13	-57.8	-56.0	-56.4		0.1	-38.8	-21.25	17.58
HE20 Beam Forming, M0 to M9 3ss	3	13	-58.2	-55.3	-55.9		0.1	-38.5	-21.25	17.21
HE20 Beam Forming, M0 to M9 1ss	4	16	-61.9	-58.8	-60.9	-61.3	0.1	-38.5	-21.25	17.22
HE20 Beam Forming, M0 to M9 2ss	4	13	-59.6	-56.7	-55.9	-60.4	0.1	-38.7	-21.25	17.41
HE20 Beam Forming, M0 to M9 3ss	4	13	-57.8	-56.0	-56.4	-59.5	0.1	-38.1	-21.25	16.89
HE20 Beam Forming, M0 to M9 4ss	4	13	-57.8	-56.0	-56.4	-59.5	0.1	-38.1	-21.25	16.89
HE20 STBC, M0 to M9 2ss	2	13	-58.2	-55.3			0.1	-40.4	-21.25	19.19
HE20 STBC, M0 to M9 2ss	3	13	-57.8	-56.0	-56.4		0.1	-38.8	-21.25	17.58
HE20 STBC, M0 to M9 2ss	4	13	-59.6	-56.7	-55.9	-60.4	0.1	-38.7	-21.25	17.41

Non HT40, 6 to 54 Mbps	1	13	-59.6				0.0	-46.6	-21.25	25.30
Non HT40, 6 to 54 Mbps	2	13	-59.6	-55.8			0.0	-41.2	-21.25	19.99
Non HT40, 6 to 54 Mbps	3	13	-59.6	-55.8	-56.5		0.0	-39.2	-21.25	17.94
Non HT40, 6 to 54 Mbps	4	13	-60.0	-56.1	-57.3	-60.2	0.0	-39.0	-21.25	17.73
HT/VHT40, M0 to M7	1	13	-58.9				0.1	-45.8	-21.25	24.54
HT/VHT40, M0 to M7	2	13	-58.9	-54.6			0.1	-40.1	-21.25	18.87
HT/VHT40, M8 to M15	2	13	-58.9	-54.6			0.1	-40.1	-21.25	18.87
HT/VHT40, M0 to M7	3	13	-59.5	-55.6	-57.8		0.1	-39.5	-21.25	18.21
HT/VHT40, M8 to M15	3	13	-59.5	-55.6	-57.8		0.1	-39.5	-21.25	18.21
HT/VHT40, M16 to M23	3	13	-59.5	-55.6	-57.8		0.1	-39.5	-21.25	18.21
HT/VHT40, M0 to M7	4	13	-59.5	-55.6	-57.8	-59.5	0.1	-38.7	-21.25	17.41
HT/VHT40, M8 to M15	4	13	-59.5	-55.6	-57.8	-59.5	0.1	-38.7	-21.25	17.41
HT/VHT40, M16 to M23	4	13	-59.5	-55.6	-57.8	-59.5	0.1	-38.7	-21.25	17.41
HT/VHT40, M24 to M31	4	13	-59.5	-55.6	-57.8	-59.5	0.1	-38.7	-21.25	17.41
HT/VHT40 Beam Forming, M0 to M7	2	13	-58.9	-54.6			0.1	-40.1	-21.25	18.87
HT/VHT40 Beam Forming, M8 to M15	2	13	-58.9	-54.6			0.1	-40.1	-21.25	18.87
HT/VHT40 Beam Forming, M0 to M7	3	15	-60.5	-55.4	-57.9		0.1	-37.6	-21.25	16.32
HT/VHT40 Beam Forming, M8 to M15	3	13	-59.5	-55.6	-57.8		0.1	-39.5	-21.25	18.21
HT/VHT40 Beam Forming, M16 to M23	3	13	-59.5	-55.6	-57.8		0.1	-39.5	-21.25	18.21
HT/VHT40 Beam Forming, M0 to M7	4	16	-62.1	-58.8	-60.7	-62.7	0.1	-38.7	-21.25	17.42
HT/VHT40 Beam Forming, M8 to M15	4	13	-59.3	-56.2	-57.8	-60.2	0.1	-39.0	-21.25	17.72

	HT/VHT40 Beam Forming, M16 to M23	4	13	-59.5	-55.6	-57.8	-59.5	0.1	-38.7	-21.25	17.41
	HT/VHT40 Beam Forming, M24 to M31	4	13	-59.5	-55.6	-57.8	-59.5	0.1	-38.7	-21.25	17.41
	HT/VHT40 STBC, M0 to M7	2	13	-58.9	-54.6			0.1	-40.1	-21.25	18.87
	HT/VHT40 STBC, M0 to M7	3	13	-59.5	-55.6	-57.8		0.1	-39.5	-21.25	18.21
	HT/VHT40 STBC, M0 to M7	4	13	-59.3	-56.2	-57.8	-60.2	0.1	-39.0	-21.25	17.72
	HE40, M0 to M9 1ss	1	13	-58.7				0.1	-45.6	-21.25	24.32
	HE40, M0 to M9 1ss	2	13	-58.7	-54.7			0.1	-40.1	-21.25	18.86
	HE40, M0 to M9 2ss	2	13	-58.7	-54.7			0.1	-40.1	-21.25	18.86
	HE40, M0 to M9 1ss	3	13	-58.7	-54.7	-56.4		0.1	-38.4	-21.25	17.15
	HE40, M0 to M9 2ss	3	13	-58.7	-54.7	-56.4		0.1	-38.4	-21.25	17.15
	HE40, M0 to M9 3ss	3	13	-58.7	-54.7	-56.4		0.1	-38.4	-21.25	17.15
	HE40, M0 to M9 1ss	4	13	-58.5	-56.2	-57.5	-59.6	0.1	-38.6	-21.25	17.36
	HE40, M0 to M9 2ss	4	13	-58.5	-56.2	-57.5	-59.6	0.1	-38.6	-21.25	17.36
	HE40, M0 to M9 3ss	4	13	-58.5	-56.2	-57.5	-59.6	0.1	-38.6	-21.25	17.36
	HE40, M0 to M9 4ss	4	13	-58.5	-56.2	-57.5	-59.6	0.1	-38.6	-21.25	17.36
	HE40 Beam Forming, M0 to M9 1ss	2	13	-58.7	-54.7			0.1	-40.1	-21.25	18.86
	HE40 Beam Forming, M0 to M9 2ss	2	13	-58.7	-54.7			0.1	-40.1	-21.25	18.86
	HE40 Beam Forming, M0 to M9 1ss	3	15	-59.2	-55.4	-58.6		0.1	-37.5	-21.25	16.24
	HE40 Beam Forming, M0 to M9 2ss	3	13	-58.7	-54.7	-56.4		0.1	-38.4	-21.25	17.15
	HE40 Beam Forming, M0 to M9 3ss	3	13	-58.7	-54.7	-56.4		0.1	-38.4	-21.25	17.15
	HE40 Beam Forming, M0 to M9 1ss	4	16	-62.3	-58.9	-60.2	-60.5	0.1	-38.2	-21.25	16.91
	HE40 Beam Forming, M0 to M9 2ss	4	13	-58.5	-56.2	-57.5	-59.6	0.1	-38.6	-21.25	17.36
	HE40 Beam Forming, M0 to M9 3ss	4	13	-58.5	-56.2	-57.5	-59.6	0.1	-38.6	-21.25	17.36
	HE40 Beam Forming, M0 to M9 4ss	4	13	-58.5	-56.2	-57.5	-59.6	0.1	-38.6	-21.25	17.36
	HE40 STBC, M0 to M9 2ss	2	13	-58.7	-54.7			0.1	-40.1	-21.25	18.86
	HE40 STBC, M0 to M9 2ss	3	13	-58.7	-54.7	-56.4		0.1	-38.4	-21.25	17.15
	HE40 STBC, M0 to M9 2ss	4	13	-58.5	-56.2	-57.5	-59.6	0.1	-38.6	-21.25	17.36
5530	Non HT80, 6 to 54 Mbps	1	13	-59.3				0.1	-46.2	-21.25	25.00
	Non HT80, 6 to 54 Mbps	2	13	-59.3	-56.4			0.1	-41.6	-21.25	20.30
	Non HT80, 6 to 54 Mbps	3	13	-59.3	-56.4	-57.9		0.1	-39.9	-21.25	18.63
	Non HT80, 6 to 54 Mbps	4	13	-61.0	-55.5	-59.3	-58.9	0.1	-39.1	-21.25	17.86
	VHT80, M0 to M9 1ss	1	13	-60.8				0.2	-47.6	-21.25	26.33
	VHT80, M0 to M9 1ss	2	13	-60.8	-56.1			0.2	-41.6	-21.25	20.37
	VHT80, M0 to M9 2ss	2	13	-60.8	-56.1			0.2	-41.6	-21.25	20.37
	VHT80, M0 to M9 1ss	3	13	-59.8	-56.1	-57.7		0.2	-39.6	-21.25	18.37
	VHT80, M0 to M9 2ss	3	13	-59.8	-56.1	-57.7		0.2	-39.6	-21.25	18.37
	VHT80, M0 to M9 3ss	3	13	-59.8	-56.1	-57.7		0.2	-39.6	-21.25	18.37
	VHT80, M0 to M9 1ss	4	13	-59.8	-56.1	-57.7	-58.8	0.2	-38.6	-21.25	17.39
	VHT80, M0 to M9 2ss	4	13	-59.8	-56.1	-57.7	-58.8	0.2	-38.6	-21.25	17.39
	VHT80, M0 to M9 3ss	4	13	-59.8	-56.1	-57.7	-58.8	0.2	-38.6	-21.25	17.39
	VHT80, M0 to M9 4ss	4	13	-59.8	-56.1	-57.7	-58.8	0.2	-38.6	-21.25	17.39
	VHT80 Beam Forming, M0 to M9 1ss	2	13	-60.8	-56.1			0.2	-41.6	-21.25	20.37



VHT80 Beam Forming, M0 to M9 2ss	2	13	-60.8	-56.1			0.2	-41.6	-21.25	20.37
VHT80 Beam Forming, M0 to M9 1ss	3	15	-61.0	-56.8	-58.1		0.2	-38.3	-21.25	17.07
VHT80 Beam Forming, M0 to M9 2ss	3	13	-59.8	-56.1	-57.7		0.2	-39.6	-21.25	18.37
VHT80 Beam Forming, M0 to M9 3ss	3	13	-59.8	-56.1	-57.7		0.2	-39.6	-21.25	18.37
VHT80 Beam Forming, M0 to M9 1ss	4	16	-62.4	-57.4	-60.2	-60.4	0.2	-37.5	-21.25	16.24
VHT80 Beam Forming, M0 to M9 2ss	4	13	-59.8	-56.1	-57.7	-58.8	0.2	-38.6	-21.25	17.39
VHT80 Beam Forming, M0 to M9 3ss	4	13	-59.8	-56.1	-57.7	-58.8	0.2	-38.6	-21.25	17.39
VHT80 Beam Forming, M0 to M9 4ss	4	13	-59.8	-56.1	-57.7	-58.8	0.2	-38.6	-21.25	17.39
VHT80 STBC, M0 to M9 1ss	2	13	-60.8	-56.1			0.2	-41.6	-21.25	20.37
VHT80 STBC, M0 to M9 1ss	3	13	-59.8	-56.1	-57.7		0.2	-39.6	-21.25	18.37
VHT80 STBC, M0 to M9 1ss	4	13	-59.8	-56.1	-57.7	-58.8	0.2	-38.6	-21.25	17.39
HE80, M0 to M9 1ss	1	13	-59.7				0.3	-46.4	-21.25	25.20
HE80, M0 to M9 1ss	2	13	-59.7	-55.9			0.3	-41.1	-21.25	19.89
HE80, M0 to M9 2ss	2	13	-59.7	-55.9			0.3	-41.1	-21.25	19.89
HE80, M0 to M9 1ss	3	13	-60.3	-56.4	-57.7		0.3	-39.8	-21.25	18.58
HE80, M0 to M9 2ss	3	13	-60.3	-56.4	-57.7		0.3	-39.8	-21.25	18.58
HE80, M0 to M9 3ss	3	13	-60.3	-56.4	-57.7		0.3	-39.8	-21.25	18.58
HE80, M0 to M9 1ss	4	13	-60.3	-56.4	-57.7	-59.5	0.3	-38.9	-21.25	17.69
HE80, M0 to M9 2ss	4	13	-60.3	-56.4	-57.7	-59.5	0.3	-38.9	-21.25	17.69
HE80, M0 to M9 3ss	4	13	-60.3	-56.4	-57.7	-59.5	0.3	-38.9	-21.25	17.69
HE80, M0 to M9 4ss	4	13	-60.3	-56.4	-57.7	-59.5	0.3	-38.9	-21.25	17.69
HE80 Beam Forming, M0 to M9 1ss	2	13	-59.7	-55.9			0.3	-41.1	-21.25	19.89
HE80 Beam Forming, M0 to M9 2ss	2	13	-59.7	-55.9			0.3	-41.1	-21.25	19.89
HE80 Beam Forming, M0 to M9 1ss	3	15	-60.2	-56.8	-58.2		0.3	-38.2	-21.25	16.91
HE80 Beam Forming, M0 to M9 2ss	3	13	-60.3	-56.4	-57.7		0.3	-39.8	-21.25	18.58
HE80 Beam Forming, M0 to M9 3ss	3	13	-60.3	-56.4	-57.7		0.3	-39.8	-21.25	18.58
HE80 Beam Forming, M0 to M9 1ss	4	16	-61.4	-57.6	-60.3	-60.3	0.3	-37.4	-21.25	16.14
HE80 Beam Forming, M0 to M9 2ss	4	13	-60.3	-56.4	-57.7	-59.5	0.3	-38.9	-21.25	17.69
HE80 Beam Forming, M0 to M9 3ss	4	13	-60.3	-56.4	-57.7	-59.5	0.3	-38.9	-21.25	17.69
HE80 Beam Forming, M0 to M9 4ss	4	13	-60.3	-56.4	-57.7	-59.5	0.3	-38.9	-21.25	17.69
HE80 STBC, M0 to M9 1ss	2	13	-59.7	-55.9			0.3	-41.1	-21.25	19.89
HE80 STBC, M0 to M9 1ss	3	13	-60.3	-56.4	-57.7		0.3	-39.8	-21.25	18.58
HE80 STBC, M0 to M9 1ss	4	13	-60.3	-56.4	-57.7	-59.5	0.3	-38.9	-21.25	17.69
5550 Non HT40, 6 to 54 Mbps	1	13	-57.5				0.0	-44.5	-21.25	23.20
5550 Non HT40, 6 to 54 Mbps	2	13	-57.5	-52.7			0.0	-38.4	-21.25	17.16
5550 Non HT40, 6 to 54 Mbps	3	13	-57.9	-53.4	-56.1		0.0	-37.6	-21.25	16.33
5550 Non HT40, 6 to 54 Mbps	4	13	-58.0	-55.5	-56.4	-57.8	0.0	-37.7	-21.25	16.48
5550 HT/VHT40, M0 to M7	1	13	-57.1				0.1	-44.0	-21.25	22.74
5550 HT/VHT40, M0 to M7	2	13	-57.1	-52.8			0.1	-38.3	-21.25	17.07
5550 HT/VHT40, M8 to M15	2	13	-57.1	-52.8			0.1	-38.3	-21.25	17.07
5550 HT/VHT40, M0 to M7	3	13	-58.3	-53.4	-57.7		0.1	-38.0	-21.25	16.75
5550 HT/VHT40, M8 to M15	3	13	-58.3	-53.4	-57.7		0.1	-38.0	-21.25	16.75

HT/VHT40, M16 to M23	3	13	-58.3	-53.4	-57.7		0.1	-38.0	-21.25	16.75
HT/VHT40, M0 to M7	4	13	-58.9	-55.6	-56.9	-59.2	0.1	-38.3	-21.25	17.01
HT/VHT40, M8 to M15	4	13	-58.9	-55.6	-56.9	-59.2	0.1	-38.3	-21.25	17.01
HT/VHT40, M16 to M23	4	13	-58.9	-55.6	-56.9	-59.2	0.1	-38.3	-21.25	17.01
HT/VHT40, M24 to M31	4	13	-58.9	-55.6	-56.9	-59.2	0.1	-38.3	-21.25	17.01
HT/VHT40 Beam Forming, M0 to M7	2	13	-58.9	-55.6			0.1	-40.8	-21.25	19.57
HT/VHT40 Beam Forming, M8 to M15	2	13	-57.1	-52.8			0.1	-38.3	-21.25	17.07
HT/VHT40 Beam Forming, M0 to M7	3	15	-61.1	-57.2	-60.2		0.1	-39.3	-21.25	18.03
HT/VHT40 Beam Forming, M8 to M15	3	13	-59.4	-56.0	-57.9		0.1	-39.7	-21.25	18.41
HT/VHT40 Beam Forming, M16 to M23	3	13	-58.3	-53.4	-57.7		0.1	-38.0	-21.25	16.75
HT/VHT40 Beam Forming, M0 to M7	4	16	-62.8	-58.2	-60.7	-62.5	0.1	-38.5	-21.25	17.26
HT/VHT40 Beam Forming, M8 to M15	4	13	-60.1	-56.4	-58.3	-59.5	0.1	-39.2	-21.25	17.95
HT/VHT40 Beam Forming, M16 to M23	4	13	-59.4	-56.0	-57.9	-60.0	0.1	-38.9	-21.25	17.66
HT/VHT40 Beam Forming, M24 to M31	4	13	-58.9	-55.6	-56.9	-59.2	0.1	-38.3	-21.25	17.01
HT/VHT40 STBC, M0 to M7	2	13	-57.1	-52.8			0.1	-38.3	-21.25	17.07
HT/VHT40 STBC, M0 to M7	3	13	-59.4	-56.0	-57.9		0.1	-39.7	-21.25	18.41
HT/VHT40 STBC, M0 to M7	4	13	-60.1	-56.4	-58.3	-59.5	0.1	-39.2	-21.25	17.95
HE40, M0 to M9 1ss	1	13	-57.2				0.1	-44.1	-21.25	22.82
HE40, M0 to M9 1ss	2	13	-57.2	-51.4			0.1	-37.3	-21.25	16.00
HE40, M0 to M9 2ss	2	13	-57.2	-51.4			0.1	-37.3	-21.25	16.00
HE40, M0 to M9 1ss	3	13	-58.0	-52.6	-55.7		0.1	-37.0	-21.25	15.72
HE40, M0 to M9 2ss	3	13	-58.0	-52.6	-55.7		0.1	-37.0	-21.25	15.72
HE40, M0 to M9 3ss	3	13	-58.0	-52.6	-55.7		0.1	-37.0	-21.25	15.72
HE40, M0 to M9 1ss	4	13	-58.1	-54.5	-56.5	-58.9	0.1	-37.5	-21.25	16.26
HE40, M0 to M9 2ss	4	13	-58.1	-54.5	-56.5	-58.9	0.1	-37.5	-21.25	16.26
HE40, M0 to M9 3ss	4	13	-58.1	-54.5	-56.5	-58.9	0.1	-37.5	-21.25	16.26
HE40, M0 to M9 4ss	4	13	-58.1	-54.5	-56.5	-58.9	0.1	-37.5	-21.25	16.26
HE40 Beam Forming, M0 to M9 1ss	2	13	-58.1	-54.5			0.1	-39.8	-21.25	18.54
HE40 Beam Forming, M0 to M9 2ss	2	13	-57.2	-51.4			0.1	-37.3	-21.25	16.00
HE40 Beam Forming, M0 to M9 1ss	3	15	-60.5	-55.9	-59.6		0.1	-38.3	-21.25	17.03
HE40 Beam Forming, M0 to M9 2ss	3	13	-59.5	-55.2	-57.1		0.1	-39.0	-21.25	17.77
HE40 Beam Forming, M0 to M9 3ss	3	13	-58.0	-52.6	-55.7		0.1	-37.0	-21.25	15.72
HE40 Beam Forming, M0 to M9 1ss	4	16	-61.9	-58.1	-60.5	-61.7	0.1	-38.1	-21.25	16.86
HE40 Beam Forming, M0 to M9 2ss	4	13	-60.4	-55.5	-57.4	-59.8	0.1	-38.7	-21.25	17.42
HE40 Beam Forming, M0 to M9 3ss	4	13	-59.5	-55.2	-57.1	-59.0	0.1	-38.2	-21.25	16.95
HE40 Beam Forming, M0 to M9 4ss	4	13	-58.1	-54.5	-56.5	-58.9	0.1	-37.5	-21.25	16.26
HE40 STBC, M0 to M9 2ss	2	13	-57.2	-51.4			0.1	-37.3	-21.25	16.00
HE40 STBC, M0 to M9 2ss	3	13	-59.5	-55.2	-57.1		0.1	-39.0	-21.25	17.77
HE40 STBC, M0 to M9 2ss	4	13	-60.4	-55.5	-57.4	-59.8	0.1	-38.7	-21.25	17.42

5560	Non HT20, 6 to 54 Mbps	1	13	-56.3				0.1	-43.2	-21.25	22.00
	Non HT20, 6 to 54 Mbps	2	13	-56.3	-52.6			0.1	-38.0	-21.25	16.76
	Non HT20, 6 to 54 Mbps	3	13	-58.3	-55.6	-56.0		0.1	-38.7	-21.25	17.41
	Non HT20, 6 to 54 Mbps	4	13	-59.5	-55.8	-57.4	-59.7	0.1	-38.7	-21.25	17.48
	Non HT20 Beam Forming, 6 to 54 Mbps	2	13	-58.3	-55.6			0.1	-40.7	-21.25	19.43
	Non HT20 Beam Forming, 6 to 54 Mbps	3	15	-60.6	-56.4	-57.5		0.1	-38.0	-21.25	16.76
	Non HT20 Beam Forming, 6 to 54 Mbps	4	16	-62.9	-58.9	-60.5	-60.3	0.1	-38.4	-21.25	17.11
	HT/VHT20, M0 to M7	1	13	-57.0				0.1	-43.9	-21.25	22.70
	HT/VHT20, M0 to M7	2	13	-57.0	-53.0			0.1	-38.5	-21.25	17.24
	HT/VHT20, M8 to M15	2	13	-57.0	-53.0			0.1	-38.5	-21.25	17.24
	HT/VHT20, M0 to M7	3	13	-58.1	-55.7	-56.9		0.1	-39.0	-21.25	17.72
	HT/VHT20, M8 to M15	3	13	-58.1	-55.7	-56.9		0.1	-39.0	-21.25	17.72
	HT/VHT20, M16 to M23	3	13	-58.1	-55.7	-56.9		0.1	-39.0	-21.25	17.72
	HT/VHT20, M0 to M7	4	13	-59.5	-55.0	-56.8	-59.7	0.1	-38.2	-21.25	16.98
	HT/VHT20, M8 to M15	4	13	-59.5	-55.0	-56.8	-59.7	0.1	-38.2	-21.25	16.98
	HT/VHT20, M16 to M23	4	13	-59.5	-55.0	-56.8	-59.7	0.1	-38.2	-21.25	16.98
	HT/VHT20, M24 to M31	4	13	-59.5	-55.0	-56.8	-59.7	0.1	-38.2	-21.25	16.98
	HT/VHT20 Beam Forming, M0 to M7	2	13	-58.1	-55.7			0.1	-40.7	-21.25	19.42
	HT/VHT20 Beam Forming, M8 to M15	2	13	-57.0	-53.0			0.1	-38.5	-21.25	17.24
	HT/VHT20 Beam Forming, M0 to M7	3	15	-60.1	-56.1	-59.0		0.1	-38.2	-21.25	16.99
	HT/VHT20 Beam Forming, M8 to M15	3	13	-59.5	-55.0	-56.8		0.1	-38.9	-21.25	17.65
	HT/VHT20 Beam Forming, M16 to M23	3	13	-58.1	-55.7	-56.9		0.1	-39.0	-21.25	17.72
	HT/VHT20 Beam Forming, M0 to M7	4	16	-62.1	-59.6	-60.6	-62.0	0.1	-38.9	-21.25	17.63
	HT/VHT20 Beam Forming, M8 to M15	4	13	-60.2	-57.2	-56.8	-60.5	0.1	-39.3	-21.25	18.03
	HT/VHT20 Beam Forming, M16 to M23	4	13	-59.5	-55.0	-56.8	-59.7	0.1	-38.2	-21.25	16.98
	HT/VHT20 Beam Forming, M24 to M31	4	13	-59.5	-55.0	-56.8	-59.7	0.1	-38.2	-21.25	16.98
	HT/VHT20 STBC, M0 to M7	2	13	-57.0	-53.0			0.1	-38.5	-21.25	17.24
	HT/VHT20 STBC, M0 to M7	3	13	-59.5	-55.0	-56.8		0.1	-38.9	-21.25	17.65
	HT/VHT20 STBC, M0 to M7	4	13	-60.2	-57.2	-56.8	-60.5	0.1	-39.3	-21.25	18.03
	HE20, M0 to M9 1ss	1	13	-56.7				0.1	-43.6	-21.25	22.38
	HE20, M0 to M9 1ss	2	13	-56.7	-52.0			0.1	-37.7	-21.25	16.42
	HE20, M0 to M9 2ss	2	13	-56.7	-52.0			0.1	-37.7	-21.25	16.42
	HE20, M0 to M9 1ss	3	13	-58.8	-54.9	-56.2		0.1	-38.5	-21.25	17.26
	HE20, M0 to M9 2ss	3	13	-58.8	-54.9	-56.2		0.1	-38.5	-21.25	17.26
	HE20, M0 to M9 3ss	3	13	-58.8	-54.9	-56.2		0.1	-38.5	-21.25	17.26
	HE20, M0 to M9 1ss	4	13	-59.3	-56.2	-57.2	-59.8	0.1	-38.8	-21.25	17.54
	HE20, M0 to M9 2ss	4	13	-59.3	-56.2	-57.2	-59.8	0.1	-38.8	-21.25	17.54
	HE20, M0 to M9 3ss	4	13	-59.3	-56.2	-57.2	-59.8	0.1	-38.8	-21.25	17.54
	HE20, M0 to M9 4ss	4	13	-59.3	-56.2	-57.2	-59.8	0.1	-38.8	-21.25	17.54
	HE20 Beam Forming, M0 to M9 1ss	2	13	-58.8	-54.9			0.1	-40.4	-21.25	19.10
	HE20 Beam Forming, M0 to M9 2ss	2	13	-56.7	-52.0			0.1	-37.7	-21.25	16.42
	HE20 Beam Forming, M0 to M9 1ss	3	15	-60.2	-57.0	-59.2		0.1	-38.8	-21.25	17.50
	HE20 Beam Forming, M0 to M9 2ss	3	13	-58.6	-55.4	-57.1		0.1	-39.0	-21.25	17.75

	HE20 Beam Forming, M0 to M9 3ss	3	13	-58.8	-54.9	-56.2		0.1	-38.5	-21.25	17.26
	HE20 Beam Forming, M0 to M9 1ss	4	16	-61.4	-57.4	-60.5	-61.9	0.1	-37.8	-21.25	16.58
	HE20 Beam Forming, M0 to M9 2ss	4	13	-60.3	-56.1	-57.3	-59.1	0.1	-38.8	-21.25	17.57
	HE20 Beam Forming, M0 to M9 3ss	4	13	-59.3	-56.2	-57.2	-59.8	0.1	-38.8	-21.25	17.54
	HE20 Beam Forming, M0 to M9 4ss	4	13	-59.3	-56.2	-57.2	-59.8	0.1	-38.8	-21.25	17.54
	HE20 STBC, M0 to M9 2ss	2	13	-56.7	-52.0			0.1	-37.7	-21.25	16.42
	HE20 STBC, M0 to M9 2ss	3	13	-58.6	-55.4	-57.1		0.1	-39.0	-21.25	17.75
	HE20 STBC, M0 to M9 2ss	4	13	-60.3	-56.1	-57.3	-59.1	0.1	-38.8	-21.25	17.57
5570	Non HT160, 6 to 54 Mbps	1	13	-59.6				0.0	-46.6	-21.25	25.30
	Non HT160, 6 to 54 Mbps	2	13	-59.6	-55.2			0.0	-40.8	-21.25	19.56
	Non HT160, 6 to 54 Mbps	3	13	-59.6	-55.2	-58.3		0.0	-39.5	-21.25	18.23
	Non HT160, 6 to 54 Mbps	4	13	-60.0	-56.6	-57.7	-60.3	0.0	-39.3	-21.25	18.06
	VHT160, M0 to M9 1ss	1	13	-54.2				0.4	-40.8	-21.25	19.54
	VHT160, M0 to M9 1ss	2	13	-54.2	-55.8			0.4	-38.5	-21.25	17.26
	VHT160, M0 to M9 2ss	2	13	-54.2	-55.8			0.4	-38.5	-21.25	17.26
	VHT160, M0 to M9 1ss	3	13	-58.7	-55.7	-56.9		0.4	-38.8	-21.25	17.50
	VHT160, M0 to M9 2ss	3	13	-58.7	-55.7	-56.9		0.4	-38.8	-21.25	17.50
	VHT160, M0 to M9 3ss	3	13	-58.7	-55.7	-56.9		0.4	-38.8	-21.25	17.50
	VHT160, M0 to M9 1ss	4	13	-58.7	-55.7	-56.9	-59.7	0.4	-38.0	-21.25	16.80
	VHT160, M0 to M9 2ss	4	13	-58.7	-55.7	-56.9	-59.7	0.4	-38.0	-21.25	16.80
	VHT160, M0 to M9 3ss	4	13	-58.7	-55.7	-56.9	-59.7	0.4	-38.0	-21.25	16.80
	VHT160, M0 to M9 4ss	4	13	-58.7	-55.7	-56.9	-59.7	0.4	-38.0	-21.25	16.80
	VHT160 Beam Forming, M0 to M9 1ss	2	13	-54.2	-55.8			0.4	-38.5	-21.25	17.26
	VHT160 Beam Forming, M0 to M9 2ss	2	13	-54.2	-55.8			0.4	-38.5	-21.25	17.26
	VHT160 Beam Forming, M0 to M9 1ss	3	15	-58.7	-55.7	-56.9		0.4	-36.8	-21.25	15.50
	VHT160 Beam Forming, M0 to M9 2ss	3	13	-58.7	-55.7	-56.9		0.4	-38.8	-21.25	17.50
	VHT160 Beam Forming, M0 to M9 3ss	3	13	-58.7	-55.7	-56.9		0.4	-38.8	-21.25	17.50
	VHT160 Beam Forming, M0 to M9 1ss	4	16	-61.9	-57.4	-61.0	-60.7	0.4	-37.5	-21.25	16.20
	VHT160 Beam Forming, M0 to M9 2ss	4	13	-58.7	-55.7	-56.9	-59.7	0.4	-38.0	-21.25	16.80
	VHT160 Beam Forming, M0 to M9 3ss	4	13	-58.7	-55.7	-56.9	-59.7	0.4	-38.0	-21.25	16.80
	VHT160 Beam Forming, M0 to M9 4ss	4	13	-58.7	-55.7	-56.9	-59.7	0.4	-38.0	-21.25	16.80
	VHT160 STBC, M0 to M9 1ss	2	13	-54.2	-55.8			0.4	-38.5	-21.25	17.26
	VHT160 STBC, M0 to M9 1ss	3	13	-58.7	-55.7	-56.9		0.4	-38.8	-21.25	17.50
	VHT160 STBC, M0 to M9 1ss	4	13	-58.7	-55.7	-56.9	-59.7	0.4	-38.0	-21.25	16.80
	HE160, M0 to M9 1ss	1	13	-59.8				0.4	-46.4	-21.25	25.12
	HE160, M0 to M9 1ss	2	13	-59.8	-56.3			0.4	-41.3	-21.25	20.01
	HE160, M0 to M9 2ss	2	13	-59.8	-56.3			0.4	-41.3	-21.25	20.01
	HE160, M0 to M9 1ss	3	13	-59.8	-56.3	-56.6		0.4	-39.1	-21.25	17.85
	HE160, M0 to M9 2ss	3	13	-59.8	-56.3	-56.6		0.4	-39.1	-21.25	17.85
	HE160, M0 to M9 3ss	3	13	-59.8	-56.3	-56.6		0.4	-39.1	-21.25	17.85
	HE160, M0 to M9 1ss	4	13	-60.0	-56.2	-55.4	-59.8	0.4	-37.9	-21.25	16.66
HE160, M0 to M9 2ss	4	13	-60.0	-56.2	-55.4	-59.8	0.4	-37.9	-21.25	16.66	

HE160, M0 to M9 3ss	4	13	-60.0	-56.2	-55.4	-59.8	0.4	-37.9	-21.25	16.66
HE160, M0 to M9 4ss	4	13	-60.0	-56.2	-55.4	-59.8	0.4	-37.9	-21.25	16.66
HE160 Beam Forming, M0 to M9 1ss	2	13	-59.8	-56.3			0.4	-41.3	-21.25	20.01
HE160 Beam Forming, M0 to M9 2ss	2	13	-59.8	-56.3			0.4	-41.3	-21.25	20.01
HE160 Beam Forming, M0 to M9 1ss	3	15	-60.0	-56.2	-57.6		0.4	-37.5	-21.25	16.21
HE160 Beam Forming, M0 to M9 2ss	3	13	-59.8	-56.3	-56.6		0.4	-39.1	-21.25	17.85
HE160 Beam Forming, M0 to M9 3ss	3	13	-59.8	-56.3	-56.6		0.4	-39.1	-21.25	17.85
HE160 Beam Forming, M0 to M9 1ss	4	16	-61.8	-57.1	-59.8	-60.7	0.4	-37.0	-21.25	15.78
HE160 Beam Forming, M0 to M9 2ss	4	13	-60.0	-56.2	-55.4	-59.8	0.4	-37.9	-21.25	16.66
HE160 Beam Forming, M0 to M9 3ss	4	13	-60.0	-56.2	-55.4	-59.8	0.4	-37.9	-21.25	16.66
HE160 Beam Forming, M0 to M9 4ss	4	13	-60.0	-56.2	-55.4	-59.8	0.4	-37.9	-21.25	16.66
HE160 STBC, M0 to M9 1ss	2	13	-59.8	-56.3			0.4	-41.3	-21.25	20.01
HE160 STBC, M0 to M9 1ss	3	13	-59.8	-56.3	-56.6		0.4	-39.1	-21.25	17.85
HE160 STBC, M0 to M9 1ss	4	13	-60.0	-56.2	-55.4	-59.8	0.4	-37.9	-21.25	16.66
Non HT80, 6 to 54 Mbps	1	13	-57.1				0.1	-44.0	-21.25	22.80
Non HT80, 6 to 54 Mbps	2	13	-57.1	-51.7			0.1	-37.5	-21.25	16.30
<b>Non HT80, 6 to 54 Mbps</b>	<b>3</b>	<b>13</b>	<b>-56.9</b>	<b>-53.5</b>	<b>-53.7</b>		<b>0.1</b>	<b>-36.6</b>	<b>-21.25</b>	<b>15.38</b>
Non HT80, 6 to 54 Mbps	4	13	-57.6	-53.9	-55.7	-57.0	0.1	-36.7	-21.25	15.49
VHT80, M0 to M9 1ss	1	13	-57.4				0.2	-44.2	-21.25	22.93
VHT80, M0 to M9 1ss	2	13	-57.4	-51.8			0.2	-37.5	-21.25	16.28
VHT80, M0 to M9 2ss	2	13	-57.4	-51.8			0.2	-37.5	-21.25	16.28
VHT80, M0 to M9 1ss	3	13	-57.9	-53.5	-56.6		0.2	-37.6	-21.25	16.36
VHT80, M0 to M9 2ss	3	13	-57.9	-53.5	-56.6		0.2	-37.6	-21.25	16.36
VHT80, M0 to M9 3ss	3	13	-57.9	-53.5	-56.6		0.2	-37.6	-21.25	16.36
VHT80, M0 to M9 1ss	4	13	-58.3	-53.3	-57.0	-59.6	0.2	-37.1	-21.25	15.87
VHT80, M0 to M9 2ss	4	13	-58.3	-53.3	-57.0	-59.6	0.2	-37.1	-21.25	15.87
VHT80, M0 to M9 3ss	4	13	-58.3	-53.3	-57.0	-59.6	0.2	-37.1	-21.25	15.87
VHT80, M0 to M9 4ss	4	13	-58.3	-53.3	-57.0	-59.6	0.2	-37.1	-21.25	15.87
VHT80 Beam Forming, M0 to M9 1ss	2	13	-58.3	-53.3			0.2	-38.9	-21.25	17.64
VHT80 Beam Forming, M0 to M9 2ss	2	13	-57.4	-51.8			0.2	-37.5	-21.25	16.28
VHT80 Beam Forming, M0 to M9 1ss	3	15	-60.8	-56.4	-56.9		0.2	-37.7	-21.25	16.40
VHT80 Beam Forming, M0 to M9 2ss	3	13	-59.9	-55.1	-57.3		0.2	-39.0	-21.25	17.77
VHT80 Beam Forming, M0 to M9 3ss	3	13	-57.9	-53.5	-56.6		0.2	-37.6	-21.25	16.36
VHT80 Beam Forming, M0 to M9 1ss	4	16	-62.3	-59.3	-60.0	-62.4	0.2	-38.5	-21.25	17.30
VHT80 Beam Forming, M0 to M9 2ss	4	13	-60.6	-56.1	-57.5	-57.9	0.2	-38.5	-21.25	17.26
VHT80 Beam Forming, M0 to M9 3ss	4	13	-59.9	-55.1	-57.3	-59.8	0.2	-38.3	-21.25	17.07
VHT80 Beam Forming, M0 to M9 4ss	4	13	-58.3	-53.3	-57.0	-59.6	0.2	-37.1	-21.25	15.87
VHT80 STBC, M0 to M9 1ss	2	13	-57.4	-51.8			0.2	-37.5	-21.25	16.28
VHT80 STBC, M0 to M9 1ss	3	13	-59.9	-55.1	-57.3		0.2	-39.0	-21.25	17.77
VHT80 STBC, M0 to M9 1ss	4	13	-60.6	-56.1	-57.5	-57.9	0.2	-38.5	-21.25	17.26
HE80, M0 to M9 1ss	1	13	-56.8				0.3	-43.5	-21.25	22.30
HE80, M0 to M9 1ss	2	13	-56.8	-52.7			0.3	-38.0	-21.25	16.77

	HE80, M0 to M9 2ss	2	13	-56.8	-52.7			0.3	-38.0	-21.25	16.77
	HE80, M0 to M9 1ss	3	13	-57.5	-53.0	-55.1		0.3	-36.8	-21.25	15.55
	HE80, M0 to M9 2ss	3	13	-57.5	-53.0	-55.1		0.3	-36.8	-21.25	15.55
	HE80, M0 to M9 3ss	3	13	-57.5	-53.0	-55.1		0.3	-36.8	-21.25	15.55
	HE80, M0 to M9 1ss	4	13	-57.9	-53.0	-56.8	-58.2	0.3	-36.6	-21.25	15.40
	HE80, M0 to M9 2ss	4	13	-57.9	-53.0	-56.8	-58.2	0.3	-36.6	-21.25	15.40
	HE80, M0 to M9 3ss	4	13	-57.9	-53.0	-56.8	-58.2	0.3	-36.6	-21.25	15.40
	HE80, M0 to M9 4ss	4	13	-57.9	-53.0	-56.8	-58.2	0.3	-36.6	-21.25	15.40
	HE80 Beam Forming, M0 to M9 1ss	2	13	-57.9	-53.0			0.3	-38.5	-21.25	17.28
	HE80 Beam Forming, M0 to M9 2ss	2	13	-56.8	-52.7			0.3	-38.0	-21.25	16.77
	HE80 Beam Forming, M0 to M9 1ss	3	15	-59.9	-55.5	-57.8		0.3	-37.3	-21.25	16.10
	HE80 Beam Forming, M0 to M9 2ss	3	13	-59.5	-54.7	-57.2		0.3	-38.7	-21.25	17.43
	HE80 Beam Forming, M0 to M9 3ss	3	13	-57.5	-53.0	-55.1		0.3	-36.8	-21.25	15.55
	HE80 Beam Forming, M0 to M9 1ss	4	16	-62.5	-58.7	-60.2	-62.1	0.3	-38.3	-21.25	17.08
	HE80 Beam Forming, M0 to M9 2ss	4	13	-60.1	-56.1	-57.9	-59.8	0.3	-38.9	-21.25	17.65
	HE80 Beam Forming, M0 to M9 3ss	4	13	-59.5	-54.7	-57.2	-59.4	0.3	-38.0	-21.25	16.71
	HE80 Beam Forming, M0 to M9 4ss	4	13	-57.9	-53.0	-56.8	-58.2	0.3	-36.6	-21.25	15.40
	HE80 STBC, M0 to M9 1ss	2	13	-56.8	-52.7			0.3	-38.0	-21.25	16.77
	HE80 STBC, M0 to M9 1ss	3	13	-59.5	-54.7	-57.2		0.3	-38.7	-21.25	17.43
	HE80 STBC, M0 to M9 1ss	4	13	-60.1	-56.1	-57.9	-59.8	0.3	-38.9	-21.25	17.65
5690	Non HT80, 6 to 54 Mbps	1	13	-58.7				0.1	-45.6	-21.25	24.40
	Non HT80, 6 to 54 Mbps	2	13	-58.7	-54.4			0.1	-40.0	-21.25	18.73
	Non HT80, 6 to 54 Mbps	3	13	-58.7	-54.4	-56.9		0.1	-38.5	-21.25	17.24
	Non HT80, 6 to 54 Mbps	4	13	-59.3	-56.3	-57.7	-58.7	0.1	-38.8	-21.25	17.53
	VHT80, M0 to M9 1ss	1	13	-58.4				0.2	-45.2	-21.25	23.93
	VHT80, M0 to M9 1ss	2	13	-58.4	-54.0			0.2	-39.4	-21.25	18.19
	VHT80, M0 to M9 2ss	2	13	-58.4	-54.0			0.2	-39.4	-21.25	18.19
	VHT80, M0 to M9 1ss	3	13	-59.5	-54.1	-57.5		0.2	-38.5	-21.25	17.21
	VHT80, M0 to M9 2ss	3	13	-59.5	-54.1	-57.5		0.2	-38.5	-21.25	17.21
	VHT80, M0 to M9 3ss	3	13	-59.5	-54.1	-57.5		0.2	-38.5	-21.25	17.21
	VHT80, M0 to M9 1ss	4	13	-59.6	-56.5	-58.2	-60.6	0.2	-39.2	-21.25	17.96
	VHT80, M0 to M9 2ss	4	13	-59.6	-56.5	-58.2	-60.6	0.2	-39.2	-21.25	17.96
	VHT80, M0 to M9 3ss	4	13	-59.6	-56.5	-58.2	-60.6	0.2	-39.2	-21.25	17.96
	VHT80, M0 to M9 4ss	4	13	-59.6	-56.5	-58.2	-60.6	0.2	-39.2	-21.25	17.96
	VHT80 Beam Forming, M0 to M9 1ss	2	13	-59.6	-56.5			0.2	-41.6	-21.25	20.30
	VHT80 Beam Forming, M0 to M9 2ss	2	13	-58.4	-54.0			0.2	-39.4	-21.25	18.19
	VHT80 Beam Forming, M0 to M9 1ss	3	15	-61.3	-57.6	-60.7		0.2	-39.6	-21.25	18.31
	VHT80 Beam Forming, M0 to M9 2ss	3	13	-61.1	-57.0	-58.4		0.2	-40.5	-21.25	19.28
	VHT80 Beam Forming, M0 to M9 3ss	3	13	-59.5	-54.1	-57.5		0.2	-38.5	-21.25	17.21
	VHT80 Beam Forming, M0 to M9 1ss	4	16	-64.0	-59.5	-61.0	-63.2	0.2	-39.3	-21.25	18.07
VHT80 Beam Forming, M0 to M9 2ss	4	13	-61.1	-55.8	-58.7	-60.3	0.2	-39.2	-21.25	17.98	
VHT80 Beam Forming, M0 to M9 3ss	4	13	-61.1	-57.0	-58.4	-60.0	0.2	-39.6	-21.25	18.36	

VHT80 Beam Forming, M0 to M9 4ss	4	13	-59.6	-56.5	-58.2	-60.6	0.2	-39.2	-21.25	17.96	
VHT80 STBC, M0 to M9 1ss	2	13	-58.4	-54.0			0.2	-39.4	-21.25	18.19	
VHT80 STBC, M0 to M9 1ss	3	13	-61.1	-57.0	-58.4		0.2	-40.5	-21.25	19.28	
VHT80 STBC, M0 to M9 1ss	4	13	-61.1	-55.8	-58.7	-60.3	0.2	-39.2	-21.25	17.98	
HE80, M0 to M9 1ss	1	13	-58.9				0.3	-45.6	-21.25	24.40	
HE80, M0 to M9 1ss	2	13	-58.9	-52.7			0.3	-38.5	-21.25	17.27	
HE80, M0 to M9 2ss	2	13	-58.9	-52.7			0.3	-38.5	-21.25	17.27	
HE80, M0 to M9 1ss	3	13	-59.0	-53.8	-57.0		0.3	-38.0	-21.25	16.79	
HE80, M0 to M9 2ss	3	13	-59.0	-53.8	-57.0		0.3	-38.0	-21.25	16.79	
HE80, M0 to M9 3ss	3	13	-59.0	-53.8	-57.0		0.3	-38.0	-21.25	16.79	
HE80, M0 to M9 1ss	4	13	-59.9	-56.6	-58.5	-60.0	0.3	-39.2	-21.25	18.00	
HE80, M0 to M9 2ss	4	13	-59.9	-56.6	-58.5	-60.0	0.3	-39.2	-21.25	18.00	
HE80, M0 to M9 3ss	4	13	-59.9	-56.6	-58.5	-60.0	0.3	-39.2	-21.25	18.00	
HE80, M0 to M9 4ss	4	13	-59.9	-56.6	-58.5	-60.0	0.3	-39.2	-21.25	18.00	
HE80 Beam Forming, M0 to M9 1ss	2	13	-59.9	-56.6			0.3	-41.7	-21.25	20.43	
HE80 Beam Forming, M0 to M9 2ss	2	13	-58.9	-52.7			0.3	-38.5	-21.25	17.27	
HE80 Beam Forming, M0 to M9 1ss	3	15	-61.2	-57.7	-59.2		0.3	-39.1	-21.25	17.87	
HE80 Beam Forming, M0 to M9 2ss	3	13	-60.5	-56.6	-57.7		0.3	-40.0	-21.25	18.71	
HE80 Beam Forming, M0 to M9 3ss	3	13	-59.0	-53.8	-57.0		0.3	-38.0	-21.25	16.79	
HE80 Beam Forming, M0 to M9 1ss	4	16	-63.0	-58.9	-61.0	-62.4	0.3	-38.8	-21.25	17.50	
HE80 Beam Forming, M0 to M9 2ss	4	13	-61.1	-57.1	-58.5	-60.6	0.3	-39.8	-21.25	18.50	
HE80 Beam Forming, M0 to M9 3ss	4	13	-60.5	-56.6	-57.7	-60.4	0.3	-39.2	-21.25	17.95	
HE80 Beam Forming, M0 to M9 4ss	4	13	-59.9	-56.6	-58.5	-60.0	0.3	-39.2	-21.25	18.00	
HE80 STBC, M0 to M9 1ss	2	13	-58.9	-52.7			0.3	-38.5	-21.25	17.27	
HE80 STBC, M0 to M9 1ss	3	13	-60.5	-56.6	-57.7		0.3	-40.0	-21.25	18.71	
HE80 STBC, M0 to M9 1ss	4	13	-61.1	-57.1	-58.5	-60.6	0.3	-39.8	-21.25	18.50	
5700	Non HT20, 6 to 54 Mbps	1	13	-59.7				0.1	-46.6	-21.25	25.40
	Non HT20, 6 to 54 Mbps	2	13	-59.7	-55.2			0.1	-40.8	-21.25	19.58
	Non HT20, 6 to 54 Mbps	3	13	-60.5	-56.8	-57.8		0.1	-40.3	-21.25	19.03
	Non HT20, 6 to 54 Mbps	4	13	-61.3	-56.6	-57.5	-60.5	0.1	-39.5	-21.25	18.22
	Non HT20 Beam Forming, 6 to 54 Mbps	2	13	-59.7	-55.2			0.1	-40.8	-21.25	19.58
	Non HT20 Beam Forming, 6 to 54 Mbps	3	15	-62.3	-56.9	-60.9		0.1	-39.6	-21.25	18.33
	Non HT20 Beam Forming, 6 to 54 Mbps	4	16	-64.0	-59.9	-61.3	-63.1	0.1	-39.7	-21.25	18.46
	HT/VHT20, M0 to M7	1	13	-61.0				0.1	-47.9	-21.25	26.70
	HT/VHT20, M0 to M7	2	13	-61.0	-57.1			0.1	-42.6	-21.25	21.31
	HT/VHT20, M8 to M15	2	13	-61.0	-57.1			0.1	-42.6	-21.25	21.31
	HT/VHT20, M0 to M7	3	13	-61.0	-57.1	-58.0		0.1	-40.6	-21.25	19.33
	HT/VHT20, M8 to M15	3	13	-61.0	-57.1	-58.0		0.1	-40.6	-21.25	19.33
	HT/VHT20, M16 to M23	3	13	-61.0	-57.1	-58.0		0.1	-40.6	-21.25	19.33
	HT/VHT20, M0 to M7	4	13	-61.0	-57.1	-58.0	-60.7	0.1	-39.8	-21.25	18.55
	HT/VHT20, M8 to M15	4	13	-61.0	-57.1	-58.0	-60.7	0.1	-39.8	-21.25	18.55
	HT/VHT20, M16 to M23	4	13	-61.0	-57.1	-58.0	-60.7	0.1	-39.8	-21.25	18.55

HT/VHT20, M24 to M31	4	13	-61.0	-57.1	-58.0	-60.7	0.1	-39.8	-21.25	18.55	
HT/VHT20 Beam Forming, M0 to M7	2	13	-61.0	-57.1			0.1	-42.6	-21.25	21.31	
HT/VHT20 Beam Forming, M8 to M15	2	13	-61.0	-57.1			0.1	-42.6	-21.25	21.31	
HT/VHT20 Beam Forming, M0 to M7	3	15	-62.2	-57.7	-61.0		0.1	-40.0	-21.25	18.79	
HT/VHT20 Beam Forming, M8 to M15	3	13	-61.0	-57.1	-58.0		0.1	-40.6	-21.25	19.33	
HT/VHT20 Beam Forming, M16 to M23	3	13	-61.0	-57.1	-58.0		0.1	-40.6	-21.25	19.33	
HT/VHT20 Beam Forming, M0 to M7	4	16	-63.8	-58.6	-60.8	-62.8	0.1	-39.0	-21.25	17.71	
HT/VHT20 Beam Forming, M8 to M15	4	13	-61.8	-57.7	-58.0	-61.4	0.1	-40.3	-21.25	19.01	
HT/VHT20 Beam Forming, M16 to M23	4	13	-61.0	-57.1	-58.0	-60.7	0.1	-39.8	-21.25	18.55	
HT/VHT20 Beam Forming, M24 to M31	4	13	-61.0	-57.1	-58.0	-60.7	0.1	-39.8	-21.25	18.55	
HT/VHT20 STBC, M0 to M7	2	13	-61.0	-57.1			0.1	-42.6	-21.25	21.31	
HT/VHT20 STBC, M0 to M7	3	13	-61.0	-57.1	-58.0		0.1	-40.6	-21.25	19.33	
HT/VHT20 STBC, M0 to M7	4	13	-61.8	-57.7	-58.0	-61.4	0.1	-40.3	-21.25	19.01	
HE20, M0 to M9 1ss	1	13	-61.8				0.1	-48.7	-21.25	27.48	
HE20, M0 to M9 1ss	2	13	-61.8	-57.1			0.1	-42.8	-21.25	21.52	
HE20, M0 to M9 2ss	2	13	-61.8	-57.1			0.1	-42.8	-21.25	21.52	
HE20, M0 to M9 1ss	3	13	-61.8	-57.1	-58.6		0.1	-40.9	-21.25	19.67	
HE20, M0 to M9 2ss	3	13	-61.8	-57.1	-58.6		0.1	-40.9	-21.25	19.67	
HE20, M0 to M9 3ss	3	13	-61.8	-57.1	-58.6		0.1	-40.9	-21.25	19.67	
HE20, M0 to M9 1ss	4	13	-61.8	-57.1	-58.6	-60.0	0.1	-40.0	-21.25	18.70	
HE20, M0 to M9 2ss	4	13	-61.8	-57.1	-58.6	-60.0	0.1	-40.0	-21.25	18.70	
HE20, M0 to M9 3ss	4	13	-61.8	-57.1	-58.6	-60.0	0.1	-40.0	-21.25	18.70	
HE20, M0 to M9 4ss	4	13	-61.8	-57.1	-58.6	-60.0	0.1	-40.0	-21.25	18.70	
HE20 Beam Forming, M0 to M9 1ss	2	13	-61.8	-57.1			0.1	-42.8	-21.25	21.52	
HE20 Beam Forming, M0 to M9 2ss	2	13	-61.8	-57.1			0.1	-42.8	-21.25	21.52	
HE20 Beam Forming, M0 to M9 1ss	3	15	-62.3	-57.9	-61.1		0.1	-40.2	-21.25	18.93	
HE20 Beam Forming, M0 to M9 2ss	3	13	-61.8	-57.1	-58.6		0.1	-40.9	-21.25	19.67	
HE20 Beam Forming, M0 to M9 3ss	3	13	-61.8	-57.1	-58.6		0.1	-40.9	-21.25	19.67	
HE20 Beam Forming, M0 to M9 1ss	4	16	-62.7	-60.3	-61.1	-62.9	0.1	-39.5	-21.25	18.28	
HE20 Beam Forming, M0 to M9 2ss	4	13	-62.1	-56.7	-59.2	-60.6	0.1	-40.1	-21.25	18.85	
HE20 Beam Forming, M0 to M9 3ss	4	13	-61.8	-57.1	-58.6	-60.0	0.1	-40.0	-21.25	18.70	
HE20 Beam Forming, M0 to M9 4ss	4	13	-61.8	-57.1	-58.6	-60.0	0.1	-40.0	-21.25	18.70	
HE20 STBC, M0 to M9 2ss	2	13	-61.8	-57.1			0.1	-42.8	-21.25	21.52	
HE20 STBC, M0 to M9 2ss	3	13	-61.8	-57.1	-58.6		0.1	-40.9	-21.25	19.67	
HE20 STBC, M0 to M9 2ss	4	13	-62.1	-56.7	-59.2	-60.6	0.1	-40.1	-21.25	18.85	
5710	Non HT40, 6 to 54 Mbps	1	13	-58.1				0.0	-45.1	-21.25	23.80
	Non HT40, 6 to 54 Mbps	2	13	-58.1	-54.0			0.0	-39.5	-21.25	18.27
	Non HT40, 6 to 54 Mbps	3	13	-58.7	-55.0	-58.4		0.0	-39.2	-21.25	17.95
	Non HT40, 6 to 54 Mbps	4	13	-59.9	-55.5	-57.5	-58.7	0.0	-38.5	-21.25	17.27
	HT/VHT40, M0 to M7	1	13	-59.2				0.1	-46.1	-21.25	24.84
	HT/VHT40, M0 to M7	2	13	-59.2	-54.2			0.1	-39.9	-21.25	18.65
	HT/VHT40, M8 to M15	2	13	-59.2	-54.2			0.1	-39.9	-21.25	18.65



HT/VHT40, M0 to M7	3	13	-60.0	-55.1	-58.2		0.1	-39.4	-21.25	18.16
HT/VHT40, M8 to M15	3	13	-60.0	-55.1	-58.2		0.1	-39.4	-21.25	18.16
HT/VHT40, M16 to M23	3	13	-60.0	-55.1	-58.2		0.1	-39.4	-21.25	18.16
HT/VHT40, M0 to M7	4	13	-60.2	-55.6	-57.7	-60.3	0.1	-38.9	-21.25	17.62
HT/VHT40, M8 to M15	4	13	-60.2	-55.6	-57.7	-60.3	0.1	-38.9	-21.25	17.62
HT/VHT40, M16 to M23	4	13	-60.2	-55.6	-57.7	-60.3	0.1	-38.9	-21.25	17.62
HT/VHT40, M24 to M31	4	13	-60.2	-55.6	-57.7	-60.3	0.1	-38.9	-21.25	17.62
HT/VHT40 Beam Forming, M0 to M7	2	13	-60.2	-55.6			0.1	-41.2	-21.25	19.95
HT/VHT40 Beam Forming, M8 to M15	2	13	-59.2	-54.2			0.1	-39.9	-21.25	18.65
HT/VHT40 Beam Forming, M0 to M7	3	15	-62.0	-57.3	-58.8		0.1	-39.1	-21.25	17.83
HT/VHT40 Beam Forming, M8 to M15	3	13	-60.0	-56.3	-58.8		0.1	-40.2	-21.25	18.95
HT/VHT40 Beam Forming, M16 to M23	3	13	-60.0	-55.1	-58.2		0.1	-39.4	-21.25	18.16
HT/VHT40 Beam Forming, M0 to M7	4	16	-63.7	-59.7	-61.3	-60.5	0.1	-38.9	-21.25	17.68
HT/VHT40 Beam Forming, M8 to M15	4	13	-62.2	-57.8	-58.2	-60.8	0.1	-40.3	-21.25	19.01
HT/VHT40 Beam Forming, M16 to M23	4	13	-60.0	-56.3	-58.8	-60.7	0.1	-39.5	-21.25	18.23
HT/VHT40 Beam Forming, M24 to M31	4	13	-60.2	-55.6	-57.7	-60.3	0.1	-38.9	-21.25	17.62
HT/VHT40 STBC, M0 to M7	2	13	-59.2	-54.2			0.1	-39.9	-21.25	18.65
HT/VHT40 STBC, M0 to M7	3	13	-60.0	-56.3	-58.8		0.1	-40.2	-21.25	18.95
HT/VHT40 STBC, M0 to M7	4	13	-62.2	-57.8	-58.2	-60.8	0.1	-40.3	-21.25	19.01
HE40, M0 to M9 1ss	1	13	-59.2				0.1	-46.1	-21.25	24.82
HE40, M0 to M9 1ss	2	13	-59.2	-54.4			0.1	-40.0	-21.25	18.77
HE40, M0 to M9 2ss	2	13	-59.2	-54.4			0.1	-40.0	-21.25	18.77
HE40, M0 to M9 1ss	3	13	-59.6	-55.5	-58.2		0.1	-39.5	-21.25	18.27
HE40, M0 to M9 2ss	3	13	-59.6	-55.5	-58.2		0.1	-39.5	-21.25	18.27
HE40, M0 to M9 3ss	3	13	-59.6	-55.5	-58.2		0.1	-39.5	-21.25	18.27
HE40, M0 to M9 1ss	4	13	-60.6	-55.9	-56.8	-59.7	0.1	-38.7	-21.25	17.42
HE40, M0 to M9 2ss	4	13	-60.6	-55.9	-56.8	-59.7	0.1	-38.7	-21.25	17.42
HE40, M0 to M9 3ss	4	13	-60.6	-55.9	-56.8	-59.7	0.1	-38.7	-21.25	17.42
HE40, M0 to M9 4ss	4	13	-60.6	-55.9	-56.8	-59.7	0.1	-38.7	-21.25	17.42
HE40 Beam Forming, M0 to M9 1ss	2	13	-60.6	-55.9			0.1	-41.5	-21.25	20.25
HE40 Beam Forming, M0 to M9 2ss	2	13	-59.2	-54.4			0.1	-40.0	-21.25	18.77
HE40 Beam Forming, M0 to M9 1ss	3	15	-62.1	-57.6	-58.8		0.1	-39.2	-21.25	17.97
HE40 Beam Forming, M0 to M9 2ss	3	13	-61.2	-56.4	-58.3		0.1	-40.3	-21.25	19.06
HE40 Beam Forming, M0 to M9 3ss	3	13	-59.6	-55.5	-58.2		0.1	-39.5	-21.25	18.27
HE40 Beam Forming, M0 to M9 1ss	4	16	-63.6	-59.8	-61.0	-61.2	0.1	-39.0	-21.25	17.79
HE40 Beam Forming, M0 to M9 2ss	4	13	-61.5	-57.3	-58.6	-60.7	0.1	-40.1	-21.25	18.80
HE40 Beam Forming, M0 to M9 3ss	4	13	-61.2	-56.4	-58.3	-60.4	0.1	-39.5	-21.25	18.26
HE40 Beam Forming, M0 to M9 4ss	4	13	-60.6	-55.9	-56.8	-59.7	0.1	-38.7	-21.25	17.42
HE40 STBC, M0 to M9 2ss	2	13	-59.2	-54.4			0.1	-40.0	-21.25	18.77
HE40 STBC, M0 to M9 2ss	3	13	-61.2	-56.4	-58.3		0.1	-40.3	-21.25	19.06
HE40 STBC, M0 to M9 2ss	4	13	-61.5	-57.3	-58.6	-60.7	0.1	-40.1	-21.25	18.80

5720	Non HT20, 6 to 54 Mbps	1	13	-58.3				0.1	-45.2	-21.25	24.00
	Non HT20, 6 to 54 Mbps	2	13	-60.4	-56.1			0.1	-41.7	-21.25	20.43
	Non HT20, 6 to 54 Mbps	3	13	-61.3	-56.6	-58.0		0.1	-40.4	-21.25	19.15
	Non HT20, 6 to 54 Mbps	4	13	-60.5	-56.5	-58.3	-60.0	0.1	-39.5	-21.25	18.21
	Non HT20 Beam Forming, 6 to 54 Mbps	2	13	-60.2	-56.8			0.1	-42.1	-21.25	20.86
	Non HT20 Beam Forming, 6 to 54 Mbps	3	15	-61.6	-56.8	-61.2		0.1	-39.5	-21.25	18.21
	Non HT20 Beam Forming, 6 to 54 Mbps	4	16	-63.6	-58.4	-60.9	-62.1	0.1	-38.7	-21.25	17.50
	HT/VHT20, M0 to M7	1	13	-58.7				0.1	-45.6	-21.25	24.40
	HT/VHT20, M0 to M7	2	13	-60.4	-55.6			0.1	-41.3	-21.25	20.06
	HT/VHT20, M8 to M15	2	13	-60.4	-55.6			0.1	-41.3	-21.25	20.06
	HT/VHT20, M0 to M7	3	13	-60.2	-56.6	-58.1		0.1	-40.2	-21.25	18.98
	HT/VHT20, M8 to M15	3	13	-60.2	-56.6	-58.1		0.1	-40.2	-21.25	18.98
	HT/VHT20, M16 to M23	3	13	-60.2	-56.6	-58.1		0.1	-40.2	-21.25	18.98
	HT/VHT20, M0 to M7	4	13	-60.6	-56.5	-58.4	-61.0	0.1	-39.7	-21.25	18.41
	HT/VHT20, M8 to M15	4	13	-60.6	-56.5	-58.4	-61.0	0.1	-39.7	-21.25	18.41
	HT/VHT20, M16 to M23	4	13	-60.6	-56.5	-58.4	-61.0	0.1	-39.7	-21.25	18.41
	HT/VHT20, M24 to M31	4	13	-60.6	-56.5	-58.4	-61.0	0.1	-39.7	-21.25	18.41
	HT/VHT20 Beam Forming, M0 to M7	2	13	-60.2	-56.6			0.1	-42.0	-21.25	20.72
	HT/VHT20 Beam Forming, M8 to M15	2	13	-60.4	-55.6			0.1	-41.3	-21.25	20.06
	HT/VHT20 Beam Forming, M0 to M7	3	15	-61.4	-56.5	-59.2		0.1	-38.8	-21.25	17.50
	HT/VHT20 Beam Forming, M8 to M15	3	13	-60.6	-56.5	-58.4		0.1	-40.4	-21.25	19.11
	HT/VHT20 Beam Forming, M16 to M23	3	13	-60.2	-56.6	-58.1		0.1	-40.2	-21.25	18.98
	HT/VHT20 Beam Forming, M0 to M7	4	16	-64.2	-59.8	-61.0	-63.0	0.1	-39.6	-21.25	18.35
	HT/VHT20 Beam Forming, M8 to M15	4	13	-61.9	-57.8	-58.3	-60.8	0.1	-40.3	-21.25	19.05
	HT/VHT20 Beam Forming, M16 to M23	4	13	-60.6	-56.5	-58.4	-61.0	0.1	-39.7	-21.25	18.41
	HT/VHT20 Beam Forming, M24 to M31	4	13	-60.6	-56.5	-58.4	-61.0	0.1	-39.7	-21.25	18.41
	HT/VHT20 STBC, M0 to M7	2	13	-60.4	-55.6			0.1	-41.3	-21.25	20.06
	HT/VHT20 STBC, M0 to M7	3	13	-60.6	-56.5	-58.4		0.1	-40.4	-21.25	19.11
	HT/VHT20 STBC, M0 to M7	4	13	-61.9	-57.8	-58.3	-60.8	0.1	-40.3	-21.25	19.05
	HE20, M0 to M9 1ss	1	13	-59.2				0.1	-46.1	-21.25	24.88
	HE20, M0 to M9 1ss	2	13	-59.4	-56.2			0.1	-41.4	-21.25	20.19
	HE20, M0 to M9 2ss	2	13	-59.4	-56.2			0.1	-41.4	-21.25	20.19
	HE20, M0 to M9 1ss	3	13	-61.2	-56.3	-58.0		0.1	-40.2	-21.25	18.97
	HE20, M0 to M9 2ss	3	13	-61.2	-56.3	-58.0		0.1	-40.2	-21.25	18.97
	HE20, M0 to M9 3ss	3	13	-61.2	-56.3	-58.0		0.1	-40.2	-21.25	18.97
	HE20, M0 to M9 1ss	4	13	-60.5	-56.7	-58.4	-60.8	0.1	-39.7	-21.25	18.44
	HE20, M0 to M9 2ss	4	13	-60.5	-56.7	-58.4	-60.8	0.1	-39.7	-21.25	18.44
	HE20, M0 to M9 3ss	4	13	-60.5	-56.7	-58.4	-60.8	0.1	-39.7	-21.25	18.44
	HE20, M0 to M9 4ss	4	13	-60.5	-56.7	-58.4	-60.8	0.1	-39.7	-21.25	18.44
	HE20 Beam Forming, M0 to M9 1ss	2	13	-61.2	-56.3			0.1	-42.0	-21.25	20.77
	HE20 Beam Forming, M0 to M9 2ss	2	13	-59.4	-56.2			0.1	-41.4	-21.25	20.19
	HE20 Beam Forming, M0 to M9 1ss	3	15	-62.1	-56.8	-60.7		0.1	-39.4	-21.25	18.17
HE20 Beam Forming, M0 to M9 2ss	3	13	-60.5	-56.7	-58.4		0.1	-40.4	-21.25	19.18	

HE20 Beam Forming, M0 to M9 3ss	3	13	-61.2	-56.3	-58.0		0.1	-40.2	-21.25	18.97
HE20 Beam Forming, M0 to M9 1ss	4	16	-64.1	-59.5	-61.5	-63.2	0.1	-39.6	-21.25	18.37
HE20 Beam Forming, M0 to M9 2ss	4	13	-60.8	-57.0	-58.7	-61.3	0.1	-40.0	-21.25	18.77
HE20 Beam Forming, M0 to M9 3ss	4	13	-60.5	-56.7	-58.4	-60.8	0.1	-39.7	-21.25	18.44
HE20 Beam Forming, M0 to M9 4ss	4	13	-60.5	-56.7	-58.4	-60.8	0.1	-39.7	-21.25	18.44
HE20 STBC, M0 to M9 2ss	2	13	-59.4	-56.2			0.1	-41.4	-21.25	20.19
HE20 STBC, M0 to M9 2ss	3	13	-60.5	-56.7	-58.4		0.1	-40.4	-21.25	19.18
HE20 STBC, M0 to M9 2ss	4	13	-60.8	-57.0	-58.7	-61.3	0.1	-40.0	-21.25	18.77

**Conducted Spurs Peak, 5610 MHz, Non HT80, 6 to 54 Mbps**

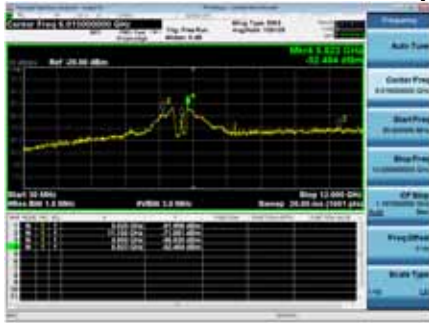

**Antenna A**

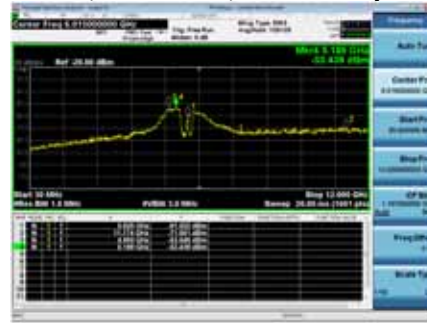

**Antenna B**



**Antenna C**

## A.6 Conducted Bandedge

**15.407(b) Undesirable emission limits.** Except as shown in paragraph (b)(7) of this section, the maximum emissions outside of the frequency bands of operation shall be attenuated in accordance with the following limits:

- (3) For transmitters operating in the 5.47-5.725 GHz band: All emissions outside of the 5.47-5.725 GHz band shall not exceed an e.i.r.p. of  $-27$  dBm/MHz.
- (6) Unwanted emissions below 1 GHz must comply with the general field strength limits set forth in §15.209.
- (7) The provisions of §15.205 apply to intentional radiators operating under this section.
- (8) When measuring the emission limits, the nominal carrier frequency shall be adjusted as close to the upper and lower frequency band edges as the design of the equipment permits

**15.205 / 15.209** - Radiated emissions which fall in the restricted bands, as defined in Section 15.205(a), must also comply with the radiated emission limits specified in Section 15.209(a) (see Section 15.205(c)).

Use formula below to substitute conducted measurements in place of radiated measurements

$$E[\text{dB}\mu\text{V}/\text{m}] = \text{EIRP}[\text{dBm}] - 20 \log(d[\text{meters}]) + 104.77, \text{ where } E = \text{field strength and } d = 3 \text{ meter}$$

- 1) Average Plot, Limit =  $-41.25$  dBm eirp
- 2) Peak plot, Limit =  $-21.25$  dBm eirp

### **KDB 789033 D02 General UNII Test Procedures New Rules v02r01**

#### **2. Unwanted Emissions that fall Outside of the Restricted Bands**

- a) For all measurements, follow the requirements in II.G.3. “*General Requirements for Unwanted Emissions Measurements.*”
- b) At frequencies below 1000 MHz, use the procedure described in II.G.4. “*Procedure for Unwanted Emissions Measurements Below 1000 MHz.*”
- c) At frequencies above 1000 MHz, use the procedure for maximum emissions described in II.G.5., “*Procedure for Unwanted Emissions Measurements Above 1000 MHz.*”
- (i) Sections 15.407(b)(1-3) specifies the unwanted emissions limit for the U-NII-1 and U-NII-2 bands. As specified, emissions above 1000 MHz that are outside of the restricted bands are subject to a peak emission limit of  $-27$  dBm/MHz.<sup>3</sup>

### **Conducted Band Edge Test Procedure**

#### **KDB 789033 D02 General UNII Test Procedures New Rules v02r01**

**Ref.** ANSI C63.10: 2013

#### **Conducted Spurious Emissions**

##### Test Procedure

1. Connect the antenna port(s) to the spectrum analyzer input.
2. Place the radio in continuous transmit mode
3. Configure Spectrum analyzer as per test parameters below (be sure to enter all losses between the transmitter output and the spectrum analyzer).
4. Use the peak marker function to determine the maximum spurs amplitude level.
5. The “measure-and-sum technique” is used for measuring in-band transmit power of a device. In the measure-and-sum approach, the conducted emission level is measured at each antenna port. The measured results at the various antenna ports are then summed mathematically to determine the total emission level from the device. Summing is performed in linear power units. The worst case output is recorded. (see ANSI C63.10:2013 section 14.3.2.2)
6. Capture graphs and record pertinent measurement data.

Ref. ANSI C63.10: 2013 section 12.7.6 (Peak) and 12.7.7.2 (Average)

KDB 789033 D02 General UNII Test Procedures New Rules v02r01, Sec. 5 (Peak), Sec. 6 (Average Method AD)

### Conducted Spurious Emissions

Test parameters

Peak	Average
RBW = 1 MHz	RBW = 1 MHz
VBW $\geq$ 3 MHz	VBW $\geq$ 3 MHz
Sweep = Auto	Sweep = Auto
Detector = Peak	Detector = RMS
Trace = Max Hold.	Power Averaging

### Samples, Systems, and Modes

System Number	Description	Samples	System under test	Support equipment
1	EUT	S01+S02	<input checked="" type="checkbox"/>	<input type="checkbox"/>
	Support		<input type="checkbox"/>	<input checked="" type="checkbox"/>

<b>Tested By :</b> Chris Blair	<b>Date of testing:</b> 20-Aug-19 - 10-Sep-19
<b>Test Result : PASS</b>	

### Test Equipment

See Appendix C for list of test equipment

## Conducted Bandedge Average Table

Frequency (MHz)	Mode	Tx Paths	Correlated Antenna Gain (dBi)	Tx 1 Bandedge Level (dBm)	Tx 2 Bandedge Level (dBm)	Tx 3 Bandedge Level (dBm)	Tx 4 Bandedge Level (dBm)	Duty Cycle Correction (dB)	Total Tx Bandedge Level (dBm)	Limit (dBm)	Margin (dB)
5500	Non HT20, 6 to 54 Mbps	1	13	-56.5				0.1	-43.4	-41.25	2.20
	Non HT20, 6 to 54 Mbps	2	13	-56.5	-61.0			0.1	-42.1	-41.25	0.88
	Non HT20, 6 to 54 Mbps	3	13	-60.2	-63.5	-61.7		0.1	-43.8	-41.25	2.52
	Non HT20, 6 to 54 Mbps	4	13	-62.1	-64.1	-63.2	-62.3	0.1	-43.8	-41.25	2.53
	Non HT20 Beam Forming, 6 to 54 Mbps	2	13	-60.2	-63.5			0.1	-45.5	-41.25	4.23
	Non HT20 Beam Forming, 6 to 54 Mbps	3	15	-65.7	-65.2	-65.7		0.1	-45.7	-41.25	4.45
	Non HT20 Beam Forming, 6 to 54 Mbps	4	16	-68.6	-67.9	-68.4	-66.9	0.1	-45.8	-41.25	4.58
	HT/VHT20, M0 to M7	1	13	-55.1				0.1	-42.0	-41.25	0.80
	<b>HT/VHT20, M0 to M7</b>	<b>2</b>	<b>13</b>	<b>-55.1</b>	<b>-62.2</b>			<b>0.1</b>	<b>-41.3</b>	<b>-41.25</b>	<b>0.02</b>
	HT/VHT20, M8 to M15	2	13	-55.1	-62.2			0.1	-41.3	-41.25	0.02
	HT/VHT20, M0 to M7	3	13	-59.4	-63.0	-62.0		0.1	-43.4	-41.25	2.12
	HT/VHT20, M8 to M15	3	13	-59.4	-63.0	-62.0		0.1	-43.4	-41.25	2.12
	HT/VHT20, M16 to M23	3	13	-59.4	-63.0	-62.0		0.1	-43.4	-41.25	2.12
	HT/VHT20, M0 to M7	4	13	-59.4	-63.0	-62.0	-61.7	0.1	-42.2	-41.25	0.99
	HT/VHT20, M8 to M15	4	13	-59.4	-63.0	-62.0	-61.7	0.1	-42.2	-41.25	0.99
	HT/VHT20, M16 to M23	4	13	-59.4	-63.0	-62.0	-61.7	0.1	-42.2	-41.25	0.99
	HT/VHT20, M24 to M31	4	13	-59.4	-63.0	-62.0	-61.7	0.1	-42.2	-41.25	0.99
	HT/VHT20 Beam Forming, M0 to M7	2	13	-59.4	-63.0			0.1	-44.8	-41.25	3.52
	HT/VHT20 Beam Forming, M8 to M15	2	13	-55.1	-62.2			0.1	-41.3	-41.25	0.02
	HT/VHT20 Beam Forming, M0 to M7	3	15	-66.3	-66.2	-65.9		0.1	-46.3	-41.25	5.06
	HT/VHT20 Beam Forming, M8 to M15	3	13	-62.6	-64.3	-62.5		0.1	-45.2	-41.25	3.98
	HT/VHT20 Beam Forming, M16 to M23	3	13	-59.4	-63.0	-62.0		0.1	-43.4	-41.25	2.12
	HT/VHT20 Beam Forming, M0 to M7	4	16	-68.5	-68.5	-67.6	-67.0	0.1	-45.8	-41.25	4.53
	HT/VHT20 Beam Forming, M8 to M15	4	13	-65.6	-65.2	-64.3	-63.8	0.1	-45.6	-41.25	4.34
	HT/VHT20 Beam Forming, M16 to M23	4	13	-62.6	-64.3	-62.5	-61.8	0.1	-43.6	-41.25	2.39
	HT/VHT20 Beam Forming, M24 to M31	4	13	-59.4	-63.0	-62.0	-61.7	0.1	-42.2	-41.25	0.99
	HT/VHT20 STBC, M0 to M7	2	13	-55.1	-62.2			0.1	-41.3	-41.25	0.02
	HT/VHT20 STBC, M0 to M7	3	13	-62.6	-64.3	-62.5		0.1	-45.2	-41.25	3.98
	HT/VHT20 STBC, M0 to M7	4	13	-65.6	-65.2	-64.3	-63.8	0.1	-45.6	-41.25	4.34



	HE20, M0 to M9 1ss	1	13	-57.5				0.1	-44.4	-41.25	3.18
	HE20, M0 to M9 1ss	2	13	-57.5	-62.8			0.1	-43.3	-41.25	2.06
	HE20, M0 to M9 2ss	2	13	-57.5	-62.8			0.1	-43.3	-41.25	2.06
	HE20, M0 to M9 1ss	3	13	-57.5	-62.8	-60.5		0.1	-41.9	-41.25	0.64
	HE20, M0 to M9 2ss	3	13	-57.5	-62.8	-60.5		0.1	-41.9	-41.25	0.64
	HE20, M0 to M9 3ss	3	13	-57.5	-62.8	-60.5		0.1	-41.9	-41.25	0.64
	HE20, M0 to M9 1ss	4	13	-60.4	-64.2	-62.3	-61.1	0.1	-42.7	-41.25	1.44
	HE20, M0 to M9 2ss	4	13	-60.4	-64.2	-62.3	-61.1	0.1	-42.7	-41.25	1.44
	HE20, M0 to M9 3ss	4	13	-60.4	-64.2	-62.3	-61.1	0.1	-42.7	-41.25	1.44
	HE20, M0 to M9 4ss	4	13	-60.4	-64.2	-62.3	-61.1	0.1	-42.7	-41.25	1.44
	HE20 Beam Forming, M0 to M9 1ss	2	13	-57.5	-62.8			0.1	-43.3	-41.25	2.06
	HE20 Beam Forming, M0 to M9 2ss	2	13	-57.5	-62.8			0.1	-43.3	-41.25	2.06
	HE20 Beam Forming, M0 to M9 1ss	3	15	-65.3	-65.6	-65.2		0.1	-45.5	-41.25	4.28
	HE20 Beam Forming, M0 to M9 2ss	3	13	-60.4	-64.2	-62.3		0.1	-44.2	-41.25	2.94
	HE20 Beam Forming, M0 to M9 3ss	3	13	-57.5	-62.8	-60.5		0.1	-41.9	-41.25	0.64
	HE20 Beam Forming, M0 to M9 1ss	4	16	-67.6	-68.6	-67.6	-66.5	0.1	-45.4	-41.25	4.18
	HE20 Beam Forming, M0 to M9 2ss	4	13	-64.8	-65.1	-64.2	-63.7	0.1	-45.3	-41.25	4.08
	HE20 Beam Forming, M0 to M9 3ss	4	13	-60.4	-64.2	-62.3	-61.1	0.1	-42.7	-41.25	1.44
	HE20 Beam Forming, M0 to M9 4ss	4	13	-60.4	-64.2	-62.3	-61.1	0.1	-42.7	-41.25	1.44
	HE20 STBC, M0 to M9 2ss	2	13	-57.5	-62.8			0.1	-43.3	-41.25	2.06
	HE20 STBC, M0 to M9 2ss	3	13	-60.4	-64.2	-62.3		0.1	-44.2	-41.25	2.94
	HE20 STBC, M0 to M9 2ss	4	13	-64.8	-65.1	-64.2	-63.7	0.1	-45.3	-41.25	4.08
5510	Non HT40, 6 to 54 Mbps	1	13	-58.5				0.0	-45.5	-41.25	4.20
	Non HT40, 6 to 54 Mbps	2	13	-58.5	-62.4			0.0	-44.0	-41.25	2.72
	Non HT40, 6 to 54 Mbps	3	13	-58.5	-62.4	-61.4		0.0	-42.6	-41.25	1.37
	Non HT40, 6 to 54 Mbps	4	13	-59.6	-62.9	-62.4	-62.0	0.0	-42.5	-41.25	1.21
	HT/VHT40, M0 to M7	1	13	-56.0				0.1	-42.9	-41.25	1.64
	HT/VHT40, M0 to M7	2	13	-56.0	-61.8			0.1	-41.9	-41.25	0.63
	HT/VHT40, M8 to M15	2	13	-56.0	-61.8			0.1	-41.9	-41.25	0.63
	HT/VHT40, M0 to M7	3	13	-59.0	-62.9	-61.9		0.1	-43.1	-41.25	1.81
	HT/VHT40, M8 to M15	3	13	-59.0	-62.9	-61.9		0.1	-43.1	-41.25	1.81
	HT/VHT40, M16 to M23	3	13	-59.0	-62.9	-61.9		0.1	-43.1	-41.25	1.81
	HT/VHT40, M0 to M7	4	13	-59.0	-62.9	-61.9	-60.8	0.1	-41.8	-41.25	0.52
	HT/VHT40, M8 to M15	4	13	-59.0	-62.9	-61.9	-60.8	0.1	-41.8	-41.25	0.52
	HT/VHT40, M16 to M23	4	13	-59.0	-62.9	-61.9	-60.8	0.1	-41.8	-41.25	0.52
	HT/VHT40, M24 to M31	4	13	-59.0	-62.9	-61.9	-60.8	0.1	-41.8	-41.25	0.52
	HT/VHT40 Beam Forming, M0 to M7	2	13	-56.0	-61.8			0.1	-41.9	-41.25	0.63
	HT/VHT40 Beam Forming, M8 to M15	2	13	-56.0	-61.8			0.1	-41.9	-41.25	0.63
	HT/VHT40 Beam Forming, M0 to M7	3	15	-63.6	-63.9	-64.2		0.1	-44.0	-41.25	2.76
	HT/VHT40 Beam Forming, M8 to M15	3	13	-59.0	-62.9	-61.9		0.1	-43.1	-41.25	1.81
HT/VHT40 Beam Forming, M16 to M23	3	13	-59.0	-62.9	-61.9		0.1	-43.1	-41.25	1.81	
HT/VHT40 Beam Forming, M0 to M7	4	16	-65.9	-66.3	-66.6	-65.8	0.1	-44.0	-41.25	2.76	



	HT/VHT40 Beam Forming, M8 to M15	4	13	-62.0	-62.9	-63.5	-62.1	0.1	-43.5	-41.25	2.20
	HT/VHT40 Beam Forming, M16 to M23	4	13	-59.0	-62.9	-61.9	-60.8	0.1	-41.8	-41.25	0.52
	HT/VHT40 Beam Forming, M24 to M31	4	13	-59.0	-62.9	-61.9	-60.8	0.1	-41.8	-41.25	0.52
	HT/VHT40 STBC, M0 to M7	2	13	-56.0	-61.8			0.1	-41.9	-41.25	0.63
	HT/VHT40 STBC, M0 to M7	3	13	-59.0	-62.9	-61.9		0.1	-43.1	-41.25	1.81
	HT/VHT40 STBC, M0 to M7	4	13	-62.0	-62.9	-63.5	-62.1	0.1	-43.5	-41.25	2.20
	HE40, M0 to M9 1ss	1	13	-56.8				0.1	-43.7	-41.25	2.42
	HE40, M0 to M9 1ss	2	13	-56.8	-61.8			0.1	-42.5	-41.25	1.22
	HE40, M0 to M9 2ss	2	13	-56.8	-61.8			0.1	-42.5	-41.25	1.22
	HE40, M0 to M9 1ss	3	13	-56.8	-61.8	-61.2		0.1	-41.4	-41.25	0.16
	HE40, M0 to M9 2ss	3	13	-56.8	-61.8	-61.2		0.1	-41.4	-41.25	0.16
	HE40, M0 to M9 3ss	3	13	-56.8	-61.8	-61.2		0.1	-41.4	-41.25	0.16
	HE40, M0 to M9 1ss	4	13	-59.9	-62.7	-61.7	-61.5	0.1	-42.2	-41.25	0.93
	HE40, M0 to M9 2ss	4	13	-59.9	-62.7	-61.7	-61.5	0.1	-42.2	-41.25	0.93
	HE40, M0 to M9 3ss	4	13	-59.9	-62.7	-61.7	-61.5	0.1	-42.2	-41.25	0.93
	HE40, M0 to M9 4ss	4	13	-59.9	-62.7	-61.7	-61.5	0.1	-42.2	-41.25	0.93
	HE40 Beam Forming, M0 to M9 1ss	2	13	-56.8	-61.8			0.1	-42.5	-41.25	1.22
	HE40 Beam Forming, M0 to M9 2ss	2	13	-56.8	-61.8			0.1	-42.5	-41.25	1.22
	HE40 Beam Forming, M0 to M9 1ss	3	15	-61.5	-63.6	-63.2		0.1	-42.8	-41.25	1.51
	HE40 Beam Forming, M0 to M9 2ss	3	13	-56.8	-61.8	-61.2		0.1	-41.4	-41.25	0.16
	HE40 Beam Forming, M0 to M9 3ss	3	13	-56.8	-61.8	-61.2		0.1	-41.4	-41.25	0.16
	HE40 Beam Forming, M0 to M9 1ss	4	16	-65.6	-65.8	-65.2	-64.7	0.1	-43.1	-41.25	1.90
	HE40 Beam Forming, M0 to M9 2ss	4	13	-59.9	-62.7	-61.7	-61.5	0.1	-42.2	-41.25	0.93
	HE40 Beam Forming, M0 to M9 3ss	4	13	-59.9	-62.7	-61.7	-61.5	0.1	-42.2	-41.25	0.93
	HE40 Beam Forming, M0 to M9 4ss	4	13	-59.9	-62.7	-61.7	-61.5	0.1	-42.2	-41.25	0.93
	HE40 STBC, M0 to M9 2ss	2	13	-56.8	-61.8			0.1	-42.5	-41.25	1.22
	HE40 STBC, M0 to M9 2ss	3	13	-56.8	-61.8	-61.2		0.1	-41.4	-41.25	0.16
	HE40 STBC, M0 to M9 2ss	4	13	-59.9	-62.7	-61.7	-61.5	0.1	-42.2	-41.25	0.93
5530	Non HT80, 6 to 54 Mbps	1	13	-57.5				0.1	-44.4	-41.25	3.20
	Non HT80, 6 to 54 Mbps	2	13	-57.5	-62.3			0.1	-43.2	-41.25	1.96
	Non HT80, 6 to 54 Mbps	3	13	-57.5	-62.3	-61.1		0.1	-42.0	-41.25	0.73
	Non HT80, 6 to 54 Mbps	4	13	-60.3	-62.0	-62.5	-60.4	0.1	-42.1	-41.25	0.87
	VHT80, M0 to M9 1ss	1	13	-55.8				0.2	-42.6	-41.25	1.33
	VHT80, M0 to M9 1ss	2	13	-55.8	-61.7			0.2	-41.6	-41.25	0.34
	VHT80, M0 to M9 2ss	2	13	-55.8	-61.7			0.2	-41.6	-41.25	0.34
	VHT80, M0 to M9 1ss	3	13	-59.0	-62.5	-61.8		0.2	-42.8	-41.25	1.59
	VHT80, M0 to M9 2ss	3	13	-59.0	-62.5	-61.8		0.2	-42.8	-41.25	1.59
	VHT80, M0 to M9 3ss	3	13	-59.0	-62.5	-61.8		0.2	-42.8	-41.25	1.59
	VHT80, M0 to M9 1ss	4	13	-59.0	-62.5	-61.8	-61.8	0.2	-41.8	-41.25	0.56
	VHT80, M0 to M9 2ss	4	13	-59.0	-62.5	-61.8	-61.8	0.2	-41.8	-41.25	0.56
	VHT80, M0 to M9 3ss	4	13	-59.0	-62.5	-61.8	-61.8	0.2	-41.8	-41.25	0.56
	VHT80, M0 to M9 4ss	4	13	-59.0	-62.5	-61.8	-61.8	0.2	-41.8	-41.25	0.56

	VHT80 Beam Forming, M0 to M9 1ss	2	13	-55.8	-61.7			0.2	-41.6	-41.25	0.34
	VHT80 Beam Forming, M0 to M9 2ss	2	13	-55.8	-61.7			0.2	-41.6	-41.25	0.34
	VHT80 Beam Forming, M0 to M9 1ss	3	15	-61.5	-63.4	-62.7		0.2	-42.5	-41.25	1.22
	VHT80 Beam Forming, M0 to M9 2ss	3	13	-59.0	-62.5	-61.8		0.2	-42.8	-41.25	1.59
	VHT80 Beam Forming, M0 to M9 3ss	3	13	-59.0	-62.5	-61.8		0.2	-42.8	-41.25	1.59
	VHT80 Beam Forming, M0 to M9 1ss	4	16	-63.9	-65.3	-65.1	-64.2	0.2	-42.3	-41.25	1.10
	VHT80 Beam Forming, M0 to M9 2ss	4	13	-59.0	-62.5	-61.8	-61.8	0.2	-41.8	-41.25	0.56
	VHT80 Beam Forming, M0 to M9 3ss	4	13	-59.0	-62.5	-61.8	-61.8	0.2	-41.8	-41.25	0.56
	VHT80 Beam Forming, M0 to M9 4ss	4	13	-59.0	-62.5	-61.8	-61.8	0.2	-41.8	-41.25	0.56
	VHT80 STBC, M0 to M9 1ss	2	13	-55.8	-61.7			0.2	-41.6	-41.25	0.34
	VHT80 STBC, M0 to M9 1ss	3	13	-59.0	-62.5	-61.8		0.2	-42.8	-41.25	1.59
	VHT80 STBC, M0 to M9 1ss	4	13	-59.0	-62.5	-61.8	-61.8	0.2	-41.8	-41.25	0.56
	HE80, M0 to M9 1ss	1	13	-56.6				0.3	-43.3	-41.25	2.10
	HE80, M0 to M9 1ss	2	13	-56.6	-62.1			0.3	-42.3	-41.25	1.02
	HE80, M0 to M9 2ss	2	13	-56.6	-62.1			0.3	-42.3	-41.25	1.02
	HE80, M0 to M9 1ss	3	13	-59.0	-62.0	-62.0		0.3	-42.7	-41.25	1.48
	HE80, M0 to M9 2ss	3	13	-59.0	-62.0	-62.0		0.3	-42.7	-41.25	1.48
	HE80, M0 to M9 3ss	3	13	-59.0	-62.0	-62.0		0.3	-42.7	-41.25	1.48
	HE80, M0 to M9 1ss	4	13	-59.0	-62.0	-62.0	-61.4	0.3	-41.6	-41.25	0.39
	HE80, M0 to M9 2ss	4	13	-59.0	-62.0	-62.0	-61.4	0.3	-41.6	-41.25	0.39
	HE80, M0 to M9 3ss	4	13	-59.0	-62.0	-62.0	-61.4	0.3	-41.6	-41.25	0.39
	HE80, M0 to M9 4ss	4	13	-59.0	-62.0	-62.0	-61.4	0.3	-41.6	-41.25	0.39
	HE80 Beam Forming, M0 to M9 1ss	2	13	-56.6	-62.1			0.3	-42.3	-41.25	1.02
	HE80 Beam Forming, M0 to M9 2ss	2	13	-56.6	-62.1			0.3	-42.3	-41.25	1.02
	HE80 Beam Forming, M0 to M9 1ss	3	15	-60.7	-63.3	-63.3		0.3	-42.2	-41.25	0.98
	HE80 Beam Forming, M0 to M9 2ss	3	13	-59.0	-62.0	-62.0		0.3	-42.7	-41.25	1.48
	HE80 Beam Forming, M0 to M9 3ss	3	13	-59.0	-62.0	-62.0		0.3	-42.7	-41.25	1.48
	HE80 Beam Forming, M0 to M9 1ss	4	16	-64.6	-64.7	-64.9	-64.3	0.3	-42.3	-41.25	1.10
	HE80 Beam Forming, M0 to M9 2ss	4	13	-59.0	-62.0	-62.0	-61.4	0.3	-41.6	-41.25	0.39
	HE80 Beam Forming, M0 to M9 3ss	4	13	-59.0	-62.0	-62.0	-61.4	0.3	-41.6	-41.25	0.39
	HE80 Beam Forming, M0 to M9 4ss	4	13	-59.0	-62.0	-62.0	-61.4	0.3	-41.6	-41.25	0.39
	HE80 STBC, M0 to M9 1ss	2	13	-56.6	-62.1			0.3	-42.3	-41.25	1.02
	HE80 STBC, M0 to M9 1ss	3	13	-59.0	-62.0	-62.0		0.3	-42.7	-41.25	1.48
	HE80 STBC, M0 to M9 1ss	4	13	-59.0	-62.0	-62.0	-61.4	0.3	-41.6	-41.25	0.39
5570	Non HT160, 6 to 54 Mbps	1	13	-57.3				0.0	-44.3	-41.25	3.00
	Non HT160, 6 to 54 Mbps	2	13	-57.3	-61.8			0.0	-42.9	-41.25	1.69
	Non HT160, 6 to 54 Mbps	3	13	-57.3	-61.8	-63.3		0.0	-42.2	-41.25	0.95
	Non HT160, 6 to 54 Mbps	4	13	-59.7	-65.0	-64.8	-60.3	0.0	-42.7	-41.25	1.47
	VHT160, M0 to M9 1ss	1	13	-56.1				0.4	-42.7	-41.25	1.44
	VHT160, M0 to M9 1ss	2	13	-56.1	-63.3			0.4	-41.9	-41.25	0.69
	VHT160, M0 to M9 2ss	2	13	-56.1	-63.3			0.4	-41.9	-41.25	0.69
	VHT160, M0 to M9 1ss	3	13	-61.1	-63.6	-63.2		0.4	-44.3	-41.25	3.06

VHT160, M0 to M9 2ss	3	13	-61.1	-63.6	-63.2		0.4	-44.3	-41.25	3.06
VHT160, M0 to M9 3ss	3	13	-61.1	-63.6	-63.2		0.4	-44.3	-41.25	3.06
VHT160, M0 to M9 1ss	4	13	-61.1	-63.6	-63.2	-62.9	0.4	-43.2	-41.25	1.91
VHT160, M0 to M9 2ss	4	13	-61.1	-63.6	-63.2	-62.9	0.4	-43.2	-41.25	1.91
VHT160, M0 to M9 3ss	4	13	-61.1	-63.6	-63.2	-62.9	0.4	-43.2	-41.25	1.91
VHT160, M0 to M9 4ss	4	13	-61.1	-63.6	-63.2	-62.9	0.4	-43.2	-41.25	1.91
VHT160 Beam Forming, M0 to M9 1ss	2	13	-56.1	-63.3			0.4	-41.9	-41.25	0.69
VHT160 Beam Forming, M0 to M9 2ss	2	13	-56.1	-63.3			0.4	-41.9	-41.25	0.69
VHT160 Beam Forming, M0 to M9 1ss	3	15	-61.1	-63.6	-63.2		0.4	-42.3	-41.25	1.06
VHT160 Beam Forming, M0 to M9 2ss	3	13	-61.1	-63.6	-63.2		0.4	-44.3	-41.25	3.06
VHT160 Beam Forming, M0 to M9 3ss	3	13	-61.1	-63.6	-63.2		0.4	-44.3	-41.25	3.06
VHT160 Beam Forming, M0 to M9 1ss	4	16	-65.0	-66.6	-65.6	-64.0	0.4	-42.8	-41.25	1.52
VHT160 Beam Forming, M0 to M9 2ss	4	13	-61.1	-63.6	-63.2	-62.9	0.4	-43.2	-41.25	1.91
VHT160 Beam Forming, M0 to M9 3ss	4	13	-61.1	-63.6	-63.2	-62.9	0.4	-43.2	-41.25	1.91
VHT160 Beam Forming, M0 to M9 4ss	4	13	-61.1	-63.6	-63.2	-62.9	0.4	-43.2	-41.25	1.91
VHT160 STBC, M0 to M9 1ss	2	13	-56.1	-63.3			0.4	-41.9	-41.25	0.69
VHT160 STBC, M0 to M9 1ss	3	13	-61.1	-63.6	-63.2		0.4	-44.3	-41.25	3.06
VHT160 STBC, M0 to M9 1ss	4	13	-61.1	-63.6	-63.2	-62.9	0.4	-43.2	-41.25	1.91
HE160, M0 to M9 1ss	1	13	-58.0				0.4	-44.6	-41.25	3.32
HE160, M0 to M9 1ss	2	13	-58.0	-62.2			0.4	-43.2	-41.25	1.92
HE160, M0 to M9 2ss	2	13	-58.0	-62.2			0.4	-43.2	-41.25	1.92
HE160, M0 to M9 1ss	3	13	-58.0	-62.2	-61.5		0.4	-41.9	-41.25	0.70
HE160, M0 to M9 2ss	3	13	-58.0	-62.2	-61.5		0.4	-41.9	-41.25	0.70
HE160, M0 to M9 3ss	3	13	-58.0	-62.2	-61.5		0.4	-41.9	-41.25	0.70
HE160, M0 to M9 1ss	4	13	-60.6	-63.0	-62.8	-61.2	0.4	-42.3	-41.25	1.07
HE160, M0 to M9 2ss	4	13	-60.6	-63.0	-62.8	-61.2	0.4	-42.3	-41.25	1.07
HE160, M0 to M9 3ss	4	13	-60.6	-63.0	-62.8	-61.2	0.4	-42.3	-41.25	1.07
HE160, M0 to M9 4ss	4	13	-60.6	-63.0	-62.8	-61.2	0.4	-42.3	-41.25	1.07
HE160 Beam Forming, M0 to M9 1ss	2	13	-58.0	-62.2			0.4	-43.2	-41.25	1.92
HE160 Beam Forming, M0 to M9 2ss	2	13	-58.0	-62.2			0.4	-43.2	-41.25	1.92
HE160 Beam Forming, M0 to M9 1ss	3	15	-62.6	-64.8	-63.8		0.4	-43.4	-41.25	2.18
HE160 Beam Forming, M0 to M9 2ss	3	13	-58.0	-62.2	-61.5		0.4	-41.9	-41.25	0.70
HE160 Beam Forming, M0 to M9 3ss	3	13	-58.0	-62.2	-61.5		0.4	-41.9	-41.25	0.70
HE160 Beam Forming, M0 to M9 1ss	4	16	-65.9	-65.8	-65.7	-64.7	0.4	-43.0	-41.25	1.79
HE160 Beam Forming, M0 to M9 2ss	4	13	-60.6	-63.0	-62.8	-61.2	0.4	-42.3	-41.25	1.07
HE160 Beam Forming, M0 to M9 3ss	4	13	-60.6	-63.0	-62.8	-61.2	0.4	-42.3	-41.25	1.07
HE160 Beam Forming, M0 to M9 4ss	4	13	-60.6	-63.0	-62.8	-61.2	0.4	-42.3	-41.25	1.07
HE160 STBC, M0 to M9 1ss	2	13	-58.0	-62.2			0.4	-43.2	-41.25	1.92
HE160 STBC, M0 to M9 1ss	3	13	-58.0	-62.2	-61.5		0.4	-41.9	-41.25	0.70
HE160 STBC, M0 to M9 1ss	4	13	-60.6	-63.0	-62.8	-61.2	0.4	-42.3	-41.25	1.07

**Conducted Bandedge Average, 5500 MHz, HT/VHT20, M0 to M7**



**Antenna A**



**Antenna B**

## Conducted Bandedge Peak Table

Frequency (MHz)	Mode	Tx Paths	Correlated Antenna Gain (dBi)	Tx 1 Bandedge Level (dBm)	Tx 2 Bandedge Level (dBm)	Tx 3 Bandedge Level (dBm)	Tx 4 Bandedge Level (dBm)	Total Tx Bandedge Level (dBm)	Limit (dBm)	Margin (dB)
5500	Non HT20, 6 to 54 Mbps	1	13	-40.7				-27.6	-21.25	6.40
	Non HT20, 6 to 54 Mbps	2	13	-40.7	-49.4			-27.1	-21.25	5.85
	Non HT20, 6 to 54 Mbps	3	13	-41.7	-51.0	-49.2		-27.5	-21.25	6.28
	Non HT20, 6 to 54 Mbps	4	13	-50.6	-51.7	-50.7	-50.3	-31.7	-21.25	10.47
	Non HT20 Beam Forming, 6 to 54 Mbps	2	13	-41.7	-51.0			-28.2	-21.25	6.92
	Non HT20 Beam Forming, 6 to 54 Mbps	3	15	-53.1	-53.7	-52.7		-33.3	-21.25	12.08
	Non HT20 Beam Forming, 6 to 54 Mbps	4	16	-56.2	-57.0	-56.3	-54.5	-33.8	-21.25	12.58
	HT/VHT20, M0 to M7	1	13	-40.6				-27.5	-21.25	6.30
	HT/VHT20, M0 to M7	2	13	-40.6	-49.4			-27.0	-21.25	5.76
	HT/VHT20, M8 to M15	2	13	-40.6	-49.4			-27.0	-21.25	5.76
	HT/VHT20, M0 to M7	3	13	-44.0	-50.1	-48.8		-29.0	-21.25	7.72
	HT/VHT20, M8 to M15	3	13	-44.0	-50.1	-48.8		-29.0	-21.25	7.72
	HT/VHT20, M16 to M23	3	13	-44.0	-50.1	-48.8		-29.0	-21.25	7.72
	HT/VHT20, M0 to M7	4	13	-44.0	-50.1	-48.8	-50.5	-28.4	-21.25	7.14
	HT/VHT20, M8 to M15	4	13	-44.0	-50.1	-48.8	-50.5	-28.4	-21.25	7.14
	HT/VHT20, M16 to M23	4	13	-44.0	-50.1	-48.8	-50.5	-28.4	-21.25	7.14
	HT/VHT20, M24 to M31	4	13	-44.0	-50.1	-48.8	-50.5	-28.4	-21.25	7.14
	HT/VHT20 Beam Forming, M0 to M7	2	13	-44.0	-50.1			-30.0	-21.25	8.74
	HT/VHT20 Beam Forming, M8 to M15	2	13	-40.6	-49.4			-27.0	-21.25	5.76
	HT/VHT20 Beam Forming, M0 to M7	3	15	-53.8	-53.9	-52.8		-33.6	-21.25	12.40
	HT/VHT20 Beam Forming, M8 to M15	3	13	-45.8	-52.4	-51.0		-30.9	-21.25	9.68
	HT/VHT20 Beam Forming, M16 to M23	3	13	-44.0	-50.1	-48.8		-29.0	-21.25	7.72
	HT/VHT20 Beam Forming, M0 to M7	4	16	-56.9	-57.2	-56.4	-56.0	-34.5	-21.25	13.28
	HT/VHT20 Beam Forming, M8 to M15	4	13	-50.4	-53.6	-50.9	-50.6	-32.1	-21.25	10.88
	HT/VHT20 Beam Forming, M16 to M23	4	13	-45.8	-52.4	-51.0	-50.7	-30.1	-21.25	8.84
	HT/VHT20 Beam Forming, M24 to M31	4	13	-44.0	-50.1	-48.8	-50.5	-28.4	-21.25	7.14
	HT/VHT20 STBC, M0 to M7	2	13	-40.6	-49.4			-27.0	-21.25	5.76
	HT/VHT20 STBC, M0 to M7	3	13	-45.8	-52.4	-51.0		-30.9	-21.25	9.68
	HT/VHT20 STBC, M0 to M7	4	13	-50.4	-53.6	-50.9	-50.6	-32.1	-21.25	10.88

	HE20, M0 to M9 1ss	1	13	-38.3				-25.2	-21.25	3.98
	HE20, M0 to M9 1ss	2	13	-38.3	-48.6			-24.8	-21.25	3.60
	HE20, M0 to M9 2ss	2	13	-38.3	-48.6			-24.8	-21.25	3.60
	HE20, M0 to M9 1ss	3	13	-38.3	-48.6	-50.0		-24.6	-21.25	3.34
	HE20, M0 to M9 2ss	3	13	-38.3	-48.6	-50.0		-24.6	-21.25	3.34
	HE20, M0 to M9 3ss	3	13	-38.3	-48.6	-50.0		-24.6	-21.25	3.34
	HE20, M0 to M9 1ss	4	13	-45.5	-51.2	-51.1	-50.2	-29.7	-21.25	8.43
	HE20, M0 to M9 2ss	4	13	-45.5	-51.2	-51.1	-50.2	-29.7	-21.25	8.43
	HE20, M0 to M9 3ss	4	13	-45.5	-51.2	-51.1	-50.2	-29.7	-21.25	8.43
	HE20, M0 to M9 4ss	4	13	-45.5	-51.2	-51.1	-50.2	-29.7	-21.25	8.43
	HE20 Beam Forming, M0 to M9 1ss	2	13	-38.3	-48.6			-24.8	-21.25	3.60
	HE20 Beam Forming, M0 to M9 2ss	2	13	-38.3	-48.6			-24.8	-21.25	3.60
	HE20 Beam Forming, M0 to M9 1ss	3	15	-51.5	-54.5	-52.6		-32.9	-21.25	11.61
	HE20 Beam Forming, M0 to M9 2ss	3	13	-45.5	-51.2	-51.1		-30.5	-21.25	9.30
	HE20 Beam Forming, M0 to M9 3ss	3	13	-38.3	-48.6	-50.0		-24.6	-21.25	3.34
	HE20 Beam Forming, M0 to M9 1ss	4	16	-56.7	-56.8	-54.7	-54.8	-33.5	-21.25	12.30
	HE20 Beam Forming, M0 to M9 2ss	4	13	-47.4	-53.0	-52.4	-51.7	-31.4	-21.25	10.15
	HE20 Beam Forming, M0 to M9 3ss	4	13	-45.5	-51.2	-51.1	-50.2	-29.7	-21.25	8.43
	HE20 Beam Forming, M0 to M9 4ss	4	13	-45.5	-51.2	-51.1	-50.2	-29.7	-21.25	8.43
	HE20 STBC, M0 to M9 2ss	2	13	-38.3	-48.6			-24.8	-21.25	3.60
	HE20 STBC, M0 to M9 2ss	3	13	-45.5	-51.2	-51.1		-30.5	-21.25	9.30
	HE20 STBC, M0 to M9 2ss	4	13	-47.4	-53.0	-52.4	-51.7	-31.4	-21.25	10.15
5510	Non HT40, 6 to 54 Mbps	1	13	-38.4				-25.4	-21.25	4.10
	Non HT40, 6 to 54 Mbps	2	13	-38.4	-50.3			-25.1	-21.25	3.83
	Non HT40, 6 to 54 Mbps	3	13	-38.4	-50.3	-50.0		-24.8	-21.25	3.56
	Non HT40, 6 to 54 Mbps	4	13	-42.7	-52.2	-52.7	-49.1	-28.1	-21.25	6.81
	HT/VHT40, M0 to M7	1	13	-40.2				-27.1	-21.25	5.84
	HT/VHT40, M0 to M7	2	13	-40.2	-51.8			-26.8	-21.25	5.55
	HT/VHT40, M8 to M15	2	13	-40.2	-51.8			-26.8	-21.25	5.55
	HT/VHT40, M0 to M7	3	13	-43.4	-51.6	-51.7		-29.2	-21.25	7.90
	HT/VHT40, M8 to M15	3	13	-43.4	-51.6	-51.7		-29.2	-21.25	7.90
	HT/VHT40, M16 to M23	3	13	-43.4	-51.6	-51.7		-29.2	-21.25	7.90
	HT/VHT40, M0 to M7	4	13	-43.4	-51.6	-51.7	-48.4	-28.2	-21.25	6.96
	HT/VHT40, M8 to M15	4	13	-43.4	-51.6	-51.7	-48.4	-28.2	-21.25	6.96
	HT/VHT40, M16 to M23	4	13	-43.4	-51.6	-51.7	-48.4	-28.2	-21.25	6.96
	HT/VHT40, M24 to M31	4	13	-43.4	-51.6	-51.7	-48.4	-28.2	-21.25	6.96
	HT/VHT40 Beam Forming, M0 to M7	2	13	-40.2	-51.8			-26.8	-21.25	5.55
	HT/VHT40 Beam Forming, M8 to M15	2	13	-40.2	-51.8			-26.8	-21.25	5.55
	HT/VHT40 Beam Forming, M0 to M7	3	15	-53.2	-53.2	-52.8		-33.2	-21.25	11.93
	HT/VHT40 Beam Forming, M8 to M15	3	13	-43.4	-51.6	-51.7		-29.2	-21.25	7.90
	HT/VHT40 Beam Forming, M16 to M23	3	13	-43.4	-51.6	-51.7		-29.2	-21.25	7.90
	HT/VHT40 Beam Forming, M0 to M7	4	16	-54.7	-54.8	-56.6	-55.2	-33.1	-21.25	11.88

	HT/VHT40 Beam Forming, M8 to M15	4	13	-49.6	-51.9	-51.4	-51.5	-31.9	-21.25	10.62
	HT/VHT40 Beam Forming, M16 to M23	4	13	-43.4	-51.6	-51.7	-48.4	-28.2	-21.25	6.96
	HT/VHT40 Beam Forming, M24 to M31	4	13	-43.4	-51.6	-51.7	-48.4	-28.2	-21.25	6.96
	HT/VHT40 STBC, M0 to M7	2	13	-40.2	-51.8			-26.8	-21.25	5.55
	HT/VHT40 STBC, M0 to M7	3	13	-43.4	-51.6	-51.7		-29.2	-21.25	7.90
	HT/VHT40 STBC, M0 to M7	4	13	-49.6	-51.9	-51.4	-51.5	-31.9	-21.25	10.62
	HE40, M0 to M9 1ss	1	13	-35.9				-22.8	-21.25	1.52
	HE40, M0 to M9 1ss	2	13	-35.9	-50.4			-22.6	-21.25	1.36
	HE40, M0 to M9 2ss	2	13	-35.9	-50.4			-22.6	-21.25	1.36
	HE40, M0 to M9 1ss	3	13	-35.9	-50.4	-48.9		-22.4	-21.25	1.16
	HE40, M0 to M9 2ss	3	13	-35.9	-50.4	-48.9		-22.4	-21.25	1.16
	HE40, M0 to M9 3ss	3	13	-35.9	-50.4	-48.9		-22.4	-21.25	1.16
	HE40, M0 to M9 1ss	4	13	-37.6	-51.7	-51.3	-51.6	-24.0	-21.25	2.72
	HE40, M0 to M9 2ss	4	13	-37.6	-51.7	-51.3	-51.6	-24.0	-21.25	2.72
	HE40, M0 to M9 3ss	4	13	-37.6	-51.7	-51.3	-51.6	-24.0	-21.25	2.72
	HE40, M0 to M9 4ss	4	13	-37.6	-51.7	-51.3	-51.6	-24.0	-21.25	2.72
	HE40 Beam Forming, M0 to M9 1ss	2	13	-35.9	-50.4			-22.6	-21.25	1.36
	HE40 Beam Forming, M0 to M9 2ss	2	13	-35.9	-50.4			-22.6	-21.25	1.36
	HE40 Beam Forming, M0 to M9 1ss	3	15	-44.0	-52.8	-52.5		-27.8	-21.25	6.57
	HE40 Beam Forming, M0 to M9 2ss	3	13	-35.9	-50.4	-48.9		-22.4	-21.25	1.16
	HE40 Beam Forming, M0 to M9 3ss	3	13	-35.9	-50.4	-48.9		-22.4	-21.25	1.16
	HE40 Beam Forming, M0 to M9 1ss	4	16	-52.5	-55.7	-55.6	-53.3	-31.9	-21.25	10.64
	HE40 Beam Forming, M0 to M9 2ss	4	13	-37.6	-51.7	-51.3	-51.6	-24.0	-21.25	2.72
	HE40 Beam Forming, M0 to M9 3ss	4	13	-37.6	-51.7	-51.3	-51.6	-24.0	-21.25	2.72
	HE40 Beam Forming, M0 to M9 4ss	4	13	-37.6	-51.7	-51.3	-51.6	-24.0	-21.25	2.72
	HE40 STBC, M0 to M9 2ss	2	13	-35.9	-50.4			-22.6	-21.25	1.36
	HE40 STBC, M0 to M9 2ss	3	13	-35.9	-50.4	-48.9		-22.4	-21.25	1.16
	HE40 STBC, M0 to M9 2ss	4	13	-37.6	-51.7	-51.3	-51.6	-24.0	-21.25	2.72
5530	Non HT80, 6 to 54 Mbps	1	13	-41.8				-28.7	-21.25	7.50
	Non HT80, 6 to 54 Mbps	2	13	-41.8	-51.8			-28.3	-21.25	7.09
	Non HT80, 6 to 54 Mbps	3	13	-41.8	-51.8	-42.9		-26.0	-21.25	4.77
	Non HT80, 6 to 54 Mbps	4	13	-46.1	-52.1	-50.7	-47.7	-29.5	-21.25	8.20
	VHT80, M0 to M9 1ss	1	13	-37.3				-24.1	-21.25	2.83
	VHT80, M0 to M9 1ss	2	13	-37.3	-51.5			-23.9	-21.25	2.67
	VHT80, M0 to M9 2ss	2	13	-37.3	-51.5			-23.9	-21.25	2.67
	VHT80, M0 to M9 1ss	3	13	-41.5	-51.8	-52.0		-27.6	-21.25	6.31
	VHT80, M0 to M9 2ss	3	13	-41.5	-51.8	-52.0		-27.6	-21.25	6.31
	VHT80, M0 to M9 3ss	3	13	-41.5	-51.8	-52.0		-27.6	-21.25	6.31
	VHT80, M0 to M9 1ss	4	13	-41.5	-51.8	-52.0	-50.6	-27.1	-21.25	5.88
	VHT80, M0 to M9 2ss	4	13	-41.5	-51.8	-52.0	-50.6	-27.1	-21.25	5.88
	VHT80, M0 to M9 3ss	4	13	-41.5	-51.8	-52.0	-50.6	-27.1	-21.25	5.88
	VHT80, M0 to M9 4ss	4	13	-41.5	-51.8	-52.0	-50.6	-27.1	-21.25	5.88

	VHT80 Beam Forming, M0 to M9 1ss	2	13	-37.3	-51.5			-23.9	-21.25	2.67
	VHT80 Beam Forming, M0 to M9 2ss	2	13	-37.3	-51.5			-23.9	-21.25	2.67
	VHT80 Beam Forming, M0 to M9 1ss	3	15	-43.8	-53.0	-54.1		-27.7	-21.25	6.49
	VHT80 Beam Forming, M0 to M9 2ss	3	13	-41.5	-51.8	-52.0		-27.6	-21.25	6.31
	VHT80 Beam Forming, M0 to M9 3ss	3	13	-41.5	-51.8	-52.0		-27.6	-21.25	6.31
	VHT80 Beam Forming, M0 to M9 1ss	4	16	-52.5	-54.2	-55.5	-54.3	-31.8	-21.25	10.50
	VHT80 Beam Forming, M0 to M9 2ss	4	13	-41.5	-51.8	-52.0	-50.6	-27.1	-21.25	5.88
	VHT80 Beam Forming, M0 to M9 3ss	4	13	-41.5	-51.8	-52.0	-50.6	-27.1	-21.25	5.88
	VHT80 Beam Forming, M0 to M9 4ss	4	13	-41.5	-51.8	-52.0	-50.6	-27.1	-21.25	5.88
	VHT80 STBC, M0 to M9 1ss	2	13	-37.3	-51.5			-23.9	-21.25	2.67
	VHT80 STBC, M0 to M9 1ss	3	13	-41.5	-51.8	-52.0		-27.6	-21.25	6.31
	VHT80 STBC, M0 to M9 1ss	4	13	-41.5	-51.8	-52.0	-50.6	-27.1	-21.25	5.88
	HE80, M0 to M9 1ss	1	13	-36.4				-23.1	-21.25	1.90
	HE80, M0 to M9 1ss	2	13	-36.4	-44.7			-22.6	-21.25	1.30
	HE80, M0 to M9 2ss	2	13	-36.4	-44.7			-22.6	-21.25	1.30
	HE80, M0 to M9 1ss	3	13	-45.3	-51.5	-50.6		-30.2	-21.25	8.94
	HE80, M0 to M9 2ss	3	13	-45.3	-51.5	-50.6		-30.2	-21.25	8.94
	HE80, M0 to M9 3ss	3	13	-45.3	-51.5	-50.6		-30.2	-21.25	8.94
	HE80, M0 to M9 1ss	4	13	-45.3	-51.5	-50.6	-52.0	-29.6	-21.25	8.37
	HE80, M0 to M9 2ss	4	13	-45.3	-51.5	-50.6	-52.0	-29.6	-21.25	8.37
	HE80, M0 to M9 3ss	4	13	-45.3	-51.5	-50.6	-52.0	-29.6	-21.25	8.37
	HE80, M0 to M9 4ss	4	13	-45.3	-51.5	-50.6	-52.0	-29.6	-21.25	8.37
	HE80 Beam Forming, M0 to M9 1ss	2	13	-36.4	-44.7			-22.6	-21.25	1.30
	HE80 Beam Forming, M0 to M9 2ss	2	13	-36.4	-44.7			-22.6	-21.25	1.30
	HE80 Beam Forming, M0 to M9 1ss	3	15	-49.1	-53.0	-52.4		-31.1	-21.25	9.87
	HE80 Beam Forming, M0 to M9 2ss	3	13	-45.3	-51.5	-50.6		-30.2	-21.25	8.94
	HE80 Beam Forming, M0 to M9 3ss	3	13	-45.3	-51.5	-50.6		-30.2	-21.25	8.94
	HE80 Beam Forming, M0 to M9 1ss	4	16	-54.5	-54.2	-54.1	-52.5	-31.5	-21.25	10.23
	HE80 Beam Forming, M0 to M9 2ss	4	13	-45.3	-51.5	-50.6	-52.0	-29.6	-21.25	8.37
	HE80 Beam Forming, M0 to M9 3ss	4	13	-45.3	-51.5	-50.6	-52.0	-29.6	-21.25	8.37
	HE80 Beam Forming, M0 to M9 4ss	4	13	-45.3	-51.5	-50.6	-52.0	-29.6	-21.25	8.37
	HE80 STBC, M0 to M9 1ss	2	13	-36.4	-44.7			-22.6	-21.25	1.30
	HE80 STBC, M0 to M9 1ss	3	13	-45.3	-51.5	-50.6		-30.2	-21.25	8.94
HE80 STBC, M0 to M9 1ss	4	13	-45.3	-51.5	-50.6	-52.0	-29.6	-21.25	8.37	
5570	Non HT160, 6 to 54 Mbps	1	13	-39.0				-26.0	-21.25	4.70
	Non HT160, 6 to 54 Mbps	2	13	-39.0	-49.0			-25.5	-21.25	4.29
	Non HT160, 6 to 54 Mbps	3	13	-39.0	-49.0	-51.0		-25.3	-21.25	4.05
	Non HT160, 6 to 54 Mbps	4	13	-42.2	-52.7	-51.4	-48.6	-27.6	-21.25	6.33
	VHT160, M0 to M9 1ss	1	13	-35.7				-22.3	-21.25	1.04
	<b>VHT160, M0 to M9 1ss</b>	<b>2</b>	<b>13</b>	<b>-35.7</b>	<b>-44.7</b>			<b>-21.8</b>	<b>-21.25</b>	<b>0.53</b>
	VHT160, M0 to M9 2ss	2	13	-35.7	-44.7			-21.8	-21.25	0.53
VHT160, M0 to M9 1ss	3	13	-40.9	-44.3	-46.1		-25.0	-21.25	3.79	



VHT160, M0 to M9 2ss	3	13	-40.9	-44.3	-46.1		-25.0	-21.25	3.79
VHT160, M0 to M9 3ss	3	13	-40.9	-44.3	-46.1		-25.0	-21.25	3.79
VHT160, M0 to M9 1ss	4	13	-40.9	-44.3	-46.1	-45.2	-24.2	-21.25	2.96
VHT160, M0 to M9 2ss	4	13	-40.9	-44.3	-46.1	-45.2	-24.2	-21.25	2.96
VHT160, M0 to M9 3ss	4	13	-40.9	-44.3	-46.1	-45.2	-24.2	-21.25	2.96
VHT160, M0 to M9 4ss	4	13	-40.9	-44.3	-46.1	-45.2	-24.2	-21.25	2.96
VHT160 Beam Forming, M0 to M9 1ss	2	13	-35.7	-44.7			-21.8	-21.25	0.53
VHT160 Beam Forming, M0 to M9 2ss	2	13	-35.7	-44.7			-21.8	-21.25	0.53
VHT160 Beam Forming, M0 to M9 1ss	3	15	-40.9	-44.3	-46.1		-23.0	-21.25	1.79
VHT160 Beam Forming, M0 to M9 2ss	3	13	-40.9	-44.3	-46.1		-25.0	-21.25	3.79
VHT160 Beam Forming, M0 to M9 3ss	3	13	-40.9	-44.3	-46.1		-25.0	-21.25	3.79
VHT160 Beam Forming, M0 to M9 1ss	4	16	-45.7	-46.9	-47.9	-48.4	-24.7	-21.25	3.42
VHT160 Beam Forming, M0 to M9 2ss	4	13	-40.9	-44.3	-46.1	-45.2	-24.2	-21.25	2.96
VHT160 Beam Forming, M0 to M9 3ss	4	13	-40.9	-44.3	-46.1	-45.2	-24.2	-21.25	2.96
VHT160 Beam Forming, M0 to M9 4ss	4	13	-40.9	-44.3	-46.1	-45.2	-24.2	-21.25	2.96
VHT160 STBC, M0 to M9 1ss	2	13	-35.7	-44.7			-21.8	-21.25	0.53
VHT160 STBC, M0 to M9 1ss	3	13	-40.9	-44.3	-46.1		-25.0	-21.25	3.79
VHT160 STBC, M0 to M9 1ss	4	13	-40.9	-44.3	-46.1	-45.2	-24.2	-21.25	2.96
HE160, M0 to M9 1ss	1	13	-39.2				-25.8	-21.25	4.52
HE160, M0 to M9 1ss	2	13	-39.2	-50.2			-25.4	-21.25	4.18
HE160, M0 to M9 2ss	2	13	-39.2	-50.2			-25.4	-21.25	4.18
HE160, M0 to M9 1ss	3	13	-39.2	-50.2	-50.3		-25.1	-21.25	3.88
HE160, M0 to M9 2ss	3	13	-39.2	-50.2	-50.3		-25.1	-21.25	3.88
HE160, M0 to M9 3ss	3	13	-39.2	-50.2	-50.3		-25.1	-21.25	3.88
HE160, M0 to M9 1ss	4	13	-42.9	-51.3	-50.6	-48.7	-27.5	-21.25	6.24
HE160, M0 to M9 2ss	4	13	-42.9	-51.3	-50.6	-48.7	-27.5	-21.25	6.24
HE160, M0 to M9 3ss	4	13	-42.9	-51.3	-50.6	-48.7	-27.5	-21.25	6.24
HE160, M0 to M9 4ss	4	13	-42.9	-51.3	-50.6	-48.7	-27.5	-21.25	6.24
HE160 Beam Forming, M0 to M9 1ss	2	13	-39.2	-50.2			-25.4	-21.25	4.18
HE160 Beam Forming, M0 to M9 2ss	2	13	-39.2	-50.2			-25.4	-21.25	4.18
HE160 Beam Forming, M0 to M9 1ss	3	15	-47.6	-52.5	-52.4		-30.0	-21.25	8.73
HE160 Beam Forming, M0 to M9 2ss	3	13	-39.2	-50.2	-50.3		-25.1	-21.25	3.88
HE160 Beam Forming, M0 to M9 3ss	3	13	-39.2	-50.2	-50.3		-25.1	-21.25	3.88
HE160 Beam Forming, M0 to M9 1ss	4	16	-51.1	-54.2	-53.6	-52.9	-30.3	-21.25	9.08
HE160 Beam Forming, M0 to M9 2ss	4	13	-42.9	-51.3	-50.6	-48.7	-27.5	-21.25	6.24
HE160 Beam Forming, M0 to M9 3ss	4	13	-42.9	-51.3	-50.6	-48.7	-27.5	-21.25	6.24
HE160 Beam Forming, M0 to M9 4ss	4	13	-42.9	-51.3	-50.6	-48.7	-27.5	-21.25	6.24
HE160 STBC, M0 to M9 1ss	2	13	-39.2	-50.2			-25.4	-21.25	4.18
HE160 STBC, M0 to M9 1ss	3	13	-39.2	-50.2	-50.3		-25.1	-21.25	3.88
HE160 STBC, M0 to M9 1ss	4	13	-42.9	-51.3	-50.6	-48.7	-27.5	-21.25	6.24

5700	Non HT20, 6 to 54 Mbps	1	13	-34.6				-21.5	-21.25	0.30
	<b>Non HT20, 6 to 54 Mbps</b>	<b>2</b>	<b>13</b>	<b>-34.6</b>	<b>-49.5</b>			<b>-21.4</b>	<b>-21.25</b>	<b>0.16</b>
	Non HT20, 6 to 54 Mbps	3	13	-39.5	-50.6	-47.0		-25.5	-21.25	4.21
	Non HT20, 6 to 54 Mbps	4	13	-46.8	-49.8	-49.1	-51.0	-29.8	-21.25	8.57
	Non HT20 Beam Forming, 6 to 54 Mbps	2	13	-34.6	-49.5			-21.4	-21.25	0.16
	Non HT20 Beam Forming, 6 to 54 Mbps	3	15	-53.2	-54.6	-53.5		-33.9	-21.25	12.65
	Non HT20 Beam Forming, 6 to 54 Mbps	4	16	-54.8	-56.5	-55.6	-55.7	-33.5	-21.25	12.29
	HT/VHT20, M0 to M7	1	13	-40.6				-27.5	-21.25	6.30
	HT/VHT20, M0 to M7	2	13	-40.6	-48.9			-26.9	-21.25	5.70
	HT/VHT20, M8 to M15	2	13	-40.6	-48.9			-26.9	-21.25	5.70
	HT/VHT20, M0 to M7	3	13	-40.6	-48.9	-47.5		-26.2	-21.25	4.99
	HT/VHT20, M8 to M15	3	13	-40.6	-48.9	-47.5		-26.2	-21.25	4.99
	HT/VHT20, M16 to M23	3	13	-40.6	-48.9	-47.5		-26.2	-21.25	4.99
	HT/VHT20, M0 to M7	4	13	-40.6	-48.9	-47.5	-49.2	-25.8	-21.25	4.57
	HT/VHT20, M8 to M15	4	13	-40.6	-48.9	-47.5	-49.2	-25.8	-21.25	4.57
	HT/VHT20, M16 to M23	4	13	-40.6	-48.9	-47.5	-49.2	-25.8	-21.25	4.57
	HT/VHT20, M24 to M31	4	13	-40.6	-48.9	-47.5	-49.2	-25.8	-21.25	4.57
	HT/VHT20 Beam Forming, M0 to M7	2	13	-40.6	-48.9			-26.9	-21.25	5.70
	HT/VHT20 Beam Forming, M8 to M15	2	13	-40.6	-48.9			-26.9	-21.25	5.70
	HT/VHT20 Beam Forming, M0 to M7	3	15	-51.3	-51.7	-50.6		-31.4	-21.25	10.10
	HT/VHT20 Beam Forming, M8 to M15	3	13	-40.6	-48.9	-47.5		-26.2	-21.25	4.99
	HT/VHT20 Beam Forming, M16 to M23	3	13	-40.6	-48.9	-47.5		-26.2	-21.25	4.99
	HT/VHT20 Beam Forming, M0 to M7	4	16	-52.1	-55.7	-53.1	-54.1	-31.5	-21.25	10.23
	HT/VHT20 Beam Forming, M8 to M15	4	13	-43.2	-51.7	-50.7	-50.4	-28.4	-21.25	7.11
	HT/VHT20 Beam Forming, M16 to M23	4	13	-40.6	-48.9	-47.5	-49.2	-25.8	-21.25	4.57
	HT/VHT20 Beam Forming, M24 to M31	4	13	-40.6	-48.9	-47.5	-49.2	-25.8	-21.25	4.57
	HT/VHT20 STBC, M0 to M7	2	13	-40.6	-48.9			-26.9	-21.25	5.70
	HT/VHT20 STBC, M0 to M7	3	13	-40.6	-48.9	-47.5		-26.2	-21.25	4.99
	HT/VHT20 STBC, M0 to M7	4	13	-43.2	-51.7	-50.7	-50.4	-28.4	-21.25	7.11
	HE20, M0 to M9 1ss	1	13	-40.9				-27.8	-21.25	6.58
	HE20, M0 to M9 1ss	2	13	-40.9	-49.0			-27.2	-21.25	5.96
	HE20, M0 to M9 2ss	2	13	-40.9	-49.0			-27.2	-21.25	5.96
	HE20, M0 to M9 1ss	3	13	-40.9	-49.0	-48.2		-26.6	-21.25	5.31
	HE20, M0 to M9 2ss	3	13	-40.9	-49.0	-48.2		-26.6	-21.25	5.31
	HE20, M0 to M9 3ss	3	13	-40.9	-49.0	-48.2		-26.6	-21.25	5.31
	HE20, M0 to M9 1ss	4	13	-40.9	-49.0	-48.2	-50.2	-26.2	-21.25	4.95
	HE20, M0 to M9 2ss	4	13	-40.9	-49.0	-48.2	-50.2	-26.2	-21.25	4.95
	HE20, M0 to M9 3ss	4	13	-40.9	-49.0	-48.2	-50.2	-26.2	-21.25	4.95
	HE20, M0 to M9 4ss	4	13	-40.9	-49.0	-48.2	-50.2	-26.2	-21.25	4.95
	HE20 Beam Forming, M0 to M9 1ss	2	13	-40.9	-49.0			-27.2	-21.25	5.96
	HE20 Beam Forming, M0 to M9 2ss	2	13	-40.9	-49.0			-27.2	-21.25	5.96
	HE20 Beam Forming, M0 to M9 1ss	3	15	-46.3	-50.6	-48.3		-28.2	-21.25	6.97
HE20 Beam Forming, M0 to M9 2ss	3	13	-40.9	-49.0	-48.2		-26.6	-21.25	5.31	

HE20 Beam Forming, M0 to M9 3ss	3	13	-40.9	-49.0	-48.2		-26.6	-21.25	5.31
HE20 Beam Forming, M0 to M9 1ss	4	16	-49.8	-54.0	-51.6	-53.3	-29.8	-21.25	8.53
HE20 Beam Forming, M0 to M9 2ss	4	13	-45.0	-50.9	-50.4	-49.3	-29.1	-21.25	7.86
HE20 Beam Forming, M0 to M9 3ss	4	13	-40.9	-49.0	-48.2	-50.2	-26.2	-21.25	4.95
HE20 Beam Forming, M0 to M9 4ss	4	13	-40.9	-49.0	-48.2	-50.2	-26.2	-21.25	4.95
HE20 STBC, M0 to M9 2ss	2	13	-40.9	-49.0			-27.2	-21.25	5.96
HE20 STBC, M0 to M9 2ss	3	13	-40.9	-49.0	-48.2		-26.6	-21.25	5.31
HE20 STBC, M0 to M9 2ss	4	13	-45.0	-50.9	-50.4	-49.3	-29.1	-21.25	7.86

**Conducted Bandedge Peak, 5570 MHz, VHT160, M0 to M9 1ss**



**Antenna A**



**Antenna B**

**Conducted Bandedge Peak, 5700 MHz, Non HT20, 6 to 54 Mbps**



**Antenna A**



**Antenna B**

## A.7 Conducted Receiver Spurious Emissions

*Spurious Of Receive Average Upp, 5500 MHz, Non HT20, 6 to 54 Mbps*



*Spurious Of Receive Peak Upper, 5500 MHz, Non HT20, 6 to 54 Mbps*

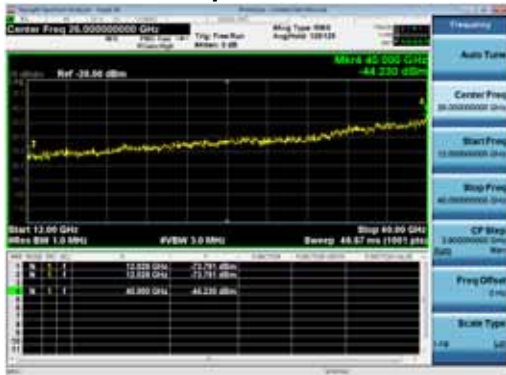

## Conducted Spurious Of Receive Average Table

Frequency (MHz)	Mode	Tx Paths	Correlated Antenna Gain (dBi)	Rx 1 Spur Power (dBm)	Rx 2 Spur Power (dBm)	Rx 3 Spur Power (dBm)	Rx 4 Spur Power (dBm)	Duty Cycle Correction (dB)	Total Conducted Spur (dBm)	Limit (dBm)	Margin (dB)
5500	Non HT20, 6 to 54 Mbps	4	13	-90.4	-90.5	-90.3	-90.4	0.1	-71.3	-41.25	30.08
	HT/VHT20, M0 to M7	4	13	-90.4	-90.5	-90.7	-90.5	0.1	-71.5	-41.25	30.20
	HE20, M0 to M9 1ss	4	13	-90.6	-90.3	-90.3	-90.5	0.1	-71.3	-41.25	30.09
5510	Non HT40, 6 to 54 Mbps	4	13	-90.2	-90.6	-90.5	-90.4	0.0	-71.4	-41.25	30.10
	HT/VHT40, M0 to M7	4	13	-90.6	-90.3	-90.4	-90.5	0.1	-71.3	-41.25	30.07
	HE40, M0 to M9 1ss	4	13	-90.7	-90.4	-90.3	-90.6	0.1	-71.3	-41.25	30.09
5530	Non HT80, 6 to 54 Mbps	4	13	-90.3	-90.3	-89.9	-90.2	0.1	-71.1	-41.25	29.85
	VHT80, M0 to M9 1ss	4	13	-90.6	-90.5	-90.4	-90.7	0.2	-71.3	-41.25	30.06
	HE80, M0 to M9 1ss	4	13	-90.3	-90.4	-90.5	-90.7	0.3	-71.2	-41.25	29.95
5550	Non HT40, 6 to 54 Mbps	4	13	-90.2	-90.6	-90.3	-90.4	0.0	-71.3	-41.25	30.05
	HT/VHT40, M0 to M7	4	13	-90.3	-90.4	-90.3	-90.3	0.1	-71.2	-41.25	29.94
	HE40, M0 to M9 1ss	4	13	-88.9	-88.3	-88.9	-88.8	0.1	-69.6	-41.25	28.31
5560	Non HT20, 6 to 54 Mbps	4	13	-88.3	-88.8	-88.4	-88.4	0.1	-69.4	-41.25	28.15
	HT/VHT20, M0 to M7	4	13	-88.7	-88.7	-88.6	-88.9	0.1	-69.7	-41.25	28.40
	HE20, M0 to M9 1ss	4	13	-89.0	-88.5	-88.8	-88.6	0.1	-69.6	-41.25	28.38
5570	Non HT160, 6 to 54 Mbps	4	13	-90.2	-90.5	-90.7	-90.5	0.0	-71.4	-41.25	30.16
	VHT160, M0 to M9 1ss	4	13	-90.5	-90.3	-90.2	-90.6	0.4	-71.0	-41.25	29.72
	HE160, M0 to M9 1ss	4	13	-90.5	-90.7	-90.5	-90.3	0.4	-71.0	-41.25	29.79
5610	Non HT80, 6 to 54 Mbps	4	13	-88.9	-88.9	-89.2	-88.6	0.1	-69.8	-41.25	28.57
	VHT80, M0 to M9 1ss	4	13	-88.4	-88.8	-88.9	-88.7	0.2	-69.5	-41.25	28.21
	<b>HE80, M0 to M9 1ss</b>	4	13	<b>-88.6</b>	<b>-88.7</b>	<b>-88.7</b>	<b>-88.3</b>	<b>0.3</b>	<b>-69.3</b>	<b>-41.25</b>	<b>28.05</b>



5690	Non HT80, 6 to 54 Mbps	4	13	-88.5	-88.6	-88.5	-88.9	0.1	-69.6	-41.25	28.30
	VHT80, M0 to M9 1ss	4	13	-88.2	-88.7	-88.7	-89.0	0.2	-69.4	-41.25	28.15
	HE80, M0 to M9 1ss	4	13	-88.7	-89.0	-88.7	-88.6	0.3	-69.5	-41.25	28.23
5700	Non HT20, 6 to 54 Mbps	4	13	-89.0	-88.7	-88.8	-88.8	0.1	-69.8	-41.25	28.50
	HT/VHT20, M0 to M7	4	13	-88.6	-88.9	-88.4	-88.9	0.1	-69.6	-41.25	28.37
	HE20, M0 to M9 1ss	4	13	-88.4	-89.0	-88.9	-88.9	0.1	-69.7	-41.25	28.46
5710	Non HT40, 6 to 54 Mbps	4	13	-89.2	-89.0	-88.6	-89.0	0.0	-69.9	-41.25	28.62
	HT/VHT40, M0 to M7	4	13	-88.6	-89.2	-88.9	-89.1	0.1	-69.8	-41.25	28.56
	HE40, M0 to M9 1ss	4	13	-89.1	-88.7	-88.8	-88.7	0.1	-69.7	-41.25	28.42
5720	Non HT20, 6 to 54 Mbps	4	13	-88.9	-88.9	-89.0	-88.9	0.1	-69.9	-41.25	28.60
	HT/VHT20, M0 to M7	4	13	-88.3	-88.4	-88.6	-88.6	0.1	-69.4	-41.25	28.15
	HE20, M0 to M9 1ss	4	13	-88.9	-88.7	-88.6	-88.4	0.1	-69.6	-41.25	28.31

*Spurious Of Receive Average, 5610 MHz, HE80, M0 to M9 1ss*



**Antenna A**

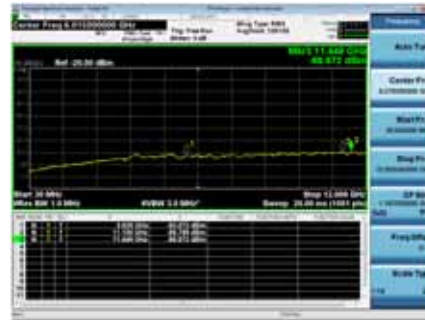

**Antenna B**



**Antenna C**

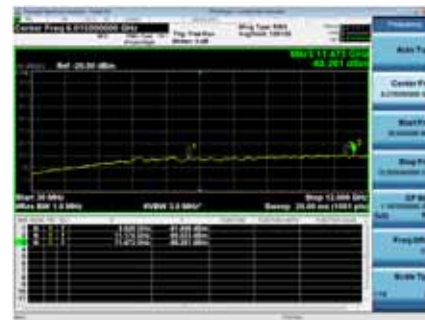

**Antenna D**



## Conducted Spurious Of Receive Table

Frequency (MHz)	Mode	Tx Paths	Correlated Antenna Gain (dBi)	Rx 1 Spur Power (dBm)	Rx 2 Spur Power (dBm)	Rx 3 Spur Power (dBm)	Rx 4 Spur Power (dBm)	Total Conducted Spur (dBm)	Limit (dBm)	Margin (dB)
5500	Non HT20, 6 to 54 Mbps	4	13	-68.8	-70.3	-71.0	-69.8	-50.8	-21.25	29.58
	HT/VHT20, M0 to M7	4	13	-69.3	-69.4	-70.3	-69.9	-50.6	-21.25	29.38
	HE20, M0 to M9 1ss	4	13	-69.6	-69.8	-69.2	-70.0	-50.6	-21.25	29.30
5510	Non HT40, 6 to 54 Mbps	4	13	-70.2	-69.5	-68.8	-69.4	-50.4	-21.25	29.13
	HT/VHT40, M0 to M7	4	13	-70.3	-69.0	-69.6	-69.8	-50.5	-21.25	29.27
	HE40, M0 to M9 1ss	4	13	-70.0	-70.4	-67.6	-70.6	-50.3	-21.25	29.06
5530	Non HT80, 6 to 54 Mbps	4	13	-70.3	-70.0	-69.7	-69.8	-50.9	-21.25	29.62
	VHT80, M0 to M9 1ss	4	13	-70.5	-69.9	-69.8	-70.0	-50.8	-21.25	29.56
	HE80, M0 to M9 1ss	4	13	-70.6	-69.6	-69.6	-68.5	-50.2	-21.25	28.99
5550	Non HT40, 6 to 54 Mbps	4	13	-70.5	-69.8	-70.0	-70.7	-51.2	-21.25	29.92
	HT/VHT40, M0 to M7	4	13	-69.3	-69.6	-69.8	-69.0	-50.3	-21.25	29.03
	HE40, M0 to M9 1ss	4	13	-69.5	-68.5	-68.8	-68.1	-49.5	-21.25	28.29
5560	Non HT20, 6 to 54 Mbps	4	13	-69.0	-67.3	-69.5	-69.3	-49.6	-21.25	28.36
	HT/VHT20, M0 to M7	4	13	-68.4	-69.0	-69.6	-69.1	-49.9	-21.25	28.68
	HE20, M0 to M9 1ss	4	13	-68.0	-69.2	-69.5	-68.5	-49.7	-21.25	28.42
5570	Non HT160, 6 to 54 Mbps	4	13	-68.6	-69.8	-69.9	-70.4	-50.6	-21.25	29.31
	VHT160, M0 to M9 1ss	4	13	-69.2	-70.0	-69.6	-70.2	-50.3	-21.25	29.06
	HE160, M0 to M9 1ss	4	13	-69.2	-68.9	-70.1	-69.9	-50.0	-21.25	28.79
5610	Non HT80, 6 to 54 Mbps	4	13	-68.7	-68.3	-69.8	-69.7	-50.0	-21.25	28.76
	<b>VHT80, M0 to M9 1ss</b>	<b>4</b>	<b>13</b>	<b>-68.3</b>	<b>-69.0</b>	<b>-68.6</b>	<b>-68.9</b>	<b>-49.5</b>	<b>-21.25</b>	<b>28.20</b>
	HE80, M0 to M9 1ss	4	13	-69.1	-69.3	-69.0	-69.0	-49.8	-21.25	28.58
5690	Non HT80, 6 to 54 Mbps	4	13	-69.7	-68.7	-69.2	-68.5	-49.9	-21.25	28.68
	VHT80, M0 to M9 1ss	4	13	-69.6	-68.2	-69.4	-68.8	-49.7	-21.25	28.48



	HE80, M0 to M9 1ss	4	13	-68.4	-68.7	-68.7	-69.8	-49.6	-21.25	28.35
5700	Non HT20, 6 to 54 Mbps	4	13	-69.5	-69.4	-69.7	-69.5	-50.5	-21.25	29.20
	HT/VHT20, M0 to M7	4	13	-68.6	-67.8	-68.1	-70.2	-49.5	-21.25	28.26
	HE20, M0 to M9 1ss	4	13	-68.6	-69.6	-69.0	-69.2	-50.0	-21.25	28.75
5710	Non HT40, 6 to 54 Mbps	4	13	-69.4	-67.8	-69.2	-68.3	-49.6	-21.25	28.31
	HT/VHT40, M0 to M7	4	13	-68.8	-68.7	-68.1	-69.4	-49.6	-21.25	28.35
	HE40, M0 to M9 1ss	4	13	-68.2	-69.7	-68.6	-69.5	-49.8	-21.25	28.55
5720	Non HT20, 6 to 54 Mbps	4	13	-68.5	-69.4	-69.6	-69.8	-50.2	-21.25	28.97
	HT/VHT20, M0 to M7	4	13	-68.9	-68.9	-69.2	-68.2	-49.7	-21.25	28.46
	HE20, M0 to M9 1ss	4	13	-69.0	-68.6	-69.5	-69.1	-50.0	-21.25	28.70

**Spurious Of Receive Peak, 5610 MHz, VHT80, M0 to M9 1ss**



**Antenna A**

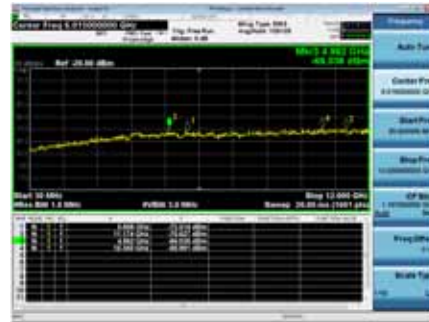

**Antenna B**

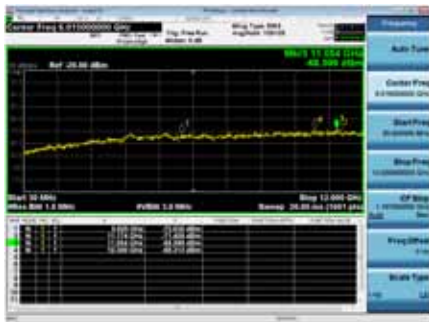

**Antenna C**

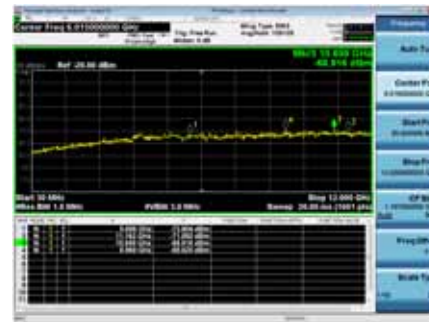

**Antenna D**



**Appendix B: Radiated & AC Conducted Emissions Test Results**  
Testing done by outside laboratory.

### Appendix C: List of Test Equipment Used to perform the test

Equip#	Manufacturer/ Model	Description	Last Cal	Next Cal	Test Item
57477	Cisco	Automation Test Insertion Loss	NA	NA	A1-A7
55108	Keysight N9030A-550	PXA Signal Analyzer, 3Hz to 50GHz	23 Oct 2018	23 Oct 2019	A1-A7
55093	NI PXI-1042	CHASSIS, PXI	NA	NA	A1-A7
57238	NI PXI-8115	Embedded Controller	NA	NA	A1-A7
57247	NI PXI-2796	40 GHz Dual 6x1 Multiplexer (SP6T)	NA	NA	A1-A7
57248	NI PXI-2799	Switch 1x1	NA	NA	A1-A7
56092	NI PXI-2796	40 GHz Dual 6x1 Multiplexer (SP6T)	NA	NA	A1-A7
7329	Omega CT485B	Chart recorder	18 Feb 2019	18 Feb 2020	A1-A7
56328	Pasternack PE5019-1	Torque wrench	14 Feb 2019	14 Feb 2020	A1-A7
56329	Pasternack PE5019-1	Torque wrench	28 Feb 2019	28 Feb 2020	A1-A7
56330	Pasternack PE5019-1	Torque wrench	28 Feb 2019	28 Feb 2020	A1-A7

## Appendix D: Abbreviation Key and Definitions

The following table defines abbreviations used within this test report.

Abbreviation	Description	Abbreviation	Description
EMC	Electro Magnetic Compatibility	°F	Degrees Fahrenheit
EMI	Electro Magnetic Interference	°C	Degrees Celsius
EUT	Equipment Under Test	Temp	Temperature
ITE	Information Technology Equipment	S/N	Serial Number
TAP	Test Assessment Schedule	Qty	Quantity
ESD	Electro Static Discharge	emf	Electromotive force
EFT	Electric Fast Transient	RMS	Root mean square
EDCS	Engineering Document Control System	Qp	Quasi Peak
Config	Configuration	Av	Average
CIS#	Cisco Number (unique identification number for Cisco test equipment)	Pk	Peak
Cal	Calibration	kHz	Kilohertz ( $1 \times 10^3$ )
EN	European Norm	MHz	MegaHertz ( $1 \times 10^6$ )
IEC	International Electro technical Commission	GHz	Gigahertz ( $1 \times 10^9$ )
CISPR	International Special Committee on Radio Interference	H	Horizontal
CDN	Coupling/Decoupling Network	V	Vertical
LISN	Line Impedance Stabilization Network	dB	decibel
PE	Protective Earth	V	Volt
GND	Ground	kV	Kilovolt ( $1 \times 10^3$ )
L1	Line 1	$\mu$ V	Microvolt ( $1 \times 10^{-6}$ )
L2	Line2	A	Amp
L3	Line 3	$\mu$ A	Micro Amp ( $1 \times 10^{-6}$ )
DC	Direct Current	mS	Milli Second ( $1 \times 10^{-3}$ )
RAW	Uncorrected measurement value, as indicated by the measuring device	$\mu$ S	Micro Second ( $1 \times 10^{-6}$ )
RF	Radio Frequency	$\mu$ S	Micro Second ( $1 \times 10^{-6}$ )
SLCE	Signal Line Conducted Emissions	m	Meter
Meas dist	Measurement distance	Spec dist	Specification distance
N/A or NA	Not Applicable	SL	Signal Line (or Telecom Line)
P	Power Line	L	Live Line
N	Neutral Line	R	Return
S	Supply	AC	Alternating Current

## Appendix E: Photographs of Test Setups

Please refer to the attachment

## **Appendix F: Software Used to Perform Testing**

Cisco Internal LabView Radio Test Automation Software rev57

## **Appendix G: Test Procedures**

Measurements were made in accordance with

- KDB 789033 - D02 General UNII Test Procedures New Rules v02r01
- KDB 662911 - MIMO
- ANSI C63.4 2014 Unintentional Radiators
- ANSI C63.10 2013 Intentional Radiators

Test procedures are summarized below:

FCC 5GHz Test Procedures	EDCS # 1445048
FCC 5GHz RSE Test Procedures	EDCS # 1511600

## **Appendix H: Scope of Accreditation (A2LA certificate number 1178-01)**

The scope of accreditation of Cisco Systems, Inc. can be found on the A2LA web page at:

<http://www.a2la.org/scopepdf/1178-01.pdf>

## **Appendix I: Test Assessment Plan**

Target Power Tables EDCS# 16415403

# **End**