





FCC PART 15.407
ISED RSS-247, ISSUE 2
DYNAMIC FREQUENCY SELECTION
TEST REPORT

For
Cisco Systems Inc.

125 West Tasman Drive,
San Jose, CA 95134 USA

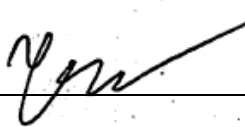
FCC ID: LDKROFSN2177
IC: 2461N-ROFSN2177

Report Type: Original Report	Product Type: Cisco Catalyst 9120AX Series
Prepared By Tri Pham Test Engineer	
Report Number R1910145-DFS	
Report Date 2019-10-28	
Reviewed By Frank Wang RF Lead	
Bay Area Compliance Laboratories Corp. 1274 Anvilwood Ave Sunnyvale, CA 94089, USA Tel: (408) 732-9162, Fax: (408) 732 9164	



Note: This test report is prepared for the customer shown above and for the device described herein. It may not be duplicated or used in part without prior written consent from Bay Area Compliance Laboratories Corp. This report **must not** be used by the customer to claim product certification, approval, or endorsement by A2LA* or any agency of the Federal Government.

* This report may contain data that are not covered by the A2LA accreditation and are marked with an asterisk “ * ”

TABLE OF CONTENTS

1	GENERAL DESCRIPTION.....	4
1.1	PRODUCT DESCRIPTION FOR EQUIPMENT UNDER TEST (EUT).....	4
1.2	MECHANICAL DESCRIPTION OF EUT.....	4
1.3	OBJECTIVE.....	4
1.4	RELATED SUBMITTAL(S)/GRANT(S).....	4
1.5	TEST METHODOLOGY.....	4
1.6	TEST FACILITY REGISTRATIONS.....	5
1.7	TEST FACILITY ACCREDITATIONS.....	5
2	EUT TEST CONFIGURATION.....	8
2.1	JUSTIFICATION.....	8
2.2	EUT EXERCISE SOFTWARE.....	8
2.3	EQUIPMENT MODIFICATIONS.....	8
2.4	LOCAL SUPPORT EQUIPMENT.....	8
2.5	INTERFACE PORTS AND CABLES.....	8
3	SUMMARY OF TEST RESULTS.....	9
4	APPLICABLE STANDARDS.....	10
4.1	DFS REQUIREMENT.....	10
4.2	DFS MEASUREMENT SYSTEM.....	13
4.3	SYSTEM BLOCK DIAGRAM.....	13
4.4	CONDUCTED METHOD.....	13
4.5	RADIATED METHOD.....	15
4.6	TEST PROCEDURE.....	15
5	TEST RESULTS.....	16
5.1	DESCRIPTION OF EUT.....	16
5.2	ANTENNA DESCRIPTION.....	16
5.3	TEST EQUIPMENT LIST AND DETAILS.....	16
5.4	RADAR WAVEFORM CALIBRATION.....	17
5.5	TEST ENVIRONMENTAL CONDITIONS.....	17
6	CHANNEL AVAILABILITY CHECK TIME (CAC).....	34
6.1	TEST PROCEDURE.....	34
6.2	RESULTS:.....	34
7	CHANNEL MOVE TIME AND CHANNEL CLOSING TRANSMISSION TIME.....	39
7.1	TEST PROCEDURE.....	39
7.2	TEST RESULTS.....	39
8	NON-OCCUPANCY PERIOD.....	42
8.1	TEST PROCEDURE.....	42
8.2	TEST RESULTS.....	42
9	RADAR DETECTION BANDWIDTH & RADAR DETECTION PERFORMANCE CHECK.....	44
9.1	DETECTION BANDWIDTH.....	44
9.2	RADAR DETECTION PERFORMANCE CHECK.....	51
10	ANNEX A- TEST SETUP PHOTOGRAPHS.....	306
11	ANNEX B - EUT EXTERNAL PHOTOGRAPHS.....	307
12	ANNEX C- EUT INTERNAL PHOTOGRAPHS.....	308
13	ANNEX D (NORMATIVE) - A2LA ELECTRICAL TESTING CERTIFICATE.....	309

DOCUMENT REVISION HISTORY

Revision Number	Report Number	Description of Revision	Date of Revision
0	R1910145-DFS	Original Report	2019-10-28

1 General Description

1.1 Product Description for Equipment under Test (EUT)

This test and measurement report was prepared on behalf of *Cisco Systems Inc.*, and their product model: *C9120AXP-B (USA)*, *C9120AXP-EWC-B (USA)*, *C9120AXP-A (Canada)*, *C9120AXP-EWC-A (Canada)*, as referred to as EUT in this report. The product is an 802.11ax Dual Band Access Point.

1.2 Mechanical Description of EUT

Length (mm)	Width (mm)	Height (mm)	Weight (g)
180	55	235	1150

1.3 Objective

This report is prepared on behalf of *Cisco System Inc.* in accordance with FCC CFR47 §15.407 (h), and KDB: 905462 D02 UNII DFS Compliance Procedures New Rules v02.

The objective is to determine compliance with FCC rules for DFS Detection Threshold, Channel Availability Check Time, Uniform Spreading U-NII Detection Bandwidth, Channel Closing Transmission Time, and Channel Move time in Master Mode.

1.4 Related Submittal(s)/Grant(s)

FCC 15.407 Reports (R1910145-407)

1.5 Test Methodology

FCC CFR 47 Part2, Part15.407 (h)

KDB: 905462 D02 UNII DFS Compliance Procedures New Rules v02.

COMPLIANCE MEASUREMENT PROCEDURES FOR UNLICENSED-NATIONAL INFORMATION INFRASTRUCTURE DEVICES OPERATING IN THE 5250-5350 MHz AND 5470-5725 MHz BANDS INCORPORATING DYNAMIC FREQUENCY SELECTION

1.6 Test Facility Registrations

BACLs test facilities that are used to perform Radiated and Conducted Emissions tests are currently recognized by the Federal Communications Commission as Accredited with NIST Designation Number US1129.

BACL's test facilities that are used to perform Radiated and Conducted Emissions tests are currently registered with Industry Canada under Registration Numbers: 3062A-1, 3062A-2, and 3062A-3.

BACL is a Chinese Taipei Bureau of Standards Metrology and Inspection (BSMI) validated Conformity Assessment Body (CAB), under Annex B, Phase I Procedures of the APEC Mutual Recognition Arrangement (MRA). BACL's BSMI Lab Code Number is: SL2-IN-E-1002R

BACL's test facilities that are used to perform AC Line Conducted Emissions, Telecommunications Line Conducted Emissions, Radiated Emissions from 30 MHz to 1 GHz, and Radiated Emissions from 1 GHz to 6 GHz are currently recognized as Accredited in accordance with the Voluntary Control Council for Interference [VCCI] Article 15 procedures under Registration Number A-0027.

1.7 Test Facility Accreditations

Bay Area Compliance Laboratories Corp. (BACL) is:

A- An independent, 3rd-Party, Commercial Test Laboratory accredited to ISO/IEC 17025:2005 by A2LA (Test Laboratory Accreditation Certificate Number 3279.02), in the fields of: Electromagnetic Compatibility and Telecommunications. Unless noted by an Asterisk (*) in the Compliance Matrix (See Section 3 of this Test Report), BACL's ISO/IEC 17025:2005 Scope of Accreditation includes all of the Test Method Standards and/or the Product Family Standards detailed in this Test Report..

BACL's ISO/IEC 17025:2005 Scope of Accreditation includes a comprehensive suite of EMC Emissions, EMC Immunity, Radio, RF Exposure, Safety and wireline Telecommunications test methods applicable to a wide range of product categories. These product categories include Central Office Telecommunications Equipment [including NEBS - Network Equipment Building Systems], Unlicensed and Licensed Wireless and RF devices, Information Technology Equipment (ITE); Telecommunications Terminal Equipment (TTE); Medical Electrical Equipment; Industrial, Scientific and Medical Test Equipment; Professional Audio and Video Equipment; Industrial and Scientific Instruments and Laboratory Apparatus; Cable Distribution Systems, and Energy Efficient Lighting.

B- A Product Certification Body accredited to ISO/IEC 17065:2012 by A2LA (Product Certification Body Accreditation Certificate Number 3279.03) to certify

- For the USA (Federal Communications Commission):

- 1- All Unlicensed radio frequency devices within FCC Scopes A1, A2, A3, and A4;
- 2- All Licensed radio frequency devices within FCC Scopes B1, B2, B3, and B4;
- 3- All Telephone Terminal Equipment within FCC Scope C.

- For the Canada (Industry Canada):

- 1 All Scope 1-Licence-Exempt Radio Frequency Devices;
- 2 All Scope 2-Licensed Personal Mobile Radio Services;
- 3 All Scope 3-Licensed General Mobile & Fixed Radio Services;
- 4 All Scope 4-Licensed Maritime & Aviation Radio Services;
- 5 All Scope 5-Licensed Fixed Microwave Radio Services
- 6 All Broadcasting Technical Standards (BETS) in the Category I Equipment Standards List.

- For Singapore (Info-Communications Development Authority (IDA)):

- 1 All Line Terminal Equipment: All Technical Specifications for Line Terminal Equipment – Table 1 of IDA MRA Recognition Scheme: 2011, Annex 2
2. All Radio-Communication Equipment: All Technical Specifications for Radio-Communication Equipment – Table 2 of IDA MRA Recognition Scheme: 2011, Annex 2

- For the Hong Kong Special Administrative Region:

- 1 All Radio Equipment, per KHCA 10XX-series Specifications;
 - 2 All GMDSS Marine Radio Equipment, per HKCA 12XX-series Specifications;
 - 3 All Fixed Network Equipment, per HKCA 20XX-series Specifications.
- For Japan:
- 1 MIC Telecommunication Business Law (Terminal Equipment):
 - All Scope A1 - Terminal Equipment for the Purpose of Calls;
 - All Scope A2 - Other Terminal Equipment
 - 2 Radio Law (Radio Equipment):
 - All Scope B1 - Specified Radio Equipment specified in Article 38-2-2, paragraph 1, item 1 of the Radio Law
 - All Scope B2 - Specified Radio Equipment specified in Article 38-2-2, paragraph 1, item 2 of the Radio Law
 - All Scope B3 - Specified Radio Equipment specified in Article 38-2-2, paragraph 1, item 3 of the Radio Law

C- A Product Certification Body accredited to ISO/IEC 17065:2012 by A2LA (Product Certification Body Accreditation Certificate Number 3279.01) to certify Products to USA's Environmental Protection Agency (EPA) ENERGY STAR Product Specifications for:

- 1 Electronics and Office Equipment:
 - for Telephony (ver. 3.0)
 - for Audio/Video (ver. 3.0)
 - for Battery Charging Systems (ver. 1.1)
 - for Set-top Boxes & Cable Boxes (ver. 4.1)
 - for Televisions (ver. 6.1)
 - for Computers (ver. 6.0)
 - for Displays (ver. 6.0)
 - for Imaging Equipment (ver. 2.0)
 - for Computer Servers (ver. 2.0)
- 2 Commercial Food Service Equipment
 - for Commercial Dishwashers (ver. 2.0)
 - for Commercial Ice Machines (ver. 2.0)
 - for Commercial Ovens (ver. 2.1)
 - for Commercial Refrigerators and Freezers
- 3 Lighting Products
 - For Decorative Light Strings (ver. 1.5)
 - For Luminaires (including sub-components) and Lamps (ver. 1.2)
 - For Compact Fluorescent Lamps (CFLs) (ver. 4.3)
 - For Integral LED Lamps (ver. 1.4)
- 4 Heating, Ventilation, and AC Products
 - for Residential Ceiling Fans (ver. 3.0)
 - for Residential Ventilating Fans (ver. 3.2)
- 5 Other
 - For Water Coolers (ver. 3.0)

D- A NIST Designated Phase-I and Phase-II Conformity Assessment Body (CAB) for the following economies and regulatory authorities under the terms of the stated MRAs/Treaties:

- Australia: ACMA (Australian Communication and Media Authority) – APEC Tel MRA -Phase I;
- Canada: (Innovation, Science and Economic development Canada - ISEDC) Foreign Certification Body – FCB – APEC Tel MRA -Phase I & Phase II;
- Chinese Taipei (Republic of China – Taiwan):
 - o BSMI (Bureau of Standards, Metrology and Inspection) APEC Tel MRA -Phase I;
 - o NCC (National Communications Commission) APEC Tel MRA -Phase I;

- European Union:
 - o EMC Directive 2014/30/EU US-EU EMC & Telecom MRA CAB (NB)
 - o Radio Equipment (RE) Directive 2014/53/EU US-EU EMC & Telecom MRA CAB (NB)
 - o Low Voltage Directive (LVD) 2014/35/EU
 - Hong Kong Special Administrative Region: (Office of the Telecommunications Authority – OFTA)
APEC Tel MRA -Phase I & Phase II
 - Israel – US-Israel MRA Phase I
 - Republic of Korea (Ministry of Communications - Radio Research Laboratory) APEC Tel MRA -Phase I
 - Singapore: (Infocomm Media Development Authority - IMDA) APEC Tel MRA -Phase I & Phase II;
 - Japan: VCCI - Voluntary Control Council for Interference US-Japan Telecom Treaty VCCI Side Letter-
 - USA:
 - o ENERGY STAR Recognized Test Laboratory – US EPA
 - o Telecommunications Certification Body (TCB) – US FCC;
 - o Nationally Recognized Test Laboratory (NRTL) – US OSHA
- Vietnam: APEC Tel MRA -Phase I;

2 EUT Test Configuration

2.1 Justification

The EUT was configured for testing according to FCC Part 15.407(h), and KDB: 905462 D02 UNII DFS Compliance Procedures New Rules v02

2.2 EUT Exercise Software

The test firmware used was CRT and test commands, provided by *Cisco System Inc.*, the software is compliant with the standard requirements being tested against.

2.3 Equipment Modifications

N/A

2.4 Local Support Equipment

Manufacturer	Description	Model	Serial Number
Sony	Laptop	Vaio SVE151D11L	54269366 0002588
ASUS	Laptop	FX504G	J6NRCX037440249

2.5 Interface Ports and Cables

Cable Description	Length	To	From
Power cable	2 m	Power Adapter	EUT
Ethernet cable	2 m	EUT	Laptop

3 Summary of Test Results

The following result table represents the list of measurements required under the FCC CFR47 §15.407 (h), and KDB: 905462 D02 UNII DFS Compliance Procedures New Rules v02.

Items	Description of Test	Results
Detection Bandwidth	UNII Detection Bandwidth	Compliant
Performance Requirements Check	Initial Channel Availability Check Time (CAC)	Compliant
	Radar Burst at the Beginning of the CAC	Compliant
	Radar Burst at the End of the CAC	Compliant
In-Service Monitoring	Channel Move Time	Compliant
	Channel Closing Transmission Time	Compliant
	Non-Occupancy Period	Compliant
Radar Detection	Statistical Performance Check	Compliant

Note: The test data is shared from R1909242-DFS report because C9120AXE and C9120AXP are the identical units except the antennas. DFS testing was performed by conducted method and C9120AXE has low antenna gain which is the worst case.

4 Applicable Standards

4.1 DFS Requirement

FCC CFR47 §15.407 (h) and KDB: 905462 D02 UNII DFS Compliance Procedures New Rules v02.

Table 1: Applicability of DFS requirements prior to use of a channel

Requirement	Operational Mode		
	Master	Client (Without radar detection)	Client (With radar detection)
Non-Occupancy Period	Yes	Not Required	Yes
DFS Detection Threshold	Yes	Not Required	Yes
Channel Availability Check Time	Yes	Not Required	Not Required
U-NII Detection Bandwidth	Yes	Not Required	Yes

Table 2: Applicability of DFS requirements during normal operation

Requirement	Operational Mode	
	Master Device or Client with Radar Detection	Client Without Radar Detection
DFS Detection Threshold	Yes	Not Required
Channel Closing Transmission Time	Yes	Yes
Channel Move Time	Yes	Yes
U-NII Detection Bandwidth	Yes	Not Required

Additional requirements for devices with multiple bandwidth modes	Master Device or Client with Radar Detection	Client Without Radar Detection
U-NII Detection Bandwidth and Statistical Performance Check	All BW modes must be tested	Not required
Channel Move Time and Channel Closing Transmission Time	Test using widest BW mode available	Test using the widest BW mode available for the link
All other tests	Any single BW mode	Not required

Note: Frequencies selected for statistical performance check (Section 7.8.4) should include several frequencies within the radar detection bandwidth and frequencies near the edge of the radar detection bandwidth. For 802.11 devices it is suggested to select frequencies in each of the bonded 20 MHz channels and the channel center frequency.

Table 3: Interference Threshold for Master and Client with Radar Detection

Maximum Transmit Power	Value (See Notes 1, 2 and 3)
EIRP \geq 200 milliwatt	-64 dBm
EIRP $<$ 200 milliwatt and power spectral density $<$ 10dBm/MHz	-62 dBm
EIRP $<$ 200 milliwatt that do not meet the power spectral density requirement	-64 dBm

Note 1: This is the level at the input of the receiver assuming a 0 dBi receive antenna.
Note 2: Throughout these test procedures an additional 1 dB has been added to the amplitude of the test transmission waveforms to account for variations in measurement equipment. This will ensure that the test signal is at or above the detection threshold level to trigger a DFS response.
Note3: EIRP is based on the highest antenna gain. For MIMO devices refer to KDB Publication 662911 D01.

Table 4: DFS Response Requirement Values

Parameter	Value
Non-occupancy period	Minimum 30 minutes
Channel Availability Check Time	60 seconds
Channel Move Time	10 seconds <i>See Note 1.</i>
Channel Closing Transmission Time	200 milliseconds + an aggregate of 60 milliseconds over remaining 10 second period. <i>See Notes 1 and 2.</i>
U-NII Detection Bandwidth	Minimum 100% of the UNII 99% transmission power bandwidth. <i>See Note 3.</i>

Note 1: Channel Move Time and the Channel Closing Transmission Time should be performed with Radar Type 0. The measurement timing begins at the end of the Radar Type 0 burst.

Note 2: The Channel Closing Transmission Time is comprised of 200 milliseconds starting at the beginning of the Channel Move Time plus any additional intermittent control signals required to facilitate a Channel move (an aggregate of 60 milliseconds) during the remainder of the 10 second period. The aggregate duration of control signals will not count quiet periods in between transmissions.

Note 3: During the U-NII Detection Bandwidth detection test, radar type 0 should be used. For each frequency step the minimum percentage of detection is 90 percent. Measurements are performed with no data traffic.

Table 5: Short Pulse Radar Test Waveforms

Radar Type	Pulse Width (Microseconds)	PRI (Microseconds)	Pulses	Minimum Percentage of Successful Detection	Minimum Number of Trials
0	1	1428	18	See Note 1	See Note 1
1	1	Test A: 15 unique PRI values randomly selected from the list of 23 PRI values in Table 5a Test B: 15 unique PRI values randomly selected within the range of 518-3066 μ sec, with a minimum increment of 1 μ sec, excluding PRI values selected in Test A	$\text{Roundup} \left\{ \begin{array}{l} \left(\frac{1}{360} \right) \\ \left(\frac{19 \cdot 10^6}{\text{PRI}_{\mu\text{sec}}} \right) \end{array} \right.$	60%	30
2	1-5	150-230	23-29	60%	30
3	6-10	200-500	16-18	60%	30
4	11-20	200-500	12-16	60%	30
Aggregate (Radar Types 1-4)				80%	120
Note 1: Short Pulse Radar Type 0 should be used for the detection bandwidth test, channel move time, and channel closing time tests.					

Table 6: Long Pulse Radar Test Signal

Radar Type	Bursts	Chirp Width (MHz)	PRI (usec)	Number of Pulses per Burst	Number of Bursts	Minimum Percentage of Successful Detection	Minimum Number of Trials
5	50-100	5-20	1000-2000	1-3	8-20	80%	30

Table 7: Frequency Hopping Radar Test Signal

Radar Type	Pulse Width (usec)	PRI (usec)	Pulses per Hop	Hopping Rate (kHz)	Hopping Sequence Length (msec)	Minimum Percentage of Successful Detection	Minimum Number of Trials
6	1	333	9	0.333	300	70%	30

4.2 DFS Measurement System

BACL DFS measurement system consists of two subsystems: (1) The radar signal generating subsystem and (2) the traffic monitoring subsystem.

4.3 System Block Diagram

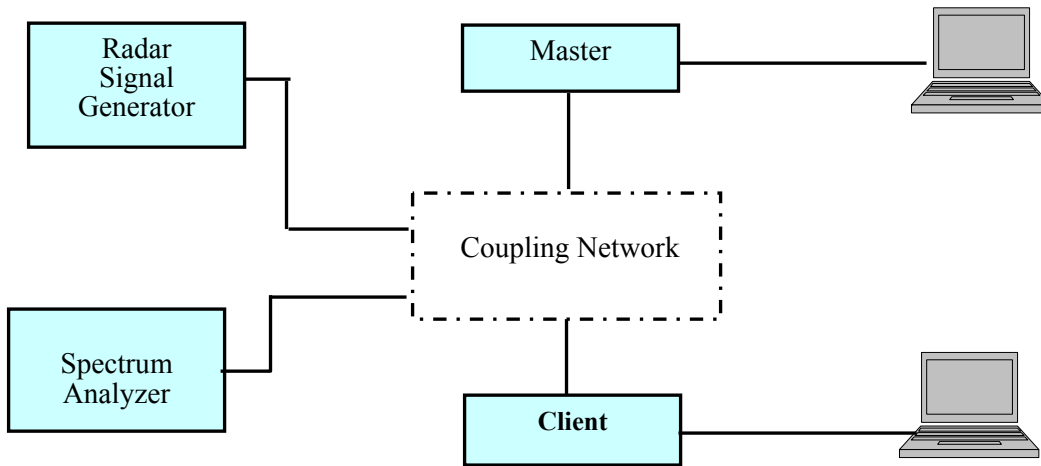

4.4 Conducted Method

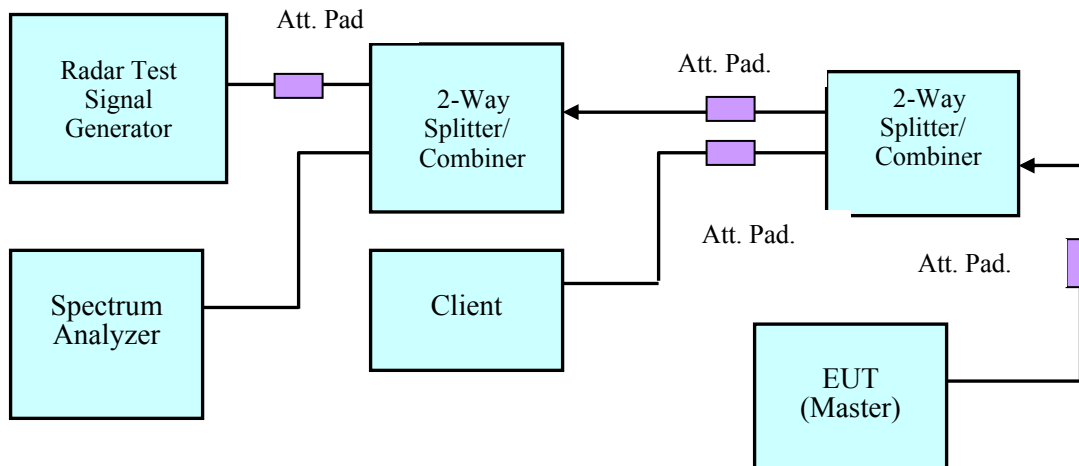

Setup for Master with injection at the Master

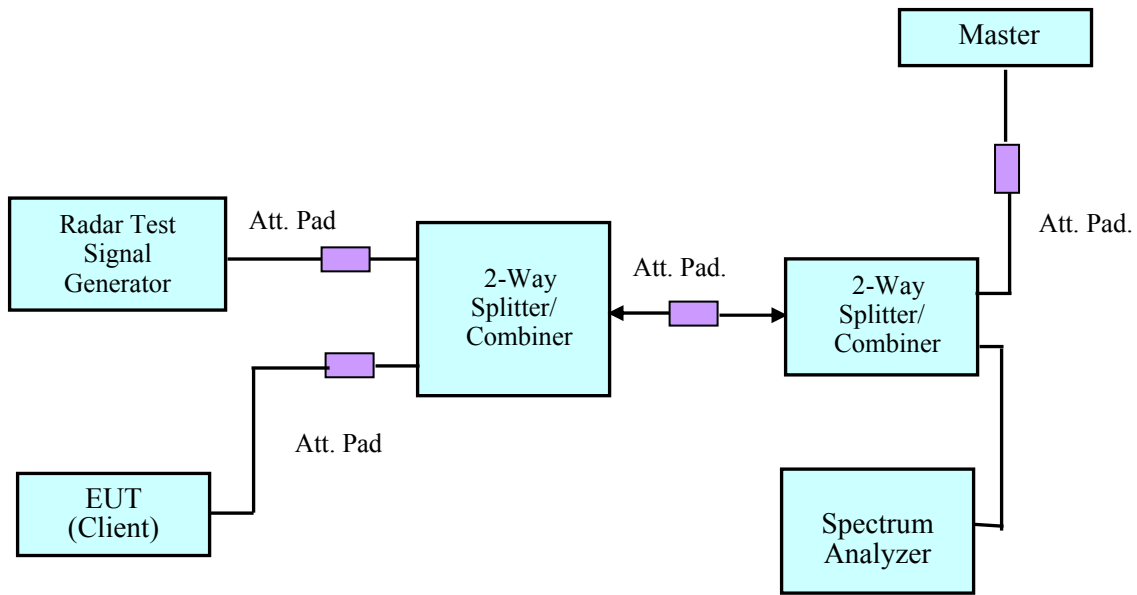

Setup for Client with injection at the Master

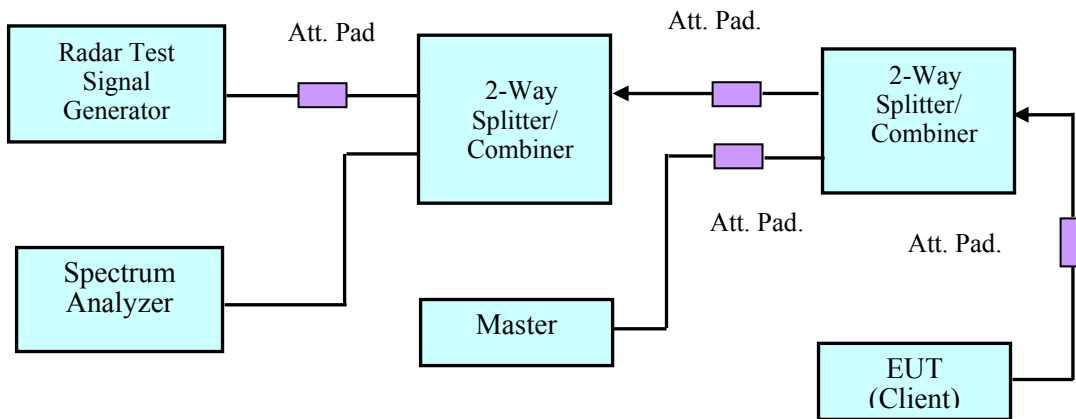

Setup for Client with injection at the Client

4.5 Radiated Method

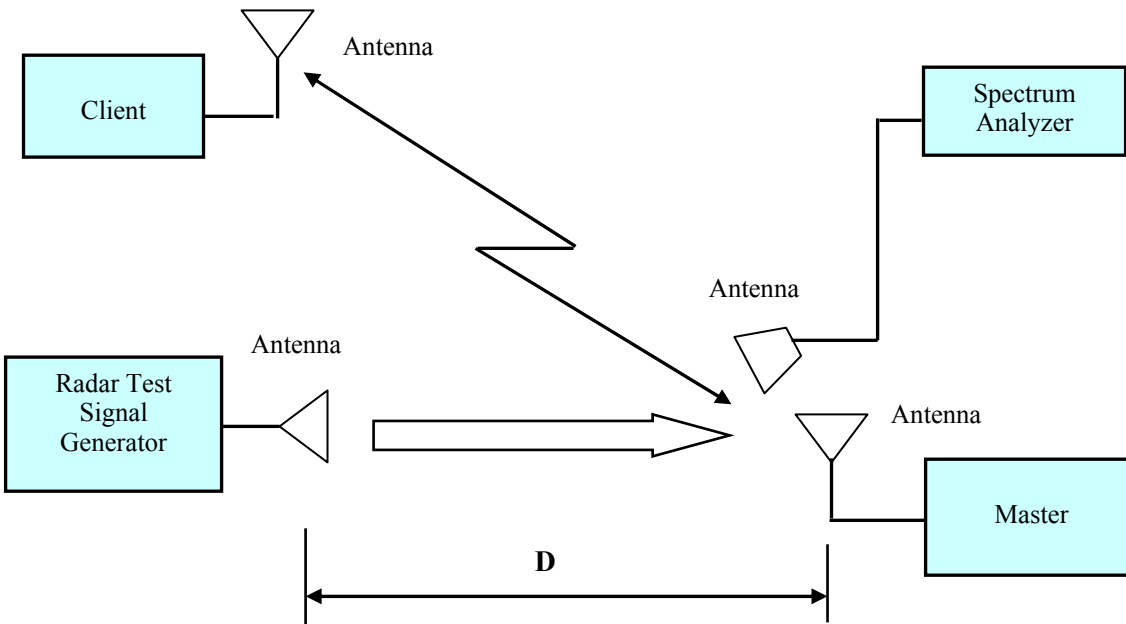

4.6 Test Procedure

A spectrum analyzer is used as a monitor that verifies the EUT's status, which includes the Channel Closing Transmission Time and the Channel Move Time. The Spectrum analyzer is used to monitor the equipment under test (EUT) does not transmit on the same channel during the Non-Occupied Period after the radar detection. It is also used to monitor EUT transmissions during the Channel Availability Check Time.

5 Test Results

5.1 Description of EUT

The EUT operates in 5230-5350 MHz and 5470-5725 MHz range in Master Mode.

The rated output power of EUT is > 23 dBm (EIRP), Therefore the required interference threshold level is -64 dBm, the required radiated threshold at antenna port is -64 dBm.

The calibrated radiated DFS detection threshold level is set to -64 dBm.

WLAN traffic is generated by streaming the video file TestFile.mpg, this file is used by IP and Frame based systems for loading the test channel during the In-service compliance testing of the U-NII device. The file is streamed from the Access Point to the Client in full motion video mode using the media player with the V2.61 Codec package.

5.2 Antenna Description

Radio	Antenna Type	Antenna Gain (dBi) @ 5 GHz
5 GHz	External	4

5.3 Test Equipment List and Details

Manufacturer	Equipment Description	Model Number	S/N	Calibration Date	Calibration Interval
National Instruments	NI PXI-1042 8-Slot chassis	PXI-1042	V08X01EE1	N/A	N/A
National Instruments	Arbitrary Waveform Generator	PXI-5421	N/A	N/A	N/A
National Instruments	RF Upconverter	PXI-5610	N/A	N/A	N/A
ASCOR	Upconverter	AS-7206	N/A	N/A	N/A
Agilent	Analyzer, Spectrum	E4440A	US45303156	2019-03-04	1 year
A. H. Systems	Antenna, Horn	SAS-200/571	261	2018-02-13	2 years
EMCO	Antenna, Horn	3115	9511-4627	2018-03-28	2 years
Mini-Circuits	Splitter/Combiner	ZFSC-2-9G+	0349	N/A	N/A
Mini-Circuits	Splitter/Combiner	ZFRSC-183-S+	N/A	N/A	N/A
Mini-Circuits	Splitter/Combiner	ZFSC-2-10G	15542	N/A	N/A
Mini-Circuits	Splitter/Combiner	ZFSC-3-42	N/A	N/A	N/A
Trescal	Splitter/Combiner	CIS-55365	N/A	2018-05-03	1 year
Trescal	Splitter/Combiner	CIS-55368	N/A	2018-04-11	1 year
Hewlett Packard	Attenuator	8495B	N/A	N/A	N/A
Hewlett Packard	Attenuator	8404B	N/A	N/A	N/A

Statement of Traceability: BACL Corp. attests that all calibrations have been performed per the A2LA requirements, traceable to the NIST.

5.4 Radar Waveform Calibration

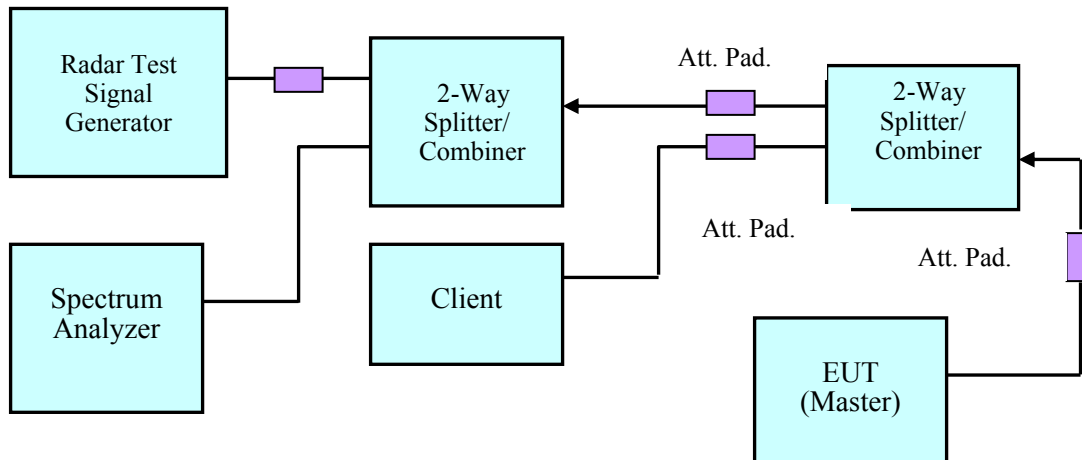

Conducted Calibration Setup Block Diagram

5.5 Test Environmental Conditions

Temperature:	22-25° C
Relative Humidity:	45-48 %
ATM Pressure:	102.1 kPa

Testing was performed by Tri Pham on 2019-09-28 to 2019-10- in the DFS Test Site.

Plots of Radar Waveforms

5500 MHz

Radar Type 0

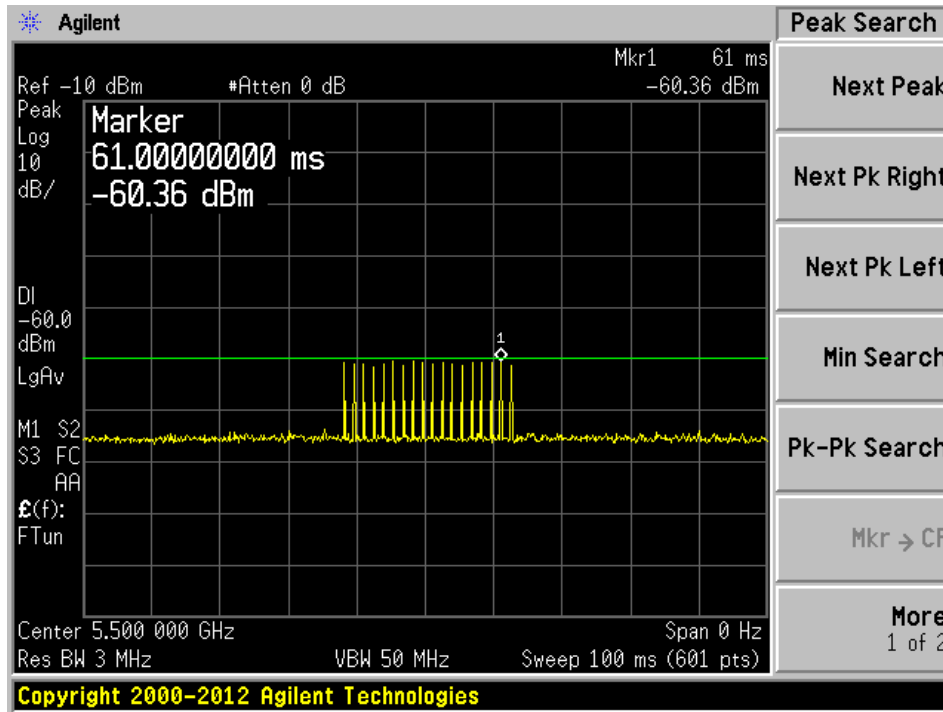

Radar Type 1A

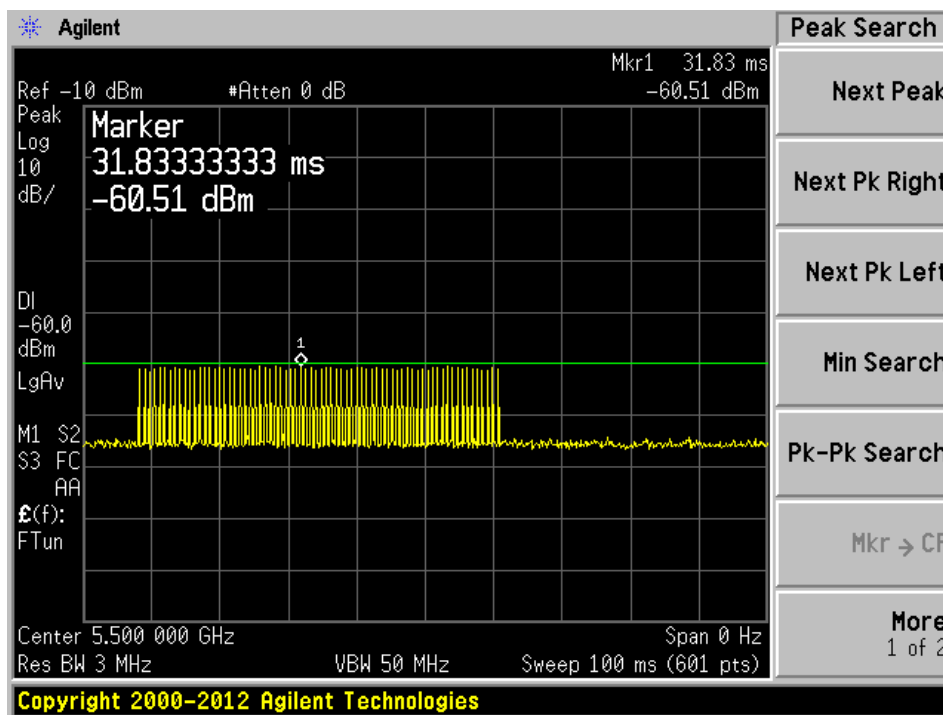

Radar Type 1B

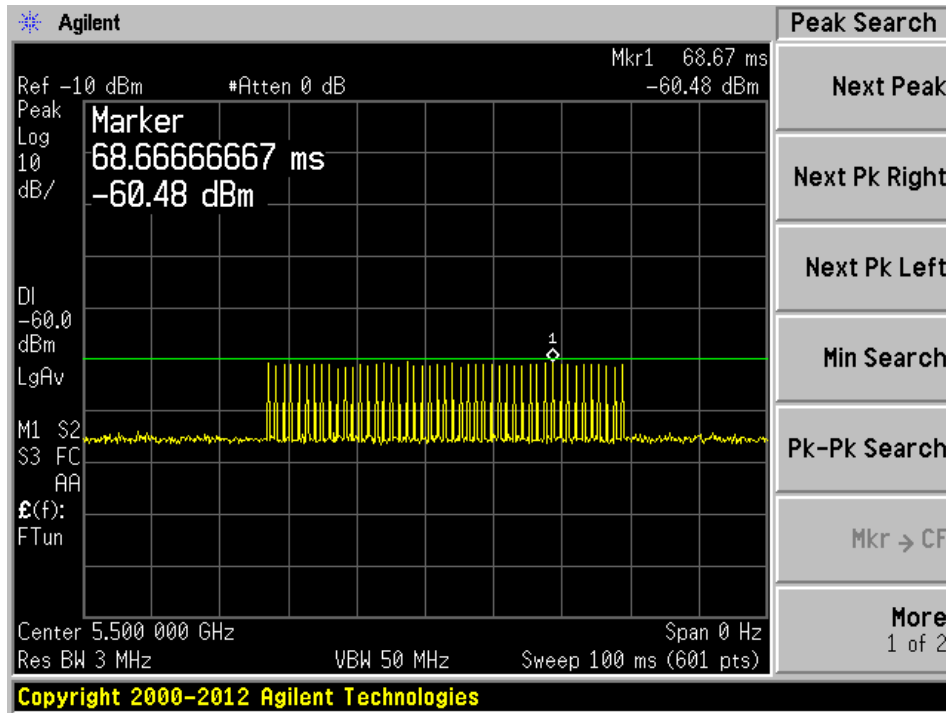

Radar Type 2

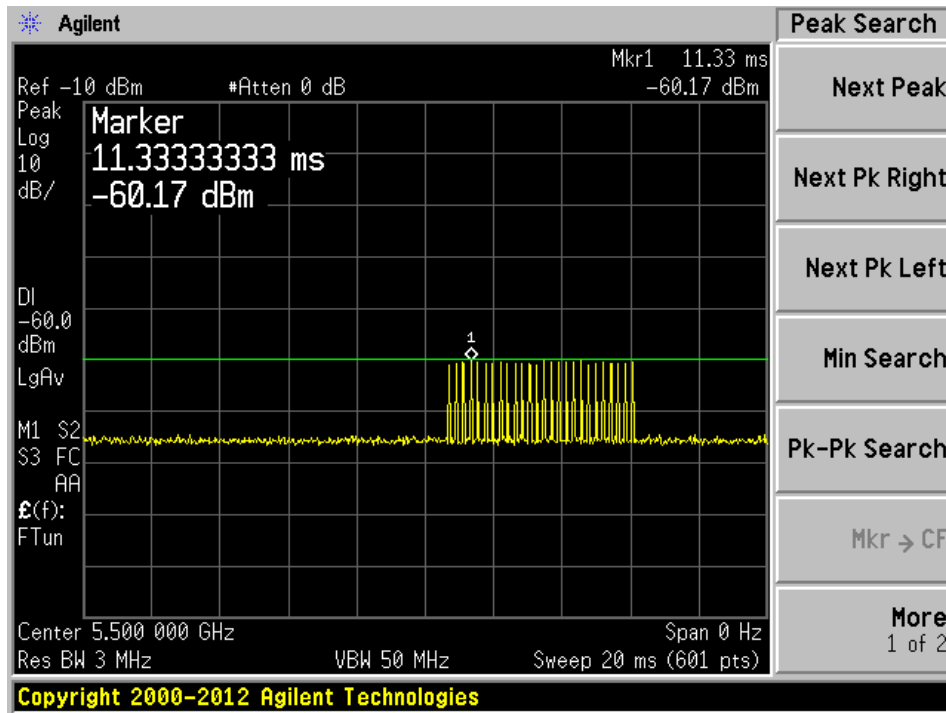

Radar Type 3

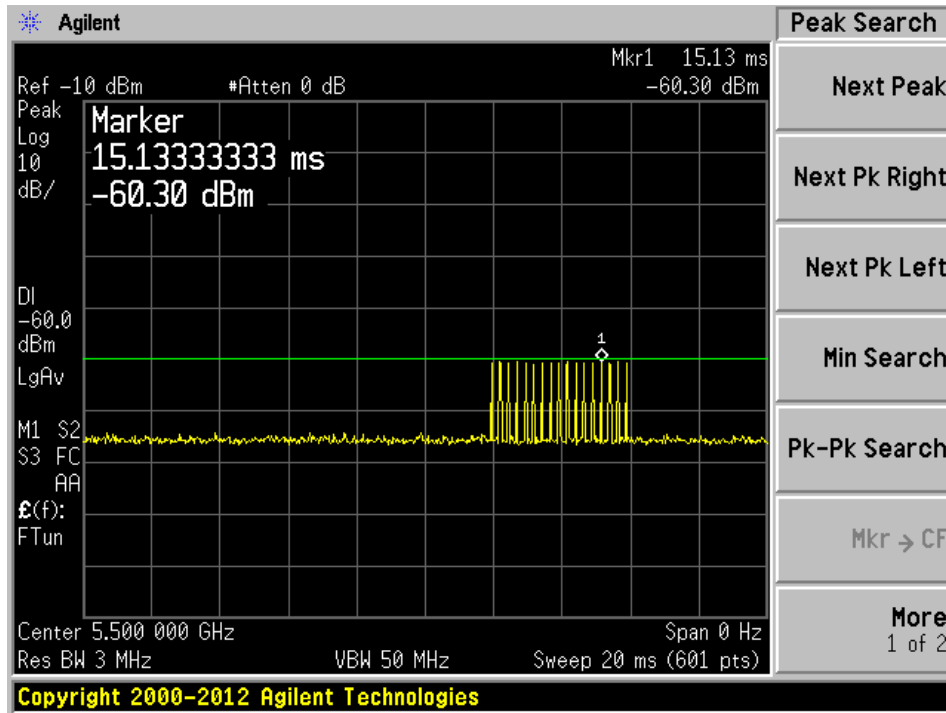

Radar Type 4

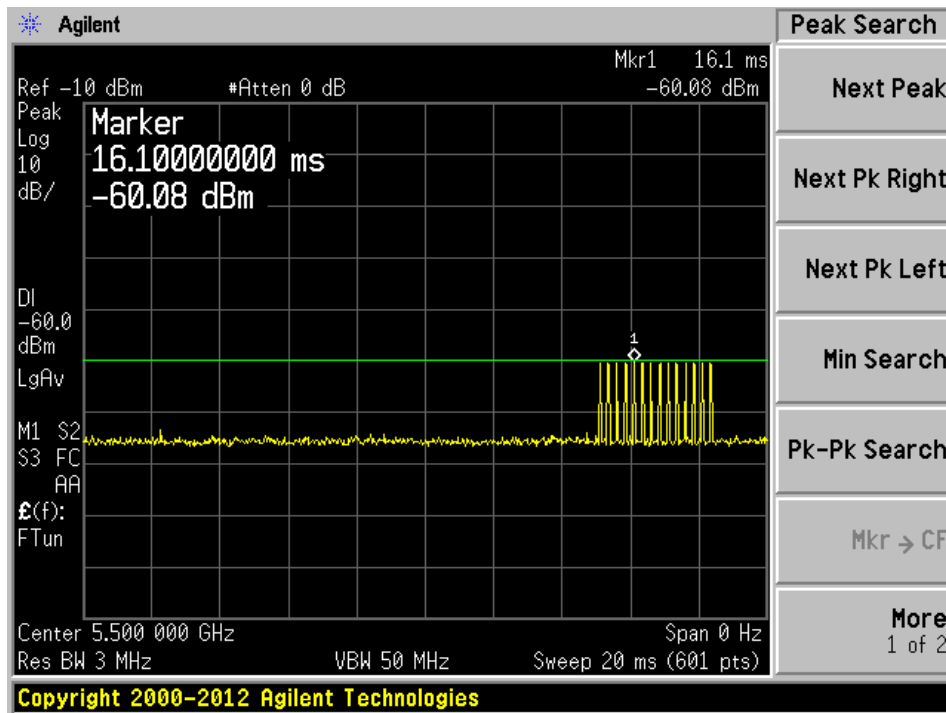

Radar Type 5

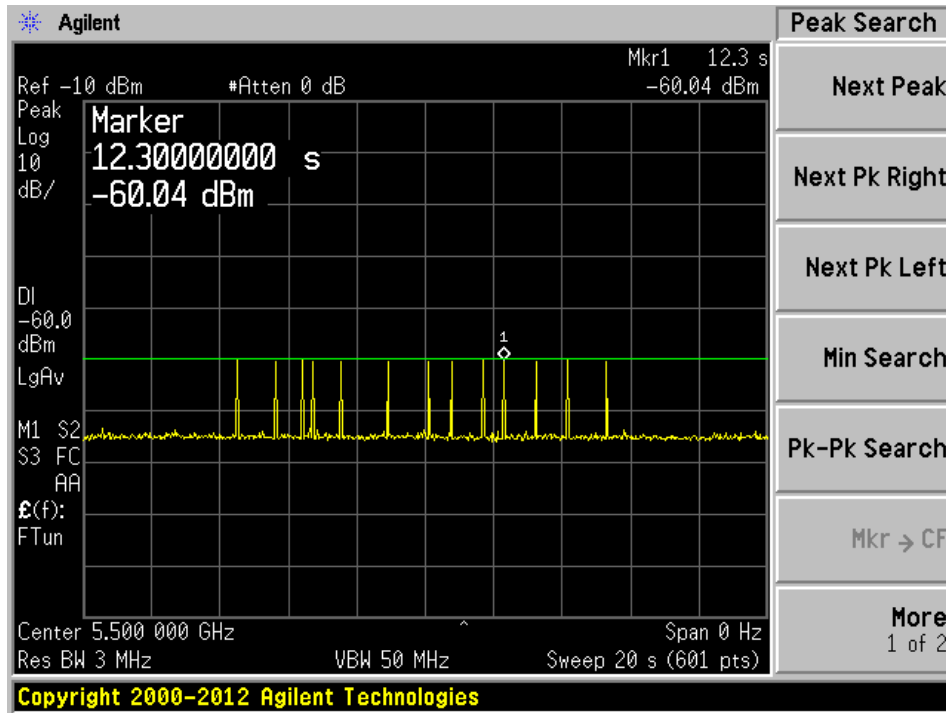

Radar Type 6

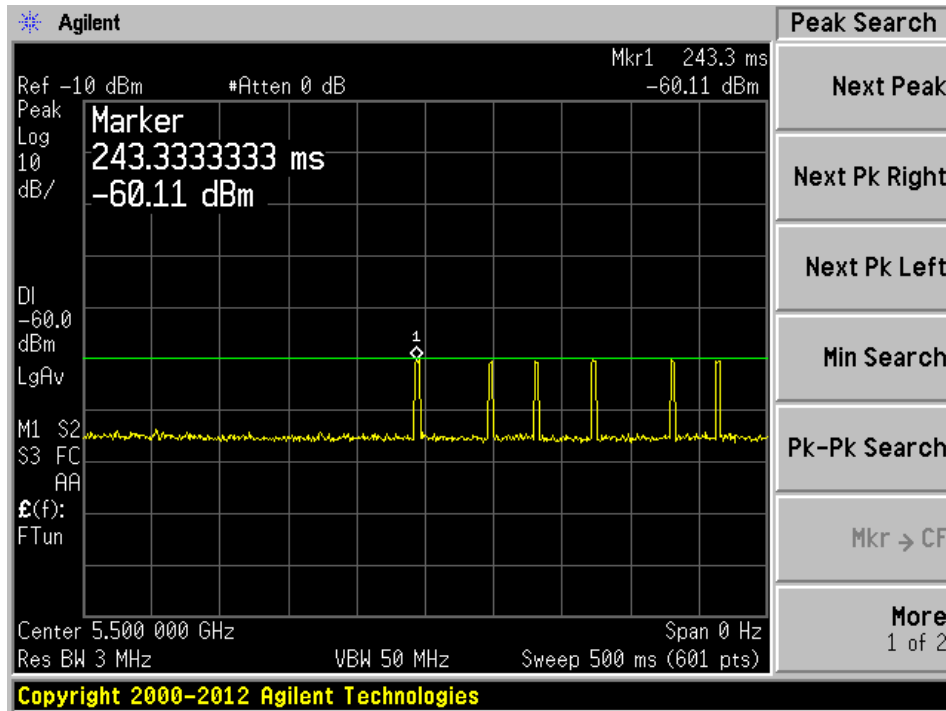

5510 MHz

Radar Type 0

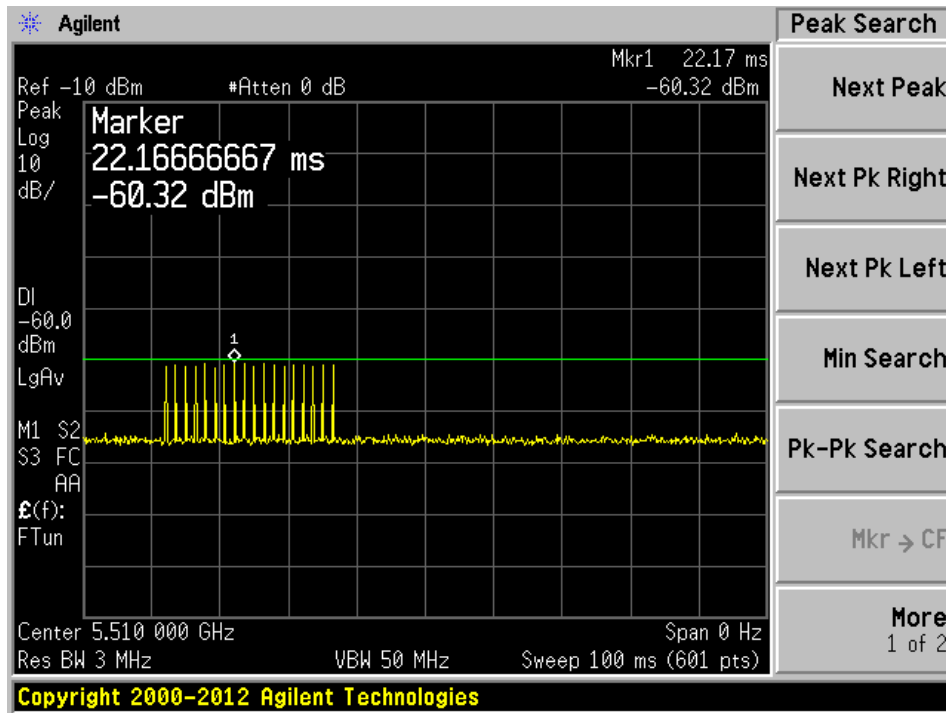

Radar Type 1A

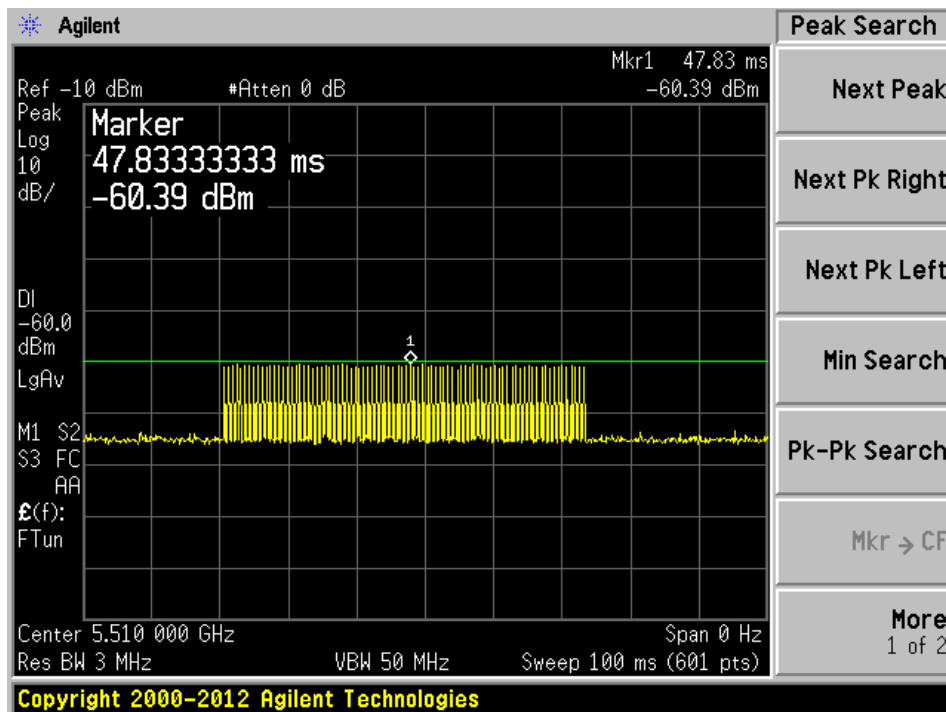

Radar Type 1B

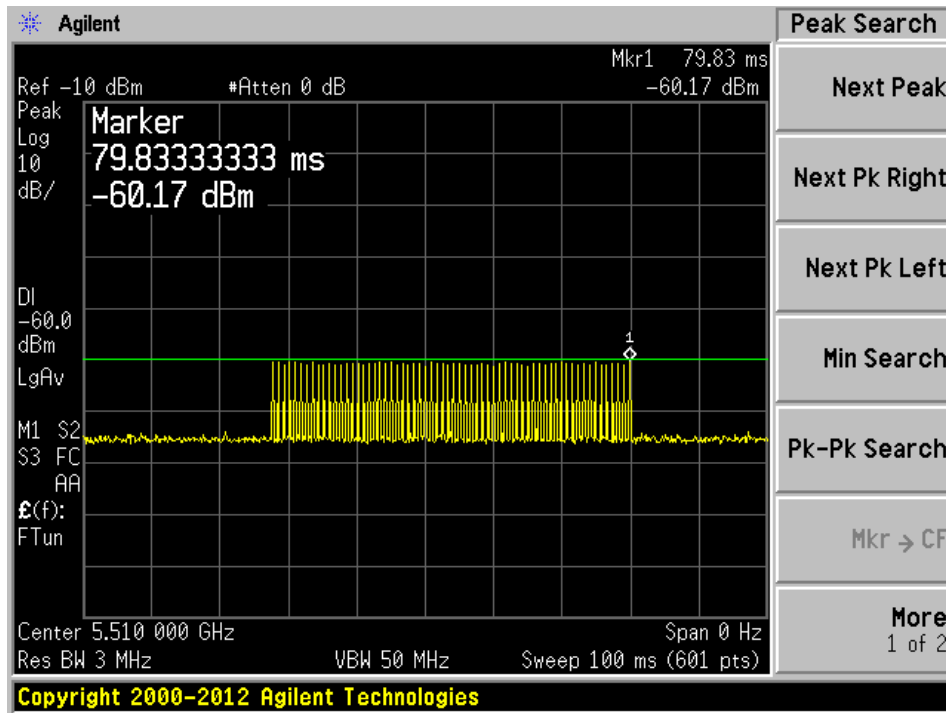

Radar Type 2

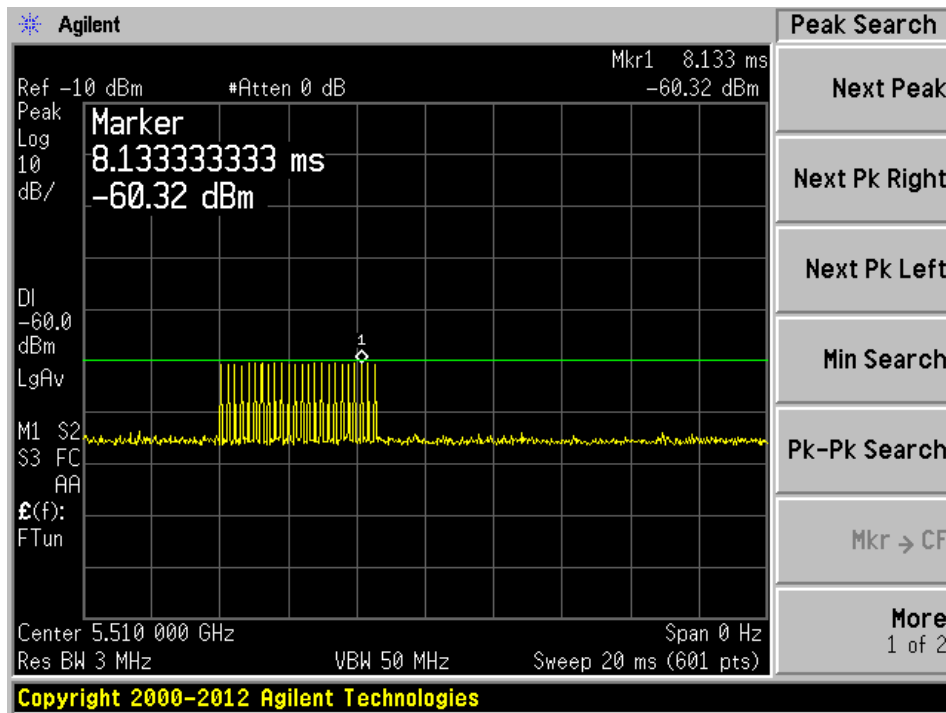

Radar Type 3

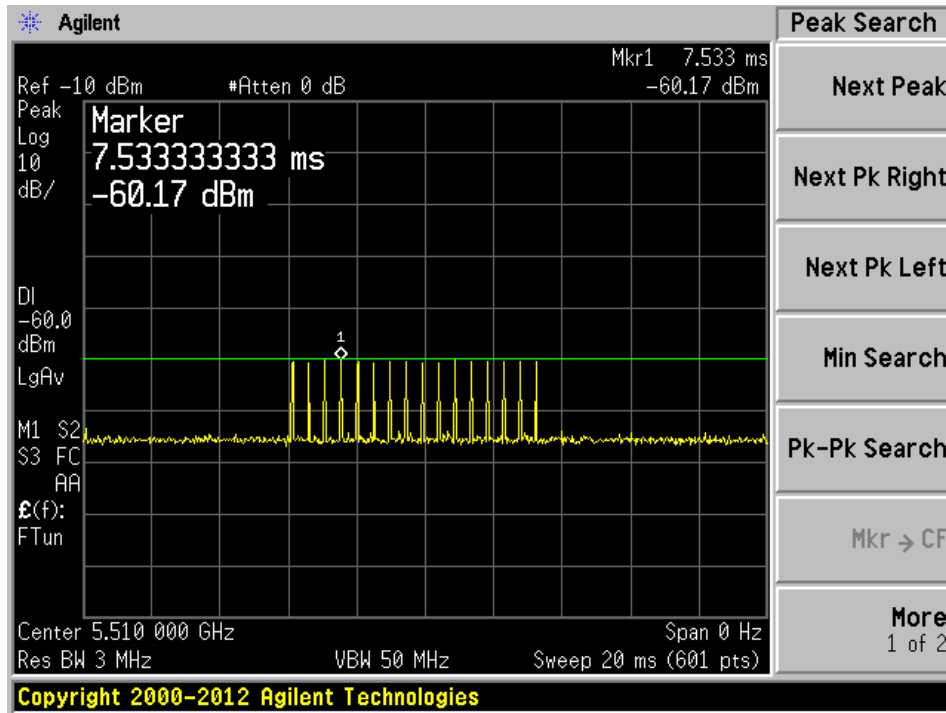

Radar Type 4

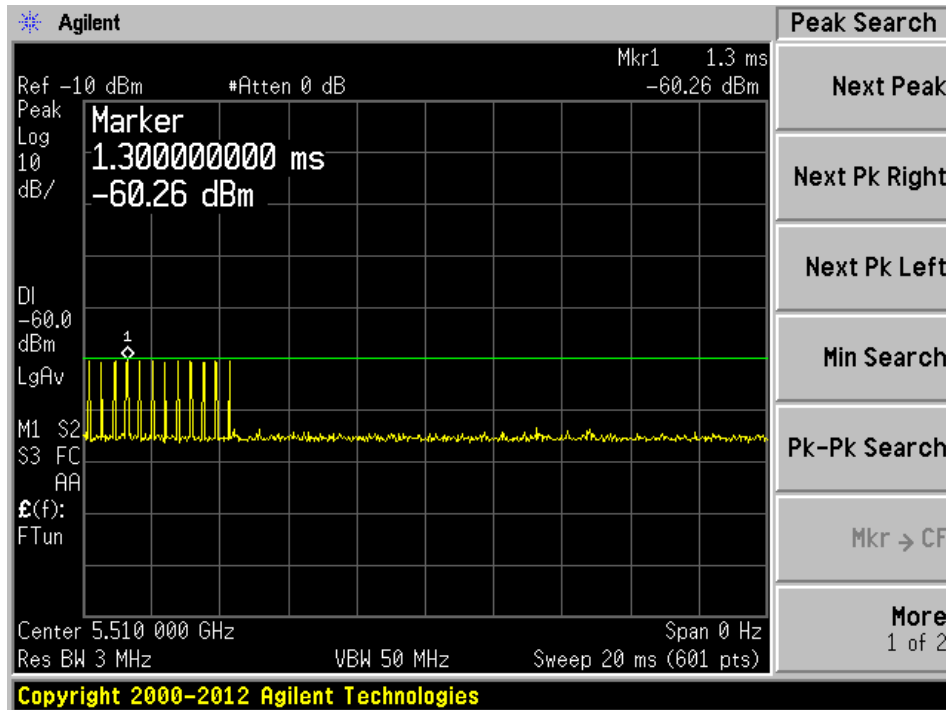

Radar Type 5

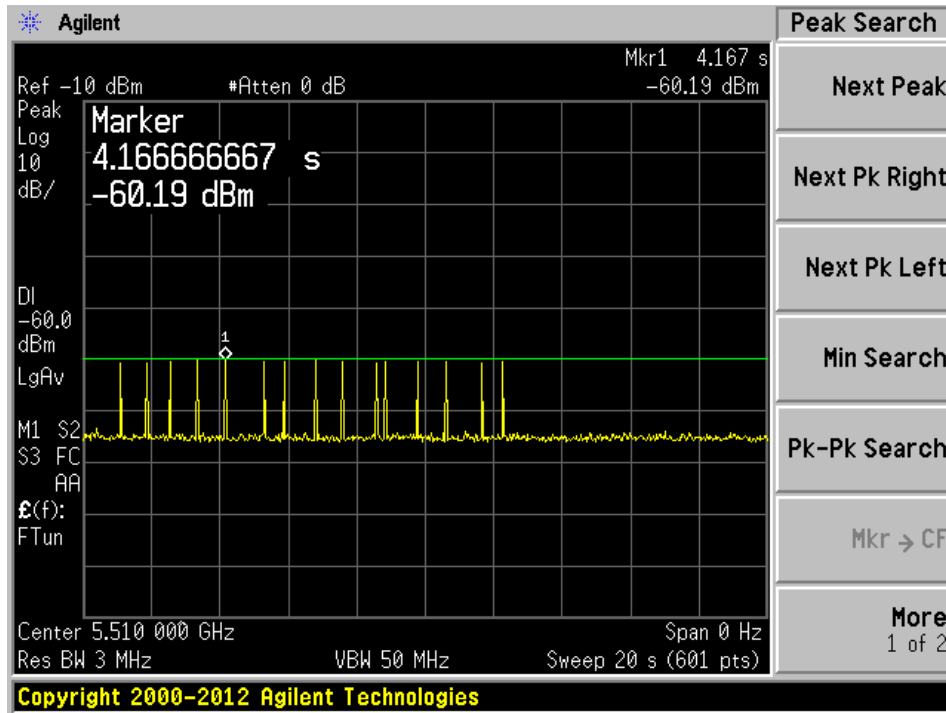

Radar Type 6

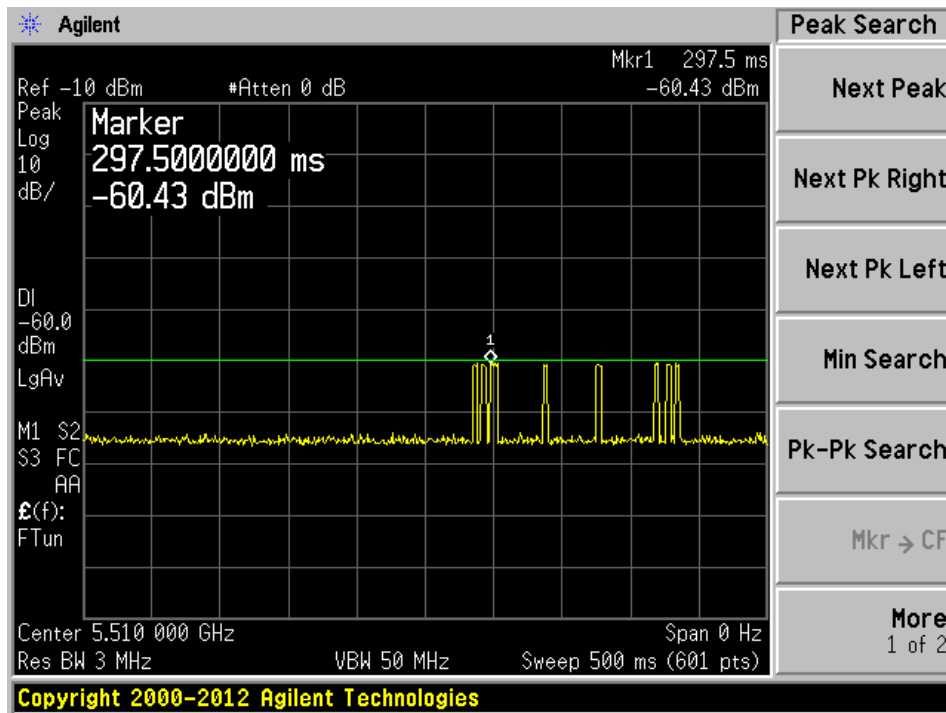

5530 MHz

Radar Type 0

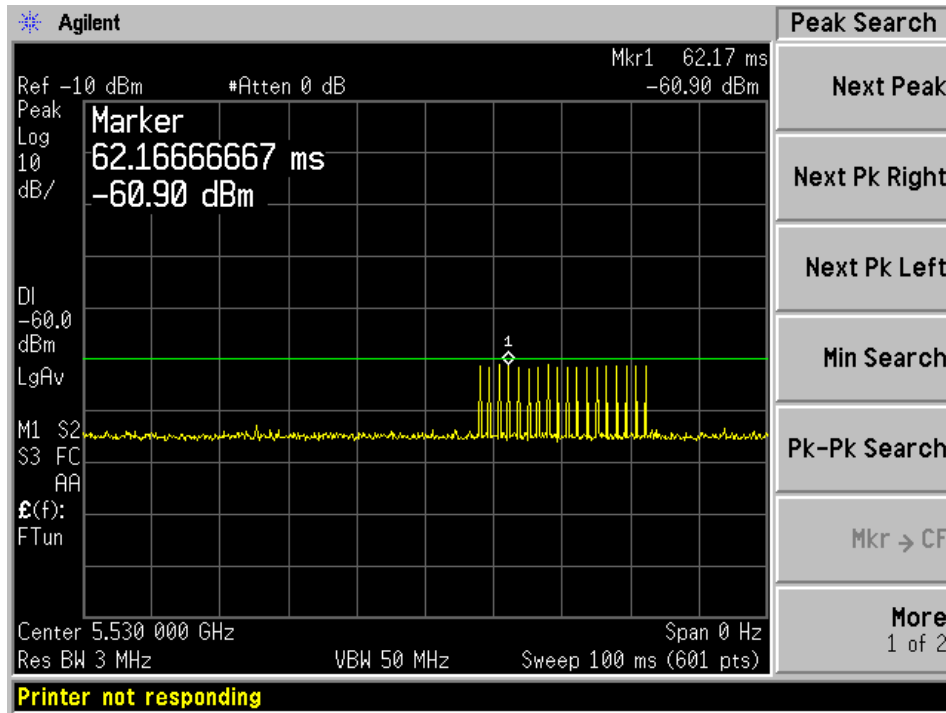

Radar Type 1A

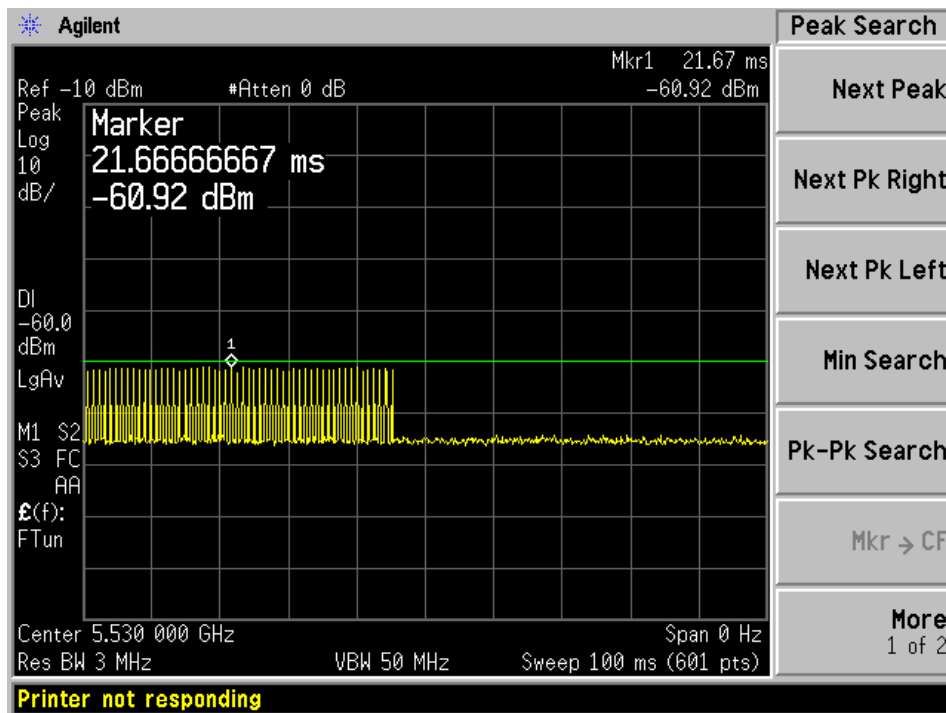

Radar Type 1B

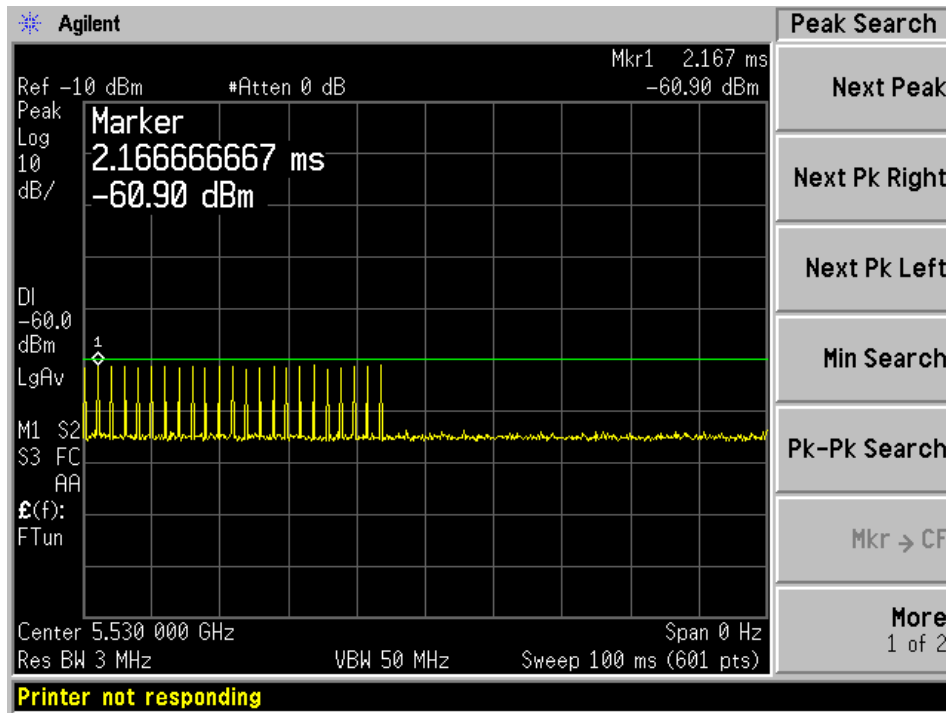

Radar Type 2

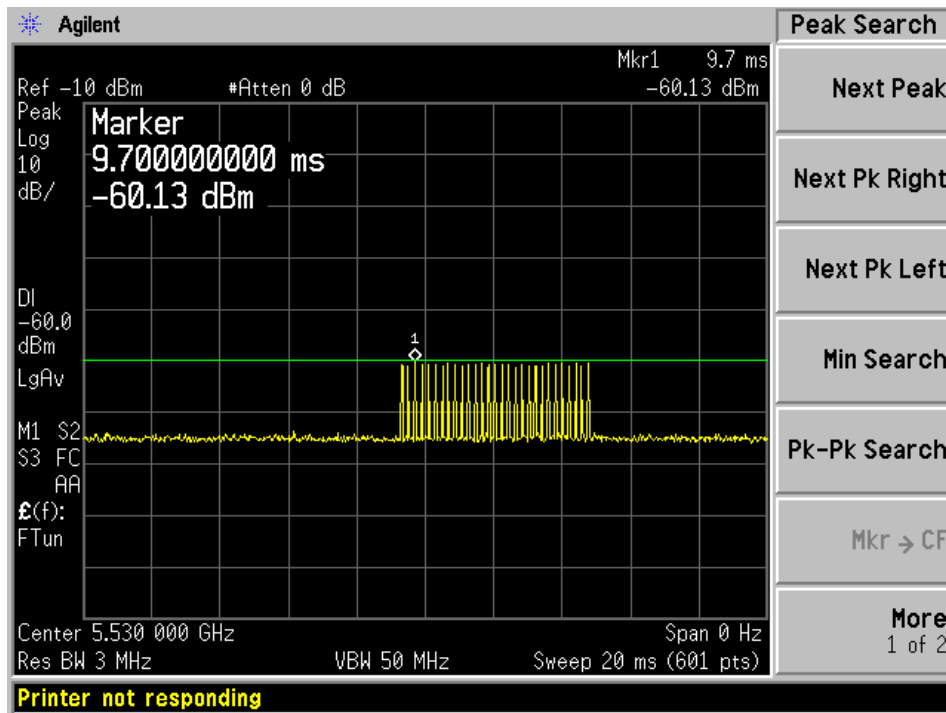

Radar Type 3

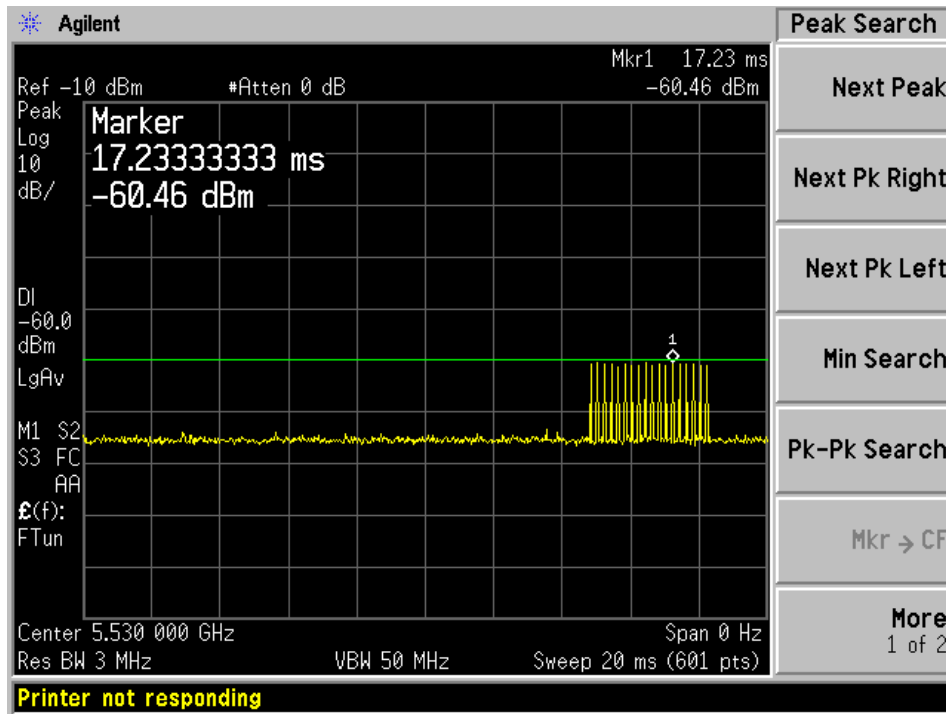

Radar Type 4

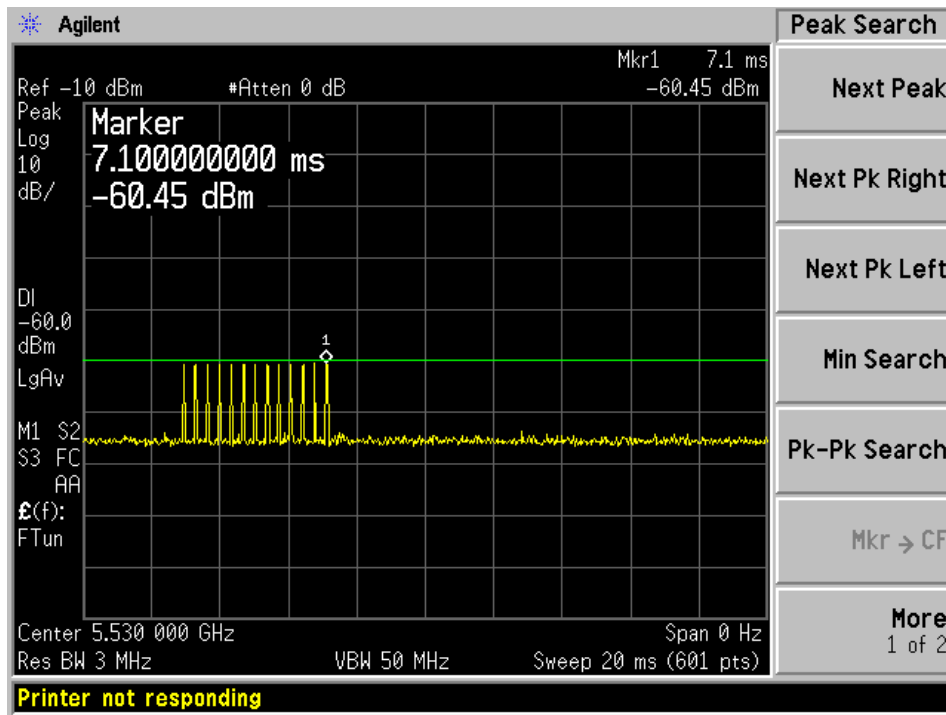

Radar Type 5

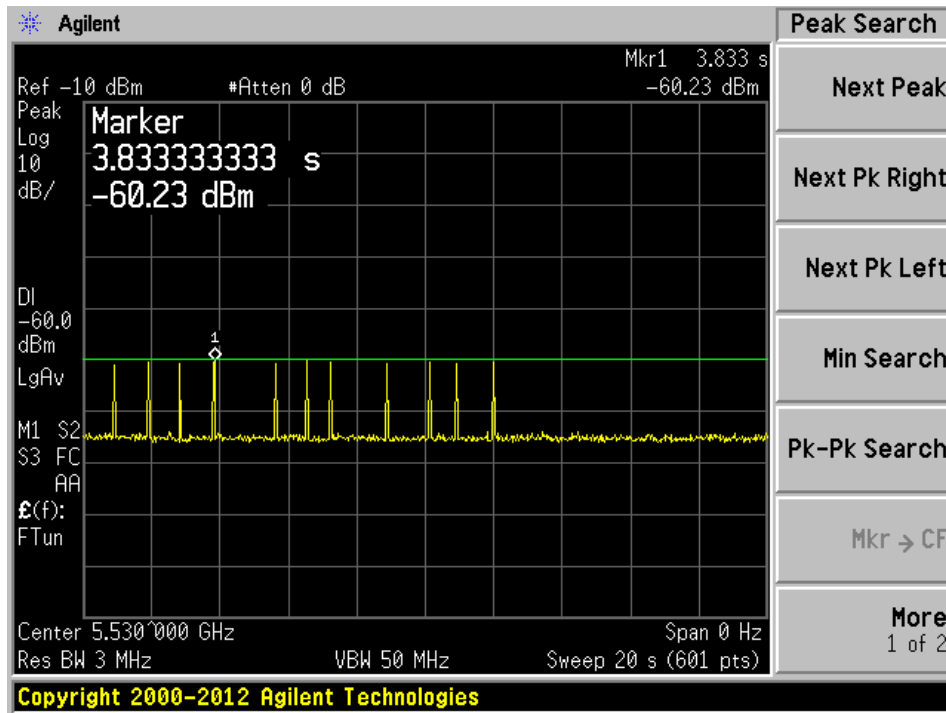

Radar Type 6

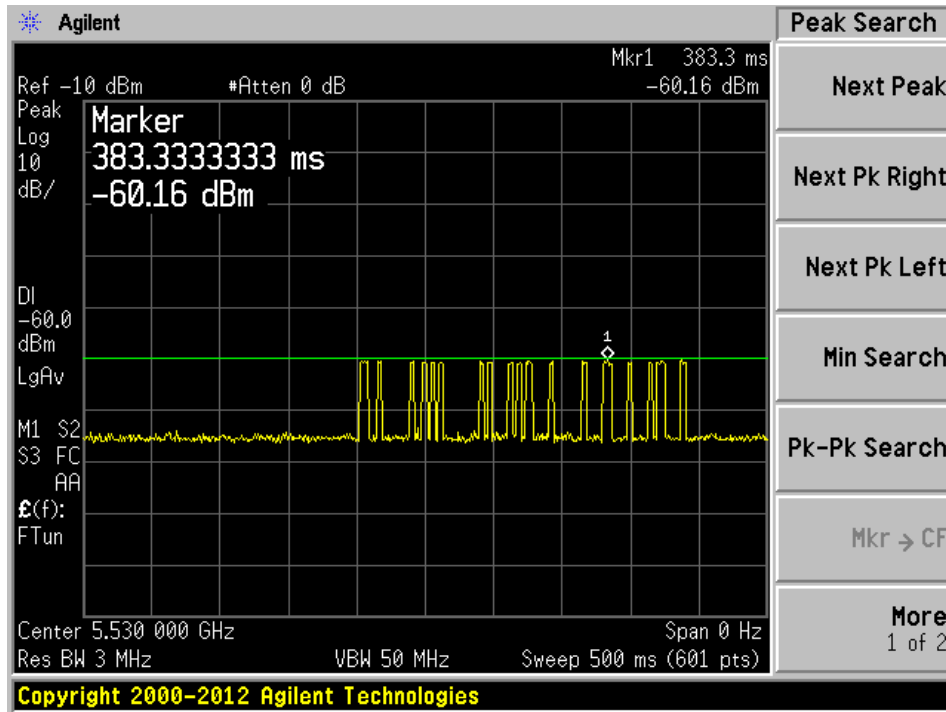

5570 MHz

Radar Type 0

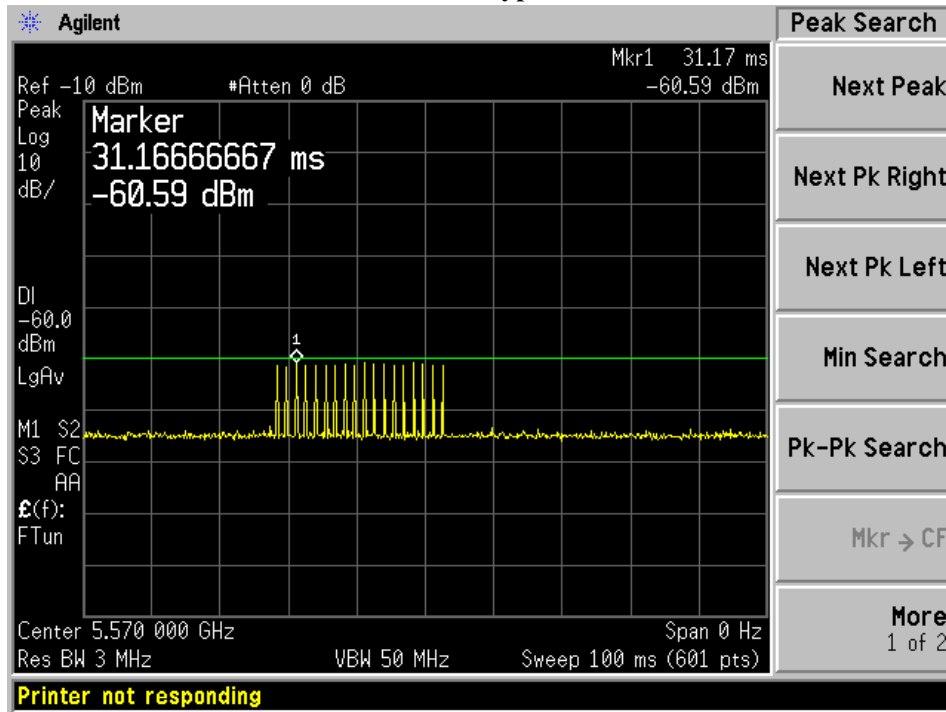

Radar Type 1A

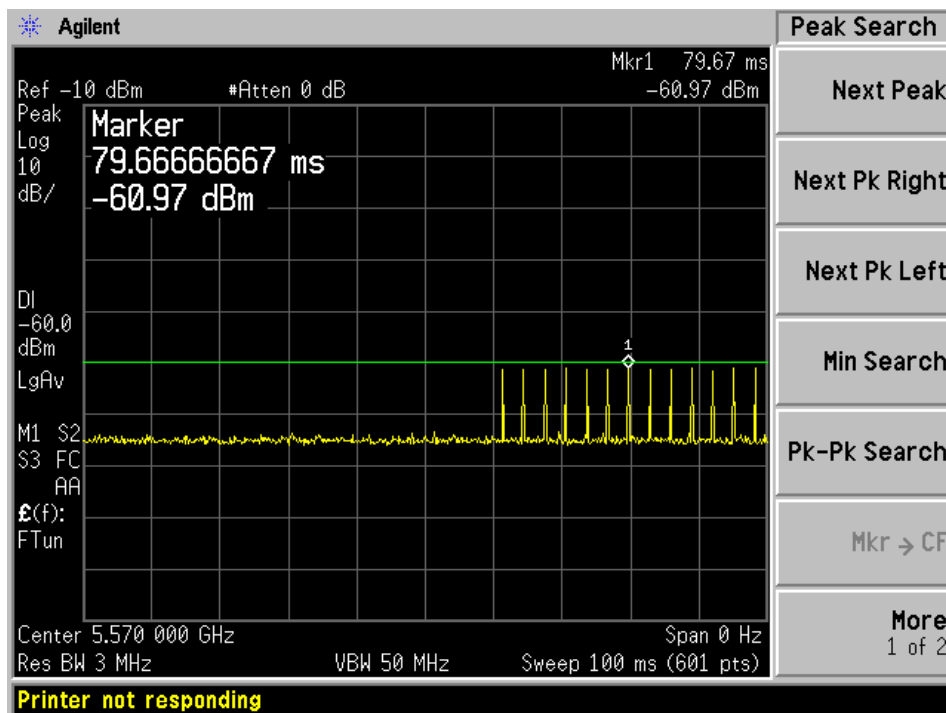

Radar Type 1B

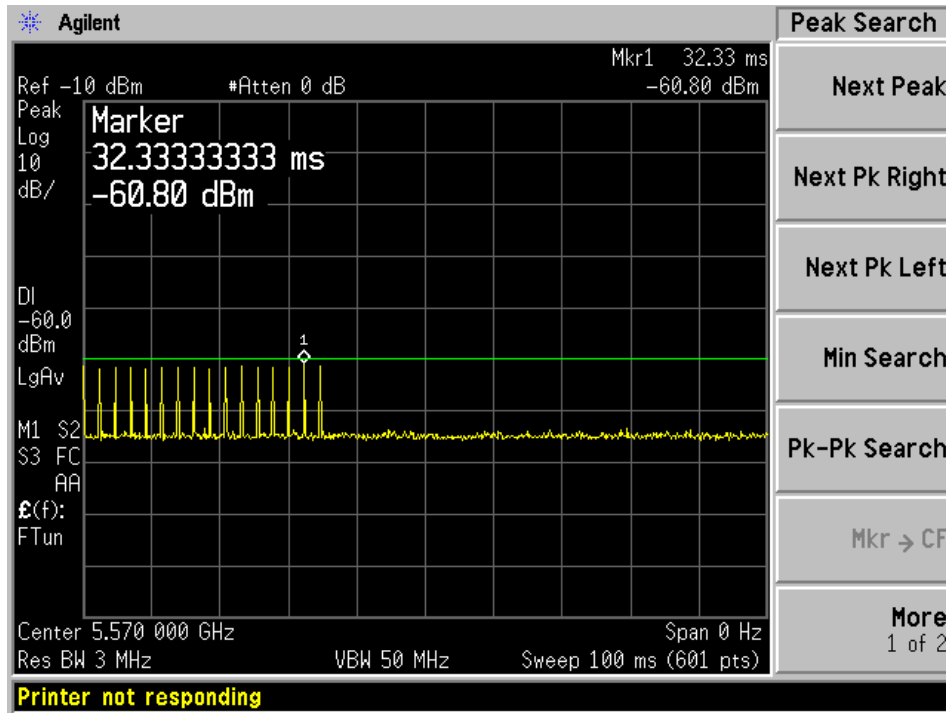

Radar Type 2

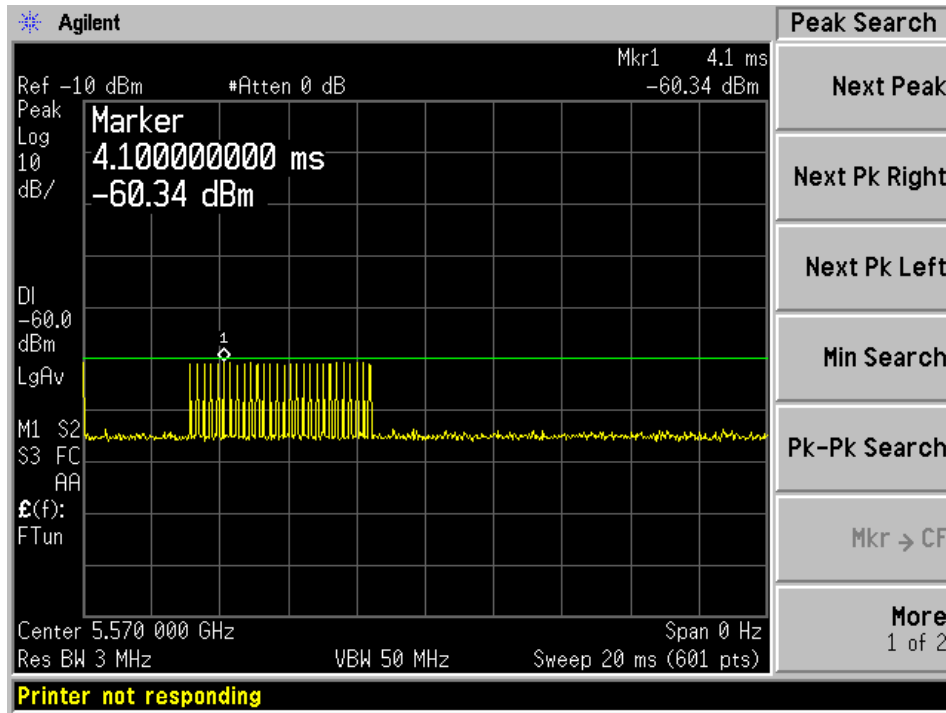

Radar Type 3

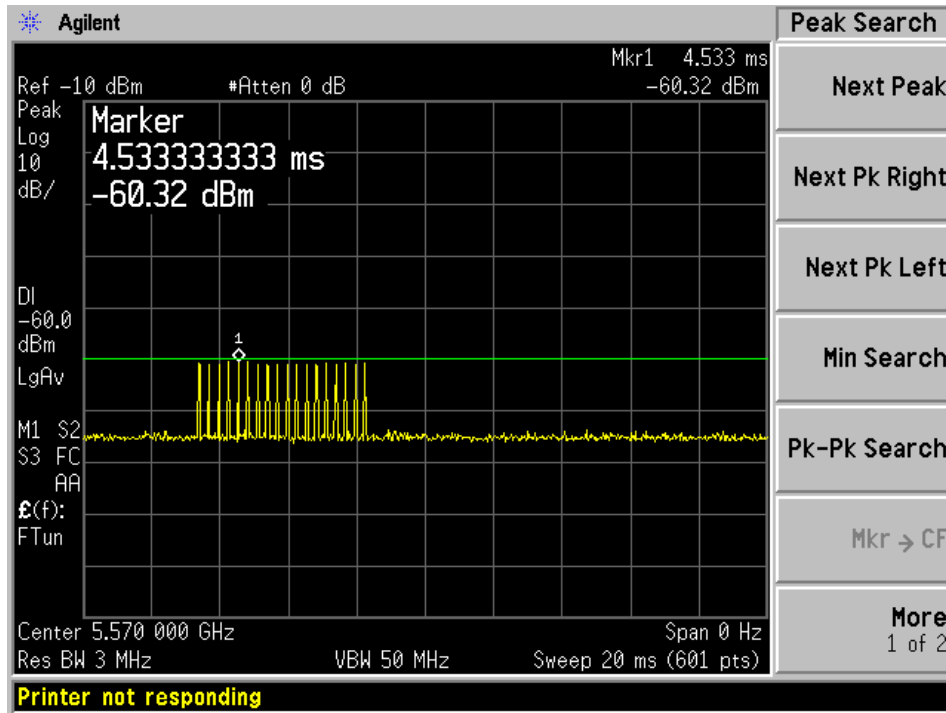

Radar Type 4

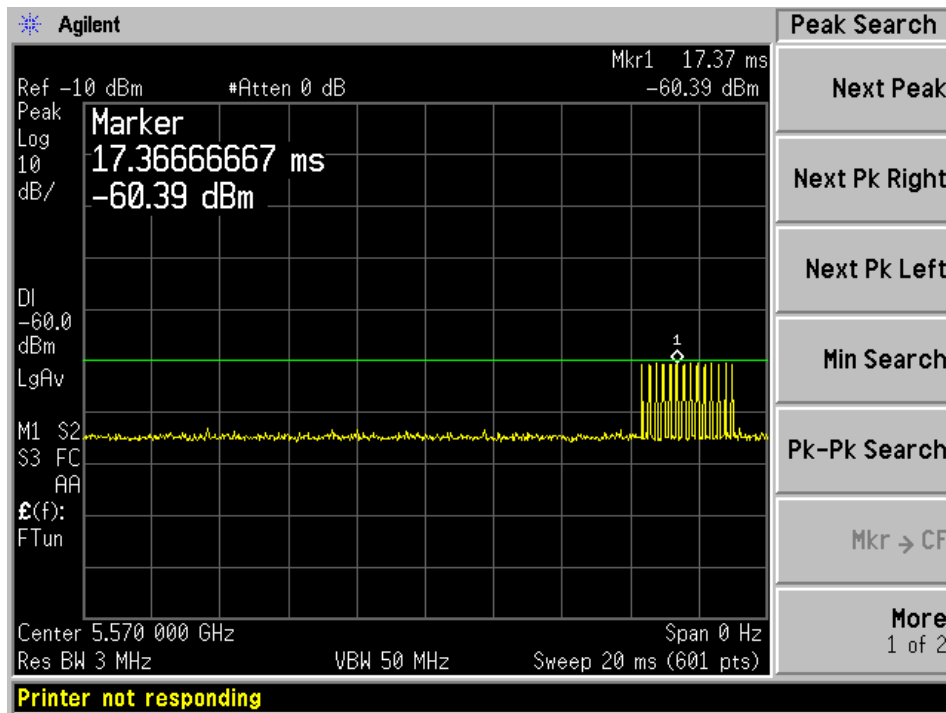

Radar Type 5

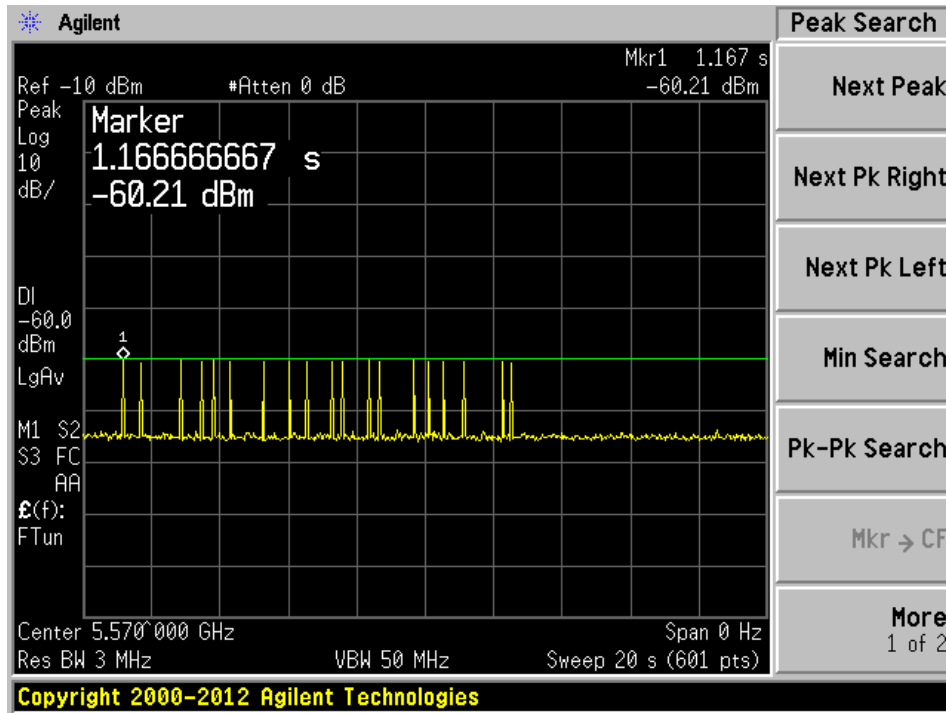

Radar Type 6

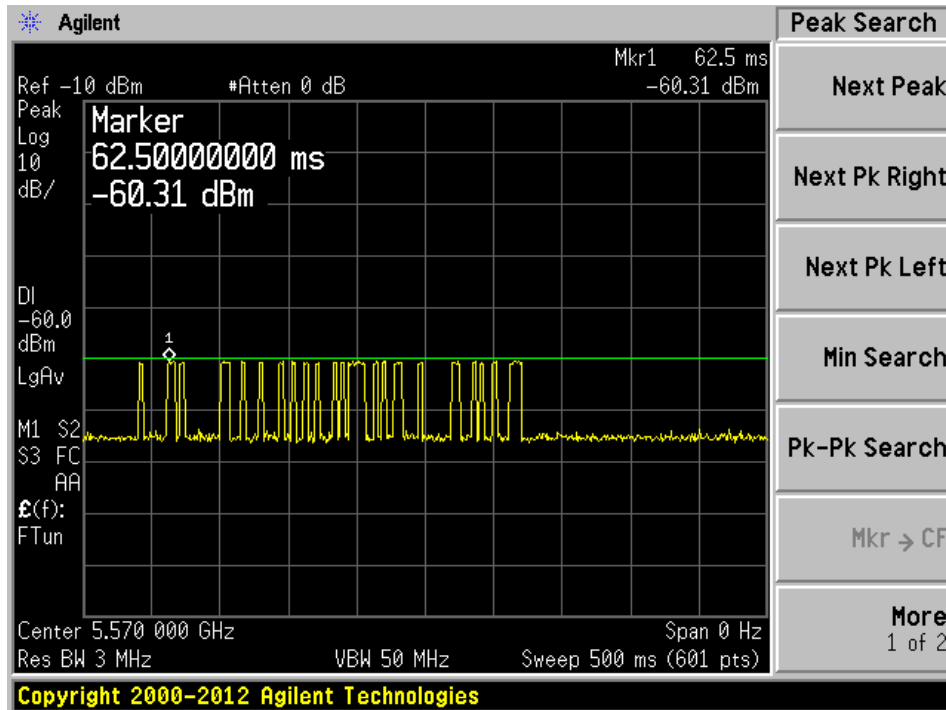

6 Channel Availability Check Time (CAC)

6.1 Test Procedure

- 1) Measure the CAC time period after executing the initiating CAC command.
- 2) With link established on channel, apply a radar signal within first 6 seconds after CAC starts; monitor the transmissions on channel from the spectrum analyzer.
- 3) With a link established on channel, apply a radar signal within last 6 seconds before CAC ends, and monitor the transmission on channel from the spectrum analyzer.

Note: EUT has command to initiate CAC

6.2 Results:

5 GHz – Regular Radio

Timing of Radar Burst	Spectrum Analyzer Display	Result
No Radar Triggered	Total CAC Period 61 second	Pass
Within 6 seconds of the CAC starting	No transmission	Pass
Within the last 6 seconds of the CAC	No transmission	Pass

5 GHz – Xor Radio

Timing of Radar Burst	Spectrum Analyzer Display	Result
No Radar Triggered	Total CAC Period 61 second	Pass
Within 6 seconds of the CAC starting	No transmission	Pass
Within the last 6 seconds of the CAC	No transmission	Pass

Note: The CAC was tested with the Radar type 0.

5 GHz – Regular Radio

5570 MHz

Plot of CAC Time Period

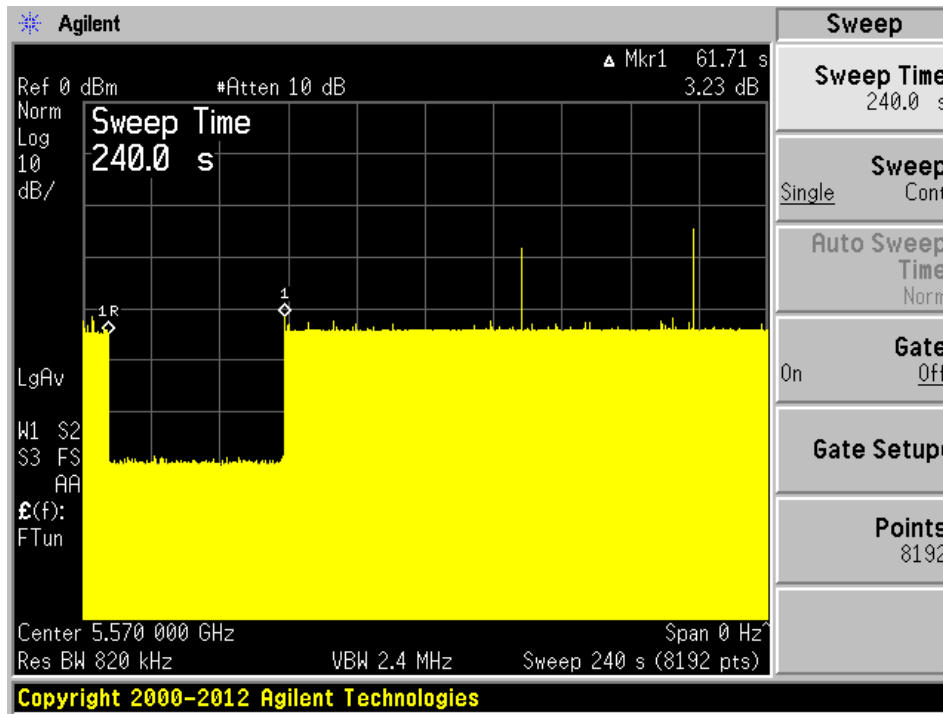

Plot of Radar signal applied within 6 seconds of start of CAC

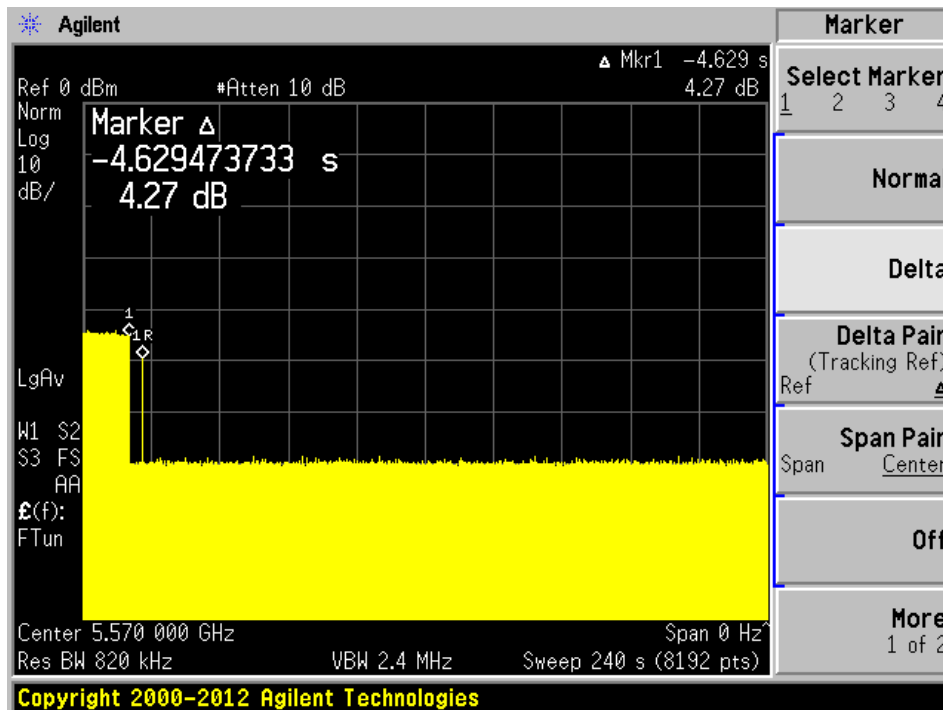

No transmissions found after radar signal applied.

Plot of Radar signal applied at the end of 6 seconds of CAC

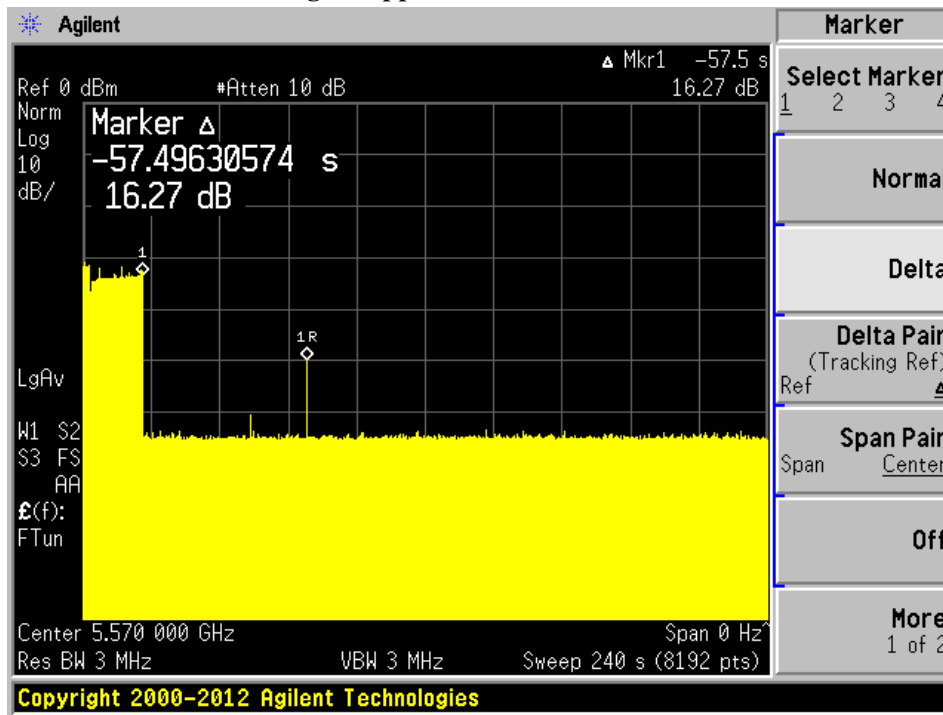

No transmissions found after radar signal applied.

5 GHz – XOR Radio

5570 MHz

Plot of CAC Time Period

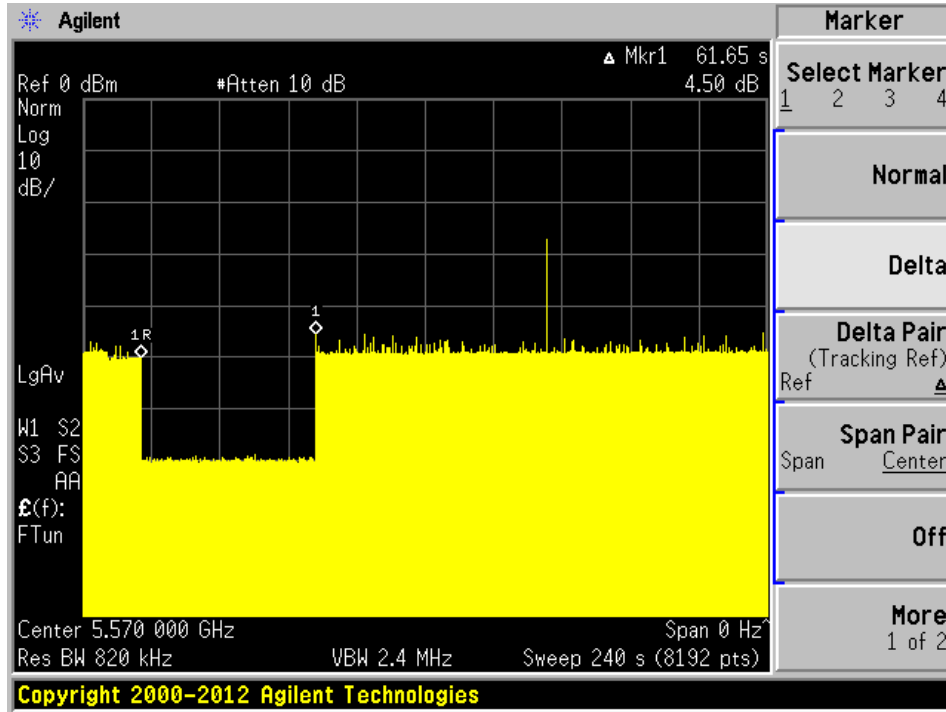

Plot of Radar signal applied within 6 seconds of start of CAC

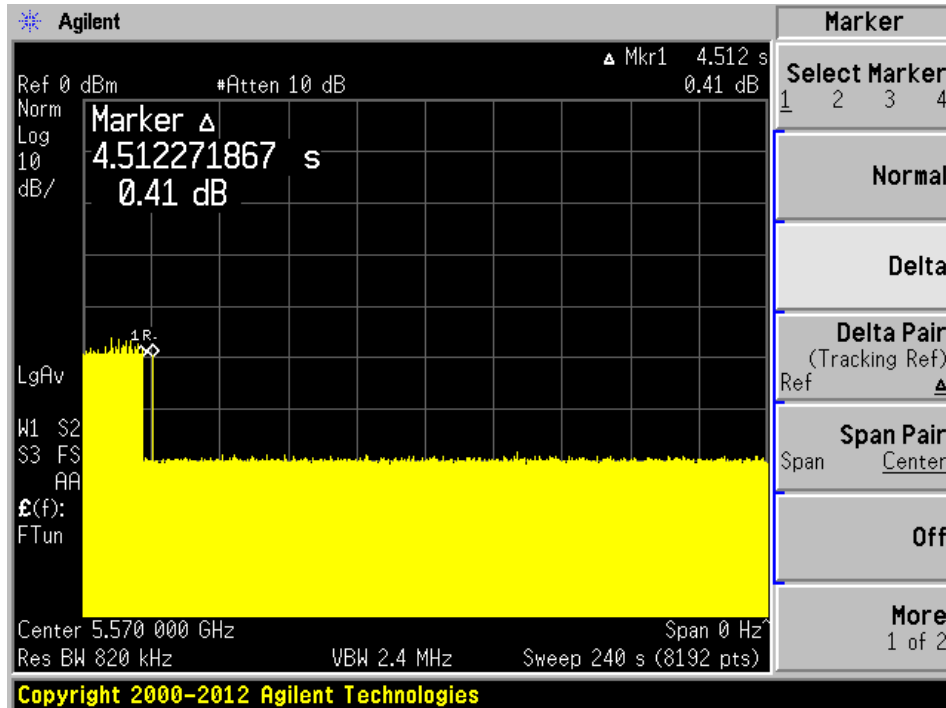

No transmissions found after radar signal applied.

Plot of Radar signal applied at the end of 6 seconds of CAC

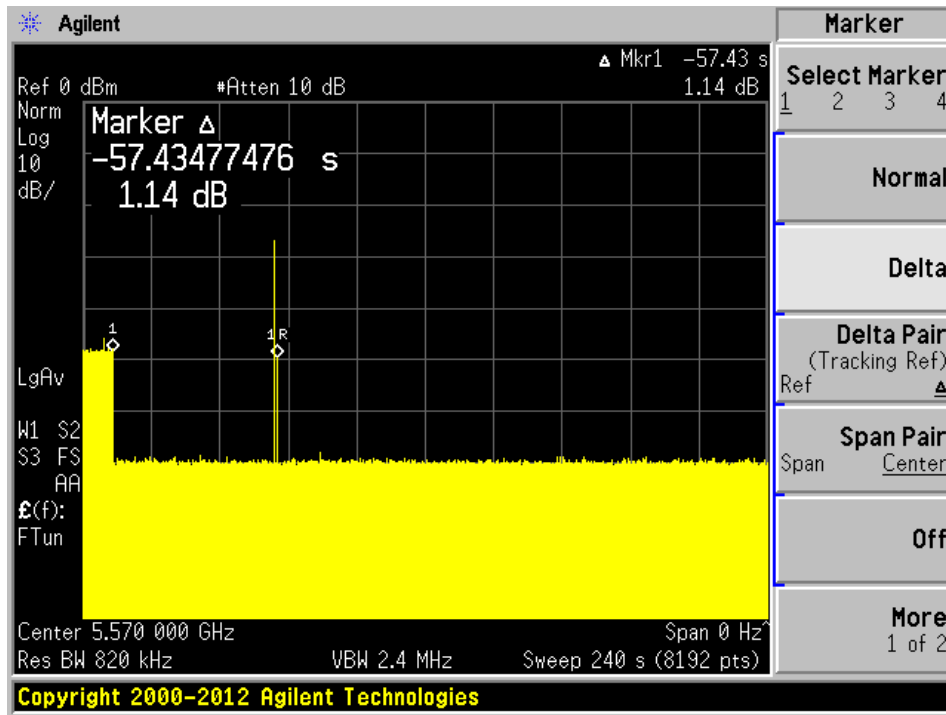

No transmissions found after radar signal applied.

7 Channel Move Time and Channel Closing Transmission Time

7.1 Test Procedure

BACL use type 0 radar signal to test the channel move time and channel closing transmission time.

The aggregate channel closing transmission time is calculated as follows:

Aggregate Transmission Time = N * Dwell Time

N is the number of spectrum analyzer bins showing a device transmission

Dwell Time is the dwell time per bin (i.e. Dwell Time = S/B, S is the sweep time and B is the number of bin, i.e. 8192)

7.2 Test Results

5 GHz – Regular Radio

Frequency (MHz)	Bandwidth (MHz)	Radar Type	Results
5570	160	Type 0	Compliant

5 GHz – Xor Radio

Frequency (MHz)	Bandwidth (MHz)	Radar Type	Results
5570	160	Type 0	Compliant

Please refer to the following tables and plots.

5 GHz – Regular Radio

5570 MHz, Bandwidth 160 MHz

Type 0 radar channel move time and channel closing transmission time result:

Channel closing transmitting time (ms)	Limit (ms)	Result
46.39 + 17.09	200+60	Pass

Channel move time (s)	Limit (s)	Result
< 10	10	Pass

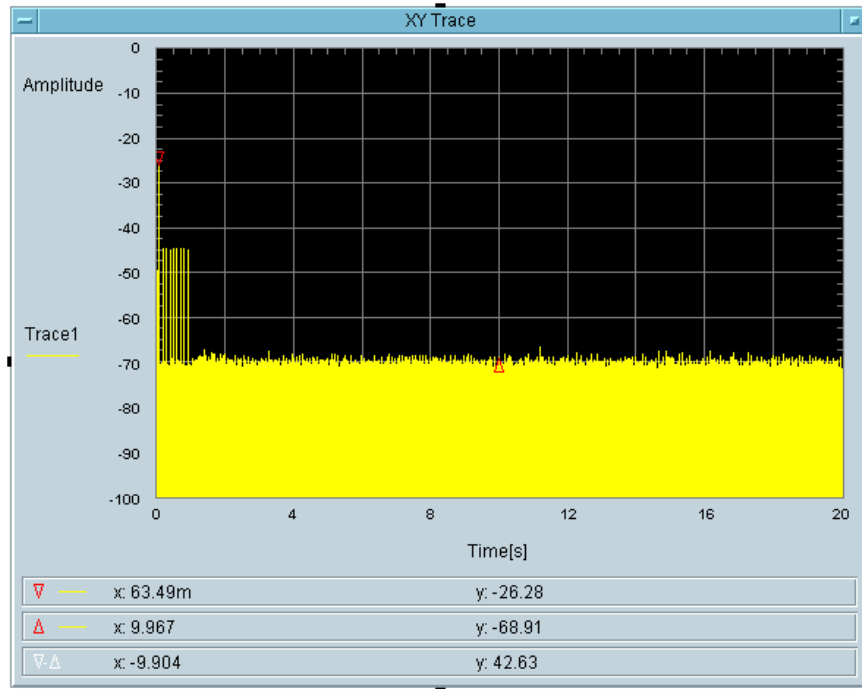

Total On Time [s]
46.39m

Total On Time After Delay [s]
17.09m

5 GHz – XOR Radio

5570 MHz, Bandwidth 160 MHz

Type 0 radar channel move time and channel closing transmission time result:

Channel closing transmitting time (ms)	Limit (ms)	Result
53.71 + 26.86	200+60	Pass

Channel move time (s)	Limit (s)	Result
< 10	10	Pass

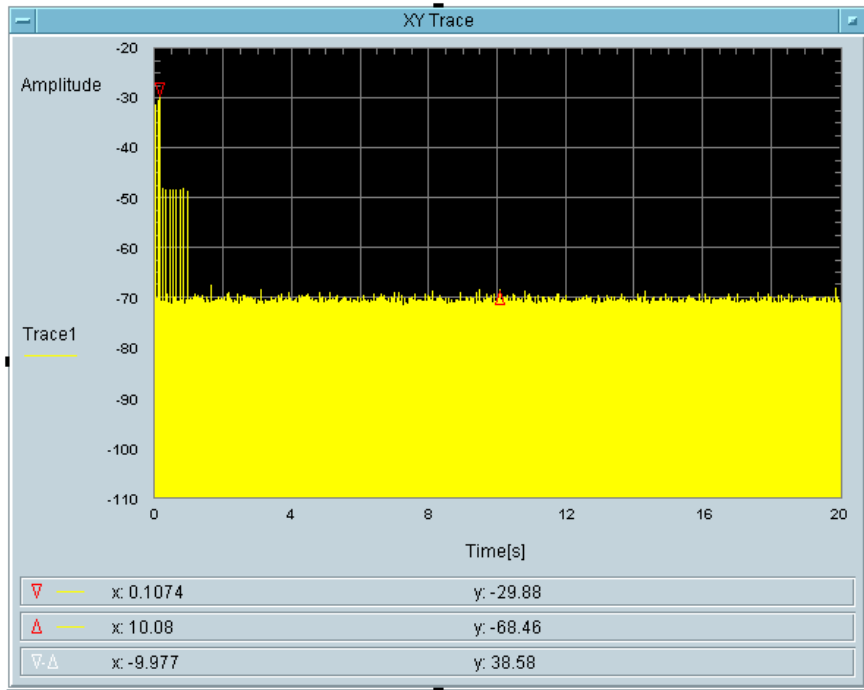

Total On Time [s]
53.71m

Total On Time After Delay [s]
26.86m

8 Non-Occupancy Period

8.1 Test Procedure

Measure the EUT for more than 30 minutes following the channel close/move time to verify that the EUT does not resume any transmissions on this channel. Provide one plot to demonstrate no transmission on the channel for the non-occupancy period (30 minutes observation time)

8.2 Test Results

5 GHz – Regular Radio

Frequency (MHz)	Bandwidth (MHz)	Spectrum Analyzer Display
5570	160	No transmission within 30 minutes

5 GHz – XOR Radio

Frequency (MHz)	Bandwidth (MHz)	Spectrum Analyzer Display
5570	160	No transmission within 30 minutes

Please refer to the following plots.

5 GHz – Regular Radio 5570 MHz, Bandwidth 160 MHz

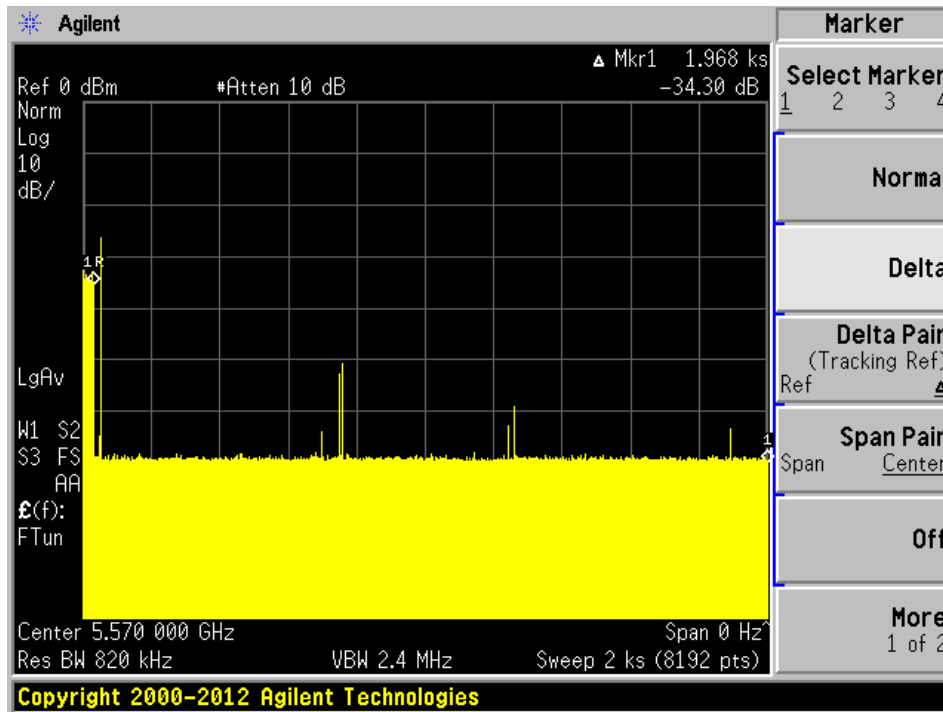

5 GHz – XOR Radio 5570 MHz, Bandwidth 160 MHz

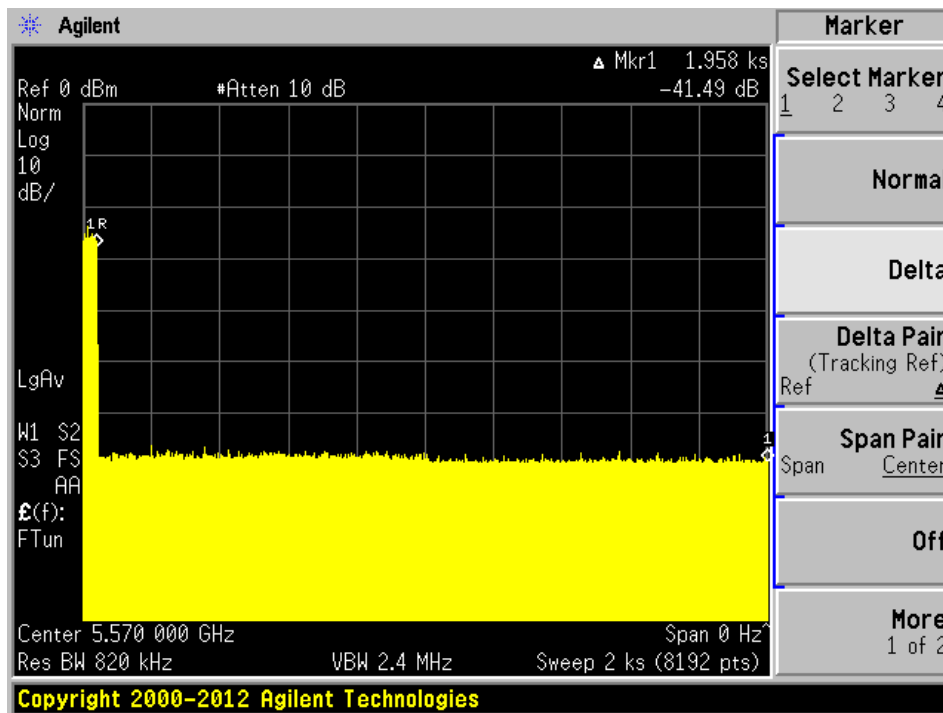

9 Radar Detection Bandwidth & Radar Detection Performance Check

9.1 Detection Bandwidth

Procedure:

Performed with any one of the short pulse radar waveforms type 0

Starting at the center frequency of the UUT operating Channel, increase the radar frequency in 5 MHz steps, repeating the above test sequence, until the detection rate falls below the U-NII Detection Bandwidth criterion specified in Table 4. Repeat this measurement in 1MHz steps at frequencies 5 MHz below where the detection rate begins to fall. Record the highest frequency (denote as F_H) at which detection is greater than or equal to the U-NII Detection Bandwidth criterion. Recording the detection rate at frequencies above F_H is not required to demonstrate compliance.

Starting at the center frequency of the UUT operating Channel, decrease the radar frequency in 5 MHz steps, repeating the above test sequence, until the detection rate falls below the U-NII Detection Bandwidth criterion specified in Table 4. Repeat this measurement in 1MHz steps at frequencies 5 MHz above where the detection rate begins to fall. Record the lowest frequency (denote as F_L) at which detection is greater than or equal to the U-NII Detection Bandwidth criterion. Recording the detection rate at frequencies below F_L is not required to demonstrate compliance.

The U-NII Detection Bandwidth is calculated as follows: U-NII Detection Bandwidth = $F_H - F_L$

Test Results

5 GHz – Regular Radio

Frequency (MHz)	F_L (MHz)	F_H (MHz)	Detection Bandwidth (MHz)	Minimum Limit (MHz)	Result
5500	5491	5509	18	17	Compliance
5510	5492	5529	37	36	Compliance
5530	5492	5568	76	76	Compliance
5570	5490	5650	160	155	Compliance

5 GHz – XOR Radio

Frequency (MHz)	F_L (MHz)	F_H (MHz)	Detection Bandwidth (MHz)	Minimum Limit (MHz)	Result
5500	5491	5508	17	17	Compliance
5510	5492	5528	36	36	Compliance
5530	5492	5568	76	76	Compliance
5570	5491	5650	159	155	Compliance

Please refer to the following tables.

5 GHz – Regular Radio**Results of Detection Bandwidth:**

EUT Frequency = 5500 MHz											
DFS Detection Trials (1 = Detected, 0 = No Detected)											
Radar Frequency (MHz)	1	2	3	4	5	6	7	8	9	10	Detection Rate (%)
5490	0	0	0	0	0	0	0	0	0	0	0 %
5491(F_L)	1	1	1	1	1	1	1	1	1	1	100 %
5495	1	1	1	1	1	1	1	1	1	1	100 %
5500(F _c)	1	1	1	1	1	1	1	1	1	1	100 %
5505	1	1	1	1	1	1	1	1	1	1	100 %
5509(F_H)	1	1	1	1	1	1	1	1	1	1	100 %
5510	0	0	0	0	0	0	0	0	0	0	0 %
Detection Bandwidth = F_H – F_L=5509-5491=18 MHz											
EUT 99% OBW = 17 MHz; 17 x 100% = 17 MHz						Result:		Pass			

EUT Frequency = 5510 MHz											
DFS Detection Trials (1 = Detected, 0 = No Detected)											
Radar Frequency (MHz)	1	2	3	4	5	6	7	8	9	10	Detection Rate (%)
5490	0	0	0	0	0	0	0	0	0	0	0 %
5491	1	0	0	0	0	0	0	0	0	0	10 %
5492(F_L)	1	1	1	1	1	1	1	1	1	1	100 %
5495	1	1	1	1	1	1	1	1	1	1	100 %
5500	1	1	1	1	1	1	1	1	1	1	100 %
5505	1	1	1	1	1	1	1	1	1	1	100 %
5510(F _c)	1	1	1	1	1	1	1	1	1	1	100 %
5515	1	1	1	1	1	1	1	1	1	1	100 %
5520	1	1	1	1	1	1	1	1	1	1	100 %
5525	1	1	1	1	1	1	1	1	1	1	100 %
5529(F_H)	1	1	1	1	1	1	1	1	1	1	100 %
5530	0	0	0	0	0	0	0	0	0	0	0 %
Detection Bandwidth = F_H – F_L=5529-5492=37 MHz											
EUT 99% OBW = 36 MHz; 36 x 100% = 36 MHz						Result:		Pass			

EUT Frequency = 5530 MHz											
DFS Detection Trials (1 = Detected, 0 = No Detected)											
Radar Frequency (MHz)	1	2	3	4	5	6	7	8	9	10	Detection Rate (%)
5490	0	0	0	0	0	0	0	0	0	0	0 %
5491	0	0	0	0	0	0	0	0	0	0	0 %
5492(F_L)	1	1	1	1	1	1	1	1	1	1	100 %
5495	1	1	1	1	1	1	1	1	1	1	100 %
5500	1	1	1	1	1	1	1	1	1	1	100 %
5505	1	1	1	1	1	1	1	1	1	1	100 %
5510	1	1	1	1	1	1	1	1	1	1	100 %
5515	1	1	1	1	1	1	1	1	1	1	100 %
5520	1	1	1	1	1	1	1	1	1	1	100 %
5525	1	1	1	1	1	1	1	1	1	1	100 %
5530(F _c)	1	1	1	1	1	1	1	1	1	1	100 %
5535	1	1	1	1	1	1	1	1	1	1	100 %
5540	1	1	1	1	1	1	1	1	1	1	100 %
5545	1	1	1	1	1	1	1	1	1	1	100 %
5550	1	1	1	1	1	1	1	1	1	1	100 %
5555	1	1	1	1	1	1	1	1	1	1	100 %
5560	1	1	1	1	1	1	1	1	1	1	100 %
5565	1	1	1	1	1	1	1	1	1	1	100 %
5568(F_H)	1	1	1	1	1	1	1	1	1	1	100 %
5569	0	0	0	0	0	0	0	0	0	0	0 %
5570	0	0	0	0	0	0	0	0	0	0	0 %
Detection Bandwidth = F _H - F _L =5568-5492=76 MHz											
EUT 99% OBW = 76 MHz; 76 x 100% = 76 MHz						Result:		Pass			

EUT Frequency = 5570 MHz											
DFS Detection Trials (1 = Detected, 0 = No Detected)											
Radar Frequency (MHz)	1	2	3	4	5	6	7	8	9	10	Detection Rate (%)
5489	0	0	0	0	0	0	0	0	0	0	0 %
5490(F_L)	1	1	1	1	1	1	1	1	1	1	100 %
5495	1	1	1	1	1	1	1	1	1	1	100 %
5500	1	1	1	1	1	1	1	1	1	1	100 %
5505	1	1	1	1	1	1	1	1	1	1	100 %
5510	1	1	1	1	1	1	1	1	1	1	100 %
5515	1	1	1	1	1	1	1	1	1	1	100 %
5520	1	1	1	1	1	1	1	1	1	1	100 %
5525	1	1	1	1	1	1	1	1	1	1	100 %
5530	1	1	1	1	1	1	1	1	1	1	100 %
5535	1	1	1	1	1	1	1	1	1	1	100 %
5540	1	1	1	1	1	1	1	1	1	1	100 %
5545	1	1	1	1	1	1	1	1	1	1	100 %
5550	1	1	1	1	1	1	1	1	1	1	100 %
5555	1	1	1	1	1	1	1	1	1	1	100 %
5560	1	1	1	1	1	1	1	1	1	1	100 %
5565	1	1	1	1	1	1	1	1	1	1	100 %
5570(F _C)	1	1	1	1	1	1	1	1	1	1	100 %
5575	1	1	1	1	1	1	1	1	1	1	100 %
5580	1	1	1	1	1	1	1	1	1	1	100 %
5585	1	1	1	1	1	1	1	1	1	1	100 %
5590	1	1	1	1	1	1	1	1	1	1	100 %
5595	1	1	1	1	1	1	1	1	1	1	100 %
5600	1	1	1	1	1	1	1	1	1	1	100 %
5605	1	1	1	1	1	1	1	1	1	1	100 %
5610	1	1	1	1	1	1	1	1	1	1	100 %
5615	1	1	1	1	1	1	1	1	1	1	100 %
5620	1	1	1	1	1	1	1	1	1	1	100 %
5625	1	1	1	1	1	1	1	1	1	1	100 %
5630	1	1	1	1	1	1	1	1	1	1	100 %
5635	1	1	1	1	1	1	1	1	1	1	100 %
5640	1	1	1	1	1	1	1	1	1	1	100 %
5645	1	1	1	1	1	1	1	1	1	1	100 %
5650(F_H)	1	1	1	1	1	1	1	1	1	1	100 %
5651	0	0	0	0	0	0	0	0	0	0	0 %
Detection Bandwidth = F_H – F_L=5650-5490=160 MHz											
EUT 99% OBW = 155 MHz; 155 x 100% = 155 MHz						Result:		Pass			

5 GHz – XOR Radio

Results of Detection Bandwidth:

EUT Frequency = 5500 MHz											
DFS Detection Trials (1 = Detected, 0 = No Detected)											
Radar Frequency (MHz)	1	2	3	4	5	6	7	8	9	10	Detection Rate (%)
5490	0	0	0	0	0	0	0	0	0	0	0 %
5491(F_L)	1	1	1	1	1	1	1	1	1	1	100 %
5495	1	1	1	1	1	1	1	1	1	1	100 %
5500(F _c)	1	1	1	1	1	1	1	1	1	1	100 %
5505	1	1	1	1	1	1	1	1	1	1	100 %
5508(F_H)	1	1	1	1	1	1	1	1	1	1	100 %
5509	0	0	0	0	0	0	0	0	0	0	0 %
5510	0	0	0	0	0	0	0	0	0	0	0 %
Detection Bandwidth = F _H – F _L =5509-5491=17 MHz											
EUT 99% OBW = 17 MHz; 17 x 100% = 17 MHz						Result:		Pass			

EUT Frequency = 5510 MHz											
DFS Detection Trials (1 = Detected, 0 = No Detected)											
Radar Frequency (MHz)	1	2	3	4	5	6	7	8	9	10	Detection Rate (%)
5490	0	0	0	0	0	0	0	0	0	0	0 %
5491	0	1	0	0	1	0	0	0	1	0	30 %
5492(F_L)	1	1	1	1	1	1	1	1	1	1	100 %
5495	1	1	1	1	1	1	1	1	1	1	100 %
5500	1	1	1	1	1	1	1	1	1	1	100 %
5505	1	1	1	1	1	1	1	1	1	1	100 %
5510(F _c)	1	1	1	1	1	1	1	1	1	1	100 %
5515	1	1	1	1	1	1	1	1	1	1	100 %
5520	1	1	1	1	1	1	1	1	1	1	100 %
5525	1	1	1	1	1	1	1	1	1	1	100 %
5528(F_H)	1	1	1	1	1	1	1	1	1	1	100 %
5529	0	0	0	0	0	0	1	1	0	1	30 %
5530	0	0	0	0	0	0	0	0	0	0	0 %
Detection Bandwidth = F _H – F _L =5529-5492=36 MHz											
EUT 99% OBW = 36 MHz; 36 x 100% = 36 MHz						Result:		Pass			

EUT Frequency = 5530 MHz											
DFS Detection Trials (1 = Detected, 0 = No Detected)											
Radar Frequency (MHz)	1	2	3	4	5	6	7	8	9	10	Detection Rate (%)
5490	0	0	0	0	0	0	0	0	0	0	0 %
5491	0	0	0	0	0	0	0	0	0	0	0 %
5492(F_L)	1	1	1	1	1	1	1	1	1	1	100 %
5495	1	1	1	1	1	1	1	1	1	1	100 %
5500	1	1	1	1	1	1	1	1	1	1	100 %
5505	1	1	1	1	1	1	1	1	1	1	100 %
5510	1	1	1	1	1	1	1	1	1	1	100 %
5515	1	1	1	1	1	1	1	1	1	1	100 %
5520	1	1	1	1	1	1	1	1	1	1	100 %
5525	1	1	1	1	1	1	1	1	1	1	100 %
5530(F _c)	1	1	1	1	1	1	1	1	1	1	100 %
5535	1	1	1	1	1	1	1	1	1	1	100 %
5540	1	1	1	1	1	1	1	1	1	1	100 %
5545	1	1	1	1	1	1	1	1	1	1	100 %
5550	1	1	1	1	1	1	1	1	1	1	100 %
5555	1	1	1	1	1	1	1	1	1	1	100 %
5560	1	1	1	1	1	1	1	1	1	1	100 %
5565	1	1	1	1	1	1	1	1	1	1	100 %
5568(F_H)	1	1	1	1	1	1	1	1	1	1	100 %
5569	0	0	0	0	0	0	0	0	0	0	0 %
5570	0	0	0	0	0	0	0	0	0	0	0 %
Detection Bandwidth = F _H - F _L =5568-5492=76 MHz											
EUT 99% OBW = 76 MHz; 76 x 100% = 76 MHz						Result:		Pass			

EUT Frequency = 5570 MHz											
DFS Detection Trials (1 = Detected, 0 = No Detected)											
Radar Frequency (MHz)	1	2	3	4	5	6	7	8	9	10	Detection Rate (%)
5490	0	0	0	0	0	0	0	0	0	0	0 %
5491(F_L)	1	1	1	1	1	1	1	1	1	1	100 %
5495	1	1	1	1	1	1	1	1	1	1	100 %
5500	1	1	1	1	1	1	1	1	1	1	100 %
5505	1	1	1	1	1	1	1	1	1	1	100 %
5510	1	1	1	1	1	1	1	1	1	1	100 %
5515	1	1	1	1	1	1	1	1	1	1	100 %
5520	1	1	1	1	1	1	1	1	1	1	100 %
5525	1	1	1	1	1	1	1	1	1	1	100 %
5530	1	1	1	1	1	1	1	1	1	1	100 %
5535	1	1	1	1	1	1	1	1	1	1	100 %
5540	1	1	1	1	1	1	1	1	1	1	100 %
5545	1	1	1	1	1	1	1	1	1	1	100 %
5550	1	1	1	1	1	1	1	1	1	1	100 %
5555	1	1	1	1	1	1	1	1	1	1	100 %
5560	1	1	1	1	1	1	1	1	1	1	100 %
5565	1	1	1	1	1	1	1	1	1	1	100 %
5570(F _C)	1	1	1	1	1	1	1	1	1	1	100 %
5575	1	1	1	1	1	1	1	1	1	1	100 %
5580	1	1	1	1	1	1	1	1	1	1	100 %
5585	1	1	1	1	1	1	1	1	1	1	100 %
5590	1	1	1	1	1	1	1	1	1	1	100 %
5595	1	1	1	1	1	1	1	1	1	1	100 %
5600	1	1	1	1	1	1	1	1	1	1	100 %
5605	1	1	1	1	1	1	1	1	1	1	100 %
5610	1	1	1	1	1	1	1	1	1	1	100 %
5615	1	1	1	1	1	1	1	1	1	1	100 %
5620	1	1	1	1	1	1	1	1	1	1	100 %
5625	1	1	1	1	1	1	1	1	1	1	100 %
5630	1	1	1	1	1	1	1	1	1	1	100 %
5635	1	1	1	1	1	1	1	1	1	1	100 %
5640	1	1	1	1	1	1	1	1	1	1	100 %
5645	1	1	1	1	1	1	1	1	1	1	100 %
5650(F_H)	1	1	1	1	1	1	1	1	1	1	100 %
5651	0	0	0	0	0	0	0	0	0	0	0 %
Detection Bandwidth = F_H - F_L = 5650 - 5491 = 159 MHz											
EUT 99% OBW = 155 MHz; 155 x 100% = 155 MHz						Result:		Pass			

9.2 Radar Detection Performance Check

Procedure:

Stream MPEG file from master to slave

Generate radar waveform

Record whether or not the waveform was detected

At least 30 trials are applied for each radar type

For radar types with randomized parameters, each trial uses a unique waveform

Perform with each of the radar types 1-6

Confirm that the detection rate for each radar type meets the minimum requirement

Type 1A&1B, 2, 3, 4: 60% each

Type 5: 80%

Type 6: 70%

Confirm that the mean of the rates for radar types 1 through 4 meets the requirement of 80%

$$\text{Detection Ratio} = \frac{\text{Total Waveform Detections}}{\text{Total Waveform Trials}} \times 100$$

Test Results:

5 GHz – Regular Radio

5500 MHz, 20 MHz Bandwidth

Radar Signal Type	Waveform/Trial Number	Detection (%)	Limit (%)	Pass/Fail
Type 1A/1B	30	100 %	60%	Pass
Type 2	30	93.3 %	60%	Pass
Type 3	30	93.3 %	60%	Pass
Type 4	30	76.7 %	60%	Pass
Aggregate (Type1 to 4)	120	90.83 %	80%	Pass
Type 5	30	100 %	80%	Pass
Type 6	30	100 %	70%	Pass

Please refer to the following statistical tables:

Table-1A/1B Radar Type 1A/1B Statistical Performance

Trial #	Fc (MHz)	Pulse/Burst	Pulse Width (µS)	PRI (µs)	Detection (1:yes; 0:no)
1	5500	83	1	638	1
2	5500	76	1	698	1
3	5500	81	1	658	1
4	5500	63	1	838	1
5	5500	57	1	938	1
6	5491	72	1	738	1
7	5491	78	1	678	1
8	5491	67	1	798	1
9	5491	92	1	578	1
10	5491	58	1	918	1
11	5509	59	1	898	1
12	5509	70	1	758	1
13	5509	62	1	858	1
14	5509	86	1	618	1
15	5509	74	1	718	1
16	5500	59	1	902	1
17	5500	39	1	1356	1
18	5500	42	1	1276	1
19	5500	29	1	1857	1
20	5500	21	1	2619	1
21	5491	23	1	2304	1
22	5491	21	1	2572	1
23	5491	48	1	1112	1
24	5491	21	1	2567	1
25	5491	19	1	2882	1
26	5509	47	1	1126	1
27	5509	32	1	1694	1
28	5509	68	1	781	1
29	5509	48	1	1101	1
30	5509	18	1	2933	1
Detection Percentage: 100 % (>60%)					

Table-2 Radar Type 2 Statistical Performance

Trial #	Fc (MHz)	Pulse/Burst	Pulse Width (μS)	PRI (μs)	Detection (1:yes; 0:no)
1	5500	24	3.1	171	1
2	5500	24	2.1	197	1
3	5500	29	2.2	184	1
4	5500	27	2.8	182	1
5	5500	28	2.2	216	1
6	5500	25	3.2	172	1
7	5500	23	3.5	158	1
8	5500	26	3.9	214	1
9	5500	27	2.3	221	1
10	5500	24	1	195	1
11	5491	25	2.8	212	1
12	5491	24	1.4	223	1
13	5491	25	1.6	158	1
14	5491	25	2	226	1
15	5491	27	3.4	178	0
16	5491	24	3	150	1
17	5491	26	2.5	175	1
18	5491	26	4	156	1
19	5491	28	1.6	192	1
20	5491	27	1.3	173	0
21	5509	25	4.9	207	1
22	5509	27	1.8	223	1
23	5509	28	2.5	226	1
24	5509	29	2.5	165	1
25	5509	25	2.9	155	1
26	5509	28	1.4	193	1
27	5509	23	1.6	198	1
28	5509	24	2.8	153	1
29	5509	23	3.3	229	1
30	5509	28	1.4	225	1
Detection Percentage: 93.3 % (>60%)					

Table-3 Radar Type 3 Statistical Performance

Trial #	Fc (MHz)	Pulse/Burst	Pulse Width (μS)	PRI (μs)	Detection (1:yes; 0:no)
1	5500	17	7.9	251	1
2	5500	16	7.1	236	1
3	5500	16	9.7	468	1
4	5500	18	6.4	256	1
5	5500	16	6	458	1
6	5500	16	6.8	465	1
7	5500	18	6.8	408	1
8	5500	16	9.1	235	1
9	5500	18	8.3	390	1
10	5500	16	6.2	305	0
11	5491	17	7.1	336	1
12	5491	17	7.1	285	1
13	5491	16	8.5	241	1
14	5491	16	9.1	221	1
15	5491	18	7.5	364	1
16	5491	16	9.7	486	1
17	5491	16	8.7	276	1
18	5491	16	7.1	464	1
19	5491	17	9.4	245	1
20	5491	17	9.1	249	1
21	5509	17	9.1	322	1
22	5509	17	7.3	331	1
23	5509	18	8.7	331	1
24	5509	18	9.8	248	1
25	5509	18	7.1	287	0
26	5509	17	9.3	342	1
27	5509	17	7.3	285	1
28	5509	18	8.9	451	1
29	5509	18	9.3	361	1
30	5509	17	7.1	359	1
Detection Percentage: 90 % (>60%)					

Table-4 Radar Type 4 Statistical Performance

Trial #	Fc (MHz)	Pulse/Burst	Pulse Width (μS)	PRI (μs)	Detection (1:yes; 0:no)
1	5500	12	17	416	1
2	5500	16	17.6	415	1
3	5500	16	15.2	235	1
4	5500	15	16	283	0
5	5500	13	11.1	232	1
6	5500	15	18.3	270	0
7	5500	14	13.9	380	1
8	5500	14	19.2	422	1
9	5500	13	15.6	212	0
10	5500	13	18.1	270	1
11	5491	15	14.2	450	1
12	5491	15	15.9	472	1
13	5491	16	14	361	1
14	5491	15	14.8	273	1
15	5491	16	17.7	365	1
16	5491	13	17.1	246	1
17	5491	12	11.5	316	1
18	5491	16	19.3	290	0
19	5491	14	18	257	1
20	5491	12	15	288	0
21	5509	15	14	422	1
22	5509	12	12.2	367	0
23	5509	16	19.4	246	1
24	5509	16	16.6	301	1
25	5509	14	18.9	474	1
26	5509	16	13.5	415	1
27	5509	13	12.6	342	1
28	5509	16	13.6	427	0
29	5509	16	15.5	357	1
30	5509	13	16.7	329	1
Detection Percentage: 76.7% (>60%)					

Table-5 Radar Type 5 Statistical Performance

Trial #	Fc (MHz)	Detection (1:yes; 0:no)
1	5500	1
2	5500	1
3	5500	1
4	5500	1
5	5500	1
6	5500	1
7	5500	1
8	5500	1
9	5500	1
10	5500	1
11	5495.8	1
12	5495.0	1
13	5496.6	1
14	5497.4	1
15	5495.4	1
16	5494.6	1
17	5497.8	1
18	5495.8	1
19	5493.4	1
20	5497.4	1
21	5504.6	1
22	5501.8	1
23	5503.4	1
24	5505.8	1
25	5505.0	1
26	5503.4	1
27	5506.2	1
28	5506.2	1
29	5506.6	1
30	5501.4	1
Detection Percentage: 100 % (>80%)		

Bin5 Statistics 1

Trial #	Pulse	Chirp (MHz)	Pulse Width (µS)	Pulse 1-2 spacing (µS)	Pulse 2-3 spacing (µS)	Pulse Start(S)	Detection (1:yes; 0:no)
0	3	12	79	1471	1354	0.240581	1
1	2	12	56.3	1571	-	1.833461	
2	2	12	68.7	1206	-	2.086336	
3	3	12	71.1	1933	1988	2.918959	
4	2	12	99.4	1806	-	4.299029	
5	1	12	65.5	-	-	5.534533	
6	2	12	66.3	1144	-	6.207744	
7	2	12	81.3	1215	-	7.320383	
8	2	12	68.5	1025	-	7.973492	
9	1	12	66.8	-	-	8.915982	
10	1	12	53	-	-	10.091749	
11	2	12	50.5	1642	-	10.345827	
12	3	12	97.1	1796	1585	11.639598	

Bin5 Statistics 2

Trial #	Pulse	Chirp (MHz)	Pulse Width (µS)	Pulse 1-2 spacing (µS)	Pulse 2-3 spacing (µS)	Pulse Start(S)	Detection (1:yes; 0:no)
0	3	13	55	1870	1110	0.131027	1
1	2	13	52.7	1933	-	0.987238	
2	1	13	52.9	-	-	1.770799	
3	3	13	74.5	1227	1485	2.589038	
4	1	13	73.4	-	-	2.836167	
5	2	13	55.1	1909	-	3.557058	
6	2	13	72.2	1289	-	4.441457	
7	3	13	66.1	1122	1348	5.236529	
8	3	13	83.7	1967	1535	5.899951	
9	2	13	98.7	1574	-	6.254503	
10	3	13	62.1	1286	1767	6.860385	
11	3	13	66.7	1545	1812	7.989026	
12	2	13	91.1	1766	-	8.559078	
13	2	13	85.8	1495	-	8.97296	
14	1	13	80.5	-	-	9.854367	
15	3	13	84.5	1432	1217	10.286726	
16	1	13	81.5	-	-	10.97165	
17	3	13	95.3	1750	1401	11.819496	

Bin5 Statistics 3

Trial #	Pulse	Chirp (MHz)	Pulse Width (µS)	Pulse 1-2 spacing (uS)	Pulse 2-3 spacing (uS)	Pulse Start(S)	Detection (1:yes; 0:no)
0	2	8	70.7	1936	-	0.236551	1
1	3	8	57.7	1857	1654	1.492792	
2	1	8	77.1	-	-	2.07464	
3	2	8	66.6	1451	-	2.502843	
4	2	8	64.5	1007	-	3.682012	
5	3	8	56.5	1375	1790	4.585156	
6	3	8	83.5	1281	1668	5.084615	
7	2	8	79.5	1495	-	5.923327	
8	2	8	96.8	1740	-	7.027416	
9	3	8	80.6	1219	1922	7.30186	
10	1	8	55.9	-	-	8.114266	
11	2	8	51.4	1098	-	8.978478	
12	1	8	73.2	-	-	9.937422	
13	3	8	66.5	1958	1563	11.088392	
14	1	8	69.4	-	-	11.680973	

Bin5 Statistics 4

Trial #	Pulse	Chirp (MHz)	Pulse Width (µS)	Pulse 1-2 spacing (uS)	Pulse 2-3 spacing (uS)	Pulse Start(S)	Detection (1:yes; 0:no)
0	2	10	53.4	1619	-	0.355096	1
1	1	10	78.8	-	-	1.351954	
2	2	10	60.4	1605	-	1.564233	
3	3	10	73.8	1427	1000	2.531525	
4	2	10	53.8	1755	-	3.476646	
5	3	10	68.2	1355	1378	4.470178	
6	1	10	55.1	-	-	5.073095	
7	2	10	64.3	1361	-	5.33874	
8	2	10	51.8	1568	-	6.695676	
9	1	10	65.5	-	-	6.85799	
10	2	10	72.9	1390	-	7.707879	
11	1	10	71.7	-	-	8.690619	
12	3	10	83.4	1439	1951	9.691696	
13	2	10	60.7	1834	-	9.774341	
14	2	10	60.6	1597	-	10.644822	
15	1	10	90.8	-	-	11.620537	

Bin5 Statistics 5

Trial #	Pulse	Chirp (MHz)	Pulse Width (µS)	Pulse 1-2 spacing (µS)	Pulse 2-3 spacing (µS)	Pulse Start(S)	Detection (1:yes; 0:no)
0	2	14	81.3	1557	-	0.210231	1
1	2	14	59	1517	-	1.809817	
2	1	14	70.2	-	-	2.183883	
3	1	14	92.1	-	-	2.914609	
4	1	14	75.2	-	-	4.441382	
5	1	14	70.5	-	-	5.220107	
6	2	14	57.1	1999	-	5.886098	
7	3	14	88.8	1626	1772	6.50994	
8	2	14	71	1842	-	7.394751	
9	3	14	70.2	1860	1332	8.994186	
10	2	14	77.1	1839	-	9.753339	
11	3	14	91.8	1662	1910	11.024373	
12	2	14	65.2	1735	-	11.743806	

Bin5 Statistics 6

Trial #	Pulse	Chirp (MHz)	Pulse Width (µS)	Pulse 1-2 spacing (µS)	Pulse 2-3 spacing (µS)	Pulse Start(S)	Detection (1:yes; 0:no)
0	2	6	76.3	1060	-	0.519709	1
1	1	6	84.1	-	-	1.918127	
2	2	6	76.7	1039	-	2.081511	
3	2	6	75.1	1570	-	3.515335	
4	3	6	81.5	1733	1278	4.254952	
5	3	6	77.7	1057	1622	5.61625	
6	2	6	97.6	1449	-	6.65004	
7	1	6	64.5	-	-	7.345035	
8	2	6	72.4	1055	-	8.699986	
9	3	6	64.7	1557	1678	9.625551	
10	2	6	86.5	1924	-	10.570256	
11	2	6	73.8	1724	-	11.795555	

Bin5 Statistics 7

Trial #	Pulse	Chirp (MHz)	Pulse Width (µS)	Pulse 1-2 spacing (µS)	Pulse 2-3 spacing (µS)	Pulse Start(S)	Detection (1:yes; 0:no)
0	2	5	57.3	1136	-	0.030599	1
1	2	5	51.4	1895	-	1.056004	
2	2	5	53.7	1456	-	1.994409	
3	2	5	98.1	1016	-	2.791247	
4	3	5	85	1374	1732	3.776817	
5	2	5	59.6	1759	-	4.529641	
6	2	5	79.3	1563	-	5.203416	
7	3	5	57.6	1945	1063	6.332619	
8	2	5	53.6	1507	-	7.176456	
9	2	5	56.5	1585	-	7.842975	
10	2	5	76.4	1578	-	8.519274	
11	1	5	60.5	-	-	8.878232	
12	1	5	85.4	-	-	10.215242	
13	1	5	88.1	-	-	10.866413	
14	3	5	95.7	1257	1044	11.369447	

Bin5 Statistics 8

Trial #	Pulse	Chirp (MHz)	Pulse Width (µS)	Pulse 1-2 spacing (µS)	Pulse 2-3 spacing (µS)	Pulse Start(S)	Detection (1:yes; 0:no)
0	3	10	59	1865	1853	0.009924	1
1	2	10	97.5	1046	-	1.167912	
2	3	10	83.8	1403	1983	2.322253	
3	1	10	61.3	-	-	3.636016	
4	2	10	99.7	1092	-	4.08821	
5	2	10	64.4	1278	-	4.974787	
6	3	10	65.1	1215	1106	5.971409	
7	2	10	90.2	1956	-	6.865336	
8	3	10	61.3	1694	1545	7.589333	
9	1	10	64.8	-	-	8.546986	
10	2	10	72.7	1314	-	10.051842	
11	2	10	87.7	1838	-	10.192411	
12	2	10	59.6	1421	-	11.762238	

Bin5 Statistics 9

Trial #	Pulse	Chirp (MHz)	Pulse Width (µS)	Pulse 1-2 spacing (µS)	Pulse 2-3 spacing (µS)	Pulse Start(S)	Detection (1:yes; 0:no)
0	2	7	84.8	1144	-	1.027566	1
1	3	7	62.2	1396	1073	1.387873	
2	3	7	77.2	1144	1003	2.984969	
3	1	7	82	-	-	3.928649	
4	1	7	80.2	-	-	4.833504	
5	2	7	66.9	1743	-	5.804525	
6	3	7	83.8	1704	1483	7.531955	
7	2	7	67.9	1579	-	7.795086	
8	3	7	57.6	1775	1382	9.277022	
9	2	7	88.2	1930	-	10.36623	
10	3	7	80.1	1764	1959	11.001933	

Bin5 Statistics 10

Trial #	Pulse	Chirp (MHz)	Pulse Width (µS)	Pulse 1-2 spacing (µS)	Pulse 2-3 spacing (µS)	Pulse Start(S)	Detection (1:yes; 0:no)
0	2	9	98.9	1617	-	0.359692	1
1	2	9	54.4	1810	-	1.218862	
2	2	9	86.2	1495	-	1.702335	
3	3	9	97.3	1455	1652	2.391232	
4	3	9	85	1497	1414	3.120802	
5	2	9	84	1814	-	3.848472	
6	3	9	72.3	1119	1081	4.146496	
7	3	9	62.1	1330	1396	4.710547	
8	1	9	89.2	-	-	5.781155	
9	1	9	53.9	-	-	6.656412	
10	3	9	67.6	1538	1389	6.838059	
11	2	9	72.8	1085	-	7.923266	
12	2	9	95	1549	-	8.188916	
13	3	9	94.6	1323	1109	9.298267	
14	1	9	78.4	-	-	9.99263	
15	2	9	68.5	1600	-	10.598	
16	2	9	88.2	1073	-	10.934965	
17	2	9	94.4	1313	-	11.850757	

Bin5 Statistics 11

Trial #	Pulse	Chirp (MHz)	Pulse Width (µS)	Pulse 1-2 spacing (uS)	Pulse 2-3 spacing (uS)	Pulse Start(S)	Detection (1:yes; 0:no)
0	1	12	63	-	-	1.366932	1
1	2	12	94	1058	-	1.544259	
2	2	12	60.5	1356	-	4.348129	
3	2	12	67.3	1678	-	5.744747	
4	1	12	61.7	-	-	6.299971	
5	3	12	81.3	1347	1081	7.899432	
6	3	12	73.6	1445	1006	10.150244	
7	3	12	72.5	1253	1067	10.942139	

Bin5 Statistics 12

Trial #	Pulse	Chirp (MHz)	Pulse Width (µS)	Pulse 1-2 spacing (uS)	Pulse 2-3 spacing (uS)	Pulse Start(S)	Detection (1:yes; 0:no)
0	2	10	56	1339	-	0.571007	1
1	3	10	93.2	1196	1841	1.284193	
2	2	10	71.4	1106	-	2.436229	
3	3	10	78.3	1616	1473	2.627664	
4	1	10	73.3	-	-	3.537367	
5	3	10	69.2	1581	1419	5.12417	
6	3	10	74.3	1251	1172	5.933881	
7	1	10	84.2	-	-	6.251419	
8	2	10	99.1	1782	-	7.576781	
9	1	10	86.5	-	-	8.025816	
10	3	10	97.8	1194	1680	9.193569	
11	3	10	99.4	1014	1279	9.981504	
12	2	10	62.4	1834	-	10.835945	
13	1	10	95.8	-	-	11.376481	

Bin5 Statistics 13

Trial #	Pulse	Chirp (MHz)	Pulse Width (µS)	Pulse 1-2 spacing (µS)	Pulse 2-3 spacing (µS)	Pulse Start(S)	Detection (1:yes; 0:no)
0	1	14	85.2	-	-	0.333521	1
1	3	14	86.6	1413	1331	1.071491	
2	3	14	79.5	1741	1825	1.960132	
3	2	14	97.4	1365	-	2.20214	
4	1	14	71.5	-	-	3.329129	
5	3	14	83.5	1010	1241	3.628527	
6	1	14	90.4	-	-	4.584923	
7	1	14	53.5	-	-	5.060494	
8	1	14	76	-	-	5.990764	
9	3	14	59.1	1015	1292	6.449795	
10	2	14	85.1	1028	-	6.851459	
11	2	14	50.2	1405	-	7.53406	
12	1	14	72.5	-	-	8.178786	
13	1	14	89.8	-	-	9.271645	
14	2	14	98.3	1736	-	9.555294	
15	2	14	81.5	1350	-	10.157448	
16	1	14	92.4	-	-	10.986644	
17	2	14	85.3	1850	-	11.592386	

Bin5 Statistics 14

Trial #	Pulse	Chirp (MHz)	Pulse Width (µS)	Pulse 1-2 spacing (µS)	Pulse 2-3 spacing (µS)	Pulse Start(S)	Detection (1:yes; 0:no)
0	1	16	66.3	-	-	0.437634	1
1	1	16	96.8	-	-	1.437255	
2	1	16	60.6	-	-	2.732723	
3	2	16	78.3	1751	-	3.55912	
4	3	16	90.4	1626	1875	4.719282	
5	2	16	93.9	1893	-	5.951115	
6	2	16	71.8	1224	-	7.391746	
7	1	16	98.6	-	-	8.588985	
8	1	16	90.2	-	-	9.056567	
9	3	16	81.2	1643	1754	10.881704	
10	2	16	97.1	1667	-	11.848152	

Bin5 Statistics 15

Trial #	Pulse	Chirp (MHz)	Pulse Width (µS)	Pulse 1-2 spacing (µS)	Pulse 2-3 spacing (µS)	Pulse Start(S)	Detection (1:yes; 0:no)
0	3	11	66	1733	1259	0.374612	1
1	2	11	77.4	1242	-	1.16943	
2	1	11	55.8	-	-	1.657696	
3	2	11	74.6	1610	-	2.918497	
4	1	11	66.5	-	-	3.322425	
5	2	11	95.3	1727	-	4.488795	
6	2	11	65.4	1154	-	5.173388	
7	1	11	66.2	-	-	5.528388	
8	2	11	55.5	1400	-	6.646326	
9	3	11	74.9	1519	1199	7.245689	
10	3	11	99.3	1357	1222	8.000989	
11	1	11	96.8	-	-	8.744207	
12	3	11	90.8	1030	1495	9.334096	
13	3	11	98.6	1985	1043	10.003501	
14	2	11	63.2	1380	-	11.149545	
15	2	11	51.2	1666	-	11.468481	

Bin5 Statistics 16

Trial #	Pulse	Chirp (MHz)	Pulse Width (µS)	Pulse 1-2 spacing (µS)	Pulse 2-3 spacing (µS)	Pulse Start(S)	Detection (1:yes; 0:no)
0	2	9	88.9	1118	-	0.328354	1
1	3	9	90.8	1518	1655	0.76115	
2	2	9	71.2	1938	-	2.001846	
3	3	9	95.2	1679	1099	2.349923	
4	3	9	51.5	1365	1397	3.238725	
5	1	9	99.1	-	-	4.046582	
6	1	9	54.9	-	-	4.588964	
7	3	9	92.8	1656	1236	5.038155	
8	1	9	77.1	-	-	5.714991	
9	2	9	97.3	1216	-	6.62223	
10	2	9	50.1	1935	-	7.081493	
11	1	9	72.7	-	-	8.449911	
12	2	9	67.8	1176	-	8.717521	
13	2	9	62.7	1019	-	9.626293	
14	3	9	86.1	1666	1987	10.154659	
15	2	9	99.2	1847	-	10.618655	
16	2	9	66.4	1562	-	11.630559	

Bin5 Statistics 17

Trial #	Pulse	Chirp (MHz)	Pulse Width (µS)	Pulse 1-2 spacing (uS)	Pulse 2-3 spacing (uS)	Pulse Start(S)	Detection (1:yes; 0:no)
0	2	17	84.3	1511	-	0.083685	1
1	2	17	81.8	1037	-	1.729116	
2	2	17	52	1756	-	3.093883	
3	2	17	76.6	1109	-	4.793891	
4	2	17	57.2	1943	-	5.961666	
5	1	17	57.1	-	-	7.059115	
6	1	17	71.9	-	-	7.960696	
7	2	17	54	1725	-	9.477328	
8	2	17	63.3	1650	-	9.654491	
9	2	17	77.8	1526	-	11.348615	

Bin5 Statistics 18

Trial #	Pulse	Chirp (MHz)	Pulse Width (µS)	Pulse 1-2 spacing (uS)	Pulse 2-3 spacing (uS)	Pulse Start(S)	Detection (1:yes; 0:no)
0	3	12	58.6	1428	1611	0.027764	1
1	3	12	79.5	1546	1329	0.968044	
2	3	12	83.6	1640	1874	2.506722	
3	2	12	66.1	1791	-	3.138049	
4	1	12	89.3	-	-	3.759667	
5	2	12	69.5	1480	-	5.319947	
6	2	12	76.8	1174	-	5.92415	
7	2	12	73.3	1873	-	6.609738	
8	3	12	62.7	1153	1682	7.469057	
9	2	12	77.3	1034	-	8.616699	
10	1	12	69.7	-	-	9.819551	
11	1	12	77.1	-	-	10.440562	
12	2	12	66	1972	-	11.116203	

Bin5 Statistics 19

Trial #	Pulse	Chirp (MHz)	Pulse Width (µS)	Pulse 1-2 spacing (uS)	Pulse 2-3 spacing (uS)	Pulse Start(S)	Detection (1:yes; 0:no)
0	2	6	75.8	1485	-	0.968569	1
1	1	6	63	-	-	2.068645	
2	2	6	81	1095	-	3.654002	
3	2	6	73.9	1236	-	4.969454	
4	2	6	64.9	1164	-	5.635709	
5	2	6	92.9	1597	-	7.32896	
6	1	6	77.2	-	-	9.043528	
7	2	6	80.6	1539	-	9.67562	
8	1	6	95.7	-	-	10.754106	

Bin5 Statistics 20

Trial #	Pulse	Chirp (MHz)	Pulse Width (µS)	Pulse 1-2 spacing (uS)	Pulse 2-3 spacing (uS)	Pulse Start(S)	Detection (1:yes; 0:no)
0	2	16	88.3	1551	-	0.554757	1
1	3	16	61.7	1866	1304	0.704939	
2	3	16	94.6	1050	1606	1.74076	
3	2	16	63.5	1915	-	2.348492	
4	2	16	72.1	1449	-	2.916798	
5	1	16	70.4	-	-	3.565903	
6	3	16	56.7	1466	1222	4.190868	
7	2	16	84.1	1203	-	4.845051	
8	2	16	50.9	1772	-	5.888475	
9	2	16	74.8	1026	-	6.165609	
10	2	16	68.3	1498	-	6.745447	
11	1	16	57.2	-	-	7.448301	
12	1	16	90.6	-	-	8.386967	
13	1	16	54	-	-	9.251458	
14	2	16	70.7	1801	-	9.719681	
15	1	16	95.4	-	-	10.417542	
16	1	16	69.2	-	-	10.695109	
17	1	16	72.8	-	-	11.786907	

Bin5 Statistics 21

Trial #	Pulse	Chirp (MHz)	Pulse Width (µS)	Pulse 1-2 spacing (uS)	Pulse 2-3 spacing (uS)	Pulse Start(S)	Detection (1:yes; 0:no)
0	3	11	87.1	1425	1777	1.007762	1
1	1	11	90.2	-	-	1.678413	
2	1	11	88.7	-	-	2.795321	
3	2	11	93.8	1537	-	4.107912	
4	3	11	68.3	1913	1978	6.24272	
5	2	11	73.3	1233	-	7.255842	
6	1	11	62.8	-	-	8.965361	
7	2	11	67.9	1806	-	10.194629	
8	1	11	94.7	-	-	11.272059	

Bin5 Statistics 22

Trial #	Pulse	Chirp (MHz)	Pulse Width (µS)	Pulse 1-2 spacing (uS)	Pulse 2-3 spacing (uS)	Pulse Start(S)	Detection (1:yes; 0:no)
0	3	18	58.7	1201	1773	0.160069	1
1	2	18	88.7	1094	-	1.142008	
2	2	18	70.7	1170	-	1.431807	
3	3	18	99.9	1819	1829	2.087837	
4	2	18	75.1	1091	-	2.859947	
5	2	18	86.8	1563	-	3.351903	
6	1	18	69.1	-	-	3.847733	
7	1	18	69	-	-	4.336646	
8	1	18	63.2	-	-	4.946565	
9	3	18	82.3	1867	1287	5.581604	
10	2	18	97.2	1394	-	6.263533	
11	2	18	54.7	1220	-	6.91326	
12	2	18	97.4	1650	-	7.619073	
13	2	18	83.8	1547	-	8.379324	
14	2	18	54.2	1747	-	8.410195	
15	3	18	81.1	1922	1110	9.064319	
16	3	18	91.4	1406	1104	9.60482	
17	3	18	70.2	1715	1097	10.407879	
18	2	18	72.6	1310	-	11.337343	
19	2	18	78.1	1355	-	11.461964	

Bin5 Statistics 23

Trial #	Pulse	Chirp (MHz)	Pulse Width (µS)	Pulse 1-2 spacing (uS)	Pulse 2-3 spacing (uS)	Pulse Start(S)	Detection (1:yes; 0:no)
0	2	14	97.9	1581	-	0.000437	1
1	1	14	99.4	-	-	0.972348	
2	3	14	72.6	1763	1398	2.032094	
3	2	14	94.9	1812	-	2.293491	
4	3	14	99.5	1107	1025	3.01636	
5	2	14	82	1283	-	3.678004	
6	2	14	74.5	1008	-	4.839733	
7	2	14	89.5	1773	-	5.034123	
8	2	14	71.8	1532	-	5.662283	
9	1	14	88.2	-	-	6.669609	
10	2	14	98.6	1210	-	7.681858	
11	3	14	86.1	1430	1089	7.891969	
12	2	14	68.6	1206	-	8.702209	
13	1	14	99.8	-	-	9.771162	
14	2	14	76.5	1425	-	10.210867	
15	2	14	80.2	1421	-	10.802089	
16	2	14	85.8	1636	-	11.733828	

Bin5 Statistics 24

Trial #	Pulse	Chirp (MHz)	Pulse Width (µS)	Pulse 1-2 spacing (uS)	Pulse 2-3 spacing (uS)	Pulse Start(S)	Detection (1:yes; 0:no)
0	1	8	55.5	-	-	1.318499	1
1	2	8	54.2	1625	-	1.622781	
2	3	8	70.7	1773	1723	4.302295	
3	2	8	88.2	1473	-	4.868305	
4	1	8	96.2	-	-	6.40386	
5	1	8	54.4	-	-	8.255398	
6	2	8	50.4	1740	-	9.51443	
7	2	8	90.8	1552	-	10.752573	

Bin5 Statistics 25

Trial #	Pulse	Chirp (MHz)	Pulse Width (µS)	Pulse 1-2 spacing (uS)	Pulse 2-3 spacing (uS)	Pulse Start(S)	Detection (1:yes; 0:no)
0	2	10	80.1	1751	-	0.142201	0
1	2	10	96	1001	-	2.417114	
2	3	10	60.3	1278	1094	3.405813	
3	3	10	97.3	1078	1030	4.665839	
4	2	10	68.9	1092	-	6.288562	
5	2	10	85	1007	-	8.349772	
6	3	10	93.3	1504	1474	9.511346	
7	2	10	79.7	1350	-	11.187901	

Bin5 Statistics 26

Trial #	Pulse	Chirp (MHz)	Pulse Width (µS)	Pulse 1-2 spacing (uS)	Pulse 2-3 spacing (uS)	Pulse Start(S)	Detection (1:yes; 0:no)
0	3	14	52.6	1827	1551	1.057254	1
1	1	14	71.3	-	-	1.458318	
2	2	14	69.9	1450	-	2.713075	
3	2	14	88.4	1695	-	4.538857	
4	3	14	51.2	1351	1530	5.487201	
5	2	14	60.4	1394	-	6.673744	
6	3	14	62	1983	1411	7.885134	
7	3	14	79	1686	1381	8.8734	
8	2	14	88.5	1550	-	10.683025	
9	2	14	77.7	1196	-	11.089462	

Bin5 Statistics 27

Trial #	Pulse	Chirp (MHz)	Pulse Width (µS)	Pulse 1-2 spacing (uS)	Pulse 2-3 spacing (uS)	Pulse Start(S)	Detection (1:yes; 0:no)
0	1	7	63.9	-	-	0.831471	1
1	1	7	51.7	-	-	1.648523	
2	1	7	79.4	-	-	1.853179	
3	2	7	58.3	1873	-	3.455866	
4	3	7	94.9	1002	1817	4.188977	
5	2	7	78.7	1020	-	4.749136	
6	2	7	69.2	1831	-	6.40337	
7	1	7	68.8	-	-	7.372563	
8	3	7	82.4	1041	1119	8.145837	
9	3	7	62.7	1932	1668	9.118745	
10	1	7	75.7	-	-	9.874352	
11	2	7	80.6	1174	-	10.411557	
12	2	7	51.4	1583	-	11.910885	

Bin5 Statistics 28

Trial #	Pulse	Chirp (MHz)	Pulse Width (µS)	Pulse 1-2 spacing (uS)	Pulse 2-3 spacing (uS)	Pulse Start(S)	Detection (1:yes; 0:no)
0	2	7	87.5	1618	-	0.922349	1
1	2	7	61.5	1712	-	1.584622	
2	2	7	71.3	1448	-	3.079243	
3	2	7	94.5	1749	-	3.830705	
4	3	7	59.2	1171	1139	4.392793	
5	2	7	81.4	1059	-	5.902306	
6	3	7	86.1	1158	1742	7.374112	
7	1	7	75.4	-	-	8.01452	
8	3	7	93	1620	1705	9.365698	
9	1	7	59	-	-	10.228838	
10	2	7	70.5	1178	-	11.845204	

Bin5 Statistics 29

Trial #	Pulse	Chirp (MHz)	Pulse Width (uS)	Pulse 1-2 spacing (uS)	Pulse 2-3 spacing (uS)	Pulse Start(S)	Detection (1:yes; 0:no)
0	3	6	90.7	1991	1722	0.36441	1
1	2	6	97.9	1014	-	0.730022	
2	3	6	93.4	1158	1037	1.447397	
3	2	6	51.9	1828	-	1.981218	
4	3	6	56.5	1707	1183	2.862327	
5	2	6	56.9	1553	-	3.443601	
6	1	6	91.7	-	-	3.925547	
7	1	6	62.7	-	-	4.213222	
8	2	6	81	1945	-	4.942955	
9	2	6	61.9	1320	-	5.893404	
10	1	6	60.7	-	-	6.392749	
11	1	6	67.7	-	-	6.617808	
12	3	6	89	1056	1565	7.55127	
13	1	6	59.2	-	-	8.026257	
14	2	6	73.8	1398	-	8.594486	
15	3	6	57.4	1916	1723	9.082254	
16	1	6	52.7	-	-	10.055294	
17	2	6	76	1618	-	10.596426	
18	3	6	71.5	1455	1758	11.364483	
19	3	6	86.9	1166	1804	11.438768	

Bin5 Statistics 30

Trial #	Pulse	Chirp (MHz)	Pulse Width (uS)	Pulse 1-2 spacing (uS)	Pulse 2-3 spacing (uS)	Pulse Start(S)	Detection (1:yes; 0:no)
0	2	19	62.6	1372	-	0.974223	1
1	2	19	59.5	1874	-	2.532096	
2	1	19	96.1	-	-	3.33315	
3	2	19	89.2	1725	-	4.824567	
4	3	19	53.4	1433	1008	6.423042	
5	2	19	54.3	1404	-	7.363015	
6	2	19	87.3	1278	-	9.255574	
7	1	19	78	-	-	9.45182	
8	1	19	86.8	-	-	11.621077	

Table-6 Radar Type 6 Statistical Performance

Trial #	Fc (MHz)	Pulse /Burst	Pulse Width (μS)	PRI (μs)	Detection (1:yes; 0:no)	Hopping Sequence
1	5500	9	1	333	1	5488.0, 5574.0, 5483.0, 5407.0, 5631.0, 5424.0, 5348.0, 5585.0, 5288.0, 5356.0, 5333.0, 5714.0, 5612.0, 5263.0, 5650.0, 5365.0, 5505.0, 5531.0, 5572.0, 5289.0, 5412.0, 5283.0, 5512.0, 5444.0, 5518.0, 5294.0, 5435.0, 5408.0, 5494.0, 5367.0, 5695.0, 5271.0, 5548.0, 5620.0, 5461.0, 5545.0, 5323.0, 5690.0, 5433.0, 5710.0, 5391.0, 5588.0, 5625.0, 5665.0, 5630.0, 5502.0, 5320.0, 5432.0, 5655.0, 5415.0, 5465.0, 5431.0, 5366.0, 5421.0, 5330.0, 5658.0, 5425.0, 5654.0, 5253.0, 5274.0, 5651.0, 5689.0, 5368.0, 5438.0, 5360.0, 5383.0, 5272.0, 5698.0, 5262.0, 5618.0, 5606.0, 5536.0, 5463.0, 5440.0, 5558.0, 5376.0, 5439.0, 5723.0, 5481.0, 5357.0, 5587.0, 5582.0, 5456.0, 5694.0, 5664.0, 5299.0, 5688.0, 5306.0, 5316.0, 5447.0, 5358.0, 5413.0, 5387.0, 5273.0, 5674.0, 5442.0, 5716.0, 5527.0, 5339.0, 5623.0 (number of hits: 3)
2	5500	9	1	333	1	5276.0, 5617.0, 5339.0, 5714.0, 5574.0, 5649.0, 5320.0, 5484.0, 5702.0, 5535.0, 5562.0, 5268.0, 5597.0, 5523.0, 5450.0, 5724.0, 5473.0, 5511.0, 5348.0, 5395.0, 5407.0, 5444.0, 5273.0, 5303.0, 5463.0, 5662.0, 5650.0, 5474.0, 5464.0, 5622.0, 5693.0, 5396.0, 5552.0, 5351.0, 5305.0, 5252.0, 5655.0, 5327.0, 5547.0, 5431.0, 5661.0, 5539.0, 5459.0, 5711.0, 5271.0, 5490.0, 5374.0, 5482.0, 5496.0, 5377.0, 5406.0, 5634.0, 5386.0, 5412.0, 5272.0, 5681.0, 5380.0, 5667.0, 5532.0, 5318.0, 5572.0, 5614.0, 5296.0, 5461.0, 5388.0, 5640.0, 5627.0, 5302.0, 5338.0, 5401.0, 5703.0, 5698.0, 5615.0, 5537.0, 5585.0, 5312.0, 5544.0, 5561.0, 5632.0, 5612.0, 5642.0, 5671.0, 5373.0, 5493.0, 5325.0, 5425.0, 5556.0, 5314.0, 5637.0, 5559.0, 5435.0, 5460.0, 5259.0, 5336.0, 5571.0, 5720.0, 5448.0, 5256.0, 5687.0, 5332.0 (number of hits: 2)
3	5500	9	1	333	1	5569.0, 5452.0, 5402.0, 5411.0, 5437.0, 5380.0, 5394.0, 5661.0, 5677.0, 5414.0, 5691.0, 5644.0, 5480.0, 5269.0, 5622.0, 5379.0, 5444.0, 5702.0, 5580.0, 5529.0, 5508.0, 5562.0, 5659.0, 5523.0, 5333.0, 5673.0, 5461.0, 5718.0, 5372.0, 5395.0, 5334.0, 5724.0, 5703.0, 5540.0, 5421.0, 5597.0, 5409.0, 5637.0, 5599.0, 5456.0, 5410.0, 5610.0, 5668.0, 5587.0, 5628.0, 5476.0, 5422.0, 5350.0, 5483.0, 5361.0, 5649.0, 5459.0, 5404.0, 5325.0, 5371.0, 5634.0, 5484.0, 5708.0, 5366.0, 5567.0,

						5463.0, 5516.0, 5692.0, 5436.0, 5715.0, 5687.0, 5306.0, 5428.0, 5595.0, 5530.0, 5642.0, 5631.0, 5335.0, 5399.0, 5502.0, 5613.0, 5351.0, 5635.0, 5317.0, 5423.0, 5416.0, 5602.0, 5364.0, 5474.0, 5532.0, 5473.0, 5723.0, 5342.0, 5711.0, 5477.0, 5627.0, 5368.0, 5626.0, 5331.0, 5253.0, 5679.0, 5719.0, 5497.0, 5363.0, 5419.0 (number of hits: 3)
4	5500	9	1	333	1	5292.0, 5581.0, 5506.0, 5468.0, 5570.0, 5447.0, 5678.0, 5282.0, 5675.0, 5403.0, 5565.0, 5448.0, 5611.0, 5404.0, 5487.0, 5638.0, 5334.0, 5555.0, 5319.0, 5455.0, 5659.0, 5433.0, 5596.0, 5469.0, 5423.0, 5529.0, 5381.0, 5276.0, 5556.0, 5328.0, 5517.0, 5670.0, 5384.0, 5601.0, 5648.0, 5297.0, 5360.0, 5353.0, 5608.0, 5256.0, 5357.0, 5662.0, 5363.0, 5426.0, 5711.0, 5303.0, 5677.0, 5537.0, 5705.0, 5661.0, 5518.0, 5617.0, 5425.0, 5291.0, 5491.0, 5590.0, 5320.0, 5640.0, 5522.0, 5509.0, 5325.0, 5515.0, 5311.0, 5321.0, 5692.0, 5524.0, 5386.0, 5714.0, 5528.0, 5618.0, 5258.0, 5475.0, 5466.0, 5713.0, 5685.0, 5377.0, 5445.0, 5378.0, 5642.0, 5495.0, 5385.0, 5571.0, 5457.0, 5533.0, 5699.0, 5577.0, 5508.0, 5688.0, 5569.0, 5391.0, 5375.0, 5641.0, 5315.0, 5673.0, 5626.0, 5358.0, 5317.0, 5559.0, 5422.0, 5526.0 (number of hits: 4)
5	5500	9	1	333	1	5489.0, 5450.0, 5472.0, 5471.0, 5500.0, 5608.0, 5620.0, 5269.0, 5369.0, 5477.0, 5660.0, 5664.0, 5372.0, 5417.0, 5560.0, 5520.0, 5712.0, 5618.0, 5406.0, 5647.0, 5668.0, 5332.0, 5573.0, 5535.0, 5386.0, 5273.0, 5498.0, 5667.0, 5561.0, 5475.0, 5274.0, 5611.0, 5612.0, 5356.0, 5399.0, 5279.0, 5270.0, 5657.0, 5721.0, 5331.0, 5488.0, 5414.0, 5469.0, 5373.0, 5501.0, 5428.0, 5254.0, 5637.0, 5330.0, 5571.0, 5281.0, 5380.0, 5346.0, 5384.0, 5325.0, 5271.0, 5411.0, 5533.0, 5511.0, 5652.0, 5602.0, 5625.0, 5594.0, 5513.0, 5585.0, 5264.0, 5629.0, 5390.0, 5658.0, 5718.0, 5392.0, 5586.0, 5462.0, 5443.0, 5387.0, 5720.0, 5272.0, 5485.0, 5408.0, 5723.0, 5334.0, 5546.0, 5348.0, 5318.0, 5703.0, 5280.0, 5507.0, 5283.0, 5622.0, 5528.0, 5494.0, 5377.0, 5687.0, 5583.0, 5635.0, 5492.0, 5382.0, 5427.0, 5295.0, 5568.0 (number of hits: 6)
6	5500	9	1	333	1	5560.0, 5336.0, 5538.0, 5359.0, 5451.0, 5624.0, 5280.0, 5579.0, 5431.0, 5428.0, 5472.0, 5676.0, 5695.0, 5577.0, 5657.0, 5541.0, 5692.0, 5353.0, 5312.0, 5505.0, 5460.0, 5570.0, 5390.0, 5723.0, 5347.0, 5354.0, 5551.0, 5331.0, 5669.0, 5643.0, 5609.0, 5544.0, 5614.0, 5633.0, 5698.0, 5508.0, 5680.0, 5647.0, 5700.0, 5262.0, 5476.0, 5368.0, 5371.0, 5282.0, 5301.0

						5563.0, 5671.0, 5575.0, 5492.0, 5533.0, 5572.0, 5344.0, 5689.0, 5682.0, 5254.0, 5384.0, 5448.0, 5588.0, 5590.0, 5382.0, 5395.0, 5351.0, 5397.0, 5364.0, 5620.0, 5521.0, 5437.0, 5361.0, 5263.0, 5683.0, 5717.0, 5450.0, 5642.0, 5718.0, 5293.0, 5547.0, 5545.0, 5491.0, 5290.0, 5548.0, 5713.0, 5536.0, 5504.0, 5387.0, 5412.0, 5419.0, 5512.0, 5576.0, 5325.0, 5569.0, 5585.0, 5518.0, 5327.0, 5485.0, 5566.0, 5338.0, 5537.0, 5564.0, 5595.0, 5333.0 (number of hits: 5)
7	5500	9	1	333	1	5672.0, 5333.0, 5496.0, 5339.0, 5341.0, 5323.0, 5265.0, 5497.0, 5270.0, 5668.0, 5525.0, 5545.0, 5429.0, 5311.0, 5380.0, 5403.0, 5466.0, 5387.0, 5715.0, 5634.0, 5512.0, 5349.0, 5434.0, 5345.0, 5514.0, 5540.0, 5389.0, 5664.0, 5423.0, 5680.0, 5495.0, 5621.0, 5508.0, 5404.0, 5596.0, 5374.0, 5335.0, 5679.0, 5614.0, 5253.0, 5391.0, 5607.0, 5635.0, 5256.0, 5722.0, 5295.0, 5260.0, 5692.0, 5599.0, 5532.0, 5563.0, 5552.0, 5509.0, 5261.0, 5681.0, 5632.0, 5329.0, 5516.0, 5396.0, 5498.0, 5628.0, 5529.0, 5353.0, 5561.0, 5351.0, 5714.0, 5581.0, 5716.0, 5301.0, 5384.0, 5539.0, 5548.0, 5285.0, 5257.0, 5602.0, 5677.0, 5556.0, 5564.0, 5468.0, 5582.0, 5317.0, 5595.0, 5623.0, 5483.0, 5459.0, 5359.0, 5616.0, 5420.0, 5584.0, 5555.0, 5437.0, 5294.0, 5588.0, 5511.0, 5258.0, 5401.0, 5455.0, 5491.0, 5456.0, 5289.0 (number of hits: 6)
8	5500	9	1	333	1	5531.0, 5286.0, 5574.0, 5442.0, 5600.0, 5607.0, 5322.0, 5434.0, 5596.0, 5575.0, 5277.0, 5470.0, 5718.0, 5618.0, 5705.0, 5627.0, 5644.0, 5253.0, 5613.0, 5532.0, 5392.0, 5553.0, 5609.0, 5580.0, 5304.0, 5370.0, 5658.0, 5583.0, 5460.0, 5689.0, 5358.0, 5637.0, 5515.0, 5452.0, 5429.0, 5556.0, 5508.0, 5564.0, 5566.0, 5379.0, 5501.0, 5252.0, 5653.0, 5662.0, 5468.0, 5720.0, 5388.0, 5584.0, 5283.0, 5308.0, 5292.0, 5516.0, 5700.0, 5315.0, 5454.0, 5426.0, 5421.0, 5289.0, 5284.0, 5261.0, 5642.0, 5352.0, 5483.0, 5628.0, 5571.0, 5519.0, 5414.0, 5599.0, 5617.0, 5440.0, 5536.0, 5544.0, 5510.0, 5448.0, 5612.0, 5535.0, 5294.0, 5646.0, 5267.0, 5677.0, 5463.0, 5529.0, 5400.0, 5605.0, 5626.0, 5624.0, 5266.0, 5623.0, 5337.0, 5660.0, 5353.0, 5682.0, 5345.0, 5321.0, 5383.0, 5696.0, 5520.0, 5355.0, 5692.0, 5582.0 (number of hits: 2)
9	5500	9	1	333	1	5302.0, 5433.0, 5270.0, 5523.0, 5257.0, 5655.0, 5647.0, 5304.0, 5266.0, 5366.0, 5335.0, 5600.0, 5698.0, 5456.0, 5679.0, 5587.0, 5616.0, 5515.0, 5319.0, 5594.0, 5264.0, 5445.0, 5685.0, 5328.0, 5464.0, 5660.0, 5537.0, 5446.0, 5413.0, 5308.0,

						5290.0, 5468.0, 5630.0, 5305.0, 5415.0, 5566.0, 5717.0, 5385.0, 5596.0, 5636.0, 5605.0, 5389.0, 5291.0, 5359.0, 5407.0, 5683.0, 5475.0, 5336.0, 5639.0, 5320.0, 5588.0, 5375.0, 5689.0, 5321.0, 5580.0, 5499.0, 5361.0, 5352.0, 5341.0, 5665.0, 5288.0, 5693.0, 5640.0, 5455.0, 5548.0, 5253.0, 5459.0, 5388.0, 5549.0, 5391.0, 5661.0, 5490.0, 5373.0, 5516.0, 5706.0, 5414.0, 5643.0, 5554.0, 5480.0, 5517.0, 5591.0, 5672.0, 5482.0, 5438.0, 5686.0, 5536.0, 5497.0, 5369.0, 5622.0, 5273.0, 5642.0, 5326.0, 5447.0, 5441.0, 5365.0, 5356.0, 5451.0, 5610.0, 5539.0, 5250.0 (number of hits: 2)
10	5500	9	1	333	1	5507.0, 5515.0, 5348.0, 5301.0, 5535.0, 5270.0, 5658.0, 5670.0, 5332.0, 5318.0, 5337.0, 5398.0, 5383.0, 5424.0, 5350.0, 5609.0, 5514.0, 5402.0, 5659.0, 5448.0, 5262.0, 5314.0, 5397.0, 5648.0, 5620.0, 5396.0, 5662.0, 5303.0, 5281.0, 5661.0, 5684.0, 5683.0, 5434.0, 5353.0, 5640.0, 5626.0, 5334.0, 5423.0, 5446.0, 5282.0, 5508.0, 5351.0, 5608.0, 5323.0, 5549.0, 5618.0, 5567.0, 5581.0, 5723.0, 5701.0, 5295.0, 5482.0, 5379.0, 5531.0, 5722.0, 5604.0, 5592.0, 5542.0, 5638.0, 5717.0, 5354.0, 5466.0, 5420.0, 5360.0, 5404.0, 5711.0, 5499.0, 5490.0, 5562.0, 5470.0, 5254.0, 5615.0, 5256.0, 5593.0, 5315.0, 5310.0, 5451.0, 5586.0, 5687.0, 5496.0, 5359.0, 5554.0, 5553.0, 5635.0, 5673.0, 5321.0, 5264.0, 5299.0, 5411.0, 5614.0, 5476.0, 5472.0, 5634.0, 5344.0, 5709.0, 5341.0, 5637.0, 5421.0, 5491.0, 5284.0 (number of hits: 5)
11	5500	9	1	333	1	5498.0, 5668.0, 5670.0, 5630.0, 5713.0, 5586.0, 5293.0, 5280.0, 5722.0, 5318.0, 5465.0, 5689.0, 5637.0, 5592.0, 5413.0, 5466.0, 5365.0, 5629.0, 5411.0, 5698.0, 5353.0, 5343.0, 5337.0, 5718.0, 5432.0, 5352.0, 5605.0, 5542.0, 5358.0, 5401.0, 5568.0, 5440.0, 5422.0, 5667.0, 5502.0, 5309.0, 5268.0, 5507.0, 5397.0, 5598.0, 5476.0, 5311.0, 5303.0, 5685.0, 5415.0, 5251.0, 5663.0, 5447.0, 5574.0, 5487.0, 5403.0, 5572.0, 5348.0, 5314.0, 5354.0, 5578.0, 5368.0, 5634.0, 5330.0, 5724.0, 5319.0, 5258.0, 5281.0, 5299.0, 5278.0, 5399.0, 5501.0, 5534.0, 5593.0, 5359.0, 5408.0, 5486.0, 5389.0, 5577.0, 5708.0, 5551.0, 5652.0, 5406.0, 5603.0, 5485.0, 5679.0, 5504.0, 5392.0, 5674.0, 5644.0, 5448.0, 5341.0, 5350.0, 5584.0, 5257.0, 5530.0, 5571.0, 5716.0, 5612.0, 5535.0, 5588.0, 5398.0, 5344.0, 5526.0, 5523.0 (number of hits: 5)
12	5500	9	1	333	1	5308.0, 5395.0, 5426.0, 5583.0, 5706.0, 5393.0, 5527.0, 5328.0, 5610.0, 5423.0, 5294.0, 5511.0, 5420.0, 5276.0, 5338.0,

						5673.0, 5516.0, 5493.0, 5489.0, 5352.0, 5281.0, 5391.0, 5413.0, 5459.0, 5402.0, 5522.0, 5675.0, 5405.0, 5586.0, 5422.0, 5720.0, 5444.0, 5628.0, 5607.0, 5304.0, 5647.0, 5645.0, 5574.0, 5400.0, 5517.0, 5596.0, 5358.0, 5359.0, 5404.0, 5442.0, 5633.0, 5713.0, 5366.0, 5336.0, 5280.0, 5377.0, 5451.0, 5411.0, 5614.0, 5457.0, 5536.0, 5449.0, 5510.0, 5394.0, 5494.0, 5415.0, 5292.0, 5556.0, 5718.0, 5300.0, 5540.0, 5272.0, 5642.0, 5487.0, 5627.0, 5469.0, 5373.0, 5701.0, 5502.0, 5322.0, 5501.0, 5306.0, 5343.0, 5514.0, 5710.0, 5424.0, 5291.0, 5565.0, 5590.0, 5491.0, 5663.0, 5520.0, 5374.0, 5360.0, 5703.0, 5433.0, 5313.0, 5564.0, 5481.0, 5430.0, 5378.0, 5676.0, 5700.0, 5455.0, 5316.0 (number of hits: 5)
13	5500	9	1	333	1	5388.0, 5425.0, 5405.0, 5588.0, 5646.0, 5460.0, 5573.0, 5409.0, 5367.0, 5458.0, 5636.0, 5691.0, 5555.0, 5559.0, 5427.0, 5641.0, 5696.0, 5343.0, 5595.0, 5461.0, 5355.0, 5286.0, 5548.0, 5671.0, 5366.0, 5518.0, 5497.0, 5561.0, 5323.0, 5634.0, 5642.0, 5302.0, 5705.0, 5465.0, 5590.0, 5657.0, 5704.0, 5429.0, 5293.0, 5263.0, 5267.0, 5484.0, 5256.0, 5630.0, 5432.0, 5635.0, 5493.0, 5512.0, 5633.0, 5309.0, 5452.0, 5585.0, 5505.0, 5583.0, 5259.0, 5669.0, 5510.0, 5471.0, 5594.0, 5380.0, 5298.0, 5605.0, 5275.0, 5660.0, 5628.0, 5587.0, 5539.0, 5394.0, 5532.0, 5443.0, 5483.0, 5342.0, 5581.0, 5359.0, 5582.0, 5400.0, 5442.0, 5550.0, 5540.0, 5593.0, 5715.0, 5467.0, 5665.0, 5499.0, 5353.0, 5480.0, 5503.0, 5337.0, 5433.0, 5365.0, 5474.0, 5327.0, 5623.0, 5482.0, 5295.0, 5701.0, 5352.0, 5376.0, 5424.0, 5536.0 (number of hits: 5)
14	5500	9	1	333	1	5454.0, 5683.0, 5495.0, 5339.0, 5649.0, 5593.0, 5554.0, 5491.0, 5338.0, 5492.0, 5333.0, 5307.0, 5371.0, 5374.0, 5384.0, 5653.0, 5650.0, 5302.0, 5415.0, 5280.0, 5426.0, 5296.0, 5486.0, 5634.0, 5642.0, 5283.0, 5471.0, 5356.0, 5400.0, 5500.0, 5292.0, 5319.0, 5694.0, 5366.0, 5707.0, 5630.0, 5550.0, 5334.0, 5324.0, 5712.0, 5368.0, 5519.0, 5385.0, 5684.0, 5641.0, 5294.0, 5287.0, 5289.0, 5685.0, 5659.0, 5464.0, 5579.0, 5363.0, 5689.0, 5668.0, 5403.0, 5638.0, 5251.0, 5699.0, 5704.0, 5483.0, 5341.0, 5548.0, 5379.0, 5565.0, 5625.0, 5443.0, 5639.0, 5693.0, 5669.0, 5362.0, 5461.0, 5376.0, 5297.0, 5387.0, 5586.0, 5306.0, 5343.0, 5275.0, 5717.0, 5266.0, 5414.0, 5427.0, 5442.0, 5620.0, 5701.0, 5459.0, 5273.0, 5382.0, 5603.0, 5360.0, 5658.0, 5696.0, 5375.0, 5441.0, 5279.0, 5438.0, 5404.0, 5542.0, 5661.0 (number of hits: 4)

15	5500	9	1	333	1	<p>5307.0, 5695.0, 5430.0, 5256.0, 5509.0, 5363.0, 5724.0, 5517.0, 5713.0, 5354.0, 5481.0, 5302.0, 5390.0, 5527.0, 5626.0, 5427.0, 5443.0, 5662.0, 5316.0, 5366.0, 5670.0, 5462.0, 5622.0, 5267.0, 5346.0, 5418.0, 5550.0, 5597.0, 5581.0, 5442.0, 5589.0, 5333.0, 5380.0, 5635.0, 5604.0, 5464.0, 5329.0, 5310.0, 5468.0, 5674.0, 5560.0, 5349.0, 5330.0, 5258.0, 5406.0, 5593.0, 5345.0, 5592.0, 5603.0, 5679.0, 5360.0, 5643.0, 5368.0, 5262.0, 5530.0, 5490.0, 5653.0, 5705.0, 5434.0, 5362.0, 5401.0, 5339.0, 5642.0, 5716.0, 5381.0, 5486.0, 5254.0, 5369.0, 5720.0, 5564.0, 5513.0, 5285.0, 5384.0, 5292.0, 5659.0, 5673.0, 5279.0, 5356.0, 5497.0, 5529.0, 5268.0, 5554.0, 5721.0, 5480.0, 5640.0, 5484.0, 5311.0, 5508.0, 5631.0, 5686.0, 5657.0, 5718.0, 5496.0, 5317.0, 5667.0, 5557.0, 5266.0, 5574.0, 5327.0, 5441.0 (number of hits: 3)</p>
16	5500	9	1	333	1	<p>5584.0, 5257.0, 5359.0, 5374.0, 5274.0, 5658.0, 5377.0, 5343.0, 5493.0, 5717.0, 5543.0, 5662.0, 5569.0, 5574.0, 5369.0, 5393.0, 5621.0, 5351.0, 5567.0, 5255.0, 5609.0, 5536.0, 5451.0, 5409.0, 5496.0, 5456.0, 5329.0, 5261.0, 5266.0, 5396.0, 5649.0, 5580.0, 5387.0, 5575.0, 5601.0, 5707.0, 5597.0, 5305.0, 5271.0, 5509.0, 5364.0, 5591.0, 5265.0, 5588.0, 5716.0, 5464.0, 5334.0, 5397.0, 5694.0, 5375.0, 5561.0, 5466.0, 5573.0, 5422.0, 5546.0, 5637.0, 5442.0, 5307.0, 5556.0, 5616.0, 5611.0, 5366.0, 5517.0, 5544.0, 5319.0, 5358.0, 5335.0, 5457.0, 5444.0, 5286.0, 5333.0, 5259.0, 5432.0, 5705.0, 5316.0, 5672.0, 5391.0, 5627.0, 5655.0, 5398.0, 5558.0, 5592.0, 5336.0, 5622.0, 5453.0, 5415.0, 5712.0, 5594.0, 5418.0, 5264.0, 5428.0, 5548.0, 5598.0, 5360.0, 5613.0, 5260.0, 5632.0, 5320.0, 5520.0, 5547.0 (number of hits: 2)</p>
17	5500	9	1	333	1	<p>5601.0, 5398.0, 5280.0, 5460.0, 5632.0, 5698.0, 5305.0, 5689.0, 5575.0, 5363.0, 5579.0, 5302.0, 5700.0, 5492.0, 5349.0, 5313.0, 5424.0, 5419.0, 5594.0, 5432.0, 5488.0, 5354.0, 5369.0, 5534.0, 5355.0, 5443.0, 5282.0, 5338.0, 5278.0, 5548.0, 5499.0, 5415.0, 5599.0, 5275.0, 5469.0, 5303.0, 5376.0, 5423.0, 5617.0, 5582.0, 5691.0, 5614.0, 5409.0, 5353.0, 5266.0, 5314.0, 5308.0, 5380.0, 5665.0, 5532.0, 5414.0, 5331.0, 5610.0, 5587.0, 5394.0, 5270.0, 5640.0, 5494.0, 5663.0, 5403.0, 5334.0, 5393.0, 5252.0, 5719.0, 5619.0, 5411.0, 5264.0, 5337.0, 5688.0, 5307.0, 5716.0, 5318.0, 5565.0, 5652.0, 5677.0, 5491.0, 5420.0, 5309.0, 5512.0, 5709.0, 5495.0, 5283.0, 5281.0, 5390.0, 5666.0, 5583.0, 5392.0, 5259.0, 5528.0, 5602.0, 5642.0, 5480.0, 5408.0, 5430.0, 5550.0,</p>

						5717.0, 5603.0, 5538.0, 5574.0, 5655.0 (number of hits: 5)
18	5500	9	1	333	1	5252.0, 5442.0, 5485.0, 5372.0, 5255.0, 5651.0, 5382.0, 5549.0, 5636.0, 5555.0, 5292.0, 5710.0, 5368.0, 5275.0, 5358.0, 5561.0, 5337.0, 5470.0, 5314.0, 5684.0, 5436.0, 5662.0, 5505.0, 5477.0, 5266.0, 5628.0, 5700.0, 5465.0, 5620.0, 5657.0, 5623.0, 5674.0, 5648.0, 5671.0, 5713.0, 5690.0, 5718.0, 5488.0, 5254.0, 5440.0, 5611.0, 5310.0, 5426.0, 5566.0, 5377.0, 5675.0, 5273.0, 5464.0, 5531.0, 5586.0, 5342.0, 5659.0, 5445.0, 5394.0, 5481.0, 5568.0, 5571.0, 5332.0, 5535.0, 5343.0, 5522.0, 5706.0, 5402.0, 5709.0, 5398.0, 5658.0, 5375.0, 5686.0, 5469.0, 5282.0, 5370.0, 5379.0, 5422.0, 5276.0, 5678.0, 5600.0, 5619.0, 5391.0, 5610.0, 5558.0, 5633.0, 5592.0, 5640.0, 5652.0, 5309.0, 5605.0, 5483.0, 5425.0, 5635.0, 5420.0, 5723.0, 5622.0, 5487.0, 5366.0, 5260.0, 5365.0, 5446.0, 5341.0, 5404.0, 5387.0 (number of hits: 1)
19	5500	9	1	333	1	5451.0, 5680.0, 5682.0, 5724.0, 5627.0, 5443.0, 5620.0, 5250.0, 5372.0, 5581.0, 5310.0, 5350.0, 5286.0, 5550.0, 5360.0, 5593.0, 5339.0, 5674.0, 5507.0, 5695.0, 5678.0, 5482.0, 5325.0, 5378.0, 5701.0, 5546.0, 5484.0, 5292.0, 5421.0, 5492.0, 5568.0, 5577.0, 5259.0, 5689.0, 5565.0, 5510.0, 5272.0, 5297.0, 5347.0, 5584.0, 5432.0, 5398.0, 5607.0, 5269.0, 5439.0, 5311.0, 5284.0, 5415.0, 5462.0, 5470.0, 5356.0, 5444.0, 5353.0, 5685.0, 5267.0, 5446.0, 5551.0, 5367.0, 5693.0, 5307.0, 5582.0, 5605.0, 5406.0, 5694.0, 5383.0, 5326.0, 5576.0, 5702.0, 5321.0, 5341.0, 5289.0, 5498.0, 5422.0, 5458.0, 5429.0, 5560.0, 5505.0, 5467.0, 5500.0, 5293.0, 5515.0, 5514.0, 5261.0, 5399.0, 5265.0, 5418.0, 5344.0, 5578.0, 5662.0, 5417.0, 5635.0, 5392.0, 5486.0, 5288.0, 5252.0, 5302.0, 5586.0, 5450.0, 5604.0, 5394.0 (number of hits: 5)
20	5500	9	1	333	1	5336.0, 5500.0, 5286.0, 5403.0, 5385.0, 5467.0, 5548.0, 5454.0, 5323.0, 5638.0, 5464.0, 5302.0, 5511.0, 5329.0, 5582.0, 5632.0, 5517.0, 5653.0, 5337.0, 5533.0, 5457.0, 5319.0, 5476.0, 5599.0, 5361.0, 5344.0, 5428.0, 5651.0, 5504.0, 5423.0, 5250.0, 5572.0, 5395.0, 5259.0, 5289.0, 5570.0, 5280.0, 5542.0, 5643.0, 5313.0, 5550.0, 5606.0, 5432.0, 5393.0, 5603.0, 5704.0, 5485.0, 5633.0, 5481.0, 5279.0, 5512.0, 5602.0, 5389.0, 5478.0, 5408.0, 5315.0, 5567.0, 5556.0, 5617.0, 5712.0, 5394.0, 5253.0, 5285.0, 5469.0, 5380.0, 5594.0, 5409.0, 5262.0, 5555.0, 5317.0, 5431.0, 5378.0, 5471.0, 5265.0, 5675.0, 5620.0, 5348.0, 5705.0, 5659.0, 5668.0,

						5672.0, 5483.0, 5683.0, 5406.0, 5349.0, 5272.0, 5695.0, 5415.0, 5685.0, 5254.0, 5257.0, 5295.0, 5487.0, 5663.0, 5452.0, 5554.0, 5709.0, 5502.0, 5581.0, 5437.0 (number of hits: 3)
21	5500	9	1	333	1	5656.0, 5695.0, 5342.0, 5306.0, 5641.0, 5630.0, 5583.0, 5621.0, 5563.0, 5628.0, 5279.0, 5343.0, 5304.0, 5357.0, 5456.0, 5506.0, 5441.0, 5557.0, 5272.0, 5541.0, 5458.0, 5408.0, 5643.0, 5537.0, 5533.0, 5266.0, 5394.0, 5251.0, 5692.0, 5287.0, 5535.0, 5385.0, 5435.0, 5468.0, 5281.0, 5355.0, 5688.0, 5298.0, 5514.0, 5337.0, 5709.0, 5694.0, 5510.0, 5463.0, 5349.0, 5253.0, 5322.0, 5348.0, 5308.0, 5257.0, 5395.0, 5503.0, 5290.0, 5359.0, 5303.0, 5372.0, 5396.0, 5593.0, 5482.0, 5388.0, 5494.0, 5449.0, 5491.0, 5504.0, 5554.0, 5677.0, 5599.0, 5366.0, 5717.0, 5411.0, 5642.0, 5414.0, 5472.0, 5592.0, 5515.0, 5325.0, 5638.0, 5682.0, 5631.0, 5485.0, 5520.0, 5386.0, 5332.0, 5328.0, 5486.0, 5264.0, 5532.0, 5415.0, 5289.0, 5492.0, 5661.0, 5470.0, 5383.0, 5439.0, 5474.0, 5326.0, 5637.0, 5552.0, 5666.0, 5684.0 (number of hits: 6)
22	5500	9	1	333	1	5278.0, 5604.0, 5621.0, 5372.0, 5534.0, 5444.0, 5377.0, 5522.0, 5583.0, 5380.0, 5502.0, 5514.0, 5253.0, 5690.0, 5554.0, 5628.0, 5321.0, 5524.0, 5387.0, 5350.0, 5280.0, 5555.0, 5370.0, 5481.0, 5275.0, 5298.0, 5527.0, 5360.0, 5688.0, 5497.0, 5434.0, 5456.0, 5624.0, 5322.0, 5338.0, 5618.0, 5530.0, 5347.0, 5529.0, 5585.0, 5655.0, 5409.0, 5551.0, 5376.0, 5358.0, 5396.0, 5449.0, 5252.0, 5619.0, 5422.0, 5632.0, 5458.0, 5695.0, 5546.0, 5698.0, 5641.0, 5406.0, 5510.0, 5601.0, 5384.0, 5393.0, 5486.0, 5475.0, 5381.0, 5590.0, 5429.0, 5586.0, 5466.0, 5257.0, 5468.0, 5710.0, 5256.0, 5391.0, 5642.0, 5568.0, 5646.0, 5675.0, 5271.0, 5540.0, 5693.0, 5559.0, 5431.0, 5482.0, 5714.0, 5414.0, 5629.0, 5645.0, 5620.0, 5694.0, 5432.0, 5337.0, 5598.0, 5677.0, 5640.0, 5505.0, 5713.0, 5711.0, 5461.0, 5283.0, 5706.0 (number of hits: 3)
23	5500	9	1	333	1	5361.0, 5629.0, 5611.0, 5387.0, 5371.0, 5713.0, 5479.0, 5492.0, 5553.0, 5377.0, 5556.0, 5448.0, 5357.0, 5292.0, 5294.0, 5285.0, 5265.0, 5315.0, 5572.0, 5546.0, 5444.0, 5536.0, 5394.0, 5688.0, 5478.0, 5282.0, 5490.0, 5291.0, 5470.0, 5716.0, 5259.0, 5518.0, 5674.0, 5584.0, 5458.0, 5610.0, 5487.0, 5471.0, 5704.0, 5400.0, 5575.0, 5507.0, 5450.0, 5596.0, 5434.0, 5531.0, 5389.0, 5644.0, 5430.0, 5616.0, 5328.0, 5465.0, 5544.0, 5498.0, 5527.0, 5262.0, 5346.0, 5500.0, 5443.0, 5564.0, 5410.0, 5283.0, 5604.0, 5510.0, 5375.0,

						5701.0, 5379.0, 5673.0, 5516.0, 5303.0, 5607.0, 5499.0, 5679.0, 5422.0, 5347.0, 5344.0, 5703.0, 5718.0, 5437.0, 5350.0, 5412.0, 5590.0, 5317.0, 5709.0, 5453.0, 5455.0, 5566.0, 5586.0, 5483.0, 5286.0, 5407.0, 5694.0, 5418.0, 5615.0, 5650.0, 5524.0, 5305.0, 5284.0, 5456.0, 5520.0 (number of hits: 5)
24	5500	9	1	333	1	5608.0, 5697.0, 5449.0, 5712.0, 5641.0, 5369.0, 5333.0, 5260.0, 5353.0, 5574.0, 5545.0, 5510.0, 5374.0, 5372.0, 5289.0, 5288.0, 5440.0, 5452.0, 5486.0, 5475.0, 5522.0, 5446.0, 5519.0, 5672.0, 5616.0, 5497.0, 5444.0, 5665.0, 5642.0, 5573.0, 5719.0, 5625.0, 5376.0, 5560.0, 5431.0, 5371.0, 5666.0, 5521.0, 5713.0, 5706.0, 5296.0, 5290.0, 5553.0, 5632.0, 5653.0, 5682.0, 5256.0, 5412.0, 5494.0, 5291.0, 5707.0, 5622.0, 5631.0, 5268.0, 5400.0, 5523.0, 5676.0, 5656.0, 5582.0, 5425.0, 5493.0, 5529.0, 5282.0, 5309.0, 5677.0, 5602.0, 5685.0, 5668.0, 5303.0, 5535.0, 5447.0, 5251.0, 5286.0, 5630.0, 5629.0, 5463.0, 5655.0, 5589.0, 5551.0, 5645.0, 5620.0, 5266.0, 5310.0, 5609.0, 5704.0, 5422.0, 5314.0, 5335.0, 5302.0, 5611.0, 5476.0, 5692.0, 5694.0, 5576.0, 5267.0, 5599.0, 5469.0, 5401.0, 5405.0, 5508.0 (number of hits: 4)
25	5500	9	1	333	1	5656.0, 5601.0, 5437.0, 5660.0, 5271.0, 5687.0, 5602.0, 5578.0, 5679.0, 5391.0, 5530.0, 5408.0, 5296.0, 5343.0, 5472.0, 5405.0, 5517.0, 5451.0, 5622.0, 5287.0, 5480.0, 5526.0, 5402.0, 5511.0, 5569.0, 5648.0, 5538.0, 5277.0, 5430.0, 5693.0, 5433.0, 5521.0, 5562.0, 5606.0, 5605.0, 5367.0, 5497.0, 5527.0, 5632.0, 5370.0, 5598.0, 5299.0, 5258.0, 5340.0, 5332.0, 5675.0, 5387.0, 5366.0, 5663.0, 5723.0, 5559.0, 5638.0, 5254.0, 5666.0, 5512.0, 5673.0, 5539.0, 5717.0, 5383.0, 5469.0, 5474.0, 5555.0, 5721.0, 5621.0, 5303.0, 5378.0, 5257.0, 5591.0, 5372.0, 5323.0, 5471.0, 5685.0, 5307.0, 5533.0, 5657.0, 5552.0, 5498.0, 5459.0, 5453.0, 5649.0, 5286.0, 5710.0, 5643.0, 5384.0, 5595.0, 5540.0, 5711.0, 5712.0, 5485.0, 5473.0, 5716.0, 5422.0, 5561.0, 5470.0, 5419.0, 5629.0, 5395.0, 5645.0, 5346.0, 5715.0 (number of hits: 2)
26	5500	9	1	333	1	5494.0, 5594.0, 5433.0, 5293.0, 5396.0, 5446.0, 5390.0, 5519.0, 5252.0, 5621.0, 5483.0, 5545.0, 5342.0, 5298.0, 5290.0, 5525.0, 5700.0, 5520.0, 5608.0, 5496.0, 5383.0, 5392.0, 5707.0, 5537.0, 5305.0, 5464.0, 5417.0, 5303.0, 5663.0, 5276.0, 5427.0, 5697.0, 5387.0, 5566.0, 5430.0, 5596.0, 5685.0, 5355.0, 5471.0, 5325.0, 5422.0, 5443.0, 5273.0, 5481.0, 5343.0, 5324.0, 5338.0, 5597.0, 5640.0, 5393.0,

						5549.0, 5377.0, 5482.0, 5381.0, 5489.0, 5717.0, 5720.0, 5385.0, 5590.0, 5687.0, 5527.0, 5630.0, 5540.0, 5326.0, 5606.0, 5259.0, 5603.0, 5552.0, 5650.0, 5659.0, 5718.0, 5358.0, 5503.0, 5353.0, 5674.0, 5357.0, 5479.0, 5565.0, 5466.0, 5400.0, 5477.0, 5461.0, 5328.0, 5491.0, 5646.0, 5472.0, 5664.0, 5349.0, 5255.0, 5286.0, 5365.0, 5329.0, 5346.0, 5699.0, 5671.0, 5454.0, 5678.0, 5690.0, 5253.0, 5409.0 (number of hits: 4)
27	5500	9	1	333	1	5692.0, 5496.0, 5674.0, 5530.0, 5519.0, 5534.0, 5453.0, 5351.0, 5387.0, 5404.0, 5294.0, 5582.0, 5711.0, 5601.0, 5327.0, 5546.0, 5575.0, 5682.0, 5645.0, 5518.0, 5600.0, 5254.0, 5671.0, 5543.0, 5464.0, 5522.0, 5677.0, 5466.0, 5723.0, 5578.0, 5523.0, 5384.0, 5509.0, 5594.0, 5705.0, 5636.0, 5275.0, 5365.0, 5717.0, 5707.0, 5268.0, 5613.0, 5653.0, 5438.0, 5364.0, 5295.0, 5307.0, 5568.0, 5256.0, 5561.0, 5343.0, 5452.0, 5400.0, 5425.0, 5639.0, 5562.0, 5584.0, 5395.0, 5430.0, 5398.0, 5308.0, 5437.0, 5666.0, 5647.0, 5407.0, 5670.0, 5531.0, 5643.0, 5655.0, 5375.0, 5449.0, 5609.0, 5644.0, 5555.0, 5390.0, 5300.0, 5376.0, 5484.0, 5284.0, 5658.0, 5445.0, 5664.0, 5649.0, 5322.0, 5570.0, 5354.0, 5503.0, 5321.0, 5292.0, 5629.0, 5480.0, 5516.0, 5396.0, 5467.0, 5703.0, 5372.0, 5297.0, 5392.0, 5626.0, 5470.0 (number of hits: 2)
28	5500	9	1	333	1	5309.0, 5360.0, 5367.0, 5670.0, 5686.0, 5316.0, 5387.0, 5458.0, 5372.0, 5323.0, 5504.0, 5617.0, 5592.0, 5500.0, 5646.0, 5498.0, 5304.0, 5573.0, 5678.0, 5589.0, 5380.0, 5378.0, 5315.0, 5494.0, 5612.0, 5516.0, 5588.0, 5613.0, 5591.0, 5545.0, 5703.0, 5389.0, 5645.0, 5251.0, 5463.0, 5513.0, 5407.0, 5352.0, 5619.0, 5518.0, 5311.0, 5656.0, 5391.0, 5722.0, 5595.0, 5569.0, 5706.0, 5427.0, 5665.0, 5532.0, 5314.0, 5648.0, 5713.0, 5402.0, 5536.0, 5590.0, 5490.0, 5652.0, 5699.0, 5335.0, 5519.0, 5675.0, 5355.0, 5578.0, 5258.0, 5369.0, 5297.0, 5485.0, 5600.0, 5267.0, 5321.0, 5506.0, 5649.0, 5499.0, 5272.0, 5615.0, 5326.0, 5477.0, 5704.0, 5357.0, 5285.0, 5340.0, 5698.0, 5370.0, 5632.0, 5435.0, 5720.0, 5411.0, 5348.0, 5423.0, 5565.0, 5627.0, 5585.0, 5550.0, 5502.0, 5497.0, 5478.0, 5418.0, 5553.0, 5668.0 (number of hits: 8)
29	5500	9	1	333	1	5568.0, 5253.0, 5420.0, 5405.0, 5377.0, 5513.0, 5491.0, 5529.0, 5258.0, 5338.0, 5356.0, 5646.0, 5371.0, 5626.0, 5689.0, 5719.0, 5308.0, 5311.0, 5673.0, 5334.0, 5574.0, 5716.0, 5427.0, 5393.0, 5484.0, 5348.0, 5501.0, 5466.0, 5252.0, 5685.0, 5336.0, 5591.0, 5493.0, 5397.0, 5638.0,

						5589.0, 5305.0, 5562.0, 5402.0, 5497.0, 5711.0, 5572.0, 5368.0, 5438.0, 5342.0, 5534.0, 5366.0, 5306.0, 5327.0, 5447.0, 5361.0, 5394.0, 5483.0, 5479.0, 5706.0, 5662.0, 5560.0, 5365.0, 5396.0, 5302.0, 5350.0, 5714.0, 5597.0, 5347.0, 5467.0, 5535.0, 5333.0, 5698.0, 5703.0, 5514.0, 5658.0, 5325.0, 5281.0, 5492.0, 5390.0, 5700.0, 5442.0, 5537.0, 5286.0, 5363.0, 5289.0, 5388.0, 5705.0, 5508.0, 5504.0, 5509.0, 5519.0, 5251.0, 5303.0, 5343.0, 5410.0, 5594.0, 5474.0, 5385.0, 5510.0, 5561.0, 5573.0, 5351.0, 5536.0, 5528.0 (number of hits: 7)
30	5500	9	1	333	1	5376.0, 5258.0, 5442.0, 5414.0, 5312.0, 5551.0, 5299.0, 5297.0, 5576.0, 5690.0, 5387.0, 5676.0, 5488.0, 5417.0, 5499.0, 5497.0, 5623.0, 5568.0, 5552.0, 5583.0, 5346.0, 5344.0, 5507.0, 5470.0, 5562.0, 5270.0, 5493.0, 5724.0, 5321.0, 5483.0, 5314.0, 5298.0, 5446.0, 5337.0, 5536.0, 5532.0, 5480.0, 5694.0, 5581.0, 5259.0, 5495.0, 5674.0, 5324.0, 5266.0, 5721.0, 5529.0, 5427.0, 5463.0, 5505.0, 5715.0, 5320.0, 5401.0, 5353.0, 5594.0, 5257.0, 5267.0, 5624.0, 5679.0, 5281.0, 5296.0, 5361.0, 5275.0, 5261.0, 5626.0, 5696.0, 5666.0, 5260.0, 5685.0, 5496.0, 5722.0, 5262.0, 5570.0, 5304.0, 5388.0, 5647.0, 5338.0, 5716.0, 5520.0, 5390.0, 5719.0, 5396.0, 5284.0, 5453.0, 5407.0, 5307.0, 5640.0, 5544.0, 5650.0, 5424.0, 5662.0, 5253.0, 5498.0, 5432.0, 5672.0, 5380.0, 5701.0, 5519.0, 5295.0, 5317.0, 5365.0 (number of hits: 8)

5510 MHz, 40 MHz Bandwidth

Radar Signal Type	Waveform/Trial Number	Detection (%)	Limit (%)	Pass/Fail
Type 1A/1B	30	100 %	60%	Pass
Type 2	30	93.3 %	60%	Pass
Type 3	30	80 %	60%	Pass
Type 4	30	83.3 %	60%	Pass
Aggregate (Type1 to 4)	120	89.15 %	80%	Pass
Type 5	30	100 %	80%	Pass
Type 6	30	100 %	70%	Pass

Please refer to the following statistical tables:

Table-1A/1B Radar Type 1A/1B Statistical Performance

Trial #	Fc (MHz)	Pulse/Burst	Pulse Width (µS)	PRI (µs)	Detection (1:yes; 0:no)
1	5510	74	1	718	1
2	5510	63	1	838	1
3	5510	95	1	558	1
4	5510	58	1	918	1
5	5510	83	1	638	1
6	5492	68	1	778	1
7	5492	81	1	658	1
8	5492	59	1	898	1
9	5492	72	1	738	1
10	5492	92	1	578	1
11	5528	18	1	3066	1
12	5528	70	1	758	1
13	5528	89	1	598	1
14	5528	65	1	818	1
15	5528	86	1	618	1
16	5510	33	1	1619	1
17	5510	23	1	2309	1
18	5510	93	1	571	1
19	5510	52	1	1020	1
20	5510	18	1	3016	1
21	5492	20	1	2678	1
22	5492	30	1	1794	1
23	5492	29	1	1847	1
24	5492	62	1	862	1
25	5492	99	1	536	1
26	5528	26	1	2071	1
27	5528	29	1	1824	1
28	5528	24	1	2280	1
29	5528	69	1	776	1
30	5528	36	1	1479	1
Detection Percentage: 100 % (>60%)					

Table-2 Radar Type 2 Statistical Performance

Trial #	Fc (MHz)	Pulse/Burst	Pulse Width (μS)	PRI (μs)	Detection (1:yes; 0:no)
1	5510	28	2.7	209	1
2	5510	25	3.3	187	1
3	5510	25	3	194	1
4	5510	24	2.7	206	1
5	5510	26	3.2	185	0
6	5510	24	3.4	183	1
7	5510	26	1.2	229	1
8	5510	29	3.1	187	1
9	5510	29	2.3	203	1
10	5510	24	1	229	1
11	5492	25	1.4	180	1
12	5492	29	4.7	193	1
13	5492	23	3.2	214	1
14	5492	27	1.8	214	1
15	5492	29	2	201	1
16	5492	27	3.9	230	1
17	5492	24	2.8	217	1
18	5492	27	3.3	171	1
19	5492	25	4.2	190	1
20	5492	24	4.8	157	1
21	5528	28	1.6	210	1
22	5528	26	4.2	157	1
23	5528	24	4.9	163	1
24	5528	27	3.4	168	1
25	5528	24	4.9	178	0
26	5528	24	3.2	203	1
27	5528	26	1.3	154	1
28	5528	24	1.6	152	1
29	5528	24	2.3	226	1
30	5528	25	3	213	1
Detection Percentage: 93.3 % (>60%)					

Table-3 Radar Type 3 Statistical Performance

Trial #	Fc (MHz)	Pulse/Burst	Pulse Width (μS)	PRI (μs)	Detection (1:yes; 0:no)
1	5510	17	6.8	435	1
2	5510	18	9.3	404	1
3	5510	17	6.1	456	1
4	5510	17	9.3	405	1
5	5510	18	8.1	222	1
6	5510	17	9	488	1
7	5510	17	6.1	210	0
8	5510	18	7.7	383	1
9	5510	17	6.7	200	1
10	5510	18	9.4	424	1
11	5492	18	6.5	473	1
12	5492	17	7.5	273	1
13	5492	18	9.5	340	1
14	5492	17	7.7	458	1
15	5492	18	6.9	289	0
16	5492	17	6.3	346	1
17	5492	17	8.9	405	1
18	5492	16	9.3	367	0
19	5492	17	8.7	231	0
20	5492	18	7.1	382	1
21	5528	17	7.1	223	1
22	5528	17	8.3	375	1
23	5528	18	7.4	262	0
24	5528	16	8.7	459	1
25	5528	16	8.3	238	1
26	5528	17	8.4	438	0
27	5528	18	8.7	436	1
28	5528	16	9.8	476	1
29	5528	16	9.8	349	1
30	5528	17	6	344	1
Detection Percentage: 80 % (>60%)					

Table-4 Radar Type 4 Statistical Performance

Trial #	Fc (MHz)	Pulse/Burst	Pulse Width (μS)	PRI (μs)	Detection (1:yes; 0:no)
1	5510	13	16.4	487	1
2	5510	12	11.6	357	1
3	5510	16	13.8	331	1
4	5510	13	16.7	202	1
5	5510	15	16	217	1
6	5510	12	16.5	375	0
7	5510	12	14.9	263	0
8	5510	16	19.1	252	1
9	5510	13	15.3	349	1
10	5510	16	18.5	225	1
11	5492	12	19.5	231	1
12	5492	13	15.1	431	1
13	5492	14	17.1	238	1
14	5492	15	19.9	267	1
15	5492	12	15.9	459	1
16	5492	13	16.4	361	1
17	5492	15	13.4	240	1
18	5492	14	14.5	409	1
19	5492	13	19.7	373	1
20	5492	15	17.5	356	0
21	5528	14	12.4	368	1
22	5528	15	19.9	478	1
23	5528	16	14.1	411	0
24	5528	13	11.9	494	1
25	5528	15	17.3	294	1
26	5528	14	19.5	332	1
27	5528	13	16.7	358	0
28	5528	13	18.9	207	1
29	5528	14	11.9	252	1
30	5528	14	12.8	296	1
Detection Percentage: 83.3 % (>60%)					

Table-5 Radar Type 5 Statistical Performance

Trial #	Fc (MHz)	Detection (1:yes; 0:no)
1	5510	1
2	5510	1
3	5510	1
4	5510	1
5	5510	1
6	5510	1
7	5510	1
8	5510	1
9	5510	1
10	5510	1
11	5496.8	1
12	5495.6	1
13	5496.8	1
14	5497.6	1
15	5498.8	1
16	5496.0	1
17	5499.2	1
18	5497.2	1
19	5499.6	1
20	5495.2	1
21	5524.0	1
22	5520.0	1
23	5524.0	1
24	5520.0	1
25	5524.4	1
26	5523.6	1
27	5524.0	1
28	5521.2	1
29	5523.2	1
30	5521.2	1
Detection Percentage: 100 % (>80%)		

Bin5 Statistics 1

Trial #	Pulse	Chirp (MHz)	Pulse Width (µS)	Pulse 1-2 spacing (uS)	Pulse 2-3 spacing (uS)	Pulse Start(S)	Detection (1:yes; 0:no)
0	1	13	91.2	-	-	0.593509	1
1	2	13	82.2	1736	-	0.824008	
2	3	13	72.2	1692	1623	2.203915	
3	2	13	98.7	1364	-	2.834149	
4	2	13	89.2	1639	-	3.385105	
5	2	13	80	1226	-	4.307933	
6	3	13	96.1	1736	1935	5.488093	
7	1	13	82.2	-	-	5.702163	
8	2	13	84.9	1958	-	6.534614	
9	1	13	73.8	-	-	7.227668	
10	1	13	97.6	-	-	8.273238	
11	2	13	83	1429	-	9.215469	
12	3	13	77.6	1254	1258	9.814462	
13	2	13	50.3	1954	-	11.172103	
14	3	13	62.8	1750	1005	11.746315	

Bin5 Statistics 2

Trial #	Pulse	Chirp (MHz)	Pulse Width (µS)	Pulse 1-2 spacing (uS)	Pulse 2-3 spacing (uS)	Pulse Start(S)	Detection (1:yes; 0:no)
0	3	7	90.4	1094	1581	0.466986	1
1	2	7	58.1	1374	-	2.197017	
2	2	7	54.2	1651	-	2.915371	
3	3	7	72.6	1470	1877	3.64705	
4	2	7	82.3	1744	-	5.085662	
5	1	7	51.2	-	-	6.312007	
6	1	7	83.2	-	-	8.028473	
7	2	7	86.5	1448	-	8.902783	
8	1	7	87.3	-	-	10.780868	
9	3	7	56.2	1522	1938	11.853877	

Bin5 Statistics 3

Trial #	Pulse	Chirp (MHz)	Pulse Width (µS)	Pulse 1-2 spacing (µS)	Pulse 2-3 spacing (µS)	Pulse Start(S)	Detection (1:yes; 0:no)
0	2	6	88.8	1062	-	0.155194	1
1	2	6	90.3	1298	-	1.423791	
2	2	6	92.8	1861	-	3.068931	
3	1	6	94.5	-	-	3.323765	
4	3	6	52.7	1402	1133	5.026521	
5	3	6	62.1	1878	1462	5.503533	
6	1	6	91.4	-	-	7.390845	
7	2	6	61.5	1933	-	8.666508	
8	1	6	94	-	-	9.599097	
9	2	6	91.7	1884	-	10.836291	
10	2	6	94.6	1801	-	11.940795	

Bin5 Statistics 4

Trial #	Pulse	Chirp (MHz)	Pulse Width (µS)	Pulse 1-2 spacing (µS)	Pulse 2-3 spacing (µS)	Pulse Start(S)	Detection (1:yes; 0:no)
0	2	13	56.3	1798	-	0.624561	1
1	2	13	97.8	1244	-	1.364243	
2	1	13	75.8	-	-	1.86906	
3	1	13	77.6	-	-	2.383041	
4	3	13	71.4	1527	1822	3.436337	
5	1	13	69.4	-	-	3.75765	
6	3	13	94.2	1738	1682	5.016071	
7	2	13	99.7	1596	-	5.420266	
8	3	13	61.8	1789	1541	6.078594	
9	3	13	74.4	1650	1025	7.16639	
10	2	13	64.4	1142	-	7.891222	
11	2	13	67.7	1535	-	8.773342	
12	2	13	71.9	1555	-	9.602226	
13	2	13	67.8	1322	-	9.927011	
14	2	13	61.6	1660	-	11.191174	
15	3	13	96.8	1885	1901	11.563611	

Bin5 Statistics 5

Trial #	Pulse	Chirp (MHz)	Pulse Width (µS)	Pulse 1-2 spacing (uS)	Pulse 2-3 spacing (uS)	Pulse Start(S)	Detection (1:yes; 0:no)
0	2	12	57.1	1263	-	0.488857	1
1	2	12	58.4	1307	-	0.975581	
2	1	12	65.7	-	-	1.982229	
3	2	12	95.7	1496	-	2.743759	
4	1	12	65	-	-	3.349128	
5	3	12	53	1376	1710	3.89565	
6	2	12	98.6	1696	-	4.982031	
7	2	12	90.6	1214	-	5.393833	
8	2	12	74.2	1664	-	6.030673	
9	2	12	98.6	1613	-	6.886192	
10	3	12	75.7	1107	1808	7.711365	
11	2	12	71.2	1071	-	8.94333	
12	2	12	73.9	1893	-	9.692379	
13	2	12	87	1313	-	9.807029	
14	2	12	83.4	1777	-	11.025657	
15	2	12	88.7	1499	-	11.414154	

Bin5 Statistics 6

Trial #	Pulse	Chirp (MHz)	Pulse Width (µS)	Pulse 1-2 spacing (uS)	Pulse 2-3 spacing (uS)	Pulse Start(S)	Detection (1:yes; 0:no)
0	2	7	91.8	1693	-	0.099743	1
1	3	7	82	1562	1762	0.926682	
2	3	7	85.2	1206	1089	1.693428	
3	2	7	60.8	1475	-	2.245967	
4	1	7	55.4	-	-	2.40999	
5	1	7	51.8	-	-	3.147307	
6	1	7	70.6	-	-	3.937747	
7	1	7	87.5	-	-	4.689496	
8	2	7	69.3	1348	-	4.862125	
9	3	7	65	1767	1826	5.572503	
10	2	7	50.1	1728	-	6.011278	
11	2	7	99.9	1145	-	6.666999	
12	2	7	67.4	1754	-	7.417255	
13	1	7	88.4	-	-	7.973966	
14	2	7	51.3	1523	-	8.720892	
15	2	7	88.6	1912	-	9.130081	
16	1	7	66.8	-	-	9.768723	
17	2	7	79.9	1119	-	10.775238	
18	1	7	69.3	-	-	11.096565	

Bin5 Statistics 7

Trial #	Pulse	Chirp (MHz)	Pulse Width (µS)	Pulse 1-2 spacing (uS)	Pulse 2-3 spacing (uS)	Pulse Start(S)	Detection (1:yes; 0:no)
0	2	16	72.9	1296	-	0.108236	1
1	2	16	71.5	1862	-	0.832729	
2	3	16	83.2	1878	1083	2.067426	
3	2	16	57.4	1726	-	2.861243	
4	2	16	64.5	1327	-	3.815701	
5	3	16	64.8	1205	1144	4.751775	
6	3	16	73.1	1242	1218	4.986547	
7	2	16	71.6	1526	-	6.358446	
8	2	16	53.5	1419	-	6.587821	
9	3	16	91.3	1557	1129	7.874922	
10	2	16	51.4	1052	-	8.61095	
11	1	16	53.6	-	-	9.299576	
12	3	16	88.7	1519	1267	9.878978	
13	1	16	70.9	-	-	11.077618	
14	2	16	66.3	1964	-	11.638298	

Bin5 Statistics 8

Trial #	Pulse	Chirp (MHz)	Pulse Width (µS)	Pulse 1-2 spacing (uS)	Pulse 2-3 spacing (uS)	Pulse Start(S)	Detection (1:yes; 0:no)
0	3	13	79.6	1877	1378	0.710077	1
1	2	13	67.1	1909	-	1.792479	
2	3	13	99.1	1713	1272	2.695802	
3	3	13	95.3	1044	1566	3.157071	
4	2	13	89.8	1496	-	3.923934	
5	2	13	78.2	1091	-	5.415138	
6	2	13	65.3	1367	-	6.265786	
7	2	13	99.9	1206	-	7.246107	
8	3	13	86.6	1514	1722	7.640637	
9	3	13	82.9	1764	1424	9.125358	
10	2	13	97.1	1866	-	9.923404	
11	1	13	95.9	-	-	10.478728	
12	2	13	80.2	1563	-	11.956675	

Bin5 Statistics 9

Trial #	Pulse	Chirp (MHz)	Pulse Width (µS)	Pulse 1-2 spacing (uS)	Pulse 2-3 spacing (uS)	Pulse Start(S)	Detection (1:yes; 0:no)
0	1	9	85.8	-	-	0.032168	0
1	2	9	65.9	1895	-	1.413771	
2	3	9	61.9	1945	1401	2.245819	
3	2	9	92.4	1092	-	4.316587	
4	2	9	85.4	1434	-	5.093561	
5	2	9	79.8	1867	-	6.241441	
6	2	9	50.5	1557	-	6.776915	
7	2	9	79.7	1741	-	8.059099	
8	2	9	70	1536	-	9.653939	
9	2	9	61.3	1465	-	10.313216	
10	1	9	66.7	-	-	11.966368	

Bin5 Statistics 10

Trial #	Pulse	Chirp (MHz)	Pulse Width (µS)	Pulse 1-2 spacing (uS)	Pulse 2-3 spacing (uS)	Pulse Start(S)	Detection (1:yes; 0:no)
0	2	15	68	1663	-	0.373128	1
1	1	15	92.6	-	-	1.038439	
2	1	15	52.4	-	-	2.389299	
3	2	15	99.7	1149	-	2.985257	
4	3	15	99.4	1901	1381	3.782237	
5	2	15	63.2	1440	-	5.082102	
6	1	15	71.7	-	-	5.607103	
7	2	15	83.8	1226	-	6.601947	
8	2	15	55.7	1806	-	7.4799	
9	2	15	98.8	1623	-	7.904507	
10	3	15	58.4	1481	1799	9.051986	
11	2	15	96.2	1684	-	9.468744	
12	2	15	82.8	1568	-	10.41805	
13	3	15	61.6	1303	1434	11.575825	

Bin5 Statistics 11

Trial #	Pulse	Chirp (MHz)	Pulse Width (µS)	Pulse 1-2 spacing (uS)	Pulse 2-3 spacing (uS)	Pulse Start(S)	Detection (1:yes; 0:no)
0	2	12	56.1	1264	-	0.020321	1
1	3	12	73.3	1149	1846	1.073737	
2	1	12	94.5	-	-	1.465881	
3	1	12	57.8	-	-	2.144188	
4	3	12	56.2	1312	1090	2.867585	
5	1	12	73.4	-	-	3.343483	
6	3	12	78.8	1921	1410	4.16844	
7	2	12	63.7	1205	-	4.501029	
8	2	12	74.7	1526	-	5.066625	
9	3	12	92.2	1601	1982	5.902731	
10	2	12	54.9	1717	-	6.551249	
11	2	12	61.8	1483	-	7.173233	
12	2	12	71.4	1739	-	7.365791	
13	2	12	90.1	1902	-	7.950227	
14	2	12	66.2	1755	-	8.454026	
15	3	12	60.2	1068	1474	9.133073	
16	3	12	56	1881	1876	9.746348	
17	2	12	62.2	1268	-	10.509826	
18	2	12	52.5	1548	-	10.874763	
19	2	12	53.2	1249	-	11.827708	

Bin5 Statistics 12

Trial #	Pulse	Chirp (MHz)	Pulse Width (µS)	Pulse 1-2 spacing (uS)	Pulse 2-3 spacing (uS)	Pulse Start(S)	Detection (1:yes; 0:no)
0	1	9	93	-	-	1.038715	1
1	2	9	92.5	1032	-	1.323414	
2	2	9	55.9	1945	-	2.80808	
3	2	9	88.3	1872	-	4.297184	
4	2	9	73.6	1928	-	5.973324	
5	2	9	52.1	1108	-	6.602222	
6	1	9	60.2	-	-	7.586625	
7	2	9	54.4	1556	-	8.635004	
8	2	9	55.7	1820	-	10.186205	
9	2	9	56.3	1219	-	11.268721	

Bin5 Statistics 13

Trial #	Pulse	Chirp (MHz)	Pulse Width (µS)	Pulse 1-2 spacing (uS)	Pulse 2-3 spacing (uS)	Pulse Start(S)	Detection (1:yes; 0:no)
0	2	12	87.4	1353	-	0.527893	1
1	1	12	72	-	-	1.37194	
2	1	12	82.9	-	-	2.704774	
3	1	12	68.9	-	-	3.026638	
4	2	12	65.5	1253	-	3.835058	
5	2	12	62.1	1913	-	4.834689	
6	3	12	89.9	1032	1178	6.195478	
7	2	12	51.8	1739	-	6.700132	
8	3	12	55.5	1129	1213	7.468145	
9	1	12	66	-	-	9.13926	
10	2	12	69.3	1059	-	9.481098	
11	3	12	76.3	1919	1303	10.502191	
12	2	12	72.1	1570	-	11.406853	

Bin5 Statistics 14

Trial #	Pulse	Chirp (MHz)	Pulse Width (µS)	Pulse 1-2 spacing (uS)	Pulse 2-3 spacing (uS)	Pulse Start(S)	Detection (1:yes; 0:no)
0	1	14	84.1	-	-	0.646371	1
1	1	14	82.8	-	-	1.324654	
2	1	14	83.8	-	-	1.922761	
3	3	14	93.7	1454	1342	2.679631	
4	3	14	75.7	1755	1640	3.655278	
5	1	14	98.9	-	-	4.286404	
6	1	14	53.7	-	-	5.85239	
7	1	14	57.7	-	-	6.303585	
8	2	14	80	1434	-	7.510497	
9	2	14	81.6	1749	-	8.472357	
10	1	14	50.4	-	-	8.889427	
11	1	14	54.3	-	-	9.772734	
12	2	14	76.7	1738	-	10.36038	
13	3	14	80.7	1158	1705	11.860116	

Bin5 Statistics 15

Trial #	Pulse	Chirp (MHz)	Pulse Width (uS)	Pulse 1-2 spacing (uS)	Pulse 2-3 spacing (uS)	Pulse Start(S)	Detection (1:yes; 0:no)
0	3	17	50.7	1593	1702	0.25206	1
1	2	17	72.2	1629	-	1.0309	
2	2	17	96.7	1486	-	1.756917	
3	1	17	88	-	-	1.977102	
4	3	17	78.3	1136	1441	2.535689	
5	3	17	95.2	1383	1484	3.549393	
6	2	17	52.5	1501	-	3.810165	
7	3	17	92.6	1474	1916	4.482693	
8	2	17	54.9	1595	-	5.211239	
9	2	17	91.5	1086	-	5.640379	
10	3	17	58	1498	1613	6.479194	
11	2	17	51.9	1211	-	6.78266	
12	3	17	77.9	1202	1341	7.592823	
13	1	17	83.4	-	-	8.112307	
14	1	17	66.9	-	-	8.803623	
15	3	17	62.1	1158	1900	9.548918	
16	2	17	77.7	1028	-	9.883744	
17	1	17	68.6	-	-	10.687572	
18	3	17	75.3	1547	1848	11.19933	
19	1	17	66.8	-	-	11.730926	

Bin5 Statistics 16

Trial #	Pulse	Chirp (MHz)	Pulse Width (uS)	Pulse 1-2 spacing (uS)	Pulse 2-3 spacing (uS)	Pulse Start(S)	Detection (1:yes; 0:no)
0	1	10	79.6	-	-	0.441758	1
1	1	10	55.3	-	-	1.735936	
2	2	10	98.4	1289	-	3.237961	
3	2	10	96.6	1480	-	4.140651	
4	1	10	90.8	-	-	4.847115	
5	1	10	91	-	-	5.847038	
6	2	10	82.2	1646	-	6.840357	
7	2	10	57.9	1535	-	8.470614	
8	3	10	81.7	1029	1645	9.294256	
9	3	10	54.9	1777	1958	10.359917	
10	1	10	53.3	-	-	11.943516	

Bin5 Statistics 17

Trial #	Pulse	Chirp (MHz)	Pulse Width (µS)	Pulse 1-2 spacing (uS)	Pulse 2-3 spacing (uS)	Pulse Start(S)	Detection (1:yes; 0:no)
0	2	18	66.5	1376	-	0.356294	1
1	3	18	76.4	1933	1591	1.636026	
2	3	18	72.6	1063	1484	2.925446	
3	1	18	51	-	-	4.3929	
4	2	18	85.9	1077	-	5.410506	
5	3	18	78	1647	1687	7.136831	
6	2	18	54.7	1238	-	7.893029	
7	2	18	86.6	1677	-	9.581145	
8	3	18	97.3	1593	1467	9.917317	
9	2	18	59.5	1508	-	11.450095	

Bin5 Statistics 18

Trial #	Pulse	Chirp (MHz)	Pulse Width (µS)	Pulse 1-2 spacing (uS)	Pulse 2-3 spacing (uS)	Pulse Start(S)	Detection (1:yes; 0:no)
0	1	13	91.9	-	-	1.041179	1
1	1	13	70.6	-	-	1.965857	
2	3	13	73.8	1940	1813	4.134192	
3	2	13	85	1096	-	4.861618	
4	2	13	96	1395	-	7.361545	
5	3	13	50.4	1215	1006	7.723615	
6	2	13	63.2	1703	-	9.820389	
7	2	13	89	1322	-	10.892789	

Bin5 Statistics 19

Trial #	Pulse	Chirp (MHz)	Pulse Width (µS)	Pulse 1-2 spacing (µS)	Pulse 2-3 spacing (µS)	Pulse Start(S)	Detection (1:yes; 0:no)
0	2	19	82.7	1215	-	0.206526	1
1	3	19	61.8	1580	1312	0.842261	
2	1	19	90.5	-	-	1.805243	
3	2	19	58.9	1602	-	2.375642	
4	2	19	70.6	1955	-	3.063114	
5	2	19	73.9	1984	-	3.550138	
6	2	19	52	1512	-	4.5791	
7	3	19	96.9	1654	1759	4.706951	
8	3	19	66.2	1582	1969	5.477434	
9	1	19	67	-	-	6.521361	
10	1	19	75.5	-	-	6.96842	
11	2	19	51.9	1685	-	7.502908	
12	2	19	96.7	1901	-	8.597643	
13	3	19	55.9	1686	1367	8.874977	
14	3	19	60.3	1011	1497	9.440611	
15	3	19	90.7	1962	1031	10.089208	
16	3	19	83.7	1154	1098	11.064907	
17	2	19	50.8	1905	-	11.465874	

Bin5 Statistics 20

Trial #	Pulse	Chirp (MHz)	Pulse Width (µS)	Pulse 1-2 spacing (µS)	Pulse 2-3 spacing (µS)	Pulse Start(S)	Detection (1:yes; 0:no)
0	3	8	74.3	1981	1077	0.222124	1
1	2	8	78	1112	-	1.377032	
2	1	8	73.1	-	-	2.715514	
3	2	8	68.7	1162	-	3.242	
4	1	8	53.4	-	-	3.941393	
5	3	8	86.4	1424	1729	5.392312	
6	3	8	70.5	1776	1779	6.255326	
7	2	8	66.7	1498	-	6.969406	
8	2	8	69.6	1121	-	7.794711	
9	2	8	85.6	1124	-	8.768977	
10	2	8	51.4	1099	-	9.307837	
11	3	8	58.6	1938	1829	10.776086	
12	1	8	68	-	-	11.228819	

Bin5 Statistics 21

Trial #	Pulse	Chirp (MHz)	Pulse Width (uS)	Pulse 1-2 spacing (uS)	Pulse 2-3 spacing (uS)	Pulse Start(S)	Detection (1:yes; 0:no)
0	2	10	94.6	1996	-	0.407817	1
1	1	10	70.9	-	-	1.22183	
2	1	10	60.7	-	-	1.726352	
3	3	10	71.1	1919	1742	2.615564	
4	2	10	90.1	1065	-	3.17205	
5	3	10	89.9	1155	1582	4.490021	
6	2	10	55.9	1778	-	5.203601	
7	2	10	98.8	1039	-	5.677462	
8	2	10	83.6	1990	-	6.630991	
9	1	10	56.2	-	-	6.846932	
10	1	10	91.3	-	-	7.545859	
11	3	10	60.9	1301	1673	8.913204	
12	1	10	96.1	-	-	9.71468	
13	2	10	71	1400	-	9.928818	
14	3	10	54.3	1547	1261	10.876903	
15	1	10	68.2	-	-	11.380841	

Bin5 Statistics 22

Trial #	Pulse	Chirp (MHz)	Pulse Width (uS)	Pulse 1-2 spacing (uS)	Pulse 2-3 spacing (uS)	Pulse Start(S)	Detection (1:yes; 0:no)
0	3	20	60.4	1557	1804	0.14938	1
1	2	20	82.6	1742	-	1.149574	
2	2	20	53	1562	-	1.682245	
3	2	20	63.4	1222	-	2.52808	
4	3	20	71.3	1826	1661	3.190849	
5	2	20	95.6	1290	-	3.496719	
6	1	20	74.6	-	-	4.40403	
7	2	20	72.9	1080	-	5.254021	
8	2	20	64.9	1787	-	5.834545	
9	3	20	78.5	1306	1345	6.486607	
10	3	20	87.7	1805	1407	7.271388	
11	2	20	78.8	1144	-	7.384887	
12	2	20	98	1374	-	8.161015	
13	3	20	57.3	1503	1330	8.993011	
14	2	20	55.2	1698	-	9.681571	
15	2	20	71.5	1506	-	10.54552	
16	2	20	64.4	1090	-	11.271788	
17	3	20	64.7	1586	1044	11.899094	

Bin5 Statistics 23

Trial #	Pulse	Chirp (MHz)	Pulse Width (µS)	Pulse 1-2 spacing (uS)	Pulse 2-3 spacing (uS)	Pulse Start(S)	Detection (1:yes; 0:no)
0	3	10	69.6	1904	1436	1.47613	1
1	2	10	71.6	1326	-	2.006112	
2	2	10	55.7	1082	-	3.830982	
3	2	10	96.8	1294	-	5.003804	
4	2	10	67.1	1056	-	6.962953	
5	1	10	95.4	-	-	8.792287	
6	1	10	84.2	-	-	9.979123	
7	3	10	78.5	1795	1508	10.608052	

Bin5 Statistics 24

Trial #	Pulse	Chirp (MHz)	Pulse Width (µS)	Pulse 1-2 spacing (uS)	Pulse 2-3 spacing (uS)	Pulse Start(S)	Detection (1:yes; 0:no)
0	1	20	53.6	-	-	0.024526	1
1	3	20	75.2	1759	1980	2.130812	
2	1	20	57.8	-	-	3.042885	
3	1	20	82.2	-	-	3.896077	
4	2	20	69.8	1400	-	5.162485	
5	2	20	80.4	1196	-	5.55144	
6	2	20	63.3	1136	-	6.57695	
7	1	20	92	-	-	7.687213	
8	1	20	81.1	-	-	9.538953	
9	2	20	58.7	1756	-	10.859903	
10	1	20	97.8	-	-	11.373914	

Bin5 Statistics 25

Trial #	Pulse	Chirp (MHz)	Pulse Width (µS)	Pulse 1-2 spacing (uS)	Pulse 2-3 spacing (uS)	Pulse Start(S)	Detection (1:yes; 0:no)
0	1	9	64.9	-	-	0.419916	1
1	2	9	95.8	1374	-	1.981111	
2	2	9	69	1167	-	3.038221	
3	2	9	55.6	1567	-	3.85835	
4	1	9	97.7	-	-	4.511979	
5	1	9	50.3	-	-	5.485557	
6	2	9	81.4	1231	-	7.251171	
7	2	9	73.3	1478	-	8.184525	
8	1	9	87.6	-	-	8.957022	
9	2	9	53.4	1967	-	10.620592	
10	2	9	75.3	1541	-	11.57655	

Bin5 Statistics 26

Trial #	Pulse	Chirp (MHz)	Pulse Width (µS)	Pulse 1-2 spacing (uS)	Pulse 2-3 spacing (uS)	Pulse Start(S)	Detection (1:yes; 0:no)
0	1	11	76.8	-	-	0.795104	1
1	3	11	92.8	1996	1778	2.244433	
2	1	11	71.2	-	-	3.121488	
3	1	11	92.6	-	-	4.704837	
4	1	11	69	-	-	7.433242	
5	2	11	89.9	1597	-	7.611962	
6	3	11	91.5	1432	1132	9.301016	
7	1	11	89.1	-	-	11.580348	

Bin5 Statistics 27

Trial #	Pulse	Chirp (MHz)	Pulse Width (µS)	Pulse 1-2 spacing (µS)	Pulse 2-3 spacing (µS)	Pulse Start(S)	Detection (1:yes; 0:no)
0	1	10	76	-	-	0.123057	1
1	2	10	82.2	1189	-	0.817951	
2	2	10	90.3	1541	-	1.736375	
3	1	10	95.2	-	-	2.192224	
4	2	10	75.3	1437	-	2.976306	
5	2	10	80.5	1084	-	3.337337	
6	3	10	50.8	1283	1286	3.832052	
7	1	10	75.7	-	-	4.550335	
8	1	10	92.8	-	-	5.571543	
9	2	10	98.2	1986	-	5.941852	
10	3	10	84.6	1820	1234	6.397623	
11	2	10	56.3	1948	-	7.375147	
12	3	10	93.3	1788	1237	7.772966	
13	2	10	92.6	1666	-	8.473326	
14	3	10	57.5	1014	1774	8.983595	
15	3	10	70.1	1477	1264	10.072046	
16	2	10	71.1	1281	-	10.588434	
17	2	10	72.2	1218	-	11.209776	
18	3	10	90.5	1730	1029	11.387997	

Bin5 Statistics 28

Trial #	Pulse	Chirp (MHz)	Pulse Width (µS)	Pulse 1-2 spacing (µS)	Pulse 2-3 spacing (µS)	Pulse Start(S)	Detection (1:yes; 0:no)
0	3	17	97.3	1489	1417	0.049163	1
1	3	17	83.8	1867	1597	1.916268	
2	1	17	86.2	-	-	3.13059	
3	2	17	58.4	1072	-	3.444907	
4	2	17	72.4	1834	-	4.669802	
5	3	17	76	1158	1547	6.176615	
6	1	17	79.1	-	-	7.588081	
7	1	17	75.4	-	-	7.947531	
8	2	17	60.9	1311	-	9.088084	
9	1	17	85.3	-	-	10.568971	
10	1	17	93.5	-	-	11.972991	

Bin5 Statistics 29

Trial #	Pulse	Chirp (MHz)	Pulse Width (µS)	Pulse 1-2 spacing (uS)	Pulse 2-3 spacing (uS)	Pulse Start(S)	Detection (1:yes; 0:no)
0	2	12	82.9	1839	-	0.760445	1
1	2	12	56.4	1209	-	2.485116	
2	2	12	82.2	1311	-	3.932169	
3	3	12	90.7	1774	1996	4.056622	
4	3	12	57.2	1105	1561	6.375674	
5	3	12	89.7	1433	1900	7.012015	
6	2	12	87.9	1182	-	8.772338	
7	2	12	89.7	1551	-	10.390947	
8	2	12	73.3	1218	-	11.239384	

Bin5 Statistics 30

Trial #	Pulse	Chirp (MHz)	Pulse Width (µS)	Pulse 1-2 spacing (uS)	Pulse 2-3 spacing (uS)	Pulse Start(S)	Detection (1:yes; 0:no)
0	1	17	55.6	-	-	0.857692	1
1	2	17	55.1	1663	-	1.939769	
2	2	17	60.4	1842	-	2.338402	
3	1	17	77.7	-	-	3.359893	
4	2	17	89.4	1253	-	4.382207	
5	2	17	76.6	1837	-	6.304567	
6	3	17	75.7	1558	1796	7.35364	
7	2	17	64.9	1557	-	8.030042	
8	3	17	77.1	1419	1532	8.764156	
9	3	17	57.9	1447	1596	10.869881	
10	2	17	83.9	1362	-	11.530556	

Table-6 Radar Type 6 Statistical Performance

Trial #	Fc (MHz)	Pulse /Burst	Pulse Width (µS)	PRI (µs)	Detection (1:yes; 0:no)	Hopping Sequence
1	5510	9	1	333	1	5467.0, 5251.0, 5389.0, 5416.0, 5432.0, 5722.0, 5535.0, 5564.0, 5515.0, 5613.0, 5345.0, 5560.0, 5628.0, 5429.0, 5357.0, 5395.0, 5627.0, 5578.0, 5475.0, 5712.0, 5605.0, 5689.0, 5340.0, 5501.0, 5495.0, 5398.0, 5696.0, 5323.0, 5408.0, 5548.0, 5549.0, 5279.0, 5671.0, 5330.0, 5324.0, 5267.0, 5449.0, 5284.0, 5312.0, 5268.0, 5680.0, 5582.0, 5611.0, 5448.0, 5622.0, 5367.0, 5575.0, 5260.0, 5476.0, 5336.0, 5439.0, 5558.0, 5490.0, 5286.0, 5366.0, 5695.0, 5335.0, 5675.0, 5508.0, 5603.0, 5656.0, 5380.0, 5435.0, 5697.0, 5252.0, 5574.0, 5341.0, 5288.0, 5711.0, 5723.0, 5451.0, 5385.0, 5599.0, 5707.0, 5658.0, 5261.0, 5310.0, 5399.0, 5272.0, 5457.0, 5555.0, 5543.0, 5256.0, 5562.0, 5620.0, 5388.0, 5331.0, 5328.0, 5563.0, 5691.0, 5526.0, 5546.0, 5488.0, 5296.0, 5699.0, 5266.0, 5700.0, 5346.0, 5376.0, 5262.0 (number of hits: 5)
2	5510	9	1	333	1	5568.0, 5563.0, 5331.0, 5387.0, 5310.0, 5316.0, 5639.0, 5445.0, 5474.0, 5343.0, 5721.0, 5375.0, 5578.0, 5351.0, 5520.0, 5545.0, 5649.0, 5407.0, 5278.0, 5427.0, 5300.0, 5607.0, 5720.0, 5708.0, 5438.0, 5311.0, 5416.0, 5362.0, 5436.0, 5494.0, 5429.0, 5385.0, 5262.0, 5550.0, 5452.0, 5295.0, 5529.0, 5306.0, 5535.0, 5430.0, 5645.0, 5488.0, 5294.0, 5508.0, 5666.0, 5658.0, 5253.0, 5585.0, 5398.0, 5414.0, 5669.0, 5684.0, 5424.0, 5326.0, 5592.0, 5400.0, 5584.0, 5426.0, 5556.0, 5305.0, 5693.0, 5267.0, 5491.0, 5275.0, 5555.0, 5425.0, 5313.0, 5613.0, 5541.0, 5569.0, 5497.0, 5404.0, 5664.0, 5281.0, 5401.0, 5582.0, 5635.0, 5678.0, 5405.0, 5391.0, 5419.0, 5388.0, 5403.0, 5371.0, 5528.0, 5702.0, 5615.0, 5418.0, 5365.0, 5594.0, 5495.0, 5480.0, 5423.0, 5354.0, 5506.0, 5583.0, 5538.0, 5366.0, 5689.0, 5548.0 (number of hits: 6)
3	5510	9	1	333	1	5363.0, 5576.0, 5583.0, 5659.0, 5340.0, 5505.0, 5624.0, 5506.0, 5619.0, 5361.0, 5653.0, 5677.0, 5554.0, 5514.0, 5304.0, 5326.0, 5428.0, 5255.0, 5519.0, 5639.0, 5579.0, 5380.0, 5386.0, 5559.0, 5333.0, 5528.0, 5516.0, 5577.0, 5389.0, 5323.0, 5557.0, 5259.0, 5543.0, 5716.0, 5634.0, 5578.0, 5655.0, 5508.0, 5480.0, 5331.0, 5344.0, 5287.0, 5511.0, 5273.0, 5703.0, 5277.0, 5294.0, 5669.0, 5689.0, 5724.0, 5447.0, 5720.0, 5664.0, 5392.0, 5336.0, 5286.0, 5502.0, 5695.0, 5532.0, 5694.0, 5400.0, 5575.0, 5697.0, 5383.0, 5341.0,

						5591.0, 5319.0, 5489.0, 5270.0, 5432.0, 5588.0, 5676.0, 5620.0, 5563.0, 5585.0, 5250.0, 5271.0, 5589.0, 5345.0, 5328.0, 5330.0, 5453.0, 5257.0, 5671.0, 5711.0, 5503.0, 5533.0, 5267.0, 5385.0, 5645.0, 5527.0, 5518.0, 5590.0, 5347.0, 5712.0, 5573.0, 5496.0, 5566.0, 5520.0, 5332.0 (number of hits: 13)
4	5510	9	1	333	1	5382.0, 5323.0, 5520.0, 5516.0, 5306.0, 5701.0, 5632.0, 5487.0, 5494.0, 5449.0, 5529.0, 5589.0, 5582.0, 5544.0, 5586.0, 5315.0, 5693.0, 5321.0, 5605.0, 5434.0, 5513.0, 5424.0, 5557.0, 5278.0, 5723.0, 5274.0, 5470.0, 5554.0, 5638.0, 5483.0, 5356.0, 5331.0, 5694.0, 5697.0, 5680.0, 5277.0, 5587.0, 5695.0, 5657.0, 5508.0, 5309.0, 5409.0, 5286.0, 5287.0, 5566.0, 5486.0, 5393.0, 5580.0, 5607.0, 5691.0, 5301.0, 5659.0, 5583.0, 5368.0, 5561.0, 5521.0, 5612.0, 5467.0, 5514.0, 5628.0, 5372.0, 5489.0, 5539.0, 5400.0, 5386.0, 5378.0, 5384.0, 5262.0, 5541.0, 5428.0, 5507.0, 5284.0, 5344.0, 5385.0, 5559.0, 5653.0, 5442.0, 5606.0, 5552.0, 5448.0, 5585.0, 5411.0, 5465.0, 5334.0, 5665.0, 5532.0, 5673.0, 5477.0, 5439.0, 5630.0, 5549.0, 5706.0, 5700.0, 5506.0, 5453.0, 5355.0, 5676.0, 5568.0, 5724.0, 5579.0 (number of hits: 9)
5	5510	9	1	333	1	5651.0, 5618.0, 5389.0, 5266.0, 5632.0, 5393.0, 5567.0, 5644.0, 5425.0, 5470.0, 5319.0, 5272.0, 5663.0, 5466.0, 5352.0, 5321.0, 5387.0, 5542.0, 5522.0, 5367.0, 5492.0, 5540.0, 5508.0, 5623.0, 5500.0, 5484.0, 5615.0, 5637.0, 5297.0, 5265.0, 5448.0, 5429.0, 5426.0, 5719.0, 5704.0, 5294.0, 5551.0, 5392.0, 5670.0, 5269.0, 5444.0, 5594.0, 5548.0, 5427.0, 5310.0, 5667.0, 5340.0, 5569.0, 5520.0, 5476.0, 5555.0, 5485.0, 5462.0, 5414.0, 5619.0, 5438.0, 5289.0, 5664.0, 5695.0, 5420.0, 5331.0, 5253.0, 5636.0, 5645.0, 5601.0, 5691.0, 5661.0, 5605.0, 5372.0, 5459.0, 5711.0, 5407.0, 5571.0, 5443.0, 5620.0, 5390.0, 5400.0, 5708.0, 5715.0, 5714.0, 5556.0, 5277.0, 5495.0, 5549.0, 5514.0, 5639.0, 5697.0, 5408.0, 5275.0, 5338.0, 5583.0, 5660.0, 5589.0, 5423.0, 5683.0, 5535.0, 5477.0, 5703.0, 5454.0, 5385.0 (number of hits: 7)
6	5510	9	1	333	1	5596.0, 5673.0, 5440.0, 5620.0, 5338.0, 5306.0, 5695.0, 5477.0, 5417.0, 5669.0, 5606.0, 5626.0, 5593.0, 5577.0, 5543.0, 5271.0, 5718.0, 5393.0, 5535.0, 5310.0, 5292.0, 5688.0, 5423.0, 5603.0, 5351.0, 5629.0, 5594.0, 5340.0, 5546.0, 5296.0, 5554.0, 5595.0, 5372.0, 5481.0, 5690.0, 5250.0, 5333.0, 5456.0, 5580.0, 5404.0, 5426.0, 5257.0, 5582.0, 5267.0, 5517.0, 5678.0, 5485.0, 5722.0, 5467.0, 5311.0

						5525.0, 5435.0, 5307.0, 5720.0, 5569.0, 5425.0, 5587.0, 5512.0, 5322.0, 5713.0, 5608.0, 5414.0, 5255.0, 5454.0, 5439.0, 5328.0, 5624.0, 5396.0, 5252.0, 5570.0, 5475.0, 5391.0, 5364.0, 5597.0, 5526.0, 5647.0, 5258.0, 5380.0, 5505.0, 5571.0, 5581.0, 5649.0, 5704.0, 5583.0, 5502.0, 5591.0, 5633.0, 5706.0, 5360.0, 5421.0, 5671.0, 5507.0, 5503.0, 5256.0, 5654.0, 5476.0, 5702.0, 5631.0, 5689.0, 5293.0 (number of hits: 8)
7	5510	9	1	333	1	5688.0, 5558.0, 5396.0, 5505.0, 5565.0, 5273.0, 5454.0, 5337.0, 5292.0, 5651.0, 5681.0, 5650.0, 5532.0, 5422.0, 5432.0, 5698.0, 5338.0, 5348.0, 5510.0, 5594.0, 5414.0, 5435.0, 5252.0, 5659.0, 5264.0, 5598.0, 5381.0, 5520.0, 5693.0, 5635.0, 5680.0, 5347.0, 5591.0, 5413.0, 5571.0, 5282.0, 5670.0, 5360.0, 5481.0, 5543.0, 5460.0, 5617.0, 5603.0, 5437.0, 5513.0, 5584.0, 5349.0, 5645.0, 5541.0, 5604.0, 5321.0, 5368.0, 5398.0, 5443.0, 5305.0, 5342.0, 5519.0, 5627.0, 5257.0, 5376.0, 5372.0, 5425.0, 5291.0, 5597.0, 5345.0, 5487.0, 5611.0, 5500.0, 5476.0, 5682.0, 5503.0, 5576.0, 5580.0, 5416.0, 5661.0, 5424.0, 5642.0, 5641.0, 5408.0, 5442.0, 5373.0, 5702.0, 5479.0, 5259.0, 5431.0, 5677.0, 5320.0, 5560.0, 5336.0, 5554.0, 5605.0, 5592.0, 5665.0, 5518.0, 5535.0, 5573.0, 5324.0, 5470.0, 5624.0, 5486.0 (number of hits: 8)
8	5510	9	1	333	1	5279.0, 5618.0, 5523.0, 5520.0, 5484.0, 5553.0, 5257.0, 5656.0, 5637.0, 5309.0, 5465.0, 5427.0, 5322.0, 5622.0, 5407.0, 5508.0, 5638.0, 5682.0, 5559.0, 5570.0, 5476.0, 5648.0, 5579.0, 5514.0, 5513.0, 5436.0, 5356.0, 5515.0, 5500.0, 5448.0, 5442.0, 5536.0, 5529.0, 5463.0, 5535.0, 5292.0, 5388.0, 5604.0, 5548.0, 5483.0, 5723.0, 5458.0, 5597.0, 5487.0, 5482.0, 5304.0, 5313.0, 5509.0, 5696.0, 5680.0, 5398.0, 5703.0, 5658.0, 5502.0, 5420.0, 5290.0, 5373.0, 5569.0, 5256.0, 5306.0, 5628.0, 5634.0, 5379.0, 5627.0, 5317.0, 5376.0, 5600.0, 5426.0, 5319.0, 5644.0, 5522.0, 5362.0, 5355.0, 5281.0, 5541.0, 5545.0, 5318.0, 5425.0, 5311.0, 5589.0, 5664.0, 5625.0, 5360.0, 5400.0, 5251.0, 5549.0, 5550.0, 5316.0, 5470.0, 5649.0, 5619.0, 5565.0, 5621.0, 5286.0, 5334.0, 5555.0, 5347.0, 5650.0, 5358.0, 5369.0 (number of hits: 10)
9	5510	9	1	333	1	5630.0, 5694.0, 5321.0, 5508.0, 5688.0, 5408.0, 5594.0, 5480.0, 5341.0, 5486.0, 5396.0, 5503.0, 5452.0, 5363.0, 5670.0, 5412.0, 5373.0, 5350.0, 5702.0, 5615.0, 5374.0, 5623.0, 5399.0, 5531.0, 5683.0, 5369.0, 5288.0, 5666.0, 5591.0, 5715.0, 5365.0, 5536.0, 5549.0, 5424.0, 5357.0

						5660.0, 5608.0, 5440.0, 5465.0, 5689.0, 5301.0, 5497.0, 5300.0, 5472.0, 5344.0, 5360.0, 5556.0, 5505.0, 5419.0, 5423.0, 5390.0, 5253.0, 5496.0, 5610.0, 5664.0, 5449.0, 5512.0, 5391.0, 5501.0, 5584.0, 5554.0, 5625.0, 5418.0, 5267.0, 5445.0, 5417.0, 5258.0, 5285.0, 5392.0, 5522.0, 5578.0, 5706.0, 5654.0, 5640.0, 5700.0, 5658.0, 5442.0, 5719.0, 5264.0, 5259.0, 5647.0, 5690.0, 5632.0, 5681.0, 5537.0, 5650.0, 5463.0, 5612.0, 5558.0, 5297.0, 5289.0, 5255.0, 5605.0, 5296.0, 5707.0, 5538.0, 5448.0, 5385.0, 5293.0, 5271.0 (number of hits: 8)
10	5510	9	1	333	1	5340.0, 5335.0, 5378.0, 5586.0, 5555.0, 5658.0, 5640.0, 5628.0, 5632.0, 5437.0, 5274.0, 5310.0, 5526.0, 5283.0, 5308.0, 5659.0, 5601.0, 5547.0, 5401.0, 5350.0, 5705.0, 5689.0, 5434.0, 5253.0, 5589.0, 5322.0, 5355.0, 5653.0, 5655.0, 5681.0, 5295.0, 5413.0, 5716.0, 5264.0, 5418.0, 5317.0, 5462.0, 5263.0, 5339.0, 5485.0, 5541.0, 5667.0, 5680.0, 5380.0, 5430.0, 5512.0, 5451.0, 5626.0, 5636.0, 5500.0, 5432.0, 5293.0, 5627.0, 5637.0, 5294.0, 5459.0, 5621.0, 5464.0, 5645.0, 5615.0, 5584.0, 5442.0, 5569.0, 5261.0, 5306.0, 5477.0, 5711.0, 5510.0, 5630.0, 5677.0, 5475.0, 5356.0, 5643.0, 5327.0, 5649.0, 5259.0, 5469.0, 5365.0, 5696.0, 5319.0, 5704.0, 5338.0, 5546.0, 5650.0, 5455.0, 5367.0, 5706.0, 5617.0, 5557.0, 5321.0, 5671.0, 5504.0, 5320.0, 5336.0, 5581.0, 5715.0, 5507.0, 5250.0, 5363.0, 5698.0 (number of hits: 6)
11	5510	9	1	333	1	5519.0, 5663.0, 5463.0, 5305.0, 5472.0, 5715.0, 5466.0, 5651.0, 5520.0, 5556.0, 5283.0, 5607.0, 5429.0, 5631.0, 5289.0, 5308.0, 5331.0, 5652.0, 5324.0, 5470.0, 5392.0, 5617.0, 5592.0, 5593.0, 5611.0, 5508.0, 5264.0, 5414.0, 5320.0, 5707.0, 5542.0, 5263.0, 5578.0, 5598.0, 5478.0, 5529.0, 5342.0, 5343.0, 5480.0, 5538.0, 5420.0, 5323.0, 5306.0, 5564.0, 5497.0, 5329.0, 5662.0, 5436.0, 5713.0, 5325.0, 5632.0, 5697.0, 5298.0, 5416.0, 5549.0, 5333.0, 5279.0, 5403.0, 5711.0, 5550.0, 5461.0, 5635.0, 5330.0, 5569.0, 5297.0, 5332.0, 5521.0, 5614.0, 5507.0, 5254.0, 5278.0, 5532.0, 5375.0, 5417.0, 5509.0, 5600.0, 5372.0, 5387.0, 5435.0, 5636.0, 5537.0, 5450.0, 5410.0, 5442.0, 5655.0, 5407.0, 5623.0, 5547.0, 5355.0, 5671.0, 5339.0, 5603.0, 5402.0, 5699.0, 5288.0, 5649.0, 5475.0, 5412.0, 5307.0, 5411.0 (number of hits: 7)
12	5510	9	1	333	1	5660.0, 5335.0, 5481.0, 5484.0, 5374.0, 5669.0, 5715.0, 5352.0, 5381.0, 5540.0, 5590.0, 5368.0, 5371.0, 5601.0, 5469.0, 5341.0, 5563.0, 5654.0, 5538.0, 5324.0,

						5598.0, 5615.0, 5536.0, 5576.0, 5513.0, 5568.0, 5263.0, 5438.0, 5395.0, 5273.0, 5449.0, 5659.0, 5415.0, 5628.0, 5709.0, 5656.0, 5299.0, 5589.0, 5690.0, 5515.0, 5492.0, 5487.0, 5665.0, 5639.0, 5257.0, 5476.0, 5390.0, 5707.0, 5255.0, 5610.0, 5382.0, 5336.0, 5508.0, 5644.0, 5361.0, 5428.0, 5539.0, 5661.0, 5312.0, 5392.0, 5614.0, 5604.0, 5470.0, 5265.0, 5643.0, 5672.0, 5266.0, 5397.0, 5569.0, 5570.0, 5345.0, 5529.0, 5525.0, 5447.0, 5606.0, 5264.0, 5697.0, 5479.0, 5387.0, 5678.0, 5677.0, 5315.0, 5493.0, 5666.0, 5309.0, 5342.0, 5286.0, 5640.0, 5292.0, 5457.0, 5258.0, 5436.0, 5370.0, 5549.0, 5579.0, 5459.0, 5577.0, 5504.0, 5685.0, 5365.0 (number of hits: 7)
13	5510	9	1	333	1	5574.0, 5654.0, 5371.0, 5723.0, 5496.0, 5474.0, 5481.0, 5368.0, 5255.0, 5467.0, 5263.0, 5470.0, 5342.0, 5387.0, 5561.0, 5385.0, 5563.0, 5661.0, 5535.0, 5322.0, 5536.0, 5480.0, 5416.0, 5325.0, 5502.0, 5565.0, 5655.0, 5401.0, 5665.0, 5449.0, 5478.0, 5521.0, 5627.0, 5275.0, 5331.0, 5542.0, 5403.0, 5669.0, 5431.0, 5362.0, 5590.0, 5299.0, 5455.0, 5525.0, 5375.0, 5598.0, 5365.0, 5300.0, 5283.0, 5634.0, 5578.0, 5709.0, 5490.0, 5564.0, 5294.0, 5556.0, 5333.0, 5427.0, 5569.0, 5288.0, 5345.0, 5475.0, 5617.0, 5688.0, 5570.0, 5551.0, 5514.0, 5681.0, 5443.0, 5652.0, 5533.0, 5591.0, 5274.0, 5378.0, 5360.0, 5351.0, 5616.0, 5673.0, 5656.0, 5326.0, 5509.0, 5254.0, 5694.0, 5689.0, 5679.0, 5441.0, 5267.0, 5594.0, 5292.0, 5442.0, 5690.0, 5290.0, 5541.0, 5526.0, 5588.0, 5504.0, 5451.0, 5447.0, 5572.0, 5409.0 (number of hits: 8)
14	5510	9	1	333	1	5251.0, 5472.0, 5387.0, 5713.0, 5385.0, 5664.0, 5381.0, 5441.0, 5621.0, 5359.0, 5477.0, 5301.0, 5667.0, 5609.0, 5545.0, 5661.0, 5476.0, 5440.0, 5332.0, 5495.0, 5708.0, 5389.0, 5380.0, 5252.0, 5714.0, 5357.0, 5568.0, 5674.0, 5474.0, 5373.0, 5419.0, 5529.0, 5652.0, 5408.0, 5467.0, 5569.0, 5391.0, 5257.0, 5598.0, 5481.0, 5431.0, 5388.0, 5309.0, 5487.0, 5308.0, 5471.0, 5677.0, 5341.0, 5627.0, 5655.0, 5603.0, 5720.0, 5297.0, 5376.0, 5695.0, 5485.0, 5320.0, 5280.0, 5384.0, 5549.0, 5628.0, 5530.0, 5587.0, 5525.0, 5612.0, 5370.0, 5362.0, 5466.0, 5632.0, 5395.0, 5643.0, 5633.0, 5613.0, 5258.0, 5483.0, 5611.0, 5456.0, 5292.0, 5274.0, 5509.0, 5371.0, 5582.0, 5449.0, 5710.0, 5607.0, 5255.0, 5659.0, 5583.0, 5264.0, 5527.0, 5552.0, 5676.0, 5640.0, 5434.0, 5311.0, 5670.0, 5618.0, 5704.0, 5346.0, 5539.0 (number of hits: 4)
15	5510	9	1	333	1	5434.0, 5465.0, 5533.0, 5710.0, 5582.0,

						5482.0, 5656.0, 5624.0, 5395.0, 5549.0, 5375.0, 5399.0, 5718.0, 5271.0, 5691.0, 5506.0, 5333.0, 5490.0, 5362.0, 5419.0, 5295.0, 5524.0, 5281.0, 5397.0, 5564.0, 5709.0, 5380.0, 5644.0, 5441.0, 5385.0, 5367.0, 5413.0, 5538.0, 5722.0, 5633.0, 5274.0, 5438.0, 5377.0, 5467.0, 5602.0, 5688.0, 5627.0, 5289.0, 5706.0, 5452.0, 5647.0, 5442.0, 5439.0, 5543.0, 5678.0, 5704.0, 5394.0, 5425.0, 5596.0, 5595.0, 5436.0, 5570.0, 5542.0, 5660.0, 5282.0, 5521.0, 5541.0, 5359.0, 5290.0, 5416.0, 5461.0, 5309.0, 5390.0, 5384.0, 5675.0, 5328.0, 5537.0, 5673.0, 5265.0, 5443.0, 5386.0, 5327.0, 5690.0, 5556.0, 5501.0, 5698.0, 5489.0, 5581.0, 5502.0, 5702.0, 5577.0, 5635.0, 5484.0, 5593.0, 5447.0, 5276.0, 5626.0, 5689.0, 5637.0, 5494.0, 5696.0, 5682.0, 5457.0, 5619.0, 5462.0 (number of hits: 6)
16	5510	9	1	333	1	5434.0, 5517.0, 5481.0, 5597.0, 5506.0, 5417.0, 5675.0, 5634.0, 5468.0, 5578.0, 5367.0, 5509.0, 5679.0, 5316.0, 5429.0, 5400.0, 5372.0, 5402.0, 5563.0, 5354.0, 5269.0, 5697.0, 5266.0, 5600.0, 5401.0, 5619.0, 5317.0, 5564.0, 5565.0, 5711.0, 5585.0, 5486.0, 5712.0, 5374.0, 5453.0, 5284.0, 5685.0, 5398.0, 5409.0, 5609.0, 5389.0, 5373.0, 5271.0, 5706.0, 5594.0, 5570.0, 5350.0, 5618.0, 5549.0, 5624.0, 5408.0, 5686.0, 5531.0, 5388.0, 5288.0, 5458.0, 5334.0, 5463.0, 5418.0, 5311.0, 5641.0, 5345.0, 5332.0, 5280.0, 5569.0, 5670.0, 5348.0, 5503.0, 5713.0, 5501.0, 5253.0, 5541.0, 5452.0, 5461.0, 5519.0, 5702.0, 5366.0, 5645.0, 5500.0, 5721.0, 5449.0, 5432.0, 5278.0, 5714.0, 5692.0, 5344.0, 5606.0, 5443.0, 5674.0, 5454.0, 5648.0, 5513.0, 5365.0, 5628.0, 5520.0, 5255.0, 5428.0, 5290.0, 5550.0, 5327.0 (number of hits: 9)
17	5510	9	1	333	1	5671.0, 5608.0, 5694.0, 5309.0, 5440.0, 5656.0, 5554.0, 5558.0, 5335.0, 5623.0, 5484.0, 5690.0, 5658.0, 5651.0, 5389.0, 5594.0, 5374.0, 5559.0, 5491.0, 5618.0, 5355.0, 5470.0, 5474.0, 5516.0, 5492.0, 5277.0, 5505.0, 5686.0, 5377.0, 5531.0, 5371.0, 5265.0, 5601.0, 5620.0, 5545.0, 5655.0, 5405.0, 5460.0, 5308.0, 5369.0, 5254.0, 5588.0, 5555.0, 5661.0, 5549.0, 5520.0, 5457.0, 5466.0, 5436.0, 5263.0, 5288.0, 5413.0, 5312.0, 5447.0, 5476.0, 5679.0, 5640.0, 5696.0, 5478.0, 5356.0, 5339.0, 5370.0, 5435.0, 5587.0, 5419.0, 5362.0, 5722.0, 5420.0, 5721.0, 5556.0, 5300.0, 5454.0, 5260.0, 5463.0, 5582.0, 5310.0, 5612.0, 5255.0, 5611.0, 5683.0, 5707.0, 5297.0, 5417.0, 5305.0, 5692.0, 5616.0, 5415.0, 5359.0, 5316.0, 5330.0, 5577.0, 5376.0, 5543.0, 5710.0, 5660.0

						5321.0, 5271.0, 5503.0, 5586.0, 5525.0 (number of hits: 6)
18	5510	9	1	333	1	5335.0, 5316.0, 5567.0, 5322.0, 5447.0, 5679.0, 5438.0, 5561.0, 5351.0, 5414.0, 5558.0, 5482.0, 5289.0, 5685.0, 5392.0, 5383.0, 5499.0, 5620.0, 5503.0, 5328.0, 5607.0, 5711.0, 5588.0, 5704.0, 5539.0, 5589.0, 5258.0, 5512.0, 5288.0, 5612.0, 5418.0, 5518.0, 5590.0, 5600.0, 5660.0, 5602.0, 5297.0, 5689.0, 5574.0, 5675.0, 5343.0, 5714.0, 5290.0, 5564.0, 5490.0, 5486.0, 5439.0, 5619.0, 5532.0, 5265.0, 5692.0, 5577.0, 5514.0, 5703.0, 5431.0, 5451.0, 5352.0, 5312.0, 5370.0, 5308.0, 5661.0, 5324.0, 5634.0, 5632.0, 5560.0, 5501.0, 5672.0, 5717.0, 5681.0, 5455.0, 5446.0, 5551.0, 5272.0, 5342.0, 5340.0, 5281.0, 5559.0, 5311.0, 5525.0, 5433.0, 5427.0, 5572.0, 5362.0, 5252.0, 5251.0, 5460.0, 5624.0, 5461.0, 5710.0, 5296.0, 5314.0, 5449.0, 5462.0, 5570.0, 5329.0, 5344.0, 5715.0, 5333.0, 5356.0, 5669.0 (number of hits: 7)
19	5510	9	1	333	1	5414.0, 5452.0, 5341.0, 5301.0, 5717.0, 5579.0, 5350.0, 5664.0, 5684.0, 5493.0, 5539.0, 5560.0, 5365.0, 5567.0, 5470.0, 5300.0, 5632.0, 5568.0, 5508.0, 5519.0, 5304.0, 5375.0, 5455.0, 5645.0, 5667.0, 5610.0, 5687.0, 5601.0, 5339.0, 5410.0, 5532.0, 5292.0, 5333.0, 5342.0, 5285.0, 5377.0, 5368.0, 5278.0, 5658.0, 5338.0, 5274.0, 5480.0, 5290.0, 5552.0, 5388.0, 5523.0, 5402.0, 5518.0, 5485.0, 5259.0, 5384.0, 5497.0, 5331.0, 5501.0, 5401.0, 5525.0, 5622.0, 5648.0, 5529.0, 5254.0, 5691.0, 5313.0, 5293.0, 5369.0, 5649.0, 5527.0, 5564.0, 5268.0, 5674.0, 5612.0, 5389.0, 5336.0, 5345.0, 5286.0, 5628.0, 5419.0, 5619.0, 5581.0, 5432.0, 5647.0, 5335.0, 5656.0, 5705.0, 5661.0, 5620.0, 5565.0, 5461.0, 5279.0, 5598.0, 5346.0, 5298.0, 5605.0, 5334.0, 5378.0, 5630.0, 5592.0, 5251.0, 5448.0, 5267.0, 5431.0 (number of hits: 9)
20	5510	9	1	333	1	5370.0, 5594.0, 5412.0, 5337.0, 5315.0, 5554.0, 5695.0, 5503.0, 5624.0, 5254.0, 5305.0, 5431.0, 5617.0, 5386.0, 5688.0, 5492.0, 5587.0, 5556.0, 5461.0, 5480.0, 5312.0, 5306.0, 5721.0, 5486.0, 5357.0, 5565.0, 5591.0, 5372.0, 5541.0, 5374.0, 5505.0, 5473.0, 5579.0, 5568.0, 5621.0, 5632.0, 5417.0, 5566.0, 5491.0, 5618.0, 5509.0, 5373.0, 5291.0, 5351.0, 5423.0, 5258.0, 5604.0, 5531.0, 5679.0, 5517.0, 5705.0, 5481.0, 5447.0, 5323.0, 5293.0, 5476.0, 5489.0, 5500.0, 5654.0, 5592.0, 5559.0, 5296.0, 5716.0, 5438.0, 5723.0, 5697.0, 5564.0, 5389.0, 5701.0, 5456.0, 5425.0, 5689.0, 5479.0, 5366.0, 5545.0, 5261.0, 5717.0, 5453.0, 5647.0, 5569.0

						5696.0, 5440.0, 5533.0, 5377.0, 5421.0, 5276.0, 5513.0, 5642.0, 5560.0, 5626.0, 5446.0, 5468.0, 5593.0, 5419.0, 5499.0, 5629.0, 5613.0, 5428.0, 5477.0, 5436.0 (number of hits: 8)
21	5510	9	1	333	1	5529.0, 5429.0, 5444.0, 5611.0, 5609.0, 5527.0, 5476.0, 5291.0, 5488.0, 5571.0, 5457.0, 5396.0, 5360.0, 5547.0, 5393.0, 5546.0, 5394.0, 5631.0, 5666.0, 5700.0, 5477.0, 5606.0, 5337.0, 5675.0, 5300.0, 5414.0, 5407.0, 5519.0, 5690.0, 5478.0, 5461.0, 5503.0, 5481.0, 5517.0, 5374.0, 5623.0, 5409.0, 5561.0, 5575.0, 5669.0, 5704.0, 5699.0, 5397.0, 5361.0, 5350.0, 5301.0, 5406.0, 5455.0, 5573.0, 5411.0, 5485.0, 5416.0, 5496.0, 5420.0, 5275.0, 5593.0, 5659.0, 5525.0, 5604.0, 5715.0, 5679.0, 5539.0, 5630.0, 5526.0, 5292.0, 5379.0, 5592.0, 5504.0, 5550.0, 5341.0, 5614.0, 5651.0, 5311.0, 5365.0, 5289.0, 5719.0, 5286.0, 5303.0, 5628.0, 5572.0, 5445.0, 5506.0, 5263.0, 5636.0, 5671.0, 5610.0, 5492.0, 5417.0, 5471.0, 5551.0, 5615.0, 5282.0, 5681.0, 5654.0, 5682.0, 5256.0, 5336.0, 5543.0, 5705.0, 5390.0 (number of hits: 10)
22	5510	9	1	333	1	5621.0, 5588.0, 5375.0, 5261.0, 5430.0, 5436.0, 5705.0, 5698.0, 5371.0, 5254.0, 5307.0, 5682.0, 5364.0, 5435.0, 5559.0, 5628.0, 5343.0, 5361.0, 5582.0, 5331.0, 5416.0, 5415.0, 5510.0, 5629.0, 5442.0, 5395.0, 5549.0, 5382.0, 5525.0, 5434.0, 5422.0, 5535.0, 5492.0, 5396.0, 5545.0, 5542.0, 5585.0, 5666.0, 5440.0, 5465.0, 5281.0, 5301.0, 5286.0, 5649.0, 5323.0, 5572.0, 5690.0, 5488.0, 5394.0, 5574.0, 5470.0, 5570.0, 5380.0, 5717.0, 5547.0, 5376.0, 5579.0, 5295.0, 5340.0, 5437.0, 5327.0, 5532.0, 5296.0, 5283.0, 5601.0, 5423.0, 5377.0, 5515.0, 5560.0, 5691.0, 5424.0, 5402.0, 5277.0, 5432.0, 5637.0, 5667.0, 5263.0, 5363.0, 5618.0, 5288.0, 5584.0, 5498.0, 5448.0, 5285.0, 5493.0, 5590.0, 5617.0, 5519.0, 5520.0, 5291.0, 5541.0, 5496.0, 5370.0, 5403.0, 5332.0, 5454.0, 5509.0, 5648.0, 5476.0, 5410.0 (number of hits: 10)
23	5510	9	1	333	1	5687.0, 5628.0, 5581.0, 5262.0, 5360.0, 5388.0, 5351.0, 5686.0, 5442.0, 5482.0, 5489.0, 5408.0, 5541.0, 5658.0, 5666.0, 5576.0, 5386.0, 5702.0, 5564.0, 5560.0, 5504.0, 5369.0, 5636.0, 5409.0, 5355.0, 5623.0, 5429.0, 5383.0, 5538.0, 5551.0, 5461.0, 5401.0, 5498.0, 5523.0, 5271.0, 5591.0, 5632.0, 5600.0, 5514.0, 5261.0, 5395.0, 5647.0, 5634.0, 5566.0, 5270.0, 5713.0, 5460.0, 5421.0, 5354.0, 5705.0, 5361.0, 5604.0, 5607.0, 5431.0, 5483.0, 5349.0, 5651.0, 5646.0, 5680.0, 5542.0, 5260.0, 5545.0, 5324.0, 5555.0, 5508.0,

						5269.0, 5573.0, 5419.0, 5459.0, 5688.0, 5582.0, 5672.0, 5554.0, 5539.0, 5679.0, 5412.0, 5525.0, 5336.0, 5486.0, 5402.0, 5650.0, 5456.0, 5644.0, 5415.0, 5268.0, 5301.0, 5377.0, 5598.0, 5676.0, 5321.0, 5300.0, 5606.0, 5453.0, 5549.0, 5603.0, 5350.0, 5673.0, 5274.0, 5254.0, 5413.0 (number of hits: 6)
24	5510	9	1	333	1	5519.0, 5347.0, 5630.0, 5350.0, 5425.0, 5263.0, 5452.0, 5324.0, 5430.0, 5592.0, 5270.0, 5552.0, 5652.0, 5480.0, 5387.0, 5478.0, 5619.0, 5614.0, 5316.0, 5463.0, 5284.0, 5435.0, 5626.0, 5695.0, 5475.0, 5576.0, 5540.0, 5514.0, 5314.0, 5346.0, 5560.0, 5642.0, 5656.0, 5356.0, 5490.0, 5359.0, 5717.0, 5590.0, 5325.0, 5509.0, 5533.0, 5283.0, 5661.0, 5663.0, 5613.0, 5294.0, 5373.0, 5300.0, 5625.0, 5468.0, 5715.0, 5319.0, 5453.0, 5666.0, 5546.0, 5428.0, 5597.0, 5696.0, 5469.0, 5280.0, 5575.0, 5262.0, 5704.0, 5570.0, 5518.0, 5492.0, 5392.0, 5555.0, 5554.0, 5605.0, 5422.0, 5364.0, 5716.0, 5326.0, 5537.0, 5676.0, 5535.0, 5267.0, 5399.0, 5493.0, 5466.0, 5620.0, 5328.0, 5668.0, 5719.0, 5718.0, 5516.0, 5628.0, 5579.0, 5298.0, 5694.0, 5381.0, 5698.0, 5543.0, 5400.0, 5584.0, 5393.0, 5472.0, 5547.0, 5405.0 (number of hits: 7)
25	5510	9	1	333	1	5299.0, 5364.0, 5625.0, 5647.0, 5433.0, 5666.0, 5713.0, 5494.0, 5569.0, 5272.0, 5279.0, 5520.0, 5708.0, 5449.0, 5355.0, 5503.0, 5546.0, 5305.0, 5349.0, 5404.0, 5287.0, 5517.0, 5545.0, 5467.0, 5444.0, 5419.0, 5475.0, 5504.0, 5684.0, 5447.0, 5436.0, 5680.0, 5290.0, 5482.0, 5375.0, 5435.0, 5486.0, 5438.0, 5391.0, 5379.0, 5320.0, 5703.0, 5636.0, 5586.0, 5534.0, 5723.0, 5260.0, 5405.0, 5276.0, 5485.0, 5603.0, 5340.0, 5514.0, 5376.0, 5298.0, 5571.0, 5675.0, 5414.0, 5371.0, 5274.0, 5413.0, 5512.0, 5256.0, 5408.0, 5650.0, 5593.0, 5263.0, 5606.0, 5254.0, 5428.0, 5353.0, 5411.0, 5643.0, 5704.0, 5622.0, 5398.0, 5291.0, 5665.0, 5430.0, 5616.0, 5629.0, 5432.0, 5556.0, 5649.0, 5682.0, 5720.0, 5555.0, 5599.0, 5459.0, 5648.0, 5686.0, 5664.0, 5605.0, 5529.0, 5694.0, 5420.0, 5608.0, 5600.0, 5333.0, 5257.0 (number of hits: 7)
26	5510	9	1	333	1	5576.0, 5451.0, 5482.0, 5625.0, 5720.0, 5586.0, 5420.0, 5400.0, 5587.0, 5352.0, 5522.0, 5618.0, 5476.0, 5268.0, 5402.0, 5555.0, 5452.0, 5633.0, 5604.0, 5681.0, 5332.0, 5548.0, 5502.0, 5603.0, 5687.0, 5394.0, 5634.0, 5382.0, 5702.0, 5273.0, 5621.0, 5303.0, 5423.0, 5413.0, 5456.0, 5518.0, 5398.0, 5531.0, 5463.0, 5699.0, 5319.0, 5358.0, 5652.0, 5414.0, 5584.0, 5496.0, 5538.0, 5628.0, 5651.0, 5286.0

						5438.0, 5282.0, 5472.0, 5290.0, 5344.0, 5670.0, 5596.0, 5440.0, 5460.0, 5654.0, 5624.0, 5251.0, 5698.0, 5709.0, 5543.0, 5533.0, 5663.0, 5638.0, 5612.0, 5416.0, 5349.0, 5711.0, 5564.0, 5682.0, 5262.0, 5561.0, 5458.0, 5410.0, 5620.0, 5342.0, 5387.0, 5686.0, 5370.0, 5579.0, 5269.0, 5703.0, 5439.0, 5465.0, 5270.0, 5552.0, 5511.0, 5551.0, 5553.0, 5285.0, 5694.0, 5328.0, 5610.0, 5384.0, 5595.0, 5715.0 (number of hits: 5)
27	5510	9	1	333	1	5398.0, 5390.0, 5391.0, 5658.0, 5508.0, 5504.0, 5510.0, 5340.0, 5432.0, 5424.0, 5296.0, 5435.0, 5405.0, 5489.0, 5374.0, 5328.0, 5680.0, 5490.0, 5339.0, 5324.0, 5716.0, 5517.0, 5649.0, 5528.0, 5606.0, 5270.0, 5714.0, 5345.0, 5600.0, 5646.0, 5713.0, 5402.0, 5704.0, 5461.0, 5341.0, 5569.0, 5676.0, 5564.0, 5480.0, 5436.0, 5258.0, 5293.0, 5428.0, 5385.0, 5448.0, 5323.0, 5651.0, 5543.0, 5689.0, 5635.0, 5684.0, 5706.0, 5535.0, 5414.0, 5572.0, 5557.0, 5506.0, 5310.0, 5277.0, 5411.0, 5394.0, 5579.0, 5696.0, 5333.0, 5442.0, 5487.0, 5434.0, 5250.0, 5524.0, 5559.0, 5722.0, 5521.0, 5425.0, 5515.0, 5332.0, 5594.0, 5441.0, 5308.0, 5621.0, 5382.0, 5685.0, 5450.0, 5268.0, 5479.0, 5292.0, 5522.0, 5287.0, 5350.0, 5634.0, 5318.0, 5380.0, 5470.0, 5275.0, 5359.0, 5492.0, 5516.0, 5690.0, 5409.0, 5362.0, 5710.0 (number of hits: 11)
28	5510	9	1	333	1	5498.0, 5311.0, 5629.0, 5458.0, 5530.0, 5456.0, 5278.0, 5572.0, 5365.0, 5372.0, 5724.0, 5583.0, 5597.0, 5490.0, 5706.0, 5413.0, 5276.0, 5324.0, 5547.0, 5381.0, 5503.0, 5258.0, 5307.0, 5663.0, 5306.0, 5592.0, 5689.0, 5367.0, 5600.0, 5679.0, 5548.0, 5698.0, 5361.0, 5610.0, 5614.0, 5550.0, 5722.0, 5578.0, 5598.0, 5380.0, 5672.0, 5556.0, 5499.0, 5485.0, 5437.0, 5508.0, 5337.0, 5650.0, 5355.0, 5616.0, 5454.0, 5630.0, 5303.0, 5719.0, 5662.0, 5251.0, 5342.0, 5415.0, 5296.0, 5661.0, 5523.0, 5542.0, 5419.0, 5580.0, 5391.0, 5625.0, 5714.0, 5291.0, 5363.0, 5384.0, 5559.0, 5436.0, 5271.0, 5686.0, 5495.0, 5668.0, 5517.0, 5566.0, 5273.0, 5585.0, 5299.0, 5648.0, 5407.0, 5532.0, 5623.0, 5451.0, 5527.0, 5442.0, 5279.0, 5460.0, 5622.0, 5310.0, 5362.0, 5484.0, 5576.0, 5379.0, 5647.0, 5364.0, 5346.0, 5554.0 (number of hits: 8)
29	5510	9	1	333	1	5470.0, 5253.0, 5258.0, 5579.0, 5701.0, 5369.0, 5545.0, 5722.0, 5333.0, 5319.0, 5617.0, 5665.0, 5515.0, 5692.0, 5353.0, 5498.0, 5484.0, 5590.0, 5534.0, 5706.0, 5292.0, 5531.0, 5557.0, 5698.0, 5634.0, 5379.0, 5385.0, 5347.0, 5261.0, 5591.0, 5647.0, 5521.0, 5294.0, 5416.0, 5669.0

						5286.0, 5382.0, 5712.0, 5250.0, 5266.0, 5624.0, 5432.0, 5392.0, 5456.0, 5396.0, 5642.0, 5377.0, 5676.0, 5589.0, 5593.0, 5556.0, 5662.0, 5519.0, 5533.0, 5325.0, 5404.0, 5596.0, 5305.0, 5563.0, 5354.0, 5394.0, 5409.0, 5444.0, 5581.0, 5713.0, 5351.0, 5473.0, 5493.0, 5654.0, 5418.0, 5338.0, 5272.0, 5621.0, 5599.0, 5410.0, 5298.0, 5357.0, 5267.0, 5507.0, 5609.0, 5383.0, 5332.0, 5643.0, 5442.0, 5468.0, 5546.0, 5334.0, 5526.0, 5350.0, 5259.0, 5586.0, 5690.0, 5287.0, 5716.0, 5658.0, 5301.0, 5311.0, 5400.0, 5256.0, 5381.0 (number of hits: 7)
30	5510	9	1	333	1	5598.0, 5380.0, 5642.0, 5641.0, 5640.0, 5479.0, 5539.0, 5434.0, 5444.0, 5589.0, 5354.0, 5261.0, 5312.0, 5327.0, 5504.0, 5433.0, 5386.0, 5651.0, 5310.0, 5622.0, 5510.0, 5657.0, 5425.0, 5290.0, 5591.0, 5378.0, 5555.0, 5392.0, 5583.0, 5687.0, 5307.0, 5296.0, 5659.0, 5606.0, 5714.0, 5423.0, 5455.0, 5311.0, 5663.0, 5502.0, 5585.0, 5418.0, 5540.0, 5417.0, 5720.0, 5536.0, 5660.0, 5356.0, 5458.0, 5524.0, 5604.0, 5383.0, 5388.0, 5393.0, 5560.0, 5661.0, 5331.0, 5435.0, 5278.0, 5603.0, 5476.0, 5484.0, 5493.0, 5464.0, 5381.0, 5688.0, 5317.0, 5546.0, 5697.0, 5677.0, 5678.0, 5700.0, 5628.0, 5468.0, 5685.0, 5367.0, 5515.0, 5513.0, 5518.0, 5385.0, 5289.0, 5514.0, 5335.0, 5600.0, 5672.0, 5357.0, 5339.0, 5610.0, 5308.0, 5608.0, 5488.0, 5654.0, 5263.0, 5291.0, 5424.0, 5350.0, 5285.0, 5497.0, 5650.0, 5420.0 (number of hits: 10)

5530 MHz, 80 MHz Bandwidth

Radar Signal Type	Waveform/Trial Number	Detection (%)	Limit (%)	Pass/Fail
Type 1A/1B	30	100 %	60%	Pass
Type 2	30	100 %	60%	Pass
Type 3	30	90 %	60%	Pass
Type 4	30	83.3 %	60%	Pass
Aggregate (Type1 to 4)	120	91.1 %	80%	Pass
Type 5	30	100 %	80%	Pass
Type 6	30	100 %	70%	Pass

Please refer to the following statistical tables:

5530 MHz, 80 MHz Bandwidth**Table-1A/1B Radar Type 1A/1B Statistical Performance**

Trial #	Fc (MHz)	Pulse/Burst	Pulse Width (µS)	PRI (µs)	Detection (1:yes; 0:no)
1	5530	59	1	898	1
2	5530	72	1	738	1
3	5530	57	1	938	1
4	5530	99	1	538	1
5	5530	61	1	878	1
6	5492	65	1	818	1
7	5492	62	1	858	1
8	5492	70	1	758	1
9	5492	83	1	638	1
10	5492	74	1	718	1
11	5568	92	1	578	1
12	5568	68	1	778	1
13	5568	95	1	558	1
14	5568	86	1	618	1
15	5568	67	1	798	1
16	5530	21	1	2628	1
17	5530	61	1	874	1
18	5530	19	1	2863	1
19	5530	51	1	1044	1
20	5530	24	1	2261	1
21	5492	51	1	1050	1
22	5492	43	1	1248	1
23	5492	27	1	2020	1
24	5492	22	1	2490	1
25	5492	59	1	903	1
26	5568	23	1	2398	1
27	5568	19	1	2924	1
28	5568	58	1	920	1
29	5568	31	1	1735	1
30	5568	19	1	2817	1
Detection Percentage: 100 % (>60%)					

Table-2 Radar Type 2 Statistical Performance

Trial #	Fc (MHz)	Pulse/Burst	Pulse Width (μS)	PRI (μs)	Detection (1:yes; 0:no)
1	5530	23	1.4	163	1
2	5530	24	4.2	223	1
3	5530	23	5	216	1
4	5530	25	2.2	212	1
5	5530	28	3.1	206	1
6	5530	24	3.3	182	1
7	5530	26	1.8	204	1
8	5530	24	3.4	193	1
9	5530	27	2.7	188	1
10	5530	24	2.2	191	1
11	5492	24	3	194	1
12	5492	25	2.8	213	1
13	5492	27	4.9	166	1
14	5492	26	3.8	155	1
15	5492	28	2.4	185	1
16	5492	23	3.3	171	1
17	5492	25	4.3	170	1
18	5492	27	2	226	1
19	5492	24	4.3	181	1
20	5492	23	4.9	229	1
21	5568	25	3.2	179	1
22	5568	28	4.3	216	1
23	5568	27	2	202	1
24	5568	29	1	210	1
25	5568	24	3.3	209	1
26	5568	23	1.2	176	1
27	5568	29	4.5	200	1
28	5568	25	1.1	202	1
29	5568	26	2	200	1
30	5568	23	3.1	171	1
Detection Percentage: 100 % (>60%)					

Table-3 Radar Type 3 Statistical Performance

Trial #	Fc (MHz)	Pulse/Burst	Pulse Width (μS)	PRI (μs)	Detection (1:yes; 0:no)
1	5530	18	8.1	433	1
2	5530	16	8	231	1
3	5530	17	6.7	292	1
4	5530	18	8.2	293	1
5	5530	17	9.9	347	1
6	5530	18	9.9	413	1
7	5530	17	7.9	286	1
8	5530	18	9.7	368	1
9	5530	16	9.2	335	1
10	5530	16	9.4	307	1
11	5492	16	9.9	260	1
12	5492	17	7.4	228	1
13	5492	17	6.9	424	1
14	5492	16	8.8	441	1
15	5492	16	9	262	1
16	5492	18	9.9	342	1
17	5492	16	7.3	309	1
18	5492	18	8.4	471	1
19	5492	17	9.4	368	1
20	5492	16	8	464	1
21	5568	16	7.5	244	1
22	5568	16	8.8	313	0
23	5568	16	7.7	290	1
24	5568	16	6	373	1
25	5568	16	9.7	288	0
26	5568	18	7.4	243	0
27	5568	17	9.5	498	1
28	5568	17	8.2	219	1
29	5568	17	7	447	1
30	5568	16	6.4	269	1
Detection Percentage: 90 % (>60%)					

Table-4 Radar Type 4 Statistical Performance

Trial #	Fc (MHz)	Pulse/Burst	Pulse Width (µS)	PRI (µs)	Detection (1:yes; 0:no)
1	5530	13	15.9	397	1
2	5530	13	18.4	401	1
3	5530	13	16.9	412	1
4	5530	14	16.3	492	0
5	5530	13	16.3	386	1
6	5530	16	12.9	337	0
7	5530	13	18.6	454	0
8	5530	15	18.8	308	1
9	5530	14	11.8	263	1
10	5530	13	19.1	269	1
11	5492	16	12	483	1
12	5492	15	15.3	309	1
13	5492	14	13.2	345	1
14	5492	16	18	341	1
15	5492	14	15	373	1
16	5492	15	16.3	359	1
17	5492	12	19.9	209	0
18	5492	14	15.8	449	1
19	5492	16	12.6	282	1
20	5492	14	14.8	378	1
21	5568	14	14.3	388	1
22	5568	12	14.9	246	1
23	5568	12	17.2	298	1
24	5568	15	19.5	475	1
25	5568	14	18.6	457	1
26	5568	13	16.8	219	1
27	5568	12	15.8	477	1
28	5568	14	15.7	296	1
29	5568	16	19.9	208	1
30	5568	13	15.8	200	0
Detection Percentage: 83.3 % (>60%)					

Table-5 Radar Type 5 Statistical Performance

Trial #	Fc (MHz)	Detection (1:yes; 0:no)
1	5530	1
2	5530	1
3	5530	1
4	5530	1
5	5530	1
6	5530	1
7	5530	1
8	5530	1
9	5530	1
10	5530	1
11	5500.0	1
12	5499.6	1
13	5495.2	1
14	5494.4	1
15	5496.0	1
16	5499.6	1
17	5497.2	1
18	5496.8	1
19	5498.8	1
20	5497.6	1
21	5561.2	1
22	5564.8	1
23	5562.8	1
24	5562.0	1
25	5563.2	1
26	5566.0	1
27	5563.2	1
28	5564.8	1
29	5560.4	1
30	5561.2	1
Detection Percentage: 100 % (>80%)		

Bin5 Statistics 1

Trial #	Pulse	Chirp (MHz)	Pulse Width (µS)	Pulse 1-2 spacing (uS)	Pulse 2-3 spacing (uS)	Pulse Start(S)	Detection (1:yes; 0:no)
0	1	15	99.3	-	-	0.467694	1
1	2	15	90.3	1533	-	1.023623	
2	2	15	83.6	1468	-	1.814204	
3	3	15	57.4	1369	1823	3.069421	
4	2	15	98.9	1941	-	4.063031	
5	2	15	53.3	1525	-	4.287332	
6	3	15	96.9	1255	1083	5.516633	
7	3	15	89.5	1620	1710	6.69857	
8	1	15	72.1	-	-	7.642617	
9	3	15	63.8	1629	1636	7.826848	
10	1	15	54.3	-	-	9.294887	
11	2	15	68	1751	-	10.176245	
12	2	15	99.7	1485	-	10.676938	
13	1	15	66.4	-	-	11.922899	

Bin5 Statistics 2

Trial #	Pulse	Chirp (MHz)	Pulse Width (µS)	Pulse 1-2 spacing (uS)	Pulse 2-3 spacing (uS)	Pulse Start(S)	Detection (1:yes; 0:no)
0	1	15	59.7	-	-	0.962499	1
1	1	15	61.2	-	-	1.676318	
2	3	15	58	1110	1770	2.442112	
3	2	15	95.7	1131	-	4.260786	
4	3	15	56.2	1632	1151	5.111074	
5	3	15	52.3	1793	1790	7.154571	
6	1	15	86.1	-	-	8.114136	
7	3	15	93.1	1009	1503	8.823592	
8	3	15	89.7	1045	1819	10.438008	
9	2	15	76	1303	-	11.41003	

Bin5 Statistics 3

Trial #	Pulse	Chirp (MHz)	Pulse Width (µS)	Pulse 1-2 spacing (µS)	Pulse 2-3 spacing (µS)	Pulse Start(S)	Detection (1:yes; 0:no)
0	2	8	92.3	1217	-	0.535119	1
1	2	8	86.5	1807	-	1.368653	
2	3	8	87.2	1219	1034	3.225394	
3	2	8	63	1821	-	3.362926	
4	2	8	96.7	1443	-	4.464287	
5	2	8	98.5	1867	-	6.305641	
6	2	8	65.9	1857	-	6.687477	
7	2	8	95.2	1344	-	7.849998	
8	2	8	83.3	1381	-	9.746395	
9	3	8	69.1	1162	1575	10.117072	
10	1	8	73.1	-	-	10.916278	

Bin5 Statistics 4

Trial #	Pulse	Chirp (MHz)	Pulse Width (µS)	Pulse 1-2 spacing (µS)	Pulse 2-3 spacing (µS)	Pulse Start(S)	Detection (1:yes; 0:no)
0	1	13	58.2	-	-	0.589479	1
1	1	13	62.4	-	-	1.59775	
2	2	13	91.7	1812	-	2.342033	
3	1	13	77.5	-	-	3.033299	
4	2	13	52.9	1967	-	4.250398	
5	2	13	88	1041	-	4.912023	
6	2	13	70.5	1854	-	5.306579	
7	1	13	51.5	-	-	6.814581	
8	3	13	95.6	1008	1134	7.062983	
9	2	13	59	1919	-	8.377737	
10	2	13	51.4	1413	-	8.908143	
11	2	13	65.9	1377	-	9.48126	
12	3	13	85	1028	1581	10.723959	
13	3	13	87.4	1809	1651	11.695153	

Bin5 Statistics 5

Trial #	Pulse	Chirp (MHz)	Pulse Width (µS)	Pulse 1-2 spacing (uS)	Pulse 2-3 spacing (uS)	Pulse Start(S)	Detection (1:yes; 0:no)
0	1	14	88.3	-	-	0.517412	1
1	2	14	97.1	1487	-	1.242685	
2	1	14	98.2	-	-	2.482087	
3	2	14	60.5	1198	-	3.522781	
4	2	14	70.7	1799	-	4.438219	
5	1	14	99.4	-	-	5.301108	
6	3	14	97.8	1512	1057	5.570259	
7	1	14	92.3	-	-	7.088588	
8	2	14	79	1811	-	8.072477	
9	1	14	82.5	-	-	8.787914	
10	2	14	54.5	1075	-	9.559139	
11	1	14	51.6	-	-	11.059484	
12	2	14	99.9	1273	-	11.266212	

Bin5 Statistics 6

Trial #	Pulse	Chirp (MHz)	Pulse Width (µS)	Pulse 1-2 spacing (uS)	Pulse 2-3 spacing (uS)	Pulse Start(S)	Detection (1:yes; 0:no)
0	3	10	87.1	1791	1937	0.051179	1
1	2	10	95.7	1208	-	1.083513	
2	2	10	88.4	1529	-	2.114127	
3	1	10	53.2	-	-	2.629282	
4	3	10	50.4	1907	1531	3.716298	
5	2	10	68.1	1421	-	5.041828	
6	2	10	78.2	1023	-	5.705862	
7	2	10	95.7	1440	-	6.338915	
8	2	10	87	1772	-	7.289108	
9	2	10	91.1	1596	-	8.209142	
10	2	10	86.1	1641	-	8.611588	
11	2	10	53.9	1586	-	9.495484	
12	2	10	77.3	1920	-	10.521972	
13	3	10	86.9	1599	1435	11.813994	

Bin5 Statistics 7

Trial #	Pulse	Chirp (MHz)	Pulse Width (µS)	Pulse 1-2 spacing (µS)	Pulse 2-3 spacing (µS)	Pulse Start(S)	Detection (1:yes; 0:no)
0	2	14	73.2	1088	-	0.519986	1
1	3	14	79.9	1988	1188	1.317078	
2	2	14	84.5	1854	-	1.730982	
3	2	14	53.4	1712	-	3.039568	
4	3	14	82	1621	1535	3.711364	
5	2	14	64.7	1243	-	4.960913	
6	2	14	92.7	1775	-	5.358269	
7	2	14	88.1	1188	-	6.108521	
8	3	14	93.7	1148	1619	7.120373	
9	2	14	98.5	1380	-	8.452176	
10	2	14	92	1371	-	8.712074	
11	3	14	95.9	1493	1127	9.920473	
12	3	14	71	1133	1613	11.120515	
13	2	14	57.5	1489	-	11.923283	

Bin5 Statistics 8

Trial #	Pulse	Chirp (MHz)	Pulse Width (µS)	Pulse 1-2 spacing (µS)	Pulse 2-3 spacing (µS)	Pulse Start(S)	Detection (1:yes; 0:no)
0	1	13	85.6	-	-	0.649869	1
1	1	13	96.3	-	-	1.322807	
2	2	13	84.1	1347	-	2.031965	
3	2	13	74.3	1863	-	2.983656	
4	2	13	98.3	1091	-	3.264086	
5	2	13	95.7	1134	-	4.242475	
6	3	13	61.4	1051	1778	4.668472	
7	2	13	85.6	1365	-	5.359469	
8	2	13	52.3	1827	-	6.20518	
9	3	13	65.8	1072	1793	7.259331	
10	2	13	60.3	1869	-	8.051111	
11	2	13	99.2	1316	-	8.834782	
12	2	13	76.3	1797	-	9.466664	
13	1	13	67.5	-	-	9.918491	
14	2	13	90.2	1148	-	11.15638	
15	3	13	85.6	1787	1978	11.495551	

Bin5 Statistics 9

Trial #	Pulse	Chirp (MHz)	Pulse Width (µS)	Pulse 1-2 spacing (uS)	Pulse 2-3 spacing (uS)	Pulse Start(S)	Detection (1:yes; 0:no)
0	1	9	56.9	-	-	0.30596	1
1	1	9	85.1	-	-	1.258705	
2	2	9	60.9	1338	-	2.461153	
3	2	9	75.6	1684	-	3.736228	
4	3	9	85.6	1547	1288	4.633409	
5	3	9	51.6	1098	1244	5.306593	
6	3	9	94.8	1375	1475	6.325944	
7	2	9	87.7	1443	-	7.891235	
8	2	9	81.2	1349	-	8.662708	
9	2	9	55.7	1329	-	9.205759	
10	2	9	78.7	1844	-	10.31732	
11	3	9	57.7	1964	1071	11.241549	

Bin5 Statistics 10

Trial #	Pulse	Chirp (MHz)	Pulse Width (µS)	Pulse 1-2 spacing (uS)	Pulse 2-3 spacing (uS)	Pulse Start(S)	Detection (1:yes; 0:no)
0	1	7	85.8	-	-	0.812383	1
1	2	7	74.6	1445	-	1.806879	
2	2	7	89.3	1541	-	2.085018	
3	2	7	69.6	1361	-	3.886931	
4	1	7	83.2	-	-	4.1483	
5	3	7	62.8	1963	1025	5.122088	
6	2	7	95.6	1198	-	6.268015	
7	3	7	53.7	1511	1770	7.120809	
8	2	7	61.5	1491	-	8.408739	
9	2	7	70.6	1948	-	9.0901	
10	2	7	75.7	1786	-	10.011666	
11	2	7	62.6	1782	-	11.507512	

Bin5 Statistics 11

Trial #	Pulse	Chirp (MHz)	Pulse Width (µS)	Pulse 1-2 spacing (µS)	Pulse 2-3 spacing (µS)	Pulse Start(S)	Detection (1:yes; 0:no)
0	2	20	55.4	1118	-	0.185976	1
1	3	20	95.4	1894	1166	1.010551	
2	3	20	72.2	1012	1607	1.836715	
3	3	20	89.6	1539	1859	2.283441	
4	2	20	66.6	1702	-	2.938006	
5	2	20	57	1496	-	3.395311	
6	1	20	65.1	-	-	4.07304	
7	1	20	95	-	-	4.818045	
8	2	20	90.9	1938	-	5.598541	
9	3	20	94.6	1597	1857	6.082552	
10	2	20	70	1467	-	6.792833	
11	3	20	99.1	1364	1072	7.628809	
12	2	20	51.7	1267	-	8.256589	
13	3	20	71	1447	1373	8.859345	
14	2	20	50.8	1138	-	9.76424	
15	1	20	73.3	-	-	10.651235	
16	2	20	54.8	1100	-	11.114635	
17	2	20	86.1	1475	-	11.678493	

Bin5 Statistics 12

Trial #	Pulse	Chirp (MHz)	Pulse Width (µS)	Pulse 1-2 spacing (µS)	Pulse 2-3 spacing (µS)	Pulse Start(S)	Detection (1:yes; 0:no)
0	2	19	78.4	1218	-	0.899793	1
1	1	19	76.1	-	-	1.225157	
2	1	19	97.1	-	-	1.951219	
3	1	19	70.4	-	-	2.841192	
4	2	19	93.5	1942	-	4.379179	
5	1	19	89	-	-	4.868218	
6	1	19	85.7	-	-	6.044918	
7	1	19	77	-	-	7.221452	
8	2	19	96.7	1272	-	7.665082	
9	2	19	79.9	1470	-	8.32217	
10	1	19	99.9	-	-	9.407347	
11	1	19	87.5	-	-	10.212177	
12	1	19	55.5	-	-	11.85886	

Bin5 Statistics 13

Trial #	Pulse	Chirp (MHz)	Pulse Width (uS)	Pulse 1-2 spacing (uS)	Pulse 2-3 spacing (uS)	Pulse Start(S)	Detection (1:yes; 0:no)
0	1	8	50.4	-	-	0.663111	1
1	3	8	65.9	1159	1137	1.633719	
2	3	8	81.5	1095	1091	1.756956	
3	2	8	63.9	1597	-	3.284344	
4	2	8	83.3	1678	-	4.209207	
5	1	8	90.1	-	-	4.430132	
6	2	8	55.5	1102	-	5.258639	
7	2	8	59.7	1413	-	6.393	
8	2	8	56.6	1780	-	7.33715	
9	2	8	60	1766	-	8.055245	
10	2	8	88.5	1046	-	9.223737	
11	3	8	77.6	1853	1776	9.867444	
12	3	8	62.4	1982	1014	10.655738	
13	2	8	94	1981	-	11.303543	

Bin5 Statistics 14

Trial #	Pulse	Chirp (MHz)	Pulse Width (uS)	Pulse 1-2 spacing (uS)	Pulse 2-3 spacing (uS)	Pulse Start(S)	Detection (1:yes; 0:no)
0	2	6	57.2	1909	-	0.335063	1
1	1	6	56.5	-	-	0.696245	
2	1	6	77.7	-	-	1.624353	
3	2	6	74.2	1903	-	2.517044	
4	3	6	84.1	1478	1799	2.930349	
5	2	6	51.8	1927	-	3.885152	
6	3	6	56.6	1977	1294	4.034567	
7	2	6	68.5	1077	-	4.919232	
8	1	6	56.7	-	-	5.834439	
9	2	6	79.3	1001	-	6.494538	
10	2	6	77.6	1296	-	6.792593	
11	2	6	82.8	1866	-	7.667893	
12	1	6	97.6	-	-	8.118053	
13	2	6	87.7	1016	-	9.21688	
14	2	6	67.7	1526	-	9.738205	
15	2	6	99.1	1149	-	10.510904	
16	2	6	82.3	1008	-	11.309742	
17	2	6	64.1	1778	-	11.829042	

Bin5 Statistics 15

Trial #	Pulse	Chirp (MHz)	Pulse Width (µS)	Pulse 1-2 spacing (uS)	Pulse 2-3 spacing (uS)	Pulse Start(S)	Detection (1:yes; 0:no)
0	3	10	96.6	1003	1625	0.178881	1
1	2	10	66.6	1250	-	1.36928	
2	1	10	96.1	-	-	2.662982	
3	3	10	66	1415	1871	3.073751	
4	1	10	59.7	-	-	4.904809	
5	2	10	75.8	1627	-	5.376467	
6	2	10	79.6	1726	-	6.091581	
7	3	10	83.5	1486	1154	7.170353	
8	1	10	55	-	-	8.232715	
9	1	10	55.2	-	-	9.038883	
10	1	10	87.7	-	-	10.943398	
11	2	10	52.1	1162	-	11.204997	

Bin5 Statistics 16

Trial #	Pulse	Chirp (MHz)	Pulse Width (µS)	Pulse 1-2 spacing (uS)	Pulse 2-3 spacing (uS)	Pulse Start(S)	Detection (1:yes; 0:no)
0	1	19	77.2	-	-	0.398696	1
1	2	19	53.4	1701	-	1.301298	
2	1	19	89.1	-	-	1.378632	
3	2	19	56.5	1256	-	2.331546	
4	2	19	61.8	1385	-	2.719556	
5	2	19	70.2	1231	-	3.415905	
6	2	19	76.7	1095	-	4.201926	
7	3	19	98.8	1236	1737	5.050533	
8	3	19	85.1	1205	1285	5.96919	
9	2	19	79.7	1864	-	6.095555	
10	3	19	93.1	1814	1074	6.750763	
11	3	19	83.2	1884	1552	7.974355	
12	3	19	90.4	1357	1064	8.127668	
13	2	19	64.2	1022	-	8.733928	
14	1	19	57.4	-	-	9.642542	
15	1	19	80.9	-	-	10.139925	
16	2	19	93.6	1411	-	10.679296	
17	2	19	95	1437	-	11.538724	

Bin5 Statistics 17

Trial #	Pulse	Chirp (MHz)	Pulse Width (µS)	Pulse 1-2 spacing (µS)	Pulse 2-3 spacing (µS)	Pulse Start(S)	Detection (1:yes; 0:no)
0	2	13	59.8	1865	-	0.671054	1
1	1	13	76.6	-	-	1.543722	
2	2	13	50.8	1162	-	3.003304	
3	2	13	59.9	1122	-	5.221616	
4	2	13	62.5	1709	-	6.333626	
5	2	13	65.5	1169	-	7.680202	
6	2	13	53	1753	-	9.159262	
7	1	13	73.3	-	-	10.165139	
8	2	13	85.5	1403	-	11.784195	

Bin5 Statistics 18

Trial #	Pulse	Chirp (MHz)	Pulse Width (µS)	Pulse 1-2 spacing (µS)	Pulse 2-3 spacing (µS)	Pulse Start(S)	Detection (1:yes; 0:no)
0	2	12	70.4	1649	-	0.137649	1
1	2	12	94.4	1669	-	0.998846	
2	2	12	84.9	1736	-	2.031087	
3	2	12	53.7	1487	-	3.119614	
4	2	12	57.2	1180	-	3.226002	
5	2	12	74.7	1266	-	4.412027	
6	2	12	71.1	1054	-	5.298022	
7	1	12	58.2	-	-	6.331854	
8	2	12	85	1703	-	7.104832	
9	2	12	53.1	1820	-	7.921499	
10	2	12	79.4	1347	-	8.498191	
11	1	12	88.6	-	-	9.296567	
12	1	12	81	-	-	10.179072	
13	1	12	88.4	-	-	11.165241	
14	3	12	84.7	1947	1491	11.40182	

Bin5 Statistics 19

Trial #	Pulse	Chirp (MHz)	Pulse Width (µS)	Pulse 1-2 spacing (µS)	Pulse 2-3 spacing (µS)	Pulse Start(S)	Detection (1:yes; 0:no)
0	1	17	67.7	-	-	0.2026	1
1	1	17	66.8	-	-	1.020467	
2	3	17	72.3	1741	1044	1.349834	
3	1	17	84.4	-	-	2.139513	
4	2	17	57.6	1149	-	2.887606	
5	2	17	90.1	1980	-	3.758998	
6	2	17	70.7	1759	-	4.164794	
7	3	17	84.5	1596	1906	4.696897	
8	3	17	73.6	1809	1500	5.928943	
9	3	17	51.3	1720	1391	6.276673	
10	2	17	70.5	1868	-	6.969503	
11	1	17	58	-	-	7.339935	
12	2	17	71.3	1208	-	8.018518	
13	2	17	56	1076	-	8.672534	
14	2	17	80.4	1172	-	9.371579	
15	1	17	63.3	-	-	10.581374	
16	3	17	87.4	1576	1871	11.253701	
17	3	17	60.7	1249	1065	11.43564	

Bin5 Statistics 20

Trial #	Pulse	Chirp (MHz)	Pulse Width (µS)	Pulse 1-2 spacing (µS)	Pulse 2-3 spacing (µS)	Pulse Start(S)	Detection (1:yes; 0:no)
0	3	14	84.2	1922	1423	0.618663	1
1	2	14	74.4	1157	-	1.039113	
2	2	14	93.9	1502	-	1.968184	
3	1	14	57.5	-	-	2.976523	
4	2	14	98.9	1505	-	3.209094	
5	2	14	55.6	1861	-	4.065536	
6	2	14	84.6	1447	-	4.952736	
7	3	14	97.1	1510	1471	5.490302	
8	2	14	50.7	1757	-	6.60005	
9	1	14	81.8	-	-	7.495347	
10	1	14	97.9	-	-	7.731754	
11	1	14	69.8	-	-	8.968059	
12	2	14	82.6	1517	-	9.737652	
13	3	14	66.2	1984	1913	9.788131	
14	2	14	74.1	1602	-	10.501973	
15	3	14	74.9	1848	1344	11.735421	

Bin5 Statistics 21

Trial #	Pulse	Chirp (MHz)	Pulse Width (µS)	Pulse 1-2 spacing (µS)	Pulse 2-3 spacing (µS)	Pulse Start(S)	Detection (1:yes; 0:no)
0	2	17	75.4	1578	-	0.576473	1
1	3	17	60.5	1368	1203	1.785124	
2	1	17	83	-	-	2.565641	
3	1	17	97.3	-	-	3.486694	
4	2	17	95.1	1042	-	4.545278	
5	2	17	95.3	1707	-	5.108113	
6	2	17	89.5	1540	-	6.521782	
7	1	17	82.8	-	-	7.963654	
8	1	17	52.4	-	-	8.117426	
9	3	17	80.4	1421	1052	9.10624	
10	2	17	50.8	1407	-	10.096889	
11	2	17	99.4	1029	-	11.976698	

Bin5 Statistics 22

Trial #	Pulse	Chirp (MHz)	Pulse Width (µS)	Pulse 1-2 spacing (µS)	Pulse 2-3 spacing (µS)	Pulse Start(S)	Detection (1:yes; 0:no)
0	2	8	58.8	1458	-	0.534182	1
1	3	8	82.9	1612	1126	0.734026	
2	3	8	68	1365	1283	1.648944	
3	1	8	83.4	-	-	1.875924	
4	2	8	58.3	1382	-	2.662963	
5	2	8	79.3	1287	-	3.25373	
6	3	8	55.5	1250	1703	4.09367	
7	2	8	52.5	1145	-	4.675989	
8	2	8	52.3	1150	-	5.257818	
9	1	8	64.1	-	-	5.660158	
10	2	8	53.9	1983	-	6.437646	
11	3	8	88.3	1172	1712	6.81728	
12	2	8	57.4	1453	-	7.421824	
13	2	8	81.4	1499	-	7.836637	
14	2	8	93.8	1219	-	8.747444	
15	1	8	71.3	-	-	9.041838	
16	2	8	71.7	1463	-	9.74799	
17	1	8	85.9	-	-	10.400834	
18	2	8	66	1422	-	10.979916	
19	2	8	51	1474	-	11.556863	

Bin5 Statistics 23

Trial #	Pulse	Chirp (MHz)	Pulse Width (µS)	Pulse 1-2 spacing (uS)	Pulse 2-3 spacing (uS)	Pulse Start(S)	Detection (1:yes; 0:no)
0	1	13	89.2	-	-	0.32427	1
1	2	13	64.3	1684	-	1.631566	
2	1	13	84.7	-	-	2.069497	
3	2	13	59.8	1246	-	2.895476	
4	2	13	74.9	1846	-	3.648858	
5	3	13	68.7	1585	1451	4.569751	
6	3	13	75.1	1566	1992	5.936205	
7	2	13	54.9	1860	-	6.033653	
8	3	13	71.2	1682	1787	6.866169	
9	1	13	72.9	-	-	8.309551	
10	2	13	60.4	1717	-	8.711196	
11	3	13	89.5	1017	1570	9.516838	
12	2	13	93.9	1375	-	10.794889	
13	1	13	73.2	-	-	11.949213	

Bin5 Statistics 24

Trial #	Pulse	Chirp (MHz)	Pulse Width (µS)	Pulse 1-2 spacing (uS)	Pulse 2-3 spacing (uS)	Pulse Start(S)	Detection (1:yes; 0:no)
0	2	15	83.3	1060	-	0.119498	1
1	1	15	77.4	-	-	1.194731	
2	2	15	98.5	1574	-	1.634316	
3	1	15	61.9	-	-	2.589014	
4	1	15	99.2	-	-	2.88965	
5	1	15	98.9	-	-	3.939368	
6	3	15	55.4	1211	1421	4.057504	
7	1	15	54.5	-	-	5.277831	
8	2	15	67.2	1617	-	5.537028	
9	2	15	51.7	1902	-	6.144818	
10	2	15	50.8	1248	-	6.967697	
11	2	15	96.9	1115	-	7.753623	
12	1	15	84.3	-	-	8.661803	
13	2	15	80.3	1633	-	9.216536	
14	2	15	75.4	1000	-	9.382082	
15	3	15	76.5	1103	1177	10.122425	
16	3	15	50.5	1321	1379	10.731097	
17	2	15	67.3	1581	-	11.536517	

Bin5 Statistics 25

Trial #	Pulse	Chirp (MHz)	Pulse Width (µS)	Pulse 1-2 spacing (µS)	Pulse 2-3 spacing (µS)	Pulse Start(S)	Detection (1:yes; 0:no)
0	3	12	94.9	1048	1286	0.03158	1
1	2	12	67.1	1499	-	1.122535	
2	1	12	66.3	-	-	2.206178	
3	3	12	80.6	1550	1609	3.163882	
4	3	12	73.2	1183	1222	4.200283	
5	2	12	62.9	1869	-	4.999677	
6	2	12	52.1	1540	-	5.845112	
7	2	12	85.1	1964	-	6.718921	
8	2	12	85.8	1646	-	7.526184	
9	2	12	53.8	1427	-	8.387767	
10	2	12	76.7	1369	-	9.898756	
11	3	12	60.9	1120	1431	10.822077	
12	3	12	87.7	1132	1051	11.649866	

Bin5 Statistics 26

Trial #	Pulse	Chirp (MHz)	Pulse Width (µS)	Pulse 1-2 spacing (µS)	Pulse 2-3 spacing (µS)	Pulse Start(S)	Detection (1:yes; 0:no)
0	3	5	65.2	1322	1140	0.646452	1
1	3	5	75.7	1578	1054	0.988251	
2	2	5	72.1	1731	-	1.870735	
3	1	5	67.6	-	-	2.651099	
4	3	5	93	1514	1796	2.934791	
5	2	5	78.1	1196	-	3.7503	
6	2	5	52.8	1965	-	4.406208	
7	1	5	83.6	-	-	4.952658	
8	2	5	96.1	1059	-	5.354088	
9	3	5	93.1	1699	1772	6.397679	
10	2	5	80.9	1794	-	6.937805	
11	2	5	96.8	1919	-	7.502681	
12	3	5	76.7	1381	1250	8.177126	
13	2	5	79.3	1597	-	9.067253	
14	2	5	88.7	1689	-	9.924697	
15	3	5	72.3	1660	1207	10.174575	
16	3	5	76	1360	1170	11.076895	
17	1	5	96.8	-	-	11.763463	

Bin5 Statistics 27

Trial #	Pulse	Chirp (MHz)	Pulse Width (µS)	Pulse 1-2 spacing (uS)	Pulse 2-3 spacing (uS)	Pulse Start(S)	Detection (1:yes; 0:no)
0	3	12	83.5	1748	1100	0.190761	1
1	3	12	67	1596	1341	0.986533	
2	2	12	95.8	1531	-	2.035185	
3	2	12	87.7	1472	-	2.144232	
4	2	12	54	1845	-	3.205929	
5	1	12	94.5	-	-	3.535315	
6	2	12	68.4	1101	-	4.913216	
7	2	12	53.9	1016	-	5.608319	
8	2	12	79	1340	-	5.808587	
9	3	12	57.8	1686	1625	6.829582	
10	2	12	59.3	1339	-	7.486501	
11	3	12	78.4	1529	1537	8.302597	
12	1	12	94.8	-	-	9.170429	
13	3	12	70.1	1956	1302	9.826336	
14	2	12	73.5	1291	-	10.570064	
15	3	12	79.8	1108	1087	10.898567	
16	3	12	68.1	1634	1553	11.639845	

Bin5 Statistics 28

Trial #	Pulse	Chirp (MHz)	Pulse Width (µS)	Pulse 1-2 spacing (uS)	Pulse 2-3 spacing (uS)	Pulse Start(S)	Detection (1:yes; 0:no)
0	2	8	94.5	1518	-	0.854147	1
1	2	8	51.4	1996	-	1.228625	
2	2	8	96.5	1628	-	3.196094	
3	2	8	75.8	1588	-	4.348304	
4	2	8	94.8	1725	-	5.4579	
5	3	8	53.9	1341	1533	6.881859	
6	2	8	79.8	1778	-	8.309519	
7	1	8	87.3	-	-	8.547628	
8	2	8	93	1867	-	9.905166	
9	1	8	97.8	-	-	11.022227	

Bin5 Statistics 29

Trial #	Pulse	Chirp (MHz)	Pulse Width (µS)	Pulse 1-2 spacing (µS)	Pulse 2-3 spacing (µS)	Pulse Start(S)	Detection (1:yes; 0:no)
0	2	19	80.1	1615	-	0.384542	1
1	3	19	65.2	1974	1673	1.619777	
2	1	19	87.1	-	-	2.438012	
3	3	19	55.5	1194	1057	2.619374	
4	1	19	50.4	-	-	3.628198	
5	2	19	82	1277	-	4.325245	
6	2	19	73.5	1218	-	5.59598	
7	2	19	91.3	1634	-	6.15696	
8	2	19	55.5	1403	-	7.605189	
9	1	19	66.3	-	-	8.549178	
10	1	19	50.5	-	-	8.797787	
11	2	19	80.7	1101	-	9.681228	
12	3	19	97.7	1058	1791	10.811587	
13	1	19	94.2	-	-	11.704706	

Bin5 Statistics 30

Trial #	Pulse	Chirp (MHz)	Pulse Width (µS)	Pulse 1-2 spacing (µS)	Pulse 2-3 spacing (µS)	Pulse Start(S)	Detection (1:yes; 0:no)
0	2	17	69	1867	-	0.093101	1
1	2	17	53.9	1394	-	1.281459	
2	3	17	99.8	1551	1361	1.902856	
3	3	17	76	1272	1052	3.367756	
4	1	17	83.4	-	-	4.034588	
5	2	17	99.4	1110	-	4.645322	
6	3	17	66.5	1461	1590	5.791803	
7	2	17	75.7	1423	-	6.201854	
8	2	17	59	1256	-	7.387366	
9	1	17	85.1	-	-	8.287494	
10	2	17	90.9	1854	-	8.934748	
11	2	17	59.2	1885	-	9.574679	
12	2	17	54.5	1330	-	10.418299	
13	1	17	89.6	-	-	11.883747	

Table-6 Radar Type 6 Statistical Performance

Trial #	Fc (MHz)	Pulse /Burst	Pulse Width (μS)	PRI (μs)	Detection (1:yes; 0:no)	Hopping Sequence
1	5530	9	1	333	1	5500.0, 5315.0, 5709.0, 5415.0, 5400.0, 5472.0, 5706.0, 5286.0, 5321.0, 5340.0, 5499.0, 5647.0, 5669.0, 5696.0, 5454.0, 5521.0, 5548.0, 5722.0, 5358.0, 5258.0, 5391.0, 5349.0, 5570.0, 5471.0, 5306.0, 5661.0, 5390.0, 5345.0, 5416.0, 5666.0, 5490.0, 5265.0, 5643.0, 5373.0, 5289.0, 5639.0, 5282.0, 5563.0, 5253.0, 5385.0, 5608.0, 5533.0, 5320.0, 5609.0, 5562.0, 5551.0, 5325.0, 5476.0, 5699.0, 5694.0, 5670.0, 5486.0, 5624.0, 5405.0, 5328.0, 5423.0, 5327.0, 5637.0, 5333.0, 5389.0, 5256.0, 5407.0, 5368.0, 5590.0, 5523.0, 5601.0, 5469.0, 5319.0, 5679.0, 5648.0, 5715.0, 5552.0, 5531.0, 5534.0, 5560.0, 5517.0, 5274.0, 5526.0, 5347.0, 5269.0, 5335.0, 5412.0, 5559.0, 5428.0, 5522.0, 5420.0, 5447.0, 5668.0, 5444.0, 5290.0, 5424.0, 5495.0, 5431.0, 5395.0, 5295.0, 5381.0, 5413.0, 5452.0, 5477.0, 5612.0 (number of hits: 18)
2	5530	9	1	333	1	5293.0, 5430.0, 5258.0, 5332.0, 5704.0, 5693.0, 5471.0, 5626.0, 5441.0, 5324.0, 5251.0, 5545.0, 5366.0, 5322.0, 5584.0, 5380.0, 5536.0, 5361.0, 5387.0, 5325.0, 5554.0, 5284.0, 5329.0, 5493.0, 5503.0, 5470.0, 5353.0, 5476.0, 5491.0, 5575.0, 5718.0, 5319.0, 5543.0, 5423.0, 5644.0, 5540.0, 5330.0, 5646.0, 5327.0, 5467.0, 5369.0, 5591.0, 5698.0, 5356.0, 5468.0, 5641.0, 5416.0, 5714.0, 5723.0, 5414.0, 5462.0, 5294.0, 5648.0, 5420.0, 5314.0, 5451.0, 5578.0, 5564.0, 5596.0, 5513.0, 5405.0, 5472.0, 5305.0, 5357.0, 5439.0, 5497.0, 5521.0, 5527.0, 5391.0, 5647.0, 5250.0, 5421.0, 5518.0, 5389.0, 5671.0, 5394.0, 5486.0, 5428.0, 5696.0, 5384.0, 5443.0, 5328.0, 5474.0, 5253.0, 5621.0, 5372.0, 5633.0, 5672.0, 5716.0, 5402.0, 5707.0, 5635.0, 5323.0, 5404.0, 5348.0, 5285.0, 5409.0, 5287.0, 5262.0, 5680.0 (number of hits: 13)
3	5530	9	1	333	1	5480.0, 5278.0, 5299.0, 5724.0, 5516.0, 5435.0, 5635.0, 5327.0, 5717.0, 5515.0, 5344.0, 5706.0, 5601.0, 5528.0, 5393.0, 5478.0, 5618.0, 5597.0, 5604.0, 5602.0, 5564.0, 5599.0, 5383.0, 5279.0, 5623.0, 5427.0, 5650.0, 5626.0, 5489.0, 5634.0, 5560.0, 5607.0, 5696.0, 5699.0, 5345.0, 5297.0, 5536.0, 5646.0, 5350.0, 5259.0, 5567.0, 5665.0, 5616.0, 5644.0, 5320.0, 5289.0, 5614.0, 5668.0, 5693.0, 5285.0, 5335.0, 5392.0, 5656.0, 5282.0, 5364.0, 5265.0, 5703.0, 5694.0, 5510.0, 5561.0,

						5655.0, 5575.0, 5683.0, 5533.0, 5569.0, 5441.0, 5580.0, 5570.0, 5557.0, 5690.0, 5677.0, 5643.0, 5286.0, 5642.0, 5534.0, 5439.0, 5573.0, 5375.0, 5559.0, 5467.0, 5398.0, 5632.0, 5431.0, 5521.0, 5545.0, 5538.0, 5305.0, 5302.0, 5563.0, 5676.0, 5390.0, 5443.0, 5312.0, 5701.0, 5708.0, 5654.0, 5713.0, 5296.0, 5497.0, 5663.0 (number of hits: 18)
4	5530	9	1	333	1	5536.0, 5721.0, 5637.0, 5264.0, 5486.0, 5474.0, 5555.0, 5395.0, 5632.0, 5627.0, 5400.0, 5717.0, 5601.0, 5704.0, 5263.0, 5254.0, 5419.0, 5407.0, 5267.0, 5319.0, 5323.0, 5504.0, 5428.0, 5387.0, 5528.0, 5540.0, 5525.0, 5434.0, 5667.0, 5558.0, 5476.0, 5309.0, 5266.0, 5292.0, 5590.0, 5719.0, 5513.0, 5605.0, 5284.0, 5322.0, 5381.0, 5503.0, 5561.0, 5695.0, 5467.0, 5358.0, 5634.0, 5592.0, 5701.0, 5652.0, 5625.0, 5392.0, 5572.0, 5607.0, 5435.0, 5382.0, 5406.0, 5338.0, 5483.0, 5534.0, 5660.0, 5568.0, 5640.0, 5390.0, 5631.0, 5418.0, 5686.0, 5477.0, 5454.0, 5351.0, 5262.0, 5646.0, 5655.0, 5460.0, 5423.0, 5612.0, 5380.0, 5582.0, 5669.0, 5571.0, 5635.0, 5509.0, 5596.0, 5527.0, 5693.0, 5373.0, 5481.0, 5348.0, 5604.0, 5543.0, 5482.0, 5546.0, 5287.0, 5705.0, 5307.0, 5298.0, 5608.0, 5597.0, 5327.0, 5442.0 (number of hits: 15)
5	5530	9	1	333	1	5283.0, 5584.0, 5373.0, 5457.0, 5315.0, 5663.0, 5274.0, 5295.0, 5312.0, 5614.0, 5555.0, 5496.0, 5472.0, 5313.0, 5585.0, 5619.0, 5541.0, 5308.0, 5488.0, 5723.0, 5255.0, 5364.0, 5368.0, 5661.0, 5544.0, 5714.0, 5523.0, 5297.0, 5366.0, 5702.0, 5402.0, 5683.0, 5700.0, 5461.0, 5557.0, 5630.0, 5679.0, 5332.0, 5266.0, 5322.0, 5433.0, 5379.0, 5459.0, 5709.0, 5434.0, 5626.0, 5271.0, 5420.0, 5514.0, 5374.0, 5413.0, 5580.0, 5468.0, 5253.0, 5553.0, 5448.0, 5311.0, 5532.0, 5424.0, 5652.0, 5616.0, 5631.0, 5648.0, 5677.0, 5250.0, 5306.0, 5567.0, 5618.0, 5651.0, 5578.0, 5699.0, 5633.0, 5455.0, 5530.0, 5286.0, 5526.0, 5436.0, 5378.0, 5486.0, 5509.0, 5390.0, 5348.0, 5707.0, 5454.0, 5450.0, 5318.0, 5329.0, 5521.0, 5512.0, 5645.0, 5608.0, 5451.0, 5647.0, 5382.0, 5272.0, 5401.0, 5678.0, 5533.0, 5337.0, 5423.0 (number of hits: 16)
6	5530	9	1	333	1	5262.0, 5519.0, 5719.0, 5647.0, 5684.0, 5634.0, 5692.0, 5587.0, 5483.0, 5475.0, 5467.0, 5576.0, 5307.0, 5349.0, 5686.0, 5347.0, 5297.0, 5340.0, 5292.0, 5696.0, 5515.0, 5471.0, 5485.0, 5383.0, 5312.0, 5531.0, 5294.0, 5257.0, 5565.0, 5439.0, 5594.0, 5301.0, 5659.0, 5523.0, 5274.0, 5689.0, 5504.0, 5680.0, 5424.0, 5552.0, 5419.0, 5406.0, 5704.0, 5525.0, 5715.0

						5632.0, 5585.0, 5414.0, 5618.0, 5446.0, 5517.0, 5682.0, 5644.0, 5298.0, 5486.0, 5299.0, 5627.0, 5373.0, 5685.0, 5703.0, 5599.0, 5474.0, 5547.0, 5304.0, 5614.0, 5630.0, 5554.0, 5279.0, 5498.0, 5710.0, 5277.0, 5641.0, 5260.0, 5434.0, 5315.0, 5611.0, 5339.0, 5540.0, 5648.0, 5355.0, 5653.0, 5302.0, 5548.0, 5427.0, 5522.0, 5603.0, 5579.0, 5572.0, 5707.0, 5549.0, 5362.0, 5453.0, 5448.0, 5722.0, 5265.0, 5506.0, 5665.0, 5403.0, 5282.0, 5333.0 (number of hits: 17)
7	5530	9	1	333	1	5302.0, 5433.0, 5695.0, 5279.0, 5538.0, 5466.0, 5567.0, 5303.0, 5451.0, 5602.0, 5254.0, 5569.0, 5544.0, 5574.0, 5401.0, 5549.0, 5584.0, 5534.0, 5464.0, 5528.0, 5621.0, 5696.0, 5481.0, 5651.0, 5384.0, 5616.0, 5665.0, 5252.0, 5289.0, 5352.0, 5402.0, 5517.0, 5266.0, 5676.0, 5419.0, 5406.0, 5607.0, 5396.0, 5408.0, 5512.0, 5666.0, 5476.0, 5415.0, 5347.0, 5294.0, 5562.0, 5653.0, 5592.0, 5551.0, 5296.0, 5698.0, 5535.0, 5274.0, 5542.0, 5395.0, 5450.0, 5256.0, 5661.0, 5615.0, 5576.0, 5369.0, 5599.0, 5278.0, 5709.0, 5586.0, 5275.0, 5644.0, 5389.0, 5460.0, 5354.0, 5495.0, 5299.0, 5656.0, 5568.0, 5335.0, 5484.0, 5439.0, 5555.0, 5561.0, 5523.0, 5285.0, 5694.0, 5459.0, 5638.0, 5667.0, 5617.0, 5640.0, 5715.0, 5560.0, 5326.0, 5626.0, 5502.0, 5348.0, 5405.0, 5334.0, 5680.0, 5700.0, 5468.0, 5591.0, 5258.0 (number of hits: 18)
8	5530	9	1	333	1	5465.0, 5412.0, 5593.0, 5470.0, 5355.0, 5275.0, 5656.0, 5288.0, 5688.0, 5570.0, 5705.0, 5566.0, 5691.0, 5413.0, 5456.0, 5397.0, 5434.0, 5605.0, 5576.0, 5663.0, 5603.0, 5418.0, 5377.0, 5369.0, 5654.0, 5350.0, 5661.0, 5703.0, 5464.0, 5334.0, 5310.0, 5442.0, 5720.0, 5604.0, 5426.0, 5621.0, 5607.0, 5254.0, 5452.0, 5330.0, 5632.0, 5437.0, 5504.0, 5650.0, 5292.0, 5571.0, 5421.0, 5378.0, 5510.0, 5436.0, 5348.0, 5677.0, 5544.0, 5698.0, 5432.0, 5323.0, 5273.0, 5255.0, 5390.0, 5389.0, 5624.0, 5664.0, 5372.0, 5325.0, 5620.0, 5302.0, 5450.0, 5549.0, 5416.0, 5505.0, 5524.0, 5522.0, 5681.0, 5496.0, 5262.0, 5318.0, 5651.0, 5653.0, 5414.0, 5344.0, 5379.0, 5695.0, 5519.0, 5272.0, 5564.0, 5556.0, 5516.0, 5386.0, 5404.0, 5473.0, 5476.0, 5365.0, 5671.0, 5583.0, 5590.0, 5329.0, 5634.0, 5467.0, 5550.0, 5592.0 (number of hits: 14)
9	5530	9	1	333	1	5649.0, 5669.0, 5640.0, 5628.0, 5670.0, 5583.0, 5346.0, 5316.0, 5625.0, 5610.0, 5372.0, 5572.0, 5261.0, 5378.0, 5648.0, 5692.0, 5423.0, 5481.0, 5464.0, 5477.0, 5700.0, 5289.0, 5333.0, 5279.0, 5534.0, 5541.0, 5353.0, 5452.0, 5310.0, 5722.0,

						5406.0, 5391.0, 5569.0, 5632.0, 5537.0, 5715.0, 5313.0, 5256.0, 5619.0, 5691.0, 5507.0, 5294.0, 5576.0, 5403.0, 5662.0, 5337.0, 5319.0, 5429.0, 5609.0, 5693.0, 5427.0, 5367.0, 5547.0, 5515.0, 5498.0, 5295.0, 5574.0, 5304.0, 5354.0, 5714.0, 5257.0, 5309.0, 5358.0, 5331.0, 5434.0, 5566.0, 5685.0, 5580.0, 5651.0, 5620.0, 5665.0, 5416.0, 5396.0, 5650.0, 5392.0, 5548.0, 5502.0, 5633.0, 5624.0, 5306.0, 5704.0, 5454.0, 5489.0, 5381.0, 5350.0, 5528.0, 5676.0, 5490.0, 5364.0, 5686.0, 5475.0, 5459.0, 5636.0, 5544.0, 5554.0, 5307.0, 5710.0, 5513.0, 5380.0, 5400.0 (number of hits: 14)
10	5530	9	1	333	1	5448.0, 5541.0, 5654.0, 5576.0, 5583.0, 5331.0, 5712.0, 5302.0, 5411.0, 5434.0, 5347.0, 5627.0, 5424.0, 5461.0, 5619.0, 5629.0, 5573.0, 5711.0, 5365.0, 5618.0, 5464.0, 5395.0, 5528.0, 5636.0, 5644.0, 5703.0, 5701.0, 5584.0, 5269.0, 5275.0, 5713.0, 5351.0, 5510.0, 5468.0, 5462.0, 5507.0, 5683.0, 5310.0, 5549.0, 5572.0, 5652.0, 5256.0, 5508.0, 5704.0, 5506.0, 5575.0, 5553.0, 5429.0, 5702.0, 5542.0, 5494.0, 5524.0, 5550.0, 5386.0, 5567.0, 5412.0, 5639.0, 5517.0, 5414.0, 5560.0, 5621.0, 5309.0, 5252.0, 5482.0, 5655.0, 5453.0, 5657.0, 5276.0, 5416.0, 5481.0, 5653.0, 5670.0, 5368.0, 5440.0, 5596.0, 5472.0, 5257.0, 5283.0, 5356.0, 5277.0, 5478.0, 5413.0, 5559.0, 5672.0, 5421.0, 5492.0, 5442.0, 5438.0, 5376.0, 5686.0, 5718.0, 5432.0, 5699.0, 5722.0, 5300.0, 5287.0, 5533.0, 5558.0, 5540.0, 5332.0 (number of hits: 20)
11	5530	9	1	333	1	5263.0, 5355.0, 5540.0, 5496.0, 5629.0, 5293.0, 5621.0, 5697.0, 5463.0, 5401.0, 5483.0, 5670.0, 5444.0, 5635.0, 5265.0, 5679.0, 5566.0, 5591.0, 5375.0, 5329.0, 5637.0, 5404.0, 5525.0, 5505.0, 5281.0, 5608.0, 5316.0, 5657.0, 5650.0, 5335.0, 5325.0, 5452.0, 5464.0, 5440.0, 5616.0, 5489.0, 5558.0, 5398.0, 5590.0, 5716.0, 5519.0, 5646.0, 5711.0, 5254.0, 5328.0, 5526.0, 5515.0, 5349.0, 5511.0, 5586.0, 5346.0, 5671.0, 5592.0, 5397.0, 5596.0, 5664.0, 5527.0, 5486.0, 5544.0, 5495.0, 5676.0, 5409.0, 5602.0, 5688.0, 5683.0, 5523.0, 5680.0, 5684.0, 5512.0, 5498.0, 5411.0, 5571.0, 5466.0, 5396.0, 5412.0, 5337.0, 5541.0, 5450.0, 5445.0, 5340.0, 5426.0, 5517.0, 5384.0, 5665.0, 5358.0, 5392.0, 5598.0, 5374.0, 5503.0, 5554.0, 5477.0, 5307.0, 5333.0, 5443.0, 5259.0, 5272.0, 5694.0, 5383.0, 5438.0, 5666.0 (number of hits: 20)
12	5530	9	1	333	1	5406.0, 5356.0, 5532.0, 5681.0, 5624.0, 5361.0, 5641.0, 5704.0, 5375.0, 5323.0, 5467.0, 5575.0, 5717.0, 5321.0, 5695.0,

						5602.0, 5477.0, 5574.0, 5629.0, 5293.0, 5553.0, 5627.0, 5300.0, 5538.0, 5268.0, 5296.0, 5270.0, 5663.0, 5278.0, 5410.0, 5546.0, 5570.0, 5698.0, 5265.0, 5547.0, 5604.0, 5342.0, 5306.0, 5476.0, 5646.0, 5685.0, 5373.0, 5291.0, 5364.0, 5510.0, 5653.0, 5582.0, 5420.0, 5680.0, 5387.0, 5503.0, 5522.0, 5684.0, 5583.0, 5521.0, 5456.0, 5336.0, 5600.0, 5330.0, 5709.0, 5673.0, 5389.0, 5613.0, 5316.0, 5257.0, 5478.0, 5578.0, 5481.0, 5559.0, 5565.0, 5668.0, 5453.0, 5699.0, 5397.0, 5413.0, 5462.0, 5514.0, 5614.0, 5339.0, 5603.0, 5412.0, 5272.0, 5310.0, 5702.0, 5512.0, 5666.0, 5526.0, 5563.0, 5482.0, 5630.0, 5376.0, 5362.0, 5700.0, 5276.0, 5299.0, 5443.0, 5618.0, 5340.0, 5431.0, 5561.0 (number of hits: 16)
13	5530	9	1	333	1	5584.0, 5357.0, 5385.0, 5413.0, 5271.0, 5359.0, 5423.0, 5326.0, 5474.0, 5677.0, 5586.0, 5528.0, 5488.0, 5636.0, 5404.0, 5303.0, 5292.0, 5694.0, 5350.0, 5695.0, 5709.0, 5631.0, 5711.0, 5530.0, 5427.0, 5588.0, 5698.0, 5491.0, 5252.0, 5510.0, 5640.0, 5339.0, 5305.0, 5297.0, 5502.0, 5382.0, 5433.0, 5667.0, 5658.0, 5376.0, 5716.0, 5573.0, 5628.0, 5572.0, 5403.0, 5505.0, 5661.0, 5555.0, 5724.0, 5256.0, 5428.0, 5506.0, 5406.0, 5681.0, 5562.0, 5422.0, 5254.0, 5354.0, 5544.0, 5321.0, 5338.0, 5546.0, 5512.0, 5673.0, 5696.0, 5473.0, 5638.0, 5420.0, 5379.0, 5623.0, 5285.0, 5324.0, 5580.0, 5602.0, 5448.0, 5568.0, 5327.0, 5517.0, 5469.0, 5600.0, 5284.0, 5645.0, 5547.0, 5314.0, 5706.0, 5261.0, 5664.0, 5504.0, 5702.0, 5644.0, 5608.0, 5471.0, 5272.0, 5436.0, 5329.0, 5582.0, 5515.0, 5307.0, 5439.0, 5356.0 (number of hits: 15)
14	5530	9	1	333	1	5551.0, 5684.0, 5398.0, 5588.0, 5322.0, 5683.0, 5661.0, 5448.0, 5384.0, 5314.0, 5511.0, 5552.0, 5719.0, 5432.0, 5596.0, 5337.0, 5578.0, 5415.0, 5397.0, 5720.0, 5402.0, 5378.0, 5558.0, 5589.0, 5546.0, 5283.0, 5440.0, 5436.0, 5716.0, 5383.0, 5338.0, 5406.0, 5643.0, 5516.0, 5575.0, 5361.0, 5503.0, 5466.0, 5549.0, 5696.0, 5527.0, 5690.0, 5476.0, 5629.0, 5711.0, 5336.0, 5287.0, 5360.0, 5525.0, 5673.0, 5583.0, 5513.0, 5335.0, 5285.0, 5507.0, 5679.0, 5282.0, 5370.0, 5328.0, 5490.0, 5645.0, 5478.0, 5501.0, 5554.0, 5404.0, 5452.0, 5630.0, 5626.0, 5329.0, 5707.0, 5417.0, 5386.0, 5562.0, 5409.0, 5631.0, 5334.0, 5442.0, 5534.0, 5355.0, 5420.0, 5438.0, 5580.0, 5352.0, 5293.0, 5584.0, 5332.0, 5721.0, 5463.0, 5362.0, 5675.0, 5426.0, 5327.0, 5344.0, 5494.0, 5508.0, 5303.0, 5646.0, 5650.0, 5464.0, 5539.0 (number of hits: 19)

15	5530	9	1	333	1	5654.0, 5500.0, 5295.0, 5406.0, 5349.0, 5448.0, 5254.0, 5563.0, 5676.0, 5651.0, 5418.0, 5551.0, 5462.0, 5478.0, 5315.0, 5484.0, 5375.0, 5440.0, 5345.0, 5604.0, 5411.0, 5324.0, 5515.0, 5505.0, 5283.0, 5680.0, 5555.0, 5708.0, 5570.0, 5251.0, 5507.0, 5323.0, 5565.0, 5287.0, 5491.0, 5401.0, 5472.0, 5458.0, 5400.0, 5408.0, 5675.0, 5328.0, 5668.0, 5416.0, 5431.0, 5619.0, 5716.0, 5611.0, 5720.0, 5366.0, 5302.0, 5442.0, 5301.0, 5667.0, 5681.0, 5483.0, 5544.0, 5641.0, 5509.0, 5549.0, 5290.0, 5692.0, 5361.0, 5256.0, 5524.0, 5348.0, 5351.0, 5593.0, 5370.0, 5381.0, 5337.0, 5539.0, 5446.0, 5618.0, 5443.0, 5380.0, 5513.0, 5598.0, 5553.0, 5278.0, 5703.0, 5661.0, 5372.0, 5573.0, 5567.0, 5723.0, 5695.0, 5334.0, 5481.0, 5363.0, 5350.0, 5552.0, 5286.0, 5335.0, 5426.0, 5368.0, 5285.0, 5341.0, 5663.0, 5568.0 (number of hits: 17)
16	5530	9	1	333	1	5411.0, 5320.0, 5582.0, 5518.0, 5553.0, 5712.0, 5721.0, 5319.0, 5368.0, 5704.0, 5306.0, 5681.0, 5662.0, 5718.0, 5697.0, 5690.0, 5431.0, 5446.0, 5347.0, 5619.0, 5566.0, 5408.0, 5650.0, 5508.0, 5623.0, 5488.0, 5428.0, 5290.0, 5458.0, 5274.0, 5457.0, 5577.0, 5474.0, 5706.0, 5490.0, 5259.0, 5683.0, 5649.0, 5653.0, 5401.0, 5251.0, 5592.0, 5665.0, 5609.0, 5643.0, 5628.0, 5686.0, 5365.0, 5504.0, 5448.0, 5573.0, 5281.0, 5503.0, 5441.0, 5719.0, 5439.0, 5625.0, 5468.0, 5422.0, 5302.0, 5556.0, 5318.0, 5336.0, 5350.0, 5424.0, 5475.0, 5668.0, 5624.0, 5502.0, 5568.0, 5547.0, 5402.0, 5429.0, 5471.0, 5634.0, 5527.0, 5541.0, 5540.0, 5699.0, 5299.0, 5275.0, 5463.0, 5530.0, 5377.0, 5304.0, 5393.0, 5678.0, 5579.0, 5545.0, 5620.0, 5298.0, 5491.0, 5265.0, 5528.0, 5338.0, 5398.0, 5425.0, 5521.0, 5654.0, 5562.0 (number of hits: 17)
17	5530	9	1	333	1	5254.0, 5658.0, 5348.0, 5363.0, 5684.0, 5334.0, 5310.0, 5498.0, 5429.0, 5710.0, 5357.0, 5513.0, 5551.0, 5388.0, 5293.0, 5688.0, 5435.0, 5346.0, 5266.0, 5678.0, 5494.0, 5722.0, 5608.0, 5368.0, 5537.0, 5402.0, 5376.0, 5626.0, 5679.0, 5657.0, 5426.0, 5440.0, 5682.0, 5323.0, 5636.0, 5524.0, 5391.0, 5515.0, 5291.0, 5674.0, 5612.0, 5508.0, 5294.0, 5369.0, 5597.0, 5681.0, 5589.0, 5566.0, 5478.0, 5279.0, 5298.0, 5531.0, 5321.0, 5364.0, 5439.0, 5286.0, 5547.0, 5503.0, 5595.0, 5482.0, 5638.0, 5382.0, 5417.0, 5420.0, 5301.0, 5650.0, 5642.0, 5487.0, 5274.0, 5495.0, 5295.0, 5428.0, 5633.0, 5471.0, 5693.0, 5643.0, 5523.0, 5603.0, 5273.0, 5538.0, 5466.0, 5526.0, 5609.0, 5532.0, 5303.0, 5645.0, 5427.0, 5663.0, 5374.0, 5555.0

						5553.0, 5470.0, 5606.0, 5353.0, 5520.0, 5270.0, 5390.0, 5572.0, 5694.0, 5656.0 (number of hits: 20)
18	5530	9	1	333	1	5634.0, 5395.0, 5254.0, 5360.0, 5637.0, 5322.0, 5416.0, 5423.0, 5276.0, 5612.0, 5449.0, 5451.0, 5344.0, 5666.0, 5324.0, 5638.0, 5699.0, 5261.0, 5626.0, 5367.0, 5576.0, 5446.0, 5413.0, 5252.0, 5352.0, 5488.0, 5679.0, 5599.0, 5636.0, 5281.0, 5702.0, 5425.0, 5301.0, 5622.0, 5722.0, 5335.0, 5337.0, 5354.0, 5326.0, 5330.0, 5383.0, 5445.0, 5368.0, 5689.0, 5262.0, 5405.0, 5517.0, 5500.0, 5468.0, 5378.0, 5635.0, 5512.0, 5543.0, 5463.0, 5499.0, 5660.0, 5673.0, 5284.0, 5436.0, 5564.0, 5536.0, 5567.0, 5473.0, 5684.0, 5408.0, 5604.0, 5394.0, 5712.0, 5374.0, 5495.0, 5518.0, 5649.0, 5464.0, 5503.0, 5580.0, 5707.0, 5476.0, 5329.0, 5585.0, 5285.0, 5640.0, 5514.0, 5624.0, 5526.0, 5462.0, 5300.0, 5312.0, 5601.0, 5290.0, 5441.0, 5435.0, 5723.0, 5347.0, 5501.0, 5581.0, 5642.0, 5578.0, 5671.0, 5672.0, 5698.0 (number of hits: 14)
19	5530	9	1	333	1	5598.0, 5563.0, 5584.0, 5528.0, 5508.0, 5608.0, 5296.0, 5408.0, 5626.0, 5533.0, 5446.0, 5361.0, 5375.0, 5564.0, 5274.0, 5674.0, 5681.0, 5525.0, 5427.0, 5706.0, 5658.0, 5406.0, 5456.0, 5260.0, 5267.0, 5574.0, 5579.0, 5677.0, 5310.0, 5641.0, 5394.0, 5721.0, 5569.0, 5716.0, 5585.0, 5379.0, 5443.0, 5590.0, 5506.0, 5633.0, 5509.0, 5530.0, 5655.0, 5696.0, 5342.0, 5593.0, 5288.0, 5474.0, 5411.0, 5628.0, 5264.0, 5291.0, 5381.0, 5545.0, 5514.0, 5271.0, 5511.0, 5453.0, 5624.0, 5670.0, 5479.0, 5678.0, 5495.0, 5363.0, 5360.0, 5675.0, 5319.0, 5450.0, 5270.0, 5642.0, 5499.0, 5470.0, 5341.0, 5322.0, 5473.0, 5352.0, 5518.0, 5570.0, 5282.0, 5489.0, 5549.0, 5431.0, 5368.0, 5687.0, 5709.0, 5455.0, 5632.0, 5335.0, 5640.0, 5340.0, 5303.0, 5399.0, 5494.0, 5281.0, 5595.0, 5560.0, 5689.0, 5312.0, 5692.0, 5355.0 (number of hits: 18)
20	5530	9	1	333	1	5458.0, 5351.0, 5337.0, 5636.0, 5649.0, 5441.0, 5549.0, 5464.0, 5604.0, 5340.0, 5610.0, 5466.0, 5678.0, 5562.0, 5366.0, 5569.0, 5494.0, 5672.0, 5346.0, 5583.0, 5721.0, 5684.0, 5606.0, 5676.0, 5669.0, 5544.0, 5664.0, 5407.0, 5283.0, 5717.0, 5551.0, 5490.0, 5363.0, 5595.0, 5619.0, 5552.0, 5616.0, 5579.0, 5620.0, 5353.0, 5285.0, 5533.0, 5663.0, 5456.0, 5581.0, 5568.0, 5516.0, 5474.0, 5671.0, 5529.0, 5294.0, 5626.0, 5354.0, 5454.0, 5320.0, 5628.0, 5702.0, 5324.0, 5297.0, 5251.0, 5654.0, 5402.0, 5592.0, 5317.0, 5260.0, 5393.0, 5492.0, 5404.0, 5432.0, 5299.0, 5418.0, 5640.0, 5710.0, 5695.0, 5548.0,

						5272.0, 5411.0, 5561.0, 5423.0, 5652.0, 5519.0, 5499.0, 5713.0, 5700.0, 5479.0, 5645.0, 5680.0, 5580.0, 5692.0, 5468.0, 5543.0, 5286.0, 5646.0, 5463.0, 5605.0, 5524.0, 5269.0, 5643.0, 5613.0, 5632.0 (number of hits: 16)
21	5530	9	1	333	1	5544.0, 5454.0, 5561.0, 5585.0, 5549.0, 5478.0, 5682.0, 5413.0, 5722.0, 5649.0, 5384.0, 5527.0, 5625.0, 5417.0, 5635.0, 5584.0, 5557.0, 5348.0, 5514.0, 5345.0, 5483.0, 5324.0, 5319.0, 5331.0, 5336.0, 5670.0, 5255.0, 5662.0, 5568.0, 5378.0, 5703.0, 5274.0, 5269.0, 5591.0, 5578.0, 5596.0, 5666.0, 5660.0, 5303.0, 5286.0, 5702.0, 5363.0, 5700.0, 5569.0, 5440.0, 5528.0, 5449.0, 5503.0, 5631.0, 5368.0, 5521.0, 5256.0, 5342.0, 5464.0, 5371.0, 5574.0, 5507.0, 5264.0, 5403.0, 5258.0, 5644.0, 5607.0, 5572.0, 5652.0, 5599.0, 5721.0, 5509.0, 5490.0, 5481.0, 5663.0, 5563.0, 5655.0, 5380.0, 5453.0, 5385.0, 5720.0, 5709.0, 5445.0, 5349.0, 5257.0, 5389.0, 5679.0, 5397.0, 5333.0, 5508.0, 5352.0, 5287.0, 5347.0, 5365.0, 5406.0, 5282.0, 5573.0, 5344.0, 5603.0, 5463.0, 5713.0, 5302.0, 5289.0, 5455.0, 5516.0 (number of hits: 14)
22	5530	9	1	333	1	5578.0, 5401.0, 5563.0, 5263.0, 5542.0, 5418.0, 5602.0, 5721.0, 5598.0, 5390.0, 5712.0, 5509.0, 5484.0, 5572.0, 5445.0, 5591.0, 5590.0, 5531.0, 5671.0, 5438.0, 5699.0, 5374.0, 5265.0, 5690.0, 5615.0, 5498.0, 5722.0, 5511.0, 5395.0, 5519.0, 5526.0, 5533.0, 5573.0, 5708.0, 5640.0, 5562.0, 5315.0, 5630.0, 5472.0, 5343.0, 5538.0, 5391.0, 5352.0, 5512.0, 5692.0, 5610.0, 5582.0, 5480.0, 5446.0, 5413.0, 5614.0, 5481.0, 5583.0, 5406.0, 5336.0, 5648.0, 5460.0, 5450.0, 5471.0, 5570.0, 5307.0, 5673.0, 5364.0, 5643.0, 5261.0, 5508.0, 5257.0, 5523.0, 5377.0, 5701.0, 5290.0, 5530.0, 5593.0, 5442.0, 5299.0, 5332.0, 5478.0, 5495.0, 5375.0, 5633.0, 5361.0, 5579.0, 5339.0, 5272.0, 5691.0, 5520.0, 5638.0, 5447.0, 5654.0, 5254.0, 5362.0, 5575.0, 5326.0, 5357.0, 5661.0, 5555.0, 5294.0, 5454.0, 5516.0, 5636.0 (number of hits: 19)
23	5530	9	1	333	1	5674.0, 5631.0, 5408.0, 5416.0, 5252.0, 5352.0, 5449.0, 5634.0, 5600.0, 5562.0, 5451.0, 5669.0, 5326.0, 5675.0, 5477.0, 5536.0, 5484.0, 5382.0, 5333.0, 5349.0, 5360.0, 5506.0, 5505.0, 5492.0, 5340.0, 5411.0, 5691.0, 5696.0, 5666.0, 5254.0, 5387.0, 5291.0, 5441.0, 5603.0, 5300.0, 5502.0, 5267.0, 5649.0, 5282.0, 5253.0, 5544.0, 5442.0, 5275.0, 5250.0, 5421.0, 5354.0, 5306.0, 5537.0, 5698.0, 5482.0, 5520.0, 5578.0, 5283.0, 5454.0, 5504.0, 5533.0, 5609.0, 5587.0, 5338.0, 5599.0,

						5257.0, 5375.0, 5540.0, 5284.0, 5525.0, 5660.0, 5414.0, 5394.0, 5405.0, 5445.0, 5511.0, 5700.0, 5407.0, 5615.0, 5428.0, 5690.0, 5317.0, 5437.0, 5517.0, 5673.0, 5521.0, 5638.0, 5679.0, 5633.0, 5424.0, 5258.0, 5312.0, 5305.0, 5373.0, 5547.0, 5629.0, 5422.0, 5450.0, 5400.0, 5353.0, 5672.0, 5656.0, 5342.0, 5678.0, 5256.0 (number of hits: 17)
24	5530	9	1	333	1	5697.0, 5660.0, 5530.0, 5546.0, 5472.0, 5607.0, 5332.0, 5523.0, 5417.0, 5305.0, 5705.0, 5467.0, 5666.0, 5699.0, 5404.0, 5297.0, 5668.0, 5369.0, 5665.0, 5613.0, 5376.0, 5704.0, 5671.0, 5399.0, 5629.0, 5680.0, 5318.0, 5262.0, 5586.0, 5276.0, 5303.0, 5534.0, 5334.0, 5583.0, 5657.0, 5565.0, 5564.0, 5619.0, 5691.0, 5323.0, 5635.0, 5312.0, 5475.0, 5263.0, 5616.0, 5543.0, 5649.0, 5670.0, 5712.0, 5371.0, 5554.0, 5453.0, 5280.0, 5496.0, 5320.0, 5611.0, 5514.0, 5261.0, 5308.0, 5683.0, 5341.0, 5492.0, 5338.0, 5442.0, 5398.0, 5517.0, 5444.0, 5285.0, 5264.0, 5695.0, 5409.0, 5277.0, 5485.0, 5256.0, 5330.0, 5296.0, 5290.0, 5346.0, 5465.0, 5667.0, 5558.0, 5528.0, 5273.0, 5448.0, 5425.0, 5595.0, 5339.0, 5687.0, 5474.0, 5645.0, 5446.0, 5382.0, 5722.0, 5326.0, 5321.0, 5294.0, 5333.0, 5310.0, 5690.0, 5267.0 (number of hits: 14)
25	5530	9	1	333	1	5288.0, 5447.0, 5618.0, 5279.0, 5456.0, 5667.0, 5330.0, 5442.0, 5381.0, 5454.0, 5655.0, 5662.0, 5436.0, 5424.0, 5643.0, 5293.0, 5331.0, 5610.0, 5357.0, 5486.0, 5587.0, 5526.0, 5719.0, 5458.0, 5477.0, 5336.0, 5432.0, 5290.0, 5449.0, 5282.0, 5557.0, 5343.0, 5328.0, 5434.0, 5285.0, 5525.0, 5387.0, 5450.0, 5688.0, 5716.0, 5414.0, 5292.0, 5588.0, 5261.0, 5575.0, 5431.0, 5490.0, 5351.0, 5669.0, 5524.0, 5506.0, 5692.0, 5620.0, 5406.0, 5457.0, 5311.0, 5270.0, 5558.0, 5713.0, 5585.0, 5407.0, 5676.0, 5268.0, 5479.0, 5622.0, 5678.0, 5694.0, 5415.0, 5536.0, 5296.0, 5539.0, 5333.0, 5705.0, 5481.0, 5356.0, 5421.0, 5544.0, 5510.0, 5626.0, 5638.0, 5391.0, 5375.0, 5612.0, 5659.0, 5552.0, 5254.0, 5543.0, 5398.0, 5505.0, 5548.0, 5635.0, 5258.0, 5400.0, 5695.0, 5599.0, 5271.0, 5500.0, 5440.0, 5341.0, 5609.0 (number of hits: 15)
26	5530	9	1	333	1	5346.0, 5448.0, 5366.0, 5252.0, 5708.0, 5431.0, 5631.0, 5690.0, 5458.0, 5591.0, 5525.0, 5319.0, 5638.0, 5364.0, 5514.0, 5619.0, 5324.0, 5256.0, 5645.0, 5474.0, 5610.0, 5302.0, 5344.0, 5402.0, 5483.0, 5406.0, 5443.0, 5516.0, 5365.0, 5698.0, 5607.0, 5615.0, 5262.0, 5283.0, 5294.0, 5569.0, 5478.0, 5583.0, 5338.0, 5363.0, 5618.0, 5554.0, 5705.0, 5389.0, 5520.0

						5411.0, 5672.0, 5423.0, 5561.0, 5384.0, 5330.0, 5560.0, 5312.0, 5469.0, 5386.0, 5718.0, 5526.0, 5369.0, 5310.0, 5272.0, 5576.0, 5354.0, 5532.0, 5565.0, 5688.0, 5656.0, 5501.0, 5491.0, 5626.0, 5646.0, 5435.0, 5362.0, 5568.0, 5697.0, 5370.0, 5702.0, 5719.0, 5462.0, 5424.0, 5541.0, 5420.0, 5447.0, 5442.0, 5356.0, 5460.0, 5418.0, 5410.0, 5456.0, 5667.0, 5692.0, 5412.0, 5696.0, 5624.0, 5699.0, 5567.0, 5428.0, 5612.0, 5720.0, 5528.0, 5426.0 (number of hits: 14)
27	5530	9	1	333	1	5304.0, 5719.0, 5365.0, 5672.0, 5347.0, 5276.0, 5352.0, 5300.0, 5442.0, 5486.0, 5488.0, 5353.0, 5448.0, 5356.0, 5657.0, 5694.0, 5453.0, 5529.0, 5523.0, 5392.0, 5598.0, 5490.0, 5594.0, 5451.0, 5570.0, 5285.0, 5476.0, 5711.0, 5554.0, 5576.0, 5449.0, 5354.0, 5689.0, 5489.0, 5272.0, 5663.0, 5651.0, 5456.0, 5546.0, 5266.0, 5447.0, 5287.0, 5278.0, 5268.0, 5637.0, 5544.0, 5407.0, 5613.0, 5603.0, 5299.0, 5472.0, 5380.0, 5654.0, 5263.0, 5357.0, 5569.0, 5621.0, 5290.0, 5467.0, 5600.0, 5525.0, 5574.0, 5612.0, 5293.0, 5618.0, 5374.0, 5721.0, 5270.0, 5617.0, 5450.0, 5720.0, 5296.0, 5283.0, 5382.0, 5335.0, 5588.0, 5434.0, 5660.0, 5596.0, 5515.0, 5326.0, 5477.0, 5254.0, 5473.0, 5584.0, 5496.0, 5350.0, 5665.0, 5363.0, 5468.0, 5653.0, 5580.0, 5558.0, 5673.0, 5379.0, 5426.0, 5328.0, 5533.0, 5520.0, 5261.0 (number of hits: 11)
28	5530	9	1	333	1	5611.0, 5307.0, 5514.0, 5408.0, 5368.0, 5709.0, 5375.0, 5705.0, 5259.0, 5676.0, 5462.0, 5558.0, 5652.0, 5596.0, 5309.0, 5407.0, 5595.0, 5369.0, 5522.0, 5273.0, 5341.0, 5640.0, 5552.0, 5692.0, 5393.0, 5645.0, 5252.0, 5525.0, 5418.0, 5359.0, 5303.0, 5616.0, 5673.0, 5638.0, 5320.0, 5587.0, 5456.0, 5597.0, 5646.0, 5707.0, 5682.0, 5340.0, 5485.0, 5477.0, 5649.0, 5425.0, 5269.0, 5430.0, 5534.0, 5585.0, 5717.0, 5420.0, 5626.0, 5458.0, 5633.0, 5535.0, 5344.0, 5404.0, 5349.0, 5478.0, 5475.0, 5396.0, 5297.0, 5283.0, 5348.0, 5251.0, 5305.0, 5416.0, 5489.0, 5438.0, 5517.0, 5684.0, 5601.0, 5271.0, 5325.0, 5512.0, 5411.0, 5536.0, 5521.0, 5651.0, 5553.0, 5391.0, 5457.0, 5382.0, 5607.0, 5326.0, 5502.0, 5529.0, 5644.0, 5276.0, 5421.0, 5488.0, 5497.0, 5608.0, 5575.0, 5367.0, 5508.0, 5561.0, 5308.0, 5494.0 (number of hits: 18)
29	5530	9	1	333	1	5702.0, 5682.0, 5669.0, 5382.0, 5594.0, 5638.0, 5600.0, 5406.0, 5464.0, 5514.0, 5642.0, 5392.0, 5484.0, 5432.0, 5408.0, 5383.0, 5614.0, 5688.0, 5671.0, 5420.0, 5288.0, 5563.0, 5376.0, 5255.0, 5433.0, 5281.0, 5470.0, 5377.0, 5699.0, 5708.0,

						5401.0, 5275.0, 5524.0, 5518.0, 5636.0, 5256.0, 5533.0, 5715.0, 5664.0, 5403.0, 5306.0, 5700.0, 5486.0, 5497.0, 5686.0, 5263.0, 5599.0, 5652.0, 5446.0, 5693.0, 5301.0, 5510.0, 5250.0, 5253.0, 5273.0, 5271.0, 5696.0, 5611.0, 5418.0, 5694.0, 5467.0, 5580.0, 5454.0, 5297.0, 5359.0, 5476.0, 5478.0, 5431.0, 5503.0, 5371.0, 5606.0, 5632.0, 5561.0, 5509.0, 5595.0, 5560.0, 5330.0, 5648.0, 5303.0, 5373.0, 5647.0, 5622.0, 5697.0, 5390.0, 5314.0, 5535.0, 5322.0, 5654.0, 5602.0, 5540.0, 5692.0, 5258.0, 5650.0, 5302.0, 5695.0, 5436.0, 5724.0, 5344.0, 5407.0, 5444.0 (number of hits: 13)
30	5530	9	1	333	1	5581.0, 5384.0, 5319.0, 5509.0, 5649.0, 5610.0, 5530.0, 5577.0, 5669.0, 5267.0, 5502.0, 5463.0, 5595.0, 5709.0, 5299.0, 5665.0, 5635.0, 5676.0, 5436.0, 5304.0, 5420.0, 5371.0, 5575.0, 5516.0, 5490.0, 5573.0, 5719.0, 5684.0, 5454.0, 5297.0, 5439.0, 5391.0, 5300.0, 5308.0, 5692.0, 5362.0, 5557.0, 5452.0, 5528.0, 5650.0, 5659.0, 5560.0, 5305.0, 5680.0, 5572.0, 5260.0, 5288.0, 5641.0, 5343.0, 5423.0, 5410.0, 5395.0, 5382.0, 5722.0, 5663.0, 5374.0, 5503.0, 5625.0, 5615.0, 5689.0, 5631.0, 5258.0, 5591.0, 5281.0, 5697.0, 5713.0, 5627.0, 5296.0, 5688.0, 5701.0, 5554.0, 5698.0, 5322.0, 5607.0, 5318.0, 5283.0, 5437.0, 5285.0, 5266.0, 5275.0, 5292.0, 5651.0, 5532.0, 5337.0, 5559.0, 5356.0, 5636.0, 5593.0, 5339.0, 5352.0, 5315.0, 5710.0, 5587.0, 5250.0, 5407.0, 5443.0, 5464.0, 5571.0, 5531.0, 5655.0 (number of hits: 12)

5570 MHz, 160 MHz Bandwidth

Radar Signal Type	Waveform/Trial Number	Detection (%)	Limit (%)	Pass/Fail
Type 1A/1B	30	100 %	60%	Pass
Type 2	30	83.3 %	60%	Pass
Type 3	30	86.7 %	60%	Pass
Type 4	30	83.3 %	60%	Pass
Aggregate (Type1 to 4)	120	88.32 %	80%	Pass
Type 5	30	100 %	80%	Pass
Type 6	30	100 %	70%	Pass

Please refer to the following statistical tables:

5570 MHz, 160 MHz Bandwidth**Table-1A/1B Radar Type 1A/1B Statistical Performance**

Trial #	Fc (MHz)	Pulse/Burst	Pulse Width (µS)	PRI (µs)	Detection (1:yes; 0:no)
1	5570	72	1	738	1
2	5570	59	1	898	1
3	5570	78	1	678	1
4	5570	83	1	638	1
5	5570	70	1	758	1
6	5492	65	1	818	1
7	5492	92	1	578	1
8	5492	95	1	558	1
9	5492	62	1	858	1
10	5492	61	1	878	1
11	5648	86	1	618	1
12	5648	18	1	3066	1
13	5648	81	1	658	1
14	5648	76	1	698	1
15	5648	99	1	538	1
16	5570	84	1	635	1
17	5570	65	1	822	1
18	5570	35	1	1529	1
19	5570	52	1	1029	1
20	5570	40	1	1351	1
21	5492	38	1	1418	1
22	5492	22	1	2472	1
23	5492	47	1	1142	1
24	5492	30	1	1785	1
25	5492	20	1	2675	1
26	5648	70	1	755	1
27	5648	37	1	1438	1
28	5648	25	1	2123	1
29	5648	19	1	2900	1
30	5648	88	1	600	1
Detection Percentage: 100 % (>60%)					

Table-2 Radar Type 2 Statistical Performance

Trial #	Fc (MHz)	Pulse/Burst	Pulse Width (μS)	PRI (μs)	Detection (1:yes; 0:no)
1	5570	29	2.3	166	1
2	5570	27	2.9	150	1
3	5570	23	4.5	223	1
4	5570	26	2.8	208	1
5	5570	29	1.1	202	1
6	5570	23	1.9	226	1
7	5570	27	3.3	165	1
8	5570	24	2.4	225	0
9	5570	26	2.1	222	1
10	5570	29	1.4	226	1
11	5492	28	1.6	226	1
12	5492	25	3.4	207	1
13	5492	29	1.4	225	0
14	5492	27	5	155	1
15	5492	29	3.9	169	1
16	5492	23	2.9	222	1
17	5492	26	2.6	195	0
18	5492	24	4.6	155	1
19	5492	25	4.8	206	1
20	5492	23	1.1	192	0
21	5648	23	4	167	1
22	5648	26	2.3	219	1
23	5648	26	3.4	168	1
24	5648	26	1.7	224	1
25	5648	24	2	222	1
26	5648	28	2.8	155	1
27	5648	24	2.1	229	1
28	5648	26	1.8	181	0
29	5648	23	3.6	216	1
30	5648	28	2.3	201	1
Detection Percentage: 83.3 % (>60%)					

Table-3 Radar Type 3 Statistical Performance

Trial #	Fc (MHz)	Pulse/Burst	Pulse Width (μS)	PRI (μs)	Detection (1:yes; 0:no)
1	5570	17	8.6	253	1
2	5570	18	8.8	289	1
3	5570	17	6.7	262	0
4	5570	18	9.9	429	1
5	5570	18	7.5	358	1
6	5570	17	9.4	297	1
7	5570	16	9.4	335	0
8	5570	18	6	247	1
9	5570	16	7.3	392	1
10	5570	16	6.3	465	1
11	5492	18	6.4	432	1
12	5492	16	6.5	271	1
13	5492	18	6.7	203	1
14	5492	17	9.5	285	1
15	5492	18	8.9	318	1
16	5492	16	9	445	1
17	5492	17	9.9	368	0
18	5492	17	6.3	311	1
19	5492	17	8.7	399	1
20	5492	16	6	222	1
21	5648	17	6.9	219	1
22	5648	18	7.6	334	1
23	5648	16	6	201	1
24	5648	16	7.4	254	1
25	5648	18	8.6	424	1
26	5648	16	6.2	351	1
27	5648	16	8.5	413	1
28	5648	16	8.2	313	0
29	5648	18	7.4	471	1
30	5648	17	7.7	483	1
Detection Percentage: 86.7 % (>60%)					

Table-4 Radar Type 4 Statistical Performance

Trial #	Fc (MHz)	Pulse/Burst	Pulse Width (µS)	PRI (µs)	Detection (1:yes; 0:no)
1	5570	12	19.7	279	1
2	5570	13	14.9	366	1
3	5570	13	18.6	330	0
4	5570	14	17.7	280	1
5	5570	14	16.9	225	1
6	5570	14	12.8	448	1
7	5570	15	11.4	455	1
8	5570	12	19.3	256	0
9	5570	13	18.4	343	1
10	5570	16	14.1	392	1
11	5492	12	15.4	253	1
12	5492	13	15.8	406	0
13	5492	13	12.6	457	0
14	5492	16	13.6	357	1
15	5492	16	12.1	315	1
16	5492	16	13.4	395	1
17	5492	16	11.1	471	0
18	5492	15	16.4	415	1
19	5492	15	11.5	315	1
20	5492	16	12.2	481	1
21	5648	14	17.1	207	1
22	5648	15	15.8	236	1
23	5648	16	11.3	478	1
24	5648	13	19.4	283	1
25	5648	16	16.9	225	1
26	5648	12	16.9	426	1
27	5648	15	12.6	283	1
28	5648	15	15.1	386	1
29	5648	15	16.4	456	1
30	5648	12	12.8	359	1
Detection Percentage: 83.3 % (>60%)					

Table-5 Radar Type 5 Statistical Performance

Trial #	Fc (MHz)	Detection (1:yes; 0:no)
1	5570	1
2	5570	1
3	5570	1
4	5570	1
5	5570	1
6	5570	1
7	5570	1
8	5570	1
9	5570	1
10	5570	1
11	5494.8	1
12	5498.8	1
13	5497.2	1
14	5498.8	1
15	5497.2	1
16	5497.6	1
17	5494.8	1
18	5495.6	1
19	5500.0	1
20	5498.8	1
21	5641.2	1
22	5645.2	1
23	5643.6	1
24	5642.4	1
25	5644.4	1
26	5644.4	1
27	5640.4	1
28	5644.4	1
29	5643.6	1
30	5642.0	1
Detection Percentage: 100 % (>80%)		

Bin5 Statistics 1

Trial #	Pulse	Chirp (MHz)	Pulse Width (µS)	Pulse 1-2 spacing (µS)	Pulse 2-3 spacing (µS)	Pulse Start(S)	Detection (1:yes; 0:no)
0	2	13	94.3	1920	-	0.774217	1
1	1	13	54.4	-	-	1.315484	
2	3	13	67.2	1720	1185	2.302798	
3	2	13	77	1814	-	3.004255	
4	1	13	60	-	-	4.267467	
5	1	13	77.7	-	-	5.444746	
6	2	13	81	1962	-	6.228422	
7	2	13	59.8	1167	-	6.933854	
8	2	13	53.4	1065	-	8.09186	
9	1	13	50.8	-	-	8.677463	
10	1	13	89.5	-	-	9.480658	
11	1	13	57.2	-	-	10.812152	
12	3	13	51.7	1192	1551	11.881371	

Bin5 Statistics 2

Trial #	Pulse	Chirp (MHz)	Pulse Width (µS)	Pulse 1-2 spacing (µS)	Pulse 2-3 spacing (µS)	Pulse Start(S)	Detection (1:yes; 0:no)
0	2	14	80	1229	-	0.290757	1
1	3	14	84.5	1256	1145	0.736369	
2	2	14	96	1142	-	1.835326	
3	1	14	52.7	-	-	2.280989	
4	2	14	77.4	1745	-	3.054179	
5	2	14	67.6	1482	-	3.284162	
6	2	14	50.5	1564	-	4.303189	
7	1	14	84.9	-	-	4.942272	
8	2	14	91	1647	-	5.249515	
9	1	14	96.4	-	-	5.69403	
10	1	14	90.2	-	-	6.517351	
11	1	14	71.6	-	-	7.341483	
12	3	14	84.2	1727	1734	8.175789	
13	2	14	96.5	1281	-	8.356908	
14	1	14	93.1	-	-	9.416081	
15	2	14	78	1357	-	9.913091	
16	3	14	66.3	1670	1206	10.126367	
17	2	14	65.9	1598	-	11.194171	
18	3	14	66	1733	1215	11.580127	

Bin5 Statistics 3

Trial #	Pulse	Chirp (MHz)	Pulse Width (µS)	Pulse 1-2 spacing (µS)	Pulse 2-3 spacing (µS)	Pulse Start(S)	Detection (1:yes; 0:no)
0	1	10	63.9	-	-	0.102366	1
1	3	10	95.2	1184	1838	0.777808	
2	2	10	76.4	1259	-	1.602199	
3	2	10	98.2	1326	-	2.596574	
4	2	10	58	1563	-	3.203141	
5	3	10	54.3	1532	1765	4.360144	
6	2	10	92.2	1223	-	4.621217	
7	1	10	69.5	-	-	5.956555	
8	1	10	69.4	-	-	6.102886	
9	2	10	66.9	1624	-	7.054473	
10	2	10	95.4	1384	-	7.624453	
11	3	10	80.5	1424	1598	8.461766	
12	3	10	62.9	1089	1037	9.134959	
13	2	10	57.2	1410	-	9.780418	
14	2	10	95.9	1135	-	11.176589	
15	2	10	93.5	1932	-	11.488918	

Bin5 Statistics 4

Trial #	Pulse	Chirp (MHz)	Pulse Width (µS)	Pulse 1-2 spacing (µS)	Pulse 2-3 spacing (µS)	Pulse Start(S)	Detection (1:yes; 0:no)
0	1	7	97	-	-	0.14049	1
1	1	7	72.2	-	-	1.46424	
2	2	7	78.4	1625	-	2.921678	
3	2	7	90.6	1874	-	4.747055	
4	2	7	86.8	1737	-	5.509377	
5	1	7	98.5	-	-	6.937159	
6	3	7	76.9	1827	1247	8.360697	
7	1	7	96.1	-	-	9.440509	
8	1	7	86.2	-	-	11.146867	

Bin5 Statistics 5

Trial #	Pulse	Chirp (MHz)	Pulse Width (µS)	Pulse 1-2 spacing (uS)	Pulse 2-3 spacing (uS)	Pulse Start(S)	Detection (1:yes; 0:no)
0	1	14	50.2	-	-	1.327275	1
1	2	14	59.4	1696	-	1.390798	
2	3	14	58.9	1309	1247	3.29991	
3	1	14	68.4	-	-	4.461599	
4	3	14	71.4	1545	1432	6.23728	
5	1	14	77.3	-	-	6.762382	
6	1	14	61.4	-	-	8.145005	
7	1	14	92.6	-	-	9.673634	
8	2	14	82.9	1098	-	11.275041	

Bin5 Statistics 6

Trial #	Pulse	Chirp (MHz)	Pulse Width (µS)	Pulse 1-2 spacing (uS)	Pulse 2-3 spacing (uS)	Pulse Start(S)	Detection (1:yes; 0:no)
0	2	12	73.6	1858	-	0.244465	1
1	1	12	75.6	-	-	0.717551	
2	2	12	65.4	1058	-	1.505978	
3	1	12	55.9	-	-	2.291279	
4	1	12	91.4	-	-	3.037176	
5	2	12	74.6	1614	-	3.509134	
6	2	12	77.7	1653	-	4.205848	
7	2	12	95.6	1447	-	4.701785	
8	2	12	55.6	1055	-	5.536496	
9	2	12	56	1551	-	6.274938	
10	2	12	75.3	1707	-	7.088452	
11	2	12	52.5	1174	-	7.691636	
12	2	12	53.4	1680	-	8.016321	
13	2	12	84	1212	-	8.670626	
14	2	12	74.2	1986	-	9.358293	
15	2	12	60.2	1412	-	10.008098	
16	1	12	73.1	-	-	11.098669	
17	1	12	93.9	-	-	11.573799	

Bin5 Statistics 7

Trial #	Pulse	Chirp (MHz)	Pulse Width (µS)	Pulse 1-2 spacing (µS)	Pulse 2-3 spacing (µS)	Pulse Start(S)	Detection (1:yes; 0:no)
0	3	9	79.8	1512	1762	0.574951	1
1	3	9	53.3	1854	1996	1.230727	
2	1	9	93.6	-	-	1.425654	
3	2	9	58.9	1496	-	2.524529	
4	2	9	90.2	1530	-	3.004248	
5	1	9	53.3	-	-	3.596672	
6	2	9	57.1	1152	-	4.654224	
7	2	9	70	1260	-	5.318065	
8	2	9	83.2	1310	-	5.547281	
9	3	9	87	1458	1484	6.594796	
10	1	9	54.5	-	-	7.14967	
11	2	9	50.1	1498	-	7.916875	
12	1	9	83.4	-	-	8.59975	
13	2	9	66.1	1643	-	8.973936	
14	2	9	64.2	1371	-	9.938554	
15	2	9	74.7	1972	-	10.38109	
16	3	9	63.7	1479	1472	11.161852	
17	2	9	76.6	1255	-	11.904655	

Bin5 Statistics 8

Trial #	Pulse	Chirp (MHz)	Pulse Width (µS)	Pulse 1-2 spacing (µS)	Pulse 2-3 spacing (µS)	Pulse Start(S)	Detection (1:yes; 0:no)
0	1	7	72.1	-	-	0.284046	1
1	1	7	78.7	-	-	1.601195	
2	2	7	71.1	1274	-	2.502947	
3	2	7	73.6	1145	-	3.369425	
4	2	7	87.6	1447	-	4.698055	
5	1	7	77	-	-	6.109736	
6	1	7	50.8	-	-	7.082144	
7	2	7	77.2	1232	-	8.575613	
8	1	7	55.2	-	-	9.355427	
9	2	7	83	1544	-	10.816358	
10	3	7	74.4	1184	1302	11.111284	

Bin5 Statistics 9

Trial #	Pulse	Chirp (MHz)	Pulse Width (µS)	Pulse 1-2 spacing (uS)	Pulse 2-3 spacing (uS)	Pulse Start(S)	Detection (1:yes; 0:no)
0	2	16	56.6	1962	-	0.279693	1
1	1	16	73.6	-	-	2.061674	
2	3	16	96.1	1937	1555	2.655486	
3	2	16	67.3	1996	-	4.730662	
4	3	16	65.8	1195	1679	5.787781	
5	1	16	78	-	-	6.344594	
6	2	16	65.3	1007	-	7.73856	
7	1	16	81.8	-	-	8.547042	
8	3	16	98.9	1613	1016	10.748775	
9	2	16	87.8	1277	-	10.954	

Bin5 Statistics 10

Trial #	Pulse	Chirp (MHz)	Pulse Width (µS)	Pulse 1-2 spacing (uS)	Pulse 2-3 spacing (uS)	Pulse Start(S)	Detection (1:yes; 0:no)
0	2	9	95.4	1461	-	0.080272	1
1	3	9	55	1224	1697	1.076733	
2	2	9	63	1536	-	1.430462	
3	2	9	84.2	1010	-	2.65018	
4	3	9	50.2	1790	1299	3.281258	
5	2	9	85.1	1943	-	3.592894	
6	2	9	94.6	1660	-	4.352284	
7	2	9	83.3	1897	-	5.164996	
8	1	9	85.1	-	-	5.67653	
9	2	9	88.2	1635	-	6.415013	
10	2	9	62.4	1321	-	6.946532	
11	2	9	50.3	1202	-	7.956163	
12	2	9	99.2	1517	-	8.471135	
13	2	9	65	1374	-	8.726686	
14	2	9	71.6	1436	-	9.949929	
15	3	9	59.6	1447	1324	10.519154	
16	2	9	57.2	1238	-	11.013468	
17	1	9	83	-	-	11.56847	

Bin5 Statistics 11

Trial #	Pulse	Chirp (MHz)	Pulse Width (µS)	Pulse 1-2 spacing (uS)	Pulse 2-3 spacing (uS)	Pulse Start(S)	Detection (1:yes; 0:no)
0	3	7	79.9	1623	1476	0.063652	1
1	2	7	62.1	1778	-	1.384351	
2	2	7	50.6	1786	-	3.48717	
3	2	7	85.9	1841	-	4.015544	
4	3	7	77.2	1258	1340	6.14859	
5	3	7	77.3	1562	1434	7.62627	
6	3	7	71.6	1221	1814	8.370699	
7	3	7	75.3	1316	1882	9.629053	
8	3	7	55.9	1755	1580	11.675875	

Bin5 Statistics 12

Trial #	Pulse	Chirp (MHz)	Pulse Width (µS)	Pulse 1-2 spacing (uS)	Pulse 2-3 spacing (uS)	Pulse Start(S)	Detection (1:yes; 0:no)
0	2	17	52.1	1587	-	0.007897	1
1	2	17	66.8	1473	-	1.196352	
2	1	17	84.8	-	-	2.474	
3	1	17	62	-	-	3.454628	
4	3	17	64.9	1383	1582	4.705018	
5	3	17	83.7	1711	1776	5.55559	
6	2	17	91.6	1022	-	6.750976	
7	1	17	96.3	-	-	7.732989	
8	2	17	67.3	1473	-	9.437633	
9	2	17	95.8	1427	-	10.592067	
10	2	17	61.5	1692	-	11.115692	

Bin5 Statistics 13

Trial #	Pulse	Chirp (MHz)	Pulse Width (µS)	Pulse 1-2 spacing (uS)	Pulse 2-3 spacing (uS)	Pulse Start(S)	Detection (1:yes; 0:no)
0	3	13	62.8	1760	1318	0.659224	1
1	2	13	76.1	1704	-	1.053388	
2	2	13	72.5	1454	-	1.968528	
3	2	13	96.4	1611	-	2.815661	
4	2	13	66.3	1858	-	3.390898	
5	3	13	56.4	1402	1376	3.73319	
6	2	13	54.7	1934	-	4.692817	
7	2	13	90.7	1725	-	5.58513	
8	3	13	97.4	1356	1390	5.930025	
9	2	13	53	1327	-	6.387309	
10	1	13	74.2	-	-	7.283793	
11	2	13	89.8	1810	-	8.07356	
12	3	13	54.8	1321	1389	8.904596	
13	3	13	64.2	1545	1354	9.429514	
14	3	13	74.9	1180	1377	10.154894	
15	2	13	99.5	1038	-	10.759362	
16	3	13	53	1785	1816	11.955271	

Bin5 Statistics 14

Trial #	Pulse	Chirp (MHz)	Pulse Width (µS)	Pulse 1-2 spacing (uS)	Pulse 2-3 spacing (uS)	Pulse Start(S)	Detection (1:yes; 0:no)
0	2	17	59.9	1721	-	0.404765	1
1	2	17	76.5	1801	-	0.787015	
2	1	17	56.4	-	-	1.393773	
3	3	17	87.8	1463	1576	2.23731	
4	2	17	91.3	1528	-	2.673892	
5	2	17	60.8	1552	-	3.234093	
6	1	17	67.1	-	-	3.989111	
7	2	17	67.5	1403	-	5.038921	
8	3	17	55.6	1624	1607	5.146329	
9	3	17	75	1451	1177	6.221308	
10	2	17	55.2	1932	-	6.837748	
11	2	17	88.9	1000	-	7.112585	
12	2	17	91	1450	-	8.092419	
13	2	17	93.1	1492	-	8.36687	
14	3	17	96.6	1057	1924	9.422913	
15	2	17	94.4	1112	-	9.764751	
16	2	17	73	1790	-	10.600791	
17	1	17	77.2	-	-	10.846794	
18	2	17	81.9	1602	-	11.809128	

Bin5 Statistics 15

Trial #	Pulse	Chirp (MHz)	Pulse Width (µS)	Pulse 1-2 spacing (uS)	Pulse 2-3 spacing (uS)	Pulse Start(S)	Detection (1:yes; 0:no)
0	2	13	96.3	1777	-	0.652368	1
1	3	13	75.7	1007	1038	1.342666	
2	1	13	66.5	-	-	2.23771	
3	2	13	63.2	1598	-	2.546201	
4	3	13	63.5	1265	1480	3.690729	
5	2	13	83.3	1791	-	4.378632	
6	3	13	84.8	1209	1794	5.153726	
7	2	13	64.9	1629	-	5.582446	
8	3	13	92.3	1992	1753	6.249691	
9	1	13	69.1	-	-	7.454206	
10	3	13	87.1	1010	1801	8.191354	
11	2	13	93.3	1335	-	8.305558	
12	2	13	59.4	1152	-	9.501728	
13	1	13	81.7	-	-	10.299634	
14	3	13	67.9	1695	1063	11.138121	
15	1	13	77.4	-	-	11.606118	

Bin5 Statistics 16

Trial #	Pulse	Chirp (MHz)	Pulse Width (µS)	Pulse 1-2 spacing (uS)	Pulse 2-3 spacing (uS)	Pulse Start(S)	Detection (1:yes; 0:no)
0	2	14	76.9	1413	-	0.584193	1
1	1	14	52	-	-	0.944152	
2	1	14	72	-	-	1.99082	
3	3	14	59.5	1275	1686	2.952752	
4	3	14	65.2	1069	1610	4.127264	
5	3	14	52	1897	1763	5.259645	
6	2	14	90.2	1876	-	5.774926	
7	2	14	60.5	1919	-	7.023082	
8	3	14	73	1964	1382	8.195862	
9	3	14	56	1315	1077	8.396368	
10	2	14	79.7	1090	-	9.955965	
11	2	14	66	1847	-	10.664103	
12	2	14	90.6	1293	-	11.543918	

Bin5 Statistics 17

Trial #	Pulse	Chirp (MHz)	Pulse Width (µS)	Pulse 1-2 spacing (uS)	Pulse 2-3 spacing (uS)	Pulse Start(S)	Detection (1:yes; 0:no)
0	2	7	67.8	1144	-	0.008059	1
1	2	7	52.1	1278	-	1.862813	
2	2	7	97.3	1084	-	2.202541	
3	2	7	66.3	1810	-	3.886828	
4	1	7	85.6	-	-	4.123954	
5	1	7	53	-	-	5.877077	
6	2	7	51.9	1709	-	6.617395	
7	2	7	72.2	1133	-	7.621545	
8	1	7	89.9	-	-	8.644033	
9	3	7	55.8	1660	1704	9.70873	
10	1	7	96.3	-	-	10.960125	
11	2	7	93.5	1612	-	11.285377	

Bin5 Statistics 18

Trial #	Pulse	Chirp (MHz)	Pulse Width (µS)	Pulse 1-2 spacing (uS)	Pulse 2-3 spacing (uS)	Pulse Start(S)	Detection (1:yes; 0:no)
0	1	9	76.3	-	-	0.158922	1
1	2	9	65.2	1583	-	1.012304	
2	1	9	95.9	-	-	1.383208	
3	3	9	51.9	1032	1802	2.325964	
4	2	9	99.8	1799	-	2.704334	
5	3	9	79.8	1242	1259	3.567462	
6	2	9	59.4	1574	-	3.908508	
7	3	9	95.6	1646	1025	4.577009	
8	3	9	77	1219	1476	5.496312	
9	3	9	82.9	1939	1035	6.264375	
10	3	9	95.6	1064	1222	6.507284	
11	2	9	69.8	1910	-	7.009429	
12	1	9	56.7	-	-	7.851805	
13	2	9	97.9	1530	-	8.674354	
14	2	9	94.1	1975	-	9.208242	
15	2	9	55.7	1945	-	9.548309	
16	2	9	60.1	1833	-	10.420453	
17	2	9	71.3	1087	-	10.884537	
18	3	9	61.3	1996	1891	11.461937	

Bin5 Statistics 19

Trial #	Pulse	Chirp (MHz)	Pulse Width (µS)	Pulse 1-2 spacing (uS)	Pulse 2-3 spacing (uS)	Pulse Start(S)	Detection (1:yes; 0:no)
0	2	20	62.9	1004	-	0.307118	1
1	2	20	80.6	1070	-	0.879598	
2	3	20	77.6	1962	1878	1.827293	
3	1	20	76.9	-	-	2.44057	
4	3	20	78.8	1934	1228	2.989378	
5	3	20	99.8	1908	1030	3.764652	
6	2	20	55.6	1213	-	4.032688	
7	2	20	99.1	1598	-	4.577749	
8	3	20	90.2	1152	1525	5.373066	
9	1	20	82.4	-	-	6.281054	
10	3	20	87.4	1737	1910	6.554443	
11	3	20	78	1871	1202	7.181149	
12	2	20	60.1	1434	-	7.927721	
13	1	20	74.3	-	-	8.321619	
14	1	20	55.5	-	-	9.233681	
15	2	20	52.7	1151	-	9.544911	
16	3	20	78.6	1586	1444	10.131893	
17	2	20	89.3	1462	-	10.739728	
18	2	20	83.4	1317	-	11.911429	

Bin5 Statistics 20

Trial #	Pulse	Chirp (MHz)	Pulse Width (µS)	Pulse 1-2 spacing (uS)	Pulse 2-3 spacing (uS)	Pulse Start(S)	Detection (1:yes; 0:no)
0	3	17	72.8	1823	1265	0.068593	1
1	1	17	93.3	-	-	2.080985	
2	2	17	90.5	1463	-	3.044871	
3	2	17	90.9	1339	-	4.516871	
4	2	17	52.3	1947	-	5.663823	
5	3	17	79.8	1304	1236	6.819134	
6	2	17	84.3	1916	-	7.982672	
7	2	17	97.5	1670	-	9.470554	
8	2	17	83.2	1717	-	10.71266	
9	1	17	76.2	-	-	10.962708	

Bin5 Statistics 21

Trial #	Pulse	Chirp (MHz)	Pulse Width (µS)	Pulse 1-2 spacing (µS)	Pulse 2-3 spacing (µS)	Pulse Start(S)	Detection (1:yes; 0:no)
0	2	17	54.7	1703	-	0.851202	1
1	2	17	78.4	1391	-	1.601453	
2	1	17	72.6	-	-	2.672209	
3	2	17	99.9	1109	-	5.154996	
4	2	17	68.1	1779	-	5.820499	
5	3	17	81.5	1217	1147	7.628515	
6	2	17	93.4	1979	-	8.59295	
7	2	17	82.7	1199	-	9.449275	
8	3	17	73.9	1037	1255	11.659255	

Bin5 Statistics 22

Trial #	Pulse	Chirp (MHz)	Pulse Width (µS)	Pulse 1-2 spacing (µS)	Pulse 2-3 spacing (µS)	Pulse Start(S)	Detection (1:yes; 0:no)
0	3	7	62.4	1988	1249	0.591335	1
1	2	7	54.1	1318	-	1.320287	
2	1	7	77	-	-	2.194483	
3	2	7	99	1343	-	2.818258	
4	3	7	52	1617	1262	4.524037	
5	2	7	89.4	1328	-	5.444708	
6	2	7	86.7	1670	-	5.726627	
7	1	7	76.3	-	-	7.269618	
8	3	7	93.5	1261	1518	7.711518	
9	2	7	78.7	1556	-	8.343776	
10	3	7	92.3	1441	1994	9.513336	
11	2	7	94.6	1278	-	10.686744	
12	2	7	57.4	1883	-	11.818473	

Bin5 Statistics 23

Trial #	Pulse	Chirp (MHz)	Pulse Width (µS)	Pulse 1-2 spacing (µS)	Pulse 2-3 spacing (µS)	Pulse Start(S)	Detection (1:yes; 0:no)
0	2	11	76.6	1898	-	0.684702	1
1	3	11	70.4	1501	1794	1.067305	
2	2	11	52	1075	-	1.697634	
3	2	11	87.9	1462	-	2.422423	
4	1	11	65.2	-	-	3.523061	
5	3	11	53.6	1582	1900	4.481366	
6	1	11	65.4	-	-	4.80782	
7	2	11	90.6	1643	-	5.964409	
8	2	11	70.8	1672	-	6.47518	
9	1	11	79.2	-	-	7.989354	
10	2	11	58.5	1502	-	8.515614	
11	3	11	56.7	1406	1154	9.499488	
12	2	11	66.6	1561	-	10.282477	
13	3	11	51.5	1508	1745	11.138006	
14	1	11	98.5	-	-	11.552986	

Bin5 Statistics 24

Trial #	Pulse	Chirp (MHz)	Pulse Width (µS)	Pulse 1-2 spacing (µS)	Pulse 2-3 spacing (µS)	Pulse Start(S)	Detection (1:yes; 0:no)
0	1	14	93.9	-	-	0.773179	1
1	2	14	79.8	1204	-	1.351192	
2	3	14	89.6	1316	1872	2.331655	
3	2	14	59.6	1891	-	3.392054	
4	2	14	63.8	1753	-	3.544647	
5	3	14	83.6	1518	1361	5.047534	
6	3	14	79.6	1359	1493	5.425126	
7	3	14	64.7	1177	1519	6.618719	
8	1	14	59.9	-	-	7.111433	
9	2	14	79.3	1934	-	8.236735	
10	2	14	62.9	1805	-	8.955501	
11	2	14	67.3	1865	-	9.897471	
12	1	14	60.7	-	-	11.045875	
13	2	14	95.3	1422	-	11.865962	

Bin5 Statistics 25

Trial #	Pulse	Chirp (MHz)	Pulse Width (µS)	Pulse 1-2 spacing (µS)	Pulse 2-3 spacing (µS)	Pulse Start(S)	Detection (1:yes; 0:no)
0	1	9	82.7	-	-	0.029231	1
1	3	9	75.2	1950	1161	0.927999	
2	3	9	84.4	1248	1666	2.453169	
3	1	9	67	-	-	3.102133	
4	2	9	67.4	1803	-	3.761583	
5	3	9	81.7	1534	1458	4.81189	
6	2	9	57.4	1109	-	5.903057	
7	2	9	64.1	1283	-	6.621001	
8	1	9	63.7	-	-	7.428181	
9	1	9	58.1	-	-	8.488309	
10	3	9	91.1	1203	1289	9.186531	
11	3	9	93.5	1905	1202	9.466149	
12	1	9	81	-	-	10.975251	
13	3	9	55.9	1480	1139	11.446054	

Bin5 Statistics 26

Trial #	Pulse	Chirp (MHz)	Pulse Width (µS)	Pulse 1-2 spacing (µS)	Pulse 2-3 spacing (µS)	Pulse Start(S)	Detection (1:yes; 0:no)
0	2	9	87.6	1097	-	0.275706	1
1	1	9	53.3	-	-	1.098541	
2	2	9	85.7	1187	-	1.928882	
3	2	9	63.2	1588	-	2.572315	
4	1	9	55.7	-	-	3.021209	
5	1	9	77	-	-	4.20626	
6	2	9	83	1119	-	4.475307	
7	3	9	57.1	1449	1913	5.535602	
8	2	9	91.7	1081	-	5.755733	
9	1	9	78.3	-	-	6.378066	
10	1	9	57.2	-	-	7.683099	
11	3	9	81.6	1670	1745	8.303596	
12	1	9	50.1	-	-	8.59279	
13	2	9	51.5	1176	-	9.199443	
14	2	9	79.2	1585	-	10.35078	
15	3	9	54.1	1089	1449	11.262612	
16	1	9	83.1	-	-	11.408555	

Bin5 Statistics 27

Trial #	Pulse	Chirp (MHz)	Pulse Width (µS)	Pulse 1-2 spacing (uS)	Pulse 2-3 spacing (uS)	Pulse Start(S)	Detection (1:yes; 0:no)
0	2	19	84.8	1733	-	0.437539	1
1	1	19	61.8	-	-	1.331271	
2	2	19	97.1	1809	-	1.573759	
3	1	19	73	-	-	2.4413	
4	2	19	88.3	1467	-	3.272422	
5	3	19	55	1404	1619	4.169853	
6	2	19	77.3	1198	-	4.747668	
7	2	19	73.5	1436	-	5.948124	
8	2	19	60.3	1840	-	6.424527	
9	1	19	88.7	-	-	6.947807	
10	2	19	96.6	1428	-	7.977936	
11	3	19	94.7	1101	1827	8.851693	
12	2	19	59.8	1409	-	9.545342	
13	1	19	82.4	-	-	9.926557	
14	2	19	57.6	1777	-	10.678564	
15	3	19	87.3	1816	1579	11.856233	

Bin5 Statistics 28

Trial #	Pulse	Chirp (MHz)	Pulse Width (µS)	Pulse 1-2 spacing (uS)	Pulse 2-3 spacing (uS)	Pulse Start(S)	Detection (1:yes; 0:no)
0	2	9	63.2	1118	-	1.177047	1
1	2	9	67.2	1741	-	2.389468	
2	2	9	69.9	1686	-	2.90667	
3	3	9	99.7	1560	1957	4.576457	
4	2	9	72.9	1122	-	5.79968	
5	1	9	63	-	-	6.942188	
6	1	9	89.6	-	-	7.889717	
7	3	9	66.1	1162	1328	9.449839	
8	1	9	81.6	-	-	9.89224	
9	1	9	74.1	-	-	11.223501	

Bin5 Statistics 29

Trial #	Pulse	Chirp (MHz)	Pulse Width (µS)	Pulse 1-2 spacing (uS)	Pulse 2-3 spacing (uS)	Pulse Start(S)	Detection (1:yes; 0:no)
0	2	11	51	1652	-	0.235182	1
1	3	11	58.8	1381	1602	1.157091	
2	3	11	74	1859	1363	1.688896	
3	1	11	67.8	-	-	2.303473	
4	1	11	67.8	-	-	2.9531	
5	3	11	76.2	1202	1890	3.33049	
6	2	11	68.5	1813	-	4.407061	
7	2	11	60.7	1520	-	4.875254	
8	1	11	63.5	-	-	5.361767	
9	3	11	90	1449	1322	6.0923	
10	1	11	56.7	-	-	6.621648	
11	3	11	71.1	1211	1682	7.066157	
12	2	11	63.3	1281	-	7.681651	
13	2	11	65.3	1412	-	8.393859	
14	1	11	78.5	-	-	8.924247	
15	2	11	65	1733	-	10.005845	
16	2	11	59.3	1135	-	10.30064	
17	2	11	81.3	1518	-	11.336391	
18	1	11	92.1	-	-	11.558343	

Bin5 Statistics 30

Trial #	Pulse	Chirp (MHz)	Pulse Width (µS)	Pulse 1-2 spacing (uS)	Pulse 2-3 spacing (uS)	Pulse Start(S)	Detection (1:yes; 0:no)
0	2	15	95.7	1938	-	0.76855	1
1	2	15	69.8	1407	-	1.158607	
2	1	15	68.1	-	-	1.994554	
3	1	15	55.6	-	-	2.901049	
4	2	15	59.5	1237	-	3.559573	
5	3	15	84.7	1336	1660	4.559613	
6	2	15	76.4	1489	-	5.211396	
7	2	15	92.7	1528	-	6.246955	
8	1	15	59.8	-	-	6.820438	
9	2	15	71.1	1173	-	7.32427	
10	1	15	50.1	-	-	8.614968	
11	1	15	64.6	-	-	8.865589	
12	1	15	81.7	-	-	10.011854	
13	3	15	99.6	1185	1912	10.525881	
14	3	15	73.9	1390	1003	11.984834	

Table-6 Radar Type 6 Statistical Performance

Trial #	Fc (MHz)	Pulse /Burst	Pulse Width (μS)	PRI (μs)	Detection (1:yes; 0:no)	Hopping Sequence
1	5570	9	1	333	1	5379.0, 5381.0, 5523.0, 5446.0, 5485.0, 5620.0, 5655.0, 5287.0, 5448.0, 5358.0, 5656.0, 5549.0, 5627.0, 5689.0, 5260.0, 5455.0, 5298.0, 5676.0, 5610.0, 5366.0, 5426.0, 5624.0, 5550.0, 5460.0, 5363.0, 5572.0, 5342.0, 5607.0, 5278.0, 5431.0, 5507.0, 5511.0, 5352.0, 5493.0, 5477.0, 5700.0, 5269.0, 5461.0, 5331.0, 5393.0, 5628.0, 5481.0, 5717.0, 5517.0, 5644.0, 5261.0, 5464.0, 5250.0, 5721.0, 5720.0, 5492.0, 5637.0, 5502.0, 5566.0, 5503.0, 5302.0, 5348.0, 5538.0, 5670.0, 5601.0, 5590.0, 5400.0, 5698.0, 5594.0, 5434.0, 5516.0, 5500.0, 5629.0, 5693.0, 5303.0, 5442.0, 5709.0, 5415.0, 5722.0, 5565.0, 5373.0, 5457.0, 5674.0, 5562.0, 5478.0, 5540.0, 5716.0, 5264.0, 5433.0, 5641.0, 5453.0, 5554.0, 5539.0, 5710.0, 5585.0, 5315.0, 5510.0, 5564.0, 5588.0, 5411.0, 5521.0, 5561.0, 5277.0, 5537.0, 5395.0 (number of hits: 40)
2	5570	9	1	333	1	5701.0, 5376.0, 5536.0, 5482.0, 5588.0, 5583.0, 5407.0, 5543.0, 5674.0, 5390.0, 5476.0, 5683.0, 5363.0, 5660.0, 5295.0, 5545.0, 5553.0, 5539.0, 5567.0, 5690.0, 5313.0, 5693.0, 5453.0, 5466.0, 5342.0, 5488.0, 5580.0, 5364.0, 5361.0, 5377.0, 5322.0, 5414.0, 5518.0, 5304.0, 5383.0, 5506.0, 5381.0, 5352.0, 5320.0, 5515.0, 5409.0, 5507.0, 5578.0, 5711.0, 5622.0, 5317.0, 5394.0, 5456.0, 5463.0, 5714.0, 5607.0, 5448.0, 5415.0, 5339.0, 5310.0, 5368.0, 5723.0, 5315.0, 5253.0, 5449.0, 5441.0, 5481.0, 5630.0, 5445.0, 5273.0, 5278.0, 5465.0, 5699.0, 5495.0, 5425.0, 5438.0, 5309.0, 5478.0, 5559.0, 5552.0, 5290.0, 5307.0, 5677.0, 5645.0, 5276.0, 5417.0, 5266.0, 5670.0, 5707.0, 5659.0, 5604.0, 5548.0, 5561.0, 5284.0, 5321.0, 5252.0, 5610.0, 5289.0, 5654.0, 5718.0, 5560.0, 5599.0, 5462.0, 5691.0, 5627.0 (number of hits: 28)
3	5570	9	1	333	1	5505.0, 5544.0, 5468.0, 5454.0, 5533.0, 5701.0, 5595.0, 5277.0, 5430.0, 5362.0, 5410.0, 5425.0, 5252.0, 5494.0, 5383.0, 5360.0, 5618.0, 5289.0, 5462.0, 5452.0, 5265.0, 5375.0, 5266.0, 5288.0, 5377.0, 5251.0, 5714.0, 5600.0, 5662.0, 5601.0, 5339.0, 5304.0, 5258.0, 5652.0, 5632.0, 5537.0, 5440.0, 5498.0, 5445.0, 5707.0, 5397.0, 5363.0, 5583.0, 5573.0, 5542.0, 5447.0, 5681.0, 5690.0, 5622.0, 5386.0, 5522.0, 5472.0, 5524.0, 5569.0, 5644.0, 5469.0, 5521.0, 5257.0, 5606.0, 5575.0

						5721.0, 5672.0, 5408.0, 5582.0, 5370.0, 5710.0, 5391.0, 5367.0, 5567.0, 5466.0, 5280.0, 5639.0, 5486.0, 5719.0, 5656.0, 5254.0, 5676.0, 5704.0, 5404.0, 5673.0, 5298.0, 5550.0, 5337.0, 5503.0, 5279.0, 5327.0, 5507.0, 5348.0, 5329.0, 5599.0, 5358.0, 5585.0, 5293.0, 5300.0, 5407.0, 5679.0, 5306.0, 5553.0, 5665.0, 5675.0 (number of hits: 31)
4	5570	9	1	333	1	5703.0, 5533.0, 5376.0, 5566.0, 5257.0, 5413.0, 5372.0, 5298.0, 5586.0, 5527.0, 5510.0, 5366.0, 5461.0, 5590.0, 5330.0, 5482.0, 5262.0, 5650.0, 5367.0, 5619.0, 5679.0, 5701.0, 5437.0, 5317.0, 5561.0, 5514.0, 5431.0, 5568.0, 5665.0, 5653.0, 5399.0, 5723.0, 5680.0, 5548.0, 5485.0, 5690.0, 5571.0, 5715.0, 5356.0, 5481.0, 5629.0, 5497.0, 5308.0, 5382.0, 5496.0, 5291.0, 5414.0, 5654.0, 5373.0, 5435.0, 5591.0, 5639.0, 5281.0, 5530.0, 5422.0, 5269.0, 5460.0, 5380.0, 5583.0, 5377.0, 5392.0, 5694.0, 5326.0, 5385.0, 5672.0, 5657.0, 5687.0, 5693.0, 5686.0, 5609.0, 5502.0, 5506.0, 5319.0, 5296.0, 5475.0, 5322.0, 5439.0, 5379.0, 5695.0, 5538.0, 5706.0, 5333.0, 5417.0, 5467.0, 5416.0, 5478.0, 5486.0, 5505.0, 5610.0, 5400.0, 5713.0, 5544.0, 5494.0, 5352.0, 5516.0, 5620.0, 5673.0, 5354.0, 5359.0, 5350.0 (number of hits: 29)
5	5570	9	1	333	1	5579.0, 5375.0, 5661.0, 5433.0, 5693.0, 5380.0, 5612.0, 5718.0, 5338.0, 5368.0, 5486.0, 5680.0, 5301.0, 5690.0, 5641.0, 5250.0, 5613.0, 5601.0, 5531.0, 5538.0, 5284.0, 5344.0, 5720.0, 5617.0, 5620.0, 5656.0, 5292.0, 5480.0, 5713.0, 5286.0, 5586.0, 5546.0, 5678.0, 5665.0, 5428.0, 5303.0, 5539.0, 5705.0, 5437.0, 5417.0, 5662.0, 5650.0, 5642.0, 5526.0, 5592.0, 5523.0, 5500.0, 5448.0, 5555.0, 5477.0, 5598.0, 5321.0, 5335.0, 5464.0, 5512.0, 5600.0, 5595.0, 5700.0, 5319.0, 5513.0, 5524.0, 5281.0, 5378.0, 5649.0, 5478.0, 5334.0, 5552.0, 5320.0, 5288.0, 5431.0, 5429.0, 5676.0, 5701.0, 5482.0, 5499.0, 5366.0, 5471.0, 5307.0, 5274.0, 5440.0, 5323.0, 5563.0, 5625.0, 5689.0, 5588.0, 5573.0, 5630.0, 5310.0, 5365.0, 5295.0, 5277.0, 5479.0, 5421.0, 5591.0, 5294.0, 5265.0, 5339.0, 5485.0, 5607.0, 5698.0 (number of hits: 33)
6	5570	9	1	333	1	5688.0, 5578.0, 5371.0, 5650.0, 5706.0, 5432.0, 5363.0, 5424.0, 5560.0, 5540.0, 5276.0, 5556.0, 5676.0, 5652.0, 5614.0, 5404.0, 5521.0, 5665.0, 5594.0, 5610.0, 5701.0, 5295.0, 5695.0, 5327.0, 5339.0, 5702.0, 5653.0, 5524.0, 5417.0, 5271.0, 5454.0, 5407.0, 5709.0, 5669.0, 5647.0, 5336.0, 5482.0, 5543.0, 5538.0, 5360.0, 5333.0, 5548.0, 5722.0, 5699.0, 5352.0,

						5343.0, 5507.0, 5370.0, 5488.0, 5446.0, 5723.0, 5487.0, 5320.0, 5633.0, 5636.0, 5592.0, 5559.0, 5291.0, 5405.0, 5433.0, 5264.0, 5509.0, 5672.0, 5638.0, 5711.0, 5463.0, 5541.0, 5497.0, 5582.0, 5459.0, 5617.0, 5573.0, 5684.0, 5558.0, 5659.0, 5490.0, 5318.0, 5704.0, 5612.0, 5498.0, 5389.0, 5595.0, 5707.0, 5457.0, 5289.0, 5465.0, 5379.0, 5694.0, 5311.0, 5602.0, 5305.0, 5477.0, 5350.0, 5470.0, 5337.0, 5297.0, 5387.0, 5620.0, 5613.0, 5657.0 (number of hits: 32)
7	5570	9	1	333	1	5398.0, 5618.0, 5417.0, 5354.0, 5349.0, 5598.0, 5345.0, 5572.0, 5642.0, 5468.0, 5513.0, 5603.0, 5357.0, 5419.0, 5665.0, 5471.0, 5541.0, 5291.0, 5496.0, 5616.0, 5446.0, 5678.0, 5453.0, 5641.0, 5697.0, 5369.0, 5320.0, 5397.0, 5273.0, 5698.0, 5547.0, 5491.0, 5716.0, 5575.0, 5458.0, 5456.0, 5374.0, 5631.0, 5476.0, 5461.0, 5673.0, 5409.0, 5455.0, 5659.0, 5361.0, 5469.0, 5546.0, 5343.0, 5296.0, 5450.0, 5289.0, 5466.0, 5293.0, 5404.0, 5588.0, 5342.0, 5314.0, 5500.0, 5669.0, 5633.0, 5715.0, 5472.0, 5285.0, 5687.0, 5274.0, 5432.0, 5565.0, 5403.0, 5674.0, 5335.0, 5708.0, 5614.0, 5280.0, 5278.0, 5512.0, 5495.0, 5390.0, 5602.0, 5338.0, 5679.0, 5652.0, 5304.0, 5667.0, 5487.0, 5597.0, 5428.0, 5427.0, 5536.0, 5465.0, 5719.0, 5364.0, 5521.0, 5593.0, 5288.0, 5367.0, 5270.0, 5542.0, 5441.0, 5556.0, 5490.0 (number of hits: 28)
8	5570	9	1	333	1	5461.0, 5523.0, 5641.0, 5486.0, 5652.0, 5374.0, 5694.0, 5418.0, 5617.0, 5525.0, 5639.0, 5497.0, 5491.0, 5656.0, 5485.0, 5528.0, 5298.0, 5556.0, 5563.0, 5477.0, 5404.0, 5526.0, 5564.0, 5296.0, 5607.0, 5335.0, 5409.0, 5406.0, 5394.0, 5637.0, 5285.0, 5403.0, 5311.0, 5658.0, 5389.0, 5327.0, 5555.0, 5677.0, 5679.0, 5608.0, 5346.0, 5324.0, 5709.0, 5289.0, 5351.0, 5323.0, 5631.0, 5514.0, 5651.0, 5413.0, 5517.0, 5460.0, 5689.0, 5326.0, 5672.0, 5263.0, 5676.0, 5378.0, 5308.0, 5325.0, 5518.0, 5590.0, 5471.0, 5544.0, 5331.0, 5502.0, 5294.0, 5344.0, 5432.0, 5458.0, 5283.0, 5468.0, 5699.0, 5707.0, 5622.0, 5408.0, 5273.0, 5580.0, 5613.0, 5451.0, 5667.0, 5642.0, 5503.0, 5583.0, 5715.0, 5281.0, 5718.0, 5383.0, 5624.0, 5659.0, 5513.0, 5353.0, 5397.0, 5387.0, 5264.0, 5318.0, 5466.0, 5663.0, 5530.0, 5482.0 (number of hits: 31)
9	5570	9	1	333	1	5665.0, 5391.0, 5299.0, 5395.0, 5276.0, 5626.0, 5288.0, 5454.0, 5474.0, 5464.0, 5463.0, 5255.0, 5348.0, 5375.0, 5684.0, 5569.0, 5550.0, 5412.0, 5361.0, 5264.0, 5408.0, 5440.0, 5403.0, 5407.0, 5687.0, 5396.0, 5317.0, 5695.0, 5524.0, 5287.0,

						5596.0, 5575.0, 5300.0, 5442.0, 5428.0, 5346.0, 5682.0, 5611.0, 5436.0, 5642.0, 5250.0, 5618.0, 5331.0, 5260.0, 5291.0, 5712.0, 5333.0, 5538.0, 5490.0, 5432.0, 5593.0, 5664.0, 5493.0, 5304.0, 5336.0, 5446.0, 5614.0, 5254.0, 5564.0, 5424.0, 5324.0, 5374.0, 5582.0, 5259.0, 5632.0, 5266.0, 5461.0, 5557.0, 5431.0, 5320.0, 5600.0, 5387.0, 5581.0, 5638.0, 5316.0, 5352.0, 5425.0, 5531.0, 5444.0, 5417.0, 5364.0, 5717.0, 5526.0, 5422.0, 5636.0, 5676.0, 5519.0, 5650.0, 5670.0, 5349.0, 5457.0, 5473.0, 5393.0, 5332.0, 5580.0, 5663.0, 5499.0, 5656.0, 5495.0, 5658.0 (number of hits: 27)
10	5570	9	1	333	1	5292.0, 5433.0, 5562.0, 5469.0, 5580.0, 5480.0, 5487.0, 5508.0, 5261.0, 5585.0, 5596.0, 5452.0, 5329.0, 5683.0, 5607.0, 5272.0, 5260.0, 5430.0, 5603.0, 5357.0, 5613.0, 5298.0, 5627.0, 5368.0, 5688.0, 5679.0, 5474.0, 5702.0, 5563.0, 5545.0, 5438.0, 5459.0, 5336.0, 5532.0, 5500.0, 5374.0, 5420.0, 5608.0, 5283.0, 5317.0, 5492.0, 5347.0, 5369.0, 5363.0, 5664.0, 5665.0, 5457.0, 5594.0, 5378.0, 5465.0, 5511.0, 5527.0, 5643.0, 5340.0, 5600.0, 5619.0, 5440.0, 5595.0, 5315.0, 5705.0, 5572.0, 5680.0, 5385.0, 5547.0, 5293.0, 5651.0, 5444.0, 5722.0, 5509.0, 5294.0, 5604.0, 5671.0, 5569.0, 5323.0, 5278.0, 5284.0, 5543.0, 5268.0, 5335.0, 5720.0, 5518.0, 5583.0, 5434.0, 5377.0, 5564.0, 5436.0, 5305.0, 5589.0, 5424.0, 5373.0, 5538.0, 5502.0, 5694.0, 5638.0, 5591.0, 5362.0, 5322.0, 5359.0, 5356.0, 5687.0 (number of hits: 36)
11	5570	9	1	333	1	5658.0, 5585.0, 5666.0, 5398.0, 5534.0, 5447.0, 5567.0, 5335.0, 5390.0, 5722.0, 5361.0, 5587.0, 5446.0, 5589.0, 5551.0, 5383.0, 5668.0, 5543.0, 5497.0, 5356.0, 5679.0, 5396.0, 5296.0, 5687.0, 5397.0, 5268.0, 5308.0, 5405.0, 5436.0, 5588.0, 5561.0, 5526.0, 5406.0, 5614.0, 5576.0, 5338.0, 5575.0, 5309.0, 5671.0, 5373.0, 5292.0, 5385.0, 5341.0, 5662.0, 5622.0, 5670.0, 5635.0, 5597.0, 5644.0, 5417.0, 5566.0, 5280.0, 5327.0, 5254.0, 5320.0, 5432.0, 5452.0, 5471.0, 5572.0, 5556.0, 5451.0, 5625.0, 5536.0, 5403.0, 5537.0, 5386.0, 5367.0, 5351.0, 5606.0, 5453.0, 5530.0, 5470.0, 5490.0, 5359.0, 5264.0, 5548.0, 5711.0, 5626.0, 5605.0, 5411.0, 5408.0, 5315.0, 5523.0, 5578.0, 5483.0, 5425.0, 5291.0, 5713.0, 5696.0, 5368.0, 5474.0, 5473.0, 5590.0, 5654.0, 5420.0, 5477.0, 5707.0, 5456.0, 5640.0, 5325.0 (number of hits: 33)
12	5570	9	1	333	1	5420.0, 5384.0, 5702.0, 5454.0, 5498.0, 5619.0, 5572.0, 5480.0, 5514.0, 5467.0, 5267.0, 5470.0, 5412.0, 5290.0, 5601.0,

						5604.0, 5501.0, 5545.0, 5466.0, 5251.0, 5408.0, 5343.0, 5597.0, 5650.0, 5472.0, 5403.0, 5617.0, 5334.0, 5295.0, 5375.0, 5613.0, 5433.0, 5256.0, 5681.0, 5319.0, 5335.0, 5569.0, 5348.0, 5270.0, 5337.0, 5715.0, 5442.0, 5471.0, 5443.0, 5462.0, 5612.0, 5481.0, 5381.0, 5423.0, 5607.0, 5294.0, 5549.0, 5544.0, 5404.0, 5434.0, 5415.0, 5344.0, 5308.0, 5495.0, 5441.0, 5298.0, 5535.0, 5422.0, 5577.0, 5392.0, 5427.0, 5588.0, 5713.0, 5293.0, 5496.0, 5602.0, 5536.0, 5347.0, 5573.0, 5666.0, 5311.0, 5723.0, 5599.0, 5395.0, 5635.0, 5590.0, 5299.0, 5407.0, 5289.0, 5620.0, 5586.0, 5574.0, 5277.0, 5521.0, 5367.0, 5363.0, 5668.0, 5658.0, 5303.0, 5479.0, 5589.0, 5370.0, 5275.0, 5660.0, 5646.0 (number of hits: 33)
13	5570	9	1	333	1	5395.0, 5275.0, 5583.0, 5575.0, 5673.0, 5490.0, 5552.0, 5269.0, 5388.0, 5626.0, 5618.0, 5516.0, 5319.0, 5301.0, 5364.0, 5302.0, 5621.0, 5311.0, 5565.0, 5653.0, 5309.0, 5662.0, 5545.0, 5320.0, 5402.0, 5578.0, 5488.0, 5709.0, 5413.0, 5585.0, 5500.0, 5455.0, 5708.0, 5406.0, 5264.0, 5466.0, 5349.0, 5287.0, 5323.0, 5717.0, 5420.0, 5486.0, 5603.0, 5400.0, 5522.0, 5586.0, 5503.0, 5384.0, 5260.0, 5722.0, 5517.0, 5616.0, 5263.0, 5446.0, 5381.0, 5321.0, 5266.0, 5721.0, 5313.0, 5399.0, 5273.0, 5389.0, 5550.0, 5598.0, 5608.0, 5546.0, 5467.0, 5454.0, 5635.0, 5493.0, 5359.0, 5577.0, 5440.0, 5387.0, 5687.0, 5589.0, 5326.0, 5404.0, 5710.0, 5357.0, 5464.0, 5437.0, 5723.0, 5515.0, 5421.0, 5526.0, 5529.0, 5329.0, 5639.0, 5666.0, 5718.0, 5428.0, 5678.0, 5719.0, 5453.0, 5543.0, 5416.0, 5439.0, 5607.0, 5679.0 (number of hits: 32)
14	5570	9	1	333	1	5674.0, 5414.0, 5384.0, 5508.0, 5638.0, 5357.0, 5615.0, 5385.0, 5469.0, 5438.0, 5590.0, 5493.0, 5363.0, 5392.0, 5673.0, 5523.0, 5700.0, 5432.0, 5533.0, 5588.0, 5284.0, 5338.0, 5429.0, 5669.0, 5418.0, 5621.0, 5627.0, 5614.0, 5407.0, 5620.0, 5458.0, 5683.0, 5316.0, 5569.0, 5452.0, 5322.0, 5703.0, 5574.0, 5309.0, 5715.0, 5351.0, 5585.0, 5391.0, 5483.0, 5633.0, 5252.0, 5285.0, 5622.0, 5548.0, 5542.0, 5632.0, 5723.0, 5607.0, 5402.0, 5293.0, 5680.0, 5668.0, 5333.0, 5394.0, 5685.0, 5650.0, 5644.0, 5361.0, 5366.0, 5553.0, 5507.0, 5665.0, 5272.0, 5324.0, 5691.0, 5419.0, 5307.0, 5624.0, 5430.0, 5536.0, 5400.0, 5318.0, 5280.0, 5552.0, 5660.0, 5302.0, 5666.0, 5421.0, 5464.0, 5596.0, 5304.0, 5496.0, 5515.0, 5637.0, 5557.0, 5525.0, 5522.0, 5488.0, 5262.0, 5566.0, 5675.0, 5579.0, 5257.0, 5423.0, 5288.0 (number of hits: 36)

15	5570	9	1	333	1	5701.0, 5697.0, 5527.0, 5618.0, 5333.0, 5459.0, 5692.0, 5421.0, 5620.0, 5335.0, 5690.0, 5391.0, 5436.0, 5610.0, 5538.0, 5287.0, 5557.0, 5627.0, 5521.0, 5686.0, 5369.0, 5640.0, 5696.0, 5574.0, 5516.0, 5720.0, 5354.0, 5488.0, 5600.0, 5309.0, 5345.0, 5524.0, 5286.0, 5370.0, 5445.0, 5684.0, 5341.0, 5477.0, 5568.0, 5623.0, 5352.0, 5405.0, 5587.0, 5506.0, 5375.0, 5363.0, 5392.0, 5578.0, 5651.0, 5672.0, 5419.0, 5438.0, 5685.0, 5676.0, 5544.0, 5569.0, 5705.0, 5541.0, 5518.0, 5494.0, 5342.0, 5337.0, 5411.0, 5507.0, 5577.0, 5699.0, 5499.0, 5289.0, 5430.0, 5252.0, 5396.0, 5612.0, 5531.0, 5282.0, 5257.0, 5417.0, 5622.0, 5379.0, 5515.0, 5270.0, 5711.0, 5570.0, 5276.0, 5552.0, 5446.0, 5683.0, 5344.0, 5383.0, 5339.0, 5472.0, 5654.0, 5402.0, 5508.0, 5695.0, 5498.0, 5647.0, 5440.0, 5511.0, 5437.0, 5271.0 (number of hits: 36)
16	5570	9	1	333	1	5339.0, 5268.0, 5361.0, 5463.0, 5610.0, 5340.0, 5541.0, 5587.0, 5383.0, 5300.0, 5539.0, 5266.0, 5265.0, 5678.0, 5507.0, 5722.0, 5528.0, 5660.0, 5357.0, 5537.0, 5487.0, 5289.0, 5607.0, 5450.0, 5534.0, 5384.0, 5491.0, 5404.0, 5313.0, 5358.0, 5279.0, 5559.0, 5485.0, 5638.0, 5260.0, 5455.0, 5320.0, 5387.0, 5291.0, 5259.0, 5278.0, 5679.0, 5409.0, 5668.0, 5675.0, 5558.0, 5671.0, 5524.0, 5623.0, 5341.0, 5323.0, 5693.0, 5350.0, 5570.0, 5377.0, 5508.0, 5555.0, 5674.0, 5670.0, 5299.0, 5468.0, 5428.0, 5295.0, 5686.0, 5689.0, 5544.0, 5362.0, 5551.0, 5393.0, 5369.0, 5456.0, 5452.0, 5694.0, 5617.0, 5577.0, 5590.0, 5304.0, 5426.0, 5690.0, 5672.0, 5552.0, 5523.0, 5478.0, 5509.0, 5427.0, 5273.0, 5568.0, 5424.0, 5442.0, 5394.0, 5449.0, 5324.0, 5437.0, 5277.0, 5399.0, 5613.0, 5609.0, 5659.0, 5561.0, 5533.0 (number of hits: 30)
17	5570	9	1	333	1	5656.0, 5710.0, 5688.0, 5415.0, 5336.0, 5301.0, 5498.0, 5298.0, 5643.0, 5330.0, 5659.0, 5692.0, 5253.0, 5419.0, 5652.0, 5420.0, 5430.0, 5355.0, 5497.0, 5256.0, 5708.0, 5722.0, 5634.0, 5327.0, 5534.0, 5270.0, 5300.0, 5438.0, 5545.0, 5403.0, 5681.0, 5674.0, 5335.0, 5334.0, 5259.0, 5261.0, 5528.0, 5698.0, 5447.0, 5567.0, 5412.0, 5463.0, 5313.0, 5354.0, 5453.0, 5369.0, 5496.0, 5721.0, 5464.0, 5588.0, 5624.0, 5595.0, 5517.0, 5660.0, 5342.0, 5658.0, 5622.0, 5314.0, 5699.0, 5274.0, 5289.0, 5372.0, 5633.0, 5439.0, 5686.0, 5311.0, 5359.0, 5461.0, 5402.0, 5375.0, 5620.0, 5684.0, 5550.0, 5598.0, 5703.0, 5613.0, 5626.0, 5504.0, 5431.0, 5297.0, 5265.0, 5590.0, 5392.0, 5404.0, 5333.0, 5648.0, 5321.0, 5491.0, 5317.0, 5329.0

						5338.0, 5549.0, 5285.0, 5601.0, 5273.0, 5399.0, 5599.0, 5275.0, 5476.0, 5401.0 (number of hits: 25)
18	5570	9	1	333	1	5384.0, 5558.0, 5520.0, 5380.0, 5324.0, 5457.0, 5369.0, 5595.0, 5614.0, 5605.0, 5337.0, 5709.0, 5379.0, 5309.0, 5499.0, 5434.0, 5475.0, 5348.0, 5495.0, 5306.0, 5670.0, 5548.0, 5618.0, 5556.0, 5702.0, 5653.0, 5537.0, 5293.0, 5435.0, 5281.0, 5490.0, 5446.0, 5345.0, 5297.0, 5340.0, 5700.0, 5453.0, 5691.0, 5616.0, 5421.0, 5473.0, 5266.0, 5650.0, 5292.0, 5367.0, 5353.0, 5604.0, 5354.0, 5696.0, 5607.0, 5497.0, 5592.0, 5524.0, 5588.0, 5485.0, 5373.0, 5664.0, 5458.0, 5491.0, 5521.0, 5627.0, 5274.0, 5465.0, 5383.0, 5447.0, 5331.0, 5681.0, 5385.0, 5697.0, 5323.0, 5715.0, 5662.0, 5632.0, 5635.0, 5693.0, 5584.0, 5411.0, 5644.0, 5639.0, 5479.0, 5300.0, 5440.0, 5420.0, 5567.0, 5261.0, 5698.0, 5679.0, 5684.0, 5466.0, 5255.0, 5624.0, 5528.0, 5412.0, 5471.0, 5484.0, 5388.0, 5554.0, 5429.0, 5612.0, 5701.0 (number of hits: 30)
19	5570	9	1	333	1	5632.0, 5295.0, 5538.0, 5580.0, 5256.0, 5422.0, 5342.0, 5403.0, 5482.0, 5678.0, 5604.0, 5509.0, 5371.0, 5621.0, 5655.0, 5571.0, 5454.0, 5528.0, 5516.0, 5483.0, 5481.0, 5722.0, 5288.0, 5502.0, 5280.0, 5506.0, 5562.0, 5608.0, 5612.0, 5569.0, 5294.0, 5366.0, 5523.0, 5394.0, 5289.0, 5671.0, 5641.0, 5451.0, 5452.0, 5593.0, 5444.0, 5596.0, 5724.0, 5470.0, 5255.0, 5685.0, 5432.0, 5540.0, 5588.0, 5574.0, 5489.0, 5688.0, 5720.0, 5633.0, 5282.0, 5557.0, 5439.0, 5620.0, 5592.0, 5708.0, 5300.0, 5359.0, 5434.0, 5490.0, 5314.0, 5442.0, 5539.0, 5414.0, 5268.0, 5270.0, 5468.0, 5650.0, 5600.0, 5565.0, 5449.0, 5396.0, 5377.0, 5601.0, 5554.0, 5527.0, 5479.0, 5348.0, 5702.0, 5328.0, 5715.0, 5543.0, 5363.0, 5322.0, 5711.0, 5436.0, 5652.0, 5560.0, 5634.0, 5438.0, 5389.0, 5435.0, 5656.0, 5267.0, 5253.0, 5676.0 (number of hits: 35)
20	5570	9	1	333	1	5709.0, 5656.0, 5570.0, 5598.0, 5537.0, 5441.0, 5689.0, 5519.0, 5601.0, 5604.0, 5277.0, 5325.0, 5609.0, 5704.0, 5550.0, 5257.0, 5513.0, 5527.0, 5655.0, 5574.0, 5283.0, 5304.0, 5563.0, 5350.0, 5363.0, 5301.0, 5438.0, 5615.0, 5661.0, 5347.0, 5447.0, 5579.0, 5344.0, 5562.0, 5358.0, 5548.0, 5517.0, 5390.0, 5634.0, 5619.0, 5417.0, 5612.0, 5256.0, 5525.0, 5682.0, 5632.0, 5552.0, 5628.0, 5526.0, 5555.0, 5404.0, 5252.0, 5505.0, 5348.0, 5295.0, 5339.0, 5399.0, 5385.0, 5565.0, 5482.0, 5697.0, 5315.0, 5663.0, 5653.0, 5386.0, 5515.0, 5330.0, 5254.0, 5313.0, 5588.0, 5572.0, 5398.0, 5625.0, 5488.0, 5674.0

						5591.0, 5357.0, 5544.0, 5436.0, 5577.0, 5434.0, 5516.0, 5475.0, 5508.0, 5466.0, 5439.0, 5424.0, 5280.0, 5480.0, 5671.0, 5391.0, 5649.0, 5557.0, 5593.0, 5546.0, 5415.0, 5564.0, 5677.0, 5679.0, 5626.0 (number of hits: 42)
21	5570	9	1	333	1	5435.0, 5482.0, 5703.0, 5374.0, 5338.0, 5627.0, 5302.0, 5321.0, 5600.0, 5455.0, 5597.0, 5356.0, 5513.0, 5535.0, 5392.0, 5390.0, 5481.0, 5371.0, 5630.0, 5522.0, 5289.0, 5410.0, 5546.0, 5465.0, 5253.0, 5333.0, 5537.0, 5271.0, 5595.0, 5632.0, 5670.0, 5388.0, 5404.0, 5710.0, 5491.0, 5611.0, 5269.0, 5691.0, 5301.0, 5278.0, 5507.0, 5437.0, 5629.0, 5345.0, 5647.0, 5421.0, 5675.0, 5497.0, 5714.0, 5339.0, 5711.0, 5422.0, 5473.0, 5561.0, 5288.0, 5336.0, 5516.0, 5364.0, 5543.0, 5498.0, 5616.0, 5375.0, 5471.0, 5500.0, 5432.0, 5483.0, 5556.0, 5515.0, 5613.0, 5456.0, 5379.0, 5494.0, 5608.0, 5373.0, 5525.0, 5559.0, 5448.0, 5262.0, 5273.0, 5361.0, 5572.0, 5365.0, 5261.0, 5380.0, 5320.0, 5621.0, 5397.0, 5601.0, 5344.0, 5451.0, 5674.0, 5653.0, 5436.0, 5579.0, 5523.0, 5699.0, 5512.0, 5671.0, 5695.0, 5651.0 (number of hits: 35)
22	5570	9	1	333	1	5372.0, 5330.0, 5477.0, 5552.0, 5641.0, 5432.0, 5491.0, 5411.0, 5341.0, 5459.0, 5381.0, 5412.0, 5516.0, 5397.0, 5499.0, 5428.0, 5614.0, 5677.0, 5695.0, 5335.0, 5522.0, 5629.0, 5593.0, 5391.0, 5535.0, 5570.0, 5470.0, 5479.0, 5400.0, 5380.0, 5638.0, 5553.0, 5669.0, 5326.0, 5426.0, 5667.0, 5447.0, 5288.0, 5343.0, 5308.0, 5507.0, 5273.0, 5615.0, 5493.0, 5640.0, 5683.0, 5340.0, 5452.0, 5619.0, 5717.0, 5485.0, 5705.0, 5255.0, 5671.0, 5489.0, 5303.0, 5608.0, 5429.0, 5427.0, 5362.0, 5533.0, 5348.0, 5252.0, 5525.0, 5551.0, 5329.0, 5389.0, 5541.0, 5561.0, 5536.0, 5278.0, 5379.0, 5269.0, 5576.0, 5687.0, 5434.0, 5584.0, 5692.0, 5624.0, 5534.0, 5277.0, 5623.0, 5711.0, 5283.0, 5702.0, 5304.0, 5616.0, 5521.0, 5532.0, 5655.0, 5366.0, 5395.0, 5557.0, 5457.0, 5644.0, 5618.0, 5505.0, 5274.0, 5531.0, 5396.0 (number of hits: 37)
23	5570	9	1	333	1	5686.0, 5660.0, 5538.0, 5289.0, 5418.0, 5307.0, 5543.0, 5445.0, 5380.0, 5681.0, 5274.0, 5552.0, 5650.0, 5614.0, 5715.0, 5400.0, 5694.0, 5677.0, 5442.0, 5504.0, 5556.0, 5257.0, 5476.0, 5705.0, 5657.0, 5470.0, 5514.0, 5607.0, 5411.0, 5529.0, 5594.0, 5266.0, 5684.0, 5469.0, 5420.0, 5602.0, 5606.0, 5687.0, 5651.0, 5367.0, 5579.0, 5386.0, 5722.0, 5298.0, 5633.0, 5342.0, 5537.0, 5533.0, 5450.0, 5383.0, 5653.0, 5559.0, 5663.0, 5570.0, 5649.0, 5668.0, 5475.0, 5611.0, 5719.0, 5335.0,

						5698.0, 5652.0, 5495.0, 5414.0, 5493.0, 5710.0, 5467.0, 5706.0, 5323.0, 5636.0, 5369.0, 5511.0, 5641.0, 5397.0, 5664.0, 5317.0, 5267.0, 5550.0, 5366.0, 5387.0, 5415.0, 5497.0, 5539.0, 5379.0, 5676.0, 5621.0, 5562.0, 5521.0, 5620.0, 5334.0, 5665.0, 5320.0, 5494.0, 5659.0, 5413.0, 5466.0, 5436.0, 5283.0, 5382.0, 5574.0 (number of hits: 33)
24	5570	9	1	333	1	5626.0, 5406.0, 5374.0, 5679.0, 5571.0, 5279.0, 5611.0, 5341.0, 5332.0, 5537.0, 5622.0, 5416.0, 5351.0, 5562.0, 5345.0, 5459.0, 5396.0, 5712.0, 5498.0, 5285.0, 5636.0, 5258.0, 5415.0, 5570.0, 5674.0, 5615.0, 5718.0, 5709.0, 5600.0, 5398.0, 5567.0, 5390.0, 5335.0, 5670.0, 5662.0, 5649.0, 5314.0, 5382.0, 5422.0, 5443.0, 5453.0, 5477.0, 5575.0, 5330.0, 5460.0, 5381.0, 5432.0, 5391.0, 5532.0, 5411.0, 5478.0, 5607.0, 5410.0, 5301.0, 5540.0, 5315.0, 5654.0, 5678.0, 5312.0, 5384.0, 5685.0, 5530.0, 5506.0, 5463.0, 5366.0, 5593.0, 5690.0, 5594.0, 5252.0, 5446.0, 5361.0, 5717.0, 5465.0, 5713.0, 5565.0, 5517.0, 5556.0, 5555.0, 5577.0, 5550.0, 5624.0, 5403.0, 5375.0, 5544.0, 5485.0, 5311.0, 5494.0, 5700.0, 5370.0, 5271.0, 5262.0, 5305.0, 5680.0, 5602.0, 5283.0, 5274.0, 5704.0, 5542.0, 5558.0, 5691.0 (number of hits: 32)
25	5570	9	1	333	1	5272.0, 5464.0, 5523.0, 5533.0, 5720.0, 5706.0, 5442.0, 5375.0, 5716.0, 5659.0, 5262.0, 5717.0, 5694.0, 5364.0, 5671.0, 5587.0, 5644.0, 5547.0, 5380.0, 5426.0, 5486.0, 5299.0, 5548.0, 5549.0, 5397.0, 5697.0, 5384.0, 5376.0, 5564.0, 5410.0, 5622.0, 5298.0, 5594.0, 5415.0, 5408.0, 5518.0, 5709.0, 5617.0, 5451.0, 5361.0, 5438.0, 5536.0, 5490.0, 5558.0, 5517.0, 5590.0, 5428.0, 5670.0, 5601.0, 5446.0, 5608.0, 5579.0, 5321.0, 5542.0, 5270.0, 5483.0, 5687.0, 5358.0, 5645.0, 5654.0, 5688.0, 5274.0, 5378.0, 5648.0, 5427.0, 5291.0, 5349.0, 5563.0, 5381.0, 5493.0, 5623.0, 5637.0, 5400.0, 5704.0, 5525.0, 5395.0, 5387.0, 5495.0, 5389.0, 5524.0, 5256.0, 5643.0, 5305.0, 5258.0, 5388.0, 5655.0, 5556.0, 5425.0, 5401.0, 5503.0, 5253.0, 5521.0, 5344.0, 5699.0, 5578.0, 5691.0, 5507.0, 5476.0, 5288.0, 5597.0 (number of hits: 35)
26	5570	9	1	333	1	5468.0, 5553.0, 5632.0, 5683.0, 5674.0, 5663.0, 5629.0, 5336.0, 5421.0, 5381.0, 5626.0, 5262.0, 5532.0, 5557.0, 5320.0, 5622.0, 5431.0, 5500.0, 5330.0, 5327.0, 5410.0, 5386.0, 5574.0, 5313.0, 5535.0, 5540.0, 5361.0, 5339.0, 5378.0, 5665.0, 5519.0, 5565.0, 5515.0, 5545.0, 5447.0, 5268.0, 5411.0, 5472.0, 5520.0, 5371.0, 5476.0, 5618.0, 5576.0, 5317.0, 5609.0

						5707.0, 5653.0, 5350.0, 5705.0, 5575.0, 5617.0, 5560.0, 5555.0, 5355.0, 5429.0, 5493.0, 5338.0, 5387.0, 5521.0, 5363.0, 5546.0, 5380.0, 5623.0, 5524.0, 5507.0, 5712.0, 5664.0, 5483.0, 5538.0, 5390.0, 5704.0, 5634.0, 5466.0, 5596.0, 5686.0, 5497.0, 5582.0, 5544.0, 5527.0, 5503.0, 5424.0, 5635.0, 5639.0, 5308.0, 5321.0, 5453.0, 5588.0, 5645.0, 5486.0, 5498.0, 5391.0, 5595.0, 5490.0, 5427.0, 5633.0, 5345.0, 5412.0, 5456.0, 5643.0, 5659.0 (number of hits: 45)
27	5570	9	1	333	1	5427.0, 5655.0, 5491.0, 5531.0, 5345.0, 5467.0, 5313.0, 5365.0, 5302.0, 5267.0, 5508.0, 5619.0, 5453.0, 5393.0, 5563.0, 5311.0, 5451.0, 5414.0, 5305.0, 5288.0, 5591.0, 5403.0, 5320.0, 5674.0, 5587.0, 5478.0, 5667.0, 5406.0, 5559.0, 5722.0, 5669.0, 5576.0, 5303.0, 5660.0, 5671.0, 5397.0, 5677.0, 5708.0, 5404.0, 5441.0, 5604.0, 5665.0, 5363.0, 5386.0, 5375.0, 5556.0, 5541.0, 5377.0, 5416.0, 5596.0, 5500.0, 5689.0, 5296.0, 5504.0, 5723.0, 5341.0, 5292.0, 5714.0, 5569.0, 5618.0, 5661.0, 5505.0, 5653.0, 5691.0, 5659.0, 5634.0, 5480.0, 5314.0, 5470.0, 5374.0, 5709.0, 5370.0, 5633.0, 5262.0, 5392.0, 5367.0, 5310.0, 5433.0, 5381.0, 5683.0, 5526.0, 5625.0, 5449.0, 5681.0, 5710.0, 5629.0, 5510.0, 5637.0, 5712.0, 5362.0, 5306.0, 5513.0, 5412.0, 5608.0, 5687.0, 5487.0, 5372.0, 5437.0, 5415.0, 5464.0 (number of hits: 26)
28	5570	9	1	333	1	5701.0, 5475.0, 5661.0, 5659.0, 5270.0, 5588.0, 5478.0, 5654.0, 5518.0, 5650.0, 5604.0, 5558.0, 5594.0, 5680.0, 5682.0, 5266.0, 5497.0, 5715.0, 5681.0, 5714.0, 5252.0, 5354.0, 5590.0, 5691.0, 5292.0, 5358.0, 5506.0, 5378.0, 5561.0, 5357.0, 5708.0, 5277.0, 5662.0, 5669.0, 5511.0, 5640.0, 5464.0, 5568.0, 5343.0, 5538.0, 5434.0, 5593.0, 5327.0, 5474.0, 5560.0, 5355.0, 5598.0, 5627.0, 5622.0, 5416.0, 5495.0, 5646.0, 5502.0, 5283.0, 5652.0, 5637.0, 5371.0, 5702.0, 5387.0, 5315.0, 5528.0, 5441.0, 5719.0, 5655.0, 5465.0, 5684.0, 5331.0, 5455.0, 5716.0, 5367.0, 5293.0, 5394.0, 5641.0, 5540.0, 5412.0, 5524.0, 5699.0, 5436.0, 5668.0, 5512.0, 5675.0, 5577.0, 5673.0, 5445.0, 5409.0, 5534.0, 5552.0, 5399.0, 5341.0, 5663.0, 5258.0, 5529.0, 5563.0, 5391.0, 5591.0, 5393.0, 5595.0, 5709.0, 5651.0, 5508.0 (number of hits: 35)
29	5570	9	1	333	1	5400.0, 5450.0, 5463.0, 5298.0, 5574.0, 5673.0, 5281.0, 5437.0, 5540.0, 5282.0, 5259.0, 5588.0, 5407.0, 5277.0, 5336.0, 5310.0, 5690.0, 5492.0, 5573.0, 5610.0, 5327.0, 5328.0, 5614.0, 5420.0, 5333.0, 5351.0, 5300.0, 5278.0, 5720.0, 5394.0,

						5388.0, 5558.0, 5569.0, 5555.0, 5572.0, 5670.0, 5352.0, 5489.0, 5621.0, 5334.0, 5384.0, 5585.0, 5274.0, 5683.0, 5257.0, 5598.0, 5444.0, 5648.0, 5557.0, 5434.0, 5299.0, 5584.0, 5515.0, 5634.0, 5568.0, 5347.0, 5366.0, 5541.0, 5717.0, 5321.0, 5570.0, 5581.0, 5375.0, 5565.0, 5705.0, 5672.0, 5513.0, 5429.0, 5436.0, 5678.0, 5688.0, 5280.0, 5563.0, 5651.0, 5617.0, 5591.0, 5287.0, 5502.0, 5275.0, 5703.0, 5301.0, 5378.0, 5626.0, 5709.0, 5712.0, 5471.0, 5427.0, 5355.0, 5288.0, 5342.0, 5689.0, 5586.0, 5694.0, 5508.0, 5459.0, 5711.0, 5676.0, 5410.0, 5406.0, 5666.0 (number of hits: 31)
30	5570	9	1	333	1	5549.0, 5559.0, 5599.0, 5686.0, 5542.0, 5557.0, 5383.0, 5664.0, 5507.0, 5263.0, 5439.0, 5403.0, 5540.0, 5370.0, 5422.0, 5500.0, 5613.0, 5304.0, 5308.0, 5649.0, 5482.0, 5409.0, 5471.0, 5357.0, 5305.0, 5564.0, 5444.0, 5551.0, 5271.0, 5294.0, 5560.0, 5579.0, 5284.0, 5492.0, 5713.0, 5276.0, 5362.0, 5639.0, 5368.0, 5270.0, 5616.0, 5483.0, 5636.0, 5519.0, 5515.0, 5721.0, 5339.0, 5535.0, 5366.0, 5398.0, 5632.0, 5695.0, 5385.0, 5452.0, 5328.0, 5581.0, 5259.0, 5497.0, 5702.0, 5633.0, 5545.0, 5534.0, 5615.0, 5377.0, 5528.0, 5544.0, 5710.0, 5627.0, 5591.0, 5394.0, 5565.0, 5703.0, 5556.0, 5352.0, 5285.0, 5704.0, 5700.0, 5253.0, 5268.0, 5261.0, 5372.0, 5647.0, 5568.0, 5258.0, 5303.0, 5667.0, 5600.0, 5473.0, 5712.0, 5425.0, 5572.0, 5441.0, 5676.0, 5478.0, 5690.0, 5392.0, 5662.0, 5432.0, 5459.0, 5554.0 (number of hits: 38)

5 GHz – XOR Radio
5500 MHz, 20 MHz Bandwidth

Radar Signal Type	Waveform/Trial Number	Detection (%)	Limit (%)	Pass/Fail
Type 1A/1B	30	100 %	60%	Pass
Type 2	30	86.7 %	60%	Pass
Type 3	30	70 %	60%	Pass
Type 4	30	83.3 %	60%	Pass
Aggregate (Type1 to 4)	120	85 %	80%	Pass
Type 5	30	86.67 %	80%	Pass
Type 6	30	70 %	70%	Pass

Please refer to the following statistical tables:

Table-1A/1B Radar Type 1A/1B Statistical Performance

Trial #	Fc (MHz)	Pulse/Burst	Pulse Width (µS)	PRI (µs)	Detection (1:yes; 0:no)
1	5500	78	1	678	1
2	5500	86	1	618	1
3	5500	89	1	598	1
4	5500	18	1	3066	1
5	5500	61	1	878	1
6	5491.5	68	1	778	1
7	5491.5	81	1	658	1
8	5491.5	59	1	898	1
9	5491.5	76	1	698	1
10	5491.5	72	1	738	1
11	5508.5	62	1	858	1
12	5508.5	74	1	718	1
13	5508.5	99	1	538	1
14	5508.5	92	1	578	1
15	5508.5	67	1	798	1
16	5500	21	1	2579	1
17	5500	75	1	713	1
18	5500	51	1	1055	1
19	5500	85	1	627	1
20	5500	25	1	2185	1
21	5491.5	20	1	2661	1
22	5491.5	62	1	865	1
23	5491.5	50	1	1058	1
24	5491.5	20	1	2750	1
25	5491.5	37	1	1438	1
26	5508.5	19	1	2842	1
27	5508.5	21	1	2523	1
28	5508.5	32	1	1700	1
29	5508.5	22	1	2405	1
30	5508.5	40	1	1347	1
Detection Percentage: 100 % (>60%)					

Table-2 Radar Type 2 Statistical Performance

Trial #	Fc (MHz)	Pulse/Burst	Pulse Width (μS)	PRI (μs)	Detection (1:yes; 0:no)
1	5500	29	2.1	150	1
2	5500	26	1.1	202	1
3	5500	23	1.3	157	1
4	5500	24	3.4	154	1
5	5500	24	4.3	228	1
6	5500	25	1.6	204	1
7	5500	29	4.8	163	0
8	5500	25	1.5	225	1
9	5500	26	5	221	1
10	5500	24	4.5	153	1
11	5491.5	23	3.5	167	1
12	5491.5	29	1.4	225	1
13	5491.5	26	3.9	191	0
14	5491.5	28	1.9	205	1
15	5491.5	28	2	212	1
16	5491.5	25	3.6	175	1
17	5491.5	24	4.6	177	1
18	5491.5	23	2.5	188	1
19	5491.5	25	3.4	221	1
20	5491.5	23	2.1	167	0
21	5508.5	29	3.5	178	1
22	5508.5	23	4.8	161	1
23	5508.5	23	3.6	178	1
24	5508.5	27	4.7	203	1
25	5508.5	28	3.2	197	1
26	5508.5	23	4.9	155	0
27	5508.5	27	2.7	203	1
28	5508.5	24	4.3	229	1
29	5508.5	25	2.2	156	1
30	5508.5	23	4	220	1
Detection Percentage: 86.7 % (>60%)					

Table-3 Radar Type 3 Statistical Performance

Trial #	Fc (MHz)	Pulse/Burst	Pulse Width (μS)	PRI (μs)	Detection (1:yes; 0:no)
1	5500	16	10	410	1
2	5500	16	8.1	480	1
3	5500	16	7.5	402	0
4	5500	18	9.8	428	1
5	5500	18	8	275	1
6	5500	17	7.8	216	0
7	5500	17	6.3	352	0
8	5500	16	6.9	265	1
9	5500	18	6	364	1
10	5500	17	6.8	399	0
11	5491.5	18	7.5	464	1
12	5491.5	18	8.7	294	1
13	5491.5	16	8	352	1
14	5491.5	18	8.5	466	1
15	5491.5	16	8.1	362	1
16	5491.5	18	9.3	306	1
17	5491.5	16	9.7	222	1
18	5491.5	17	7.7	336	1
19	5491.5	18	9.6	482	1
20	5491.5	18	9	378	0
21	5508.5	16	7.1	401	1
22	5508.5	18	10	284	1
23	5508.5	16	8.3	357	1
24	5508.5	17	7.2	386	1
25	5508.5	17	7.7	358	1
26	5508.5	16	6.3	240	1
27	5508.5	17	8.6	216	0
28	5508.5	16	7.7	469	0
29	5508.5	16	7.7	241	0
30	5508.5	16	8.2	275	0
Detection Percentage: 70 % (>60%)					

Table-4 Radar Type 4 Statistical Performance

Trial #	Fc (MHz)	Pulse/Burst	Pulse Width (μS)	PRI (μs)	Detection (1:yes; 0:no)
1	5500	12	16.8	381	1
2	5500	16	18.5	479	1
3	5500	14	12.9	451	1
4	5500	16	15.5	228	1
5	5500	13	19.1	361	0
6	5500	16	12.5	397	0
7	5500	16	12.3	311	1
8	5500	16	14.7	425	1
9	5500	13	12.7	313	0
10	5500	12	14.7	314	0
11	5491.5	16	13.4	492	1
12	5491.5	15	12.3	428	1
13	5491.5	13	16.5	445	0
14	5491.5	13	11.2	348	1
15	5491.5	13	15.9	409	1
16	5491.5	13	17.9	315	1
17	5491.5	14	11.1	439	1
18	5491.5	16	16.8	213	1
19	5491.5	12	13.7	218	1
20	5491.5	14	15.6	376	1
21	5508.5	16	17.6	478	1
22	5508.5	12	13.8	236	1
23	5508.5	13	19.5	207	1
24	5508.5	14	15.8	437	1
25	5508.5	15	18.6	291	1
26	5508.5	15	14.2	320	1
27	5508.5	12	18.4	276	1
28	5508.5	16	16.7	221	1
29	5508.5	14	13.8	408	1
30	5508.5	15	13.4	300	1
Detection Percentage: 83.3% (>60%)					

Table-5 Radar Type 5 Statistical Performance

Trial #	Fc (MHz)	Detection (1:yes; 0:no)
1	5500	1
2	5500	1
3	5500	1
4	5500	1
5	5500	1
6	5500	1
7	5500	1
8	5500	1
9	5500	1
10	5500	1
11	5497.5	1
12	5494.3	1
13	5496.3	1
14	5495.1	0
15	5497.5	0
16	5497.5	1
17	5495.5	1
18	5496.3	0
19	5495.5	1
20	5497.1	0
21	5502.9	1
22	5506.5	1
23	5501.3	1
24	5500.9	1
25	5504.1	1
26	5501.3	1
27	5503.7	1
28	5503.3	1
29	5504.9	1
30	5502.9	1
Detection Percentage: 86.67 % (>80%)		

Bin5 Statistics 1

Trial #	Pulse	Chirp (MHz)	Pulse Width (µS)	Pulse 1-2 spacing (µS)	Pulse 2-3 spacing (µS)	Pulse Start(S)	Detection (1:yes; 0:no)
0	1	8	60.1	-	-	0.56921	1
1	1	8	85.8	-	-	1.350763	
2	2	8	78.4	1492	-	2.076343	
3	2	8	53.1	1173	-	3.300253	
4	2	8	95.8	1720	-	3.700787	
5	2	8	88.8	1893	-	5.365426	
6	3	8	87.3	1374	1944	5.746969	
7	3	8	61.7	1587	1020	6.642976	
8	2	8	52.9	1107	-	7.884581	
9	2	8	66.6	1817	-	8.688096	
10	2	8	98.7	1180	-	9.428982	
11	2	8	97.8	1358	-	10.371097	
12	1	8	88.3	-	-	11.463907	

Bin5 Statistics 2

Trial #	Pulse	Chirp (MHz)	Pulse Width (µS)	Pulse 1-2 spacing (µS)	Pulse 2-3 spacing (µS)	Pulse Start(S)	Detection (1:yes; 0:no)
0	3	6	66.9	1600	1451	0.658067	1
1	3	6	85.5	1323	1131	2.056028	
2	1	6	87.7	-	-	2.897752	
3	2	6	99.2	1059	-	3.425063	
4	2	6	91.8	1230	-	5.42066	
5	1	6	52.1	-	-	6.378644	
6	2	6	81.3	1292	-	7.069503	
7	2	6	94.8	1643	-	7.688493	
8	3	6	60.3	1041	1958	8.768798	
9	2	6	89.4	1796	-	9.938603	
10	2	6	85.7	1177	-	10.973371	

Bin5 Statistics 3

Trial #	Pulse	Chirp (MHz)	Pulse Width (µS)	Pulse 1-2 spacing (µS)	Pulse 2-3 spacing (µS)	Pulse Start(S)	Detection (1:yes; 0:no)
0	2	5	59.4	1696	-	0.690461	1
1	2	5	93.8	1831	-	1.753732	
2	2	5	50.9	1534	-	3.159676	
3	1	5	66.5	-	-	3.905476	
4	2	5	85.8	1316	-	5.612156	
5	2	5	76.2	1047	-	6.609774	
6	2	5	56.6	1989	-	7.864295	
7	3	5	73.4	1751	1762	9.523927	
8	1	5	56.6	-	-	10.533545	
9	3	5	78.4	1881	1784	11.750813	

Bin5 Statistics 4

Trial #	Pulse	Chirp (MHz)	Pulse Width (µS)	Pulse 1-2 spacing (µS)	Pulse 2-3 spacing (µS)	Pulse Start(S)	Detection (1:yes; 0:no)
0	2	6	92	1132	-	0.603641	1
1	2	6	59.1	1570	-	2.302424	
2	1	6	91.9	-	-	3.833675	
3	2	6	84.1	1065	-	4.020479	
4	1	6	52.8	-	-	6.022261	
5	3	6	85.6	1278	1276	7.791982	
6	3	6	97.2	1822	1882	9.138678	
7	1	6	98.7	-	-	10.26838	
8	1	6	81.5	-	-	11.426163	

Bin5 Statistics 5

Trial #	Pulse	Chirp (MHz)	Pulse Width (µS)	Pulse 1-2 spacing (µS)	Pulse 2-3 spacing (µS)	Pulse Start(S)	Detection (1:yes; 0:no)
0	2	6	59.4	1781	-	0.946854	1
1	2	6	59.9	1458	-	1.336414	
2	2	6	75.8	1839	-	3.308447	
3	2	6	74.8	1261	-	4.575152	
4	2	6	68.7	1812	-	6.231788	
5	2	6	96.5	1883	-	7.239153	
6	1	6	63.1	-	-	8.360383	
7	2	6	85.4	1789	-	9.867072	
8	3	6	56	1280	1849	11.188263	

Bin5 Statistics 6

Trial #	Pulse	Chirp (MHz)	Pulse Width (µS)	Pulse 1-2 spacing (µS)	Pulse 2-3 spacing (µS)	Pulse Start(S)	Detection (1:yes; 0:no)
0	2	5	98.2	1499	-	1.010642	1
1	2	5	53.3	1364	-	1.461182	
2	1	5	75	-	-	2.986558	
3	3	5	73.5	1008	1129	4.012354	
4	2	5	54.2	1609	-	4.738298	
5	1	5	65.3	-	-	5.637786	
6	1	5	74.5	-	-	7.527106	
7	3	5	72	1607	1054	7.663608	
8	3	5	63.1	1000	1561	9.618664	
9	2	5	61.1	1115	-	10.77873	
10	2	5	87.7	1086	-	11.692593	

Bin5 Statistics 7

Trial #	Pulse	Chirp (MHz)	Pulse Width (µS)	Pulse 1-2 spacing (µS)	Pulse 2-3 spacing (µS)	Pulse Start(S)	Detection (1:yes; 0:no)
0	2	13	65.7	1259	-	0.406668	1
1	2	13	99.3	1410	-	1.258361	
2	3	13	61.8	1205	1998	1.546458	
3	2	13	82.6	1358	-	2.662702	
4	2	13	81.2	1066	-	3.574431	
5	1	13	91.7	-	-	4.362246	
6	3	13	70.4	1789	1708	4.799455	
7	2	13	59.7	1948	-	5.856803	
8	1	13	64.6	-	-	6.464392	
9	2	13	56.5	1669	-	7.000105	
10	3	13	93.2	1102	1492	7.502246	
11	3	13	85.4	1573	1378	8.904145	
12	2	13	97.6	1723	-	9.258533	
13	2	13	51.8	1135	-	10.204934	
14	1	13	81.6	-	-	11.063792	
15	3	13	50.7	1826	1844	11.397759	

Bin5 Statistics 8

Trial #	Pulse	Chirp (MHz)	Pulse Width (µS)	Pulse 1-2 spacing (µS)	Pulse 2-3 spacing (µS)	Pulse Start(S)	Detection (1:yes; 0:no)
0	2	6	87.1	1012	-	0.011255	1
1	2	6	51.7	1949	-	1.568894	
2	3	6	84.6	1033	1150	2.102889	
3	2	6	50.6	1002	-	2.783629	
4	2	6	71.8	1124	-	3.226776	
5	2	6	89.2	1424	-	4.568543	
6	2	6	65	1784	-	5.220319	
7	2	6	73.8	1675	-	5.609646	
8	3	6	63	1743	1044	6.583086	
9	2	6	69.7	1745	-	7.617324	
10	1	6	77.7	-	-	8.132358	
11	2	6	78.7	1245	-	9.431247	
12	2	6	90.1	1313	-	10.290219	
13	3	6	90.4	1112	1379	10.891481	
14	2	6	75.7	1015	-	11.585838	

Bin5 Statistics 9

Trial #	Pulse	Chirp (MHz)	Pulse Width (µS)	Pulse 1-2 spacing (uS)	Pulse 2-3 spacing (uS)	Pulse Start(S)	Detection (1:yes; 0:no)
0	1	12	68.3	-	-	0.227814	1
1	2	12	54.1	1585	-	1.301871	
2	2	12	52	1952	-	3.078006	
3	2	12	86.7	1698	-	4.792751	
4	1	12	86.5	-	-	4.947315	
5	3	12	92.9	1177	1284	6.313812	
6	2	12	75.9	1879	-	7.701959	
7	2	12	97.5	1639	-	8.939448	
8	2	12	53.2	1904	-	10.747726	
9	1	12	91.6	-	-	11.913836	

Bin5 Statistics 10

Trial #	Pulse	Chirp (MHz)	Pulse Width (µS)	Pulse 1-2 spacing (uS)	Pulse 2-3 spacing (uS)	Pulse Start(S)	Detection (1:yes; 0:no)
0	1	11	66.8	-	-	0.219629	1
1	3	11	57.1	1612	1244	1.104862	
2	1	11	65.7	-	-	1.842052	
3	2	11	80	1191	-	1.97861	
4	2	11	81.4	1126	-	2.995271	
5	2	11	94.5	1605	-	3.242073	
6	2	11	82	1639	-	3.801211	
7	1	11	74.2	-	-	4.80599	
8	2	11	67	1783	-	5.107324	
9	1	11	65.8	-	-	5.886538	
10	2	11	96	1173	-	6.80798	
11	3	11	51.2	1095	1090	7.057833	
12	3	11	65.3	1356	1197	7.812574	
13	2	11	84.2	1109	-	8.548607	
14	2	11	66	1062	-	8.988594	
15	1	11	81.4	-	-	9.483197	
16	2	11	83.3	1888	-	10.222923	
17	2	11	81.4	1348	-	11.176022	
18	3	11	55.5	1088	1450	11.421312	

Bin5 Statistics 11

Trial #	Pulse	Chirp (MHz)	Pulse Width (µS)	Pulse 1-2 spacing (µS)	Pulse 2-3 spacing (µS)	Pulse Start(S)	Detection (1:yes; 0:no)
0	3	15	94.1	1641	1425	0.177925	1
1	2	15	55.3	1970	-	1.309241	
2	2	15	77.1	1435	-	1.910591	
3	2	15	66	1911	-	2.848776	
4	3	15	63.9	1052	1959	3.584143	
5	2	15	83.8	1231	-	4.667459	
6	3	15	50.3	1299	1525	5.48196	
7	3	15	93.2	1246	1899	6.086825	
8	1	15	75.7	-	-	6.459723	
9	1	15	93	-	-	7.932219	
10	2	15	93.6	1962	-	8.486164	
11	3	15	51.1	1817	1286	9.555058	
12	2	15	80.9	1522	-	10.027501	
13	2	15	63.8	1653	-	10.722855	
14	3	15	70.8	1341	1931	11.775619	

Bin5 Statistics 12

Trial #	Pulse	Chirp (MHz)	Pulse Width (µS)	Pulse 1-2 spacing (µS)	Pulse 2-3 spacing (µS)	Pulse Start(S)	Detection (1:yes; 0:no)
0	1	7	88.6	-	-	0.314521	1
1	2	7	94.6	1008	-	1.243996	
2	1	7	50.1	-	-	1.475246	
3	2	7	63.7	1431	-	2.192999	
4	2	7	94.1	1099	-	3.251059	
5	2	7	51.2	1912	-	3.97171	
6	1	7	74.9	-	-	4.245674	
7	3	7	66.7	1017	1782	5.196853	
8	2	7	86	1988	-	5.692734	
9	2	7	75.5	1097	-	6.22971	
10	2	7	90	1368	-	7.286242	
11	3	7	50.8	1869	1928	7.856196	
12	1	7	76.8	-	-	8.024055	
13	2	7	74.8	1130	-	8.899515	
14	2	7	62.5	1420	-	9.725962	
15	3	7	82.6	1345	1323	10.22108	
16	2	7	84.6	1504	-	10.709353	
17	1	7	70.3	-	-	11.55053	

Bin5 Statistics 13

Trial #	Pulse	Chirp (MHz)	Pulse Width (µS)	Pulse 1-2 spacing (µS)	Pulse 2-3 spacing (µS)	Pulse Start(S)	Detection (1:yes; 0:no)
0	3	12	76.7	1065	1628	0.623444	1
1	1	12	60.3	-	-	1.230146	
2	2	12	53.9	1185	-	2.621781	
3	3	12	97.1	1611	1976	3.405522	
4	1	12	92	-	-	4.224281	
5	1	12	58.8	-	-	5.738535	
6	2	12	77.3	1576	-	6.559456	
7	1	12	89.3	-	-	7.676285	
8	3	12	81.5	1576	1040	8.21909	
9	2	12	98	1615	-	9.863663	
10	2	12	85.3	1337	-	10.746276	
11	2	12	56.9	1893	-	11.319795	

Bin5 Statistics 14

Trial #	Pulse	Chirp (MHz)	Pulse Width (µS)	Pulse 1-2 spacing (µS)	Pulse 2-3 spacing (µS)	Pulse Start(S)	Detection (1:yes; 0:no)
0	3	9	63.4	1119	1708	0.463295	0
1	2	9	80.4	1774	-	1.851377	
2	1	9	68.9	-	-	2.670459	
3	3	9	87	1058	1040	4.608806	
4	1	9	51.4	-	-	6.116217	
5	2	9	78.2	1403	-	7.076559	
6	3	9	82.9	1539	1813	8.994642	
7	2	9	66.9	1325	-	10.592504	
8	3	9	96.2	1741	1018	11.185752	

Bin5 Statistics 15

Trial #	Pulse	Chirp (MHz)	Pulse Width (µS)	Pulse 1-2 spacing (uS)	Pulse 2-3 spacing (uS)	Pulse Start(S)	Detection (1:yes; 0:no)
0	2	15	86.4	1737	-	0.889327	0
1	1	15	87.6	-	-	2.315105	
2	2	15	62.4	1540	-	3.256418	
3	1	15	67.6	-	-	5.226646	
4	2	15	51.7	1813	-	5.623304	
5	2	15	67.4	1678	-	7.570718	
6	3	15	72.3	1969	1936	8.317915	
7	2	15	55.8	1378	-	9.818225	
8	3	15	80	1814	1476	11.303334	

Bin5 Statistics 16

Trial #	Pulse	Chirp (MHz)	Pulse Width (µS)	Pulse 1-2 spacing (uS)	Pulse 2-3 spacing (uS)	Pulse Start(S)	Detection (1:yes; 0:no)
0	2	15	85.7	1042	-	0.330579	1
1	2	15	91.5	1397	-	2.099311	
2	2	15	62	1744	-	4.226211	
3	1	15	97.5	-	-	5.084198	
4	3	15	54.8	1386	1951	7.15446	
5	3	15	54.2	1562	1195	7.719625	
6	1	15	56.4	-	-	9.170803	
7	3	15	99.6	1152	1620	10.541484	

Bin5 Statistics 17

Trial #	Pulse	Chirp (MHz)	Pulse Width (µS)	Pulse 1-2 spacing (µS)	Pulse 2-3 spacing (µS)	Pulse Start(S)	Detection (1:yes; 0:no)
0	2	10	52.4	1930	-	0.105668	1
1	1	10	54.4	-	-	1.451492	
2	1	10	92.5	-	-	2.201952	
3	2	10	53.6	1743	-	3.103692	
4	2	10	80.6	1254	-	4.387439	
5	3	10	68.1	1072	1002	5.249305	
6	3	10	72.2	1769	1114	6.07755	
7	3	10	91.5	1541	1361	6.663415	
8	2	10	53.5	1150	-	8.285016	
9	2	10	95.4	1455	-	8.968552	
10	2	10	51.3	1229	-	9.370492	
11	2	10	70.9	1800	-	10.272546	
12	2	10	65.8	1827	-	11.488589	

Bin5 Statistics 18

Trial #	Pulse	Chirp (MHz)	Pulse Width (µS)	Pulse 1-2 spacing (µS)	Pulse 2-3 spacing (µS)	Pulse Start(S)	Detection (1:yes; 0:no)
0	2	12	86.8	1707	-	0.649547	0
1	1	12	84	-	-	1.166918	
2	3	12	55.2	1969	1555	2.344455	
3	1	12	71.6	-	-	2.555979	
4	1	12	67.9	-	-	3.937913	
5	2	12	53.5	1933	-	4.065247	
6	3	12	75.2	1748	1844	5.156357	
7	2	12	75.2	1451	-	6.38016	
8	2	12	66.4	1078	-	6.811136	
9	3	12	79.9	1493	1791	7.856913	
10	2	12	91.6	1957	-	8.56256	
11	2	12	58.9	1308	-	8.939738	
12	2	12	57.8	1173	-	10.049758	
13	2	12	98.8	1083	-	10.433734	
14	2	12	91.2	1441	-	11.549641	

Bin5 Statistics 19

Trial #	Pulse	Chirp (MHz)	Pulse Width (µS)	Pulse 1-2 spacing (uS)	Pulse 2-3 spacing (uS)	Pulse Start(S)	Detection (1:yes; 0:no)
0	2	10	70.9	1228	-	0.548989	1
1	3	10	73.6	1041	1510	1.891486	
2	2	10	93.4	1208	-	2.923387	
3	1	10	50.2	-	-	3.49978	
4	2	10	92	1146	-	4.211834	
5	3	10	99.9	1729	1580	5.081618	
6	2	10	51.9	1207	-	6.079383	
7	2	10	57.3	1543	-	7.614304	
8	2	10	98.6	1499	-	8.709431	
9	3	10	66.2	1812	1180	9.9843	
10	2	10	90.4	1575	-	10.024074	
11	3	10	62.8	1775	1294	11.02191	

Bin5 Statistics 20

Trial #	Pulse	Chirp (MHz)	Pulse Width (µS)	Pulse 1-2 spacing (uS)	Pulse 2-3 spacing (uS)	Pulse Start(S)	Detection (1:yes; 0:no)
0	3	14	62.3	1680	1432	0.181171	0
1	1	14	75.5	-	-	1.404357	
2	1	14	82.9	-	-	1.636693	
3	1	14	91.6	-	-	2.300604	
4	1	14	97.2	-	-	3.423866	
5	1	14	97.9	-	-	3.725078	
6	3	14	95.6	1368	1742	4.71213	
7	1	14	97.3	-	-	5.447531	
8	2	14	75.9	1883	-	5.873582	
9	2	14	60.1	1304	-	6.854213	
10	2	14	64.9	1168	-	7.229272	
11	3	14	56.2	1295	1527	8.193509	
12	1	14	93.9	-	-	8.714542	
13	1	14	76.9	-	-	9.861997	
14	2	14	61.4	1486	-	9.913678	
15	2	14	93.2	1620	-	11.121351	
16	2	14	96.8	1481	-	11.505459	

Bin5 Statistics 21

Trial #	Pulse	Chirp (MHz)	Pulse Width (µS)	Pulse 1-2 spacing (uS)	Pulse 2-3 spacing (uS)	Pulse Start(S)	Detection (1:yes; 0:no)
0	3	14	73.6	1670	1959	0.291741	1
1	1	14	90.5	-	-	1.628026	
2	1	14	53.1	-	-	2.369557	
3	2	14	51.2	1776	-	3.771744	
4	1	14	90.4	-	-	4.931371	
5	3	14	69.8	1849	1904	5.571438	
6	2	14	76.6	1266	-	6.712708	
7	2	14	60.3	1855	-	7.095919	
8	2	14	67.6	1419	-	8.893619	
9	3	14	87.3	1034	1221	9.106823	
10	2	14	66.4	1002	-	10.110859	
11	2	14	56.3	1125	-	11.65589	

Bin5 Statistics 22

Trial #	Pulse	Chirp (MHz)	Pulse Width (µS)	Pulse 1-2 spacing (uS)	Pulse 2-3 spacing (uS)	Pulse Start(S)	Detection (1:yes; 0:no)
0	1	5	71.9	-	-	0.007462	1
1	2	5	63.1	1809	-	1.911958	
2	2	5	57.2	1152	-	2.809066	
3	1	5	67.9	-	-	4.032918	
4	2	5	97.6	1479	-	4.814253	
5	2	5	68.7	1837	-	6.243229	
6	2	5	84.1	1931	-	6.787617	
7	1	5	66.7	-	-	8.657725	
8	2	5	55.2	1558	-	9.711182	
9	2	5	77.3	1732	-	10.458488	
10	2	5	52.5	1514	-	10.988653	

Bin5 Statistics 23

Trial #	Pulse	Chirp (MHz)	Pulse Width (µS)	Pulse 1-2 spacing (uS)	Pulse 2-3 spacing (uS)	Pulse Start(S)	Detection (1:yes; 0:no)
0	2	18	87.1	1183	-	0.681153	1
1	3	18	67.5	1248	1296	1.675799	
2	3	18	83.4	1107	1359	2.809313	
3	3	18	99	1987	1354	4.034121	
4	3	18	57.4	1670	1965	5.26308	
5	1	18	77.5	-	-	6.212558	
6	2	18	99.5	1916	-	7.50091	
7	3	18	54.5	1944	1503	8.661324	
8	2	18	85.1	1625	-	10.131979	
9	2	18	78.2	1578	-	11.329303	

Bin5 Statistics 24

Trial #	Pulse	Chirp (MHz)	Pulse Width (µS)	Pulse 1-2 spacing (uS)	Pulse 2-3 spacing (uS)	Pulse Start(S)	Detection (1:yes; 0:no)
0	2	19	71.6	1200	-	0.511683	1
1	1	19	68.8	-	-	1.29816	
2	2	19	70.8	1681	-	1.922241	
3	1	19	53.1	-	-	2.297225	
4	2	19	52.9	1833	-	3.310043	
5	1	19	91	-	-	3.533198	
6	1	19	77.9	-	-	4.523488	
7	2	19	57.7	1183	-	5.266998	
8	2	19	64.7	1878	-	5.990016	
9	3	19	88.5	1855	1467	6.157542	
10	1	19	65.3	-	-	7.257448	
11	2	19	70.8	1397	-	7.941304	
12	1	19	77.2	-	-	8.257259	
13	2	19	69.9	1935	-	9.171045	
14	3	19	66.2	1357	1239	9.339442	
15	2	19	85.7	1153	-	10.149225	
16	3	19	61.7	1592	1314	10.705635	
17	2	19	60	1181	-	11.606562	

Bin5 Statistics 25

Trial #	Pulse	Chirp (MHz)	Pulse Width (uS)	Pulse 1-2 spacing (uS)	Pulse 2-3 spacing (uS)	Pulse Start(S)	Detection (1:yes; 0:no)
0	2	11	51.9	1644	-	0.151276	1
1	1	11	71.1	-	-	0.872472	
2	3	11	97.5	1437	1545	1.718877	
3	1	11	75.9	-	-	3.147512	
4	2	11	94.9	1084	-	3.669426	
5	2	11	99.1	1505	-	5.013518	
6	1	11	92	-	-	5.473317	
7	2	11	52.2	1431	-	6.132057	
8	2	11	78.9	1145	-	7.401729	
9	2	11	80.3	1407	-	7.872286	
10	2	11	62.8	1066	-	9.312889	
11	2	11	78.6	1935	-	9.822727	
12	1	11	84.8	-	-	10.671901	
13	3	11	62.2	1004	1476	11.928418	

Bin5 Statistics 26

Trial #	Pulse	Chirp (MHz)	Pulse Width (uS)	Pulse 1-2 spacing (uS)	Pulse 2-3 spacing (uS)	Pulse Start(S)	Detection (1:yes; 0:no)
0	3	18	65.8	1329	1128	0.475401	1
1	3	18	55.9	1766	1611	1.119504	
2	3	18	71.1	1086	1370	1.819929	
3	2	18	70	1019	-	2.540885	
4	1	18	58.5	-	-	2.831116	
5	1	18	84.1	-	-	3.466016	
6	3	18	60.5	1201	1412	4.545462	
7	1	18	69.8	-	-	5.289232	
8	1	18	81	-	-	5.788893	
9	3	18	84.6	1286	1868	6.003421	
10	3	18	63.3	1855	1287	7.037391	
11	2	18	69.3	1334	-	7.520679	
12	2	18	98.4	1521	-	8.223994	
13	2	18	80.7	1785	-	8.83471	
14	1	18	91.9	-	-	9.66277	
15	2	18	50.1	1397	-	10.009943	
16	1	18	81.4	-	-	10.76813	
17	2	18	60.3	1395	-	11.830024	

Bin5 Statistics 27

Trial #	Pulse	Chirp (MHz)	Pulse Width (µS)	Pulse 1-2 spacing (uS)	Pulse 2-3 spacing (uS)	Pulse Start(S)	Detection (1:yes; 0:no)
0	2	12	94.5	1750	-	0.629532	1
1	2	12	98.9	1980	-	1.813527	
2	3	12	65.6	1024	1848	3.400619	
3	2	12	67.6	1437	-	4.206502	
4	3	12	88.1	1055	1608	5.908506	
5	3	12	59.1	1117	1181	6.884367	
6	2	12	97.9	1268	-	7.503643	
7	2	12	80.3	1843	-	8.987704	
8	3	12	85.3	1511	1866	9.623347	
9	2	12	54.9	1968	-	11.442324	

Bin5 Statistics 28

Trial #	Pulse	Chirp (MHz)	Pulse Width (µS)	Pulse 1-2 spacing (uS)	Pulse 2-3 spacing (uS)	Pulse Start(S)	Detection (1:yes; 0:no)
0	1	13	78	-	-	0.51956	1
1	2	13	59.9	1034	-	1.423416	
2	1	13	80.7	-	-	1.653615	
3	3	13	68.8	1205	1766	2.841917	
4	2	13	72	1412	-	3.256463	
5	2	13	78.6	1555	-	4.370338	
6	2	13	75.6	1925	-	5.554162	
7	1	13	84.5	-	-	6.311014	
8	1	13	62.3	-	-	6.418497	
9	2	13	60.3	1833	-	7.298547	
10	3	13	73.4	1687	1267	8.082252	
11	1	13	75.9	-	-	9.384662	
12	2	13	89	1492	-	9.671677	
13	3	13	88.9	1353	1405	10.630726	
14	2	13	58.5	1505	-	11.954863	

Bin5 Statistics 29

Trial #	Pulse	Chirp (MHz)	Pulse Width (µS)	Pulse 1-2 spacing (µS)	Pulse 2-3 spacing (µS)	Pulse Start(S)	Detection (1:yes; 0:no)
0	2	9	51.8	1662	-	0.15025	1
1	3	9	70.5	1097	1770	1.243508	
2	3	9	65.6	1669	1062	1.820857	
3	2	9	95.3	1071	-	2.693309	
4	2	9	65.6	1571	-	3.135665	
5	3	9	71.3	1259	1829	3.710836	
6	2	9	81.5	1838	-	4.828449	
7	1	9	81.4	-	-	5.55109	
8	3	9	70.3	1078	1509	6.04416	
9	2	9	64.9	1193	-	6.361155	
10	2	9	52.5	1518	-	7.612598	
11	3	9	51.2	1900	1214	8.026468	
12	2	9	67.7	1955	-	9.121082	
13	3	9	55.4	1181	1817	9.286983	
14	2	9	62.4	1596	-	10.29768	
15	1	9	91.7	-	-	10.68962	
16	1	9	73.7	-	-	11.4943	

Bin5 Statistics 30

Trial #	Pulse	Chirp (MHz)	Pulse Width (µS)	Pulse 1-2 spacing (µS)	Pulse 2-3 spacing (µS)	Pulse Start(S)	Detection (1:yes; 0:no)
0	2	14	78.1	1659	-	0.670567	1
1	1	14	91.5	-	-	1.15744	
2	2	14	55.2	1553	-	1.938646	
3	1	14	64.2	-	-	2.164058	
4	3	14	64.5	1099	1573	3.076167	
5	2	14	91	1931	-	3.562664	
6	2	14	54.1	1745	-	4.921167	
7	2	14	65.8	1603	-	4.949217	
8	1	14	74.3	-	-	6.157934	
9	2	14	94.6	1237	-	6.780695	
10	3	14	65	1838	1283	7.144708	
11	1	14	80.9	-	-	7.99317	
12	1	14	95.1	-	-	8.67742	
13	1	14	98	-	-	9.624741	
14	1	14	99.4	-	-	10.212009	
15	3	14	87.5	1369	1843	10.867849	
16	1	14	70.1	-	-	11.700398	

Table-6 Radar Type 6 Statistical Performance

Trial #	Fc (MHz)	Pulse /Burst	Pulse Width (μS)	PRI (μs)	Detection (1:yes; 0:no)	Hopping Sequence
1	5500	9	1	333	1	5560.0, 5321.0, 5650.0, 5518.0, 5514.0, 5583.0, 5495.0, 5443.0, 5568.0, 5578.0, 5447.0, 5705.0, 5679.0, 5307.0, 5720.0, 5345.0, 5580.0, 5300.0, 5391.0, 5384.0, 5452.0, 5710.0, 5280.0, 5561.0, 5259.0, 5550.0, 5528.0, 5558.0, 5636.0, 5303.0, 5357.0, 5523.0, 5588.0, 5294.0, 5641.0, 5377.0, 5279.0, 5667.0, 5587.0, 5621.0, 5308.0, 5579.0, 5332.0, 5255.0, 5549.0, 5316.0, 5426.0, 5396.0, 5609.0, 5591.0, 5479.0, 5344.0, 5319.0, 5261.0, 5676.0, 5285.0, 5370.0, 5576.0, 5438.0, 5607.0, 5536.0, 5289.0, 5535.0, 5468.0, 5486.0, 5299.0, 5260.0, 5642.0, 5520.0, 5455.0, 5254.0, 5682.0, 5437.0, 5392.0, 5700.0, 5472.0, 5414.0, 5293.0, 5250.0, 5654.0, 5658.0, 5567.0, 5601.0, 5358.0, 5257.0, 5552.0, 5598.0, 5593.0, 5439.0, 5628.0, 5651.0, 5287.0, 5616.0, 5330.0, 5364.0, 5644.0, 5488.0, 5313.0, 5441.0, 5276.0 (number of hits: 1)
2	5500	9	1	333	1	5269.0, 5564.0, 5263.0, 5544.0, 5364.0, 5634.0, 5385.0, 5257.0, 5352.0, 5703.0, 5372.0, 5596.0, 5279.0, 5273.0, 5471.0, 5678.0, 5595.0, 5608.0, 5315.0, 5401.0, 5617.0, 5569.0, 5532.0, 5304.0, 5602.0, 5722.0, 5359.0, 5404.0, 5306.0, 5542.0, 5427.0, 5672.0, 5689.0, 5255.0, 5554.0, 5553.0, 5549.0, 5309.0, 5500.0, 5632.0, 5485.0, 5464.0, 5653.0, 5316.0, 5614.0, 5723.0, 5717.0, 5432.0, 5320.0, 5470.0, 5327.0, 5395.0, 5611.0, 5695.0, 5459.0, 5558.0, 5521.0, 5310.0, 5397.0, 5442.0, 5337.0, 5646.0, 5704.0, 5382.0, 5579.0, 5531.0, 5398.0, 5400.0, 5631.0, 5580.0, 5329.0, 5339.0, 5504.0, 5706.0, 5657.0, 5499.0, 5403.0, 5264.0, 5287.0, 5588.0, 5705.0, 5280.0, 5615.0, 5514.0, 5671.0, 5682.0, 5354.0, 5522.0, 5643.0, 5348.0, 5636.0, 5451.0, 5323.0, 5574.0, 5297.0, 5376.0, 5441.0, 5562.0, 5480.0, 5698.0 (number of hits: 3)
3	5500	9	1	333	1	5475.0, 5598.0, 5413.0, 5686.0, 5682.0, 5301.0, 5373.0, 5342.0, 5396.0, 5679.0, 5657.0, 5324.0, 5568.0, 5287.0, 5589.0, 5349.0, 5486.0, 5656.0, 5636.0, 5535.0, 5709.0, 5581.0, 5488.0, 5715.0, 5516.0, 5662.0, 5412.0, 5294.0, 5351.0, 5631.0, 5677.0, 5534.0, 5316.0, 5566.0, 5590.0, 5498.0, 5309.0, 5366.0, 5529.0, 5347.0, 5720.0, 5454.0, 5484.0, 5695.0, 5352.0, 5447.0, 5280.0, 5381.0, 5276.0, 5502.0, 5333.0, 5719.0, 5473.0, 5493.0, 5271.0, 5643.0, 5254.0, 5523.0, 5570.0, 5546.0,

						5388.0, 5672.0, 5261.0, 5489.0, 5572.0, 5718.0, 5491.0, 5509.0, 5436.0, 5437.0, 5701.0, 5307.0, 5277.0, 5453.0, 5723.0, 5481.0, 5692.0, 5646.0, 5258.0, 5652.0, 5465.0, 5340.0, 5304.0, 5621.0, 5601.0, 5443.0, 5476.0, 5374.0, 5410.0, 5511.0, 5394.0, 5397.0, 5356.0, 5375.0, 5557.0, 5619.0, 5496.0, 5696.0, 5464.0, 5474.0 (number of hits: 4)
4	5500	9	1	333	1	5333.0, 5270.0, 5598.0, 5636.0, 5512.0, 5278.0, 5694.0, 5255.0, 5581.0, 5523.0, 5483.0, 5683.0, 5429.0, 5391.0, 5611.0, 5590.0, 5688.0, 5399.0, 5567.0, 5584.0, 5279.0, 5318.0, 5558.0, 5718.0, 5662.0, 5345.0, 5398.0, 5479.0, 5283.0, 5367.0, 5419.0, 5712.0, 5377.0, 5474.0, 5569.0, 5562.0, 5711.0, 5723.0, 5540.0, 5439.0, 5612.0, 5476.0, 5376.0, 5508.0, 5274.0, 5566.0, 5326.0, 5441.0, 5546.0, 5415.0, 5407.0, 5370.0, 5485.0, 5434.0, 5322.0, 5432.0, 5352.0, 5604.0, 5519.0, 5355.0, 5343.0, 5472.0, 5304.0, 5664.0, 5689.0, 5445.0, 5263.0, 5470.0, 5331.0, 5484.0, 5490.0, 5491.0, 5686.0, 5371.0, 5681.0, 5521.0, 5285.0, 5356.0, 5507.0, 5501.0, 5713.0, 5685.0, 5679.0, 5583.0, 5494.0, 5556.0, 5560.0, 5344.0, 5293.0, 5615.0, 5375.0, 5358.0, 5428.0, 5680.0, 5536.0, 5314.0, 5380.0, 5396.0, 5413.0, 5362.0 (number of hits: 3)
5	5500	9	1	333	1	5333.0, 5473.0, 5572.0, 5319.0, 5687.0, 5519.0, 5518.0, 5338.0, 5346.0, 5689.0, 5501.0, 5628.0, 5710.0, 5448.0, 5612.0, 5375.0, 5317.0, 5464.0, 5428.0, 5315.0, 5621.0, 5656.0, 5606.0, 5401.0, 5552.0, 5268.0, 5635.0, 5541.0, 5434.0, 5387.0, 5278.0, 5604.0, 5643.0, 5599.0, 5694.0, 5452.0, 5395.0, 5302.0, 5267.0, 5334.0, 5442.0, 5713.0, 5619.0, 5680.0, 5331.0, 5371.0, 5605.0, 5642.0, 5438.0, 5297.0, 5670.0, 5632.0, 5353.0, 5339.0, 5310.0, 5368.0, 5341.0, 5363.0, 5664.0, 5364.0, 5447.0, 5615.0, 5701.0, 5388.0, 5432.0, 5312.0, 5623.0, 5688.0, 5439.0, 5407.0, 5287.0, 5525.0, 5340.0, 5613.0, 5709.0, 5636.0, 5575.0, 5717.0, 5416.0, 5275.0, 5666.0, 5494.0, 5327.0, 5264.0, 5705.0, 5556.0, 5554.0, 5324.0, 5266.0, 5721.0, 5431.0, 5718.0, 5655.0, 5399.0, 5547.0, 5361.0, 5696.0, 5284.0, 5562.0, 5675.0 (number of hits: 2)
6	5500	9	1	333	1	5452.0, 5495.0, 5575.0, 5654.0, 5436.0, 5393.0, 5555.0, 5334.0, 5599.0, 5343.0, 5321.0, 5378.0, 5453.0, 5275.0, 5324.0, 5254.0, 5623.0, 5285.0, 5583.0, 5401.0, 5647.0, 5365.0, 5466.0, 5483.0, 5533.0, 5591.0, 5356.0, 5439.0, 5250.0, 5640.0, 5325.0, 5532.0, 5530.0, 5718.0, 5448.0, 5600.0, 5377.0, 5394.0, 5369.0, 5631.0, 5257.0, 5715.0, 5523.0, 5455.0, 5387.0

						5490.0, 5327.0, 5723.0, 5659.0, 5534.0, 5306.0, 5299.0, 5271.0, 5385.0, 5326.0, 5291.0, 5492.0, 5444.0, 5619.0, 5442.0, 5574.0, 5445.0, 5673.0, 5580.0, 5550.0, 5677.0, 5266.0, 5435.0, 5476.0, 5648.0, 5264.0, 5465.0, 5679.0, 5486.0, 5411.0, 5313.0, 5477.0, 5396.0, 5419.0, 5342.0, 5272.0, 5292.0, 5617.0, 5695.0, 5370.0, 5629.0, 5538.0, 5682.0, 5639.0, 5720.0, 5298.0, 5607.0, 5581.0, 5517.0, 5256.0, 5456.0, 5627.0, 5625.0, 5553.0, 5304.0 (number of hits: 2)
7	5500	9	1	333	0	-
8	5500	9	1	333	1	5382.0, 5409.0, 5317.0, 5596.0, 5354.0, 5560.0, 5298.0, 5371.0, 5700.0, 5592.0, 5267.0, 5499.0, 5420.0, 5450.0, 5545.0, 5522.0, 5529.0, 5698.0, 5256.0, 5553.0, 5617.0, 5375.0, 5310.0, 5536.0, 5613.0, 5376.0, 5631.0, 5694.0, 5314.0, 5556.0, 5562.0, 5442.0, 5373.0, 5531.0, 5696.0, 5566.0, 5677.0, 5579.0, 5585.0, 5498.0, 5589.0, 5287.0, 5519.0, 5362.0, 5514.0, 5517.0, 5451.0, 5485.0, 5338.0, 5640.0, 5547.0, 5407.0, 5541.0, 5513.0, 5370.0, 5270.0, 5476.0, 5701.0, 5680.0, 5581.0, 5559.0, 5608.0, 5437.0, 5472.0, 5611.0, 5291.0, 5605.0, 5272.0, 5719.0, 5260.0, 5708.0, 5582.0, 5670.0, 5561.0, 5392.0, 5424.0, 5393.0, 5643.0, 5464.0, 5683.0, 5299.0, 5647.0, 5252.0, 5323.0, 5329.0, 5662.0, 5263.0, 5288.0, 5258.0, 5697.0, 5445.0, 5305.0, 5325.0, 5576.0, 5718.0, 5457.0, 5624.0, 5606.0, 5653.0, 5377.0 (number of hits: 2)
9	5500	9	1	333	0	-
10	5500	9	1	333	1	5453.0, 5530.0, 5411.0, 5308.0, 5390.0, 5698.0, 5305.0, 5311.0, 5685.0, 5680.0, 5573.0, 5643.0, 5329.0, 5458.0, 5287.0, 5284.0, 5663.0, 5438.0, 5328.0, 5354.0, 5656.0, 5636.0, 5392.0, 5416.0, 5268.0, 5696.0, 5677.0, 5386.0, 5420.0, 5333.0, 5346.0, 5603.0, 5655.0, 5435.0, 5507.0, 5332.0, 5704.0, 5496.0, 5658.0, 5427.0, 5365.0, 5408.0, 5667.0, 5414.0, 5397.0, 5382.0, 5265.0, 5721.0, 5678.0, 5561.0, 5360.0, 5492.0, 5398.0, 5598.0, 5724.0, 5587.0, 5514.0, 5577.0, 5401.0, 5299.0, 5547.0, 5511.0, 5581.0, 5465.0, 5388.0, 5615.0, 5447.0, 5509.0, 5682.0, 5705.0, 5639.0, 5391.0, 5499.0, 5548.0, 5341.0, 5254.0, 5264.0, 5597.0, 5292.0, 5296.0, 5675.0, 5280.0, 5362.0, 5683.0, 5669.0, 5578.0, 5353.0, 5273.0, 5668.0, 5616.0, 5337.0, 5653.0, 5274.0, 5368.0, 5622.0, 5611.0, 5291.0, 5516.0, 5635.0, 5290.0 (number of hits: 4)
11	5500	9	1	333	1	5344.0, 5377.0, 5368.0, 5482.0, 5640.0, 5324.0, 5545.0, 5544.0, 5533.0, 5379.0, 5720.0, 5721.0, 5362.0, 5610.0, 5312.0, 5486.0, 5376.0, 5413.0, 5663.0, 5443.0,

						5365.0, 5308.0, 5509.0, 5468.0, 5536.0, 5332.0, 5568.0, 5287.0, 5659.0, 5656.0, 5278.0, 5604.0, 5622.0, 5420.0, 5361.0, 5316.0, 5582.0, 5261.0, 5284.0, 5350.0, 5636.0, 5333.0, 5419.0, 5479.0, 5714.0, 5429.0, 5470.0, 5590.0, 5559.0, 5293.0, 5342.0, 5397.0, 5632.0, 5653.0, 5418.0, 5552.0, 5643.0, 5557.0, 5666.0, 5294.0, 5276.0, 5363.0, 5670.0, 5389.0, 5687.0, 5675.0, 5446.0, 5360.0, 5331.0, 5412.0, 5507.0, 5516.0, 5615.0, 5508.0, 5334.0, 5550.0, 5499.0, 5354.0, 5706.0, 5406.0, 5599.0, 5296.0, 5366.0, 5292.0, 5672.0, 5571.0, 5319.0, 5701.0, 5251.0, 5280.0, 5521.0, 5619.0, 5458.0, 5551.0, 5378.0, 5525.0, 5263.0, 5597.0, 5475.0, 5268.0 (number of hits: 2)
12	5500	9	1	333	1	5604.0, 5588.0, 5524.0, 5664.0, 5706.0, 5479.0, 5425.0, 5590.0, 5628.0, 5540.0, 5470.0, 5653.0, 5531.0, 5378.0, 5269.0, 5255.0, 5430.0, 5552.0, 5553.0, 5597.0, 5404.0, 5598.0, 5682.0, 5580.0, 5683.0, 5595.0, 5672.0, 5659.0, 5409.0, 5327.0, 5311.0, 5720.0, 5579.0, 5640.0, 5369.0, 5670.0, 5384.0, 5496.0, 5461.0, 5278.0, 5506.0, 5516.0, 5680.0, 5315.0, 5555.0, 5713.0, 5423.0, 5325.0, 5502.0, 5487.0, 5424.0, 5474.0, 5510.0, 5526.0, 5358.0, 5343.0, 5647.0, 5572.0, 5499.0, 5478.0, 5607.0, 5410.0, 5514.0, 5500.0, 5582.0, 5609.0, 5385.0, 5395.0, 5643.0, 5359.0, 5529.0, 5563.0, 5711.0, 5632.0, 5600.0, 5619.0, 5525.0, 5336.0, 5633.0, 5578.0, 5441.0, 5493.0, 5421.0, 5676.0, 5328.0, 5337.0, 5709.0, 5360.0, 5448.0, 5449.0, 5700.0, 5504.0, 5477.0, 5318.0, 5321.0, 5263.0, 5382.0, 5296.0, 5512.0, 5508.0 (number of hits: 7)
13	5500	9	1	333	0	-
14	5500	9	1	333	1	5601.0, 5394.0, 5672.0, 5456.0, 5688.0, 5302.0, 5259.0, 5379.0, 5566.0, 5717.0, 5709.0, 5370.0, 5662.0, 5311.0, 5364.0, 5658.0, 5253.0, 5502.0, 5278.0, 5636.0, 5530.0, 5282.0, 5273.0, 5549.0, 5355.0, 5270.0, 5303.0, 5540.0, 5409.0, 5674.0, 5378.0, 5346.0, 5554.0, 5497.0, 5649.0, 5261.0, 5559.0, 5561.0, 5571.0, 5385.0, 5655.0, 5452.0, 5344.0, 5573.0, 5470.0, 5371.0, 5635.0, 5468.0, 5630.0, 5389.0, 5386.0, 5686.0, 5654.0, 5562.0, 5611.0, 5563.0, 5301.0, 5436.0, 5413.0, 5352.0, 5375.0, 5579.0, 5482.0, 5449.0, 5313.0, 5557.0, 5616.0, 5720.0, 5296.0, 5450.0, 5668.0, 5314.0, 5431.0, 5451.0, 5711.0, 5410.0, 5425.0, 5492.0, 5293.0, 5659.0, 5632.0, 5401.0, 5443.0, 5548.0, 5403.0, 5316.0, 5494.0, 5447.0, 5560.0, 5640.0, 5438.0, 5331.0, 5715.0, 5631.0, 5622.0, 5258.0, 5650.0, 5583.0, 5647.0, 5519.0 (number of hits: 4)

15	5500	9	1	333	0	-
16	5500	9	1	333	0	-
17	5500	9	1	333	1	5631.0, 5666.0, 5516.0, 5522.0, 5376.0, 5341.0, 5342.0, 5723.0, 5269.0, 5292.0, 5608.0, 5409.0, 5556.0, 5276.0, 5653.0, 5570.0, 5636.0, 5301.0, 5634.0, 5330.0, 5672.0, 5492.0, 5260.0, 5466.0, 5528.0, 5677.0, 5319.0, 5553.0, 5637.0, 5638.0, 5521.0, 5483.0, 5359.0, 5566.0, 5474.0, 5661.0, 5686.0, 5514.0, 5558.0, 5496.0, 5724.0, 5588.0, 5368.0, 5384.0, 5336.0, 5564.0, 5321.0, 5284.0, 5334.0, 5297.0, 5531.0, 5685.0, 5554.0, 5585.0, 5667.0, 5632.0, 5371.0, 5322.0, 5399.0, 5264.0, 5413.0, 5717.0, 5622.0, 5437.0, 5463.0, 5706.0, 5460.0, 5458.0, 5265.0, 5387.0, 5589.0, 5541.0, 5436.0, 5333.0, 5633.0, 5303.0, 5364.0, 5346.0, 5533.0, 5396.0, 5335.0, 5441.0, 5689.0, 5536.0, 5252.0, 5406.0, 5324.0, 5506.0, 5500.0, 5543.0, 5302.0, 5306.0, 5559.0, 5630.0, 5650.0, 5476.0, 5250.0, 5615.0, 5318.0, 5663.0 (number of hits: 4)
18	5500	9	1	333	1	5599.0, 5693.0, 5396.0, 5529.0, 5563.0, 5472.0, 5620.0, 5310.0, 5560.0, 5597.0, 5309.0, 5452.0, 5336.0, 5447.0, 5622.0, 5264.0, 5385.0, 5542.0, 5515.0, 5573.0, 5483.0, 5574.0, 5701.0, 5716.0, 5361.0, 5290.0, 5432.0, 5331.0, 5434.0, 5308.0, 5626.0, 5526.0, 5722.0, 5307.0, 5673.0, 5528.0, 5423.0, 5366.0, 5435.0, 5713.0, 5357.0, 5710.0, 5708.0, 5367.0, 5565.0, 5287.0, 5480.0, 5378.0, 5504.0, 5285.0, 5475.0, 5525.0, 5252.0, 5635.0, 5441.0, 5266.0, 5487.0, 5430.0, 5405.0, 5281.0, 5321.0, 5685.0, 5510.0, 5253.0, 5459.0, 5546.0, 5706.0, 5652.0, 5535.0, 5438.0, 5322.0, 5567.0, 5398.0, 5262.0, 5717.0, 5692.0, 5534.0, 5275.0, 5588.0, 5614.0, 5584.0, 5362.0, 5650.0, 5271.0, 5476.0, 5543.0, 5485.0, 5670.0, 5707.0, 5484.0, 5458.0, 5342.0, 5328.0, 5578.0, 5272.0, 5327.0, 5604.0, 5585.0, 5463.0, 5531.0 (number of hits: 1)
19	5500	9	1	333	0	-
20	5500	9	1	333	1	5446.0, 5634.0, 5638.0, 5361.0, 5595.0, 5379.0, 5653.0, 5515.0, 5683.0, 5356.0, 5524.0, 5371.0, 5607.0, 5542.0, 5327.0, 5397.0, 5385.0, 5615.0, 5659.0, 5640.0, 5598.0, 5299.0, 5281.0, 5709.0, 5402.0, 5518.0, 5317.0, 5303.0, 5688.0, 5442.0, 5297.0, 5555.0, 5706.0, 5700.0, 5458.0, 5375.0, 5571.0, 5350.0, 5374.0, 5377.0, 5655.0, 5277.0, 5423.0, 5636.0, 5614.0, 5344.0, 5546.0, 5427.0, 5418.0, 5503.0, 5362.0, 5448.0, 5325.0, 5540.0, 5392.0, 5578.0, 5525.0, 5269.0, 5520.0, 5541.0, 5662.0, 5304.0, 5567.0, 5470.0, 5673.0, 5278.0, 5347.0, 5475.0, 5389.0, 5443.0, 5456.0, 5438.0, 5591.0, 5301.0, 5290.0,

						5511.0, 5329.0, 5422.0, 5512.0, 5538.0, 5326.0, 5590.0, 5279.0, 5487.0, 5573.0, 5682.0, 5430.0, 5708.0, 5449.0, 5444.0, 5684.0, 5298.0, 5722.0, 5565.0, 5626.0, 5360.0, 5564.0, 5484.0, 5306.0, 5650.0 (number of hits: 1)
21	5500	9	1	333	0	-
22	5500	9	1	333	1	5518.0, 5381.0, 5698.0, 5521.0, 5701.0, 5607.0, 5429.0, 5330.0, 5635.0, 5266.0, 5309.0, 5296.0, 5410.0, 5423.0, 5444.0, 5483.0, 5681.0, 5404.0, 5310.0, 5702.0, 5498.0, 5288.0, 5369.0, 5372.0, 5307.0, 5353.0, 5271.0, 5384.0, 5431.0, 5719.0, 5435.0, 5311.0, 5306.0, 5382.0, 5586.0, 5675.0, 5571.0, 5467.0, 5704.0, 5436.0, 5259.0, 5465.0, 5644.0, 5322.0, 5601.0, 5354.0, 5529.0, 5566.0, 5651.0, 5272.0, 5503.0, 5712.0, 5638.0, 5278.0, 5312.0, 5319.0, 5289.0, 5349.0, 5283.0, 5438.0, 5406.0, 5260.0, 5317.0, 5501.0, 5292.0, 5507.0, 5613.0, 5506.0, 5615.0, 5547.0, 5654.0, 5574.0, 5378.0, 5339.0, 5523.0, 5340.0, 5373.0, 5269.0, 5533.0, 5594.0, 5461.0, 5703.0, 5256.0, 5662.0, 5281.0, 5293.0, 5687.0, 5490.0, 5290.0, 5374.0, 5443.0, 5250.0, 5479.0, 5402.0, 5265.0, 5632.0, 5593.0, 5543.0, 5695.0, 5362.0 (number of hits: 5)
23	5500	9	1	333	1	5275.0, 5481.0, 5564.0, 5325.0, 5373.0, 5430.0, 5378.0, 5417.0, 5654.0, 5502.0, 5652.0, 5300.0, 5370.0, 5292.0, 5693.0, 5379.0, 5369.0, 5703.0, 5676.0, 5459.0, 5327.0, 5255.0, 5669.0, 5304.0, 5501.0, 5479.0, 5349.0, 5593.0, 5507.0, 5347.0, 5456.0, 5397.0, 5342.0, 5549.0, 5433.0, 5372.0, 5262.0, 5283.0, 5497.0, 5289.0, 5535.0, 5309.0, 5411.0, 5626.0, 5376.0, 5476.0, 5541.0, 5601.0, 5582.0, 5638.0, 5612.0, 5391.0, 5389.0, 5374.0, 5254.0, 5415.0, 5319.0, 5562.0, 5639.0, 5343.0, 5260.0, 5616.0, 5518.0, 5493.0, 5698.0, 5437.0, 5578.0, 5563.0, 5548.0, 5403.0, 5435.0, 5591.0, 5553.0, 5604.0, 5565.0, 5667.0, 5718.0, 5402.0, 5323.0, 5624.0, 5446.0, 5331.0, 5352.0, 5310.0, 5651.0, 5550.0, 5410.0, 5665.0, 5322.0, 5334.0, 5646.0, 5419.0, 5620.0, 5345.0, 5514.0, 5579.0, 5532.0, 5452.0, 5308.0, 5356.0 (number of hits: 5)
24	5500	9	1	333	1	5661.0, 5585.0, 5598.0, 5522.0, 5424.0, 5679.0, 5673.0, 5276.0, 5640.0, 5289.0, 5428.0, 5455.0, 5487.0, 5406.0, 5609.0, 5490.0, 5319.0, 5351.0, 5560.0, 5670.0, 5429.0, 5627.0, 5532.0, 5562.0, 5703.0, 5309.0, 5533.0, 5696.0, 5505.0, 5667.0, 5656.0, 5507.0, 5638.0, 5399.0, 5474.0, 5272.0, 5625.0, 5281.0, 5468.0, 5502.0, 5323.0, 5328.0, 5295.0, 5391.0, 5662.0, 5547.0, 5420.0, 5304.0, 5265.0, 5326.0, 5407.0, 5542.0, 5392.0, 5608.0, 5591.0,

						5476.0, 5623.0, 5402.0, 5464.0, 5481.0, 5571.0, 5513.0, 5607.0, 5648.0, 5711.0, 5432.0, 5698.0, 5358.0, 5317.0, 5612.0, 5338.0, 5254.0, 5361.0, 5458.0, 5634.0, 5695.0, 5561.0, 5619.0, 5479.0, 5559.0, 5410.0, 5566.0, 5582.0, 5469.0, 5549.0, 5665.0, 5384.0, 5519.0, 5570.0, 5647.0, 5637.0, 5552.0, 5322.0, 5451.0, 5581.0, 5520.0, 5362.0, 5535.0, 5329.0, 5282.0 (number of hits: 3)
25	5500	9	1	333	0	-
26	5500	9	1	333	1	5366.0, 5631.0, 5256.0, 5497.0, 5501.0, 5515.0, 5407.0, 5495.0, 5303.0, 5478.0, 5571.0, 5260.0, 5312.0, 5616.0, 5388.0, 5708.0, 5408.0, 5621.0, 5354.0, 5353.0, 5490.0, 5279.0, 5250.0, 5368.0, 5724.0, 5532.0, 5592.0, 5365.0, 5705.0, 5660.0, 5675.0, 5427.0, 5624.0, 5687.0, 5335.0, 5585.0, 5686.0, 5512.0, 5333.0, 5552.0, 5347.0, 5357.0, 5617.0, 5445.0, 5496.0, 5510.0, 5688.0, 5698.0, 5337.0, 5563.0, 5387.0, 5406.0, 5719.0, 5697.0, 5661.0, 5525.0, 5375.0, 5597.0, 5608.0, 5612.0, 5699.0, 5643.0, 5509.0, 5291.0, 5263.0, 5259.0, 5524.0, 5378.0, 5523.0, 5659.0, 5603.0, 5650.0, 5633.0, 5271.0, 5426.0, 5570.0, 5502.0, 5670.0, 5437.0, 5483.0, 5284.0, 5320.0, 5584.0, 5516.0, 5593.0, 5550.0, 5373.0, 5604.0, 5383.0, 5555.0, 5489.0, 5628.0, 5391.0, 5678.0, 5627.0, 5351.0, 5439.0, 5716.0, 5334.0, 5280.0 (number of hits: 5)
27	5500	9	1	333	1	5618.0, 5527.0, 5677.0, 5568.0, 5380.0, 5567.0, 5617.0, 5596.0, 5440.0, 5721.0, 5675.0, 5403.0, 5356.0, 5473.0, 5615.0, 5367.0, 5358.0, 5455.0, 5485.0, 5620.0, 5595.0, 5713.0, 5400.0, 5702.0, 5672.0, 5443.0, 5334.0, 5308.0, 5476.0, 5396.0, 5402.0, 5447.0, 5315.0, 5650.0, 5659.0, 5665.0, 5533.0, 5314.0, 5427.0, 5484.0, 5260.0, 5306.0, 5701.0, 5622.0, 5371.0, 5515.0, 5350.0, 5351.0, 5613.0, 5541.0, 5461.0, 5624.0, 5501.0, 5369.0, 5635.0, 5320.0, 5523.0, 5310.0, 5393.0, 5295.0, 5498.0, 5640.0, 5389.0, 5554.0, 5271.0, 5432.0, 5458.0, 5487.0, 5307.0, 5398.0, 5605.0, 5600.0, 5534.0, 5488.0, 5410.0, 5547.0, 5475.0, 5610.0, 5591.0, 5518.0, 5302.0, 5436.0, 5251.0, 5397.0, 5361.0, 5437.0, 5438.0, 5507.0, 5626.0, 5491.0, 5588.0, 5257.0, 5556.0, 5333.0, 5512.0, 5426.0, 5311.0, 5401.0, 5584.0, 5297.0 (number of hits: 3)
28	5500	9	1	333	0	-
29	5500	9	1	333	1	5434.0, 5510.0, 5690.0, 5406.0, 5327.0, 5291.0, 5635.0, 5357.0, 5326.0, 5337.0, 5705.0, 5343.0, 5504.0, 5545.0, 5703.0, 5517.0, 5621.0, 5495.0, 5507.0, 5392.0, 5439.0, 5529.0, 5554.0, 5615.0, 5577.0, 5298.0, 5313.0, 5400.0, 5525.0, 5718.0,

						5492.0, 5714.0, 5386.0, 5427.0, 5485.0, 5493.0, 5447.0, 5370.0, 5694.0, 5692.0, 5390.0, 5470.0, 5544.0, 5605.0, 5378.0, 5294.0, 5255.0, 5667.0, 5325.0, 5586.0, 5398.0, 5657.0, 5519.0, 5704.0, 5506.0, 5363.0, 5539.0, 5572.0, 5339.0, 5520.0, 5490.0, 5399.0, 5494.0, 5253.0, 5527.0, 5356.0, 5483.0, 5266.0, 5379.0, 5553.0, 5308.0, 5536.0, 5265.0, 5590.0, 5432.0, 5599.0, 5301.0, 5388.0, 5501.0, 5389.0, 5598.0, 5516.0, 5445.0, 5292.0, 5424.0, 5627.0, 5679.0, 5478.0, 5300.0, 5347.0, 5571.0, 5340.0, 5328.0, 5345.0, 5295.0, 5335.0, 5387.0, 5643.0, 5475.0, 5591.0 (number of hits: 8)
30	5500	9	1	333	1	5568.0, 5669.0, 5702.0, 5416.0, 5388.0, 5318.0, 5310.0, 5267.0, 5284.0, 5543.0, 5515.0, 5508.0, 5493.0, 5381.0, 5624.0, 5440.0, 5570.0, 5468.0, 5551.0, 5400.0, 5342.0, 5626.0, 5470.0, 5408.0, 5256.0, 5533.0, 5484.0, 5528.0, 5683.0, 5671.0, 5328.0, 5516.0, 5469.0, 5271.0, 5684.0, 5500.0, 5358.0, 5467.0, 5294.0, 5599.0, 5296.0, 5365.0, 5723.0, 5638.0, 5315.0, 5252.0, 5595.0, 5316.0, 5717.0, 5340.0, 5370.0, 5618.0, 5278.0, 5430.0, 5272.0, 5548.0, 5629.0, 5275.0, 5279.0, 5525.0, 5617.0, 5708.0, 5317.0, 5643.0, 5485.0, 5705.0, 5302.0, 5300.0, 5304.0, 5707.0, 5546.0, 5462.0, 5505.0, 5699.0, 5491.0, 5674.0, 5632.0, 5719.0, 5277.0, 5611.0, 5682.0, 5517.0, 5474.0, 5483.0, 5476.0, 5325.0, 5565.0, 5541.0, 5580.0, 5652.0, 5337.0, 5397.0, 5513.0, 5598.0, 5295.0, 5261.0, 5620.0, 5666.0, 5524.0, 5603.0 (number of hits: 3)

5510 MHz, 40 MHz Bandwidth

Radar Signal Type	Waveform/Trial Number	Detection (%)	Limit (%)	Pass/Fail
Type 1A/1B	30	100 %	60%	Pass
Type 2	30	73.3 %	60%	Pass
Type 3	30	86.7 %	60%	Pass
Type 4	30	70 %	60%	Pass
Aggregate (Type1 to 4)	120	82.5 %	80%	Pass
Type 5	30	100 %	80%	Pass
Type 6	30	100 %	70%	Pass

Please refer to the following statistical tables:

Table-1A/1B Radar Type 1A/1B Statistical Performance

Trial #	Fc (MHz)	Pulse/Burst	Pulse Width (µS)	PRI (µs)	Detection (1:yes; 0:no)
1	5510	99	1	538	1
2	5510	68	1	778	1
3	5510	67	1	798	1
4	5510	83	1	638	1
5	5510	61	1	878	1
6	5492	65	1	818	1
7	5492	18	1	3066	1
8	5492	81	1	658	1
9	5492	102	1	518	1
10	5492	76	1	698	1
11	5528	78	1	678	1
12	5528	92	1	578	1
13	5528	58	1	918	1
14	5528	70	1	758	1
15	5528	57	1	938	1
16	5510	39	1	1373	1
17	5510	40	1	1345	1
18	5510	28	1	1928	1
19	5510	70	1	754	1
20	5510	35	1	1520	1
21	5492	20	1	2764	1
22	5492	33	1	1618	1
23	5492	96	1	555	1
24	5492	61	1	877	1
25	5492	21	1	2622	1
26	5528	98	1	543	1
27	5528	34	1	1592	1
28	5528	20	1	2717	1
29	5528	22	1	2405	1
30	5528	21	1	2562	1
Detection Percentage: 100 % (>60%)					

Table-2 Radar Type 2 Statistical Performance

Trial #	Fc (MHz)	Pulse/Burst	Pulse Width (μS)	PRI (μs)	Detection (1:yes; 0:no)
1	5510	24	1	197	1
2	5510	27	4.9	220	1
3	5510	26	2.7	205	1
4	5510	28	1.1	188	1
5	5510	26	1.1	178	1
6	5510	29	5	222	0
7	5510	25	3.5	202	0
8	5510	23	1	214	1
9	5510	26	1.3	214	1
10	5510	28	2.1	169	1
11	5492	25	2.1	216	1
12	5492	25	4.1	163	1
13	5492	28	1.6	163	1
14	5492	25	2.3	206	0
15	5492	29	3.8	171	1
16	5492	24	1.9	159	0
17	5492	29	2.8	150	1
18	5492	27	4.4	165	0
19	5492	23	3.1	150	1
20	5492	25	2.4	196	1
21	5528	29	2.2	168	1
22	5528	27	4.3	170	0
23	5528	26	1.5	199	0
24	5528	29	2.6	196	1
25	5528	27	1.1	219	1
26	5528	26	2.7	161	1
27	5528	29	5	219	1
28	5528	29	1.5	226	1
29	5528	27	2.1	201	0
30	5528	29	1.2	174	1
Detection Percentage: 73.3 % (>60%)					

Table-3 Radar Type 3 Statistical Performance

Trial #	Fc (MHz)	Pulse/Burst	Pulse Width (μS)	PRI (μs)	Detection (1:yes; 0:no)
1	5510	18	7.7	377	1
2	5510	18	8.6	278	1
3	5510	17	9.9	259	0
4	5510	18	9.1	239	0
5	5510	18	7.1	264	1
6	5510	17	6.1	396	1
7	5510	17	6.8	473	1
8	5510	16	7.1	301	1
9	5510	18	6	307	1
10	5510	17	6.1	412	0
11	5492	17	6.7	412	1
12	5492	16	9.5	309	1
13	5492	17	9.9	300	1
14	5492	18	7.7	271	1
15	5492	17	9.3	250	1
16	5492	18	8.9	346	1
17	5492	18	7.1	470	1
18	5492	16	10	402	1
19	5492	18	8.5	468	0
20	5492	16	10	494	1
21	5528	18	8.3	396	1
22	5528	18	9.2	456	1
23	5528	17	9.4	409	1
24	5528	16	9.8	369	1
25	5528	17	8.7	425	1
26	5528	17	7.6	402	1
27	5528	17	8.8	292	1
28	5528	17	8.7	271	1
29	5528	18	8.8	439	1
30	5528	18	8	206	1
Detection Percentage: 86.7 % (>60%)					

Table-4 Radar Type 4 Statistical Performance

Trial #	Fc (MHz)	Pulse/Burst	Pulse Width (μS)	PRI (μs)	Detection (1:yes; 0:no)
1	5510	15	14.3	493	1
2	5510	16	17.9	304	1
3	5510	15	14.6	433	1
4	5510	13	15.2	451	0
5	5510	15	15.2	365	0
6	5510	12	19.8	390	1
7	5510	15	16.2	291	1
8	5510	12	19.9	258	1
9	5510	15	12.6	389	0
10	5510	16	16	289	0
11	5492	16	17.2	416	1
12	5492	15	19.2	473	1
13	5492	14	17.7	438	1
14	5492	12	13.6	306	0
15	5492	16	17.5	365	0
16	5492	16	18.8	412	1
17	5492	14	13.3	256	0
18	5492	14	15.3	395	0
19	5492	12	17.2	373	1
20	5492	13	14.4	481	1
21	5528	15	13.2	234	1
22	5528	16	18.6	439	1
23	5528	12	12.3	282	1
24	5528	14	15.3	209	0
25	5528	15	14.9	461	1
26	5528	15	18.3	376	1
27	5528	14	19.4	222	1
28	5528	14	11.6	203	1
29	5528	12	17.3	374	1
30	5528	16	17.8	238	1
Detection Percentage: 70 % (>60%)					

Table-5 Radar Type 5 Statistical Performance

Trial #	Fc (MHz)	Detection (1:yes; 0:no)
1	5510	1
2	5510	1
3	5510	1
4	5510	1
5	5510	1
6	5510	1
7	5510	1
8	5510	1
9	5510	1
10	5510	1
11	5495.6	1
12	5499.2	1
13	5495.6	1
14	5495.6	1
15	5497.2	1
16	5498.8	1
17	5494.8	1
18	5497.6	1
19	5495.2	1
20	5497.6	1
21	5524.8	1
22	5524.4	1
23	5525.2	1
24	5521.2	1
25	5523.2	1
26	5525.2	1
27	5521.6	1
28	5520.4	1
29	5522.0	1
30	5526.0	1
Detection Percentage: 100 % (>80%)		

Bin5 Statistics 1

Trial #	Pulse	Chirp (MHz)	Pulse Width (µS)	Pulse 1-2 spacing (µS)	Pulse 2-3 spacing (µS)	Pulse Start(S)	Detection (1:yes; 0:no)
0	1	16	94.1	-	-	0.408422	1
1	2	16	58	1689	-	0.825941	
2	2	16	54.7	1056	-	2.01933	
3	3	16	96.2	1708	1331	3.161875	
4	2	16	55	1811	-	3.629131	
5	2	16	93.6	1278	-	4.78427	
6	2	16	55.6	1213	-	5.234528	
7	2	16	82.4	1697	-	5.64412	
8	2	16	58.1	1327	-	7.173329	
9	2	16	50	1067	-	7.268399	
10	2	16	78.1	1017	-	8.248395	
11	3	16	68.1	1849	1343	9.293774	
12	2	16	99.2	1922	-	9.930667	
13	2	16	63.4	1825	-	10.47678	
14	1	16	72.5	-	-	11.350467	

Bin5 Statistics 2

Trial #	Pulse	Chirp (MHz)	Pulse Width (µS)	Pulse 1-2 spacing (µS)	Pulse 2-3 spacing (µS)	Pulse Start(S)	Detection (1:yes; 0:no)
0	3	15	58	1623	1670	0.16851	1
1	3	15	54.3	1146	1764	0.917229	
2	2	15	96.6	1132	-	2.505404	
3	3	15	73.3	1881	1452	3.334094	
4	3	15	96.7	1760	1747	3.735434	
5	1	15	74.8	-	-	4.645401	
6	1	15	64.7	-	-	5.593501	
7	1	15	68.8	-	-	6.616459	
8	1	15	75.3	-	-	7.528426	
9	2	15	56.3	1754	-	8.193985	
10	1	15	89.2	-	-	8.774546	
11	1	15	62.1	-	-	10.120039	
12	1	15	59.2	-	-	11.016077	
13	1	15	64.6	-	-	11.983841	

Bin5 Statistics 3

Trial #	Pulse	Chirp (MHz)	Pulse Width (µS)	Pulse 1-2 spacing (µS)	Pulse 2-3 spacing (µS)	Pulse Start(S)	Detection (1:yes; 0:no)
0	3	8	53.2	1745	1653	0.592343	1
1	2	8	77.1	1402	-	1.032942	
2	1	8	78.6	-	-	1.856635	
3	2	8	97.9	1382	-	2.799097	
4	2	8	51.6	1881	-	3.508217	
5	2	8	79.9	1073	-	3.736887	
6	2	8	86.5	1027	-	4.559818	
7	2	8	57.3	1010	-	5.228343	
8	2	8	60.2	1585	-	6.230041	
9	3	8	79.9	1102	1927	7.022267	
10	3	8	89.5	1473	1874	7.514737	
11	2	8	88.9	1058	-	8.437623	
12	2	8	90.3	1636	-	8.81368	
13	2	8	65.5	1574	-	9.582183	
14	1	8	83.5	-	-	9.999076	
15	2	8	50.2	1636	-	11.258654	
16	1	8	53.2	-	-	11.760305	

Bin5 Statistics 4

Trial #	Pulse	Chirp (MHz)	Pulse Width (µS)	Pulse 1-2 spacing (µS)	Pulse 2-3 spacing (µS)	Pulse Start(S)	Detection (1:yes; 0:no)
0	2	15	74.1	1417	-	0.374875	1
1	2	15	56.5	1910	-	1.223325	
2	3	15	86.1	1416	1508	1.646722	
3	2	15	54.2	1962	-	2.407704	
4	2	15	79.7	1876	-	2.982146	
5	1	15	63.9	-	-	3.174187	
6	1	15	59.4	-	-	4.316679	
7	2	15	84	1747	-	4.823701	
8	2	15	93.6	1905	-	5.098944	
9	1	15	51.9	-	-	6.150468	
10	2	15	78.3	1909	-	6.714325	
11	3	15	88.5	1619	1936	7.321324	
12	1	15	86.2	-	-	7.580405	
13	3	15	99.6	1415	1660	8.257777	
14	2	15	79.3	1782	-	9.115814	
15	2	15	68.4	1506	-	9.740358	
16	3	15	68.2	1403	1868	10.409122	
17	3	15	81.2	1625	1861	11.162293	
18	2	15	79.8	1470	-	11.646635	

Bin5 Statistics 5

Trial #	Pulse	Chirp (MHz)	Pulse Width (µS)	Pulse 1-2 spacing (µS)	Pulse 2-3 spacing (µS)	Pulse Start(S)	Detection (1:yes; 0:no)
0	2	7	98.4	1620	-	0.091395	1
1	3	7	55.2	1182	1513	1.008608	
2	2	7	80.8	1866	-	1.848416	
3	3	7	68.2	1035	1891	3.319417	
4	3	7	52.5	1368	1228	4.473028	
5	1	7	95.6	-	-	5.461229	
6	1	7	67.7	-	-	6.28336	
7	2	7	82.8	1375	-	7.269149	
8	2	7	64.4	1155	-	8.222645	
9	3	7	56.9	1745	1901	8.50771	
10	3	7	95.7	1505	1200	9.549063	
11	1	7	54.9	-	-	10.257541	
12	3	7	96.2	1821	1713	11.616415	

Bin5 Statistics 6

Trial #	Pulse	Chirp (MHz)	Pulse Width (µS)	Pulse 1-2 spacing (µS)	Pulse 2-3 spacing (µS)	Pulse Start(S)	Detection (1:yes; 0:no)
0	1	7	99.8	-	-	0.232839	1
1	2	7	93.9	1515	-	1.432053	
2	2	7	80.3	1060	-	1.866308	
3	1	7	67	-	-	2.37527	
4	2	7	93.1	1328	-	3.612039	
5	1	7	92.3	-	-	3.789091	
6	2	7	95.8	1477	-	5.145646	
7	1	7	76.6	-	-	5.789981	
8	3	7	62.1	1886	1698	6.668874	
9	2	7	62.8	1111	-	7.24062	
10	2	7	92.6	1815	-	7.891065	
11	2	7	77.9	1080	-	8.660677	
12	2	7	63.1	1671	-	9.458102	
13	2	7	91.1	1535	-	10.032289	
14	3	7	76.8	1114	1357	11.204547	
15	1	7	99.4	-	-	11.842011	

Bin5 Statistics 7

Trial #	Pulse	Chirp (MHz)	Pulse Width (µS)	Pulse 1-2 spacing (µS)	Pulse 2-3 spacing (µS)	Pulse Start(S)	Detection (1:yes; 0:no)
0	2	7	71.7	1161	-	0.225851	1
1	3	7	93.4	1109	1615	0.991666	
2	1	7	68.3	-	-	1.375625	
3	2	7	64.3	1381	-	2.247808	
4	1	7	61.5	-	-	3.31562	
5	2	7	78.2	1998	-	3.40882	
6	2	7	91.9	1176	-	4.252606	
7	3	7	71	1686	1078	4.729767	
8	2	7	84.5	1692	-	5.536648	
9	3	7	97.8	1731	1586	6.595004	
10	3	7	70	1669	1532	7.289158	
11	2	7	89.7	1903	-	7.817995	
12	2	7	88.8	1209	-	8.016302	
13	1	7	81.5	-	-	8.8859	
14	1	7	76.2	-	-	9.404634	
15	1	7	53.8	-	-	10.187971	
16	3	7	61	1407	1726	10.9034	
17	3	7	76.9	1902	1885	11.473659	

Bin5 Statistics 8

Trial #	Pulse	Chirp (MHz)	Pulse Width (µS)	Pulse 1-2 spacing (µS)	Pulse 2-3 spacing (µS)	Pulse Start(S)	Detection (1:yes; 0:no)
0	1	12	99	-	-	0.53781	1
1	2	12	78.4	1851	-	1.187687	
2	2	12	75.4	1453	-	1.868509	
3	2	12	69.7	1113	-	3.280452	
4	1	12	62.9	-	-	3.945355	
5	3	12	92.3	1997	1349	4.318807	
6	2	12	69.2	1977	-	5.665778	
7	2	12	68.7	1004	-	6.053673	
8	3	12	74.1	1858	1334	7.476466	
9	2	12	62.6	1929	-	8.476696	
10	2	12	66.2	1488	-	8.762533	
11	2	12	79	1650	-	9.475931	
12	1	12	87.1	-	-	10.328637	
13	3	12	63.2	1809	1729	11.297774	

Bin5 Statistics 9

Trial #	Pulse	Chirp (MHz)	Pulse Width (µS)	Pulse 1-2 spacing (µS)	Pulse 2-3 spacing (µS)	Pulse Start(S)	Detection (1:yes; 0:no)
0	3	7	68.5	1624	1051	0.211599	1
1	2	7	66.1	1168	-	1.128935	
2	2	7	70.3	1612	-	1.438218	
3	1	7	77.7	-	-	2.412363	
4	1	7	82.1	-	-	3.211383	
5	2	7	59.7	1049	-	3.649465	
6	2	7	98.3	1958	-	4.562795	
7	3	7	94.1	1120	1670	4.920099	
8	3	7	96.4	1903	1357	5.366277	
9	2	7	93.8	1258	-	6.206677	
10	3	7	85	1180	1578	6.76659	
11	3	7	58.8	1930	1195	7.556918	
12	1	7	78.5	-	-	8.11389	
13	3	7	81.4	1014	1713	9.092645	
14	2	7	80.4	1107	-	9.492243	
15	1	7	92.2	-	-	10.357938	
16	2	7	89.8	1924	-	11.067335	
17	2	7	53.2	1702	-	11.761178	

Bin5 Statistics 10

Trial #	Pulse	Chirp (MHz)	Pulse Width (µS)	Pulse 1-2 spacing (uS)	Pulse 2-3 spacing (uS)	Pulse Start(S)	Detection (1:yes; 0:no)
0	3	10	94.2	1820	1480	0.412986	1
1	1	10	83.1	-	-	1.453073	
2	2	10	94.8	1006	-	2.499227	
3	3	10	58.1	1277	1482	3.315416	
4	3	10	65.3	1900	1829	4.624999	
5	3	10	75.6	1923	1170	5.052195	
6	1	10	60.9	-	-	6.597457	
7	2	10	96.4	1067	-	7.184771	
8	1	10	74.1	-	-	8.474441	
9	3	10	84.6	1846	1353	9.86964	
10	2	10	61	1830	-	10.805108	
11	3	10	65.2	1826	1414	11.549906	

Bin5 Statistics 11

Trial #	Pulse	Chirp (MHz)	Pulse Width (µS)	Pulse 1-2 spacing (uS)	Pulse 2-3 spacing (uS)	Pulse Start(S)	Detection (1:yes; 0:no)
0	2	9	54.6	1705	-	0.155168	1
1	2	9	61.4	1783	-	1.487375	
2	2	9	64	1724	-	1.824346	
3	2	9	58	1318	-	2.71153	
4	3	9	83.3	1156	1960	3.605462	
5	2	9	50.6	1836	-	4.242809	
6	3	9	51.9	1215	1551	5.140724	
7	3	9	86.9	1013	1154	5.673453	
8	2	9	75.3	1867	-	6.920018	
9	2	9	91.9	1361	-	7.699955	
10	2	9	85.3	1872	-	8.509863	
11	2	9	55.4	1818	-	9.223678	
12	2	9	72.1	1766	-	9.859836	
13	3	9	80.2	1507	1737	10.932316	
14	1	9	68.8	-	-	11.628051	

Bin5 Statistics 12

Trial #	Pulse	Chirp (MHz)	Pulse Width (µS)	Pulse 1-2 spacing (µS)	Pulse 2-3 spacing (µS)	Pulse Start(S)	Detection (1:yes; 0:no)
0	2	18	72.9	1428	-	0.503522	1
1	1	18	72.8	-	-	1.368799	
2	3	18	75.9	1770	1184	2.23069	
3	1	18	54.1	-	-	2.547149	
4	2	18	85.4	1293	-	3.456546	
5	1	18	94.8	-	-	3.831761	
6	2	18	57.4	1674	-	5.053321	
7	2	18	65	1097	-	5.278423	
8	1	18	80.4	-	-	6.456993	
9	2	18	72.9	1999	-	7.043856	
10	1	18	74.7	-	-	8.183234	
11	1	18	61	-	-	8.372653	
12	1	18	89.1	-	-	9.596823	
13	1	18	96.7	-	-	10.393953	
14	2	18	83.7	1326	-	10.926154	
15	2	18	71.2	1204	-	11.680748	

Bin5 Statistics 13

Trial #	Pulse	Chirp (MHz)	Pulse Width (µS)	Pulse 1-2 spacing (µS)	Pulse 2-3 spacing (µS)	Pulse Start(S)	Detection (1:yes; 0:no)
0	1	9	87.5	-	-	0.504809	1
1	2	9	53.4	1091	-	0.691739	
2	2	9	54.7	1912	-	1.90698	
3	2	9	95.7	1950	-	2.260278	
4	1	9	82.1	-	-	3.292747	
5	2	9	80.5	1948	-	3.568298	
6	2	9	53.7	1193	-	4.569824	
7	2	9	74	1998	-	5.249629	
8	2	9	85	1480	-	5.67833	
9	2	9	69.9	1671	-	6.50869	
10	3	9	83.2	1410	1802	7.229322	
11	2	9	87	1466	-	7.640344	
12	1	9	65.4	-	-	8.195981	
13	3	9	81.9	1384	1907	9.30953	
14	2	9	65.1	1310	-	9.561274	
15	3	9	71.9	1001	1626	10.654556	
16	2	9	76.3	1988	-	10.925519	
17	1	9	95.2	-	-	11.881646	

Bin5 Statistics 14

Trial #	Pulse	Chirp (MHz)	Pulse Width (µS)	Pulse 1-2 spacing (µS)	Pulse 2-3 spacing (µS)	Pulse Start(S)	Detection (1:yes; 0:no)
0	1	9	90.1	-	-	0.55668	1
1	3	9	77.8	1177	1174	0.736337	
2	2	9	64.4	1254	-	1.545169	
3	1	9	96.4	-	-	2.313323	
4	1	9	62.8	-	-	2.488719	
5	3	9	91.4	1997	1909	3.446937	
6	2	9	57.2	1987	-	4.05733	
7	2	9	97.6	1013	-	4.544639	
8	2	9	67.2	1315	-	5.06272	
9	2	9	66.4	1959	-	5.475769	
10	2	9	67	1196	-	6.553943	
11	1	9	58.6	-	-	6.867909	
12	1	9	97	-	-	7.60392	
13	2	9	97.2	1614	-	8.139956	
14	3	9	90.4	1322	1488	8.83326	
15	2	9	50.2	1645	-	9.105959	
16	3	9	69.8	1972	1262	9.885528	
17	2	9	83.1	1094	-	10.783884	
18	2	9	73.7	1499	-	11.117482	
19	3	9	88	1882	1881	11.425883	

Bin5 Statistics 15

Trial #	Pulse	Chirp (MHz)	Pulse Width (µS)	Pulse 1-2 spacing (µS)	Pulse 2-3 spacing (µS)	Pulse Start(S)	Detection (1:yes; 0:no)
0	1	13	66.6	-	-	0.663913	1
1	1	13	73.8	-	-	1.042842	
2	1	13	53.6	-	-	1.859052	
3	1	13	88.8	-	-	2.264826	
4	2	13	74.6	1589	-	3.134987	
5	2	13	51.3	1553	-	3.969384	
6	3	13	83.1	1619	1187	4.73546	
7	2	13	85.8	1560	-	5.588787	
8	2	13	75.2	1548	-	6.390441	
9	1	13	62.2	-	-	7.272434	
10	1	13	83.9	-	-	8.182116	
11	2	13	89.2	1513	-	8.880729	
12	1	13	50.1	-	-	9.234268	
13	1	13	82.4	-	-	10.337186	
14	2	13	85.8	1015	-	10.891909	
15	2	13	78.9	1471	-	11.289525	

Bin5 Statistics 16

Trial #	Pulse	Chirp (MHz)	Pulse Width (µS)	Pulse 1-2 spacing (uS)	Pulse 2-3 spacing (uS)	Pulse Start(S)	Detection (1:yes; 0:no)
0	3	17	98.3	1845	1411	0.636684	1
1	1	17	71.3	-	-	1.250548	
2	2	17	57.1	1807	-	2.105997	
3	1	17	99.4	-	-	2.759252	
4	3	17	62.8	1216	1714	3.032525	
5	3	17	81.8	1874	1210	4.05267	
6	3	17	75.3	1903	1620	4.798565	
7	1	17	62.9	-	-	5.490051	
8	1	17	79.6	-	-	6.628919	
9	2	17	63.3	1666	-	7.400247	
10	1	17	70.9	-	-	7.759872	
11	1	17	70.9	-	-	8.703654	
12	3	17	80.6	1346	1627	9.451158	
13	1	17	85.1	-	-	10.210244	
14	1	17	66	-	-	11.027793	
15	2	17	73.5	1926	-	11.628338	

Bin5 Statistics 17

Trial #	Pulse	Chirp (MHz)	Pulse Width (µS)	Pulse 1-2 spacing (uS)	Pulse 2-3 spacing (uS)	Pulse Start(S)	Detection (1:yes; 0:no)
0	2	7	78.6	1986	-	0.099321	1
1	1	7	83.6	-	-	1.161251	
2	1	7	90.9	-	-	2.641266	
3	2	7	82.3	1081	-	3.25231	
4	3	7	86.9	1561	1500	4.417535	
5	3	7	58.8	1360	1831	5.060798	
6	2	7	55.2	1481	-	5.809726	
7	3	7	65.3	1210	1042	6.888049	
8	3	7	69.6	1534	1855	7.494367	
9	2	7	93.6	1823	-	8.522076	
10	1	7	83.7	-	-	10.036343	
11	1	7	98.6	-	-	10.412528	
12	2	7	98	1278	-	11.504231	

Bin5 Statistics 18

Trial #	Pulse	Chirp (MHz)	Pulse Width (µS)	Pulse 1-2 spacing (uS)	Pulse 2-3 spacing (uS)	Pulse Start(S)	Detection (1:yes; 0:no)
0	2	14	75.1	1047	-	0.380997	1
1	1	14	77.5	-	-	1.32073	
2	1	14	83.5	-	-	2.570575	
3	3	14	97.4	1712	1262	4.022241	
4	2	14	71.9	1476	-	5.28152	
5	3	14	84.2	1971	1045	6.179593	
6	2	14	81.9	1857	-	7.38732	
7	2	14	71.7	1709	-	9.182189	
8	3	14	76.8	1798	1928	10.523947	
9	1	14	93	-	-	11.732149	

Bin5 Statistics 19

Trial #	Pulse	Chirp (MHz)	Pulse Width (µS)	Pulse 1-2 spacing (uS)	Pulse 2-3 spacing (uS)	Pulse Start(S)	Detection (1:yes; 0:no)
0	2	8	97	1868	-	0.958437	1
1	2	8	61.5	1614	-	1.117207	
2	2	8	88	1472	-	2.107765	
3	2	8	68.8	1879	-	3.276013	
4	2	8	96.1	1848	-	4.487001	
5	2	8	72.3	1684	-	5.580765	
6	2	8	86.8	1004	-	6.101831	
7	2	8	74.7	1760	-	7.667982	
8	3	8	61.8	1397	1391	8.61316	
9	2	8	86.3	1915	-	9.169269	
10	2	8	77.3	1848	-	10.875173	
11	3	8	60.7	1137	1112	11.923401	

Bin5 Statistics 20

Trial #	Pulse	Chirp (MHz)	Pulse Width (µS)	Pulse 1-2 spacing (µS)	Pulse 2-3 spacing (µS)	Pulse Start(S)	Detection (1:yes; 0:no)
0	1	14	82.8	-	-	0.138913	1
1	2	14	68.6	1005	-	1.094014	
2	2	14	85.6	1756	-	2.683222	
3	2	14	56.7	1177	-	3.315569	
4	3	14	56.7	1358	1119	4.277889	
5	1	14	57.8	-	-	5.508265	
6	2	14	63.8	1016	-	6.113072	
7	1	14	83.5	-	-	6.830468	
8	2	14	67.1	1393	-	7.466208	
9	2	14	86	1451	-	9.100178	
10	2	14	59	1418	-	9.505631	
11	2	14	71.4	1977	-	10.215613	
12	1	14	82.2	-	-	11.761845	

Bin5 Statistics 21

Trial #	Pulse	Chirp (MHz)	Pulse Width (µS)	Pulse 1-2 spacing (µS)	Pulse 2-3 spacing (µS)	Pulse Start(S)	Detection (1:yes; 0:no)
0	2	8	69	1236	-	0.091493	1
1	3	8	69.7	1005	1717	1.251086	
2	2	8	78.7	1321	-	1.436773	
3	3	8	56.8	1196	1900	2.179157	
4	2	8	58.7	1147	-	3.154826	
5	1	8	90.1	-	-	3.587391	
6	1	8	58.8	-	-	4.410326	
7	1	8	91.1	-	-	5.559547	
8	2	8	99.1	1238	-	6.0752	
9	2	8	97	1067	-	6.508668	
10	1	8	86.8	-	-	7.350459	
11	2	8	99.1	1043	-	8.321917	
12	1	8	91	-	-	8.90117	
13	1	8	54.8	-	-	9.401961	
14	3	8	74.7	1624	1008	10.164413	
15	2	8	85.8	1781	-	10.678953	
16	1	8	64.7	-	-	11.471852	

Bin5 Statistics 22

Trial #	Pulse	Chirp (MHz)	Pulse Width (µS)	Pulse 1-2 spacing (uS)	Pulse 2-3 spacing (uS)	Pulse Start(S)	Detection (1:yes; 0:no)
0	2	9	94.4	1863	-	0.577027	1
1	3	9	70.1	1731	1195	1.074062	
2	2	9	79.2	1056	-	2.158238	
3	2	9	97.4	1911	-	2.594681	
4	3	9	85	1770	1675	4.228149	
5	1	9	66.3	-	-	4.746838	
6	1	9	64.7	-	-	5.444374	
7	2	9	56.7	1925	-	6.743305	
8	2	9	83	1021	-	7.376956	
9	2	9	77.5	1818	-	8.315151	
10	1	9	60.4	-	-	9.244872	
11	3	9	94.5	1394	1184	10.012297	
12	2	9	83.4	1074	-	11.089832	
13	2	9	57.2	1105	-	11.563281	

Bin5 Statistics 23

Trial #	Pulse	Chirp (MHz)	Pulse Width (µS)	Pulse 1-2 spacing (uS)	Pulse 2-3 spacing (uS)	Pulse Start(S)	Detection (1:yes; 0:no)
0	1	7	59.6	-	-	0.036798	1
1	1	7	90.7	-	-	0.855383	
2	2	7	91.7	1459	-	1.756261	
3	3	7	90.9	1746	1486	2.512053	
4	2	7	52	1904	-	2.585713	
5	2	7	70.6	1010	-	3.26234	
6	3	7	54	1932	1056	4.352825	
7	1	7	90.9	-	-	4.78654	
8	3	7	76.9	1064	1568	5.213578	
9	3	7	58.2	1047	1344	5.804042	
10	3	7	95.3	1645	1886	6.659516	
11	2	7	59.5	1702	-	7.528657	
12	2	7	78.3	1450	-	7.737916	
13	2	7	74.3	1772	-	8.525468	
14	2	7	64.8	1142	-	9.364455	
15	3	7	63.2	1934	1314	10.005293	
16	2	7	70.7	1314	-	10.245014	
17	2	7	73.9	1974	-	10.975691	
18	3	7	99.7	1966	1163	11.981049	

Bin5 Statistics 24

Trial #	Pulse	Chirp (MHz)	Pulse Width (uS)	Pulse 1-2 spacing (uS)	Pulse 2-3 spacing (uS)	Pulse Start(S)	Detection (1:yes; 0:no)
0	2	17	97.5	1931	-	0.325761	1
1	3	17	95.5	1882	1947	1.278034	
2	2	17	57.9	1242	-	2.164612	
3	2	17	75.3	1732	-	2.417492	
4	3	17	50.9	1539	1156	3.705897	
5	2	17	78.7	1971	-	4.575799	
6	2	17	83.3	1798	-	5.3664	
7	2	17	65.1	1763	-	6.120158	
8	2	17	68.4	1199	-	6.49988	
9	2	17	93.3	1215	-	7.626098	
10	2	17	55.1	1730	-	8.273104	
11	2	17	68.3	1436	-	8.956062	
12	1	17	71.8	-	-	9.889299	
13	2	17	53.6	1105	-	11.18878	
14	2	17	67.5	1604	-	11.655484	

Bin5 Statistics 25

Trial #	Pulse	Chirp (MHz)	Pulse Width (uS)	Pulse 1-2 spacing (uS)	Pulse 2-3 spacing (uS)	Pulse Start(S)	Detection (1:yes; 0:no)
0	2	12	56	1229	-	0.333908	1
1	2	12	56.8	1781	-	1.365731	
2	2	12	64.4	1823	-	2.125698	
3	2	12	69.3	1374	-	3.450643	
4	2	12	57.9	1177	-	4.68305	
5	1	12	53.4	-	-	5.778729	
6	3	12	59.1	1495	1285	6.858263	
7	3	12	96.6	1234	1239	7.416826	
8	3	12	82.1	1442	1251	8.942677	
9	1	12	61.5	-	-	9.516117	
10	2	12	50.4	1591	-	10.878074	
11	1	12	55.3	-	-	11.743035	

Bin5 Statistics 26

Trial #	Pulse	Chirp (MHz)	Pulse Width (µS)	Pulse 1-2 spacing (µS)	Pulse 2-3 spacing (µS)	Pulse Start(S)	Detection (1:yes; 0:no)
0	2	7	93.5	1751	-	0.611686	1
1	2	7	53.5	1162	-	1.457979	
2	2	7	85.5	1765	-	2.990119	
3	1	7	81.8	-	-	4.119587	
4	1	7	68.3	-	-	6.57954	
5	3	7	58.8	1416	1015	7.578165	
6	2	7	51.8	1048	-	9.2935	
7	3	7	75.3	1857	1940	9.783523	
8	1	7	90.5	-	-	11.243034	

Bin5 Statistics 27

Trial #	Pulse	Chirp (MHz)	Pulse Width (µS)	Pulse 1-2 spacing (µS)	Pulse 2-3 spacing (µS)	Pulse Start(S)	Detection (1:yes; 0:no)
0	2	16	56.4	1751	-	0.680985	1
1	2	16	57.1	1336	-	0.938258	
2	2	16	62	1870	-	2.072947	
3	1	16	57.6	-	-	2.739003	
4	3	16	85.2	1925	1568	3.673673	
5	2	16	95.2	1609	-	4.144456	
6	2	16	99.7	1065	-	5.061007	
7	2	16	80.7	1338	-	5.960358	
8	1	16	91.9	-	-	6.340649	
9	1	16	58.8	-	-	6.851644	
10	2	16	50.2	1741	-	8.16749	
11	3	16	75.3	1656	1720	8.850863	
12	2	16	63.8	1109	-	9.716714	
13	3	16	74.1	1138	1604	10.309691	
14	2	16	93.9	1043	-	11.010538	
15	2	16	51.4	1520	-	11.313949	

Bin5 Statistics 28

Trial #	Pulse	Chirp (MHz)	Pulse Width (µS)	Pulse 1-2 spacing (µS)	Pulse 2-3 spacing (µS)	Pulse Start(S)	Detection (1:yes; 0:no)
0	1	19	76.4	-	-	1.086719	1
1	2	19	90.3	1065	-	1.825475	
2	3	19	70	1025	1923	4.305294	
3	1	19	65.4	-	-	5.177934	
4	2	19	63.1	1350	-	6.231612	
5	1	19	51	-	-	7.850211	
6	2	19	68	1527	-	10.254116	
7	2	19	71.1	1340	-	11.835676	

Bin5 Statistics 29

Trial #	Pulse	Chirp (MHz)	Pulse Width (µS)	Pulse 1-2 spacing (µS)	Pulse 2-3 spacing (µS)	Pulse Start(S)	Detection (1:yes; 0:no)
0	3	15	95.3	1195	1222	0.514158	1
1	2	15	64.9	1762	-	1.319447	
2	1	15	85.1	-	-	1.869285	
3	3	15	65.2	1342	1763	2.364921	
4	3	15	71.5	1584	1352	3.031422	
5	3	15	62.4	1739	1481	3.985599	
6	1	15	73.3	-	-	4.900609	
7	2	15	55.1	1681	-	5.068397	
8	1	15	70.8	-	-	6.30778	
9	3	15	53.8	1489	1990	7.030541	
10	2	15	66.9	1664	-	7.29788	
11	3	15	59.5	1552	1315	7.986822	
12	2	15	65.6	1249	-	9.11631	
13	2	15	59.5	1386	-	9.735546	
14	2	15	67.6	1923	-	10.221622	
15	2	15	59.4	1174	-	10.899084	
16	2	15	94.6	1486	-	11.910534	

Bin5 Statistics 30

Trial #	Pulse	Chirp (MHz)	Pulse Width (µS)	Pulse 1-2 spacing (uS)	Pulse 2-3 spacing (uS)	Pulse Start(S)	Detection (1:yes; 0:no)
0	2	5	68.5	1392	-	0.105917	1
1	2	5	91.4	1646	-	1.30152	
2	2	5	79.3	1262	-	1.927387	
3	1	5	85.7	-	-	3.623599	
4	3	5	56.4	1863	1208	3.888866	
5	2	5	58.1	1066	-	4.63592	
6	2	5	52	1873	-	5.795781	
7	2	5	95.5	1433	-	7.155794	
8	2	5	70.2	1611	-	7.773385	
9	1	5	89.7	-	-	9.141432	
10	2	5	97.1	1304	-	9.9997	
11	2	5	77.7	1909	-	10.185147	
12	3	5	77.5	1313	1223	11.919517	

Table-6 Radar Type 6 Statistical Performance

Trial #	Fc (MHz)	Pulse /Burst	Pulse Width (μS)	PRI (μs)	Detection (1:yes; 0:no)	Hopping Sequence
1	5510	9	1	333	1	5700.0, 5308.0, 5704.0, 5522.0, 5254.0, 5417.0, 5286.0, 5675.0, 5360.0, 5525.0, 5598.0, 5285.0, 5444.0, 5332.0, 5694.0, 5606.0, 5351.0, 5307.0, 5664.0, 5318.0, 5290.0, 5370.0, 5305.0, 5443.0, 5554.0, 5424.0, 5575.0, 5347.0, 5413.0, 5662.0, 5379.0, 5476.0, 5302.0, 5538.0, 5546.0, 5480.0, 5673.0, 5429.0, 5688.0, 5645.0, 5569.0, 5665.0, 5584.0, 5256.0, 5698.0, 5287.0, 5464.0, 5382.0, 5697.0, 5325.0, 5519.0, 5468.0, 5639.0, 5255.0, 5615.0, 5711.0, 5637.0, 5506.0, 5315.0, 5541.0, 5442.0, 5707.0, 5428.0, 5625.0, 5465.0, 5646.0, 5321.0, 5531.0, 5583.0, 5511.0, 5384.0, 5708.0, 5272.0, 5450.0, 5622.0, 5369.0, 5703.0, 5559.0, 5685.0, 5512.0, 5684.0, 5654.0, 5557.0, 5669.0, 5354.0, 5406.0, 5403.0, 5655.0, 5627.0, 5545.0, 5601.0, 5269.0, 5550.0, 5604.0, 5473.0, 5563.0, 5579.0, 5586.0, 5270.0, 5643.0 (number of hits: 6)
2	5510	9	1	333	1	5640.0, 5437.0, 5493.0, 5450.0, 5590.0, 5432.0, 5594.0, 5474.0, 5302.0, 5269.0, 5284.0, 5352.0, 5531.0, 5371.0, 5408.0, 5250.0, 5633.0, 5449.0, 5433.0, 5684.0, 5664.0, 5280.0, 5648.0, 5573.0, 5393.0, 5343.0, 5686.0, 5261.0, 5446.0, 5562.0, 5268.0, 5307.0, 5497.0, 5288.0, 5533.0, 5290.0, 5593.0, 5646.0, 5520.0, 5553.0, 5267.0, 5616.0, 5321.0, 5660.0, 5341.0, 5265.0, 5600.0, 5694.0, 5576.0, 5367.0, 5589.0, 5712.0, 5479.0, 5554.0, 5514.0, 5579.0, 5330.0, 5315.0, 5602.0, 5253.0, 5435.0, 5473.0, 5509.0, 5631.0, 5374.0, 5492.0, 5532.0, 5537.0, 5264.0, 5586.0, 5699.0, 5606.0, 5721.0, 5666.0, 5296.0, 5337.0, 5282.0, 5475.0, 5635.0, 5596.0, 5546.0, 5377.0, 5270.0, 5289.0, 5273.0, 5585.0, 5391.0, 5642.0, 5654.0, 5342.0, 5703.0, 5383.0, 5422.0, 5331.0, 5723.0, 5459.0, 5363.0, 5327.0, 5630.0, 5510.0 (number of hits: 7)
3	5510	9	1	333	1	5601.0, 5666.0, 5497.0, 5517.0, 5682.0, 5670.0, 5434.0, 5409.0, 5336.0, 5360.0, 5491.0, 5662.0, 5673.0, 5589.0, 5554.0, 5264.0, 5462.0, 5435.0, 5445.0, 5316.0, 5309.0, 5575.0, 5712.0, 5392.0, 5669.0, 5558.0, 5714.0, 5548.0, 5583.0, 5481.0, 5344.0, 5476.0, 5520.0, 5447.0, 5454.0, 5490.0, 5566.0, 5529.0, 5676.0, 5506.0, 5600.0, 5475.0, 5449.0, 5659.0, 5302.0, 5416.0, 5650.0, 5536.0, 5512.0, 5507.0, 5285.0, 5699.0, 5422.0, 5425.0, 5518.0, 5715.0, 5288.0, 5327.0, 5322.0, 5501.0, 5686.0, 5557.0, 5325.0, 5621.0, 5611.0,

						5591.0, 5495.0, 5496.0, 5502.0, 5523.0, 5307.0, 5708.0, 5671.0, 5377.0, 5380.0, 5356.0, 5486.0, 5414.0, 5615.0, 5329.0, 5390.0, 5692.0, 5287.0, 5363.0, 5582.0, 5720.0, 5315.0, 5664.0, 5610.0, 5297.0, 5503.0, 5648.0, 5424.0, 5299.0, 5401.0, 5376.0, 5267.0, 5511.0, 5695.0, 5678.0 (number of hits: 14)
4	5510	9	1	333	1	5445.0, 5314.0, 5453.0, 5556.0, 5268.0, 5716.0, 5539.0, 5463.0, 5692.0, 5678.0, 5342.0, 5308.0, 5256.0, 5376.0, 5387.0, 5474.0, 5366.0, 5339.0, 5409.0, 5668.0, 5433.0, 5583.0, 5432.0, 5560.0, 5384.0, 5439.0, 5580.0, 5681.0, 5296.0, 5694.0, 5647.0, 5705.0, 5721.0, 5333.0, 5686.0, 5356.0, 5496.0, 5273.0, 5530.0, 5404.0, 5538.0, 5637.0, 5491.0, 5609.0, 5660.0, 5663.0, 5389.0, 5298.0, 5431.0, 5418.0, 5406.0, 5326.0, 5403.0, 5379.0, 5466.0, 5257.0, 5685.0, 5565.0, 5391.0, 5553.0, 5362.0, 5544.0, 5614.0, 5402.0, 5328.0, 5605.0, 5606.0, 5662.0, 5521.0, 5329.0, 5479.0, 5382.0, 5429.0, 5604.0, 5360.0, 5578.0, 5455.0, 5337.0, 5492.0, 5378.0, 5449.0, 5290.0, 5383.0, 5327.0, 5364.0, 5519.0, 5654.0, 5709.0, 5489.0, 5608.0, 5607.0, 5708.0, 5286.0, 5359.0, 5675.0, 5532.0, 5505.0, 5450.0, 5653.0, 5558.0 (number of hits: 5)
5	5510	9	1	333	1	5629.0, 5253.0, 5508.0, 5708.0, 5456.0, 5689.0, 5421.0, 5558.0, 5462.0, 5428.0, 5398.0, 5497.0, 5591.0, 5353.0, 5440.0, 5534.0, 5548.0, 5541.0, 5644.0, 5634.0, 5533.0, 5450.0, 5378.0, 5625.0, 5600.0, 5272.0, 5431.0, 5288.0, 5292.0, 5360.0, 5438.0, 5471.0, 5315.0, 5287.0, 5424.0, 5309.0, 5259.0, 5381.0, 5709.0, 5285.0, 5710.0, 5437.0, 5564.0, 5422.0, 5668.0, 5477.0, 5413.0, 5312.0, 5655.0, 5666.0, 5411.0, 5677.0, 5255.0, 5690.0, 5390.0, 5480.0, 5560.0, 5517.0, 5330.0, 5331.0, 5472.0, 5697.0, 5445.0, 5664.0, 5426.0, 5676.0, 5415.0, 5507.0, 5356.0, 5537.0, 5423.0, 5324.0, 5295.0, 5527.0, 5434.0, 5336.0, 5672.0, 5542.0, 5670.0, 5701.0, 5569.0, 5572.0, 5326.0, 5339.0, 5702.0, 5337.0, 5340.0, 5540.0, 5551.0, 5720.0, 5582.0, 5566.0, 5536.0, 5363.0, 5488.0, 5660.0, 5565.0, 5386.0, 5567.0, 5406.0 (number of hits: 5)
6	5510	9	1	333	1	5455.0, 5689.0, 5536.0, 5412.0, 5305.0, 5335.0, 5564.0, 5576.0, 5557.0, 5388.0, 5396.0, 5266.0, 5320.0, 5322.0, 5408.0, 5707.0, 5422.0, 5584.0, 5488.0, 5256.0, 5520.0, 5575.0, 5703.0, 5717.0, 5538.0, 5473.0, 5566.0, 5384.0, 5568.0, 5319.0, 5714.0, 5531.0, 5390.0, 5486.0, 5636.0, 5608.0, 5706.0, 5621.0, 5586.0, 5580.0, 5265.0, 5704.0, 5554.0, 5503.0, 5611.0, 5526.0, 5333.0, 5597.0, 5502.0, 5261.0,

						5282.0, 5678.0, 5271.0, 5405.0, 5314.0, 5307.0, 5358.0, 5416.0, 5693.0, 5544.0, 5312.0, 5540.0, 5492.0, 5287.0, 5625.0, 5519.0, 5444.0, 5675.0, 5417.0, 5482.0, 5286.0, 5698.0, 5370.0, 5578.0, 5655.0, 5723.0, 5338.0, 5364.0, 5521.0, 5485.0, 5366.0, 5399.0, 5670.0, 5699.0, 5351.0, 5705.0, 5691.0, 5606.0, 5601.0, 5291.0, 5537.0, 5512.0, 5397.0, 5487.0, 5381.0, 5411.0, 5499.0, 5432.0, 5365.0, 5582.0 (number of hits: 9)
7	5510	9	1	333	1	5589.0, 5400.0, 5625.0, 5640.0, 5533.0, 5677.0, 5708.0, 5706.0, 5286.0, 5688.0, 5444.0, 5555.0, 5538.0, 5543.0, 5606.0, 5496.0, 5595.0, 5697.0, 5556.0, 5604.0, 5691.0, 5382.0, 5601.0, 5495.0, 5663.0, 5501.0, 5290.0, 5384.0, 5668.0, 5269.0, 5681.0, 5321.0, 5655.0, 5420.0, 5271.0, 5315.0, 5273.0, 5694.0, 5485.0, 5612.0, 5327.0, 5530.0, 5512.0, 5469.0, 5475.0, 5539.0, 5492.0, 5619.0, 5398.0, 5317.0, 5547.0, 5428.0, 5587.0, 5608.0, 5573.0, 5603.0, 5528.0, 5674.0, 5689.0, 5424.0, 5649.0, 5594.0, 5541.0, 5403.0, 5505.0, 5546.0, 5704.0, 5614.0, 5256.0, 5434.0, 5426.0, 5698.0, 5261.0, 5267.0, 5542.0, 5550.0, 5281.0, 5418.0, 5333.0, 5326.0, 5448.0, 5683.0, 5615.0, 5431.0, 5722.0, 5472.0, 5575.0, 5340.0, 5465.0, 5669.0, 5516.0, 5319.0, 5519.0, 5301.0, 5661.0, 5653.0, 5292.0, 5454.0, 5504.0, 5460.0 (number of hits: 9)
8	5510	9	1	333	1	5383.0, 5307.0, 5641.0, 5406.0, 5711.0, 5464.0, 5545.0, 5588.0, 5595.0, 5439.0, 5576.0, 5498.0, 5527.0, 5535.0, 5404.0, 5261.0, 5505.0, 5348.0, 5421.0, 5495.0, 5429.0, 5273.0, 5586.0, 5254.0, 5476.0, 5616.0, 5621.0, 5359.0, 5338.0, 5252.0, 5581.0, 5492.0, 5665.0, 5521.0, 5424.0, 5319.0, 5327.0, 5666.0, 5264.0, 5655.0, 5290.0, 5679.0, 5716.0, 5706.0, 5617.0, 5699.0, 5379.0, 5557.0, 5503.0, 5282.0, 5469.0, 5656.0, 5339.0, 5367.0, 5519.0, 5582.0, 5279.0, 5313.0, 5548.0, 5614.0, 5295.0, 5710.0, 5551.0, 5318.0, 5481.0, 5669.0, 5430.0, 5719.0, 5685.0, 5609.0, 5353.0, 5304.0, 5435.0, 5363.0, 5368.0, 5487.0, 5560.0, 5433.0, 5695.0, 5532.0, 5678.0, 5467.0, 5262.0, 5672.0, 5450.0, 5462.0, 5714.0, 5434.0, 5717.0, 5515.0, 5437.0, 5300.0, 5377.0, 5584.0, 5357.0, 5531.0, 5517.0, 5473.0, 5602.0, 5266.0 (number of hits: 10)
9	5510	9	1	333	1	5296.0, 5706.0, 5722.0, 5495.0, 5584.0, 5384.0, 5449.0, 5250.0, 5326.0, 5604.0, 5683.0, 5460.0, 5676.0, 5550.0, 5386.0, 5663.0, 5637.0, 5513.0, 5329.0, 5665.0, 5276.0, 5411.0, 5719.0, 5563.0, 5694.0, 5378.0, 5469.0, 5564.0, 5578.0, 5374.0, 5558.0, 5487.0, 5459.0, 5678.0, 5568.0,

						5626.0, 5704.0, 5712.0, 5367.0, 5515.0, 5271.0, 5556.0, 5628.0, 5286.0, 5708.0, 5382.0, 5477.0, 5655.0, 5714.0, 5554.0, 5565.0, 5394.0, 5508.0, 5659.0, 5339.0, 5509.0, 5462.0, 5428.0, 5395.0, 5536.0, 5344.0, 5614.0, 5358.0, 5331.0, 5467.0, 5621.0, 5521.0, 5590.0, 5303.0, 5475.0, 5707.0, 5259.0, 5661.0, 5400.0, 5656.0, 5651.0, 5327.0, 5538.0, 5423.0, 5369.0, 5351.0, 5598.0, 5254.0, 5577.0, 5448.0, 5532.0, 5562.0, 5441.0, 5629.0, 5520.0, 5567.0, 5418.0, 5620.0, 5465.0, 5713.0, 5575.0, 5313.0, 5431.0, 5463.0, 5391.0 (number of hits: 7)
10	5510	9	1	333	1	5647.0, 5676.0, 5655.0, 5389.0, 5675.0, 5307.0, 5298.0, 5539.0, 5253.0, 5254.0, 5529.0, 5563.0, 5661.0, 5368.0, 5289.0, 5623.0, 5486.0, 5440.0, 5446.0, 5268.0, 5714.0, 5699.0, 5395.0, 5718.0, 5311.0, 5285.0, 5492.0, 5464.0, 5451.0, 5473.0, 5508.0, 5692.0, 5658.0, 5695.0, 5547.0, 5445.0, 5542.0, 5306.0, 5515.0, 5376.0, 5600.0, 5636.0, 5583.0, 5434.0, 5417.0, 5684.0, 5329.0, 5284.0, 5679.0, 5414.0, 5614.0, 5721.0, 5723.0, 5701.0, 5270.0, 5586.0, 5308.0, 5427.0, 5571.0, 5259.0, 5652.0, 5436.0, 5263.0, 5419.0, 5681.0, 5433.0, 5654.0, 5597.0, 5388.0, 5526.0, 5346.0, 5300.0, 5643.0, 5365.0, 5353.0, 5330.0, 5582.0, 5659.0, 5463.0, 5504.0, 5663.0, 5258.0, 5558.0, 5617.0, 5432.0, 5549.0, 5404.0, 5303.0, 5483.0, 5722.0, 5706.0, 5338.0, 5591.0, 5499.0, 5572.0, 5637.0, 5357.0, 5484.0, 5628.0, 5387.0 (number of hits: 6)
11	5510	9	1	333	1	5482.0, 5654.0, 5630.0, 5440.0, 5717.0, 5444.0, 5640.0, 5485.0, 5513.0, 5277.0, 5394.0, 5327.0, 5432.0, 5547.0, 5554.0, 5273.0, 5362.0, 5546.0, 5340.0, 5426.0, 5280.0, 5515.0, 5643.0, 5255.0, 5405.0, 5697.0, 5333.0, 5481.0, 5415.0, 5373.0, 5523.0, 5259.0, 5298.0, 5441.0, 5556.0, 5714.0, 5710.0, 5397.0, 5510.0, 5636.0, 5475.0, 5719.0, 5314.0, 5663.0, 5569.0, 5465.0, 5391.0, 5423.0, 5504.0, 5469.0, 5454.0, 5455.0, 5684.0, 5589.0, 5677.0, 5610.0, 5600.0, 5520.0, 5591.0, 5384.0, 5268.0, 5564.0, 5541.0, 5611.0, 5467.0, 5334.0, 5642.0, 5575.0, 5524.0, 5284.0, 5466.0, 5712.0, 5271.0, 5651.0, 5272.0, 5626.0, 5540.0, 5555.0, 5296.0, 5599.0, 5295.0, 5456.0, 5349.0, 5681.0, 5562.0, 5678.0, 5708.0, 5625.0, 5375.0, 5722.0, 5293.0, 5590.0, 5263.0, 5254.0, 5646.0, 5694.0, 5313.0, 5286.0, 5325.0, 5359.0 (number of hits: 7)
12	5510	9	1	333	1	5622.0, 5422.0, 5318.0, 5428.0, 5419.0, 5507.0, 5338.0, 5483.0, 5668.0, 5403.0, 5431.0, 5443.0, 5514.0, 5695.0, 5593.0, 5699.0, 5423.0, 5332.0, 5417.0, 5351.0

						5620.0, 5631.0, 5266.0, 5276.0, 5302.0, 5345.0, 5308.0, 5452.0, 5515.0, 5310.0, 5261.0, 5694.0, 5563.0, 5328.0, 5664.0, 5669.0, 5539.0, 5612.0, 5613.0, 5362.0, 5456.0, 5384.0, 5391.0, 5580.0, 5464.0, 5595.0, 5540.0, 5538.0, 5530.0, 5388.0, 5371.0, 5412.0, 5294.0, 5688.0, 5714.0, 5611.0, 5262.0, 5718.0, 5333.0, 5337.0, 5579.0, 5335.0, 5521.0, 5645.0, 5588.0, 5409.0, 5418.0, 5614.0, 5317.0, 5686.0, 5654.0, 5637.0, 5556.0, 5536.0, 5678.0, 5490.0, 5469.0, 5589.0, 5564.0, 5254.0, 5348.0, 5510.0, 5378.0, 5682.0, 5251.0, 5271.0, 5320.0, 5462.0, 5715.0, 5690.0, 5376.0, 5674.0, 5299.0, 5523.0, 5693.0, 5609.0, 5465.0, 5314.0, 5652.0, 5311.0 (number of hits: 6)
13	5510	9	1	333	1	5502.0, 5720.0, 5501.0, 5615.0, 5711.0, 5482.0, 5308.0, 5595.0, 5515.0, 5414.0, 5683.0, 5329.0, 5318.0, 5694.0, 5285.0, 5269.0, 5574.0, 5603.0, 5279.0, 5369.0, 5651.0, 5440.0, 5546.0, 5660.0, 5699.0, 5410.0, 5252.0, 5568.0, 5589.0, 5545.0, 5690.0, 5267.0, 5642.0, 5275.0, 5416.0, 5578.0, 5717.0, 5594.0, 5491.0, 5388.0, 5485.0, 5723.0, 5499.0, 5684.0, 5405.0, 5344.0, 5607.0, 5257.0, 5415.0, 5339.0, 5484.0, 5612.0, 5283.0, 5520.0, 5357.0, 5715.0, 5263.0, 5525.0, 5348.0, 5316.0, 5315.0, 5480.0, 5442.0, 5592.0, 5301.0, 5653.0, 5444.0, 5261.0, 5314.0, 5529.0, 5280.0, 5549.0, 5321.0, 5453.0, 5291.0, 5602.0, 5469.0, 5420.0, 5389.0, 5701.0, 5288.0, 5587.0, 5385.0, 5554.0, 5271.0, 5345.0, 5419.0, 5666.0, 5430.0, 5662.0, 5463.0, 5632.0, 5590.0, 5609.0, 5588.0, 5383.0, 5486.0, 5535.0, 5670.0, 5682.0 (number of hits: 6)
14	5510	9	1	333	1	5437.0, 5587.0, 5715.0, 5588.0, 5460.0, 5268.0, 5339.0, 5398.0, 5670.0, 5384.0, 5475.0, 5548.0, 5613.0, 5517.0, 5711.0, 5285.0, 5586.0, 5528.0, 5358.0, 5388.0, 5366.0, 5281.0, 5690.0, 5664.0, 5696.0, 5549.0, 5575.0, 5271.0, 5563.0, 5303.0, 5335.0, 5685.0, 5698.0, 5440.0, 5719.0, 5527.0, 5559.0, 5319.0, 5421.0, 5316.0, 5492.0, 5675.0, 5408.0, 5407.0, 5507.0, 5474.0, 5363.0, 5361.0, 5683.0, 5449.0, 5401.0, 5599.0, 5417.0, 5717.0, 5632.0, 5346.0, 5630.0, 5578.0, 5580.0, 5660.0, 5426.0, 5508.0, 5412.0, 5393.0, 5272.0, 5530.0, 5471.0, 5646.0, 5595.0, 5457.0, 5513.0, 5439.0, 5414.0, 5350.0, 5429.0, 5360.0, 5582.0, 5304.0, 5629.0, 5658.0, 5529.0, 5256.0, 5423.0, 5370.0, 5609.0, 5397.0, 5623.0, 5509.0, 5714.0, 5427.0, 5602.0, 5352.0, 5661.0, 5456.0, 5585.0, 5347.0, 5462.0, 5436.0, 5467.0, 5702.0 (number of hits: 7)
15	5510	9	1	333	1	5692.0, 5581.0, 5604.0, 5373.0, 5417.0,

						5382.0, 5541.0, 5452.0, 5295.0, 5440.0, 5502.0, 5388.0, 5396.0, 5321.0, 5519.0, 5563.0, 5344.0, 5284.0, 5633.0, 5271.0, 5317.0, 5313.0, 5595.0, 5723.0, 5385.0, 5397.0, 5522.0, 5305.0, 5623.0, 5439.0, 5353.0, 5337.0, 5579.0, 5465.0, 5450.0, 5608.0, 5677.0, 5479.0, 5524.0, 5513.0, 5261.0, 5386.0, 5401.0, 5339.0, 5585.0, 5387.0, 5487.0, 5574.0, 5474.0, 5626.0, 5260.0, 5625.0, 5550.0, 5603.0, 5367.0, 5429.0, 5390.0, 5352.0, 5444.0, 5681.0, 5640.0, 5645.0, 5490.0, 5674.0, 5706.0, 5357.0, 5641.0, 5469.0, 5333.0, 5634.0, 5683.0, 5426.0, 5698.0, 5704.0, 5557.0, 5400.0, 5497.0, 5554.0, 5445.0, 5636.0, 5489.0, 5431.0, 5671.0, 5721.0, 5486.0, 5684.0, 5468.0, 5484.0, 5511.0, 5492.0, 5405.0, 5406.0, 5498.0, 5404.0, 5448.0, 5503.0, 5425.0, 5350.0, 5252.0, 5647.0 (number of hits: 10)
16	5510	9	1	333	1	5522.0, 5398.0, 5385.0, 5565.0, 5546.0, 5555.0, 5342.0, 5254.0, 5319.0, 5513.0, 5631.0, 5311.0, 5452.0, 5465.0, 5520.0, 5290.0, 5361.0, 5662.0, 5400.0, 5333.0, 5283.0, 5521.0, 5680.0, 5554.0, 5620.0, 5277.0, 5692.0, 5651.0, 5596.0, 5336.0, 5265.0, 5677.0, 5425.0, 5309.0, 5703.0, 5433.0, 5364.0, 5675.0, 5583.0, 5503.0, 5416.0, 5537.0, 5709.0, 5345.0, 5678.0, 5474.0, 5390.0, 5275.0, 5505.0, 5469.0, 5352.0, 5508.0, 5455.0, 5510.0, 5294.0, 5556.0, 5329.0, 5498.0, 5509.0, 5387.0, 5564.0, 5558.0, 5578.0, 5516.0, 5273.0, 5686.0, 5453.0, 5609.0, 5669.0, 5427.0, 5349.0, 5379.0, 5288.0, 5417.0, 5634.0, 5632.0, 5626.0, 5705.0, 5429.0, 5393.0, 5404.0, 5606.0, 5359.0, 5629.0, 5714.0, 5532.0, 5300.0, 5612.0, 5657.0, 5423.0, 5667.0, 5260.0, 5645.0, 5278.0, 5271.0, 5535.0, 5658.0, 5501.0, 5282.0, 5418.0 (number of hits: 12)
17	5510	9	1	333	1	5561.0, 5610.0, 5532.0, 5407.0, 5496.0, 5453.0, 5357.0, 5445.0, 5640.0, 5582.0, 5440.0, 5678.0, 5531.0, 5439.0, 5629.0, 5665.0, 5673.0, 5388.0, 5345.0, 5449.0, 5657.0, 5412.0, 5302.0, 5645.0, 5519.0, 5635.0, 5415.0, 5276.0, 5426.0, 5719.0, 5286.0, 5591.0, 5256.0, 5652.0, 5446.0, 5326.0, 5602.0, 5593.0, 5289.0, 5616.0, 5671.0, 5517.0, 5341.0, 5663.0, 5697.0, 5626.0, 5720.0, 5700.0, 5311.0, 5468.0, 5528.0, 5457.0, 5384.0, 5474.0, 5312.0, 5324.0, 5674.0, 5575.0, 5545.0, 5533.0, 5620.0, 5703.0, 5303.0, 5712.0, 5479.0, 5664.0, 5600.0, 5434.0, 5627.0, 5547.0, 5651.0, 5280.0, 5649.0, 5448.0, 5708.0, 5676.0, 5692.0, 5318.0, 5375.0, 5369.0, 5588.0, 5618.0, 5576.0, 5355.0, 5365.0, 5400.0, 5642.0, 5574.0, 5614.0, 5284.0, 5287.0, 5374.0, 5481.0, 5399.0, 5413.0

						5260.0, 5402.0, 5565.0, 5507.0, 5586.0 (number of hits: 4)
18	5510	9	1	333	1	5497.0, 5446.0, 5599.0, 5624.0, 5326.0, 5505.0, 5594.0, 5645.0, 5673.0, 5487.0, 5380.0, 5475.0, 5459.0, 5582.0, 5604.0, 5503.0, 5426.0, 5458.0, 5638.0, 5506.0, 5686.0, 5636.0, 5261.0, 5266.0, 5427.0, 5298.0, 5695.0, 5279.0, 5680.0, 5472.0, 5461.0, 5489.0, 5595.0, 5619.0, 5622.0, 5516.0, 5700.0, 5448.0, 5693.0, 5330.0, 5570.0, 5703.0, 5528.0, 5468.0, 5341.0, 5568.0, 5301.0, 5322.0, 5370.0, 5257.0, 5338.0, 5633.0, 5670.0, 5289.0, 5649.0, 5585.0, 5552.0, 5561.0, 5538.0, 5455.0, 5260.0, 5319.0, 5402.0, 5476.0, 5391.0, 5629.0, 5689.0, 5704.0, 5418.0, 5603.0, 5713.0, 5353.0, 5550.0, 5259.0, 5607.0, 5502.0, 5379.0, 5285.0, 5453.0, 5566.0, 5457.0, 5444.0, 5681.0, 5521.0, 5284.0, 5634.0, 5304.0, 5320.0, 5387.0, 5281.0, 5556.0, 5325.0, 5597.0, 5709.0, 5666.0, 5433.0, 5392.0, 5544.0, 5606.0, 5482.0 (number of hits: 7)
19	5510	9	1	333	1	5342.0, 5436.0, 5491.0, 5575.0, 5453.0, 5260.0, 5640.0, 5687.0, 5382.0, 5477.0, 5536.0, 5370.0, 5416.0, 5383.0, 5315.0, 5281.0, 5494.0, 5578.0, 5485.0, 5709.0, 5560.0, 5606.0, 5517.0, 5426.0, 5442.0, 5483.0, 5367.0, 5499.0, 5584.0, 5380.0, 5712.0, 5594.0, 5256.0, 5411.0, 5401.0, 5635.0, 5353.0, 5390.0, 5633.0, 5688.0, 5312.0, 5443.0, 5295.0, 5463.0, 5293.0, 5648.0, 5368.0, 5532.0, 5489.0, 5464.0, 5614.0, 5645.0, 5604.0, 5501.0, 5481.0, 5468.0, 5678.0, 5319.0, 5612.0, 5701.0, 5496.0, 5653.0, 5706.0, 5488.0, 5520.0, 5716.0, 5661.0, 5639.0, 5583.0, 5379.0, 5504.0, 5329.0, 5279.0, 5484.0, 5702.0, 5253.0, 5502.0, 5385.0, 5359.0, 5685.0, 5490.0, 5525.0, 5294.0, 5626.0, 5530.0, 5576.0, 5599.0, 5388.0, 5657.0, 5597.0, 5650.0, 5427.0, 5593.0, 5441.0, 5519.0, 5616.0, 5369.0, 5551.0, 5554.0, 5478.0 (number of hits: 10)
20	5510	9	1	333	1	5424.0, 5598.0, 5274.0, 5577.0, 5464.0, 5507.0, 5309.0, 5319.0, 5444.0, 5591.0, 5603.0, 5421.0, 5677.0, 5320.0, 5720.0, 5622.0, 5431.0, 5292.0, 5422.0, 5286.0, 5611.0, 5316.0, 5676.0, 5692.0, 5580.0, 5338.0, 5538.0, 5310.0, 5721.0, 5333.0, 5267.0, 5439.0, 5465.0, 5430.0, 5461.0, 5277.0, 5382.0, 5704.0, 5500.0, 5426.0, 5328.0, 5264.0, 5616.0, 5339.0, 5261.0, 5564.0, 5250.0, 5379.0, 5298.0, 5387.0, 5313.0, 5317.0, 5597.0, 5363.0, 5563.0, 5435.0, 5485.0, 5548.0, 5586.0, 5599.0, 5406.0, 5486.0, 5294.0, 5414.0, 5450.0, 5719.0, 5262.0, 5530.0, 5635.0, 5449.0, 5672.0, 5508.0, 5581.0, 5311.0, 5327.0, 5383.0, 5526.0, 5610.0, 5470.0, 5271.0,

						5273.0, 5335.0, 5466.0, 5557.0, 5278.0, 5584.0, 5693.0, 5536.0, 5303.0, 5370.0, 5396.0, 5534.0, 5540.0, 5260.0, 5555.0, 5268.0, 5391.0, 5299.0, 5372.0, 5392.0 (number of hits: 4)
21	5510	9	1	333	1	5459.0, 5461.0, 5713.0, 5285.0, 5422.0, 5426.0, 5668.0, 5334.0, 5373.0, 5673.0, 5551.0, 5353.0, 5349.0, 5570.0, 5263.0, 5434.0, 5531.0, 5483.0, 5706.0, 5561.0, 5448.0, 5490.0, 5630.0, 5626.0, 5327.0, 5268.0, 5278.0, 5494.0, 5586.0, 5711.0, 5658.0, 5363.0, 5299.0, 5532.0, 5564.0, 5663.0, 5393.0, 5512.0, 5348.0, 5253.0, 5441.0, 5508.0, 5415.0, 5362.0, 5409.0, 5279.0, 5328.0, 5485.0, 5712.0, 5618.0, 5652.0, 5344.0, 5590.0, 5472.0, 5669.0, 5724.0, 5319.0, 5576.0, 5289.0, 5703.0, 5473.0, 5495.0, 5649.0, 5467.0, 5449.0, 5250.0, 5615.0, 5522.0, 5404.0, 5634.0, 5550.0, 5288.0, 5384.0, 5542.0, 5307.0, 5378.0, 5465.0, 5464.0, 5309.0, 5517.0, 5413.0, 5479.0, 5661.0, 5659.0, 5607.0, 5581.0, 5410.0, 5696.0, 5686.0, 5511.0, 5680.0, 5574.0, 5536.0, 5340.0, 5454.0, 5584.0, 5452.0, 5496.0, 5672.0, 5656.0 (number of hits: 8)
22	5510	9	1	333	1	5299.0, 5339.0, 5413.0, 5257.0, 5291.0, 5370.0, 5710.0, 5250.0, 5560.0, 5601.0, 5267.0, 5590.0, 5558.0, 5686.0, 5609.0, 5650.0, 5378.0, 5676.0, 5330.0, 5403.0, 5720.0, 5484.0, 5301.0, 5493.0, 5472.0, 5708.0, 5276.0, 5672.0, 5280.0, 5494.0, 5653.0, 5389.0, 5680.0, 5434.0, 5624.0, 5608.0, 5320.0, 5435.0, 5264.0, 5448.0, 5356.0, 5688.0, 5327.0, 5538.0, 5682.0, 5277.0, 5580.0, 5350.0, 5318.0, 5296.0, 5421.0, 5475.0, 5259.0, 5598.0, 5424.0, 5269.0, 5541.0, 5483.0, 5451.0, 5652.0, 5254.0, 5420.0, 5503.0, 5442.0, 5570.0, 5552.0, 5540.0, 5252.0, 5460.0, 5520.0, 5358.0, 5584.0, 5585.0, 5488.0, 5617.0, 5449.0, 5713.0, 5716.0, 5588.0, 5572.0, 5523.0, 5373.0, 5367.0, 5352.0, 5355.0, 5582.0, 5308.0, 5571.0, 5464.0, 5426.0, 5300.0, 5261.0, 5416.0, 5694.0, 5578.0, 5274.0, 5526.0, 5371.0, 5646.0, 5331.0 (number of hits: 6)
23	5510	9	1	333	1	5522.0, 5328.0, 5593.0, 5599.0, 5505.0, 5506.0, 5258.0, 5567.0, 5266.0, 5563.0, 5411.0, 5504.0, 5385.0, 5716.0, 5534.0, 5698.0, 5289.0, 5651.0, 5598.0, 5554.0, 5483.0, 5499.0, 5327.0, 5357.0, 5587.0, 5594.0, 5527.0, 5319.0, 5500.0, 5512.0, 5465.0, 5449.0, 5521.0, 5435.0, 5372.0, 5265.0, 5539.0, 5711.0, 5310.0, 5364.0, 5614.0, 5569.0, 5424.0, 5343.0, 5440.0, 5495.0, 5373.0, 5580.0, 5638.0, 5542.0, 5404.0, 5381.0, 5456.0, 5282.0, 5653.0, 5402.0, 5252.0, 5497.0, 5426.0, 5363.0, 5490.0, 5528.0, 5342.0, 5720.0, 5565.0,

						5545.0, 5656.0, 5281.0, 5611.0, 5661.0, 5300.0, 5287.0, 5531.0, 5683.0, 5686.0, 5335.0, 5600.0, 5326.0, 5639.0, 5434.0, 5324.0, 5713.0, 5617.0, 5388.0, 5487.0, 5320.0, 5351.0, 5399.0, 5477.0, 5547.0, 5419.0, 5341.0, 5347.0, 5344.0, 5553.0, 5681.0, 5468.0, 5723.0, 5298.0, 5696.0 (number of hits: 11)
24	5510	9	1	333	1	5368.0, 5535.0, 5461.0, 5559.0, 5657.0, 5589.0, 5511.0, 5314.0, 5684.0, 5447.0, 5397.0, 5509.0, 5304.0, 5256.0, 5588.0, 5578.0, 5720.0, 5263.0, 5608.0, 5718.0, 5411.0, 5702.0, 5564.0, 5365.0, 5541.0, 5555.0, 5378.0, 5661.0, 5363.0, 5669.0, 5448.0, 5364.0, 5326.0, 5537.0, 5648.0, 5295.0, 5599.0, 5632.0, 5719.0, 5431.0, 5466.0, 5283.0, 5376.0, 5407.0, 5330.0, 5522.0, 5491.0, 5451.0, 5662.0, 5678.0, 5614.0, 5490.0, 5706.0, 5423.0, 5317.0, 5653.0, 5688.0, 5296.0, 5503.0, 5462.0, 5656.0, 5313.0, 5349.0, 5383.0, 5331.0, 5524.0, 5286.0, 5536.0, 5534.0, 5713.0, 5391.0, 5642.0, 5489.0, 5520.0, 5611.0, 5268.0, 5316.0, 5257.0, 5367.0, 5396.0, 5328.0, 5332.0, 5618.0, 5561.0, 5563.0, 5444.0, 5530.0, 5309.0, 5446.0, 5459.0, 5622.0, 5486.0, 5641.0, 5607.0, 5476.0, 5430.0, 5468.0, 5528.0, 5387.0, 5412.0 (number of hits: 6)
25	5510	9	1	333	1	5574.0, 5339.0, 5489.0, 5252.0, 5436.0, 5455.0, 5254.0, 5295.0, 5274.0, 5577.0, 5717.0, 5508.0, 5262.0, 5720.0, 5518.0, 5616.0, 5261.0, 5685.0, 5621.0, 5561.0, 5338.0, 5536.0, 5399.0, 5449.0, 5610.0, 5398.0, 5595.0, 5303.0, 5335.0, 5646.0, 5591.0, 5291.0, 5300.0, 5500.0, 5454.0, 5525.0, 5364.0, 5517.0, 5347.0, 5437.0, 5565.0, 5722.0, 5712.0, 5353.0, 5701.0, 5556.0, 5570.0, 5638.0, 5723.0, 5439.0, 5485.0, 5304.0, 5412.0, 5589.0, 5464.0, 5382.0, 5512.0, 5585.0, 5691.0, 5630.0, 5380.0, 5522.0, 5372.0, 5442.0, 5670.0, 5433.0, 5283.0, 5424.0, 5716.0, 5480.0, 5587.0, 5410.0, 5415.0, 5680.0, 5663.0, 5572.0, 5692.0, 5401.0, 5623.0, 5451.0, 5515.0, 5640.0, 5358.0, 5379.0, 5463.0, 5447.0, 5365.0, 5362.0, 5666.0, 5400.0, 5592.0, 5324.0, 5586.0, 5710.0, 5351.0, 5434.0, 5438.0, 5617.0, 5627.0, 5637.0 (number of hits: 8)
26	5510	9	1	333	1	5338.0, 5304.0, 5518.0, 5497.0, 5560.0, 5333.0, 5511.0, 5457.0, 5544.0, 5667.0, 5491.0, 5648.0, 5532.0, 5412.0, 5716.0, 5342.0, 5521.0, 5265.0, 5287.0, 5564.0, 5541.0, 5257.0, 5502.0, 5328.0, 5616.0, 5391.0, 5404.0, 5308.0, 5378.0, 5527.0, 5305.0, 5484.0, 5523.0, 5430.0, 5270.0, 5535.0, 5448.0, 5365.0, 5329.0, 5644.0, 5548.0, 5555.0, 5420.0, 5434.0, 5577.0, 5668.0, 5719.0, 5517.0, 5326.0, 5650.0,

						5705.0, 5276.0, 5683.0, 5547.0, 5259.0, 5610.0, 5363.0, 5282.0, 5596.0, 5266.0, 5325.0, 5443.0, 5405.0, 5465.0, 5400.0, 5432.0, 5470.0, 5316.0, 5651.0, 5654.0, 5539.0, 5619.0, 5574.0, 5327.0, 5722.0, 5397.0, 5332.0, 5537.0, 5317.0, 5476.0, 5662.0, 5306.0, 5436.0, 5344.0, 5663.0, 5550.0, 5690.0, 5629.0, 5314.0, 5299.0, 5702.0, 5490.0, 5381.0, 5709.0, 5417.0, 5645.0, 5468.0, 5717.0, 5275.0, 5666.0 (number of hits: 8)
27	5510	9	1	333	1	5343.0, 5415.0, 5373.0, 5411.0, 5306.0, 5507.0, 5620.0, 5274.0, 5312.0, 5385.0, 5410.0, 5708.0, 5446.0, 5427.0, 5714.0, 5308.0, 5676.0, 5378.0, 5371.0, 5263.0, 5701.0, 5265.0, 5490.0, 5379.0, 5270.0, 5695.0, 5487.0, 5347.0, 5592.0, 5540.0, 5588.0, 5310.0, 5294.0, 5322.0, 5696.0, 5633.0, 5424.0, 5416.0, 5661.0, 5396.0, 5318.0, 5577.0, 5508.0, 5279.0, 5693.0, 5641.0, 5418.0, 5518.0, 5495.0, 5475.0, 5391.0, 5334.0, 5580.0, 5626.0, 5288.0, 5324.0, 5315.0, 5311.0, 5698.0, 5413.0, 5648.0, 5383.0, 5647.0, 5559.0, 5492.0, 5465.0, 5421.0, 5351.0, 5556.0, 5700.0, 5603.0, 5286.0, 5618.0, 5316.0, 5565.0, 5464.0, 5429.0, 5275.0, 5339.0, 5417.0, 5434.0, 5523.0, 5504.0, 5635.0, 5297.0, 5517.0, 5574.0, 5505.0, 5355.0, 5365.0, 5253.0, 5666.0, 5707.0, 5659.0, 5342.0, 5374.0, 5697.0, 5629.0, 5480.0, 5268.0 (number of hits: 9)
28	5510	9	1	333	1	5342.0, 5402.0, 5616.0, 5436.0, 5672.0, 5382.0, 5428.0, 5635.0, 5503.0, 5624.0, 5554.0, 5393.0, 5501.0, 5670.0, 5584.0, 5708.0, 5510.0, 5485.0, 5283.0, 5292.0, 5444.0, 5408.0, 5459.0, 5496.0, 5303.0, 5606.0, 5409.0, 5681.0, 5374.0, 5434.0, 5615.0, 5252.0, 5431.0, 5324.0, 5476.0, 5543.0, 5678.0, 5617.0, 5421.0, 5449.0, 5608.0, 5379.0, 5329.0, 5345.0, 5652.0, 5504.0, 5412.0, 5621.0, 5437.0, 5572.0, 5487.0, 5665.0, 5312.0, 5579.0, 5631.0, 5285.0, 5287.0, 5269.0, 5698.0, 5641.0, 5657.0, 5555.0, 5514.0, 5540.0, 5611.0, 5719.0, 5626.0, 5707.0, 5446.0, 5481.0, 5653.0, 5470.0, 5471.0, 5697.0, 5357.0, 5619.0, 5414.0, 5677.0, 5714.0, 5591.0, 5359.0, 5605.0, 5467.0, 5627.0, 5398.0, 5535.0, 5494.0, 5456.0, 5522.0, 5298.0, 5454.0, 5266.0, 5300.0, 5286.0, 5700.0, 5253.0, 5644.0, 5310.0, 5278.0, 5439.0 (number of hits: 8)
29	5510	9	1	333	1	5472.0, 5360.0, 5358.0, 5702.0, 5609.0, 5499.0, 5411.0, 5256.0, 5442.0, 5617.0, 5541.0, 5683.0, 5520.0, 5621.0, 5438.0, 5677.0, 5348.0, 5393.0, 5436.0, 5698.0, 5706.0, 5691.0, 5487.0, 5425.0, 5561.0, 5402.0, 5582.0, 5287.0, 5657.0, 5555.0, 5424.0, 5284.0, 5296.0, 5589.0, 5347.0,

						5416.0, 5522.0, 5352.0, 5709.0, 5659.0, 5532.0, 5719.0, 5500.0, 5343.0, 5627.0, 5268.0, 5342.0, 5669.0, 5537.0, 5329.0, 5543.0, 5493.0, 5295.0, 5403.0, 5305.0, 5423.0, 5655.0, 5616.0, 5687.0, 5346.0, 5671.0, 5484.0, 5721.0, 5280.0, 5322.0, 5397.0, 5512.0, 5496.0, 5275.0, 5410.0, 5602.0, 5707.0, 5470.0, 5550.0, 5456.0, 5434.0, 5301.0, 5618.0, 5585.0, 5588.0, 5676.0, 5664.0, 5409.0, 5661.0, 5371.0, 5414.0, 5492.0, 5317.0, 5699.0, 5564.0, 5478.0, 5690.0, 5321.0, 5449.0, 5516.0, 5277.0, 5474.0, 5315.0, 5716.0, 5304.0 (number of hits: 9)
30	5510	9	1	333	1	5399.0, 5523.0, 5448.0, 5487.0, 5639.0, 5626.0, 5545.0, 5383.0, 5479.0, 5429.0, 5527.0, 5404.0, 5696.0, 5690.0, 5431.0, 5618.0, 5338.0, 5470.0, 5428.0, 5477.0, 5478.0, 5421.0, 5512.0, 5253.0, 5268.0, 5289.0, 5363.0, 5497.0, 5540.0, 5329.0, 5358.0, 5270.0, 5664.0, 5300.0, 5416.0, 5447.0, 5343.0, 5461.0, 5287.0, 5290.0, 5547.0, 5670.0, 5584.0, 5476.0, 5597.0, 5434.0, 5566.0, 5460.0, 5354.0, 5706.0, 5464.0, 5525.0, 5654.0, 5710.0, 5575.0, 5716.0, 5475.0, 5679.0, 5579.0, 5650.0, 5648.0, 5715.0, 5694.0, 5674.0, 5623.0, 5705.0, 5295.0, 5308.0, 5271.0, 5291.0, 5691.0, 5544.0, 5713.0, 5582.0, 5386.0, 5659.0, 5583.0, 5496.0, 5471.0, 5430.0, 5446.0, 5673.0, 5516.0, 5501.0, 5585.0, 5542.0, 5723.0, 5511.0, 5344.0, 5510.0, 5632.0, 5432.0, 5602.0, 5708.0, 5369.0, 5375.0, 5330.0, 5463.0, 5637.0, 5302.0 (number of hits: 10)

5530 MHz, 80 MHz Bandwidth

Radar Signal Type	Waveform/Trial Number	Detection (%)	Limit (%)	Pass/Fail
Type 1A/1B	30	100 %	60%	Pass
Type 2	30	80 %	60%	Pass
Type 3	30	73.3 %	60%	Pass
Type 4	30	73.3 %	60%	Pass
Aggregate (Type1 to 4)	120	81.65 %	80%	Pass
Type 5	30	100 %	80%	Pass
Type 6	30	100 %	70%	Pass

Please refer to the following statistical tables:

5530 MHz, 80 MHz Bandwidth**Table-1A/1B Radar Type 1A/1B Statistical Performance**

Trial #	Fc (MHz)	Pulse/Burst	Pulse Width (µS)	PRI (µs)	Detection (1:yes; 0:no)
1	5530	59	1	898	1
2	5530	92	1	578	1
3	5530	67	1	798	1
4	5530	58	1	918	1
5	5530	63	1	838	1
6	5492	78	1	678	1
7	5492	62	1	858	1
8	5492	83	1	638	1
9	5492	68	1	778	1
10	5492	61	1	878	1
11	5568	89	1	598	1
12	5568	86	1	618	1
13	5568	99	1	538	1
14	5568	81	1	658	1
15	5568	76	1	698	1
16	5530	32	1	1671	1
17	5530	23	1	2398	1
18	5530	26	1	2048	1
19	5530	21	1	2580	1
20	5530	30	1	1802	1
21	5492	26	1	2080	1
22	5492	19	1	2903	1
23	5492	22	1	2403	1
24	5492	22	1	2422	1
25	5492	19	1	2866	1
26	5568	44	1	1225	1
27	5568	53	1	1012	1
28	5568	25	1	2199	1
29	5568	42	1	1284	1
30	5568	20	1	2726	1
Detection Percentage: 100 % (>60%)					

Table-2 Radar Type 2 Statistical Performance

Trial #	Fc (MHz)	Pulse/Burst	Pulse Width (µS)	PRI (µs)	Detection (1:yes; 0:no)
1	5530	24	2.5	217	1
2	5530	28	4.7	213	0
3	5530	23	1.2	228	1
4	5530	26	2.5	187	1
5	5530	23	1	217	0
6	5530	23	2.7	169	1
7	5530	24	2.7	187	0
8	5530	26	1	201	1
9	5530	24	4.9	222	1
10	5530	28	1.2	196	1
11	5492	25	1.5	174	1
12	5492	26	4	226	1
13	5492	24	1.2	192	0
14	5492	26	1.6	180	1
15	5492	25	3.8	152	0
16	5492	24	4.2	210	1
17	5492	26	4.1	169	1
18	5492	24	2.3	223	0
19	5492	29	2.9	184	1
20	5492	24	2.8	152	1
21	5568	24	1.9	187	1
22	5568	24	3.5	229	1
23	5568	24	3.3	155	1
24	5568	25	1.5	189	1
25	5568	24	2	175	1
26	5568	26	2.8	183	1
27	5568	27	3.4	196	1
28	5568	28	4.2	220	1
29	5568	25	1.9	159	1
30	5568	28	3.1	204	1
Detection Percentage: 80 % (>60%)					

Table-3 Radar Type 3 Statistical Performance

Trial #	Fc (MHz)	Pulse/Burst	Pulse Width (μS)	PRI (μs)	Detection (1:yes; 0:no)
1	5530	16	7.8	405	1
2	5530	18	7	317	0
3	5530	18	7.3	447	0
4	5530	16	9.8	488	0
5	5530	17	9.8	303	1
6	5530	16	9.7	448	0
7	5530	17	6.7	414	1
8	5530	16	8.5	477	0
9	5530	18	8.3	490	0
10	5530	18	8	475	0
11	5492	18	10	249	1
12	5492	17	8.3	205	0
13	5492	18	7.3	221	1
14	5492	16	8.1	407	1
15	5492	17	8.3	391	1
16	5492	16	6.4	476	1
17	5492	17	8.7	334	1
18	5492	16	7.6	430	1
19	5492	17	7.8	310	1
20	5492	16	8.7	445	1
21	5568	16	8.4	435	1
22	5568	17	8.9	358	1
23	5568	18	9.9	406	1
24	5568	17	8.2	270	1
25	5568	17	8.8	391	1
26	5568	18	7.4	438	1
27	5568	17	7	245	1
28	5568	17	9.8	247	1
29	5568	18	8.6	432	1
30	5568	17	7	347	1
Detection Percentage: 73.3 % (>60%)					

Table-4 Radar Type 4 Statistical Performance

Trial #	Fc (MHz)	Pulse/Burst	Pulse Width (µS)	PRI (µs)	Detection (1:yes; 0:no)
1	5530	13	11.5	498	1
2	5530	16	14.7	483	0
3	5530	15	12.7	402	0
4	5530	14	15.8	218	0
5	5530	15	12.4	254	1
6	5530	13	12.4	274	1
7	5530	13	12.1	310	0
8	5530	16	14.3	226	0
9	5530	13	17.3	317	0
10	5530	14	15.7	479	1
11	5492	15	16.1	315	1
12	5492	15	15.1	256	1
13	5492	15	16.7	355	1
14	5492	16	13.4	429	1
15	5492	16	11.5	328	0
16	5492	13	19.4	234	1
17	5492	16	17.3	233	1
18	5492	16	18.2	461	1
19	5492	16	11.4	497	1
20	5492	15	16.2	428	1
21	5568	16	17.9	308	1
22	5568	16	14.5	294	1
23	5568	13	15.6	349	1
24	5568	12	14.4	228	0
25	5568	13	16.2	478	1
26	5568	12	18.2	221	1
27	5568	13	19.3	360	1
28	5568	16	18.8	388	1
29	5568	15	19.5	381	1
30	5568	13	13.4	492	1
Detection Percentage: 73.3 % (>60%)					

Table-5 Radar Type 5 Statistical Performance

Trial #	Fc (MHz)	Detection (1:yes; 0:no)
1	5530	1
2	5530	1
3	5530	1
4	5530	1
5	5530	1
6	5530	1
7	5530	1
8	5530	1
9	5530	1
10	5530	1
11	5500.0	1
12	5498.8	1
13	5498.0	1
14	5497.6	1
15	5495.2	1
16	5497.6	1
17	5494.4	1
18	5500.0	1
19	5496.0	1
20	5500.0	1
21	5560.8	1
22	5560.0	1
23	5565.2	1
24	5561.6	1
25	5564.4	1
26	5560.4	1
27	5565.6	1
28	5561.2	1
29	5563.2	1
30	5562.4	1
Detection Percentage: 100 % (>80%)		

Bin5 Statistics 1

Trial #	Pulse	Chirp (MHz)	Pulse Width (μ S)	Pulse 1-2 spacing (μ S)	Pulse 2-3 spacing (μ S)	Pulse Start(S)	Detection (1:yes; 0:no)
0	2	8	68.6	1614	-	1.450652	1
1	2	8	82.7	1552	-	2.673598	
2	2	8	53	1625	-	3.738658	
3	1	8	56	-	-	5.981721	
4	3	8	74.7	1663	1509	6.686359	
5	3	8	69.1	1347	1711	7.595714	
6	2	8	91.2	1278	-	10.044604	
7	3	8	78.4	1248	1755	10.671366	

Bin5 Statistics 2

Trial #	Pulse	Chirp (MHz)	Pulse Width (μ S)	Pulse 1-2 spacing (μ S)	Pulse 2-3 spacing (μ S)	Pulse Start(S)	Detection (1:yes; 0:no)
0	2	14	84.6	1773	-	1.020694	1
1	3	14	94.4	1015	1476	1.182574	
2	1	14	67.4	-	-	2.653291	
3	3	14	89.2	1665	1814	3.710473	
4	2	14	99.7	1896	-	5.392511	
5	2	14	52.1	1186	-	6.405865	
6	2	14	96	1734	-	6.786869	
7	1	14	94.5	-	-	7.719003	
8	3	14	67.1	1165	1511	9.632392	
9	1	14	61.3	-	-	10.480031	
10	3	14	66.3	1660	1963	11.672759	

Bin5 Statistics 3

Trial #	Pulse	Chirp (MHz)	Pulse Width (µS)	Pulse 1-2 spacing (uS)	Pulse 2-3 spacing (uS)	Pulse Start(S)	Detection (1:yes; 0:no)
0	3	9	88.6	1028	1006	0.675649	1
1	2	9	55.8	1853	-	1.078311	
2	1	9	87.5	-	-	2.224847	
3	2	9	92.2	1745	-	3.317608	
4	1	9	86.9	-	-	3.561606	
5	2	9	76.6	1325	-	4.690858	
6	2	9	65.3	1010	-	5.985679	
7	3	9	72.8	1986	1908	6.771772	
8	3	9	79	1809	1577	7.144819	
9	1	9	59.6	-	-	8.03276	
10	3	9	74.3	1606	1842	9.41322	
11	2	9	97.9	1929	-	10.018903	
12	1	9	78.9	-	-	10.614941	
13	2	9	77.5	1065	-	11.522535	

Bin5 Statistics 4

Trial #	Pulse	Chirp (MHz)	Pulse Width (µS)	Pulse 1-2 spacing (uS)	Pulse 2-3 spacing (uS)	Pulse Start(S)	Detection (1:yes; 0:no)
0	2	15	54.4	1036	-	0.727651	1
1	1	15	94.4	-	-	2.319688	
2	1	15	76.6	-	-	3.141205	
3	3	15	81.6	1235	1545	3.948262	
4	3	15	99.3	1888	1570	5.629959	
5	1	15	54.1	-	-	6.218617	
6	1	15	72	-	-	7.937533	
7	2	15	87.9	1170	-	9.207941	
8	2	15	83.9	1426	-	9.776094	
9	2	15	72.7	1952	-	11.338418	

Bin5 Statistics 5

Trial #	Pulse	Chirp (MHz)	Pulse Width (µS)	Pulse 1-2 spacing (uS)	Pulse 2-3 spacing (uS)	Pulse Start(S)	Detection (1:yes; 0:no)
0	3	13	69.1	1493	1288	0.563222	1
1	1	13	63.9	-	-	1.716381	
2	1	13	80.9	-	-	1.901433	
3	2	13	81.3	1192	-	3.455833	
4	3	13	51.3	1048	1408	4.137685	
5	2	13	62.1	1368	-	5.104582	
6	1	13	70.1	-	-	5.914631	
7	2	13	97.1	1281	-	6.804108	
8	3	13	87.7	1350	1327	7.811774	
9	1	13	97.1	-	-	8.890844	
10	2	13	77.7	1637	-	9.469029	
11	1	13	71.1	-	-	10.882887	
12	1	13	99.1	-	-	11.196325	

Bin5 Statistics 6

Trial #	Pulse	Chirp (MHz)	Pulse Width (µS)	Pulse 1-2 spacing (uS)	Pulse 2-3 spacing (uS)	Pulse Start(S)	Detection (1:yes; 0:no)
0	3	16	80.6	1922	1636	1.166255	1
1	1	16	69.7	-	-	2.01693	
2	2	16	75.2	1976	-	3.190271	
3	3	16	51.6	1904	1599	4.594803	
4	2	16	82.7	1919	-	6.835318	
5	1	16	90	-	-	8.349474	
6	1	16	64.9	-	-	10.420968	
7	2	16	53.6	1967	-	10.651412	

Bin5 Statistics 7

Trial #	Pulse	Chirp (MHz)	Pulse Width (µS)	Pulse 1-2 spacing (µS)	Pulse 2-3 spacing (µS)	Pulse Start(S)	Detection (1:yes; 0:no)
0	1	12	68	-	-	0.239072	1
1	1	12	87.2	-	-	0.764822	
2	2	12	94.3	1565	-	1.234446	
3	1	12	93.6	-	-	2.264482	
4	1	12	99	-	-	2.884029	
5	1	12	92.2	-	-	3.102398	
6	3	12	68.6	1272	1901	4.119131	
7	2	12	86.5	1555	-	4.306505	
8	2	12	90	1852	-	5.30391	
9	2	12	99.6	1001	-	5.679244	
10	3	12	67.8	1290	1144	6.196462	
11	1	12	81	-	-	6.773921	
12	2	12	79.8	1604	-	7.585383	
13	2	12	79.3	1534	-	8.086395	
14	3	12	53.8	1038	1960	8.595049	
15	2	12	89.4	1978	-	9.500046	
16	3	12	53.1	1558	1144	9.805503	
17	2	12	84.3	1478	-	10.299585	
18	2	12	66.1	1496	-	11.362598	
19	2	12	52.9	1580	-	11.569584	

Bin5 Statistics 8

Trial #	Pulse	Chirp (MHz)	Pulse Width (µS)	Pulse 1-2 spacing (µS)	Pulse 2-3 spacing (µS)	Pulse Start(S)	Detection (1:yes; 0:no)
0	2	7	93.1	1456	-	0.712863	1
1	2	7	89.4	1974	-	2.103141	
2	1	7	74	-	-	3.221879	
3	2	7	58	1894	-	3.591044	
4	2	7	79.1	1824	-	5.407318	
5	3	7	64.3	1616	1765	5.665882	
6	2	7	79	1099	-	7.377851	
7	2	7	99.4	1835	-	8.155227	
8	1	7	96.6	-	-	9.48979	
9	2	7	53.5	1422	-	10.71323	
10	2	7	50.1	1143	-	11.016837	

Bin5 Statistics 9

Trial #	Pulse	Chirp (MHz)	Pulse Width (µS)	Pulse 1-2 spacing (µS)	Pulse 2-3 spacing (µS)	Pulse Start(S)	Detection (1:yes; 0:no)
0	2	14	89.6	1140	-	0.535654	1
1	2	14	57.3	1319	-	1.01935	
2	2	14	50.5	1954	-	1.331316	
3	2	14	73.7	1556	-	2.078259	
4	3	14	82.9	1971	1677	2.814189	
5	1	14	90.5	-	-	3.695714	
6	2	14	55.7	1789	-	3.970721	
7	2	14	81.7	1644	-	4.688167	
8	1	14	51.2	-	-	5.555072	
9	2	14	60.4	1971	-	5.885569	
10	3	14	57.8	1229	1143	6.717242	
11	3	14	64.7	1538	1396	7.107743	
12	1	14	71.5	-	-	8.022532	
13	2	14	64	1905	-	8.532734	
14	3	14	69.6	1151	1056	9.044973	
15	2	14	54.1	1496	-	9.558046	
16	3	14	56.5	1041	1944	10.485228	
17	3	14	86	1690	1589	11.049602	
18	3	14	57.2	1849	1065	11.847454	

Bin5 Statistics 10

Trial #	Pulse	Chirp (MHz)	Pulse Width (µS)	Pulse 1-2 spacing (µS)	Pulse 2-3 spacing (µS)	Pulse Start(S)	Detection (1:yes; 0:no)
0	2	15	68.4	1696	-	0.289195	1
1	2	15	74.6	1466	-	1.152865	
2	1	15	85.6	-	-	1.357269	
3	2	15	78.6	1532	-	2.446105	
4	2	15	91.2	1341	-	2.810388	
5	2	15	83.9	1421	-	3.979765	
6	2	15	52.8	1974	-	4.312057	
7	2	15	95	1957	-	4.818051	
8	2	15	78.3	1098	-	5.760476	
9	1	15	98.6	-	-	6.243482	
10	2	15	93.1	1728	-	6.940734	
11	2	15	52.5	1335	-	7.414235	
12	1	15	74.3	-	-	8.009842	
13	2	15	96.6	1661	-	8.969773	
14	1	15	53.6	-	-	9.711906	
15	1	15	93	-	-	10.463959	
16	2	15	59.6	1872	-	10.714132	
17	2	15	98.3	1434	-	11.753155	

Bin5 Statistics 11

Trial #	Pulse	Chirp (MHz)	Pulse Width (µS)	Pulse 1-2 spacing (uS)	Pulse 2-3 spacing (uS)	Pulse Start(S)	Detection (1:yes; 0:no)
0	2	20	94.3	1730	-	0.097633	1
1	2	20	50.6	1944	-	1.364641	
2	2	20	73.4	1202	-	1.758648	
3	3	20	97.6	1044	1749	2.825028	
4	2	20	58.1	1875	-	3.29899	
5	2	20	77.8	1762	-	4.309056	
6	3	20	59.2	1760	1657	4.71087	
7	2	20	52.2	1996	-	5.508101	
8	3	20	94	1795	1941	6.238606	
9	1	20	51.3	-	-	6.881686	
10	2	20	61.4	1590	-	7.740667	
11	2	20	99.3	1606	-	8.70025	
12	1	20	56.7	-	-	9.608457	
13	2	20	52.4	1575	-	9.888496	
14	1	20	80.4	-	-	11.107251	
15	1	20	96.7	-	-	11.566077	

Bin5 Statistics 12

Trial #	Pulse	Chirp (MHz)	Pulse Width (µS)	Pulse 1-2 spacing (uS)	Pulse 2-3 spacing (uS)	Pulse Start(S)	Detection (1:yes; 0:no)
0	2	17	73.4	1860	-	0.896811	1
1	1	17	60.1	-	-	1.159275	
2	3	17	87.8	1566	1137	2.510067	
3	2	17	57.2	1245	-	3.590467	
4	2	17	62.3	1740	-	4.455986	
5	2	17	59.8	1142	-	5.78914	
6	2	17	90.8	1939	-	7.240059	
7	1	17	98.9	-	-	7.906651	
8	2	17	76	1269	-	9.484514	
9	2	17	81.8	1983	-	10.533284	
10	2	17	65.9	1820	-	11.487809	

Bin5 Statistics 13

Trial #	Pulse	Chirp (MHz)	Pulse Width (µS)	Pulse 1-2 spacing (µS)	Pulse 2-3 spacing (µS)	Pulse Start(S)	Detection (1:yes; 0:no)
0	2	15	72.3	1042	-	0.235927	1
1	2	15	77.2	1213	-	1.63218	
2	2	15	73.5	1143	-	2.901185	
3	2	15	71.1	1897	-	3.584693	
4	2	15	97	1736	-	4.498345	
5	3	15	99.9	1901	1276	5.639708	
6	2	15	92.3	1454	-	6.114549	
7	2	15	87.4	1251	-	7.908074	
8	3	15	64.9	1541	1275	8.258663	
9	3	15	89.8	1254	1055	9.737674	
10	1	15	86.6	-	-	10.884187	
11	1	15	50.3	-	-	11.031764	

Bin5 Statistics 14

Trial #	Pulse	Chirp (MHz)	Pulse Width (µS)	Pulse 1-2 spacing (µS)	Pulse 2-3 spacing (µS)	Pulse Start(S)	Detection (1:yes; 0:no)
0	2	14	87.4	1366	-	0.323491	1
1	2	14	57	1662	-	1.455297	
2	1	14	69.3	-	-	1.733821	
3	2	14	85.3	1705	-	2.62116	
4	2	14	87.6	1437	-	3.758415	
5	1	14	93.9	-	-	4.664101	
6	1	14	60.4	-	-	4.996771	
7	2	14	51.7	1586	-	5.900311	
8	2	14	99.6	1316	-	7.094561	
9	1	14	62.3	-	-	7.378892	
10	2	14	67	1378	-	8.056034	
11	2	14	92	1302	-	9.521911	
12	2	14	54.8	1821	-	10.026796	
13	3	14	85.4	1799	1371	10.638228	
14	2	14	80	1909	-	11.723597	

Bin5 Statistics 15

Trial #	Pulse	Chirp (MHz)	Pulse Width (µS)	Pulse 1-2 spacing (uS)	Pulse 2-3 spacing (uS)	Pulse Start(S)	Detection (1:yes; 0:no)
0	2	8	78.6	1922	-	0.235268	1
1	3	8	79.4	1882	1452	1.21502	
2	2	8	83	1659	-	1.722924	
3	3	8	99	1175	1036	2.346612	
4	2	8	91.1	1798	-	3.55759	
5	3	8	60.5	1551	1142	3.798137	
6	2	8	58.5	1006	-	4.501224	
7	2	8	59	1278	-	5.268088	
8	2	8	82.7	1003	-	6.539987	
9	2	8	96	1426	-	7.056377	
10	1	8	73.6	-	-	8.157232	
11	2	8	72.5	1305	-	8.406969	
12	1	8	88	-	-	9.107256	
13	2	8	56.7	1854	-	9.879015	
14	2	8	99.5	1031	-	11.213883	
15	2	8	72	1623	-	11.467657	

Bin5 Statistics 16

Trial #	Pulse	Chirp (MHz)	Pulse Width (µS)	Pulse 1-2 spacing (uS)	Pulse 2-3 spacing (uS)	Pulse Start(S)	Detection (1:yes; 0:no)
0	2	14	78.4	1809	-	0.185184	1
1	2	14	66.1	1485	-	1.152421	
2	2	14	69.1	1704	-	1.81203	
3	1	14	53.3	-	-	2.019115	
4	3	14	58.6	1299	1621	3.054	
5	2	14	81.8	1086	-	3.489853	
6	1	14	59.4	-	-	4.664244	
7	3	14	75.7	1119	1721	5.194354	
8	2	14	77.1	1936	-	5.976294	
9	1	14	85.6	-	-	6.043342	
10	2	14	70	1164	-	6.767178	
11	2	14	74.3	1042	-	7.939031	
12	2	14	62.2	1884	-	8.521025	
13	1	14	78.2	-	-	8.714755	
14	2	14	98.4	1386	-	9.472038	
15	2	14	68.5	1270	-	10.597109	
16	2	14	60.6	1018	-	11.083827	
17	3	14	88.1	1239	1591	11.386644	

Bin5 Statistics 17

Trial #	Pulse	Chirp (MHz)	Pulse Width (µS)	Pulse 1-2 spacing (uS)	Pulse 2-3 spacing (uS)	Pulse Start(S)	Detection (1:yes; 0:no)
0	2	6	85.1	1566	-	0.684569	1
1	3	6	89.7	1303	1495	1.167619	
2	3	6	98.5	1855	1435	1.692543	
3	1	6	99.7	-	-	3.082651	
4	2	6	76	1346	-	3.761037	
5	3	6	55.5	1579	1709	4.003637	
6	2	6	82.9	1486	-	5.192904	
7	2	6	88.1	1951	-	6.190486	
8	1	6	70	-	-	7.097523	
9	1	6	80.4	-	-	7.259663	
10	1	6	85.1	-	-	8.263931	
11	2	6	88.3	1816	-	8.885039	
12	2	6	58.8	1073	-	10.071584	
13	2	6	59.4	1616	-	10.874346	
14	2	6	76.8	1816	-	11.803376	

Bin5 Statistics 18

Trial #	Pulse	Chirp (MHz)	Pulse Width (µS)	Pulse 1-2 spacing (uS)	Pulse 2-3 spacing (uS)	Pulse Start(S)	Detection (1:yes; 0:no)
0	1	20	95.3	-	-	0.65795	1
1	2	20	78.6	1223	-	1.861421	
2	1	20	51.6	-	-	2.778909	
3	3	20	90.2	1515	1500	4.038532	
4	1	20	91.3	-	-	5.378431	
5	2	20	58.1	1322	-	6.902082	
6	2	20	92.4	1120	-	7.822154	
7	1	20	66.2	-	-	9.025164	
8	2	20	87.2	1792	-	10.023241	
9	2	20	62.9	1143	-	11.61055	

Bin5 Statistics 19

Trial #	Pulse	Chirp (MHz)	Pulse Width (µS)	Pulse 1-2 spacing (uS)	Pulse 2-3 spacing (uS)	Pulse Start(S)	Detection (1:yes; 0:no)
0	3	10	58.1	1407	1857	0.203377	1
1	2	10	80.8	1597	-	1.930693	
2	2	10	60.1	1851	-	3.774579	
3	1	10	72.3	-	-	4.877629	
4	1	10	69.1	-	-	5.700638	
5	1	10	55.9	-	-	7.338477	
6	1	10	95.2	-	-	9.314246	
7	3	10	81.4	1086	1119	10.447258	
8	3	10	74.4	1596	1693	11.836201	

Bin5 Statistics 20

Trial #	Pulse	Chirp (MHz)	Pulse Width (µS)	Pulse 1-2 spacing (uS)	Pulse 2-3 spacing (uS)	Pulse Start(S)	Detection (1:yes; 0:no)
0	1	20	57.2	-	-	0.59605	1
1	2	20	71.6	1604	-	2.145001	
2	3	20	63.3	1087	1656	2.528337	
3	2	20	57.6	1327	-	4.22526	
4	2	20	80.1	1638	-	5.176994	
5	1	20	75.1	-	-	6.716193	
6	2	20	53.4	1966	-	7.698784	
7	2	20	99.9	1746	-	9.246754	
8	3	20	59.8	1711	1290	10.632576	
9	2	20	98.7	1692	-	11.381766	

Bin5 Statistics 21

Trial #	Pulse	Chirp (MHz)	Pulse Width (µS)	Pulse 1-2 spacing (µS)	Pulse 2-3 spacing (µS)	Pulse Start(S)	Detection (1:yes; 0:no)
0	3	18	81.4	1798	1552	0.184481	1
1	3	18	99.3	1123	1422	0.776882	
2	2	18	65.9	1712	-	1.277514	
3	2	18	55.8	1436	-	2.519021	
4	2	18	57.8	1138	-	2.875576	
5	2	18	60.5	1106	-	3.580498	
6	3	18	76.7	1032	1803	4.136406	
7	1	18	88.9	-	-	5.00338	
8	3	18	58.5	1078	1570	5.188929	
9	1	18	91.9	-	-	6.07353	
10	2	18	89.4	1607	-	6.572987	
11	2	18	84.2	1634	-	7.489824	
12	3	18	73.8	1533	1240	7.897604	
13	2	18	68.7	1996	-	8.22949	
14	3	18	64.7	1123	1367	9.102562	
15	1	18	63.7	-	-	9.685974	
16	1	18	55.1	-	-	10.318584	
17	1	18	98.4	-	-	11.278312	
18	2	18	84.9	1269	-	11.811072	

Bin5 Statistics 22

Trial #	Pulse	Chirp (MHz)	Pulse Width (µS)	Pulse 1-2 spacing (µS)	Pulse 2-3 spacing (µS)	Pulse Start(S)	Detection (1:yes; 0:no)
0	1	20	76	-	-	0.602334	1
1	3	20	60.6	1030	1170	1.765912	
2	2	20	93.6	1572	-	2.234009	
3	3	20	97.8	1207	1979	3.519121	
4	1	20	90.2	-	-	5.365757	
5	1	20	82.9	-	-	5.88826	
6	1	20	98.1	-	-	7.616668	
7	3	20	78.1	1913	1231	8.148247	
8	3	20	98.6	1418	1557	8.989263	
9	2	20	73.7	1346	-	10.707776	
10	1	20	80.1	-	-	11.211323	

Bin5 Statistics 23

Trial #	Pulse	Chirp (MHz)	Pulse Width (µS)	Pulse 1-2 spacing (uS)	Pulse 2-3 spacing (uS)	Pulse Start(S)	Detection (1:yes; 0:no)
0	3	7	82.5	1048	1219	0.955319	1
1	1	7	59.8	-	-	1.068302	
2	1	7	77.7	-	-	2.799195	
3	3	7	91.6	1330	1196	3.563159	
4	1	7	62.4	-	-	4.184927	
5	2	7	51.3	1346	-	5.408819	
6	2	7	98.8	1227	-	6.379797	
7	2	7	56.4	1501	-	7.251256	
8	2	7	54.6	1510	-	8.071276	
9	2	7	91.4	1077	-	9.111474	
10	2	7	93.6	1580	-	10.978544	
11	2	7	86	1749	-	11.233546	

Bin5 Statistics 24

Trial #	Pulse	Chirp (MHz)	Pulse Width (µS)	Pulse 1-2 spacing (uS)	Pulse 2-3 spacing (uS)	Pulse Start(S)	Detection (1:yes; 0:no)
0	1	16	88.1	-	-	0.663105	1
1	3	16	92.8	1056	1397	1.592998	
2	3	16	67.2	1150	1053	3.392493	
3	2	16	56.2	1860	-	5.016285	
4	1	16	82.3	-	-	5.612126	
5	2	16	54.2	1223	-	7.963214	
6	2	16	79	1819	-	8.95408	
7	2	16	65.2	1186	-	10.288455	
8	1	16	76.9	-	-	11.308576	

Bin5 Statistics 25

Trial #	Pulse	Chirp (MHz)	Pulse Width (uS)	Pulse 1-2 spacing (uS)	Pulse 2-3 spacing (uS)	Pulse Start(S)	Detection (1:yes; 0:no)
0	1	9	70.1	-	-	0.556597	1
1	2	9	63.4	1237	-	1.359105	
2	3	9	73.8	1395	1976	1.95629	
3	1	9	95.9	-	-	2.846919	
4	2	9	86.7	1853	-	3.467996	
5	1	9	58.7	-	-	4.089631	
6	1	9	91.4	-	-	5.108276	
7	3	9	71.1	1501	1913	5.612818	
8	2	9	78.2	1977	-	6.42263	
9	1	9	94.9	-	-	7.315534	
10	2	9	50.8	1877	-	7.829466	
11	3	9	80	1659	1174	8.54177	
12	1	9	73.9	-	-	9.027742	
13	2	9	62.1	1956	-	10.095584	
14	2	9	73.2	1738	-	10.875902	
15	2	9	98.1	1137	-	11.504656	

Bin5 Statistics 26

Trial #	Pulse	Chirp (MHz)	Pulse Width (uS)	Pulse 1-2 spacing (uS)	Pulse 2-3 spacing (uS)	Pulse Start(S)	Detection (1:yes; 0:no)
0	2	19	70.6	1061	-	0.625022	1
1	3	19	55.8	1029	1324	0.692623	
2	3	19	79.5	1518	1440	1.553549	
3	3	19	56.8	1866	1288	2.430582	
4	1	19	71.3	-	-	2.72084	
5	2	19	67.3	1646	-	3.40832	
6	3	19	67.3	1201	1622	4.625051	
7	2	19	82.4	1354	-	5.131856	
8	2	19	94.2	1877	-	5.521805	
9	2	19	74.7	1844	-	6.348227	
10	1	19	80.4	-	-	6.944798	
11	1	19	53	-	-	7.736875	
12	2	19	74.9	1278	-	8.142672	
13	2	19	92.8	1244	-	8.821737	
14	2	19	72	1783	-	9.400079	
15	1	19	75	-	-	10.657166	
16	3	19	53.5	1160	1040	11.153052	
17	1	19	87.4	-	-	11.991189	

Bin5 Statistics 27

Trial #	Pulse	Chirp (MHz)	Pulse Width (µS)	Pulse 1-2 spacing (uS)	Pulse 2-3 spacing (uS)	Pulse Start(S)	Detection (1:yes; 0:no)
0	2	6	94.2	1424	-	0.207529	1
1	2	6	51.6	1843	-	2.022535	
2	3	6	97.8	1968	1675	3.003994	
3	2	6	76	1950	-	4.071331	
4	3	6	72.9	1308	1014	4.426297	
5	1	6	87.5	-	-	5.660027	
6	2	6	57	1363	-	7.563947	
7	2	6	89.4	1328	-	8.049278	
8	2	6	58.9	1116	-	9.194245	
9	2	6	91.2	1316	-	10.728485	
10	1	6	58.7	-	-	11.411393	

Bin5 Statistics 28

Trial #	Pulse	Chirp (MHz)	Pulse Width (µS)	Pulse 1-2 spacing (uS)	Pulse 2-3 spacing (uS)	Pulse Start(S)	Detection (1:yes; 0:no)
0	2	17	94.9	1845	-	0.104112	1
1	2	17	66.8	1681	-	1.047394	
2	3	17	81.6	1274	1988	1.493779	
3	2	17	82.4	1202	-	2.05107	
4	1	17	80.5	-	-	2.810156	
5	3	17	56.2	1572	1881	3.435339	
6	2	17	79.8	1688	-	4.370628	
7	3	17	70.7	1474	1313	4.939639	
8	2	17	82.7	1593	-	5.595186	
9	2	17	54.9	1198	-	5.964048	
10	2	17	50.1	1054	-	6.648061	
11	1	17	68.5	-	-	7.388556	
12	3	17	95.1	1568	1097	7.584974	
13	1	17	79	-	-	8.355713	
14	2	17	76.9	1340	-	8.998436	
15	1	17	97.7	-	-	9.999118	
16	2	17	79.9	1003	-	10.609701	
17	1	17	84.4	-	-	11.131479	
18	3	17	73.3	1039	1068	11.568049	

Bin5 Statistics 29

Trial #	Pulse	Chirp (MHz)	Pulse Width (µS)	Pulse 1-2 spacing (uS)	Pulse 2-3 spacing (uS)	Pulse Start(S)	Detection (1:yes; 0:no)
0	2	12	50.3	1633	-	0.636005	1
1	2	12	62.4	1555	-	1.094133	
2	2	12	89.2	1628	-	1.883772	
3	2	12	79.1	1575	-	2.802901	
4	3	12	51.3	1446	1896	3.513665	
5	2	12	52.7	1317	-	3.799702	
6	2	12	94.8	1727	-	5.04182	
7	2	12	78.2	1929	-	5.724127	
8	2	12	60	1581	-	6.055251	
9	2	12	56.1	1363	-	7.135824	
10	1	12	60.2	-	-	8.00104	
11	2	12	93.8	1373	-	8.965885	
12	2	12	92.7	1442	-	9.715482	
13	2	12	98.9	1559	-	10.131814	
14	2	12	61.3	1020	-	10.843165	
15	1	12	73.6	-	-	11.899529	

Bin5 Statistics 30

Trial #	Pulse	Chirp (MHz)	Pulse Width (µS)	Pulse 1-2 spacing (uS)	Pulse 2-3 spacing (uS)	Pulse Start(S)	Detection (1:yes; 0:no)
0	2	14	68.4	1313	-	0.166382	1
1	1	14	51.8	-	-	1.132648	
2	1	14	95.6	-	-	1.683961	
3	1	14	95.4	-	-	2.299532	
4	2	14	52.9	1684	-	2.859597	
5	3	14	80.4	1431	1765	3.775446	
6	2	14	55.6	1487	-	3.968014	
7	1	14	79.8	-	-	4.872434	
8	3	14	91.4	1213	1316	5.143935	
9	2	14	61.4	1365	-	6.209799	
10	2	14	97.8	1901	-	6.433087	
11	1	14	95.5	-	-	7.035103	
12	2	14	91.1	1403	-	7.943634	
13	2	14	66.9	1131	-	8.364878	
14	3	14	86.4	1409	1889	9.012955	
15	2	14	59.1	1298	-	9.760891	
16	1	14	93.6	-	-	10.263271	
17	3	14	57.5	1857	1590	11.144341	
18	1	14	76.3	-	-	11.477999	

Table-6 Radar Type 6 Statistical Performance

Trial #	Fc (MHz)	Pulse /Burst	Pulse Width (µS)	PRI (µs)	Detection (1:yes; 0:no)	Hopping Sequence
1	5530	9	1	333	1	5694.0, 5483.0, 5432.0, 5356.0, 5419.0, 5424.0, 5344.0, 5529.0, 5492.0, 5486.0, 5485.0, 5439.0, 5674.0, 5479.0, 5666.0, 5430.0, 5715.0, 5303.0, 5578.0, 5339.0, 5713.0, 5298.0, 5269.0, 5342.0, 5482.0, 5370.0, 5305.0, 5448.0, 5552.0, 5394.0, 5609.0, 5626.0, 5500.0, 5477.0, 5708.0, 5700.0, 5528.0, 5568.0, 5520.0, 5426.0, 5619.0, 5524.0, 5471.0, 5352.0, 5493.0, 5526.0, 5721.0, 5663.0, 5278.0, 5403.0, 5587.0, 5282.0, 5650.0, 5695.0, 5579.0, 5589.0, 5662.0, 5293.0, 5301.0, 5377.0, 5415.0, 5681.0, 5256.0, 5511.0, 5563.0, 5675.0, 5533.0, 5455.0, 5595.0, 5572.0, 5385.0, 5451.0, 5381.0, 5348.0, 5561.0, 5627.0, 5570.0, 5673.0, 5603.0, 5716.0, 5280.0, 5473.0, 5271.0, 5400.0, 5494.0, 5373.0, 5333.0, 5698.0, 5657.0, 5441.0, 5365.0, 5624.0, 5532.0, 5462.0, 5369.0, 5447.0, 5625.0, 5688.0, 5300.0, 5608.0 (number of hits: 15)
2	5530	9	1	333	1	5697.0, 5546.0, 5506.0, 5454.0, 5511.0, 5635.0, 5459.0, 5578.0, 5296.0, 5388.0, 5333.0, 5675.0, 5673.0, 5374.0, 5581.0, 5631.0, 5518.0, 5654.0, 5626.0, 5672.0, 5455.0, 5662.0, 5496.0, 5365.0, 5495.0, 5575.0, 5494.0, 5326.0, 5613.0, 5620.0, 5522.0, 5617.0, 5438.0, 5369.0, 5623.0, 5665.0, 5300.0, 5661.0, 5263.0, 5491.0, 5515.0, 5402.0, 5398.0, 5436.0, 5604.0, 5337.0, 5316.0, 5416.0, 5519.0, 5606.0, 5288.0, 5677.0, 5616.0, 5684.0, 5355.0, 5567.0, 5362.0, 5717.0, 5359.0, 5533.0, 5503.0, 5537.0, 5538.0, 5703.0, 5352.0, 5322.0, 5599.0, 5358.0, 5646.0, 5332.0, 5265.0, 5294.0, 5411.0, 5514.0, 5252.0, 5698.0, 5269.0, 5481.0, 5630.0, 5632.0, 5325.0, 5722.0, 5335.0, 5570.0, 5562.0, 5490.0, 5489.0, 5592.0, 5600.0, 5370.0, 5560.0, 5439.0, 5464.0, 5584.0, 5482.0, 5607.0, 5433.0, 5351.0, 5468.0, 5389.0 (number of hits: 18)
3	5530	9	1	333	1	5364.0, 5475.0, 5440.0, 5384.0, 5443.0, 5566.0, 5633.0, 5435.0, 5256.0, 5446.0, 5508.0, 5250.0, 5653.0, 5412.0, 5547.0, 5379.0, 5269.0, 5374.0, 5311.0, 5723.0, 5559.0, 5535.0, 5562.0, 5358.0, 5479.0, 5333.0, 5434.0, 5601.0, 5582.0, 5315.0, 5568.0, 5428.0, 5580.0, 5710.0, 5587.0, 5514.0, 5607.0, 5635.0, 5573.0, 5551.0, 5285.0, 5258.0, 5663.0, 5406.0, 5390.0, 5418.0, 5282.0, 5480.0, 5492.0, 5617.0, 5324.0, 5655.0, 5703.0, 5303.0, 5489.0, 5595.0, 5253.0, 5515.0, 5474.0, 5458.0, 5410.0, 5631.0, 5424.0, 5451.0, 5400.0

						5616.0, 5388.0, 5298.0, 5513.0, 5439.0, 5467.0, 5375.0, 5265.0, 5505.0, 5585.0, 5651.0, 5425.0, 5423.0, 5642.0, 5332.0, 5350.0, 5521.0, 5630.0, 5584.0, 5520.0, 5532.0, 5445.0, 5565.0, 5444.0, 5598.0, 5495.0, 5605.0, 5693.0, 5615.0, 5570.0, 5680.0, 5277.0, 5579.0, 5523.0, 5618.0 (number of hits: 18)
4	5530	9	1	333	1	5466.0, 5522.0, 5542.0, 5268.0, 5276.0, 5312.0, 5621.0, 5380.0, 5357.0, 5366.0, 5448.0, 5391.0, 5670.0, 5478.0, 5689.0, 5415.0, 5551.0, 5360.0, 5569.0, 5389.0, 5529.0, 5365.0, 5295.0, 5526.0, 5552.0, 5379.0, 5409.0, 5480.0, 5521.0, 5408.0, 5308.0, 5433.0, 5562.0, 5513.0, 5508.0, 5479.0, 5602.0, 5638.0, 5611.0, 5279.0, 5495.0, 5284.0, 5655.0, 5472.0, 5642.0, 5251.0, 5488.0, 5261.0, 5556.0, 5707.0, 5250.0, 5654.0, 5700.0, 5677.0, 5696.0, 5318.0, 5403.0, 5431.0, 5399.0, 5534.0, 5281.0, 5674.0, 5351.0, 5641.0, 5702.0, 5548.0, 5662.0, 5712.0, 5561.0, 5393.0, 5459.0, 5286.0, 5493.0, 5377.0, 5502.0, 5311.0, 5694.0, 5298.0, 5713.0, 5370.0, 5639.0, 5593.0, 5432.0, 5416.0, 5708.0, 5334.0, 5290.0, 5624.0, 5302.0, 5364.0, 5443.0, 5504.0, 5310.0, 5285.0, 5550.0, 5455.0, 5506.0, 5630.0, 5266.0, 5392.0 (number of hits: 20)
5	5530	9	1	333	1	5402.0, 5503.0, 5678.0, 5305.0, 5558.0, 5276.0, 5312.0, 5622.0, 5652.0, 5281.0, 5723.0, 5523.0, 5410.0, 5609.0, 5433.0, 5258.0, 5478.0, 5468.0, 5436.0, 5577.0, 5473.0, 5639.0, 5670.0, 5673.0, 5335.0, 5460.0, 5477.0, 5550.0, 5724.0, 5317.0, 5479.0, 5689.0, 5711.0, 5451.0, 5475.0, 5681.0, 5719.0, 5350.0, 5697.0, 5261.0, 5342.0, 5501.0, 5428.0, 5506.0, 5316.0, 5628.0, 5511.0, 5398.0, 5563.0, 5568.0, 5300.0, 5476.0, 5293.0, 5330.0, 5551.0, 5391.0, 5303.0, 5662.0, 5579.0, 5566.0, 5611.0, 5505.0, 5522.0, 5419.0, 5285.0, 5262.0, 5593.0, 5643.0, 5527.0, 5706.0, 5512.0, 5362.0, 5564.0, 5360.0, 5337.0, 5710.0, 5524.0, 5519.0, 5375.0, 5535.0, 5404.0, 5278.0, 5370.0, 5489.0, 5562.0, 5630.0, 5582.0, 5718.0, 5319.0, 5571.0, 5385.0, 5525.0, 5290.0, 5585.0, 5273.0, 5295.0, 5510.0, 5526.0, 5405.0, 5546.0 (number of hits: 23)
6	5530	9	1	333	1	5269.0, 5594.0, 5658.0, 5721.0, 5426.0, 5548.0, 5589.0, 5423.0, 5349.0, 5336.0, 5281.0, 5333.0, 5364.0, 5507.0, 5665.0, 5583.0, 5370.0, 5320.0, 5708.0, 5316.0, 5640.0, 5258.0, 5605.0, 5355.0, 5454.0, 5634.0, 5273.0, 5371.0, 5669.0, 5635.0, 5663.0, 5377.0, 5382.0, 5673.0, 5282.0, 5619.0, 5408.0, 5562.0, 5674.0, 5335.0, 5711.0, 5720.0, 5679.0, 5367.0, 5608.0, 5675.0, 5624.0, 5313.0, 5513.0, 5348.0,

						5263.0, 5369.0, 5362.0, 5489.0, 5681.0, 5366.0, 5716.0, 5581.0, 5524.0, 5545.0, 5453.0, 5590.0, 5311.0, 5557.0, 5618.0, 5421.0, 5709.0, 5272.0, 5487.0, 5257.0, 5615.0, 5255.0, 5660.0, 5689.0, 5565.0, 5251.0, 5279.0, 5354.0, 5260.0, 5697.0, 5491.0, 5666.0, 5427.0, 5490.0, 5686.0, 5620.0, 5422.0, 5668.0, 5683.0, 5296.0, 5645.0, 5482.0, 5542.0, 5390.0, 5636.0, 5383.0, 5495.0, 5259.0, 5626.0, 5299.0 (number of hits: 10)
7	5530	9	1	333	1	5475.0, 5673.0, 5633.0, 5609.0, 5421.0, 5703.0, 5601.0, 5510.0, 5598.0, 5648.0, 5611.0, 5493.0, 5556.0, 5371.0, 5563.0, 5353.0, 5617.0, 5530.0, 5379.0, 5391.0, 5404.0, 5324.0, 5671.0, 5664.0, 5521.0, 5314.0, 5614.0, 5618.0, 5388.0, 5603.0, 5585.0, 5283.0, 5301.0, 5577.0, 5706.0, 5695.0, 5713.0, 5640.0, 5678.0, 5384.0, 5427.0, 5292.0, 5534.0, 5389.0, 5537.0, 5533.0, 5257.0, 5501.0, 5287.0, 5305.0, 5580.0, 5698.0, 5274.0, 5390.0, 5658.0, 5297.0, 5616.0, 5570.0, 5424.0, 5575.0, 5345.0, 5331.0, 5422.0, 5356.0, 5681.0, 5669.0, 5551.0, 5433.0, 5496.0, 5349.0, 5254.0, 5374.0, 5504.0, 5711.0, 5412.0, 5278.0, 5465.0, 5251.0, 5514.0, 5302.0, 5708.0, 5456.0, 5253.0, 5688.0, 5699.0, 5670.0, 5629.0, 5300.0, 5509.0, 5694.0, 5333.0, 5483.0, 5701.0, 5256.0, 5359.0, 5449.0, 5258.0, 5340.0, 5444.0, 5554.0 (number of hits: 16)
8	5530	9	1	333	1	5618.0, 5382.0, 5288.0, 5293.0, 5411.0, 5566.0, 5450.0, 5341.0, 5615.0, 5274.0, 5419.0, 5346.0, 5272.0, 5423.0, 5520.0, 5586.0, 5265.0, 5271.0, 5457.0, 5571.0, 5456.0, 5652.0, 5610.0, 5703.0, 5468.0, 5268.0, 5436.0, 5545.0, 5393.0, 5660.0, 5517.0, 5649.0, 5330.0, 5323.0, 5623.0, 5449.0, 5443.0, 5670.0, 5593.0, 5547.0, 5452.0, 5284.0, 5626.0, 5261.0, 5477.0, 5499.0, 5685.0, 5637.0, 5575.0, 5723.0, 5636.0, 5662.0, 5551.0, 5607.0, 5251.0, 5522.0, 5714.0, 5554.0, 5446.0, 5470.0, 5608.0, 5645.0, 5567.0, 5421.0, 5433.0, 5561.0, 5414.0, 5302.0, 5665.0, 5362.0, 5484.0, 5372.0, 5371.0, 5650.0, 5273.0, 5374.0, 5300.0, 5562.0, 5415.0, 5471.0, 5510.0, 5358.0, 5628.0, 5348.0, 5680.0, 5582.0, 5356.0, 5599.0, 5275.0, 5679.0, 5708.0, 5473.0, 5308.0, 5674.0, 5497.0, 5316.0, 5260.0, 5641.0, 5624.0, 5531.0 (number of hits: 15)
9	5530	9	1	333	1	5603.0, 5527.0, 5515.0, 5411.0, 5293.0, 5323.0, 5508.0, 5385.0, 5595.0, 5539.0, 5610.0, 5636.0, 5613.0, 5322.0, 5676.0, 5419.0, 5579.0, 5267.0, 5547.0, 5623.0, 5266.0, 5455.0, 5256.0, 5599.0, 5706.0, 5668.0, 5482.0, 5538.0, 5644.0, 5526.0, 5641.0, 5276.0, 5628.0, 5686.0, 5535.0

						5397.0, 5663.0, 5721.0, 5649.0, 5622.0, 5444.0, 5437.0, 5433.0, 5400.0, 5602.0, 5374.0, 5368.0, 5617.0, 5568.0, 5461.0, 5551.0, 5666.0, 5310.0, 5529.0, 5499.0, 5467.0, 5557.0, 5307.0, 5513.0, 5563.0, 5299.0, 5517.0, 5273.0, 5325.0, 5525.0, 5601.0, 5409.0, 5331.0, 5401.0, 5360.0, 5660.0, 5701.0, 5597.0, 5646.0, 5253.0, 5716.0, 5384.0, 5514.0, 5585.0, 5705.0, 5519.0, 5440.0, 5357.0, 5351.0, 5593.0, 5578.0, 5675.0, 5457.0, 5264.0, 5584.0, 5707.0, 5336.0, 5334.0, 5611.0, 5665.0, 5629.0, 5287.0, 5306.0, 5345.0, 5518.0 (number of hits: 19)
10	5530	9	1	333	1	5251.0, 5711.0, 5636.0, 5357.0, 5709.0, 5337.0, 5320.0, 5322.0, 5610.0, 5625.0, 5406.0, 5718.0, 5597.0, 5545.0, 5307.0, 5343.0, 5524.0, 5608.0, 5280.0, 5385.0, 5506.0, 5305.0, 5663.0, 5631.0, 5492.0, 5485.0, 5379.0, 5454.0, 5508.0, 5590.0, 5552.0, 5687.0, 5321.0, 5570.0, 5686.0, 5606.0, 5470.0, 5390.0, 5351.0, 5477.0, 5464.0, 5423.0, 5329.0, 5644.0, 5548.0, 5424.0, 5577.0, 5355.0, 5518.0, 5576.0, 5519.0, 5611.0, 5462.0, 5591.0, 5334.0, 5633.0, 5325.0, 5292.0, 5494.0, 5400.0, 5475.0, 5497.0, 5394.0, 5615.0, 5484.0, 5411.0, 5483.0, 5513.0, 5614.0, 5289.0, 5526.0, 5697.0, 5333.0, 5646.0, 5444.0, 5350.0, 5388.0, 5436.0, 5592.0, 5425.0, 5658.0, 5348.0, 5554.0, 5358.0, 5422.0, 5255.0, 5685.0, 5335.0, 5430.0, 5503.0, 5627.0, 5634.0, 5544.0, 5447.0, 5298.0, 5472.0, 5642.0, 5609.0, 5452.0, 5338.0 (number of hits: 16)
11	5530	9	1	333	1	5462.0, 5468.0, 5287.0, 5641.0, 5434.0, 5435.0, 5512.0, 5568.0, 5550.0, 5558.0, 5482.0, 5615.0, 5478.0, 5703.0, 5275.0, 5683.0, 5402.0, 5385.0, 5661.0, 5456.0, 5571.0, 5477.0, 5427.0, 5721.0, 5613.0, 5499.0, 5276.0, 5723.0, 5311.0, 5716.0, 5383.0, 5490.0, 5259.0, 5304.0, 5460.0, 5511.0, 5447.0, 5707.0, 5312.0, 5673.0, 5465.0, 5700.0, 5371.0, 5517.0, 5325.0, 5692.0, 5484.0, 5566.0, 5532.0, 5386.0, 5712.0, 5506.0, 5315.0, 5574.0, 5408.0, 5690.0, 5467.0, 5274.0, 5653.0, 5341.0, 5588.0, 5407.0, 5698.0, 5695.0, 5393.0, 5619.0, 5563.0, 5252.0, 5485.0, 5461.0, 5475.0, 5556.0, 5523.0, 5346.0, 5270.0, 5636.0, 5701.0, 5398.0, 5396.0, 5678.0, 5525.0, 5458.0, 5658.0, 5508.0, 5265.0, 5269.0, 5261.0, 5488.0, 5448.0, 5481.0, 5606.0, 5543.0, 5357.0, 5293.0, 5504.0, 5399.0, 5388.0, 5313.0, 5277.0, 5292.0 (number of hits: 16)
12	5530	9	1	333	1	5675.0, 5723.0, 5672.0, 5522.0, 5285.0, 5581.0, 5525.0, 5388.0, 5670.0, 5513.0, 5376.0, 5364.0, 5475.0, 5251.0, 5570.0, 5425.0, 5315.0, 5588.0, 5409.0, 5684.0,

						5253.0, 5514.0, 5702.0, 5419.0, 5293.0, 5324.0, 5344.0, 5597.0, 5408.0, 5398.0, 5643.0, 5457.0, 5391.0, 5531.0, 5610.0, 5721.0, 5678.0, 5383.0, 5287.0, 5563.0, 5696.0, 5362.0, 5410.0, 5627.0, 5501.0, 5460.0, 5621.0, 5319.0, 5679.0, 5704.0, 5549.0, 5568.0, 5322.0, 5540.0, 5342.0, 5575.0, 5666.0, 5412.0, 5481.0, 5351.0, 5372.0, 5689.0, 5445.0, 5334.0, 5356.0, 5300.0, 5695.0, 5709.0, 5263.0, 5436.0, 5653.0, 5260.0, 5365.0, 5534.0, 5384.0, 5645.0, 5440.0, 5547.0, 5380.0, 5268.0, 5378.0, 5539.0, 5625.0, 5431.0, 5311.0, 5292.0, 5680.0, 5521.0, 5310.0, 5647.0, 5611.0, 5461.0, 5420.0, 5363.0, 5601.0, 5628.0, 5366.0, 5583.0, 5265.0, 5374.0 (number of hits: 13)
13	5530	9	1	333	1	5479.0, 5679.0, 5502.0, 5441.0, 5419.0, 5523.0, 5336.0, 5334.0, 5331.0, 5439.0, 5299.0, 5533.0, 5325.0, 5417.0, 5666.0, 5643.0, 5442.0, 5610.0, 5699.0, 5339.0, 5332.0, 5709.0, 5584.0, 5475.0, 5696.0, 5354.0, 5528.0, 5405.0, 5459.0, 5687.0, 5426.0, 5720.0, 5515.0, 5264.0, 5660.0, 5251.0, 5568.0, 5686.0, 5266.0, 5707.0, 5619.0, 5368.0, 5300.0, 5671.0, 5440.0, 5678.0, 5477.0, 5631.0, 5675.0, 5434.0, 5713.0, 5581.0, 5514.0, 5682.0, 5281.0, 5361.0, 5491.0, 5649.0, 5594.0, 5282.0, 5349.0, 5591.0, 5710.0, 5639.0, 5474.0, 5399.0, 5375.0, 5558.0, 5644.0, 5257.0, 5642.0, 5626.0, 5655.0, 5313.0, 5353.0, 5317.0, 5535.0, 5374.0, 5722.0, 5495.0, 5695.0, 5501.0, 5428.0, 5541.0, 5371.0, 5432.0, 5438.0, 5547.0, 5641.0, 5483.0, 5335.0, 5373.0, 5569.0, 5587.0, 5478.0, 5291.0, 5640.0, 5430.0, 5556.0, 5309.0 (number of hits: 13)
14	5530	9	1	333	1	5411.0, 5412.0, 5581.0, 5393.0, 5641.0, 5639.0, 5371.0, 5652.0, 5397.0, 5279.0, 5446.0, 5465.0, 5421.0, 5535.0, 5507.0, 5637.0, 5496.0, 5509.0, 5500.0, 5266.0, 5479.0, 5269.0, 5329.0, 5445.0, 5541.0, 5710.0, 5636.0, 5563.0, 5622.0, 5549.0, 5574.0, 5439.0, 5295.0, 5621.0, 5351.0, 5530.0, 5554.0, 5360.0, 5601.0, 5643.0, 5692.0, 5543.0, 5645.0, 5649.0, 5679.0, 5584.0, 5540.0, 5260.0, 5640.0, 5533.0, 5460.0, 5395.0, 5413.0, 5448.0, 5389.0, 5454.0, 5631.0, 5443.0, 5588.0, 5398.0, 5698.0, 5330.0, 5646.0, 5474.0, 5467.0, 5352.0, 5458.0, 5520.0, 5377.0, 5625.0, 5473.0, 5616.0, 5623.0, 5556.0, 5583.0, 5277.0, 5288.0, 5340.0, 5553.0, 5546.0, 5278.0, 5603.0, 5346.0, 5382.0, 5290.0, 5560.0, 5431.0, 5575.0, 5667.0, 5483.0, 5402.0, 5521.0, 5548.0, 5604.0, 5250.0, 5362.0, 5611.0, 5610.0, 5537.0, 5367.0 (number of hits: 21)
15	5530	9	1	333	1	5308.0, 5415.0, 5654.0, 5608.0, 5386.0,

						5356.0, 5255.0, 5662.0, 5694.0, 5290.0, 5529.0, 5289.0, 5513.0, 5432.0, 5661.0, 5618.0, 5403.0, 5499.0, 5600.0, 5265.0, 5483.0, 5596.0, 5459.0, 5272.0, 5526.0, 5436.0, 5396.0, 5433.0, 5378.0, 5602.0, 5367.0, 5462.0, 5684.0, 5435.0, 5621.0, 5357.0, 5552.0, 5309.0, 5717.0, 5674.0, 5405.0, 5284.0, 5419.0, 5669.0, 5696.0, 5553.0, 5505.0, 5539.0, 5671.0, 5293.0, 5456.0, 5637.0, 5392.0, 5256.0, 5533.0, 5690.0, 5445.0, 5506.0, 5385.0, 5342.0, 5548.0, 5612.0, 5304.0, 5587.0, 5515.0, 5464.0, 5544.0, 5715.0, 5331.0, 5543.0, 5672.0, 5673.0, 5306.0, 5343.0, 5721.0, 5624.0, 5629.0, 5536.0, 5399.0, 5471.0, 5666.0, 5319.0, 5346.0, 5675.0, 5454.0, 5558.0, 5287.0, 5482.0, 5447.0, 5595.0, 5503.0, 5658.0, 5712.0, 5286.0, 5619.0, 5373.0, 5625.0, 5434.0, 5722.0, 5620.0 (number of hits: 17)
16	5530	9	1	333	1	5449.0, 5423.0, 5321.0, 5552.0, 5664.0, 5638.0, 5334.0, 5563.0, 5600.0, 5482.0, 5283.0, 5656.0, 5285.0, 5596.0, 5461.0, 5553.0, 5587.0, 5284.0, 5603.0, 5602.0, 5363.0, 5450.0, 5291.0, 5702.0, 5300.0, 5719.0, 5359.0, 5708.0, 5477.0, 5649.0, 5660.0, 5529.0, 5428.0, 5452.0, 5459.0, 5626.0, 5611.0, 5427.0, 5551.0, 5710.0, 5413.0, 5464.0, 5441.0, 5473.0, 5555.0, 5425.0, 5393.0, 5522.0, 5401.0, 5306.0, 5436.0, 5419.0, 5467.0, 5557.0, 5513.0, 5256.0, 5432.0, 5707.0, 5457.0, 5570.0, 5383.0, 5681.0, 5678.0, 5460.0, 5663.0, 5294.0, 5493.0, 5701.0, 5605.0, 5397.0, 5486.0, 5348.0, 5655.0, 5440.0, 5673.0, 5292.0, 5584.0, 5510.0, 5298.0, 5278.0, 5559.0, 5456.0, 5345.0, 5617.0, 5336.0, 5706.0, 5519.0, 5414.0, 5303.0, 5661.0, 5712.0, 5715.0, 5458.0, 5387.0, 5266.0, 5504.0, 5582.0, 5317.0, 5711.0, 5447.0 (number of hits: 14)
17	5530	9	1	333	1	5682.0, 5360.0, 5647.0, 5330.0, 5474.0, 5560.0, 5477.0, 5609.0, 5480.0, 5287.0, 5582.0, 5339.0, 5352.0, 5373.0, 5533.0, 5625.0, 5662.0, 5544.0, 5375.0, 5392.0, 5314.0, 5283.0, 5338.0, 5413.0, 5556.0, 5404.0, 5724.0, 5630.0, 5604.0, 5254.0, 5427.0, 5580.0, 5489.0, 5305.0, 5326.0, 5306.0, 5456.0, 5286.0, 5627.0, 5636.0, 5638.0, 5366.0, 5603.0, 5433.0, 5610.0, 5316.0, 5655.0, 5676.0, 5512.0, 5658.0, 5635.0, 5551.0, 5446.0, 5253.0, 5573.0, 5645.0, 5279.0, 5376.0, 5384.0, 5385.0, 5574.0, 5600.0, 5463.0, 5382.0, 5470.0, 5466.0, 5538.0, 5593.0, 5328.0, 5522.0, 5510.0, 5437.0, 5333.0, 5345.0, 5685.0, 5419.0, 5577.0, 5393.0, 5539.0, 5657.0, 5484.0, 5302.0, 5379.0, 5546.0, 5540.0, 5569.0, 5453.0, 5552.0, 5400.0, 5443.0, 5276.0, 5575.0, 5252.0, 5321.0, 5656.0

						5388.0, 5468.0, 5718.0, 5311.0, 5262.0 (number of hits: 13)
18	5530	9	1	333	1	5522.0, 5284.0, 5479.0, 5430.0, 5716.0, 5432.0, 5679.0, 5564.0, 5656.0, 5705.0, 5534.0, 5713.0, 5505.0, 5627.0, 5286.0, 5370.0, 5607.0, 5457.0, 5380.0, 5690.0, 5585.0, 5515.0, 5341.0, 5598.0, 5486.0, 5531.0, 5720.0, 5312.0, 5532.0, 5393.0, 5322.0, 5477.0, 5273.0, 5279.0, 5447.0, 5570.0, 5571.0, 5667.0, 5388.0, 5595.0, 5462.0, 5654.0, 5283.0, 5302.0, 5401.0, 5267.0, 5296.0, 5567.0, 5310.0, 5305.0, 5250.0, 5586.0, 5643.0, 5521.0, 5441.0, 5367.0, 5470.0, 5309.0, 5546.0, 5274.0, 5287.0, 5442.0, 5525.0, 5611.0, 5316.0, 5550.0, 5434.0, 5684.0, 5326.0, 5510.0, 5596.0, 5603.0, 5349.0, 5626.0, 5616.0, 5574.0, 5280.0, 5289.0, 5511.0, 5702.0, 5449.0, 5257.0, 5645.0, 5621.0, 5541.0, 5481.0, 5294.0, 5526.0, 5400.0, 5332.0, 5704.0, 5533.0, 5425.0, 5703.0, 5254.0, 5721.0, 5353.0, 5639.0, 5673.0, 5536.0 (number of hits: 18)
19	5530	9	1	333	1	5646.0, 5293.0, 5588.0, 5713.0, 5415.0, 5629.0, 5666.0, 5632.0, 5254.0, 5549.0, 5490.0, 5622.0, 5478.0, 5449.0, 5448.0, 5561.0, 5619.0, 5446.0, 5365.0, 5270.0, 5512.0, 5570.0, 5268.0, 5511.0, 5288.0, 5483.0, 5529.0, 5350.0, 5306.0, 5467.0, 5351.0, 5627.0, 5721.0, 5276.0, 5671.0, 5631.0, 5550.0, 5336.0, 5682.0, 5477.0, 5709.0, 5567.0, 5267.0, 5439.0, 5533.0, 5498.0, 5702.0, 5453.0, 5569.0, 5661.0, 5705.0, 5301.0, 5537.0, 5489.0, 5431.0, 5501.0, 5387.0, 5594.0, 5421.0, 5323.0, 5591.0, 5476.0, 5681.0, 5539.0, 5469.0, 5394.0, 5436.0, 5311.0, 5644.0, 5606.0, 5445.0, 5296.0, 5289.0, 5578.0, 5382.0, 5667.0, 5542.0, 5428.0, 5516.0, 5534.0, 5371.0, 5545.0, 5706.0, 5339.0, 5405.0, 5593.0, 5358.0, 5596.0, 5314.0, 5683.0, 5500.0, 5259.0, 5426.0, 5514.0, 5400.0, 5685.0, 5701.0, 5716.0, 5541.0, 5386.0 (number of hits: 19)
20	5530	9	1	333	1	5589.0, 5269.0, 5541.0, 5566.0, 5460.0, 5703.0, 5430.0, 5283.0, 5722.0, 5445.0, 5544.0, 5442.0, 5619.0, 5683.0, 5309.0, 5721.0, 5680.0, 5520.0, 5361.0, 5582.0, 5670.0, 5590.0, 5419.0, 5511.0, 5268.0, 5614.0, 5454.0, 5401.0, 5312.0, 5527.0, 5393.0, 5618.0, 5637.0, 5526.0, 5628.0, 5350.0, 5633.0, 5646.0, 5515.0, 5304.0, 5320.0, 5381.0, 5289.0, 5470.0, 5279.0, 5409.0, 5567.0, 5473.0, 5521.0, 5717.0, 5555.0, 5379.0, 5282.0, 5684.0, 5447.0, 5422.0, 5290.0, 5585.0, 5261.0, 5551.0, 5365.0, 5301.0, 5714.0, 5385.0, 5623.0, 5371.0, 5493.0, 5339.0, 5502.0, 5542.0, 5308.0, 5671.0, 5449.0, 5575.0, 5627.0, 5557.0, 5405.0, 5468.0, 5477.0, 5418.0,

						5508.0, 5550.0, 5506.0, 5505.0, 5474.0, 5274.0, 5265.0, 5617.0, 5658.0, 5691.0, 5467.0, 5423.0, 5319.0, 5644.0, 5435.0, 5343.0, 5666.0, 5639.0, 5513.0, 5510.0 (number of hits: 22)
21	5530	9	1	333	1	5553.0, 5371.0, 5677.0, 5461.0, 5418.0, 5634.0, 5667.0, 5285.0, 5716.0, 5723.0, 5545.0, 5423.0, 5622.0, 5512.0, 5435.0, 5261.0, 5604.0, 5572.0, 5303.0, 5331.0, 5721.0, 5623.0, 5329.0, 5557.0, 5627.0, 5321.0, 5642.0, 5253.0, 5555.0, 5446.0, 5491.0, 5661.0, 5521.0, 5637.0, 5351.0, 5715.0, 5280.0, 5413.0, 5360.0, 5682.0, 5538.0, 5492.0, 5453.0, 5666.0, 5342.0, 5676.0, 5349.0, 5497.0, 5611.0, 5252.0, 5305.0, 5257.0, 5445.0, 5598.0, 5509.0, 5504.0, 5263.0, 5483.0, 5607.0, 5382.0, 5618.0, 5304.0, 5410.0, 5608.0, 5625.0, 5584.0, 5365.0, 5345.0, 5569.0, 5379.0, 5444.0, 5436.0, 5476.0, 5539.0, 5395.0, 5671.0, 5355.0, 5633.0, 5267.0, 5561.0, 5352.0, 5681.0, 5290.0, 5508.0, 5348.0, 5315.0, 5392.0, 5260.0, 5610.0, 5270.0, 5513.0, 5485.0, 5464.0, 5587.0, 5601.0, 5559.0, 5496.0, 5386.0, 5641.0, 5487.0 (number of hits: 17)
22	5530	9	1	333	1	5459.0, 5563.0, 5717.0, 5688.0, 5427.0, 5608.0, 5550.0, 5575.0, 5700.0, 5284.0, 5597.0, 5394.0, 5378.0, 5252.0, 5525.0, 5292.0, 5414.0, 5658.0, 5448.0, 5398.0, 5555.0, 5323.0, 5508.0, 5542.0, 5349.0, 5691.0, 5625.0, 5629.0, 5601.0, 5274.0, 5336.0, 5266.0, 5622.0, 5537.0, 5706.0, 5671.0, 5596.0, 5442.0, 5623.0, 5421.0, 5433.0, 5462.0, 5391.0, 5275.0, 5560.0, 5431.0, 5648.0, 5590.0, 5428.0, 5630.0, 5665.0, 5328.0, 5600.0, 5677.0, 5553.0, 5574.0, 5500.0, 5289.0, 5653.0, 5660.0, 5392.0, 5606.0, 5607.0, 5594.0, 5604.0, 5467.0, 5400.0, 5599.0, 5364.0, 5584.0, 5603.0, 5570.0, 5382.0, 5457.0, 5527.0, 5341.0, 5351.0, 5355.0, 5390.0, 5306.0, 5333.0, 5589.0, 5530.0, 5529.0, 5287.0, 5659.0, 5396.0, 5362.0, 5403.0, 5519.0, 5276.0, 5408.0, 5610.0, 5699.0, 5611.0, 5277.0, 5577.0, 5296.0, 5693.0, 5551.0 (number of hits: 15)
23	5530	9	1	333	1	5471.0, 5369.0, 5668.0, 5344.0, 5295.0, 5254.0, 5647.0, 5658.0, 5297.0, 5389.0, 5506.0, 5603.0, 5263.0, 5269.0, 5404.0, 5314.0, 5699.0, 5433.0, 5250.0, 5504.0, 5686.0, 5693.0, 5407.0, 5462.0, 5707.0, 5455.0, 5439.0, 5592.0, 5285.0, 5605.0, 5560.0, 5311.0, 5721.0, 5262.0, 5590.0, 5595.0, 5700.0, 5267.0, 5339.0, 5691.0, 5719.0, 5283.0, 5623.0, 5422.0, 5540.0, 5555.0, 5291.0, 5580.0, 5541.0, 5665.0, 5566.0, 5403.0, 5300.0, 5607.0, 5684.0, 5530.0, 5643.0, 5382.0, 5529.0, 5319.0, 5543.0, 5671.0, 5401.0, 5615.0, 5628.0,

						5593.0, 5287.0, 5474.0, 5354.0, 5411.0, 5641.0, 5714.0, 5666.0, 5451.0, 5567.0, 5364.0, 5440.0, 5553.0, 5396.0, 5652.0, 5373.0, 5432.0, 5286.0, 5341.0, 5526.0, 5604.0, 5483.0, 5565.0, 5459.0, 5383.0, 5579.0, 5316.0, 5490.0, 5355.0, 5417.0, 5260.0, 5614.0, 5509.0, 5366.0, 5536.0 (number of hits: 16)
24	5530	9	1	333	1	5600.0, 5274.0, 5379.0, 5536.0, 5293.0, 5438.0, 5270.0, 5534.0, 5508.0, 5509.0, 5639.0, 5525.0, 5608.0, 5312.0, 5641.0, 5285.0, 5267.0, 5667.0, 5452.0, 5412.0, 5611.0, 5435.0, 5287.0, 5680.0, 5445.0, 5352.0, 5342.0, 5683.0, 5341.0, 5292.0, 5530.0, 5663.0, 5263.0, 5678.0, 5471.0, 5500.0, 5613.0, 5340.0, 5359.0, 5594.0, 5717.0, 5524.0, 5538.0, 5276.0, 5281.0, 5621.0, 5666.0, 5701.0, 5322.0, 5470.0, 5473.0, 5389.0, 5262.0, 5355.0, 5295.0, 5447.0, 5664.0, 5319.0, 5349.0, 5542.0, 5632.0, 5491.0, 5272.0, 5656.0, 5374.0, 5251.0, 5616.0, 5439.0, 5694.0, 5527.0, 5523.0, 5598.0, 5403.0, 5623.0, 5676.0, 5261.0, 5474.0, 5572.0, 5377.0, 5277.0, 5719.0, 5421.0, 5375.0, 5595.0, 5564.0, 5453.0, 5367.0, 5515.0, 5521.0, 5253.0, 5640.0, 5547.0, 5569.0, 5511.0, 5385.0, 5451.0, 5437.0, 5310.0, 5602.0, 5360.0 (number of hits: 17)
25	5530	9	1	333	1	5554.0, 5443.0, 5652.0, 5252.0, 5708.0, 5600.0, 5695.0, 5699.0, 5556.0, 5294.0, 5374.0, 5389.0, 5283.0, 5407.0, 5361.0, 5530.0, 5662.0, 5591.0, 5275.0, 5393.0, 5324.0, 5465.0, 5654.0, 5444.0, 5645.0, 5685.0, 5279.0, 5260.0, 5300.0, 5630.0, 5621.0, 5711.0, 5596.0, 5593.0, 5486.0, 5712.0, 5386.0, 5615.0, 5289.0, 5400.0, 5565.0, 5341.0, 5493.0, 5541.0, 5502.0, 5668.0, 5555.0, 5391.0, 5590.0, 5287.0, 5487.0, 5264.0, 5339.0, 5573.0, 5404.0, 5568.0, 5562.0, 5474.0, 5397.0, 5455.0, 5624.0, 5343.0, 5609.0, 5709.0, 5267.0, 5669.0, 5429.0, 5456.0, 5723.0, 5665.0, 5507.0, 5536.0, 5519.0, 5269.0, 5650.0, 5512.0, 5335.0, 5715.0, 5402.0, 5350.0, 5613.0, 5276.0, 5698.0, 5258.0, 5701.0, 5606.0, 5522.0, 5525.0, 5436.0, 5520.0, 5516.0, 5655.0, 5666.0, 5316.0, 5553.0, 5329.0, 5381.0, 5614.0, 5570.0, 5327.0 (number of hits: 18)
26	5530	9	1	333	1	5296.0, 5703.0, 5343.0, 5554.0, 5441.0, 5528.0, 5253.0, 5449.0, 5651.0, 5286.0, 5291.0, 5573.0, 5668.0, 5575.0, 5708.0, 5612.0, 5543.0, 5537.0, 5271.0, 5434.0, 5288.0, 5468.0, 5420.0, 5606.0, 5685.0, 5551.0, 5687.0, 5540.0, 5602.0, 5488.0, 5671.0, 5455.0, 5581.0, 5437.0, 5409.0, 5481.0, 5422.0, 5426.0, 5585.0, 5650.0, 5659.0, 5427.0, 5680.0, 5451.0, 5469.0, 5297.0, 5460.0, 5533.0, 5558.0, 5473.0,

						5430.0, 5639.0, 5254.0, 5418.0, 5359.0, 5664.0, 5413.0, 5516.0, 5710.0, 5594.0, 5638.0, 5660.0, 5582.0, 5354.0, 5283.0, 5262.0, 5402.0, 5658.0, 5255.0, 5645.0, 5479.0, 5621.0, 5570.0, 5648.0, 5513.0, 5661.0, 5328.0, 5701.0, 5270.0, 5669.0, 5681.0, 5315.0, 5399.0, 5470.0, 5549.0, 5562.0, 5300.0, 5350.0, 5466.0, 5705.0, 5349.0, 5713.0, 5508.0, 5666.0, 5376.0, 5712.0, 5382.0, 5555.0, 5524.0, 5655.0 (number of hits: 15)
27	5530	9	1	333	1	5503.0, 5561.0, 5512.0, 5277.0, 5691.0, 5297.0, 5368.0, 5347.0, 5616.0, 5677.0, 5271.0, 5538.0, 5639.0, 5712.0, 5276.0, 5708.0, 5527.0, 5598.0, 5315.0, 5526.0, 5481.0, 5656.0, 5563.0, 5574.0, 5427.0, 5587.0, 5567.0, 5471.0, 5650.0, 5431.0, 5458.0, 5311.0, 5543.0, 5531.0, 5465.0, 5441.0, 5258.0, 5372.0, 5351.0, 5632.0, 5583.0, 5653.0, 5673.0, 5695.0, 5273.0, 5317.0, 5459.0, 5412.0, 5621.0, 5686.0, 5671.0, 5290.0, 5599.0, 5256.0, 5402.0, 5666.0, 5436.0, 5361.0, 5306.0, 5371.0, 5387.0, 5282.0, 5647.0, 5281.0, 5476.0, 5585.0, 5327.0, 5701.0, 5536.0, 5349.0, 5303.0, 5692.0, 5461.0, 5678.0, 5506.0, 5455.0, 5700.0, 5642.0, 5307.0, 5511.0, 5270.0, 5474.0, 5581.0, 5603.0, 5384.0, 5537.0, 5690.0, 5286.0, 5268.0, 5659.0, 5395.0, 5549.0, 5434.0, 5419.0, 5496.0, 5550.0, 5352.0, 5628.0, 5556.0, 5607.0 (number of hits: 18)
28	5530	9	1	333	1	5388.0, 5310.0, 5287.0, 5380.0, 5664.0, 5366.0, 5555.0, 5544.0, 5297.0, 5356.0, 5331.0, 5448.0, 5674.0, 5281.0, 5705.0, 5261.0, 5429.0, 5496.0, 5680.0, 5291.0, 5399.0, 5548.0, 5392.0, 5515.0, 5691.0, 5583.0, 5606.0, 5305.0, 5629.0, 5311.0, 5374.0, 5572.0, 5441.0, 5718.0, 5278.0, 5722.0, 5337.0, 5582.0, 5546.0, 5663.0, 5343.0, 5411.0, 5618.0, 5268.0, 5451.0, 5340.0, 5332.0, 5391.0, 5598.0, 5446.0, 5523.0, 5561.0, 5455.0, 5273.0, 5330.0, 5426.0, 5398.0, 5584.0, 5615.0, 5371.0, 5508.0, 5333.0, 5557.0, 5364.0, 5533.0, 5626.0, 5264.0, 5542.0, 5303.0, 5402.0, 5589.0, 5509.0, 5372.0, 5347.0, 5387.0, 5257.0, 5644.0, 5276.0, 5468.0, 5608.0, 5282.0, 5512.0, 5547.0, 5616.0, 5651.0, 5263.0, 5549.0, 5290.0, 5327.0, 5482.0, 5636.0, 5308.0, 5357.0, 5381.0, 5378.0, 5513.0, 5669.0, 5560.0, 5708.0, 5612.0 (number of hits: 18)
29	5530	9	1	333	1	5509.0, 5332.0, 5474.0, 5314.0, 5568.0, 5256.0, 5613.0, 5251.0, 5331.0, 5512.0, 5358.0, 5315.0, 5661.0, 5427.0, 5373.0, 5633.0, 5650.0, 5301.0, 5261.0, 5354.0, 5655.0, 5454.0, 5663.0, 5487.0, 5552.0, 5363.0, 5441.0, 5496.0, 5456.0, 5413.0, 5665.0, 5688.0, 5294.0, 5277.0, 5339.0

						5367.0, 5388.0, 5272.0, 5682.0, 5545.0, 5539.0, 5308.0, 5417.0, 5285.0, 5258.0, 5360.0, 5543.0, 5338.0, 5642.0, 5289.0, 5478.0, 5415.0, 5603.0, 5626.0, 5300.0, 5685.0, 5573.0, 5316.0, 5718.0, 5403.0, 5268.0, 5365.0, 5279.0, 5602.0, 5667.0, 5394.0, 5369.0, 5511.0, 5637.0, 5680.0, 5489.0, 5344.0, 5706.0, 5502.0, 5638.0, 5359.0, 5260.0, 5574.0, 5401.0, 5597.0, 5702.0, 5453.0, 5575.0, 5371.0, 5439.0, 5400.0, 5636.0, 5295.0, 5553.0, 5587.0, 5612.0, 5253.0, 5337.0, 5534.0, 5525.0, 5588.0, 5707.0, 5286.0, 5460.0, 5557.0 (number of hits: 13)
30	5530	9	1	333	1	5343.0, 5404.0, 5675.0, 5513.0, 5382.0, 5647.0, 5336.0, 5260.0, 5516.0, 5335.0, 5401.0, 5314.0, 5690.0, 5504.0, 5501.0, 5292.0, 5344.0, 5526.0, 5431.0, 5389.0, 5636.0, 5676.0, 5604.0, 5693.0, 5547.0, 5492.0, 5316.0, 5277.0, 5384.0, 5253.0, 5453.0, 5564.0, 5612.0, 5723.0, 5721.0, 5267.0, 5520.0, 5339.0, 5458.0, 5411.0, 5565.0, 5671.0, 5566.0, 5461.0, 5402.0, 5299.0, 5616.0, 5321.0, 5463.0, 5289.0, 5407.0, 5561.0, 5656.0, 5711.0, 5633.0, 5666.0, 5603.0, 5713.0, 5334.0, 5255.0, 5688.0, 5685.0, 5515.0, 5400.0, 5357.0, 5646.0, 5409.0, 5275.0, 5337.0, 5486.0, 5414.0, 5308.0, 5284.0, 5451.0, 5580.0, 5471.0, 5610.0, 5665.0, 5457.0, 5469.0, 5350.0, 5552.0, 5669.0, 5270.0, 5444.0, 5625.0, 5678.0, 5488.0, 5390.0, 5698.0, 5542.0, 5412.0, 5543.0, 5600.0, 5377.0, 5484.0, 5274.0, 5318.0, 5300.0, 5258.0 (number of hits: 16)

5570 MHz, 160 MHz Bandwidth

Radar Signal Type	Waveform/Trial Number	Detection (%)	Limit (%)	Pass/Fail
Type 1A/1B	30	96.65 %	60%	Pass
Type 2	30	93.3 %	60%	Pass
Type 3	30	76.7 %	60%	Pass
Type 4	30	76.7 %	60%	Pass
Aggregate (Type1 to 4)	120	85.84 %	80%	Pass
Type 5	30	100 %	80%	Pass
Type 6	30	100 %	70%	Pass

Please refer to the following statistical tables:

5570 MHz, 160 MHz Bandwidth**Table-1A/1B Radar Type 1A/1B Statistical Performance**

Trial #	Fc (MHz)	Pulse/Burst	Pulse Width (µS)	PRI (µs)	Detection (1:yes; 0:no)
1	5570	67	1	798	1
2	5570	61	1	878	1
3	5570	74	1	718	1
4	5570	72	1	738	0
5	5570	62	1	858	1
6	5492.5	102	1	518	1
7	5492.5	70	1	758	1
8	5492.5	95	1	558	1
9	5492.5	65	1	818	1
10	5492.5	92	1	578	1
11	5647.5	86	1	618	1
12	5647.5	63	1	838	1
13	5647.5	68	1	778	1
14	5647.5	81	1	658	1
15	5647.5	18	1	3066	1
16	5570	21	1	2598	1
17	5570	52	1	1024	1
18	5570	20	1	2708	1
19	5570	24	1	2255	1
20	5570	72	1	743	1
21	5492.5	61	1	875	1
22	5492.5	24	1	2257	1
23	5492.5	33	1	1644	1
24	5492.5	22	1	2447	1
25	5492.5	32	1	1661	1
26	5647.5	65	1	815	1
27	5647.5	20	1	2731	1
28	5647.5	31	1	1706	1
29	5647.5	88	1	606	1
30	5647.5	20	1	2729	1
Detection Percentage: 96.65 % (>60%)					

Table-2 Radar Type 2 Statistical Performance

Trial #	Fc (MHz)	Pulse/Burst	Pulse Width (μS)	PRI (μs)	Detection (1:yes; 0:no)
1	5570	27	1.7	161	1
2	5570	26	3.9	216	1
3	5570	27	2.2	191	1
4	5570	24	2.2	203	1
5	5570	25	2.1	177	1
6	5570	27	5	163	1
7	5570	27	1.7	205	1
8	5570	29	1.6	156	1
9	5570	27	1.1	200	1
10	5570	26	4.1	156	1
11	5492.5	26	1.2	200	1
12	5492.5	26	2.4	206	0
13	5492.5	27	4	218	1
14	5492.5	29	2.6	219	1
15	5492.5	26	4.3	158	1
16	5492.5	25	2.6	166	1
17	5492.5	26	2.3	165	1
18	5492.5	25	1.2	228	0
19	5492.5	23	2.7	219	1
20	5492.5	25	2.1	219	1
21	5647.5	28	4.6	190	1
22	5647.5	27	2.3	169	1
23	5647.5	24	3	195	1
24	5647.5	28	3.1	227	1
25	5647.5	28	3.8	223	1
26	5647.5	23	3.1	166	1
27	5647.5	24	4.9	155	1
28	5647.5	26	1.5	208	1
29	5647.5	23	3.8	151	1
30	5647.5	25	3.8	223	1
Detection Percentage: 93.3 % (>60%)					

Table-3 Radar Type 3 Statistical Performance

Trial #	Fc (MHz)	Pulse/Burst	Pulse Width (μS)	PRI (μs)	Detection (1:yes; 0:no)
1	5570	16	9.2	268	1
2	5570	18	9.2	301	1
3	5570	18	8.1	435	1
4	5570	16	8.1	347	1
5	5570	18	8.7	447	1
6	5570	17	8.1	463	1
7	5570	16	6.3	342	1
8	5570	17	8	407	0
9	5570	17	6.2	392	0
10	5570	17	6.1	272	1
11	5492.5	17	6.8	396	1
12	5492.5	18	6.6	243	1
13	5492.5	18	8.1	358	1
14	5492.5	18	6.4	236	1
15	5492.5	16	8.1	292	1
16	5492.5	16	7.6	491	1
17	5492.5	17	7.7	415	0
18	5492.5	17	9.8	243	1
19	5492.5	18	7.3	248	1
20	5492.5	16	8.2	466	0
21	5647.5	16	6.6	304	1
22	5647.5	16	8.3	398	0
23	5647.5	18	6.3	335	1
24	5647.5	16	6	294	1
25	5647.5	16	7	366	0
26	5647.5	17	6.2	482	1
27	5647.5	16	7.1	294	0
28	5647.5	18	6.9	438	1
29	5647.5	17	6.3	201	1
30	5647.5	18	6.2	471	1
Detection Percentage: 76.7 % (>60%)					

Table-4 Radar Type 4 Statistical Performance

Trial #	Fc (MHz)	Pulse/Burst	Pulse Width (µS)	PRI (µs)	Detection (1:yes; 0:no)
1	5570	13	17.6	425	1
2	5570	15	17.6	284	1
3	5570	15	11.1	466	0
4	5570	16	15.3	442	1
5	5570	13	19.3	366	0
6	5570	14	14.7	450	1
7	5570	14	17.8	322	1
8	5570	16	14.4	216	1
9	5570	16	19.6	330	1
10	5570	12	13.3	271	0
11	5492.5	14	12.8	354	1
12	5492.5	13	16.7	227	1
13	5492.5	12	17	469	0
14	5492.5	15	19.7	440	1
15	5492.5	15	11.4	388	1
16	5492.5	12	14.3	379	1
17	5492.5	14	16.8	203	1
18	5492.5	14	14.9	307	1
19	5492.5	14	11	397	1
20	5492.5	13	19	491	0
21	5647.5	12	19.6	258	1
22	5647.5	13	13.5	319	1
23	5647.5	13	13.1	428	1
24	5647.5	16	12.5	449	1
25	5647.5	14	20	469	1
26	5647.5	16	19.9	226	1
27	5647.5	12	14	445	1
28	5647.5	13	12.1	418	1
29	5647.5	14	12.3	363	0
30	5647.5	12	16.7	484	0
Detection Percentage: 76.7 % (>60%)					

Table-5 Radar Type 5 Statistical Performance

Trial #	Fc (MHz)	Detection (1:yes; 0:no)
1	5570	1
2	5570	1
3	5570	1
4	5570	1
5	5570	1
6	5570	1
7	5570	1
8	5570	1
9	5570	1
10	5570	1
11	5495.7	1
12	5494.5	1
13	5496.9	1
14	5499.7	1
15	5497.7	1
16	5494.9	1
17	5495.3	1
18	5498.5	1
19	5495.3	1
20	5495.7	1
21	5640.3	1
22	5640.3	1
23	5645.1	1
24	5642.7	1
25	5642.7	1
26	5641.9	1
27	5644.7	1
28	5643.5	1
29	5639.9	1
30	5640.7	1
Detection Percentage: 100 % (>80%)		

Bin5 Statistics 1

Trial #	Pulse	Chirp (MHz)	Pulse Width (µS)	Pulse 1-2 spacing (µS)	Pulse 2-3 spacing (µS)	Pulse Start(S)	Detection (1:yes; 0:no)
0	2	5	63.5	1387	-	0.141931	1
1	2	5	73.6	1445	-	1.074898	
2	2	5	78.5	1111	-	1.587662	
3	2	5	66	1776	-	2.088547	
4	3	5	99.6	1643	1135	3.117066	
5	2	5	53.9	1335	-	3.205687	
6	1	5	96.4	-	-	4.304895	
7	1	5	63.5	-	-	4.583461	
8	2	5	85	1412	-	5.127967	
9	1	5	90.9	-	-	5.688912	
10	2	5	89.1	1628	-	6.783878	
11	2	5	90.2	1192	-	7.470008	
12	2	5	67.9	1468	-	7.838823	
13	3	5	55.9	1222	1131	8.578434	
14	1	5	94.9	-	-	9.459614	
15	2	5	59.9	1738	-	9.711172	
16	2	5	84.9	1136	-	10.562256	
17	2	5	95.6	1121	-	11.218363	
18	2	5	81.2	1490	-	11.994178	

Bin5 Statistics 2

Trial #	Pulse	Chirp (MHz)	Pulse Width (µS)	Pulse 1-2 spacing (µS)	Pulse 2-3 spacing (µS)	Pulse Start(S)	Detection (1:yes; 0:no)
0	2	12	84.2	1094	-	0.405158	1
1	1	12	80.7	-	-	1.206855	
2	2	12	88	1121	-	1.671131	
3	2	12	99.5	1156	-	2.510577	
4	3	12	64.3	1902	1990	3.096564	
5	3	12	95	1110	1202	3.278424	
6	2	12	69.3	1723	-	4.067589	
7	3	12	90.4	1397	1958	4.931697	
8	2	12	55.8	1074	-	5.081885	
9	3	12	92.9	1208	1787	6.29449	
10	2	12	61.5	1547	-	6.612308	
11	1	12	65.1	-	-	7.545061	
12	2	12	87	1625	-	7.903929	
13	2	12	54.2	1011	-	8.350269	
14	1	12	86.7	-	-	9.232609	
15	1	12	80.4	-	-	10.037878	
16	2	12	62.5	1195	-	10.594097	
17	1	12	51.7	-	-	10.89756	
18	3	12	65.1	1839	1953	11.510085	

Bin5 Statistics 3

Trial #	Pulse	Chirp (MHz)	Pulse Width (µS)	Pulse 1-2 spacing (µS)	Pulse 2-3 spacing (µS)	Pulse Start(S)	Detection (1:yes; 0:no)
0	1	14	58.6	-	-	0.197112	1
1	3	14	63.5	1343	1013	0.91028	
2	1	14	92.2	-	-	1.638195	
3	2	14	62.9	1164	-	2.453408	
4	2	14	72.4	1739	-	3.649222	
5	2	14	90	1504	-	3.971877	
6	2	14	61.8	1963	-	4.890422	
7	3	14	63.3	1234	1267	5.99282	
8	1	14	57.7	-	-	6.056751	
9	3	14	61.3	1115	1374	7.30096	
10	3	14	66.4	1737	1330	7.845917	
11	2	14	50	1464	-	8.971821	
12	3	14	66	1871	1190	9.563966	
13	3	14	92.6	1980	1145	10.280198	
14	2	14	95.9	1068	-	10.506644	
15	1	14	82.3	-	-	11.616106	

Bin5 Statistics 4

Trial #	Pulse	Chirp (MHz)	Pulse Width (µS)	Pulse 1-2 spacing (uS)	Pulse 2-3 spacing (uS)	Pulse Start(S)	Detection (1:yes; 0:no)
0	2	8	74.3	1449	-	0.493363	1
1	3	8	97.3	1155	1004	1.698314	
2	3	8	94.3	1792	1930	3.237771	
3	1	8	93.8	-	-	3.860954	
4	2	8	98.6	1314	-	5.465325	
5	1	8	93.7	-	-	6.761727	
6	3	8	79.7	1904	1772	7.791373	
7	3	8	70.7	1276	1054	9.016805	
8	1	8	93.8	-	-	9.976964	
9	3	8	86.4	1414	1691	11.116029	

Bin5 Statistics 5

Trial #	Pulse	Chirp (MHz)	Pulse Width (µS)	Pulse 1-2 spacing (uS)	Pulse 2-3 spacing (uS)	Pulse Start(S)	Detection (1:yes; 0:no)
0	3	13	88.7	1063	1463	0.472834	1
1	2	13	57.1	1765	-	1.505183	
2	2	13	77.2	1161	-	2.083664	
3	3	13	77.7	1752	1264	3.395643	
4	1	13	83.5	-	-	3.656354	
5	2	13	71.1	1040	-	4.482442	
6	3	13	68.3	1935	1601	5.825053	
7	3	13	93.6	1896	1596	6.610374	
8	1	13	58.6	-	-	7.227695	
9	2	13	76.2	1900	-	8.527824	
10	3	13	83.5	1240	1371	9.374223	
11	2	13	71.3	1931	-	10.051212	
12	2	13	66.9	1665	-	10.390174	
13	2	13	51.9	1279	-	11.522752	

Bin5 Statistics 6

Trial #	Pulse	Chirp (MHz)	Pulse Width (µS)	Pulse 1-2 spacing (uS)	Pulse 2-3 spacing (uS)	Pulse Start(S)	Detection (1:yes; 0:no)
0	3	12	71.2	1423	1481	1.194344	1
1	2	12	58.2	1175	-	1.374441	
2	2	12	50.7	1509	-	3.115075	
3	3	12	56.1	1759	1401	4.824556	
4	3	12	70.4	1466	1329	6.656772	
5	2	12	88.3	1059	-	7.594174	
6	1	12	90.7	-	-	8.843325	
7	1	12	79.7	-	-	9.757278	
8	2	12	50.8	1911	-	11.074267	

Bin5 Statistics 7

Trial #	Pulse	Chirp (MHz)	Pulse Width (µS)	Pulse 1-2 spacing (uS)	Pulse 2-3 spacing (uS)	Pulse Start(S)	Detection (1:yes; 0:no)
0	1	10	95.8	-	-	0.499976	1
1	3	10	77.8	1589	1022	1.294411	
2	2	10	94.8	1101	-	1.63967	
3	1	10	54.5	-	-	2.808448	
4	1	10	79.4	-	-	3.134179	
5	2	10	51.9	1037	-	4.083491	
6	2	10	70.8	1140	-	4.261241	
7	3	10	99.4	1846	1494	4.948116	
8	3	10	54.7	1056	1725	6.082509	
9	1	10	61.3	-	-	7.016209	
10	3	10	79.4	1864	1788	7.18717	
11	2	10	80.9	1568	-	7.828767	
12	2	10	72.4	1708	-	8.632644	
13	1	10	60.9	-	-	9.482268	
14	1	10	83.8	-	-	9.969147	
15	2	10	51.4	1325	-	10.887975	
16	2	10	93.4	1998	-	11.505441	

Bin5 Statistics 8

Trial #	Pulse	Chirp (MHz)	Pulse Width (µS)	Pulse 1-2 spacing (uS)	Pulse 2-3 spacing (uS)	Pulse Start(S)	Detection (1:yes; 0:no)
0	1	13	63.6	-	-	0.199735	1
1	3	13	61.7	1016	1348	1.14774	
2	2	13	71.8	1712	-	2.09536	
3	2	13	50.5	1910	-	2.145421	
4	3	13	54.6	1777	1168	3.378222	
5	1	13	57.5	-	-	3.880666	
6	2	13	58.5	1846	-	4.346516	
7	2	13	56.5	1412	-	5.337735	
8	2	13	53.2	1735	-	6.300494	
9	1	13	84.5	-	-	7.018049	
10	3	13	97.3	1856	1699	7.392405	
11	1	13	71.2	-	-	8.412993	
12	1	13	76.1	-	-	9.075793	
13	2	13	67.4	1528	-	9.61475	
14	3	13	74.6	1562	1961	10.09551	
15	2	13	62	1707	-	10.650187	
16	1	13	56.6	-	-	11.875807	

Bin5 Statistics 9

Trial #	Pulse	Chirp (MHz)	Pulse Width (µS)	Pulse 1-2 spacing (uS)	Pulse 2-3 spacing (uS)	Pulse Start(S)	Detection (1:yes; 0:no)
0	3	7	62.2	1991	1434	0.799989	1
1	1	7	87.5	-	-	1.255341	
2	2	7	62.8	1407	-	2.932742	
3	1	7	64.1	-	-	3.362949	
4	3	7	99.5	1554	1330	5.377959	
5	1	7	60.4	-	-	6.226734	
6	2	7	60.8	1241	-	7.005218	
7	1	7	62.1	-	-	7.8091	
8	2	7	66.8	1503	-	8.862186	
9	2	7	97	1034	-	10.074593	
10	2	7	62.5	1130	-	11.930404	

Bin5 Statistics 10

Trial #	Pulse	Chirp (MHz)	Pulse Width (µS)	Pulse 1-2 spacing (µS)	Pulse 2-3 spacing (µS)	Pulse Start(S)	Detection (1:yes; 0:no)
0	2	9	74	1516	-	0.039007	1
1	1	9	65.2	-	-	2.061628	
2	1	9	86.4	-	-	3.305207	
3	2	9	94.9	1886	-	4.352246	
4	3	9	94.8	1080	1210	5.501826	
5	2	9	73.8	1741	-	6.564743	
6	2	9	54.8	1283	-	7.425431	
7	1	9	75.2	-	-	9.456511	
8	2	9	97	1832	-	9.763854	
9	3	9	93.2	1593	1590	11.761348	

Bin5 Statistics 11

Trial #	Pulse	Chirp (MHz)	Pulse Width (µS)	Pulse 1-2 spacing (µS)	Pulse 2-3 spacing (µS)	Pulse Start(S)	Detection (1:yes; 0:no)
0	2	8	55	1948	-	0.620159	1
1	1	8	70.8	-	-	0.873082	
2	2	8	54	1470	-	1.606277	
3	1	8	61.5	-	-	2.05064	
4	2	8	70.3	1663	-	2.672074	
5	2	8	63.2	1545	-	3.368541	
6	3	8	54.6	1383	1573	4.52894	
7	1	8	67	-	-	4.962852	
8	2	8	97.8	1232	-	5.454172	
9	3	8	54.8	1745	1958	6.60498	
10	3	8	67.4	1537	1998	6.765806	
11	1	8	85.4	-	-	7.836213	
12	3	8	51.2	1688	1897	8.461118	
13	3	8	85.1	1889	1086	8.674926	
14	2	8	52.7	1854	-	9.336468	
15	2	8	79.8	1764	-	10.352306	
16	1	8	75.5	-	-	10.797262	
17	2	8	73.3	1009	-	11.557493	

Bin5 Statistics 12

Trial #	Pulse	Chirp (MHz)	Pulse Width (µS)	Pulse 1-2 spacing (uS)	Pulse 2-3 spacing (uS)	Pulse Start(S)	Detection (1:yes; 0:no)
0	2	5	74	1720	-	0.360748	1
1	2	5	83.9	1553	-	1.077737	
2	2	5	67	1701	-	1.578716	
3	1	5	91.5	-	-	2.129265	
4	2	5	79.5	1584	-	2.845526	
5	2	5	85.2	1208	-	3.28836	
6	3	5	91.1	1398	1305	4.397341	
7	3	5	85.3	1277	1258	4.792743	
8	3	5	77.9	1756	1218	5.082277	
9	2	5	60	1596	-	6.011547	
10	3	5	60.7	1497	1308	6.902501	
11	2	5	64.9	1598	-	7.066886	
12	2	5	59.9	1989	-	7.696924	
13	3	5	85.5	1704	1936	8.489617	
14	3	5	82.1	1376	1431	9.188461	
15	2	5	88.4	1905	-	9.910495	
16	3	5	70.7	1215	1022	10.147768	
17	2	5	63.4	1257	-	10.773961	
18	1	5	80.4	-	-	11.493485	

Bin5 Statistics 13

Trial #	Pulse	Chirp (MHz)	Pulse Width (µS)	Pulse 1-2 spacing (uS)	Pulse 2-3 spacing (uS)	Pulse Start(S)	Detection (1:yes; 0:no)
0	3	11	82.3	1378	1142	0.646153	1
1	3	11	60.1	1383	1514	2.474371	
2	1	11	51.7	-	-	3.405844	
3	3	11	67.5	1301	1821	5.124675	
4	2	11	51	1692	-	5.81874	
5	3	11	68.5	1844	1601	7.386488	
6	2	11	56.7	1229	-	8.745903	
7	2	11	89.4	1107	-	10.629661	
8	2	11	98.2	1685	-	11.593466	

Bin5 Statistics 14

Trial #	Pulse	Chirp (MHz)	Pulse Width (µS)	Pulse 1-2 spacing (uS)	Pulse 2-3 spacing (uS)	Pulse Start(S)	Detection (1:yes; 0:no)
0	2	18	70.3	1606	-	0.318065	1
1	2	18	82.1	1951	-	1.47177	
2	1	18	89.6	-	-	1.935251	
3	2	18	67.4	1288	-	2.750762	
4	2	18	66.7	1628	-	3.319916	
5	1	18	72.6	-	-	4.295779	
6	1	18	78.1	-	-	5.549519	
7	3	18	61	1679	1571	5.845136	
8	1	18	56.9	-	-	6.502313	
9	3	18	70.4	1416	1914	7.583775	
10	2	18	79.1	1436	-	8.526609	
11	2	18	84.6	1919	-	9.304176	
12	3	18	69.9	1552	1383	10.173511	
13	2	18	74.6	1384	-	10.776675	
14	3	18	72.8	1230	1867	11.219869	

Bin5 Statistics 15

Trial #	Pulse	Chirp (MHz)	Pulse Width (µS)	Pulse 1-2 spacing (uS)	Pulse 2-3 spacing (uS)	Pulse Start(S)	Detection (1:yes; 0:no)
0	2	13	61.8	1148	-	0.756299	1
1	3	13	77.8	1713	1389	0.805336	
2	2	13	77.9	1707	-	1.823802	
3	2	13	89.5	1329	-	2.621597	
4	2	13	97.4	1816	-	3.643232	
5	2	13	54.7	1753	-	4.371615	
6	1	13	84.7	-	-	5.295978	
7	2	13	64.1	1463	-	6.177647	
8	2	13	72.1	1672	-	7.035318	
9	3	13	50.4	1311	1742	7.967911	
10	2	13	98.5	1500	-	8.319421	
11	3	13	62.4	1790	1374	9.14326	
12	3	13	78.8	1708	1750	10.234343	
13	3	13	81.7	1084	1591	11.097615	
14	1	13	86.4	-	-	11.807248	

Bin5 Statistics 16

Trial #	Pulse	Chirp (MHz)	Pulse Width (µS)	Pulse 1-2 spacing (µS)	Pulse 2-3 spacing (µS)	Pulse Start(S)	Detection (1:yes; 0:no)
0	1	6	81.8	-	-	0.169172	1
1	2	6	59.3	1513	-	1.017492	
2	3	6	82.2	1313	1170	2.245614	
3	2	6	72.2	1371	-	3.633808	
4	2	6	50.3	1222	-	4.54074	
5	2	6	50.1	1354	-	5.848691	
6	2	6	59.9	1187	-	6.559394	
7	1	6	84.9	-	-	7.079764	
8	3	6	57.9	1671	1038	8.012732	
9	1	6	88.4	-	-	9.905051	
10	3	6	89.2	1291	1560	10.198222	
11	2	6	80.6	1496	-	11.46698	

Bin5 Statistics 17

Trial #	Pulse	Chirp (MHz)	Pulse Width (µS)	Pulse 1-2 spacing (µS)	Pulse 2-3 spacing (µS)	Pulse Start(S)	Detection (1:yes; 0:no)
0	2	7	60.4	1278	-	0.820599	1
1	3	7	99.1	1752	1012	1.674532	
2	2	7	58.6	1523	-	3.180743	
3	2	7	69.1	1629	-	4.395627	
4	1	7	90.3	-	-	5.401634	
5	2	7	84.1	1856	-	7.779612	
6	1	7	64.1	-	-	8.398365	
7	3	7	75.2	1794	1565	9.337269	
8	2	7	56.6	1541	-	11.202539	

Bin5 Statistics 18

Trial #	Pulse	Chirp (MHz)	Pulse Width (µS)	Pulse 1-2 spacing (uS)	Pulse 2-3 spacing (uS)	Pulse Start(S)	Detection (1:yes; 0:no)
0	2	15	71.7	1000	-	0.369217	1
1	2	15	64.4	1832	-	1.161275	
2	3	15	98.2	1795	1025	2.336679	
3	3	15	57.8	1102	1822	2.800919	
4	3	15	72.1	1748	1236	3.793198	
5	1	15	97.4	-	-	4.775618	
6	1	15	76.6	-	-	5.986763	
7	3	15	67.8	1010	1998	6.510868	
8	1	15	83.2	-	-	7.367791	
9	1	15	70.9	-	-	8.427073	
10	2	15	83.6	1821	-	8.789967	
11	1	15	89.4	-	-	9.68554	
12	1	15	55.6	-	-	10.927456	
13	1	15	53.4	-	-	11.392259	

Bin5 Statistics 19

Trial #	Pulse	Chirp (MHz)	Pulse Width (µS)	Pulse 1-2 spacing (uS)	Pulse 2-3 spacing (uS)	Pulse Start(S)	Detection (1:yes; 0:no)
0	1	7	83.8	-	-	1.355958	1
1	2	7	92	1800	-	2.054662	
2	1	7	56.7	-	-	3.901709	
3	3	7	88.4	1574	1364	5.624259	
4	2	7	85.2	1768	-	7.022556	
5	2	7	56	1798	-	7.890443	
6	3	7	51.5	1190	1674	9.202149	
7	2	7	75.8	1155	-	11.224281	

Bin5 Statistics 20

Trial #	Pulse	Chirp (MHz)	Pulse Width (µS)	Pulse 1-2 spacing (uS)	Pulse 2-3 spacing (uS)	Pulse Start(S)	Detection (1:yes; 0:no)
0	1	8	87.5	-	-	1.050719	1
1	3	8	76.7	1218	1361	1.813468	
2	1	8	83.1	-	-	2.660701	
3	3	8	74.9	1762	1296	4.081834	
4	2	8	100	1663	-	4.509851	
5	2	8	98.3	1807	-	5.659514	
6	3	8	65	1200	1219	6.890423	
7	1	8	96.9	-	-	8.009719	
8	3	8	90.3	1600	1869	8.996404	
9	2	8	61.7	1522	-	10.565442	
10	1	8	66.4	-	-	11.984184	

Bin5 Statistics 21

Trial #	Pulse	Chirp (MHz)	Pulse Width (µS)	Pulse 1-2 spacing (uS)	Pulse 2-3 spacing (uS)	Pulse Start(S)	Detection (1:yes; 0:no)
0	1	18	60.5	-	-	0.51935	1
1	2	18	55.6	1327	-	1.141069	
2	2	18	69.3	1079	-	1.642216	
3	2	18	64.4	1315	-	2.591466	
4	3	18	94.1	1907	1952	3.00008	
5	1	18	50.1	-	-	3.550683	
6	2	18	69.1	1607	-	4.416225	
7	1	18	58.6	-	-	5.283878	
8	2	18	55.7	1230	-	6.156065	
9	2	18	57.4	1393	-	6.748693	
10	3	18	79.6	1008	1164	7.356053	
11	3	18	80.6	1165	1596	8.365749	
12	2	18	76.7	1002	-	8.995336	
13	1	18	92	-	-	9.531627	
14	2	18	64.6	1292	-	10.152909	
15	3	18	73.1	1276	1278	10.744024	
16	1	18	88.7	-	-	11.424883	

Bin5 Statistics 22

Trial #	Pulse	Chirp (MHz)	Pulse Width (uS)	Pulse 1-2 spacing (uS)	Pulse 2-3 spacing (uS)	Pulse Start(S)	Detection (1:yes; 0:no)
0	2	18	99	1498	-	0.649844	1
1	2	18	53.4	1236	-	1.050801	
2	2	18	84.4	1556	-	1.82705	
3	2	18	60.6	1343	-	3.374372	
4	3	18	61.9	1439	1276	4.097678	
5	1	18	61.9	-	-	5.04287	
6	2	18	66.9	1620	-	5.926057	
7	2	18	51	1337	-	6.804418	
8	2	18	95.7	1835	-	7.571094	
9	2	18	94	1176	-	8.130121	
10	1	18	89.8	-	-	8.852818	
11	3	18	50.7	1687	1866	10.190277	
12	1	18	84.7	-	-	10.877788	
13	1	18	66.2	-	-	11.869537	

Bin5 Statistics 23

Trial #	Pulse	Chirp (MHz)	Pulse Width (uS)	Pulse 1-2 spacing (uS)	Pulse 2-3 spacing (uS)	Pulse Start(S)	Detection (1:yes; 0:no)
0	2	6	61.8	1173	-	0.493633	1
1	1	6	76.2	-	-	1.620124	
2	1	6	53.1	-	-	2.282911	
3	1	6	85.6	-	-	3.61399	
4	2	6	70.8	1968	-	4.525309	
5	2	6	78.6	1426	-	5.500634	
6	1	6	52.5	-	-	6.651459	
7	2	6	60.4	1076	-	7.746983	
8	3	6	75	1233	1674	8.439332	
9	2	6	60.7	1134	-	9.154514	
10	3	6	57.2	1583	1156	10.06043	
11	2	6	60.7	1966	-	11.920327	

Bin5 Statistics 24

Trial #	Pulse	Chirp (MHz)	Pulse Width (µS)	Pulse 1-2 spacing (µS)	Pulse 2-3 spacing (µS)	Pulse Start(S)	Detection (1:yes; 0:no)
0	2	12	75.4	1675	-	0.382836	1
1	2	12	68.9	1205	-	1.691679	
2	1	12	88.7	-	-	2.277574	
3	2	12	58.6	1297	-	2.673043	
4	2	12	50.2	1837	-	3.973915	
5	3	12	59.2	1571	1504	5.064612	
6	2	12	56.9	1728	-	5.972775	
7	3	12	77.7	1401	1500	6.405548	
8	2	12	72.2	1785	-	6.951847	
9	2	12	51.4	1618	-	7.725875	
10	1	12	97.8	-	-	8.732739	
11	2	12	55	1933	-	9.450733	
12	2	12	53.8	1641	-	10.762598	
13	2	12	90.1	1020	-	11.322454	

Bin5 Statistics 25

Trial #	Pulse	Chirp (MHz)	Pulse Width (µS)	Pulse 1-2 spacing (µS)	Pulse 2-3 spacing (µS)	Pulse Start(S)	Detection (1:yes; 0:no)
0	1	12	91.9	-	-	0.19067	1
1	1	12	74.3	-	-	1.286171	
2	1	12	92.4	-	-	1.995135	
3	2	12	80.2	1390	-	2.553063	
4	2	12	98.8	1923	-	3.541232	
5	2	12	52.6	1781	-	4.570054	
6	1	12	97.2	-	-	5.424258	
7	2	12	98.7	1497	-	5.994932	
8	3	12	56	1709	1774	7.04193	
9	3	12	68.8	1862	1013	7.434954	
10	3	12	67.7	1851	1678	8.546559	
11	2	12	94.6	1580	-	8.906795	
12	2	12	83.9	1368	-	10.00471	
13	1	12	82.2	-	-	10.664189	
14	1	12	71.2	-	-	11.766494	

Bin5 Statistics 26

Trial #	Pulse	Chirp (MHz)	Pulse Width (µS)	Pulse 1-2 spacing (uS)	Pulse 2-3 spacing (uS)	Pulse Start(S)	Detection (1:yes; 0:no)
0	2	14	56.2	1776	-	0.460109	1
1	2	14	90.8	1219	-	1.820468	
2	1	14	51.1	-	-	3.074019	
3	2	14	63	1891	-	4.614014	
4	2	14	72.1	1964	-	4.959367	
5	1	14	94	-	-	6.372823	
6	1	14	65.4	-	-	7.955114	
7	2	14	61.4	1571	-	9.409649	
8	1	14	89.8	-	-	10.728546	
9	2	14	66.8	1681	-	10.930261	

Bin5 Statistics 27

Trial #	Pulse	Chirp (MHz)	Pulse Width (µS)	Pulse 1-2 spacing (uS)	Pulse 2-3 spacing (uS)	Pulse Start(S)	Detection (1:yes; 0:no)
0	3	7	70.6	1766	1099	0.47264	1
1	2	7	54.1	1461	-	1.151278	
2	2	7	95.7	1376	-	1.934267	
3	1	7	88.9	-	-	2.510769	
4	3	7	68.7	1873	1230	3.27196	
5	3	7	79.5	1931	1172	4.205213	
6	3	7	69.2	1433	1288	4.988271	
7	3	7	53.1	1842	1902	6.216988	
8	2	7	50.2	1841	-	6.562376	
9	2	7	96.2	1085	-	7.919178	
10	2	7	93.6	1664	-	8.479343	
11	2	7	50.9	1666	-	9.228103	
12	2	7	78.7	1557	-	9.857789	
13	2	7	56	1439	-	10.632156	
14	3	7	74.8	1507	1546	11.94912	

Bin5 Statistics 28

Trial #	Pulse	Chirp (MHz)	Pulse Width (µS)	Pulse 1-2 spacing (µS)	Pulse 2-3 spacing (µS)	Pulse Start(S)	Detection (1:yes; 0:no)
0	2	10	83.6	1242	-	0.083417	1
1	1	10	69.4	-	-	1.299454	
2	2	10	66.8	1019	-	1.927929	
3	2	10	68.4	1120	-	2.777916	
4	1	10	77.2	-	-	3.683449	
5	1	10	79.3	-	-	4.354434	
6	2	10	52.8	1113	-	5.216431	
7	2	10	72.3	1214	-	5.501484	
8	2	10	62	1688	-	6.477352	
9	2	10	55.6	1486	-	6.897608	
10	2	10	78.1	1409	-	7.578506	
11	2	10	54.2	1893	-	8.412469	
12	2	10	57.8	1207	-	9.582317	
13	2	10	66.6	1009	-	10.340709	
14	2	10	56.9	1124	-	10.667396	
15	3	10	81	1879	1132	11.471979	

Bin5 Statistics 29

Trial #	Pulse	Chirp (MHz)	Pulse Width (µS)	Pulse 1-2 spacing (µS)	Pulse 2-3 spacing (µS)	Pulse Start(S)	Detection (1:yes; 0:no)
0	1	19	56.3	-	-	0.530195	1
1	2	19	94.5	1352	-	1.010933	
2	1	19	79.9	-	-	2.145246	
3	2	19	62.2	1558	-	3.49823	
4	2	19	79.4	1976	-	3.89262	
5	2	19	61.1	1311	-	4.679839	
6	3	19	76.9	1503	1755	6.300784	
7	2	19	68.8	1679	-	6.74618	
8	3	19	81.5	1631	1955	7.636511	
9	2	19	60.1	1676	-	8.884425	
10	2	19	69.2	1020	-	9.974272	
11	1	19	52.1	-	-	10.221916	
12	2	19	89.1	1533	-	11.138025	

Bin5 Statistics 30

Trial #	Pulse	Chirp (MHz)	Pulse Width (µS)	Pulse 1-2 spacing (uS)	Pulse 2-3 spacing (uS)	Pulse Start(S)	Detection (1:yes; 0:no)
0	2	17	62.4	1013	-	0.691993	1
1	3	17	84.5	1769	1548	0.972419	
2	3	17	92.3	1148	1716	2.389424	
3	2	17	57.3	1552	-	2.961975	
4	2	17	55.9	1383	-	4.45881	
5	3	17	56	1394	1417	4.967645	
6	2	17	77.5	1324	-	6.324993	
7	2	17	65.5	1023	-	6.623965	
8	1	17	81.9	-	-	7.882101	
9	3	17	58	1410	1614	8.42639	
10	1	17	89.3	-	-	9.310165	
11	3	17	62.7	1264	1326	10.971837	
12	3	17	83.8	1958	1357	11.182324	

Table-6 Radar Type 6 Statistical Performance

Trial #	Fc (MHz)	Pulse /Burst	Pulse Width (μS)	PRI (μs)	Detection (1:yes; 0:no)	Hopping Sequence
1	5570	9	1	333	1	5386.0, 5470.0, 5707.0, 5309.0, 5433.0, 5348.0, 5430.0, 5419.0, 5432.0, 5451.0, 5479.0, 5544.0, 5330.0, 5526.0, 5562.0, 5495.0, 5630.0, 5695.0, 5402.0, 5627.0, 5517.0, 5251.0, 5336.0, 5283.0, 5686.0, 5426.0, 5434.0, 5321.0, 5656.0, 5381.0, 5282.0, 5512.0, 5322.0, 5653.0, 5540.0, 5353.0, 5299.0, 5605.0, 5289.0, 5343.0, 5490.0, 5337.0, 5619.0, 5552.0, 5537.0, 5474.0, 5592.0, 5621.0, 5585.0, 5611.0, 5468.0, 5258.0, 5396.0, 5694.0, 5610.0, 5541.0, 5578.0, 5447.0, 5383.0, 5485.0, 5604.0, 5424.0, 5445.0, 5465.0, 5639.0, 5635.0, 5623.0, 5676.0, 5405.0, 5678.0, 5539.0, 5362.0, 5679.0, 5722.0, 5313.0, 5344.0, 5661.0, 5583.0, 5568.0, 5528.0, 5346.0, 5464.0, 5558.0, 5652.0, 5380.0, 5359.0, 5590.0, 5580.0, 5671.0, 5412.0, 5401.0, 5514.0, 5505.0, 5685.0, 5364.0, 5640.0, 5672.0, 5506.0, 5325.0, 5271.0 (number of hits: 35)
2	5570	9	1	333	1	5618.0, 5514.0, 5334.0, 5467.0, 5518.0, 5712.0, 5322.0, 5409.0, 5540.0, 5666.0, 5709.0, 5569.0, 5538.0, 5396.0, 5402.0, 5627.0, 5401.0, 5410.0, 5505.0, 5669.0, 5419.0, 5629.0, 5435.0, 5632.0, 5622.0, 5603.0, 5359.0, 5414.0, 5282.0, 5438.0, 5290.0, 5536.0, 5486.0, 5416.0, 5676.0, 5592.0, 5315.0, 5497.0, 5654.0, 5392.0, 5512.0, 5567.0, 5546.0, 5453.0, 5286.0, 5724.0, 5700.0, 5329.0, 5623.0, 5716.0, 5668.0, 5616.0, 5671.0, 5506.0, 5503.0, 5278.0, 5297.0, 5515.0, 5674.0, 5456.0, 5547.0, 5388.0, 5347.0, 5696.0, 5575.0, 5516.0, 5675.0, 5687.0, 5471.0, 5559.0, 5686.0, 5327.0, 5449.0, 5382.0, 5430.0, 5348.0, 5667.0, 5566.0, 5683.0, 5394.0, 5562.0, 5333.0, 5639.0, 5429.0, 5376.0, 5576.0, 5476.0, 5398.0, 5554.0, 5705.0, 5342.0, 5428.0, 5287.0, 5281.0, 5662.0, 5354.0, 5383.0, 5469.0, 5265.0, 5678.0 (number of hits: 32)
3	5570	9	1	333	1	5599.0, 5535.0, 5558.0, 5712.0, 5452.0, 5437.0, 5663.0, 5627.0, 5303.0, 5331.0, 5655.0, 5703.0, 5326.0, 5537.0, 5439.0, 5257.0, 5302.0, 5701.0, 5612.0, 5254.0, 5373.0, 5578.0, 5389.0, 5623.0, 5404.0, 5672.0, 5284.0, 5570.0, 5549.0, 5410.0, 5684.0, 5456.0, 5414.0, 5675.0, 5654.0, 5511.0, 5696.0, 5274.0, 5338.0, 5716.0, 5670.0, 5679.0, 5618.0, 5557.0, 5352.0, 5464.0, 5300.0, 5337.0, 5402.0, 5474.0, 5458.0, 5700.0, 5288.0, 5449.0, 5723.0, 5606.0, 5468.0, 5513.0, 5465.0, 5335.0

						5609.0, 5588.0, 5548.0, 5364.0, 5711.0, 5520.0, 5278.0, 5604.0, 5492.0, 5617.0, 5508.0, 5324.0, 5412.0, 5282.0, 5361.0, 5669.0, 5504.0, 5721.0, 5579.0, 5647.0, 5630.0, 5347.0, 5450.0, 5448.0, 5268.0, 5681.0, 5572.0, 5424.0, 5476.0, 5260.0, 5265.0, 5428.0, 5401.0, 5645.0, 5638.0, 5531.0, 5294.0, 5390.0, 5375.0, 5453.0 (number of hits: 31)
4	5570	9	1	333	1	5665.0, 5414.0, 5651.0, 5477.0, 5586.0, 5647.0, 5640.0, 5561.0, 5471.0, 5670.0, 5570.0, 5709.0, 5724.0, 5704.0, 5440.0, 5305.0, 5407.0, 5609.0, 5551.0, 5598.0, 5588.0, 5287.0, 5687.0, 5482.0, 5600.0, 5587.0, 5253.0, 5498.0, 5699.0, 5716.0, 5567.0, 5526.0, 5447.0, 5316.0, 5444.0, 5328.0, 5659.0, 5385.0, 5409.0, 5617.0, 5654.0, 5365.0, 5512.0, 5481.0, 5464.0, 5705.0, 5457.0, 5290.0, 5566.0, 5426.0, 5266.0, 5446.0, 5712.0, 5595.0, 5462.0, 5648.0, 5672.0, 5571.0, 5306.0, 5276.0, 5579.0, 5628.0, 5622.0, 5611.0, 5465.0, 5559.0, 5634.0, 5430.0, 5689.0, 5403.0, 5294.0, 5690.0, 5322.0, 5592.0, 5537.0, 5638.0, 5313.0, 5320.0, 5608.0, 5311.0, 5279.0, 5433.0, 5618.0, 5415.0, 5534.0, 5402.0, 5578.0, 5424.0, 5285.0, 5637.0, 5655.0, 5656.0, 5468.0, 5533.0, 5325.0, 5289.0, 5580.0, 5688.0, 5508.0, 5554.0 (number of hits: 37)
5	5570	9	1	333	1	5501.0, 5634.0, 5693.0, 5394.0, 5355.0, 5513.0, 5348.0, 5632.0, 5289.0, 5719.0, 5451.0, 5622.0, 5498.0, 5503.0, 5458.0, 5679.0, 5433.0, 5486.0, 5304.0, 5264.0, 5402.0, 5579.0, 5569.0, 5711.0, 5446.0, 5480.0, 5718.0, 5581.0, 5649.0, 5545.0, 5443.0, 5428.0, 5723.0, 5489.0, 5257.0, 5658.0, 5325.0, 5499.0, 5324.0, 5673.0, 5712.0, 5500.0, 5387.0, 5646.0, 5419.0, 5262.0, 5618.0, 5411.0, 5427.0, 5550.0, 5677.0, 5357.0, 5346.0, 5602.0, 5687.0, 5564.0, 5266.0, 5477.0, 5641.0, 5463.0, 5303.0, 5555.0, 5659.0, 5381.0, 5648.0, 5426.0, 5407.0, 5293.0, 5533.0, 5716.0, 5540.0, 5358.0, 5643.0, 5347.0, 5272.0, 5315.0, 5255.0, 5354.0, 5709.0, 5635.0, 5508.0, 5615.0, 5651.0, 5374.0, 5664.0, 5627.0, 5286.0, 5312.0, 5314.0, 5491.0, 5365.0, 5488.0, 5674.0, 5404.0, 5351.0, 5269.0, 5671.0, 5296.0, 5329.0, 5701.0 (number of hits: 27)
6	5570	9	1	333	1	5338.0, 5258.0, 5476.0, 5722.0, 5616.0, 5579.0, 5367.0, 5681.0, 5330.0, 5368.0, 5696.0, 5272.0, 5467.0, 5654.0, 5518.0, 5453.0, 5656.0, 5649.0, 5461.0, 5666.0, 5375.0, 5383.0, 5668.0, 5377.0, 5404.0, 5388.0, 5354.0, 5575.0, 5509.0, 5393.0, 5618.0, 5574.0, 5512.0, 5700.0, 5286.0, 5397.0, 5268.0, 5676.0, 5466.0, 5348.0, 5667.0, 5582.0, 5478.0, 5311.0, 5690.0,

						5256.0, 5614.0, 5498.0, 5328.0, 5472.0, 5637.0, 5711.0, 5577.0, 5263.0, 5451.0, 5386.0, 5716.0, 5709.0, 5566.0, 5721.0, 5576.0, 5609.0, 5714.0, 5552.0, 5278.0, 5385.0, 5664.0, 5265.0, 5643.0, 5299.0, 5707.0, 5595.0, 5293.0, 5459.0, 5458.0, 5287.0, 5648.0, 5360.0, 5615.0, 5545.0, 5446.0, 5513.0, 5358.0, 5433.0, 5306.0, 5591.0, 5350.0, 5369.0, 5662.0, 5329.0, 5457.0, 5531.0, 5364.0, 5374.0, 5444.0, 5295.0, 5704.0, 5316.0, 5594.0, 5489.0 (number of hits: 25)
7	5570	9	1	333	1	5655.0, 5260.0, 5619.0, 5502.0, 5590.0, 5660.0, 5450.0, 5679.0, 5316.0, 5509.0, 5643.0, 5685.0, 5275.0, 5716.0, 5355.0, 5432.0, 5564.0, 5490.0, 5395.0, 5458.0, 5475.0, 5528.0, 5477.0, 5560.0, 5557.0, 5601.0, 5375.0, 5677.0, 5586.0, 5279.0, 5405.0, 5326.0, 5402.0, 5348.0, 5460.0, 5302.0, 5370.0, 5350.0, 5547.0, 5365.0, 5398.0, 5413.0, 5571.0, 5669.0, 5442.0, 5539.0, 5538.0, 5714.0, 5411.0, 5334.0, 5624.0, 5589.0, 5568.0, 5294.0, 5290.0, 5340.0, 5633.0, 5650.0, 5274.0, 5364.0, 5512.0, 5721.0, 5353.0, 5320.0, 5688.0, 5266.0, 5596.0, 5489.0, 5251.0, 5576.0, 5623.0, 5496.0, 5506.0, 5692.0, 5617.0, 5336.0, 5638.0, 5678.0, 5358.0, 5401.0, 5573.0, 5471.0, 5277.0, 5445.0, 5664.0, 5382.0, 5620.0, 5656.0, 5286.0, 5288.0, 5686.0, 5291.0, 5703.0, 5621.0, 5404.0, 5641.0, 5681.0, 5642.0, 5416.0, 5701.0 (number of hits: 32)
8	5570	9	1	333	1	5253.0, 5397.0, 5559.0, 5478.0, 5629.0, 5509.0, 5569.0, 5671.0, 5508.0, 5404.0, 5457.0, 5360.0, 5312.0, 5563.0, 5538.0, 5295.0, 5380.0, 5364.0, 5303.0, 5695.0, 5519.0, 5437.0, 5620.0, 5344.0, 5677.0, 5384.0, 5258.0, 5641.0, 5319.0, 5665.0, 5534.0, 5723.0, 5464.0, 5512.0, 5645.0, 5369.0, 5705.0, 5456.0, 5724.0, 5405.0, 5394.0, 5532.0, 5571.0, 5678.0, 5497.0, 5546.0, 5520.0, 5446.0, 5458.0, 5378.0, 5347.0, 5525.0, 5504.0, 5431.0, 5565.0, 5445.0, 5601.0, 5468.0, 5336.0, 5379.0, 5615.0, 5589.0, 5717.0, 5372.0, 5625.0, 5548.0, 5523.0, 5709.0, 5365.0, 5673.0, 5511.0, 5425.0, 5552.0, 5261.0, 5584.0, 5510.0, 5367.0, 5561.0, 5329.0, 5554.0, 5325.0, 5387.0, 5349.0, 5426.0, 5381.0, 5526.0, 5482.0, 5713.0, 5684.0, 5342.0, 5628.0, 5557.0, 5283.0, 5521.0, 5395.0, 5654.0, 5506.0, 5720.0, 5640.0, 5277.0 (number of hits: 39)
9	5570	9	1	333	1	5651.0, 5540.0, 5300.0, 5644.0, 5250.0, 5639.0, 5584.0, 5483.0, 5533.0, 5494.0, 5287.0, 5562.0, 5303.0, 5692.0, 5503.0, 5385.0, 5520.0, 5268.0, 5507.0, 5279.0, 5621.0, 5369.0, 5325.0, 5705.0, 5614.0, 5355.0, 5640.0, 5348.0, 5321.0, 5354.0,

						5440.0, 5537.0, 5328.0, 5378.0, 5419.0, 5603.0, 5605.0, 5475.0, 5293.0, 5456.0, 5391.0, 5470.0, 5266.0, 5671.0, 5511.0, 5437.0, 5650.0, 5529.0, 5449.0, 5636.0, 5446.0, 5501.0, 5539.0, 5417.0, 5401.0, 5721.0, 5353.0, 5723.0, 5382.0, 5397.0, 5611.0, 5320.0, 5610.0, 5646.0, 5575.0, 5265.0, 5601.0, 5516.0, 5288.0, 5309.0, 5695.0, 5405.0, 5377.0, 5637.0, 5622.0, 5717.0, 5541.0, 5653.0, 5688.0, 5373.0, 5473.0, 5313.0, 5572.0, 5344.0, 5488.0, 5365.0, 5712.0, 5474.0, 5664.0, 5477.0, 5403.0, 5588.0, 5318.0, 5459.0, 5570.0, 5350.0, 5472.0, 5630.0, 5421.0, 5333.0 (number of hits: 34)
10	5570	9	1	333	1	5306.0, 5258.0, 5505.0, 5710.0, 5701.0, 5508.0, 5599.0, 5532.0, 5724.0, 5391.0, 5536.0, 5295.0, 5631.0, 5597.0, 5595.0, 5283.0, 5487.0, 5303.0, 5641.0, 5400.0, 5713.0, 5573.0, 5454.0, 5664.0, 5683.0, 5491.0, 5288.0, 5326.0, 5279.0, 5534.0, 5554.0, 5328.0, 5348.0, 5598.0, 5253.0, 5585.0, 5320.0, 5277.0, 5382.0, 5688.0, 5296.0, 5629.0, 5266.0, 5335.0, 5423.0, 5401.0, 5426.0, 5676.0, 5570.0, 5448.0, 5574.0, 5578.0, 5528.0, 5558.0, 5677.0, 5457.0, 5305.0, 5474.0, 5706.0, 5368.0, 5672.0, 5265.0, 5442.0, 5321.0, 5709.0, 5682.0, 5473.0, 5447.0, 5252.0, 5267.0, 5561.0, 5612.0, 5304.0, 5712.0, 5547.0, 5466.0, 5414.0, 5357.0, 5360.0, 5600.0, 5501.0, 5334.0, 5617.0, 5373.0, 5687.0, 5584.0, 5479.0, 5610.0, 5359.0, 5549.0, 5535.0, 5718.0, 5691.0, 5313.0, 5477.0, 5449.0, 5607.0, 5392.0, 5647.0, 5675.0 (number of hits: 32)
11	5570	9	1	333	1	5702.0, 5517.0, 5409.0, 5668.0, 5499.0, 5688.0, 5342.0, 5419.0, 5252.0, 5443.0, 5652.0, 5536.0, 5566.0, 5680.0, 5522.0, 5451.0, 5289.0, 5299.0, 5330.0, 5399.0, 5540.0, 5363.0, 5463.0, 5405.0, 5318.0, 5453.0, 5631.0, 5380.0, 5519.0, 5447.0, 5427.0, 5552.0, 5373.0, 5362.0, 5321.0, 5408.0, 5628.0, 5416.0, 5361.0, 5295.0, 5481.0, 5425.0, 5641.0, 5339.0, 5531.0, 5656.0, 5722.0, 5465.0, 5721.0, 5569.0, 5538.0, 5559.0, 5483.0, 5434.0, 5714.0, 5327.0, 5407.0, 5337.0, 5304.0, 5306.0, 5326.0, 5693.0, 5279.0, 5261.0, 5282.0, 5719.0, 5524.0, 5649.0, 5537.0, 5550.0, 5654.0, 5685.0, 5262.0, 5692.0, 5477.0, 5297.0, 5712.0, 5370.0, 5283.0, 5718.0, 5396.0, 5658.0, 5516.0, 5723.0, 5325.0, 5591.0, 5661.0, 5606.0, 5354.0, 5398.0, 5420.0, 5276.0, 5450.0, 5556.0, 5491.0, 5660.0, 5526.0, 5329.0, 5280.0, 5665.0 (number of hits: 23)
12	5570	9	1	333	1	5290.0, 5617.0, 5640.0, 5565.0, 5268.0, 5396.0, 5495.0, 5323.0, 5285.0, 5365.0, 5613.0, 5604.0, 5253.0, 5333.0, 5335.0,

						5263.0, 5379.0, 5269.0, 5407.0, 5432.0, 5459.0, 5448.0, 5648.0, 5494.0, 5560.0, 5711.0, 5632.0, 5278.0, 5319.0, 5452.0, 5357.0, 5500.0, 5519.0, 5318.0, 5306.0, 5707.0, 5592.0, 5446.0, 5456.0, 5598.0, 5530.0, 5539.0, 5563.0, 5376.0, 5684.0, 5362.0, 5301.0, 5398.0, 5642.0, 5371.0, 5414.0, 5699.0, 5697.0, 5381.0, 5471.0, 5594.0, 5667.0, 5487.0, 5573.0, 5508.0, 5393.0, 5275.0, 5602.0, 5537.0, 5694.0, 5505.0, 5419.0, 5553.0, 5621.0, 5343.0, 5599.0, 5603.0, 5416.0, 5652.0, 5380.0, 5287.0, 5372.0, 5352.0, 5679.0, 5484.0, 5582.0, 5385.0, 5254.0, 5417.0, 5397.0, 5346.0, 5485.0, 5555.0, 5531.0, 5280.0, 5723.0, 5564.0, 5587.0, 5387.0, 5501.0, 5511.0, 5509.0, 5449.0, 5714.0, 5375.0 (number of hits: 35)
13	5570	9	1	333	1	5679.0, 5463.0, 5693.0, 5531.0, 5571.0, 5442.0, 5674.0, 5718.0, 5658.0, 5540.0, 5283.0, 5534.0, 5335.0, 5282.0, 5687.0, 5602.0, 5641.0, 5273.0, 5308.0, 5615.0, 5685.0, 5328.0, 5525.0, 5399.0, 5672.0, 5703.0, 5476.0, 5639.0, 5472.0, 5695.0, 5558.0, 5664.0, 5648.0, 5276.0, 5251.0, 5496.0, 5621.0, 5520.0, 5299.0, 5470.0, 5682.0, 5342.0, 5485.0, 5391.0, 5488.0, 5277.0, 5504.0, 5596.0, 5657.0, 5524.0, 5675.0, 5583.0, 5715.0, 5461.0, 5537.0, 5597.0, 5259.0, 5290.0, 5281.0, 5389.0, 5547.0, 5528.0, 5625.0, 5363.0, 5683.0, 5704.0, 5465.0, 5310.0, 5392.0, 5357.0, 5270.0, 5644.0, 5440.0, 5593.0, 5719.0, 5353.0, 5256.0, 5721.0, 5424.0, 5717.0, 5386.0, 5570.0, 5632.0, 5269.0, 5521.0, 5360.0, 5346.0, 5407.0, 5643.0, 5714.0, 5267.0, 5459.0, 5651.0, 5456.0, 5415.0, 5627.0, 5332.0, 5614.0, 5372.0, 5530.0 (number of hits: 31)
14	5570	9	1	333	1	5311.0, 5534.0, 5682.0, 5283.0, 5584.0, 5344.0, 5394.0, 5573.0, 5320.0, 5308.0, 5558.0, 5384.0, 5576.0, 5398.0, 5707.0, 5341.0, 5701.0, 5561.0, 5338.0, 5256.0, 5284.0, 5647.0, 5268.0, 5586.0, 5510.0, 5327.0, 5306.0, 5631.0, 5661.0, 5438.0, 5361.0, 5602.0, 5356.0, 5683.0, 5535.0, 5428.0, 5405.0, 5267.0, 5577.0, 5504.0, 5363.0, 5628.0, 5612.0, 5713.0, 5653.0, 5623.0, 5357.0, 5528.0, 5468.0, 5564.0, 5413.0, 5294.0, 5649.0, 5495.0, 5465.0, 5604.0, 5642.0, 5652.0, 5656.0, 5401.0, 5665.0, 5672.0, 5483.0, 5388.0, 5685.0, 5482.0, 5347.0, 5423.0, 5330.0, 5254.0, 5722.0, 5448.0, 5676.0, 5532.0, 5620.0, 5568.0, 5720.0, 5379.0, 5385.0, 5374.0, 5625.0, 5278.0, 5675.0, 5277.0, 5592.0, 5716.0, 5546.0, 5302.0, 5333.0, 5695.0, 5630.0, 5391.0, 5404.0, 5416.0, 5621.0, 5265.0, 5559.0, 5343.0, 5687.0, 5476.0 (number of hits: 31)

15	5570	9	1	333	1	5478.0, 5535.0, 5342.0, 5469.0, 5540.0, 5524.0, 5523.0, 5391.0, 5299.0, 5675.0, 5399.0, 5321.0, 5474.0, 5537.0, 5444.0, 5708.0, 5637.0, 5422.0, 5513.0, 5685.0, 5621.0, 5495.0, 5311.0, 5282.0, 5635.0, 5402.0, 5470.0, 5479.0, 5316.0, 5616.0, 5265.0, 5679.0, 5705.0, 5713.0, 5541.0, 5403.0, 5302.0, 5446.0, 5447.0, 5396.0, 5331.0, 5423.0, 5277.0, 5359.0, 5493.0, 5530.0, 5597.0, 5309.0, 5413.0, 5673.0, 5665.0, 5441.0, 5295.0, 5330.0, 5362.0, 5350.0, 5576.0, 5653.0, 5281.0, 5389.0, 5694.0, 5689.0, 5554.0, 5373.0, 5716.0, 5543.0, 5622.0, 5680.0, 5271.0, 5497.0, 5672.0, 5545.0, 5336.0, 5566.0, 5390.0, 5346.0, 5358.0, 5252.0, 5294.0, 5547.0, 5633.0, 5385.0, 5395.0, 5505.0, 5376.0, 5371.0, 5387.0, 5550.0, 5584.0, 5443.0, 5274.0, 5492.0, 5454.0, 5284.0, 5296.0, 5317.0, 5658.0, 5660.0, 5480.0, 5414.0 (number of hits: 28)
16	5570	9	1	333	1	5495.0, 5301.0, 5261.0, 5506.0, 5680.0, 5406.0, 5661.0, 5362.0, 5415.0, 5278.0, 5395.0, 5573.0, 5553.0, 5545.0, 5536.0, 5657.0, 5617.0, 5461.0, 5262.0, 5704.0, 5724.0, 5416.0, 5348.0, 5594.0, 5371.0, 5398.0, 5718.0, 5375.0, 5310.0, 5670.0, 5525.0, 5299.0, 5433.0, 5602.0, 5443.0, 5408.0, 5412.0, 5567.0, 5540.0, 5715.0, 5501.0, 5285.0, 5588.0, 5321.0, 5595.0, 5700.0, 5328.0, 5610.0, 5479.0, 5414.0, 5458.0, 5651.0, 5673.0, 5672.0, 5275.0, 5308.0, 5396.0, 5288.0, 5438.0, 5589.0, 5642.0, 5497.0, 5460.0, 5531.0, 5490.0, 5309.0, 5417.0, 5462.0, 5641.0, 5291.0, 5429.0, 5662.0, 5600.0, 5517.0, 5267.0, 5365.0, 5380.0, 5560.0, 5624.0, 5486.0, 5307.0, 5599.0, 5319.0, 5287.0, 5649.0, 5714.0, 5281.0, 5606.0, 5272.0, 5360.0, 5455.0, 5709.0, 5716.0, 5449.0, 5266.0, 5373.0, 5425.0, 5551.0, 5325.0, 5660.0 (number of hits: 28)
17	5570	9	1	333	1	5387.0, 5602.0, 5535.0, 5352.0, 5450.0, 5666.0, 5686.0, 5646.0, 5559.0, 5580.0, 5527.0, 5520.0, 5700.0, 5590.0, 5318.0, 5513.0, 5467.0, 5468.0, 5359.0, 5472.0, 5404.0, 5360.0, 5395.0, 5407.0, 5343.0, 5288.0, 5660.0, 5418.0, 5302.0, 5369.0, 5701.0, 5491.0, 5615.0, 5554.0, 5502.0, 5678.0, 5547.0, 5476.0, 5462.0, 5622.0, 5469.0, 5560.0, 5540.0, 5452.0, 5543.0, 5658.0, 5382.0, 5586.0, 5310.0, 5297.0, 5338.0, 5376.0, 5355.0, 5611.0, 5460.0, 5649.0, 5377.0, 5453.0, 5257.0, 5333.0, 5664.0, 5305.0, 5504.0, 5638.0, 5251.0, 5298.0, 5386.0, 5266.0, 5614.0, 5286.0, 5546.0, 5379.0, 5425.0, 5437.0, 5605.0, 5642.0, 5597.0, 5663.0, 5596.0, 5408.0, 5485.0, 5635.0, 5348.0, 5577.0, 5561.0, 5253.0, 5693.0, 5691.0, 5388.0, 5494.0

						5252.0, 5631.0, 5489.0, 5271.0, 5326.0, 5708.0, 5517.0, 5717.0, 5650.0, 5313.0 (number of hits: 33)
18	5570	9	1	333	1	5581.0, 5577.0, 5526.0, 5666.0, 5681.0, 5576.0, 5612.0, 5656.0, 5354.0, 5611.0, 5292.0, 5414.0, 5264.0, 5506.0, 5503.0, 5352.0, 5279.0, 5319.0, 5253.0, 5648.0, 5523.0, 5426.0, 5599.0, 5436.0, 5595.0, 5560.0, 5329.0, 5485.0, 5275.0, 5528.0, 5705.0, 5377.0, 5682.0, 5677.0, 5371.0, 5294.0, 5661.0, 5465.0, 5487.0, 5544.0, 5614.0, 5719.0, 5512.0, 5699.0, 5684.0, 5267.0, 5327.0, 5721.0, 5702.0, 5521.0, 5616.0, 5529.0, 5315.0, 5493.0, 5565.0, 5539.0, 5583.0, 5510.0, 5694.0, 5425.0, 5638.0, 5343.0, 5578.0, 5441.0, 5328.0, 5269.0, 5290.0, 5572.0, 5454.0, 5556.0, 5358.0, 5422.0, 5552.0, 5357.0, 5303.0, 5716.0, 5484.0, 5390.0, 5306.0, 5287.0, 5483.0, 5468.0, 5724.0, 5438.0, 5476.0, 5713.0, 5643.0, 5439.0, 5378.0, 5541.0, 5644.0, 5412.0, 5254.0, 5652.0, 5557.0, 5472.0, 5613.0, 5601.0, 5481.0, 5373.0 (number of hits: 35)
19	5570	9	1	333	1	5406.0, 5279.0, 5635.0, 5479.0, 5363.0, 5328.0, 5283.0, 5620.0, 5440.0, 5380.0, 5449.0, 5417.0, 5542.0, 5643.0, 5572.0, 5414.0, 5538.0, 5401.0, 5691.0, 5290.0, 5301.0, 5689.0, 5548.0, 5284.0, 5351.0, 5564.0, 5563.0, 5518.0, 5514.0, 5506.0, 5668.0, 5460.0, 5416.0, 5562.0, 5296.0, 5603.0, 5360.0, 5641.0, 5349.0, 5717.0, 5392.0, 5403.0, 5693.0, 5720.0, 5667.0, 5422.0, 5670.0, 5638.0, 5433.0, 5311.0, 5266.0, 5367.0, 5492.0, 5458.0, 5377.0, 5504.0, 5268.0, 5437.0, 5396.0, 5294.0, 5270.0, 5566.0, 5276.0, 5426.0, 5291.0, 5475.0, 5509.0, 5391.0, 5531.0, 5495.0, 5687.0, 5559.0, 5494.0, 5547.0, 5419.0, 5611.0, 5407.0, 5358.0, 5370.0, 5316.0, 5647.0, 5626.0, 5399.0, 5674.0, 5707.0, 5688.0, 5339.0, 5649.0, 5309.0, 5633.0, 5421.0, 5640.0, 5669.0, 5690.0, 5529.0, 5589.0, 5308.0, 5537.0, 5381.0, 5277.0 (number of hits: 33)
20	5570	9	1	333	1	5704.0, 5314.0, 5511.0, 5329.0, 5599.0, 5671.0, 5390.0, 5458.0, 5466.0, 5378.0, 5580.0, 5311.0, 5477.0, 5660.0, 5356.0, 5603.0, 5447.0, 5361.0, 5410.0, 5310.0, 5593.0, 5529.0, 5616.0, 5398.0, 5692.0, 5411.0, 5654.0, 5250.0, 5359.0, 5484.0, 5585.0, 5556.0, 5363.0, 5574.0, 5272.0, 5690.0, 5407.0, 5317.0, 5343.0, 5716.0, 5702.0, 5452.0, 5623.0, 5516.0, 5302.0, 5548.0, 5274.0, 5367.0, 5280.0, 5515.0, 5544.0, 5435.0, 5300.0, 5370.0, 5397.0, 5560.0, 5646.0, 5604.0, 5261.0, 5575.0, 5402.0, 5265.0, 5572.0, 5637.0, 5633.0, 5355.0, 5503.0, 5719.0, 5497.0, 5368.0, 5323.0, 5287.0, 5424.0, 5276.0, 5270.0,

						5293.0, 5439.0, 5491.0, 5566.0, 5551.0, 5550.0, 5710.0, 5605.0, 5532.0, 5362.0, 5351.0, 5613.0, 5263.0, 5598.0, 5288.0, 5720.0, 5358.0, 5479.0, 5536.0, 5352.0, 5301.0, 5621.0, 5718.0, 5691.0, 5347.0 (number of hits: 33)
21	5570	9	1	333	1	5683.0, 5353.0, 5558.0, 5632.0, 5693.0, 5575.0, 5573.0, 5396.0, 5650.0, 5326.0, 5511.0, 5630.0, 5682.0, 5414.0, 5673.0, 5495.0, 5487.0, 5559.0, 5684.0, 5527.0, 5337.0, 5287.0, 5384.0, 5329.0, 5444.0, 5274.0, 5254.0, 5662.0, 5614.0, 5290.0, 5628.0, 5268.0, 5619.0, 5451.0, 5589.0, 5635.0, 5669.0, 5504.0, 5298.0, 5289.0, 5488.0, 5570.0, 5659.0, 5533.0, 5443.0, 5528.0, 5710.0, 5317.0, 5540.0, 5622.0, 5594.0, 5385.0, 5521.0, 5642.0, 5315.0, 5452.0, 5339.0, 5438.0, 5441.0, 5394.0, 5641.0, 5454.0, 5367.0, 5319.0, 5585.0, 5344.0, 5618.0, 5272.0, 5259.0, 5572.0, 5364.0, 5500.0, 5354.0, 5410.0, 5606.0, 5520.0, 5523.0, 5392.0, 5679.0, 5338.0, 5720.0, 5551.0, 5271.0, 5425.0, 5524.0, 5680.0, 5568.0, 5604.0, 5405.0, 5360.0, 5508.0, 5463.0, 5398.0, 5462.0, 5418.0, 5491.0, 5489.0, 5578.0, 5529.0, 5623.0 (number of hits: 39)
22	5570	9	1	333	1	5403.0, 5422.0, 5717.0, 5667.0, 5501.0, 5367.0, 5338.0, 5383.0, 5268.0, 5659.0, 5648.0, 5636.0, 5463.0, 5430.0, 5336.0, 5460.0, 5280.0, 5406.0, 5531.0, 5316.0, 5564.0, 5332.0, 5370.0, 5581.0, 5306.0, 5627.0, 5603.0, 5606.0, 5552.0, 5633.0, 5453.0, 5535.0, 5508.0, 5720.0, 5333.0, 5529.0, 5258.0, 5498.0, 5322.0, 5295.0, 5376.0, 5381.0, 5505.0, 5647.0, 5443.0, 5408.0, 5563.0, 5566.0, 5723.0, 5697.0, 5470.0, 5516.0, 5537.0, 5285.0, 5413.0, 5528.0, 5618.0, 5674.0, 5261.0, 5409.0, 5549.0, 5622.0, 5254.0, 5542.0, 5279.0, 5716.0, 5276.0, 5689.0, 5482.0, 5349.0, 5478.0, 5323.0, 5402.0, 5649.0, 5639.0, 5266.0, 5296.0, 5366.0, 5657.0, 5282.0, 5378.0, 5507.0, 5297.0, 5558.0, 5355.0, 5357.0, 5712.0, 5283.0, 5391.0, 5310.0, 5637.0, 5320.0, 5401.0, 5256.0, 5375.0, 5417.0, 5385.0, 5593.0, 5293.0, 5484.0 (number of hits: 30)
23	5570	9	1	333	1	5350.0, 5711.0, 5342.0, 5369.0, 5328.0, 5642.0, 5719.0, 5484.0, 5316.0, 5640.0, 5720.0, 5634.0, 5690.0, 5424.0, 5609.0, 5382.0, 5676.0, 5669.0, 5464.0, 5571.0, 5475.0, 5503.0, 5338.0, 5423.0, 5665.0, 5516.0, 5455.0, 5298.0, 5371.0, 5561.0, 5388.0, 5422.0, 5270.0, 5538.0, 5466.0, 5502.0, 5655.0, 5285.0, 5550.0, 5526.0, 5539.0, 5322.0, 5677.0, 5602.0, 5265.0, 5596.0, 5567.0, 5290.0, 5408.0, 5512.0, 5413.0, 5499.0, 5673.0, 5723.0, 5697.0, 5447.0, 5663.0, 5710.0, 5330.0, 5277.0

						5646.0, 5515.0, 5497.0, 5419.0, 5649.0, 5623.0, 5563.0, 5540.0, 5592.0, 5427.0, 5477.0, 5358.0, 5706.0, 5284.0, 5553.0, 5348.0, 5334.0, 5675.0, 5325.0, 5686.0, 5309.0, 5362.0, 5573.0, 5310.0, 5292.0, 5648.0, 5691.0, 5337.0, 5507.0, 5651.0, 5687.0, 5721.0, 5406.0, 5340.0, 5654.0, 5476.0, 5636.0, 5387.0, 5272.0, 5488.0 (number of hits: 29)
24	5570	9	1	333	1	5457.0, 5378.0, 5480.0, 5711.0, 5371.0, 5295.0, 5272.0, 5663.0, 5584.0, 5499.0, 5266.0, 5297.0, 5402.0, 5525.0, 5490.0, 5381.0, 5307.0, 5701.0, 5255.0, 5554.0, 5638.0, 5374.0, 5354.0, 5541.0, 5710.0, 5367.0, 5344.0, 5403.0, 5303.0, 5516.0, 5404.0, 5257.0, 5466.0, 5447.0, 5323.0, 5350.0, 5678.0, 5352.0, 5435.0, 5476.0, 5262.0, 5668.0, 5481.0, 5338.0, 5598.0, 5408.0, 5518.0, 5605.0, 5609.0, 5571.0, 5336.0, 5617.0, 5687.0, 5692.0, 5314.0, 5532.0, 5454.0, 5680.0, 5526.0, 5722.0, 5273.0, 5489.0, 5693.0, 5359.0, 5360.0, 5650.0, 5384.0, 5590.0, 5657.0, 5522.0, 5456.0, 5485.0, 5339.0, 5569.0, 5259.0, 5472.0, 5313.0, 5618.0, 5315.0, 5643.0, 5529.0, 5270.0, 5278.0, 5347.0, 5370.0, 5349.0, 5479.0, 5572.0, 5577.0, 5622.0, 5685.0, 5536.0, 5331.0, 5704.0, 5690.0, 5608.0, 5433.0, 5703.0, 5570.0, 5699.0 (number of hits: 27)
25	5570	9	1	333	1	5719.0, 5445.0, 5400.0, 5426.0, 5402.0, 5568.0, 5686.0, 5628.0, 5411.0, 5312.0, 5446.0, 5675.0, 5409.0, 5618.0, 5285.0, 5372.0, 5670.0, 5571.0, 5302.0, 5359.0, 5613.0, 5472.0, 5704.0, 5520.0, 5296.0, 5665.0, 5529.0, 5310.0, 5276.0, 5251.0, 5547.0, 5355.0, 5376.0, 5300.0, 5540.0, 5666.0, 5669.0, 5544.0, 5561.0, 5269.0, 5417.0, 5373.0, 5313.0, 5668.0, 5557.0, 5438.0, 5480.0, 5295.0, 5309.0, 5687.0, 5559.0, 5434.0, 5713.0, 5664.0, 5324.0, 5663.0, 5503.0, 5621.0, 5267.0, 5584.0, 5655.0, 5703.0, 5268.0, 5639.0, 5369.0, 5288.0, 5605.0, 5614.0, 5468.0, 5579.0, 5504.0, 5482.0, 5659.0, 5586.0, 5507.0, 5545.0, 5676.0, 5615.0, 5322.0, 5281.0, 5617.0, 5367.0, 5485.0, 5418.0, 5460.0, 5252.0, 5476.0, 5641.0, 5510.0, 5403.0, 5573.0, 5706.0, 5354.0, 5581.0, 5454.0, 5606.0, 5674.0, 5548.0, 5408.0, 5601.0 (number of hits: 33)
26	5570	9	1	333	1	5510.0, 5400.0, 5576.0, 5461.0, 5310.0, 5447.0, 5276.0, 5462.0, 5636.0, 5263.0, 5616.0, 5439.0, 5536.0, 5617.0, 5612.0, 5288.0, 5399.0, 5502.0, 5353.0, 5651.0, 5284.0, 5362.0, 5639.0, 5713.0, 5526.0, 5298.0, 5277.0, 5605.0, 5367.0, 5708.0, 5364.0, 5519.0, 5448.0, 5394.0, 5690.0, 5531.0, 5306.0, 5388.0, 5274.0, 5351.0, 5590.0, 5658.0, 5652.0, 5303.0, 5523.0

						5433.0, 5464.0, 5371.0, 5265.0, 5587.0, 5488.0, 5283.0, 5478.0, 5331.0, 5638.0, 5548.0, 5546.0, 5599.0, 5428.0, 5295.0, 5381.0, 5278.0, 5382.0, 5692.0, 5471.0, 5620.0, 5468.0, 5365.0, 5621.0, 5688.0, 5631.0, 5556.0, 5454.0, 5595.0, 5449.0, 5662.0, 5573.0, 5615.0, 5709.0, 5509.0, 5649.0, 5384.0, 5643.0, 5676.0, 5720.0, 5640.0, 5693.0, 5602.0, 5666.0, 5633.0, 5390.0, 5465.0, 5398.0, 5459.0, 5318.0, 5269.0, 5508.0, 5540.0, 5715.0, 5606.0 (number of hits: 35)
27	5570	9	1	333	1	5556.0, 5488.0, 5703.0, 5719.0, 5524.0, 5395.0, 5518.0, 5515.0, 5368.0, 5537.0, 5497.0, 5670.0, 5507.0, 5640.0, 5639.0, 5644.0, 5707.0, 5305.0, 5369.0, 5280.0, 5613.0, 5463.0, 5506.0, 5634.0, 5503.0, 5411.0, 5462.0, 5357.0, 5546.0, 5327.0, 5511.0, 5454.0, 5479.0, 5421.0, 5672.0, 5487.0, 5375.0, 5596.0, 5412.0, 5545.0, 5442.0, 5510.0, 5373.0, 5697.0, 5310.0, 5579.0, 5514.0, 5260.0, 5689.0, 5622.0, 5693.0, 5268.0, 5696.0, 5663.0, 5386.0, 5625.0, 5555.0, 5339.0, 5428.0, 5342.0, 5464.0, 5578.0, 5666.0, 5482.0, 5509.0, 5252.0, 5502.0, 5614.0, 5523.0, 5616.0, 5348.0, 5704.0, 5418.0, 5585.0, 5366.0, 5612.0, 5508.0, 5629.0, 5264.0, 5657.0, 5681.0, 5461.0, 5492.0, 5285.0, 5437.0, 5627.0, 5527.0, 5611.0, 5549.0, 5584.0, 5469.0, 5441.0, 5626.0, 5302.0, 5541.0, 5698.0, 5377.0, 5521.0, 5483.0, 5304.0 (number of hits: 43)
28	5570	9	1	333	1	5612.0, 5432.0, 5437.0, 5602.0, 5499.0, 5584.0, 5336.0, 5344.0, 5670.0, 5573.0, 5652.0, 5623.0, 5654.0, 5678.0, 5279.0, 5374.0, 5435.0, 5614.0, 5333.0, 5647.0, 5720.0, 5611.0, 5415.0, 5705.0, 5610.0, 5422.0, 5421.0, 5268.0, 5373.0, 5655.0, 5601.0, 5482.0, 5306.0, 5687.0, 5444.0, 5484.0, 5309.0, 5535.0, 5362.0, 5272.0, 5367.0, 5695.0, 5402.0, 5645.0, 5532.0, 5261.0, 5574.0, 5281.0, 5411.0, 5370.0, 5582.0, 5487.0, 5495.0, 5274.0, 5538.0, 5531.0, 5491.0, 5504.0, 5722.0, 5496.0, 5579.0, 5454.0, 5369.0, 5420.0, 5468.0, 5280.0, 5685.0, 5278.0, 5313.0, 5341.0, 5521.0, 5494.0, 5510.0, 5358.0, 5541.0, 5350.0, 5680.0, 5660.0, 5427.0, 5452.0, 5335.0, 5560.0, 5419.0, 5613.0, 5716.0, 5700.0, 5609.0, 5577.0, 5470.0, 5501.0, 5547.0, 5319.0, 5668.0, 5669.0, 5410.0, 5282.0, 5634.0, 5298.0, 5291.0, 5469.0 (number of hits: 33)
29	5570	9	1	333	1	5555.0, 5632.0, 5626.0, 5562.0, 5608.0, 5583.0, 5529.0, 5703.0, 5720.0, 5368.0, 5593.0, 5364.0, 5540.0, 5333.0, 5332.0, 5284.0, 5458.0, 5624.0, 5611.0, 5503.0, 5508.0, 5299.0, 5656.0, 5309.0, 5280.0, 5450.0, 5274.0, 5279.0, 5487.0, 5371.0,

						5477.0, 5493.0, 5628.0, 5261.0, 5462.0, 5548.0, 5650.0, 5460.0, 5715.0, 5480.0, 5587.0, 5258.0, 5644.0, 5441.0, 5420.0, 5439.0, 5454.0, 5633.0, 5598.0, 5496.0, 5318.0, 5719.0, 5355.0, 5665.0, 5516.0, 5286.0, 5345.0, 5254.0, 5623.0, 5629.0, 5588.0, 5428.0, 5606.0, 5459.0, 5435.0, 5285.0, 5552.0, 5363.0, 5294.0, 5710.0, 5433.0, 5556.0, 5649.0, 5479.0, 5415.0, 5704.0, 5615.0, 5393.0, 5721.0, 5259.0, 5673.0, 5469.0, 5444.0, 5295.0, 5637.0, 5463.0, 5502.0, 5256.0, 5621.0, 5581.0, 5302.0, 5446.0, 5596.0, 5287.0, 5265.0, 5327.0, 5308.0, 5651.0, 5630.0, 5356.0 (number of hits: 35)
30	5570	9	1	333	1	5353.0, 5464.0, 5615.0, 5580.0, 5597.0, 5448.0, 5480.0, 5388.0, 5678.0, 5478.0, 5472.0, 5298.0, 5654.0, 5258.0, 5360.0, 5452.0, 5603.0, 5707.0, 5465.0, 5543.0, 5429.0, 5345.0, 5312.0, 5507.0, 5449.0, 5575.0, 5351.0, 5408.0, 5470.0, 5446.0, 5665.0, 5708.0, 5327.0, 5620.0, 5431.0, 5300.0, 5262.0, 5365.0, 5396.0, 5354.0, 5288.0, 5690.0, 5277.0, 5403.0, 5574.0, 5639.0, 5614.0, 5631.0, 5346.0, 5428.0, 5558.0, 5410.0, 5459.0, 5273.0, 5439.0, 5276.0, 5642.0, 5391.0, 5632.0, 5349.0, 5296.0, 5663.0, 5515.0, 5532.0, 5523.0, 5540.0, 5385.0, 5538.0, 5468.0, 5390.0, 5651.0, 5537.0, 5717.0, 5339.0, 5493.0, 5445.0, 5535.0, 5414.0, 5433.0, 5453.0, 5719.0, 5350.0, 5542.0, 5553.0, 5592.0, 5517.0, 5333.0, 5316.0, 5444.0, 5369.0, 5494.0, 5271.0, 5430.0, 5669.0, 5497.0, 5524.0, 5418.0, 5617.0, 5269.0, 5610.0 (number of hits: 32)

10 Annex A– Test Setup Photographs

Please refer to the attachment

11 Annex B - EUT External Photographs

Please refer to the attachment

12 Annex C– EUT Internal Photographs

Please refer to the attachment

13 Annex D (Normative) - A2LA Electrical Testing Certificate



Accredited Laboratory

A2LA has accredited

BAY AREA COMPLIANCE LABORATORIES CORP.

Sunnyvale, CA

for technical competence in the field of

Electrical Testing

This laboratory is accredited in accordance with the recognized International Standard ISO/IEC 17025:2005 General requirements for the competence of testing and calibration laboratories. This laboratory also meets A2LA R222 - Specific Requirements EPA ENERGY STAR Accreditation Program. This accreditation demonstrates technical competence for a defined scope and the operation of a laboratory quality management system (refer to joint ISO-ILAC-IAF Communiqué dated April 2017).



Presented this 2nd day of October 2018.

A handwritten signature in blue ink, appearing to be 'A. ...', written over a horizontal line.

Vice President, Accreditation Services
For the Accreditation Council
Certificate Number 3297.02
Valid to September 30, 2020
Revised June 5, 2019

For the tests to which this accreditation applies, please refer to the laboratory's Electrical Scope of Accreditation.

Please follow the web link below for a full ISO 17025 scope

<https://www.a2la.org/scopepdf/3297-02.pdf>

--- END OF REPORT ---