

**Test Report**  
**Model: C1920AXP-x & C1920AXP-EWC-x**  
**Cisco Catalyst C9120AX Series**  
**(x=B)**

FCC ID: LDKROFSN2177



**5725-5850 MHz**

Against the following Specifications:

CFR47 Part 15.407



Cisco Systems  
170 West Tasman Drive  
San Jose, CA 95134

	
<b>Author:</b> Abhishek Upadhyay <b>Tested By:</b> Abhishek Upadhyay	<b>Approved By:</b> Gerard Thorpe <b>Title:</b> Manager <b>Revision:</b> Controlled by Doc Central

This report replaces any previously entered test report under EDCS – 18352977. This test report has been electronically authorized and archived using the CISCO Engineering Document Control system.

<b>SECTION 1: OVERVIEW .....</b>	<b>3</b>
<b>SECTION 2: ASSESSMENT INFORMATION .....</b>	<b>4</b>
2.1 GENERAL .....	4
2.2 DATE OF TESTING.....	6
2.3 REPORT ISSUE DATE .....	6
2.4 TESTING FACILITIES .....	6
2.5 EQUIPMENT ASSESSED (EUT).....	6
2.6 EUT DESCRIPTION.....	7
<b>SECTION 3: RESULT SUMMARY .....</b>	<b>8</b>
3.1 RESULTS SUMMARY TABLE .....	8
<b>SECTION 4: SAMPLE DETAILS.....</b>	<b>9</b>
4.1 SAMPLE DETAILS .....	9
4.2 SYSTEM DETAILS .....	9
4.3 MODE OF OPERATION DETAILS.....	9
<b>APPENDIX A: EMISSION TEST RESULTS .....</b>	<b>10</b>
CONDUCTED TEST SETUP DIAGRAM.....	10
TARGET MAXIMUM CHANNEL POWER .....	10
A.1 DUTY CYCLE .....	11
A.2 6dB BANDWIDTH.....	13
A.3 99% AND 26dB BANDWIDTH .....	17
A.4 MAXIMUM CONDUCTED OUTPUT POWER .....	21
A.5 POWER SPECTRAL DENSITY .....	25
A.6 CONDUCTED SPURIOUS EMISSIONS.....	30
A.7 CONDUCTED BANDEDGE.....	38
<b>APPENDIX B: EMISSION TEST RESULTS .....</b>	<b>44</b>
B.1 RADIATED SPURIOUS EMISSIONS .....	45
B.2 RECEIVER SPURIOUS EMISSIONS .....	46
B.3 RADIATED EMISSIONS 30MHZ TO 1GHZ .....	47
B.4 AC CONDUCTED EMISSIONS .....	48
<b>APPENDIX C: LIST OF TEST EQUIPMENT USED TO PERFORM THE TEST .....</b>	<b>49</b>
<b>APPENDIX D: ABBREVIATION KEY AND DEFINITIONS.....</b>	<b>50</b>
<b>APPENDIX E:     PHOTOGRAPHS OF TEST SETUPS .....</b>	<b>51</b>
<b>APPENDIX F:     SOFTWARE USED TO PERFORM TESTING.....</b>	<b>52</b>
<b>APPENDIX G: TEST PROCEDURES.....</b>	<b>52</b>
<b>APPENDIX H: SCOPE OF ACCREDITATION (A2LA CERTIFICATE NUMBER 1178-01).....</b>	<b>52</b>
<b>APPENDIX I: TEST ASSESSMENT PLAN .....</b>	<b>52</b>



**Section 1: Overview**

The samples were assessed against the tests detailed in section 3 under the requirements of the following specifications:

<b>Specifications:</b>
CFR47 Part 15.407

## Section 2: Assessment Information

### 2.1 General

This report contains an assessment of an apparatus against Electromagnetic Compatibility Standards based upon tests carried out on the samples submitted. The testing was performed by and for the use of Cisco systems Inc:

With regard to this assessment, the following points should be noted:

- a) The results contained in this report relate only to the items tested and were obtained in the period between the date of the initial assessment and the date of issue of the report. Manufactured products will not necessarily give identical results due to production and measurement tolerances.
- b) The apparatus was set up and exercised using the configuration and modes of operation defined in this report only.
- c) Where relevant, the apparatus was only assessed using the susceptibility criteria defined in this report and the Test Assessment Plan (TAP).
- d) All testing was performed under the following environmental conditions:

Temperature	15°C to 35°C (54°F to 95°F)
Atmospheric Pressure	860mbar to 1060mbar (25.4" to 31.3")
Humidity	10% to 75*%
- e) All AC testing was performed at one or more of the following supply voltages:  
110V 60 Hz (+/-20%)

### Units of Measurement

The units of measurements defined in the appendices are reported in specific terms, which are test dependent. Where radiated measurements are concerned these are defined at a particular distance. Basic voltage measurements are defined in units of [dBuV]

As an example, the basic calculation for all measurements is as follows:

$$\text{Emission level [dBuV]} = \text{Indicated voltage level [dBuV]} + \text{Cable Loss [dB]} + \text{Other correction factors [dB]}$$

The combinations of correction factors are dependent upon the exact test configurations [see test equipment lists for further details] and may include:-

Antenna Factors, Pre Amplifier Gain, LISN Loss, Pulse Limiter Loss and Filter Insertion Loss

Note: to convert the results from dBuV/m to uV/m use the following formula:-

$$\text{Level in uV/m} = \text{Common Antilogarithm} [(X \text{ dBuV/m})/20] = Y \text{ uV/m}$$

## Measurement Uncertainty Values

voltage and power measurements	± 2 dB
conducted EIRP measurements	± 1.4 dB
radiated measurements	± 3.2 dB
frequency measurements	± 2.4 10 <sup>-7</sup>
temperature measurements	± 0.54°
humidity measurements	± 2.3%
DC and low frequency measurements	± 2.5%

Where relevant measurement uncertainty levels have been estimated for tests performed on the apparatus. This uncertainty represents an expanded uncertainty expressed at approximately the 95% confidence level using a coverage factor of k=2.

## Radiated emissions (expanded uncertainty, confidence interval 95%)

30 MHz - 300 MHz	+/- 3.8 dB
300 MHz - 1000 MHz	+/- 4.3 dB
1 GHz - 10 GHz	+/- 4.0 dB
10 GHz - 18GHz	+/- 8.2 dB
18GHz - 26.5GHz	+/- 4.1 dB
26.5GHz - 40GHz	+/- 3.9 dB

## Conducted emissions (expanded uncertainty, confidence interval 95%)

30 MHz – 40GHz	+/- 0.38 dB
----------------	-------------

A product is considered to comply with a requirement if the nominal measured value is below the limit line. The product is considered to not be in compliance in case the nominal measured value is above the limit line.

**This report must not be reproduced except in full, without written approval of Cisco Systems.**

**2.2 Date of testing**

16-Sep-19 - 24-Sep-19

**2.3 Report Issue Date**

10/15/2019

Cisco uses an electronic system to issue, store and control the revision of test reports. This system is called the Engineering Document Control System (EDCS). The actual report issue date is embedded into the original file on EDCS. Any copies of this report, either electronic or paper, that are not on EDCS must be considered uncontrolled.

**2.4 Testing facilities**

This assessment was performed by:

**Testing Laboratory****Testing Laboratory**

Cisco Systems, Inc.  
125 West Tasman Drive (Building P)  
San Jose, CA 95134  
USA

**Headquarters**

Cisco Systems, Inc.,  
170 West Tasman Drive  
San Jose, CA 95134,  
USA

**Registration Numbers for Industry Canada**

<b>Cisco System Site</b>	<b>Address</b>	<b>Site Identifier</b>
Building P, 10m Chamber	125 West Tasman Dr San Jose, CA 95134	Company #: 2461N-2
Building P, 5m Chamber	125 West Tasman Dr San Jose, CA 95134	Company #: 2461N-1
Building I, 5m Chamber	285 W. Tasman Drive San Jose, California 95134	Company #: 2461M-1

**Test Engineers**

Abhishek Upadhyay

**2.5 Equipment Assessed (EUT)**

C9120AXP-B

## 2.6 EUT Description

The Cisco Aironet 802.11ac Radio supports the following modes of operation. The modes are further defined in the radio Theory of Operation. The modes included in this report represent the worst case data for all modes.

802.11a - Non HT20, One Antenna, 6 to 54 Mbps, 1ss

The following antennas are supported by this product series.

The data included in this report represent the worst case data for all antennas.

Frequency	Part Number	Antenna Type	Antenna Gain (dBi)
<b>-E SKU</b>			
2.4GHz&5GHz	AIR-ANT2524DB-R/=	2.4 GHz 2 dBi/5 GHz 4 dBi Dipole Ant., Black, connectors RP-TNC	2dBi@2.4GHz 4dBi@5GHz
2.4GHz&5GHz	AIR-ANT2524DG-R/=	2.4 GHz 2 dBi/5 GHz 4 dBi Dipole Ant., Gray, connectors RP-TNC	2dBi@2.4GHz 4dBi@5GHz
2.4GHz&5GHz	AIR-ANT2524DW-R/=	2.4 GHz 2 dBi/5 GHz 4 dBi Dipole Ant., White, connectors RP-TNC	2dBi@2.4GHz 4dBi@5GHz
2.4GHz&5GHz	AIR-ANT2535SDW-R	2.4 GHz 3dBi/5 GHz 5 dBi Low Profile Antenna, White, connectors RP-TNC	3dBi@2.4GHz 5dBi@5GHz
2.4GHz&5GHz	AIR-ANT2566P4W-R=	2.4 GHz 6 dBi/5 GHz 6 dBi Directionnel Ant., 4-port, connectors RP-TNC	6dBi@2.4GHz 6dBi@5GHz
2.4GHz&5GHz	AIR-ANT2524V4C-R=	2.4GHz 2 dBi/5GHz 4 dBi Ceiling Mount Omni Ant., 4-port, connectors RP-TNC	2dBi@2.4GHz 4dBi@5GHz
2.4GHz&5GHz	AIR-ANT2544V4M-R=	2.4GHz 4 dBi/5GHz 4 dBi Wall Mount Omni Ant., 4-port, connectors RP-TNC	4dBi@2.4GHz 4dBi@5GHz
2.4GHz&5GHz	AIR-ANT2566D4M-R=	2.4 GHz 6 dBi/5 GHz 6 dBi 60 Deg. Patch Ant., 4-port, RP-TNC	6dBi@2.4GHz 6dBi@5GHz
<b>-P SKU</b>			
2.4GHz&5GHz	AIR-ANT2513P4M-N=	2.4 GHz 13 dBi/5 GHz 13 dBi Patch Ant., 4-port, N Type	13dBi@2.4GHz 13dBi@5GHz

### Section 3: Result Summary

#### 3.1 Results Summary Table

##### Conducted emissions

Basic Standard	Technical Requirements / Details	Result
FCC 15.407	<b>6dB Bandwidth:</b> Systems using digital modulation techniques may operate in the 2400-2483.5MHz band. The minimum 6dB bandwidth shall be at least 500 kHz.	Pass
FCC 15.407	<b>99% &amp; 26 dB Bandwidth:</b> The 99% occupied bandwidth is the frequency bandwidth such that, below its lower and above its upper frequency limits, the mean powers are each equal to 0.5% of the total mean power of the given emission. There is no limit for 99% OBW.  The 26 dB emission is the width of the emission that is constrained by the frequencies associated with the two outermost amplitude points (upper and lower frequencies) that are attenuated by 26 dB relative to the maximum level measured in the fundamental emission.	Pass
FCC 15.407	<b>Output Power:</b> For the band 5.725-5.85 GHz, the maximum conducted output power over the frequency band of operation shall not exceed 1 W.	Pass
FCC 15.407	<b>Power Spectral Density:</b> <b>15.407</b> The maximum power spectral density shall not exceed 30 dBm in any 500-kHz band.	Pass
FCC 15.407	<b>Conducted Spurious Emissions / Band-Edge:</b> For transmitters operating in the 5.725-5.85 GHz band: All emissions within the frequency range from the band edge to 10 MHz above or below the band edge shall not exceed an e.i.r.p. of -17 dBm/MHz; for frequencies 10 MHz or greater above or below the band edge, emissions shall not exceed an e.i.r.p. of -27 dBm/MHz.	Pass
FCC 15.209 FCC 152.05	<b>Restricted band:</b> Unwanted emissions falling within the restricted bands, as defined in FCC 15.205 (a) must also comply with the radiated emission limits specified in FCC 15.209 (a).	Pass

##### Radiated Emissions (General requirements)

Basic Standard	Technical Requirements / Details	Result
FCC 15.209 FCC 15.205	<b>TX Spurious Emissions:</b> Except as provided elsewhere in this subpart, the emissions from an intentional radiator shall not exceed the field strength levels specified in the filed strength limits table in this section.	Not covered in this report
FCC 15.207	<b>AC conducted Emissions:</b> Except when the requirements applicable to a given device state otherwise, for any radio apparatus equipped to operate from the public utility AC power supply, either directly or indirectly (such as with a battery charger), the radio frequency voltage of emissions conducted back onto the AC power lines in the frequency range of 0.15 MHz to 30 MHz shall not exceed the limits shown in the table in these sections. The more stringent limit applies at the frequency range boundaries.	Not covered in this report

\* MPE calculation is recorded in a separate report



## Section 4: Sample Details

Note: Each sample was evaluated to ensure that its condition was suitable to be used as a test sample prior to the commencement of testing.

### 4.1 Sample Details

Sample No.	Equipment Details	Manufacturer	Hardware Rev.	Firmware Rev.	Software Rev.	Serial Number
S01	C9120AXP-B	Cisco Systems	P2-2	1268.14948 .r14702 14702	cheetah-build6:/san2/BUILD/workspace/Nightly-Cheetah-axel-bcm-mfg-c8_10_throttle Rev Compiled Fri Sep 6 08:06:05 PDT 2019	FOC23302F0Q

### 4.2 System Details

System #	Description	Samples
1	C9120AXP-B	S01

### 4.3 Mode of Operation Details

Mode#	Description	Comments
1	Continuous Transmitting, RF conducted measurements	Continuously Transmitting, 97.02% duty cycle  Cisco AP Software, (ap1g7), [cheetah-build6:/san2/BUILD/workspace/Nightly-Cheetah-axel-bcm-mfg-c8_10_throttle]  Compiled Fri Sep 6 08:06:05 PDT 2019

**Appendix A: Emission Test Results**

**Conducted Test Setup Diagram**

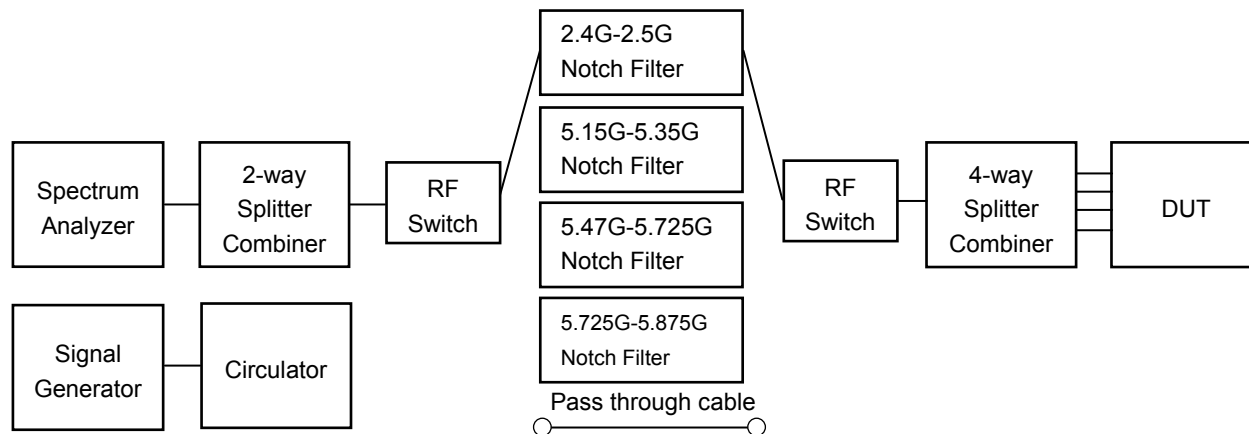

**Target Maximum Channel Power**

The following table details the maximum supported Total Channel Power for all operating modes.

Operating Mode	Maximum Channel Power (dBm)			
	Frequency (MHz)			
	5720	5745	5785	5825
<b>Non HT20, 6 to 54 Mbps</b>	<b>6</b>	<b>13</b>	<b>14</b>	<b>14</b>

## A.1 Duty Cycle

### Duty Cycle Test Requirement

From KDB 789033 D02 General UNII Test Procedures New Rules v02r01

#### B. Duty Cycle (x), Transmission Duration (T), and Maximum Power Control Level

1. All measurements are to be performed with the EUT transmitting at 100 percent duty cycle at its maximum power control level; however, if 100 percent duty cycle cannot be achieved, measurements of duty cycle, x, and maximum-power transmission duration, T, are required for each tested mode of operation.

### Duty Cycle Test Method

From KDB 789033 D02 General UNII Test Procedures New Rules v02r01:

#### B. Duty Cycle (x), Transmission Duration (T), and Maximum Power Control Level

The zero-span mode on a spectrum analyzer or EMI receiver, if the response time and spacing between bins on the sweep are sufficient to permit accurate measurements of the on and off times of the transmitted signal. Set the center frequency of the instrument to the center frequency of the transmission. Set  $RBW \geq EBW$  if possible; otherwise, set RBW to the largest available value. Set  $VBW \geq RBW$ . Set detector = peak or average. The zero-span measurement method shall not be used unless both RBW and VBW are  $> 50/T$ , where T is defined in section II.B.1.a), and the number of sweep points across duration T exceeds 100. (For example, if VBW and/or RBW are limited to 3 MHz, then the zero-span method of measuring duty cycle shall not be used if  $T \leq 16.7$  microseconds.)

### Duty Cycle Test Information

#### Samples, Systems, and Modes

System Number	Description	Samples	System under test	Support equipment
1	EUT	S01	<input checked="" type="checkbox"/>	<input type="checkbox"/>
	Support	NA	<input type="checkbox"/>	<input checked="" type="checkbox"/>

<b>Tested By :</b> Abhishek Upadhyay	<b>Date of testing:</b> 16-Sep-19 to 24-Sep-19
<b>Test Result : PASS</b>	

#### Test Equipment

See Appendix C for list of test equipment

### Duty Cycle Data Table

Duty Cycle table and screen captures are shown below for power/psd modes.

Mode	Data Rate	On-time (ms)	Total Time (ms)	Duty Cycle (%)	Correction Factor (dB)
NonHT20	6Mbps	0.293	0.303	97.02	0.13

### Duty Cycle Data Screenshots

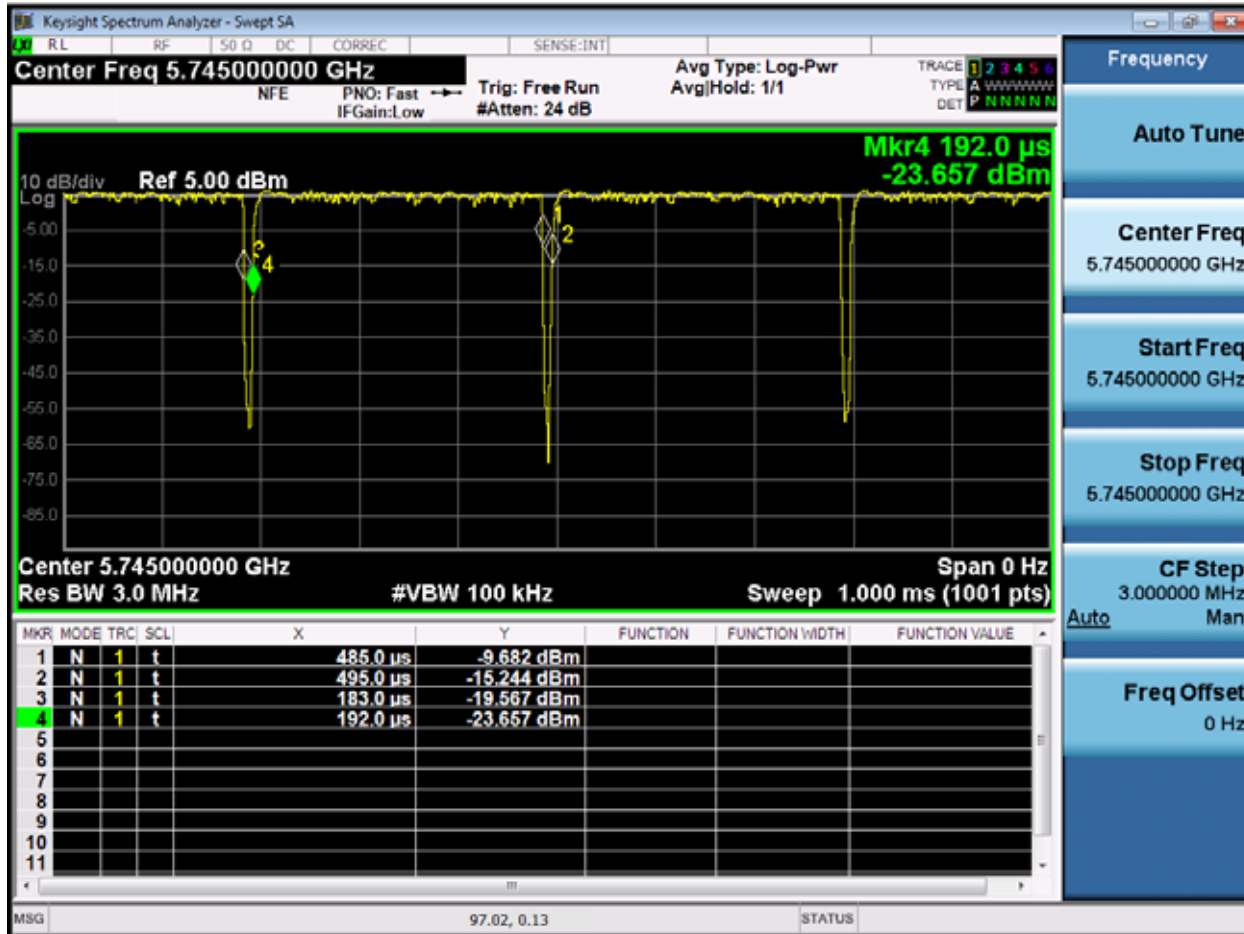

## A.2 6dB Bandwidth

### 6dB Bandwidth Test Requirement

#### 15.407 e

Within the 5.725-5.85 GHz band, the minimum 6 dB bandwidth of U-NII devices shall be at least 500 kHz

#### Emission bandwidth (EBW) in U-NII bands

**Band-crossing emissions:** For an emission that crosses the boundary between two adjacent U-NII bands, the boundary frequency between the bands serves as one edge for defining the portion of the EBW that falls within a particular U-NII band. However, the -26 dB points are measured relative to the highest point on the contiguous segment—regardless of which band contains that highest point (Figure3).

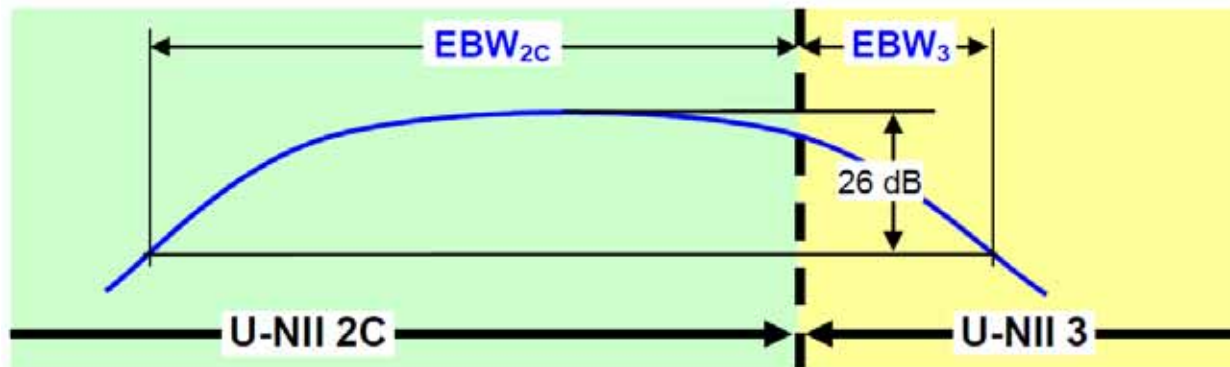

Figure 3. Emission Bandwidth (EBW) within a Band for Band-Crossing Signals

### 6dB Bandwidth Test Procedure

From KDB 789033 D02 General UNII Test Procedures New Rules v02r01

#### Section C. Bandwidth Measurement

##### 6 BW

##### Test Procedure

1. Set the radio in the continuous transmitting mode.
2. Allow the trace to stabilize.
3. Setting the x-dB bandwidth mode to -6dB within the measurement set up function.
4. Select the automatic OBW measurement function of an instrument to perform bandwidth measurement.
5. Capture graphs and record pertinent measurement data.

From KDB 789033 D02 General UNII Test Procedures New Rules v02r01

#### Section C. Bandwidth Measurement

##### 6 BW

##### Test parameters

2. Minimum Emission Bandwidth for the band 5.725-5.85 GHz
  - a) Set RBW = 100 kHz.
  - b) Set the video bandwidth (VBW)  $\geq 3 \times$  RBW.
  - c) Detector = Peak.
  - d) Trace mode = max hold.
  - e) Sweep = auto couple.

f) Allow the trace to stabilize.  
 g) Measure the maximum width of the emission that is constrained by the frequencies associated with the two outermost amplitude points (upper and lower frequencies) that are attenuated by 6 dB relative to the maximum level measured in the fundamental emission.

Note: The automatic bandwidth measurement capability of a spectrum analyzer or EMI receiver may be employed if it implements the functionality described above.

System Number	Description	Samples	System under test	Support equipment
1	EUT	S01	<input checked="" type="checkbox"/>	<input type="checkbox"/>
	Support	NA	<input type="checkbox"/>	<input checked="" type="checkbox"/>

<b>Tested By :</b> Abhishek Upadhyay	<b>Date of testing:</b> 16-Sep-19 - 24-Sep-19
<b>Test Result : PASS</b>	

#### Test Equipment

See Appendix C for list of test equipment



Frequency (MHz)	Mode	Data Rate (Mbps)	6dB BW (MHz)	Limit (kHz)	Margin (MHz)
5720	Non HT20, 6 to 54 Mbps	6	3.2	>500	2.7
5745	Non HT20, 6 to 54 Mbps	6	16.4	>500	15.9
5785	Non HT20, 6 to 54 Mbps	6	16.4	>500	15.9
5825	Non HT20, 6 to 54 Mbps	6	16.4	>500	15.9

**6dB Bandwidth, 5720 MHz, Non HT20, 6 to 54 Mbps**





## A.3 99% and 26dB Bandwidth

### 99% and 26dB Bandwidth Test Requirement

There is no requirement for the value of bandwidth.

However, the 26dB BW (EBW) is used to calculate the power limits in 15.407 (a) (2). Power measurements are made using the 99% Bandwidth as the integration bandwidth.

**Band-crossing emissions:** For an emission that crosses the boundary between two adjacent U-NII bands, the boundary frequency between the bands serves as one edge for defining the portion of the EBW that falls within a particular U-NII band. However, the -26 dB points are measured relative to the highest point on the contiguous segment—regardless of which band contains that highest point (Figure4).

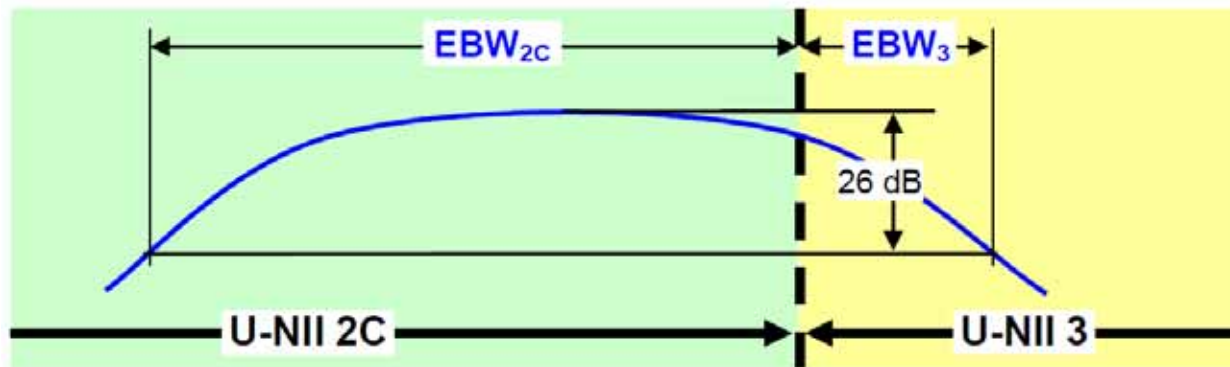

Figure 3. Emission Bandwidth (EBW) within a Band for Band-Crossing Signals

### 99% and 26dB Bandwidth Test Procedure

The 99-percent occupied bandwidth is the frequency bandwidth such that, below its lower and above its upper frequency limits, the mean powers are each equal to 0.5 % of the total mean power of the given emission. Measurement of the 99-percent occupied bandwidth is required only as a condition for using the optional band-edge measurement techniques described in section II.G.3.d). Measurements of 99-percent occupied bandwidth may also optionally be used in lieu of the EBW to define the minimum frequency range over which the spectrum is integrated when measuring maximum conducted output power as described in section II.E. However, the EBW must be measured to determine bandwidth dependent limits on maximum conducted output power in accordance with 15.407(a).

#### From KDB 789033 D02 General UNII Test Procedures New Rules v02r01 Section D. 99 Percent Occupied Bandwidth

##### 99% BW

##### Test Parameters

1. Set center frequency to the nominal EUT channel center frequency.
2. Set span = 1.5 times to 5.0 times the OBW.
3. Set RBW = 1 % to 5 % of the OBW
4. Set VBW  $\geq 3 \cdot$  RBW
5. Video averaging is not permitted. Where practical, a sample detection and single sweep mode shall be used. Otherwise, peak detection and max hold mode (until the trace stabilizes) shall be used.
6. Use the 99 % power bandwidth function of the instrument (if available).

**From KDB 789033 D02 General UNII Test Procedures New Rules v02r01**  
**Section C. Measurement Bandwidth, Section 1**

**26 BW**

Test parameters

X dB BW = -26dB (using the OBW function of the spectrum analyzer)

Emission Bandwidth (EBW)

- a) Set RBW = approximately 1% of the emission bandwidth.
- b) Set the VBW > RBW.
- c) Detector = Peak.
- d) Trace mode = max hold.
- e) Measure the maximum width of the emission that is 26 dB down from the maximum of the emission. Compare this with the RBW setting of the analyzer. Readjust RBW and repeat measurement as needed until the RBW/EBW ratio is approximately 1%.

System Number	Description	Samples	System under test	Support equipment
1	EUT	S01	<input checked="" type="checkbox"/>	<input type="checkbox"/>
	Support	NA	<input type="checkbox"/>	<input checked="" type="checkbox"/>

**Tested By :**

Abhishek Upadhyay

**Date of testing:**

16-Sep-19 - 24-Sep-19

**Test Result : PASS****Test Equipment**

See Appendix C for list of test equipment



Frequency (MHz)	Mode	Data Rate (Mbps)	26dB BW (MHz)	99% BW (MHz)
5720	Non HT20, 6 to 54 Mbps	6	8.2	7.847
5745	Non HT20, 6 to 54 Mbps	6	25.5	16.659
5785	Non HT20, 6 to 54 Mbps	6	31.0	16.759
5825	Non HT20, 6 to 54 Mbps	6	32.8	16.842

**26dB / 99% Bandwidth, 5720 MHz, Non HT20, 6 to 54 Mbps**



**26dB / 99% Bandwidth, 5825 MHz, Non HT20, 6 to 54 Mbps**



## A.4 Maximum Conducted Output Power

### Maximum Conducted Output Power Test Requirement

#### 15.407 a) (3)

For the band 5.725-5.85 GHz, the maximum conducted output power over the frequency band of operation shall not exceed 1 W. If transmitting antennas of directional gain greater than 6 dBi are used, both the maximum conducted output power and the maximum power spectral density shall be reduced by the amount in dB that the directional gain of the antenna exceeds 6 dBi. However, fixed point-to-point U-NII devices operating in this band may employ transmitting antennas with directional gain greater than 6 dBi without any corresponding reduction in transmitter conducted power. Fixed, point-to-point operations exclude the use of point-to-multipoint systems, omnidirectional applications, and multiple collocated transmitters transmitting the same information. The operator of the U-NII device, or if the equipment is professionally installed, the installer, is responsible for ensuring that systems employing high gain directional antennas are used exclusively for fixed, point-to-point operations.

**Band-Crossing Signals** When measuring the portion of the maximum conducted output power within a single U-NII band, the power shall be integrated across only the portion of the EBW that falls within that band. That is, if an EBW extends across the boundary between two adjacent bands, the boundary frequency between the bands serves as one edge of the frequency range to be integrated. Integration across an entire U-NII band without regard to 26 dB points is also acceptable for determining conducted output power within that band.

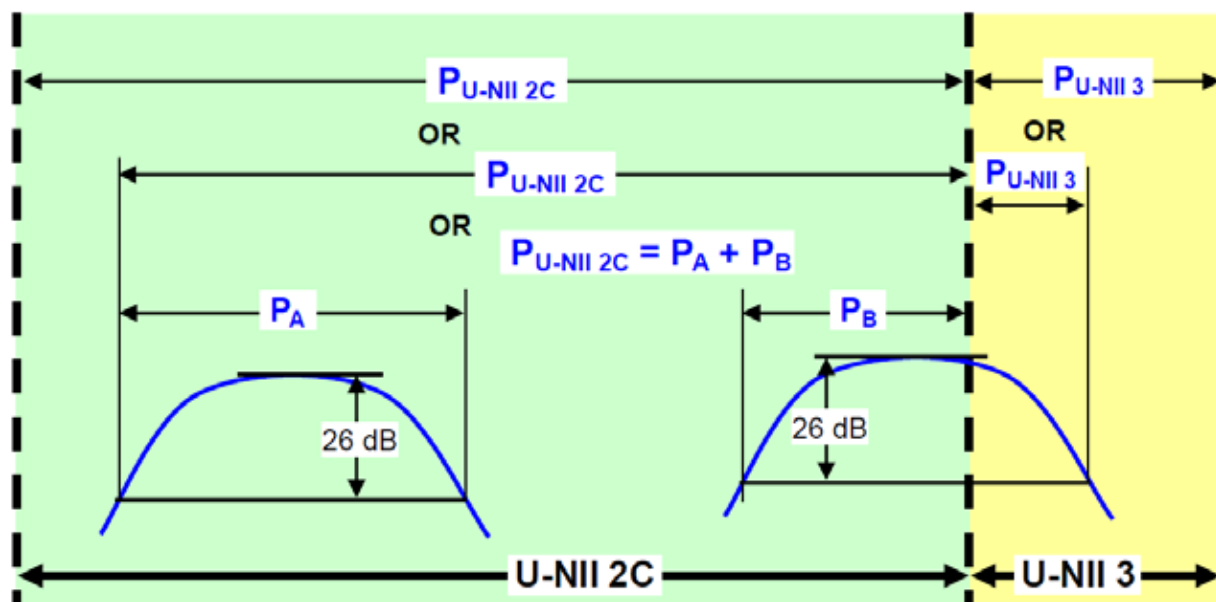

**Conducted output power within a U-NII band:** Integrate over the band or integrate over a span including the 26 dB EBWs of transmission segments within the band or integrate over 26 dB EBW of each transmission segment in the band and sum.

Figure 4. Conducted Output Power Measurement Examples

### Maximum Conducted Output Power Test Procedure

Ref. KDB 789033 D02 General UNII Test Procedures New Rules v02r01  
ANSI C63.10: 2013

#### Maximum Conducted Output Power

**Test Procedure**

1. Set the radio in the continuous transmitting mode at full power
2. Compute power by integrating the spectrum across the EBW (or alternatively entire 99% OBW) of the signal using the instrument's band power measurement function. The integration shall be performed using the spectrum analyzer band-power measurement function with band limits set equal to the EBW or the OBW band edges.
3. Capture graphs and record pertinent measurement data.

**Ref. KDB 789033 D02 General UNII Test Procedures New Rules v02r01****2. Measurement using a Spectrum Analyzer or EMI Receiver (SA), (d) Method SA-2****Maximum Conducted Output Power**

## Test parameters

- Method SA-2 (trace averaging across on and off times of the EUT transmissions, followed by duty cycle correction).
- (i) Measure the duty cycle,  $x$ , of the transmitter output signal as described in section II.B.
  - (ii) Set span to encompass the EBW (or, alternatively, the entire 99% occupied bandwidth) of the signal.
  - (iii) Set RBW = 1 MHz.
  - (iv) Set VBW  $\geq$  3 MHz.
  - (v) Number of points in sweep  $\geq$  2 Span / RBW. (This ensures that bin-to-bin spacing is  $\leq$  RBW/2, so that narrowband signals are not lost between frequency bins.)
  - (vi) Sweep time = auto.
  - (vii) Detector = RMS (i.e., power averaging), if available. Otherwise, use sample detector mode.
  - (viii) Do not use sweep triggering. Allow the sweep to "free run".
  - (ix) Trace average at least 100 traces in power averaging (i.e., RMS) mode; however, the number of traces to be averaged shall be increased above 100 as needed to ensure that the average accurately represents the true average over the on and off periods of the transmitter.
  - (x) Compute power by integrating the spectrum across the EBW (or, alternatively, the entire 99% occupied bandwidth) of the signal using the instrument's band power measurement function with band limits set equal to the EBW (or occupied bandwidth)

The "measure-and-sum technique" is used for measuring in-band transmit power of a device. In the measure-and-sum approach, the conducted emission level is measured at each antenna port. The measured results at the various antenna ports are then summed mathematically to determine the total emission level from the device. Summing is performed in linear power units. ANSI C63.10 section 14.3.2.2

System Number	Description	Samples	System under test	Support equipment
1	EUT	S01	<input checked="" type="checkbox"/>	<input type="checkbox"/>
	Support	NA	<input type="checkbox"/>	<input checked="" type="checkbox"/>

**Tested By :**

Abhishek Upadhyay

**Date of testing:**

16-Sep-19 - 24-Sep-19

**Test Result : PASS****Test Equipment**

See Appendix C for list of test equipment



Frequency (MHz)	Mode	Tx Paths	Correlated Antenna Gain (dBi)	Tx 1 Max Power (dBm)	Duty Cycle correction (dBm)	Total Tx Channel Power (dBm)	Limit (dBm)	Margin (dB)
5720	Non HT20, 6 to 54 Mbps	1	13	5.6	0.1	5.7	23.0	17.3
5745	Non HT20, 6 to 54 Mbps	1	13	13.1	0.1	13.2	23.0	9.8
5785	Non HT20, 6 to 54 Mbps	1	13	13.6	0.1	13.7	23.0	9.3
5825	Non HT20, 6 to 54 Mbps	1	13	13.8	0.1	13.9	23.0	9.1

**Maximum Transmit Output Power, 5825 MHz, Non HT20, 6 to 54 Mbps**

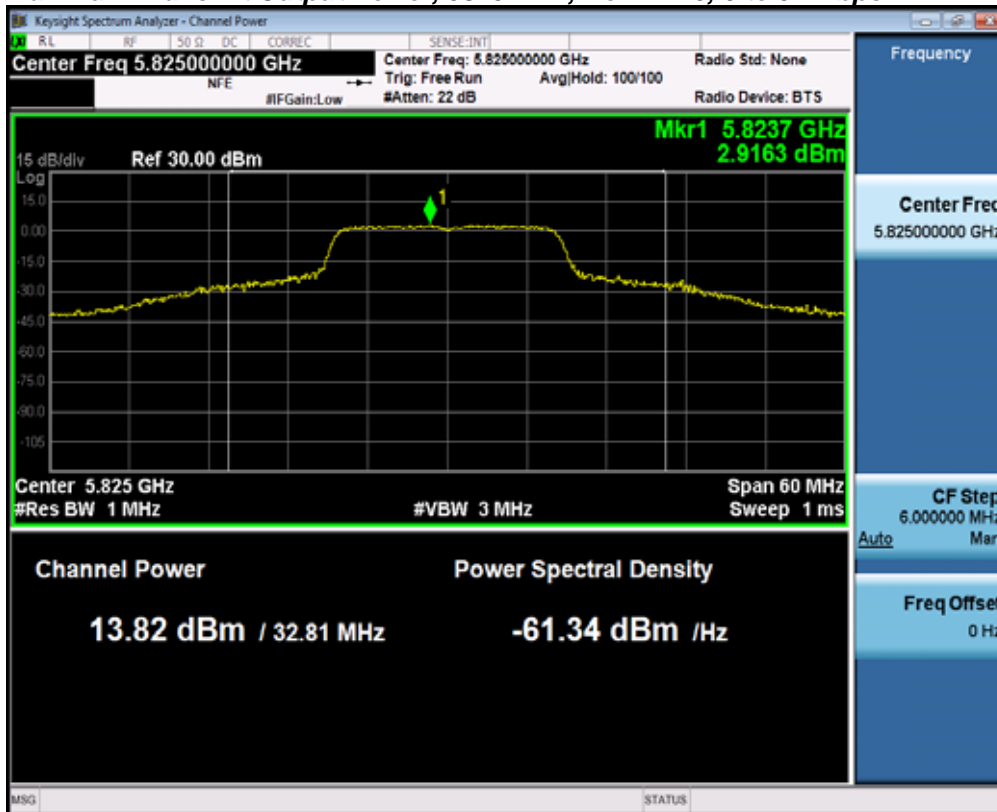

Antenna A



## A.5 Power Spectral Density

### Power Spectral Density Test Requirement

#### 15.407

(3) For the band 5.725-5.85 GHz...the maximum power spectral density shall not exceed 30 dBm in any 500-kHz band. If transmitting antennas of directional gain greater than 6 dBi are used, both the maximum conducted output power and the maximum power spectral density shall be reduced by the amount in dB that the directional gain of the antenna exceeds 6 dBi. However, fixed point-to-point U-NII devices operating in this band may employ transmitting antennas with directional gain greater than 6 dBi without any corresponding reduction in transmitter conducted power. Fixed, point-to-point operations exclude the use of point-to-multipoint systems, omnidirectional applications, and multiple collocated transmitters transmitting the same information. The operator of the U-NII device, or if the equipment is professionally installed, the installer, is responsible for ensuring that systems employing high gain directional antennas are used exclusively for fixed, point-to-point operations.

(5) The maximum power spectral density is measured as a conducted emission by direct connection of a calibrated test instrument to the equipment under test. If the device cannot be connected directly, alternative techniques acceptable to the Commission may be used. Measurements in the 5.725-5.85 GHz band are made over a reference bandwidth of 500 kHz or the 26 dB emission bandwidth of the device, whichever is less. Measurements in the 5.15-5.25 GHz, 5.25-5.35 GHz, and the 5.47-5.725 GHz bands are made over a bandwidth of 1 MHz or the 26 dB emission bandwidth of the device, whichever is less. A narrower resolution bandwidth can be used, provided that the measured power is integrated over the full reference bandwidth.

#### Band-Crossing Signals

When measuring the portion of the maximum conducted output power within a single U-NII band, the power shall be integrated across only the portion of the EBW that falls within that band. That is, if an EBW extends across the boundary between two adjacent bands, the boundary frequency between the bands serves as one edge of the frequency range to be integrated. Integration across an entire U-NII band without regard to 26 dB points is also acceptable for determining conducted output power within that band.

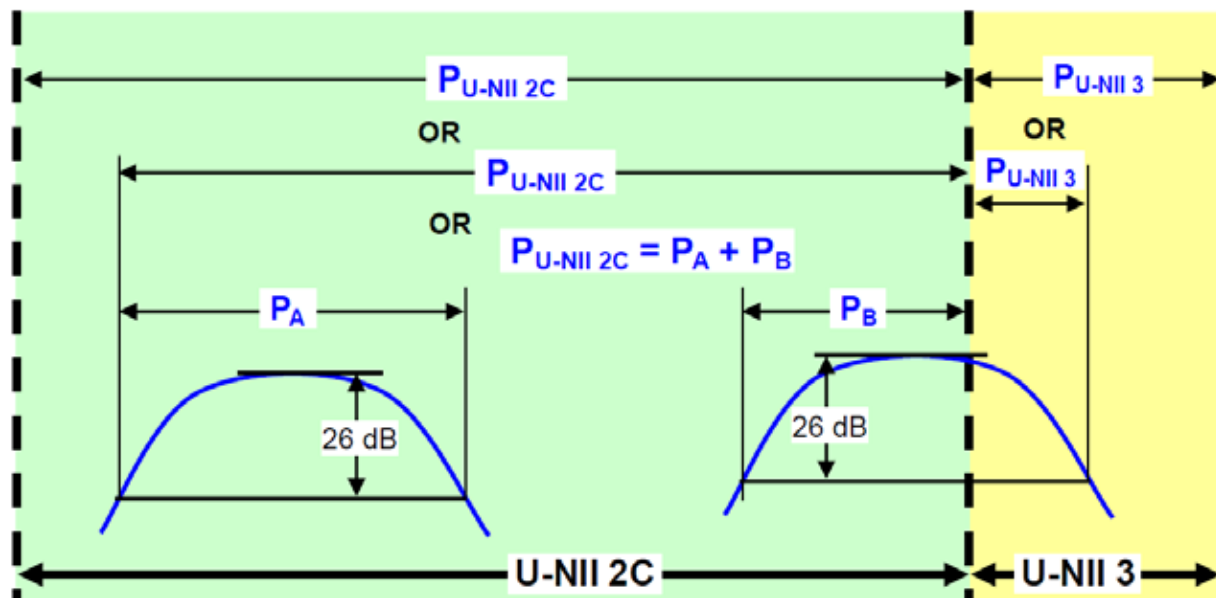

**Conducted output power within a U-NII band:** Integrate over the band or integrate over a span including the 26 dB EBWs of transmission segments within the band or integrate over 26 dB EBW of each transmission segment in the band and sum.

**Figure 4. Conducted Output Power Measurement Examples**

## Power Spectral Density Test Procedure

Ref. KDB 789033 D02 General UNII Test Procedures New Rules v02r01

### F. Maximum Power Spectral Density (PSD)

#### Power Spectral Density

##### Test Procedure

The rules requires “maximum power spectral density” measurements where the intent is to measure the maximum value of the time average of the power spectral density measured during a period of continuous transmission.

1. Create an average power spectrum for the EUT operating mode being tested by following the instructions in section II.E.2. for measuring maximum conducted output power using a spectrum analyzer or EMI receiver: select the appropriate test method (SA-1, SA-2, SA-3, or alternatives to each) and apply it up to, but not including, the step labeled, “Compute power...”. (This procedure is required even if the maximum conducted output power measurement was performed using a power meter, method PM.)

2. Use the peak search function on the instrument to find the peak of the spectrum and record its value.

3. Make the following adjustments to the peak value of the spectrum, if applicable: a) If Method SA-2 or SA-2 Alternative was used, add  $10 \log(1/x)$ , where  $x$  is the duty cycle, to the peak of the spectrum.

b) If Method SA-3 Alternative was used and the linear mode was used in step II.E.2.g)(viii), add 1 dB to the final result to compensate for the difference between linear averaging and power averaging.

4. The result is the Maximum PSD over 1 MHz reference bandwidth.

5. For devices operating in the bands 5.15-5.25 GHz, 5.25-5.35 GHz, and 5.47-5.725 GHz, the above procedures make use of 1 MHz RBW to satisfy directly the 1 MHz reference bandwidth specified in § 15.407(a)(5). **For devices operating in the band 5.725-5.85 GHz, the rules specify a measurement bandwidth of 500 kHz.**

Ref. KDB 789033 D02 General UNII Test Procedures New Rules v02r01

### 2. Measurement using a Spectrum Analyzer or EMI Receiver (SA), (d) Method SA-2

## Power Spectral Density

### Test parameters

Method SA-2 (trace averaging across on and off times of the EUT transmissions, followed by duty cycle correction).

- (i) Measure the duty cycle,  $x$ , of the transmitter output signal as described in section II.B.
- (ii) Set span to encompass the EBW (or, alternatively, the entire 99% occupied bandwidth) of the signal.
- (iii) Set RBW = 1 MHz. (this should be 500kHz per KDB789033, Section F, (5))
- (iv) Set VBW  $\geq$  3 MHz.
- (v) Number of points in sweep  $\geq$  2 Span / RBW. (This ensures that bin-to-bin spacing is  $\leq$  RBW/2, so that narrowband signals are not lost between frequency bins.)
- (vi) Sweep time = auto.
- (vii) Detector = RMS (i.e., power averaging), if available. Otherwise, use sample detector mode.
- (viii) Do not use sweep triggering. Allow the sweep to “free run”.
- (ix) Trace average at least 100 traces in power averaging (i.e., RMS) mode; however, the number of traces to be averaged shall be increased above 100 as needed to ensure that the average accurately represents the true average over the on and off periods of the transmitter.
- (x) Compute power by integrating the spectrum across the EBW (or, alternatively, the entire 99% occupied bandwidth) of the signal using the instrument’s band power measurement function with band limits set equal to the EBW (or occupied bandwidth)

### F. Maximum Power Spectral Density (PSD)

2. Use the peak search function on the instrument to find the peak of the spectrum and record its value.
3. Make the following adjustments to the peak value of the spectrum, if applicable: a) If Method SA-2 or SA-2 Alternative was used, add  $10 \log(1/x)$ , where  $x$  is the duty cycle, to the peak of the spectrum.
5. . . . **For devices operating in the band 5.725-5.85 GHz, the rules specify a measurement bandwidth of 500 kHz.**

The “measure-and-sum technique” is used for measuring in-band transmit power of a device. In the measure-and-sum approach, the conducted emission level is measured at each antenna port. The measured results at the various antenna ports are then summed mathematically to determine the total emission level from the device. Summing is performed in linear power units. ANSI C63.10 section 14.3.2.2

System Number	Description	Samples	System under test	Support equipment
1	EUT	S01	<input checked="" type="checkbox"/>	<input type="checkbox"/>
	Support	NA	<input type="checkbox"/>	<input checked="" type="checkbox"/>

<b>Tested By :</b> Abhishek Upadhyay	<b>Date of testing:</b> 16-Sep-19 - 24-Sep-19
<b>Test Result : PASS</b>	

### Test Equipment

See Appendix C for list of test equipment

Frequency (MHz)	Mode	Tx Paths	Correlated Antenna Gain (dBi)	Tx 1 PSD (dBm/MHz)	Duty Cycle correction (dBm/MHz)	Total PSD (dBm/500MHz)	Limit (dBm/500MHz)	Margin (dB)
5720	Non HT20, 6 to 54 Mbps	1	13	-1.9	0.1	-1.8	23.0	24.8
5745	Non HT20, 6 to 54 Mbps	1	13	-1.0	0.1	-0.9	23.0	23.9
5785	Non HT20, 6 to 54 Mbps	1	13	-0.6	0.1	-0.5	23.0	23.5
5825	Non HT20, 6 to 54 Mbps	1	13	-0.4	0.1	-0.3	23.0	23.3

**Power Spectral Density, 5825 MHz, Non HT20, 6 to 54 Mbps**



**Antenna A**

## A.6 Conducted Spurious Emissions

### Conducted Spurious Emissions Test Requirement

#### 15.407

(b) *Undesirable emission limits.* Except as shown in paragraph (b)(7) of this section, the maximum emissions outside of the frequency bands of operation shall be attenuated in accordance with the following limits:

(4) For transmitters operating in the 5.725-5.85 GHz band:

(i) All emissions shall be limited to a level of -27 dBm/MHz at 75 MHz or more above or below the band edge increasing linearly to 10 dBm/MHz at 25 MHz above or below the band edge, and from 25 MHz above or below the band edge increasing linearly to a level of 15.6 dBm/MHz at 5 MHz above or below the band edge, and from 5 MHz above or below the band edge increasing linearly to a level of 27 dBm/MHz at the band edge.

(6) Unwanted emissions below 1 GHz must comply with the general field strength limits set forth in §15.209.

(7) The provisions of §15.205 apply to intentional radiators operating under this section.

**15.205 / 15.209** - Radiated emissions which fall in the restricted bands, as defined in Section 15.205(a), must also comply with the radiated emission limits specified in Section 15.209(a) (see Section 15.205(c)).

Use formula below to substitute conducted measurements in place of radiated measurements

$$E[\text{dB}\mu\text{V}/\text{m}] = \text{EIRP}[\text{dBm}] - 20 \log(d[\text{meters}]) + 104.77, \text{ where } E = \text{field strength and } d = 3 \text{ meter}$$

- 1) Average Plot, Limit= -41.25 dBm eirp
- 2) Peak plot, Limit = -21.25 dBm eirp

### Conducted Spurious Emissions Test Procedure

From **KDB 789033 D02 General UNII Test Procedures New Rules v02r01**  
**ANSI C63.10: 2013**

#### Conducted Spurious Emissions

##### Test Procedure

1. Connect the antenna port(s) to the spectrum analyzer input.
2. Place the radio in continuous transmit mode. Use the procedures in KDB 789033 D02 General UNII Test Procedures New Rules v01r03 to substitute conducted measurements in place of radiated measurements.
3. Configure Spectrum analyzer as per test parameters below (be sure to enter all losses between the transmitter output and the spectrum analyzer).
4. Record the marker waveform peak to spur difference. Also measure any emissions in the restricted bands.
5. The "measure-and-sum technique" is used for measuring in-band transmit power of a device. In the measure-and-sum approach, the conducted emission level is measured at each antenna port. The measured results at the various antenna ports are then summed mathematically to determine the total emission level from the device. Summing is performed in linear power units. The worst case output is recorded.
6. Capture graphs and record pertinent measurement data.

Ref. KDB 789033 D02 General UNII Test Procedures New Rules v01r03  
 ANSI C63.10: 2013 section 12.7.7.3 (average) & 12.7.6 (peak)

#### Conducted Spurious Emissions

##### Test parameters

Span = 30MHz to 18GHz / 18GHz to 40GHz  
 RBW = 1 MHz  
 VBW ≥ 3 x RBW for Peak, 1kHz for Average  
 Sweep = Auto couple  
 Detector = Peak  
 Trace = Max Hold.



Add the max antenna gain + ground reflection factor (4.7 dB for frequencies between 30 MHz and 1000 MHz, and 0 dB for frequencies > 1000 MHz).

System Number	Description	Samples	System under test	Support equipment
1	EUT	S01	<input checked="" type="checkbox"/>	<input type="checkbox"/>
	Support	NA	<input type="checkbox"/>	<input checked="" type="checkbox"/>

<b>Tested By :</b> Abhishek Upadhyay	<b>Date of testing:</b> 16-Sep-19 - 24-Sep-19
<b>Test Result : PASS</b>	

**Test Equipment**

See Appendix C for list of test equipment

**Conducted Spurs Average Upper, 5745 MHz, Non HT20, 6 to 54 Mbps**

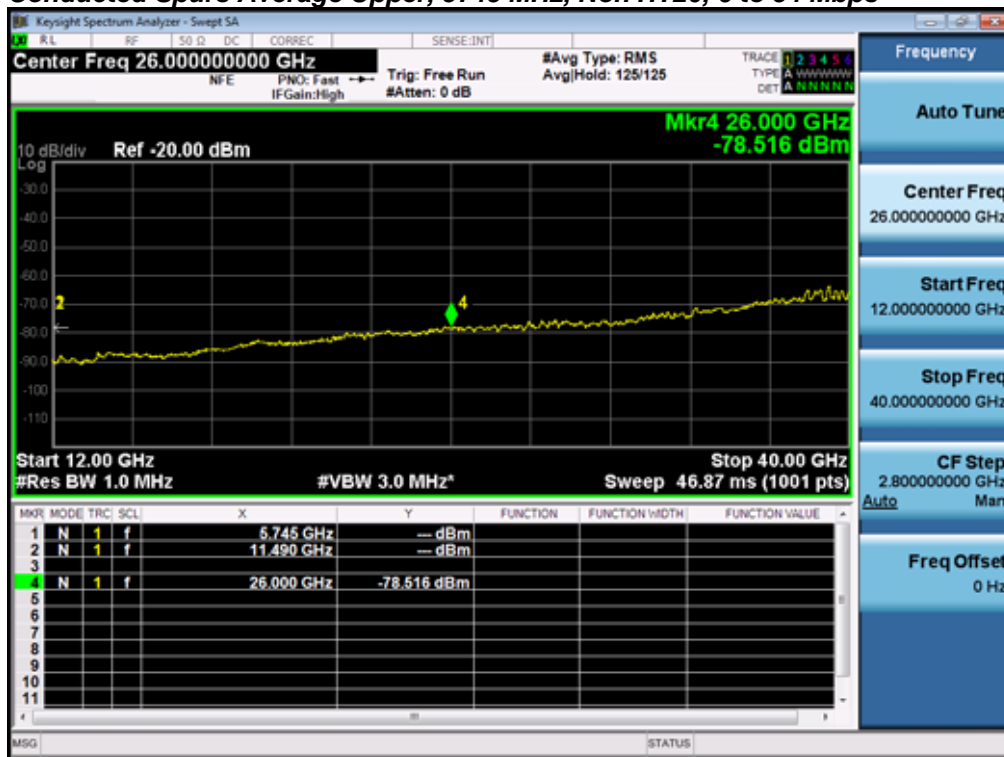

**Conducted Spurs Peak Upper, 5745 MHz, Non HT20, 6 to 54 Mbps**







**Conducted Spurious Emissions – Upper (Peak and Average)**

Frequency (MHz)	Mode	Tx Paths	Correlated Antenna Gain (dBi)	Tx 1 Spur Power (dBm)	Total Conducted Spur (dBm)	Limit (dBm)	Margin (dB)
5745	Non HT20, 6 to 54 Mbps	1	13	-44.7	-31.7	-21.25	10.45
5745	Non HT20, 6 to 54 Mbps	1	13	-78.5	-65.5	-41.25	24.25

Frequency (MHz)	Mode	Tx Paths	Correlated Antenna Gain (dBi)	Tx 1 Spur Power (dBm)	Duty Cycle correction (dBm)	Total Conducted Spur (dBm)	Limit (dBm)	Margin (dB)
5720	Non HT20, 6 to 54 Mbps	1	13	-60.2	0.1	-47.1	-41.25	5.9
5745	Non HT20, 6 to 54 Mbps	1	13	-60.9	0.1	-47.8	-41.25	6.6
5785	Non HT20, 6 to 54 Mbps	1	13	-62.7	0.1	-49.6	-41.25	8.4
5825	Non HT20, 6 to 54 Mbps	1	13	-62.9	0.1	-49.8	-41.25	8.6

**Conducted Spurs Average, 5720 MHz, Non HT20, 6 to 54 Mbps**

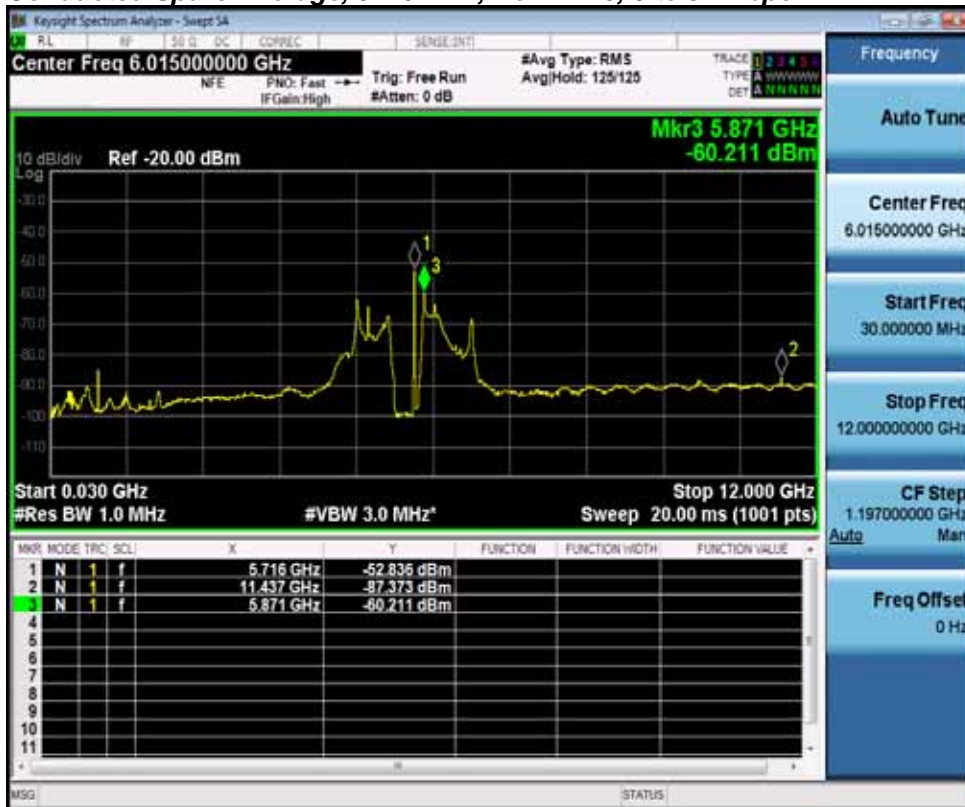

Antenna A



Frequency (MHz)	Mode	Tx Paths	Correlated Antenna Gain (dBi)	Tx 1 Spur Power (dBm)	Duty Cycle correction (dBm)	Total Conducted Spur (dBm)	Limit (dBm)	Margin (dB)
5720	Non HT20, 6 to 54 Mbps	1	13	-51.2	0.1	-38.1	-21.25	16.9
5745	Non HT20, 6 to 54 Mbps	1	13	-50.4	0.1	-37.3	-21.25	16.1
5785	Non HT20, 6 to 54 Mbps	1	13	-50.5	0.1	-37.4	-21.25	16.2
5825	Non HT20, 6 to 54 Mbps	1	13	-50.6	0.1	-37.5	-21.25	16.3

**Conducted Spurs Peak, 5745 MHz, Non HT20, 6 to 54 Mbps**

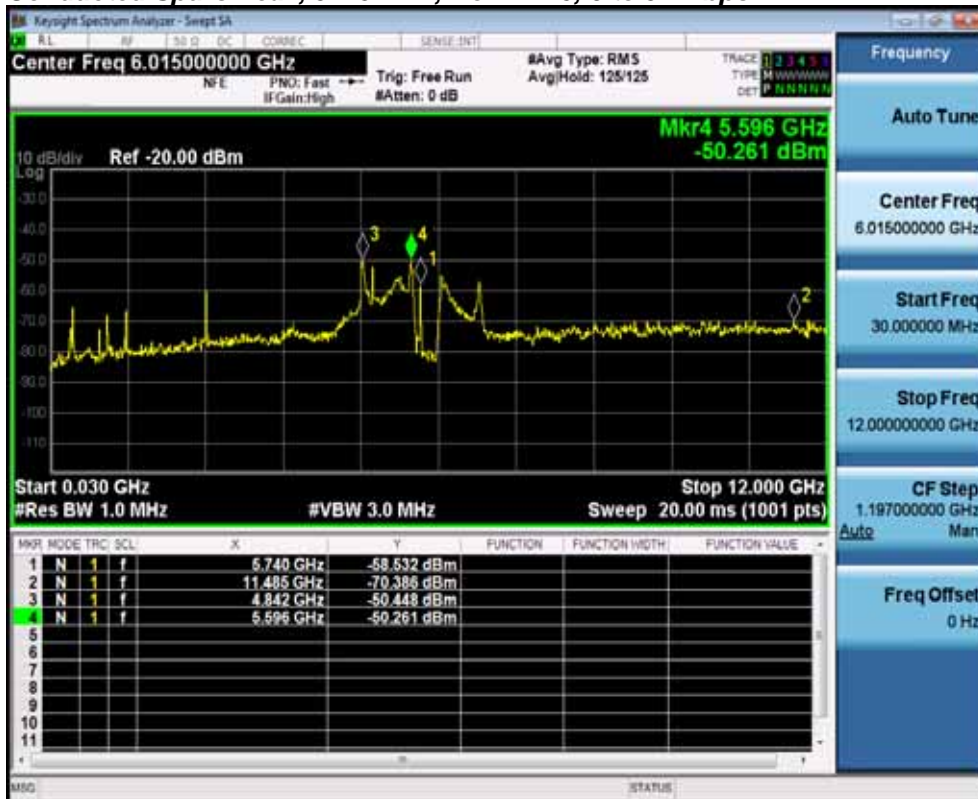

Antenna A

## A.7 Conducted Bandedge

### Conducted Band Edge Test Requirement

#### 15.407

(b) *Undesirable emission limits.* Except as shown in paragraph (b)(7) of this section, the maximum emissions outside of the frequency bands of operation shall be attenuated in accordance with the following limits:

(4) For transmitters operating in the 5.725-5.85 GHz band:

(i) All emissions shall be limited to a level of  $-27$  dBm/MHz at 75 MHz or more above or below the band edge increasing linearly to  $10$  dBm/MHz at 25 MHz above or below the band edge, and from 25 MHz above or below the band edge increasing linearly to a level of  $15.6$  dBm/MHz at 5 MHz above or below the band edge, and from 5 MHz above or below the band edge increasing linearly to a level of  $27$  dBm/MHz at the band edge.

(6) Unwanted emissions below 1 GHz must comply with the general field strength limits set forth in §15.209.

(7) The provisions of §15.205 apply to intentional radiators operating under this section.

(8) When measuring the emission limits, the nominal carrier frequency shall be adjusted as close to the upper and lower frequency band edges as the design of the equipment permits

#### KDB 789033 D02 General UNII Test Procedures New Rules v02r01

##### 2. Unwanted Emissions that fall Outside of the Restricted Bands

a) For all measurements, follow the requirements in II.G.3. “*General Requirements for Unwanted Emissions Measurements.*”

b) At frequencies below 1000 MHz, use the procedure described in II.G.4. “*Procedure for Unwanted Emissions Measurements Below 1000 MHz.*”

c) At frequencies above 1000 MHz, use the procedure for maximum emissions described in II.G.5., “*Procedure for Unwanted Emissions Measurements Above 1000 MHz.*”

(i) Sections 15.407(b)(1-3) specifies the unwanted emissions limit for the U-NII-1 and U-NII-2 bands. As specified, emissions above 1000 MHz that are outside of the restricted bands are subject to a peak emission limit of  $-27$  dBm/MHz.<sup>3</sup>

(ii) Section 15.407(b)(4) specifies the unwanted emissions limit for the U-NII-3 band. A band emissions mask is specified in Section 15.407(b)(4)(i). The emission limits are based on the use of a peak detector.

### Conducted Band Edge Test Procedure

#### Ref. 789033 D02 General UNII Test Procedures New Rules v02r01

##### ANSI C63.10: 2013

#### Conducted Band edge

##### Test Procedure

1. Connect the antenna port(s) to the spectrum analyzer input.
2. Place the radio in continuous transmit mode. Use the procedures in KDB 558074 D01 DTS Meas Guidance v03r05 to substitute conducted measurements in place of radiated measurements.
3. Configure Spectrum analyzer as per test parameters below (be sure to enter all losses between the transmitter output and the spectrum analyzer).
4. Place a marker at the end of the restricted band closest to the transmit frequency to show compliance. Also measure any emissions in the restricted bands..
5. The “measure-and-sum technique” is used for measuring in-band transmit power of a device. In the measure-and-sum approach, the conducted emission level is measured at each antenna port. The measured results at the various antenna ports are then summed mathematically to determine the total emission level from the device. Summing is performed in linear power units. The worst case output is recorded.
6. Place a marker at the end of the restricted band closest to the transmit frequency to show compliance. Also measure any emissions in the restricted bands
7. Capture graphs and record pertinent measurement data.

**Ref.** 789033 D02 General UNII Test Procedures New Rules v02r01  
ANSI C63.10: 2013 Section 12.7.6 (Peak), Section 12.7.7.2 (Method AD)

<b>Conducted Spurious Emissions</b>	
Test parameters	
<b>Peak</b> Span = 30MHz to 26.5GHz / 26.5GHz to 40GHz RBW = 1 MHz VBW $\geq$ 3 MHz Sweep = Auto couple Detector = Peak Trace = Max Hold.	<b>Average</b> Span = 30MHz to 26.5GHz / 26.5GHz to 40GHz RBW = 1 MHz VBW $\geq$ 3 MHz Sweep = Auto couple Detector = RMS Power Averaging

System Number	Description	Samples	System under test	Support equipment
1	EUT	S01	<input checked="" type="checkbox"/>	<input type="checkbox"/>
	Support	NA	<input type="checkbox"/>	<input checked="" type="checkbox"/>

<b>Tested By :</b> Abhishek Upadhyay	<b>Date of testing:</b> 16-Sep-19 - 24-Sep-19
<b>Test Result : PASS</b>	

**Test Equipment**

See Appendix C for list of test equipment



Frequency (MHz) 5745	Mode	Tx Paths	Correlated Antenna Gain (dBi)	Tx 1 Bandedge Level (dBm)	Total Tx Bandedge Level (dBm)	Limit (dBm)	Margin (dB)
	Non HT20, 6 to 54 Mbps	1	13	-57.0	-43.9	-27.00	16.9



**Conducted Bandedge Peak 15407L, 5745 MHz, Non HT20, 6 to 54 Mbps**



**Antenna A**



Frequency (MHz)	Mode	Tx Paths	Correlated Antenna Gain (dBi)	Tx 1 Bandedge Level (dBm)	Total Tx Bandedge Level (dBm)	Limit (dBm)	Margin (dB)
5785	Non HT20, 6 to 54 Mbps	1	13	-54.7	-41.6	-27.00	14.6
5825	Non HT20, 6 to 54 Mbps	1	13	-55.0	-41.9	-27.00	14.9

**Conducted Bandedge Peak 15407R, 5785 MHz, Non HT20, 6 to 54 Mbps**

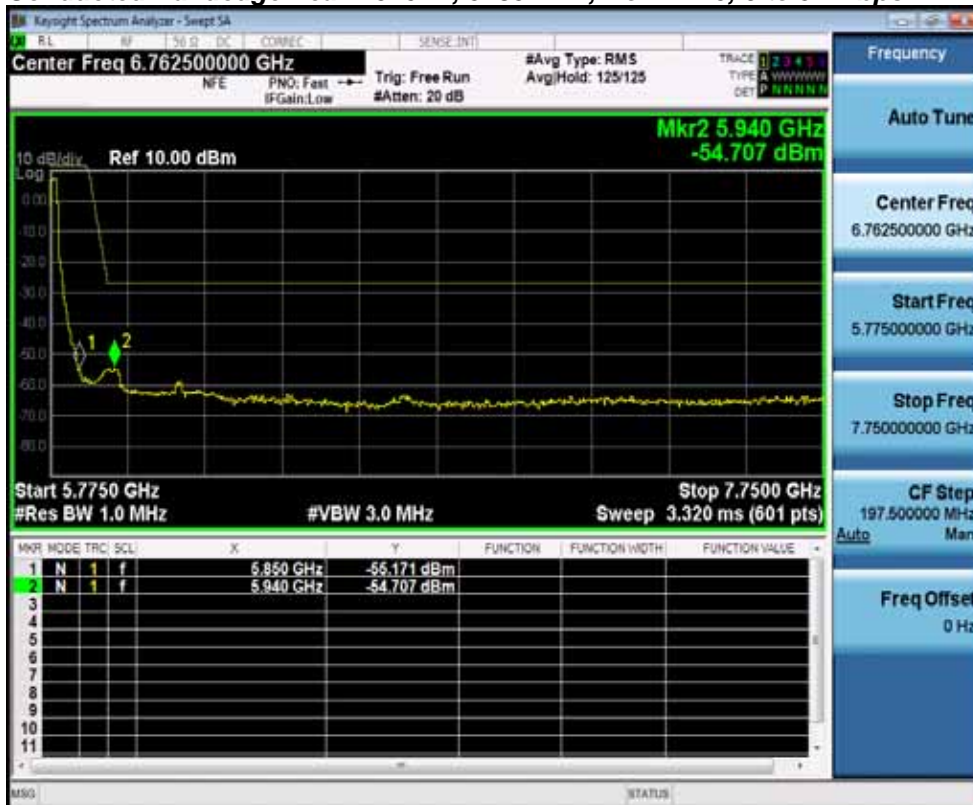

**Antenna A**

### Appendix B: Emission Test Results

Testing Laboratory: Cisco Systems, Inc., 125 West Tasman Drive, San Jose, CA 95134, USA

### Radiated Emission Setup Diagram-Below 1G

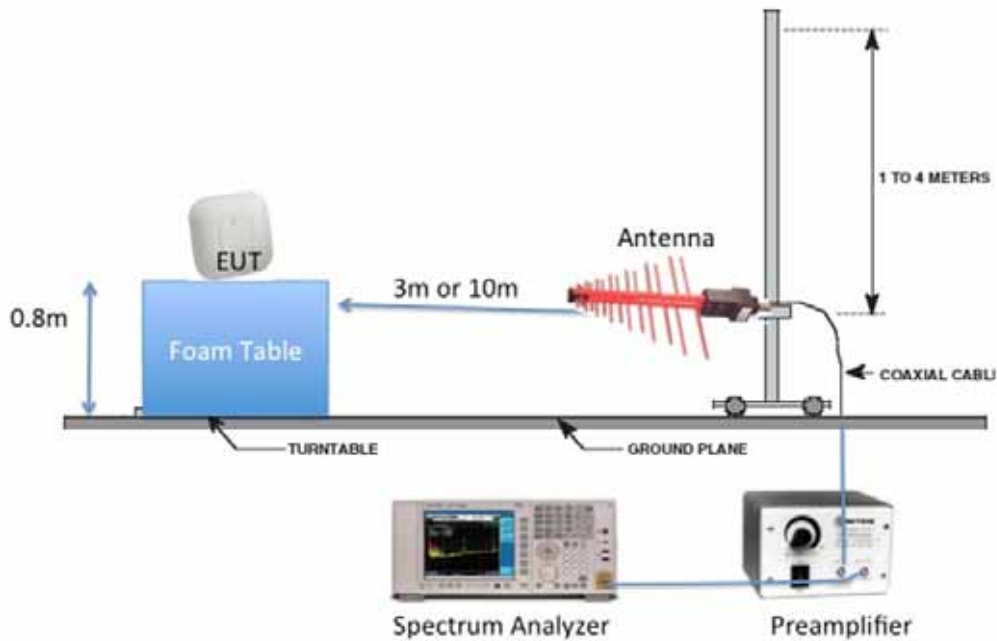

### Radiated Emission Setup Diagram-Above 1G

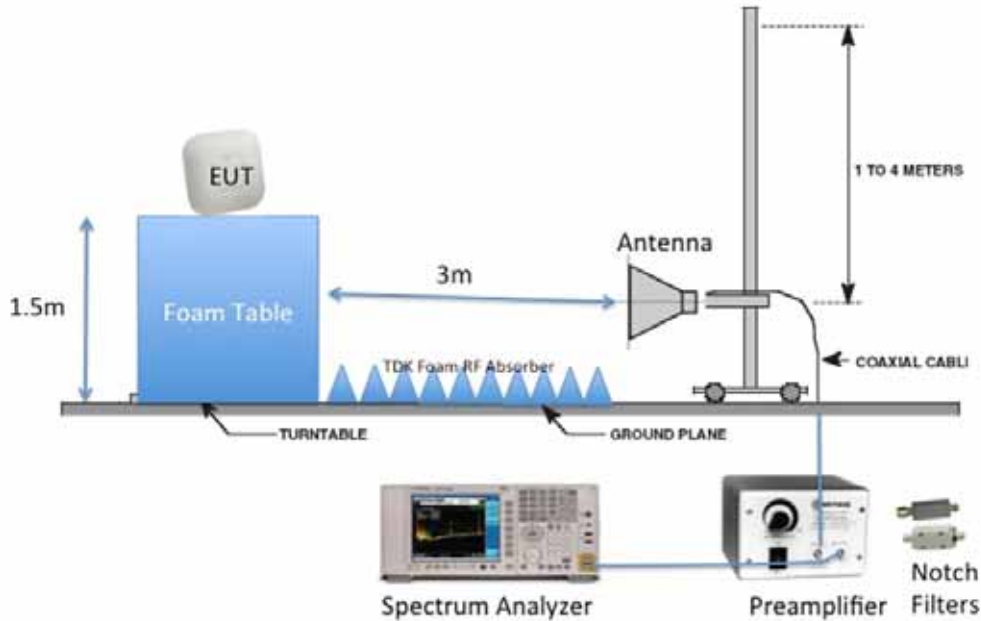

## **B.1 Radiated Spurious Emissions**

Not covered by the scope of this test report.

## B.2 Receiver Spurious Emissions

Not covered by the scope of this test report.

## **B.3 Radiated Emissions 30MHz to 1GHz**

Not covered by the scope of this test report.

## B.4 AC Conducted Emissions

Not covered by the scope of this test report.



### Appendix C: List of Test Equipment Used to perform the test

Equip#	Manufacturer/ Model	Description	Last Cal	Next Due	Test Item
57478	Cisco	Automation Test Insertion Loss	Cal not required		A1-A8
53615	Keysight N9030A-550	PXA Signal Analyzer, 3Hz to 50GHz	16 Jul 2019	16 Jul 2020	A1-A8
55096	NI PXI-1042	CHASSIS, PXI	Cal not required		A1-A8
57239	NI PXI-8115	Embedded Controller	Cal not required		A1-A8
57250	NI PXI-2796	40 GHz Dual 6x1 Multiplexer (SP6T)	Cal not required		A1-A8
57251	NI PXI-2799	Switch 1x1	Cal not required		A1-A8
56093	NI PXI-2796	40 GHz Dual 6x1 Multiplexer (SP6T)	Cal not required		A1-A8
7329	Omega CT485B	Chart recorder	18 Feb 2019	18 Feb 2020	A1-A8
56328	Pasternack PE5019-1	Torque wrench	14 Feb 2019	14 Feb 2020	A1-A8
56329	Pasternack PE5019-1	Torque wrench	28 Feb 2019	28 Feb 2020	A1-A8
56330	Pasternack PE5019-1	Torque wrench	28 Feb 2019	28 Feb 2020	A1-A8
54303	Keysight N5182B	MXG X-Series RF Vector Signal Generator	8 Oct 2018	27 Dec 2019	A1-A8
49389	ROHDE & SCHWARZ NRP2	Power Meter	21 Nov 2018	21 Nov 2019	A1-A8
49390	ROHDE & SCHWARZ NRP-Z21	Power Sensor	21 Nov 2018	21 Nov 2019	A1-A8

## Appendix D: Abbreviation Key and Definitions

The following table defines abbreviations used within this test report.

Abbreviation	Description	Abbreviation	Description
EMC	Electro Magnetic Compatibility	°F	Degrees Fahrenheit
EMI	Electro Magnetic Interference	°C	Degrees Celsius
EUT	Equipment Under Test	Temp	Temperature
ITE	Information Technology Equipment	S/N	Serial Number
TAP	Test Assessment Schedule	Qty	Quantity
ESD	Electro Static Discharge	emf	Electromotive force
EFT	Electric Fast Transient	RMS	Root mean square
EDCS	Engineering Document Control System	Qp	Quasi Peak
Config	Configuration	Av	Average
CIS#	Cisco Number (unique identification number for Cisco test equipment)	Pk	Peak
Cal	Calibration	kHz	Kilohertz ( $1 \times 10^3$ )
EN	European Norm	MHz	MegaHertz ( $1 \times 10^6$ )
IEC	International Electro technical Commission	GHz	Gigahertz ( $1 \times 10^9$ )
CISPR	International Special Committee on Radio Interference	H	Horizontal
CDN	Coupling/Decoupling Network	V	Vertical
LISN	Line Impedance Stabilization Network	dB	decibel
PE	Protective Earth	V	Volt
GND	Ground	kV	Kilovolt ( $1 \times 10^3$ )
L1	Line 1	$\mu$ V	Microvolt ( $1 \times 10^{-6}$ )
L2	Line2	A	Amp
L3	Line 3	$\mu$ A	Micro Amp ( $1 \times 10^{-6}$ )
DC	Direct Current	mS	Milli Second ( $1 \times 10^{-3}$ )
RAW	Uncorrected measurement value, as indicated by the measuring device	$\mu$ S	Micro Second ( $1 \times 10^{-6}$ )
RF	Radio Frequency	$\mu$ S	Micro Second ( $1 \times 10^{-6}$ )
SLCE	Signal Line Conducted Emissions	m	Meter
Meas dist	Measurement distance	Spec dist	Specification distance
N/A or NA	Not Applicable	SL	Signal Line (or Telecom Line)
P	Power Line	L	Live Line
N	Neutral Line	R	Return
S	Supply	AC	Alternating Current

## Appendix E: Photographs of Test Setups

Please refer to the attachment



## Appendix F: Software Used to Perform Testing

Cisco Internal LabView Radio Test Automation Software – RF Automation Main rev 57 patch 91  
Cisco Internal LabView Radio Test Automation Software – Report Generation Main rev 44

## Appendix G: Test Procedures

Measurements were made in accordance with

- KDB 789033 - D02 General UNII Test Procedures New Rules v02r01
- KDB 662911 - MIMO
- ANSI C63.4 2014 Unintentional Radiators
- ANSI C63.10 2013 Intentional Radiators

Test procedures are summarized below:

FCC 5GHz Test Procedures	EDCS # 1445048
FCC 5GHz RSE Test Procedures	EDCS # 1511600

## Appendix H: Scope of Accreditation (A2LA certificate number 1178-01)

The scope of accreditation of Cisco Systems, Inc. can be found on the A2LA web page at:

<http://www.a2la.org/scopepdf/1178-01.pdf>

## Appendix I: Test Assessment Plan

Radio Reg Plan: EDCS# 16415403

**----- End -----**