

FCC Radio Test Report

FCC ID : LDKMU6CR2417
Equipment : Cisco Catalyst 9136I Access Point
Brand Name : Cisco
Model Name : C9136I-B
Applicant : Cisco Systems Inc
125 West Tasman Drive , San Jose, CA 95134, USA.
Manufacturer : Cisco Systems, Inc.
170 West Tasman Drive, San Jose, CA 95134, USA.
Standard : 47 CFR FCC Part 15.247

The product was received on Aug. 09, 2021, and testing was started from Aug. 12, 2021 and completed on Sep. 28, 2021. We, SPORTON INTERNATIONAL INC. Hsinhua Laboratory, would like to declare that the tested sample has been evaluated in accordance with the procedures given in ANSI C63.10-2013 and shown compliance with the applicable technical standards.

The test results in this report apply exclusively to the tested model / sample. Without written approval of SPORTON INTERNATIONAL INC. Hsinhua Laboratory, the test report shall not be reproduced except in full.



Approved by: Allen Lin

SPORTON INTERNATIONAL INC. Hsinhua Laboratory

No.52, Huaya 1st Rd., Guishan Dist., Taoyuan City 333411, Taiwan (R.O.C.)



Table of Contents

HISTORY OF THIS TEST REPORT3

SUMMARY OF TEST RESULT4

1 GENERAL DESCRIPTION5

1.1 Information.....5

1.2 Testing Applied Standards8

1.3 Testing Location Information8

1.4 Measurement Uncertainty8

2 TEST CONFIGURATION OF EUT.....9

2.1 Test Channel Mode9

2.2 The Worst Case Measurement Configuration10

2.3 Accessories11

2.4 Support Equipment.....11

2.5 Test Setup Diagram12

3 TRANSMITTER TEST RESULT14

3.1 AC Power-line Conducted Emissions14

3.2 DTS Bandwidth.....16

3.3 Maximum Conducted Output Power17

3.4 Power Spectral Density19

3.5 Emissions in Non-restricted Frequency Bands20

3.6 Emissions in Restricted Frequency Bands.....21

4 TEST EQUIPMENT AND CALIBRATION DATA.....25

APPENDIX A. TEST RESULTS OF AC POWER-LINE CONDUCTED EMISSIONS

APPENDIX B. TEST RESULTS OF DTS BANDWIDTH

APPENDIX C. TEST RESULTS OF MAXIMUM CONDUCTED OUTPUT POWER

APPENDIX D. TEST RESULTS OF POWER SPECTRAL DENSITY

APPENDIX E. TEST RESULTS OF EMISSIONS IN NON-RESTRICTED FREQUENCY BANDS

APPENDIX F. TEST RESULTS OF EMISSIONS IN RESTRICTED FREQUENCY BANDS

APPENDIX G. TEST PHOTOS

PHOTOGRAPHS OF EUT V01



Summary of Test Result

Report Clause	Ref.Std. Clause	Test Items	Result (PASS/FAIL)	Remark
1.1.2	15.203	Antenna Requirement	PASS	-
3.1	15.207	AC Power-line Conducted Emissions	PASS	-
3.2	15.247(a)	DTS Bandwidth	PASS	-
3.3	15.247(b)	Maximum Conducted Output Power	PASS	-
3.4	15.247(e)	Power Spectral Density	PASS	-
3.5	15.247(d)	Emissions in Non-restricted Frequency Bands	PASS	-
3.6	15.247(d)	Emissions in Restricted Frequency Bands	PASS	-

Declaration of Conformity:
The test results with all measurement uncertainty excluded are presented in accordance with the regulation limits or requirements declared by manufacturers.
Comments and explanations:
None

Reviewed by: Ben Tseng

Report Producer: Amber Chiu

1 General Description

1.1 Information

1.1.1 RF General Information

Frequency Range (MHz)	Bluetooth Mode	Ch. Frequency (MHz)	Channel Number
2400-2483.5	LE	2402-2480	0-39 [40]

Band	Mode	BWch (MHz)	Nant
2.4-2.4835GHz	BT-LE(1Mbps)	1.0	1TX
2.4-2.4835GHz	BT-LE(125kbps)	1.0	1TX
2.4-2.4835GHz	BT-LE(500kbps)	1.0	1TX
2.4-2.4835GHz	BT-LE(2Mbps)	2.0	1TX

Note:

- ◆ Bluetooth LE uses a GFSK (125kbps/500kbps/1Mbps/2Mbps) modulation.
- ◆ BWch is the nominal channel bandwidth.

1.1.2 Antenna Information

Ant.	Brand	Model Name	Antenna Type	Connector
1	Foxconn	361.01530.005	PIFA	I-PEX
2	Foxconn	361.01530.005	PIFA	I-PEX
3	Foxconn	361.01530.005	PIFA	I-PEX
4	Foxconn	361.01530.005	PIFA	I-PEX
5	Foxconn	361.01530.005	Dipole	I-PEX
6	Foxconn	361.01530.005	Dipole	I-PEX
7	Foxconn	361.01530.005	Dipole	I-PEX
8	Foxconn	361.01530.005	Dipole	I-PEX
9	Foxconn	361.01530.005	PIFA	I-PEX
10	Foxconn	361.01530.005	PIFA	I-PEX
11	Foxconn	361.01530.005	PIFA	I-PEX
12	Foxconn	361.01530.005	PIFA	I-PEX
13	Foxconn	361.01530.005	PIFA	I-PEX
14	Foxconn	361.01530.005	PIFA	I-PEX
15	Foxconn	361.01530.005	PIFA	I-PEX



Serving Radio

Ant.	Port	Gain (dBi)					
		2.4G	5G Primary	5G Secondary	5G Dual	6G	BT
1	1	4	5	-	5	-	-
2	2	4	5	-	5	-	-
3	3	4	5	-	5	-	-
4	4	4	5	-	5	-	-
5	5	-	-	5	5	-	-
6	6	-	-	5	5	-	-
7	7	-	-	5	5	-	-
8	8	-	-	5	5	-	-
9	1	-	-	-	-	6	-
10	2	-	-	-	-	6	-
11	3	-	-	-	-	6	-
12	4	-	-	-	-	6	-

Scanning Radio

Ant.	Port	Gain (dBi)			
		2.4G	5G	6G	BT
13	1	6	6	6	-
14	2	6	6	6	-

Ant.	Port	Gain (dBi)			
		2.4G	5G	6G	BT
15	1	-	-	-	5

Note 1: The EUT has fifteen antennas.

Note 2: The antenna for dual mode is cross polarized.

For 2.4GHz function:

For IEEE 802.11 b/g/n/VHT/ax mode (2TX/2RX)

Ant. 13 (port 1) and Ant. 14 (port 2) could transmit/receive simultaneously.

For IEEE 802.11 b/g/n/VHT/ax mode (4TX/4RX)

Ant. 1 (port 1), Ant. 2 (port 2), Ant. 3 (port 3) and Ant. 4 (port 4) could transmit/receive simultaneously.

For BT function:

For IEEE 802.15.1 Bluetooth mode (1TX/1RX)

Only Ant. 15 (port 1) can be used as transmitting/receiving antenna.

For 5GHz function:

For IEEE 802.11 a/n/ac/ax mode (2TX/2RX)

Ant. 13 (port 1) and Ant. 14 (port 2) could transmit/receive simultaneously.



For IEEE 802.11 a/n/ac/ax mode (4TX/4RX)

Ant. 1 (port 1), Ant. 2 (port 2), Ant. 3 (port 3) and Ant. 4 (port 4) could transmit/receive simultaneously.

Ant. 5 (port 5), Ant. 6 (port 6), Ant. 7 (port 7) and Ant. 8 (port 8) could transmit/receive simultaneously.

For IEEE 802.11 a/n/ac/ax mode (8TX/8RX)

Ant. 1 (port 1), Ant. 2 (port 2), Ant. 3 (port 3), Ant. 4 (port 4), Ant. 5 (port 5), Ant. 6 (port 6), Ant. 7(port 7), and Ant. 8 (port 8) could transmit/receive simultaneously.

For 6GHz function:

For IEEE 802.11 a/ax mode (2TX/2RX)

Ant. 13 (port 1) and Ant. 14 (port 2) could transmit/receive simultaneously.

For IEEE 802.11 a/ax mode (4TX/4RX)

Ant. 9 (port 1), Ant. 10 (port 2), Ant. 11(port 3) and Ant. 12 (port 4) could transmit/receive simultaneously.

1.1.3 EUT Information

Operational Condition	
EUT Power Type	From PoE
EUT Function	<input checked="" type="checkbox"/> Point-to-multipoint <input type="checkbox"/> Point-to-point
Type of EUT	
<input checked="" type="checkbox"/>	Stand-alone
<input type="checkbox"/>	Combined (EUT where the radio part is fully integrated within another device)
	Combined Equipment - Brand Name / Model No.: ...
<input type="checkbox"/>	Plug-in radio (EUT intended for a variety of host systems)
	Host System - Brand Name / Model No.: ...
<input type="checkbox"/>	Other:

1.1.4 Mode Test Duty Cycle

Mode	DC	DCF(dB)	T(s)	VBW(Hz) ≥ 1/T
BT-LE(1Mbps)	0.868	0.61	2.171m	1k
BT-LE(125kbps)	0.959	0.18	17.093m	100
BT-LE(500kbps)	0.919	0.37	4.594m	300
BT-LE(2Mbps)	0.593	2.27	1.116m	1k

Note. If DC < 0.98, the DCF was added while measuring Output power and PSD.

1.2 Testing Applied Standards

According to the specifications of the manufacturer, the EUT must comply with the requirements of the following standards:

- ◆ 47 CFR FCC Part 15
- ◆ ANSI C63.10-2013

The following reference test guidance is not within the scope of accreditation of TAF:

- ◆ KDB 558074 D01 v05r02
- ◆ KDB 414788 D01 v01r01

1.3 Testing Location Information

Test Lab. : Sporton International Inc. Hsinhua Laboratory				
<input checked="" type="checkbox"/>	Hsinhua (TAF: 3785)	ADD: No.52, Huaya 1st Rd., Guishan Dist., Taoyuan City 333411, Taiwan (R.O.C.)		
		TEL: 886-3-327-3456	FAX: 886-3-327-0973	
Test site Designation No. TW3785 with FCC.				
Test Condition	Test Site No.	Test Engineer	Test Environment	Test Date
AC Conduction	CO04-HY	Tony Chang	22.1~23.7°C / 51~60%	27/Aug/2021
RF Conducted	TH01-HY	Barry Hsiao	24.2~26.9°C / 49~60%	12/Aug/2021~28/Sep/2021
Radiated	03CH02-HY	Tony Chang	23.7~24.1°C / 47~52%	27/Aug/2021
<input type="checkbox"/>	Wen 33rd.St. (TAF: 3785)	ADD: No.14-1, Ln. 19, Wen 33rd St., Guishan Dist., Taoyuan City 333010, Taiwan (R.O.C.)		
		TEL: 886-3-318-0787	FAX: 886-3-318-0287	
Test site Designation No. TW0008 with FCC.				

1.4 Measurement Uncertainty

ISO/IEC 17025 requires that an estimate of the measurement uncertainties associated with the emissions test results be included in the report. The measurement uncertainties given below are based on a 95% confidence level (based on a coverage factor (k=2))

Test Items	Uncertainty	Remark
Conducted Emission (150kHz ~ 30MHz)	0.9 dB	Confidence levels of 95%
Radiated Emission (9kHz ~ 30MHz)	2.4 dB	Confidence levels of 95%
Radiated Emission (30MHz ~ 1,000MHz)	3.7 dB	Confidence levels of 95%
Radiated Emission (1GHz ~ 18GHz)	3.6 dB	Confidence levels of 95%
Radiated Emission (18GHz ~ 40GHz)	3.5 dB	Confidence levels of 95%
Conducted Emission	1.0 dB	Confidence levels of 95%
Temperature	0.41 °C	Confidence levels of 95%
Humidity	3.4 %	Confidence levels of 95%



2 Test Configuration of EUT



2.1 Test Channel Mode

Test Software	Putty
Mode	Power Setting
BT-LE(1Mbps)	-
2402MHz	17
2440MHz	20
2480MHz	16
BT-LE(2Mbps)	-
2402MHz	17
2440MHz	20
2480MHz	12
BT-LE(125kbps)	-
2402MHz	15
2440MHz	16
2480MHz	16
BT-LE(500kbps)	-
2402MHz	17
2440MHz	20
2480MHz	15

2.2 The Worst Case Measurement Configuration

The Worst Case Mode for Following Conformance Tests	
Tests Item	AC power-line conducted emissions
Condition	AC power-line conducted measurement for line and neutral Test Voltage: 120Vac / 60Hz
Operating Mode	CTX
1	PoE mode

The Worst Case Mode for Following Conformance Tests	
Tests Item	DTS Bandwidth Maximum Conducted Output Power Power Spectral Density Emissions in Non-restricted Frequency Bands Emissions in Restricted Frequency Bands
Test Condition	Conducted measurement at transmit chains

The Worst Case Mode for Following Conformance Tests			
Tests Item	Emissions in Restricted Frequency Bands		
Test Condition	Radiated measurement If EUT consist of multiple antenna assembly (multiple antenna are used in EUT regardless of spatial multiplexing MIMO configuration), the radiated test should be performed with highest antenna gain of each antenna type.		
Operating Mode < 1GHz	CTX		
1	PoE mode		
Operating Mode > 1GHz	CTX		
Orthogonal Planes of EUT	X Plane	Y Plane	Z Plane
			
Worst Planes of EUT		V	

The Worst Case Mode for Following Conformance Tests	
Tests Item	Simultaneous Transmission Analysis
Operating Mode	CTX
1	WLAN 2.4G (do0)+ WLAN 5G (do1)+ WLAN 5G (do2)+ WLAN 6G (do3)+ Bluetooth
Refer to Sporton Test Report No.: FA180526 for Co-location RF Exposure Evaluation.	

2.3 Accessories

Accessories				
PoE	Brand Name	DELTA	Model Name	ADH-65AR B
	Power Rating	I/P: 100 - 240 Vac, 2.0 A, O/P: 56 Vdc, 1.161 A		

Reminder: Regarding to more detail and other information, please refer to user manual.

2.4 Support Equipment

Support Equipment – AC Conduction				
No.	Equipment	Brand Name	Model Name	Remark
1	RJ45 cable	Power sync	CAT-6E-10	-

Support Equipment – Conducted				
No.	Equipment	Brand Name	Model Name	Remark
1	Notebook	DELL	E5410	-
2	Adapter for NB	DELL	HA65NM130	-

Support Equipment – Radiated				
No.	Equipment	Brand Name	Model Name	Remark
1	RJ45 cable	Power sync	CAT-6E-10	-

2.5 Test Setup Diagram

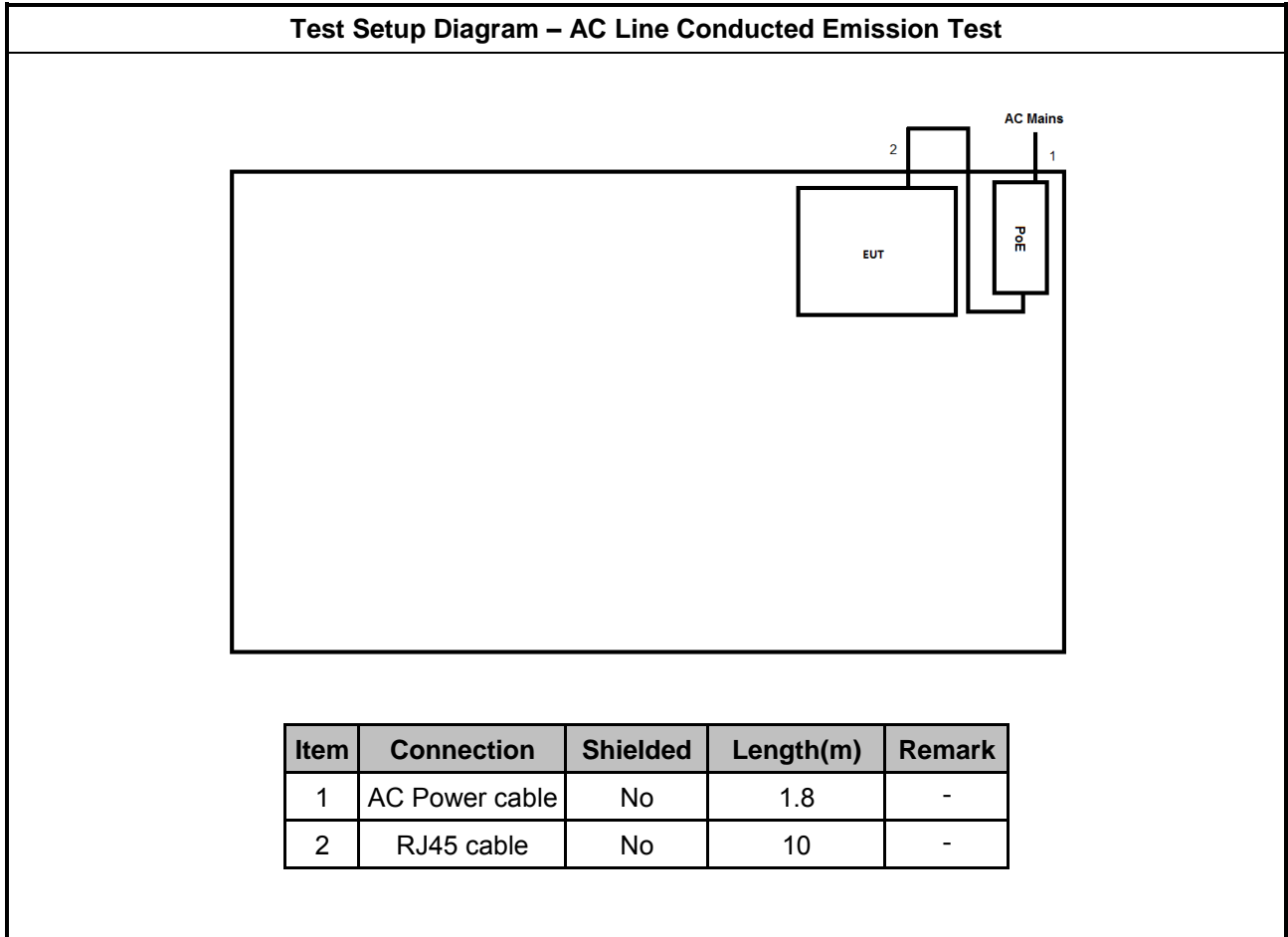

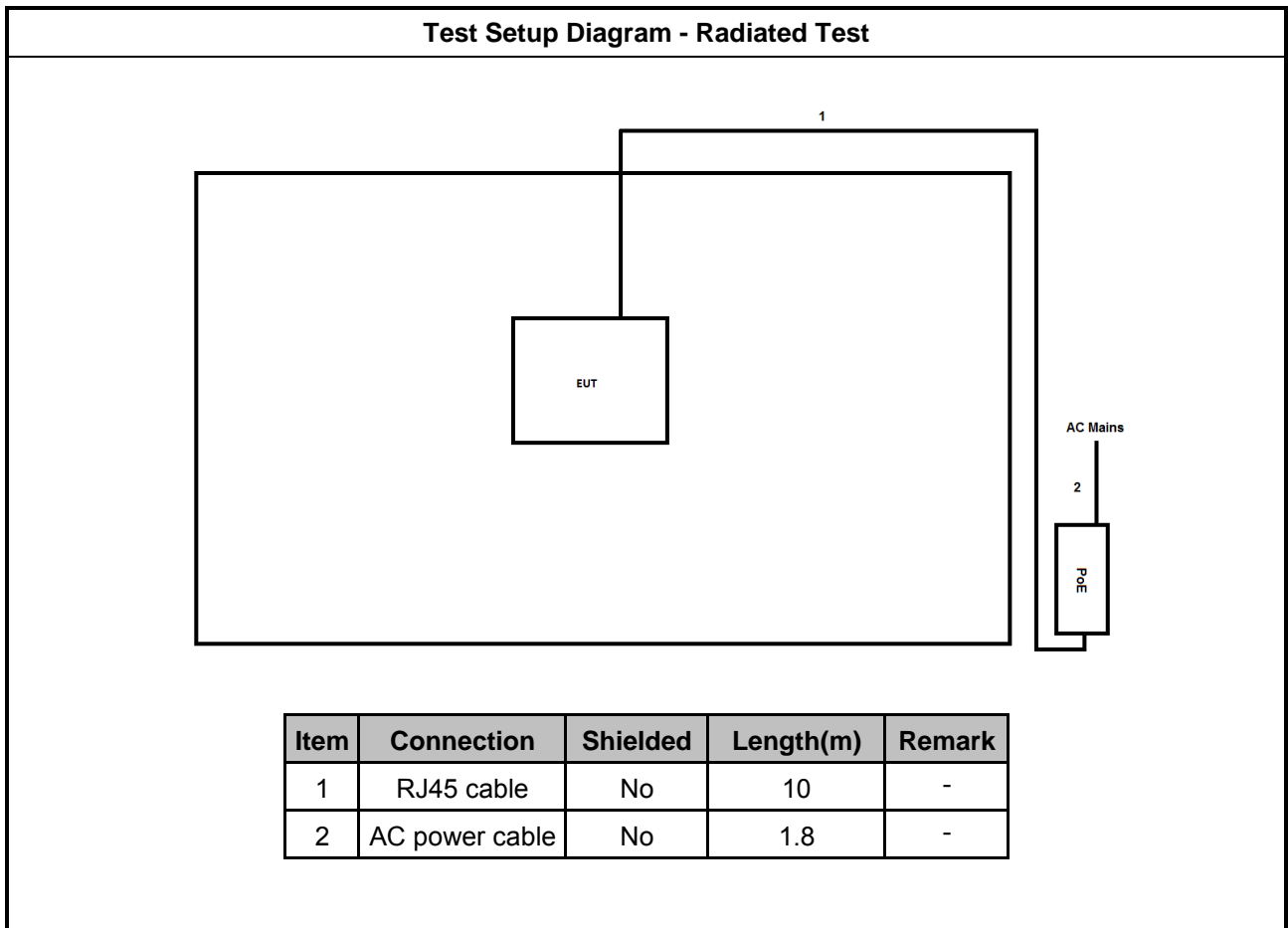



3 Transmitter Test Result

3.1 AC Power-line Conducted Emissions

3.1.1 AC Power-line Conducted Emissions Limit

AC Power-line Conducted Emissions Limit		
Frequency Emission (MHz)	Quasi-Peak	Average
0.15-0.5	66 - 56 *	56 - 46 *
0.5-5	56	46
5-30	60	50

Note 1: * Decreases with the logarithm of the frequency.

3.1.2 Measuring Instruments

Refer a test equipment and calibration data table in this test report.

3.1.3 Test Procedures

Test Method
▪ Refer as ANSI C63.10-2013, clause 6.2 foray power-line conducted emissions.

3.1.4 Measurement Results Calculation

The measured Level is calculated using:

Corrected Reading: Raw(Read Level) +LISN(LISN Factor) + CL(Cable Loss) + AT(Attenuator).

3.1.5 Test Setup

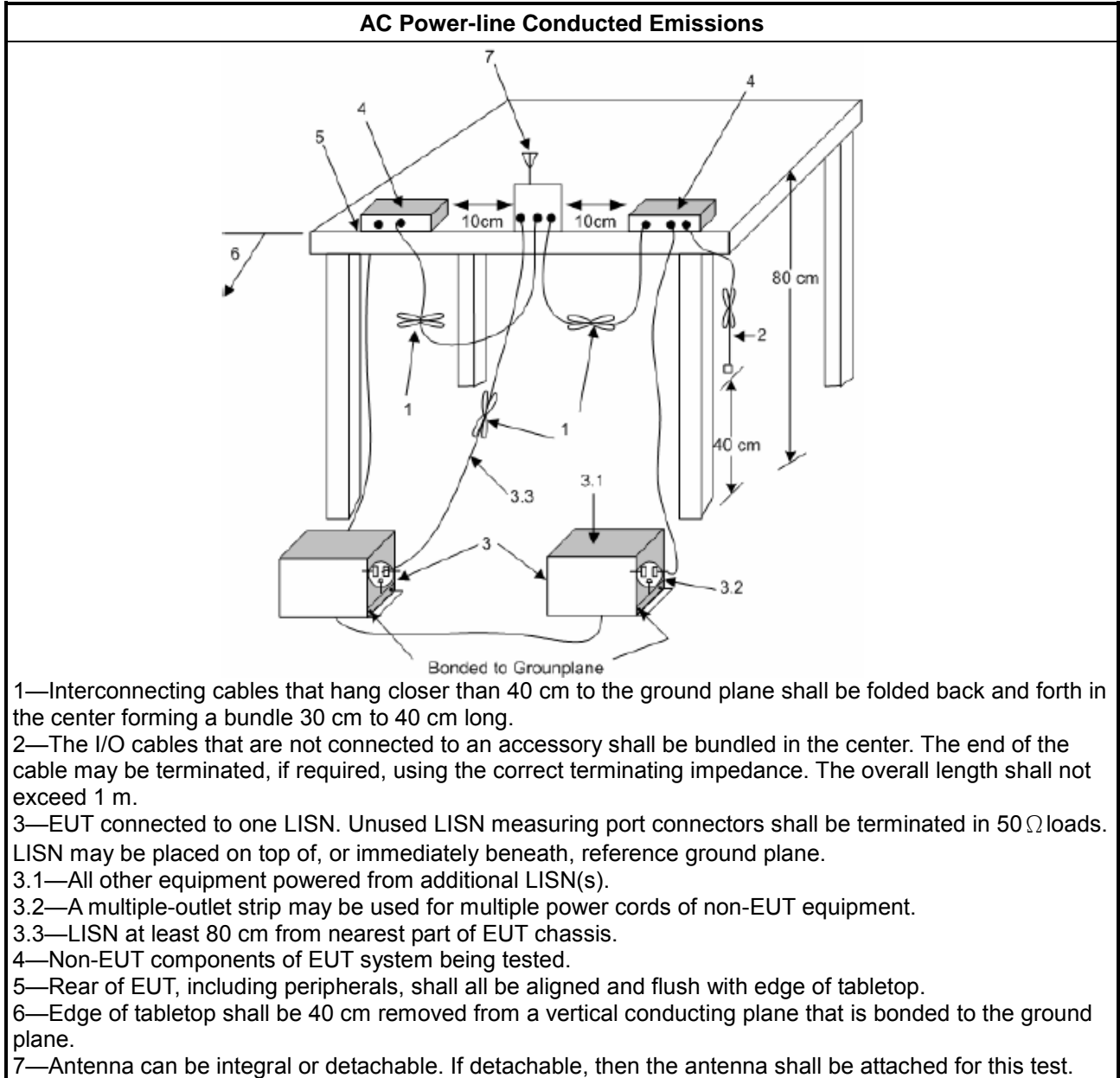

3.1.6 Test Result of AC Power-line Conducted Emissions

Refer as Appendix A

3.2 DTS Bandwidth

3.2.1 6dB Bandwidth Limit

6dB Bandwidth Limit
Systems using digital modulation techniques:
<ul style="list-style-type: none"> ▪ 6 dB bandwidth \geq 500 kHz.

3.2.2 Measuring Instruments

Refer a test equipment and calibration data table in this test report.

3.2.3 Test Procedures

Test Method
<ul style="list-style-type: none"> ▪ For the emission bandwidth shall be measured using one of the options below:
<input checked="" type="checkbox"/> Refer as KDB 558074, clause 8.2 (11.8 of ANSI C63.10) DTS bandwidth measurement.
<input type="checkbox"/> Refer as RSS-Gen, clause 6.7 for occupied bandwidth testing.
<input type="checkbox"/> Refer as ANSI C63.10, clause 6.9.3 for occupied bandwidth testing.

3.2.4 Test Setup

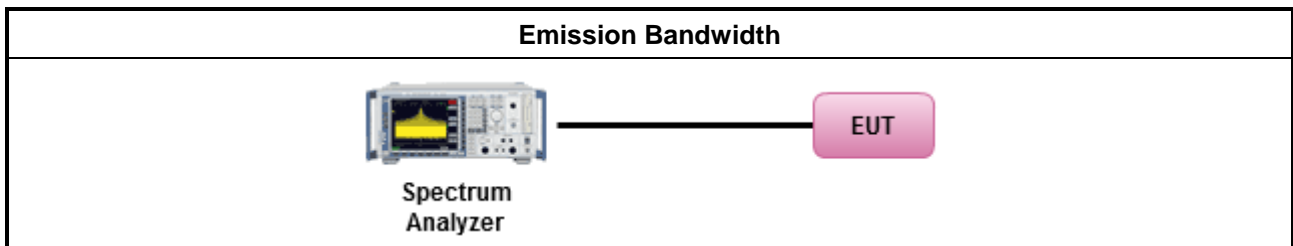

3.2.5 Test Result of Emission Bandwidth

Refer as Appendix B

3.3 Maximum Conducted Output Power

3.3.1 Maximum Conducted Output Power Limit

Maximum Conducted Output Power Limit	
	<ul style="list-style-type: none"> ▪ If $G_{TX} \leq 6$ dBi, then $P_{Out} \leq 30$ dBm (1 W)
	<ul style="list-style-type: none"> ▪ Point-to-multipoint systems (P2M): If $G_{TX} > 6$ dBi, then $P_{Out} = 30 - (G_{TX} - 6)$ dBm
	<ul style="list-style-type: none"> ▪ Point-to-point systems (P2P): If $G_{TX} > 6$ dBi, then $P_{Out} = 30 - (G_{TX} - 6)/3$ dBm
	<ul style="list-style-type: none"> ▪ Smart antenna system (SAS):
	<ul style="list-style-type: none"> - Single beam: If $G_{TX} > 6$ dBi, then $P_{Out} = 30 - (G_{TX} - 6)/3$ dBm
	<ul style="list-style-type: none"> - Overlap beam: If $G_{TX} > 6$ dBi, then $P_{Out} = 30 - (G_{TX} - 6)/3$ dBm
	<ul style="list-style-type: none"> - Aggregate power on all beams: If $G_{TX} > 6$ dBi, then $P_{Out} = 30 - (G_{TX} - 6)/3 + 8$ dB dBm
e.i.r.p. Power Limit:	
	<ul style="list-style-type: none"> ▪ 2400-2483.5 MHz Band
	<ul style="list-style-type: none"> ▪ Point-to-multipoint systems (P2M): $P_{eirp} \leq 36$ dBm (4 W)
	<ul style="list-style-type: none"> ▪ Point-to-point systems (P2P): $P_{eirp} \leq \text{MAX}(36, [P_{Out} + G_{TX}])$ dBm
	<ul style="list-style-type: none"> ▪ Smart antenna system (SAS)
	<ul style="list-style-type: none"> - Single beam: $P_{eirp} \leq \text{MAX}(36, P_{Out} + G_{TX})$ dBm
	<ul style="list-style-type: none"> - Overlap beam: $P_{eirp} \leq \text{MAX}(36, P_{Out} + G_{TX})$ dBm
	<ul style="list-style-type: none"> - Aggregate power on all beams: $P_{eirp} \leq \text{MAX}(36, [P_{Out} + G_{TX} + 8])$ dBm
P_{Out} = maximum peak conducted output power or maximum conducted output power in dBm, G_{TX} = the maximum transmitting antenna directional gain in dBi.	

3.3.2 Measuring Instruments

Refer a test equipment and calibration data table in this test report.

3.3.3 Test Procedures

Test Method	
<ul style="list-style-type: none"> ▪ Maximum Peak Conducted Output Power 	
<input type="checkbox"/>	Refer as KDB 558074, clause 8.3.1.1 (11.9.1.1 of ANSI C63.10) RBW ≥ EBW method.
<input type="checkbox"/>	Refer as KDB 558074, clause 8.3.1.2 (11.9.1.2 of ANSI C63.10) integrated band power method.
<input type="checkbox"/>	Refer as KDB 558074, clause 8.3.1.3 (11.9.1.3 of ANSI C63.10) peak power meter.
<ul style="list-style-type: none"> ▪ Maximum Average Conducted Output Power 	
<input type="checkbox"/>	Refer as KDB 558074, clause 8.3.2.2 (11.9.2.2 of ANSI C63.10) using a spectrum analyzer.
<input checked="" type="checkbox"/>	Refer as KDB 558074, clause 8.3.2.3 (11.9.2.3 of ANSI C63.10) using a power meter.
<ul style="list-style-type: none"> ▪ For conducted measurement. 	
<ul style="list-style-type: none"> ▪ If the EUT supports multiple transmit chains using options given below: Refer as KDB 662911, In-band power measurements. Using the measure-and-sum approach, measured all transmit ports individually. Sum the power (in linear power units e.g., mW) of all ports for each individual sample and save them. 	
<ul style="list-style-type: none"> ▪ If multiple transmit chains, EIRP calculation could be following as methods: $P_{total} = P_1 + P_2 + \dots + P_n$ (calculated in linear unit [mW] and transfer to log unit [dBm]) $EIRP_{total} = P_{total} + DG$ 	

3.3.4 Test Setup

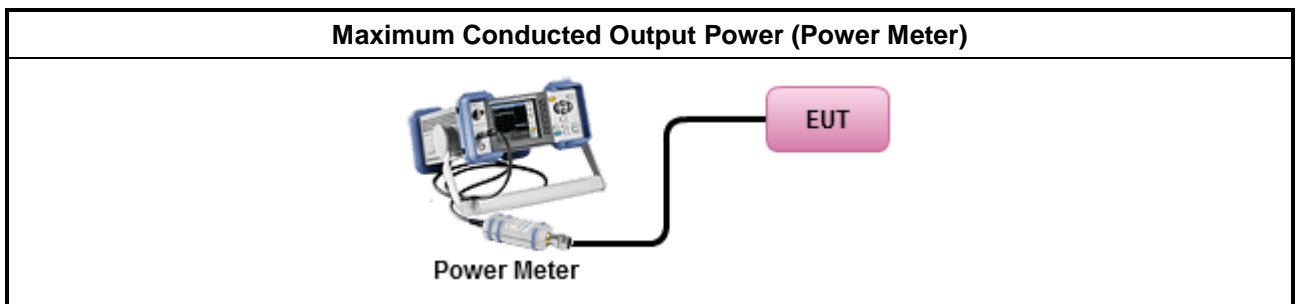

3.3.5 Test Result of Maximum Conducted Output Power

Refer as Appendix C

3.4 Power Spectral Density

3.4.1 Power Spectral Density Limit

Power Spectral Density Limit
<ul style="list-style-type: none"> Power Spectral Density (PSD) ≤ 8 dBm/3kHz

3.4.2 Measuring Instruments

Refer a test equipment and calibration data table in this test report.

3.4.3 Test Procedures

Test Method
<ul style="list-style-type: none"> Peak power spectral density procedures that the same method as used to determine the conducted output power. If maximum peak conducted output power was measured to demonstrate compliance to the output power limit, then the peak PSD procedure below (Method PKPSD) shall be used. If maximum conducted output power was measured to demonstrate compliance to the output power limit, then one of the average PSD procedures shall be used, as applicable based on the following criteria (the peak PSD procedure is also an acceptable option).
<input checked="" type="checkbox"/> Refer as KDB 558074, clause 8.4 (11.10 of ANSI C63.10) Max. PSD.
<ul style="list-style-type: none"> For conducted measurement. <ul style="list-style-type: none"> If The EUT supports multiple transmit chains using options given below: <ul style="list-style-type: none"> Measure and sum the spectra across the outputs. Refer as KDB 662911, In-band power spectral density (PSD). Sample all transmit ports simultaneously using a spectrum analyzer for each transmit port. Where the trace bin-by-bin of each transmit port summing can be performed. (i.e., in the first spectral bin of output 1 is summed with that in the first spectral bin of output 2 and that from the first spectral bin of output 3, and so on up to the NTX output to obtain the value for the first frequency bin of the summed spectrum.). Add up the amplitude (power) values for the different transmit chains and use this as the new data trace.

3.4.4 Test Setup

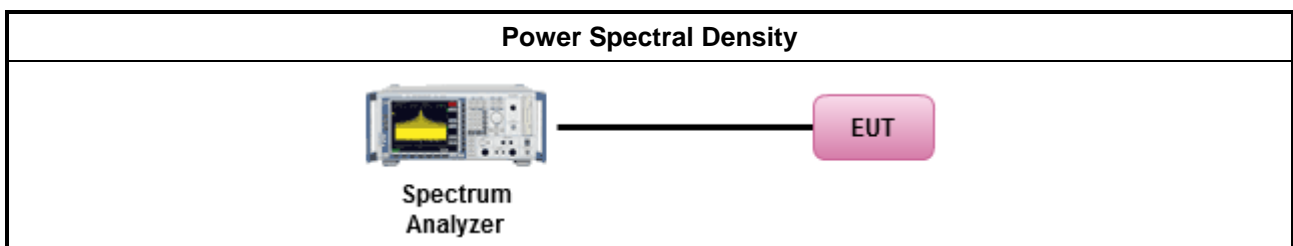

3.4.5 Test Result of Power Spectral Density

Refer as Appendix D

3.5 Emissions in Non-restricted Frequency Bands

3.5.1 Emissions in Non-restricted Frequency Bands Limit

Un-restricted Band Emissions Limit	
RF output power procedure	Limit (dB)
Peak output power procedure	20
Average output power procedure	30

Note 1: If the peak output power procedure is used to measure the fundamental emission power to demonstrate compliance to requirements, then the peak conducted output power measured within any 100 kHz outside the authorized frequency band shall be attenuated by at least 20 dB relative to the maximum measured in-band peak level.

Note 2: If the average output power procedure is used to measure the fundamental emission power to demonstrate compliance to requirements, then the power in any 100 kHz outside of the authorized frequency band shall be attenuated by at least 30 dB relative to the maximum measured in-band average level.

3.5.2 Measuring Instruments

Refer a test equipment and calibration data table in this test report.

3.5.3 Test Procedures

Test Method
<ul style="list-style-type: none"> Refer as KDB 558074, clause 8.5 (11.11 of ANSI C63.10) for non-restricted frequency bands.

3.5.4 Test Setup

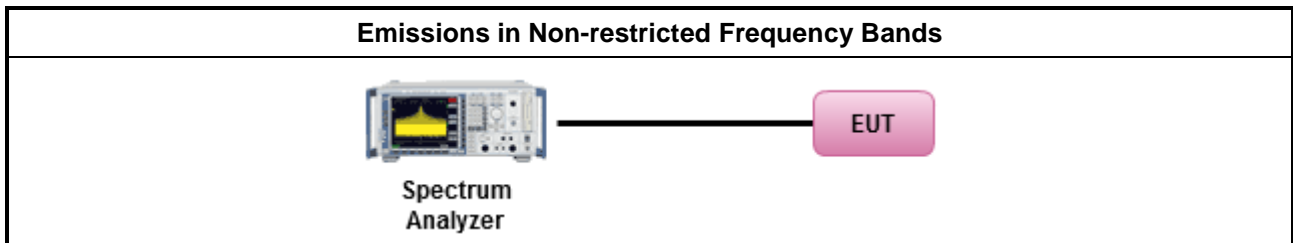

3.5.5 Test Result of Emissions in Non-restricted Frequency Bands

Refer as Appendix E

3.6 Emissions in Restricted Frequency Bands

3.6.1 Emissions in Restricted Frequency Bands Limit

Restricted Band Emissions Limit			
Frequency Range (MHz)	Field Strength (uV/m)	Field Strength (dBuV/m)	Measure Distance (m)
0.009~0.490	2400/F(kHz)	48.5 - 13.8	300
0.490~1.705	24000/F(kHz)	33.8 - 23	30
1.705~30.0	30	29	30
30~88	100	40	3
88~216	150	43.5	3
216~960	200	46	3
Above 960	500	54	3

Note 1: Test distance for frequencies at or above 30 MHz, measurements may be performed at a distance other than the limit distance provided they are not performed in the near field and the emissions to be measured can be detected by the measurement equipment. When performing measurements at a distance other than that specified, the results shall be extrapolated to the specified distance using an extrapolation factor of 20 dB/decade (inverse of linear distance for field-strength measurements, inverse of linear distance-squared for power-density measurements).

Note 2: Test distance for frequencies at below 30 MHz, measurements may be performed at a distance closer than the EUT limit distance; however, an attempt should be made to avoid making measurements in the near field. When performing measurements below 30 MHz at a closer distance than the limit distance, the results shall be extrapolated to the specified distance by either making measurements at a minimum of two or more distances on at least one radial to determine the proper extrapolation factor or by using the square of an inverse linear distance extrapolation factor (40 dB / decade). The test report shall specify the extrapolation method used to determine compliance of the EUT.

Note 3: Using the distance of 1m during the test for above 18 GHz, and the test value to correct for the distance factor at 3m.

3.6.2 Measuring Instruments

Refer a test equipment and calibration data table in this test report.

3.6.3 Test Procedures

Test Method	
	<ul style="list-style-type: none"> ▪ The average emission levels shall be measured in [duty cycle ≥ 98 or duty factor].
	<ul style="list-style-type: none"> ▪ Refer as ANSI C63.10, clause 6.10.3 band-edge testing shall be performed at the lowest frequency channel and highest frequency channel within the allowed operating band.
	<ul style="list-style-type: none"> ▪ For the transmitter unwanted emissions shall be measured using following options below: <ul style="list-style-type: none"> ▪ Refer as KDB 558074, clause 8.6 (11.12 of ANSI C63.10) for restricted frequency bands.
	<ul style="list-style-type: none"> ▪ For the transmitter band-edge emissions shall be measured using following options below: <ul style="list-style-type: none"> ▪ Refer as KDB 558074 clause 8.7.1, When the performing peak or average radiated measurements, emissions within 2 MHz of the authorized band edge may be measured using the marker-delta method described below. ▪ Refer as KDB 558074, clause 8.7.2 (6.10.6 of ANSI C63.10) for marker-delta method for band-edge measurements. ▪ Refer as KDB 558074, clause 8.7.3 for narrower resolution bandwidth (100kHz) using the band power and summing the spectral levels.
	<ul style="list-style-type: none"> ▪ Use the following spectrum analyzer settings: <ul style="list-style-type: none"> ▪ Set RBW=100 kHz for f < 1 GHz; VBW=3 * RBW; Sweep = auto; Detector function = peak; Trace = max hold. ▪ Set RBW = 1 MHz, VBW= 3MHz for f ≥ 1 GHz for peak measurement. For average measurement, refer as 1.1.4.
	<ul style="list-style-type: none"> ▪ KDB 414788 Open-Field Test Sites and Chamber Correlation Justification. <ul style="list-style-type: none"> ▪ Based on FCC 15.31(f)(2): measurements may be performed at a distance closer than that specified in regulations; however, an attempt should be made to avoid making measurements in the near field. ▪ Open-field site and chamber correlation testing had been performed and chamber measured test result is the worst case test result.
	<ul style="list-style-type: none"> ▪ For conducted and cabinet radiation measurement, refer as KDB 558074, clause 3 (12.7.4.2 of ANSI C63.10). <ul style="list-style-type: none"> ▪ For conducted unwanted emissions into restricted bands (absolute emission limits). Devices with multiple transmit chains using options given below: <ol style="list-style-type: none"> (1) Measure and sum the spectra across the outputs or (2) Measure and add 10 log(N) dB ▪ For KDB 662911 The methodology described here may overestimate array gain, thereby resulting in apparent failures to satisfy the out-of-band limits even if the device is actually compliant. In such cases, compliance may be demonstrated by performing radiated tests around the frequencies at which the apparent failures occurred.

3.6.4 Measurement Results Calculation

The measured Level is calculated using:

Corrected Reading: Raw(Read Level) + AF(Antenna Factor) + CL(Cable Loss) - PA(Preamplifier Factor)

3.6.5 Test Setup

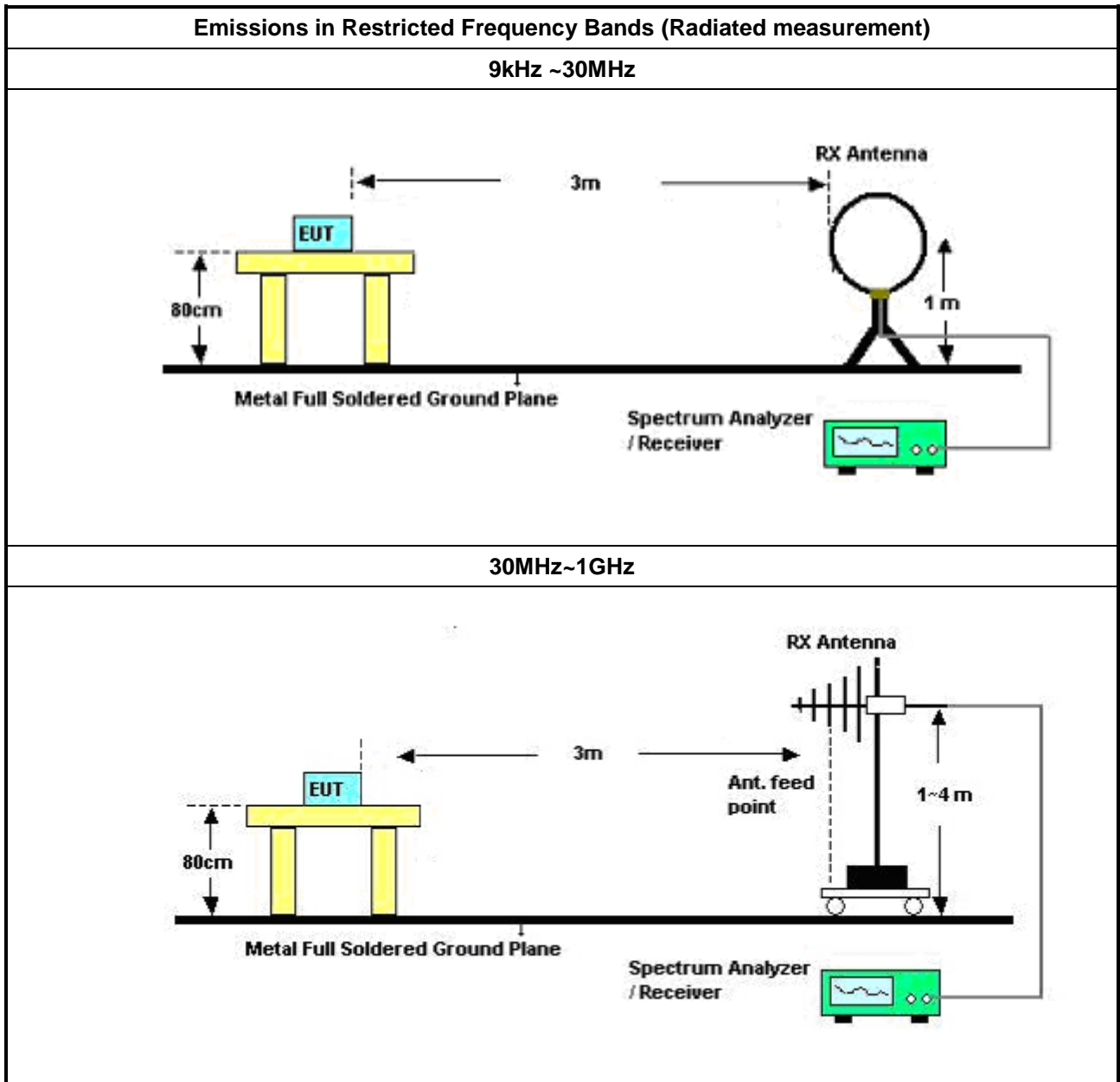

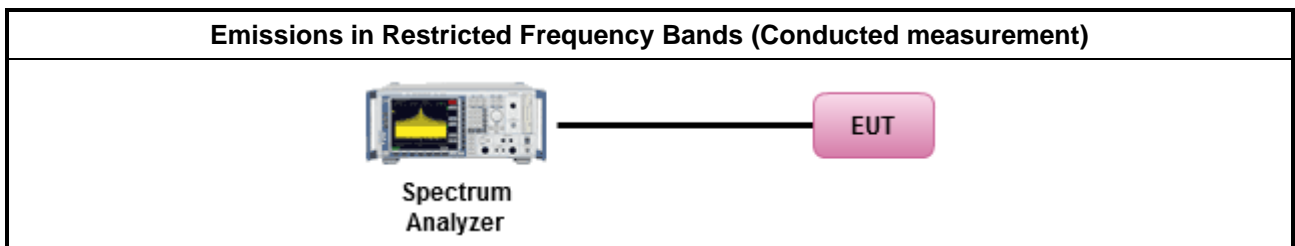
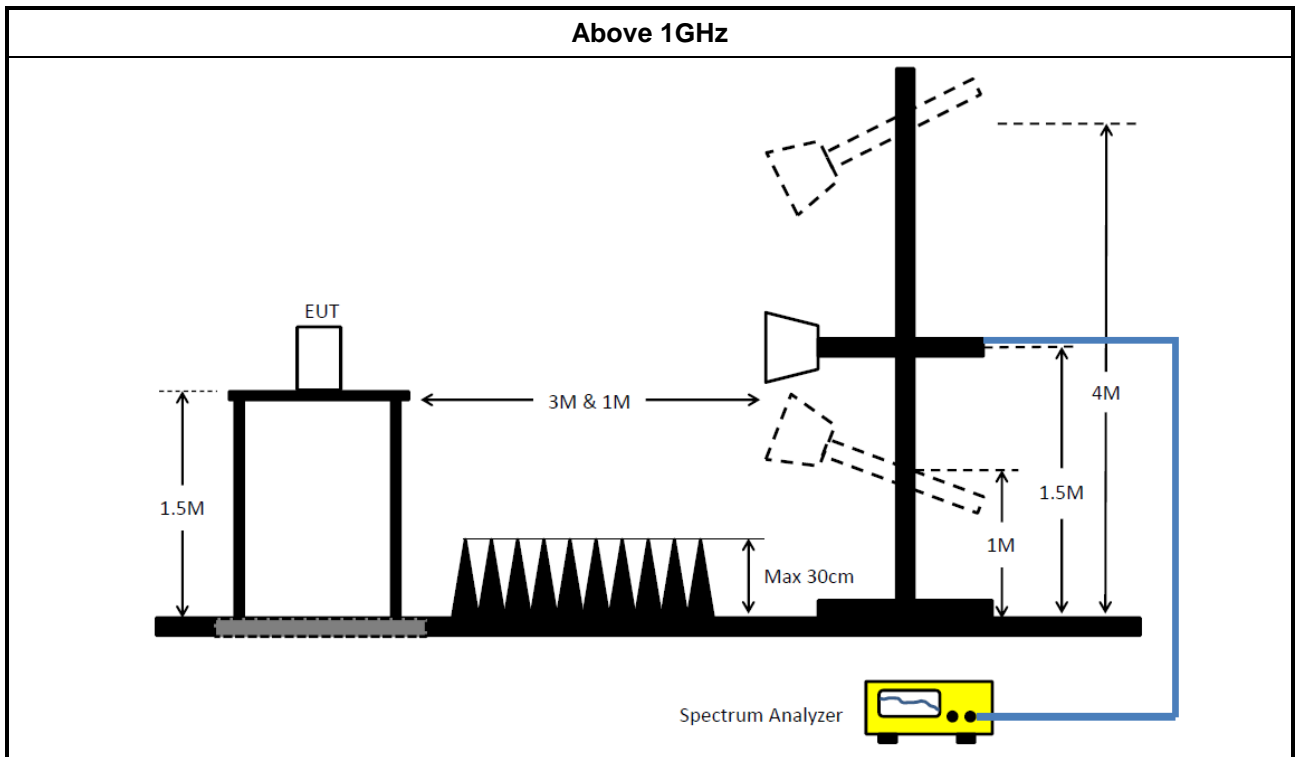

3.6.6 Test Result of Emissions in Restricted Frequency Bands (Below 30MHz)

The amplitude of spurious emissions which are attenuated by more than 20dB below the permissible value has no need to be reported.

3.6.7 Test Result of Emissions in Restricted Frequency Bands

Refer as Appendix F

4 Test Equipment and Calibration Data

Instrument for AC Conduction

Instrument	Manufacturer /Brand	Model No.	Serial No.	Spec.	Calibration Date	Calibration Due Date
EMI Test Receiver	R&S	ESR	102052	9kHz ~ 3.6GHz	19/Apr/2021	18/Apr/2022
LISN	R&S	ENV216	101295	9kHz ~ 30MHz	11/Nov/2020	10/Nov/2021
RF Cable 5m	TITAN	TITAN	CO04-cable-01	0.1MHz~200MHz	03/Mar/2021	02/Mar/2022
Impuls Begrenzer Pulse Limiter	SCHWARZBECK	VTSD 9561-F	9561-F041	9kHz ~ 30MHz	21/Sep/2020	20/Sep/2021

Instrument for Conducted Test

Instrument	Manufacturer /Brand	Model No.	Serial No.	Spec.	Calibration Date	Calibration Due Date
Signal Analyzer	R&S	FSV 40	101013	10Hz~40GHz	30/Mar/2021	29/Mar/2022
SMB100A Signal Generator	R&S	SMB100A03	181147	100kHz~40GHz	20/Oct/2020	19/Oct/2021
Pulse Sensor	Anritsu	MA2411B	0917017	300MHz~40GHz	23/Feb/2021	22/Feb/2022
Power Meter	Anritsu	ML2495A	0949003	300MHz~40GHz	23/Feb/2021	22/Feb/2022



Instrument for Radiated Test

Instrument	Manufacturer /Brand	Model No.	Serial No.	Spec.	Calibration Date	Calibration Due Date
3m Semi Anechoic Chamber	SIDT FRANKONIA	SAC-3M	03CH02-HY	30MHz~1GHz 3m	02/Aug/2021	01/Aug/2022
3m Semi Anechoic Chamber	SIDT FRANKONIA	SAC-3M	03CH02-HY	1GHz~18GHz 3m	01/Aug/2021	31/Jul/2022
Signal Analyzer	R&S	FSP40	100593	9kHz~40GHz	12/Mar/2021	11/Mar/2022
Amplifier	Agilent	8447D	2944A11149	100kHz~1.3GHz	29/Jun/2021	28/Jun/2022
Microwave Preamplifier	Agilent	8449B	3008A02373	1GHz~26.5GHz	23/Oct/2020	22/Oct/2021
Bilog Antenna & 5dB Attenuator	SCHAFFNER / MTJ	CBL 6112B / MTJ6102-05	2723 / 2	30MHz~1GHz	06/Sep/2020	05/Sep/2021
Double Ridged Guide Horn Antenna	SCHWARZBEC	BBHA 9120 D	BBHA 9120 D 01543	1GHz~18GHz	04/Jun/2021	03/Jun/2022
RF Cable	MVE	400LL	MVE-1-0802	9kHz~30MHz	05/May/2021	04/May/2022
RF Cable	MVE	400LL	MVE-1-0802	30MHz~1GHz	05/May/2021	04/May/2022
RF Cable-R03m	HUBER+SUHNER	SUCOFLEX1 04	805193/4+805192/4	1GHz~40GHz	06/Apr/2021	05/Apr/2022
Broadband Horn Antenna	SCHWARZBECK	BBHA 9170	BBHA 9170221	15GHz~40GHz	11/Mar/2021	10/Mar/2022
Microwave Premplifier	EMC INSTRUMENTS	EM18G40G	060604	18GHz~40GHz	09/Mar/2021	08/Mar/2022
Loop Antenna	TESEQ	HLA 6120	31244	9kHz~30MHz	16/Mar/2021	15/Mar/2022
EMI Test Receiver	R&S	ESR3	102052	9kHz~3.6GHz	19/Apr/2021	18/Apr/2022



Summary

Mode	Result	Type	Freq (Hz)	Level (dBuV)	Limit (dBuV)	Margin (dB)	Condition
Mode 1	Pass	QP	154.868k	45.68	65.73	-20.05	Line



Result

Mode	Result	Type	Freq (Hz)	Level (dBuV)	Limit (dBuV)	Margin (dB)	Condition	Comments
Mode 1	Pass	QP	154.868k	45.68	65.73	-20.05	Line	-
Mode 1	Pass	AV	154.868k	30.79	55.73	-24.94	Line	-
Mode 1	Pass	QP	169.084k	43.19	65.01	-21.82	Line	-
Mode 1	Pass	AV	169.084k	29.38	55.01	-25.63	Line	-
Mode 1	Pass	QP	198.359k	37.38	63.69	-26.31	Line	-
Mode 1	Pass	AV	198.359k	24.15	53.69	-29.54	Line	-
Mode 1	Pass	QP	2.625M	21.45	56.00	-34.55	Line	-
Mode 1	Pass	AV	2.625M	16.44	46.00	-29.56	Line	-
Mode 1	Pass	QP	3.007M	22.31	56.00	-33.69	Line	-
Mode 1	Pass	AV	3.007M	18.12	46.00	-27.88	Line	-
Mode 1	Pass	QP	15.699M	23.00	60.00	-37.00	Line	-
Mode 1	Pass	AV	15.699M	17.69	50.00	-32.31	Line	-
Mode 1	Pass	QP	154.251k	45.37	65.77	-20.40	Neutral	-
Mode 1	Pass	AV	154.251k	29.27	55.77	-26.50	Neutral	-
Mode 1	Pass	QP	182.408k	40.41	64.37	-23.96	Neutral	-
Mode 1	Pass	AV	182.408k	25.82	54.37	-28.55	Neutral	-
Mode 1	Pass	QP	233.633k	31.79	62.31	-30.52	Neutral	-
Mode 1	Pass	AV	233.633k	21.83	52.31	-30.48	Neutral	-
Mode 1	Pass	QP	1.977M	24.24	56.00	-31.76	Neutral	-
Mode 1	Pass	AV	1.977M	19.28	46.00	-26.72	Neutral	-
Mode 1	Pass	QP	3.472M	23.63	56.00	-32.37	Neutral	-
Mode 1	Pass	AV	3.472M	19.27	46.00	-26.73	Neutral	-
Mode 1	Pass	QP	26.803M	22.20	60.00	-37.80	Neutral	-
Mode 1	Pass	AV	26.803M	19.40	50.00	-30.60	Neutral	-

Conducted Emissions at Powerline_Mode 1

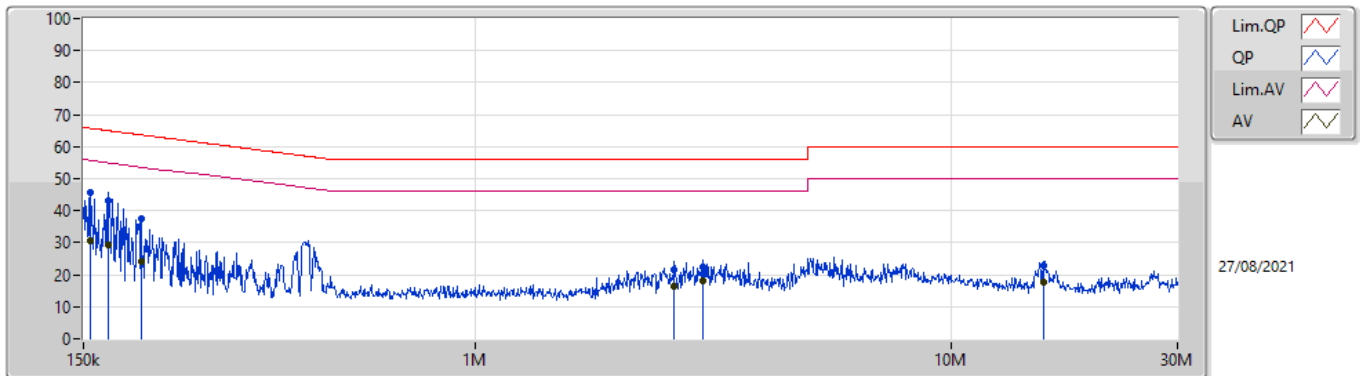

Type	Freq (Hz)	Level (dBuV)	Limit (dBuV)	Margin (dB)	Factor (dB)	Condition	Comment	Raw (dBuV)	LISN (dB)	CL (dB)	AT (dB)
QP	154.868k	45.68	65.73	-20.05	19.63	Line	-	26.05	9.69	0.04	9.90
AV	154.868k	30.79	55.73	-24.94	19.63	Line	-	11.16	9.69	0.04	9.90
QP	169.084k	43.19	65.01	-21.82	19.63	Line	-	23.56	9.69	0.04	9.90
AV	169.084k	29.38	55.01	-25.63	19.63	Line	-	9.75	9.69	0.04	9.90
QP	198.359k	37.38	63.69	-26.31	19.62	Line	-	17.76	9.68	0.04	9.90
AV	198.359k	24.15	53.69	-29.54	19.62	Line	-	4.53	9.68	0.04	9.90
QP	2.625M	21.45	56.00	-34.55	19.64	Line	-	1.81	9.68	0.12	9.84
AV	2.625M	16.44	46.00	-29.56	19.64	Line	-	-3.20	9.68	0.12	9.84
QP	3.007M	22.31	56.00	-33.69	19.67	Line	-	2.64	9.69	0.12	9.86
AV	3.007M	18.12	46.00	-27.88	19.67	Line	-	-1.55	9.69	0.12	9.86
QP	15.699M	23.00	60.00	-37.00	19.85	Line	-	3.15	9.69	0.26	9.90
AV	15.699M	17.69	50.00	-32.31	19.85	Line	-	-2.16	9.69	0.26	9.90

Conducted Emissions at Powerline_Mode 1

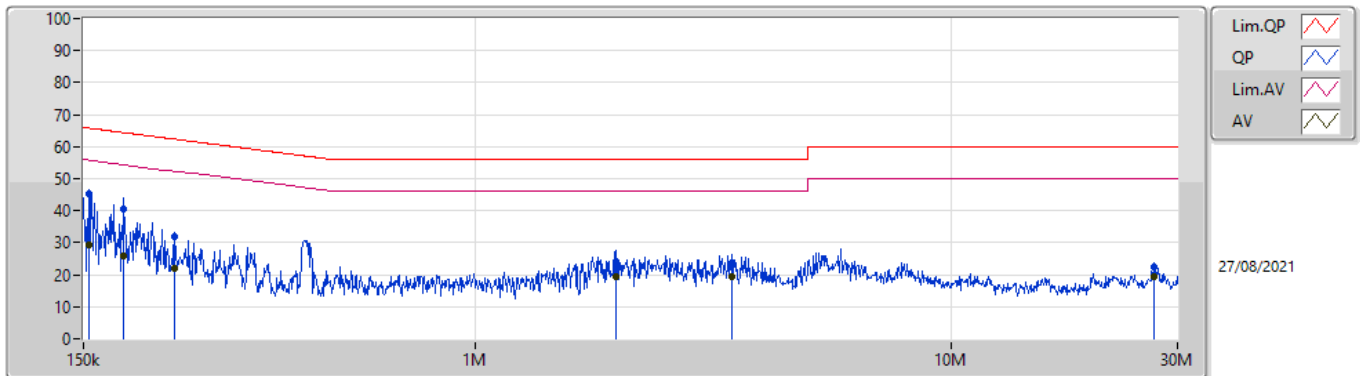

Type	Freq (Hz)	Level (dBuV)	Limit (dBuV)	Margin (dB)	Factor (dB)	Condition	Comment	Raw (dBuV)	LISN (dB)	CL (dB)	AT (dB)
QP	154.251k	45.37	65.77	-20.40	19.63	Neutral	-	25.74	9.69	0.04	9.90
AV	154.251k	29.27	55.77	-26.50	19.63	Neutral	-	9.64	9.69	0.04	9.90
QP	182.408k	40.41	64.37	-23.96	19.62	Neutral	-	20.79	9.68	0.04	9.90
AV	182.408k	25.82	54.37	-28.55	19.62	Neutral	-	6.20	9.68	0.04	9.90
QP	233.633k	31.79	62.31	-30.52	19.62	Neutral	-	12.17	9.68	0.04	9.90
AV	233.633k	21.83	52.31	-30.48	19.62	Neutral	-	2.21	9.68	0.04	9.90
QP	1.977M	24.24	56.00	-31.76	19.58	Neutral	-	4.66	9.68	0.10	9.80
AV	1.977M	19.28	46.00	-26.72	19.58	Neutral	-	-0.30	9.68	0.10	9.80
QP	3.472M	23.63	56.00	-32.37	19.70	Neutral	-	3.93	9.69	0.13	9.88
AV	3.472M	19.27	46.00	-26.73	19.70	Neutral	-	-0.43	9.69	0.13	9.88
QP	26.803M	22.20	60.00	-37.80	19.94	Neutral	-	2.26	9.71	0.33	9.90
AV	26.803M	19.40	50.00	-30.60	19.94	Neutral	-	-0.54	9.71	0.33	9.90



Summary

Mode	Max-N dB (Hz)	Max-OBW (Hz)	ITU-Code	Min-N dB (Hz)	Min-OBW (Hz)
2.4-2.4835GHz	-	-	-	-	-
BT-LE(1Mbps)	641.25k	1.042M	1M04F1D	636.25k	1.034M
BT-LE(2Mbps)	1.088M	2.096M	2M10F1D	1.083M	2.091M
BT-LE(125kbps)	635k	1.122M	1M12F1D	613.75k	1.121M
BT-LE(500kbps)	726.25k	1.088M	1M09F1D	721.25k	1.082M

Max-N dB = Maximum 6dB down bandwidth; Max-OBW = Maximum 99% occupied bandwidth;
Min-N dB = Minimum 6dB down bandwidth; Min-OBW = Minimum 99% occupied bandwidth

Result

Mode	Result	Limit (Hz)	Port 1-N dB (Hz)	Port 1-OBW (Hz)
BT-LE(1Mbps)	-	-	-	-
2402MHz	Pass	500k	641.25k	1.034M
2440MHz	Pass	500k	637.5k	1.042M
2480MHz	Pass	500k	636.25k	1.041M
BT-LE(2Mbps)	-	-	-	-
2402MHz	Pass	500k	1.088M	2.091M
2440MHz	Pass	500k	1.088M	2.091M
2480MHz	Pass	500k	1.083M	2.096M
BT-LE(125kbps)	-	-	-	-
2402MHz	Pass	500k	613.75k	1.122M
2440MHz	Pass	500k	613.75k	1.122M
2480MHz	Pass	500k	635k	1.121M
BT-LE(500kbps)	-	-	-	-
2402MHz	Pass	500k	726.25k	1.088M
2440MHz	Pass	500k	726.25k	1.084M
2480MHz	Pass	500k	721.25k	1.082M

Port X-N dB = Port X 6dB down bandwidth;
 Port X-OBW = Port X 99% occupied bandwidth

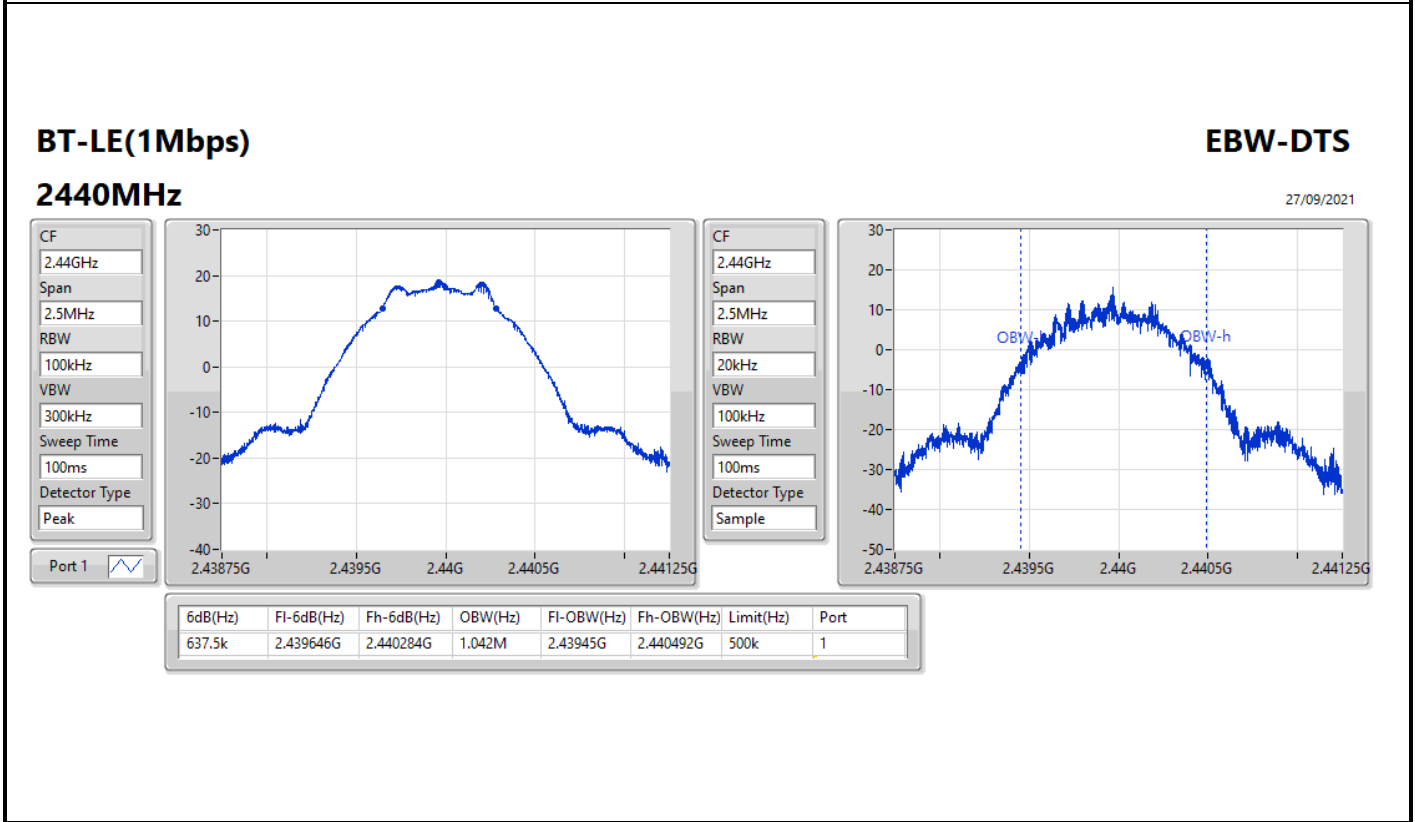
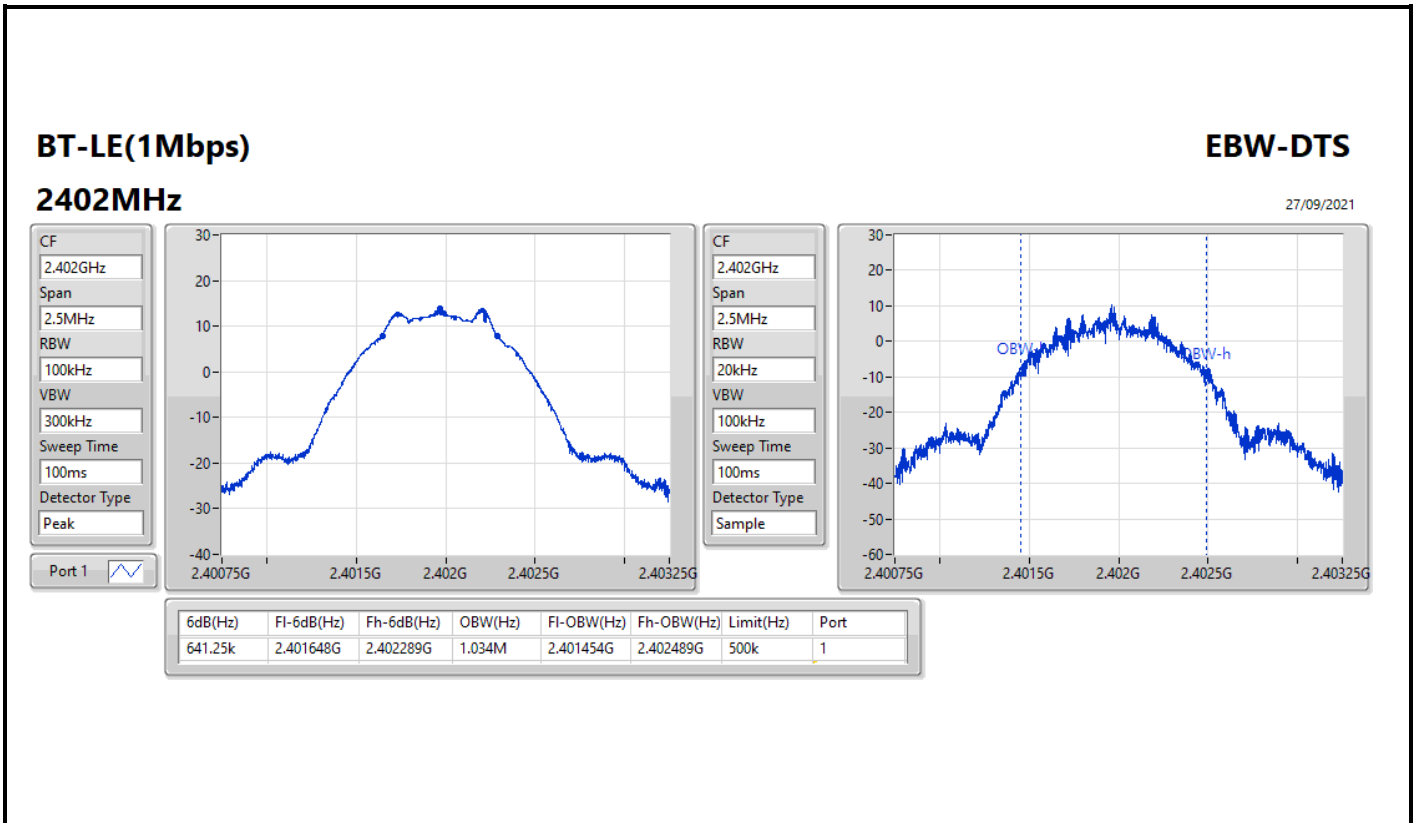

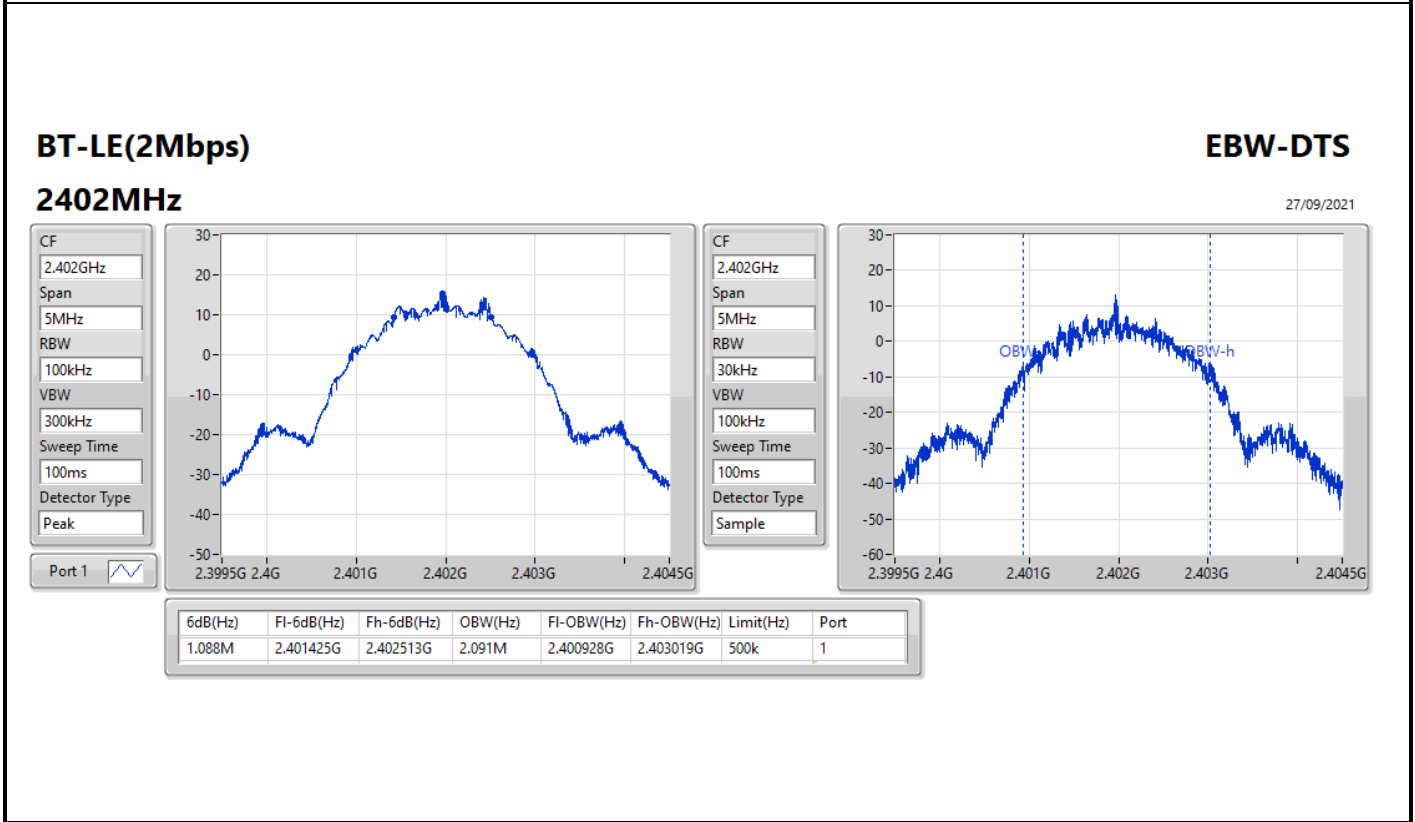
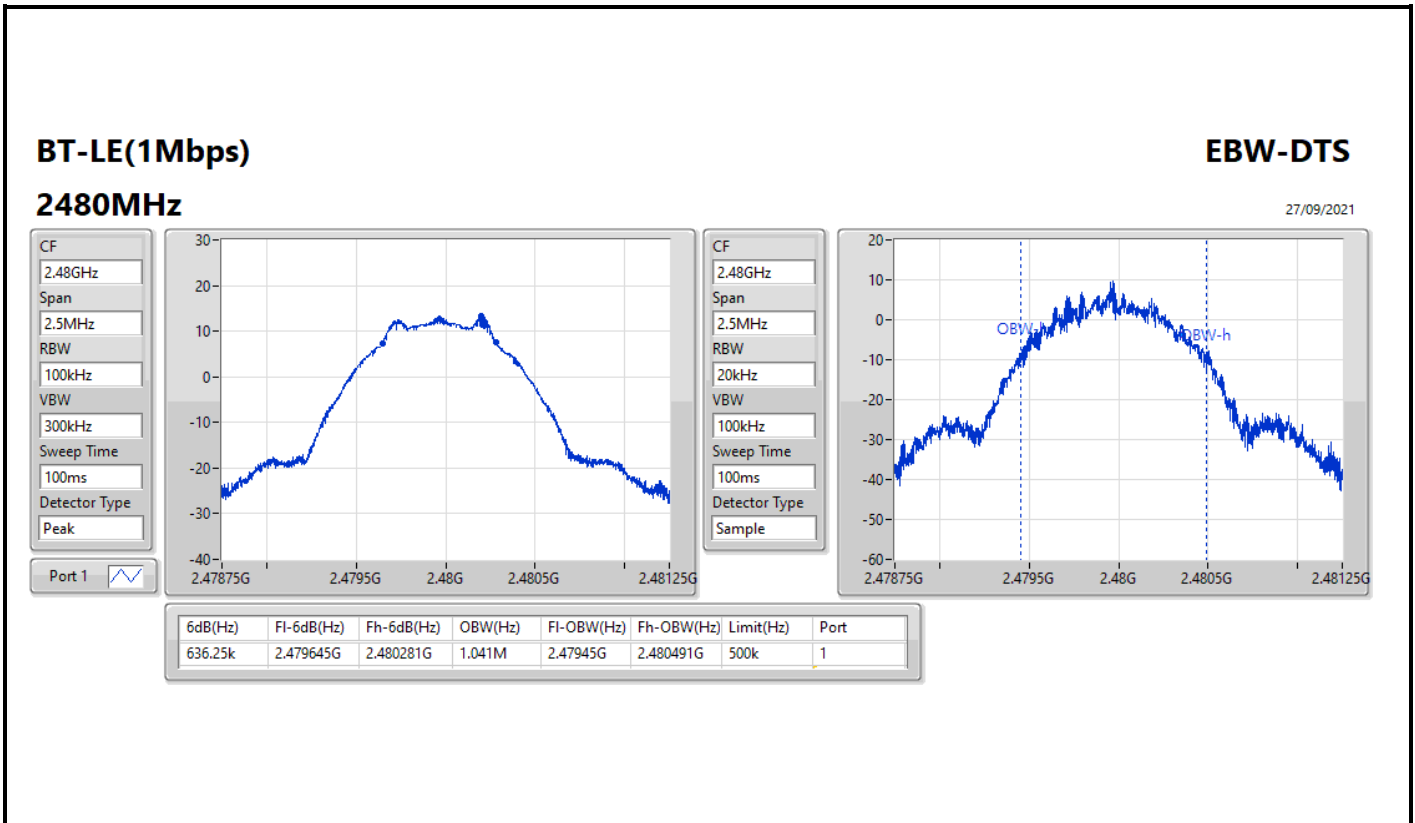

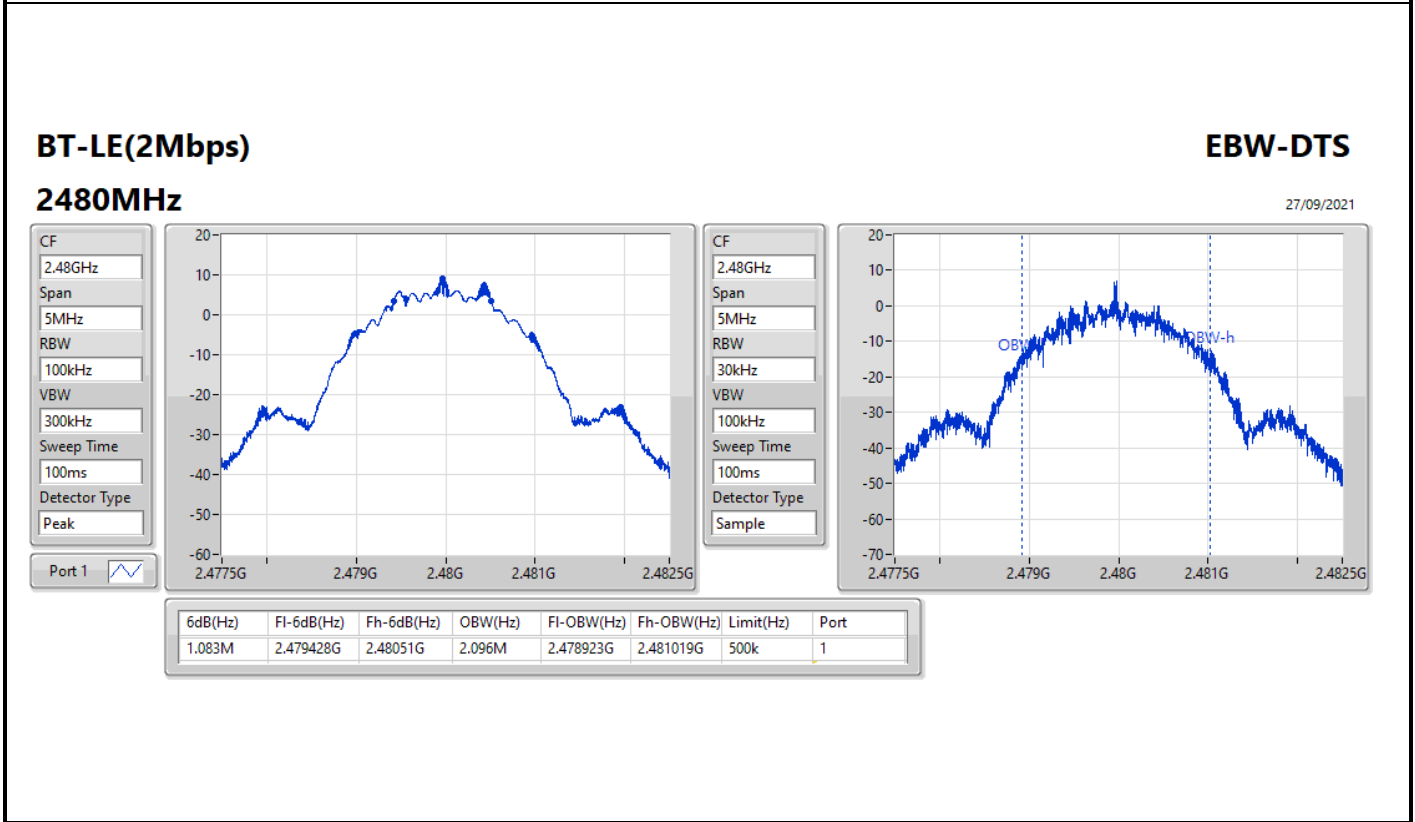
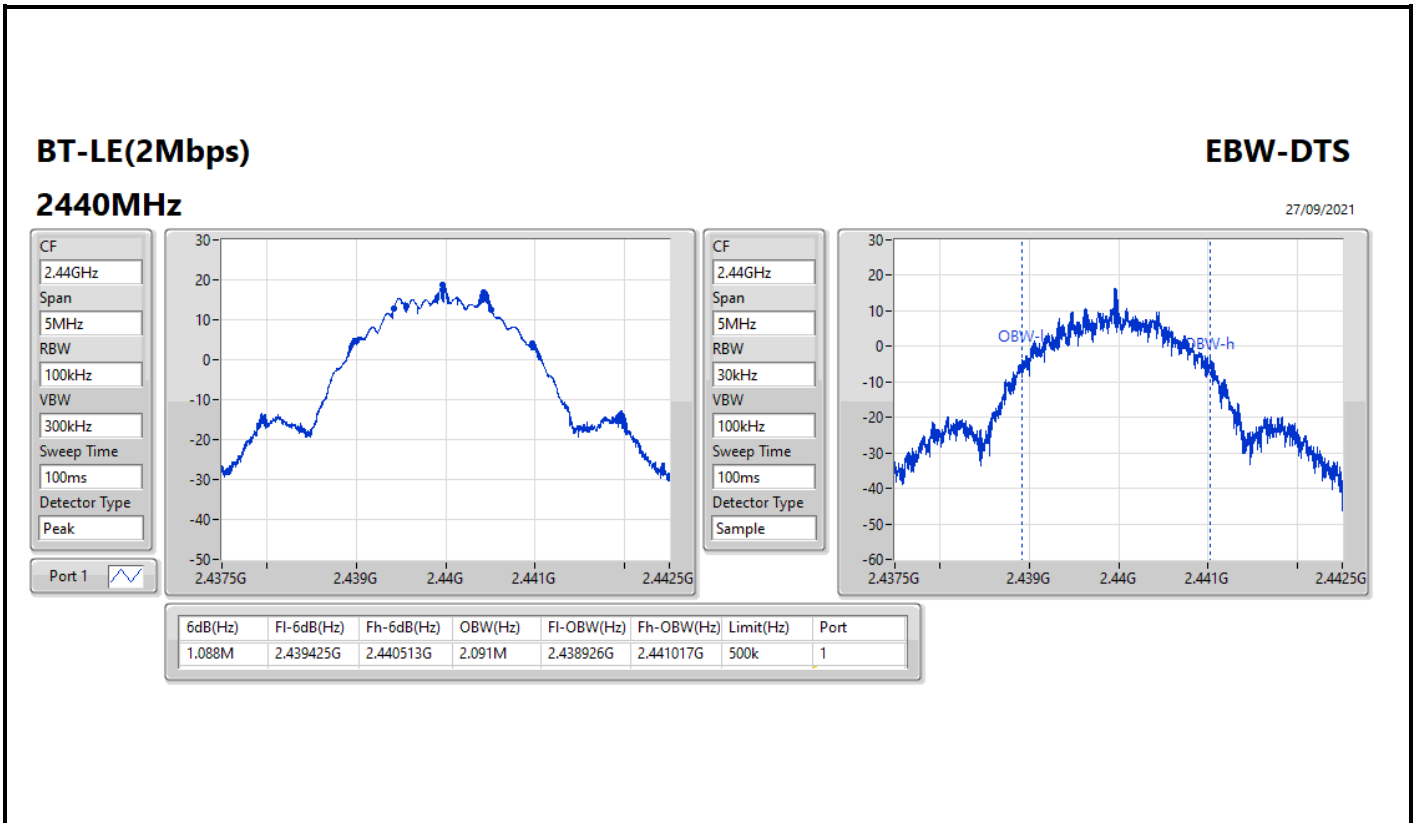

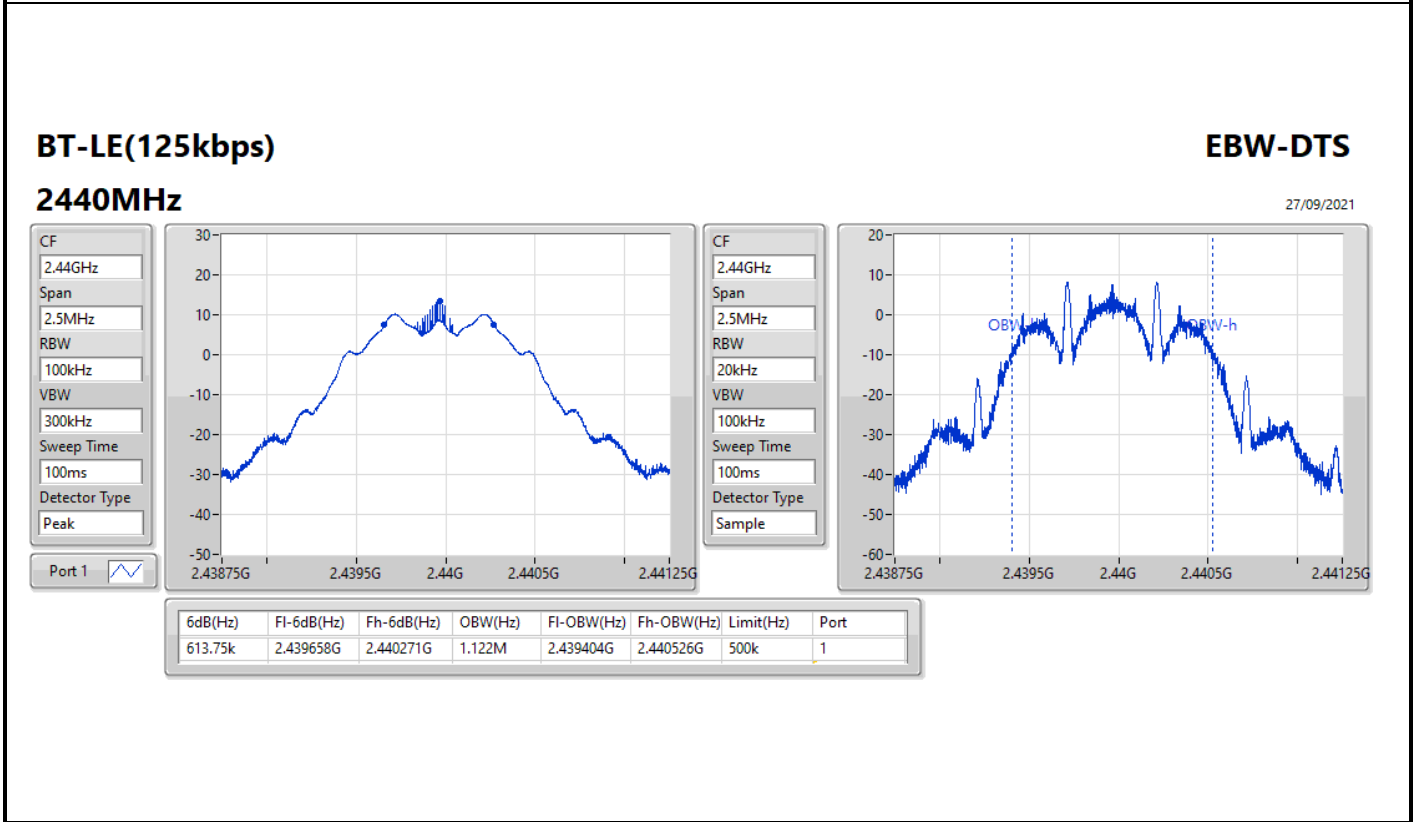
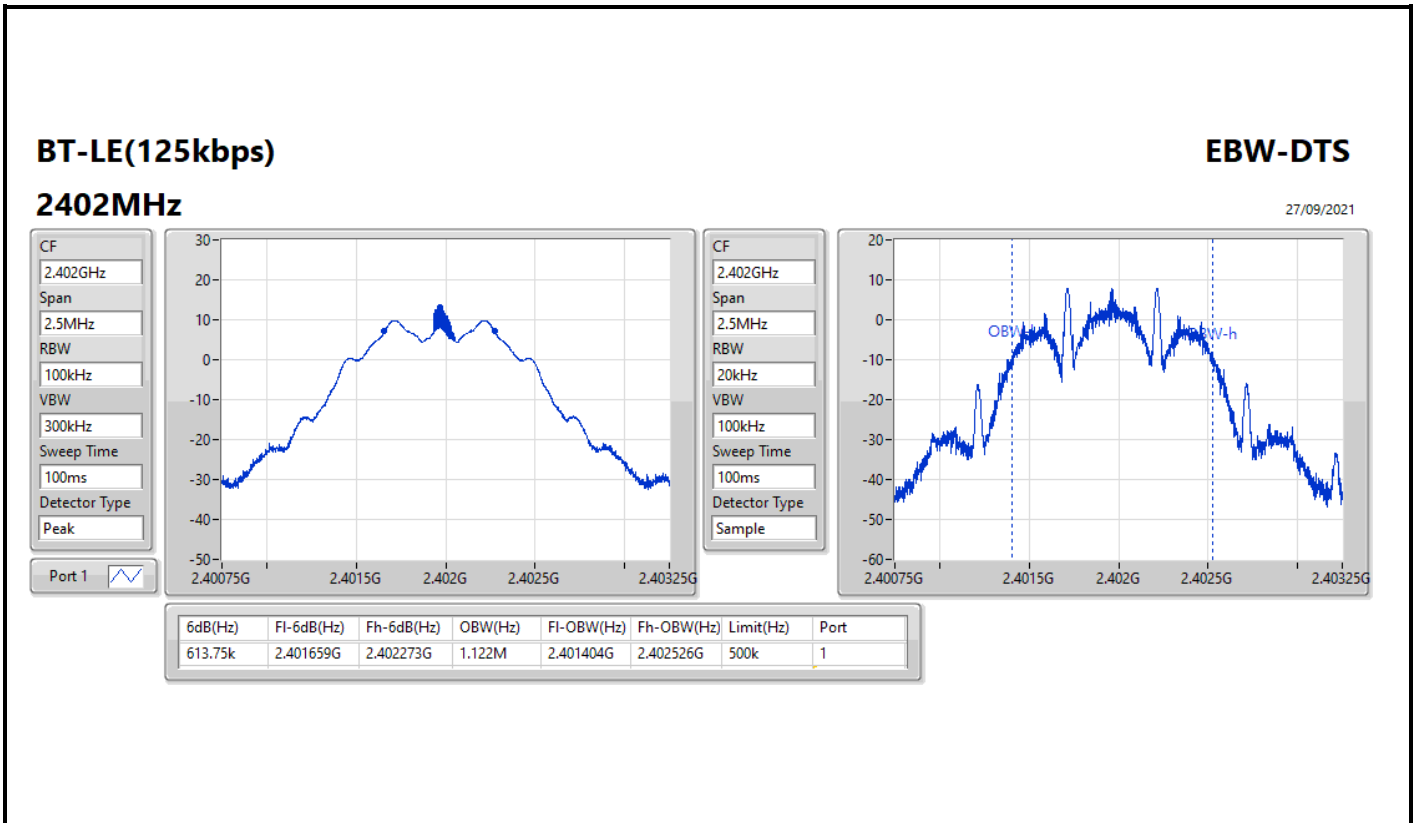

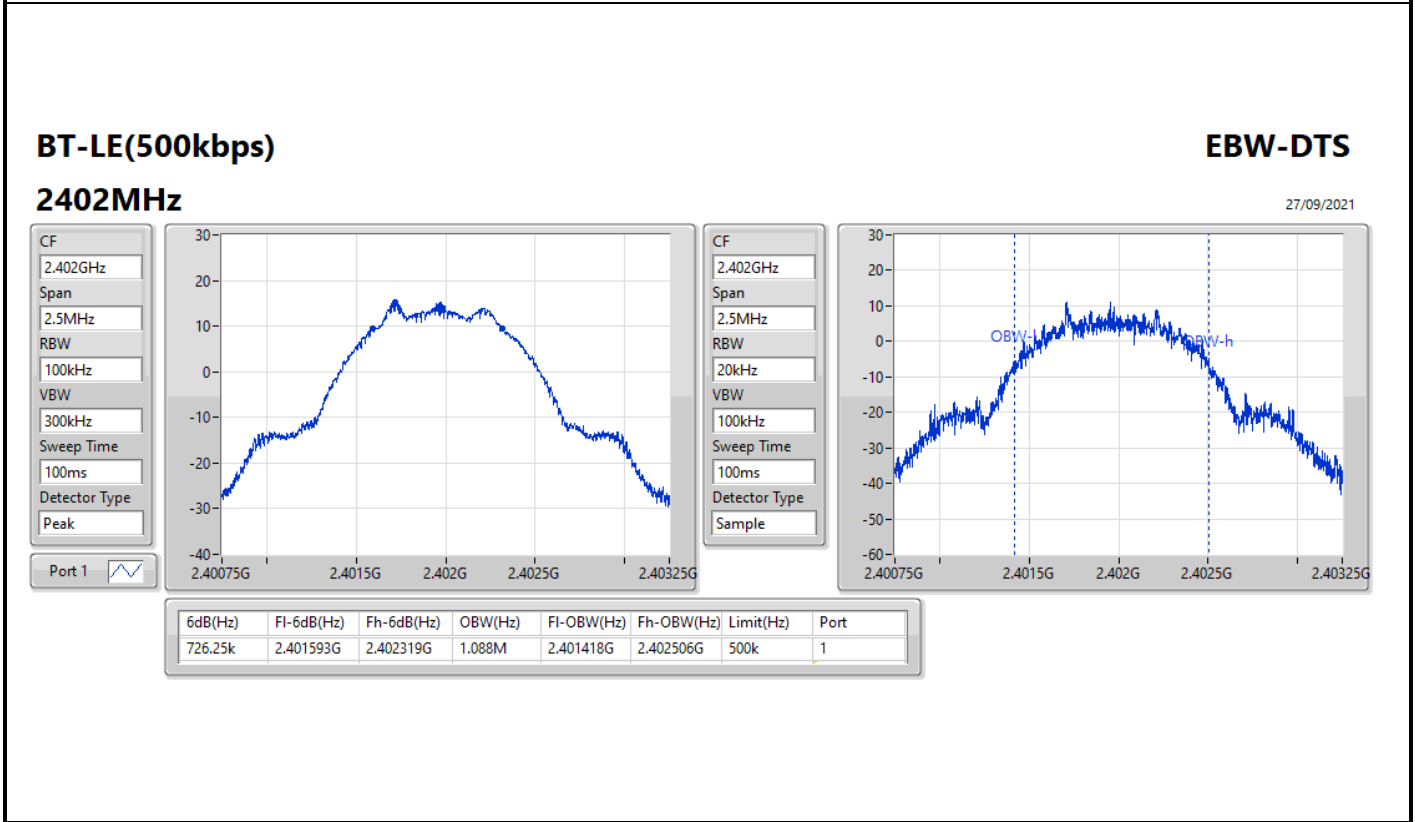
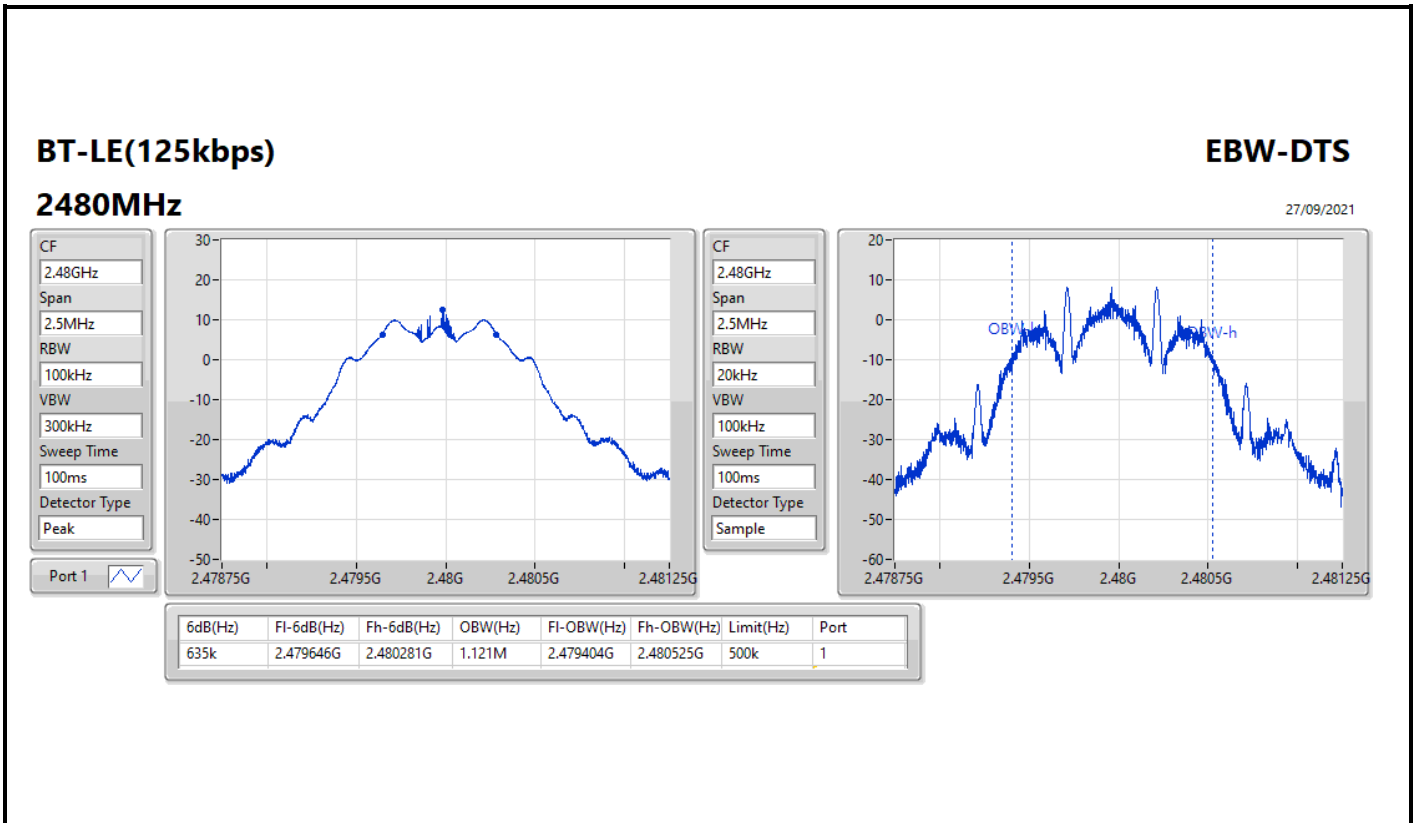

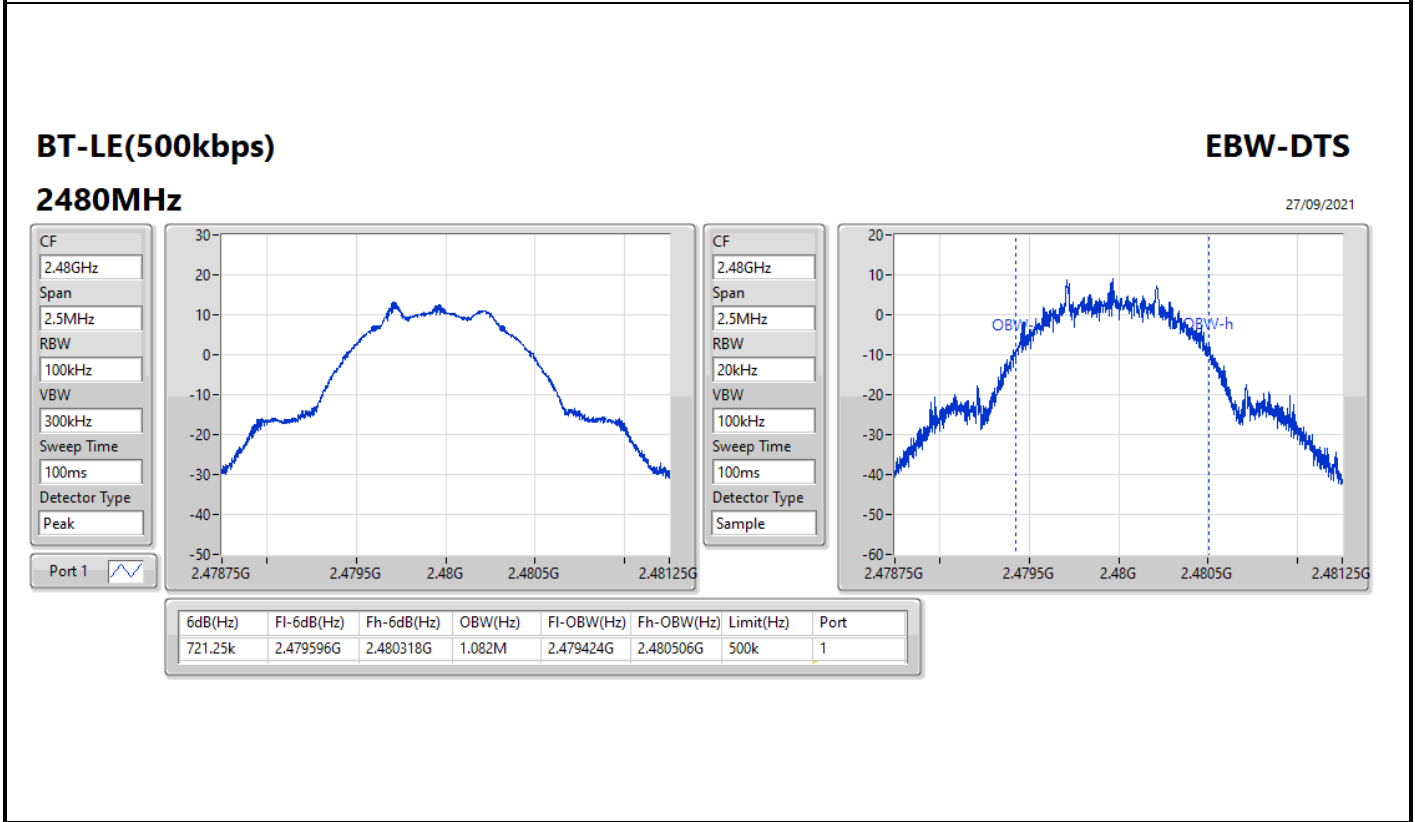
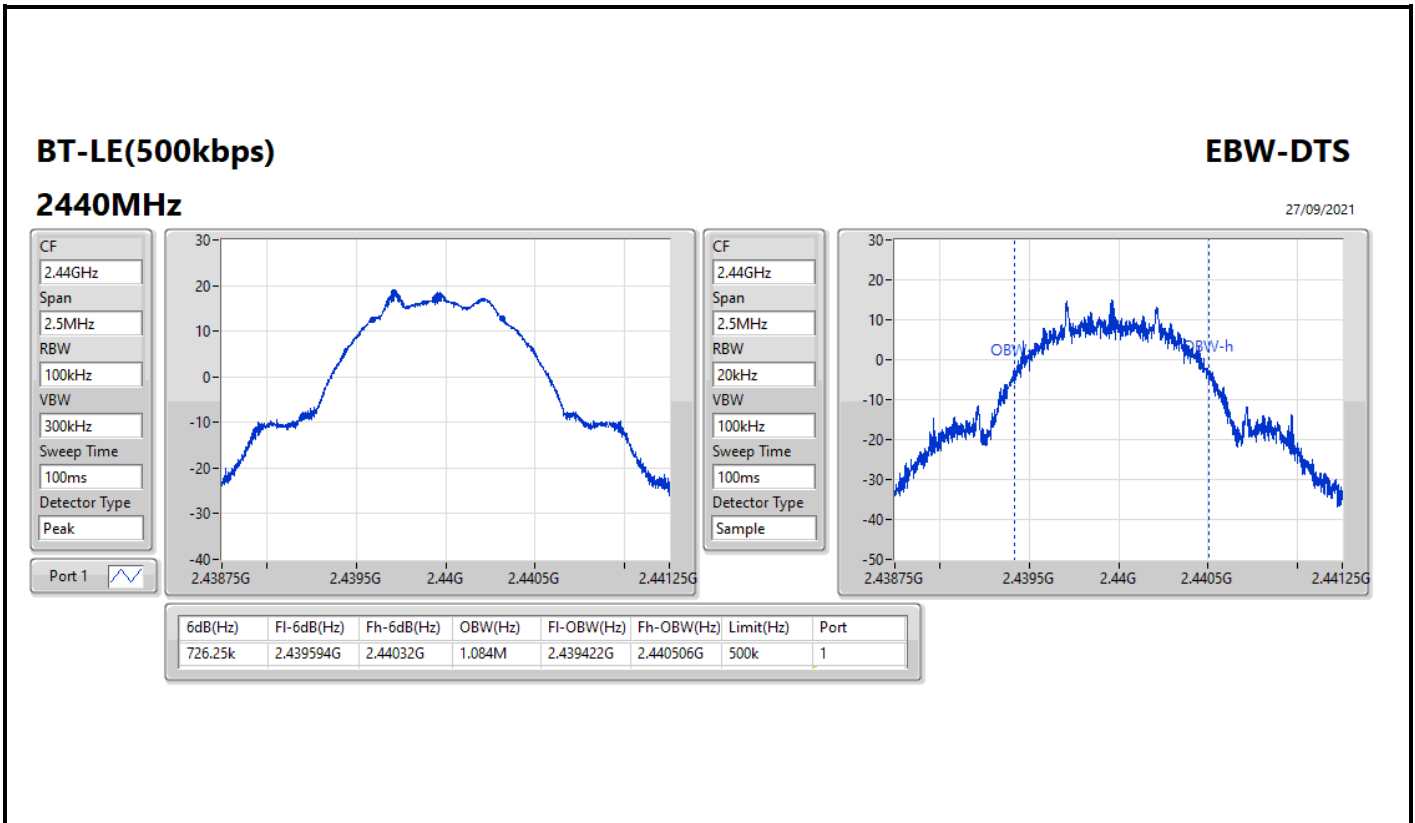



Summary

Mode	Power (dBm)	Power (W)
2.4-2.4835GHz	-	-
BT-LE(1Mbps)	18.78	0.07551
BT-LE(2Mbps)	18.77	0.07534
BT-LE(125kbps)	13.68	0.02333
BT-LE(500kbps)	18.75	0.07499



Result

Mode	Result	Gain (dBi)	Power (dBm)	Power Limit (dBm)
BT-LE(1Mbps)	-	-	-	-
2402MHz	Pass	5.00	15.57	30.00
2440MHz	Pass	5.00	18.78	30.00
2480MHz	Pass	5.00	13.48	30.00
BT-LE(2Mbps)	-	-	-	-
2402MHz	Pass	5.00	15.36	30.00
2440MHz	Pass	5.00	18.77	30.00
2480MHz	Pass	5.00	9.34	30.00
BT-LE(125kbps)	-	-	-	-
2402MHz	Pass	5.00	13.26	30.00
2440MHz	Pass	5.00	13.68	30.00
2480MHz	Pass	5.00	13.53	30.00
BT-LE(500kbps)	-	-	-	-
2402MHz	Pass	5.00	15.65	30.00
2440MHz	Pass	5.00	18.75	30.00
2480MHz	Pass	5.00	12.80	30.00

DG = Directional Gain; Port X = Port X output power



Summary

Mode	PD (dBm/RBW)
2.4-2.4835GHz	-
BT-LE(1Mbps)	2.66
BT-LE(2Mbps)	0.47
BT-LE(125kbps)	7.92
BT-LE(500kbps)	6.68

RBW = 3kHz;



Result

Mode	Result	Gain (dBi)	PD (dBm/RBW)	PD Limit (dBm/RBW)
BT-LE(1Mbps)	-	-	-	-
2402MHz	Pass	5.00	-0.43	8.00
2440MHz	Pass	5.00	2.66	8.00
2480MHz	Pass	5.00	-2.59	8.00
BT-LE(2Mbps)	-	-	-	-
2402MHz	Pass	5.00	-1.92	8.00
2440MHz	Pass	5.00	0.47	8.00
2480MHz	Pass	5.00	-8.28	8.00
BT-LE(125kbps)	-	-	-	-
2402MHz	Pass	5.00	7.60	8.00
2440MHz	Pass	5.00	7.92	8.00
2480MHz	Pass	5.00	7.66	8.00
BT-LE(500kbps)	-	-	-	-
2402MHz	Pass	5.00	2.68	8.00
2440MHz	Pass	5.00	3.48	8.00
2480MHz	Pass	5.00	6.68	8.00

DG = Directional Gain; RBW = 3kHz;
PD = trace bin-by-bin of each transmits port summing can be performed maximum power density; Port X = Port X Power Density;

BT-LE(1Mbps)

PSD

2402MHz

27/09/2021

CF
2.402GHz

Span
2.5MHz

RBW
3kHz

VBW
10kHz

Sweep Time
632.051us

Detector Type
Peak

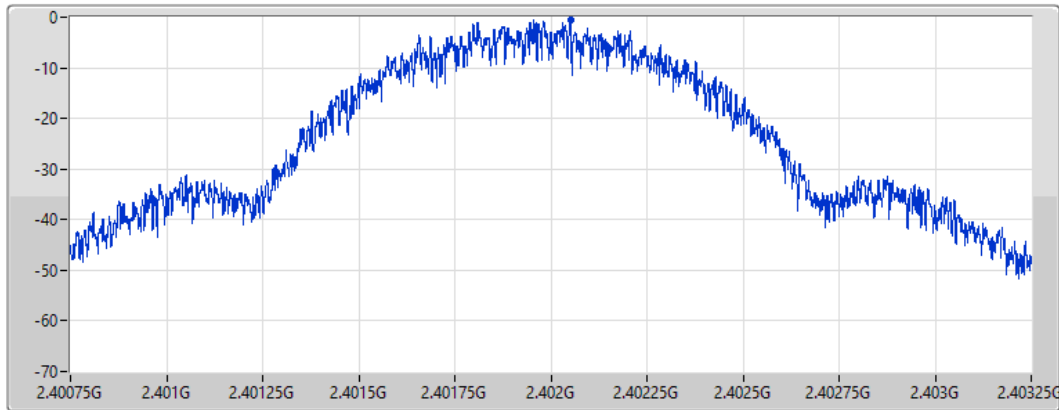

Port 1 

Sum	PD	Port 1
(dBm/RBW)	(dBm/RBW)	(dBm/RBW)
-0.43	-0.43	-0.43

BT-LE(1Mbps)

PSD

2440MHz

27/09/2021

CF
2.44GHz

Span
2.5MHz

RBW
3kHz

VBW
10kHz

Sweep Time
632.051us

Detector Type
Peak

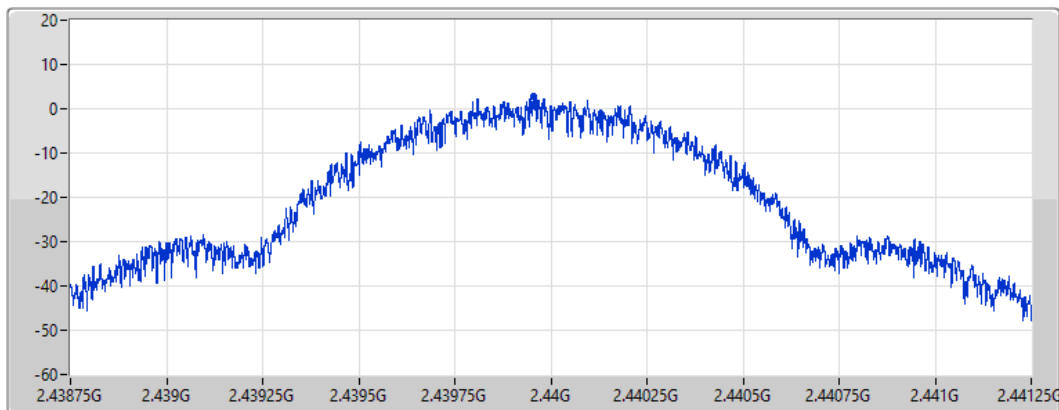

Port 1 

Sum	PD	Port 1
(dBm/RBW)	(dBm/RBW)	(dBm/RBW)
2.66	2.66	2.66

BT-LE(1Mbps)

PSD

2480MHz

27/09/2021

CF
2.48GHz

Span
2.5MHz

RBW
3kHz

VBW
10kHz

Sweep Time
632.051us

Detector Type
Peak

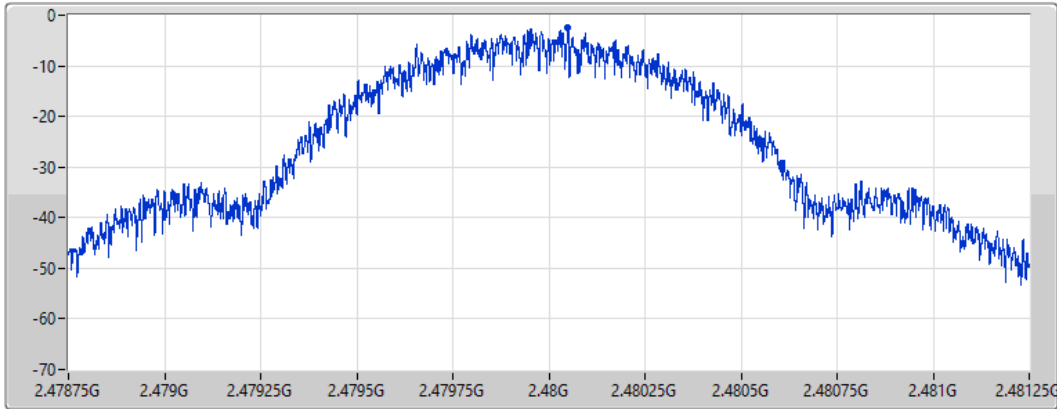

Sum	PD	Port 1
(dBm/RBW)	(dBm/RBW)	(dBm/RBW)
-2.59	-2.59	-2.59

BT-LE(2Mbps)

PSD

2402MHz

27/09/2021

CF
2.402GHz

Span
5MHz

RBW
3kHz

VBW
10kHz

Sweep Time
1.264102ms

Detector Type
Peak

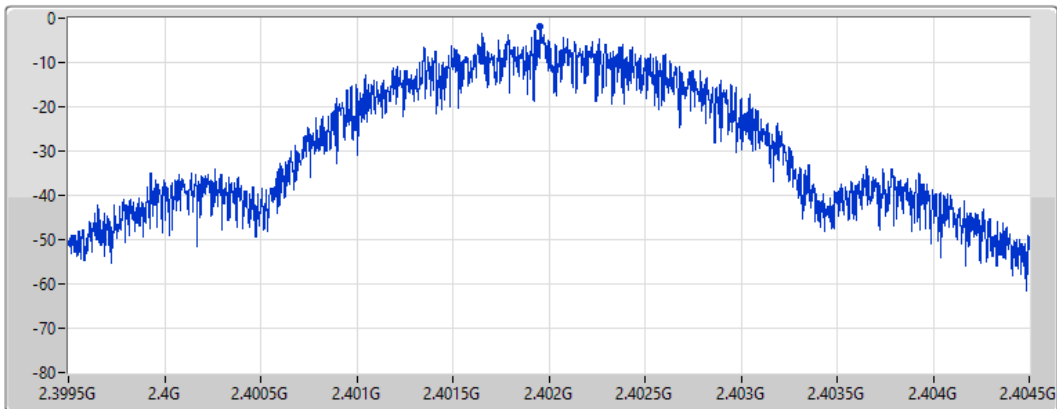

Sum	PD	Port 1
(dBm/RBW)	(dBm/RBW)	(dBm/RBW)
-1.92	-1.92	-1.92

BT-LE(2Mbps)

PSD

2440MHz

27/09/2021

CF
2.44GHz

Span
5MHz

RBW
3kHz

VBW
10kHz

Sweep Time
1.264102ms

Detector Type
Peak

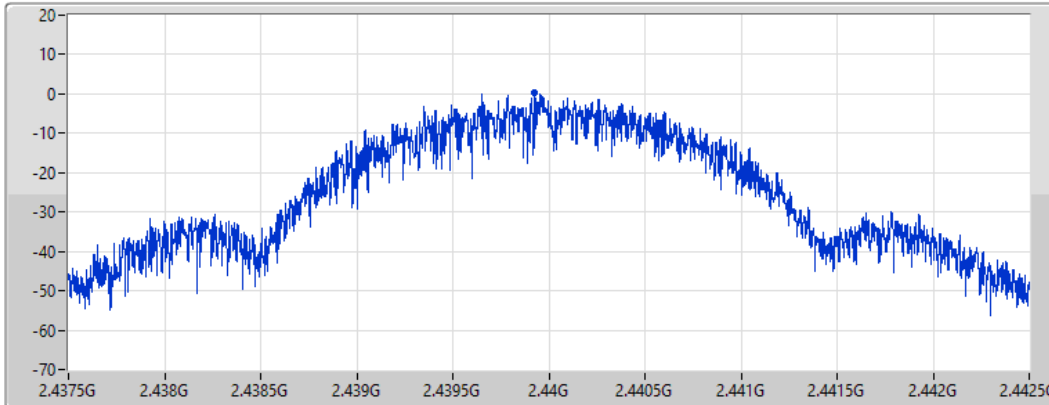

Port 1 

Sum	PD	Port 1
(dBm/RBW)	(dBm/RBW)	(dBm/RBW)
0.47	0.47	0.47

BT-LE(2Mbps)

PSD

2480MHz

27/09/2021

CF
2.48GHz

Span
5MHz

RBW
3kHz

VBW
10kHz

Sweep Time
1.264102ms

Detector Type
Peak

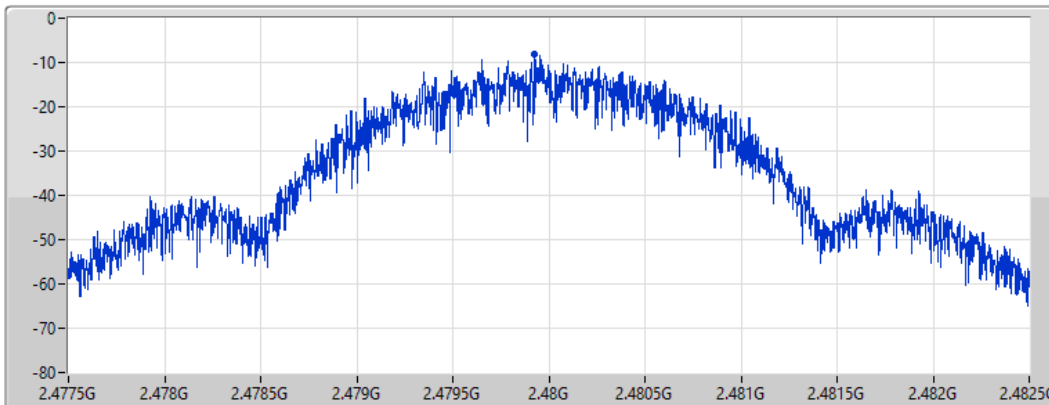

Port 1 

Sum	PD	Port 1
(dBm/RBW)	(dBm/RBW)	(dBm/RBW)
-8.28	-8.28	-8.28

BT-LE(125kbps)

PSD

2402MHz

27/09/2021

CF
2.402GHz

Span
2.5MHz

RBW
3kHz

VBW
10kHz

Sweep Time
632.051us

Detector Type
Peak

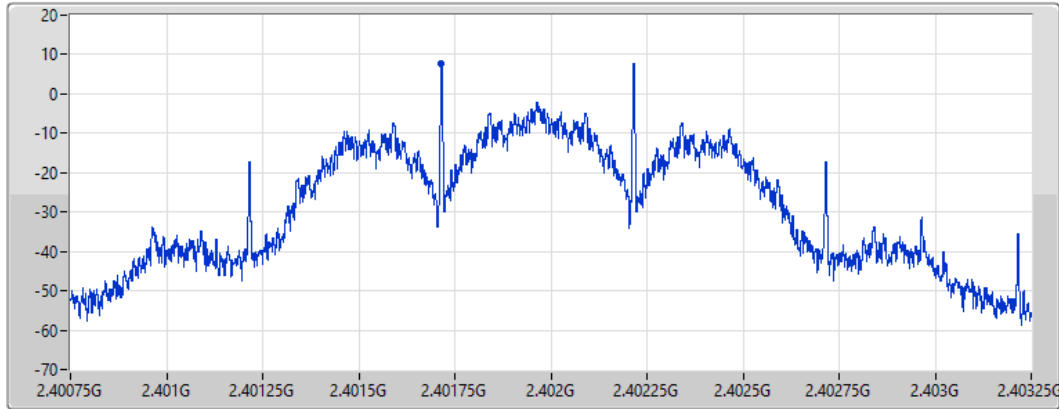

Port 1 

Sum	PD	Port 1
(dBm/RBW)	(dBm/RBW)	(dBm/RBW)
7.60	7.60	7.60

BT-LE(125kbps)

PSD

2440MHz

27/09/2021

CF
2.44GHz

Span
2.5MHz

RBW
3kHz

VBW
10kHz

Sweep Time
632.051us

Detector Type
Peak

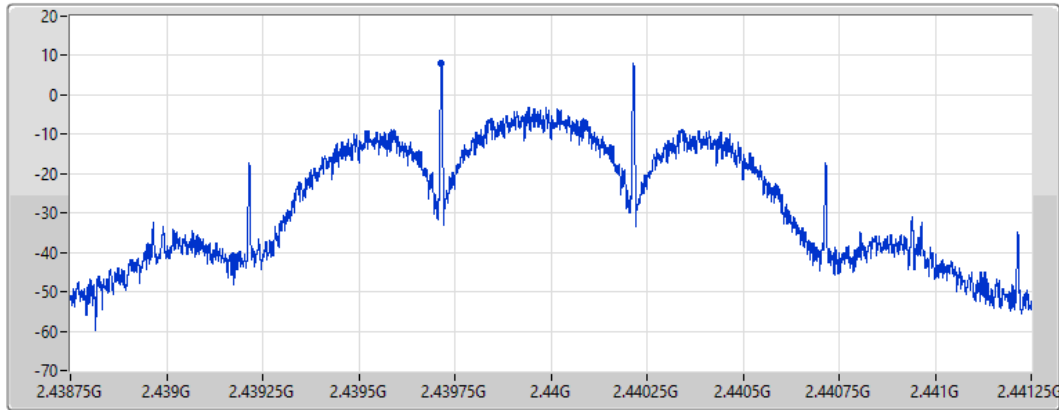

Port 1 

Sum	PD	Port 1
(dBm/RBW)	(dBm/RBW)	(dBm/RBW)
7.92	7.92	7.92

BT-LE(125kbps)

PSD

2480MHz

27/09/2021

CF
2.48GHz

Span
2.5MHz

RBW
3kHz

VBW
10kHz

Sweep Time
632.051us

Detector Type
Peak

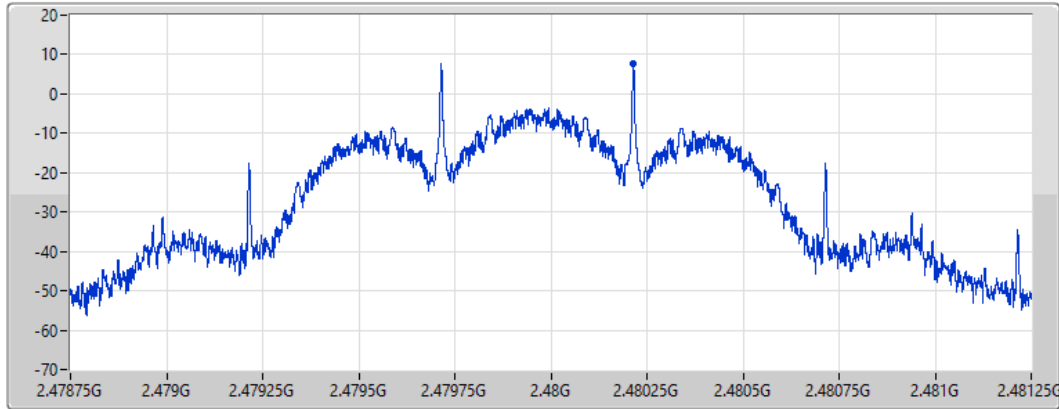

Port 1 

Sum	PD	Port 1
(dBm/RBW)	(dBm/RBW)	(dBm/RBW)
7.66	7.66	7.66

BT-LE(500kbps)

PSD

2402MHz

27/09/2021

CF
2.402GHz

Span
2.5MHz

RBW
3kHz

VBW
10kHz

Sweep Time
632.051us

Detector Type
Peak

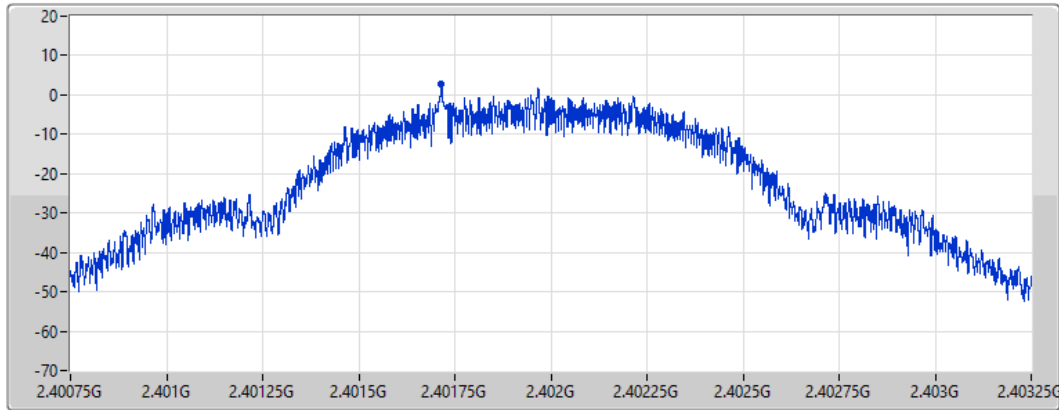

Port 1 

Sum	PD	Port 1
(dBm/RBW)	(dBm/RBW)	(dBm/RBW)
2.68	2.68	2.68

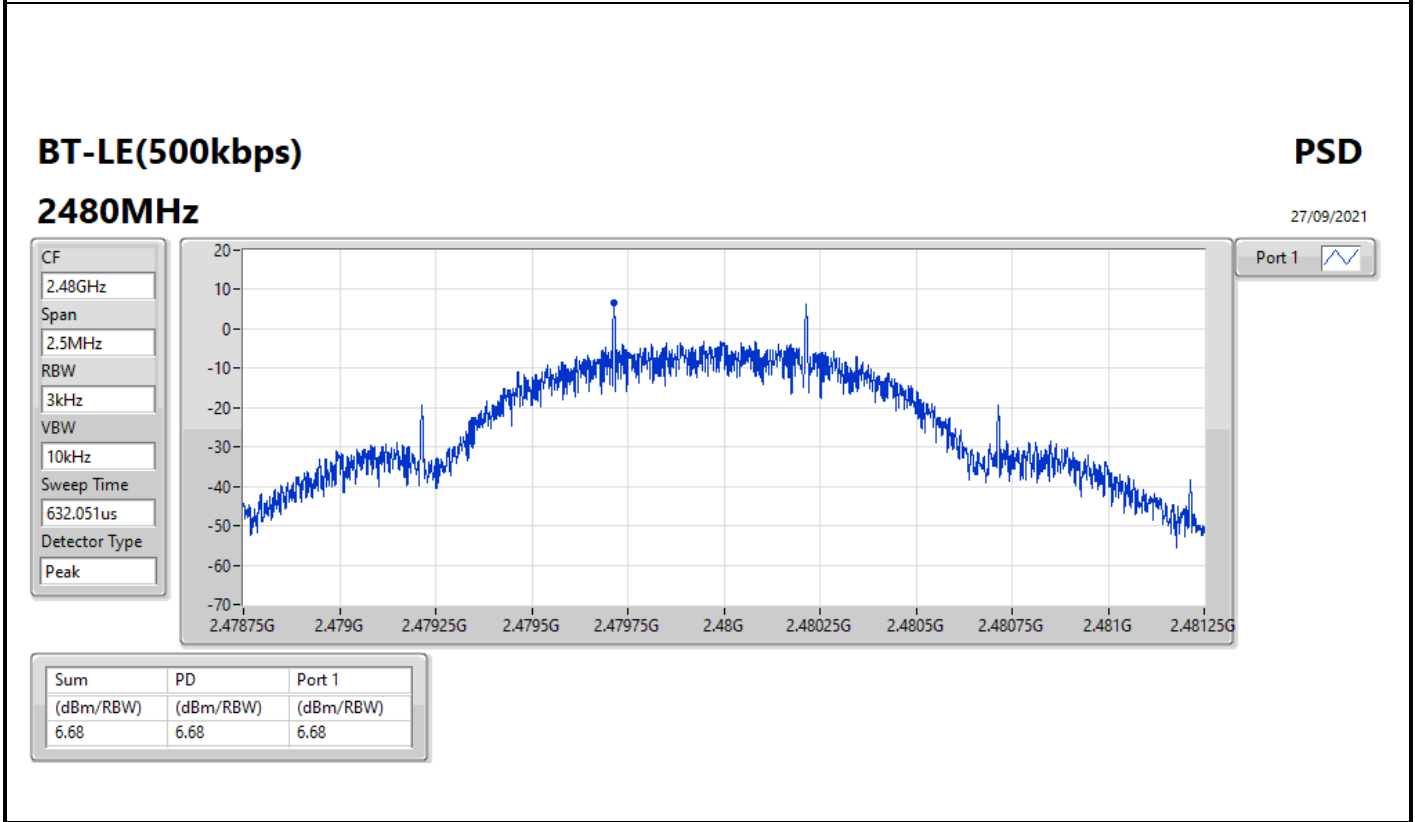
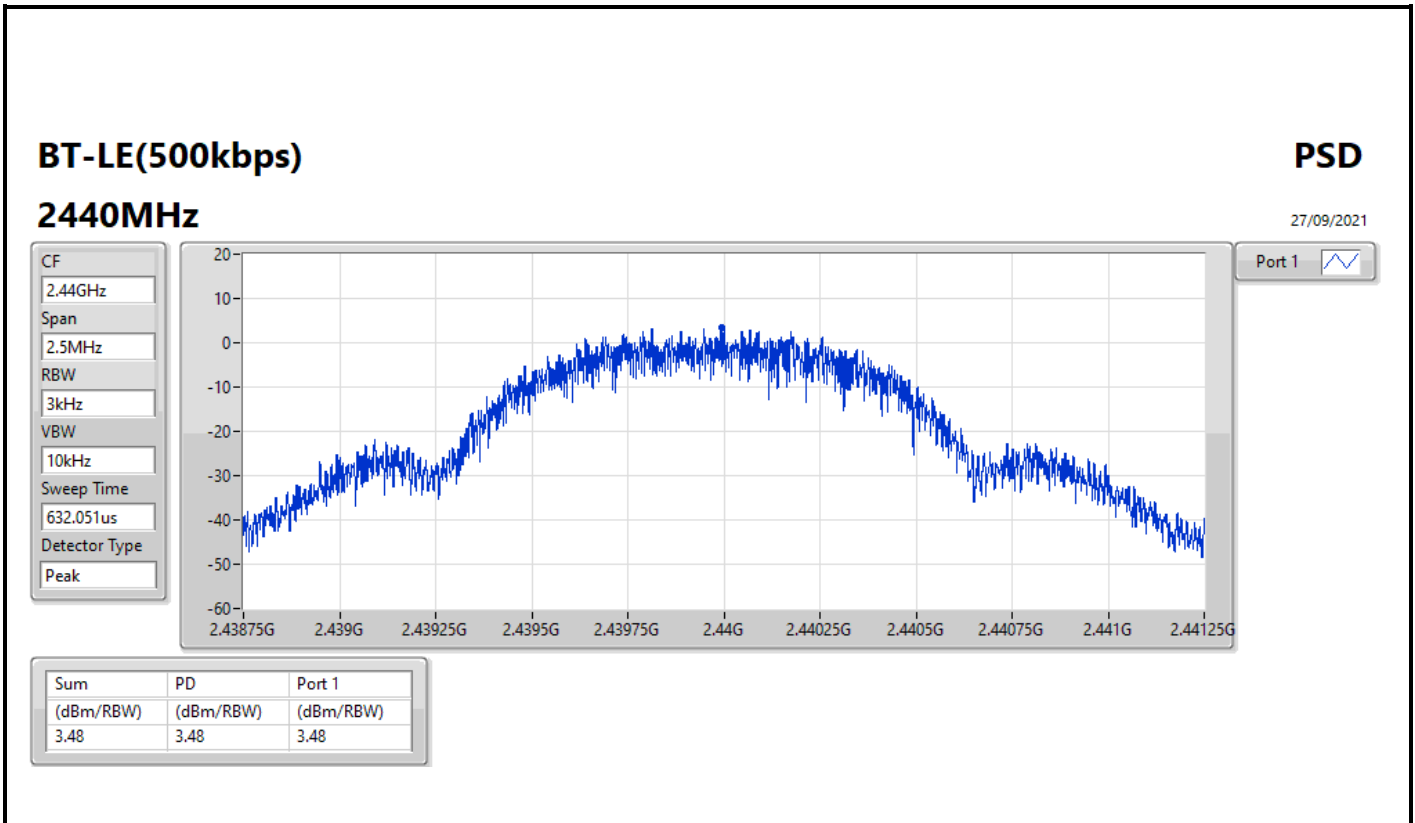



Summary

Mode	Result	Ref (Hz)	Ref (dBm)	Limit (dBm)	Freq (Hz)	Level (dBm)	Freq (Hz)	Level (dBm)	Freq (Hz)	Level (dBm)	Freq (Hz)	Level (dBm)	Freq (Hz)	Level (dBm)	Port
2.4-2.4835GHz	-	-	-	-	-	-	-	-	-	-	-	-	-	-	-
BT-LE(1Mbps)	Pass	2.44021G	18.52	-11.48	2.09271G	-58.90	2.39991G	-38.10	2.4G	-39.13	2.49444G	-57.41	23.49273G	-47.43	1
BT-LE(2Mbps)	Pass	2.43995G	18.49	-11.51	2.03602G	-59.13	2.39997G	-17.24	2.4G	-19.94	2.50122G	-56.90	17.17403G	-47.76	1
BT-LE(125kbps)	Pass	2.4397G	10.05	-19.95	2.18759G	-59.27	2.39995G	-39.83	2.4G	-39.52	2.48893G	-57.51	24.17888G	-47.82	1
BT-LE(500kbps)	Pass	2.44G	17.78	-12.22	2.30715G	-58.85	2.39984G	-37.62	2.4G	-38.35	2.49643G	-57.03	24.19856G	-47.10	1



Result

Mode	Result	Ref (Hz)	Ref (dBm)	Limit (dBm)	Freq (Hz)	Level (dBm)	Freq (Hz)	Level (dBm)	Freq (Hz)	Level (dBm)	Freq (Hz)	Level (dBm)	Freq (Hz)	Level (dBm)	Port
BT-LE(1Mbps)	-	-	-	-	-	-	-	-	-	-	-	-	-	-	-
2402MHz	Pass	2.44021G	18.52	-11.48	2.09271G	-58.90	2.39991G	-38.10	2.4G	-39.13	2.49444G	-57.41	23.49273G	-47.43	1
2440MHz	Pass	2.44021G	18.52	-11.48	2.19523G	-58.58	2.39611G	-57.62	2.4G	-57.89	2.49442G	-56.80	16.48789G	-48.08	1
2480MHz	Pass	2.44021G	18.52	-11.48	1.71025G	-59.04	2.39159G	-57.25	2.4835G	-47.72	2.4836G	-44.38	23.14123G	-47.67	1
BT-LE(2Mbps)	-	-	-	-	-	-	-	-	-	-	-	-	-	-	-
2402MHz	Pass	2.43995G	18.49	-11.51	2.03602G	-59.13	2.39997G	-17.24	2.4G	-19.94	2.50122G	-56.90	17.17403G	-47.76	1
2440MHz	Pass	2.43995G	18.49	-11.51	1.87064G	-59.16	2.39104G	-57.15	2.4G	-58.70	2.50276G	-56.12	16.70442G	-47.88	1
2480MHz	Pass	2.43995G	18.49	-11.51	2.17438G	-59.30	2.39657G	-55.29	2.4835G	-46.08	2.48361G	-45.56	21.85893G	-47.97	1
BT-LE(125kbps)	-	-	-	-	-	-	-	-	-	-	-	-	-	-	-
2402MHz	Pass	2.4397G	10.05	-19.95	2.18759G	-59.27	2.39995G	-39.83	2.4G	-39.52	2.48893G	-57.51	24.17888G	-47.82	1
2440MHz	Pass	2.4397G	10.05	-19.95	2.11915G	-59.08	2.39278G	-56.83	2.4G	-59.96	2.48376G	-56.96	24.54445G	-47.82	1
2480MHz	Pass	2.4397G	10.05	-19.95	2.11886G	-58.35	2.39094G	-57.62	2.4835G	-44.59	2.48362G	-44.04	16.87033G	-47.86	1
BT-LE(500kbps)	-	-	-	-	-	-	-	-	-	-	-	-	-	-	-
2402MHz	Pass	2.44G	17.78	-12.22	2.30715G	-58.85	2.39984G	-37.62	2.4G	-38.35	2.49643G	-57.03	24.19856G	-47.10	1
2440MHz	Pass	2.44G	17.78	-12.22	1.64856G	-58.68	2.3958G	-57.33	2.4835G	-60.62	2.49079G	-56.61	24.55569G	-48.07	1
2480MHz	Pass	2.44G	17.78	-12.22	1.76401G	-58.50	2.39182G	-58.30	2.4835G	-45.32	2.48395G	-45.63	24.49102G	-47.62	1

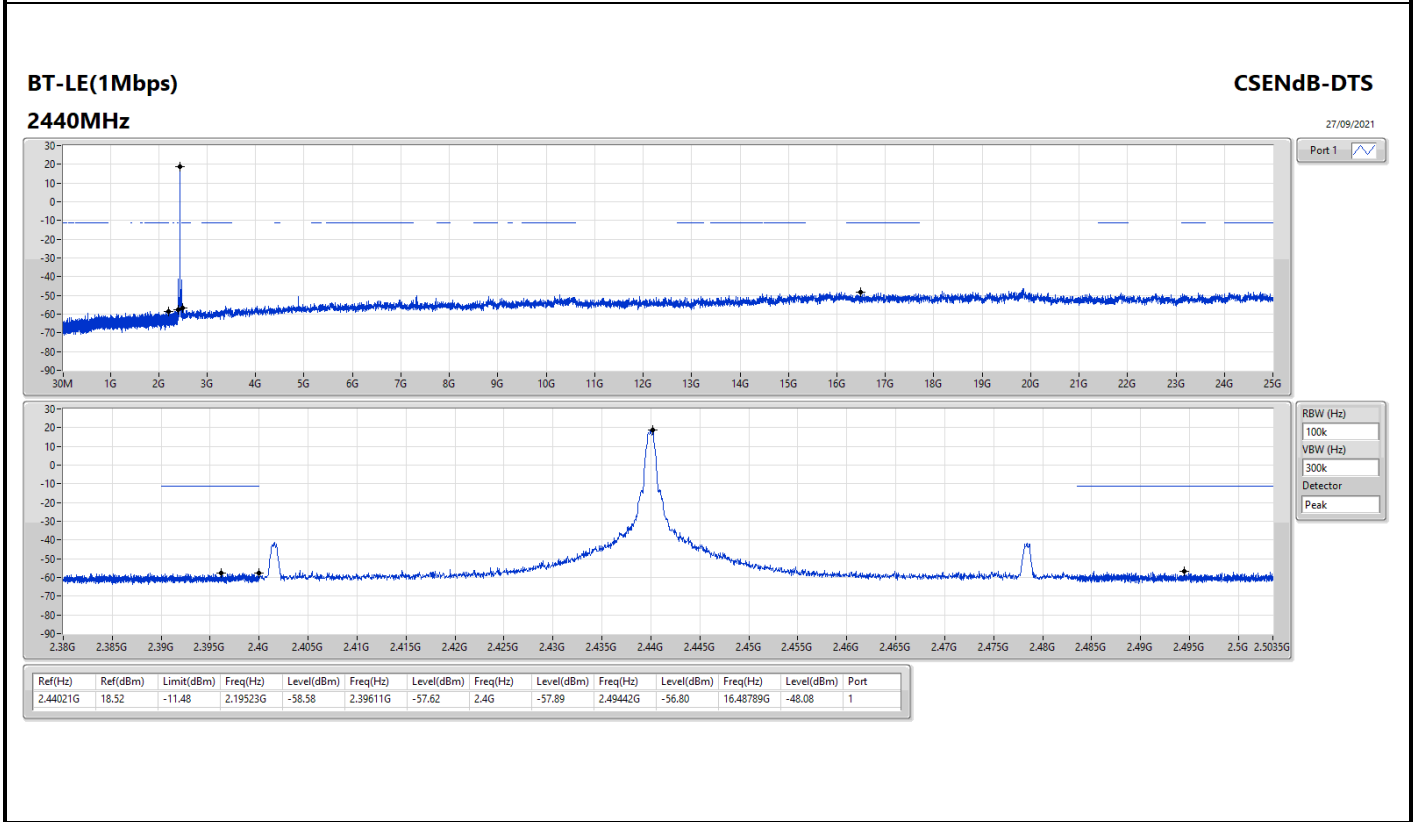
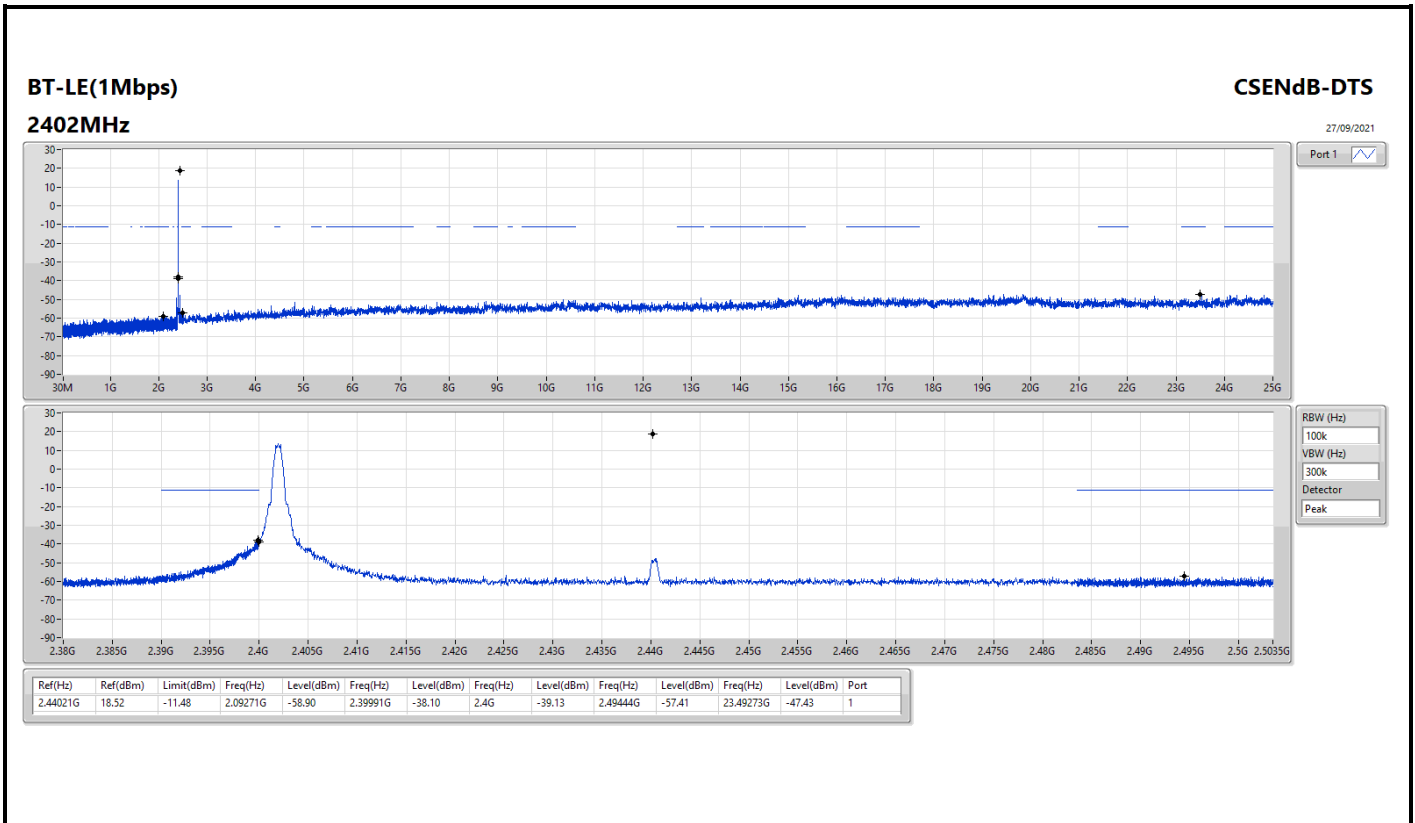

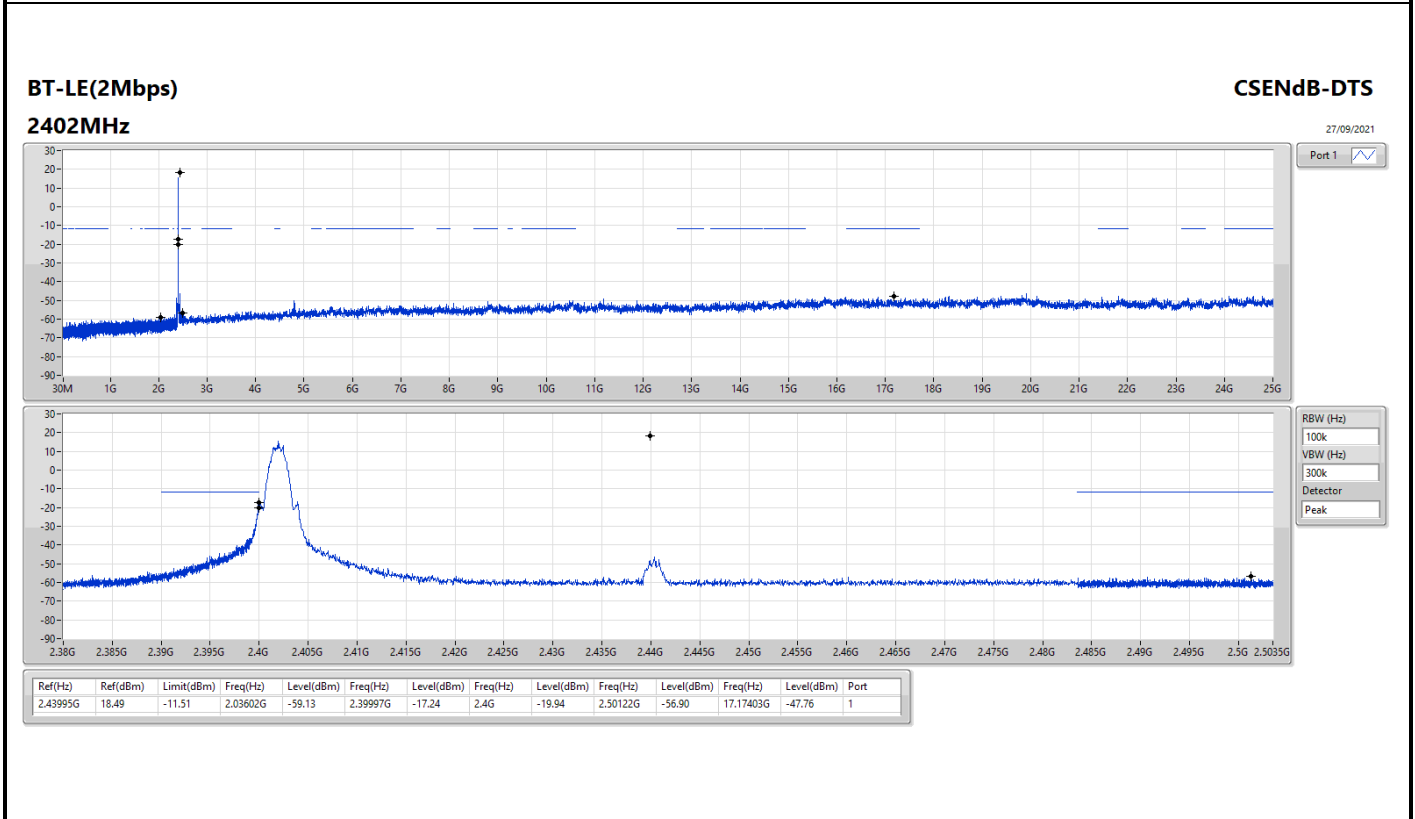
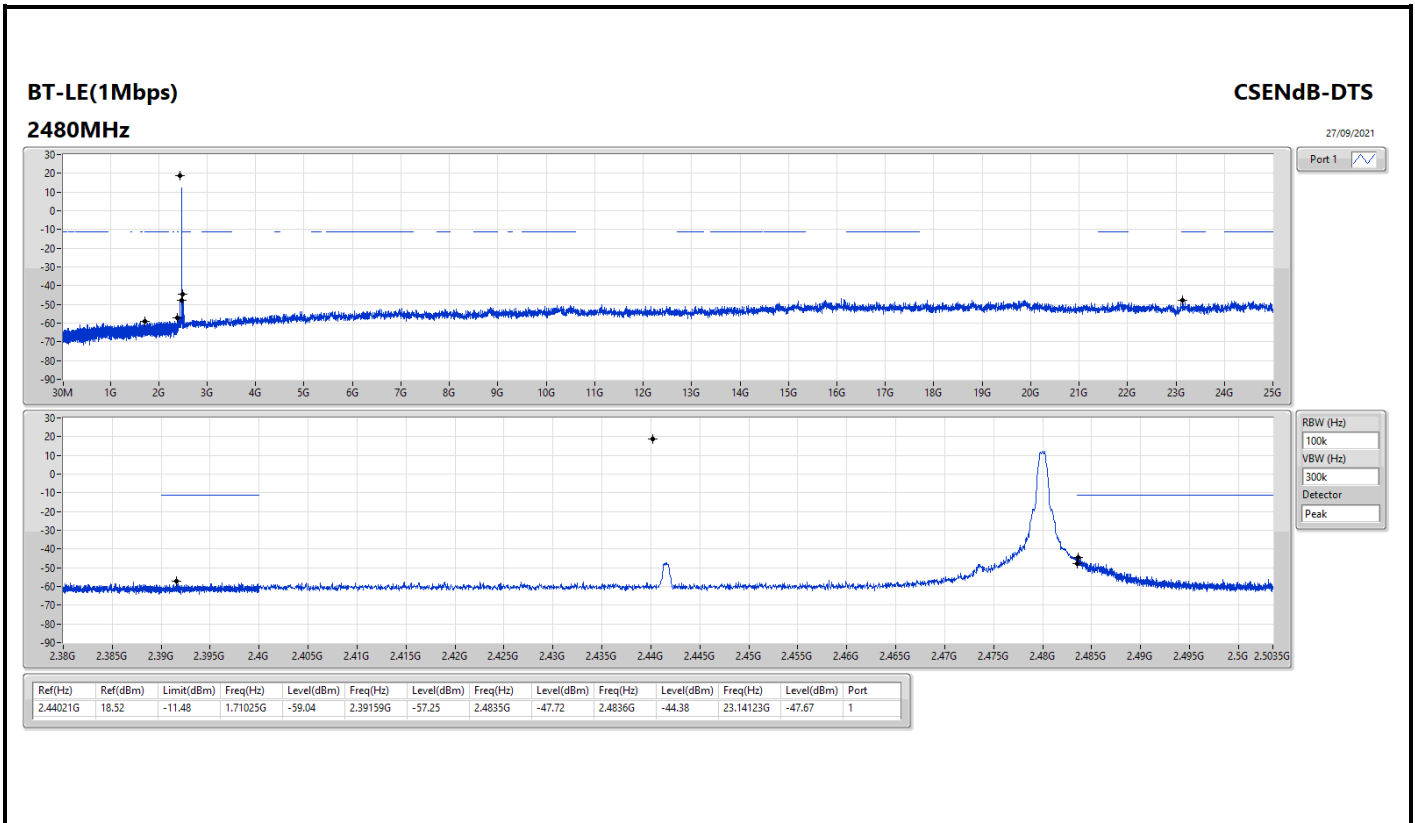

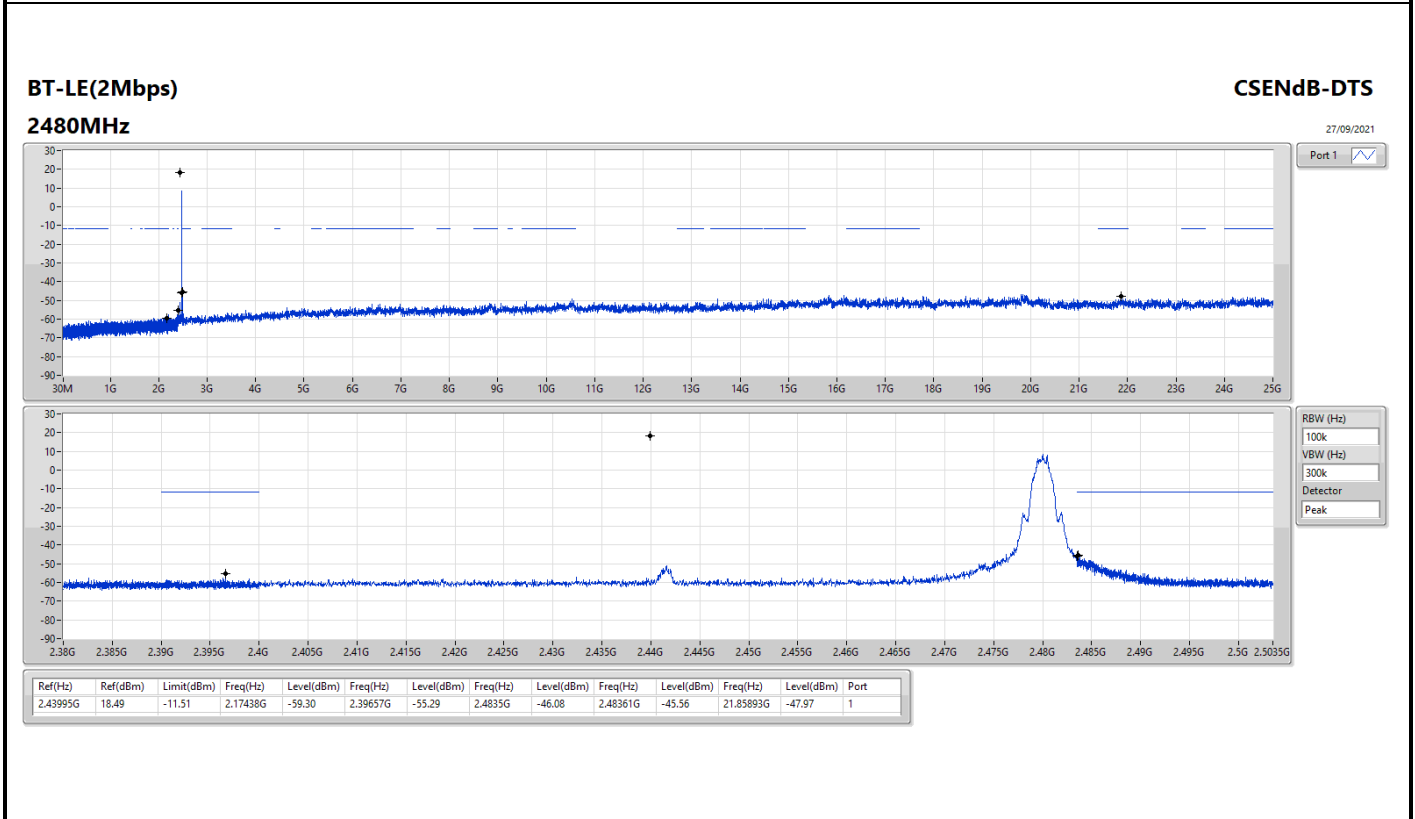
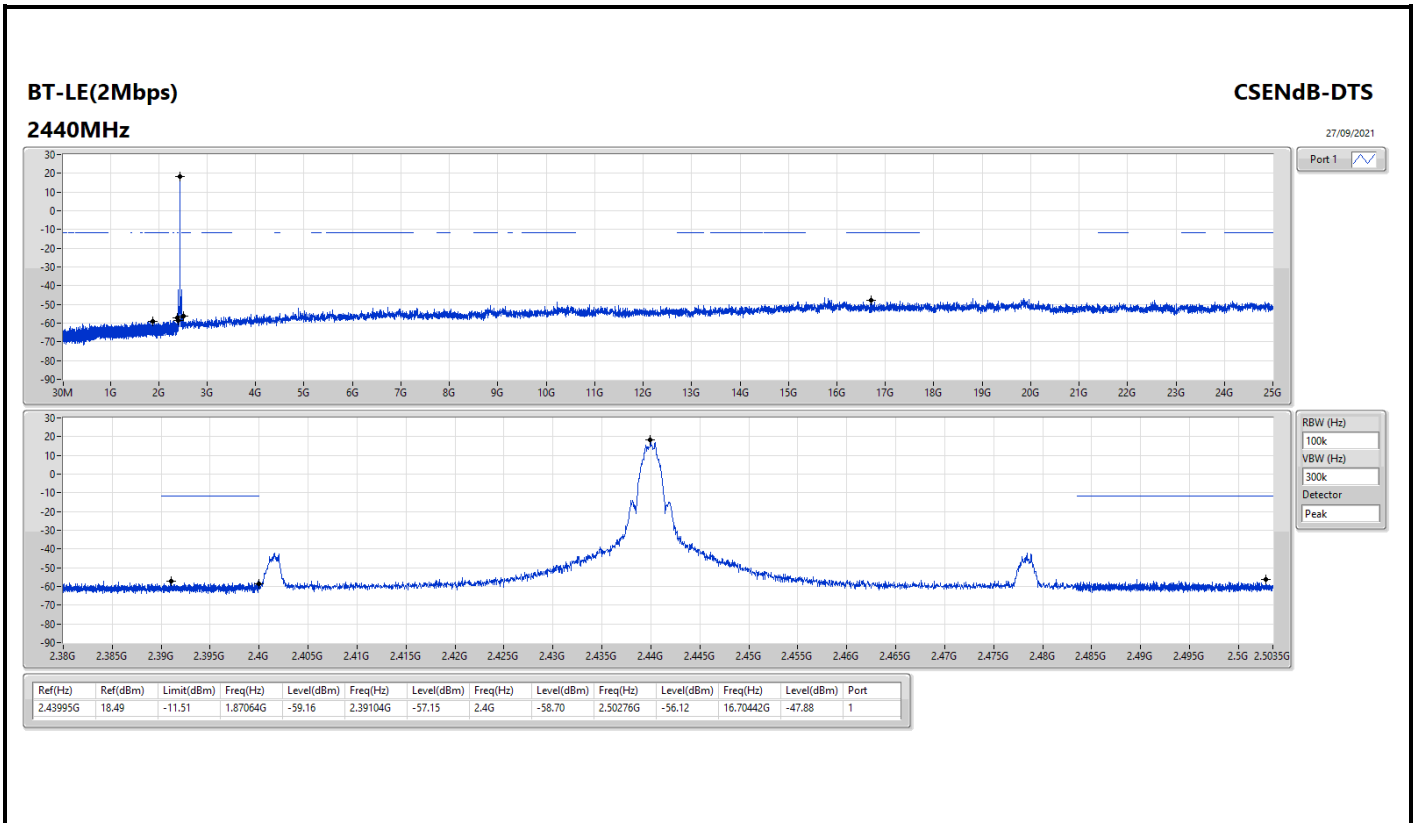

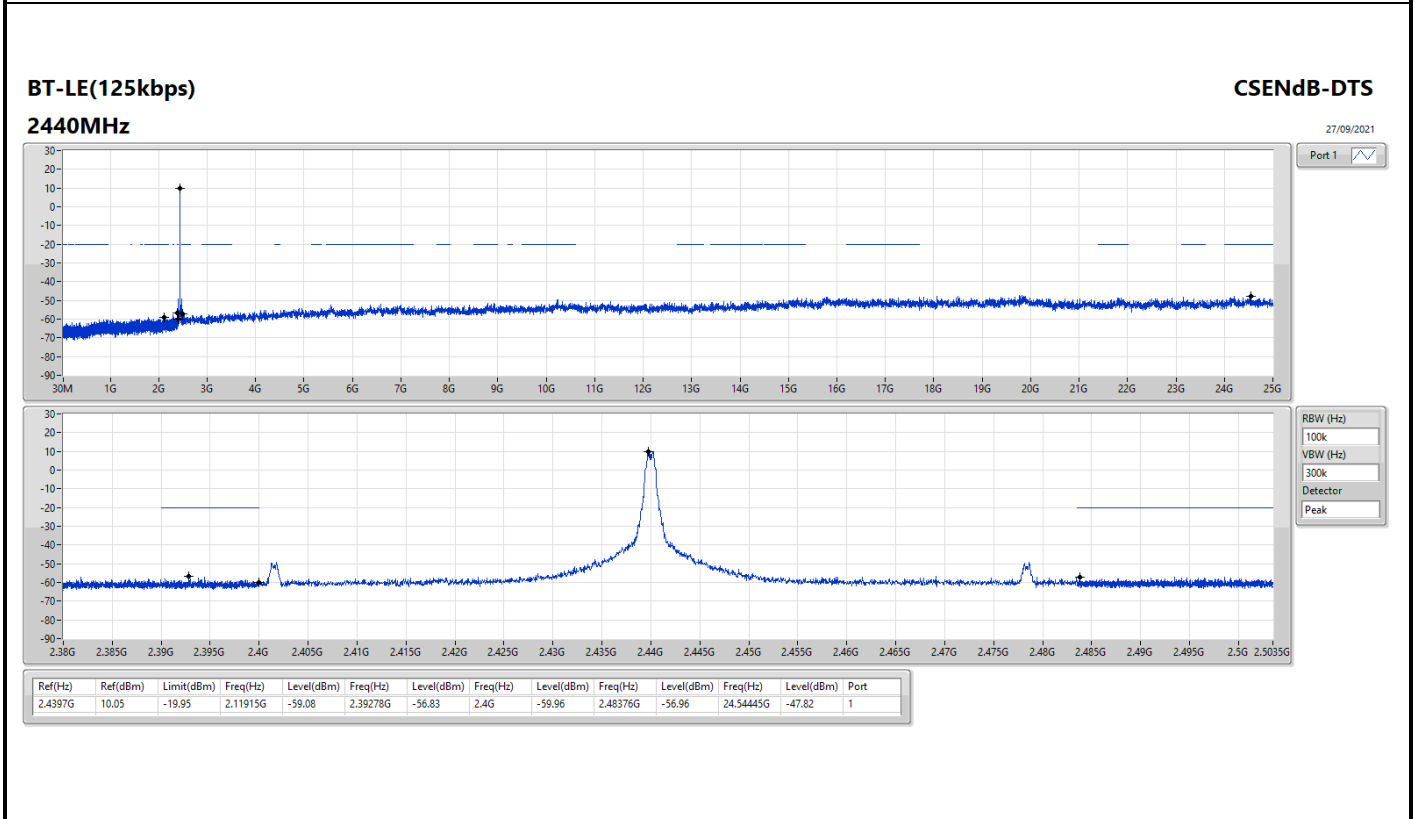
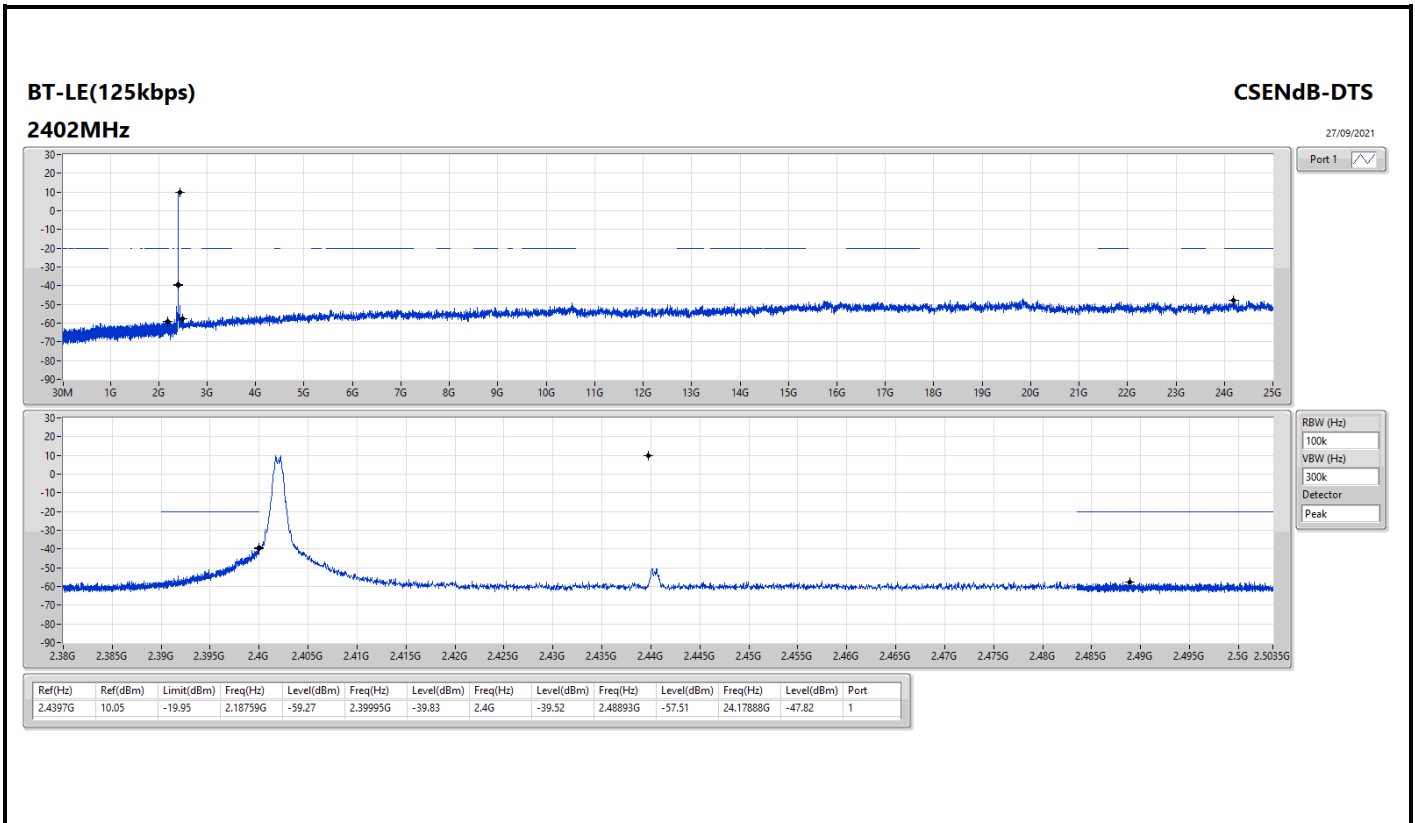

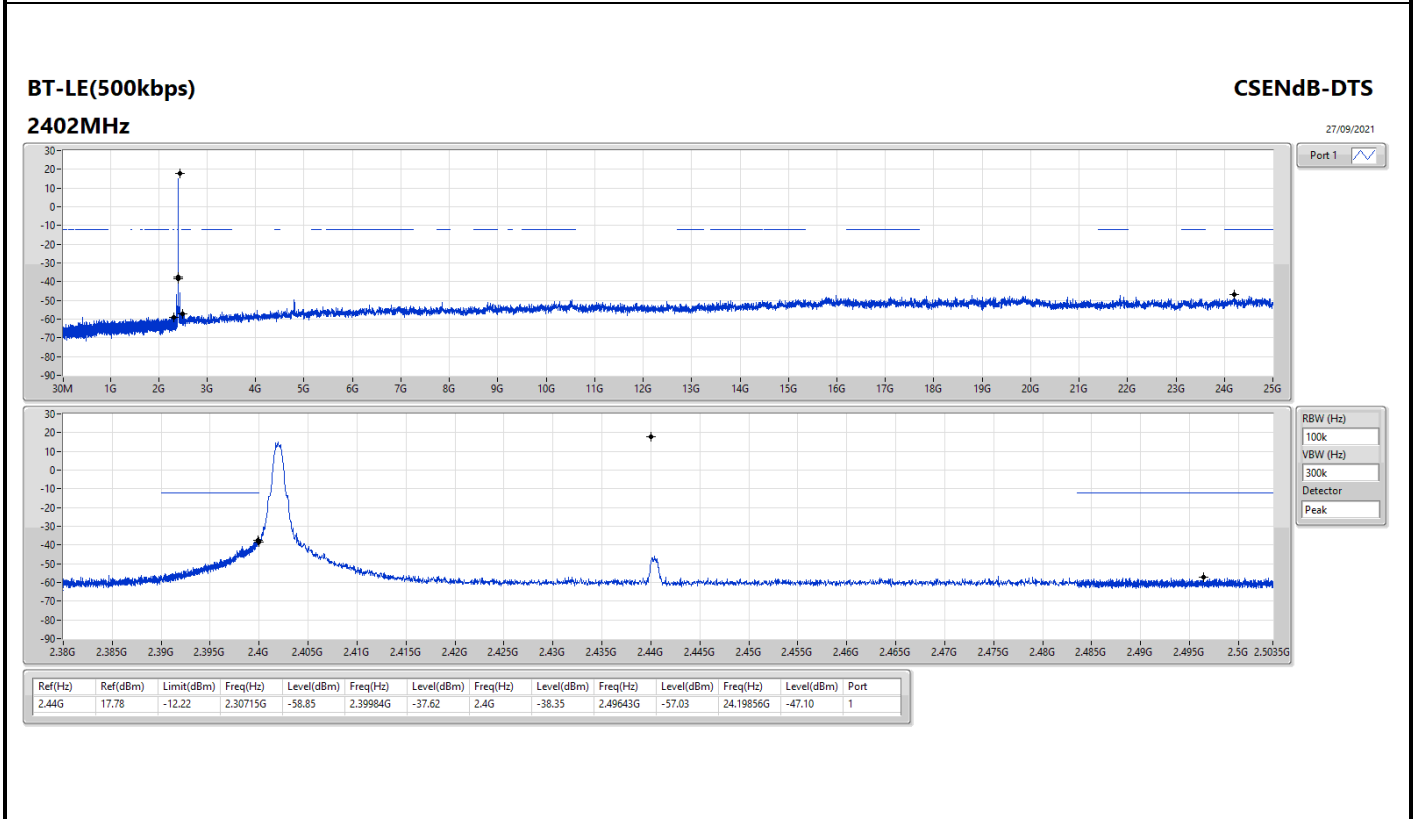
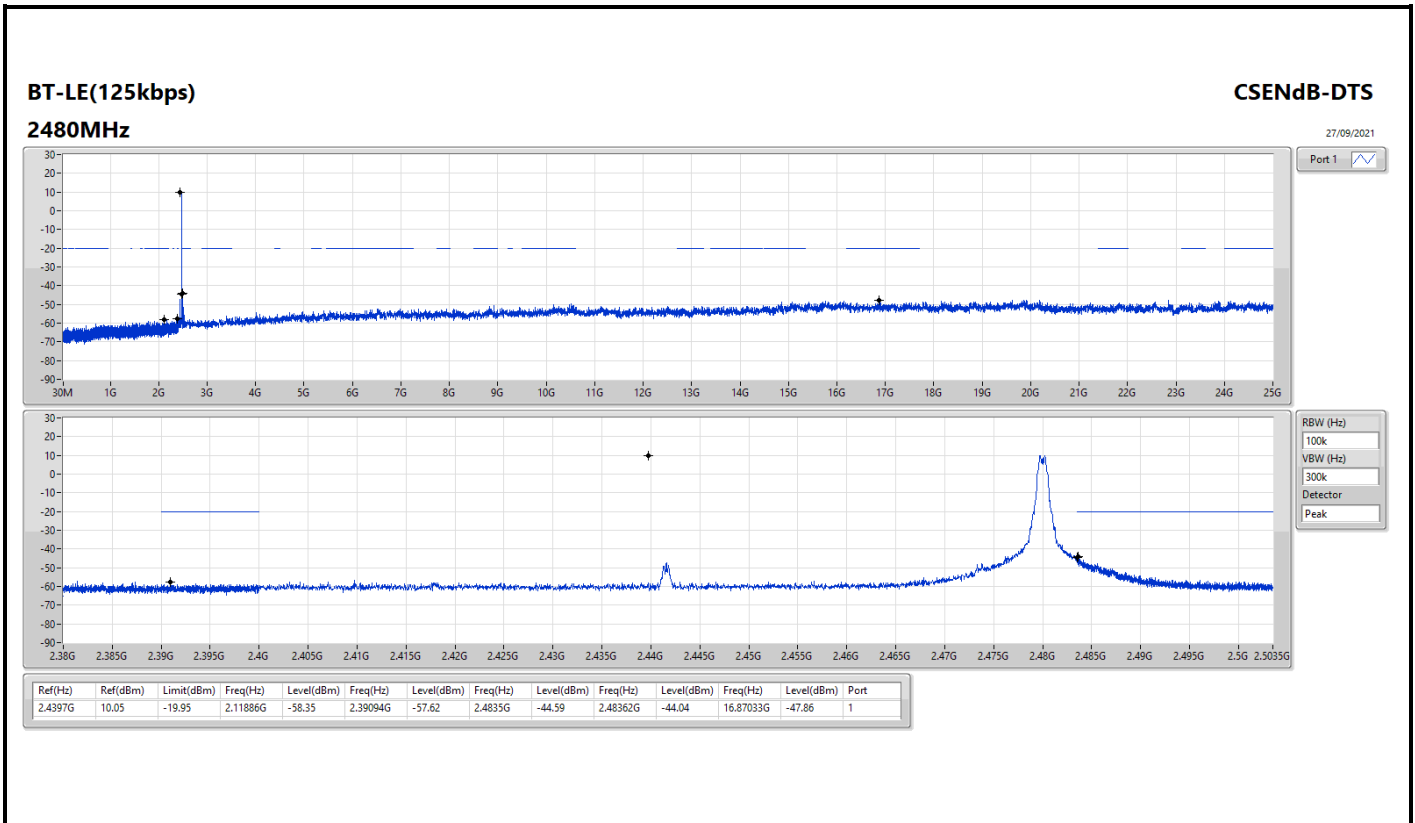

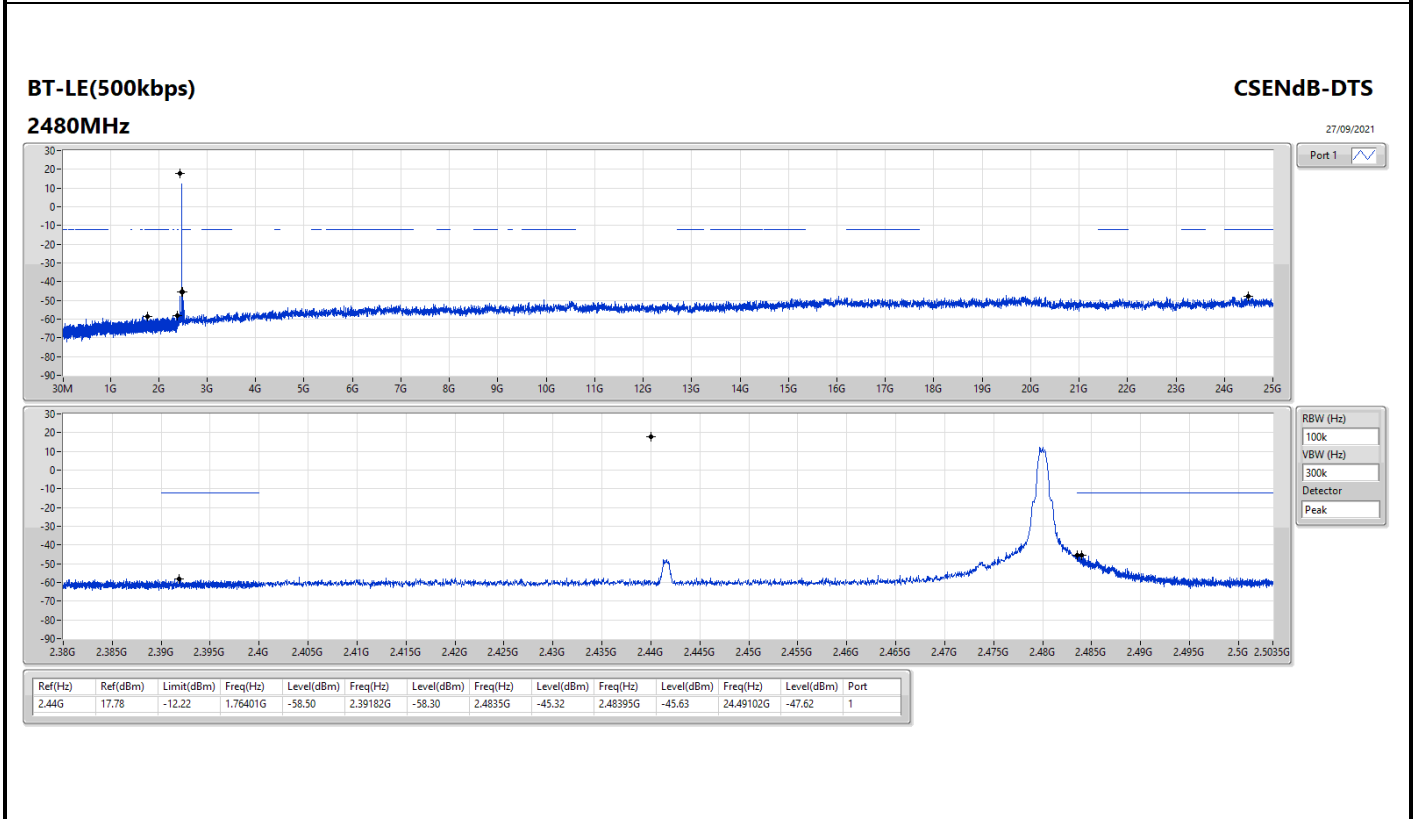
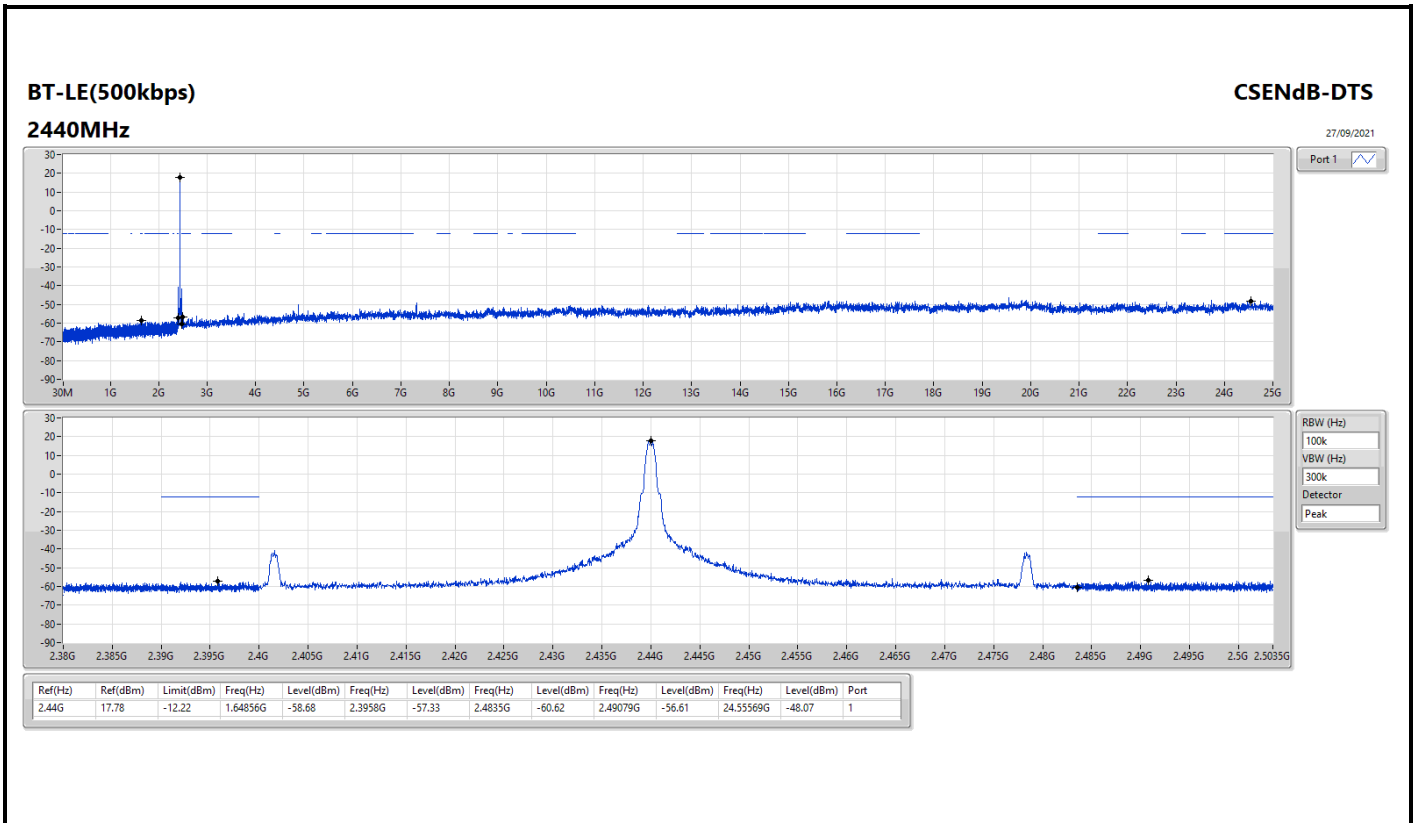



Summary

Mode	Result	Type	Freq (Hz)	Level (dBuV/m)	Limit (dBuV/m)	Margin (dB)	Dist (m)	Condition	Azimuth (°)	Height (m)	Comments
2.4-2.4835GHz	-	-	-	-	-	-	-	-	-	-	-
BT-LE(2Mbps)	Pass	PK	163.86M	39.51	43.50	-3.99	3	Vertical	360	1.00	-



Result

Mode	Result	Type	Freq (Hz)	Level (dBuV/m)	Limit (dBuV/m)	Margin (dB)	Dist (m)	Condition	Azimuth (°)	Height (m)	Comments
BT-LE(2Mbps)	-	-	-	-	-	-	-	-	-	-	-
2440MHz	Pass	PK	53.28M	32.49	40.00	-7.51	3	Vertical	360	1.00	-
2440MHz	Pass	PK	163.86M	39.51	43.50	-3.99	3	Vertical	360	1.00	-
2440MHz	Pass	PK	212.36M	31.81	43.50	-11.69	3	Vertical	360	1.00	-
2440MHz	Pass	PK	303.54M	33.06	46.00	-12.94	3	Vertical	360	1.00	-
2440MHz	Pass	PK	385.02M	31.69	46.00	-14.31	3	Vertical	360	1.00	-
2440MHz	Pass	PK	646.92M	29.85	46.00	-16.15	3	Vertical	360	1.00	-
2440MHz	Pass	PK	31.94M	29.60	40.00	-10.40	3	Horizontal	0	1.00	-
2440MHz	Pass	PK	163.86M	32.29	43.50	-11.21	3	Horizontal	0	1.00	-
2440MHz	Pass	PK	210.42M	25.95	43.50	-17.55	3	Horizontal	0	1.00	-
2440MHz	Pass	PK	385.02M	25.85	46.00	-20.15	3	Horizontal	0	1.00	-
2440MHz	Pass	PK	515M	27.96	46.00	-18.04	3	Horizontal	0	1.00	-
2440MHz	Pass	PK	643.04M	30.00	46.00	-16.00	3	Horizontal	0	1.00	-

BT-LE(2Mbps)

2440MHz_PoE

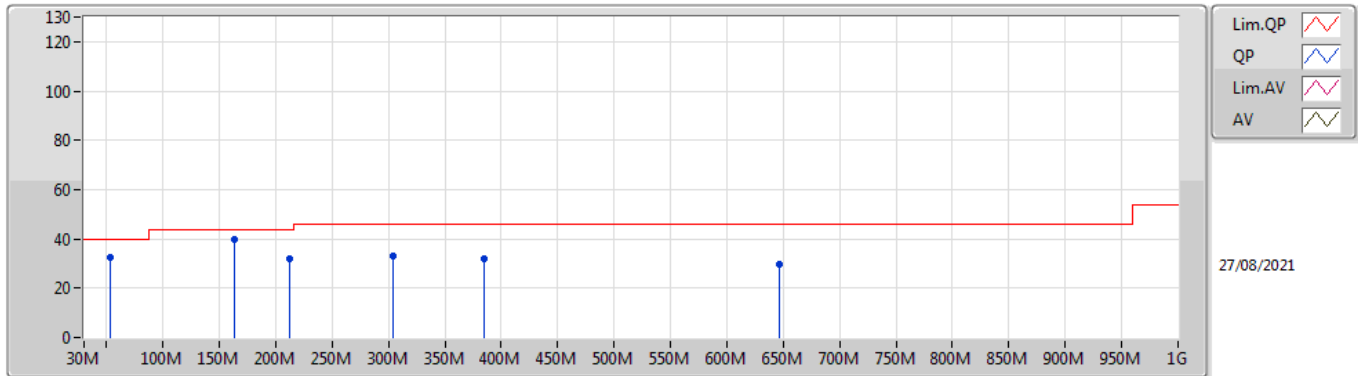

Type	Freq (Hz)	Level (dBuV/m)	Limit (dBuV/m)	Margin (dB)	Factor (dB)	Dist (m)	Condition	Azimuth (°)	Height (m)	Comment	Raw (dBuV)	AF (dB)	CL (dB)	PA (dB)
PK	53.28M	32.49	40.00	-7.51	-14.48	3	Vertical	360	1.00	-	46.97	12.16	1.09	27.73
PK	163.86M	39.51	43.50	-3.99	-10.70	3	Vertical	360	1.00	-	50.21	15.02	1.79	27.51
PK	212.36M	31.81	43.50	-11.69	-11.10	3	Vertical	360	1.00	-	42.91	14.14	2.01	27.25
PK	303.54M	33.06	46.00	-12.94	-6.17	3	Vertical	360	1.00	-	39.23	18.54	2.37	27.08
PK	385.02M	31.69	46.00	-14.31	-4.64	3	Vertical	360	1.00	-	36.33	20.33	2.68	27.65
PK	646.92M	29.85	46.00	-16.15	-0.53	3	Vertical	360	1.00	-	30.38	24.23	3.45	28.21

BT-LE(2Mbps)

2440MHz_PoE

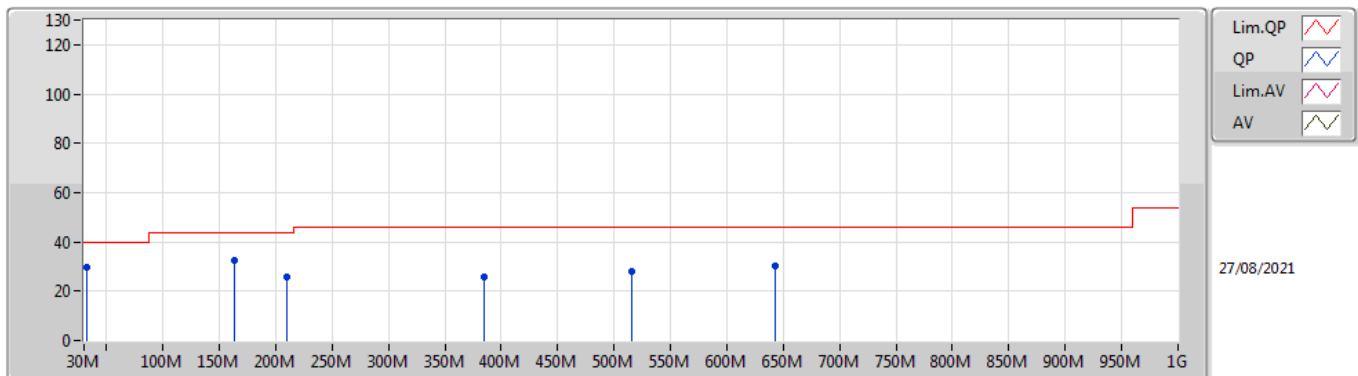

Type	Freq (Hz)	Level (dBuV/m)	Limit (dBuV/m)	Margin (dB)	Factor (dB)	Dist (m)	Condition	Azimuth (°)	Height (m)	Comment	Raw (dBuV)	AF (dB)	CL (dB)	PA (dB)
PK	31.94M	29.60	40.00	-10.40	-4.14	3	Horizontal	0	1.00	-	33.74	22.03	0.88	27.05
PK	163.86M	32.29	43.50	-11.21	-10.70	3	Horizontal	0	1.00	-	42.99	15.02	1.79	27.51
PK	210.42M	25.95	43.50	-17.55	-11.05	3	Horizontal	0	1.00	-	37.00	14.21	2.00	27.26
PK	385.02M	25.85	46.00	-20.15	-4.64	3	Horizontal	0	1.00	-	30.49	20.33	2.68	27.65
PK	515M	27.96	46.00	-18.04	-2.40	3	Horizontal	0	1.00	-	30.36	22.83	3.11	28.34
PK	643.04M	30.00	46.00	-16.00	-0.51	3	Horizontal	0	1.00	-	30.51	24.28	3.44	28.23



Summary

Mode	Result	Type	Freq (Hz)	Level (dBuV/m)	Limit (dBuV/m)	Margin (dB)	Dist (m)	Condition	Azimuth (°)	Height (m)	Comments
2.4-2.4835GHz	-	-	-	-	-	-	-	-	-	-	-
BT-LE(2Mbps)	Pass	AV	7.32118G	36.54	54.00	-17.46	3	Vertical	56	2.17	-



Result

Mode	Result	Type	Freq (Hz)	Level (dBuV/m)	Limit (dBuV/m)	Margin (dB)	Dist (m)	Condition	Azimuth (°)	Height (m)	Comments
BT-LE(2Mbps)	-	-	-	-	-	-	-	-	-	-	-
2440MHz	Pass	AV	4.87952G	30.28	54.00	-23.72	3	Vertical	247	1.35	-
2440MHz	Pass	AV	7.32118G	36.54	54.00	-17.46	3	Vertical	56	2.17	-
2440MHz	Pass	PK	4.87992G	43.01	74.00	-30.99	3	Vertical	247	1.35	-
2440MHz	Pass	PK	7.31973G	49.71	74.00	-24.29	3	Vertical	56	2.17	-
2440MHz	Pass	AV	4.88009G	30.35	54.00	-23.65	3	Horizontal	180	1.11	-
2440MHz	Pass	AV	7.3178G	36.54	54.00	-17.46	3	Horizontal	296	1.77	-
2440MHz	Pass	PK	4.88014G	44.05	74.00	-29.95	3	Horizontal	180	1.11	-
2440MHz	Pass	PK	7.32005G	49.46	74.00	-24.54	3	Horizontal	296	1.77	-

BT-LE(2Mbps)

2440MHz_TX

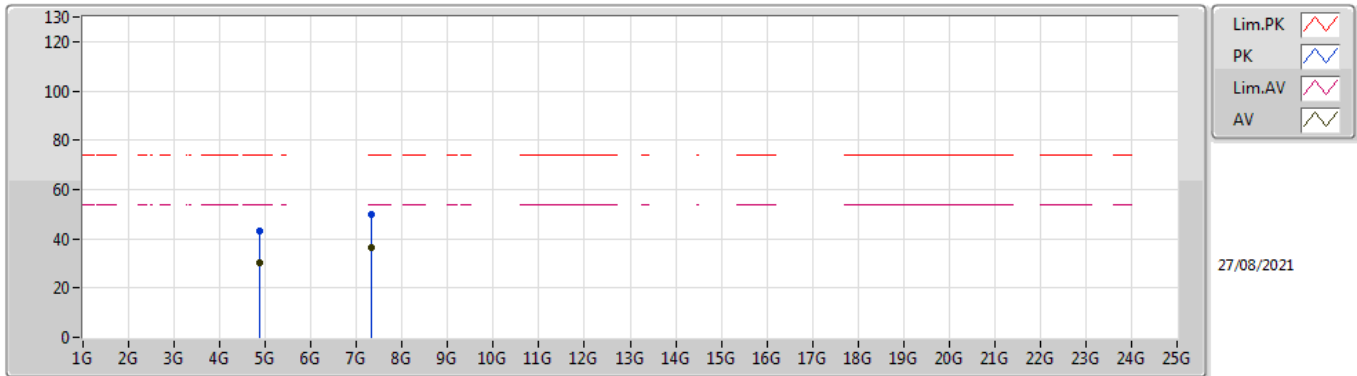

Type	Freq (Hz)	Level (dBuV/m)	Limit (dBuV/m)	Margin (dB)	Factor (dB)	Dist (m)	Condition	Azimuth (°)	Height (m)	Comment	Raw (dBuV)	AF (dB)	CL (dB)	PA (dB)
AV	4.87952G	30.28	54.00	-23.72	5.90	3	Vertical	247	1.35	-	24.38	31.20	8.96	34.26
AV	7.32118G	36.54	54.00	-17.46	12.42	3	Vertical	56	2.17	-	24.12	36.36	10.63	34.57
PK	4.87992G	43.01	74.00	-30.99	5.90	3	Vertical	247	1.35	-	37.11	31.20	8.96	34.26
PK	7.31973G	49.71	74.00	-24.29	12.42	3	Vertical	56	2.17	-	37.29	36.36	10.63	34.57

BT-LE(2Mbps)

2440MHz_TX

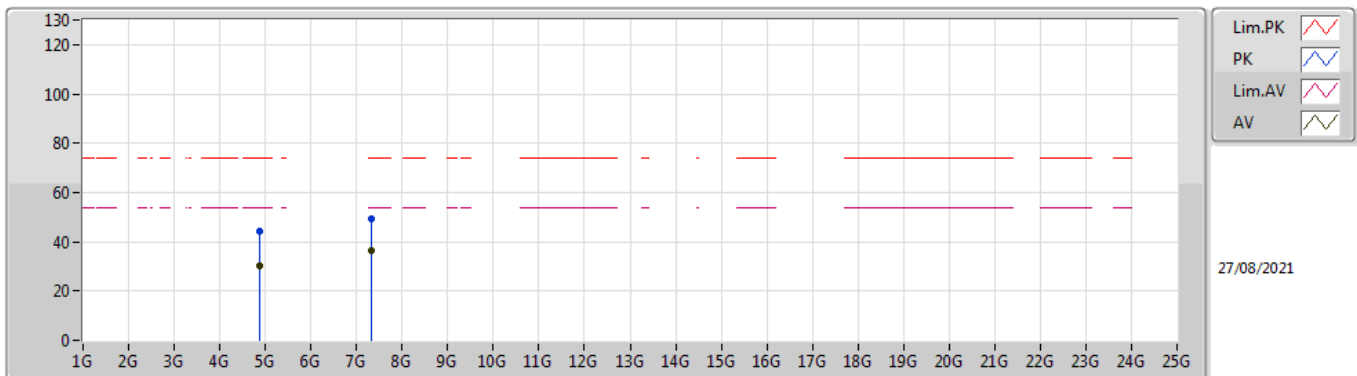

Type	Freq (Hz)	Level (dBuV/m)	Limit (dBuV/m)	Margin (dB)	Factor (dB)	Dist (m)	Condition	Azimuth (°)	Height (m)	Comment	Raw (dBuV)	AF (dB)	CL (dB)	PA (dB)
AV	4.88009G	30.35	54.00	-23.65	5.90	3	Horizontal	180	1.11	-	24.45	31.20	8.96	34.26
AV	7.3178G	36.54	54.00	-17.46	12.42	3	Horizontal	296	1.77	-	24.12	36.36	10.63	34.57
PK	4.88014G	44.05	74.00	-29.95	5.90	3	Horizontal	180	1.11	-	38.15	31.20	8.96	34.26
PK	7.32005G	49.46	74.00	-24.54	12.42	3	Horizontal	296	1.77	-	37.04	36.36	10.63	34.57



Summary

Mode	Result	F-Start (Hz)	F-Stop (Hz)	Type	Freq (Hz)	DG (dBi)	Psum (dBm)	EIRP (dBm)	Limit (dBm)	Margin (dB)	P1 (dBm)
2.4-2.4835GHz	-	-	-	-	-	-	-	-	-	-	-
BT-LE(1Mbps)	Pass	2.36G	2.5235G	AV	2.36352G	5.00	-46.24	-41.24	-41.20	-0.04	-46.24
BT-LE(2Mbps)	Pass	2.36G	2.5235G	AV	2.48352G	5.00	-46.88	-41.88	-41.20	-0.68	-46.88
BT-LE(125kbps)	Pass	2.36G	2.5235G	AV	2.48352G	5.00	-46.25	-41.25	-41.20	-0.05	-46.25
BT-LE(500kbps)	Pass	2.36G	2.5235G	AV	2.3636G	5.00	-46.46	-41.46	-41.20	-0.26	-46.46

DG = Directional Gain ; PX=Port X; Psum=P1+P2+...PX



Result

Mode	Result	F-Start (Hz)	F-Stop (Hz)	Type	Freq (Hz)	DG (dBi)	Psum (dBm)	EIRP (dBm)	Limit (dBm)	Margin (dB)	P1 (dBm)
BT-LE(1Mbps)	-	-	-	-	-	-	-	-	-	-	-
2402MHz	Pass	2.36G	2.5235G	AV	2.36352G	5.00	-46.24	-41.24	-41.20	-0.04	-46.24
2402MHz	Pass	2.36G	2.5235G	AV	2.49677G	5.00	-68.73	-63.73	-41.20	-22.53	-68.73
2402MHz	Pass	2.36G	2.5235G	PK	2.36327G	5.00	-43.72	-38.72	-21.20	-17.52	-43.72
2402MHz	Pass	2.36G	2.5235G	PK	2.49096G	5.00	-56.49	-51.49	-21.20	-30.29	-56.49
2440MHz	Pass	2.36G	2.5235G	AV	2.36327G	5.00	-63.92	-58.92	-41.20	-17.72	-63.92
2440MHz	Pass	2.36G	2.5235G	AV	2.49121G	5.00	-66.19	-61.19	-41.20	-19.99	-66.19
2440MHz	Pass	2.36G	2.5235G	PK	2.36294G	5.00	-52.64	-47.64	-21.20	-26.44	-52.64
2440MHz	Pass	2.36G	2.5235G	PK	2.49521G	5.00	-55.35	-50.35	-21.20	-29.15	-55.35
2480MHz	Pass	2.36G	2.5235G	AV	2.36458G	5.00	-68.32	-63.32	-41.20	-22.12	-68.32
2480MHz	Pass	2.36G	2.5235G	AV	2.48352G	5.00	-46.30	-41.30	-41.20	-0.10	-46.30
2480MHz	Pass	2.36G	2.5235G	PK	2.36491G	5.00	-56.80	-51.80	-21.20	-30.60	-56.80
2480MHz	Pass	2.36G	2.5235G	PK	2.48361G	5.00	-35.82	-30.82	-21.20	-9.62	-35.82
BT-LE(2Mbps)	-	-	-	-	-	-	-	-	-	-	-
2402MHz	Pass	2.36G	2.5235G	AV	2.36343G	5.00	-47.51	-42.51	-41.20	-1.31	-47.51
2402MHz	Pass	2.36G	2.5235G	AV	2.36352G	5.00	-47.51	-42.51	-41.20	-1.31	-47.51
2402MHz	Pass	2.36G	2.5235G	AV	2.48352G	5.00	-68.56	-63.56	-41.20	-22.36	-68.56
2402MHz	Pass	2.36G	2.5235G	PK	2.36311G	5.00	-43.12	-38.12	-21.20	-16.92	-43.12
2402MHz	Pass	2.36G	2.5235G	PK	2.49268G	5.00	-57.56	-52.56	-21.20	-31.36	-57.56
2440MHz	Pass	2.36G	2.5235G	AV	2.36311G	5.00	-64.35	-59.35	-41.20	-18.15	-64.35
2440MHz	Pass	2.36G	2.5235G	AV	2.48573G	5.00	-66.35	-61.35	-41.20	-20.15	-66.35
2440MHz	Pass	2.36G	2.5235G	PK	2.36335G	5.00	-52.47	-47.47	-21.20	-26.27	-52.47
2440MHz	Pass	2.36G	2.5235G	PK	2.48876G	5.00	-54.92	-49.92	-21.20	-28.72	-54.92
2480MHz	Pass	2.36G	2.5235G	AV	2.36482G	5.00	-69.83	-64.83	-41.20	-23.63	-69.83
2480MHz	Pass	2.36G	2.5235G	AV	2.48352G	5.00	-46.88	-41.88	-41.20	-0.68	-46.88
2480MHz	Pass	2.36G	2.5235G	PK	2.37831G	5.00	-58.44	-53.44	-21.20	-32.24	-58.44
2480MHz	Pass	2.36G	2.5235G	PK	2.48377G	5.00	-36.39	-31.39	-21.20	-10.19	-36.39
BT-LE(125kbps)	-	-	-	-	-	-	-	-	-	-	-
2402MHz	Pass	2.36G	2.5235G	AV	2.36352G	5.00	-49.25	-44.25	-41.20	-3.05	-49.25
2402MHz	Pass	2.36G	2.5235G	AV	2.48933G	5.00	-69.15	-64.15	-41.20	-22.95	-69.15
2402MHz	Pass	2.36G	2.5235G	PK	2.36327G	5.00	-46.02	-41.02	-21.20	-19.82	-46.02
2402MHz	Pass	2.36G	2.5235G	PK	2.48957G	5.00	-57.45	-52.45	-21.20	-31.25	-57.45
2440MHz	Pass	2.36G	2.5235G	AV	2.36294G	5.00	-67.65	-62.65	-41.20	-21.45	-67.65
2440MHz	Pass	2.36G	2.5235G	AV	2.48352G	5.00	-68.56	-63.56	-41.20	-22.36	-68.56
2440MHz	Pass	2.36G	2.5235G	PK	2.37946G	5.00	-57.39	-52.39	-21.20	-31.19	-57.39
2440MHz	Pass	2.36G	2.5235G	PK	2.48442G	5.00	-56.99	-51.99	-21.20	-30.79	-56.99
2480MHz	Pass	2.36G	2.5235G	AV	2.36458G	5.00	-68.15	-63.15	-41.20	-21.95	-68.15
2480MHz	Pass	2.36G	2.5235G	AV	2.48352G	5.00	-46.25	-41.25	-41.20	-0.05	-46.25
2480MHz	Pass	2.36G	2.5235G	PK	2.38788G	5.00	-57.36	-52.36	-21.20	-31.16	-57.36
2480MHz	Pass	2.36G	2.5235G	PK	2.48352G	5.00	-35.67	-30.67	-21.20	-9.47	-35.67
BT-LE(500kbps)	-	-	-	-	-	-	-	-	-	-	-
2402MHz	Pass	2.36G	2.5235G	AV	2.3636G	5.00	-46.46	-41.46	-41.20	-0.26	-46.46
2402MHz	Pass	2.36G	2.5235G	AV	2.49718G	5.00	-68.73	-63.73	-41.20	-22.53	-68.73
2402MHz	Pass	2.36G	2.5235G	PK	2.36319G	5.00	-43.25	-38.25	-21.20	-17.05	-43.25
2402MHz	Pass	2.36G	2.5235G	PK	2.48933G	5.00	-57.14	-52.14	-21.20	-30.94	-57.14
2440MHz	Pass	2.36G	2.5235G	AV	2.36302G	5.00	-63.81	-58.81	-41.20	-17.61	-63.81
2440MHz	Pass	2.36G	2.5235G	AV	2.48393G	5.00	-66.06	-61.06	-41.20	-19.86	-66.06
2440MHz	Pass	2.36G	2.5235G	PK	2.36319G	5.00	-51.88	-46.88	-21.20	-25.68	-51.88
2440MHz	Pass	2.36G	2.5235G	PK	2.48467G	5.00	-54.61	-49.61	-21.20	-28.41	-54.61
2480MHz	Pass	2.36G	2.5235G	AV	2.36466G	5.00	-68.49	-63.49	-41.20	-22.29	-68.49
2480MHz	Pass	2.36G	2.5235G	AV	2.48352G	5.00	-46.84	-41.84	-41.20	-0.64	-46.84
2480MHz	Pass	2.36G	2.5235G	PK	2.36392G	5.00	-57.87	-52.87	-21.20	-31.67	-57.87
2480MHz	Pass	2.36G	2.5235G	PK	2.48352G	5.00	-35.31	-30.31	-21.20	-9.11	-35.31

DG = Directional Gain ; PX=Port X; Psum=P1+P2+...PX

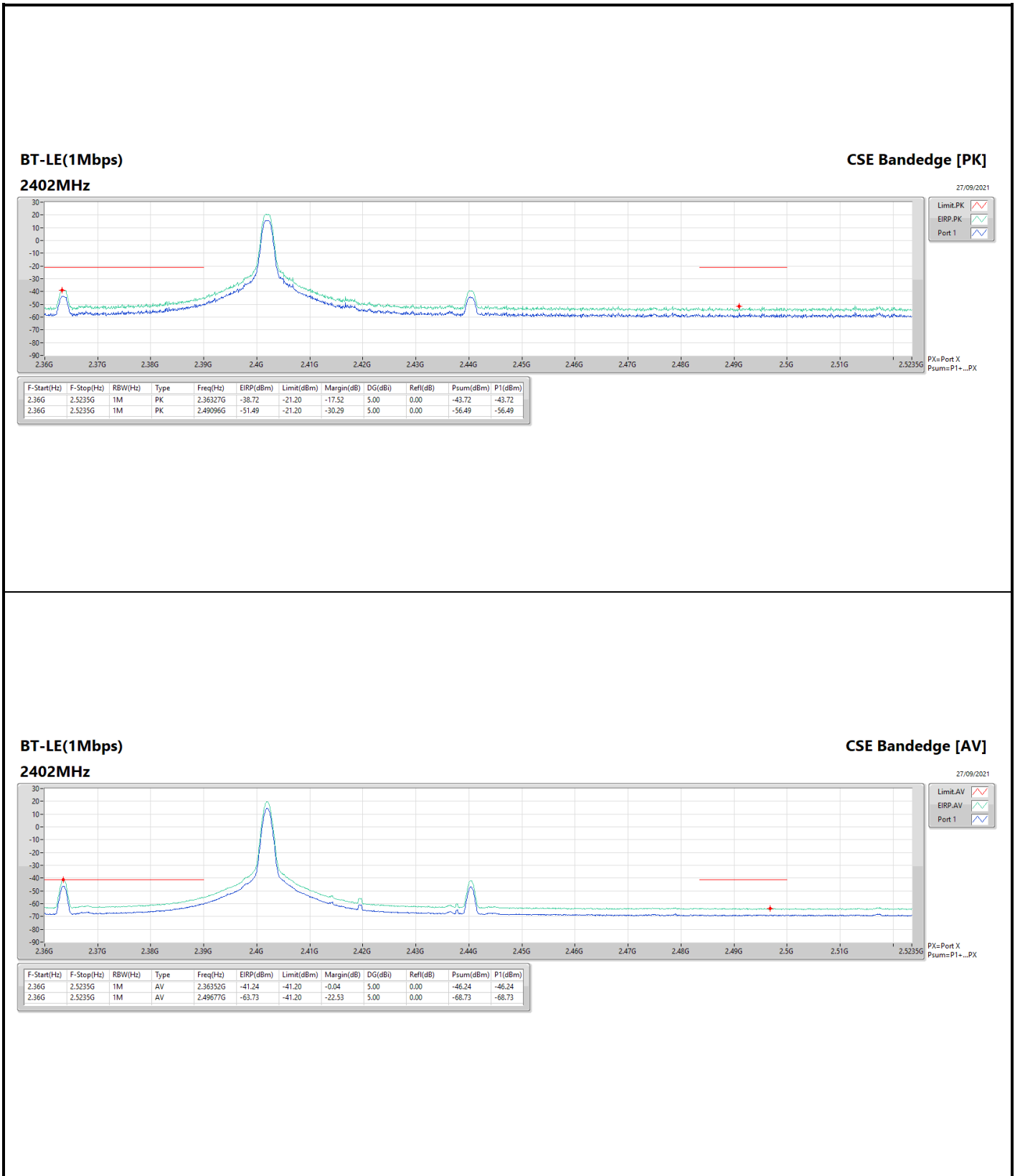

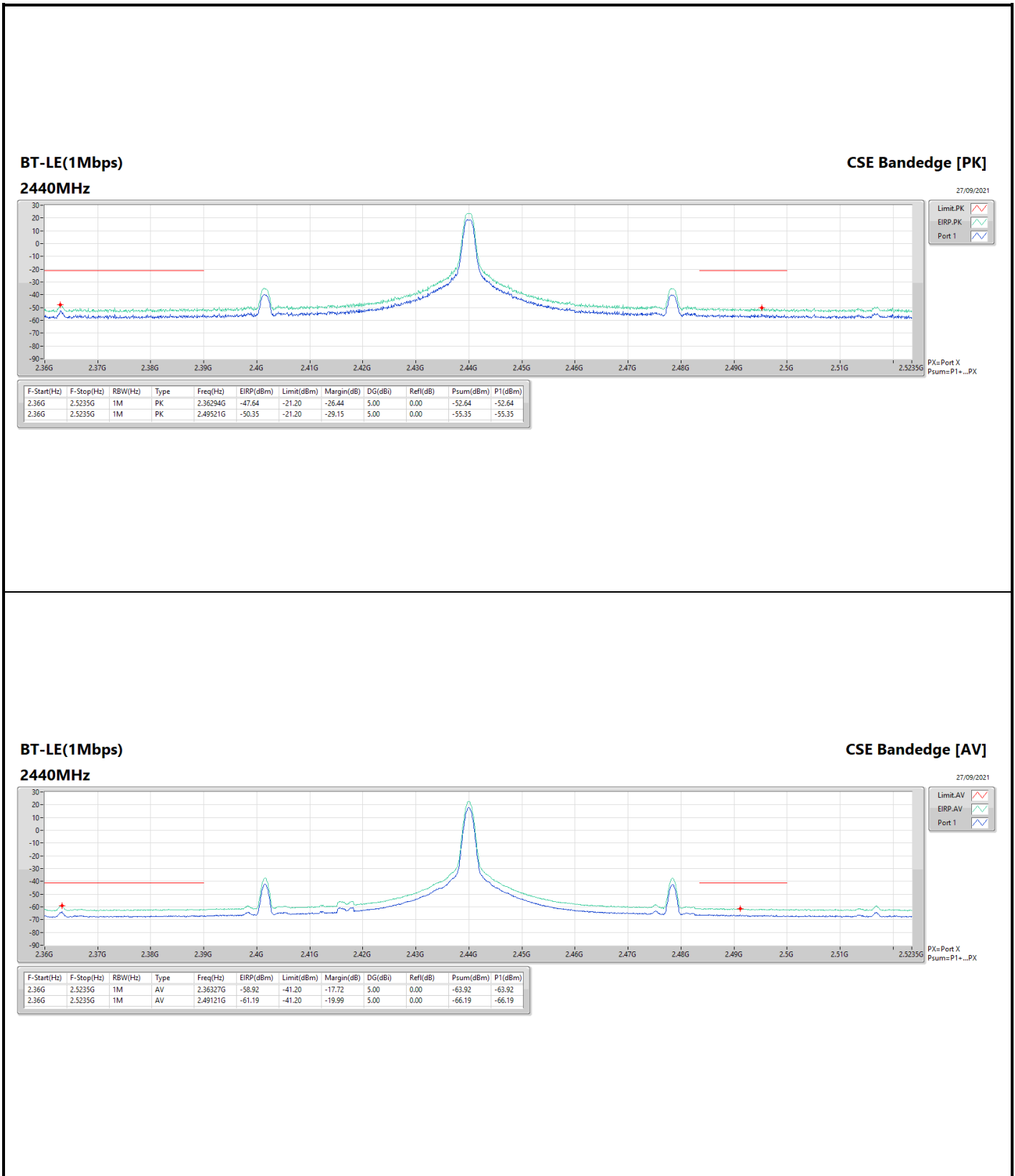

BT-LE(1Mbps)
2480MHz

CSE Bandedge [PK]

27/09/2021

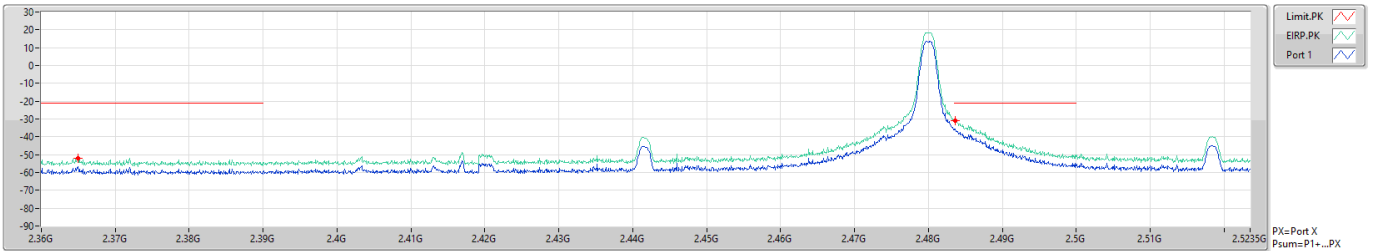

F-Start(Hz)	F-Stop(Hz)	RBW(Hz)	Type	Freq(Hz)	EIRP(dBm)	Limit(dBm)	Margin(dB)	DG(dBi)	Ref(dB)	Psum(dBm)	P1(dBm)
2.36G	2.5235G	1M	PK	2.36491G	-51.80	-21.20	-30.60	5.00	0.00	-56.80	-56.80
2.36G	2.5235G	1M	PK	2.48361G	-30.82	-21.20	-9.62	5.00	0.00	-35.82	-35.82

BT-LE(1Mbps)
2480MHz

CSE Bandedge [AV]

27/09/2021

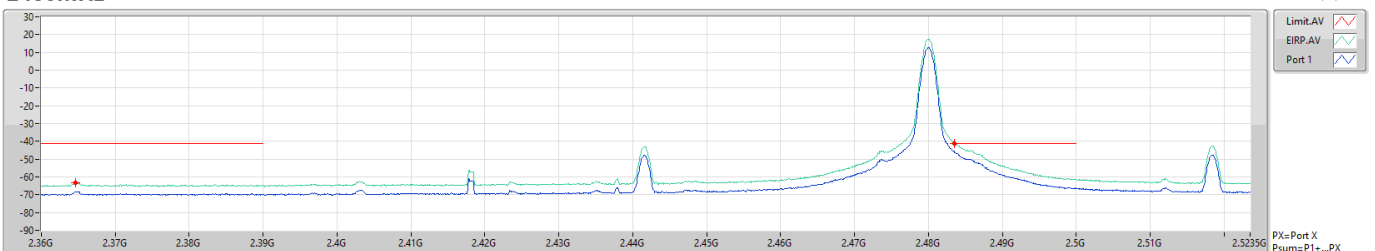

F-Start(Hz)	F-Stop(Hz)	RBW(Hz)	Type	Freq(Hz)	EIRP(dBm)	Limit(dBm)	Margin(dB)	DG(dBi)	Ref(dB)	Psum(dBm)	P1(dBm)
2.36G	2.5235G	1M	AV	2.36498G	-63.32	-41.20	-22.12	5.00	0.00	-68.32	-68.32
2.36G	2.5235G	1M	AV	2.48352G	-41.30	-41.20	-0.10	5.00	0.00	-46.30	-46.30

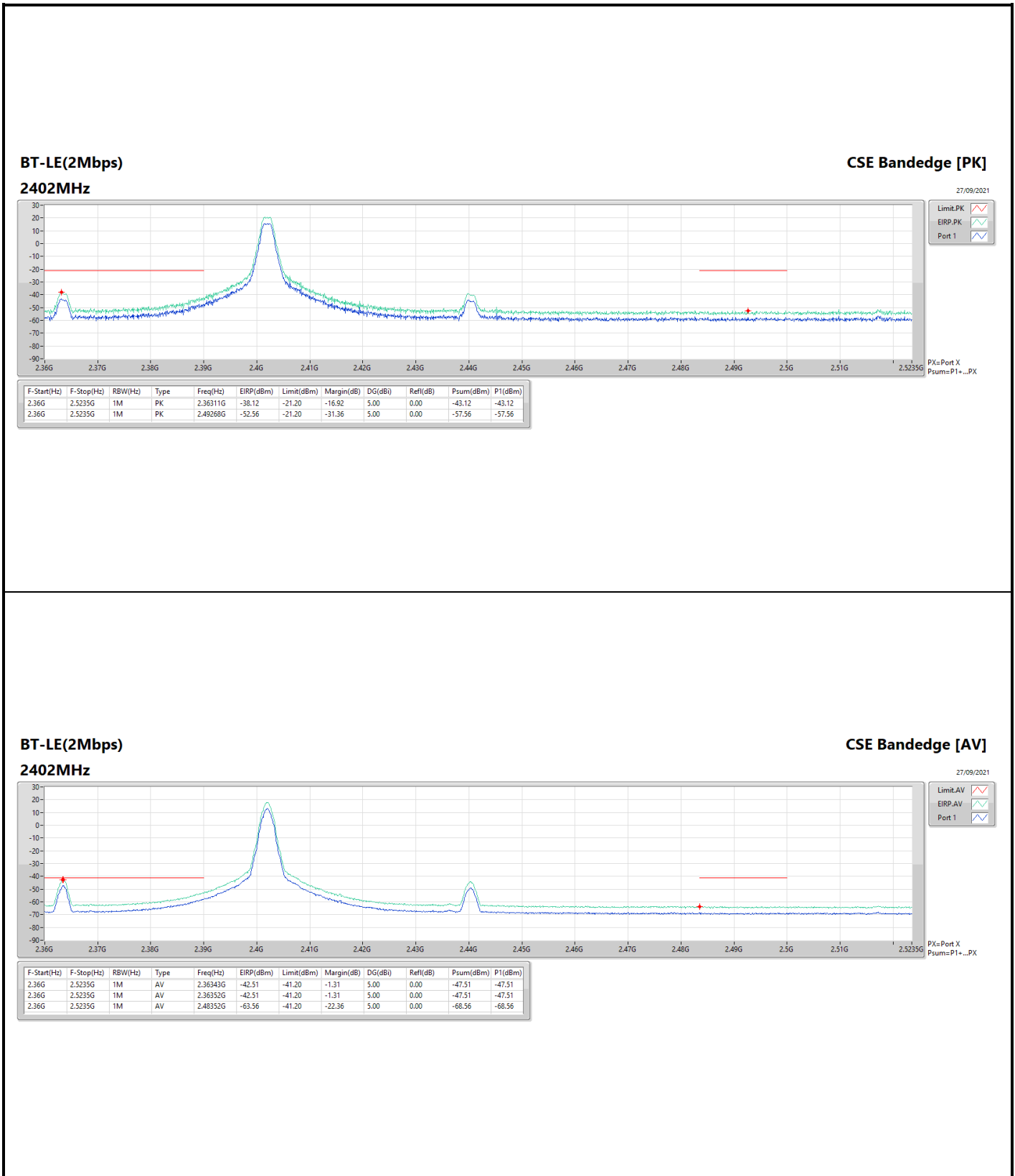

BT-LE(2Mbps)

CSE Bandedge [PK]

2440MHz

27/09/2021

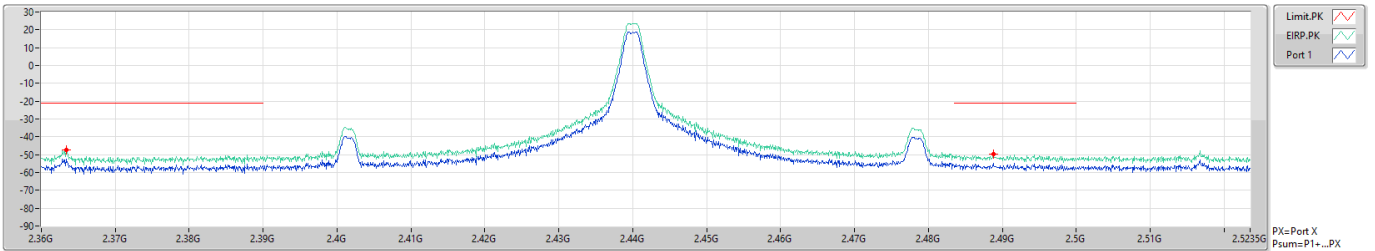

F-Start(Hz)	F-Stop(Hz)	RBW(Hz)	Type	Freq(Hz)	EIRP(dBm)	Limit(dBm)	Margin(dB)	DG(dBi)	Ref(dB)	Psum(dBm)	P1(dBm)
2.36G	2.5235G	1M	PK	2.36335G	-47.47	-21.20	-26.27	5.00	0.00	-52.47	-52.47
2.36G	2.5235G	1M	PK	2.48876G	-49.92	-21.20	-28.72	5.00	0.00	-54.92	-54.92

BT-LE(2Mbps)

CSE Bandedge [AV]

2440MHz

27/09/2021

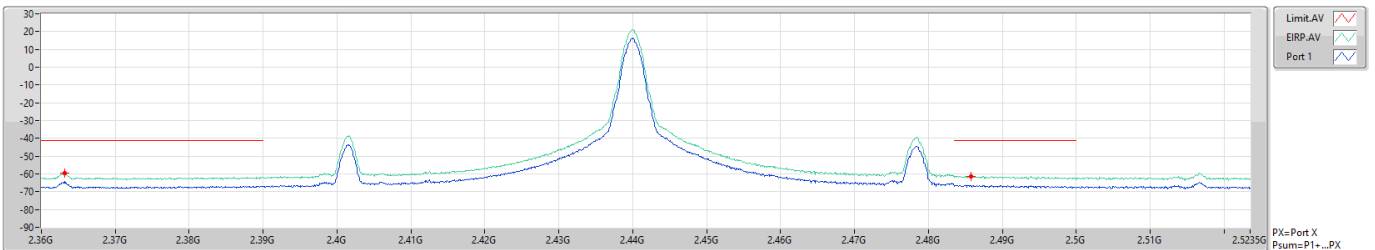

F-Start(Hz)	F-Stop(Hz)	RBW(Hz)	Type	Freq(Hz)	EIRP(dBm)	Limit(dBm)	Margin(dB)	DG(dBi)	Ref(dB)	Psum(dBm)	P1(dBm)
2.36G	2.5235G	1M	AV	2.36311G	-59.35	-41.20	-18.15	5.00	0.00	-64.35	-64.35
2.36G	2.5235G	1M	AV	2.48573G	-61.35	-41.20	-20.15	5.00	0.00	-66.35	-66.35

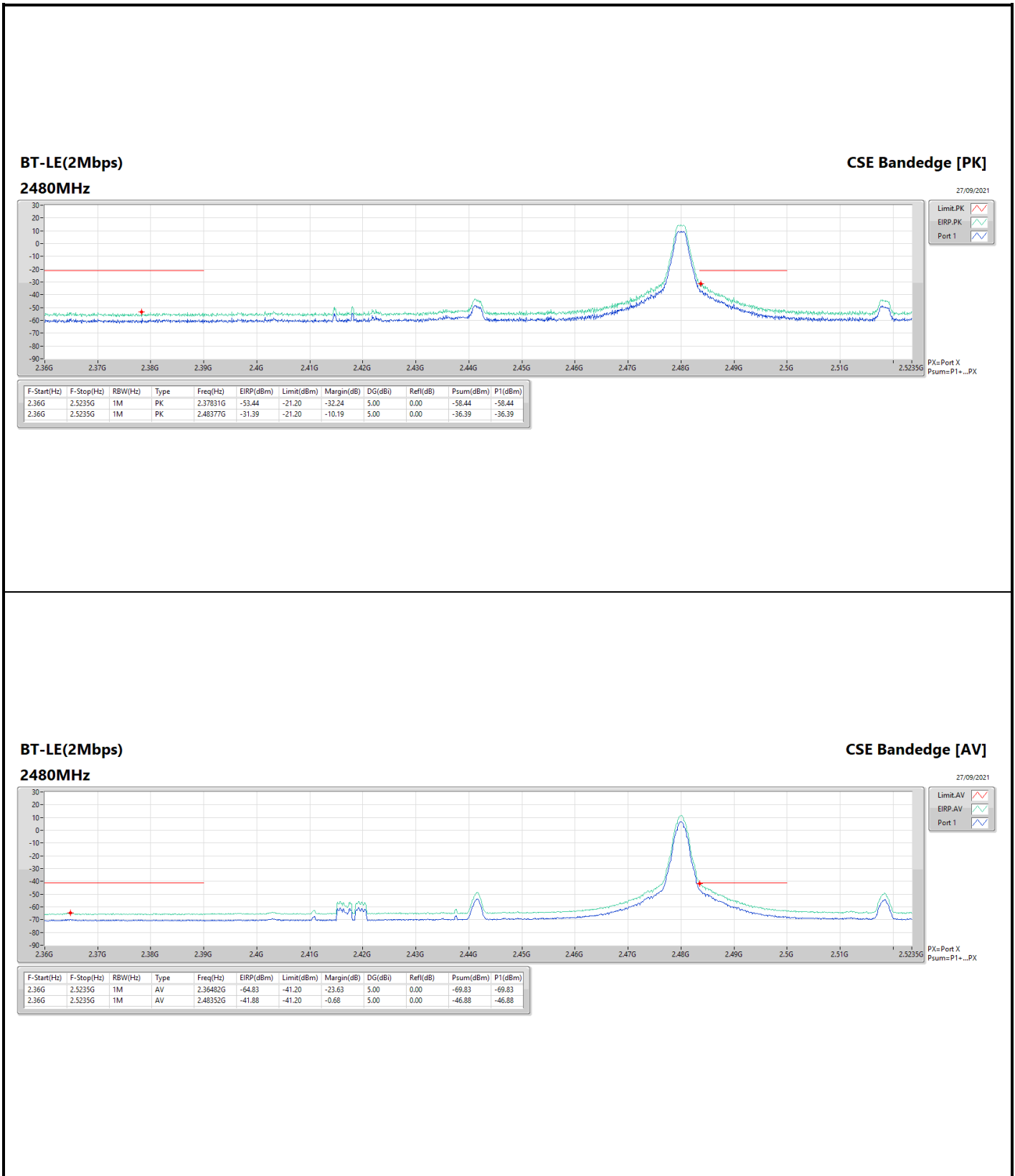

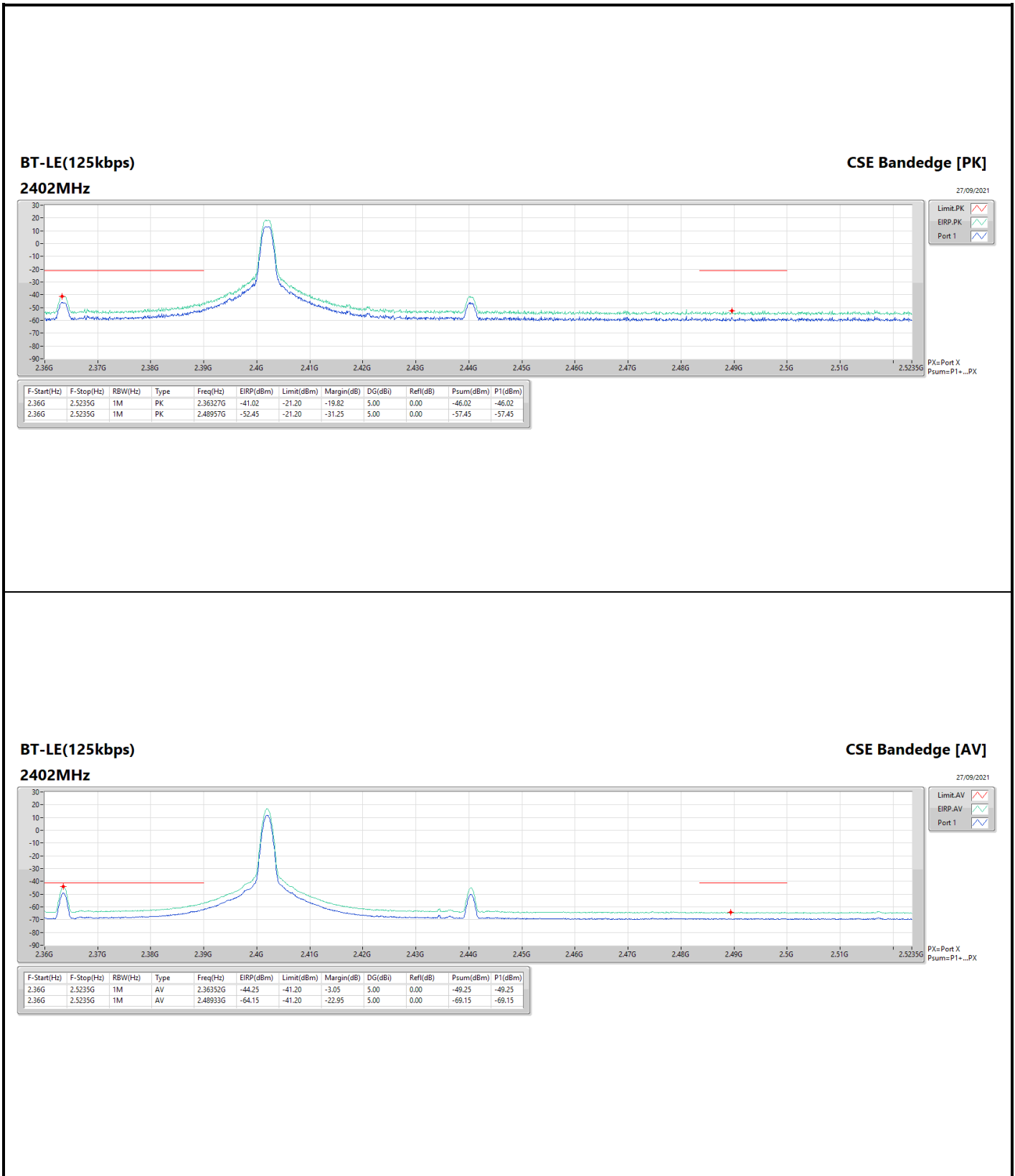

BT-LE(125kbps)

CSE Bandedge [PK]

2440MHz

27/09/2021

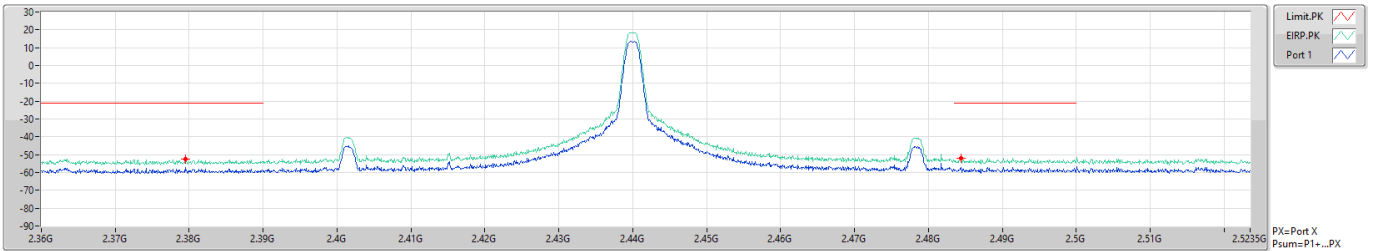

F-Start(Hz)	F-Stop(Hz)	RBW(Hz)	Type	Freq(Hz)	EIRP(dBm)	Limit(dBm)	Margin(dB)	DG(dBi)	Ref(dB)	Psum(dBm)	P1(dBm)
2.36G	2.5235G	1M	PK	2.37946G	-52.39	-21.20	-31.19	5.00	0.00	-57.39	-57.39
2.36G	2.5235G	1M	PK	2.48442G	-51.99	-21.20	-30.79	5.00	0.00	-56.99	-56.99

BT-LE(125kbps)

CSE Bandedge [AV]

2440MHz

27/09/2021

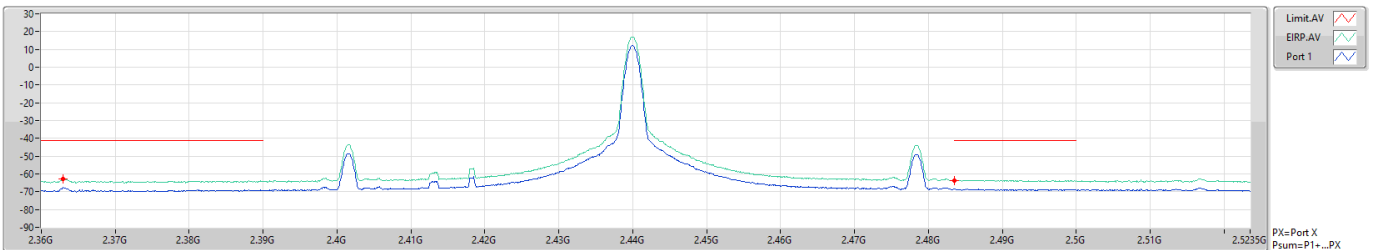

F-Start(Hz)	F-Stop(Hz)	RBW(Hz)	Type	Freq(Hz)	EIRP(dBm)	Limit(dBm)	Margin(dB)	DG(dBi)	Ref(dB)	Psum(dBm)	P1(dBm)
2.36G	2.5235G	1M	AV	2.36294G	-62.65	-41.20	-21.45	5.00	0.00	-67.65	-67.65
2.36G	2.5235G	1M	AV	2.48352G	-63.56	-41.20	-22.36	5.00	0.00	-68.56	-68.56

BT-LE(125kbps)

CSE Bandedge [PK]

2480MHz

27/09/2021

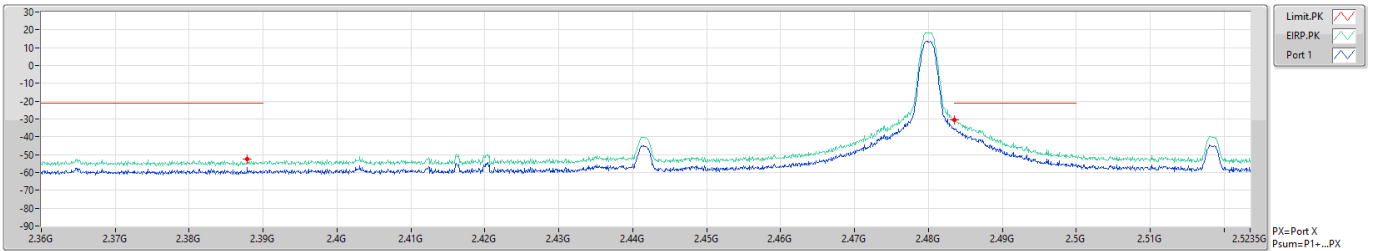

F-Start(Hz)	F-Stop(Hz)	RBW(Hz)	Type	Freq(Hz)	EIRP(dBm)	Limit(dBm)	Margin(dB)	DG(dBi)	Ref(dB)	Psum(dBm)	P1(dBm)
2.36G	2.5235G	1M	PK	2.38788G	-52.36	-21.20	-31.16	5.00	0.00	-57.36	-57.36
2.36G	2.5235G	1M	PK	2.48352G	-30.67	-21.20	-9.47	5.00	0.00	-35.67	-35.67

BT-LE(125kbps)

CSE Bandedge [AV]

2480MHz

27/09/2021

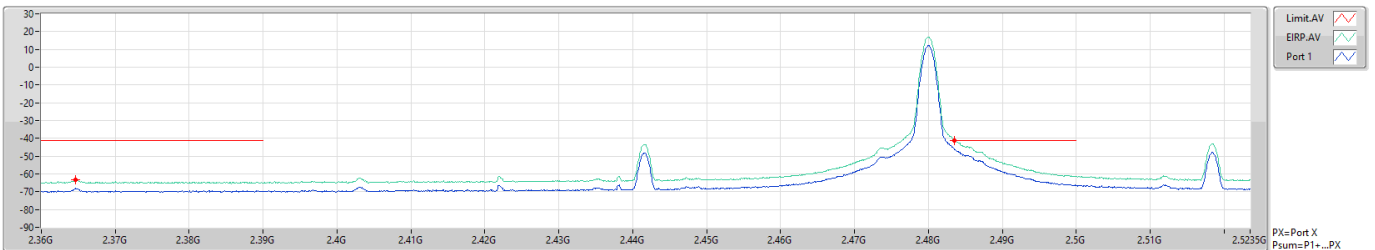

F-Start(Hz)	F-Stop(Hz)	RBW(Hz)	Type	Freq(Hz)	EIRP(dBm)	Limit(dBm)	Margin(dB)	DG(dBi)	Ref(dB)	Psum(dBm)	P1(dBm)
2.36G	2.5235G	1M	AV	2.36498G	-63.15	-41.20	-21.95	5.00	0.00	-68.15	-68.15
2.36G	2.5235G	1M	AV	2.48352G	-41.25	-41.20	-0.05	5.00	0.00	-46.25	-46.25

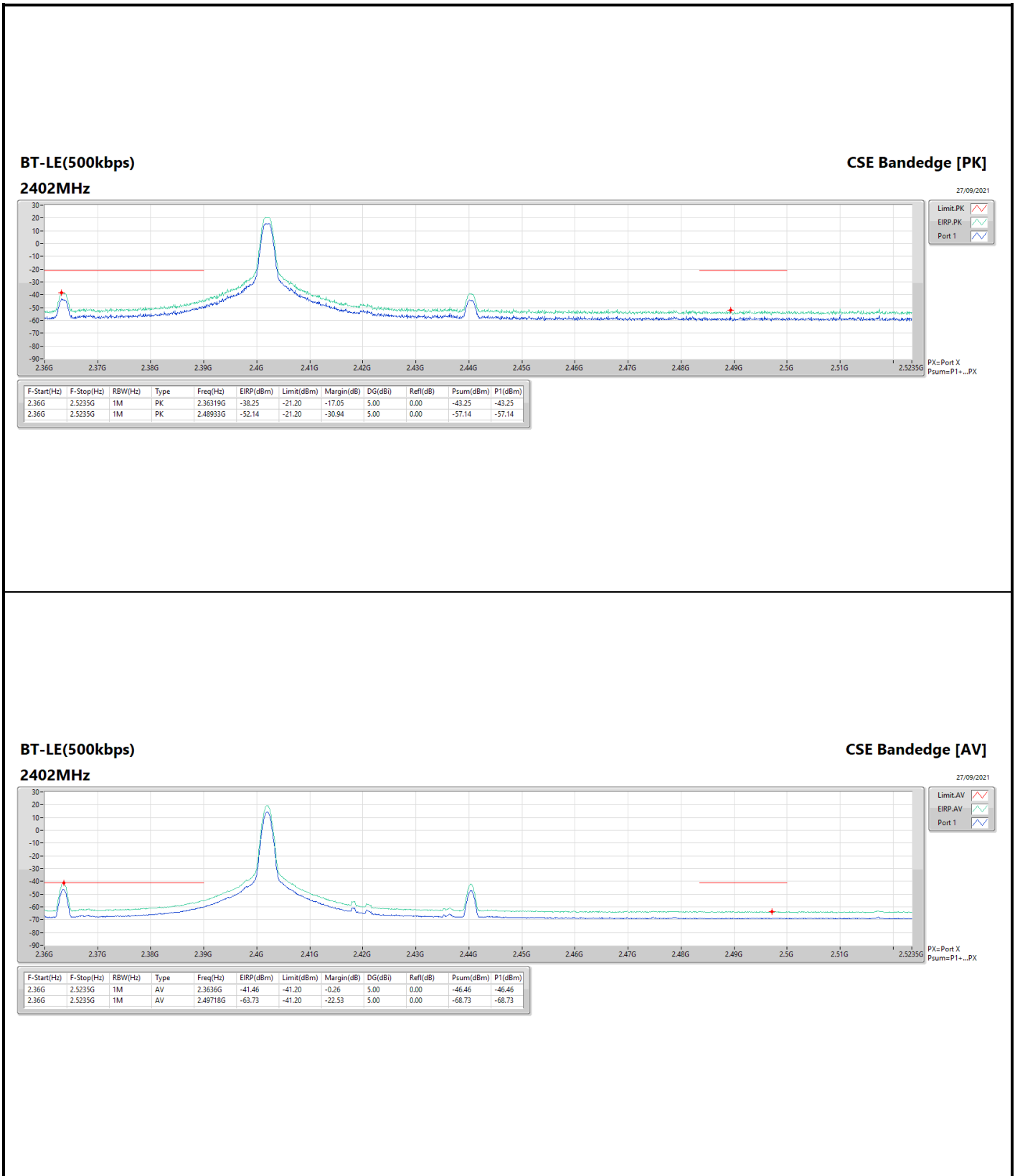

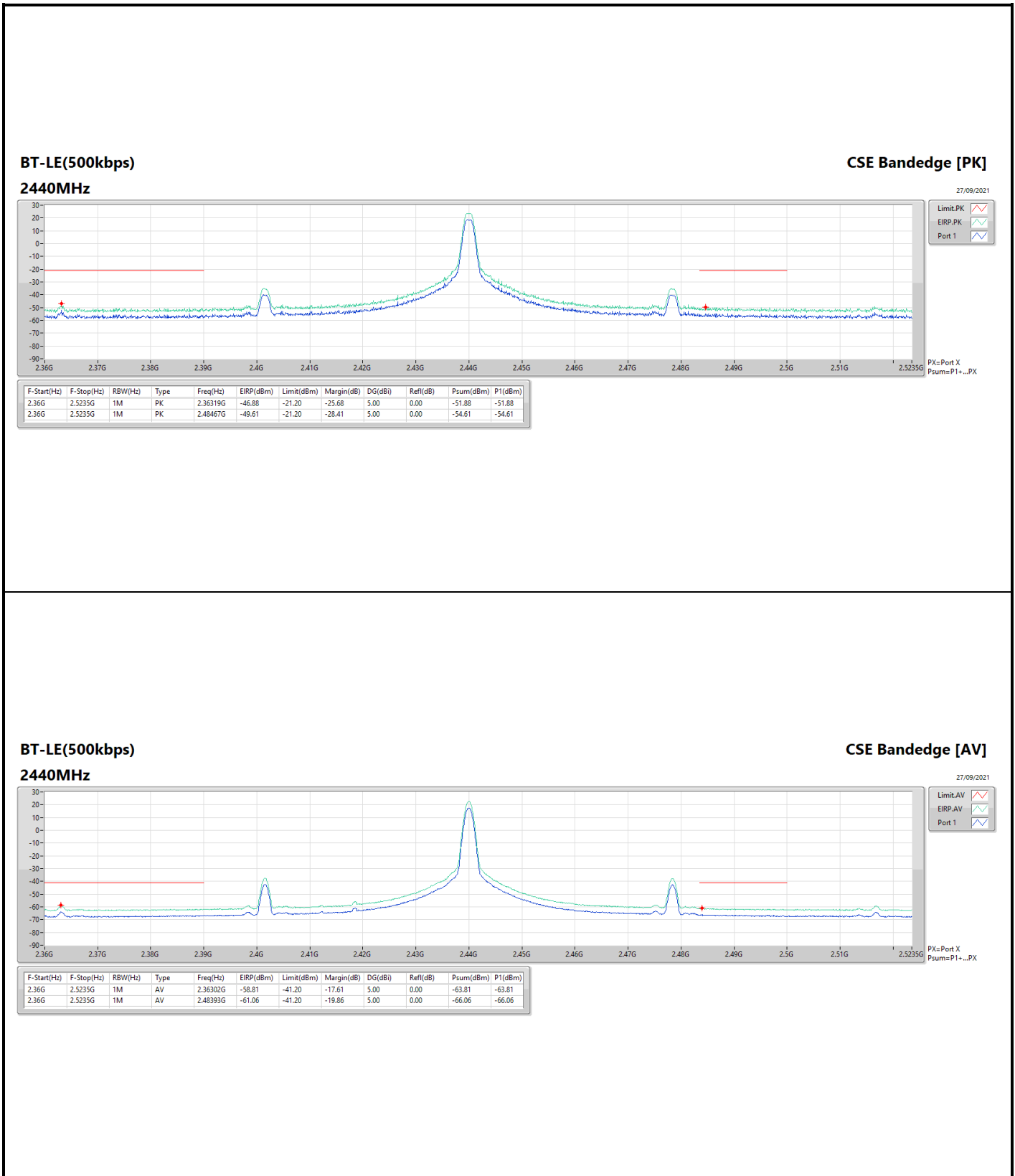

BT-LE(500kbps)

CSE Bandedge [PK]

2480MHz

27/09/2021

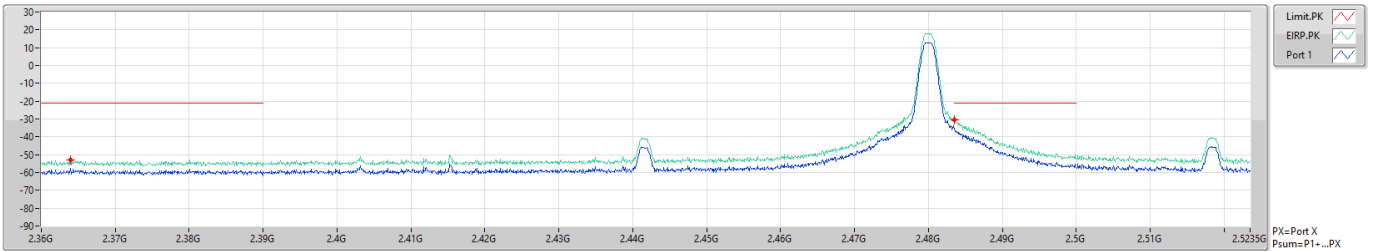

F-Start(Hz)	F-Stop(Hz)	RBW(Hz)	Type	Freq(Hz)	EIRP(dBm)	Limit(dBm)	Margin(dB)	DG(dBi)	Ref(dB)	Psum(dBm)	P1(dBm)
2.36G	2.5235G	1M	PK	2.36392G	-52.87	-21.20	-31.67	5.00	0.00	-57.87	-57.87
2.36G	2.5235G	1M	PK	2.48352G	-30.31	-21.20	-9.11	5.00	0.00	-35.31	-35.31

BT-LE(500kbps)

CSE Bandedge [AV]

2480MHz

27/09/2021

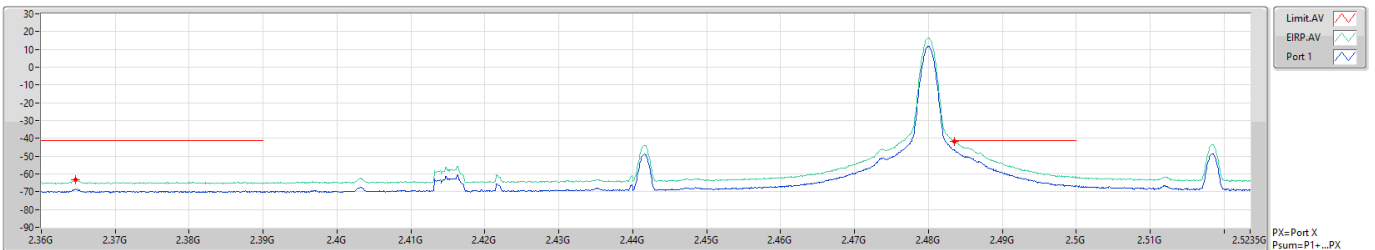

F-Start(Hz)	F-Stop(Hz)	RBW(Hz)	Type	Freq(Hz)	EIRP(dBm)	Limit(dBm)	Margin(dB)	DG(dBi)	Ref(dB)	Psum(dBm)	P1(dBm)
2.36G	2.5235G	1M	AV	2.36466G	-63.49	-41.20	-22.29	5.00	0.00	-68.49	-68.49
2.36G	2.5235G	1M	AV	2.48352G	-41.84	-41.20	-0.64	5.00	0.00	-46.84	-46.84



Summary

Mode	Result	F-Start (Hz)	F-Stop (Hz)	Type	Freq (Hz)	DG (dBi)	Psum (dBm)	EIRP (dBm)	Limit (dBm)	Margin (dB)	P1 (dBm)
2.4-2.4835GHz	-	-	-	-	-	-	-	-	-	-	-
BT-LE(1Mbps)	Pass	1G	25G	AV	7.31875G	5.00	-50.27	-45.27	-41.20	-4.07	-50.27
BT-LE(2Mbps)	Pass	1G	25G	AV	7.31875G	5.00	-50.07	-45.07	-41.20	-3.87	-50.07
BT-LE(125kbps)	Pass	1G	25G	AV	7.32025G	5.00	-56.26	-51.26	-41.20	-10.06	-56.26
BT-LE(500kbps)	Pass	1G	25G	AV	7.31875G	5.00	-49.38	-44.38	-41.20	-3.18	-49.38

DG = Directional Gain ; PX=Port X; Psum=P1+P2+...PX



Result

Mode	Result	F-Start (Hz)	F-Stop (Hz)	Type	Freq (Hz)	DG (dBi)	Psum (dBm)	EIRP (dBm)	Limit (dBm)	Margin (dB)	P1 (dBm)
BT-LE(1Mbps)	-	-	-	-	-	-	-	-	-	-	-
2402MHz	Pass	1G	25G	AV	4.80325G	5.00	-59.79	-54.79	-41.20	-13.59	-59.79
2402MHz	Pass	1G	25G	AV	19.8505G	5.00	-57.10	-52.10	-41.20	-10.90	-57.10
2402MHz	Pass	1G	25G	PK	4.804G	5.00	-54.94	-49.94	-21.20	-28.74	-54.94
2402MHz	Pass	1G	25G	PK	19.88575G	5.00	-48.49	-43.49	-21.20	-22.29	-48.49
2440MHz	Pass	1G	25G	AV	4.87975G	5.00	-59.72	-54.72	-41.20	-13.52	-59.72
2440MHz	Pass	1G	25G	AV	7.31875G	5.00	-50.27	-45.27	-41.20	-4.07	-50.27
2440MHz	Pass	1G	25G	PK	4.87975G	5.00	-55.47	-50.47	-21.20	-29.27	-55.47
2440MHz	Pass	1G	25G	PK	7.321G	5.00	-46.47	-41.47	-21.20	-20.27	-46.47
2480MHz	Pass	1G	25G	AV	4.96G	5.00	-58.42	-53.42	-41.20	-12.22	-58.42
2480MHz	Pass	1G	25G	AV	15.74125G	5.00	-57.00	-52.00	-41.20	-10.80	-57.00
2480MHz	Pass	1G	25G	PK	4.95925G	5.00	-53.28	-48.28	-21.20	-27.08	-53.28
2480MHz	Pass	1G	25G	PK	19.88875G	5.00	-47.76	-42.76	-21.20	-21.56	-47.76
BT-LE(2Mbps)	-	-	-	-	-	-	-	-	-	-	-
2402MHz	Pass	1G	25G	AV	4.80325G	5.00	-61.64	-56.64	-41.20	-15.44	-61.64
2402MHz	Pass	1G	25G	AV	19.84675G	5.00	-57.22	-52.22	-41.20	-11.02	-57.22
2402MHz	Pass	1G	25G	PK	4.80475G	5.00	-54.10	-49.10	-21.20	-27.90	-54.10
2402MHz	Pass	1G	25G	PK	19.8355G	5.00	-47.60	-42.60	-21.20	-21.40	-47.60
2440MHz	Pass	1G	25G	AV	4.879G	5.00	-63.63	-58.63	-41.20	-17.43	-63.63
2440MHz	Pass	1G	25G	AV	7.31875G	5.00	-50.07	-45.07	-41.20	-3.87	-50.07
2440MHz	Pass	1G	25G	PK	4.87975G	5.00	-58.50	-53.50	-21.20	-32.30	-58.50
2440MHz	Pass	1G	25G	PK	7.321G	5.00	-45.82	-40.82	-21.20	-19.62	-45.82
2480MHz	Pass	1G	25G	AV	4.96G	5.00	-63.44	-58.44	-41.20	-17.24	-63.44
2480MHz	Pass	1G	25G	AV	19.84525G	5.00	-57.22	-52.22	-41.20	-11.02	-57.22
2480MHz	Pass	1G	25G	PK	4.96075G	5.00	-55.91	-50.91	-21.20	-29.71	-55.91
2480MHz	Pass	1G	25G	PK	19.819G	5.00	-48.50	-43.50	-21.20	-22.30	-48.50
BT-LE(125kbps)	-	-	-	-	-	-	-	-	-	-	-
2402MHz	Pass	1G	25G	AV	4.804G	5.00	-58.55	-53.55	-41.20	-12.35	-58.55
2402MHz	Pass	1G	25G	AV	19.83475G	5.00	-56.98	-51.98	-41.20	-10.78	-56.98
2402MHz	Pass	1G	25G	PK	4.804G	5.00	-51.78	-46.78	-21.20	-25.58	-51.78
2402MHz	Pass	1G	25G	PK	18.26425G	5.00	-47.86	-42.86	-21.20	-21.66	-47.86
2440MHz	Pass	1G	25G	AV	4.8805G	5.00	-58.28	-53.28	-41.20	-12.08	-58.28
2440MHz	Pass	1G	25G	AV	7.32025G	5.00	-56.26	-51.26	-41.20	-10.06	-56.26
2440MHz	Pass	1G	25G	PK	4.8805G	5.00	-54.16	-49.16	-21.20	-27.96	-54.16
2440MHz	Pass	1G	25G	PK	15.7555G	5.00	-47.97	-42.97	-21.20	-21.77	-47.97
2480MHz	Pass	1G	25G	AV	4.95925G	5.00	-59.64	-54.64	-41.20	-13.44	-59.64
2480MHz	Pass	1G	25G	AV	19.87975G	5.00	-57.13	-52.13	-41.20	-10.93	-57.13
2480MHz	Pass	1G	25G	PK	4.95925G	5.00	-52.57	-47.57	-21.20	-26.37	-52.57
2480MHz	Pass	1G	25G	PK	15.81175G	5.00	-48.08	-43.08	-21.20	-21.88	-48.08
BT-LE(500kbps)	-	-	-	-	-	-	-	-	-	-	-
2402MHz	Pass	1G	25G	AV	4.80325G	5.00	-59.46	-54.46	-41.20	-13.26	-59.46
2402MHz	Pass	1G	25G	AV	19.83925G	5.00	-56.86	-51.86	-41.20	-10.66	-56.86
2402MHz	Pass	1G	25G	PK	4.80325G	5.00	-52.95	-47.95	-21.20	-26.75	-52.95
2402MHz	Pass	1G	25G	PK	15.8545G	5.00	-48.65	-43.65	-21.20	-22.45	-48.65
2440MHz	Pass	1G	25G	AV	4.87975G	5.00	-60.49	-55.49	-41.20	-14.29	-60.49
2440MHz	Pass	1G	25G	AV	7.31875G	5.00	-49.38	-44.38	-41.20	-3.18	-49.38
2440MHz	Pass	1G	25G	PK	4.87975G	5.00	-55.28	-50.28	-21.20	-29.08	-55.28
2440MHz	Pass	1G	25G	PK	7.321G	5.00	-45.63	-40.63	-21.20	-19.43	-45.63
2480MHz	Pass	1G	25G	AV	4.96G	5.00	-58.81	-53.81	-41.20	-12.61	-58.81
2480MHz	Pass	1G	25G	AV	19.861G	5.00	-56.63	-51.63	-41.20	-10.43	-56.63
2480MHz	Pass	1G	25G	PK	4.95925G	5.00	-53.17	-48.17	-21.20	-26.97	-53.17
2480MHz	Pass	1G	25G	PK	19.86025G	5.00	-47.52	-42.52	-21.20	-21.32	-47.52

DG = Directional Gain ; PX=Port X; Psum=P1+P2+...PX

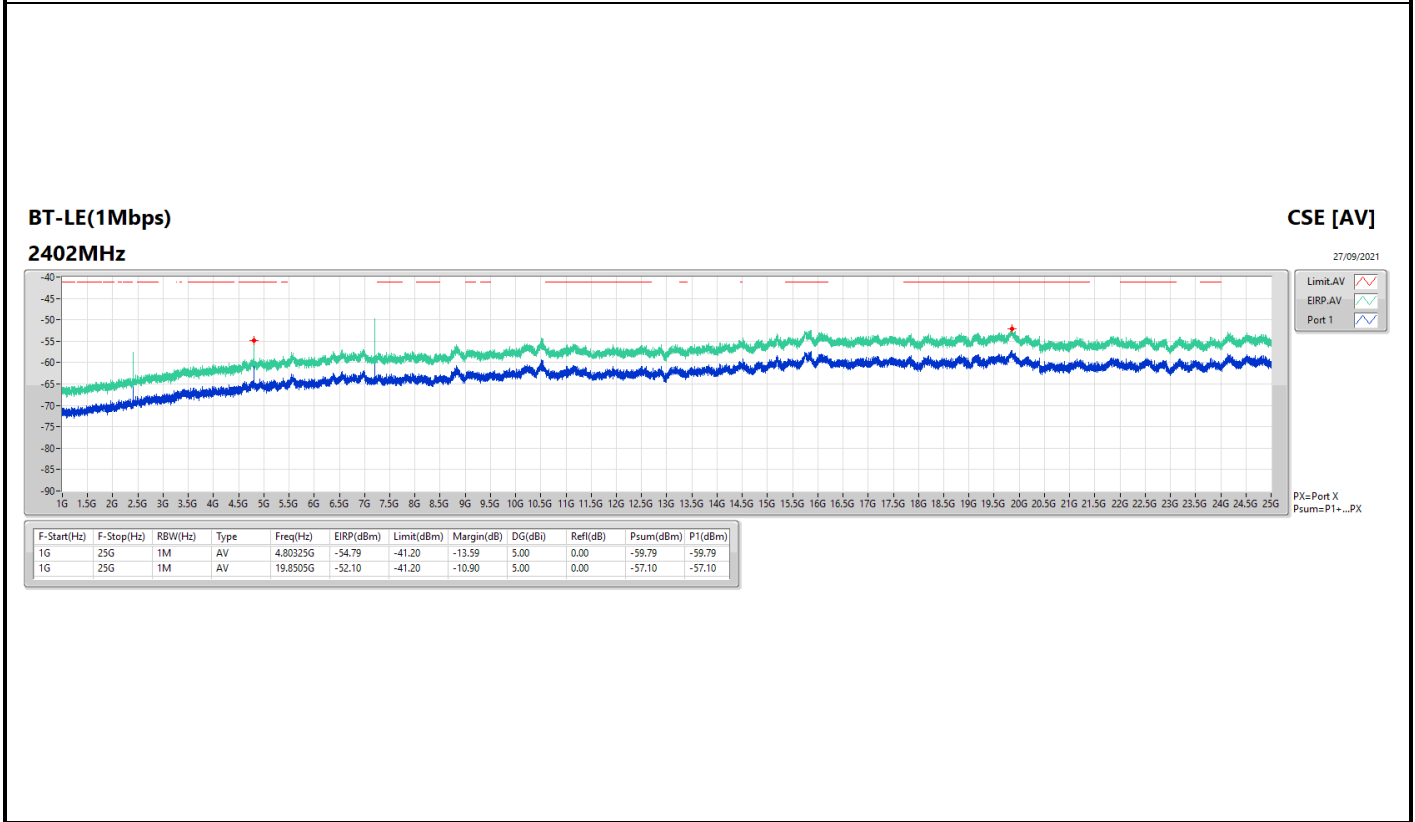
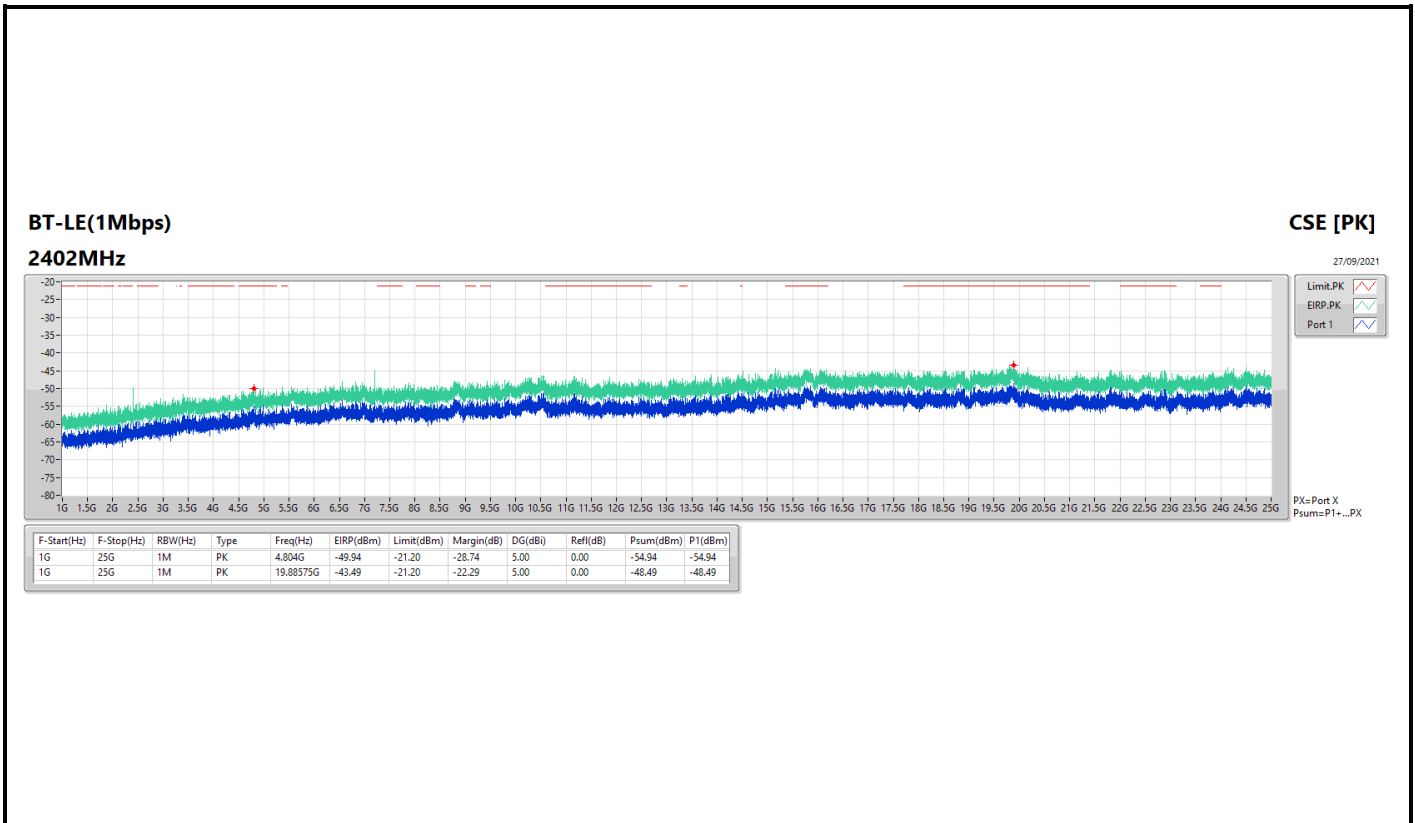

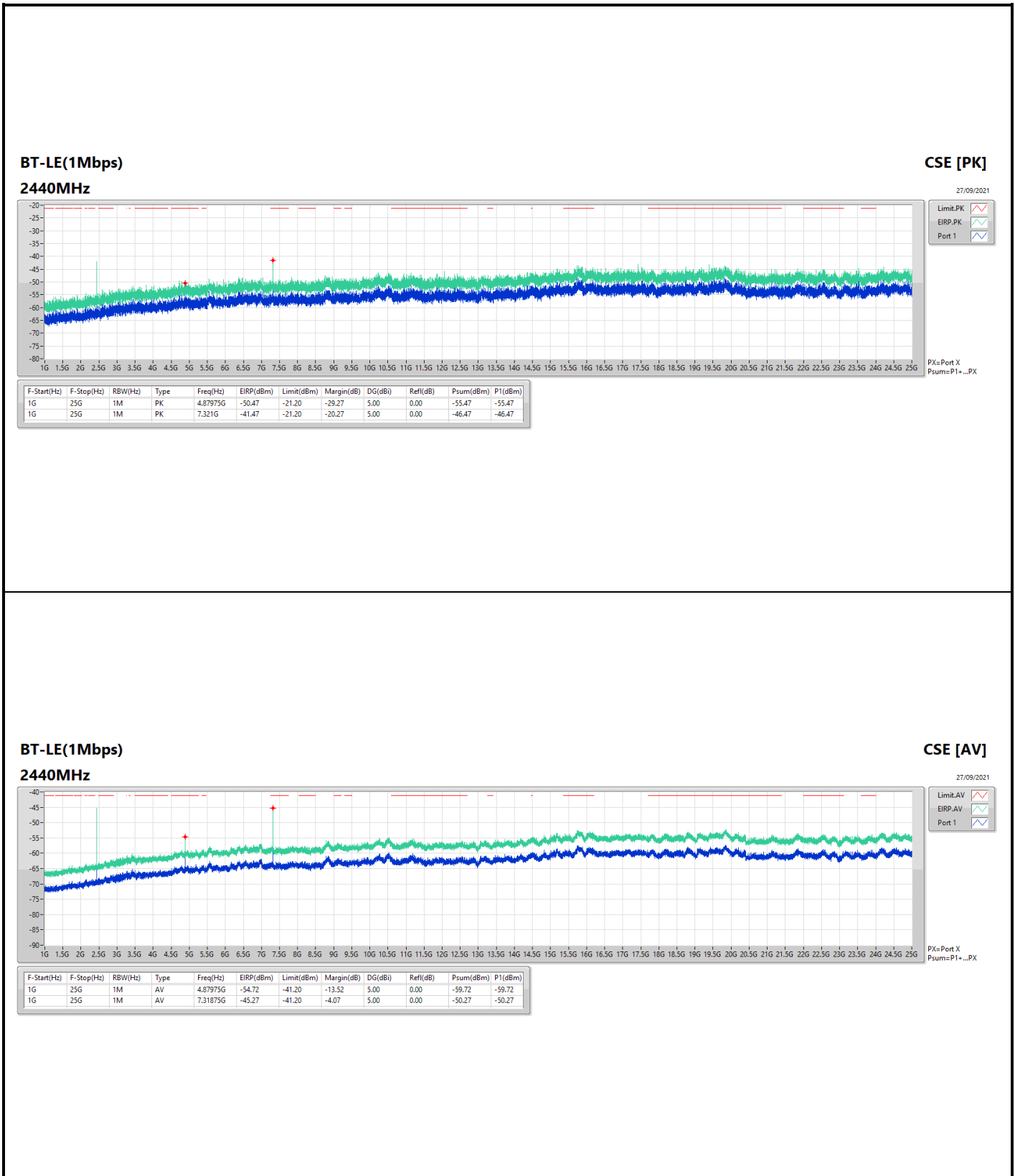

BT-LE(1Mbps)
2440MHz

CSE [AV]

27/09/2021

Limit.AV

EIRP.AV

Port.1

PX=Port X
Psum=P1+...PX

BT-LE(1Mbps)

CSE [PK]

2480MHz

27/09/2021

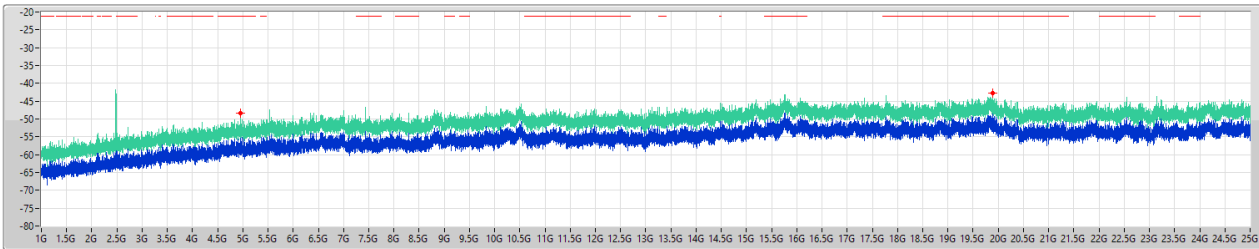

Legend for CSE [PK]:
 Limit.PK (Red dashed line)
 EIRP.PK (Green line)
 Port.1 (Blue line)

PX=Port X
 Psum=P1+...PX

F-Start(Hz)	F-Stop(Hz)	RBW(Hz)	Type	Freq(Hz)	EIRP(dBm)	Limit(dBm)	Margin(dB)	DG(dBi)	Ref(dB)	Psum(dBm)	P1(dBm)
1G	25G	1M	PK	4.95925G	-48.28	-21.20	-27.08	5.00	0.00	-53.28	-53.28
1G	25G	1M	PK	19.88875G	-42.76	-21.20	-21.56	5.00	0.00	-47.76	-47.76

BT-LE(1Mbps)

CSE [AV]

2480MHz

27/09/2021

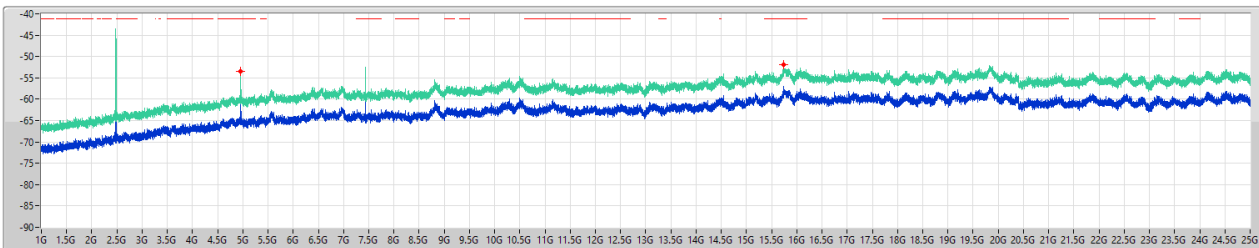

Legend for CSE [AV]:
 Limit.AV (Red dashed line)
 EIRP.AV (Green line)
 Port.1 (Blue line)

PX=Port X
 Psum=P1+...PX

F-Start(Hz)	F-Stop(Hz)	RBW(Hz)	Type	Freq(Hz)	EIRP(dBm)	Limit(dBm)	Margin(dB)	DG(dBi)	Ref(dB)	Psum(dBm)	P1(dBm)
1G	25G	1M	AV	4.96G	-53.42	-41.20	-12.22	5.00	0.00	-58.42	-58.42
1G	25G	1M	AV	15.74125G	-52.00	-41.20	-10.80	5.00	0.00	-57.00	-57.00

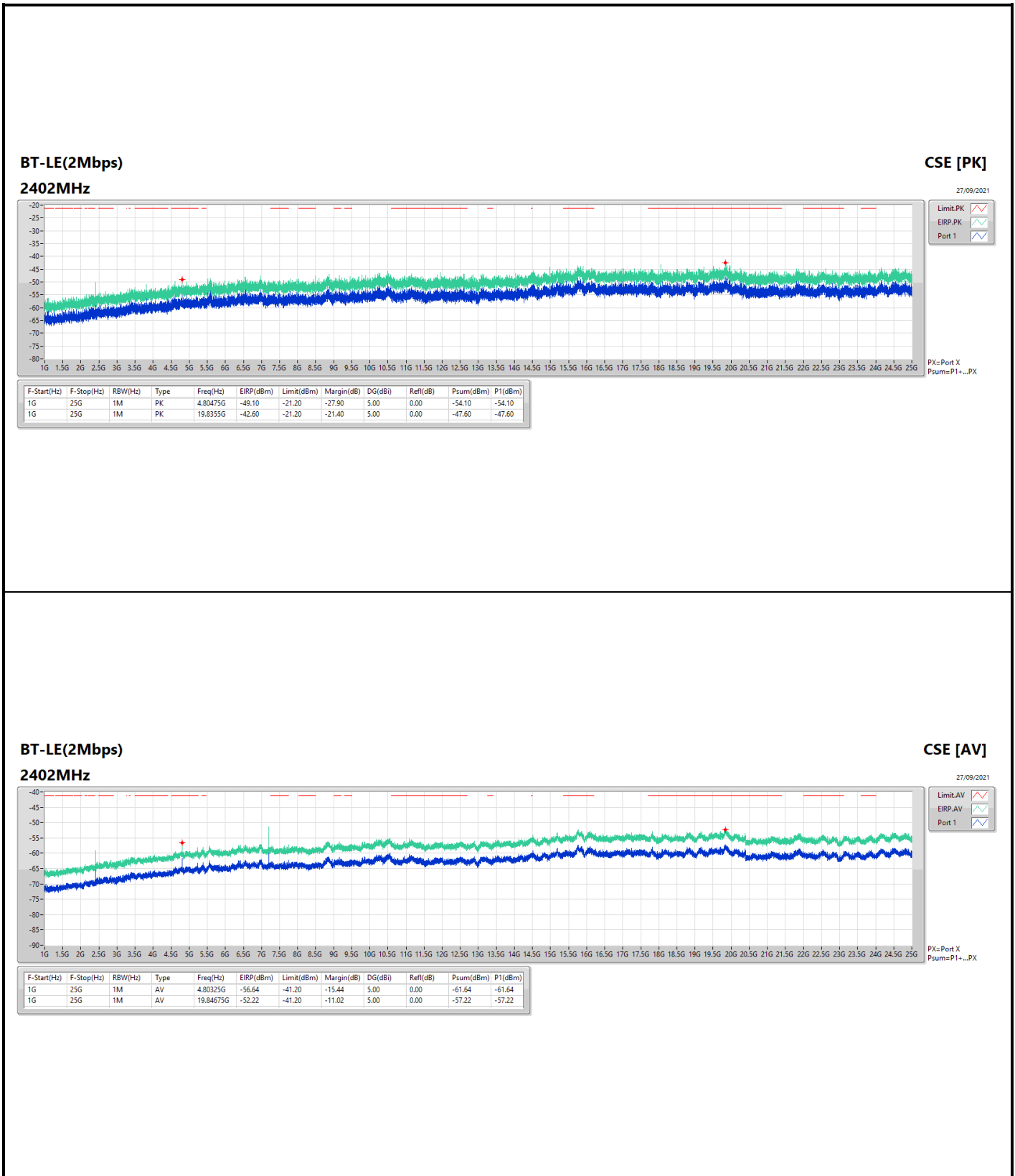

BT-LE(2Mbps)

CSE [PK]

2440MHz

27/09/2021

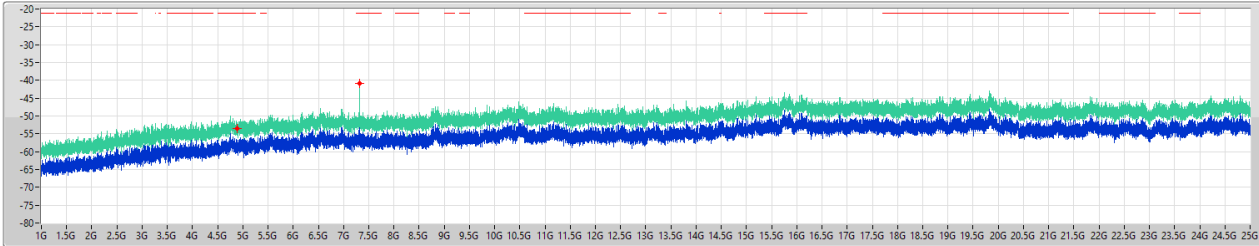

Limit.PK 
 EIRP.PK 
 Port.1 

PX=Port X
Psum=P1+...PX

F-Start(Hz)	F-Stop(Hz)	RBW(Hz)	Type	Freq(Hz)	EIRP(dBm)	Limit(dBm)	Margin(dB)	DG(dBi)	Ref(dB)	Psum(dBm)	P1(dBm)
1G	25G	1M	PK	4.87975G	-53.50	-21.20	-32.30	5.00	0.00	-58.50	-58.50
1G	25G	1M	PK	7.321G	-40.82	-21.20	-19.62	5.00	0.00	-45.82	-45.82

BT-LE(2Mbps)

CSE [AV]

2440MHz

27/09/2021

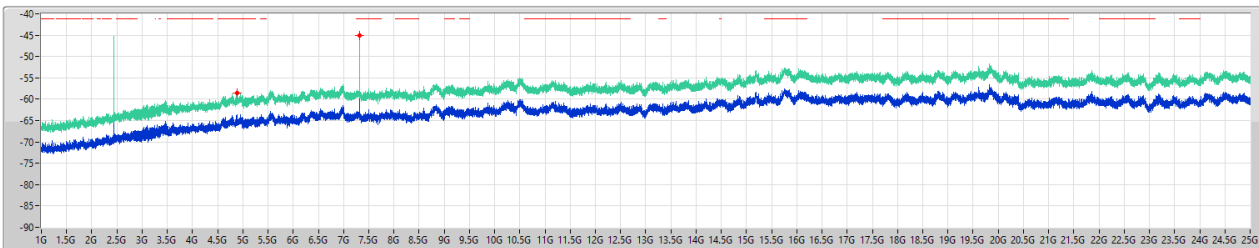

Limit.AV 
 EIRP.AV 
 Port.1 

PX=Port X
Psum=P1+...PX

F-Start(Hz)	F-Stop(Hz)	RBW(Hz)	Type	Freq(Hz)	EIRP(dBm)	Limit(dBm)	Margin(dB)	DG(dBi)	Ref(dB)	Psum(dBm)	P1(dBm)
1G	25G	1M	AV	4.879G	-58.63	-41.20	-17.43	5.00	0.00	-63.63	-63.63
1G	25G	1M	AV	7.31875G	-45.07	-41.20	-3.87	5.00	0.00	-50.07	-50.07

BT-LE(2Mbps)
2480MHz

CSE [PK]

27/09/2021

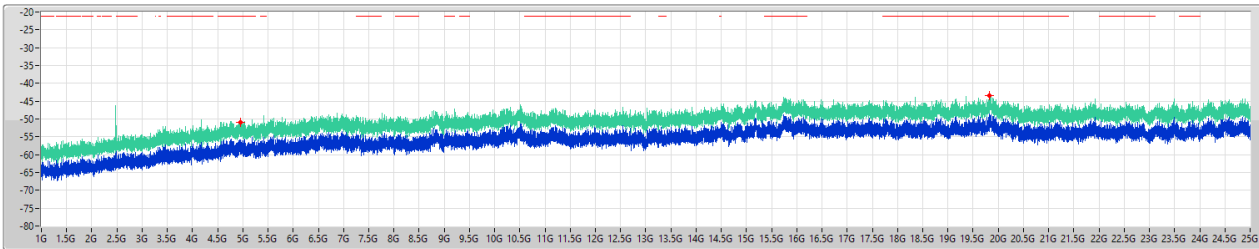

Legend:
Limit.PK (Red dashed line)
EIRP.PK (Green line)
Port.1 (Blue line)

PX=Port X
Psum=P1+...PX

F-Start(Hz)	F-Stop(Hz)	RBW(Hz)	Type	Freq(Hz)	EIRP(dBm)	Limit(dBm)	Margin(dB)	DG(dBi)	Ref(dB)	Psum(dBm)	P1(dBm)
1G	25G	1M	PK	4.96075G	-50.91	-21.20	-29.71	5.00	0.00	-55.91	-55.91
1G	25G	1M	PK	19.819G	-43.50	-21.20	-22.30	5.00	0.00	-48.50	-48.50

BT-LE(2Mbps)
2480MHz

CSE [AV]

27/09/2021

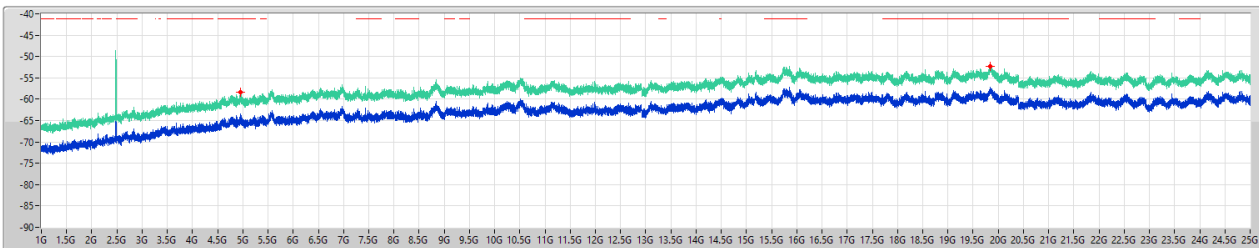

Legend:
Limit.AV (Red dashed line)
EIRP.AV (Green line)
Port.1 (Blue line)

PX=Port X
Psum=P1+...PX

F-Start(Hz)	F-Stop(Hz)	RBW(Hz)	Type	Freq(Hz)	EIRP(dBm)	Limit(dBm)	Margin(dB)	DG(dBi)	Ref(dB)	Psum(dBm)	P1(dBm)
1G	25G	1M	AV	4.96G	-58.44	-41.20	-17.24	5.00	0.00	-63.44	-63.44
1G	25G	1M	AV	19.84525G	-52.22	-41.20	-11.02	5.00	0.00	-57.22	-57.22

BT-LE(125kbps)
2402MHz

CSE [PK]

27/09/2021

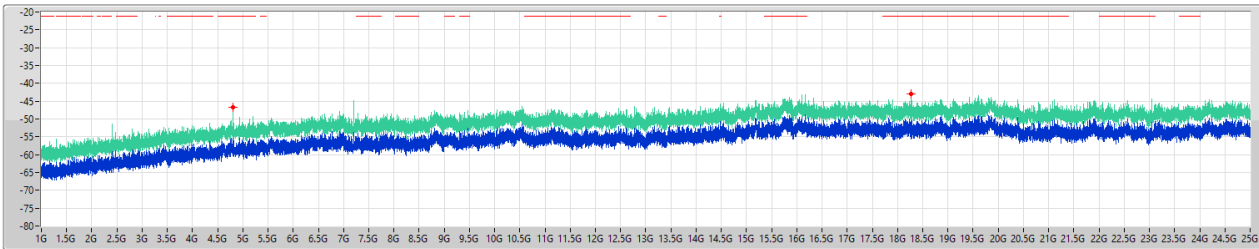

Limit.PK
EIRP.PK
Port.1

PX=Port X
Psum=P1+...PX

F-Start(Hz)	F-Stop(Hz)	RBW(Hz)	Type	Freq(Hz)	EIRP(dBm)	Limit(dBm)	Margin(dB)	DG(dBi)	Ref(dB)	Psum(dBm)	P1(dBm)
1G	25G	1M	PK	4.804G	-46.78	-21.20	-25.58	5.00	0.00	-51.78	-51.78
1G	25G	1M	PK	18.26425G	-42.86	-21.20	-21.66	5.00	0.00	-47.86	-47.86

BT-LE(125kbps)
2402MHz

CSE [AV]

27/09/2021

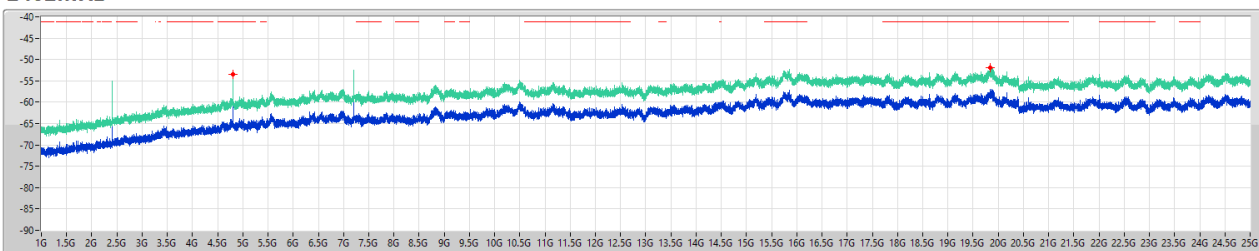

Limit.AV
EIRP.AV
Port.1

PX=Port X
Psum=P1+...PX

F-Start(Hz)	F-Stop(Hz)	RBW(Hz)	Type	Freq(Hz)	EIRP(dBm)	Limit(dBm)	Margin(dB)	DG(dBi)	Ref(dB)	Psum(dBm)	P1(dBm)
1G	25G	1M	AV	4.804G	-53.55	-41.20	-12.35	5.00	0.00	-58.55	-58.55
1G	25G	1M	AV	19.83475G	-51.98	-41.20	-10.78	5.00	0.00	-56.98	-56.98

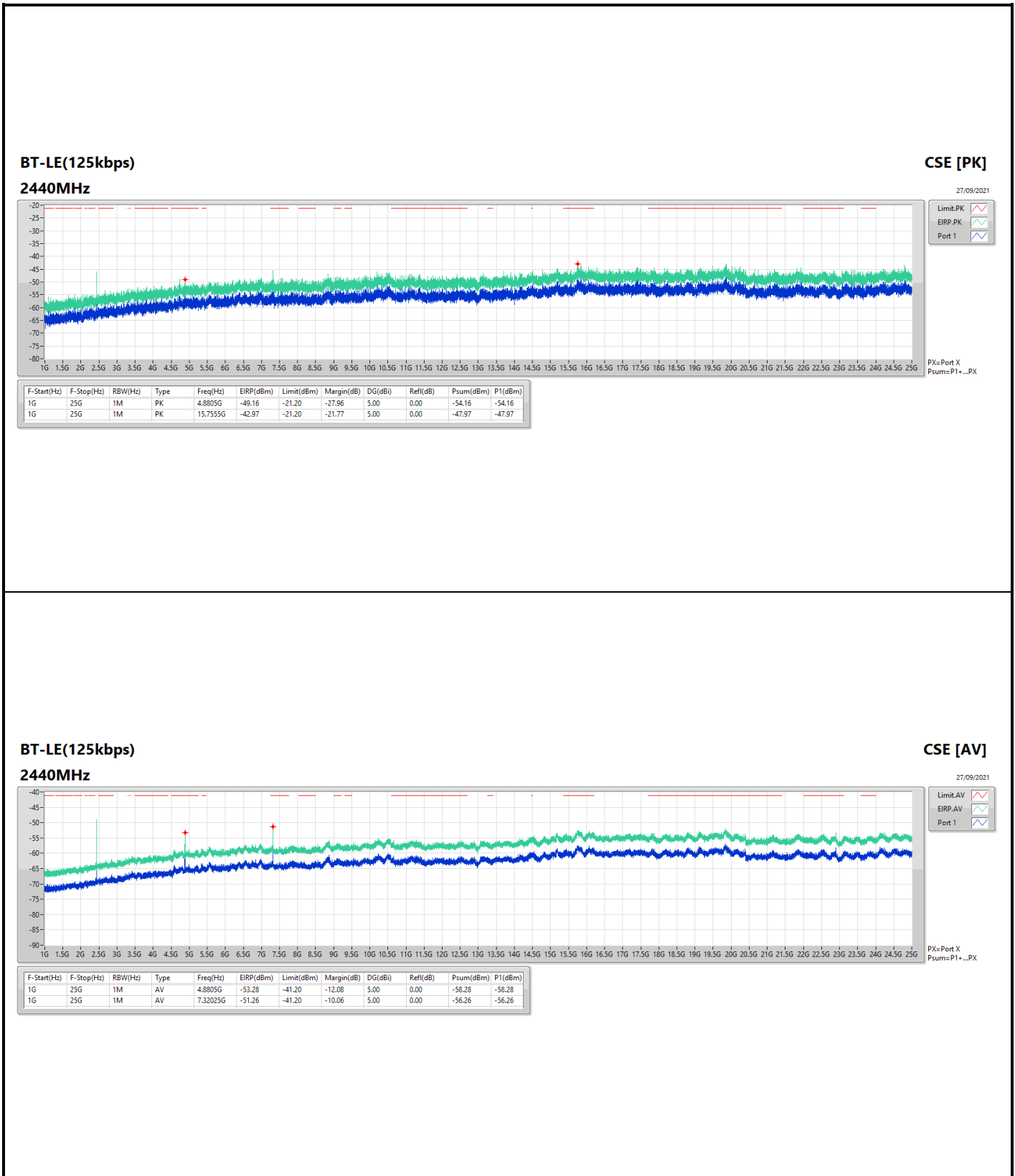

BT-LE(125kbps)
2480MHz

CSE [PK]

27/09/2021

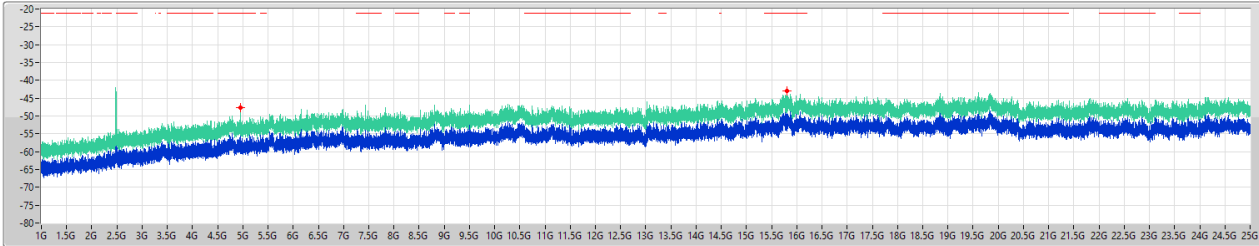

Limit.PK
EIRP.PK
Port.1

PX=Port X
Psum=P1+...PX

F-Start(Hz)	F-Stop(Hz)	RBW(Hz)	Type	Freq(Hz)	EIRP(dBm)	Limit(dBm)	Margin(dB)	DG(dBi)	Ref(dB)	Psum(dBm)	P1(dBm)
1G	25G	1M	PK	4.95925G	-47.57	-21.20	-26.37	5.00	0.00	-52.57	-52.57
1G	25G	1M	PK	15.81175G	-43.08	-21.20	-21.88	5.00	0.00	-48.08	-48.08

BT-LE(125kbps)
2480MHz

CSE [AV]

27/09/2021

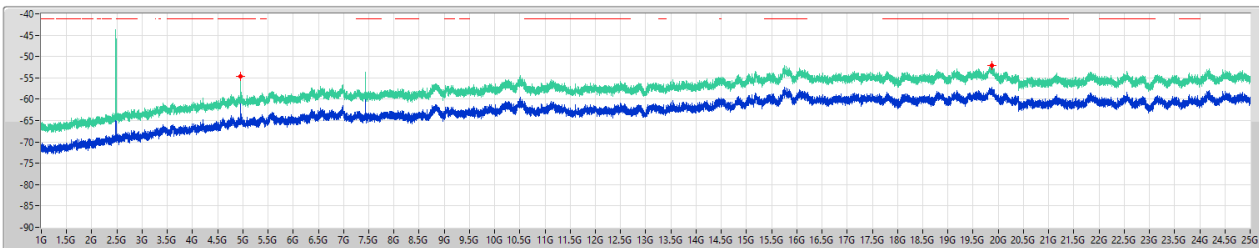

Limit.AV
EIRP.AV
Port.1

PX=Port X
Psum=P1+...PX

F-Start(Hz)	F-Stop(Hz)	RBW(Hz)	Type	Freq(Hz)	EIRP(dBm)	Limit(dBm)	Margin(dB)	DG(dBi)	Ref(dB)	Psum(dBm)	P1(dBm)
1G	25G	1M	AV	4.95925G	-54.64	-41.20	-13.44	5.00	0.00	-59.64	-59.64
1G	25G	1M	AV	19.87975G	-52.13	-41.20	-10.93	5.00	0.00	-57.13	-57.13

BT-LE(500kbps)
2402MHz

CSE [PK]

27/09/2021

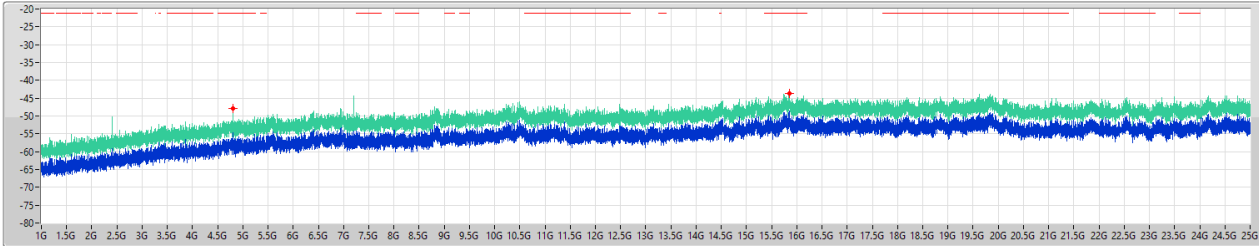

PX=Port X
Psum=P1+...PX

F-Start(Hz)	F-Stop(Hz)	RBW(Hz)	Type	Freq(Hz)	EIRP(dBm)	Limit(dBm)	Margin(dB)	DG(dBi)	Ref(dB)	Psum(dBm)	P1(dBm)
1G	25G	1M	PK	4.80325G	-47.95	-21.20	-26.75	5.00	0.00	-52.95	-52.95
1G	25G	1M	PK	15.8545G	-43.65	-21.20	-22.45	5.00	0.00	-48.65	-48.65

BT-LE(500kbps)
2402MHz

CSE [AV]

27/09/2021

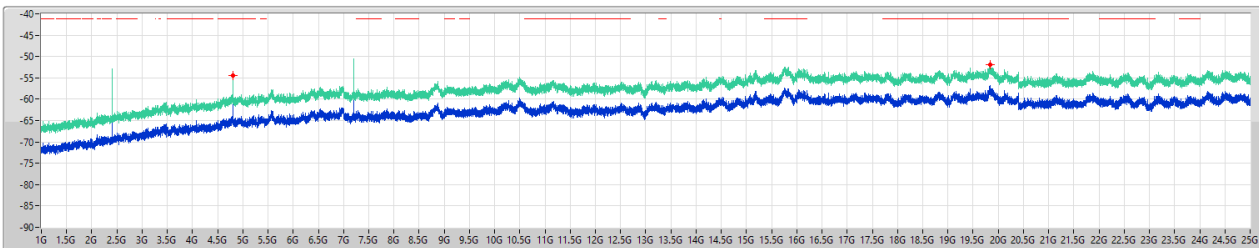

PX=Port X
Psum=P1+...PX

F-Start(Hz)	F-Stop(Hz)	RBW(Hz)	Type	Freq(Hz)	EIRP(dBm)	Limit(dBm)	Margin(dB)	DG(dBi)	Ref(dB)	Psum(dBm)	P1(dBm)
1G	25G	1M	AV	4.80325G	-54.46	-41.20	-13.26	5.00	0.00	-59.46	-59.46
1G	25G	1M	AV	19.83925G	-51.86	-41.20	-10.66	5.00	0.00	-56.86	-56.86

BT-LE(500kbps)
2440MHz

CSE [PK]

27/09/2021

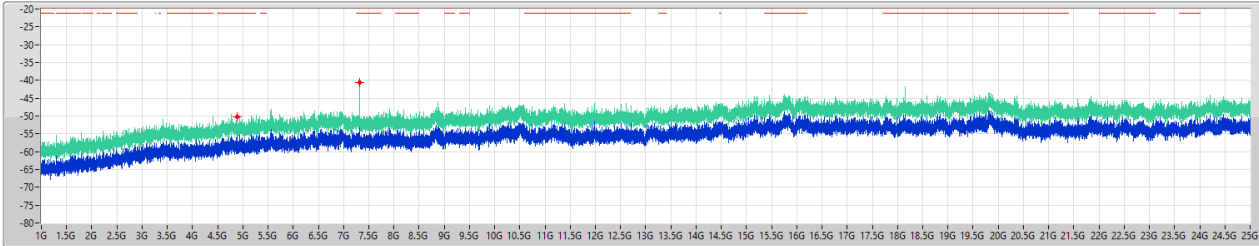

Limit.PK
EIRP.PK
Port.1

PX=Port X
Psum=P1+...PX

F-Start(Hz)	F-Stop(Hz)	RBW(Hz)	Type	Freq(Hz)	EIRP(dBm)	Limit(dBm)	Margin(dB)	DG(dBi)	Ref(dB)	Psum(dBm)	P1(dBm)
1G	25G	1M	PK	4.87975G	-50.28	-21.20	-29.08	5.00	0.00	-55.28	-55.28
1G	25G	1M	PK	7.321G	-40.63	-21.20	-19.43	5.00	0.00	-45.63	-45.63

BT-LE(500kbps)
2440MHz

CSE [AV]

27/09/2021

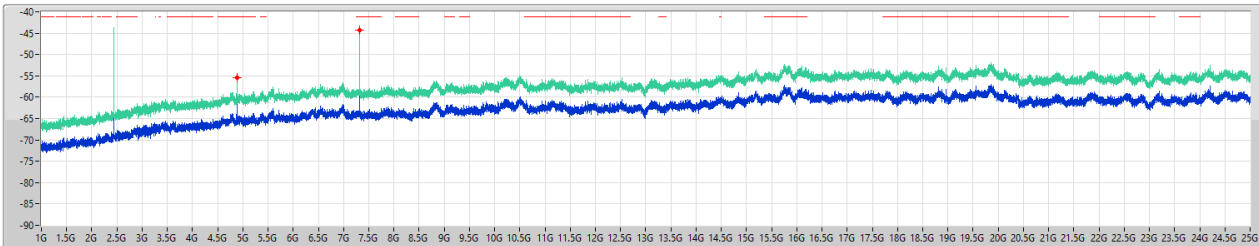

Limit.AV
EIRP.AV
Port.1

PX=Port X
Psum=P1+...PX

F-Start(Hz)	F-Stop(Hz)	RBW(Hz)	Type	Freq(Hz)	EIRP(dBm)	Limit(dBm)	Margin(dB)	DG(dBi)	Ref(dB)	Psum(dBm)	P1(dBm)
1G	25G	1M	AV	4.87975G	-55.49	-41.20	-14.29	5.00	0.00	-60.49	-60.49
1G	25G	1M	AV	7.31875G	-44.38	-41.20	-3.18	5.00	0.00	-49.38	-49.38

BT-LE(500kbps)
2480MHz

CSE [PK]

27/09/2021

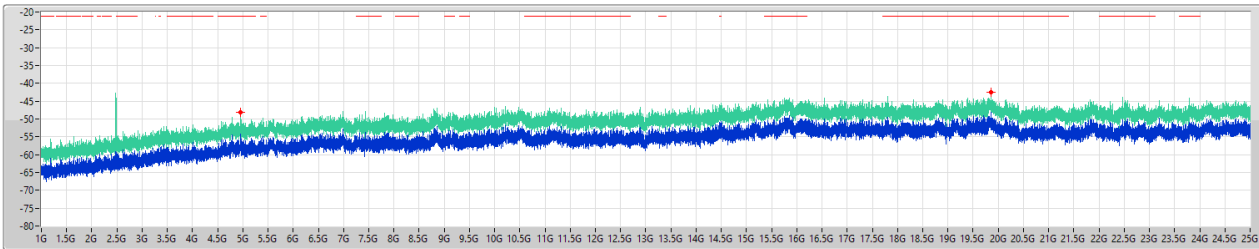

Limit.PK
EIRP.PK
Port.1

PX=Port X
Psum=P1+...PX

F-Start(Hz)	F-Stop(Hz)	RBW(Hz)	Type	Freq(Hz)	EIRP(dBm)	Limit(dBm)	Margin(dB)	DG(dBi)	Ref(dB)	Psum(dBm)	P1(dBm)
1G	25G	1M	PK	4.95925G	-48.17	-21.20	-26.97	5.00	0.00	-53.17	-53.17
1G	25G	1M	PK	19.86025G	-42.52	-21.20	-21.32	5.00	0.00	-47.52	-47.52

BT-LE(500kbps)
2480MHz

CSE [AV]

27/09/2021

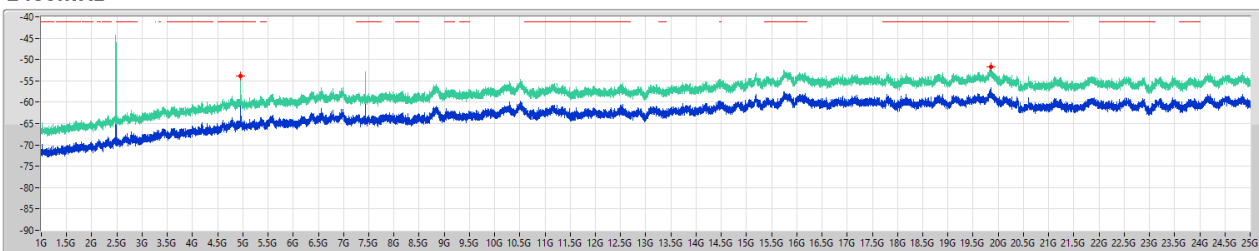

Limit.AV
EIRP.AV
Port.1

PX=Port X
Psum=P1+...PX

F-Start(Hz)	F-Stop(Hz)	RBW(Hz)	Type	Freq(Hz)	EIRP(dBm)	Limit(dBm)	Margin(dB)	DG(dBi)	Ref(dB)	Psum(dBm)	P1(dBm)
1G	25G	1M	AV	4.96G	-53.81	-41.20	-12.61	5.00	0.00	-58.81	-58.81
1G	25G	1M	AV	19.861G	-51.63	-41.20	-10.43	5.00	0.00	-56.63	-56.63