



# RADIO TEST REPORT

**FCC ID** : LDKIW9167IH  
**Equipment** : Cisco Catalyst IW9167I Heavy Duty Access Point  
**Brand Name** : CISCO  
**Model Name** : IW9167IH-B , IW9167IH-ROW  
**Applicant** : Cisco Systems Inc  
125 West Tasman Drive San Jose California United States 95134-1706  
**Manufacturer** : Cisco Systems Inc  
125 West Tasman Drive San Jose California United States 95134-1706  
**Standard** : 47 CFR FCC Part 15.247

The product was received on Feb. 16, 2023, and testing was started from Mar. 17, 2023 and completed on Jul. 10, 2023. We, Sporton International Inc. Hsinchu Laboratory, would like to declare that the tested sample has been evaluated in accordance with the procedures given in ANSI C63.10-2013 and shown compliance with the applicable technical standards.

The test results in this report apply exclusively to the tested model / sample. Without written approval of Sporton International Inc. Hsinchu Laboratory, the test report shall not be reproduced except in full.



Approved by: Sam Chen

**Sporton International Inc. Hsinchu Laboratory**

No.8, Ln. 724, Bo'ai St., Zhubei City, Hsinchu County 302010, Taiwan (R.O.C.)



## Table of Contents

**History of this test report.....3**

**Summary of Test Result.....4**

**1 General Description .....5**

1.1 Information.....5

1.2 Applicable Standards .....10

1.3 Testing Location Information .....10

1.4 Measurement Uncertainty .....11

**2 Test Configuration of EUT .....12**

2.1 Test Channel Mode .....12

2.2 The Worst Case Measurement Configuration .....15

2.3 EUT Operation during Test .....17

2.4 Accessories .....18

2.5 Support Equipment.....18

2.6 Test Setup Diagram .....20

**3 Transmitter Test Result .....23**

3.1 AC Power-line Conducted Emissions .....23

3.2 DTS Bandwidth.....25

3.3 Maximum Conducted Output Power .....26

3.4 Power Spectral Density .....29

3.5 Emissions in Non-restricted Frequency Bands .....31

3.6 Emissions in Restricted Frequency Bands.....32

**4 Test Equipment and Calibration Data .....37**

**Appendix A. Test Results of AC Power-line Conducted Emissions**

**Appendix B. Test Results of DTS Bandwidth**

**Appendix C. Test Results of Maximum Conducted Output Power**

**Appendix D. Test Results of Power Spectral Density**

**Appendix E. Test Results of Emissions in Non-restricted Frequency Bands**

**Appendix F. Test Results of Emissions in Restricted Frequency Bands**

**Appendix G. Test Results of Radiated Emission Co-location**

**Appendix H. Test Photos**

**Photographs of EUT v01**





### Summary of Test Result

Report Clause	Ref Std. Clause	Test Items	Result (PASS/FAIL)	Remark
1.1.2	15.203	Antenna Requirement	PASS	-
3.1	15.207	AC Power-line Conducted Emissions	PASS	-
3.2	15.247(a)	DTS Bandwidth	PASS	-
3.3	15.247(b)	Maximum Conducted Output Power	PASS	-
3.4	15.247(e)	Power Spectral Density	PASS	-
3.5	15.247(d)	Emissions in Non-restricted Frequency Bands	PASS	-
3.6	15.247(d)	Emissions in Restricted Frequency Bands	PASS	-

**Conformity Assessment Condition:**

1. The test results (PASS/FAIL) with all measurement uncertainty excluded are presented against the regulation limits or in accordance with the requirements stipulated by the applicant/manufacturer who shall bear all the risks of non-compliance that may potentially occur if measurement uncertainty is taken into account.
2. The measurement uncertainty please refer to each test result in the chapter "Measurement Uncertainty".

**Disclaimer:**

The product specifications of the EUT presented in the test report that may affect the test assessments are declared by the manufacturer who shall take full responsibility for the authenticity.

**Reviewed by: Sam Chen**  
**Report Producer: Sophia Shiung**



# 1 General Description

## 1.1 Information

### 1.1.1 RF General Information

Frequency Range (MHz)	IEEE Std. 802.11	Ch. Frequency (MHz)	Channel Number
2400-2483.5	b, g, n (HT20), VHT20, ax (HEW20)	2412-2462	1-11 [11]

#### For Iron Radio 1

Band	Mode	BWch (MHz)	Nant
2.4-2.4835GHz	802.11b	20	1, 2, 4TX
2.4-2.4835GHz	802.11g	20	1, 2, 4TX
2.4-2.4835GHz	802.11n HT20	20	1, 2, 4TX
2.4-2.4835GHz	802.11n HT20-BF	20	1, 2, 4TX
2.4-2.4835GHz	VHT20	20	1, 2, 4TX
2.4-2.4835GHz	VHT20-BF	20	1, 2, 4TX
2.4-2.4835GHz	802.11ax HEW20	20	1, 2, 4TX
2.4-2.4835GHz	802.11ax HEW20-BF	20	1, 2, 4TX

#### For Scanning Radio 3

Band	Mode	BWch (MHz)	Nant
2.4-2.4835GHz	802.11b	20	1TX
2.4-2.4835GHz	802.11g	20	1TX
2.4-2.4835GHz	802.11n HT20	20	1TX
2.4-2.4835GHz	VHT20	20	1TX
2.4-2.4835GHz	802.11ax HEW20	20	1TX

**Note:**

- ◆ 11b mode uses a combination of DSSS-DBPSK, DQPSK, CCK modulation.
- ◆ 11g and HT20 use a combination of OFDM-BPSK, QPSK, 16QAM, 64QAM modulation.
- ◆ VHT20 use a combination of OFDM-BPSK, QPSK, 16QAM, 64QAM, 256QAM modulation.
- ◆ HEW20 use a combination of OFDMA-BPSK, QPSK, 16QAM, 64QAM, 256QAM, 1024QAM modulation.
- ◆ BWch is the nominal channel bandwidth.



**1.1.2 Antenna Information**

Ant.	Brand	Model Name	Antenna Type	Connector	Gain (dBi)
1	WNC	95XEAK15.G66	PIFA Antenna	I-PEX	Note 1
2	WNC	95XEAK15.G67	PIFA Antenna	I-PEX	
3	WNC	95XEAK15.G68	PIFA Antenna	I-PEX	
4	WNC	95XEAK15.G69	PIFA Antenna	I-PEX	
5	WNC	95XEAK15.G70	PIFA Antenna	I-PEX	
6	WNC	95XEAK15.G71	PIFA Antenna	I-PEX	
7	WNC	95XEAK15.G72	PIFA Antenna	I-PEX	
8	WNC	95XEAK15.G73	PIFA Antenna	I-PEX	
9	WNC	95XEAK15.G74	PIFA Antenna	I-PEX	
10	WNC	95XEAK15.G75	PIFA Antenna	I-PEX	
11	WNC	95XEAK15.G76	PIFA Antenna	I-PEX	
12	WNC	95XEAK15.G77	PIFA Antenna	I-PEX	

Ant.	Port					
	Iron Radio 1		Scanning Radio 3		Radio 4	Radio 5
	WLAN 2.4GHz	WLAN 5GHz	WLAN 2.4GHz	WLAN 5GHz	Bluetooth	GPS
1	3	2	-	-	-	-
2	2	3	-	-	-	-
3	1	4	-	-	-	-
4	4	1	-	-	-	-
5-8	-	-	-	-	-	-
9	-	-	2	2	-	-
10	-	-	1	1	-	-
11	-	-	-	-	1	-
12	-	-	-	-	-	1

Note 1:

Ant.	Antenna Gain (dBi)				
	Iron Radio 1				
	WLAN 2.4GHz	WLAN 5GHz			
	UNII 1	UNII 2A	UNII 2C	UNII 3	
1	2.17	1.39	1.71	3.09	3.45
2	3.28	3.37	3.54	4.2	4.12
3	3.95	3.42	3.05	3.92	4.41
4	2.63	1.47	1.36	2.39	2.26

Ant.	Antenna Gain (dBi)						
	WLAN 2.4GHz	Scanning Radio 3				Radio 4	Radio 5
		WLAN 5GHz				Bluetooth	GPS
	UNII 1	UNII 2A	UNII 2C	UNII 3			
9	3.06	3.81	3.38	3.2	2.54	-	-
10	2.52	3.21	2.86	3.11	3.78	-	-
11	-	-	-	-	-	3.05	-
12	-	-	-	-	-	-	2.4



Item	Directional Gain (dBi)				
	WLAN 2.4GHz	WLAN 5GHz			
		UNII 1	UNII 2A	UNII 2C	UNII 3
2T1S	6.28	2.85	2.93	5.09	5.42
2T2S	3.95	1.47	1.71	3.09	3.45
4T1S	8.04	6.58	6.15	6.87	7.35
4T2S	5.04	3.58	3.54	4.2	4.41
4T4S	3.95	3.42	3.54	4.2	4.41

Note 2: The above information (except antenna gain and directional gain of Ant. 1~11) was declared by manufacturer.

Note 3: The antenna gain and directional gain of Ant. 1~11 are measured which follow the procedure of KDB 662911 D03.

Note 4: The EUT does not enable the Ant. 5~8.

Note 5: **For Iron Radio 1**

**For 2.4GHz function:**

**For IEEE 802.11 b/g/n/VHT/ax (1TX/4RX):**

Only Port 1 can be use as transmitting antenna.

Port 1~4 can be used as receiving antenna.

Port 1~4 can receive simultaneously.

**For IEEE 802.11 b/g/n/VHT/ax (2TX/4RX):**

Port 1 and Port 2 can be used as transmitting antenna.

Port 1~4 can be used as receiving antenna.

Port 1 and Port 2 can transmit simultaneously; Port 1~4 can receive simultaneously.

**For IEEE 802.11 b/g/n/VHT/ax (4TX/4RX):**

Port 1~4 can be used as transmitting/receiving antenna.

Port 1~4 can transmit/receive simultaneously.

**For 5GHz function:**

**For IEEE 802.11 a/n/ac/ax (1TX/4RX):**

Only Port 1 can be use as transmitting antenna.

Port 1~4 can be used as receiving antenna.

Port 1~4 can receive simultaneously.

**For IEEE 802.11 a/n/ac/ax (2TX/4RX):**

Port 1 and Port 2 can be used as transmitting antenna.

Port 1~4 can be used as receiving antenna.

Port 1 and Port 2 can transmit simultaneously; Port 1~4 can receive simultaneously.

**For IEEE 802.11 a/n/ac/ax (4TX/4RX):**

Port 1~4 can be used as transmitting/receiving antenna.

Port 1~4 can transmit/receive simultaneously.



**For Scanning Radio 3**

**For 2.4GHz function:**

**For IEEE 802.11 b/g/n/VHT/ax (1TX/2RX):**

Only Port 1 can be use as transmitting antenna.  
Port 1 and Port 2 can be used as receiving antenna.  
Port 1 and Port 2 can receive simultaneously.

**For 5GHz function:**

**For IEEE 802.11 a/n/ac/ax (1TX/2RX):**

Only Port 1 can be use as transmitting antenna.  
Port 1 and Port 2 can be used as receiving antenna.  
Port 1 and Port 2 can receive simultaneously.

**For Radio 4**

**For bluetooth function (1TX/1RX):**

Only Port 1 can be used as transmitting/receiving antenna.

**For Radio 5**

**For GPS function (1RX):**

Only Port 1 can be used as receiving antenna.

**1.1.3 Mode Test Duty Cycle**

**For Iron Radio 1**

Mode	DC	DCF(dB)	T(s)	VBW(Hz) ≥ 1/T
802.11b	0.233	6.33	665u	3k
802.11g	0.941	0.26	1.977m	1k
802.11ax HEW20	0.797	0.99	5.446m	300

**For Scanning Radio 3**

Mode	DC	DCF(dB)	T(s)	VBW(Hz) ≥ 1/T
802.11b	0.299	5.24	665u	3k
802.11g	0.943	0.25	1.977m	1k
802.11ax HEW20	0.809	0.92	5.446m	300

**Note:**

- ◆ DC is Duty Cycle.
- ◆ DCF is Duty Cycle Factor.





**1.1.4 EUT Operational Condition**

<b>EUT Power Type</b>	From power adapter or PoE or DC 48V			
<b>Beamforming Function</b>	<input checked="" type="checkbox"/>	With beamforming	<input type="checkbox"/>	Without beamforming
	The product has beamforming function for n/VHT/ax in 2.4GHz and n/ac/ax in 5GHz in Iron Radio 1.			
<b>Function</b>	<input checked="" type="checkbox"/>	Point-to-multipoint	<input type="checkbox"/>	Point-to-point
<b>Support RU</b>	<input checked="" type="checkbox"/>	Full RU	<input type="checkbox"/>	Partial RU
<b>Test Software Version</b>	QSPR 5.0-00201			
<b>Supported Software Product IDs (PID)</b>	IW9167IH-B, IW9167IH-ROW IW9167IH-B-AP, IW9167IH-ROW-AP			

Note: The above information was declared by manufacturer.

**1.1.5 Table for Radio Function**

<b>Radio (R)</b>	<b>WLAN 2.4GHz</b>	<b>WLAN 5GHz</b>	<b>Bluetooth</b>	<b>GPS</b>
R1 (Iron Radio)	V (20MHz)	V (20/40/80MHz)	-	-
R2	-	-	-	-
R3 (Scanning Radio)	V (20MHz)	V (20/40/80/160MHz)	-	-
R4	-	-	V	-
R5	-	-	-	V

Note 1: The Radio 1 and Radio 3 can't operate at the same frequency.

Note 2: The above information was declared by manufacturer.

**1.1.6 Table for Multiple Listing**

The model names in the following table are all refer to the identical product.

<b>Model Name</b>	<b>Description</b>
IW9167IH-B	All the models are identical, the difference model names served as marketing strategy.
IW9167IH-ROW	

Note 1: From the above models, model: IW9167IH-B was selected as representative model for the test and its data was recorded in this report.

Note 2: The above information was declared by manufacturer.



### 1.2 Applicable Standards

According to the specifications of the manufacturer, the EUT must comply with the requirements of the following standards:

- ◆ 47 CFR FCC Part 15.247
- ◆ ANSI C63.10-2013

The following reference test guidance is not within the scope of accreditation of TAF.

- ◆ FCC KDB 558074 D01 v05r02
- ◆ FCC KDB 662911 D03 v01
- ◆ FCC KDB 414788 D01 v01r01

### 1.3 Testing Location Information

Testing Location Information	
Test Lab. : Sporton International Inc. Hsinchu Laboratory	
Hsinchu	ADD: No.8, Ln. 724, Bo'ai St., Zhubei City, Hsinchu County 302010, Taiwan (R.O.C.)
(TAF: 3787)	TEL: 886-3-656-9065 FAX: 886-3-656-9085
	Test site Designation No. TW3787 with FCC.
	Conformity Assessment Body Identifier (CABID) TW3787 with ISED.

Test Condition	Test Site No.	Test Engineer	Test Environment (°C / %)	Test Date
RF Conducted (For R1)	TH02-CB	Gino Huang	22.6~23.2 / 59~62	Mar. 17, 2023~ Mar. 23, 2023
				Jun. 13, 2023~ Jun. 14, 2023
RF Conducted (For R3)	TH02-CB	Gino Huang	22.6~23.2 / 59~62	Mar. 17, 2023~ May 04, 2023
Radiated < 1GHz	03CH05-CB	Roy Mai	24.2~25.1 / 57~61	Mar. 24, 2023~ May 25, 2023
	03CH06-CB		22.7~24.2 / 59~63	
Radiated > 1GHz	03CH01-CB		23.8~24.9 / 55~58	
Radiated (Co-location)	03CH05-CB		24.2~25.1 / 57~61	
AC Conduction	CO01-CB	Elvin Yeh	21~23 / 51~54	Jul. 10, 2023



### 1.4 Measurement Uncertainty

ISO/IEC 17025 requires that an estimate of the measurement uncertainties associated with the emissions test results be included in the report. The measurement uncertainties given below are based on a 95% confidence level (based on a coverage factor (k=2))

**Before Jun. 01, 2023**

Test Items	Uncertainty	Remark
Radiated Emission (9kHz ~ 30MHz)	3.4 dB	Confidence levels of 95%
Radiated Emission (30MHz ~ 1,000MHz)	5.6 dB	Confidence levels of 95%
Radiated Emission (1GHz ~ 18GHz)	5.2 dB	Confidence levels of 95%
Radiated Emission (18GHz ~ 40GHz)	4.7 dB	Confidence levels of 95%
Conducted Emission	3.2 dB	Confidence levels of 95%
Output Power Measurement	0.8 dB	Confidence levels of 95%
Power Density Measurement	3.2 dB	Confidence levels of 95%
Bandwidth Measurement	2.0 %	Confidence levels of 95%

**After May 31, 2023**

Test Items	Uncertainty	Remark
Conducted Emission (150kHz ~ 30MHz)	3.4 dB	Confidence levels of 95%
Conducted Emission	3.1 dB	Confidence levels of 95%
Output Power Measurement	0.8 dB	Confidence levels of 95%
Power Density Measurement	3.1 dB	Confidence levels of 95%



## 2 Test Configuration of EUT

### 2.1 Test Channel Mode

For Iron Radio 1

Mode	Power Setting
802.11b_Nss1,(1Mbps)_1TX	-
2412MHz	24
2437MHz	24
2462MHz	22.5
802.11g_Nss1,(6Mbps)_1TX	-
2412MHz	22
2437MHz	24
2457MHz	22
2462MHz	18.5
802.11ax HEW20_Nss1,(MCS0)_1TX	-
2412MHz	21.5
2437MHz	24
2457MHz	20.5
2462MHz	16.5
802.11b_Nss1,(1Mbps)_2TX	-
2412MHz	23
2437MHz	24
2457MHz	21
2462MHz	21
802.11g_Nss1,(6Mbps)_2TX	-
2412MHz	18.5
2417MHz	20.5
2437MHz	24
2457MHz	19
2462MHz	16
802.11ax HEW20_Nss1,(MCS0)_2TX	-
2412MHz	16.5
2417MHz	19.5
2437MHz	23
2457MHz	18
2462MHz	13.5
802.11b_Nss1,(1Mbps)_4TX	-
2412MHz	20.5
2437MHz	23
2457MHz	18



<b>Mode</b>	<b>Power Setting</b>
2462MHz	18
802.11g_Nss1,(6Mbps)_4TX	-
2412MHz	16.5
2437MHz	19
2457MHz	15
2462MHz	12
802.11ax HEW20_Nss1,(MCS0)_4TX	-
2412MHz	14.5
2417MHz	17.5
2437MHz	19
2457MHz	13.5
2462MHz	10
802.11ax HEW20-BF_Nss1,(MCS0)_2TX	-
2412MHz	16.5
2417MHz	19.5
2437MHz	23
2457MHz	18
2462MHz	13.5
802.11ax HEW20-BF_Nss1,(MCS0)_4TX	-
2412MHz	14.5
2417MHz	17.5
2437MHz	19
2457MHz	13.5
2462MHz	10



**For Scanning Radio 3**

Mode	Power Setting
802.11b_Nss1,(1Mbps)_1TX	-
2412MHz	24
2437MHz	24
2462MHz	24
802.11g_Nss1,(6Mbps)_1TX	-
2412MHz	22
2437MHz	24
2462MHz	22
802.11ax HEW20_Nss1,(MCS0)_1TX	-
2412MHz	21
2417MHz	22.5
2437MHz	24
2457MHz	22.5
2462MHz	20

**Note:**

- ♦ The EUT supports non-beamforming and beamforming modes, after evaluating, the non-beamforming mode has been evaluated to be the worst case, so it was selected to test. The beamforming mode evaluates the output power only.
- ♦ Evaluated HEW20 mode only, due to similar modulation. The power setting of HT20 / VHT20 modes are the same or lower than HEW20.



## 2.2 The Worst Case Measurement Configuration

The Worst Case Mode for Following Conformance Tests	
<b>Tests Item</b>	AC power-line conducted emissions
<b>Condition</b>	AC power-line conducted measurement for line and neutral Test Voltage: 120Vac / 60Hz
<b>Operating Mode</b>	Normal Link
1	EUT + Adapter_WLAN 2.4GHz (R1) + WLAN 5GHz (R1) + WLAN 2.4GHz (R3)
2	EUT + Adapter_WLAN 2.4GHz (R1) + WLAN 5GHz (R1) + WLAN 5GHz (R3)
Mode 2 has been evaluated to be the worst case among Mode 1~2, so measurement for Mode 3~5 will follow this same test mode.	
3	EUT + PoE_WLAN 2.4GHz (R1) + WLAN 5GHz (R1) + WLAN 5GHz (R3)
4	EUT + Ethernet cable + DC 48V_WLAN 2.4GHz (R1) + WLAN 5GHz (R1) + WLAN 5GHz (R3)
5	EUT + Ethernet cable + PoE_WLAN 2.4GHz (R1) + WLAN 5GHz (R1) + WLAN 5GHz (R3)
For operating, Mode 5 is the worst case and it was record in this test report.	

The Worst Case Mode for Following Conformance Tests	
<b>Tests Item</b>	DTS Bandwidth Maximum Conducted Output Power Power Spectral Density Emissions in Non-restricted Frequency Bands
<b>Test Condition</b>	Conducted measurement at transmit chains
1	R1: 1T1S
2	R1: 2T1S
3	R1: 4T1S
4	R3: 1T1S



<b>The Worst Case Mode for Following Conformance Tests</b>	
<b>Tests Item</b>	Emissions in Restricted Frequency Bands
<b>Test Condition</b>	Radiated measurement If EUT consist of multiple antenna assembly (multiple antenna are used in EUT regardless of spatial multiplexing MIMO configuration), the radiated test should be performed with highest antenna gain of each antenna type.
<b>Operating Mode &lt; 1GHz</b>	CTX
After evaluating, the worst cases of axis position for each band were found at Radiated measurement above 1GHz, and the results are listed below. Thus, the measurement will follow these test configurations.	
1	EUT in Y axis + Adapter_WLAN 2.4GHz (R1)
2	EUT in Y axis + PoE_WLAN 2.4GHz (R1)
Mode 2 has been evaluated to be the worst case among Mode 1~2, thus measurement for Mode 3~6 will follow this same test mode.	
3	EUT in Y axis + PoE_WLAN 5GHz (R1)
4	EUT in Y axis + PoE_WLAN 2.4GHz (R3)
5	EUT in Y axis + PoE_WLAN 5GHz (R3)
6	EUT in Z axis + PoE_Bluetooth (R4)
Mode 3 has been evaluated to be the worst case among Mode 1~6, thus measurement for Mode 7~8 will follow this same test mode.	
7	EUT in Y axis + Ethernet cable + DC 48V_WLAN 5GHz (R1)
8	EUT in Y axis + Ethernet cable + PoE_WLAN 5GHz (R1)
For operating, Mode 3 is the worst case and it was record in this test report.	

<b>The Worst Case Mode for Following Conformance Tests</b>	
<b>Tests Item</b>	Emissions in Restricted Frequency Bands
<b>Test Condition</b>	Conducted measurement at transmit chains
<b>Operating Mode &gt; 1GHz</b>	CTX (Harmonic and bandedge)
1	R1: 1T1S
2	R1: 2T1S
3	R1: 4T1S
4	R3: 1T1S





The Worst Case Mode for Following Conformance Tests	
<b>Tests Item</b>	Emissions in Restricted Frequency Bands
<b>Test Condition</b>	Radiated measurement
<b>Operating Mode &gt; 1GHz</b>	CTX (Cabinet)
After evaluating, the worst cases of axis position for each band were found, and the results are listed below. Thus, the measurement will follow these test configurations.	
1	EUT in Y axis_R1: 1T1S
2	EUT in Y axis_R1: 2T1S
3	EUT in Z axis_R1: 4T1S
4	EUT in Y axis_R3: 1T1S

The Worst Case Mode for Following Conformance Tests	
<b>Tests Item</b>	Simultaneous Transmission Analysis - Radiated Emission Co-location
<b>Test Condition</b>	Radiated measurement
<b>Operating Mode</b>	Normal Link
1	WLAN 2.4GHz (R1) + WLAN 5GHz (R1)
Refer to Appendix G for Radiated Emission Co-location.	

The Worst Case Mode for Following Conformance Tests	
<b>Tests Item</b>	Simultaneous Transmission Analysis - Co-location RF Exposure Evaluation
<b>Operating Mode</b>	
1	WLAN 2.4GHz (R1) + WLAN 5GHz (R1) + WLAN 2.4GHz (R3) + Bluetooth (R4)
2	WLAN 2.4GHz (R1) + WLAN 5GHz (R1) + WLAN 5GHz (R3) + Bluetooth (R4)
Refer to Sporton Test Report No.: FA322212 for Co-location RF Exposure Evaluation.	

Note: The adapter and PoE were for measurement only and would not be marketed. Their information is shown as below:

Equipment	Brand Name	Model Name	FCC ID
Adapter	LITEON	PA-1600-1C	N/A
PoE	CISCO	POE075U-1BT-C	N/A

### 2.3 EUT Operation during Test

**For CTX Mode:**

The EUT was programmed to be in continuously transmitting mode.

**For Normal Link Mode:**

During the test, the EUT operation to normal function.



## 2.4 Accessories

Accessories
Waterproof cover 1*1
Waterproof cover 2*1
Waterproof cover 3*1
Wall bracket 1*1
Wall bracket 2*1
Ground cable*1: Non-shielded, 0.8m
DC cable (Yellow)*1: Non-shielded, 2.6m
DC cable connector*1
Ethernet cable*2: Shielded, 3m
Ethernet cable connector*2

## 2.5 Support Equipment

For AC Conduction:

Support Equipment				
No.	Equipment	Brand Name	Model Name	FCC ID
A	LAN NB	DELL	E6430	N/A
B	SFP LAN NB	DELL	E6430	N/A
C	2.4G Client	WNC	N/A	N/A
D	2.4G Client NB	DELL	E6430	N/A
E	5G Client	WNC	N/A	N/A
F	5G Client NB	DELL	E6430	N/A
G	Scan Radio Client	WNC	N/A	N/A
H	Scan Radio Client NB	DELL	E6430	N/A
I	GPS Simulator	WELNAVIGATE	GS-100	N/A
J	PoE	CISCO	POE075U-1BT-C	N/A



**For Radiated:  
<Below 1GHz>**

Support Equipment				
No.	Equipment	Brand Name	Model Name	FCC ID
A	NB	DELL	E4300	N/A
B	PoE	CISCO	POE075U-1BT-C	N/A

**<Above 1GHz>**

Support Equipment				
No.	Equipment	Brand Name	Model Name	FCC ID
A	NB	DELL	E4300	N/A
B	Adapter	LITEON	PA-1600-1C	N/A

**For RF Conducted:**

Support Equipment				
No.	Equipment	Brand Name	Model Name	FCC ID
A	NB	DELL	E4300	N/A
B	Adapter	LITEON	PA-1600-1C	N/A

## 2.6 Test Setup Diagram

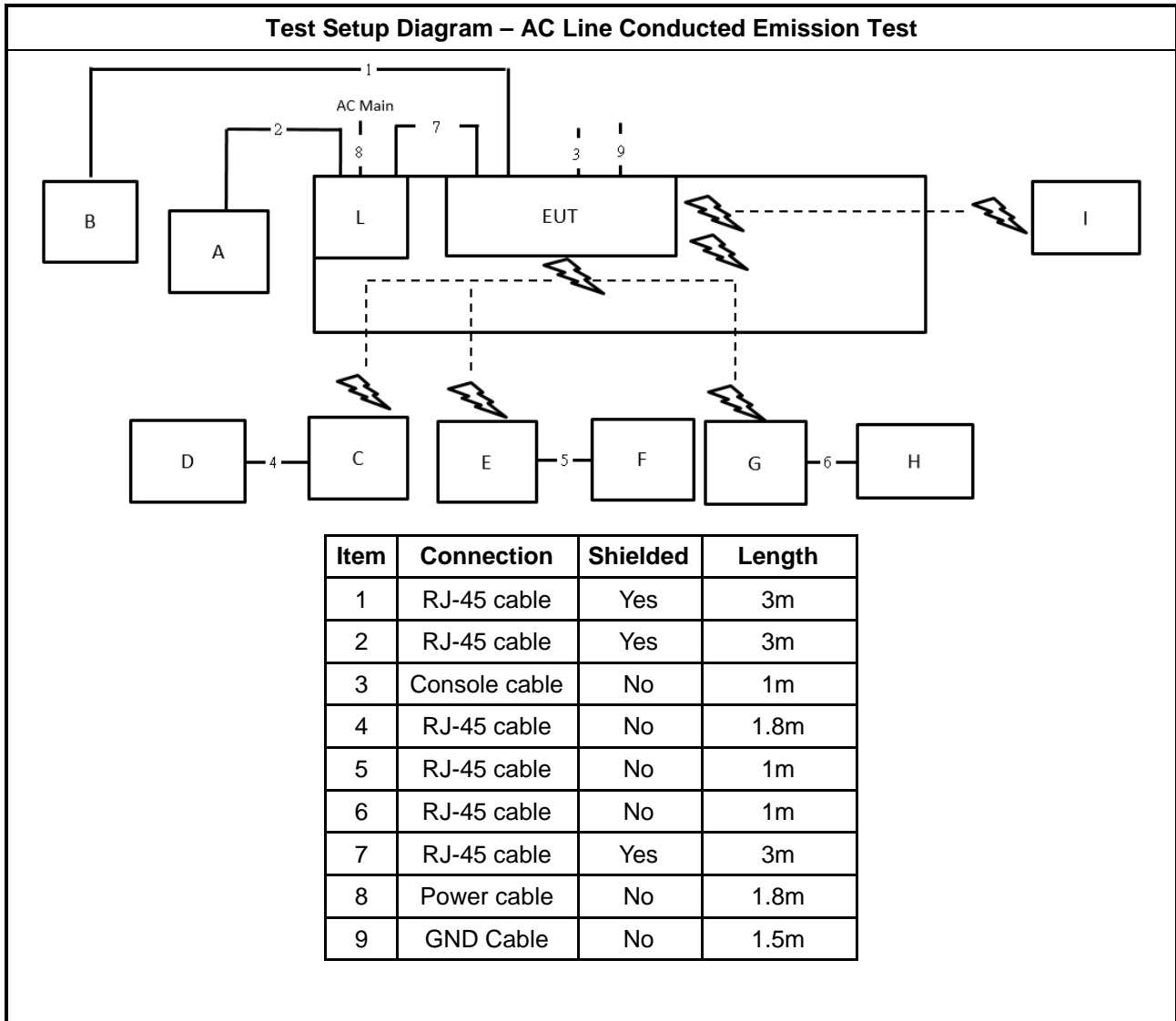

**Test Setup Diagram - Radiated Test < 1GHz**

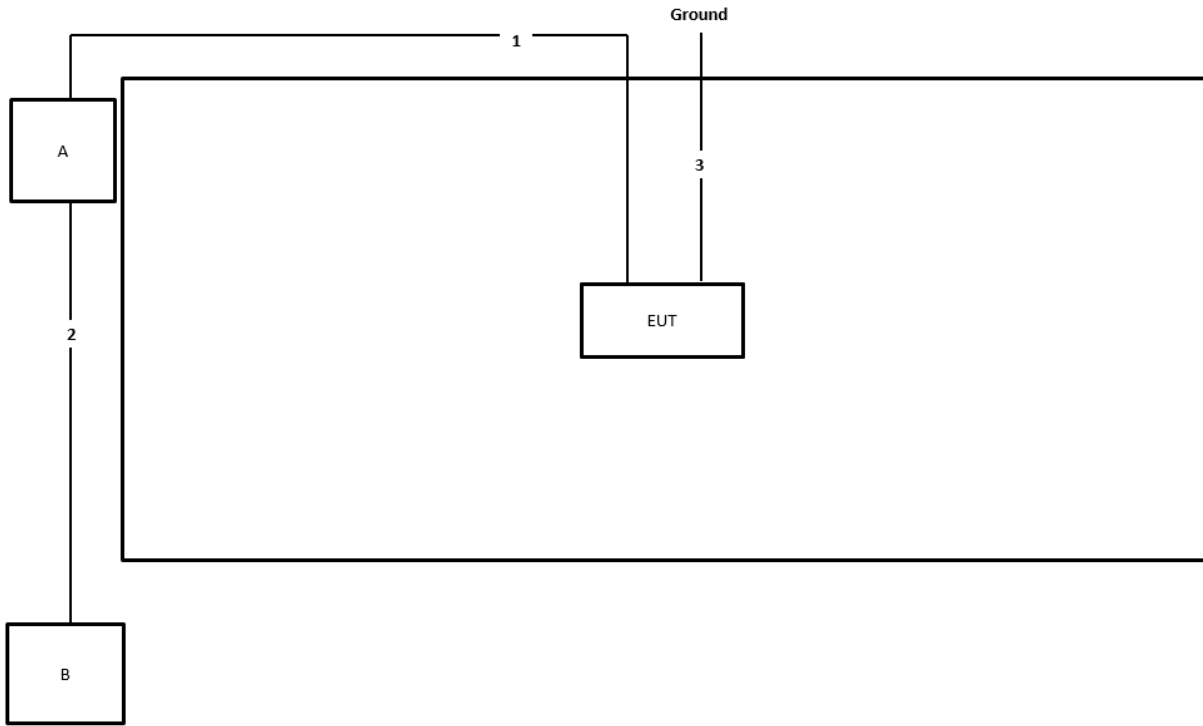

Item	Connection	Shielded	Length
1	RJ-45 cable	No	1.5m
2	RJ-45 cable	No	1.5m
3	Ground cable	No	0.8m

**Test Setup Diagram - Radiated Test > 1GHz**

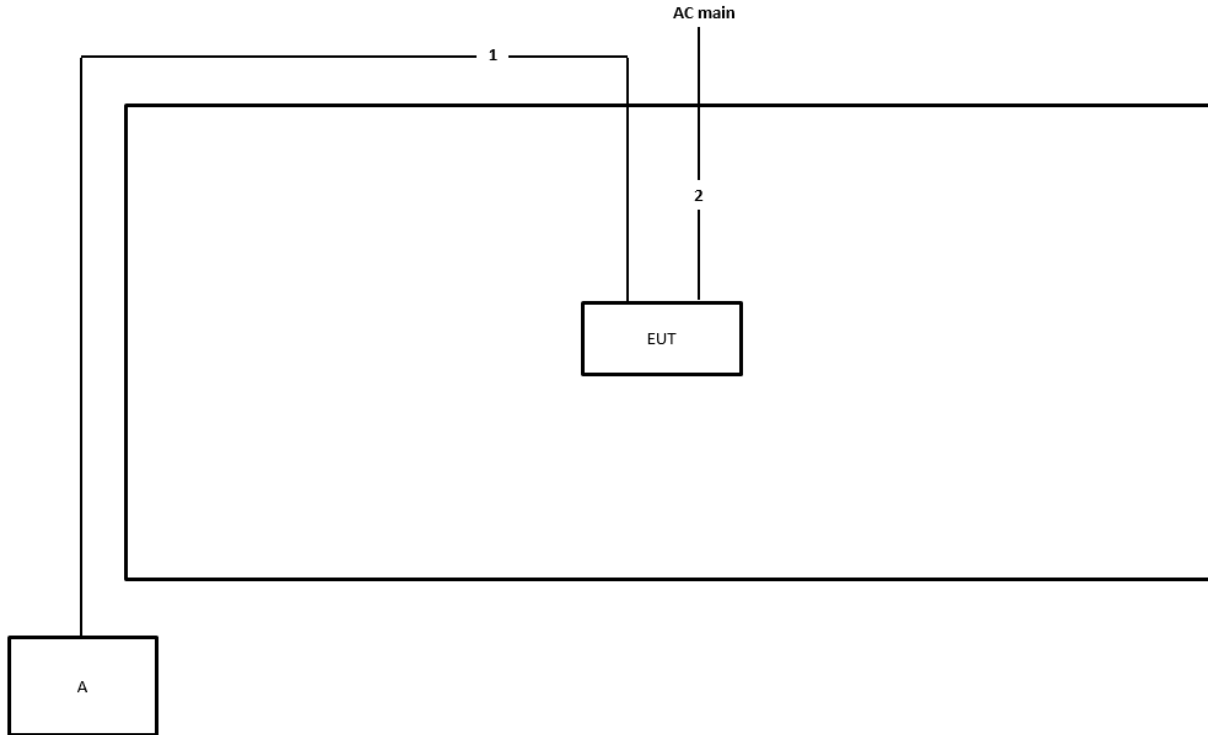

Item	Connection	Shielded	Length
1	RJ-45 cable	No	10m
2	Power cable	No	2.6m



### 3 Transmitter Test Result

#### 3.1 AC Power-line Conducted Emissions

##### 3.1.1 AC Power-line Conducted Emissions Limit

AC Power-line Conducted Emissions Limit		
Frequency Emission (MHz)	Quasi-Peak	Average
0.15-0.5	66 - 56 *	56 - 46 *
0.5-5	56	46
5-30	60	50

Note 1: \* Decreases with the logarithm of the frequency.

##### 3.1.2 Measuring Instruments

Refer a test equipment and calibration data table in this test report.

##### 3.1.3 Test Procedures

Test Method
<input checked="" type="checkbox"/> Refer as ANSI C63.10-2013, clause 6.2 for AC power-line conducted emissions.

### 3.1.4 Test Setup

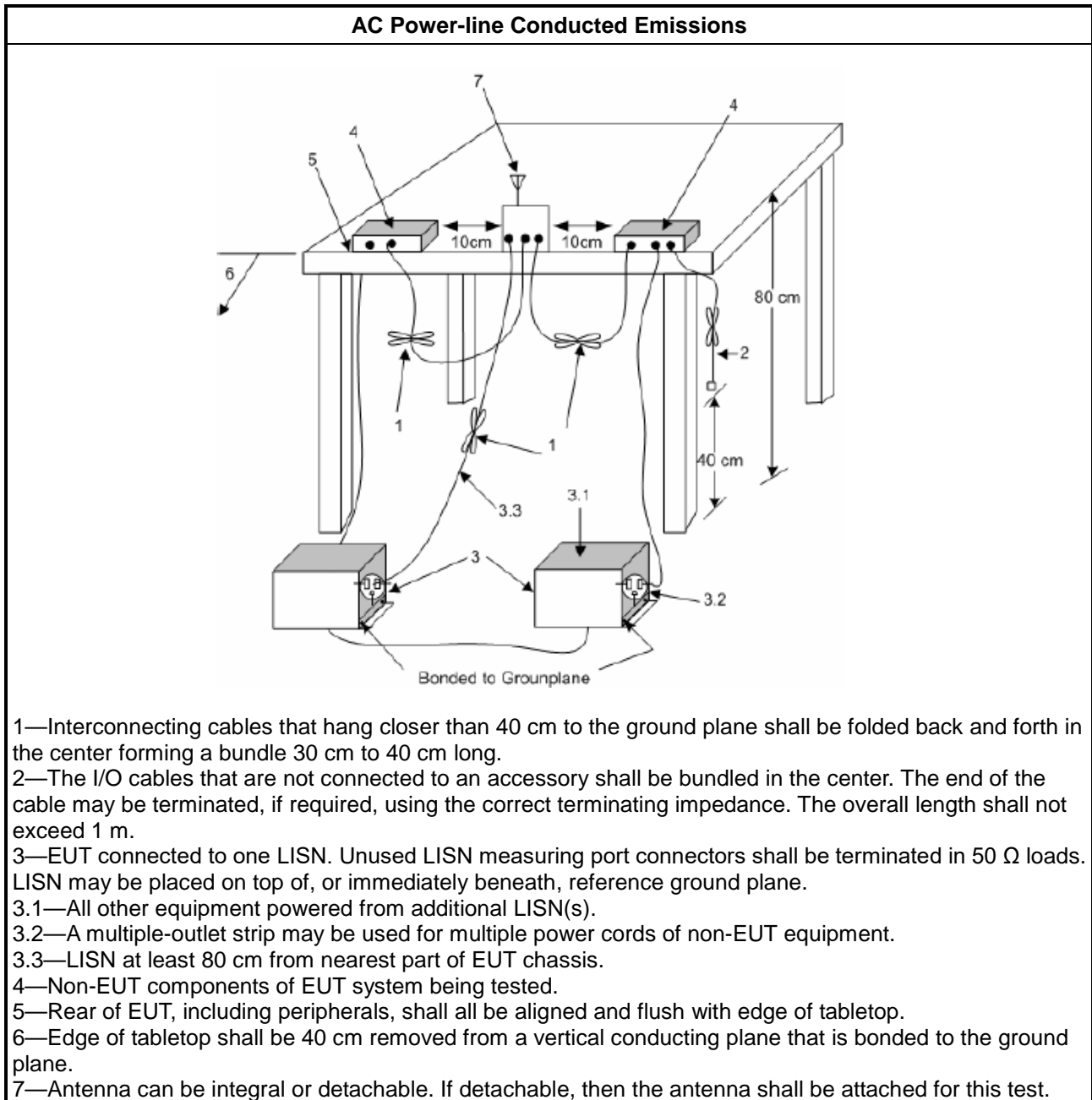

### 3.1.5 Measurement Results Calculation

The measured Level is calculated using:

- a. Corrected Reading: LISN Factor (LISN) + Attenuator (AT/AUX) + Cable Loss (CL) + Read Level (Raw) = Level
- b. Margin = -Limit + Level

### 3.1.6 Test Result of AC Power-line Conducted Emissions

Refer as Appendix A



### 3.2 DTS Bandwidth

#### 3.2.1 6dB Bandwidth Limit

6dB Bandwidth Limit
<b>Systems using digital modulation techniques:</b>
<ul style="list-style-type: none"> <li>▪ 6 dB bandwidth <math>\geq</math> 500 kHz.</li> </ul>

#### 3.2.2 Measuring Instruments

Refer a test equipment and calibration data table in this test report.

#### 3.2.3 Test Procedures

Test Method
<ul style="list-style-type: none"> <li>▪ For the emission bandwidth shall be measured using one of the options below:</li> </ul>
<input checked="" type="checkbox"/> Refer as FCC KDB 558074, clause 8.2 & C63.10 clause 11.8.1 Option 1 for 6 dB bandwidth measurement.
<input type="checkbox"/> Refer as FCC KDB 558074, clause 8.2 & C63.10 clause 11.8.2 Option 2 for 6 dB bandwidth measurement.
<input type="checkbox"/> Refer as ANSI C63.10, clause 6.9.1 for occupied bandwidth testing.

#### 3.2.4 Test Setup

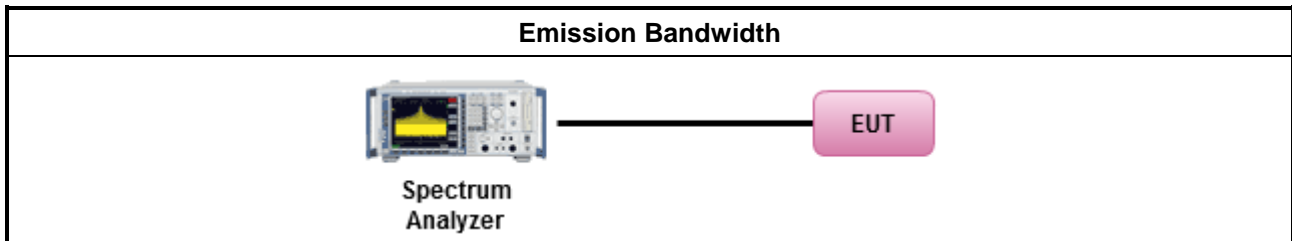

#### 3.2.5 Test Result of Emission Bandwidth

Refer as Appendix B



### 3.3 Maximum Conducted Output Power

#### 3.3.1 Maximum Conducted Output Power Limit

Maximum Conducted Output Power Limit	
	<ul style="list-style-type: none"> <li>▪ If <math>G_{TX} \leq 6</math> dBi, then <math>P_{Out} \leq 30</math> dBm (1 W)</li> </ul>
	<ul style="list-style-type: none"> <li>▪ Point-to-multipoint systems (P2M): If <math>G_{TX} &gt; 6</math> dBi, then <math>P_{Out} = 30 - (G_{TX} - 6)</math> dBm</li> </ul>
	<ul style="list-style-type: none"> <li>▪ Point-to-point systems (P2P): If <math>G_{TX} &gt; 6</math> dBi, then <math>P_{Out} = 30 - (G_{TX} - 6)/3</math> dBm</li> </ul>
	<ul style="list-style-type: none"> <li>▪ Smart antenna system (SAS):</li> </ul>
	<ul style="list-style-type: none"> <li>- Single beam: If <math>G_{TX} &gt; 6</math> dBi, then <math>P_{Out} = 30 - (G_{TX} - 6)/3</math> dBm</li> </ul>
	<ul style="list-style-type: none"> <li>- Overlap beam: If <math>G_{TX} &gt; 6</math> dBi, then <math>P_{Out} = 30 - (G_{TX} - 6)/3</math> dBm</li> </ul>
	<ul style="list-style-type: none"> <li>- Aggregate power on all beams: If <math>G_{TX} &gt; 6</math> dBi, then <math>P_{Out} = 30 - (G_{TX} - 6)/3 + 8</math> dB dBm</li> </ul>
<p><math>P_{Out}</math> = maximum peak conducted output power or maximum conducted output power in dBm,  <math>G_{TX}</math> = the maximum transmitting antenna directional gain in dBi.</p>	

#### 3.3.2 Measuring Instruments

Refer a test equipment and calibration data table in this test report.



**3.3.3 Test Procedures**

Test Method	
<ul style="list-style-type: none"> <li>▪ Maximum Peak Conducted Output Power</li> </ul>	
	<input type="checkbox"/> Refer as FCC KDB 558074, clause 8.3.1.1 & C63.10 clause 11.9.1.1 (RBW ≥ EBW method).
	<input type="checkbox"/> Refer as FCC KDB 558074, clause 8.3.1.3 & C63.10 clause 11.9.1.3 (peak power meter).
<ul style="list-style-type: none"> <li>▪ Maximum Conducted Output Power</li> </ul>	
[duty cycle ≥ 98% or external video / power trigger]	
	<input type="checkbox"/> Refer as FCC KDB 558074, clause 8.3.2.2 & C63.10 clause 11.9.2.2.2 Method AVGSA-1.
	<input type="checkbox"/> Refer as FCC KDB 558074, clause 8.3.2.2 & C63.10 clause 11.9.2.2.3 Method AVGSA-1A. (alternative)
duty cycle < 98% and average over on/off periods with duty factor	
	<input type="checkbox"/> Refer as FCC KDB 558074, clause 8.3.2.2 & C63.10 clause 11.9.2.2.4 Method AVGSA-2.
	<input type="checkbox"/> Refer as FCC KDB 558074, clause 8.3.2.2 & C63.10 clause 11.9.2.2.5 Method AVGSA-2A (alternative)
	<input type="checkbox"/> Refer as FCC KDB 558074, clause 8.3.2.2 & C63.10 clause 11.9.2.2.6 Method AVGSA-3
	<input type="checkbox"/> Refer as FCC KDB 558074, clause 8.3.2.2 & C63.10 clause 11.9.2.2.7 Method AVGSA-3A (alternative)
Measurement using a power meter (PM)	
	<input type="checkbox"/> Refer as FCC KDB 558074, clause 8.3.2.3 & C63.10 clause 11.9.2.3.1 Method AVGPM (using an RF average power meter).
	<input checked="" type="checkbox"/> Refer as FCC KDB 558074, clause 8.3.2.3 & C63.10 clause 11.9.2.3.2 Method AVGPM-G (using an gate RF average power meter).
<ul style="list-style-type: none"> <li>▪ For conducted measurement.</li> </ul>	
	<ul style="list-style-type: none"> <li>▪ If the EUT supports multiple transmit chains using options given below: Refer as FCC KDB 662911, In-band power measurements. Using the measure-and-sum approach, measured all transmit ports individually. Sum the power (in linear power units e.g., mW) of all ports for each individual sample and save them.</li> </ul>
	<ul style="list-style-type: none"> <li>▪ If multiple transmit chains, EIRP calculation could be following as methods:  <math>P_{total} = P_1 + P_2 + \dots + P_n</math>            (calculated in linear unit [mW] and transfer to log unit [dBm])  <math>EIRP_{total} = P_{total} + DG</math> </li> </ul>

### 3.3.4 Test Setup

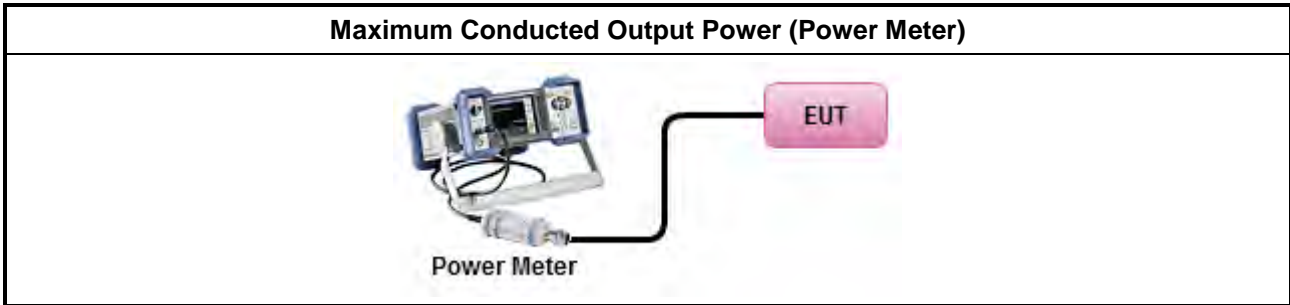

### 3.3.5 Test Result of Maximum Conducted Output Power

Refer as Appendix C



### 3.4 Power Spectral Density

#### 3.4.1 Power Spectral Density Limit

Power Spectral Density Limit
<ul style="list-style-type: none"> <li>Power Spectral Density (PSD) <math>\leq</math> 8 dBm/3kHz</li> </ul>

#### 3.4.2 Measuring Instruments

Refer a test equipment and calibration data table in this test report.

#### 3.4.3 Test Procedures

Test Method			
<ul style="list-style-type: none"> <li>Peak power spectral density procedures that the same method as used to determine the conducted output power. If maximum peak conducted output power was measured to demonstrate compliance to the output power limit, then the peak PSD procedure below (Method PKPSD) shall be used. If maximum conducted output power was measured to demonstrate compliance to the output power limit, then one of the average PSD procedures shall be used, as applicable based on the following criteria (the peak PSD procedure is also an acceptable option).</li> </ul>			
<input checked="" type="checkbox"/> Refer as FCC KDB 558074, clause 8.4 & C63.10 clause 11.10 Method Max. PSD.			
<ul style="list-style-type: none"> <li>For conducted measurement.             <ul style="list-style-type: none"> <li>If The EUT supports multiple transmit chains using options given below:                 <table border="1"> <tbody> <tr> <td> <input checked="" type="checkbox"/> Option 1: Measure and sum the spectra across the outputs. Refer as FCC KDB 662911, In-band power spectral density (PSD). Sample all transmit ports simultaneously using a spectrum analyzer for each transmit port. Where the trace bin-by-bin of each transmit port summing can be performed. (i.e., in the first spectral bin of output 1 is summed with that in the first spectral bin of output 2 and that from the first spectral bin of output 3, and so on up to the NTX output to obtain the value for the first frequency bin of the summed spectrum.). Add up the amplitude (power) values for the different transmit chains and use this as the new data trace.                 </td> </tr> <tr> <td> <input type="checkbox"/> Option 2: Measure and sum spectral maxima across the outputs. With this technique, spectra are measured at each output of the device at the required resolution bandwidth. The maximum value (peak) of each spectrum is determined. These maximum values are then summed mathematically in linear power units across the outputs. These operations shall be performed separately over frequency spans that have different out-of-band or spurious emission limits,                 </td> </tr> <tr> <td> <input type="checkbox"/> Option 3: Measure and add 10 log(N) dB, where N is the number of transmit chains. Refer as FCC KDB 662911, In-band power spectral density (PSD). Performed at each transmit chains and each transmit chains shall be compared with the limit have been reduced with 10 log(N). Or each transmit chains shall be add 10 log(N) to compared with the limit.                 </td> </tr> </tbody> </table> </li> </ul> </li> </ul>	<input checked="" type="checkbox"/> Option 1: Measure and sum the spectra across the outputs. Refer as FCC KDB 662911, In-band power spectral density (PSD). Sample all transmit ports simultaneously using a spectrum analyzer for each transmit port. Where the trace bin-by-bin of each transmit port summing can be performed. (i.e., in the first spectral bin of output 1 is summed with that in the first spectral bin of output 2 and that from the first spectral bin of output 3, and so on up to the NTX output to obtain the value for the first frequency bin of the summed spectrum.). Add up the amplitude (power) values for the different transmit chains and use this as the new data trace.	<input type="checkbox"/> Option 2: Measure and sum spectral maxima across the outputs. With this technique, spectra are measured at each output of the device at the required resolution bandwidth. The maximum value (peak) of each spectrum is determined. These maximum values are then summed mathematically in linear power units across the outputs. These operations shall be performed separately over frequency spans that have different out-of-band or spurious emission limits,	<input type="checkbox"/> Option 3: Measure and add 10 log(N) dB, where N is the number of transmit chains. Refer as FCC KDB 662911, In-band power spectral density (PSD). Performed at each transmit chains and each transmit chains shall be compared with the limit have been reduced with 10 log(N). Or each transmit chains shall be add 10 log(N) to compared with the limit.
<input checked="" type="checkbox"/> Option 1: Measure and sum the spectra across the outputs. Refer as FCC KDB 662911, In-band power spectral density (PSD). Sample all transmit ports simultaneously using a spectrum analyzer for each transmit port. Where the trace bin-by-bin of each transmit port summing can be performed. (i.e., in the first spectral bin of output 1 is summed with that in the first spectral bin of output 2 and that from the first spectral bin of output 3, and so on up to the NTX output to obtain the value for the first frequency bin of the summed spectrum.). Add up the amplitude (power) values for the different transmit chains and use this as the new data trace.			
<input type="checkbox"/> Option 2: Measure and sum spectral maxima across the outputs. With this technique, spectra are measured at each output of the device at the required resolution bandwidth. The maximum value (peak) of each spectrum is determined. These maximum values are then summed mathematically in linear power units across the outputs. These operations shall be performed separately over frequency spans that have different out-of-band or spurious emission limits,			
<input type="checkbox"/> Option 3: Measure and add 10 log(N) dB, where N is the number of transmit chains. Refer as FCC KDB 662911, In-band power spectral density (PSD). Performed at each transmit chains and each transmit chains shall be compared with the limit have been reduced with 10 log(N). Or each transmit chains shall be add 10 log(N) to compared with the limit.			

### 3.4.4 Test Setup

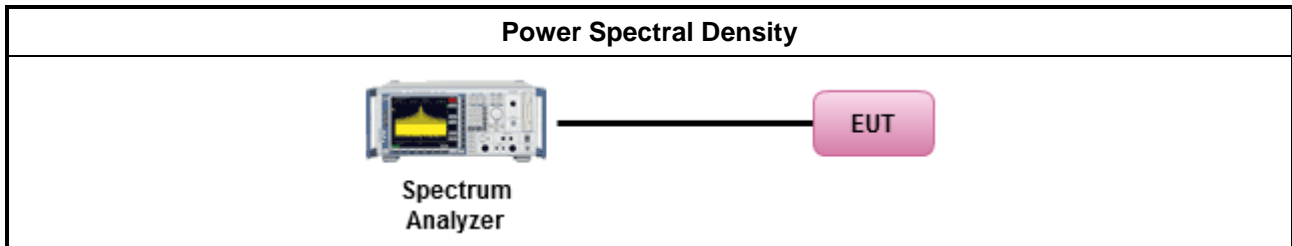

### 3.4.5 Test Result of Power Spectral Density

Refer as Appendix D

### 3.5 Emissions in Non-restricted Frequency Bands

#### 3.5.1 Emissions in Non-restricted Frequency Bands Limit

Un-restricted Band Emissions Limit	
RF output power procedure	Limit (dBc)
Peak output power procedure	20
Average output power procedure	30

Note 1: If the peak output power procedure is used to measure the fundamental emission power to demonstrate compliance to requirements, then the peak conducted output power measured within any 100 kHz outside the authorized frequency band shall be attenuated by at least 20 dB relative to the maximum measured in-band peak PSD level.

Note 2: If the average output power procedure is used to measure the fundamental emission power to demonstrate compliance to requirements, then the power in any 100 kHz outside of the authorized frequency band shall be attenuated by at least 30 dB relative to the maximum measured in-band average PSD level.

#### 3.5.2 Measuring Instruments

Refer a test equipment and calibration data table in this test report.

#### 3.5.3 Test Procedures

Test Method
<ul style="list-style-type: none"> <li>Refer as FCC KDB 558074, clause 8.5 for unwanted emissions into non-restricted bands.</li> </ul>

#### 3.5.4 Test Setup

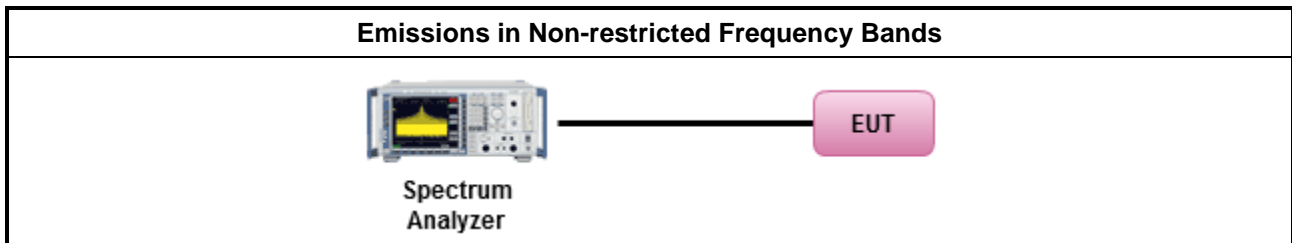

#### 3.5.5 Test Result of Emissions in Non-restricted Frequency Bands

Refer as Appendix E



### 3.6 Emissions in Restricted Frequency Bands

#### 3.6.1 Emissions in Restricted Frequency Bands Limit

Restricted Band Emissions Limit			
Frequency Range (MHz)	Field Strength (uV/m)	Field Strength (dBuV/m)	Measure Distance (m)
0.009~0.490	2400/F(kHz)	48.5 - 13.8	300
0.490~1.705	24000/F(kHz)	33.8 - 23	30
1.705~30.0	30	29	30
30~88	100	40	3
88~216	150	43.5	3
216~960	200	46	3
Above 960	500	54	3

Note 1: Test distance for frequencies at or above 30 MHz, measurements may be performed at a distance other than the limit distance provided they are not performed in the near field and the emissions to be measured can be detected by the measurement equipment. When performing measurements at a distance other than that specified, the results shall be extrapolated to the specified distance using an extrapolation factor of 20 dB/decade (inverse of linear distance for field-strength measurements, inverse of linear distance-squared for power-density measurements).

Note 2: Test distance for frequencies at below 30 MHz, measurements may be performed at a distance closer than the EUT limit distance; however, an attempt should be made to avoid making measurements in the near field. When performing measurements below 30 MHz at a closer distance than the limit distance, the results shall be extrapolated to the specified distance by either making measurements at a minimum of two or more distances on at least one radial to determine the proper extrapolation factor or by using the square of an inverse linear distance extrapolation factor (40 dB/decade). The test report shall specify the extrapolation method used to determine compliance of the EUT.

Note 3: Using the distance of 1m during the test for above 18 GHz, and the test value to correct for the distance factor at 3m.

#### 3.6.2 Measuring Instruments

Refer a test equipment and calibration data table in this test report.





**3.6.3 Test Procedures**

<b>Test Method</b>	
<ul style="list-style-type: none"> <li>▪ The average emission levels shall be measured in [duty cycle ≥ 98 or duty factor].</li> </ul>	
<ul style="list-style-type: none"> <li>▪ Refer as ANSI C63.10, clause 6.10.3 band-edge testing shall be performed at the lowest frequency channel and highest frequency channel within the allowed operating band.</li> </ul>	
<ul style="list-style-type: none"> <li>▪ For the transmitter unwanted emissions shall be measured using following options below:</li> </ul>	
	<ul style="list-style-type: none"> <li>▪ Refer as FCC KDB 558074, clause 8.6 for unwanted emissions into restricted bands.</li> </ul>
	<input type="checkbox"/> Refer as FCC KDB 558074, clause 8.6 & C63.10 clause 11.12.2.5.1(trace averaging for duty cycle ≥98%).
	<input type="checkbox"/> Refer as FCC KDB 558074, clause 8.6 & C63.10 clause 11.12.2.5.2(trace averaging + duty factor).
	<input checked="" type="checkbox"/> Refer as FCC KDB 558074, clause 8.6 & C63.10 clause 11.12.2.5.3(Reduced VBW≥1/T).
	<input type="checkbox"/> Refer as ANSI C63.10, clause 11.12.2.5.3 (Reduced VBW). VBW ≥ 1/T, where T is pulse time.
	<input type="checkbox"/> Refer as ANSI C63.10, clause 7.5 average value of pulsed emissions.
	<input checked="" type="checkbox"/> Refer as FCC KDB 558074, clause 8.6 & C63.10 clause 11.12.2.4 measurement procedure peak limit.
<ul style="list-style-type: none"> <li>▪ For the transmitter band-edge emissions shall be measured using following options below:</li> </ul>	
	<ul style="list-style-type: none"> <li>▪ Refer as FCC KDB 558074 clause 8.7 &amp; C63.10 clause 11.13.1, When the performing peak or average radiated measurements, emissions within 2 MHz of the authorized band edge may be measured using the marker-delta method described below.</li> </ul>
	<ul style="list-style-type: none"> <li>▪ Refer as FCC KDB 558074, clause 8.7 (ANSI C63.10, clause 6.10.6) for marker-delta method for band-edge measurements.</li> </ul>
	<ul style="list-style-type: none"> <li>▪ Refer as FCC KDB 558074, clause 8.7 for narrower resolution bandwidth (100kHz) using the band power and summing the spectral levels (i.e., 1 MHz).</li> </ul>
	<ul style="list-style-type: none"> <li>▪ For conducted unwanted emissions into restricted bands (absolute emission limits). Devices with multiple transmit chains using options given below:                (1) Measure and sum the spectra across the outputs or                (2) Measure and add 10 log(N) dB             </li> </ul>
	<ul style="list-style-type: none"> <li>▪ For FCC KDB 662911 The methodology described here may overestimate array gain, thereby resulting in apparent failures to satisfy the out-of-band limits even if the device is actually compliant. In such cases, compliance may be demonstrated by performing radiated tests around the frequencies at which the apparent failures occurred.</li> </ul>

<b>Test Method</b>	
▪	For conducted and cabinet radiation measurement, refer as FCC KDB 558074, clause 8.6 & C63.10 clause 11.12.2.2.
▪	For conducted unwanted emissions into non-restricted bands (relative emission limits). Devices with multiple transmit chains: Refer as FCC KDB 662911, when testing out-of-band and spurious emissions against relative emission limits, tests may be performed on each output individually without summing or adding 10 log(N) if the measurements are made relative to the in-band emissions on the individual outputs.
▪	For conducted unwanted emissions into restricted bands (absolute emission limits). Devices with multiple transmit chains using options given below: (1) Measure and sum the spectra across the outputs or (2) Measure and add 10 log(N) dB
▪	For FCC KDB 662911 The methodology described here may overestimate array gain, thereby resulting in apparent failures to satisfy the out-of-band limits even if the device is actually compliant. In such cases, compliance may be demonstrated by performing radiated tests around the frequencies at which the apparent failures occurred.

### 3.6.4 Test Setup

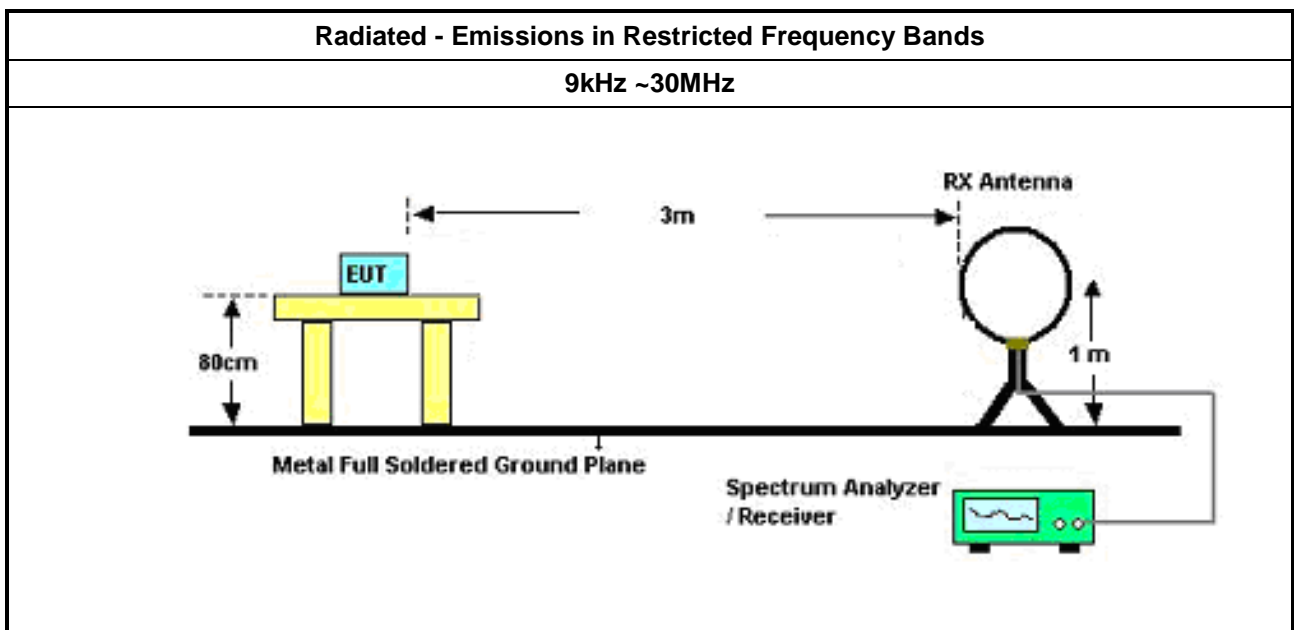

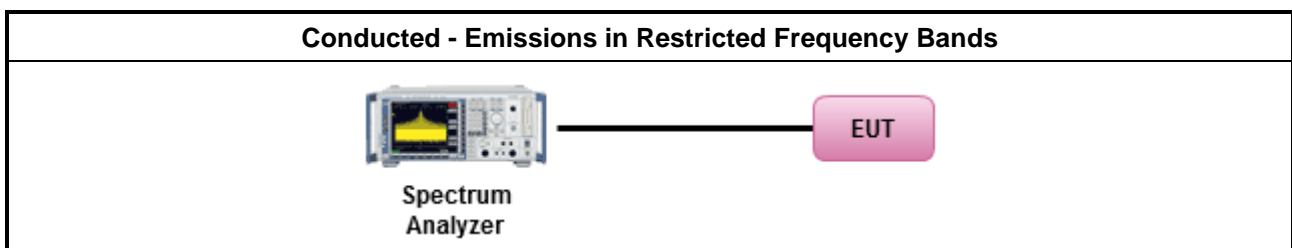
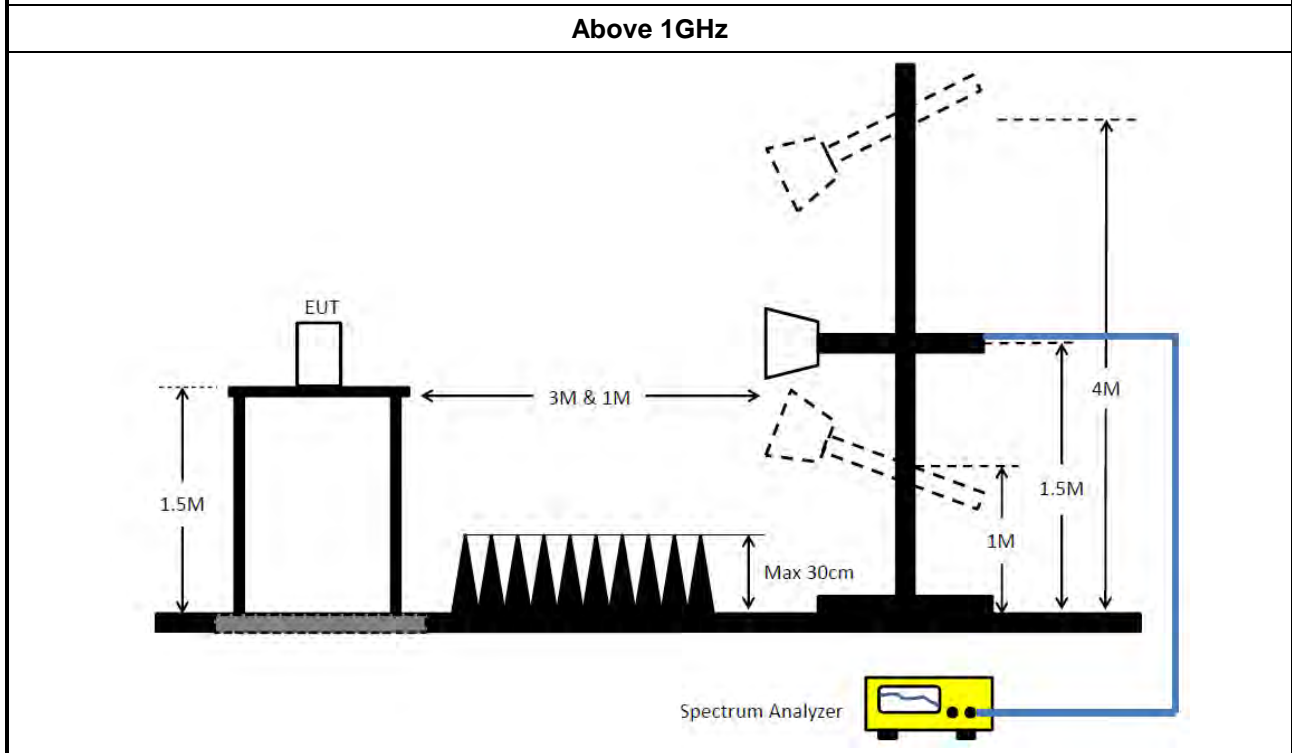
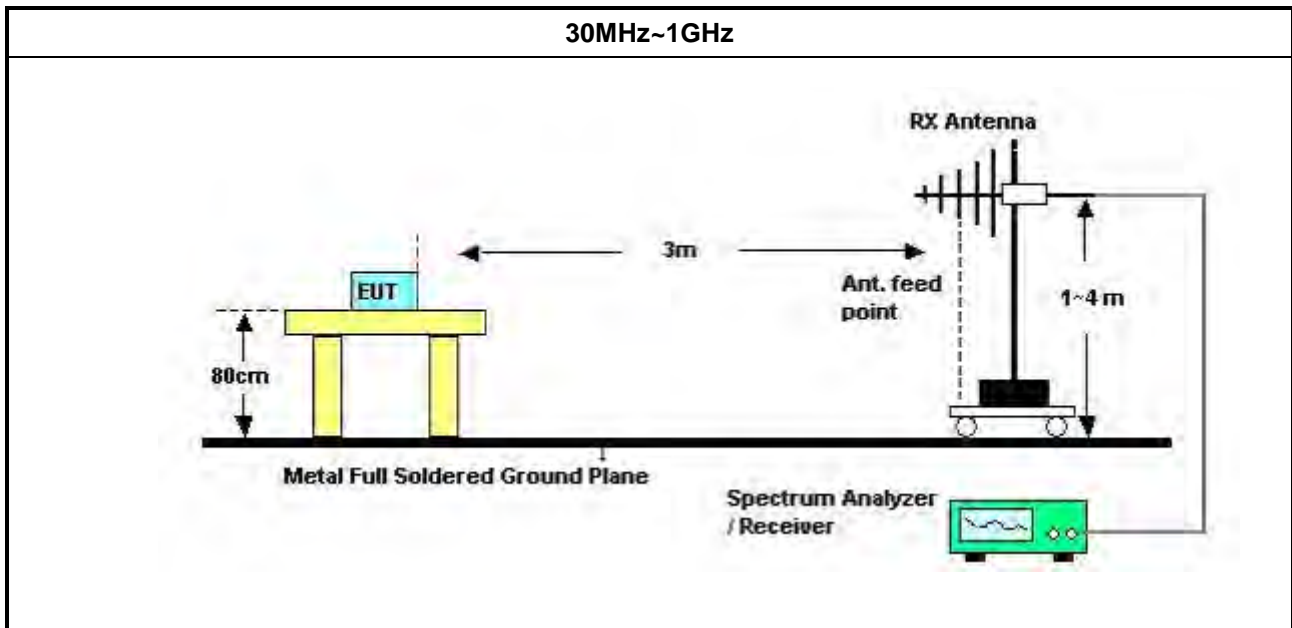



### **3.6.5 Measurement Results Calculation**

The measured Level is calculated using:

Corrected Reading: Antenna factor (AF) + Cable loss (CL) + Read level (Raw) - Preamp factor (PA)(if applicable) = Level.

### **3.6.6 Emissions in Restricted Frequency Bands (Below 30MHz)**

There is a comparison data of both open-field test site and alternative test site - semi-Anechoic chamber according to KDB414788 Radiated Test Site, and the result came out very similar.

All amplitude of spurious emissions that are attenuated by more than 20 dB below the permissible value has no need to be reported.

The radiated emissions were investigated from 9 kHz or the lowest frequency generated within the device, up to the 10th harmonic or 40 GHz, whichever is appropriate.

### **3.6.7 Test Result of Emissions in Restricted Frequency Bands**

Refer as Appendix F



## 4 Test Equipment and Calibration Data

Instrument	Brand	Model No.	Serial No.	Characteristics	Calibration Date	Calibration Due Date	Remark
EMI Receiver	Agilent	N9038A	My52260123	9kHz ~ 8.4GHz	Feb. 20, 2023	Feb. 19, 2024	Conduction (CO01-CB)
LISN	F.C.C.	FCC-LISN-50-16-2	04083	150kHz ~ 100MHz	Feb. 16, 2023	Feb. 15, 2024	Conduction (CO01-CB)
LISN	Schwarzbeck	NSLK 8127	8127647	9kHz ~ 30MHz	Apr. 27, 2023	Apr. 26, 2024	Conduction (CO01-CB)
Pulse Limiter	Rohde & Schwarz	ESH3-Z2	100430	9kHz ~ 30MHz	Feb. 09, 2023	Feb. 08, 2024	Conduction (CO01-CB)
COND Cable	Woken	Cable	Low cable-CO01	9kHz ~ 30MHz	Oct. 18, 2022	Oct. 17, 2023	Conduction (CO01-CB)
Software	SPORTON	SENSE	V5.10	-	N.C.R.	N.C.R.	Conduction (CO01-CB)
Loop Antenna	Teseq	HLA 6120	31244	9kHz - 30 MHz	Mar. 23, 2023	Mar. 22, 2024	Radiation (03CH05-CB)
3m Semi Anechoic Chamber NSA	TDK	SAC-3M	03CH05-CB	30 MHz ~ 1 GHz	Aug. 03, 2022	Aug. 02, 2023	Radiation (03CH05-CB)
3m Semi Anechoic Chamber VSWR	TDK	SAC-3M	03CH05-CB	1GHz ~18GHz 3m	Nov. 06, 2022	Nov. 05, 2023	Radiation (03CH05-CB)
Bilog Antenna with 6dB Attenuator	TESEQ & EMCI	CBL 6112D & N-6-06	35236 & AT-N0610	30MHz ~ 2GHz	Mar. 24, 2023	Mar. 23, 2024	Radiation (03CH05-CB)
Horn Antenna	SCHWARZBECK	BBHA9120D	BBHA 9120 D-1291	1GHz~18GHz	Jun. 23, 2022	Jun. 22, 2023	Radiation (03CH05-CB)
Horn Antenna	Schwarzbeck	BBHA 9170	BBHA9170252	15GHz ~ 40GHz	Aug. 22, 2022	Aug. 21, 2023	Radiation (03CH05-CB)
Pre-Amplifier	EMCI	EMC330N	980331	20MHz ~ 3GHz	Apr. 26, 2022	Apr. 25, 2023	Radiation (03CH05-CB)
Amplifier	EMCI	EMC330N	980331	20MHz ~ 3GHz	May 03, 2023	May 02, 2024	Radiation (03CH05-CB)
Pre-Amplifier	EMCI	EMC12630SE	980287	1GHz ~ 26.5GHz	Jul. 01, 2022	Jun. 30, 2023	Radiation (03CH05-CB)
Pre-Amplifier	SGH	SGH184	20221107-3	18GHz ~ 40GHz	Nov. 16, 2022	Nov. 15, 2023	Radiation (03CH05-CB)
Signal Analyzer	R&S	FSV40	101904	9kHz ~ 40GHz	Apr. 26, 2022	Apr. 25, 2023	Radiation (03CH05-CB)
Spectrum Analyzer	R&S	FSP40	100304	9kHz ~ 40GHz	Apr. 18, 2023	Apr. 17, 2024	Radiation (03CH05-CB)
EMI Test Receiver	R&S	ESCS	826547/017	9kHz ~ 2.75GHz	Jun. 17, 2022	Jun. 16, 2023	Radiation (03CH05-CB)
RF Cable-low	Woken	RG402	Low Cable-04+23	30MHz~1GHz	Oct. 03, 2022	Oct. 02, 2023	Radiation (03CH05-CB)



Instrument	Brand	Model No.	Serial No.	Characteristics	Calibration Date	Calibration Due Date	Remark
RF Cable-high	Woken	RG402	High Cable-28	1GHz~18GHz	Oct. 03, 2022	Oct. 02, 2023	Radiation (03CH05-CB)
RF Cable-high	Woken	RG402	High Cable-04+28	1GHz~18GHz	Oct. 03, 2022	Oct. 02, 2023	Radiation (03CH05-CB)
High Cable	Woken	WCA0929M	40G#5+6	1GHz ~ 40 GHz	Dec. 07, 2022	Dec. 06, 2023	Radiation (03CH05-CB)
High Cable	Woken	WCA0929M	40G#5	1GHz ~ 40 GHz	Dec. 07, 2022	Dec. 06, 2023	Radiation (03CH05-CB)
High Cable	Woken	WCA0929M	40G#6	1GHz ~ 40 GHz	Dec. 07, 2022	Dec. 06, 2023	Radiation (03CH05-CB)
Test Software	SPORTON	SENSE	V5.10	-	N.C.R.	N.C.R.	Radiation (03CH05-CB)
Loop Antenna	Teseq	HLA 6120	31244	9kHz - 30 MHz	Mar. 23, 2023	Mar. 22, 2024	Radiation (03CH06-CB)
3m Semi Anechoic Chamber NSA	TDK	SAC-3M	03CH06-CB	30 MHz ~ 1 GHz	Aug. 04, 2022	Aug. 03, 2023	Radiation (03CH06-CB)
Bilog Antenna with 6 dB attenuator	TESEQ & EMCI	CBL6112D & N-6-06	37878 & AT-N0606	20MHz ~ 2GHz	Jul. 31, 2022	Jul. 30, 2023	Radiation (03CH06-CB)
Pre-Amplifier	Agilent	310N	187290	0.1MHz ~ 1GHz	Nov. 04, 2022	Nov. 03, 2023	Radiation (03CH06-CB)
Spectrum analyzer	R&S	FSP40	100080	9kHz~40GHz	Dec. 21, 2022	Dec. 20, 2023	Radiation (03CH06-CB)
EMI Test Receiver	R&S	ESCS	826547/017	9kHz ~ 2.75GHz	Jun. 17, 2022	Jun. 16, 2023	Radiation (03CH06-CB)
RF Cable-low	Woken	RG402	Low Cable-24+68	30MHz~1GHz	Oct. 03, 2022	Oct. 02, 2023	Radiation (03CH06-CB)
Test Software	SPORTON	SENSE	V5.10	-	N.C.R.	N.C.R.	Radiation (03CH06-CB)
3m Semi Anechoic Chamber VSWR	TDK	SAC-3M	03CH01-CB	1GHz ~18GHz 3m	May 06, 2022	May 05, 2023	Radiation (03CH01-CB)
3m Semi Anechoic Chamber VSWR	TDK	SAC-3M	03CH01-CB	1GHz ~18GHz 3m	May 05, 2023	May 04, 2024	Radiation (03CH01-CB)
Horn Antenna	ETS-LINDGREN	3115	00075790	750MHz ~ 18GHz	Nov. 04, 2022	Nov. 03, 2023	Radiation (03CH01-CB)
Horn Antenna	Schwarzbeck	BBHA 9170	BBHA9170252	15GHz ~ 40GHz	Aug. 22, 2022	Aug. 21, 2023	Radiation (03CH01-CB)
Pre-Amplifier	Agilent	8449B	3008A02121	1GHz ~ 26.5GHz	May 19, 2022	May 18, 2023	Radiation (03CH01-CB)
Pre-Amplifier	Agilent	8449B	3008A02121	1GHz ~ 26.5GHz	May 18, 2023	May 17, 2024	Radiation (03CH01-CB)
Pre-Amplifier	SGH	SGH184	20221107-3	18GHz ~ 40GHz	Nov. 16, 2022	Nov. 15, 2023	Radiation (03CH01-CB)



Instrument	Brand	Model No.	Serial No.	Characteristics	Calibration Date	Calibration Due Date	Remark
Signal Analyzer	R&S	FSV3044	101437	10kHz ~ 44GHz	Nov. 29, 2022	Nov. 29, 2023	Radiation (03CH01-CB)
RF Cable-high	Woken	RG402	High Cable-16	1 GHz ~ 18 GHz	Oct. 03, 2022	Oct. 02, 2023	Radiation (03CH01-CB)
RF Cable-high	Woken	RG402	High Cable-16+17	1 GHz ~ 18 GHz	Oct. 03, 2022	Oct. 02, 2023	Radiation (03CH01-CB)
High Cable	Woken	WCA0929M	40G#5+6	1GHz ~ 40 GHz	Dec. 07, 2022	Dec. 06, 2023	Radiation (03CH01-CB)
High Cable	Woken	WCA0929M	40G#5	1GHz ~ 40 GHz	Dec. 07, 2022	Dec. 06, 2023	Radiation (03CH01-CB)
High Cable	Woken	WCA0929M	40G#6	1GHz ~ 40 GHz	Dec. 07, 2022	Dec. 06, 2023	Radiation (03CH01-CB)
Test Software	SPORTON	SENSE	V5.10	-	N.C.R.	N.C.R.	Radiation (03CH01-CB)
Spectrum analyzer	R&S	FSV40	101027	9kHz~40GHz	Aug. 15, 2022	Aug. 14, 2023	Conducted (TH02-CB)
Power Sensor	Anritsu	MA2411B	1126203	300MHz~40GHz	Oct. 17, 2022	Oct. 16, 2023	Conducted (TH02-CB)
Power Meter	Anritsu	ML2495A	1210004	300MHz~40GHz	Oct. 17, 2022	Oct. 16, 2023	Conducted (TH02-CB)
RF Cable-high	Woken	RG402	High Cable-01	1 GHz ~ 18 GHz	Oct. 03, 2022	Oct. 02, 2023	Conducted (TH02-CB)
RF Cable-high	Woken	RG402	High Cable-02	1 GHz ~ 18 GHz	Oct. 03, 2022	Oct. 02, 2023	Conducted (TH02-CB)
RF Cable-high	Woken	RG402	High Cable-03	1 GHz ~ 18 GHz	Oct. 03, 2022	Oct. 02, 2023	Conducted (TH02-CB)
RF Cable-high	Woken	RG402	High Cable-04	1 GHz ~ 18 GHz	Oct. 03, 2022	Oct. 02, 2023	Conducted (TH02-CB)
RF Cable-high	Woken	RG402	High Cable-05	1 GHz ~ 18 GHz	Oct. 03, 2022	Oct. 02, 2023	Conducted (TH02-CB)
High Cable	Woken	WCA0929M	40G#5+6	1GHz ~ 40 GHz	Dec. 07, 2022	Dec. 06, 2023	Conducted (TH02-CB)
High Cable	Woken	WCA0929M	40G#5	1GHz ~ 40 GHz	Dec. 07, 2022	Dec. 06, 2023	Conducted (TH02-CB)
High Cable	Woken	WCA0929M	40G#6	1GHz ~ 40 GHz	Dec. 07, 2022	Dec. 06, 2023	Conducted (TH02-CB)
Switch	SPTCB	SP-SWI	SWI-02	1 GHz ~26.5 GHz	Oct. 04, 2022	Oct. 03, 2023	Conducted (TH02-CB)
Test Software	SPORTON	SENSE	V5.10	-	N.C.R.	N.C.R.	Conducted (TH02-CB)

Note: Calibration Interval of instruments listed above is one year.

NCR means Non-Calibration required.



**Summary**

Mode	Result	Type	Freq (Hz)	Level (dBuV)	Limit (dBuV)	Margin (dB)	Condition
Mode 5	Pass	AV	12.723M	45.38	50.00	-4.62	Line



Mode 5

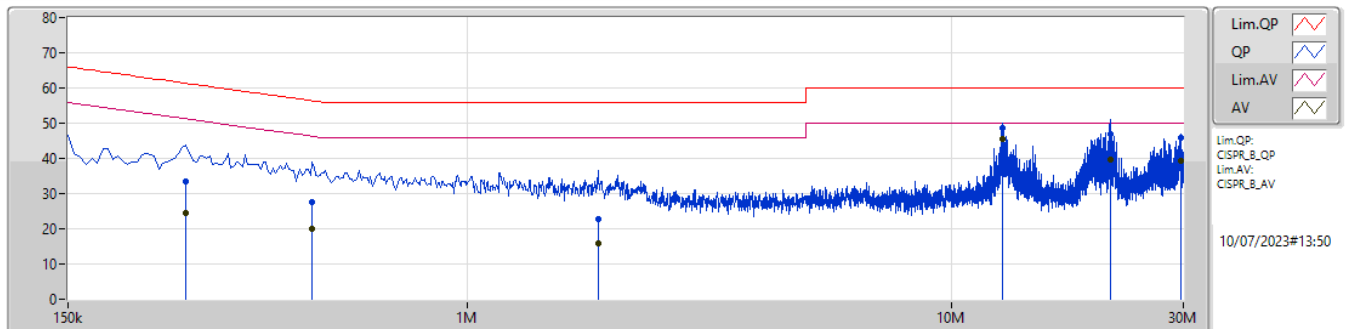

Type	Freq (Hz)	Level (dBuV)	Limit (dBuV)	Margin (dB)	Factor (dB)	Condition	Comment	Raw (dBuV)	LISN (dB)	CL (dB)	AT (dB)
QP	262.5k	33.42	61.35	-27.93	10.01	Line	-	23.41	0.08	0.05	9.88
AV	262.5k	24.42	51.35	-26.93	10.01	Line	-	14.41	0.08	0.05	9.88
QP	478.5k	27.52	56.36	-28.84	10.05	Line	-	17.47	0.09	0.06	9.90
AV	478.5k	19.95	46.36	-26.41	10.05	Line	-	9.90	0.09	0.06	9.90
QP	1.86M	22.88	56.00	-33.12	10.12	Line	-	12.76	0.14	0.08	9.90
AV	1.86M	15.70	46.00	-30.30	10.12	Line	-	5.58	0.14	0.08	9.90
QP	12.723M	48.72	60.00	-11.28	10.40	Line	-	38.32	0.27	0.17	9.96
AV	12.723M	45.38	50.00	-4.62	10.40	Line	"Worst"	34.98	0.27	0.17	9.96
QP	21.251M	47.05	60.00	-12.95	10.56	Line	-	36.49	0.30	0.24	10.02
AV	21.251M	39.73	50.00	-10.27	10.56	Line	-	29.17	0.30	0.24	10.02
QP	29.594M	45.81	60.00	-14.19	10.77	Line	-	35.04	0.33	0.34	10.10
AV	29.594M	39.19	50.00	-10.81	10.77	Line	-	28.42	0.33	0.34	10.10

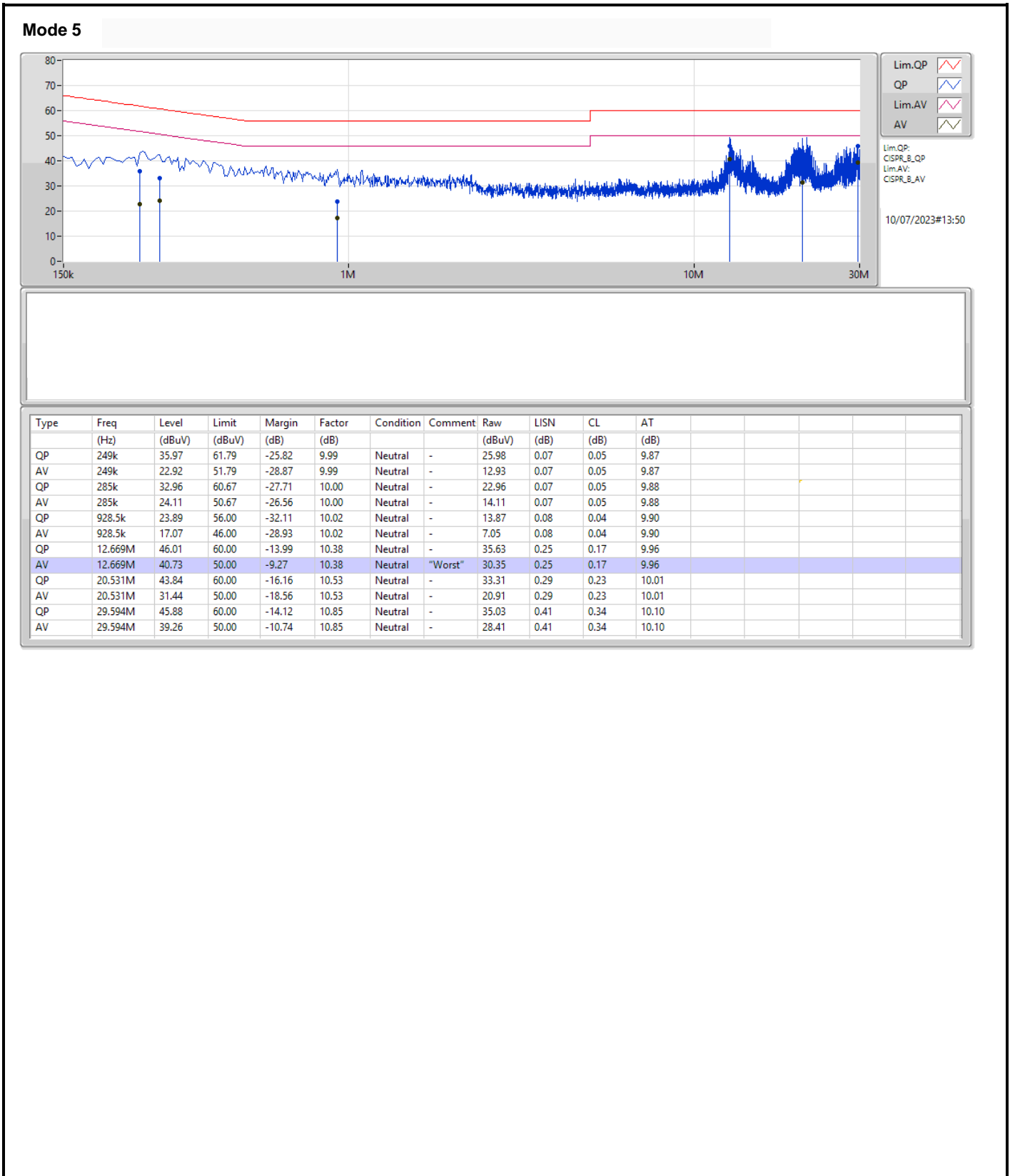



**Summary**

Mode	Max-N dB (Hz)	Max-OBW (Hz)	ITU-Code	Min-N dB (Hz)	Min-OBW (Hz)
2.4-2.4835GHz	-	-	-	-	-
802.11b_Nss1,(1Mbps)_1TX	8M	12.884M	12M9G1D	7.525M	12.826M
802.11b_Nss1,(1Mbps)_2TX	8.05M	13M	13M0G1D	7.05M	12.812M
802.11b_Nss1,(1Mbps)_4TX	8.05M	13M	13M0G1D	7.05M	12.841M
802.11g_Nss1,(6Mbps)_1TX	16.3M	16.376M	16M4D1D	16.3M	16.354M
802.11g_Nss1,(6Mbps)_2TX	16.325M	16.439M	16M4D1D	16.3M	16.354M
802.11g_Nss1,(6Mbps)_4TX	16.325M	16.376M	16M4D1D	15.925M	16.312M
802.11ax HEW20_Nss1,(MCS0)_1TX	18.925M	18.929M	18M9D1D	18.85M	18.88M
802.11ax HEW20_Nss1,(MCS0)_2TX	18.875M	18.929M	18M9D1D	18.5M	18.88M
802.11ax HEW20_Nss1,(MCS0)_4TX	18.925M	18.929M	18M9D1D	18.5M	18.905M

Max-N dB = Maximum 6dB down bandwidth; Max-OBW = Maximum 99% occupied bandwidth;  
 Min-N dB = Minimum 6dB down bandwidth; Min-OBW = Minimum 99% occupied bandwidth

**Result**

Mode	Result	Limit (Hz)	Port 1-N dB (Hz)	Port 1-OBW (Hz)	Port 2-N dB (Hz)	Port 2-OBW (Hz)	Port 3-N dB (Hz)	Port 3-OBW (Hz)	Port 4-N dB (Hz)	Port 4-OBW (Hz)
802.11b_Nss1,(1Mbps)_1TX	-	-	-	-	-	-	-	-	-	-
2412MHz	Pass	500k	7.525M	12.855M	-	-	-	-	-	-
2437MHz	Pass	500k	8M	12.826M	-	-	-	-	-	-
2462MHz	Pass	500k	7.55M	12.884M	-	-	-	-	-	-
802.11g_Nss1,(6Mbps)_1TX	-	-	-	-	-	-	-	-	-	-
2412MHz	Pass	500k	16.3M	16.354M	-	-	-	-	-	-
2437MHz	Pass	500k	16.3M	16.376M	-	-	-	-	-	-
2462MHz	Pass	500k	16.3M	16.354M	-	-	-	-	-	-
802.11ax HEW20_Nss1,(MCS0)_1TX	-	-	-	-	-	-	-	-	-	-
2412MHz	Pass	500k	18.9M	18.88M	-	-	-	-	-	-
2437MHz	Pass	500k	18.925M	18.905M	-	-	-	-	-	-
2462MHz	Pass	500k	18.85M	18.929M	-	-	-	-	-	-
802.11b_Nss1,(1Mbps)_2TX	-	-	-	-	-	-	-	-	-	-
2412MHz	Pass	500k	8.025M	12.855M	7.55M	12.812M	-	-	-	-
2437MHz	Pass	500k	7.1M	12.913M	7.05M	12.913M	-	-	-	-
2462MHz	Pass	500k	8.05M	13M	8.05M	12.884M	-	-	-	-
802.11g_Nss1,(6Mbps)_2TX	-	-	-	-	-	-	-	-	-	-
2412MHz	Pass	500k	16.3M	16.376M	16.325M	16.354M	-	-	-	-
2437MHz	Pass	500k	16.3M	16.397M	16.3M	16.439M	-	-	-	-
2462MHz	Pass	500k	16.3M	16.376M	16.3M	16.354M	-	-	-	-
802.11ax HEW20_Nss1,(MCS0)_2TX	-	-	-	-	-	-	-	-	-	-
2412MHz	Pass	500k	18.725M	18.905M	18.725M	18.929M	-	-	-	-
2437MHz	Pass	500k	18.675M	18.88M	18.775M	18.929M	-	-	-	-
2462MHz	Pass	500k	18.5M	18.88M	18.875M	18.905M	-	-	-	-
802.11b_Nss1,(1Mbps)_4TX	-	-	-	-	-	-	-	-	-	-
2412MHz	Pass	500k	7.075M	12.942M	8M	12.841M	8.025M	12.87M	7.1M	12.913M
2437MHz	Pass	500k	8.025M	12.942M	7.1M	12.855M	7.525M	12.884M	7.05M	12.942M
2462MHz	Pass	500k	8.05M	13M	8.05M	12.884M	8.05M	12.942M	7.1M	12.971M
802.11g_Nss1,(6Mbps)_4TX	-	-	-	-	-	-	-	-	-	-
2412MHz	Pass	500k	16.325M	16.376M	16.275M	16.354M	16.325M	16.376M	16.325M	16.354M
2437MHz	Pass	500k	16.325M	16.376M	16.3M	16.312M	16.3M	16.354M	16.3M	16.354M
2462MHz	Pass	500k	15.925M	16.312M	16.325M	16.376M	16.3M	16.376M	16.3M	16.376M
802.11ax HEW20_Nss1,(MCS0)_4TX	-	-	-	-	-	-	-	-	-	-
2412MHz	Pass	500k	18.5M	18.905M	18.925M	18.929M	18.9M	18.929M	18.925M	18.905M
2437MHz	Pass	500k	18.6M	18.929M	18.925M	18.905M	18.925M	18.929M	18.875M	18.929M
2462MHz	Pass	500k	18.575M	18.905M	18.875M	18.929M	18.85M	18.929M	18.925M	18.929M

Port X-N dB = Port X 6dB down bandwidth;  
 Port X-OBW = Port X 99% occupied bandwidth

2.4-2.4835GHz\_802.11b\_Nss1,(1Mbps)\_1TX

EBW

2412MHz

18/03/2023

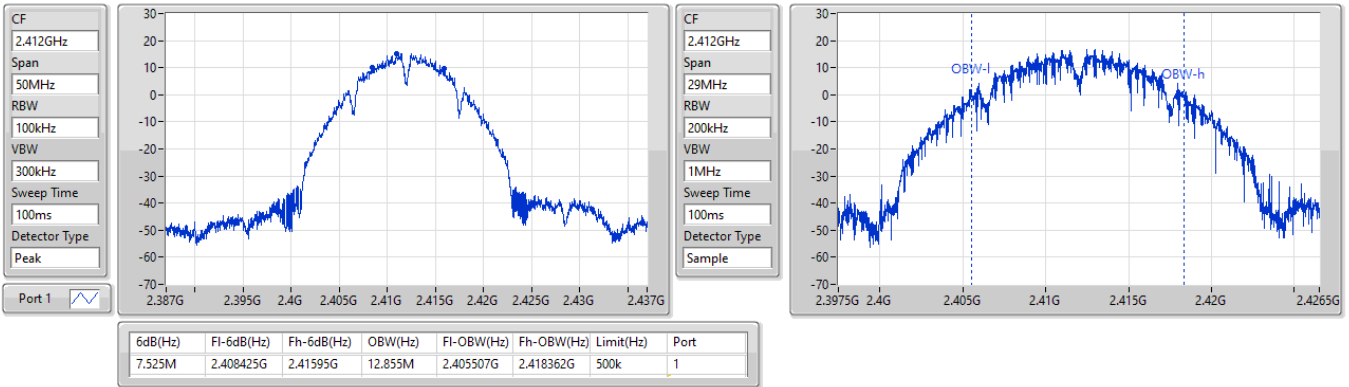

2.4-2.4835GHz\_802.11b\_Nss1,(1Mbps)\_1TX

EBW

2437MHz

18/03/2023

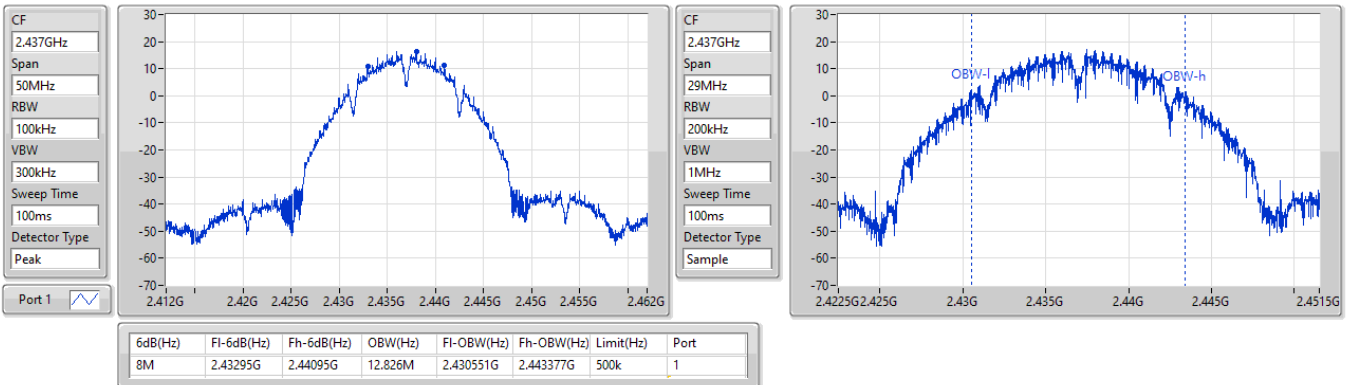

2.4-2.4835GHz\_802.11b\_Nss1,(1Mbps)\_1TX

EBW

2462MHz

18/03/2023

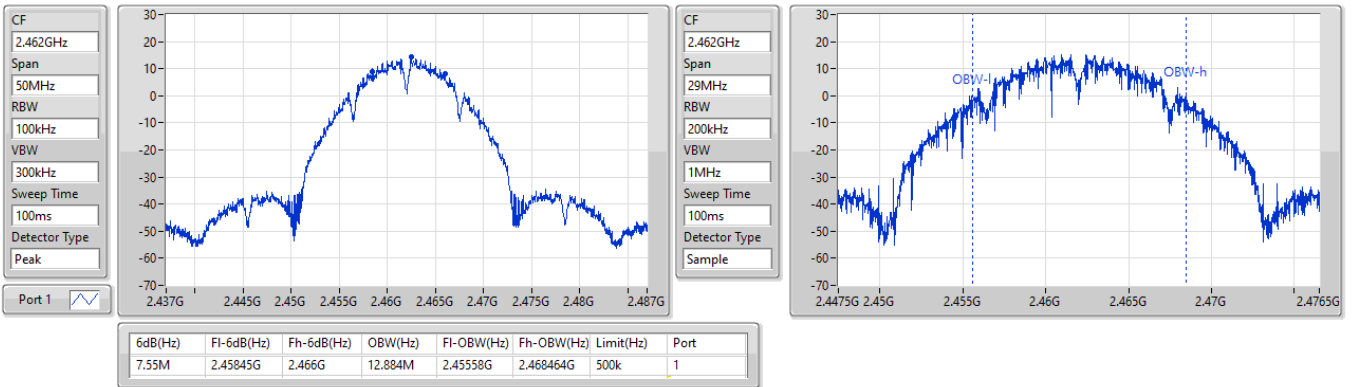

2.4-2.4835GHz\_802.11g\_Nss1,(6Mbps)\_1TX

EBW

2412MHz

17/03/2023

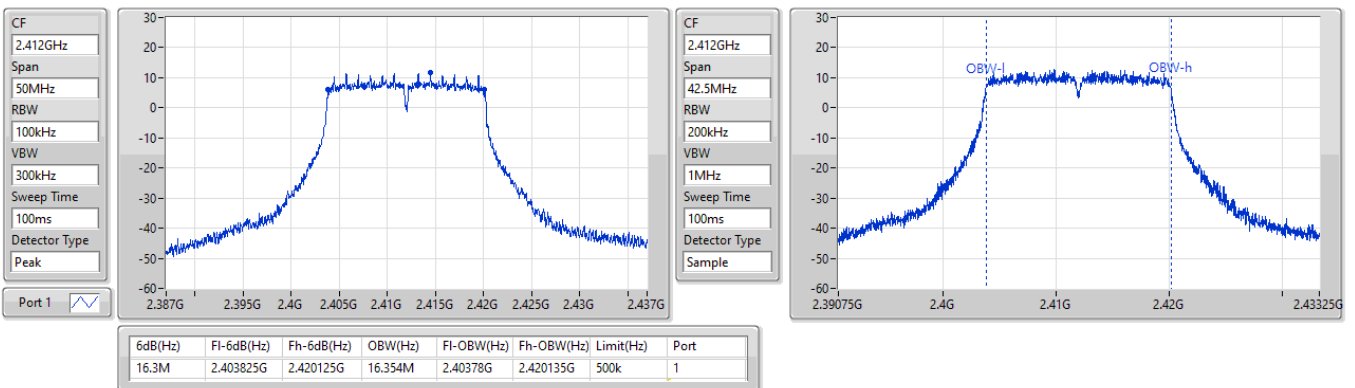

2.4-2.4835GHz\_802.11g\_Nss1,(6Mbps)\_1TX

EBW

2437MHz

17/03/2023

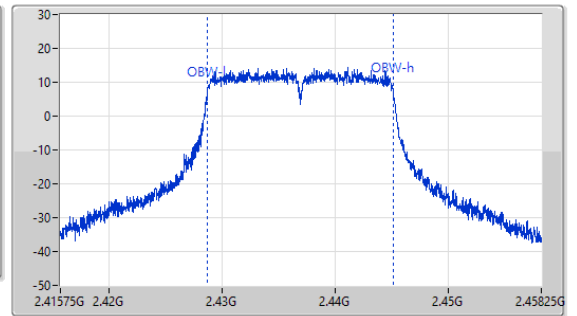
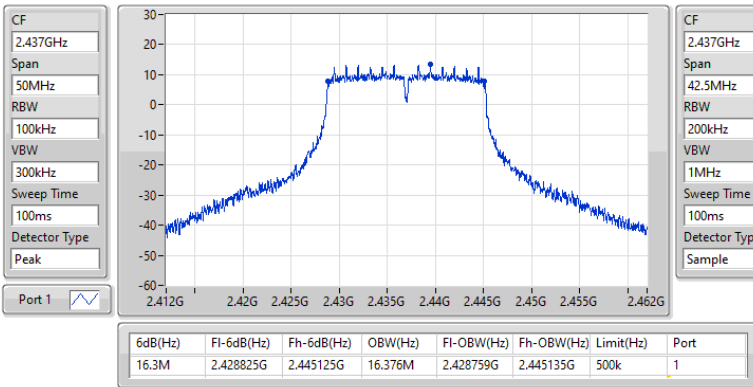

2.4-2.4835GHz\_802.11g\_Nss1,(6Mbps)\_1TX

EBW

2462MHz

17/03/2023

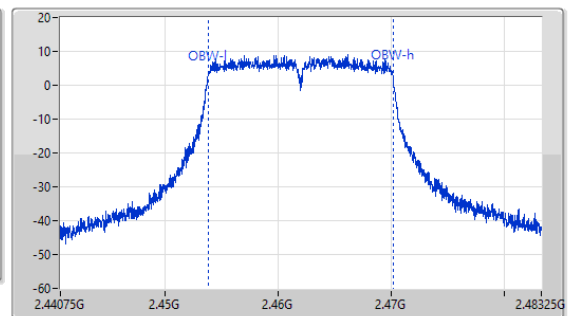
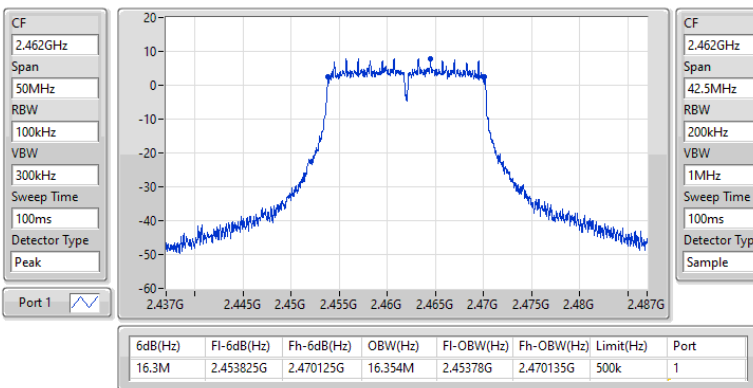

2.4-2.4835GHz\_802.11ax HEW20\_Nss1,(MCS0)\_1TX

EBW

2412MHz

17/03/2023

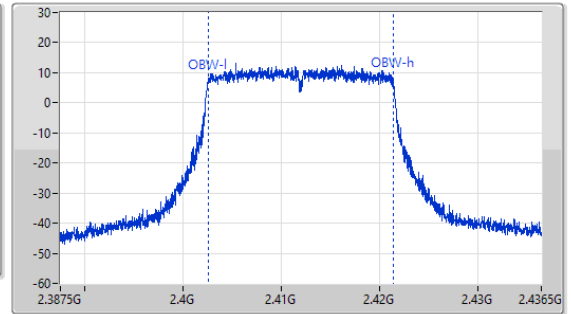
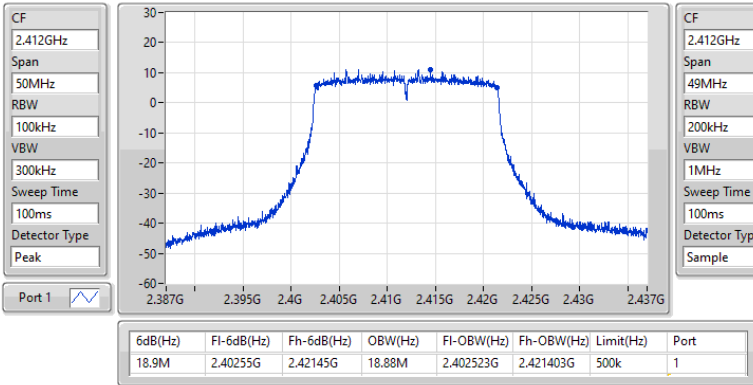

2.4-2.4835GHz\_802.11ax HEW20\_Nss1,(MCS0)\_1TX

EBW

2437MHz

17/03/2023

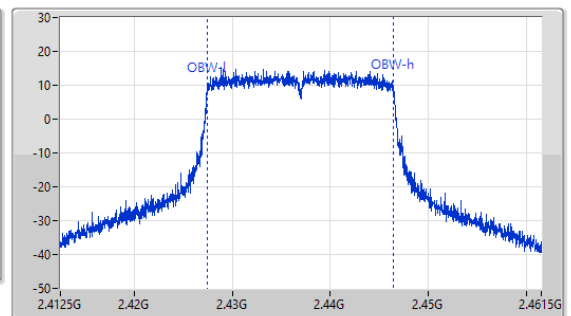
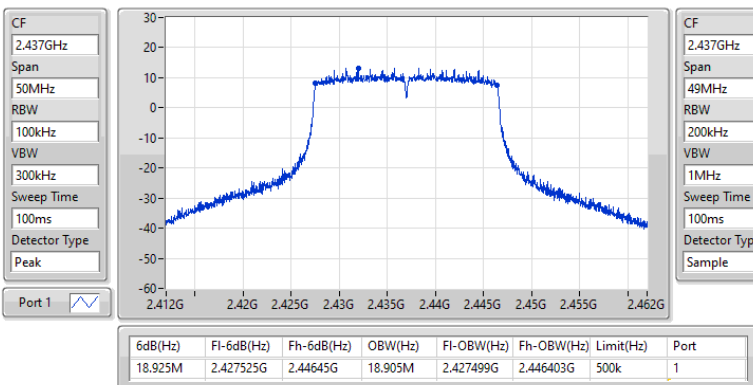



2.4-2.4835GHz\_802.11ax\_HEW20\_Nss1,(MCS0)\_1TX

EBW

2462MHz

17/03/2023

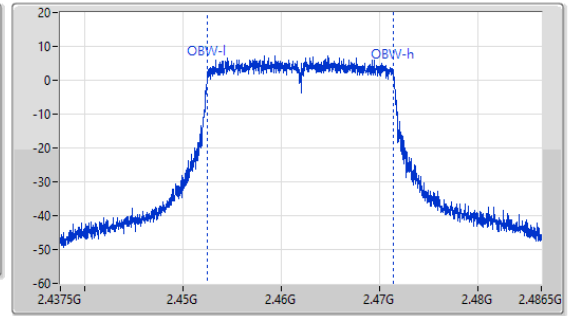
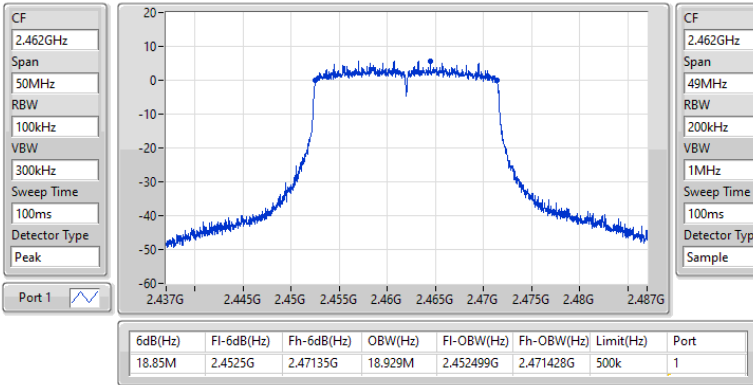

2.4-2.4835GHz\_802.11b\_Nss1,(1Mbps)\_2TX

EBW

2412MHz

17/03/2023

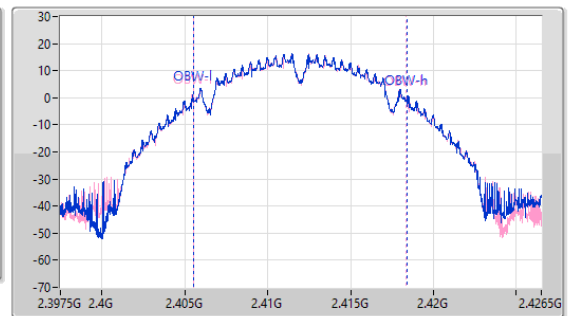
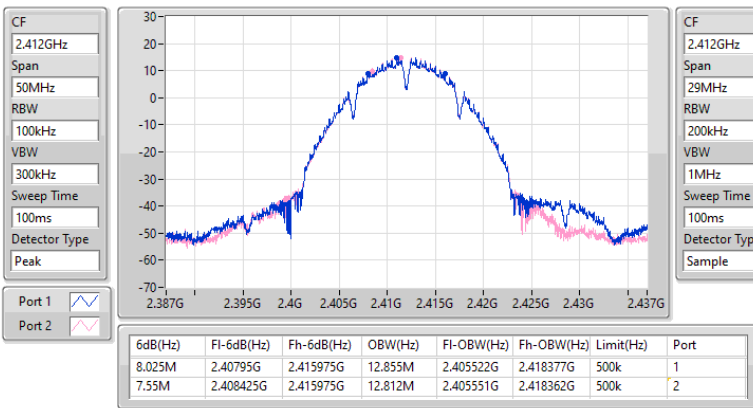

2.4-2.4835GHz\_802.11b\_Nss1,(1Mbps)\_2TX

EBW

2437MHz

17/03/2023

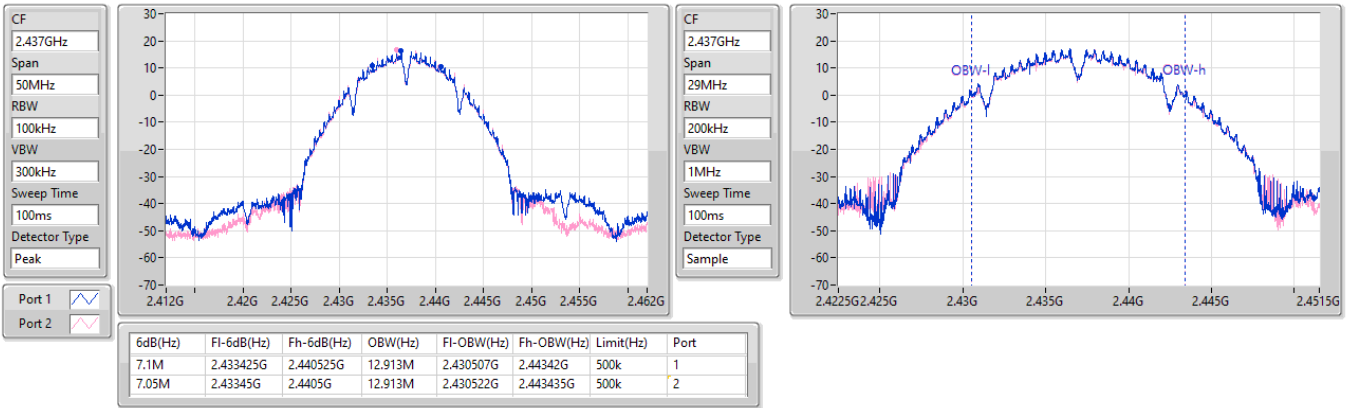

2.4-2.4835GHz\_802.11b\_Nss1,(1Mbps)\_2TX

EBW

2462MHz

17/03/2023

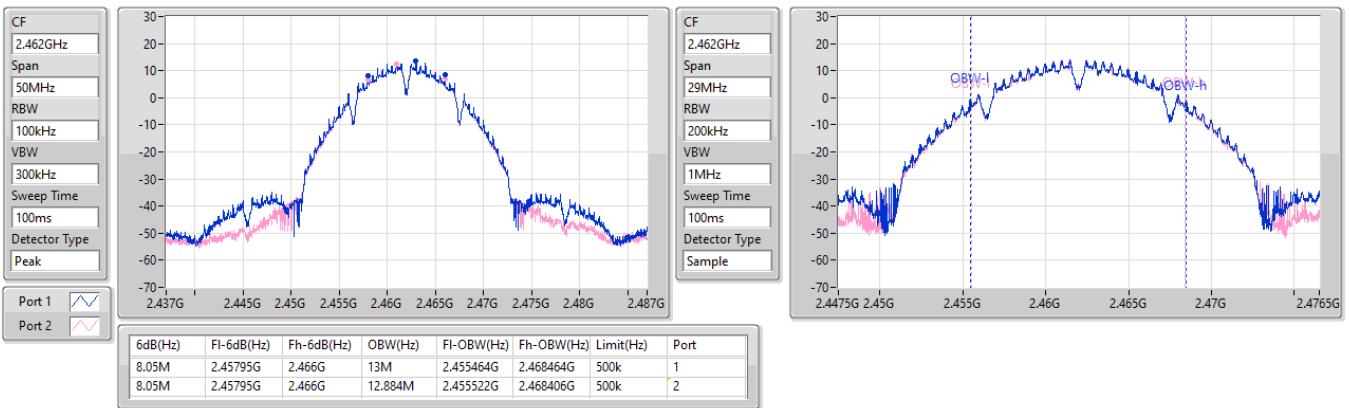

2.4-2.4835GHz\_802.11g\_Nss1,(6Mbps)\_2TX

EBW

2412MHz

17/03/2023

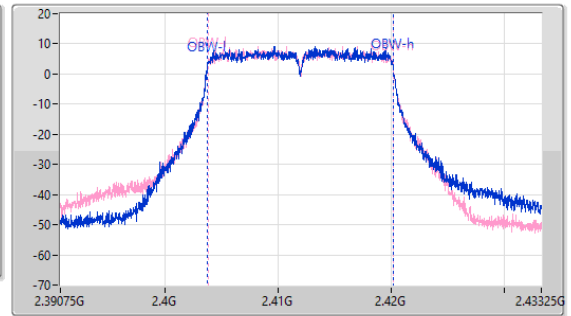
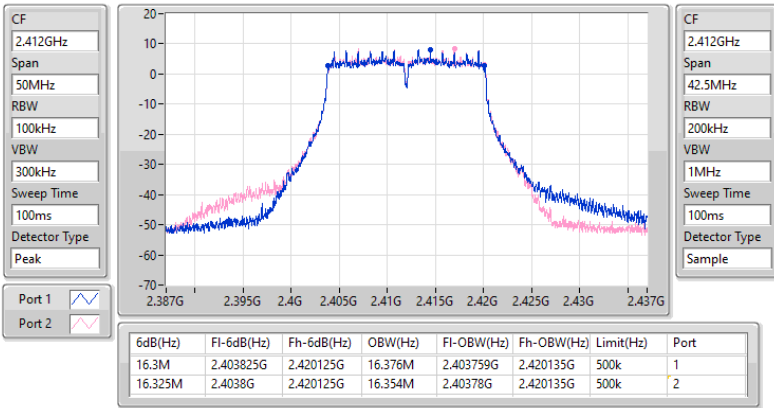

2.4-2.4835GHz\_802.11g\_Nss1,(6Mbps)\_2TX

EBW

2437MHz

17/03/2023

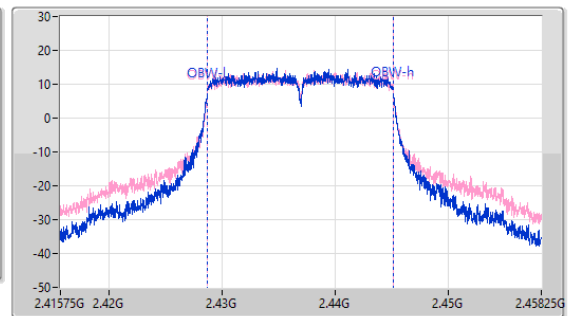
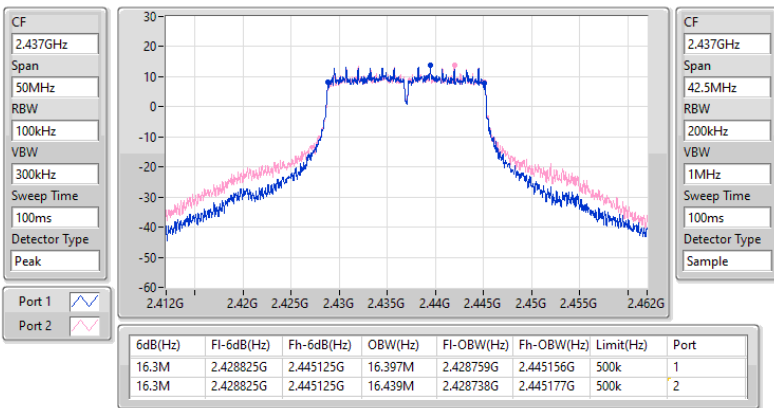

2.4-2.4835GHz\_802.11g\_Nss1,(6Mbps)\_2TX

EBW

2462MHz

17/03/2023

CF  
2.462GHz  
Span  
50MHz  
RBW  
100kHz  
VBW  
300kHz  
Sweep Time  
100ms  
Detector Type  
Peak

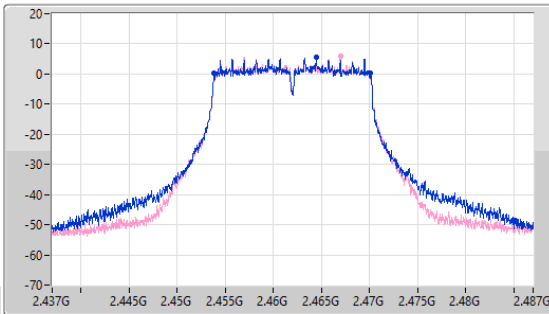

CF  
2.462GHz  
Span  
42.5MHz  
RBW  
200kHz  
VBW  
1MHz  
Sweep Time  
100ms  
Detector Type  
Sample

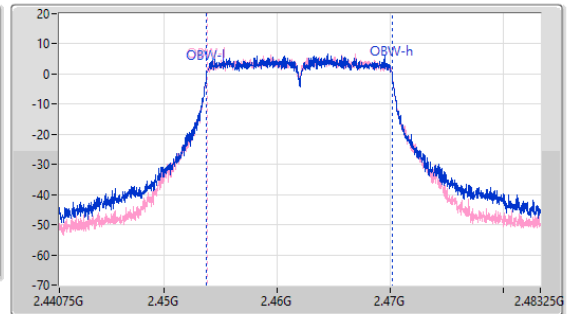

6dB(Hz)	Fl-6dB(Hz)	Fh-6dB(Hz)	OBW(Hz)	Fl-OBW(Hz)	Fh-OBW(Hz)	Limit(Hz)	Port
16.3M	2.453825G	2.470125G	16.376M	2.453759G	2.470135G	500k	1
16.3M	2.453825G	2.470125G	16.354M	2.45378G	2.470135G	500k	2

2.4-2.4835GHz\_802.11ax\_HEW20\_Nss1,(MCS0)\_2TX

EBW

2412MHz

17/03/2023

CF  
2.412GHz  
Span  
50MHz  
RBW  
100kHz  
VBW  
300kHz  
Sweep Time  
100ms  
Detector Type  
Peak

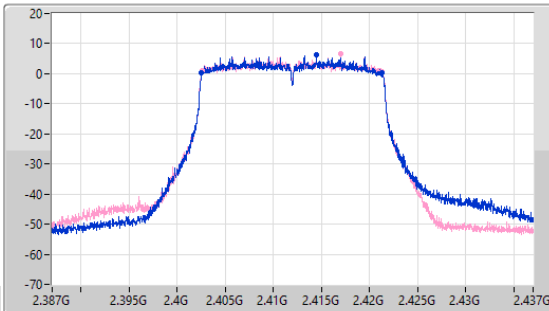

CF  
2.412GHz  
Span  
49MHz  
RBW  
200kHz  
VBW  
1MHz  
Sweep Time  
100ms  
Detector Type  
Sample

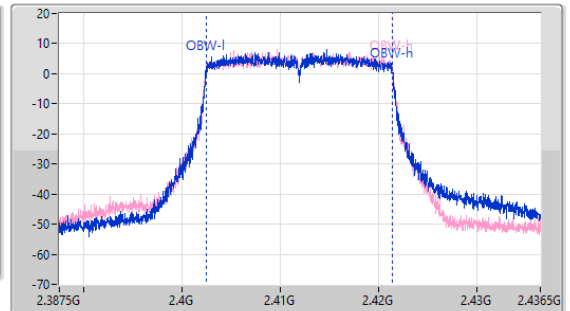

6dB(Hz)	Fl-6dB(Hz)	Fh-6dB(Hz)	OBW(Hz)	Fl-OBW(Hz)	Fh-OBW(Hz)	Limit(Hz)	Port
18.725M	2.402525G	2.42125G	18.905M	2.402499G	2.421403G	500k	1
18.725M	2.4026G	2.421325G	18.929M	2.402499G	2.421428G	500k	2

2.4-2.4835GHz\_802.11ax HEW20\_Nss1,(MCS0)\_2TX

EBW

2437MHz

17/03/2023

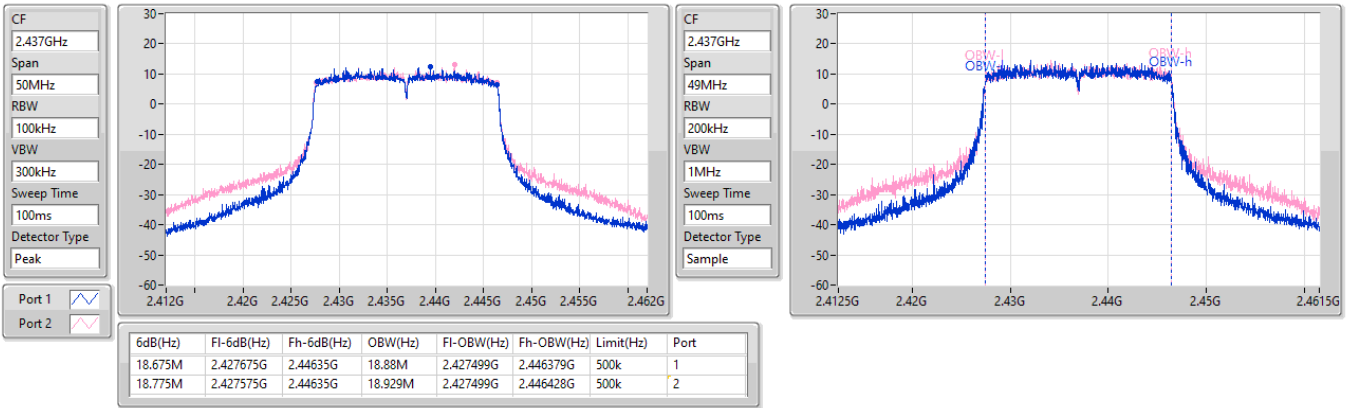

2.4-2.4835GHz\_802.11ax HEW20\_Nss1,(MCS0)\_2TX

EBW

2462MHz

17/03/2023

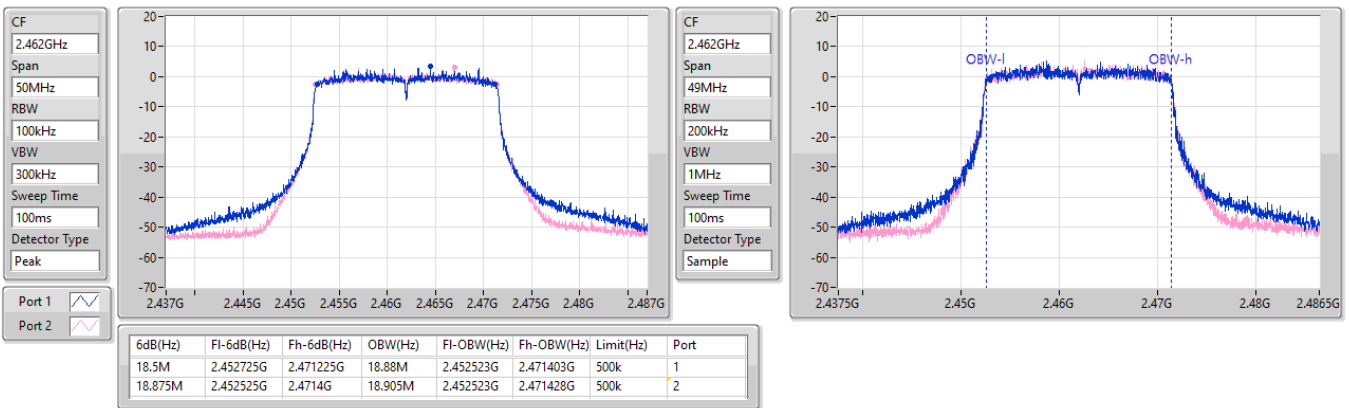

2.4-2.4835GHz\_802.11b\_Nss1,(1Mbps)\_4TX

EBW

2412MHz

18/03/2023

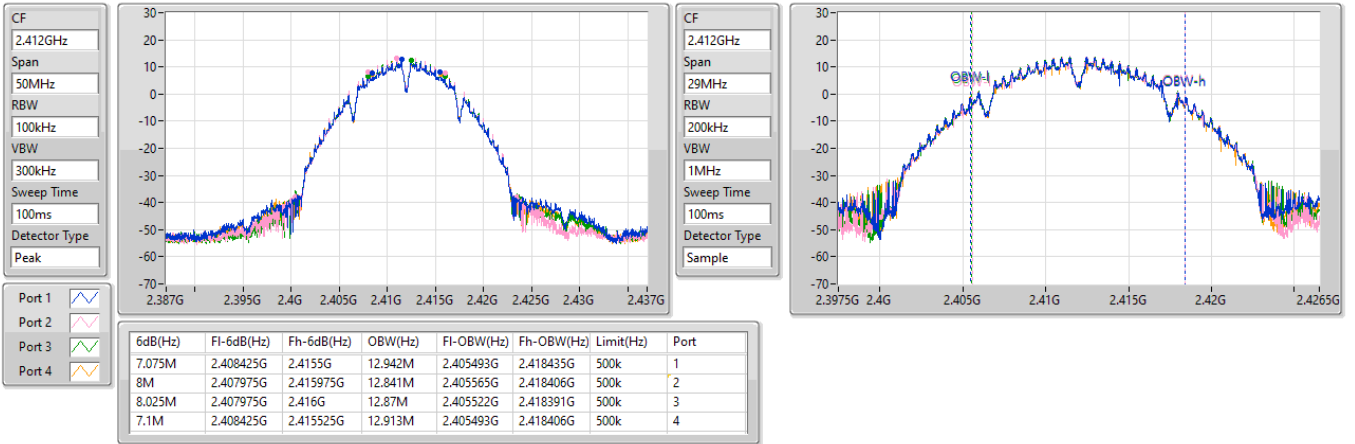

2.4-2.4835GHz\_802.11b\_Nss1,(1Mbps)\_4TX

EBW

2437MHz

18/03/2023

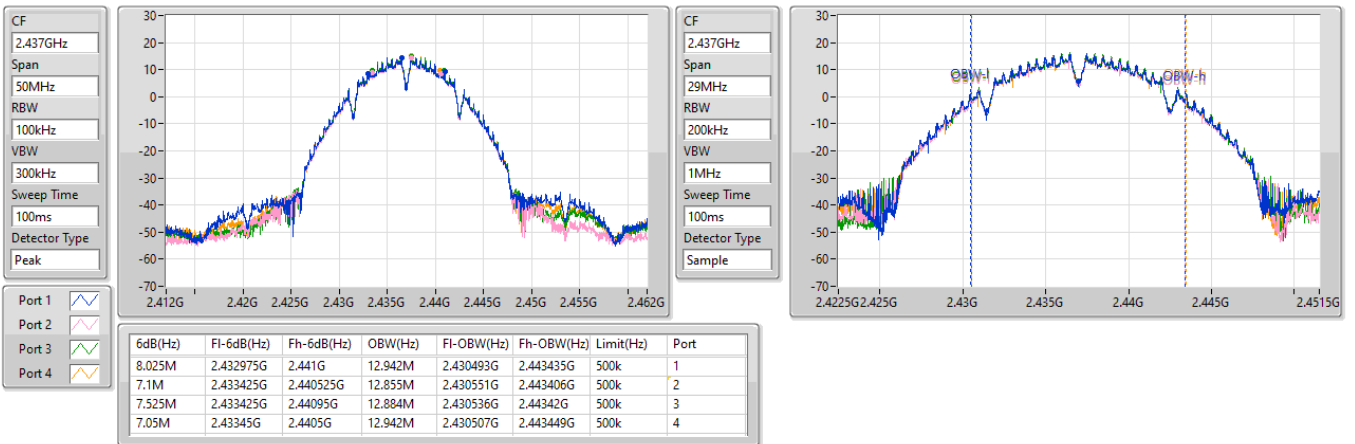

2.4-2.4835GHz\_802.11b\_Nss1,(1Mbps)\_4TX

EBW

2462MHz

18/03/2023

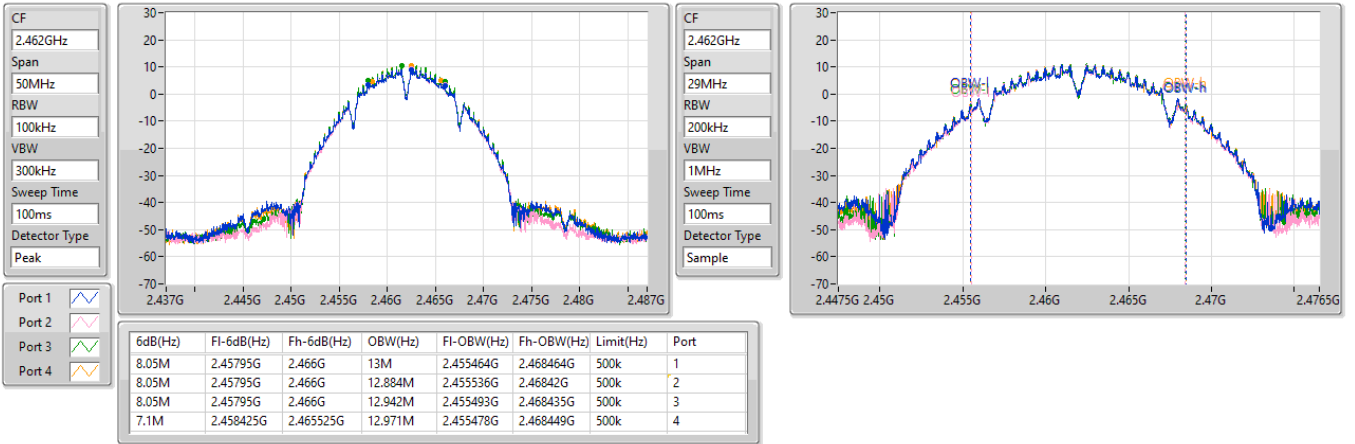

2.4-2.4835GHz\_802.11g\_Nss1,(6Mbps)\_4TX

EBW

2412MHz

18/03/2023

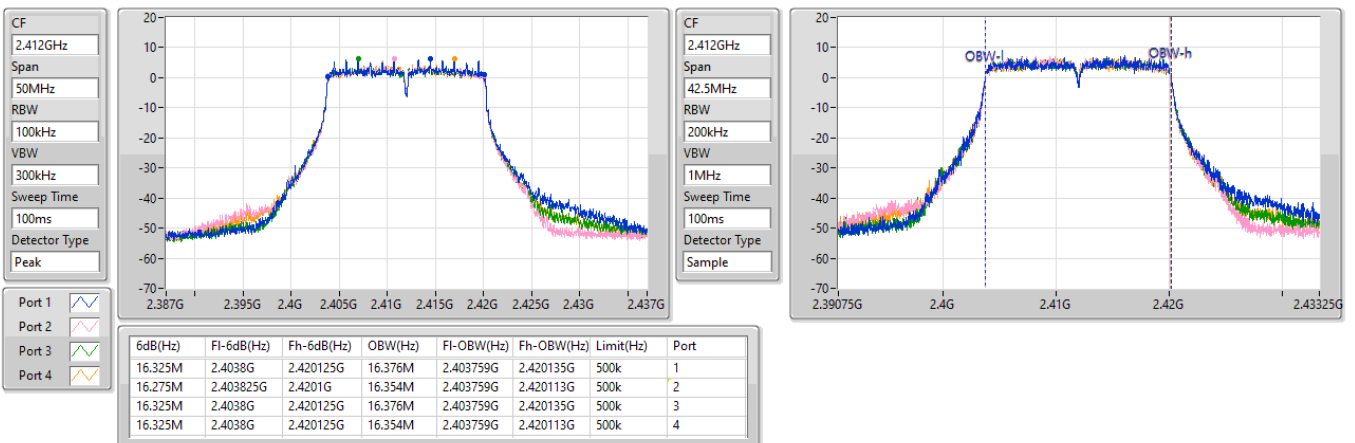

2.4-2.4835GHz\_802.11g\_Nss1,(6Mbps)\_4TX

EBW

2437MHz

18/03/2023

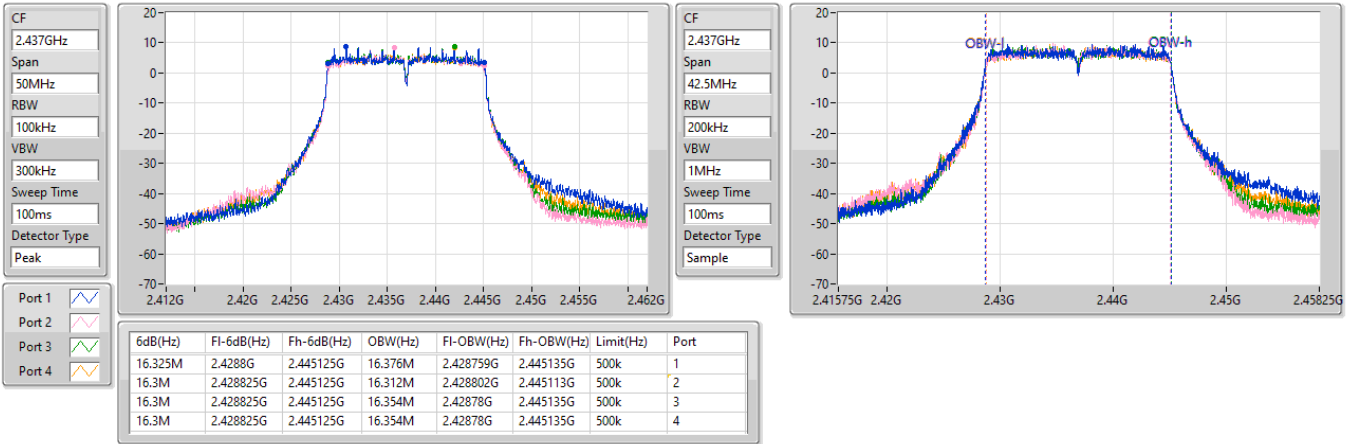

2.4-2.4835GHz\_802.11g\_Nss1,(6Mbps)\_4TX

EBW

2462MHz

18/03/2023

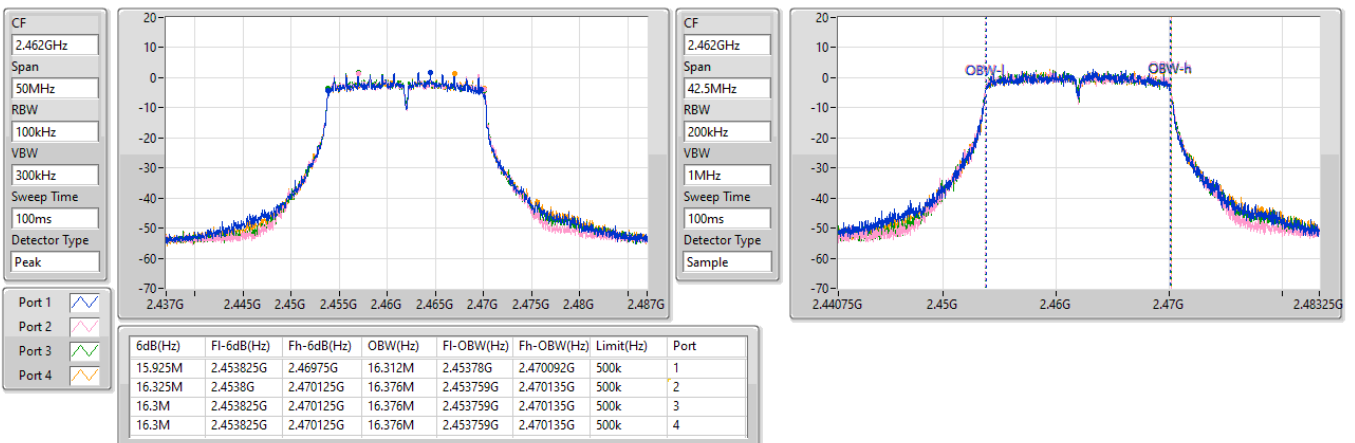



2.4-2.4835GHz\_802.11ax HEW20\_Nss1,(MCS0)\_4TX

EBW

2412MHz

18/03/2023

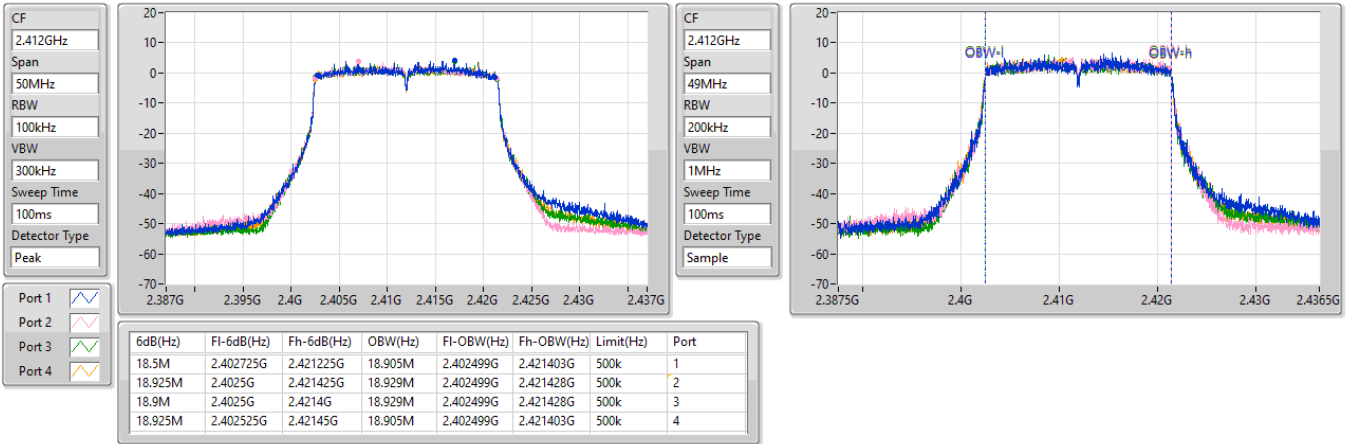

2.4-2.4835GHz\_802.11ax HEW20\_Nss1,(MCS0)\_4TX

EBW

2437MHz

18/03/2023

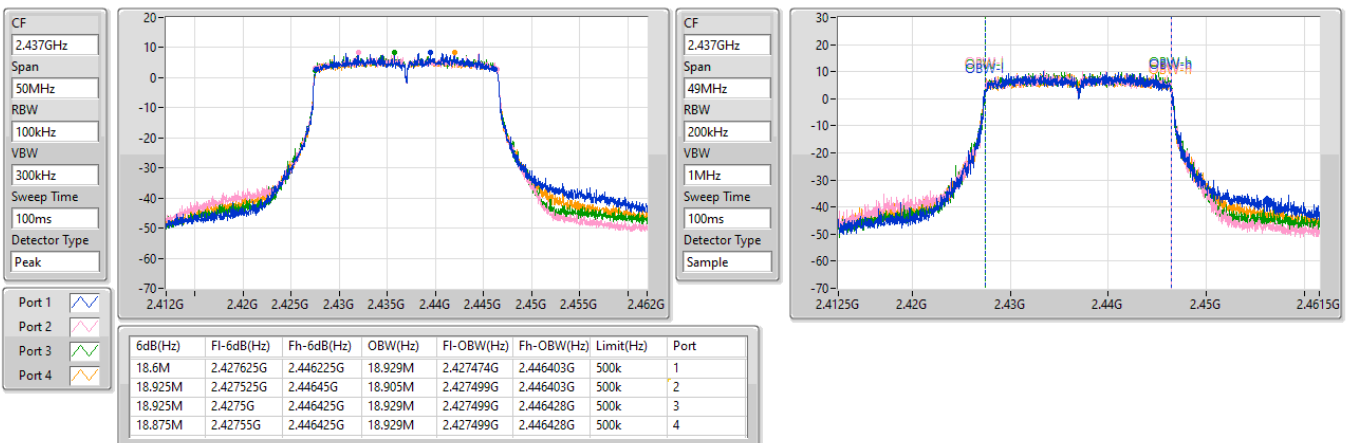

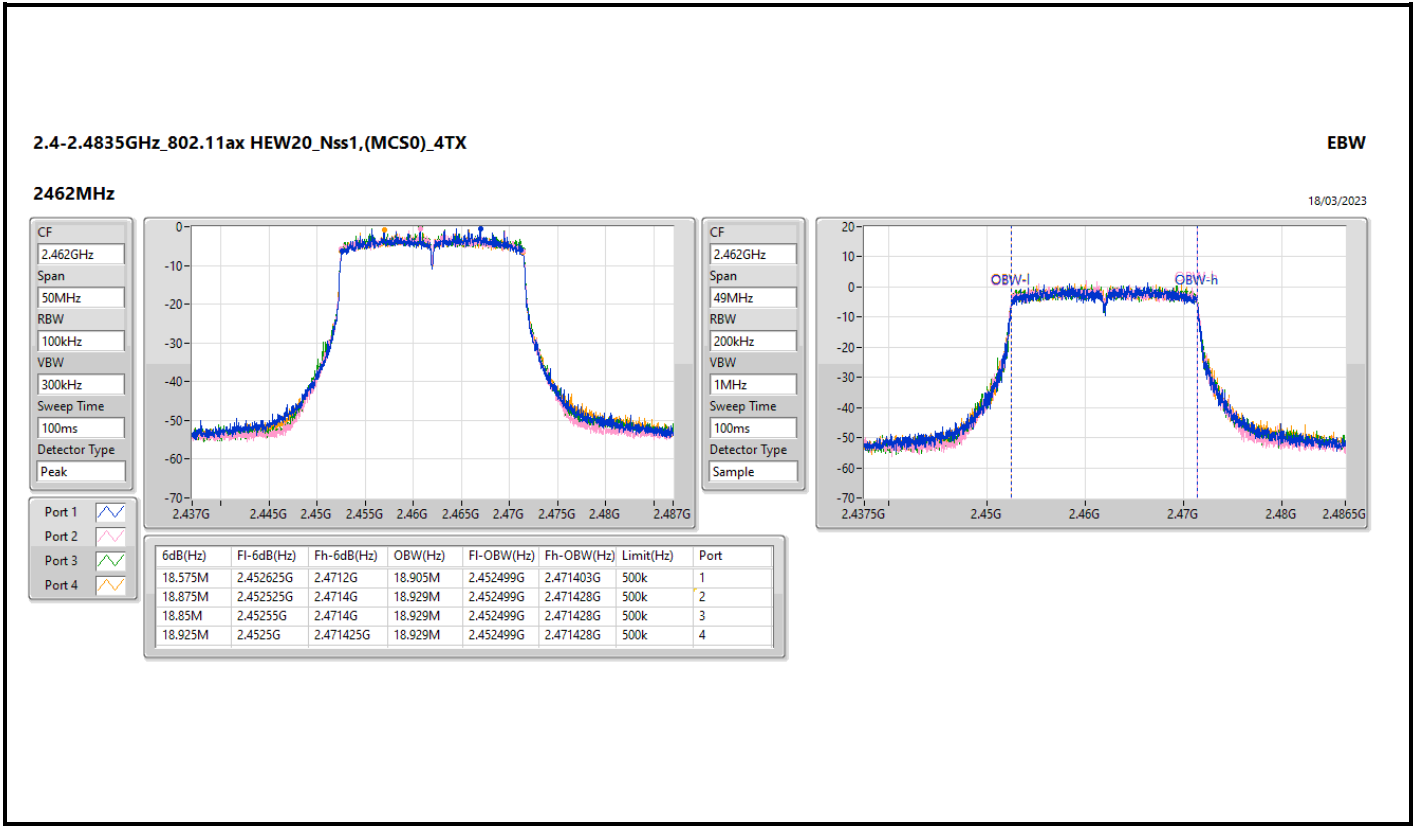



**Summary**

Mode	Max-N dB (Hz)	Max-OBW (Hz)	ITU-Code	Min-N dB (Hz)	Min-OBW (Hz)
2.4-2.4835GHz	-	-	-	-	-
802.11b_Nss1,(1Mbps)_1TX	8.075M	13.013M	13M0G1D	8.025M	12.984M
802.11g_Nss1,(6Mbps)_1TX	16.05M	16.354M	16M4D1D	16.05M	16.333M
802.11ax HEW20_Nss1,(MCS0)_1TX	18.75M	18.88M	18M9D1D	18.475M	18.856M

Max-N dB = Maximum 6dB down bandwidth; Max-OBW = Maximum 99% occupied bandwidth;  
Min-N dB = Minimum 6dB down bandwidth; Min-OBW = Minimum 99% occupied bandwidth



Result

Mode	Result	Limit (Hz)	Port 1-N dB (Hz)	Port 1-OBW (Hz)
802.11b_Nss1,(1Mbps)_1TX	-	-	-	-
2412MHz	Pass	500k	8.075M	13.013M
2437MHz	Pass	500k	8.075M	13.013M
2462MHz	Pass	500k	8.025M	12.984M
802.11g_Nss1,(6Mbps)_1TX	-	-	-	-
2412MHz	Pass	500k	16.05M	16.333M
2437MHz	Pass	500k	16.05M	16.354M
2462MHz	Pass	500k	16.05M	16.333M
802.11ax HEW20_Nss1,(MCS0)_1TX	-	-	-	-
2412MHz	Pass	500k	18.525M	18.856M
2437MHz	Pass	500k	18.75M	18.88M
2462MHz	Pass	500k	18.475M	18.88M

Port X-N dB = Port X 6dB down bandwidth;  
Port X-OBW = Port X 99% occupied bandwidth

2.4-2.4835GHz\_802.11b\_Nss1,(1Mbps)\_1TX

EBW

2412MHz

04/05/2023

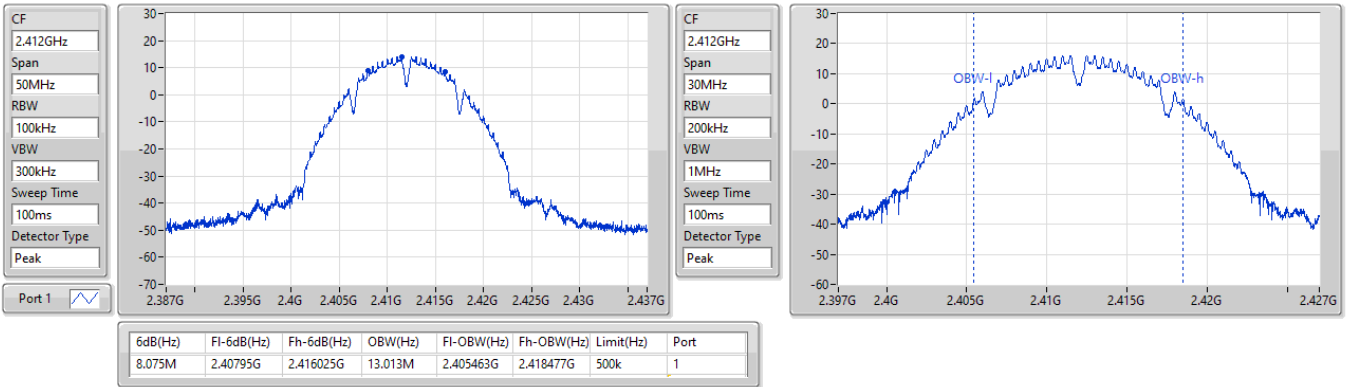

2.4-2.4835GHz\_802.11b\_Nss1,(1Mbps)\_1TX

EBW

2437MHz

04/05/2023

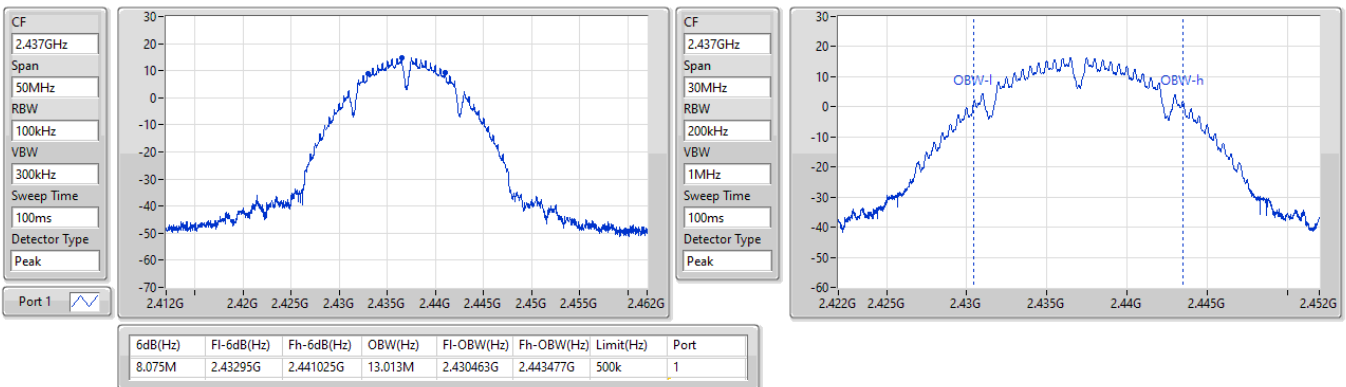

2.4-2.4835GHz\_802.11b\_Nss1,(1Mbps)\_1TX

EBW

2462MHz

04/05/2023

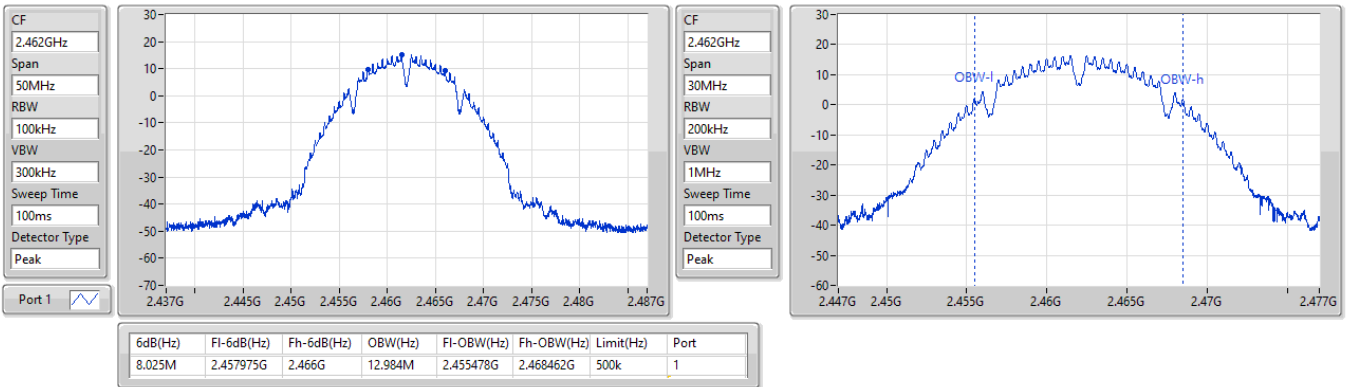

2.4-2.4835GHz\_802.11g\_Nss1,(6Mbps)\_1TX

EBW

2412MHz

21/03/2023

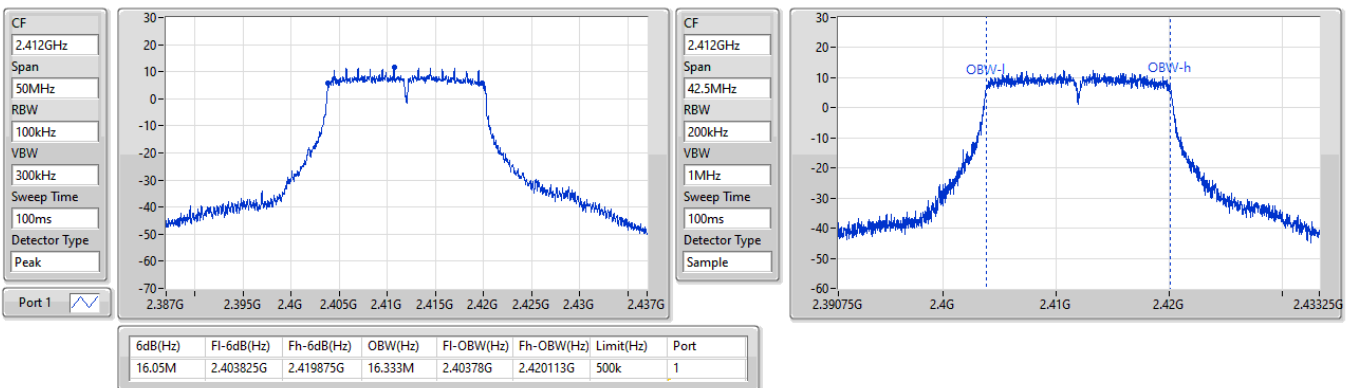

2.4-2.4835GHz\_802.11g\_Nss1,(6Mbps)\_1TX

EBW

2437MHz

21/03/2023

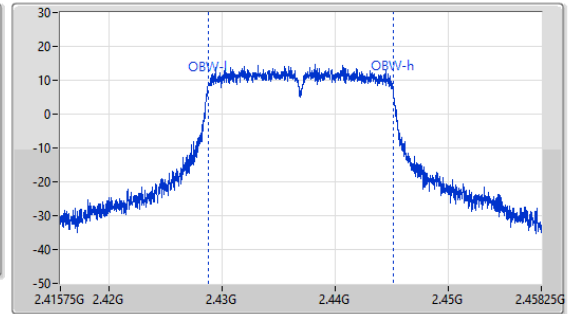
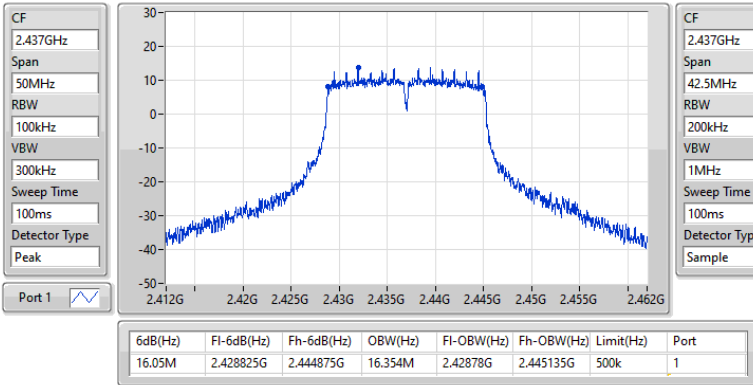

2.4-2.4835GHz\_802.11g\_Nss1,(6Mbps)\_1TX

EBW

2462MHz

21/03/2023

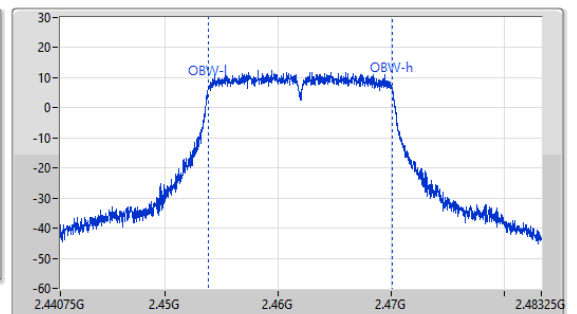
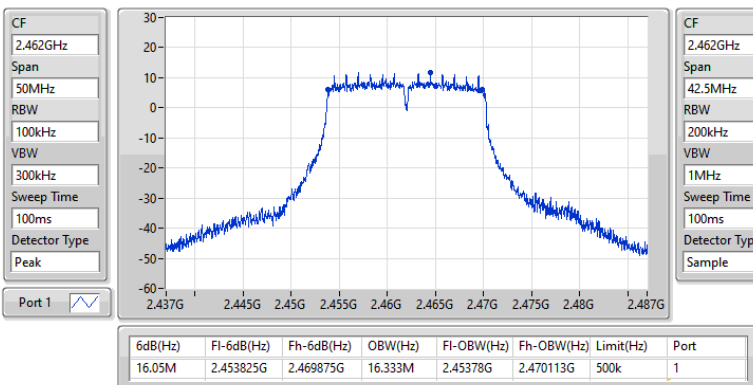

2.4-2.4835GHz\_802.11ax HEW20\_Nss1,(MCS0)\_1TX

EBW

2412MHz

21/03/2023

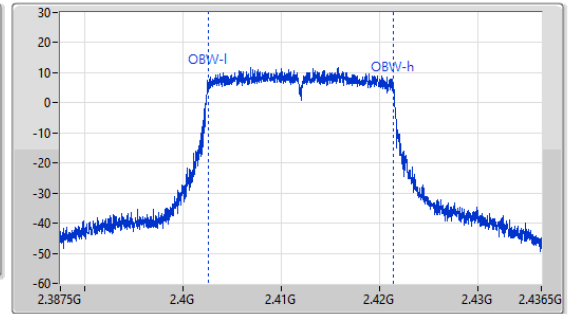
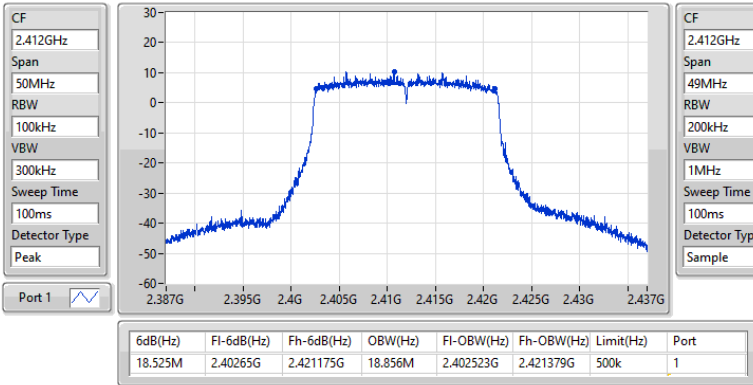

2.4-2.4835GHz\_802.11ax HEW20\_Nss1,(MCS0)\_1TX

EBW

2437MHz

21/03/2023

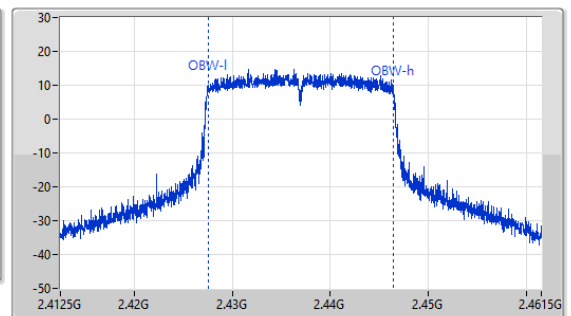
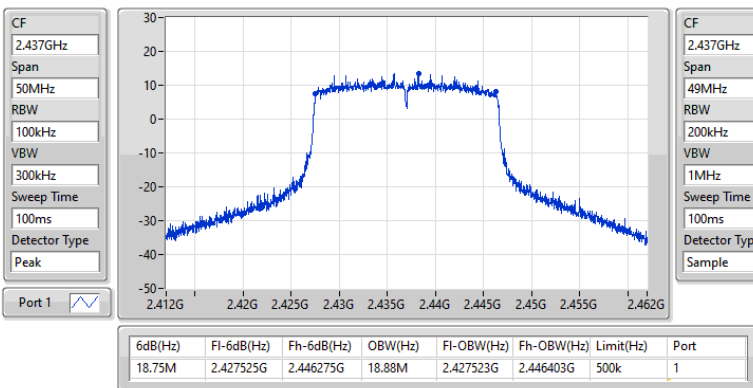



2.4-2.4835GHz\_802.11ax HEW20\_Nss1,(MCS0)\_1TX

EBW

2462MHz

21/03/2023

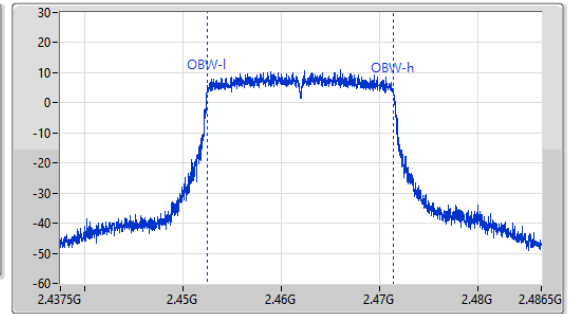
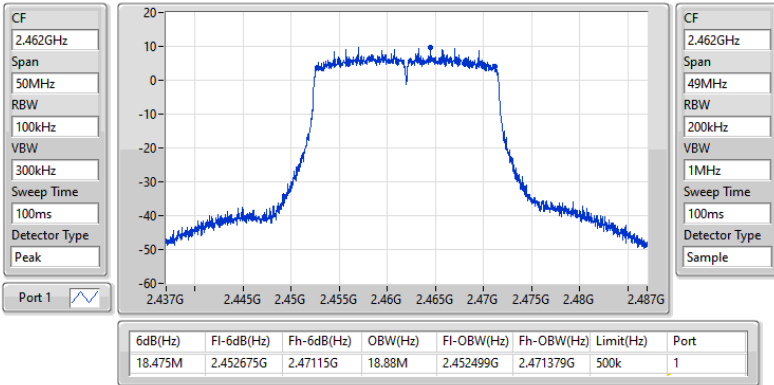



Summary

Mode	Total Power (dBm)	Total Power (W)
2.4-2.4835GHz	-	-
802.11b_Nss1,(1Mbps)_1TX	24.17	0.26122
802.11b_Nss1,(1Mbps)_2TX	27.08	0.51050
802.11b_Nss1,(1Mbps)_4TX	29.07	0.80724
802.11g_Nss1,(6Mbps)_1TX	24.30	0.26915
802.11g_Nss1,(6Mbps)_2TX	27.29	0.53580
802.11g_Nss1,(6Mbps)_4TX	25.38	0.34514
802.11ax HEW20_Nss1,(MCS0)_1TX	24.56	0.28576
802.11ax HEW20_Nss1,(MCS0)_2TX	26.50	0.44668
802.11ax HEW20_Nss1,(MCS0)_4TX	25.44	0.34995
802.11ax HEW20-BF_Nss1,(MCS0)_2TX	26.50	0.44668
802.11ax HEW20-BF_Nss1,(MCS0)_4TX	25.44	0.34995



# Average Power\_Radio 1

# Appendix C.1

## Result

Mode	Result	DG (dBi)	Port 1 (dBm)	Port 2 (dBm)	Port 3 (dBm)	Port 4 (dBm)	Total Power (dBm)	Power Limit (dBm)
802.11b_Nss1,(1Mbps)_1TX	-	-	-	-	-	-	-	-
2412MHz	Pass	3.95	24.17	-	-	-	24.17	30.00
2437MHz	Pass	3.95	24.11	-	-	-	24.11	30.00
2462MHz	Pass	3.95	22.53	-	-	-	22.53	30.00
802.11g_Nss1,(6Mbps)_1TX	-	-	-	-	-	-	-	-
2412MHz	Pass	3.95	22.4	-	-	-	22.40	30.00
2437MHz	Pass	3.95	24.3	-	-	-	24.30	30.00
2457MHz	Pass	3.95	22.21	-	-	-	22.21	30.00
2462MHz	Pass	3.95	18.85	-	-	-	18.85	30.00
802.11ax HEW20_Nss1,(MCS0)_1TX	-	-	-	-	-	-	-	-
2412MHz	Pass	3.95	22.07	-	-	-	22.07	30.00
2437MHz	Pass	3.95	24.56	-	-	-	24.56	30.00
2457MHz	Pass	3.95	20.81	-	-	-	20.81	30.00
2462MHz	Pass	3.95	16.91	-	-	-	16.91	30.00
802.11b_Nss1,(1Mbps)_2TX	-	-	-	-	-	-	-	-
2412MHz	Pass	3.95	23.11	23.21	-	-	26.17	30.00
2437MHz	Pass	3.95	24.19	23.94	-	-	27.08	30.00
2457MHz	Pass	3.95	20.9	20.93	-	-	23.93	30.00
2462MHz	Pass	3.95	20.93	21	-	-	23.98	30.00
802.11g_Nss1,(6Mbps)_2TX	-	-	-	-	-	-	-	-
2412MHz	Pass	3.95	18.97	19.23	-	-	22.11	30.00
2417MHz	Pass	3.95	20.93	21.18	-	-	24.07	30.00
2437MHz	Pass	3.95	24.27	24.28	-	-	27.29	30.00
2457MHz	Pass	3.95	19.13	19.25	-	-	22.20	30.00
2462MHz	Pass	3.95	16.24	16.39	-	-	19.33	30.00
802.11ax HEW20_Nss1,(MCS0)_2TX	-	-	-	-	-	-	-	-
2412MHz	Pass	3.95	17.17	17.32	-	-	20.26	30.00
2417MHz	Pass	3.95	20.17	20.37	-	-	23.28	30.00
2437MHz	Pass	3.95	23.54	23.43	-	-	26.50	30.00
2457MHz	Pass	3.95	18.3	18.03	-	-	21.18	30.00
2462MHz	Pass	3.95	14	13.93	-	-	16.98	30.00
802.11b_Nss1,(1Mbps)_4TX	-	-	-	-	-	-	-	-
2412MHz	Pass	3.95	20.49	20.53	20.94	20.65	26.68	30.00
2437MHz	Pass	3.95	23.02	22.85	23.43	22.87	29.07	30.00
2457MHz	Pass	3.95	17.62	17.72	17.92	18.03	23.85	30.00
2462MHz	Pass	3.95	17.65	17.83	18.05	18.22	23.96	30.00
802.11g_Nss1,(6Mbps)_4TX	-	-	-	-	-	-	-	-
2412MHz	Pass	3.95	16.94	17.01	16.93	17.01	22.99	30.00
2437MHz	Pass	3.95	19.36	19.26	19.42	19.4	25.38	30.00
2457MHz	Pass	3.95	15.3	15.31	15.37	15.46	21.38	30.00
2462MHz	Pass	3.95	12.31	12.09	12.56	12.48	18.38	30.00
802.11ax HEW20_Nss1,(MCS0)_4TX	-	-	-	-	-	-	-	-
2412MHz	Pass	3.95	15.11	15.2	15.14	15.02	21.14	30.00
2417MHz	Pass	3.95	17.91	18.36	18.18	18.12	24.17	30.00
2437MHz	Pass	3.95	19.41	19.22	19.62	19.43	25.44	30.00
2457MHz	Pass	3.95	13.91	14	14.01	14.11	20.03	30.00
2462MHz	Pass	3.95	10.63	10.47	10.78	10.73	16.67	30.00
802.11ax HEW20-BF_Nss1,(MCS0)_2TX	-	-	-	-	-	-	-	-
2412MHz	Pass	6.28	17.17	17.32	-	-	20.26	29.72
2417MHz	Pass	6.28	20.17	20.37	-	-	23.28	29.72
2437MHz	Pass	6.28	23.54	23.43	-	-	26.50	29.72
2457MHz	Pass	6.28	18.3	18.03	-	-	21.18	29.72
2462MHz	Pass	6.28	14	13.93	-	-	16.98	29.72
802.11ax HEW20-BF_Nss1,(MCS0)_4TX	-	-	-	-	-	-	-	-
2412MHz	Pass	8.04	15.11	15.2	15.14	15.02	21.14	27.96



## Average Power\_Radio 1

## Appendix C.1

Mode	Result	DG (dBi)	Port 1 (dBm)	Port 2 (dBm)	Port 3 (dBm)	Port 4 (dBm)	Total Power (dBm)	Power Limit (dBm)
2417MHz	Pass	8.04	17.91	18.36	18.18	18.12	24.17	27.96
2437MHz	Pass	8.04	19.41	19.22	19.62	19.43	25.44	27.96
2457MHz	Pass	8.04	13.91	14	14.01	14.11	20.03	27.96
2462MHz	Pass	8.04	10.63	10.47	10.78	10.73	16.67	27.96

DG = Directional Gain; Port X = Port X output power



**Summary**

Mode	Total Power (dBm)	Total Power (W)
2.4-2.4835GHz	-	-
802.11b_Nss1,(1Mbps)_1TX	24.04	0.25351
802.11g_Nss1,(6Mbps)_1TX	24.51	0.28249
802.11ax HEW20_Nss1,(MCS0)_1TX	24.60	0.28840



Result

Mode	Result	DG (dBi)	Port 1 (dBm)	Total Power (dBm)	Power Limit (dBm)
802.11b_Nss1,(1Mbps)_1TX	-	-	-	-	-
2412MHz	Pass	2.52	23.95	23.95	30.00
2437MHz	Pass	2.52	24.04	24.04	30.00
2462MHz	Pass	2.52	23.93	23.93	30.00
802.11g_Nss1,(6Mbps)_1TX	-	-	-	-	-
2412MHz	Pass	2.52	22.39	22.39	30.00
2437MHz	Pass	2.52	24.51	24.51	30.00
2462MHz	Pass	2.52	22.40	22.40	30.00
802.11ax HEW20_Nss1,(MCS0)_1TX	-	-	-	-	-
2412MHz	Pass	2.52	21.31	21.31	30.00
2417MHz	Pass	2.52	22.97	22.97	30.00
2437MHz	Pass	2.52	24.60	24.60	30.00
2457MHz	Pass	2.52	23.01	23.01	30.00
2462MHz	Pass	2.52	19.66	19.66	30.00

DG = Directional Gain; Port X = Port X output power



Summary

Mode	PD (dBm/RBW)
2.4-2.4835GHz	-
802.11b_Nss1,(1Mbps)_1TX	1.21
802.11b_Nss1,(1Mbps)_2TX	6.10
802.11b_Nss1,(1Mbps)_4TX	3.78
802.11g_Nss1,(6Mbps)_1TX	-0.78
802.11g_Nss1,(6Mbps)_2TX	2.33
802.11g_Nss1,(6Mbps)_4TX	-2.88
802.11ax HEW20_Nss1,(MCS0)_1TX	-0.52
802.11ax HEW20_Nss1,(MCS0)_2TX	1.51
802.11ax HEW20_Nss1,(MCS0)_4TX	-3.62

RBW = 3kHz;



Result

Mode	Result	DG (dBi)	Port 1 (dBm/RBW)	Port 2 (dBm/RBW)	Port 3 (dBm/RBW)	Port 4 (dBm/RBW)	PD (dBm/RBW)	PD Limit (dBm/RBW)
802.11b_Nss1,(1Mbps)_1TX	-	-	-	-	-	-	-	-
2412MHz	Pass	3.95	0.69	-	-	-	0.69	8.00
2437MHz	Pass	3.95	0.08	-	-	-	0.08	8.00
2462MHz	Pass	3.95	1.21	-	-	-	1.21	8.00
802.11g_Nss1,(6Mbps)_1TX	-	-	-	-	-	-	-	-
2412MHz	Pass	3.95	-1.66	-	-	-	-1.66	8.00
2437MHz	Pass	3.95	-0.78	-	-	-	-0.78	8.00
2462MHz	Pass	3.95	-6.03	-	-	-	-6.03	8.00
802.11ax HEW20_Nss1,(MCS0)_1TX	-	-	-	-	-	-	-	-
2412MHz	Pass	3.95	-2.45	-	-	-	-2.45	8.00
2437MHz	Pass	3.95	-0.52	-	-	-	-0.52	8.00
2462MHz	Pass	3.95	-7.89	-	-	-	-7.89	8.00
802.11b_Nss1,(1Mbps)_2TX	-	-	-	-	-	-	-	-
2412MHz	Pass	6.28	2.14	1.88	-	-	5.02	7.72
2437MHz	Pass	6.28	2.69	3.53	-	-	6.10	7.72
2462MHz	Pass	6.28	0.42	0.54	-	-	3.49	7.72
802.11g_Nss1,(6Mbps)_2TX	-	-	-	-	-	-	-	-
2412MHz	Pass	6.28	-6.04	-5.66	-	-	-2.91	7.72
2437MHz	Pass	6.28	-0.68	0.06	-	-	2.33	7.72
2462MHz	Pass	6.28	-8.15	-8.89	-	-	-5.57	7.72
802.11ax HEW20_Nss1,(MCS0)_2TX	-	-	-	-	-	-	-	-
2412MHz	Pass	6.28	-6.69	-6.66	-	-	-3.66	7.72
2437MHz	Pass	6.28	-1.28	-1.19	-	-	1.51	7.72
2462MHz	Pass	6.28	-10.43	-10.27	-	-	-8.16	7.72
802.11b_Nss1,(1Mbps)_4TX	-	-	-	-	-	-	-	-
2412MHz	Pass	8.04	-2.67	-1.52	-0.66	-4.08	3.78	5.96
2437MHz	Pass	8.04	-4.10	-4.61	-3.21	-4.23	1.47	5.96
2462MHz	Pass	8.04	-1.48	-4.00	-1.10	-2.23	3.55	5.96
802.11g_Nss1,(6Mbps)_4TX	-	-	-	-	-	-	-	-
2412MHz	Pass	8.04	-10.55	-7.77	-9.95	-9.95	-4.83	5.96
2437MHz	Pass	8.04	-8.40	-8.66	-7.49	-7.61	-2.88	5.96
2462MHz	Pass	8.04	-14.20	-14.29	-15.04	-15.21	-9.98	5.96
802.11ax HEW20_Nss1,(MCS0)_4TX	-	-	-	-	-	-	-	-
2412MHz	Pass	8.04	-11.29	-10.57	-12.40	-12.19	-7.32	5.96
2437MHz	Pass	8.04	-5.70	-7.21	-7.04	-6.80	-3.62	5.96
2462MHz	Pass	8.04	-14.11	-16.06	-15.79	-15.89	-12.26	5.96

DG = Directional Gain; RBW = 3kHz;  
 PD = Trace bin-by-bin of each transmits port summing can be performed maximum power density; Port X = Port X Power Density;



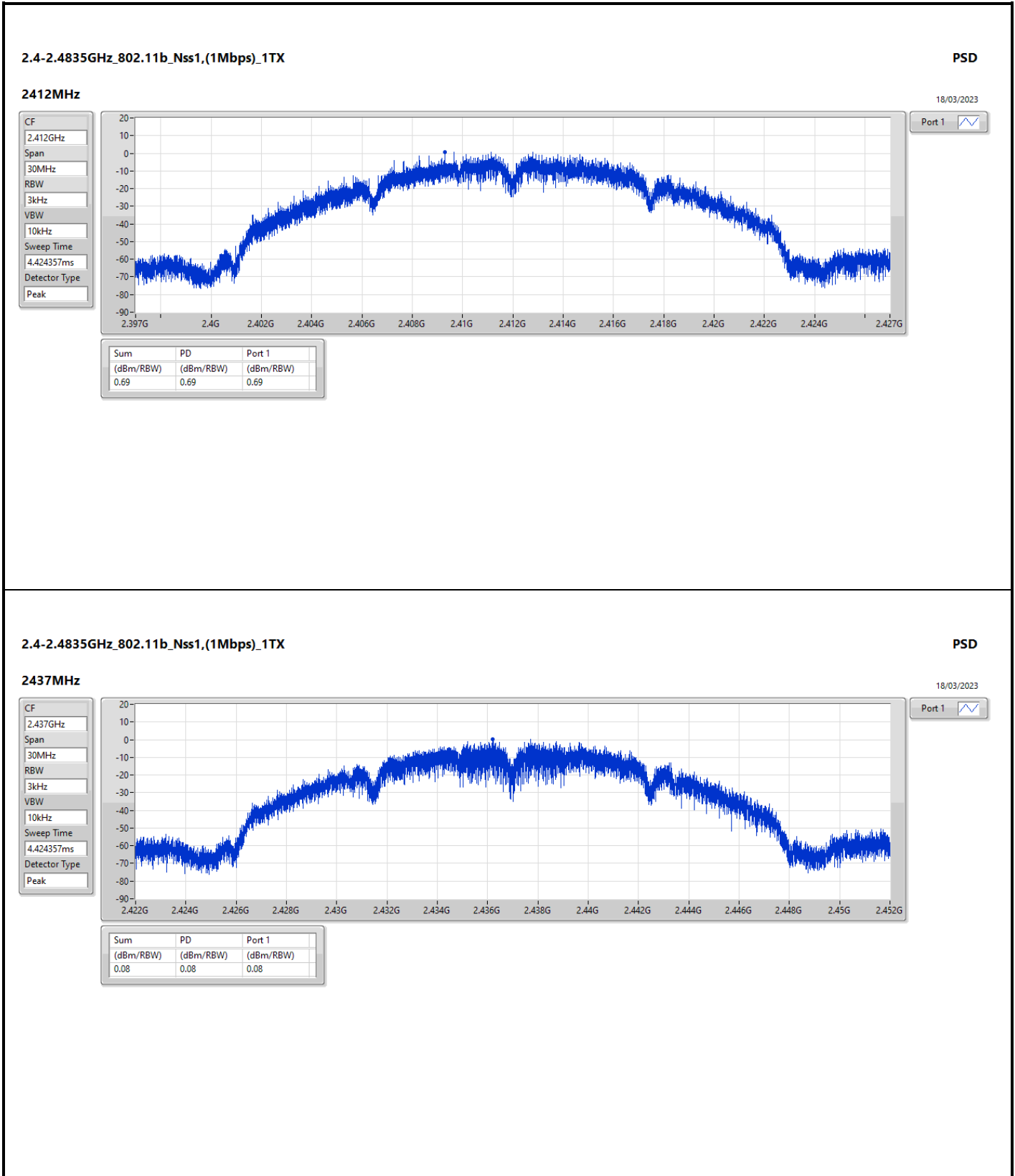

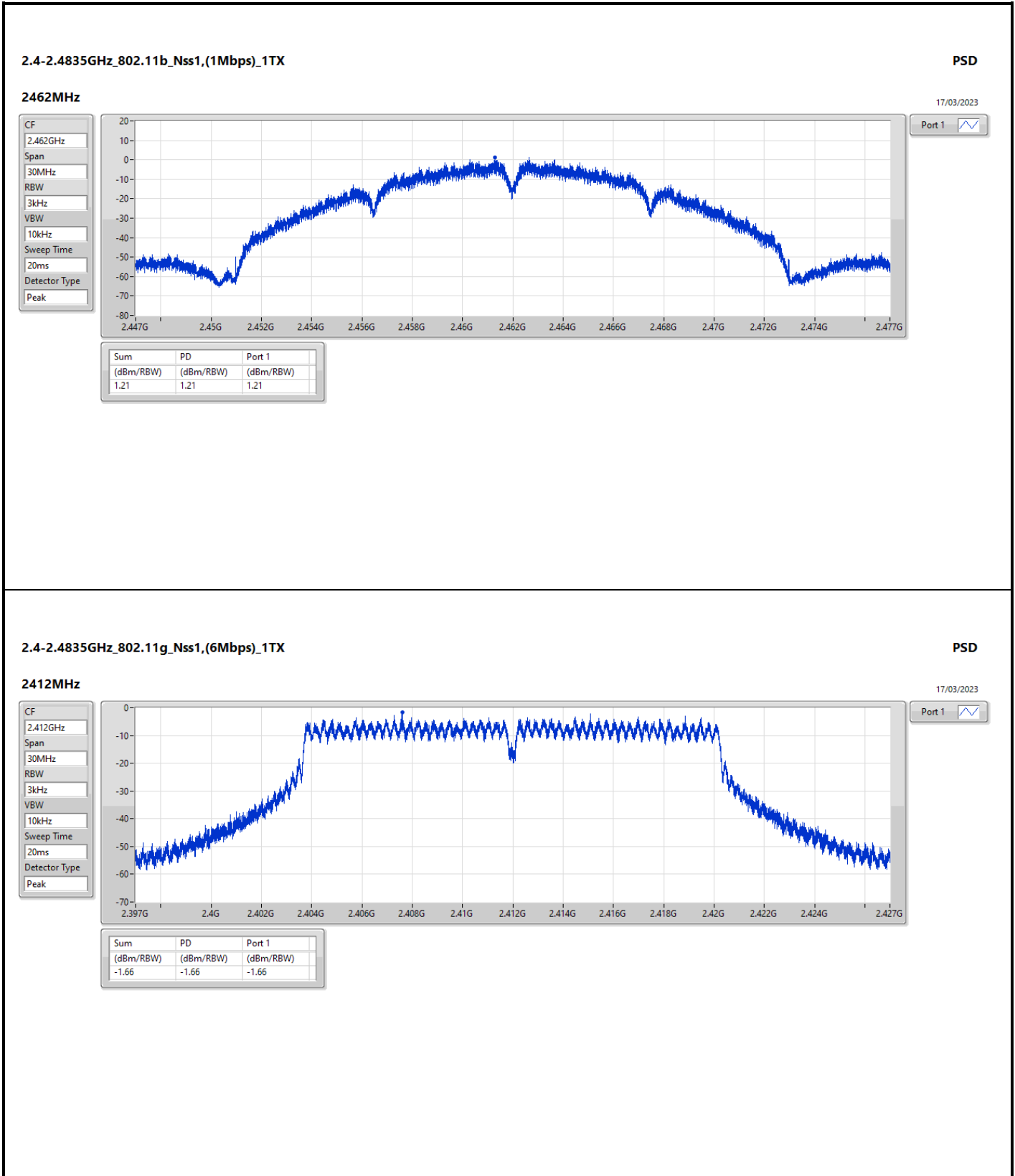

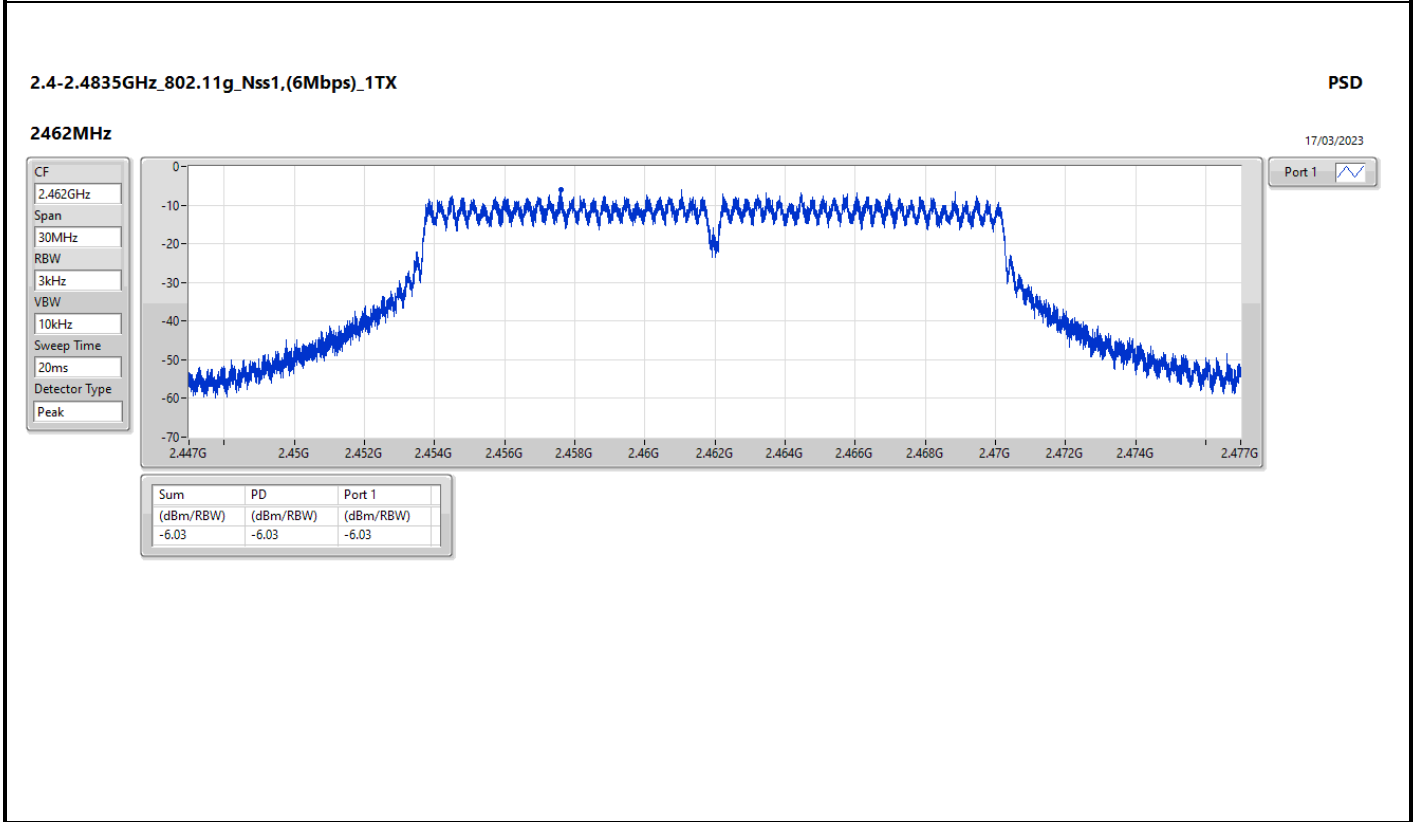
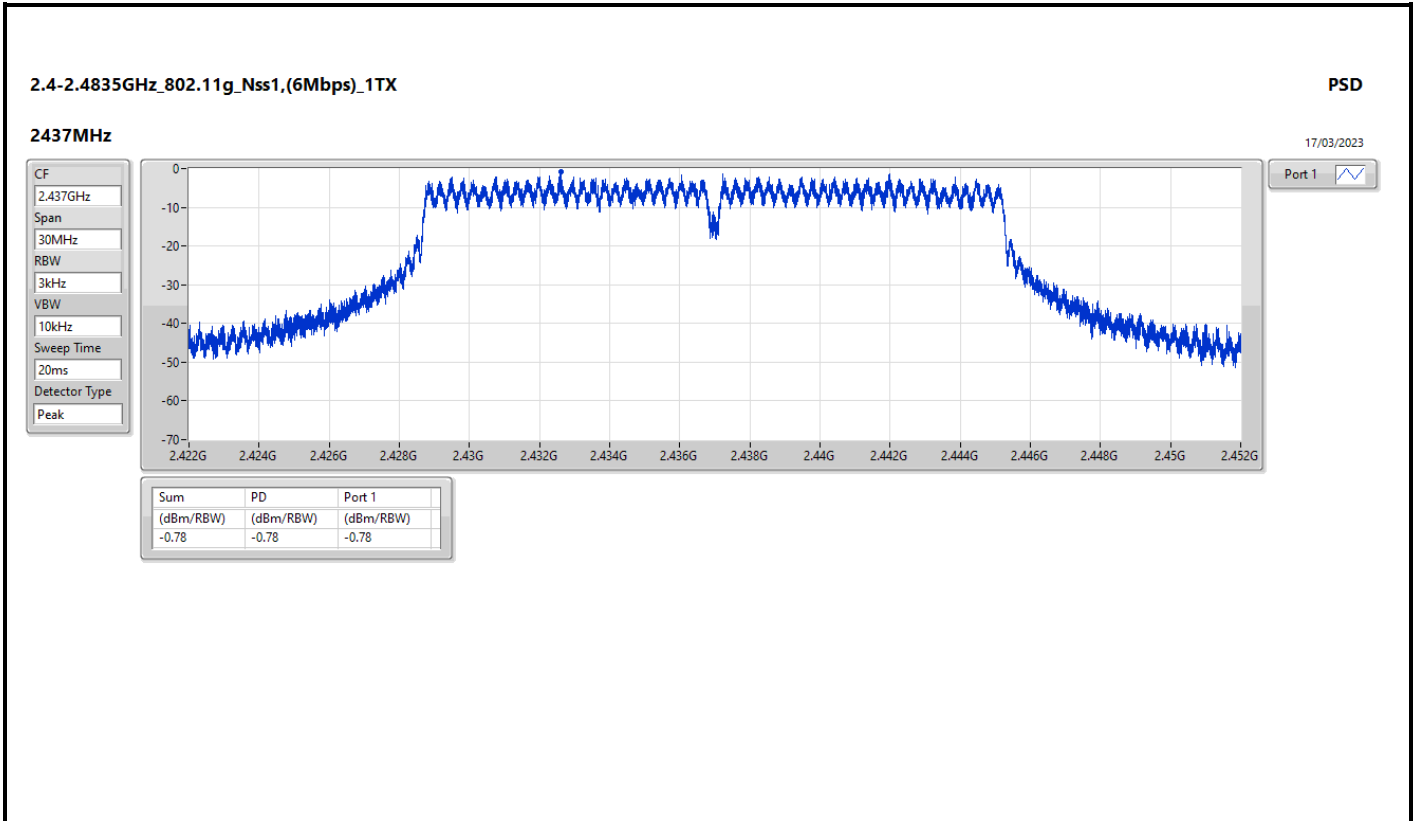

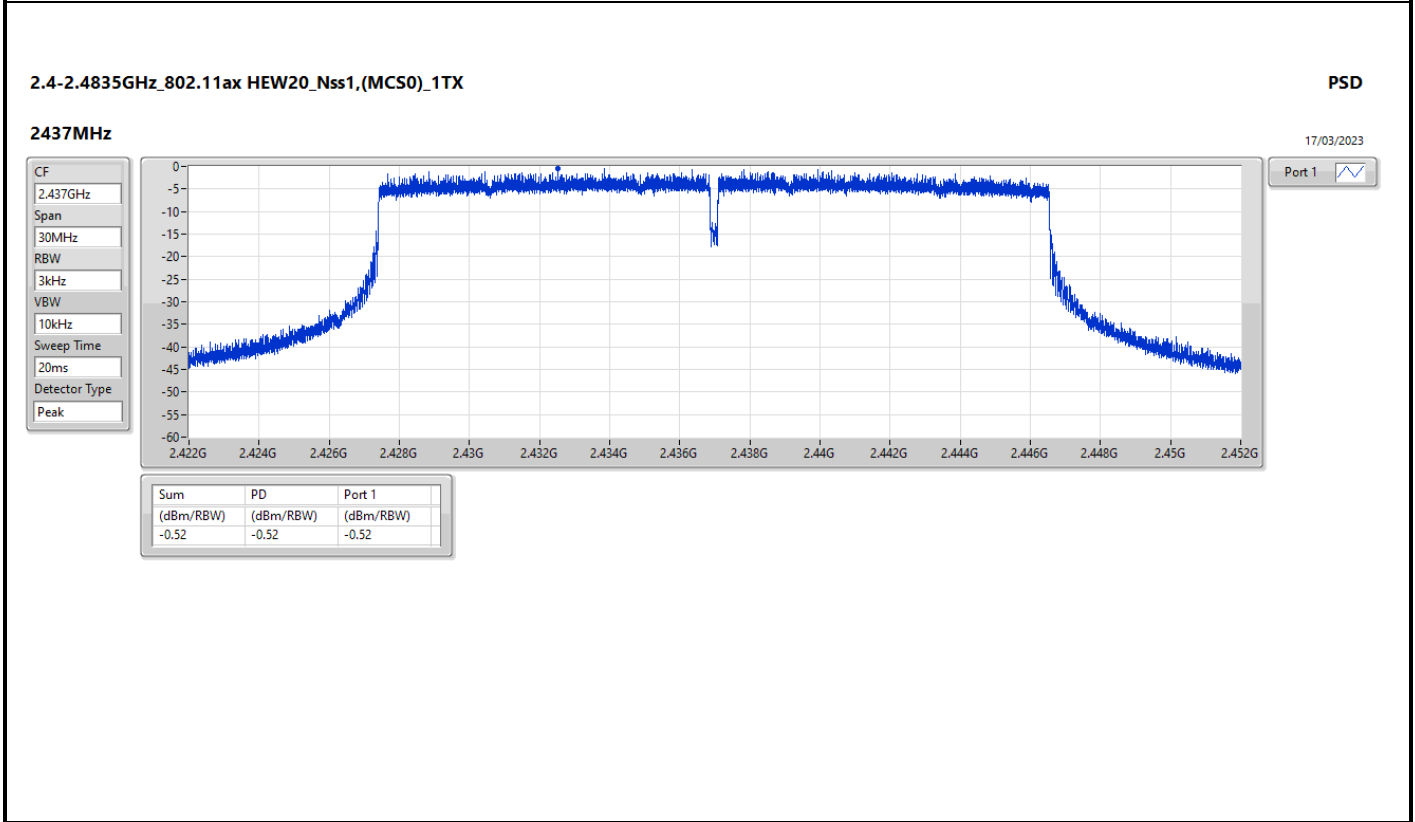
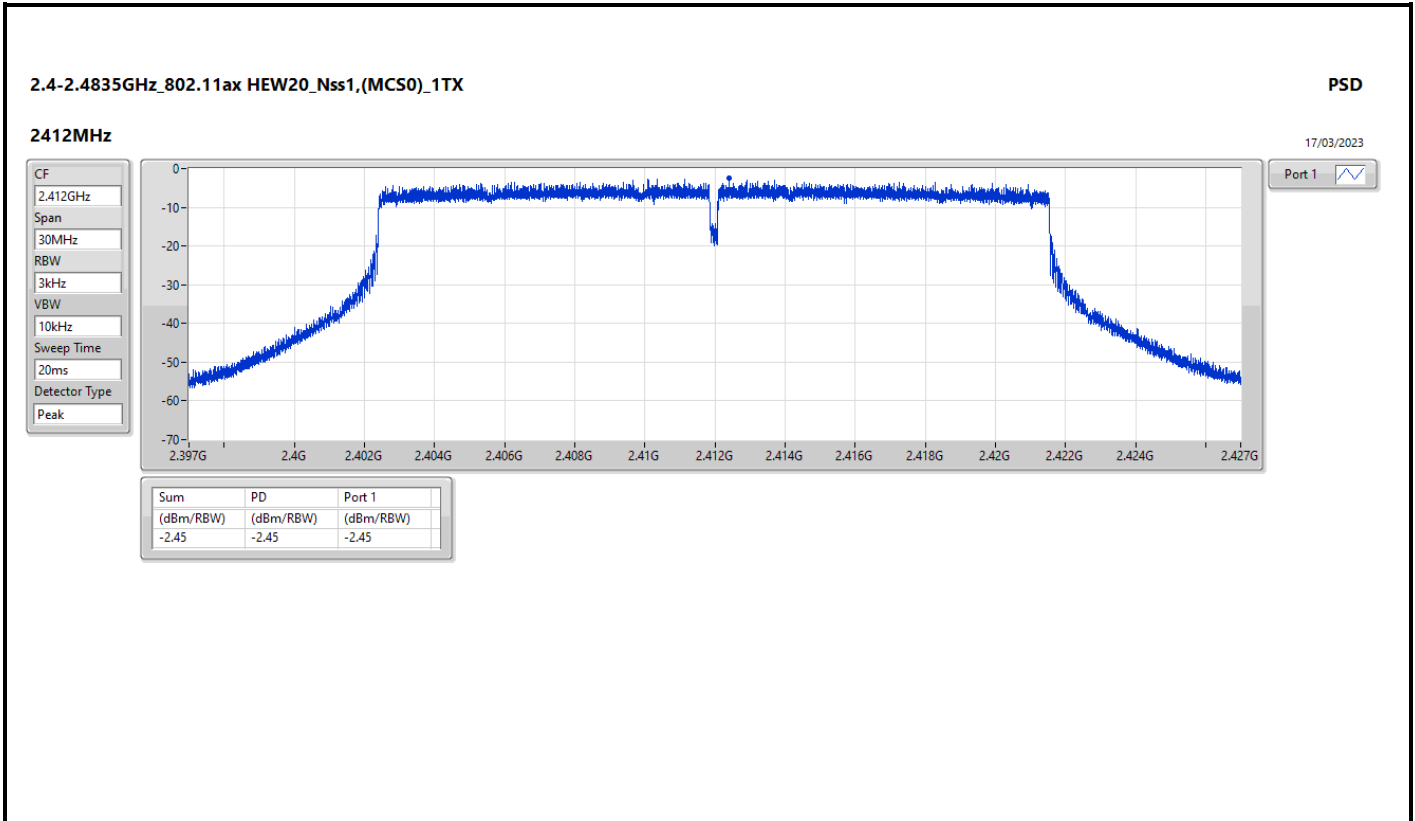

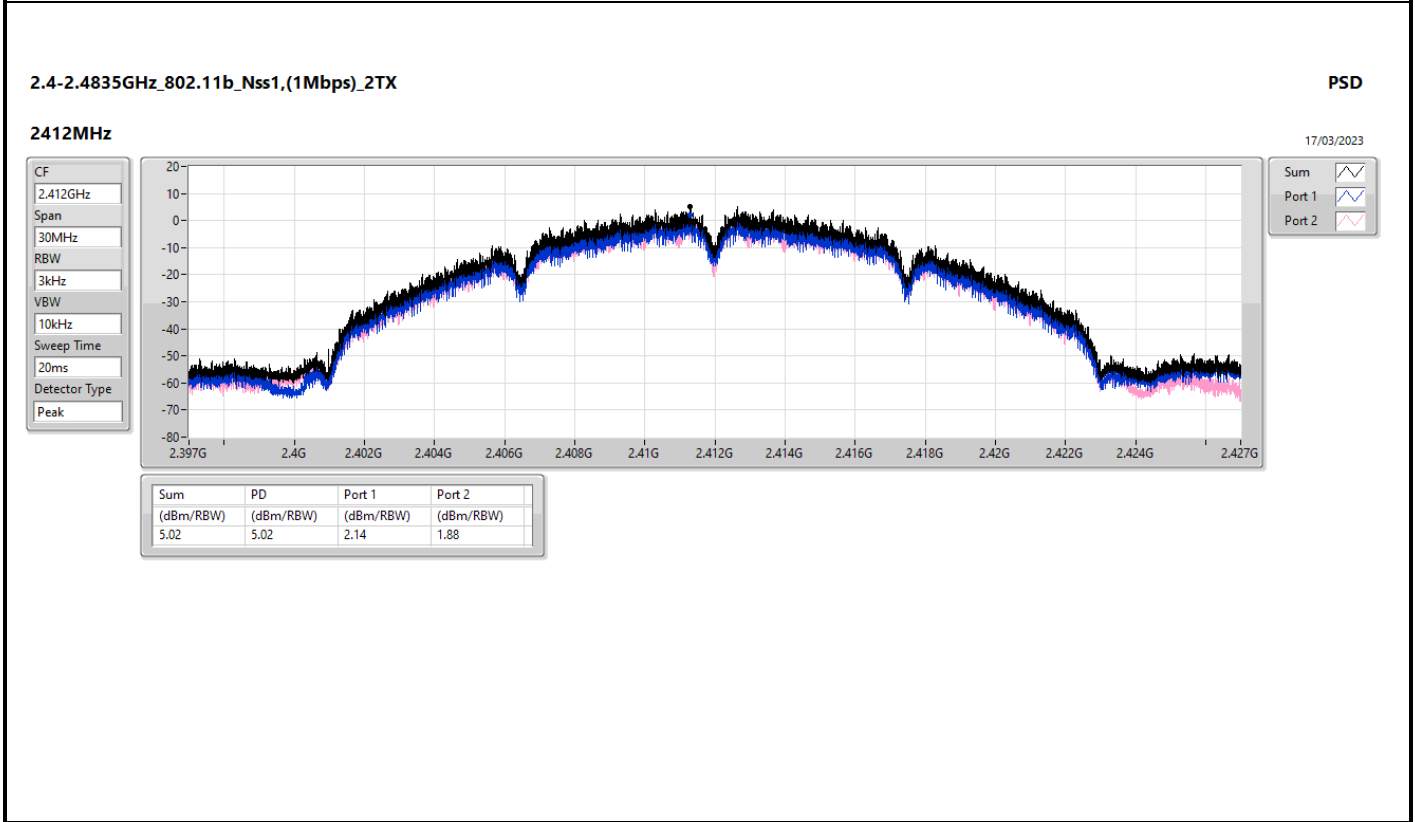
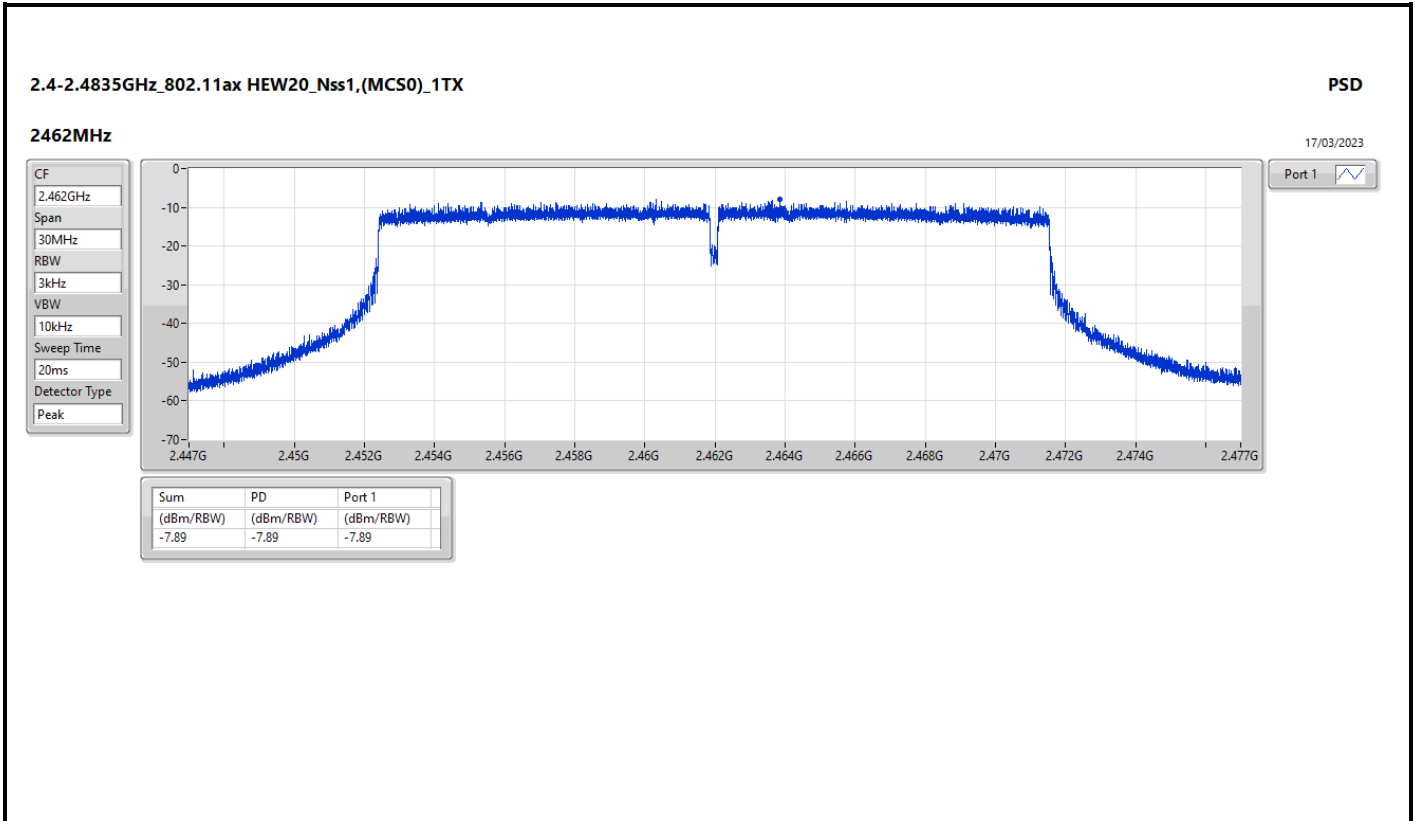

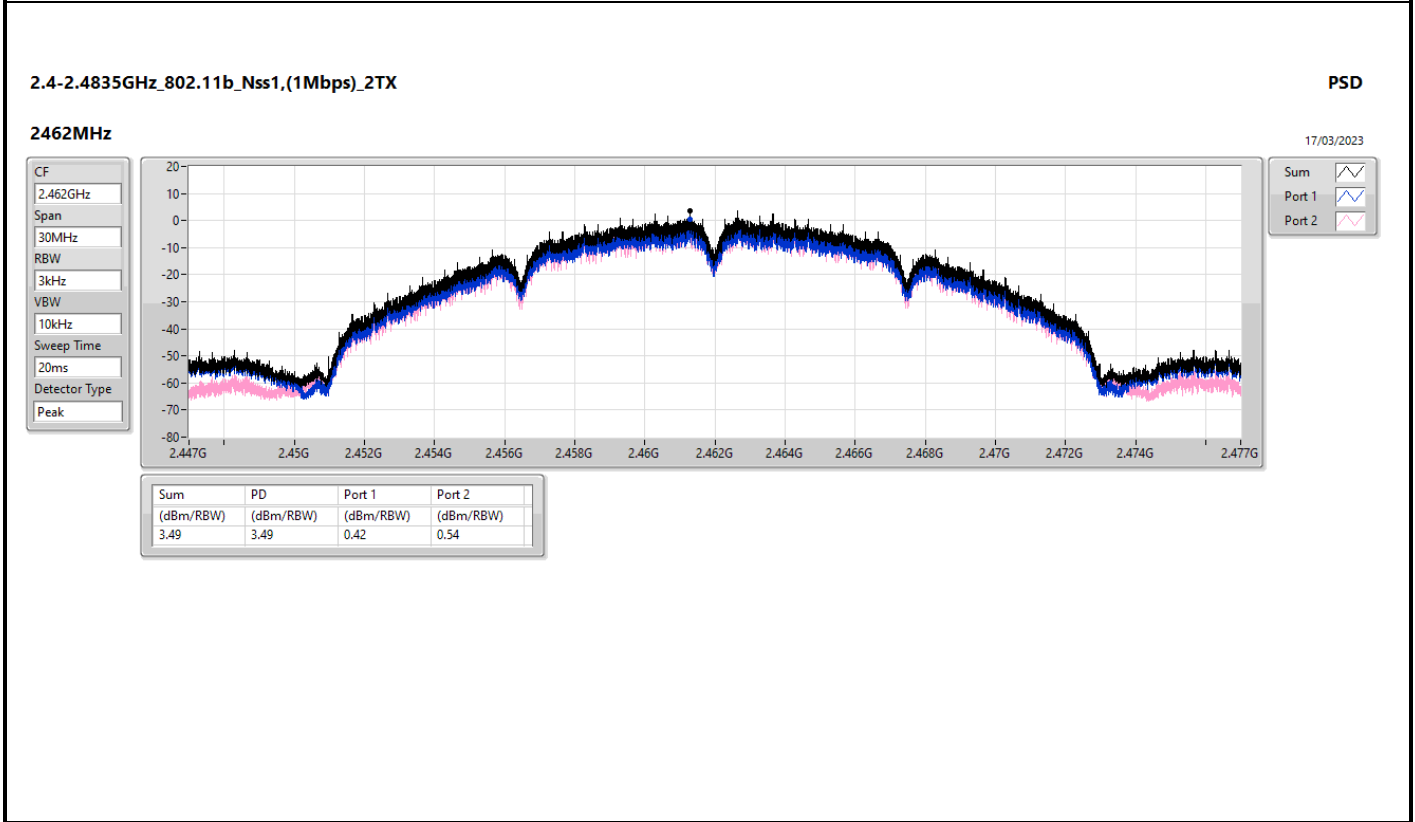
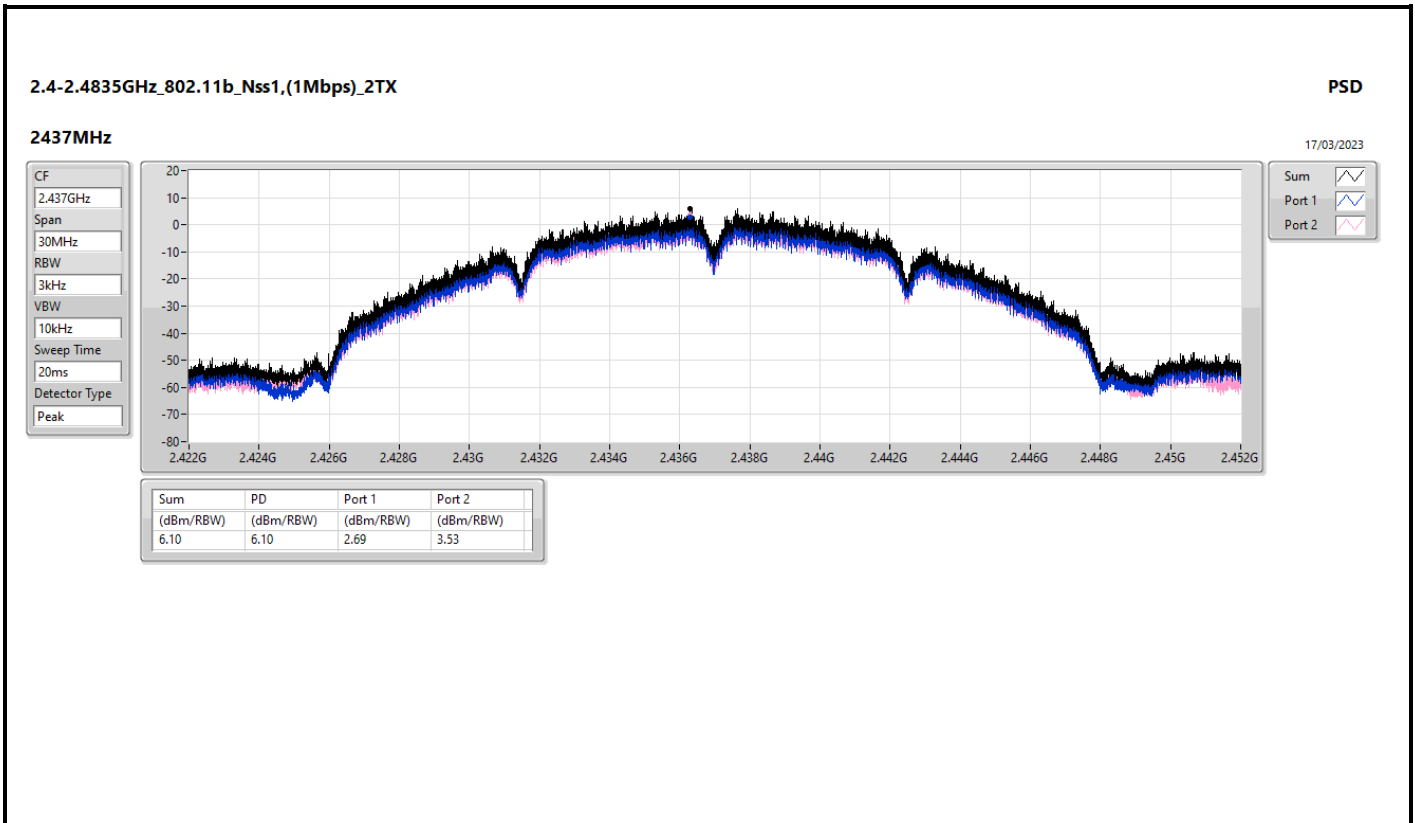

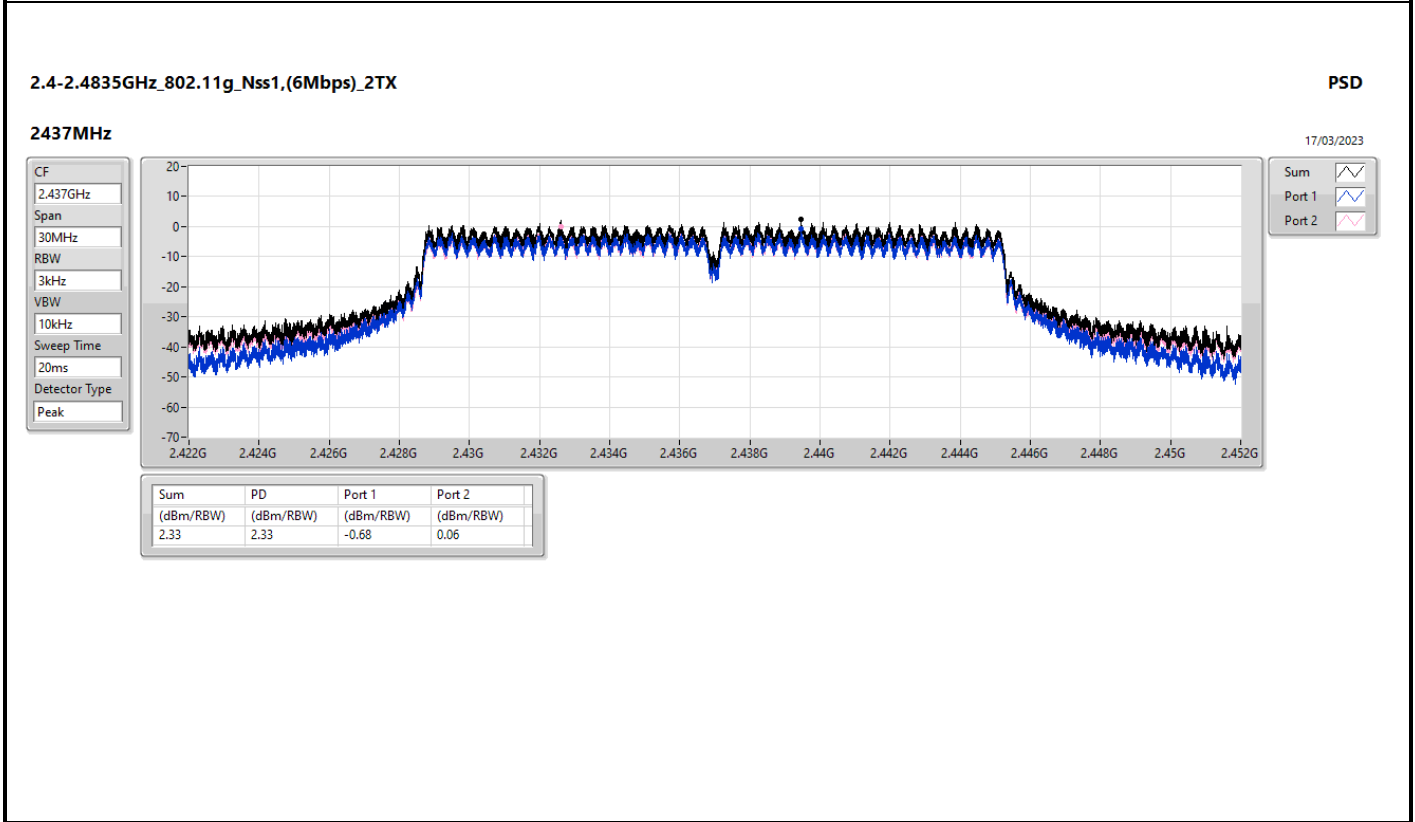
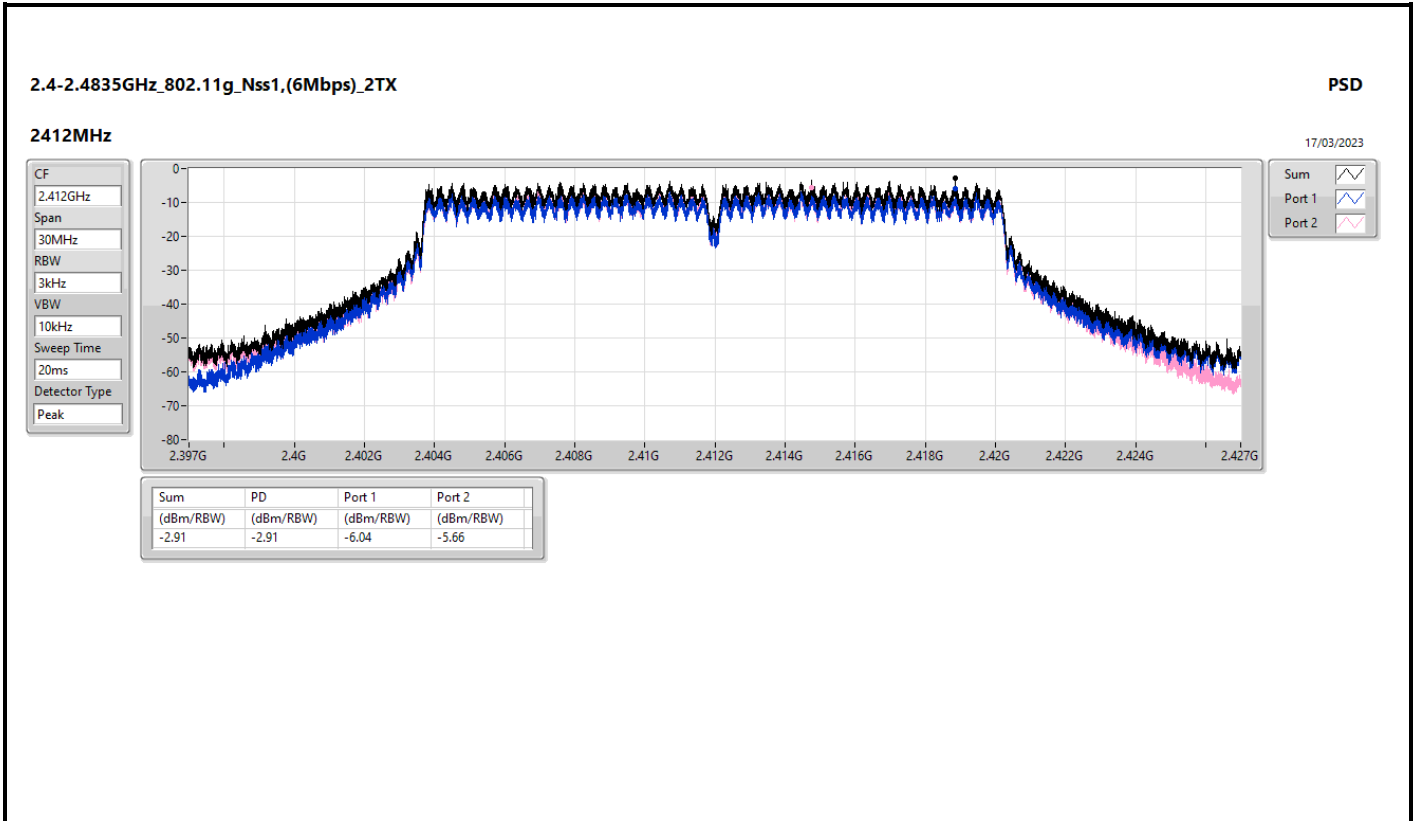

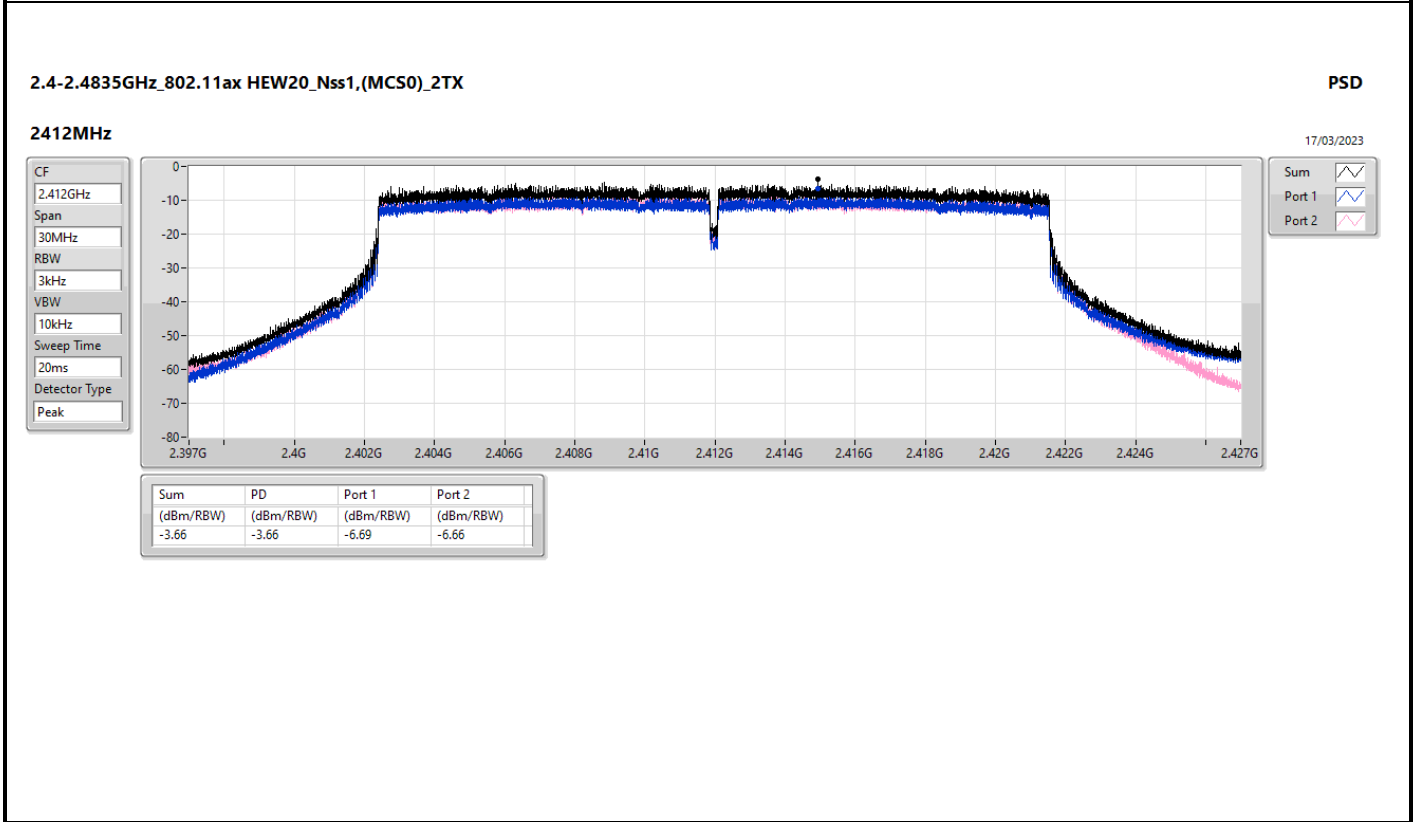
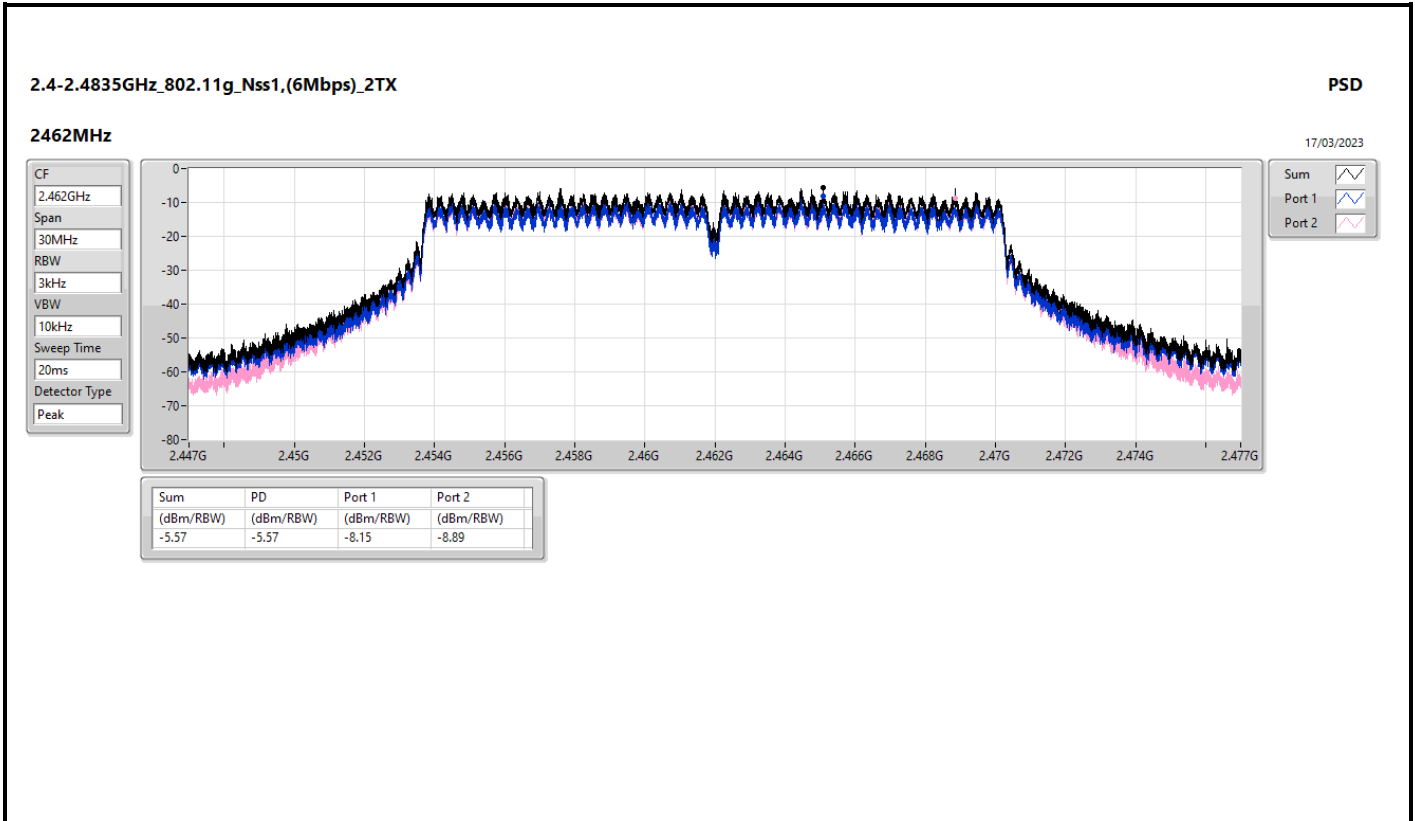



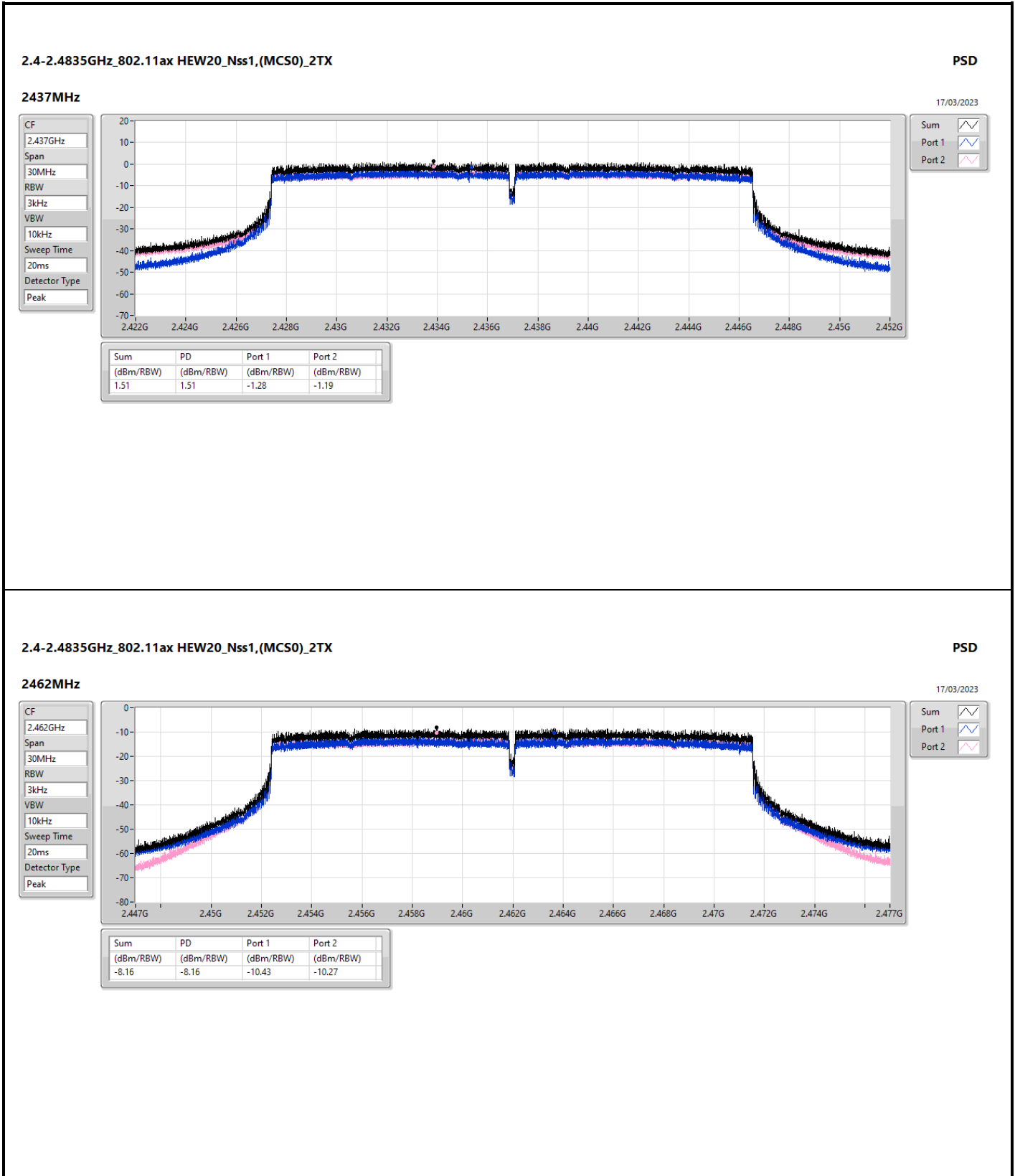

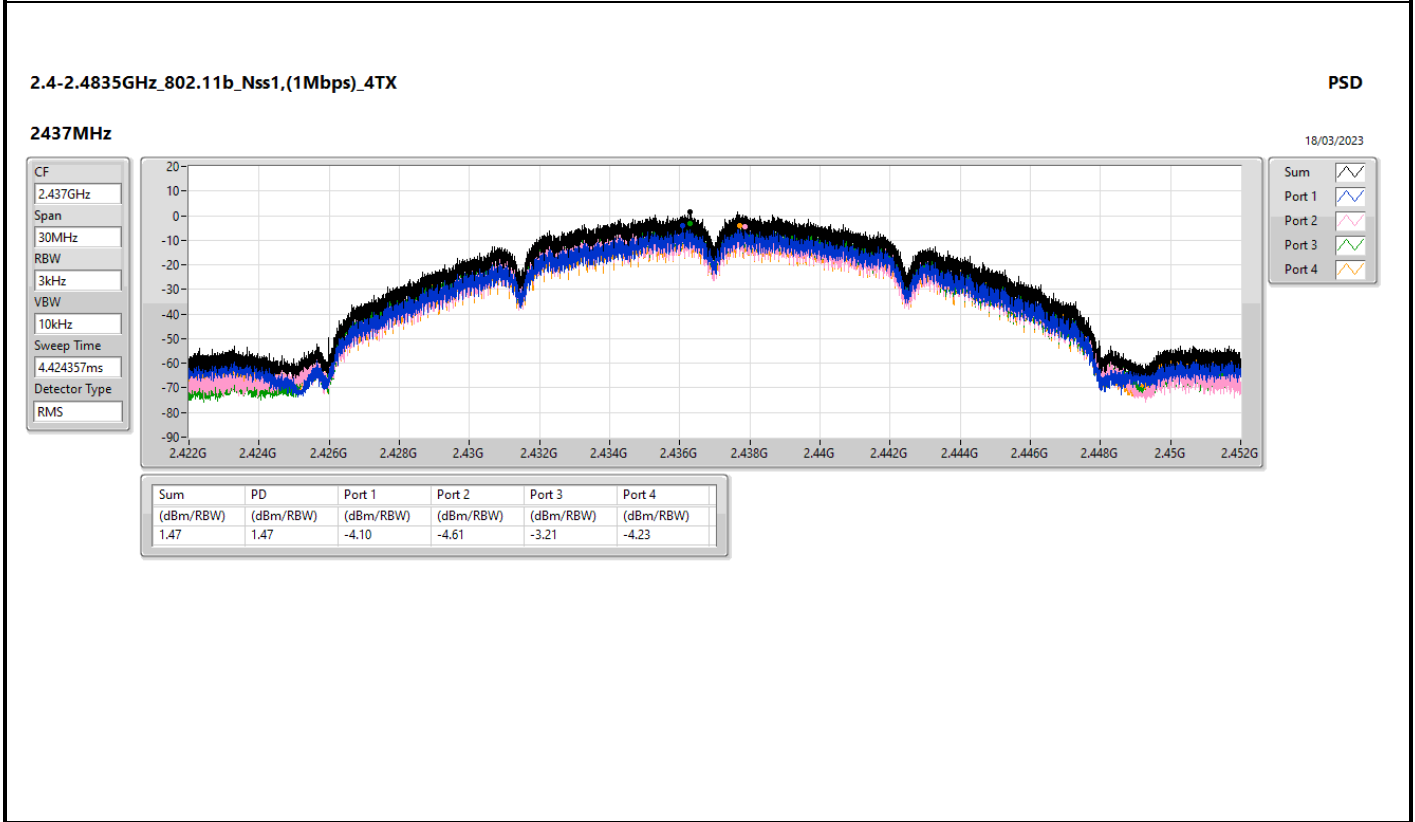
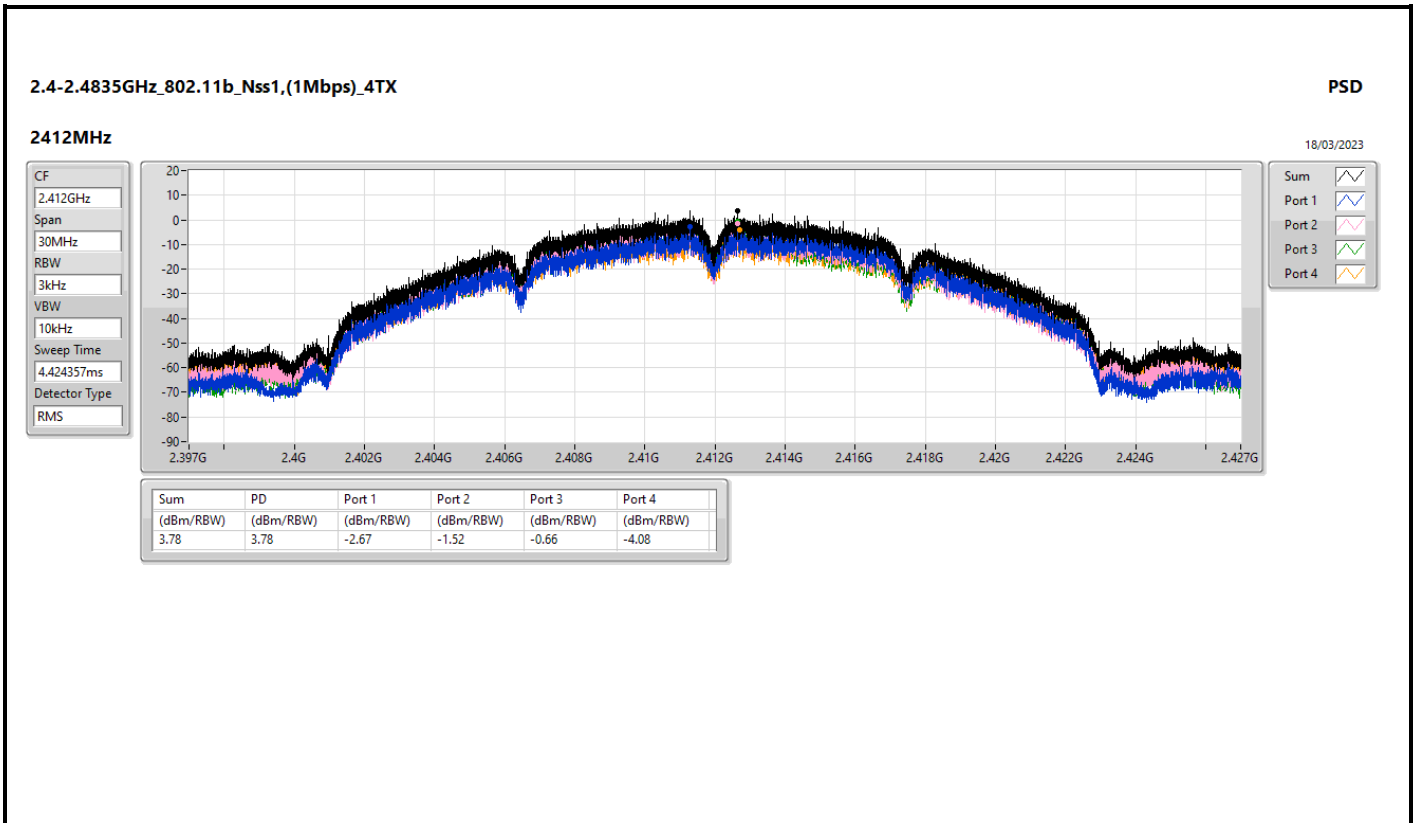

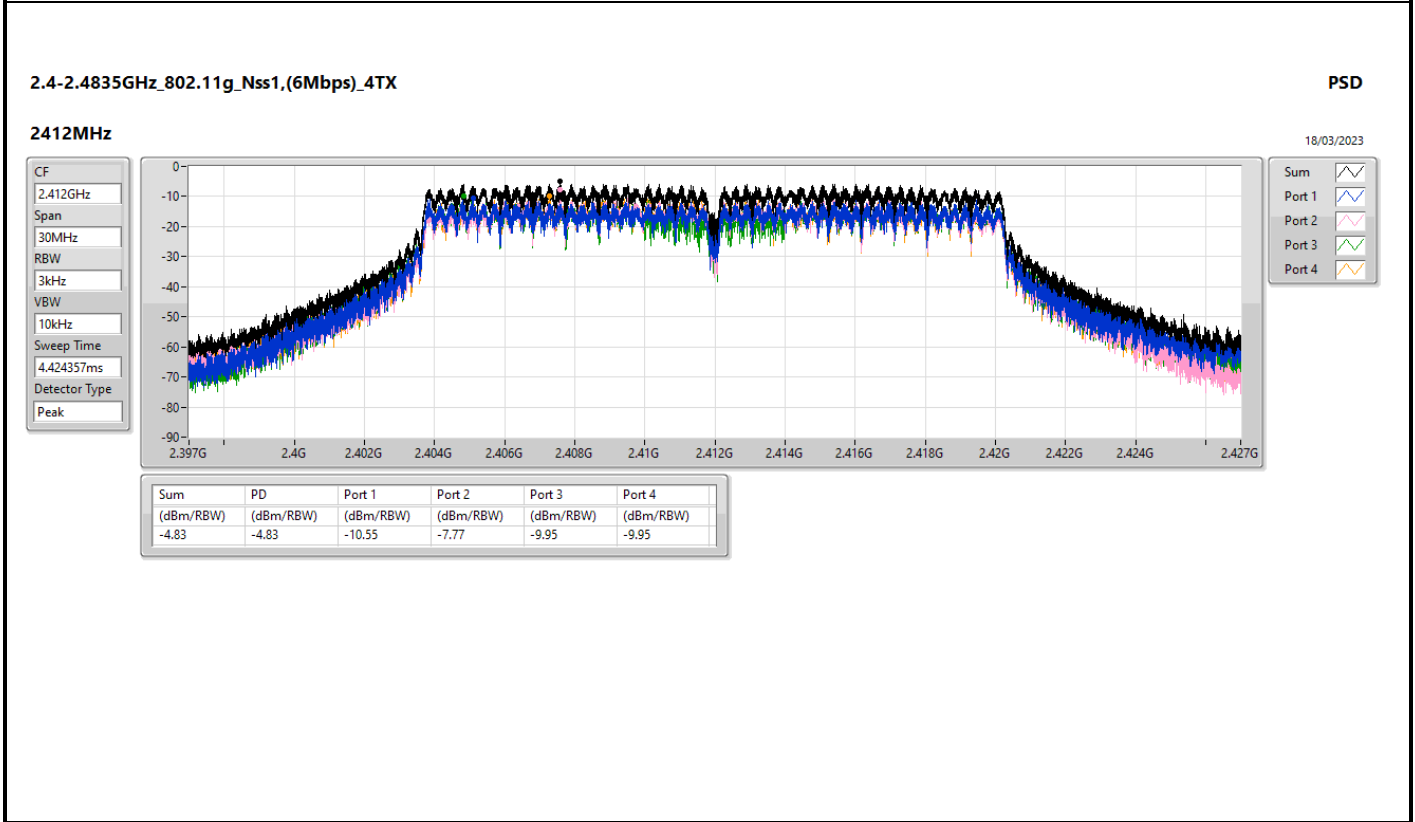
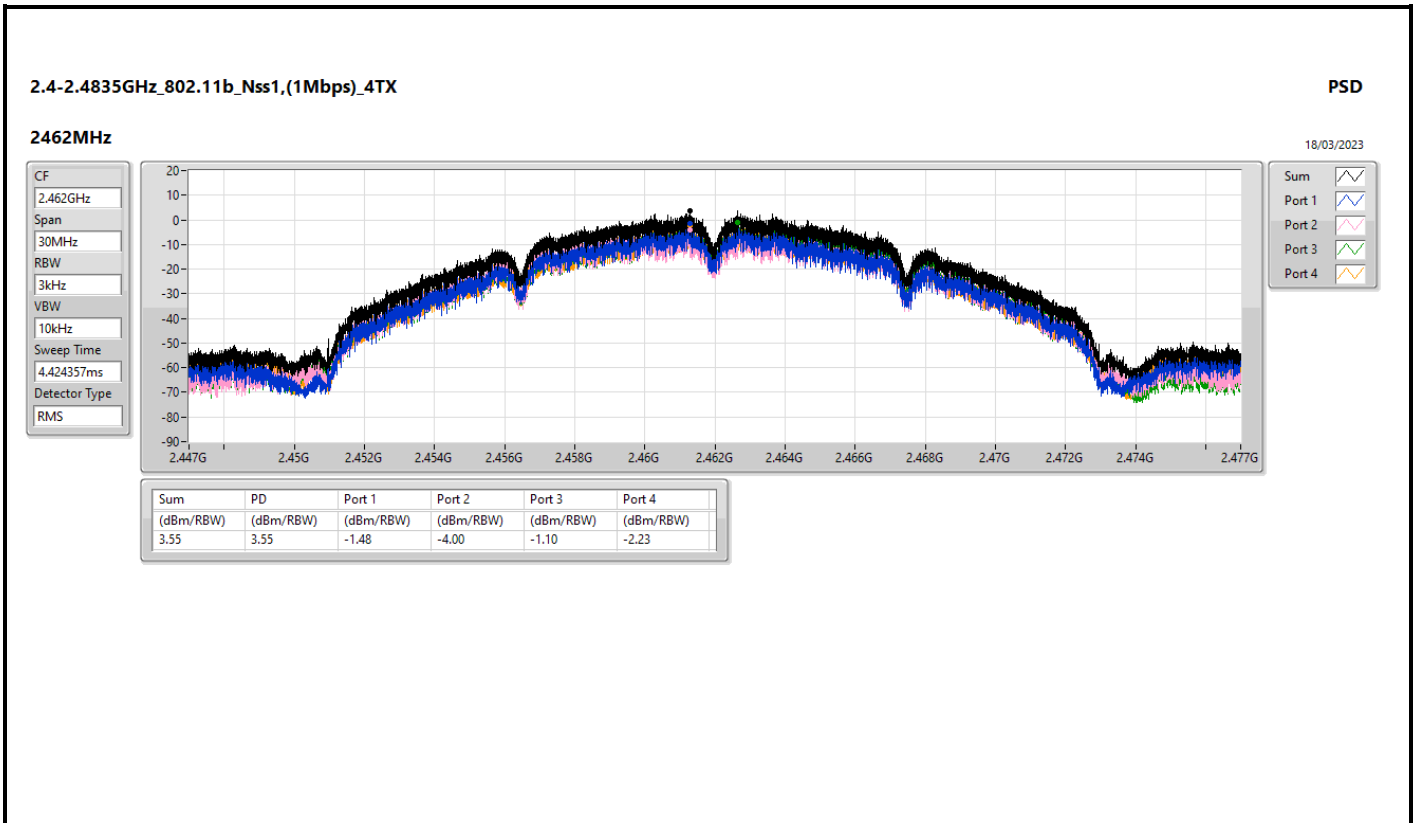

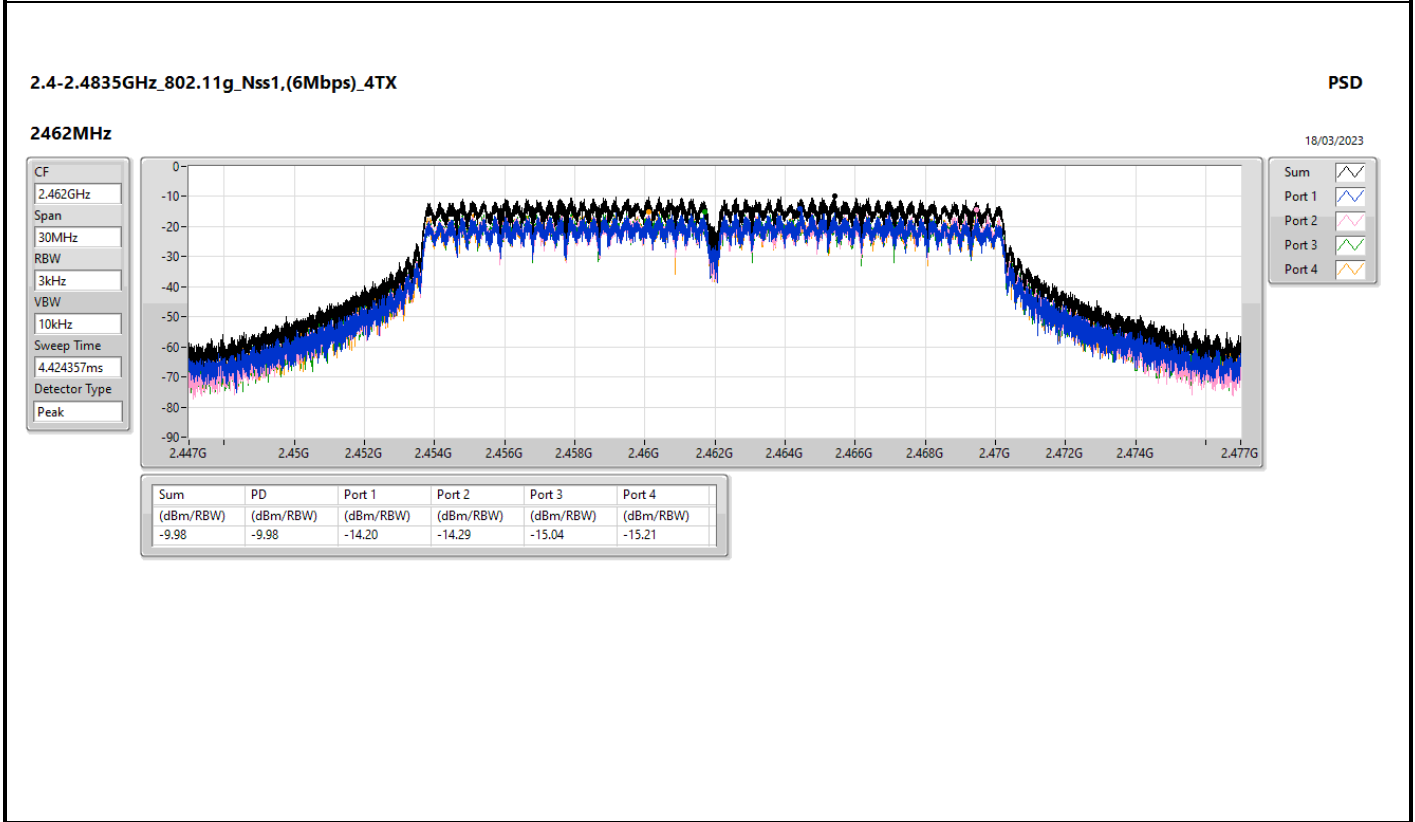
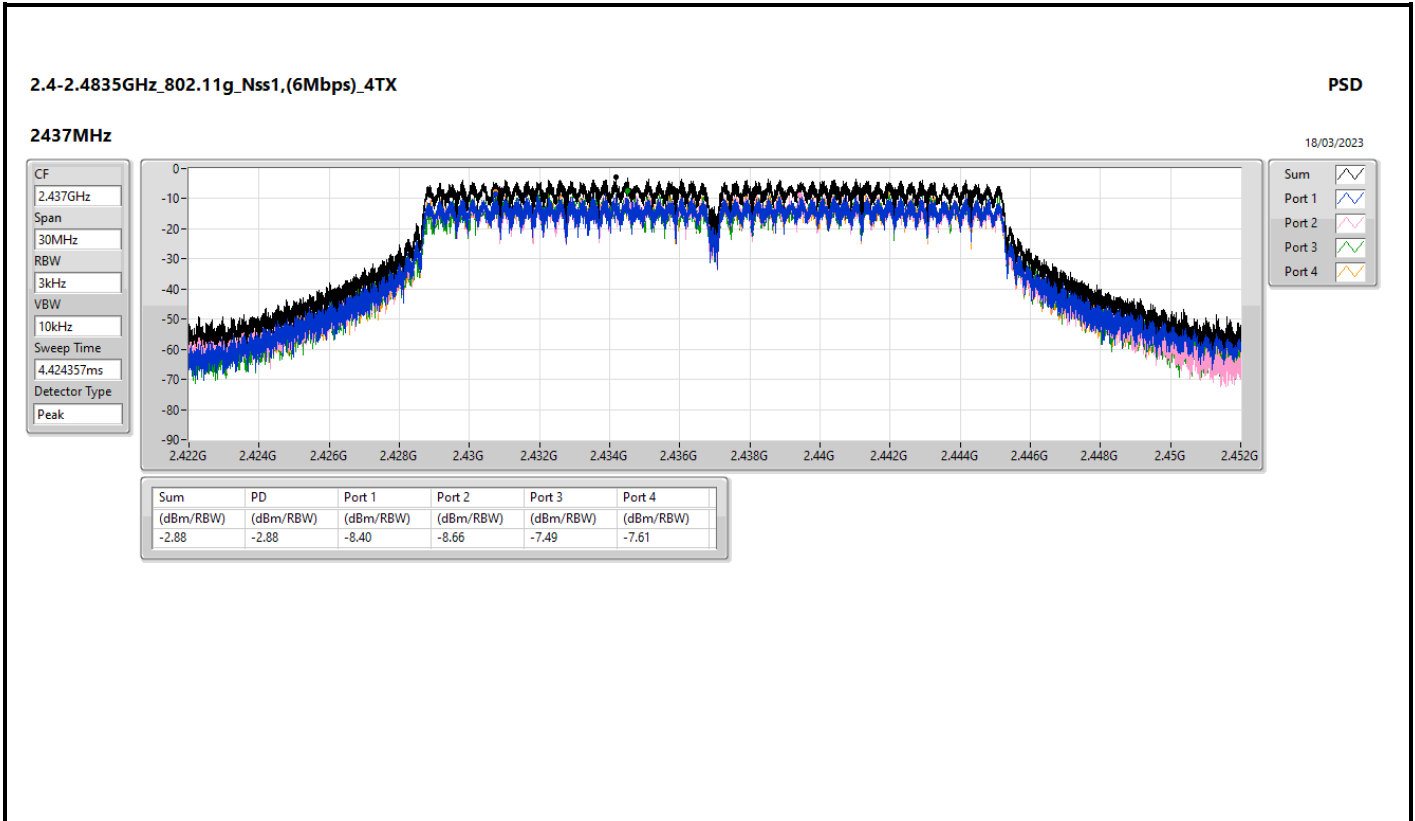

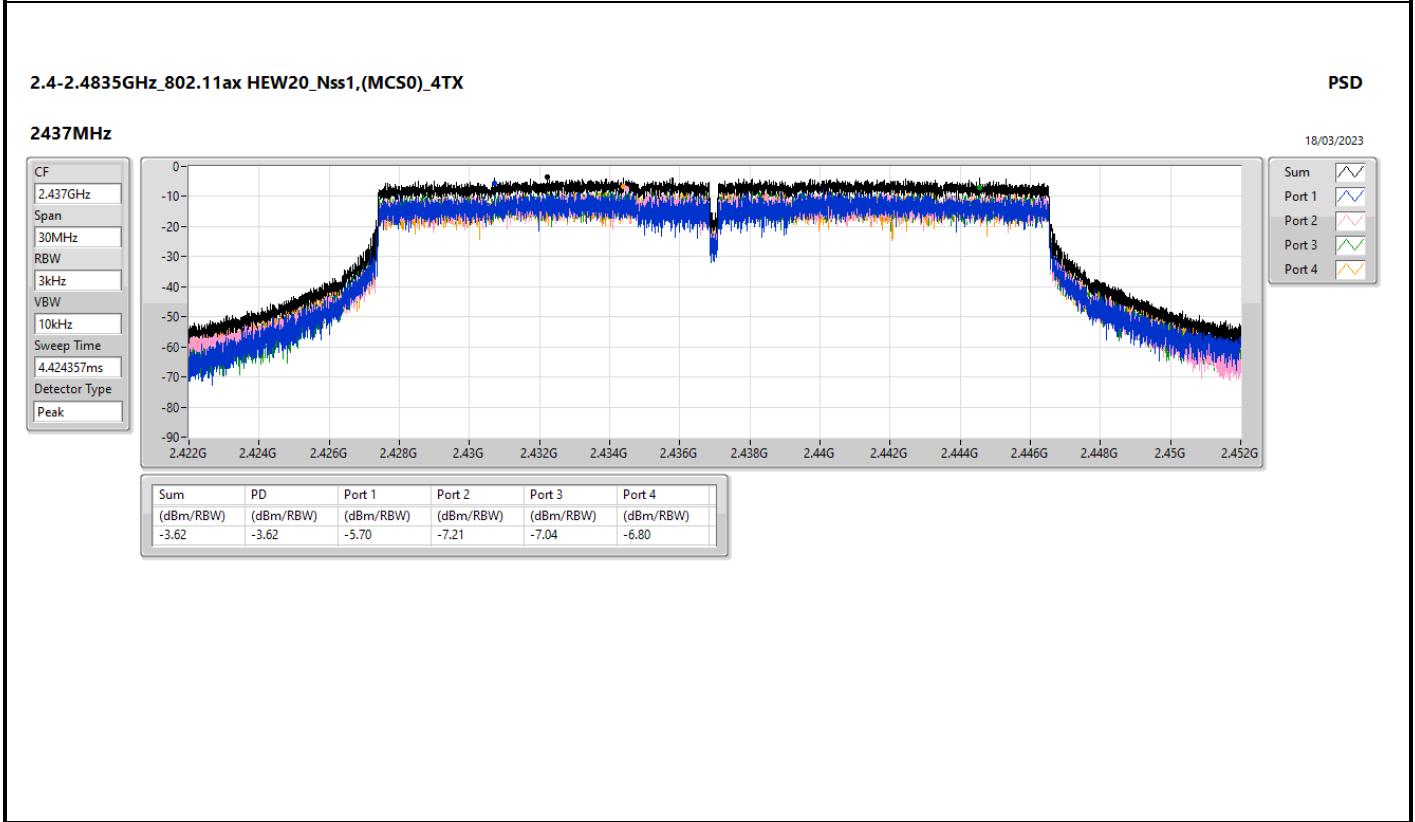
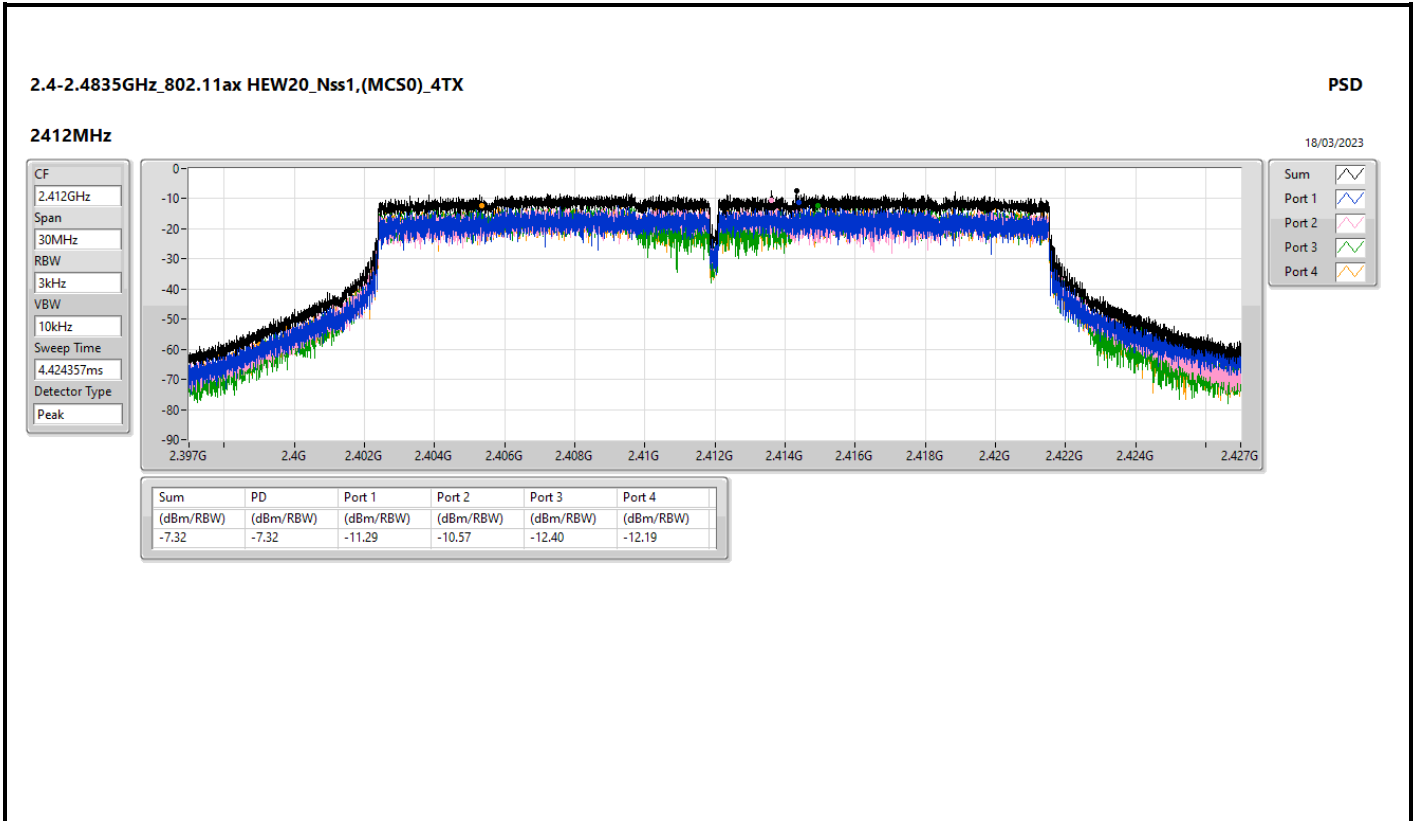

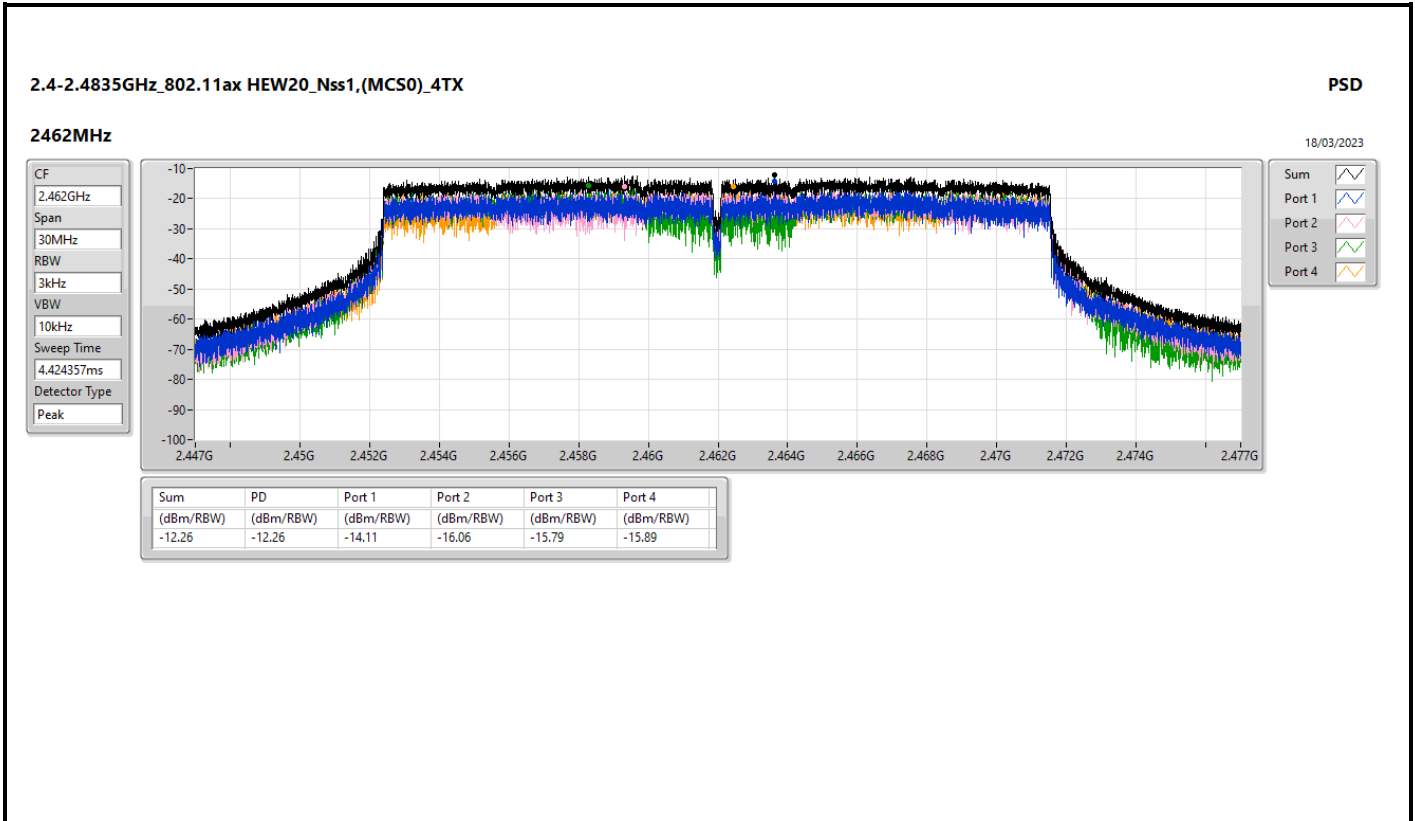



Summary

Mode	PD (dBm/RBW)
2.4-2.4835GHz	-
802.11b_Nss1,(1Mbps)_1TX	-0.01
802.11g_Nss1,(6Mbps)_1TX	-3.60
802.11ax HEW20_Nss1,(MCS0)_1TX	-1.87

RBW = 3kHz:



Result

Mode	Result	DG (dBi)	Port 1 (dBm/RBW)	PD (dBm/RBW)	PD Limit (dBm/RBW)
802.11b_Nss1,(1Mbps)_1TX	-	-	-	-	-
2412MHz	Pass	2.52	-0.19	-0.19	8.00
2437MHz	Pass	2.52	-0.36	-0.36	8.00
2462MHz	Pass	2.52	-0.01	-0.01	8.00
802.11g_Nss1,(6Mbps)_1TX	-	-	-	-	-
2412MHz	Pass	2.52	-4.53	-4.53	8.00
2437MHz	Pass	2.52	-3.60	-3.60	8.00
2462MHz	Pass	2.52	-4.89	-4.89	8.00
802.11ax HEW20_Nss1,(MCS0)_1TX	-	-	-	-	-
2412MHz	Pass	2.52	-5.16	-5.16	8.00
2437MHz	Pass	2.52	-1.87	-1.87	8.00
2462MHz	Pass	2.52	-5.54	-5.54	8.00

DG = Directional Gain; RBW = 3kHz;  
PD = trace bin-by-bin of each transmits port summing can be performed maximum power density; Port X = Port X Power Density;



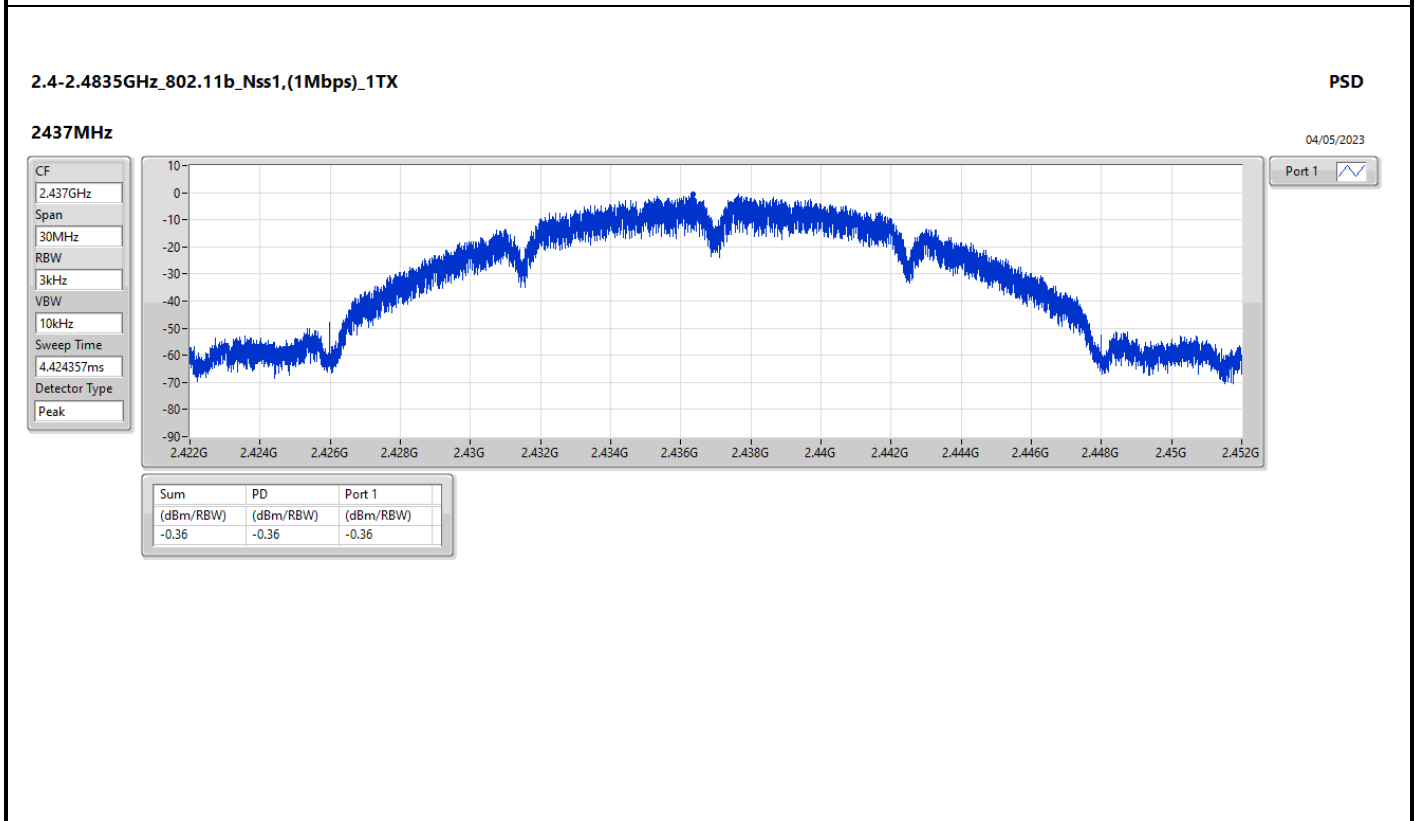
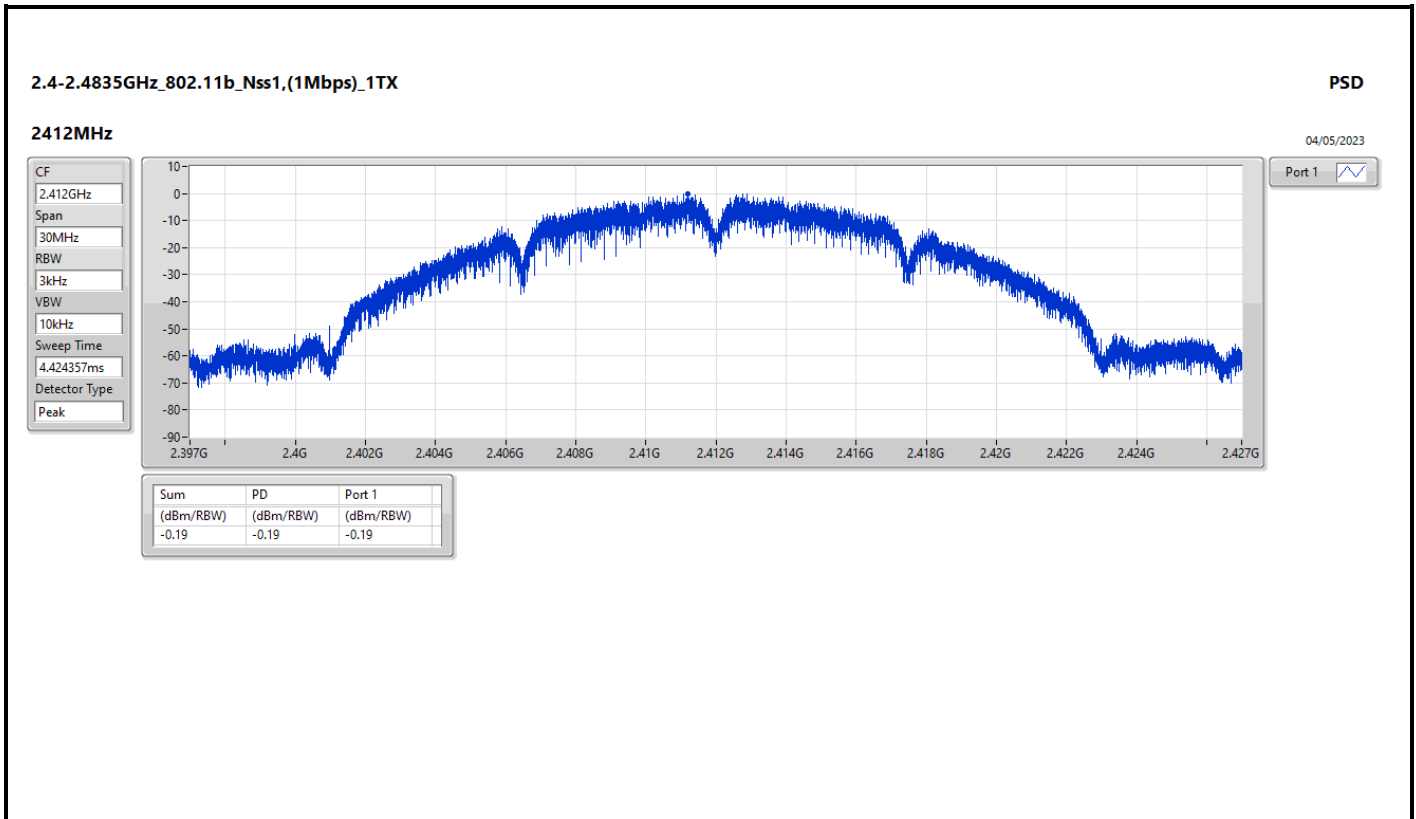

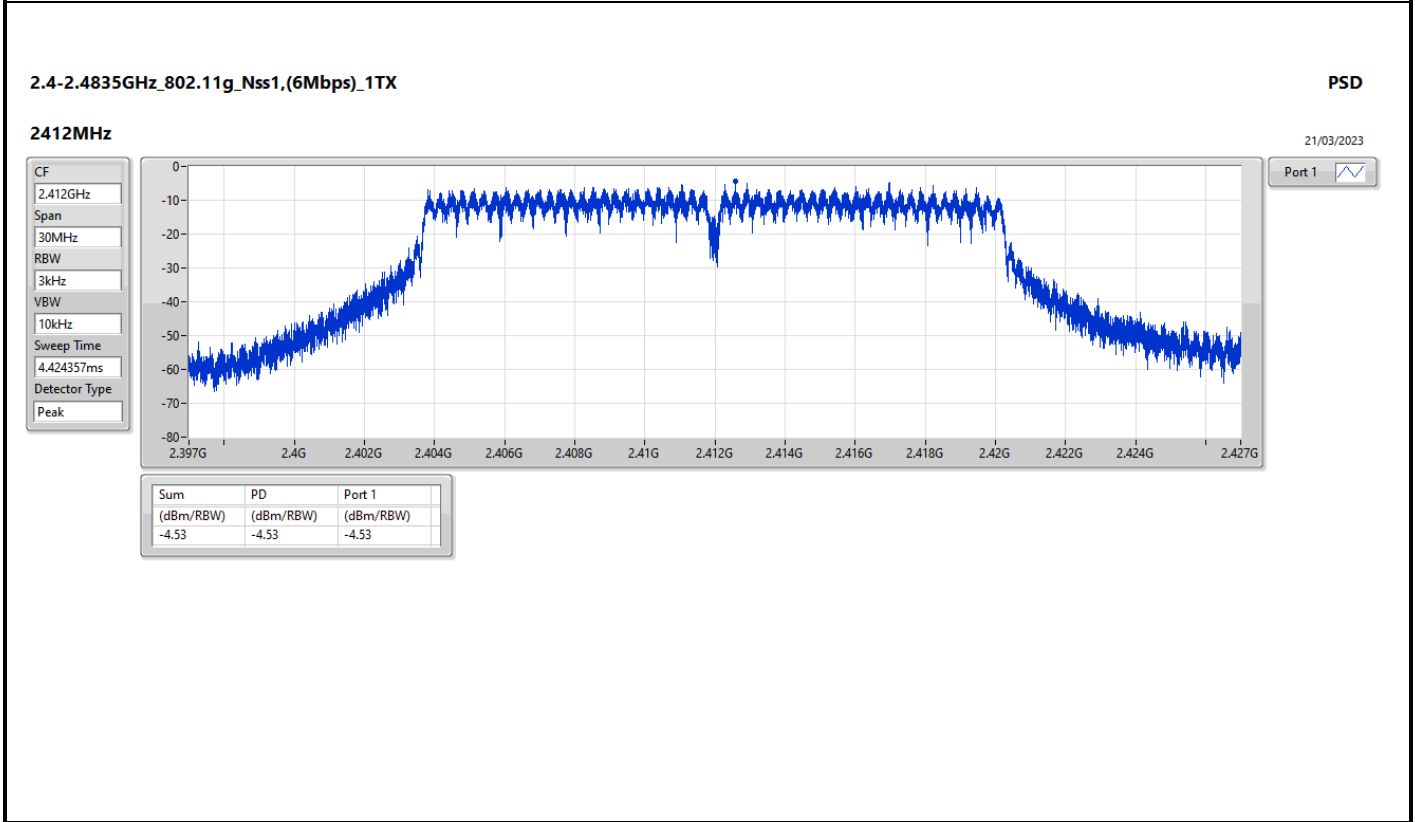
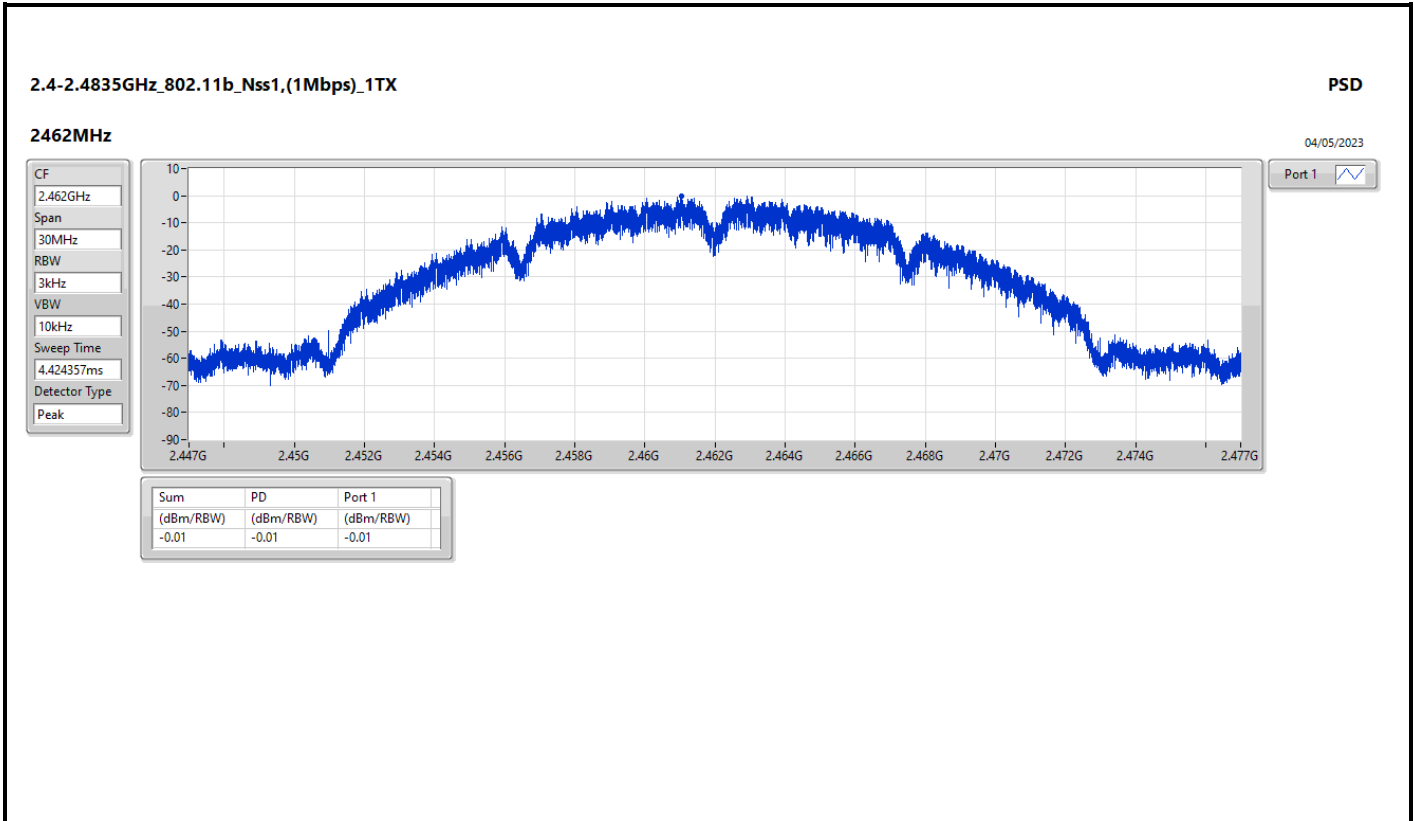

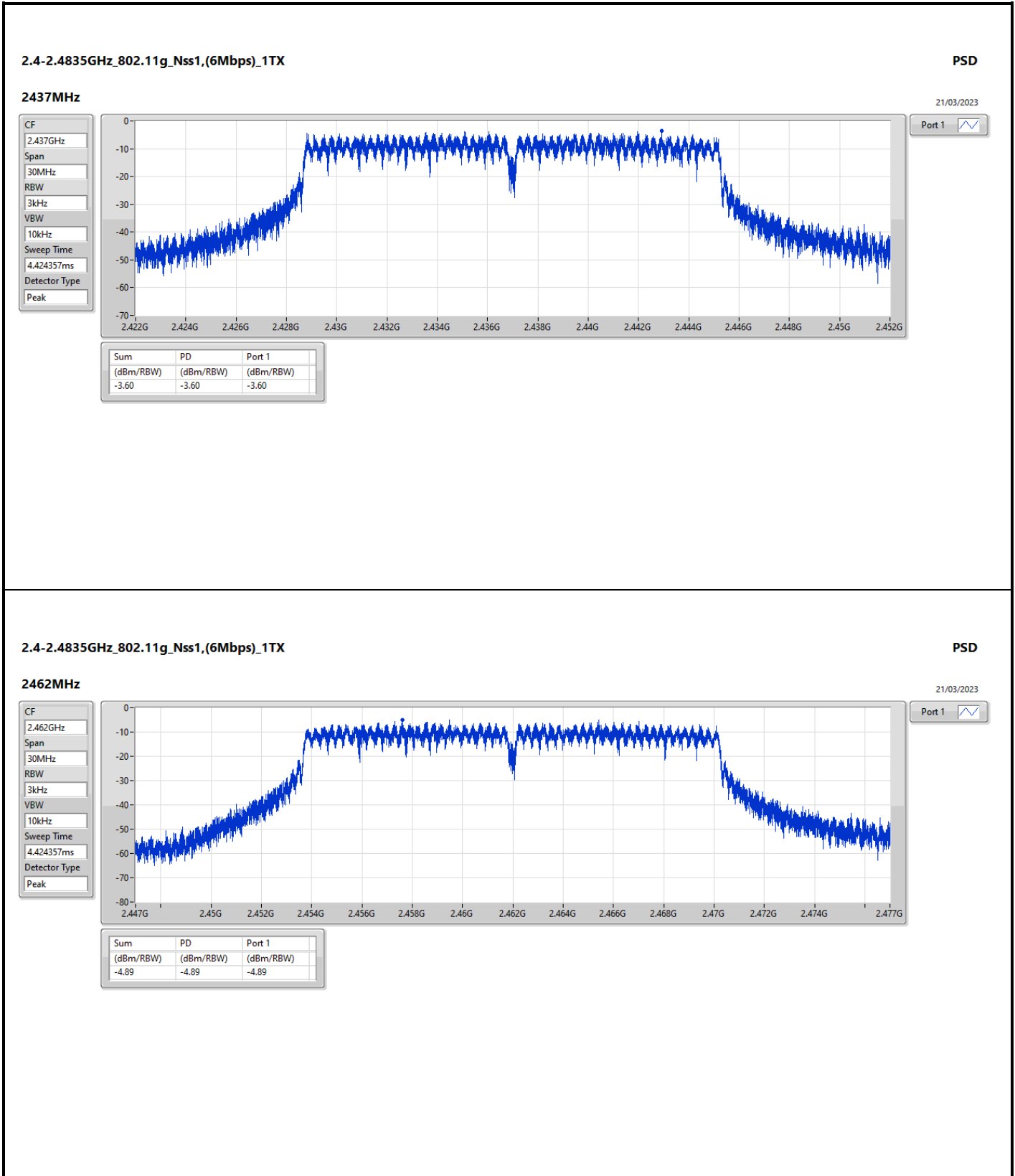

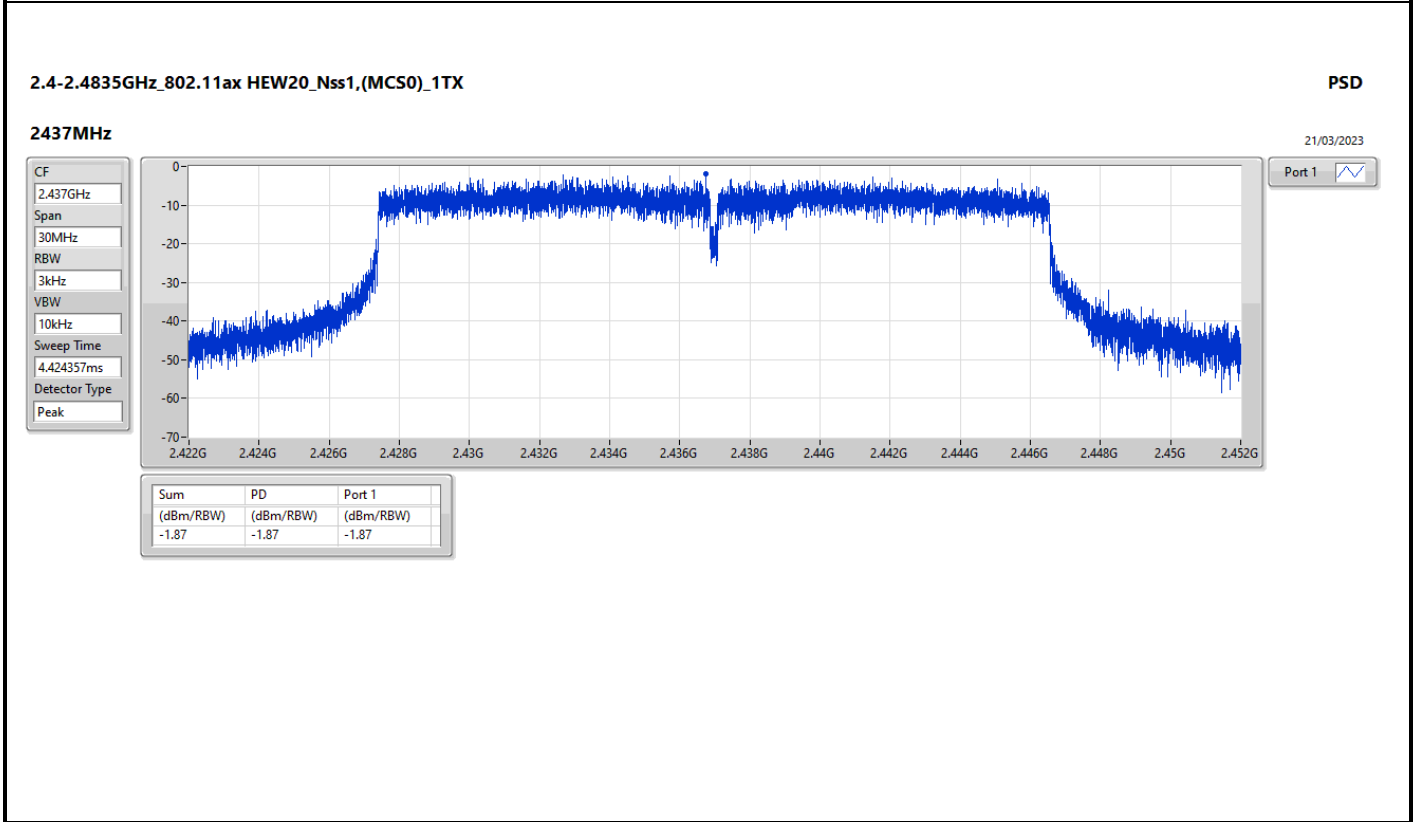
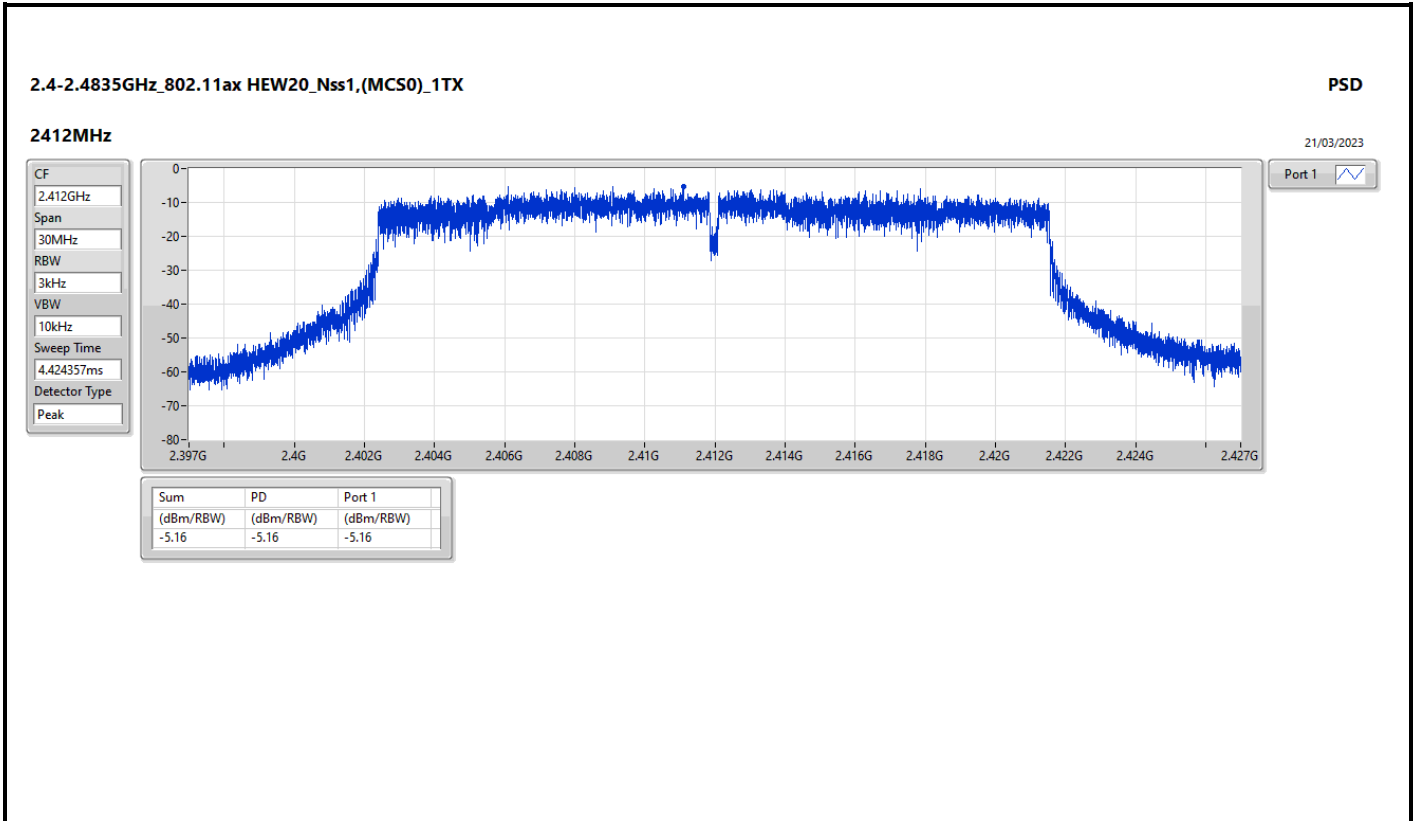

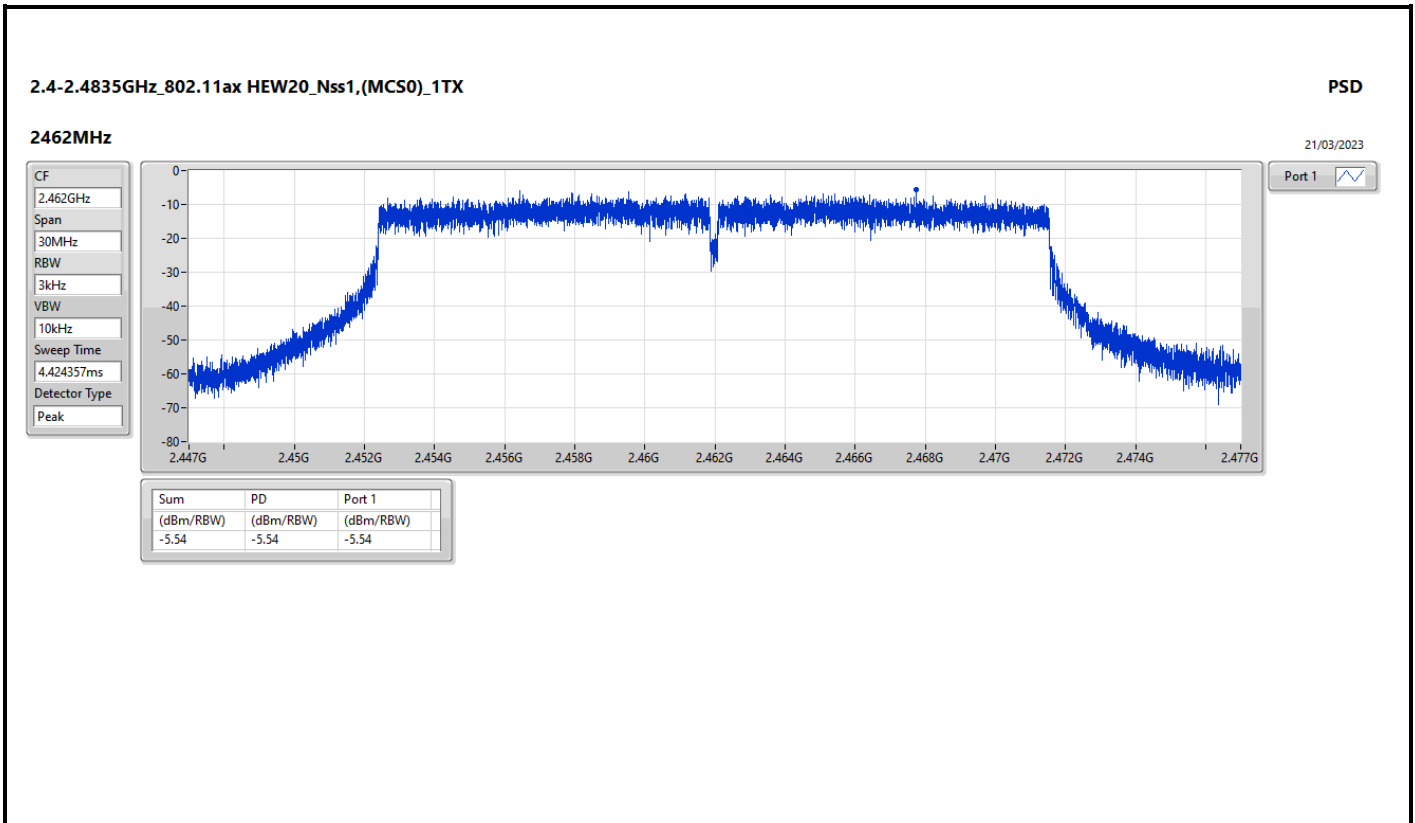



Summary

Mode	Result	Ref (Hz)	Ref (dBm)	Limit (dBm)	Freq (Hz)	Level (dBm)	Freq (Hz)	Level (dBm)	Freq (Hz)	Level (dBm)	Freq (Hz)	Level (dBm)	Freq (Hz)	Level (dBm)	Port
2.4-2.4835GHz	-	-	-	-	-	-	-	-	-	-	-	-	-	-	-
802.11b_Nss1,(1Mbps)_1TX	Pass	2.46296G	16.79	-13.21	2.30292G	-50.38	2.39992G	-36.35	2.4G	-35.77	2.51526G	-50.41	17.69233G	-48.09	1
802.11b_Nss1,(1Mbps)_2TX	Pass	2.41086G	17.09	-12.91	2.19108G	-51.51	2.39992G	-34.07	2.4G	-33.70	2.50374G	-50.42	17.66985G	-46.80	2
802.11b_Nss1,(1Mbps)_4TX	Pass	2.43741G	16.20	-13.80	2.17826G	-51.65	2.39968G	-34.78	2.4G	-34.56	2.51734G	-50.04	6.98789G	-47.43	2
802.11g_Nss1,(6Mbps)_1TX	Pass	2.46446G	13.34	-16.66	2.30059G	-49.67	2.4G	-22.21	2.4G	-22.06	2.5019G	-49.51	17.69233G	-46.76	1
802.11g_Nss1,(6Mbps)_2TX	Pass	2.46697G	13.93	-16.07	2.19923G	-50.29	2.3992G	-18.24	2.4G	-17.54	2.50766G	-49.32	6.0495G	-47.50	2
802.11g_Nss1,(6Mbps)_4TX	Pass	2.44192G	13.39	-16.61	349.21M	-42.97	2.39968G	-21.03	2.4G	-19.91	2.51254G	-50.43	5.18416G	-40.72	4
802.11ax HEW20_Nss1,(MCS0)_1TX	Pass	2.41319G	13.31	-16.69	2.30874G	-50.01	2.39992G	-20.38	2.4G	-20.57	2.5035G	-49.69	6.09164G	-47.87	1
802.11ax HEW20_Nss1,(MCS0)_2TX	Pass	2.46697G	13.67	-16.33	2.18991G	-49.70	2.4G	-17.52	2.4G	-20.58	2.51534G	-49.72	6.14784G	-48.15	2
802.11ax HEW20_Nss1,(MCS0)_4TX	Pass	2.43574G	13.36	-16.64	349.21M	-44.64	2.39968G	-20.90	2.4G	-22.25	2.52014G	-50.31	5.18416G	-40.37	4



Result

Mode	Result	Ref (Hz)	Ref (dBm)	Limit (dBm)	Freq (Hz)	Level (dBm)	Freq (Hz)	Level (dBm)	Freq (Hz)	Level (dBm)	Freq (Hz)	Level (dBm)	Freq (Hz)	Level (dBm)	Port
802.11b_Nss1,(1Mbps)_1TX	-	-	-	-	-	-	-	-	-	-	-	-	-	-	-
2412MHz	Pass	2.46296G	16.79	-13.21	2.30292G	-50.38	2.39992G	-36.35	2.4G	-35.77	2.51526G	-50.41	17.69233G	-48.09	1
2437MHz	Pass	2.46296G	16.79	-13.21	2.30874G	-50.80	2.3928G	-49.90	2.4G	-51.18	2.51702G	-50.29	24.85109G	-48.15	1
2462MHz	Pass	2.46296G	16.79	-13.21	2.14448G	-51.54	2.39944G	-50.33	2.4G	-53.27	2.5027G	-48.69	6.97666G	-47.17	1
802.11g_Nss1,(6Mbps)_1TX	-	-	-	-	-	-	-	-	-	-	-	-	-	-	-
2412MHz	Pass	2.46446G	13.34	-16.66	2.30059G	-49.67	2.4G	-22.21	2.4G	-22.06	2.5019G	-49.51	17.69233G	-46.76	1
2437MHz	Pass	2.46446G	13.34	-16.66	2.30059G	-49.65	2.39944G	-47.51	2.4G	-46.62	2.50206G	-49.22	17.69795G	-47.29	1
2462MHz	Pass	2.46446G	13.34	-16.66	2.30175G	-50.43	2.39848G	-48.05	2.4G	-50.37	2.50014G	-44.88	15.3323G	-47.87	1
802.11ax HEW20_Nss1,(MCS0)_1TX	-	-	-	-	-	-	-	-	-	-	-	-	-	-	-
2412MHz	Pass	2.41319G	13.31	-16.69	2.30874G	-50.01	2.39992G	-20.38	2.4G	-20.57	2.5035G	-49.69	6.09164G	-47.87	1
2437MHz	Pass	2.41319G	13.31	-16.69	2.19224G	-50.78	2.39976G	-45.95	2.4G	-45.84	2.50262G	-48.25	6.82213G	-47.69	1
2462MHz	Pass	2.41319G	13.31	-16.69	2.30874G	-48.97	2.4G	-47.77	2.4G	-48.98	2.5011G	-43.63	17.67547G	-47.22	1
802.11b_Nss1,(1Mbps)_2TX	-	-	-	-	-	-	-	-	-	-	-	-	-	-	-
2412MHz	Pass	2.41086G	17.09	-12.91	2.19224G	-50.77	2.39992G	-36.48	2.4G	-36.40	2.50806G	-50.67	6.98509G	-47.15	1
2412MHz	Pass	2.41086G	17.09	-12.91	2.19108G	-51.51	2.39992G	-34.07	2.4G	-33.70	2.50374G	-50.42	17.66985G	-46.80	2
2437MHz	Pass	2.41086G	17.09	-12.91	2.19108G	-52.20	2.39632G	-49.28	2.4G	-49.88	2.51806G	-49.59	24.53361G	-48.12	1
2437MHz	Pass	2.41086G	17.09	-12.91	2.30525G	-49.71	2.3988G	-50.19	2.4G	-51.44	2.50374G	-50.39	17.67828G	-47.42	2
2462MHz	Pass	2.41086G	17.09	-12.91	2.18292G	-51.72	2.39592G	-49.94	2.4G	-51.44	2.50094G	-47.43	17.68952G	-47.61	1
2462MHz	Pass	2.41086G	17.09	-12.91	2.1771G	-51.97	2.39664G	-49.58	2.4G	-52.21	2.5011G	-48.11	5.18135G	-47.20	2
802.11g_Nss1,(6Mbps)_2TX	-	-	-	-	-	-	-	-	-	-	-	-	-	-	-
2412MHz	Pass	2.46697G	13.93	-16.07	2.30175G	-50.91	2.4G	-24.91	2.4G	-23.40	2.51326G	-49.49	16.58536G	-47.85	1
2412MHz	Pass	2.46697G	13.93	-16.07	2.19923G	-50.29	2.3992G	-18.24	2.4G	-17.54	2.50766G	-49.32	6.0495G	-47.50	2
2437MHz	Pass	2.46697G	13.93	-16.07	2.30408G	-49.92	2.39976G	-46.50	2.4G	-47.21	2.51014G	-47.86	6.92047G	-47.64	1
2437MHz	Pass	2.46697G	13.93	-16.07	2.18525G	-50.37	2.39864G	-45.70	2.4G	-46.37	2.51318G	-48.75	6.71537G	-46.84	2
2462MHz	Pass	2.46697G	13.93	-16.07	2.30292G	-50.67	2.39504G	-46.92	2.4G	-50.05	2.50094G	-44.27	17.69233G	-47.27	1
2462MHz	Pass	2.46697G	13.93	-16.07	2.30758G	-49.86	2.39048G	-49.37	2.4G	-50.77	2.50038G	-45.68	6.59737G	-47.79	2
802.11ax HEW20_Nss1,(MCS0)_2TX	-	-	-	-	-	-	-	-	-	-	-	-	-	-	-
2412MHz	Pass	2.46697G	13.67	-16.33	2.18875G	-51.06	2.39984G	-24.04	2.4G	-24.53	2.51342G	-49.36	6.97385G	-48.11	1
2412MHz	Pass	2.46697G	13.67	-16.33	2.18991G	-49.70	2.4G	-17.52	2.4G	-20.58	2.51534G	-49.72	6.14784G	-48.15	2
2437MHz	Pass	2.46697G	13.67	-16.33	2.30874G	-50.84	2.3988G	-46.02	2.4G	-46.79	2.50006G	-48.02	17.69795G	-47.70	1
2437MHz	Pass	2.46697G	13.67	-16.33	2.18758G	-51.27	2.39976G	-41.94	2.4G	-44.08	2.50102G	-48.84	17.67547G	-48.07	2
2462MHz	Pass	2.46697G	13.67	-16.33	2.30059G	-50.91	2.39704G	-47.44	2.4G	-48.25	2.50174G	-43.37	15.29858G	-48.19	1
2462MHz	Pass	2.46697G	13.67	-16.33	2.30991G	-50.46	2.3968G	-48.54	2.4G	-49.35	2.50286G	-43.98	6.9317G	-47.66	2
802.11b_Nss1,(1Mbps)_4TX	-	-	-	-	-	-	-	-	-	-	-	-	-	-	-
2412MHz	Pass	2.43741G	16.20	-13.80	2.14914G	-52.52	2.4G	-37.27	2.4G	-36.85	2.52294G	-50.41	24.05599G	-47.95	1
2412MHz	Pass	2.43741G	16.20	-13.80	2.17826G	-51.65	2.39968G	-34.78	2.4G	-34.56	2.51734G	-50.04	6.98789G	-47.43	2
2412MHz	Pass	2.43741G	16.20	-13.80	2.30991G	-52.44	2.39968G	-35.24	2.4G	-35.00	2.5203G	-50.32	16.59098G	-47.73	3
2412MHz	Pass	2.43741G	16.20	-13.80	353.87M	-42.03	2.39992G	-35.04	2.4G	-35.73	2.50574G	-50.47	5.17011G	-42.50	4
2437MHz	Pass	2.43741G	16.20	-13.80	2.18059G	-51.28	2.39712G	-49.80	2.4G	-52.05	2.5199G	-50.80	16.65279G	-47.71	1
2437MHz	Pass	2.43741G	16.20	-13.80	2.30758G	-50.90	2.39816G	-48.64	2.4G	-51.32	2.5123G	-49.82	17.67547G	-48.13	2
2437MHz	Pass	2.43741G	16.20	-13.80	2.30525G	-51.99	2.3992G	-50.18	2.4G	-52.51	2.52182G	-50.60	17.67266G	-46.92	3
2437MHz	Pass	2.43741G	16.20	-13.80	304.94M	-40.32	2.39824G	-50.07	2.4G	-51.77	2.51078G	-51.12	5.18135G	-42.32	4
2462MHz	Pass	2.43741G	16.20	-13.80	2.15729G	-51.77	2.39216G	-50.60	2.4G	-50.66	2.50358G	-50.19	5.94836G	-48.01	1
2462MHz	Pass	2.43741G	16.20	-13.80	2.30408G	-51.72	2.3984G	-49.56	2.4G	-52.52	2.50222G	-49.69	17.66142G	-47.81	2
2462MHz	Pass	2.43741G	16.20	-13.80	2.30874G	-51.89	2.39312G	-48.74	2.4G	-52.18	2.50142G	-48.82	15.31544G	-47.45	3
2462MHz	Pass	2.43741G	16.20	-13.80	2.1969G	-51.75	2.39832G	-50.47	2.4G	-52.61	2.50014G	-48.96	5.18416G	-41.51	4
802.11g_Nss1,(6Mbps)_4TX	-	-	-	-	-	-	-	-	-	-	-	-	-	-	-
2412MHz	Pass	2.44192G	13.39	-16.61	2.30758G	-51.23	2.39968G	-28.76	2.4G	-28.10	2.50718G	-50.24	6.95137G	-47.74	1
2412MHz	Pass	2.44192G	13.39	-16.61	2.30292G	-51.05	2.39984G	-23.39	2.4G	-25.41	2.5071G	-50.86	5.77697G	-47.36	2
2412MHz	Pass	2.44192G	13.39	-16.61	2.30525G	-51.71	2.39984G	-23.19	2.4G	-23.02	2.52262G	-49.95	21.40095G	-47.81	3
2412MHz	Pass	2.44192G	13.39	-16.61	349.21M	-42.97	2.39968G	-21.03	2.4G	-19.91	2.51254G	-50.43	5.18416G	-40.72	4
2437MHz	Pass	2.44192G	13.39	-16.61	2.30641G	-50.03	2.39824G	-47.49	2.4G	-48.10	2.51774G	-48.41	6.9907G	-46.76	1
2437MHz	Pass	2.44192G	13.39	-16.61	2.19108G	-51.06	2.39888G	-45.51	2.4G	-46.86	2.50254G	-49.31	16.63593G	-47.42	2
2437MHz	Pass	2.44192G	13.39	-16.61	2.18642G	-50.63	2.39664G	-42.55	2.4G	-43.56	2.50222G	-49.26	15.27049G	-46.98	3
2437MHz	Pass	2.44192G	13.39	-16.61	309.6M	-36.66	2.39984G	-41.03	2.4G	-42.99	2.50302G	-49.12	5.18416G	-41.48	4
2462MHz	Pass	2.44192G	13.39	-16.61	2.30874G	-50.94	2.39744G	-49.26	2.4G	-49.73	2.50094G	-45.68	17.67266G	-47.44	1
2462MHz	Pass	2.44192G	13.39	-16.61	2.30059G	-51.56	2.39384G	-48.85	2.4G	-49.76	2.50134G	-46.04	16.68931G	-48.20	2
2462MHz	Pass	2.44192G	13.39	-16.61	2.30408G	-50.56	2.3928G	-49.13	2.4G	-50.34	2.50294G	-42.90	16.52355G	-48.02	3
2462MHz	Pass	2.44192G	13.39	-16.61	239.7M	-40.94	2.39696G	-46.89	2.4G	-51.03	2.50326G	-43.60	5.18416G	-40.06	4
802.11ax HEW20_Nss1,(MCS0)_4TX	-	-	-	-	-	-	-	-	-	-	-	-	-	-	-
2412MHz	Pass	2.43574G	13.36	-16.64	2.19574G	-51.83	2.4G	-27.24	2.4G	-26.91	2.51998G	-50.68	15.25082G	-47.63	1



Mode	Result	Ref (Hz)	Ref (dBm)	Limit (dBm)	Freq (Hz)	Level (dBm)	Freq (Hz)	Level (dBm)	Freq (Hz)	Level (dBm)	Freq (Hz)	Level (dBm)	Freq (Hz)	Level (dBm)	Port
2412MHz	Pass	2.43574G	13.36	-16.64	2.16079G	-51.50	2.39944G	-24.98	2.4G	-21.67	2.50534G	-50.81	16.22574G	-47.30	2
2412MHz	Pass	2.43574G	13.36	-16.64	2.30758G	-50.87	2.3996G	-24.77	2.4G	-23.51	2.52166G	-50.14	17.6839G	-47.49	3
2412MHz	Pass	2.43574G	13.36	-16.64	349.21M	-44.64	2.39968G	-20.90	2.4G	-22.25	2.52014G	-50.31	5.18416G	-40.37	4
2437MHz	Pass	2.43574G	13.36	-16.64	2.1969G	-50.14	2.39992G	-46.81	2.4G	-47.53	2.50478G	-49.22	15.23115G	-47.70	1
2437MHz	Pass	2.43574G	13.36	-16.64	2.30175G	-50.27	2.39984G	-42.07	2.4G	-42.54	2.50022G	-48.34	16.72303G	-48.01	2
2437MHz	Pass	2.43574G	13.36	-16.64	2.30991G	-51.08	2.39896G	-40.16	2.4G	-40.65	2.50526G	-48.43	16.66965G	-47.55	3
2437MHz	Pass	2.43574G	13.36	-16.64	309.6M	-39.16	2.39936G	-39.21	2.4G	-40.41	2.50166G	-48.24	5.18135G	-39.85	4
2462MHz	Pass	2.43574G	13.36	-16.64	2.30292G	-50.71	2.39464G	-48.36	2.4G	-49.84	2.50246G	-44.11	16.56288G	-47.71	1
2462MHz	Pass	2.43574G	13.36	-16.64	2.30641G	-51.42	2.3952G	-48.95	2.4G	-50.62	2.50358G	-44.76	17.69795G	-47.71	2
2462MHz	Pass	2.43574G	13.36	-16.64	2.11768G	-51.48	2.39376G	-48.31	2.4G	-49.55	2.50166G	-42.07	17.65861G	-47.83	3
2462MHz	Pass	2.43574G	13.36	-16.64	239.7M	-41.96	2.39784G	-48.88	2.4G	-49.99	2.5003G	-43.04	5.18416G	-42.07	4



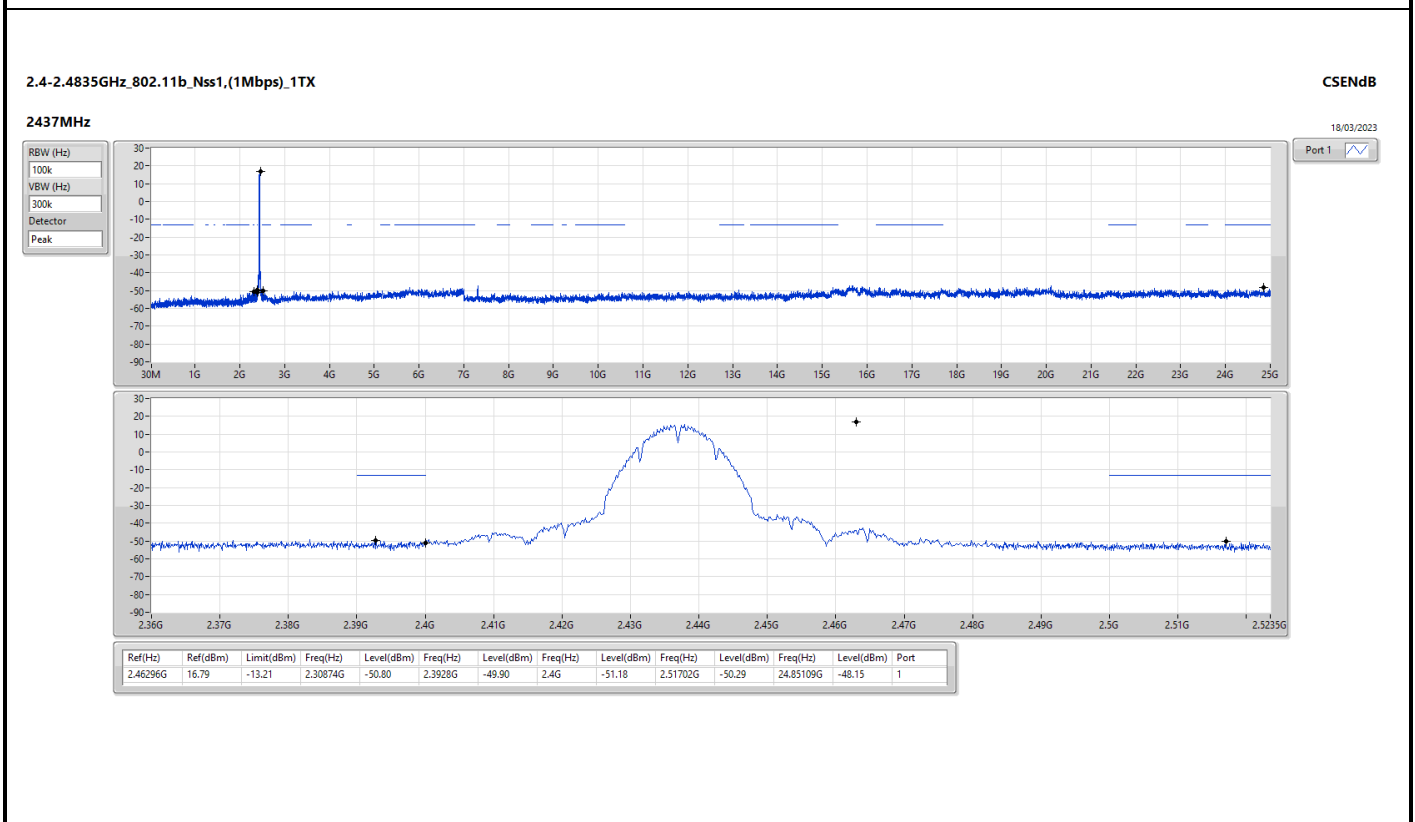
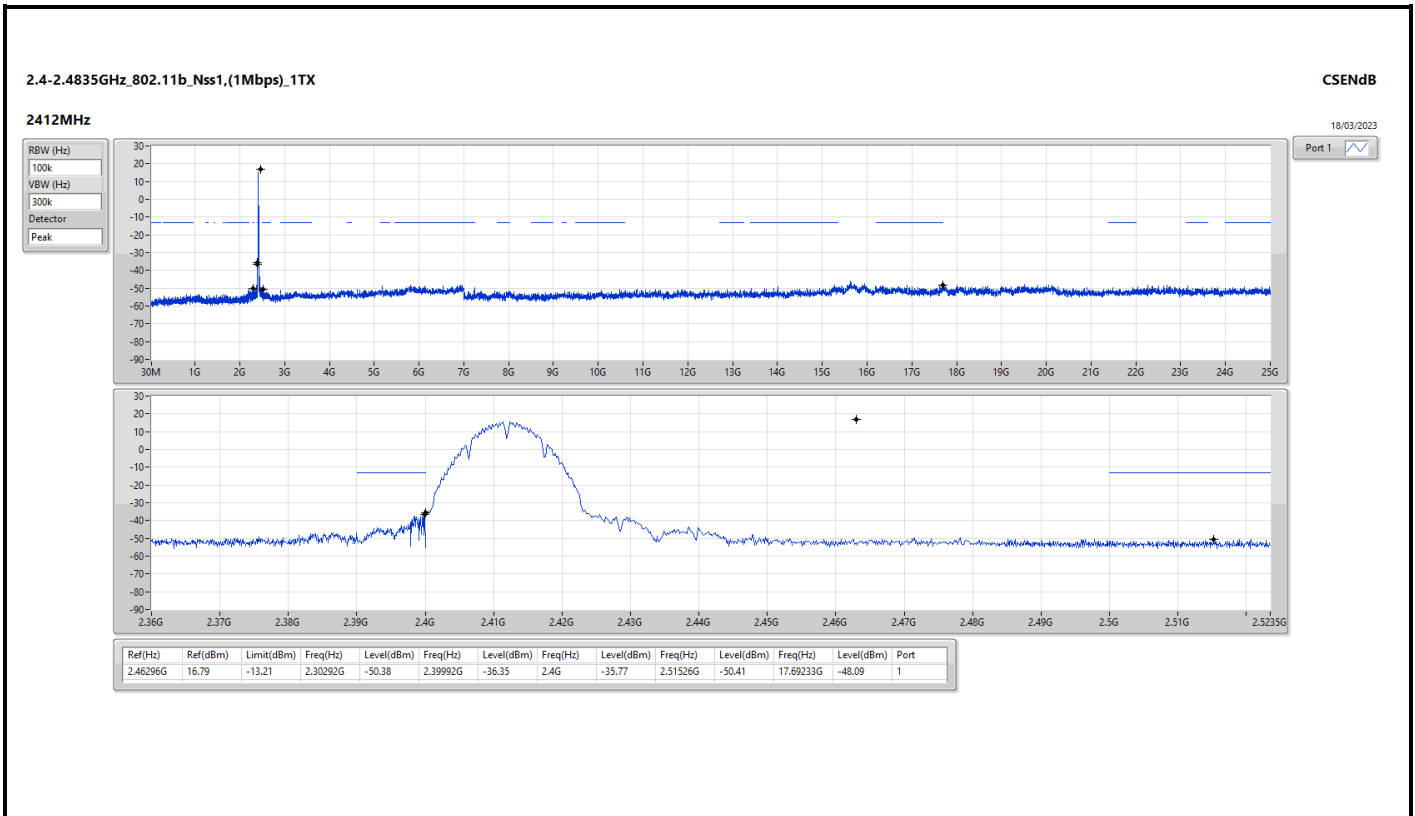

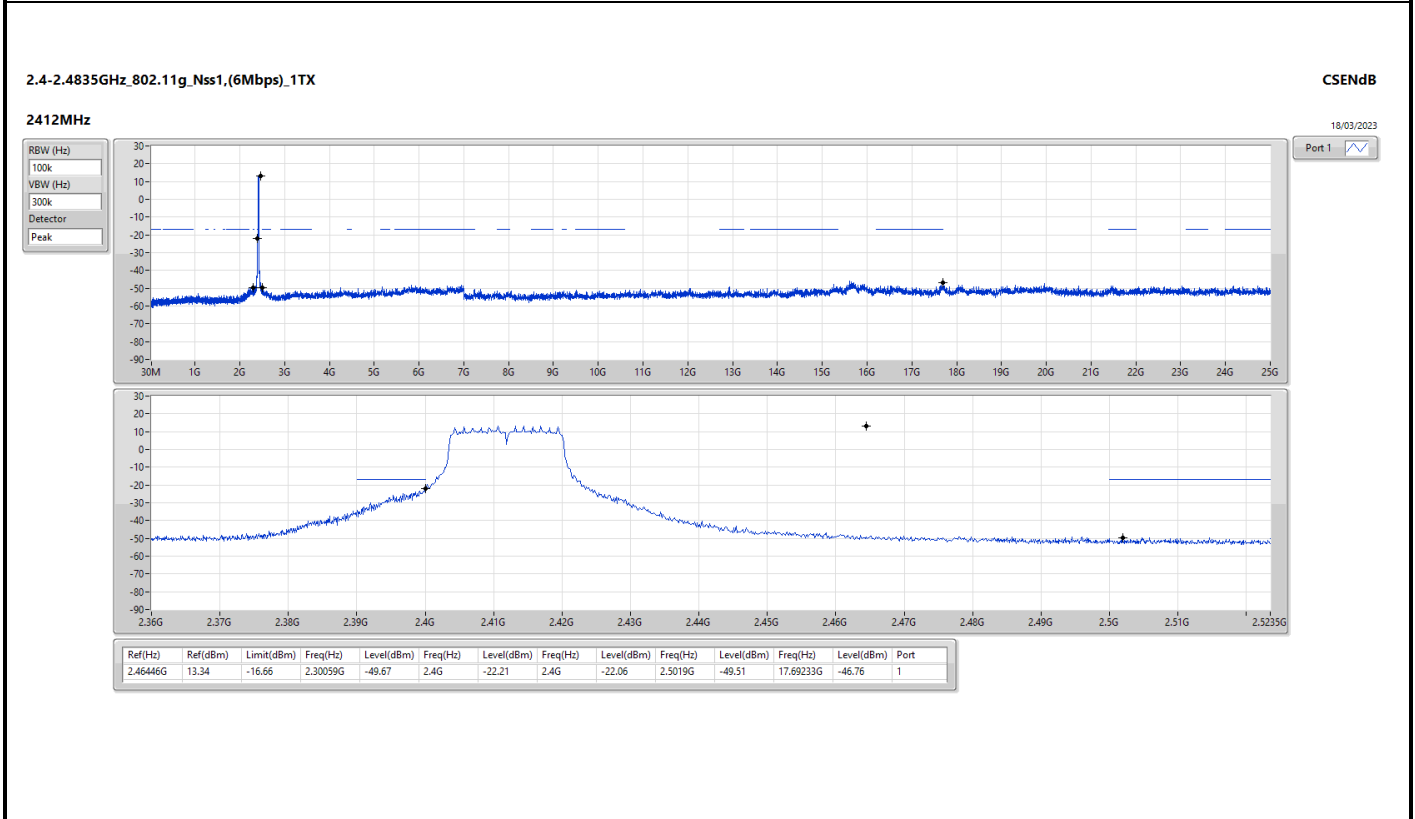
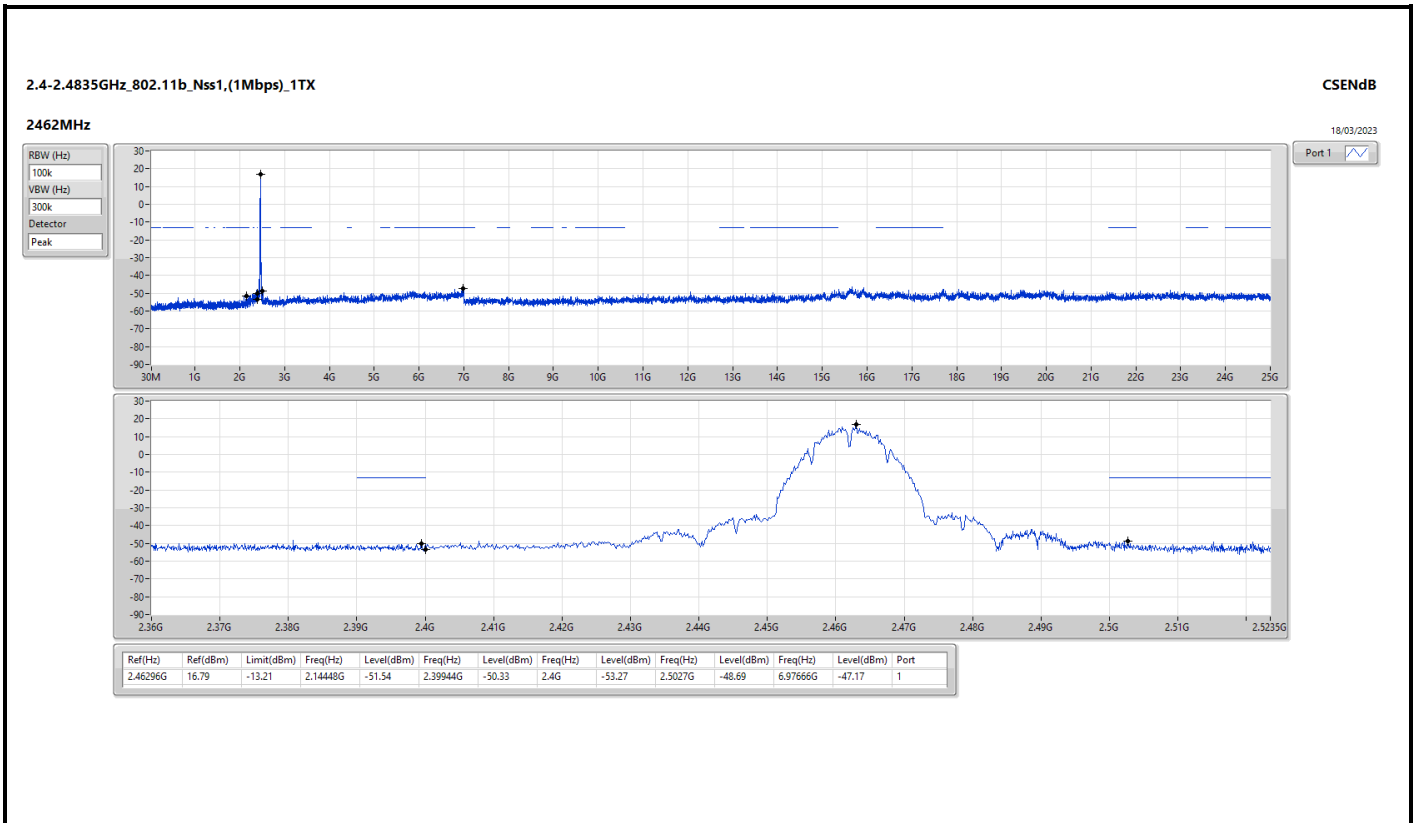

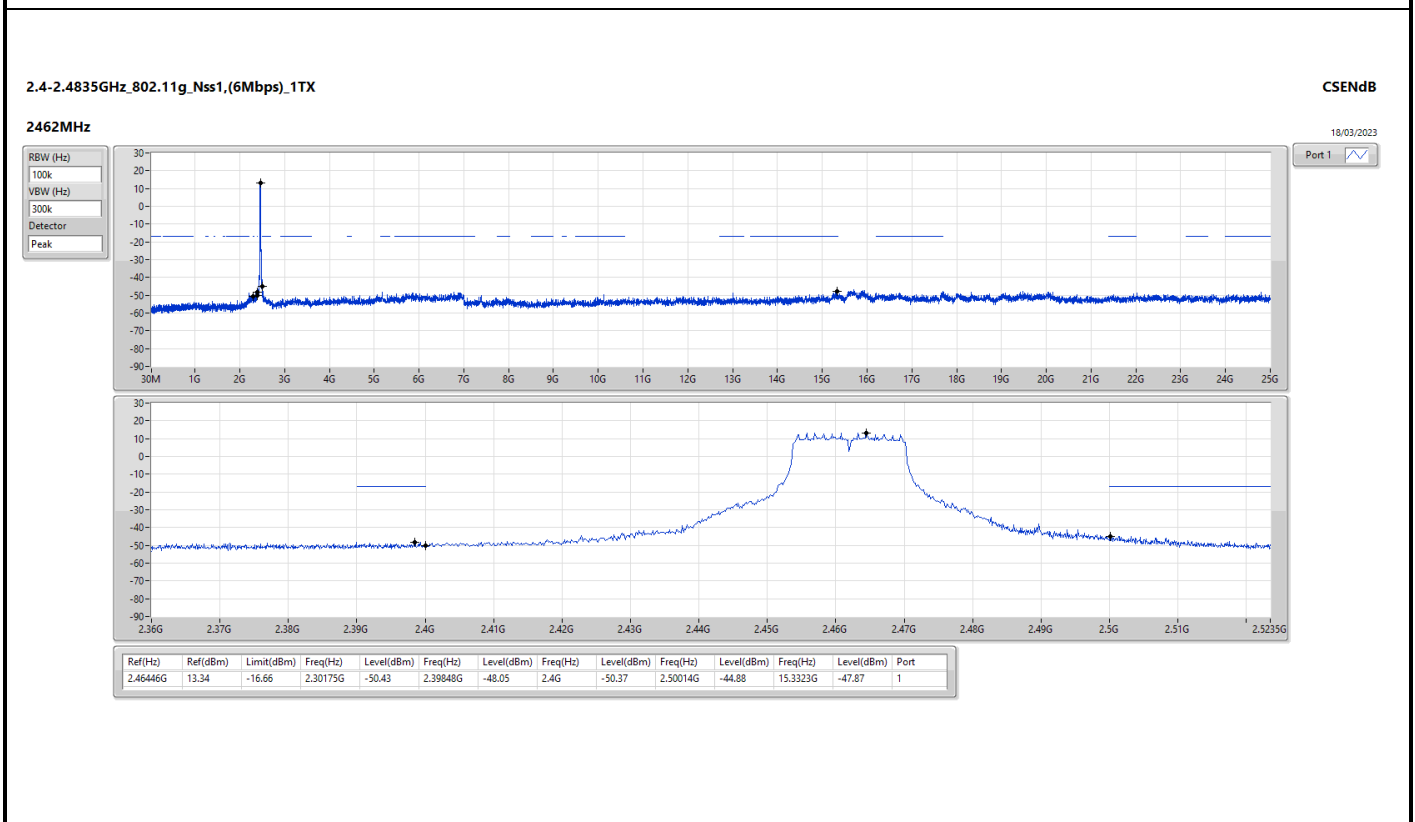
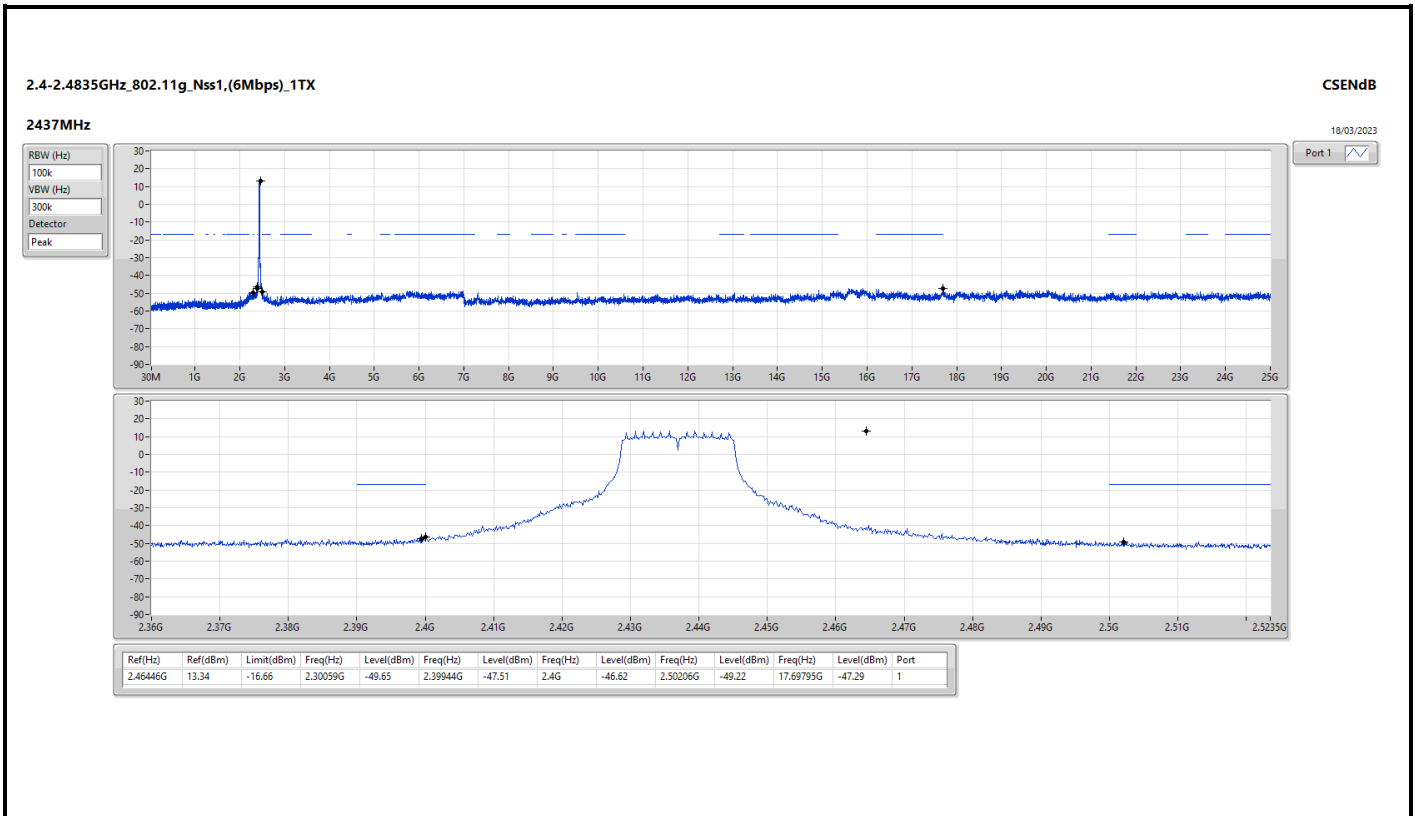

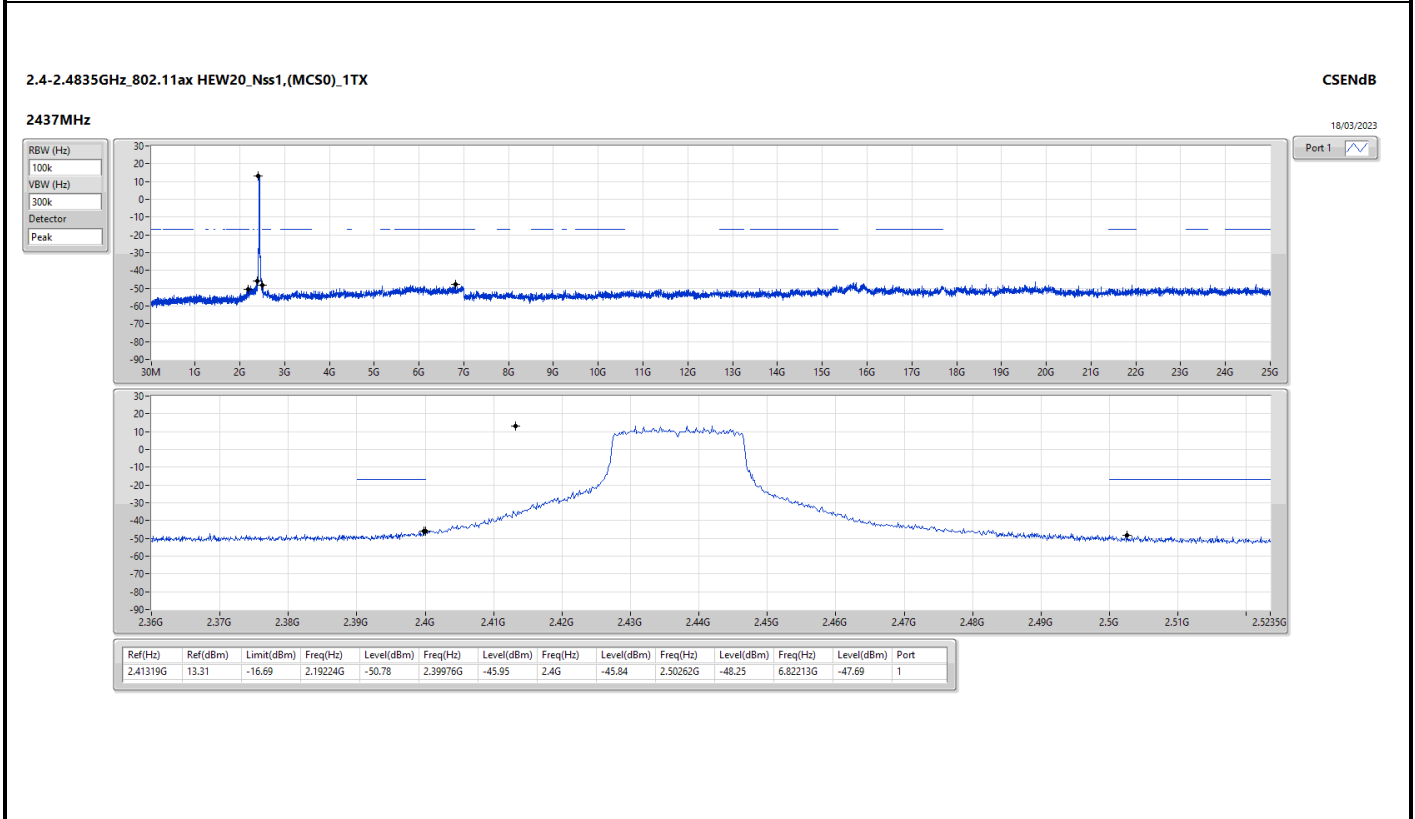
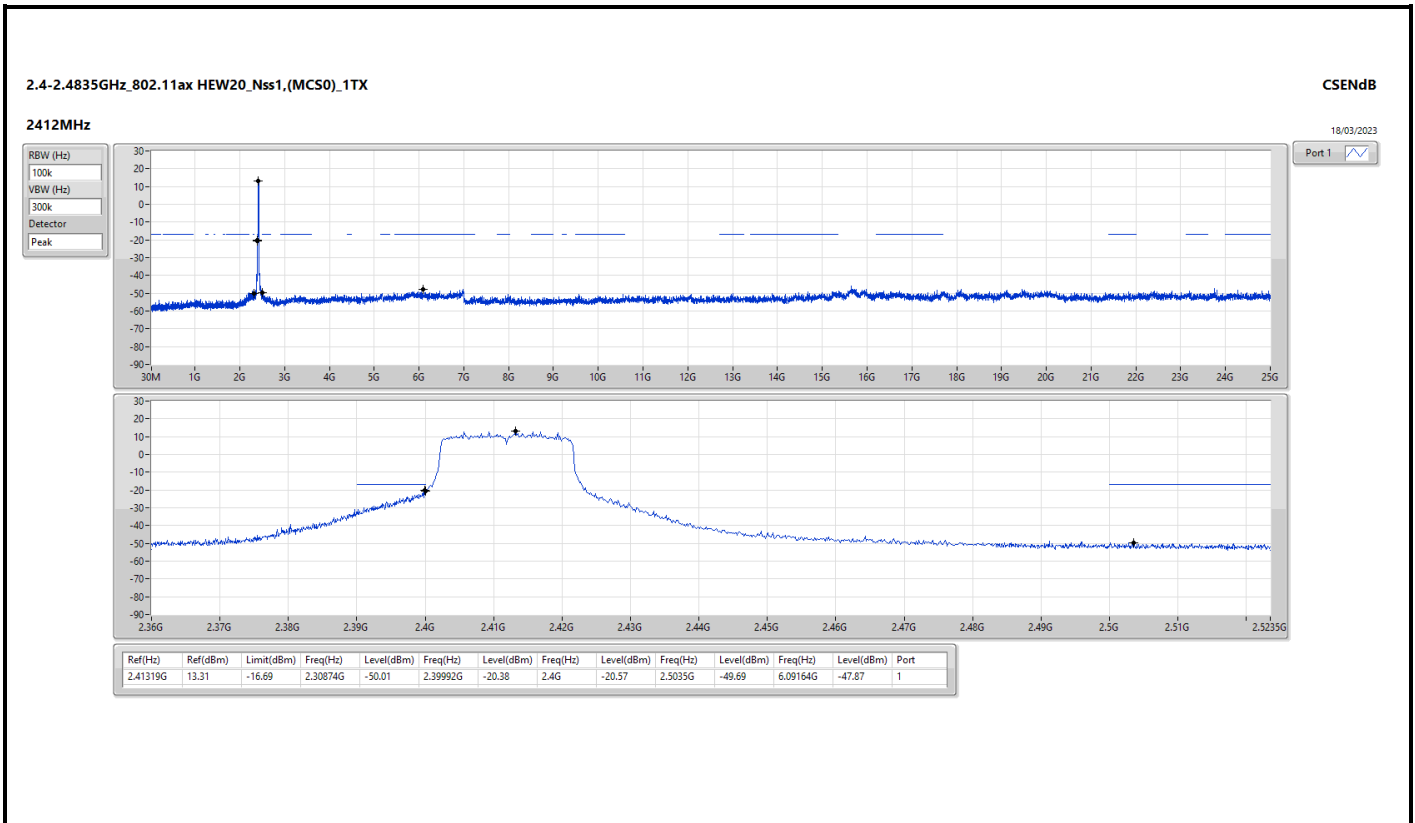

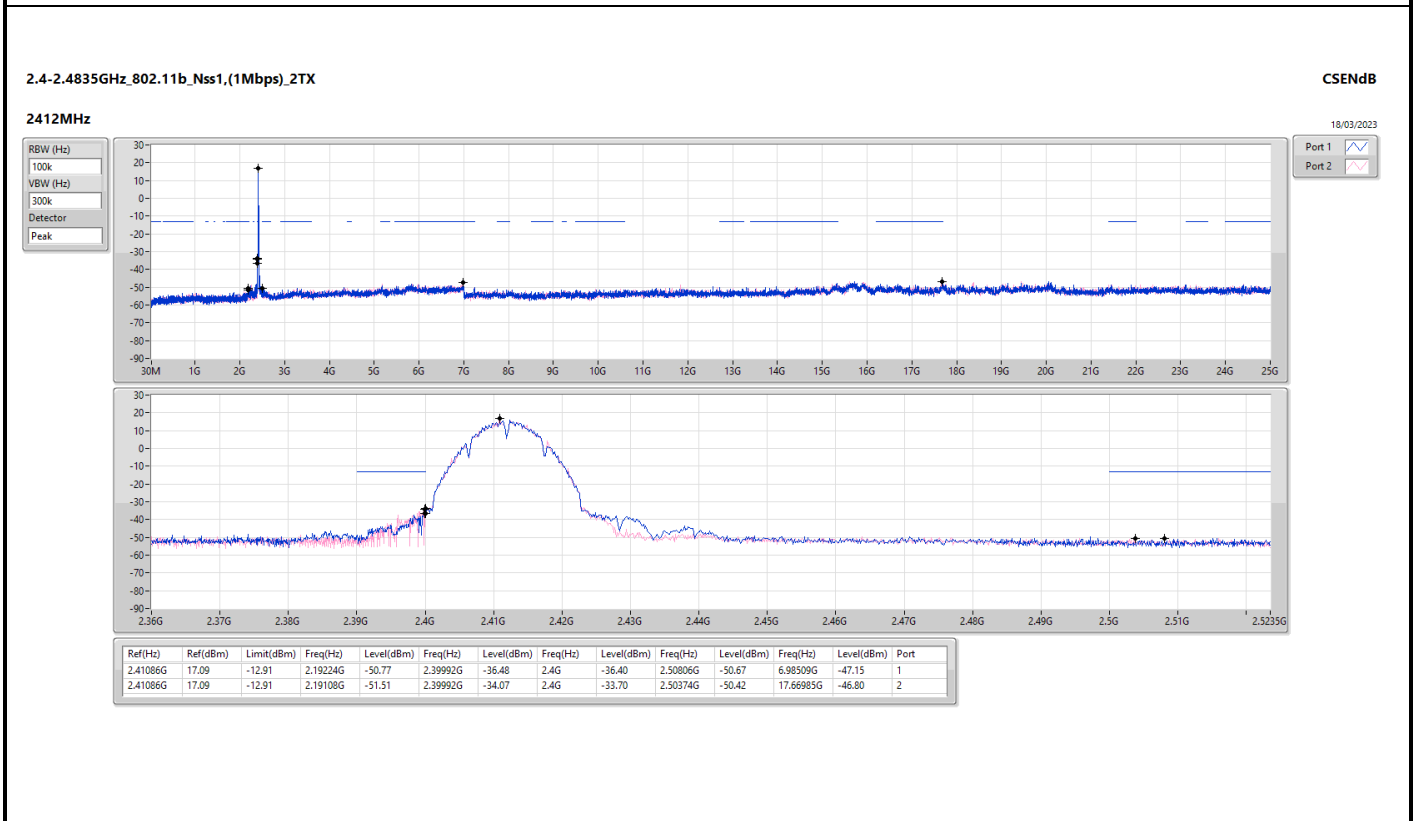
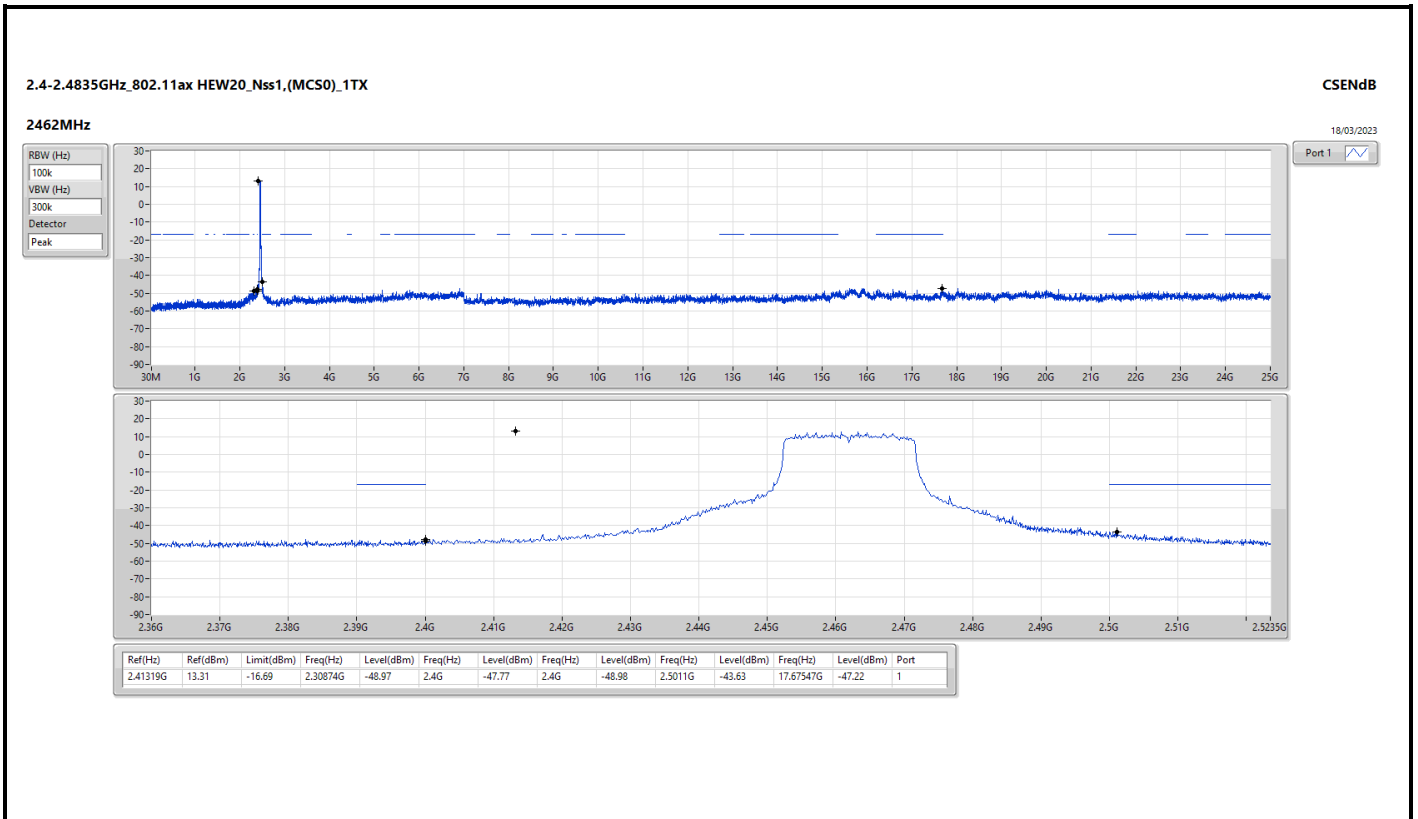

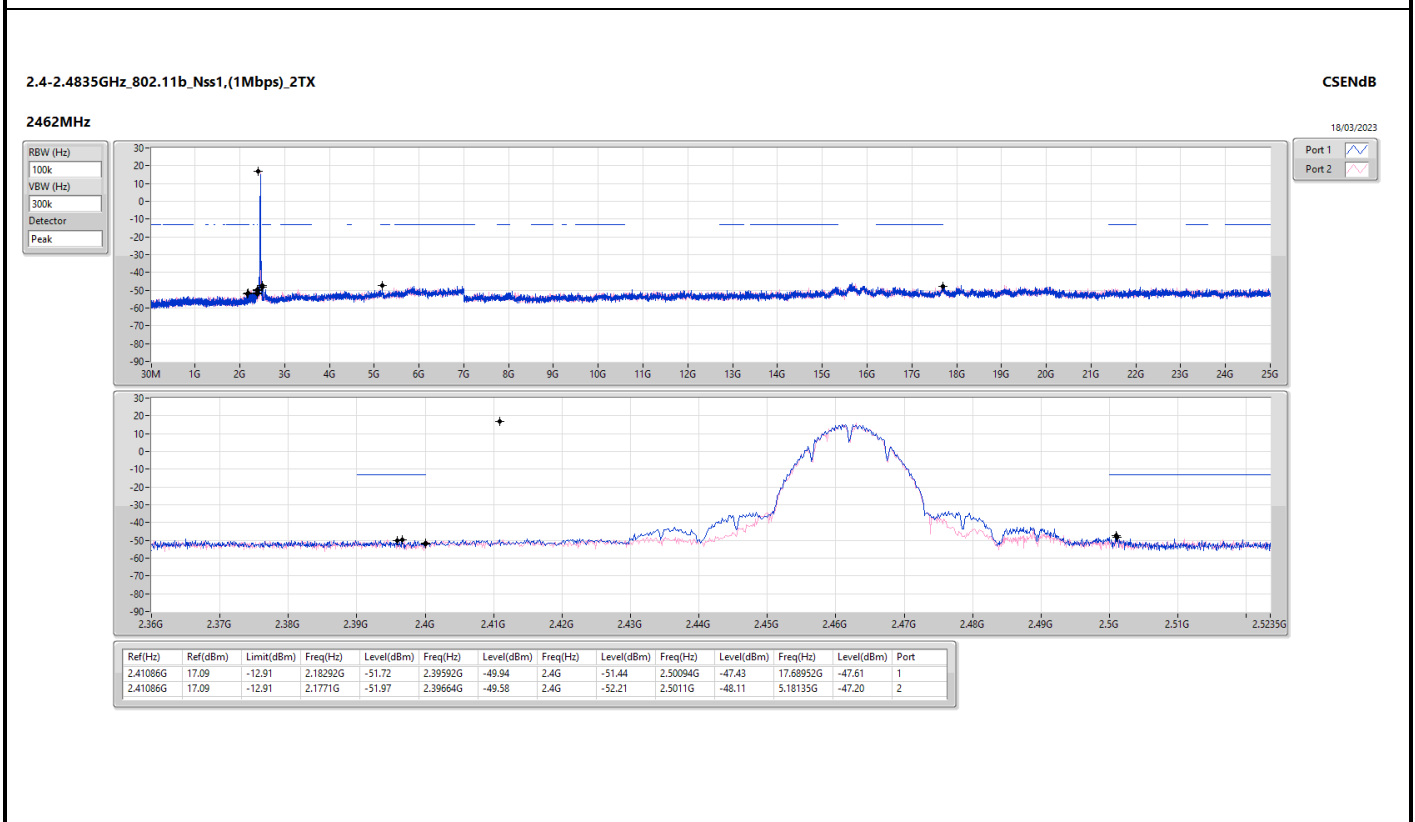
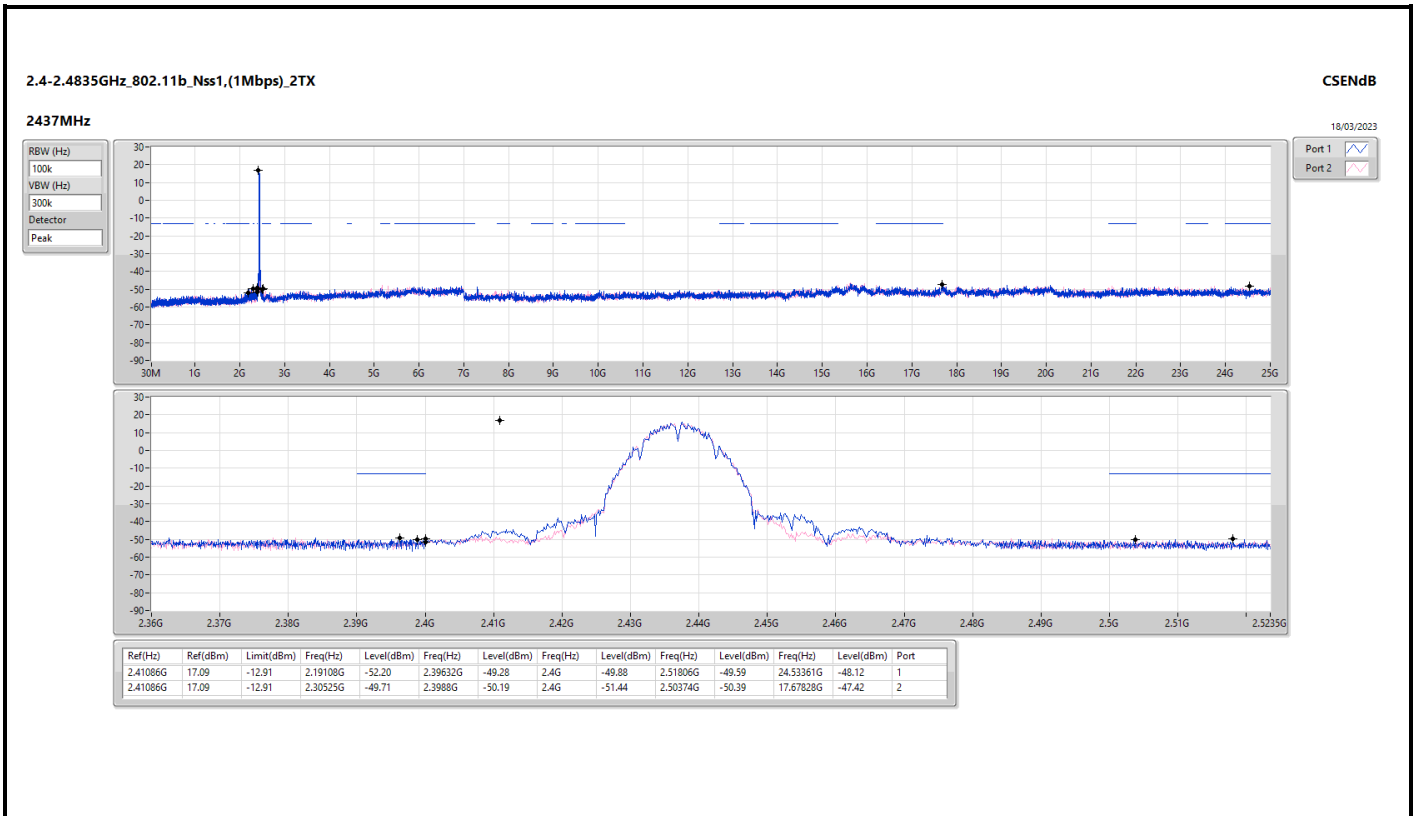

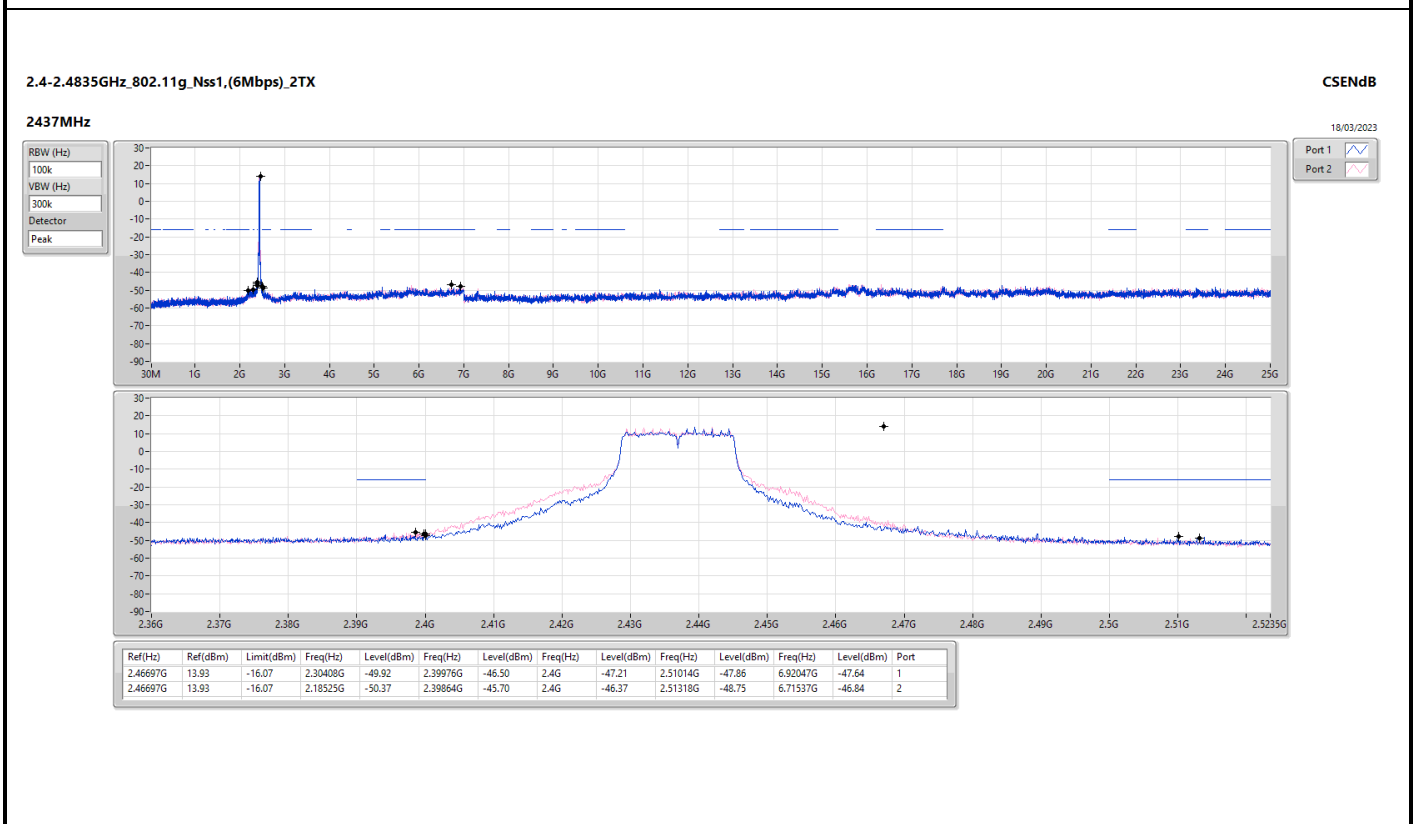
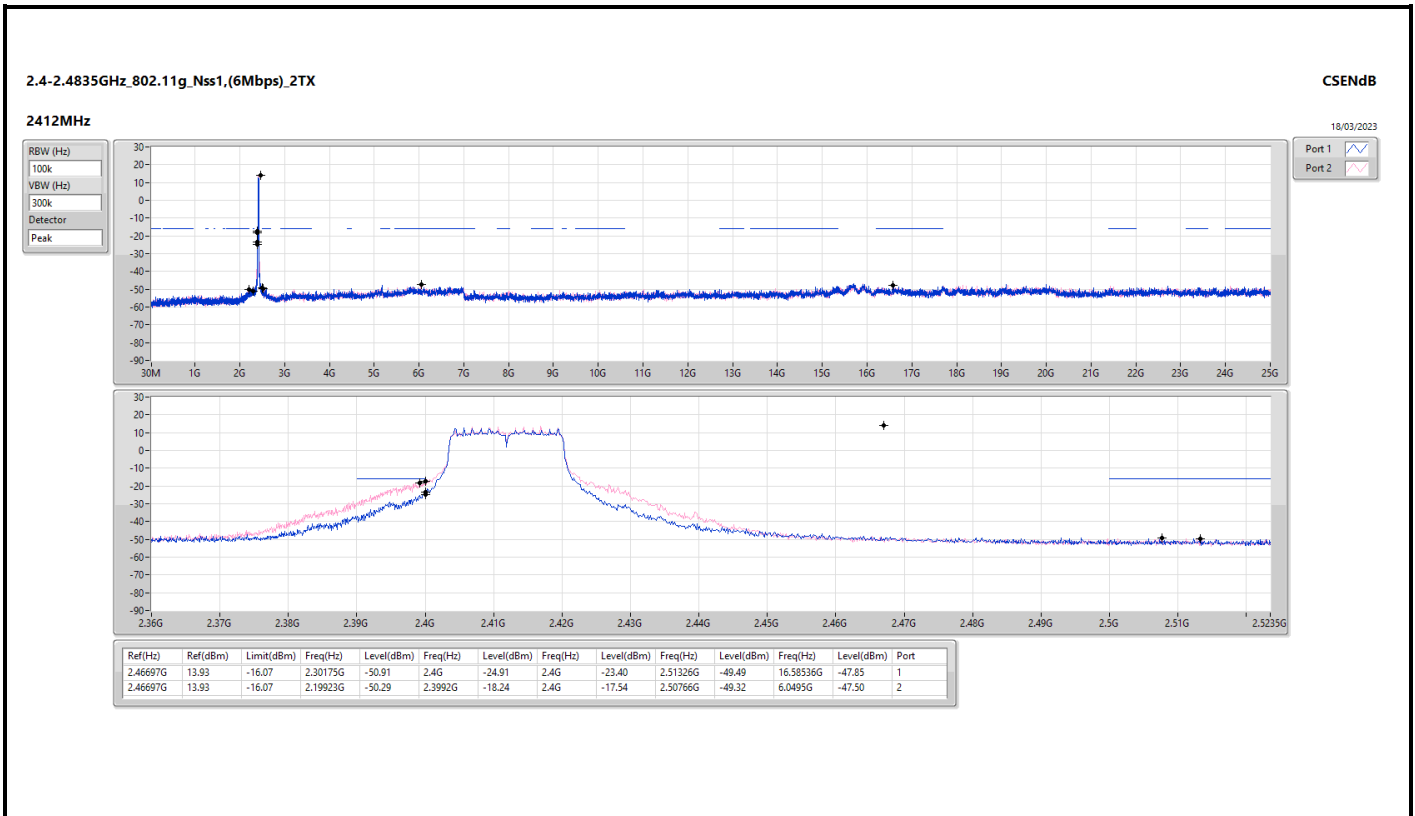

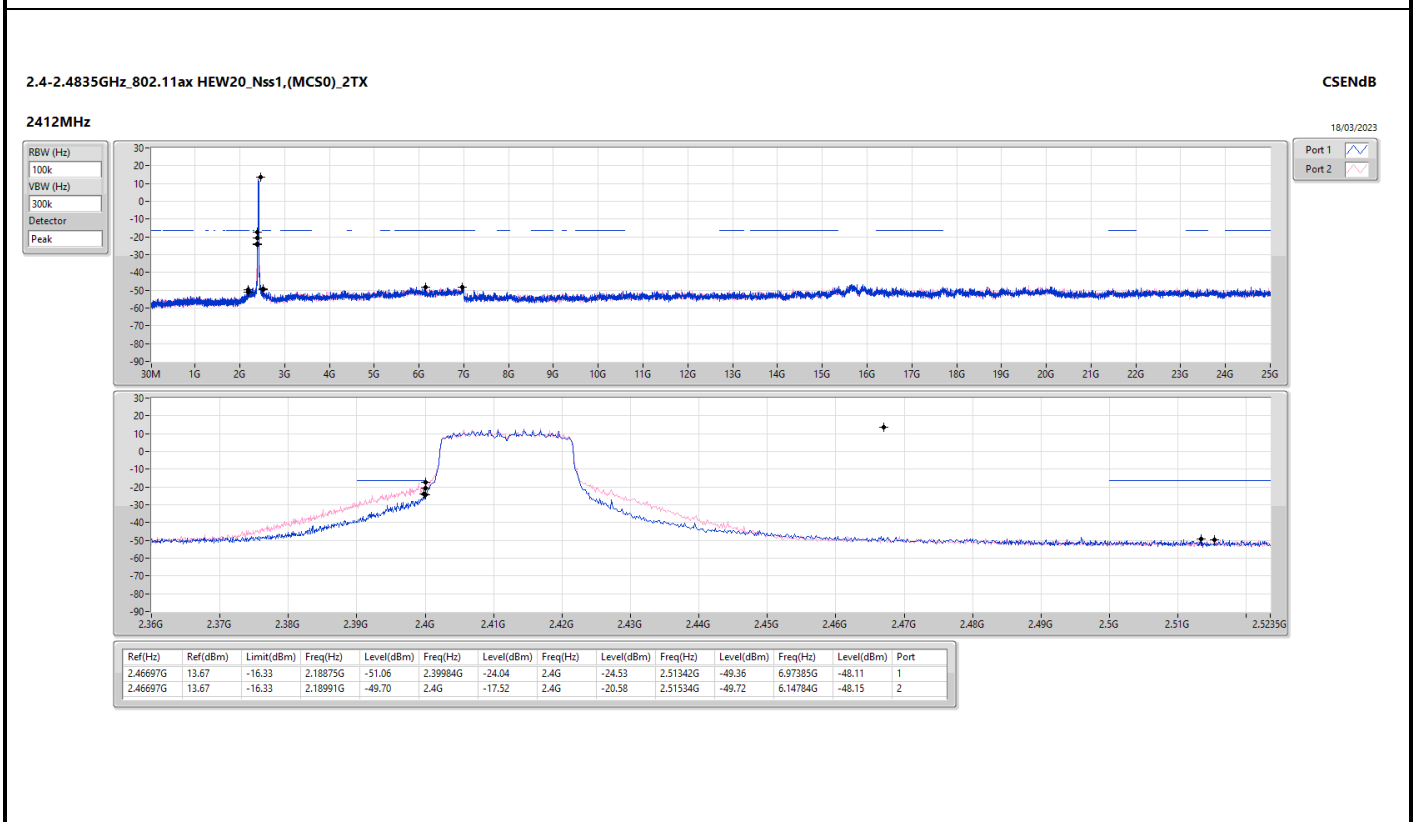
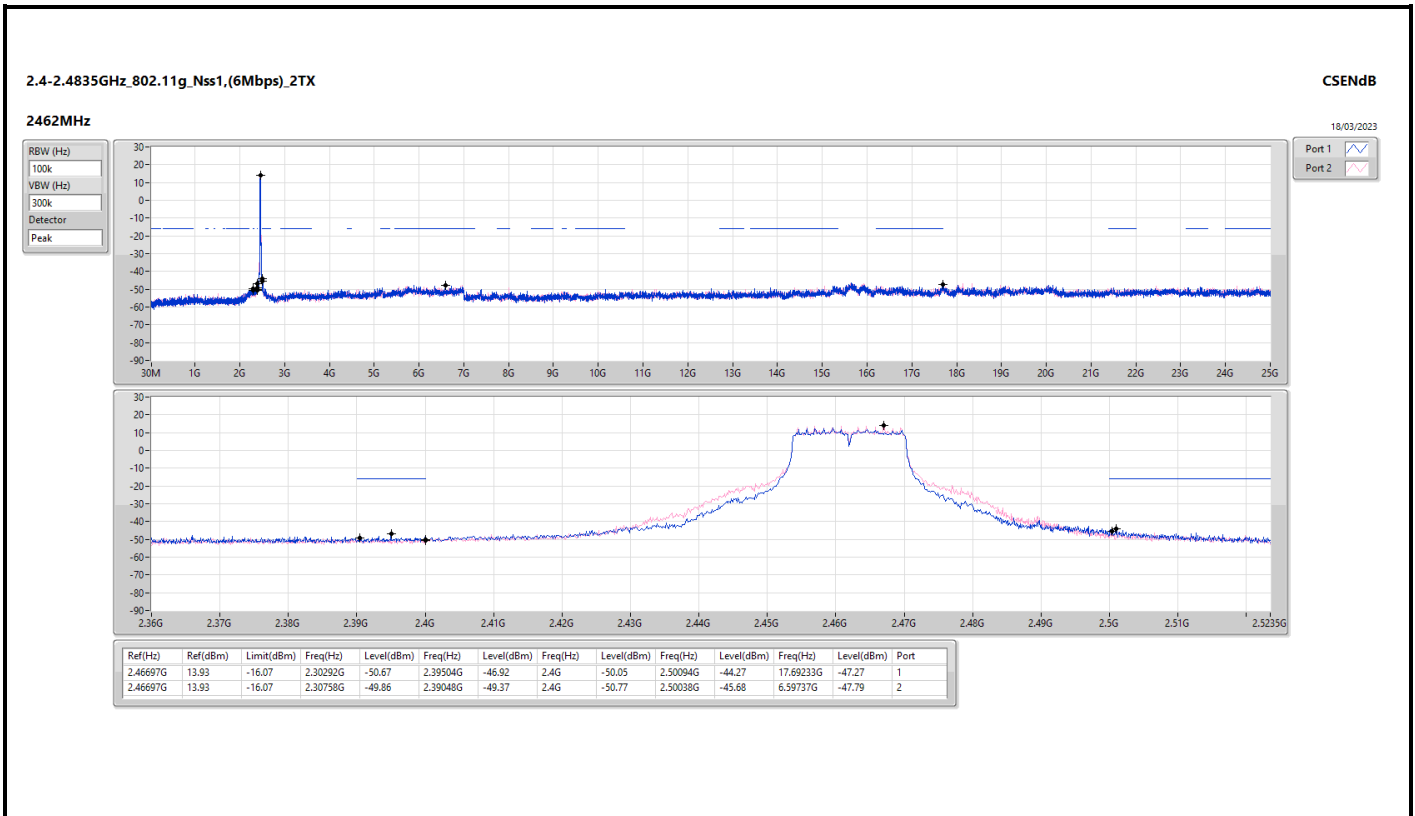



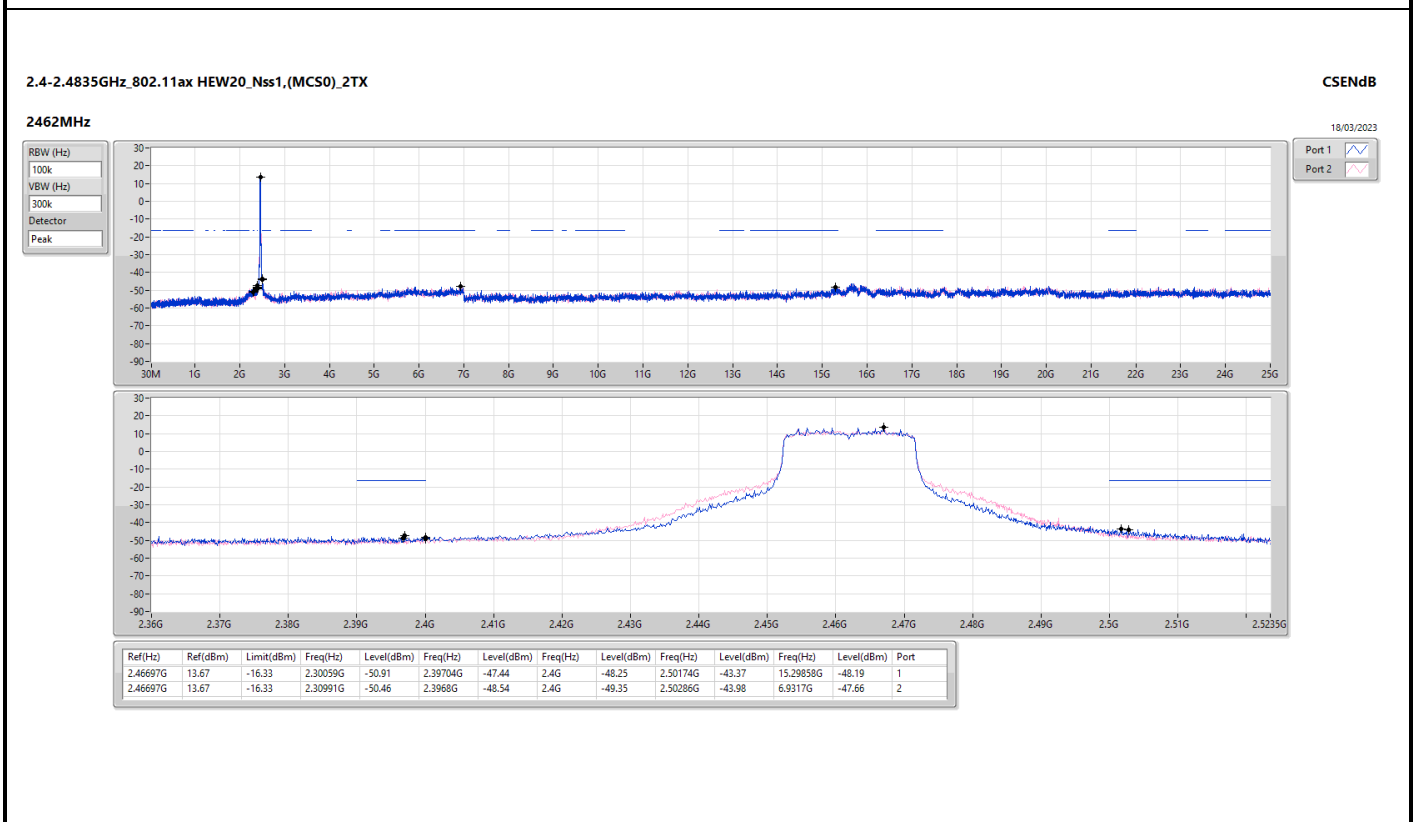
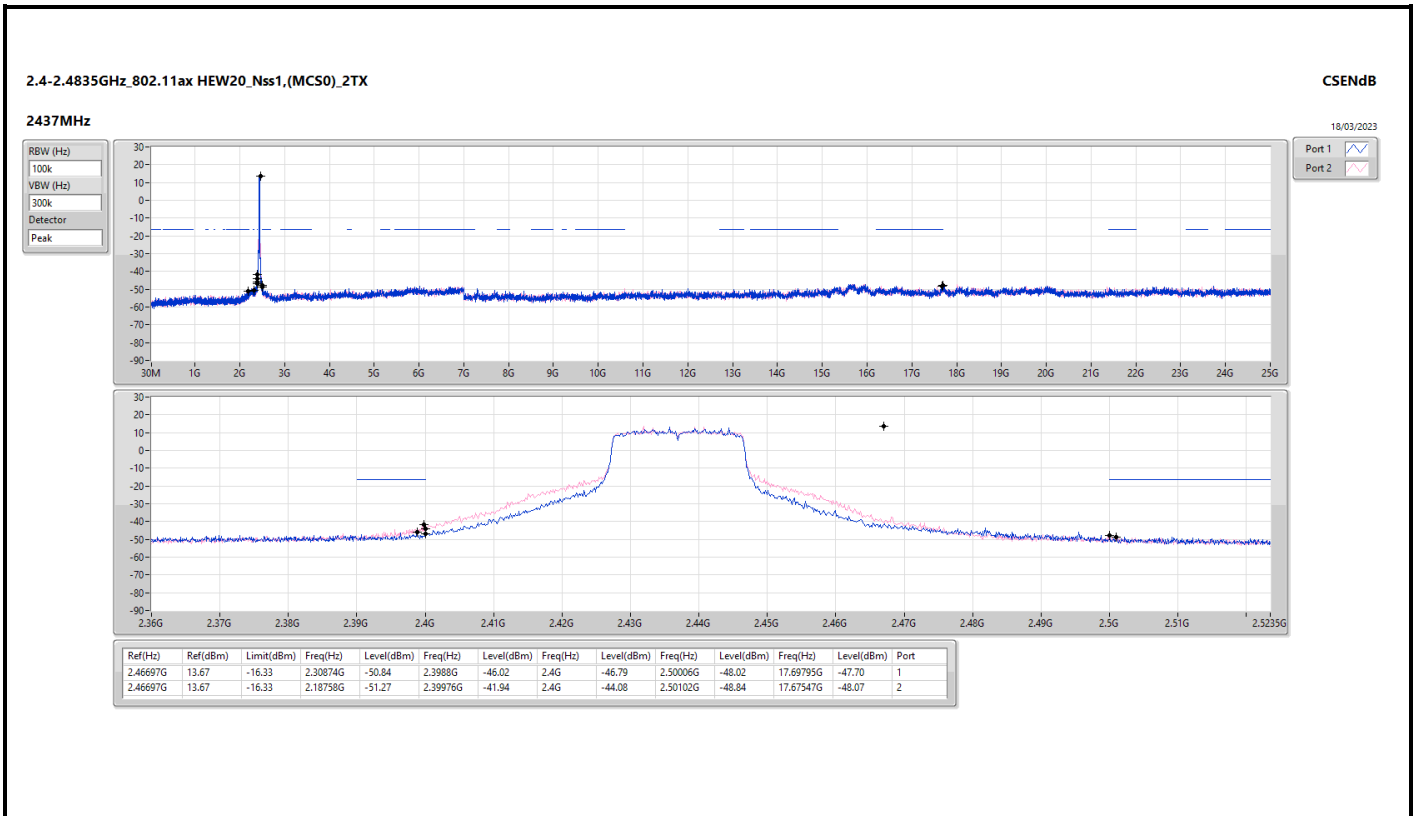

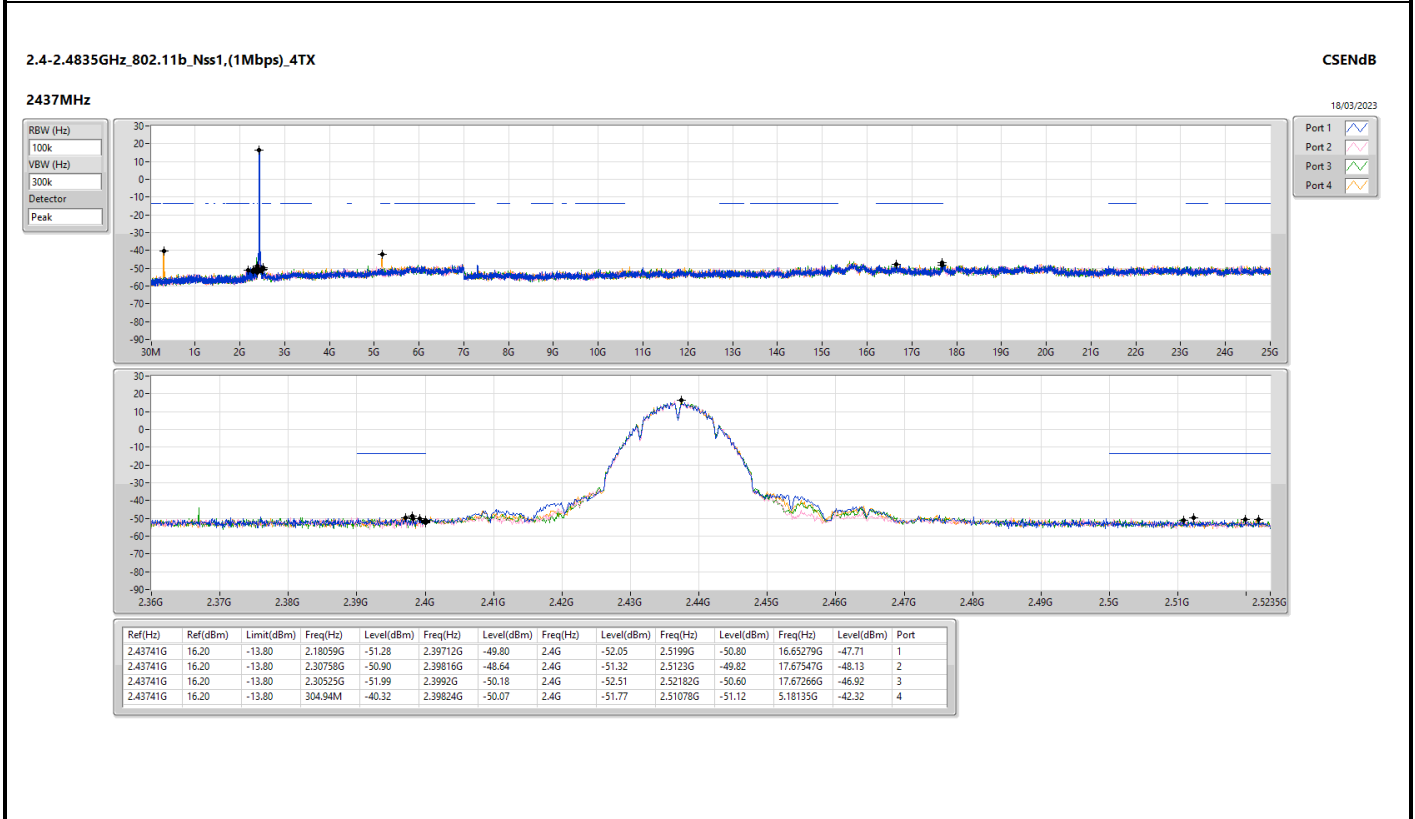
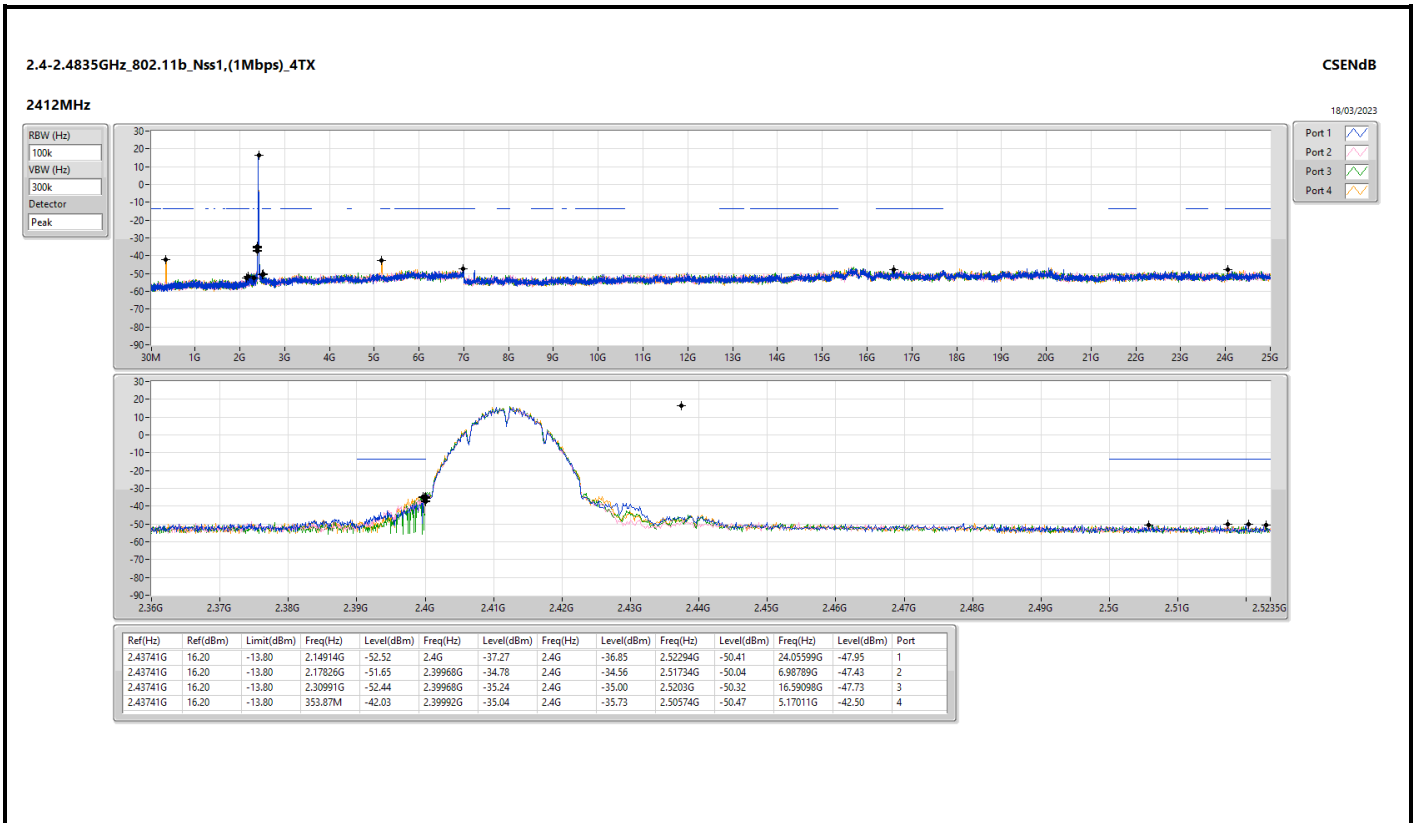

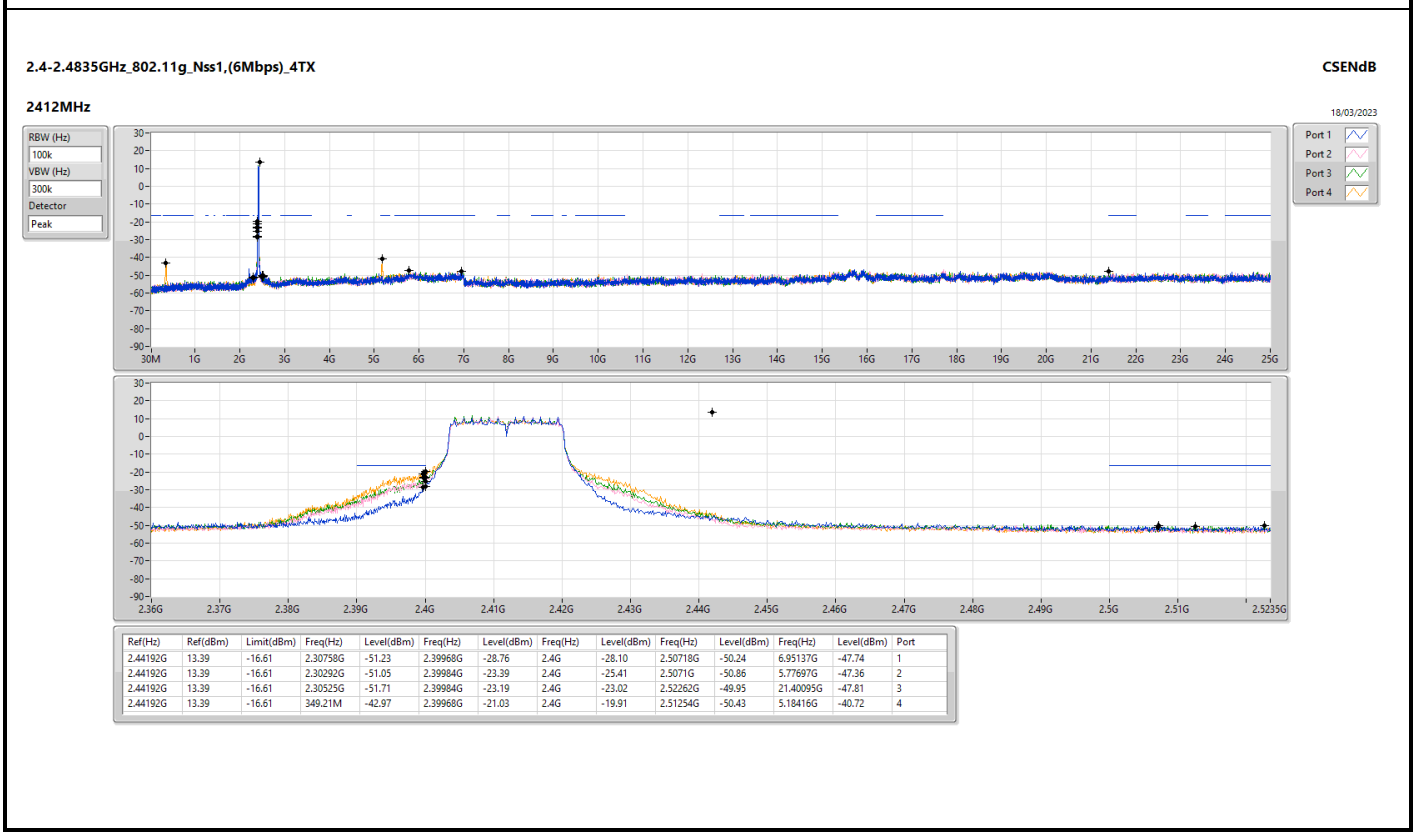
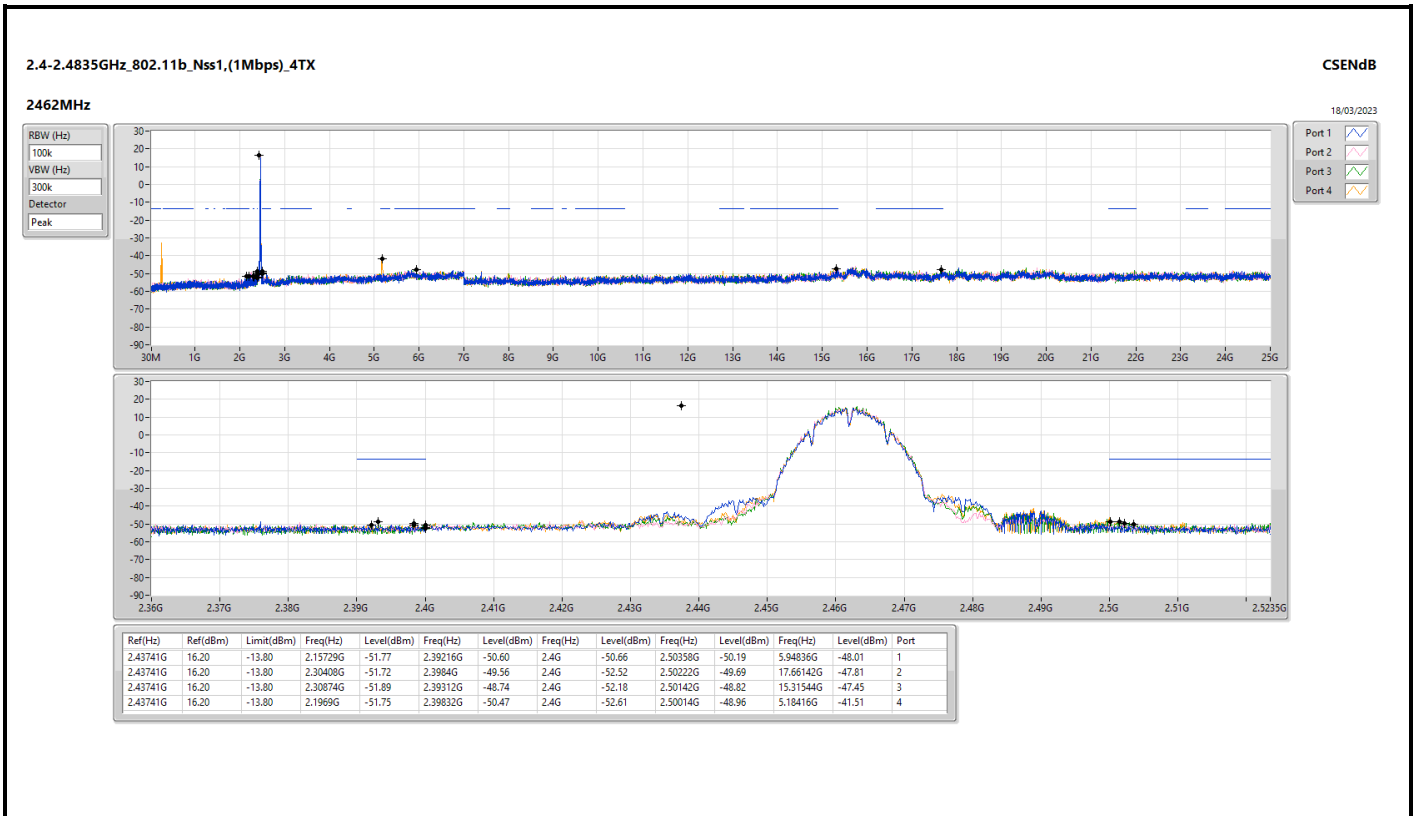

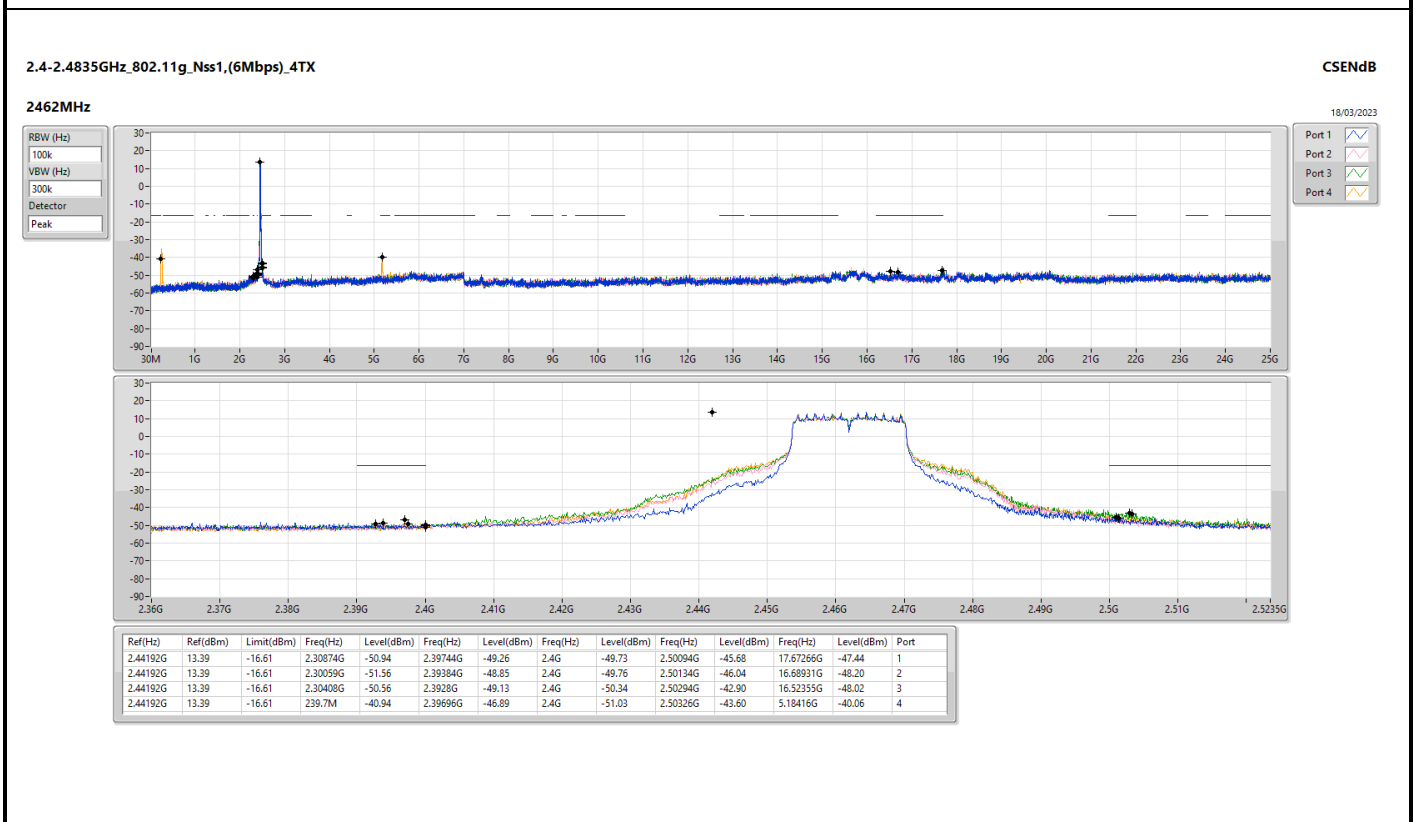
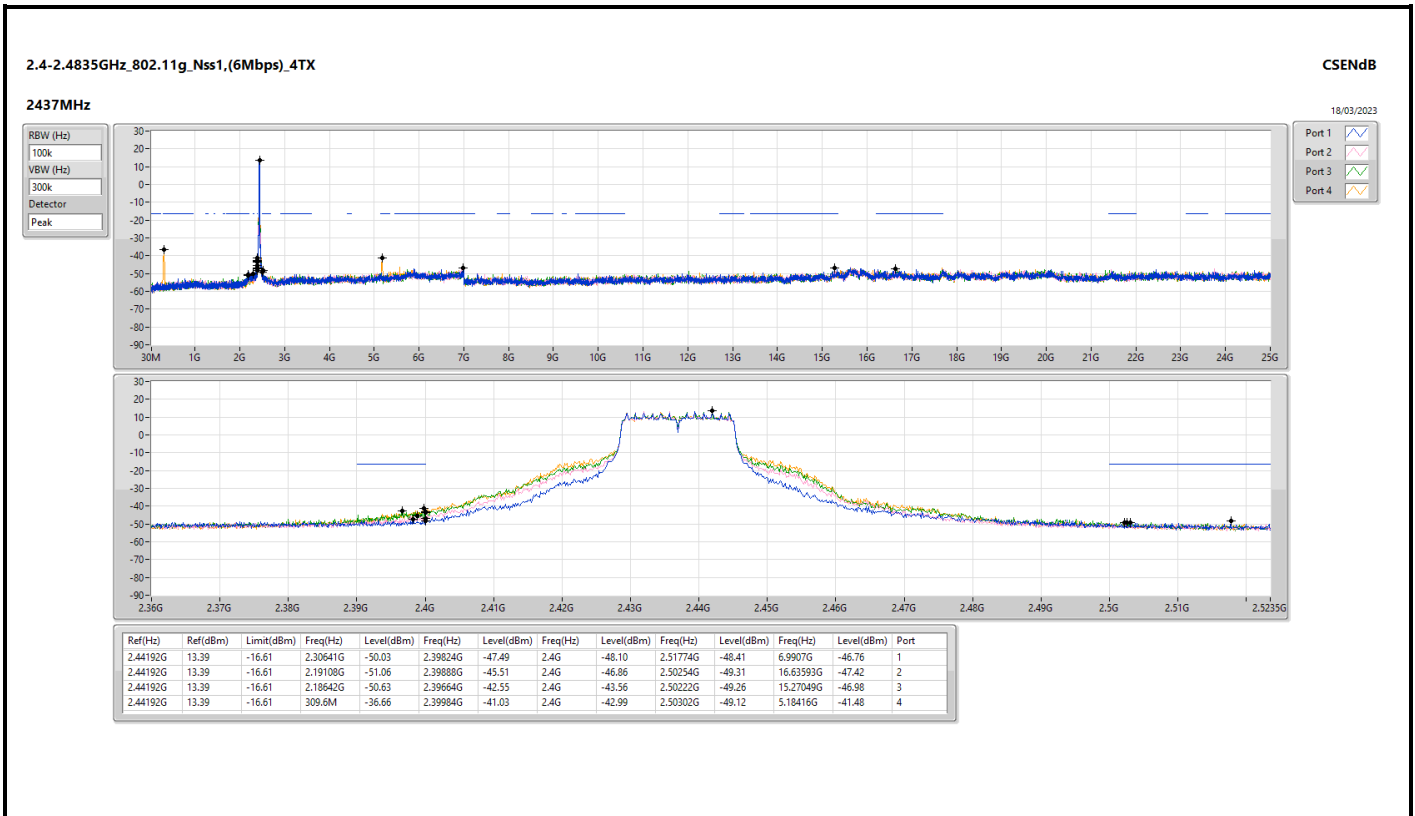

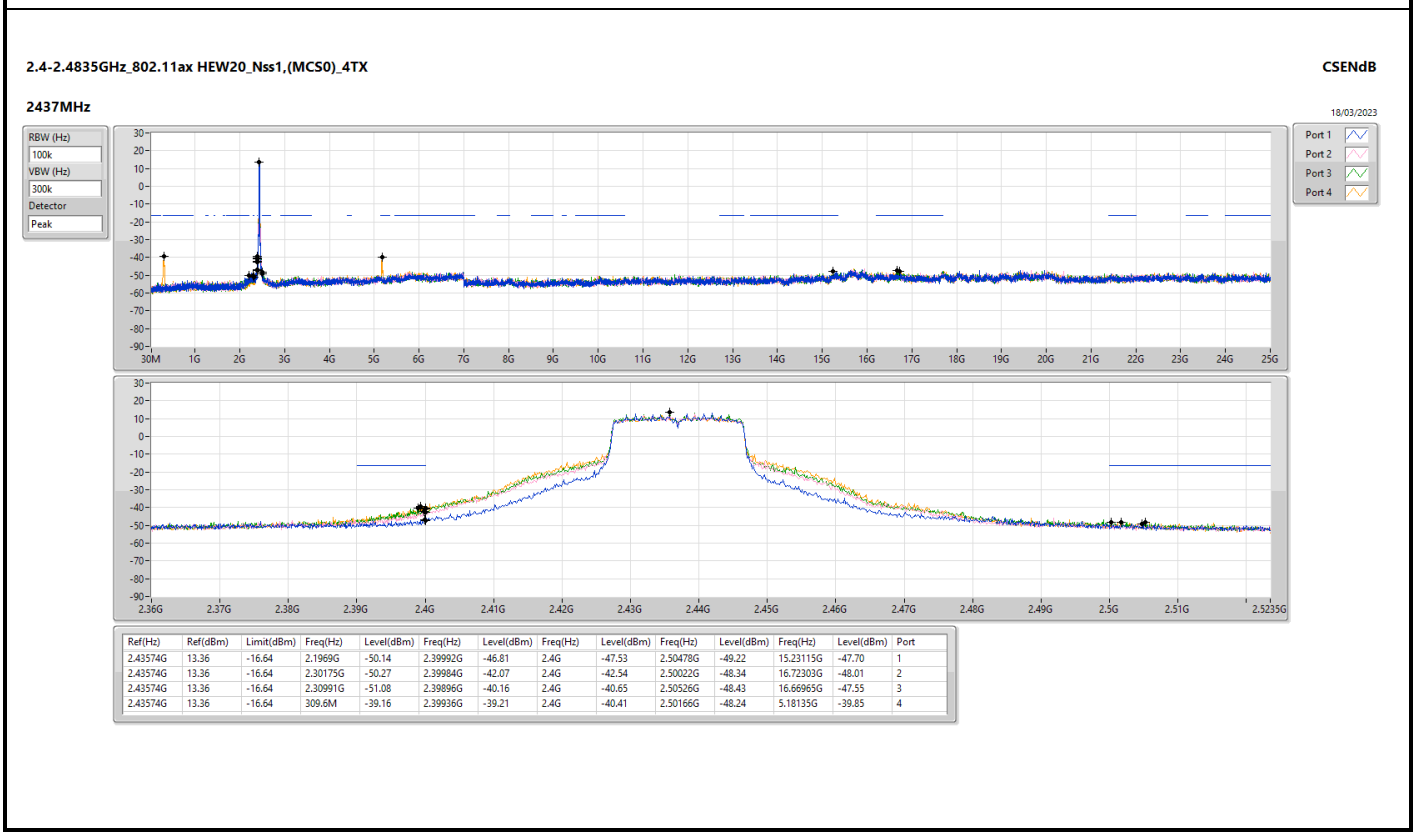
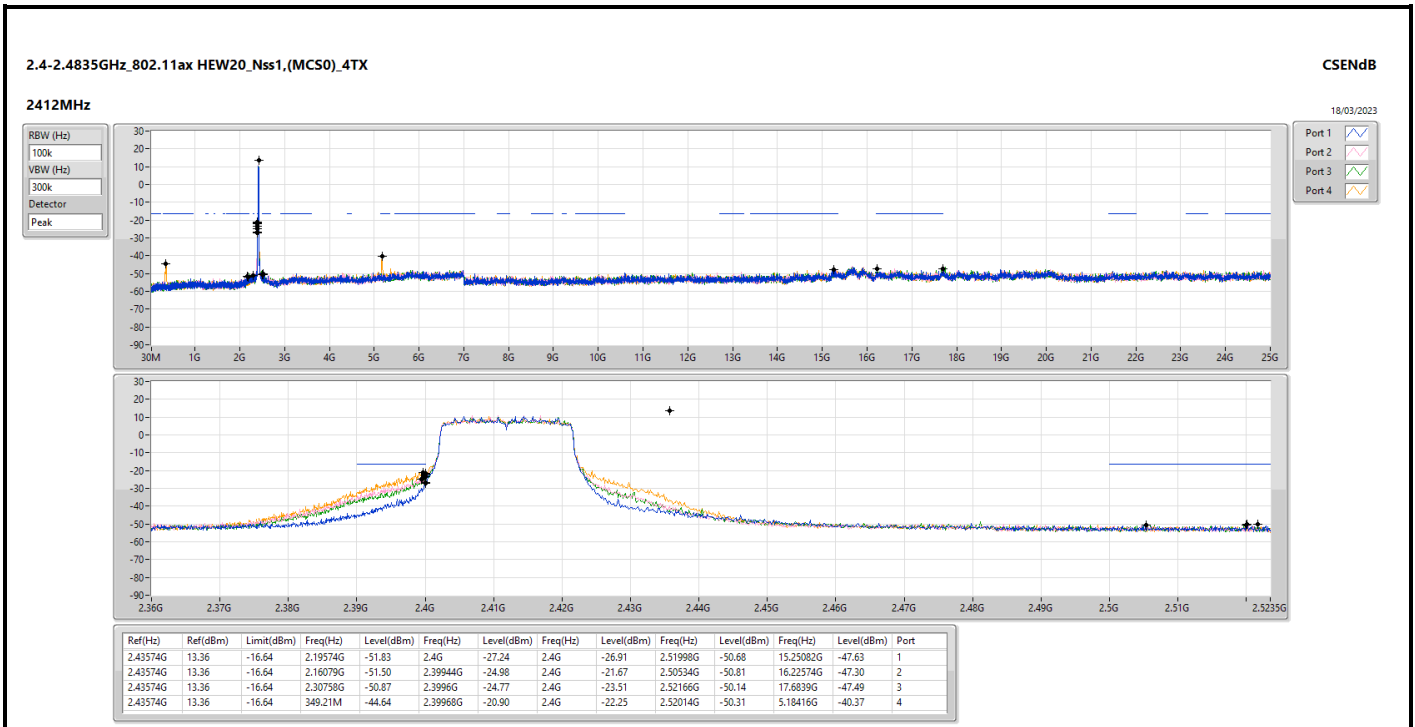

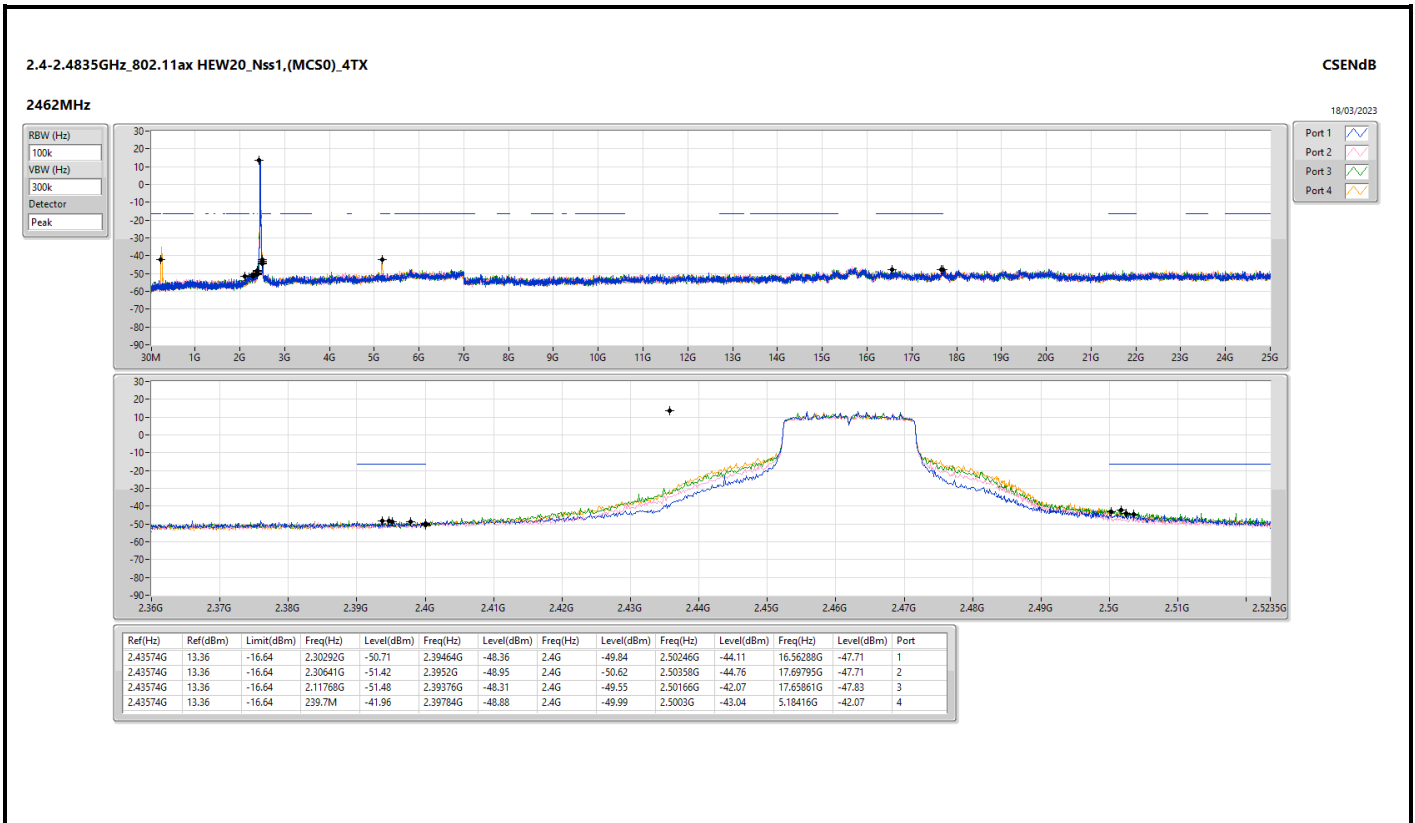



Summary

Mode	Result	Ref (Hz)	Ref (dBm)	Limit (dBm)	Freq (Hz)	Level (dBm)	Freq (Hz)	Level (dBm)	Freq (Hz)	Level (dBm)	Freq (Hz)	Level (dBm)	Freq (Hz)	Level (dBm)	Port
2.4-2.4835GHz	-	-	-	-	-	-	-	-	-	-	-	-	-	-	-
802.11b_Nss1,(1Mbps)_1TX	Pass	2.43641G	15.23	-14.77	2.30641G	-51.38	2.39856G	-37.75	2.4G	-35.86	2.5143G	-51.38	16.43645G	-44.70	1
802.11g_Nss1,(6Mbps)_1TX	Pass	2.43941G	13.75	-16.25	2.30758G	-49.20	2.4G	-22.23	2.4G	-20.86	2.51838G	-50.75	16.63031G	-47.47	1
802.11ax HEW20_Nss1,(MCS0)_1TX	Pass	2.44192G	13.34	-16.66	2.19224G	-50.57	2.4G	-20.12	2.4G	-18.98	2.51462G	-50.60	6.73784G	-47.68	1



Result

Mode	Result	Ref (Hz)	Ref (dBm)	Limit (dBm)	Freq (Hz)	Level (dBm)	Freq (Hz)	Level (dBm)	Freq (Hz)	Level (dBm)	Freq (Hz)	Level (dBm)	Freq (Hz)	Level (dBm)	Port
802.11b_Nss1,(1Mbps)_1TX	-	-	-	-	-	-	-	-	-	-	-	-	-	-	-
2412MHz	Pass	2.43641G	15.23	-14.77	2.30641G	-51.38	2.39856G	-37.75	2.4G	-35.86	2.5143G	-51.38	16.43645G	-44.70	1
2437MHz	Pass	2.43641G	15.23	-14.77	2.30525G	-48.66	2.39912G	-48.70	2.4G	-48.84	2.51862G	-50.60	17.10794G	-44.56	1
2462MHz	Pass	2.43641G	15.23	-14.77	2.30991G	-48.27	2.4G	-49.46	2.4G	-50.07	2.50654G	-50.42	21.6201G	-44.33	1
802.11g_Nss1,(6Mbps)_1TX	-	-	-	-	-	-	-	-	-	-	-	-	-	-	-
2412MHz	Pass	2.43941G	13.75	-16.25	2.30758G	-49.20	2.4G	-22.23	2.4G	-20.86	2.51838G	-50.75	16.63031G	-47.47	1
2437MHz	Pass	2.43941G	13.75	-16.25	2.30758G	-49.46	2.4G	-46.98	2.4G	-48.32	2.52246G	-50.68	17.66704G	-46.70	1
2462MHz	Pass	2.43941G	13.75	-16.25	2.30874G	-48.59	2.4G	-48.93	2.4G	-49.50	2.50166G	-48.68	5.82474G	-47.46	1
802.11ax HEW20_Nss1,(MCS0)_1TX	-	-	-	-	-	-	-	-	-	-	-	-	-	-	-
2412MHz	Pass	2.44192G	13.34	-16.66	2.19224G	-50.57	2.4G	-20.12	2.4G	-18.98	2.51462G	-50.60	6.73784G	-47.68	1
2437MHz	Pass	2.44192G	13.34	-16.66	2.30408G	-50.48	2.3996G	-44.38	2.4G	-46.08	2.5175G	-49.87	16.6275G	-47.69	1
2462MHz	Pass	2.44192G	13.34	-16.66	2.30292G	-49.27	2.4G	-48.98	2.4G	-49.78	2.50222G	-46.60	16.7146G	-47.01	1



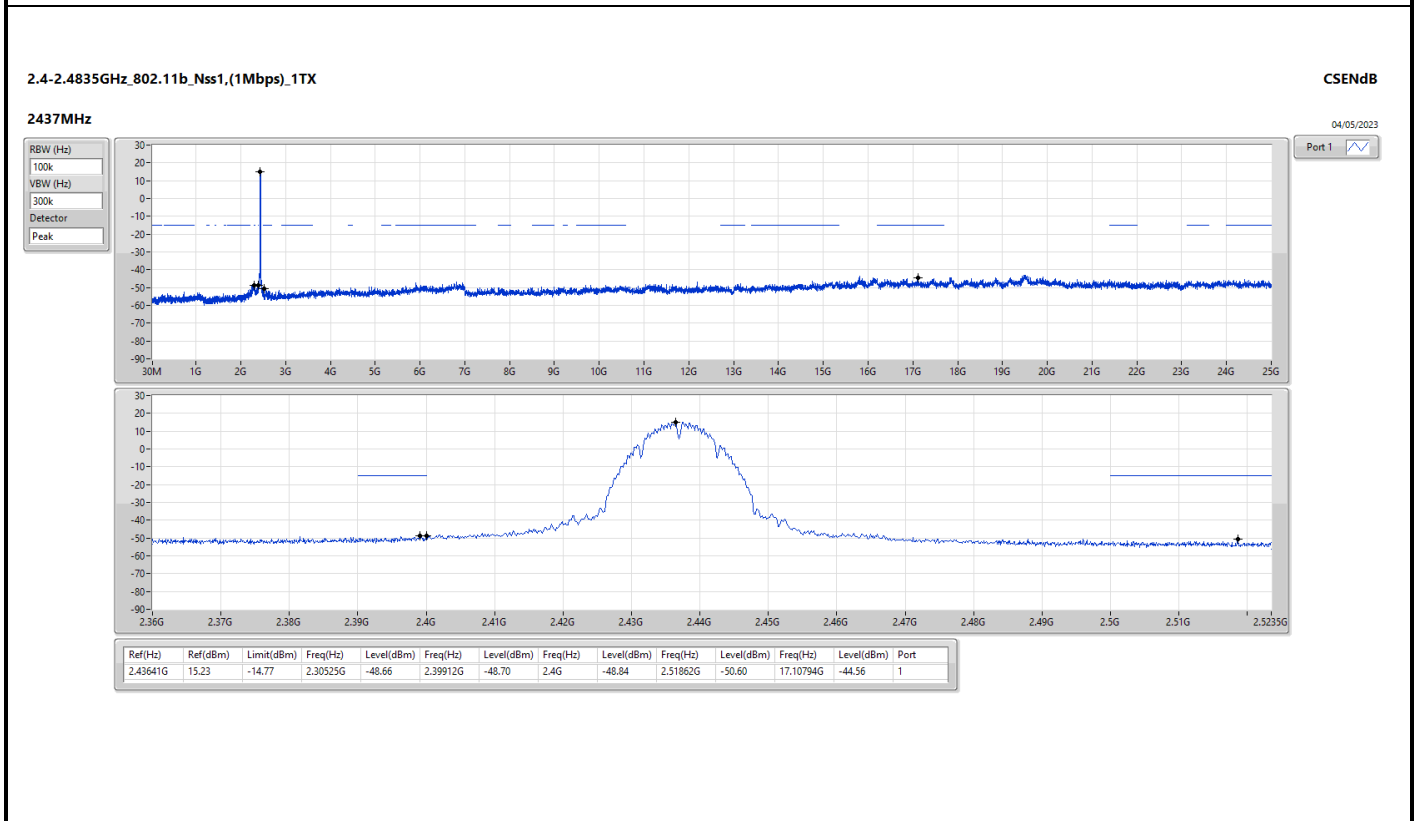
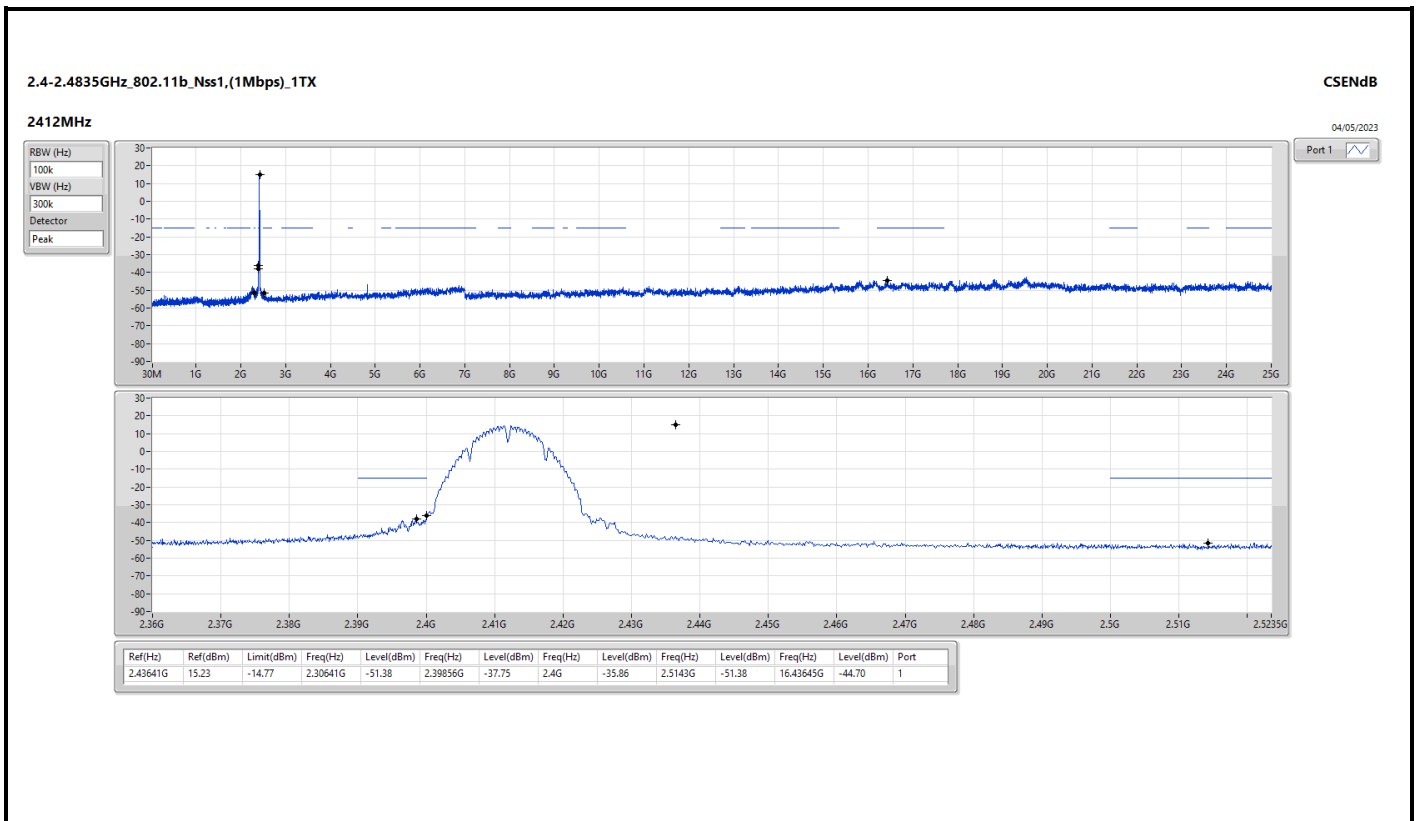

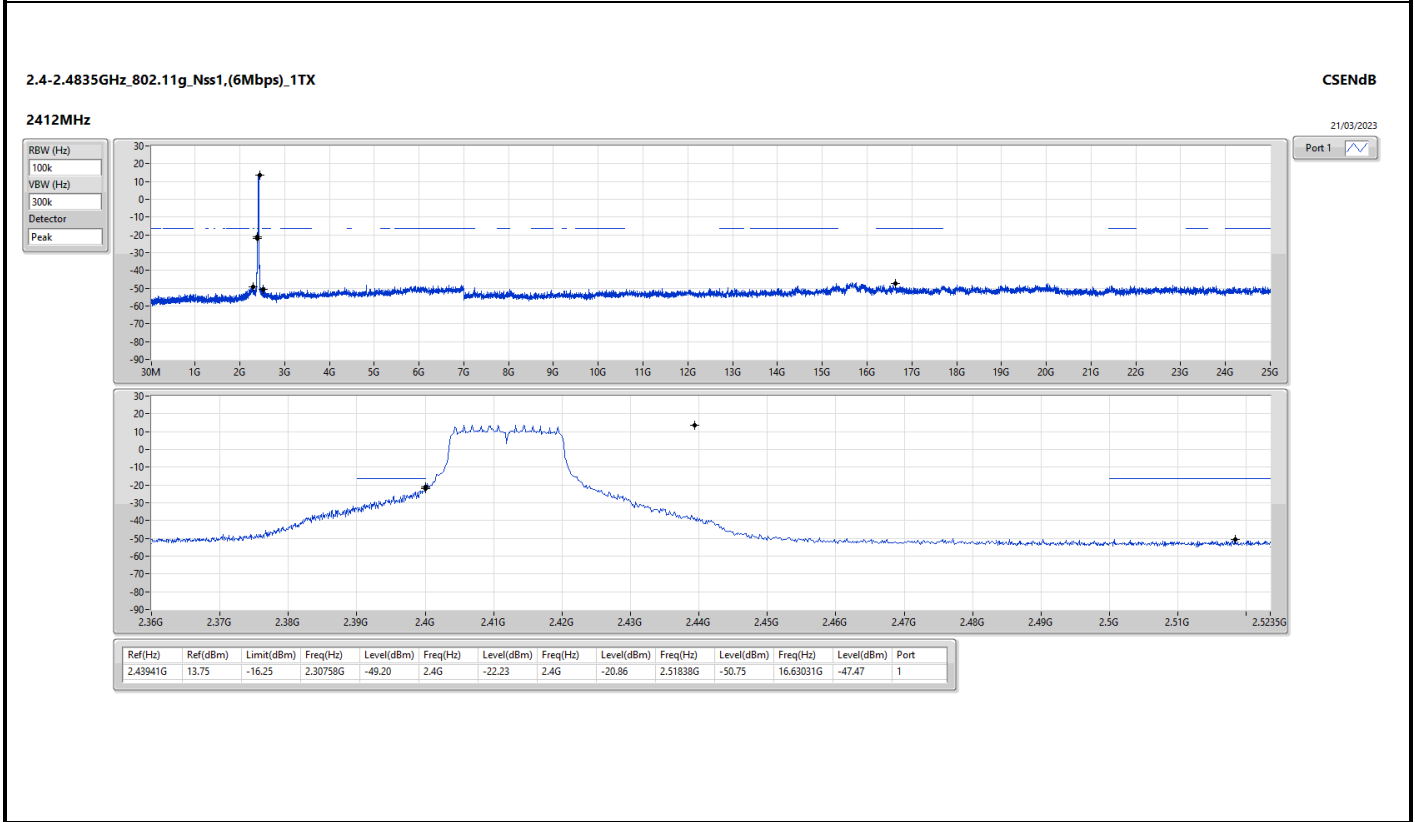
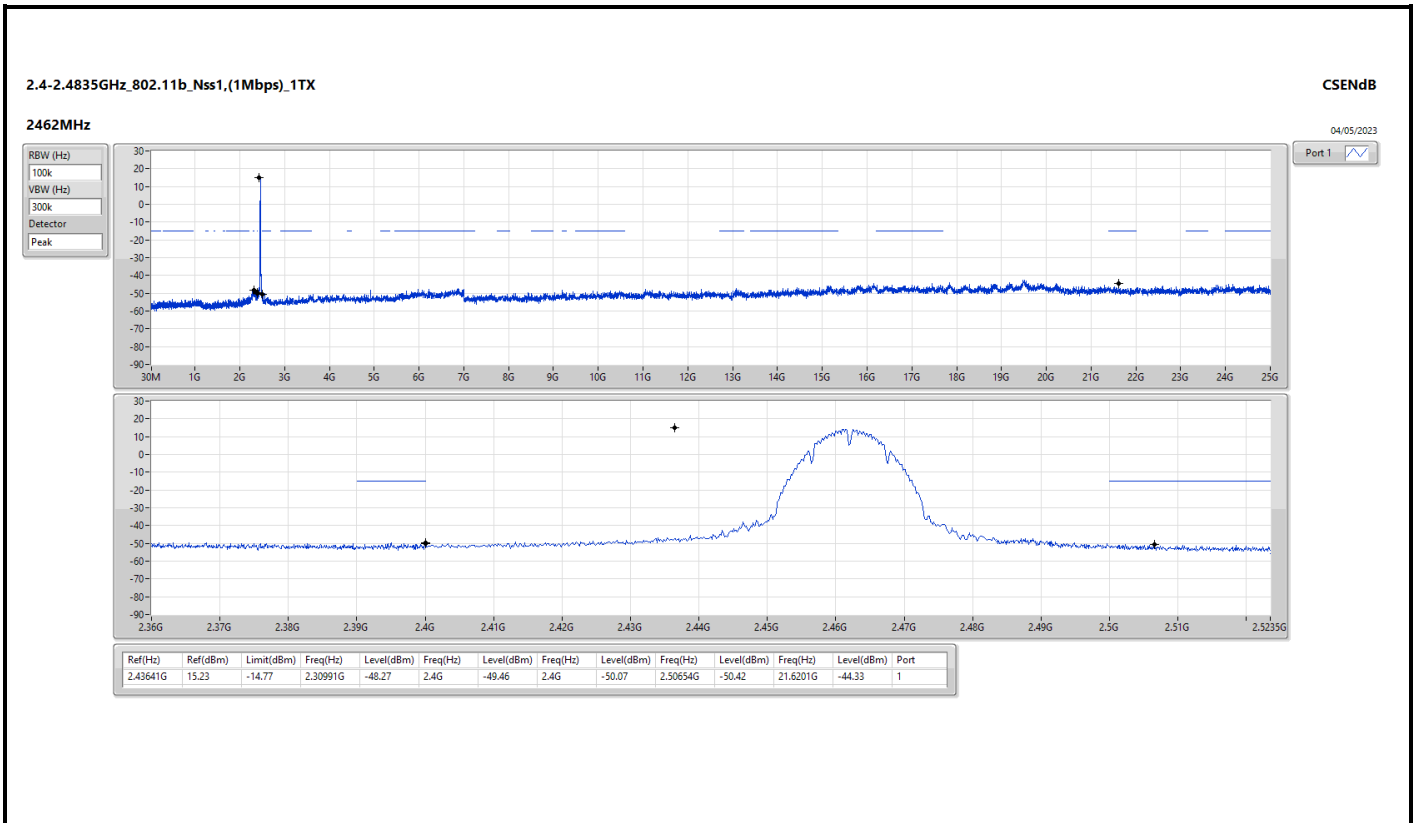

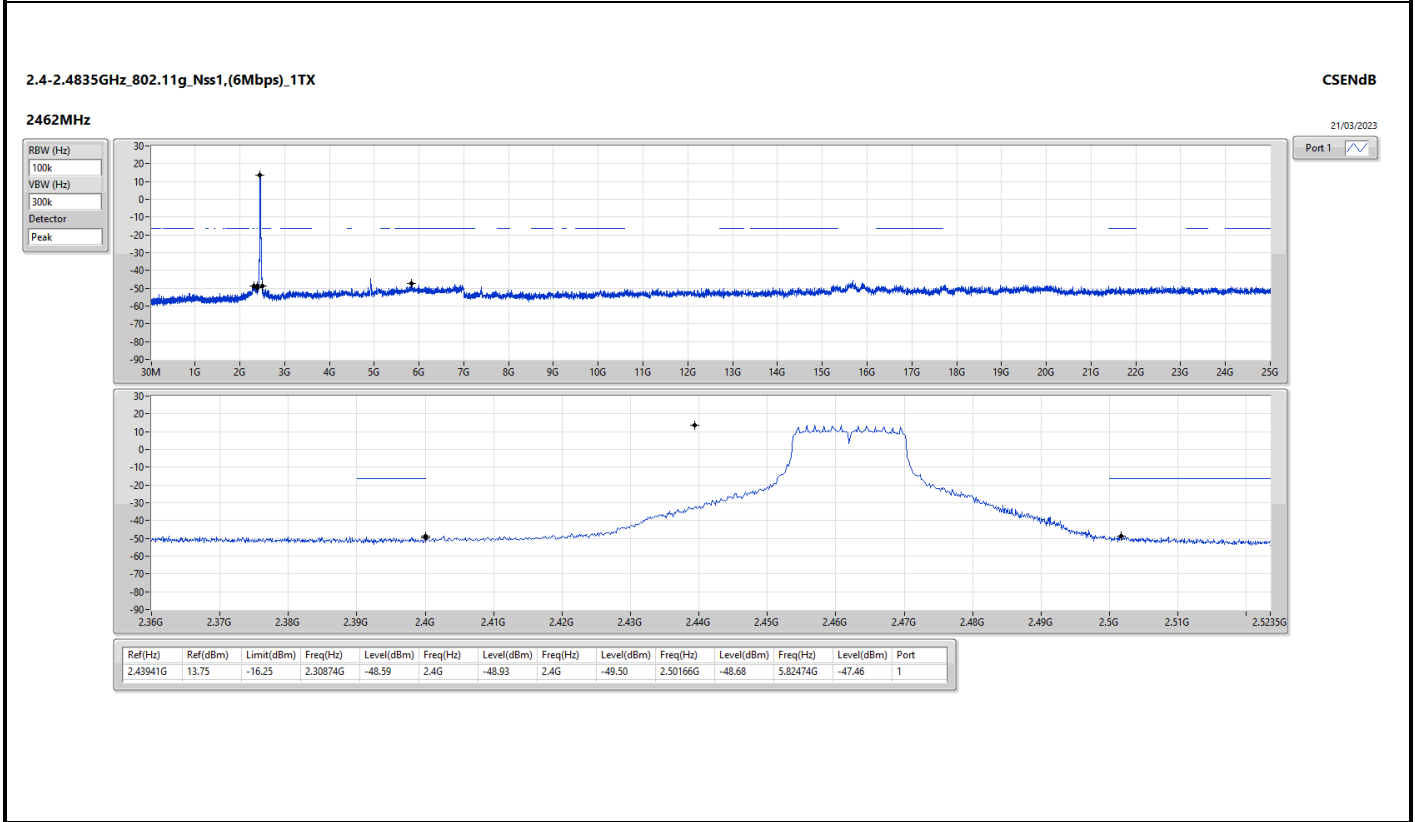
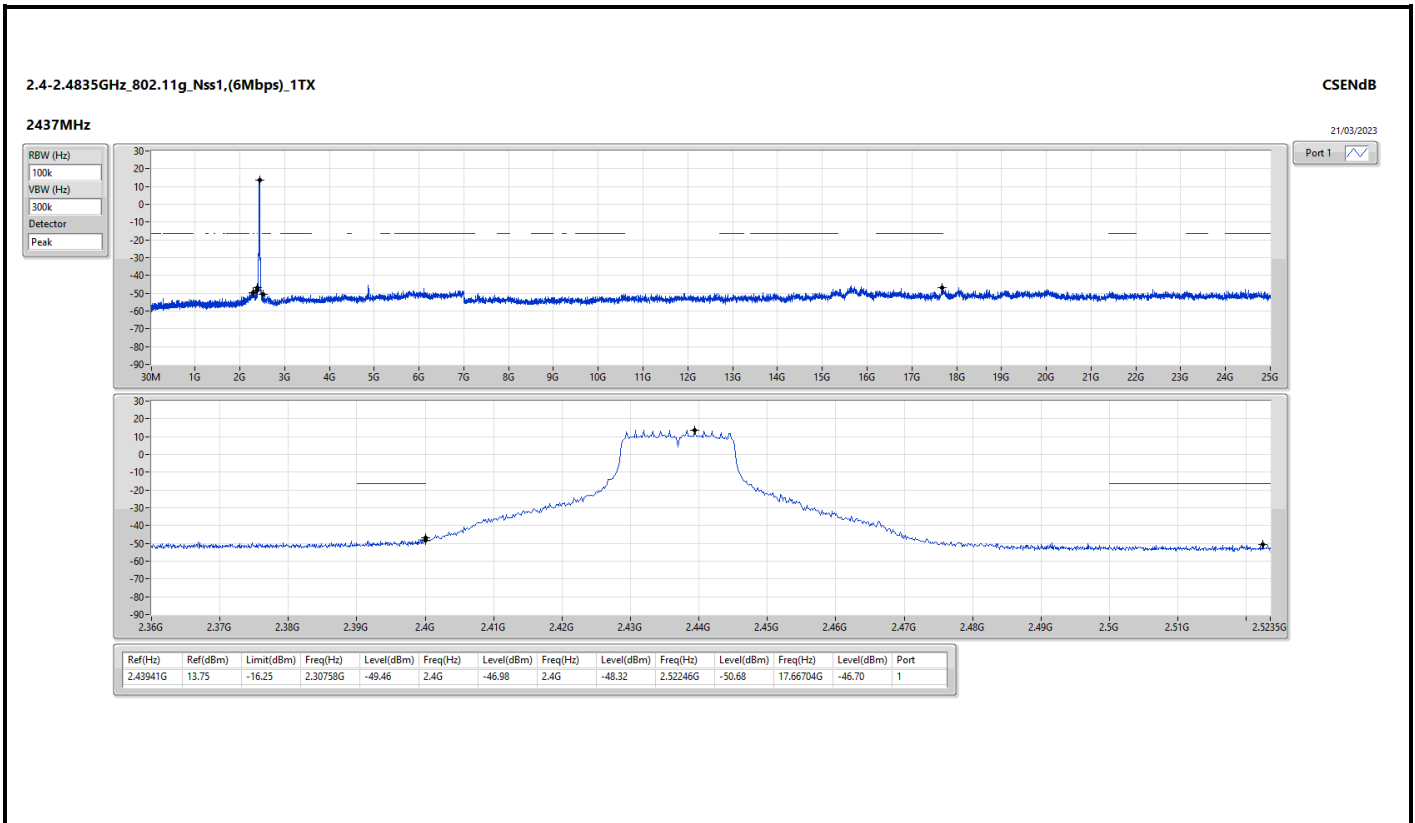

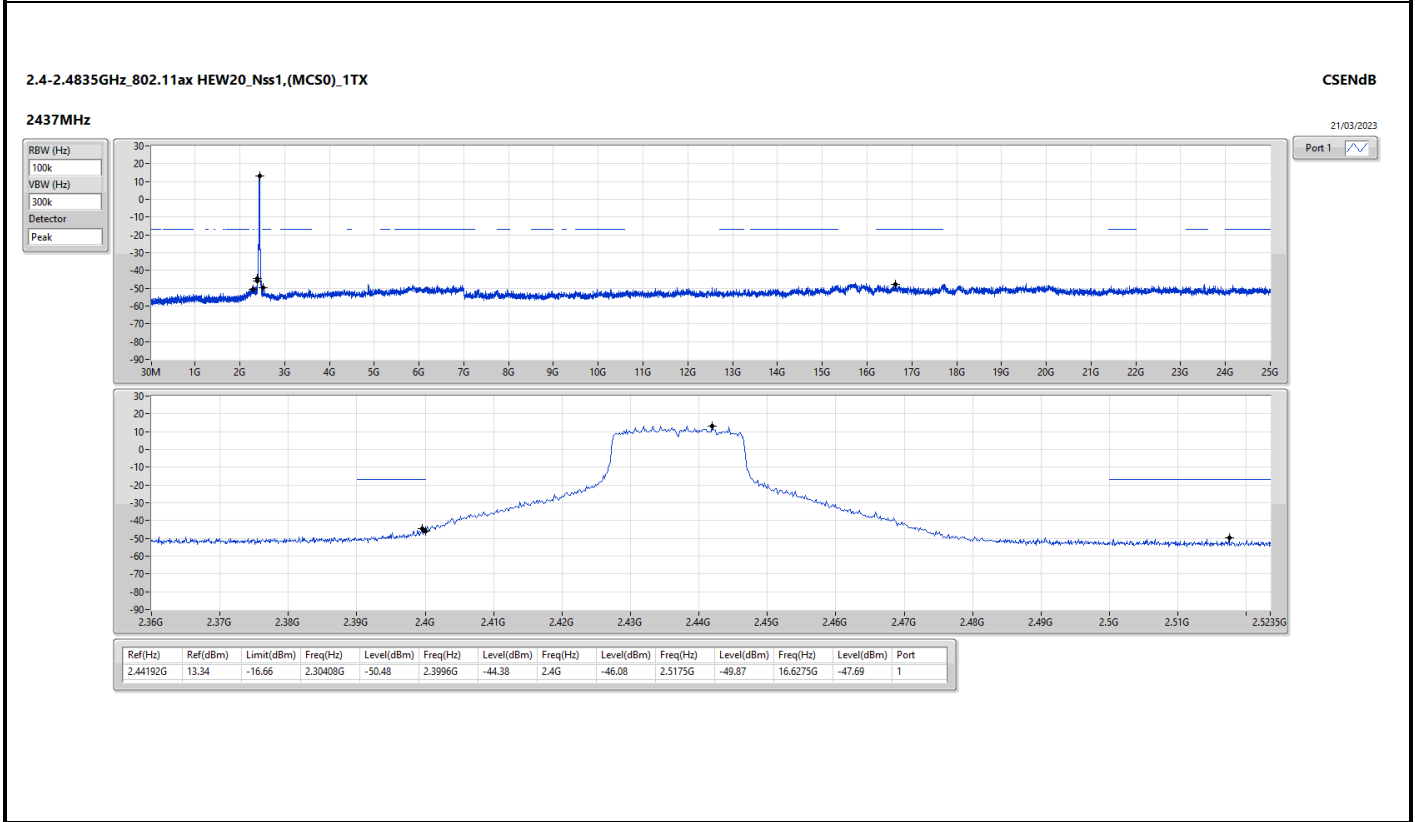
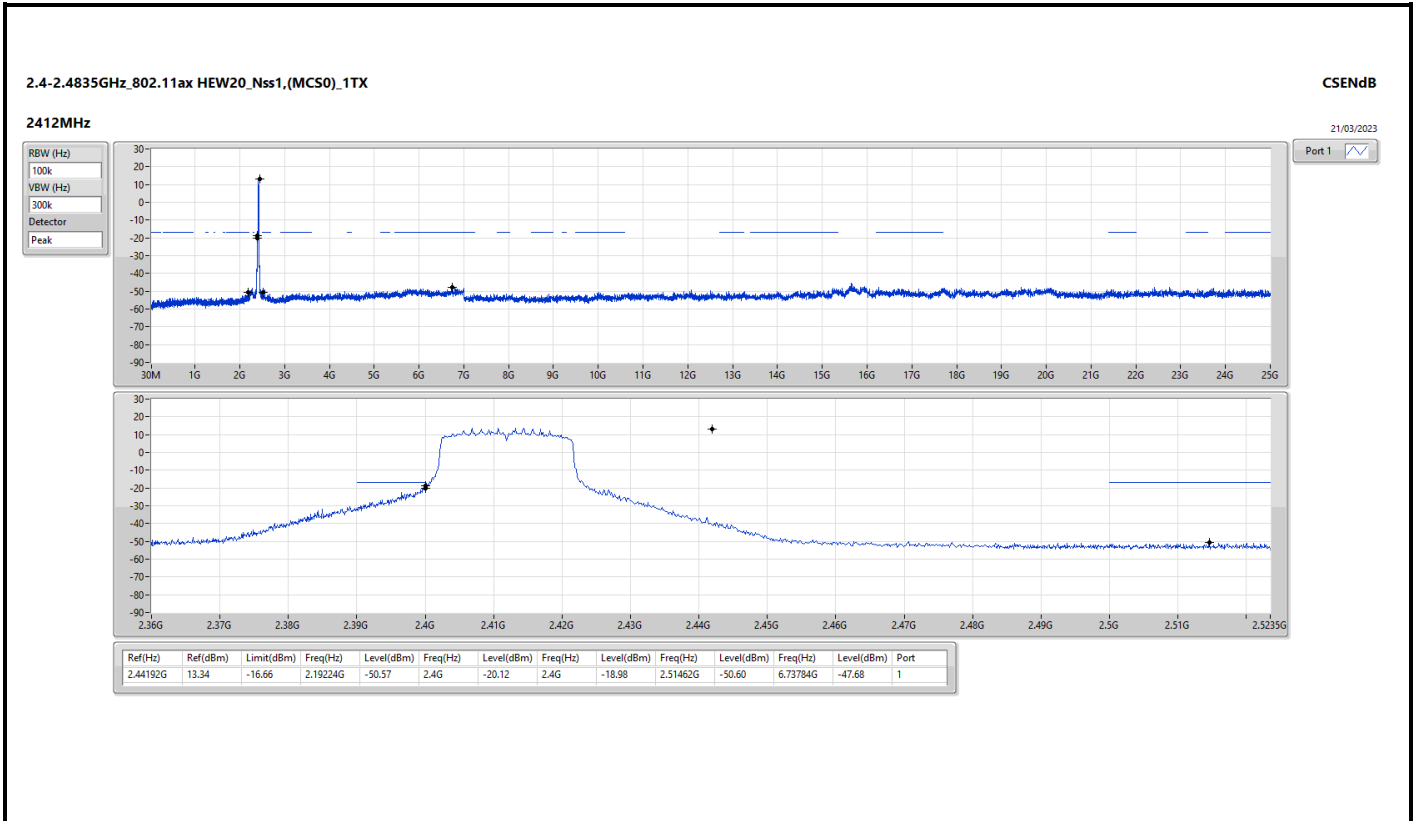

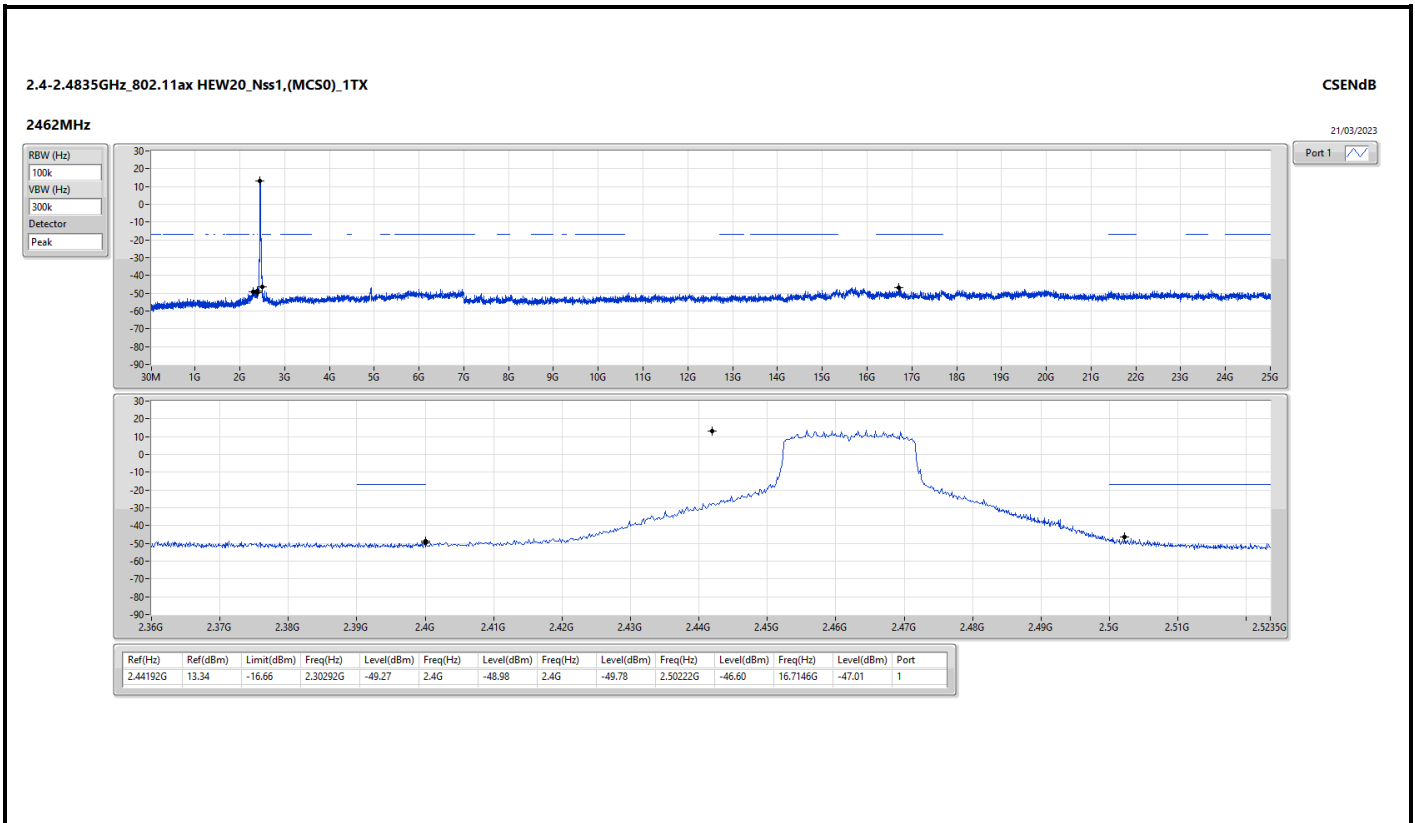



**Summary**

Mode	Result	Type	Freq (Hz)	Level (dBuV/m)	Limit (dBuV/m)	Margin (dB)	Condition
Mode 3	Pass	PK	88M	40.44	43.50	-3.06	Horizontal

Mode 3

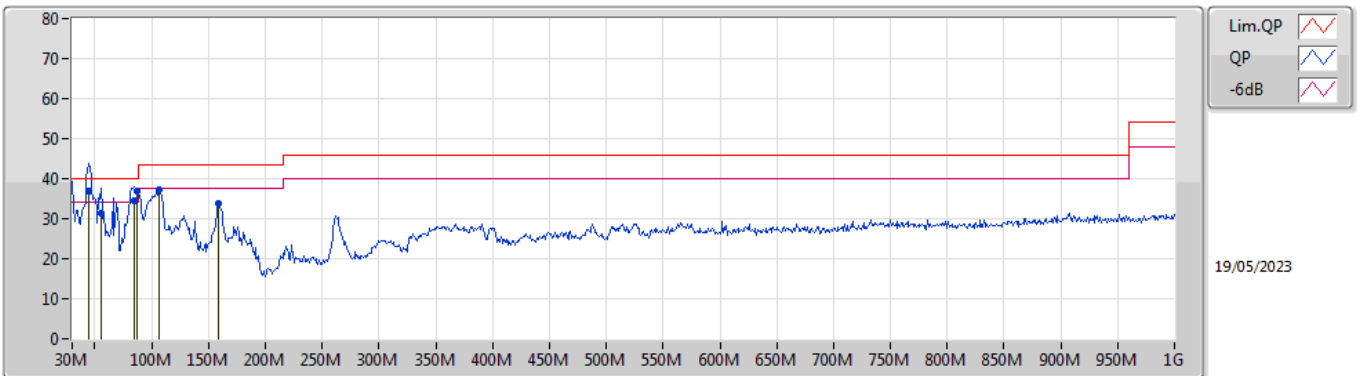

Type	Freq (Hz)	Level (dBuV/m)	Limit (dBuV/m)	Margin (dB)	Factor (dB/m)	Dist (m)	Condition	Azimuth (°)	Height (m)	Comment	Raw (dBuV/m)	AF (dB/m)	CL (dB)	PA (dB)
QP	44.55M	36.86	40.00	-3.14	-14.46	3	Vertical	5	1.00	"Worst"	51.32	16.76	0.95	32.17
QP	55.22M	31.28	40.00	-8.72	-18.22	3	Vertical	18	1.25	-	49.50	12.92	1.08	32.22
QP	84.32M	34.58	40.00	-5.42	-17.12	3	Vertical	354	3.00	-	51.70	13.62	1.23	31.97
PK	87.23M	36.73	40.00	-3.27	-16.60	3	Vertical	97	1.25	-	53.33	14.16	1.25	32.01
PK	106.63M	37.25	43.50	-6.25	-13.28	3	Vertical	158	1.00	-	50.53	17.41	1.39	32.08
PK	159.01M	33.72	43.50	-9.78	-14.33	3	Vertical	123	1.00	-	48.05	16.10	1.65	32.08

Mode 3

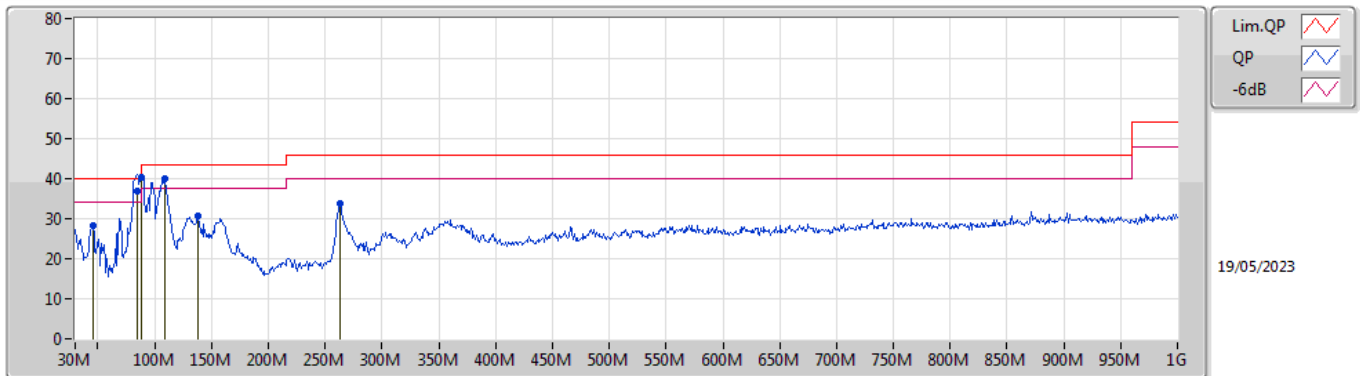

Type	Freq (Hz)	Level (dBuV/m)	Limit (dBuV/m)	Margin (dB)	Factor (dB/m)	Dist (m)	Condition	Azimuth (°)	Height (m)	Comment	Raw (dBuV/m)	AF (dB/m)	CL (dB)	PA (dB)
PK	45.52M	28.30	40.00	-11.70	-14.88	3	Horizontal	245	2.00	-	43.18	16.34	0.95	32.17
QP	84.32M	36.78	40.00	-3.22	-17.12	3	Horizontal	254	2.00	-	53.90	13.62	1.23	31.97
PK	88M	40.44	43.50	-3.06	-16.50	3	Horizontal	245	2.00	"Worst"	56.94	14.27	1.25	32.02
PK	108.57M	40.09	43.50	-3.41	-13.07	3	Horizontal	254	3.00	-	53.16	17.57	1.41	32.05
PK	137.67M	30.68	43.50	-12.82	-13.18	3	Horizontal	88	2.00	-	43.86	17.30	1.52	32.00
PK	262.8M	33.85	46.00	-12.15	-10.07	3	Horizontal	243	1.25	-	43.92	19.64	2.16	31.87





Summary

Mode	Result	F-Start (Hz)	F-Stop (Hz)	Type	Freq (Hz)	DG (dBi)	P1 (dBm)	P2 (dBm)	P3 (dBm)	P4 (dBm)	Psum (dBm)	EIRP (dBm)	Limit (dBm)	Margin (dB)
2.4-2.4835GHz	-	-	-	-	-	-	-	-	-	-	-	-	-	-
802.11b_Nss1,(1Mbps)_1TX	Pass	1G	3G	AV	2.208G	3.95	-51.31	-	-	-	-51.31	-47.36	-41.20	-6.16
802.11b_Nss1,(1Mbps)_2TX	Pass	1G	3G	AV	2.266G	3.95	-52.35	-52.09	-	-	-49.21	-45.26	-41.20	-4.06
802.11b_Nss1,(1Mbps)_4TX	Pass	1G	3G	AV	2.256G	3.95	-53.20	-53.96	-52.63	-54.45	-47.48	-43.53	-41.20	-2.33
802.11g_Nss1,(6Mbps)_1TX	Pass	1G	3G	AV	2.208G	3.95	-51.12	-	-	-	-51.12	-47.17	-41.20	-5.97
802.11g_Nss1,(6Mbps)_2TX	Pass	1G	3G	AV	2.366G	3.95	-51.30	-52.53	-	-	-48.86	-44.91	-41.20	-3.71
802.11g_Nss1,(6Mbps)_4TX	Pass	1G	3G	AV	2.256G	3.95	-54.37	-54.89	-53.13	-56.02	-48.46	-44.51	-41.20	-3.31
802.11ax HEW20_Nss1,(MCS0)_1TX	Pass	1G	3G	AV	2.364G	3.95	-51.38	-	-	-	-51.38	-47.43	-41.20	-6.23
802.11ax HEW20_Nss1,(MCS0)_2TX	Pass	1G	3G	AV	2.274G	3.95	-51.58	-51.40	-	-	-48.48	-44.53	-41.20	-3.33
802.11ax HEW20_Nss1,(MCS0)_4TX	Pass	1G	3G	AV	2.256G	3.95	-54.45	-51.42	-52.30	-55.92	-47.16	-43.21	-41.20	-2.01

DG = Directional Gain ; PX=Port X; Psum=P1+P2+...PX



CSE (Band Reject Filter)\_Radio 1 (Harmonic 1~3GHz)

Appendix F.2

Result

Mode	Result	F-Start (Hz)	F-Stop (Hz)	Type	Freq (Hz)	DG (dBi)	P1 (dBm)	P2 (dBm)	P3 (dBm)	P4 (dBm)	Psum (dBm)	EIRP (dBm)	Limit (dBm)	Margin (dB)
802.11b_Nss1,(1Mbps)_1TX	-	-	-	-	-	-	-	-	-	-	-	-	-	-
2412MHz	Pass	1G	3G	AV	2.208G	3.95	-51.57	-	-	-	-51.57	-47.62	-41.20	-6.42
2412MHz	Pass	1G	3G	AV	2.316G	3.95	-52.56	-	-	-	-52.56	-48.61	-41.20	-7.41
2412MHz	Pass	1G	3G	AV	2.51G	3.95	-55.19	-	-	-	-55.19	-51.24	-41.20	-10.04
2412MHz	Pass	1G	3G	PK	2.294G	3.95	-39.89	-	-	-	-39.89	-35.94	-21.20	-14.74
2412MHz	Pass	1G	3G	PK	2.366G	3.95	-44.46	-	-	-	-44.46	-40.51	-21.20	-19.31
2412MHz	Pass	1G	3G	PK	2.534G	3.95	-45.09	-	-	-	-45.09	-41.14	-21.20	-19.94
2437MHz	Pass	1G	3G	AV	2.208G	3.95	-51.31	-	-	-	-51.31	-47.36	-41.20	-6.16
2437MHz	Pass	1G	3G	AV	2.318G	3.95	-52.42	-	-	-	-52.42	-48.47	-41.20	-7.27
2437MHz	Pass	1G	3G	AV	2.556G	3.95	-55.20	-	-	-	-55.20	-51.25	-41.20	-10.05
2437MHz	Pass	1G	3G	PK	2.318G	3.95	-39.42	-	-	-	-39.42	-35.47	-21.20	-14.27
2437MHz	Pass	1G	3G	PK	2.556G	3.95	-44.72	-	-	-	-44.72	-40.77	-21.20	-19.57
2462MHz	Pass	1G	3G	AV	2.268G	3.95	-54.52	-	-	-	-54.52	-50.57	-41.20	-9.37
2462MHz	Pass	1G	3G	AV	2.326G	3.95	-55.24	-	-	-	-55.24	-51.29	-41.20	-10.09
2462MHz	Pass	1G	3G	AV	2.592G	3.95	-56.51	-	-	-	-56.51	-52.56	-41.20	-11.36
2462MHz	Pass	1G	3G	PK	2.342G	3.95	-43.12	-	-	-	-43.12	-39.17	-21.20	-17.97
2462MHz	Pass	1G	3G	PK	2.544G	3.95	-48.62	-	-	-	-48.62	-44.67	-21.20	-23.47
802.11g_Nss1,(6Mbps)_1TX	-	-	-	-	-	-	-	-	-	-	-	-	-	-
2412MHz	Pass	1G	3G	AV	2.208G	3.95	-52.33	-	-	-	-52.33	-48.38	-41.20	-7.18
2412MHz	Pass	1G	3G	AV	2.384G	3.95	-52.78	-	-	-	-52.78	-48.83	-41.20	-7.63
2412MHz	Pass	1G	3G	AV	2.592G	3.95	-55.58	-	-	-	-55.58	-51.63	-41.20	-10.43
2412MHz	Pass	1G	3G	PK	2.294G	3.95	-40.57	-	-	-	-40.57	-36.62	-21.20	-15.42
2412MHz	Pass	1G	3G	PK	2.32G	3.95	-43.86	-	-	-	-43.86	-39.91	-21.20	-18.71
2412MHz	Pass	1G	3G	PK	2.532G	3.95	-44.88	-	-	-	-44.88	-40.93	-21.20	-19.73
2437MHz	Pass	1G	3G	AV	2.208G	3.95	-51.12	-	-	-	-51.12	-47.17	-41.20	-5.97
2437MHz	Pass	1G	3G	AV	2.368G	3.95	-51.60	-	-	-	-51.60	-47.65	-41.20	-6.45
2437MHz	Pass	1G	3G	AV	2.514G	3.95	-53.95	-	-	-	-53.95	-50.00	-41.20	-8.80
2437MHz	Pass	1G	3G	PK	2.318G	3.95	-36.39	-	-	-	-36.39	-32.44	-21.20	-11.24
2437MHz	Pass	1G	3G	PK	2.556G	3.95	-41.97	-	-	-	-41.97	-38.02	-21.20	-16.82
2462MHz	Pass	1G	3G	AV	2.208G	3.95	-55.53	-	-	-	-55.53	-51.58	-41.20	-10.38
2462MHz	Pass	1G	3G	AV	2.31G	3.95	-56.49	-	-	-	-56.49	-52.54	-41.20	-11.34
2462MHz	Pass	1G	3G	AV	2.504G	3.95	-57.64	-	-	-	-57.64	-53.69	-41.20	-12.49
2462MHz	Pass	1G	3G	PK	2.342G	3.95	-44.88	-	-	-	-44.88	-40.93	-21.20	-19.73
2462MHz	Pass	1G	3G	PK	2.504G	3.95	-47.49	-	-	-	-47.49	-43.54	-21.20	-22.34
802.11ax HEW20_Nss1,(MCS0)_1TX	-	-	-	-	-	-	-	-	-	-	-	-	-	-
2412MHz	Pass	1G	3G	AV	2.208G	3.95	-52.55	-	-	-	-52.55	-48.60	-41.20	-7.40
2412MHz	Pass	1G	3G	AV	2.374G	3.95	-53.06	-	-	-	-53.06	-49.11	-41.20	-7.91
2412MHz	Pass	1G	3G	AV	2.512G	3.95	-55.59	-	-	-	-55.59	-51.64	-41.20	-10.44
2412MHz	Pass	1G	3G	PK	2.276G	3.95	-43.48	-	-	-	-43.48	-39.53	-21.20	-18.33
2412MHz	Pass	1G	3G	PK	2.376G	3.95	-44.32	-	-	-	-44.32	-40.37	-21.20	-19.17
2412MHz	Pass	1G	3G	PK	2.534G	3.95	-44.75	-	-	-	-44.75	-40.80	-21.20	-19.60
2437MHz	Pass	1G	3G	AV	2.364G	3.95	-51.38	-	-	-	-51.38	-47.43	-41.20	-6.23
2437MHz	Pass	1G	3G	AV	2.508G	3.95	-53.46	-	-	-	-53.46	-49.51	-41.20	-8.31
2437MHz	Pass	1G	3G	PK	2.318G	3.95	-37.78	-	-	-	-37.78	-33.83	-21.20	-12.63
2437MHz	Pass	1G	3G	PK	2.51G	3.95	-44.76	-	-	-	-44.76	-40.81	-21.20	-19.61
2462MHz	Pass	1G	3G	AV	2.208G	3.95	-55.64	-	-	-	-55.64	-51.69	-41.20	-10.49
2462MHz	Pass	1G	3G	AV	2.366G	3.95	-57.32	-	-	-	-57.32	-53.37	-41.20	-12.17
2462MHz	Pass	1G	3G	AV	2.592G	3.95	-57.14	-	-	-	-57.14	-53.19	-41.20	-11.99
2462MHz	Pass	1G	3G	PK	2.208G	3.95	-47.93	-	-	-	-47.93	-43.98	-21.20	-22.78
2462MHz	Pass	1G	3G	PK	2.328G	3.95	-48.53	-	-	-	-48.53	-44.58	-21.20	-23.38
2462MHz	Pass	1G	3G	PK	2.502G	3.95	-49.12	-	-	-	-49.12	-45.17	-21.20	-23.97
802.11b_Nss1,(1Mbps)_2TX	-	-	-	-	-	-	-	-	-	-	-	-	-	-
2412MHz	Pass	1G	3G	AV	2.208G	3.95	-53.33	-55.12	-	-	-51.12	-47.17	-41.20	-5.97
2412MHz	Pass	1G	3G	AV	2.374G	3.95	-55.63	-55.15	-	-	-52.37	-48.42	-41.20	-7.22
2412MHz	Pass	1G	3G	AV	2.558G	3.95	-56.53	-58.56	-	-	-54.42	-50.47	-41.20	-9.27
2412MHz	Pass	1G	3G	PK	2.268G	3.95	-44.99	-46.30	-	-	-42.59	-38.64	-21.20	-17.44
2412MHz	Pass	1G	3G	PK	2.32G	3.95	-47.17	-46.88	-	-	-44.01	-40.06	-21.20	-18.86
2412MHz	Pass	1G	3G	PK	2.532G	3.95	-46.74	-51.75	-	-	-45.55	-41.60	-21.20	-20.40
2437MHz	Pass	1G	3G	AV	2.266G	3.95	-52.35	-52.09	-	-	-49.21	-45.26	-41.20	-4.06
2437MHz	Pass	1G	3G	AV	2.3G	3.95	-53.23	-52.52	-	-	-49.85	-45.90	-41.20	-4.70
2437MHz	Pass	1G	3G	AV	2.556G	3.95	-55.41	-55.20	-	-	-52.29	-48.34	-41.20	-7.14
2437MHz	Pass	1G	3G	PK	2.318G	3.95	-37.51	-46.51	-	-	-37.00	-33.05	-21.20	-11.85
2437MHz	Pass	1G	3G	PK	2.508G	3.95	-46.21	-47.73	-	-	-43.89	-39.94	-21.20	-18.74
2462MHz	Pass	1G	3G	AV	2.262G	3.95	-55.61	-54.27	-	-	-51.88	-47.93	-41.20	-6.73
2462MHz	Pass	1G	3G	AV	2.318G	3.95	-55.08	-55.36	-	-	-52.21	-48.26	-41.20	-7.06
2462MHz	Pass	1G	3G	AV	2.51G	3.95	-58.03	-56.73	-	-	-54.32	-50.37	-41.20	-9.17
2462MHz	Pass	1G	3G	PK	2.342G	3.95	-44.25	-48.24	-	-	-42.79	-38.84	-21.20	-17.64
2462MHz	Pass	1G	3G	PK	2.57G	3.95	-48.27	-50.32	-	-	-46.16	-42.21	-21.20	-21.01
802.11g_Nss1,(6Mbps)_2TX	-	-	-	-	-	-	-	-	-	-	-	-	-	-



CSE (Band Reject Filter)\_Radio 1 (Harmonic 1~3GHz)

Appendix F.2

Mode	Result	F-Start (Hz)	F-Stop (Hz)	Type	Freq (Hz)	DG (dBi)	P1 (dBm)	P2 (dBm)	P3 (dBm)	P4 (dBm)	Psum (dBm)	EIRP (dBm)	Limit (dBm)	Margin (dB)
2412MHz	Pass	1G	3G	AV	2.208G	3.95	-55.85	-56.18	-	-	-53.00	-49.05	-41.20	-7.85
2412MHz	Pass	1G	3G	AV	2.324G	3.95	-56.77	-56.45	-	-	-53.60	-49.65	-41.20	-8.45
2412MHz	Pass	1G	3G	AV	2.592G	3.95	-57.68	-59.38	-	-	-55.44	-51.49	-41.20	-10.29
2412MHz	Pass	1G	3G	PK	2.294G	3.95	-45.95	-48.52	-	-	-44.04	-40.09	-21.20	-18.89
2412MHz	Pass	1G	3G	PK	2.324G	3.95	-47.27	-48.90	-	-	-45.00	-41.05	-21.20	-19.85
2412MHz	Pass	1G	3G	PK	2.562G	3.95	-48.26	-50.17	-	-	-46.10	-42.15	-21.20	-20.95
2437MHz	Pass	1G	3G	AV	2.366G	3.95	-51.30	-52.53	-	-	-48.86	-44.91	-41.20	-3.71
2437MHz	Pass	1G	3G	AV	2.512G	3.95	-53.96	-54.50	-	-	-51.21	-47.26	-41.20	-6.06
2437MHz	Pass	1G	3G	PK	2.318G	3.95	-37.57	-44.65	-	-	-36.79	-32.84	-21.20	-11.64
2437MHz	Pass	1G	3G	PK	2.56G	3.95	-43.00	-48.99	-	-	-42.02	-38.07	-21.20	-16.87
2462MHz	Pass	1G	3G	AV	2.284G	3.95	-57.30	-56.19	-	-	-53.70	-49.75	-41.20	-8.55
2462MHz	Pass	1G	3G	AV	2.32G	3.95	-57.85	-56.46	-	-	-54.09	-50.14	-41.20	-8.94
2462MHz	Pass	1G	3G	AV	2.52G	3.95	-58.13	-58.57	-	-	-55.33	-51.38	-41.20	-10.18
2462MHz	Pass	1G	3G	PK	2.342G	3.95	-45.17	-49.07	-	-	-43.69	-39.74	-21.20	-18.54
2462MHz	Pass	1G	3G	PK	2.512G	3.95	-48.61	-50.33	-	-	-46.38	-42.43	-21.20	-21.23
802.11ax HEW20_Nss1,(MCSO)_2TX	-	-	-	-	-	-	-	-	-	-	-	-	-	-
2412MHz	Pass	1G	3G	AV	2.208G	3.95	-56.18	-56.53	-	-	-53.34	-49.39	-41.20	-8.19
2412MHz	Pass	1G	3G	AV	2.364G	3.95	-56.98	-56.31	-	-	-53.62	-49.67	-41.20	-8.47
2412MHz	Pass	1G	3G	AV	2.524G	3.95	-58.40	-58.86	-	-	-55.61	-51.66	-41.20	-10.46
2412MHz	Pass	1G	3G	PK	2.37G	3.95	-47.75	-48.16	-	-	-44.94	-40.99	-21.20	-19.79
2412MHz	Pass	1G	3G	PK	2.532G	3.95	-49.79	-51.15	-	-	-47.41	-43.46	-21.20	-22.26
2437MHz	Pass	1G	3G	AV	2.274G	3.95	-51.58	-51.40	-	-	-48.48	-44.53	-41.20	-3.33
2437MHz	Pass	1G	3G	AV	2.37G	3.95	-51.78	-52.37	-	-	-49.05	-45.10	-41.20	-3.90
2437MHz	Pass	1G	3G	AV	2.508G	3.95	-53.80	-54.51	-	-	-51.13	-47.18	-41.20	-5.98
2437MHz	Pass	1G	3G	PK	2.318G	3.95	-36.39	-44.43	-	-	-35.76	-31.81	-21.20	-10.61
2437MHz	Pass	1G	3G	PK	2.556G	3.95	-43.89	-47.24	-	-	-42.24	-38.29	-21.20	-17.09
2462MHz	Pass	1G	3G	AV	2.258G	3.95	-57.20	-56.86	-	-	-54.02	-50.07	-41.20	-8.87
2462MHz	Pass	1G	3G	AV	2.32G	3.95	-57.60	-57.36	-	-	-54.47	-50.52	-41.20	-9.32
2462MHz	Pass	1G	3G	AV	2.516G	3.95	-58.89	-57.87	-	-	-55.34	-51.39	-41.20	-10.19
2462MHz	Pass	1G	3G	PK	2.34G	3.95	-46.61	-50.80	-	-	-45.21	-41.26	-21.20	-20.06
2462MHz	Pass	1G	3G	PK	2.506G	3.95	-50.23	-48.92	-	-	-46.52	-42.57	-21.20	-21.37
802.11b_Nss1,(1Mbps)_4TX	-	-	-	-	-	-	-	-	-	-	-	-	-	-
2412MHz	Pass	1G	3G	AV	2.256G	3.95	-54.37	-54.29	-54.80	-56.33	-48.85	-44.90	-41.20	-3.70
2412MHz	Pass	1G	3G	AV	2.314G	3.95	-55.66	-55.46	-56.26	-56.26	-49.87	-45.92	-41.20	-4.72
2412MHz	Pass	1G	3G	AV	2.52G	3.95	-57.45	-58.13	-58.13	-58.87	-52.10	-48.15	-41.20	-6.95
2412MHz	Pass	1G	3G	PK	2.256G	3.95	-47.59	-47.48	-47.40	-47.44	-41.46	-37.51	-21.20	-16.31
2412MHz	Pass	1G	3G	PK	2.352G	3.95	-50.43	-49.41	-44.55	-49.86	-41.81	-37.86	-21.20	-16.66
2412MHz	Pass	1G	3G	PK	2.532G	3.95	-50.13	-51.54	-51.02	-45.90	-42.98	-39.03	-21.20	-17.83
2437MHz	Pass	1G	3G	AV	2.256G	3.95	-53.20	-53.96	-52.63	-54.45	-47.48	-43.53	-41.20	-2.33
2437MHz	Pass	1G	3G	AV	2.318G	3.95	-54.90	-54.99	-53.12	-54.46	-48.28	-44.33	-41.20	-3.13
2437MHz	Pass	1G	3G	AV	2.52G	3.95	-57.19	-56.81	-56.11	-56.11	-50.51	-46.56	-41.20	-5.36
2437MHz	Pass	1G	3G	PK	2.318G	3.95	-45.01	-48.31	-45.51	-42.00	-38.62	-34.67	-21.20	-13.47
2437MHz	Pass	1G	3G	PK	2.56G	3.95	-50.97	-49.79	-48.36	-43.85	-41.29	-37.34	-21.20	-16.14
2462MHz	Pass	1G	3G	AV	2.256G	3.95	-54.45	-54.89	-54.37	-56.87	-49.02	-45.07	-41.20	-3.87
2462MHz	Pass	1G	3G	AV	2.318G	3.95	-55.74	-56.68	-55.84	-56.25	-50.09	-46.14	-41.20	-4.94
2462MHz	Pass	1G	3G	AV	2.522G	3.95	-58.41	-57.98	-57.05	-57.18	-51.60	-47.65	-41.20	-6.45
2462MHz	Pass	1G	3G	PK	2.256G	3.95	-48.26	-46.06	-46.86	-49.50	-41.46	-37.51	-21.20	-16.31
2462MHz	Pass	1G	3G	PK	2.34G	3.95	-45.45	-48.67	-49.94	-50.15	-42.08	-38.13	-21.20	-16.93
2462MHz	Pass	1G	3G	PK	2.522G	3.95	-50.11	-50.52	-44.95	-49.20	-42.03	-38.08	-21.20	-16.88
802.11g_Nss1,(6Mbps)_4TX	-	-	-	-	-	-	-	-	-	-	-	-	-	-
2412MHz	Pass	1G	3G	AV	2.256G	3.95	-55.07	-55.72	-56.23	-58.45	-50.18	-46.23	-41.20	-5.03
2412MHz	Pass	1G	3G	AV	2.328G	3.95	-56.87	-56.02	-57.58	-57.83	-51.00	-47.05	-41.20	-5.85
2412MHz	Pass	1G	3G	AV	2.52G	3.95	-58.72	-58.87	-59.35	-58.72	-52.89	-48.94	-41.20	-7.74
2412MHz	Pass	1G	3G	PK	2.294G	3.95	-44.77	-49.70	-50.47	-45.73	-40.98	-37.03	-21.20	-15.83
2412MHz	Pass	1G	3G	PK	2.364G	3.95	-47.83	-49.04	-48.24	-49.56	-42.59	-38.64	-21.20	-17.44
2412MHz	Pass	1G	3G	PK	2.532G	3.95	-48.20	-51.41	-51.41	-47.80	-43.35	-39.40	-21.20	-18.20
2437MHz	Pass	1G	3G	AV	2.256G	3.95	-54.37	-54.89	-53.13	-56.02	-48.46	-44.51	-41.20	-3.31
2437MHz	Pass	1G	3G	AV	2.31G	3.95	-57.39	-56.38	-53.75	-55.87	-49.61	-45.66	-41.20	-4.46
2437MHz	Pass	1G	3G	AV	2.52G	3.95	-57.58	-58.27	-56.45	-56.69	-51.17	-47.22	-41.20	-6.02
2437MHz	Pass	1G	3G	PK	2.318G	3.95	-43.28	-48.83	-46.08	-42.54	-38.52	-34.57	-21.20	-13.37
2437MHz	Pass	1G	3G	PK	2.558G	3.95	-47.78	-50.08	-48.61	-43.61	-40.77	-36.82	-21.20	-15.62
2462MHz	Pass	1G	3G	AV	2.256G	3.95	-58.86	-59.15	-59.00	-60.73	-53.35	-49.40	-41.20	-8.20
2462MHz	Pass	1G	3G	AV	2.328G	3.95	-59.33	-59.96	-60.12	-60.80	-54.00	-50.05	-41.20	-8.85
2462MHz	Pass	1G	3G	AV	2.592G	3.95	-58.73	-60.86	-60.86	-61.28	-54.29	-50.34	-41.20	-9.14
2462MHz	Pass	1G	3G	PK	2.292G	3.95	-51.31	-49.70	-50.15	-52.50	-44.76	-40.81	-21.20	-19.61
2462MHz	Pass	1G	3G	PK	2.344G	3.95	-49.06	-52.31	-52.94	-52.65	-45.41	-41.46	-21.20	-20.26
2462MHz	Pass	1G	3G	PK	2.51G	3.95	-52.78	-52.40	-51.24	-51.57	-45.93	-41.98	-21.20	-20.78
802.11ax HEW20_Nss1,(MCSO)_4TX	-	-	-	-	-	-	-	-	-	-	-	-	-	-
2412MHz	Pass	1G	3G	AV	2.256G	3.95	-55.44	-55.72	-56.23	-58.86	-50.35	-46.40	-41.20	-5.20
2412MHz	Pass	1G	3G	AV	2.328G	3.95	-56.43	-56.54	-56.87	-58.35	-50.96	-47.01	-41.20	-5.81



CSE (Band Reject Filter)\_Radio 1 (Harmonic 1~3GHz)

Appendix F.2

Mode	Result	F-Start (Hz)	F-Stop (Hz)	Type	Freq (Hz)	DG (dBi)	P1 (dBm)	P2 (dBm)	P3 (dBm)	P4 (dBm)	Psum (dBm)	EIRP (dBm)	Limit (dBm)	Margin (dB)
2412MHz	Pass	1G	3G	AV	2.52G	3.95	-58.72	-58.72	-58.57	-59.03	-52.74	-48.79	-41.20	-7.59
2412MHz	Pass	1G	3G	PK	2.292G	3.95	-45.67	-49.23	-50.31	-50.85	-42.47	-38.52	-21.20	-17.32
2412MHz	Pass	1G	3G	PK	2.362G	3.95	-49.05	-48.77	-48.13	-50.23	-42.96	-39.01	-21.20	-17.81
2412MHz	Pass	1G	3G	PK	2.532G	3.95	-50.90	-51.09	-49.37	-47.54	-43.46	-39.51	-21.20	-18.31
2437MHz	Pass	1G	3G	AV	2.256G	3.95	-54.45	-51.42	-52.30	-55.92	-47.16	-43.21	-41.20	-2.01
2437MHz	Pass	1G	3G	AV	2.328G	3.95	-55.81	-53.78	-54.87	-55.81	-48.96	-45.01	-41.20	-3.81
2437MHz	Pass	1G	3G	AV	2.512G	3.95	-58.45	-55.81	-56.14	-56.14	-50.50	-46.55	-41.20	-5.35
2437MHz	Pass	1G	3G	PK	2.256G	3.95	-47.78	-43.57	-45.56	-47.67	-39.77	-35.82	-21.20	-14.62
2437MHz	Pass	1G	3G	PK	2.316G	3.95	-44.91	-46.15	-47.14	-47.29	-40.24	-36.29	-21.20	-15.09
2437MHz	Pass	1G	3G	PK	2.538G	3.95	-49.04	-47.69	-48.45	-48.00	-42.25	-38.30	-21.20	-17.10
2462MHz	Pass	1G	3G	AV	2.256G	3.95	-59.29	-59.29	-58.86	-61.09	-53.53	-49.58	-41.20	-8.38
2462MHz	Pass	1G	3G	AV	2.31G	3.95	-60.34	-60.01	-60.17	-60.68	-54.27	-50.32	-41.20	-9.12
2462MHz	Pass	1G	3G	AV	2.592G	3.95	-58.57	-61.28	-61.28	-60.86	-54.32	-50.37	-41.20	-9.17
2462MHz	Pass	1G	3G	PK	2.256G	3.95	-51.05	-51.17	-50.14	-53.84	-45.33	-41.38	-21.20	-20.18
2462MHz	Pass	1G	3G	PK	2.3G	3.95	-50.35	-51.48	-51.30	-53.34	-45.47	-41.52	-21.20	-20.32
2462MHz	Pass	1G	3G	PK	2.558G	3.95	-51.57	-51.43	-52.42	-51.77	-45.76	-41.81	-21.20	-20.61

DG = Directional Gain ; PX=Port X; Psum=P1+P2+...PX

2.4-2.4835GHz\_802.11b\_Nss1,(1Mbps)\_1TX

CSE Other [PK]

2412MHz

13/06/2023

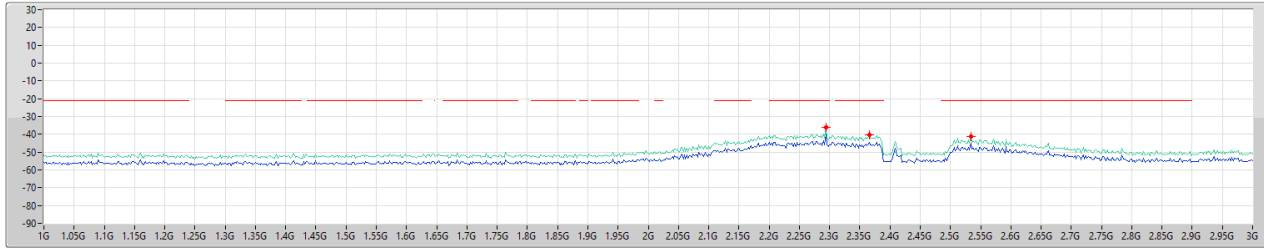

F-Start(Hz)	F-Stop(Hz)	RBW(Hz)	Type	Freq(Hz)	EIRP(dBm)	Limit(dBm)	Margin(dB)	DG(dB)	Ref1(dB)	Psum(dBm)	P1(dBm)
1G	3G	1M	PK	2.294G	-35.94	-21.20	-14.74	3.95	0.00	-39.89	-39.89
1G	3G	1M	PK	2.366G	-40.51	-21.20	-19.31	3.95	0.00	-44.46	-44.46
1G	3G	1M	PK	2.534G	-41.14	-21.20	-19.94	3.95	0.00	-45.09	-45.09

2.4-2.4835GHz\_802.11b\_Nss1,(1Mbps)\_1TX

CSE Other [AV]

2412MHz

13/06/2023

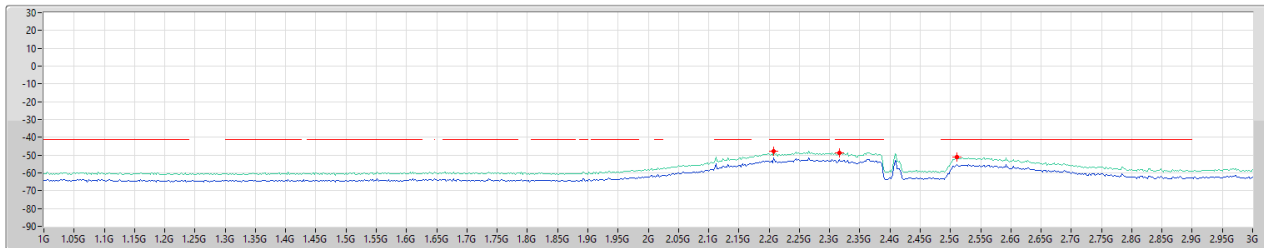

F-Start(Hz)	F-Stop(Hz)	RBW(Hz)	Type	Freq(Hz)	EIRP(dBm)	Limit(dBm)	Margin(dB)	DG(dB)	Ref1(dB)	Psum(dBm)	P1(dBm)
1G	3G	1M	AV	2.208G	-47.62	-41.20	-6.42	3.95	0.00	-51.57	-51.57
1G	3G	1M	AV	2.316G	-46.61	-41.20	-7.41	3.95	0.00	-52.56	-52.56
1G	3G	1M	AV	2.51G	-51.24	-41.20	-10.04	3.95	0.00	-55.19	-55.19