

5725-5825MHz Formal Test Report for IW9165E-B & IW9165E-ROW

Supports

BLE/4.9GHz/ 5GHz 802.11 a/ac/ax/n Wi-Fi radio

FCC ID: LDKIW9165E

Against the following Specifications:

47 CFR 15.205

47 CFR 15.209

47 CFR 15.407

LP0002:2020

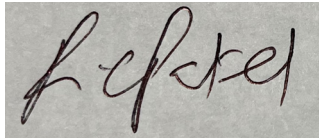
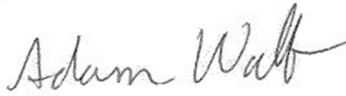

Cisco Systems, Inc.
170 West Tasman Drive
San Jose, CA 95134

	
Author: Ronak Patel Tested By: Ronak Patel	Approved By: Adam Walb Title: Revision: 1.0

This report replaces any previously entered test report under **EDCS # 24348977**. This test report has been electronically authorized and archived using the CISCO Engineering Document Control system. Test Report Template EDCS# 11644120.

SECTION 1: OVERVIEW	3
SECTION 2: ASSESSMENT INFORMATION	4
2.1: GENERAL.....	4
2.2: DATE OF TESTING	5
2.3: REPORT ISSUE DATE	5
2.4: TESTING FACILITIES	5
2.5: EQUIPMENT ASSESSED (EUT).....	6
2.6: EUT DESCRIPTION	6
SECTION 3: RESULT SUMMARY	9
3.1: RESULTS SUMMARY TABLE.....	9
SECTION 4: SAMPLE DETAILS	11
4.1: SYSTEM DETAILS.....	11
4.2: MODE OF OPERATION DETAILS	11
APPENDIX A: EMISSION TEST RESULTS	12
A.1: DUTY CYCLE	13
A.2: 6dB BANDWIDTH.....	16
A.3: 99% AND 26dB BANDWIDTH	21
A.4: MAXIMUM CONDUCTED OUTPUT POWER	26
A.5: POWER SPECTRAL DENSITY.....	55
A.6: CONDUCTED SPURIOUS EMISSIONS	85
A.7: CONDUCTED BAND EDGE.....	117
APPENDIX B: EMISSION TEST RESULTS	138
B.1: RADIATED SPURIOUS EMISSIONS	139
B.2: RADIATED EMISSIONS 30MHZ TO 1GHZ	139
B.3: AC CONDUCTED EMISSIONS	139
APPENDIX C: LIST OF TEST EQUIPMENT USED TO PERFORM THE TEST	143
APPENDIX D: ABBREVIATION KEY AND DEFINITIONS	145
APPENDIX E: PHOTOGRAPHS OF TEST SETUPS	146
APPENDIX F: SOFTWARE USED TO PERFORM TESTING	146
APPENDIX G: TEST PROCEDURES	146
APPENDIX H: SCOPE OF ACCREDITATION (A2LA CERTIFICATE NUMBER 1178-01)	146
APPENDIX I: TEST ASSESSMENT PLAN	146
APPENDIX J: WORST CASE JUSTIFICATION	146

Section 1: Overview

The samples were assessed against the tests detailed in section 3 under the requirements of the following specifications:

Specifications:
CFR47 Part 15.407 LP0002:2020

Section 2: Assessment Information

2.1: General

This report contains an assessment of an apparatus against Electromagnetic Compatibility Standards based upon tests carried out on the samples submitted. The testing was performed by and for the use of Cisco systems Inc:

With regard to this assessment, the following points should be noted:

- a) The results contained in this report relate only to the items tested and were obtained in the period between the date of the initial assessment and the date of issue of the report. Manufactured products will not necessarily give identical results due to production and measurement tolerances.
- b) The apparatus was set up and exercised using the configuration and modes of operation defined in this report only.
- c) Where relevant, the apparatus was only assessed using the susceptibility criteria defined in this report and the Test Assessment Plan (TAP).
- d) All testing was performed under the following environmental conditions:

Temperature	15 °C to 35 °C (54 °F to 95 °F)
Atmospheric Pressure	860 mbar to 1060 mbar (25.4" to 31.3")
Humidity	10% to 75*%

- e) All AC testing was performed at one or more of the following supply voltages:

110V 60 Hz (+/-20%)

Units of Measurement

The units of measurements defined in the appendices are reported in specific terms, which are test dependent. Where radiated measurements are concerned these are defined at a particular distance. Basic voltage measurements are defined in units of [dBuV]

As an example, the basic calculation for all measurements is as follows:

$$\text{Emission level [dBuV]} = \text{Indicated voltage level [dBuV]} + \text{Cable Loss [dB]} + \text{Other correction factors [dB]}$$

The combinations of correction factors are dependent upon the exact test configurations [see test equipment lists for further details] and may include:

Antenna Factors, Pre-Amplifier Gain, LISN Loss, Pulse Limiter Loss and Filter Insertion Loss

Note: To convert the results from dBuV/m to uV/m use the following formula:

$$\text{Level in uV/m} = \text{Common Antilogarithm} [(X \text{ dBuV/m})/20] = Y \text{ uV/m}$$

Measurement Uncertainty Values

voltage and power measurements	± 2 dB
conducted EIRP measurements	± 1.4 dB
radiated measurements	± 3.2 dB
frequency measurements	± 2.4 10 ⁻⁷
temperature measurements	± 0.54°
humidity measurements	± 2.3%
DC and low frequency measurements	± 2.5%

Where relevant measurement uncertainty levels have been estimated for tests performed on the apparatus. This uncertainty represents an expanded uncertainty expressed at approximately the 95% confidence level using a coverage factor of $k=2$.

Radiated emissions (expanded uncertainty, confidence interval 95%)

30 MHz – 300 MHz	± 3.8 dB
300 MHz – 1000 MHz	± 4.3 dB
1 GHz – 10 GHz	± 4.0 dB
10 GHz – 18GHz	± 8.2 dB
18GHz – 26.5GHz	± 4.1 dB
26.5GHz – 40GHz	± 3.9 dB

Conducted emissions (expanded uncertainty, confidence interval 95%)

30 MHz – 40 GHz	± 0.38 dB
-----------------	-----------

A product is considered to comply with a requirement if the nominal measured value is below the limit line. The product is considered to not be in compliance in case the nominal measured value is above the limit line.

This report must not be reproduced except in full, without written approval of Cisco Systems.

2.2: Date of testing

11/1/2022 - 2/10/2023

2.3: Report Issue Date

8/7/2023

Cisco uses an electronic system to issue, store and control the revision of test reports. This system is called the Engineering Document Control System (EDCS). The actual report issue date is embedded into the original file on EDCS. Any copies of this report, either electronic or paper, that are not on EDCS must be considered uncontrolled.

2.4: Testing facilities

This assessment was performed by: NIST Designated Phase-I and Phase-II Conformity Assessment Body (CAB) for the following economies and regulatory authorities under the terms of the stated MRAs/Treaties: NCC (National Communications Commission) APEC Tel MRA – Phase I.

Testing Laboratory
Cisco Systems, Inc.
125 West Tasman Drive (Building P)
San Jose, CA 95134
USA

Headquarters
Cisco Systems, Inc.,
170 West Tasman Drive
San Jose, CA 95134,
USA

Registration Number

Cisco System Site	Address	Site Identifier
Building P, 10m Chamber	125 West Tasman Dr San Jose, CA 95134	Company #: 2461A

Test Engineer(s):

Ronak Patel

2.5: Equipment Assessed (EUT)

IW9165E-B

2.6: EUT Description

RF General Information			
Evaluation Mode	Frequency Range (MHz)	Operating Frequency (MHz)	Modulation Type
5GHz WLAN	5150-5250 5250-5350 5470-5725 5725-5850	5180-5250 5250-5320 5500-5720 5745-5825	802.11a/n: OFDM (BPSK, QPSK, 16QAM, 64QAM) 802.11ac: OFDM (BPSK, QPSK, 16QAM, 64QAM, 256QAM) 802.11ax: OFDMA (BPSK, QPSK, 16QAM, 64QAM, 256QAM, 1024QAM)
4.9GHz WLAN	4940-4990	4945-4985	OFDM (BPSK, QPSK, 16QAM, 64QAM)
Bluetooth	2400-2483.5	2402-2480	LE: GFSK

R1	-	V (AP: 20/40/80) (P2P/P2MP: 20/40/80)	V	-	-	-
R2	-	V (AP: 20/40/80/160) (P2P/P2MP: 20/40/80/160)	V	-	-	-
R3	-	-	-	-	V	-
R4	-	-	-	-	-	V

Note 1: 160MHz is supported in the future release.

For Radio1 - 5GHz UNII 1~UNII 3 and 4.9GHz:

For IEEE 802.11b/g/n/VHT/ax mode (1TX, 2TX/2RX):

1TX

Only Port 1 can be use as transmitting antenna.

2TX

Port 1, Port 2 can be use as transmitting antenna. Port 1, Port 2 could transmit simultaneously.

2RX

Port 1, Port 2, Port 3, Port 4 can be used as receiving antennas. Port 1 and Port 2 could receive simultaneously.

For Radio 2 - 5GHz UNII 1~UNII 3 and 4.9GHz:

For IEEE 802.11a/n/ac/ax mode (1TX, 2TX/2RX):

1TX

Only Port 1 can be use as transmitting antenna.

2TX

Port 1, Port 2 can be use as transmitting antenna. Port 1, Port 2 could transmit simultaneously.

2RX

Port 1, Port 2, Port 3, Port 4 can be used as receiving antennas. Port 1 and Port 2 could receive simultaneously.

For Radio 3 - BLE

Bluetooth(1TX):

Only Port 1 can be used as transmitting/receiving antenna.

For Radio 4 – GNSS (1Rx)

Only Port 1 can be used as receiving antenna.

The following antennas are supported by this product series. Please note, the antenna information has been provided by the customer (the Cisco business unit). The data included in this report represent the worst-case data for all antennas.

Note: As per KDB 353028 D01 Antennas Part 15 Transmitters v01r01 Clause III (A), When submitting test data for part 15 transmitters to be used with multiple antennas, FCC require testing for the highest gain of each type of antenna (e.g., highest gain for each patch, yagi, grid, dish, monopole, etc.). As per the below table IW9165E and IW9165D supports Dipole, Two-port panel antenna and four port panel antennas. Based on the KDB requirement Cisco will provide test data for 3dBi / 8dBi/ 15dBi.

Magnum IW9165 Supported External Antenna List												
Product ID	Family	Description	Supported by IW9165DHD?	Supported by IW9165E?	Peak Gain 2.4 GHz (dBi)	Peak Gain 4.9 GHz (dBi)	Peak Gain 5 GHz (dBi)	Gain > 30° Elevation UNII-1 (dBi)	Peak Gain 6 GHz (dBi)	Gain > 30° Elevation UNII-5 & 7	5 GHz Fixed Point-to-Point?	5 GHz Point-to-Multipoint?
IW-ANT-OMM-53-N=	Legacy	5 GHz 3 dBi Omnidirectional Antenna, Multi-polarized, N Female Connector	No	Yes	N/A	3	3	0	N/A	N/A	No	Yes
AIR-ANT5180V-N=	Legacy	5 GHz 8 dBi Omnidirectional Colinear Array Antenna, N Male Connector	Yes	Yes	N/A	8	8	-3	N/A	N/A	No	Yes
IW-ANT-PNL-59-N=	Legacy	5 GHz 9 dBi 2-Element Patch Array Antenna, Slant 145 Polarized, N Female Connectors	Yes	Yes	N/A	N/A	10	7	N/A	N/A	Yes	Yes
AIR-ANTS114P2M-N=	Legacy	5 GHz 13 dBi 2-Element Patch Array Antenna, N Male Connectors	Yes	Yes	N/A	N/A	13	4	N/A	N/A	Yes	Yes
AIR-ANTS114P2M-NS=	SIA		Yes	Yes	N/A	N/A	13	3	N/A	N/A	Yes	Yes
IW-ANT-SKD-513-Q=	Legacy	5 GHz 14 dBi 2-Element Shark Antenna, Slant 145 Polarized, QMA Female Connectors	No	Yes	N/A	13	13	8	N/A	N/A	No	Yes
IW-ANT-SKS-514-Q=	Legacy	5 GHz 14 dBi 2-Element Shark Antenna, Slant 145 Polarized, QMA Female Connectors	No	Yes	N/A	13	13	8	N/A	N/A	No	Yes
AIR-ANT2547V-N=	Legacy	2.4 GHz 4 dBi / 5 GHz 7 dBi Omnidirectional Colinear Array Antenna, N male connector	Yes	Yes	4	N/A	7	-3	N/A	N/A	No	Yes
AIR-ANT2547VG-N=	Legacy	2.4 GHz 4 dBi / 5 GHz 7 dBi Omnidirectional Colinear Array	Yes	Yes	4	N/A	7	-3	N/A	N/A	No	Yes
AIR-ANT2547VG-NS=	SIA	2.4 GHz 6 dBi / 5 GHz 8 dBi Omnidirectional Antenna, N Male	Yes	Yes	4	N/A	7	-3	N/A	N/A	No	Yes
AIR-ANT2568VG-N=	Legacy	2.4 GHz 6 dBi / 5 GHz 8 dBi Omnidirectional Antenna, N Male	Yes	Yes	6	N/A	8	3	N/A	N/A	No	Yes
AIR-ANT2568VG-NS=	SIA	2.4 GHz 8 dBi / 5 GHz 8 dBi 4-Element Dual-Polarized Patch Antenna, N	Yes	Yes	6	N/A	8	3	N/A	N/A	No	Yes
AIR-ANT2588P4M-NS=	SIA	2.4 GHz 8 dBi / 5 GHz 8 dBi 4-Element Dual-Polarized Patch Antenna, N	No	Yes	8	N/A	8	-2	N/A	N/A	No	Yes
AIR-ANT2513P4M-N=	Legacy	2.4 GHz 13 dBi / 5 GHz 13 dBi Polarization Diverse Patch Array	No	Yes	13	N/A	13	1	N/A	N/A	Yes	Yes
AIR-ANT2513P4M-NS=	SIA	2.4 GHz 13 dBi / 5 GHz 13 dBi Polarization Diverse Patch Array	No	Yes	13	N/A	13	1	N/A	N/A	Yes	Yes
IW-ANT-OMV-2567-N	SIA	Tri-band 2.4 GHz 4 dBi, 5/6 GHz 7 dBi Omnidirectional Colinear Array Antenna, Vertically Polarized, N Male Connector	Yes	Yes	4	7	7	-7	7	-6	No	Yes
IW-ANT-OMH-2567-N	SIA	Tri-band 2.4 GHz 4 dBi, 5/6 GHz 7 dBi Omnidirectional Colinear Array Antenna, Horizontally Polarized, N Male Connector	Yes	Yes	4	7	7	-6	7	-4	No	Yes
IW-ANT-PNL-515-N=	SIA	Tri-band 5 GHz 15dBi Panel Antenna	Yes	Yes		15	15	3			Yes	Yes

Section 3: Result Summary**3.1: Results Summary Table****Conducted testing summary**

Basic Standard	Technical Requirements / Details	Result
FCC 15.407 LP0002 (2020-07-01) (5.7.5)	6dB Bandwidth: (e) Within the 5.725-5.85 GHz band, the minimum 6 dB bandwidth of U-NII devices shall be at least 500 kHz.	Pass
FCC 15.407 LP0002 (2020-07-01) (5.7.2.3)	99% & 26 dB Bandwidth: The 99% occupied bandwidth is the frequency bandwidth such that, below its lower and above its upper frequency limits, the mean powers are each equal to 0.5% of the total mean power of the given emission. There is no limit for 99% OBW. The 26 dB emission is the width of the emission that is constrained by the frequencies associated with the two outermost amplitude points (upper and lower frequencies) that are attenuated by 26 dB relative to the maximum level measured in the fundamental emission.	Pass
FCC 15.407 LP0002 (2020-07-01) (5.7.3.3) (1), (3)	Output Power: (3) For the band 5.725-5.85 GHz, the maximum conducted output power over the frequency band of operation shall not exceed 1 W. ... If transmitting antennas of directional gain greater than 6 dBi are used, both the maximum conducted output power and the maximum power spectral density shall be reduced by the amount in dB that the directional gain of the antenna exceeds 6 dBi. However, fixed point-to-point U-NII devices operating in this band may employ transmitting antennas with directional gain greater than 6 dBi without any corresponding reduction in transmitter conducted power.	Pass
FCC 15.407 LP0002 (2020-07-01) (5.7.3.3) (2), (3)	Power Spectral Density: (3) For the band 5.725-5.85 GHz... the maximum power spectral density shall not exceed 30 dBm in any 500-kHz band. If transmitting antennas of directional gain greater than 6 dBi are used, both the maximum conducted output power and the maximum power spectral density shall be reduced by the amount in dB that the directional gain of the antenna exceeds 6 dBi. However, fixed point-to-point U-NII devices operating in this band may employ transmitting antennas with directional gain greater than 6 dBi without any corresponding reduction in transmitter conducted power.	Pass
FCC 15.407 LP0002 (2020-07-01) (5.7.4.2)	Conducted Spurious Emissions / Band-Edge: (4) For transmitters operating in the 5.725-5.85 GHz band: (i) All emissions shall be limited to a level of -27 dBm/MHz at 75 MHz or more above or below the band edge increasing linearly to 10 dBm/MHz at 25 MHz above or below the band edge, and from 25 MHz above or below the band edge increasing linearly to a level of 15.6 dBm/MHz at 5 MHz above or below the band edge, and from 5 MHz above or below the band edge increasing linearly to a level of 27 dBm/MHz at the band edge.	Pass
FCC 15.407 FCC 15.205 FCC 15.209 LP0002 (2020-07-01) (3.5), (3.6)	Restricted band: Unwanted emissions must comply with the general field strength limits set forth in §15.209. (7) The provisions of §15.205 apply to intentional radiators operating under this section.	Pass

Radiated Emissions (General requirements)

Basic Standard	Technical Requirements / Details	Result
FCC 15.407 FCC 15.205 FCC 15.209 LP0002 (2018-01-10) (3.6)	<p>TX Spurious Emissions: Unwanted emissions must comply with the general field strength limits set forth in §15.209. (7) The provisions of §15.205 apply to intentional radiators operating under this section.</p>	[EDCS # 24346978]
FCC 15.207 LP0002 (2020-07-01) (3.3)	<p>AC conducted Emissions: Except when the requirements applicable to a given device state otherwise, for any radio apparatus equipped to operate from the public utility AC power supply, either directly or indirectly (such as with a battery charger), the radio frequency voltage of emissions conducted back onto the AC power lines in the frequency range of 0.15 MHz to 30 MHz shall not exceed the limits shown in the table in these sections. The more stringent limit applies at the frequency range boundaries.</p>	[Enter the AC Line EDCS #]

* MPE calculation is recorded in a separate report

Section 4: Sample Details

Note: Each sample was evaluated to ensure that its condition was suitable to be used as a test sample prior to the commencement of testing.

Sample No.	Equipment Details	Manufacturer	Hardware Rev.	Firmware Rev.	Software Rev.	Serial Number
S01	IW9165E-B	Cisco Systems	P2A	QC_IMAGE_VERSION_STRING=WLAN.HK.2.4-02142-QCAHKSWP_L_SILICONZ-1	[sjc-ads-6561:/nobackup/haijia/ap_wlc_me/m22_mfg]	FOC2638BKX3
S02	IW-PWRADPT-MFIT4P	Cisco Systems	V00	-	-	LIN264450C6

4.1: System Details

System #	Description	Samples
1	IW9165E-B	S01
2	IW-PWRADPT-MFIT4P	S02

4.2: Mode of Operation Details

Mode#	Description	Comments
1	Continuous Transmitting	

Function	Support Band
AP	BLE,5GHz, 4.9GHz
P2P/P2MP	5GHz, 4.9GHz

Appendix A: Emission Test Results

Conducted Test Setup Diagram

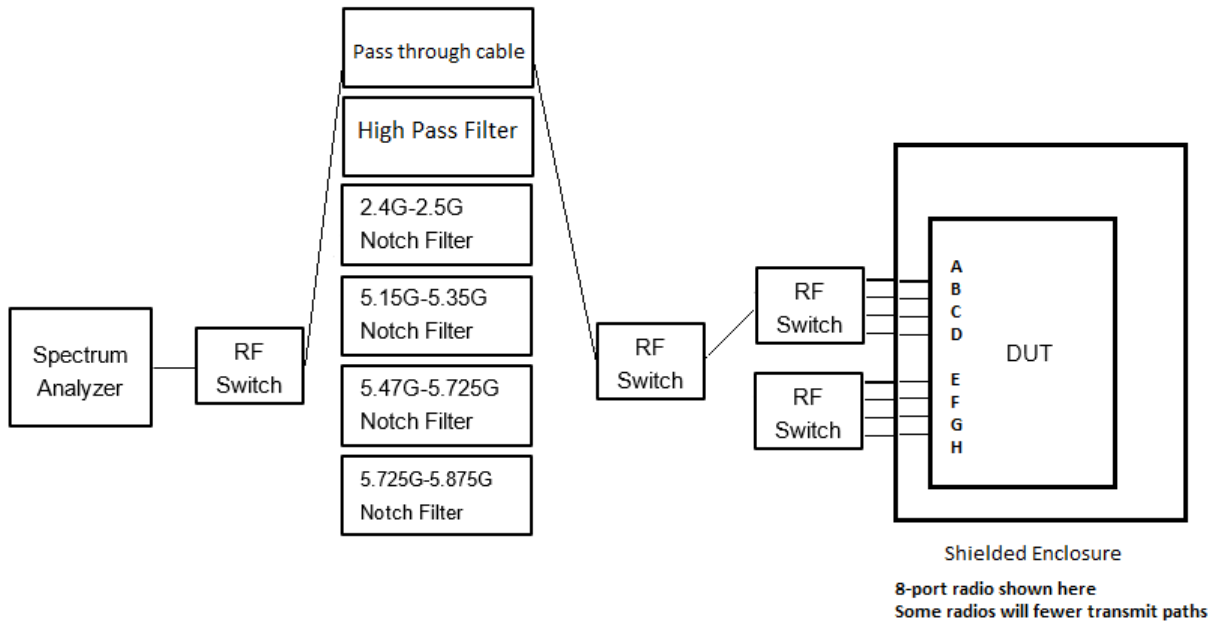

Test Setup Description

The EUT was placed inside an RF shielded enclosure. RF cables connect to each antenna port on the EUT inside the enclosure. Those cables are routed to RF switch cards in a National Instruments chassis. There are different paths, some paths contain a notch filter or high pass filter as shown above. The signal is then routed to the spectrum analyzer where measurements are made.

Plots listed herein represent the measured worst-case per antenna, frequency, and modulation.

A.1: Duty Cycle

Duty Cycle Test Requirement

From KDB 789033 D02 General UNII Test Procedures New Rules v02r01:

B. Duty Cycle (x), Transmission Duration (T), and Maximum Power Control Level

1. All measurements are to be performed with the EUT transmitting at 100 percent duty cycle at its maximum power control level; however, if 100 percent duty cycle cannot be achieved, measurements of duty cycle, x, and maximum-power transmission duration, T, are required for each tested mode of operation.

Duty Cycle Test Method

From KDB 789033 D02 General UNII Test Procedures New Rules v02r01:

B. Duty Cycle (x), Transmission Duration (T), and Maximum Power Control Level

The zero-span mode on a spectrum analyzer or EMI receiver, if the response time and spacing between bins on the sweep are sufficient to permit accurate measurements of the on and off times of the transmitted signal. Set the center frequency of the instrument to the center frequency of the transmission. Set $RBW \geq EBW$ if possible; otherwise, set RBW to the largest available value. Set $VBW \geq RBW$. Set detector = peak or average. The zero-span measurement method shall not be used unless both RBW and VBW are $> 50/T$, where T is defined in section II.B.1.a), and the number of sweep points across duration T exceeds 100. (For example, if VBW and/or RBW are limited to 3 MHz, then the zero-span method of measuring duty cycle shall not be used if $T \leq 16.7$ microseconds.)

Duty Cycle Test Information

Tested By: Ronak Patel	Date of testing: 11/1/2022 - 2/10/2023
Test Result: PASS	

Test Equipment

See Appendix C for list of test equipment

Duty Cycle Data Table

Duty Cycle table and screen captures are shown below for Power/PSD modes.

Frequency (MHz)	Mode	Data Rate (Mbps)	Duty Cycle (dB)
5745	Non HT20, 6 to 54 Mbps	6.0	0.3574
	HT/VHT20, M0 to M7	m0	0.35081
	HE20, M0 to M11 1ss	m0h1	0.3278
5755	Non HT40, 6 to 54 Mbps	6.0	0.28214
	HT/VHT40, M0 to M7	m0	0.37252
	HE40, M0 to M11 1ss	m0h1	0.38199
5775	Non HT80, 6 to 54 Mbps	6.0	0.43303
	VHT80, M0 to M11 1ss	m0x1	0.48371
	HE80, M0 to M11 1ss	m0h1	0.31284
5785	Non HT20, 6 to 54 Mbps	6.0	0.3574
	HT/VHT20, M0 to M7	m0	0.35081
	HE20, M0 to M11 1ss	m0h1	0.3278
5795	Non HT40, 6 to 54 Mbps	6.0	0.28214
	HT/VHT40, M0 to M7	m0	0.37252
	HE40, M0 to M11 1ss	m0h1	0.38199
5825	Non HT20, 6 to 54 Mbps	6.0	0.3574
	HT/VHT20, M0 to M7	m0	0.35081
	HE20, M0 to M11 1ss	m0h1	0.3278

Data Screenshots

5775 MHz: VHT80, M0 to M11 1ss

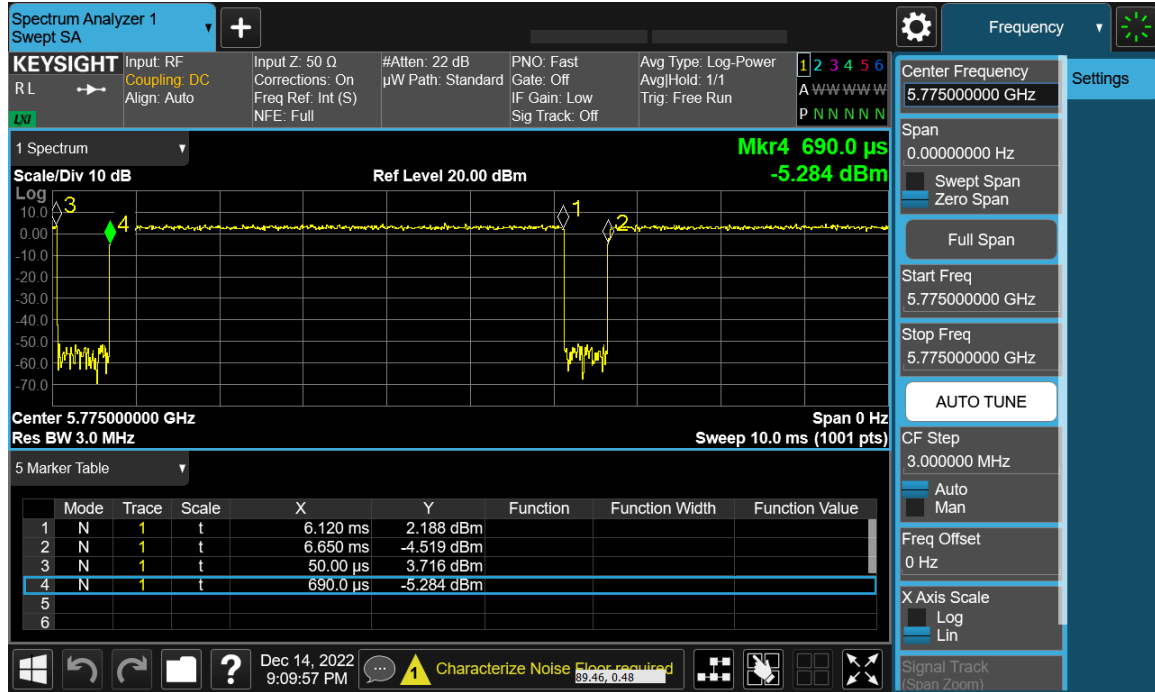

Antenna A

A.2: 6dB Bandwidth

6dB Bandwidth Test Requirement

15.407 e | LP0002 (2020-07-01) (5.7.5):

Within the 5.725-5.85 GHz band, the minimum 6 dB bandwidth of U-NII devices shall be at least 500 kHz

Emission bandwidth (EBW) in U-NII bands:

Band-crossing emissions: For an emission that crosses the boundary between two adjacent U-NII bands, the boundary frequency between the bands serves as one edge for defining the portion of the EBW that falls within a particular U-NII band. However, the -26 dB points are measured relative to the highest point on the contiguous segment—regardless of which band contains that highest point (Figure3).

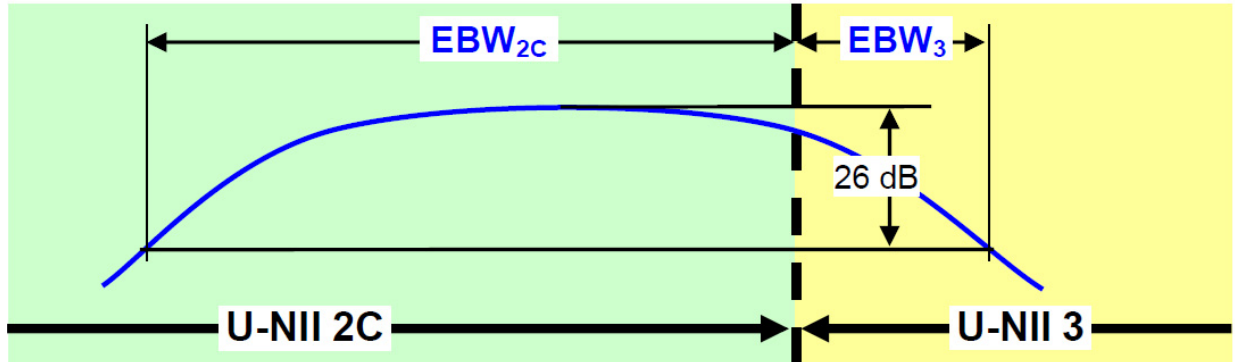

Figure 3. Emission Bandwidth (EBW) within a Band for Band-Crossing Signals

6dB Bandwidth Test Procedure

Ref. ANSI C63.10:2013

From KDB 789033 D02 General UNII Test Procedures New Rules v02r01

Section C. Bandwidth Measurement

6 BW Test Procedure
<ol style="list-style-type: none"> 1. Set the radio in the continuous transmitting mode. 2. Allow the trace to stabilize. 3. Setting the x-dB bandwidth mode to -6dB within the measurement set up function. 4. Select the automatic OBW measurement function of an instrument to perform bandwidth measurement. 5. Capture graphs and record pertinent measurement data.

Ref. ANSI C63.10: 2013 section 11.8.2 Option 2

From KDB 789033 D02 General UNII Test Procedures New Rules v02r01

Section C. Bandwidth Measurement

6 BW Test parameters
2. Minimum Emission Bandwidth for the band 5.725-5.85 GHz a) Set RBW = 100 kHz. b) Set the video bandwidth (VBW) $\geq 3 \times$ RBW. c) Detector = Peak. d) Trace mode = max hold. e) Sweep = auto couple. f) Allow the trace to stabilize. g) Measure the maximum width of the emission that is constrained by the frequencies associated with the two outermost amplitude points (upper and lower frequencies) that are attenuated by 6 dB relative to the maximum level measured in the fundamental emission. Note: The automatic bandwidth measurement capability of a spectrum analyzer or EMI receiver may be employed if it implements the functionality described above.

Tested By: Ronak Patel	Date of testing: 11/1/2022 - 2/10/2023
Test Result: PASS	

Test Equipment

See Appendix C for list of test equipment

6 dB Bandwidth Tables

Frequency (MHz)	Mode	Data Rate (Mbps)	6dB BW (MHz)	Limit (kHz)	Margin (MHz)
5745	Non HT20, 6 to 54 Mbps	6.0	16.3	>500	15.8
	HT/VHT20, M0 to M7	m0	17.6	>500	17.1
	HE20, M0 to M11 1ss	m0h1	19.1	>500	18.6
5755	Non HT40, 6 to 54 Mbps	6.0	35.3	>500	34.8
	HT/VHT40, M0 to M7	m0	35.4	>500	34.9
	HE40, M0 to M11 1ss	m0h1	37.1	>500	36.6
5775	Non HT80, 6 to 54 Mbps	6.0	75.4	>500	74.9
	VHT80, M0 to M11 1ss	m0x1	74.3	>500	73.8
	HE80, M0 to M11 1ss	m0h1	77.9	>500	77.4
5785	Non HT20, 6 to 54 Mbps	6.0	16.3	>500	15.8
	HT/VHT20, M0 to M7	m0	17.6	>500	17.1
	HE20, M0 to M11 1ss	m0h1	19.0	>500	18.5
5795	Non HT40, 6 to 54 Mbps	6.0	35.3	>500	34.8
	HT/VHT40, M0 to M7	m0	35.3	>500	34.8
	HE40, M0 to M11 1ss	m0h1	38.0	>500	37.5
5825	Non HT20, 6 to 54 Mbps	6.0	16.3	>500	15.8
	HT/VHT20, M0 to M7	m0	17.6	>500	17.1
	HE20, M0 to M11 1ss	m0h1	19.0	>500	18.5

Data Screenshots

5745 MHz: HE20, M0 to M11 1ss

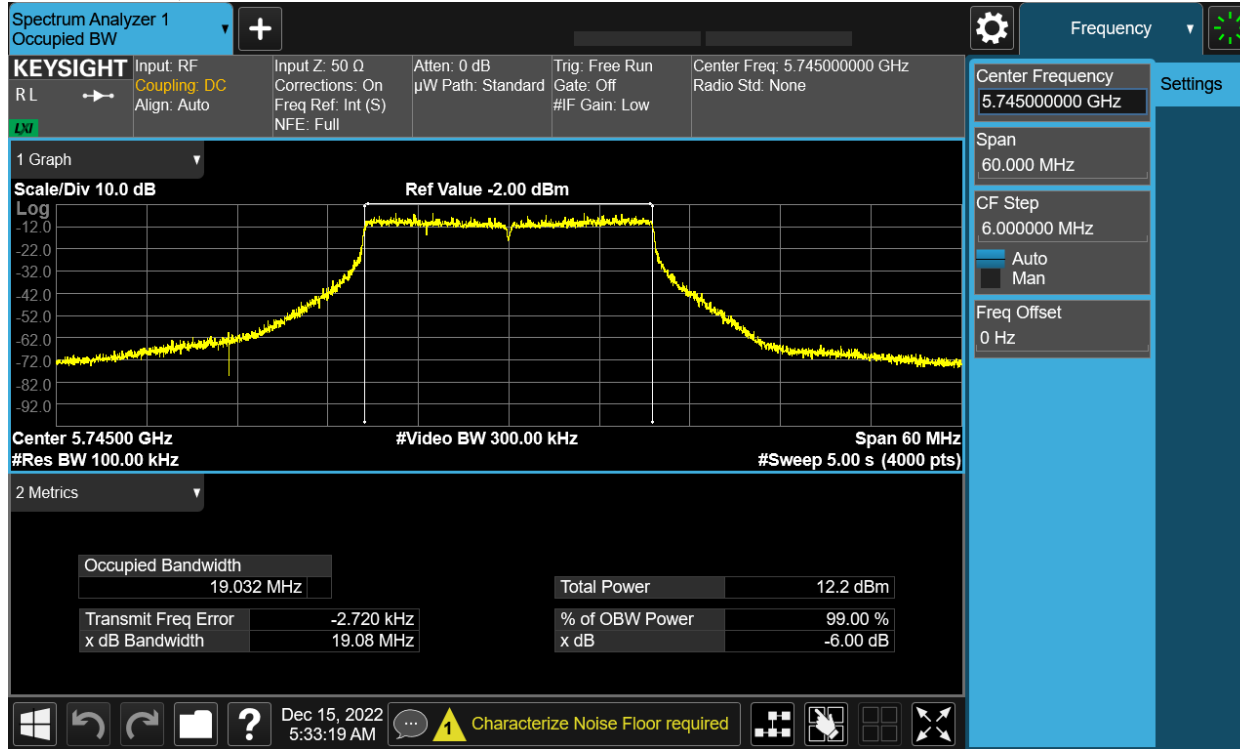

Antenna B

5795 MHz: HE40, M0 to M11 1ss

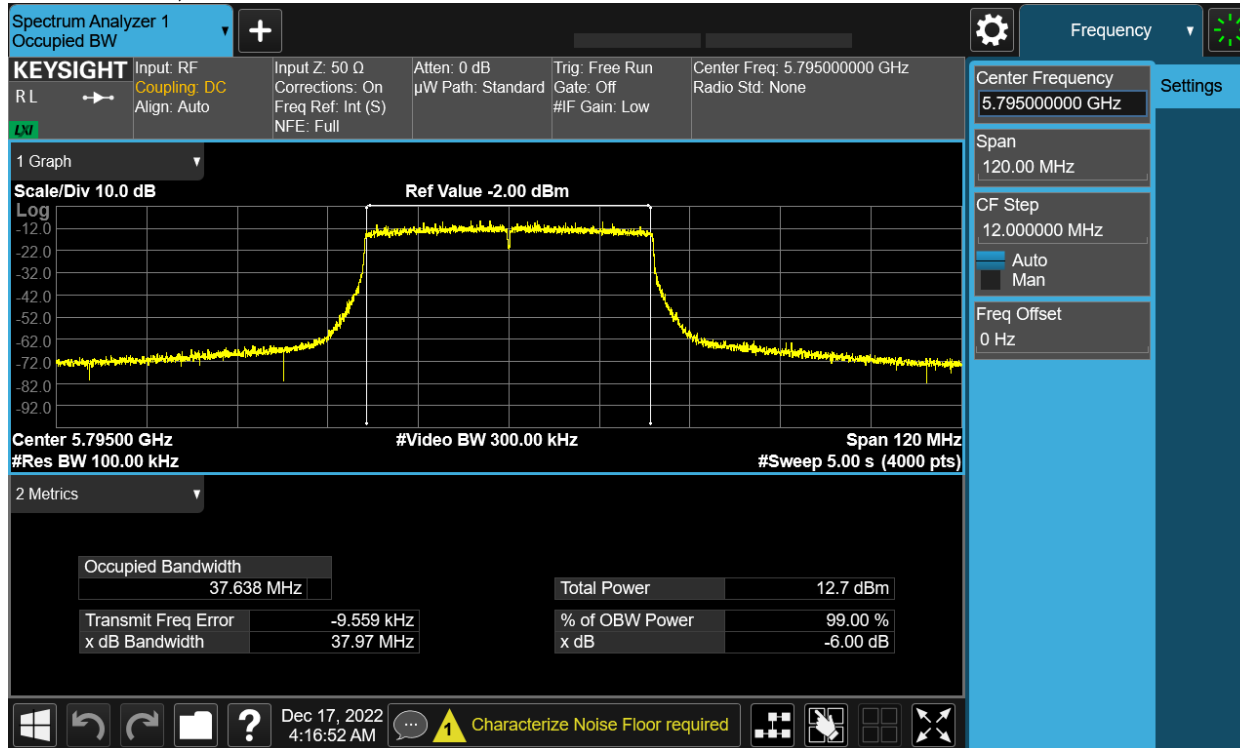

Antenna A

5775 MHz: HE80, M0 to M11 1ss

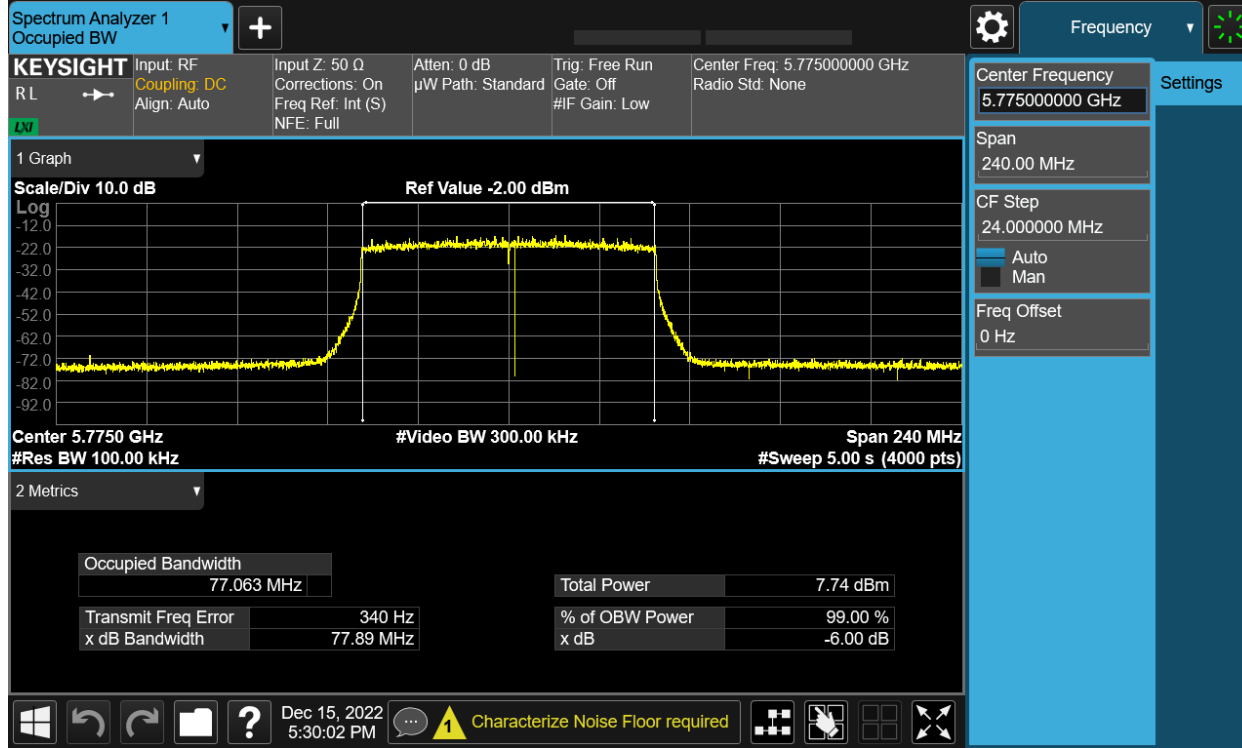

Antenna A

A.3: 99% and 26dB Bandwidth**99% and 26dB Bandwidth Test Requirement**

There is no requirement for the value of bandwidth. However, the 26dB BW (EBW) is used to calculate the power limits in 15.407 (a) (2).

Power measurements are made using the 99% Bandwidth as the integration bandwidth.

Band-crossing emissions: For an emission that crosses the boundary between two adjacent U-NII bands, the boundary frequency between the bands serves as one edge for defining the portion of the EBW that falls within a particular U-NII band. However, the -26 dB points are measured relative to the highest point on the contiguous segment—regardless of which band contains that highest point (Figure4).

LP0002 (2020-07-01) (5.7.2.3):

The 26dB emission is the width of the emission that is constrained by the frequencies associated with the two outermost amplitude points (upper and lower frequencies) that are attenuated by 26 dB relative to the maximum level measured in the fundamental emission.

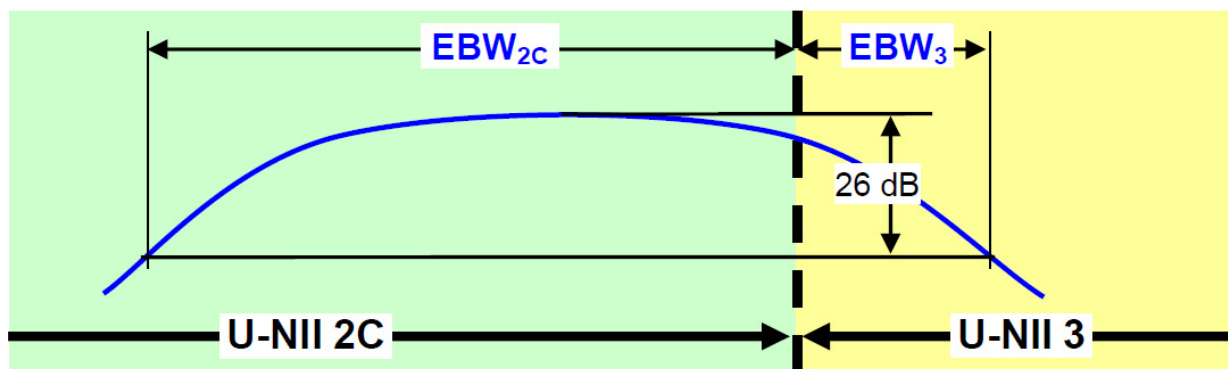

Figure 3. Emission Bandwidth (EBW) within a Band for Band-Crossing Signals

99% and 26dB Bandwidth Test Procedure

The 99-percent occupied bandwidth is the frequency bandwidth such that, below its lower and above its upper frequency limits, the mean powers are each equal to 0.5 % of the total mean power of the given emission. Measurement of the 99-percent occupied bandwidth is required only as a condition for using the optional band-edge measurement techniques described in section II.G.3.d). Measurements of 99-percent occupied bandwidth may also optionally be used in lieu of the EBW to define the minimum frequency range over which the spectrum is integrated when measuring maximum conducted output power as described in section II.E. However, the EBW must be measured to determine bandwidth dependent limits on maximum conducted output power in accordance with 15.407(a).

From KDB 789033 D02 General UNII Test Procedures New Rules v02r01

Section D. 99 Percent Occupied Bandwidth

99% BW Test Parameters
<ol style="list-style-type: none"> 1. Set center frequency to the nominal EUT channel center frequency. 2. Set span = 1.5 times to 5.0 times the OBW. 3. Set RBW = 1 % to 5 % of the OBW 4. Set VBW $\geq 3 \cdot$ RBW 5. Video averaging is not permitted. Where practical, a sample detection and single sweep mode shall be used. Otherwise, peak detection and max hold mode (until the trace stabilizes) shall be used. 6. Use the 99 % power bandwidth function of the instrument (if available).

From KDB 789033 D02 General UNII Test Procedures New Rules v02r01
Section C. Measurement Bandwidth, Section 1

26 BW
Test parameters
X dB BW = -26dB (using the OBW function of the spectrum analyzer) Emission Bandwidth (EBW) a) Set RBW = approximately 1% of the emission bandwidth. b) Set the VBW > RBW. c) Detector = Peak. d) Trace mode = max hold. e) Measure the maximum width of the emission that is 26 dB down from the maximum of the emission. Compare this with the RBW setting of the analyzer. Readjust RBW and repeat measurement as needed until the RBW/EBW ratio is approximately 1%.

Tested By: Ronak Patel	Date of testing: 11/1/2022 - 2/10/2023
Test Result: PASS	

Test Equipment

See Appendix C for list of test equipment

99% and 26dB Bandwidth Table

Frequency (MHz)	Mode	Data Rate (Mbps)	26dB BW (MHz)	99% BW (MHz)
5745	Non HT20, 6 to 54 Mbps	6.0	20.4	16.536
	HT/VHT20, M0 to M7	m0	21.7	17.757
	HE20, M0 to M11 1ss	m0h1	21.9	19.105
5755	Non HT40, 6 to 54 Mbps	6.0	58.7	36.176
	HT/VHT40, M0 to M7	m0	39.3	35.904
	HE40, M0 to M11 1ss	m0h1	39.6	37.672
5775	Non HT80, 6 to 54 Mbps	6.0	80.4	75.571
	VHT80, M0 to M11 1ss	m0x1	80.1	75.338
	HE80, M0 to M11 1ss	m0h1	81.0	77.199
5785	Non HT20, 6 to 54 Mbps	6.0	20.4	16.538
	HT/VHT20, M0 to M7	m0	21.7	17.749
	HE20, M0 to M11 1ss	m0h1	22.0	19.098
5795	Non HT40, 6 to 54 Mbps	6.0	61.3	36.212
	HT/VHT40, M0 to M7	m0	39.1	35.89
	HE40, M0 to M11 1ss	m0h1	40.0	37.624
5825	Non HT20, 6 to 54 Mbps	6.0	20.4	16.536
	HT/VHT20, M0 to M7	m0	21.5	17.755
	HE20, M0 to M11 1ss	m0h1	22.1	19.098

Data Screenshots

5745 MHz: HE20, M0 to M11 1ss

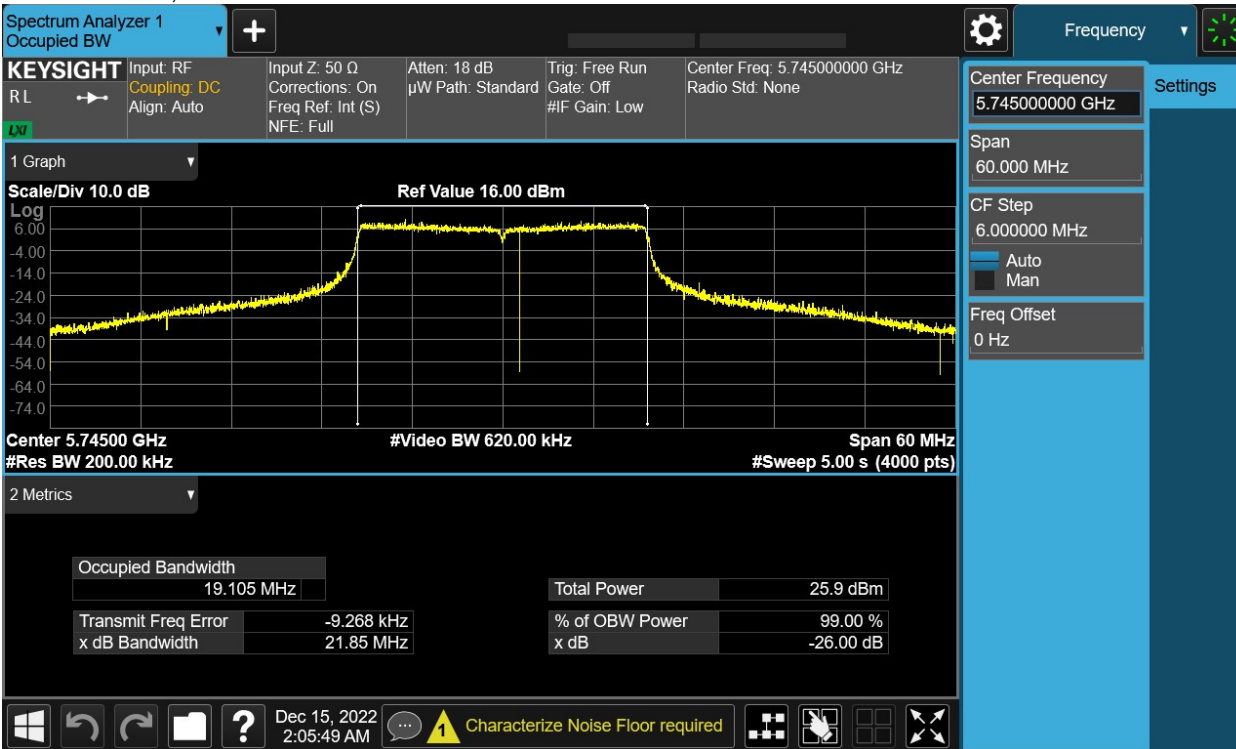

Antenna A

5755 MHz: HE40, M0 to M11 1ss

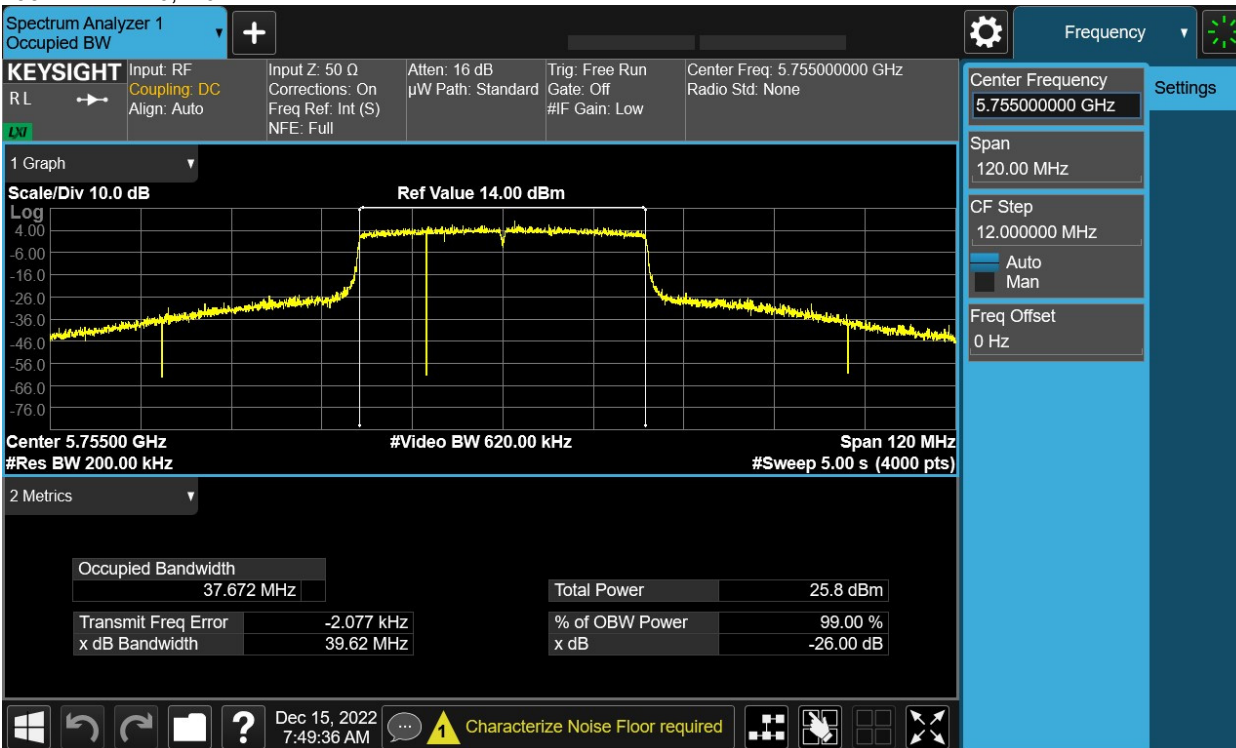

Antenna A

5775 MHz: HE80, M0 to M11 1ss

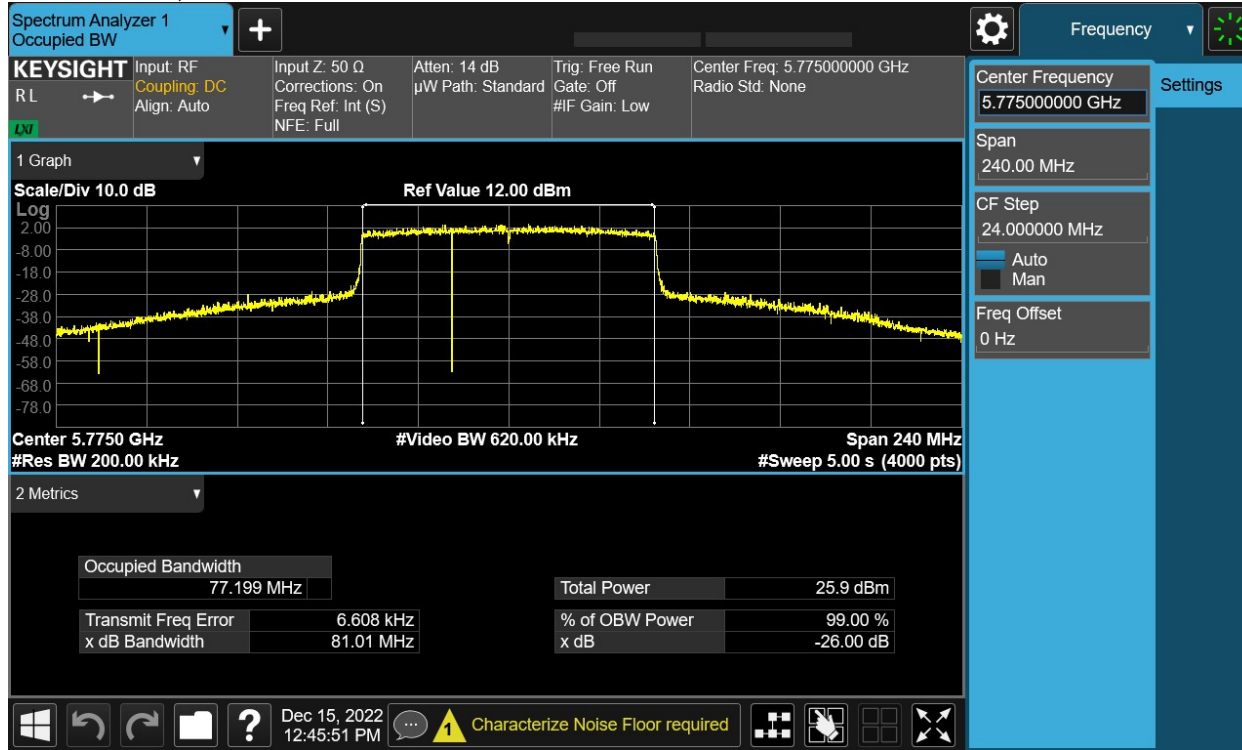

Antenna A

A.4: Maximum Conducted Output Power

Maximum Conducted Output Power Test Requirement

LP0002 (2020-07-01) (5.7.3.3):

For the 5.725 GHz~5.850 GHz band

- (1) The maximum conducted output power shall be less than or equal to 1 Watt.
- (3) Fixed point-to-point U-NII devices operating in this band may employ transmitting antennas with directional gain greater than 6 dBi without any corresponding reduction in transmitter conducted power.
- (4) In addition to (3), if transmitting antennas of directional gain greater than 6 dBi are used, both the maximum conducted output power and the maximum power spectral density shall be reduced by the amount in dBi that the directional gain of the antenna exceeds 6 dBi.

15.407 a) (3):

For the band 5.725-5.85 GHz, the maximum conducted output power over the frequency band of operation shall not exceed 1 W. If transmitting antennas of directional gain greater than 6 dBi are used, both the maximum conducted output power and the maximum power spectral density shall be reduced by the amount in dB that the directional gain of the antenna exceeds 6 dBi. However, fixed point-to-point U-NII devices operating in this band may employ transmitting antennas with directional gain greater than 6 dBi without any corresponding reduction in transmitter conducted power. Fixed, point-to-point operations exclude the use of point-to-multipoint systems, omnidirectional applications, and multiple collocated transmitters transmitting the same information. The operator of the U-NII device, or if the equipment is professionally installed, the installer, is responsible for ensuring that systems employing high gain directional antennas are used exclusively for fixed, point-to-point operations.

Band-Crossing Signals:

When measuring the portion of the maximum conducted output power within a single U-NII band, the power shall be integrated across only the portion of the EBW that falls within that band. That is, if an EBW extends across the boundary between two adjacent bands, the boundary frequency between the bands serves as one edge of the frequency range to be integrated. Integration across an entire U-NII band without regard to 26 dB points is also acceptable for determining conducted output power within that band.

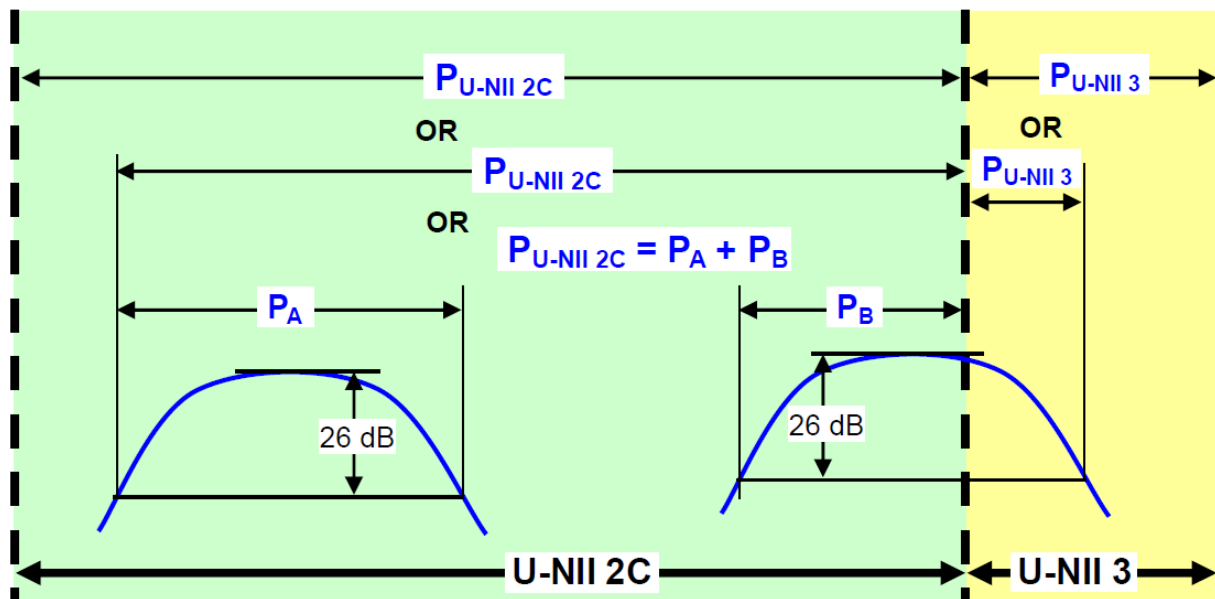

Conducted output power within a U-NII band: Integrate over the band or integrate over a span including the 26 dB EBWs of transmission segments within the band or integrate over 26 dB EBW of each transmission segment in the band and sum.

Figure 4. Conducted Output Power Measurement Examples

Maximum Conducted Output Power Test Procedure

Ref. KDB 789033 D02 General UNII Test Procedures New Rules v02r01
ANSI C63.10: 2013

Maximum Conducted Output Power Test Procedure
<ol style="list-style-type: none"> 1. Set the radio in the continuous transmitting mode at full power 2. Compute power by integrating the spectrum across the EBW (or alternatively entire 99% OBW) of the signal using the instrument's band power measurement function. The integration shall be performed using the spectrum analyzer band-power measurement function with band limits set equal to the EBW or the OBW band edges. 3. Capture graphs and record pertinent measurement data.

Ref. KDB 789033 D02 General UNII Test Procedures New Rules v02r01
2. Measurement using a Spectrum Analyzer or EMI Receiver (SA), (d) Method SA-2

Maximum Conducted Output Power Test parameters
<p>FCC, AUS/NZ, Taiwan, India: Method SA-2 (trace averaging across on and off times of the EUT transmissions, followed by duty cycle correction).</p> <ol style="list-style-type: none"> (i) Measure the duty cycle, x, of the transmitter output signal as described in section II.B. (ii) Set span to encompass the EBW (or, alternatively, the entire 99% occupied bandwidth) of the signal. (iii) Set RBW = 1 MHz. (iv) Set VBW \geq 3 MHz. (v) Number of points in sweep \geq 2 Span / RBW. (This ensures that bin-to-bin spacing is \leq RBW/2, so that narrowband signals are not lost between frequency bins.) (vi) Sweep time = auto. (vii) Detector = RMS (i.e., power averaging), if available. Otherwise, use sample detector mode. (viii) Do not use sweep triggering. Allow the sweep to "free run". (ix) Trace average at least 100 traces in power averaging (i.e., RMS) mode; however, the number of traces to be averaged shall be increased above 100 as needed to ensure that the average accurately represents the true average over the on and off periods of the transmitter. (x) Compute power by integrating the spectrum across the EBW (or, alternatively, the entire 99% occupied bandwidth) of the signal using the instrument's band power measurement function with band limits set equal to the EBW (or occupied bandwidth)

The "measure-and-sum technique" is used for measuring in-band transmit power of a device. In the measure-and-sum approach, the conducted emission level is measured at each antenna port. The measured results at the various antenna ports are then summed mathematically to determine the total emission level from the device. Summing is performed in linear power units. ANSI C63.10 section 14.3.2.2

Samples, Systems, and Modes

Tested By: Ronak Patel	Date of testing: 11/1/2022 - 2/10/2023
Test Result: PASS	

Test Equipment

See Appendix C for list of test equipment

Maximum Transmit EIRP – Antenna gain 3dBi.**Frequency 5745 MHz**

Mode	Tx Paths	Correlated Antenna Gain (dBi)	Tx 1 Max Power (dBm)	Tx 2 Max Power (dBm)	Duty Cycle (dB)	Total Tx Channel Power (dBm)	Limit (dBm)	Margin (dB)
Non HT20, 6 to 54 Mbps	1	3	17.5		0.36	20.8	36	15.18
Non HT20, 6 to 54 Mbps	2	3	17.5	17.6	0.36	23.9	36	12.08
Non HT20 Beam Forming, 6 to 54 Mbps	2	6	17.5	17.6	0.36	26.9	36	9.08
HT/VHT20, M0 to M7	1	3	17.4		0.35	20.7	36	15.27
HT/VHT20, M0 to M7	2	3	17.4	17.2	0.35	23.7	36	12.34
HT/VHT20, M8 to M15	2	3	17.4	17.2	0.35	23.7	36	12.34
HT/VHT20 Beam Forming, M0 to M7	2	6	17.4	17.2	0.35	26.7	36	9.34
HT/VHT20 Beam Forming, M8 to M15	2	3	17.4	17.2	0.35	23.7	36	12.34
HT/VHT20 STBC, M8 to M15	2	3	17.4	17.2	0.35	23.7	36	12.34
HE20, M0 to M11 1ss	1	3	18.2		0.33	21.5	36	14.52
HE20, M0 to M11 1ss	2	3	18.2	18.1	0.33	24.5	36	11.52
HE20, M0 to M11 2ss	2	3	18.2	18.1	0.33	24.5	36	11.52
HE20 Beam Forming, M0 to M11 1ss	2	6	18.2	18.1	0.33	27.5	36	8.52
HE20 Beam Forming, M0 to M11 2ss	2	3	18.2	18.1	0.33	24.5	36	11.52
HE20 STBC, M0 to M11 2ss	2	3	18.2	18.1	0.33	24.5	36	11.52

Frequency 5755 MHz

Mode	Tx Paths	Correlated Antenna Gain (dBi)	Tx 1 Max Power (dBm)	Tx 2 Max Power (dBm)	Duty Cycle (dB)	Total Tx Channel Power (dBm)	Limit (dBm)	Margin (dB)
Non HT40, 6 to 54 Mbps	1	3	17.5		0.28	20.8	36	15.19
Non HT40, 6 to 54 Mbps	2	3	17.5	17.5	0.28	23.8	36	12.21
HT/VHT40, M0 to M7	1	3	18.1		0.37	21.5	36	14.51
HT/VHT40, M0 to M7	2	3	18.1	17.8	0.37	24.3	36	11.65
HT/VHT40, M8 to M15	2	3	18.1	17.8	0.37	24.3	36	11.65
HT/VHT40 Beam Forming, M0 to M7	2	6	18.1	17.8	0.37	27.3	36	8.65
HT/VHT40 Beam Forming, M8 to M15	2	3	18.1	17.8	0.37	24.3	36	11.65
HT/VHT40 STBC, M8 to M15	2	3	18.1	17.8	0.37	24.3	36	11.65
HE40, M0 to M11 1ss	1	3	17.9		0.38	21.2	36	14.75
HE40, M0 to M11 1ss	2	3	17.9	17.7	0.38	24.2	36	11.83
HE40, M0 to M11 2ss	2	3	17.9	17.7	0.38	24.2	36	11.83
HE40 Beam Forming, M0 to M11 1ss	2	6	17.9	17.7	0.38	27.2	36	8.83
HE40 Beam Forming, M0 to M11 2ss	2	3	17.9	17.7	0.38	24.2	36	11.83
HE40 STBC, M0 to M11 2ss	2	3	17.9	17.7	0.38	24.2	36	11.83

Frequency 5775 MHz

Mode	Tx Paths	Correlated Antenna Gain (dBi)	Tx 1 Max Power (dBm)	Tx 2 Max Power (dBm)	Duty Cycle (dB)	Total Tx Channel Power (dBm)	Limit (dBm)	Margin (dB)
Non HT80, 6 to 54 Mbps	1	3	17.7		0.43	21.2	36	14.83
Non HT80, 6 to 54 Mbps	2	3	17.7	17.4	0.43	24.0	36	11.98
VHT80, M0 to M11 1ss	1	3	18.2		0.48	21.6	36	14.36
VHT80, M0 to M11 1ss	2	3	18.2	17.5	0.48	24.3	36	11.66
VHT80, M0 to M11 2ss	2	3	18.2	17.5	0.48	24.3	36	11.66
VHT80 Beam Forming, M0 to M11 1ss	2	6	18.2	17.5	0.48	27.3	36	8.66
VHT80 Beam Forming, M0 to M11 2ss	2	3	18.2	17.5	0.48	24.3	36	11.66
VHT80 STBC, M0 to M11 2ss	2	3	18.2	17.5	0.48	24.3	36	11.66
HE80, M0 to M11 1ss	1	3	18.3		0.31	21.6	36	14.38
HE80, M0 to M11 1ss	2	3	18.3	17.9	0.31	24.4	36	11.58
HE80, M0 to M11 2ss	2	3	18.3	17.9	0.31	24.4	36	11.58
HE80 Beam Forming, M0 to M11 1ss	2	6	18.3	17.9	0.31	27.4	36	8.58
HE80 Beam Forming, M0 to M11 2ss	2	3	18.3	17.9	0.31	24.4	36	11.58
HE80 STBC, M0 to M11 2ss	2	3	18.3	17.9	0.31	24.4	36	11.58

Frequency 5785 MHz

Mode	Tx Paths	Correlated Antenna Gain (dBi)	Tx 1 Max Power (dBm)	Tx 2 Max Power (dBm)	Duty Cycle (dB)	Total Tx Channel Power (dBm)	Limit (dBm)	Margin (dB)
Non HT20, 6 to 54 Mbps	1	3	17.6		0.36	21.0	36	15.02
Non HT20, 6 to 54 Mbps	2	3	17.6	17.2	0.36	23.8	36	12.22
Non HT20 Beam Forming, 6 to 54 Mbps	2	6	17.6	17.2	0.36	26.8	36	9.22
HT/VHT20, M0 to M7	1	3	17.3		0.35	20.7	36	15.33
HT/VHT20, M0 to M7	2	3	17.3	16.8	0.35	23.4	36	12.57
HT/VHT20, M8 to M15	2	3	17.3	16.8	0.35	23.4	36	12.57
HT/VHT20 Beam Forming, M0 to M7	2	6	17.3	16.8	0.35	26.4	36	9.57
HT/VHT20 Beam Forming, M8 to M15	2	3	17.3	16.8	0.35	23.4	36	12.57
HT/VHT20 STBC, M8 to M15	2	3	17.3	16.8	0.35	23.4	36	12.57
HE20, M0 to M11 1ss	1	3	17.8		0.33	21.2	36	14.84
HE20, M0 to M11 1ss	2	3	17.8	17.5	0.33	24.0	36	11.99
HE20, M0 to M11 2ss	2	3	17.8	17.5	0.33	24.0	36	11.99
HE20 Beam Forming, M0 to M11 1ss	2	6	17.8	17.5	0.33	27.0	36	8.99
HE20 Beam Forming, M0 to M11 2ss	2	3	17.8	17.5	0.33	24.0	36	11.99
HE20 STBC, M0 to M11 2ss	2	3	17.8	17.5	0.33	24.0	36	11.99

Frequency 5795 MHz

Mode	Tx Paths	Correlated Antenna Gain (dBi)	Tx 1 Max Power (dBm)	Tx 2 Max Power (dBm)	Duty Cycle (dB)	Total Tx Channel Power (dBm)	Limit (dBm)	Margin (dB)
Non HT40, 6 to 54 Mbps	1	3	17.4		0.28	20.7	36	15.31
Non HT40, 6 to 54 Mbps	2	3	17.4	17.2	0.28	23.6	36	12.41
HT/VHT40, M0 to M7	1	3	17.6		0.37	21.0	36	15.04
HT/VHT40, M0 to M7	2	3	17.6	17.1	0.37	23.8	36	12.25
HT/VHT40, M8 to M15	2	3	17.6	17.1	0.37	23.8	36	12.25
HT/VHT40 Beam Forming, M0 to M7	2	6	17.6	17.1	0.37	26.8	36	9.25
HT/VHT40 Beam Forming, M8 to M15	2	3	17.6	17.1	0.37	23.8	36	12.25
HT/VHT40 STBC, M8 to M15	2	3	17.6	17.1	0.37	23.8	36	12.25
HE40, M0 to M11 1ss	1	3	17.8		0.38	21.1	36	14.86
HE40, M0 to M11 1ss	2	3	17.8	17.5	0.38	24.0	36	11.96
HE40, M0 to M11 2ss	2	3	17.8	17.5	0.38	24.0	36	11.96
HE40 Beam Forming, M0 to M11 1ss	2	6	17.8	17.5	0.38	27.0	36	8.96
HE40 Beam Forming, M0 to M11 2ss	2	3	17.8	17.5	0.38	24.0	36	11.96
HE40 STBC, M0 to M11 2ss	2	3	17.8	17.5	0.38	24.0	36	11.96

Frequency 5825 MHz

Mode	Tx Paths	Correlated Antenna Gain (dBi)	Tx 1 Max Power (dBm)	Tx 2 Max Power (dBm)	Duty Cycle (dB)	Total Tx Channel Power (dBm)	Limit (dBm)	Margin (dB)
Non HT20, 6 to 54 Mbps	1	3	17.4		0.36	20.7	36	15.28
Non HT20, 6 to 54 Mbps	2	3	17.4	17.3	0.36	23.7	36	12.32
Non HT20 Beam Forming, 6 to 54 Mbps	2	6	17.4	17.3	0.36	26.7	36	9.32
HT/VHT20, M0 to M7	1	3	17.2		0.35	20.6	36	15.4
HT/VHT20, M0 to M7	2	3	17.2	17.1	0.35	23.5	36	12.47
HT/VHT20, M8 to M15	2	3	17.2	17.1	0.35	23.5	36	12.47
HT/VHT20 Beam Forming, M0 to M7	2	6	17.2	17.1	0.35	26.5	36	9.47
HT/VHT20 Beam Forming, M8 to M15	2	3	17.2	17.1	0.35	23.5	36	12.47
HT/VHT20 STBC, M8 to M15	2	3	17.2	17.1	0.35	23.5	36	12.47
HE20, M0 to M11 1ss	1	3	17.8		0.33	21.1	36	14.89
HE20, M0 to M11 1ss	2	3	17.8	17.7	0.33	24.1	36	11.91
HE20, M0 to M11 2ss	2	3	17.8	17.7	0.33	24.1	36	11.91
HE20 Beam Forming, M0 to M11 1ss	2	6	17.8	17.7	0.33	27.1	36	8.91
HE20 Beam Forming, M0 to M11 2ss	2	3	17.8	17.7	0.33	24.1	36	11.91
HE20 STBC, M0 to M11 2ss	2	3	17.8	17.7	0.33	24.1	36	11.91

Maximum Transmit EIRP – Antenna gain 8dBi.**Frequency 5745 MHz**

Mode	Tx Paths	Correlated Antenna Gain (dBi)	Tx 1 Max Power (dBm)	Tx 2 Max Power (dBm)	Duty Cycle (dB)	Total Tx Channel Power (dBm)	Limit (dBm)	Margin (dB)
Non HT20, 6 to 54 Mbps	1	8	17.5		0.36	25.8	36	10.18
Non HT20, 6 to 54 Mbps	2	8	17.5	17.6	0.36	28.9	36	7.08
Non HT20 Beam Forming, 6 to 54 Mbps	2	11	17.5	17.6	0.36	31.9	36	4.08
HT/VHT20, M0 to M7	1	8	17.4		0.35	25.7	36	10.27
HT/VHT20, M0 to M7	2	8	17.4	17.2	0.35	28.7	36	7.34
HT/VHT20, M8 to M15	2	8	17.4	17.2	0.35	28.7	36	7.34
HT/VHT20 Beam Forming, M0 to M7	2	11	17.4	17.2	0.35	31.7	36	4.34
HT/VHT20 Beam Forming, M8 to M15	2	8	17.4	17.2	0.35	28.7	36	7.34
HT/VHT20 STBC, M8 to M15	2	8	17.4	17.2	0.35	28.7	36	7.34
HE20, M0 to M11 1ss	1	8	18.2		0.33	26.5	36	9.52
HE20, M0 to M11 1ss	2	8	18.2	18.1	0.33	29.5	36	6.52
HE20, M0 to M11 2ss	2	8	18.2	18.1	0.33	29.5	36	6.52
HE20 Beam Forming, M0 to M11 1ss	2	11	18.2	18.1	0.33	32.5	36	3.52
HE20 Beam Forming, M0 to M11 2ss	2	8	18.2	18.1	0.33	29.5	36	6.52
HE20 STBC, M0 to M11 2ss	2	8	18.2	18.1	0.33	29.5	36	6.52

Frequency 5755 MHz

Mode	Tx Paths	Correlated Antenna Gain (dBi)	Tx 1 Max Power (dBm)	Tx 2 Max Power (dBm)	Duty Cycle (dB)	Total Tx Channel Power (dBm)	Limit (dBm)	Margin (dB)
Non HT40, 6 to 54 Mbps	1	8	17.5		0.28	25.8	36	10.19
Non HT40, 6 to 54 Mbps	2	8	17.5	17.5	0.28	28.8	36	7.21
HT/VHT40, M0 to M7	1	8	18.1		0.37	26.5	36	9.51
HT/VHT40, M0 to M7	2	8	18.1	17.8	0.37	29.3	36	6.65
HT/VHT40, M8 to M15	2	8	18.1	17.8	0.37	29.3	36	6.65
HT/VHT40 Beam Forming, M0 to M7	2	11	18.1	17.8	0.37	32.3	36	3.65
HT/VHT40 Beam Forming, M8 to M15	2	8	18.1	17.8	0.37	29.3	36	6.65
HT/VHT40 STBC, M8 to M15	2	8	18.1	17.8	0.37	29.3	36	6.65
HE40, M0 to M11 1ss	1	8	17.9		0.38	26.2	36	9.75
HE40, M0 to M11 1ss	2	8	17.9	17.7	0.38	29.2	36	6.83
HE40, M0 to M11 2ss	2	8	17.9	17.7	0.38	29.2	36	6.83
HE40 Beam Forming, M0 to M11 1ss	2	11	17.9	17.7	0.38	32.2	36	3.83
HE40 Beam Forming, M0 to M11 2ss	2	8	17.9	17.7	0.38	29.2	36	6.83
HE40 STBC, M0 to M11 2ss	2	8	17.9	17.7	0.38	29.2	36	6.83

Frequency 5775 MHz

Mode	Tx Paths	Correlated Antenna Gain (dBi)	Tx 1 Max Power (dBm)	Tx 2 Max Power (dBm)	Duty Cycle (dB)	Total Tx Channel Power (dBm)	Limit (dBm)	Margin (dB)
Non HT80, 6 to 54 Mbps	1	8	17.7		0.43	26.2	36	9.83
Non HT80, 6 to 54 Mbps	2	8	17.7	17.4	0.43	29.0	36	6.98
VHT80, M0 to M11 1ss	1	8	18.2		0.48	26.6	36	9.36
VHT80, M0 to M11 1ss	2	8	18.2	17.5	0.48	29.3	36	6.66
VHT80, M0 to M11 2ss	2	8	18.2	17.5	0.48	29.3	36	6.66
VHT80 Beam Forming, M0 to M11 1ss	2	11	18.2	17.5	0.48	32.3	36	3.66
VHT80 Beam Forming, M0 to M11 2ss	2	8	18.2	17.5	0.48	29.3	36	6.66
VHT80 STBC, M0 to M11 2ss	2	8	18.2	17.5	0.48	29.3	36	6.66
HE80, M0 to M11 1ss	1	8	18.3		0.31	26.6	36	9.38
HE80, M0 to M11 1ss	2	8	18.3	17.9	0.31	29.4	36	6.58
HE80, M0 to M11 2ss	2	8	18.3	17.9	0.31	29.4	36	6.58
HE80 Beam Forming, M0 to M11 1ss	2	11	18.3	17.9	0.31	32.4	36	3.58
HE80 Beam Forming, M0 to M11 2ss	2	8	18.3	17.9	0.31	29.4	36	6.58
HE80 STBC, M0 to M11 2ss	2	8	18.3	17.9	0.31	29.4	36	6.58

Frequency 5785 MHz

Mode	Tx Paths	Correlated Antenna Gain (dBi)	Tx 1 Max Power (dBm)	Tx 2 Max Power (dBm)	Duty Cycle (dB)	Total Tx Channel Power (dBm)	Limit (dBm)	Margin (dB)
Non HT20, 6 to 54 Mbps	1	8	17.6		0.36	26.0	36	10.02
Non HT20, 6 to 54 Mbps	2	8	17.6	17.2	0.36	28.8	36	7.22
Non HT20 Beam Forming, 6 to 54 Mbps	2	11	17.6	17.2	0.36	31.8	36	4.22
HT/VHT20, M0 to M7	1	8	17.3		0.35	25.7	36	10.33
HT/VHT20, M0 to M7	2	8	17.3	16.8	0.35	28.4	36	7.57
HT/VHT20, M8 to M15	2	8	17.3	16.8	0.35	28.4	36	7.57
HT/VHT20 Beam Forming, M0 to M7	2	11	17.3	16.8	0.35	31.4	36	4.57
HT/VHT20 Beam Forming, M8 to M15	2	8	17.3	16.8	0.35	28.4	36	7.57
HT/VHT20 STBC, M8 to M15	2	8	17.3	16.8	0.35	28.4	36	7.57
HE20, M0 to M11 1ss	1	8	17.8		0.33	26.2	36	9.84
HE20, M0 to M11 1ss	2	8	17.8	17.5	0.33	29.0	36	6.99
HE20, M0 to M11 2ss	2	8	17.8	17.5	0.33	29.0	36	6.99
HE20 Beam Forming, M0 to M11 1ss	2	11	17.8	17.5	0.33	32.0	36	3.99
HE20 Beam Forming, M0 to M11 2ss	2	8	17.8	17.5	0.33	29.0	36	6.99
HE20 STBC, M0 to M11 2ss	2	8	17.8	17.5	0.33	29.0	36	6.99

Frequency 5795 MHz

Mode	Tx Paths	Correlated Antenna Gain (dBi)	Tx 1 Max Power (dBm)	Tx 2 Max Power (dBm)	Duty Cycle (dB)	Total Tx Channel Power (dBm)	Limit (dBm)	Margin (dB)
Non HT40, 6 to 54 Mbps	1	8	17.4		0.28	25.7	36	10.31
Non HT40, 6 to 54 Mbps	2	8	17.4	17.2	0.28	28.6	36	7.41
HT/VHT40, M0 to M7	1	8	17.6		0.37	26.0	36	10.04
HT/VHT40, M0 to M7	2	8	17.6	17.1	0.37	28.8	36	7.25
HT/VHT40, M8 to M15	2	8	17.6	17.1	0.37	28.8	36	7.25
HT/VHT40 Beam Forming, M0 to M7	2	11	17.6	17.1	0.37	31.8	36	4.25
HT/VHT40 Beam Forming, M8 to M15	2	8	17.6	17.1	0.37	28.8	36	7.25
HT/VHT40 STBC, M8 to M15	2	8	17.6	17.1	0.37	28.8	36	7.25
HE40, M0 to M11 1ss	1	8	17.8		0.38	26.1	36	9.86
HE40, M0 to M11 1ss	2	8	17.8	17.5	0.38	29.0	36	6.96
HE40, M0 to M11 2ss	2	8	17.8	17.5	0.38	29.0	36	6.96
HE40 Beam Forming, M0 to M11 1ss	2	11	17.8	17.5	0.38	32.0	36	3.96
HE40 Beam Forming, M0 to M11 2ss	2	8	17.8	17.5	0.38	29.0	36	6.96
HE40 STBC, M0 to M11 2ss	2	8	17.8	17.5	0.38	29.0	36	6.96

Frequency 5825 MHz

Mode	Tx Paths	Correlated Antenna Gain (dBi)	Tx 1 Max Power (dBm)	Tx 2 Max Power (dBm)	Duty Cycle (dB)	Total Tx Channel Power (dBm)	Limit (dBm)	Margin (dB)
Non HT20, 6 to 54 Mbps	1	8	17.4		0.36	25.7	36	10.28
Non HT20, 6 to 54 Mbps	2	8	17.4	17.3	0.36	28.7	36	7.32
Non HT20 Beam Forming, 6 to 54 Mbps	2	11	17.4	17.3	0.36	31.7	36	4.32
HT/VHT20, M0 to M7	1	8	17.2		0.35	25.6	36	10.4
HT/VHT20, M0 to M7	2	8	17.2	17.1	0.35	28.5	36	7.47
HT/VHT20, M8 to M15	2	8	17.2	17.1	0.35	28.5	36	7.47
HT/VHT20 Beam Forming, M0 to M7	2	11	17.2	17.1	0.35	31.5	36	4.47
HT/VHT20 Beam Forming, M8 to M15	2	8	17.2	17.1	0.35	28.5	36	7.47
HT/VHT20 STBC, M8 to M15	2	8	17.2	17.1	0.35	28.5	36	7.47
HE20, M0 to M11 1ss	1	8	17.8		0.33	26.1	36	9.89
HE20, M0 to M11 1ss	2	8	17.8	17.7	0.33	29.1	36	6.91
HE20, M0 to M11 2ss	2	8	17.8	17.7	0.33	29.1	36	6.91
HE20 Beam Forming, M0 to M11 1ss	2	11	17.8	17.7	0.33	32.1	36	3.91
HE20 Beam Forming, M0 to M11 2ss	2	8	17.8	17.7	0.33	29.1	36	6.91
HE20 STBC, M0 to M11 2ss	2	8	17.8	17.7	0.33	29.1	36	6.91

Maximum Transmit EIRP – Antenna gain 15dBi.**Frequency 5745 MHz**

Mode	Tx Paths	Correlated Antenna Gain (dBi)	Tx 1 Max Power (dBm)	Tx 2 Max Power (dBm)	Duty Cycle (dB)	Total Tx Channel Power (dBm)	Limit (dBm)	Margin (dB)
Non HT20, 6 to 54 Mbps	1	15	17.5		0.36	32.8	36	3.18
Non HT20, 6 to 54 Mbps	2	15	17.5	17.6	0.36	35.9	36	0.08
Non HT20 Beam Forming, 6 to 54 Mbps	2	15	17.5	17.6	0.36	35.9	36	0.08
HT/VHT20, M0 to M7	1	15	17.4		0.35	32.7	36	3.27
HT/VHT20, M0 to M7	2	15	17.4	17.2	0.35	35.7	36	0.34
HT/VHT20, M8 to M15	2	15	17.4	17.2	0.35	35.7	36	0.34
HT/VHT20 Beam Forming, M0 to M7	2	15	17.4	17.2	0.35	35.7	36	0.34
HT/VHT20 Beam Forming, M8 to M15	2	15	17.4	17.2	0.35	35.7	36	0.34
HT/VHT20 STBC, M8 to M15	2	15	17.4	17.2	0.35	35.7	36	0.34
HE20, M0 to M11 1ss	1	15	18.2		0.33	33.5	36	2.52
HE20, M0 to M11 1ss	2	15	17.2	17.0	0.33	35.4	36	0.58
HE20, M0 to M11 2ss	2	15	17.2	17.0	0.33	35.4	36	0.58
HE20 Beam Forming, M0 to M11 1ss	2	15	17.2	17.0	0.33	35.4	36	0.58
HE20 Beam Forming, M0 to M11 2ss	2	15	17.2	17.0	0.33	35.4	36	0.58
HE20 STBC, M0 to M11 2ss	2	15	17.2	17.0	0.33	35.4	36	0.58

Frequency 5755 MHz

Mode	Tx Paths	Correlated Antenna Gain (dBi)	Tx 1 Max Power (dBm)	Tx 2 Max Power (dBm)	Duty Cycle (dB)	Total Tx Channel Power (dBm)	Limit (dBm)	Margin (dB)
Non HT40, 6 to 54 Mbps	1	15	17.5		0.28	32.8	36	3.19
Non HT40, 6 to 54 Mbps	2	15	17.5	17.5	0.28	35.8	36	0.21
HT/VHT40, M0 to M7	1	15	18.1		0.37	33.5	36	2.51
HT/VHT40, M0 to M7	2	15	17.0	16.9	0.37	35.3	36	0.67
HT/VHT40, M8 to M15	2	15	17.0	16.9	0.37	35.3	36	0.67
HT/VHT40 Beam Forming, M0 to M7	2	15	17.0	16.9	0.37	35.3	36	0.67
HT/VHT40 Beam Forming, M8 to M15	2	15	17.0	16.9	0.37	35.3	36	0.67
HT/VHT40 STBC, M8 to M15	2	15	17.0	16.9	0.37	35.3	36	0.67
HE40, M0 to M11 1ss	1	15	17.9		0.38	33.2	36	2.75
HE40, M0 to M11 1ss	2	15	16.8	16.6	0.38	35.1	36	0.93
HE40, M0 to M11 2ss	2	15	16.8	16.6	0.38	35.1	36	0.93
HE40 Beam Forming, M0 to M11 1ss	2	15	16.8	16.6	0.38	35.1	36	0.93
HE40 Beam Forming, M0 to M11 2ss	2	15	16.8	16.6	0.38	35.1	36	0.93
HE40 STBC, M0 to M11 2ss	2	15	16.8	16.6	0.38	35.1	36	0.93

Frequency 5775 MHz

Mode	Tx Paths	Correlated Antenna Gain (dBi)	Tx 1 Max Power (dBm)	Tx 2 Max Power (dBm)	Duty Cycle (dB)	Total Tx Channel Power (dBm)	Limit (dBm)	Margin (dB)
Non HT80, 6 to 54 Mbps	1	15	17.7		0.43	33.2	36	2.83
Non HT80, 6 to 54 Mbps	2	15	16.9	16.6	0.43	35.2	36	0.76
VHT80, M0 to M11 1ss	1	15	18.2		0.48	33.6	36	2.36
VHT80, M0 to M11 1ss	2	15	16.9	16.6	0.48	35.2	36	0.77
VHT80, M0 to M11 2ss	2	15	16.9	16.6	0.48	35.2	36	0.77
VHT80 Beam Forming, M0 to M11 1ss	2	15	16.9	16.6	0.48	35.2	36	0.77
VHT80 Beam Forming, M0 to M11 2ss	2	15	16.9	16.6	0.48	35.2	36	0.77
VHT80 STBC, M0 to M11 2ss	2	15	16.9	16.6	0.48	35.2	36	0.77
HE80, M0 to M11 1ss	1	15	18.3		0.31	33.6	36	2.38
HE80, M0 to M11 1ss	2	15	17.2	16.9	0.31	35.4	36	0.6
HE80, M0 to M11 2ss	2	15	17.2	16.9	0.31	35.4	36	0.6
HE80 Beam Forming, M0 to M11 1ss	2	15	17.2	16.9	0.31	35.4	36	0.6
HE80 Beam Forming, M0 to M11 2ss	2	15	17.2	16.9	0.31	35.4	36	0.6
HE80 STBC, M0 to M11 2ss	2	15	17.2	16.9	0.31	35.4	36	0.6

Frequency 5785 MHz

Mode	Tx Paths	Correlated Antenna Gain (dBi)	Tx 1 Max Power (dBm)	Tx 2 Max Power (dBm)	Duty Cycle (dB)	Total Tx Channel Power (dBm)	Limit (dBm)	Margin (dB)
Non HT20, 6 to 54 Mbps	1	15	17.6		0.36	33.0	36	3.02
Non HT20, 6 to 54 Mbps	2	15	17.6	17.2	0.36	35.8	36	0.22
Non HT20 Beam Forming, 6 to 54 Mbps	2	15	17.6	17.2	0.36	35.8	36	0.22
HT/VHT20, M0 to M7	1	15	17.3		0.35	32.7	36	3.33
HT/VHT20, M0 to M7	2	15	17.3	16.8	0.35	35.4	36	0.57
HT/VHT20, M8 to M15	2	15	17.3	16.8	0.35	35.4	36	0.57
HT/VHT20 Beam Forming, M0 to M7	2	15	17.3	16.8	0.35	35.4	36	0.57
HT/VHT20 Beam Forming, M8 to M15	2	15	17.3	16.8	0.35	35.4	36	0.57
HT/VHT20 STBC, M8 to M15	2	15	17.3	16.8	0.35	35.4	36	0.57
HE20, M0 to M11 1ss	1	15	17.8		0.33	33.2	36	2.84
HE20, M0 to M11 1ss	2	15	16.9	16.5	0.33	35.1	36	0.93
HE20, M0 to M11 2ss	2	15	16.9	16.5	0.33	35.1	36	0.93
HE20 Beam Forming, M0 to M11 1ss	2	15	16.9	16.5	0.33	35.1	36	0.93
HE20 Beam Forming, M0 to M11 2ss	2	15	16.9	16.5	0.33	35.1	36	0.93
HE20 STBC, M0 to M11 2ss	2	15	16.9	16.5	0.33	35.1	36	0.93

Frequency 5795 MHz

Mode	Tx Paths	Correlated Antenna Gain (dBi)	Tx 1 Max Power (dBm)	Tx 2 Max Power (dBm)	Duty Cycle (dB)	Total Tx Channel Power (dBm)	Limit (dBm)	Margin (dB)
Non HT40, 6 to 54 Mbps	1	15	17.4		0.28	32.7	36	3.31
Non HT40, 6 to 54 Mbps	2	15	17.4	17.2	0.28	35.6	36	0.41
HT/VHT40, M0 to M7	1	15	17.6		0.37	33.0	36	3.04
HT/VHT40, M0 to M7	2	15	17.6	17.1	0.37	35.8	36	0.25
HT/VHT40, M8 to M15	2	15	17.6	17.1	0.37	35.8	36	0.25
HT/VHT40 Beam Forming, M0 to M7	2	15	17.6	17.1	0.37	35.8	36	0.25
HT/VHT40 Beam Forming, M8 to M15	2	15	17.6	17.1	0.37	35.8	36	0.25
HT/VHT40 STBC, M8 to M15	2	15	17.6	17.1	0.37	35.8	36	0.25
HE40, M0 to M11 1ss	1	15	17.8		0.38	33.1	36	2.86
HE40, M0 to M11 1ss	2	15	16.8	16.5	0.38	35.0	36	0.96
HE40, M0 to M11 2ss	2	15	16.8	16.5	0.38	35.0	36	0.96
HE40 Beam Forming, M0 to M11 1ss	2	15	16.8	16.5	0.38	35.0	36	0.96
HE40 Beam Forming, M0 to M11 2ss	2	15	16.8	16.5	0.38	35.0	36	0.96
HE40 STBC, M0 to M11 2ss	2	15	16.8	16.5	0.38	35.0	36	0.96

Frequency 5825 MHz

Mode	Tx Paths	Correlated Antenna Gain (dBi)	Tx 1 Max Power (dBm)	Tx 2 Max Power (dBm)	Duty Cycle (dB)	Total Tx Channel Power (dBm)	Limit (dBm)	Margin (dB)
Non HT20, 6 to 54 Mbps	1	15	17.4		0.36	32.7	36	3.28
Non HT20, 6 to 54 Mbps	2	15	17.4	17.3	0.36	35.7	36	0.32
Non HT20 Beam Forming, 6 to 54 Mbps	2	15	17.4	17.3	0.36	35.7	36	0.32
HT/VHT20, M0 to M7	1	15	17.2		0.35	32.6	36	3.4
HT/VHT20, M0 to M7	2	15	17.2	17.1	0.35	35.5	36	0.47
HT/VHT20, M8 to M15	2	15	17.2	17.1	0.35	35.5	36	0.47
HT/VHT20 Beam Forming, M0 to M7	2	15	17.2	17.1	0.35	35.5	36	0.47
HT/VHT20 Beam Forming, M8 to M15	2	15	17.2	17.1	0.35	35.5	36	0.47
HT/VHT20 STBC, M8 to M15	2	15	17.2	17.1	0.35	35.5	36	0.47
HE20, M0 to M11 1ss	1	15	17.8		0.33	33.1	36	2.89
HE20, M0 to M11 1ss	2	15	16.8	16.8	0.33	35.1	36	0.88
HE20, M0 to M11 2ss	2	15	16.8	16.8	0.33	35.1	36	0.88
HE20 Beam Forming, M0 to M11 1ss	2	15	16.8	16.8	0.33	35.1	36	0.88
HE20 Beam Forming, M0 to M11 2ss	2	15	16.8	16.8	0.33	35.1	36	0.88
HE20 STBC, M0 to M11 2ss	2	15	16.8	16.8	0.33	35.1	36	0.88

Maximum Conducted Power Tables – Antenna gain 3dBi.**Frequency 5745 MHz**

Mode	Tx Paths	Correlated Antenna Gain (dBi)	Tx 1 Max Power (dBm)	Tx 2 Max Power (dBm)	Duty Cycle (dB)	Total Tx Channel Power (dBm)	Limit (dBm)	Margin (dB)
Non HT20, 6 to 54 Mbps	1	3	17.5		0.36	17.8	30	12.18
Non HT20, 6 to 54 Mbps	2	3	17.5	17.6	0.36	20.9	30	9.08
Non HT20 Beam Forming, 6 to 54 Mbps	2	6	17.5	17.6	0.36	20.9	30	9.08
HT/VHT20, M0 to M7	1	3	17.4		0.35	17.7	30	12.27
HT/VHT20, M0 to M7	2	3	17.4	17.2	0.35	20.7	30	9.34
HT/VHT20, M8 to M15	2	3	17.4	17.2	0.35	20.7	30	9.34
HT/VHT20 Beam Forming, M0 to M7	2	6	17.4	17.2	0.35	20.7	30	9.34
HT/VHT20 Beam Forming, M8 to M15	2	3	17.4	17.2	0.35	20.7	30	9.34
HT/VHT20 STBC, M8 to M15	2	3	17.4	17.2	0.35	20.7	30	9.34
HE20, M0 to M11 1ss	1	3	18.2		0.33	18.5	30	11.52
HE20, M0 to M11 1ss	2	3	18.2	18.1	0.33	21.5	30	8.52
HE20, M0 to M11 2ss	2	3	18.2	18.1	0.33	21.5	30	8.52
HE20 Beam Forming, M0 to M11 1ss	2	6	18.2	18.1	0.33	21.5	30	8.52
HE20 Beam Forming, M0 to M11 2ss	2	3	18.2	18.1	0.33	21.5	30	8.52
HE20 STBC, M0 to M11 2ss	2	3	18.2	18.1	0.33	21.5	30	8.52

Frequency 5755 MHz

Mode	Tx Paths	Correlated Antenna Gain (dBi)	Tx 1 Max Power (dBm)	Tx 2 Max Power (dBm)	Duty Cycle (dB)	Total Tx Channel Power (dBm)	Limit (dBm)	Margin (dB)
Non HT40, 6 to 54 Mbps	1	3	17.5		0.28	17.8	30	12.19
Non HT40, 6 to 54 Mbps	2	3	17.5	17.5	0.28	20.8	30	9.21
HT/VHT40, M0 to M7	1	3	18.1		0.37	18.5	30	11.51
HT/VHT40, M0 to M7	2	3	18.1	17.8	0.37	21.3	30	8.65
HT/VHT40, M8 to M15	2	3	18.1	17.8	0.37	21.3	30	8.65
HT/VHT40 Beam Forming, M0 to M7	2	6	18.1	17.8	0.37	21.3	30	8.65
HT/VHT40 Beam Forming, M8 to M15	2	3	18.1	17.8	0.37	21.3	30	8.65
HT/VHT40 STBC, M8 to M15	2	3	18.1	17.8	0.37	21.3	30	8.65
HE40, M0 to M11 1ss	1	3	17.9		0.38	18.2	30	11.75
HE40, M0 to M11 1ss	2	3	17.9	17.7	0.38	21.2	30	8.83
HE40, M0 to M11 2ss	2	3	17.9	17.7	0.38	21.2	30	8.83
HE40 Beam Forming, M0 to M11 1ss	2	6	17.9	17.7	0.38	21.2	30	8.83
HE40 Beam Forming, M0 to M11 2ss	2	3	17.9	17.7	0.38	21.2	30	8.83
HE40 STBC, M0 to M11 2ss	2	3	17.9	17.7	0.38	21.2	30	8.83

Frequency 5775 MHz

Mode	Tx Paths	Correlated Antenna Gain (dBi)	Tx 1 Max Power (dBm)	Tx 2 Max Power (dBm)	Duty Cycle (dB)	Total Tx Channel Power (dBm)	Limit (dBm)	Margin (dB)
Non HT80, 6 to 54 Mbps	1	3	17.7		0.43	18.2	30	11.83
Non HT80, 6 to 54 Mbps	2	3	17.7	17.4	0.43	21.0	30	8.98
VHT80, M0 to M11 1ss	1	3	18.2		0.48	18.6	30	11.36
VHT80, M0 to M11 1ss	2	3	18.2	17.5	0.48	21.3	30	8.66
VHT80, M0 to M11 2ss	2	3	18.2	17.5	0.48	21.3	30	8.66
VHT80 Beam Forming, M0 to M11 1ss	2	6	18.2	17.5	0.48	21.3	30	8.66
VHT80 Beam Forming, M0 to M11 2ss	2	3	18.2	17.5	0.48	21.3	30	8.66
VHT80 STBC, M0 to M11 2ss	2	3	18.2	17.5	0.48	21.3	30	8.66
HE80, M0 to M11 1ss	1	3	18.3		0.31	18.6	30	11.38
HE80, M0 to M11 1ss	2	3	18.3	17.9	0.31	21.4	30	8.58
HE80, M0 to M11 2ss	2	3	18.3	17.9	0.31	21.4	30	8.58
HE80 Beam Forming, M0 to M11 1ss	2	6	18.3	17.9	0.31	21.4	30	8.58
HE80 Beam Forming, M0 to M11 2ss	2	3	18.3	17.9	0.31	21.4	30	8.58
HE80 STBC, M0 to M11 2ss	2	3	18.3	17.9	0.31	21.4	30	8.58

Frequency 5785 MHz

Mode	Tx Paths	Correlated Antenna Gain (dBi)	Tx 1 Max Power (dBm)	Tx 2 Max Power (dBm)	Duty Cycle (dB)	Total Tx Channel Power (dBm)	Limit (dBm)	Margin (dB)
Non HT20, 6 to 54 Mbps	1	3	17.6		0.36	18.0	30	12.02
Non HT20, 6 to 54 Mbps	2	3	17.6	17.2	0.36	20.8	30	9.22
Non HT20 Beam Forming, 6 to 54 Mbps	2	6	17.6	17.2	0.36	20.8	30	9.22
HT/VHT20, M0 to M7	1	3	17.3		0.35	17.7	30	12.33
HT/VHT20, M0 to M7	2	3	17.3	16.8	0.35	20.4	30	9.57
HT/VHT20, M8 to M15	2	3	17.3	16.8	0.35	20.4	30	9.57
HT/VHT20 Beam Forming, M0 to M7	2	6	17.3	16.8	0.35	20.4	30	9.57
HT/VHT20 Beam Forming, M8 to M15	2	3	17.3	16.8	0.35	20.4	30	9.57
HT/VHT20 STBC, M8 to M15	2	3	17.3	16.8	0.35	20.4	30	9.57
HE20, M0 to M11 1ss	1	3	17.8		0.33	18.2	30	11.84
HE20, M0 to M11 1ss	2	3	17.8	17.5	0.33	21.0	30	8.99
HE20, M0 to M11 2ss	2	3	17.8	17.5	0.33	21.0	30	8.99
HE20 Beam Forming, M0 to M11 1ss	2	6	17.8	17.5	0.33	21.0	30	8.99
HE20 Beam Forming, M0 to M11 2ss	2	3	17.8	17.5	0.33	21.0	30	8.99
HE20 STBC, M0 to M11 2ss	2	3	17.8	17.5	0.33	21.0	30	8.99

Frequency 5795 MHz

Mode	Tx Paths	Correlated Antenna Gain (dBi)	Tx 1 Max Power (dBm)	Tx 2 Max Power (dBm)	Duty Cycle (dB)	Total Tx Channel Power (dBm)	Limit (dBm)	Margin (dB)
Non HT40, 6 to 54 Mbps	1	3	17.4		0.28	17.7	30	12.31
Non HT40, 6 to 54 Mbps	2	3	17.4	17.2	0.28	20.6	30	9.41
HT/VHT40, M0 to M7	1	3	17.6		0.37	18.0	30	12.04
HT/VHT40, M0 to M7	2	3	17.6	17.1	0.37	20.8	30	9.25
HT/VHT40, M8 to M15	2	3	17.6	17.1	0.37	20.8	30	9.25
HT/VHT40 Beam Forming, M0 to M7	2	6	17.6	17.1	0.37	20.8	30	9.25
HT/VHT40 Beam Forming, M8 to M15	2	3	17.6	17.1	0.37	20.8	30	9.25
HT/VHT40 STBC, M8 to M15	2	3	17.6	17.1	0.37	20.8	30	9.25
HE40, M0 to M11 1ss	1	3	17.8		0.38	18.1	30	11.86
HE40, M0 to M11 1ss	2	3	17.8	17.5	0.38	21.0	30	8.96
HE40, M0 to M11 2ss	2	3	17.8	17.5	0.38	21.0	30	8.96
HE40 Beam Forming, M0 to M11 1ss	2	6	17.8	17.5	0.38	21.0	30	8.96
HE40 Beam Forming, M0 to M11 2ss	2	3	17.8	17.5	0.38	21.0	30	8.96
HE40 STBC, M0 to M11 2ss	2	3	17.8	17.5	0.38	21.0	30	8.96

Frequency 5825 MHz

Mode	Tx Paths	Correlated Antenna Gain (dBi)	Tx 1 Max Power (dBm)	Tx 2 Max Power (dBm)	Duty Cycle (dB)	Total Tx Channel Power (dBm)	Limit (dBm)	Margin (dB)
Non HT20, 6 to 54 Mbps	1	3	17.4		0.36	17.7	30	12.28
Non HT20, 6 to 54 Mbps	2	3	17.4	17.3	0.36	20.7	30	9.32
Non HT20 Beam Forming, 6 to 54 Mbps	2	6	17.4	17.3	0.36	20.7	30	9.32
HT/VHT20, M0 to M7	1	3	17.2		0.35	17.6	30	12.4
HT/VHT20, M0 to M7	2	3	17.2	17.1	0.35	20.5	30	9.47
HT/VHT20, M8 to M15	2	3	17.2	17.1	0.35	20.5	30	9.47
HT/VHT20 Beam Forming, M0 to M7	2	6	17.2	17.1	0.35	20.5	30	9.47
HT/VHT20 Beam Forming, M8 to M15	2	3	17.2	17.1	0.35	20.5	30	9.47
HT/VHT20 STBC, M8 to M15	2	3	17.2	17.1	0.35	20.5	30	9.47
HE20, M0 to M11 1ss	1	3	17.8		0.33	18.1	30	11.89
HE20, M0 to M11 1ss	2	3	17.8	17.7	0.33	21.1	30	8.91
HE20, M0 to M11 2ss	2	3	17.8	17.7	0.33	21.1	30	8.91
HE20 Beam Forming, M0 to M11 1ss	2	6	17.8	17.7	0.33	21.1	30	8.91
HE20 Beam Forming, M0 to M11 2ss	2	3	17.8	17.7	0.33	21.1	30	8.91
HE20 STBC, M0 to M11 2ss	2	3	17.8	17.7	0.33	21.1	30	8.91

Maximum Conducted output power – Antenna gain 8dBi.**Frequency 5745 MHz**

Mode	Tx Paths	Correlated Antenna Gain (dBi)	Tx 1 Max Power (dBm)	Tx 2 Max Power (dBm)	Duty Cycle (dB)	Total Tx Channel Power (dBm)	Limit (dBm)	Margin (dB)
Non HT20, 6 to 54 Mbps	1	8	17.5		0.36	17.8	30	12.18
Non HT20, 6 to 54 Mbps	2	8	17.5	17.6	0.36	20.9	30	9.08
Non HT20 Beam Forming, 6 to 54 Mbps	2	11	17.5	17.6	0.36	20.9	30	9.08
HT/VHT20, M0 to M7	1	8	17.4		0.35	17.7	30	12.27
HT/VHT20, M0 to M7	2	8	17.4	17.2	0.35	20.7	30	9.34
HT/VHT20, M8 to M15	2	8	17.4	17.2	0.35	20.7	30	9.34
HT/VHT20 Beam Forming, M0 to M7	2	11	17.4	17.2	0.35	20.7	30	9.34
HT/VHT20 Beam Forming, M8 to M15	2	8	17.4	17.2	0.35	20.7	30	9.34
HT/VHT20 STBC, M8 to M15	2	8	17.4	17.2	0.35	20.7	30	9.34
HE20, M0 to M11 1ss	1	8	18.2		0.33	18.5	30	11.52
HE20, M0 to M11 1ss	2	8	18.2	18.1	0.33	21.5	30	8.52
HE20, M0 to M11 2ss	2	8	18.2	18.1	0.33	21.5	30	8.52
HE20 Beam Forming, M0 to M11 1ss	2	11	18.2	18.1	0.33	21.5	30	8.52
HE20 Beam Forming, M0 to M11 2ss	2	8	18.2	18.1	0.33	21.5	30	8.52
HE20 STBC, M0 to M11 2ss	2	8	18.2	18.1	0.33	21.5	30	8.52

Frequency 5755 MHz

Mode	Tx Paths	Correlated Antenna Gain (dBi)	Tx 1 Max Power (dBm)	Tx 2 Max Power (dBm)	Duty Cycle (dB)	Total Tx Channel Power (dBm)	Limit (dBm)	Margin (dB)
Non HT40, 6 to 54 Mbps	1	8	17.5		0.28	17.8	30	12.19
Non HT40, 6 to 54 Mbps	2	8	17.5	17.5	0.28	20.8	30	9.21
HT/VHT40, M0 to M7	1	8	18.1		0.37	18.5	30	11.51
HT/VHT40, M0 to M7	2	8	18.1	17.8	0.37	21.3	30	8.65
HT/VHT40, M8 to M15	2	8	18.1	17.8	0.37	21.3	30	8.65
HT/VHT40 Beam Forming, M0 to M7	2	11	18.1	17.8	0.37	21.3	30	8.65
HT/VHT40 Beam Forming, M8 to M15	2	8	18.1	17.8	0.37	21.3	30	8.65
HT/VHT40 STBC, M8 to M15	2	8	18.1	17.8	0.37	21.3	30	8.65
HE40, M0 to M11 1ss	1	8	17.9		0.38	18.2	30	11.75
HE40, M0 to M11 1ss	2	8	17.9	17.7	0.38	21.2	30	8.83
HE40, M0 to M11 2ss	2	8	17.9	17.7	0.38	21.2	30	8.83
HE40 Beam Forming, M0 to M11 1ss	2	11	17.9	17.7	0.38	21.2	30	8.83
HE40 Beam Forming, M0 to M11 2ss	2	8	17.9	17.7	0.38	21.2	30	8.83
HE40 STBC, M0 to M11 2ss	2	8	17.9	17.7	0.38	21.2	30	8.83

Frequency 5775 MHz

Mode	Tx Paths	Correlated Antenna Gain (dBi)	Tx 1 Max Power (dBm)	Tx 2 Max Power (dBm)	Duty Cycle (dB)	Total Tx Channel Power (dBm)	Limit (dBm)	Margin (dB)
Non HT80, 6 to 54 Mbps	1	8	17.7		0.43	18.2	30	11.83
Non HT80, 6 to 54 Mbps	2	8	17.7	17.4	0.43	21.0	30	8.98
VHT80, M0 to M11 1ss	1	8	18.2		0.48	18.6	30	11.36
VHT80, M0 to M11 1ss	2	8	18.2	17.5	0.48	21.3	30	8.66
VHT80, M0 to M11 2ss	2	8	18.2	17.5	0.48	21.3	30	8.66
VHT80 Beam Forming, M0 to M11 1ss	2	11	18.2	17.5	0.48	21.3	30	8.66
VHT80 Beam Forming, M0 to M11 2ss	2	8	18.2	17.5	0.48	21.3	30	8.66
VHT80 STBC, M0 to M11 2ss	2	8	18.2	17.5	0.48	21.3	30	8.66
HE80, M0 to M11 1ss	1	8	18.3		0.31	18.6	30	11.38
HE80, M0 to M11 1ss	2	8	18.3	17.9	0.31	21.4	30	8.58
HE80, M0 to M11 2ss	2	8	18.3	17.9	0.31	21.4	30	8.58
HE80 Beam Forming, M0 to M11 1ss	2	11	18.3	17.9	0.31	21.4	30	8.58
HE80 Beam Forming, M0 to M11 2ss	2	8	18.3	17.9	0.31	21.4	30	8.58
HE80 STBC, M0 to M11 2ss	2	8	18.3	17.9	0.31	21.4	30	8.58

Frequency 5785 MHz

Mode	Tx Paths	Correlated Antenna Gain (dBi)	Tx 1 Max Power (dBm)	Tx 2 Max Power (dBm)	Duty Cycle (dB)	Total Tx Channel Power (dBm)	Limit (dBm)	Margin (dB)
Non HT20, 6 to 54 Mbps	1	8	17.6		0.36	18.0	30	12.02
Non HT20, 6 to 54 Mbps	2	8	17.6	17.2	0.36	20.8	30	9.22
Non HT20 Beam Forming, 6 to 54 Mbps	2	11	17.6	17.2	0.36	20.8	30	9.22
HT/VHT20, M0 to M7	1	8	17.3		0.35	17.7	30	12.33
HT/VHT20, M0 to M7	2	8	17.3	16.8	0.35	20.4	30	9.57
HT/VHT20, M8 to M15	2	8	17.3	16.8	0.35	20.4	30	9.57
HT/VHT20 Beam Forming, M0 to M7	2	11	17.3	16.8	0.35	20.4	30	9.57
HT/VHT20 Beam Forming, M8 to M15	2	8	17.3	16.8	0.35	20.4	30	9.57
HT/VHT20 STBC, M8 to M15	2	8	17.3	16.8	0.35	20.4	30	9.57
HE20, M0 to M11 1ss	1	8	17.8		0.33	18.2	30	11.84
HE20, M0 to M11 1ss	2	8	17.8	17.5	0.33	21.0	30	8.99
HE20, M0 to M11 2ss	2	8	17.8	17.5	0.33	21.0	30	8.99
HE20 Beam Forming, M0 to M11 1ss	2	11	17.8	17.5	0.33	21.0	30	8.99
HE20 Beam Forming, M0 to M11 2ss	2	8	17.8	17.5	0.33	21.0	30	8.99
HE20 STBC, M0 to M11 2ss	2	8	17.8	17.5	0.33	21.0	30	8.99

Frequency 5795 MHz

Mode	Tx Paths	Correlated Antenna Gain (dBi)	Tx 1 Max Power (dBm)	Tx 2 Max Power (dBm)	Duty Cycle (dB)	Total Tx Channel Power (dBm)	Limit (dBm)	Margin (dB)
Non HT40, 6 to 54 Mbps	1	8	17.4		0.28	17.7	30	12.31
Non HT40, 6 to 54 Mbps	2	8	17.4	17.2	0.28	20.6	30	9.41
HT/VHT40, M0 to M7	1	8	17.6		0.37	18.0	30	12.04
HT/VHT40, M0 to M7	2	8	17.6	17.1	0.37	20.8	30	9.25
HT/VHT40, M8 to M15	2	8	17.6	17.1	0.37	20.8	30	9.25
HT/VHT40 Beam Forming, M0 to M7	2	11	17.6	17.1	0.37	20.8	30	9.25
HT/VHT40 Beam Forming, M8 to M15	2	8	17.6	17.1	0.37	20.8	30	9.25
HT/VHT40 STBC, M8 to M15	2	8	17.6	17.1	0.37	20.8	30	9.25
HE40, M0 to M11 1ss	1	8	17.8		0.38	18.1	30	11.86
HE40, M0 to M11 1ss	2	8	17.8	17.5	0.38	21.0	30	8.96
HE40, M0 to M11 2ss	2	8	17.8	17.5	0.38	21.0	30	8.96
HE40 Beam Forming, M0 to M11 1ss	2	11	17.8	17.5	0.38	21.0	30	8.96
HE40 Beam Forming, M0 to M11 2ss	2	8	17.8	17.5	0.38	21.0	30	8.96
HE40 STBC, M0 to M11 2ss	2	8	17.8	17.5	0.38	21.0	30	8.96

Frequency 5825 MHz

Mode	Tx Paths	Correlated Antenna Gain (dBi)	Tx 1 Max Power (dBm)	Tx 2 Max Power (dBm)	Duty Cycle (dB)	Total Tx Channel Power (dBm)	Limit (dBm)	Margin (dB)
Non HT20, 6 to 54 Mbps	1	8	17.4		0.36	17.7	30	12.28
Non HT20, 6 to 54 Mbps	2	8	17.4	17.3	0.36	20.7	30	9.32
Non HT20 Beam Forming, 6 to 54 Mbps	2	11	17.4	17.3	0.36	20.7	30	9.32
HT/VHT20, M0 to M7	1	8	17.2		0.35	17.6	30	12.4
HT/VHT20, M0 to M7	2	8	17.2	17.1	0.35	20.5	30	9.47
HT/VHT20, M8 to M15	2	8	17.2	17.1	0.35	20.5	30	9.47
HT/VHT20 Beam Forming, M0 to M7	2	11	17.2	17.1	0.35	20.5	30	9.47
HT/VHT20 Beam Forming, M8 to M15	2	8	17.2	17.1	0.35	20.5	30	9.47
HT/VHT20 STBC, M8 to M15	2	8	17.2	17.1	0.35	20.5	30	9.47
HE20, M0 to M11 1ss	1	8	17.8		0.33	18.1	30	11.89
HE20, M0 to M11 1ss	2	8	17.8	17.7	0.33	21.1	30	8.91
HE20, M0 to M11 2ss	2	8	17.8	17.7	0.33	21.1	30	8.91
HE20 Beam Forming, M0 to M11 1ss	2	11	17.8	17.7	0.33	21.1	30	8.91
HE20 Beam Forming, M0 to M11 2ss	2	8	17.8	17.7	0.33	21.1	30	8.91
HE20 STBC, M0 to M11 2ss	2	8	17.8	17.7	0.33	21.1	30	8.91

Maximum Conducted output power – Antenna gain 15dBi.**Frequency 5745 MHz**

Mode	Tx Paths	Correlated Antenna Gain (dBi)	Tx 1 Max Power (dBm)	Tx 2 Max Power (dBm)	Duty Cycle (dB)	Total Tx Channel Power (dBm)	Limit (dBm)	Margin (dB)
Non HT20, 6 to 54 Mbps	1	15	17.5		0.36	17.8	30	12.18
Non HT20, 6 to 54 Mbps	2	15	17.5	17.6	0.36	20.9	30	9.08
Non HT20 Beam Forming, 6 to 54 Mbps	2	15	17.5	17.6	0.36	20.9	30	9.08
HT/VHT20, M0 to M7	1	15	17.4		0.35	17.7	30	12.27
HT/VHT20, M0 to M7	2	15	17.4	17.2	0.35	20.7	30	9.34
HT/VHT20, M8 to M15	2	15	17.4	17.2	0.35	20.7	30	9.34
HT/VHT20 Beam Forming, M0 to M7	2	15	17.4	17.2	0.35	20.7	30	9.34
HT/VHT20 Beam Forming, M8 to M15	2	15	17.4	17.2	0.35	20.7	30	9.34
HT/VHT20 STBC, M8 to M15	2	15	17.4	17.2	0.35	20.7	30	9.34
HE20, M0 to M11 1ss	1	15	18.2		0.33	18.5	30	11.52
HE20, M0 to M11 1ss	2	15	17.2	17.0	0.33	20.4	30	9.58
HE20, M0 to M11 2ss	2	15	17.2	17.0	0.33	20.4	30	9.58
HE20 Beam Forming, M0 to M11 1ss	2	15	17.2	17.0	0.33	20.4	30	9.58
HE20 Beam Forming, M0 to M11 2ss	2	15	17.2	17.0	0.33	20.4	30	9.58
HE20 STBC, M0 to M11 2ss	2	15	17.2	17.0	0.33	20.4	30	9.58

Frequency 5755 MHz

Mode	Tx Paths	Correlated Antenna Gain (dBi)	Tx 1 Max Power (dBm)	Tx 2 Max Power (dBm)	Duty Cycle (dB)	Total Tx Channel Power (dBm)	Limit (dBm)	Margin (dB)
Non HT40, 6 to 54 Mbps	1	15	17.5		0.28	17.8	30	12.19
Non HT40, 6 to 54 Mbps	2	15	17.5	17.5	0.28	20.8	30	9.21
HT/VHT40, M0 to M7	1	15	18.1		0.37	18.5	30	11.51
HT/VHT40, M0 to M7	2	15	17.0	16.9	0.37	20.3	30	9.67
HT/VHT40, M8 to M15	2	15	17.0	16.9	0.37	20.3	30	9.67
HT/VHT40 Beam Forming, M0 to M7	2	15	17.0	16.9	0.37	20.3	30	9.67
HT/VHT40 Beam Forming, M8 to M15	2	15	17.0	16.9	0.37	20.3	30	9.67
HT/VHT40 STBC, M8 to M15	2	15	17.0	16.9	0.37	20.3	30	9.67
HE40, M0 to M11 1ss	1	15	17.9		0.38	18.2	30	11.75
HE40, M0 to M11 1ss	2	15	16.8	16.6	0.38	20.1	30	9.93
HE40, M0 to M11 2ss	2	15	16.8	16.6	0.38	20.1	30	9.93
HE40 Beam Forming, M0 to M11 1ss	2	15	16.8	16.6	0.38	20.1	30	9.93
HE40 Beam Forming, M0 to M11 2ss	2	15	16.8	16.6	0.38	20.1	30	9.93
HE40 STBC, M0 to M11 2ss	2	15	16.8	16.6	0.38	20.1	30	9.93

Frequency 5775 MHz

Mode	Tx Paths	Correlated Antenna Gain (dBi)	Tx 1 Max Power (dBm)	Tx 2 Max Power (dBm)	Duty Cycle (dB)	Total Tx Channel Power (dBm)	Limit (dBm)	Margin (dB)
Non HT80, 6 to 54 Mbps	1	15	17.7		0.43	18.2	30	11.83
Non HT80, 6 to 54 Mbps	2	15	16.9	16.6	0.43	20.2	30	9.76
VHT80, M0 to M11 1ss	1	15	18.2		0.48	18.6	30	11.36
VHT80, M0 to M11 1ss	2	15	16.9	16.6	0.48	20.2	30	9.77
VHT80, M0 to M11 2ss	2	15	16.9	16.6	0.48	20.2	30	9.77
VHT80 Beam Forming, M0 to M11 1ss	2	15	16.9	16.6	0.48	20.2	30	9.77
VHT80 Beam Forming, M0 to M11 2ss	2	15	16.9	16.6	0.48	20.2	30	9.77
VHT80 STBC, M0 to M11 2ss	2	15	16.9	16.6	0.48	20.2	30	9.77
HE80, M0 to M11 1ss	1	15	18.3		0.31	18.6	30	11.38
HE80, M0 to M11 1ss	2	15	17.2	16.9	0.31	20.4	30	9.6
HE80, M0 to M11 2ss	2	15	17.2	16.9	0.31	20.4	30	9.6
HE80 Beam Forming, M0 to M11 1ss	2	15	17.2	16.9	0.31	20.4	30	9.6
HE80 Beam Forming, M0 to M11 2ss	2	15	17.2	16.9	0.31	20.4	30	9.6
HE80 STBC, M0 to M11 2ss	2	15	17.2	16.9	0.31	20.4	30	9.6

Frequency 5785 MHz

Mode	Tx Paths	Correlated Antenna Gain (dBi)	Tx 1 Max Power (dBm)	Tx 2 Max Power (dBm)	Duty Cycle (dB)	Total Tx Channel Power (dBm)	Limit (dBm)	Margin (dB)
Non HT20, 6 to 54 Mbps	1	15	17.6		0.36	18.0	30	12.02
Non HT20, 6 to 54 Mbps	2	15	17.6	17.2	0.36	20.8	30	9.22
Non HT20 Beam Forming, 6 to 54 Mbps	2	15	17.6	17.2	0.36	20.8	30	9.22
HT/VHT20, M0 to M7	1	15	17.3		0.35	17.7	30	12.33
HT/VHT20, M0 to M7	2	15	17.3	16.8	0.35	20.4	30	9.57
HT/VHT20, M8 to M15	2	15	17.3	16.8	0.35	20.4	30	9.57
HT/VHT20 Beam Forming, M0 to M7	2	15	17.3	16.8	0.35	20.4	30	9.57
HT/VHT20 Beam Forming, M8 to M15	2	15	17.3	16.8	0.35	20.4	30	9.57
HT/VHT20 STBC, M8 to M15	2	15	17.3	16.8	0.35	20.4	30	9.57
HE20, M0 to M11 1ss	1	15	17.8		0.33	18.2	30	11.84
HE20, M0 to M11 1ss	2	15	16.9	16.5	0.33	20.1	30	9.93
HE20, M0 to M11 2ss	2	15	16.9	16.5	0.33	20.1	30	9.93
HE20 Beam Forming, M0 to M11 1ss	2	15	16.9	16.5	0.33	20.1	30	9.93
HE20 Beam Forming, M0 to M11 2ss	2	15	16.9	16.5	0.33	20.1	30	9.93
HE20 STBC, M0 to M11 2ss	2	15	16.9	16.5	0.33	20.1	30	9.93

Frequency 5795 MHz

Mode	Tx Paths	Correlated Antenna Gain (dBi)	Tx 1 Max Power (dBm)	Tx 2 Max Power (dBm)	Duty Cycle (dB)	Total Tx Channel Power (dBm)	Limit (dBm)	Margin (dB)
Non HT40, 6 to 54 Mbps	1	15	17.4		0.28	17.7	30	12.31
Non HT40, 6 to 54 Mbps	2	15	17.4	17.2	0.28	20.6	30	9.41
HT/VHT40, M0 to M7	1	15	17.6		0.37	18.0	30	12.04
HT/VHT40, M0 to M7	2	15	17.6	17.1	0.37	20.8	30	9.25
HT/VHT40, M8 to M15	2	15	17.6	17.1	0.37	20.8	30	9.25
HT/VHT40 Beam Forming, M0 to M7	2	15	17.6	17.1	0.37	20.8	30	9.25
HT/VHT40 Beam Forming, M8 to M15	2	15	17.6	17.1	0.37	20.8	30	9.25
HT/VHT40 STBC, M8 to M15	2	15	17.6	17.1	0.37	20.8	30	9.25
HE40, M0 to M11 1ss	1	15	17.8		0.38	18.1	30	11.86
HE40, M0 to M11 1ss	2	15	16.8	16.5	0.38	20.0	30	9.96
HE40, M0 to M11 2ss	2	15	16.8	16.5	0.38	20.0	30	9.96
HE40 Beam Forming, M0 to M11 1ss	2	15	16.8	16.5	0.38	20.0	30	9.96
HE40 Beam Forming, M0 to M11 2ss	2	15	16.8	16.5	0.38	20.0	30	9.96
HE40 STBC, M0 to M11 2ss	2	15	16.8	16.5	0.38	20.0	30	9.96

Frequency 5825 MHz

Mode	Tx Paths	Correlated Antenna Gain (dBi)	Tx 1 Max Power (dBm)	Tx 2 Max Power (dBm)	Duty Cycle (dB)	Total Tx Channel Power (dBm)	Limit (dBm)	Margin (dB)
Non HT20, 6 to 54 Mbps	1	15	17.4		0.36	17.7	30	12.28
Non HT20, 6 to 54 Mbps	2	15	17.4	17.3	0.36	20.7	30	9.32
Non HT20 Beam Forming, 6 to 54 Mbps	2	15	17.4	17.3	0.36	20.7	30	9.32
HT/VHT20, M0 to M7	1	15	17.2		0.35	17.6	30	12.4
HT/VHT20, M0 to M7	2	15	17.2	17.1	0.35	20.5	30	9.47
HT/VHT20, M8 to M15	2	15	17.2	17.1	0.35	20.5	30	9.47
HT/VHT20 Beam Forming, M0 to M7	2	15	17.2	17.1	0.35	20.5	30	9.47
HT/VHT20 Beam Forming, M8 to M15	2	15	17.2	17.1	0.35	20.5	30	9.47
HT/VHT20 STBC, M8 to M15	2	15	17.2	17.1	0.35	20.5	30	9.47
HE20, M0 to M11 1ss	1	15	17.8		0.33	18.1	30	11.89
HE20, M0 to M11 1ss	2	15	16.8	16.8	0.33	20.1	30	9.88
HE20, M0 to M11 2ss	2	15	16.8	16.8	0.33	20.1	30	9.88
HE20 Beam Forming, M0 to M11 1ss	2	15	16.8	16.8	0.33	20.1	30	9.88
HE20 Beam Forming, M0 to M11 2ss	2	15	16.8	16.8	0.33	20.1	30	9.88
HE20 STBC, M0 to M11 2ss	2	15	16.8	16.8	0.33	20.1	30	9.88

Data Screenshots – Antenna gain 3dBi.

5745 MHz: HE20 Beam Forming, M0 to M11 1ss.

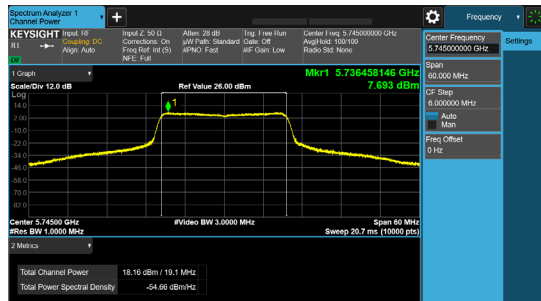

Antenna A

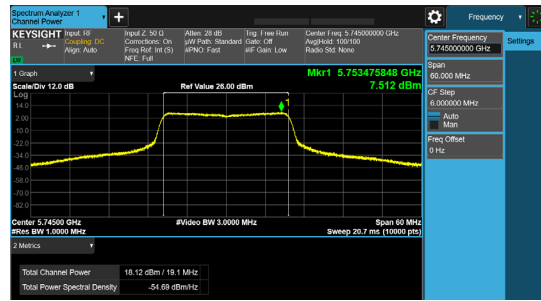

Antenna B

5775 MHz: HE80 Beam Forming, M0 to M11 1ss

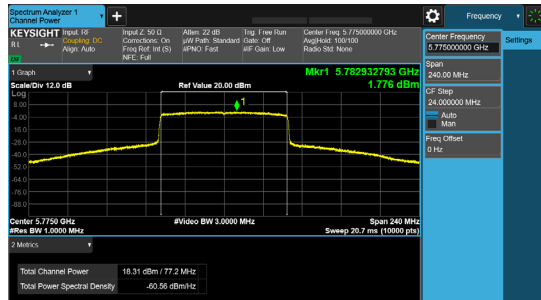

Antenna A

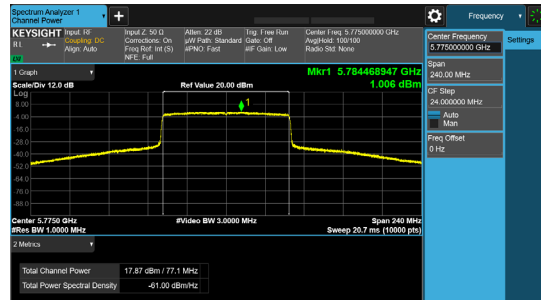

Antenna B

5755 MHz: HT/VHT40 Beam Forming, M0 to M7

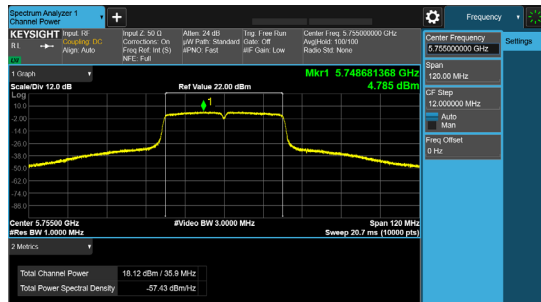

Antenna A

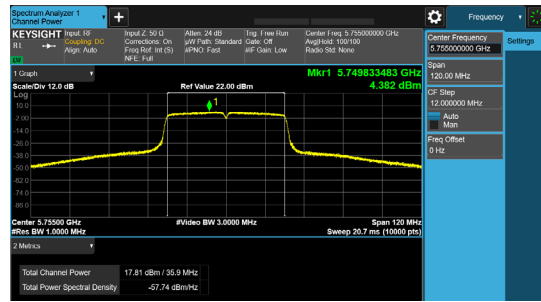

Antenna B

Data Screenshots – Antenna gain 8dBi.

5745 MHz: HE20, M0 to M11 1ss

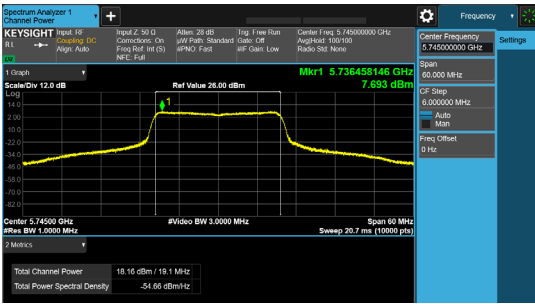

Antenna A

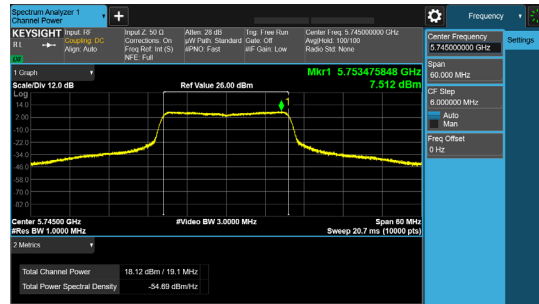

Antenna B

5745 MHz: HE20, M0 to M11 2ss

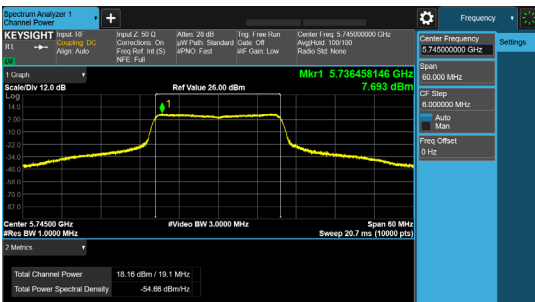

Antenna A

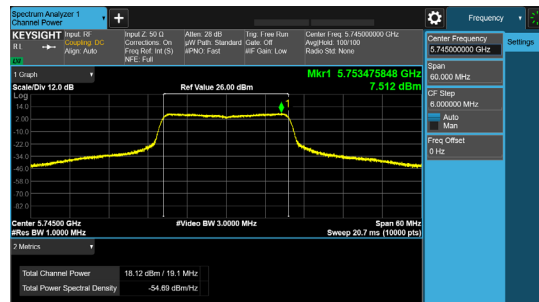

Antenna B

5745 MHz: HE20 Beam Forming, M0 to M11 1ss

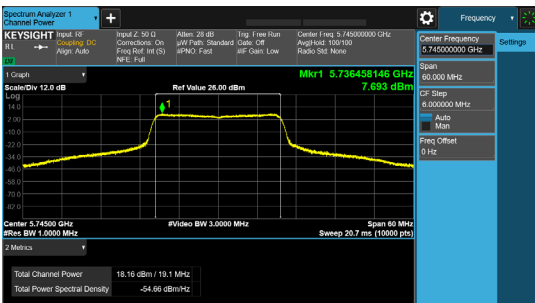

Antenna A

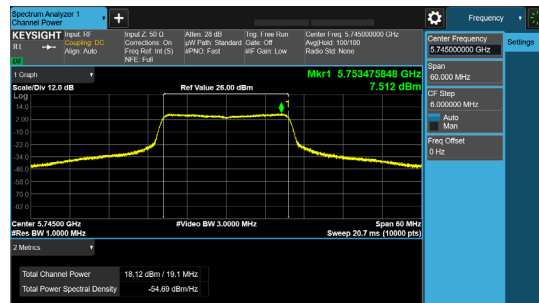

Antenna B

Data Screenshots – Antenna gain 15dBi.

5745 MHz: Non HT20, 6 to 54 Mbps

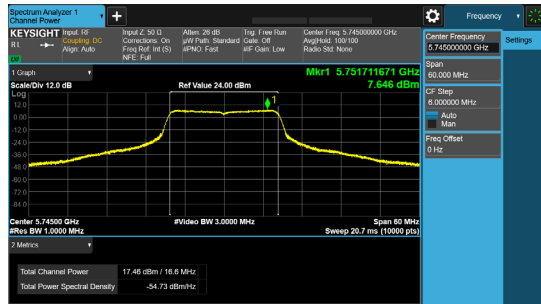

Antenna A

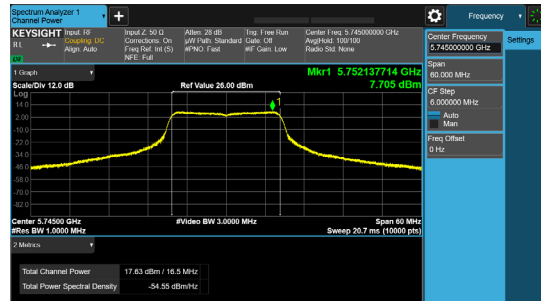

Antenna B

5745 MHz: Non HT20 Beam Forming, 6 to 54 Mbps

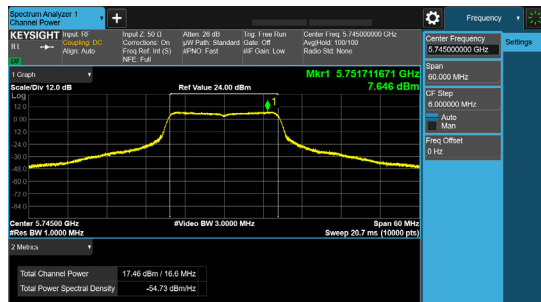

Antenna A

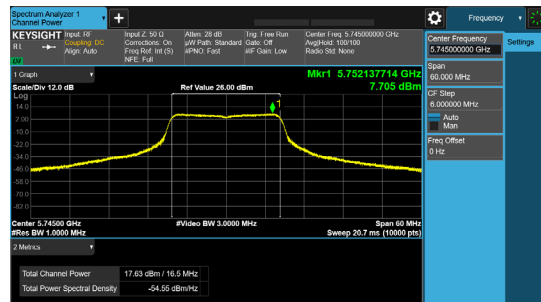

Antenna B

5755 MHz: Non HT40, 6 to 54 Mbps

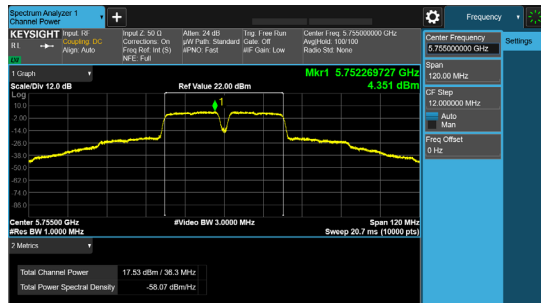

Antenna A

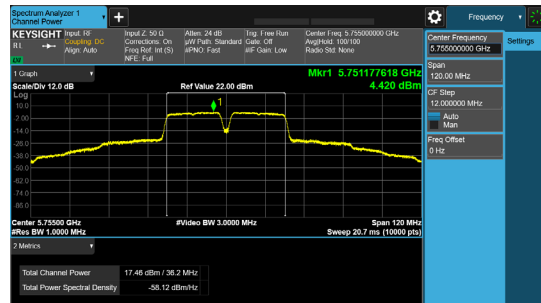

Antenna B

A.5: Power Spectral Density

Power Spectral Density Test Requirement

LP0002 (2020-07-01) (5.7.3.3):

- (2) The maximum power spectral density shall be less than or equal to 30 dBm in any 500 kHz band.
- (3) Fixed point-to-point U-NII devices operating in this band may employ transmitting antennas with directional gain greater than 6 dBi without any corresponding reduction in transmitter conducted power.
- (4) In addition to (3), if transmitting antennas of directional gain greater than 6 dBi are used, both the maximum conducted output power and the maximum power spectral density shall be reduced by the amount in dBi that the directional gain of the antenna exceeds 6 dBi.

15.407:

(3) For the band 5.725-5.85 GHz...the maximum power spectral density shall not exceed 30 dBm in any 500-kHz band. If transmitting antennas of directional gain greater than 6 dBi are used, both the maximum conducted output power and the maximum power spectral density shall be reduced by the amount in dB that the directional gain of the antenna exceeds 6 dBi. However, fixed point-to-point U-NII devices operating in this band may employ transmitting antennas with directional gain greater than 6 dBi without any corresponding reduction in transmitter conducted power. Fixed, point-to-point operations exclude the use of point-to-multipoint systems, omnidirectional applications, and multiple collocated transmitters transmitting the same information. The operator of the U-NII device, or if the equipment is professionally installed, the installer, is responsible for ensuring that systems employing high gain directional antennas are used exclusively for fixed, point-to-point operations.

(5) The maximum power spectral density is measured as a conducted emission by direct connection of a calibrated test instrument to the equipment under test. If the device cannot be connected directly, alternative techniques acceptable to the Commission may be used. Measurements in the 5.725-5.85 GHz band are made over a reference bandwidth of 500 kHz or the 26 dB emission bandwidth of the device, whichever is less. Measurements in the 5.15-5.25 GHz, 5.25-5.35 GHz, and the 5.47-5.725 GHz bands are made over a bandwidth of 1 MHz or the 26 dB emission bandwidth of the device, whichever is less. A narrower resolution bandwidth can be used, provided that the measured power is integrated over the full reference bandwidth.

Band-Crossing Signals:

When measuring the portion of the maximum conducted output power within a single U-NII band, the power shall be integrated across only the portion of the EBW that falls within that band. That is, if an EBW extends across the boundary between two adjacent bands, the boundary frequency between the bands serves as one edge of the frequency range to be integrated. Integration across an entire U-NII band without regard to 26 dB points is also acceptable for determining conducted output power within that band.

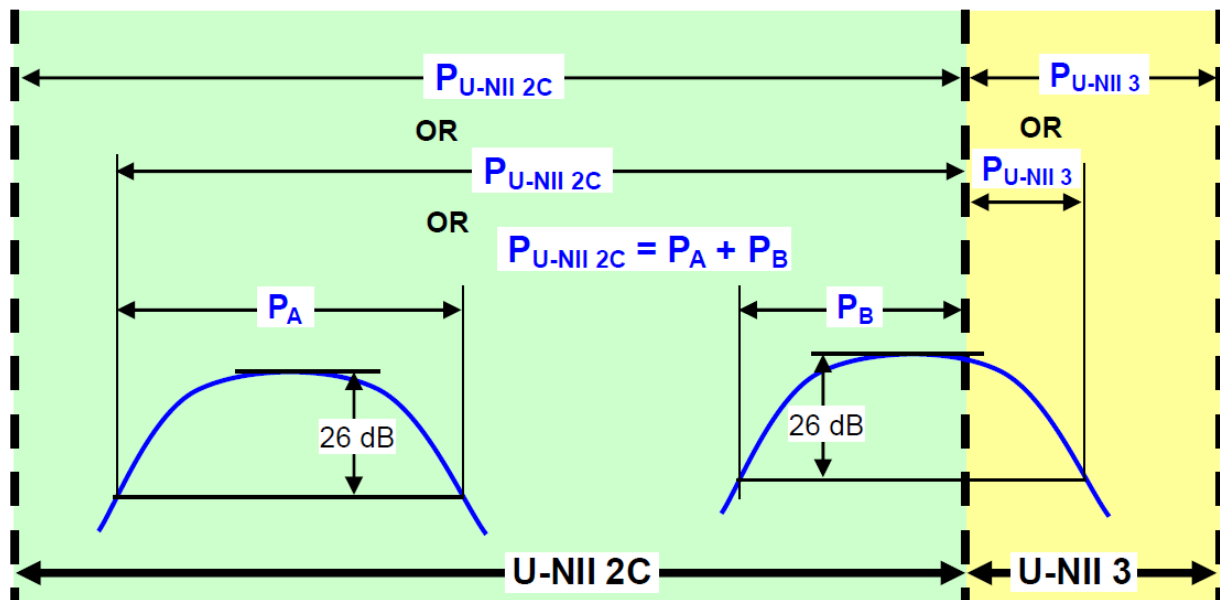

Conducted output power within a U-NII band: Integrate over the band or integrate over a span including the 26 dB EBWs of transmission segments within the band or integrate over 26 dB EBW of each transmission segment in the band and sum.

Figure 4. Conducted Output Power Measurement Examples

Power Spectral Density Test Procedure

Ref. KDB 789033 D02 General UNII Test Procedures New Rules v02r01

F. Maximum Power Spectral Density (PSD)

ANSI C63.10:2013

Power Spectral Density Test Procedure

The rules requires “maximum power spectral density” measurements where the intent is to measure the maximum value of the time average of the power spectral density measured during a period of continuous transmission.

1. Create an average power spectrum for the EUT operating mode being tested by following the instructions in section II.E.2. for measuring maximum conducted output power using a spectrum analyzer or EMI receiver: select the appropriate test method (SA-1, SA-2, SA-3, or alternatives to each) and apply it up to, but not including, the step labeled, “Compute power...”. (This procedure is required even if the maximum conducted output power measurement was performed using a power meter, method PM.)
2. Use the peak search function on the instrument to find the peak of the spectrum and record its value.
3. Make the following adjustments to the peak value of the spectrum, if applicable: a) If Method SA-2 or SA-2 Alternative was used, add $10 \log(1/x)$, where x is the duty cycle, to the peak of the spectrum.
b) If Method SA-3 Alternative was used and the linear mode was used in step II.E.2.g)(viii), add 1 dB to the final result to compensate for the difference between linear averaging and power averaging.
4. The result is the Maximum PSD over 1 MHz reference bandwidth.
5. For devices operating in the bands 5.15-5.25 GHz, 5.25-5.35 GHz, and 5.47-5.725 GHz, the above procedures make use of 1 MHz RBW to satisfy directly the 1 MHz reference bandwidth specified in § 15.407(a)(5). **For devices operating in the band 5.725-5.85 GHz, the rules specify a measurement bandwidth of 500 kHz.**

Ref. KDB 789033 D02 General UNII Test Procedures New Rules v02r01

2. Measurement using a Spectrum Analyzer or EMI Receiver (SA), (d) Method SA-2

<p>Power Spectral Density Test parameters</p> <p>Method SA-2 (trace averaging across on and off times of the EUT transmissions, followed by duty cycle correction). (i) Measure the duty cycle, x, of the transmitter output signal as described in section II.B. (ii) Set span to encompass the EBW (or, alternatively, the entire 99% occupied bandwidth) of the signal. (iii) Set RBW = 1 MHz. (this should be 500kHz per KDB789033, Section F, (5)) (iv) Set VBW \geq 3 MHz. (v) Number of points in sweep \geq 2 Span / RBW. (This ensures that bin-to-bin spacing is \leq RBW/2, so that narrowband signals are not lost between frequency bins.) (vi) Sweep time = auto. (vii) Detector = RMS (i.e., power averaging), if available. Otherwise, use sample detector mode. (viii) Do not use sweep triggering. Allow the sweep to “free run”. (ix) Trace average at least 100 traces in power averaging (i.e., RMS) mode; however, the number of traces to be averaged shall be increased above 100 as needed to ensure that the average accurately represents the true average over the on and off periods of the transmitter. (x) Compute power by integrating the spectrum across the EBW (or, alternatively, the entire 99% occupied bandwidth) of the signal using the instrument’s band power measurement function with band limits set equal to the EBW (or occupied bandwidth)</p> <p>F. Maximum Power Spectral Density (PSD) 2. Use the peak search function on the instrument to find the peak of the spectrum and record its value. 3. Make the following adjustments to the peak value of the spectrum, if applicable: a) If Method SA-2 or SA-2 Alternative was used, add $10 \log(1/x)$, where x is the duty cycle, to the peak of the spectrum. 5. ... For devices operating in the band 5.725-5.85 GHz, the rules specify a measurement bandwidth of 500 kHz.</p>
--

The “measure-and-sum technique” is used for measuring in-band transmit power of a device. In the measure-and-sum approach, the conducted emission level is measured at each antenna port. The measured results at the various antenna ports are then summed mathematically to determine the total emission level from the device. Summing is performed in linear power units. ANSI C63.10 section 14.3.2.2

Tested By: Ronak Patel	Date of testing: 11/1/2022 - 2/10/2023
Test Result: PASS	

Test Equipment

See Appendix C for list of test equipment

Power Spectral Density EIRP – Antenna gain 3dBi.**Frequency 5745 MHz**

Mode	Tx Paths	Correlated Antenna Gain (dBi)	Tx 1 PSD (dBm/MHz)	Tx 2 PSD (dBm/MHz)	Duty Cycle (dB)	Total PSD (dBm/MHz)	Limit (dBm/MHz)	Margin (dB)
Non HT20, 6 to 54 Mbps	1	3	10.6		0.36	14.0	36	22.02
Non HT20, 6 to 54 Mbps	2	6	10.6	9.7	0.36	19.6	36	16.44
Non HT20 Beam Forming, 6 to 54 Mbps	2	6	10.6	9.7	0.36	19.6	36	16.44
HT/VHT20, M0 to M7	1	3	9.6		0.35	13.0	36	23.03
HT/VHT20, M0 to M7	2	6	9.6	10.3	0.35	19.4	36	16.65
HT/VHT20, M8 to M15	2	3	9.6	10.3	0.35	16.4	36	19.65
HT/VHT20 Beam Forming, M0 to M7	2	6	9.6	10.3	0.35	19.4	36	16.65
HT/VHT20 Beam Forming, M8 to M15	2	3	9.6	10.3	0.35	16.4	36	19.65
HT/VHT20 STBC, M8 to M15	2	3	9.6	10.3	0.35	16.4	36	19.65
HE20, M0 to M11 1ss	1	3	11.9		0.33	15.2	36	20.81
HE20, M0 to M11 1ss	2	6	11.9	9.8	0.33	20.3	36	15.72
HE20, M0 to M11 2ss	2	3	11.9	9.8	0.33	17.3	36	18.72
HE20 Beam Forming, M0 to M11 1ss	2	6	11.9	9.8	0.33	20.3	36	15.72
HE20 Beam Forming, M0 to M11 2ss	2	3	11.9	9.8	0.33	17.3	36	18.72
HE20 STBC, M0 to M11 2ss	2	3	11.9	9.8	0.33	17.3	36	18.72

Frequency 5755 MHz

Mode	Tx Paths	Correlated Antenna Gain (dBi)	Tx 1 PSD (dBm/MHz)	Tx 2 PSD (dBm/MHz)	Duty Cycle (dB)	Total PSD (dBm/MHz)	Limit (dBm/MHz)	Margin (dB)
Non HT40, 6 to 54 Mbps	1	3	6.7		0.28	10.0	36	25.98
Non HT40, 6 to 54 Mbps	2	6	6.7	6.4	0.28	15.8	36	20.16
HT/VHT40, M0 to M7	1	3	6.8		0.37	10.1	36	25.87
HT/VHT40, M0 to M7	2	6	6.8	7.0	0.37	16.3	36	19.71
HT/VHT40, M8 to M15	2	3	6.8	7.0	0.37	13.3	36	22.71
HT/VHT40 Beam Forming, M0 to M7	2	6	6.8	7.0	0.37	16.3	36	19.71
HT/VHT40 Beam Forming, M8 to M15	2	3	6.8	7.0	0.37	13.3	36	22.71
HT/VHT40 STBC, M8 to M15	2	3	6.8	7.0	0.37	13.3	36	22.71
HE40, M0 to M11 1ss	1	3	7.2		0.38	10.5	36	25.45
HE40, M0 to M11 1ss	2	6	7.2	7.6	0.38	16.8	36	19.22
HE40, M0 to M11 2ss	2	3	7.2	7.6	0.38	13.8	36	22.22
HE40 Beam Forming, M0 to M11 1ss	2	6	7.2	7.6	0.38	16.8	36	19.22
HE40 Beam Forming, M0 to M11 2ss	2	3	7.2	7.6	0.38	13.8	36	22.22
HE40 STBC, M0 to M11 2ss	2	3	7.2	7.6	0.38	13.8	36	22.22

Frequency 5775 MHz

Mode	Tx Paths	Correlated Antenna Gain (dBi)	Tx 1 PSD (dBm/MHz)	Tx 2 PSD (dBm/MHz)	Duty Cycle (dB)	Total PSD (dBm/MHz)	Limit (dBm/MHz)	Margin (dB)
Non HT80, 6 to 54 Mbps	1	3	5.0		0.43	8.4	36	27.58
Non HT80, 6 to 54 Mbps	2	6	5.0	3.7	0.43	13.8	36	22.16
VHT80, M0 to M11 1ss	1	3	2.8		0.48	6.2	36	29.76
VHT80, M0 to M11 1ss	2	6	2.8	2.6	0.48	12.2	36	23.82
VHT80, M0 to M11 2ss	2	3	2.8	2.6	0.48	9.2	36	26.82
VHT80 Beam Forming, M0 to M11 1ss	2	6	2.8	2.6	0.48	12.2	36	23.82
VHT80 Beam Forming, M0 to M11 2ss	2	3	2.8	2.6	0.48	9.2	36	26.82
VHT80 STBC, M0 to M11 2ss	2	3	2.8	2.6	0.48	9.2	36	26.82
HE80, M0 to M11 1ss	1	3	5.3		0.31	8.6	36	27.36
HE80, M0 to M11 1ss	2	6	5.3	4.1	0.31	14.1	36	21.92
HE80, M0 to M11 2ss	2	3	5.3	4.1	0.31	11.1	36	24.92
HE80 Beam Forming, M0 to M11 1ss	2	6	5.3	4.1	0.31	14.1	36	21.92
HE80 Beam Forming, M0 to M11 2ss	2	3	5.3	4.1	0.31	11.1	36	24.92
HE80 STBC, M0 to M11 2ss	2	3	5.3	4.1	0.31	11.1	36	24.92

Frequency 5785 MHz

Mode	Tx Paths	Correlated Antenna Gain (dBi)	Tx 1 PSD (dBm/MHz)	Tx 2 PSD (dBm/MHz)	Duty Cycle (dB)	Total PSD (dBm/MHz)	Limit (dBm/MHz)	Margin (dB)
Non HT20, 6 to 54 Mbps	1	3	11.0		0.36	14.3	36	21.68
Non HT20, 6 to 54 Mbps	2	6	11.0	9.9	0.36	19.8	36	16.17
Non HT20 Beam Forming, 6 to 54 Mbps	2	6	11.0	9.9	0.36	19.8	36	16.17
HT/VHT20, M0 to M7	1	3	10.7		0.35	14.1	36	21.92
HT/VHT20, M0 to M7	2	6	10.7	10.5	0.35	20.0	36	16.01
HT/VHT20, M8 to M15	2	3	10.7	10.5	0.35	17.0	36	19.01
HT/VHT20 Beam Forming, M0 to M7	2	6	10.7	10.5	0.35	20.0	36	16.01
HT/VHT20 Beam Forming, M8 to M15	2	3	10.7	10.5	0.35	17.0	36	19.01
HT/VHT20 STBC, M8 to M15	2	3	10.7	10.5	0.35	17.0	36	19.01
HE20, M0 to M11 1ss	1	3	12.0		0.33	15.3	36	20.71
HE20, M0 to M11 1ss	2	6	12.0	9.4	0.33	20.2	36	15.81
HE20, M0 to M11 2ss	2	3	12.0	9.4	0.33	17.2	36	18.81
HE20 Beam Forming, M0 to M11 1ss	2	6	12.0	9.4	0.33	20.2	36	15.81
HE20 Beam Forming, M0 to M11 2ss	2	3	12.0	9.4	0.33	17.2	36	18.81
HE20 STBC, M0 to M11 2ss	2	3	12.0	9.4	0.33	17.2	36	18.81

Frequency 5795 MHz

Mode	Tx Paths	Correlated Antenna Gain (dBi)	Tx 1 PSD (dBm/MHz)	Tx 2 PSD (dBm/MHz)	Duty Cycle (dB)	Total PSD (dBm/MHz)	Limit (dBm/MHz)	Margin (dB)
Non HT40, 6 to 54 Mbps	1	3	7.5		0.28	10.7	36	25.26
Non HT40, 6 to 54 Mbps	2	6	7.5	7.1	0.28	16.6	36	19.45
HT/VHT40, M0 to M7	1	3	8.6		0.37	11.9	36	24.08
HT/VHT40, M0 to M7	2	6	8.6	6.9	0.37	17.2	36	18.8
HT/VHT40, M8 to M15	2	3	8.6	6.9	0.37	14.2	36	21.8
HT/VHT40 Beam Forming, M0 to M7	2	6	8.6	6.9	0.37	17.2	36	18.8
HT/VHT40 Beam Forming, M8 to M15	2	3	8.6	6.9	0.37	14.2	36	21.8
HT/VHT40 STBC, M8 to M15	2	3	8.6	6.9	0.37	14.2	36	21.8
HE40, M0 to M11 1ss	1	3	9.5		0.38	12.8	36	23.17
HE40, M0 to M11 1ss	2	6	9.5	7.8	0.38	18.1	36	17.9
HE40, M0 to M11 2ss	2	3	9.5	7.8	0.38	15.1	36	20.9
HE40 Beam Forming, M0 to M11 1ss	2	6	9.5	7.8	0.38	18.1	36	17.9
HE40 Beam Forming, M0 to M11 2ss	2	3	9.5	7.8	0.38	15.1	36	20.9
HE40 STBC, M0 to M11 2ss	2	3	9.5	7.8	0.38	15.1	36	20.9

Frequency 5825 MHz

Mode	Tx Paths	Correlated Antenna Gain (dBi)	Tx 1 PSD (dBm/MHz)	Tx 2 PSD (dBm/MHz)	Duty Cycle (dB)	Total PSD (dBm/MHz)	Limit (dBm/MHz)	Margin (dB)
Non HT20, 6 to 54 Mbps	1	3	8.8		0.36	12.2	36	23.83
Non HT20, 6 to 54 Mbps	2	6	8.8	9.7	0.36	18.7	36	17.33
Non HT20 Beam Forming, 6 to 54 Mbps	2	6	8.8	9.7	0.36	18.7	36	17.33
HT/VHT20, M0 to M7	1	3	9.3		0.35	12.6	36	23.37
HT/VHT20, M0 to M7	2	6	9.3	-25.2	0.35	15.6	36	20.37
HT/VHT20, M8 to M15	2	3	9.3	-25.2	0.35	12.6	36	23.37
HT/VHT20 Beam Forming, M0 to M7	2	6	9.3	-25.2	0.35	15.6	36	20.37
HT/VHT20 Beam Forming, M8 to M15	2	3	9.3	-25.2	0.35	12.6	36	23.37
HT/VHT20 STBC, M8 to M15	2	3	9.3	-25.2	0.35	12.6	36	23.37
HE20, M0 to M11 1ss	1	3	10.7		0.33	14.0	36	22.01
HE20, M0 to M11 1ss	2	6	10.7	12.7	0.33	21.1	36	14.88
HE20, M0 to M11 2ss	2	3	10.7	12.7	0.33	18.1	36	17.88
HE20 Beam Forming, M0 to M11 1ss	2	6	10.7	12.7	0.33	21.1	36	14.88
HE20 Beam Forming, M0 to M11 2ss	2	3	10.7	12.7	0.33	18.1	36	17.88
HE20 STBC, M0 to M11 2ss	2	3	10.7	12.7	0.33	18.1	36	17.88

Power Spectral Density EIRP – Antenna gain 8dBi.**Frequency 5745 MHz**

Mode	Tx Paths	Correlated Antenna Gain (dBi)	Tx 1 PSD (dBm/MHz)	Tx 2 PSD (dBm/MHz)	Duty Cycle (dB)	Total PSD (dBm/MHz)	Limit (dBm/MHz)	Margin (dB)
Non HT20, 6 to 54 Mbps	1	8	10.6		0.36	19.0	36	17.02
Non HT20, 6 to 54 Mbps	2	11	10.6	9.7	0.36	24.6	36	11.44
Non HT20 Beam Forming, 6 to 54 Mbps	2	11	10.6	9.7	0.36	24.6	36	11.44
HT/VHT20, M0 to M7	1	8	9.6		0.35	18.0	36	18.03
HT/VHT20, M0 to M7	2	11	9.6	10.3	0.35	24.4	36	11.65
HT/VHT20, M8 to M15	2	8	9.6	10.3	0.35	21.4	36	14.65
HT/VHT20 Beam Forming, M0 to M7	2	11	9.6	10.3	0.35	24.4	36	11.65
HT/VHT20 Beam Forming, M8 to M15	2	8	9.6	10.3	0.35	21.4	36	14.65
HT/VHT20 STBC, M8 to M15	2	8	9.6	10.3	0.35	21.4	36	14.65
HE20, M0 to M11 1ss	1	8	11.9		0.33	20.2	36	15.81
HE20, M0 to M11 1ss	2	11	11.9	9.8	0.33	25.3	36	10.72
HE20, M0 to M11 2ss	2	8	11.9	9.8	0.33	22.3	36	13.72
HE20 Beam Forming, M0 to M11 1ss	2	11	11.9	9.8	0.33	25.3	36	10.72
HE20 Beam Forming, M0 to M11 2ss	2	8	11.9	9.8	0.33	22.3	36	13.72
HE20 STBC, M0 to M11 2ss	2	8	11.9	9.8	0.33	22.3	36	13.72

Frequency 5755 MHz

Mode	Tx Paths	Correlated Antenna Gain (dBi)	Tx 1 PSD (dBm/MHz)	Tx 2 PSD (dBm/MHz)	Duty Cycle (dB)	Total PSD (dBm/MHz)	Limit (dBm/MHz)	Margin (dB)
Non HT40, 6 to 54 Mbps	1	8	6.7		0.28	15.0	36	20.98
Non HT40, 6 to 54 Mbps	2	11	6.7	6.4	0.28	20.8	36	15.16
HT/VHT40, M0 to M7	1	8	6.8		0.37	15.1	36	20.87
HT/VHT40, M0 to M7	2	11	6.8	7.0	0.37	21.3	36	14.71
HT/VHT40, M8 to M15	2	8	6.8	7.0	0.37	18.3	36	17.71
HT/VHT40 Beam Forming, M0 to M7	2	11	6.8	7.0	0.37	21.3	36	14.71
HT/VHT40 Beam Forming, M8 to M15	2	8	6.8	7.0	0.37	18.3	36	17.71
HT/VHT40 STBC, M8 to M15	2	8	6.8	7.0	0.37	18.3	36	17.71
HE40, M0 to M11 1ss	1	8	7.2		0.38	15.5	36	20.45
HE40, M0 to M11 1ss	2	11	7.2	7.6	0.38	21.8	36	14.22
HE40, M0 to M11 2ss	2	8	7.2	7.6	0.38	18.8	36	17.22
HE40 Beam Forming, M0 to M11 1ss	2	11	7.2	7.6	0.38	21.8	36	14.22
HE40 Beam Forming, M0 to M11 2ss	2	8	7.2	7.6	0.38	18.8	36	17.22
HE40 STBC, M0 to M11 2ss	2	8	7.2	7.6	0.38	18.8	36	17.22

Frequency 5775 MHz

Mode	Tx Paths	Correlated Antenna Gain (dBi)	Tx 1 PSD (dBm/MHz)	Tx 2 PSD (dBm/MHz)	Duty Cycle (dB)	Total PSD (dBm/MHz)	Limit (dBm/MHz)	Margin (dB)
Non HT80, 6 to 54 Mbps	1	8	5.0		0.43	13.4	36	22.58
Non HT80, 6 to 54 Mbps	2	11	5.0	3.7	0.43	18.8	36	17.16
VHT80, M0 to M11 1ss	1	8	2.8		0.48	11.2	36	24.76
VHT80, M0 to M11 1ss	2	11	2.8	2.6	0.48	17.2	36	18.82
VHT80, M0 to M11 2ss	2	8	2.8	2.6	0.48	14.2	36	21.82
VHT80 Beam Forming, M0 to M11 1ss	2	11	2.8	2.6	0.48	17.2	36	18.82
VHT80 Beam Forming, M0 to M11 2ss	2	8	2.8	2.6	0.48	14.2	36	21.82
VHT80 STBC, M0 to M11 2ss	2	8	2.8	2.6	0.48	14.2	36	21.82
HE80, M0 to M11 1ss	1	8	5.3		0.31	13.6	36	22.36
HE80, M0 to M11 1ss	2	11	5.3	4.1	0.31	19.1	36	16.92
HE80, M0 to M11 2ss	2	8	5.3	4.1	0.31	16.1	36	19.92
HE80 Beam Forming, M0 to M11 1ss	2	11	5.3	4.1	0.31	19.1	36	16.92
HE80 Beam Forming, M0 to M11 2ss	2	8	5.3	4.1	0.31	16.1	36	19.92
HE80 STBC, M0 to M11 2ss	2	8	5.3	4.1	0.31	16.1	36	19.92

Frequency 5785 MHz

Mode	Tx Paths	Correlated Antenna Gain (dBi)	Tx 1 PSD (dBm/MHz)	Tx 2 PSD (dBm/MHz)	Duty Cycle (dB)	Total PSD (dBm/MHz)	Limit (dBm/MHz)	Margin (dB)
Non HT20, 6 to 54 Mbps	1	8	11.0		0.36	19.3	36	16.68
Non HT20, 6 to 54 Mbps	2	11	11.0	9.9	0.36	24.8	36	11.17
Non HT20 Beam Forming, 6 to 54 Mbps	2	11	11.0	9.9	0.36	24.8	36	11.17
HT/VHT20, M0 to M7	1	8	10.7		0.35	19.1	36	16.92
HT/VHT20, M0 to M7	2	11	10.7	10.5	0.35	25.0	36	11.01
HT/VHT20, M8 to M15	2	8	10.7	10.5	0.35	22.0	36	14.01
HT/VHT20 Beam Forming, M0 to M7	2	11	10.7	10.5	0.35	25.0	36	11.01
HT/VHT20 Beam Forming, M8 to M15	2	8	10.7	10.5	0.35	22.0	36	14.01
HT/VHT20 STBC, M8 to M15	2	8	10.7	10.5	0.35	22.0	36	14.01
HE20, M0 to M11 1ss	1	8	12.0		0.33	20.3	36	15.71
HE20, M0 to M11 1ss	2	11	12.0	9.4	0.33	25.2	36	10.81
HE20, M0 to M11 2ss	2	8	12.0	9.4	0.33	22.2	36	13.81
HE20 Beam Forming, M0 to M11 1ss	2	11	12.0	9.4	0.33	25.2	36	10.81
HE20 Beam Forming, M0 to M11 2ss	2	8	12.0	9.4	0.33	22.2	36	13.81
HE20 STBC, M0 to M11 2ss	2	8	12.0	9.4	0.33	22.2	36	13.81

Frequency 5795 MHz

Mode	Tx Paths	Correlated Antenna Gain (dBi)	Tx 1 PSD (dBm/MHz)	Tx 2 PSD (dBm/MHz)	Duty Cycle (dB)	Total PSD (dBm/MHz)	Limit (dBm/MHz)	Margin (dB)
Non HT40, 6 to 54 Mbps	1	8	7.5		0.28	15.7	36	20.26
Non HT40, 6 to 54 Mbps	2	11	7.5	7.1	0.28	21.6	36	14.45
HT/VHT40, M0 to M7	1	8	8.6		0.37	16.9	36	19.08
HT/VHT40, M0 to M7	2	11	8.6	6.9	0.37	22.2	36	13.8
HT/VHT40, M8 to M15	2	8	8.6	6.9	0.37	19.2	36	16.8
HT/VHT40 Beam Forming, M0 to M7	2	11	8.6	6.9	0.37	22.2	36	13.8
HT/VHT40 Beam Forming, M8 to M15	2	8	8.6	6.9	0.37	19.2	36	16.8
HT/VHT40 STBC, M8 to M15	2	8	8.6	6.9	0.37	19.2	36	16.8
HE40, M0 to M11 1ss	1	8	9.5		0.38	17.8	36	18.17
HE40, M0 to M11 1ss	2	11	9.5	7.8	0.38	23.1	36	12.9
HE40, M0 to M11 2ss	2	8	9.5	7.8	0.38	20.1	36	15.9
HE40 Beam Forming, M0 to M11 1ss	2	11	9.5	7.8	0.38	23.1	36	12.9
HE40 Beam Forming, M0 to M11 2ss	2	8	9.5	7.8	0.38	20.1	36	15.9
HE40 STBC, M0 to M11 2ss	2	8	9.5	7.8	0.38	20.1	36	15.9

Frequency 5825 MHz

Mode	Tx Paths	Correlated Antenna Gain (dBi)	Tx 1 PSD (dBm/MHz)	Tx 2 PSD (dBm/MHz)	Duty Cycle (dB)	Total PSD (dBm/MHz)	Limit (dBm/MHz)	Margin (dB)
Non HT20, 6 to 54 Mbps	1	8	8.8		0.36	17.2	36	18.83
Non HT20, 6 to 54 Mbps	2	11	8.8	9.7	0.36	23.7	36	12.33
Non HT20 Beam Forming, 6 to 54 Mbps	2	11	8.8	9.7	0.36	23.7	36	12.33
HT/VHT20, M0 to M7	1	8	9.3		0.35	17.6	36	18.37
HT/VHT20, M0 to M7	2	11	9.3	-25.2	0.35	20.6	36	15.37
HT/VHT20, M8 to M15	2	8	9.3	-25.2	0.35	17.6	36	18.37
HT/VHT20 Beam Forming, M0 to M7	2	11	9.3	-25.2	0.35	20.6	36	15.37
HT/VHT20 Beam Forming, M8 to M15	2	8	9.3	-25.2	0.35	17.6	36	18.37
HT/VHT20 STBC, M8 to M15	2	8	9.3	-25.2	0.35	17.6	36	18.37
HE20, M0 to M11 1ss	1	8	10.7		0.33	19.0	36	17.01
HE20, M0 to M11 1ss	2	11	10.7	12.7	0.33	26.1	36	9.88
HE20, M0 to M11 2ss	2	8	10.7	12.7	0.33	23.1	36	12.88
HE20 Beam Forming, M0 to M11 1ss	2	11	10.7	12.7	0.33	26.1	36	9.88
HE20 Beam Forming, M0 to M11 2ss	2	8	10.7	12.7	0.33	23.1	36	12.88
HE20 STBC, M0 to M11 2ss	2	8	10.7	12.7	0.33	23.1	36	12.88

Power Spectral Density EIRP – Antenna gain 15dBi.**Frequency 5745 MHz**

Mode	Tx Paths	Correlated Antenna Gain (dBi)	Tx 1 PSD (dBm/MHz)	Tx 2 PSD (dBm/MHz)	Duty Cycle (dB)	Total PSD (dBm/MHz)	Limit (dBm/MHz)	Margin (dB)
Non HT20, 6 to 54 Mbps	1	15	10.6		0.36	26.0	36	10.02
Non HT20, 6 to 54 Mbps	2	15	10.6	9.7	0.36	28.6	36	7.44
Non HT20 Beam Forming, 6 to 54 Mbps	2	15	10.6	9.7	0.36	28.6	36	7.44
HT/VHT20, M0 to M7	1	15	9.6		0.35	25.0	36	11.03
HT/VHT20, M0 to M7	2	15	9.6	10.3	0.35	28.4	36	7.65
HT/VHT20, M8 to M15	2	15	9.6	10.3	0.35	28.4	36	7.65
HT/VHT20 Beam Forming, M0 to M7	2	15	9.6	10.3	0.35	28.4	36	7.65
HT/VHT20 Beam Forming, M8 to M15	2	15	9.6	10.3	0.35	28.4	36	7.65
HT/VHT20 STBC, M8 to M15	2	15	9.6	10.3	0.35	28.4	36	7.65
HE20, M0 to M11 1ss	1	15	11.9		0.33	27.2	36	8.81
HE20, M0 to M11 1ss	2	15	10.2	10.8	0.33	28.9	36	7.14
HE20, M0 to M11 2ss	2	15	10.2	10.8	0.33	28.9	36	7.14
HE20 Beam Forming, M0 to M11 1ss	2	15	10.2	10.8	0.33	28.9	36	7.14
HE20 Beam Forming, M0 to M11 2ss	2	15	10.2	10.8	0.33	28.9	36	7.14
HE20 STBC, M0 to M11 2ss	2	15	10.2	10.8	0.33	28.9	36	7.14

Frequency 5755 MHz

Mode	Tx Paths	Correlated Antenna Gain (dBi)	Tx 1 PSD (dBm/MHz)	Tx 2 PSD (dBm/MHz)	Duty Cycle (dB)	Total PSD (dBm/MHz)	Limit (dBm/MHz)	Margin (dB)
Non HT40, 6 to 54 Mbps	1	15	6.7		0.28	22.0	36	13.98
Non HT40, 6 to 54 Mbps	2	15	6.7	6.4	0.28	24.8	36	11.16
HT/VHT40, M0 to M7	1	15	6.8		0.37	22.1	36	13.87
HT/VHT40, M0 to M7	2	15	5.9	6.0	0.37	24.3	36	11.65
HT/VHT40, M8 to M15	2	15	5.9	6.0	0.37	24.3	36	11.65
HT/VHT40 Beam Forming, M0 to M7	2	15	5.9	6.0	0.37	24.3	36	11.65
HT/VHT40 Beam Forming, M8 to M15	2	15	5.9	6.0	0.37	24.3	36	11.65
HT/VHT40 STBC, M8 to M15	2	15	5.9	6.0	0.37	24.3	36	11.65
HE40, M0 to M11 1ss	1	15	7.2		0.38	22.5	36	13.45
HE40, M0 to M11 1ss	2	15	6.8	6.8	0.38	25.2	36	10.83
HE40, M0 to M11 2ss	2	15	6.8	6.8	0.38	25.2	36	10.83
HE40 Beam Forming, M0 to M11 1ss	2	15	6.8	6.8	0.38	25.2	36	10.83
HE40 Beam Forming, M0 to M11 2ss	2	15	6.8	6.8	0.38	25.2	36	10.83
HE40 STBC, M0 to M11 2ss	2	15	6.8	6.8	0.38	25.2	36	10.83

Frequency 5775 MHz

Mode	Tx Paths	Correlated Antenna Gain (dBi)	Tx 1 PSD (dBm/MHz)	Tx 2 PSD (dBm/MHz)	Duty Cycle (dB)	Total PSD (dBm/MHz)	Limit (dBm/MHz)	Margin (dB)
Non HT80, 6 to 54 Mbps	1	15	5.0		0.43	20.4	36	15.58
Non HT80, 6 to 54 Mbps	2	15	3.3	2.8	0.43	21.5	36	14.52
VHT80, M0 to M11 1ss	1	15	2.8		0.48	18.2	36	17.76
VHT80, M0 to M11 1ss	2	15	4.9	2.2	0.48	22.3	36	13.74
VHT80, M0 to M11 2ss	2	15	4.9	2.2	0.48	22.3	36	13.74
VHT80 Beam Forming, M0 to M11 1ss	2	15	4.9	2.2	0.48	22.3	36	13.74
VHT80 Beam Forming, M0 to M11 2ss	2	15	4.9	2.2	0.48	22.3	36	13.74
VHT80 STBC, M0 to M11 2ss	2	15	4.9	2.2	0.48	22.3	36	13.74
HE80, M0 to M11 1ss	1	15	5.3		0.31	20.6	36	15.36
HE80, M0 to M11 1ss	2	15	2.8	3.7	0.31	21.6	36	14.42
HE80, M0 to M11 2ss	2	15	2.8	3.7	0.31	21.6	36	14.42
HE80 Beam Forming, M0 to M11 1ss	2	15	2.8	3.7	0.31	21.6	36	14.42
HE80 Beam Forming, M0 to M11 2ss	2	15	2.8	3.7	0.31	21.6	36	14.42
HE80 STBC, M0 to M11 2ss	2	15	2.8	3.7	0.31	21.6	36	14.42

Frequency 5785 MHz

Mode	Tx Paths	Correlated Antenna Gain (dBi)	Tx 1 PSD (dBm/MHz)	Tx 2 PSD (dBm/MHz)	Duty Cycle (dB)	Total PSD (dBm/MHz)	Limit (dBm/MHz)	Margin (dB)
Non HT20, 6 to 54 Mbps	1	15	11.0		0.36	26.3	36	9.68
Non HT20, 6 to 54 Mbps	2	15	11.0	9.9	0.36	28.8	36	7.17
Non HT20 Beam Forming, 6 to 54 Mbps	2	15	11.0	9.9	0.36	28.8	36	7.17
HT/VHT20, M0 to M7	1	15	10.7		0.35	26.1	36	9.92
HT/VHT20, M0 to M7	2	15	10.7	10.5	0.35	29.0	36	7.01
HT/VHT20, M8 to M15	2	15	10.7	10.5	0.35	29.0	36	7.01
HT/VHT20 Beam Forming, M0 to M7	2	15	10.7	10.5	0.35	29.0	36	7.01
HT/VHT20 Beam Forming, M8 to M15	2	15	10.7	10.5	0.35	29.0	36	7.01
HT/VHT20 STBC, M8 to M15	2	15	10.7	10.5	0.35	29.0	36	7.01
HE20, M0 to M11 1ss	1	15	12.0		0.33	27.3	36	8.71
HE20, M0 to M11 1ss	2	15	10.7	11.8	0.33	29.6	36	6.39
HE20, M0 to M11 2ss	2	15	10.7	11.8	0.33	29.6	36	6.39
HE20 Beam Forming, M0 to M11 1ss	2	15	10.7	11.8	0.33	29.6	36	6.39
HE20 Beam Forming, M0 to M11 2ss	2	15	10.7	11.8	0.33	29.6	36	6.39
HE20 STBC, M0 to M11 2ss	2	15	10.7	11.8	0.33	29.6	36	6.39

Frequency 5795 MHz

Mode	Tx Paths	Correlated Antenna Gain (dBi)	Tx 1 PSD (dBm/MHz)	Tx 2 PSD (dBm/MHz)	Duty Cycle (dB)	Total PSD (dBm/MHz)	Limit (dBm/MHz)	Margin (dB)
Non HT40, 6 to 54 Mbps	1	15	7.5		0.28	22.7	36	13.26
Non HT40, 6 to 54 Mbps	2	15	7.5	7.1	0.28	25.6	36	10.45
HT/VHT40, M0 to M7	1	15	8.6		0.37	23.9	36	12.08
HT/VHT40, M0 to M7	2	15	8.6	6.9	0.37	26.2	36	9.8
HT/VHT40, M8 to M15	2	15	8.6	6.9	0.37	26.2	36	9.8
HT/VHT40 Beam Forming, M0 to M7	2	15	8.6	6.9	0.37	26.2	36	9.8
HT/VHT40 Beam Forming, M8 to M15	2	15	8.6	6.9	0.37	26.2	36	9.8
HT/VHT40 STBC, M8 to M15	2	15	8.6	6.9	0.37	26.2	36	9.8
HE40, M0 to M11 1ss	1	15	9.5		0.38	24.8	36	11.17
HE40, M0 to M11 1ss	2	15	7.0	7.5	0.38	25.6	36	10.37
HE40, M0 to M11 2ss	2	15	7.0	7.5	0.38	25.6	36	10.37
HE40 Beam Forming, M0 to M11 1ss	2	15	7.0	7.5	0.38	25.6	36	10.37
HE40 Beam Forming, M0 to M11 2ss	2	15	7.0	7.5	0.38	25.6	36	10.37
HE40 STBC, M0 to M11 2ss	2	15	7.0	7.5	0.38	25.6	36	10.37

Frequency 5825 MHz

Mode	Tx Paths	Correlated Antenna Gain (dBi)	Tx 1 PSD (dBm/MHz)	Tx 2 PSD (dBm/MHz)	Duty Cycle (dB)	Total PSD (dBm/MHz)	Limit (dBm/MHz)	Margin (dB)
Non HT20, 6 to 54 Mbps	1	15	8.8		0.36	24.2	36	11.83
Non HT20, 6 to 54 Mbps	2	15	8.8	9.7	0.36	27.7	36	8.33
Non HT20 Beam Forming, 6 to 54 Mbps	2	15	8.8	9.7	0.36	27.7	36	8.33
HT/VHT20, M0 to M7	1	15	9.3		0.35	24.6	36	11.37
HT/VHT20, M0 to M7	2	15	9.3	-25.2	0.35	24.6	36	11.37
HT/VHT20, M8 to M15	2	15	9.3	-25.2	0.35	24.6	36	11.37
HT/VHT20 Beam Forming, M0 to M7	2	15	9.3	-25.2	0.35	24.6	36	11.37
HT/VHT20 Beam Forming, M8 to M15	2	15	9.3	-25.2	0.35	24.6	36	11.37
HT/VHT20 STBC, M8 to M15	2	15	9.3	-25.2	0.35	24.6	36	11.37
HE20, M0 to M11 1ss	1	15	10.7		0.33	26.0	36	10.01
HE20, M0 to M11 1ss	2	15	10.0	9.9	0.33	28.3	36	7.72
HE20, M0 to M11 2ss	2	15	10.0	9.9	0.33	28.3	36	7.72
HE20 Beam Forming, M0 to M11 1ss	2	15	10.0	9.9	0.33	28.3	36	7.72
HE20 Beam Forming, M0 to M11 2ss	2	15	10.0	9.9	0.33	28.3	36	7.72
HE20 STBC, M0 to M11 2ss	2	15	10.0	9.9	0.33	28.3	36	7.72

Conducted Power Spectral Density Tables – Antenna gain 3dBi.**Frequency 5745 MHz**

Mode	Tx Paths	Correlated Antenna Gain (dBi)	Tx 1 PSD (dBm/MHz)	Tx 2 PSD (dBm/MHz)	Duty Cycle (dB)	Total PSD (dBm/MHz)	Limit (dBm/MHz)	Margin (dB)
Non HT20, 6 to 54 Mbps	1	3	10.6		0.36	11.0	30	19.02
Non HT20, 6 to 54 Mbps	2	6	10.6	9.7	0.36	13.6	30	16.44
Non HT20 Beam Forming, 6 to 54 Mbps	2	6	10.6	9.7	0.36	13.6	30	16.44
HT/VHT20, M0 to M7	1	3	9.6		0.35	10.0	30	20.03
HT/VHT20, M0 to M7	2	6	9.6	10.3	0.35	13.4	30	16.65
HT/VHT20, M8 to M15	2	3	9.6	10.3	0.35	13.4	30	16.65
HT/VHT20 Beam Forming, M0 to M7	2	6	9.6	10.3	0.35	13.4	30	16.65
HT/VHT20 Beam Forming, M8 to M15	2	3	9.6	10.3	0.35	13.4	30	16.65
HT/VHT20 STBC, M8 to M15	2	3	9.6	10.3	0.35	13.4	30	16.65
HE20, M0 to M11 1ss	1	3	11.9		0.33	12.2	30	17.81
HE20, M0 to M11 1ss	2	6	11.9	9.8	0.33	14.3	30	15.72
HE20, M0 to M11 2ss	2	3	11.9	9.8	0.33	14.3	30	15.72
HE20 Beam Forming, M0 to M11 1ss	2	6	11.9	9.8	0.33	14.3	30	15.72
HE20 Beam Forming, M0 to M11 2ss	2	3	11.9	9.8	0.33	14.3	30	15.72
HE20 STBC, M0 to M11 2ss	2	3	11.9	9.8	0.33	14.3	30	15.72

Frequency 5755 MHz

Mode	Tx Paths	Correlated Antenna Gain (dBi)	Tx 1 PSD (dBm/MHz)	Tx 2 PSD (dBm/MHz)	Duty Cycle (dB)	Total PSD (dBm/MHz)	Limit (dBm/MHz)	Margin (dB)
Non HT40, 6 to 54 Mbps	1	3	6.7		0.28	7.0	30	22.98
Non HT40, 6 to 54 Mbps	2	6	6.7	6.4	0.28	9.8	30	20.16
HT/VHT40, M0 to M7	1	3	6.8		0.37	7.1	30	22.87
HT/VHT40, M0 to M7	2	6	6.8	7.0	0.37	10.3	30	19.71
HT/VHT40, M8 to M15	2	3	6.8	7.0	0.37	10.3	30	19.71
HT/VHT40 Beam Forming, M0 to M7	2	6	6.8	7.0	0.37	10.3	30	19.71
HT/VHT40 Beam Forming, M8 to M15	2	3	6.8	7.0	0.37	10.3	30	19.71
HT/VHT40 STBC, M8 to M15	2	3	6.8	7.0	0.37	10.3	30	19.71
HE40, M0 to M11 1ss	1	3	7.2		0.38	7.5	30	22.45
HE40, M0 to M11 1ss	2	6	7.2	7.6	0.38	10.8	30	19.22
HE40, M0 to M11 2ss	2	3	7.2	7.6	0.38	10.8	30	19.22
HE40 Beam Forming, M0 to M11 1ss	2	6	7.2	7.6	0.38	10.8	30	19.22
HE40 Beam Forming, M0 to M11 2ss	2	3	7.2	7.6	0.38	10.8	30	19.22
HE40 STBC, M0 to M11 2ss	2	3	7.2	7.6	0.38	10.8	30	19.22

Frequency 5775 MHz

Mode	Tx Paths	Correlated Antenna Gain (dBi)	Tx 1 PSD (dBm/MHz)	Tx 2 PSD (dBm/MHz)	Duty Cycle (dB)	Total PSD (dBm/MHz)	Limit (dBm/MHz)	Margin (dB)
Non HT80, 6 to 54 Mbps	1	3	5.0		0.43	5.4	30	24.58
Non HT80, 6 to 54 Mbps	2	6	5.0	3.7	0.43	7.8	30	22.16
VHT80, M0 to M11 1ss	1	3	2.8		0.48	3.2	30	26.76
VHT80, M0 to M11 1ss	2	6	2.8	2.6	0.48	6.2	30	23.82
VHT80, M0 to M11 2ss	2	3	2.8	2.6	0.48	6.2	30	23.82
VHT80 Beam Forming, M0 to M11 1ss	2	6	2.8	2.6	0.48	6.2	30	23.82
VHT80 Beam Forming, M0 to M11 2ss	2	3	2.8	2.6	0.48	6.2	30	23.82
VHT80 STBC, M0 to M11 2ss	2	3	2.8	2.6	0.48	6.2	30	23.82
HE80, M0 to M11 1ss	1	3	5.3		0.31	5.6	30	24.36
HE80, M0 to M11 1ss	2	6	5.3	4.1	0.31	8.1	30	21.92
HE80, M0 to M11 2ss	2	3	5.3	4.1	0.31	8.1	30	21.92
HE80 Beam Forming, M0 to M11 1ss	2	6	5.3	4.1	0.31	8.1	30	21.92
HE80 Beam Forming, M0 to M11 2ss	2	3	5.3	4.1	0.31	8.1	30	21.92
HE80 STBC, M0 to M11 2ss	2	3	5.3	4.1	0.31	8.1	30	21.92

Frequency 5785 MHz

Mode	Tx Paths	Correlated Antenna Gain (dBi)	Tx 1 PSD (dBm/MHz)	Tx 2 PSD (dBm/MHz)	Duty Cycle (dB)	Total PSD (dBm/MHz)	Limit (dBm/MHz)	Margin (dB)
Non HT20, 6 to 54 Mbps	1	3	11.0		0.36	11.3	30	18.68
Non HT20, 6 to 54 Mbps	2	6	11.0	9.9	0.36	13.8	30	16.17
Non HT20 Beam Forming, 6 to 54 Mbps	2	6	11.0	9.9	0.36	13.8	30	16.17
HT/VHT20, M0 to M7	1	3	10.7		0.35	11.1	30	18.92
HT/VHT20, M0 to M7	2	6	10.7	10.5	0.35	14.0	30	16.01
HT/VHT20, M8 to M15	2	3	10.7	10.5	0.35	14.0	30	16.01
HT/VHT20 Beam Forming, M0 to M7	2	6	10.7	10.5	0.35	14.0	30	16.01
HT/VHT20 Beam Forming, M8 to M15	2	3	10.7	10.5	0.35	14.0	30	16.01
HT/VHT20 STBC, M8 to M15	2	3	10.7	10.5	0.35	14.0	30	16.01
HE20, M0 to M11 1ss	1	3	12.0		0.33	12.3	30	17.71
HE20, M0 to M11 1ss	2	6	12.0	9.4	0.33	14.2	30	15.81
HE20, M0 to M11 2ss	2	3	12.0	9.4	0.33	14.2	30	15.81
HE20 Beam Forming, M0 to M11 1ss	2	6	12.0	9.4	0.33	14.2	30	15.81
HE20 Beam Forming, M0 to M11 2ss	2	3	12.0	9.4	0.33	14.2	30	15.81
HE20 STBC, M0 to M11 2ss	2	3	12.0	9.4	0.33	14.2	30	15.81

Frequency 5795 MHz

Mode	Tx Paths	Correlated Antenna Gain (dBi)	Tx 1 PSD (dBm/MHz)	Tx 2 PSD (dBm/MHz)	Duty Cycle (dB)	Total PSD (dBm/MHz)	Limit (dBm/MHz)	Margin (dB)
Non HT40, 6 to 54 Mbps	1	3	7.5		0.28	7.7	30	22.26
Non HT40, 6 to 54 Mbps	2	6	7.5	7.1	0.28	10.6	30	19.45
HT/VHT40, M0 to M7	1	3	8.6		0.37	8.9	30	21.08
HT/VHT40, M0 to M7	2	6	8.6	6.9	0.37	11.2	30	18.8
HT/VHT40, M8 to M15	2	3	8.6	6.9	0.37	11.2	30	18.8
HT/VHT40 Beam Forming, M0 to M7	2	6	8.6	6.9	0.37	11.2	30	18.8
HT/VHT40 Beam Forming, M8 to M15	2	3	8.6	6.9	0.37	11.2	30	18.8
HT/VHT40 STBC, M8 to M15	2	3	8.6	6.9	0.37	11.2	30	18.8
HE40, M0 to M11 1ss	1	3	9.5		0.38	9.8	30	20.17
HE40, M0 to M11 1ss	2	6	9.5	7.8	0.38	12.1	30	17.9
HE40, M0 to M11 2ss	2	3	9.5	7.8	0.38	12.1	30	17.9
HE40 Beam Forming, M0 to M11 1ss	2	6	9.5	7.8	0.38	12.1	30	17.9
HE40 Beam Forming, M0 to M11 2ss	2	3	9.5	7.8	0.38	12.1	30	17.9
HE40 STBC, M0 to M11 2ss	2	3	9.5	7.8	0.38	12.1	30	17.9

Frequency 5825 MHz

Mode	Tx Paths	Correlated Antenna Gain (dBi)	Tx 1 PSD (dBm/MHz)	Tx 2 PSD (dBm/MHz)	Duty Cycle (dB)	Total PSD (dBm/MHz)	Limit (dBm/MHz)	Margin (dB)
Non HT20, 6 to 54 Mbps	1	3	8.8		0.36	9.2	30	20.83
Non HT20, 6 to 54 Mbps	2	6	8.8	9.7	0.36	12.7	30	17.33
Non HT20 Beam Forming, 6 to 54 Mbps	2	6	8.8	9.7	0.36	12.7	30	17.33
HT/VHT20, M0 to M7	1	3	9.3		0.35	9.6	30	20.37
HT/VHT20, M0 to M7	2	6	9.3	-25.2	0.35	9.6	30	20.37
HT/VHT20, M8 to M15	2	3	9.3	-25.2	0.35	9.6	30	20.37
HT/VHT20 Beam Forming, M0 to M7	2	6	9.3	-25.2	0.35	9.6	30	20.37
HT/VHT20 Beam Forming, M8 to M15	2	3	9.3	-25.2	0.35	9.6	30	20.37
HT/VHT20 STBC, M8 to M15	2	3	9.3	-25.2	0.35	9.6	30	20.37
HE20, M0 to M11 1ss	1	3	10.7		0.33	11.0	30	19.01
HE20, M0 to M11 1ss	2	6	10.7	12.7	0.33	15.1	30	14.88
HE20, M0 to M11 2ss	2	3	10.7	12.7	0.33	15.1	30	14.88
HE20 Beam Forming, M0 to M11 1ss	2	6	10.7	12.7	0.33	15.1	30	14.88
HE20 Beam Forming, M0 to M11 2ss	2	3	10.7	12.7	0.33	15.1	30	14.88
HE20 STBC, M0 to M11 2ss	2	3	10.7	12.7	0.33	15.1	30	14.88

Conducted Power Spectral Density – Antenna gain 8dBi.**Frequency 5745 MHz**

Mode	Tx Paths	Correlated Antenna Gain (dBi)	Tx 1 PSD (dBm/MHz)	Tx 2 PSD (dBm/MHz)	Duty Cycle (dB)	Total PSD (dBm/MHz)	Limit (dBm/MHz)	Margin (dB)
Non HT20, 6 to 54 Mbps	1	8	10.6		0.36	11.0	30	19.02
Non HT20, 6 to 54 Mbps	2	11	10.6	9.7	0.36	13.6	30	16.44
Non HT20 Beam Forming, 6 to 54 Mbps	2	11	10.6	9.7	0.36	13.6	30	16.44
HT/VHT20, M0 to M7	1	8	9.6		0.35	10.0	30	20.03
HT/VHT20, M0 to M7	2	11	9.6	10.3	0.35	13.4	30	16.65
HT/VHT20, M8 to M15	2	8	9.6	10.3	0.35	13.4	30	16.65
HT/VHT20 Beam Forming, M0 to M7	2	11	9.6	10.3	0.35	13.4	30	16.65
HT/VHT20 Beam Forming, M8 to M15	2	8	9.6	10.3	0.35	13.4	30	16.65
HT/VHT20 STBC, M8 to M15	2	8	9.6	10.3	0.35	13.4	30	16.65
HE20, M0 to M11 1ss	1	8	11.9		0.33	12.2	30	17.81
HE20, M0 to M11 1ss	2	11	11.9	9.8	0.33	14.3	30	15.72
HE20, M0 to M11 2ss	2	8	11.9	9.8	0.33	14.3	30	15.72
HE20 Beam Forming, M0 to M11 1ss	2	11	11.9	9.8	0.33	14.3	30	15.72
HE20 Beam Forming, M0 to M11 2ss	2	8	11.9	9.8	0.33	14.3	30	15.72
HE20 STBC, M0 to M11 2ss	2	8	11.9	9.8	0.33	14.3	30	15.72

Frequency 5755 MHz

Mode	Tx Paths	Correlated Antenna Gain (dBi)	Tx 1 PSD (dBm/MHz)	Tx 2 PSD (dBm/MHz)	Duty Cycle (dB)	Total PSD (dBm/MHz)	Limit (dBm/MHz)	Margin (dB)
Non HT40, 6 to 54 Mbps	1	8	6.7		0.28	7.0	30	22.98
Non HT40, 6 to 54 Mbps	2	11	6.7	6.4	0.28	9.8	30	20.16
HT/VHT40, M0 to M7	1	8	6.8		0.37	7.1	30	22.87
HT/VHT40, M0 to M7	2	11	6.8	7.0	0.37	10.3	30	19.71
HT/VHT40, M8 to M15	2	8	6.8	7.0	0.37	10.3	30	19.71
HT/VHT40 Beam Forming, M0 to M7	2	11	6.8	7.0	0.37	10.3	30	19.71
HT/VHT40 Beam Forming, M8 to M15	2	8	6.8	7.0	0.37	10.3	30	19.71
HT/VHT40 STBC, M8 to M15	2	8	6.8	7.0	0.37	10.3	30	19.71
HE40, M0 to M11 1ss	1	8	7.2		0.38	7.5	30	22.45
HE40, M0 to M11 1ss	2	11	7.2	7.6	0.38	10.8	30	19.22
HE40, M0 to M11 2ss	2	8	7.2	7.6	0.38	10.8	30	19.22
HE40 Beam Forming, M0 to M11 1ss	2	11	7.2	7.6	0.38	10.8	30	19.22
HE40 Beam Forming, M0 to M11 2ss	2	8	7.2	7.6	0.38	10.8	30	19.22
HE40 STBC, M0 to M11 2ss	2	8	7.2	7.6	0.38	10.8	30	19.22

Frequency 5775 MHz

Mode	Tx Paths	Correlated Antenna Gain (dBi)	Tx 1 PSD (dBm/MHz)	Tx 2 PSD (dBm/MHz)	Duty Cycle (dB)	Total PSD (dBm/MHz)	Limit (dBm/MHz)	Margin (dB)
Non HT80, 6 to 54 Mbps	1	8	5.0		0.43	5.4	30	24.58
Non HT80, 6 to 54 Mbps	2	11	5.0	3.7	0.43	7.8	30	22.16
VHT80, M0 to M11 1ss	1	8	2.8		0.48	3.2	30	26.76
VHT80, M0 to M11 1ss	2	11	2.8	2.6	0.48	6.2	30	23.82
VHT80, M0 to M11 2ss	2	8	2.8	2.6	0.48	6.2	30	23.82
VHT80 Beam Forming, M0 to M11 1ss	2	11	2.8	2.6	0.48	6.2	30	23.82
VHT80 Beam Forming, M0 to M11 2ss	2	8	2.8	2.6	0.48	6.2	30	23.82
VHT80 STBC, M0 to M11 2ss	2	8	2.8	2.6	0.48	6.2	30	23.82
HE80, M0 to M11 1ss	1	8	5.3		0.31	5.6	30	24.36
HE80, M0 to M11 1ss	2	11	5.3	4.1	0.31	8.1	30	21.92
HE80, M0 to M11 2ss	2	8	5.3	4.1	0.31	8.1	30	21.92
HE80 Beam Forming, M0 to M11 1ss	2	11	5.3	4.1	0.31	8.1	30	21.92
HE80 Beam Forming, M0 to M11 2ss	2	8	5.3	4.1	0.31	8.1	30	21.92
HE80 STBC, M0 to M11 2ss	2	8	5.3	4.1	0.31	8.1	30	21.92

Frequency 5785 MHz

Mode	Tx Paths	Correlated Antenna Gain (dBi)	Tx 1 PSD (dBm/MHz)	Tx 2 PSD (dBm/MHz)	Duty Cycle (dB)	Total PSD (dBm/MHz)	Limit (dBm/MHz)	Margin (dB)
Non HT20, 6 to 54 Mbps	1	8	11.0		0.36	11.3	30	18.68
Non HT20, 6 to 54 Mbps	2	11	11.0	9.9	0.36	13.8	30	16.17
Non HT20 Beam Forming, 6 to 54 Mbps	2	11	11.0	9.9	0.36	13.8	30	16.17
HT/VHT20, M0 to M7	1	8	10.7		0.35	11.1	30	18.92
HT/VHT20, M0 to M7	2	11	10.7	10.5	0.35	14.0	30	16.01
HT/VHT20, M8 to M15	2	8	10.7	10.5	0.35	14.0	30	16.01
HT/VHT20 Beam Forming, M0 to M7	2	11	10.7	10.5	0.35	14.0	30	16.01
HT/VHT20 Beam Forming, M8 to M15	2	8	10.7	10.5	0.35	14.0	30	16.01
HT/VHT20 STBC, M8 to M15	2	8	10.7	10.5	0.35	14.0	30	16.01
HE20, M0 to M11 1ss	1	8	12.0		0.33	12.3	30	17.71
HE20, M0 to M11 1ss	2	11	12.0	9.4	0.33	14.2	30	15.81
HE20, M0 to M11 2ss	2	8	12.0	9.4	0.33	14.2	30	15.81
HE20 Beam Forming, M0 to M11 1ss	2	11	12.0	9.4	0.33	14.2	30	15.81
HE20 Beam Forming, M0 to M11 2ss	2	8	12.0	9.4	0.33	14.2	30	15.81
HE20 STBC, M0 to M11 2ss	2	8	12.0	9.4	0.33	14.2	30	15.81

Frequency 5795 MHz

Mode	Tx Paths	Correlated Antenna Gain (dBi)	Tx 1 PSD (dBm/MHz)	Tx 2 PSD (dBm/MHz)	Duty Cycle (dB)	Total PSD (dBm/MHz)	Limit (dBm/MHz)	Margin (dB)
Non HT40, 6 to 54 Mbps	1	8	7.5		0.28	7.7	30	22.26
Non HT40, 6 to 54 Mbps	2	11	7.5	7.1	0.28	10.6	30	19.45
HT/VHT40, M0 to M7	1	8	8.6		0.37	8.9	30	21.08
HT/VHT40, M0 to M7	2	11	8.6	6.9	0.37	11.2	30	18.8
HT/VHT40, M8 to M15	2	8	8.6	6.9	0.37	11.2	30	18.8
HT/VHT40 Beam Forming, M0 to M7	2	11	8.6	6.9	0.37	11.2	30	18.8
HT/VHT40 Beam Forming, M8 to M15	2	8	8.6	6.9	0.37	11.2	30	18.8
HT/VHT40 STBC, M8 to M15	2	8	8.6	6.9	0.37	11.2	30	18.8
HE40, M0 to M11 1ss	1	8	9.5		0.38	9.8	30	20.17
HE40, M0 to M11 1ss	2	11	9.5	7.8	0.38	12.1	30	17.9
HE40, M0 to M11 2ss	2	8	9.5	7.8	0.38	12.1	30	17.9
HE40 Beam Forming, M0 to M11 1ss	2	11	9.5	7.8	0.38	12.1	30	17.9
HE40 Beam Forming, M0 to M11 2ss	2	8	9.5	7.8	0.38	12.1	30	17.9
HE40 STBC, M0 to M11 2ss	2	8	9.5	7.8	0.38	12.1	30	17.9

Frequency 5825 MHz

Mode	Tx Paths	Correlated Antenna Gain (dBi)	Tx 1 PSD (dBm/MHz)	Tx 2 PSD (dBm/MHz)	Duty Cycle (dB)	Total PSD (dBm/MHz)	Limit (dBm/MHz)	Margin (dB)
Non HT20, 6 to 54 Mbps	1	8	8.8		0.36	9.2	30	20.83
Non HT20, 6 to 54 Mbps	2	11	8.8	9.7	0.36	12.7	30	17.33
Non HT20 Beam Forming, 6 to 54 Mbps	2	11	8.8	9.7	0.36	12.7	30	17.33
HT/VHT20, M0 to M7	1	8	9.3		0.35	9.6	30	20.37
HT/VHT20, M0 to M7	2	11	9.3	-25.2	0.35	9.6	30	20.37
HT/VHT20, M8 to M15	2	8	9.3	-25.2	0.35	9.6	30	20.37
HT/VHT20 Beam Forming, M0 to M7	2	11	9.3	-25.2	0.35	9.6	30	20.37
HT/VHT20 Beam Forming, M8 to M15	2	8	9.3	-25.2	0.35	9.6	30	20.37
HT/VHT20 STBC, M8 to M15	2	8	9.3	-25.2	0.35	9.6	30	20.37
HE20, M0 to M11 1ss	1	8	10.7		0.33	11.0	30	19.01
HE20, M0 to M11 1ss	2	11	10.7	12.7	0.33	15.1	30	14.88
HE20, M0 to M11 2ss	2	8	10.7	12.7	0.33	15.1	30	14.88
HE20 Beam Forming, M0 to M11 1ss	2	11	10.7	12.7	0.33	15.1	30	14.88
HE20 Beam Forming, M0 to M11 2ss	2	8	10.7	12.7	0.33	15.1	30	14.88
HE20 STBC, M0 to M11 2ss	2	8	10.7	12.7	0.33	15.1	30	14.88

Conducted Power Spectral Density Tables – Antenna gain 15dBi.**Frequency 5745 MHz**

Mode	Tx Paths	Correlated Antenna Gain (dBi)	Tx 1 PSD (dBm/MHz)	Tx 2 PSD (dBm/MHz)	Duty Cycle (dB)	Total PSD (dBm/MHz)	Limit (dBm/MHz)	Margin (dB)
Non HT20, 6 to 54 Mbps	1	15	10.6		0.36	11.0	30	19.02
Non HT20, 6 to 54 Mbps	2	15	10.6	9.7	0.36	13.6	30	16.44
Non HT20 Beam Forming, 6 to 54 Mbps	2	15	10.6	9.7	0.36	13.6	30	16.44
HT/VHT20, M0 to M7	1	15	9.6		0.35	10.0	30	20.03
HT/VHT20, M0 to M7	2	15	9.6	10.3	0.35	13.4	30	16.65
HT/VHT20, M8 to M15	2	15	9.6	10.3	0.35	13.4	30	16.65
HT/VHT20 Beam Forming, M0 to M7	2	15	9.6	10.3	0.35	13.4	30	16.65
HT/VHT20 Beam Forming, M8 to M15	2	15	9.6	10.3	0.35	13.4	30	16.65
HT/VHT20 STBC, M8 to M15	2	15	9.6	10.3	0.35	13.4	30	16.65
HE20, M0 to M11 1ss	1	15	11.9		0.33	12.2	30	17.81
HE20, M0 to M11 1ss	2	15	10.2	10.8	0.33	13.9	30	16.14
HE20, M0 to M11 2ss	2	15	10.2	10.8	0.33	13.9	30	16.14
HE20 Beam Forming, M0 to M11 1ss	2	15	10.2	10.8	0.33	13.9	30	16.14
HE20 Beam Forming, M0 to M11 2ss	2	15	10.2	10.8	0.33	13.9	30	16.14
HE20 STBC, M0 to M11 2ss	2	15	10.2	10.8	0.33	13.9	30	16.14

Frequency 5755 MHz

Mode	Tx Paths	Correlated Antenna Gain (dBi)	Tx 1 PSD (dBm/MHz)	Tx 2 PSD (dBm/MHz)	Duty Cycle (dB)	Total PSD (dBm/MHz)	Limit (dBm/MHz)	Margin (dB)
Non HT40, 6 to 54 Mbps	1	15	6.7		0.28	7.0	30	22.98
Non HT40, 6 to 54 Mbps	2	15	6.7	6.4	0.28	9.8	30	20.16
HT/VHT40, M0 to M7	1	15	6.8		0.37	7.1	30	22.87
HT/VHT40, M0 to M7	2	15	5.9	6.0	0.37	9.3	30	20.65
HT/VHT40, M8 to M15	2	15	5.9	6.0	0.37	9.3	30	20.65
HT/VHT40 Beam Forming, M0 to M7	2	15	5.9	6.0	0.37	9.3	30	20.65
HT/VHT40 Beam Forming, M8 to M15	2	15	5.9	6.0	0.37	9.3	30	20.65
HT/VHT40 STBC, M8 to M15	2	15	5.9	6.0	0.37	9.3	30	20.65
HE40, M0 to M11 1ss	1	15	7.2		0.38	7.5	30	22.45
HE40, M0 to M11 1ss	2	15	6.8	6.8	0.38	10.2	30	19.83
HE40, M0 to M11 2ss	2	15	6.8	6.8	0.38	10.2	30	19.83
HE40 Beam Forming, M0 to M11 1ss	2	15	6.8	6.8	0.38	10.2	30	19.83
HE40 Beam Forming, M0 to M11 2ss	2	15	6.8	6.8	0.38	10.2	30	19.83
HE40 STBC, M0 to M11 2ss	2	15	6.8	6.8	0.38	10.2	30	19.83

Frequency 5775 MHz

Mode	Tx Paths	Correlated Antenna Gain (dBi)	Tx 1 PSD (dBm/MHz)	Tx 2 PSD (dBm/MHz)	Duty Cycle (dB)	Total PSD (dBm/MHz)	Limit (dBm/MHz)	Margin (dB)
Non HT80, 6 to 54 Mbps	1	15	5.0		0.43	5.4	30	24.58
Non HT80, 6 to 54 Mbps	2	15	3.3	2.8	0.43	6.5	30	23.52
VHT80, M0 to M11 1ss	1	15	2.8		0.48	3.2	30	26.76
VHT80, M0 to M11 1ss	2	15	4.9	2.2	0.48	7.3	30	22.74
VHT80, M0 to M11 2ss	2	15	4.9	2.2	0.48	7.3	30	22.74
VHT80 Beam Forming, M0 to M11 1ss	2	15	4.9	2.2	0.48	7.3	30	22.74
VHT80 Beam Forming, M0 to M11 2ss	2	15	4.9	2.2	0.48	7.3	30	22.74
VHT80 STBC, M0 to M11 2ss	2	15	4.9	2.2	0.48	7.3	30	22.74
HE80, M0 to M11 1ss	1	15	5.3		0.31	5.6	30	24.36
HE80, M0 to M11 1ss	2	15	2.8	3.7	0.31	6.6	30	23.42
HE80, M0 to M11 2ss	2	15	2.8	3.7	0.31	6.6	30	23.42
HE80 Beam Forming, M0 to M11 1ss	2	15	2.8	3.7	0.31	6.6	30	23.42
HE80 Beam Forming, M0 to M11 2ss	2	15	2.8	3.7	0.31	6.6	30	23.42
HE80 STBC, M0 to M11 2ss	2	15	2.8	3.7	0.31	6.6	30	23.42

Frequency 5785 MHz

Mode	Tx Paths	Correlated Antenna Gain (dBi)	Tx 1 PSD (dBm/MHz)	Tx 2 PSD (dBm/MHz)	Duty Cycle (dB)	Total PSD (dBm/MHz)	Limit (dBm/MHz)	Margin (dB)
Non HT20, 6 to 54 Mbps	1	15	11.0		0.36	11.3	30	18.68
Non HT20, 6 to 54 Mbps	2	15	11.0	9.9	0.36	13.8	30	16.17
Non HT20 Beam Forming, 6 to 54 Mbps	2	15	11.0	9.9	0.36	13.8	30	16.17
HT/VHT20, M0 to M7	1	15	10.7		0.35	11.1	30	18.92
HT/VHT20, M0 to M7	2	15	10.7	10.5	0.35	14.0	30	16.01
HT/VHT20, M8 to M15	2	15	10.7	10.5	0.35	14.0	30	16.01
HT/VHT20 Beam Forming, M0 to M7	2	15	10.7	10.5	0.35	14.0	30	16.01
HT/VHT20 Beam Forming, M8 to M15	2	15	10.7	10.5	0.35	14.0	30	16.01
HT/VHT20 STBC, M8 to M15	2	15	10.7	10.5	0.35	14.0	30	16.01
HE20, M0 to M11 1ss	1	15	12.0		0.33	12.3	30	17.71
HE20, M0 to M11 1ss	2	15	10.7	11.8	0.33	14.6	30	15.39
HE20, M0 to M11 2ss	2	15	10.7	11.8	0.33	14.6	30	15.39
HE20 Beam Forming, M0 to M11 1ss	2	15	10.7	11.8	0.33	14.6	30	15.39
HE20 Beam Forming, M0 to M11 2ss	2	15	10.7	11.8	0.33	14.6	30	15.39
HE20 STBC, M0 to M11 2ss	2	15	10.7	11.8	0.33	14.6	30	15.39

Frequency 5795 MHz

Mode	Tx Paths	Correlated Antenna Gain (dBi)	Tx 1 PSD (dBm/MHz)	Tx 2 PSD (dBm/MHz)	Duty Cycle (dB)	Total PSD (dBm/MHz)	Limit (dBm/MHz)	Margin (dB)
Non HT40, 6 to 54 Mbps	1	15	7.5		0.28	7.7	30	22.26
Non HT40, 6 to 54 Mbps	2	15	7.5	7.1	0.28	10.6	30	19.45
HT/VHT40, M0 to M7	1	15	8.6		0.37	8.9	30	21.08
HT/VHT40, M0 to M7	2	15	8.6	6.9	0.37	11.2	30	18.8
HT/VHT40, M8 to M15	2	15	8.6	6.9	0.37	11.2	30	18.8
HT/VHT40 Beam Forming, M0 to M7	2	15	8.6	6.9	0.37	11.2	30	18.8
HT/VHT40 Beam Forming, M8 to M15	2	15	8.6	6.9	0.37	11.2	30	18.8
HT/VHT40 STBC, M8 to M15	2	15	8.6	6.9	0.37	11.2	30	18.8
HE40, M0 to M11 1ss	1	15	9.5		0.38	9.8	30	20.17
HE40, M0 to M11 1ss	2	15	7.0	7.5	0.38	10.6	30	19.37
HE40, M0 to M11 2ss	2	15	7.0	7.5	0.38	10.6	30	19.37
HE40 Beam Forming, M0 to M11 1ss	2	15	7.0	7.5	0.38	10.6	30	19.37
HE40 Beam Forming, M0 to M11 2ss	2	15	7.0	7.5	0.38	10.6	30	19.37
HE40 STBC, M0 to M11 2ss	2	15	7.0	7.5	0.38	10.6	30	19.37

Frequency 5825 MHz

Mode	Tx Paths	Correlated Antenna Gain (dBi)	Tx 1 PSD (dBm/MHz)	Tx 2 PSD (dBm/MHz)	Duty Cycle (dB)	Total PSD (dBm/MHz)	Limit (dBm/MHz)	Margin (dB)
Non HT20, 6 to 54 Mbps	1	15	8.8		0.36	9.2	30	20.83
Non HT20, 6 to 54 Mbps	2	15	8.8	9.7	0.36	12.7	30	17.33
Non HT20 Beam Forming, 6 to 54 Mbps	2	15	8.8	9.7	0.36	12.7	30	17.33
HT/VHT20, M0 to M7	1	15	9.3		0.35	9.6	30	20.37
HT/VHT20, M0 to M7	2	15	9.3	-25.2	0.35	9.6	30	20.37
HT/VHT20, M8 to M15	2	15	9.3	-25.2	0.35	9.6	30	20.37
HT/VHT20 Beam Forming, M0 to M7	2	15	9.3	-25.2	0.35	9.6	30	20.37
HT/VHT20 Beam Forming, M8 to M15	2	15	9.3	-25.2	0.35	9.6	30	20.37
HT/VHT20 STBC, M8 to M15	2	15	9.3	-25.2	0.35	9.6	30	20.37
HE20, M0 to M11 1ss	1	15	10.7		0.33	11.0	30	19.01
HE20, M0 to M11 1ss	2	15	10.0	9.9	0.33	13.3	30	16.72
HE20, M0 to M11 2ss	2	15	10.0	9.9	0.33	13.3	30	16.72
HE20 Beam Forming, M0 to M11 1ss	2	15	10.0	9.9	0.33	13.3	30	16.72
HE20 Beam Forming, M0 to M11 2ss	2	15	10.0	9.9	0.33	13.3	30	16.72
HE20 STBC, M0 to M11 2ss	2	15	10.0	9.9	0.33	13.3	30	16.72

Data Screenshots – Antenna gain 3dBi.

5825 MHz: HE20, M0 to M11 1ss

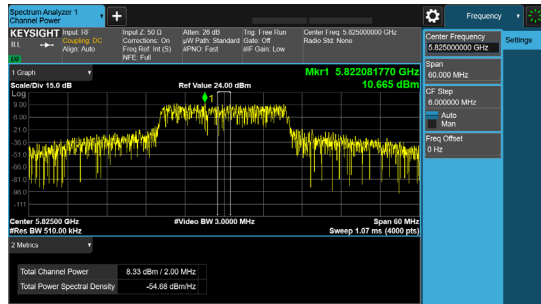

Antenna A

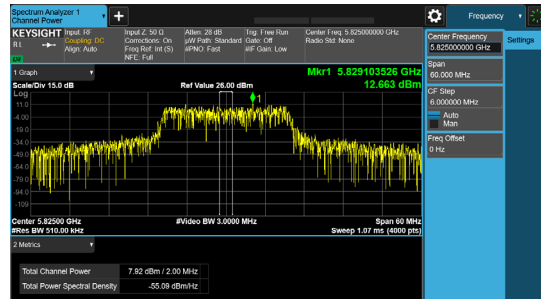

Antenna B

5825 MHz: HE20 Beam Forming, M0 to M11 1ss

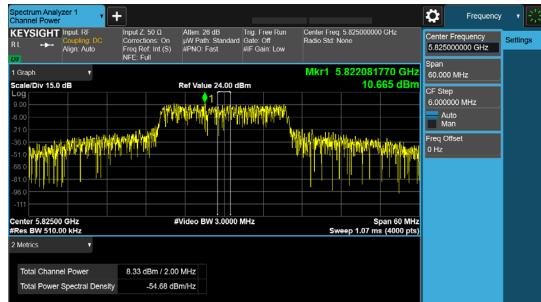

Antenna A

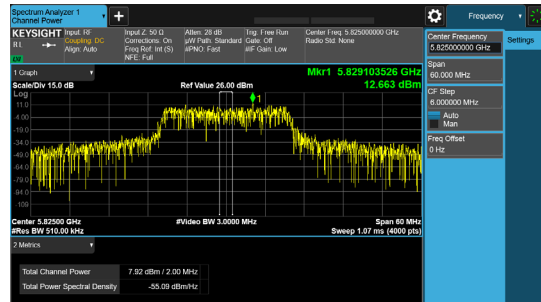

Antenna B

5720 MHz: HE20, M0 to M11 1ss

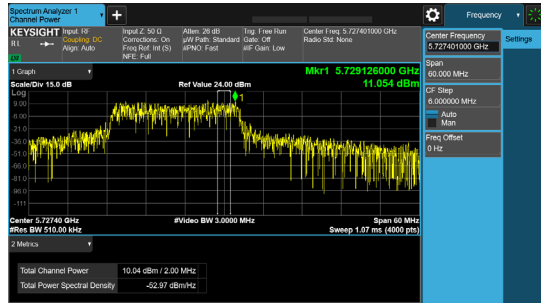

Antenna A

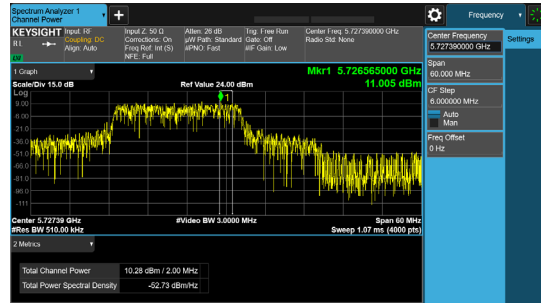

Antenna B

Data Screenshots – Antenna gain 8dBi.

5825 MHz: HE20, M0 to M11 1ss

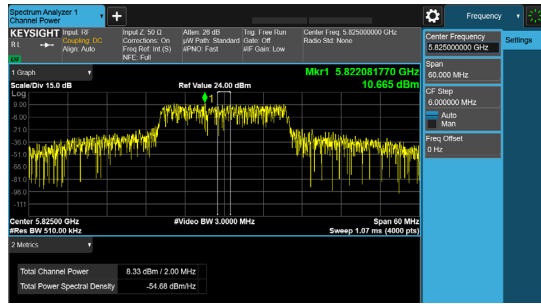

Antenna A

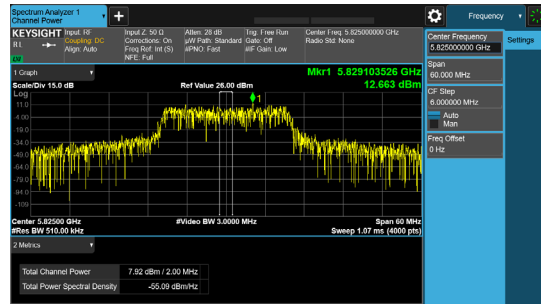

Antenna B

5825 MHz: HE20 Beam Forming, M0 to M11 1ss

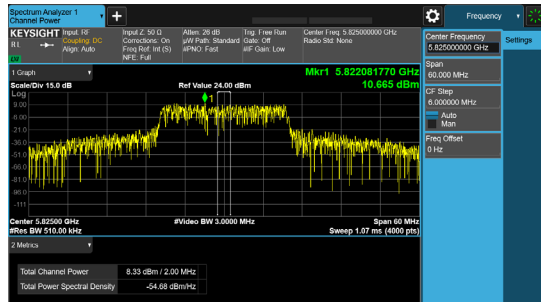

Antenna A

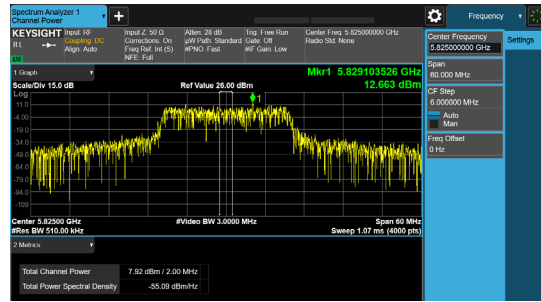

Antenna B

5745 MHz: HE20, M0 to M11 1ss

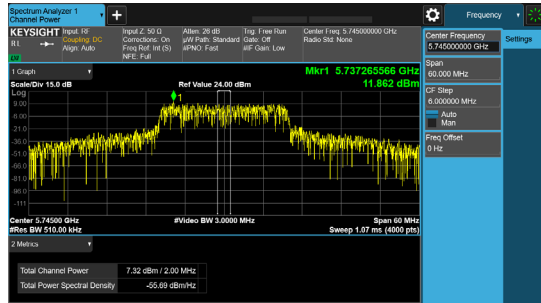

Antenna A

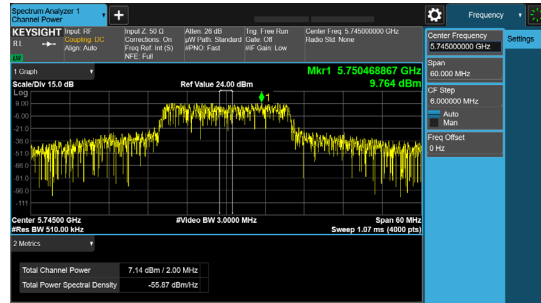

Antenna B

Data Screenshots – Antenna gain 15dBi.

5785 MHz: HE20, M0 to M11 1ss

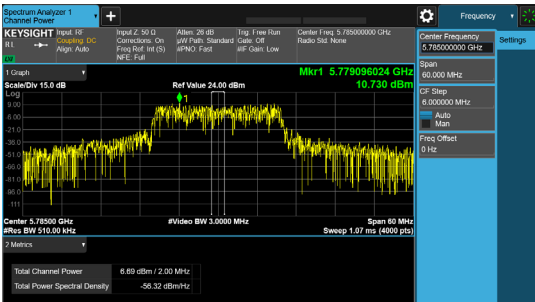

Antenna A

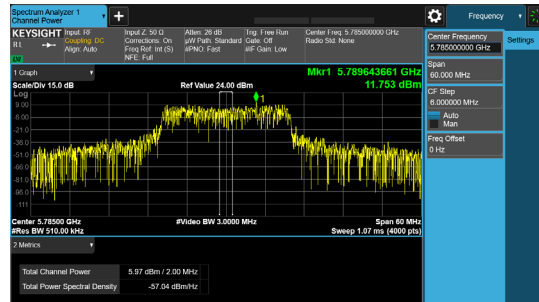

Antenna B

5785 MHz: HE20, M0 to M11 2ss

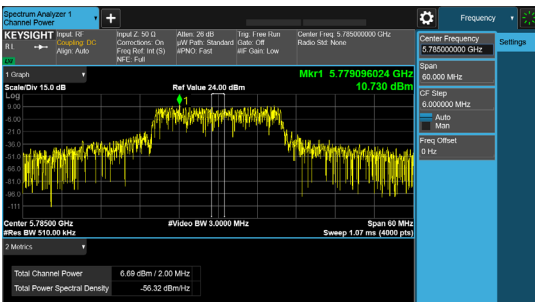

Antenna A

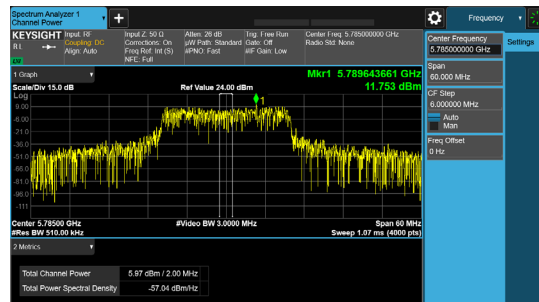

Antenna B

5785 MHz: HE20 Beam Forming, M0 to M11 1ss

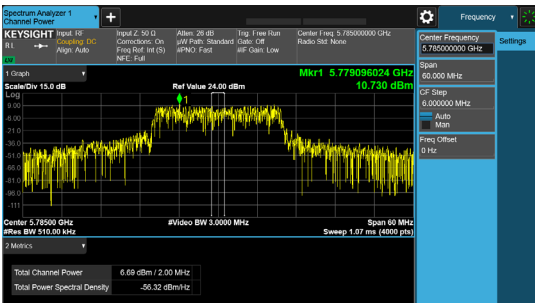

Antenna A

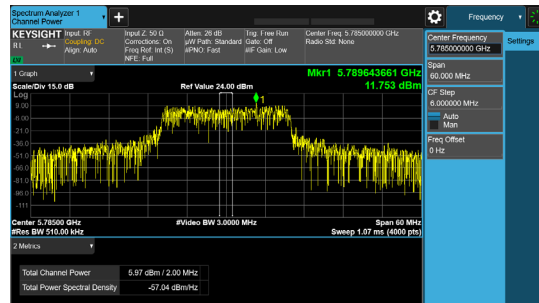

Antenna B

A.6: Conducted Spurious Emissions

Conducted Spurious Emissions Test Requirement

LP0002 (2020-07-01) (5.7.4.2):

For transmitters operating in the 5.725 GHz~5.850 GHz band: All emissions within the frequency range from the band edge to 5 MHz above or below the band edge shall be less than or equal to an EIRP of 27 dBm/MHz~15.6 dBm/MHz (limits corresponding to linear method); all emissions within the frequency range from the band edge to 5 MHz~25 MHz above or below the band edge shall be less than or equal to an EIRP of 15.6 dBm/MHz~10 dBm/MHz (limits corresponding to linear method); all emissions within the frequency range from the band edge to 25 MHz~75 MHz above or below the band edge shall be less than or equal to an EIRP of 10 dBm/MHz~ -27 dBm/MHz (limits corresponding to linear method); for frequencies 75 MHz or greater above or below the band edge, emissions shall be less than or equal to an EIRP of -27 dBm/MHz; for the mask limit, please see Figure 4.

15.407:

(b) Undesirable emission limits. Except as shown in paragraph (b)(7) of this section, the maximum emissions outside of the frequency bands of operation shall be attenuated in accordance with the following limits:

(4) For transmitters operating in the 5.725-5.85 GHz band:

(i) All emissions shall be limited to a level of -27 dBm/MHz at 75 MHz or more above or below the band edge increasing linearly to 10 dBm/MHz at 25 MHz above or below the band edge, and from 25 MHz above or below the band edge increasing linearly to a level of 15.6 dBm/MHz at 5 MHz above or below the band edge, and from 5 MHz above or below the band edge increasing linearly to a level of 27 dBm/MHz at the band edge.

(6) Unwanted emissions below 1 GHz must comply with the general field strength limits set forth in §15.209.

(7) The provisions of §15.205 apply to intentional radiators operating under this section.

15.205 | 15.209:

Radiated emissions which fall in the restricted bands, as defined in Section 15.205(a), must also comply with the radiated emission limits specified in Section 15.209(a) (see Section 15.205(c)).

Use formula below to substitute conducted measurements in place of radiated measurements

$E[\text{dB}\mu\text{V}/\text{m}] = \text{EIRP}[\text{dBm}] - 20 \log(d[\text{meters}]) + 104.77$, where E = field strength and d = 3 meter

1) Average Plot, Limit= -41.25 dBm eirp

2) Peak plot, Limit = -21.25 dBm eirp

Conducted Spurious Emissions Test Procedure

From KDB 789033 D02 General UNII Test Procedures New Rules v02r01
ANSI C63.10: 2013

Conducted Spurious Emissions Test Procedure
<ol style="list-style-type: none"> 1. Connect the antenna port(s) to the spectrum analyzer input. 2. Place the radio in continuous transmit mode 3. Configure Spectrum analyzer as per test parameters below (be sure to enter all losses between the transmitter output and the spectrum analyzer). 4. Use the peak marker function to determine the maximum spurs amplitude level. 5. Out-of-band and spurious emissions tests are performed on each output individually without summing or adding 10 log(N) since the measurements are made relative to the in-band emissions on the individual outputs. The worst-case output is recorded. 6. Capture graphs and record pertinent measurement data. <p>ISED:</p> <ol style="list-style-type: none"> 1. Connect the antenna port(s) to the spectrum analyzer input. 2. Place the radio in continuous transmit mode 3. Configure Spectrum analyzer as per test parameters below (be sure to enter all losses between the transmitter output and the spectrum analyzer). 4. Use the peak marker function to determine the maximum spurs amplitude level. 5. The "measure-and-sum technique" is used for measuring in-band transmit power of a device. In the measure-and-sum approach, the conducted emission level is measured at each antenna port. The measured results at the various antenna ports are then summed mathematically to determine the total emission level from the device. Summing is performed in linear power units. The worst-case output is recorded. (see ANSI C63.10:2013 section 14.3.2.2) 6. Capture graphs and record pertinent measurement data.

Ref. KDB 789033 D02 General UNII Test Procedures New Rules v02r01, Sec. 5 (Peak), Sec. 6 (Average Method AD)
ANSI C63.10: 2013 Section 12.7.6 (Peak), Section 12.7.7.2 (Method AD)

Conducted Spurious Emissions Test parameters	
<p>Peak</p> <p>Span = 30MHz to 26.5GHz / 26.5GHz to 40GHz RBW = 1 MHz VBW ≥ 3 MHz Sweep = Auto couple Detector = Peak Trace = Max Hold.</p>	<p>Average</p> <p>Span = 30MHz to 26.5GHz / 26.5GHz to 40GHz RBW = 1 MHz VBW ≥ 3 MHz Sweep = Auto couple Detector = RMS Power Averaging</p>

Add the max antenna gain + ground reflection factor (4.7 dB for frequencies between 30 MHz and 1000 MHz, and 0 dB for frequencies > 1000 MHz).

Tested By: Ronak Patel	Date of testing: 11/1/2022 - 2/10/2023
Test Result: PASS	

Test Equipment

See Appendix C for list of test equipment

Note: Although 100kHz RBW is required for emissions below 1GHz, 1MHz RBW was used in order to show compliance under worst-case setting

Note: emissions above 12GHz are only noise floor and that data can be additionally shown in radiated report

Conducted Spurs Average

Frequency 5745 MHz

Mode	Tx Paths	Correlated Antenna Gain (dBi)	Tx 1 Spur Power (dBm)	Tx 2 Spur Power (dBm)	Duty Cycle (dB)	Total Conducted Spur (dBm)	Limit (dB)	Margin (dB)
Non HT20, 6 to 54 Mbps	1	3	-59.7		0.36	-56.3	-41	15.09
Non HT20, 6 to 54 Mbps	2	3	-59.7	-62.2	0.36	-54.4	-41	13.15
Non HT20 Beam Forming, 6 to 54 Mbps	2	6	-59.7	-62.2	0.36	-51.4	-41	10.15
HT/VHT20, M0 to M7	1	3	-61.2		0.35	-57.8	-41	16.6
HT/VHT20, M0 to M7	2	3	-61.2	-62.3	0.35	-55.4	-41	14.1
HT/VHT20, M8 to M15	2	3	-61.2	-62.3	0.35	-55.4	-41	14.1
HT/VHT20 Beam Forming, M0 to M7	2	6	-61.2	-62.3	0.35	-52.4	-41	11.1
HT/VHT20 Beam Forming, M8 to M15	2	3	-61.2	-62.3	0.35	-55.4	-41	14.1
HT/VHT20 STBC, M8 to M15	2	3	-61.2	-62.3	0.35	-55.4	-41	14.1
HE20, M0 to M11 1ss	1	3	-61.9		0.33	-58.6	-41	17.32
HE20, M0 to M11 1ss	2	3	-61.9	-61.8	0.33	-55.5	-41	14.26
HE20, M0 to M11 2ss	2	3	-61.9	-61.8	0.33	-55.5	-41	14.26
HE20 Beam Forming, M0 to M11 1ss	2	6	-61.9	-61.8	0.33	-52.5	-41	11.26
HE20 Beam Forming, M0 to M11 2ss	2	3	-61.9	-61.8	0.33	-55.5	-41	14.26
HE20 STBC, M0 to M11 2ss	2	3	-61.9	-61.8	0.33	-55.5	-41	14.26

Frequency 5755 MHz

Mode	Tx Paths	Correlated Antenna Gain (dBi)	Tx 1 Spur Power (dBm)	Tx 2 Spur Power (dBm)	Duty Cycle (dB)	Total Conducted Spur (dBm)	Limit (dB)	Margin (dB)
Non HT40, 6 to 54 Mbps	1	3	-59.4		0.28	-56.1	-41	14.87
Non HT40, 6 to 54 Mbps	2	3	-59.4	-61.9	0.28	-54.2	-41	12.93
HT/VHT40, M0 to M7	1	3	-61.8		0.37	-58.4	-41	17.18
HT/VHT40, M0 to M7	2	3	-61.8	-62.1	0.37	-55.6	-41	14.31
HT/VHT40, M8 to M15	2	3	-61.8	-62.1	0.37	-55.6	-41	14.31
HT/VHT40 Beam Forming, M0 to M7	2	6	-61.8	-62.1	0.37	-52.6	-41	11.31
HT/VHT40 Beam Forming, M8 to M15	2	3	-61.8	-62.1	0.37	-55.6	-41	14.31
HT/VHT40 STBC, M8 to M15	2	3	-61.8	-62.1	0.37	-55.6	-41	14.31
HE40, M0 to M11 1ss	1	3	-61.8		0.38	-58.4	-41	17.17
HE40, M0 to M11 1ss	2	3	-61.8	-62.1	0.38	-55.6	-41	14.31
HE40, M0 to M11 2ss	2	3	-61.8	-62.1	0.38	-55.6	-41	14.31
HE40 Beam Forming, M0 to M11 1ss	2	6	-61.8	-62.1	0.38	-52.6	-41	11.31
HE40 Beam Forming, M0 to M11 2ss	2	3	-61.8	-62.1	0.38	-55.6	-41	14.31
HE40 STBC, M0 to M11 2ss	2	3	-61.8	-62.1	0.38	-55.6	-41	14.31

Frequency 5775 MHz

Mode	Tx Paths	Correlated Antenna Gain (dBi)	Tx 1 Spur Power (dBm)	Tx 2 Spur Power (dBm)	Duty Cycle (dB)	Total Conducted Spur (dBm)	Limit (dB)	Margin (dB)
Non HT80, 6 to 54 Mbps	1	3	-64.2		0.43	-60.8	-41	19.52
Non HT80, 6 to 54 Mbps	2	3	-64.2	-64.8	0.43	-58.0	-41	16.8
VHT80, M0 to M11 1ss	1	3	-63.7		0.48	-60.2	-41	18.97
VHT80, M0 to M11 1ss	2	3	-63.7	-64.4	0.48	-57.5	-41	16.29
VHT80, M0 to M11 2ss	2	3	-63.7	-64.4	0.48	-57.5	-41	16.29
VHT80 Beam Forming, M0 to M11 1ss	2	6	-63.7	-64.4	0.48	-54.5	-41	13.29
VHT80 Beam Forming, M0 to M11 2ss	2	3	-63.7	-64.4	0.48	-57.5	-41	16.29
VHT80 STBC, M0 to M11 2ss	2	3	-63.7	-64.4	0.48	-57.5	-41	16.29
HE80, M0 to M11 1ss	1	3	-64.3		0.31	-61.0	-41	19.74
HE80, M0 to M11 1ss	2	3	-64.3	-64.4	0.31	-58.0	-41	16.78
HE80, M0 to M11 2ss	2	3	-64.3	-64.4	0.31	-58.0	-41	16.78
HE80 Beam Forming, M0 to M11 1ss	2	6	-64.3	-64.4	0.31	-55.0	-41	13.78
HE80 Beam Forming, M0 to M11 2ss	2	3	-64.3	-64.4	0.31	-58.0	-41	16.78
HE80 STBC, M0 to M11 2ss	2	3	-64.3	-64.4	0.31	-58.0	-41	16.78

Frequency 5785 MHz

Mode	Tx Paths	Correlated Antenna Gain (dBi)	Tx 1 Spur Power (dBm)	Tx 2 Spur Power (dBm)	Duty Cycle (dB)	Total Conducted Spur (dBm)	Limit (dB)	Margin (dB)
Non HT20, 6 to 54 Mbps	1	3	-62.9		0.36	-59.5	-41	18.29
Non HT20, 6 to 54 Mbps	2	3	-62.9	-62.2	0.36	-56.2	-41	14.92
Non HT20 Beam Forming, 6 to 54 Mbps	2	6	-62.9	-62.2	0.36	-53.2	-41	11.92
HT/VHT20, M0 to M7	1	3	-63.0		0.35	-59.6	-41	18.4
HT/VHT20, M0 to M7	2	3	-63.0	-62.3	0.35	-56.3	-41	15.02
HT/VHT20, M8 to M15	2	3	-63.0	-62.3	0.35	-56.3	-41	15.02
HT/VHT20 Beam Forming, M0 to M7	2	6	-63.0	-62.3	0.35	-53.3	-41	12.02
HT/VHT20 Beam Forming, M8 to M15	2	3	-63.0	-62.3	0.35	-56.3	-41	15.02
HT/VHT20 STBC, M8 to M15	2	3	-63.0	-62.3	0.35	-56.3	-41	15.02
HE20, M0 to M11 1ss	1	3	-60.6		0.33	-57.3	-41	16.02
HE20, M0 to M11 1ss	2	3	-60.6	-61.3	0.33	-54.6	-41	13.35
HE20, M0 to M11 2ss	2	3	-60.6	-61.3	0.33	-54.6	-41	13.35
HE20 Beam Forming, M0 to M11 1ss	2	6	-60.6	-61.3	0.33	-51.6	-41	10.35
HE20 Beam Forming, M0 to M11 2ss	2	3	-60.6	-61.3	0.33	-54.6	-41	13.35
HE20 STBC, M0 to M11 2ss	2	3	-60.6	-61.3	0.33	-54.6	-41	13.35

Frequency 5795 MHz

Mode	Tx Paths	Correlated Antenna Gain (dBi)	Tx 1 Spur Power (dBm)	Tx 2 Spur Power (dBm)	Duty Cycle (dB)	Total Conducted Spur (dBm)	Limit (dB)	Margin (dB)
Non HT40, 6 to 54 Mbps	1	3	-62.6		0.28	-59.3	-41	18.07
Non HT40, 6 to 54 Mbps	2	3	-62.6	-62.1	0.28	-56.1	-41	14.8
HT/VHT40, M0 to M7	1	3	-63.2		0.37	-59.8	-41	18.58
HT/VHT40, M0 to M7	2	3	-63.2	-62.7	0.37	-56.6	-41	15.31
HT/VHT40, M8 to M15	2	3	-63.2	-62.7	0.37	-56.6	-41	15.31
HT/VHT40 Beam Forming, M0 to M7	2	6	-63.2	-62.7	0.37	-53.6	-41	12.31
HT/VHT40 Beam Forming, M8 to M15	2	3	-63.2	-62.7	0.37	-56.6	-41	15.31
HT/VHT40 STBC, M8 to M15	2	3	-63.2	-62.7	0.37	-56.6	-41	15.31
HE40, M0 to M11 1ss	1	3	-60.3		0.38	-56.9	-41	15.67
HE40, M0 to M11 1ss	2	3	-60.3	-61.1	0.38	-54.3	-41	13.04
HE40, M0 to M11 2ss	2	3	-60.3	-61.1	0.38	-54.3	-41	13.04
HE40 Beam Forming, M0 to M11 1ss	2	6	-60.3	-61.1	0.38	-51.3	-41	10.04
HE40 Beam Forming, M0 to M11 2ss	2	3	-60.3	-61.1	0.38	-54.3	-41	13.04
HE40 STBC, M0 to M11 2ss	2	3	-60.3	-61.1	0.38	-54.3	-41	13.04

Frequency 5825 MHz

Mode	Tx Paths	Correlated Antenna Gain (dBi)	Tx 1 Spur Power (dBm)	Tx 2 Spur Power (dBm)	Duty Cycle (dB)	Total Conducted Spur (dBm)	Limit (dB)	Margin (dB)
Non HT20, 6 to 54 Mbps	1	3	-61.2		0.36	-57.8	-41	16.59
Non HT20, 6 to 54 Mbps	2	3	-61.2	-62.0	0.36	-55.2	-41	13.96
Non HT20 Beam Forming, 6 to 54 Mbps	2	6	-61.2	-62.0	0.36	-52.2	-41	10.96
HT/VHT20, M0 to M7	1	3	-61.0		0.35	-57.6	-41	16.4
HT/VHT20, M0 to M7	2	3	-61.0	-62.0	0.35	-55.1	-41	13.86
HT/VHT20, M8 to M15	2	3	-61.0	-62.0	0.35	-55.1	-41	13.86
HT/VHT20 Beam Forming, M0 to M7	2	6	-61.0	-62.0	0.35	-52.1	-41	10.86
HT/VHT20 Beam Forming, M8 to M15	2	3	-61.0	-62.0	0.35	-55.1	-41	13.86
HT/VHT20 STBC, M8 to M15	2	3	-61.0	-62.0	0.35	-55.1	-41	13.86
HE20, M0 to M11 1ss	1	3	-60.9		0.33	-57.6	-41	16.32
HE20, M0 to M11 1ss	2	3	-60.9	-61.9	0.33	-55.0	-41	13.78
HE20, M0 to M11 2ss	2	3	-60.9	-61.9	0.33	-55.0	-41	13.78
HE20 Beam Forming, M0 to M11 1ss	2	6	-60.9	-61.9	0.33	-52.0	-41	10.78
HE20 Beam Forming, M0 to M11 2ss	2	3	-60.9	-61.9	0.33	-55.0	-41	13.78
HE20 STBC, M0 to M11 2ss	2	3	-60.9	-61.9	0.33	-55.0	-41	13.78