

5150-5250MHz Formal Test Report for IW9165E-B & IW9165E-ROW

Supports

BLE/4.9GHz/ 5GHz 802.11 a/ac/ax/n Wi-Fi radio

FCC ID: LDKIW9165E

Against the following Specifications:

47 CFR 15.205



47 CFR 15.209

47 CFR 15.407

LP0002:2020

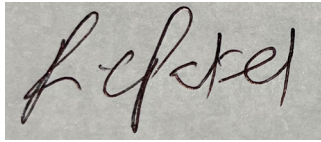

Cisco Systems, Inc.
170 West Tasman Drive
San Jose, CA 95134

	
Author: Ronak Patel Tested By: Ronak Patel	Approved By: Adam Walb Title: Revision: 1.0

This report replaces any previously entered test report under **EDCS # 24347167**. This test report has been electronically authorized and archived using the CISCO Engineering Document Control system. Test Report Template EDCS# 11644120.

SECTION 1: OVERVIEW	3
SECTION 2: ASSESSMENT INFORMATION	4
2.1: GENERAL.....	4
2.2: DATE OF TESTING	5
2.3: REPORT ISSUE DATE	5
2.4: TESTING FACILITIES	5
2.5: EQUIPMENT ASSESSED (EUT).....	6
2.6: EUT DESCRIPTION	6
SECTION 3: RESULT SUMMARY	9
3.1: RESULTS SUMMARY TABLE.....	9
SECTION 4: SAMPLE DETAILS	11
4.1: SAMPLE DETAILS	11
4.2: SYSTEM DETAILS.....	11
4.3: MODE OF OPERATION DETAILS	11
APPENDIX A: EMISSION TEST RESULTS	12
A.1: DUTY CYCLE	13
A.2: 99% AND 26DB BANDWIDTH	17
A.3: MAXIMUM CONDUCTED OUTPUT POWER	21
A.4: POWER SPECTRAL DENSITY.....	58
A.5: CONDUCTED SPURIOUS EMISSIONS	81
A.6: CONDUCTED BAND EDGE.....	103
APPENDIX B: EMISSION TEST RESULTS	121
B.1: RADIATED SPURIOUS EMISSIONS	122
B.2: RADIATED EMISSIONS 30MHZ TO 1GHZ	122
B.3: AC CONDUCTED EMISSIONS	122
APPENDIX C: LIST OF TEST EQUIPMENT USED TO PERFORM THE TEST	126
APPENDIX D: ABBREVIATION KEY AND DEFINITIONS	128
APPENDIX E: PHOTOGRAPHS OF TEST SETUPS	129
APPENDIX F: SOFTWARE USED TO PERFORM TESTING	129
APPENDIX G: TEST PROCEDURES	129
APPENDIX H: SCOPE OF ACCREDITATION (A2LA CERTIFICATE NUMBER 1178-01)	129
APPENDIX I: TEST ASSESSMENT PLAN	129
APPENDIX J: WORST CASE JUSTIFICATION	129

Section 1: Overview

The samples were assessed against the tests detailed in section 3 under the requirements of the following specifications:

Specifications:
CFR47 Part 15.407 LP0002:2020

Section 2: Assessment Information

2.1: General

This report contains an assessment of an apparatus against Electromagnetic Compatibility Standards based upon tests carried out on the samples submitted. The testing was performed by and for the use of Cisco systems Inc:

With regard to this assessment, the following points should be noted:

- a) The results contained in this report relate only to the items tested and were obtained in the period between the date of the initial assessment and the date of issue of the report. Manufactured products will not necessarily give identical results due to production and measurement tolerances.
- b) The apparatus was set up and exercised using the configuration and modes of operation defined in this report only.
- c) Where relevant, the apparatus was only assessed using the susceptibility criteria defined in this report and the Test Assessment Plan (TAP).
- d) All testing was performed under the following environmental conditions:

Temperature	15 °C to 35 °C (54 °F to 95 °F)
Atmospheric Pressure	860 mbar to 1060 mbar (25.4" to 31.3")
Humidity	10% to 75*%

- e) All AC testing was performed at one or more of the following supply voltages:

110V 60 Hz (+/-20%)

Units of Measurement

The units of measurements defined in the appendices are reported in specific terms, which are test dependent. Where radiated measurements are concerned these are defined at a particular distance. Basic voltage measurements are defined in units of [dBuV]

As an example, the basic calculation for all measurements is as follows:

$$\text{Emission level [dBuV]} = \text{Indicated voltage level [dBuV]} + \text{Cable Loss [dB]} + \text{Other correction factors [dB]}$$

The combinations of correction factors are dependent upon the exact test configurations [see test equipment lists for further details] and may include:

Antenna Factors, Pre-Amplifier Gain, LISN Loss, Pulse Limiter Loss and Filter Insertion Loss

Note: To convert the results from dBuV/m to uV/m use the following formula:

$$\text{Level in uV/m} = \text{Common Antilogarithm} [(X \text{ dBuV/m})/20] = Y \text{ uV/m}$$

Measurement Uncertainty Values

voltage and power measurements	± 2 dB
conducted EIRP measurements	± 1.4 dB
radiated measurements	± 3.2 dB
frequency measurements	± 2.4 10 ⁻⁷
temperature measurements	± 0.54°
humidity measurements	± 2.3%
DC and low frequency measurements	± 2.5%

Where relevant measurement uncertainty levels have been estimated for tests performed on the apparatus. This uncertainty represents an expanded uncertainty expressed at approximately the 95% confidence level using a coverage factor of $k=2$.

Radiated emissions (expanded uncertainty, confidence interval 95%)

30 MHz – 300 MHz	± 3.8 dB
300 MHz – 1000 MHz	± 4.3 dB
1 GHz – 10 GHz	± 4.0 dB
10 GHz – 18GHz	± 8.2 dB
18GHz – 26.5GHz	± 4.1 dB
26.5GHz – 40GHz	± 3.9 dB

Conducted emissions (expanded uncertainty, confidence interval 95%)

30 MHz – 40 GHz	± 0.38 dB
-----------------	-----------

A product is considered to comply with a requirement if the nominal measured value is below the limit line. The product is considered to not be in compliance in case the nominal measured value is above the limit line.

This report must not be reproduced except in full, without written approval of Cisco Systems.

2.2: Date of testing

11/1/2022 - 2/10/2023

2.3: Report Issue Date

7/26/2023

Cisco uses an electronic system to issue, store and control the revision of test reports. This system is called the Engineering Document Control System (EDCS). The actual report issue date is embedded into the original file on EDCS. Any copies of this report, either electronic or paper, that are not on EDCS must be considered uncontrolled.

2.4: Testing facilities

This assessment was performed by: NIST Designated Phase-I and Phase-II Conformity Assessment Body (CAB) for the following economies and regulatory authorities under the terms of the stated MRAs/Treaties: NCC (National Communications Commission) APEC Tel MRA – Phase I.

Testing Laboratory
Cisco Systems, Inc.
125 West Tasman Drive (Building P)
San Jose, CA 95134
USA

Headquarters
Cisco Systems, Inc.,
170 West Tasman Drive
San Jose, CA 95134,
USA

Registration Number

Cisco System Site	Address	Site Identifier
Building P, 10m Chamber	125 West Tasman Dr San Jose, CA 95134	Company #: 2461A

Test Engineer(s):

Ronak Patel

2.5: Equipment Assessed (EUT)

IW9165E-B

2.6: EUT Description

RF General Information			
Evaluation Mode	Frequency Range (MHz)	Operating Frequency (MHz)	Modulation Type
5GHz WLAN	5150-5250 5250-5350 5470-5725 5725-5850	5180-5250 5250-5320 5500-5720 5745-5825	802.11a/n: OFDM (BPSK, QPSK, 16QAM, 64QAM) 802.11ac: OFDM (BPSK, QPSK, 16QAM, 64QAM, 256QAM) 802.11ax: OFDMA (BPSK, QPSK, 16QAM, 64QAM, 256QAM, 1024QAM)
4.9GHz WLAN	4940-4990	4945-4985	OFDM (BPSK, QPSK, 16QAM, 64QAM)
Bluetooth	2400-2483.5	2402-2480	LE: GFSK

R1	-	V (AP: 20/40/80) (P2P/P2MP: 20/40/80)	V	-	-	-
R2	-	V (AP: 20/40/80/160) (P2P/P2MP: 20/40/80/160)	V	-	-	-
R3	-	-	-	-	V	-
R4	-	-	-	-	-	V

Note 1: 160MHz is supported in the future release.

**For Radio1 - 5GHz UNII 1~UNII 3 and 4.9GHz:
For IEEE 802.11 a/an/ac/ax mode (1TX, 2TX/2RX):**

1TX

Only Port 1 can be use as transmitting antenna.

2TX

Port 1, Port 2 can be use as transmitting antenna. Port 1, Port 2 could transmit simultaneously.

2RX

Port 1, Port 2, Port 3, Port 4 can be used as receiving antennas. Port 1 and Port 2 could receive simultaneously.

For Radio 2 - 5GHz UNII 1~UNII 3 and 4.9GHz:

For IEEE 802.11a/n/ac/ax mode (1TX, 2TX/2RX):

1TX

Only Port 1 can be use as transmitting antenna.

2TX

Port 1, Port 2 can be use as transmitting antenna. Port 1, Port 2 could transmit simultaneously.

2RX

Port 1, Port 2, Port 3, Port 4 can be used as receiving antennas. Port 1 and Port 2 could receive simultaneously.

For Radio 3 - BLE

Bluetooth(1TX):

Only Port 1 can be used as transmitting/receiving antenna.

For Radio 4 – GNSS (1Rx)

Only Port 1 can be used as receiving antenna.

The following antennas are supported by this product series. Please note, the antenna information has been provided by the customer (the Cisco business unit). The data included in this report represent the worst-case data for all antennas.

Note: As per KDB 353028 D01 Antennas Part 15 Transmitters v01r01 Clause III (A), When submitting test data for part 15 transmitters to be used with multiple antennas, FCC require testing for the highest gain of each type of antenna (e.g., highest gain for each patch, yagi, grid, dish, monopole, etc.). As per the below table IW9165E and IW9165D supports Dipole, Two-port panel antenna and four port panel antennas. Based on the KDB requirement Cisco will provide test data for 3dBi / 8dBi/ 15dBi. 10dBi antenna gain data is documented for EIRP >30 degree because it represents worst case.

Magnum IW9165 Supported External Antenna List

Product ID	Family	Description	Supported by IW9165DHD?	Supported by IW9165E?	Peak Gain 2.4 GHz (dBi)	Peak Gain 4.9 GHz (dBi)	Peak Gain 5 GHz (dBi)	Gain > 30° Elevation UNII-1 (dBi)	Peak Gain 6 GHz (dBi)	Gain > 30° Elevation UNII-5 & 7	5 GHz Fixed Point-to-Point?	5 GHz Point-to-Multipoint?
IW-ANT-OMM-53-N=	Legacy	5 GHz 3 dBi Omnidirectional Antenna, Multi-polarized, N Female Connector	No	Yes	N/A	3	3	0	N/A	N/A	No	Yes
AIR-ANT5180V-N=	Legacy	5 GHz 8 dBi Omnidirectional Colinear Array Antenna, N Male Connector	Yes	Yes	N/A	8	8	-3	N/A	N/A	No	Yes
IW-ANT-PNL-59-N=	Legacy	5 GHz 9 dBi 2-Element Patch Array Antenna, Slant 145 Polarized, N Female Connectors	Yes	Yes	N/A	N/A	10	7	N/A	N/A	Yes	Yes
AIR-ANTS114P2M-N=	Legacy	5 GHz 13 dBi 2-Element Patch Array Antenna, N Male Connectors	Yes	Yes	N/A	N/A	13	4	N/A	N/A	Yes	Yes
AIR-ANTS114P2M-NS=	SIA		Yes	Yes	N/A	N/A	13	3	N/A	N/A	Yes	Yes
IW-ANT-SKD-513-Q=	Legacy	5 GHz 14 dBi 2-Element Shark Antenna, Slant 145 Polarized, QMA Female Connectors	No	Yes	N/A	13	13	8	N/A	N/A	No	Yes
IW-ANT-SKS-514-Q=	Legacy	5 GHz 14 dBi 2-Element Shark Antenna, Slant 145 Polarized, QMA Female Connectors	No	Yes	N/A	13	13	8	N/A	N/A	No	Yes
AIR-ANT2547V-N=	Legacy	2.4 GHz 4 dBi / 5 GHz 7 dBi Omnidirectional Colinear Array Antenna, N male connector	Yes	Yes	4	N/A	7	-3	N/A	N/A	No	Yes
AIR-ANT2547VG-N=	Legacy	2.4 GHz 4 dBi / 5 GHz 7 dBi Omnidirectional Colinear Array	Yes	Yes	4	N/A	7	-3	N/A	N/A	No	Yes
AIR-ANT2547VG-NS=	SIA	2.4 GHz 6 dBi / 5 GHz 8 dBi Omnidirectional Antenna, N Male	Yes	Yes	4	N/A	7	-3	N/A	N/A	No	Yes
AIR-ANT2568VG-N=	Legacy	2.4 GHz 6 dBi / 5 GHz 8 dBi Omnidirectional Antenna, N Male	Yes	Yes	6	N/A	8	3	N/A	N/A	No	Yes
AIR-ANT2568VG-NS=	SIA	2.4 GHz 8 dBi / 5 GHz 8 dBi 4-Element Dual-Polarized Patch Antenna, N	Yes	Yes	6	N/A	8	3	N/A	N/A	No	Yes
AIR-ANT2588P4M-NS=	SIA	2.4 GHz 8 dBi / 5 GHz 8 dBi 4-Element Dual-Polarized Patch Antenna, N	No	Yes	8	N/A	8	-2	N/A	N/A	No	Yes
AIR-ANT2513P4M-N=	Legacy	2.4 GHz 13 dBi / 5 GHz 13 dBi Polarization Diverse Patch Array	No	Yes	13	N/A	13	1	N/A	N/A	Yes	Yes
AIR-ANT2513P4M-NS=	SIA	2.4 GHz 13 dBi / 5 GHz 13 dBi Polarization Diverse Patch Array	No	Yes	13	N/A	13	1	N/A	N/A	Yes	Yes
IW-ANT-OMV-2567-N	SIA	Tri-band 2.4 GHz 4 dBi, 5/6 GHz 7 dBi Omnidirectional Colinear Array Antenna, Vertically Polarized, N Male Connector	Yes	Yes	4	7	7	-7	7	-6	No	Yes
IW-ANT-OMH-2567-N	SIA	Tri-band 2.4 GHz 4 dBi, 5/6 GHz 7 dBi Omnidirectional Colinear Array Antenna, Horizontally Polarized, N Male Connector	Yes	Yes	4	7	7	-6	7	-4	No	Yes
IW-ANT-PNL-515-N=	SIA	Tri-band 5 GHz 15dBi Panel Antenna	Yes	Yes		15	15	3			Yes	Yes

Section 3: Result Summary

3.1: Results Summary Table

Conducted test summary.

Basic Standard	Technical Requirements / Details	Result
FCC 15.407 LP0002:2020 5.7.2.3 5.7.3.4 (2) (B)	<p>99%- & 26-dB Bandwidth: The 99% occupied bandwidth is the frequency bandwidth such that, below its lower and above its upper frequency limits, the mean powers are each equal to 0.5% of the total mean power of the given emission. There is no limit for 99% OBW.</p> <p>The 26 dB emission is the width of the emission that is constrained by the frequencies associated with the two outermost amplitude points (upper and lower frequencies) that are attenuated by 26 dB relative to the maximum level measured in the fundamental emission.</p>	Pass
FCC 15.407 LP0002:2020 Clause 5.7.3.2 (1)	<p>Output Power: For an outdoor access point operating in the band 5.15–5.25 GHz, the maximum conducted output power over the frequency band of operation shall not exceed 1 W provided the maximum antenna gain does not exceed 6 dBi. In addition, the maximum power spectral density shall not exceed 17 dBm in any 1-megahertz band. If transmitting antennas of directional gain greater than 6 dBi are used, both the maximum conducted output power and the maximum power spectral density shall be reduced by the amount in dB that the directional gain of the antenna exceeds 6 dBi. The maximum e.i.r.p. at any elevation angle above 30 degrees as measured from the horizon must not exceed 125 mW (21 dBm).</p>	Pass
15.407 LP0002:2020 Clause 5.7.3.2 (2)	<p>Power Spectral Density: For an outdoor access point operating in the band 5.15–5.25 GHz, the maximum conducted output power over the frequency band of operation shall not exceed 1 W provided the maximum antenna gain does not exceed 6 dBi. In addition, the maximum power spectral density shall not exceed 17 dBm in any 1-megahertz band. If transmitting antennas of directional gain greater than 6 dBi are used, both the maximum conducted output power and the maximum power spectral density shall be reduced by the amount in dB that the directional gain of the antenna exceeds 6 dBi. The maximum e.i.r.p. at any elevation angle above 30 degrees as measured from the horizon must not exceed 125 mW (21 dBm).</p>	Pass
15.407 LP0002:2020 Clause 5.7.4.1, 3.5 & 3.6	<p>Conducted Spurious Emissions / Band-Edge: 1For transmitters operating in the 5.15–5.25 GHz band: All emissions outside of the 5.15–5.35 GHz band shall not exceed an e.i.r.p. of –27 dBm/MHz.</p>	Pass
FCC 15.407 FCC 15.209 FCC 15.205 LP0002:2020 Clause 5.7.4.1, 3.5 & 3.6	<p>Restricted band: Unwanted emissions falling within the restricted bands, as defined in FCC 15.205 (a) must also comply with the radiated emission limits specified in FCC 15.209 (a).</p>	Pass

Radiated Emissions (General requirements)

Basic Standard	Technical Requirements / Details	Result
FCC 15.407 FCC 15.205 FCC 15.209 LP0002 (2020-01-10) (3.6)	<p>TX Spurious Emissions: Unwanted emissions must comply with the general field strength limits set forth in §15.209. (7) The provisions of §15.205 apply to intentional radiators operating under this section.</p>	[EDCS # 24042661]
FCC 15.207 LP0002 (2020-07-01) (3.3)	<p>AC conducted Emissions: Except when the requirements applicable to a given device state otherwise, for any radio apparatus equipped to operate from the public utility AC power supply, either directly or indirectly (such as with a battery charger), the radio frequency voltage of emissions conducted back onto the AC power lines in the frequency range of 0.15 MHz to 30 MHz shall not exceed the limits shown in the table in these sections. The more stringent limit applies at the frequency range boundaries.</p>	Pass

* MPE calculation is recorded in a separate report

Section 4: Sample Details

Note: Each sample was evaluated to ensure that its condition was suitable to be used as a test sample prior to the commencement of testing.

4.1: Sample Details

Sample No.	Equipment Details	Manufacturer	Hardware Rev.	Firmware Rev.	Software Rev.	Serial Number
S01	IW9165E-B	Cisco Systems	P2A	QC_IMAGE_VERSION_STRING=WLAN.HK.2.4-02142-QCAHKSWP_L_SILICONZ-1	[sjc-ads-6561:/nobackup/haijia/ap_wlc_me/m22_mfg]	FOC2638BKX3
S02	IW-PWRADPT-MFIT4P	Cisco Systems	V00	-	-	LIN264450C6

4.2: System Details

System #	Description	Samples
1	IW9165E-B	S01
2	IW-PWRADPT-MFIT4P	S02

4.3: Mode of Operation Details

Mode#	Description	Comments
1	Continuous Transmitting	

Function	Support Band
AP	BLE,5GHz, 4.9GHz
P2P/P2MP	5GHz, 4.9GHz

Appendix A: Emission Test Results

Conducted Test Setup Diagram

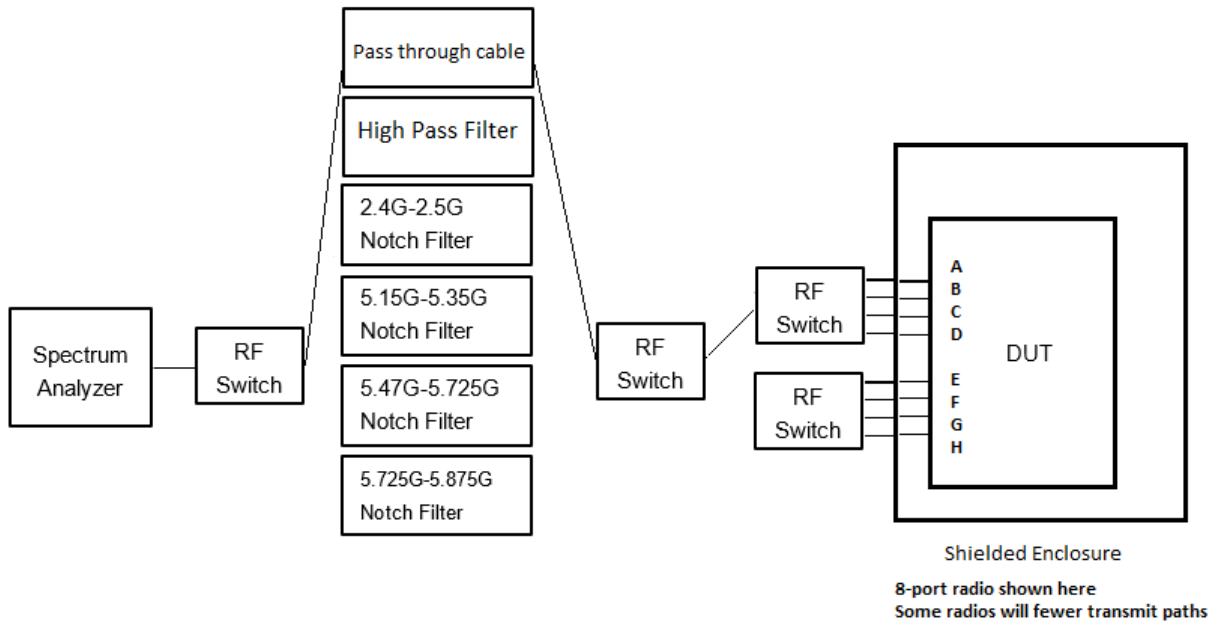

Test Setup Description

The EUT was placed inside an RF shielded enclosure. RF cables connect to each antenna port on the EUT inside the enclosure. Those cables are routed to RF switch cards in a National Instruments chassis. There are different paths, some paths contain a notch filter or high pass filter as shown above. The signal is then routed to the spectrum analyzer where measurements are made.

Plots listed herein represent the measured worst-case per antenna, frequency, and modulation.

A.1: Duty Cycle

Duty Cycle Test Requirement

From KDB 789033 D02 General UNII Test Procedures New Rules v02r01

B. Duty Cycle (x), Transmission Duration (T), and Maximum Power Control Level

1. All measurements are to be performed with the EUT transmitting at 100 percent duty cycle at its maximum power control level; however, if 100 percent duty cycle cannot be achieved, measurements of duty cycle, x , and maximum-power transmission duration, T , are required for each tested mode of operation.

Duty Cycle Test Method

From KDB 789033 D02 General UNII Test Procedures New Rules v02r01:

B. Duty Cycle (x), Transmission Duration (T), and Maximum Power Control Level

The zero-span mode on a spectrum analyzer or EMI receiver, if the response time and spacing between bins on the sweep are sufficient to permit accurate measurements of the on and off times of the transmitted signal. Set the center frequency of the instrument to the center frequency of the transmission. Set $RBW \geq EBW$ if possible; otherwise, set RBW to the largest available value. Set $VBW \geq RBW$. Set detector = peak or average. The zero-span measurement method shall not be used unless both RBW and VBW are $> 50/T$, where T is defined in section II.B.1.a), and the number of sweep points across duration T exceeds 100. (For example, if VBW and/or RBW are limited to 3 MHz, then the zero-span method of measuring duty cycle shall not be used if $T \leq 16.7$ microseconds.)

Duty Cycle Test Information

Tested By: Ronak Patel	Date of testing: 11/1/2022 - 2/10/2023
Test Result: PASS	

Test Equipment

See Appendix C for list of test equipment

Duty Cycle Data Table

Duty Cycle table and screen captures are shown below for Power/PSD modes.

Frequency (MHz)	Mode	Data Rate (Mbps)	Duty Cycle (dB)
5180	Non HT20, 6 to 54 Mbps	6.0	0.4072
	HT/VHT20, M0 to M7	m0	0.30538
	HE20, M0 to M11 1ss	m0h1	0.20543
5190	Non HT40, 6 to 54 Mbps	6.0	0.45661
	HT/VHT40, M0 to M7	m0	0.54728
	HE40, M0 to M11 1ss	m0h1	0.25765
5210	Non HT80, 6 to 54 Mbps	6.0	0.23009
	VHT80, M0 to M11 1ss	m0x1	0.54728
	HE80, M0 to M11 1ss	m0h1	0.23054
5220	Non HT20, 6 to 54 Mbps	6.0	0.4072
	HT/VHT20, M0 to M7	m0	0.30538
	HE20, M0 to M11 1ss	m0h1	0.20543
5230	Non HT40, 6 to 54 Mbps	6.0	0.45661
	HT/VHT40, M0 to M7	m0	0.54728
	HE40, M0 to M11 1ss	m0h1	0.25765
5240	Non HT20, 6 to 54 Mbps	6.0	0.4072
	HT/VHT20, M0 to M7	m0	0.30538
	HE20, M0 to M11 1ss	m0h1	0.20543

Data Screenshots

5190 MHz: HT/VHT40, M0 to M7

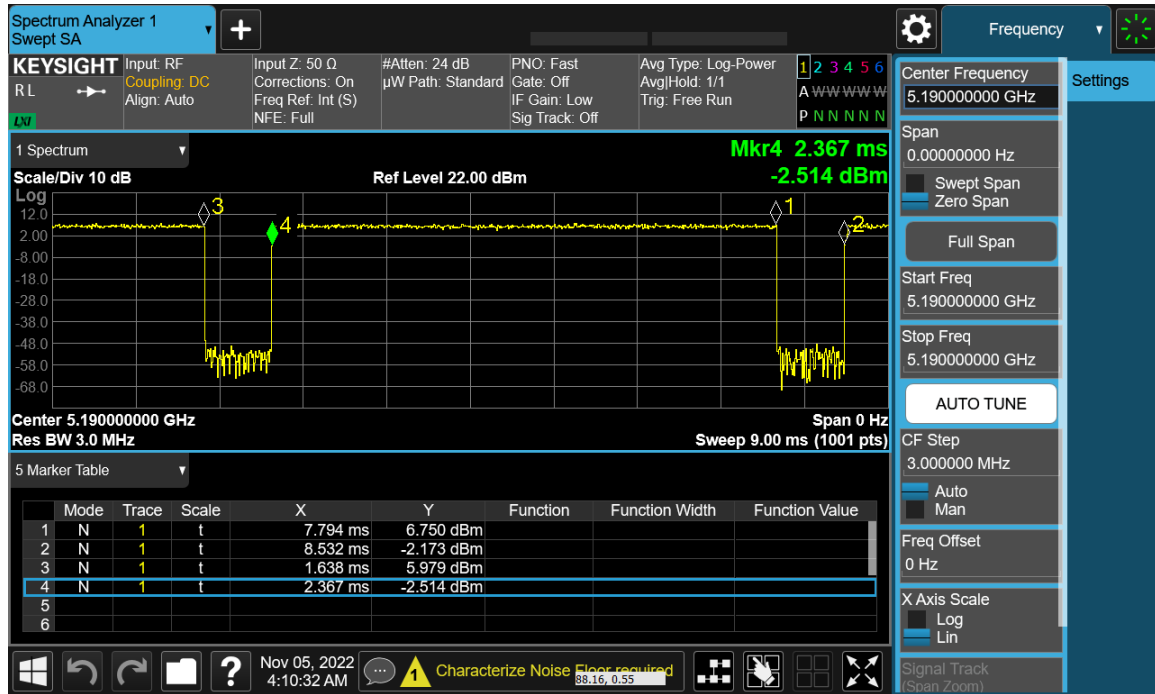

Antenna A

5210 MHz: VHT80, M0 to M11 1ss

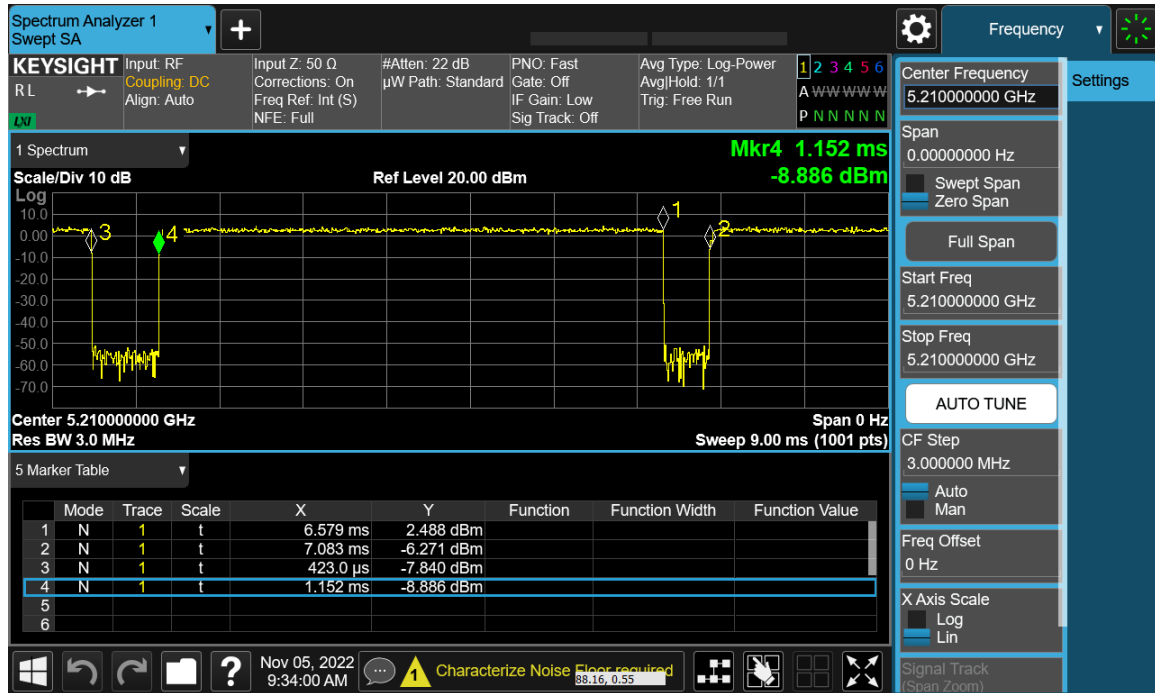

Antenna A

5230 MHz: HT/VHT40, M0 to M7

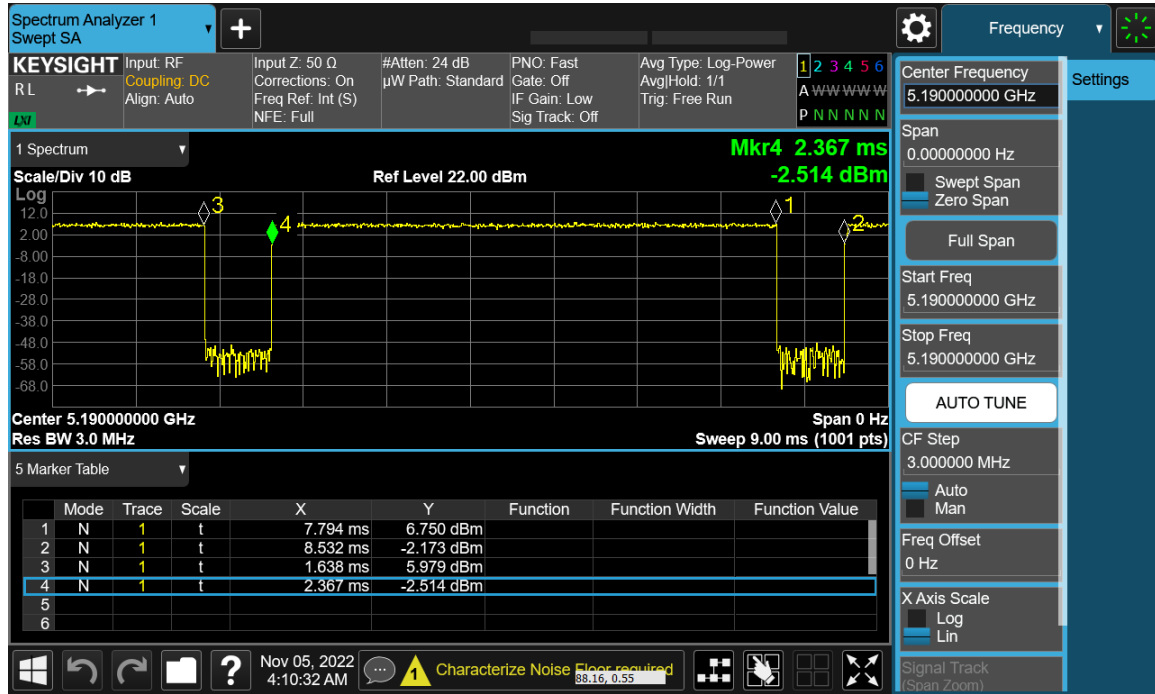

Antenna A

A.2: 99% and 26dB Bandwidth**99% and 26dB Bandwidth Test Requirement**

For the FCC:

There is no requirement for the value of bandwidth.

Power measurements are made using the 99% Bandwidth as the integration bandwidth.

99% and 26dB Bandwidth Test Procedure

The 99-percent occupied bandwidth is the frequency bandwidth such that, below its lower and above its upper frequency limits, the mean powers are each equal to 0.5 % of the total mean power of the given emission. Measurement of the 99-percent occupied bandwidth is required only as a condition for using the optional band-edge measurement techniques described in section II.G.3.d). Measurements of 99-percent occupied bandwidth may also optionally be used in lieu of the EBW to define the minimum frequency range over which the spectrum is integrated when measuring maximum conducted output power as described in section II.E. However, the EBW must be measured to determine bandwidth dependent limits on maximum conducted output power in accordance with 15.407(a).

Ref. KDB 789033 Section D. 99 Percent Occupied Bandwidth

99% BW
Test Parameters
<ol style="list-style-type: none"> 1. Set center frequency to the nominal EUT channel center frequency. 2. Set span = 1.5 times to 5.0 times the OBW. 3. Set RBW = 1 % to 5 % of the OBW 4. Set VBW $\geq 3 \cdot$ RBW. Video averaging is not permitted. Where practical, a sample detection and single sweep mode shall be used. Otherwise, peak detection and max hold mode (until the trace stabilizes) shall be used. 6. Use the 99 % power bandwidth function of the instrument (if available).

Ref KDB 789033 in Section C. Measurement Bandwidth, Section 1

26 BW
Test parameters
<p>X dB BW = -26dB (using the OBW function of the spectrum analyzer)</p> <p>Emission Bandwidth (EBW)</p> <ol style="list-style-type: none"> a) Set RBW = approximately 1% of the emission bandwidth. b) Set the VBW > RBW. c) Detector = Peak. d) Trace mode = max hold. e) Measure the maximum width of the emission that is 26 dB down from the maximum of the emission. Compare this with the RBW setting of the analyzer. Readjust RBW and repeat measurement as needed until the RBW/EBW ratio is approximately 1%.

Tested By: Ronak Patel	Date of testing: 11/1/2022 - 2/10/2023
Test Result: PASS	

Test Equipment

See Appendix C for list of test equipment

99% and 26dB Bandwidth Table

Frequency (MHz)	Mode	Data Rate (Mbps)	26dB BW (MHz)	99% BW (MHz)
5180	Non HT20, 6 to 54 Mbps	6.0	19.9	16.339
	HT/VHT20, M0 to M7	m0	20.8	17.572
	HE20 Beam Forming, M0 to M11 1ss	m0h1	21.4	18.895
5190	Non HT40, 6 to 54 Mbps	6.0	40.0	36.025
	HT/VHT40, M0 to M7	m0	40.6	35.973
	HE40, M0 to M11 1ss	m0h1	40.6	37.754
5210	Non HT80, 6 to 54 Mbps	6.0	80.5	75.483
	VHT80, M0 to M11 1ss	m0x1	79.7	75.299
	HE80, M0 to M11 1ss	m0h1	80.9	77.132
5220	Non HT20, 6 to 54 Mbps	6.0	20.0	16.347
	HT/VHT20 Beam Forming, M0 to M7	m0	20.9	17.585
	HE20, M0 to M11 1ss	m0h1	21.8	18.941
5230	Non HT40, 6 to 54 Mbps	6.0	39.6	36.02
	HT/VHT40 Beam Forming, M0 to M7	m0	39.9	35.96
	HE40 Beam Forming, M0 to M11 1ss	m0h1	40.3	37.655
5240	Non HT20 Beam Forming, 6 to 54 Mbps	6.0	20.1	16.341
	HT/VHT20, M0 to M7	m0	20.8	17.573
	HE20, M0 to M11 1ss	m0h1	21.8	18.899

Data Screenshots

5220 MHz: HE20, M0 to M11 1ss



Antenna A

5190 MHz: HE40, M0 to M11 1ss

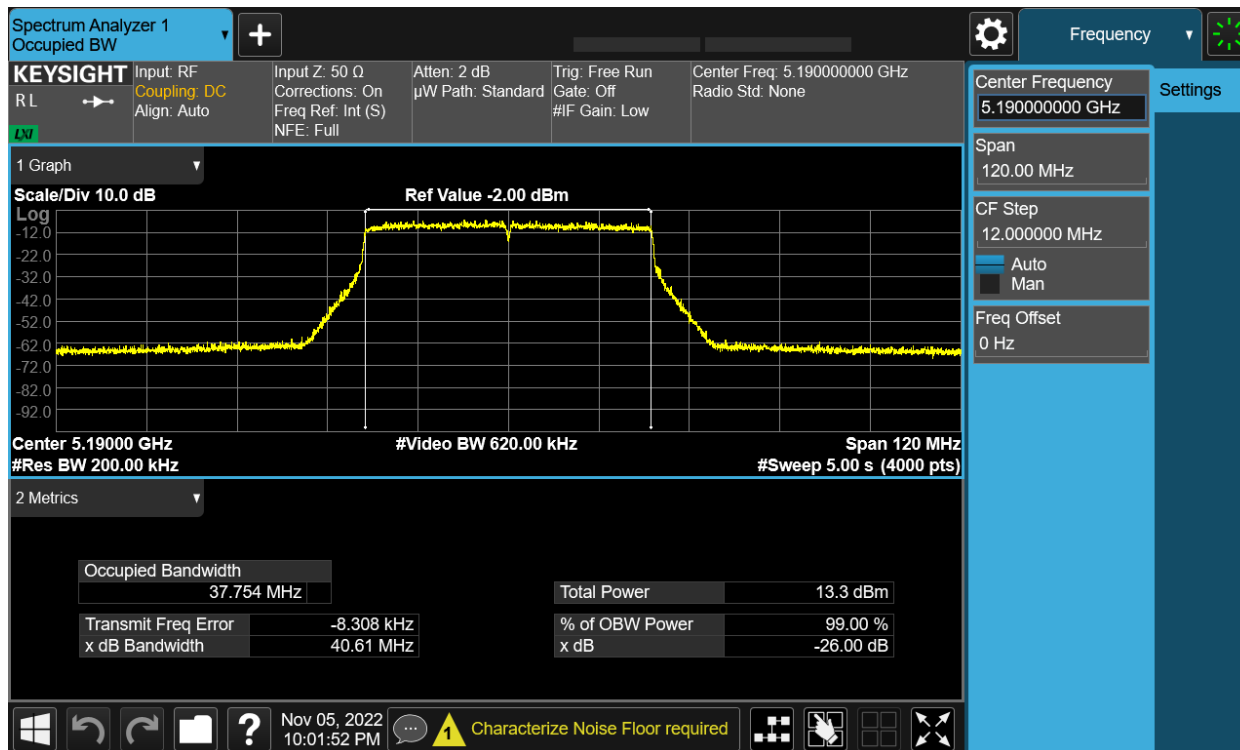

Antenna A

5210 MHz: HE80, M0 to M11 1ss

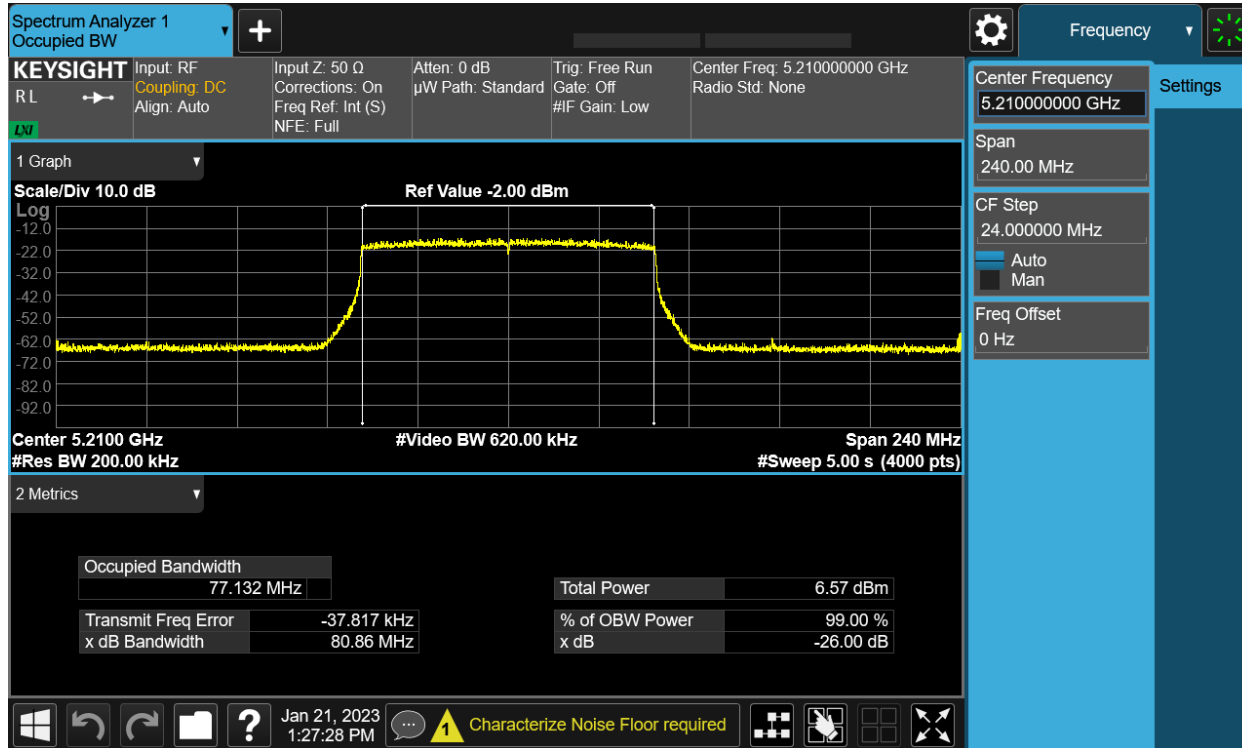

Antenna A

A.3: Maximum Conducted Output Power

Maximum Conducted Output Power Test Requirement

15.407 General technical requirements, (a) Power limits: (1) For the band 5.15-5.25 GHz:

(i) For an outdoor access point operating in the band 5.15-5.25 GHz, the maximum conducted output power over the frequency band of operation shall not exceed 1 W provided the maximum antenna gain does not exceed 6 dBi. ... If transmitting antennas of directional gain greater than 6 dBi are used, both the maximum conducted output power and the maximum power spectral density shall be reduced by the amount in dB that the directional gain of the antenna exceeds 6 dBi. The maximum e.i.r.p. at any elevation angle above 30 degrees as measured from the horizon must not exceed 125 mW (21 dBm).

(ii) For an indoor access point operating in the band 5.15-5.25 GHz, the maximum conducted output power over the frequency band of operation shall not exceed 1 W provided the maximum antenna gain does not exceed 6 dBi. ... If transmitting antennas of directional gain greater than 6 dBi are used, both the maximum conducted output power and the maximum power spectral density shall be reduced by the amount in dB that the directional gain of the antenna exceeds 6 dBi.

(iii) For fixed point-to-point access points operating in the band 5.15-5.25 GHz, the maximum conducted output power over the frequency band of operation shall not exceed 1 W. ... Fixed point-to-point U-NII devices may employ antennas with directional gain up to 23 dBi without any corresponding reduction in the maximum conducted output power or maximum power spectral density. For fixed point-to-point transmitters that employ a directional antenna gain greater than 23 dBi, a 1 dB reduction in maximum conducted output power and maximum power spectral density is required for each 1 dB of antenna gain in excess of 23 dBi. Fixed, point-to-point operations exclude the use of point-to-multipoint systems, omnidirectional applications, and multiple collocated transmitters transmitting the same information. The operator of the U-NII device, or if the equipment is professionally installed, the installer, is responsible for ensuring that systems employing high gain directional antennas are used exclusively for fixed, point-to-point operations.

(iv) For client devices in the 5.15-5.25 GHz band, the maximum conducted output power over the frequency band of operation shall not exceed 250 mW provided the maximum antenna gain does not exceed 6 dBi. In addition, the maximum power spectral density shall not exceed 11 dBm in any 1 megahertz band. If transmitting antennas of directional gain greater than 6 dBi are used, both the maximum conducted output power and the maximum power spectral density shall be reduced by the amount in dB that the directional gain of the antenna exceeds 6 dBi.

Maximum Conducted Output Power Test Procedure

Ref. KDB 789033 D02 General UNII Test Procedures New Rules v02r01
ANSI C63.10: 2013

Maximum Conducted Output Power Test Procedure
<ol style="list-style-type: none">1. Set the radio in the continuous transmitting mode at full power2. Compute power by integrating the spectrum across the EBW (or alternatively entire 99% OBW) of the signal using the instrument's band power measurement function. The integration shall be performed using the spectrum analyzer band-power measurement function with band limits set equal to the EBW or the OBW band edges.3. Capture graphs and record pertinent measurement data.

Ref. KDB 789033 D02 General UNII Test Procedures New Rules v02r01**2. Measurement using a Spectrum Analyzer or EMI Receiver (SA), (d) Method SA-2**

Maximum Conducted Output Power
Test parameters
Method SA-2 (trace averaging across on and off times of the EUT transmissions, followed by duty cycle correction). (i) Measure the duty cycle, x , of the transmitter output signal as described in section II.B. (ii) Set span to encompass the EBW (or, alternatively, the entire 99% occupied bandwidth) of the signal. (iii) Set RBW = 1 MHz. (iv) Set VBW \geq 3 MHz. (v) Number of points in sweep \geq 2 Span / RBW. (This ensures that bin-to-bin spacing is \leq RBW/2, so that narrowband signals are not lost between frequency bins.) (vi) Sweep time = auto. (vii) Detector = RMS (i.e., power averaging), if available. Otherwise, use sample detector mode. (viii) Do not use sweep triggering. Allow the sweep to "free run". (ix) Trace average at least 100 traces in power averaging (i.e., RMS) mode; however, the number of traces to be averaged shall be increased above 100 as needed to ensure that the average accurately represents the true average over the on and off periods of the transmitter. (x) Compute power by integrating the spectrum across the EBW (or, alternatively, the entire 99% occupied bandwidth) of the signal using the instrument's band power measurement function with band limits set equal to the EBW (or occupied bandwidth)

The "measure-and-sum technique" is used for measuring in-band transmit power of a device. In the measure-and-sum approach, the conducted emission level is measured at each antenna port. The measured results at the various antenna ports are then summed mathematically to determine the total emission level from the device. Summing is performed in linear power units. ANSI C63.10 section 14.3.2.2

Tested By: Ronak Patel	Date of testing: 11/1/2022 - 2/10/2023
Test Result: PASS	

Test Equipment

See Appendix C for list of test equipment

Maximum EIRP – Antenna gain 3dBi.**Frequency 5180 MHz**

Mode	Tx Paths	Correlated Antenna Gain (dBi)	Tx 1 Max Power (dBm)	Tx 2 Max Power (dBm)	Duty Cycle (dB)	Total Tx Channel Power (dBm)	Limit (dBm)	Margin (dB)
Non HT20, 6 to 54 Mbps	1	3	20.5		0.41	23.9	36	12.14
Non HT20, 6 to 54 Mbps	2	3	17.3	17.1	0.41	23.6	36	12.38
Non HT20 Beam Forming, 6 to 54 Mbps	2	6	14.2	14.1	0.41	23.6	36	12.43
HT/VHT20, M0 to M7	1	3	19.8		0.31	23.1	36	12.88
HT/VHT20, M0 to M7	2	3	16.9	16.6	0.31	23.1	36	12.93
HT/VHT20, M8 to M15	2	3	16.9	16.6	0.31	23.1	36	12.93
HT/VHT20 Beam Forming, M0 to M7	2	6	13.8	13.7	0.31	23.1	36	12.93
HT/VHT20 Beam Forming, M8 to M15	2	3	16.9	16.6	0.31	23.1	36	12.93
HT/VHT20 STBC, M8 to M15	2	3	16.9	16.6	0.31	23.1	36	12.93
HE20, M0 to M11 1ss	1	3	19.9		0.21	23.1	36	12.91
HE20, M0 to M11 1ss	2	3	17.0	16.5	0.21	23.0	36	13.02
HE20, M0 to M11 2ss	2	3	17.0	16.5	0.21	23.0	36	13.02
HE20 Beam Forming, M0 to M11 1ss	2	6	14.7	14.7	0.21	23.9	36	12.07
HE20 Beam Forming, M0 to M11 2ss	2	3	17.0	16.5	0.21	23.0	36	13.02
HE20 STBC, M0 to M11 2ss	2	3	17.0	16.5	0.21	23.0	36	13.02

Frequency 5190 MHz

Mode	Tx Paths	Correlated Antenna Gain (dBi)	Tx 1 Max Power (dBm)	Tx 2 Max Power (dBm)	Duty Cycle (dB)	Total Tx Channel Power (dBm)	Limit (dBm)	Margin (dB)
Non HT40, 6 to 54 Mbps	1	3	17.7		0.46	21.1	36	14.89
Non HT40, 6 to 54 Mbps	2	3	17.0	16.6	0.46	23.3	36	12.75
HT/VHT40, M0 to M7	1	3	19.8		0.55	23.3	36	12.7
HT/VHT40, M0 to M7	2	3	16.8	16.1	0.55	23.0	36	13.01
HT/VHT40, M8 to M15	2	3	16.8	16.1	0.55	23.0	36	13.01
HT/VHT40 Beam Forming, M0 to M7	2	6	13.7	13.3	0.55	23.1	36	12.94
HT/VHT40 Beam Forming, M8 to M15	2	3	16.8	16.1	0.55	23.0	36	13.01
HT/VHT40 STBC, M8 to M15	2	3	16.8	16.1	0.55	23.0	36	13.01
HE40, M0 to M11 1ss	1	3	19.4		0.26	22.7	36	13.35
HE40, M0 to M11 1ss	2	3	17.5	17.1	0.26	23.6	36	12.42
HE40, M0 to M11 2ss	2	3	17.5	17.1	0.26	23.6	36	12.42
HE40 Beam Forming, M0 to M11 1ss	2	6	14.4	14.1	0.26	23.5	36	12.52
HE40 Beam Forming, M0 to M11 2ss	2	3	17.5	17.1	0.26	23.6	36	12.42
HE40 STBC, M0 to M11 2ss	2	3	17.5	17.1	0.26	23.6	36	12.42

Frequency 5210 MHz

Mode	Tx Paths	Correlated Antenna Gain (dBi)	Tx 1 Max Power (dBm)	Tx 2 Max Power (dBm)	Duty Cycle (dB)	Total Tx Channel Power (dBm)	Limit (dBm)	Margin (dB)
Non HT80, 6 to 54 Mbps	1	3	19.3		0.23	22.6	36	13.43
Non HT80, 6 to 54 Mbps	2	3	17.3	17.0	0.23	23.4	36	12.59
VHT80, M0 to M11 1ss	1	3	18.7		0.55	22.2	36	13.77
VHT80, M0 to M11 1ss	2	3	16.3	16.8	0.55	23.1	36	12.88
VHT80, M0 to M11 2ss	2	3	16.3	16.8	0.55	23.1	36	12.88
VHT80 Beam Forming, M0 to M11 1ss	2	6	13.5	13.7	0.55	23.2	36	12.82
VHT80 Beam Forming, M0 to M11 2ss	2	3	16.3	16.8	0.55	23.1	36	12.88
VHT80 STBC, M0 to M11 2ss	2	3	16.3	16.8	0.55	23.1	36	12.88
HE80, M0 to M11 1ss	1	3	18.9		0.23	22.1	36	13.87
HE80, M0 to M11 1ss	2	3	17.8	17.7	0.23	24.0	36	12.0
HE80, M0 to M11 2ss	2	3	17.8	17.7	0.23	24.0	36	12.0
HE80 Beam Forming, M0 to M11 1ss	2	6	14.6	14.8	0.23	23.9	36	12.08
HE80 Beam Forming, M0 to M11 2ss	2	3	17.8	17.7	0.23	24.0	36	12.0
HE80 STBC, M0 to M11 2ss	2	3	17.8	17.7	0.23	24.0	36	12.0

Frequency 5220 MHz

Mode	Tx Paths	Correlated Antenna Gain (dBi)	Tx 1 Max Power (dBm)	Tx 2 Max Power (dBm)	Duty Cycle (dB)	Total Tx Channel Power (dBm)	Limit (dBm)	Margin (dB)
Non HT20, 6 to 54 Mbps	1	3	19.6		0.41	23.0	36	13.04
Non HT20, 6 to 54 Mbps	2	3	17.7	17.3	0.41	23.9	36	12.09
Non HT20 Beam Forming, 6 to 54 Mbps	2	6	14.3	14.4	0.41	23.8	36	12.23
HT/VHT20, M0 to M7	1	3	20.0		0.31	23.4	36	12.65
HT/VHT20, M0 to M7	2	3	17.1	17.0	0.31	23.4	36	12.59
HT/VHT20, M8 to M15	2	3	17.1	17.0	0.31	23.4	36	12.59
HT/VHT20 Beam Forming, M0 to M7	2	6	13.9	13.8	0.31	23.2	36	12.84
HT/VHT20 Beam Forming, M8 to M15	2	3	17.1	17.0	0.31	23.4	36	12.59
HT/VHT20 STBC, M8 to M15	2	3	17.1	17.0	0.31	23.4	36	12.59
HE20, M0 to M11 1ss	1	3	20.3		0.21	23.5	36	12.52
HE20, M0 to M11 1ss	2	3	17.6	17.2	0.21	23.6	36	12.36
HE20, M0 to M11 2ss	2	3	17.6	17.2	0.21	23.6	36	12.36
HE20 Beam Forming, M0 to M11 1ss	2	6	13.9	14.1	0.21	23.2	36	12.8
HE20 Beam Forming, M0 to M11 2ss	2	3	17.6	17.2	0.21	23.6	36	12.36
HE20 STBC, M0 to M11 2ss	2	3	17.6	17.2	0.21	23.6	36	12.36

Frequency 5230 MHz

Mode	Tx Paths	Correlated Antenna Gain (dBi)	Tx 1 Max Power (dBm)	Tx 2 Max Power (dBm)	Duty Cycle (dB)	Total Tx Channel Power (dBm)	Limit (dBm)	Margin (dB)
Non HT40, 6 to 54 Mbps	1	3	20.2		0.46	23.6	36	12.39
Non HT40, 6 to 54 Mbps	2	3	17.4	17.1	0.46	23.7	36	12.27
HT/VHT40, M0 to M7	1	3	20.3		0.55	23.8	36	12.18
HT/VHT40, M0 to M7	2	3	16.8	16.8	0.55	23.3	36	12.66
HT/VHT40, M8 to M15	2	3	16.8	16.8	0.55	23.3	36	12.66
HT/VHT40 Beam Forming, M0 to M7	2	6	13.8	13.9	0.55	23.4	36	12.56
HT/VHT40 Beam Forming, M8 to M15	2	3	16.8	16.8	0.55	23.3	36	12.66
HT/VHT40 STBC, M8 to M15	2	3	16.8	16.8	0.55	23.3	36	12.66
HE40, M0 to M11 1ss	1	3	20.2		0.26	23.4	36	12.59
HE40, M0 to M11 1ss	2	3	16.6	16.7	0.26	22.9	36	13.08
HE40, M0 to M11 2ss	2	3	16.6	16.7	0.26	22.9	36	13.08
HE40 Beam Forming, M0 to M11 1ss	2	6	14.6	14.8	0.26	23.9	36	12.07
HE40 Beam Forming, M0 to M11 2ss	2	3	16.6	16.7	0.26	22.9	36	13.08
HE40 STBC, M0 to M11 2ss	2	3	16.6	16.7	0.26	22.9	36	13.08

Frequency 5240 MHz

Mode	Tx Paths	Correlated Antenna Gain (dBi)	Tx 1 Max Power (dBm)	Tx 2 Max Power (dBm)	Duty Cycle (dB)	Total Tx Channel Power (dBm)	Limit (dBm)	Margin (dB)
Non HT20, 6 to 54 Mbps	1	3	20.6		0.41	24.0	36	12.0
Non HT20, 6 to 54 Mbps	2	3	17.5	16.7	0.41	23.5	36	12.47
Non HT20 Beam Forming, 6 to 54 Mbps	2	6	14.4	14.0	0.41	23.6	36	12.4
HT/VHT20, M0 to M7	1	3	20.3		0.31	23.6	36	12.4
HT/VHT20, M0 to M7	2	3	17.2	16.4	0.31	23.1	36	12.86
HT/VHT20, M8 to M15	2	3	17.2	16.4	0.31	23.1	36	12.86
HT/VHT20 Beam Forming, M0 to M7	2	6	13.9	13.7	0.31	23.1	36	12.88
HT/VHT20 Beam Forming, M8 to M15	2	3	17.2	16.4	0.31	23.1	36	12.86
HT/VHT20 STBC, M8 to M15	2	3	17.2	16.4	0.31	23.1	36	12.86
HE20, M0 to M11 1ss	1	3	20.4		0.21	23.6	36	12.37
HE20, M0 to M11 1ss	2	3	17.3	16.5	0.21	23.2	36	12.85
HE20, M0 to M11 2ss	2	3	17.3	16.5	0.21	23.2	36	12.85
HE20 Beam Forming, M0 to M11 1ss	2	6	14.8	14.4	0.21	23.9	36	12.15
HE20 Beam Forming, M0 to M11 2ss	2	3	17.3	16.5	0.21	23.2	36	12.85
HE20 STBC, M0 to M11 2ss	2	3	17.3	16.5	0.21	23.2	36	12.85

Maximum EIRP – Antenna gain 8dBi.**Frequency 5180 MHz**

Mode	Tx Paths	Correlated Antenna Gain (dBi)	Tx 1 Max Power (dBm)	Tx 2 Max Power (dBm)	Duty Cycle (dB)	Total Tx Channel Power (dBm)	Limit (dBm)	Margin (dB)
Non HT20, 6 to 54 Mbps	1	8	17.3		0.41	25.8	36	10.25
Non HT20, 6 to 54 Mbps	2	8	14.2	14.1	0.41	25.6	36	10.43
Non HT20 Beam Forming, 6 to 54 Mbps	2	11	11.1	11.0	0.41	25.5	36	10.55
HT/VHT20, M0 to M7	1	8	16.9		0.31	25.2	36	10.78
HT/VHT20, M0 to M7	2	8	13.8	13.7	0.31	25.1	36	10.93
HT/VHT20, M8 to M15	2	8	13.8	13.7	0.31	25.1	36	10.93
HT/VHT20 Beam Forming, M0 to M7	2	11	10.7	10.6	0.31	25.0	36	11.01
HT/VHT20 Beam Forming, M8 to M15	2	8	13.8	13.7	0.31	25.1	36	10.93
HT/VHT20 STBC, M8 to M15	2	8	13.8	13.7	0.31	25.1	36	10.93
HE20, M0 to M11 1ss	1	8	17.0		0.21	25.2	36	10.82
HE20, M0 to M11 1ss	2	8	14.7	14.7	0.21	25.9	36	10.07
HE20, M0 to M11 2ss	2	8	14.7	14.7	0.21	25.9	36	10.07
HE20 Beam Forming, M0 to M11 1ss	2	11	11.8	11.6	0.21	25.9	36	10.09
HE20 Beam Forming, M0 to M11 2ss	2	8	14.7	14.7	0.21	25.9	36	10.07
HE20 STBC, M0 to M11 2ss	2	8	14.7	14.7	0.21	25.9	36	10.07

Frequency 5190 MHz

Mode	Tx Paths	Correlated Antenna Gain (dBi)	Tx 1 Max Power (dBm)	Tx 2 Max Power (dBm)	Duty Cycle (dB)	Total Tx Channel Power (dBm)	Limit (dBm)	Margin (dB)
Non HT40, 6 to 54 Mbps	1	8	17.0		0.46	25.4	36	10.55
Non HT40, 6 to 54 Mbps	2	8	14.5	14.4	0.46	25.9	36	10.08
HT/VHT40, M0 to M7	1	8	16.8		0.55	25.3	36	10.68
HT/VHT40, M0 to M7	2	8	13.7	13.3	0.55	25.1	36	10.94
HT/VHT40, M8 to M15	2	8	13.7	13.3	0.55	25.1	36	10.94
HT/VHT40 Beam Forming, M0 to M7	2	11	10.5	10.1	0.55	24.8	36	11.16
HT/VHT40 Beam Forming, M8 to M15	2	8	13.7	13.3	0.55	25.1	36	10.94
HT/VHT40 STBC, M8 to M15	2	8	13.7	13.3	0.55	25.1	36	10.94
HE40, M0 to M11 1ss	1	8	17.5		0.26	25.8	36	10.23
HE40, M0 to M11 1ss	2	8	14.4	14.1	0.26	25.5	36	10.52
HE40, M0 to M11 2ss	2	8	14.4	14.1	0.26	25.5	36	10.52
HE40 Beam Forming, M0 to M11 1ss	2	11	11.3	11.0	0.26	25.5	36	10.55
HE40 Beam Forming, M0 to M11 2ss	2	8	14.4	14.1	0.26	25.5	36	10.52
HE40 STBC, M0 to M11 2ss	2	8	14.4	14.1	0.26	25.5	36	10.52

Frequency 5210 MHz

Mode	Tx Paths	Correlated Antenna Gain (dBi)	Tx 1 Max Power (dBm)	Tx 2 Max Power (dBm)	Duty Cycle (dB)	Total Tx Channel Power (dBm)	Limit (dBm)	Margin (dB)
Non HT80, 6 to 54 Mbps	1	8	17.3		0.23	25.5	36	10.48
Non HT80, 6 to 54 Mbps	2	8	14.0	14.4	0.23	25.5	36	10.52
VHT80, M0 to M11 1ss	1	8	16.3		0.55	24.9	36	11.11
VHT80, M0 to M11 1ss	2	8	13.5	13.7	0.55	25.2	36	10.82
VHT80, M0 to M11 2ss	2	8	13.5	13.7	0.55	25.2	36	10.82
VHT80 Beam Forming, M0 to M11 1ss	2	11	10.3	10.7	0.55	25.0	36	10.97
VHT80 Beam Forming, M0 to M11 2ss	2	8	13.5	13.7	0.55	25.2	36	10.82
VHT80 STBC, M0 to M11 2ss	2	8	13.5	13.7	0.55	25.2	36	10.82
HE80, M0 to M11 1ss	1	8	16.6		0.23	24.8	36	11.21
HE80, M0 to M11 1ss	2	8	14.6	14.8	0.23	25.9	36	10.08
HE80, M0 to M11 2ss	2	8	14.6	14.8	0.23	25.9	36	10.08
HE80 Beam Forming, M0 to M11 1ss	2	11	11.3	11.4	0.23	25.6	36	10.43
HE80 Beam Forming, M0 to M11 2ss	2	8	14.6	14.8	0.23	25.9	36	10.08
HE80 STBC, M0 to M11 2ss	2	8	14.6	14.8	0.23	25.9	36	10.08

Frequency 5220 MHz

Mode	Tx Paths	Correlated Antenna Gain (dBi)	Tx 1 Max Power (dBm)	Tx 2 Max Power (dBm)	Duty Cycle (dB)	Total Tx Channel Power (dBm)	Limit (dBm)	Margin (dB)
Non HT20, 6 to 54 Mbps	1	8	16.5		0.41	24.9	36	11.07
Non HT20, 6 to 54 Mbps	2	8	14.3	14.4	0.41	25.8	36	10.23
Non HT20 Beam Forming, 6 to 54 Mbps	2	11	11.2	11.1	0.41	25.6	36	10.44
HT/VHT20, M0 to M7	1	8	17.1		0.31	25.5	36	10.54
HT/VHT20, M0 to M7	2	8	13.9	13.8	0.31	25.2	36	10.84
HT/VHT20, M8 to M15	2	8	13.9	13.8	0.31	25.2	36	10.84
HT/VHT20 Beam Forming, M0 to M7	2	11	10.8	10.6	0.31	25.0	36	10.96
HT/VHT20 Beam Forming, M8 to M15	2	8	13.9	13.8	0.31	25.2	36	10.84
HT/VHT20 STBC, M8 to M15	2	8	13.9	13.8	0.31	25.2	36	10.84
HE20, M0 to M11 1ss	1	8	17.6		0.21	25.8	36	10.17
HE20, M0 to M11 1ss	2	8	13.9	14.1	0.21	25.2	36	10.8
HE20, M0 to M11 2ss	2	8	13.9	14.1	0.21	25.2	36	10.8
HE20 Beam Forming, M0 to M11 1ss	2	11	11.0	10.9	0.21	25.1	36	10.88
HE20 Beam Forming, M0 to M11 2ss	2	8	13.9	14.1	0.21	25.2	36	10.8
HE20 STBC, M0 to M11 2ss	2	8	13.9	14.1	0.21	25.2	36	10.8

Frequency 5230 MHz

Mode	Tx Paths	Correlated Antenna Gain (dBi)	Tx 1 Max Power (dBm)	Tx 2 Max Power (dBm)	Duty Cycle (dB)	Total Tx Channel Power (dBm)	Limit (dBm)	Margin (dB)
Non HT40, 6 to 54 Mbps	1	8	17.4		0.46	25.9	36	10.11
Non HT40, 6 to 54 Mbps	2	8	14.1	14.2	0.46	25.6	36	10.4
HT/VHT40, M0 to M7	1	8	16.8		0.55	25.3	36	10.68
HT/VHT40, M0 to M7	2	8	13.8	13.9	0.55	25.4	36	10.56
HT/VHT40, M8 to M15	2	8	13.8	13.9	0.55	25.4	36	10.56
HT/VHT40 Beam Forming, M0 to M7	2	11	10.6	10.8	0.55	25.3	36	10.72
HT/VHT40 Beam Forming, M8 to M15	2	8	13.8	13.9	0.55	25.4	36	10.56
HT/VHT40 STBC, M8 to M15	2	8	13.8	13.9	0.55	25.4	36	10.56
HE40, M0 to M11 1ss	1	8	16.6		0.26	24.9	36	11.13
HE40, M0 to M11 1ss	2	8	14.6	14.8	0.26	25.9	36	10.07
HE40, M0 to M11 2ss	2	8	14.6	14.8	0.26	25.9	36	10.07
HE40 Beam Forming, M0 to M11 1ss	2	11	11.5	11.4	0.26	25.7	36	10.27
HE40 Beam Forming, M0 to M11 2ss	2	8	14.6	14.8	0.26	25.9	36	10.07
HE40 STBC, M0 to M11 2ss	2	8	14.6	14.8	0.26	25.9	36	10.07

Frequency 5240 MHz

Mode	Tx Paths	Correlated Antenna Gain (dBi)	Tx 1 Max Power (dBm)	Tx 2 Max Power (dBm)	Duty Cycle (dB)	Total Tx Channel Power (dBm)	Limit (dBm)	Margin (dB)
Non HT20, 6 to 54 Mbps	1	8	17.5		0.41	25.9	36	10.12
Non HT20, 6 to 54 Mbps	2	8	14.4	14.0	0.41	25.6	36	10.4
Non HT20 Beam Forming, 6 to 54 Mbps	2	11	11.5	10.9	0.41	25.6	36	10.36
HT/VHT20, M0 to M7	1	8	17.2		0.31	25.5	36	10.5
HT/VHT20, M0 to M7	2	8	13.9	13.7	0.31	25.1	36	10.88
HT/VHT20, M8 to M15	2	8	13.9	13.7	0.31	25.1	36	10.88
HT/VHT20 Beam Forming, M0 to M7	2	11	11.1	10.5	0.31	25.1	36	10.9
HT/VHT20 Beam Forming, M8 to M15	2	8	13.9	13.7	0.31	25.1	36	10.88
HT/VHT20 STBC, M8 to M15	2	8	13.9	13.7	0.31	25.1	36	10.88
HE20, M0 to M11 1ss	1	8	17.3		0.21	25.5	36	10.48
HE20, M0 to M11 1ss	2	8	14.8	14.4	0.21	25.9	36	10.15
HE20, M0 to M11 2ss	2	8	14.8	14.4	0.21	25.9	36	10.15
HE20 Beam Forming, M0 to M11 1ss	2	11	11.2	10.5	0.21	25.0	36	10.96
HE20 Beam Forming, M0 to M11 2ss	2	8	14.8	14.4	0.21	25.9	36	10.15
HE20 STBC, M0 to M11 2ss	2	8	14.8	14.4	0.21	25.9	36	10.15

Maximum EIRP – Antenna gain 15dBi.**Frequency 5180 MHz**

Mode	Tx Paths	Correlated Antenna Gain (dBi)	Tx 1 Max Power (dBm)	Tx 2 Max Power (dBm)	Duty Cycle (dB)	Total Tx Channel Power (dBm)	Limit (dBm)	Margin (dB)
Non HT20, 6 to 54 Mbps	1	15	17.3		0.41	32.8	36	3.25
Non HT20, 6 to 54 Mbps	2	15	14.2	14.1	0.41	32.6	36	3.43
Non HT20 Beam Forming, 6 to 54 Mbps	2	15	14.2	14.1	0.41	32.6	36	3.43
HT/VHT20, M0 to M7	1	15	15.9		0.31	31.2	36	4.83
HT/VHT20, M0 to M7	2	15	13.8	13.7	0.31	32.1	36	3.93
HT/VHT20, M8 to M15	2	15	13.8	13.7	0.31	32.1	36	3.93
HT/VHT20 Beam Forming, M0 to M7	2	15	13.8	13.7	0.31	32.1	36	3.93
HT/VHT20 Beam Forming, M8 to M15	2	15	13.8	13.7	0.31	32.1	36	3.93
HT/VHT20 STBC, M8 to M15	2	15	13.8	13.7	0.31	32.1	36	3.93
HE20, M0 to M11 1ss	1	15	17.0		0.21	32.2	36	3.82
HE20, M0 to M11 1ss	2	15	13.9	13.8	0.21	32.0	36	3.96
HE20, M0 to M11 2ss	2	15	13.9	13.8	0.21	32.0	36	3.96
HE20 Beam Forming, M0 to M11 1ss	2	15	13.9	13.8	0.21	32.0	36	3.96
HE20 Beam Forming, M0 to M11 2ss	2	15	13.9	13.8	0.21	32.0	36	3.96
HE20 STBC, M0 to M11 2ss	2	15	13.9	13.8	0.21	32.0	36	3.96

Frequency 5190 MHz

Mode	Tx Paths	Correlated Antenna Gain (dBi)	Tx 1 Max Power (dBm)	Tx 2 Max Power (dBm)	Duty Cycle (dB)	Total Tx Channel Power (dBm)	Limit (dBm)	Margin (dB)
Non HT40, 6 to 54 Mbps	1	15	17.0		0.46	32.4	36	3.55
Non HT40, 6 to 54 Mbps	2	15	14.5	14.4	0.46	32.9	36	3.08
HT/VHT40, M0 to M7	1	15	16.8		0.55	32.3	36	3.68
HT/VHT40, M0 to M7	2	15	12.7	12.4	0.55	31.1	36	4.89
HT/VHT40, M8 to M15	2	15	12.7	12.4	0.55	31.1	36	4.89
HT/VHT40 Beam Forming, M0 to M7	2	15	12.7	12.4	0.55	31.1	36	4.89
HT/VHT40 Beam Forming, M8 to M15	2	15	12.7	12.4	0.55	31.1	36	4.89
HT/VHT40 STBC, M8 to M15	2	15	12.7	12.4	0.55	31.1	36	4.89
HE40, M0 to M11 1ss	1	15	17.5		0.26	32.8	36	3.23
HE40, M0 to M11 1ss	2	15	13.2	13.1	0.26	31.4	36	4.57
HE40, M0 to M11 2ss	2	15	13.2	13.1	0.26	31.4	36	4.57
HE40 Beam Forming, M0 to M11 1ss	2	15	13.2	13.1	0.26	31.4	36	4.57
HE40 Beam Forming, M0 to M11 2ss	2	15	13.2	13.1	0.26	31.4	36	4.57
HE40 STBC, M0 to M11 2ss	2	15	13.2	13.1	0.26	31.4	36	4.57

Frequency 5210 MHz

Mode	Tx Paths	Correlated Antenna Gain (dBi)	Tx 1 Max Power (dBm)	Tx 2 Max Power (dBm)	Duty Cycle (dB)	Total Tx Channel Power (dBm)	Limit (dBm)	Margin (dB)
Non HT80, 6 to 54 Mbps	1	15	17.3		0.23	32.5	36	3.48
Non HT80, 6 to 54 Mbps	2	15	13.2	13.3	0.23	31.5	36	4.47
VHT80, M0 to M11 1ss	1	15	16.3		0.55	31.9	36	4.11
VHT80, M0 to M11 1ss	2	15	13.5	13.7	0.55	32.2	36	3.82
VHT80, M0 to M11 2ss	2	15	13.5	13.7	0.55	32.2	36	3.82
VHT80 Beam Forming, M0 to M11 1ss	2	15	13.5	13.7	0.55	32.2	36	3.82
VHT80 Beam Forming, M0 to M11 2ss	2	15	13.5	13.7	0.55	32.2	36	3.82
VHT80 STBC, M0 to M11 2ss	2	15	13.5	13.7	0.55	32.2	36	3.82
HE80, M0 to M11 1ss	1	15	16.6		0.23	31.8	36	4.21
HE80, M0 to M11 1ss	2	15	12.6	12.8	0.23	30.9	36	5.07
HE80, M0 to M11 2ss	2	15	12.6	12.8	0.23	30.9	36	5.07
HE80 Beam Forming, M0 to M11 1ss	2	15	12.6	12.8	0.23	30.9	36	5.07
HE80 Beam Forming, M0 to M11 2ss	2	15	12.6	12.8	0.23	30.9	36	5.07
HE80 STBC, M0 to M11 2ss	2	15	12.6	12.8	0.23	30.9	36	5.07

Frequency 5220 MHz

Mode	Tx Paths	Correlated Antenna Gain (dBi)	Tx 1 Max Power (dBm)	Tx 2 Max Power (dBm)	Duty Cycle (dB)	Total Tx Channel Power (dBm)	Limit (dBm)	Margin (dB)
Non HT20, 6 to 54 Mbps	1	15	16.5		0.41	31.9	36	4.07
Non HT20, 6 to 54 Mbps	2	15	14.3	14.4	0.41	32.8	36	3.23
Non HT20 Beam Forming, 6 to 54 Mbps	2	15	14.3	14.4	0.41	32.8	36	3.23
HT/VHT20, M0 to M7	1	15	17.1		0.31	32.5	36	3.54
HT/VHT20, M0 to M7	2	15	13.9	13.8	0.31	32.2	36	3.84
HT/VHT20, M8 to M15	2	15	13.9	13.8	0.31	32.2	36	3.84
HT/VHT20 Beam Forming, M0 to M7	2	15	13.9	13.8	0.31	32.2	36	3.84
HT/VHT20 Beam Forming, M8 to M15	2	15	13.9	13.8	0.31	32.2	36	3.84
HT/VHT20 STBC, M8 to M15	2	15	13.9	13.8	0.31	32.2	36	3.84
HE20, M0 to M11 1ss	1	15	17.6		0.21	32.8	36	3.17
HE20, M0 to M11 1ss	2	15	13.9	14.1	0.21	32.2	36	3.8
HE20, M0 to M11 2ss	2	15	13.9	14.1	0.21	32.2	36	3.8
HE20 Beam Forming, M0 to M11 1ss	2	15	13.9	14.1	0.21	32.2	36	3.8
HE20 Beam Forming, M0 to M11 2ss	2	15	13.9	14.1	0.21	32.2	36	3.8
HE20 STBC, M0 to M11 2ss	2	15	13.9	14.1	0.21	32.2	36	3.8

Frequency 5230 MHz

Mode	Tx Paths	Correlated Antenna Gain (dBi)	Tx 1 Max Power (dBm)	Tx 2 Max Power (dBm)	Duty Cycle (dB)	Total Tx Channel Power (dBm)	Limit (dBm)	Margin (dB)
Non HT40, 6 to 54 Mbps	1	15	17.4		0.46	32.9	36	3.11
Non HT40, 6 to 54 Mbps	2	15	14.1	14.2	0.46	32.6	36	3.4
HT/VHT40, M0 to M7	1	15	16.8		0.55	32.3	36	3.68
HT/VHT40, M0 to M7	2	15	13.8	13.9	0.55	32.4	36	3.56
HT/VHT40, M8 to M15	2	15	13.8	13.9	0.55	32.4	36	3.56
HT/VHT40 Beam Forming, M0 to M7	2	15	13.8	13.9	0.55	32.4	36	3.56
HT/VHT40 Beam Forming, M8 to M15	2	15	13.8	13.9	0.55	32.4	36	3.56
HT/VHT40 STBC, M8 to M15	2	15	13.8	13.9	0.55	32.4	36	3.56
HE40, M0 to M11 1ss	1	15	16.6		0.26	31.9	36	4.13
HE40, M0 to M11 1ss	2	15	14.6	14.8	0.26	32.9	36	3.07
HE40, M0 to M11 2ss	2	15	14.6	14.8	0.26	32.9	36	3.07
HE40 Beam Forming, M0 to M11 1ss	2	15	14.6	14.8	0.26	32.9	36	3.07
HE40 Beam Forming, M0 to M11 2ss	2	15	14.6	14.8	0.26	32.9	36	3.07
HE40 STBC, M0 to M11 2ss	2	15	14.6	14.8	0.26	32.9	36	3.07

Frequency 5240 MHz

Mode	Tx Paths	Correlated Antenna Gain (dBi)	Tx 1 Max Power (dBm)	Tx 2 Max Power (dBm)	Duty Cycle (dB)	Total Tx Channel Power (dBm)	Limit (dBm)	Margin (dB)
Non HT20, 6 to 54 Mbps	1	15	17.5		0.41	32.9	36	3.12
Non HT20, 6 to 54 Mbps	2	15	14.4	14.0	0.41	32.6	36	3.4
Non HT20 Beam Forming, 6 to 54 Mbps	2	15	14.4	14.0	0.41	32.6	36	3.4
HT/VHT20, M0 to M7	1	15	17.2		0.31	32.5	36	3.5
HT/VHT20, M0 to M7	2	15	13.9	13.7	0.31	32.1	36	3.88
HT/VHT20, M8 to M15	2	15	13.9	13.7	0.31	32.1	36	3.88
HT/VHT20 Beam Forming, M0 to M7	2	15	13.9	13.7	0.31	32.1	36	3.88
HT/VHT20 Beam Forming, M8 to M15	2	15	13.9	13.7	0.31	32.1	36	3.88
HT/VHT20 STBC, M8 to M15	2	15	13.9	13.7	0.31	32.1	36	3.88
HE20, M0 to M11 1ss	1	15	17.3		0.21	32.5	36	3.48
HE20, M0 to M11 1ss	2	15	14.8	14.4	0.21	32.9	36	3.15
HE20, M0 to M11 2ss	2	15	14.8	14.4	0.21	32.9	36	3.15
HE20 Beam Forming, M0 to M11 1ss	2	15	14.8	14.4	0.21	32.9	36	3.15
HE20 Beam Forming, M0 to M11 2ss	2	15	14.8	14.4	0.21	32.9	36	3.15
HE20 STBC, M0 to M11 2ss	2	15	14.8	14.4	0.21	32.9	36	3.15

Maximum Conducted Output Power – Antenna gain 3dBi.**Frequency 5180 MHz**

Mode	Tx Paths	Correlated Antenna Gain (dBi)	Tx 1 Max Power (dBm)	Tx 2 Max Power (dBm)	Duty Cycle (dB)	Total Tx Channel Power (dBm)	Limit (dBm)	Margin (dB)
Non HT20, 6 to 54 Mbps	1	3	20.5		0.41	20.9	30	9.14
Non HT20, 6 to 54 Mbps	2	3	17.3	17.1	0.41	20.6	30	9.38
Non HT20 Beam Forming, 6 to 54 Mbps	2	6	14.2	14.1	0.41	17.6	30	12.43
HT/VHT20, M0 to M7	1	3	19.8		0.31	20.1	30	9.88
HT/VHT20, M0 to M7	2	3	16.9	16.6	0.31	20.1	30	9.93
HT/VHT20, M8 to M15	2	3	16.9	16.6	0.31	20.1	30	9.93
HT/VHT20 Beam Forming, M0 to M7	2	6	13.8	13.7	0.31	17.1	30	12.93
HT/VHT20 Beam Forming, M8 to M15	2	3	16.9	16.6	0.31	20.1	30	9.93
HT/VHT20 STBC, M8 to M15	2	3	16.9	16.6	0.31	20.1	30	9.93
HE20, M0 to M11 1ss	1	3	19.9		0.21	20.1	30	9.91
HE20, M0 to M11 1ss	2	3	17.0	16.5	0.21	20.0	30	10.02
HE20, M0 to M11 2ss	2	3	17.0	16.5	0.21	20.0	30	10.02
HE20 Beam Forming, M0 to M11 1ss	2	6	14.7	14.7	0.21	17.9	30	12.07
HE20 Beam Forming, M0 to M11 2ss	2	3	17.0	16.5	0.21	20.0	30	10.02
HE20 STBC, M0 to M11 2ss	2	3	17.0	16.5	0.21	20.0	30	10.02

Frequency 5190 MHz

Mode	Tx Paths	Correlated Antenna Gain (dBi)	Tx 1 Max Power (dBm)	Tx 2 Max Power (dBm)	Duty Cycle (dB)	Total Tx Channel Power (dBm)	Limit (dBm)	Margin (dB)
Non HT40, 6 to 54 Mbps	1	3	17.7		0.46	18.1	30	11.89
Non HT40, 6 to 54 Mbps	2	3	17.0	16.6	0.46	20.3	30	9.75
HT/VHT40, M0 to M7	1	3	19.8		0.55	20.3	30	9.7
HT/VHT40, M0 to M7	2	3	16.8	16.1	0.55	20.0	30	10.01
HT/VHT40, M8 to M15	2	3	16.8	16.1	0.55	20.0	30	10.01
HT/VHT40 Beam Forming, M0 to M7	2	6	13.7	13.3	0.55	17.1	30	12.94
HT/VHT40 Beam Forming, M8 to M15	2	3	16.8	16.1	0.55	20.0	30	10.01
HT/VHT40 STBC, M8 to M15	2	3	16.8	16.1	0.55	20.0	30	10.01
HE40, M0 to M11 1ss	1	3	19.4		0.26	19.7	30	10.35
HE40, M0 to M11 1ss	2	3	17.5	17.1	0.26	20.6	30	9.42
HE40, M0 to M11 2ss	2	3	17.5	17.1	0.26	20.6	30	9.42
HE40 Beam Forming, M0 to M11 1ss	2	6	14.4	14.1	0.26	17.5	30	12.52
HE40 Beam Forming, M0 to M11 2ss	2	3	17.5	17.1	0.26	20.6	30	9.42
HE40 STBC, M0 to M11 2ss	2	3	17.5	17.1	0.26	20.6	30	9.42

Frequency 5210 MHz

Mode	Tx Paths	Correlated Antenna Gain (dBi)	Tx 1 Max Power (dBm)	Tx 2 Max Power (dBm)	Duty Cycle (dB)	Total Tx Channel Power (dBm)	Limit (dBm)	Margin (dB)
Non HT80, 6 to 54 Mbps	1	3	19.3		0.23	19.6	30	10.43
Non HT80, 6 to 54 Mbps	2	3	17.3	17.0	0.23	20.4	30	9.59
VHT80, M0 to M11 1ss	1	3	18.7		0.55	19.2	30	10.77
VHT80, M0 to M11 1ss	2	3	16.3	16.8	0.55	20.1	30	9.88
VHT80, M0 to M11 2ss	2	3	16.3	16.8	0.55	20.1	30	9.88
VHT80 Beam Forming, M0 to M11 1ss	2	6	13.5	13.7	0.55	17.2	30	12.82
VHT80 Beam Forming, M0 to M11 2ss	2	3	16.3	16.8	0.55	20.1	30	9.88
VHT80 STBC, M0 to M11 2ss	2	3	16.3	16.8	0.55	20.1	30	9.88
HE80, M0 to M11 1ss	1	3	18.9		0.23	19.1	30	10.87
HE80, M0 to M11 1ss	2	3	17.8	17.7	0.23	21.0	30	9.0
HE80, M0 to M11 2ss	2	3	17.8	17.7	0.23	21.0	30	9.0
HE80 Beam Forming, M0 to M11 1ss	2	6	14.6	14.8	0.23	17.9	30	12.08
HE80 Beam Forming, M0 to M11 2ss	2	3	17.8	17.7	0.23	21.0	30	9.0
HE80 STBC, M0 to M11 2ss	2	3	17.8	17.7	0.23	21.0	30	9.0

Frequency 5220 MHz

Mode	Tx Paths	Correlated Antenna Gain (dBi)	Tx 1 Max Power (dBm)	Tx 2 Max Power (dBm)	Duty Cycle (dB)	Total Tx Channel Power (dBm)	Limit (dBm)	Margin (dB)
Non HT20, 6 to 54 Mbps	1	3	19.6		0.41	20.0	30	10.04
Non HT20, 6 to 54 Mbps	2	3	17.7	17.3	0.41	20.9	30	9.09
Non HT20 Beam Forming, 6 to 54 Mbps	2	6	14.3	14.4	0.41	17.8	30	12.23
HT/VHT20, M0 to M7	1	3	20.0		0.31	20.4	30	9.65
HT/VHT20, M0 to M7	2	3	17.1	17.0	0.31	20.4	30	9.59
HT/VHT20, M8 to M15	2	3	17.1	17.0	0.31	20.4	30	9.59
HT/VHT20 Beam Forming, M0 to M7	2	6	13.9	13.8	0.31	17.2	30	12.84
HT/VHT20 Beam Forming, M8 to M15	2	3	17.1	17.0	0.31	20.4	30	9.59
HT/VHT20 STBC, M8 to M15	2	3	17.1	17.0	0.31	20.4	30	9.59
HE20, M0 to M11 1ss	1	3	20.3		0.21	20.5	30	9.52
HE20, M0 to M11 1ss	2	3	17.6	17.2	0.21	20.6	30	9.36
HE20, M0 to M11 2ss	2	3	17.6	17.2	0.21	20.6	30	9.36
HE20 Beam Forming, M0 to M11 1ss	2	6	13.9	14.1	0.21	17.2	30	12.8
HE20 Beam Forming, M0 to M11 2ss	2	3	17.6	17.2	0.21	20.6	30	9.36
HE20 STBC, M0 to M11 2ss	2	3	17.6	17.2	0.21	20.6	30	9.36

Frequency 5230 MHz

Mode	Tx Paths	Correlated Antenna Gain (dBi)	Tx 1 Max Power (dBm)	Tx 2 Max Power (dBm)	Duty Cycle (dB)	Total Tx Channel Power (dBm)	Limit (dBm)	Margin (dB)
Non HT40, 6 to 54 Mbps	1	3	20.2		0.46	20.6	30	9.39
Non HT40, 6 to 54 Mbps	2	3	17.4	17.1	0.46	20.7	30	9.27
HT/VHT40, M0 to M7	1	3	20.3		0.55	20.8	30	9.18
HT/VHT40, M0 to M7	2	3	16.8	16.8	0.55	20.3	30	9.66
HT/VHT40, M8 to M15	2	3	16.8	16.8	0.55	20.3	30	9.66
HT/VHT40 Beam Forming, M0 to M7	2	6	13.8	13.9	0.55	17.4	30	12.56
HT/VHT40 Beam Forming, M8 to M15	2	3	16.8	16.8	0.55	20.3	30	9.66
HT/VHT40 STBC, M8 to M15	2	3	16.8	16.8	0.55	20.3	30	9.66
HE40, M0 to M11 1ss	1	3	20.2		0.26	20.4	30	9.59
HE40, M0 to M11 1ss	2	3	16.6	16.7	0.26	19.9	30	10.08
HE40, M0 to M11 2ss	2	3	16.6	16.7	0.26	19.9	30	10.08
HE40 Beam Forming, M0 to M11 1ss	2	6	14.6	14.8	0.26	17.9	30	12.07
HE40 Beam Forming, M0 to M11 2ss	2	3	16.6	16.7	0.26	19.9	30	10.08
HE40 STBC, M0 to M11 2ss	2	3	16.6	16.7	0.26	19.9	30	10.08

Frequency 5240 MHz

Mode	Tx Paths	Correlated Antenna Gain (dBi)	Tx 1 Max Power (dBm)	Tx 2 Max Power (dBm)	Duty Cycle (dB)	Total Tx Channel Power (dBm)	Limit (dBm)	Margin (dB)
Non HT20, 6 to 54 Mbps	1	3	20.6		0.41	21.0	30	9.0
Non HT20, 6 to 54 Mbps	2	3	17.5	16.7	0.41	20.5	30	9.47
Non HT20 Beam Forming, 6 to 54 Mbps	2	6	14.4	14.0	0.41	17.6	30	12.4
HT/VHT20, M0 to M7	1	3	20.3		0.31	20.6	30	9.4
HT/VHT20, M0 to M7	2	3	17.2	16.4	0.31	20.1	30	9.86
HT/VHT20, M8 to M15	2	3	17.2	16.4	0.31	20.1	30	9.86
HT/VHT20 Beam Forming, M0 to M7	2	6	13.9	13.7	0.31	17.1	30	12.88
HT/VHT20 Beam Forming, M8 to M15	2	3	17.2	16.4	0.31	20.1	30	9.86
HT/VHT20 STBC, M8 to M15	2	3	17.2	16.4	0.31	20.1	30	9.86
HE20, M0 to M11 1ss	1	3	20.4		0.21	20.6	30	9.37
HE20, M0 to M11 1ss	2	3	17.3	16.5	0.21	20.2	30	9.85
HE20, M0 to M11 2ss	2	3	17.3	16.5	0.21	20.2	30	9.85
HE20 Beam Forming, M0 to M11 1ss	2	6	14.8	14.4	0.21	17.9	30	12.15
HE20 Beam Forming, M0 to M11 2ss	2	3	17.3	16.5	0.21	20.2	30	9.85
HE20 STBC, M0 to M11 2ss	2	3	17.3	16.5	0.21	20.2	30	9.85

Maximum Conducted Output Power – Antenna gain 8dBi.**Frequency 5180 MHz**

Mode	Tx Paths	Correlated Antenna Gain (dBi)	Tx 1 Max Power (dBm)	Tx 2 Max Power (dBm)	Duty Cycle (dB)	Total Tx Channel Power (dBm)	Limit (dBm)	Margin (dB)
Non HT20, 6 to 54 Mbps	1	8	17.3		0.41	17.8	30	12.25
Non HT20, 6 to 54 Mbps	2	8	14.2	14.1	0.41	17.6	30	12.43
Non HT20 Beam Forming, 6 to 54 Mbps	2	11	11.1	11.0	0.41	14.5	30	15.55
HT/VHT20, M0 to M7	1	8	16.9		0.31	17.2	30	12.78
HT/VHT20, M0 to M7	2	8	13.8	13.7	0.31	17.1	30	12.93
HT/VHT20, M8 to M15	2	8	13.8	13.7	0.31	17.1	30	12.93
HT/VHT20 Beam Forming, M0 to M7	2	11	10.7	10.6	0.31	14.0	30	16.01
HT/VHT20 Beam Forming, M8 to M15	2	8	13.8	13.7	0.31	17.1	30	12.93
HT/VHT20 STBC, M8 to M15	2	8	13.8	13.7	0.31	17.1	30	12.93
HE20, M0 to M11 1ss	1	8	17.0		0.21	17.2	30	12.82
HE20, M0 to M11 1ss	2	8	14.7	14.7	0.21	17.9	30	12.07
HE20, M0 to M11 2ss	2	8	14.7	14.7	0.21	17.9	30	12.07
HE20 Beam Forming, M0 to M11 1ss	2	11	11.8	11.6	0.21	14.9	30	15.09
HE20 Beam Forming, M0 to M11 2ss	2	8	14.7	14.7	0.21	17.9	30	12.07
HE20 STBC, M0 to M11 2ss	2	8	14.7	14.7	0.21	17.9	30	12.07

Frequency 5190 MHz

Mode	Tx Paths	Correlated Antenna Gain (dBi)	Tx 1 Max Power (dBm)	Tx 2 Max Power (dBm)	Duty Cycle (dB)	Total Tx Channel Power (dBm)	Limit (dBm)	Margin (dB)
Non HT40, 6 to 54 Mbps	1	8	17.0		0.46	17.4	30	12.55
Non HT40, 6 to 54 Mbps	2	8	14.5	14.4	0.46	17.9	30	12.08
HT/VHT40, M0 to M7	1	8	16.8		0.55	17.3	30	12.68
HT/VHT40, M0 to M7	2	8	13.7	13.3	0.55	17.1	30	12.94
HT/VHT40, M8 to M15	2	8	13.7	13.3	0.55	17.1	30	12.94
HT/VHT40 Beam Forming, M0 to M7	2	11	10.5	10.1	0.55	13.8	30	16.16
HT/VHT40 Beam Forming, M8 to M15	2	8	13.7	13.3	0.55	17.1	30	12.94
HT/VHT40 STBC, M8 to M15	2	8	13.7	13.3	0.55	17.1	30	12.94
HE40, M0 to M11 1ss	1	8	17.5		0.26	17.8	30	12.23
HE40, M0 to M11 1ss	2	8	14.4	14.1	0.26	17.5	30	12.52
HE40, M0 to M11 2ss	2	8	14.4	14.1	0.26	17.5	30	12.52
HE40 Beam Forming, M0 to M11 1ss	2	11	11.3	11.0	0.26	14.5	30	15.55
HE40 Beam Forming, M0 to M11 2ss	2	8	14.4	14.1	0.26	17.5	30	12.52
HE40 STBC, M0 to M11 2ss	2	8	14.4	14.1	0.26	17.5	30	12.52

Frequency 5210 MHz

Mode	Tx Paths	Correlated Antenna Gain (dBi)	Tx 1 Max Power (dBm)	Tx 2 Max Power (dBm)	Duty Cycle (dB)	Total Tx Channel Power (dBm)	Limit (dBm)	Margin (dB)
Non HT80, 6 to 54 Mbps	1	8	17.3		0.23	17.5	30	12.48
Non HT80, 6 to 54 Mbps	2	8	14.0	14.4	0.23	17.5	30	12.52
VHT80, M0 to M11 1ss	1	8	16.3		0.55	16.9	30	13.11
VHT80, M0 to M11 1ss	2	8	13.5	13.7	0.55	17.2	30	12.82
VHT80, M0 to M11 2ss	2	8	13.5	13.7	0.55	17.2	30	12.82
VHT80 Beam Forming, M0 to M11 1ss	2	11	10.3	10.7	0.55	14.0	30	15.97
VHT80 Beam Forming, M0 to M11 2ss	2	8	13.5	13.7	0.55	17.2	30	12.82
VHT80 STBC, M0 to M11 2ss	2	8	13.5	13.7	0.55	17.2	30	12.82
HE80, M0 to M11 1ss	1	8	16.6		0.23	16.8	30	13.21
HE80, M0 to M11 1ss	2	8	14.6	14.8	0.23	17.9	30	12.08
HE80, M0 to M11 2ss	2	8	14.6	14.8	0.23	17.9	30	12.08
HE80 Beam Forming, M0 to M11 1ss	2	11	11.3	11.4	0.23	14.6	30	15.43
HE80 Beam Forming, M0 to M11 2ss	2	8	14.6	14.8	0.23	17.9	30	12.08
HE80 STBC, M0 to M11 2ss	2	8	14.6	14.8	0.23	17.9	30	12.08

Frequency 5220 MHz

Mode	Tx Paths	Correlated Antenna Gain (dBi)	Tx 1 Max Power (dBm)	Tx 2 Max Power (dBm)	Duty Cycle (dB)	Total Tx Channel Power (dBm)	Limit (dBm)	Margin (dB)
Non HT20, 6 to 54 Mbps	1	8	16.5		0.41	16.9	30	13.07
Non HT20, 6 to 54 Mbps	2	8	14.3	14.4	0.41	17.8	30	12.23
Non HT20 Beam Forming, 6 to 54 Mbps	2	11	11.2	11.1	0.41	14.6	30	15.44
HT/VHT20, M0 to M7	1	8	17.1		0.31	17.5	30	12.54
HT/VHT20, M0 to M7	2	8	13.9	13.8	0.31	17.2	30	12.84
HT/VHT20, M8 to M15	2	8	13.9	13.8	0.31	17.2	30	12.84
HT/VHT20 Beam Forming, M0 to M7	2	11	10.8	10.6	0.31	14.0	30	15.96
HT/VHT20 Beam Forming, M8 to M15	2	8	13.9	13.8	0.31	17.2	30	12.84
HT/VHT20 STBC, M8 to M15	2	8	13.9	13.8	0.31	17.2	30	12.84
HE20, M0 to M11 1ss	1	8	17.6		0.21	17.8	30	12.17
HE20, M0 to M11 1ss	2	8	13.9	14.1	0.21	17.2	30	12.8
HE20, M0 to M11 2ss	2	8	13.9	14.1	0.21	17.2	30	12.8
HE20 Beam Forming, M0 to M11 1ss	2	11	11.0	10.9	0.21	14.1	30	15.88
HE20 Beam Forming, M0 to M11 2ss	2	8	13.9	14.1	0.21	17.2	30	12.8
HE20 STBC, M0 to M11 2ss	2	8	13.9	14.1	0.21	17.2	30	12.8

Frequency 5230 MHz

Mode	Tx Paths	Correlated Antenna Gain (dBi)	Tx 1 Max Power (dBm)	Tx 2 Max Power (dBm)	Duty Cycle (dB)	Total Tx Channel Power (dBm)	Limit (dBm)	Margin (dB)
Non HT40, 6 to 54 Mbps	1	8	17.4		0.46	17.9	30	12.11
Non HT40, 6 to 54 Mbps	2	8	14.1	14.2	0.46	17.6	30	12.4
HT/VHT40, M0 to M7	1	8	16.8		0.55	17.3	30	12.68
HT/VHT40, M0 to M7	2	8	13.8	13.9	0.55	17.4	30	12.56
HT/VHT40, M8 to M15	2	8	13.8	13.9	0.55	17.4	30	12.56
HT/VHT40 Beam Forming, M0 to M7	2	11	10.6	10.8	0.55	14.3	30	15.72
HT/VHT40 Beam Forming, M8 to M15	2	8	13.8	13.9	0.55	17.4	30	12.56
HT/VHT40 STBC, M8 to M15	2	8	13.8	13.9	0.55	17.4	30	12.56
HE40, M0 to M11 1ss	1	8	16.6		0.26	16.9	30	13.13
HE40, M0 to M11 1ss	2	8	14.6	14.8	0.26	17.9	30	12.07
HE40, M0 to M11 2ss	2	8	14.6	14.8	0.26	17.9	30	12.07
HE40 Beam Forming, M0 to M11 1ss	2	11	11.5	11.4	0.26	14.7	30	15.27
HE40 Beam Forming, M0 to M11 2ss	2	8	14.6	14.8	0.26	17.9	30	12.07
HE40 STBC, M0 to M11 2ss	2	8	14.6	14.8	0.26	17.9	30	12.07

Frequency 5240 MHz

Mode	Tx Paths	Correlated Antenna Gain (dBi)	Tx 1 Max Power (dBm)	Tx 2 Max Power (dBm)	Duty Cycle (dB)	Total Tx Channel Power (dBm)	Limit (dBm)	Margin (dB)
Non HT20, 6 to 54 Mbps	1	8	17.5		0.41	17.9	30	12.12
Non HT20, 6 to 54 Mbps	2	8	14.4	14.0	0.41	17.6	30	12.4
Non HT20 Beam Forming, 6 to 54 Mbps	2	11	11.5	10.9	0.41	14.6	30	15.36
HT/VHT20, M0 to M7	1	8	17.2		0.31	17.5	30	12.5
HT/VHT20, M0 to M7	2	8	13.9	13.7	0.31	17.1	30	12.88
HT/VHT20, M8 to M15	2	8	13.9	13.7	0.31	17.1	30	12.88
HT/VHT20 Beam Forming, M0 to M7	2	11	11.1	10.5	0.31	14.1	30	15.9
HT/VHT20 Beam Forming, M8 to M15	2	8	13.9	13.7	0.31	17.1	30	12.88
HT/VHT20 STBC, M8 to M15	2	8	13.9	13.7	0.31	17.1	30	12.88
HE20, M0 to M11 1ss	1	8	17.3		0.21	17.5	30	12.48
HE20, M0 to M11 1ss	2	8	14.8	14.4	0.21	17.9	30	12.15
HE20, M0 to M11 2ss	2	8	14.8	14.4	0.21	17.9	30	12.15
HE20 Beam Forming, M0 to M11 1ss	2	11	11.2	10.5	0.21	14.0	30	15.96
HE20 Beam Forming, M0 to M11 2ss	2	8	14.8	14.4	0.21	17.9	30	12.15
HE20 STBC, M0 to M11 2ss	2	8	14.8	14.4	0.21	17.9	30	12.15

Conducted Output Power – Antenna gain 15dBi.**Frequency 5180 MHz**

Mode	Tx Paths	Correlated Antenna Gain (dBi)	Tx 1 Max Power (dBm)	Tx 2 Max Power (dBm)	Duty Cycle (dB)	Total Tx Channel Power (dBm)	Limit (dBm)	Margin (dB)
Non HT20, 6 to 54 Mbps	1	15	17.3		0.41	17.8	30	12.25
Non HT20, 6 to 54 Mbps	2	15	14.2	14.1	0.41	17.6	30	12.43
Non HT20 Beam Forming, 6 to 54 Mbps	2	15	14.2	14.1	0.41	17.6	30	12.43
HT/VHT20, M0 to M7	1	15	15.9		0.31	16.2	30	13.83
HT/VHT20, M0 to M7	2	15	13.8	13.7	0.31	17.1	30	12.93
HT/VHT20, M8 to M15	2	15	13.8	13.7	0.31	17.1	30	12.93
HT/VHT20 Beam Forming, M0 to M7	2	15	13.8	13.7	0.31	17.1	30	12.93
HT/VHT20 Beam Forming, M8 to M15	2	15	13.8	13.7	0.31	17.1	30	12.93
HT/VHT20 STBC, M8 to M15	2	15	13.8	13.7	0.31	17.1	30	12.93
HE20, M0 to M11 1ss	1	15	17.0		0.21	17.2	30	12.82
HE20, M0 to M11 1ss	2	15	13.9	13.8	0.21	17.0	30	12.96
HE20, M0 to M11 2ss	2	15	13.9	13.8	0.21	17.0	30	12.96
HE20 Beam Forming, M0 to M11 1ss	2	15	13.9	13.8	0.21	17.0	30	12.96
HE20 Beam Forming, M0 to M11 2ss	2	15	13.9	13.8	0.21	17.0	30	12.96
HE20 STBC, M0 to M11 2ss	2	15	13.9	13.8	0.21	17.0	30	12.96

Frequency 5190 MHz

Mode	Tx Paths	Correlated Antenna Gain (dBi)	Tx 1 Max Power (dBm)	Tx 2 Max Power (dBm)	Duty Cycle (dB)	Total Tx Channel Power (dBm)	Limit (dBm)	Margin (dB)
Non HT40, 6 to 54 Mbps	1	15	17.0		0.46	17.4	30	12.55
Non HT40, 6 to 54 Mbps	2	15	14.5	14.4	0.46	17.9	30	12.08
HT/VHT40, M0 to M7	1	15	16.8		0.55	17.3	30	12.68
HT/VHT40, M0 to M7	2	15	12.7	12.4	0.55	16.1	30	13.89
HT/VHT40, M8 to M15	2	15	12.7	12.4	0.55	16.1	30	13.89
HT/VHT40 Beam Forming, M0 to M7	2	15	12.7	12.4	0.55	16.1	30	13.89
HT/VHT40 Beam Forming, M8 to M15	2	15	12.7	12.4	0.55	16.1	30	13.89
HT/VHT40 STBC, M8 to M15	2	15	12.7	12.4	0.55	16.1	30	13.89
HE40, M0 to M11 1ss	1	15	17.5		0.26	17.8	30	12.23
HE40, M0 to M11 1ss	2	15	13.2	13.1	0.26	16.4	30	13.57
HE40, M0 to M11 2ss	2	15	13.2	13.1	0.26	16.4	30	13.57
HE40 Beam Forming, M0 to M11 1ss	2	15	13.2	13.1	0.26	16.4	30	13.57
HE40 Beam Forming, M0 to M11 2ss	2	15	13.2	13.1	0.26	16.4	30	13.57
HE40 STBC, M0 to M11 2ss	2	15	13.2	13.1	0.26	16.4	30	13.57

Frequency 5210 MHz

Mode	Tx Paths	Correlated Antenna Gain (dBi)	Tx 1 Max Power (dBm)	Tx 2 Max Power (dBm)	Duty Cycle (dB)	Total Tx Channel Power (dBm)	Limit (dBm)	Margin (dB)
Non HT80, 6 to 54 Mbps	1	15	17.3		0.23	17.5	30	12.48
Non HT80, 6 to 54 Mbps	2	15	13.2	13.3	0.23	16.5	30	13.47
VHT80, M0 to M11 1ss	1	15	16.3		0.55	16.9	30	13.11
VHT80, M0 to M11 1ss	2	15	13.5	13.7	0.55	17.2	30	12.82
VHT80, M0 to M11 2ss	2	15	13.5	13.7	0.55	17.2	30	12.82
VHT80 Beam Forming, M0 to M11 1ss	2	15	13.5	13.7	0.55	17.2	30	12.82
VHT80 Beam Forming, M0 to M11 2ss	2	15	13.5	13.7	0.55	17.2	30	12.82
VHT80 STBC, M0 to M11 2ss	2	15	13.5	13.7	0.55	17.2	30	12.82
HE80, M0 to M11 1ss	1	15	16.6		0.23	16.8	30	13.21
HE80, M0 to M11 1ss	2	15	12.6	12.8	0.23	15.9	30	14.07
HE80, M0 to M11 2ss	2	15	12.6	12.8	0.23	15.9	30	14.07
HE80 Beam Forming, M0 to M11 1ss	2	15	12.6	12.8	0.23	15.9	30	14.07
HE80 Beam Forming, M0 to M11 2ss	2	15	12.6	12.8	0.23	15.9	30	14.07
HE80 STBC, M0 to M11 2ss	2	15	12.6	12.8	0.23	15.9	30	14.07

Frequency 5220 MHz

Mode	Tx Paths	Correlated Antenna Gain (dBi)	Tx 1 Max Power (dBm)	Tx 2 Max Power (dBm)	Duty Cycle (dB)	Total Tx Channel Power (dBm)	Limit (dBm)	Margin (dB)
Non HT20, 6 to 54 Mbps	1	15	16.5		0.41	16.9	30	13.07
Non HT20, 6 to 54 Mbps	2	15	14.3	14.4	0.41	17.8	30	12.23
Non HT20 Beam Forming, 6 to 54 Mbps	2	15	14.3	14.4	0.41	17.8	30	12.23
HT/VHT20, M0 to M7	1	15	17.1		0.31	17.5	30	12.54
HT/VHT20, M0 to M7	2	15	13.9	13.8	0.31	17.2	30	12.84
HT/VHT20, M8 to M15	2	15	13.9	13.8	0.31	17.2	30	12.84
HT/VHT20 Beam Forming, M0 to M7	2	15	13.9	13.8	0.31	17.2	30	12.84
HT/VHT20 Beam Forming, M8 to M15	2	15	13.9	13.8	0.31	17.2	30	12.84
HT/VHT20 STBC, M8 to M15	2	15	13.9	13.8	0.31	17.2	30	12.84
HE20, M0 to M11 1ss	1	15	17.6		0.21	17.8	30	12.17
HE20, M0 to M11 1ss	2	15	13.9	14.1	0.21	17.2	30	12.8
HE20, M0 to M11 2ss	2	15	13.9	14.1	0.21	17.2	30	12.8
HE20 Beam Forming, M0 to M11 1ss	2	15	13.9	14.1	0.21	17.2	30	12.8
HE20 Beam Forming, M0 to M11 2ss	2	15	13.9	14.1	0.21	17.2	30	12.8
HE20 STBC, M0 to M11 2ss	2	15	13.9	14.1	0.21	17.2	30	12.8

Frequency 5230 MHz

Mode	Tx Paths	Correlated Antenna Gain (dBi)	Tx 1 Max Power (dBm)	Tx 2 Max Power (dBm)	Duty Cycle (dB)	Total Tx Channel Power (dBm)	Limit (dBm)	Margin (dB)
Non HT40, 6 to 54 Mbps	1	15	17.4		0.46	17.9	30	12.11
Non HT40, 6 to 54 Mbps	2	15	14.1	14.2	0.46	17.6	30	12.4
HT/VHT40, M0 to M7	1	15	16.8		0.55	17.3	30	12.68
HT/VHT40, M0 to M7	2	15	13.8	13.9	0.55	17.4	30	12.56
HT/VHT40, M8 to M15	2	15	13.8	13.9	0.55	17.4	30	12.56
HT/VHT40 Beam Forming, M0 to M7	2	15	13.8	13.9	0.55	17.4	30	12.56
HT/VHT40 Beam Forming, M8 to M15	2	15	13.8	13.9	0.55	17.4	30	12.56
HT/VHT40 STBC, M8 to M15	2	15	13.8	13.9	0.55	17.4	30	12.56
HE40, M0 to M11 1ss	1	15	16.6		0.26	16.9	30	13.13
HE40, M0 to M11 1ss	2	15	14.6	14.8	0.26	17.9	30	12.07
HE40, M0 to M11 2ss	2	15	14.6	14.8	0.26	17.9	30	12.07
HE40 Beam Forming, M0 to M11 1ss	2	15	14.6	14.8	0.26	17.9	30	12.07
HE40 Beam Forming, M0 to M11 2ss	2	15	14.6	14.8	0.26	17.9	30	12.07
HE40 STBC, M0 to M11 2ss	2	15	14.6	14.8	0.26	17.9	30	12.07

Frequency 5240 MHz

Mode	Tx Paths	Correlated Antenna Gain (dBi)	Tx 1 Max Power (dBm)	Tx 2 Max Power (dBm)	Duty Cycle (dB)	Total Tx Channel Power (dBm)	Limit (dBm)	Margin (dB)
Non HT20, 6 to 54 Mbps	1	15	17.5		0.41	17.9	30	12.12
Non HT20, 6 to 54 Mbps	2	15	14.4	14.0	0.41	17.6	30	12.4
Non HT20 Beam Forming, 6 to 54 Mbps	2	15	14.4	14.0	0.41	17.6	30	12.4
HT/VHT20, M0 to M7	1	15	17.2		0.31	17.5	30	12.5
HT/VHT20, M0 to M7	2	15	13.9	13.7	0.31	17.1	30	12.88
HT/VHT20, M8 to M15	2	15	13.9	13.7	0.31	17.1	30	12.88
HT/VHT20 Beam Forming, M0 to M7	2	15	13.9	13.7	0.31	17.1	30	12.88
HT/VHT20 Beam Forming, M8 to M15	2	15	13.9	13.7	0.31	17.1	30	12.88
HT/VHT20 STBC, M8 to M15	2	15	13.9	13.7	0.31	17.1	30	12.88
HE20, M0 to M11 1ss	1	15	17.3		0.21	17.5	30	12.48
HE20, M0 to M11 1ss	2	15	14.8	14.4	0.21	17.9	30	12.15
HE20, M0 to M11 2ss	2	15	14.8	14.4	0.21	17.9	30	12.15
HE20 Beam Forming, M0 to M11 1ss	2	15	14.8	14.4	0.21	17.9	30	12.15
HE20 Beam Forming, M0 to M11 2ss	2	15	14.8	14.4	0.21	17.9	30	12.15
HE20 STBC, M0 to M11 2ss	2	15	14.8	14.4	0.21	17.9	30	12.15

Data Screenshots – Antenna gain 3dBi.

5240 MHz: Non HT20, 6 to 54 Mbps

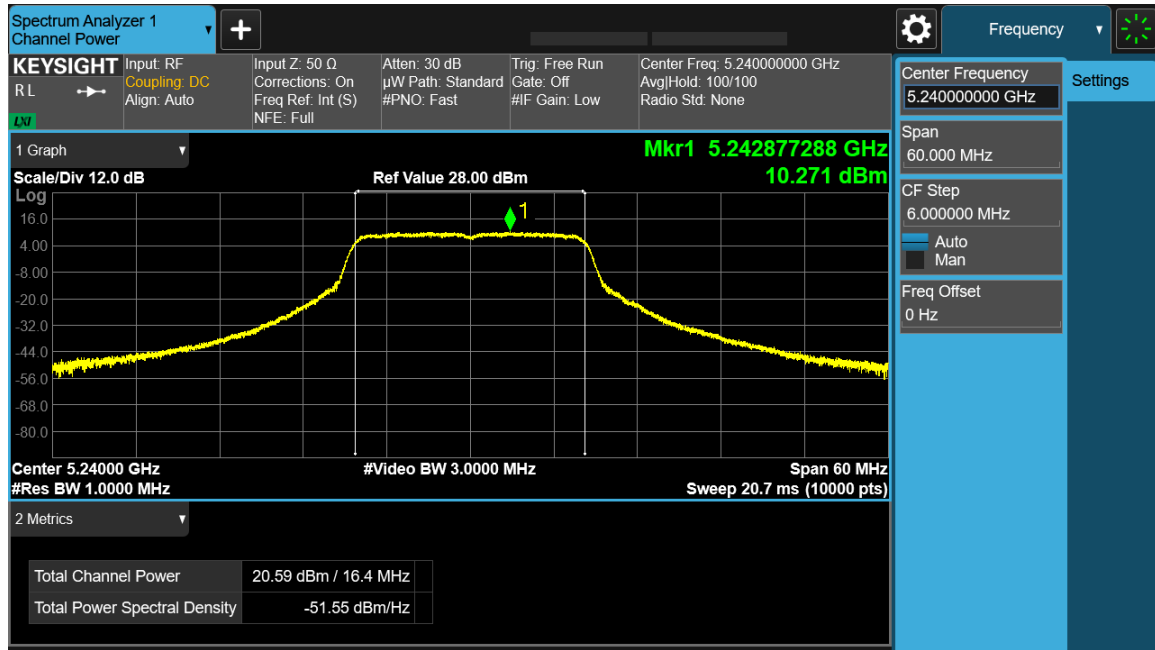

Antenna A

5210 MHz: HE80, M0 to M11 1ss

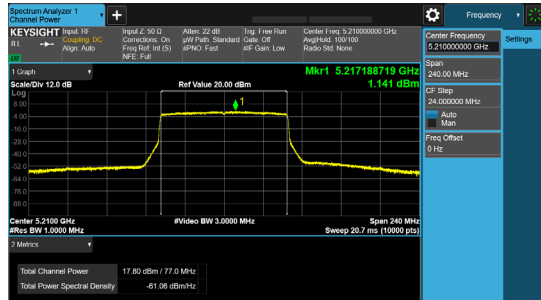

Antenna A

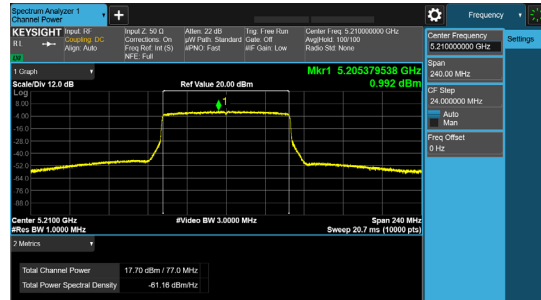

Antenna B

5210 MHz: HE80, M0 to M11 2ss

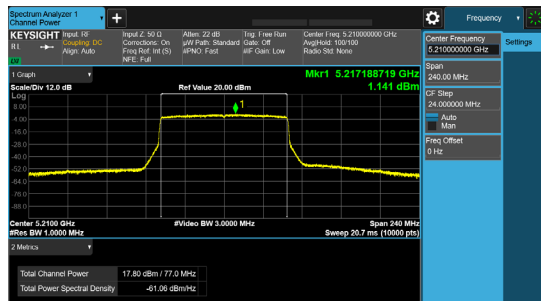

Antenna A

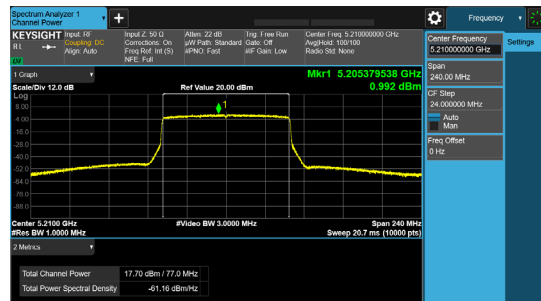

Antenna B

Data Screenshots -Antenna gain 8dBi.

5230 MHz: HE40, M0 to M11 1ss

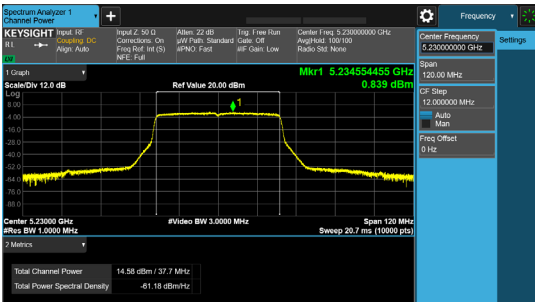

Antenna A

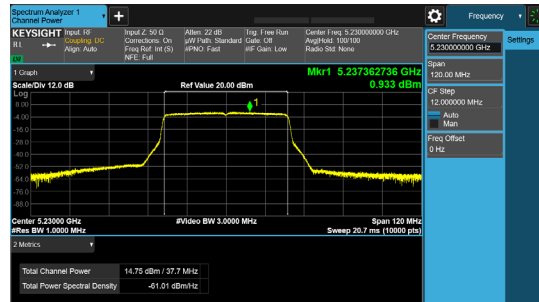

Antenna B

5230 MHz: HE40, M0 to M11 2ss

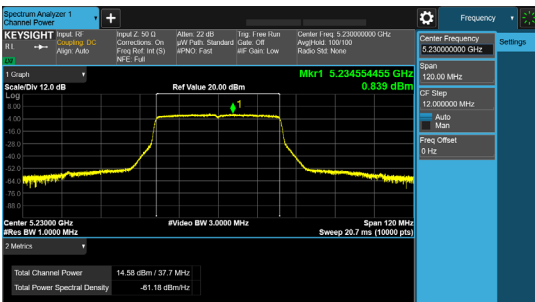

Antenna A

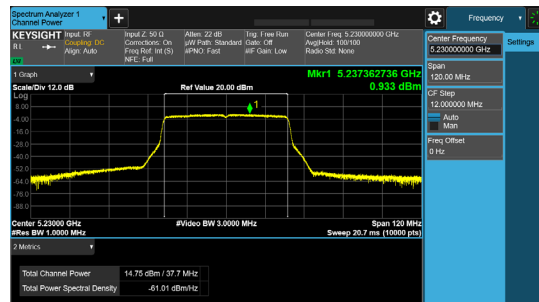

Antenna B

5230 MHz: HE40 Beam Forming, M0 to M11 2ss

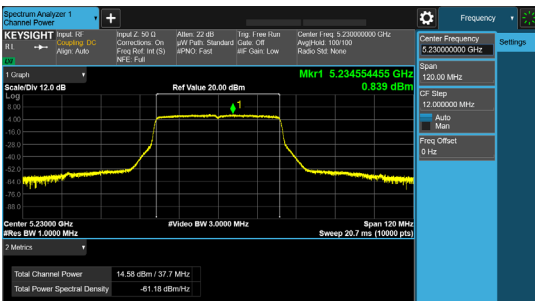

Antenna A

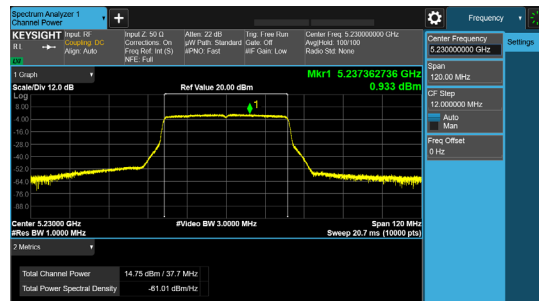

Antenna B

Data Screenshots – Antenna gain 15dBi.

5230 MHz: HE40, M0 to M11 1ss

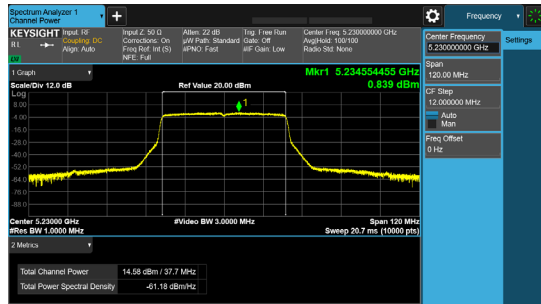

Antenna A

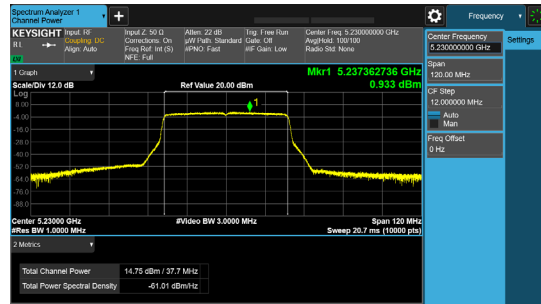

Antenna B

5230 MHz: HE40, M0 to M11 2ss

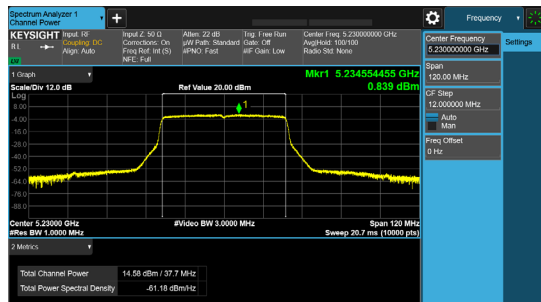

Antenna A

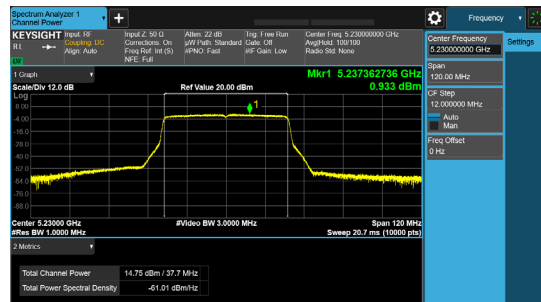

Antenna B

5230 MHz: HE40 Beam Forming, M0 to M11 1ss.

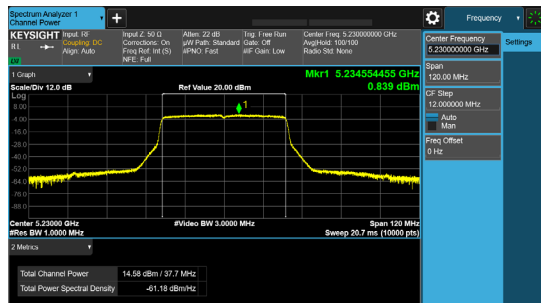

Antenna A

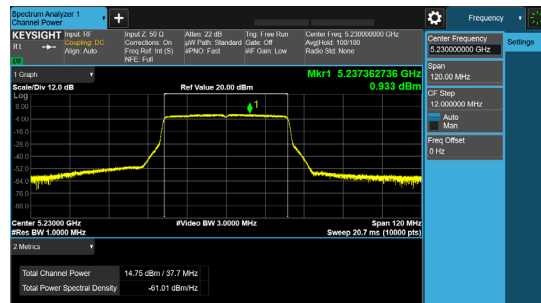

Antenna B

Maximum Transmit Power > 30°. – Antenna gain 3dBi (0dBi).**Frequency 5180 MHz**

Mode	Tx Paths	Correlated Antenna Gain (dBi)	Tx 1 Max Power (dBm)	Tx 2 Max Power (dBm)	Duty Cycle (dB)	Total Channel Power (dBm)	Limit (dBm)	Margin (dB)
Non HT20, 6 to 54 Mbps	1		20.5		0.41	20.9	21	0.14
Non HT20, 6 to 54 Mbps	2		17.3	17.1	0.41	20.6	21	0.38
Non HT20 Beam Forming, 6 to 54 Mbps	2	3	14.2	14.1	0.41	20.6	21	0.43
HT/VHT20, M0 to M7	1		19.8		0.31	20.1	21	0.88
HT/VHT20, M0 to M7	2		16.9	16.6	0.31	20.1	21	0.93
HT/VHT20, M8 to M15	2		16.9	16.6	0.31	20.1	21	0.93
HT/VHT20 Beam Forming, M0 to M7	2	3	13.8	13.7	0.31	20.1	21	0.93
HT/VHT20 Beam Forming, M8 to M15	2		16.9	16.6	0.31	20.1	21	0.93
HT/VHT20 STBC, M8 to M15	2		16.9	16.6	0.31	20.1	21	0.93
HE20, M0 to M11 1ss	1		19.9		0.21	20.1	21	0.91
HE20, M0 to M11 1ss	2		17.0	16.5	0.21	20.0	21	1.02
HE20, M0 to M11 2ss	2		17.0	16.5	0.21	20.0	21	1.02
HE20 Beam Forming, M0 to M11 1ss	2	3	14.7	14.7	0.21	20.9	21	0.07
HE20 Beam Forming, M0 to M11 2ss	2		17.0	16.5	0.21	20.0	21	1.02
HE20 STBC, M0 to M11 2ss	2		17.0	16.5	0.21	20.0	21	1.02

Frequency 5190 MHz

Mode	Tx Paths	Correlated Antenna Gain (dBi)	Tx 1 Max Power (dBm)	Tx 2 Max Power (dBm)	Duty Cycle (dB)	Total Channel Power (dBm)	Limit (dBm)	Margin (dB)
Non HT40, 6 to 54 Mbps	1		17.7		0.46	18.1	21	2.89
Non HT40, 6 to 54 Mbps	2		17.0	16.6	0.46	20.3	21	0.75
HT/VHT40, M0 to M7	1		19.8		0.55	20.3	21	0.7
HT/VHT40, M0 to M7	2		16.8	16.1	0.55	20.0	21	1.01
HT/VHT40, M8 to M15	2		16.8	16.1	0.55	20.0	21	1.01
HT/VHT40 Beam Forming, M0 to M7	2	3	13.7	13.3	0.55	20.1	21	0.94
HT/VHT40 Beam Forming, M8 to M15	2		16.8	16.1	0.55	20.0	21	1.01
HT/VHT40 STBC, M8 to M15	2		16.8	16.1	0.55	20.0	21	1.01
HE40, M0 to M11 1ss	1		19.4		0.26	19.7	21	1.35
HE40, M0 to M11 1ss	2		17.5	17.1	0.26	20.6	21	0.42
HE40, M0 to M11 2ss	2		17.5	17.1	0.26	20.6	21	0.42
HE40 Beam Forming, M0 to M11 1ss	2	3	14.4	14.1	0.26	20.5	21	0.52
HE40 Beam Forming, M0 to M11 2ss	2		17.5	17.1	0.26	20.6	21	0.42
HE40 STBC, M0 to M11 2ss	2		17.5	17.1	0.26	20.6	21	0.42

Frequency 5210 MHz

Mode	Tx Paths	Correlated Antenna Gain (dBi)	Tx 1 Max Power (dBm)	Tx 2 Max Power (dBm)	Duty Cycle (dB)	Total Channel Power (dBm)	Limit (dBm)	Margin (dB)
Non HT80, 6 to 54 Mbps	1		19.3		0.23	19.6	21	1.43
Non HT80, 6 to 54 Mbps	2		17.3	17.0	0.23	20.4	21	0.59
VHT80, M0 to M11 1ss	1		18.7		0.55	19.2	21	1.77
VHT80, M0 to M11 1ss	2		16.3	16.8	0.55	20.1	21	0.88
VHT80, M0 to M11 2ss	2		16.3	16.8	0.55	20.1	21	0.88
VHT80 Beam Forming, M0 to M11 1ss	2	3	13.5	13.7	0.55	20.2	21	0.82
VHT80 Beam Forming, M0 to M11 2ss	2		16.3	16.8	0.55	20.1	21	0.88
VHT80 STBC, M0 to M11 2ss	2		16.3	16.8	0.55	20.1	21	0.88
HE80, M0 to M11 1ss	1		18.9		0.23	19.1	21	1.87
HE80, M0 to M11 1ss	2		17.8	17.7	0.23	21.0	21	0.0
HE80, M0 to M11 2ss	2		17.8	17.7	0.23	21.0	21	0.0
HE80 Beam Forming, M0 to M11 1ss	2	3	14.6	14.8	0.23	20.9	21	0.08
HE80 Beam Forming, M0 to M11 2ss	2		17.8	17.7	0.23	21.0	21	0.0
HE80 STBC, M0 to M11 2ss	2		17.8	17.7	0.23	21.0	21	0.0

Frequency 5220 MHz

Mode	Tx Paths	Correlated Antenna Gain (dBi)	Tx 1 Max Power (dBm)	Tx 2 Max Power (dBm)	Duty Cycle (dB)	Total Channel Power (dBm)	Limit (dBm)	Margin (dB)
Non HT20, 6 to 54 Mbps	1		19.6		0.41	20.0	21	1.04
Non HT20, 6 to 54 Mbps	2		17.7	17.3	0.41	20.9	21	0.09
Non HT20 Beam Forming, 6 to 54 Mbps	2	3	14.3	14.4	0.41	20.8	21	0.23
HT/VHT20, M0 to M7	1		20.0		0.31	20.4	21	0.65
HT/VHT20, M0 to M7	2		17.1	17.0	0.31	20.4	21	0.59
HT/VHT20, M8 to M15	2		17.1	17.0	0.31	20.4	21	0.59
HT/VHT20 Beam Forming, M0 to M7	2	3	13.9	13.8	0.31	20.2	21	0.84
HT/VHT20 Beam Forming, M8 to M15	2		17.1	17.0	0.31	20.4	21	0.59
HT/VHT20 STBC, M8 to M15	2		17.1	17.0	0.31	20.4	21	0.59
HE20, M0 to M11 1ss	1		20.3		0.21	20.5	21	0.52
HE20, M0 to M11 1ss	2		17.6	17.2	0.21	20.6	21	0.36
HE20, M0 to M11 2ss	2		17.6	17.2	0.21	20.6	21	0.36
HE20 Beam Forming, M0 to M11 1ss	2	3	13.9	14.1	0.21	20.2	21	0.8
HE20 Beam Forming, M0 to M11 2ss	2		17.6	17.2	0.21	20.6	21	0.36
HE20 STBC, M0 to M11 2ss	2		17.6	17.2	0.21	20.6	21	0.36

Frequency 5230 MHz

Mode	Tx Paths	Correlated Antenna Gain (dBi)	Tx 1 Max Power (dBm)	Tx 2 Max Power (dBm)	Duty Cycle (dB)	Total Channel Power (dBm)	Limit (dBm)	Margin (dB)
Non HT40, 6 to 54 Mbps	1		20.2		0.46	20.6	21	0.39
Non HT40, 6 to 54 Mbps	2		17.4	17.1	0.46	20.7	21	0.27
HT/VHT40, M0 to M7	1		20.3		0.55	20.8	21	0.18
HT/VHT40, M0 to M7	2		16.8	16.8	0.55	20.3	21	0.66
HT/VHT40, M8 to M15	2		16.8	16.8	0.55	20.3	21	0.66
HT/VHT40 Beam Forming, M0 to M7	2	3	13.8	13.9	0.55	20.4	21	0.56
HT/VHT40 Beam Forming, M8 to M15	2		16.8	16.8	0.55	20.3	21	0.66
HT/VHT40 STBC, M8 to M15	2		16.8	16.8	0.55	20.3	21	0.66
HE40, M0 to M11 1ss	1		20.2		0.26	20.4	21	0.59
HE40, M0 to M11 1ss	2		16.6	16.7	0.26	19.9	21	1.08
HE40, M0 to M11 2ss	2		16.6	16.7	0.26	19.9	21	1.08
HE40 Beam Forming, M0 to M11 1ss	2	3	14.6	14.8	0.26	20.9	21	0.07
HE40 Beam Forming, M0 to M11 2ss	2		16.6	16.7	0.26	19.9	21	1.08
HE40 STBC, M0 to M11 2ss	2		16.6	16.7	0.26	19.9	21	1.08

Frequency 5240 MHz

Mode	Tx Paths	Correlated Antenna Gain (dBi)	Tx 1 Max Power (dBm)	Tx 2 Max Power (dBm)	Duty Cycle (dB)	Total Channel Power (dBm)	Limit (dBm)	Margin (dB)
Non HT20, 6 to 54 Mbps	1		20.6		0.41	21.0	21	0.0
Non HT20, 6 to 54 Mbps	2		17.5	16.7	0.41	20.5	21	0.47
Non HT20 Beam Forming, 6 to 54 Mbps	2	3	14.4	14.0	0.41	20.6	21	0.4
HT/VHT20, M0 to M7	1		20.3		0.31	20.6	21	0.4
HT/VHT20, M0 to M7	2		17.2	16.4	0.31	20.1	21	0.86
HT/VHT20, M8 to M15	2		17.2	16.4	0.31	20.1	21	0.86
HT/VHT20 Beam Forming, M0 to M7	2	3	13.9	13.7	0.31	20.1	21	0.88
HT/VHT20 Beam Forming, M8 to M15	2		17.2	16.4	0.31	20.1	21	0.86
HT/VHT20 STBC, M8 to M15	2		17.2	16.4	0.31	20.1	21	0.86
HE20, M0 to M11 1ss	1		20.4		0.21	20.6	21	0.37
HE20, M0 to M11 1ss	2		17.3	16.5	0.21	20.2	21	0.85
HE20, M0 to M11 2ss	2		17.3	16.5	0.21	20.2	21	0.85
HE20 Beam Forming, M0 to M11 1ss	2	3	14.8	14.4	0.21	20.9	21	0.15
HE20 Beam Forming, M0 to M11 2ss	2		17.3	16.5	0.21	20.2	21	0.85
HE20 STBC, M0 to M11 2ss	2		17.3	16.5	0.21	20.2	21	0.85

Maximum Transmit Power > 30°. – Antenna gain 8dBi (3dBi).**Frequency 5180 MHz**

Mode	Tx Paths	Correlated Antenna Gain (dBi)	Tx 1 Max Power (dBm)	Tx 2 Max Power (dBm)	Duty Cycle (dB)	Total Channel Power (dBm)	Limit (dBm)	Margin (dB)
Non HT20, 6 to 54 Mbps	1	3	17.3		0.41	20.8	21	0.25
Non HT20, 6 to 54 Mbps	2	3	14.2	14.1	0.41	20.6	21	0.43
Non HT20 Beam Forming, 6 to 54 Mbps	2	6	11.1	11.0	0.41	20.5	21	0.55
HT/VHT20, M0 to M7	1	3	16.9		0.31	20.2	21	0.78
HT/VHT20, M0 to M7	2	3	13.8	13.7	0.31	20.1	21	0.93
HT/VHT20, M8 to M15	2	3	13.8	13.7	0.31	20.1	21	0.93
HT/VHT20 Beam Forming, M0 to M7	2	6	10.7	10.6	0.31	20.0	21	1.01
HT/VHT20 Beam Forming, M8 to M15	2	3	13.8	13.7	0.31	20.1	21	0.93
HT/VHT20 STBC, M8 to M15	2	3	13.8	13.7	0.31	20.1	21	0.93
HE20, M0 to M11 1ss	1	3	17.0		0.21	20.2	21	0.82
HE20, M0 to M11 1ss	2	3	14.7	14.7	0.21	20.9	21	0.07
HE20, M0 to M11 2ss	2	3	14.7	14.7	0.21	20.9	21	0.07
HE20 Beam Forming, M0 to M11 1ss	2	6	11.8	11.6	0.21	20.9	21	0.09
HE20 Beam Forming, M0 to M11 2ss	2	3	14.7	14.7	0.21	20.9	21	0.07
HE20 STBC, M0 to M11 2ss	2	3	14.7	14.7	0.21	20.9	21	0.07

Frequency 5190 MHz

Mode	Tx Paths	Correlated Antenna Gain (dBi)	Tx 1 Max Power (dBm)	Tx 2 Max Power (dBm)	Duty Cycle (dB)	Total Channel Power (dBm)	Limit (dBm)	Margin (dB)
Non HT40, 6 to 54 Mbps	1	3	17.0		0.46	20.4	21	0.55
Non HT40, 6 to 54 Mbps	2	3	14.5	14.4	0.46	20.9	21	0.08
HT/VHT40, M0 to M7	1	3	16.8		0.55	20.3	21	0.68
HT/VHT40, M0 to M7	2	3	13.7	13.3	0.55	20.1	21	0.94
HT/VHT40, M8 to M15	2	3	13.7	13.3	0.55	20.1	21	0.94
HT/VHT40 Beam Forming, M0 to M7	2	6	10.5	10.1	0.55	19.8	21	1.16
HT/VHT40 Beam Forming, M8 to M15	2	3	13.7	13.3	0.55	20.1	21	0.94
HT/VHT40 STBC, M8 to M15	2	3	13.7	13.3	0.55	20.1	21	0.94
HE40, M0 to M11 1ss	1	3	17.5		0.26	20.8	21	0.23
HE40, M0 to M11 1ss	2	3	14.4	14.1	0.26	20.5	21	0.52
HE40, M0 to M11 2ss	2	3	14.4	14.1	0.26	20.5	21	0.52
HE40 Beam Forming, M0 to M11 1ss	2	6	11.3	11.0	0.26	20.5	21	0.55
HE40 Beam Forming, M0 to M11 2ss	2	3	14.4	14.1	0.26	20.5	21	0.52
HE40 STBC, M0 to M11 2ss	2	3	14.4	14.1	0.26	20.5	21	0.52

Frequency 5210 MHz

Mode	Tx Paths	Correlated Antenna Gain (dBi)	Tx 1 Max Power (dBm)	Tx 2 Max Power (dBm)	Duty Cycle (dB)	Total Channel Power (dBm)	Limit (dBm)	Margin (dB)
Non HT80, 6 to 54 Mbps	1	3	17.3		0.23	20.5	21	0.48
Non HT80, 6 to 54 Mbps	2	3	14.0	14.4	0.23	20.5	21	0.52
VHT80, M0 to M11 1ss	1	3	16.3		0.55	19.9	21	1.11
VHT80, M0 to M11 1ss	2	3	13.5	13.7	0.55	20.2	21	0.82
VHT80, M0 to M11 2ss	2	3	13.5	13.7	0.55	20.2	21	0.82
VHT80 Beam Forming, M0 to M11 1ss	2	6	10.3	10.7	0.55	20.0	21	0.97
VHT80 Beam Forming, M0 to M11 2ss	2	3	13.5	13.7	0.55	20.2	21	0.82
VHT80 STBC, M0 to M11 2ss	2	3	13.5	13.7	0.55	20.2	21	0.82
HE80, M0 to M11 1ss	1	3	16.6		0.23	19.8	21	1.21
HE80, M0 to M11 1ss	2	3	14.6	14.8	0.23	20.9	21	0.08
HE80, M0 to M11 2ss	2	3	14.6	14.8	0.23	20.9	21	0.08
HE80 Beam Forming, M0 to M11 1ss	2	6	11.3	11.4	0.23	20.6	21	0.43
HE80 Beam Forming, M0 to M11 2ss	2	3	14.6	14.8	0.23	20.9	21	0.08
HE80 STBC, M0 to M11 2ss	2	3	14.6	14.8	0.23	20.9	21	0.08

Frequency 5220 MHz

Mode	Tx Paths	Correlated Antenna Gain (dBi)	Tx 1 Max Power (dBm)	Tx 2 Max Power (dBm)	Duty Cycle (dB)	Total Channel Power (dBm)	Limit (dBm)	Margin (dB)
Non HT20, 6 to 54 Mbps	1	3	16.5		0.41	19.9	21	1.07
Non HT20, 6 to 54 Mbps	2	3	14.3	14.4	0.41	20.8	21	0.23
Non HT20 Beam Forming, 6 to 54 Mbps	2	6	11.2	11.1	0.41	20.6	21	0.44
HT/VHT20, M0 to M7	1	3	17.1		0.31	20.5	21	0.54
HT/VHT20, M0 to M7	2	3	13.9	13.8	0.31	20.2	21	0.84
HT/VHT20, M8 to M15	2	3	13.9	13.8	0.31	20.2	21	0.84
HT/VHT20 Beam Forming, M0 to M7	2	6	10.8	10.6	0.31	20.0	21	0.96
HT/VHT20 Beam Forming, M8 to M15	2	3	13.9	13.8	0.31	20.2	21	0.84
HT/VHT20 STBC, M8 to M15	2	3	13.9	13.8	0.31	20.2	21	0.84
HE20, M0 to M11 1ss	1	3	17.6		0.21	20.8	21	0.17
HE20, M0 to M11 1ss	2	3	13.9	14.1	0.21	20.2	21	0.8
HE20, M0 to M11 2ss	2	3	13.9	14.1	0.21	20.2	21	0.8
HE20 Beam Forming, M0 to M11 1ss	2	6	11.0	10.9	0.21	20.1	21	0.88
HE20 Beam Forming, M0 to M11 2ss	2	3	13.9	14.1	0.21	20.2	21	0.8
HE20 STBC, M0 to M11 2ss	2	3	13.9	14.1	0.21	20.2	21	0.8

Frequency 5230 MHz

Mode	Tx Paths	Correlated Antenna Gain (dBi)	Tx 1 Max Power (dBm)	Tx 2 Max Power (dBm)	Duty Cycle (dB)	Total Channel Power (dBm)	Limit (dBm)	Margin (dB)
Non HT40, 6 to 54 Mbps	1	3	17.4		0.46	20.9	21	0.11
Non HT40, 6 to 54 Mbps	2	3	14.1	14.2	0.46	20.6	21	0.4
HT/VHT40, M0 to M7	1	3	16.8		0.55	20.3	21	0.68
HT/VHT40, M0 to M7	2	3	13.8	13.9	0.55	20.4	21	0.56
HT/VHT40, M8 to M15	2	3	13.8	13.9	0.55	20.4	21	0.56
HT/VHT40 Beam Forming, M0 to M7	2	6	10.6	10.8	0.55	20.3	21	0.72
HT/VHT40 Beam Forming, M8 to M15	2	3	13.8	13.9	0.55	20.4	21	0.56
HT/VHT40 STBC, M8 to M15	2	3	13.8	13.9	0.55	20.4	21	0.56
HE40, M0 to M11 1ss	1	3	16.6		0.26	19.9	21	1.13
HE40, M0 to M11 1ss	2	3	14.6	14.8	0.26	20.9	21	0.07
HE40, M0 to M11 2ss	2	3	14.6	14.8	0.26	20.9	21	0.07
HE40 Beam Forming, M0 to M11 1ss	2	6	11.5	11.4	0.26	20.7	21	0.27
HE40 Beam Forming, M0 to M11 2ss	2	3	14.6	14.8	0.26	20.9	21	0.07
HE40 STBC, M0 to M11 2ss	2	3	14.6	14.8	0.26	20.9	21	0.07

Frequency 5240 MHz

Mode	Tx Paths	Correlated Antenna Gain (dBi)	Tx 1 Max Power (dBm)	Tx 2 Max Power (dBm)	Duty Cycle (dB)	Total Channel Power (dBm)	Limit (dBm)	Margin (dB)
Non HT20, 6 to 54 Mbps	1	3	17.5		0.41	20.9	21	0.12
Non HT20, 6 to 54 Mbps	2	3	14.4	14.0	0.41	20.6	21	0.4
Non HT20 Beam Forming, 6 to 54 Mbps	2	6	11.5	10.9	0.41	20.6	21	0.36
HT/VHT20, M0 to M7	1	3	17.2		0.31	20.5	21	0.5
HT/VHT20, M0 to M7	2	3	13.9	13.7	0.31	20.1	21	0.88
HT/VHT20, M8 to M15	2	3	13.9	13.7	0.31	20.1	21	0.88
HT/VHT20 Beam Forming, M0 to M7	2	6	11.1	10.5	0.31	20.1	21	0.9
HT/VHT20 Beam Forming, M8 to M15	2	3	13.9	13.7	0.31	20.1	21	0.88
HT/VHT20 STBC, M8 to M15	2	3	13.9	13.7	0.31	20.1	21	0.88
HE20, M0 to M11 1ss	1	3	17.3		0.21	20.5	21	0.48
HE20, M0 to M11 1ss	2	3	14.8	14.4	0.21	20.9	21	0.15
HE20, M0 to M11 2ss	2	3	14.8	14.4	0.21	20.9	21	0.15
HE20 Beam Forming, M0 to M11 1ss	2	6	11.2	10.5	0.21	20.0	21	0.96
HE20 Beam Forming, M0 to M11 2ss	2	3	14.8	14.4	0.21	20.9	21	0.15
HE20 STBC, M0 to M11 2ss	2	3	14.8	14.4	0.21	20.9	21	0.15

Maximum Transmit Power > 30°. – Antenna gain 15dBi (3dBi).**Frequency 5180 MHz**

Mode	Tx Paths	Correlated Antenna Gain (dBi)	Tx 1 Max Power (dBm)	Tx 2 Max Power (dBm)	Duty Cycle (dB)	Total Channel Power (dBm)	Limit (dBm)	Margin (dB)
Non HT20, 6 to 54 Mbps	1	3	17.3		0.41	20.8	21	0.25
Non HT20, 6 to 54 Mbps	2	3	14.2	14.1	0.41	20.6	21	0.43
Non HT20 Beam Forming, 6 to 54 Mbps	2	3	14.2	14.1	0.41	20.6	21	0.43
HT/VHT20, M0 to M7	1	3	15.9		0.31	19.2	21	1.83
HT/VHT20, M0 to M7	2	3	13.8	13.7	0.31	20.1	21	0.93
HT/VHT20, M8 to M15	2	3	13.8	13.7	0.31	20.1	21	0.93
HT/VHT20 Beam Forming, M0 to M7	2	3	13.8	13.7	0.31	20.1	21	0.93
HT/VHT20 Beam Forming, M8 to M15	2	3	13.8	13.7	0.31	20.1	21	0.93
HT/VHT20 STBC, M8 to M15	2	3	13.8	13.7	0.31	20.1	21	0.93
HE20, M0 to M11 1ss	1	3	17.0		0.21	20.2	21	0.82
HE20, M0 to M11 1ss	2	3	13.9	13.8	0.21	20.0	21	0.96
HE20, M0 to M11 2ss	2	3	13.9	13.8	0.21	20.0	21	0.96
HE20 Beam Forming, M0 to M11 1ss	2	3	13.9	13.8	0.21	20.0	21	0.96
HE20 Beam Forming, M0 to M11 2ss	2	3	13.9	13.8	0.21	20.0	21	0.96
HE20 STBC, M0 to M11 2ss	2	3	13.9	13.8	0.21	20.0	21	0.96

Frequency 5190 MHz

Mode	Tx Paths	Correlated Antenna Gain (dBi)	Tx 1 Max Power (dBm)	Tx 2 Max Power (dBm)	Duty Cycle (dB)	Total Channel Power (dBm)	Limit (dBm)	Margin (dB)
Non HT40, 6 to 54 Mbps	1	3	17.0		0.46	20.4	21	0.55
Non HT40, 6 to 54 Mbps	2	3	14.5	14.4	0.46	20.9	21	0.08
HT/VHT40, M0 to M7	1	3	16.8		0.55	20.3	21	0.68
HT/VHT40, M0 to M7	2	3	12.7	12.4	0.55	19.1	21	1.89
HT/VHT40, M8 to M15	2	3	12.7	12.4	0.55	19.1	21	1.89
HT/VHT40 Beam Forming, M0 to M7	2	3	12.7	12.4	0.55	19.1	21	1.89
HT/VHT40 Beam Forming, M8 to M15	2	3	12.7	12.4	0.55	19.1	21	1.89
HT/VHT40 STBC, M8 to M15	2	3	12.7	12.4	0.55	19.1	21	1.89
HE40, M0 to M11 1ss	1	3	17.5		0.26	20.8	21	0.23
HE40, M0 to M11 1ss	2	3	13.2	13.1	0.26	19.4	21	1.57
HE40, M0 to M11 2ss	2	3	13.2	13.1	0.26	19.4	21	1.57
HE40 Beam Forming, M0 to M11 1ss	2	3	13.2	13.1	0.26	19.4	21	1.57
HE40 Beam Forming, M0 to M11 2ss	2	3	13.2	13.1	0.26	19.4	21	1.57
HE40 STBC, M0 to M11 2ss	2	3	13.2	13.1	0.26	19.4	21	1.57

Frequency 5210 MHz

Mode	Tx Paths	Correlated Antenna Gain (dBi)	Tx 1 Max Power (dBm)	Tx 2 Max Power (dBm)	Duty Cycle (dB)	Total Channel Power (dBm)	Limit (dBm)	Margin (dB)
Non HT80, 6 to 54 Mbps	1	3	17.3		0.23	20.5	21	0.48
Non HT80, 6 to 54 Mbps	2	3	13.2	13.3	0.23	19.5	21	1.47
VHT80, M0 to M11 1ss	1	3	16.3		0.55	19.9	21	1.11
VHT80, M0 to M11 1ss	2	3	13.5	13.7	0.55	20.2	21	0.82
VHT80, M0 to M11 2ss	2	3	13.5	13.7	0.55	20.2	21	0.82
VHT80 Beam Forming, M0 to M11 1ss	2	3	13.5	13.7	0.55	20.2	21	0.82
VHT80 Beam Forming, M0 to M11 2ss	2	3	13.5	13.7	0.55	20.2	21	0.82
VHT80 STBC, M0 to M11 2ss	2	3	13.5	13.7	0.55	20.2	21	0.82
HE80, M0 to M11 1ss	1	3	16.6		0.23	19.8	21	1.21
HE80, M0 to M11 1ss	2	3	12.6	12.8	0.23	18.9	21	2.07
HE80, M0 to M11 2ss	2	3	12.6	12.8	0.23	18.9	21	2.07
HE80 Beam Forming, M0 to M11 1ss	2	3	12.6	12.8	0.23	18.9	21	2.07
HE80 Beam Forming, M0 to M11 2ss	2	3	12.6	12.8	0.23	18.9	21	2.07
HE80 STBC, M0 to M11 2ss	2	3	12.6	12.8	0.23	18.9	21	2.07

Frequency 5220 MHz

Mode	Tx Paths	Correlated Antenna Gain (dBi)	Tx 1 Max Power (dBm)	Tx 2 Max Power (dBm)	Duty Cycle (dB)	Total Channel Power (dBm)	Limit (dBm)	Margin (dB)
Non HT20, 6 to 54 Mbps	1	3	16.5		0.41	19.9	21	1.07
Non HT20, 6 to 54 Mbps	2	3	14.3	14.4	0.41	20.8	21	0.23
Non HT20 Beam Forming, 6 to 54 Mbps	2	3	14.3	14.4	0.41	20.8	21	0.23
HT/VHT20, M0 to M7	1	3	17.1		0.31	20.5	21	0.54
HT/VHT20, M0 to M7	2	3	13.9	13.8	0.31	20.2	21	0.84
HT/VHT20, M8 to M15	2	3	13.9	13.8	0.31	20.2	21	0.84
HT/VHT20 Beam Forming, M0 to M7	2	3	13.9	13.8	0.31	20.2	21	0.84
HT/VHT20 Beam Forming, M8 to M15	2	3	13.9	13.8	0.31	20.2	21	0.84
HT/VHT20 STBC, M8 to M15	2	3	13.9	13.8	0.31	20.2	21	0.84
HE20, M0 to M11 1ss	1	3	17.6		0.21	20.8	21	0.17
HE20, M0 to M11 1ss	2	3	13.9	14.1	0.21	20.2	21	0.8
HE20, M0 to M11 2ss	2	3	13.9	14.1	0.21	20.2	21	0.8
HE20 Beam Forming, M0 to M11 1ss	2	3	13.9	14.1	0.21	20.2	21	0.8
HE20 Beam Forming, M0 to M11 2ss	2	3	13.9	14.1	0.21	20.2	21	0.8
HE20 STBC, M0 to M11 2ss	2	3	13.9	14.1	0.21	20.2	21	0.8

Frequency 5230 MHz

Mode	Tx Paths	Correlated Antenna Gain (dBi)	Tx 1 Max Power (dBm)	Tx 2 Max Power (dBm)	Duty Cycle (dB)	Total Channel Power (dBm)	Limit (dBm)	Margin (dB)
Non HT40, 6 to 54 Mbps	1	3	17.4		0.46	20.9	21	0.11
Non HT40, 6 to 54 Mbps	2	3	14.1	14.2	0.46	20.6	21	0.4
HT/VHT40, M0 to M7	1	3	16.8		0.55	20.3	21	0.68
HT/VHT40, M0 to M7	2	3	13.8	13.9	0.55	20.4	21	0.56
HT/VHT40, M8 to M15	2	3	13.8	13.9	0.55	20.4	21	0.56
HT/VHT40 Beam Forming, M0 to M7	2	3	13.8	13.9	0.55	20.4	21	0.56
HT/VHT40 Beam Forming, M8 to M15	2	3	13.8	13.9	0.55	20.4	21	0.56
HT/VHT40 STBC, M8 to M15	2	3	13.8	13.9	0.55	20.4	21	0.56
HE40, M0 to M11 1ss	1	3	16.6		0.26	19.9	21	1.13
HE40, M0 to M11 1ss	2	3	14.6	14.8	0.26	20.9	21	0.07
HE40, M0 to M11 2ss	2	3	14.6	14.8	0.26	20.9	21	0.07
HE40 Beam Forming, M0 to M11 1ss	2	3	14.6	14.8	0.26	20.9	21	0.07
HE40 Beam Forming, M0 to M11 2ss	2	3	14.6	14.8	0.26	20.9	21	0.07
HE40 STBC, M0 to M11 2ss	2	3	14.6	14.8	0.26	20.9	21	0.07

Frequency 5240 MHz

Mode	Tx Paths	Correlated Antenna Gain (dBi)	Tx 1 Max Power (dBm)	Tx 2 Max Power (dBm)	Duty Cycle (dB)	Total Channel Power (dBm)	Limit (dBm)	Margin (dB)
Non HT20, 6 to 54 Mbps	1	3	17.5		0.41	20.9	21	0.12
Non HT20, 6 to 54 Mbps	2	3	14.4	14.0	0.41	20.6	21	0.4
Non HT20 Beam Forming, 6 to 54 Mbps	2	3	14.4	14.0	0.41	20.6	21	0.4
HT/VHT20, M0 to M7	1	3	17.2		0.31	20.5	21	0.5
HT/VHT20, M0 to M7	2	3	13.9	13.7	0.31	20.1	21	0.88
HT/VHT20, M8 to M15	2	3	13.9	13.7	0.31	20.1	21	0.88
HT/VHT20 Beam Forming, M0 to M7	2	3	13.9	13.7	0.31	20.1	21	0.88
HT/VHT20 Beam Forming, M8 to M15	2	3	13.9	13.7	0.31	20.1	21	0.88
HT/VHT20 STBC, M8 to M15	2	3	13.9	13.7	0.31	20.1	21	0.88
HE20, M0 to M11 1ss	1	3	17.3		0.21	20.5	21	0.48
HE20, M0 to M11 1ss	2	3	14.8	14.4	0.21	20.9	21	0.15
HE20, M0 to M11 2ss	2	3	14.8	14.4	0.21	20.9	21	0.15
HE20 Beam Forming, M0 to M11 1ss	2	3	14.8	14.4	0.21	20.9	21	0.15
HE20 Beam Forming, M0 to M11 2ss	2	3	14.8	14.4	0.21	20.9	21	0.15
HE20 STBC, M0 to M11 2ss	2	3	14.8	14.4	0.21	20.9	21	0.15

Data Screenshots – Antenna gain 3dBi (0dBi).

5240 MHz: Non HT20, 6 to 54 Mbps

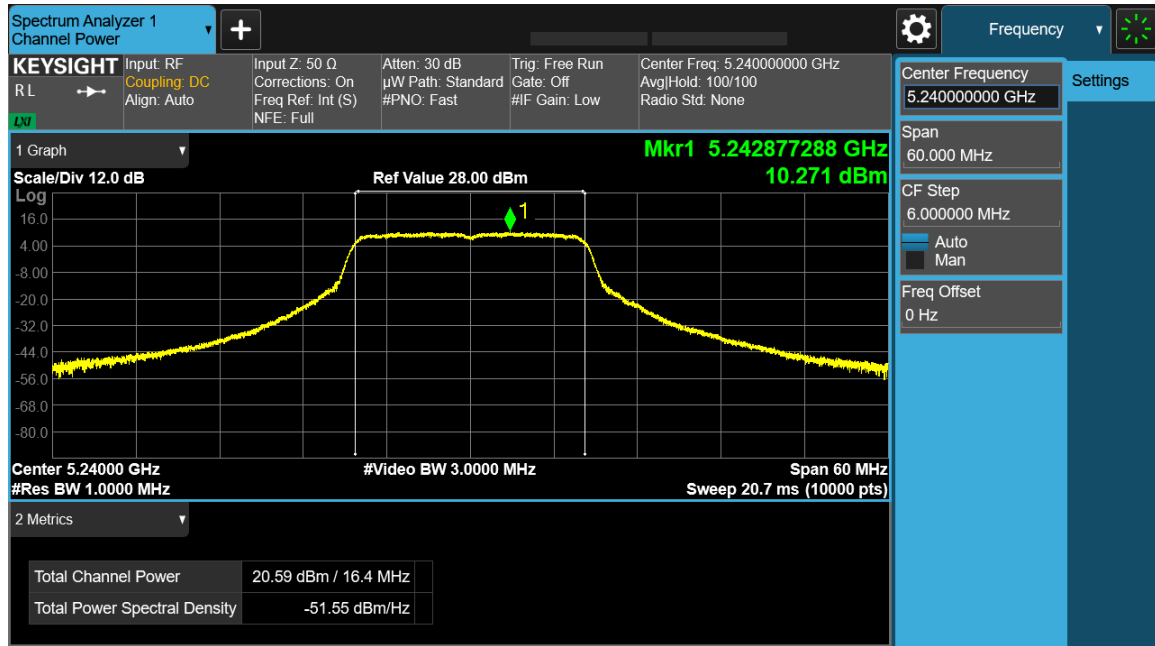

Antenna A

5210 MHz: HE80, M0 to M11 1ss

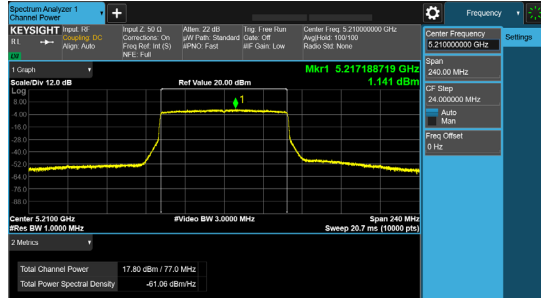

Antenna A

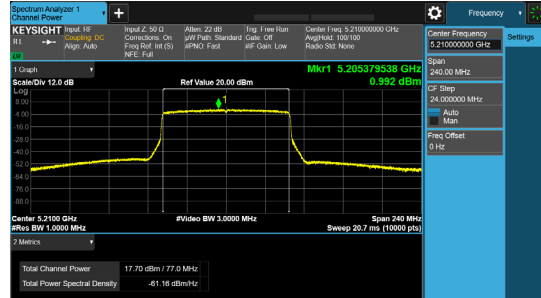

Antenna B

5210 MHz: HE80, M0 to M11 2ss

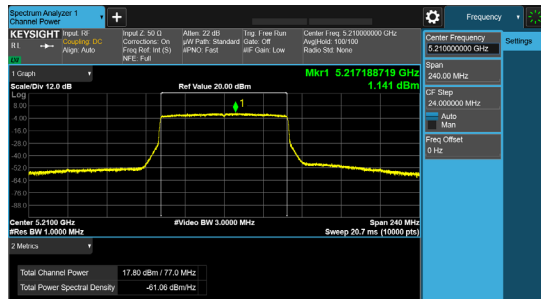

Antenna A

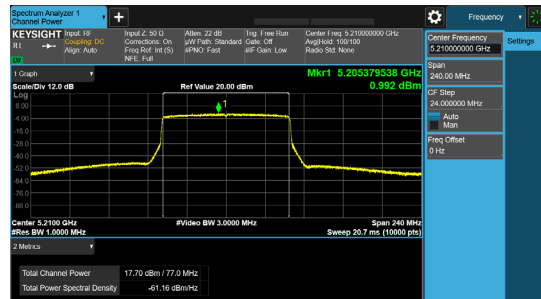

Antenna B

Data Screenshots – Antenna gain 8dBi (3dBi).

5230 MHz: HE40, M0 to M11 1ss

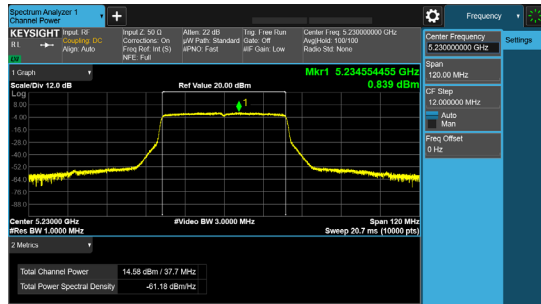

Antenna A

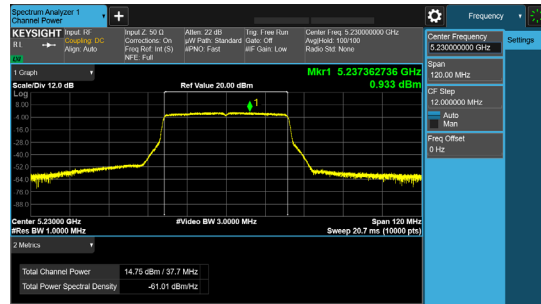

Antenna B

5230 MHz: HE40, M0 to M11 2ss

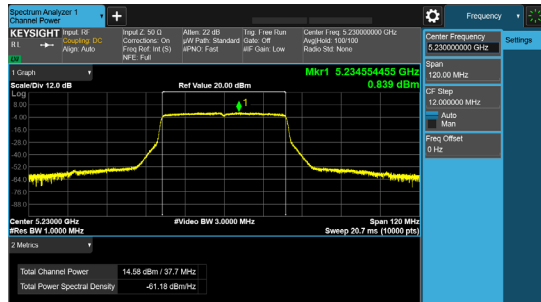

Antenna A

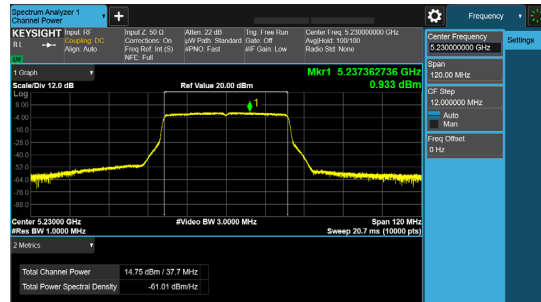

Antenna B

5230 MHz: HE40 Beam Forming, M0 to M11 2ss

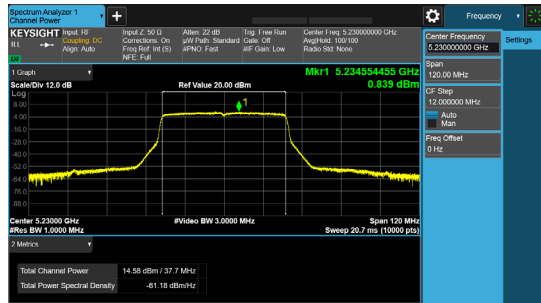

Antenna A

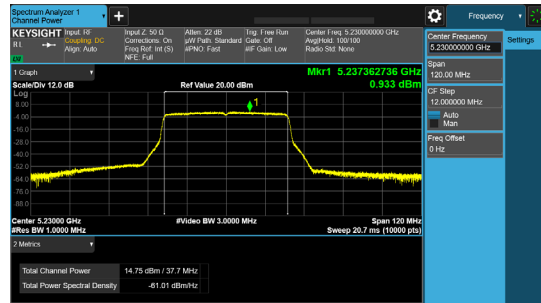

Antenna B

Data Screenshots – Antenna gain 10dBi (8dBi).

5190 MHz: Non HT40, 6 to 54 Mbps

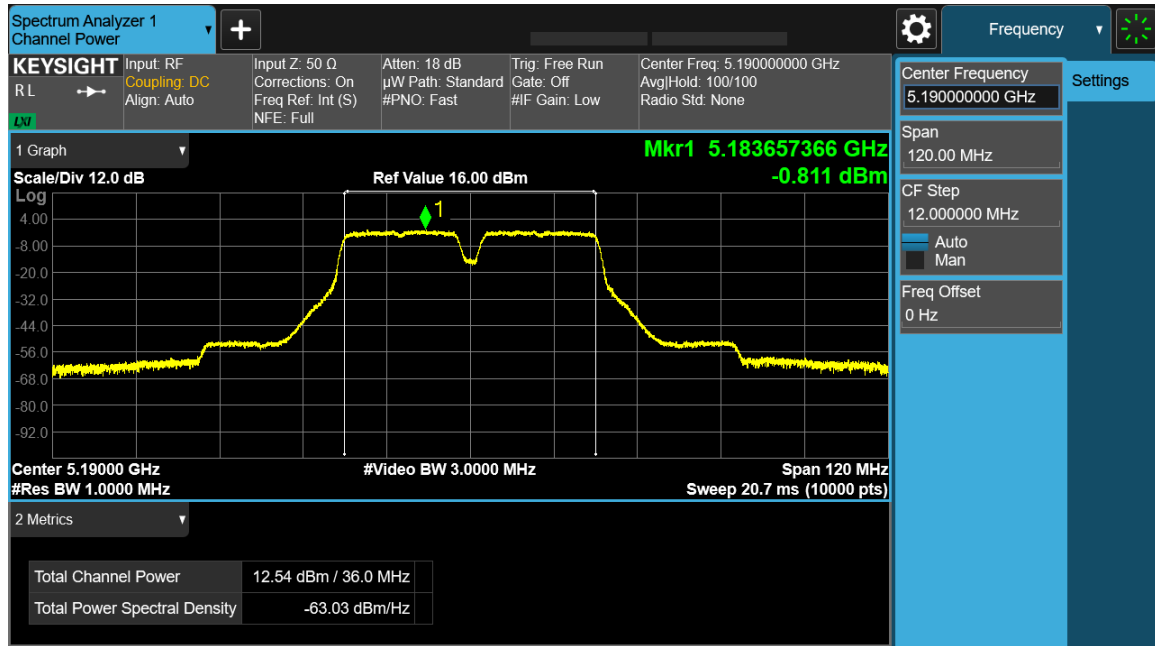

Antenna A

5210 MHz: VHT80, M0 to M11 1ss

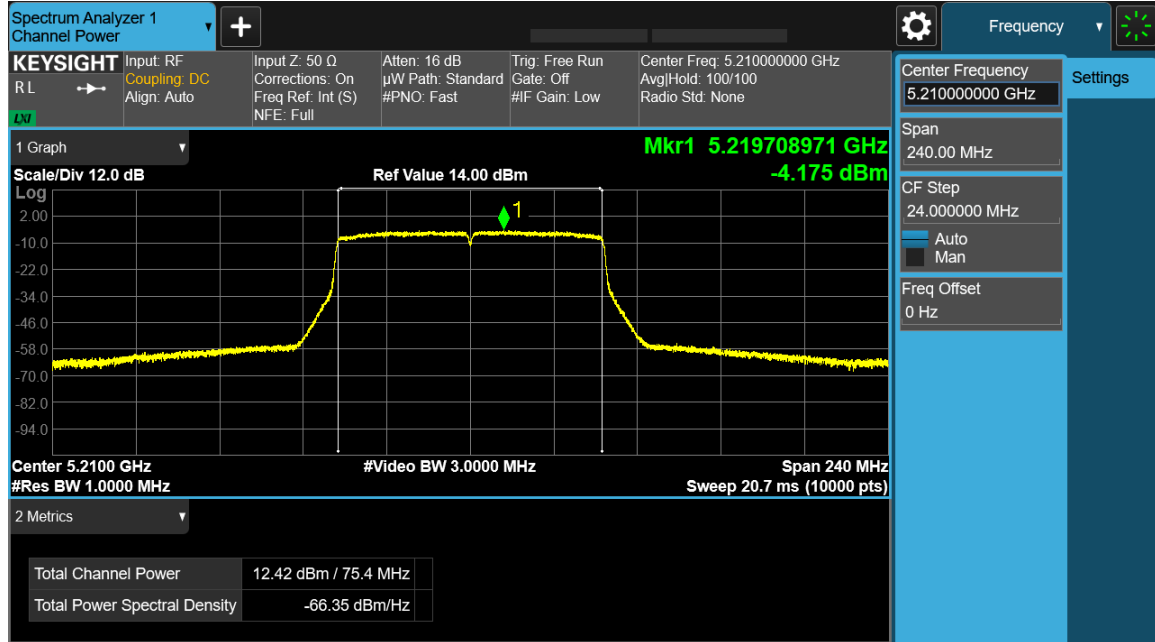

Antenna A

5210 MHz: HE80, M0 to M11 1ss

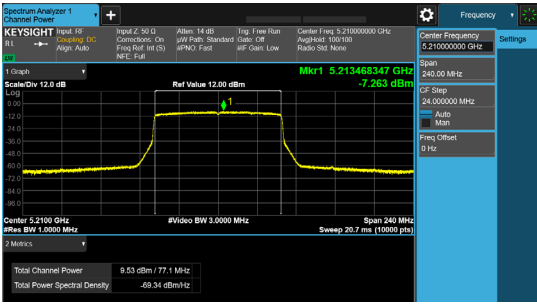

Antenna A

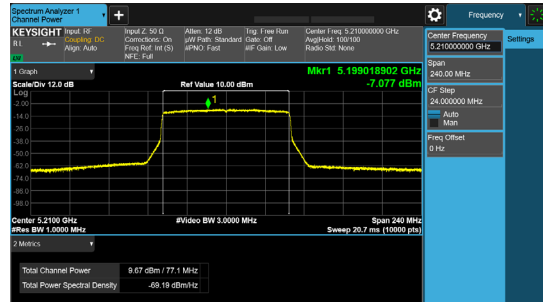

Antenna B

Data Screenshots – Antenna gain 15dBi (3dBi).

5230 MHz: HE40, M0 to M11 1ss

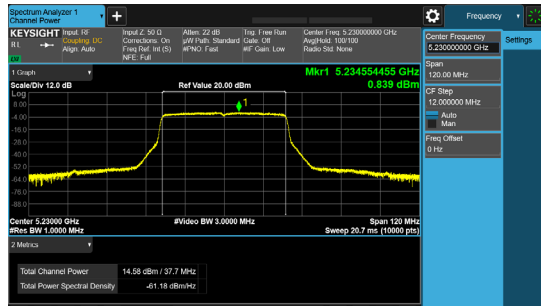

Antenna A

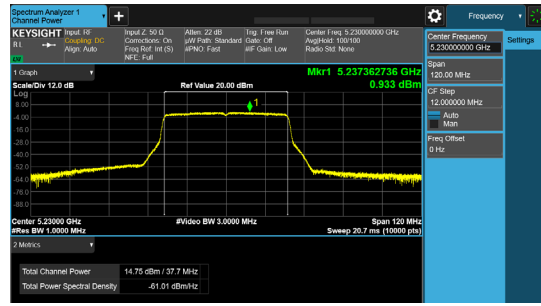

Antenna B

5230 MHz: HE40, M0 to M11 2ss

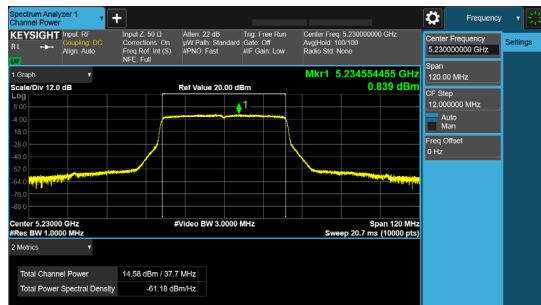

Antenna A

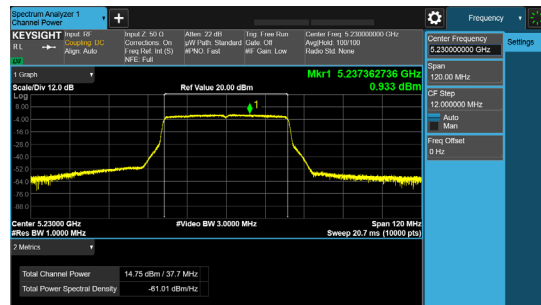

Antenna B

5230 MHz: HE40 Beam Forming, M0 to M11 1ss

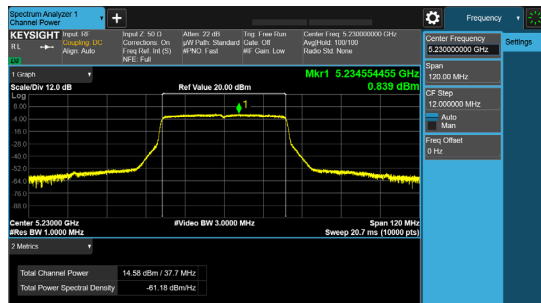

Antenna A

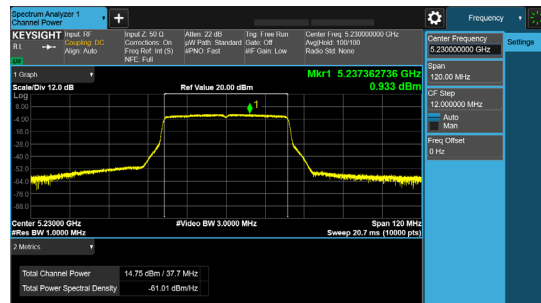

Antenna B

A.4: Power Spectral Density

Power Spectral Density Test Requirement

15.407 General technical requirements, (a) Power limits: (1) For the band 5.15-5.25 GHz:

(i) For an outdoor access point operating in the band 5.15-5.25 GHz ... the maximum power spectral density shall not exceed 17 dBm in any 1 megahertz band. If transmitting antennas of directional gain greater than 6 dBi are used, both the maximum conducted output power and the maximum power spectral density shall be reduced by the amount in dB that the directional gain of the antenna exceeds 6 dBi.

(ii) For an indoor access point operating in the band 5.15-5.25 GHz... the maximum power spectral density shall not exceed 17 dBm in any 1 megahertz band. If transmitting antennas of directional gain greater than 6 dBi are used, both the maximum conducted output power and the maximum power spectral density shall be reduced by the amount in dB that the directional gain of the antenna exceeds 6 dBi.

(iii) For fixed point-to-point access points operating in the band 5.15-5.25 GHz...the maximum power spectral density shall not exceed 17 dBm in any 1 megahertz band. Fixed point-to-point U-NII devices may employ antennas with directional gain up to 23 dBi without any corresponding reduction in the maximum conducted output power or maximum power spectral density. For fixed point-to-point transmitters that employ a directional antenna gain greater than 23 dBi, a 1 dB reduction in maximum conducted output power and maximum power spectral density is required for each 1 dB of antenna gain in excess of 23 dBi. Fixed, point-to-point operations exclude the use of point-to-multipoint systems, omnidirectional applications, and multiple collocated transmitters transmitting the same information. The operator of the U-NII device, or if the equipment is professionally installed, the installer, is responsible for ensuring that systems employing high gain directional antennas are used exclusively for fixed, point-to-point operations.

(iv) For client devices in the 5.15-5.25 GHz band, the maximum power spectral density shall not exceed 11 dBm in any 1 megahertz band. If transmitting antennas of directional gain greater than 6 dBi are used, both the maximum conducted output power and the maximum power spectral density shall be reduced by the amount in dB that the directional gain of the antenna exceeds 6 dBi.

Power Spectral Density Test Procedure

Ref. KDB 789033 D02 General UNII Test Procedures New Rules v02r01

F. Maximum Power Spectral Density (PSD)

Power Spectral Density Test Procedure
--

The rules requires "maximum power spectral density" measurements where the intent is to measure the maximum value of the time average of the power spectral density measured during a period of continuous transmission.
--

1. Create an average power spectrum for the EUT operating mode being tested by following the instructions in section II.E.2. for measuring maximum conducted output power using a spectrum analyzer or EMI receiver: select the appropriate test method (SA-1, SA-2, SA-3, or alternatives to each) and apply it up to, but not including, the step labeled, "Compute power...". (This procedure is required even if the maximum conducted output power measurement was performed using a power meter, method PM.)
--

2. Use the peak search function on the instrument to find the peak of the spectrum and record its value.
--

3. Make the following adjustments to the peak value of the spectrum, if applicable: a) If Method SA-2 or SA-2 Alternative was used, add $10 \log(1/x)$, where x is the duty cycle, to the peak of the spectrum.
--

b) If Method SA-3 Alternative was used and the linear mode was used in step II.E.2.g)(viii), add 1 dB to the final result to compensate for the difference between linear averaging and power averaging.
--

4. The result is the Maximum PSD over 1 MHz reference bandwidth.
--

Ref. KDB 789033 D02 General UNII Test Procedures New Rules v02r01

2. Measurement using a Spectrum Analyzer or EMI Receiver (SA), (d) Method SA-2

<p>Power Spectral Density Test parameters</p> <p>Method SA-2 (trace averaging across on and off times of the EUT transmissions, followed by duty cycle correction). (i) Measure the duty cycle, x, of the transmitter output signal as described in section II.B. (ii) Set span to encompass the EBW (or, alternatively, the entire 99% occupied bandwidth) of the signal. (iii) Set RBW = 1 MHz. (iv) Set VBW \geq 3 MHz. (v) Number of points in sweep \geq 2 Span / RBW. (This ensures that bin-to-bin spacing is \leq RBW/2, so that narrowband signals are not lost between frequency bins.) (vi) Sweep time = auto. (vii) Detector = RMS (i.e., power averaging), if available. Otherwise, use sample detector mode. (viii) Do not use sweep triggering. Allow the sweep to “free run”. (ix) Trace average at least 100 traces in power averaging (i.e., RMS) mode; however, the number of traces to be averaged shall be increased above 100 as needed to ensure that the average accurately represents the true average over the on and off periods of the transmitter. (x) Compute power by integrating the spectrum across the EBW (or, alternatively, the entire 99% occupied bandwidth) of the signal using the instrument’s band power measurement function with band limits set equal to the EBW (or occupied bandwidth)</p> <p>F. Maximum Power Spectral Density (PSD) 2. Use the peak search function on the instrument to find the peak of the spectrum and record its value. 3. Make the following adjustments to the peak value of the spectrum, if applicable: a) If Method SA-2 or SA-2 Alternative was used, add $10 \log(1/x)$, where x is the duty cycle, to the peak of the spectrum.</p>
--

The “measure-and-sum technique” is used for measuring in-band transmit power of a device. In the measure-and-sum approach, the conducted emission level is measured at each antenna port. The measured results at the various antenna ports are then summed mathematically to determine the total emission level from the device. Summing is performed in linear power units. ANSI C63.10 section 14.3.2.2

Tested By: Ronak Patel	Date of testing: 11/1/2022 - 2/10/2023
Test Result: PASS	

Test Equipment

See Appendix C for list of test equipment

Power Spectral Density EIRP – Antenna gain 3dBi.**Frequency 5180 MHz**

Mode	Tx Paths	Correlated Antenna Gain (dBi)	Tx 1 PSD (dBm/MHz)	Tx 2 PSD (dBm/MHz)	Duty Cycle (dB)	Total PSD (dBm/MHz)	Limit (dBm/MHz)	Margin (dB)
Non HT20, 6 to 54 Mbps	1	3	10.3		0.41	13.7	23	9.34
Non HT20, 6 to 54 Mbps	2	6	7.0	6.9	0.41	16.4	23	6.63
Non HT20 Beam Forming, 6 to 54 Mbps	2	6	4.0	3.8	0.41	13.3	23	9.71
HT/VHT20, M0 to M7	1	3	9.3		0.31	12.6	23	10.4
HT/VHT20, M0 to M7	2	6	6.6	6.4	0.31	15.8	23	7.2
HT/VHT20, M8 to M15	2	3	6.6	6.4	0.31	12.8	23	10.2
HT/VHT20 Beam Forming, M0 to M7	2	6	3.3	3.0	0.31	12.5	23	10.53
HT/VHT20 Beam Forming, M8 to M15	2	3	6.6	6.4	0.31	12.8	23	10.2
HT/VHT20 STBC, M8 to M15	2	3	6.6	6.4	0.31	12.8	23	10.2
HE20, M0 to M11 1ss	1	3	9.0		0.21	12.2	23	10.79
HE20, M0 to M11 1ss	2	6	6.2	5.8	0.21	15.2	23	7.77
HE20, M0 to M11 2ss	2	3	6.2	5.8	0.21	12.2	23	10.77
HE20 Beam Forming, M0 to M11 1ss	2	6	4.4	4.1	0.21	13.5	23	9.53
HE20 Beam Forming, M0 to M11 2ss	2	3	6.2	5.8	0.21	12.2	23	10.77
HE20 STBC, M0 to M11 2ss	2	3	6.2	5.8	0.21	12.2	23	10.77

Frequency 5190 MHz

Mode	Tx Paths	Correlated Antenna Gain (dBi)	Tx 1 PSD (dBm/MHz)	Tx 2 PSD (dBm/MHz)	Duty Cycle (dB)	Total PSD (dBm/MHz)	Limit (dBm/MHz)	Margin (dB)
Non HT40, 6 to 54 Mbps	1	3	4.3		0.46	7.7	23	15.26
Non HT40, 6 to 54 Mbps	2	6	3.6	3.2	0.46	12.9	23	10.14
HT/VHT40, M0 to M7	1	3	6.1		0.55	9.6	23	13.38
HT/VHT40, M0 to M7	2	6	3.2	2.5	0.55	12.4	23	10.62
HT/VHT40, M8 to M15	2	3	3.2	2.5	0.55	9.4	23	13.62
HT/VHT40 Beam Forming, M0 to M7	2	6	0.1	-0.3	0.55	9.5	23	13.54
HT/VHT40 Beam Forming, M8 to M15	2	3	3.2	2.5	0.55	9.4	23	13.62
HT/VHT40 STBC, M8 to M15	2	3	3.2	2.5	0.55	9.4	23	13.62
HE40, M0 to M11 1ss	1	3	5.8		0.26	9.1	23	13.93
HE40, M0 to M11 1ss	2	6	3.8	3.5	0.26	12.9	23	10.09
HE40, M0 to M11 2ss	2	3	3.8	3.5	0.26	9.9	23	13.09
HE40 Beam Forming, M0 to M11 1ss	2	6	0.6	0.4	0.26	9.8	23	13.22
HE40 Beam Forming, M0 to M11 2ss	2	3	3.8	3.5	0.26	9.9	23	13.09
HE40 STBC, M0 to M11 2ss	2	3	3.8	3.5	0.26	9.9	23	13.09

Frequency 5210 MHz

Mode	Tx Paths	Correlated Antenna Gain (dBi)	Tx 1 PSD (dBm/MHz)	Tx 2 PSD (dBm/MHz)	Duty Cycle (dB)	Total PSD (dBm/MHz)	Limit (dBm/MHz)	Margin (dB)
Non HT80, 6 to 54 Mbps	1	3	3.6		0.23	6.8	23	16.2
Non HT80, 6 to 54 Mbps	2	6	1.8	1.5	0.23	10.9	23	12.11
VHT80, M0 to M11 1ss	1	3	2.0		0.55	5.5	23	17.47
VHT80, M0 to M11 1ss	2	6	-0.3	0.2	0.55	9.5	23	13.48
VHT80, M0 to M11 2ss	2	3	-0.3	0.2	0.55	6.5	23	16.48
VHT80 Beam Forming, M0 to M11 1ss	2	6	-3.0	-2.6	0.55	6.7	23	16.27
VHT80 Beam Forming, M0 to M11 2ss	2	3	-0.3	0.2	0.55	6.5	23	16.48
VHT80 STBC, M0 to M11 2ss	2	3	-0.3	0.2	0.55	6.5	23	16.48
HE80, M0 to M11 1ss	1	3	2.1		0.23	5.4	23	17.65
HE80, M0 to M11 1ss	2	6	1.1	1.0	0.23	10.3	23	12.69
HE80, M0 to M11 2ss	2	3	1.1	1.0	0.23	7.3	23	15.69
HE80 Beam Forming, M0 to M11 1ss	2	6	-1.9	-1.8	0.23	7.4	23	15.59
HE80 Beam Forming, M0 to M11 2ss	2	3	1.1	1.0	0.23	7.3	23	15.69
HE80 STBC, M0 to M11 2ss	2	3	1.1	1.0	0.23	7.3	23	15.69

Frequency 5220 MHz

Mode	Tx Paths	Correlated Antenna Gain (dBi)	Tx 1 PSD (dBm/MHz)	Tx 2 PSD (dBm/MHz)	Duty Cycle (dB)	Total PSD (dBm/MHz)	Limit (dBm/MHz)	Margin (dB)
Non HT20, 6 to 54 Mbps	1	3	9.3		0.41	12.7	23	10.32
Non HT20, 6 to 54 Mbps	2	6	7.5	7.1	0.41	16.7	23	6.27
Non HT20 Beam Forming, 6 to 54 Mbps	2	6	4.0	4.0	0.41	13.4	23	9.58
HT/VHT20, M0 to M7	1	3	9.6		0.31	12.9	23	10.13
HT/VHT20, M0 to M7	2	6	6.7	6.5	0.31	15.9	23	7.06
HT/VHT20, M8 to M15	2	3	6.7	6.5	0.31	12.9	23	10.06
HT/VHT20 Beam Forming, M0 to M7	2	6	3.1	3.4	0.31	12.6	23	10.43
HT/VHT20 Beam Forming, M8 to M15	2	3	6.7	6.5	0.31	12.9	23	10.06
HT/VHT20 STBC, M8 to M15	2	3	6.7	6.5	0.31	12.9	23	10.06
HE20, M0 to M11 1ss	1	3	9.6		0.21	12.8	23	10.19
HE20, M0 to M11 1ss	2	6	6.8	6.4	0.21	15.8	23	7.19
HE20, M0 to M11 2ss	2	3	6.8	6.4	0.21	12.8	23	10.19
HE20 Beam Forming, M0 to M11 1ss	2	6	3.3	3.4	0.21	12.5	23	10.46
HE20 Beam Forming, M0 to M11 2ss	2	3	6.8	6.4	0.21	12.8	23	10.19
HE20 STBC, M0 to M11 2ss	2	3	6.8	6.4	0.21	12.8	23	10.19

Frequency 5230 MHz

Mode	Tx Paths	Correlated Antenna Gain (dBi)	Tx 1 PSD (dBm/MHz)	Tx 2 PSD (dBm/MHz)	Duty Cycle (dB)	Total PSD (dBm/MHz)	Limit (dBm/MHz)	Margin (dB)
Non HT40, 6 to 54 Mbps	1	3	6.8		0.46	10.2	23	12.77
Non HT40, 6 to 54 Mbps	2	6	4.1	4.0	0.46	13.5	23	9.5
HT/VHT40, M0 to M7	1	3	6.8		0.55	10.3	23	12.69
HT/VHT40, M0 to M7	2	6	3.2	3.2	0.55	12.8	23	10.23
HT/VHT40, M8 to M15	2	3	3.2	3.2	0.55	9.8	23	13.23
HT/VHT40 Beam Forming, M0 to M7	2	6	0.3	0.5	0.55	9.9	23	13.05
HT/VHT40 Beam Forming, M8 to M15	2	3	3.2	3.2	0.55	9.8	23	13.23
HT/VHT40 STBC, M8 to M15	2	3	3.2	3.2	0.55	9.8	23	13.23
HE40, M0 to M11 1ss	1	3	6.5		0.26	9.8	23	13.19
HE40, M0 to M11 1ss	2	6	3.1	3.1	0.26	12.4	23	10.63
HE40, M0 to M11 2ss	2	3	3.1	3.1	0.26	9.4	23	13.63
HE40 Beam Forming, M0 to M11 1ss	2	6	0.8	0.9	0.26	10.2	23	12.85
HE40 Beam Forming, M0 to M11 2ss	2	3	3.1	3.1	0.26	9.4	23	13.63
HE40 STBC, M0 to M11 2ss	2	3	3.1	3.1	0.26	9.4	23	13.63

Frequency 5240 MHz

Mode	Tx Paths	Correlated Antenna Gain (dBi)	Tx 1 PSD (dBm/MHz)	Tx 2 PSD (dBm/MHz)	Duty Cycle (dB)	Total PSD (dBm/MHz)	Limit (dBm/MHz)	Margin (dB)
Non HT20, 6 to 54 Mbps	1	3	10.3		0.41	13.7	23	9.32
Non HT20, 6 to 54 Mbps	2	6	7.2	6.3	0.41	16.2	23	6.84
Non HT20 Beam Forming, 6 to 54 Mbps	2	6	4.1	3.8	0.41	13.4	23	9.63
HT/VHT20, M0 to M7	1	3	9.8		0.31	13.1	23	9.88
HT/VHT20, M0 to M7	2	6	6.8	5.9	0.31	15.7	23	7.3
HT/VHT20, M8 to M15	2	3	6.8	5.9	0.31	12.7	23	10.3
HT/VHT20 Beam Forming, M0 to M7	2	6	3.3	3.2	0.31	12.6	23	10.44
HT/VHT20 Beam Forming, M8 to M15	2	3	6.8	5.9	0.31	12.7	23	10.3
HT/VHT20 STBC, M8 to M15	2	3	6.8	5.9	0.31	12.7	23	10.3
HE20, M0 to M11 1ss	1	3	9.7		0.21	12.9	23	10.13
HE20, M0 to M11 1ss	2	6	6.5	5.7	0.21	15.4	23	7.63
HE20, M0 to M11 2ss	2	3	6.5	5.7	0.21	12.4	23	10.63
HE20 Beam Forming, M0 to M11 1ss	2	6	4.3	3.9	0.21	13.3	23	9.66
HE20 Beam Forming, M0 to M11 2ss	2	3	6.5	5.7	0.21	12.4	23	10.63
HE20 STBC, M0 to M11 2ss	2	3	6.5	5.7	0.21	12.4	23	10.63

Power Spectral Density EIRP – Antenna gain 8dBi.

Frequency 5180 MHz

Mode	Tx Paths	Correlated Antenna Gain (dBi)	Tx 1 PSD (dBm/MHz)	Tx 2 PSD (dBm/MHz)	Duty Cycle (dB)	Total PSD (dBm/MHz)	Limit (dBm/MHz)	Margin (dB)
Non HT20, 6 to 54 Mbps	1	8	7.0		0.41	15.4	23	7.63
Non HT20, 6 to 54 Mbps	2	11	4.0	3.8	0.41	18.3	23	4.71
Non HT20 Beam Forming, 6 to 54 Mbps	2	11	0.7	0.9	0.41	15.2	23	7.77
HT/VHT20, M0 to M7	1	8	6.6		0.31	14.9	23	8.14
HT/VHT20, M0 to M7	2	11	3.3	3.0	0.31	17.5	23	5.53
HT/VHT20, M8 to M15	2	8	3.3	3.0	0.31	14.5	23	8.53
HT/VHT20 Beam Forming, M0 to M7	2	11	0.3	0.1	0.31	14.5	23	8.45
HT/VHT20 Beam Forming, M8 to M15	2	8	3.3	3.0	0.31	14.5	23	8.53
HT/VHT20 STBC, M8 to M15	2	8	3.3	3.0	0.31	14.5	23	8.53
HE20, M0 to M11 1ss	1	8	6.2		0.21	14.4	23	8.59
HE20, M0 to M11 1ss	2	11	4.4	4.1	0.21	18.5	23	4.53
HE20, M0 to M11 2ss	2	8	4.4	4.1	0.21	15.5	23	7.53
HE20 Beam Forming, M0 to M11 1ss	2	11	1.0	1.1	0.21	15.3	23	7.71
HE20 Beam Forming, M0 to M11 2ss	2	8	4.4	4.1	0.21	15.5	23	7.53
HE20 STBC, M0 to M11 2ss	2	8	4.4	4.1	0.21	15.5	23	7.53

Frequency 5190 MHz

Mode	Tx Paths	Correlated Antenna Gain (dBi)	Tx 1 PSD (dBm/MHz)	Tx 2 PSD (dBm/MHz)	Duty Cycle (dB)	Total PSD (dBm/MHz)	Limit (dBm/MHz)	Margin (dB)
Non HT40, 6 to 54 Mbps	1	8	3.6		0.46	12.1	23	10.93
Non HT40, 6 to 54 Mbps	2	11	1.3	1.1	0.46	15.6	23	7.36
HT/VHT40, M0 to M7	1	8	3.2		0.55	11.7	23	11.3
HT/VHT40, M0 to M7	2	11	0.1	-0.3	0.55	14.5	23	8.54
HT/VHT40, M8 to M15	2	8	0.1	-0.3	0.55	11.5	23	11.54
HT/VHT40 Beam Forming, M0 to M7	2	11	-2.9	-3.5	0.55	11.4	23	11.62
HT/VHT40 Beam Forming, M8 to M15	2	8	0.1	-0.3	0.55	11.5	23	11.54
HT/VHT40 STBC, M8 to M15	2	8	0.1	-0.3	0.55	11.5	23	11.54
HE40, M0 to M11 1ss	1	8	3.8		0.26	12.1	23	10.93
HE40, M0 to M11 1ss	2	11	0.6	0.4	0.26	14.8	23	8.22
HE40, M0 to M11 2ss	2	8	0.6	0.4	0.26	11.8	23	11.22
HE40 Beam Forming, M0 to M11 1ss	2	11	-2.1	-2.7	0.26	11.9	23	11.13
HE40 Beam Forming, M0 to M11 2ss	2	8	0.6	0.4	0.26	11.8	23	11.22
HE40 STBC, M0 to M11 2ss	2	8	0.6	0.4	0.26	11.8	23	11.22

Frequency 5210 MHz

Mode	Tx Paths	Correlated Antenna Gain (dBi)	Tx 1 PSD (dBm/MHz)	Tx 2 PSD (dBm/MHz)	Duty Cycle (dB)	Total PSD (dBm/MHz)	Limit (dBm/MHz)	Margin (dB)
Non HT80, 6 to 54 Mbps	1	8	1.8		0.23	10.0	23	12.99
Non HT80, 6 to 54 Mbps	2	11	-1.7	-1.4	0.23	12.7	23	10.35
VHT80, M0 to M11 1ss	1	8	-0.3		0.55	8.3	23	14.72
VHT80, M0 to M11 1ss	2	11	-3.0	-2.6	0.55	11.7	23	11.27
VHT80, M0 to M11 2ss	2	8	-3.0	-2.6	0.55	8.7	23	14.27
VHT80 Beam Forming, M0 to M11 1ss	2	11	-6.5	-5.7	0.55	8.5	23	14.52
VHT80 Beam Forming, M0 to M11 2ss	2	8	-3.0	-2.6	0.55	8.7	23	14.27
VHT80 STBC, M0 to M11 2ss	2	8	-3.0	-2.6	0.55	8.7	23	14.27
HE80, M0 to M11 1ss	1	8	-0.2		0.23	8.0	23	15.0
HE80, M0 to M11 1ss	2	11	-1.9	-1.8	0.23	12.4	23	10.59
HE80, M0 to M11 2ss	2	8	-1.9	-1.8	0.23	9.4	23	13.59
HE80 Beam Forming, M0 to M11 1ss	2	11	-5.4	-5.1	0.23	9.0	23	14.0
HE80 Beam Forming, M0 to M11 2ss	2	8	-1.9	-1.8	0.23	9.4	23	13.59
HE80 STBC, M0 to M11 2ss	2	8	-1.9	-1.8	0.23	9.4	23	13.59

Frequency 5220 MHz

Mode	Tx Paths	Correlated Antenna Gain (dBi)	Tx 1 PSD (dBm/MHz)	Tx 2 PSD (dBm/MHz)	Duty Cycle (dB)	Total PSD (dBm/MHz)	Limit (dBm/MHz)	Margin (dB)
Non HT20, 6 to 54 Mbps	1	8	6.2		0.41	14.6	23	8.41
Non HT20, 6 to 54 Mbps	2	11	4.0	4.0	0.41	18.4	23	4.58
Non HT20 Beam Forming, 6 to 54 Mbps	2	11	1.0	0.9	0.41	15.4	23	7.63
HT/VHT20, M0 to M7	1	8	6.7		0.31	15.0	23	7.95
HT/VHT20, M0 to M7	2	11	3.1	3.4	0.31	17.6	23	5.43
HT/VHT20, M8 to M15	2	8	3.1	3.4	0.31	14.6	23	8.43
HT/VHT20 Beam Forming, M0 to M7	2	11	0.4	0.1	0.31	14.6	23	8.43
HT/VHT20 Beam Forming, M8 to M15	2	8	3.1	3.4	0.31	14.6	23	8.43
HT/VHT20 STBC, M8 to M15	2	8	3.1	3.4	0.31	14.6	23	8.43
HE20, M0 to M11 1ss	1	8	6.8		0.21	15.0	23	7.98
HE20, M0 to M11 1ss	2	11	3.3	3.4	0.21	17.5	23	5.46
HE20, M0 to M11 2ss	2	8	3.3	3.4	0.21	14.5	23	8.46
HE20 Beam Forming, M0 to M11 1ss	2	11	0.1	0.2	0.21	14.4	23	8.63
HE20 Beam Forming, M0 to M11 2ss	2	8	3.3	3.4	0.21	14.5	23	8.46
HE20 STBC, M0 to M11 2ss	2	8	3.3	3.4	0.21	14.5	23	8.46

Frequency 5230 MHz

Mode	Tx Paths	Correlated Antenna Gain (dBi)	Tx 1 PSD (dBm/MHz)	Tx 2 PSD (dBm/MHz)	Duty Cycle (dB)	Total PSD (dBm/MHz)	Limit (dBm/MHz)	Margin (dB)
Non HT40, 6 to 54 Mbps	1	8	4.1		0.46	12.6	23	10.44
Non HT40, 6 to 54 Mbps	2	11	0.7	0.9	0.46	15.3	23	7.75
HT/VHT40, M0 to M7	1	8	3.2		0.55	11.8	23	11.23
HT/VHT40, M0 to M7	2	11	0.3	0.5	0.55	14.9	23	8.05
HT/VHT40, M8 to M15	2	8	0.3	0.5	0.55	11.9	23	11.05
HT/VHT40 Beam Forming, M0 to M7	2	11	-2.9	-2.5	0.55	11.9	23	11.14
HT/VHT40 Beam Forming, M8 to M15	2	8	0.3	0.5	0.55	11.9	23	11.05
HT/VHT40 STBC, M8 to M15	2	8	0.3	0.5	0.55	11.9	23	11.05
HE40, M0 to M11 1ss	1	8	3.1		0.26	11.4	23	11.62
HE40, M0 to M11 1ss	2	11	0.8	0.9	0.26	15.2	23	7.85
HE40, M0 to M11 2ss	2	8	0.8	0.9	0.26	12.2	23	10.85
HE40 Beam Forming, M0 to M11 1ss	2	11	-2.0	-1.9	0.26	12.3	23	10.71
HE40 Beam Forming, M0 to M11 2ss	2	8	0.8	0.9	0.26	12.2	23	10.85
HE40 STBC, M0 to M11 2ss	2	8	0.8	0.9	0.26	12.2	23	10.85

Frequency 5240 MHz

Mode	Tx Paths	Correlated Antenna Gain (dBi)	Tx 1 PSD (dBm/MHz)	Tx 2 PSD (dBm/MHz)	Duty Cycle (dB)	Total PSD (dBm/MHz)	Limit (dBm/MHz)	Margin (dB)
Non HT20, 6 to 54 Mbps	1	8	7.2		0.41	15.6	23	7.43
Non HT20, 6 to 54 Mbps	2	11	4.1	3.8	0.41	18.4	23	4.63
Non HT20 Beam Forming, 6 to 54 Mbps	2	11	1.2	0.5	0.41	15.3	23	7.72
HT/VHT20, M0 to M7	1	8	6.8		0.31	15.1	23	7.91
HT/VHT20, M0 to M7	2	11	3.3	3.2	0.31	17.6	23	5.44
HT/VHT20, M8 to M15	2	8	3.3	3.2	0.31	14.6	23	8.44
HT/VHT20 Beam Forming, M0 to M7	2	11	0.8	0.1	0.31	14.8	23	8.25
HT/VHT20 Beam Forming, M8 to M15	2	8	3.3	3.2	0.31	14.6	23	8.44
HT/VHT20 STBC, M8 to M15	2	8	3.3	3.2	0.31	14.6	23	8.44
HE20, M0 to M11 1ss	1	8	6.5		0.21	14.7	23	8.26
HE20, M0 to M11 1ss	2	11	4.3	3.9	0.21	18.3	23	4.66
HE20, M0 to M11 2ss	2	8	4.3	3.9	0.21	15.3	23	7.66
HE20 Beam Forming, M0 to M11 1ss	2	11	0.4	-0.1	0.21	14.4	23	8.6
HE20 Beam Forming, M0 to M11 2ss	2	8	4.3	3.9	0.21	15.3	23	7.66
HE20 STBC, M0 to M11 2ss	2	8	4.3	3.9	0.21	15.3	23	7.66

Power Spectral Density EIRP – Antenna gain 15dBi.**Frequency 5180 MHz**

Mode	Tx Paths	Correlated Antenna Gain (dBi)	Tx 1 PSD (dBm/MHz)	Tx 2 PSD (dBm/MHz)	Duty Cycle (dB)	Total PSD (dBm/MHz)	Limit (dBm/MHz)	Margin (dB)
Non HT20, 6 to 54 Mbps	1	15	7.0		0.41	22.4	23	0.63
Non HT20, 6 to 54 Mbps	2	15	4.0	3.8	0.41	22.3	23	0.71
Non HT20 Beam Forming, 6 to 54 Mbps	2	15	4.0	3.8	0.41	22.3	23	0.71
HT/VHT20, M0 to M7	1	15	5.6		0.31	20.9	23	2.12
HT/VHT20, M0 to M7	2	15	3.3	3.0	0.31	21.5	23	1.53
HT/VHT20, M8 to M15	2	15	3.3	3.0	0.31	21.5	23	1.53
HT/VHT20 Beam Forming, M0 to M7	2	15	3.3	3.0	0.31	21.5	23	1.53
HT/VHT20 Beam Forming, M8 to M15	2	15	3.3	3.0	0.31	21.5	23	1.53
HT/VHT20 STBC, M8 to M15	2	15	3.3	3.0	0.31	21.5	23	1.53
HE20, M0 to M11 1ss	1	15	6.2		0.21	21.4	23	1.59
HE20, M0 to M11 1ss	2	15	3.1	3.1	0.21	21.3	23	1.69
HE20, M0 to M11 2ss	2	15	3.1	3.1	0.21	21.3	23	1.69
HE20 Beam Forming, M0 to M11 1ss	2	15	3.1	3.1	0.21	21.3	23	1.69
HE20 Beam Forming, M0 to M11 2ss	2	15	3.1	3.1	0.21	21.3	23	1.69
HE20 STBC, M0 to M11 2ss	2	15	3.1	3.1	0.21	21.3	23	1.69

Frequency 5190 MHz

Mode	Tx Paths	Correlated Antenna Gain (dBi)	Tx 1 PSD (dBm/MHz)	Tx 2 PSD (dBm/MHz)	Duty Cycle (dB)	Total PSD (dBm/MHz)	Limit (dBm/MHz)	Margin (dB)
Non HT40, 6 to 54 Mbps	1	15	3.6		0.46	19.1	23	3.93
Non HT40, 6 to 54 Mbps	2	15	1.3	1.1	0.46	19.6	23	3.36
HT/VHT40, M0 to M7	1	15	3.2		0.55	18.7	23	4.3
HT/VHT40, M0 to M7	2	15	-0.6	-1.3	0.55	17.7	23	5.34
HT/VHT40, M8 to M15	2	15	-0.6	-1.3	0.55	17.7	23	5.34
HT/VHT40 Beam Forming, M0 to M7	2	15	-0.6	-1.3	0.55	17.7	23	5.34
HT/VHT40 Beam Forming, M8 to M15	2	15	-0.6	-1.3	0.55	17.7	23	5.34
HT/VHT40 STBC, M8 to M15	2	15	-0.6	-1.3	0.55	17.7	23	5.34
HE40, M0 to M11 1ss	1	15	3.8		0.26	19.1	23	3.93
HE40, M0 to M11 1ss	2	15	-0.5	-0.5	0.26	17.8	23	5.23
HE40, M0 to M11 2ss	2	15	-0.5	-0.5	0.26	17.8	23	5.23
HE40 Beam Forming, M0 to M11 1ss	2	15	-0.5	-0.5	0.26	17.8	23	5.23
HE40 Beam Forming, M0 to M11 2ss	2	15	-0.5	-0.5	0.26	17.8	23	5.23
HE40 STBC, M0 to M11 2ss	2	15	-0.5	-0.5	0.26	17.8	23	5.23

Frequency 5210 MHz

Mode	Tx Paths	Correlated Antenna Gain (dBi)	Tx 1 PSD (dBm/MHz)	Tx 2 PSD (dBm/MHz)	Duty Cycle (dB)	Total PSD (dBm/MHz)	Limit (dBm/MHz)	Margin (dB)
Non HT80, 6 to 54 Mbps	1	15	1.8		0.23	17.0	23	5.99
Non HT80, 6 to 54 Mbps	2	15	-2.4	-2.3	0.23	15.9	23	7.14
VHT80, M0 to M11 1ss	1	15	-0.3		0.55	15.3	23	7.72
VHT80, M0 to M11 1ss	2	15	-3.0	-2.6	0.55	15.7	23	7.27
VHT80, M0 to M11 2ss	2	15	-3.0	-2.6	0.55	15.7	23	7.27
VHT80 Beam Forming, M0 to M11 1ss	2	15	-3.0	-2.6	0.55	15.7	23	7.27
VHT80 Beam Forming, M0 to M11 2ss	2	15	-3.0	-2.6	0.55	15.7	23	7.27
VHT80 STBC, M0 to M11 2ss	2	15	-3.0	-2.6	0.55	15.7	23	7.27
HE80, M0 to M11 1ss	1	15	-0.2		0.23	15.0	23	8.0
HE80, M0 to M11 1ss	2	15	-4.2	-3.9	0.23	14.2	23	8.82
HE80, M0 to M11 2ss	2	15	-4.2	-3.9	0.23	14.2	23	8.82
HE80 Beam Forming, M0 to M11 1ss	2	15	-4.2	-3.9	0.23	14.2	23	8.82
HE80 Beam Forming, M0 to M11 2ss	2	15	-4.2	-3.9	0.23	14.2	23	8.82
HE80 STBC, M0 to M11 2ss	2	15	-4.2	-3.9	0.23	14.2	23	8.82

Frequency 5220 MHz

Mode	Tx Paths	Correlated Antenna Gain (dBi)	Tx 1 PSD (dBm/MHz)	Tx 2 PSD (dBm/MHz)	Duty Cycle (dB)	Total PSD (dBm/MHz)	Limit (dBm/MHz)	Margin (dB)
Non HT20, 6 to 54 Mbps	1	15	6.2		0.41	21.6	23	1.41
Non HT20, 6 to 54 Mbps	2	15	4.0	4.0	0.41	22.4	23	0.58
Non HT20 Beam Forming, 6 to 54 Mbps	2	15	4.0	4.0	0.41	22.4	23	0.58
HT/VHT20, M0 to M7	1	15	6.7		0.31	22.0	23	0.95
HT/VHT20, M0 to M7	2	15	3.1	3.4	0.31	21.6	23	1.43
HT/VHT20, M8 to M15	2	15	3.1	3.4	0.31	21.6	23	1.43
HT/VHT20 Beam Forming, M0 to M7	2	15	3.1	3.4	0.31	21.6	23	1.43
HT/VHT20 Beam Forming, M8 to M15	2	15	3.1	3.4	0.31	21.6	23	1.43
HT/VHT20 STBC, M8 to M15	2	15	3.1	3.4	0.31	21.6	23	1.43
HE20, M0 to M11 1ss	1	15	6.8		0.21	22.0	23	0.98
HE20, M0 to M11 1ss	2	15	3.3	3.4	0.21	21.5	23	1.46
HE20, M0 to M11 2ss	2	15	3.3	3.4	0.21	21.5	23	1.46
HE20 Beam Forming, M0 to M11 1ss	2	15	3.3	3.4	0.21	21.5	23	1.46
HE20 Beam Forming, M0 to M11 2ss	2	15	3.3	3.4	0.21	21.5	23	1.46
HE20 STBC, M0 to M11 2ss	2	15	3.3	3.4	0.21	21.5	23	1.46

Frequency 5230 MHz

Mode	Tx Paths	Correlated Antenna Gain (dBi)	Tx 1 PSD (dBm/MHz)	Tx 2 PSD (dBm/MHz)	Duty Cycle (dB)	Total PSD (dBm/MHz)	Limit (dBm/MHz)	Margin (dB)
Non HT40, 6 to 54 Mbps	1	15	4.1		0.46	19.6	23	3.44
Non HT40, 6 to 54 Mbps	2	15	0.7	0.9	0.46	19.3	23	3.75
HT/VHT40, M0 to M7	1	15	3.2		0.55	18.8	23	4.23
HT/VHT40, M0 to M7	2	15	0.3	0.5	0.55	18.9	23	4.05
HT/VHT40, M8 to M15	2	15	0.3	0.5	0.55	18.9	23	4.05
HT/VHT40 Beam Forming, M0 to M7	2	15	0.3	0.5	0.55	18.9	23	4.05
HT/VHT40 Beam Forming, M8 to M15	2	15	0.3	0.5	0.55	18.9	23	4.05
HT/VHT40 STBC, M8 to M15	2	15	0.3	0.5	0.55	18.9	23	4.05
HE40, M0 to M11 1ss	1	15	3.1		0.26	18.4	23	4.62
HE40, M0 to M11 1ss	2	15	0.8	0.9	0.26	19.2	23	3.85
HE40, M0 to M11 2ss	2	15	0.8	0.9	0.26	19.2	23	3.85
HE40 Beam Forming, M0 to M11 1ss	2	15	0.8	0.9	0.26	19.2	23	3.85
HE40 Beam Forming, M0 to M11 2ss	2	15	0.8	0.9	0.26	19.2	23	3.85
HE40 STBC, M0 to M11 2ss	2	15	0.8	0.9	0.26	19.2	23	3.85

Frequency 5240 MHz

Mode	Tx Paths	Correlated Antenna Gain (dBi)	Tx 1 PSD (dBm/MHz)	Tx 2 PSD (dBm/MHz)	Duty Cycle (dB)	Total PSD (dBm/MHz)	Limit (dBm/MHz)	Margin (dB)
Non HT20, 6 to 54 Mbps	1	15	7.2		0.41	22.6	23	0.43
Non HT20, 6 to 54 Mbps	2	15	4.1	3.8	0.41	22.4	23	0.63
Non HT20 Beam Forming, 6 to 54 Mbps	2	15	4.1	3.8	0.41	22.4	23	0.63
HT/VHT20, M0 to M7	1	15	6.8		0.31	22.1	23	0.91
HT/VHT20, M0 to M7	2	15	3.3	3.2	0.31	21.6	23	1.44
HT/VHT20, M8 to M15	2	15	3.3	3.2	0.31	21.6	23	1.44
HT/VHT20 Beam Forming, M0 to M7	2	15	3.3	3.2	0.31	21.6	23	1.44
HT/VHT20 Beam Forming, M8 to M15	2	15	3.3	3.2	0.31	21.6	23	1.44
HT/VHT20 STBC, M8 to M15	2	15	3.3	3.2	0.31	21.6	23	1.44
HE20, M0 to M11 1ss	1	15	6.5		0.21	21.7	23	1.26
HE20, M0 to M11 1ss	2	15	4.3	3.9	0.21	22.3	23	0.66
HE20, M0 to M11 2ss	2	15	4.3	3.9	0.21	22.3	23	0.66
HE20 Beam Forming, M0 to M11 1ss	2	15	4.3	3.9	0.21	22.3	23	0.66
HE20 Beam Forming, M0 to M11 2ss	2	15	4.3	3.9	0.21	22.3	23	0.66
HE20 STBC, M0 to M11 2ss	2	15	4.3	3.9	0.21	22.3	23	0.66

Conducted Power Spectral Density – Antenna gain 3dBi.**Frequency 5180 MHz**

Mode	Tx Paths	Correlated Antenna Gain (dBi)	Tx 1 PSD (dBm/MHz)	Tx 2 PSD (dBm/MHz)	Duty Cycle (dB)	Total PSD (dBm/MHz)	Limit (dBm/MHz)	Margin (dB)
Non HT20, 6 to 54 Mbps	1	3	10.3		0.41	10.7	17	6.34
Non HT20, 6 to 54 Mbps	2	6	7.0	6.9	0.41	10.4	17	6.63
Non HT20 Beam Forming, 6 to 54 Mbps	2	6	4.0	3.8	0.41	7.3	17	9.71
HT/VHT20, M0 to M7	1	3	9.3		0.31	9.6	17	7.4
HT/VHT20, M0 to M7	2	6	6.6	6.4	0.31	9.8	17	7.2
HT/VHT20, M8 to M15	2	3	6.6	6.4	0.31	9.8	17	7.2
HT/VHT20 Beam Forming, M0 to M7	2	6	3.3	3.0	0.31	6.5	17	10.53
HT/VHT20 Beam Forming, M8 to M15	2	3	6.6	6.4	0.31	9.8	17	7.2
HT/VHT20 STBC, M8 to M15	2	3	6.6	6.4	0.31	9.8	17	7.2
HE20, M0 to M11 1ss	1	3	9.0		0.21	9.2	17	7.79
HE20, M0 to M11 1ss	2	6	6.2	5.8	0.21	9.2	17	7.77
HE20, M0 to M11 2ss	2	3	6.2	5.8	0.21	9.2	17	7.77
HE20 Beam Forming, M0 to M11 1ss	2	6	4.4	4.1	0.21	7.5	17	9.53
HE20 Beam Forming, M0 to M11 2ss	2	3	6.2	5.8	0.21	9.2	17	7.77
HE20 STBC, M0 to M11 2ss	2	3	6.2	5.8	0.21	9.2	17	7.77

Frequency 5190 MHz

Mode	Tx Paths	Correlated Antenna Gain (dBi)	Tx 1 PSD (dBm/MHz)	Tx 2 PSD (dBm/MHz)	Duty Cycle (dB)	Total PSD (dBm/MHz)	Limit (dBm/MHz)	Margin (dB)
Non HT40, 6 to 54 Mbps	1	3	4.3		0.46	4.7	17	12.26
Non HT40, 6 to 54 Mbps	2	6	3.6	3.2	0.46	6.9	17	10.14
HT/VHT40, M0 to M7	1	3	6.1		0.55	6.6	17	10.38
HT/VHT40, M0 to M7	2	6	3.2	2.5	0.55	6.4	17	10.62
HT/VHT40, M8 to M15	2	3	3.2	2.5	0.55	6.4	17	10.62
HT/VHT40 Beam Forming, M0 to M7	2	6	0.1	-0.3	0.55	3.5	17	13.54
HT/VHT40 Beam Forming, M8 to M15	2	3	3.2	2.5	0.55	6.4	17	10.62
HT/VHT40 STBC, M8 to M15	2	3	3.2	2.5	0.55	6.4	17	10.62
HE40, M0 to M11 1ss	1	3	5.8		0.26	6.1	17	10.93
HE40, M0 to M11 1ss	2	6	3.8	3.5	0.26	6.9	17	10.09
HE40, M0 to M11 2ss	2	3	3.8	3.5	0.26	6.9	17	10.09
HE40 Beam Forming, M0 to M11 1ss	2	6	0.6	0.4	0.26	3.8	17	13.22
HE40 Beam Forming, M0 to M11 2ss	2	3	3.8	3.5	0.26	6.9	17	10.09
HE40 STBC, M0 to M11 2ss	2	3	3.8	3.5	0.26	6.9	17	10.09

Frequency 5210 MHz

Mode	Tx Paths	Correlated Antenna Gain (dBi)	Tx 1 PSD (dBm/MHz)	Tx 2 PSD (dBm/MHz)	Duty Cycle (dB)	Total PSD (dBm/MHz)	Limit (dBm/MHz)	Margin (dB)
Non HT80, 6 to 54 Mbps	1	3	3.6		0.23	3.8	17	13.2
Non HT80, 6 to 54 Mbps	2	6	1.8	1.5	0.23	4.9	17	12.11
VHT80, M0 to M11 1ss	1	3	2.0		0.55	2.5	17	14.47
VHT80, M0 to M11 1ss	2	6	-0.3	0.2	0.55	3.5	17	13.48
VHT80, M0 to M11 2ss	2	3	-0.3	0.2	0.55	3.5	17	13.48
VHT80 Beam Forming, M0 to M11 1ss	2	6	-3.0	-2.6	0.55	0.7	17	16.27
VHT80 Beam Forming, M0 to M11 2ss	2	3	-0.3	0.2	0.55	3.5	17	13.48
VHT80 STBC, M0 to M11 2ss	2	3	-0.3	0.2	0.55	3.5	17	13.48
HE80, M0 to M11 1ss	1	3	2.1		0.23	2.4	17	14.65
HE80, M0 to M11 1ss	2	6	1.1	1.0	0.23	4.3	17	12.69
HE80, M0 to M11 2ss	2	3	1.1	1.0	0.23	4.3	17	12.69
HE80 Beam Forming, M0 to M11 1ss	2	6	-1.9	-1.8	0.23	1.4	17	15.59
HE80 Beam Forming, M0 to M11 2ss	2	3	1.1	1.0	0.23	4.3	17	12.69
HE80 STBC, M0 to M11 2ss	2	3	1.1	1.0	0.23	4.3	17	12.69

Frequency 5220 MHz

Mode	Tx Paths	Correlated Antenna Gain (dBi)	Tx 1 PSD (dBm/MHz)	Tx 2 PSD (dBm/MHz)	Duty Cycle (dB)	Total PSD (dBm/MHz)	Limit (dBm/MHz)	Margin (dB)
Non HT20, 6 to 54 Mbps	1	3	9.3		0.41	9.7	17	7.32
Non HT20, 6 to 54 Mbps	2	6	7.5	7.1	0.41	10.7	17	6.27
Non HT20 Beam Forming, 6 to 54 Mbps	2	6	4.0	4.0	0.41	7.4	17	9.58
HT/VHT20, M0 to M7	1	3	9.6		0.31	9.9	17	7.13
HT/VHT20, M0 to M7	2	6	6.7	6.5	0.31	9.9	17	7.06
HT/VHT20, M8 to M15	2	3	6.7	6.5	0.31	9.9	17	7.06
HT/VHT20 Beam Forming, M0 to M7	2	6	3.1	3.4	0.31	6.6	17	10.43
HT/VHT20 Beam Forming, M8 to M15	2	3	6.7	6.5	0.31	9.9	17	7.06
HT/VHT20 STBC, M8 to M15	2	3	6.7	6.5	0.31	9.9	17	7.06
HE20, M0 to M11 1ss	1	3	9.6		0.21	9.8	17	7.19
HE20, M0 to M11 1ss	2	6	6.8	6.4	0.21	9.8	17	7.19
HE20, M0 to M11 2ss	2	3	6.8	6.4	0.21	9.8	17	7.19
HE20 Beam Forming, M0 to M11 1ss	2	6	3.3	3.4	0.21	6.5	17	10.46
HE20 Beam Forming, M0 to M11 2ss	2	3	6.8	6.4	0.21	9.8	17	7.19
HE20 STBC, M0 to M11 2ss	2	3	6.8	6.4	0.21	9.8	17	7.19

Frequency 5230 MHz

Mode	Tx Paths	Correlated Antenna Gain (dBi)	Tx 1 PSD (dBm/MHz)	Tx 2 PSD (dBm/MHz)	Duty Cycle (dB)	Total PSD (dBm/MHz)	Limit (dBm/MHz)	Margin (dB)
Non HT40, 6 to 54 Mbps	1	3	6.8		0.46	7.2	17	9.77
Non HT40, 6 to 54 Mbps	2	6	4.1	4.0	0.46	7.5	17	9.5
HT/VHT40, M0 to M7	1	3	6.8		0.55	7.3	17	9.69
HT/VHT40, M0 to M7	2	6	3.2	3.2	0.55	6.8	17	10.23
HT/VHT40, M8 to M15	2	3	3.2	3.2	0.55	6.8	17	10.23
HT/VHT40 Beam Forming, M0 to M7	2	6	0.3	0.5	0.55	3.9	17	13.05
HT/VHT40 Beam Forming, M8 to M15	2	3	3.2	3.2	0.55	6.8	17	10.23
HT/VHT40 STBC, M8 to M15	2	3	3.2	3.2	0.55	6.8	17	10.23
HE40, M0 to M11 1ss	1	3	6.5		0.26	6.8	17	10.19
HE40, M0 to M11 1ss	2	6	3.1	3.1	0.26	6.4	17	10.63
HE40, M0 to M11 2ss	2	3	3.1	3.1	0.26	6.4	17	10.63
HE40 Beam Forming, M0 to M11 1ss	2	6	0.8	0.9	0.26	4.2	17	12.85
HE40 Beam Forming, M0 to M11 2ss	2	3	3.1	3.1	0.26	6.4	17	10.63
HE40 STBC, M0 to M11 2ss	2	3	3.1	3.1	0.26	6.4	17	10.63

Frequency 5240 MHz

Mode	Tx Paths	Correlated Antenna Gain (dBi)	Tx 1 PSD (dBm/MHz)	Tx 2 PSD (dBm/MHz)	Duty Cycle (dB)	Total PSD (dBm/MHz)	Limit (dBm/MHz)	Margin (dB)
Non HT20, 6 to 54 Mbps	1	3	10.3		0.41	10.7	17	6.32
Non HT20, 6 to 54 Mbps	2	6	7.2	6.3	0.41	10.2	17	6.84
Non HT20 Beam Forming, 6 to 54 Mbps	2	6	4.1	3.8	0.41	7.4	17	9.63
HT/VHT20, M0 to M7	1	3	9.8		0.31	10.1	17	6.88
HT/VHT20, M0 to M7	2	6	6.8	5.9	0.31	9.7	17	7.3
HT/VHT20, M8 to M15	2	3	6.8	5.9	0.31	9.7	17	7.3
HT/VHT20 Beam Forming, M0 to M7	2	6	3.3	3.2	0.31	6.6	17	10.44
HT/VHT20 Beam Forming, M8 to M15	2	3	6.8	5.9	0.31	9.7	17	7.3
HT/VHT20 STBC, M8 to M15	2	3	6.8	5.9	0.31	9.7	17	7.3
HE20, M0 to M11 1ss	1	3	9.7		0.21	9.9	17	7.13
HE20, M0 to M11 1ss	2	6	6.5	5.7	0.21	9.4	17	7.63
HE20, M0 to M11 2ss	2	3	6.5	5.7	0.21	9.4	17	7.63
HE20 Beam Forming, M0 to M11 1ss	2	6	4.3	3.9	0.21	7.3	17	9.66
HE20 Beam Forming, M0 to M11 2ss	2	3	6.5	5.7	0.21	9.4	17	7.63
HE20 STBC, M0 to M11 2ss	2	3	6.5	5.7	0.21	9.4	17	7.63

Conducted Power Spectral Density – Antenna gain 8dBi.**Frequency 5180 MHz**

Mode	Tx Paths	Correlated Antenna Gain (dBi)	Tx 1 PSD (dBm/MHz)	Tx 2 PSD (dBm/MHz)	Duty Cycle (dB)	Total PSD (dBm/MHz)	Limit (dBm/MHz)	Margin (dB)
Non HT20, 6 to 54 Mbps	1	8	7.0		0.41	7.4	17	9.63
Non HT20, 6 to 54 Mbps	2	11	4.0	3.8	0.41	7.3	17	9.71
Non HT20 Beam Forming, 6 to 54 Mbps	2	11	0.7	0.9	0.41	4.2	17	12.77
HT/VHT20, M0 to M7	1	8	6.6		0.31	6.9	17	10.14
HT/VHT20, M0 to M7	2	11	3.3	3.0	0.31	6.5	17	10.53
HT/VHT20, M8 to M15	2	8	3.3	3.0	0.31	6.5	17	10.53
HT/VHT20 Beam Forming, M0 to M7	2	11	0.3	0.1	0.31	3.5	17	13.45
HT/VHT20 Beam Forming, M8 to M15	2	8	3.3	3.0	0.31	6.5	17	10.53
HT/VHT20 STBC, M8 to M15	2	8	3.3	3.0	0.31	6.5	17	10.53
HE20, M0 to M11 1ss	1	8	6.2		0.21	6.4	17	10.59
HE20, M0 to M11 1ss	2	11	4.4	4.1	0.21	7.5	17	9.53
HE20, M0 to M11 2ss	2	8	4.4	4.1	0.21	7.5	17	9.53
HE20 Beam Forming, M0 to M11 1ss	2	11	1.0	1.1	0.21	4.3	17	12.71
HE20 Beam Forming, M0 to M11 2ss	2	8	4.4	4.1	0.21	7.5	17	9.53
HE20 STBC, M0 to M11 2ss	2	8	4.4	4.1	0.21	7.5	17	9.53

Frequency 5190 MHz

Mode	Tx Paths	Correlated Antenna Gain (dBi)	Tx 1 PSD (dBm/MHz)	Tx 2 PSD (dBm/MHz)	Duty Cycle (dB)	Total PSD (dBm/MHz)	Limit (dBm/MHz)	Margin (dB)
Non HT40, 6 to 54 Mbps	1	8	3.6		0.46	4.1	17	12.93
Non HT40, 6 to 54 Mbps	2	11	1.3	1.1	0.46	4.6	17	12.36
HT/VHT40, M0 to M7	1	8	3.2		0.55	3.7	17	13.3
HT/VHT40, M0 to M7	2	11	0.1	-0.3	0.55	3.5	17	13.54
HT/VHT40, M8 to M15	2	8	0.1	-0.3	0.55	3.5	17	13.54
HT/VHT40 Beam Forming, M0 to M7	2	11	-2.9	-3.5	0.55	0.4	17	16.62
HT/VHT40 Beam Forming, M8 to M15	2	8	0.1	-0.3	0.55	3.5	17	13.54
HT/VHT40 STBC, M8 to M15	2	8	0.1	-0.3	0.55	3.5	17	13.54
HE40, M0 to M11 1ss	1	8	3.8		0.26	4.1	17	12.93
HE40, M0 to M11 1ss	2	11	0.6	0.4	0.26	3.8	17	13.22
HE40, M0 to M11 2ss	2	8	0.6	0.4	0.26	3.8	17	13.22
HE40 Beam Forming, M0 to M11 1ss	2	11	-2.1	-2.7	0.26	0.9	17	16.13
HE40 Beam Forming, M0 to M11 2ss	2	8	0.6	0.4	0.26	3.8	17	13.22
HE40 STBC, M0 to M11 2ss	2	8	0.6	0.4	0.26	3.8	17	13.22

Frequency 5210 MHz

Mode	Tx Paths	Correlated Antenna Gain (dBi)	Tx 1 PSD (dBm/MHz)	Tx 2 PSD (dBm/MHz)	Duty Cycle (dB)	Total PSD (dBm/MHz)	Limit (dBm/MHz)	Margin (dB)
Non HT80, 6 to 54 Mbps	1	8	1.8		0.23	2.0	17	14.99
Non HT80, 6 to 54 Mbps	2	11	-1.7	-1.4	0.23	1.7	17	15.35
VHT80, M0 to M11 1ss	1	8	-0.3		0.55	0.3	17	16.72
VHT80, M0 to M11 1ss	2	11	-3.0	-2.6	0.55	0.7	17	16.27
VHT80, M0 to M11 2ss	2	8	-3.0	-2.6	0.55	0.7	17	16.27
VHT80 Beam Forming, M0 to M11 1ss	2	11	-6.5	-5.7	0.55	-2.5	17	19.52
VHT80 Beam Forming, M0 to M11 2ss	2	8	-3.0	-2.6	0.55	0.7	17	16.27
VHT80 STBC, M0 to M11 2ss	2	8	-3.0	-2.6	0.55	0.7	17	16.27
HE80, M0 to M11 1ss	1	8	-0.2		0.23	-0.0	17	17.0
HE80, M0 to M11 1ss	2	11	-1.9	-1.8	0.23	1.4	17	15.59
HE80, M0 to M11 2ss	2	8	-1.9	-1.8	0.23	1.4	17	15.59
HE80 Beam Forming, M0 to M11 1ss	2	11	-5.4	-5.1	0.23	-2.0	17	19.0
HE80 Beam Forming, M0 to M11 2ss	2	8	-1.9	-1.8	0.23	1.4	17	15.59
HE80 STBC, M0 to M11 2ss	2	8	-1.9	-1.8	0.23	1.4	17	15.59

Frequency 5220 MHz

Mode	Tx Paths	Correlated Antenna Gain (dBi)	Tx 1 PSD (dBm/MHz)	Tx 2 PSD (dBm/MHz)	Duty Cycle (dB)	Total PSD (dBm/MHz)	Limit (dBm/MHz)	Margin (dB)
Non HT20, 6 to 54 Mbps	1	8	6.2		0.41	6.6	17	10.41
Non HT20, 6 to 54 Mbps	2	11	4.0	4.0	0.41	7.4	17	9.58
Non HT20 Beam Forming, 6 to 54 Mbps	2	11	1.0	0.9	0.41	4.4	17	12.63
HT/VHT20, M0 to M7	1	8	6.7		0.31	7.0	17	9.95
HT/VHT20, M0 to M7	2	11	3.1	3.4	0.31	6.6	17	10.43
HT/VHT20, M8 to M15	2	8	3.1	3.4	0.31	6.6	17	10.43
HT/VHT20 Beam Forming, M0 to M7	2	11	0.4	0.1	0.31	3.6	17	13.43
HT/VHT20 Beam Forming, M8 to M15	2	8	3.1	3.4	0.31	6.6	17	10.43
HT/VHT20 STBC, M8 to M15	2	8	3.1	3.4	0.31	6.6	17	10.43
HE20, M0 to M11 1ss	1	8	6.8		0.21	7.0	17	9.98
HE20, M0 to M11 1ss	2	11	3.3	3.4	0.21	6.5	17	10.46
HE20, M0 to M11 2ss	2	8	3.3	3.4	0.21	6.5	17	10.46
HE20 Beam Forming, M0 to M11 1ss	2	11	0.1	0.2	0.21	3.4	17	13.63
HE20 Beam Forming, M0 to M11 2ss	2	8	3.3	3.4	0.21	6.5	17	10.46
HE20 STBC, M0 to M11 2ss	2	8	3.3	3.4	0.21	6.5	17	10.46

Frequency 5230 MHz

Mode	Tx Paths	Correlated Antenna Gain (dBi)	Tx 1 PSD (dBm/MHz)	Tx 2 PSD (dBm/MHz)	Duty Cycle (dB)	Total PSD (dBm/MHz)	Limit (dBm/MHz)	Margin (dB)
Non HT40, 6 to 54 Mbps	1	8	4.1		0.46	4.6	17	12.44
Non HT40, 6 to 54 Mbps	2	11	0.7	0.9	0.46	4.3	17	12.75
HT/VHT40, M0 to M7	1	8	3.2		0.55	3.8	17	13.23
HT/VHT40, M0 to M7	2	11	0.3	0.5	0.55	3.9	17	13.05
HT/VHT40, M8 to M15	2	8	0.3	0.5	0.55	3.9	17	13.05
HT/VHT40 Beam Forming, M0 to M7	2	11	-2.9	-2.5	0.55	0.9	17	16.14
HT/VHT40 Beam Forming, M8 to M15	2	8	0.3	0.5	0.55	3.9	17	13.05
HT/VHT40 STBC, M8 to M15	2	8	0.3	0.5	0.55	3.9	17	13.05
HE40, M0 to M11 1ss	1	8	3.1		0.26	3.4	17	13.62
HE40, M0 to M11 1ss	2	11	0.8	0.9	0.26	4.2	17	12.85
HE40, M0 to M11 2ss	2	8	0.8	0.9	0.26	4.2	17	12.85
HE40 Beam Forming, M0 to M11 1ss	2	11	-2.0	-1.9	0.26	1.3	17	15.71
HE40 Beam Forming, M0 to M11 2ss	2	8	0.8	0.9	0.26	4.2	17	12.85
HE40 STBC, M0 to M11 2ss	2	8	0.8	0.9	0.26	4.2	17	12.85

Frequency 5240 MHz

Mode	Tx Paths	Correlated Antenna Gain (dBi)	Tx 1 PSD (dBm/MHz)	Tx 2 PSD (dBm/MHz)	Duty Cycle (dB)	Total PSD (dBm/MHz)	Limit (dBm/MHz)	Margin (dB)
Non HT20, 6 to 54 Mbps	1	8	7.2		0.41	7.6	17	9.43
Non HT20, 6 to 54 Mbps	2	11	4.1	3.8	0.41	7.4	17	9.63
Non HT20 Beam Forming, 6 to 54 Mbps	2	11	1.2	0.5	0.41	4.3	17	12.72
HT/VHT20, M0 to M7	1	8	6.8		0.31	7.1	17	9.91
HT/VHT20, M0 to M7	2	11	3.3	3.2	0.31	6.6	17	10.44
HT/VHT20, M8 to M15	2	8	3.3	3.2	0.31	6.6	17	10.44
HT/VHT20 Beam Forming, M0 to M7	2	11	0.8	0.1	0.31	3.8	17	13.25
HT/VHT20 Beam Forming, M8 to M15	2	8	3.3	3.2	0.31	6.6	17	10.44
HT/VHT20 STBC, M8 to M15	2	8	3.3	3.2	0.31	6.6	17	10.44
HE20, M0 to M11 1ss	1	8	6.5		0.21	6.7	17	10.26
HE20, M0 to M11 1ss	2	11	4.3	3.9	0.21	7.3	17	9.66
HE20, M0 to M11 2ss	2	8	4.3	3.9	0.21	7.3	17	9.66
HE20 Beam Forming, M0 to M11 1ss	2	11	0.4	-0.1	0.21	3.4	17	13.6
HE20 Beam Forming, M0 to M11 2ss	2	8	4.3	3.9	0.21	7.3	17	9.66
HE20 STBC, M0 to M11 2ss	2	8	4.3	3.9	0.21	7.3	17	9.66

Conducted Power Spectral Density – Antenna gain 15dBi.**Frequency 5180 MHz**

Mode	Tx Paths	Correlated Antenna Gain (dBi)	Tx 1 PSD (dBm/MHz)	Tx 2 PSD (dBm/MHz)	Duty Cycle (dB)	Total PSD (dBm/MHz)	Limit (dBm/MHz)	Margin (dB)
Non HT20, 6 to 54 Mbps	1	15	7.0		0.41	7.4	17	9.63
Non HT20, 6 to 54 Mbps	2	15	4.0	3.8	0.41	7.3	17	9.71
Non HT20 Beam Forming, 6 to 54 Mbps	2	15	4.0	3.8	0.41	7.3	17	9.71
HT/VHT20, M0 to M7	1	15	5.6		0.31	5.9	17	11.12
HT/VHT20, M0 to M7	2	15	3.3	3.0	0.31	6.5	17	10.53
HT/VHT20, M8 to M15	2	15	3.3	3.0	0.31	6.5	17	10.53
HT/VHT20 Beam Forming, M0 to M7	2	15	3.3	3.0	0.31	6.5	17	10.53
HT/VHT20 Beam Forming, M8 to M15	2	15	3.3	3.0	0.31	6.5	17	10.53
HT/VHT20 STBC, M8 to M15	2	15	3.3	3.0	0.31	6.5	17	10.53
HE20, M0 to M11 1ss	1	15	6.2		0.21	6.4	17	10.59
HE20, M0 to M11 1ss	2	15	3.1	3.1	0.21	6.3	17	10.69
HE20, M0 to M11 2ss	2	15	3.1	3.1	0.21	6.3	17	10.69
HE20 Beam Forming, M0 to M11 1ss	2	15	3.1	3.1	0.21	6.3	17	10.69
HE20 Beam Forming, M0 to M11 2ss	2	15	3.1	3.1	0.21	6.3	17	10.69
HE20 STBC, M0 to M11 2ss	2	15	3.1	3.1	0.21	6.3	17	10.69

Frequency 5190 MHz

Mode	Tx Paths	Correlated Antenna Gain (dBi)	Tx 1 PSD (dBm/MHz)	Tx 2 PSD (dBm/MHz)	Duty Cycle (dB)	Total PSD (dBm/MHz)	Limit (dBm/MHz)	Margin (dB)
Non HT40, 6 to 54 Mbps	1	15	3.6		0.46	4.1	17	12.93
Non HT40, 6 to 54 Mbps	2	15	1.3	1.1	0.46	4.6	17	12.36
HT/VHT40, M0 to M7	1	15	3.2		0.55	3.7	17	13.3
HT/VHT40, M0 to M7	2	15	-0.6	-1.3	0.55	2.7	17	14.34
HT/VHT40, M8 to M15	2	15	-0.6	-1.3	0.55	2.7	17	14.34
HT/VHT40 Beam Forming, M0 to M7	2	15	-0.6	-1.3	0.55	2.7	17	14.34
HT/VHT40 Beam Forming, M8 to M15	2	15	-0.6	-1.3	0.55	2.7	17	14.34
HT/VHT40 STBC, M8 to M15	2	15	-0.6	-1.3	0.55	2.7	17	14.34
HE40, M0 to M11 1ss	1	15	3.8		0.26	4.1	17	12.93
HE40, M0 to M11 1ss	2	15	-0.5	-0.5	0.26	2.8	17	14.23
HE40, M0 to M11 2ss	2	15	-0.5	-0.5	0.26	2.8	17	14.23
HE40 Beam Forming, M0 to M11 1ss	2	15	-0.5	-0.5	0.26	2.8	17	14.23
HE40 Beam Forming, M0 to M11 2ss	2	15	-0.5	-0.5	0.26	2.8	17	14.23
HE40 STBC, M0 to M11 2ss	2	15	-0.5	-0.5	0.26	2.8	17	14.23

Frequency 5210 MHz

Mode	Tx Paths	Correlated Antenna Gain (dBi)	Tx 1 PSD (dBm/MHz)	Tx 2 PSD (dBm/MHz)	Duty Cycle (dB)	Total PSD (dBm/MHz)	Limit (dBm/MHz)	Margin (dB)
Non HT80, 6 to 54 Mbps	1	15	1.8		0.23	2.0	17	14.99
Non HT80, 6 to 54 Mbps	2	15	-2.4	-2.3	0.23	0.9	17	16.14
VHT80, M0 to M11 1ss	1	15	-0.3		0.55	0.3	17	16.72
VHT80, M0 to M11 1ss	2	15	-3.0	-2.6	0.55	0.7	17	16.27
VHT80, M0 to M11 2ss	2	15	-3.0	-2.6	0.55	0.7	17	16.27
VHT80 Beam Forming, M0 to M11 1ss	2	15	-3.0	-2.6	0.55	0.7	17	16.27
VHT80 Beam Forming, M0 to M11 2ss	2	15	-3.0	-2.6	0.55	0.7	17	16.27
VHT80 STBC, M0 to M11 2ss	2	15	-3.0	-2.6	0.55	0.7	17	16.27
HE80, M0 to M11 1ss	1	15	-0.2		0.23	-0.0	17	17.0
HE80, M0 to M11 1ss	2	15	-4.2	-3.9	0.23	-0.8	17	17.82
HE80, M0 to M11 2ss	2	15	-4.2	-3.9	0.23	-0.8	17	17.82
HE80 Beam Forming, M0 to M11 1ss	2	15	-4.2	-3.9	0.23	-0.8	17	17.82
HE80 Beam Forming, M0 to M11 2ss	2	15	-4.2	-3.9	0.23	-0.8	17	17.82
HE80 STBC, M0 to M11 2ss	2	15	-4.2	-3.9	0.23	-0.8	17	17.82

Frequency 5220 MHz

Mode	Tx Paths	Correlated Antenna Gain (dBi)	Tx 1 PSD (dBm/MHz)	Tx 2 PSD (dBm/MHz)	Duty Cycle (dB)	Total PSD (dBm/MHz)	Limit (dBm/MHz)	Margin (dB)
Non HT20, 6 to 54 Mbps	1	15	6.2		0.41	6.6	17	10.41
Non HT20, 6 to 54 Mbps	2	15	4.0	4.0	0.41	7.4	17	9.58
Non HT20 Beam Forming, 6 to 54 Mbps	2	15	4.0	4.0	0.41	7.4	17	9.58
HT/VHT20, M0 to M7	1	15	6.7		0.31	7.0	17	9.95
HT/VHT20, M0 to M7	2	15	3.1	3.4	0.31	6.6	17	10.43
HT/VHT20, M8 to M15	2	15	3.1	3.4	0.31	6.6	17	10.43
HT/VHT20 Beam Forming, M0 to M7	2	15	3.1	3.4	0.31	6.6	17	10.43
HT/VHT20 Beam Forming, M8 to M15	2	15	3.1	3.4	0.31	6.6	17	10.43
HT/VHT20 STBC, M8 to M15	2	15	3.1	3.4	0.31	6.6	17	10.43
HE20, M0 to M11 1ss	1	15	6.8		0.21	7.0	17	9.98
HE20, M0 to M11 1ss	2	15	3.3	3.4	0.21	6.5	17	10.46
HE20, M0 to M11 2ss	2	15	3.3	3.4	0.21	6.5	17	10.46
HE20 Beam Forming, M0 to M11 1ss	2	15	3.3	3.4	0.21	6.5	17	10.46
HE20 Beam Forming, M0 to M11 2ss	2	15	3.3	3.4	0.21	6.5	17	10.46
HE20 STBC, M0 to M11 2ss	2	15	3.3	3.4	0.21	6.5	17	10.46

Frequency 5230 MHz

Mode	Tx Paths	Correlated Antenna Gain (dBi)	Tx 1 PSD (dBm/MHz)	Tx 2 PSD (dBm/MHz)	Duty Cycle (dB)	Total PSD (dBm/MHz)	Limit (dBm/MHz)	Margin (dB)
Non HT40, 6 to 54 Mbps	1	15	4.1		0.46	4.6	17	12.44
Non HT40, 6 to 54 Mbps	2	15	0.7	0.9	0.46	4.3	17	12.75
HT/VHT40, M0 to M7	1	15	3.2		0.55	3.8	17	13.23
HT/VHT40, M0 to M7	2	15	0.3	0.5	0.55	3.9	17	13.05
HT/VHT40, M8 to M15	2	15	0.3	0.5	0.55	3.9	17	13.05
HT/VHT40 Beam Forming, M0 to M7	2	15	0.3	0.5	0.55	3.9	17	13.05
HT/VHT40 Beam Forming, M8 to M15	2	15	0.3	0.5	0.55	3.9	17	13.05
HT/VHT40 STBC, M8 to M15	2	15	0.3	0.5	0.55	3.9	17	13.05
HE40, M0 to M11 1ss	1	15	3.1		0.26	3.4	17	13.62
HE40, M0 to M11 1ss	2	15	0.8	0.9	0.26	4.2	17	12.85
HE40, M0 to M11 2ss	2	15	0.8	0.9	0.26	4.2	17	12.85
HE40 Beam Forming, M0 to M11 1ss	2	15	0.8	0.9	0.26	4.2	17	12.85
HE40 Beam Forming, M0 to M11 2ss	2	15	0.8	0.9	0.26	4.2	17	12.85
HE40 STBC, M0 to M11 2ss	2	15	0.8	0.9	0.26	4.2	17	12.85

Frequency 5240 MHz

Mode	Tx Paths	Correlated Antenna Gain (dBi)	Tx 1 PSD (dBm/MHz)	Tx 2 PSD (dBm/MHz)	Duty Cycle (dB)	Total PSD (dBm/MHz)	Limit (dBm/MHz)	Margin (dB)
Non HT20, 6 to 54 Mbps	1	15	7.2		0.41	7.6	17	9.43
Non HT20, 6 to 54 Mbps	2	15	4.1	3.8	0.41	7.4	17	9.63
Non HT20 Beam Forming, 6 to 54 Mbps	2	15	4.1	3.8	0.41	7.4	17	9.63
HT/VHT20, M0 to M7	1	15	6.8		0.31	7.1	17	9.91
HT/VHT20, M0 to M7	2	15	3.3	3.2	0.31	6.6	17	10.44
HT/VHT20, M8 to M15	2	15	3.3	3.2	0.31	6.6	17	10.44
HT/VHT20 Beam Forming, M0 to M7	2	15	3.3	3.2	0.31	6.6	17	10.44
HT/VHT20 Beam Forming, M8 to M15	2	15	3.3	3.2	0.31	6.6	17	10.44
HT/VHT20 STBC, M8 to M15	2	15	3.3	3.2	0.31	6.6	17	10.44
HE20, M0 to M11 1ss	1	15	6.5		0.21	6.7	17	10.26
HE20, M0 to M11 1ss	2	15	4.3	3.9	0.21	7.3	17	9.66
HE20, M0 to M11 2ss	2	15	4.3	3.9	0.21	7.3	17	9.66
HE20 Beam Forming, M0 to M11 1ss	2	15	4.3	3.9	0.21	7.3	17	9.66
HE20 Beam Forming, M0 to M11 2ss	2	15	4.3	3.9	0.21	7.3	17	9.66
HE20 STBC, M0 to M11 2ss	2	15	4.3	3.9	0.21	7.3	17	9.66

Data Screenshots – Antenna gain 3dBi.

5220 MHz: Non HT20, 6 to 54 Mbps

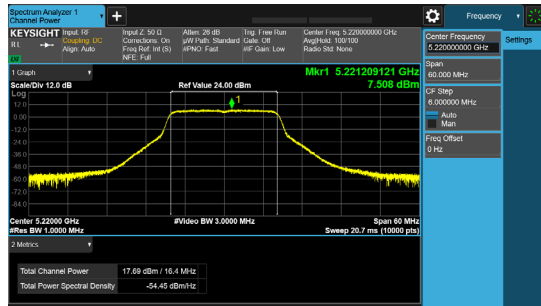

Antenna A

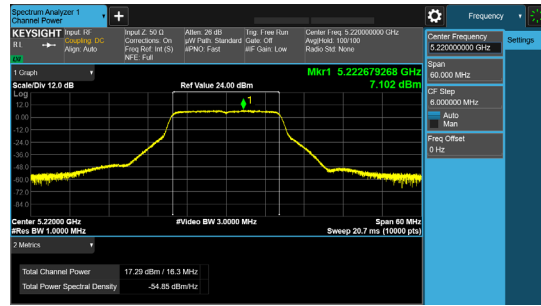

Antenna B

5180 MHz: Non HT20, 6 to 54 Mbps

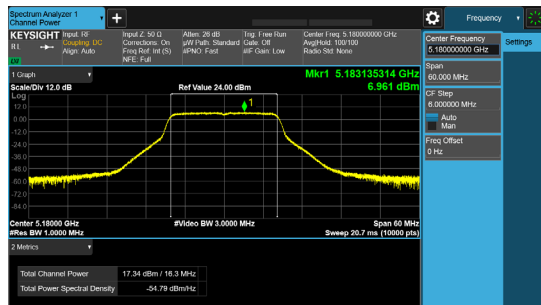

Antenna A

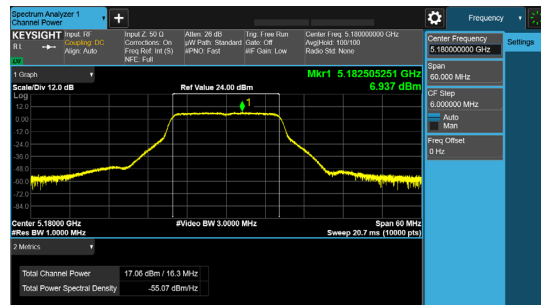

Antenna B

5240 MHz: Non HT20, 6 to 54 Mbps

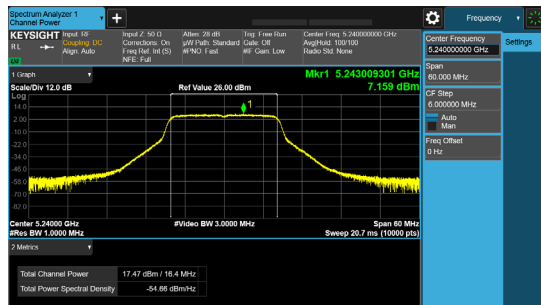

Antenna A

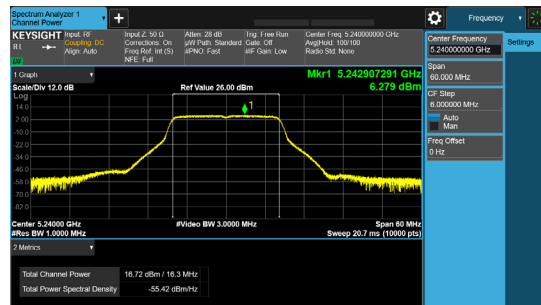

Antenna B

Data Screenshots – Antenna gain 8dBi.

5180 MHz: HE20, M0 to M11 1ss

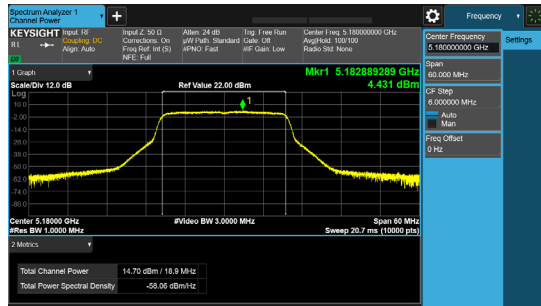

Antenna A

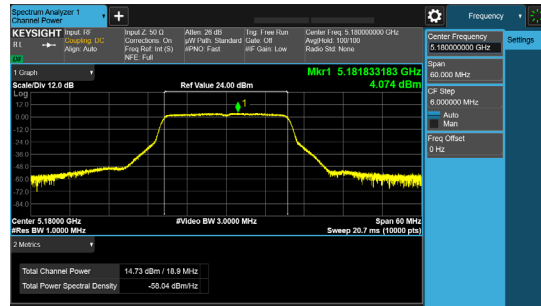

Antenna B

5220 MHz: Non HT20, 6 to 54 Mbps

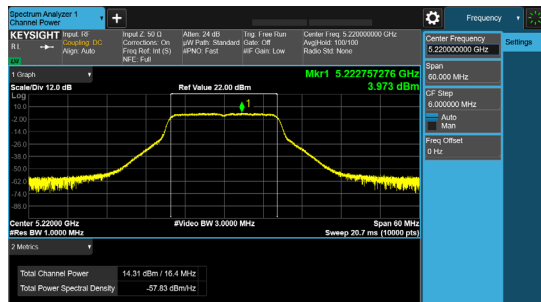

Antenna A

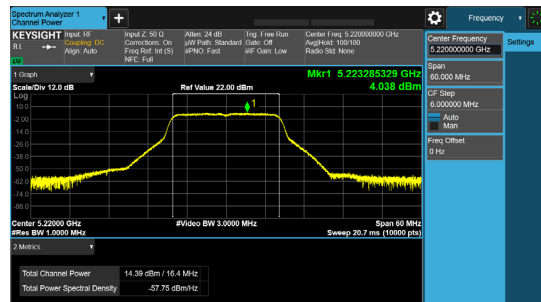

Antenna B

5240 MHz: Non HT20, 6 to 54 Mbps

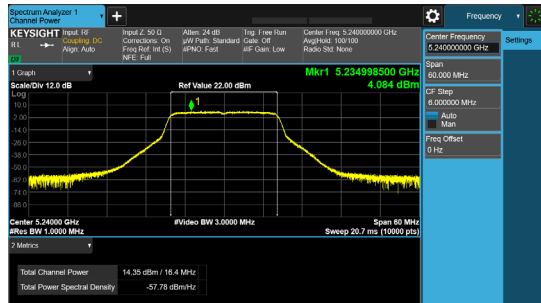

Antenna A

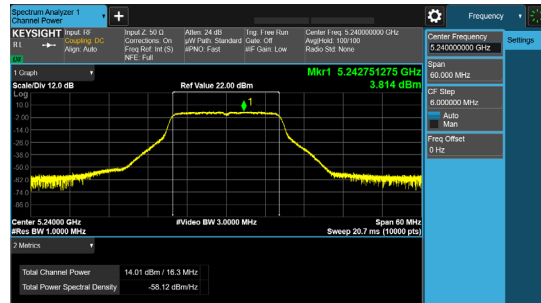

Antenna B

Data Screenshots – Antenna gain 15dBi.

5240 MHz: Non HT20, 6 to 54 Mbps

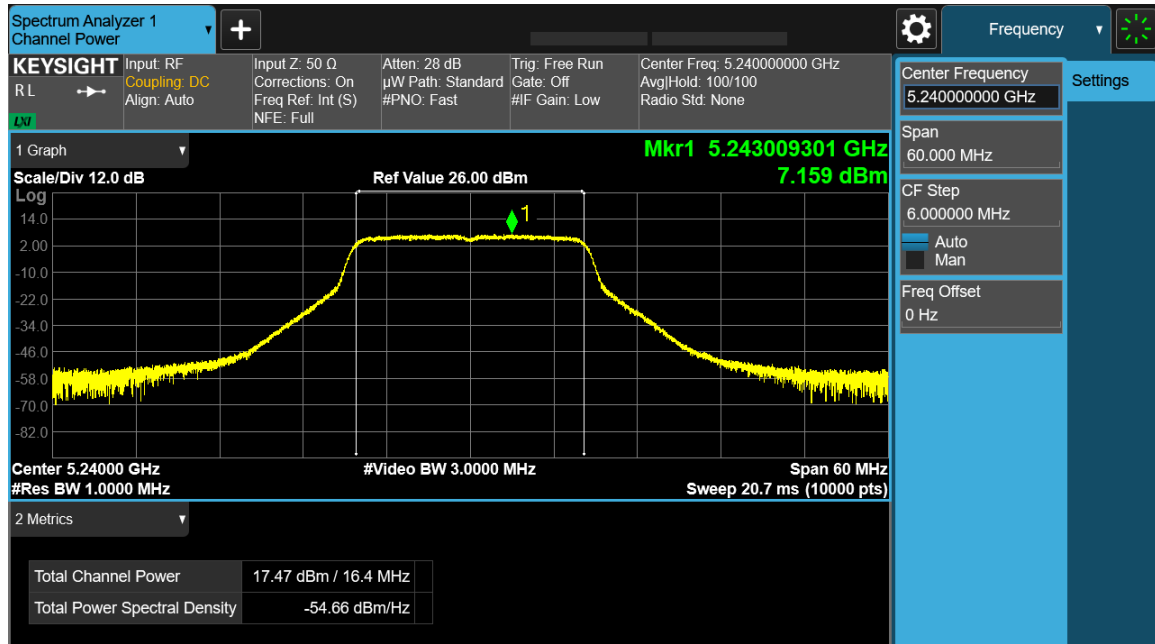

Antenna A

5220 MHz: Non HT20, 6 to 54 Mbps

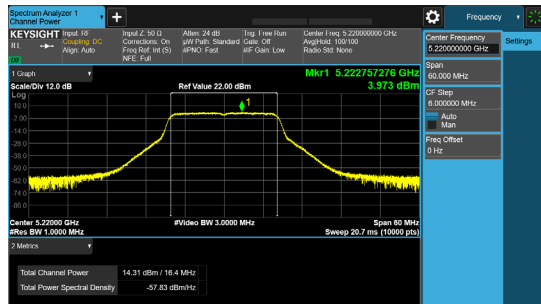

Antenna A

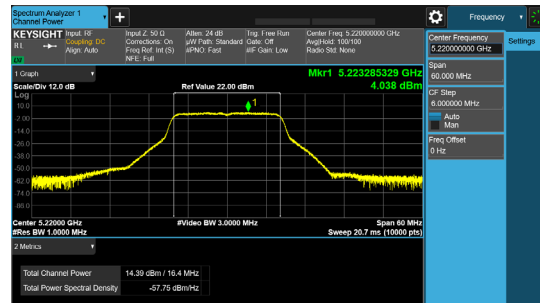

Antenna B

5220 MHz: Non HT20 Beam Forming, 6 to 54 Mbps

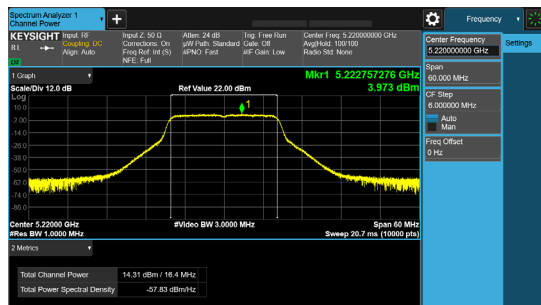

Antenna A

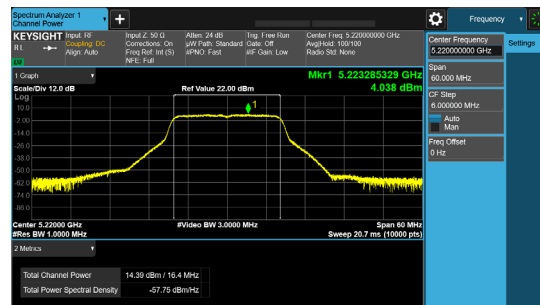

Antenna B