

# 5250-5350MHz Formal Test Report for IW9165DH-B & IW9165DH-ROW

Supports

BLE/4.9GHz/ 5GHz 802.11 a/ac/ax/n Wi-Fi radio

**FCC ID: LDKIW9165DH**

Against the following Specifications:

47 CFR 15.205



47 CFR 15.209

47 CFR 15.407

LP0002:2020

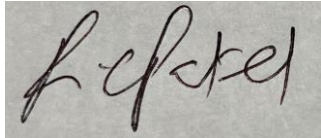

**Cisco Systems, Inc.**  
170 West Tasman Drive  
San Jose, CA 95134

	
<b>Author:</b> Ronak Patel <b>Tested By:</b> Ronak Patel	<b>Approved By:</b> Adam Walb <b>Title:</b> <b>Revision:</b> 1.0

This report replaces any previously entered test report under **EDCS # 24339408**. This test report has been electronically authorized and archived using the CISCO Engineering Document Control system. Test Report Template EDCS# 11644120.

<b>SECTION 1: OVERVIEW</b> .....	<b>3</b>
<b>SECTION 2: ASSESSMENT INFORMATION</b> .....	<b>4</b>
2.1: GENERAL.....	4
2.2: DATE OF TESTING .....	5
2.3: REPORT ISSUE DATE .....	5
2.4: TESTING FACILITIES .....	5
2.5: EQUIPMENT ASSESSED (EUT).....	6
2.6: EUT DESCRIPTION .....	6
<b>SECTION 3: RESULT SUMMARY</b> .....	<b>9</b>
3.1: RESULTS SUMMARY TABLE.....	9
<b>SECTION 4: SAMPLE DETAILS</b> .....	<b>11</b>
4.1: SAMPLE DETAILS.....	11
4.2: SYSTEM DETAILS.....	11
4.3: MODE OF OPERATION DETAILS .....	11
<b>APPENDIX A: EMISSION TEST RESULTS</b> .....	<b>12</b>
A.1: DUTY CYCLE .....	13
A.2: 99% AND 26DB BANDWIDTH .....	17
A.3: MAXIMUM CONDUCTED OUTPUT POWER .....	21
A.4: POWER SPECTRAL DENSITY.....	30
A.5: CONDUCTED SPURIOUS EMISSIONS .....	39
A.6: CONDUCTED BAND EDGE .....	49
<b>APPENDIX B: EMISSION TEST RESULTS</b> .....	<b>57</b>
B.1: RADIATED SPURIOUS EMISSIONS .....	58
B.2: RADIATED EMISSIONS 30MHZ TO 1GHZ .....	59
B.3: AC CONDUCTED EMISSIONS .....	60
<b>APPENDIX C: LIST OF TEST EQUIPMENT USED TO PERFORM THE TEST</b> .....	<b>66</b>
<b>APPENDIX D: ABBREVIATION KEY AND DEFINITIONS</b> .....	<b>68</b>
<b>APPENDIX E: PHOTOGRAPHS OF TEST SETUPS</b> .....	<b>69</b>
<b>APPENDIX F: SOFTWARE USED TO PERFORM TESTING</b> .....	<b>69</b>
<b>APPENDIX G: TEST PROCEDURES</b> .....	<b>69</b>
<b>APPENDIX H: SCOPE OF ACCREDITATION (A2LA CERTIFICATE NUMBER 1178-01)</b> .....	<b>69</b>
<b>APPENDIX I: TEST ASSESSMENT PLAN</b> .....	<b>69</b>
<b>APPENDIX J: WORST CASE JUSTIFICATION</b> .....	<b>69</b>

Radio Test Report No: **EDCS # 24339408**

## **Section 1: Overview**

The samples were assessed against the tests detailed in section 3 under the requirements of the following specifications:

<b>Specifications:</b>
CFR47 Part 15.407 LP0002:2020

## Section 2: Assessment Information

### 2.1: General

This report contains an assessment of an apparatus against Electromagnetic Compatibility Standards based upon tests carried out on the samples submitted. The testing was performed by and for the use of Cisco systems Inc:

With regard to this assessment, the following points should be noted:

- a) The results contained in this report relate only to the items tested and were obtained in the period between the date of the initial assessment and the date of issue of the report. Manufactured products will not necessarily give identical results due to production and measurement tolerances.
- b) The apparatus was set up and exercised using the configuration and modes of operation defined in this report only.
- c) Where relevant, the apparatus was only assessed using the susceptibility criteria defined in this report and the Test Assessment Plan (TAP).
- d) All testing was performed under the following environmental conditions:

Temperature	15 °C to 35 °C (54 °F to 95 °F)
Atmospheric Pressure	860 mbar to 1060 mbar (25.4" to 31.3")
Humidity	10% to 75*%

- e) All AC testing was performed at one or more of the following supply voltages:

110V 60 Hz (+/-20%)

#### Units of Measurement

The units of measurements defined in the appendices are reported in specific terms, which are test dependent. Where radiated measurements are concerned these are defined at a particular distance. Basic voltage measurements are defined in units of [dBuV]

As an example, the basic calculation for all measurements is as follows:

$$\text{Emission level [dBuV]} = \text{Indicated voltage level [dBuV]} + \text{Cable Loss [dB]} + \text{Other correction factors [dB]}$$

The combinations of correction factors are dependent upon the exact test configurations [see test equipment lists for further details] and may include:

Antenna Factors, Pre-Amplifier Gain, LISN Loss, Pulse Limiter Loss and Filter Insertion Loss

Note: To convert the results from dBuV/m to uV/m use the following formula:

$$\text{Level in uV/m} = \text{Common Antilogarithm} [(X \text{ dBuV/m})/20] = Y \text{ uV/m}$$

#### Measurement Uncertainty Values

voltage and power measurements	± 2 dB
conducted EIRP measurements	± 1.4 dB
radiated measurements	± 3.2 dB
frequency measurements	± 2.4 10 <sup>-7</sup>
temperature measurements	± 0.54°
humidity measurements	± 2.3%
DC and low frequency measurements	± 2.5%

Radio Test Report No: **EDCS # 24339408**

Where relevant measurement uncertainty levels have been estimated for tests performed on the apparatus. This uncertainty represents an expanded uncertainty expressed at approximately the 95% confidence level using a coverage factor of  $k=2$ .

Radiated emissions (expanded uncertainty, confidence interval 95%)

30 MHz – 300 MHz	± 3.8 dB
300 MHz – 1000 MHz	± 4.3 dB
1 GHz – 10 GHz	± 4.0 dB
10 GHz – 18GHz	± 8.2 dB
18GHz – 26.5GHz	± 4.1 dB
26.5GHz – 40GHz	± 3.9 dB

Conducted emissions (expanded uncertainty, confidence interval 95%)

30 MHz – 40 GHz	± 0.38 dB
-----------------	-----------

A product is considered to comply with a requirement if the nominal measured value is below the limit line. The product is considered to not be in compliance in case the nominal measured value is above the limit line.

**This report must not be reproduced except in full, without written approval of Cisco Systems.**

## 2.2: Date of testing

3/22/2023 - 6/2/2023

## 2.3: Report Issue Date

7/24/2023

Cisco uses an electronic system to issue, store and control the revision of test reports. This system is called the Engineering Document Control System (EDCS). The actual report issue date is embedded into the original file on EDCS. Any copies of this report, either electronic or paper, that are not on EDCS must be considered uncontrolled.

## 2.4: Testing facilities

This assessment was performed by: NIST Designated Phase-I and Phase-II Conformity Assessment Body (CAB) for the following economies and regulatory authorities under the terms of the stated MRAs/Treaties: NCC (National Communications Commission) APEC Tel MRA – Phase I.

Testing Laboratory  
Cisco Systems, Inc.  
125 West Tasman Drive (Building P)  
San Jose, CA 95134  
USA

Headquarters  
Cisco Systems, Inc.,  
170 West Tasman Drive  
San Jose, CA 95134,  
USA

Registration Number

Cisco System Site	Address	Site Identifier
Building P, 10m Chamber	125 West Tasman Dr San Jose, CA 95134	Company #: 2461A

## Test Engineer(s):

Ronak Patel

**2.5: Equipment Assessed (EUT)**

IW9165DH-B

**2.6: EUT Description**

RF General Information			
Evaluation Mode	Frequency Range (MHz)	Operating Frequency (MHz)	Modulation Type
5GHz WLAN	5150-5250 5250-5350 5470-5725 5725-5850	5180-5250 5250-5320 5500-5720 5745-5825	802.11a/n: OFDM (BPSK, QPSK, 16QAM, 64QAM) 802.11ac: OFDM (BPSK, QPSK, 16QAM, 64QAM, 256QAM) 802.11ax: OFDMA (BPSK, QPSK, 16QAM, 64QAM, 256QAM, 1024QAM)
4.9GHz WLAN	4940-4990	4945-4985	OFDM (BPSK, QPSK, 16QAM, 64QAM)
Bluetooth	2400-2483.5	2402-2480	LE: GFSK

R1	-	V (AP: 20/40/80) (P2P/P2MP: 20/40/80)	V	-	-	-
R2	-	V (AP: 20/40/80/160) (P2P/P2MP: 20/40/80/160)	V	-	-	-
R3	-	-	-	-	V	-
R4	-	-	-	-	-	V

Note 1: 160MHz is supported in the future release.

**For Radio1 - 5GHz UNII 1~UNII 3 and 4.9GHz:  
For IEEE 802.11a/n/ac/ax mode (1TX, 2TX/2RX):1TX**

Only Port 1 can be use as transmitting antenna.

**2TX**

Port 1, Port 2 can be use as transmitting antenna. Port 1, Port 2 could transmit simultaneously.

**2RX**

Port 1, Port 2, Port 3, Port 4 can be used as receiving antennas. Port 1 and Port 2 could receive simultaneously.

Radio Test Report No: **EDCS # 24339408**

**For Radio 2 - 5GHz UNII 1~UNII 3 and 4.9GHz:  
For IEEE 802.11a/n/ac/ax mode (1TX, 2TX/2RX):**

**1TX**

Only Port 1 can be use as transmitting antenna.

**2TX**

Port 1, Port 2 can be use as transmitting antenna. Port 1, Port 2 could transmit simultaneously.

**2RX**

Port 1, Port 2, Port 3, Port 4 can be used as receiving antennas. Port 1 and Port 2 could receive simultaneously.

**For Radio 3 - BLE**

**Bluetooth(1TX):**

Only Port 1 can be used as transmitting/receiving antenna.

**For Radio 4 – GNSS (1Rx)**

Only Port 1 can be used as receiving antenna.

Radio Test Report No: **EDCS # 24339408**

The following antennas are supported by this product series. Please note, the antenna information has been provided by the customer (the Cisco business unit). The data included in this report represent the worst-case data for all antennas.

**Magnum IW9165 Supported External Antenna List**

Product ID	Family	Description	Supported by IW9165DHD?	Supported by IW9165E?	Peak Gain 2.4 GHz (dBi)	Peak Gain 4.9 GHz (dBi)	Peak Gain 5 GHz (dBi)	Gain > 30° Elevation UNII-1 (dBi)	Peak Gain 6 GHz (dBi)	Gain > 30° Elevation UNII-5 & 7	5 GHz Fixed Point-to-Point?	5 GHz Point-to-Multipoint?
IW-ANT-OMM-53-N=	Legacy	5 GHz 3 dBi Omnidirectional Antenna, Multi-polarized, N Female Connector	No	Yes	N/A	3	3	0	N/A	N/A	No	Yes
AIR-ANT5180V-N=	Legacy	5 GHz 8 dBi Omnidirectional Colinear Array Antenna, N Male Connector	Yes	Yes	N/A	8	8	-3	N/A	N/A	No	Yes
IW-ANT-PNL-59-N=	Legacy	5 GHz 9 dBi 2-Element Patch Array Antenna, Slant ±45 Polarized, N Female Connectors	Yes	Yes	N/A	N/A	10	7	N/A	N/A	Yes	Yes
AIR-ANT5114P2M-N=	Legacy	5 GHz 13 dBi 2-Element Patch Array Antenna, N Male Connectors	Yes	Yes	N/A	N/A	13	4	N/A	N/A	Yes	Yes
AIR-ANT5114P2M-NS=	SIA	5 GHz 13 dBi 2-Element Patch Array Antenna, N Male Connectors	Yes	Yes	N/A	N/A	13	3	N/A	N/A	Yes	Yes
IW-ANT-SKD-513-Q=	Legacy	5 GHz 14 dBi 2-Element Shark Antenna, Slant ±45 Polarized, QMA Female Connectors	No	Yes	N/A	13	13	8	N/A	N/A	No	Yes
IW-ANT-SKS-514-Q=	Legacy	5 GHz 14 dBi 2-Element Shark Antenna, Slant ±45 Polarized, QMA Female Connectors	No	Yes	N/A	13	13	8	N/A	N/A	No	Yes
AIR-ANT2547V-N=	Legacy	2.4 GHz 4 dBi / 5 GHz 7 dBi Omnidirectional Colinear Array Antenna, N male connector	Yes	Yes	4	N/A	7	-3	N/A	N/A	No	Yes
AIR-ANT2547VG-N=	Legacy	2.4 GHz 4 dBi / 5 GHz 7 dBi Omnidirectional Colinear Array	Yes	Yes	4	N/A	7	-3	N/A	N/A	No	Yes
AIR-ANT2547VG-NS=	SIA	2.4 GHz 4 dBi / 5 GHz 7 dBi Omnidirectional Colinear Array	Yes	Yes	4	N/A	7	-3	N/A	N/A	No	Yes
AIR-ANT2588VG-N=	Legacy	2.4 GHz 6 dBi / 5 GHz 8 dBi Omnidirectional Antenna, N Male	Yes	Yes	6	N/A	8	3	N/A	N/A	No	Yes
AIR-ANT2588VG-NS=	SIA	2.4 GHz 6 dBi / 5 GHz 8 dBi Omnidirectional Antenna, N Male	Yes	Yes	6	N/A	8	3	N/A	N/A	No	Yes
AIR-ANT2588P4M-NS=	SIA	2.4 GHz 8 dBi / 5 GHz 8 dBi 4-Element Dual-Polarized Patch Antenna, N	No	Yes	8	N/A	8	-2	N/A	N/A	No	Yes
AIR-ANT2513P4M-N=	Legacy	2.4 GHz 13 dBi / 5 GHz 13 dBi Polarization Diverse Patch Array	No	Yes	13	N/A	13	1	N/A	N/A	Yes	Yes
AIR-ANT2513P4M-NS=	SIA	2.4 GHz 13 dBi / 5 GHz 13 dBi Polarization Diverse Patch Array	No	Yes	13	N/A	13	1	N/A	N/A	Yes	Yes
IW-ANT-OMV-2567-N	SIA	Tri-band 2.4 GHz 4 dBi, 5/6 GHz 7 dBi Omnidirectional Colinear Array Antenna, Vertically Polarized, N Male Connector	Yes	Yes	4	7	7	-7	7	-6	No	Yes
IW-ANT-OMH-2567-N	SIA	Tri-band 2.4 GHz 4 dBi, 5/6 GHz 7 dBi Omnidirectional Colinear Array Antenna, Horizontally Polarized, N Male Connector	Yes	Yes	4	7	7	-6	7	-4	No	Yes
IW-ANT-PNL-515-N=	SIA	Tri-band 5 GHz 15dBi Panel Antenna	Yes	Yes		15	15	3			Yes	Yes



**Section 3: Result Summary****3.1: Results Summary Table****Conducted emissions.**

Basic Standard	Technical Requirements / Details	Result
FCC 15.407 FCC 15.407 LP0002:2020 5.7.2.3 5.7.3.4 (2) (B)	<b>99%- &amp; 26-dB Bandwidth:</b> The 99% occupied bandwidth is the frequency bandwidth such that, below its lower and above its upper frequency limits, the mean powers are each equal to 0.5% of the total mean power of the given emission. There is no limit for 99% OBW.  The 26 dB emission is the width of the emission that is constrained by the frequencies associated with the two outermost amplitude points (upper and lower frequencies) that are attenuated by 26 dB relative to the maximum level measured in the fundamental emission.	Pass
FCC 15.407 LP0002:2020 Clause 5.7.3.2 (1)	<b>Output Power:</b> <b>15.407 (2)</b> For the 5.25-5.35 GHz and 5.47-5.725 GHz bands, the maximum conducted output power over the frequency bands of operation shall not exceed the lesser of 250 mW or 11 dBm + 10 log B, where B is the 26 dB emission bandwidth in megahertz. In addition, the maximum power spectral density shall not exceed 11 dBm in any 1-megahertz band. If transmitting antennas of directional gain greater than 6 dBi are used, both the maximum conducted output power and the maximum power spectral density shall be reduced by the amount in dB that the directional gain of the antenna exceeds 6 dBi.	Pass
15.407 LP0002:2020 Clause 5.7.3.2 (2)	<b>Power Spectral Density:</b> <b>15.407 (2)</b> For the 5.25-5.35 GHz and 5.47-5.725 GHz bands...the maximum power spectral density shall not exceed 11 dBm in any 1-megahertz band. If transmitting antennas of directional gain greater than 6 dBi are used, both the maximum conducted output power and the maximum power spectral density shall be reduced by the amount in dB that the directional gain of the antenna exceeds 6 dBi.	Pass
15.407 LP0002:2020 Clause 5.7.4.1, 3.5 & 3.6	<b>Conducted Spurious Emissions / Band-Edge:</b> <b>15.407 (3)</b> For transmitters operating in the 5.47-5.725 GHz band: All emissions outside of the 5.47-5.725 GHz band shall not exceed an e.i.r.p. of -27 dBm/MHz	Pass
FCC 15.407 FCC 15.209 FCC 15.205 LP0002:2020 Clause 5.7.4.1, 3.5 & 3.6	<b>Restricted band:</b> Unwanted emissions falling within the restricted bands, as defined in FCC 15.205 (a) must also comply with the radiated emission limits specified in FCC 15.209 (a).	Pass

**Radiated Emissions (General requirements)**

Basic Standard	Technical Requirements / Details	Result
FCC 15.407 FCC 15.205 FCC 15.209 LP0002 (2018-01-10) (3.6)	<p><b>TX Spurious Emissions:</b>                      Unwanted emissions must comply with the general field strength limits set forth in §15.209. (7) The provisions of §15.205 apply to intentional radiators operating under this section.</p>	[EDCS # 24042661]
FCC 15.207 LP0002 (2020-07-01) (3.3)	<p><b>AC conducted Emissions:</b>                      Except when the requirements applicable to a given device state otherwise, for any radio apparatus equipped to operate from the public utility AC power supply, either directly or indirectly (such as with a battery charger), the radio frequency voltage of emissions conducted back onto the AC power lines in the frequency range of 0.15 MHz to 30 MHz shall not exceed the limits shown in the table in these sections. The more stringent limit applies at the frequency range boundaries.</p>	Pass

\* MPE calculation is recorded in a separate report

**Section 4: Sample Details**

Note: Each sample was evaluated to ensure that its condition was suitable to be used as a test sample prior to the commencement of testing.

**4.1: Sample Details**

Sample No.	Equipment Details	Manufacturer	Hardware Rev.	Firmware Rev.	Software Rev.	Serial Number
S01	IW9165DH-B	Cisco Systems	P2A	QC_IMAGE_VERSION_STRING=WLAN.HK.2.4-02142-QCAHKSWPL_SILICONZ-1	[sjc-ads-6561:/nobackup/haijia/ap_wlc_me/m22_mfg]	FOC2638BL7H
S02	IW-PWRADPT-MFIT4P	Cisco Systems	V00	-	-	LIN264450C6

**4.2: System Details**

System #	Description	Samples
1	IW9165DH-B	S01
2	IW-PWRADPT-MFIT4P	S02

**4.3: Mode of Operation Details**

Mode#	Description	Comments
1	Continuous Transmitting	

Function	Support Band
AP	BLE,5GHz, 4.9GHz
P2P/P2MP	5GHz, 4.9GHz

## Appendix A: Emission Test Results

### Conducted Test Setup Diagram

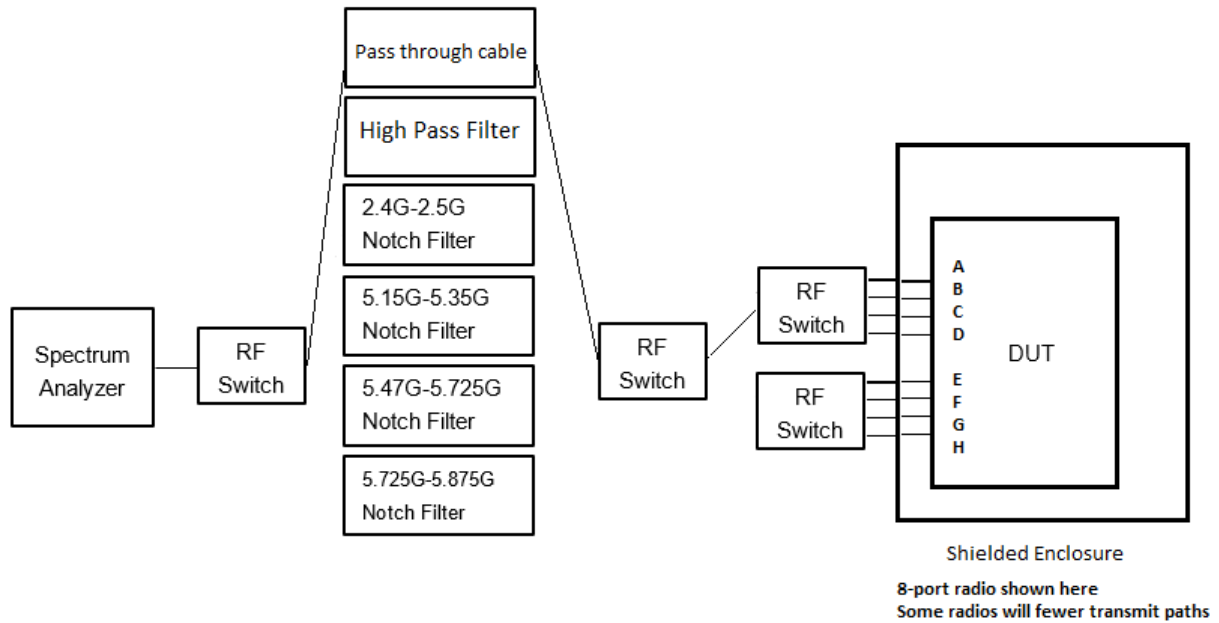

### Test Setup Description

The EUT was placed inside an RF shielded enclosure. RF cables connect to each antenna port on the EUT inside the enclosure. Those cables are routed to RF switch cards in a National Instruments chassis. There are different paths, some paths contain a notch filter or high pass filter as shown above. The signal is then routed to the spectrum analyzer where measurements are made.

Plots listed herein represent the measured worst-case per antenna, frequency, and modulation.

## A.1: Duty Cycle

### Duty Cycle Test Requirement

From KDB 789033 D02 General UNII Test Procedures New Rules v02r01

#### B. Duty Cycle (x), Transmission Duration (T), and Maximum Power Control Level

1. All measurements are to be performed with the EUT transmitting at 100 percent duty cycle at its maximum power control level; however, if 100 percent duty cycle cannot be achieved, measurements of duty cycle,  $x$ , and maximum-power transmission duration,  $T$ , are required for each tested mode of operation.

### Duty Cycle Test Method

From KDB 789033 D02 General UNII Test Procedures New Rules v02r01:

#### B. Duty Cycle (x), Transmission Duration (T), and Maximum Power Control Level

The zero-span mode on a spectrum analyzer or EMI receiver, if the response time and spacing between bins on the sweep are sufficient to permit accurate measurements of the on and off times of the transmitted signal. Set the center frequency of the instrument to the center frequency of the transmission. Set  $RBW \geq EBW$  if possible; otherwise, set RBW to the largest available value. Set  $VBW \geq RBW$ . Set detector = peak or average. The zero-span measurement method shall not be used unless both RBW and VBW are  $> 50/T$ , where  $T$  is defined in section II.B.1.a), and the number of sweep points across duration  $T$  exceeds 100. (For example, if VBW and/or RBW are limited to 3 MHz, then the zero-span method of measuring duty cycle shall not be used if  $T \leq 16.7$  microseconds.)

### Duty Cycle Test Information

<b>Tested By:</b> Ronak Patel	<b>Date of testing:</b> 3/22/2023 - 6/2/2023
<b>Test Result:</b> PASS	

### Test Equipment

See Appendix C for list of test equipment

**Duty Cycle Data Table**

Duty Cycle table and screen captures are shown below for power/psd modes.

Frequency (MHz)	Mode	Data Rate (Mbps)	Duty Cycle (dB)
5260	Non HT20, 6 to 54 Mbps	6.0	0.17819
	HT/VHT20, M0 to M7	m0	0.22322
	HE20, M0 to M11 1ss	m0h1	0.20315
5270	Non HT40, 6 to 54 Mbps	6.0	0.29839
	HT/VHT40, M0 to M7	m0	0.55369
	HE40, M0 to M11 1ss	m0h1	0.27057
5290	Non HT80, 6 to 54 Mbps	6.0	0.35835
	VHT80, M0 to M11 1ss	m0x1	0.54728
	HE80, M0 to M11 1ss	m0h1	0.21774
5300	Non HT20, 6 to 54 Mbps	6.0	0.17819
	HT/VHT20, M0 to M7	m0	0.22322
	HE20, M0 to M11 1ss	m0h1	0.20315
5310	Non HT40, 6 to 54 Mbps	6.0	0.29839
	HT/VHT40, M0 to M7	m0	0.55369
	HE40, M0 to M11 1ss	m0h1	0.27057
5320	Non HT20, 6 to 54 Mbps	6.0	0.17819
	HT/VHT20, M0 to M7	m0	0.22322
	HE20, M0 to M11 1ss	m0h1	0.20315

## Data Screenshots

5270 MHz: HT/VHT40, M0 to M7

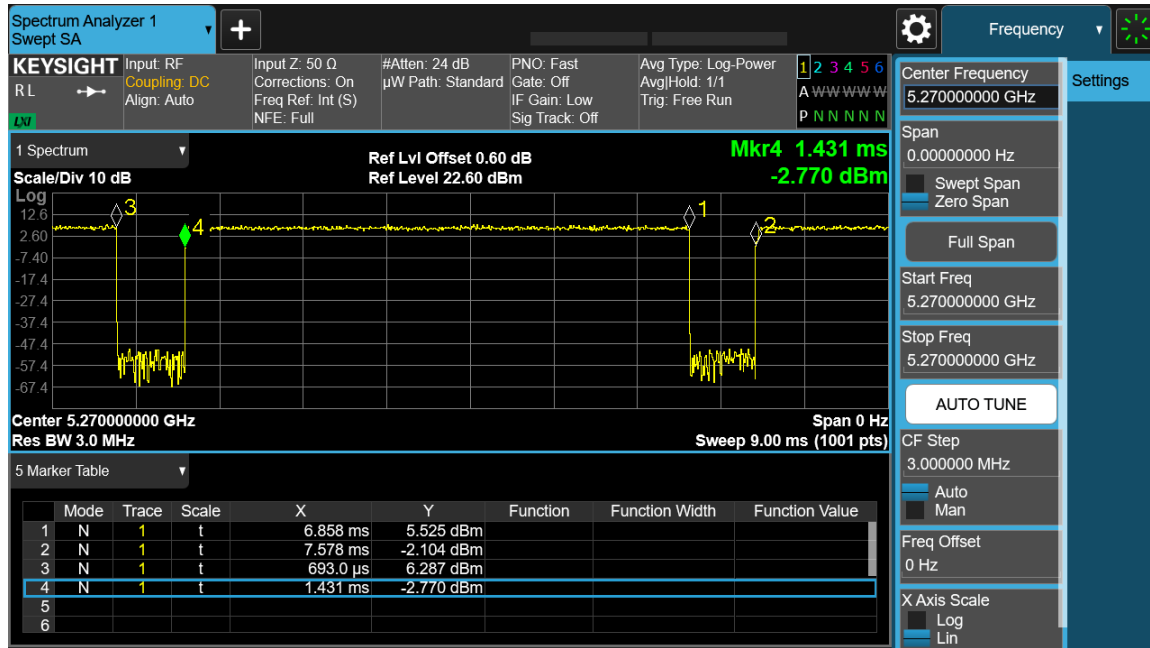

Antenna A

5310 MHz: HT/VHT40, M0 to M7

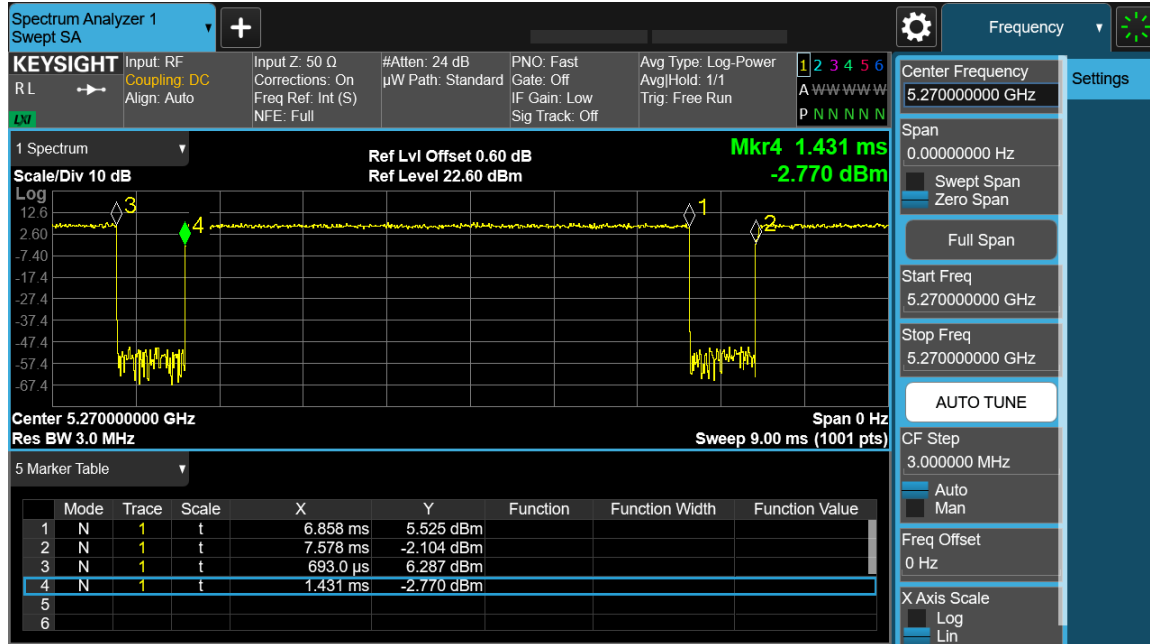

Antenna A

Radio Test Report No: **EDCS # 24339408**

5290 MHz: VHT80, M0 to M11 1ss

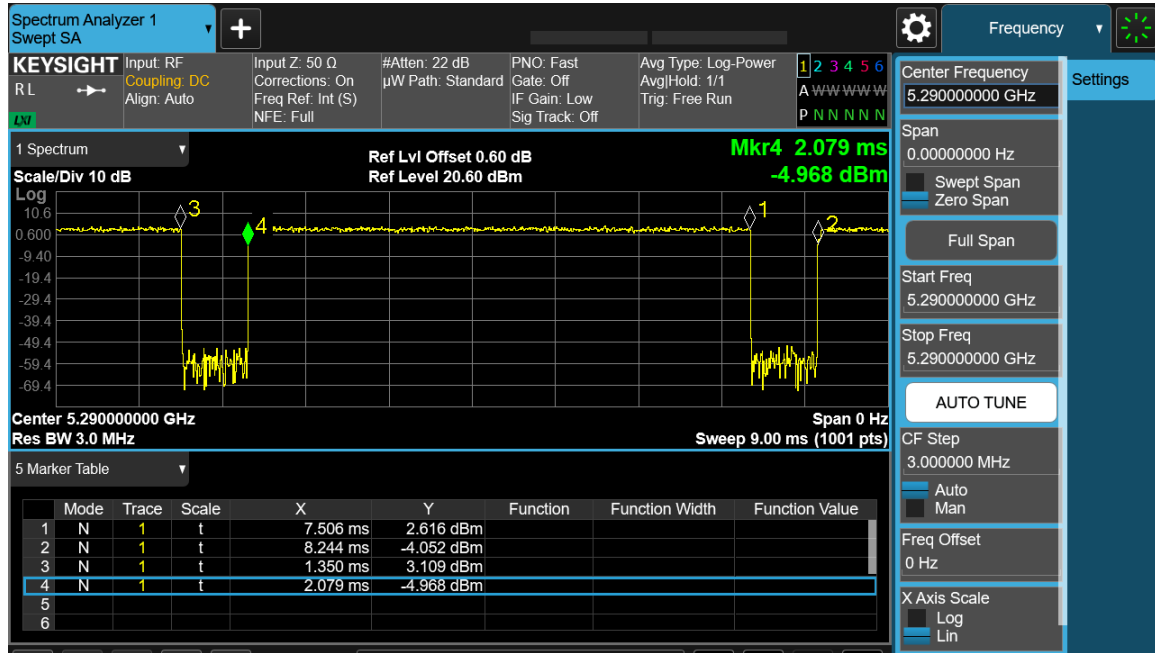

Antenna A



## A.2: 99% and 26dB Bandwidth

### 99% and 26dB Bandwidth Test Requirement

There is no requirement for the value of bandwidth. However, the 26dB BW (EBW) is used to calculate the power limits in 15.407 (a) (2). Power measurements are made using the 99% Bandwidth as the integration bandwidth.

### 99% and 26dB Bandwidth Test Procedure

The 99-percent occupied bandwidth is the frequency bandwidth such that, below its lower and above its upper frequency limits, the mean powers are each equal to 0.5 % of the total mean power of the given emission. Measurement of the 99-percent occupied bandwidth is required only as a condition for using the optional band-edge measurement techniques described in section II.G.3.d). Measurements of 99-percent occupied bandwidth may also optionally be used in lieu of the EBW to define the minimum frequency range over which the spectrum is integrated when measuring maximum conducted output power as described in section II.E. However, the EBW must be measured to determine bandwidth dependent limits on maximum conducted output power in accordance with 15.407(a).

### ANSI C63.10: 2013

#### Ref. KDB 789033 D02 General UNII Test Procedures New Rules v02r01 Section D. 99 Percent Occupied Bandwidth

<b>99% BW</b> Test Parameters
<ol style="list-style-type: none"> <li>1. Set center frequency to the nominal EUT channel center frequency.</li> <li>2. Set span = 1.5 times to 5.0 times the OBW.</li> <li>3. Set RBW = 1 % to 5 % of the OBW</li> <li>4. Set VBW <math>\geq 3 \cdot</math> RBW</li> <li>5. Video averaging is not permitted. Where practical, a sample detection and single sweep mode shall be used. Otherwise, peak detection and max hold mode (until the trace stabilizes) shall be used.</li> <li>6. Use the 99 % power bandwidth function of the instrument (if available).</li> </ol>

#### Ref KDB 789033 D02 General UNII Test Procedures New Rules v02r01 Section C. Measurement Bandwidth, Section 1

<b>26 BW</b> Test parameters
X dB BW = -26dB (using the OBW function of the spectrum analyzer) Emission Bandwidth (EBW) <ol style="list-style-type: none"> <li>a) Set RBW = approximately 1% of the emission bandwidth.</li> <li>b) Set the VBW &gt; RBW.</li> <li>c) Detector = Peak.</li> <li>d) Trace mode = max hold.</li> <li>e) Measure the maximum width of the emission that is 26 dB down from the maximum of the emission. Compare this with the RBW setting of the analyzer. Readjust RBW and repeat measurement as needed until the RBW/EBW ratio is approximately 1%.</li> </ol>

<b>Tested By:</b> Ronak Patel	<b>Date of testing:</b> 3/22/2023 - 6/2/2023
<b>Test Result: PASS</b>	

### Test Equipment

See Appendix C for list of test equipment

**99% and 26dB Bandwidth Table**

Frequency (MHz)	Mode	Data Rate (Mbps)	26dB BW (MHz)	99% BW (MHz)
5260	Non HT20, 6 to 54 Mbps	6.0	20.8	16.579
	HT/VHT20, M0 to M7	m0	21.7	17.74
	HE20, M0 to M11 1ss	m0h1	22.1	18.989
5270	Non HT40, 6 to 54 Mbps	6.0	41.4	36.313
	HT/VHT40, M0 to M7	m0	41.4	36.152
	HE40, M0 to M11 1ss	m0h1	41.6	37.827
5290	Non HT80, 6 to 54 Mbps	6.0	83.3	75.975
	VHT80, M0 to M11 1ss	m0x1	83.0	75.249
	HE80, M0 to M11 1ss	m0h1	83.4	77.168
5300	Non HT20, 6 to 54 Mbps	6.0	20.8	16.558
	HT/VHT20, M0 to M7	m0	21.6	17.719
	HE20, M0 to M11 1ss	m0h1	22.2	18.976
5310	Non HT40, 6 to 54 Mbps	6.0	41.1	36.288
	HT/VHT40, M0 to M7	m0	41.3	36.177
	HE40, M0 to M11 1ss	m0h1	41.4	37.791
5320	Non HT20, 6 to 54 Mbps	6.0	20.9	16.57
	HT/VHT20, M0 to M7	m0	21.4	17.748
	HE20, M0 to M11 1ss	m0h1	22.1	19.001

## Data Screenshots

5320 MHz: HE20, M0 to M11 1ss



Antenna A

5270 MHz: HE40, M0 to M11 1ss

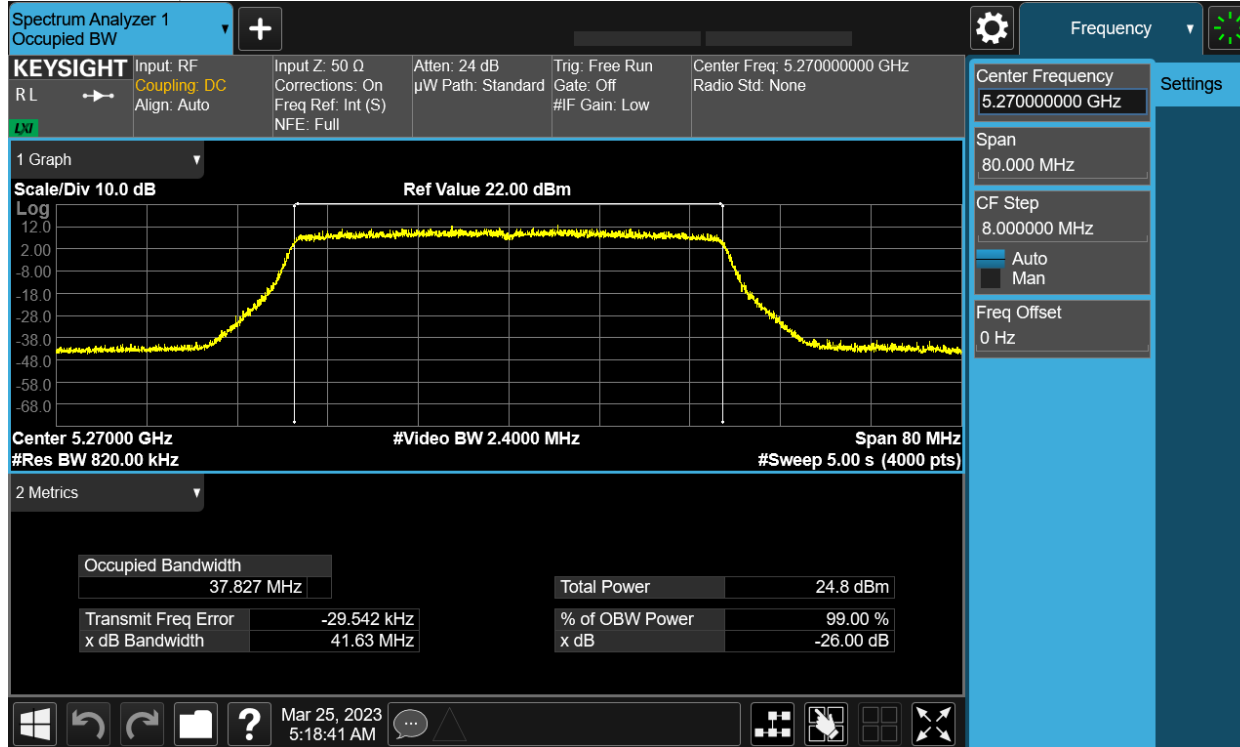

Antenna A

5290 MHz: HE80, M0 to M11 1ss

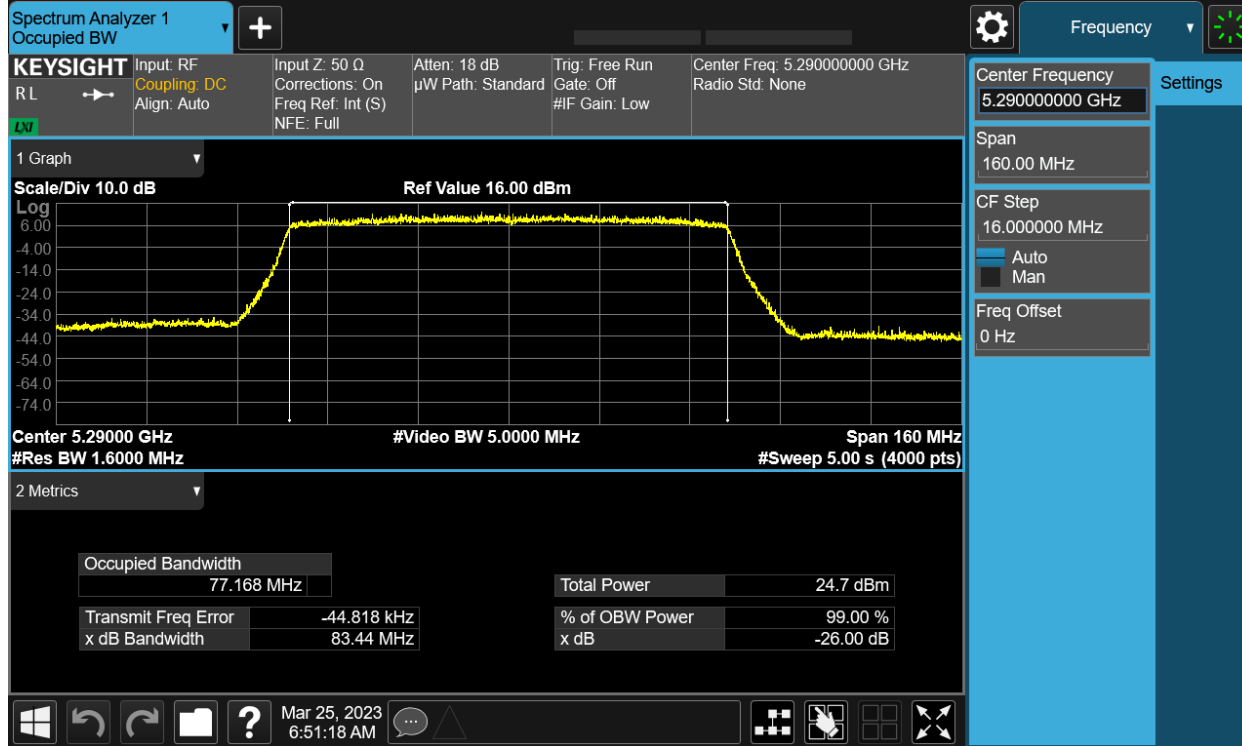

Antenna B

### **A.3: Maximum Conducted Output Power**

#### **Maximum Conducted Output Power Test Requirement**

**15.407 (2):**

For the 5.25-5.35 GHz and 5.47-5.725 GHz bands, the maximum conducted output power over the frequency bands of operation shall not exceed the lesser of 250 mW or 11 dBm + 10 log B, where B is the 26 dB emission bandwidth in megahertz. ... If transmitting antennas of directional gain greater than 6 dBi are used, both the maximum conducted output power and the maximum power spectral density shall be reduced by the amount in dB that the directional gain of the antenna exceeds 6 dBi.

**15.407:**

(5) The maximum power spectral density is measured as a conducted emission by direct connection of a calibrated test instrument to the equipment under test. If the device cannot be connected directly, alternative techniques acceptable to the Commission may be used. Measurements in the 5.15-5.25 GHz, 5.25-5.35 GHz, and the 5.47-5.725 GHz bands are made over a bandwidth of 1 MHz or the 26 dB emission bandwidth of the device, whichever is less. A narrower resolution bandwidth can be used, provided that the measured power is integrated over the full reference bandwidth.

**Referencing “644545 D03 Guidance for IEEE 802.11ac v01”**

Covering signals that cross the boundary between two adjacent UNII bands, the FCC describes a procedure to measure EBW, power, and PSD in each UNII band. For the case of a 160MHz signal equally distributed between UNII-1 and UNII-2a, we apply the following alternate procedure. Rather than measure:

- The half of the signal in UNII-1, measured against the 30dBm power / 17dBm/MHz PSD limits
- The half of the signal in UNII-2a, measured against the 24dBm power / 11dBm/MHz PSD limits

If a 160MHz signal (equally distributed between the two bands) produces a total power of 27dBm across the entire 160 MHz EBW, the total power in each band would be half of the total, or 24dBm (which meets both the UNII-1 and UNII-2a limits) and would have a PSD no greater than 11dBm/MHz in either sub-band.

Given these facts, we have measured the complete 160 MHz EBW (across both sub-bands) against 27dBm power and 11dBm/MHz PSD limits, rather than individual sub band measurements against the individual sub band limits.”

#### **Maximum Conducted Output Power Test Procedure**

**ANSI C63.10: 2013**

**Ref. KDB 789033 D02 General UNII Test Procedures New Rules v02r01**

<b>Maximum Conducted Output Power Test Procedure</b>
<ol style="list-style-type: none"><li>1. Set the radio in the continuous transmitting mode at full power</li><li>2. Compute power by integrating the spectrum across the EBW (or alternatively entire 99% OBW) of the signal using the instrument's band power measurement function. The integration shall be performed using the spectrum analyzer band-power measurement function with band limits set equal to the EBW or the OBW band edges.</li><li>3. Capture graphs and record pertinent measurement data.</li></ol>

**Ref. KDB 789033 D02 General UNII Test Procedures New Rules v02r01**

**2. Measurement using a Spectrum Analyzer or EMI Receiver (SA), (d) Method SA-2**

<b>Maximum Conducted Output Power</b>
Test parameters
Method SA-2 (trace averaging across on and off times of the EUT transmissions, followed by duty cycle correction). (i) Measure the duty cycle, $x$ , of the transmitter output signal as described in section II.B. (ii) Set span to encompass the EBW (or, alternatively, the entire 99% occupied bandwidth) of the signal. (iii) Set RBW = 1 MHz. (iv) Set VBW $\geq$ 3 MHz. (v) Number of points in sweep $\geq$ 2 Span / RBW. (This ensures that bin-to-bin spacing is $\leq$ RBW/2, so that narrowband signals are not lost between frequency bins.) (vi) Sweep time = auto. (vii) Detector = RMS (i.e., power averaging), if available. Otherwise, use sample detector mode. (viii) Do not use sweep triggering. Allow the sweep to "free run". (ix) Trace average at least 100 traces in power averaging (i.e., RMS) mode; however, the number of traces to be averaged shall be increased above 100 as needed to ensure that the average accurately represents the true average over the on and off periods of the transmitter. (x) Compute power by integrating the spectrum across the EBW (or, alternatively, the entire 99% occupied bandwidth) of the signal using the instrument's band power measurement function with band limits set equal to the EBW (or occupied bandwidth)

The "measure-and-sum technique" is used for measuring in-band transmit power of a device. In the measure-and-sum approach, the conducted emission level is measured at each antenna port. The measured results at the various antenna ports are then summed mathematically to determine the total emission level from the device. Summing is performed in linear power units. ANSI C63.10 section 14.3.2.2

<b>Tested By:</b> Ronak Patel	<b>Date of testing:</b> 3/22/2023 - 6/2/2023
<b>Test Result:</b> PASS	

**Test Equipment**

See Appendix C for list of test equipment

## Maximum EIRP

## Frequency 5260 MHz

Mode	Tx Paths	Correlated Antenna Gain (dBi)	Tx 1 Max Power (dBm)	Tx 2 Max Power (dBm)	Duty Cycle (dB)	Total Tx Channel Power (dBm)	Limit (dBm)	Margin (dB)
Non HT20, 6 to 54 Mbps	1	15	11.9		0.18	27.1	30	2.95
Non HT20, 6 to 54 Mbps	2	15	9.1	8.7	0.18	27.1	30	2.94
Non HT20 Beam Forming, 6 to 54 Mbps	2	15	9.1	8.7	0.18	27.1	30	2.94
HT/VHT20, M0 to M7	1	15	11.5		0.22	26.7	30	3.3
HT/VHT20, M0 to M7	2	15	8.8	8.6	0.22	26.9	30	3.07
HT/VHT20, M8 to M15	2	15	8.8	8.6	0.22	26.9	30	3.07
HT/VHT20 Beam Forming, M0 to M7	2	15	8.8	8.6	0.22	26.9	30	3.07
HT/VHT20 Beam Forming, M8 to M15	2	15	8.8	8.6	0.22	26.9	30	3.07
HT/VHT20 STBC, M8 to M15	2	15	8.8	8.6	0.22	26.9	30	3.07
HE20, M0 to M11 1ss	1	15	12.5		0.2	27.7	30	2.33
HE20, M0 to M11 1ss	2	15	8.9	8.4	0.2	26.8	30	3.15
HE20, M0 to M11 2ss	2	15	8.9	8.4	0.2	26.8	30	3.15
HE20 Beam Forming, M0 to M11 1ss	2	15	8.9	8.4	0.2	26.8	30	3.15
HE20 Beam Forming, M0 to M11 2ss	2	15	8.9	8.4	0.2	26.8	30	3.15
HE20 STBC, M0 to M11 2ss	2	15	8.9	8.4	0.2	26.8	30	3.15

## Frequency 5270 MHz

Mode	Tx Paths	Correlated Antenna Gain (dBi)	Tx 1 Max Power (dBm)	Tx 2 Max Power (dBm)	Duty Cycle (dB)	Total Tx Channel Power (dBm)	Limit (dBm)	Margin (dB)
Non HT40, 6 to 54 Mbps	1	15	13.9		0.3	29.2	30	0.83
<b>Non HT40, 6 to 54 Mbps</b>	<b>2</b>	<b>15</b>	<b>11.7</b>	<b>11.6</b>	<b>0.3</b>	<b>30.0</b>	<b>30</b>	<b>0.01</b>
HT/VHT40, M0 to M7	1	15	13.7		0.55	29.3	30	0.72
<b>HT/VHT40, M0 to M7</b>	<b>2</b>	<b>15</b>	<b>11.5</b>	<b>11.3</b>	<b>0.55</b>	<b>30.0</b>	<b>30</b>	<b>0.01</b>
<b>HT/VHT40, M8 to M15</b>	<b>2</b>	<b>15</b>	<b>11.5</b>	<b>11.3</b>	<b>0.55</b>	<b>30.0</b>	<b>30</b>	<b>0.01</b>
HT/VHT40 Beam Forming, M0 to M7	2	15	11.5	11.3	0.55	30.0	30	0.01
HT/VHT40 Beam Forming, M8 to M15	2	15	11.5	11.3	0.55	30.0	30	0.01
HT/VHT40 STBC, M8 to M15	2	15	11.5	11.3	0.55	30.0	30	0.01
HE40, M0 to M11 1ss	1	15	14.6		0.27	29.8	30	0.17
HE40, M0 to M11 1ss	2	15	11.2	11.0	0.27	29.4	30	0.63
HE40, M0 to M11 2ss	2	15	11.2	11.0	0.27	29.4	30	0.63
HE40 Beam Forming, M0 to M11 1ss	2	15	11.2	11.0	0.27	29.4	30	0.63
HE40 Beam Forming, M0 to M11 2ss	2	15	11.2	11.0	0.27	29.4	30	0.63
HE40 STBC, M0 to M11 2ss	2	15	11.2	11.0	0.27	29.4	30	0.63

**Frequency 5290 MHz**

<b>Mode</b>	<b>Tx Paths</b>	<b>Correlated Antenna Gain (dBi)</b>	<b>Tx 1 Max Power (dBm)</b>	<b>Tx 2 Max Power (dBm)</b>	<b>Duty Cycle (dB)</b>	<b>Total Tx Channel Power (dBm)</b>	<b>Limit (dBm)</b>	<b>Margin (dB)</b>
Non HT80, 6 to 54 Mbps	1	15	12.0		0.36	27.4	30	2.62
Non HT80, 6 to 54 Mbps	2	15	10.6	10.6	0.36	29.0	30	1.03
VHT80, M0 to M11 1ss	1	15	13.0		0.55	28.5	30	1.5
VHT80, M0 to M11 1ss	2	15	9.6	10.2	0.55	28.4	30	1.56
VHT80, M0 to M11 2ss	2	15	9.6	10.2	0.55	28.4	30	1.56
VHT80 Beam Forming, M0 to M11 1ss	2	15	9.6	10.2	0.55	28.4	30	1.56
VHT80 Beam Forming, M0 to M11 2ss	2	15	9.6	10.2	0.55	28.4	30	1.56
VHT80 STBC, M0 to M11 2ss	2	15	9.6	10.2	0.55	28.4	30	1.56
HE80, M0 to M11 1ss	1	15	12.0		0.22	27.3	30	2.74
HE80, M0 to M11 1ss	2	15	9.8	10.2	0.22	28.2	30	1.79
HE80, M0 to M11 2ss	2	15	9.8	10.2	0.22	28.2	30	1.79
HE80 Beam Forming, M0 to M11 1ss	2	15	9.8	10.2	0.22	28.2	30	1.79
HE80 Beam Forming, M0 to M11 2ss	2	15	9.8	10.2	0.22	28.2	30	1.79
HE80 STBC, M0 to M11 2ss	2	15	9.8	10.2	0.22	28.2	30	1.79

**Frequency 5300 MHz**

<b>Mode</b>	<b>Tx Paths</b>	<b>Correlated Antenna Gain (dBi)</b>	<b>Tx 1 Max Power (dBm)</b>	<b>Tx 2 Max Power (dBm)</b>	<b>Duty Cycle (dB)</b>	<b>Total Tx Channel Power (dBm)</b>	<b>Limit (dBm)</b>	<b>Margin (dB)</b>
Non HT20, 6 to 54 Mbps	1	15	11.1		0.18	26.3	30	3.71
Non HT20, 6 to 54 Mbps	2	15	8.8	9.1	0.18	27.2	30	2.85
Non HT20 Beam Forming, 6 to 54 Mbps	2	15	8.8	9.1	0.18	27.2	30	2.85
HT/VHT20, M0 to M7	1	15	11.6		0.22	26.8	30	3.17
HT/VHT20, M0 to M7	2	15	8.5	8.7	0.22	26.8	30	3.16
HT/VHT20, M8 to M15	2	15	8.5	8.7	0.22	26.8	30	3.16
HT/VHT20 Beam Forming, M0 to M7	2	15	8.5	8.7	0.22	26.8	30	3.16
HT/VHT20 Beam Forming, M8 to M15	2	15	8.5	8.7	0.22	26.8	30	3.16
HT/VHT20 STBC, M8 to M15	2	15	8.5	8.7	0.22	26.8	30	3.16
HE20, M0 to M11 1ss	1	15	11.7		0.2	26.9	30	3.06
HE20, M0 to M11 1ss	2	15	8.5	8.7	0.2	26.8	30	3.18
HE20, M0 to M11 2ss	2	15	8.5	8.7	0.2	26.8	30	3.18
HE20 Beam Forming, M0 to M11 1ss	2	15	8.5	8.7	0.2	26.8	30	3.18
HE20 Beam Forming, M0 to M11 2ss	2	15	8.5	8.7	0.2	26.8	30	3.18
HE20 STBC, M0 to M11 2ss	2	15	8.5	8.7	0.2	26.8	30	3.18



## Frequency 5310 MHz

Mode	Tx Paths	Correlated Antenna Gain (dBi)	Tx 1 Max Power (dBm)	Tx 2 Max Power (dBm)	Duty Cycle (dB)	Total Tx Channel Power (dBm)	Limit (dBm)	Margin (dB)
Non HT40, 6 to 54 Mbps	1	15	14.1		0.3	29.4	30	0.61
Non HT40, 6 to 54 Mbps	2	15	11.3	11.5	0.3	29.7	30	0.28
HT/VHT40, M0 to M7	1	15	13.1		0.55	28.6	30	1.37
HT/VHT40, M0 to M7	2	15	11.1	11.3	0.55	29.8	30	0.21
HT/VHT40, M8 to M15	2	15	11.1	11.3	0.55	29.8	30	0.21
HT/VHT40 Beam Forming, M0 to M7	2	15	11.1	11.3	0.55	29.8	30	0.21
HT/VHT40 Beam Forming, M8 to M15	2	15	11.1	11.3	0.55	29.8	30	0.21
HT/VHT40 STBC, M8 to M15	2	15	11.1	11.3	0.55	29.8	30	0.21
HE40, M0 to M11 1ss	1	15	13.0		0.27	28.3	30	1.7
HE40, M0 to M11 1ss	2	15	11.0	11.2	0.27	29.4	30	0.62
HE40, M0 to M11 2ss	2	15	11.0	11.2	0.27	29.4	30	0.62
HE40 Beam Forming, M0 to M11 1ss	2	15	11.0	11.2	0.27	29.4	30	0.62
HE40 Beam Forming, M0 to M11 2ss	2	15	11.0	11.2	0.27	29.4	30	0.62
HE40 STBC, M0 to M11 2ss	2	15	11.0	11.2	0.27	29.4	30	0.62

## Frequency 5320 MHz

Mode	Tx Paths	Correlated Antenna Gain (dBi)	Tx 1 Max Power (dBm)	Tx 2 Max Power (dBm)	Duty Cycle (dB)	Total Tx Channel Power (dBm)	Limit (dBm)	Margin (dB)
Non HT20, 6 to 54 Mbps	1	15	11.3		0.18	26.4	30	3.57
Non HT20, 6 to 54 Mbps	2	15	9.1	8.7	0.18	27.0	30	2.95
Non HT20 Beam Forming, 6 to 54 Mbps	2	15	9.1	8.7	0.18	27.0	30	2.95
HT/VHT20, M0 to M7	1	15	11.8		0.22	27.0	30	2.96
HT/VHT20, M0 to M7	2	15	8.7	8.3	0.22	26.8	30	3.22
HT/VHT20, M8 to M15	2	15	8.7	8.3	0.22	26.8	30	3.22
HT/VHT20 Beam Forming, M0 to M7	2	15	8.7	8.3	0.22	26.8	30	3.22
HT/VHT20 Beam Forming, M8 to M15	2	15	8.7	8.3	0.22	26.8	30	3.22
HT/VHT20 STBC, M8 to M15	2	15	8.7	8.3	0.22	26.8	30	3.22
HE20, M0 to M11 1ss	1	15	11.9		0.2	27.1	30	2.94
HE20, M0 to M11 1ss	2	15	8.8	8.3	0.2	26.8	30	3.23
HE20, M0 to M11 2ss	2	15	8.8	8.3	0.2	26.8	30	3.23
HE20 Beam Forming, M0 to M11 1ss	2	15	8.8	8.3	0.2	26.8	30	3.23
HE20 Beam Forming, M0 to M11 2ss	2	15	8.8	8.3	0.2	26.8	30	3.23
HE20 STBC, M0 to M11 2ss	2	15	8.8	8.3	0.2	26.8	30	3.23

**Maximum Conducted Output Power****Frequency 5260 MHz**

<b>Mode</b>	<b>Tx Paths</b>	<b>Correlated Antenna Gain (dBi)</b>	<b>Tx 1 Max Power (dBm)</b>	<b>Tx 2 Max Power (dBm)</b>	<b>Duty Cycle (dB)</b>	<b>Total Tx Channel Power (dBm)</b>	<b>Limit (dBm)</b>	<b>Margin (dB)</b>
Non HT20, 6 to 54 Mbps	1	15	11.9		0.18	12.1	24	11.95
Non HT20, 6 to 54 Mbps	2	15	9.1	8.7	0.18	12.1	24	11.94
Non HT20 Beam Forming, 6 to 54 Mbps	2	15	9.1	8.7	0.18	12.1	24	11.94
HT/VHT20, M0 to M7	1	15	11.5		0.22	11.7	24	12.3
HT/VHT20, M0 to M7	2	15	8.8	8.6	0.22	11.9	24	12.07
HT/VHT20, M8 to M15	2	15	8.8	8.6	0.22	11.9	24	12.07
HT/VHT20 Beam Forming, M0 to M7	2	15	8.8	8.6	0.22	11.9	24	12.07
HT/VHT20 Beam Forming, M8 to M15	2	15	8.8	8.6	0.22	11.9	24	12.07
HT/VHT20 STBC, M8 to M15	2	15	8.8	8.6	0.22	11.9	24	12.07
HE20, M0 to M11 1ss	1	15	12.5		0.2	12.7	24	11.33
HE20, M0 to M11 1ss	2	15	8.9	8.4	0.2	11.8	24	12.15
HE20, M0 to M11 2ss	2	15	8.9	8.4	0.2	11.8	24	12.15
HE20 Beam Forming, M0 to M11 1ss	2	15	8.9	8.4	0.2	11.8	24	12.15
HE20 Beam Forming, M0 to M11 2ss	2	15	8.9	8.4	0.2	11.8	24	12.15
HE20 STBC, M0 to M11 2ss	2	15	8.9	8.4	0.2	11.8	24	12.15

**Frequency 5270 MHz**

<b>Mode</b>	<b>Tx Paths</b>	<b>Correlated Antenna Gain (dBi)</b>	<b>Tx 1 Max Power (dBm)</b>	<b>Tx 2 Max Power (dBm)</b>	<b>Duty Cycle (dB)</b>	<b>Total Tx Channel Power (dBm)</b>	<b>Limit (dBm)</b>	<b>Margin (dB)</b>
Non HT40, 6 to 54 Mbps	1	15	13.9		0.3	14.2	24	9.83
<b>Non HT40, 6 to 54 Mbps</b>	<b>2</b>	<b>15</b>	<b>11.7</b>	<b>11.6</b>	<b>0.3</b>	<b>15.0</b>	<b>24</b>	<b>9.01</b>
HT/VHT40, M0 to M7	1	15	13.7		0.55	14.3	24	9.72
<b>HT/VHT40, M0 to M7</b>	<b>2</b>	<b>15</b>	<b>11.5</b>	<b>11.3</b>	<b>0.55</b>	<b>15.0</b>	<b>24</b>	<b>9.01</b>
<b>HT/VHT40, M8 to M15</b>	<b>2</b>	<b>15</b>	<b>11.5</b>	<b>11.3</b>	<b>0.55</b>	<b>15.0</b>	<b>24</b>	<b>9.01</b>
HT/VHT40 Beam Forming, M0 to M7	2	15	11.5	11.3	0.55	15.0	24	9.01
HT/VHT40 Beam Forming, M8 to M15	2	15	11.5	11.3	0.55	15.0	24	9.01
HT/VHT40 STBC, M8 to M15	2	15	11.5	11.3	0.55	15.0	24	9.01
HE40, M0 to M11 1ss	1	15	14.6		0.27	14.8	24	9.17
HE40, M0 to M11 1ss	2	15	11.2	11.0	0.27	14.4	24	9.63
HE40, M0 to M11 2ss	2	15	11.2	11.0	0.27	14.4	24	9.63
HE40 Beam Forming, M0 to M11 1ss	2	15	11.2	11.0	0.27	14.4	24	9.63
HE40 Beam Forming, M0 to M11 2ss	2	15	11.2	11.0	0.27	14.4	24	9.63
HE40 STBC, M0 to M11 2ss	2	15	11.2	11.0	0.27	14.4	24	9.63

**Frequency 5290 MHz**

<b>Mode</b>	<b>Tx Paths</b>	<b>Correlated Antenna Gain (dBi)</b>	<b>Tx 1 Max Power (dBm)</b>	<b>Tx 2 Max Power (dBm)</b>	<b>Duty Cycle (dB)</b>	<b>Total Tx Channel Power (dBm)</b>	<b>Limit (dBm)</b>	<b>Margin (dB)</b>
Non HT80, 6 to 54 Mbps	1	15	12.0		0.36	12.4	24	11.62
Non HT80, 6 to 54 Mbps	2	15	10.6	10.6	0.36	14.0	24	10.03
VHT80, M0 to M11 1ss	1	15	13.0		0.55	13.5	24	10.5
VHT80, M0 to M11 1ss	2	15	9.6	10.2	0.55	13.4	24	10.56
VHT80, M0 to M11 2ss	2	15	9.6	10.2	0.55	13.4	24	10.56
VHT80 Beam Forming, M0 to M11 1ss	2	15	9.6	10.2	0.55	13.4	24	10.56
VHT80 Beam Forming, M0 to M11 2ss	2	15	9.6	10.2	0.55	13.4	24	10.56
VHT80 STBC, M0 to M11 2ss	2	15	9.6	10.2	0.55	13.4	24	10.56
HE80, M0 to M11 1ss	1	15	12.0		0.22	12.3	24	11.74
HE80, M0 to M11 1ss	2	15	9.8	10.2	0.22	13.2	24	10.79
HE80, M0 to M11 2ss	2	15	9.8	10.2	0.22	13.2	24	10.79
HE80 Beam Forming, M0 to M11 1ss	2	15	9.8	10.2	0.22	13.2	24	10.79
HE80 Beam Forming, M0 to M11 2ss	2	15	9.8	10.2	0.22	13.2	24	10.79
HE80 STBC, M0 to M11 2ss	2	15	9.8	10.2	0.22	13.2	24	10.79

**Frequency 5300 MHz**

<b>Mode</b>	<b>Tx Paths</b>	<b>Correlated Antenna Gain (dBi)</b>	<b>Tx 1 Max Power (dBm)</b>	<b>Tx 2 Max Power (dBm)</b>	<b>Duty Cycle (dB)</b>	<b>Total Tx Channel Power (dBm)</b>	<b>Limit (dBm)</b>	<b>Margin (dB)</b>
Non HT20, 6 to 54 Mbps	1	15	11.1		0.18	11.3	24	12.71
Non HT20, 6 to 54 Mbps	2	15	8.8	9.1	0.18	12.2	24	11.85
Non HT20 Beam Forming, 6 to 54 Mbps	2	15	8.8	9.1	0.18	12.2	24	11.85
HT/VHT20, M0 to M7	1	15	11.6		0.22	11.8	24	12.17
HT/VHT20, M0 to M7	2	15	8.5	8.7	0.22	11.8	24	12.16
HT/VHT20, M8 to M15	2	15	8.5	8.7	0.22	11.8	24	12.16
HT/VHT20 Beam Forming, M0 to M7	2	15	8.5	8.7	0.22	11.8	24	12.16
HT/VHT20 Beam Forming, M8 to M15	2	15	8.5	8.7	0.22	11.8	24	12.16
HT/VHT20 STBC, M8 to M15	2	15	8.5	8.7	0.22	11.8	24	12.16
HE20, M0 to M11 1ss	1	15	11.7		0.2	11.9	24	12.06
HE20, M0 to M11 1ss	2	15	8.5	8.7	0.2	11.8	24	12.18
HE20, M0 to M11 2ss	2	15	8.5	8.7	0.2	11.8	24	12.18
HE20 Beam Forming, M0 to M11 1ss	2	15	8.5	8.7	0.2	11.8	24	12.18
HE20 Beam Forming, M0 to M11 2ss	2	15	8.5	8.7	0.2	11.8	24	12.18
HE20 STBC, M0 to M11 2ss	2	15	8.5	8.7	0.2	11.8	24	12.18

## Frequency 5310 MHz

Mode	Tx Paths	Correlated Antenna Gain (dBi)	Tx 1 Max Power (dBm)	Tx 2 Max Power (dBm)	Duty Cycle (dB)	Total Tx Channel Power (dBm)	Limit (dBm)	Margin (dB)
Non HT40, 6 to 54 Mbps	1	15	14.1		0.3	14.4	24	9.61
Non HT40, 6 to 54 Mbps	2	15	11.3	11.5	0.3	14.7	24	9.28
HT/VHT40, M0 to M7	1	15	13.1		0.55	13.6	24	10.37
HT/VHT40, M0 to M7	2	15	11.1	11.3	0.55	14.8	24	9.21
HT/VHT40, M8 to M15	2	15	11.1	11.3	0.55	14.8	24	9.21
HT/VHT40 Beam Forming, M0 to M7	2	15	11.1	11.3	0.55	14.8	24	9.21
HT/VHT40 Beam Forming, M8 to M15	2	15	11.1	11.3	0.55	14.8	24	9.21
HT/VHT40 STBC, M8 to M15	2	15	11.1	11.3	0.55	14.8	24	9.21
HE40, M0 to M11 1ss	1	15	13.0		0.27	13.3	24	10.7
HE40, M0 to M11 1ss	2	15	11.0	11.2	0.27	14.4	24	9.62
HE40, M0 to M11 2ss	2	15	11.0	11.2	0.27	14.4	24	9.62
HE40 Beam Forming, M0 to M11 1ss	2	15	11.0	11.2	0.27	14.4	24	9.62
HE40 Beam Forming, M0 to M11 2ss	2	15	11.0	11.2	0.27	14.4	24	9.62
HE40 STBC, M0 to M11 2ss	2	15	11.0	11.2	0.27	14.4	24	9.62

## Frequency 5320 MHz

Mode	Tx Paths	Correlated Antenna Gain (dBi)	Tx 1 Max Power (dBm)	Tx 2 Max Power (dBm)	Duty Cycle (dB)	Total Tx Channel Power (dBm)	Limit (dBm)	Margin (dB)
Non HT20, 6 to 54 Mbps	1	15	11.3		0.18	11.4	24	12.57
Non HT20, 6 to 54 Mbps	2	15	9.1	8.7	0.18	12.0	24	11.95
Non HT20 Beam Forming, 6 to 54 Mbps	2	15	9.1	8.7	0.18	12.0	24	11.95
HT/VHT20, M0 to M7	1	15	11.8		0.22	12.0	24	11.96
HT/VHT20, M0 to M7	2	15	8.7	8.3	0.22	11.8	24	12.22
HT/VHT20, M8 to M15	2	15	8.7	8.3	0.22	11.8	24	12.22
HT/VHT20 Beam Forming, M0 to M7	2	15	8.7	8.3	0.22	11.8	24	12.22
HT/VHT20 Beam Forming, M8 to M15	2	15	8.7	8.3	0.22	11.8	24	12.22
HT/VHT20 STBC, M8 to M15	2	15	8.7	8.3	0.22	11.8	24	12.22
HE20, M0 to M11 1ss	1	15	11.9		0.2	12.1	24	11.94
HE20, M0 to M11 1ss	2	15	8.8	8.3	0.2	11.8	24	12.23
HE20, M0 to M11 2ss	2	15	8.8	8.3	0.2	11.8	24	12.23
HE20 Beam Forming, M0 to M11 1ss	2	15	8.8	8.3	0.2	11.8	24	12.23
HE20 Beam Forming, M0 to M11 2ss	2	15	8.8	8.3	0.2	11.8	24	12.23
HE20 STBC, M0 to M11 2ss	2	15	8.8	8.3	0.2	11.8	24	12.23

## Data Screenshots

5270 MHz: Non HT40, 6 to 54 Mbps

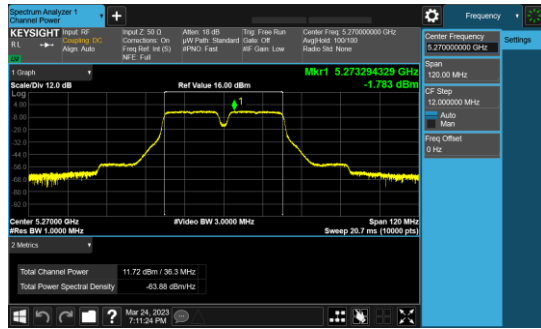

Antenna A



Antenna B

5270 MHz: HT/VHT40, M0 to M7

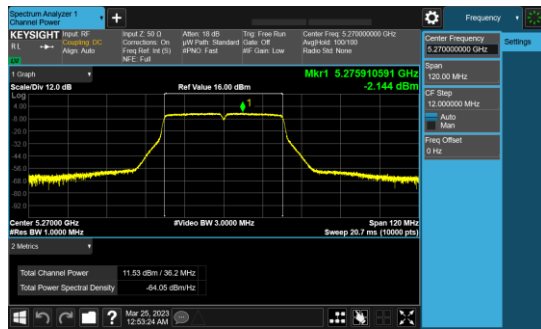

Antenna A

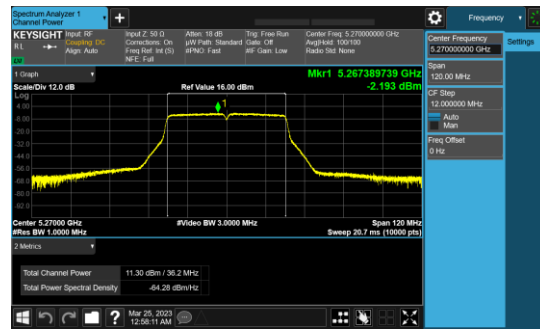

Antenna B

5270 MHz: HT/VHT40, M8 to M15

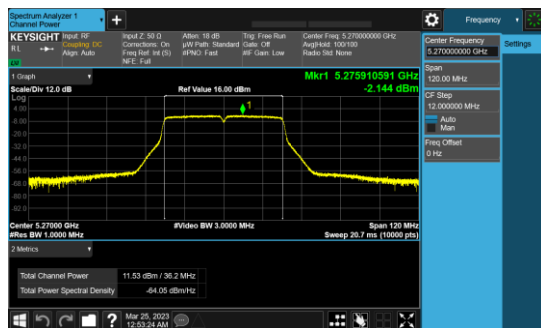

Antenna A

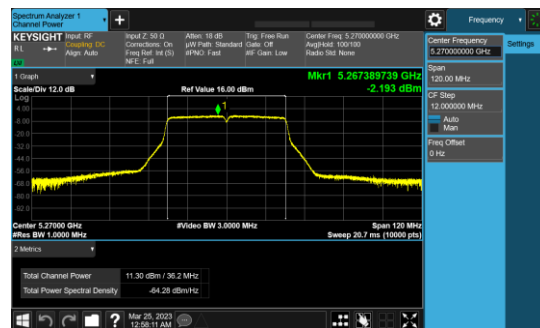

Antenna B

## **A.4: Power Spectral Density**

### **Power Spectral Density Test Requirement**

#### **15.407:**

(2) For the 5.25-5.35 GHz and 5.47-5.725 GHz bands, the maximum conducted output power over the frequency bands of operation shall not exceed the lesser of 250 mW or 11 dBm + 10 log B, where B is the 26 dB emission bandwidth in megahertz. In addition, the maximum power spectral density shall not exceed 11 dBm in any 1 megahertz band. If transmitting antennas of directional gain greater than 6 dBi are used, both the maximum conducted output power and the maximum power spectral density shall be reduced by the amount in dB that the directional gain of the antenna exceeds 6 dBi.

#### **15.407:**

(5) The maximum power spectral density is measured as a conducted emission by direct connection of a calibrated test instrument to the equipment under test. If the device cannot be connected directly, alternative techniques acceptable to the Commission may be used. Measurements in the 5.15-5.25 GHz, 5.25-5.35 GHz, and the 5.47-5.725 GHz bands are made over a bandwidth of 1 MHz or the 26 dB emission bandwidth of the device, whichever is less. A narrower resolution bandwidth can be used, provided that the measured power is integrated over the full reference bandwidth.

#### **Referencing “644545 D03 Guidance for IEEE 802.11ac v01”**

Covering signals that cross the boundary between two adjacent UNII bands, the FCC describes a procedure to measure EBW, power, and PSD in each UNII band. For the case of a 160MHz signal equally distributed between UNII-1 and UNII-2a, we apply the following alternate procedure. Rather than measure:

- The half of the signal in UNII-1, measured against the 30dBm power / 17dBm/MHz PSD limits
- The half of the signal in UNII-2a, measured against the 24dBm power / 11dBm/MHz PSD limits

If a 160MHz signal (equally distributed between the two bands) produces a total power of 27dBm across the entire 160 MHz EBW, the total power in each band would be half of the total, or 24dBm (which meets both the UNII-1 and UNII-2a limits) and would have a PSD no greater than 11dBm/MHz in either sub-band.

Given these facts, we have measured the complete 160 MHz EBW (across both sub-bands) against 27dBm power and 11dBm/MHz PSD limits, rather than individual sub band measurements against the individual sub band limits.”

### **Power Spectral Density Test Procedure**

#### **Ref. KDB 789033 D02 General UNII Test Procedures New Rules v02r01**

##### **F. Maximum Power Spectral Density (PSD)**

###### **Power Spectral Density Test Procedure**

The rules requires “maximum power spectral density” measurements where the intent is to measure the maximum value of the time average of the power spectral density measured during a period of continuous transmission.

1. Create an average power spectrum for the EUT operating mode being tested by following the instructions in section II.E.2. for measuring maximum conducted output power using a spectrum analyzer or EMI receiver: select the appropriate test method (SA-1, SA-2, SA-3, or alternatives to each) and apply it up to, but not including, the step labeled, “Compute power...”. (This procedure is required even if the maximum conducted output power measurement was performed using a power meter, method PM.)

2. Use the peak search function on the instrument to find the peak of the spectrum and record its value.

3. Make the following adjustments to the peak value of the spectrum, if applicable: a) If Method SA-2 or SA-2 Alternative was used, add  $10 \log(1/x)$ , where x is the duty cycle, to the peak of the spectrum.

b) If Method SA-3 Alternative was used and the linear mode was used in step II.E.2.g)(viii), add 1 dB to the final result to compensate for the difference between linear averaging and power averaging.

4. The result is the Maximum PSD over 1 MHz reference bandwidth.

**Ref. KDB 789033 D02 General UNII Test Procedures New Rules v02r01**

**2. Measurement using a Spectrum Analyzer or EMI Receiver (SA), (d) Method SA-2**

<p><b>Power Spectral Density</b> Test parameters</p> <p>Method SA-2 (trace averaging across on and off times of the EUT transmissions, followed by duty cycle correction).                  (i) Measure the duty cycle, <math>x</math>, of the transmitter output signal as described in section II.B.                  (ii) Set span to encompass the EBW (or, alternatively, the entire 99% occupied bandwidth) of the signal.                  (iii) Set RBW = 1 MHz.                  (iv) Set VBW <math>\geq</math> 3 MHz.                  (v) Number of points in sweep <math>\geq</math> 2 Span / RBW. (This ensures that bin-to-bin spacing is <math>\leq</math> RBW/2, so that narrowband signals are not lost between frequency bins.)                  (vi) Sweep time = auto.                  (vii) Detector = RMS (i.e., power averaging), if available. Otherwise, use sample detector mode.(viii) Do not use sweep triggering. Allow the sweep to “free run”.                  (ix) Trace average at least 100 traces in power averaging (i.e., RMS) mode; however, the number of traces to be averaged shall be increased above 100 as needed to ensure that the average accurately represents the true average over the on and off periods of the transmitter.                  (x) Compute power by integrating the spectrum across the EBW (or, alternatively, the entire 99% occupied bandwidth) of the signal using the instrument’s band power measurement function with band limits set equal to the EBW (or occupied bandwidth)</p> <p><b>F. Maximum Power Spectral Density (PSD)</b>                  2. Use the peak search function on the instrument to find the peak of the spectrum and record its value.                  3. Make the following adjustments to the peak value of the spectrum, if applicable: a) If Method SA-2 or SA-2 Alternative was used, add <math>10 \log(1/x)</math>, where <math>x</math> is the duty cycle, to the peak of the spectrum.</p>
--

The “measure-and-sum technique” is used for measuring in-band transmit power of a device. In the measure-and-sum approach, the conducted emission level is measured at each antenna port. The measured results at the various antenna ports are then summed mathematically to determine the total emission level from the device. Summing is performed in linear power units. (See ANSI C63.10 section 14.3.2.2)

<b>Tested By:</b> Ronak Patel	<b>Date of testing:</b> 3/22/2023 - 6/2/2023
<b>Test Result:</b> PASS	

**Test Equipment**

See Appendix C for list of test equipment

## Power Spectral Density EIRP

## Frequency 5260 MHz

Mode	Tx Paths	Correlated Antenna Gain (dBi)	Tx 1 PSD (dBm/MHz)	Tx 2 PSD (dBm/MHz)	Duty Cycle (dB)	Total PSD (dBm/MHz)	Limit (dBm/MHz)	Margin (dB)
Non HT20, 6 to 54 Mbps	1	15	1.6		0.18	16.8	17	0.22
Non HT20, 6 to 54 Mbps	2	15	-1.2	-1.8	0.18	16.7	17	0.3
Non HT20 Beam Forming, 6 to 54 Mbps	2	15	-1.2	-1.8	0.18	16.7	17	0.3
HT/VHT20, M0 to M7	1	15	0.8		0.22	16.0	17	0.97
HT/VHT20, M0 to M7	2	15	-1.8	-1.9	0.22	16.4	17	0.59
HT/VHT20, M8 to M15	2	15	-1.8	-1.9	0.22	16.4	17	0.59
HT/VHT20 Beam Forming, M0 to M7	2	15	-1.8	-1.9	0.22	16.4	17	0.59
HT/VHT20 Beam Forming, M8 to M15	2	15	-1.8	-1.9	0.22	16.4	17	0.59
HT/VHT20 STBC, M8 to M15	2	15	-1.8	-1.9	0.22	16.4	17	0.59
<b>HE20, M0 to M11 1ss</b>	<b>1</b>	<b>15</b>	<b>1.7</b>		<b>0.2</b>	<b>16.9</b>	<b>17</b>	<b>0.08</b>
HE20, M0 to M11 1ss	2	15	-2.0	-2.3	0.2	16.1	17	0.92
HE20, M0 to M11 2ss	2	15	-2.0	-2.3	0.2	16.1	17	0.92
HE20 Beam Forming, M0 to M11 1ss	2	15	-2.0	-2.3	0.2	16.1	17	0.92
HE20 Beam Forming, M0 to M11 2ss	2	15	-2.0	-2.3	0.2	16.1	17	0.92
HE20 STBC, M0 to M11 2ss	2	15	-2.0	-2.3	0.2	16.1	17	0.92

## Frequency 5270 MHz

Mode	Tx Paths	Correlated Antenna Gain (dBi)	Tx 1 PSD (dBm/MHz)	Tx 2 PSD (dBm/MHz)	Duty Cycle (dB)	Total PSD (dBm/MHz)	Limit (dBm/MHz)	Margin (dB)
Non HT40, 6 to 54 Mbps	1	15	0.4		0.3	15.7	17	1.32
Non HT40, 6 to 54 Mbps	2	15	-1.8	-1.9	0.3	16.5	17	0.53
HT/VHT40, M0 to M7	1	15	0.1		0.55	15.6	17	1.38
HT/VHT40, M0 to M7	2	15	-2.1	-2.2	0.55	16.4	17	0.6
HT/VHT40, M8 to M15	2	15	-2.1	-2.2	0.55	16.4	17	0.6
HT/VHT40 Beam Forming, M0 to M7	2	15	-2.1	-2.2	0.55	16.4	17	0.6
HT/VHT40 Beam Forming, M8 to M15	2	15	-2.1	-2.2	0.55	16.4	17	0.6
HT/VHT40 STBC, M8 to M15	2	15	-2.1	-2.2	0.55	16.4	17	0.6
HE40, M0 to M11 1ss	1	15	1.1		0.27	16.3	17	0.68
HE40, M0 to M11 1ss	2	15	-2.3	-2.7	0.27	15.8	17	1.23
HE40, M0 to M11 2ss	2	15	-2.3	-2.7	0.27	15.8	17	1.23
HE40 Beam Forming, M0 to M11 1ss	2	15	-2.3	-2.7	0.27	15.8	17	1.23
HE40 Beam Forming, M0 to M11 2ss	2	15	-2.3	-2.7	0.27	15.8	17	1.23
HE40 STBC, M0 to M11 2ss	2	15	-2.3	-2.7	0.27	15.8	17	1.23



## Frequency 5290 MHz

Mode	Tx Paths	Correlated Antenna Gain (dBi)	Tx 1 PSD (dBm/MHz)	Tx 2 PSD (dBm/MHz)	Duty Cycle (dB)	Total PSD (dBm/MHz)	Limit (dBm/MHz)	Margin (dB)
Non HT80, 6 to 54 Mbps	1	15	-3.4		0.36	12.0	17	5.03
Non HT80, 6 to 54 Mbps	2	15	-5.0	-5.0	0.36	13.4	17	3.65
VHT80, M0 to M11 1ss	1	15	-3.5		0.55	12.1	17	4.95
VHT80, M0 to M11 1ss	2	15	-7.1	-6.3	0.55	11.9	17	5.13
VHT80, M0 to M11 2ss	2	15	-7.1	-6.3	0.55	11.9	17	5.13
VHT80 Beam Forming, M0 to M11 1ss	2	15	-7.1	-6.3	0.55	11.9	17	5.13
VHT80 Beam Forming, M0 to M11 2ss	2	15	-7.1	-6.3	0.55	11.9	17	5.13
VHT80 STBC, M0 to M11 2ss	2	15	-7.1	-6.3	0.55	11.9	17	5.13
HE80, M0 to M11 1ss	1	15	-4.4		0.22	10.8	17	6.16
HE80, M0 to M11 1ss	2	15	-6.8	-6.5	0.22	11.6	17	5.43
HE80, M0 to M11 2ss	2	15	-6.8	-6.5	0.22	11.6	17	5.43
HE80 Beam Forming, M0 to M11 1ss	2	15	-6.8	-6.5	0.22	11.6	17	5.43
HE80 Beam Forming, M0 to M11 2ss	2	15	-6.8	-6.5	0.22	11.6	17	5.43
HE80 STBC, M0 to M11 2ss	2	15	-6.8	-6.5	0.22	11.6	17	5.43

## Frequency 5300 MHz

Mode	Tx Paths	Correlated Antenna Gain (dBi)	Tx 1 PSD (dBm/MHz)	Tx 2 PSD (dBm/MHz)	Duty Cycle (dB)	Total PSD (dBm/MHz)	Limit (dBm/MHz)	Margin (dB)
Non HT20, 6 to 54 Mbps	1	15	0.8		0.18	16.0	17	1.02
Non HT20, 6 to 54 Mbps	2	15	-1.5	-1.2	0.18	16.8	17	0.17
Non HT20 Beam Forming, 6 to 54 Mbps	2	15	-1.5	-1.2	0.18	16.8	17	0.17
HT/VHT20, M0 to M7	1	15	1.3		0.22	16.5	17	0.49
HT/VHT20, M0 to M7	2	15	-2.0	-1.6	0.22	16.4	17	0.56
HT/VHT20, M8 to M15	2	15	-2.0	-1.6	0.22	16.4	17	0.56
HT/VHT20 Beam Forming, M0 to M7	2	15	-2.0	-1.6	0.22	16.4	17	0.56
HT/VHT20 Beam Forming, M8 to M15	2	15	-2.0	-1.6	0.22	16.4	17	0.56
HT/VHT20 STBC, M8 to M15	2	15	-2.0	-1.6	0.22	16.4	17	0.56
HE20, M0 to M11 1ss	1	15	0.9		0.2	16.1	17	0.87
HE20, M0 to M11 1ss	2	15	-2.3	-2.0	0.2	16.1	17	0.92
HE20, M0 to M11 2ss	2	15	-2.3	-2.0	0.2	16.1	17	0.92
HE20 Beam Forming, M0 to M11 1ss	2	15	-2.3	-2.0	0.2	16.1	17	0.92
HE20 Beam Forming, M0 to M11 2ss	2	15	-2.3	-2.0	0.2	16.1	17	0.92
HE20 STBC, M0 to M11 2ss	2	15	-2.3	-2.0	0.2	16.1	17	0.92

## Frequency 5310 MHz

Mode	Tx Paths	Correlated Antenna Gain (dBi)	Tx 1 PSD (dBm/MHz)	Tx 2 PSD (dBm/MHz)	Duty Cycle (dB)	Total PSD (dBm/MHz)	Limit (dBm/MHz)	Margin (dB)
Non HT40, 6 to 54 Mbps	1	15	0.8		0.3	16.1	17	0.88
Non HT40, 6 to 54 Mbps	2	15	-1.9	-1.8	0.3	16.5	17	0.53
HT/VHT40, M0 to M7	1	15	-0.5		0.55	15.1	17	1.95
HT/VHT40, M0 to M7	2	15	-2.4	-2.1	0.55	16.3	17	0.68
HT/VHT40, M8 to M15	2	15	-2.4	-2.1	0.55	16.3	17	0.68
HT/VHT40 Beam Forming, M0 to M7	2	15	-2.4	-2.1	0.55	16.3	17	0.68
HT/VHT40 Beam Forming, M8 to M15	2	15	-2.4	-2.1	0.55	16.3	17	0.68
HT/VHT40 STBC, M8 to M15	2	15	-2.4	-2.1	0.55	16.3	17	0.68
HE40, M0 to M11 1ss	1	15	-0.6		0.27	14.7	17	2.28
HE40, M0 to M11 1ss	2	15	-2.5	-2.6	0.27	15.7	17	1.27
HE40, M0 to M11 2ss	2	15	-2.5	-2.6	0.27	15.7	17	1.27
HE40 Beam Forming, M0 to M11 1ss	2	15	-2.5	-2.6	0.27	15.7	17	1.27
HE40 Beam Forming, M0 to M11 2ss	2	15	-2.5	-2.6	0.27	15.7	17	1.27
HE40 STBC, M0 to M11 2ss	2	15	-2.5	-2.6	0.27	15.7	17	1.27

## Frequency 5320 MHz

Mode	Tx Paths	Correlated Antenna Gain (dBi)	Tx 1 PSD (dBm/MHz)	Tx 2 PSD (dBm/MHz)	Duty Cycle (dB)	Total PSD (dBm/MHz)	Limit (dBm/MHz)	Margin (dB)
Non HT20, 6 to 54 Mbps	1	15	0.8		0.18	16.0	17	1.0
<b>Non HT20, 6 to 54 Mbps</b>	<b>2</b>	<b>15</b>	<b>-1.4</b>	<b>-1.1</b>	<b>0.18</b>	<b>17.0</b>	<b>17</b>	<b>0.05</b>
<b>Non HT20 Beam Forming, 6 to 54 Mbps</b>	<b>2</b>	<b>15</b>	<b>-1.4</b>	<b>-1.1</b>	<b>0.18</b>	<b>17.0</b>	<b>17</b>	<b>0.05</b>
HT/VHT20, M0 to M7	1	15	1.5		0.22	16.7	17	0.31
HT/VHT20, M0 to M7	2	15	-2.0	-2.3	0.22	16.1	17	0.88
HT/VHT20, M8 to M15	2	15	-2.0	-2.3	0.22	16.1	17	0.88
HT/VHT20 Beam Forming, M0 to M7	2	15	-2.0	-2.3	0.22	16.1	17	0.88
HT/VHT20 Beam Forming, M8 to M15	2	15	-2.0	-2.3	0.22	16.1	17	0.88
HT/VHT20 STBC, M8 to M15	2	15	-2.0	-2.3	0.22	16.1	17	0.88
HE20, M0 to M11 1ss	1	15	1.1		0.2	16.3	17	0.69
HE20, M0 to M11 1ss	2	15	-2.0	-2.2	0.2	16.1	17	0.92
HE20, M0 to M11 2ss	2	15	-2.0	-2.2	0.2	16.1	17	0.92
HE20 Beam Forming, M0 to M11 1ss	2	15	-2.0	-2.2	0.2	16.1	17	0.92
HE20 Beam Forming, M0 to M11 2ss	2	15	-2.0	-2.2	0.2	16.1	17	0.92
HE20 STBC, M0 to M11 2ss	2	15	-2.0	-2.2	0.2	16.1	17	0.92

**Power Spectral Density – Conducted****Frequency 5260 MHz**

<b>Mode</b>	<b>Tx Paths</b>	<b>Correlated Antenna Gain (dBi)</b>	<b>Tx 1 PSD (dBm/MHz)</b>	<b>Tx 2 PSD (dBm/MHz)</b>	<b>Duty Cycle (dB)</b>	<b>Total PSD (dBm/MHz)</b>	<b>Limit (dBm/MHz)</b>	<b>Margin (dB)</b>
Non HT20, 6 to 54 Mbps	1	15	1.6		0.18	1.8	11	9.22
Non HT20, 6 to 54 Mbps	2	15	-1.2	-1.8	0.18	1.7	11	9.3
Non HT20 Beam Forming, 6 to 54 Mbps	2	15	-1.2	-1.8	0.18	1.7	11	9.3
HT/VHT20, M0 to M7	1	15	0.8		0.22	1.0	11	9.97
HT/VHT20, M0 to M7	2	15	-1.8	-1.9	0.22	1.4	11	9.59
HT/VHT20, M8 to M15	2	15	-1.8	-1.9	0.22	1.4	11	9.59
HT/VHT20 Beam Forming, M0 to M7	2	15	-1.8	-1.9	0.22	1.4	11	9.59
HT/VHT20 Beam Forming, M8 to M15	2	15	-1.8	-1.9	0.22	1.4	11	9.59
HT/VHT20 STBC, M8 to M15	2	15	-1.8	-1.9	0.22	1.4	11	9.59
<b>HE20, M0 to M11 1ss</b>	<b>1</b>	<b>15</b>	<b>1.7</b>		<b>0.2</b>	<b>1.9</b>	<b>11</b>	<b>9.08</b>
HE20, M0 to M11 1ss	2	15	-2.0	-2.3	0.2	1.1	11	9.92
HE20, M0 to M11 2ss	2	15	-2.0	-2.3	0.2	1.1	11	9.92
HE20 Beam Forming, M0 to M11 1ss	2	15	-2.0	-2.3	0.2	1.1	11	9.92
HE20 Beam Forming, M0 to M11 2ss	2	15	-2.0	-2.3	0.2	1.1	11	9.92
HE20 STBC, M0 to M11 2ss	2	15	-2.0	-2.3	0.2	1.1	11	9.92

**Frequency 5270 MHz**

<b>Mode</b>	<b>Tx Paths</b>	<b>Correlated Antenna Gain (dBi)</b>	<b>Tx 1 PSD (dBm/MHz)</b>	<b>Tx 2 PSD (dBm/MHz)</b>	<b>Duty Cycle (dB)</b>	<b>Total PSD (dBm/MHz)</b>	<b>Limit (dBm/MHz)</b>	<b>Margin (dB)</b>
Non HT40, 6 to 54 Mbps	1	15	0.4		0.3	0.7	11	10.32
Non HT40, 6 to 54 Mbps	2	15	-1.8	-1.9	0.3	1.5	11	9.53
HT/VHT40, M0 to M7	1	15	0.1		0.55	0.6	11	10.38
HT/VHT40, M0 to M7	2	15	-2.1	-2.2	0.55	1.4	11	9.6
HT/VHT40, M8 to M15	2	15	-2.1	-2.2	0.55	1.4	11	9.6
HT/VHT40 Beam Forming, M0 to M7	2	15	-2.1	-2.2	0.55	1.4	11	9.6
HT/VHT40 Beam Forming, M8 to M15	2	15	-2.1	-2.2	0.55	1.4	11	9.6
HT/VHT40 STBC, M8 to M15	2	15	-2.1	-2.2	0.55	1.4	11	9.6
HE40, M0 to M11 1ss	1	15	1.1		0.27	1.3	11	9.68
HE40, M0 to M11 1ss	2	15	-2.3	-2.7	0.27	0.8	11	10.23
HE40, M0 to M11 2ss	2	15	-2.3	-2.7	0.27	0.8	11	10.23
HE40 Beam Forming, M0 to M11 1ss	2	15	-2.3	-2.7	0.27	0.8	11	10.23
HE40 Beam Forming, M0 to M11 2ss	2	15	-2.3	-2.7	0.27	0.8	11	10.23
HE40 STBC, M0 to M11 2ss	2	15	-2.3	-2.7	0.27	0.8	11	10.23

## Frequency 5290 MHz

Mode	Tx Paths	Correlated Antenna Gain (dBi)	Tx 1 PSD (dBm/MHz)	Tx 2 PSD (dBm/MHz)	Duty Cycle (dB)	Total PSD (dBm/MHz)	Limit (dBm/MHz)	Margin (dB)
Non HT80, 6 to 54 Mbps	1	15	-3.4		0.36	-3.0	11	14.03
Non HT80, 6 to 54 Mbps	2	15	-5.0	-5.0	0.36	-1.6	11	12.65
VHT80, M0 to M11 1ss	1	15	-3.5		0.55	-2.9	11	13.95
VHT80, M0 to M11 1ss	2	15	-7.1	-6.3	0.55	-3.1	11	14.13
VHT80, M0 to M11 2ss	2	15	-7.1	-6.3	0.55	-3.1	11	14.13
VHT80 Beam Forming, M0 to M11 1ss	2	15	-7.1	-6.3	0.55	-3.1	11	14.13
VHT80 Beam Forming, M0 to M11 2ss	2	15	-7.1	-6.3	0.55	-3.1	11	14.13
VHT80 STBC, M0 to M11 2ss	2	15	-7.1	-6.3	0.55	-3.1	11	14.13
HE80, M0 to M11 1ss	1	15	-4.4		0.22	-4.2	11	15.16
HE80, M0 to M11 1ss	2	15	-6.8	-6.5	0.22	-3.4	11	14.43
HE80, M0 to M11 2ss	2	15	-6.8	-6.5	0.22	-3.4	11	14.43
HE80 Beam Forming, M0 to M11 1ss	2	15	-6.8	-6.5	0.22	-3.4	11	14.43
HE80 Beam Forming, M0 to M11 2ss	2	15	-6.8	-6.5	0.22	-3.4	11	14.43
HE80 STBC, M0 to M11 2ss	2	15	-6.8	-6.5	0.22	-3.4	11	14.43

## Frequency 5300 MHz

Mode	Tx Paths	Correlated Antenna Gain (dBi)	Tx 1 PSD (dBm/MHz)	Tx 2 PSD (dBm/MHz)	Duty Cycle (dB)	Total PSD (dBm/MHz)	Limit (dBm/MHz)	Margin (dB)
Non HT20, 6 to 54 Mbps	1	15	0.8		0.18	1.0	11	10.02
Non HT20, 6 to 54 Mbps	2	15	-1.5	-1.2	0.18	1.8	11	9.17
Non HT20 Beam Forming, 6 to 54 Mbps	2	15	-1.5	-1.2	0.18	1.8	11	9.17
HT/VHT20, M0 to M7	1	15	1.3		0.22	1.5	11	9.49
HT/VHT20, M0 to M7	2	15	-2.0	-1.6	0.22	1.4	11	9.56
HT/VHT20, M8 to M15	2	15	-2.0	-1.6	0.22	1.4	11	9.56
HT/VHT20 Beam Forming, M0 to M7	2	15	-2.0	-1.6	0.22	1.4	11	9.56
HT/VHT20 Beam Forming, M8 to M15	2	15	-2.0	-1.6	0.22	1.4	11	9.56
HT/VHT20 STBC, M8 to M15	2	15	-2.0	-1.6	0.22	1.4	11	9.56
HE20, M0 to M11 1ss	1	15	0.9		0.2	1.1	11	9.87
HE20, M0 to M11 1ss	2	15	-2.3	-2.0	0.2	1.1	11	9.92
HE20, M0 to M11 2ss	2	15	-2.3	-2.0	0.2	1.1	11	9.92
HE20 Beam Forming, M0 to M11 1ss	2	15	-2.3	-2.0	0.2	1.1	11	9.92
HE20 Beam Forming, M0 to M11 2ss	2	15	-2.3	-2.0	0.2	1.1	11	9.92
HE20 STBC, M0 to M11 2ss	2	15	-2.3	-2.0	0.2	1.1	11	9.92

**Frequency 5310 MHz**

<b>Mode</b>	<b>Tx Paths</b>	<b>Correlated Antenna Gain (dBi)</b>	<b>Tx 1 PSD (dBm/MHz)</b>	<b>Tx 2 PSD (dBm/MHz)</b>	<b>Duty Cycle (dB)</b>	<b>Total PSD (dBm/MHz)</b>	<b>Limit (dBm/MHz)</b>	<b>Margin (dB)</b>
Non HT40, 6 to 54 Mbps	1	15	0.8		0.3	1.1	11	9.88
Non HT40, 6 to 54 Mbps	2	15	-1.9	-1.8	0.3	1.5	11	9.53
HT/VHT40, M0 to M7	1	15	-0.5		0.55	0.1	11	10.95
HT/VHT40, M0 to M7	2	15	-2.4	-2.1	0.55	1.3	11	9.68
HT/VHT40, M8 to M15	2	15	-2.4	-2.1	0.55	1.3	11	9.68
HT/VHT40 Beam Forming, M0 to M7	2	15	-2.4	-2.1	0.55	1.3	11	9.68
HT/VHT40 Beam Forming, M8 to M15	2	15	-2.4	-2.1	0.55	1.3	11	9.68
HT/VHT40 STBC, M8 to M15	2	15	-2.4	-2.1	0.55	1.3	11	9.68
HE40, M0 to M11 1ss	1	15	-0.6		0.27	-0.3	11	11.28
HE40, M0 to M11 1ss	2	15	-2.5	-2.6	0.27	0.7	11	10.28
HE40, M0 to M11 2ss	2	15	-2.5	-2.6	0.27	0.7	11	10.28
HE40 Beam Forming, M0 to M11 1ss	2	15	-2.5	-2.6	0.27	0.7	11	10.28
HE40 Beam Forming, M0 to M11 2ss	2	15	-2.5	-2.6	0.27	0.7	11	10.28
HE40 STBC, M0 to M11 2ss	2	15	-2.5	-2.6	0.27	0.7	11	10.28

**Frequency 5320 MHz**

<b>Mode</b>	<b>Tx Paths</b>	<b>Correlated Antenna Gain (dBi)</b>	<b>Tx 1 PSD (dBm/MHz)</b>	<b>Tx 2 PSD (dBm/MHz)</b>	<b>Duty Cycle (dB)</b>	<b>Total PSD (dBm/MHz)</b>	<b>Limit (dBm/MHz)</b>	<b>Margin (dB)</b>
Non HT20, 6 to 54 Mbps	1	15	0.8		0.18	1.0	11	10.0
<b>Non HT20, 6 to 54 Mbps</b>	<b>2</b>	<b>15</b>	<b>-1.4</b>	<b>-1.1</b>	<b>0.18</b>	<b>2.0</b>	<b>11</b>	<b>9.05</b>
<b>Non HT20 Beam Forming, 6 to 54 Mbps</b>	<b>2</b>	<b>15</b>	<b>-1.4</b>	<b>-1.1</b>	<b>0.18</b>	<b>2.0</b>	<b>11</b>	<b>9.05</b>
HT/VHT20, M0 to M7	1	15	1.5		0.22	1.7	11	9.31
HT/VHT20, M0 to M7	2	15	-2.0	-2.3	0.22	1.1	11	9.88
HT/VHT20, M8 to M15	2	15	-2.0	-2.3	0.22	1.1	11	9.88
HT/VHT20 Beam Forming, M0 to M7	2	15	-2.0	-2.3	0.22	1.1	11	9.88
HT/VHT20 Beam Forming, M8 to M15	2	15	-2.0	-2.3	0.22	1.1	11	9.88
HT/VHT20 STBC, M8 to M15	2	15	-2.0	-2.3	0.22	1.1	11	9.88
HE20, M0 to M11 1ss	1	15	1.1		0.2	1.3	11	9.69
HE20, M0 to M11 1ss	2	15	-2.0	-2.2	0.2	1.1	11	9.92
HE20, M0 to M11 2ss	2	15	-2.0	-2.2	0.2	1.1	11	9.92
HE20 Beam Forming, M0 to M11 1ss	2	15	-2.0	-2.2	0.2	1.1	11	9.92
HE20 Beam Forming, M0 to M11 2ss	2	15	-2.0	-2.2	0.2	1.1	11	9.92
HE20 STBC, M0 to M11 2ss	2	15	-2.0	-2.2	0.2	1.1	11	9.92

## Data Screenshots

5320 MHz: Non HT20, 6 to 54 Mbps

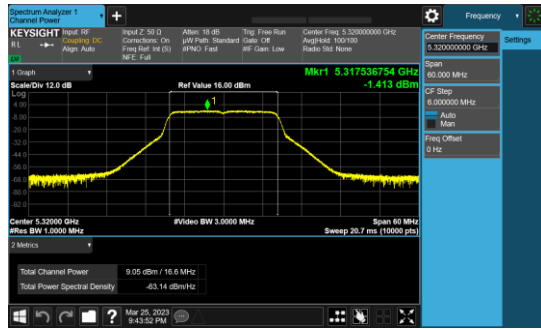

Antenna A

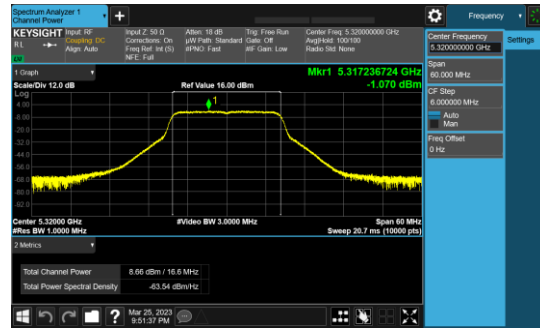

Antenna B

5320 MHz: Non HT20 Beam Forming, 6 to 54 Mbps

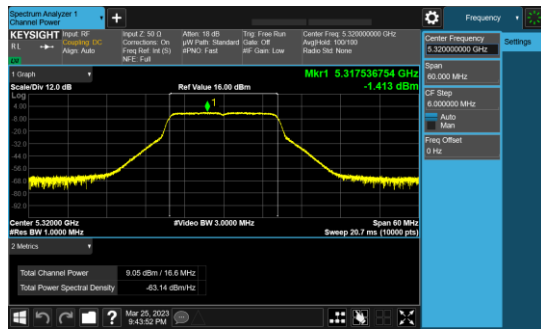

Antenna A

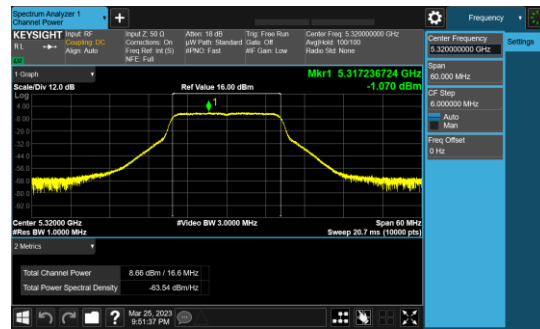

Antenna B

5260 MHz: HE20, M0 to M11 1ss

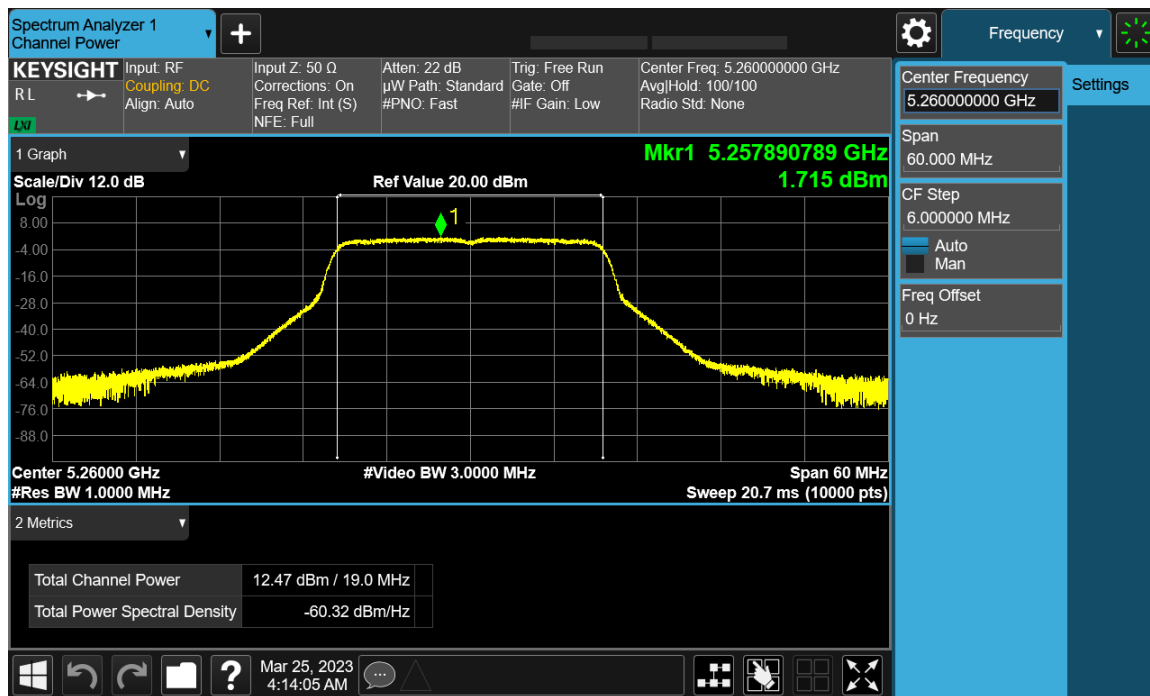

Antenna A

## **A.5: Conducted Spurious Emissions**

### **Conducted Spurious Emissions Test Requirement**

#### **15.407(b):**

*Undesirable emission limits.* Except as shown in paragraph (b)(7) of this section, the maximum emissions outside of the frequency bands of operation shall be attenuated in accordance with the following limits:

- (2) For transmitters operating in the 5.25-5.35 GHz band: All emissions outside of the 5.15-5.35 GHz band shall not exceed an e.i.r.p. of -27 dBm/MHz.
- (6) Unwanted emissions below 1 GHz must comply with the general field strength limits set forth in §15.209.
- (7) The provisions of §15.205 apply to intentional radiators operating under this section.

Use formula below to substitute conducted measurements in place of radiated measurements

$E[\text{dB}\mu\text{V}/\text{m}] = \text{EIRP}[\text{dBm}] - 20 \log(d[\text{meters}]) + 104.77$ , where E = field strength and d = 3 meter

- 1) Average Plot, Limit= -41.25 dBm eirp
- 2) Peak plot, Limit = -21.25 dBm eirp

### **Conducted Spurious Emissions Test Procedure**

Ref. **ANSI C63.10: 2013**

**KDB 789033 D02 General UNII Test Procedures New Rules v02r01**

<b>Conducted Spurious Emissions Test Procedure</b>
<ol style="list-style-type: none"><li>1. Connect the antenna port(s) to the spectrum analyzer input.</li><li>2. Place the radio in continuous transmit mode</li><li>3. Configure Spectrum analyzer as per test parameters below (be sure to enter all losses between the transmitter output and the spectrum analyzer).</li><li>4. Use the peak marker function to determine the maximum spurs amplitude level.</li><li>5. The "measure-and-sum technique" is used for measuring in-band transmit power of a device. In the measure-and-sum approach, the conducted emission level is measured at each antenna port. The measured results at the various antenna ports are then summed mathematically to determine the total emission level from the device. Summing is performed in linear power units. The worst case output is recorded. (see ANSI C63.10:2013 section 14.3.2.2)</li><li>6. Capture graphs and record pertinent measurement data.</li></ol>

Radio Test Report No: **EDCS # 24339408**

**Ref. ANSI C63.10: 2013 section 12.7.6 (Peak) and 12.7.7.2 (Average)  
KDB 789033 D02 General UNII Test Procedures New Rules v02r01, Sec. 5 (Peak), Sec. 6 (Average Method AD)**

<b>Conducted Spurious Emissions</b> Test parameters	
<b>Peak</b> RBW = 1 MHz VBW ≥ 3 MHz Sweep = Auto Detector = Peak Trace = Max Hold.	<b>Average</b> RBW = 1 MHz VBW ≥ 3 MHz Sweep = Auto Detector = RMS Power Averaging

Add the max antenna gain + ground reflection factor (4.7 dB for frequencies between 30 MHz and 1000 MHz, and 0 dB for frequencies > 1000 MHz).

<b>Tested By:</b> Ronak Patel	<b>Date of testing:</b> 3/22/2023 - 6/2/2023
<b>Test Result: PASS</b>	

**Test Equipment**

See Appendix C for list of test equipment

**Note:**

1. Although 100kHz RBW is required for emissions below 1GHz, 1MHz RBW was used in order to show compliance under worst-case setting
2. Emissions above 12GHz are only noise floor and that data can be additionally shown in radiated report



**Conducted Spurious emissions - Average****Frequency 5260 MHz**

<b>Mode</b>	<b>Tx Paths</b>	<b>Correlated Antenna Gain (dBi)</b>	<b>Tx 1 Spur Power (dBm)</b>	<b>Tx 2 Spur Power (dBm)</b>	<b>Duty Cycle (dB)</b>	<b>Total Conducted Spur (dBm)</b>	<b>Limit (dB)</b>	<b>Margin (dB)</b>
Non HT20, 6 to 54 Mbps	1	15	-59.2		0.18	-44.0	-41	2.77
Non HT20, 6 to 54 Mbps	2	15	-59.2	-62.3	0.18	-42.3	-41	1.04
Non HT20 Beam Forming, 6 to 54 Mbps	2	15	-59.2	-62.3	0.18	-42.3	-41	1.04
HT/VHT20, M0 to M7	1	15	-59.5		0.22	-44.3	-41	3.03
HT/VHT20, M0 to M7	2	15	-59.6	-62.6	0.22	-42.6	-41	1.36
HT/VHT20, M8 to M15	2	15	-59.6	-62.6	0.22	-42.6	-41	1.36
HT/VHT20 Beam Forming, M0 to M7	2	15	-59.6	-62.6	0.22	-42.6	-41	1.36
HT/VHT20 Beam Forming, M8 to M15	2	15	-59.6	-62.6	0.22	-42.6	-41	1.36
HT/VHT20 STBC, M8 to M15	2	15	-59.6	-62.6	0.22	-42.6	-41	1.36
HE20, M0 to M11 1ss	1	15	-59.3		0.2	-44.1	-41	2.85
<b>HE20, M0 to M11 1ss</b>	<b>2</b>	<b>15</b>	<b>-58.9</b>	<b>-62.1</b>	<b>0.2</b>	<b>-42.0</b>	<b>-41</b>	<b>0.75</b>
<b>HE20, M0 to M11 2ss</b>	<b>2</b>	<b>15</b>	<b>-58.9</b>	<b>-62.1</b>	<b>0.2</b>	<b>-42.0</b>	<b>-41</b>	<b>0.75</b>
<b>HE20 Beam Forming, M0 to M11 1ss</b>	<b>2</b>	<b>15</b>	<b>-58.9</b>	<b>-62.1</b>	<b>0.2</b>	<b>-42.0</b>	<b>-41</b>	<b>0.75</b>
HE20 Beam Forming, M0 to M11 2ss	2	15	-58.9	-62.1	0.2	-42.0	-41	0.75
HE20 STBC, M0 to M11 2ss	2	15	-58.9	-62.1	0.2	-42.0	-41	0.75

**Frequency 5270 MHz**

<b>Mode</b>	<b>Tx Paths</b>	<b>Correlated Antenna Gain (dBi)</b>	<b>Tx 1 Spur Power (dBm)</b>	<b>Tx 2 Spur Power (dBm)</b>	<b>Duty Cycle (dB)</b>	<b>Total Conducted Spur (dBm)</b>	<b>Limit (dB)</b>	<b>Margin (dB)</b>
Non HT40, 6 to 54 Mbps	1	15	-61.0		0.3	-45.7	-41	4.45
Non HT40, 6 to 54 Mbps	2	15	-61.0	-63.0	0.3	-43.6	-41	2.33
HT/VHT40, M0 to M7	1	15	-61.0		0.55	-45.4	-41	4.2
HT/VHT40, M0 to M7	2	15	-61.4	-63.1	0.55	-43.6	-41	2.35
HT/VHT40, M8 to M15	2	15	-61.4	-63.1	0.55	-43.6	-41	2.35
HT/VHT40 Beam Forming, M0 to M7	2	15	-61.4	-63.1	0.55	-43.6	-41	2.35
HT/VHT40 Beam Forming, M8 to M15	2	15	-61.4	-63.1	0.55	-43.6	-41	2.35
HT/VHT40 STBC, M8 to M15	2	15	-61.4	-63.1	0.55	-43.6	-41	2.35
HE40, M0 to M11 1ss	1	15	-60.7		0.27	-45.4	-41	4.18
HE40, M0 to M11 1ss	2	15	-60.7	-62.3	0.27	-43.1	-41	1.9
HE40, M0 to M11 2ss	2	15	-60.7	-62.3	0.27	-43.1	-41	1.9
HE40 Beam Forming, M0 to M11 1ss	2	15	-60.7	-62.3	0.27	-43.1	-41	1.9
HE40 Beam Forming, M0 to M11 2ss	2	15	-60.7	-62.3	0.27	-43.1	-41	1.9
HE40 STBC, M0 to M11 2ss	2	15	-60.7	-62.3	0.27	-43.1	-41	1.9

**Frequency 5290 MHz**

<b>Mode</b>	<b>Tx Paths</b>	<b>Correlated Antenna Gain (dBi)</b>	<b>Tx 1 Spur Power (dBm)</b>	<b>Tx 2 Spur Power (dBm)</b>	<b>Duty Cycle (dB)</b>	<b>Total Conducted Spur (dBm)</b>	<b>Limit (dB)</b>	<b>Margin (dB)</b>
Non HT80, 6 to 54 Mbps	1	15	-64.1		0.36	-48.7	-41	7.49
Non HT80, 6 to 54 Mbps	2	15	-64.5	-62.6	0.36	-45.1	-41	3.83
VHT80, M0 to M11 1ss	1	15	-63.3		0.55	-47.8	-41	6.5
VHT80, M0 to M11 1ss	2	15	-65.0	-62.8	0.55	-45.2	-41	3.95
VHT80, M0 to M11 2ss	2	15	-65.0	-62.8	0.55	-45.2	-41	3.95
VHT80 Beam Forming, M0 to M11 1ss	2	15	-65.0	-62.8	0.55	-45.2	-41	3.95
VHT80 Beam Forming, M0 to M11 2ss	2	15	-65.0	-62.8	0.55	-45.2	-41	3.95
VHT80 STBC, M0 to M11 2ss	2	15	-65.0	-62.8	0.55	-45.2	-41	3.95
HE80, M0 to M11 1ss	1	15	-64.2		0.22	-49.0	-41	7.73
HE80, M0 to M11 1ss	2	15	-64.3	-62.3	0.22	-45.0	-41	3.71
HE80, M0 to M11 2ss	2	15	-64.3	-62.3	0.22	-45.0	-41	3.71
HE80 Beam Forming, M0 to M11 1ss	2	15	-64.3	-62.3	0.22	-45.0	-41	3.71
HE80 Beam Forming, M0 to M11 2ss	2	15	-64.3	-62.3	0.22	-45.0	-41	3.71
HE80 STBC, M0 to M11 2ss	2	15	-64.3	-62.3	0.22	-45.0	-41	3.71

**Frequency 5300 MHz**

<b>Mode</b>	<b>Tx Paths</b>	<b>Correlated Antenna Gain (dBi)</b>	<b>Tx 1 Spur Power (dBm)</b>	<b>Tx 2 Spur Power (dBm)</b>	<b>Duty Cycle (dB)</b>	<b>Total Conducted Spur (dBm)</b>	<b>Limit (dB)</b>	<b>Margin (dB)</b>
Non HT20, 6 to 54 Mbps	1	15	-64.1		0.18	-48.9	-41	7.67
Non HT20, 6 to 54 Mbps	2	15	-64.4	-62.5	0.18	-45.2	-41	3.91
Non HT20 Beam Forming, 6 to 54 Mbps	2	15	-64.4	-62.5	0.18	-45.2	-41	3.91
HT/VHT20, M0 to M7	1	15	-64.2		0.22	-49.0	-41	7.73
HT/VHT20, M0 to M7	2	15	-64.5	-63.0	0.22	-45.5	-41	4.2
HT/VHT20, M8 to M15	2	15	-64.5	-63.0	0.22	-45.5	-41	4.2
HT/VHT20 Beam Forming, M0 to M7	2	15	-64.5	-63.0	0.22	-45.5	-41	4.2
HT/VHT20 Beam Forming, M8 to M15	2	15	-64.5	-63.0	0.22	-45.5	-41	4.2
HT/VHT20 STBC, M8 to M15	2	15	-64.5	-63.0	0.22	-45.5	-41	4.2
HE20, M0 to M11 1ss	1	15	-64.1		0.2	-48.9	-41	7.65
HE20, M0 to M11 1ss	2	15	-64.2	-62.8	0.2	-45.2	-41	3.98
HE20, M0 to M11 2ss	2	15	-64.2	-62.8	0.2	-45.2	-41	3.98
HE20 Beam Forming, M0 to M11 1ss	2	15	-64.2	-62.8	0.2	-45.2	-41	3.98
HE20 Beam Forming, M0 to M11 2ss	2	15	-64.2	-62.8	0.2	-45.2	-41	3.98
HE20 STBC, M0 to M11 2ss	2	15	-64.2	-62.8	0.2	-45.2	-41	3.98

## Frequency 5310 MHz

Mode	Tx Paths	Correlated Antenna Gain (dBi)	Tx 1 Spur Power (dBm)	Tx 2 Spur Power (dBm)	Duty Cycle (dB)	Total Conducted Spur (dBm)	Limit (dB)	Margin (dB)
Non HT40, 6 to 54 Mbps	1	15	-63.0		0.3	-47.7	-41	6.45
Non HT40, 6 to 54 Mbps	2	15	-64.3	-62.3	0.3	-44.9	-41	3.63
HT/VHT40, M0 to M7	1	15	-63.0		0.55	-47.4	-41	6.2
HT/VHT40, M0 to M7	2	15	-64.4	-62.5	0.55	-44.8	-41	3.53
HT/VHT40, M8 to M15	2	15	-64.4	-62.5	0.55	-44.8	-41	3.53
HT/VHT40 Beam Forming, M0 to M7	2	15	-64.4	-62.5	0.55	-44.8	-41	3.53
HT/VHT40 Beam Forming, M8 to M15	2	15	-64.4	-62.5	0.55	-44.8	-41	3.53
HT/VHT40 STBC, M8 to M15	2	15	-64.4	-62.5	0.55	-44.8	-41	3.53
HE40, M0 to M11 1ss	1	15	-62.6		0.27	-47.3	-41	6.08
HE40, M0 to M11 1ss	2	15	-64.0	-62.3	0.27	-44.8	-41	3.54
HE40, M0 to M11 2ss	2	15	-64.0	-62.3	0.27	-44.8	-41	3.54
HE40 Beam Forming, M0 to M11 1ss	2	15	-64.0	-62.3	0.27	-44.8	-41	3.54
HE40 Beam Forming, M0 to M11 2ss	2	15	-64.0	-62.3	0.27	-44.8	-41	3.54
HE40 STBC, M0 to M11 2ss	2	15	-64.0	-62.3	0.27	-44.8	-41	3.54

## Frequency 5320 MHz

Mode	Tx Paths	Correlated Antenna Gain (dBi)	Tx 1 Spur Power (dBm)	Tx 2 Spur Power (dBm)	Duty Cycle (dB)	Total Conducted Spur (dBm)	Limit (dB)	Margin (dB)
Non HT20, 6 to 54 Mbps	1	15	-64.1		0.18	-48.9	-41	7.67
Non HT20, 6 to 54 Mbps	2	15	-63.7	-62.5	0.18	-44.9	-41	3.62
Non HT20 Beam Forming, 6 to 54 Mbps	2	15	-63.7	-62.5	0.18	-44.9	-41	3.62
HT/VHT20, M0 to M7	1	15	-64.1		0.22	-48.9	-41	7.63
HT/VHT20, M0 to M7	2	15	-63.9	-63.6	0.22	-45.5	-41	4.26
HT/VHT20, M8 to M15	2	15	-63.9	-63.6	0.22	-45.5	-41	4.26
HT/VHT20 Beam Forming, M0 to M7	2	15	-63.9	-63.6	0.22	-45.5	-41	4.26
HT/VHT20 Beam Forming, M8 to M15	2	15	-63.9	-63.6	0.22	-45.5	-41	4.26
HT/VHT20 STBC, M8 to M15	2	15	-63.9	-63.6	0.22	-45.5	-41	4.26
HE20, M0 to M11 1ss	1	15	-64.1		0.2	-48.9	-41	7.65
HE20, M0 to M11 1ss	2	15	-63.8	-62.6	0.2	-44.9	-41	3.7
HE20, M0 to M11 2ss	2	15	-63.8	-62.6	0.2	-44.9	-41	3.7
HE20 Beam Forming, M0 to M11 1ss	2	15	-63.8	-62.6	0.2	-44.9	-41	3.7
HE20 Beam Forming, M0 to M11 2ss	2	15	-63.8	-62.6	0.2	-44.9	-41	3.7
HE20 STBC, M0 to M11 2ss	2	15	-63.8	-62.6	0.2	-44.9	-41	3.7

## Data Screenshots

5260 MHz: HE20, M0 to M11 1ss

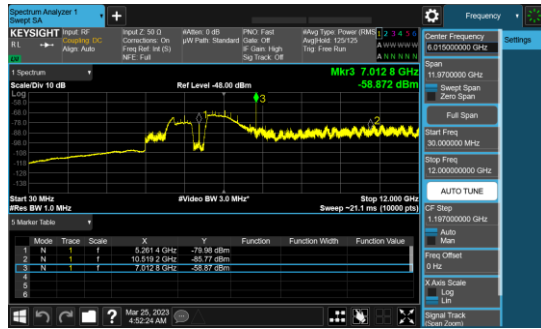

5260 MHz: HE20, M0 to M11 2ss

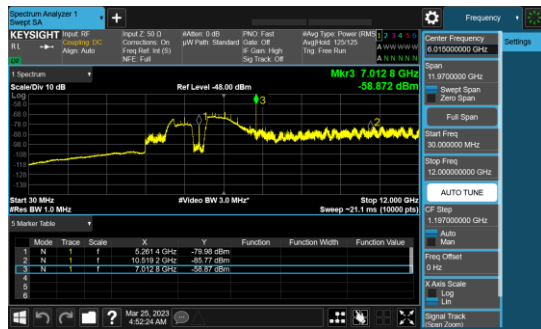

5260 MHz: HE20 Beam Forming, M0 to M11 1ss

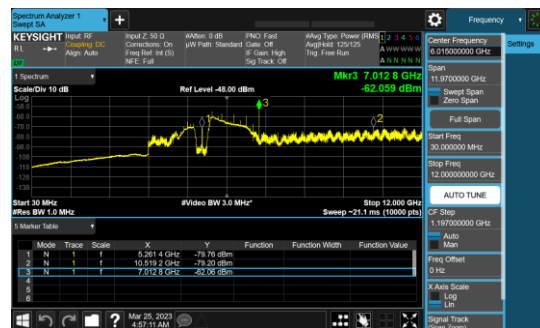
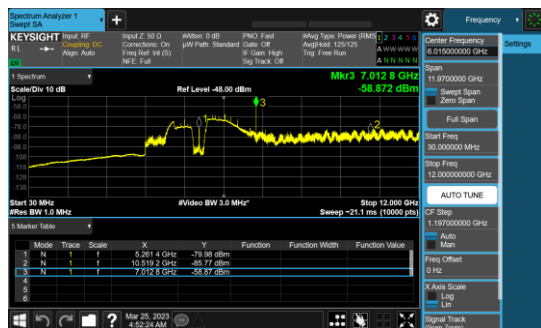

## Conducted Spurs Peak

## Frequency 5260 MHz

Mode	Tx Paths	Correlated Antenna Gain (dBi)	Tx 1 Spur Power (dBm)	Tx 2 Spur Power (dBm)	Duty Cycle (dB)	Total Conducted Spur (dBm)	Limit (dB)	Margin (dB)
Non HT20, 6 to 54 Mbps	1	15	-63.4		0.18	-48.2	-27	21.22
Non HT20, 6 to 54 Mbps	2	15	-62.3	-63.6	0.18	-44.7	-27	17.71
Non HT20 Beam Forming, 6 to 54 Mbps	2	15	-62.3	-63.6	0.18	-44.7	-27	17.71
HT/VHT20, M0 to M7	1	15	-62.8		0.22	-47.6	-27	20.58
HT/VHT20, M0 to M7	2	15	-63.0	-62.9	0.22	-44.7	-27	17.72
HT/VHT20, M8 to M15	2	15	-63.0	-62.9	0.22	-44.7	-27	17.72
HT/VHT20 Beam Forming, M0 to M7	2	15	-63.0	-62.9	0.22	-44.7	-27	17.72
HT/VHT20 Beam Forming, M8 to M15	2	15	-63.0	-62.9	0.22	-44.7	-27	17.72
HT/VHT20 STBC, M8 to M15	2	15	-63.0	-62.9	0.22	-44.7	-27	17.72
HE20, M0 to M11 1ss	1	15	-63.3		0.2	-48.1	-27	21.1
HE20, M0 to M11 1ss	2	15	-63.6	-63.1	0.2	-45.1	-27	18.13
HE20, M0 to M11 2ss	2	15	-63.6	-63.1	0.2	-45.1	-27	18.13
HE20 Beam Forming, M0 to M11 1ss	2	15	-63.6	-63.1	0.2	-45.1	-27	18.13
HE20 Beam Forming, M0 to M11 2ss	2	15	-63.6	-63.1	0.2	-45.1	-27	18.13
HE20 STBC, M0 to M11 2ss	2	15	-63.6	-63.1	0.2	-45.1	-27	18.13

## Frequency 5270 MHz

Mode	Tx Paths	Correlated Antenna Gain (dBi)	Tx 1 Spur Power (dBm)	Tx 2 Spur Power (dBm)	Duty Cycle (dB)	Total Conducted Spur (dBm)	Limit (dB)	Margin (dB)
Non HT40, 6 to 54 Mbps	1	15	-63.4		0.3	-48.1	-27	21.1
Non HT40, 6 to 54 Mbps	2	15	-63.0	-63.5	0.3	-44.9	-27	17.93
HT/VHT40, M0 to M7	1	15	-63.1		0.55	-47.5	-27	20.55
HT/VHT40, M0 to M7	2	15	-63.8	-62.8	0.55	-44.7	-27	17.71
HT/VHT40, M8 to M15	2	15	-63.8	-62.8	0.55	-44.7	-27	17.71
HT/VHT40 Beam Forming, M0 to M7	2	15	-63.8	-62.8	0.55	-44.7	-27	17.71
HT/VHT40 Beam Forming, M8 to M15	2	15	-63.8	-62.8	0.55	-44.7	-27	17.71
HT/VHT40 STBC, M8 to M15	2	15	-63.8	-62.8	0.55	-44.7	-27	17.71
HE40, M0 to M11 1ss	1	15	-63.7		0.27	-48.4	-27	21.43
HE40, M0 to M11 1ss	2	15	-62.8	-62.7	0.27	-44.5	-27	17.47
HE40, M0 to M11 2ss	2	15	-62.8	-62.7	0.27	-44.5	-27	17.47
HE40 Beam Forming, M0 to M11 1ss	2	15	-62.8	-62.7	0.27	-44.5	-27	17.47
HE40 Beam Forming, M0 to M11 2ss	2	15	-62.8	-62.7	0.27	-44.5	-27	17.47
HE40 STBC, M0 to M11 2ss	2	15	-62.8	-62.7	0.27	-44.5	-27	17.47

**Frequency 5290 MHz**

<b>Mode</b>	<b>Tx Paths</b>	<b>Correlated Antenna Gain (dBi)</b>	<b>Tx 1 Spur Power (dBm)</b>	<b>Tx 2 Spur Power (dBm)</b>	<b>Duty Cycle (dB)</b>	<b>Total Conducted Spur (dBm)</b>	<b>Limit (dB)</b>	<b>Margin (dB)</b>
Non HT80, 6 to 54 Mbps	1	15	-62.5		0.36	-47.1	-27	20.14
Non HT80, 6 to 54 Mbps	2	15	-63.7	-63.1	0.36	-45.0	-27	18.02
VHT80, M0 to M11 1ss	1	15	-62.7		0.55	-47.2	-27	20.15
<b>VHT80, M0 to M11 1ss</b>	<b>2</b>	<b>15</b>	<b>-63.0</b>	<b>-62.9</b>	<b>0.55</b>	<b>-44.4</b>	<b>-27</b>	<b>17.39</b>
<b>VHT80, M0 to M11 2ss</b>	<b>2</b>	<b>15</b>	<b>-63.0</b>	<b>-62.9</b>	<b>0.55</b>	<b>-44.4</b>	<b>-27</b>	<b>17.39</b>
<b>VHT80 Beam Forming, M0 to M11 1ss</b>	<b>2</b>	<b>15</b>	<b>-63.0</b>	<b>-62.9</b>	<b>0.55</b>	<b>-44.4</b>	<b>-27</b>	<b>17.39</b>
VHT80 Beam Forming, M0 to M11 2ss	2	15	-63.0	-62.9	0.55	-44.4	-27	17.39
VHT80 STBC, M0 to M11 2ss	2	15	-63.0	-62.9	0.55	-44.4	-27	17.39
HE80, M0 to M11 1ss	1	15	-63.3		0.22	-48.1	-27	21.08
HE80, M0 to M11 1ss	2	15	-63.6	-63.0	0.22	-45.1	-27	18.06
HE80, M0 to M11 2ss	2	15	-63.6	-63.0	0.22	-45.1	-27	18.06
HE80 Beam Forming, M0 to M11 1ss	2	15	-63.6	-63.0	0.22	-45.1	-27	18.06
HE80 Beam Forming, M0 to M11 2ss	2	15	-63.6	-63.0	0.22	-45.1	-27	18.06
HE80 STBC, M0 to M11 2ss	2	15	-63.6	-63.0	0.22	-45.1	-27	18.06

**Frequency 5300 MHz**

<b>Mode</b>	<b>Tx Paths</b>	<b>Correlated Antenna Gain (dBi)</b>	<b>Tx 1 Spur Power (dBm)</b>	<b>Tx 2 Spur Power (dBm)</b>	<b>Duty Cycle (dB)</b>	<b>Total Conducted Spur (dBm)</b>	<b>Limit (dB)</b>	<b>Margin (dB)</b>
Non HT20, 6 to 54 Mbps	1	15	-62.9		0.18	-47.7	-27	20.72
Non HT20, 6 to 54 Mbps	2	15	-62.6	-63.5	0.18	-44.8	-27	17.84
Non HT20 Beam Forming, 6 to 54 Mbps	2	15	-62.6	-63.5	0.18	-44.8	-27	17.84
HT/VHT20, M0 to M7	1	15	-63.1		0.22	-47.9	-27	20.88
HT/VHT20, M0 to M7	2	15	-63.4	-63.9	0.22	-45.4	-27	18.41
HT/VHT20, M8 to M15	2	15	-63.4	-63.9	0.22	-45.4	-27	18.41
HT/VHT20 Beam Forming, M0 to M7	2	15	-63.4	-63.9	0.22	-45.4	-27	18.41
HT/VHT20 Beam Forming, M8 to M15	2	15	-63.4	-63.9	0.22	-45.4	-27	18.41
HT/VHT20 STBC, M8 to M15	2	15	-63.4	-63.9	0.22	-45.4	-27	18.41
HE20, M0 to M11 1ss	1	15	-62.7		0.2	-47.5	-27	20.5
HE20, M0 to M11 1ss	2	15	-63.7	-62.0	0.2	-44.6	-27	17.55
HE20, M0 to M11 2ss	2	15	-63.7	-62.0	0.2	-44.6	-27	17.55
HE20 Beam Forming, M0 to M11 1ss	2	15	-63.7	-62.0	0.2	-44.6	-27	17.55
HE20 Beam Forming, M0 to M11 2ss	2	15	-63.7	-62.0	0.2	-44.6	-27	17.55
HE20 STBC, M0 to M11 2ss	2	15	-63.7	-62.0	0.2	-44.6	-27	17.55

## Frequency 5310 MHz

Mode	Tx Paths	Correlated Antenna Gain (dBi)	Tx 1 Spur Power (dBm)	Tx 2 Spur Power (dBm)	Duty Cycle (dB)	Total Conducted Spur (dBm)	Limit (dB)	Margin (dB)
Non HT40, 6 to 54 Mbps	1	15	-63.2		0.3	-47.9	-27	20.9
Non HT40, 6 to 54 Mbps	2	15	-63.6	-62.7	0.3	-44.8	-27	17.82
HT/VHT40, M0 to M7	1	15	-62.8		0.55	-47.2	-27	20.25
HT/VHT40, M0 to M7	2	15	-62.7	-63.3	0.55	-44.4	-27	17.43
HT/VHT40, M8 to M15	2	15	-62.7	-63.3	0.55	-44.4	-27	17.43
HT/VHT40 Beam Forming, M0 to M7	2	15	-62.7	-63.3	0.55	-44.4	-27	17.43
HT/VHT40 Beam Forming, M8 to M15	2	15	-62.7	-63.3	0.55	-44.4	-27	17.43
HT/VHT40 STBC, M8 to M15	2	15	-62.7	-63.3	0.55	-44.4	-27	17.43
HE40, M0 to M11 1ss	1	15	-62.7		0.27	-47.4	-27	20.43
HE40, M0 to M11 1ss	2	15	-63.5	-63.1	0.27	-45.0	-27	18.01
HE40, M0 to M11 2ss	2	15	-63.5	-63.1	0.27	-45.0	-27	18.01
HE40 Beam Forming, M0 to M11 1ss	2	15	-63.5	-63.1	0.27	-45.0	-27	18.01
HE40 Beam Forming, M0 to M11 2ss	2	15	-63.5	-63.1	0.27	-45.0	-27	18.01
HE40 STBC, M0 to M11 2ss	2	15	-63.5	-63.1	0.27	-45.0	-27	18.01

## Frequency 5320 MHz

Mode	Tx Paths	Correlated Antenna Gain (dBi)	Tx 1 Spur Power (dBm)	Tx 2 Spur Power (dBm)	Duty Cycle (dB)	Total Conducted Spur (dBm)	Limit (dB)	Margin (dB)
Non HT20, 6 to 54 Mbps	1	15	-63.4		0.18	-48.2	-27	21.22
Non HT20, 6 to 54 Mbps	2	15	-63.2	-63.2	0.18	-45.0	-27	18.01
Non HT20 Beam Forming, 6 to 54 Mbps	2	15	-63.2	-63.2	0.18	-45.0	-27	18.01
HT/VHT20, M0 to M7	1	15	-62.7		0.22	-47.5	-27	20.48
HT/VHT20, M0 to M7	2	15	-63.3	-63.6	0.22	-45.2	-27	18.21
HT/VHT20, M8 to M15	2	15	-63.3	-63.6	0.22	-45.2	-27	18.21
HT/VHT20 Beam Forming, M0 to M7	2	15	-63.3	-63.6	0.22	-45.2	-27	18.21
HT/VHT20 Beam Forming, M8 to M15	2	15	-63.3	-63.6	0.22	-45.2	-27	18.21
HT/VHT20 STBC, M8 to M15	2	15	-63.3	-63.6	0.22	-45.2	-27	18.21
HE20, M0 to M11 1ss	1	15	-63.9		0.2	-48.7	-27	21.7
HE20, M0 to M11 1ss	2	15	-63.6	-63.1	0.2	-45.1	-27	18.13
HE20, M0 to M11 2ss	2	15	-63.6	-63.1	0.2	-45.1	-27	18.13
HE20 Beam Forming, M0 to M11 1ss	2	15	-63.6	-63.1	0.2	-45.1	-27	18.13
HE20 Beam Forming, M0 to M11 2ss	2	15	-63.6	-63.1	0.2	-45.1	-27	18.13
HE20 STBC, M0 to M11 2ss	2	15	-63.6	-63.1	0.2	-45.1	-27	18.13

## Data Screenshots

5290 MHz: VHT80, M0 to M11 1ss

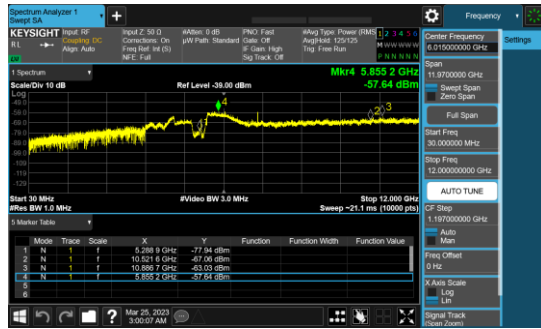

Antenna A



Antenna B

5290 MHz: VHT80, M0 to M11 2ss

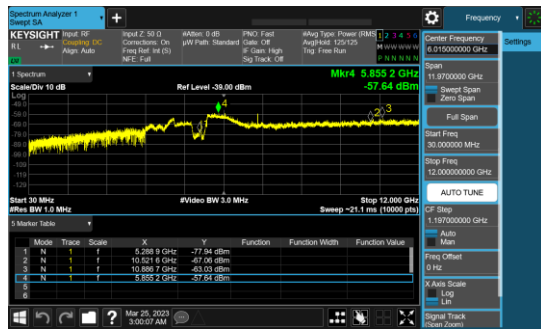

Antenna A



Antenna B

5290 MHz: VHT80 Beam Forming, M0 to M11 1ss

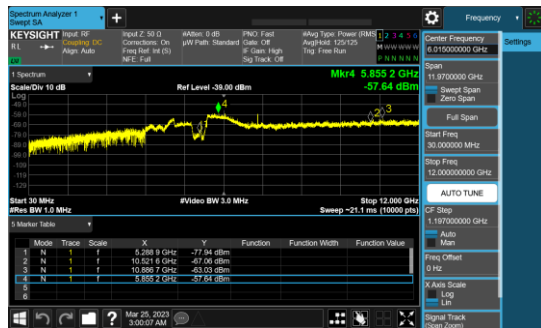

Antenna A

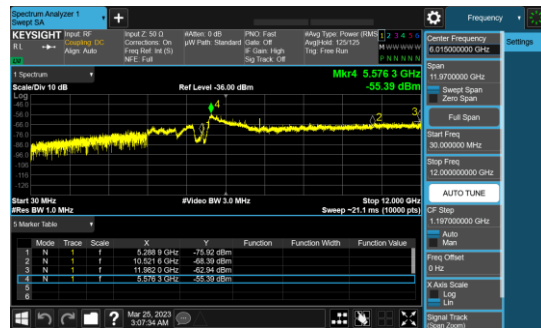

Antenna B



**A.6: Conducted Band edge.**

**Conducted Band Edge Test Requirement**

**15.407(b):**

*Undesirable emission limits.* Except as shown in paragraph (b)(7) of this section, the maximum emissions outside of the frequency bands of operation shall be attenuated in accordance with the following limits:

- (2) For transmitters operating in the 5.25-5.35 GHz band: All emissions outside of the 5.15-5.35 GHz band shall not exceed an e.i.r.p. of -27 dBm/MHz.
- (6) Unwanted emissions below 1 GHz must comply with the general field strength limits set forth in §15.209.
- (7) The provisions of §15.205 apply to intentional radiators operating under this section.
- (8) When measuring the emission limits, the nominal carrier frequency shall be adjusted as close to the upper and lower frequency band edges as the design of the equipment permits.

**KDB 789033 D02 General UNII Test Procedures New Rules v02r01**

**2. Unwanted Emissions that fall Outside of the Restricted Bands**

- a) For all measurements, follow the requirements in II.G.3. *“General Requirements for Unwanted Emissions Measurements.”*
- b) At frequencies below 1000 MHz, use the procedure described in II.G.4. *“Procedure for Unwanted Emissions Measurements Below 1000 MHz.”*
- c) At frequencies above 1000 MHz, use the procedure for maximum emissions described in II.G.5., *“Procedure for Unwanted Emissions Measurements Above 1000 MHz.”*
- (i) Sections 15.407(b) (1-3) specifies the unwanted emissions limit for the U-NII-1 and U-NII-2 bands. As specified, emissions above 1000 MHz that are outside of the restricted bands are subject to a peak emission limit of -27 dBm/MHz.

**Conducted Band Edge Test Procedure**

**Ref. ANSI C63.10: 2013**

**KDB 789033 D02 General UNII Test Procedures New Rules v02r01**

<p><b>Conducted Spurious Emissions</b> Test Procedure</p>
<ol style="list-style-type: none"> <li>1. Connect the antenna port(s) to the spectrum analyzer input.</li> <li>2. Place the radio in continuous transmit mode</li> <li>3. Configure Spectrum analyzer as per test parameters below (be sure to enter all losses between the transmitter output and the spectrum analyzer).</li> <li>4. Use the peak marker function to determine the maximum spurs amplitude level.</li> <li>5. The “measure-and-sum technique” is used for measuring in-band transmit power of a device. In the measure-and-sum approach, the conducted emission level is measured at each antenna port. The measured results at the various antenna ports are then summed mathematically to determine the total emission level from the device. Summing is performed in linear power units. The worst-case output is recorded. (See ANSI C63.10:2013 section 14.3.2.2)</li> <li>6. Capture graphs and record pertinent measurement data.</li> </ol>

**Ref. ANSI C63.10: 2013 section 12.7.6 (Peak) and 12.7.7.2 (Average)**

**KDB 789033 D02 General UNII Test Procedures New Rules v02r01, Sec. 5 (Peak), Sec. 6 (Average Method AD)**

<p><b>Conducted Spurious Emissions</b> Test parameters</p>	
<p><b>Peak</b> RBW = 1 MHz VBW ≥ 3 MHz Sweep = Auto Detector = Peak Trace = Max Hold.</p>	<p><b>Average</b> RBW = 1 MHz VBW ≥ 3 MHz Sweep = Auto Detector = RMS Power Averaging</p>

<p><b>Tested By:</b> Ronak Patel</p>	<p><b>Date of testing:</b> 3/22/2023 - 6/2/2023</p>
<p><b>Test Result:</b> PASS</p>	

**Test Equipment**

See Appendix C for list of test equipment

**Conducted Band edge Average.****Frequency 5290 MHz**

<b>Mode</b>	<b>Tx Paths</b>	<b>Correlated Antenna Gain (dBi)</b>	<b>Tx 1 Bandedge Level (dBm)</b>	<b>Tx 2 Bandedge Level (dBm)</b>	<b>Duty Cycle (dB)</b>	<b>Total Tx Bandedge Level (dBm)</b>	<b>Limit (dB)</b>	<b>Margin (dB)</b>
Non HT80, 6 to 54 Mbps	1	15	-58.0		0.36	-42.6	-41	1.39
Non HT80, 6 to 54 Mbps	2	15	-60.1	-60.7	0.36	-42.0	-41	0.77
<b>VHT80, M0 to M11 1ss</b>	<b>1</b>	<b>15</b>	<b>-57.2</b>		<b>0.55</b>	<b>-41.7</b>	<b>-41</b>	<b>0.4</b>
VHT80, M0 to M11 1ss	2	15	-60.4	-60.8	0.55	-42.0	-41	0.79
VHT80, M0 to M11 2ss	2	15	-60.4	-60.8	0.55	-42.0	-41	0.79
VHT80 Beam Forming, M0 to M11 1ss	2	15	-60.4	-60.8	0.55	-42.0	-41	0.79
VHT80 Beam Forming, M0 to M11 2ss	2	15	-60.4	-60.8	0.55	-42.0	-41	0.79
VHT80 STBC, M0 to M11 2ss	2	15	-60.4	-60.8	0.55	-42.0	-41	0.79
<b>HE80, M0 to M11 1ss</b>	<b>1</b>	<b>15</b>	<b>-56.5</b>		<b>0.22</b>	<b>-41.3</b>	<b>-41</b>	<b>0.03</b>
HE80, M0 to M11 1ss	2	15	-60.5	-60.2	0.22	-42.1	-41	0.87
HE80, M0 to M11 2ss	2	15	-60.5	-60.2	0.22	-42.1	-41	0.87
HE80 Beam Forming, M0 to M11 1ss	2	15	-60.5	-60.2	0.22	-42.1	-41	0.87
HE80 Beam Forming, M0 to M11 2ss	2	15	-60.5	-60.2	0.22	-42.1	-41	0.87
HE80 STBC, M0 to M11 2ss	2	15	-60.5	-60.2	0.22	-42.1	-41	0.87

**Frequency 5310 MHz**

<b>Mode</b>	<b>Tx Paths</b>	<b>Correlated Antenna Gain (dBi)</b>	<b>Tx 1 Bandedge Level (dBm)</b>	<b>Tx 2 Bandedge Level (dBm)</b>	<b>Duty Cycle (dB)</b>	<b>Total Tx Bandedge Level (dBm)</b>	<b>Limit (dB)</b>	<b>Margin (dB)</b>
<b>Non HT40, 6 to 54 Mbps</b>	<b>1</b>	<b>15</b>	<b>-56.6</b>		<b>0.3</b>	<b>-41.3</b>	<b>-41</b>	<b>0.05</b>
Non HT40, 6 to 54 Mbps	2	15	-60.7	-61.0	0.3	-42.5	-41	1.29
HT/VHT40, M0 to M7	1	15	-58.1		0.55	-42.5	-41	1.3
HT/VHT40, M0 to M7	2	15	-60.9	-61.5	0.55	-42.6	-41	1.38
HT/VHT40, M8 to M15	2	15	-60.9	-61.5	0.55	-42.6	-41	1.38
HT/VHT40 Beam Forming, M0 to M7	2	15	-60.9	-61.5	0.55	-42.6	-41	1.38
HT/VHT40 Beam Forming, M8 to M15	2	15	-60.9	-61.5	0.55	-42.6	-41	1.38
HT/VHT40 STBC, M8 to M15	2	15	-60.9	-61.5	0.55	-42.6	-41	1.38
HE40, M0 to M11 1ss	1	15	-57.7		0.27	-42.4	-41	1.18
HE40, M0 to M11 1ss	2	15	-60.6	-61.0	0.27	-42.5	-41	1.26
HE40, M0 to M11 2ss	2	15	-60.6	-61.0	0.27	-42.5	-41	1.26
HE40 Beam Forming, M0 to M11 1ss	2	15	-60.6	-61.0	0.27	-42.5	-41	1.26
HE40 Beam Forming, M0 to M11 2ss	2	15	-60.6	-61.0	0.27	-42.5	-41	1.26
HE40 STBC, M0 to M11 2ss	2	15	-60.6	-61.0	0.27	-42.5	-41	1.26

## Frequency 5320 MHz

Mode	Tx Paths	Correlated Antenna Gain (dBi)	Tx 1 Bandedge Level (dBm)	Tx 2 Bandedge Level (dBm)	Duty Cycle (dB)	Total Tx Bandedge Level (dBm)	Limit (dB)	Margin (dB)
Non HT20, 6 to 54 Mbps	1	15	-61.3		0.18	-46.1	-41	4.87
Non HT20, 6 to 54 Mbps	2	15	-63.8	-62.3	0.18	-44.8	-41	3.55
Non HT20 Beam Forming, 6 to 54 Mbps	2	15	-63.8	-62.3	0.18	-44.8	-41	3.55
HT/VHT20, M0 to M7	1	15	-61.1		0.22	-45.9	-41	4.63
HT/VHT20, M0 to M7	2	15	-63.8	-63.4	0.22	-45.4	-41	4.11
HT/VHT20, M8 to M15	2	15	-63.8	-63.4	0.22	-45.4	-41	4.11
HT/VHT20 Beam Forming, M0 to M7	2	15	-63.8	-63.4	0.22	-45.4	-41	4.11
HT/VHT20 Beam Forming, M8 to M15	2	15	-63.8	-63.4	0.22	-45.4	-41	4.11
HT/VHT20 STBC, M8 to M15	2	15	-63.8	-63.4	0.22	-45.4	-41	4.11
HE20, M0 to M11 1ss	1	15	-60.8		0.2	-45.6	-41	4.35
HE20, M0 to M11 1ss	2	15	-63.1	-62.3	0.2	-44.5	-41	3.22
HE20, M0 to M11 2ss	2	15	-63.1	-62.3	0.2	-44.5	-41	3.22
HE20 Beam Forming, M0 to M11 1ss	2	15	-63.1	-62.3	0.2	-44.5	-41	3.22
HE20 Beam Forming, M0 to M11 2ss	2	15	-63.1	-62.3	0.2	-44.5	-41	3.22
HE20 STBC, M0 to M11 2ss	2	15	-63.1	-62.3	0.2	-44.5	-41	3.22

## Data Screenshots

5290 MHz: HE80, M0 to M11 1ss

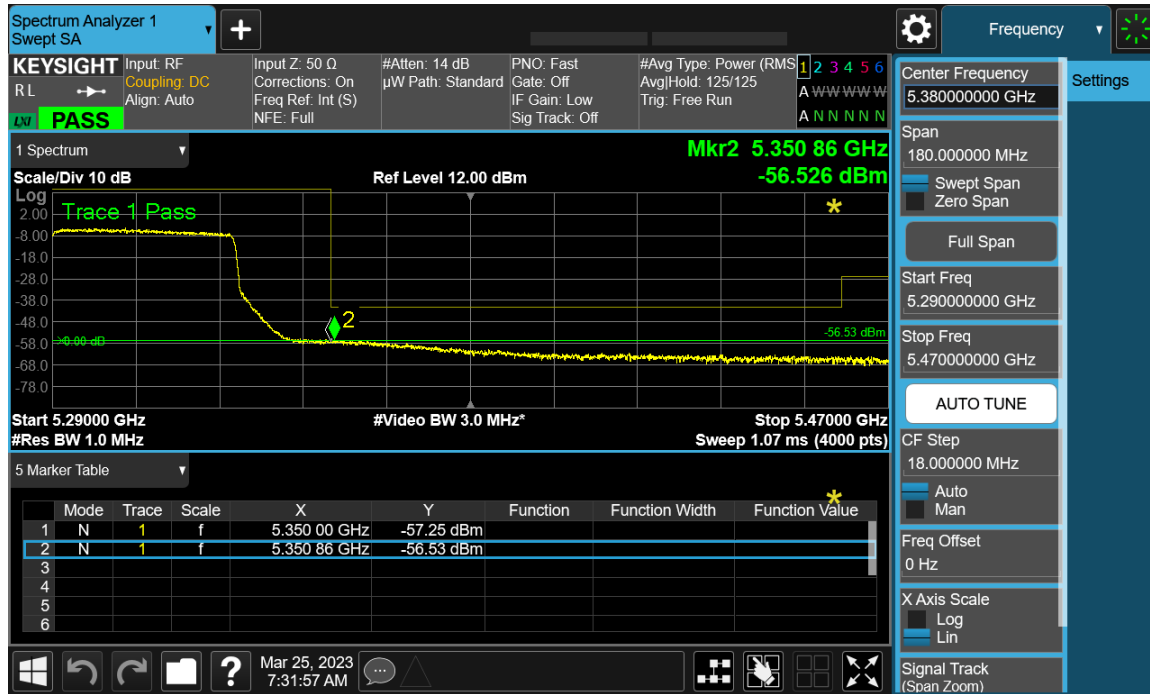

Antenna A

5310 MHz: Non HT40, 6 to 54 Mbps

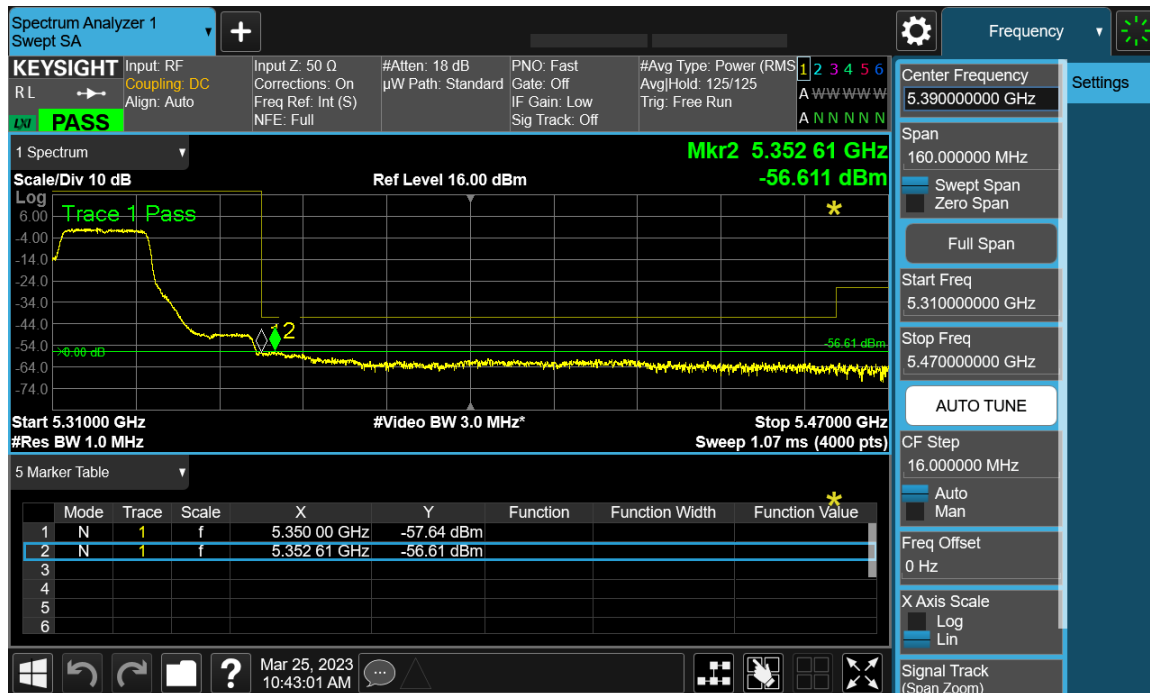

Antenna A

5290 MHz: VHT80, M0 to M11 1ss

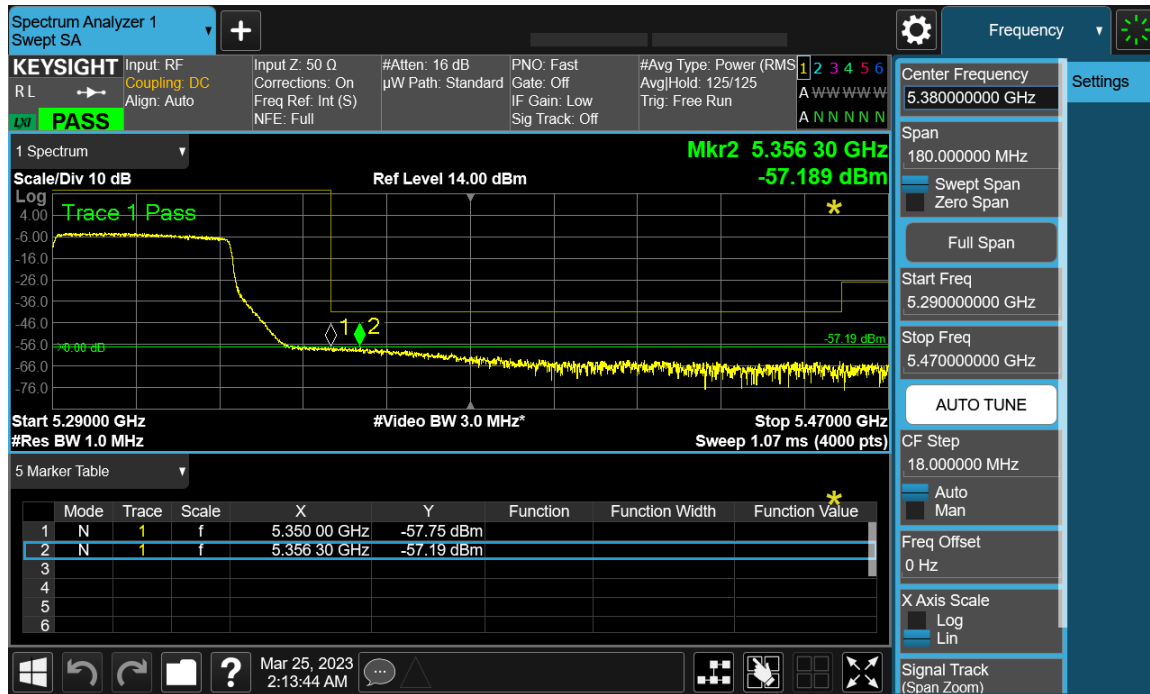

Antenna A

**Conducted Band edge Peak.****Frequency 5290 MHz**

<b>Mode</b>	<b>Tx Paths</b>	<b>Correlated Antenna Gain (dBi)</b>	<b>Tx 1 Bandedge Level (dBm)</b>	<b>Tx 2 Bandedge Level (dBm)</b>	<b>Total Tx Bandedge Level (dBm)</b>	<b>Limit (dB)</b>	<b>Margin (dB)</b>
Non HT80, 6 to 54 Mbps	1	15	-48.2		-32.8	-27	5.84
<b>Non HT80, 6 to 54 Mbps</b>	<b>2</b>	<b>15</b>	<b>-44.6</b>	<b>-49.7</b>	<b>-28.1</b>	<b>-27</b>	<b>1.07</b>
VHT80, M0 to M11 1ss	1	15	-46.4		-30.9	-27	3.85
VHT80, M0 to M11 1ss	2	15	-50.5	-50.3	-31.8	-27	4.84
VHT80, M0 to M11 2ss	2	15	-50.5	-50.3	-31.8	-27	4.84
VHT80 Beam Forming, M0 to M11 1ss	2	15	-50.5	-50.3	-31.8	-27	4.84
VHT80 Beam Forming, M0 to M11 2ss	2	15	-50.5	-50.3	-31.8	-27	4.84
VHT80 STBC, M0 to M11 2ss	2	15	-50.5	-50.3	-31.8	-27	4.84
HE80, M0 to M11 1ss	1	15	-46.7		-31.5	-27	4.48
<b>HE80, M0 to M11 1ss</b>	<b>2</b>	<b>15</b>	<b>-47.7</b>	<b>-49.4</b>	<b>-30.2</b>	<b>-27</b>	<b>3.24</b>
<b>HE80, M0 to M11 2ss</b>	<b>2</b>	<b>15</b>	<b>-47.7</b>	<b>-49.4</b>	<b>-30.2</b>	<b>-27</b>	<b>3.24</b>
HE80 Beam Forming, M0 to M11 1ss	2	15	-47.7	-49.4	-30.2	-27	3.24
HE80 Beam Forming, M0 to M11 2ss	2	15	-47.7	-49.4	-30.2	-27	3.24
HE80 STBC, M0 to M11 2ss	2	15	-47.7	-49.4	-30.2	-27	3.24

**Frequency 5310 MHz**

<b>Mode</b>	<b>Tx Paths</b>	<b>Correlated Antenna Gain (dBi)</b>	<b>Tx 1 Bandedge Level (dBm)</b>	<b>Tx 2 Bandedge Level (dBm)</b>	<b>Total Tx Bandedge Level (dBm)</b>	<b>Limit (dB)</b>	<b>Margin (dB)</b>
Non HT40, 6 to 54 Mbps	1	15	-45.6		-30.3	-27	3.3
Non HT40, 6 to 54 Mbps	2	15	-48.1	-49.7	-30.5	-27	3.52
HT/VHT40, M0 to M7	1	15	-47.3		-31.7	-27	4.75
HT/VHT40, M0 to M7	2	15	-50.4	-49.5	-31.4	-27	4.36
HT/VHT40, M8 to M15	2	15	-50.4	-49.5	-31.4	-27	4.36
HT/VHT40 Beam Forming, M0 to M7	2	15	-50.4	-49.5	-31.4	-27	4.36
HT/VHT40 Beam Forming, M8 to M15	2	15	-50.4	-49.5	-31.4	-27	4.36
HT/VHT40 STBC, M8 to M15	2	15	-50.4	-49.5	-31.4	-27	4.36
HE40, M0 to M11 1ss	1	15	-47.5		-32.2	-27	5.23
HE40, M0 to M11 1ss	2	15	-49.4	-48.5	-30.6	-27	3.65
HE40, M0 to M11 2ss	2	15	-49.4	-48.5	-30.6	-27	3.65
HE40 Beam Forming, M0 to M11 1ss	2	15	-49.4	-48.5	-30.6	-27	3.65
HE40 Beam Forming, M0 to M11 2ss	2	15	-49.4	-48.5	-30.6	-27	3.65
HE40 STBC, M0 to M11 2ss	2	15	-49.4	-48.5	-30.6	-27	3.65

## Frequency 5320 MHz

Mode	Tx Paths	Correlated Antenna Gain (dBi)	Tx 1 Bandedge Level (dBm)	Tx 2 Bandedge Level (dBm)	Total Tx Bandedge Level (dBm)	Limit (dB)	Margin (dB)
Non HT20, 6 to 54 Mbps	1	15	-47.3		-32.1	-27	5.12
Non HT20, 6 to 54 Mbps	2	15	-51.7	-51.2	-33.3	-27	6.25
Non HT20 Beam Forming, 6 to 54 Mbps	2	15	-51.7	-51.2	-33.3	-27	6.25
HT/VHT20, M0 to M7	1	15	-48.3		-33.1	-27	6.08
HT/VHT20, M0 to M7	2	15	-50.8	-52.3	-33.3	-27	6.25
HT/VHT20, M8 to M15	2	15	-50.8	-52.3	-33.3	-27	6.25
HT/VHT20 Beam Forming, M0 to M7	2	15	-50.8	-52.3	-33.3	-27	6.25
HT/VHT20 Beam Forming, M8 to M15	2	15	-50.8	-52.3	-33.3	-27	6.25
HT/VHT20 STBC, M8 to M15	2	15	-50.8	-52.3	-33.3	-27	6.25
HE20, M0 to M11 1ss	1	15	-48.1		-32.9	-27	5.9
HE20, M0 to M11 1ss	2	15	-50.9	-52.1	-33.2	-27	6.25
HE20, M0 to M11 2ss	2	15	-50.9	-52.1	-33.2	-27	6.25
HE20 Beam Forming, M0 to M11 1ss	2	15	-50.9	-52.1	-33.2	-27	6.25
HE20 Beam Forming, M0 to M11 2ss	2	15	-50.9	-52.1	-33.2	-27	6.25
HE20 STBC, M0 to M11 2ss	2	15	-50.9	-52.1	-33.2	-27	6.25

## Data Screenshots

5290 MHz: Non HT80, 6 to 54 Mbps

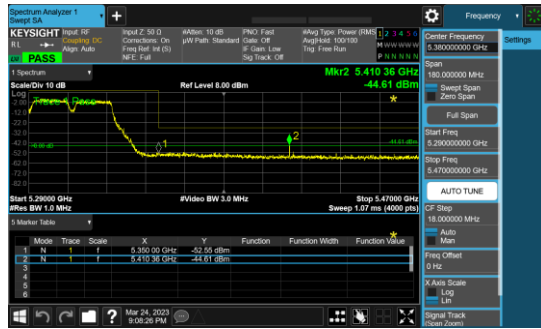

Antenna A



Antenna B

5290 MHz: HE80, M0 to M11 1ss



Antenna A

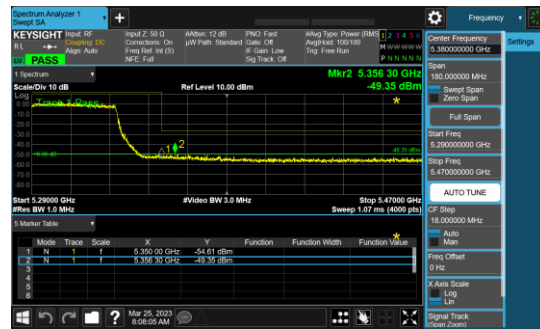

Antenna B

5290 MHz: HE80, M0 to M11 2ss

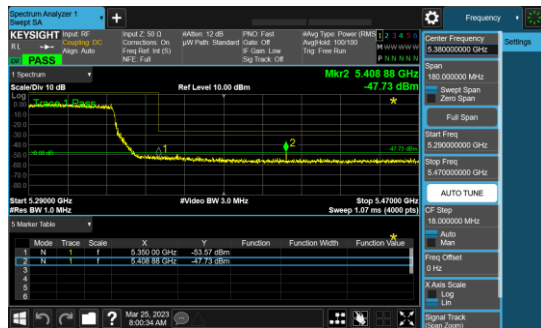

Antenna A



Antenna B



## Appendix B: Emission Test Results

Testing Laboratory: Cisco Systems, Inc., 125 West Tasman Drive, San Jose, CA 95134, USA

### Radiated Emission Setup Diagram-Below 1G

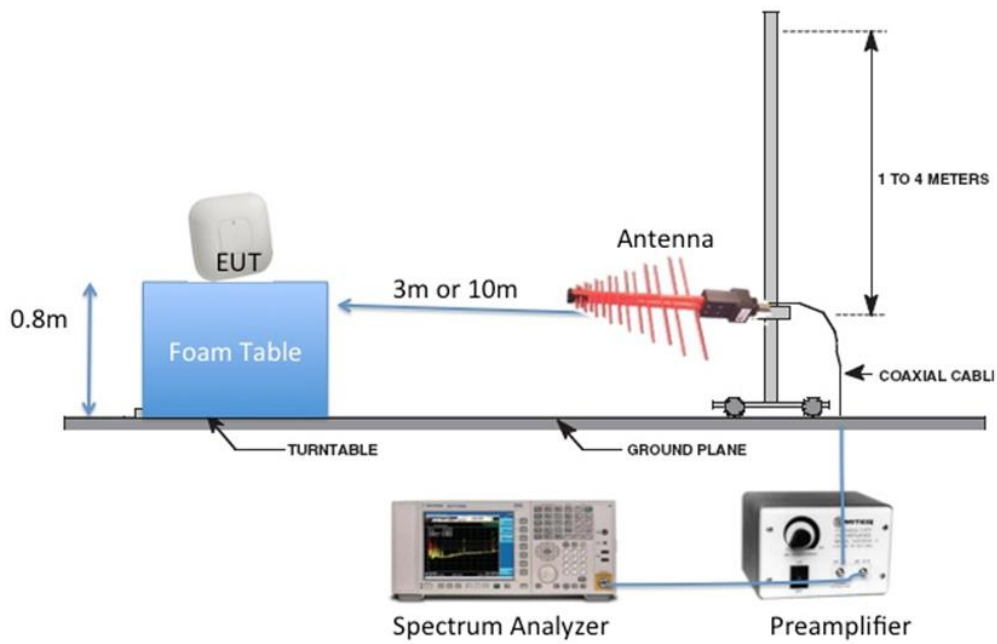

### Radiated Emission Setup Diagram-Above 1G

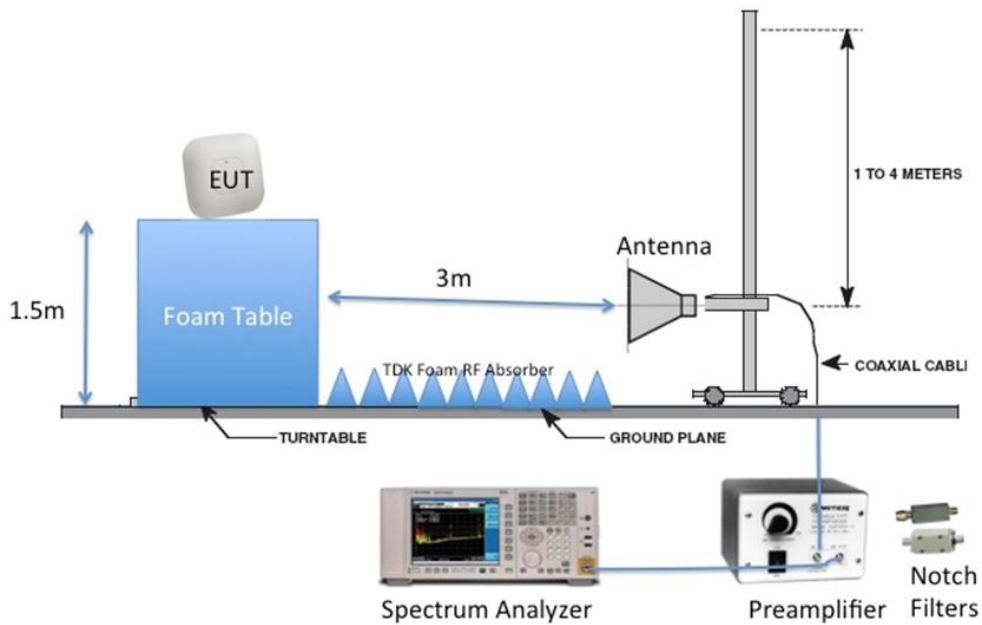

Radio Test Report No: **EDCS # 24339408**

## **B.1: Radiated Spurious Emissions**

### **FCC 15.205 | 15.407 | LP0002 (2018-01-10) (3.6)**

Radiated emissions which fall in the restricted bands, as defined in Section 15.205(a), must also comply with the radiated emission limits specified in Section 15.209(a) (see Section 15.205(c)).

Radiated Spurious emissions are in **EDCS # 24042661**

Radio Test Report No: **EDCS # 24339408**

## **B.2: Radiated Emissions 30MHz to 1GHz**

### **FCC 15.209 | 15.205 | 15.407**

Radiated emissions which fall in the restricted bands, as defined in Section 15.205(a), must also comply with the radiated emission limits specified in Section 15.209(a) (see Section 15.205(c)) and RSS-Gen §8.9.

**Ref.** ANSI C63.10: 2013 section 6.5

Radiated Spurious emissions are in **EDCS # 24042661**

### **B.3: AC Conducted Emissions**

#### **FCC 15.207 | LP0002 (2020-07-01) (3.3)**

Except when the requirements applicable to a given device state otherwise, for any radio apparatus equipped to operate from the public utility AC power supply, either directly or indirectly (such as with a battery charger), the radio frequency voltage of emissions conducted back onto the AC power lines in the frequency range of 0.15 MHz to 30 MHz shall not exceed the limits shown in the table in these sections. The more stringent limit applies at the frequency range boundaries.

#### **Measurement Procedure**

**Accordance with ANSI C63.10:2013 section 6.2**

**Section 1 : Test Case Details**

<b>Test Case ID: 5088</b>		<b>Test Type: Conducted Emissions</b>	
<b>Product Standard</b>	<b>Port Type</b>	<b>Test Details</b>	<b>Comments</b>
15.207	DC (Indoor)	Start Freq: 0.15MHz - Stop Freq: 30MHz Power: DC Range : 150KHz to 30MHz. Class: N/A Measure: Voltage(dBuV) Detector(s): Quasi-Peak and Average 150kHz - 500kHz - 89dBuV (QP) 76(AV) 500kHz - 30MHz - 83dBuV (QP) 70(AV)	ANSI C63.4.
<b>Overall Result</b>		Pass	
<b>Deviation</b>		NA	

**Section 2:****Subtest Details**

<b>Subtest Number: 5088-1 Subtest Date : 5/31/2023</b>		
<b>Engineer</b>	Evelyn Preza	
<b>Lab Information</b>	Bldg. P - Shield Room 1	
<b>Subtest Results</b>		
<b>Subtest Title</b>	5088-1	
<b>Port Reference</b>	[J] DC Input	
<b>Measured Voltage</b>	48.1VDC	
<b>Transducer</b>	LISN	
<b>Subtest Result</b>	Pass	
<b>Comments on the above Test Results</b>	EUT powered by 48VDC. DC Input unit is under test. Test results verified by Jose Huamani.	
<b>Environmental Conditions</b>		
<b>Temperature: (59 to 95)°F</b>	70.6	
<b>Humidity: (10 to 75)%</b>	60	
<b>Test Result File</b>	<b>Start Freq[MHz]</b>	<b>Stop Freq[MHz]</b>
plce_48vdc_return [26-5-2023 10.23]	.15	30
plce_48vdc_supply [26-5-2023 10.23]	.15	30

**Section 3:****Operation Mode**

<b>Mode#</b>	<b>Title</b>	<b>Description</b>
1	Formal Test	EUT is set to auto-boot with Linux version 4.4.60 (root@137067b22dab) (gcc version 5.2.0 (OpenWrt GCC 5.2.0 c17576669+r49254) ) #41 SMP PREEMPT Tue Oct 25 15:03:29 UTC 2022

**Section 4:****Hardware Configuration**

<b>Config#</b>	<b>Title</b>	<b>Description</b>
1	Mode-1 (DC Generator without M12)	Configuration 1: M22D powered up through DC Generator, without M12

**Section 5:  
Systems Details**

System Number	Description	Samples	System under Test
5	IXIA Traffic Generator (Support)	1, 3, 2	No
3	Support: 2.4GHz & 5GHz Clients, Switch, and Laptop	4, 5, 8, 9	No
1	EUT - Configuration 1: M22D powered up through DC Generator, without M12	2	Yes

**Section 6: Test Results Details**

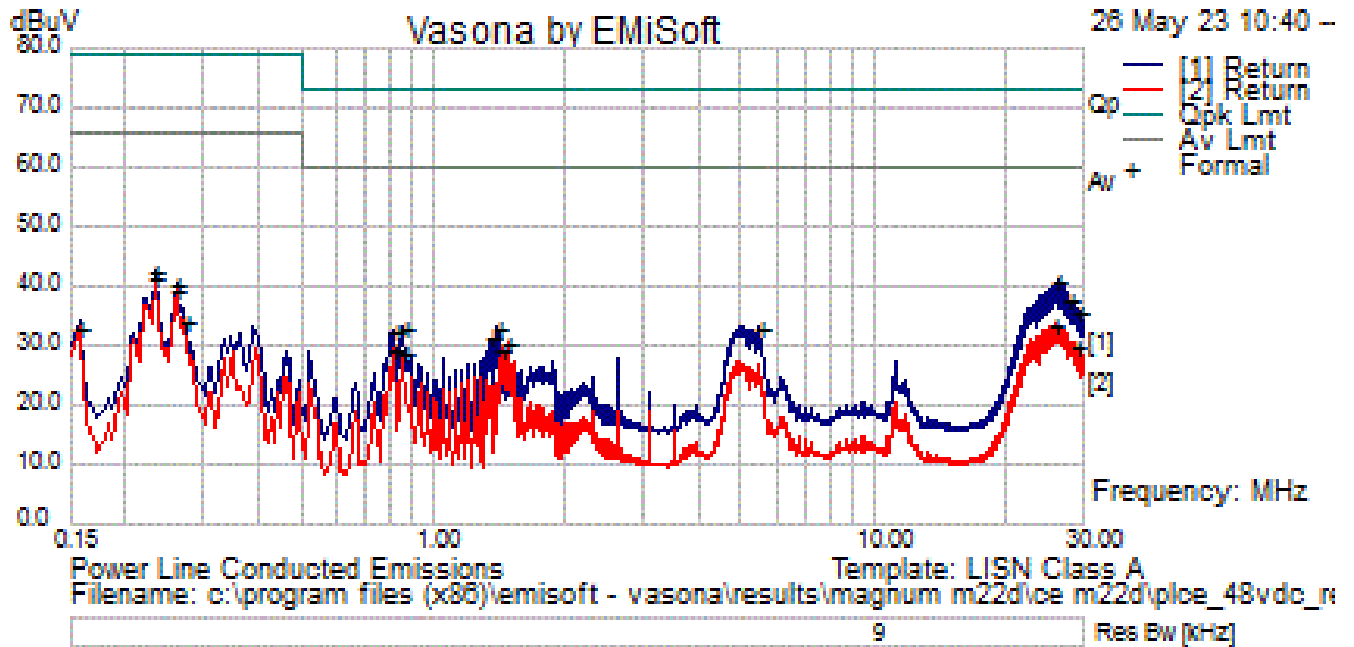

Formal Data											
No	Frequency MHz	Raw dBuV	Cable Loss	Factors dB	Level dBuV	Measurement Type	Line	Limit dBuV	Margin dB	Pass /Fail	Comments
1	.233	21.3	19.9	.0	41.2	Average	Return	66.0	-24.8	Pass	
2	25.865	12.6	20.5	.3	33.5	Average	Return	60.0	-26.5	Pass	
3	.260	19.4	19.9	.0	39.3	Average	Return	66.0	-26.7	Pass	
4	1.478	10.4	19.9	.0	30.3	Average	Return	60.0	-29.7	Pass	
5	28.646	8.6	20.6	.4	29.6	Average	Return	60.0	-30.4	Pass	
6	1.433	9.4	19.9	.0	29.3	Average	Return	60.0	-30.7	Pass	
7	.814	9.4	19.9	.0	29.3	Average	Return	60.0	-30.7	Pass	
8	.852	9.1	19.9	.0	29.0	Average	Return	60.0	-31.0	Pass	
9	.272	14.4	19.8	.0	34.3	Average	Return	66.0	-31.7	Pass	
10	26.140	20.2	20.5	.3	41.1	Quasi Peak	Return	73.0	-31.9	Pass	
11	.157	12.3	20.9	.1	33.3	Average	Return	66.0	-32.7	Pass	
12	27.825	17.0	20.6	.4	37.9	Quasi Peak	Return	73.0	-35.1	Pass	
13	.233	22.6	19.9	.0	42.5	Quasi Peak	Return	79.0	-36.5	Pass	
14	29.528	14.5	20.6	.4	35.5	Quasi Peak	Return	73.0	-37.5	Pass	
15	.260	20.6	19.9	.0	40.5	Quasi Peak	Return	79.0	-38.5	Pass	
16	1.392	13.3	19.9	.0	33.2	Quasi Peak	Return	73.0	-39.8	Pass	
17	.852	13.3	19.9	.0	33.2	Quasi Peak	Return	73.0	-39.8	Pass	
18	5.498	13.1	20.0	.1	33.1	Quasi Peak	Return	73.0	-39.9	Pass	
19	.814	12.7	19.9	.0	32.6	Quasi Peak	Return	73.0	-40.4	Pass	
20	1.352	11.3	19.9	.0	31.2	Quasi Peak	Return	73.0	-41.8	Pass	

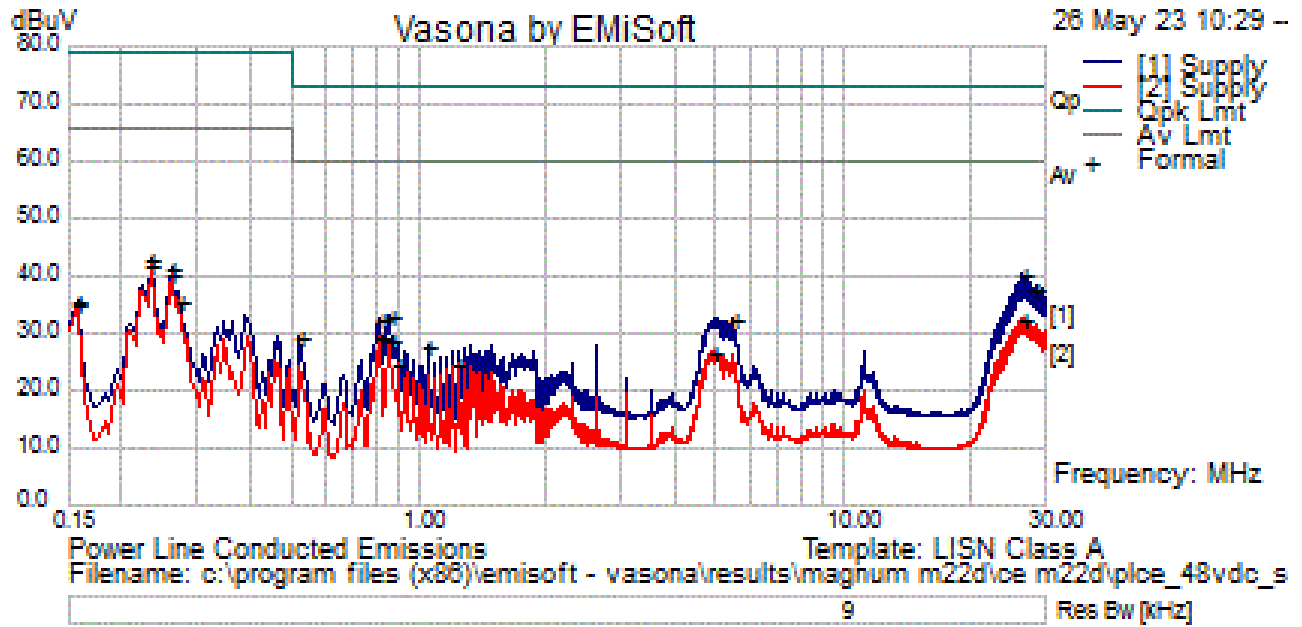

Formal Data											
No	Frequency MHz	Raw dBuV	Cable Loss	Factors dB	Level dBuV	Measurement Type	Line	Limit dBuV	Margin dB	Pass /Fail	Comments
1	.233	22.2	19.9	.0	42.1	Average	Supply	66.0	-23.9	Pass	
2	.260	20.6	19.9	.0	40.4	Average	Supply	66.0	-25.6	Pass	
3	26.529	11.6	20.5	.3	32.5	Average	Supply	60.0	-27.5	Pass	
4	.272	16.0	19.8	.0	35.9	Average	Supply	66.0	-30.1	Pass	
5	.157	14.3	20.9	.1	35.2	Average	Supply	66.0	-30.8	Pass	
6	.814	9.2	19.9	.0	29.1	Average	Supply	60.0	-30.9	Pass	
7	.852	9.1	19.9	.0	29.0	Average	Supply	60.0	-31.0	Pass	
8	26.507	19.5	20.5	.3	40.4	Quasi Peak	Supply	73.0	-32.6	Pass	
9	4.954	6.8	20.0	.1	26.9	Average	Supply	60.0	-33.1	Pass	
10	28.460	16.9	20.6	.4	37.9	Quasi Peak	Supply	73.0	-35.1	Pass	
11	.890	4.7	19.9	.0	24.6	Average	Supply	60.0	-35.4	Pass	
12	1.239	4.5	19.9	.0	24.4	Average	Supply	60.0	-35.6	Pass	
13	.233	23.1	19.9	.0	43.0	Quasi Peak	Supply	79.0	-36.0	Pass	
14	.260	21.4	19.9	.0	41.3	Quasi Peak	Supply	79.0	-37.7	Pass	



Radio Test Report No: **EDCS # 24339408**

15	.852	13.3	19.9	.0	33.2	Quasi Peak	Supply	73.0	-39.8	Pass	
16	5.498	12.7	20.0	.1	32.8	Quasi Peak	Supply	73.0	-40.2	Pass	
17	.814	12.7	19.9	.0	32.6	Quasi Peak	Supply	73.0	-40.4	Pass	
18	.157	14.9	20.9	.1	35.9	Quasi Peak	Supply	79.0	-43.1	Pass	
19	.524	9.6	19.9	.0	29.5	Quasi Peak	Supply	73.0	-43.5	Pass	
20	1.048	7.9	19.9	.0	27.8	Quasi Peak	Supply	73.0	-45.2	Pass	

**Section 7: Questions & Answers**

<p>The category of cable simulated by the AAN, where emissions from wired network ports are measured using an AAN. See Table EN55032 C.2</p>	<p>N/A</p>
--	------------

**Appendix C: List of Test Equipment Used to perform the test.**

Equipment #	Manufacturer/ Model	Description	Last Cal	Next Due	Test Item
<b>Test Equipment used for conducted tests – Rack 11</b>					
58721	Cisco/Automation Test Insertion Loss	Rack 11	Verify Before Use	Verify Before Use	A.1-A.6
58785	Keysight (Agilent/HP)/ N9030B-550 OPT LNP EPO	PXA Signal Analyzer, 2Hz-50GHz with Options LNP and EPO	20 <sup>th</sup> July 2022	20 <sup>th</sup> July 2023	A.1-A.6
58803	NATIONAL INSTRUMENTS / PXIe-1085	CHASSIS	Cal Not Required	Cal Not Required	A.1-A.6
58787	NATIONAL INSTRUMENTS / PXIe-8840	Up to 2.6 GHz Quad-Core PXI Express Controller	Cal Not Required	Cal Not Required	A.1-A.6
58788	NATIONAL INSTRUMENTS / PXI-2796	40 GHz Dual 6x1 Multiplexer (SP6T)	Verify Before Use	Verify Before Use	A.1-A.6
58789	NATIONAL INSTRUMENTS / PXI-2796	40 GHz Dual 6x1 Multiplexer (SP6T)	Verify Before Use	Verify Before Use	A.1-A.6
58786	NATIONAL INSTRUMENTS / PXI-2799	Switch 1x1	Verify Before Use	Verify Before Use	A.1-A.6
54235	PASTERNAK/ PE5019-1	Torque Wrench	23 <sup>rd</sup> March 2023	23 <sup>rd</sup> March 2024	A.1-A.6
58256	COMET/ T7611-4	WEB SENSOR FOR REMOTE THERMOMETER HYGROMETER	2 <sup>nd</sup> Feb 2023	2 <sup>nd</sup> Feb 2024	A.1-A.6
56122	PASTERNAK/PE6072	SMA 50 Ohm Termination	1 <sup>st</sup> Sep 2022	1 <sup>st</sup> Sep 2023	A.1-A.6
56127	PASTERNAK/PE6072	SMA 50 Ohm Termination	1 <sup>st</sup> Sep 2022	1 <sup>st</sup> Sep 2023	A.1-A.6

**Test Equipment used for AC line Conducted emissions.**

<b>Cis-Id</b>	<b>Manufacturer</b>	<b>Model</b>	<b>Description</b>	<b>Calibrated Date</b>	<b>Calibration Due Date</b>
004003	Fischer Custom Communications	FCC-801-M2-32A	CDN, 2-LINE, 32A	11/30/2022	11/30/2023
008496	Fischer Custom Communications	FCC-450B-2.4-N	Instrumentation Limiter	2/14/2023	2/14/2024
018960	York	CNE V	Comparison Noise Emitter, 30 - 1000MHz	NA	NA
045435	Hefley	PAT 50A	EFT Attenuator	7/22/2022	7/22/2023
046002	Fischer Custom Communications	F-090527-1009-1	Line Impedance Stabilization Network	12/20/2022	12/20/2023
046003	Fischer Custom Communications	F-090527-1009-2	LISN Adapter	12/19/2022	12/19/2023
049534	TTE	H785-150K-50-21378	150kHz HI Pass Filter	2/13/2023	2/13/2024
058276	ROHDE & SCHWARZ	ESR3	EMI Receiver	7/29/2022	7/29/2023
058758	Coleman	RG-223	RF Coaxial Cable to 1GHz, 7.6m	8/2/2022	8/2/2023

**Appendix D: Abbreviation Key and Definitions**

The following table defines abbreviations used within this test report.

<b>Abbreviation</b>	<b>Description</b>	<b>Abbreviation</b>	<b>Description</b>
EMC	Electro Magnetic Compatibility	°F	Degrees Fahrenheit
EMI	Electro Magnetic Interference	°C	Degrees Celsius
EUT	Equipment Under Test	Temp	Temperature
ITE	Information Technology Equipment	S/N	Serial Number
TAP	Test Assessment Schedule	Qty	Quantity
ESD	Electro Static Discharge	emf	Electromotive force
EFT	Electric Fast Transient	RMS	Root mean square
EDCS	Engineering Document Control System	Qp	Quasi Peak
Config	Configuration	Av	Average
CIS#	Cisco Number (unique identification number for Cisco test equipment)	Pk	Peak
Cal	Calibration	kHz	Kilohertz (1x10 <sup>3</sup> )
EN	European Norm	MHz	MegaHertz (1x10 <sup>6</sup> )
IEC	International Electro technical Commission	GHz	Gigahertz (1x10 <sup>9</sup> )
CISPR	International Special Committee on Radio Interference	H	Horizontal
CDN	Coupling/Decoupling Network	V	Vertical
LISN	Line Impedance Stabilization Network	dB	decibel
PE	Protective Earth	V	Volt
GND	Ground	kV	Kilovolt (1x10 <sup>3</sup> )
L1	Line 1	µV	Microvolt (1x10 <sup>-6</sup> )
L2	Line2	A	Amp
L3	Line 3	µA	Micro Amp (1x10 <sup>-6</sup> )
DC	Direct Current	mS	Milli Second (1x10 <sup>-3</sup> )
RAW	Uncorrected measurement value, as indicated by the measuring device	µS	Micro Second (1x10 <sup>-6</sup> )
RF	Radio Frequency	µS	Micro Second (1x10 <sup>-6</sup> )
SLCE	Signal Line Conducted Emissions	m	Meter
Meas dist	Measurement distance	Spec dist	Specification distance
N/A or NA	Not Applicable	SL	Signal Line (or Telecom Line)
P	Power Line	L	Live Line
N	Neutral Line	R	Return
S	Supply	AC	Alternating Current

## **Appendix E: Photographs of Test Setups**

EUT Photos have been omitted from this test report. Photos can be found in the supplementary exhibit included in the submission and EDCS# 24259624.

## **Appendix F: Software Used to Perform Testing**

Cisco Internal LabView Radio Test Automation Software:

RF Automation Main versions: 208, 218  
RF Domain Report Generation - version 3

## **Appendix G: Test Procedures**

Measurements were made in accordance with:

- LP0002 (2020-07-01)
- KDB Publication No. 789033 - D02 General UNII Test Procedures New Rules v02r01
- KDB Publication No. 662911 - MIMO
- ANSI C63.4 2014 Unintentional Radiators
- ANSI C63.10 2013 Intentional Radiators

Test procedures are summarized below:

FCC 5GHz Test Procedures	EDCS # 1445048
FCC 5GHz RSE Test Procedures	EDCS # 1511600

## **Appendix H: Scope of Accreditation (A2LA certificate number 1178-01)**

The scope of accreditation of Cisco Systems, Inc. can be found on the A2LA web page at:

<http://www.a2la.org/scopepdf/1178-01.pdf>

## **Appendix I: Test Assessment Plan**

Compliance Test Plan (Excel) EDCS# 23771097  
Target Power Tables EDCS# 23074232

## **Appendix J: Worst Case Justification**

N/A

# **End**