

**Test Report**  
**AIR-CAP3702P-B-K9**

**Cisco Aironet 802.11ac Dual Band Access Points**

**FCC ID: LDK102087P**

**5745-5825 MHz**

**Antenna Gain 13 dBi**

**Against the following Specifications:**

**CFR47 Part 15.407**

**Cisco Systems**

170 West Tasman Drive

San Jose, CA 95134

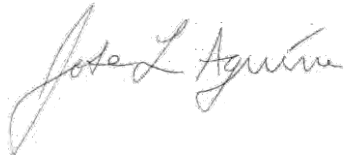
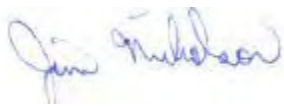
	
<b>Author:</b> Jose Aguirre <b>Tested By</b>	<b>Approved By:</b> Jim Nicolson <b>Title:</b> Technical Leader, Engineering <b>Revision:</b> 2

This report replaces any previously entered test report under EDCS – **1518138**. This test report has been electronically authorized and archived using the CISCO Engineering Document Control system.

This test report has been electronically authorized and archived using the CISCO Engineering Document Control system.

<b>SECTION 1: OVERVIEW .....</b>	<b>3</b>
<b>SECTION 2: ASSESSMENT INFORMATION .....</b>	<b>4</b>
2.1 GENERAL .....	4
2.2 DATE OF TESTING.....	6
2.3 REPORT ISSUE DATE .....	6
2.4 TESTING FACILITIES .....	6
2.5 EQUIPMENT ASSESSED (EUT).....	6
2.6 EUT DESCRIPTION.....	7
<b>SECTION 3: RESULT SUMMARY .....</b>	<b>9</b>
3.1 RESULTS SUMMARY TABLE .....	9
<b>SECTION 4: SAMPLE DETAILS.....</b>	<b>11</b>
<b>APPENDIX A: EMISSION TEST RESULTS .....</b>	<b>12</b>
CONDUCTED TEST SETUP DIAGRAM.....	12
TARGET MAXIMUM CHANNEL POWER .....	12
A.1 6dB BANDWIDTH .....	13
A.2 99% AND 26dB BANDWIDTH.....	21
A.3 MAXIMUM CONDUCTED OUTPUT POWER.....	29
A.4 POWER SPECTRAL DENSITY .....	36
A.5 CONDUCTED SPURIOUS EMISSIONS .....	42
A.5 CONDUCTED BAND EDGE .....	55
<b>APPENDIX B: EMISSION TEST RESULTS.....</b>	<b>63</b>
RADIATED EMISSION SETUP DIAGRAM-BELOW 1G .....	63
RADIATED EMISSION SETUP DIAGRAM-ABOVE 1G .....	63
B.1 RADIATED SPURIOUS EMISSIONS.....	64
B.2 RADIATED EMISSIONS 30MHZ TO 1GHZ.....	75
B.3 AC CONDUCTED EMISSIONS.....	77
<b>APPENDIX C: LIST OF TEST EQUIPMENT USED TO PERFORM THE TEST .....</b>	<b>82</b>
<b>APPENDIX E: ABBREVIATION KEY AND DEFINITIONS .....</b>	<b>84</b>

## Section 1: Overview

The samples were assessed against the tests detailed in section 3 under the requirements of the following specifications:

<b>Specifications:</b>
CFR47 Part 15.407

Measurements were made in accordance with

- ANSI C63.10:2013
- KDB 789033 D02 General UNII Test Procedures New Rules v01
- KDB 662911 D01 Multiple Transmitter Output

## Section 2: Assessment Information

### 2.1 General

This report contains an assessment of an apparatus against Electromagnetic Compatibility Standards based upon tests carried out on the samples submitted. The testing was performed by and for the use of Cisco systems Inc:

With regard to this assessment, the following points should be noted:

- a) The results contained in this report relate only to the items tested and were obtained in the period between the date of the initial assessment and the date of issue of the report. Manufactured products will not necessarily give identical results due to production and measurement tolerances.
- b) The apparatus was set up and exercised using the configuration and modes of operation defined in this report only.
- c) Where relevant, the apparatus was only assessed using the susceptibility criteria defined in this report and the Test Assessment Plan (TAP).
- d) All testing was performed under the following environmental conditions:

Temperature	15°C to 35°C (54°F to 95°F)
Atmospheric Pressure	860mbar to 1060mbar (25.4" to 31.3")
Humidity	10% to 75*%
- e) All AC testing was performed at one or more of the following supply voltages:  
110V 60 Hz (+/-20%)

### Units of Measurement

The units of measurements defined in the appendices are reported in specific terms, which are test dependent. Where radiated measurements are concerned these are defined at a particular distance. Basic voltage measurements are defined in units of [dBuV]

As an example, the basic calculation for all measurements is as follows:

$$\text{Emission level [dBuV]} = \text{Indicated voltage level [dBuV]} + \text{Cable Loss [dB]} + \text{Other correction factors [dB]}$$

The combinations of correction factors are dependent upon the exact test configurations [see test equipment lists for further details] and may include:-

Antenna Factors, Pre Amplifier Gain, LISN Loss, Pulse Limiter Loss and Filter Insertion Loss

Note: to convert the results from dBuV/m to uV/m use the following formula:-

$$\text{Level in uV/m} = \text{Common Antilogarithm} [(X \text{ dBuV/m})/20] = Y \text{ uV/m}$$

## Measurement Uncertainty Values

voltage and power measurements	± 2 dB
conducted EIRP measurements	± 1.4 dB
radiated measurements	± 3.2 dB
frequency measurements	± 2.4 10 <sup>-7</sup>
temperature measurements	± 0.54°
humidity measurements	± 2.3%
DC and low frequency measurements	± 2.5%

Where relevant measurement uncertainty levels have been estimated for tests performed on the apparatus. This uncertainty represents an expanded uncertainty expressed at approximately the 95% confidence level using a coverage factor of k=2.

## Radiated emissions (expanded uncertainty, confidence interval 95%)

30 MHz - 300 MHz	+/- 3.8 dB
300 MHz - 1000 MHz	+/- 4.3 dB
1 GHz - 10 GHz	+/- 4.0 dB
10 GHz - 18GHz	+/- 8.2 dB
18GHz - 26.5GHz	+/- 4.1 dB
26.5GHz - 40GHz	+/- 3.9 dB

## Conducted emissions (expanded uncertainty, confidence interval 95%)

30 MHz – 40GHz	+/- 0.38 dB
----------------	-------------

A product is considered to comply with a requirement if the nominal measured value is below the limit line. The product is considered to not be in compliance in case the nominal measured value is above the limit line.

**This report must not be reproduced except in full, without written approval of Cisco Systems.**

**2.2 Date of testing**

03-Jul-15 - 30-Aug-15

**2.3 Report Issue Date**

03-November-2015

Cisco uses an electronic system to issue, store and control the revision of test reports. This system is called the Engineering Document Control System (EDCS). The actual report issue date is embedded into the original file on EDCS. Any copies of this report, either electronic or paper, that are not on EDCS must be considered uncontrolled.

**2.4 Testing facilities**

This assessment was performed by:

**Testing Laboratory**

Cisco Systems, Inc.,  
125 West Tasman Drive  
San Jose, CA 95134, USA

**Registration Numbers for Industry Canada**

<b>Cisco System Site</b>	<b>Address</b>	<b>Site Identifier</b>
Building P, 10m Chamber	125 West Tasman Dr San Jose, CA 95134	Company #: 2461N-2
Building P, 5m Chamber	125 West Tasman Dr San Jose, CA 95134	Company #: 2461N-1
Building I, 5m Chamber	285 W. Tasman Drive San Jose, California 95134	Company #: 2461M-1

**Test Engineers**

Jose Aguirre

**2.5 Equipment Assessed (EUT)**

AIR-CAP3702P-B-K9

## 2.6 EUT Description

The 3702P Cisco Aironet 802.11ac Radio supports the following modes of operation. The modes are further defined in the radio Theory of Operation. The modes included in this report represent the worst case data for all modes.

- 802.11n/ac - Non HT/VHT20, One Antenna, 6 to 54 Mbps
- 802.11n/ac - Non HT/VHT20, Two Antennas, 6 to 54 Mbps
- 802.11n/ac - Non HT/VHT20, Three Antennas, 6 to 54 Mbps
- 802.11n/ac - Non HT/VHT20, Four Antennas, 6 to 54 Mbps
  
- 802.11n/ac - Non HT/VHT20 Beam Forming, Two Antennas, 6 to 54 Mbps
- 802.11n/ac - Non HT/VHT20 Beam Forming, Three Antennas, 6 to 54 Mbps
- 802.11n/ac - Non HT/VHT20 Beam Forming, Four Antennas, 6 to 54 Mbps
  
- 802.11n/ac - HT/VHT20, One Antenna, M0 to M7, M0 to M9 1ss
- 802.11n/ac - HT/VHT20, Two Antennas, M0 to M7, M0 to M9 1ss
- 802.11n/ac - HT/VHT20, Two Antennas, M8 to M15, M0 to M9 2ss
- 802.11n/ac - HT/VHT20, Three Antennas, M0 to M7, M0 to M9 1ss
- 802.11n/ac - HT/VHT20, Three Antennas, M8 to M15, M0 to M9 2ss
- 802.11n/ac - HT/VHT20, Three Antennas, M16 to M23, M0 to M9 3ss
- 802.11n/ac - HT/VHT20, Four Antennas, M0 to M7, M0 to M9 1ss
- 802.11n/ac - HT/VHT20, Four Antennas, M8 to M15, M0 to M9 2ss
- 802.11n/ac - HT/VHT20, Four Antennas, M16 to M23, M0 to M9 3ss
  
- 802.11n/ac - HT/VHT20 Beam Forming, Two Antennas, M0 to M7, M0 to M9 1ss
- 802.11n/ac - HT/VHT20 Beam Forming, Two Antennas, M8 to M15, M0 to M9 2ss
- 802.11n/ac - HT/VHT20 Beam Forming, Three Antennas, M0 to M7, M0 to M9 1ss
- 802.11n/ac - HT/VHT20 Beam Forming, Three Antennas, M8 to M15, M0 to M9 2ss
- 802.11n/ac - HT/VHT20 Beam Forming, Three Antennas, M16 to M23, M0 to M9 3ss
- 802.11n/ac - HT/VHT20 Beam Forming, Four Antennas, M0 to M7, M0 to M9 1ss
- 802.11n/ac - HT/VHT20 Beam Forming, Four Antennas, M8 to M15, M0 to M9 2ss
- 802.11n/ac - HT/VHT20 Beam Forming, Four Antennas, M16 to M23, M0 to M9 3ss
  
- 802.11n/ac - HT/VHT20 STBC, Two Antennas, M0 to M7, M0 to M9 1ss
- 802.11n/ac - HT/VHT20 STBC, Three Antennas, M0 to M7, M0 to M9 1ss
- 802.11n/ac - HT/VHT20 STBC, Four Antennas, M0 to M7, M0 to M9 1ss
  
- 802.11n/ac - Non HT/VHT40 Duplicate, One Antenna, 6 to 54 Mbps
- 802.11n/ac - Non HT/VHT40 Duplicate, Two Antennas, 6 to 54 Mbps
- 802.11n/ac - Non HT/VHT40 Duplicate, Three Antennas, 6 to 54 Mbps
- 802.11n/ac - Non HT/VHT40 Duplicate, Four Antennas, 6 to 54 Mbps
  
- 802.11n/ac - HT/VHT40, One Antenna, M0 to M7, M0 to M9 1ss
- 802.11n/ac - HT/VHT40, Two Antennas, M0 to M7, M0 to M9 1ss
- 802.11n/ac - HT/VHT40, Two Antennas, M8 to M15, M0 to M9 2ss
- 802.11n/ac - HT/VHT40, Three Antennas, M0 to M7, M0 to M9 1ss
- 802.11n/ac - HT/VHT40, Three Antennas, M8 to M15, M0 to M9 2ss
- 802.11n/ac - HT/VHT40, Three Antennas, M16 to M23, M0 to M9 3ss
- 802.11n/ac - HT/VHT40, Four Antennas, M0 to M7, M0 to M9 1ss
- 802.11n/ac - HT/VHT40, Four Antennas, M8 to M15, M0 to M9 2ss
- 802.11n/ac - HT/VHT40, Four Antennas, M16 to M23, M0 to M9 3ss
  
- 802.11n/ac - HT/VHT40 Beam Forming, Two Antennas, M0 to M7, M0 to M9 1ss
- 802.11n/ac - HT/VHT40 Beam Forming, Two Antennas, M8 to M15, M0 to M9 2ss
- 802.11n/ac - HT/VHT40 Beam Forming, Three Antennas, M0 to M7, M0 to M9 1ss
- 802.11n/ac - HT/VHT40 Beam Forming, Three Antennas, M8 to M15, M0 to M9 2ss
- 802.11n/ac - HT/VHT40 Beam Forming, Three Antennas, M16 to M23, M0 to M9 3ss

802.11n/ac - HT/VHT40 Beam Forming, Four Antennas, M0 to M7, M0 to M9 1ss  
 802.11n/ac - HT/VHT40 Beam Forming, Four Antennas, M8 to M15, M0 to M9 2ss  
 802.11n/ac - HT/VHT40 Beam Forming, Four Antennas, M16 to M23, M0 to M9 3ss

802.11n/ac - HT/VHT40 STBC, Two Antennas, M0 to M7, M0 to M9 1ss  
 802.11n/ac - HT/VHT40 STBC, Three Antennas, M0 to M7, M0 to M9 1ss  
 802.11n/ac - HT/VHT40 STBC, Four Antennas, M0 to M7, M0 to M9 1ss

802.11n/ac - Non HT/VHT80 Duplicate, One Antenna, 6 to 54 Mbps  
 802.11n/ac - Non HT/VHT80 Duplicate, Two Antennas, 6 to 54 Mbps  
 802.11n/ac - Non HT/VHT80 Duplicate, Three Antennas, 6 to 54 Mbps  
 802.11n/ac - Non HT/VHT80 Duplicate, Four Antennas, 6 to 54 Mbps

802.11n/ac - HT/VHT80, One Antenna, M0 to M7, M0 to M9 1ss  
 802.11n/ac - HT/VHT80, Two Antennas, M0 to M7, M0 to M9 1ss  
 802.11n/ac - HT/VHT80, Two Antennas, M8 to M15, M0 to M9 2ss  
 802.11n/ac - HT/VHT80, Three Antennas, M0 to M7, M0 to M9 1ss  
 802.11n/ac - HT/VHT80, Three Antennas, M8 to M15, M0 to M9 2ss  
 802.11n/ac - HT/VHT80, Three Antennas, M16 to M23, M0 to M9 3ss  
 802.11n/ac - HT/VHT80, Four Antennas, M0 to M7, M0 to M9 1ss  
 802.11n/ac - HT/VHT80, Four Antennas, M8 to M15, M0 to M9 2ss  
 802.11n/ac - HT/VHT80, Four Antennas, M16 to M23, M0 to M9 3ss

802.11n/ac - HT/VHT80 Beam Forming, Two Antennas, M0 to M7, M0 to M9 1ss  
 802.11n/ac - HT/VHT80 Beam Forming, Two Antennas, M8 to M15, M0 to M9 2ss  
 802.11n/ac - HT/VHT80 Beam Forming, Three Antennas, M0 to M7, M0 to M9 1ss  
 802.11n/ac - HT/VHT80 Beam Forming, Three Antennas, M8 to M15, M0 to M9 2ss  
 802.11n/ac - HT/VHT80 Beam Forming, Three Antennas, M16 to M23, M0 to M9 3ss  
 802.11n/ac - HT/VHT80 Beam Forming, Four Antennas, M0 to M7, M0 to M9 1ss  
 802.11n/ac - HT/VHT80 Beam Forming, Four Antennas, M8 to M15, M0 to M9 2ss  
 802.11n/ac - HT/VHT80 Beam Forming, Four Antennas, M16 to M23, M0 to M9 3ss

802.11n/ac - HT/VHT80 STBC, Two Antennas, M0 to M7, M0 to M9 1ss  
 802.11n/ac - HT/VHT80 STBC, Three Antennas, M0 to M7, M0 to M9 1ss  
 802.11n/ac - HT/VHT80 STBC, Four Antennas, M0 to M7, M0 to M9 1ss

The following antennas are supported by this product series.

The data included in this report represent the worst case data for all antennas.

Frequency	Part Number	Antenna Type	Antenna Gain (dBi)	Antenna Gain >30 degrees (dBi)
2.4/5 GHz	AIR-ANT2524DB-R	Dual-resonant black dipole	2 / 4	NA
	AIR-ANT2524DW-R	Dual-resonant white dipole	2 / 4	NA
	AIR-ANT2524DG-R	Dual-resonant gray dipole	2 / 4	NA
	AIR-ANT2524V4C-R	Dual-resonant ceiling mount omni (4-pack)	2 / 4	NA
	AIR-ANT2544V4M-R8	Dual-resonant omni (4-pack)	3 / 2	1
	AIR-ANT2544V4M-R	Dual-resonant omni (4-pack)	4 / 4	1
	AIR-ANT2566P4W-R	Dual-resonant "directional" antenna (4-pack)	6 / 6	3
	AIR-ANT2566D4M-R	Dual-Band Polarization-Diverse Directional Array	6 / 6	3
	AIR-ANT2547V-N	Dual Band Omni	4 / 7	-7
	AIR-ANT2513P4M-N	Dual-resonant cross-pol "directional" antenna (4-pack)	13 / 13	-7



### Section 3: Result Summary

#### 3.1 Results Summary Table

##### Conducted emissions

Basic Standard	Technical Requirements / Details	Result
FCC 15.407	<b>6dB Bandwidth:</b> Systems using digital modulation techniques may operate in the 2400-2483.5MHz band. The minimum 6dB bandwidth shall be at least 500 kHz.	Pass
FCC 15.407	<b>99% &amp; 26 dB Bandwidth:</b> The 99% occupied bandwidth is the frequency bandwidth such that, below its lower and above its upper frequency limits, the mean powers are each equal to 0.5% of the total mean power of the given emission. There is no limit for 99% OBW.  The 26 dB emission is the width of the emission that is constrained by the frequencies associated with the two outermost amplitude points (upper and lower frequencies) that are attenuated by 26 dB relative to the maximum level measured in the fundamental emission.	Pass
FCC 15.407	<b>Output Power:</b> For the band 5.725-5.85 GHz, the maximum conducted output power over the frequency band of operation shall not exceed 1 W.	Pass
FCC 15.407	<b>Power Spectral Density:</b> <b>15.407</b> The maximum power spectral density shall not exceed 30 dBm in any 500-kHz band.	Pass
FCC 15.407	<b>Conducted Spurious Emissions / Band-Edge:</b> For transmitters operating in the 5.725-5.85 GHz band: All emissions within the frequency range from the band edge to 10 MHz above or below the band edge shall not exceed an e.i.r.p. of -17 dBm/MHz; for frequencies 10 MHz or greater above or below the band edge, emissions shall not exceed an e.i.r.p. of -27 dBm/MHz.	Pass
FCC 15.407 FCC 15.209 FCC 152.05	<b>Restricted band:</b> Unwanted emissions falling within the restricted bands, as defined in FCC 15.205 (a) must also comply with the radiated emission limits specified in FCC 15.209 (a).	Pass

**Radiated Emissions (General requirements)**

<b>Basic Standard</b>	<b>Technical Requirements / Details</b>	<b>Result</b>
FCC 15.407 FCC 15.209 FCC 15.205	<b>TX Spurious Emissions:</b> Except as provided elsewhere in this subpart, the emissions from an intentional radiator shall not exceed the field strength levels specified in the filed strength limits table in this section.	Pass
FCC 15.207	<b>AC conducted Emissions:</b> Except when the requirements applicable to a given device state otherwise, for any radio apparatus equipped to operate from the public utility AC power supply, either directly or indirectly (such as with a battery charger), the radio frequency voltage of emissions conducted back onto the AC power lines in the frequency range of 0.15 MHz to 30 MHz shall not exceed the limits shown in the table in these sections. The more stringent limit applies at the frequency range boundaries.	Pass

\* MPE calculation is recorded in a separate report

## Section 4: Sample Details

Note: Each sample was evaluated to ensure that its condition was suitable to be used as a test sample prior to the commencement of testing.

### 4.1 Sample Details

Sample No.	Equipment Details	Manufacturer	Hardware Rev.	Firmware Rev.	Software Rev.	Serial Number
S01	AIR-CAP3702P-B-K9	Cisco Systems	V02	AP3G2-K9W7-M	IOS 15.3	FTX1850R0F5
S02*	AIR-PWR-C	Meanwell	A0	NA	NA	EB46E93226

(\*) S02 are support equipment Power supplies for EUT S01

### 4.2 System Details

System #	Description	Samples
1	AIR-SAP3702P-B-K9 (EUT)	S01
2	AIR-PWR-C (Support power supply)	S02

### 4.3 Mode of Operation Details

Mode#	Description	Comments
1	Continuous Transmitting	Continuous Transmitting

All measurements were made in accordance with

- ANSI C63.10:2013
- KDB 789033 D02 General UNII Test Procedures New Rules v01
- KDB 662911 D01 Multiple Transmitter Output

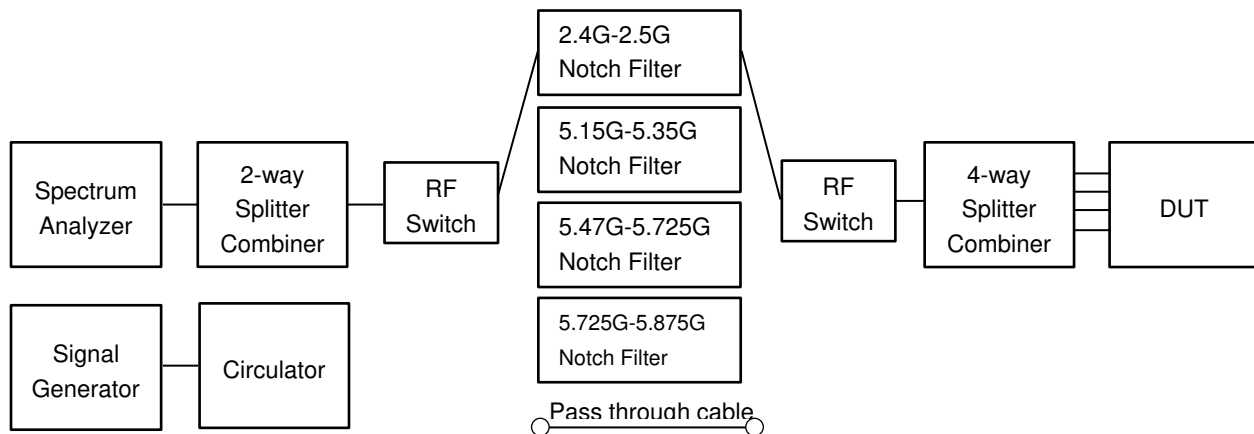
**Appendix A: Emission Test Results****Conducted Test Setup Diagram****Target Maximum Channel Power**

The following table details the maximum supported Total Channel Power for all operating modes.

Operating Mode	Maximum Channel Power (dBm)	
	Frequency (MHz)	
	5745	5785
Non HT/VHT20, 6 to 54 Mbps	17	22
Non HT/VHT20 Beam Forming, 6 to 54 Mbps	16	22
HT/VHT20, M0 to M23, M0 to M9 1-3ss	18	22
HT/VHT20 Beam Forming, M0 to M23, M0 to M9 1-3ss	18	22
HT/VHT20 STBC, M0 to M7, M0 to M9 1-1ss	18	22
	5755	5795
Non HT/VHT40, 6 to 54 Mbps	12	14
HT/VHT40, M0 to M23, M0 to M9 1-3ss	14	17
HT/VHT40 Beam Forming, M0 to M23, M0 to M9 1-3ss	14	17
HT/VHT40 STBC, M0 to M7, M0 to M9 1-1ss	14	17
	5775	
Non HT/VHT80, 6 to 54 Mbps	7	
HT/VHT80, M0 to M23, M0 to M9 1-3ss	11	
HT/VHT80 Beam Forming, M0 to M23, M0 to M9 1-3ss	11	
HT/VHT80 STBC, M0 to M7, M0 to M9 1-1ss	11	



## A.1 6dB Bandwidth

15.407 Within the 5.725-5.85 GHz band, the minimum 6 dB bandwidth of U-NII devices shall be at least 500 kHz.

### Test Procedure

Ref. KDB 789033 D02 General UNII Test Procedures New Rules v01  
ANSI C63.10: 2013

<b>6 BW</b>
Test Procedure
<ol style="list-style-type: none"> <li>1. Set the radio in the continuous transmitting mode.</li> <li>2. Allow the trace to stabilize.</li> <li>3. Setting the x-dB bandwidth mode to -6dB within the measurement set up function.</li> <li>4. Select the automatic OBW measurement function of an instrument to perform bandwidth measurement.</li> <li>5. Capture graphs and record pertinent measurement data.</li> </ol>

Ref. KDB 789033 D02 General UNII Test Procedures New Rules v01  
ANSI C63.10: 2013 section 11.8.2 Option 2

<b>6 BW</b>
Test parameters
X dB BW = 6dB (using the OBW function of the spectrum analyzer) Span = Large enough to capture the entire EBW RBW = 100 KHz VBW ≥ 3 x RBW Sweep = Auto couple Detector = Peak or where practical sample shall be used Trace = Max. Hold

System Number	Description	Samples	System under test	Support equipment
1	EUT	S01	<input checked="" type="checkbox"/>	<input type="checkbox"/>
	Support	S02	<input type="checkbox"/>	<input checked="" type="checkbox"/>

<b>Tested By :</b> Jose Aguirre	<b>Date of testing:</b> 03-Jul-15 - 08-Aug-15
<b>Test Result : PASS</b>	

See Appendix C for list of test equipment

Frequency (MHz)	Mode	Data Rate (Mbps)	6dB BW (MHz)	Limit (kHz)	Margin (MHz)
5745	Non HT/VHT20, 6 to 54 Mbps	6	16.4	>500	15.9
	HT/VHT20, M0 to M23, M0 to M9 1-3ss	m0	17.1	>500	16.6
5755	Non HT/VHT40, 6 to 54 Mbps	6	35.7	>500	35.2
	HT/VHT40, M0 to M23, M0 to M9 1-3ss	m0	35.5	>500	35.0
5775	Non HT/VHT80, 6 to 54 Mbps	6	76.5	>500	76.0
	HT/VHT80, M0 to M23, M0 to M9 1-3ss	m0x1	76.4	>500	75.9
5785	Non HT/VHT20, 6 to 54 Mbps	6	16.4	>500	15.9
	HT/VHT20, M0 to M23, M0 to M9 1-3ss	m0	17.3	>500	16.8
5795	Non HT/VHT40, 6 to 54 Mbps	6	35.7	>500	35.2
	HT/VHT40, M0 to M23, M0 to M9 1-3ss	m0	35.5	>500	35.0
5825	Non HT/VHT20, 6 to 54 Mbps	6	16.4	>500	15.9
	HT/VHT20, M0 to M23, M0 to M9 1-3ss	m0	17.2	>500	16.7

**6dB Bandwidth, 5745 MHz, Non HT/VHT20, 6 to 54 Mbps**

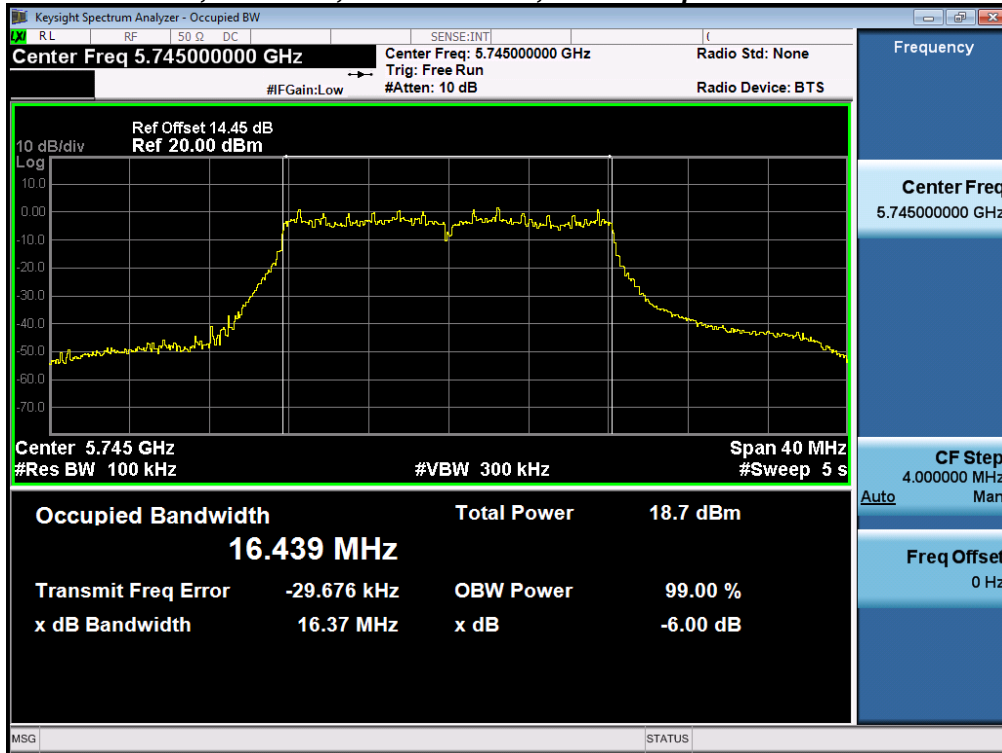

**6dB Bandwidth, 5745 MHz, HT/VHT20, M0 to M23, M0 to M9 1-3ss**

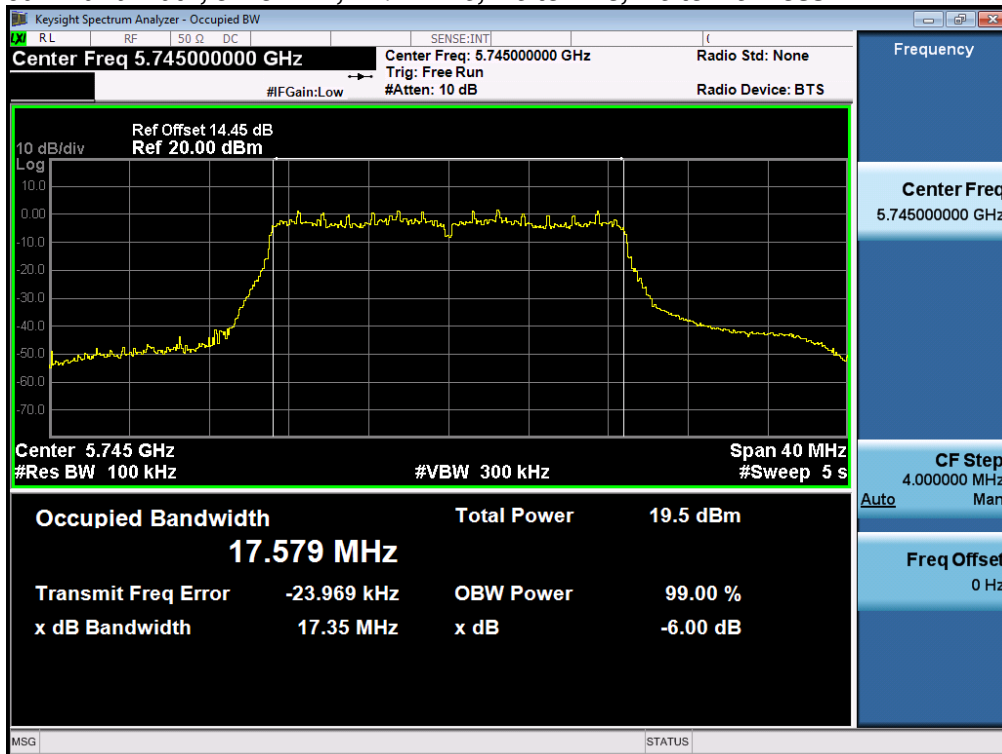

**6dB Bandwidth, 5755 MHz, Non HT/VHT40, 6 to 54 Mbps**

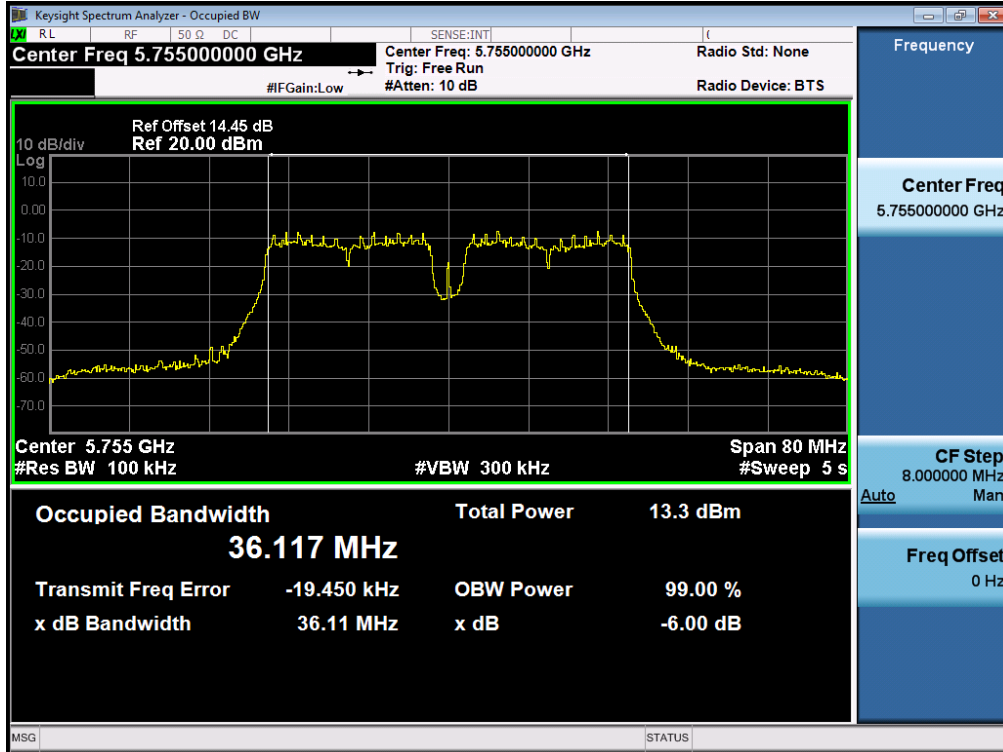

**6dB Bandwidth, 5755 MHz, HT/VHT40, M0 to M23, M0 to M9 1-3ss**

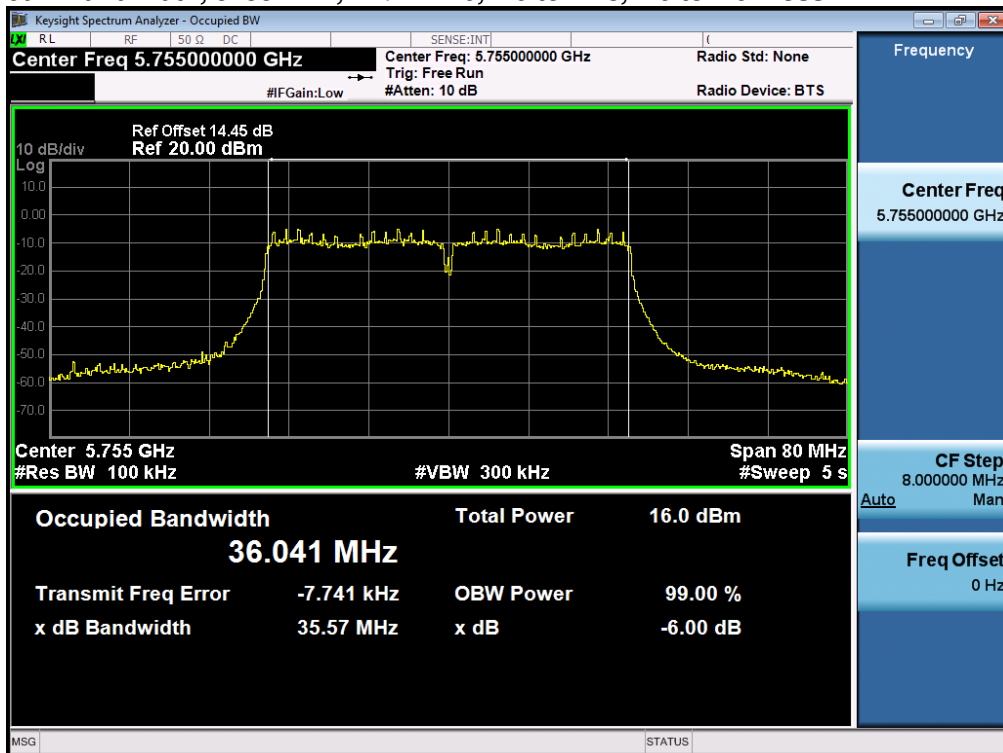



**6dB Bandwidth, 5775 MHz, Non HT/VHT80, 6 to 54 Mbps**

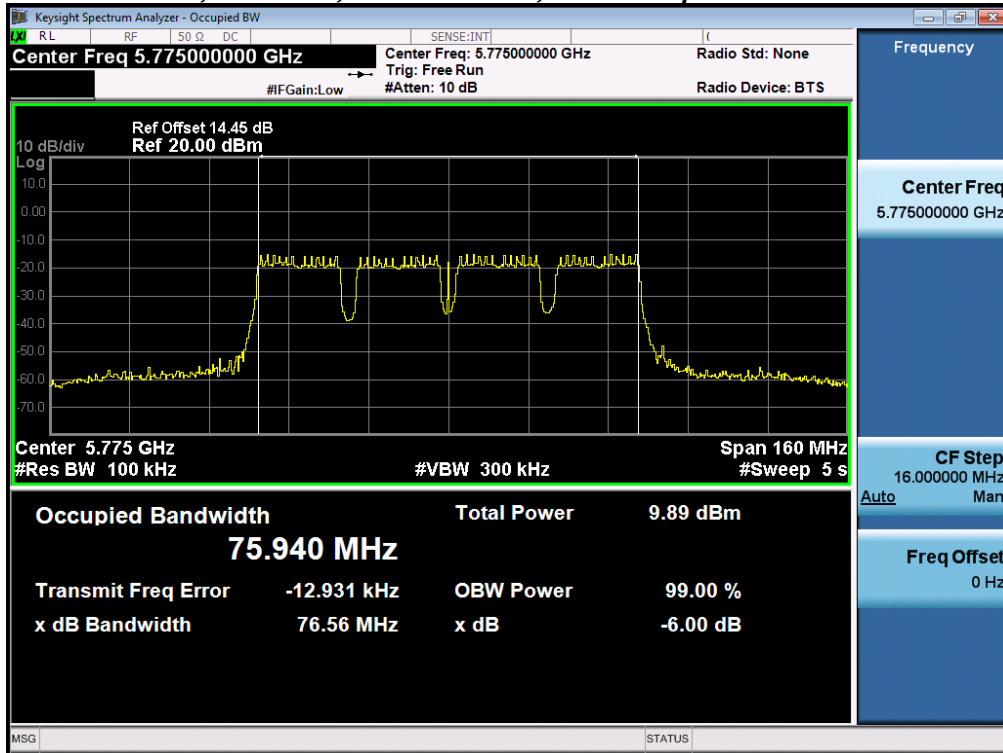

**6dB Bandwidth, 5775 MHz, HT/VHT80, M0 to M23, M0 to M9 1-3ss**

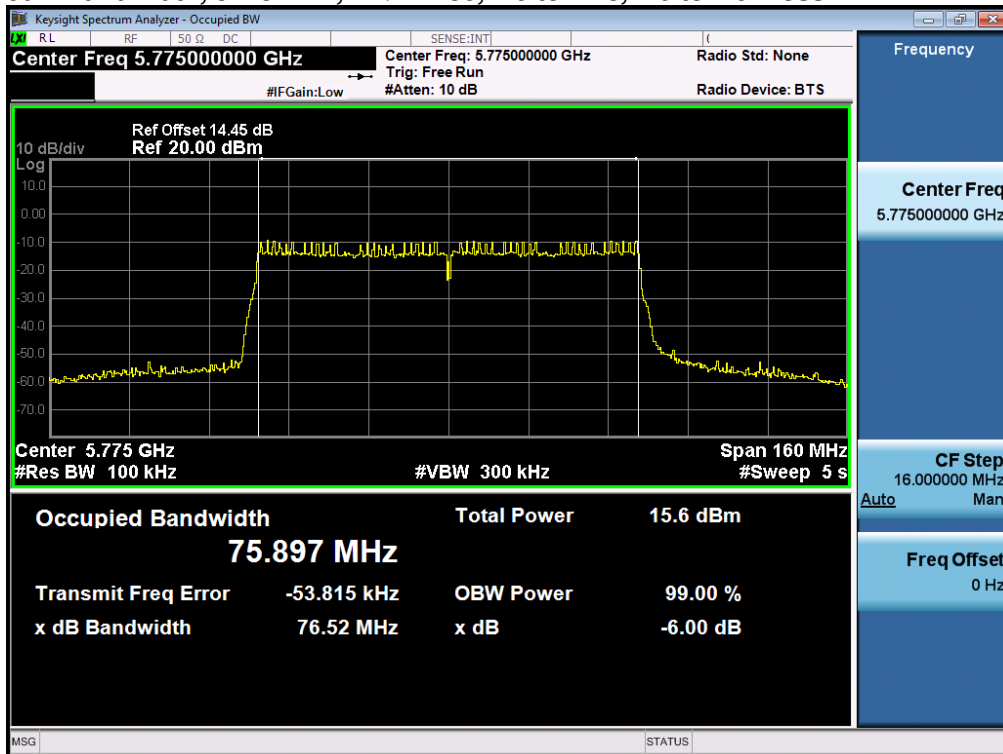

**6dB Bandwidth, 5785 MHz, Non HT/VHT20, 6 to 54 Mbps**

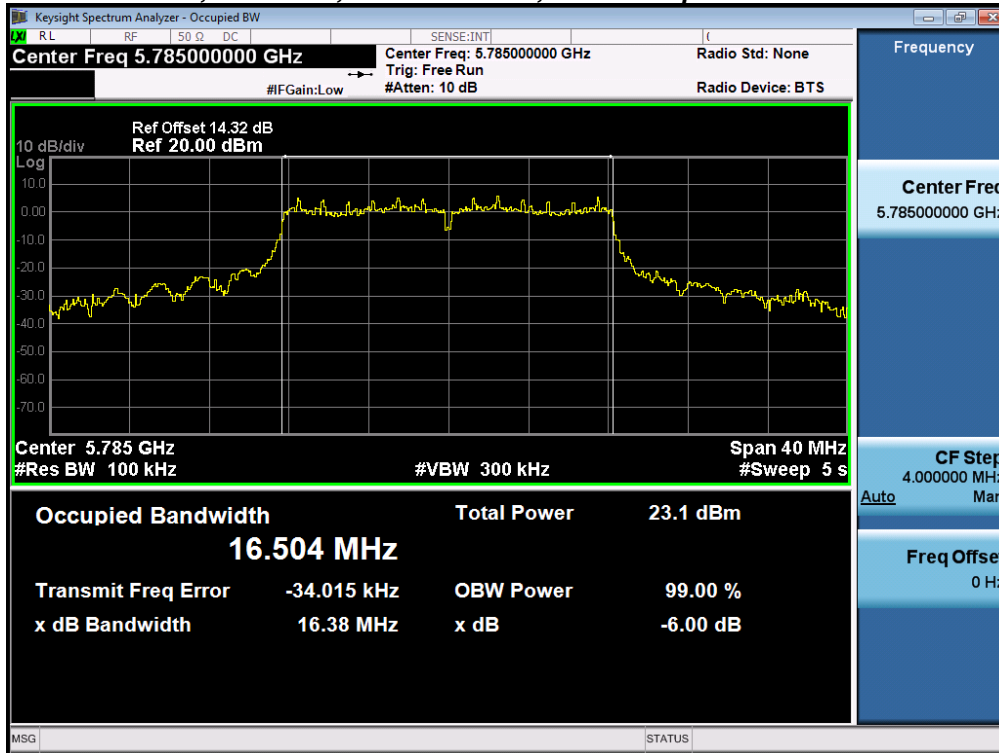

**6dB Bandwidth, 5785 MHz, HT/VHT20, M0 to M23, M0 to M9 1-3ss**

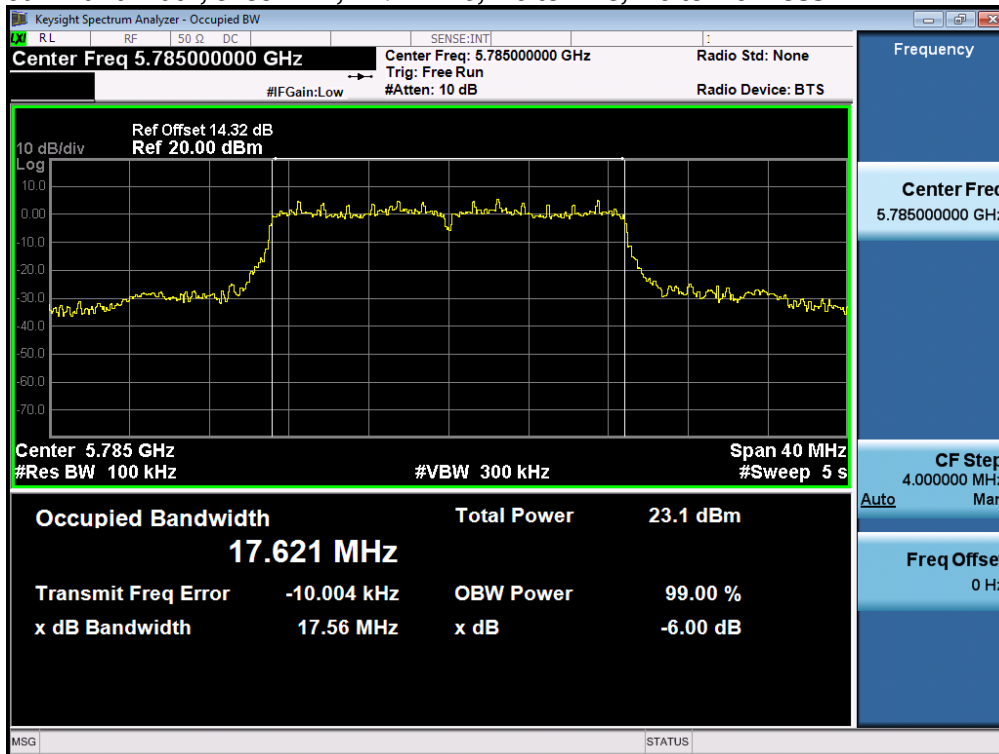

**6dB Bandwidth, 5795 MHz, Non HT/VHT40, 6 to 54 Mbps**

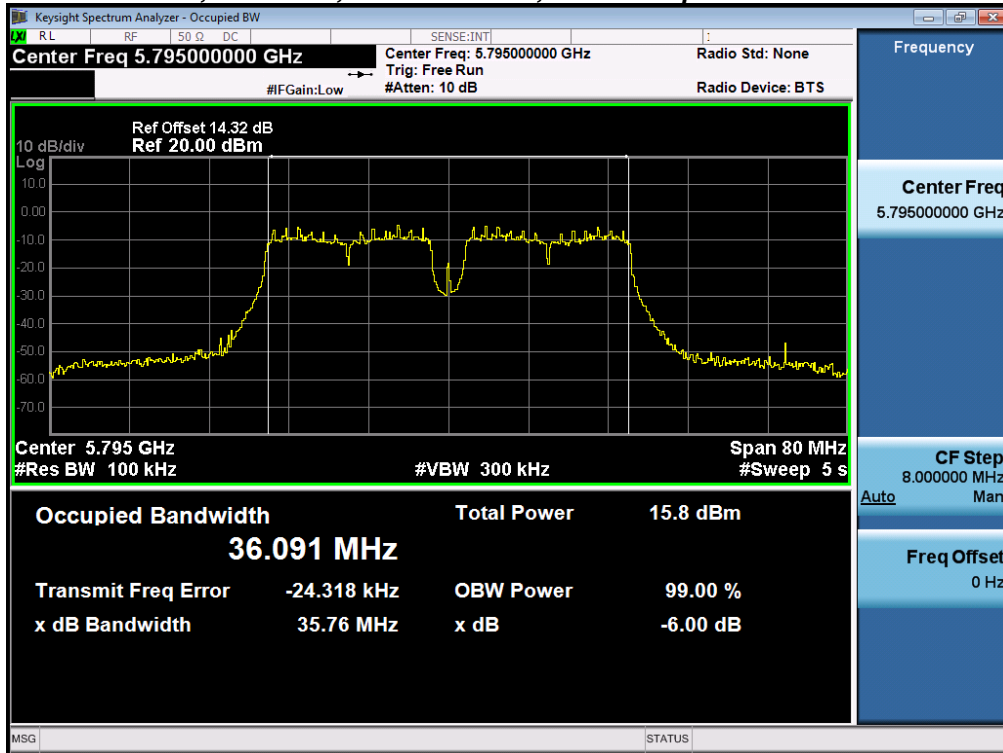

**6dB Bandwidth, 5795 MHz, HT/VHT40, M0 to M23, M0 to M9 1-3ss**

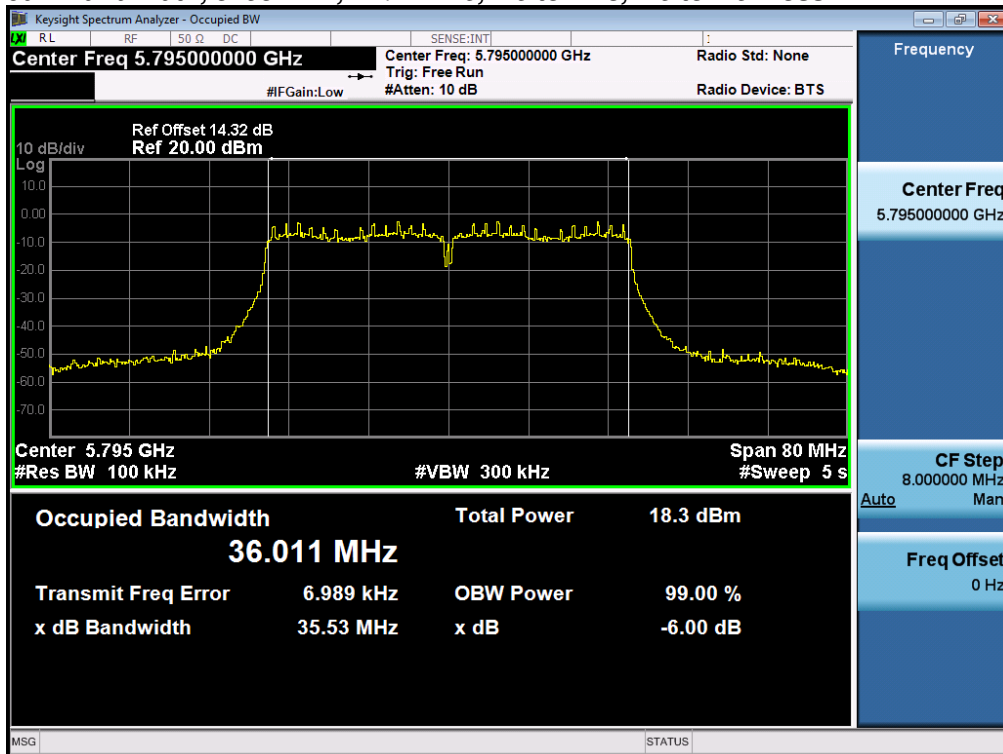

**6dB Bandwidth, 5825 MHz, Non HT/VHT20, 6 to 54 Mbps**

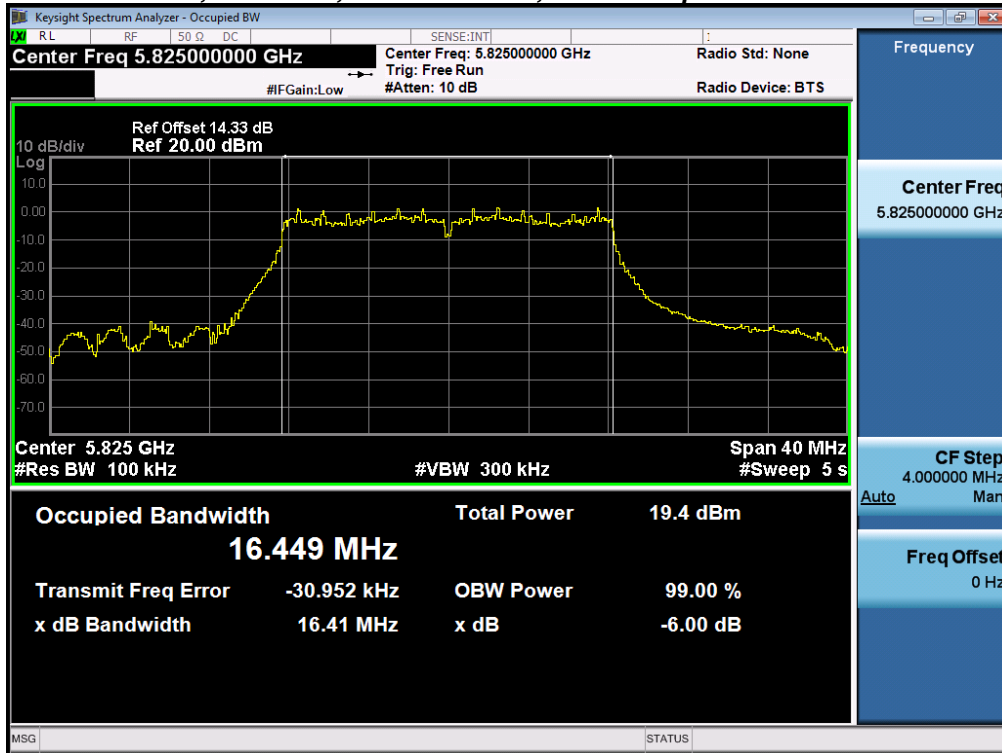

**6dB Bandwidth, 5825 MHz, HT/VHT20, M0 to M23, M0 to M9 1-3ss**

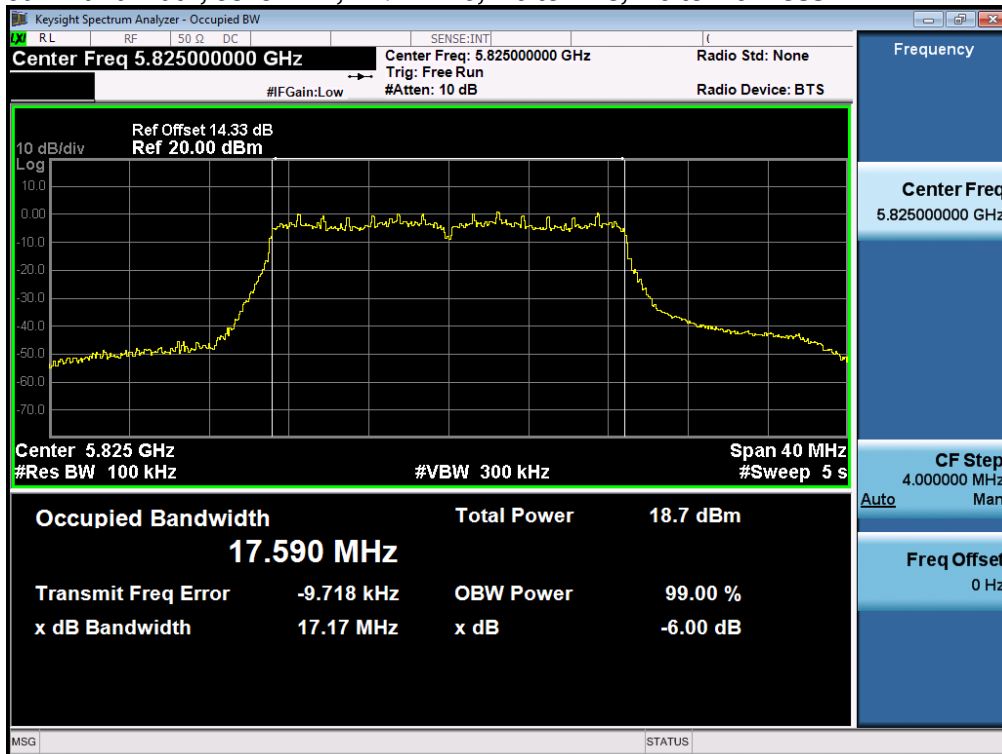

## A.2 99% and 26dB Bandwidth

**FCC 15.407** The 99% occupied bandwidth is the frequency bandwidth such that, below its lower and above its upper frequency limits, the mean powers are each equal to 0.5% of the total mean power of the given emission. There is no limit for 99% OBW.

The 26 dB emission is the width of the emission that is constrained by the frequencies associated with the two outermost amplitude points (upper and lower frequencies) that are attenuated by 26 dB relative to the maximum level measured in the fundamental emission.

### Test Procedure

Ref. ANSI C63.10: 2013 Section 6.9.3

#### 99% BW and EBW (-26dB)

Test Procedure

1. Set the radio in the continuous transmitting mode.
2. Allow the trace to stabilize.
3. Setting the x-dB bandwidth mode to -26dB and OBW power function to 99% within the measurement set up function.
4. Select the automatic OBW measurement function of an instrument to perform bandwidth measurement.
5. Capture graphs and record pertinent measurement data.

Ref. ANSI C63.10: 2013 Section 6.9.3

#### 99% BW and EBW (-26dB)

Test parameters

Span = 1.5 x to 5.0 times OBW

RBW = approx. 1% to 5% of the OBW

VBW  $\geq$  3 x RBW

Detector = Peak or where practical sample shall be used

Trace = Max. Hold

System Number	Description	Samples	System under test	Support equipment
1	EUT	S01	<input checked="" type="checkbox"/>	<input type="checkbox"/>
	Support	S02	<input type="checkbox"/>	<input checked="" type="checkbox"/>

**Tested By :**

Jose Aguirre

**Date of testing:**

03-Jul-15 - 08-Aug-15

**Test Result : PASS**

See Appendix C for list of test equipment

Frequency (MHz)	Mode	Data Rate (Mbps)	26dB BW (MHz)	99% BW (MHz)
5745	Non HT/VHT20, 6 to 54 Mbps	6	22.6	17.7
	HT/VHT20, M0 to M23, M0 to M9 1-3ss	m0	22.4	18.2
5755	Non HT/VHT40, 6 to 54 Mbps	6	41.9	36.5
	HT/VHT40, M0 to M23, M0 to M9 1-3ss	m0	42.2	36.5
5775	Non HT/VHT80, 6 to 54 Mbps	6	87.6	76.3
	HT/VHT80, M0 to M23, M0 to M9 1-3ss	m0x1	82.7	76.6
5785	Non HT/VHT20, 6 to 54 Mbps	6	24.1	17.9
	HT/VHT20, M0 to M23, M0 to M9 1-3ss	m0	22.4	18.2
5795	Non HT/VHT40, 6 to 54 Mbps	6	42.6	36.6
	HT/VHT40, M0 to M23, M0 to M9 1-3ss	m0	42.0	36.5
5825	Non HT/VHT20, 6 to 54 Mbps	6	22.1	17.7
	HT/VHT20, M0 to M23, M0 to M9 1-3ss	m0	22.1	18.1

**26dB / 99% Bandwidth, 5745 MHz, Non HT/VHT20, 6 to 54 Mbps**

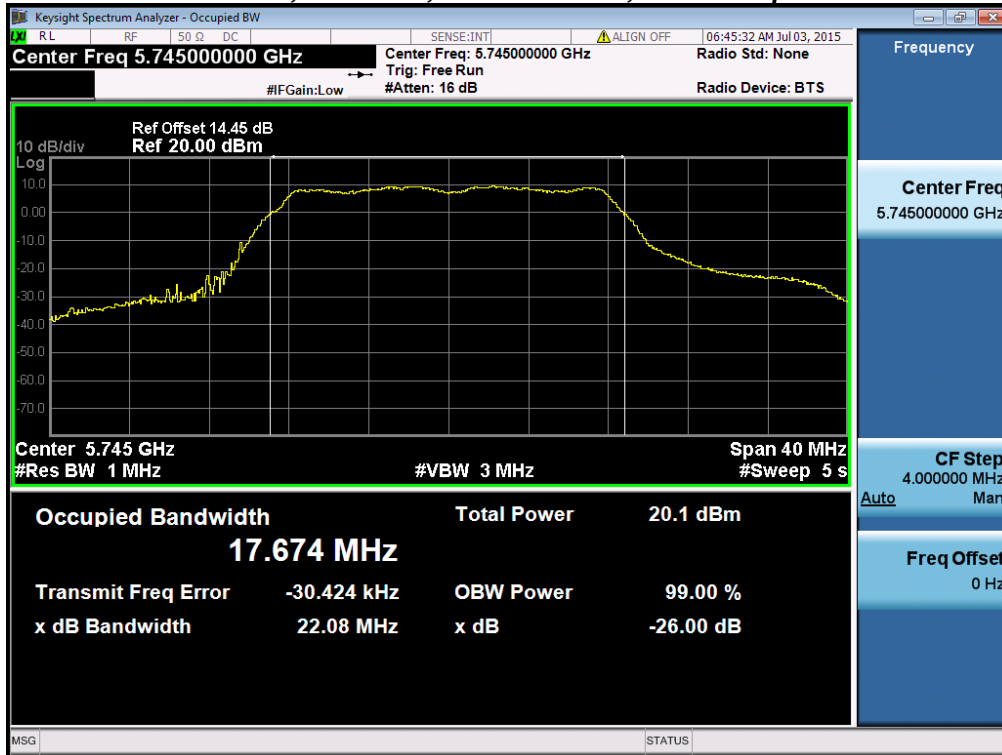

**26dB / 99% Bandwidth, 5745 MHz, HT/VHT20, M0 to M23, M0 to M9 1-3ss**

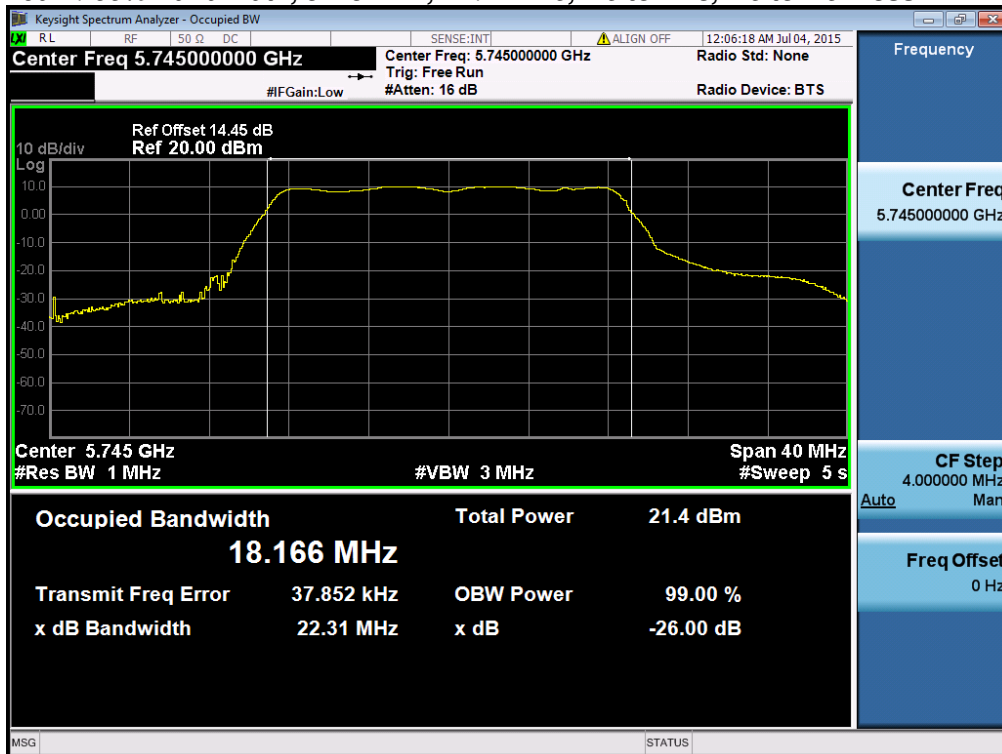

**26dB / 99% Bandwidth, 5755 MHz, Non HT/VHT40, 6 to 54 Mbps**

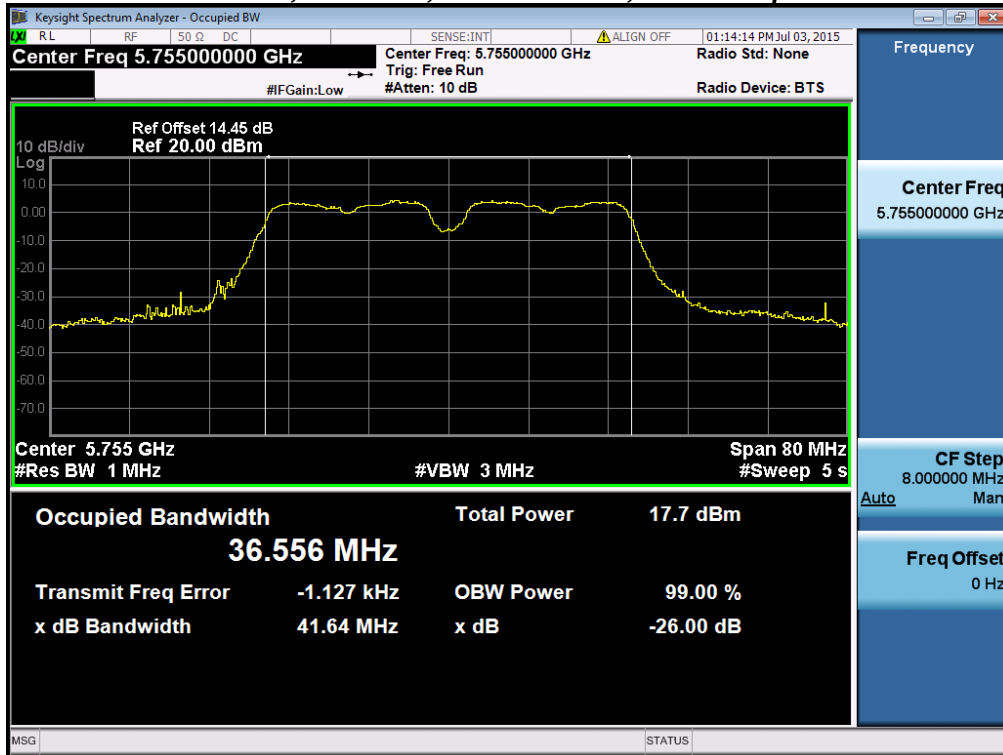

**26dB / 99% Bandwidth, 5755 MHz, HT/VHT40, M0 to M23, M0 to M9 1-3ss**

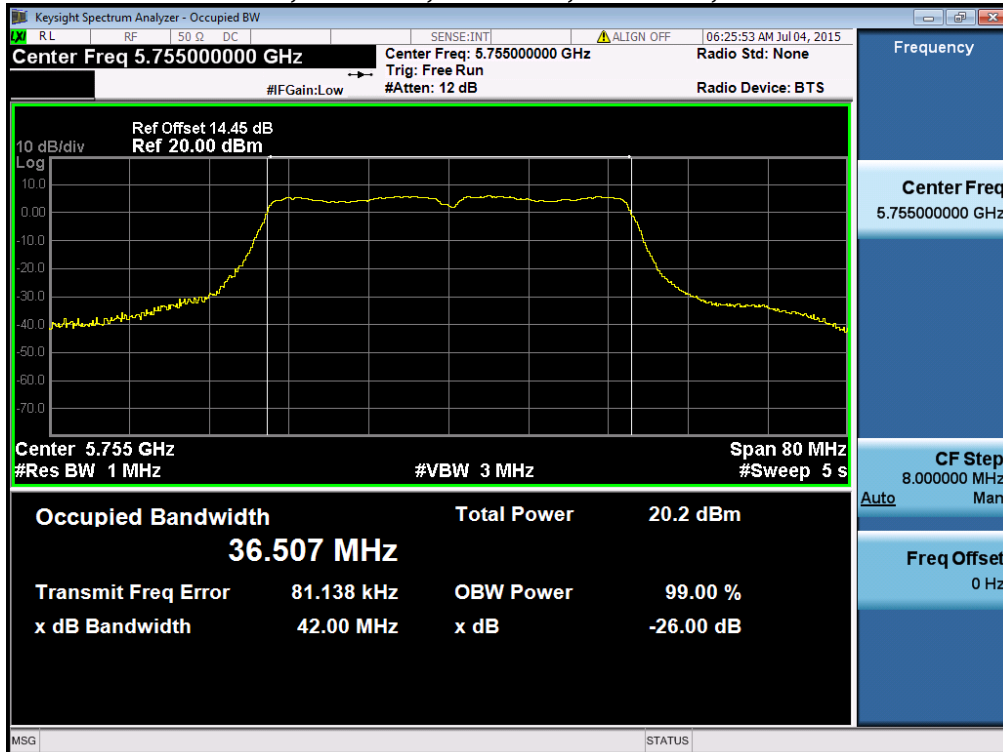



**26dB / 99% Bandwidth, 5775 MHz, Non HT/VHT80, 6 to 54 Mbps**

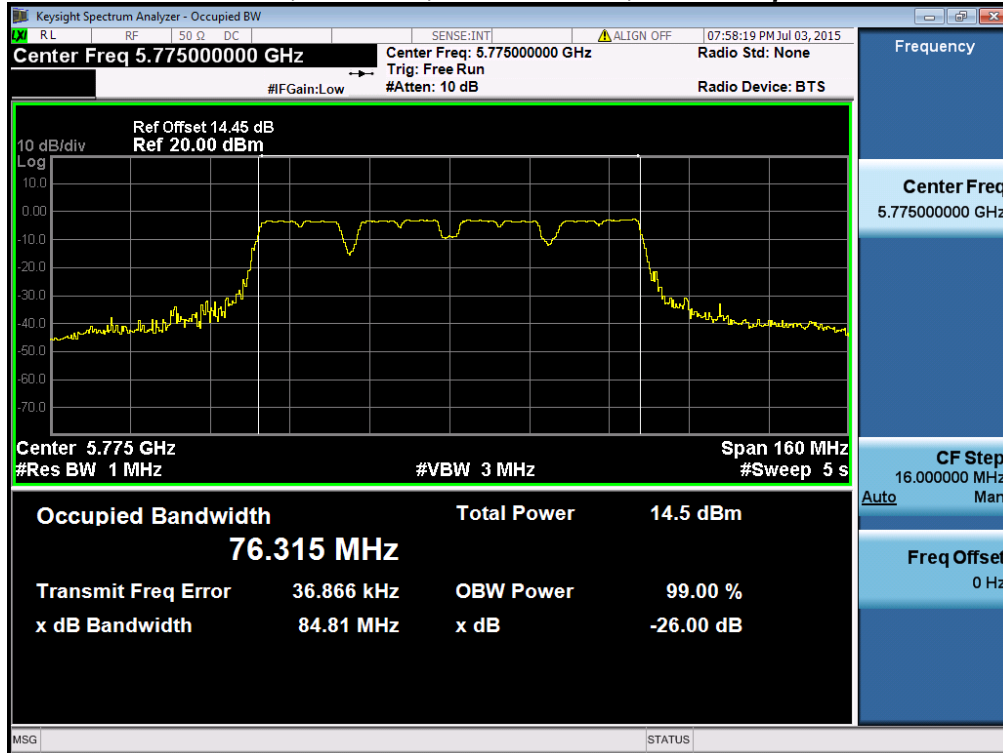

**26dB / 99% Bandwidth, 5775 MHz, HT/VHT80, M0 to M23, M0 to M9 1-3ss**

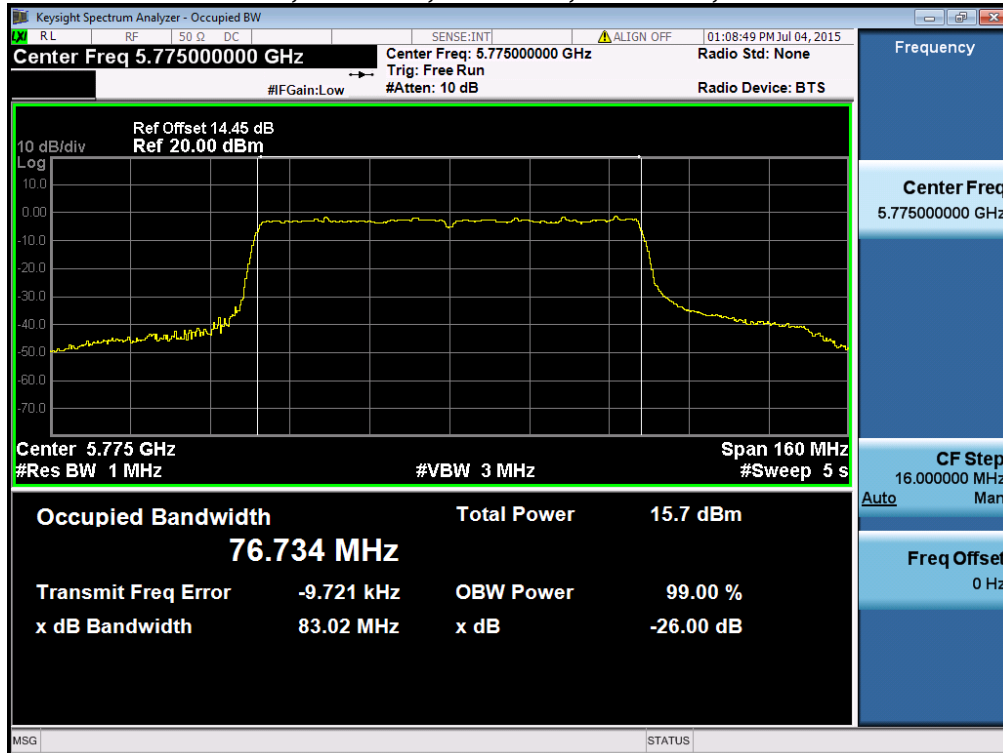

**26dB / 99% Bandwidth, 5785 MHz, Non HT/VHT20, 6 to 54 Mbps**

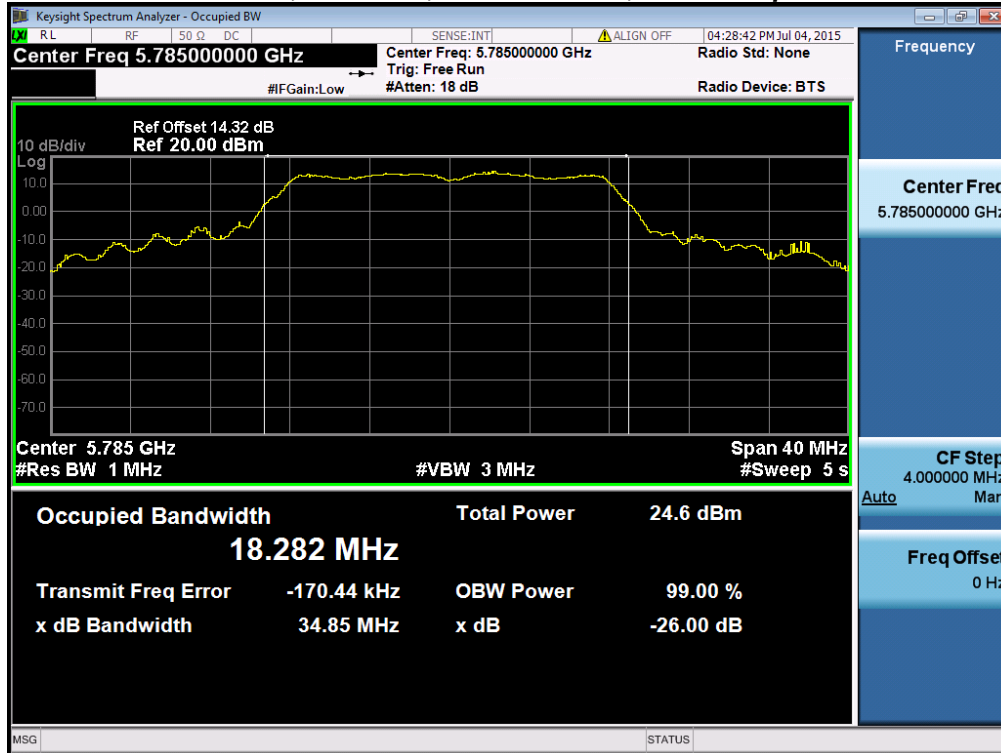

**26dB / 99% Bandwidth, 5785 MHz, HT/VHT20, M0 to M23, M0 to M9 1-3ss**

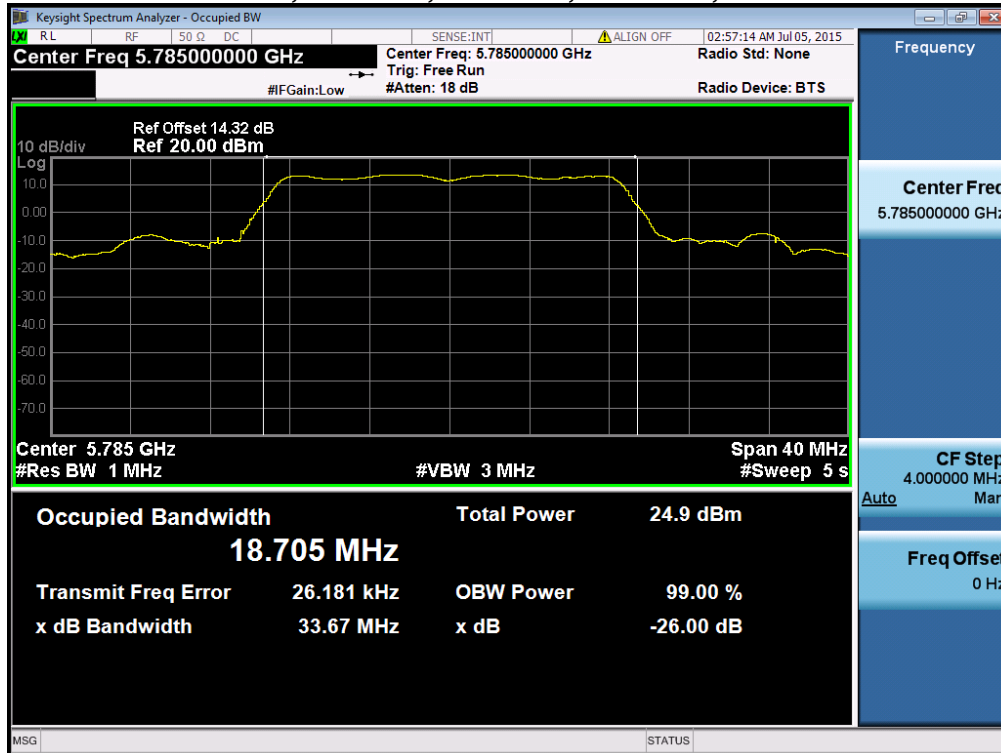

**26dB / 99% Bandwidth, 5795 MHz, Non HT/VHT40, 6 to 54 Mbps**

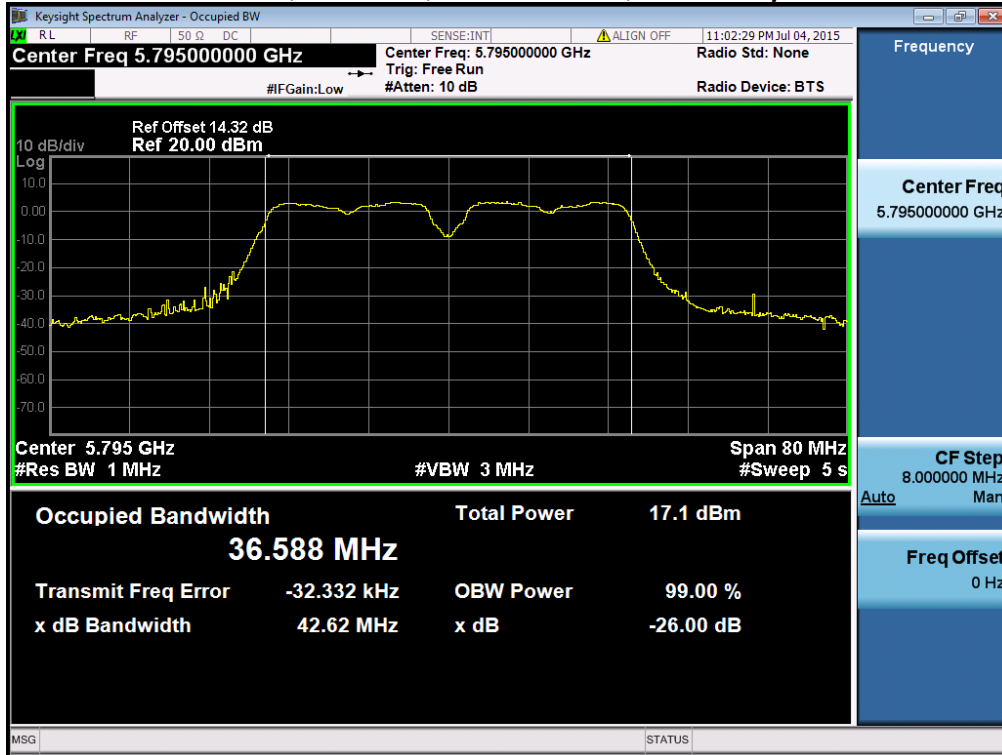

**26dB / 99% Bandwidth, 5795 MHz, HT/VHT40, M0 to M23, M0 to M9 1-3ss**

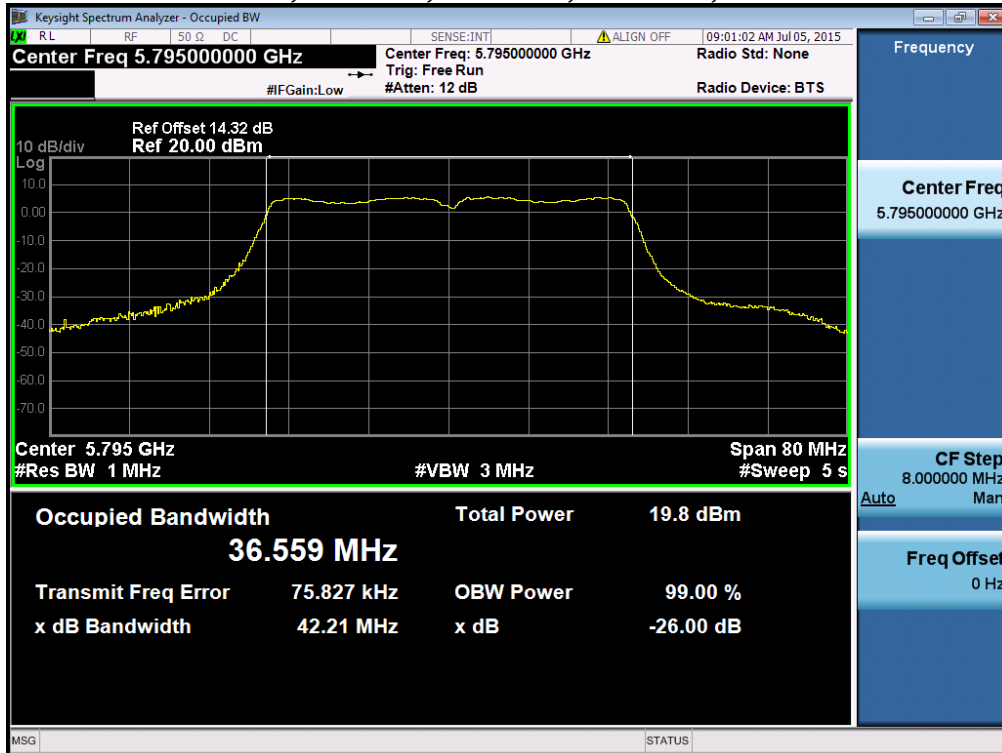

**26dB / 99% Bandwidth, 5825 MHz, Non HT/VHT20, 6 to 54 Mbps**

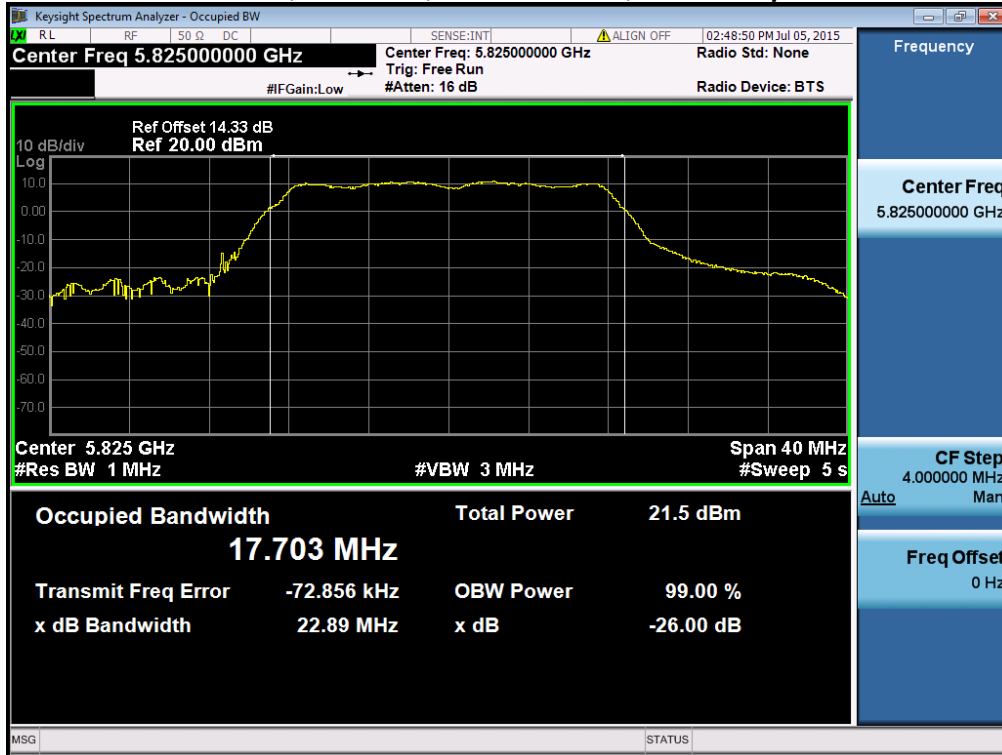

**26dB / 99% Bandwidth, 5825 MHz, HT/VHT20, M0 to M23, M0 to M9 1-3ss**

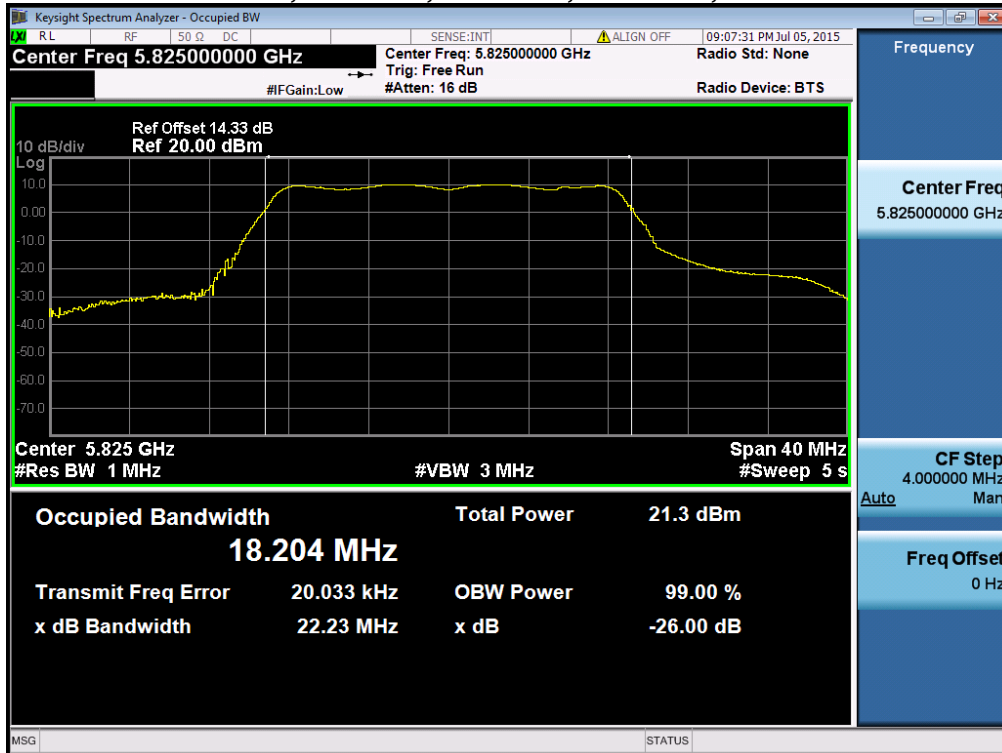

## A.3 Maximum Conducted Output Power

### 15.407 a.3

(3) For the band 5.725-5.85 GHz, the maximum conducted output power over the frequency band of operation shall not exceed 1 W. If transmitting antennas of directional gain greater than 6 dBi are used, both the maximum conducted output power and the maximum power spectral density shall be reduced by the amount in dB that the directional gain of the antenna exceeds 6 dBi. However, fixed point-to-point U-NII devices operating in this band may employ transmitting antennas with directional gain greater than 6 dBi without any corresponding reduction in transmitter conducted power. Fixed, point-to-point operations exclude the use of point-to-multipoint systems, omnidirectional applications, and multiple collocated transmitters transmitting the same information. The operator of the U-NII device, or if the equipment is professionally installed, the installer, is responsible for ensuring that systems employing high gain directional antennas are used exclusively for fixed, point-to-point operations.

### Test Procedure

Ref. KDB 789033 D02 General UNII Test Procedures New Rules v01  
ANSI C63.10: 2013

<b>Output Power</b>
Test Procedure
<ol style="list-style-type: none"> <li>1. Set the radio in the continuous transmitting mode at full power</li> <li>2. Compute power by integrating the spectrum across the EBW (or alternatively entire 99% OBW) of the signal using the instrument's band power measurement function. The integration shall be performed using the spectrum analyzer band-power measurement function with band limits set equal to the EBW or the OBW band edges.</li> <li>3. Capture graphs and record pertinent measurement data.</li> </ol>

Ref. KDB 789033 D02 General UNII Test Procedures New Rules v01  
ANSI C63.10: 2013 section 12.3.2.2 Method SA-1

<b>Output Power</b>
Test parameters
Span = >1.5 times the OBW RBW = 1MHz VBW ≥ 3 x RBW Sweep = Auto couple Detector = sample Trace = Trace Average 100

The "measure-and-sum technique" is used for measuring in-band transmit power of a device. In the measure-and-sum approach, the conducted emission level is measured at each antenna port. The measured results at the various antenna ports are then summed mathematically to determine the total emission level from the device. Summing is performed in linear power units. (See ANSI C63.10 section 14.3.2.2)

System Number	Description	Samples	System under test	Support equipment
1	EUT	S01	<input checked="" type="checkbox"/>	<input type="checkbox"/>
	Support	S02	<input type="checkbox"/>	<input checked="" type="checkbox"/>

<b>Tested By :</b> Jose Aguirre	<b>Date of testing:</b> 03-Jul-15 - 08-Aug-15
------------------------------------	--



<b>Test Result : PASS</b>	

See Appendix C for list of test equipment

Frequency (MHz)	Mode	Tx Paths	Correlated Antenna Gain (dBi)	Tx 1 Max Power (dBm)	Tx 2 Max Power (dBm)	Tx 3 Max Power (dBm)	Tx 4 Max Power (dBm)	Total Tx Channel Power (dBm)	Limit (dBm)	Margin (dB)
5745	Non HT/VHT20, 6 to 54 Mbps	1	13	11.8				11.8	30.0	18.2
	Non HT/VHT20, 6 to 54 Mbps	2	13	11.8	11.2			14.5	30.0	15.5
	Non HT/VHT20, 6 to 54 Mbps	3	13	11.8	11.2	11.0		16.1	30.0	13.9
	Non HT/VHT20, 6 to 54 Mbps	4	13	11.8	11.2	11.0	10.7	17.2	30.0	12.8
	Non HT/VHT20 Beam Forming, 6 to 54 Mbps	2	13	11.8	11.2			14.5	30.0	15.5
	Non HT/VHT20 Beam Forming, 6 to 54 Mbps	3	16	11.8	11.2	11.0		16.1	30.0	13.9
	Non HT/VHT20 Beam Forming, 6 to 54 Mbps	4	16	9.8	9.1	8.9	8.5	15.1	30.0	14.9
	HT/VHT20, M0 to M7, M0 to M9 1ss	1	13	12.9				12.9	30.0	17.1
	HT/VHT20, M0 to M7, M0 to M9 1ss	2	13	12.9	12.3			15.6	30.0	14.4
	HT/VHT20, M8 to M15, M0 to M9 2ss	2	13	12.9	12.3			15.6	30.0	14.4
	HT/VHT20, M0 to M7, M0 to M9 1ss	3	13	12.0	11.6	11.2		16.4	30.0	13.6
	HT/VHT20, M8 to M15, M0 to M9 2ss	3	13	12.0	11.6	11.2		16.4	30.0	13.6
	HT/VHT20, M16 to M23, M0 to M9 3ss	3	13	12.0	11.6	11.2		16.4	30.0	13.6
	HT/VHT20, M0 to M7, M0 to M9 1ss	4	13	12.0	11.6	11.2	11.1	17.5	30.0	12.5
	HT/VHT20, M8 to M15, M0 to M9 2ss	4	13	12.0	11.6	11.2	11.1	17.5	30.0	12.5
	HT/VHT20, M16 to M23, M0 to M9 3ss	4	13	12.0	11.6	11.2	11.1	17.5	30.0	12.5
	HT/VHT20 Beam Forming, M0 to M7, M0 to M9 1ss	2	13	12.9	12.3			15.6	30.0	14.4
	HT/VHT20 Beam Forming, M8 to M15, M0 to M9 2ss	2	13	12.9	12.3			15.6	30.0	14.4
	HT/VHT20 Beam Forming, M0 to M7, M0 to M9 1ss	3	16	10.2	9.6	9.2		14.5	30.0	15.5
	HT/VHT20 Beam Forming, M8 to M15, M0 to M9 2ss	3	13	12.0	11.6	11.2		16.4	30.0	13.6
	HT/VHT20 Beam Forming, M16 to M23, M0 to M9 3ss	3	13	12.0	11.6	11.2		16.4	30.0	13.6
	HT/VHT20 Beam Forming, M0 to M7, M0 to M9 1ss	4	16	10.2	9.6	9.2	9.0	15.5	30.0	14.5
	HT/VHT20 Beam Forming, M8 to M15, M0 to M9 2ss	4	13	12.0	11.6	11.2	11.1	17.5	30.0	12.5
	HT/VHT20 Beam Forming, M16 to M23, M0 to M9 3ss	4	13	12.0	11.6	11.2	11.1	17.5	30.0	12.5
	HT/VHT20 STBC, M0 to M7, M0 to M9 1ss	2	13	12.9	12.3			15.6	30.0	14.4
	HT/VHT20 STBC, M0 to M7, M0 to M9 1ss	3	13	12.0	11.6	11.2		16.4	30.0	13.6
	HT/VHT20 STBC, M0 to M7, M0 to M9 1ss	4	13	12.0	11.6	11.2	11.1	17.5	30.0	12.5
	5755	Non HT/VHT40, 6 to 54 Mbps	1	13	9.3				9.3	30.0
Non HT/VHT40, 6 to 54 Mbps		2	13	7.4	6.7			10.1	30.0	19.9
Non HT/VHT40, 6 to 54 Mbps		3	13	7.4	6.7	6.7		11.7	30.0	18.3
Non HT/VHT40, 6 to 54 Mbps		4	13	6.4	5.7	5.7	5.5	11.9	30.0	18.1
HT/VHT40, M0 to M7, M0 to M9 1ss		1	13	11.9				11.9	30.0	18.1
HT/VHT40, M0 to M7, M0 to M9 1ss		2	13	10.0	9.4			12.7	30.0	17.3
HT/VHT40, M8 to M15, M0 to M9 2ss		2	13	10.0	9.4			12.7	30.0	17.3

	HT/VHT40, M0 to M7, M0 to M9 1ss	3	13	8.7	8.2	8.0		13.1	30.0	16.9
	HT/VHT40, M8 to M15, M0 to M9 2ss	3	13	8.7	8.2	8.0		13.1	30.0	16.9
	HT/VHT40, M16 to M23, M0 to M9 3ss	3	13	8.7	8.2	8.0		13.1	30.0	16.9
	HT/VHT40, M0 to M7, M0 to M9 1ss	4	13	8.7	8.2	8.0	7.6	14.2	30.0	15.8
	HT/VHT40, M8 to M15, M0 to M9 2ss	4	13	8.7	8.2	8.0	7.6	14.2	30.0	15.8
	HT/VHT40, M16 to M23, M0 to M9 3ss	4	13	8.7	8.2	8.0	7.6	14.2	30.0	15.8
	HT/VHT40 Beam Forming, M0 to M7, M0 to M9 1ss	2	13	10.0	9.4			12.7	30.0	17.3
	HT/VHT40 Beam Forming, M8 to M15, M0 to M9 2ss	2	13	10.0	9.4			12.7	30.0	17.3
	HT/VHT40 Beam Forming, M0 to M7, M0 to M9 1ss	3	16	7.7	7.1	7.0		12.0	30.0	18.0
	HT/VHT40 Beam Forming, M8 to M15, M0 to M9 2ss	3	13	8.7	8.2	8.0		13.1	30.0	16.9
	HT/VHT40 Beam Forming, M16 to M23, M0 to M9 3ss	3	13	8.7	8.2	8.0		13.1	30.0	16.9
	HT/VHT40 Beam Forming, M0 to M7, M0 to M9 1ss	4	16	6.8	6.1	6.0	5.8	12.2	30.0	17.8
	HT/VHT40 Beam Forming, M8 to M15, M0 to M9 2ss	4	13	8.7	8.2	8.0	7.6	14.2	30.0	15.8
	HT/VHT40 Beam Forming, M16 to M23, M0 to M9 3ss	4	13	8.7	8.2	8.0	7.6	14.2	30.0	15.8
	HT/VHT40 STBC, M0 to M7, M0 to M9 1ss	2	13	10.0	9.4			12.7	30.0	17.3
	HT/VHT40 STBC, M0 to M7, M0 to M9 1ss	3	13	8.7	8.2	8.0		13.1	30.0	16.9
	HT/VHT40 STBC, M0 to M7, M0 to M9 1ss	4	13	8.7	8.2	8.0	7.6	14.2	30.0	15.8
5775	Non HT/VHT80, 6 to 54 Mbps	1	13	6.2				6.2	30.0	23.8
	Non HT/VHT80, 6 to 54 Mbps	2	13	2.9	2.4			5.7	30.0	24.3
	Non HT/VHT80, 6 to 54 Mbps	3	13	1.0	0.6	0.6		5.5	30.0	24.5
	Non HT/VHT80, 6 to 54 Mbps	4	13	1.0	0.6	0.6	0.4	6.7	30.0	23.3
	HT/VHT80, M0 to M7, M0 to M9 1ss	1	13	10.2				10.2	30.0	19.8
	HT/VHT80, M0 to M7, M0 to M9 1ss	2	13	8.2	7.4			10.8	30.0	19.2
	HT/VHT80, M8 to M15, M0 to M9 2ss	2	13	8.2	7.4			10.8	30.0	19.2
	HT/VHT80, M0 to M7, M0 to M9 1ss	3	13	7.3	6.3	6.2		11.4	30.0	18.6
	HT/VHT80, M8 to M15, M0 to M9 2ss	3	13	7.3	6.3	6.2		11.4	30.0	18.6
	HT/VHT80, M16 to M23, M0 to M9 3ss	3	13	7.3	6.3	6.2		11.4	30.0	18.6
	HT/VHT80, M0 to M7, M0 to M9 1ss	4	13	5.2	4.3	4.0	4.2	10.5	30.0	19.5
	HT/VHT80, M8 to M15, M0 to M9 2ss	4	13	5.2	4.3	4.0	4.2	10.5	30.0	19.5
	HT/VHT80, M16 to M23, M0 to M9 3ss	4	13	5.2	4.3	4.0	4.2	10.5	30.0	19.5
	HT/VHT80 Beam Forming, M0 to M7, M0 to M9 1ss	2	13	8.2	7.4			10.8	30.0	19.2
	HT/VHT80 Beam Forming, M8 to M15, M0 to M9 2ss	2	13	8.2	7.4			10.8	30.0	19.2
	HT/VHT80 Beam Forming, M0 to M7, M0 to M9 1ss	3	13	7.3	6.3	6.2		11.4	30.0	18.6
	HT/VHT80 Beam Forming, M8 to M15, M0 to M9 2ss	3	13	7.3	6.3	6.2		11.4	30.0	18.6
	HT/VHT80 Beam Forming, M16 to M23, M0 to M9 3ss	3	13	7.3	6.3	6.2		11.4	30.0	18.6
	HT/VHT80 Beam Forming, M0 to M7, M0 to M9 1ss	4	13	5.2	4.3	4.0	4.2	10.5	30.0	19.5
	HT/VHT80 Beam Forming, M8 to M15, M0 to M9 2ss	4	13	5.2	4.3	4.0	4.2	10.5	30.0	19.5
	HT/VHT80 Beam Forming, M16 to M23, M0 to M9 3ss	4	13	5.2	4.3	4.0	4.2	10.5	30.0	19.5
	HT/VHT80 STBC, M0 to M7, M0 to M9 1ss	2	13	8.2	7.4			10.8	30.0	19.2
	HT/VHT80 STBC, M0 to M7, M0 to M9 1ss	3	13	7.3	6.3	6.2		11.4	30.0	18.6
HT/VHT80 STBC, M0 to M7, M0 to M9 1ss	4	13	5.2	4.3	4.0	4.2	10.5	30.0	19.5	



5785	Non HT/VHT20, 6 to 54 Mbps	1	13	16.4				16.4	30.0	13.6
	Non HT/VHT20, 6 to 54 Mbps	2	13	16.4	16.4			19.4	30.0	10.6
	Non HT/VHT20, 6 to 54 Mbps	3	13	16.4	16.4	15.9		21.0	30.0	9.0
	<b>Non HT/VHT20, 6 to 54 Mbps</b>	<b>4</b>	<b>13</b>	<b>16.4</b>	<b>16.4</b>	<b>15.9</b>	<b>16.1</b>	<b>22.2</b>	<b>30.0</b>	<b>7.8</b>
	Non HT/VHT20 Beam Forming, 6 to 54 Mbps	2	13	16.4	16.4			19.4	30.0	10.6
	Non HT/VHT20 Beam Forming, 6 to 54 Mbps	3	16	16.4	16.4	15.9		21.0	30.0	9.0
	Non HT/VHT20 Beam Forming, 6 to 54 Mbps	4	16	16.4	16.4	15.9	16.1	22.2	30.0	7.8
	HT/VHT20, M0 to M7, M0 to M9 1ss	1	13	16.5				16.5	30.0	13.5
	HT/VHT20, M0 to M7, M0 to M9 1ss	2	13	16.5	16.4			19.5	30.0	10.5
	HT/VHT20, M8 to M15, M0 to M9 2ss	2	13	16.5	16.4			19.5	30.0	10.5
	HT/VHT20, M0 to M7, M0 to M9 1ss	3	13	16.5	16.4	15.9		21.0	30.0	9.0
	HT/VHT20, M8 to M15, M0 to M9 2ss	3	13	16.5	16.4	15.9		21.0	30.0	9.0
	HT/VHT20, M16 to M23, M0 to M9 3ss	3	13	16.5	16.4	15.9		21.0	30.0	9.0
	HT/VHT20, M0 to M7, M0 to M9 1ss	4	13	16.5	16.4	15.9	16.0	22.2	30.0	7.8
	HT/VHT20, M8 to M15, M0 to M9 2ss	4	13	16.5	16.4	15.9	16.0	22.2	30.0	7.8
	HT/VHT20, M16 to M23, M0 to M9 3ss	4	13	16.5	16.4	15.9	16.0	22.2	30.0	7.8
	HT/VHT20 Beam Forming, M0 to M7, M0 to M9 1ss	2	13	16.5	16.4			19.5	30.0	10.5
	HT/VHT20 Beam Forming, M8 to M15, M0 to M9 2ss	2	13	16.5	16.4			19.5	30.0	10.5
	HT/VHT20 Beam Forming, M0 to M7, M0 to M9 1ss	3	16	16.5	16.4	15.9		21.0	30.0	9.0
	HT/VHT20 Beam Forming, M8 to M15, M0 to M9 2ss	3	13	16.5	16.4	15.9		21.0	30.0	9.0
	HT/VHT20 Beam Forming, M16 to M23, M0 to M9 3ss	3	13	16.5	16.4	15.9		21.0	30.0	9.0
	HT/VHT20 Beam Forming, M0 to M7, M0 to M9 1ss	4	16	16.5	16.4	15.9	16.0	22.2	30.0	7.8
	HT/VHT20 Beam Forming, M8 to M15, M0 to M9 2ss	4	13	16.5	16.4	15.9	16.0	22.2	30.0	7.8
HT/VHT20 Beam Forming, M16 to M23, M0 to M9 3ss	4	13	16.5	16.4	15.9	16.0	22.2	30.0	7.8	
HT/VHT20 STBC, M0 to M7, M0 to M9 1ss	2	13	16.5	16.4			19.5	30.0	10.5	
HT/VHT20 STBC, M0 to M7, M0 to M9 1ss	3	13	16.5	16.4	15.9		21.0	30.0	9.0	
HT/VHT20 STBC, M0 to M7, M0 to M9 1ss	4	13	16.5	16.4	15.9	16.0	22.2	30.0	7.8	
5795	Non HT/VHT40, 6 to 54 Mbps	1	13	11.6				11.6	30.0	18.4
	Non HT/VHT40, 6 to 54 Mbps	2	13	8.9	8.1			11.5	30.0	18.5
	Non HT/VHT40, 6 to 54 Mbps	3	13	8.9	8.1	7.5		13.0	30.0	17.0
	Non HT/VHT40, 6 to 54 Mbps	4	13	8.9	8.1	7.5	7.6	14.1	30.0	15.9
	HT/VHT40, M0 to M7, M0 to M9 1ss	1	13	12.5				12.5	30.0	17.5
	HT/VHT40, M0 to M7, M0 to M9 1ss	2	13	11.4	10.6			14.0	30.0	16.0
	HT/VHT40, M8 to M15, M0 to M9 2ss	2	13	11.4	10.6			14.0	30.0	16.0
	HT/VHT40, M0 to M7, M0 to M9 1ss	3	13	11.4	10.6	10.1		15.5	30.0	14.5
	HT/VHT40, M8 to M15, M0 to M9 2ss	3	13	11.4	10.6	10.1		15.5	30.0	14.5
	HT/VHT40, M16 to M23, M0 to M9 3ss	3	13	11.4	10.6	10.1		15.5	30.0	14.5
	HT/VHT40, M0 to M7, M0 to M9 1ss	4	13	11.4	10.6	10.1	10.1	16.6	30.0	13.4
	HT/VHT40, M8 to M15, M0 to M9 2ss	4	13	11.4	10.6	10.1	10.1	16.6	30.0	13.4
	HT/VHT40, M16 to M23, M0 to M9 3ss	4	13	11.4	10.6	10.1	10.1	16.6	30.0	13.4

	HT/VHT40 Beam Forming, M0 to M7, M0 to M9 1ss	2	13	11.4	10.6			14.0	30.0	16.0
	HT/VHT40 Beam Forming, M8 to M15, M0 to M9 2ss	2	13	11.4	10.6			14.0	30.0	16.0
	HT/VHT40 Beam Forming, M0 to M7, M0 to M9 1ss	3	16	11.4	10.6	10.1		15.5	30.0	14.5
	HT/VHT40 Beam Forming, M8 to M15, M0 to M9 2ss	3	13	11.4	10.6	10.1		15.5	30.0	14.5
	HT/VHT40 Beam Forming, M16 to M23, M0 to M9 3ss	3	13	11.4	10.6	10.1		15.5	30.0	14.5
	HT/VHT40 Beam Forming, M0 to M7, M0 to M9 1ss	4	16	9.3	8.5	8.1	8.2	14.6	30.0	15.4
	HT/VHT40 Beam Forming, M8 to M15, M0 to M9 2ss	4	13	11.4	10.6	10.1	10.1	16.6	30.0	13.4
	HT/VHT40 Beam Forming, M16 to M23, M0 to M9 3ss	4	13	11.4	10.6	10.1	10.1	16.6	30.0	13.4
	HT/VHT40 STBC, M0 to M7, M0 to M9 1ss	2	13	11.4	10.6			14.0	30.0	16.0
	HT/VHT40 STBC, M0 to M7, M0 to M9 1ss	3	13	11.4	10.6	10.1		15.5	30.0	14.5
	HT/VHT40 STBC, M0 to M7, M0 to M9 1ss	4	13	11.4	10.6	10.1	10.1	16.6	30.0	13.4
	Non HT/VHT20, 6 to 54 Mbps	1	13	13.2				13.2	30.0	16.8
	Non HT/VHT20, 6 to 54 Mbps	2	13	12.3	11.8			15.1	30.0	14.9
	Non HT/VHT20, 6 to 54 Mbps	3	13	12.3	11.8	10.7		16.4	30.0	13.6
	Non HT/VHT20, 6 to 54 Mbps	4	13	11.6	10.9	9.7	9.8	16.6	30.0	13.4
	Non HT/VHT20 Beam Forming, 6 to 54 Mbps	2	13	12.3	11.8			15.1	30.0	14.9
	Non HT/VHT20 Beam Forming, 6 to 54 Mbps	3	16	11.6	10.9	9.7		15.6	30.0	14.4
	Non HT/VHT20 Beam Forming, 6 to 54 Mbps	4	16	10.4	9.7	8.6	8.6	15.4	30.0	14.6
	HT/VHT20, M0 to M7, M0 to M9 1ss	1	13	13.1				13.1	30.0	16.9
	HT/VHT20, M0 to M7, M0 to M9 1ss	2	13	12.5	12.0			15.3	30.0	14.7
	HT/VHT20, M8 to M15, M0 to M9 2ss	2	13	12.5	12.0			15.3	30.0	14.7
	HT/VHT20, M0 to M7, M0 to M9 1ss	3	13	12.5	12.0	10.7		16.6	30.0	13.4
	HT/VHT20, M8 to M15, M0 to M9 2ss	3	13	12.5	12.0	10.7		16.6	30.0	13.4
	HT/VHT20, M16 to M23, M0 to M9 3ss	3	13	12.5	12.0	10.7		16.6	30.0	13.4
	HT/VHT20, M0 to M7, M0 to M9 1ss	4	13	12.5	12.0	10.7	10.9	17.6	30.0	12.4
	HT/VHT20, M8 to M15, M0 to M9 2ss	4	13	12.5	12.0	10.7	10.9	17.6	30.0	12.4
	HT/VHT20, M16 to M23, M0 to M9 3ss	4	13	12.5	12.0	10.7	10.9	17.6	30.0	12.4
	HT/VHT20 Beam Forming, M0 to M7, M0 to M9 1ss	2	13	12.5	12.0			15.3	30.0	14.7
	HT/VHT20 Beam Forming, M8 to M15, M0 to M9 2ss	2	13	12.5	12.0			15.3	30.0	14.7
	HT/VHT20 Beam Forming, M0 to M7, M0 to M9 1ss	3	16	10.5	10.0	8.7		14.6	30.0	15.4
	HT/VHT20 Beam Forming, M8 to M15, M0 to M9 2ss	3	13	12.5	12.0	10.7		16.6	30.0	13.4
	HT/VHT20 Beam Forming, M16 to M23, M0 to M9 3ss	3	13	12.5	12.0	10.7		16.6	30.0	13.4
	HT/VHT20 Beam Forming, M0 to M7, M0 to M9 1ss	4	16	10.5	10.0	8.7	9.0	15.6	30.0	14.4
	HT/VHT20 Beam Forming, M8 to M15, M0 to M9 2ss	4	13	12.5	12.0	10.7	10.9	17.6	30.0	12.4
	HT/VHT20 Beam Forming, M16 to M23, M0 to M9 3ss	4	13	12.5	12.0	10.7	10.9	17.6	30.0	12.4
	HT/VHT20 STBC, M0 to M7, M0 to M9 1ss	2	13	12.5	12.0			15.3	30.0	14.7
	HT/VHT20 STBC, M0 to M7, M0 to M9 1ss	3	13	12.5	12.0	10.7		16.6	30.0	13.4
	HT/VHT20 STBC, M0 to M7, M0 to M9 1ss	4	13	12.5	12.0	10.7	10.9	17.6	30.0	12.4

**Peak Output Power, 5785 MHz, HT/VHT20, M0 to M7, M0 to M9 1ss**

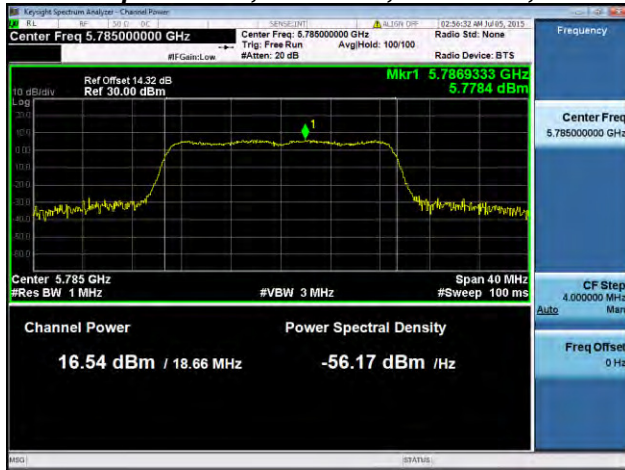

**Antenna A**

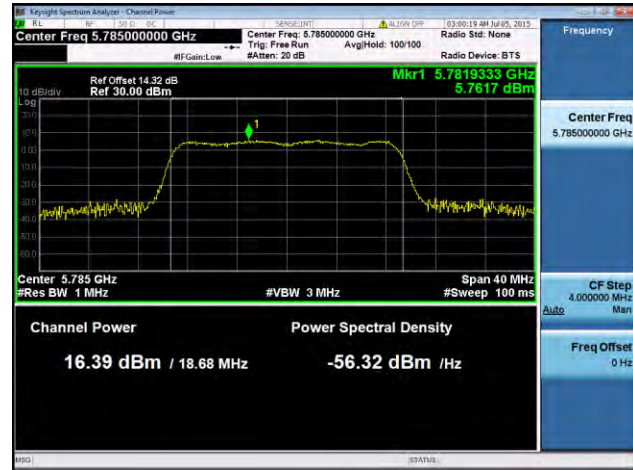

**Antenna B**

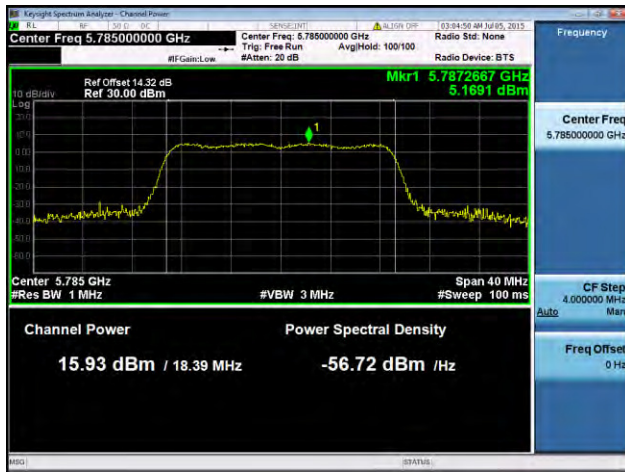

**Antenna C**

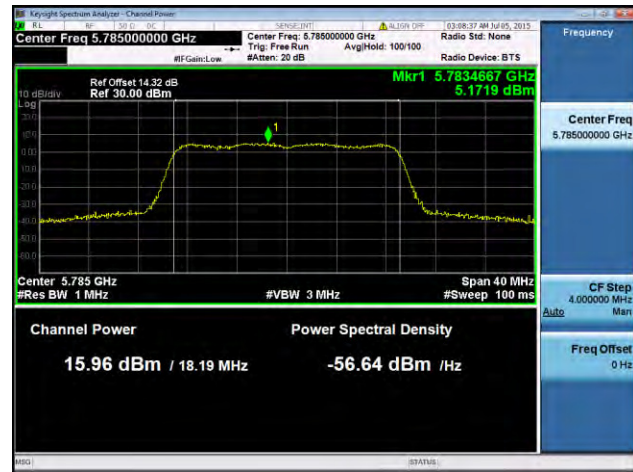

**Antenna D**

## A.4 Power Spectral Density

### 15.407

The power spectral density shall not exceed 30 dBm in any 500 kHz band. If transmitting antennas of directional gain greater than 6 dBi are used, both the maximum conducted output power and the power spectral density shall be reduced by the amount in dB that the directional gain of the antenna exceeds 6 dBi.

### Test Procedure

Ref. KDB 789033 D02 General UNII Test Procedures New Rules v01

<b>Power Spectral Density</b> Test Procedure
1. Connect the antenna port(s) to the spectrum analyzer input. 2. Set the radio in the continuous transmitting mode at full power 3. Configure Spectrum analyzer as per test parameters below and Peak search marker 4. Capture graphs and record pertinent measurement data.

Ref. KDB 789033 D02 v01 section F.5

<b>Power Spectral Density</b> Test parameters
Span = >1.5 times the OBW RBW = 500 kHz. VBW $\geq$ 3 x RBW Sweep = 10s Detector = Peak Trace = Single Sweep Marker = Peak Search

The "Measure and add 10 log(N) dB technique", where N is the number of outputs, is used for measuring in-band Power Spectral Density. With this technique, spectrum measurements are performed at each output of the device, and the quantity 10 log(4) (or 6dB) is added to the worst case spectrum value before comparing to the emission limit. (ANSI C63.10 2013 section 14.3.2.3)

System Number	Description	Samples	System under test	Support equipment
1	EUT	S01	<input checked="" type="checkbox"/>	<input type="checkbox"/>
	Support	S02	<input type="checkbox"/>	<input checked="" type="checkbox"/>

<b>Tested By :</b> Jose Aguirre	<b>Date of testing:</b> 03-Jul-15 - 08-Aug-15
<b>Test Result : PASS</b>	

See Appendix C for list of test equipment



Frequency (MHz)	Mode	Tx Paths	Correlated Antenna Gain (dBi)	Tx 1 PSD (dBm/500kHz)	Tx 2 PSD (dBm/500kHz)	Tx 3 PSD (dBm/500kHz)	Tx 4 PSD (dBm/500kHz)	Total PSD (dBm/500kHz)	Limit (dBm/500kHz)	Margin (dB)
5745	Non HT/VHT20, 6 to 54 Mbps	1	13	-1.6				-1.6	23.0	24.6
	Non HT/VHT20, 6 to 54 Mbps	2	13	-1.6	-1.9			1.3	23.0	21.7
	Non HT/VHT20, 6 to 54 Mbps	3	13	-1.6	-1.9	-2.4		2.8	23.0	20.2
	Non HT/VHT20, 6 to 54 Mbps	4	13	-1.6	-1.9	-2.4	-2.8	3.9	23.0	19.1
	Non HT/VHT20 Beam Forming, 6 to 54 Mbps	2	13	-1.6	-1.9			1.3	23.0	21.7
	Non HT/VHT20 Beam Forming, 6 to 54 Mbps	3	16	-1.6	-1.9	-2.4		2.8	20.0	17.2
	Non HT/VHT20 Beam Forming, 6 to 54 Mbps	4	16	-3.4	-4.2	-4.5	-4.7	1.8	20.0	18.2
	HT/VHT20, M0 to M7, M0 to M9 1ss	1	13	-0.6				-0.6	23.0	23.6
	HT/VHT20, M0 to M7, M0 to M9 1ss	2	13	-0.6	-1.5			2.0	23.0	21.0
	HT/VHT20, M8 to M15, M0 to M9 2ss	2	13	-0.6	-1.5			2.0	23.0	21.0
	HT/VHT20, M0 to M7, M0 to M9 1ss	3	13	-1.5	-1.8	-2.3		2.9	23.0	20.1
	HT/VHT20, M8 to M15, M0 to M9 2ss	3	13	-1.5	-1.8	-2.3		2.9	23.0	20.1
	HT/VHT20, M16 to M23, M0 to M9 3ss	3	13	-1.5	-1.8	-2.3		2.9	23.0	20.1
	HT/VHT20, M0 to M7, M0 to M9 1ss	4	13	-1.5	-1.8	-2.3	-2.8	3.9	23.0	19.1
	HT/VHT20, M8 to M15, M0 to M9 2ss	4	13	-1.5	-1.8	-2.3	-2.8	3.9	23.0	19.1
	HT/VHT20, M16 to M23, M0 to M9 3ss	4	13	-1.5	-1.8	-2.3	-2.8	3.9	23.0	19.1
	HT/VHT20 Beam Forming, M0 to M7, M0 to M9 1ss	2	13	-0.6	-1.5			2.0	23.0	21.0
	HT/VHT20 Beam Forming, M8 to M15, M0 to M9 2ss	2	13	-0.6	-1.5			2.0	23.0	21.0
	HT/VHT20 Beam Forming, M0 to M7, M0 to M9 1ss	3	16	-3.4	-3.9	-4.4		0.9	20.0	19.1
	HT/VHT20 Beam Forming, M8 to M15, M0 to M9 2ss	3	13	-1.5	-1.8	-2.3		2.9	23.0	20.1
	HT/VHT20 Beam Forming, M16 to M23, M0 to M9 3ss	3	13	-1.5	-1.8	-2.3		2.9	23.0	20.1
	HT/VHT20 Beam Forming, M0 to M7, M0 to M9 1ss	4	16	-3.4	-3.9	-4.4	-4.4	2.0	20.0	18.0
	HT/VHT20 Beam Forming, M8 to M15, M0 to M9 2ss	4	13	-1.5	-1.8	-2.3	-2.8	3.9	23.0	19.1
	HT/VHT20 Beam Forming, M16 to M23, M0 to M9 3ss	4	13	-1.5	-1.8	-2.3	-2.8	3.9	23.0	19.1
	HT/VHT20 STBC, M0 to M7, M0 to M9 1ss	2	13	-0.6	-1.5			2.0	23.0	21.0
	HT/VHT20 STBC, M0 to M7, M0 to M9 1ss	3	13	-1.5	-1.8	-2.3		2.9	23.0	20.1
HT/VHT20 STBC, M0 to M7, M0 to M9 1ss	4	13	-1.5	-1.8	-2.3	-2.8	3.9	23.0	19.1	
5755	Non HT/VHT40, 6 to 54 Mbps	1	13	-6.7				-6.7	23.0	29.7
	Non HT/VHT40, 6 to 54 Mbps	2	13	-8.8	-9.6			-6.2	23.0	29.2
	Non HT/VHT40, 6 to 54 Mbps	3	13	-8.8	-9.6	-9.3		-4.4	23.0	27.4
	Non HT/VHT40, 6 to 54 Mbps	4	13	-9.6	-10.3	-10.7	-10.8	-4.3	23.0	27.3
	HT/VHT40, M0 to M7, M0 to M9 1ss	1	13	-4.6				-4.6	23.0	27.6
	HT/VHT40, M0 to M7, M0 to M9 1ss	2	13	-6.6	-7.3			-3.9	23.0	26.9
	HT/VHT40, M8 to M15, M0 to M9 2ss	2	13	-6.6	-7.3			-3.9	23.0	26.9

	HT/VHT40, M0 to M7, M0 to M9 1ss	3	13	-7.8	-8.3	-8.6		-3.4	23.0	26.4
	HT/VHT40, M8 to M15, M0 to M9 2ss	3	13	-7.8	-8.3	-8.6		-3.4	23.0	26.4
	HT/VHT40, M16 to M23, M0 to M9 3ss	3	13	-7.8	-8.3	-8.6		-3.4	23.0	26.4
	HT/VHT40, M0 to M7, M0 to M9 1ss	4	13	-7.8	-8.3	-8.6	-8.9	-2.4	23.0	25.4
	HT/VHT40, M8 to M15, M0 to M9 2ss	4	13	-7.8	-8.3	-8.6	-8.9	-2.4	23.0	25.4
	HT/VHT40, M16 to M23, M0 to M9 3ss	4	13	-7.8	-8.3	-8.6	-8.9	-2.4	23.0	25.4
	HT/VHT40 Beam Forming, M0 to M7, M0 to M9 1ss	2	13	-6.6	-7.3			-3.9	23.0	26.9
	HT/VHT40 Beam Forming, M8 to M15, M0 to M9 2ss	2	13	-6.6	-7.3			-3.9	23.0	26.9
	HT/VHT40 Beam Forming, M0 to M7, M0 to M9 1ss	3	16	-8.8	-9.2	-9.5		-4.4	20.0	24.4
	HT/VHT40 Beam Forming, M8 to M15, M0 to M9 2ss	3	13	-7.8	-8.3	-8.6		-3.4	23.0	26.4
	HT/VHT40 Beam Forming, M16 to M23, M0 to M9 3ss	3	13	-7.8	-8.3	-8.6		-3.4	23.0	26.4
	HT/VHT40 Beam Forming, M0 to M7, M0 to M9 1ss	4	16	-9.6	-10.5	-10.4	-10.9	-4.3	20.0	24.3
	HT/VHT40 Beam Forming, M8 to M15, M0 to M9 2ss	4	13	-7.8	-8.3	-8.6	-8.9	-2.4	23.0	25.4
	HT/VHT40 Beam Forming, M16 to M23, M0 to M9 3ss	4	13	-7.8	-8.3	-8.6	-8.9	-2.4	23.0	25.4
	HT/VHT40 STBC, M0 to M7, M0 to M9 1ss	2	13	-6.6	-7.3			-3.9	23.0	26.9
	HT/VHT40 STBC, M0 to M7, M0 to M9 1ss	3	13	-7.8	-8.3	-8.6		-3.4	23.0	26.4
	HT/VHT40 STBC, M0 to M7, M0 to M9 1ss	4	13	-7.8	-8.3	-8.6	-8.9	-2.4	23.0	25.4
5775	Non HT/VHT80, 6 to 54 Mbps	1	13	-12.5				-12.5	23.0	35.5
	Non HT/VHT80, 6 to 54 Mbps	2	13	-16.7	-16.7			-13.7	23.0	36.7
	Non HT/VHT80, 6 to 54 Mbps	3	13	-18.5	-17.2	-19.1		-13.4	23.0	36.4
	Non HT/VHT80, 6 to 54 Mbps	4	13	-18.5	-17.2	-19.1	-19.4	-12.4	23.0	35.4
	HT/VHT80, M0 to M7, M0 to M9 1ss	1	13	-9.8				-9.8	23.0	32.8
	HT/VHT80, M0 to M7, M0 to M9 1ss	2	13	-11.4	-12.2			-8.8	23.0	31.8
	HT/VHT80, M8 to M15, M0 to M9 2ss	2	13	-11.4	-12.2			-8.8	23.0	31.8
	HT/VHT80, M0 to M7, M0 to M9 1ss	3	13	-12.9	-13.3	-13.8		-8.5	23.0	31.5
	HT/VHT80, M8 to M15, M0 to M9 2ss	3	13	-12.9	-13.3	-13.8		-8.5	23.0	31.5
	HT/VHT80, M16 to M23, M0 to M9 3ss	3	13	-12.9	-13.3	-13.8		-8.5	23.0	31.5
	HT/VHT80, M0 to M7, M0 to M9 1ss	4	13	-14.9	-15.1	-16.0	-15.9	-9.4	23.0	32.4
	HT/VHT80, M8 to M15, M0 to M9 2ss	4	13	-14.9	-15.1	-16.0	-15.9	-9.4	23.0	32.4
	HT/VHT80, M16 to M23, M0 to M9 3ss	4	13	-14.9	-15.1	-16.0	-15.9	-9.4	23.0	32.4
	HT/VHT80 Beam Forming, M0 to M7, M0 to M9 1ss	2	13	-11.4	-12.2			-8.8	23.0	31.8
	HT/VHT80 Beam Forming, M8 to M15, M0 to M9 2ss	2	13	-11.4	-12.2			-8.8	23.0	31.8
	HT/VHT80 Beam Forming, M0 to M7, M0 to M9 1ss	3	13	-12.9	-13.3	-13.8		-8.5	23.0	31.5
	HT/VHT80 Beam Forming, M8 to M15, M0 to M9 2ss	3	13	-12.9	-13.3	-13.8		-8.5	23.0	31.5
	HT/VHT80 Beam Forming, M16 to M23, M0 to M9 3ss	3	13	-12.9	-13.3	-13.8		-8.5	23.0	31.5
	HT/VHT80 Beam Forming, M0 to M7, M0 to M9 1ss	4	13	-14.9	-15.1	-16.0	-15.9	-9.4	23.0	32.4
	HT/VHT80 Beam Forming, M8 to M15, M0 to M9 2ss	4	13	-14.9	-15.1	-16.0	-15.9	-9.4	23.0	32.4
	HT/VHT80 Beam Forming, M16 to M23, M0 to M9 3ss	4	13	-14.9	-15.1	-16.0	-15.9	-9.4	23.0	32.4
	HT/VHT80 STBC, M0 to M7, M0 to M9 1ss	2	13	-11.4	-12.2			-8.8	23.0	31.8
	HT/VHT80 STBC, M0 to M7, M0 to M9 1ss	3	13	-12.9	-13.3	-13.8		-8.5	23.0	31.5
HT/VHT80 STBC, M0 to M7, M0 to M9 1ss	4	13	-14.9	-15.1	-16.0	-15.9	-9.4	23.0	32.4	

5785	Non HT/VHT20, 6 to 54 Mbps	1	13	3.2				3.2	23.0	19.8
	Non HT/VHT20, 6 to 54 Mbps	2	13	3.2	2.9			6.1	23.0	16.9
	Non HT/VHT20, 6 to 54 Mbps	3	13	3.2	2.9	2.5		7.6	23.0	15.4
	Non HT/VHT20, 6 to 54 Mbps	4	13	3.2	2.9	2.5	2.7	8.9	23.0	14.1
	Non HT/VHT20 Beam Forming, 6 to 54 Mbps	2	13	3.2	2.9			6.1	23.0	16.9
	Non HT/VHT20 Beam Forming, 6 to 54 Mbps	3	16	3.2	2.9	2.5		7.6	20.0	12.4
	<b>Non HT/VHT20 Beam Forming, 6 to 54 Mbps</b>	<b>4</b>	<b>16</b>	<b>3.2</b>	<b>2.9</b>	<b>2.5</b>	<b>2.7</b>	<b>8.9</b>	<b>20.0</b>	<b>11.1</b>
	HT/VHT20, M0 to M7, M0 to M9 1ss	1	13	2.9				2.9	23.0	20.1
	HT/VHT20, M0 to M7, M0 to M9 1ss	2	13	2.9	2.7			5.8	23.0	17.2
	HT/VHT20, M8 to M15, M0 to M9 2ss	2	13	2.9	2.7			5.8	23.0	17.2
	HT/VHT20, M0 to M7, M0 to M9 1ss	3	13	2.9	2.7	2.4		7.4	23.0	15.6
	HT/VHT20, M8 to M15, M0 to M9 2ss	3	13	2.9	2.7	2.4		7.4	23.0	15.6
	HT/VHT20, M16 to M23, M0 to M9 3ss	3	13	2.9	2.7	2.4		7.4	23.0	15.6
	HT/VHT20, M0 to M7, M0 to M9 1ss	4	13	2.9	2.7	2.4	2.4	8.6	23.0	14.4
	HT/VHT20, M8 to M15, M0 to M9 2ss	4	13	2.9	2.7	2.4	2.4	8.6	23.0	14.4
	HT/VHT20, M16 to M23, M0 to M9 3ss	4	13	2.9	2.7	2.4	2.4	8.6	23.0	14.4
	HT/VHT20 Beam Forming, M0 to M7, M0 to M9 1ss	2	13	2.9	2.7			5.8	23.0	17.2
	HT/VHT20 Beam Forming, M8 to M15, M0 to M9 2ss	2	13	2.9	2.7			5.8	23.0	17.2
	HT/VHT20 Beam Forming, M0 to M7, M0 to M9 1ss	3	16	2.9	2.7	2.4		7.4	20.0	12.6
	HT/VHT20 Beam Forming, M8 to M15, M0 to M9 2ss	3	13	2.9	2.7	2.4		7.4	23.0	15.6
	HT/VHT20 Beam Forming, M16 to M23, M0 to M9 3ss	3	13	2.9	2.7	2.4		7.4	23.0	15.6
	HT/VHT20 Beam Forming, M0 to M7, M0 to M9 1ss	4	16	2.9	2.7	2.4	2.4	8.6	20.0	11.4
	HT/VHT20 Beam Forming, M8 to M15, M0 to M9 2ss	4	13	2.9	2.7	2.4	2.4	8.6	23.0	14.4
HT/VHT20 Beam Forming, M16 to M23, M0 to M9 3ss	4	13	2.9	2.7	2.4	2.4	8.6	23.0	14.4	
HT/VHT20 STBC, M0 to M7, M0 to M9 1ss	2	13	2.9	2.7			5.8	23.0	17.2	
HT/VHT20 STBC, M0 to M7, M0 to M9 1ss	3	13	2.9	2.7	2.4		7.4	23.0	15.6	
HT/VHT20 STBC, M0 to M7, M0 to M9 1ss	4	13	2.9	2.7	2.4	2.4	8.6	23.0	14.4	
5795	Non HT/VHT40, 6 to 54 Mbps	1	13	-4.6				-4.6	23.0	27.6
	Non HT/VHT40, 6 to 54 Mbps	2	13	-7.6	-7.9			-4.7	23.0	27.7
	Non HT/VHT40, 6 to 54 Mbps	3	13	-7.6	-7.9	-8.9		-3.3	23.0	26.3
	Non HT/VHT40, 6 to 54 Mbps	4	13	-7.6	-7.9	-8.9	-8.8	-2.2	23.0	25.2
	HT/VHT40, M0 to M7, M0 to M9 1ss	1	13	-4.3				-4.3	23.0	27.3
	HT/VHT40, M0 to M7, M0 to M9 1ss	2	13	-5.3	-5.7			-2.5	23.0	25.5
	HT/VHT40, M8 to M15, M0 to M9 2ss	2	13	-5.3	-5.7			-2.5	23.0	25.5
	HT/VHT40, M0 to M7, M0 to M9 1ss	3	13	-5.3	-5.7	-6.6		-1.1	23.0	24.1
	HT/VHT40, M8 to M15, M0 to M9 2ss	3	13	-5.3	-5.7	-6.6		-1.1	23.0	24.1
	HT/VHT40, M16 to M23, M0 to M9 3ss	3	13	-5.3	-5.7	-6.6		-1.1	23.0	24.1
	HT/VHT40, M0 to M7, M0 to M9 1ss	4	13	-5.3	-5.7	-6.6	-6.8	0.0	23.0	23.0
	HT/VHT40, M8 to M15, M0 to M9 2ss	4	13	-5.3	-5.7	-6.6	-6.8	0.0	23.0	23.0
	HT/VHT40, M16 to M23, M0 to M9 3ss	4	13	-5.3	-5.7	-6.6	-6.8	0.0	23.0	23.0

	HT/VHT40 Beam Forming, M0 to M7, M0 to M9 1ss	2	13	-5.3	-5.7			-2.5	23.0	25.5
	HT/VHT40 Beam Forming, M8 to M15, M0 to M9 2ss	2	13	-5.3	-5.7			-2.5	23.0	25.5
	HT/VHT40 Beam Forming, M0 to M7, M0 to M9 1ss	3	16	-5.3	-5.7	-6.6		-1.1	20.0	21.1
	HT/VHT40 Beam Forming, M8 to M15, M0 to M9 2ss	3	13	-5.3	-5.7	-6.6		-1.1	23.0	24.1
	HT/VHT40 Beam Forming, M16 to M23, M0 to M9 3ss	3	13	-5.3	-5.7	-6.6		-1.1	23.0	24.1
	HT/VHT40 Beam Forming, M0 to M7, M0 to M9 1ss	4	16	-7.5	-8.0	-8.6	-8.5	-2.1	20.0	22.1
	HT/VHT40 Beam Forming, M8 to M15, M0 to M9 2ss	4	13	-5.3	-5.7	-6.6	-6.8	0.0	23.0	23.0
	HT/VHT40 Beam Forming, M16 to M23, M0 to M9 3ss	4	13	-5.3	-5.7	-6.6	-6.8	0.0	23.0	23.0
	HT/VHT40 STBC, M0 to M7, M0 to M9 1ss	2	13	-5.3	-5.7			-2.5	23.0	25.5
	HT/VHT40 STBC, M0 to M7, M0 to M9 1ss	3	13	-5.3	-5.7	-6.6		-1.1	23.0	24.1
	HT/VHT40 STBC, M0 to M7, M0 to M9 1ss	4	13	-5.3	-5.7	-6.6	-6.8	0.0	23.0	23.0
5825	Non HT/VHT20, 6 to 54 Mbps	1	13	-0.3				-0.3	23.0	23.3
	Non HT/VHT20, 6 to 54 Mbps	2	13	-1.1	-1.5			1.7	23.0	21.3
	Non HT/VHT20, 6 to 54 Mbps	3	13	-1.1	-1.5	-2.2		3.2	23.0	19.8
	Non HT/VHT20, 6 to 54 Mbps	4	13	-1.5	-2.4	-3.7	-3.6	3.3	23.0	19.7
	Non HT/VHT20 Beam Forming, 6 to 54 Mbps	2	13	-1.1	-1.5			1.7	23.0	21.3
	Non HT/VHT20 Beam Forming, 6 to 54 Mbps	3	16	-1.5	-2.4	-3.7		2.3	20.0	17.7
	Non HT/VHT20 Beam Forming, 6 to 54 Mbps	4	16	-3.0	-3.6	-4.8	-4.8	2.0	20.0	18.0
	HT/VHT20, M0 to M7, M0 to M9 1ss	1	13	-0.5				-0.5	23.0	23.5
	HT/VHT20, M0 to M7, M0 to M9 1ss	2	13	-1.2	-1.9			1.5	23.0	21.5
	HT/VHT20, M8 to M15, M0 to M9 2ss	2	13	-1.2	-1.9			1.5	23.0	21.5
	HT/VHT20, M0 to M7, M0 to M9 1ss	3	13	-1.2	-1.9	-2.8		2.9	23.0	20.1
	HT/VHT20, M8 to M15, M0 to M9 2ss	3	13	-1.2	-1.9	-2.8		2.9	23.0	20.1
	HT/VHT20, M16 to M23, M0 to M9 3ss	3	13	-1.2	-1.9	-2.8		2.9	23.0	20.1
	HT/VHT20, M0 to M7, M0 to M9 1ss	4	13	-1.2	-1.9	-2.8	-2.8	3.9	23.0	19.1
	HT/VHT20, M8 to M15, M0 to M9 2ss	4	13	-1.2	-1.9	-2.8	-2.8	3.9	23.0	19.1
	HT/VHT20, M16 to M23, M0 to M9 3ss	4	13	-1.2	-1.9	-2.8	-2.8	3.9	23.0	19.1
	HT/VHT20 Beam Forming, M0 to M7, M0 to M9 1ss	2	13	-1.2	-1.9			1.5	23.0	21.5
	HT/VHT20 Beam Forming, M8 to M15, M0 to M9 2ss	2	13	-1.2	-1.9			1.5	23.0	21.5
	HT/VHT20 Beam Forming, M0 to M7, M0 to M9 1ss	3	16	-3.0	-3.9	-4.7		1.0	20.0	19.0
	HT/VHT20 Beam Forming, M8 to M15, M0 to M9 2ss	3	13	-1.2	-1.9	-2.8		2.9	23.0	20.1
	HT/VHT20 Beam Forming, M16 to M23, M0 to M9 3ss	3	13	-1.2	-1.9	-2.8		2.9	23.0	20.1
	HT/VHT20 Beam Forming, M0 to M7, M0 to M9 1ss	4	16	-3.0	-3.9	-4.7	-4.4	2.1	20.0	17.9
	HT/VHT20 Beam Forming, M8 to M15, M0 to M9 2ss	4	13	-1.2	-1.9	-2.8	-2.8	3.9	23.0	19.1
	HT/VHT20 Beam Forming, M16 to M23, M0 to M9 3ss	4	13	-1.2	-1.9	-2.8	-2.8	3.9	23.0	19.1
	HT/VHT20 STBC, M0 to M7, M0 to M9 1ss	2	13	-1.2	-1.9			1.5	23.0	21.5
	HT/VHT20 STBC, M0 to M7, M0 to M9 1ss	3	13	-1.2	-1.9	-2.8		2.9	23.0	20.1
	HT/VHT20 STBC, M0 to M7, M0 to M9 1ss	4	13	-1.2	-1.9	-2.8	-2.8	3.9	23.0	19.1



**Power Spectral Density, 5785 MHz, Non HT/VHT20 Beam Forming, 6 to 54 Mbps**

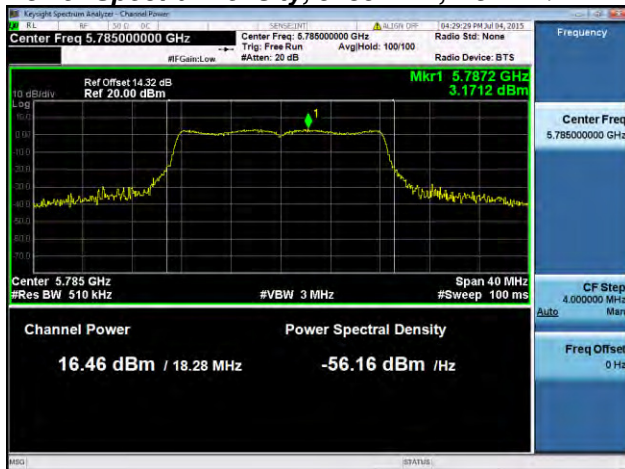

**Antenna A**

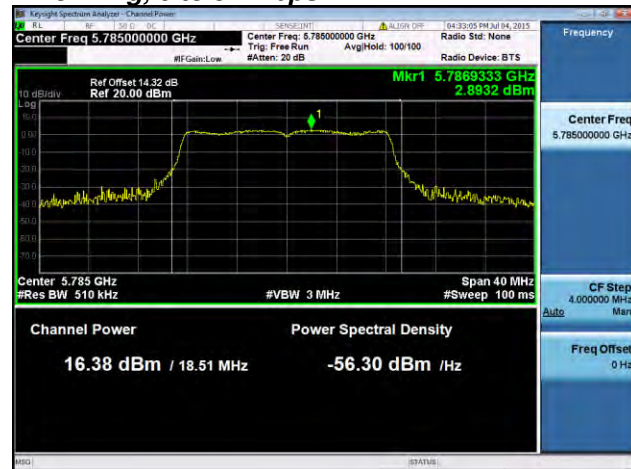

**Antenna B**

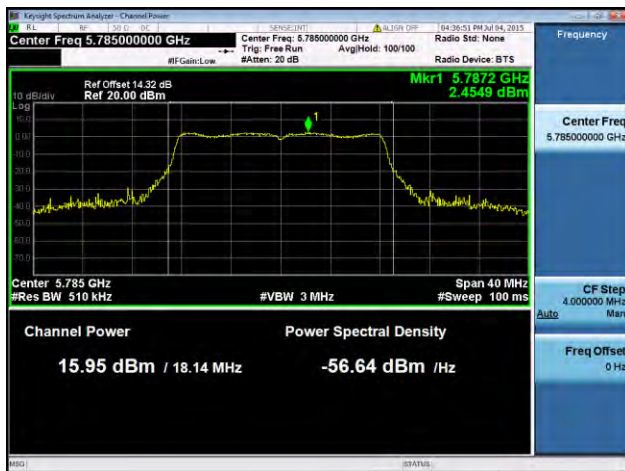

**Antenna C**

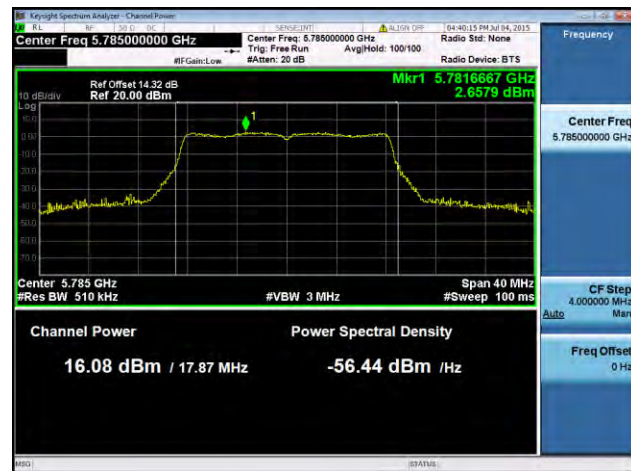

**Antenna D**

## A.5 Conducted Spurious Emissions

**15.407** (b) *Undesirable emission limits.* Except as shown in paragraph (b)(7) of this section, the maximum emissions outside of the frequency bands of operation shall be attenuated in accordance with the following limits:

(4) For transmitters operating in the 5.725-5.85 GHz band: All emissions within the frequency range from the band edge to 10 MHz above or below the band edge shall not exceed an e.i.r.p. of -17 dBm/MHz; for frequencies 10 MHz or greater above or below the band edge, emissions shall not exceed an e.i.r.p. of -27 dBm/MHz.

(6) Unwanted emissions below 1 GHz must comply with the general field strength limits set forth in §15.209.

(7) The provisions of §15.205 apply to intentional radiators operating under this section.

### Test Procedure

Ref. KDB 789033 D02 General UNII Test Procedures New Rules v01  
ANSI C63.10: 2013

#### Conducted Spurious Emissions

##### Test Procedure

1. Connect the antenna port(s) to the spectrum analyzer input.
2. Place the radio in continuous transmit mode. Use the procedures in KDB 789033 D02 General UNII Test Procedures New Rules v01 to substitute conducted measurements in place of radiated measurements.
3. Configure Spectrum analyzer as per test parameters below (be sure to enter all losses between the transmitter output and the spectrum analyzer).
4. Record the marker waveform peak to spur difference. Also measure any emissions in the restricted bands.
5. The "measure-and-sum technique" is used for measuring in-band transmit power of a device. In the measure-and-sum approach, the conducted emission level is measured at each antenna port. The measured results at the various antenna ports are then summed mathematically to determine the total emission level from the device. Summing is performed in linear power units. The worst case output is recorded.
6. Capture graphs and record pertinent measurement data.

Ref. KDB 789033 D02 General UNII Test Procedures New Rules v01  
ANSI C63.10: 2013 section 12.7.7.3 (average) & 12.7.6 (peak)

#### Conducted Spurious Emissions

##### Test parameters

Span = 30MHz to 18GHz / 18GHz to 40GHz  
 RBW = 1 MHz  
 VBW ≥ 3 x RBW for Peak, 1kHz for Average  
 Sweep = Auto couple  
 Detector = Peak  
 Trace = Max Hold.

System Number	Description	Samples	System under test	Support equipment
1	EUT	S01	<input checked="" type="checkbox"/>	<input type="checkbox"/>
	Support	S02	<input type="checkbox"/>	<input checked="" type="checkbox"/>

<b>Tested By :</b> Jose Aguirre	<b>Date of testing:</b> 03-Jul-15 - 08-Aug-15
<b>Test Result : PASS</b>	

See Appendix C for list of test equipment

Frequency (MHz)	Mode	Tx Paths	Correlated Antenna Gain (dBi)	Tx 1 Spur Power (dBm)	Tx 2 Spur Power (dBm)	Tx 3 Spur Power (dBm)	Tx 4 Spur Power (dBm)	Total Conducted Spur (dBm)	Limit (dBm)	Margin (dB)
5745	Non HT/VHT20, 6 to 54 Mbps	1	13	-63.9				-50.9	-41.25	9.7
	Non HT/VHT20, 6 to 54 Mbps	2	13	-63.9	-65.9			-48.8	-41.25	7.5
	Non HT/VHT20, 6 to 54 Mbps	3	13	-63.9	-65.9	-65.1		-47.1	-41.25	5.9
	Non HT/VHT20, 6 to 54 Mbps	4	13	-63.9	-65.9	-65.1	-64.7	-45.8	-41.25	4.6
	Non HT/VHT20 Beam Forming, 6 to 54 Mbps	2	13	-63.9	-65.9			-48.8	-41.25	7.5
	Non HT/VHT20 Beam Forming, 6 to 54 Mbps	3	16	-63.9	-65.9	-65.1		-44.1	-41.25	2.9
	Non HT/VHT20 Beam Forming, 6 to 54 Mbps	4	16	-63.6	-66.1	-65.4	-65.3	-43.0	-41.25	1.7
	HT/VHT20, M0 to M7, M0 to M9 1ss	1	13	-63.8				-50.8	-41.25	9.6
	HT/VHT20, M0 to M7, M0 to M9 1ss	2	13	-63.8	-65.9			-48.7	-41.25	7.5
	HT/VHT20, M8 to M15, M0 to M9 2ss	2	13	-63.8	-65.9			-48.7	-41.25	7.5
	HT/VHT20, M0 to M7, M0 to M9 1ss	3	13	-64.2	-66.2	-65.4		-47.4	-41.25	6.2
	HT/VHT20, M8 to M15, M0 to M9 2ss	3	13	-64.2	-66.2	-65.4		-47.4	-41.25	6.2
	HT/VHT20, M16 to M23, M0 to M9 3ss	3	13	-64.2	-66.2	-65.4		-47.4	-41.25	6.2
	HT/VHT20, M0 to M7, M0 to M9 1ss	4	13	-64.2	-66.2	-65.4	-66.1	-46.4	-41.25	5.1
	HT/VHT20, M8 to M15, M0 to M9 2ss	4	13	-64.2	-66.2	-65.4	-66.1	-46.4	-41.25	5.1
	HT/VHT20, M16 to M23, M0 to M9 3ss	4	13	-64.2	-66.2	-65.4	-66.1	-46.4	-41.25	5.1
	HT/VHT20 Beam Forming, M0 to M7, M0 to M9 1ss	2	13	-63.8	-65.9			-48.7	-41.25	7.5
	HT/VHT20 Beam Forming, M8 to M15, M0 to M9 2ss	2	13	-63.8	-65.9			-48.7	-41.25	7.5
	HT/VHT20 Beam Forming, M0 to M7, M0 to M9 1ss	3	16	-63.8	-66.0	-65.4		-44.2	-41.25	2.9
	HT/VHT20 Beam Forming, M8 to M15, M0 to M9 2ss	3	13	-64.2	-66.2	-65.4		-47.4	-41.25	6.2
	HT/VHT20 Beam Forming, M16 to M23, M0 to M9 3ss	3	13	-64.2	-66.2	-65.4		-47.4	-41.25	6.2
	HT/VHT20 Beam Forming, M0 to M7, M0 to M9 1ss	4	16	-63.8	-66.0	-65.4	-65.5	-43.1	-41.25	1.8
	HT/VHT20 Beam Forming, M8 to M15, M0 to M9 2ss	4	13	-64.2	-66.2	-65.4	-66.1	-46.4	-41.25	5.1
	HT/VHT20 Beam Forming, M16 to M23, M0 to M9 3ss	4	13	-64.2	-66.2	-65.4	-66.1	-46.4	-41.25	5.1
HT/VHT20 STBC, M0 to M7, M0 to M9 1ss	2	13	-63.8	-65.9			-48.7	-41.25	7.5	
HT/VHT20 STBC, M0 to M7, M0 to M9 1ss	3	13	-64.2	-66.2	-65.4		-47.4	-41.25	6.2	
HT/VHT20 STBC, M0 to M7, M0 to M9 1ss	4	13	-64.2	-66.2	-65.4	-66.1	-46.4	-41.25	5.1	
5755	Non HT/VHT40, 6 to 54 Mbps	1	13	-64.1				-51.1	-41.25	9.8
	Non HT/VHT40, 6 to 54 Mbps	2	13	-63.8	-65.8			-48.7	-41.25	7.4
	Non HT/VHT40, 6 to 54 Mbps	3	13	-63.8	-65.8	-64.7		-46.9	-41.25	5.7
	Non HT/VHT40, 6 to 54 Mbps	4	13	-64.0	-66.1	-65.4	-65.1	-46.1	-41.25	4.8
	HT/VHT40, M0 to M7, M0 to M9 1ss	1	13	-63.9				-50.9	-41.25	9.7
	HT/VHT40, M0 to M7, M0 to M9 1ss	2	13	-64.3	-66.2			-49.1	-41.25	7.9
	HT/VHT40, M8 to M15, M0 to M9 2ss	2	13	-64.3	-66.2			-49.1	-41.25	7.9

	HT/VHT40, M0 to M7, M0 to M9 1ss	3	13	-64.3	-65.8	-65.7		-47.4	-41.25	6.2
	HT/VHT40, M8 to M15, M0 to M9 2ss	3	13	-64.3	-65.8	-65.7		-47.4	-41.25	6.2
	HT/VHT40, M16 to M23, M0 to M9 3ss	3	13	-64.3	-65.8	-65.7		-47.4	-41.25	6.2
	HT/VHT40, M0 to M7, M0 to M9 1ss	4	13	-64.3	-65.8	-65.7	-65.4	-46.2	-41.25	5.0
	HT/VHT40, M8 to M15, M0 to M9 2ss	4	13	-64.3	-65.8	-65.7	-65.4	-46.2	-41.25	5.0
	HT/VHT40, M16 to M23, M0 to M9 3ss	4	13	-64.3	-65.8	-65.7	-65.4	-46.2	-41.25	5.0
	HT/VHT40 Beam Forming, M0 to M7, M0 to M9 1ss	2	13	-64.3	-66.2			-49.1	-41.25	7.9
	HT/VHT40 Beam Forming, M8 to M15, M0 to M9 2ss	2	13	-64.3	-66.2			-49.1	-41.25	7.9
	HT/VHT40 Beam Forming, M0 to M7, M0 to M9 1ss	3	16	-64.3	-66.0	-65.8		-44.5	-41.25	3.3
	HT/VHT40 Beam Forming, M8 to M15, M0 to M9 2ss	3	13	-64.3	-65.8	-65.7		-47.4	-41.25	6.2
	HT/VHT40 Beam Forming, M16 to M23, M0 to M9 3ss	3	13	-64.3	-65.8	-65.7		-47.4	-41.25	6.2
	HT/VHT40 Beam Forming, M0 to M7, M0 to M9 1ss	4	16	-64.3	-66.0	-65.7	-65.4	-43.3	-41.25	2.0
	HT/VHT40 Beam Forming, M8 to M15, M0 to M9 2ss	4	13	-64.3	-65.8	-65.7	-65.4	-46.2	-41.25	5.0
	HT/VHT40 Beam Forming, M16 to M23, M0 to M9 3ss	4	13	-64.3	-65.8	-65.7	-65.4	-46.2	-41.25	5.0
	HT/VHT40 STBC, M0 to M7, M0 to M9 1ss	2	13	-64.3	-66.2			-49.1	-41.25	7.9
	HT/VHT40 STBC, M0 to M7, M0 to M9 1ss	3	13	-64.3	-65.8	-65.7		-47.4	-41.25	6.2
	HT/VHT40 STBC, M0 to M7, M0 to M9 1ss	4	13	-64.3	-65.8	-65.7	-65.4	-46.2	-41.25	5.0
5775	Non HT/VHT80, 6 to 54 Mbps	1	13	-64.2				-51.2	-41.25	10.0
	Non HT/VHT80, 6 to 54 Mbps	2	13	-64.1	-66.1			-49.0	-41.25	7.7
	Non HT/VHT80, 6 to 54 Mbps	3	13	-63.9	-66.1	-65.0		-47.1	-41.25	5.9
	Non HT/VHT80, 6 to 54 Mbps	4	13	-63.9	-66.1	-65.0	-64.8	-45.9	-41.25	4.6
	HT/VHT80, M0 to M7, M0 to M9 1ss	1	13	-64.5				-51.5	-41.25	10.3
	HT/VHT80, M0 to M7, M0 to M9 1ss	2	13	-64.7	-66.3			-49.4	-41.25	8.2
	HT/VHT80, M8 to M15, M0 to M9 2ss	2	13	-64.7	-66.3			-49.4	-41.25	8.2
	HT/VHT80, M0 to M7, M0 to M9 1ss	3	13	-63.9	-65.9	-65.8		-47.3	-41.25	6.1
	HT/VHT80, M8 to M15, M0 to M9 2ss	3	13	-63.9	-65.9	-65.8		-47.3	-41.25	6.1
	HT/VHT80, M16 to M23, M0 to M9 3ss	3	13	-63.9	-65.9	-65.8		-47.3	-41.25	6.1
	HT/VHT80, M0 to M7, M0 to M9 1ss	4	13	-63.8	-66.2	-64.9	-65.5	-46.0	-41.25	4.7
	HT/VHT80, M8 to M15, M0 to M9 2ss	4	13	-63.8	-66.2	-64.9	-65.5	-46.0	-41.25	4.7
	HT/VHT80, M16 to M23, M0 to M9 3ss	4	13	-63.8	-66.2	-64.9	-65.5	-46.0	-41.25	4.7
	HT/VHT80 Beam Forming, M0 to M7, M0 to M9 1ss	2	13	-64.7	-66.3			-49.4	-41.25	8.2
	HT/VHT80 Beam Forming, M8 to M15, M0 to M9 2ss	2	13	-64.7	-66.3			-49.4	-41.25	8.2
	HT/VHT80 Beam Forming, M0 to M7, M0 to M9 1ss	3	13	-63.9	-65.9	-65.8		-47.3	-41.25	6.1
	HT/VHT80 Beam Forming, M8 to M15, M0 to M9 2ss	3	13	-63.9	-65.9	-65.8		-47.3	-41.25	6.1
	HT/VHT80 Beam Forming, M16 to M23, M0 to M9 3ss	3	13	-63.9	-65.9	-65.8		-47.3	-41.25	6.1
	HT/VHT80 Beam Forming, M0 to M7, M0 to M9 1ss	4	13	-63.8	-66.2	-64.9	-65.5	-46.0	-41.25	4.7
	HT/VHT80 Beam Forming, M8 to M15, M0 to M9 2ss	4	13	-63.8	-66.2	-64.9	-65.5	-46.0	-41.25	4.7
	HT/VHT80 Beam Forming, M16 to M23, M0 to M9 3ss	4	13	-63.8	-66.2	-64.9	-65.5	-46.0	-41.25	4.7
	HT/VHT80 STBC, M0 to M7, M0 to M9 1ss	2	13	-64.7	-66.3			-49.4	-41.25	8.2
	HT/VHT80 STBC, M0 to M7, M0 to M9 1ss	3	13	-63.9	-65.9	-65.8		-47.3	-41.25	6.1
HT/VHT80 STBC, M0 to M7, M0 to M9 1ss	4	13	-63.8	-66.2	-64.9	-65.5	-46.0	-41.25	4.7	

5785	Non HT/VHT20, 6 to 54 Mbps	1	13	-63.5				-50.5	-41.25	9.3
	Non HT/VHT20, 6 to 54 Mbps	2	13	-63.5	-66.2			-48.6	-41.25	7.4
	Non HT/VHT20, 6 to 54 Mbps	3	13	-63.5	-66.2	-66.8		-47.5	-41.25	6.2
	Non HT/VHT20, 6 to 54 Mbps	4	13	-63.5	-66.2	-66.8	-66.2	-46.4	-41.25	5.2
	Non HT/VHT20 Beam Forming, 6 to 54 Mbps	2	13	-63.5	-66.2			-48.6	-41.25	7.4
	Non HT/VHT20 Beam Forming, 6 to 54 Mbps	3	16	-63.5	-66.2	-66.8		-44.5	-41.25	3.2
	Non HT/VHT20 Beam Forming, 6 to 54 Mbps	4	16	-63.5	-66.2	-66.8	-66.2	-43.4	-41.25	2.2
	HT/VHT20, M0 to M7, M0 to M9 1ss	1	13	-63.8				-50.8	-41.25	9.6
	HT/VHT20, M0 to M7, M0 to M9 1ss	2	13	-63.8	-66.0			-48.8	-41.25	7.5
	HT/VHT20, M8 to M15, M0 to M9 2ss	2	13	-63.8	-66.0			-48.8	-41.25	7.5
	HT/VHT20, M0 to M7, M0 to M9 1ss	3	13	-63.8	-66.0	-66.3		-47.4	-41.25	6.2
	HT/VHT20, M8 to M15, M0 to M9 2ss	3	13	-63.8	-66.0	-66.3		-47.4	-41.25	6.2
	HT/VHT20, M16 to M23, M0 to M9 3ss	3	13	-63.8	-66.0	-66.3		-47.4	-41.25	6.2
	HT/VHT20, M0 to M7, M0 to M9 1ss	4	13	-63.8	-66.0	-66.3	-66.0	-46.4	-41.25	5.1
	HT/VHT20, M8 to M15, M0 to M9 2ss	4	13	-63.8	-66.0	-66.3	-66.0	-46.4	-41.25	5.1
	HT/VHT20, M16 to M23, M0 to M9 3ss	4	13	-63.8	-66.0	-66.3	-66.0	-46.4	-41.25	5.1
	HT/VHT20 Beam Forming, M0 to M7, M0 to M9 1ss	2	13	-63.8	-66.0			-48.8	-41.25	7.5
	HT/VHT20 Beam Forming, M8 to M15, M0 to M9 2ss	2	13	-63.8	-66.0			-48.8	-41.25	7.5
	HT/VHT20 Beam Forming, M0 to M7, M0 to M9 1ss	3	16	-63.8	-66.0	-66.3		-44.4	-41.25	3.2
	HT/VHT20 Beam Forming, M8 to M15, M0 to M9 2ss	3	13	-63.8	-66.0	-66.3		-47.4	-41.25	6.2
	HT/VHT20 Beam Forming, M16 to M23, M0 to M9 3ss	3	13	-63.8	-66.0	-66.3		-47.4	-41.25	6.2
	HT/VHT20 Beam Forming, M0 to M7, M0 to M9 1ss	4	16	-63.8	-66.0	-66.3	-66.0	-43.4	-41.25	2.1
	HT/VHT20 Beam Forming, M8 to M15, M0 to M9 2ss	4	13	-63.8	-66.0	-66.3	-66.0	-46.4	-41.25	5.1
HT/VHT20 Beam Forming, M16 to M23, M0 to M9 3ss	4	13	-63.8	-66.0	-66.3	-66.0	-46.4	-41.25	5.1	
HT/VHT20 STBC, M0 to M7, M0 to M9 1ss	2	13	-63.8	-66.0			-48.8	-41.25	7.5	
HT/VHT20 STBC, M0 to M7, M0 to M9 1ss	3	13	-63.8	-66.0	-66.3		-47.4	-41.25	6.2	
HT/VHT20 STBC, M0 to M7, M0 to M9 1ss	4	13	-63.8	-66.0	-66.3	-66.0	-46.4	-41.25	5.1	
5795	Non HT/VHT40, 6 to 54 Mbps	1	13	-63.9				-50.9	-41.25	9.7
	Non HT/VHT40, 6 to 54 Mbps	2	13	-64.0	-66.2			-49.0	-41.25	7.7
	Non HT/VHT40, 6 to 54 Mbps	3	13	-64.0	-66.2	-65.6		-47.4	-41.25	6.1
	Non HT/VHT40, 6 to 54 Mbps	4	13	-64.0	-66.2	-65.6	-65.3	-46.2	-41.25	4.9
	HT/VHT40, M0 to M7, M0 to M9 1ss	1	13	-64.0				-51.0	-41.25	9.8
	HT/VHT40, M0 to M7, M0 to M9 1ss	2	13	-64.3	-66.0			-49.1	-41.25	7.8
	HT/VHT40, M8 to M15, M0 to M9 2ss	2	13	-64.3	-66.0			-49.1	-41.25	7.8
	HT/VHT40, M0 to M7, M0 to M9 1ss	3	13	-64.3	-66.0	-65.1		-47.3	-41.25	6.1
	HT/VHT40, M8 to M15, M0 to M9 2ss	3	13	-64.3	-66.0	-65.1		-47.3	-41.25	6.1
	HT/VHT40, M16 to M23, M0 to M9 3ss	3	13	-64.3	-66.0	-65.1		-47.3	-41.25	6.1
	HT/VHT40, M0 to M7, M0 to M9 1ss	4	13	-64.3	-66.0	-65.1	-65.0	-46.0	-41.25	4.8
	HT/VHT40, M8 to M15, M0 to M9 2ss	4	13	-64.3	-66.0	-65.1	-65.0	-46.0	-41.25	4.8
	HT/VHT40, M16 to M23, M0 to M9 3ss	4	13	-64.3	-66.0	-65.1	-65.0	-46.0	-41.25	4.8

	HT/VHT40 Beam Forming, M0 to M7, M0 to M9 1ss	2	13	-64.3	-66.0			-49.1	-41.25	7.8
	HT/VHT40 Beam Forming, M8 to M15, M0 to M9 2ss	2	13	-64.3	-66.0			-49.1	-41.25	7.8
	HT/VHT40 Beam Forming, M0 to M7, M0 to M9 1ss	3	16	-64.3	-66.0	-65.1		-44.3	-41.25	3.1
	HT/VHT40 Beam Forming, M8 to M15, M0 to M9 2ss	3	13	-64.3	-66.0	-65.1		-47.3	-41.25	6.1
	HT/VHT40 Beam Forming, M16 to M23, M0 to M9 3ss	3	13	-64.3	-66.0	-65.1		-47.3	-41.25	6.1
	HT/VHT40 Beam Forming, M0 to M7, M0 to M9 1ss	4	16	-63.8	-66.1	-65.2	-65.0	-42.9	-41.25	1.7
	HT/VHT40 Beam Forming, M8 to M15, M0 to M9 2ss	4	13	-64.3	-66.0	-65.1	-65.0	-46.0	-41.25	4.8
	HT/VHT40 Beam Forming, M16 to M23, M0 to M9 3ss	4	13	-64.3	-66.0	-65.1	-65.0	-46.0	-41.25	4.8
	HT/VHT40 STBC, M0 to M7, M0 to M9 1ss	2	13	-64.3	-66.0			-49.1	-41.25	7.8
	HT/VHT40 STBC, M0 to M7, M0 to M9 1ss	3	13	-64.3	-66.0	-65.1		-47.3	-41.25	6.1
	HT/VHT40 STBC, M0 to M7, M0 to M9 1ss	4	13	-64.3	-66.0	-65.1	-65.0	-46.0	-41.25	4.8
5825	Non HT/VHT20, 6 to 54 Mbps	1	13	-63.6				-50.6	-41.25	9.4
	Non HT/VHT20, 6 to 54 Mbps	2	13	-64.0	-66.1			-48.9	-41.25	7.7
	Non HT/VHT20, 6 to 54 Mbps	3	13	-64.0	-66.1	-65.5		-47.3	-41.25	6.1
	Non HT/VHT20, 6 to 54 Mbps	4	13	-64.4	-66.2	-65.1	-64.4	-45.9	-41.25	4.7
	Non HT/VHT20 Beam Forming, 6 to 54 Mbps	2	13	-64.0	-66.1			-48.9	-41.25	7.7
	Non HT/VHT20 Beam Forming, 6 to 54 Mbps	3	16	-64.4	-66.2	-65.1		-44.4	-41.25	3.2
	Non HT/VHT20 Beam Forming, 6 to 54 Mbps	4	16	-64.4	-66.0	-65.3	-64.8	-43.1	-41.25	1.8
	HT/VHT20, M0 to M7, M0 to M9 1ss	1	13	-63.6				-50.6	-41.25	9.4
	HT/VHT20, M0 to M7, M0 to M9 1ss	2	13	-63.7	-66.2			-48.8	-41.25	7.5
	HT/VHT20, M8 to M15, M0 to M9 2ss	2	13	-63.7	-66.2			-48.8	-41.25	7.5
	HT/VHT20, M0 to M7, M0 to M9 1ss	3	13	-63.7	-66.2	-65.1		-47.1	-41.25	5.9
	HT/VHT20, M8 to M15, M0 to M9 2ss	3	13	-63.7	-66.2	-65.1		-47.1	-41.25	5.9
	HT/VHT20, M16 to M23, M0 to M9 3ss	3	13	-63.7	-66.2	-65.1		-47.1	-41.25	5.9
	HT/VHT20, M0 to M7, M0 to M9 1ss	4	13	-63.7	-66.2	-65.1	-64.6	-45.8	-41.25	4.5
	HT/VHT20, M8 to M15, M0 to M9 2ss	4	13	-63.7	-66.2	-65.1	-64.6	-45.8	-41.25	4.5
	HT/VHT20, M16 to M23, M0 to M9 3ss	4	13	-63.7	-66.2	-65.1	-64.6	-45.8	-41.25	4.5
	HT/VHT20 Beam Forming, M0 to M7, M0 to M9 1ss	2	13	-63.7	-66.2			-48.8	-41.25	7.5
	HT/VHT20 Beam Forming, M8 to M15, M0 to M9 2ss	2	13	-63.7	-66.2			-48.8	-41.25	7.5
	HT/VHT20 Beam Forming, M0 to M7, M0 to M9 1ss	3	16	-63.9	-66.0	-64.9		-44.1	-41.25	2.8
	HT/VHT20 Beam Forming, M8 to M15, M0 to M9 2ss	3	13	-63.7	-66.2	-65.1		-47.1	-41.25	5.9
	HT/VHT20 Beam Forming, M16 to M23, M0 to M9 3ss	3	13	-63.7	-66.2	-65.1		-47.1	-41.25	5.9
	<b>HT/VHT20 Beam Forming, M0 to M7, M0 to M9 1ss</b>	<b>4</b>	<b>16</b>	<b>-63.9</b>	<b>-66.0</b>	<b>-64.9</b>	<b>-64.9</b>	<b>-42.8</b>	<b>-41.25</b>	<b>1.6</b>
	HT/VHT20 Beam Forming, M8 to M15, M0 to M9 2ss	4	13	-63.7	-66.2	-65.1	-64.6	-45.8	-41.25	4.5
	HT/VHT20 Beam Forming, M16 to M23, M0 to M9 3ss	4	13	-63.7	-66.2	-65.1	-64.6	-45.8	-41.25	4.5
	HT/VHT20 STBC, M0 to M7, M0 to M9 1ss	2	13	-63.7	-66.2			-48.8	-41.25	7.5
	HT/VHT20 STBC, M0 to M7, M0 to M9 1ss	3	13	-63.7	-66.2	-65.1		-47.1	-41.25	5.9
	HT/VHT20 STBC, M0 to M7, M0 to M9 1ss	4	13	-63.7	-66.2	-65.1	-64.6	-45.8	-41.25	4.5

Frequency (MHz)	Mode	Tx Paths	Correlated Antenna Gain (dBi)	Tx 1 Spur Power (dBm)	Tx 2 Spur Power (dBm)	Tx 3 Spur Power (dBm)	Tx 4 Spur Power (dBm)	Total Conducted Spur (dBm)	Limit (dBm)	Margin (dB)
5745	Non HT/VHT20, 6 to 54 Mbps	1	13	-61.0				-48.0	-21.25	26.8
	Non HT/VHT20, 6 to 54 Mbps	2	13	-61.0	-62.1			-45.5	-21.25	24.3
	Non HT/VHT20, 6 to 54 Mbps	3	13	-61.0	-62.1	-62.0		-43.9	-21.25	22.6
	Non HT/VHT20, 6 to 54 Mbps	4	13	-61.0	-62.1	-62.0	-63.7	-43.1	-21.25	21.8
	Non HT/VHT20 Beam Forming, 6 to 54 Mbps	2	13	-61.0	-62.1			-45.5	-21.25	24.3
	Non HT/VHT20 Beam Forming, 6 to 54 Mbps	3	16	-61.0	-62.1	-62.0		-40.9	-21.25	19.6
	Non HT/VHT20 Beam Forming, 6 to 54 Mbps	4	16	-63.0	-64.0	-64.0	-63.5	-41.6	-21.25	20.3
	HT/VHT20, M0 to M7, M0 to M9 1ss	1	13	-62.0				-49.0	-21.25	27.8
	HT/VHT20, M0 to M7, M0 to M9 1ss	2	13	-62.0	-61.8			-45.9	-21.25	24.6
	HT/VHT20, M8 to M15, M0 to M9 2ss	2	13	-62.0	-61.8			-45.9	-21.25	24.6
	HT/VHT20, M0 to M7, M0 to M9 1ss	3	13	-62.9	-62.0	-62.1		-44.5	-21.25	23.3
	HT/VHT20, M8 to M15, M0 to M9 2ss	3	13	-62.9	-62.0	-62.1		-44.5	-21.25	23.3
	HT/VHT20, M16 to M23, M0 to M9 3ss	3	13	-62.9	-62.0	-62.1		-44.5	-21.25	23.3
	HT/VHT20, M0 to M7, M0 to M9 1ss	4	13	-62.9	-62.0	-62.1	-61.3	-43.0	-21.25	21.8
	HT/VHT20, M8 to M15, M0 to M9 2ss	4	13	-62.9	-62.0	-62.1	-61.3	-43.0	-21.25	21.8
	HT/VHT20, M16 to M23, M0 to M9 3ss	4	13	-62.9	-62.0	-62.1	-61.3	-43.0	-21.25	21.8
	HT/VHT20 Beam Forming, M0 to M7, M0 to M9 1ss	2	13	-62.0	-61.8			-45.9	-21.25	24.6
	HT/VHT20 Beam Forming, M8 to M15, M0 to M9 2ss	2	13	-62.0	-61.8			-45.9	-21.25	24.6
	HT/VHT20 Beam Forming, M0 to M7, M0 to M9 1ss	3	16	-62.5	-63.2	-62.9		-42.1	-21.25	20.8
	HT/VHT20 Beam Forming, M8 to M15, M0 to M9 2ss	3	13	-62.9	-62.0	-62.1		-44.5	-21.25	23.3
	HT/VHT20 Beam Forming, M16 to M23, M0 to M9 3ss	3	13	-62.9	-62.0	-62.1		-44.5	-21.25	23.3
	HT/VHT20 Beam Forming, M0 to M7, M0 to M9 1ss	4	16	-62.5	-63.2	-62.9	-61.5	-40.5	-21.25	19.2
	HT/VHT20 Beam Forming, M8 to M15, M0 to M9 2ss	4	13	-62.9	-62.0	-62.1	-61.3	-43.0	-21.25	21.8
	HT/VHT20 Beam Forming, M16 to M23, M0 to M9 3ss	4	13	-62.9	-62.0	-62.1	-61.3	-43.0	-21.25	21.8
HT/VHT20 STBC, M0 to M7, M0 to M9 1ss	2	13	-62.0	-61.8			-45.9	-21.25	24.6	
HT/VHT20 STBC, M0 to M7, M0 to M9 1ss	3	13	-62.9	-62.0	-62.1		-44.5	-21.25	23.3	
HT/VHT20 STBC, M0 to M7, M0 to M9 1ss	4	13	-62.9	-62.0	-62.1	-61.3	-43.0	-21.25	21.8	
5755	Non HT/VHT40, 6 to 54 Mbps	1	13	-64.0				-51.0	-21.25	29.8
	Non HT/VHT40, 6 to 54 Mbps	2	13	-62.3	-62.8			-46.5	-21.25	25.3
	Non HT/VHT40, 6 to 54 Mbps	3	13	-62.3	-62.8	-62.6		-44.8	-21.25	23.5
	Non HT/VHT40, 6 to 54 Mbps	4	13	-63.5	-63.2	-62.7	-62.9	-44.0	-21.25	22.8
	HT/VHT40, M0 to M7, M0 to M9 1ss	1	13	-63.1				-50.1	-21.25	28.9
	HT/VHT40, M0 to M7, M0 to M9 1ss	2	13	-61.5	-62.6			-46.0	-21.25	24.8
	HT/VHT40, M8 to M15, M0 to M9 2ss	2	13	-61.5	-62.6			-46.0	-21.25	24.8



	HT/VHT40, M0 to M7, M0 to M9 1ss	3	13	-61.0	-63.2	-61.8		-44.1	-21.25	22.9
	HT/VHT40, M8 to M15, M0 to M9 2ss	3	13	-61.0	-63.2	-61.8		-44.1	-21.25	22.9
	HT/VHT40, M16 to M23, M0 to M9 3ss	3	13	-61.0	-63.2	-61.8		-44.1	-21.25	22.9
	HT/VHT40, M0 to M7, M0 to M9 1ss	4	13	-61.0	-63.2	-61.8	-62.8	-43.1	-21.25	21.8
	HT/VHT40, M8 to M15, M0 to M9 2ss	4	13	-61.0	-63.2	-61.8	-62.8	-43.1	-21.25	21.8
	HT/VHT40, M16 to M23, M0 to M9 3ss	4	13	-61.0	-63.2	-61.8	-62.8	-43.1	-21.25	21.8
	HT/VHT40 Beam Forming, M0 to M7, M0 to M9 1ss	2	13	-61.5	-62.6			-46.0	-21.25	24.8
	HT/VHT40 Beam Forming, M8 to M15, M0 to M9 2ss	2	13	-61.5	-62.6			-46.0	-21.25	24.8
	HT/VHT40 Beam Forming, M0 to M7, M0 to M9 1ss	3	16	-62.2	-62.7	-62.3		-41.6	-21.25	20.4
	HT/VHT40 Beam Forming, M8 to M15, M0 to M9 2ss	3	13	-61.0	-63.2	-61.8		-44.1	-21.25	22.9
	HT/VHT40 Beam Forming, M16 to M23, M0 to M9 3ss	3	13	-61.0	-63.2	-61.8		-44.1	-21.25	22.9
	HT/VHT40 Beam Forming, M0 to M7, M0 to M9 1ss	4	16	-62.6	-63.2	-60.5	-64.3	-40.4	-21.25	19.1
	HT/VHT40 Beam Forming, M8 to M15, M0 to M9 2ss	4	13	-61.0	-63.2	-61.8	-62.8	-43.1	-21.25	21.8
	HT/VHT40 Beam Forming, M16 to M23, M0 to M9 3ss	4	13	-61.0	-63.2	-61.8	-62.8	-43.1	-21.25	21.8
	HT/VHT40 STBC, M0 to M7, M0 to M9 1ss	2	13	-61.5	-62.6			-46.0	-21.25	24.8
	HT/VHT40 STBC, M0 to M7, M0 to M9 1ss	3	13	-61.0	-63.2	-61.8		-44.1	-21.25	22.9
	HT/VHT40 STBC, M0 to M7, M0 to M9 1ss	4	13	-61.0	-63.2	-61.8	-62.8	-43.1	-21.25	21.8
5775	Non HT/VHT80, 6 to 54 Mbps	1	13	-63.4				-50.4	-21.25	29.2
	Non HT/VHT80, 6 to 54 Mbps	2	13	-64.2	-63.7			-47.9	-21.25	26.7
	Non HT/VHT80, 6 to 54 Mbps	3	13	-62.3	-63.4	-64.4		-45.5	-21.25	24.3
	Non HT/VHT80, 6 to 54 Mbps	4	13	-62.3	-63.4	-64.4	-61.9	-43.9	-21.25	22.6
	HT/VHT80, M0 to M7, M0 to M9 1ss	1	13	-62.6				-49.6	-21.25	28.4
	HT/VHT80, M0 to M7, M0 to M9 1ss	2	13	-62.5	-61.9			-46.2	-21.25	24.9
	HT/VHT80, M8 to M15, M0 to M9 2ss	2	13	-62.5	-61.9			-46.2	-21.25	24.9
	HT/VHT80, M0 to M7, M0 to M9 1ss	3	13	-62.8	-63.6	-64.8		-45.9	-21.25	24.6
	HT/VHT80, M8 to M15, M0 to M9 2ss	3	13	-62.8	-63.6	-64.8		-45.9	-21.25	24.6
	HT/VHT80, M16 to M23, M0 to M9 3ss	3	13	-62.8	-63.6	-64.8		-45.9	-21.25	24.6
	HT/VHT80, M0 to M7, M0 to M9 1ss	4	13	-64.0	-63.4	-61.7	-61.3	-43.4	-21.25	22.2
	HT/VHT80, M8 to M15, M0 to M9 2ss	4	13	-64.0	-63.4	-61.7	-61.3	-43.4	-21.25	22.2
	HT/VHT80, M16 to M23, M0 to M9 3ss	4	13	-64.0	-63.4	-61.7	-61.3	-43.4	-21.25	22.2
	HT/VHT80 Beam Forming, M0 to M7, M0 to M9 1ss	2	13	-62.5	-61.9			-46.2	-21.25	24.9
	HT/VHT80 Beam Forming, M8 to M15, M0 to M9 2ss	2	13	-62.5	-61.9			-46.2	-21.25	24.9
	HT/VHT80 Beam Forming, M0 to M7, M0 to M9 1ss	3	13	-62.8	-63.6	-64.8		-45.9	-21.25	24.6
	HT/VHT80 Beam Forming, M8 to M15, M0 to M9 2ss	3	13	-62.8	-63.6	-64.8		-45.9	-21.25	24.6
	HT/VHT80 Beam Forming, M16 to M23, M0 to M9 3ss	3	13	-62.8	-63.6	-64.8		-45.9	-21.25	24.6
	HT/VHT80 Beam Forming, M0 to M7, M0 to M9 1ss	4	13	-64.0	-63.4	-61.7	-61.3	-43.4	-21.25	22.2
	HT/VHT80 Beam Forming, M8 to M15, M0 to M9 2ss	4	13	-64.0	-63.4	-61.7	-61.3	-43.4	-21.25	22.2
	HT/VHT80 Beam Forming, M16 to M23, M0 to M9 3ss	4	13	-64.0	-63.4	-61.7	-61.3	-43.4	-21.25	22.2
	HT/VHT80 STBC, M0 to M7, M0 to M9 1ss	2	13	-62.5	-61.9			-46.2	-21.25	24.9
	HT/VHT80 STBC, M0 to M7, M0 to M9 1ss	3	13	-62.8	-63.6	-64.8		-45.9	-21.25	24.6
HT/VHT80 STBC, M0 to M7, M0 to M9 1ss	4	13	-64.0	-63.4	-61.7	-61.3	-43.4	-21.25	22.2	

5785	Non HT/VHT20, 6 to 54 Mbps	1	13	-61.4				-48.4	-21.25	27.2
	Non HT/VHT20, 6 to 54 Mbps	2	13	-61.4	-62.8			-46.0	-21.25	24.8
	Non HT/VHT20, 6 to 54 Mbps	3	13	-61.4	-62.8	-61.6		-44.1	-21.25	22.9
	Non HT/VHT20, 6 to 54 Mbps	4	13	-61.4	-62.8	-61.6	-62.0	-42.9	-21.25	21.6
	Non HT/VHT20 Beam Forming, 6 to 54 Mbps	2	13	-61.4	-62.8			-46.0	-21.25	24.8
	Non HT/VHT20 Beam Forming, 6 to 54 Mbps	3	16	-61.4	-62.8	-61.6		-41.1	-21.25	19.9
	Non HT/VHT20 Beam Forming, 6 to 54 Mbps	4	16	-61.4	-62.8	-61.6	-62.0	-39.9	-21.25	18.6
	HT/VHT20, M0 to M7, M0 to M9 1ss	1	13	-60.9				-47.9	-21.25	26.7
	HT/VHT20, M0 to M7, M0 to M9 1ss	2	13	-60.9	-62.8			-45.7	-21.25	24.5
	HT/VHT20, M8 to M15, M0 to M9 2ss	2	13	-60.9	-62.8			-45.7	-21.25	24.5
	HT/VHT20, M0 to M7, M0 to M9 1ss	3	13	-60.9	-62.8	-62.0		-44.1	-21.25	22.8
	HT/VHT20, M8 to M15, M0 to M9 2ss	3	13	-60.9	-62.8	-62.0		-44.1	-21.25	22.8
	HT/VHT20, M16 to M23, M0 to M9 3ss	3	13	-60.9	-62.8	-62.0		-44.1	-21.25	22.8
	HT/VHT20, M0 to M7, M0 to M9 1ss	4	13	-60.9	-62.8	-62.0	-61.5	-42.7	-21.25	21.5
	HT/VHT20, M8 to M15, M0 to M9 2ss	4	13	-60.9	-62.8	-62.0	-61.5	-42.7	-21.25	21.5
	HT/VHT20, M16 to M23, M0 to M9 3ss	4	13	-60.9	-62.8	-62.0	-61.5	-42.7	-21.25	21.5
	HT/VHT20 Beam Forming, M0 to M7, M0 to M9 1ss	2	13	-60.9	-62.8			-45.7	-21.25	24.5
	HT/VHT20 Beam Forming, M8 to M15, M0 to M9 2ss	2	13	-60.9	-62.8			-45.7	-21.25	24.5
	HT/VHT20 Beam Forming, M0 to M7, M0 to M9 1ss	3	16	-60.9	-62.8	-62.0		-41.1	-21.25	19.8
	HT/VHT20 Beam Forming, M8 to M15, M0 to M9 2ss	3	13	-60.9	-62.8	-62.0		-44.1	-21.25	22.8
	HT/VHT20 Beam Forming, M16 to M23, M0 to M9 3ss	3	13	-60.9	-62.8	-62.0		-44.1	-21.25	22.8
	<b>HT/VHT20 Beam Forming, M0 to M7, M0 to M9 1ss</b>	<b>4</b>	<b>16</b>	<b>-60.9</b>	<b>-62.8</b>	<b>-62.0</b>	<b>-61.5</b>	<b>-39.7</b>	<b>-21.25</b>	<b>18.5</b>
	HT/VHT20 Beam Forming, M8 to M15, M0 to M9 2ss	4	13	-60.9	-62.8	-62.0	-61.5	-42.7	-21.25	21.5
	HT/VHT20 Beam Forming, M16 to M23, M0 to M9 3ss	4	13	-60.9	-62.8	-62.0	-61.5	-42.7	-21.25	21.5
HT/VHT20 STBC, M0 to M7, M0 to M9 1ss	2	13	-60.9	-62.8			-45.7	-21.25	24.5	
HT/VHT20 STBC, M0 to M7, M0 to M9 1ss	3	13	-60.9	-62.8	-62.0		-44.1	-21.25	22.8	
HT/VHT20 STBC, M0 to M7, M0 to M9 1ss	4	13	-60.9	-62.8	-62.0	-61.5	-42.7	-21.25	21.5	
5795	Non HT/VHT40, 6 to 54 Mbps	1	13	-62.1				-49.1	-21.25	27.9
	Non HT/VHT40, 6 to 54 Mbps	2	13	-63.5	-62.0			-46.7	-21.25	25.4
	Non HT/VHT40, 6 to 54 Mbps	3	13	-63.5	-62.0	-60.3		-44.0	-21.25	22.7
	Non HT/VHT40, 6 to 54 Mbps	4	13	-63.5	-62.0	-60.3	-62.5	-42.9	-21.25	21.6
	HT/VHT40, M0 to M7, M0 to M9 1ss	1	13	-61.9				-48.9	-21.25	27.7
	HT/VHT40, M0 to M7, M0 to M9 1ss	2	13	-62.2	-62.4			-46.3	-21.25	25.0
	HT/VHT40, M8 to M15, M0 to M9 2ss	2	13	-62.2	-62.4			-46.3	-21.25	25.0
	HT/VHT40, M0 to M7, M0 to M9 1ss	3	13	-62.2	-62.4	-63.0		-44.7	-21.25	23.5
	HT/VHT40, M8 to M15, M0 to M9 2ss	3	13	-62.2	-62.4	-63.0		-44.7	-21.25	23.5
	HT/VHT40, M16 to M23, M0 to M9 3ss	3	13	-62.2	-62.4	-63.0		-44.7	-21.25	23.5
	HT/VHT40, M0 to M7, M0 to M9 1ss	4	13	-62.2	-62.4	-63.0	-63.1	-43.6	-21.25	22.4
	HT/VHT40, M8 to M15, M0 to M9 2ss	4	13	-62.2	-62.4	-63.0	-63.1	-43.6	-21.25	22.4
	HT/VHT40, M16 to M23, M0 to M9 3ss	4	13	-62.2	-62.4	-63.0	-63.1	-43.6	-21.25	22.4

	HT/VHT40 Beam Forming, M0 to M7, M0 to M9 1ss	2	13	-62.2	-62.4			-46.3	-21.25	25.0
	HT/VHT40 Beam Forming, M8 to M15, M0 to M9 2ss	2	13	-62.2	-62.4			-46.3	-21.25	25.0
	HT/VHT40 Beam Forming, M0 to M7, M0 to M9 1ss	3	16	-62.2	-62.4	-63.0		-41.7	-21.25	20.5
	HT/VHT40 Beam Forming, M8 to M15, M0 to M9 2ss	3	13	-62.2	-62.4	-63.0		-44.7	-21.25	23.5
	HT/VHT40 Beam Forming, M16 to M23, M0 to M9 3ss	3	13	-62.2	-62.4	-63.0		-44.7	-21.25	23.5
	HT/VHT40 Beam Forming, M0 to M7, M0 to M9 1ss	4	16	-63.0	-61.9	-62.9	-62.2	-40.5	-21.25	19.2
	HT/VHT40 Beam Forming, M8 to M15, M0 to M9 2ss	4	13	-62.2	-62.4	-63.0	-63.1	-43.6	-21.25	22.4
	HT/VHT40 Beam Forming, M16 to M23, M0 to M9 3ss	4	13	-62.2	-62.4	-63.0	-63.1	-43.6	-21.25	22.4
	HT/VHT40 STBC, M0 to M7, M0 to M9 1ss	2	13	-62.2	-62.4			-46.3	-21.25	25.0
	HT/VHT40 STBC, M0 to M7, M0 to M9 1ss	3	13	-62.2	-62.4	-63.0		-44.7	-21.25	23.5
	HT/VHT40 STBC, M0 to M7, M0 to M9 1ss	4	13	-62.2	-62.4	-63.0	-63.1	-43.6	-21.25	22.4
	Non HT/VHT20, 6 to 54 Mbps	1	13	-61.3				-48.3	-21.25	27.1
	Non HT/VHT20, 6 to 54 Mbps	2	13	-63.3	-62.0			-46.6	-21.25	25.3
	Non HT/VHT20, 6 to 54 Mbps	3	13	-63.3	-62.0	-62.5		-44.8	-21.25	23.5
	Non HT/VHT20, 6 to 54 Mbps	4	13	-61.3	-63.2	-62.3	-63.0	-43.4	-21.25	22.1
	Non HT/VHT20 Beam Forming, 6 to 54 Mbps	2	13	-63.3	-62.0			-46.6	-21.25	25.3
	Non HT/VHT20 Beam Forming, 6 to 54 Mbps	3	16	-61.3	-63.2	-62.3		-41.4	-21.25	20.2
	Non HT/VHT20 Beam Forming, 6 to 54 Mbps	4	16	-63.5	-61.2	-64.0	-63.4	-40.9	-21.25	19.6
	HT/VHT20, M0 to M7, M0 to M9 1ss	1	13	-62.1				-49.1	-21.25	27.9
	HT/VHT20, M0 to M7, M0 to M9 1ss	2	13	-62.2	-63.8			-46.9	-21.25	25.7
	HT/VHT20, M8 to M15, M0 to M9 2ss	2	13	-62.2	-63.8			-46.9	-21.25	25.7
	HT/VHT20, M0 to M7, M0 to M9 1ss	3	13	-62.2	-63.8	-63.0		-45.2	-21.25	23.9
	HT/VHT20, M8 to M15, M0 to M9 2ss	3	13	-62.2	-63.8	-63.0		-45.2	-21.25	23.9
	HT/VHT20, M16 to M23, M0 to M9 3ss	3	13	-62.2	-63.8	-63.0		-45.2	-21.25	23.9
	HT/VHT20, M0 to M7, M0 to M9 1ss	4	13	-62.2	-63.8	-63.0	-62.2	-43.7	-21.25	22.5
	HT/VHT20, M8 to M15, M0 to M9 2ss	4	13	-62.2	-63.8	-63.0	-62.2	-43.7	-21.25	22.5
	HT/VHT20, M16 to M23, M0 to M9 3ss	4	13	-62.2	-63.8	-63.0	-62.2	-43.7	-21.25	22.5
	HT/VHT20 Beam Forming, M0 to M7, M0 to M9 1ss	2	13	-62.2	-63.8			-46.9	-21.25	25.7
	HT/VHT20 Beam Forming, M8 to M15, M0 to M9 2ss	2	13	-62.2	-63.8			-46.9	-21.25	25.7
	HT/VHT20 Beam Forming, M0 to M7, M0 to M9 1ss	3	16	-64.2	-63.2	-61.8		-42.2	-21.25	20.9
	HT/VHT20 Beam Forming, M8 to M15, M0 to M9 2ss	3	13	-62.2	-63.8	-63.0		-45.2	-21.25	23.9
	HT/VHT20 Beam Forming, M16 to M23, M0 to M9 3ss	3	13	-62.2	-63.8	-63.0		-45.2	-21.25	23.9
	HT/VHT20 Beam Forming, M0 to M7, M0 to M9 1ss	4	16	-64.2	-63.2	-61.8	-65.1	-41.4	-21.25	20.1
	HT/VHT20 Beam Forming, M8 to M15, M0 to M9 2ss	4	13	-62.2	-63.8	-63.0	-62.2	-43.7	-21.25	22.5
	HT/VHT20 Beam Forming, M16 to M23, M0 to M9 3ss	4	13	-62.2	-63.8	-63.0	-62.2	-43.7	-21.25	22.5
	HT/VHT20 STBC, M0 to M7, M0 to M9 1ss	2	13	-62.2	-63.8			-46.9	-21.25	25.7
	HT/VHT20 STBC, M0 to M7, M0 to M9 1ss	3	13	-62.2	-63.8	-63.0		-45.2	-21.25	23.9
	HT/VHT20 STBC, M0 to M7, M0 to M9 1ss	4	13	-62.2	-63.8	-63.0	-62.2	-43.7	-21.25	22.5

**Conducted Spurs Average, All Antennas**

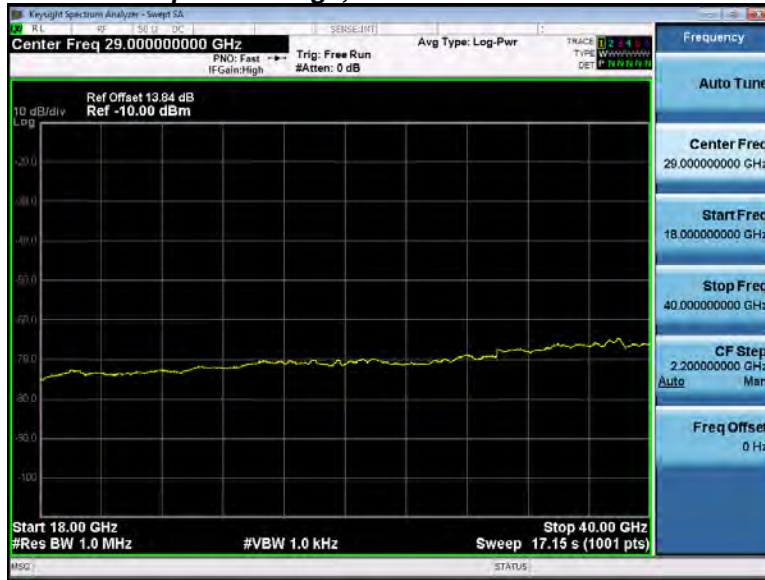

**Conducted Spurs Peak, All Antennas**

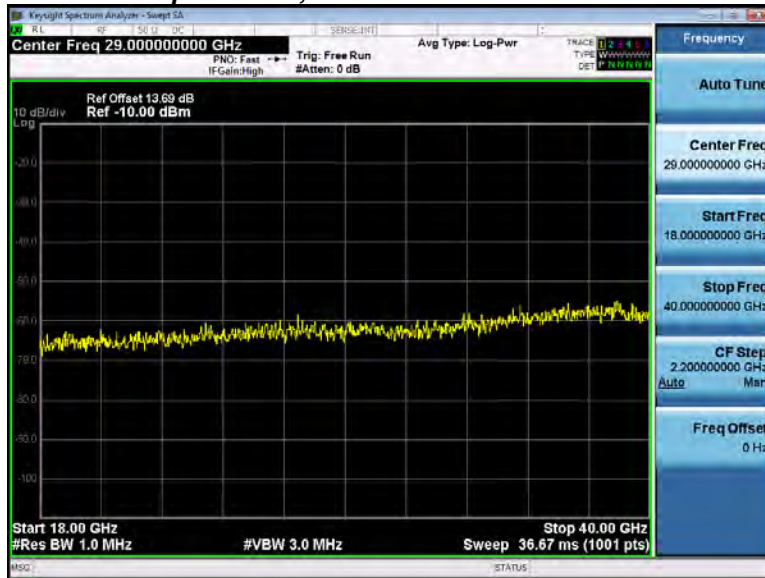

**Conducted Spurs Average, 5825 MHz, HT/VHT20 Beam Forming, M0 to M7, M0 to M9 1ss**



**Antenna A**



**Antenna B**

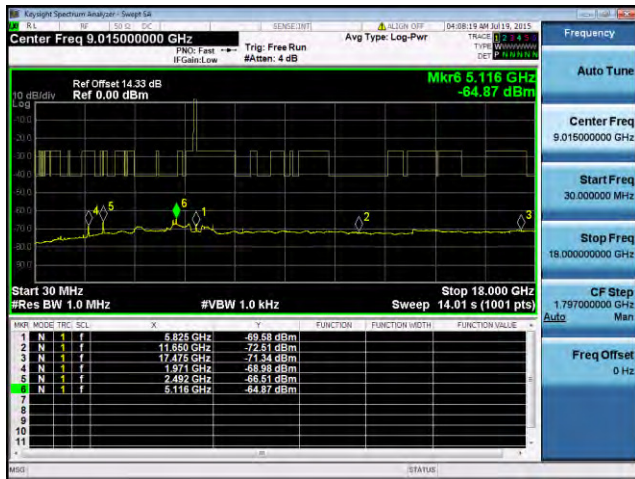

**Antenna C**

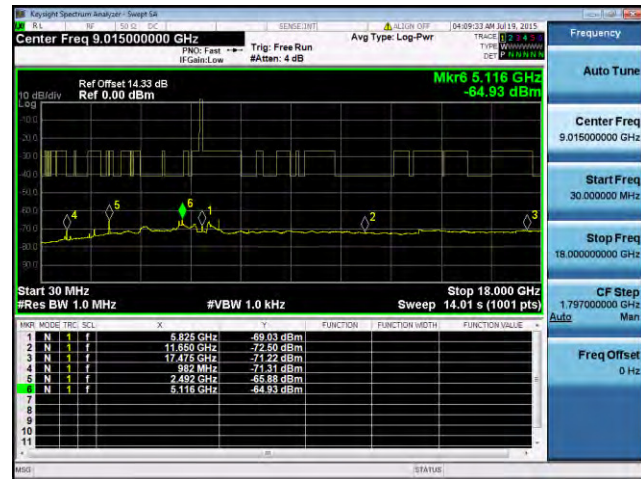

**Antenna D**

**Conducted Spurs Peak, 5785 MHz, HT/VHT20 Beam Forming, M0 to M7, M0 to M9 1ss**



**Antenna A**

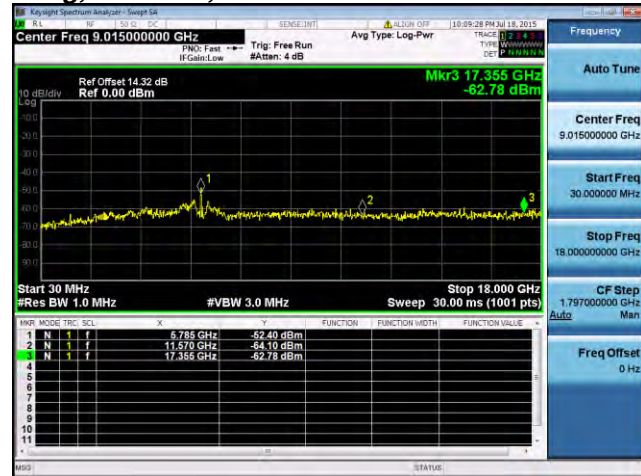

**Antenna B**

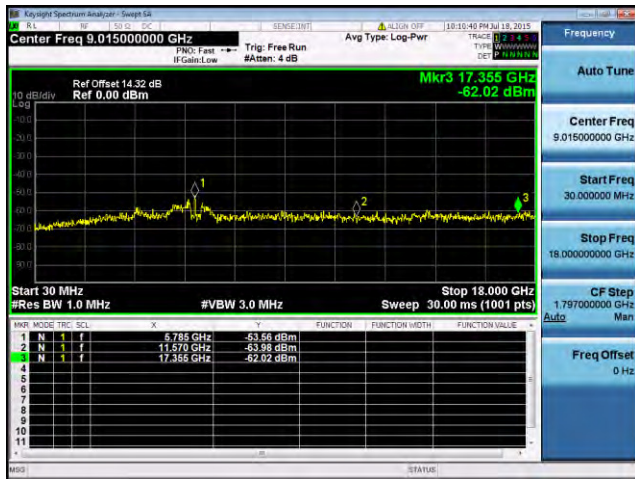

**Antenna C**

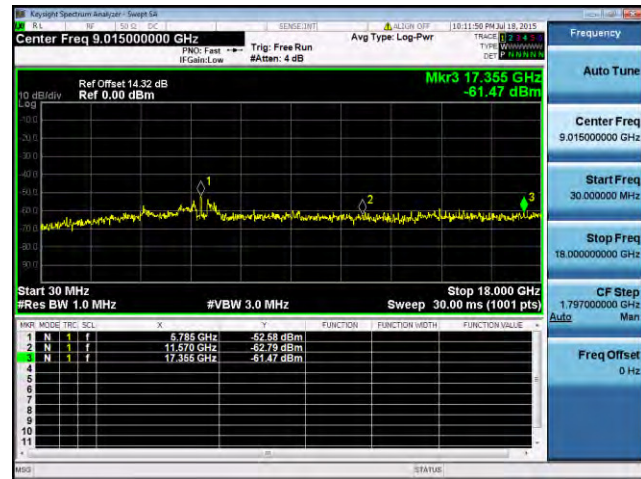

**Antenna D**

## A.5 Conducted Band edge

**15.407 (b) *Undesirable emission limits.*** Except as shown in paragraph (b) (7) of this section, the maximum emissions outside of the frequency bands of operation shall be attenuated in accordance with the following limits:

(4) For transmitters operating in the 5.725-5.85 GHz band: All emissions within the frequency range from the band edge to 10 MHz above or below the band edge shall not exceed an e.i.r.p. of -17 dBm/MHz; for frequencies 10 MHz or greater above or below the band edge, emissions shall not exceed an e.i.r.p. of -27 dBm/MHz.

(6) Unwanted emissions below 1 GHz must comply with the general field strength limits set forth in 15.209.

(7) The provisions of §15.205 apply to intentional radiators operating under this section.

(8) When measuring the emission limits, the nominal carrier frequency shall be adjusted as close to the upper and lower frequency band edges as the design of the equipment permits

### Test Procedure

Ref. KDB 789033 D02 General UNII Test Procedures New Rules v01  
ANSI C63.10: 2013

#### Conducted Band edge

##### Test Procedure

1. Connect the antenna port(s) to the spectrum analyzer input.
2. Place the radio in continuous transmit mode. Use the procedures in ANSI C63.10: 2013 to substitute conducted measurements in place of radiated measurements.
3. Configure Spectrum analyzer as per test parameters below (be sure to enter all losses between the transmitter output and the spectrum analyzer).
4. Place a marker at the end of the restricted band closest to the transmit frequency to show compliance. Also measure any emissions in the restricted bands.
5. The "measure-and-sum technique" is used for measuring in-band transmit power of a device. In the measure-and-sum approach, the conducted emission level is measured at each antenna port. The measured results at the various antenna ports are then summed mathematically to determine the total emission level from the device. Summing is performed in linear power units. The worst case output is recorded.
6. Place a marker at the end of the restricted band closest to the transmit frequency to show compliance. Also measure any emissions in the restricted bands
7. Capture graphs and record pertinent measurement data.

Ref. ANSI C63.10: 2013 section 12.7.6 (peak) & 12.7.7.3 (average, Method VB-A (Alternative))

#### Conducted Band edge

##### Test parameters restricted Band

RBW = 1 MHz  
VBW  $\geq 3 \times$  RBW for Peak, 100Hz for Average  
Sweep = Auto couple  
Detector = Peak  
Trace = Max Hold.

System Number	Description	Samples	System under test	Support equipment
1	EUT	S01	<input checked="" type="checkbox"/>	<input type="checkbox"/>
	Support	S02	<input type="checkbox"/>	<input checked="" type="checkbox"/>

<b>Tested By :</b> Jose Aguirre	<b>Date of testing:</b> 03-Jul-15 - 08-Aug-15
<b>Test Result : PASS</b>	

See Appendix C for list of test equipment



Frequency (MHz)	Mode	Tx Paths	Correlated Antenna Gain (dBi)	Tx 1 Bandedge Level (dBm)	Tx 2 Bandedge Level (dBm)	Tx 3 Bandedge Level (dBm)	Tx 4 Bandedge Level (dBm)	Total Tx Bandedge Level (dBm)	Limit (dBm)	Margin (dB)
5745	Non HT/VHT20, 6 to 54 Mbps	1	13	-46.5				-33.5	-27.00	6.5
	Non HT/VHT20, 6 to 54 Mbps	2	13	-46.5	-49.3			-31.7	-27.00	4.7
	Non HT/VHT20, 6 to 54 Mbps	3	13	-46.5	-49.3	-48.1		-30.0	-27.00	3.0
	Non HT/VHT20, 6 to 54 Mbps	4	13	-46.5	-49.3	-48.1	-48.0	-28.8	-27.00	1.8
	Non HT/VHT20 Beam Forming, 6 to 54 Mbps	2	13	-46.5	-49.3			-31.7	-27.00	4.7
	<b>Non HT/VHT20 Beam Forming, 6 to 54 Mbps</b>	<b>3</b>	<b>16</b>	<b>-46.5</b>	<b>-49.3</b>	<b>-48.1</b>		<b>-27.0</b>	<b>-27.00</b>	<b>0.0</b>
	Non HT/VHT20 Beam Forming, 6 to 54 Mbps	4	16	-49.6	-50.0	-50.8	-50.0	-28.1	-27.00	1.1
	HT/VHT20, M0 to M7, M0 to M9 1ss	1	13	-42.4				-29.4	-27.00	2.4
	HT/VHT20, M0 to M7, M0 to M9 1ss	2	13	-42.4	-45.7			-27.7	-27.00	0.7
	HT/VHT20, M8 to M15, M0 to M9 2ss	2	13	-42.4	-45.7			-27.7	-27.00	0.7
	HT/VHT20, M0 to M7, M0 to M9 1ss	3	13	-46.7	-46.0	-47.6		-28.9	-27.00	1.9
	HT/VHT20, M8 to M15, M0 to M9 2ss	3	13	-46.7	-46.0	-47.6		-28.9	-27.00	1.9
	HT/VHT20, M16 to M23, M0 to M9 3ss	3	13	-46.7	-46.0	-47.6		-28.9	-27.00	1.9
	HT/VHT20, M0 to M7, M0 to M9 1ss	4	13	-46.7	-46.0	-47.6	-45.3	-27.3	-27.00	0.3
	HT/VHT20, M8 to M15, M0 to M9 2ss	4	13	-46.7	-46.0	-47.6	-45.3	-27.3	-27.00	0.3
	HT/VHT20, M16 to M23, M0 to M9 3ss	4	13	-46.7	-46.0	-47.6	-45.3	-27.3	-27.00	0.3
	HT/VHT20 Beam Forming, M0 to M7, M0 to M9 1ss	2	13	-42.4	-45.7			-27.7	-27.00	0.7
	HT/VHT20 Beam Forming, M8 to M15, M0 to M9 2ss	2	13	-42.4	-45.7			-27.7	-27.00	0.7
	HT/VHT20 Beam Forming, M0 to M7, M0 to M9 1ss	3	16	-50.0	-50.4	-49.1		-29.0	-27.00	2.0
	HT/VHT20 Beam Forming, M8 to M15, M0 to M9 2ss	3	13	-46.7	-46.0	-47.6		-28.9	-27.00	1.9
	HT/VHT20 Beam Forming, M16 to M23, M0 to M9 3ss	3	13	-46.7	-46.0	-47.6		-28.9	-27.00	1.9
	HT/VHT20 Beam Forming, M0 to M7, M0 to M9 1ss	4	16	-50.0	-50.4	-49.1	-50.0	-27.8	-27.00	0.8
	HT/VHT20 Beam Forming, M8 to M15, M0 to M9 2ss	4	13	-46.7	-46.0	-47.6	-45.3	-27.3	-27.00	0.3
	HT/VHT20 Beam Forming, M16 to M23, M0 to M9 3ss	4	13	-46.7	-46.0	-47.6	-45.3	-27.3	-27.00	0.3
	HT/VHT20 STBC, M0 to M7, M0 to M9 1ss	2	13	-42.4	-45.7			-27.7	-27.00	0.7
	HT/VHT20 STBC, M0 to M7, M0 to M9 1ss	3	13	-46.7	-46.0	-47.6		-28.9	-27.00	1.9
HT/VHT20 STBC, M0 to M7, M0 to M9 1ss	4	13	-46.7	-46.0	-47.6	-45.3	-27.3	-27.00	0.3	
5755	Non HT/VHT40, 6 to 54 Mbps	1	13	-40.3				-27.3	-27.00	0.3
	Non HT/VHT40, 6 to 54 Mbps	2	13	-46.3	-44.0			-29.0	-27.00	2.0
	Non HT/VHT40, 6 to 54 Mbps	3	13	-46.3	-44.0	-47.7		-28.0	-27.00	1.0
	Non HT/VHT40, 6 to 54 Mbps	4	13	-49.7	-47.9	-45.2	-44.6	-27.4	-27.00	0.4
	HT/VHT40, M0 to M7, M0 to M9 1ss	1	13	-40.3				-27.3	-27.00	0.3
	HT/VHT40, M0 to M7, M0 to M9 1ss	2	13	-44.0	-42.8			-27.3	-27.00	0.3

	HT/VHT40, M8 to M15, M0 to M9 2ss	2	13	-44.0	-42.8			-27.3	-27.00	0.3
	HT/VHT40, M0 to M7, M0 to M9 1ss	3	13	-47.6	-45.6	-47.0		-28.9	-27.00	1.9
	HT/VHT40, M8 to M15, M0 to M9 2ss	3	13	-47.6	-45.6	-47.0		-28.9	-27.00	1.9
	HT/VHT40, M16 to M23, M0 to M9 3ss	3	13	-47.6	-45.6	-47.0		-28.9	-27.00	1.9
	HT/VHT40, M0 to M7, M0 to M9 1ss	4	13	-47.6	-45.6	-47.0	-45.7	-27.4	-27.00	0.4
	HT/VHT40, M8 to M15, M0 to M9 2ss	4	13	-47.6	-45.6	-47.0	-45.7	-27.4	-27.00	0.4
	HT/VHT40, M16 to M23, M0 to M9 3ss	4	13	-47.6	-45.6	-47.0	-45.7	-27.4	-27.00	0.4
	HT/VHT40 Beam Forming, M0 to M7, M0 to M9 1ss	2	13	-44.0	-42.8			-27.3	-27.00	0.3
	HT/VHT40 Beam Forming, M8 to M15, M0 to M9 2ss	2	13	-44.0	-42.8			-27.3	-27.00	0.3
	HT/VHT40 Beam Forming, M0 to M7, M0 to M9 1ss	3	16	-47.4	-49.2	-48.6		-27.6	-27.00	0.6
	HT/VHT40 Beam Forming, M8 to M15, M0 to M9 2ss	3	13	-47.6	-45.6	-47.0		-28.9	-27.00	1.9
	HT/VHT40 Beam Forming, M16 to M23, M0 to M9 3ss	3	13	-47.6	-45.6	-47.0		-28.9	-27.00	1.9
	HT/VHT40 Beam Forming, M0 to M7, M0 to M9 1ss	4	16	-49.1	-49.4	-50.2	-49.7	-27.6	-27.00	0.6
	HT/VHT40 Beam Forming, M8 to M15, M0 to M9 2ss	4	13	-47.6	-45.6	-47.0	-45.7	-27.4	-27.00	0.4
	HT/VHT40 Beam Forming, M16 to M23, M0 to M9 3ss	4	13	-47.6	-45.6	-47.0	-45.7	-27.4	-27.00	0.4
	HT/VHT40 STBC, M0 to M7, M0 to M9 1ss	2	13	-44.0	-42.8			-27.3	-27.00	0.3
	HT/VHT40 STBC, M0 to M7, M0 to M9 1ss	3	13	-47.6	-45.6	-47.0		-28.9	-27.00	1.9
	HT/VHT40 STBC, M0 to M7, M0 to M9 1ss	4	13	-47.6	-45.6	-47.0	-45.7	-27.4	-27.00	0.4
5775	Non HT/VHT80, 6 to 54 Mbps	1	13	-40.0				-27.0	-27.00	0.0
	Non HT/VHT80, 6 to 54 Mbps	2	13	-42.2	-44.6			-27.2	-27.00	0.2
	Non HT/VHT80, 6 to 54 Mbps	3	13	-46.0	-47.7	-47.3		-29.2	-27.00	2.2
	Non HT/VHT80, 6 to 54 Mbps	4	13	-46.0	-47.7	-47.3	-47.5	-28.1	-27.00	1.1
	HT/VHT80, M0 to M7, M0 to M9 1ss	1	13	-41.6				-28.6	-27.00	1.6
	HT/VHT80, M0 to M7, M0 to M9 1ss	2	13	-43.3	-43.6			-27.4	-27.00	0.4
	HT/VHT80, M8 to M15, M0 to M9 2ss	2	13	-43.3	-43.6			-27.4	-27.00	0.4
	HT/VHT80, M0 to M7, M0 to M9 1ss	3	13	-44.2	-46.2	-46.1		-27.6	-27.00	0.6
	HT/VHT80, M8 to M15, M0 to M9 2ss	3	13	-44.2	-46.2	-46.1		-27.6	-27.00	0.6
	HT/VHT80, M16 to M23, M0 to M9 3ss	3	13	-44.2	-46.2	-46.1		-27.6	-27.00	0.6
	HT/VHT80, M0 to M7, M0 to M9 1ss	4	13	-46.7	-45.3	-47.7	-46.1	-27.3	-27.00	0.3
	HT/VHT80, M8 to M15, M0 to M9 2ss	4	13	-46.7	-45.3	-47.7	-46.1	-27.3	-27.00	0.3
	HT/VHT80, M16 to M23, M0 to M9 3ss	4	13	-46.7	-45.3	-47.7	-46.1	-27.3	-27.00	0.3
	HT/VHT80 Beam Forming, M0 to M7, M0 to M9 1ss	2	13	-43.3	-43.6			-27.4	-27.00	0.4
	HT/VHT80 Beam Forming, M8 to M15, M0 to M9 2ss	2	13	-43.3	-43.6			-27.4	-27.00	0.4
	HT/VHT80 Beam Forming, M0 to M7, M0 to M9 1ss	3	13	-44.2	-46.2	-46.1		-27.6	-27.00	0.6
	HT/VHT80 Beam Forming, M8 to M15, M0 to M9 2ss	3	13	-44.2	-46.2	-46.1		-27.6	-27.00	0.6
	HT/VHT80 Beam Forming, M16 to M23, M0 to M9 3ss	3	13	-44.2	-46.2	-46.1		-27.6	-27.00	0.6
	HT/VHT80 Beam Forming, M0 to M7, M0 to M9 1ss	4	13	-46.7	-45.3	-47.7	-46.1	-27.3	-27.00	0.3
	HT/VHT80 Beam Forming, M8 to M15, M0 to M9 2ss	4	13	-46.7	-45.3	-47.7	-46.1	-27.3	-27.00	0.3
	HT/VHT80 Beam Forming, M16 to M23, M0 to M9 3ss	4	13	-46.7	-45.3	-47.7	-46.1	-27.3	-27.00	0.3
	HT/VHT80 STBC, M0 to M7, M0 to M9 1ss	2	13	-43.3	-43.6			-27.4	-27.00	0.4
	HT/VHT80 STBC, M0 to M7, M0 to M9 1ss	3	13	-44.2	-46.2	-46.1		-27.6	-27.00	0.6

	HT/VHT80 STBC, M0 to M7, M0 to M9 1ss	4	13	-46.7	-45.3	-47.7	-46.1	-27.3	-27.00	0.3
5795	Non HT/VHT40, 6 to 54 Mbps	1	13	-40.5				-27.5	-27.00	0.5
	Non HT/VHT40, 6 to 54 Mbps	2	13	-44.0	-44.9			-28.4	-27.00	1.4
	Non HT/VHT40, 6 to 54 Mbps	3	13	-44.0	-44.9	-51.4		-28.0	-27.00	1.0
	Non HT/VHT40, 6 to 54 Mbps	4	13	-44.0	-44.9	-51.4	-51.2	-27.6	-27.00	0.6
	HT/VHT40, M0 to M7, M0 to M9 1ss	1	13	-41.8				-28.8	-27.00	1.8
	HT/VHT40, M0 to M7, M0 to M9 1ss	2	13	-46.1	-48.4			-31.1	-27.00	4.1
	HT/VHT40, M8 to M15, M0 to M9 2ss	2	13	-46.1	-48.4			-31.1	-27.00	4.1
	HT/VHT40, M0 to M7, M0 to M9 1ss	3	13	-46.1	-48.4	-50.5		-30.2	-27.00	3.2
	HT/VHT40, M8 to M15, M0 to M9 2ss	3	13	-46.1	-48.4	-50.5		-30.2	-27.00	3.2
	HT/VHT40, M16 to M23, M0 to M9 3ss	3	13	-46.1	-48.4	-50.5		-30.2	-27.00	3.2
	HT/VHT40, M0 to M7, M0 to M9 1ss	4	13	-46.1	-48.4	-50.5	-50.7	-29.5	-27.00	2.5
	HT/VHT40, M8 to M15, M0 to M9 2ss	4	13	-46.1	-48.4	-50.5	-50.7	-29.5	-27.00	2.5
	HT/VHT40, M16 to M23, M0 to M9 3ss	4	13	-46.1	-48.4	-50.5	-50.7	-29.5	-27.00	2.5
	HT/VHT40 Beam Forming, M0 to M7, M0 to M9 1ss	2	13	-46.1	-48.4			-31.1	-27.00	4.1
	HT/VHT40 Beam Forming, M8 to M15, M0 to M9 2ss	2	13	-46.1	-48.4			-31.1	-27.00	4.1
	HT/VHT40 Beam Forming, M0 to M7, M0 to M9 1ss	3	16	-46.1	-48.4	-50.5		-27.2	-27.00	0.2
	HT/VHT40 Beam Forming, M8 to M15, M0 to M9 2ss	3	13	-46.1	-48.4	-50.5		-30.2	-27.00	3.2
	HT/VHT40 Beam Forming, M16 to M23, M0 to M9 3ss	3	13	-46.1	-48.4	-50.5		-30.2	-27.00	3.2
	HT/VHT40 Beam Forming, M0 to M7, M0 to M9 1ss	4	16	-52.1	-52.1	-51.9	-53.1	-30.3	-27.00	3.3
	HT/VHT40 Beam Forming, M8 to M15, M0 to M9 2ss	4	13	-46.1	-48.4	-50.5	-50.7	-29.5	-27.00	2.5
HT/VHT40 Beam Forming, M16 to M23, M0 to M9 3ss	4	13	-46.1	-48.4	-50.5	-50.7	-29.5	-27.00	2.5	
HT/VHT40 STBC, M0 to M7, M0 to M9 1ss	2	13	-46.1	-48.4			-31.1	-27.00	4.1	
HT/VHT40 STBC, M0 to M7, M0 to M9 1ss	3	13	-46.1	-48.4	-50.5		-30.2	-27.00	3.2	
HT/VHT40 STBC, M0 to M7, M0 to M9 1ss	4	13	-46.1	-48.4	-50.5	-50.7	-29.5	-27.00	2.5	
5825	Non HT/VHT20, 6 to 54 Mbps	1	13	-32.3				-19.3	-17.00	2.3
	Non HT/VHT20, 6 to 54 Mbps	2	13	-46.3	-43.0			-28.3	-27.00	1.3
	Non HT/VHT20, 6 to 54 Mbps	3	13	-46.3	-43.0	-49.3		-27.7	-27.00	0.7
	Non HT/VHT20, 6 to 54 Mbps	4	13	-48.1	-46.0	-50.4	-51.1	-29.4	-27.00	2.4
	Non HT/VHT20 Beam Forming, 6 to 54 Mbps	2	13	-46.3	-43.0			-28.3	-27.00	1.3
	<b>Non HT/VHT20 Beam Forming, 6 to 54 Mbps</b>	<b>3</b>	<b>16</b>	<b>-48.1</b>	<b>-46.0</b>	<b>-50.4</b>		<b>-27.0</b>	<b>-27.00</b>	<b>0.0</b>
	Non HT/VHT20 Beam Forming, 6 to 54 Mbps	4	16	-50.7	-49.4	-50.3	-51.2	-28.3	-27.00	1.3
	HT/VHT20, M0 to M7, M0 to M9 1ss	1	13	-42.0				-29.0	-27.00	2.0
	HT/VHT20, M0 to M7, M0 to M9 1ss	2	13	-46.5	-45.8			-30.1	-27.00	3.1
	HT/VHT20, M8 to M15, M0 to M9 2ss	2	13	-46.5	-45.8			-30.1	-27.00	3.1
	HT/VHT20, M0 to M7, M0 to M9 1ss	3	13	-46.5	-45.8	-49.6		-29.2	-27.00	2.2
	HT/VHT20, M8 to M15, M0 to M9 2ss	3	13	-46.5	-45.8	-49.6		-29.2	-27.00	2.2
	HT/VHT20, M16 to M23, M0 to M9 3ss	3	13	-46.5	-45.8	-49.6		-29.2	-27.00	2.2
	HT/VHT20, M0 to M7, M0 to M9 1ss	4	13	-46.5	-45.8	-49.6	-46.8	-27.9	-27.00	0.9
HT/VHT20, M8 to M15, M0 to M9 2ss	4	13	-46.5	-45.8	-49.6	-46.8	-27.9	-27.00	0.9	

HT/VHT20, M16 to M23, M0 to M9 3ss	4	13	-46.5	-45.8	-49.6	-46.8	-27.9	-27.00	0.9
HT/VHT20 Beam Forming, M0 to M7, M0 to M9 1ss	2	13	-46.5	-45.8			-30.1	-27.00	3.1
HT/VHT20 Beam Forming, M8 to M15, M0 to M9 2ss	2	13	-46.5	-45.8			-30.1	-27.00	3.1
HT/VHT20 Beam Forming, M0 to M7, M0 to M9 1ss	3	16	-49.5	-47.9	-50.0		-28.3	-27.00	1.3
HT/VHT20 Beam Forming, M8 to M15, M0 to M9 2ss	3	13	-46.5	-45.8	-49.6		-29.2	-27.00	2.2
HT/VHT20 Beam Forming, M16 to M23, M0 to M9 3ss	3	13	-46.5	-45.8	-49.6		-29.2	-27.00	2.2
HT/VHT20 Beam Forming, M0 to M7, M0 to M9 1ss	4	16	-49.5	-47.9	-50.0	-49.9	-27.2	-27.00	0.2
HT/VHT20 Beam Forming, M8 to M15, M0 to M9 2ss	4	13	-46.5	-45.8	-49.6	-46.8	-27.9	-27.00	0.9
HT/VHT20 Beam Forming, M16 to M23, M0 to M9 3ss	4	13	-46.5	-45.8	-49.6	-46.8	-27.9	-27.00	0.9
HT/VHT20 STBC, M0 to M7, M0 to M9 1ss	2	13	-46.5	-45.8			-30.1	-27.00	3.1
HT/VHT20 STBC, M0 to M7, M0 to M9 1ss	3	13	-46.5	-45.8	-49.6		-29.2	-27.00	2.2
HT/VHT20 STBC, M0 to M7, M0 to M9 1ss	4	13	-46.5	-45.8	-49.6	-46.8	-27.9	-27.00	0.9

**Conducted Bandedge Peak, 5775 MHz, Non HT/VHT80, 6 to 54 Mbps**



**Antenna A**

### Conducted Bandedge Peak, 5825 MHz, Non HT/VHT20 Beam Forming, 6 to 54 Mbps



Antenna A



Antenna B



Antenna C

**Appendix B: Emission Test Results**

Testing Laboratory: Cisco Systems, Inc., 125 West Tasman Drive, San Jose, CA 95134, USA

**Radiated Emission Setup Diagram-Below 1G**

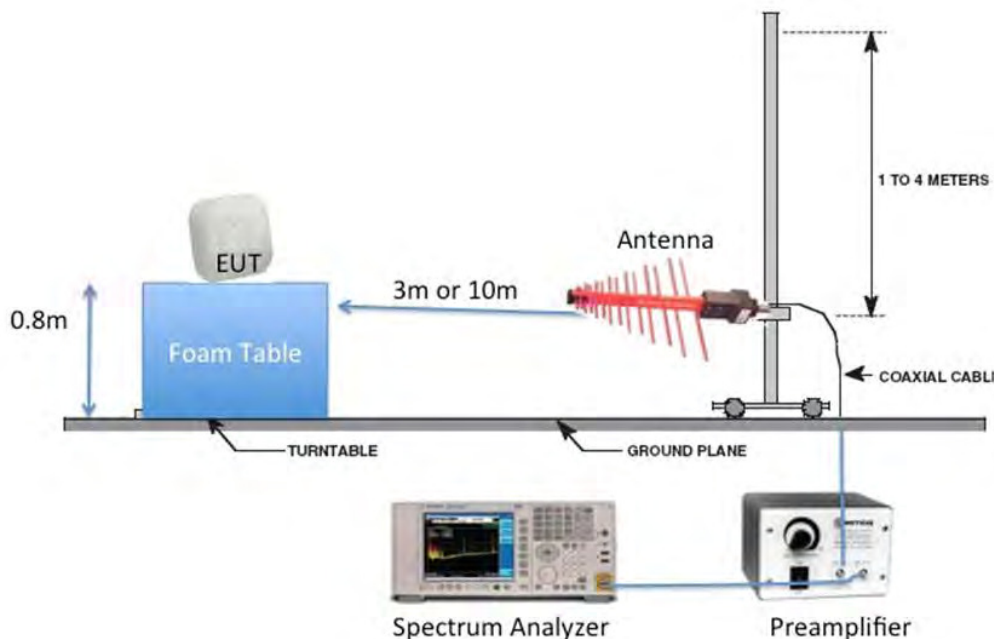

**Radiated Emission Setup Diagram-Above 1G**

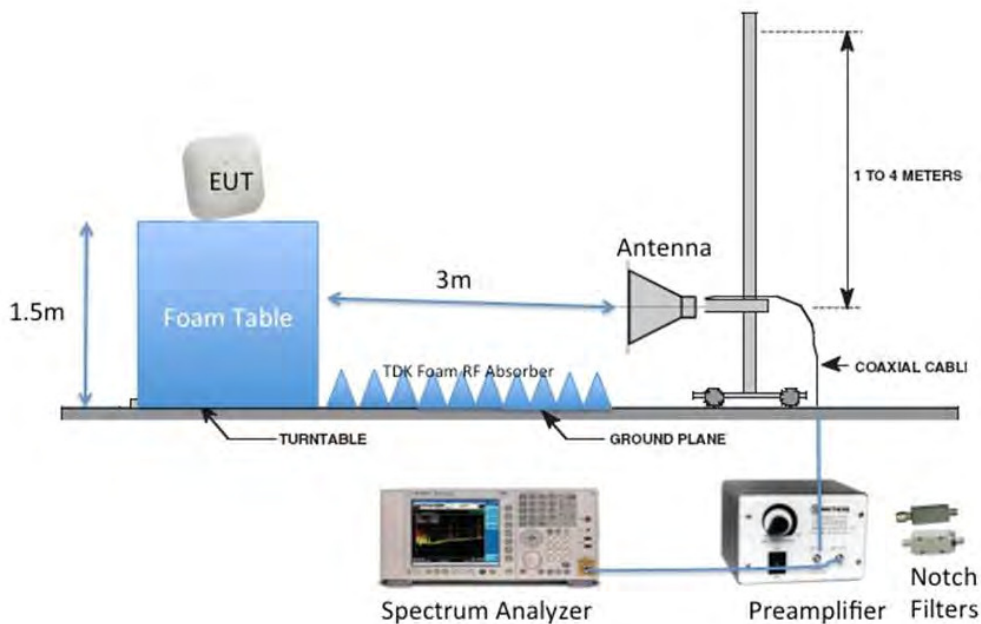

## B.1 Radiated Spurious Emissions

**15.407 (b) Undesirable emission limits.** Except as shown in paragraph (b) (7) of this section, the maximum emissions outside of the frequency bands of operation shall be attenuated in accordance with the following limits:

(4) For transmitters operating in the 5.725-5.85 GHz band: All emissions within the frequency range from the band edge to 10 MHz above or below the band edge shall not exceed an e.i.r.p. of -17 dBm/MHz; for frequencies 10 MHz or greater above or below the band edge, emissions shall not exceed an e.i.r.p. of -27 dBm/MHz.

(6) Unwanted emissions below 1 GHz must comply with the general field strength limits set forth in 15.209.

(7) The provisions of §15.205 apply to intentional radiators operating under this section.

(8) When measuring the emission limits, the nominal carrier frequency shall be adjusted as close to the upper and lower frequency band edges as the design of the equipment permits

**Ref. ANSI C63.10: 2013 section 12.7.6 (peak) & 12.7.7.3 (average)**

Using Vasona, configure the spectrum analyzer as shown below (be sure to enter all losses between the transmitter output and the spectrum analyzer). Place the radio in continuous transmit mode.

Span:	1GHz – 18 GHz/18GHz-26G/26GHz-40GHz
Reference Level:	80 dBuV
Attenuation:	10 dB
Sweep Time:	Coupled
Resolution Bandwidth:	1MHz
Video Bandwidth:	3 MHz for peak, 1 KHz for average
Detector:	Peak

Terminate the access Point RF ports with 50 ohm loads.

Maximize Turntable (find worst case table angle), Maximize Antenna (find worst case height)

Save 2 plots: 1) Average plot (Vertical and Horizontal), Limit= 54dBuV/m @3m  
2) Peak plot (Vertical and Horizontal), Limit = 74dBuV/m @3m

Place a marker at the end of the restricted band closest to the transmit frequency to show compliance. Also measure any emissions in the restricted bands.

This report represents the worst case data for all supported operating modes and antennas. There are no measurable emissions above 18 GHz.

System Number	Description	Samples	System under test	Support equipment
2	EUT	S03	<input checked="" type="checkbox"/>	<input type="checkbox"/>
	Support	S04	<input type="checkbox"/>	<input checked="" type="checkbox"/>

<b>Tested By :</b> Jose Aguirre	<b>Date of testing:</b> 03-Jul-15 - 30-Aug-15
<b>Test Result : PASS</b>	

See Appendix C for list of test equipment



**B.1.A Transmitter Radiated Spurious Emissions-Average Worst Case**

Frequency (MHz)	Mode	Data Rate (Mbps)	Spurious Emission Level (dBuV/m)	Limit (dBuV/m)	Margin (MHz)
5745	Non HT/VHT20, 6 to 54 Mbps	6	49.8	54	4.2
5755	HT/VHT40, M0 to M7, M0 to M9 1ss	m0	50.6	54	3.4
5775	HT/VHT80, M0 to M7, M0 to M9 1ss	m0x1	49.5	54	4.5
5785	Non HT/VHT20, 6 to 54 Mbps	6	50.5	54	3.5
5795	HT/VHT40, M0 to M7, M0 to M9 1ss	m0	49.9	54	4.1
5825	Non HT/VHT20, 6 to 54 Mbps	6	50.6	54	3.4

**B.1.A.1 Radiated Transmitter Spurs, 5745 MHz, Non HT/VHT20, 6 to 54 Mbps, Average (1-18GHz)**

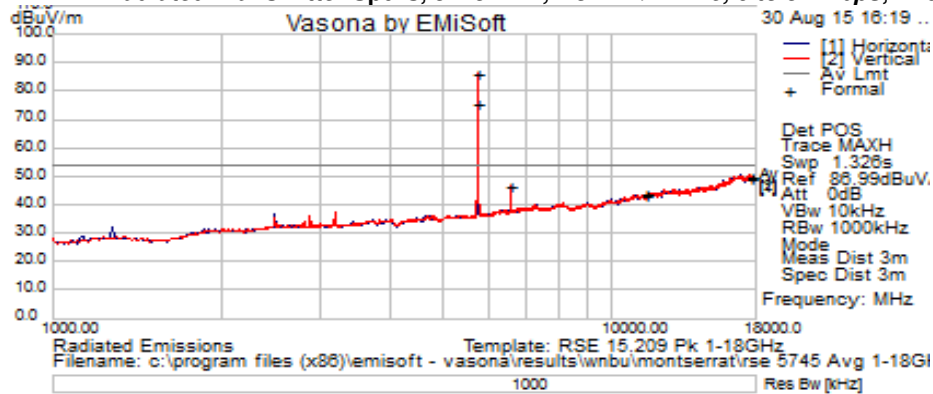

Frequency MHz	Raw dBuV	Cable Loss	AF dB	Level dBuV/m	Measurement Type	P ol	Hgt cm	Azt Deg	Limit dBuV/m	Margin dB	Pass /Fail
5739.385	71.05	7.97	-3.29	75.73	Average.	H	182	0	--	--	--
5749.375	81.67	7.96	-3.25	86.38	Average.	V	200	2	--	--	--
6567.5	39.4	8.68	-1.31	46.78	Average.	V	180	18	54	-7.23	Pass
11494.625	26.9	12.5	4.4	43.8	Average.	V	200	2	54	-10.2	Pass
11494.625	26.5	12.5	4.4	43.4	Average.	H	182	4	54	-10.6	Pass
17617.5	26.8	17	5.9	49.8	Average.	H	182	4	54	-4.2	Pass
17617.5	26.4	17	5.9	49.4	Average.	V	200	2	54	-4.6	Pass

**B.1.A.2 Radiated Transmitter Spurs, 5755 MHz, HT/VHT40, M0 to M7, M0 to M9 1ss , Average (1-18GHz)**



Frequency MHz	Raw dBuV	Cable Loss	AF dB	Level dBuV/m	Measurement Type	P ol	Hgt cm	Azt Deg	Limit dBuV/m	Margin dB	Pass /Fail
5760	76.9	8	-3.2	81.71	Average.	V	167	18	--	--	--
5770.515	65.5	8	-3.2	70.34	Average.	H	108	304	--	--	--
6567.5	38.97	8.68	-1.31	46.35	Average.	V	180	353	54	-7.65	Pass
11510	26.8	12.5	4.4	43.7	Average.	H	108	304	54	-10.3	Pass
11510	26.8	12.5	4.4	43.7	Average.	V	167	18	54	-10.3	Pass
17265	27.4	16.4	5.9	49.7	Average.	H	108	304	54	-4.3	Pass
17265	27.2	16.4	5.9	49.5	Average.	V	167	18	54	-4.5	Pass
17628.125	27.79	16.99	5.85	50.63	Average.	H	180	122	54	-3.37	Pass

**B.1.A.3 Radiated Transmitter Spurs, 5775 MHz, HT/VHT80, M0 to M7, M0 to M9 1ss , Average (1-18GHz)**

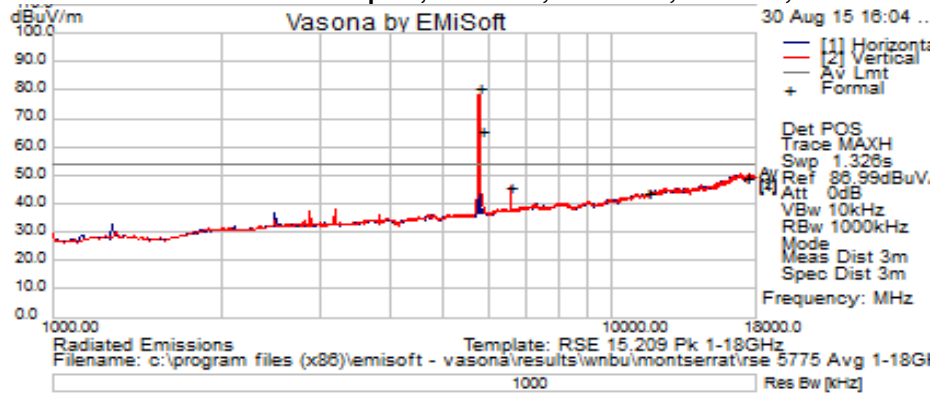

Frequency MHz	Raw dBuV	Cable Loss	AF dB	Level dBuV/m	Measurement Type	P ol	Hgt cm	Azt Deg	Limit dBuV/m	Margin dB	Pass /Fail
5795.125	75.84	8.07	-3.18	80.73	Average.	V	196	9	--	--	--
5811.375	61.03	8.06	-3.17	65.92	Average.	H	113	356	--	--	--
11549.672	27	12.5	4.3	43.8	Average.	V	194	9	54	-10.2	Pass
17325.155	27.3	16.4	5.8	49.5	Average.	V	194	9	54	-4.5	Pass
11550.735	26.9	12.5	4.3	43.7	Average.	H	113	356	54	-10.3	Pass
17325.531	27.2	16.4	5.8	49.4	Average.	H	113	356	54	-4.6	Pass
6567.5	38.38	8.68	-1.31	45.76	Average.	V	100	340	54	-8.24	Pass

**B.1.A.4 Radiated Transmitter Spurs, 5785 MHz, Non HT/VHT20, 6 to 54 Mbps, Average (1-18GHz)**

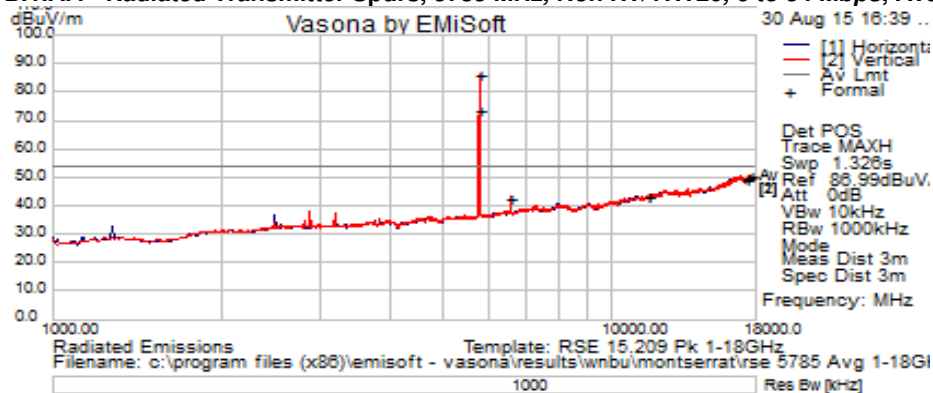

Frequency MHz	Raw dBuV	Cable Loss	AF dB	Level dBuV/m	Measurement Type	P ol	Hgt cm	Azt Deg	Limit dBuV/m	Margin dB	Pass /Fail
5781.912	69	8	-3.2	73.85	Average.	H	106	70	--	--	--
5791.875	81.36	8.07	-3.19	86.24	Average.	V	180	18	--	--	--
6567.02	35.41	8.68	-1.31	42.78	Average.	H	181	0	54	-11.22	Pass
11570	26.4	12.5	4.3	43.2	Average.	V	180	18	54	-10.8	Pass
11570	26.4	12.5	4.3	43.2	Average.	H	106	70	54	-10.8	Pass
17355	26.8	16.4	5.8	49	Average.	V	0	0	54	-5	Pass
17355	27.5	16.4	5.8	49.7	Average.	H	106	70	54	-4.3	Pass
17617.5	27.53	17.04	5.95	50.51	Average.	V	180	216	54	-3.49	Pass

**B.1.A.5 Radiated Transmitter Spurs, 5825 MHz, Non HT/VHT20, 6 to 54 Mbps, Average (1-18GHz)**

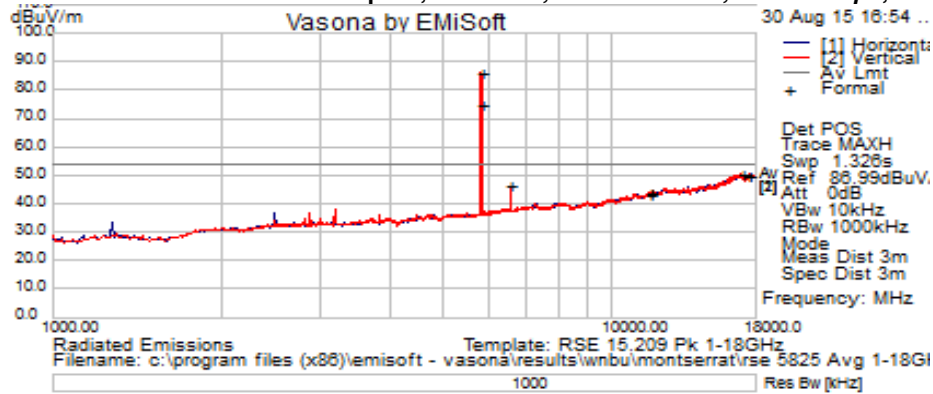

Frequency MHz	Raw dBuV	Cable Loss	AF dB	Level dBuV/m	Measurement Type	P ol	Hgt cm	Azt Deg	Limit dBuV/m	Margin dB	Pass /Fail
5823.75	81	8.1	-3.2	85.93	Average.	V	173	26	--	--	--
5823.762	70.3	8.1	-3.2	75.2	Average.	H	106	358	--	--	--
6567.5	38.9	8.68	-1.31	46.28	Average.	V	180	18	54	-7.72	Pass
11650	26.9	12.6	4.4	43.9	Average.	V	173	26	54	-10.1	Pass
11650	26.3	12.6	4.4	43.3	Average.	H	106	358	54	-10.7	Pass
16990.625	28.4	16.23	5.93	50.57	Average.	H	180	261	54	-3.43	Pass
17475	27.8	16.6	5.4	49.9	Average.	H	106	358	54	-4.1	Pass
17475	27.5	16.6	5.4	49.6	Average.	V	173	26	54	-4.4	Pass

**B.1.A.6 Radiated Transmitter Spurs, 5795 MHz, HT/VHT40, M0 to M7, M0 to M9 1ss, Average (1-18GHz)**

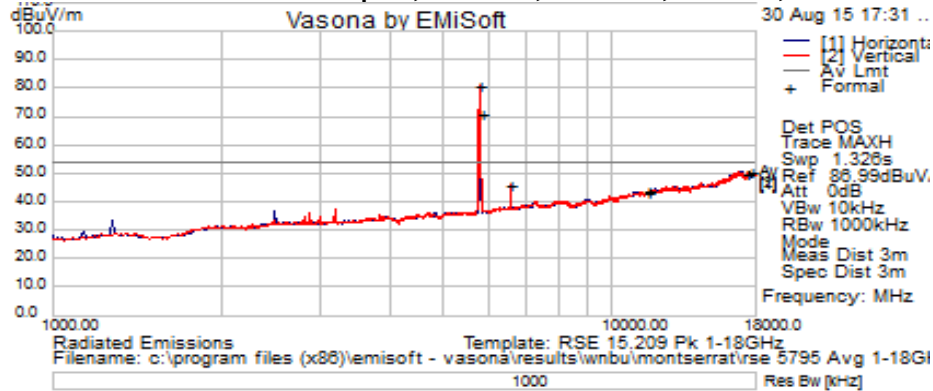

Frequency MHz	Raw dBuV	Cable Loss	AF dB	Level dBuV/m	Measurement Type	P ol	Hgt cm	Azt Deg	Limit dBuV/m	Margin dB	Pass /Fail
5791.875	76.08	8.07	-3.19	80.97	Average.	V	180	18	--	--	--
5813.034	65.9	8.1	-3.2	70.81	Average.	H	130	155	--	--	--
6567.5	38.27	8.68	-1.31	45.65	Average.	V	180	18	54	-8.35	Pass
17617.5	27.77	17.04	5.95	50.76	Average.	V	200	272	54	-3.25	Pass
11590	26.7	12.4	4.4	43.5	Average.	V	180	18	54	-10.5	Pass
17385	27.6	16.6	5.4	49.6	Average.	V	180	18	54	-4.4	Pass
11590	27	12.4	4.4	43.8	Average.	H	130	155	54	-10.2	Pass
17385	27.9	16.6	5.4	49.9	Average.	H	130	155	54	-4.1	Pass

**B.1.A.7 Radiated Transmitter Spurs, All rate, All modes, Average (18-26.5GHz)**



**B.1.A.8 Radiated Transmitter Spurs, All rate, All modes, Average (26.5- 40GHz)**



**B.1.P Transmitter Radiated Spurious Emissions-Peak Worst Case**

Frequency (MHz)	Mode	Data Rate (Mbps)	Spurious Emission Level (dBuV/m)	Limit (dBuV/m)	Margin (MHz)
5745	Non HT/VHT20, 6 to 54 Mbps	6	<b>61.8</b>	68.2	6.4
5755	HT/VHT40, M0 to M7, M0 to M9 1ss	m0	<b>59.9</b>	68.2	8.3
5775	HT/VHT80, M0 to M7, M0 to M9 1ss	m0x1	<b>59.9</b>	68.2	8.3
5785	Non HT/VHT20, 6 to 54 Mbps	6	<b>59.2</b>	68.2	9
5795	HT/VHT40, M0 to M7, M0 to M9 1ss	m0	<b>59.7</b>	68.2	8.5
5825	Non HT/VHT20, 6 to 54 Mbps	6	<b>59.8</b>	68.2	8.4

**B.1.P.1 Radiated Transmitter Spurs, 5745 MHz, Non HT/VHT20, 6 to 54 Mbps, (1-18GHz)**

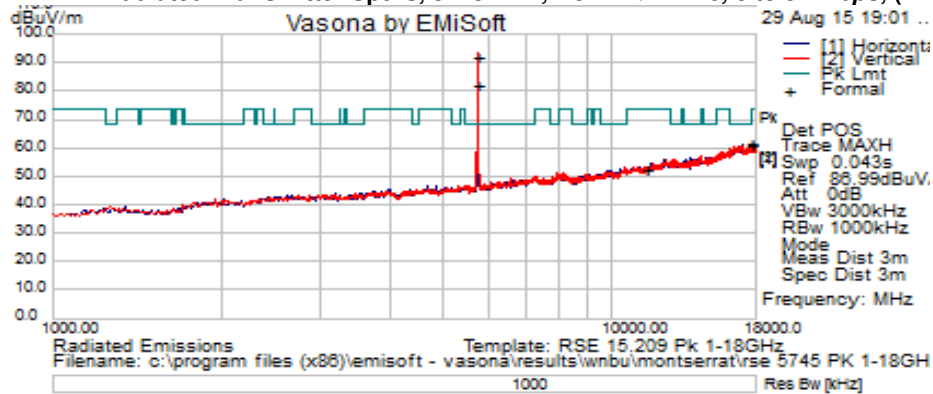

Frequency MHz	Raw dBuV	Cable Loss	AF dB	Level dBuV/m	Measurement Type	Pol	Hgt cm	Azt Deg	Limit dBuV/m	Margin dB	Pass /Fail
5745.331	77.3	7.96	-3.26	82	Peak.	H	155	75	--	--	--
5746.438	87.24	7.96	-3.26	91.94	Peak.	V	180	0	--	--	--
11494.625	35.3	12.5	4.4	52.25	Peak.	H	155	75	74	-21.8	Pass
11494.625	35.6	12.5	4.4	52.5	Peak.	V	180	4	74	-21.5	Pass
17617.5	38.1	17	5.9	61.08	Peak.	H	155	75	68.2	-7.1	Pass
17617.5	38.8	17	5.9	61.8	Peak.	V	180	4	68.2	-6.4	Pass

**B.1.P.2 Radiated Transmitter Spurs, 5755 MHz, HT/VHT40, M0 to M7, M0 to M9 1ss, Peak (1-18GHz)**

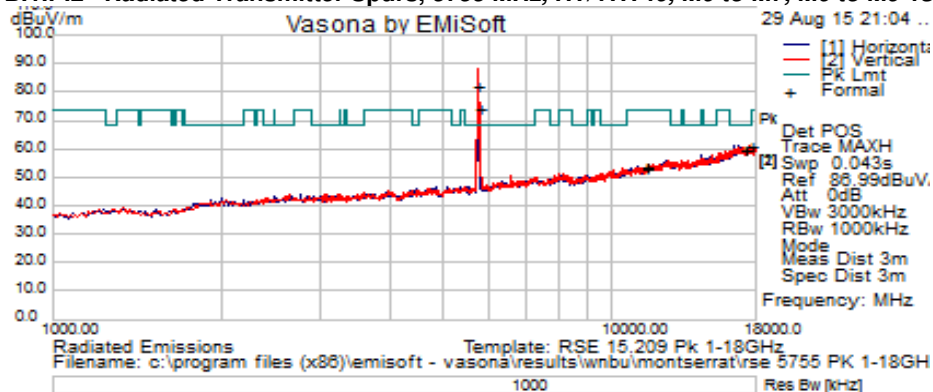

Frequency MHz	Raw dBuV	Cable Loss	AF dB	Level dBuV/m	Measurement Type	Pol	Hgt cm	Azt Deg	Limit dBuV/m	Margin dB	Pass /Fail
5749.375	77.46	7.96	-3.25	82.18	Peak.	V	167	9	--	--	--
5758.915	69.61	7.98	-3.2	74.38	Peak.	H	108	304	--	--	--
17628.125	38.25	16.99	5.85	61.09	Peak.	H	100	101	68.2	-7.11	Pass
11510	36.3	12.5	4.4	53.2	Peak.	V	167	9	74	-20.8	Pass
17265	37.3	16.4	5.9	59.6	Peak.	V	167	9	68.2	-8.6	Pass
11510	36.7	12.5	4.4	53.6	Peak.	H	108	304	74	-20.4	Pass
17265	37.6	16.4	5.9	59.9	Peak.	H	108	304	68.2	-8.3	Pass

**B.1.P.3 Radiated Transmitter Spurs, 5775 MHz, HT/VHT80, M0 to M7, M0 to M9 1ss, Peak (1-18GHz)**

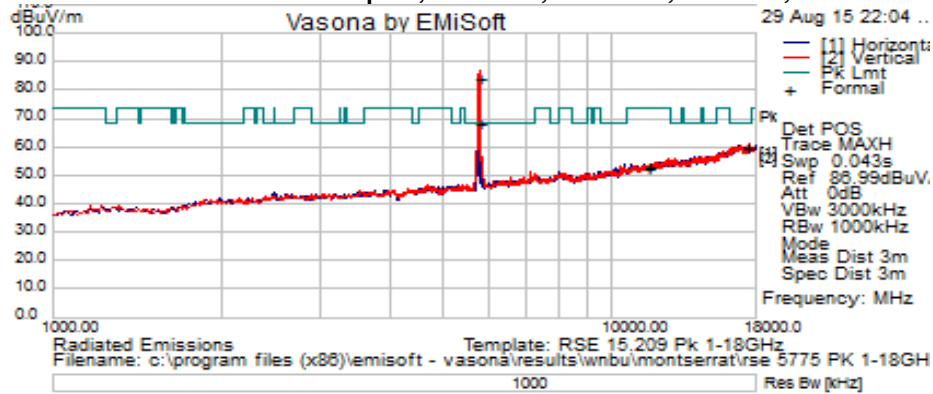

Frequency MHz	Raw dBuV	Cable Loss	AF dB	Level dBuV/m	Measurement Type	P ol	Hgt cm	Azt Deg	Limit dBuV/m	Margin dB	Pass /Fail
5791.875	79.19	8.07	-3.19	84.07	Peak.	V	197	9	--	--	--
5793.129	63.76	8.07	-3.19	68.64	Peak.	H	112	356	--	--	--
11550	36	12.5	4.3	52.8	Peak.	V	197	9	74	-21.2	Pass
17325	37.7	16.4	5.8	59.9	Peak.	V	197	9	68.2	-8.3	Pass
11550	36.1	12.5	4.3	52.9	Peak.	H	112	356	74	-21.1	Pass
17325	37.4	16.4	5.8	59.6	Peak.	H	112	356	68.2	-8.6	Pass

**B.1.P.4 Radiated Transmitter Spurs, 5785 MHz, Non HT/VHT20, 6 to 54 Mbps, Peak (1-18GHz)**

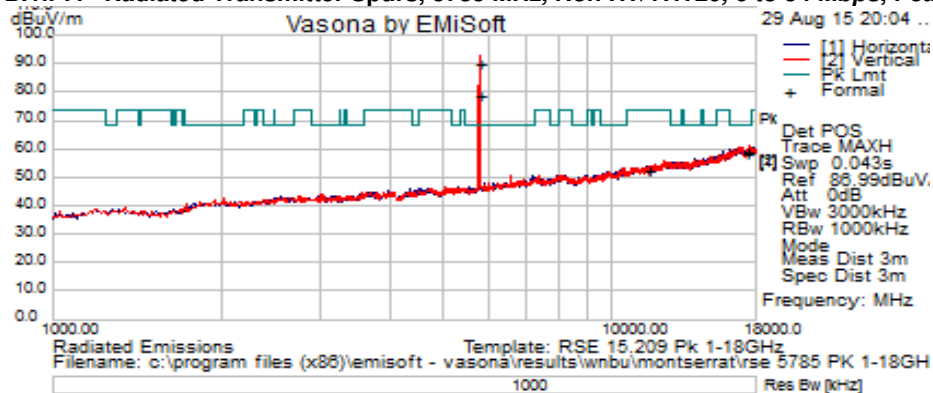

Frequency MHz	Raw dBuV	Cable Loss	AF dB	Level dBuV/m	Measurement Type	P ol	Hgt cm	Azt Deg	Limit dBuV/m	Margin dB	Pass /Fail
5781.25	85.53	8.04	-3.2	90.37	Peak.	V	200	6	--	--	--
5786.788	74.31	8.05	-3.19	79.18	Peak.	H	106	70	--	--	--
11570	35.6	12.5	4.3	52.4	Peak.	H	106	79	74	-21.6	Pass
11570	35.4	12.5	4.3	52.2	Peak.	V	200	6	74	-21.8	Pass
17355	37	16.4	5.8	59.2	Peak.	H	106	70	68.2	-9	Pass
17355	36.4	16.4	5.8	58.6	Peak.	V	200	6	68.2	-9.6	Pass



**B.1.P.5 Radiated Transmitter Spurs, 5825 MHz, Non HT/VHT20, 6 to 54 Mbps, Peak (1-18GHz)**

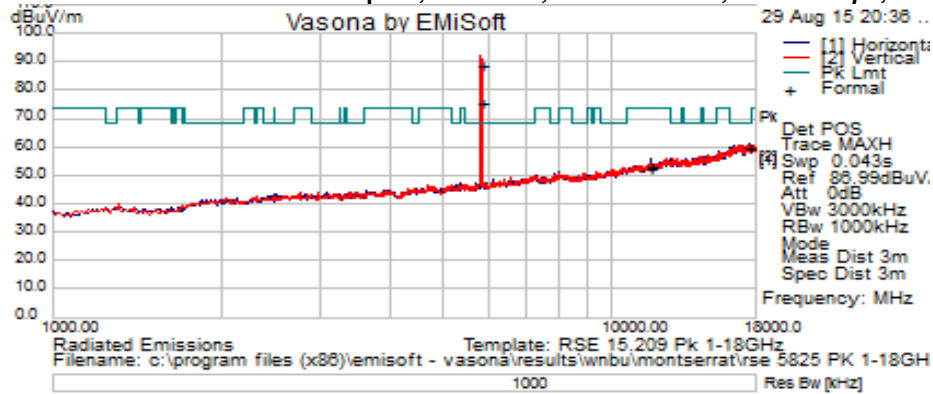

Frequency MHz	Raw dBuV	Cable Loss	AF dB	Level dBuV/m	Measurement Type	P ol	Hgt cm	Azt Deg	Limit dBuV/m	Margin dB	Pass /Fail
5823.75	83.83	8.06	-3.15	88.74	Peak.	V	173	26	--	--	--
5824.564	70.55	8.06	-3.15	75.46	Peak.	H	106	358	--	--	--
11650	35.5	12.6	4.4	52.5	Peak.	V	173	26	74	-21.5	Pass
17475	37.4	16.6	5.4	59.5	Peak.	V	173	26	68.2	-8.7	Pass
11650	36.1	12.6	4.4	53.1	Peak.	H	106	358	74	-20.9	Pass
17475	37.7	16.6	5.4	59.8	Peak.	H	106	358	68.2	-8.4	Pass

**B.1.P.6 Radiated Transmitter Spurs, 5795 MHz, HT/VHT40, M0 to M7, M0 to M9 1ss, Peak (1-18GHz)**

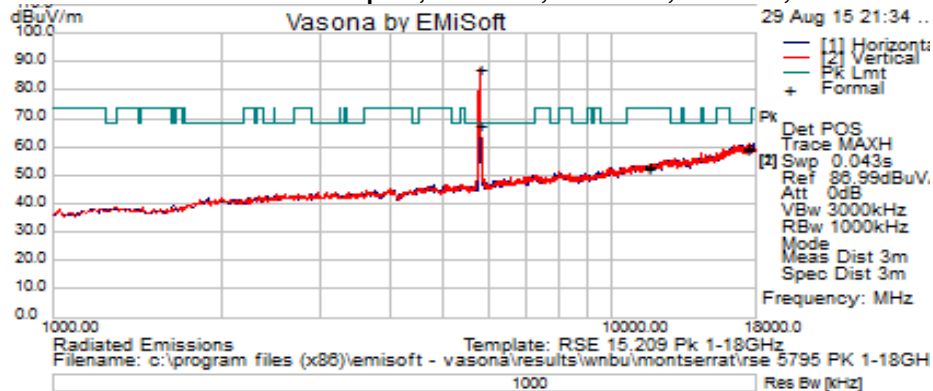

Frequency MHz	Raw dBuV	Cable Loss	AF dB	Level dBuV/m	Measurement Type	P ol	Hgt cm	Azt Deg	Limit dBuV/m	Margin dB	Pass /Fail
5793.125	82.3	8.1	-3.2	87.2	Peak.	V	190	4	--	--	--
5803.621	63.03	8.07	-3.17	67.92	Peak.	H	121	142	--	--	--
11590	35.9	12.4	4.4	52.7	Peak.	V	190	4	74	-21.3	Pass
17385	37.3	16.6	5.4	59.3	Peak.	V	190	4	68.2	-8.9	Pass
11590	36.1	12.4	4.4	52.9	Peak.	H	121	142	74	-21.1	Pass
17385	37.7	16.6	5.4	59.7	Peak.	H	121	142	68.2	-8.5	Pass

**B.1.P.7 Radiated Transmitter Spurs, All rate, All modes, Peak (18-26.5GHz)**

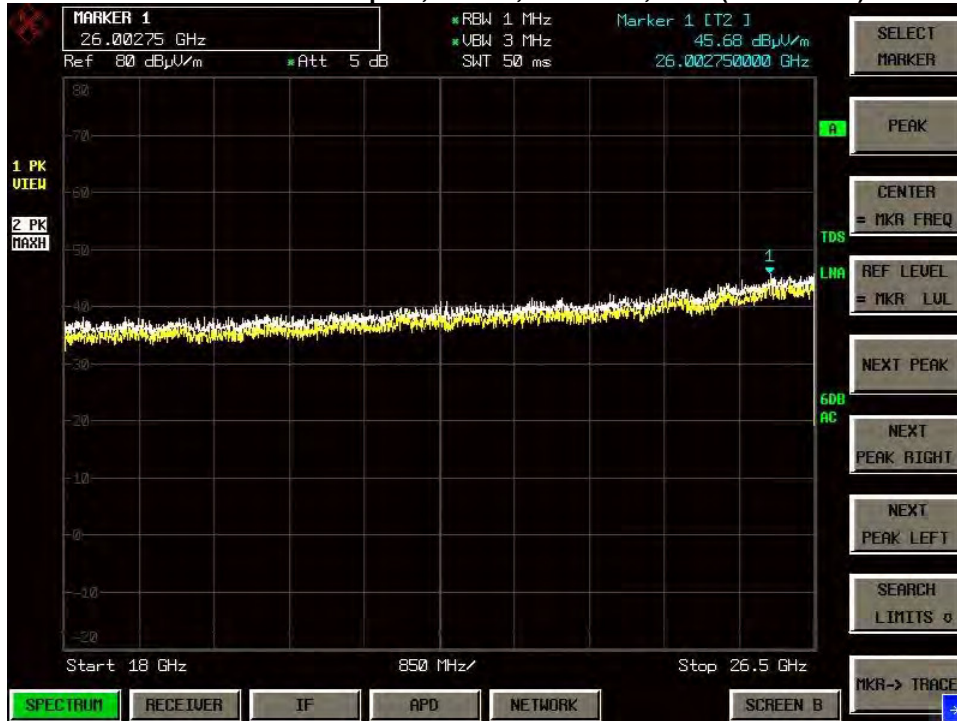

**B.1.P.8 Radiated Transmitter Spurs, All rate, All modes, Peak (26.5-40GHz)**



## B.2 Radiated Emissions 30MHz to 1GHz

### FCC 15.205 / 15.209

(7) The provisions of 15.205 apply to intentional radiators operating under this section.

(6) Unwanted emissions below 1 GHz must comply with the general field strength limits set forth in 15.209.

### Ref. ANSI C63.10: 2013 section 6.5

Using Vasona, configure the spectrum analyzer as shown below (be sure to enter all losses between the transmitter output and the spectrum analyzer). Place the radio in continuous transmit mode.

Span:	30MHz – 1GHz
Reference Level:	80 dBuV
Attenuation:	10 dB
Sweep Time:	Coupled
Resolution Bandwidth:	100kHz
Video Bandwidth:	300kHz
Detector:	Peak for Pre-scan, Quasi-Peak

Compliance shall be determined using CISPR quasi-peak detection; however, peak detection is permitted as an alternative to quasi-peak detection.

Terminate the access Point RF ports with 50 ohm loads.

Maximize Turntable (find worst case table angle), Maximize Antenna (find worst case height)

This report represents the worst case data for all supported operating modes and antennas.

System Number	Description	Samples	System under test	Support equipment
2	EUT	S03	<input checked="" type="checkbox"/>	<input type="checkbox"/>
	Support	S04	<input type="checkbox"/>	<input checked="" type="checkbox"/>

<b>Tested By :</b> Jose Aguirre	<b>Date of testing:</b> 03-Jul-15 - 30-Aug-15
<b>Test Result : PASS</b>	

See Appendix C for list of test equipment

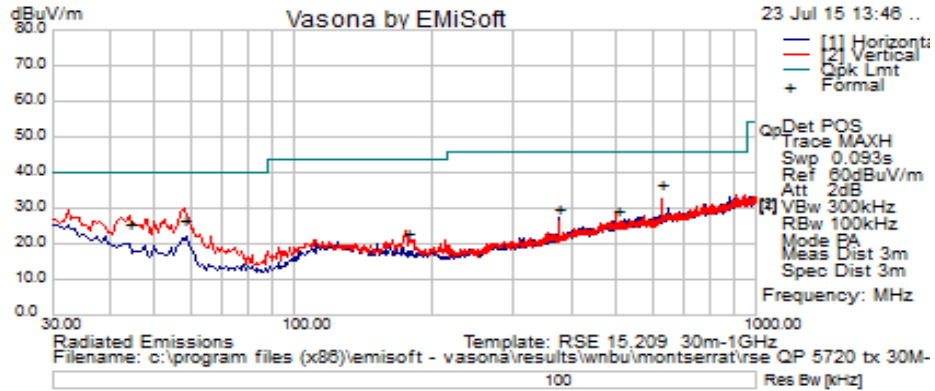

Frequency MHz	Raw dBuV	Cable Loss	AF dB	Level dBuV/m	Measurement Type	P ol	Hgt cm	Azt Deg	Limit dBuV/m	Margin dB	Pass /Fail
625.025	14.46	2.86	19.4	36.72	Quasi Max	V	111	195	46	-9.28	Pass
43.826	14.26	0.66	10.99	25.9	Quasi Max	V	118	287	40	-14.1	Pass
57.506	18.47	0.8	7.35	26.61	Quasi Max	V	109	282	40	-13.39	Pass
375.035	12.55	2.19	15.1	29.84	Quasi Max	H	107	116	46	-16.16	Pass
499.843	8.96	2.55	17.8	29.31	Quasi Max	V	137	94	46	-16.69	Pass
174.981	10.09	1.43	11.5	23.03	Quasi Max	V	177	323	43.5	-20.47	Pass

## B.3 AC Conducted Emissions

**FCC 15.207** Except when the requirements applicable to a given device state otherwise, for any radio apparatus equipped to operate from the public utility AC power supply, either directly or indirectly (such as with a battery charger), the radio frequency voltage of emissions conducted back onto the AC power lines in the frequency range of 0.15 MHz to 30 MHz shall not exceed the limits shown in the table in these sections. The more stringent limit applies at the frequency range boundaries.

Measurement Procedure  
Accordance with ANSI C63.10:2013 section 6.2

Using Vasona, configure the spectrum analyzer as shown below (be sure to enter all losses between the transmitter output and the spectrum analyzer). Place the radio in continuous transmit mode.

Span:	150 KHz – 30 MHz
Attenuation:	10 dB
Sweep Time:	Coupled
Resolution Bandwidth:	9 KHz
Video Bandwidth:	30 KHz
Detector:	Quasi-Peak / Average

System Number	Description	Samples	System under test	Support equipment
1	EUT	S01	<input checked="" type="checkbox"/>	<input type="checkbox"/>
	Support	S02	<input type="checkbox"/>	<input checked="" type="checkbox"/>

<b>Tested By :</b> Jose Aguirre	<b>Date of testing:</b> 03-Jul-15 - 30-Aug-15
<b>Test Result : PASS</b>	

See Appendix C for list of test equipment

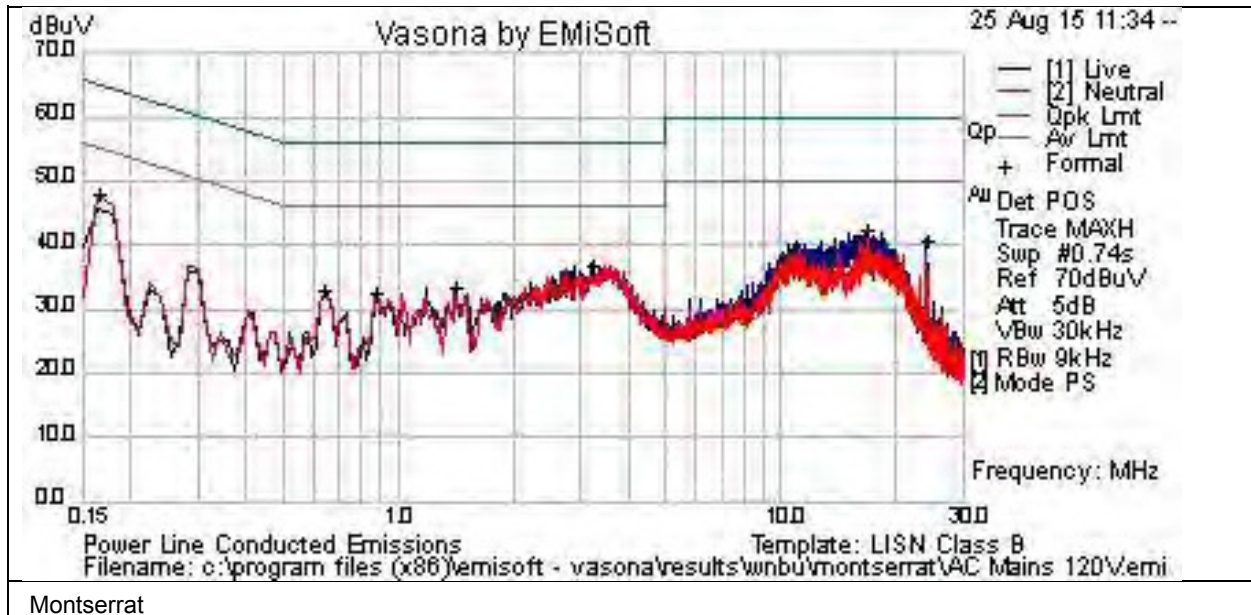

**Test Results Table**

Frequency MHz	Raw dBuV	Cable Loss	Factors dB	Level dBuV	Measurement Type	Line	Limit dBuV	Margin dB	Pass /Fail	Comments
0.164925	26.9	21	0.1	48	Peak	L	55.2	-7.2	Pass	
16.896	22	20.3	0.1	42.4	Peak	L	50	-7.6	Pass	
3.21	17	20	0	37.1	Peak	L	46	-8.9	Pass	
24.015	19.8	20.9	0.2	40.9	Peak	L	50	-9.1	Pass	
1.419	13.3	20	0	33.3	Peak	L	46	-12.7	Pass	
0.881325	12.8	20	0	32.8	Peak	L	46	-13.2	Pass	
0.164925	26.9	21	0	48	Peak	N	55.2	-7.2	Pass	
16.896	22.1	20.3	0.1	42.4	Peak	N	50	-7.6	Pass	
3.21	17.1	20	0	37.1	Peak	N	46	-8.9	Pass	
24.015	19.8	20.9	0.2	40.9	Peak	N	50	-9.1	Pass	
1.419	13.3	20	0	33.3	Peak	N	46	-12.7	Pass	
0.642525	12.8	20	0	32.8	Peak	N	46	-13.2	Pass	
0.881325	12.8	20	0	32.8	Peak	N	46	-13.2	Pass	

## Test Setup Photos:

AIR-CAP3702P-B-K9 Conducted Test setup photo

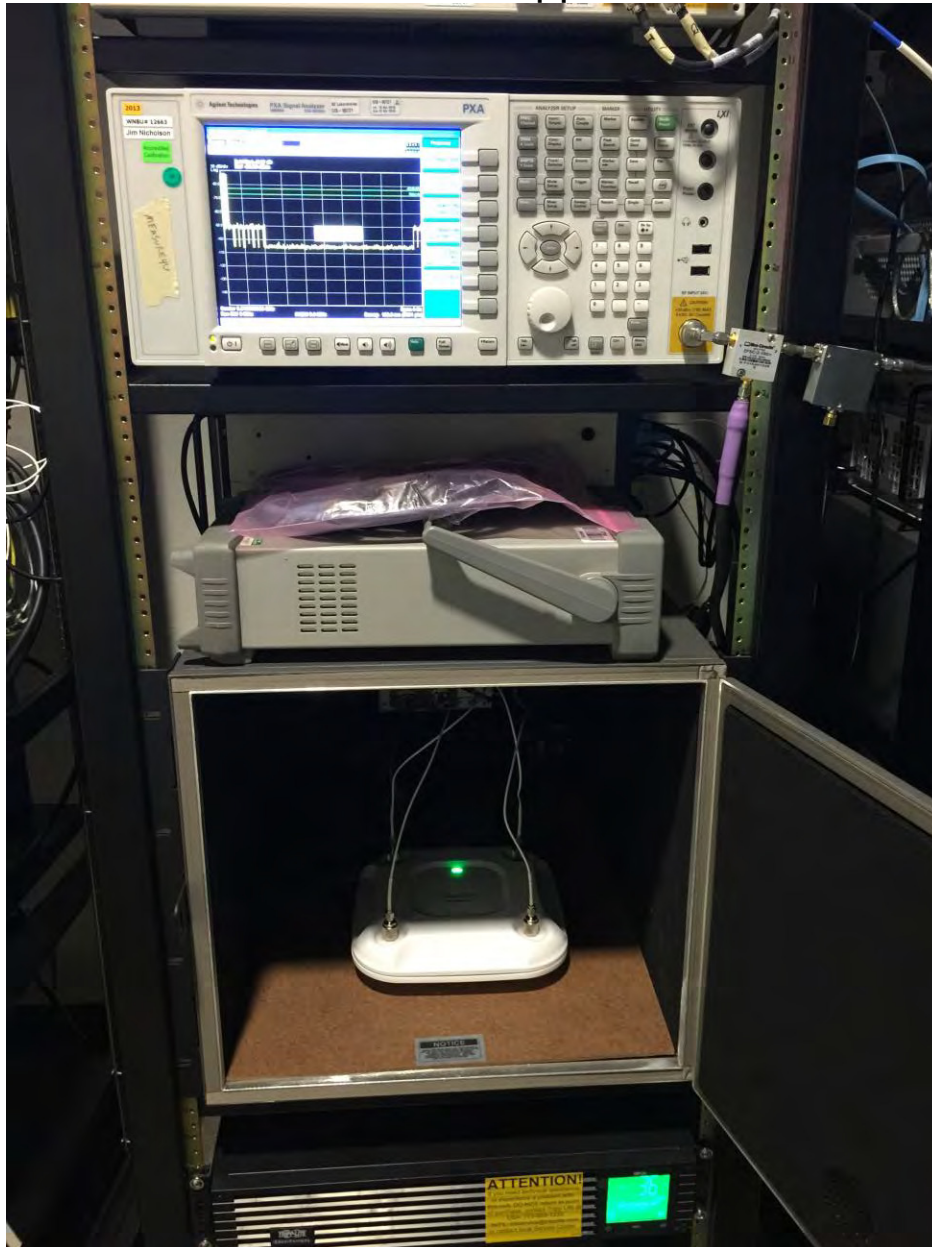

**AIR-CAP3702P-B-K9 Radiated Test setup photo 30MHz to 1GHz**





**AIR-CAP3702P-B-K9 Radiated Test setup photo above 1GHz**

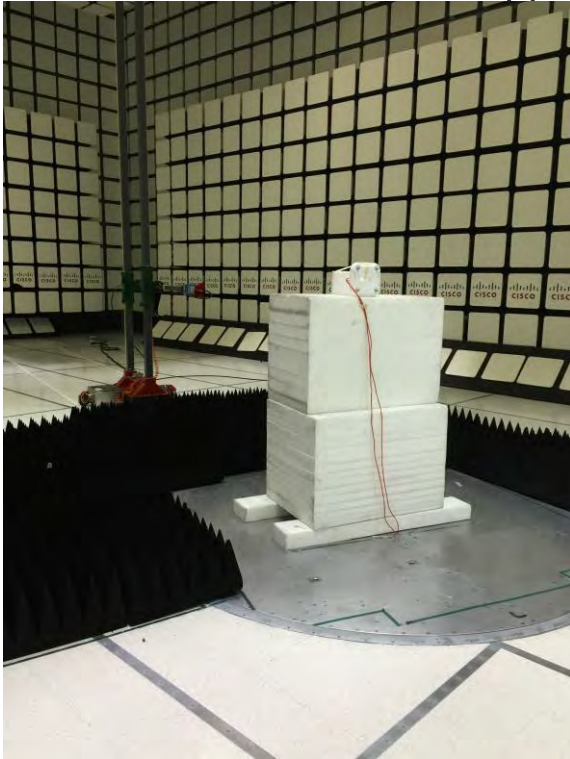

**AIR-CAP3702P-B-K9 AC Conducted Emissions setup photo**



## Appendix C: List of Test Equipment Used to perform the test

Equip#	Manufacturer/ Model	Description	Last Cal	Next Due	Test Item
<b>Test Equipment used for Radiated Emissions</b>					
CIS008447	Cisco / NSA 10m Chamber	NSA 10m Chamber	14-Oct-15	14-Oct-16	B.2
CIS030652	Sunol Sciences / JB1	Combination Antenna, 30MHz-2GHz	5-Nov-14	5-Nov-15	B.2
CIS044940	ROHDE & SCHWARZ / ESU40	EMI RECEIVER, 40GHZ	27-May-15	27-May-16	B.1
CIS033988	Agilent /E4446A	PSA Spectrum Analyzer	9-Dec-14	9-Dec-15	B.1
CIS041929	Newport /iBTHP-5-DB9	5 inch Temp/RH/Press Sensor w/20ft cable	20-Dec-14	20-Dec-15	B.1, B.2
CIS024998	MICRO-COAX / UFB197C-1-0240-504504	Coaxial RF Cable, 26.5 GHz	11-Mar-15	11-Mar-16	B.1, B.2
CIS035284	ETS Lindgren / 3117	Double Ridged Horn Antenna	30-Sep-15	30-Sep-16	B.1
CIS049516	Keysight / N9030A	PXA Spectrum Analyzer	12-Nov-14	12-Nov-15	B.1, B.2
CIS043124	Cisco /Above 1GHz Site Cal	Above 1GHz Cspr Site Verification	15-Jan-15	15-Jan-16	B.1
CIS008166	HP / 8491B Opt 010	10dB Attenuator	2-Feb-15	2-Feb-16	B.1
CIS020975	Micro-Coax / UFB311A-0-1344-520520	RF Coaxial Cable, to 18GHz, 134.4 in	18-Feb-15	18-Feb-16	B.1, B.2
CIS030559	Micro-Coax / UFB311A-1-0950-504504	RF Coaxial Cable, to 18GHz, 95 in	20-Feb-15	20-Feb-16	B.1, B.2
CIS003003	HP / 83731B	Synthesized Signal Generator	13-Mar-15	13-Mar-16	B.1
CIS005691	Miteq / NSP1800-25-S1	Broadband Preamp (1-18GHz)	29-Jan-15	29-Jan-16	B.1.
CIS005691	Miteq / NSP1800-25-S1	Broadband Preamp (1-18GHz)	25-Jun-15	25-Jun-16	B.1.
CIS041979	Cisco / 1840	18-40GHz EMI Test Head/Verification Fixture	13-Jul-15	13-Jul-16	B.1
CIS047410	Agilent / N9038A	EMI Receiver	17-Feb-15	17-Feb-16	B.1, B.2
CIS051642	Huber+Suhner / Sucoflex 106PA	RF N Type Cable 8.5m	10-Feb-15	10-Feb-16	B.1, B.2
<b>Test Equipment used for AC Mains Conducted Emissions</b>					
CIS008192	Fischer Custom Communications FCC-450B-2.4-N	Instrumentation Limiter	28-JUL-15	28-JUL-16	B.3
CIS008197	TTE /H613-150K-50-21378	Hi Pass Filter - 150KHz cutoff	16-APR-15	16-APR-16	B.3
CIS008471	Bird / 5-T-MB	50 Ohm, 5W Terminator, Type BNC	16-SEP-15	16-SEP-16	B.3
CIS019337	Fischer Custom Communications FCC-LISN-50/250-50-2-01	LISN	15-SEP-15	15-SEP-16	B.3
CIS019136	Fischer Custom Communications FCC-801-M3-32A	Power Line Coupling/Decoupling Network	12-NOV-14	12-NOV-15	B.3
CIS023874	Fischer Custom Communications FCC-LISN-PA-NEMA-5-15	Power Adaptor, Polarized 120VAC	15-SEP-15	15-SEP-16	B.3
CIS035235	Lufkin / HY1035CME	5 Meter Tape Measure	Cal Not Required	N/A	B.3
CIS036031	York / CNE V	Comparison Noise Emitter	Cal Not Required	N/A	B.3
CIS039110	Coleman /RG-223	25 ft BNC cable	24-NOV-14	24-NOV-15	B.3
CIS045050	ROHDE & SCHWARZ/ ESCI	EMI Test Receiver	31-Oct-2014	31 Oct 2015	B.3
<b>RF Conducted at output antenna port</b>					
CIS050721	N9030A/ Keysight	PXA Signal Analyzer	13-Apr-16	13-Apr-16	A1 thru A4

CIS054609	ZFSC-2-10G /Mini-Circuits	Splitter	01-June-15	01-June-16	A1 thru A4
CIS054608	D3C2060 / Ditom	Splitter	01-June-15	01-June-16	A1 thru A4
CIS054607	PS4-09-452/4S/ Pulsar	Splitter	01-June-15	01-June-16	A1 thru A4
CIS054606	BRC50705-02/ Micro-Tronics	Notch Filter	01-June-15	01-June-16	A1 thru A4
CIS054605	BRC50703-02 / Micro-Tronics	Notch Filter	01-June-15	01-June-16	A1 thru A4
CIS054604	BRC50704-02/ Micro-Tronics	Notch Filter	01-June-15	01-June-16	A1 thru A4
CIS054603	BRM50702-02/ Micro-Tronics	Notch Filter	01-June-15	01-June-16	A1 thru A4
CIS054637	BWS30-W2/ Aeroflex	SMA 30dB Attenuator	02-June-15	02-June-16	A1 thru A4
CIS054636	BWS20-W2/ Aeroflex	20dB SMA Attenuator	02-June-15	02-June-16	A1 thru A4
CIS054625	RA08-S1S1-24/Megaphase	SMA cable 24"	02-June-15	02-June-16	A1 thru A4
CIS054624	RA08-S1S1-18/Megaphase	SMA cable 18"	02-June-15	02-June-16	A1 thru A4
CIS054623	RA08-S1S1-18/Megaphase	SMA cable 18"	02-June-15	02-June-16	A1 thru A4
CIS054622	RA08-S1S1-18/Megaphase	SMA cable 18"	02-June-15	02-June-16	A1 thru A4
CIS054621	RA08-S1S1-18/Megaphase	SMA cable 18"	02-June-15	02-June-16	A1 thru A4

**Appendix E: Abbreviation Key and Definitions**

The following table defines abbreviations used within this test report.

Abbreviation	Description	Abbreviation	Description
EMC	Electro Magnetic Compatibility	°F	Degrees Fahrenheit
EMI	Electro Magnetic Interference	°C	Degrees Celsius
EUT	Equipment Under Test	Temp	Temperature
ITE	Information Technology Equipment	S/N	Serial Number
TAP	Test Assessment Schedule	Qty	Quantity
ESD	Electro Static Discharge	emf	Electromotive force
EFT	Electric Fast Transient	RMS	Root mean square
EDCS	Engineering Document Control System	Qp	Quasi Peak
Config	Configuration	Av	Average
CIS#	Cisco Number (unique identification number for Cisco test equipment)	Pk	Peak
Cal	Calibration	kHz	Kilohertz ( $1 \times 10^3$ )
EN	European Norm	MHz	MegaHertz ( $1 \times 10^6$ )
IEC	International Electro technical Commission	GHz	Gigahertz ( $1 \times 10^9$ )
CISPR	International Special Committee on Radio Interference	H	Horizontal
CDN	Coupling/Decoupling Network	V	Vertical
LISN	Line Impedance Stabilization Network	dB	decibel
PE	Protective Earth	V	Volt
GND	Ground	kV	Kilovolt ( $1 \times 10^3$ )
L1	Line 1	$\mu$ V	Microvolt ( $1 \times 10^{-6}$ )
L2	Line2	A	Amp
L3	Line 3	$\mu$ A	Micro Amp ( $1 \times 10^{-6}$ )
DC	Direct Current	mS	Milli Second ( $1 \times 10^{-3}$ )
RAW	Uncorrected measurement value, as indicated by the measuring device	$\mu$ S	Micro Second ( $1 \times 10^{-6}$ )
RF	Radio Frequency	$\mu$ S	Micro Second ( $1 \times 10^{-6}$ )
SLCE	Signal Line Conducted Emissions	m	Meter
Meas dist	Measurement distance	Spec dist	Specification distance
N/A or NA	Not Applicable	SL	Signal Line (or Telecom Line)
P	Power Line	L	Live Line
N	Neutral Line	R	Return
S	Supply	AC	Alternating Current

**End**