

Project No: TM-2201000472P FCC ID: LDKHS7222538 Page: 1 / 86
 Report No.: TMWK2201000417KR IC: 2461N-HS7222538 Rev.: 00

RADIO TEST REPORT

FCC 47 CFR PART 15 SUBPART C

INDUSTRY CANADA RSS-247

Test Standard	FCC Part 15.247 RSS-247 issue 2 and RSS-GEN issue 5
Product name	Cisco Headset 720
Brand Name	Cisco
Model No.	HS-WL-722, HS-WL-721
Test Result	Pass
Statements of Conformity	Determination of compliance is based on the results of the compliance measurement, not taking into account measurement instrumentation uncertainty.

The test Result was tested by Compliance Certification Services Inc. The test data, data evaluation, test procedures, and equipment configurations shown in this report were given in ANSI C63.10: 2013 and compliance standards.

The test results of this report relate only to the tested sample (EUT) identified in this report.

The test Report of full or partial shall not copy. Without written approval of Compliance Certification Services Inc.(Wugu Laboratory)

Approved by:



Dally Hong
Sr. Engineer

Unless otherwise stated the results shown in this test report refer only to the sample(s) tested and such sample(s) are retained for 90 days only.
 除非另有說明，此報告結果僅對測試之樣品負責，同時此樣品僅保留90天。本報告未經本公司書面許可，不可部份複製。

This document is issued by the Company subject to its General Conditions of Service printed overleaf, available on request or accessible at <http://www.sgs.com.tw/Terms-and-Conditions> and, for electronic format documents, subject to Terms and Conditions for Electronic Documents at <http://www.sgs.com.tw/Terms-and-Conditions>. Attention is drawn to the limitation of liability, indemnification and jurisdiction issues defined therein. Any holder of this document is advised that information contained hereon reflects the Company's findings at the time of its intervention only and within the limits of client's instruction, if any. The Company's sole responsibility is to its Client and this document does not exonerate parties to a transaction from exercising all their rights and obligations under the transaction documents. This document cannot be reproduced, except in full, without prior written approval of the Company. Any unauthorized alteration, forgery or falsification of the content or appearance of this document is unlawful and offenders may be prosecuted to the fullest extent of the law.

Revision History

Rev.	Issue Date	Revisions	Effect Page	Revised By
00	July 1, 2022	Initial Issue	ALL	Doris Chu

Table of contents

1. GENERAL INFORMATION	4
1.1 EUT INFORMATION	4
1.2 INFORMATION ABOUT THE FHSS CHARACTERISTICS	6
1.3 EUT CHANNEL INFORMATION	7
1.4 ANTENNA INFORMATION	7
1.5 MEASUREMENT UNCERTAINTY	8
1.6 FACILITIES AND TEST LOCATION	9
1.7 INSTRUMENT CALIBRATION	9
1.8 SUPPORT AND EUT ACCESSORIES EQUIPMENT	11
1.9 TEST METHODOLOGY AND APPLIED STANDARDS	11
2. TEST SUMMARY	12
3. DESCRIPTION OF TEST MODES	13
3.1 THE WORST MODE OF OPERATING CONDITION	13
3.2 THE WORST MODE OF MEASUREMENT	14
3.3 EUT DUTY CYCLE	16
4. TEST RESULT	20
4.1 AC POWER LINE CONDUCTED EMISSION	20
4.2 20DB BANDWIDTH AND OCCUPIED BANDWIDTH (99%)	23
4.3 OUTPUT POWER MEASUREMENT	31
4.4 FREQUENCY SEPARATION	35
4.5 NUMBER OF HOPPING	40
4.6 CONDUCTED BANDEDGE AND SPURIOUS EMISSION	43
4.7 TIME OF OCCUPANCY (DWELL TIME)	51
4.8 RADIATION BANDEDGE AND SPURIOUS EMISSION	56
APPENDIX 1 - PHOTOGRAPHS OF EUT	

Report No.: TMWK2201000417KR

1. GENERAL INFORMATION

1.1 EUT INFORMATION

Applicant	For FCC: Cisco Systems Inc 125 West Tasman Drive San Jose, CA 95134-1706 United States For IC: Cisco Systems Inc. 125 West Tasman Dr. Bldg. P San Jose CA 95134 United States Of America (Excluding The States Of Alaska)
Manufacturer	For FCC: Cisco Systems Inc 125 West Tasman Drive San Jose, CA 95134-1706 United States For IC: Cisco Systems Inc. 125 West Tasman Dr. Bldg. P San Jose CA 95134 United States Of America (Excluding The States Of Alaska)
Factory	1. Merry Electronics (Huizhou) Co., Ltd. JINSHAN INDUSTRIAL PARK, QINGXI, LONGMEN TOWN, HUIZHOU CITY, GUANGDONG PROVINCE, CHINA 2. Merry & Luxshare (Viet nam) Co., Ltd. No. 6, DEMOCRACY ROAD, NGHE AN VSIP INDUSTRIAL PARK, HUNG TAY COMMUNE, HUNG NGUYEN DISTRICT, NGHE AN PROVINCE
Equipment	Cisco Headset 720
Model No.	HS-WL-722, HS-WL-721
Model Discrepancy	Basic model HS-WL-722: Wireless Dual On-Ear Headset Multi model HS-W-721 : Wireless Mono On-Ear Headset (One Speaker connected only) Difference in earphone number and accompany circuit board, electronic components, wire and indicator LED only for the extra earphone.
Trade Name	Cisco
Received Date	January 25, 2022
Date of Test	January 27 ~ February 17, 2022

Report No.: TMWK2201000417KR

Power Supply	1. Power via USB cable. 2. Power from Battery. Rating: 5Vdc, 1.85Wh
HW Version	HDT606-MAIN-R2-20211015
SW Version	1-8-m-168
EUT Serial #	EMC255000AB

Remark:

1. For more details, please refer to the User's manual of the EUT.
2. Disclaimer: Antenna information is provided by the applicant, test results of this report are applicable to the sample EUT received.
3. Disclaimer: Variant information between/among model numbers / trademarks are provided by the applicant, test results of this report are applicable to the sample EUT received of main test model name.)

Report No.: TMWK2201000417KR

1.2 INFORMATION ABOUT THE FHSS CHARACTERISTICS

1.2.1 Pseudorandom Frequency Hopping Sequence

The channel is represented by a pseudo-random hopping sequence hopping through the 79 RF channels. The hopping sequence is unique for the piconet and is determined by the Bluetooth device address of the master; the phase in the hopping sequence is determined by the Bluetooth clock of the master. The channel is divided into time slots where each slot corresponds to an RF hop frequency. Consecutive hops correspond to different RF hop frequencies. The nominal hop rate is 1 600 hops/s.

1.2.2 Equal Hopping Frequency Use

The channels of this system will be used equally over the long-term distribution of the hopsets.

1.2.3 Example of a 79 hopping sequence in data mode:

02, 05, 31, 24, 20, 10, 43, 36, 30, 23, 40, 06, 21, 50, 44, 09, 71, 78, 01, 13, 73, 07, 70, 72, 35, 62, 42, 11, 41, 08, 16, 29, 60, 15, 34, 61, 58, 04, 67, 12, 22, 53, 57, 18, 27, 76, 39, 32, 17, 77, 52, 33, 56, 46, 37, 47, 64, 49, 45, 38, 69, 14, 51, 26, 79, 19, 28, 65, 75, 54, 48, 03, 25, 66, 05, 16, 68, 74, 59, 63, 55

1.2.4 System Receiver Input Bandwidth

Each channel bandwidth is 1MHz.

The system receivers have input bandwidths that match the hopping channel bandwidths of their corresponding transmitters and shift frequencies in synchronization with the transmitted signals.

1.2.5 Equipment Description

RSS-247, 5.1 (a): The system shall hop to channel frequencies that are selected at the system hopping rate from a pseudo randomly ordered list of hopping frequencies. The system receivers shall have input bandwidths that match the hopping channel bandwidths of their corresponding transmitters and shall shift frequencies in synchronization with the transmitted signals.

Report No.: TMWK2201000417KR

1.3 EUT CHANNEL INFORMATION

Frequency Range	2402MHz-2480MHz
Modulation Type	1. GFSK for BDR-1Mbps 2. $\pi/4$ -DQPSK for EDR-2Mbps 3. 8DPSK for EDR-3Mbps
Number of channel	79 Channels

Remark:

Refer as ANSI C63.10: 2013 clause 5.6.1 Table 4 and RSS-GEN Table 1 for test channels

Number of frequencies to be tested		
Frequency range in which device operates	Number of frequencies	Location in frequency range of operation
<input type="checkbox"/> 1 MHz or less	1	Middle
<input type="checkbox"/> 1 MHz to 10 MHz	2	1 near top and 1 near bottom
<input checked="" type="checkbox"/> More than 10 MHz	3	1 near top, 1 near middle, and 1 near bottom

1.4 ANTENNA INFORMATION

Antenna Type	<input checked="" type="checkbox"/> Monopole <input type="checkbox"/> PCB <input type="checkbox"/> Dipole <input type="checkbox"/> Coils
Antenna Gain	Gain :5.01 dBi

Remark:

1.The antenna(s) of the EUT are permanently attached and there are no provisions for connection to an external antenna. So the EUT complies with the requirements of §15.203 and RSS-Gen 6.8.

1.5 MEASUREMENT UNCERTAINTY

PARAMETER	UNCERTAINTY
AC Powerline Conducted Emission	+/- 1.2575
Emission bandwidth, 20dB bandwidth	+/- 0.0014
RF output power, conducted	+/- 1.14
Power density, conducted	+/- 1.40
3M Semi Anechoic Chamber / 9K~30M	+/- 2.25
3M Semi Anechoic Chamber / 30M~1G (Horizontally)	+/- 3.91
3M Semi Anechoic Chamber / 30M~1G (Vertically)	+/- 4.57
3M Semi Anechoic Chamber / 1G~6G	+/- 5.20
3M Semi Anechoic Chamber / 6G~18G	+/- 5.18
3M Semi Anechoic Chamber / 18G~40G	+/- 3.68

Remark:

- 1.This uncertainty represents an expanded uncertainty expressed at approximately the 95% confidence level using a coverage factor of k=2
2. ISO/IEC 17025 requires that an estimate of the measurement uncertainties associated with the emissions test results be included in the report.

1.6 FACILITIES AND TEST LOCATION

All measurement facilities used to collect the measurement data are located at No.11, Wugong 6th Rd., Wugu Dist., New Taipei City, Taiwan. (R.O.C.)
CAB identifier: TW1309

Test site	Test Engineer	Remark
AC Conduction Room	Jack Chen	-
Radiation	Ray Li, Tony Chao	-
RF Conducted	Marco Chan	-

Remark: The lab has been recognized as the FCC accredited lab under the KDB 974614 D01 and is listed in the FCC public Access Link (PAL) database, FCC Registration No. :444940, the FCC Designation No.:TW1309”

1.7 INSTRUMENT CALIBRATION

RF Conducted Test Site					
Name of Equipment	Manufacturer	Model	Serial Number	Calibration Date	Calibration Due
EXA Signal Analyzer	KEYSIGHT	N9010B	MY59071573	05/25/2021	05/24/2022
Power Meter	Anritsu	ML2496A	2136002	12/06/2021	12/05/2022
Power Sensor	Anritsu	MA2411B	1911386	08/19/2021	08/18/2022
Power Sensor	Anritsu	MA2411B	1911387	08/19/2021	08/18/2022
Software	Radio Test Software Ver. 21				

Conducted Emission Room					
Name of Equipment	Manufacturer	Model	Serial Number	Calibration Date	Calibration Due
CABLE	EMCI	CFD300-NL	CERF	06/28/2021	06/27/2022
EMI Test Receiver	R&S	ESCI	100064	07/05/2021	07/04/2022
LISN	SCHWARZBECK	NSLK 8127	8127-01068	01/17/2022	01/16/2023
Software	EZ-EMC(CCS-3A1-CE)				

3M 966 Chamber Test Site					
Equipment	Manufacturer	Model	Serial Number	Cal Date	Cal Due
Band Reject Filters	MICRO TRONICS	BRM 50702	112	11/23/2021	11/22/2022
Bilog Antenna	Sunol Sciences	JB3	A030105	07/19/2021	07/18/2022
Coaxial Cable	HUBER SUHNER	SUCOFLEX 104PEA	20995	02/24/2021	02/23/2022
Coaxial Cable	EMCI	EMC105	190914+1111	09/17/2021	09/16/2022
Coaxial Cable	Woken	J-1099	201709090004	12/21/2021	12/20/2022
Digital Thermo-Hygro Meter	WISEWIND	1206	D07	12/28/2021	12/27/2022
Horn Antenna	ETS LINDGREN	3116	00026370	11/30/2021	11/29/2022
Horn Antenna	ETS LINDGREN	3117	00055165	07/29/2021	07/28/2022
K Type Cable	Huber+Suhner	SUCOFLEX 102	29406/2	12/05/2021	12/04/2022
Loop Ant	COM-POWER	AL-130	121051	04/07/2021	04/06/2022
Pre-Amplifier	EMEC	EM330	060609	02/24/2021	02/23/2022
Pre-Amplifier	HP	8449B	3008A00965	12/24/2021	12/23/2022
PSA Series Spectrum Analyzer	Agilent	E4446A	MY46180323	12/06/2021	12/05/2022
Antenna Tower	CCS	CC-A-1F	N/A	N.C.R	N.C.R
Controller	CCS	CC-C-1F	N/A	N.C.R	N.C.R
Turn Table	CCS	CC-T-1F	N/A	N.C.R	N.C.R
Software	e3 6.11-20180413				

Remark: Each piece of equipment is scheduled for calibration once a year.

1.8 SUPPORT AND EUT ACCESSORIES EQUIPMENT

EUT Accessories Equipment					
No.	Equipment	Brand	Model	Series No.	FCC ID
1.	Charging Stand	Cisco	HS-WL-720-DSKCH	(PID) HS-WL-720-DSKCH-A	N/A

Support Equipment						
No.	Equipment	Brand	Model	Series No.	FCC ID	IC
1	NB(G)	Lenovo	IBM 1951	N/A	CJ6UPA3489WL	N/A
2	NB(J)	TOSHIBA	PT345T-00L002	N/A	PD97260H	1000M-7260H

1.9 TEST METHODOLOGY AND APPLIED STANDARDS

The test methodology, setups and results comply with all requirements in accordance with ANSI C63.10:2013, FCC Part 2, FCC Part 15.247, RSS-247 Issue 2 and RSS-GEN Issue 5.

2. TEST SUMMARY

FCC Standard Section	IC Standard Section	Report Section	Test Item	Result
15.203	RSS-Gen 6.8	1.3	Antenna Requirement	Pass
15.207(a)	RSS-GEN 8.8	4.1	AC Conducted Emission	Pass
15.247(a)(1)	RSS-247(5.1)(a)	4.2	20 dB Bandwidth	Pass
-	RSS-GEN 6.7	4.2	Occupied Bandwidth (99%)	Pass
15.247(b)(1)	RSS-247(5.4)(b)	4.3	Output Power Measurement	Pass
15.247(a)(1)	RSS-247(5.1)(b)	4.4	Frequency Separation	Pass
15.247(a)(1)(iii)	RSS-247(5.1)(d)	4.5	Number of Hopping	Pass
15.247(d)	RSS-247(5.5)	4.6	Conducted Band Edge	Pass
15.247(d)	RSS-247(5.5)	4.6	Conducted Spurious Emission	Pass
15.247(a)(1)(iii)	RSS-247(5.1)(d)	4.7	Time of Occupancy	Pass
15.247(d)	RSS-GEN 8.9, 8.10	4.8	Radiation Band Edge	Pass
15.247(d)	RSS-GEN 8.9, 8.10	4.8	Radiation Spurious Emission	Pass

Report No.: TMWK2201000417KR

3. DESCRIPTION OF TEST MODES

3.1 THE WORST MODE OF OPERATING CONDITION

Operation mode	GFSK for BDR-1Mbps (DH5) $\pi/4$ -DQPSK for EDR-2Mbps (2DH5) 8DPSK for EDR-3Mbps (3DH5)
Test Channel Frequencies	<p>GFSK for BDR-1Mbps: 1.Lowest Channel: 2402MHz 2.Middle Channel: 2441MHz 3.Highest Channel: 2480MHz</p> <p>$\pi/4$-DQPSK for EDR-2Mbps (2DH5) 1.Lowest Channel: 2402MHz 2.Middle Channel: 2441MHz 3.Highest Channel: 2480MHz</p> <p>8DPSK for EDR-3Mbps: 1.Lowest Channel: 2402MHz 2.Middle Channel: 2441MHz 3.Highest Channel: 2480MHz</p>

Remark:

1. EUT pre-scanned data rate of output power for each mode, the worst data rate were recorded in this report.
2. For EDR-2/3Mbps, because the characteristics are the same, so choose the high power as a hopping test.

3.2 THE WORST MODE OF MEASUREMENT

AC Power Line Conducted Emission	
Test Condition	AC Power line conducted emission for line and neutral
Power supply Mode	HS-WL-722 (Stereo) Mode 1: EUT power by DC5V(TypeA To TypeC) Mode 2: EUT power by Charging stand(TypeA To TypeC) HS-WL-721(Mono) Mode 3: EUT power by DC5V(TypeA To TypeC) Mode 4: EUT power by Charging stand(TypeA To TypeC)
Worst Mode	<input type="checkbox"/> Mode 1 <input checked="" type="checkbox"/> Mode 2 <input type="checkbox"/> Mode 3 <input type="checkbox"/> Mode 4

Report No.: TMWK2201000417KR

Radiated Emission Measurement Above 1G	
Test Condition	Radiated Emission Above 1G
Power supply Mode	HS-WL-722 (Stereo) Mode 1: EUT power by DC5V(TypeA To TypeC) Mode 2: EUT power by Charging stand(TypeA To TypeC)
	HS-WL-721(Mono) Mode 3: EUT power by DC5V(TypeA To TypeC) Mode 4: EUT power by Charging stand(TypeA To TypeC)
Worst Mode	<input checked="" type="checkbox"/> Mode 1 <input type="checkbox"/> Mode 2 <input type="checkbox"/> Mode 3 <input type="checkbox"/> Mode 4
Worst Position	<input type="checkbox"/> Placed in fixed position. <input checked="" type="checkbox"/> Placed in fixed position at X-Plane (E2-Plane) <input type="checkbox"/> Placed in fixed position at Y-Plane (E1-Plane) <input type="checkbox"/> Placed in fixed position at Z-Plane (H-Plane)

Radiated Emission Measurement Below 1G	
Test Condition	Radiated Emission Below 1G
Power supply Mode	HS-WL-722 (Stereo) Mode 1: EUT power by DC5V(TypeA To TypeC) Mode 2: EUT power by Charging stand(TypeA To TypeC)
	HS-WL-721(Mono) Mode 3: EUT power by DC5V(TypeA To TypeC) Mode 4: EUT power by Charging stand(TypeA To TypeC)
Worst Mode	<input checked="" type="checkbox"/> Mode 1 <input type="checkbox"/> Mode 2 <input type="checkbox"/> Mode 3 <input type="checkbox"/> Mode 4

Remark:

1. The worst mode was record in this test report.
2. EUT pre-scanned in three axis ,X,Y, Z and two polarity, for radiated measurement. The worst case(X-Plane) were recorded in this report
3. AC power line conducted emission and for below 1G radiation emission were performed the EUT transmit at the highest output power channel as worse case.

Report No.: TMWK2201000417KR

3.3 EUT DUTY CYCLE

Temperature: 22.1 ~ 22.4°C

Humidity: 55 ~ 62% RH

Tested by: Marco Chan

Test date: January 27 ~ 28, 2022

For GFSK (1Mbps)

PACKET TYPE	Duty Cycle (%) = Ton / (Ton+Toff)	Duty Factor (dB) =10*log (1/Duty Cycle)	1/T (kHz)	VBW setting (kHz)
DH1	31.20	5.06	2.56	3.00
DH3	65.60	1.83	0.61	1.00
DH5	77.20	1.12	0.35	1.00

For π/4 DQPSK (2Mbps)

PACKET TYPE	Duty Cycle (%) = Ton / (Ton+Toff)	Duty Factor (dB) =10*log (1/Duty Cycle)	1/T (kHz)	VBW setting (kHz)
2DH1	31.60	5.00	2.53	3.00
2DH3	66.00	1.80	0.61	1.00
2DH5	77.20	1.12	0.35	1.00

For 8-DPSK (3Mbps)

PACKET TYPE	Duty Cycle (%) = Ton / (Ton+Toff)	Duty Factor (dB) =10*log (1/Duty Cycle)	1/T (kHz)	VBW setting (kHz)
3DH1	32.00	4.95	2.50	3.00
3DH3	66.00	1.80	0.61	1.00
3DH5	77.60	1.10	0.34	1.00

Report No.: TMWK2201000417KR

For GFSK (1Mbps)



Report No.: TMWK2201000417KR

For $\pi/4$ DQPSK (2Mbps)



Report No.: TMWK2201000417KR

For 8-DPSK (3Mbps)



Report No.: TMWK2201000417KR

4. TEST RESULT

4.1 AC POWER LINE CONDUCTED EMISSION

4.1.1 Test Limit

According to §15.207(a) and RSS-GEN section 8.8,

Frequency Range (MHz)	Limits(dBμV)	
	Quasi-peak	Average
0.15 to 0.50	66 to 56*	56 to 46*
0.50 to 5	56	46
5 to 30	60	50

* Decreases with the logarithm of the frequency.

4.1.2 Test Procedure

Test method Refer as ANSI C63.10: 2013 clause 6.2,

1. The EUT was placed on a non-conducted table, which is 0.8m above horizontal ground plane and 0.4m above vertical ground plane.
2. EUT connected to the line impedance stabilization network (LISN)
3. Receiver set RBW of 9kHz and Detector Peak, and note as quasi-peak and average.
4. Maximum procedure was performed on the six highest emissions to ensure EUT compliance.
5. Recorded Line for Neutral and Line.

4.1.3 Test Setup

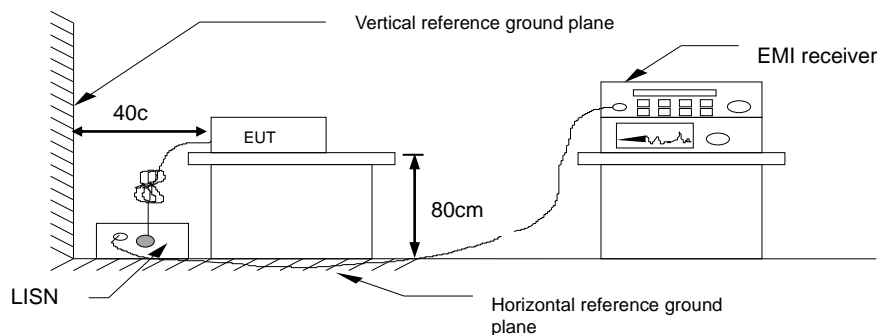

4.1.4 Test Result

PASS

Test Data

Test Mode:	Mode 3	Temp/Hum	21.7(°C)/ 55%RH
Phase:	Line	Test Date	February 17, 2022
		Test Engineer	Jack Chen

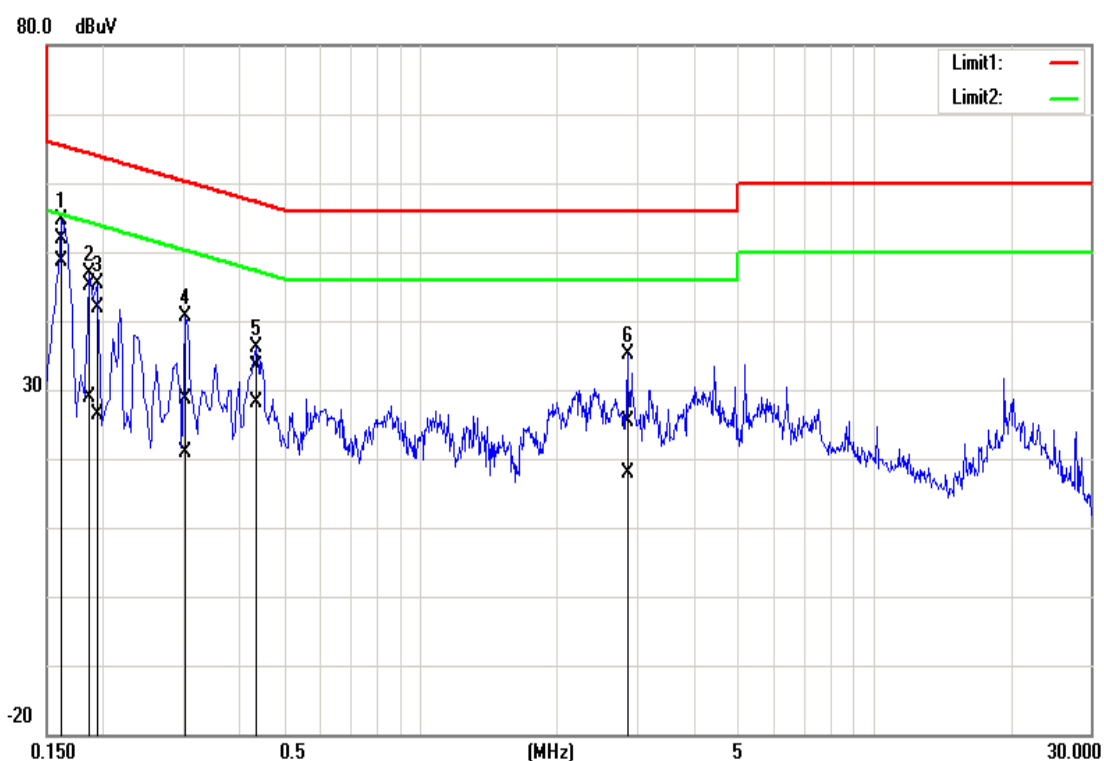

Frequency (MHz)	Quasi Peak reading (dBuV)	Average reading (dBuV)	Correction factor (dB)	Quasi Peak result (dBuV)	Average result (dBuV)	Quasi Peak limit (dBuV)	Average limit (dBuV)	Quasi Peak margin (dB)	Average margin (dB)	Remark
0.1620	51.77	48.57	0.08	51.85	48.65	65.36	55.36	-13.51	-6.71	Pass
0.1860	45.07	28.90	0.09	45.16	28.99	64.21	54.21	-19.05	-25.22	Pass
0.1940	41.67	26.40	0.09	41.76	26.49	63.86	53.86	-22.10	-27.37	Pass
0.3020	28.64	20.85	0.10	28.74	20.95	60.19	50.19	-31.45	-29.24	Pass
0.4340	33.18	28.05	0.10	33.28	28.15	57.18	47.18	-23.90	-19.03	Pass
2.8620	25.15	17.73	0.17	25.32	17.90	56.00	46.00	-30.68	-28.10	Pass

Note: Correction factor = LISN loss + Cable loss.

Test Mode:	Mode 3	Temp/Hum	21.7(°C)/ 55%RH
Phase:	Neutral	Test Date	February 17, 2022
		Test Engineer	Jack Chen

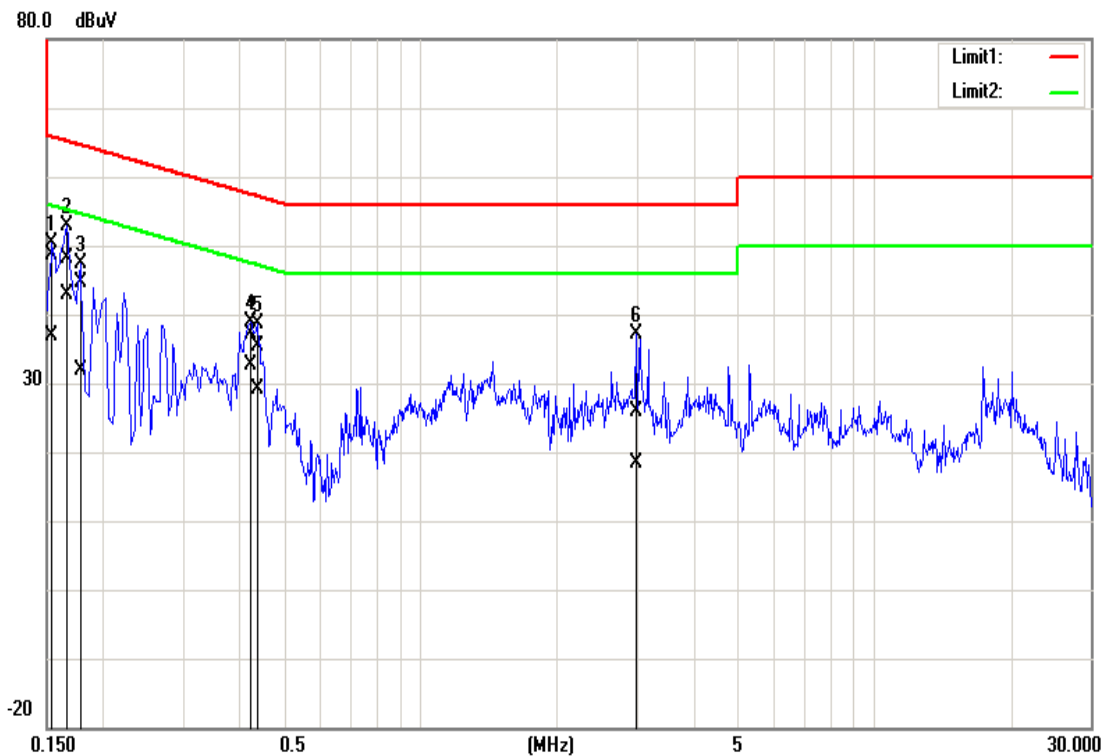

Frequency (MHz)	Quasi Peak reading (dBuV)	Average reading (dBuV)	Correction factor (dB)	Quasi Peak result (dBuV)	Average result (dBuV)	Quasi Peak limit (dBuV)	Average limit (dBuV)	Quasi Peak margin (dB)	Average margin (dB)	Remark
0.1540	48.52	36.74	0.09	48.61	36.83	65.78	55.78	-17.17	-18.95	Pass
0.1660	47.94	42.87	0.09	48.03	42.96	65.16	55.16	-17.13	-12.20	Pass
0.1780	44.55	31.91	0.09	44.64	32.00	64.58	54.58	-19.94	-22.58	Pass
0.4220	36.91	32.58	0.10	37.01	32.68	57.41	47.41	-20.40	-14.73	Pass
0.4380	35.26	29.13	0.10	35.36	29.23	57.10	47.10	-21.74	-17.87	Pass
2.9860	25.64	18.12	0.18	25.82	18.30	56.00	46.00	-30.18	-27.70	Pass

Note: Correction factor = LISN loss + Cable loss.

Report No.: TMWK2201000417KR

4.2 20dB BANDWIDTH AND OCCUPIED BANDWIDTH (99%)

4.2.1 Test Limit

According to §15.247(a) (1), RSS-247 section 5.1(a) and RSS-GEN 6.7,

20 dB Bandwidth : For reporting purposes only.

Occupied Bandwidth(99%) : For reporting purposes only.

4.2.2 Test Procedure

Test method Refer as ANSI C63.10: 2013 clause 7.8.7,

1. The EUT RF output connected to the spectrum analyzer by RF cable.
2. Setting maximum power transmit of EUT
3. SA set RBW = 1% ~ 5% OBW, VBW $\geq 3 \times$ RBW and Detector = Peak, to measurement 20 dB Bandwidth.
4. SA set RBW = 1% ~ 5% OBW, VBW \geq three times the RBW and Detector = Peak, to measurement 99% Bandwidth
5. Measure and record the result of 20 dB Bandwidth and 99% Bandwidth. in the test report.

4.2.3 Test Setup

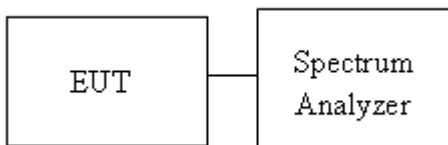

Report No.: TMWK2201000417KR

4.2.4 Test Result

Temperature: 22.1 ~ 22.4°C

Humidity: 55 ~ 62% RH

Tested by: Marco Chan

Test date: January 27 ~ 28, 2022

Test mode: GFSK_BDR-1Mbps mode / 2402-2480 MHz			
Channel	Frequency (MHz)	OBW(99%) (MHz)	20dB BW (MHz)
Low	2402	0.86050	0.9631
Mid	2441	0.86601	0.9639
High	2480	0.86266	0.9630

Test mode: $\pi/4$ -DQPSK_EDR -2Mbps mode / 2402-2480 MHz			
Channel	Frequency (MHz)	OBW(99%) (MHz)	20dB BW (MHz)
Low	2402	1.1898	1.335
Mid	2441	1.1909	1.335
High	2480	1.1912	1.336

Test mode: 8DPSK_EDR-3Mbps mode / 2402-2480 MHz			
Channel	Frequency (MHz)	OBW(99%) (MHz)	20dB BW (MHz)
Low	2402	1.1815	1.312
Mid	2441	1.1829	1.313
High	2480	1.1830	1.312

Report No.: TMWK2201000417KR

Test Data

20dB BANDWIDTH

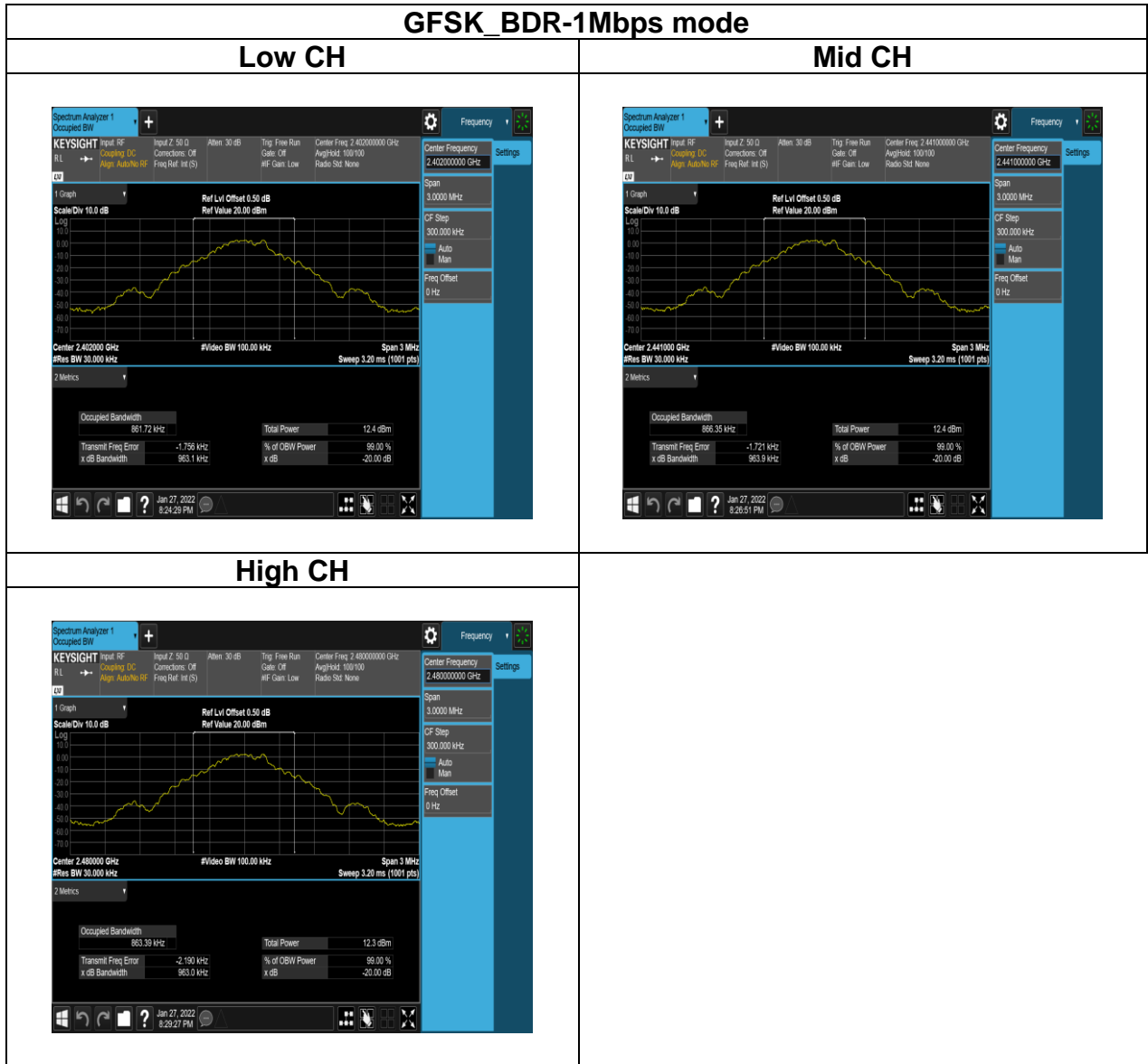

Report No.: TMWK2201000417KR

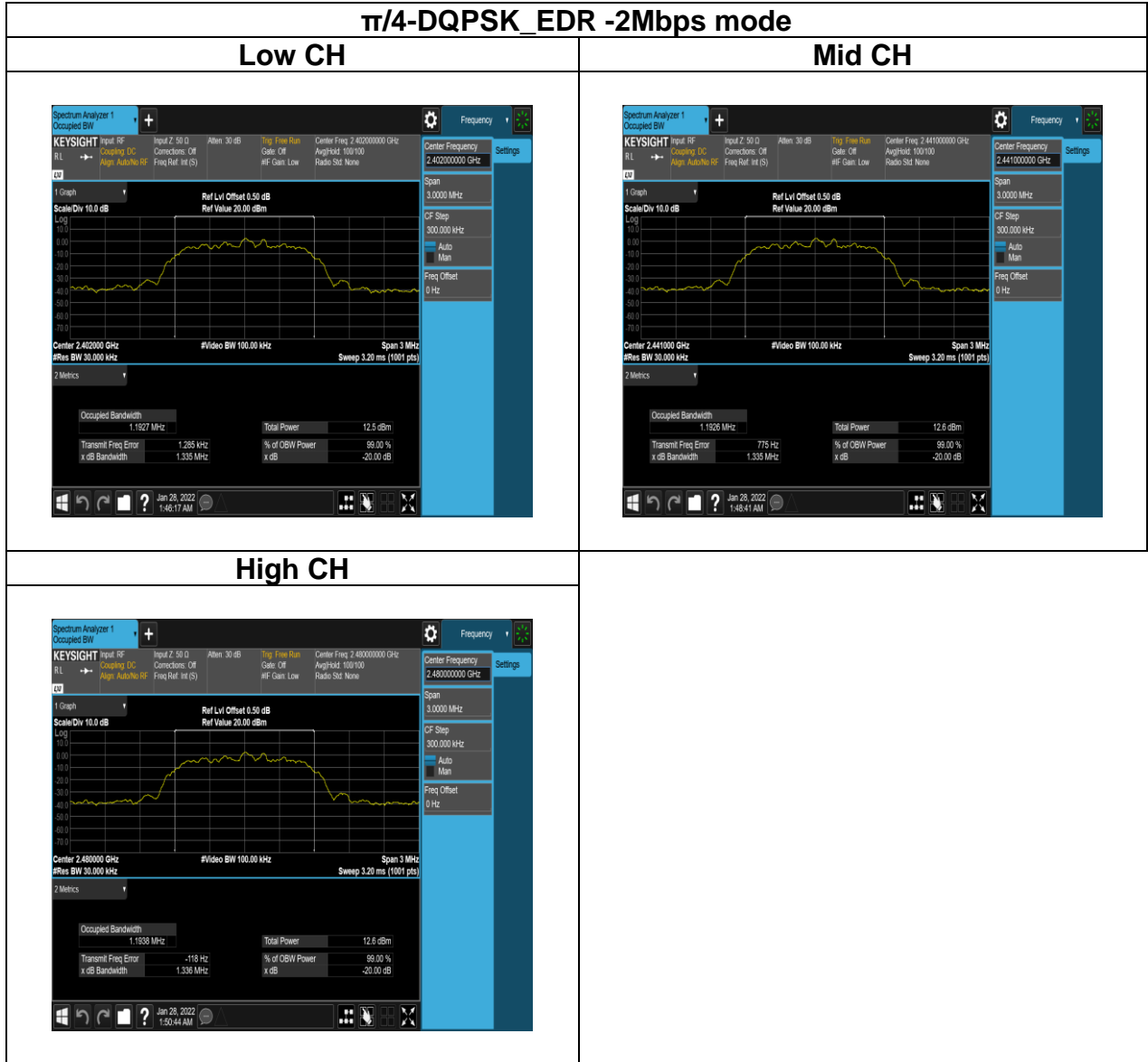

Report No.: TMWK2201000417KR

8DPSK_EDR-3Mbps mode

Low CH

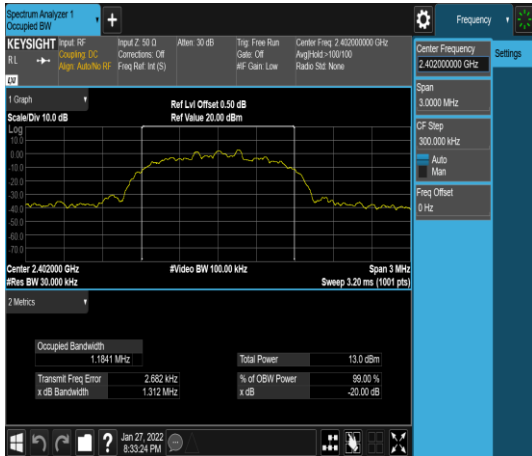

Mid CH

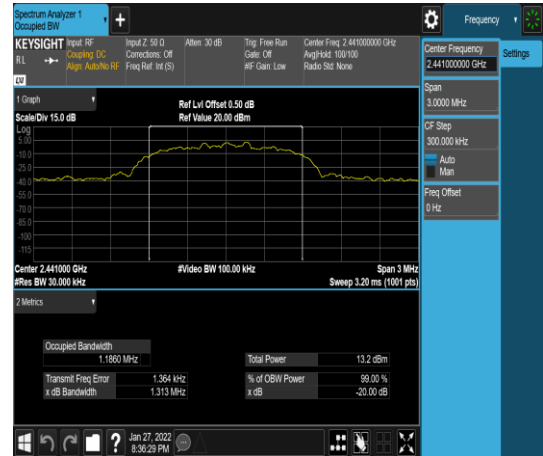

High CH

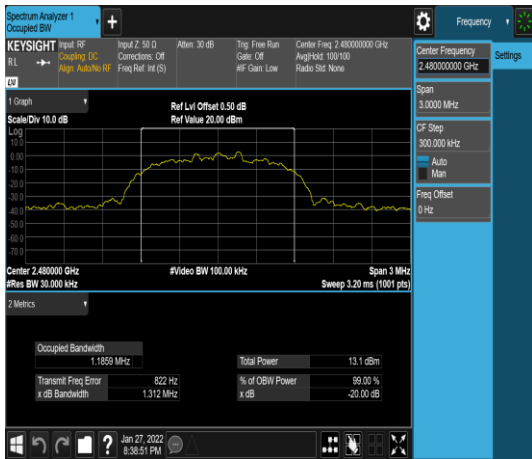

Report No.: TMWK2201000417KR

Test Data

BANDWIDTH 99%

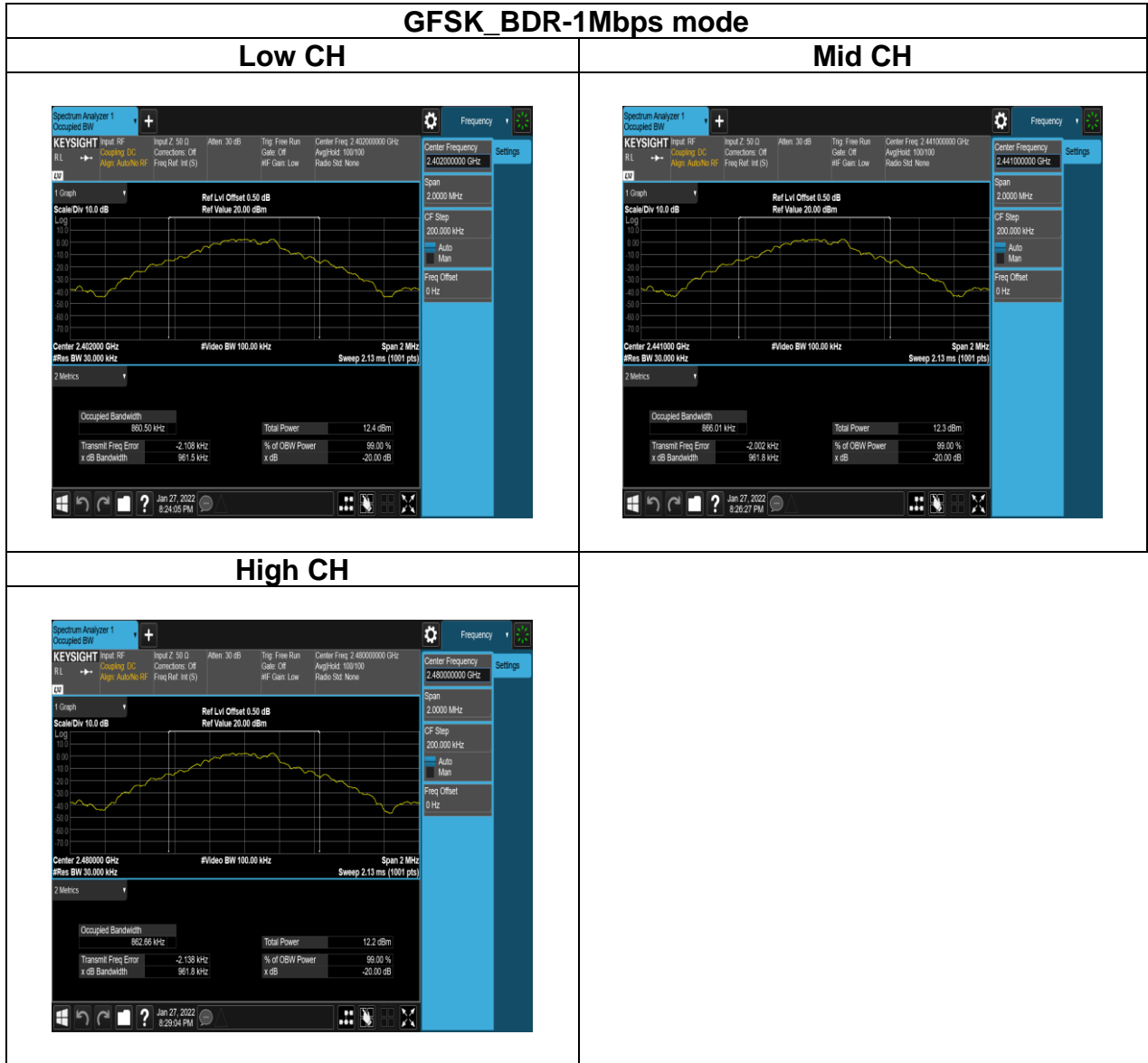

Report No.: TMWK2201000417KR

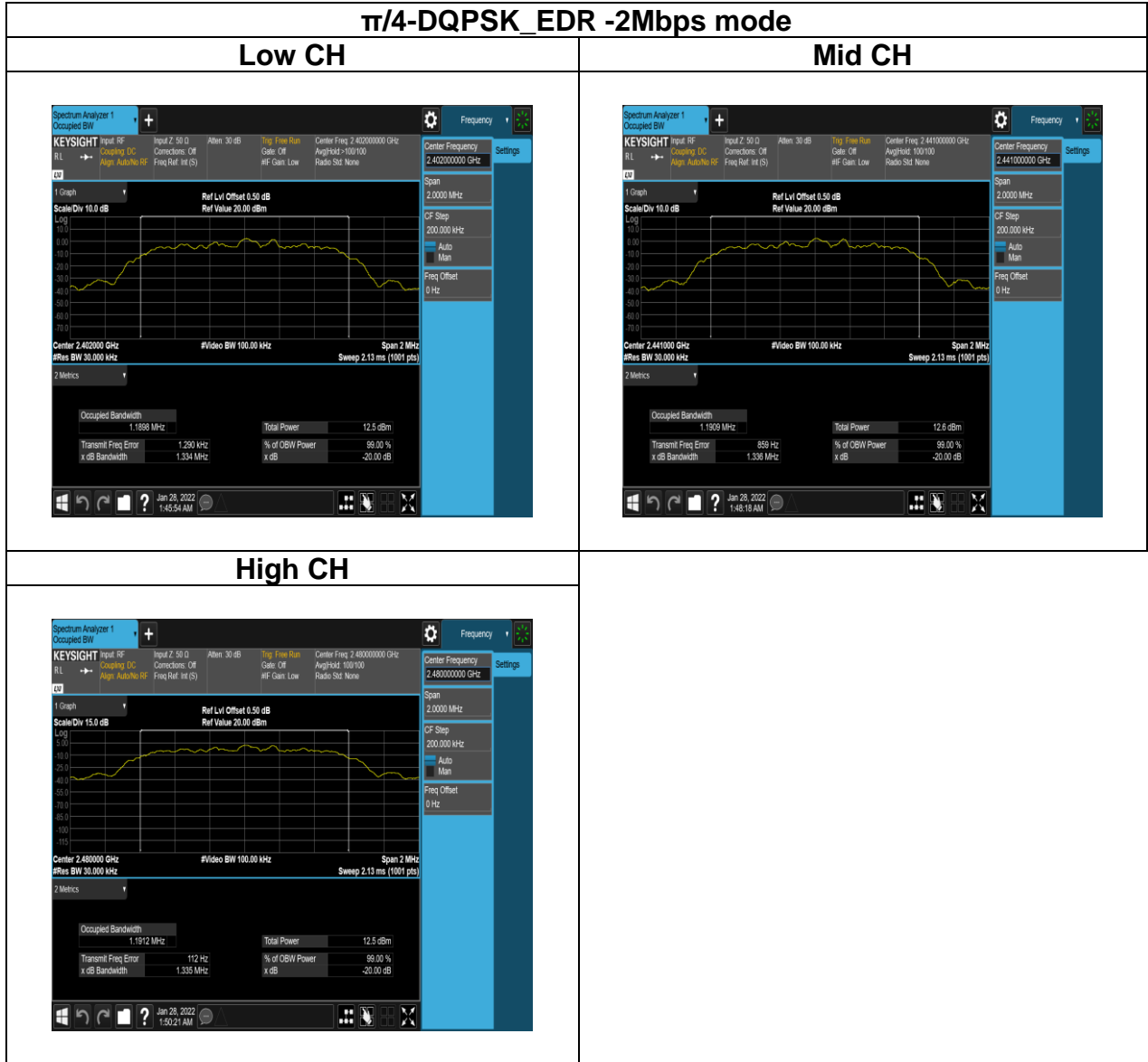

Report No.: TMWK2201000417KR

8DPSK_EDR-3Mbps mode

Low CH



Mid CH

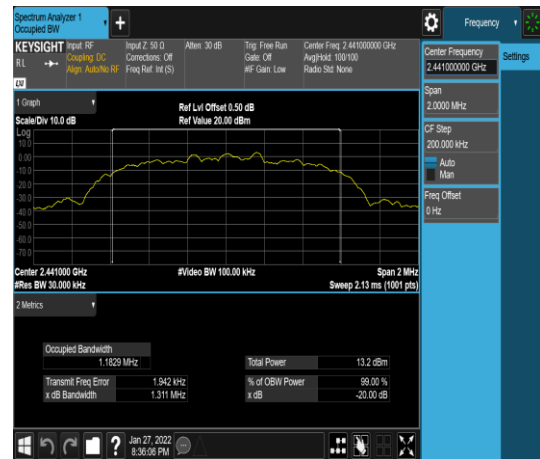

High CH

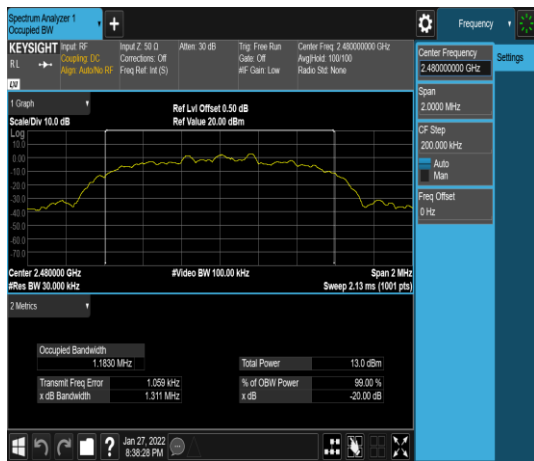

Report No.: TMWK2201000417KR

4.3 OUTPUT POWER MEASUREMENT

4.3.1 Test Limit

According to §15.247(a)(1) and RSS-247 section 5.4(b)

Peak output power :

FCC

Alternatively, frequency hopping systems operating in the 2400-2483.5 MHz band may have hopping channel carrier frequencies that are separated by 25 kHz or two-thirds of the 20 dB bandwidth of the hopping channel, whichever is greater, provided the systems operate with an output power no greater than 125 mW.

IC

According to RSS-247 section 5.4(b), For FHSs operating in the band 2400-2483.5 MHz, the maximum peak conducted output power shall not exceed 1.0 W if the hopset uses 75 or more hopping channels; the maximum peak conducted output power shall not exceed 0.125 W if the hopset uses less than 75 hopping channels. The e.i.r.p. shall not exceed 4 W, except as provided in section 5.4(e).

Limit	<input checked="" type="checkbox"/> Antenna not exceed 6 dBi : 21dBm <input type="checkbox"/> Antenna with DG greater than 6 dBi : 21dBm [Limit = 30 – (DG – 6)]
-------	---

Average output power : For reporting purposes only.

4.3.2 Test Procedure

1. The EUT RF output connected to the power meter by RF cable.
2. Setting maximum power transmit of EUT.
3. The path loss was compensated to the results for each measurement.
4. Measure and record the result of Peak output power and Average output power. in the test report.

4.3.3 Test Setup

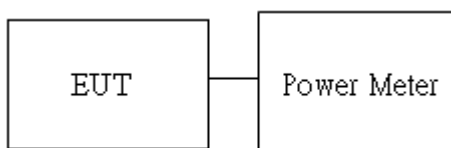

Report No.: TMWK2201000417KR

4.3.4 Test Result

Temperature: 22.1 ~ 22.4°C

Humidity: 55 ~ 62% RH

Tested by: Marco Chan

Test date: January 27 ~ 28, 2022

Peak output power :

1M BR mode (Peak):

CH	Freq. (MHz)	Power set	Peak Output Power (dBm)	Output Power (mW)	Limit (mW)
Low	2402	10	4.75	2.985	125
Mid	2441	10	4.82	3.034	125
High	2480	10	4.72	2.965	125

2M EDR mode (Peak):

CH	Freq. (MHz)	Power set	Peak Output Power (dBm)	Output Power (mW)	Limit (mW)
Low	2402	10	7.28	5.346	125
Mid	2441	10	7.19	5.236	125
High	2480	10	7.10	5.129	125

3M EDR mode (Peak):

CH	Freq. (MHz)	Power set	Peak Output Power (dBm)	Output Power (mW)	Limit (mW)
Low	2402	10	7.74	5.943	125
Mid	2441	10	7.76	5.970	125
High	2480	10	7.62	5.781	125

Report No.: TMWK2201000417KR

Average output power :

1M BR mode (Average):

CH	Freq. (MHz)	Power set	Max. Avg.Output include tune up tolerance Power (dBm)	Output Power (mW)	Limit (mW)
Low	2402	10	3.96	2.486	125
Mid	2441	10	3.99	2.503	125
High	2480	10	3.95	2.480	125

2M EDR mode (Average):

CH	Freq. (MHz)	Power set	Max. Avg.Output include tune up tolerance Power (dBm)	Output Power (mW)	Limit (mW)
Low	2402	10	3.85	2.424	125
Mid	2441	10	3.84	2.418	125
High	2480	10	3.86	2.429	125

3M EDR mode (Average):

CH	Freq. (MHz)	Power set	Max. Avg.Output include tune up tolerance Power (dBm)	Output Power (mW)	Limit (mW)
Low	2402	10	3.95	2.480	125
Mid	2441	10	3.97	2.492	125
High	2480	10	3.98	2.498	125

EIRP power :

1M BR mode EIRP

Channel	Frequency (MHz)	Power set	Max. Avg. Output include tune up tolerance Power (dBm)	Antenna Gain (dBi)	EIRP (mW)	Limit (mW)
Low	2402	10	3.96	3.32	5.340	4000
Mid	2441	10	3.99	3.32	5.377	4000
High	2480	10	3.95	3.32	5.327	4000

2M EDR mode EIRP

Channel	Frequency (MHz)	Power set	Max. Avg. Output include tune up tolerance Power (dBm)	Antenna Gain (dBi)	EIRP (mW)	Limit (mW)
Low	2402	10	3.85	3.32	5.206	4000
Mid	2441	10	3.84	3.32	5.194	4000
High	2480	10	3.86	3.32	5.218	4000

3M EDR mode EIRP

Channel	Frequency (MHz)	Power set	Max. Avg. Output include tune up tolerance Power (dBm)	Antenna Gain (dBi)	EIRP (mW)	Limit (mW)
Low	2402	10	3.95	3.32	5.327	4000
Mid	2441	10	3.97	3.32	5.352	4000
High	2480	10	3.98	3.32	5.364	4000

4.4 FREQUENCY SEPARATION

4.4.1 Test Limit

According to §15.247(a)(1) and RSS-247 section 5.1(b)

Alternatively, frequency hopping systems operating in the 2400-2483.5 MHz band may have hopping channel carrier frequencies that are separated by 25 kHz or two-thirds of the 20 dB bandwidth of the hopping channel, whichever is greater, provided the systems operate with an output power no greater than 125 mW.

Limit	> two-thirds of the 20 dB bandwidth
-------	-------------------------------------

4.4.2 Test Procedure

1. Place the EUT on the table and set it in transmitting mode.
2. EUT RF output port connected to the SA by RF cable.
3. Set the spectrum analyzer as RBW = 300kHz, VBW = 300kHz, Sweep = auto.
Max hold, mark 3 peaks of hopping channel and record the 3 peaks frequency

4.4.3 Test Setup

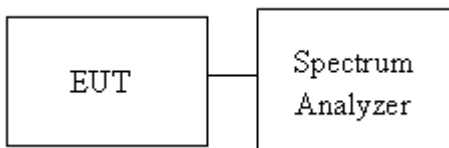

Report No.: TMWK2201000417KR

4.4.4 Test Result

Temperature: 22.1 ~ 22.4°C

Humidity: 55 ~ 62% RH

Tested by: Marco Chan

Test date: January 27 ~ 28, 2022

Test mode: GFSK_BDR-1Mbps mode / 2402-2480 MHz				
Channel	Frequency (MHz)	Channel Separation (MHz)	Channel Separation Limits (MHz)	Result
Low	2402	1.000	0.64	PASS
Mid	2441	1.000	0.64	PASS
High	2480	1.000	0.64	PASS

Test mode: $\pi/4$ -DQPSK_EDR -2Mbps mode / 2402-2480 MHz				
Channel	Frequency (MHz)	Channel Separation (MHz)	Channel Separation Limits (MHz)	Result
Low	2402	1.000	0.89	PASS
Mid	2441	1.000	0.89	PASS
High	2480	1.000	0.89	PASS

Test mode: 8DPSK_EDR-3Mbps mode / 2402-2480 MHz				
Channel	Frequency (MHz)	Channel Separation (MHz)	Channel Separation Limits (MHz)	Result
Low	2402	1.000	0.87	PASS
Mid	2441	1.000	0.88	PASS
High	2480	1.000	0.87	PASS

Report No.: TMWK2201000417KR

Test Data



Report No.: TMWK2201000417KR



Report No.: TMWK2201000417KR

8DPSK_EDR-3Mbps mode

CH Low



CH Mid

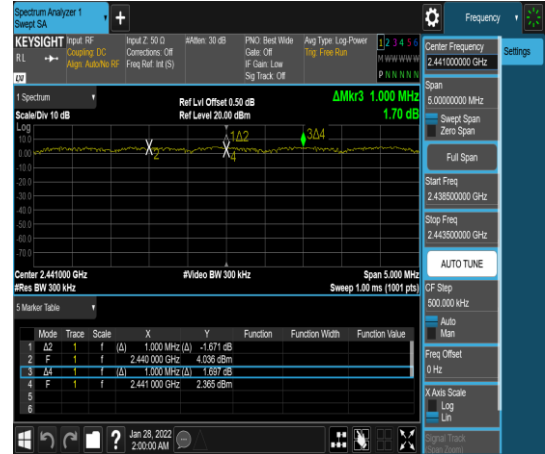

CH High



4.5 NUMBER OF HOPPING

4.5.1 Test Limit

According to §15.247(a)(1)(iii) and RSS-247 section 5.1(d)

Frequency hopping systems in the 2400-2483.5 MHz band shall use at least 15 channels.

4.5.2 Test Procedure

Test method Refer as ANSI C63.10: 2013 clause 7.8.3

1. Place the EUT on the table and set it in transmitting mode.
2. EUT RF output port connected to the SA by RF cable.
3. Set spectrum analyzer Start Freq. = 2400 MHz, Stop Freq. = 2441 MHz for Low range, Start Freq. = 2441 MHz, Stop Freq. = 2483.5 MHz for High range ; RBW=430KHz, VBW = 1.5MHz.
4. Max hold, view and count how many channel in the band.

4.5.3 Test Setup

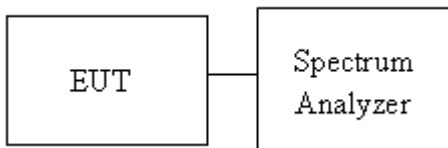

4.5.4 Test Result

Temperature: 22.1 ~ 22.4°C

Humidity: 55 ~ 62% RH

Tested by: Marco Chan

Test date: January 27 ~ 28, 2022

Number of Hopping				
Mode	Frequency (MHz)	Hopping Channel Number	Hopping Channel Number Limits	Result
BDR-1Mbps	2402-2480	79	15	Pass
EDR-3Mbps	2402-2480	79	15	

Report No.: TMWK2201000417KR

Test Data

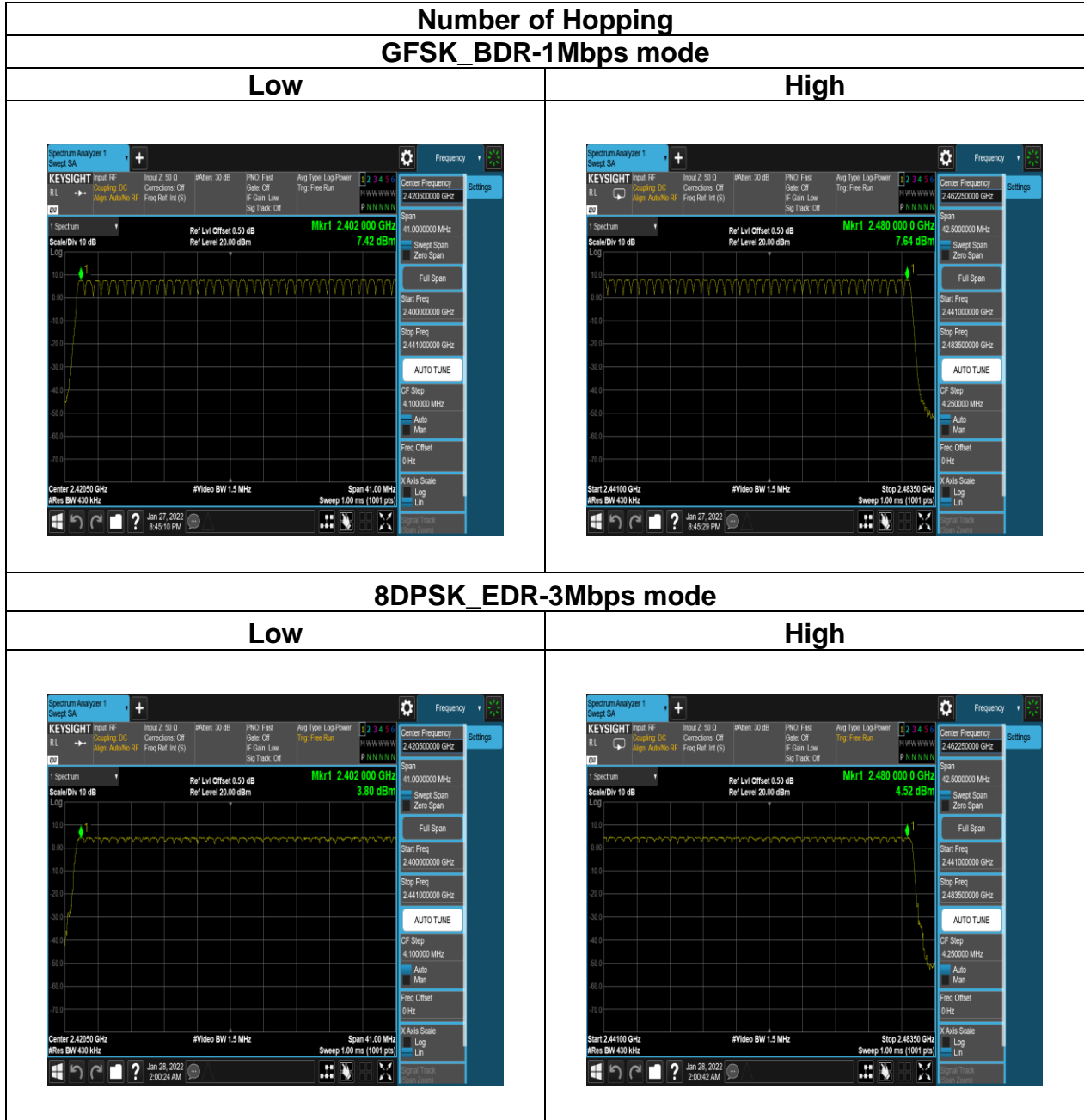

Report No.: TMWK2201000417KR

4.6 CONDUCTED BANDEDGE AND SPURIOUS EMISSION

4.6.1 Test Limit

According to §15.247(d) and RSS-247 section 5.5

Limit	-20 dBc
-------	---------

4.6.2 Test Procedure

1. EUT RF output port connected to the SA by RF cable, and the path loss was compensated to result.
2. SA setting, RBW=100kHz, VBW=300kHz, Detector=Peak, Trace mode = max hold, SWT = Auto.
3. The Band Edge at 2.4GHz and 2.4835GHz are investigated with both hopping "ON" and "OFF" modes ".

4.6.3 Test Setup

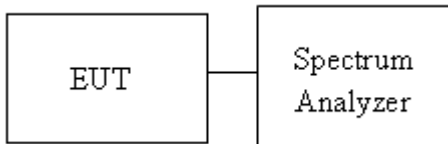

Report No.: TMWK2201000417KR

4.6.4 Test Result

Temperature: 22.1 ~ 22.4°C

Humidity: 55 ~ 62% RH

Tested by: Marco Chan

Test date: January 27 ~ 28, 2022

Test Data

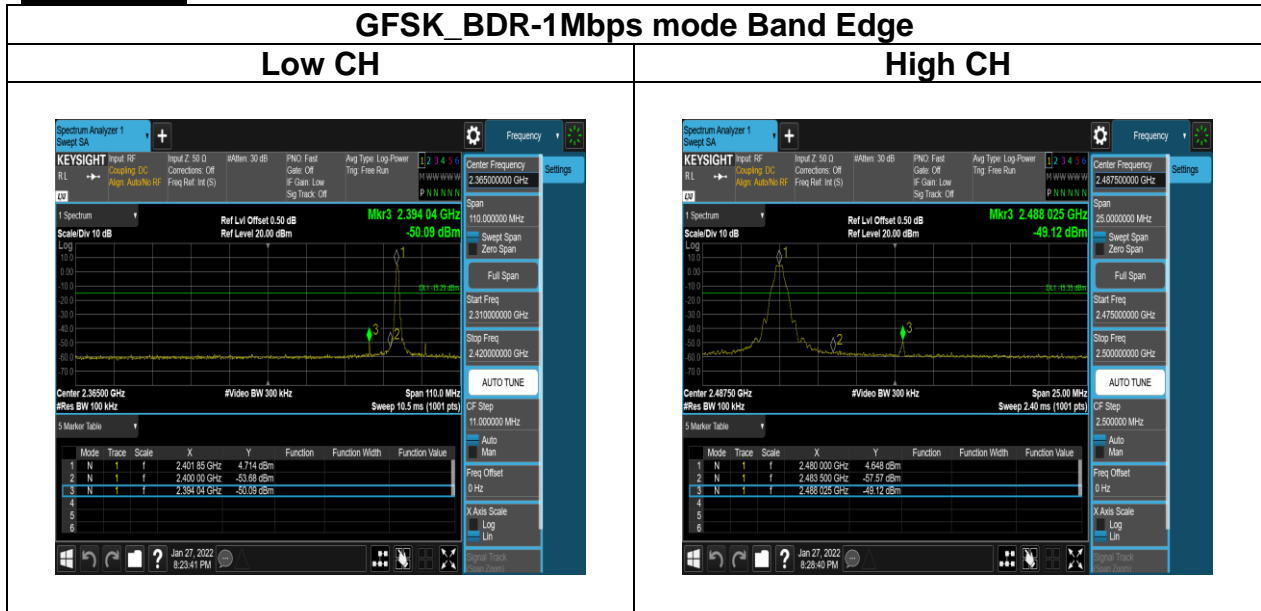

Report No.: TMWK2201000417KR

GFSK_BDR-1Mbps mode Spurious Emission 30MHz-25GHz

Low CH

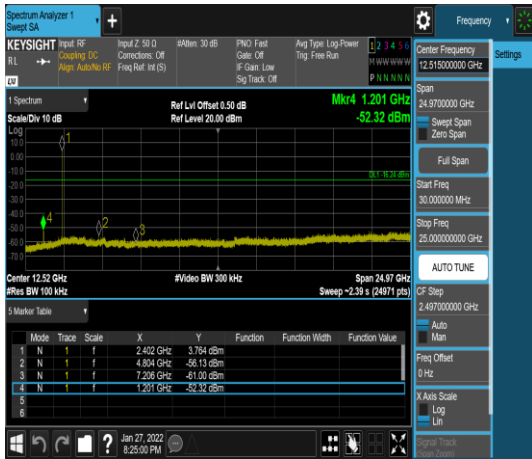

Mid CH

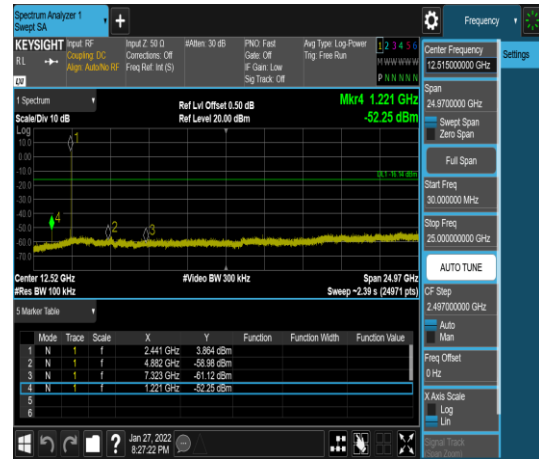

High CH

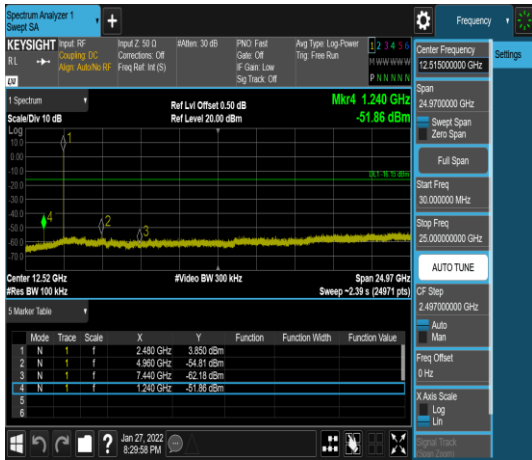

Report No.: TMWK2201000417KR

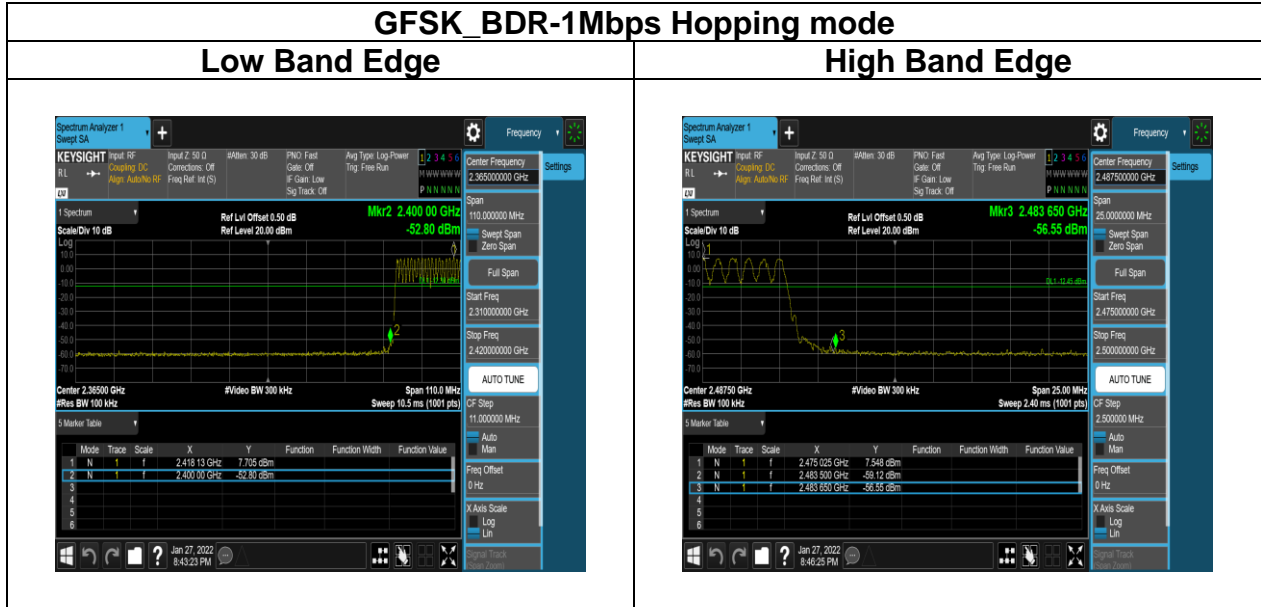

Report No.: TMWK2201000417KR

π/4-DQPSK_EDR-2Mbps mode Spurious Emission 30MHz-25GHz

Low CH

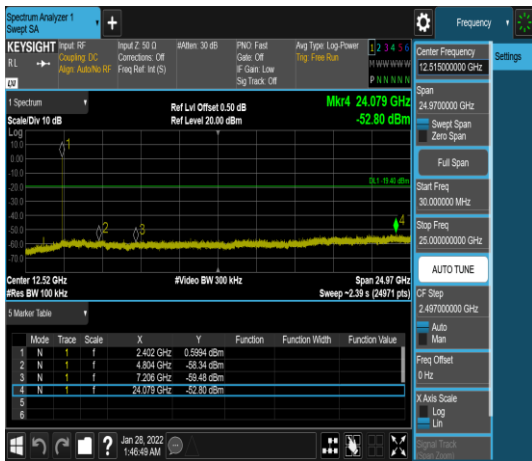

Mid CH



High CH



Report No.: TMWK2201000417KR

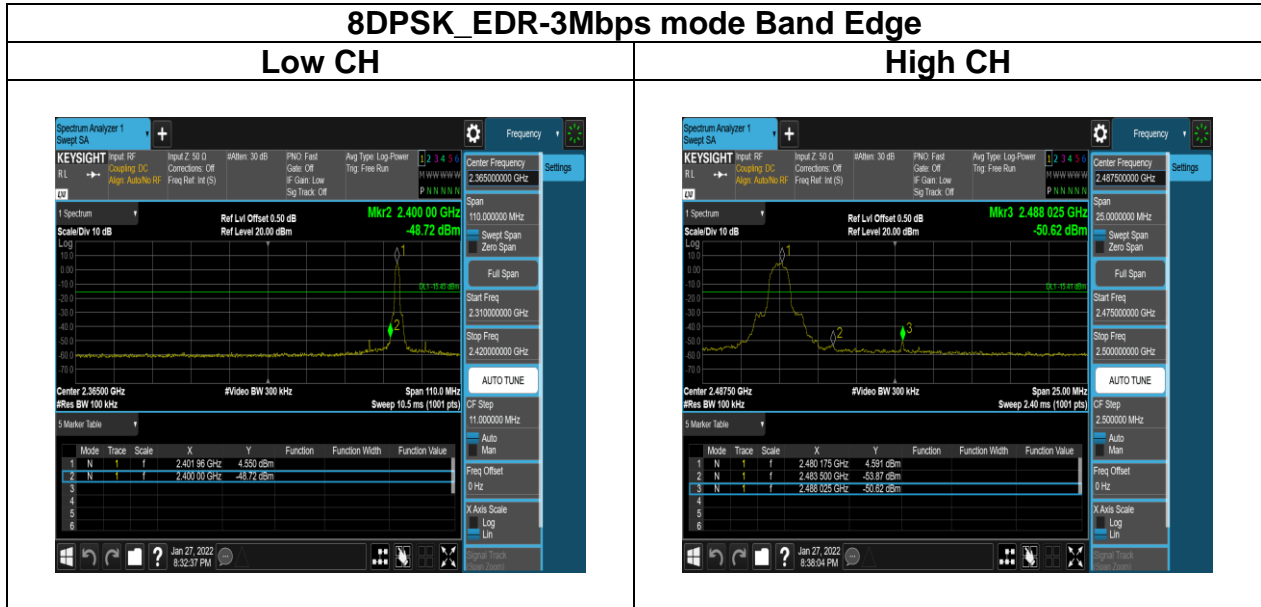

Report No.: TMWK2201000417KR

8DPSK_EDR-3Mbps mode Spurious Emission 30MHz-25GHz

Low CH

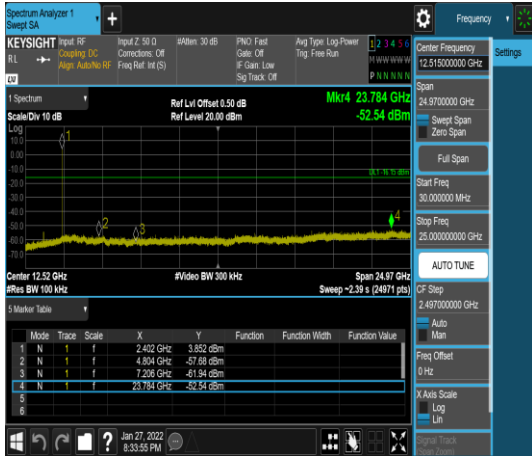

Mid CH

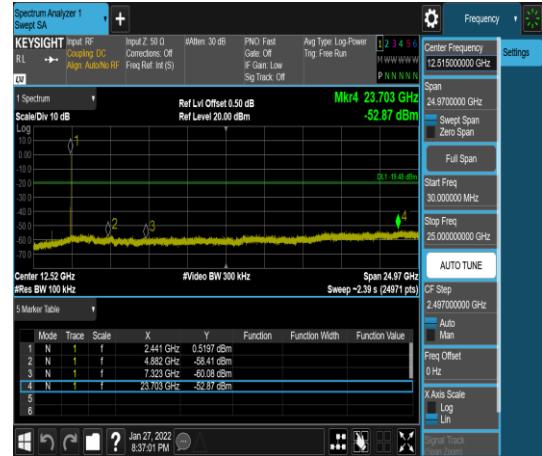

High CH

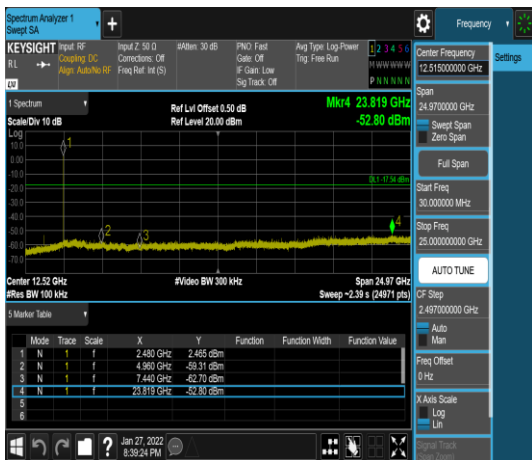

Report No.: TMWK2201000417KR

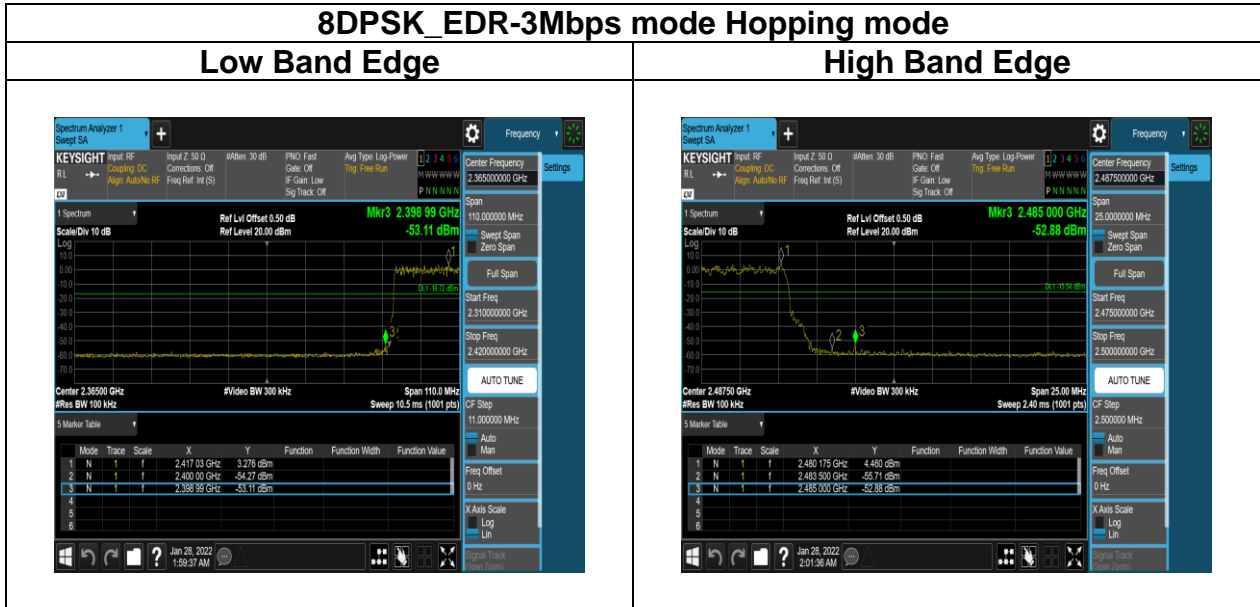

4.7 TIME OF OCCUPANCY (DWELL TIME)

4.7.1 Test Limit

According to §15.247(a)(1)(iii) and RSS-247 section 5.1(d)

The average time of occupancy on any channel shall not be greater than 0.4 seconds within a period of 0.4 seconds multiplied by the number of hopping channels employed.

4.7.2 Test Procedure

1. EUT RF output port connected to the SA by RF cable.
2. Set center frequency of spectrum analyzer = operating frequency.
3. Set the spectrum analyzer as RBW, VBW=1MHz, Sweep = 1 ms

4.7.3 Test Setup

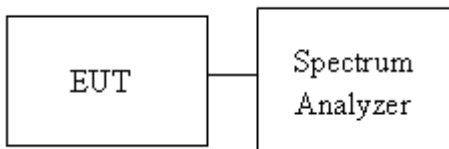

4.7.4 Test Result

Temperature: 22.1 ~ 22.4°C

Humidity: 55 ~ 62% RH

Tested by: Marco Chan

Test date: January 27 ~ 28, 2022

For GFSK (1Mbps)

Channel	PACKET TYPE	Measurement Result (ms)	Dwell Time (ms)	Ton+off (ms)	Limit (ms)	VBW setting (kHz)
Mid	DH1	124.80	0.390	1.250	400ms	3.00
	DH3	262.40	1.640	2.500	400ms	1.00
	DH5	308.80	2.895	3.750	400ms	1.00

CH Mid DH1 time slot = 0.390 * (1600/2/79) * 31.6 = 124.80 (ms)
 DH3 time slot = 1.640 * (1600/4/79) * 31.6 = 262.40 (ms)
 DH5 time slot = 2.895 * (1600/6/79) * 31.6 = 308.80 (ms)

For π/4 DQPSK (2Mbps)

Channel	PACKET TYPE	Measurement Result (ms)	Dwell Time (ms)	Ton+off (ms)	Limit (ms)	VBW setting (kHz)
Mid	2DH1	126.40	0.395	1.250	400ms	3.00
	2DH3	264.00	1.650	2.500	400ms	1.00
	2DH5	308.80	2.895	3.750	400ms	1.00

CH Mid 2DH1 time slot = 0.395 * (1600/2/79) * 31.6 = 126.40 (ms)
 2DH3 time slot = 1.650 * (1600/4/79) * 31.6 = 264.00 (ms)
 2DH5 time slot = 2.895 * (1600/6/79) * 31.6 = 308.80 (ms)

For 8-DPSK (3Mbps)

Channel	PACKET TYPE	Measurement Result (ms)	Dwell Time (ms)	Ton+off (ms)	Limit (ms)	VBW setting (kHz)
Mid	3DH1	128.00	0.400	1.250	400ms	3.00
	3DH3	264.00	1.650	2.500	400ms	1.00
	3DH5	310.40	2.910	3.750	400ms	1.00

CH Mid 3DH1 time slot = 0.400 * (1600/2/79) * 31.6 = 128.00 (ms)
 3DH3 time slot = 1.650 * (1600/4/79) * 31.6 = 264.00 (ms)
 3DH5 time slot = 2.910 * (1600/6/79) * 31.6 = 310.40 (ms)

Report No.: TMWK2201000417KR

For GFSK (1Mbps)



Report No.: TMWK2201000417KR

For $\pi/4$ DQPSK (2Mbps)



Report No.: TMWK2201000417KR

For 8-DPSK (3Mbps)



Report No.: TMWK2201000417KR

4.8 RADIATION BANDEDGE AND SPURIOUS EMISSION

4.8.1 Test Limit

FCC according to §15.247(d), §15.209 and §15.205,

In any 100 kHz bandwidth outside the authorized frequency band, all harmonic and spurious must be least 20 dB below the highest emission level with the authorized frequency band. Radiation emission which fall in the restricted bands must also follow the FCC section 15.209 as below limit in table.

Below 30 MHz

Frequency	Field Strength (microvolts/m)	Magnetic H-Field (microamperes/m)	Measurement Distance (metres)
9-490 kHz	2,400/F (F in kHz)	2,400/F (F in kHz)	300
490-1,705 kHz	24,000/F (F in kHz)	24,000/F (F in kHz)	30
1.705-30 MHz	30	N/A	30

Above 30 MHz

Frequency (MHz)	Field Strength microvolts/m at 3 metres (watts, e.i.r.p.)	
	Transmitters	Receivers
30-88	100 (3 nW)	100 (3 nW)
88-216	150 (6.8 nW)	150 (6.8 nW)
216-960	200 (12 nW)	200 (12 nW)
Above 960	500 (75 nW)	500 (75 nW)

Remark:

Although these tests were performed other than open area test site, adequate comparison measurements were confirmed against 30 m open are test site. Therefore sufficient tests were made to demonstrate that the alternative site produces results that correlate with the ones of tests made in an open field based on KDB 414788.

Report No.: TMWK2201000417KR

IC according to RSS-247 section 5.5, RSS-Gen, Section 8.9 and 8.10

RSS-Gen Table 3 and Table 5 – General Field Strength Limits for Transmitters and Receivers at Frequencies Above 30 MHz ^(Note)

Frequency (MHz)	Field Strength microvolts/m at 3 metres (watts, e.i.r.p.)	
	Transmitters	Receivers
30-88	100 (3 nW)	100 (3 nW)
88-216	150 (6.8 nW)	150 (6.8 nW)
216-960	200 (12 nW)	200 (12 nW)
Above 960	500 (75 nW)	500 (75 nW)

Note: Measurements for compliance with the limits in table 3 may be performed at distances other than 3 metres, in accordance with Section 6.6.

RSS-Gen Table 6: General Field Strength Limits for Transmitters at Frequencies Below 30 MHz (Transmit)

Frequency	Magnetic field strength (H-Field) ($\mu\text{A/m}$)	Measurement Distance (m)
9-490 kHz ^{Note}	6.37/F (F in kHz)	300
490-1,705 kHz	63.7/F (F in kHz)	30
1.705-30 MHz	0.08	30

Note: The emission limits for the ranges 9-90 kHz and 110-490 kHz are based on measurements employing a linear average detector.

Report No.: TMWK2201000417KR

4.8.2 Test Procedure

1. The EUT is placed on a turntable, Above 1 GHz is 1.5m and below 1 GHz is 0.8m above ground plane. The EUT Configured un accordance with ANSI C63.10: 2013, and the EUT set in a continuous mode.

2. The turntable shall be rotated for 360 degrees to determine the position of maximum emission level. And EUT is set 3m away from the receiving antenna, which is scanned from 1m to 4m above the ground plane to find out the highest emissions. Measurement are made polarized in both the vertical and the horizontal positions with antenna.

3. Span shall wide enough to full capture the emission measured. The SA from 9kHz to 26.5GHz set to the low, Mid and High channels with the EUT transmit.

Note: No emission found between lowest internal used/generated frequency to 30MHz(9KHz~30MHz)

4. For harmonic, the worst case of output power was BDR-1Mbps. Therefore only BDR-1Mbps record in the report.

5. The SA setting following :

(1) Below 1G : RBW = 100kHz, VBW \geq 3 RBW, Sweep = Auto, Detector = Peak, Trace = Max hold.

(2) Above 1G :

(2.1) For Peak measurement : RBW = 1MHz, VBW \geq 3 RBW, Sweep = Auto, Detector = Peak, Trace = Max hold.

(2.2) For Average measurement : RBW = 1MHz, VBW

·If Duty Cycle \geq 98%, VBW=10Hz.

·If Duty Cycle < 98%, VBW \geq 1/T.

6. Data result

Actual FS=Spectrum Reading Level + Factor

Margin=Actual FS- Limit

4.8.3 Test Setup

9kHz ~ 30MHz

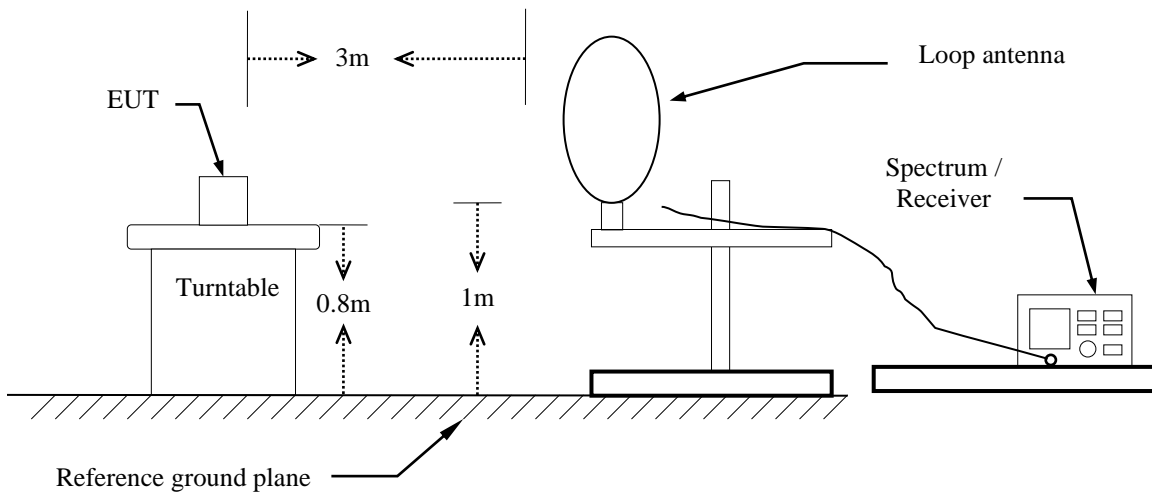

30MHz ~ 1GHz

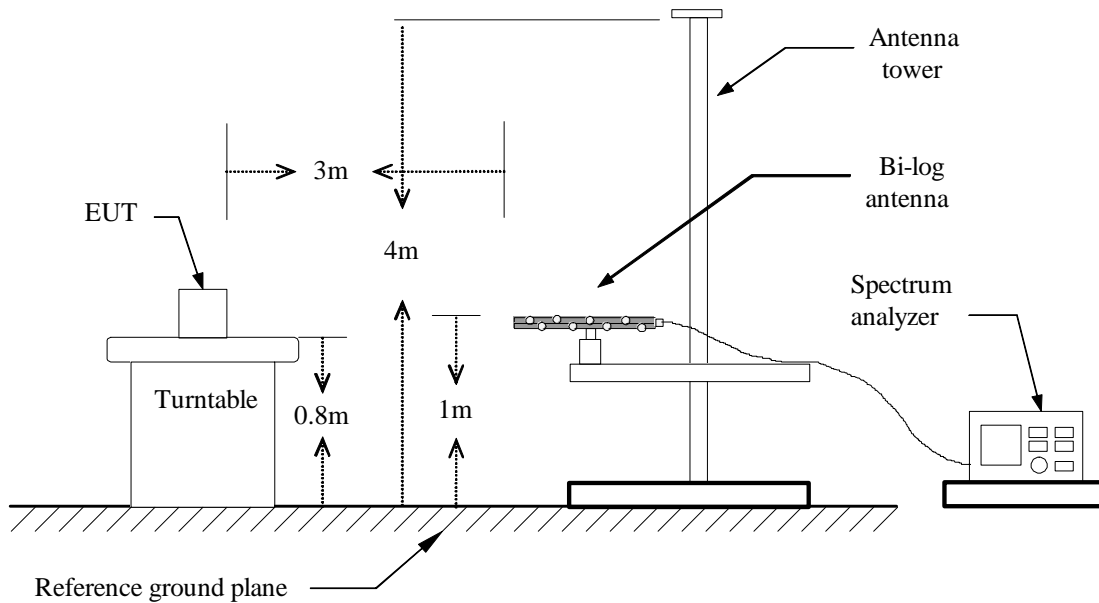

Above 1 GHz

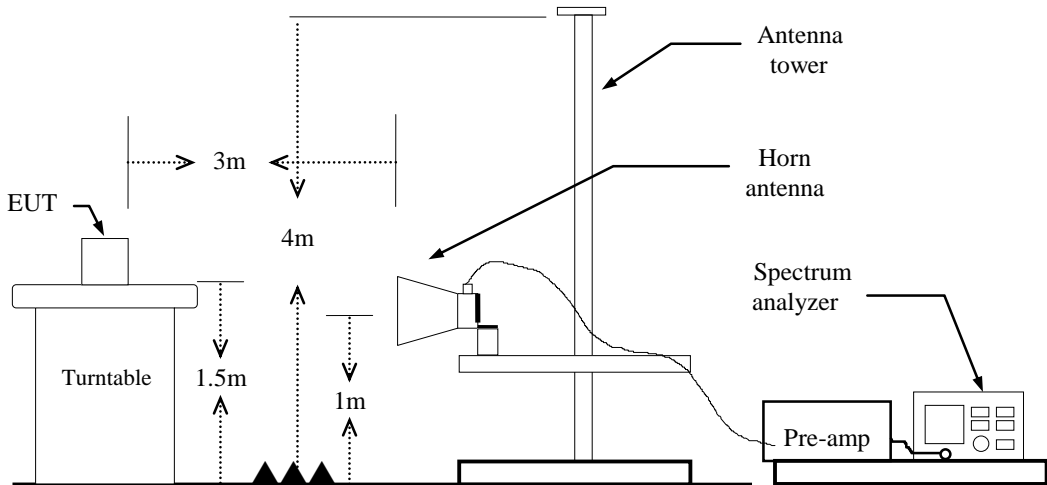

Report No.: TMWK2201000417KR

4.8.4 Test Result

Band Edge Test Data

Test Mode:	GFSK_BDR-1Mbps Low CH	Temp/Hum	21.1(°C)/ 57%RH
Test Item	Band Edge	Test Date	February 16, 2022
Polarize	Vertical	Test Engineer	Tony Chao
Detector	Peak / Average		

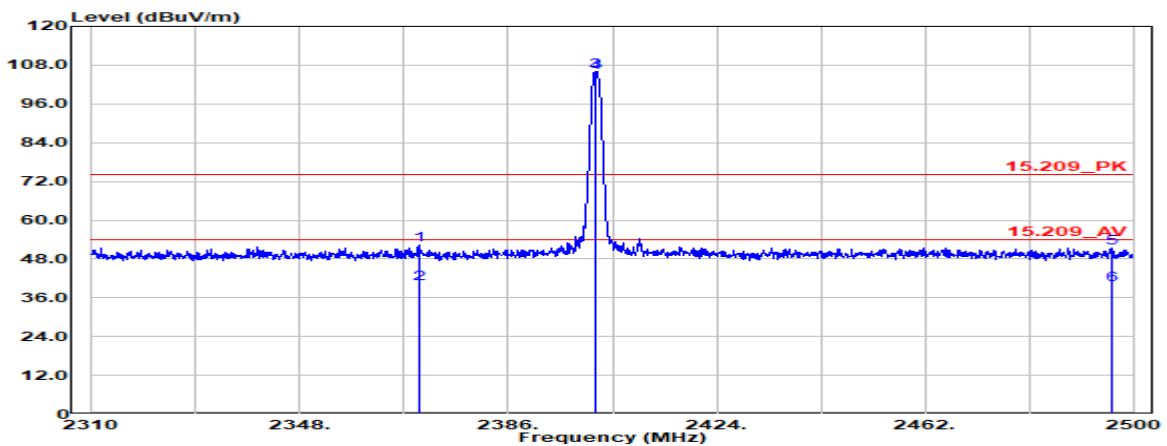

Freq. MHz	Detector Mode PK/QP/AV	Spectrum Reading Level dBµV	Factor dB	Actual FS dBµV/m	Limit @3m dBµV/m	Margin dB
2369.66	Peak	39.89	12.38	52.27	74.00	-21.73
2369.66	Average	28.09	12.38	40.47	54.00	-13.53
2402.00	Peak	93.46	12.54	106.00	-	-
2402.00	Average	93.05	12.54	105.59	-	-
2496.01	Peak	38.36	13.16	51.52	74.00	-22.48
2496.01	Average	26.69	13.16	39.86	54.00	-14.14

Report No.: TMWK2201000417KR

Test Mode:	GFSK_BDR-1Mbps Low CH	Temp/Hum	21.1(°C)/ 57%RH
Test Item	Band Edge	Test Date	February 16, 2022
Polarize	Horizontal	Test Engineer	Tony Chao
Detector	Peak / Average		

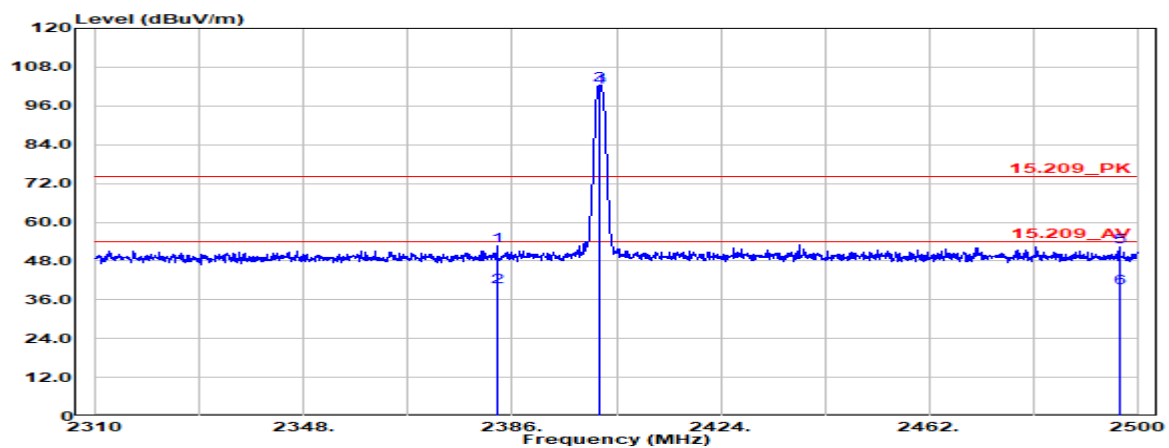

Freq. MHz	Detector Mode PK/QP/AV	Spectrum Reading Level dB μ V	Factor dB	Actual FS dB μ V/m	Limit @3m dB μ V/m	Margin dB
2383.25	Peak	40.34	12.45	52.79	74.00	-21.21
2383.25	Average	27.42	12.45	39.86	54.00	-14.14
2402.00	Peak	89.78	12.54	102.32	-	-
2402.00	Average	89.40	12.54	101.94	-	-
2496.77	Peak	39.23	13.17	52.40	74.00	-21.60
2496.77	Average	26.63	13.17	39.80	54.00	-14.20

Report No.: TMWK2201000417KR

Test Mode:	GFSK_BDR-1Mbps High CH	Temp/Hum	21.1(°C)/ 57%RH
Test Item	Band Edge	Test Date	February 16, 2022
Polarize	Vertical	Test Engineer	Tony Chao
Detector	Peak / Average		

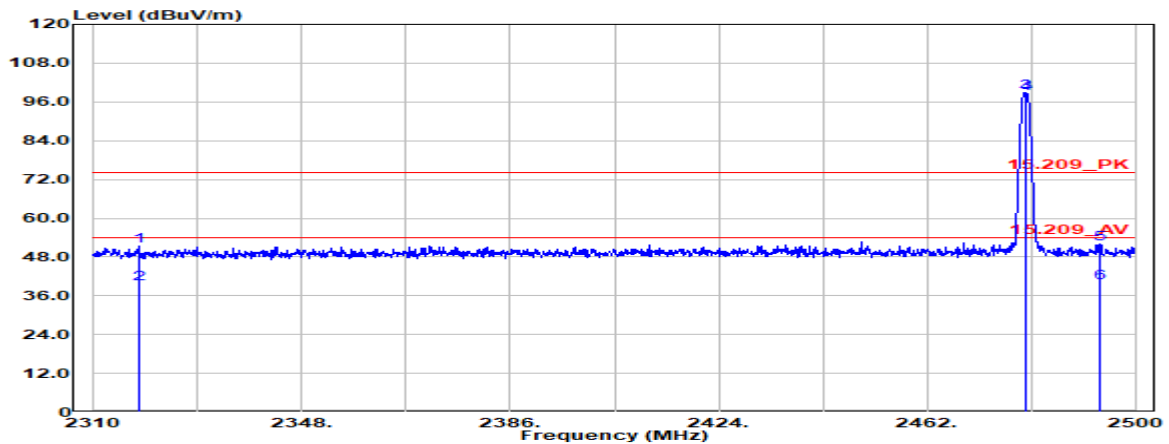

Freq. MHz	Detector Mode PK/QP/AV	Spectrum Reading Level dB μ V	Factor dB	Actual FS dB μ V/m	Limit @3m dB μ V/m	Margin dB
2318.17	Peak	39.19	12.23	51.42	74.00	-22.58
2318.17	Average	27.51	12.23	39.74	54.00	-14.26
2480.00	Peak	85.95	13.05	99.00	-	-
2480.00	Average	85.56	13.05	98.62	-	-
2493.73	Peak	38.95	13.15	52.09	74.00	-21.91
2493.73	Average	26.97	13.15	40.11	54.00	-13.89

Report No.: TMWK2201000417KR

Test Mode:	GFSK_BDR-1Mbps High CH	Temp/Hum	21.1(°C)/ 57%RH
Test Item	Band Edge	Test Date	February 16, 2022
Polarize	Horizontal	Test Engineer	Tony Chao
Detector	Peak / Average		

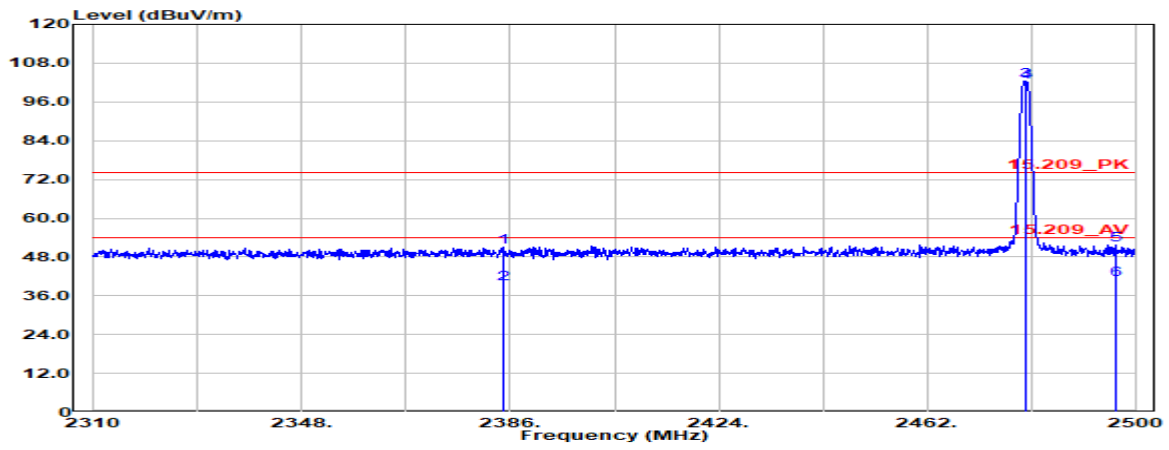

Freq. MHz	Detector Mode PK/QP/AV	Spectrum Reading Level dBμV	Factor dB	Actual FS dBμV/m	Limit @3m dBμV/m	Margin dB
2384.77	Peak	38.73	12.45	51.18	74.00	-22.82
2384.77	Average	27.11	12.45	39.57	54.00	-14.43
2480.00	Peak	89.41	13.05	102.47	-	-
2480.00	Average	89.03	13.05	102.08	-	-
2496.58	Peak	38.61	13.17	51.78	74.00	-22.22
2496.58	Average	27.75	13.17	40.91	54.00	-13.09

Test Mode:	GFSK_BDR-1Mbps Hopping	Temp/Hum	21.1(°C)/ 57%RH
Test Item	Band Edge	Test Date	February 16, 2022
Polarize	Vertical	Test Engineer	Tony Chao
Detector	Peak / Average		

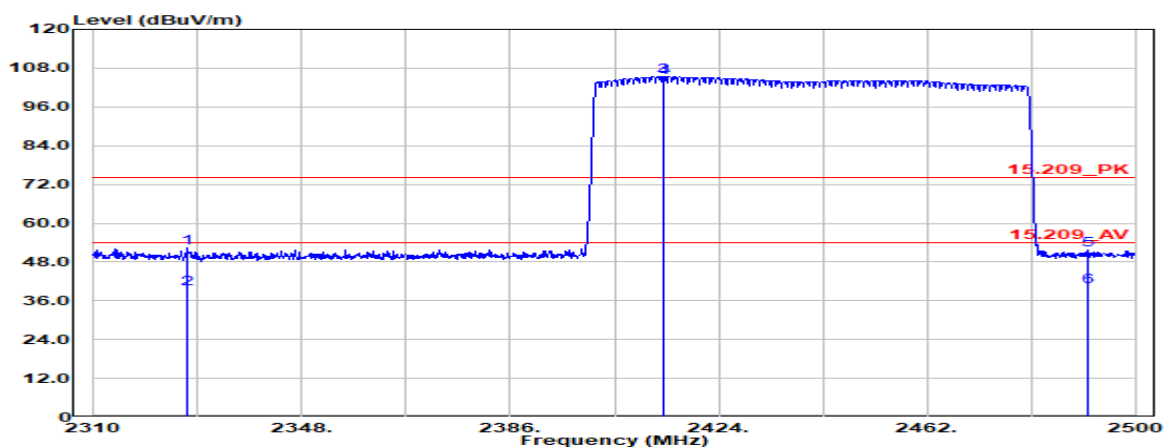

Freq. MHz	Detector Mode PK/QP/AV	Spectrum Reading Level dBμV	Factor dB	Actual FS dBμV/m	Limit @3m dBμV/m	Margin dB
2326.91	Peak	40.04	12.24	52.29	74.00	-21.71
2326.91	Average	27.59	12.24	39.83	54.00	-14.17
2414.12	Peak	92.73	12.62	105.35	-	-
2414.12	Average	92.36	12.62	104.98	-	-
2491.26	Peak	38.57	13.13	51.70	74.00	-22.30
2491.26	Average	27.15	13.13	40.28	54.00	-13.72

Test Mode:	GFSK_BDR-1Mbps Hopping	Temp/Hum	21.1(°C)/ 57%RH
Test Item	Band Edge	Test Date	February 16, 2022
Polarize	Horizontal	Test Engineer	Tony Chao
Detector	Peak / Average		

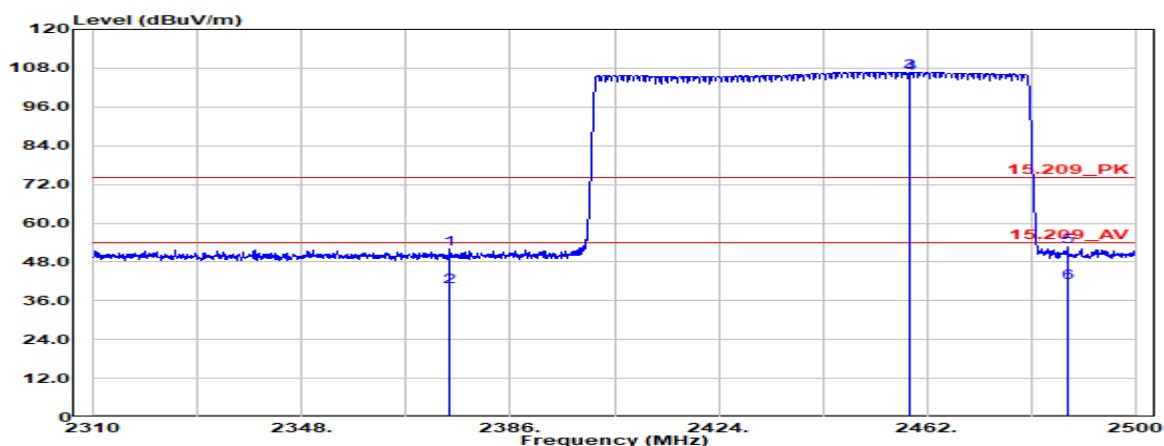

Freq. MHz	Detector Mode PK/QP/AV	Spectrum Reading Level dB μ V	Factor dB	Actual FS dB μ V/m	Limit @3m dB μ V/m	Margin dB
2374.98	Peak	39.53	12.40	51.93	74.00	-22.07
2374.98	Average	28.05	12.40	40.45	54.00	-13.55
2458.87	Peak	93.90	12.91	106.81	-	-
2458.87	Average	93.49	12.91	106.40	-	-
2487.65	Peak	39.46	13.11	52.57	74.00	-21.43
2487.65	Average	28.54	13.11	41.64	54.00	-12.36

Report No.: TMWK2201000417KR

Test Mode:	8DPSK_EDR-3Mbps Low CH	Temp/Hum	21.1(°C)/ 57%RH
Test Item	Band Edge	Test Date	February 16, 2022
Polarize	Vertical	Test Engineer	Tony Chao
Detector	Peak / Average		

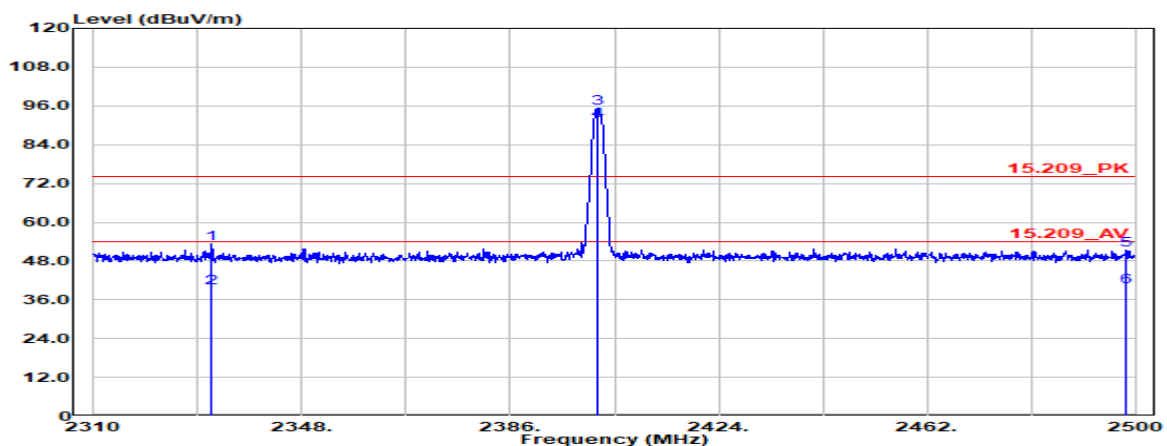

Freq. MHz	Detector Mode PK/QP/AV	Spectrum Reading Level dB μ V	Factor dB	Actual FS dB μ V/m	Limit @3m dB μ V/m	Margin dB
2331.57	Peak	40.93	12.25	53.18	74.00	-20.82
2331.57	Average	27.51	12.25	39.76	54.00	-14.24
2402.00	Peak	82.83	12.54	95.37	-	-
2402.00	Average	78.86	12.54	91.40	-	-
2498.39	Peak	38.19	13.18	51.37	74.00	-22.63
2498.39	Average	26.70	13.18	39.88	54.00	-14.12

Report No.: TMWK2201000417KR

Test Mode:	8DPSK_EDR-3Mbps Low CH	Temp/Hum	21.1(°C)/ 57%RH
Test Item	Band Edge	Test Date	February 16, 2022
Polarize	Horizontal	Test Engineer	Tony Chao
Detector	Peak / Average		

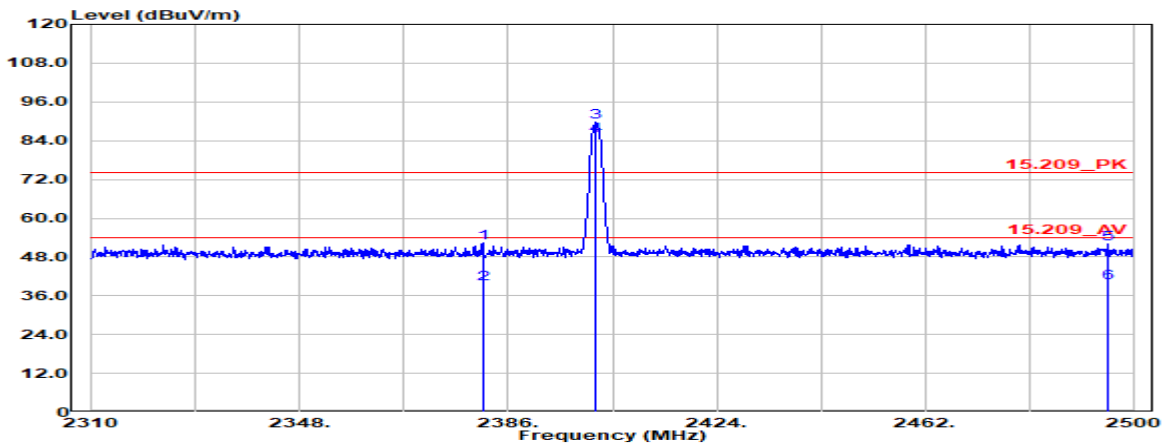

Freq. MHz	Detector Mode PK/QP/AV	Spectrum Reading Level dB μ V	Factor dB	Actual FS dB μ V/m	Limit @3m dB μ V/m	Margin dB
2381.35	Peak	39.76	12.44	52.20	74.00	-21.80
2381.35	Average	27.17	12.44	39.61	54.00	-14.39
2402.00	Peak	77.16	12.54	89.71	-	-
2402.00	Average	73.14	12.54	85.68	-	-
2495.25	Peak	38.72	13.16	51.88	74.00	-22.12
2495.25	Average	26.73	13.16	39.89	54.00	-14.11

Report No.: TMWK2201000417KR

Test Mode:	8DPSK_EDR-3Mbps High CH	Temp/Hum	21.1(°C)/ 57%RH
Test Item	Band Edge	Test Date	February 16, 2022
Polarize	Vertical	Test Engineer	Tony Chao
Detector	Peak / Average		

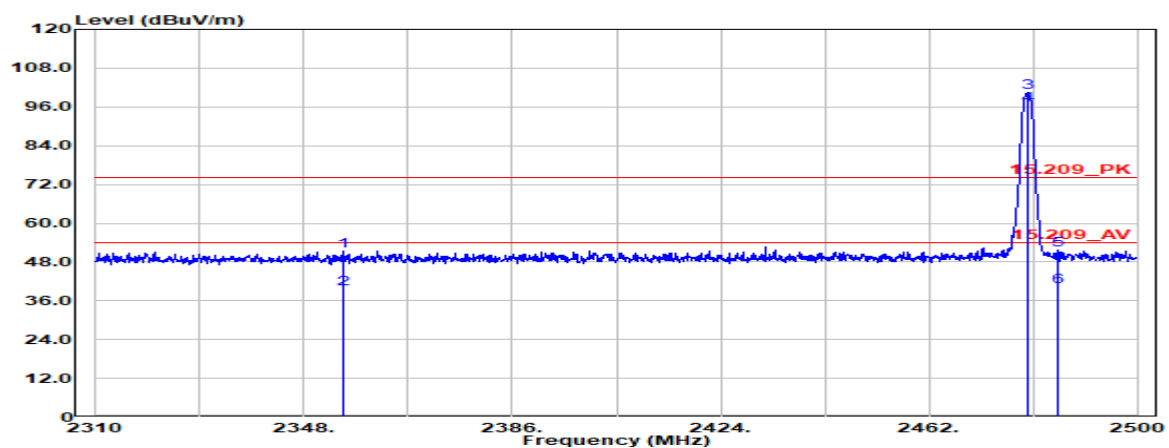

Freq. MHz	Detector Mode PK/QP/AV	Spectrum Reading Level dB μ V	Factor dB	Actual FS dB μ V/m	Limit @3m dB μ V/m	Margin dB
2355.03	Peak	39.06	12.31	51.37	74.00	-22.63
2355.03	Average	27.24	12.31	39.54	54.00	-14.46
2480.00	Peak	87.42	13.05	100.48	-	-
2480.00	Average	83.53	13.05	96.58	-	-
2485.47	Peak	38.49	13.09	51.58	74.00	-22.42
2485.47	Average	27.29	13.09	40.39	54.00	-13.61

Report No.: TMWK2201000417KR

Test Mode:	8DPSK_EDR-3Mbps High CH	Temp/Hum	21.1(°C)/ 57%RH
Test Item	Band Edge	Test Date	February 16, 2022
Polarize	Horizontal	Test Engineer	Tony Chao
Detector	Peak / Average		

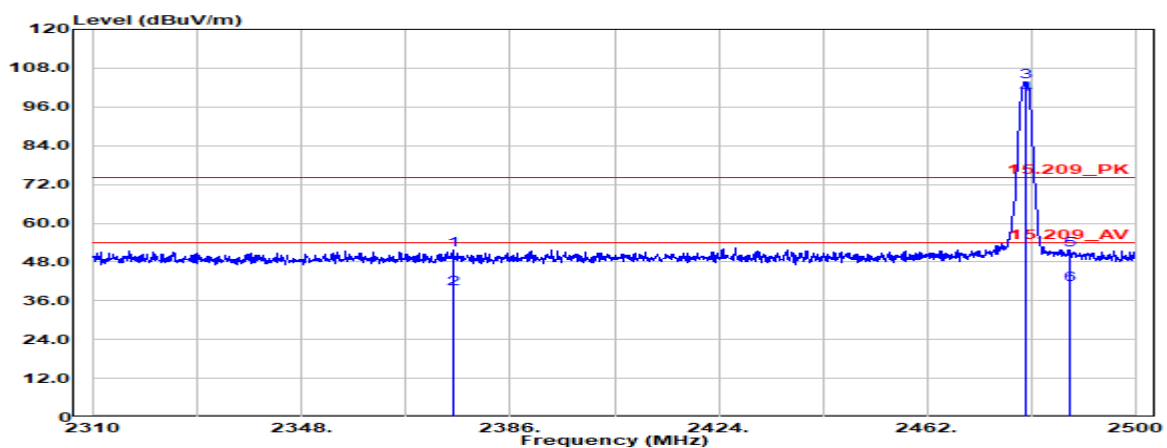

Freq. MHz	Detector Mode PK/QP/AV	Spectrum Reading Level dB μ V	Factor dB	Actual FS dB μ V/m	Limit @3m dB μ V/m	Margin dB
2375.46	Peak	39.18	12.41	51.59	74.00	-22.41
2375.46	Average	27.25	12.41	39.66	54.00	-14.34
2480.00	Peak	90.70	13.05	103.75	-	-
2480.00	Average	86.86	13.05	99.92	-	-
2487.94	Peak	38.59	13.11	51.70	74.00	-22.30
2487.94	Average	27.96	13.11	41.07	54.00	-12.93

Report No.: TMWK2201000417KR

Test Mode:	8DPSK_EDR-3Mbps Hopping	Temp/Hum	21.1(°C)/ 57%RH
Test Item	Band Edge	Test Date	February 16, 2022
Polarize	Vertical	Test Engineer	Tony Chao
Detector	Peak / Average		

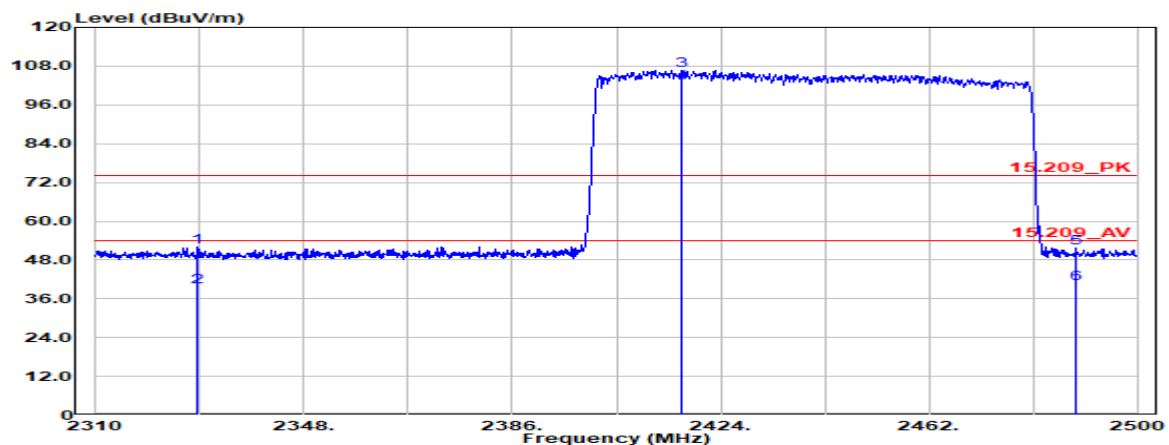

Freq. MHz	Detector Mode PK/QP/AV	Spectrum Reading Level dB μ V	Factor dB	Actual FS dB μ V/m	Limit @3m dB μ V/m	Margin dB
2328.62	Peak	39.91	12.25	52.16	74.00	-21.84
2328.62	Average	27.48	12.25	39.73	54.00	-14.27
2416.97	Peak	93.96	12.64	106.60	-	-
2416.97	Average	90.12	12.64	102.76	-	-
2488.79	Peak	38.67	13.11	51.78	74.00	-22.22
2488.79	Average	27.58	13.11	40.70	54.00	-13.30

Report No.: TMWK2201000417KR

Test Mode:	8DPSK_EDR-3Mbps Hopping	Temp/Hum	21.1(°C)/ 57%RH
Test Item	Band Edge	Test Date	February 16, 2022
Polarize	Horizontal	Test Engineer	Tony Chao
Detector	Peak / Average		

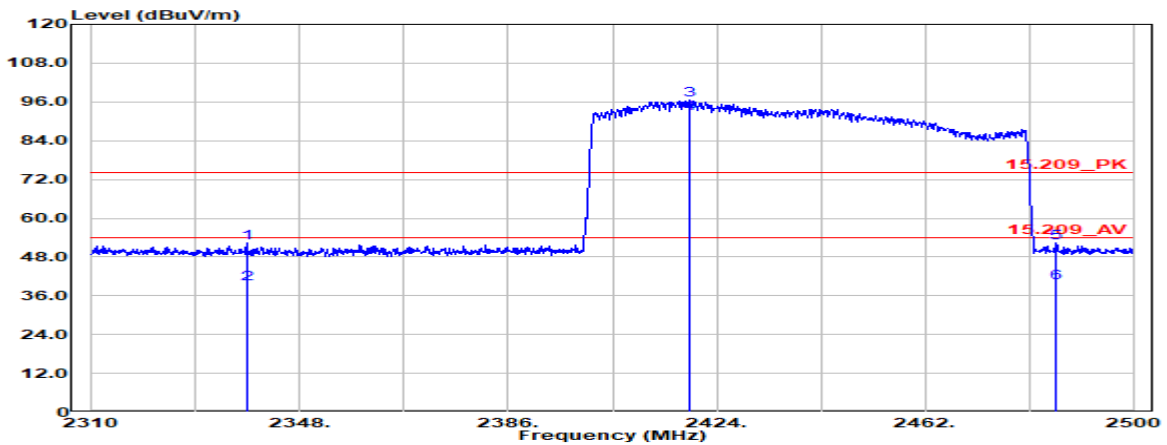

Freq. MHz	Detector Mode PK/QP/AV	Spectrum Reading Level dB μ V	Factor dB	Actual FS dB μ V/m	Limit @3m dB μ V/m	Margin dB
2338.22	Peak	39.98	12.26	52.24	74.00	-21.76
2338.22	Average	27.57	12.26	39.83	54.00	-14.17
2419.06	Peak	83.77	12.65	96.42	-	-
2419.06	Average	79.82	12.65	92.47	-	-
2485.94	Peak	39.33	13.09	52.42	74.00	-21.58
2485.94	Average	26.97	13.09	40.06	54.00	-13.94

Report No.: TMWK2201000417KR

Below 1G Test Data

Test Mode:	BT Mode	Temp/Hum	21.1(°C)/ 57%RH
Test Item	30MHz-1GHz	Test Date	February 16, 2022
Polarize	Vertical	Test Engineer	Ray Li
Detector	Peak		

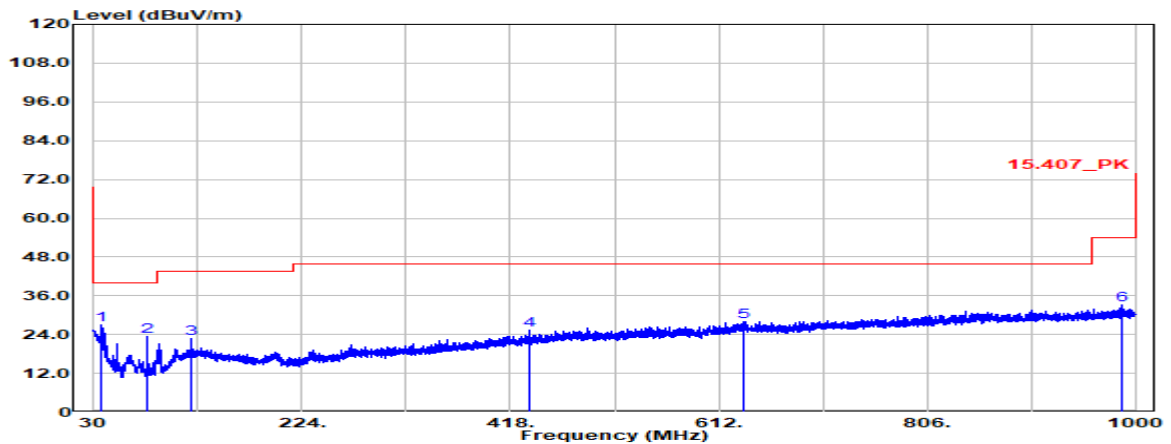

Freq. MHz	Detector Mode PK/QP/AV	Spectrum Reading Level dBµV	Factor dB	Actual FS dBµV/m	Limit @3m dBµV/m	Margin dB
35.94	Peak	33.54	-6.69	26.85	40.00	-13.15
79.96	Peak	38.91	-15.63	23.28	40.00	-16.72
119.97	Peak	31.80	-9.18	22.63	43.50	-20.87
436.43	Peak	29.98	-4.78	25.21	46.00	-20.79
635.52	Peak	28.47	-0.60	27.87	46.00	-18.13
987.88	Peak	28.81	4.32	33.13	54.00	-20.87

Report No.: TMWK2201000417KR

Test Mode:	BT Mode	Temp/Hum	21.1(°C)/ 57%RH
Test Item	30MHz-1GHz	Test Date	February 16, 2022
Polarize	Horizontal	Test Engineer	Ray Li
Detector	Peak		

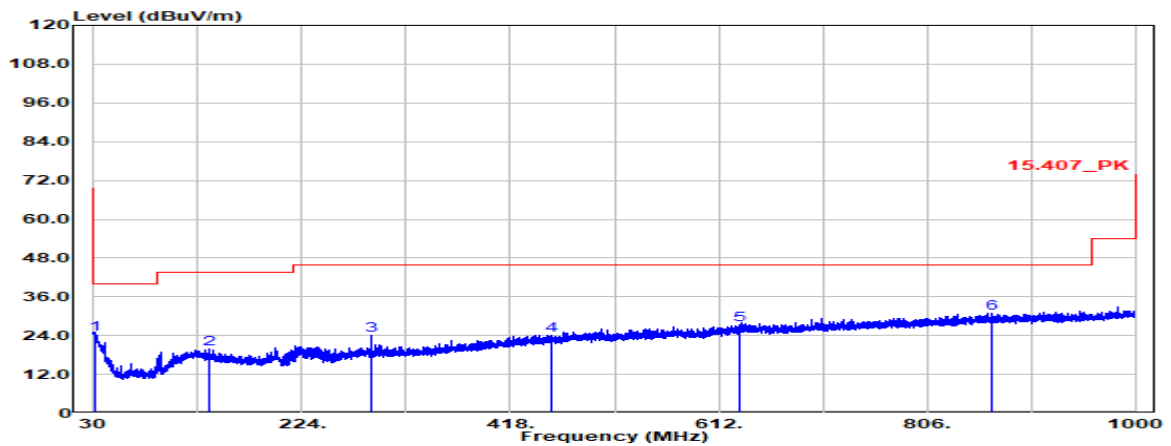

Freq. MHz	Detector Mode PK/QP/AV	Spectrum Reading Level dB μ V	Factor dB	Actual FS dB μ V/m	Limit @3m dB μ V/m	Margin dB
31.33	Peak	27.91	-3.41	24.50	40.00	-15.50
137.55	Peak	29.62	-9.77	19.85	43.50	-23.65
288.02	Peak	32.78	-8.83	23.95	46.00	-22.05
456.92	Peak	28.27	-4.25	24.02	46.00	-21.98
631.89	Peak	28.06	-0.76	27.29	46.00	-18.71
866.75	Peak	28.44	2.51	30.95	46.00	-15.05

Report No.: TMWK2201000417KR

Above 1G Test Data

Test Mode:	GFSK_BDR-1Mbps Low CH	Temp/Hum	21.1(°C)/ 57%RH
Test Item	Harmonic	Test Date	February 16, 2022
Polarize	Vertical	Test Engineer	Tony Chao
Detector	Peak & Average		

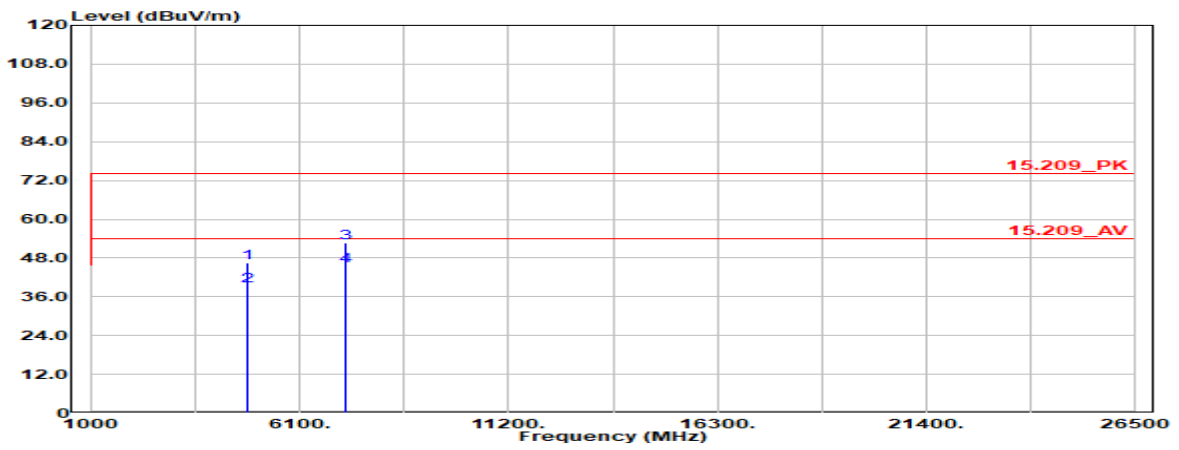

Freq. MHz	Detector Mode PK/QP/AV	Spectrum Reading Level dB μ V	Factor dB	Actual FS dB μ V/m	Limit @3m dB μ V/m	Margin dB
4804.00	Peak	37.00	9.46	46.46	74.00	-27.54
4804.00	Average	30.04	9.46	39.50	54.00	-14.50
7206.00	Peak	39.18	13.51	52.69	74.00	-21.31
7206.00	Average	32.15	13.51	45.66	54.00	-8.34

Remark:

- Measuring frequencies from 1 GHz to the 10th harmonic of highest fundamental frequency.

Report No.: TMWK2201000417KR

Test Mode:	GFSK_BDR-1Mbps Low CH	Temp/Hum	21.1(°C)/ 57%RH
Test Item	Harmonic	Test Date	February 16, 2022
Polarize	Horizontal	Test Engineer	Tony Chao
Detector	Peak & Average		

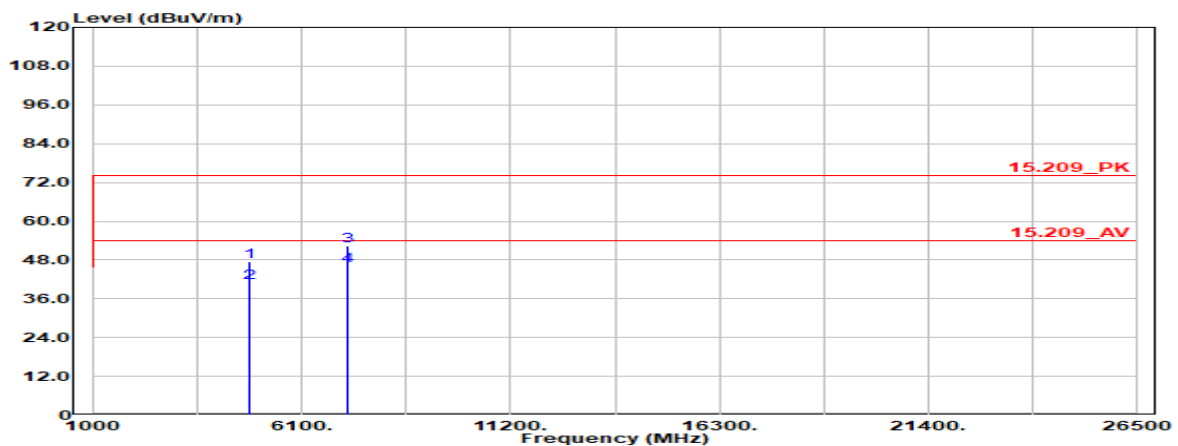

Freq. MHz	Detector Mode PK/QP/AV	Spectrum Reading Level dB μ V	Factor dB	Actual FS dB μ V/m	Limit @3m dB μ V/m	Margin dB
4804.00	Peak	38.15	9.46	47.61	74.00	-26.39
4804.00	Average	31.60	9.46	41.06	54.00	-12.94
7206.00	Peak	38.72	13.51	52.23	74.00	-21.77
7206.00	Average	32.79	13.51	46.30	54.00	-7.70

Remark:

1. Measuring frequencies from 1 GHz to the 10th harmonic of highest fundamental frequency.

Report No.: TMWK2201000417KR

Test Mode:	GFSK_BDR-1Mbps Mid CH	Temp/Hum	21.1(°C)/ 57%RH
Test Item	Harmonic	Test Date	February 16, 2022
Polarize	Vertical	Test Engineer	Tony Chao
Detector	Peak & Average		

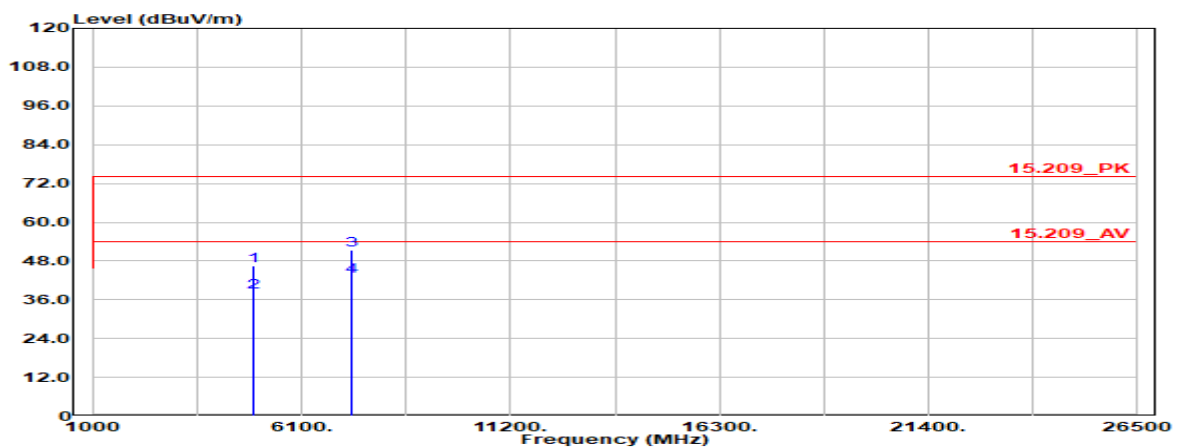

Freq. MHz	Detector Mode PK/QP/AV	Spectrum Reading Level d μ V	Factor dB	Actual FS d μ V/m	Limit @3m d μ V/m	Margin dB
4882.00	Peak	36.91	9.59	46.50	74.00	-27.50
4882.00	Average	28.68	9.59	38.27	54.00	-15.73
7323.00	Peak	38.08	13.24	51.32	74.00	-22.68
7323.00	Average	29.97	13.24	43.21	54.00	-10.79

Remark:

1. Measuring frequencies from 1 GHz to the 10th harmonic of highest fundamental frequency.

Report No.: TMWK2201000417KR

Test Mode:	GFSK_BDR-1Mbps Mid CH	Temp/Hum	21.1(°C)/ 57%RH
Test Item	Harmonic	Test Date	February 16, 2022
Polarize	Horizontal	Test Engineer	Tony Chao
Detector	Peak & Average		

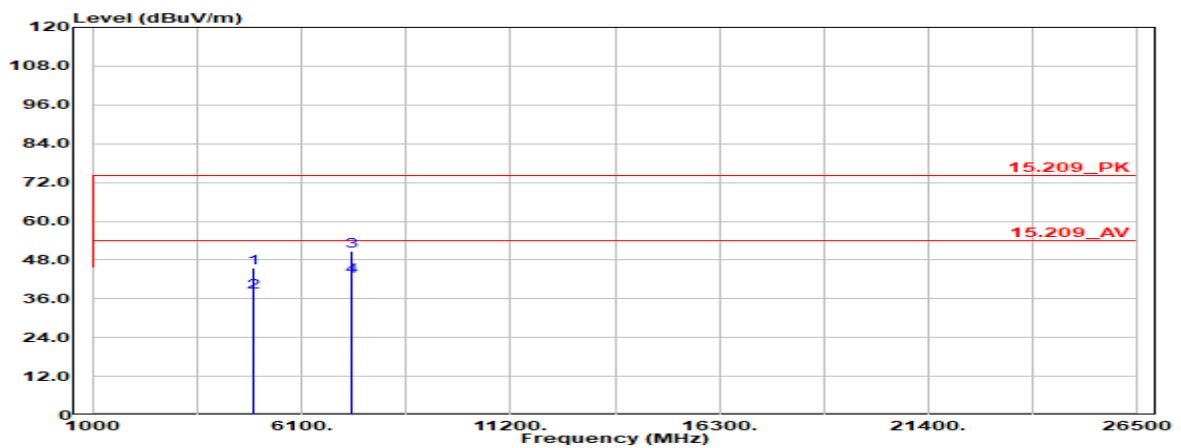

Freq. MHz	Detector Mode PK/QP/AV	Spectrum Reading Level dB μ V	Factor dB	Actual FS dB μ V/m	Limit @3m dB μ V/m	Margin dB
4882.00	Peak	35.83	9.59	45.42	74.00	-28.58
4882.00	Average	28.41	9.59	38.00	54.00	-16.00
7323.00	Peak	37.36	13.24	50.60	74.00	-23.40
7323.00	Average	29.71	13.24	42.95	54.00	-11.05

Remark:

1. Measuring frequencies from 1 GHz to the 10th harmonic of highest fundamental frequency.

Report No.: TMWK2201000417KR

Test Mode:	GFSK_BDR-1Mbps High CH	Temp/Hum	21.1(°C)/ 57%RH
Test Item	Harmonic	Test Date	February 16, 2022
Polarize	Vertical	Test Engineer	Ray Li
Detector	Peak & Average		

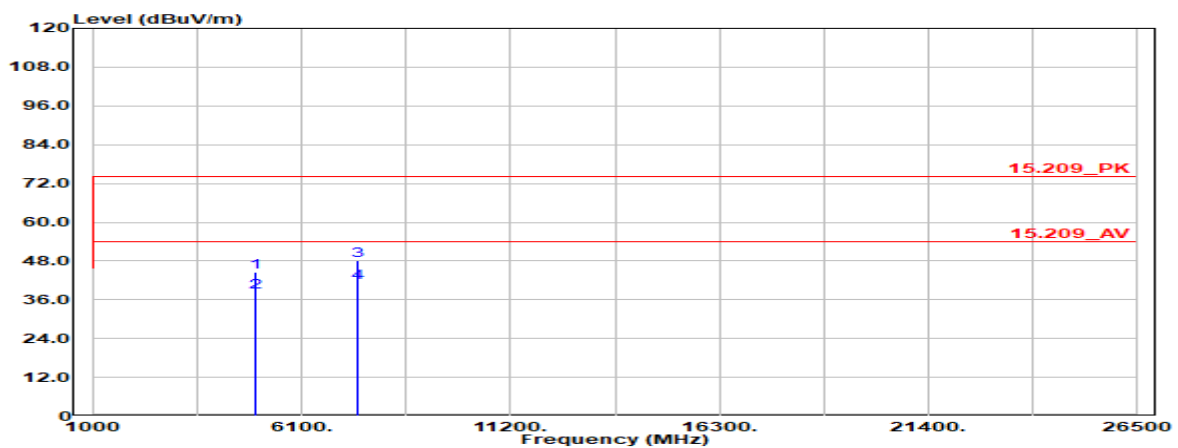

Freq. MHz	Detector Mode PK/QP/AV	Spectrum Reading Level dB μ V	Factor dB	Actual FS dB μ V/m	Limit @3m dB μ V/m	Margin dB
4960.00	Peak	34.90	9.71	44.61	74.00	-29.39
4960.00	Average	28.53	9.71	38.23	54.00	-15.77
7440.00	Peak	34.68	13.54	48.22	74.00	-25.78
7440.00	Average	27.72	13.54	41.26	54.00	-12.74

Remark:

1. Measuring frequencies from 1 GHz to the 10th harmonic of highest fundamental frequency.

Report No.: TMWK2201000417KR

Test Mode:	GFSK_BDR-1Mbps High CH	Temp/Hum	21.1(°C)/ 57%RH
Test Item	Harmonic	Test Date	February 16, 2022
Polarize	Horizontal	Test Engineer	Ray Li
Detector	Peak & Average		

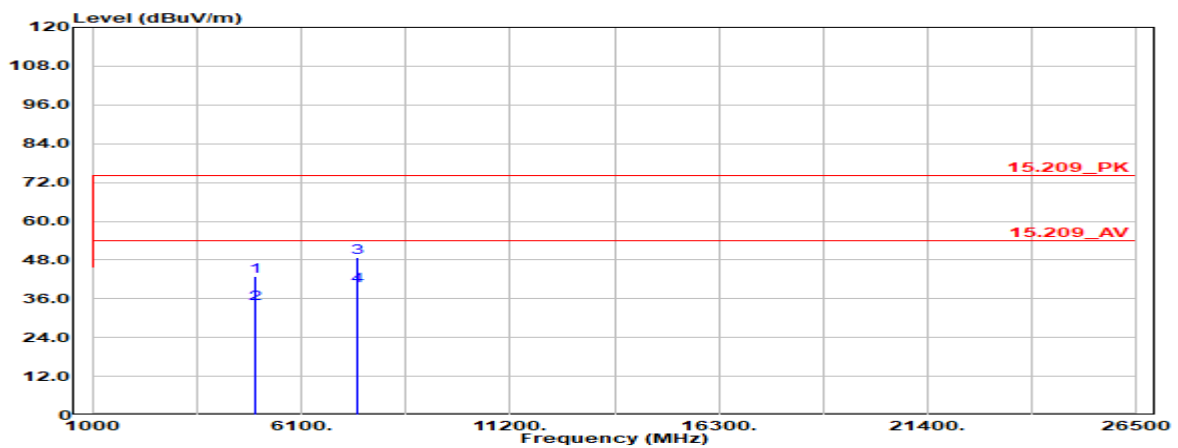

Freq. MHz	Detector Mode PK/QP/AV	Spectrum Reading Level dB μ V	Factor dB	Actual FS dB μ V/m	Limit @3m dB μ V/m	Margin dB
4960.00	Peak	33.30	9.71	43.00	74.00	-31.00
4960.00	Average	24.73	9.71	34.44	54.00	-19.56
7440.00	Peak	35.26	13.54	48.80	74.00	-25.20
7440.00	Average	26.56	13.54	40.10	54.00	-13.90

Remark:

1. Measuring frequencies from 1 GHz to the 10th harmonic of highest fundamental frequency.

Test Mode	8DPSK_EDR-3Mbps Low CH	Temp/Hum	21.1(°C)/ 57%RH
Test Item	Harmonic	Test Date	February 16, 2022
Polarize	Vertical	Test Engineer	Ray Li
Detector	Peak & Average		

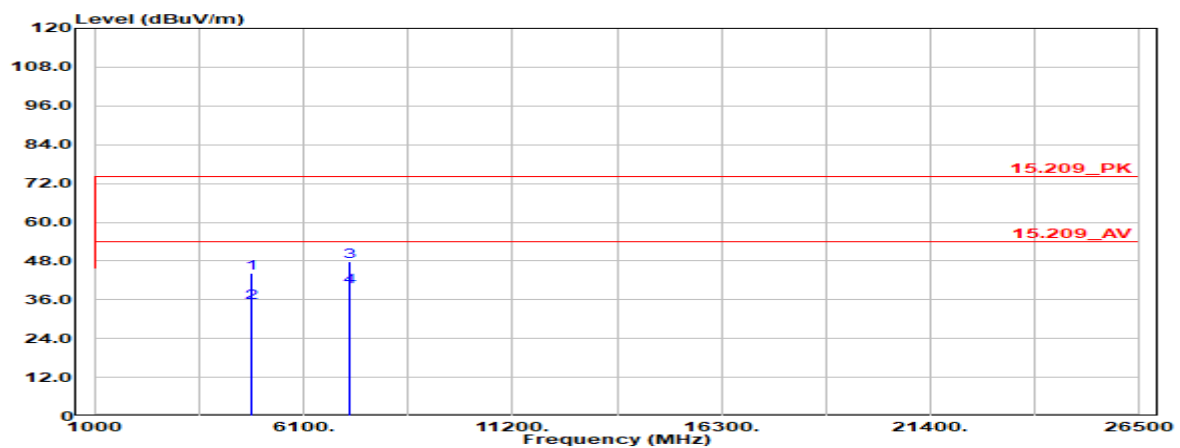

Freq. MHz	Detector Mode PK/QP/AV	Spectrum Reading Level dB μ V	Factor dB	Actual FS dB μ V/m	Limit @3m dB μ V/m	Margin dB
4804.00	Peak	34.83	9.46	44.29	74.00	-29.71
4804.00	Average	25.76	9.46	35.22	54.00	-18.78
7206.00	Peak	34.25	13.51	47.76	74.00	-26.24
7206.00	Average	26.60	13.51	40.11	54.00	-13.89

Remark:

1. Measuring frequencies from 1 GHz to the 10th harmonic of highest fundamental frequency.

Report No.: TMWK2201000417KR

Test Mode	8DPSK_EDR-3Mbps Low CH	Temp/Hum	21.1(°C)/ 57%RH
Test Item	Harmonic	Test Date	February 16, 2022
Polarize	Horizontal	Test Engineer	Ray Li
Detector	Peak & Average		

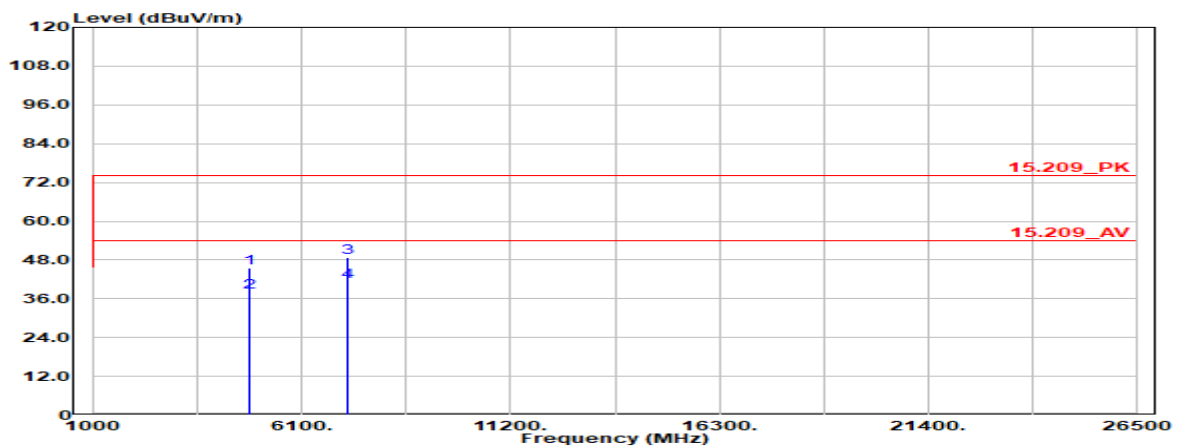

Freq. MHz	Detector Mode PK/QP/AV	Spectrum Reading Level dB μ V	Factor dB	Actual FS dB μ V/m	Limit @3m dB μ V/m	Margin dB
4804.00	Peak	35.94	9.46	45.41	74.00	-28.59
4804.00	Average	28.72	9.46	38.18	54.00	-15.82
7206.00	Peak	35.35	13.51	48.86	74.00	-25.14
7206.00	Average	27.72	13.51	41.23	54.00	-12.77

Remark:

1. Measuring frequencies from 1 GHz to the 10th harmonic of highest fundamental frequency.

Report No.: TMWK2201000417KR

Test Mode	8DPSK_EDR-3Mbps Mid CH	Temp/Hum	21.1(°C)/ 57%RH
Test Item	Harmonic	Test Date	February 16, 2022
Polarize	Vertical	Test Engineer	Ray Li
Detector	Peak & Average		

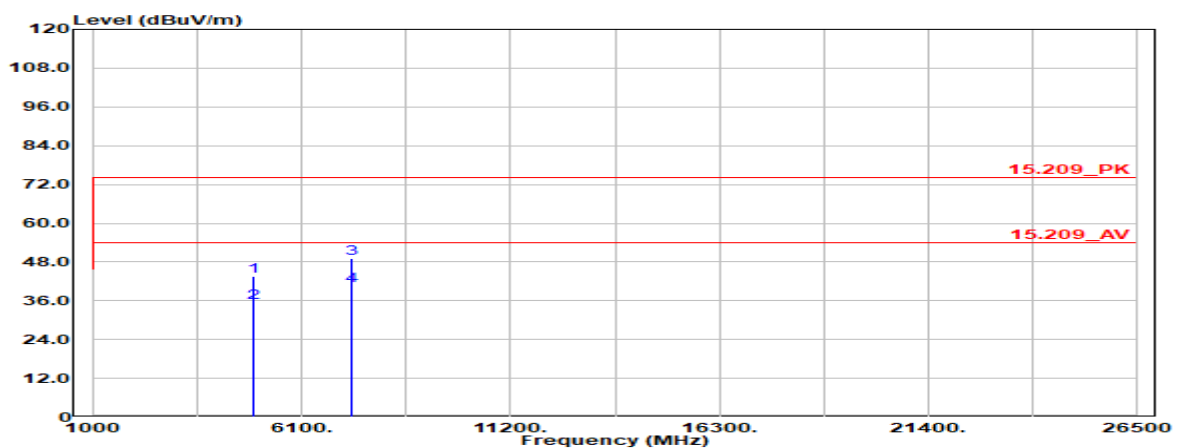

Freq. MHz	Detector Mode PK/QP/AV	Spectrum Reading Level dB μ V	Factor dB	Actual FS dB μ V/m	Limit @3m dB μ V/m	Margin dB
4882.00	Peak	33.99	9.59	43.58	74.00	-30.42
4882.00	Average	25.90	9.59	35.49	54.00	-18.51
7323.00	Peak	35.84	13.24	49.08	74.00	-24.92
7323.00	Average	27.26	13.24	40.50	54.00	-13.50

Remark:

1. Measuring frequencies from 1 GHz to the 10th harmonic of highest fundamental frequency.

Report No.: TMWK2201000417KR

Test Mode	8DPSK_EDR-3Mbps Mid CH	Temp/Hum	21.1(°C)/ 57%RH
Test Item	Harmonic	Test Date	February 16, 2022
Polarize	Horizontal	Test Engineer	Ray Li
Detector	Peak & Average		

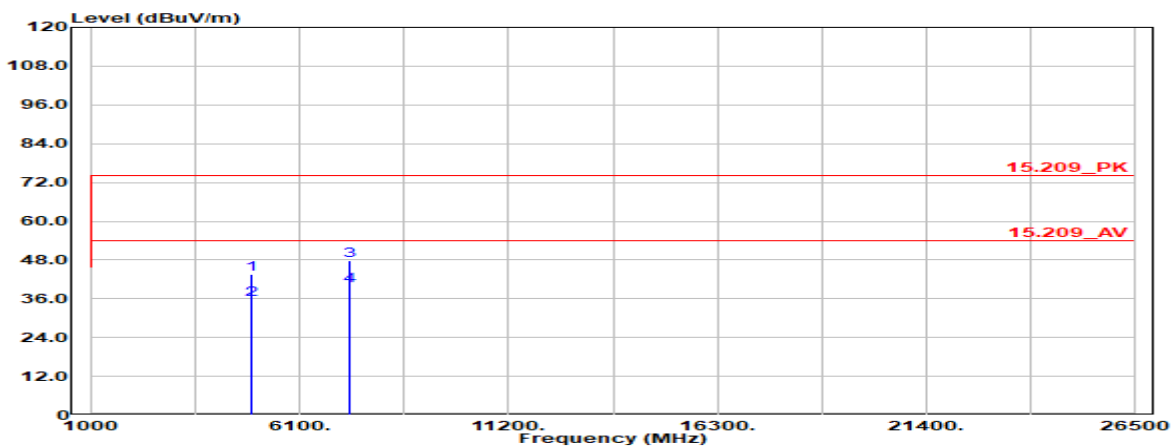

Freq. MHz	Detector Mode PK/QP/AV	Spectrum Reading Level dB μ V	Factor dB	Actual FS dB μ V/m	Limit @3m dB μ V/m	Margin dB
4882.00	Peak	33.93	9.59	43.52	74.00	-30.48
4882.00	Average	26.26	9.59	35.85	54.00	-18.15
7323.00	Peak	34.61	13.24	47.85	74.00	-26.15
7323.00	Average	26.61	13.24	39.85	54.00	-14.15

Remark:

1. Measuring frequencies from 1 GHz to the 10th harmonic of highest fundamental frequency.

Report No.: TMWK2201000417KR

Test Mode	8DPSK_EDR-3Mbps High CH	Temp/Hum	21.1(°C)/ 57%RH
Test Item	Harmonic	Test Date	February 16, 2022
Polarize	Vertical	Test Engineer	Ray Li
Detector	Peak & Average		

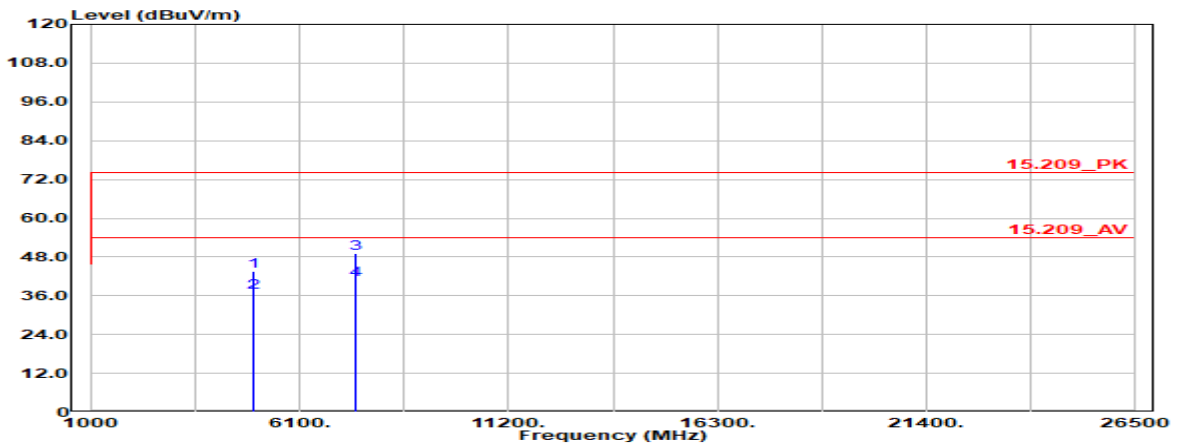

Freq. MHz	Detector Mode PK/QP/AV	Spectrum Reading Level dB μ V	Factor dB	Actual FS dB μ V/m	Limit @3m dB μ V/m	Margin dB
4960.00	Peak	33.98	9.71	43.69	74.00	-30.31
4960.00	Average	27.23	9.71	36.94	54.00	-17.06
7440.00	Peak	35.44	13.54	48.98	74.00	-25.02
7440.00	Average	27.42	13.54	40.96	54.00	-13.04

Remark:

1. Measuring frequencies from 1 GHz to the 10th harmonic of highest fundamental frequency.

Report No.: TMWK2201000417KR

Test Mode	8DPSK_EDR-3Mbps High CH	Temp/Hum	21.1(°C)/ 57%RH
Test Item	Harmonic	Test Date	February 16, 2022
Polarize	Horizontal	Test Engineer	Ray Li
Detector	Peak & Average		

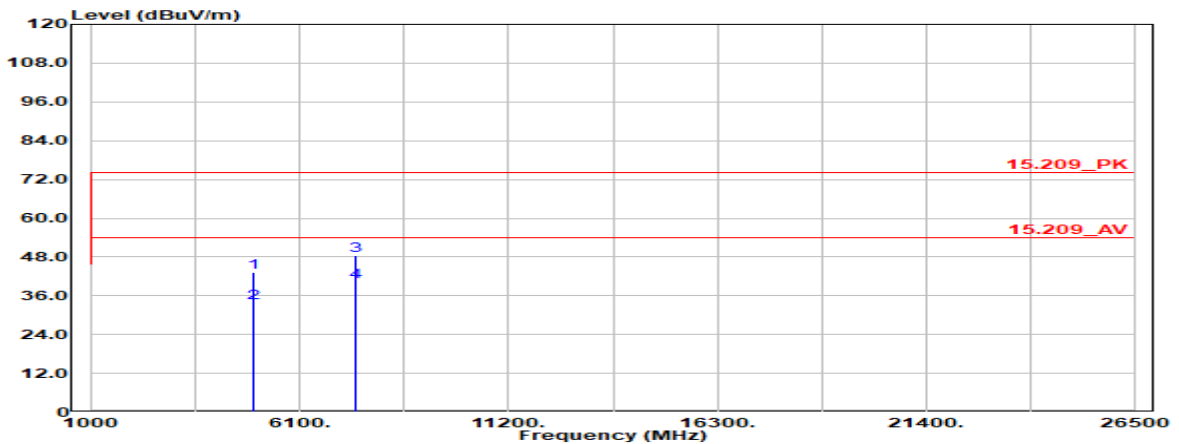

Freq. MHz	Detector Mode PK/QP/AV	Spectrum Reading Level dB μ V	Factor dB	Actual FS dB μ V/m	Limit @3m dB μ V/m	Margin dB
4960.00	Peak	33.50	9.71	43.21	74.00	-30.79
4960.00	Average	24.17	9.71	33.88	54.00	-20.12
7440.00	Peak	34.97	13.54	48.51	74.00	-25.49
7440.00	Average	26.79	13.54	40.33	54.00	-13.67

Remark:

1. Measuring frequencies from 1 GHz to the 10th harmonic of highest fundamental frequency.

- End of Test Report -