

## Test Report

# C9120AXE-x

(x=A, B)

## Cisco Catalyst C9120AX Series 802.11ax Access Point

### XOR 5GHz Radio

FCC ID: LDKEDAC92157

IC: 2461N-EDAC92157

**5725-5850 MHz**

Against the following Specifications:

CFR47 Part 15.407

RSS-247



Cisco Systems

170 West Tasman Drive

San Jose, CA 95134

	
<p><b>Author:</b> Chris Blair <b>Tested By:</b> Chris Blair</p>	<p><b>Approved By:</b> Gez Thorpe <b>Title:</b> Radio Compliance Manager <b>Revision:</b> See EDCS</p>

This report replaces any previously entered test report under EDCS – **18351924**. This test report has been electronically authorized and archived using the CISCO Engineering Document Control system.

This test report has been electronically authorized and archived using the CISCO Engineering Document Control system.

<b>SECTION 1: OVERVIEW .....</b>	<b>3</b>
<b>SECTION 2: ASSESSMENT INFORMATION .....</b>	<b>4</b>
2.1 GENERAL .....	4
2.2 DATE OF TESTING.....	6
2.3 REPORT ISSUE DATE .....	6
2.4 TESTING FACILITIES .....	6
2.5 EQUIPMENT ASSESSED (EUT).....	6
2.6 EUT DESCRIPTION.....	7
<b>SECTION 3: RESULT SUMMARY .....</b>	<b>13</b>
3.1 RESULTS SUMMARY TABLE .....	13
<b>SECTION 4: SAMPLE DETAILS.....</b>	<b>14</b>
4.1 SAMPLE DETAILS .....	14
4.2 SYSTEM DETAILS .....	14
4.3 MODE OF OPERATION DETAILS.....	14
ALL MEASUREMENTS WERE MADE IN ACCORDANCE WITH.....	14
<b>APPENDIX A: EMISSION TEST RESULTS .....</b>	<b>15</b>
CONDUCTED TEST SETUP DIAGRAM.....	15
TARGET MAXIMUM CHANNEL POWER .....	15
A.1 DUTY CYCLE .....	19
A.2 6dB BANDWIDTH.....	22
A.3 99% AND 26dB BANDWIDTH.....	25
A.4 MAXIMUM CONDUCTED OUTPUT POWER .....	28
A.5 POWER SPECTRAL DENSITY .....	59
A.6 CONDUCTED SPURIOUS EMISSIONS .....	90
A.7 CONDUCTED RECEIVER SPURIOUS EMISSIONS .....	153
A.8 CONDUCTED BANDEDGE.....	165
<b>APPENDIX B: RADIATED &amp; AC CONDUCTED EMISSIONS TEST RESULTS .....</b>	<b>202</b>
<b>APPENDIX C: LIST OF TEST EQUIPMENT USED TO PERFORM THE TEST .....</b>	<b>203</b>
<b>APPENDIX D: ABBREVIATION KEY AND DEFINITIONS.....</b>	<b>204</b>
<b>APPENDIX E:     PHOTOGRAPHS OF TEST SETUPS .....</b>	<b>205</b>
<b>APPENDIX F:     SOFTWARE USED TO PERFORM TESTING.....</b>	<b>206</b>
<b>APPENDIX G:     TEST PROCEDURES .....</b>	<b>206</b>
<b>APPENDIX H:     SCOPE OF ACCREDITATION (A2LA CERTIFICATE NUMBER 1178-01) .....</b>	<b>206</b>
<b>APPENDIX I:     TEST ASSESSMENT PLAN .....</b>	<b>206</b>
<b>APPENDIX J:     UUT SOFTWARE INFO .....</b>	<b>207</b>



**Section 1: Overview**

The samples were assessed against the tests detailed in section 3 under the requirements of the following specifications:

<b>Specifications:</b>
CFR47 Part 15.407 RSS-247

Measurements were made in accordance with

- ANSI C63.10:2013
- KDB 789033 D02 General UNII Test Procedures New Rules v01r03
- KDB 662911 D01 Multiple Transmitter Output v02r01

## Section 2: Assessment Information

### 2.1 General

This report contains an assessment of an apparatus against Electromagnetic Compatibility Standards based upon tests carried out on the samples submitted. The testing was performed by and for the use of Cisco systems Inc:

With regard to this assessment, the following points should be noted:

- a) The results contained in this report relate only to the items tested and were obtained in the period between the date of the initial assessment and the date of issue of the report. Manufactured products will not necessarily give identical results due to production and measurement tolerances.
- b) The apparatus was set up and exercised using the configuration and modes of operation defined in this report only.
- c) Where relevant, the apparatus was only assessed using the susceptibility criteria defined in this report and the Test Assessment Plan (TAP).
- d) All testing was performed under the following environmental conditions:

Temperature	15°C to 35°C (54°F to 95°F)
Atmospheric Pressure	860mbar to 1060mbar (25.4" to 31.3")
Humidity	10% to 75*%

### Units of Measurement

The units of measurements defined in the appendices are reported in specific terms, which are test dependent. Where radiated measurements are concerned these are defined at a particular distance. Basic voltage measurements are defined in units of [dBuV]

As an example, the basic calculation for all measurements is as follows:

$$\text{Emission level [dBuV]} = \text{Indicated voltage level [dBuV]} + \text{Cable Loss [dB]} + \text{Other correction factors [dB]}$$

The combinations of correction factors are dependent upon the exact test configurations [see test equipment lists for further details] and may include:-

Antenna Factors, Pre Amplifier Gain, LISN Loss, Pulse Limiter Loss and Filter Insertion Loss

Note: to convert the results from dBuV/m to uV/m use the following formula:-

$$\text{Level in uV/m} = \text{Common Antilogarithm } [(X \text{ dBuV/m})/20] = Y \text{ uV/m}$$

## Measurement Uncertainty Values

voltage and power measurements	± 2 dB
conducted EIRP measurements	± 1.4 dB
radiated measurements	± 3.2 dB
frequency measurements	± 2.4 10 <sup>-7</sup>
temperature measurements	± 0.54°
humidity measurements	± 2.3%
DC and low frequency measurements	± 2.5%

Where relevant measurement uncertainty levels have been estimated for tests performed on the apparatus. This uncertainty represents an expanded uncertainty expressed at approximately the 95% confidence level using a coverage factor of k=2.

## Radiated emissions (expanded uncertainty, confidence interval 95%)

30 MHz - 300 MHz	+/- 3.8 dB
300 MHz - 1000 MHz	+/- 4.3 dB
1 GHz - 10 GHz	+/- 4.0 dB
10 GHz - 18GHz	+/- 8.2 dB
18GHz - 26.5GHz	+/- 4.1 dB
26.5GHz - 40GHz	+/- 3.9 dB

## Conducted emissions (expanded uncertainty, confidence interval 95%)

30 MHz – 40GHz	+/- 0.38 dB
----------------	-------------

A product is considered to comply with a requirement if the nominal measured value is below the limit line. The product is considered to not be in compliance in case the nominal measured value is above the limit line.

**This report must not be reproduced except in full, without written approval of Cisco Systems.**

**2.2 Date of testing**

25-Sep-19 - 01-Oct-19

**2.3 Report Issue Date**

23-Oct-19

Cisco uses an electronic system to issue, store and control the revision of test reports. This system is called the Engineering Document Control System. The actual report issue date is embedded into the original file on EDCS. Any copies of this report, either electronic or paper, that are not on EDCS must be considered uncontrolled.

**2.4 Testing facilities**

This assessment was performed by: Chris Blair &amp; Julian Land

**Testing Laboratory**

Cisco Systems, Inc.,  
125 West Tasman Drive  
San Jose, CA 95134, USA

**Registration Numbers for Industry Canada**

<b>Cisco System Site</b>	<b>Address</b>	<b>Site Identifier</b>
Building P, 10m Chamber	125 West Tasman Dr San Jose, CA 95134	Company #: 2461N-2
Building P, 5m Chamber	125 West Tasman Dr San Jose, CA 95134	Company #: 2461N-1
Building I, 5m Chamber	285 W. Tasman Drive San Jose, California 95134	Company #: 2461M-1

**Test Engineers**

Chris Blair

**2.5 Equipment Assessed (EUT)**

C9120AXE-x

## 2.6 EUT Description

The Cisco Aironet 802.11ax Radio supports the following modes of operation. The modes are further defined in the radio Theory of Operation. The modes included in this report represent the worst case data for all modes.

802.11a - Non HT20, One Antenna, 6 to 54 Mbps, 1ss

802.11a - Non HT20, Two Antennas, 6 to 54 Mbps, 1ss

802.11a - Non HT20, Three Antennas, 6 to 54 Mbps, 1ss

802.11a - Non HT20, Four Antennas, 6 to 54 Mbps, 1ss

802.11a - Non HT20 Beam Forming, Two Antennas, 6 to 54 Mbps, 1ss

802.11a - Non HT20 Beam Forming, Three Antennas, 6 to 54 Mbps, 1ss

802.11a - Non HT20 Beam Forming, Four Antennas, 6 to 54 Mbps, 1ss

802.11n/ac - HT/VHT20, One Antenna, M0 to M7, 1ss

802.11n/ac - HT/VHT20, Two Antennas, M0 to M7, 1ss

802.11n/ac - HT/VHT20, Two Antennas, M8 to M15, 2ss

802.11n/ac - HT/VHT20, Three Antennas, M0 to M7, 1ss

802.11n/ac - HT/VHT20, Three Antennas, M8 to M15, 2ss

802.11n/ac - HT/VHT20, Three Antennas, M16 to M23, 3ss

802.11n/ac - HT/VHT20, Four Antennas, M0 to M7, 1ss

802.11n/ac - HT/VHT20, Four Antennas, M8 to M15, 2ss

802.11n/ac - HT/VHT20, Four Antennas, M16 to M23, 3ss

802.11n/ac - HT/VHT20, Four Antennas, M24 to M31, 4ss

802.11n/ac - HT/VHT20 Beam Forming, Two Antennas, M0 to M7, 1ss

802.11n/ac - HT/VHT20 Beam Forming, Two Antennas, M8 to M15, 2ss

802.11n/ac - HT/VHT20 Beam Forming, Three Antennas, M0 to M7, 1ss

802.11n/ac - HT/VHT20 Beam Forming, Three Antennas, M8 to M15, 2ss

802.11n/ac - HT/VHT20 Beam Forming, Three Antennas, M16 to M23, 3ss

802.11n/ac - HT/VHT20 Beam Forming, Four Antennas, M0 to M7, 1ss

802.11n/ac - HT/VHT20 Beam Forming, Four Antennas, M8 to M15, 2ss

802.11n/ac - HT/VHT20 Beam Forming, Four Antennas, M16 to M23, 3ss

802.11n/ac - HT/VHT20 Beam Forming, Four Antennas, M24 to M31, 4ss

802.11n/ac - HT/VHT20 STBC, Two Antennas, M0 to M7, 2ss

802.11n/ac - HT/VHT20 STBC, Three Antennas, M0 to M7, 2ss

802.11n/ac - HT/VHT20 STBC, Four Antennas, M0 to M7, 2ss

802.11ax - HE20, One Antenna, M0 to M9 1ss

802.11ax - HE20, Two Antennas, M0 to M9 1ss

802.11ax - HE20, Two Antennas, M0 to M9 2ss

802.11ax - HE20, Three Antennas, M0 to M9 1ss

802.11ax - HE20, Three Antennas, M0 to M9 2ss

802.11ax - HE20, Three Antennas, M0 to M9 3ss

802.11ax - HE20, Four Antennas, M0 to M9 1ss

802.11ax - HE20, Four Antennas, M0 to M9 2ss

802.11ax - HE20, Four Antennas, M0 to M9 3ss

802.11ax - HE20, Four Antennas, M0 to M9 4ss

802.11ax - HE20 Beam Forming, Two Antennas, M0 to M9 1ss  
802.11ax - HE20 Beam Forming, Two Antennas, M0 to M9 2ss  
802.11ax - HE20 Beam Forming, Three Antennas, M0 to M9 1ss  
802.11ax - HE20 Beam Forming, Three Antennas, M0 to M9 2ss  
802.11ax - HE20 Beam Forming, Three Antennas, M0 to M9 3ss  
802.11ax - HE20 Beam Forming, Four Antennas, M0 to M9 1ss  
802.11ax - HE20 Beam Forming, Four Antennas, M0 to M9 2ss  
802.11ax - HE20 Beam Forming, Four Antennas, M0 to M9 3ss  
802.11ax - HE20 Beam Forming, Four Antennas, M0 to M9 4ss

802.11ax - HE20 STBC, Two Antennas, M0 to M9 2ss  
802.11ax - HE20 STBC, Three Antennas, M0 to M9 2ss  
802.11ax - HE20 STBC, Four Antennas, M0 to M9 2ss

802.11a - Non HT40, One Antenna, 6 to 54 Mbps, 1ss  
802.11a - Non HT40, Two Antennas, 6 to 54 Mbps, 1ss  
802.11a - Non HT40, Three Antennas, 6 to 54 Mbps, 1ss  
802.11a - Non HT40, Four Antennas, 6 to 54 Mbps, 1ss

802.11n/ac - HT/VHT40, One Antenna, M0 to M7, 1ss  
802.11n/ac - HT/VHT40, Two Antennas, M0 to M7, 1ss  
802.11n/ac - HT/VHT40, Two Antennas, M8 to M15, 2ss  
802.11n/ac - HT/VHT40, Three Antennas, M0 to M7, 1ss  
802.11n/ac - HT/VHT40, Three Antennas, M8 to M15, 2ss  
802.11n/ac - HT/VHT40, Three Antennas, M16 to M23, 3ss  
802.11n/ac - HT/VHT40, Four Antennas, M0 to M7, 1ss  
802.11n/ac - HT/VHT40, Four Antennas, M8 to M15, 2ss  
802.11n/ac - HT/VHT40, Four Antennas, M16 to M23, 3ss  
802.11n/ac - HT/VHT40, Four Antennas, M24 to M31, 4ss

802.11n/ac - HT/VHT40 Beam Forming, Two Antennas, M0 to M7, 1ss  
802.11n/ac - HT/VHT40 Beam Forming, Two Antennas, M8 to M15, 2ss  
802.11n/ac - HT/VHT40 Beam Forming, Three Antennas, M0 to M7, 1ss  
802.11n/ac - HT/VHT40 Beam Forming, Three Antennas, M8 to M15, 2ss  
802.11n/ac - HT/VHT40 Beam Forming, Three Antennas, M16 to M23, 3ss  
802.11n/ac - HT/VHT40 Beam Forming, Four Antennas, M0 to M7, 1ss  
802.11n/ac - HT/VHT40 Beam Forming, Four Antennas, M8 to M15, 2ss  
802.11n/ac - HT/VHT40 Beam Forming, Four Antennas, M16 to M23, 3ss  
802.11n/ac - HT/VHT40 Beam Forming, Four Antennas, M24 to M31, 4ss

802.11n/ac - HT/VHT40 STBC, Two Antennas, M0 to M7, 2ss  
802.11n/ac - HT/VHT40 STBC, Three Antennas, M0 to M7, 2ss  
802.11n/ac - HT/VHT40 STBC, Four Antennas, M0 to M7, 2ss

802.11ax - HE40, One Antenna, M0 to M9 1ss  
802.11ax - HE40, Two Antennas, M0 to M9 1ss





- 802.11ax - HE40, Two Antennas, M0 to M9 2ss
- 802.11ax - HE40, Three Antennas, M0 to M9 1ss
- 802.11ax - HE40, Three Antennas, M0 to M9 2ss
- 802.11ax - HE40, Three Antennas, M0 to M9 3ss
- 802.11ax - HE40, Four Antennas, M0 to M9 1ss
- 802.11ax - HE40, Four Antennas, M0 to M9 2ss
- 802.11ax - HE40, Four Antennas, M0 to M9 3ss
- 802.11ax - HE40, Four Antennas, M0 to M9 4ss
  
- 802.11ax - HE40 Beam Forming, Two Antennas, M0 to M9 1ss
- 802.11ax - HE40 Beam Forming, Two Antennas, M0 to M9 2ss
- 802.11ax - HE40 Beam Forming, Three Antennas, M0 to M9 1ss
- 802.11ax - HE40 Beam Forming, Three Antennas, M0 to M9 2ss
- 802.11ax - HE40 Beam Forming, Three Antennas, M0 to M9 3ss
- 802.11ax - HE40 Beam Forming, Four Antennas, M0 to M9 1ss
- 802.11ax - HE40 Beam Forming, Four Antennas, M0 to M9 2ss
- 802.11ax - HE40 Beam Forming, Four Antennas, M0 to M9 3ss
- 802.11ax - HE40 Beam Forming, Four Antennas, M0 to M9 4ss
  
- 802.11ax - HE40 STBC, Two Antennas, M0 to M9 2ss
- 802.11ax - HE40 STBC, Three Antennas, M0 to M9 2ss
- 802.11ax - HE40 STBC, Four Antennas, M0 to M9 2ss
  
- 802.11a - Non HT80, One Antenna, 6 to 54 Mbps, 1ss
- 802.11a - Non HT80, Two Antennas, 6 to 54 Mbps, 1ss
- 802.11a - Non HT80, Three Antennas, 6 to 54 Mbps, 1ss
- 802.11a - Non HT80, Four Antennas, 6 to 54 Mbps, 1ss
  
- 802.11ac - VHT80, One Antenna, M0 to M9 1ss
- 802.11ac - VHT80, Two Antennas, M0 to M9 1ss
- 802.11ac - VHT80, Two Antennas, M0 to M9 2ss
- 802.11ac - VHT80, Three Antennas, M0 to M9 1ss
- 802.11ac - VHT80, Three Antennas, M0 to M9 2ss
- 802.11ac - VHT80, Three Antennas, M0 to M9 3ss
- 802.11ac - VHT80, Four Antennas, M0 to M9 1ss
- 802.11ac - VHT80, Four Antennas, M0 to M9 2ss
- 802.11ac - VHT80, Four Antennas, M0 to M9 3ss
- 802.11ac - VHT80, Four Antennas, M0 to M9 4ss
  
- 802.11ac - VHT80 Beam Forming, Two Antennas, M0 to M9 1ss
- 802.11ac - VHT80 Beam Forming, Two Antennas, M0 to M9 2ss
- 802.11ac - VHT80 Beam Forming, Three Antennas, M0 to M9 1ss
- 802.11ac - VHT80 Beam Forming, Three Antennas, M0 to M9 2ss
- 802.11ac - VHT80 Beam Forming, Three Antennas, M0 to M9 3ss
- 802.11ac - VHT80 Beam Forming, Four Antennas, M0 to M9 1ss
- 802.11ac - VHT80 Beam Forming, Four Antennas, M0 to M9 2ss
- 802.11ac - VHT80 Beam Forming, Four Antennas, M0 to M9 3ss
- 802.11ac - VHT80 Beam Forming, Four Antennas, M0 to M9 4ss

802.11ac - VHT80 STBC, Two Antennas, M0 to M9 2ss  
802.11ac - VHT80 STBC, Three Antennas, M0 to M9 2ss  
802.11ac - VHT80 STBC, Four Antennas, M0 to M9 2ss

802.11ax - HE80, One Antenna, M0 to M9 1ss  
802.11ax - HE80, Two Antennas, M0 to M9 1ss  
802.11ax - HE80, Two Antennas, M0 to M9 2ss  
802.11ax - HE80, Three Antennas, M0 to M9 1ss  
802.11ax - HE80, Three Antennas, M0 to M9 2ss  
802.11ax - HE80, Three Antennas, M0 to M9 3ss  
802.11ax - HE80, Four Antennas, M0 to M9 1ss  
802.11ax - HE80, Four Antennas, M0 to M9 2ss  
802.11ax - HE80, Four Antennas, M0 to M9 3ss  
802.11ax - HE80, Four Antennas, M0 to M9 4ss

802.11ax - HE80 Beam Forming, Two Antennas, M0 to M9 1ss  
802.11ax - HE80 Beam Forming, Two Antennas, M0 to M9 2ss  
802.11ax - HE80 Beam Forming, Three Antennas, M0 to M9 1ss  
802.11ax - HE80 Beam Forming, Three Antennas, M0 to M9 2ss  
802.11ax - HE80 Beam Forming, Three Antennas, M0 to M9 3ss  
802.11ax - HE80 Beam Forming, Four Antennas, M0 to M9 1ss  
802.11ax - HE80 Beam Forming, Four Antennas, M0 to M9 2ss  
802.11ax - HE80 Beam Forming, Four Antennas, M0 to M9 3ss  
802.11ax - HE80 Beam Forming, Four Antennas, M0 to M9 4ss

802.11ax - HE80 STBC, Two Antennas, M0 to M9 2ss  
802.11ax - HE80 STBC, Three Antennas, M0 to M9 2ss  
802.11ax - HE80 STBC, Four Antennas, M0 to M9 2ss

802.11a - Non HT160, One Antenna, 6 to 54 Mbps, 1ss  
802.11a - Non HT160, Two Antennas, 6 to 54 Mbps, 1ss  
802.11a - Non HT160, Three Antennas, 6 to 54 Mbps, 1ss  
802.11a - Non HT160, Four Antennas, 6 to 54 Mbps, 1ss

802.11ac - VHT160, One Antenna, M0 to M9 1ss  
802.11ac - VHT160, Two Antennas, M0 to M9 1ss  
802.11ac - VHT160, Two Antennas, M0 to M9 2ss  
802.11ac - VHT160, Three Antennas, M0 to M9 1ss  
802.11ac - VHT160, Three Antennas, M0 to M9 2ss  
802.11ac - VHT160, Three Antennas, M0 to M9 3ss  
802.11ac - VHT160, Four Antennas, M0 to M9 1ss  
802.11ac - VHT160, Four Antennas, M0 to M9 2ss  
802.11ac - VHT160, Four Antennas, M0 to M9 3ss  
802.11ac - VHT160, Four Antennas, M0 to M9 4ss

802.11ac - VHT160 Beam Forming, Two Antennas, M0 to M9 1ss  
802.11ac - VHT160 Beam Forming, Two Antennas, M0 to M9 2ss

802.11ac - VHT160 Beam Forming, Three Antennas, M0 to M9 1ss  
802.11ac - VHT160 Beam Forming, Three Antennas, M0 to M9 2ss  
802.11ac - VHT160 Beam Forming, Three Antennas, M0 to M9 3ss  
802.11ac - VHT160 Beam Forming, Four Antennas, M0 to M9 1ss  
802.11ac - VHT160 Beam Forming, Four Antennas, M0 to M9 2ss  
802.11ac - VHT160 Beam Forming, Four Antennas, M0 to M9 3ss  
802.11ac - VHT160 Beam Forming, Four Antennas, M0 to M9 4ss

802.11ac - VHT160 STBC, Two Antennas, M0 to M9 2ss  
802.11ac - VHT160 STBC, Three Antennas, M0 to M9 2ss  
802.11ac - VHT160 STBC, Four Antennas, M0 to M9 2ss

802.11ax - HE160, One Antenna, M0 to M9 1ss  
802.11ax - HE160, Two Antennas, M0 to M9 1ss  
802.11ax - HE160, Two Antennas, M0 to M9 2ss  
802.11ax - HE160, Three Antennas, M0 to M9 1ss  
802.11ax - HE160, Three Antennas, M0 to M9 2ss  
802.11ax - HE160, Three Antennas, M0 to M9 3ss  
802.11ax - HE160, Four Antennas, M0 to M9 1ss  
802.11ax - HE160, Four Antennas, M0 to M9 2ss  
802.11ax - HE160, Four Antennas, M0 to M9 3ss  
802.11ax - HE160, Four Antennas, M0 to M9 4ss

802.11ax - HE160 Beam Forming, Two Antennas, M0 to M9 1ss  
802.11ax - HE160 Beam Forming, Two Antennas, M0 to M9 2ss  
802.11ax - HE160 Beam Forming, Three Antennas, M0 to M9 1ss  
802.11ax - HE160 Beam Forming, Three Antennas, M0 to M9 2ss  
802.11ax - HE160 Beam Forming, Three Antennas, M0 to M9 3ss  
802.11ax - HE160 Beam Forming, Four Antennas, M0 to M9 1ss  
802.11ax - HE160 Beam Forming, Four Antennas, M0 to M9 2ss  
802.11ax - HE160 Beam Forming, Four Antennas, M0 to M9 3ss  
802.11ax - HE160 Beam Forming, Four Antennas, M0 to M9 4ss

802.11ax - HE160 STBC, Two Antennas, M0 to M9 2ss  
802.11ax - HE160 STBC, Three Antennas, M0 to M9 2ss  
802.11ax - HE160 STBC, Four Antennas, M0 to M9 2ss

The following antennas are supported by this product series.

The data included in this report represent the worst case data for all antennas.

Frequency	Part Number	Antenna Type	Antenna Gain (dBi)
<b>-E SKU</b>			
2.4GHz&5GHz	AIR-ANT2524DB-R/=	2.4 GHz 2 dBi/5 GHz 4 dBi Dipole Ant., Black, connectors RP-TNC	2dBi@2.4GHz 4dBi@5GHz
2.4GHz&5GHz	AIR-ANT2524DG-R/=	2.4 GHz 2 dBi/5 GHz 4 dBi Dipole Ant., Gray, connectors RP-TNC	2dBi@2.4GHz 4dBi@5GHz
2.4GHz&5GHz	AIR-ANT2524DW-R/=	2.4 GHz 2 dBi/5 GHz 4 dBi Dipole Ant., White, connectors RP-TNC	2dBi@2.4GHz 4dBi@5GHz
2.4GHz&5GHz	AIR-ANT2535SDW-R	2.4 GHz 3dBi/5 GHz 5 dBi Low Profile Antenna, White, connectors RP-TNC	3dBi@2.4GHz 5dBi@5GHz
2.4GHz&5GHz	AIR-ANT2566P4W-R=	2.4 GHz 6 dBi/5 GHz 6 dBi Directionnel Ant., 4-port, connectors RP-TNC	6dBi@2.4GHz 6dBi@5GHz
2.4GHz&5GHz	AIR-ANT2524V4C-R=	2.4GHz 2 dBi/5GHz 4 dBi Ceiling Mount Omni Ant., 4-port, connectors RP-TNC	2dBi@2.4GHz 4dBi@5GHz
2.4GHz&5GHz	AIR-ANT2544V4M-R=	2.4GHz 4 dBi/5GHz 4 dBi Wall Mount Omni Ant., 4-port, connectors RP-TNC	4dBi@2.4GHz 4dBi@5GHz
2.4GHz&5GHz	AIR-ANT2566D4M-R=	2.4 GHz 6 dBi/5 GHz 6 dBi 60 Deg. Patch Ant., 4-port, RP-TNC	6dBi@2.4GHz 6dBi@5GHz

### Section 3: Result Summary

#### 3.1 Results Summary Table

##### Conducted emissions

Basic Standard	Technical Requirements / Details	Result
FCC 15.407 RSS-247	<b>6dB Bandwidth:</b> Systems using digital modulation techniques may operate in the 2400-2483.5MHz band. The minimum 6dB bandwidth shall be at least 500 kHz.	Pass
FCC 15.407 RSS-GEN	<b>99% &amp; 26 dB Bandwidth:</b> The 99% occupied bandwidth is the frequency bandwidth such that, below its lower and above its upper frequency limits, the mean powers are each equal to 0.5% of the total mean power of the given emission. There is no limit for 99% OBW.  The 26 dB emission is the width of the emission that is constrained by the frequencies associated with the two outermost amplitude points (upper and lower frequencies) that are attenuated by 26 dB relative to the maximum level measured in the fundamental emission.	Pass
FCC 15.407 RSS-247	<b>Output Power:</b> For the band 5.725-5.85 GHz, the maximum conducted output power over the frequency band of operation shall not exceed 1 W.	Pass
FCC 15.407 RSS-247	<b>Power Spectral Density:</b> <b>15.407</b> The maximum power spectral density shall not exceed 30 dBm in any 500-kHz band.	Pass
FCC 15.407 RSS-247	<b>Conducted Spurious Emissions / Band-Edge:</b> For transmitters operating in the 5.725-5.85 GHz band: All emissions within the frequency range from the band edge to 10 MHz above or below the band edge shall not exceed an e.i.r.p. of -17 dBm/MHz; for frequencies 10 MHz or greater above or below the band edge, emissions shall not exceed an e.i.r.p. of -27 dBm/MHz.	Pass
FCC 15.209 FCC 152.05 RSS-GEN	<b>Restricted band:</b> Unwanted emissions falling within the restricted bands, as defined in FCC 15.205 (a) must also comply with the radiated emission limits specified in FCC 15.209 (a).	Pass

##### Radiated Emissions (General requirements)

Basic Standard	Technical Requirements / Details	Result
FCC 15.209 FCC 15.205 RSS-GEN	<b>TX Spurious Emissions:</b> Except as provided elsewhere in this subpart, the emissions from an intentional radiator shall not exceed the field strength levels specified in the filed strength limits table in this section.	Not Tested
FCC 15.207 RSS-GEN	<b>AC conducted Emissions:</b> Except when the requirements applicable to a given device state otherwise, for any radio apparatus equipped to operate from the public utility AC power supply, either directly or indirectly (such as with a battery charger), the radio frequency voltage of emissions conducted back onto the AC power lines in the frequency range of 0.15 MHz to 30 MHz shall not exceed the limits shown in the table in these sections. The more stringent limit applies at the frequency range boundaries.	Not Tested

## Section 4: Sample Details

Note: Each sample was evaluated to ensure that its condition was suitable to be used as a test sample prior to the commencement of testing.

### 4.1 Sample Details

Sample No.	Equipment Details	Manufacturer	Hardware Rev.	Firmware Rev.	Software Rev.	Serial Number
S01	C9120AXE-x	Foxconn	P2-2	1268.14948.r 146 146	Cisco AP Software, (ap1g7), [cheetah-build6:/san2/BU LD/workspace/Nightly-Ch eetah-axel-bcm-mfg-c8_1 0_throttle] Compiled Tue Aug 6 08:07:11 PDT 2019	FOC23302F3B
S02	DART cable 37-100909-01	Amphenol	NA	NA	NA	NA

### 4.2 System Details

System #	Description	Samples
1	C9120AXE-x	S01+S02

### 4.3 Mode of Operation Details

Mode#	Description	Comments
1	Continuously Transmitting	Constant duty cycle

#### All measurements were made in accordance with

- ANSI C63.10:2013
- KDB 789033 D02 General UNII Test Procedures New Rules v01r03
- KDB 662911 D01 Multiple Transmitter Output v02r01

**Appendix A: Emission Test Results**

**Conducted Test Setup Diagram**

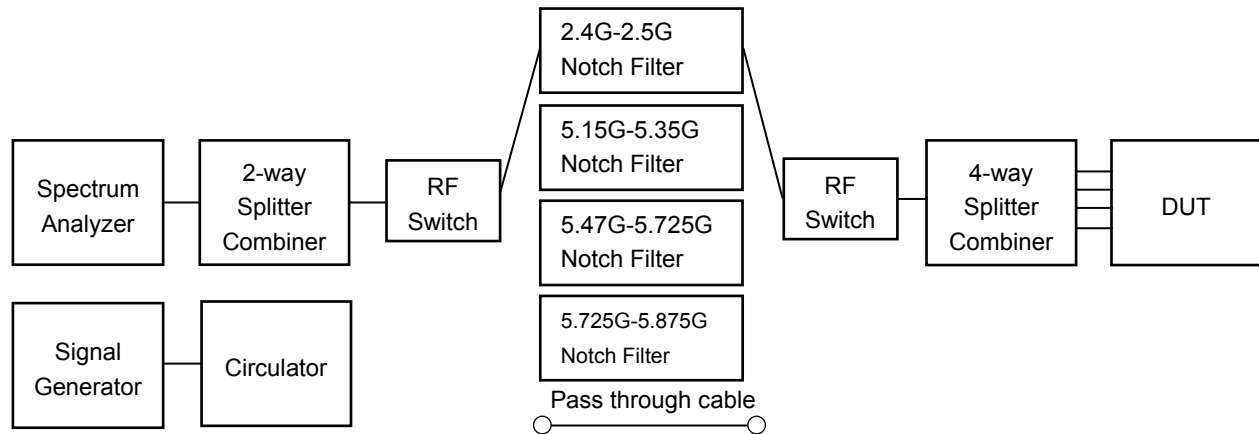

**Target Maximum Channel Power**

The following tables detail the maximum supported Total Channel Power for all operating modes.

Operating Mode	Maximum Channel Power, 4dBi (dBm)			
	Frequency (MHz)			
	5720 <sup>1</sup>	5745	5785	5825
Non HT20, 6 to 54 Mbps	14	22	22	22
Non HT20 Beam Forming, 6 to 54 Mbps	11	22	22	22
HT/VHT20, M0 to M31	14	22	22	22
HT/VHT20 Beam Forming, M0 to M31	14	22	22	22
HT/VHT20 STBC, M0 to M7	14	22	22	22
HE20, M0 to M9, M0 to M9 1-2ss	15	23	23	23
HE20 Beam Forming, M0 to M9, M0 to M9 1-2ss	15	23	23	23
HE20 STBC, M0 to M9 2ss	15	23	23	23
	5755	5795		
Non HT40, 6 to 54 Mbps	22	22		
HT/VHT40, M0 to M31	22	22		
HT/VHT40 Beam Forming, M0 to M31	22	22		
HT/VHT40 STBC, M0 to M7	22	22		
HE40, M0 to M9, M0 to M9 1-2ss	22	22		
HE40 Beam Forming, M0 to M9, M0 to M9 1-2ss	22	22		
HE40 STBC, M0 to M9 2ss	22	22		
	5775			
Non HT80, 6 to 54 Mbps	21			
VHT80, M0 to M9, M0 to M9 1-2ss	21			
VHT80 Beam Forming, M0 to M9, M0 to M9 1-2ss	21			
VHT80 STBC, M0 to M9 1ss	21			
HE80, M0 to M9, M0 to M9 1-2ss	22			
HE80 Beam Forming, M0 to M9, M0 to M9 1-2ss	22			
HE80 STBC, M0 to M9 1ss	22			

<sup>1</sup> 5720 (ch144) not supported for Canada.



Operating Mode	Maximum Channel Power, 5dBi (dBm)			
	Frequency (MHz)			
	5720 <sup>2</sup>	5745	5785	5825
Non HT20, 6 to 54 Mbps	14	22	22	22
Non HT20 Beam Forming, 6 to 54 Mbps	11	22	22	22
HT/VHT20, M0 to M31	14	22	22	22
HT/VHT20 Beam Forming, M0 to M31	14	22	22	22
HT/VHT20 STBC, M0 to M7	13	22	22	22
HE20, M0 to M9, M0 to M9 1-2ss	15	23	23	23
HE20 Beam Forming, M0 to M9, M0 to M9 1-2ss	15	23	23	23
HE20 STBC, M0 to M9 2ss	14	23	23	23
	5755	5795		
Non HT40, 6 to 54 Mbps	22	22		
HT/VHT40, M0 to M31	22	22		
HT/VHT40 Beam Forming, M0 to M31	22	22		
HT/VHT40 STBC, M0 to M7	22	22		
HE40, M0 to M9, M0 to M9 1-2ss	22	22		
HE40 Beam Forming, M0 to M9, M0 to M9 1-2ss	22	22		
HE40 STBC, M0 to M9 2ss	22	22		
	5775			
Non HT80, 6 to 54 Mbps	21			
VHT80, M0 to M9, M0 to M9 1-2ss	21			
VHT80 Beam Forming, M0 to M9, M0 to M9 1-2ss	21			
VHT80 STBC, M0 to M9 1ss	21			
HE80, M0 to M9, M0 to M9 1-2ss	22			
HE80 Beam Forming, M0 to M9, M0 to M9 1-2ss	22			
HE80 STBC, M0 to M9 1ss	22			

<sup>2</sup> 5720 (ch144) not supported for Canada.

Operating Mode	Maximum Channel Power, 6dBi (dBm)			
	Frequency (MHz)			
	5720 <sup>3</sup>	5745	5785	5825
Non HT20, 6 to 54 Mbps	14	22	22	22
Non HT20 Beam Forming, 6 to 54 Mbps	10	22	22	22
HT/VHT20, M0 to M31	14	22	22	22
HT/VHT20 Beam Forming, M0 to M31	14	22	22	22
HT/VHT20 STBC, M0 to M7	13	22	22	22
HE20, M0 to M9, M0 to M9 1-2ss	15	23	23	23
HE20 Beam Forming, M0 to M9, M0 to M9 1-2ss	15	23	23	23
HE20 STBC, M0 to M9 2ss	13	23	23	23
	5755	5795		
Non HT40, 6 to 54 Mbps	22	22		
HT/VHT40, M0 to M31	22	22		
HT/VHT40 Beam Forming, M0 to M31	22	22		
HT/VHT40 STBC, M0 to M7	22	22		
HE40, M0 to M9, M0 to M9 1-2ss	22	22		
HE40 Beam Forming, M0 to M9, M0 to M9 1-2ss	22	22		
HE40 STBC, M0 to M9 2ss	22	22		
	5775			
Non HT80, 6 to 54 Mbps	21			
VHT80, M0 to M9, M0 to M9 1-2ss	21			
VHT80 Beam Forming, M0 to M9, M0 to M9 1-2ss	21			
VHT80 STBC, M0 to M9 1ss	21			
HE80, M0 to M9, M0 to M9 1-2ss	22			
HE80 Beam Forming, M0 to M9, M0 to M9 1-2ss	22			
HE80 STBC, M0 to M9 1ss	22			

<sup>3</sup> 5720 (ch144) not supported for Canada.



## A.1 Duty Cycle

### Duty Cycle Test Requirement

From KDB 789033 D02 General UNII Test Procedures New Rules v02r01

#### B. Duty Cycle (x), Transmission Duration (T), and Maximum Power Control Level

1. All measurements are to be performed with the EUT transmitting at 100 percent duty cycle at its maximum power control level; however, if 100 percent duty cycle cannot be achieved, measurements of duty cycle, x, and maximum-power transmission duration, T, are required for each tested mode of operation.

### Duty Cycle Test Method

From KDB 789033 D02 General UNII Test Procedures New Rules v02r01:

#### B. Duty Cycle (x), Transmission Duration (T), and Maximum Power Control Level

The zero-span mode on a spectrum analyzer or EMI receiver, if the response time and spacing between bins on the sweep are sufficient to permit accurate measurements of the on and off times of the transmitted signal. Set the center frequency of the instrument to the center frequency of the transmission. Set RBW ≥ EBW if possible; otherwise, set RBW to the largest available value. Set VBW ≥ RBW. Set detector = peak or average. The zero-span measurement method shall not be used unless both RBW and VBW are > 50/T, where T is defined in section II.B.1.a), and the number of sweep points across duration T exceeds 100. (For example, if VBW and/or RBW are limited to 3 MHz, then the zero-span method of measuring duty cycle shall not be used if T ≤ 16.7 microseconds.)

### Duty Cycle Test Information

<b>Tested By :</b> Chris Blair	<b>Date of testing:</b> 25-Sep-19 - 01-Oct-19
<b>Test Result : PASS</b>	

#### Test Equipment

See Appendix C for list of test equipment

#### Samples, Systems, and Modes

System Number	Description	Samples	System under test	Support equipment
1	EUT	S01+S02	<input checked="" type="checkbox"/>	<input type="checkbox"/>
	Support		<input type="checkbox"/>	<input checked="" type="checkbox"/>

### Duty Cycle Data Table

Duty Cycle table and screen captures are shown below for power/psd modes.

Frequency	Mode	Data Rate	Duty Cycle correction (dB)
5720 <sup>4</sup>	Non HT20, 6 to 54 Mbps	6	0.1
	HT/VHT20, M0 to M31	m0	0.1
	HE20, M0 to M9, M0 to M9 1-2ss	m0h1	0.1
<hr/>			
5745	Non HT20, 6 to 54 Mbps	6	0.1
	HT/VHT20, M0 to M31	m0	0.1
	HE20, M0 to M9, M0 to M9 1-2ss	m0h1	0.1
<hr/>			
5755	Non HT40, 6 to 54 Mbps	6	0.1
	HT/VHT40, M0 to M31	m0	0.1
	HE40, M0 to M9, M0 to M9 1-2ss	m0h1	0.1
<hr/>			
5775	Non HT80, 6 to 54 Mbps	6	0.0
	VHT80, M0 to M9, M0 to M9 1-2ss	m0x1	0.2
	<b>HE80, M0 to M9, M0 to M9 1-2ss</b>	<b>m0h1</b>	<b>0.2</b>
<hr/>			
5785	Non HT20, 6 to 54 Mbps	6	0.1
	HT/VHT20, M0 to M31	m0	0.1
	HE20, M0 to M9, M0 to M9 1-2ss	m0h1	0.1
<hr/>			
5795	Non HT40, 6 to 54 Mbps	6	0.1
	HT/VHT40, M0 to M31	m0	0.1
	HE40, M0 to M9, M0 to M9 1-2ss	m0h1	0.1
<hr/>			
5825	Non HT20, 6 to 54 Mbps	6	0.1
	HT/VHT20, M0 to M31	m0	0.1
	HE20, M0 to M9, M0 to M9 1-2ss	m0h1	0.1

<sup>4</sup> 5720 (ch144) not supported for Canada.



Duty Cycle, 5775 MHz, HE80, M0 to M9, M0 to M9 1-2ss

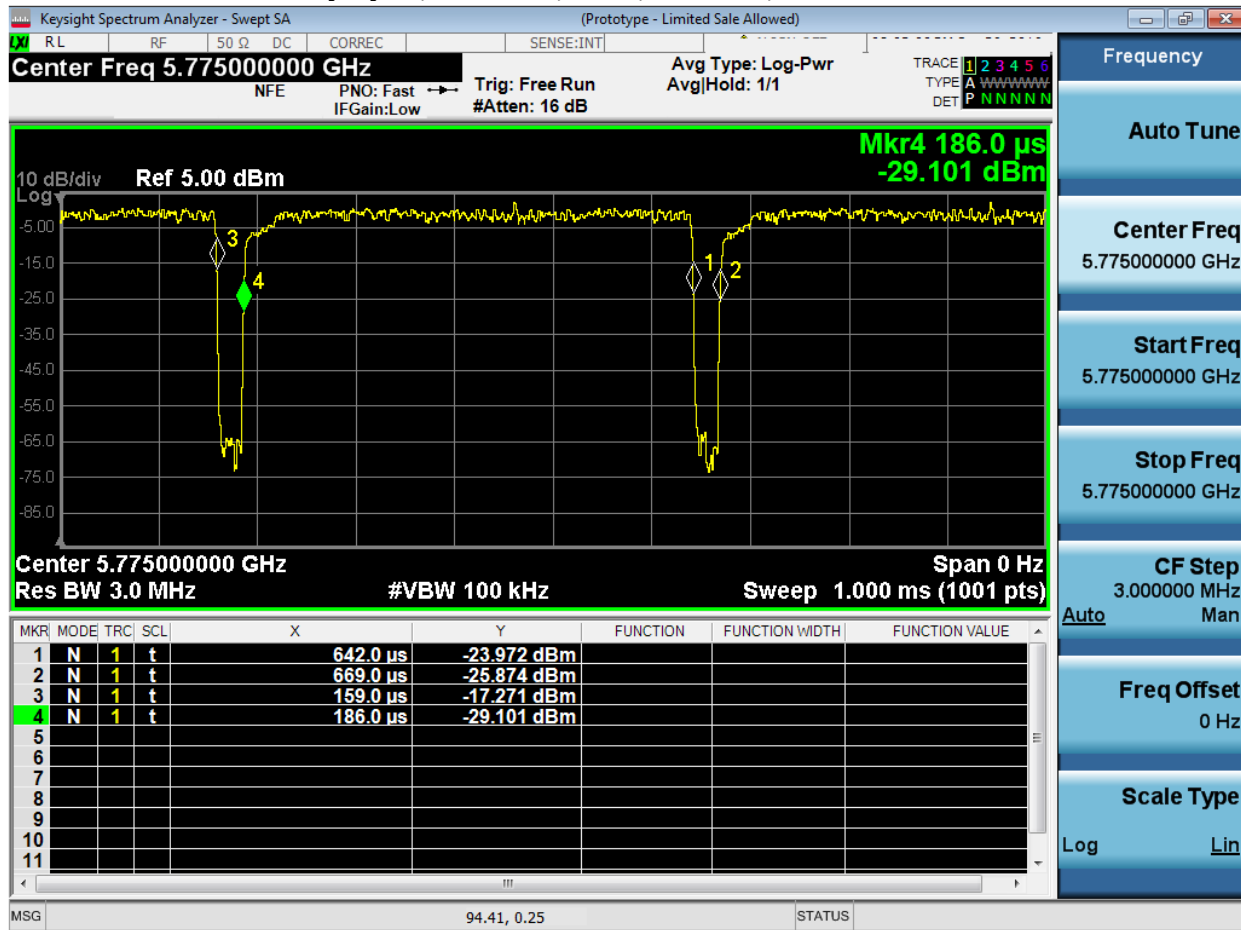

## A.2 6dB Bandwidth

**15.407 / RSS-247** Within the 5.725-5.85 GHz band, the minimum 6 dB bandwidth of U-NII devices shall be at least 500 kHz.

### Test Procedure

Ref. KDB 789033 D02 General UNII Test Procedures New Rules v01r03  
ANSI C63.10: 2013

<b>6 BW</b> Test Procedure
<ol style="list-style-type: none"> <li>1. Set the radio in the continuous transmitting mode.</li> <li>2. Allow the trace to stabilize.</li> <li>3. Setting the x-dB bandwidth mode to -6dB within the measurement set up function.</li> <li>4. Select the automatic OBW measurement function of an instrument to perform bandwidth measurement.</li> <li>5. Capture graphs and record pertinent measurement data.</li> </ol>

Ref. KDB 789033 D02 General UNII Test Procedures New Rules v01r03  
ANSI C63.10: 2013 section 11.8.2 Option 2

<b>6 BW</b> Test parameters
X dB BW = 6dB (using the OBW function of the spectrum analyzer) Span = Large enough to capture the entire EBW RBW = 100 KHz VBW $\geq$ 3 x RBW Sweep = Auto couple Detector = Peak or where practical sample shall be used Trace = Max. Hold

System Number	Description	Samples	System under test	Support equipment
1	EUT	S01+S02	<input checked="" type="checkbox"/>	<input type="checkbox"/>
	Support		<input type="checkbox"/>	<input checked="" type="checkbox"/>

<b>Tested By :</b> Chris Blair	<b>Date of testing:</b> 25-Sep-19 - 01-Oct-19
<b>Test Result : PASS</b>	

See Appendix C for list of test equipment

## 6dB Bandwidth Table

Frequency (MHz)	Mode	Data Rate (Mbps)	6dB BW (MHz)	Limit (kHz)	Margin (MHz)
5720 <sup>5</sup>	<b>Non HT20, 6 to 54 Mbps</b>	<b>6</b>	<b>3.2</b>	<b>&gt;500</b>	<b>2.70</b>
	HT/VHT20, M0 to M31	m0	3.8	>500	3.30
	HE20, M0 to M9, M0 to M9 1-2ss	m0h1	4.5	>500	4.00
5745	<b>Non HT20, 6 to 54 Mbps</b>	<b>6</b>	<b>16.4</b>	<b>&gt;500</b>	<b>15.90</b>
	HT/VHT20, M0 to M31	m0	17.6	>500	17.10
	HE20, M0 to M9, M0 to M9 1-2ss	m0h1	19.1	>500	18.60
5755	Non HT40, 6 to 54 Mbps	6	36.5	>500	36.00
	HT/VHT40, M0 to M31	m0	36.3	>500	35.80
	HE40, M0 to M9, M0 to M9 1-2ss	m0h1	37.5	>500	37.00
5775	Non HT80, 6 to 54 Mbps	6	76.4	>500	75.90
	VHT80, M0 to M9, M0 to M9 1-2ss	m0x1	76.0	>500	75.50
	HE80, M0 to M9, M0 to M9 1-2ss	m0h1	77.2	>500	76.70
5785	Non HT20, 6 to 54 Mbps	6	16.4	>500	15.90
	HT/VHT20, M0 to M31	m0	17.6	>500	17.10
	HE20, M0 to M9, M0 to M9 1-2ss	m0h1	19.1	>500	18.60
5795	Non HT40, 6 to 54 Mbps	6	36.4	>500	35.90
	HT/VHT40, M0 to M31	m0	36.3	>500	35.80
	HE40, M0 to M9, M0 to M9 1-2ss	m0h1	37.4	>500	36.90
5825	Non HT20, 6 to 54 Mbps	6	16.4	>500	15.90
	HT/VHT20, M0 to M31	m0	17.6	>500	17.10
	HE20, M0 to M9, M0 to M9 1-2ss	m0h1	19.1	>500	18.60

<sup>5</sup> 5720 (ch144) not supported for Canada.



**6dB Bandwidth, 5720 MHz, Non HT20, 6 to 54 Mbps<sup>6</sup>**



**6dB Bandwidth, 5745 MHz, Non HT20, 6 to 54 Mbps**

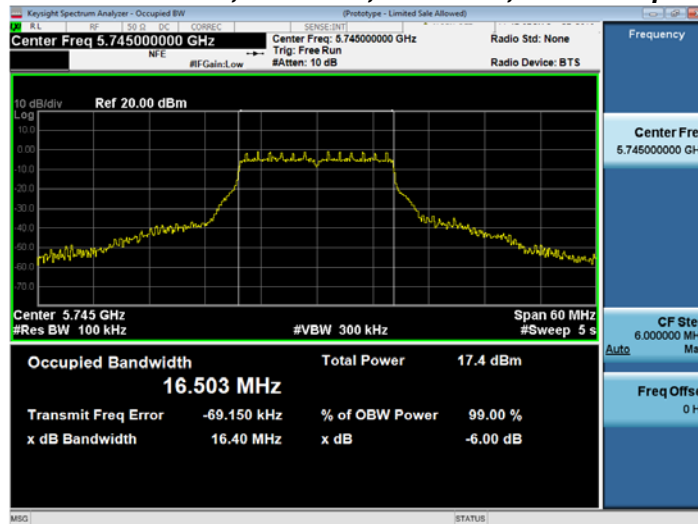

<sup>6</sup> 5720 (ch144) not supported for Canada.



## A.3 99% and 26dB Bandwidth

**FCC 15.407 / RSS-GEN** The 99% occupied bandwidth is the frequency bandwidth such that, below its lower and above its upper frequency limits, the mean powers are each equal to 0.5% of the total mean power of the given emission. There is no limit for 99% OBW.

The 26 dB emission is the width of the emission that is constrained by the frequencies associated with the two outermost amplitude points (upper and lower frequencies) that are attenuated by 26 dB relative to the maximum level measured in the fundamental emission.

### Test Procedure

Ref. ANSI C63.10: 2013 Section 6.9.3

<b>99% BW and EBW (-26dB)</b>
Test Procedure
<ol style="list-style-type: none"> <li>1. Set the radio in the continuous transmitting mode.</li> <li>2. Allow the trace to stabilize.</li> <li>3. Setting the x-dB bandwidth mode to -26dB and OBW power function to 99% within the measurement set up function.</li> <li>4. Select the automatic OBW measurement function of an instrument to perform bandwidth measurement.</li> <li>5. Capture graphs and record pertinent measurement data.</li> </ol>

Ref. ANSI C63.10: 2013 Section 6.9.3

<b>99% BW and EBW (-26dB)</b>
Test parameters
Span = 1.5 x to 5.0 times OBW
RBW = approx. 1% to 5% of the OBW
VBW ≥ 3 x RBW
Detector = Peak or where practical sample shall be used
Trace = Max. Hold

System Number	Description	Samples	System under test	Support equipment
1	EUT	S01+S02	<input checked="" type="checkbox"/>	<input type="checkbox"/>
	Support		<input type="checkbox"/>	<input checked="" type="checkbox"/>

<b>Tested By :</b> Chris Blair	<b>Date of testing:</b> 25-Sep-19 - 01-Oct-19
<b>Test Result : PASS</b>	

See Appendix C for list of test equipment

## 99% and 26dB Bandwidth Table

Frequency (MHz)	Mode	Data Rate (Mbps)	26dB BW (MHz)	99% BW (MHz)
5720 <sup>7</sup>	Non HT20, 6 to 54 Mbps	6	5.6	4.736
	<b>HT/VHT20, M0 to M31</b>	<b>m0</b>	<b>5.8</b>	<b>4.702</b>
	HE20, M0 to M9, M0 to M9 1-2ss	m0h1	5.8	4.925
5745	Non HT20, 6 to 54 Mbps	6	21.2	16.802
	HT/VHT20, M0 to M31	m0	21.8	18.077
	HE20, M0 to M9, M0 to M9 1-2ss	m0h1	21.5	19.162
5755	Non HT40, 6 to 54 Mbps	6	39.9	36.400
	HT/VHT40, M0 to M31	m0	40.3	36.487
	HE40, M0 to M9, M0 to M9 1-2ss	m0h1	39.9	37.610
5775	Non HT80, 6 to 54 Mbps	6	84.8	76.393
	VHT80, M0 to M9, M0 to M9 1-2ss	m0x1	82.4	76.199
	HE80, M0 to M9, M0 to M9 1-2ss	m0h1	82.0	77.101
5785	<b>Non HT20, 6 to 54 Mbps</b>	<b>6</b>	<b>21.1</b>	<b>16.787</b>
	HT/VHT20, M0 to M31	m0	21.7	18.056
	HE20, M0 to M9, M0 to M9 1-2ss	m0h1	21.5	19.145
5795	Non HT40, 6 to 54 Mbps	6	39.8	36.401
	HT/VHT40, M0 to M31	m0	40.3	36.465
	HE40, M0 to M9, M0 to M9 1-2ss	m0h1	40.0	37.621
5825	Non HT20, 6 to 54 Mbps	6	21.2	16.801
	HT/VHT20, M0 to M31	m0	21.8	18.080
	HE20, M0 to M9, M0 to M9 1-2ss	m0h1	21.5	19.171

<sup>7</sup> 5720 (ch144) not supported for Canada.

**26dB / 99% Bandwidth, 5720 MHz, HT/VHT20 Beam Forming, M0 to M7<sup>8</sup>**



**26dB / 99% Bandwidth, 5785 MHz, Non HT20, 6 to 54 Mbps**



<sup>8</sup> 5720 (ch144) not supported for Canada.

## A.4 Maximum Conducted Output Power

**15.407 / RSS-247** For the band 5.725-5.85 GHz, the maximum conducted output power over the frequency band of operation shall not exceed 1 W. If transmitting antennas of directional gain greater than 6 dBi are used, both the maximum conducted output power and the maximum power spectral density shall be reduced by the amount in dB that the directional gain of the antenna exceeds 6 dBi. However, fixed point-to-point U-NII devices operating in this band may employ transmitting antennas with directional gain greater than 6 dBi without any corresponding reduction in transmitter conducted power. Fixed, point-to-point operations exclude the use of point-to-multipoint systems, omnidirectional applications, and multiple collocated transmitters transmitting the same information. The operator of the U-NII device, or if the equipment is professionally installed, the installer, is responsible for ensuring that systems employing high gain directional antennas are used exclusively for fixed, point-to-point operations.

The peak correlated gain for each mode is listed in the table below. See the Theory of Operation for details on the correlated gain for each mode.

### Test Procedure

Ref. KDB 789033 D02 General UNII Test Procedures New Rules v01r03  
ANSI C63.10: 2013

<b>Output Power</b> Test Procedure
<ol style="list-style-type: none"> <li>1. Set the radio in the continuous transmitting mode at full power</li> <li>2. Compute power by integrating the spectrum across the EBW (or alternatively entire 99% OBW) of the signal using the instrument's band power measurement function. The integration shall be performed using the spectrum analyzer band-power measurement function with band limits set equal to the EBW or the OBW band edges.</li> <li>3. Capture graphs and record pertinent measurement data.</li> </ol>

Ref. KDB 789033 D02 General UNII Test Procedures New Rules v01r03  
ANSI C63.10: 2013 section 12.3.2.2 Method SA-1

<b>Output Power</b> Test parameters
Span = >1.5 times the OBW RBW = 1MHz VBW ≥ 3 x RBW Sweep = Auto couple Detector = sample Trace = Trace Average 100

The “measure-and-sum technique” is used for measuring in-band transmit power of a device. In the measure-and-sum approach, the conducted emission level is measured at each antenna port. The measured results at the various antenna ports are then summed mathematically to determine the total emission level from the device. Summing is performed in linear power units. (See ANSI C63.10 section 14.3.2.2)

System Number	Description	Samples	System under test	Support equipment
1	EUT	S01+S02	<input checked="" type="checkbox"/>	<input type="checkbox"/>
	Support		<input type="checkbox"/>	<input checked="" type="checkbox"/>

<b>Tested By :</b> Chris Blair	<b>Date of testing:</b> 25-Sep-19 - 01-Oct-19
<b>Test Result : PASS</b>	

See Appendix C for list of test equipment

### Maximum Output Power, 4dBi

Frequency (MHz)	Mode	Tx Paths	Correlated Antenna Gain (dBi)	Tx 1 Max Power (dBm)	Tx 2 Max Power (dBm)	Tx 3 Max Power (dBm)	Tx 4 Max Power (dBm)	Duty Cycle Correction (dB)	Total Tx Channel Power (dBm)	Limit (dBm)	Margin (dB)	
5720 <sup>9</sup>	Non HT20, 6 to 54 Mbps	1	4	4.7				0.1	4.8	30.0	25.25	
	Non HT20, 6 to 54 Mbps	2	4	4.7	8.4			0.1	10.0	30.0	20.01	
	Non HT20, 6 to 54 Mbps	3	4	4.7	8.4	8.8		0.1	12.5	30.0	17.53	
	Non HT20, 6 to 54 Mbps	4	4	4.7	8.4	8.8	8.7	0.1	14.0	30.0	15.99	
	Non HT20 Beam Forming, 6 to 54 Mbps	2	7	4.7	8.4			0.1	10.0	29.0	19.01	
	Non HT20 Beam Forming, 6 to 54 Mbps	3	9	4.7	7.0	7.5		0.1	11.4	27.0	15.62	
	Non HT20 Beam Forming, 6 to 54 Mbps	4	10	4.7	5.2	5.5	5.3	0.1	11.3	26.0	14.74	
	HT/VHT20, M0 to M7	1	4	5.1					0.1	5.2	30.0	24.85
	HT/VHT20, M0 to M7	2	4	5.1	8.8				0.1	10.4	30.0	19.60
	HT/VHT20, M8 to M15	2	4	5.1	8.8				0.1	10.4	30.0	19.60
	HT/VHT20, M0 to M7	3	4	5.1	8.8	9.3			0.1	12.9	30.0	17.08
	HT/VHT20, M8 to M15	3	4	5.1	8.8	9.3			0.1	12.9	30.0	17.08
	HT/VHT20, M16 to M23	3	4	5.1	8.8	9.3			0.1	12.9	30.0	17.08
	HT/VHT20, M0 to M7	4	4	5.1	8.8	9.3	9.0		0.1	14.4	30.0	15.59
	HT/VHT20, M8 to M15	4	4	5.1	8.8	9.3	9.0		0.1	14.4	30.0	15.59
	HT/VHT20, M16 to M23	4	4	5.1	8.8	9.3	9.0		0.1	14.4	30.0	15.59
	HT/VHT20, M24 to M31	4	4	5.1	8.8	9.3	9.0		0.1	14.4	30.0	15.59
	HT/VHT20 Beam Forming, M0 to M7	2	7	5.1	8.8				0.1	10.4	29.0	18.60
	HT/VHT20 Beam Forming, M8 to M15	2	4	5.1	8.8				0.1	10.4	30.0	19.60
	HT/VHT20 Beam Forming, M0 to M7	3	9	5.1	7.6	8.0			0.1	11.9	27.0	15.10
	HT/VHT20 Beam Forming, M8 to M15	3	6	5.1	8.8	9.3			0.1	12.9	30.0	17.08
	HT/VHT20 Beam Forming, M16 to M23	3	4	5.1	8.8	9.3			0.1	12.9	30.0	17.08
	HT/VHT20 Beam Forming, M0 to M7	4	10	5.1	5.6	5.9	5.7		0.1	11.7	26.0	14.34
	HT/VHT20 Beam Forming, M8 to M15	4	7	5.1	8.8	9.3	9.0		0.1	14.4	29.0	14.59
	HT/VHT20 Beam Forming, M16 to M23	4	5	5.1	8.8	9.3	9.0		0.1	14.4	30.0	15.59
	HT/VHT20 Beam Forming, M24 to M31	4	4	5.1	8.8	9.3	9.0		0.1	14.4	30.0	15.59
	HT/VHT20 STBC, M0 to M7	2	4	5.1	8.8				0.1	10.4	30.0	19.60
	HT/VHT20 STBC, M0 to M7	3	4	5.1	8.8	9.3			0.1	12.9	30.0	17.08
	HT/VHT20 STBC, M0 to M7	4	4	5.1	8.8	9.3	9.0		0.1	14.4	30.0	15.59
	HE20, M0 to M9 1ss	1	4	5.5					0.1	5.6	30.0	24.43

<sup>9</sup> 5720 (ch144) not supported for Canada.

	HE20, M0 to M9 1ss	2	4	5.5	9.2			0.1	10.8	30.0	19.19
	HE20, M0 to M9 2ss	2	4	5.5	9.2			0.1	10.8	30.0	19.19
	HE20, M0 to M9 1ss	3	4	5.5	9.2	9.6		0.1	13.3	30.0	16.71
	HE20, M0 to M9 2ss	3	4	5.5	9.2	9.6		0.1	13.3	30.0	16.71
	HE20, M0 to M9 3ss	3	4	5.5	9.2	9.6		0.1	13.3	30.0	16.71
	HE20, M0 to M9 1ss	4	4	5.5	9.2	9.6	9.6	0.1	14.9	30.0	15.15
	HE20, M0 to M9 2ss	4	4	5.5	9.2	9.6	9.6	0.1	14.9	30.0	15.15
	HE20, M0 to M9 3ss	4	4	5.5	9.2	9.6	9.6	0.1	14.9	30.0	15.15
	HE20, M0 to M9 4ss	4	4	5.5	9.2	9.6	9.6	0.1	14.9	30.0	15.15
	HE20 Beam Forming, M0 to M9 1ss	2	7	5.5	9.2			0.1	10.8	29.0	18.19
	HE20 Beam Forming, M0 to M9 2ss	2	4	5.5	9.2			0.1	10.8	30.0	19.19
	HE20 Beam Forming, M0 to M9 1ss	3	9	5.5	8.2	8.6		0.1	12.5	27.0	14.53
	HE20 Beam Forming, M0 to M9 2ss	3	6	5.5	9.2	9.6		0.1	13.3	30.0	16.71
	HE20 Beam Forming, M0 to M9 3ss	3	4	5.5	9.2	9.6		0.1	13.3	30.0	16.71
	HE20 Beam Forming, M0 to M9 1ss	4	10	5.5	6.1	6.4	6.1	0.1	12.1	26.0	13.87
	HE20 Beam Forming, M0 to M9 2ss	4	7	5.5	9.2	9.6	9.6	0.1	14.9	29.0	14.15
	HE20 Beam Forming, M0 to M9 3ss	4	5	5.5	9.2	9.6	9.6	0.1	14.9	30.0	15.15
	HE20 Beam Forming, M0 to M9 4ss	4	4	5.5	9.2	9.6	9.6	0.1	14.9	30.0	15.15
	HE20 STBC, M0 to M9 2ss	2	4	5.5	9.2			0.1	10.8	30.0	19.19
	HE20 STBC, M0 to M9 2ss	3	4	5.5	9.2	9.6		0.1	13.3	30.0	16.71
	HE20 STBC, M0 to M9 2ss	4	4	5.5	9.2	9.6	9.6	0.1	14.9	30.0	15.15
5745	Non HT20, 6 to 54 Mbps	1	4	11.2				0.1	11.3	30.0	18.75
	Non HT20, 6 to 54 Mbps	2	4	11.2	16.9			0.1	18.0	30.0	12.01
	Non HT20, 6 to 54 Mbps	3	4	11.2	16.9	18.1		0.1	21.1	30.0	8.92
	Non HT20, 6 to 54 Mbps	4	4	11.2	16.9	18.1	15.8	0.1	22.2	30.0	7.78
	Non HT20 Beam Forming, 6 to 54 Mbps	2	7	11.2	16.9			0.1	18.0	29.0	11.01
	Non HT20 Beam Forming, 6 to 54 Mbps	3	9	11.2	16.9	18.1		0.1	21.1	27.0	5.92
	Non HT20 Beam Forming, 6 to 54 Mbps	4	10	11.2	16.9	18.1	15.8	0.1	22.2	26.0	3.78
	HT/VHT20, M0 to M7	1	4	11.3				0.1	11.4	30.0	18.65
	HT/VHT20, M0 to M7	2	4	11.3	17.1			0.1	18.2	30.0	11.83
	HT/VHT20, M8 to M15	2	4	11.3	17.1			0.1	18.2	30.0	11.83
	HT/VHT20, M0 to M7	3	4	11.3	17.1	18.0		0.1	21.1	30.0	8.88
	HT/VHT20, M8 to M15	3	4	11.3	17.1	18.0		0.1	21.1	30.0	8.88
	HT/VHT20, M16 to M23	3	4	11.3	17.1	18.0		0.1	21.1	30.0	8.88
	HT/VHT20, M0 to M7	4	4	11.3	17.1	18.0	15.9	0.1	22.3	30.0	7.73
	HT/VHT20, M8 to M15	4	4	11.3	17.1	18.0	15.9	0.1	22.3	30.0	7.73
	HT/VHT20, M16 to M23	4	4	11.3	17.1	18.0	15.9	0.1	22.3	30.0	7.73
	HT/VHT20, M24 to M31	4	4	11.3	17.1	18.0	15.9	0.1	22.3	30.0	7.73
	HT/VHT20 Beam Forming, M0 to M7	2	7	11.3	17.1			0.1	18.2	29.0	10.83
	HT/VHT20 Beam Forming, M8 to M15	2	4	11.3	17.1			0.1	18.2	30.0	11.83
	HT/VHT20 Beam Forming, M0 to M7	3	9	11.3	17.1	18.0		0.1	21.1	27.0	5.88
HT/VHT20 Beam Forming, M8 to M15	3	6	11.3	17.1	18.0		0.1	21.1	30.0	8.88	

	HT/VHT20 Beam Forming, M16 to M23	3	4	11.3	17.1	18.0		0.1	21.1	30.0	8.88
	HT/VHT20 Beam Forming, M0 to M7	4	10	11.3	17.1	18.0	15.9	0.1	22.3	26.0	3.73
	HT/VHT20 Beam Forming, M8 to M15	4	7	11.3	17.1	18.0	15.9	0.1	22.3	29.0	6.73
	HT/VHT20 Beam Forming, M16 to M23	4	5	11.3	17.1	18.0	15.9	0.1	22.3	30.0	7.73
	HT/VHT20 Beam Forming, M24 to M31	4	4	11.3	17.1	18.0	15.9	0.1	22.3	30.0	7.73
	HT/VHT20 STBC, M0 to M7	2	4	11.3	17.1			0.1	18.2	30.0	11.83
	HT/VHT20 STBC, M0 to M7	3	4	11.3	17.1	18.0		0.1	21.1	30.0	8.88
	HT/VHT20 STBC, M0 to M7	4	4	11.3	17.1	18.0	15.9	0.1	22.3	30.0	7.73
	HE20, M0 to M9 1ss	1	4	11.6				0.1	11.7	30.0	18.33
	HE20, M0 to M9 1ss	2	4	11.6	17.3			0.1	18.4	30.0	11.60
	HE20, M0 to M9 2ss	2	4	11.6	17.3			0.1	18.4	30.0	11.60
	HE20, M0 to M9 1ss	3	4	11.6	17.3	18.4		0.1	21.4	30.0	8.55
	HE20, M0 to M9 2ss	3	4	11.6	17.3	18.4		0.1	21.4	30.0	8.55
	HE20, M0 to M9 3ss	3	4	11.6	17.3	18.4		0.1	21.4	30.0	8.55
	HE20, M0 to M9 1ss	4	4	11.6	17.3	18.4	16.3	0.1	22.6	30.0	7.38
	HE20, M0 to M9 2ss	4	4	11.6	17.3	18.4	16.3	0.1	22.6	30.0	7.38
	HE20, M0 to M9 3ss	4	4	11.6	17.3	18.4	16.3	0.1	22.6	30.0	7.38
	HE20, M0 to M9 4ss	4	4	11.6	17.3	18.4	16.3	0.1	22.6	30.0	7.38
	HE20 Beam Forming, M0 to M9 1ss	2	7	11.6	17.3			0.1	18.4	29.0	10.60
	HE20 Beam Forming, M0 to M9 2ss	2	4	11.6	17.3			0.1	18.4	30.0	11.60
	HE20 Beam Forming, M0 to M9 1ss	3	9	11.6	17.3	18.4		0.1	21.4	27.0	5.55
	HE20 Beam Forming, M0 to M9 2ss	3	6	11.6	17.3	18.4		0.1	21.4	30.0	8.55
	HE20 Beam Forming, M0 to M9 3ss	3	4	11.6	17.3	18.4		0.1	21.4	30.0	8.55
	HE20 Beam Forming, M0 to M9 1ss	4	10	11.6	17.3	18.4	16.3	0.1	22.6	26.0	3.38
	HE20 Beam Forming, M0 to M9 2ss	4	7	11.6	17.3	18.4	16.3	0.1	22.6	29.0	6.38
	HE20 Beam Forming, M0 to M9 3ss	4	5	11.6	17.3	18.4	16.3	0.1	22.6	30.0	7.38
	HE20 Beam Forming, M0 to M9 4ss	4	4	11.6	17.3	18.4	16.3	0.1	22.6	30.0	7.38
	HE20 STBC, M0 to M9 2ss	2	4	11.6	17.3			0.1	18.4	30.0	11.60
	HE20 STBC, M0 to M9 2ss	3	4	11.6	17.3	18.4		0.1	21.4	30.0	8.55
	HE20 STBC, M0 to M9 2ss	4	4	11.6	17.3	18.4	16.3	0.1	22.6	30.0	7.38
5755	Non HT40, 6 to 54 Mbps	1	4	10.3				0.1	10.4	30.0	19.65
	Non HT40, 6 to 54 Mbps	2	4	10.3	16.7			0.1	17.6	30.0	12.35
	Non HT40, 6 to 54 Mbps	3	4	10.3	16.7	17.6		0.1	20.7	30.0	9.34
	Non HT40, 6 to 54 Mbps	4	4	10.3	16.7	17.6	15.5	0.1	21.8	30.0	8.17
	HT/VHT40, M0 to M7	1	4	10.4				0.1	10.5	30.0	19.49
	HT/VHT40, M0 to M7	2	4	10.4	16.9			0.1	17.9	30.0	12.11
	HT/VHT40, M8 to M15	2	4	10.4	16.9			0.1	17.9	30.0	12.11
	HT/VHT40, M0 to M7	3	4	10.4	16.9	17.6		0.1	20.8	30.0	9.19
	HT/VHT40, M8 to M15	3	4	10.4	16.9	17.6		0.1	20.8	30.0	9.19
	HT/VHT40, M16 to M23	3	4	10.4	16.9	17.6		0.1	20.8	30.0	9.19
	HT/VHT40, M0 to M7	4	4	10.4	16.9	17.6	15.4	0.1	21.9	30.0	8.07
	HT/VHT40, M8 to M15	4	4	10.4	16.9	17.6	15.4	0.1	21.9	30.0	8.07

	HT/VHT40, M16 to M23	4	4	10.4	16.9	17.6	15.4	0.1	21.9	30.0	8.07
	HT/VHT40, M24 to M31	4	4	10.4	16.9	17.6	15.4	0.1	21.9	30.0	8.07
	HT/VHT40 Beam Forming, M0 to M7	2	7	10.4	16.9			0.1	17.9	29.0	11.11
	HT/VHT40 Beam Forming, M8 to M15	2	4	10.4	16.9			0.1	17.9	30.0	12.11
	HT/VHT40 Beam Forming, M0 to M7	3	9	10.4	16.9	17.6		0.1	20.8	27.0	6.19
	HT/VHT40 Beam Forming, M8 to M15	3	6	10.4	16.9	17.6		0.1	20.8	30.0	9.19
	HT/VHT40 Beam Forming, M16 to M23	3	4	10.4	16.9	17.6		0.1	20.8	30.0	9.19
	HT/VHT40 Beam Forming, M0 to M7	4	10	10.4	16.9	17.6	15.4	0.1	21.9	26.0	4.07
	HT/VHT40 Beam Forming, M8 to M15	4	7	10.4	16.9	17.6	15.4	0.1	21.9	29.0	7.07
	HT/VHT40 Beam Forming, M16 to M23	4	5	10.4	16.9	17.6	15.4	0.1	21.9	30.0	8.07
	HT/VHT40 Beam Forming, M24 to M31	4	4	10.4	16.9	17.6	15.4	0.1	21.9	30.0	8.07
	HT/VHT40 STBC, M0 to M7	2	4	10.4	16.9			0.1	17.9	30.0	12.11
	HT/VHT40 STBC, M0 to M7	3	4	10.4	16.9	17.6		0.1	20.8	30.0	9.19
	HT/VHT40 STBC, M0 to M7	4	4	10.4	16.9	17.6	15.4	0.1	21.9	30.0	8.07
	HE40, M0 to M9 1ss	1	4	10.6				0.1	10.7	30.0	19.27
	HE40, M0 to M9 1ss	2	4	10.6	17.0			0.1	18.0	30.0	11.98
	HE40, M0 to M9 2ss	2	4	10.6	17.0			0.1	18.0	30.0	11.98
	HE40, M0 to M9 1ss	3	4	10.6	17.0	17.8		0.1	21.0	30.0	9.02
	HE40, M0 to M9 2ss	3	4	10.6	17.0	17.8		0.1	21.0	30.0	9.02
	HE40, M0 to M9 3ss	3	4	10.6	17.0	17.8		0.1	21.0	30.0	9.02
	HE40, M0 to M9 1ss	4	4	10.6	17.0	17.8	15.6	0.1	22.1	30.0	7.88
	HE40, M0 to M9 2ss	4	4	10.6	17.0	17.8	15.6	0.1	22.1	30.0	7.88
	HE40, M0 to M9 3ss	4	4	10.6	17.0	17.8	15.6	0.1	22.1	30.0	7.88
	HE40, M0 to M9 4ss	4	4	10.6	17.0	17.8	15.6	0.1	22.1	30.0	7.88
	HE40 Beam Forming, M0 to M9 1ss	2	7	10.6	17.0			0.1	18.0	29.0	10.98
	HE40 Beam Forming, M0 to M9 2ss	2	4	10.6	17.0			0.1	18.0	30.0	11.98
	HE40 Beam Forming, M0 to M9 1ss	3	9	10.6	17.0	17.8		0.1	21.0	27.0	6.02
	HE40 Beam Forming, M0 to M9 2ss	3	6	10.6	17.0	17.8		0.1	21.0	30.0	9.02
	HE40 Beam Forming, M0 to M9 3ss	3	4	10.6	17.0	17.8		0.1	21.0	30.0	9.02
	HE40 Beam Forming, M0 to M9 1ss	4	10	10.6	17.0	17.8	15.6	0.1	22.1	26.0	3.88
	HE40 Beam Forming, M0 to M9 2ss	4	7	10.6	17.0	17.8	15.6	0.1	22.1	29.0	6.88
	HE40 Beam Forming, M0 to M9 3ss	4	5	10.6	17.0	17.8	15.6	0.1	22.1	30.0	7.88
	HE40 Beam Forming, M0 to M9 4ss	4	4	10.6	17.0	17.8	15.6	0.1	22.1	30.0	7.88
	HE40 STBC, M0 to M9 2ss	2	4	10.6	17.0			0.1	18.0	30.0	11.98
	HE40 STBC, M0 to M9 2ss	3	4	10.6	17.0	17.8		0.1	21.0	30.0	9.02
	HE40 STBC, M0 to M9 2ss	4	4	10.6	17.0	17.8	15.6	0.1	22.1	30.0	7.88
5775	Non HT80, 6 to 54 Mbps	1	4	10.4				0.0	10.4	30.0	19.55
	Non HT80, 6 to 54 Mbps	2	4	10.4	15.5			0.0	16.7	30.0	13.28
	Non HT80, 6 to 54 Mbps	3	4	10.4	15.5	16.9		0.0	19.8	30.0	10.15
	Non HT80, 6 to 54 Mbps	4	4	10.4	15.5	16.9	15.3	0.0	21.2	30.0	8.83
	VHT80, M0 to M9 1ss	1	4	10.4				0.2	10.6	30.0	19.38
	VHT80, M0 to M9 1ss	2	4	10.4	15.8			0.2	17.1	30.0	12.88



VHT80, M0 to M9 2ss	2	4	10.4	15.8			0.2	17.1	30.0	12.88
VHT80, M0 to M9 1ss	3	4	10.4	15.8	16.8		0.2	20.1	30.0	9.92
VHT80, M0 to M9 2ss	3	4	10.4	15.8	16.8		0.2	20.1	30.0	9.92
VHT80, M0 to M9 3ss	3	4	10.4	15.8	16.8		0.2	20.1	30.0	9.92
VHT80, M0 to M9 1ss	4	4	10.4	15.8	16.8	15.4	0.2	21.4	30.0	8.59
VHT80, M0 to M9 2ss	4	4	10.4	15.8	16.8	15.4	0.2	21.4	30.0	8.59
VHT80, M0 to M9 3ss	4	4	10.4	15.8	16.8	15.4	0.2	21.4	30.0	8.59
VHT80, M0 to M9 4ss	4	4	10.4	15.8	16.8	15.4	0.2	21.4	30.0	8.59
VHT80 Beam Forming, M0 to M9 1ss	2	7	10.4	15.8			0.2	17.1	29.0	11.88
VHT80 Beam Forming, M0 to M9 2ss	2	4	10.4	15.8			0.2	17.1	30.0	12.88
VHT80 Beam Forming, M0 to M9 1ss	3	9	10.4	15.8	16.8		0.2	20.1	27.0	6.92
VHT80 Beam Forming, M0 to M9 2ss	3	6	10.4	15.8	16.8		0.2	20.1	30.0	9.92
VHT80 Beam Forming, M0 to M9 3ss	3	4	10.4	15.8	16.8		0.2	20.1	30.0	9.92
VHT80 Beam Forming, M0 to M9 1ss	4	10	10.4	15.8	16.8	15.4	0.2	21.4	26.0	4.59
VHT80 Beam Forming, M0 to M9 2ss	4	7	10.4	15.8	16.8	15.4	0.2	21.4	29.0	7.59
VHT80 Beam Forming, M0 to M9 3ss	4	5	10.4	15.8	16.8	15.4	0.2	21.4	30.0	8.59
VHT80 Beam Forming, M0 to M9 4ss	4	4	10.4	15.8	16.8	15.4	0.2	21.4	30.0	8.59
VHT80 STBC, M0 to M9 1ss	2	4	10.4	15.8			0.2	17.1	30.0	12.88
VHT80 STBC, M0 to M9 1ss	3	4	10.4	15.8	16.8		0.2	20.1	30.0	9.92
VHT80 STBC, M0 to M9 1ss	4	4	10.4	15.8	16.8	15.4	0.2	21.4	30.0	8.59
HE80, M0 to M9 1ss	1	4	10.6				0.2	10.8	30.0	19.15
HE80, M0 to M9 1ss	2	4	10.6	16.0			0.2	17.4	30.0	12.65
HE80, M0 to M9 2ss	2	4	10.6	16.0			0.2	17.4	30.0	12.65
HE80, M0 to M9 1ss	3	4	10.6	16.0	17.3		0.2	20.5	30.0	9.54
HE80, M0 to M9 2ss	3	4	10.6	16.0	17.3		0.2	20.5	30.0	9.54
HE80, M0 to M9 3ss	3	4	10.6	16.0	17.3		0.2	20.5	30.0	9.54
HE80, M0 to M9 1ss	4	4	10.6	16.0	17.3	15.7	0.2	21.8	30.0	8.22
HE80, M0 to M9 2ss	4	4	10.6	16.0	17.3	15.7	0.2	21.8	30.0	8.22
HE80, M0 to M9 3ss	4	4	10.6	16.0	17.3	15.7	0.2	21.8	30.0	8.22
HE80, M0 to M9 4ss	4	4	10.6	16.0	17.3	15.7	0.2	21.8	30.0	8.22
HE80 Beam Forming, M0 to M9 1ss	2	7	10.6	16.0			0.2	17.4	29.0	11.65
HE80 Beam Forming, M0 to M9 2ss	2	4	10.6	16.0			0.2	17.4	30.0	12.65
HE80 Beam Forming, M0 to M9 1ss	3	9	10.6	16.0	17.3		0.2	20.5	27.0	6.54
HE80 Beam Forming, M0 to M9 2ss	3	6	10.6	16.0	17.3		0.2	20.5	30.0	9.54
HE80 Beam Forming, M0 to M9 3ss	3	4	10.6	16.0	17.3		0.2	20.5	30.0	9.54
HE80 Beam Forming, M0 to M9 1ss	4	10	10.6	16.0	17.3	15.7	0.2	21.8	26.0	4.22
HE80 Beam Forming, M0 to M9 2ss	4	7	10.6	16.0	17.3	15.7	0.2	21.8	29.0	7.22
HE80 Beam Forming, M0 to M9 3ss	4	5	10.6	16.0	17.3	15.7	0.2	21.8	30.0	8.22
HE80 Beam Forming, M0 to M9 4ss	4	4	10.6	16.0	17.3	15.7	0.2	21.8	30.0	8.22
HE80 STBC, M0 to M9 1ss	2	4	10.6	16.0			0.2	17.4	30.0	12.65
HE80 STBC, M0 to M9 1ss	3	4	10.6	16.0	17.3		0.2	20.5	30.0	9.54
HE80 STBC, M0 to M9 1ss	4	4	10.6	16.0	17.3	15.7	0.2	21.8	30.0	8.22

5785	Non HT20, 6 to 54 Mbps	1	4	11.7				0.1	11.8	30.0	18.25
	Non HT20, 6 to 54 Mbps	2	4	11.7	17.1			0.1	18.3	30.0	11.75
	Non HT20, 6 to 54 Mbps	3	4	11.7	17.1	18.1		0.1	21.2	30.0	8.79
	Non HT20, 6 to 54 Mbps	4	4	11.7	17.1	18.1	16.4	0.1	22.5	30.0	7.54
	Non HT20 Beam Forming, 6 to 54 Mbps	2	7	11.7	17.1			0.1	18.3	29.0	10.75
	Non HT20 Beam Forming, 6 to 54 Mbps	3	9	11.7	17.1	18.1		0.1	21.2	27.0	5.79
	Non HT20 Beam Forming, 6 to 54 Mbps	4	10	11.7	17.1	18.1	16.4	0.1	22.5	26.0	3.54
	HT/VHT20, M0 to M7	1	4	11.6				0.1	11.7	30.0	18.35
	HT/VHT20, M0 to M7	2	4	11.6	16.9			0.1	18.1	30.0	11.92
	HT/VHT20, M8 to M15	2	4	11.6	16.9			0.1	18.1	30.0	11.92
	HT/VHT20, M0 to M7	3	4	11.6	16.9	18.0		0.1	21.1	30.0	8.93
	HT/VHT20, M8 to M15	3	4	11.6	16.9	18.0		0.1	21.1	30.0	8.93
	HT/VHT20, M16 to M23	3	4	11.6	16.9	18.0		0.1	21.1	30.0	8.93
	HT/VHT20, M0 to M7	4	4	11.6	16.9	18.0	16.2	0.1	22.3	30.0	7.69
	HT/VHT20, M8 to M15	4	4	11.6	16.9	18.0	16.2	0.1	22.3	30.0	7.69
	HT/VHT20, M16 to M23	4	4	11.6	16.9	18.0	16.2	0.1	22.3	30.0	7.69
	HT/VHT20, M24 to M31	4	4	11.6	16.9	18.0	16.2	0.1	22.3	30.0	7.69
	HT/VHT20 Beam Forming, M0 to M7	2	7	11.6	16.9			0.1	18.1	29.0	10.92
	HT/VHT20 Beam Forming, M8 to M15	2	4	11.6	16.9			0.1	18.1	30.0	11.92
	HT/VHT20 Beam Forming, M0 to M7	3	9	11.6	16.9	18.0		0.1	21.1	27.0	5.93
	HT/VHT20 Beam Forming, M8 to M15	3	6	11.6	16.9	18.0		0.1	21.1	30.0	8.93
	HT/VHT20 Beam Forming, M16 to M23	3	4	11.6	16.9	18.0		0.1	21.1	30.0	8.93
	HT/VHT20 Beam Forming, M0 to M7	4	10	11.6	16.9	18.0	16.2	0.1	22.3	26.0	3.69
	HT/VHT20 Beam Forming, M8 to M15	4	7	11.6	16.9	18.0	16.2	0.1	22.3	29.0	6.69
	HT/VHT20 Beam Forming, M16 to M23	4	5	11.6	16.9	18.0	16.2	0.1	22.3	30.0	7.69
	HT/VHT20 Beam Forming, M24 to M31	4	4	11.6	16.9	18.0	16.2	0.1	22.3	30.0	7.69
	HT/VHT20 STBC, M0 to M7	2	4	11.6	16.9			0.1	18.1	30.0	11.92
	HT/VHT20 STBC, M0 to M7	3	4	11.6	16.9	18.0		0.1	21.1	30.0	8.93
	HT/VHT20 STBC, M0 to M7	4	4	11.6	16.9	18.0	16.2	0.1	22.3	30.0	7.69
	HE20, M0 to M9 1ss	1	4	11.8				0.1	11.9	30.0	18.13
	HE20, M0 to M9 1ss	2	4	11.8	17.3			0.1	18.4	30.0	11.55
	HE20, M0 to M9 2ss	2	4	11.8	17.3			0.1	18.4	30.0	11.55
	HE20, M0 to M9 1ss	3	4	11.8	17.3	18.4		0.1	21.5	30.0	8.53
	HE20, M0 to M9 2ss	3	4	11.8	17.3	18.4		0.1	21.5	30.0	8.53
	HE20, M0 to M9 3ss	3	4	11.8	17.3	18.4		0.1	21.5	30.0	8.53
	HE20, M0 to M9 1ss	4	4	11.8	17.3	18.4	16.6	0.1	22.7	30.0	7.29
	HE20, M0 to M9 2ss	4	4	11.8	17.3	18.4	16.6	0.1	22.7	30.0	7.29
	HE20, M0 to M9 3ss	4	4	11.8	17.3	18.4	16.6	0.1	22.7	30.0	7.29
	HE20, M0 to M9 4ss	4	4	11.8	17.3	18.4	16.6	0.1	22.7	30.0	7.29
	HE20 Beam Forming, M0 to M9 1ss	2	7	11.8	17.3			0.1	18.4	29.0	10.55
HE20 Beam Forming, M0 to M9 2ss	2	4	11.8	17.3			0.1	18.4	30.0	11.55	
HE20 Beam Forming, M0 to M9 1ss	3	9	11.8	17.3	18.4		0.1	21.5	27.0	5.53	

	HE20 Beam Forming, M0 to M9 2ss	3	6	11.8	17.3	18.4		0.1	21.5	30.0	8.53
	HE20 Beam Forming, M0 to M9 3ss	3	4	11.8	17.3	18.4		0.1	21.5	30.0	8.53
	<b>HE20 Beam Forming, M0 to M9 1ss</b>	<b>4</b>	<b>10</b>	<b>11.8</b>	<b>17.3</b>	<b>18.4</b>	<b>16.6</b>	<b>0.1</b>	<b>22.7</b>	<b>26.0</b>	<b>3.29</b>
	HE20 Beam Forming, M0 to M9 2ss	4	7	11.8	17.3	18.4	16.6	0.1	22.7	29.0	6.29
	HE20 Beam Forming, M0 to M9 3ss	4	5	11.8	17.3	18.4	16.6	0.1	22.7	30.0	7.29
	HE20 Beam Forming, M0 to M9 4ss	4	4	11.8	17.3	18.4	16.6	0.1	22.7	30.0	7.29
	HE20 STBC, M0 to M9 2ss	2	4	11.8	17.3			0.1	18.4	30.0	11.55
	HE20 STBC, M0 to M9 2ss	3	4	11.8	17.3	18.4		0.1	21.5	30.0	8.53
	HE20 STBC, M0 to M9 2ss	4	4	11.8	17.3	18.4	16.6	0.1	22.7	30.0	7.29
5795	Non HT40, 6 to 54 Mbps	1	4	11.0				0.1	11.1	30.0	18.95
	Non HT40, 6 to 54 Mbps	2	4	11.0	16.8			0.1	17.9	30.0	12.14
	Non HT40, 6 to 54 Mbps	3	4	11.0	16.8	17.6		0.1	20.8	30.0	9.23
	Non HT40, 6 to 54 Mbps	4	4	11.0	16.8	17.6	16.0	0.1	22.0	30.0	7.97
	HT/VHT40, M0 to M7	1	4	10.9				0.1	11.0	30.0	18.99
	HT/VHT40, M0 to M7	2	4	10.9	16.6			0.1	17.7	30.0	12.25
	HT/VHT40, M8 to M15	2	4	10.9	16.6			0.1	17.7	30.0	12.25
	HT/VHT40, M0 to M7	3	4	10.9	16.6	17.7		0.1	20.8	30.0	9.21
	HT/VHT40, M8 to M15	3	4	10.9	16.6	17.7		0.1	20.8	30.0	9.21
	HT/VHT40, M16 to M23	3	4	10.9	16.6	17.7		0.1	20.8	30.0	9.21
	HT/VHT40, M0 to M7	4	4	10.9	16.6	17.7	15.9	0.1	22.0	30.0	7.96
	HT/VHT40, M8 to M15	4	4	10.9	16.6	17.7	15.9	0.1	22.0	30.0	7.96
	HT/VHT40, M16 to M23	4	4	10.9	16.6	17.7	15.9	0.1	22.0	30.0	7.96
	HT/VHT40, M24 to M31	4	4	10.9	16.6	17.7	15.9	0.1	22.0	30.0	7.96
	HT/VHT40 Beam Forming, M0 to M7	2	7	10.9	16.6			0.1	17.7	29.0	11.25
	HT/VHT40 Beam Forming, M8 to M15	2	4	10.9	16.6			0.1	17.7	30.0	12.25
	HT/VHT40 Beam Forming, M0 to M7	3	9	10.9	16.6	17.7		0.1	20.8	27.0	6.21
	HT/VHT40 Beam Forming, M8 to M15	3	6	10.9	16.6	17.7		0.1	20.8	30.0	9.21
	HT/VHT40 Beam Forming, M16 to M23	3	4	10.9	16.6	17.7		0.1	20.8	30.0	9.21
	HT/VHT40 Beam Forming, M0 to M7	4	10	10.9	16.6	17.7	15.9	0.1	22.0	26.0	3.96
	HT/VHT40 Beam Forming, M8 to M15	4	7	10.9	16.6	17.7	15.9	0.1	22.0	29.0	6.96
	HT/VHT40 Beam Forming, M16 to M23	4	5	10.9	16.6	17.7	15.9	0.1	22.0	30.0	7.96
	HT/VHT40 Beam Forming, M24 to M31	4	4	10.9	16.6	17.7	15.9	0.1	22.0	30.0	7.96
	HT/VHT40 STBC, M0 to M7	2	4	10.9	16.6			0.1	17.7	30.0	12.25
	HT/VHT40 STBC, M0 to M7	3	4	10.9	16.6	17.7		0.1	20.8	30.0	9.21
	HT/VHT40 STBC, M0 to M7	4	4	10.9	16.6	17.7	15.9	0.1	22.0	30.0	7.96
	HE40, M0 to M9 1ss	1	4	11.2				0.1	11.3	30.0	18.67
	HE40, M0 to M9 1ss	2	4	11.2	17.0			0.1	18.1	30.0	11.86
	HE40, M0 to M9 2ss	2	4	11.2	17.0			0.1	18.1	30.0	11.86
	HE40, M0 to M9 1ss	3	4	11.2	17.0	17.8		0.1	21.0	30.0	8.96
	HE40, M0 to M9 2ss	3	4	11.2	17.0	17.8		0.1	21.0	30.0	8.96
	HE40, M0 to M9 3ss	3	4	11.2	17.0	17.8		0.1	21.0	30.0	8.96
HE40, M0 to M9 1ss	4	4	11.2	17.0	17.8	16.2	0.1	22.3	30.0	7.69	

	HE40, M0 to M9 2ss	4	4	11.2	17.0	17.8	16.2	0.1	22.3	30.0	7.69
	HE40, M0 to M9 3ss	4	4	11.2	17.0	17.8	16.2	0.1	22.3	30.0	7.69
	HE40, M0 to M9 4ss	4	4	11.2	17.0	17.8	16.2	0.1	22.3	30.0	7.69
	HE40 Beam Forming, M0 to M9 1ss	2	7	11.2	17.0			0.1	18.1	29.0	10.86
	HE40 Beam Forming, M0 to M9 2ss	2	4	11.2	17.0			0.1	18.1	30.0	11.86
	HE40 Beam Forming, M0 to M9 1ss	3	9	11.2	17.0	17.8		0.1	21.0	27.0	5.96
	HE40 Beam Forming, M0 to M9 2ss	3	6	11.2	17.0	17.8		0.1	21.0	30.0	8.96
	HE40 Beam Forming, M0 to M9 3ss	3	4	11.2	17.0	17.8		0.1	21.0	30.0	8.96
	HE40 Beam Forming, M0 to M9 1ss	4	10	11.2	17.0	17.8	16.2	0.1	22.3	26.0	3.69
	HE40 Beam Forming, M0 to M9 2ss	4	7	11.2	17.0	17.8	16.2	0.1	22.3	29.0	6.69
	HE40 Beam Forming, M0 to M9 3ss	4	5	11.2	17.0	17.8	16.2	0.1	22.3	30.0	7.69
	HE40 Beam Forming, M0 to M9 4ss	4	4	11.2	17.0	17.8	16.2	0.1	22.3	30.0	7.69
	HE40 STBC, M0 to M9 2ss	2	4	11.2	17.0			0.1	18.1	30.0	11.86
	HE40 STBC, M0 to M9 2ss	3	4	11.2	17.0	17.8		0.1	21.0	30.0	8.96
	HE40 STBC, M0 to M9 2ss	4	4	11.2	17.0	17.8	16.2	0.1	22.3	30.0	7.69
	Non HT20, 6 to 54 Mbps	1	4	12.0				0.1	12.1	30.0	17.95
	Non HT20, 6 to 54 Mbps	2	4	12.0	16.6			0.1	17.9	30.0	12.06
	Non HT20, 6 to 54 Mbps	3	4	12.0	16.6	18.1		0.1	21.1	30.0	8.94
	Non HT20, 6 to 54 Mbps	4	4	12.0	16.6	18.1	16.5	0.1	22.4	30.0	7.62
	Non HT20 Beam Forming, 6 to 54 Mbps	2	7	12.0	16.6			0.1	17.9	29.0	11.06
	Non HT20 Beam Forming, 6 to 54 Mbps	3	9	12.0	16.6	18.1		0.1	21.1	27.0	5.94
	Non HT20 Beam Forming, 6 to 54 Mbps	4	10	12.0	16.6	18.1	16.5	0.1	22.4	26.0	3.62
	HT/VHT20, M0 to M7	1	4	12.0				0.1	12.1	30.0	17.95
	HT/VHT20, M0 to M7	2	4	12.0	16.6			0.1	17.9	30.0	12.05
	HT/VHT20, M8 to M15	2	4	12.0	16.6			0.1	17.9	30.0	12.05
	HT/VHT20, M0 to M7	3	4	12.0	16.6	18.1		0.1	21.1	30.0	8.94
	HT/VHT20, M8 to M15	3	4	12.0	16.6	18.1		0.1	21.1	30.0	8.94
	HT/VHT20, M16 to M23	3	4	12.0	16.6	18.1		0.1	21.1	30.0	8.94
	HT/VHT20, M0 to M7	4	4	12.0	16.6	18.1	16.5	0.1	22.4	30.0	7.62
	HT/VHT20, M8 to M15	4	4	12.0	16.6	18.1	16.5	0.1	22.4	30.0	7.62
	HT/VHT20, M16 to M23	4	4	12.0	16.6	18.1	16.5	0.1	22.4	30.0	7.62
	HT/VHT20, M24 to M31	4	4	12.0	16.6	18.1	16.5	0.1	22.4	30.0	7.62
	HT/VHT20 Beam Forming, M0 to M7	2	7	12.0	16.6			0.1	17.9	29.0	11.05
	HT/VHT20 Beam Forming, M8 to M15	2	4	12.0	16.6			0.1	17.9	30.0	12.05
	HT/VHT20 Beam Forming, M0 to M7	3	9	12.0	16.6	18.1		0.1	21.1	27.0	5.94
	HT/VHT20 Beam Forming, M8 to M15	3	6	12.0	16.6	18.1		0.1	21.1	30.0	8.94
	HT/VHT20 Beam Forming, M16 to M23	3	4	12.0	16.6	18.1		0.1	21.1	30.0	8.94
	HT/VHT20 Beam Forming, M0 to M7	4	10	12.0	16.6	18.1	16.5	0.1	22.4	26.0	3.62
	HT/VHT20 Beam Forming, M8 to M15	4	7	12.0	16.6	18.1	16.5	0.1	22.4	29.0	6.62
	HT/VHT20 Beam Forming, M16 to M23	4	5	12.0	16.6	18.1	16.5	0.1	22.4	30.0	7.62
	HT/VHT20 Beam Forming, M24 to M31	4	4	12.0	16.6	18.1	16.5	0.1	22.4	30.0	7.62
	HT/VHT20 STBC, M0 to M7	2	4	12.0	16.6			0.1	17.9	30.0	12.05



HT/VHT20 STBC, M0 to M7	3	4	12.0	16.6	18.1		0.1	21.1	30.0	8.94
HT/VHT20 STBC, M0 to M7	4	4	12.0	16.6	18.1	16.5	0.1	22.4	30.0	7.62
HE20, M0 to M9 1ss	1	4	12.1				0.1	12.2	30.0	17.83
HE20, M0 to M9 1ss	2	4	12.1	16.6			0.1	18.0	30.0	12.01
HE20, M0 to M9 2ss	2	4	12.1	16.6			0.1	18.0	30.0	12.01
HE20, M0 to M9 1ss	3	4	12.1	16.6	18.3		0.1	21.2	30.0	8.81
HE20, M0 to M9 2ss	3	4	12.1	16.6	18.3		0.1	21.2	30.0	8.81
HE20, M0 to M9 3ss	3	4	12.1	16.6	18.3		0.1	21.2	30.0	8.81
HE20, M0 to M9 1ss	4	4	12.1	16.6	18.3	16.7	0.1	22.5	30.0	7.47
HE20, M0 to M9 2ss	4	4	12.1	16.6	18.3	16.7	0.1	22.5	30.0	7.47
HE20, M0 to M9 3ss	4	4	12.1	16.6	18.3	16.7	0.1	22.5	30.0	7.47
HE20, M0 to M9 4ss	4	4	12.1	16.6	18.3	16.7	0.1	22.5	30.0	7.47
HE20 Beam Forming, M0 to M9 1ss	2	7	12.1	16.6			0.1	18.0	29.0	11.01
HE20 Beam Forming, M0 to M9 2ss	2	4	12.1	16.6			0.1	18.0	30.0	12.01
HE20 Beam Forming, M0 to M9 1ss	3	9	12.1	16.6	18.3		0.1	21.2	27.0	5.81
HE20 Beam Forming, M0 to M9 2ss	3	6	12.1	16.6	18.3		0.1	21.2	30.0	8.81
HE20 Beam Forming, M0 to M9 3ss	3	4	12.1	16.6	18.3		0.1	21.2	30.0	8.81
HE20 Beam Forming, M0 to M9 1ss	4	10	12.1	16.6	18.3	16.7	0.1	22.5	26.0	3.47
HE20 Beam Forming, M0 to M9 2ss	4	7	12.1	16.6	18.3	16.7	0.1	22.5	29.0	6.47
HE20 Beam Forming, M0 to M9 3ss	4	5	12.1	16.6	18.3	16.7	0.1	22.5	30.0	7.47
HE20 Beam Forming, M0 to M9 4ss	4	4	12.1	16.6	18.3	16.7	0.1	22.5	30.0	7.47
HE20 STBC, M0 to M9 2ss	2	4	12.1	16.6			0.1	18.0	30.0	12.01
HE20 STBC, M0 to M9 2ss	3	4	12.1	16.6	18.3		0.1	21.2	30.0	8.81
HE20 STBC, M0 to M9 2ss	4	4	12.1	16.6	18.3	16.7	0.1	22.5	30.0	7.47

**Maximum Transmit Output Power, 4dBi  
5785 MHz, HE20 Beam Forming, M0 to M9 1ss**

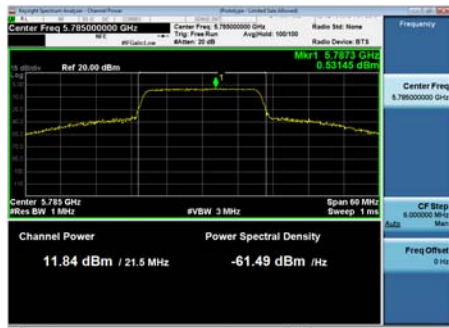

**Antenna A**

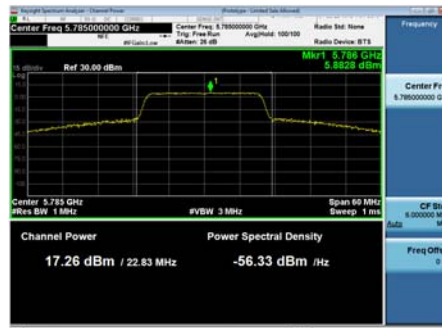

**Antenna B**

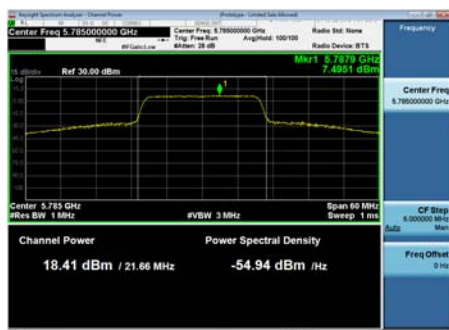

**Antenna C**

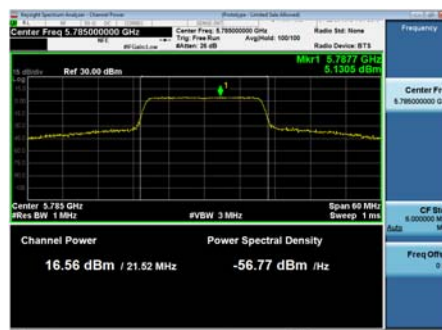

**Antenna D**

## Maximum Output Power, 5dBi

Frequency (MHz)	Mode	Tx Paths	Correlated Antenna Gain (dBi)	Tx 1 Max Power (dBm)	Tx 2 Max Power (dBm)	Tx 3 Max Power (dBm)	Tx 4 Max Power (dBm)	Duty Cycle Correction (dB)	Total Tx Channel Power (dBm)	Limit (dBm)	Margin (dB)
5720 <sup>10</sup>	Non HT20, 6 to 54 Mbps	1	5	4.7				0.1	4.8	30.0	25.25
	Non HT20, 6 to 54 Mbps	2	5	4.7	8.4			0.1	10.0	30.0	20.01
	Non HT20, 6 to 54 Mbps	3	5	4.7	8.4	8.8		0.1	12.5	30.0	17.53
	Non HT20, 6 to 54 Mbps	4	5	4.7	8.4	8.8	8.7	0.1	14.0	30.0	15.99
	Non HT20 Beam Forming, 6 to 54 Mbps	2	8	4.7	8.4			0.1	10.0	28.0	18.01
	Non HT20 Beam Forming, 6 to 54 Mbps	3	10	4.7	6.0	6.4		0.1	10.6	26.0	15.42
	Non HT20 Beam Forming, 6 to 54 Mbps	4	11	4.7	4.1	4.2	4.3	0.1	10.4	25.0	14.60
	HT/VHT20, M0 to M7	1	5	5.1				0.1	5.2	30.0	24.85
	HT/VHT20, M0 to M7	2	5	5.1	8.8			0.1	10.4	30.0	19.60
	HT/VHT20, M8 to M15	2	5	5.1	8.8			0.1	10.4	30.0	19.60
	HT/VHT20, M0 to M7	3	5	5.1	8.8	9.3		0.1	12.9	30.0	17.08
	HT/VHT20, M8 to M15	3	5	5.1	8.8	9.3		0.1	12.9	30.0	17.08
	HT/VHT20, M16 to M23	3	5	5.1	8.8	9.3		0.1	12.9	30.0	17.08
	HT/VHT20, M0 to M7	4	5	5.1	8.8	9.3	9.0	0.1	14.4	30.0	15.59
	HT/VHT20, M8 to M15	4	5	5.1	8.8	9.3	9.0	0.1	14.4	30.0	15.59
	HT/VHT20, M16 to M23	4	5	5.1	8.8	9.3	9.0	0.1	14.4	30.0	15.59
	HT/VHT20, M24 to M31	4	5	5.1	8.8	9.3	9.0	0.1	14.4	30.0	15.59
	HT/VHT20 Beam Forming, M0 to M7	2	8	5.1	8.8			0.1	10.4	28.0	17.60
	HT/VHT20 Beam Forming, M8 to M15	2	5	5.1	8.8			0.1	10.4	30.0	19.60
	HT/VHT20 Beam Forming, M0 to M7	3	10	5.1	6.5	7.0		0.1	11.1	26.0	14.90
	HT/VHT20 Beam Forming, M8 to M15	3	7	5.1	8.8	9.3		0.1	12.9	29.0	16.08
	HT/VHT20 Beam Forming, M16 to M23	3	5	5.1	8.8	9.3		0.1	12.9	30.0	17.08
	HT/VHT20 Beam Forming, M0 to M7	4	11	5.1	4.5	4.8	4.6	0.1	10.8	25.0	14.17
	HT/VHT20 Beam Forming, M8 to M15	4	8	5.1	7.6	8.0	8.0	0.1	13.4	28.0	14.60
	HT/VHT20 Beam Forming, M16 to M23	4	6	5.1	8.8	9.3	9.0	0.1	14.4	30.0	15.59
	HT/VHT20 Beam Forming, M24 to M31	4	5	5.1	8.8	9.3	9.0	0.1	14.4	30.0	15.59
	HT/VHT20 STBC, M0 to M7	2	5	5.1	8.8			0.1	10.4	30.0	19.60
	HT/VHT20 STBC, M0 to M7	3	5	5.1	8.8	9.3		0.1	12.9	30.0	17.08
	HT/VHT20 STBC, M0 to M7	4	5	5.1	7.6	8.0	8.0	0.1	13.4	30.0	16.60

<sup>10</sup> 5720 (ch144) not supported for Canada.



	HE20, M0 to M9 1ss	1	5	5.5				0.1	5.6	30.0	24.43
	HE20, M0 to M9 1ss	2	5	5.5	9.2			0.1	10.8	30.0	19.19
	HE20, M0 to M9 2ss	2	5	5.5	9.2			0.1	10.8	30.0	19.19
	HE20, M0 to M9 1ss	3	5	5.5	9.2	9.6		0.1	13.3	30.0	16.71
	HE20, M0 to M9 2ss	3	5	5.5	9.2	9.6		0.1	13.3	30.0	16.71
	HE20, M0 to M9 3ss	3	5	5.5	9.2	9.6		0.1	13.3	30.0	16.71
	HE20, M0 to M9 1ss	4	5	5.5	9.2	9.6	9.6	0.1	14.9	30.0	15.15
	HE20, M0 to M9 2ss	4	5	5.5	9.2	9.6	9.6	0.1	14.9	30.0	15.15
	HE20, M0 to M9 3ss	4	5	5.5	9.2	9.6	9.6	0.1	14.9	30.0	15.15
	HE20, M0 to M9 4ss	4	5	5.5	9.2	9.6	9.6	0.1	14.9	30.0	15.15
	HE20 Beam Forming, M0 to M9 1ss	2	8	5.5	9.2			0.1	10.8	28.0	17.19
	HE20 Beam Forming, M0 to M9 2ss	2	5	5.5	9.2			0.1	10.8	30.0	19.19
	HE20 Beam Forming, M0 to M9 1ss	3	10	5.5	6.9	7.7		0.1	11.6	26.0	14.37
	HE20 Beam Forming, M0 to M9 2ss	3	7	5.5	9.2	9.6		0.1	13.3	29.0	15.71
	HE20 Beam Forming, M0 to M9 3ss	3	5	5.5	9.2	9.6		0.1	13.3	30.0	16.71
	HE20 Beam Forming, M0 to M9 1ss	4	11	5.5	5.0	5.2	5.0	0.1	11.3	25.0	13.73
	HE20 Beam Forming, M0 to M9 2ss	4	8	5.5	8.2	8.6	8.5	0.1	14.0	28.0	14.04
	HE20 Beam Forming, M0 to M9 3ss	4	6	5.5	9.2	9.6	9.6	0.1	14.9	30.0	15.15
	HE20 Beam Forming, M0 to M9 4ss	4	5	5.5	9.2	9.6	9.6	0.1	14.9	30.0	15.15
	HE20 STBC, M0 to M9 2ss	2	5	5.5	9.2			0.1	10.8	30.0	19.19
	HE20 STBC, M0 to M9 2ss	3	5	5.5	9.2	9.6		0.1	13.3	30.0	16.71
	HE20 STBC, M0 to M9 2ss	4	5	5.5	8.2	8.6	8.5	0.1	14.0	30.0	16.04
5745	Non HT20, 6 to 54 Mbps	1	5	11.2				0.1	11.3	30.0	18.75
	Non HT20, 6 to 54 Mbps	2	5	11.2	16.9			0.1	18.0	30.0	12.01
	Non HT20, 6 to 54 Mbps	3	5	11.2	16.9	18.1		0.1	21.1	30.0	8.92
	Non HT20, 6 to 54 Mbps	4	5	11.2	16.9	18.1	15.8	0.1	22.2	30.0	7.78
	Non HT20 Beam Forming, 6 to 54 Mbps	2	8	11.2	16.9			0.1	18.0	28.0	10.01
	Non HT20 Beam Forming, 6 to 54 Mbps	3	10	11.2	16.9	18.1		0.1	21.1	26.0	4.92
	Non HT20 Beam Forming, 6 to 54 Mbps	4	11	11.2	16.9	18.1	15.8	0.1	22.2	25.0	2.78
	HT/VHT20, M0 to M7	1	5	11.3				0.1	11.4	30.0	18.65
	HT/VHT20, M0 to M7	2	5	11.3	17.1			0.1	18.2	30.0	11.83
	HT/VHT20, M8 to M15	2	5	11.3	17.1			0.1	18.2	30.0	11.83
	HT/VHT20, M0 to M7	3	5	11.3	17.1	18.0		0.1	21.1	30.0	8.88
	HT/VHT20, M8 to M15	3	5	11.3	17.1	18.0		0.1	21.1	30.0	8.88
	HT/VHT20, M16 to M23	3	5	11.3	17.1	18.0		0.1	21.1	30.0	8.88
	HT/VHT20, M0 to M7	4	5	11.3	17.1	18.0	15.9	0.1	22.3	30.0	7.73
	HT/VHT20, M8 to M15	4	5	11.3	17.1	18.0	15.9	0.1	22.3	30.0	7.73
	HT/VHT20, M16 to M23	4	5	11.3	17.1	18.0	15.9	0.1	22.3	30.0	7.73
	HT/VHT20, M24 to M31	4	5	11.3	17.1	18.0	15.9	0.1	22.3	30.0	7.73
	HT/VHT20 Beam Forming, M0 to M7	2	8	11.3	17.1			0.1	18.2	28.0	9.83
	HT/VHT20 Beam Forming, M8 to M15	2	5	11.3	17.1			0.1	18.2	30.0	11.83
HT/VHT20 Beam Forming, M0 to M7	3	10	11.3	17.1	18.0		0.1	21.1	26.0	4.88	



	HT/VHT20 Beam Forming, M8 to M15	3	7	11.3	17.1	18.0		0.1	21.1	29.0	7.88
	HT/VHT20 Beam Forming, M16 to M23	3	5	11.3	17.1	18.0		0.1	21.1	30.0	8.88
	HT/VHT20 Beam Forming, M0 to M7	4	11	11.3	17.1	18.0	15.9	0.1	22.3	25.0	2.73
	HT/VHT20 Beam Forming, M8 to M15	4	8	11.3	17.1	18.0	15.9	0.1	22.3	28.0	5.73
	HT/VHT20 Beam Forming, M16 to M23	4	6	11.3	17.1	18.0	15.9	0.1	22.3	30.0	7.73
	HT/VHT20 Beam Forming, M24 to M31	4	5	11.3	17.1	18.0	15.9	0.1	22.3	30.0	7.73
	HT/VHT20 STBC, M0 to M7	2	5	11.3	17.1			0.1	18.2	30.0	11.83
	HT/VHT20 STBC, M0 to M7	3	5	11.3	17.1	18.0		0.1	21.1	30.0	8.88
	HT/VHT20 STBC, M0 to M7	4	5	11.3	17.1	18.0	15.9	0.1	22.3	30.0	7.73
	HE20, M0 to M9 1ss	1	5	11.6				0.1	11.7	30.0	18.33
	HE20, M0 to M9 1ss	2	5	11.6	17.3			0.1	18.4	30.0	11.60
	HE20, M0 to M9 2ss	2	5	11.6	17.3			0.1	18.4	30.0	11.60
	HE20, M0 to M9 1ss	3	5	11.6	17.3	18.4		0.1	21.4	30.0	8.55
	HE20, M0 to M9 2ss	3	5	11.6	17.3	18.4		0.1	21.4	30.0	8.55
	HE20, M0 to M9 3ss	3	5	11.6	17.3	18.4		0.1	21.4	30.0	8.55
	HE20, M0 to M9 1ss	4	5	11.6	17.3	18.4	16.3	0.1	22.6	30.0	7.38
	HE20, M0 to M9 2ss	4	5	11.6	17.3	18.4	16.3	0.1	22.6	30.0	7.38
	HE20, M0 to M9 3ss	4	5	11.6	17.3	18.4	16.3	0.1	22.6	30.0	7.38
	HE20, M0 to M9 4ss	4	5	11.6	17.3	18.4	16.3	0.1	22.6	30.0	7.38
	HE20 Beam Forming, M0 to M9 1ss	2	8	11.6	17.3			0.1	18.4	28.0	9.60
	HE20 Beam Forming, M0 to M9 2ss	2	5	11.6	17.3			0.1	18.4	30.0	11.60
	HE20 Beam Forming, M0 to M9 1ss	3	10	11.6	17.3	18.4		0.1	21.4	26.0	4.55
	HE20 Beam Forming, M0 to M9 2ss	3	7	11.6	17.3	18.4		0.1	21.4	29.0	7.55
	HE20 Beam Forming, M0 to M9 3ss	3	5	11.6	17.3	18.4		0.1	21.4	30.0	8.55
	HE20 Beam Forming, M0 to M9 1ss	4	11	11.6	17.3	18.4	16.3	0.1	22.6	25.0	2.38
	HE20 Beam Forming, M0 to M9 2ss	4	8	11.6	17.3	18.4	16.3	0.1	22.6	28.0	5.38
	HE20 Beam Forming, M0 to M9 3ss	4	6	11.6	17.3	18.4	16.3	0.1	22.6	30.0	7.38
	HE20 Beam Forming, M0 to M9 4ss	4	5	11.6	17.3	18.4	16.3	0.1	22.6	30.0	7.38
	HE20 STBC, M0 to M9 2ss	2	5	11.6	17.3			0.1	18.4	30.0	11.60
	HE20 STBC, M0 to M9 2ss	3	5	11.6	17.3	18.4		0.1	21.4	30.0	8.55
	HE20 STBC, M0 to M9 2ss	4	5	11.6	17.3	18.4	16.3	0.1	22.6	30.0	7.38
5755	Non HT40, 6 to 54 Mbps	1	5	10.3				0.1	10.4	30.0	19.65
	Non HT40, 6 to 54 Mbps	2	5	10.3	16.7			0.1	17.6	30.0	12.35
	Non HT40, 6 to 54 Mbps	3	5	10.3	16.7	17.6		0.1	20.7	30.0	9.34
	Non HT40, 6 to 54 Mbps	4	5	10.3	16.7	17.6	15.5	0.1	21.8	30.0	8.17
	HT/VHT40, M0 to M7	1	5	10.4				0.1	10.5	30.0	19.49
	HT/VHT40, M0 to M7	2	5	10.4	16.9			0.1	17.9	30.0	12.11
	HT/VHT40, M8 to M15	2	5	10.4	16.9			0.1	17.9	30.0	12.11
	HT/VHT40, M0 to M7	3	5	10.4	16.9	17.6		0.1	20.8	30.0	9.19
	HT/VHT40, M8 to M15	3	5	10.4	16.9	17.6		0.1	20.8	30.0	9.19
	HT/VHT40, M16 to M23	3	5	10.4	16.9	17.6		0.1	20.8	30.0	9.19
	HT/VHT40, M0 to M7	4	5	10.4	16.9	17.6	15.4	0.1	21.9	30.0	8.07

	HT/VHT40, M8 to M15	4	5	10.4	16.9	17.6	15.4	0.1	21.9	30.0	8.07
	HT/VHT40, M16 to M23	4	5	10.4	16.9	17.6	15.4	0.1	21.9	30.0	8.07
	HT/VHT40, M24 to M31	4	5	10.4	16.9	17.6	15.4	0.1	21.9	30.0	8.07
	HT/VHT40 Beam Forming, M0 to M7	2	8	10.4	16.9			0.1	17.9	28.0	10.11
	HT/VHT40 Beam Forming, M8 to M15	2	5	10.4	16.9			0.1	17.9	30.0	12.11
	HT/VHT40 Beam Forming, M0 to M7	3	10	10.4	16.9	17.6		0.1	20.8	26.0	5.19
	HT/VHT40 Beam Forming, M8 to M15	3	7	10.4	16.9	17.6		0.1	20.8	29.0	8.19
	HT/VHT40 Beam Forming, M16 to M23	3	5	10.4	16.9	17.6		0.1	20.8	30.0	9.19
	HT/VHT40 Beam Forming, M0 to M7	4	11	10.4	16.9	17.6	15.4	0.1	21.9	25.0	3.07
	HT/VHT40 Beam Forming, M8 to M15	4	8	10.4	16.9	17.6	15.4	0.1	21.9	28.0	6.07
	HT/VHT40 Beam Forming, M16 to M23	4	6	10.4	16.9	17.6	15.4	0.1	21.9	30.0	8.07
	HT/VHT40 Beam Forming, M24 to M31	4	5	10.4	16.9	17.6	15.4	0.1	21.9	30.0	8.07
	HT/VHT40 STBC, M0 to M7	2	5	10.4	16.9			0.1	17.9	30.0	12.11
	HT/VHT40 STBC, M0 to M7	3	5	10.4	16.9	17.6		0.1	20.8	30.0	9.19
	HT/VHT40 STBC, M0 to M7	4	5	10.4	16.9	17.6	15.4	0.1	21.9	30.0	8.07
	HE40, M0 to M9 1ss	1	5	10.6				0.1	10.7	30.0	19.27
	HE40, M0 to M9 1ss	2	5	10.6	17.0			0.1	18.0	30.0	11.98
	HE40, M0 to M9 2ss	2	5	10.6	17.0			0.1	18.0	30.0	11.98
	HE40, M0 to M9 1ss	3	5	10.6	17.0	17.8		0.1	21.0	30.0	9.02
	HE40, M0 to M9 2ss	3	5	10.6	17.0	17.8		0.1	21.0	30.0	9.02
	HE40, M0 to M9 3ss	3	5	10.6	17.0	17.8		0.1	21.0	30.0	9.02
	HE40, M0 to M9 1ss	4	5	10.6	17.0	17.8	15.6	0.1	22.1	30.0	7.88
	HE40, M0 to M9 2ss	4	5	10.6	17.0	17.8	15.6	0.1	22.1	30.0	7.88
	HE40, M0 to M9 3ss	4	5	10.6	17.0	17.8	15.6	0.1	22.1	30.0	7.88
	HE40, M0 to M9 4ss	4	5	10.6	17.0	17.8	15.6	0.1	22.1	30.0	7.88
	HE40 Beam Forming, M0 to M9 1ss	2	8	10.6	17.0			0.1	18.0	28.0	9.98
	HE40 Beam Forming, M0 to M9 2ss	2	5	10.6	17.0			0.1	18.0	30.0	11.98
	HE40 Beam Forming, M0 to M9 1ss	3	10	10.6	17.0	17.8		0.1	21.0	26.0	5.02
	HE40 Beam Forming, M0 to M9 2ss	3	7	10.6	17.0	17.8		0.1	21.0	29.0	8.02
	HE40 Beam Forming, M0 to M9 3ss	3	5	10.6	17.0	17.8		0.1	21.0	30.0	9.02
	HE40 Beam Forming, M0 to M9 1ss	4	11	10.6	17.0	17.8	15.6	0.1	22.1	25.0	2.88
	HE40 Beam Forming, M0 to M9 2ss	4	8	10.6	17.0	17.8	15.6	0.1	22.1	28.0	5.88
	HE40 Beam Forming, M0 to M9 3ss	4	6	10.6	17.0	17.8	15.6	0.1	22.1	30.0	7.88
	HE40 Beam Forming, M0 to M9 4ss	4	5	10.6	17.0	17.8	15.6	0.1	22.1	30.0	7.88
	HE40 STBC, M0 to M9 2ss	2	5	10.6	17.0			0.1	18.0	30.0	11.98
	HE40 STBC, M0 to M9 2ss	3	5	10.6	17.0	17.8		0.1	21.0	30.0	9.02
	HE40 STBC, M0 to M9 2ss	4	5	10.6	17.0	17.8	15.6	0.1	22.1	30.0	7.88
5775	Non HT80, 6 to 54 Mbps	1	5	10.4				0.0	10.4	30.0	19.55
	Non HT80, 6 to 54 Mbps	2	5	10.4	15.5			0.0	16.7	30.0	13.28
	Non HT80, 6 to 54 Mbps	3	5	10.4	15.5	16.9		0.0	19.8	30.0	10.15
	Non HT80, 6 to 54 Mbps	4	5	10.4	15.5	16.9	15.3	0.0	21.2	30.0	8.83
	VHT80, M0 to M9 1ss	1	5	10.4				0.2	10.6	30.0	19.38

VHT80, M0 to M9 1ss	2	5	10.4	15.8			0.2	17.1	30.0	12.88
VHT80, M0 to M9 2ss	2	5	10.4	15.8			0.2	17.1	30.0	12.88
VHT80, M0 to M9 1ss	3	5	10.4	15.8	16.8		0.2	20.1	30.0	9.92
VHT80, M0 to M9 2ss	3	5	10.4	15.8	16.8		0.2	20.1	30.0	9.92
VHT80, M0 to M9 3ss	3	5	10.4	15.8	16.8		0.2	20.1	30.0	9.92
VHT80, M0 to M9 1ss	4	5	10.4	15.8	16.8	15.4	0.2	21.4	30.0	8.59
VHT80, M0 to M9 2ss	4	5	10.4	15.8	16.8	15.4	0.2	21.4	30.0	8.59
VHT80, M0 to M9 3ss	4	5	10.4	15.8	16.8	15.4	0.2	21.4	30.0	8.59
VHT80, M0 to M9 4ss	4	5	10.4	15.8	16.8	15.4	0.2	21.4	30.0	8.59
VHT80 Beam Forming, M0 to M9 1ss	2	8	10.4	15.8			0.2	17.1	28.0	10.88
VHT80 Beam Forming, M0 to M9 2ss	2	5	10.4	15.8			0.2	17.1	30.0	12.88
VHT80 Beam Forming, M0 to M9 1ss	3	10	10.4	15.8	16.8		0.2	20.1	26.0	5.92
VHT80 Beam Forming, M0 to M9 2ss	3	7	10.4	15.8	16.8		0.2	20.1	29.0	8.92
VHT80 Beam Forming, M0 to M9 3ss	3	5	10.4	15.8	16.8		0.2	20.1	30.0	9.92
VHT80 Beam Forming, M0 to M9 1ss	4	11	10.4	15.8	16.8	15.4	0.2	21.4	25.0	3.59
VHT80 Beam Forming, M0 to M9 2ss	4	8	10.4	15.8	16.8	15.4	0.2	21.4	28.0	6.59
VHT80 Beam Forming, M0 to M9 3ss	4	6	10.4	15.8	16.8	15.4	0.2	21.4	30.0	8.59
VHT80 Beam Forming, M0 to M9 4ss	4	5	10.4	15.8	16.8	15.4	0.2	21.4	30.0	8.59
VHT80 STBC, M0 to M9 1ss	2	5	10.4	15.8			0.2	17.1	30.0	12.88
VHT80 STBC, M0 to M9 1ss	3	5	10.4	15.8	16.8		0.2	20.1	30.0	9.92
VHT80 STBC, M0 to M9 1ss	4	5	10.4	15.8	16.8	15.4	0.2	21.4	30.0	8.59
HE80, M0 to M9 1ss	1	5	10.6				0.2	10.8	30.0	19.15
HE80, M0 to M9 1ss	2	5	10.6	16.0			0.2	17.4	30.0	12.65
HE80, M0 to M9 2ss	2	5	10.6	16.0			0.2	17.4	30.0	12.65
HE80, M0 to M9 1ss	3	5	10.6	16.0	17.3		0.2	20.5	30.0	9.54
HE80, M0 to M9 2ss	3	5	10.6	16.0	17.3		0.2	20.5	30.0	9.54
HE80, M0 to M9 3ss	3	5	10.6	16.0	17.3		0.2	20.5	30.0	9.54
HE80, M0 to M9 1ss	4	5	10.6	16.0	17.3	15.7	0.2	21.8	30.0	8.22
HE80, M0 to M9 2ss	4	5	10.6	16.0	17.3	15.7	0.2	21.8	30.0	8.22
HE80, M0 to M9 3ss	4	5	10.6	16.0	17.3	15.7	0.2	21.8	30.0	8.22
HE80, M0 to M9 4ss	4	5	10.6	16.0	17.3	15.7	0.2	21.8	30.0	8.22
HE80 Beam Forming, M0 to M9 1ss	2	8	10.6	16.0			0.2	17.4	28.0	10.65
HE80 Beam Forming, M0 to M9 2ss	2	5	10.6	16.0			0.2	17.4	30.0	12.65
HE80 Beam Forming, M0 to M9 1ss	3	10	10.6	16.0	17.3		0.2	20.5	26.0	5.54
HE80 Beam Forming, M0 to M9 2ss	3	7	10.6	16.0	17.3		0.2	20.5	29.0	8.54
HE80 Beam Forming, M0 to M9 3ss	3	5	10.6	16.0	17.3		0.2	20.5	30.0	9.54
HE80 Beam Forming, M0 to M9 1ss	4	11	10.6	16.0	17.3	15.7	0.2	21.8	25.0	3.22
HE80 Beam Forming, M0 to M9 2ss	4	8	10.6	16.0	17.3	15.7	0.2	21.8	28.0	6.22
HE80 Beam Forming, M0 to M9 3ss	4	6	10.6	16.0	17.3	15.7	0.2	21.8	30.0	8.22
HE80 Beam Forming, M0 to M9 4ss	4	5	10.6	16.0	17.3	15.7	0.2	21.8	30.0	8.22
HE80 STBC, M0 to M9 1ss	2	5	10.6	16.0			0.2	17.4	30.0	12.65
HE80 STBC, M0 to M9 1ss	3	5	10.6	16.0	17.3		0.2	20.5	30.0	9.54
HE80 STBC, M0 to M9 1ss	4	5	10.6	16.0	17.3	15.7	0.2	21.8	30.0	8.22

5785	Non HT20, 6 to 54 Mbps	1	5	11.7				0.1	11.8	30.0	18.25
	Non HT20, 6 to 54 Mbps	2	5	11.7	17.1			0.1	18.3	30.0	11.75
	Non HT20, 6 to 54 Mbps	3	5	11.7	17.1	18.1		0.1	21.2	30.0	8.79
	Non HT20, 6 to 54 Mbps	4	5	11.7	17.1	18.1	16.4	0.1	22.5	30.0	7.54
	Non HT20 Beam Forming, 6 to 54 Mbps	2	8	11.7	17.1			0.1	18.3	28.0	9.75
	Non HT20 Beam Forming, 6 to 54 Mbps	3	10	11.7	17.1	18.1		0.1	21.2	26.0	4.79
	Non HT20 Beam Forming, 6 to 54 Mbps	4	11	11.7	17.1	18.1	16.4	0.1	22.5	25.0	2.54
	HT/VHT20, M0 to M7	1	5	11.6				0.1	11.7	30.0	18.35
	HT/VHT20, M0 to M7	2	5	11.6	16.9			0.1	18.1	30.0	11.92
	HT/VHT20, M8 to M15	2	5	11.6	16.9			0.1	18.1	30.0	11.92
	HT/VHT20, M0 to M7	3	5	11.6	16.9	18.0		0.1	21.1	30.0	8.93
	HT/VHT20, M8 to M15	3	5	11.6	16.9	18.0		0.1	21.1	30.0	8.93
	HT/VHT20, M16 to M23	3	5	11.6	16.9	18.0		0.1	21.1	30.0	8.93
	HT/VHT20, M0 to M7	4	5	11.6	16.9	18.0	16.2	0.1	22.3	30.0	7.69
	HT/VHT20, M8 to M15	4	5	11.6	16.9	18.0	16.2	0.1	22.3	30.0	7.69
	HT/VHT20, M16 to M23	4	5	11.6	16.9	18.0	16.2	0.1	22.3	30.0	7.69
	HT/VHT20, M24 to M31	4	5	11.6	16.9	18.0	16.2	0.1	22.3	30.0	7.69
	HT/VHT20 Beam Forming, M0 to M7	2	8	11.6	16.9			0.1	18.1	28.0	9.92
	HT/VHT20 Beam Forming, M8 to M15	2	5	11.6	16.9			0.1	18.1	30.0	11.92
	HT/VHT20 Beam Forming, M0 to M7	3	10	11.6	16.9	18.0		0.1	21.1	26.0	4.93
	HT/VHT20 Beam Forming, M8 to M15	3	7	11.6	16.9	18.0		0.1	21.1	29.0	7.93
	HT/VHT20 Beam Forming, M16 to M23	3	5	11.6	16.9	18.0		0.1	21.1	30.0	8.93
	HT/VHT20 Beam Forming, M0 to M7	4	11	11.6	16.9	18.0	16.2	0.1	22.3	25.0	2.69
	HT/VHT20 Beam Forming, M8 to M15	4	8	11.6	16.9	18.0	16.2	0.1	22.3	28.0	5.69
	HT/VHT20 Beam Forming, M16 to M23	4	6	11.6	16.9	18.0	16.2	0.1	22.3	30.0	7.69
	HT/VHT20 Beam Forming, M24 to M31	4	5	11.6	16.9	18.0	16.2	0.1	22.3	30.0	7.69
	HT/VHT20 STBC, M0 to M7	2	5	11.6	16.9			0.1	18.1	30.0	11.92
	HT/VHT20 STBC, M0 to M7	3	5	11.6	16.9	18.0		0.1	21.1	30.0	8.93
	HT/VHT20 STBC, M0 to M7	4	5	11.6	16.9	18.0	16.2	0.1	22.3	30.0	7.69
	HE20, M0 to M9 1ss	1	5	11.8				0.1	11.9	30.0	18.13
	HE20, M0 to M9 1ss	2	5	11.8	17.3			0.1	18.4	30.0	11.55
	HE20, M0 to M9 2ss	2	5	11.8	17.3			0.1	18.4	30.0	11.55
	HE20, M0 to M9 1ss	3	5	11.8	17.3	18.4		0.1	21.5	30.0	8.53
	HE20, M0 to M9 2ss	3	5	11.8	17.3	18.4		0.1	21.5	30.0	8.53
	HE20, M0 to M9 3ss	3	5	11.8	17.3	18.4		0.1	21.5	30.0	8.53
	HE20, M0 to M9 1ss	4	5	11.8	17.3	18.4	16.6	0.1	22.7	30.0	7.29
	HE20, M0 to M9 2ss	4	5	11.8	17.3	18.4	16.6	0.1	22.7	30.0	7.29
	HE20, M0 to M9 3ss	4	5	11.8	17.3	18.4	16.6	0.1	22.7	30.0	7.29
	HE20, M0 to M9 4ss	4	5	11.8	17.3	18.4	16.6	0.1	22.7	30.0	7.29
	HE20 Beam Forming, M0 to M9 1ss	2	8	11.8	17.3			0.1	18.4	28.0	9.55
HE20 Beam Forming, M0 to M9 2ss	2	5	11.8	17.3			0.1	18.4	30.0	11.55	

	HE20 Beam Forming, M0 to M9 1ss	3	10	11.8	17.3	18.4		0.1	21.5	26.0	4.53
	HE20 Beam Forming, M0 to M9 2ss	3	7	11.8	17.3	18.4		0.1	21.5	29.0	7.53
	HE20 Beam Forming, M0 to M9 3ss	3	5	11.8	17.3	18.4		0.1	21.5	30.0	8.53
	<b>HE20 Beam Forming, M0 to M9 1ss</b>	<b>4</b>	<b>11</b>	<b>11.8</b>	<b>17.3</b>	<b>18.4</b>	<b>16.6</b>	<b>0.1</b>	<b>22.7</b>	<b>25.0</b>	<b>2.29</b>
	HE20 Beam Forming, M0 to M9 2ss	4	8	11.8	17.3	18.4	16.6	0.1	22.7	28.0	5.29
	HE20 Beam Forming, M0 to M9 3ss	4	6	11.8	17.3	18.4	16.6	0.1	22.7	30.0	7.29
	HE20 Beam Forming, M0 to M9 4ss	4	5	11.8	17.3	18.4	16.6	0.1	22.7	30.0	7.29
	HE20 STBC, M0 to M9 2ss	2	5	11.8	17.3			0.1	18.4	30.0	11.55
	HE20 STBC, M0 to M9 2ss	3	5	11.8	17.3	18.4		0.1	21.5	30.0	8.53
	HE20 STBC, M0 to M9 2ss	4	5	11.8	17.3	18.4	16.6	0.1	22.7	30.0	7.29
5795	Non HT40, 6 to 54 Mbps	1	5	11.0				0.1	11.1	30.0	18.95
	Non HT40, 6 to 54 Mbps	2	5	11.0	16.8			0.1	17.9	30.0	12.14
	Non HT40, 6 to 54 Mbps	3	5	11.0	16.8	17.6		0.1	20.8	30.0	9.23
	Non HT40, 6 to 54 Mbps	4	5	11.0	16.8	17.6	16.0	0.1	22.0	30.0	7.97
	HT/VHT40, M0 to M7	1	5	10.9				0.1	11.0	30.0	18.99
	HT/VHT40, M0 to M7	2	5	10.9	16.6			0.1	17.7	30.0	12.25
	HT/VHT40, M8 to M15	2	5	10.9	16.6			0.1	17.7	30.0	12.25
	HT/VHT40, M0 to M7	3	5	10.9	16.6	17.7		0.1	20.8	30.0	9.21
	HT/VHT40, M8 to M15	3	5	10.9	16.6	17.7		0.1	20.8	30.0	9.21
	HT/VHT40, M16 to M23	3	5	10.9	16.6	17.7		0.1	20.8	30.0	9.21
	HT/VHT40, M0 to M7	4	5	10.9	16.6	17.7	15.9	0.1	22.0	30.0	7.96
	HT/VHT40, M8 to M15	4	5	10.9	16.6	17.7	15.9	0.1	22.0	30.0	7.96
	HT/VHT40, M16 to M23	4	5	10.9	16.6	17.7	15.9	0.1	22.0	30.0	7.96
	HT/VHT40, M24 to M31	4	5	10.9	16.6	17.7	15.9	0.1	22.0	30.0	7.96
	HT/VHT40 Beam Forming, M0 to M7	2	8	10.9	16.6			0.1	17.7	28.0	10.25
	HT/VHT40 Beam Forming, M8 to M15	2	5	10.9	16.6			0.1	17.7	30.0	12.25
	HT/VHT40 Beam Forming, M0 to M7	3	10	10.9	16.6	17.7		0.1	20.8	26.0	5.21
	HT/VHT40 Beam Forming, M8 to M15	3	7	10.9	16.6	17.7		0.1	20.8	29.0	8.21
	HT/VHT40 Beam Forming, M16 to M23	3	5	10.9	16.6	17.7		0.1	20.8	30.0	9.21
	HT/VHT40 Beam Forming, M0 to M7	4	11	10.9	16.6	17.7	15.9	0.1	22.0	25.0	2.96
	HT/VHT40 Beam Forming, M8 to M15	4	8	10.9	16.6	17.7	15.9	0.1	22.0	28.0	5.96
	HT/VHT40 Beam Forming, M16 to M23	4	6	10.9	16.6	17.7	15.9	0.1	22.0	30.0	7.96
	HT/VHT40 Beam Forming, M24 to M31	4	5	10.9	16.6	17.7	15.9	0.1	22.0	30.0	7.96
	HT/VHT40 STBC, M0 to M7	2	5	10.9	16.6			0.1	17.7	30.0	12.25
	HT/VHT40 STBC, M0 to M7	3	5	10.9	16.6	17.7		0.1	20.8	30.0	9.21
	HT/VHT40 STBC, M0 to M7	4	5	10.9	16.6	17.7	15.9	0.1	22.0	30.0	7.96
	HE40, M0 to M9 1ss	1	5	11.2				0.1	11.3	30.0	18.67
	HE40, M0 to M9 1ss	2	5	11.2	17.0			0.1	18.1	30.0	11.86
	HE40, M0 to M9 2ss	2	5	11.2	17.0			0.1	18.1	30.0	11.86
	HE40, M0 to M9 1ss	3	5	11.2	17.0	17.8		0.1	21.0	30.0	8.96
	HE40, M0 to M9 2ss	3	5	11.2	17.0	17.8		0.1	21.0	30.0	8.96
	HE40, M0 to M9 3ss	3	5	11.2	17.0	17.8		0.1	21.0	30.0	8.96

	HE40, M0 to M9 1ss	4	5	11.2	17.0	17.8	16.2	0.1	22.3	30.0	7.69
	HE40, M0 to M9 2ss	4	5	11.2	17.0	17.8	16.2	0.1	22.3	30.0	7.69
	HE40, M0 to M9 3ss	4	5	11.2	17.0	17.8	16.2	0.1	22.3	30.0	7.69
	HE40, M0 to M9 4ss	4	5	11.2	17.0	17.8	16.2	0.1	22.3	30.0	7.69
	HE40 Beam Forming, M0 to M9 1ss	2	8	11.2	17.0			0.1	18.1	28.0	9.86
	HE40 Beam Forming, M0 to M9 2ss	2	5	11.2	17.0			0.1	18.1	30.0	11.86
	HE40 Beam Forming, M0 to M9 1ss	3	10	11.2	17.0	17.8		0.1	21.0	26.0	4.96
	HE40 Beam Forming, M0 to M9 2ss	3	7	11.2	17.0	17.8		0.1	21.0	29.0	7.96
	HE40 Beam Forming, M0 to M9 3ss	3	5	11.2	17.0	17.8		0.1	21.0	30.0	8.96
	HE40 Beam Forming, M0 to M9 1ss	4	11	11.2	17.0	17.8	16.2	0.1	22.3	25.0	2.69
	HE40 Beam Forming, M0 to M9 2ss	4	8	11.2	17.0	17.8	16.2	0.1	22.3	28.0	5.69
	HE40 Beam Forming, M0 to M9 3ss	4	6	11.2	17.0	17.8	16.2	0.1	22.3	30.0	7.69
	HE40 Beam Forming, M0 to M9 4ss	4	5	11.2	17.0	17.8	16.2	0.1	22.3	30.0	7.69
	HE40 STBC, M0 to M9 2ss	2	5	11.2	17.0			0.1	18.1	30.0	11.86
	HE40 STBC, M0 to M9 2ss	3	5	11.2	17.0	17.8		0.1	21.0	30.0	8.96
	HE40 STBC, M0 to M9 2ss	4	5	11.2	17.0	17.8	16.2	0.1	22.3	30.0	7.69
5825	Non HT20, 6 to 54 Mbps	1	5	12.0				0.1	12.1	30.0	17.95
	Non HT20, 6 to 54 Mbps	2	5	12.0	16.6			0.1	17.9	30.0	12.06
	Non HT20, 6 to 54 Mbps	3	5	12.0	16.6	18.1		0.1	21.1	30.0	8.94
	Non HT20, 6 to 54 Mbps	4	5	12.0	16.6	18.1	16.5	0.1	22.4	30.0	7.62
	Non HT20 Beam Forming, 6 to 54 Mbps	2	8	12.0	16.6			0.1	17.9	28.0	10.06
	Non HT20 Beam Forming, 6 to 54 Mbps	3	10	12.0	16.6	18.1		0.1	21.1	26.0	4.94
	Non HT20 Beam Forming, 6 to 54 Mbps	4	11	12.0	16.6	18.1	16.5	0.1	22.4	25.0	2.62
	HT/VHT20, M0 to M7	1	5	12.0				0.1	12.1	30.0	17.95
	HT/VHT20, M0 to M7	2	5	12.0	16.6			0.1	17.9	30.0	12.05
	HT/VHT20, M8 to M15	2	5	12.0	16.6			0.1	17.9	30.0	12.05
	HT/VHT20, M0 to M7	3	5	12.0	16.6	18.1		0.1	21.1	30.0	8.94
	HT/VHT20, M8 to M15	3	5	12.0	16.6	18.1		0.1	21.1	30.0	8.94
	HT/VHT20, M16 to M23	3	5	12.0	16.6	18.1		0.1	21.1	30.0	8.94
	HT/VHT20, M0 to M7	4	5	12.0	16.6	18.1	16.5	0.1	22.4	30.0	7.62
	HT/VHT20, M8 to M15	4	5	12.0	16.6	18.1	16.5	0.1	22.4	30.0	7.62
	HT/VHT20, M16 to M23	4	5	12.0	16.6	18.1	16.5	0.1	22.4	30.0	7.62
	HT/VHT20, M24 to M31	4	5	12.0	16.6	18.1	16.5	0.1	22.4	30.0	7.62
	HT/VHT20 Beam Forming, M0 to M7	2	8	12.0	16.6			0.1	17.9	28.0	10.05
	HT/VHT20 Beam Forming, M8 to M15	2	5	12.0	16.6			0.1	17.9	30.0	12.05
	HT/VHT20 Beam Forming, M0 to M7	3	10	12.0	16.6	18.1		0.1	21.1	26.0	4.94
	HT/VHT20 Beam Forming, M8 to M15	3	7	12.0	16.6	18.1		0.1	21.1	29.0	7.94
	HT/VHT20 Beam Forming, M16 to M23	3	5	12.0	16.6	18.1		0.1	21.1	30.0	8.94
	HT/VHT20 Beam Forming, M0 to M7	4	11	12.0	16.6	18.1	16.5	0.1	22.4	25.0	2.62
	HT/VHT20 Beam Forming, M8 to M15	4	8	12.0	16.6	18.1	16.5	0.1	22.4	28.0	5.62
	HT/VHT20 Beam Forming, M16 to M23	4	6	12.0	16.6	18.1	16.5	0.1	22.4	30.0	7.62
HT/VHT20 Beam Forming, M24 to M31	4	5	12.0	16.6	18.1	16.5	0.1	22.4	30.0	7.62	





HT/VHT20 STBC, M0 to M7	2	5	12.0	16.6			0.1	17.9	30.0	12.05
HT/VHT20 STBC, M0 to M7	3	5	12.0	16.6	18.1		0.1	21.1	30.0	8.94
HT/VHT20 STBC, M0 to M7	4	5	12.0	16.6	18.1	16.5	0.1	22.4	30.0	7.62
HE20, M0 to M9 1ss	1	5	12.1				0.1	12.2	30.0	17.83
HE20, M0 to M9 1ss	2	5	12.1	16.6			0.1	18.0	30.0	12.01
HE20, M0 to M9 2ss	2	5	12.1	16.6			0.1	18.0	30.0	12.01
HE20, M0 to M9 1ss	3	5	12.1	16.6	18.3		0.1	21.2	30.0	8.81
HE20, M0 to M9 2ss	3	5	12.1	16.6	18.3		0.1	21.2	30.0	8.81
HE20, M0 to M9 3ss	3	5	12.1	16.6	18.3		0.1	21.2	30.0	8.81
HE20, M0 to M9 1ss	4	5	12.1	16.6	18.3	16.7	0.1	22.5	30.0	7.47
HE20, M0 to M9 2ss	4	5	12.1	16.6	18.3	16.7	0.1	22.5	30.0	7.47
HE20, M0 to M9 3ss	4	5	12.1	16.6	18.3	16.7	0.1	22.5	30.0	7.47
HE20, M0 to M9 4ss	4	5	12.1	16.6	18.3	16.7	0.1	22.5	30.0	7.47
HE20 Beam Forming, M0 to M9 1ss	2	8	12.1	16.6			0.1	18.0	28.0	10.01
HE20 Beam Forming, M0 to M9 2ss	2	5	12.1	16.6			0.1	18.0	30.0	12.01
HE20 Beam Forming, M0 to M9 1ss	3	10	12.1	16.6	18.3		0.1	21.2	26.0	4.81
HE20 Beam Forming, M0 to M9 2ss	3	7	12.1	16.6	18.3		0.1	21.2	29.0	7.81
HE20 Beam Forming, M0 to M9 3ss	3	5	12.1	16.6	18.3		0.1	21.2	30.0	8.81
HE20 Beam Forming, M0 to M9 1ss	4	11	12.1	16.6	18.3	16.7	0.1	22.5	25.0	2.47
HE20 Beam Forming, M0 to M9 2ss	4	8	12.1	16.6	18.3	16.7	0.1	22.5	28.0	5.47
HE20 Beam Forming, M0 to M9 3ss	4	6	12.1	16.6	18.3	16.7	0.1	22.5	30.0	7.47
HE20 Beam Forming, M0 to M9 4ss	4	5	12.1	16.6	18.3	16.7	0.1	22.5	30.0	7.47
HE20 STBC, M0 to M9 2ss	2	5	12.1	16.6			0.1	18.0	30.0	12.01
HE20 STBC, M0 to M9 2ss	3	5	12.1	16.6	18.3		0.1	21.2	30.0	8.81
HE20 STBC, M0 to M9 2ss	4	5	12.1	16.6	18.3	16.7	0.1	22.5	30.0	7.47

**Maximum Transmit Output Power, 5dBi  
5785 MHz, HE20 Beam Forming, M0 to M9 1ss**

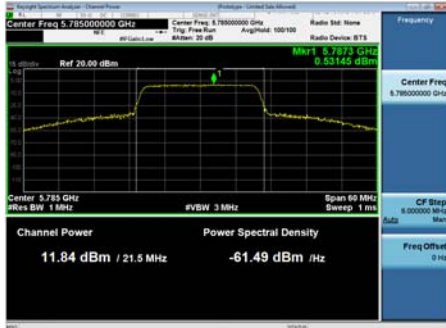

**Antenna A**

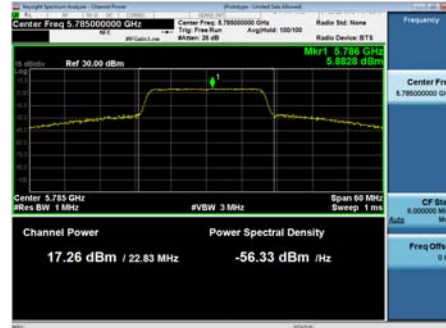

**Antenna B**

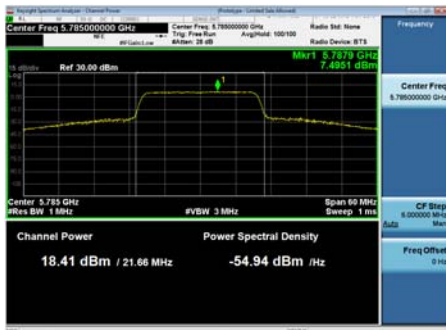

**Antenna C**

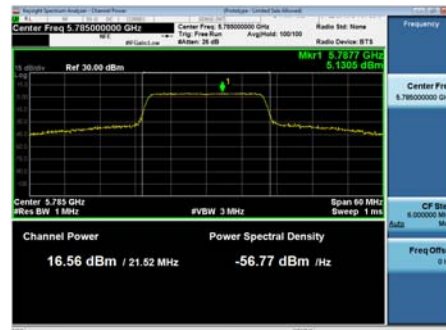

**Antenna D**



## Maximum Output Power, 6dBi

Frequency (MHz)	Mode	Tx Paths	Correlated Antenna Gain (dBi)	Tx 1 Max Power (dBm)	Tx 2 Max Power (dBm)	Tx 3 Max Power (dBm)	Tx 4 Max Power (dBm)	Duty Cycle Correction (dB)	Total Tx Channel Power (dBm)	Limit (dBm)	Margin (dB)
5720 <sup>11</sup>	Non HT20, 6 to 54 Mbps	1	6	4.7				0.1	4.8	30.0	25.25
	Non HT20, 6 to 54 Mbps	2	6	4.7	8.4			0.1	10.0	30.0	20.01
	Non HT20, 6 to 54 Mbps	3	6	4.7	8.4	8.8		0.1	12.5	30.0	17.53
	Non HT20, 6 to 54 Mbps	4	6	4.7	8.4	8.8	8.7	0.1	14.0	30.0	15.99
	Non HT20 Beam Forming, 6 to 54 Mbps	2	9	4.7	8.4			0.1	10.0	27.0	17.01
	Non HT20 Beam Forming, 6 to 54 Mbps	3	11	4.7	5.2	5.5		0.1	10.0	25.0	15.03
	Non HT20 Beam Forming, 6 to 54 Mbps	4	12	4.7	3.0	3.3	3.1	0.1	9.7	24.0	14.35
	HT/VHT20, M0 to M7	1	6	5.1				0.1	5.2	30.0	24.85
	HT/VHT20, M0 to M7	2	6	5.1	8.8			0.1	10.4	30.0	19.60
	HT/VHT20, M8 to M15	2	6	5.1	8.8			0.1	10.4	30.0	19.60
	HT/VHT20, M0 to M7	3	6	5.1	8.8	9.3		0.1	12.9	30.0	17.08
	HT/VHT20, M8 to M15	3	6	5.1	8.8	9.3		0.1	12.9	30.0	17.08
	HT/VHT20, M16 to M23	3	6	5.1	8.8	9.3		0.1	12.9	30.0	17.08
	HT/VHT20, M0 to M7	4	6	5.1	8.8	9.3	9.0	0.1	14.4	30.0	15.59
	HT/VHT20, M8 to M15	4	6	5.1	8.8	9.3	9.0	0.1	14.4	30.0	15.59
	HT/VHT20, M16 to M23	4	6	5.1	8.8	9.3	9.0	0.1	14.4	30.0	15.59
	HT/VHT20, M24 to M31	4	6	5.1	8.8	9.3	9.0	0.1	14.4	30.0	15.59
	HT/VHT20 Beam Forming, M0 to M7	2	9	5.1	8.8			0.1	10.4	27.0	16.60
	HT/VHT20 Beam Forming, M8 to M15	2	6	5.1	8.8			0.1	10.4	30.0	19.60
	HT/VHT20 Beam Forming, M0 to M7	3	11	5.1	5.6	5.9		0.1	10.4	25.0	14.63
	HT/VHT20 Beam Forming, M8 to M15	3	8	5.1	8.8	9.3		0.1	12.9	28.0	15.08
	HT/VHT20 Beam Forming, M16 to M23	3	6	5.1	8.8	9.3		0.1	12.9	30.0	17.08
	HT/VHT20 Beam Forming, M0 to M7	4	12	5.1	3.4	3.9	3.7	0.1	10.1	24.0	13.85
	HT/VHT20 Beam Forming, M8 to M15	4	9	5.1	6.5	7.0	6.8	0.1	12.5	27.0	14.52
	HT/VHT20 Beam Forming, M16 to M23	4	7	5.1	8.8	9.3	9.0	0.1	14.4	29.0	14.59
	HT/VHT20 Beam Forming, M24 to M31	4	6	5.1	8.8	9.3	9.0	0.1	14.4	30.0	15.59
	HT/VHT20 STBC, M0 to M7	2	6	5.1	8.8			0.1	10.4	30.0	19.60
	HT/VHT20 STBC, M0 to M7	3	6	5.1	8.8	9.3		0.1	12.9	30.0	17.08
	HT/VHT20 STBC, M0 to M7	4	6	5.1	6.5	7.0	6.8	0.1	12.5	30.0	17.52

<sup>11</sup> 5720 (ch144) not supported for Canada.

	HE20, M0 to M9 1ss	1	6	5.5				0.1	5.6	30.0	24.43
	HE20, M0 to M9 1ss	2	6	5.5	9.2			0.1	10.8	30.0	19.19
	HE20, M0 to M9 2ss	2	6	5.5	9.2			0.1	10.8	30.0	19.19
	HE20, M0 to M9 1ss	3	6	5.5	9.2	9.6		0.1	13.3	30.0	16.71
	HE20, M0 to M9 2ss	3	6	5.5	9.2	9.6		0.1	13.3	30.0	16.71
	HE20, M0 to M9 3ss	3	6	5.5	9.2	9.6		0.1	13.3	30.0	16.71
	HE20, M0 to M9 1ss	4	6	5.5	9.2	9.6	9.6	0.1	14.9	30.0	15.15
	HE20, M0 to M9 2ss	4	6	5.5	9.2	9.6	9.6	0.1	14.9	30.0	15.15
	HE20, M0 to M9 3ss	4	6	5.5	9.2	9.6	9.6	0.1	14.9	30.0	15.15
	HE20, M0 to M9 4ss	4	6	5.5	9.2	9.6	9.6	0.1	14.9	30.0	15.15
	HE20 Beam Forming, M0 to M9 1ss	2	9	5.5	9.2			0.1	10.8	27.0	16.19
	HE20 Beam Forming, M0 to M9 2ss	2	6	5.5	9.2			0.1	10.8	30.0	19.19
	HE20 Beam Forming, M0 to M9 1ss	3	11	5.5	6.1	6.4		0.1	10.9	25.0	14.15
	HE20 Beam Forming, M0 to M9 2ss	3	8	5.5	9.2	9.6		0.1	13.3	28.0	14.71
	HE20 Beam Forming, M0 to M9 3ss	3	6	5.5	9.2	9.6		0.1	13.3	30.0	16.71
	HE20 Beam Forming, M0 to M9 1ss	4	12	5.5	4.0	4.2	4.1	0.1	10.6	24.0	13.42
	HE20 Beam Forming, M0 to M9 2ss	4	9	5.5	6.9	7.7	7.4	0.1	13.0	27.0	13.96
	HE20 Beam Forming, M0 to M9 3ss	4	7	5.5	9.2	9.6	9.6	0.1	14.9	29.0	14.15
	HE20 Beam Forming, M0 to M9 4ss	4	6	5.5	9.2	9.6	9.6	0.1	14.9	30.0	15.15
	HE20 STBC, M0 to M9 2ss	2	6	5.5	9.2			0.1	10.8	30.0	19.19
	HE20 STBC, M0 to M9 2ss	3	6	5.5	9.2	9.6		0.1	13.3	30.0	16.71
	HE20 STBC, M0 to M9 2ss	4	6	5.5	6.9	7.7	7.4	0.1	13.0	30.0	16.96
5745	Non HT20, 6 to 54 Mbps	1	6	11.2				0.1	11.3	30.0	18.75
	Non HT20, 6 to 54 Mbps	2	6	11.2	16.9			0.1	18.0	30.0	12.01
	Non HT20, 6 to 54 Mbps	3	6	11.2	16.9	18.1		0.1	21.1	30.0	8.92
	Non HT20, 6 to 54 Mbps	4	6	11.2	16.9	18.1	15.8	0.1	22.2	30.0	7.78
	Non HT20 Beam Forming, 6 to 54 Mbps	2	9	11.2	16.9			0.1	18.0	27.0	9.01
	Non HT20 Beam Forming, 6 to 54 Mbps	3	11	11.2	16.9	18.1		0.1	21.1	25.0	3.92
	Non HT20 Beam Forming, 6 to 54 Mbps	4	12	11.2	16.9	18.1	15.8	0.1	22.2	24.0	1.78
	HT/VHT20, M0 to M7	1	6	11.3				0.1	11.4	30.0	18.65
	HT/VHT20, M0 to M7	2	6	11.3	17.1			0.1	18.2	30.0	11.83
	HT/VHT20, M8 to M15	2	6	11.3	17.1			0.1	18.2	30.0	11.83
	HT/VHT20, M0 to M7	3	6	11.3	17.1	18.0		0.1	21.1	30.0	8.88
	HT/VHT20, M8 to M15	3	6	11.3	17.1	18.0		0.1	21.1	30.0	8.88
	HT/VHT20, M16 to M23	3	6	11.3	17.1	18.0		0.1	21.1	30.0	8.88
	HT/VHT20, M0 to M7	4	6	11.3	17.1	18.0	15.9	0.1	22.3	30.0	7.73
	HT/VHT20, M8 to M15	4	6	11.3	17.1	18.0	15.9	0.1	22.3	30.0	7.73
	HT/VHT20, M16 to M23	4	6	11.3	17.1	18.0	15.9	0.1	22.3	30.0	7.73
	HT/VHT20, M24 to M31	4	6	11.3	17.1	18.0	15.9	0.1	22.3	30.0	7.73
	HT/VHT20 Beam Forming, M0 to M7	2	9	11.3	17.1			0.1	18.2	27.0	8.83
	HT/VHT20 Beam Forming, M8 to M15	2	6	11.3	17.1			0.1	18.2	30.0	11.83
HT/VHT20 Beam Forming, M0 to M7	3	11	11.3	17.1	18.0		0.1	21.1	25.0	3.88	

	HT/VHT20 Beam Forming, M8 to M15	3	8	11.3	17.1	18.0		0.1	21.1	28.0	6.88
	HT/VHT20 Beam Forming, M16 to M23	3	6	11.3	17.1	18.0		0.1	21.1	30.0	8.88
	HT/VHT20 Beam Forming, M0 to M7	4	12	11.3	17.1	18.0	15.9	0.1	22.3	24.0	1.73
	HT/VHT20 Beam Forming, M8 to M15	4	9	11.3	17.1	18.0	15.9	0.1	22.3	27.0	4.73
	HT/VHT20 Beam Forming, M16 to M23	4	7	11.3	17.1	18.0	15.9	0.1	22.3	29.0	6.73
	HT/VHT20 Beam Forming, M24 to M31	4	6	11.3	17.1	18.0	15.9	0.1	22.3	30.0	7.73
	HT/VHT20 STBC, M0 to M7	2	6	11.3	17.1			0.1	18.2	30.0	11.83
	HT/VHT20 STBC, M0 to M7	3	6	11.3	17.1	18.0		0.1	21.1	30.0	8.88
	HT/VHT20 STBC, M0 to M7	4	6	11.3	17.1	18.0	15.9	0.1	22.3	30.0	7.73
	HE20, M0 to M9 1ss	1	6	11.6				0.1	11.7	30.0	18.33
	HE20, M0 to M9 1ss	2	6	11.6	17.3			0.1	18.4	30.0	11.60
	HE20, M0 to M9 2ss	2	6	11.6	17.3			0.1	18.4	30.0	11.60
	HE20, M0 to M9 1ss	3	6	11.6	17.3	18.4		0.1	21.4	30.0	8.55
	HE20, M0 to M9 2ss	3	6	11.6	17.3	18.4		0.1	21.4	30.0	8.55
	HE20, M0 to M9 3ss	3	6	11.6	17.3	18.4		0.1	21.4	30.0	8.55
	HE20, M0 to M9 1ss	4	6	11.6	17.3	18.4	16.3	0.1	22.6	30.0	7.38
	HE20, M0 to M9 2ss	4	6	11.6	17.3	18.4	16.3	0.1	22.6	30.0	7.38
	HE20, M0 to M9 3ss	4	6	11.6	17.3	18.4	16.3	0.1	22.6	30.0	7.38
	HE20, M0 to M9 4ss	4	6	11.6	17.3	18.4	16.3	0.1	22.6	30.0	7.38
	HE20 Beam Forming, M0 to M9 1ss	2	9	11.6	17.3			0.1	18.4	27.0	8.60
	HE20 Beam Forming, M0 to M9 2ss	2	6	11.6	17.3			0.1	18.4	30.0	11.60
	HE20 Beam Forming, M0 to M9 1ss	3	11	11.6	17.3	18.4		0.1	21.4	25.0	3.55
	HE20 Beam Forming, M0 to M9 2ss	3	8	11.6	17.3	18.4		0.1	21.4	28.0	6.55
	HE20 Beam Forming, M0 to M9 3ss	3	6	11.6	17.3	18.4		0.1	21.4	30.0	8.55
	HE20 Beam Forming, M0 to M9 1ss	4	12	11.6	17.3	18.4	16.3	0.1	22.6	24.0	1.38
	HE20 Beam Forming, M0 to M9 2ss	4	9	11.6	17.3	18.4	16.3	0.1	22.6	27.0	4.38
	HE20 Beam Forming, M0 to M9 3ss	4	7	11.6	17.3	18.4	16.3	0.1	22.6	29.0	6.38
	HE20 Beam Forming, M0 to M9 4ss	4	6	11.6	17.3	18.4	16.3	0.1	22.6	30.0	7.38
	HE20 STBC, M0 to M9 2ss	2	6	11.6	17.3			0.1	18.4	30.0	11.60
	HE20 STBC, M0 to M9 2ss	3	6	11.6	17.3	18.4		0.1	21.4	30.0	8.55
	HE20 STBC, M0 to M9 2ss	4	6	11.6	17.3	18.4	16.3	0.1	22.6	30.0	7.38
5755	Non HT40, 6 to 54 Mbps	1	6	10.3				0.1	10.4	30.0	19.65
	Non HT40, 6 to 54 Mbps	2	6	10.3	16.7			0.1	17.6	30.0	12.35
	Non HT40, 6 to 54 Mbps	3	6	10.3	16.7	17.6		0.1	20.7	30.0	9.34
	Non HT40, 6 to 54 Mbps	4	6	10.3	16.7	17.6	15.5	0.1	21.8	30.0	8.17
	HT/VHT40, M0 to M7	1	6	10.4				0.1	10.5	30.0	19.49
	HT/VHT40, M0 to M7	2	6	10.4	16.9			0.1	17.9	30.0	12.11
	HT/VHT40, M8 to M15	2	6	10.4	16.9			0.1	17.9	30.0	12.11
	HT/VHT40, M0 to M7	3	6	10.4	16.9	17.6		0.1	20.8	30.0	9.19
	HT/VHT40, M8 to M15	3	6	10.4	16.9	17.6		0.1	20.8	30.0	9.19
	HT/VHT40, M16 to M23	3	6	10.4	16.9	17.6		0.1	20.8	30.0	9.19
	HT/VHT40, M0 to M7	4	6	10.4	16.9	17.6	15.4	0.1	21.9	30.0	8.07

	HT/VHT40, M8 to M15	4	6	10.4	16.9	17.6	15.4	0.1	21.9	30.0	8.07
	HT/VHT40, M16 to M23	4	6	10.4	16.9	17.6	15.4	0.1	21.9	30.0	8.07
	HT/VHT40, M24 to M31	4	6	10.4	16.9	17.6	15.4	0.1	21.9	30.0	8.07
	HT/VHT40 Beam Forming, M0 to M7	2	9	10.4	16.9			0.1	17.9	27.0	9.11
	HT/VHT40 Beam Forming, M8 to M15	2	6	10.4	16.9			0.1	17.9	30.0	12.11
	HT/VHT40 Beam Forming, M0 to M7	3	11	10.4	16.9	17.6		0.1	20.8	25.0	4.19
	HT/VHT40 Beam Forming, M8 to M15	3	8	10.4	16.9	17.6		0.1	20.8	28.0	7.19
	HT/VHT40 Beam Forming, M16 to M23	3	6	10.4	16.9	17.6		0.1	20.8	30.0	9.19
	HT/VHT40 Beam Forming, M0 to M7	4	12	10.4	16.9	17.6	15.4	0.1	21.9	24.0	2.07
	HT/VHT40 Beam Forming, M8 to M15	4	9	10.4	16.9	17.6	15.4	0.1	21.9	27.0	5.07
	HT/VHT40 Beam Forming, M16 to M23	4	7	10.4	16.9	17.6	15.4	0.1	21.9	29.0	7.07
	HT/VHT40 Beam Forming, M24 to M31	4	6	10.4	16.9	17.6	15.4	0.1	21.9	30.0	8.07
	HT/VHT40 STBC, M0 to M7	2	6	10.4	16.9			0.1	17.9	30.0	12.11
	HT/VHT40 STBC, M0 to M7	3	6	10.4	16.9	17.6		0.1	20.8	30.0	9.19
	HT/VHT40 STBC, M0 to M7	4	6	10.4	16.9	17.6	15.4	0.1	21.9	30.0	8.07
	HE40, M0 to M9 1ss	1	6	10.6				0.1	10.7	30.0	19.27
	HE40, M0 to M9 1ss	2	6	10.6	17.0			0.1	18.0	30.0	11.98
	HE40, M0 to M9 2ss	2	6	10.6	17.0			0.1	18.0	30.0	11.98
	HE40, M0 to M9 1ss	3	6	10.6	17.0	17.8		0.1	21.0	30.0	9.02
	HE40, M0 to M9 2ss	3	6	10.6	17.0	17.8		0.1	21.0	30.0	9.02
	HE40, M0 to M9 3ss	3	6	10.6	17.0	17.8		0.1	21.0	30.0	9.02
	HE40, M0 to M9 1ss	4	6	10.6	17.0	17.8	15.6	0.1	22.1	30.0	7.88
	HE40, M0 to M9 2ss	4	6	10.6	17.0	17.8	15.6	0.1	22.1	30.0	7.88
	HE40, M0 to M9 3ss	4	6	10.6	17.0	17.8	15.6	0.1	22.1	30.0	7.88
	HE40, M0 to M9 4ss	4	6	10.6	17.0	17.8	15.6	0.1	22.1	30.0	7.88
	HE40 Beam Forming, M0 to M9 1ss	2	9	10.6	17.0			0.1	18.0	27.0	8.98
	HE40 Beam Forming, M0 to M9 2ss	2	6	10.6	17.0			0.1	18.0	30.0	11.98
	HE40 Beam Forming, M0 to M9 1ss	3	11	10.6	17.0	17.8		0.1	21.0	25.0	4.02
	HE40 Beam Forming, M0 to M9 2ss	3	8	10.6	17.0	17.8		0.1	21.0	28.0	7.02
	HE40 Beam Forming, M0 to M9 3ss	3	6	10.6	17.0	17.8		0.1	21.0	30.0	9.02
	HE40 Beam Forming, M0 to M9 1ss	4	12	10.6	17.0	17.8	15.6	0.1	22.1	24.0	1.88
	HE40 Beam Forming, M0 to M9 2ss	4	9	10.6	17.0	17.8	15.6	0.1	22.1	27.0	4.88
	HE40 Beam Forming, M0 to M9 3ss	4	7	10.6	17.0	17.8	15.6	0.1	22.1	29.0	6.88
	HE40 Beam Forming, M0 to M9 4ss	4	6	10.6	17.0	17.8	15.6	0.1	22.1	30.0	7.88
	HE40 STBC, M0 to M9 2ss	2	6	10.6	17.0			0.1	18.0	30.0	11.98
	HE40 STBC, M0 to M9 2ss	3	6	10.6	17.0	17.8		0.1	21.0	30.0	9.02
	HE40 STBC, M0 to M9 2ss	4	6	10.6	17.0	17.8	15.6	0.1	22.1	30.0	7.88
5775	Non HT80, 6 to 54 Mbps	1	6	10.4				0.0	10.4	30.0	19.55
	Non HT80, 6 to 54 Mbps	2	6	10.4	15.5			0.0	16.7	30.0	13.28
	Non HT80, 6 to 54 Mbps	3	6	10.4	15.5	16.9		0.0	19.8	30.0	10.15
	Non HT80, 6 to 54 Mbps	4	6	10.4	15.5	16.9	15.3	0.0	21.2	30.0	8.83
	VHT80, M0 to M9 1ss	1	6	10.4				0.2	10.6	30.0	19.38

VHT80, M0 to M9 1ss	2	6	10.4	15.8			0.2	17.1	30.0	12.88
VHT80, M0 to M9 2ss	2	6	10.4	15.8			0.2	17.1	30.0	12.88
VHT80, M0 to M9 1ss	3	6	10.4	15.8	16.8		0.2	20.1	30.0	9.92
VHT80, M0 to M9 2ss	3	6	10.4	15.8	16.8		0.2	20.1	30.0	9.92
VHT80, M0 to M9 3ss	3	6	10.4	15.8	16.8		0.2	20.1	30.0	9.92
VHT80, M0 to M9 1ss	4	6	10.4	15.8	16.8	15.4	0.2	21.4	30.0	8.59
VHT80, M0 to M9 2ss	4	6	10.4	15.8	16.8	15.4	0.2	21.4	30.0	8.59
VHT80, M0 to M9 3ss	4	6	10.4	15.8	16.8	15.4	0.2	21.4	30.0	8.59
VHT80, M0 to M9 4ss	4	6	10.4	15.8	16.8	15.4	0.2	21.4	30.0	8.59
VHT80 Beam Forming, M0 to M9 1ss	2	9	10.4	15.8			0.2	17.1	27.0	9.88
VHT80 Beam Forming, M0 to M9 2ss	2	6	10.4	15.8			0.2	17.1	30.0	12.88
VHT80 Beam Forming, M0 to M9 1ss	3	11	10.4	15.8	16.8		0.2	20.1	25.0	4.92
VHT80 Beam Forming, M0 to M9 2ss	3	8	10.4	15.8	16.8		0.2	20.1	28.0	7.92
VHT80 Beam Forming, M0 to M9 3ss	3	6	10.4	15.8	16.8		0.2	20.1	30.0	9.92
VHT80 Beam Forming, M0 to M9 1ss	4	12	10.4	15.8	16.8	15.4	0.2	21.4	24.0	2.59
VHT80 Beam Forming, M0 to M9 2ss	4	9	10.4	15.8	16.8	15.4	0.2	21.4	27.0	5.59
VHT80 Beam Forming, M0 to M9 3ss	4	7	10.4	15.8	16.8	15.4	0.2	21.4	29.0	7.59
VHT80 Beam Forming, M0 to M9 4ss	4	6	10.4	15.8	16.8	15.4	0.2	21.4	30.0	8.59
VHT80 STBC, M0 to M9 1ss	2	6	10.4	15.8			0.2	17.1	30.0	12.88
VHT80 STBC, M0 to M9 1ss	3	6	10.4	15.8	16.8		0.2	20.1	30.0	9.92
VHT80 STBC, M0 to M9 1ss	4	6	10.4	15.8	16.8	15.4	0.2	21.4	30.0	8.59
HE80, M0 to M9 1ss	1	6	10.6				0.2	10.8	30.0	19.15
HE80, M0 to M9 1ss	2	6	10.6	16.0			0.2	17.4	30.0	12.65
HE80, M0 to M9 2ss	2	6	10.6	16.0			0.2	17.4	30.0	12.65
HE80, M0 to M9 1ss	3	6	10.6	16.0	17.3		0.2	20.5	30.0	9.54
HE80, M0 to M9 2ss	3	6	10.6	16.0	17.3		0.2	20.5	30.0	9.54
HE80, M0 to M9 3ss	3	6	10.6	16.0	17.3		0.2	20.5	30.0	9.54
HE80, M0 to M9 1ss	4	6	10.6	16.0	17.3	15.7	0.2	21.8	30.0	8.22
HE80, M0 to M9 2ss	4	6	10.6	16.0	17.3	15.7	0.2	21.8	30.0	8.22
HE80, M0 to M9 3ss	4	6	10.6	16.0	17.3	15.7	0.2	21.8	30.0	8.22
HE80, M0 to M9 4ss	4	6	10.6	16.0	17.3	15.7	0.2	21.8	30.0	8.22
HE80 Beam Forming, M0 to M9 1ss	2	9	10.6	16.0			0.2	17.4	27.0	9.65
HE80 Beam Forming, M0 to M9 2ss	2	6	10.6	16.0			0.2	17.4	30.0	12.65
HE80 Beam Forming, M0 to M9 1ss	3	11	10.6	16.0	17.3		0.2	20.5	25.0	4.54
HE80 Beam Forming, M0 to M9 2ss	3	8	10.6	16.0	17.3		0.2	20.5	28.0	7.54
HE80 Beam Forming, M0 to M9 3ss	3	6	10.6	16.0	17.3		0.2	20.5	30.0	9.54
HE80 Beam Forming, M0 to M9 1ss	4	12	10.6	16.0	17.3	15.7	0.2	21.8	24.0	2.22
HE80 Beam Forming, M0 to M9 2ss	4	9	10.6	16.0	17.3	15.7	0.2	21.8	27.0	5.22
HE80 Beam Forming, M0 to M9 3ss	4	7	10.6	16.0	17.3	15.7	0.2	21.8	29.0	7.22
HE80 Beam Forming, M0 to M9 4ss	4	6	10.6	16.0	17.3	15.7	0.2	21.8	30.0	8.22
HE80 STBC, M0 to M9 1ss	2	6	10.6	16.0			0.2	17.4	30.0	12.65
HE80 STBC, M0 to M9 1ss	3	6	10.6	16.0	17.3		0.2	20.5	30.0	9.54
HE80 STBC, M0 to M9 1ss	4	6	10.6	16.0	17.3	15.7	0.2	21.8	30.0	8.22

5785	Non HT20, 6 to 54 Mbps	1	6	11.7				0.1	11.8	30.0	18.25
	Non HT20, 6 to 54 Mbps	2	6	11.7	17.1			0.1	18.3	30.0	11.75
	Non HT20, 6 to 54 Mbps	3	6	11.7	17.1	18.1		0.1	21.2	30.0	8.79
	Non HT20, 6 to 54 Mbps	4	6	11.7	17.1	18.1	16.4	0.1	22.5	30.0	7.54
	Non HT20 Beam Forming, 6 to 54 Mbps	2	9	11.7	17.1			0.1	18.3	27.0	8.75
	Non HT20 Beam Forming, 6 to 54 Mbps	3	11	11.7	17.1	18.1		0.1	21.2	25.0	3.79
	Non HT20 Beam Forming, 6 to 54 Mbps	4	12	11.7	17.1	18.1	16.4	0.1	22.5	24.0	1.54
	HT/VHT20, M0 to M7	1	6	11.6				0.1	11.7	30.0	18.35
	HT/VHT20, M0 to M7	2	6	11.6	16.9			0.1	18.1	30.0	11.92
	HT/VHT20, M8 to M15	2	6	11.6	16.9			0.1	18.1	30.0	11.92
	HT/VHT20, M0 to M7	3	6	11.6	16.9	18.0		0.1	21.1	30.0	8.93
	HT/VHT20, M8 to M15	3	6	11.6	16.9	18.0		0.1	21.1	30.0	8.93
	HT/VHT20, M16 to M23	3	6	11.6	16.9	18.0		0.1	21.1	30.0	8.93
	HT/VHT20, M0 to M7	4	6	11.6	16.9	18.0	16.2	0.1	22.3	30.0	7.69
	HT/VHT20, M8 to M15	4	6	11.6	16.9	18.0	16.2	0.1	22.3	30.0	7.69
	HT/VHT20, M16 to M23	4	6	11.6	16.9	18.0	16.2	0.1	22.3	30.0	7.69
	HT/VHT20, M24 to M31	4	6	11.6	16.9	18.0	16.2	0.1	22.3	30.0	7.69
	HT/VHT20 Beam Forming, M0 to M7	2	9	11.6	16.9			0.1	18.1	27.0	8.92
	HT/VHT20 Beam Forming, M8 to M15	2	6	11.6	16.9			0.1	18.1	30.0	11.92
	HT/VHT20 Beam Forming, M0 to M7	3	11	11.6	16.9	18.0		0.1	21.1	25.0	3.93
	HT/VHT20 Beam Forming, M8 to M15	3	8	11.6	16.9	18.0		0.1	21.1	28.0	6.93
	HT/VHT20 Beam Forming, M16 to M23	3	6	11.6	16.9	18.0		0.1	21.1	30.0	8.93
	HT/VHT20 Beam Forming, M0 to M7	4	12	11.6	16.9	18.0	16.2	0.1	22.3	24.0	1.69
	HT/VHT20 Beam Forming, M8 to M15	4	9	11.6	16.9	18.0	16.2	0.1	22.3	27.0	4.69
	HT/VHT20 Beam Forming, M16 to M23	4	7	11.6	16.9	18.0	16.2	0.1	22.3	29.0	6.69
	HT/VHT20 Beam Forming, M24 to M31	4	6	11.6	16.9	18.0	16.2	0.1	22.3	30.0	7.69
	HT/VHT20 STBC, M0 to M7	2	6	11.6	16.9			0.1	18.1	30.0	11.92
	HT/VHT20 STBC, M0 to M7	3	6	11.6	16.9	18.0		0.1	21.1	30.0	8.93
	HT/VHT20 STBC, M0 to M7	4	6	11.6	16.9	18.0	16.2	0.1	22.3	30.0	7.69
	HE20, M0 to M9 1ss	1	6	11.8				0.1	11.9	30.0	18.13
	HE20, M0 to M9 1ss	2	6	11.8	17.3			0.1	18.4	30.0	11.55
	HE20, M0 to M9 2ss	2	6	11.8	17.3			0.1	18.4	30.0	11.55
	HE20, M0 to M9 1ss	3	6	11.8	17.3	18.4		0.1	21.5	30.0	8.53
	HE20, M0 to M9 2ss	3	6	11.8	17.3	18.4		0.1	21.5	30.0	8.53
	HE20, M0 to M9 3ss	3	6	11.8	17.3	18.4		0.1	21.5	30.0	8.53
	HE20, M0 to M9 1ss	4	6	11.8	17.3	18.4	16.6	0.1	22.7	30.0	7.29
	HE20, M0 to M9 2ss	4	6	11.8	17.3	18.4	16.6	0.1	22.7	30.0	7.29
	HE20, M0 to M9 3ss	4	6	11.8	17.3	18.4	16.6	0.1	22.7	30.0	7.29
	HE20, M0 to M9 4ss	4	6	11.8	17.3	18.4	16.6	0.1	22.7	30.0	7.29
	HE20 Beam Forming, M0 to M9 1ss	2	9	11.8	17.3			0.1	18.4	27.0	8.55
	HE20 Beam Forming, M0 to M9 2ss	2	6	11.8	17.3			0.1	18.4	30.0	11.55



	HE20 Beam Forming, M0 to M9 1ss	3	11	11.8	17.3	18.4		0.1	21.5	25.0	3.53
	HE20 Beam Forming, M0 to M9 2ss	3	8	11.8	17.3	18.4		0.1	21.5	28.0	6.53
	HE20 Beam Forming, M0 to M9 3ss	3	6	11.8	17.3	18.4		0.1	21.5	30.0	8.53
	<b>HE20 Beam Forming, M0 to M9 1ss</b>	<b>4</b>	<b>12</b>	<b>11.8</b>	<b>17.3</b>	<b>18.4</b>	<b>16.6</b>	<b>0.1</b>	<b>22.7</b>	<b>24.0</b>	<b>1.29</b>
	HE20 Beam Forming, M0 to M9 2ss	4	9	11.8	17.3	18.4	16.6	0.1	22.7	27.0	4.29
	HE20 Beam Forming, M0 to M9 3ss	4	7	11.8	17.3	18.4	16.6	0.1	22.7	29.0	6.29
	HE20 Beam Forming, M0 to M9 4ss	4	6	11.8	17.3	18.4	16.6	0.1	22.7	30.0	7.29
	HE20 STBC, M0 to M9 2ss	2	6	11.8	17.3			0.1	18.4	30.0	11.55
	HE20 STBC, M0 to M9 2ss	3	6	11.8	17.3	18.4		0.1	21.5	30.0	8.53
	HE20 STBC, M0 to M9 2ss	4	6	11.8	17.3	18.4	16.6	0.1	22.7	30.0	7.29
5795	Non HT40, 6 to 54 Mbps	1	6	11.0				0.1	11.1	30.0	18.95
	Non HT40, 6 to 54 Mbps	2	6	11.0	16.8			0.1	17.9	30.0	12.14
	Non HT40, 6 to 54 Mbps	3	6	11.0	16.8	17.6		0.1	20.8	30.0	9.23
	Non HT40, 6 to 54 Mbps	4	6	11.0	16.8	17.6	16.0	0.1	22.0	30.0	7.97
	HT/VHT40, M0 to M7	1	6	10.9				0.1	11.0	30.0	18.99
	HT/VHT40, M0 to M7	2	6	10.9	16.6			0.1	17.7	30.0	12.25
	HT/VHT40, M8 to M15	2	6	10.9	16.6			0.1	17.7	30.0	12.25
	HT/VHT40, M0 to M7	3	6	10.9	16.6	17.7		0.1	20.8	30.0	9.21
	HT/VHT40, M8 to M15	3	6	10.9	16.6	17.7		0.1	20.8	30.0	9.21
	HT/VHT40, M16 to M23	3	6	10.9	16.6	17.7		0.1	20.8	30.0	9.21
	HT/VHT40, M0 to M7	4	6	10.9	16.6	17.7	15.9	0.1	22.0	30.0	7.96
	HT/VHT40, M8 to M15	4	6	10.9	16.6	17.7	15.9	0.1	22.0	30.0	7.96
	HT/VHT40, M16 to M23	4	6	10.9	16.6	17.7	15.9	0.1	22.0	30.0	7.96
	HT/VHT40, M24 to M31	4	6	10.9	16.6	17.7	15.9	0.1	22.0	30.0	7.96
	HT/VHT40 Beam Forming, M0 to M7	2	9	10.9	16.6			0.1	17.7	27.0	9.25
	HT/VHT40 Beam Forming, M8 to M15	2	6	10.9	16.6			0.1	17.7	30.0	12.25
	HT/VHT40 Beam Forming, M0 to M7	3	11	10.9	16.6	17.7		0.1	20.8	25.0	4.21
	HT/VHT40 Beam Forming, M8 to M15	3	8	10.9	16.6	17.7		0.1	20.8	28.0	7.21
	HT/VHT40 Beam Forming, M16 to M23	3	6	10.9	16.6	17.7		0.1	20.8	30.0	9.21
	HT/VHT40 Beam Forming, M0 to M7	4	12	10.9	16.6	17.7	15.9	0.1	22.0	24.0	1.96
	HT/VHT40 Beam Forming, M8 to M15	4	9	10.9	16.6	17.7	15.9	0.1	22.0	27.0	4.96
	HT/VHT40 Beam Forming, M16 to M23	4	7	10.9	16.6	17.7	15.9	0.1	22.0	29.0	6.96
	HT/VHT40 Beam Forming, M24 to M31	4	6	10.9	16.6	17.7	15.9	0.1	22.0	30.0	7.96
	HT/VHT40 STBC, M0 to M7	2	6	10.9	16.6			0.1	17.7	30.0	12.25
	HT/VHT40 STBC, M0 to M7	3	6	10.9	16.6	17.7		0.1	20.8	30.0	9.21
	HT/VHT40 STBC, M0 to M7	4	6	10.9	16.6	17.7	15.9	0.1	22.0	30.0	7.96
	HE40, M0 to M9 1ss	1	6	11.2				0.1	11.3	30.0	18.67
	HE40, M0 to M9 1ss	2	6	11.2	17.0			0.1	18.1	30.0	11.86
	HE40, M0 to M9 2ss	2	6	11.2	17.0			0.1	18.1	30.0	11.86
	HE40, M0 to M9 1ss	3	6	11.2	17.0	17.8		0.1	21.0	30.0	8.96
	HE40, M0 to M9 2ss	3	6	11.2	17.0	17.8		0.1	21.0	30.0	8.96
	HE40, M0 to M9 3ss	3	6	11.2	17.0	17.8		0.1	21.0	30.0	8.96

	HE40, M0 to M9 1ss	4	6	11.2	17.0	17.8	16.2	0.1	22.3	30.0	7.69
	HE40, M0 to M9 2ss	4	6	11.2	17.0	17.8	16.2	0.1	22.3	30.0	7.69
	HE40, M0 to M9 3ss	4	6	11.2	17.0	17.8	16.2	0.1	22.3	30.0	7.69
	HE40, M0 to M9 4ss	4	6	11.2	17.0	17.8	16.2	0.1	22.3	30.0	7.69
	HE40 Beam Forming, M0 to M9 1ss	2	9	11.2	17.0			0.1	18.1	27.0	8.86
	HE40 Beam Forming, M0 to M9 2ss	2	6	11.2	17.0			0.1	18.1	30.0	11.86
	HE40 Beam Forming, M0 to M9 1ss	3	11	11.2	17.0	17.8		0.1	21.0	25.0	3.96
	HE40 Beam Forming, M0 to M9 2ss	3	8	11.2	17.0	17.8		0.1	21.0	28.0	6.96
	HE40 Beam Forming, M0 to M9 3ss	3	6	11.2	17.0	17.8		0.1	21.0	30.0	8.96
	HE40 Beam Forming, M0 to M9 1ss	4	12	11.2	17.0	17.8	16.2	0.1	22.3	24.0	1.69
	HE40 Beam Forming, M0 to M9 2ss	4	9	11.2	17.0	17.8	16.2	0.1	22.3	27.0	4.69
	HE40 Beam Forming, M0 to M9 3ss	4	7	11.2	17.0	17.8	16.2	0.1	22.3	29.0	6.69
	HE40 Beam Forming, M0 to M9 4ss	4	6	11.2	17.0	17.8	16.2	0.1	22.3	30.0	7.69
	HE40 STBC, M0 to M9 2ss	2	6	11.2	17.0			0.1	18.1	30.0	11.86
	HE40 STBC, M0 to M9 2ss	3	6	11.2	17.0	17.8		0.1	21.0	30.0	8.96
	HE40 STBC, M0 to M9 2ss	4	6	11.2	17.0	17.8	16.2	0.1	22.3	30.0	7.69
5825	Non HT20, 6 to 54 Mbps	1	6	12.0				0.1	12.1	30.0	17.95
	Non HT20, 6 to 54 Mbps	2	6	12.0	16.6			0.1	17.9	30.0	12.06
	Non HT20, 6 to 54 Mbps	3	6	12.0	16.6	18.1		0.1	21.1	30.0	8.94
	Non HT20, 6 to 54 Mbps	4	6	12.0	16.6	18.1	16.5	0.1	22.4	30.0	7.62
	Non HT20 Beam Forming, 6 to 54 Mbps	2	9	12.0	16.6			0.1	17.9	27.0	9.06
	Non HT20 Beam Forming, 6 to 54 Mbps	3	11	12.0	16.6	18.1		0.1	21.1	25.0	3.94
	Non HT20 Beam Forming, 6 to 54 Mbps	4	12	12.0	16.6	18.1	16.5	0.1	22.4	24.0	1.62
	HT/VHT20, M0 to M7	1	6	12.0				0.1	12.1	30.0	17.95
	HT/VHT20, M0 to M7	2	6	12.0	16.6			0.1	17.9	30.0	12.05
	HT/VHT20, M8 to M15	2	6	12.0	16.6			0.1	17.9	30.0	12.05
	HT/VHT20, M0 to M7	3	6	12.0	16.6	18.1		0.1	21.1	30.0	8.94
	HT/VHT20, M8 to M15	3	6	12.0	16.6	18.1		0.1	21.1	30.0	8.94
	HT/VHT20, M16 to M23	3	6	12.0	16.6	18.1		0.1	21.1	30.0	8.94
	HT/VHT20, M0 to M7	4	6	12.0	16.6	18.1	16.5	0.1	22.4	30.0	7.62
	HT/VHT20, M8 to M15	4	6	12.0	16.6	18.1	16.5	0.1	22.4	30.0	7.62
	HT/VHT20, M16 to M23	4	6	12.0	16.6	18.1	16.5	0.1	22.4	30.0	7.62
	HT/VHT20, M24 to M31	4	6	12.0	16.6	18.1	16.5	0.1	22.4	30.0	7.62
	HT/VHT20 Beam Forming, M0 to M7	2	9	12.0	16.6			0.1	17.9	27.0	9.05
	HT/VHT20 Beam Forming, M8 to M15	2	6	12.0	16.6			0.1	17.9	30.0	12.05
	HT/VHT20 Beam Forming, M0 to M7	3	11	12.0	16.6	18.1		0.1	21.1	25.0	3.94
	HT/VHT20 Beam Forming, M8 to M15	3	8	12.0	16.6	18.1		0.1	21.1	28.0	6.94
	HT/VHT20 Beam Forming, M16 to M23	3	6	12.0	16.6	18.1		0.1	21.1	30.0	8.94
	HT/VHT20 Beam Forming, M0 to M7	4	12	12.0	16.6	18.1	16.5	0.1	22.4	24.0	1.62
	HT/VHT20 Beam Forming, M8 to M15	4	9	12.0	16.6	18.1	16.5	0.1	22.4	27.0	4.62
	HT/VHT20 Beam Forming, M16 to M23	4	7	12.0	16.6	18.1	16.5	0.1	22.4	29.0	6.62
HT/VHT20 Beam Forming, M24 to M31	4	6	12.0	16.6	18.1	16.5	0.1	22.4	30.0	7.62	





HT/VHT20 STBC, M0 to M7	2	6	12.0	16.6			0.1	17.9	30.0	12.05
HT/VHT20 STBC, M0 to M7	3	6	12.0	16.6	18.1		0.1	21.1	30.0	8.94
HT/VHT20 STBC, M0 to M7	4	6	12.0	16.6	18.1	16.5	0.1	22.4	30.0	7.62
HE20, M0 to M9 1ss	1	6	12.1				0.1	12.2	30.0	17.83
HE20, M0 to M9 1ss	2	6	12.1	16.6			0.1	18.0	30.0	12.01
HE20, M0 to M9 2ss	2	6	12.1	16.6			0.1	18.0	30.0	12.01
HE20, M0 to M9 1ss	3	6	12.1	16.6	18.3		0.1	21.2	30.0	8.81
HE20, M0 to M9 2ss	3	6	12.1	16.6	18.3		0.1	21.2	30.0	8.81
HE20, M0 to M9 3ss	3	6	12.1	16.6	18.3		0.1	21.2	30.0	8.81
HE20, M0 to M9 1ss	4	6	12.1	16.6	18.3	16.7	0.1	22.5	30.0	7.47
HE20, M0 to M9 2ss	4	6	12.1	16.6	18.3	16.7	0.1	22.5	30.0	7.47
HE20, M0 to M9 3ss	4	6	12.1	16.6	18.3	16.7	0.1	22.5	30.0	7.47
HE20, M0 to M9 4ss	4	6	12.1	16.6	18.3	16.7	0.1	22.5	30.0	7.47
HE20 Beam Forming, M0 to M9 1ss	2	9	12.1	16.6			0.1	18.0	27.0	9.01
HE20 Beam Forming, M0 to M9 2ss	2	6	12.1	16.6			0.1	18.0	30.0	12.01
HE20 Beam Forming, M0 to M9 1ss	3	11	12.1	16.6	18.3		0.1	21.2	25.0	3.81
HE20 Beam Forming, M0 to M9 2ss	3	8	12.1	16.6	18.3		0.1	21.2	28.0	6.81
HE20 Beam Forming, M0 to M9 3ss	3	6	12.1	16.6	18.3		0.1	21.2	30.0	8.81
HE20 Beam Forming, M0 to M9 1ss	4	12	12.1	16.6	18.3	16.7	0.1	22.5	24.0	1.47
HE20 Beam Forming, M0 to M9 2ss	4	9	12.1	16.6	18.3	16.7	0.1	22.5	27.0	4.47
HE20 Beam Forming, M0 to M9 3ss	4	7	12.1	16.6	18.3	16.7	0.1	22.5	29.0	6.47
HE20 Beam Forming, M0 to M9 4ss	4	6	12.1	16.6	18.3	16.7	0.1	22.5	30.0	7.47
HE20 STBC, M0 to M9 2ss	2	6	12.1	16.6			0.1	18.0	30.0	12.01
HE20 STBC, M0 to M9 2ss	3	6	12.1	16.6	18.3		0.1	21.2	30.0	8.81
HE20 STBC, M0 to M9 2ss	4	6	12.1	16.6	18.3	16.7	0.1	22.5	30.0	7.47

**Maximum Transmit Output Power, 6dB  
5785 MHz, HE20 Beam Forming, M0 to M9 1ss**

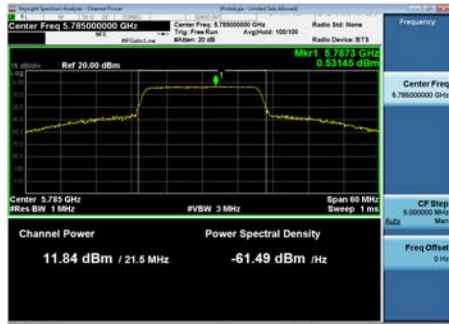

**Antenna A**

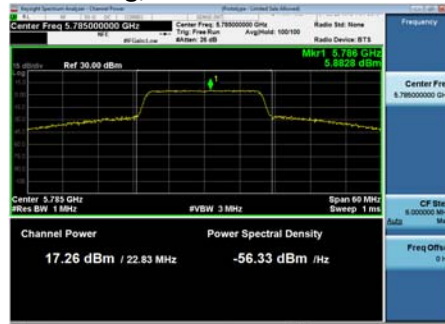

**Antenna B**

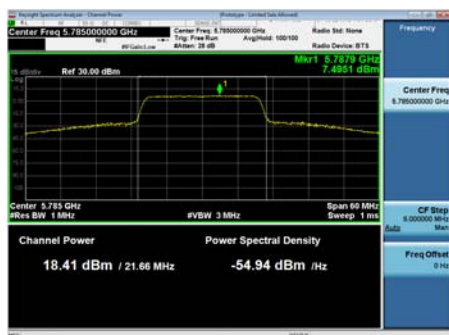

**Antenna C**

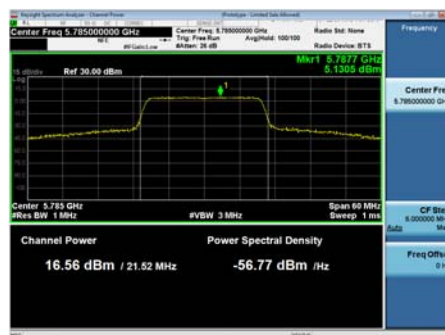

**Antenna D**



## A.5 Power Spectral Density

**15.407 / RSS-247** The power spectral density shall not exceed 30 dBm in any 500 kHz band. If transmitting antennas of directional gain greater than 6 dBi are used, both the maximum conducted output power and the power spectral density shall be reduced by the amount in dB that the directional gain of the antenna exceeds 6 dBi.

### Test Procedure

Ref. KDB 789033 D02 General UNII Test Procedures New Rules v01

<b>Power Spectral Density</b>
Test Procedure
<ol style="list-style-type: none"> <li>1. Connect the antenna port(s) to the spectrum analyzer input.</li> <li>2. Set the radio in the continuous transmitting mode at full power</li> <li>3. Configure Spectrum analyzer as per test parameters below and Peak search marker</li> <li>4. Capture graphs and record pertinent measurement data.</li> </ol>

Ref. KDB 789033 D02 v01 section F.5

<b>Power Spectral Density</b>
Test parameters
Span = >1.5 times the OBW RBW = 500 kHz. VBW ≥ 3 x RBW Sweep = 10s Detector = Peak Trace = Single Sweep Marker = Peak Search

The “Measure and add 10 log(N) dB technique”, where N is the number of outputs, is used for measuring in-band Power Spectral Density. With this technique, spectrum measurements are performed at each output of the device, and the quantity 10 log(4) (or 6dB) is added to the worst case spectrum value before comparing to the emission limit. (ANSI C63.10 2013 section 14.3.2.3)

System Number	Description	Samples	System under test	Support equipment
1	EUT	S01+S02	<input checked="" type="checkbox"/>	<input type="checkbox"/>
	Support		<input type="checkbox"/>	<input checked="" type="checkbox"/>

<b>Tested By :</b> Chris Blair	<b>Date of testing:</b> 25-Sep-19 - 01-Oct-19
<b>Test Result : PASS</b>	

See Appendix C for list of test equipment

## Power Spectral Density, 4dBi

Frequency (MHz)	Mode	Tx Paths	Correlated Antenna Gain (dBi)	Tx 1 PSD (dBm/500kHz)	Tx 2 PSD (dBm/500kHz)	Tx 3 PSD (dBm/500kHz)	Tx 4 PSD (dBm/500kHz)	Duty Cycle Correction (dB)	Total PSD (dBm/500kHz)	Limit (dBm/500kHz)	Margin (dB)	
5720 <sup>12</sup>	Non HT20, 6 to 54 Mbps	1	4	-4.0				0.1	-3.9	30.0	33.95	
	Non HT20, 6 to 54 Mbps	2	7	-4.0	-0.4			0.1	1.2	29.0	27.78	
	Non HT20, 6 to 54 Mbps	3	9	-4.0	-0.4	0.2		0.1	3.8	27.0	23.23	
	Non HT20, 6 to 54 Mbps	4	10	-4.0	-0.4	0.2	0.0	0.1	5.3	26.0	20.69	
	Non HT20 Beam Forming, 6 to 54 Mbps	2	7	-4.0	-0.4			0.1	1.2	29.0	27.78	
	Non HT20 Beam Forming, 6 to 54 Mbps	3	9	-4.0	-1.4	-1.1		0.1	2.8	27.0	24.16	
	Non HT20 Beam Forming, 6 to 54 Mbps	4	10	-4.0	-3.4	-3.2	-3.4	0.1	2.6	26.0	23.42	
	HT/VHT20, M0 to M7	1	4	-4.0					0.1	-3.9	30.0	33.95
	HT/VHT20, M0 to M7	2	7	-4.0	-0.3				0.1	1.3	29.0	27.70
	HT/VHT20, M8 to M15	2	4	-4.0	-0.3				0.1	1.3	30.0	28.70
	HT/VHT20, M0 to M7	3	9	-4.0	-0.3	0.5			0.1	4.0	27.0	23.05
	HT/VHT20, M8 to M15	3	6	-4.0	-0.3	0.5			0.1	4.0	30.0	26.05
	HT/VHT20, M16 to M23	3	4	-4.0	-0.3	0.5			0.1	4.0	30.0	26.05
	HT/VHT20, M0 to M7	4	10	-4.0	-0.3	0.5	-0.1		0.1	5.4	26.0	20.59
	HT/VHT20, M8 to M15	4	7	-4.0	-0.3	0.5	-0.1		0.1	5.4	29.0	23.59
	HT/VHT20, M16 to M23	4	5	-4.0	-0.3	0.5	-0.1		0.1	5.4	30.0	24.59
	HT/VHT20, M24 to M31	4	4	-4.0	-0.3	0.5	-0.1		0.1	5.4	30.0	24.59
	HT/VHT20 Beam Forming, M0 to M7	2	7	-4.0	-0.3				0.1	1.3	29.0	27.70
	HT/VHT20 Beam Forming, M8 to M15	2	4	-4.0	-0.3				0.1	1.3	30.0	28.70
	HT/VHT20 Beam Forming, M0 to M7	3	9	-4.0	-1.7	-1.3			0.1	2.6	27.0	24.36
	HT/VHT20 Beam Forming, M8 to M15	3	6	-4.0	-0.3	0.5			0.1	4.0	30.0	26.05
	HT/VHT20 Beam Forming, M16 to M23	3	4	-4.0	-0.3	0.5			0.1	4.0	30.0	26.05
	HT/VHT20 Beam Forming, M0 to M7	4	10	-4.0	-3.7	-3.4	-3.4		0.1	2.5	26.0	23.54
	HT/VHT20 Beam Forming, M8 to M15	4	7	-4.0	-0.3	0.5	-0.1		0.1	5.4	29.0	23.59
	HT/VHT20 Beam Forming, M16 to M23	4	5	-4.0	-0.3	0.5	-0.1		0.1	5.4	30.0	24.59
	HT/VHT20 Beam Forming, M24 to M31	4	4	-4.0	-0.3	0.5	-0.1		0.1	5.4	30.0	24.59
	HT/VHT20 STBC, M0 to M7	2	4	-4.0	-0.3				0.1	1.3	30.0	28.70
	HT/VHT20 STBC, M0 to M7	3	6	-4.0	-0.3	0.5			0.1	4.0	30.0	26.05
	HT/VHT20 STBC, M0 to M7	4	7	-4.0	-0.3	0.5	-0.1		0.1	5.4	29.0	23.59

<sup>12</sup> 5720 (ch144) not supported for Canada.

	HE20, M0 to M9 1ss	1	4	-4.3				0.1	-4.2	30.0	34.23
	HE20, M0 to M9 1ss	2	7	-4.3	-0.6			0.1	1.0	29.0	27.99
	HE20, M0 to M9 2ss	2	4	-4.3	-0.6			0.1	1.0	30.0	28.99
	HE20, M0 to M9 1ss	3	9	-4.3	-0.6	0.0		0.1	3.6	27.0	23.42
	HE20, M0 to M9 2ss	3	6	-4.3	-0.6	0.0		0.1	3.6	30.0	26.42
	HE20, M0 to M9 3ss	3	4	-4.3	-0.6	0.0		0.1	3.6	30.0	26.42
	HE20, M0 to M9 1ss	4	10	-4.3	-0.6	0.0	-0.2	0.1	5.1	26.0	20.88
	HE20, M0 to M9 2ss	4	7	-4.3	-0.6	0.0	-0.2	0.1	5.1	29.0	23.88
	HE20, M0 to M9 3ss	4	5	-4.3	-0.6	0.0	-0.2	0.1	5.1	30.0	24.88
	HE20, M0 to M9 4ss	4	4	-4.3	-0.6	0.0	-0.2	0.1	5.1	30.0	24.88
	HE20 Beam Forming, M0 to M9 1ss	2	7	-4.3	-0.6			0.1	1.0	29.0	27.99
	HE20 Beam Forming, M0 to M9 2ss	2	4	-4.3	-0.6			0.1	1.0	30.0	28.99
	HE20 Beam Forming, M0 to M9 1ss	3	9	-4.3	-1.8	-0.8		0.1	2.8	27.0	24.23
	HE20 Beam Forming, M0 to M9 2ss	3	6	-4.3	-0.6	0.0		0.1	3.6	30.0	26.42
	HE20 Beam Forming, M0 to M9 3ss	3	4	-4.3	-0.6	0.0		0.1	3.6	30.0	26.42
	HE20 Beam Forming, M0 to M9 1ss	4	10	-4.3	-3.7	-3.3	-3.5	0.1	2.4	26.0	23.60
	HE20 Beam Forming, M0 to M9 2ss	4	7	-4.3	-0.6	0.0	-0.2	0.1	5.1	29.0	23.88
	HE20 Beam Forming, M0 to M9 3ss	4	5	-4.3	-0.6	0.0	-0.2	0.1	5.1	30.0	24.88
	HE20 Beam Forming, M0 to M9 4ss	4	4	-4.3	-0.6	0.0	-0.2	0.1	5.1	30.0	24.88
	HE20 STBC, M0 to M9 2ss	2	4	-4.3	-0.6			0.1	1.0	30.0	28.99
	HE20 STBC, M0 to M9 2ss	3	6	-4.3	-0.6	0.0		0.1	3.6	30.0	26.42
	HE20 STBC, M0 to M9 2ss	4	7	-4.3	-0.6	0.0	-0.2	0.1	5.1	29.0	23.88
5745	Non HT20, 6 to 54 Mbps	1	4	-3.0				0.1	-2.9	30.0	32.95
	Non HT20, 6 to 54 Mbps	2	7	-3.0	2.8			0.1	3.9	29.0	25.14
	Non HT20, 6 to 54 Mbps	3	9	-3.0	2.8	3.7		0.1	6.8	27.0	20.18
	Non HT20, 6 to 54 Mbps	4	10	-3.0	2.8	3.7	1.6	0.1	8.0	26.0	18.03
	Non HT20 Beam Forming, 6 to 54 Mbps	2	7	-3.0	2.8			0.1	3.9	29.0	25.14
	Non HT20 Beam Forming, 6 to 54 Mbps	3	9	-3.0	2.8	3.7		0.1	6.8	27.0	20.18
	Non HT20 Beam Forming, 6 to 54 Mbps	4	10	-3.0	2.8	3.7	1.6	0.1	8.0	26.0	18.03
	HT/VHT20, M0 to M7	1	4	-3.2				0.1	-3.1	30.0	33.15
	HT/VHT20, M0 to M7	2	7	-3.2	2.2			0.1	3.4	29.0	25.65
	HT/VHT20, M8 to M15	2	4	-3.2	2.2			0.1	3.4	30.0	26.65
	HT/VHT20, M0 to M7	3	9	-3.2	2.2	3.7		0.1	6.6	27.0	20.43
	HT/VHT20, M8 to M15	3	6	-3.2	2.2	3.7		0.1	6.6	30.0	23.43
	HT/VHT20, M16 to M23	3	4	-3.2	2.2	3.7		0.1	6.6	30.0	23.43
	HT/VHT20, M0 to M7	4	10	-3.2	2.2	3.7	1.4	0.1	7.7	26.0	18.27
	HT/VHT20, M8 to M15	4	7	-3.2	2.2	3.7	1.4	0.1	7.7	29.0	21.27
	HT/VHT20, M16 to M23	4	5	-3.2	2.2	3.7	1.4	0.1	7.7	30.0	22.27
	HT/VHT20, M24 to M31	4	4	-3.2	2.2	3.7	1.4	0.1	7.7	30.0	22.27
	HT/VHT20 Beam Forming, M0 to M7	2	7	-3.2	2.2			0.1	3.4	29.0	25.65
	HT/VHT20 Beam Forming, M8 to M15	2	4	-3.2	2.2			0.1	3.4	30.0	26.65
HT/VHT20 Beam Forming, M0 to M7	3	9	-3.2	2.2	3.7		0.1	6.6	27.0	20.43	

	HT/VHT20 Beam Forming, M8 to M15	3	6	-3.2	2.2	3.7		0.1	6.6	30.0	23.43
	HT/VHT20 Beam Forming, M16 to M23	3	4	-3.2	2.2	3.7		0.1	6.6	30.0	23.43
	HT/VHT20 Beam Forming, M0 to M7	4	10	-3.2	2.2	3.7	1.4	0.1	7.7	26.0	18.27
	HT/VHT20 Beam Forming, M8 to M15	4	7	-3.2	2.2	3.7	1.4	0.1	7.7	29.0	21.27
	HT/VHT20 Beam Forming, M16 to M23	4	5	-3.2	2.2	3.7	1.4	0.1	7.7	30.0	22.27
	HT/VHT20 Beam Forming, M24 to M31	4	4	-3.2	2.2	3.7	1.4	0.1	7.7	30.0	22.27
	HT/VHT20 STBC, M0 to M7	2	4	-3.2	2.2			0.1	3.4	30.0	26.65
	HT/VHT20 STBC, M0 to M7	3	6	-3.2	2.2	3.7		0.1	6.6	30.0	23.43
	HT/VHT20 STBC, M0 to M7	4	7	-3.2	2.2	3.7	1.4	0.1	7.7	29.0	21.27
	HE20, M0 to M9 1ss	1	4	-3.1				0.1	-3.0	30.0	33.03
	HE20, M0 to M9 1ss	2	7	-3.1	2.4			0.1	3.5	29.0	25.45
	HE20, M0 to M9 2ss	2	4	-3.1	2.4			0.1	3.5	30.0	26.45
	HE20, M0 to M9 1ss	3	9	-3.1	2.4	3.6		0.1	6.6	27.0	20.38
	HE20, M0 to M9 2ss	3	6	-3.1	2.4	3.6		0.1	6.6	30.0	23.38
	HE20, M0 to M9 3ss	3	4	-3.1	2.4	3.6		0.1	6.6	30.0	23.38
	HE20, M0 to M9 1ss	4	10	-3.1	2.4	3.6	2.3	0.1	8.0	26.0	18.00
	HE20, M0 to M9 2ss	4	7	-3.1	2.4	3.6	2.3	0.1	8.0	29.0	21.00
	HE20, M0 to M9 3ss	4	5	-3.1	2.4	3.6	2.3	0.1	8.0	30.0	22.00
	HE20, M0 to M9 4ss	4	4	-3.1	2.4	3.6	2.3	0.1	8.0	30.0	22.00
	HE20 Beam Forming, M0 to M9 1ss	2	7	-3.1	2.4			0.1	3.5	29.0	25.45
	HE20 Beam Forming, M0 to M9 2ss	2	4	-3.1	2.4			0.1	3.5	30.0	26.45
	HE20 Beam Forming, M0 to M9 1ss	3	9	-3.1	2.4	3.6		0.1	6.6	27.0	20.38
	HE20 Beam Forming, M0 to M9 2ss	3	6	-3.1	2.4	3.6		0.1	6.6	30.0	23.38
	HE20 Beam Forming, M0 to M9 3ss	3	4	-3.1	2.4	3.6		0.1	6.6	30.0	23.38
	HE20 Beam Forming, M0 to M9 1ss	4	10	-3.1	2.4	3.6	2.3	0.1	8.0	26.0	18.00
	HE20 Beam Forming, M0 to M9 2ss	4	7	-3.1	2.4	3.6	2.3	0.1	8.0	29.0	21.00
	HE20 Beam Forming, M0 to M9 3ss	4	5	-3.1	2.4	3.6	2.3	0.1	8.0	30.0	22.00
	HE20 Beam Forming, M0 to M9 4ss	4	4	-3.1	2.4	3.6	2.3	0.1	8.0	30.0	22.00
	HE20 STBC, M0 to M9 2ss	2	4	-3.1	2.4			0.1	3.5	30.0	26.45
	HE20 STBC, M0 to M9 2ss	3	6	-3.1	2.4	3.6		0.1	6.6	30.0	23.38
	HE20 STBC, M0 to M9 2ss	4	7	-3.1	2.4	3.6	2.3	0.1	8.0	29.0	21.00
5755	Non HT40, 6 to 54 Mbps	1	4	-6.8				0.1	-6.7	30.0	36.75
	Non HT40, 6 to 54 Mbps	2	7	-6.8	-0.5			0.1	0.5	29.0	28.53
	Non HT40, 6 to 54 Mbps	3	9	-6.8	-0.5	0.4		0.1	3.5	27.0	23.53
	Non HT40, 6 to 54 Mbps	4	10	-6.8	-0.5	0.4	-1.6	0.1	4.7	26.0	21.34
	HT/VHT40, M0 to M7	1	4	-6.8				0.1	-6.7	30.0	36.69
	HT/VHT40, M0 to M7	2	7	-6.8	-0.5			0.1	0.5	29.0	28.48
	HT/VHT40, M8 to M15	2	4	-6.8	-0.5			0.1	0.5	30.0	29.48
	HT/VHT40, M0 to M7	3	9	-6.8	-0.5	0.2		0.1	3.4	27.0	23.57
	HT/VHT40, M8 to M15	3	6	-6.8	-0.5	0.2		0.1	3.4	30.0	26.57
	HT/VHT40, M16 to M23	3	4	-6.8	-0.5	0.2		0.1	3.4	30.0	26.57
	HT/VHT40, M0 to M7	4	10	-6.8	-0.5	0.2	-1.8	0.1	4.6	26.0	21.41

	HT/VHT40, M8 to M15	4	7	-6.8	-0.5	0.2	-1.8	0.1	4.6	29.0	24.41
	HT/VHT40, M16 to M23	4	5	-6.8	-0.5	0.2	-1.8	0.1	4.6	30.0	25.41
	HT/VHT40, M24 to M31	4	4	-6.8	-0.5	0.2	-1.8	0.1	4.6	30.0	25.41
	HT/VHT40 Beam Forming, M0 to M7	2	7	-6.8	-0.5			0.1	0.5	29.0	28.48
	HT/VHT40 Beam Forming, M8 to M15	2	4	-6.8	-0.5			0.1	0.5	30.0	29.48
	HT/VHT40 Beam Forming, M0 to M7	3	9	-6.8	-0.5	0.2		0.1	3.4	27.0	23.57
	HT/VHT40 Beam Forming, M8 to M15	3	6	-6.8	-0.5	0.2		0.1	3.4	30.0	26.57
	HT/VHT40 Beam Forming, M16 to M23	3	4	-6.8	-0.5	0.2		0.1	3.4	30.0	26.57
	HT/VHT40 Beam Forming, M0 to M7	4	10	-6.8	-0.5	0.2	-1.8	0.1	4.6	26.0	21.41
	HT/VHT40 Beam Forming, M8 to M15	4	7	-6.8	-0.5	0.2	-1.8	0.1	4.6	29.0	24.41
	HT/VHT40 Beam Forming, M16 to M23	4	5	-6.8	-0.5	0.2	-1.8	0.1	4.6	30.0	25.41
	HT/VHT40 Beam Forming, M24 to M31	4	4	-6.8	-0.5	0.2	-1.8	0.1	4.6	30.0	25.41
	HT/VHT40 STBC, M0 to M7	2	4	-6.8	-0.5			0.1	0.5	30.0	29.48
	HT/VHT40 STBC, M0 to M7	3	6	-6.8	-0.5	0.2		0.1	3.4	30.0	26.57
	HT/VHT40 STBC, M0 to M7	4	7	-6.8	-0.5	0.2	-1.8	0.1	4.6	29.0	24.41
	HE40, M0 to M9 1ss	1	4	-6.8				0.1	-6.7	30.0	36.67
	HE40, M0 to M9 1ss	2	7	-6.8	-0.6			0.1	0.5	29.0	28.54
	HE40, M0 to M9 2ss	2	4	-6.8	-0.6			0.1	0.5	30.0	29.54
	HE40, M0 to M9 1ss	3	9	-6.8	-0.6	0.5		0.1	3.6	27.0	23.45
	HE40, M0 to M9 2ss	3	6	-6.8	-0.6	0.5		0.1	3.6	30.0	26.45
	HE40, M0 to M9 3ss	3	4	-6.8	-0.6	0.5		0.1	3.6	30.0	26.45
	HE40, M0 to M9 1ss	4	10	-6.8	-0.6	0.5	-2.0	0.1	4.6	26.0	21.35
	HE40, M0 to M9 2ss	4	7	-6.8	-0.6	0.5	-2.0	0.1	4.6	29.0	24.35
	HE40, M0 to M9 3ss	4	5	-6.8	-0.6	0.5	-2.0	0.1	4.6	30.0	25.35
	HE40, M0 to M9 4ss	4	4	-6.8	-0.6	0.5	-2.0	0.1	4.6	30.0	25.35
	HE40 Beam Forming, M0 to M9 1ss	2	7	-6.8	-0.6			0.1	0.5	29.0	28.54
	HE40 Beam Forming, M0 to M9 2ss	2	4	-6.8	-0.6			0.1	0.5	30.0	29.54
	HE40 Beam Forming, M0 to M9 1ss	3	9	-6.8	-0.6	0.5		0.1	3.6	27.0	23.45
	HE40 Beam Forming, M0 to M9 2ss	3	6	-6.8	-0.6	0.5		0.1	3.6	30.0	26.45
	HE40 Beam Forming, M0 to M9 3ss	3	4	-6.8	-0.6	0.5		0.1	3.6	30.0	26.45
	HE40 Beam Forming, M0 to M9 1ss	4	10	-6.8	-0.6	0.5	-2.0	0.1	4.6	26.0	21.35
	HE40 Beam Forming, M0 to M9 2ss	4	7	-6.8	-0.6	0.5	-2.0	0.1	4.6	29.0	24.35
	HE40 Beam Forming, M0 to M9 3ss	4	5	-6.8	-0.6	0.5	-2.0	0.1	4.6	30.0	25.35
	HE40 Beam Forming, M0 to M9 4ss	4	4	-6.8	-0.6	0.5	-2.0	0.1	4.6	30.0	25.35
	HE40 STBC, M0 to M9 2ss	2	4	-6.8	-0.6			0.1	0.5	30.0	29.54
	HE40 STBC, M0 to M9 2ss	3	6	-6.8	-0.6	0.5		0.1	3.6	30.0	26.45
	HE40 STBC, M0 to M9 2ss	4	7	-6.8	-0.6	0.5	-2.0	0.1	4.6	29.0	24.35
5775	Non HT80, 6 to 54 Mbps	1	4	-9.6				0.0	-9.6	30.0	39.55
	Non HT80, 6 to 54 Mbps	2	7	-9.6	-4.2			0.0	-3.1	29.0	32.05
	Non HT80, 6 to 54 Mbps	3	9	-9.6	-4.2	-3.2		0.0	-0.1	27.0	27.09
	Non HT80, 6 to 54 Mbps	4	10	-9.6	-4.2	-3.2	-4.8	0.0	1.2	26.0	24.81
	VHT80, M0 to M9 1ss	1	4	-9.8				0.2	-9.6	30.0	39.58



VHT80, M0 to M9 1ss	2	7	-9.8	-4.4			0.2	-3.1	29.0	32.08
VHT80, M0 to M9 2ss	2	4	-9.8	-4.4			0.2	-3.1	30.0	33.08
VHT80, M0 to M9 1ss	3	9	-9.8	-4.4	-3.6		0.2	-0.2	27.0	27.21
VHT80, M0 to M9 2ss	3	6	-9.8	-4.4	-3.6		0.2	-0.2	30.0	30.21
VHT80, M0 to M9 3ss	3	4	-9.8	-4.4	-3.6		0.2	-0.2	30.0	30.21
VHT80, M0 to M9 1ss	4	10	-9.8	-4.4	-3.6	-5.1	0.2	1.1	26.0	24.94
VHT80, M0 to M9 2ss	4	7	-9.8	-4.4	-3.6	-5.1	0.2	1.1	29.0	27.94
VHT80, M0 to M9 3ss	4	5	-9.8	-4.4	-3.6	-5.1	0.2	1.1	30.0	28.94
VHT80, M0 to M9 4ss	4	4	-9.8	-4.4	-3.6	-5.1	0.2	1.1	30.0	28.94
VHT80 Beam Forming, M0 to M9 1ss	2	7	-9.8	-4.4			0.2	-3.1	29.0	32.08
VHT80 Beam Forming, M0 to M9 2ss	2	4	-9.8	-4.4			0.2	-3.1	30.0	33.08
VHT80 Beam Forming, M0 to M9 1ss	3	9	-9.8	-4.4	-3.6		0.2	-0.2	27.0	27.21
VHT80 Beam Forming, M0 to M9 2ss	3	6	-9.8	-4.4	-3.6		0.2	-0.2	30.0	30.21
VHT80 Beam Forming, M0 to M9 3ss	3	4	-9.8	-4.4	-3.6		0.2	-0.2	30.0	30.21
VHT80 Beam Forming, M0 to M9 1ss	4	10	-9.8	-4.4	-3.6	-5.1	0.2	1.1	26.0	24.94
VHT80 Beam Forming, M0 to M9 2ss	4	7	-9.8	-4.4	-3.6	-5.1	0.2	1.1	29.0	27.94
VHT80 Beam Forming, M0 to M9 3ss	4	5	-9.8	-4.4	-3.6	-5.1	0.2	1.1	30.0	28.94
VHT80 Beam Forming, M0 to M9 4ss	4	4	-9.8	-4.4	-3.6	-5.1	0.2	1.1	30.0	28.94
VHT80 STBC, M0 to M9 1ss	2	4	-9.8	-4.4			0.2	-3.1	30.0	33.08
VHT80 STBC, M0 to M9 1ss	3	4	-9.8	-4.4	-3.6		0.2	-0.2	30.0	30.21
VHT80 STBC, M0 to M9 1ss	4	4	-9.8	-4.4	-3.6	-5.1	0.2	1.1	30.0	28.94
HE80, M0 to M9 1ss	1	4	-9.6				0.2	-9.4	30.0	39.35
HE80, M0 to M9 1ss	2	7	-9.6	-4.3			0.2	-2.9	29.0	31.93
HE80, M0 to M9 2ss	2	4	-9.6	-4.3			0.2	-2.9	30.0	32.93
HE80, M0 to M9 1ss	3	9	-9.6	-4.3	-3.0		0.2	0.2	27.0	26.83
HE80, M0 to M9 2ss	3	6	-9.6	-4.3	-3.0		0.2	0.2	30.0	29.83
HE80, M0 to M9 3ss	3	4	-9.6	-4.3	-3.0		0.2	0.2	30.0	29.83
HE80, M0 to M9 1ss	4	10	-9.6	-4.3	-3.0	-4.9	0.2	1.4	26.0	24.59
HE80, M0 to M9 2ss	4	7	-9.6	-4.3	-3.0	-4.9	0.2	1.4	29.0	27.59
HE80, M0 to M9 3ss	4	5	-9.6	-4.3	-3.0	-4.9	0.2	1.4	30.0	28.59
HE80, M0 to M9 4ss	4	4	-9.6	-4.3	-3.0	-4.9	0.2	1.4	30.0	28.59
HE80 Beam Forming, M0 to M9 1ss	2	7	-9.6	-4.3			0.2	-2.9	29.0	31.93
HE80 Beam Forming, M0 to M9 2ss	2	4	-9.6	-4.3			0.2	-2.9	30.0	32.93
HE80 Beam Forming, M0 to M9 1ss	3	9	-9.6	-4.3	-3.0		0.2	0.2	27.0	26.83
HE80 Beam Forming, M0 to M9 2ss	3	6	-9.6	-4.3	-3.0		0.2	0.2	30.0	29.83
HE80 Beam Forming, M0 to M9 3ss	3	4	-9.6	-4.3	-3.0		0.2	0.2	30.0	29.83
HE80 Beam Forming, M0 to M9 1ss	4	10	-9.6	-4.3	-3.0	-4.9	0.2	1.4	26.0	24.59
HE80 Beam Forming, M0 to M9 2ss	4	7	-9.6	-4.3	-3.0	-4.9	0.2	1.4	29.0	27.59
HE80 Beam Forming, M0 to M9 3ss	4	5	-9.6	-4.3	-3.0	-4.9	0.2	1.4	30.0	28.59
HE80 Beam Forming, M0 to M9 4ss	4	4	-9.6	-4.3	-3.0	-4.9	0.2	1.4	30.0	28.59
HE80 STBC, M0 to M9 1ss	2	4	-9.6	-4.3			0.2	-2.9	30.0	32.93
HE80 STBC, M0 to M9 1ss	3	4	-9.6	-4.3	-3.0		0.2	0.2	30.0	29.83
HE80 STBC, M0 to M9 1ss	4	4	-9.6	-4.3	-3.0	-4.9	0.2	1.4	30.0	28.59



5785	Non HT20, 6 to 54 Mbps	1	4	-2.4				0.1	-2.3	30.0	32.35
	Non HT20, 6 to 54 Mbps	2	7	-2.4	2.7			0.1	3.9	29.0	25.08
	Non HT20, 6 to 54 Mbps	3	9	-2.4	2.7	4.0		0.1	7.0	27.0	20.00
	<b>Non HT20, 6 to 54 Mbps</b>	<b>4</b>	<b>10</b>	<b>-2.4</b>	<b>2.7</b>	<b>4.0</b>	<b>2.3</b>	<b>0.1</b>	<b>8.3</b>	<b>26.0</b>	<b>17.72</b>
	Non HT20 Beam Forming, 6 to 54 Mbps	2	7	-2.4	2.7			0.1	3.9	29.0	25.08
	Non HT20 Beam Forming, 6 to 54 Mbps	3	9	-2.4	2.7	4.0		0.1	7.0	27.0	20.00
	Non HT20 Beam Forming, 6 to 54 Mbps	4	10	-2.4	2.7	4.0	2.3	0.1	8.3	26.0	17.72
	HT/VHT20, M0 to M7	1	4	-2.7				0.1	-2.6	30.0	32.65
	HT/VHT20, M0 to M7	2	7	-2.7	2.5			0.1	3.7	29.0	25.30
	HT/VHT20, M8 to M15	2	4	-2.7	2.5			0.1	3.7	30.0	26.30
	HT/VHT20, M0 to M7	3	9	-2.7	2.5	3.6		0.1	6.7	27.0	20.31
	HT/VHT20, M8 to M15	3	6	-2.7	2.5	3.6		0.1	6.7	30.0	23.31
	HT/VHT20, M16 to M23	3	4	-2.7	2.5	3.6		0.1	6.7	30.0	23.31
	HT/VHT20, M0 to M7	4	10	-2.7	2.5	3.6	1.7	0.1	7.9	26.0	18.10
	HT/VHT20, M8 to M15	4	7	-2.7	2.5	3.6	1.7	0.1	7.9	29.0	21.10
	HT/VHT20, M16 to M23	4	5	-2.7	2.5	3.6	1.7	0.1	7.9	30.0	22.10
	HT/VHT20, M24 to M31	4	4	-2.7	2.5	3.6	1.7	0.1	7.9	30.0	22.10
	HT/VHT20 Beam Forming, M0 to M7	2	7	-2.7	2.5			0.1	3.7	29.0	25.30
	HT/VHT20 Beam Forming, M8 to M15	2	4	-2.7	2.5			0.1	3.7	30.0	26.30
	HT/VHT20 Beam Forming, M0 to M7	3	9	-2.7	2.5	3.6		0.1	6.7	27.0	20.31
	HT/VHT20 Beam Forming, M8 to M15	3	6	-2.7	2.5	3.6		0.1	6.7	30.0	23.31
	HT/VHT20 Beam Forming, M16 to M23	3	4	-2.7	2.5	3.6		0.1	6.7	30.0	23.31
	HT/VHT20 Beam Forming, M0 to M7	4	10	-2.7	2.5	3.6	1.7	0.1	7.9	26.0	18.10
	HT/VHT20 Beam Forming, M8 to M15	4	7	-2.7	2.5	3.6	1.7	0.1	7.9	29.0	21.10
	HT/VHT20 Beam Forming, M16 to M23	4	5	-2.7	2.5	3.6	1.7	0.1	7.9	30.0	22.10
	HT/VHT20 Beam Forming, M24 to M31	4	4	-2.7	2.5	3.6	1.7	0.1	7.9	30.0	22.10
	HT/VHT20 STBC, M0 to M7	2	4	-2.7	2.5			0.1	3.7	30.0	26.30
	HT/VHT20 STBC, M0 to M7	3	6	-2.7	2.5	3.6		0.1	6.7	30.0	23.31
	HT/VHT20 STBC, M0 to M7	4	7	-2.7	2.5	3.6	1.7	0.1	7.9	29.0	21.10
	HE20, M0 to M9 1ss	1	4	-2.8				0.1	-2.7	30.0	32.73
	HE20, M0 to M9 1ss	2	7	-2.8	2.8			0.1	3.9	29.0	25.08
	HE20, M0 to M9 2ss	2	4	-2.8	2.8			0.1	3.9	30.0	26.08
	HE20, M0 to M9 1ss	3	9	-2.8	2.8	3.6		0.1	6.8	27.0	20.19
	HE20, M0 to M9 2ss	3	6	-2.8	2.8	3.6		0.1	6.8	30.0	23.19
	HE20, M0 to M9 3ss	3	4	-2.8	2.8	3.6		0.1	6.8	30.0	23.19
	HE20, M0 to M9 1ss	4	10	-2.8	2.8	3.6	1.8	0.1	8.0	26.0	17.98
	HE20, M0 to M9 2ss	4	7	-2.8	2.8	3.6	1.8	0.1	8.0	29.0	20.98
	HE20, M0 to M9 3ss	4	5	-2.8	2.8	3.6	1.8	0.1	8.0	30.0	21.98
	HE20, M0 to M9 4ss	4	4	-2.8	2.8	3.6	1.8	0.1	8.0	30.0	21.98
	HE20 Beam Forming, M0 to M9 1ss	2	7	-2.8	2.8			0.1	3.9	29.0	25.08
HE20 Beam Forming, M0 to M9 2ss	2	4	-2.8	2.8			0.1	3.9	30.0	26.08	

	HE20 Beam Forming, M0 to M9 1ss	3	9	-2.8	2.8	3.6		0.1	6.8	27.0	20.19	
	HE20 Beam Forming, M0 to M9 2ss	3	6	-2.8	2.8	3.6		0.1	6.8	30.0	23.19	
	HE20 Beam Forming, M0 to M9 3ss	3	4	-2.8	2.8	3.6		0.1	6.8	30.0	23.19	
	HE20 Beam Forming, M0 to M9 1ss	4	10	-2.8	2.8	3.6	1.8	0.1	8.0	26.0	17.98	
	HE20 Beam Forming, M0 to M9 2ss	4	7	-2.8	2.8	3.6	1.8	0.1	8.0	29.0	20.98	
	HE20 Beam Forming, M0 to M9 3ss	4	5	-2.8	2.8	3.6	1.8	0.1	8.0	30.0	21.98	
	HE20 Beam Forming, M0 to M9 4ss	4	4	-2.8	2.8	3.6	1.8	0.1	8.0	30.0	21.98	
	HE20 STBC, M0 to M9 2ss	2	4	-2.8	2.8			0.1	3.9	30.0	26.08	
	HE20 STBC, M0 to M9 2ss	3	6	-2.8	2.8	3.6		0.1	6.8	30.0	23.19	
	HE20 STBC, M0 to M9 2ss	4	7	-2.8	2.8	3.6	1.8	0.1	8.0	29.0	20.98	
5795	Non HT40, 6 to 54 Mbps	1	4	-6.2				0.1	-6.1	30.0	36.15	
	Non HT40, 6 to 54 Mbps	2	7	-6.2	-0.3			0.1	0.7	29.0	28.26	
	Non HT40, 6 to 54 Mbps	3	9	-6.2	-0.3	1.0		0.1	3.9	27.0	23.09	
	Non HT40, 6 to 54 Mbps	4	10	-6.2	-0.3	1.0	-1.3	0.1	5.1	26.0	20.93	
	HT/VHT40, M0 to M7	1	4	-6.7				0.1	-6.6	30.0	36.59	
	HT/VHT40, M0 to M7	2	7	-6.7	-0.9			0.1	0.2	29.0	28.78	
	HT/VHT40, M8 to M15	2	4	-6.7	-0.9			0.1	0.2	30.0	29.78	
	HT/VHT40, M0 to M7	3	9	-6.7	-0.9	0.1		0.1	3.2	27.0	23.77	
	HT/VHT40, M8 to M15	3	6	-6.7	-0.9	0.1		0.1	3.2	30.0	26.77	
	HT/VHT40, M16 to M23	3	4	-6.7	-0.9	0.1		0.1	3.2	30.0	26.77	
	HT/VHT40, M0 to M7	4	10	-6.7	-0.9	0.1	-1.6	0.1	4.5	26.0	21.51	
	HT/VHT40, M8 to M15	4	7	-6.7	-0.9	0.1	-1.6	0.1	4.5	29.0	24.51	
	HT/VHT40, M16 to M23	4	5	-6.7	-0.9	0.1	-1.6	0.1	4.5	30.0	25.51	
	HT/VHT40, M24 to M31	4	4	-6.7	-0.9	0.1	-1.6	0.1	4.5	30.0	25.51	
	HT/VHT40 Beam Forming, M0 to M7	2	7	-6.7	-0.9			0.1	0.2	29.0	28.78	
	HT/VHT40 Beam Forming, M8 to M15	2	4	-6.7	-0.9			0.1	0.2	30.0	29.78	
	HT/VHT40 Beam Forming, M0 to M7	3	9	-6.7	-0.9	0.1		0.1	3.2	27.0	23.77	
	HT/VHT40 Beam Forming, M8 to M15	3	6	-6.7	-0.9	0.1		0.1	3.2	30.0	26.77	
	HT/VHT40 Beam Forming, M16 to M23	3	4	-6.7	-0.9	0.1		0.1	3.2	30.0	26.77	
	HT/VHT40 Beam Forming, M0 to M7	4	10	-6.7	-0.9	0.1	-1.6	0.1	4.5	26.0	21.51	
	HT/VHT40 Beam Forming, M8 to M15	4	7	-6.7	-0.9	0.1	-1.6	0.1	4.5	29.0	24.51	
	HT/VHT40 Beam Forming, M16 to M23	4	5	-6.7	-0.9	0.1	-1.6	0.1	4.5	30.0	25.51	
	HT/VHT40 Beam Forming, M24 to M31	4	4	-6.7	-0.9	0.1	-1.6	0.1	4.5	30.0	25.51	
	HT/VHT40 STBC, M0 to M7	2	4	-6.7	-0.9			0.1	0.2	30.0	29.78	
	HT/VHT40 STBC, M0 to M7	3	6	-6.7	-0.9	0.1		0.1	3.2	30.0	26.77	
	HT/VHT40 STBC, M0 to M7	4	7	-6.7	-0.9	0.1	-1.6	0.1	4.5	29.0	24.51	
	HE40, M0 to M9 1ss	1	4	-6.6					0.1	-6.5	30.0	36.47
	HE40, M0 to M9 1ss	2	7	-6.6	-0.6				0.1	0.5	29.0	28.50
	HE40, M0 to M9 2ss	2	4	-6.6	-0.6				0.1	0.5	30.0	29.50
	HE40, M0 to M9 1ss	3	9	-6.6	-0.6	0.1			0.1	3.4	27.0	23.63
	HE40, M0 to M9 2ss	3	6	-6.6	-0.6	0.1			0.1	3.4	30.0	26.63
	HE40, M0 to M9 3ss	3	4	-6.6	-0.6	0.1			0.1	3.4	30.0	26.63

	HE40, M0 to M9 1ss	4	10	-6.6	-0.6	0.1	-1.6	0.1	4.6	26.0	21.40
	HE40, M0 to M9 2ss	4	7	-6.6	-0.6	0.1	-1.6	0.1	4.6	29.0	24.40
	HE40, M0 to M9 3ss	4	5	-6.6	-0.6	0.1	-1.6	0.1	4.6	30.0	25.40
	HE40, M0 to M9 4ss	4	4	-6.6	-0.6	0.1	-1.6	0.1	4.6	30.0	25.40
	HE40 Beam Forming, M0 to M9 1ss	2	7	-6.6	-0.6			0.1	0.5	29.0	28.50
	HE40 Beam Forming, M0 to M9 2ss	2	4	-6.6	-0.6			0.1	0.5	30.0	29.50
	HE40 Beam Forming, M0 to M9 1ss	3	9	-6.6	-0.6	0.1		0.1	3.4	27.0	23.63
	HE40 Beam Forming, M0 to M9 2ss	3	6	-6.6	-0.6	0.1		0.1	3.4	30.0	26.63
	HE40 Beam Forming, M0 to M9 3ss	3	4	-6.6	-0.6	0.1		0.1	3.4	30.0	26.63
	HE40 Beam Forming, M0 to M9 1ss	4	10	-6.6	-0.6	0.1	-1.6	0.1	4.6	26.0	21.40
	HE40 Beam Forming, M0 to M9 2ss	4	7	-6.6	-0.6	0.1	-1.6	0.1	4.6	29.0	24.40
	HE40 Beam Forming, M0 to M9 3ss	4	5	-6.6	-0.6	0.1	-1.6	0.1	4.6	30.0	25.40
	HE40 Beam Forming, M0 to M9 4ss	4	4	-6.6	-0.6	0.1	-1.6	0.1	4.6	30.0	25.40
	HE40 STBC, M0 to M9 2ss	2	4	-6.6	-0.6			0.1	0.5	30.0	29.50
	HE40 STBC, M0 to M9 2ss	3	6	-6.6	-0.6	0.1		0.1	3.4	30.0	26.63
	HE40 STBC, M0 to M9 2ss	4	7	-6.6	-0.6	0.1	-1.6	0.1	4.6	29.0	24.40
5825	Non HT20, 6 to 54 Mbps	1	4	-2.1				0.1	-2.0	30.0	32.05
	Non HT20, 6 to 54 Mbps	2	7	-2.1	2.3			0.1	3.7	29.0	25.30
	Non HT20, 6 to 54 Mbps	3	9	-2.1	2.3	3.9		0.1	6.8	27.0	20.16
	Non HT20, 6 to 54 Mbps	4	10	-2.1	2.3	3.9	2.2	0.1	8.1	26.0	17.87
	Non HT20 Beam Forming, 6 to 54 Mbps	2	7	-2.1	2.3			0.1	3.7	29.0	25.30
	Non HT20 Beam Forming, 6 to 54 Mbps	3	9	-2.1	2.3	3.9		0.1	6.8	27.0	20.16
	Non HT20 Beam Forming, 6 to 54 Mbps	4	10	-2.1	2.3	3.9	2.2	0.1	8.1	26.0	17.87
	HT/VHT20, M0 to M7	1	4	-2.4				0.1	-2.3	30.0	32.35
	HT/VHT20, M0 to M7	2	7	-2.4	2.3			0.1	3.6	29.0	25.38
	HT/VHT20, M8 to M15	2	4	-2.4	2.3			0.1	3.6	30.0	26.38
	HT/VHT20, M0 to M7	3	9	-2.4	2.3	3.5		0.1	6.6	27.0	20.40
	HT/VHT20, M8 to M15	3	6	-2.4	2.3	3.5		0.1	6.6	30.0	23.40
	HT/VHT20, M16 to M23	3	4	-2.4	2.3	3.5		0.1	6.6	30.0	23.40
	HT/VHT20, M0 to M7	4	10	-2.4	2.3	3.5	1.9	0.1	7.9	26.0	18.12
	HT/VHT20, M8 to M15	4	7	-2.4	2.3	3.5	1.9	0.1	7.9	29.0	21.12
	HT/VHT20, M16 to M23	4	5	-2.4	2.3	3.5	1.9	0.1	7.9	30.0	22.12
	HT/VHT20, M24 to M31	4	4	-2.4	2.3	3.5	1.9	0.1	7.9	30.0	22.12
	HT/VHT20 Beam Forming, M0 to M7	2	7	-2.4	2.3			0.1	3.6	29.0	25.38
	HT/VHT20 Beam Forming, M8 to M15	2	4	-2.4	2.3			0.1	3.6	30.0	26.38
	HT/VHT20 Beam Forming, M0 to M7	3	9	-2.4	2.3	3.5		0.1	6.6	27.0	20.40
	HT/VHT20 Beam Forming, M8 to M15	3	6	-2.4	2.3	3.5		0.1	6.6	30.0	23.40
	HT/VHT20 Beam Forming, M16 to M23	3	4	-2.4	2.3	3.5		0.1	6.6	30.0	23.40
	HT/VHT20 Beam Forming, M0 to M7	4	10	-2.4	2.3	3.5	1.9	0.1	7.9	26.0	18.12
	HT/VHT20 Beam Forming, M8 to M15	4	7	-2.4	2.3	3.5	1.9	0.1	7.9	29.0	21.12
HT/VHT20 Beam Forming, M16 to M23	4	5	-2.4	2.3	3.5	1.9	0.1	7.9	30.0	22.12	
HT/VHT20 Beam Forming, M24 to M31	4	4	-2.4	2.3	3.5	1.9	0.1	7.9	30.0	22.12	



HT/VHT20 STBC, M0 to M7	2	4	-2.4	2.3				0.1	3.6	30.0	26.38
HT/VHT20 STBC, M0 to M7	3	6	-2.4	2.3	3.5			0.1	6.6	30.0	23.40
HT/VHT20 STBC, M0 to M7	4	7	-2.4	2.3	3.5	1.9		0.1	7.9	29.0	21.12
HE20, M0 to M9 1ss	1	4	-2.6					0.1	-2.5	30.0	32.53
HE20, M0 to M9 1ss	2	7	-2.6	2.0				0.1	3.4	29.0	25.64
HE20, M0 to M9 2ss	2	4	-2.6	2.0				0.1	3.4	30.0	26.64
HE20, M0 to M9 1ss	3	9	-2.6	2.0	3.8			0.1	6.6	27.0	20.37
HE20, M0 to M9 2ss	3	6	-2.6	2.0	3.8			0.1	6.6	30.0	23.37
HE20, M0 to M9 3ss	3	4	-2.6	2.0	3.8			0.1	6.6	30.0	23.37
HE20, M0 to M9 1ss	4	10	-2.6	2.0	3.8	2.0		0.1	7.9	26.0	18.07
HE20, M0 to M9 2ss	4	7	-2.6	2.0	3.8	2.0		0.1	7.9	29.0	21.07
HE20, M0 to M9 3ss	4	5	-2.6	2.0	3.8	2.0		0.1	7.9	30.0	22.07
HE20, M0 to M9 4ss	4	4	-2.6	2.0	3.8	2.0		0.1	7.9	30.0	22.07
HE20 Beam Forming, M0 to M9 1ss	2	7	-2.6	2.0				0.1	3.4	29.0	25.64
HE20 Beam Forming, M0 to M9 2ss	2	4	-2.6	2.0				0.1	3.4	30.0	26.64
HE20 Beam Forming, M0 to M9 1ss	3	9	-2.6	2.0	3.8			0.1	6.6	27.0	20.37
HE20 Beam Forming, M0 to M9 2ss	3	6	-2.6	2.0	3.8			0.1	6.6	30.0	23.37
HE20 Beam Forming, M0 to M9 3ss	3	4	-2.6	2.0	3.8			0.1	6.6	30.0	23.37
HE20 Beam Forming, M0 to M9 1ss	4	10	-2.6	2.0	3.8	2.0		0.1	7.9	26.0	18.07
HE20 Beam Forming, M0 to M9 2ss	4	7	-2.6	2.0	3.8	2.0		0.1	7.9	29.0	21.07
HE20 Beam Forming, M0 to M9 3ss	4	5	-2.6	2.0	3.8	2.0		0.1	7.9	30.0	22.07
HE20 Beam Forming, M0 to M9 4ss	4	4	-2.6	2.0	3.8	2.0		0.1	7.9	30.0	22.07
HE20 STBC, M0 to M9 2ss	2	4	-2.6	2.0				0.1	3.4	30.0	26.64
HE20 STBC, M0 to M9 2ss	3	6	-2.6	2.0	3.8			0.1	6.6	30.0	23.37
HE20 STBC, M0 to M9 2ss	4	7	-2.6	2.0	3.8	2.0		0.1	7.9	29.0	21.07

**Power Spectral Density, 4dBi**  
**5785 MHz, Non HT20, 6 to 54 Mbps**

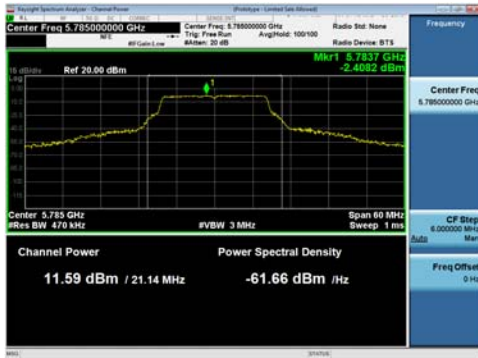

**Antenna A**

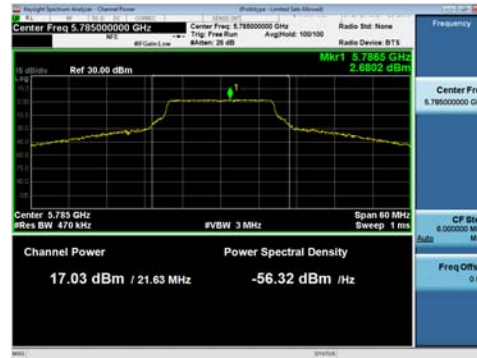

**Antenna B**

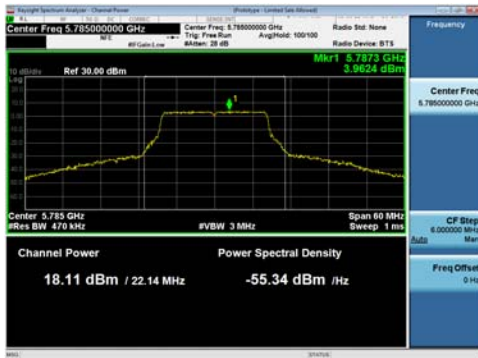

**Antenna C**

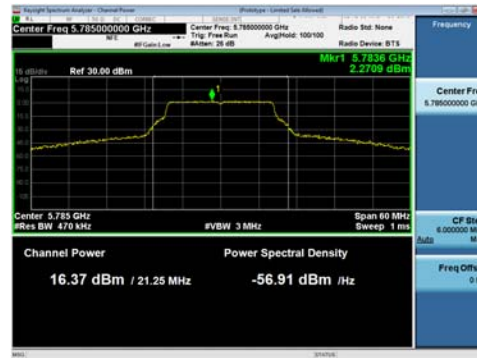

**Antenna D**

## Power Spectral Density, 5dBi

Frequency (MHz)	Mode	Tx Paths	Correlated Antenna Gain (dBi)	Tx 1 PSD (dBm/500kHz)	Tx 2 PSD (dBm/500kHz)	Tx 3 PSD (dBm/500kHz)	Tx 4 PSD (dBm/500kHz)	Duty Cycle Correction (dB)	Total PSD (dBm/500kHz)	Limit (dBm/500kHz)	Margin (dB)
5720 <sup>13</sup>	Non HT20, 6 to 54 Mbps	1	5	-4.0				0.1	-3.9	30.0	33.95
	Non HT20, 6 to 54 Mbps	2	8	-4.0	-0.4			0.1	1.2	28.0	26.78
	Non HT20, 6 to 54 Mbps	3	10	-4.0	-0.4	0.2		0.1	3.8	26.0	22.23
	Non HT20, 6 to 54 Mbps	4	11	-4.0	-0.4	0.2	0.0	0.1	5.3	25.0	19.69
	Non HT20 Beam Forming, 6 to 54 Mbps	2	8	-4.0	-0.4			0.1	1.2	28.0	26.78
	Non HT20 Beam Forming, 6 to 54 Mbps	3	10	-4.0	-2.6	-1.8		0.1	2.1	26.0	23.89
	Non HT20 Beam Forming, 6 to 54 Mbps	4	11	-4.0	-4.4	-4.4	-4.4	0.1	1.8	25.0	23.23
	HT/VHT20, M0 to M7	1	5	-4.0				0.1	-3.9	30.0	33.95
	HT/VHT20, M0 to M7	2	8	-4.0	-0.3			0.1	1.3	28.0	26.70
	HT/VHT20, M8 to M15	2	5	-4.0	-0.3			0.1	1.3	30.0	28.70
	HT/VHT20, M0 to M7	3	10	-4.0	-0.3	0.5		0.1	4.0	26.0	22.05
	HT/VHT20, M8 to M15	3	7	-4.0	-0.3	0.5		0.1	4.0	29.0	25.05
	HT/VHT20, M16 to M23	3	5	-4.0	-0.3	0.5		0.1	4.0	30.0	26.05
	HT/VHT20, M0 to M7	4	11	-4.0	-0.3	0.5	-0.1	0.1	5.4	25.0	19.59
	HT/VHT20, M8 to M15	4	8	-4.0	-0.3	0.5	-0.1	0.1	5.4	28.0	22.59
	HT/VHT20, M16 to M23	4	6	-4.0	-0.3	0.5	-0.1	0.1	5.4	30.0	24.59
	HT/VHT20, M24 to M31	4	5	-4.0	-0.3	0.5	-0.1	0.1	5.4	30.0	24.59
	HT/VHT20 Beam Forming, M0 to M7	2	8	-4.0	-0.3			0.1	1.3	28.0	26.70
	HT/VHT20 Beam Forming, M8 to M15	2	5	-4.0	-0.3			0.1	1.3	30.0	28.70
	HT/VHT20 Beam Forming, M0 to M7	3	10	-4.0	-2.6	-2.3		0.1	1.9	26.0	24.08
	HT/VHT20 Beam Forming, M8 to M15	3	7	-4.0	-0.3	0.5		0.1	4.0	29.0	25.05
	HT/VHT20 Beam Forming, M16 to M23	3	5	-4.0	-0.3	0.5		0.1	4.0	30.0	26.05
	HT/VHT20 Beam Forming, M0 to M7	4	11	-4.0	-4.5	-4.6	-4.6	0.1	1.7	25.0	23.34
	HT/VHT20 Beam Forming, M8 to M15	4	8	-4.0	-1.7	-1.3	-1.2	0.1	4.2	28.0	23.84
	HT/VHT20 Beam Forming, M16 to M23	4	6	-4.0	-0.3	0.5	-0.1	0.1	5.4	30.0	24.59
	HT/VHT20 Beam Forming, M24 to M31	4	5	-4.0	-0.3	0.5	-0.1	0.1	5.4	30.0	24.59
	HT/VHT20 STBC, M0 to M7	2	5	-4.0	-0.3			0.1	1.3	30.0	28.70
	HT/VHT20 STBC, M0 to M7	3	7	-4.0	-0.3	0.5		0.1	4.0	29.0	25.05
	HT/VHT20 STBC, M0 to M7	4	8	-4.0	-1.7	-1.3	-1.2	0.1	4.2	28.0	23.84

<sup>13</sup> 5720 (ch144) not supported for Canada.



	HE20, M0 to M9 1ss	1	5	-4.3				0.1	-4.2	30.0	34.23
	HE20, M0 to M9 1ss	2	8	-4.3	-0.6			0.1	1.0	28.0	26.99
	HE20, M0 to M9 2ss	2	5	-4.3	-0.6			0.1	1.0	30.0	28.99
	HE20, M0 to M9 1ss	3	10	-4.3	-0.6	0.0		0.1	3.6	26.0	22.42
	HE20, M0 to M9 2ss	3	7	-4.3	-0.6	0.0		0.1	3.6	29.0	25.42
	HE20, M0 to M9 3ss	3	5	-4.3	-0.6	0.0		0.1	3.6	30.0	26.42
	HE20, M0 to M9 1ss	4	11	-4.3	-0.6	0.0	-0.2	0.1	5.1	25.0	19.88
	HE20, M0 to M9 2ss	4	8	-4.3	-0.6	0.0	-0.2	0.1	5.1	28.0	22.88
	HE20, M0 to M9 3ss	4	6	-4.3	-0.6	0.0	-0.2	0.1	5.1	30.0	24.88
	HE20, M0 to M9 4ss	4	5	-4.3	-0.6	0.0	-0.2	0.1	5.1	30.0	24.88
	HE20 Beam Forming, M0 to M9 1ss	2	8	-4.3	-0.6			0.1	1.0	28.0	26.99
	HE20 Beam Forming, M0 to M9 2ss	2	5	-4.3	-0.6			0.1	1.0	30.0	28.99
	HE20 Beam Forming, M0 to M9 1ss	3	10	-4.3	-2.7	-2.4		0.1	1.8	26.0	24.22
	HE20 Beam Forming, M0 to M9 2ss	3	7	-4.3	-0.6	0.0		0.1	3.6	29.0	25.42
	HE20 Beam Forming, M0 to M9 3ss	3	5	-4.3	-0.6	0.0		0.1	3.6	30.0	26.42
	HE20 Beam Forming, M0 to M9 1ss	4	11	-4.3	-4.5	-4.6	-4.8	0.1	1.5	25.0	23.46
	HE20 Beam Forming, M0 to M9 2ss	4	8	-4.3	-1.8	-0.8	-1.5	0.1	4.2	28.0	23.83
	HE20 Beam Forming, M0 to M9 3ss	4	6	-4.3	-0.6	0.0	-0.2	0.1	5.1	30.0	24.88
	HE20 Beam Forming, M0 to M9 4ss	4	5	-4.3	-0.6	0.0	-0.2	0.1	5.1	30.0	24.88
	HE20 STBC, M0 to M9 2ss	2	5	-4.3	-0.6			0.1	1.0	30.0	28.99
	HE20 STBC, M0 to M9 2ss	3	7	-4.3	-0.6	0.0		0.1	3.6	29.0	25.42
	HE20 STBC, M0 to M9 2ss	4	8	-4.3	-1.8	-0.8	-1.5	0.1	4.2	28.0	23.83
5745	Non HT20, 6 to 54 Mbps	1	5	-3.0				0.1	-2.9	30.0	32.95
	Non HT20, 6 to 54 Mbps	2	8	-3.0	2.8			0.1	3.9	28.0	24.14
	Non HT20, 6 to 54 Mbps	3	10	-3.0	2.8	3.7		0.1	6.8	26.0	19.18
	Non HT20, 6 to 54 Mbps	4	11	-3.0	2.8	3.7	1.6	0.1	8.0	25.0	17.03
	Non HT20 Beam Forming, 6 to 54 Mbps	2	8	-3.0	2.8			0.1	3.9	28.0	24.14
	Non HT20 Beam Forming, 6 to 54 Mbps	3	10	-3.0	2.8	3.7		0.1	6.8	26.0	19.18
	Non HT20 Beam Forming, 6 to 54 Mbps	4	11	-3.0	2.8	3.7	1.6	0.1	8.0	25.0	17.03
	HT/VHT20, M0 to M7	1	5	-3.2				0.1	-3.1	30.0	33.15
	HT/VHT20, M0 to M7	2	8	-3.2	2.2			0.1	3.4	28.0	24.65
	HT/VHT20, M8 to M15	2	5	-3.2	2.2			0.1	3.4	30.0	26.65
	HT/VHT20, M0 to M7	3	10	-3.2	2.2	3.7		0.1	6.6	26.0	19.43
	HT/VHT20, M8 to M15	3	7	-3.2	2.2	3.7		0.1	6.6	29.0	22.43
	HT/VHT20, M16 to M23	3	5	-3.2	2.2	3.7		0.1	6.6	30.0	23.43
	HT/VHT20, M0 to M7	4	11	-3.2	2.2	3.7	1.4	0.1	7.7	25.0	17.27
	HT/VHT20, M8 to M15	4	8	-3.2	2.2	3.7	1.4	0.1	7.7	28.0	20.27
	HT/VHT20, M16 to M23	4	6	-3.2	2.2	3.7	1.4	0.1	7.7	30.0	22.27
	HT/VHT20, M24 to M31	4	5	-3.2	2.2	3.7	1.4	0.1	7.7	30.0	22.27
	HT/VHT20 Beam Forming, M0 to M7	2	8	-3.2	2.2			0.1	3.4	28.0	24.65
	HT/VHT20 Beam Forming, M8 to M15	2	5	-3.2	2.2			0.1	3.4	30.0	26.65
HT/VHT20 Beam Forming, M0 to M7	3	10	-3.2	2.2	3.7		0.1	6.6	26.0	19.43	



	HT/VHT20 Beam Forming, M8 to M15	3	7	-3.2	2.2	3.7		0.1	6.6	29.0	22.43
	HT/VHT20 Beam Forming, M16 to M23	3	5	-3.2	2.2	3.7		0.1	6.6	30.0	23.43
	HT/VHT20 Beam Forming, M0 to M7	4	11	-3.2	2.2	3.7	1.4	0.1	7.7	25.0	17.27
	HT/VHT20 Beam Forming, M8 to M15	4	8	-3.2	2.2	3.7	1.4	0.1	7.7	28.0	20.27
	HT/VHT20 Beam Forming, M16 to M23	4	6	-3.2	2.2	3.7	1.4	0.1	7.7	30.0	22.27
	HT/VHT20 Beam Forming, M24 to M31	4	5	-3.2	2.2	3.7	1.4	0.1	7.7	30.0	22.27
	HT/VHT20 STBC, M0 to M7	2	5	-3.2	2.2			0.1	3.4	30.0	26.65
	HT/VHT20 STBC, M0 to M7	3	7	-3.2	2.2	3.7		0.1	6.6	29.0	22.43
	HT/VHT20 STBC, M0 to M7	4	8	-3.2	2.2	3.7	1.4	0.1	7.7	28.0	20.27
	HE20, M0 to M9 1ss	1	5	-3.1				0.1	-3.0	30.0	33.03
	HE20, M0 to M9 1ss	2	8	-3.1	2.4			0.1	3.5	28.0	24.45
	HE20, M0 to M9 2ss	2	5	-3.1	2.4			0.1	3.5	30.0	26.45
	HE20, M0 to M9 1ss	3	10	-3.1	2.4	3.6		0.1	6.6	26.0	19.38
	HE20, M0 to M9 2ss	3	7	-3.1	2.4	3.6		0.1	6.6	29.0	22.38
	HE20, M0 to M9 3ss	3	5	-3.1	2.4	3.6		0.1	6.6	30.0	23.38
	HE20, M0 to M9 1ss	4	11	-3.1	2.4	3.6	2.3	0.1	8.0	25.0	17.00
	HE20, M0 to M9 2ss	4	8	-3.1	2.4	3.6	2.3	0.1	8.0	28.0	20.00
	HE20, M0 to M9 3ss	4	6	-3.1	2.4	3.6	2.3	0.1	8.0	30.0	22.00
	HE20, M0 to M9 4ss	4	5	-3.1	2.4	3.6	2.3	0.1	8.0	30.0	22.00
	HE20 Beam Forming, M0 to M9 1ss	2	8	-3.1	2.4			0.1	3.5	28.0	24.45
	HE20 Beam Forming, M0 to M9 2ss	2	5	-3.1	2.4			0.1	3.5	30.0	26.45
	HE20 Beam Forming, M0 to M9 1ss	3	10	-3.1	2.4	3.6		0.1	6.6	26.0	19.38
	HE20 Beam Forming, M0 to M9 2ss	3	7	-3.1	2.4	3.6		0.1	6.6	29.0	22.38
	HE20 Beam Forming, M0 to M9 3ss	3	5	-3.1	2.4	3.6		0.1	6.6	30.0	23.38
	HE20 Beam Forming, M0 to M9 1ss	4	11	-3.1	2.4	3.6	2.3	0.1	8.0	25.0	17.00
	HE20 Beam Forming, M0 to M9 2ss	4	8	-3.1	2.4	3.6	2.3	0.1	8.0	28.0	20.00
	HE20 Beam Forming, M0 to M9 3ss	4	6	-3.1	2.4	3.6	2.3	0.1	8.0	30.0	22.00
	HE20 Beam Forming, M0 to M9 4ss	4	5	-3.1	2.4	3.6	2.3	0.1	8.0	30.0	22.00
	HE20 STBC, M0 to M9 2ss	2	5	-3.1	2.4			0.1	3.5	30.0	26.45
	HE20 STBC, M0 to M9 2ss	3	7	-3.1	2.4	3.6		0.1	6.6	29.0	22.38
	HE20 STBC, M0 to M9 2ss	4	8	-3.1	2.4	3.6	2.3	0.1	8.0	28.0	20.00
5755	Non HT40, 6 to 54 Mbps	1	5	-6.8				0.1	-6.7	30.0	36.75
	Non HT40, 6 to 54 Mbps	2	8	-6.8	-0.5			0.1	0.5	28.0	27.53
	Non HT40, 6 to 54 Mbps	3	10	-6.8	-0.5	0.4		0.1	3.5	26.0	22.53
	Non HT40, 6 to 54 Mbps	4	11	-6.8	-0.5	0.4	-1.6	0.1	4.7	25.0	20.34
	HT/VHT40, M0 to M7	1	5	-6.8				0.1	-6.7	30.0	36.69
	HT/VHT40, M0 to M7	2	8	-6.8	-0.5			0.1	0.5	28.0	27.48
	HT/VHT40, M8 to M15	2	5	-6.8	-0.5			0.1	0.5	30.0	29.48
	HT/VHT40, M0 to M7	3	10	-6.8	-0.5	0.2		0.1	3.4	26.0	22.57
	HT/VHT40, M8 to M15	3	7	-6.8	-0.5	0.2		0.1	3.4	29.0	25.57
	HT/VHT40, M16 to M23	3	5	-6.8	-0.5	0.2		0.1	3.4	30.0	26.57
	HT/VHT40, M0 to M7	4	11	-6.8	-0.5	0.2	-1.8	0.1	4.6	25.0	20.41



	HT/VHT40, M8 to M15	4	8	-6.8	-0.5	0.2	-1.8	0.1	4.6	28.0	23.41
	HT/VHT40, M16 to M23	4	6	-6.8	-0.5	0.2	-1.8	0.1	4.6	30.0	25.41
	HT/VHT40, M24 to M31	4	5	-6.8	-0.5	0.2	-1.8	0.1	4.6	30.0	25.41
	HT/VHT40 Beam Forming, M0 to M7	2	8	-6.8	-0.5			0.1	0.5	28.0	27.48
	HT/VHT40 Beam Forming, M8 to M15	2	5	-6.8	-0.5			0.1	0.5	30.0	29.48
	HT/VHT40 Beam Forming, M0 to M7	3	10	-6.8	-0.5	0.2		0.1	3.4	26.0	22.57
	HT/VHT40 Beam Forming, M8 to M15	3	7	-6.8	-0.5	0.2		0.1	3.4	29.0	25.57
	HT/VHT40 Beam Forming, M16 to M23	3	5	-6.8	-0.5	0.2		0.1	3.4	30.0	26.57
	HT/VHT40 Beam Forming, M0 to M7	4	11	-6.8	-0.5	0.2	-1.8	0.1	4.6	25.0	20.41
	HT/VHT40 Beam Forming, M8 to M15	4	8	-6.8	-0.5	0.2	-1.8	0.1	4.6	28.0	23.41
	HT/VHT40 Beam Forming, M16 to M23	4	6	-6.8	-0.5	0.2	-1.8	0.1	4.6	30.0	25.41
	HT/VHT40 Beam Forming, M24 to M31	4	5	-6.8	-0.5	0.2	-1.8	0.1	4.6	30.0	25.41
	HT/VHT40 STBC, M0 to M7	2	5	-6.8	-0.5			0.1	0.5	30.0	29.48
	HT/VHT40 STBC, M0 to M7	3	7	-6.8	-0.5	0.2		0.1	3.4	29.0	25.57
	HT/VHT40 STBC, M0 to M7	4	8	-6.8	-0.5	0.2	-1.8	0.1	4.6	28.0	23.41
	HE40, M0 to M9 1ss	1	5	-6.8				0.1	-6.7	30.0	36.67
	HE40, M0 to M9 1ss	2	8	-6.8	-0.6			0.1	0.5	28.0	27.54
	HE40, M0 to M9 2ss	2	5	-6.8	-0.6			0.1	0.5	30.0	29.54
	HE40, M0 to M9 1ss	3	10	-6.8	-0.6	0.5		0.1	3.6	26.0	22.45
	HE40, M0 to M9 2ss	3	7	-6.8	-0.6	0.5		0.1	3.6	29.0	25.45
	HE40, M0 to M9 3ss	3	5	-6.8	-0.6	0.5		0.1	3.6	30.0	26.45
	HE40, M0 to M9 1ss	4	11	-6.8	-0.6	0.5	-2.0	0.1	4.6	25.0	20.35
	HE40, M0 to M9 2ss	4	8	-6.8	-0.6	0.5	-2.0	0.1	4.6	28.0	23.35
	HE40, M0 to M9 3ss	4	6	-6.8	-0.6	0.5	-2.0	0.1	4.6	30.0	25.35
	HE40, M0 to M9 4ss	4	5	-6.8	-0.6	0.5	-2.0	0.1	4.6	30.0	25.35
	HE40 Beam Forming, M0 to M9 1ss	2	8	-6.8	-0.6			0.1	0.5	28.0	27.54
	HE40 Beam Forming, M0 to M9 2ss	2	5	-6.8	-0.6			0.1	0.5	30.0	29.54
	HE40 Beam Forming, M0 to M9 1ss	3	10	-6.8	-0.6	0.5		0.1	3.6	26.0	22.45
	HE40 Beam Forming, M0 to M9 2ss	3	7	-6.8	-0.6	0.5		0.1	3.6	29.0	25.45
	HE40 Beam Forming, M0 to M9 3ss	3	5	-6.8	-0.6	0.5		0.1	3.6	30.0	26.45
	HE40 Beam Forming, M0 to M9 1ss	4	11	-6.8	-0.6	0.5	-2.0	0.1	4.6	25.0	20.35
	HE40 Beam Forming, M0 to M9 2ss	4	8	-6.8	-0.6	0.5	-2.0	0.1	4.6	28.0	23.35
	HE40 Beam Forming, M0 to M9 3ss	4	6	-6.8	-0.6	0.5	-2.0	0.1	4.6	30.0	25.35
	HE40 Beam Forming, M0 to M9 4ss	4	5	-6.8	-0.6	0.5	-2.0	0.1	4.6	30.0	25.35
	HE40 STBC, M0 to M9 2ss	2	5	-6.8	-0.6			0.1	0.5	30.0	29.54
	HE40 STBC, M0 to M9 2ss	3	7	-6.8	-0.6	0.5		0.1	3.6	29.0	25.45
	HE40 STBC, M0 to M9 2ss	4	8	-6.8	-0.6	0.5	-2.0	0.1	4.6	28.0	23.35
5775	Non HT80, 6 to 54 Mbps	1	5	-9.6				0.0	-9.6	30.0	39.55
	Non HT80, 6 to 54 Mbps	2	8	-9.6	-4.2			0.0	-3.1	28.0	31.05
	Non HT80, 6 to 54 Mbps	3	10	-9.6	-4.2	-3.2		0.0	-0.1	26.0	26.09
	Non HT80, 6 to 54 Mbps	4	11	-9.6	-4.2	-3.2	-4.8	0.0	1.2	25.0	23.81
	VHT80, M0 to M9 1ss	1	5	-9.8				0.2	-9.6	30.0	39.58

VHT80, M0 to M9 1ss	2	8	-9.8	-4.4			0.2	-3.1	28.0	31.08
VHT80, M0 to M9 2ss	2	5	-9.8	-4.4			0.2	-3.1	30.0	33.08
VHT80, M0 to M9 1ss	3	10	-9.8	-4.4	-3.6		0.2	-0.2	26.0	26.21
VHT80, M0 to M9 2ss	3	7	-9.8	-4.4	-3.6		0.2	-0.2	29.0	29.21
VHT80, M0 to M9 3ss	3	5	-9.8	-4.4	-3.6		0.2	-0.2	30.0	30.21
VHT80, M0 to M9 1ss	4	11	-9.8	-4.4	-3.6	-5.1	0.2	1.1	25.0	23.94
VHT80, M0 to M9 2ss	4	8	-9.8	-4.4	-3.6	-5.1	0.2	1.1	28.0	26.94
VHT80, M0 to M9 3ss	4	6	-9.8	-4.4	-3.6	-5.1	0.2	1.1	30.0	28.94
VHT80, M0 to M9 4ss	4	5	-9.8	-4.4	-3.6	-5.1	0.2	1.1	30.0	28.94
VHT80 Beam Forming, M0 to M9 1ss	2	8	-9.8	-4.4			0.2	-3.1	28.0	31.08
VHT80 Beam Forming, M0 to M9 2ss	2	5	-9.8	-4.4			0.2	-3.1	30.0	33.08
VHT80 Beam Forming, M0 to M9 1ss	3	10	-9.8	-4.4	-3.6		0.2	-0.2	26.0	26.21
VHT80 Beam Forming, M0 to M9 2ss	3	7	-9.8	-4.4	-3.6		0.2	-0.2	29.0	29.21
VHT80 Beam Forming, M0 to M9 3ss	3	5	-9.8	-4.4	-3.6		0.2	-0.2	30.0	30.21
VHT80 Beam Forming, M0 to M9 1ss	4	11	-9.8	-4.4	-3.6	-5.1	0.2	1.1	25.0	23.94
VHT80 Beam Forming, M0 to M9 2ss	4	8	-9.8	-4.4	-3.6	-5.1	0.2	1.1	28.0	26.94
VHT80 Beam Forming, M0 to M9 3ss	4	6	-9.8	-4.4	-3.6	-5.1	0.2	1.1	30.0	28.94
VHT80 Beam Forming, M0 to M9 4ss	4	5	-9.8	-4.4	-3.6	-5.1	0.2	1.1	30.0	28.94
VHT80 STBC, M0 to M9 1ss	2	5	-9.8	-4.4			0.2	-3.1	30.0	33.08
VHT80 STBC, M0 to M9 1ss	3	5	-9.8	-4.4	-3.6		0.2	-0.2	30.0	30.21
VHT80 STBC, M0 to M9 1ss	4	5	-9.8	-4.4	-3.6	-5.1	0.2	1.1	30.0	28.94
HE80, M0 to M9 1ss	1	5	-9.6				0.2	-9.4	30.0	39.35
HE80, M0 to M9 1ss	2	8	-9.6	-4.3			0.2	-2.9	28.0	30.93
HE80, M0 to M9 2ss	2	5	-9.6	-4.3			0.2	-2.9	30.0	32.93
HE80, M0 to M9 1ss	3	10	-9.6	-4.3	-3.0		0.2	0.2	26.0	25.83
HE80, M0 to M9 2ss	3	7	-9.6	-4.3	-3.0		0.2	0.2	29.0	28.83
HE80, M0 to M9 3ss	3	5	-9.6	-4.3	-3.0		0.2	0.2	30.0	29.83
HE80, M0 to M9 1ss	4	11	-9.6	-4.3	-3.0	-4.9	0.2	1.4	25.0	23.59
HE80, M0 to M9 2ss	4	8	-9.6	-4.3	-3.0	-4.9	0.2	1.4	28.0	26.59
HE80, M0 to M9 3ss	4	6	-9.6	-4.3	-3.0	-4.9	0.2	1.4	30.0	28.59
HE80, M0 to M9 4ss	4	5	-9.6	-4.3	-3.0	-4.9	0.2	1.4	30.0	28.59
HE80 Beam Forming, M0 to M9 1ss	2	8	-9.6	-4.3			0.2	-2.9	28.0	30.93
HE80 Beam Forming, M0 to M9 2ss	2	5	-9.6	-4.3			0.2	-2.9	30.0	32.93
HE80 Beam Forming, M0 to M9 1ss	3	10	-9.6	-4.3	-3.0		0.2	0.2	26.0	25.83
HE80 Beam Forming, M0 to M9 2ss	3	7	-9.6	-4.3	-3.0		0.2	0.2	29.0	28.83
HE80 Beam Forming, M0 to M9 3ss	3	5	-9.6	-4.3	-3.0		0.2	0.2	30.0	29.83
HE80 Beam Forming, M0 to M9 1ss	4	11	-9.6	-4.3	-3.0	-4.9	0.2	1.4	25.0	23.59
HE80 Beam Forming, M0 to M9 2ss	4	8	-9.6	-4.3	-3.0	-4.9	0.2	1.4	28.0	26.59
HE80 Beam Forming, M0 to M9 3ss	4	6	-9.6	-4.3	-3.0	-4.9	0.2	1.4	30.0	28.59
HE80 Beam Forming, M0 to M9 4ss	4	5	-9.6	-4.3	-3.0	-4.9	0.2	1.4	30.0	28.59
HE80 STBC, M0 to M9 1ss	2	5	-9.6	-4.3			0.2	-2.9	30.0	32.93
HE80 STBC, M0 to M9 1ss	3	5	-9.6	-4.3	-3.0		0.2	0.2	30.0	29.83
HE80 STBC, M0 to M9 1ss	4	5	-9.6	-4.3	-3.0	-4.9	0.2	1.4	30.0	28.59

5785	Non HT20, 6 to 54 Mbps	1	5	-2.4				0.1	-2.3	30.0	32.35
	Non HT20, 6 to 54 Mbps	2	8	-2.4	2.7			0.1	3.9	28.0	24.08
	Non HT20, 6 to 54 Mbps	3	10	-2.4	2.7	4.0		0.1	7.0	26.0	19.00
	<b>Non HT20, 6 to 54 Mbps</b>	<b>4</b>	<b>11</b>	<b>-2.4</b>	<b>2.7</b>	<b>4.0</b>	<b>2.3</b>	<b>0.1</b>	<b>8.3</b>	<b>25.0</b>	<b>16.72</b>
	Non HT20 Beam Forming, 6 to 54 Mbps	2	8	-2.4	2.7			0.1	3.9	28.0	24.08
	Non HT20 Beam Forming, 6 to 54 Mbps	3	10	-2.4	2.7	4.0		0.1	7.0	26.0	19.00
	Non HT20 Beam Forming, 6 to 54 Mbps	4	11	-2.4	2.7	4.0	2.3	0.1	8.3	25.0	16.72
	HT/VHT20, M0 to M7	1	5	-2.7				0.1	-2.6	30.0	32.65
	HT/VHT20, M0 to M7	2	8	-2.7	2.5			0.1	3.7	28.0	24.30
	HT/VHT20, M8 to M15	2	5	-2.7	2.5			0.1	3.7	30.0	26.30
	HT/VHT20, M0 to M7	3	10	-2.7	2.5	3.6		0.1	6.7	26.0	19.31
	HT/VHT20, M8 to M15	3	7	-2.7	2.5	3.6		0.1	6.7	29.0	22.31
	HT/VHT20, M16 to M23	3	5	-2.7	2.5	3.6		0.1	6.7	30.0	23.31
	HT/VHT20, M0 to M7	4	11	-2.7	2.5	3.6	1.7	0.1	7.9	25.0	17.10
	HT/VHT20, M8 to M15	4	8	-2.7	2.5	3.6	1.7	0.1	7.9	28.0	20.10
	HT/VHT20, M16 to M23	4	6	-2.7	2.5	3.6	1.7	0.1	7.9	30.0	22.10
	HT/VHT20, M24 to M31	4	5	-2.7	2.5	3.6	1.7	0.1	7.9	30.0	22.10
	HT/VHT20 Beam Forming, M0 to M7	2	8	-2.7	2.5			0.1	3.7	28.0	24.30
	HT/VHT20 Beam Forming, M8 to M15	2	5	-2.7	2.5			0.1	3.7	30.0	26.30
	HT/VHT20 Beam Forming, M0 to M7	3	10	-2.7	2.5	3.6		0.1	6.7	26.0	19.31
	HT/VHT20 Beam Forming, M8 to M15	3	7	-2.7	2.5	3.6		0.1	6.7	29.0	22.31
	HT/VHT20 Beam Forming, M16 to M23	3	5	-2.7	2.5	3.6		0.1	6.7	30.0	23.31
	HT/VHT20 Beam Forming, M0 to M7	4	11	-2.7	2.5	3.6	1.7	0.1	7.9	25.0	17.10
	HT/VHT20 Beam Forming, M8 to M15	4	8	-2.7	2.5	3.6	1.7	0.1	7.9	28.0	20.10
	HT/VHT20 Beam Forming, M16 to M23	4	6	-2.7	2.5	3.6	1.7	0.1	7.9	30.0	22.10
	HT/VHT20 Beam Forming, M24 to M31	4	5	-2.7	2.5	3.6	1.7	0.1	7.9	30.0	22.10
	HT/VHT20 STBC, M0 to M7	2	5	-2.7	2.5			0.1	3.7	30.0	26.30
	HT/VHT20 STBC, M0 to M7	3	7	-2.7	2.5	3.6		0.1	6.7	29.0	22.31
	HT/VHT20 STBC, M0 to M7	4	8	-2.7	2.5	3.6	1.7	0.1	7.9	28.0	20.10
	HE20, M0 to M9 1ss	1	5	-2.8				0.1	-2.7	30.0	32.73
	HE20, M0 to M9 1ss	2	8	-2.8	2.8			0.1	3.9	28.0	24.08
	HE20, M0 to M9 2ss	2	5	-2.8	2.8			0.1	3.9	30.0	26.08
	HE20, M0 to M9 1ss	3	10	-2.8	2.8	3.6		0.1	6.8	26.0	19.19
	HE20, M0 to M9 2ss	3	7	-2.8	2.8	3.6		0.1	6.8	29.0	22.19
	HE20, M0 to M9 3ss	3	5	-2.8	2.8	3.6		0.1	6.8	30.0	23.19
	HE20, M0 to M9 1ss	4	11	-2.8	2.8	3.6	1.8	0.1	8.0	25.0	16.98
	HE20, M0 to M9 2ss	4	8	-2.8	2.8	3.6	1.8	0.1	8.0	28.0	19.98
	HE20, M0 to M9 3ss	4	6	-2.8	2.8	3.6	1.8	0.1	8.0	30.0	21.98
	HE20, M0 to M9 4ss	4	5	-2.8	2.8	3.6	1.8	0.1	8.0	30.0	21.98
	HE20 Beam Forming, M0 to M9 1ss	2	8	-2.8	2.8			0.1	3.9	28.0	24.08
	HE20 Beam Forming, M0 to M9 2ss	2	5	-2.8	2.8			0.1	3.9	30.0	26.08

	HE20 Beam Forming, M0 to M9 1ss	3	10	-2.8	2.8	3.6		0.1	6.8	26.0	19.19	
	HE20 Beam Forming, M0 to M9 2ss	3	7	-2.8	2.8	3.6		0.1	6.8	29.0	22.19	
	HE20 Beam Forming, M0 to M9 3ss	3	5	-2.8	2.8	3.6		0.1	6.8	30.0	23.19	
	HE20 Beam Forming, M0 to M9 1ss	4	11	-2.8	2.8	3.6	1.8	0.1	8.0	25.0	16.98	
	HE20 Beam Forming, M0 to M9 2ss	4	8	-2.8	2.8	3.6	1.8	0.1	8.0	28.0	19.98	
	HE20 Beam Forming, M0 to M9 3ss	4	6	-2.8	2.8	3.6	1.8	0.1	8.0	30.0	21.98	
	HE20 Beam Forming, M0 to M9 4ss	4	5	-2.8	2.8	3.6	1.8	0.1	8.0	30.0	21.98	
	HE20 STBC, M0 to M9 2ss	2	5	-2.8	2.8			0.1	3.9	30.0	26.08	
	HE20 STBC, M0 to M9 2ss	3	7	-2.8	2.8	3.6		0.1	6.8	29.0	22.19	
	HE20 STBC, M0 to M9 2ss	4	8	-2.8	2.8	3.6	1.8	0.1	8.0	28.0	19.98	
5795	Non HT40, 6 to 54 Mbps	1	5	-6.2				0.1	-6.1	30.0	36.15	
	Non HT40, 6 to 54 Mbps	2	8	-6.2	-0.3			0.1	0.7	28.0	27.26	
	Non HT40, 6 to 54 Mbps	3	10	-6.2	-0.3	1.0		0.1	3.9	26.0	22.09	
	Non HT40, 6 to 54 Mbps	4	11	-6.2	-0.3	1.0	-1.3	0.1	5.1	25.0	19.93	
	HT/VHT40, M0 to M7	1	5	-6.7				0.1	-6.6	30.0	36.59	
	HT/VHT40, M0 to M7	2	8	-6.7	-0.9			0.1	0.2	28.0	27.78	
	HT/VHT40, M8 to M15	2	5	-6.7	-0.9			0.1	0.2	30.0	29.78	
	HT/VHT40, M0 to M7	3	10	-6.7	-0.9	0.1		0.1	3.2	26.0	22.77	
	HT/VHT40, M8 to M15	3	7	-6.7	-0.9	0.1		0.1	3.2	29.0	25.77	
	HT/VHT40, M16 to M23	3	5	-6.7	-0.9	0.1		0.1	3.2	30.0	26.77	
	HT/VHT40, M0 to M7	4	11	-6.7	-0.9	0.1	-1.6	0.1	4.5	25.0	20.51	
	HT/VHT40, M8 to M15	4	8	-6.7	-0.9	0.1	-1.6	0.1	4.5	28.0	23.51	
	HT/VHT40, M16 to M23	4	6	-6.7	-0.9	0.1	-1.6	0.1	4.5	30.0	25.51	
	HT/VHT40, M24 to M31	4	5	-6.7	-0.9	0.1	-1.6	0.1	4.5	30.0	25.51	
	HT/VHT40 Beam Forming, M0 to M7	2	8	-6.7	-0.9			0.1	0.2	28.0	27.78	
	HT/VHT40 Beam Forming, M8 to M15	2	5	-6.7	-0.9			0.1	0.2	30.0	29.78	
	HT/VHT40 Beam Forming, M0 to M7	3	10	-6.7	-0.9	0.1		0.1	3.2	26.0	22.77	
	HT/VHT40 Beam Forming, M8 to M15	3	7	-6.7	-0.9	0.1		0.1	3.2	29.0	25.77	
	HT/VHT40 Beam Forming, M16 to M23	3	5	-6.7	-0.9	0.1		0.1	3.2	30.0	26.77	
	HT/VHT40 Beam Forming, M0 to M7	4	11	-6.7	-0.9	0.1	-1.6	0.1	4.5	25.0	20.51	
	HT/VHT40 Beam Forming, M8 to M15	4	8	-6.7	-0.9	0.1	-1.6	0.1	4.5	28.0	23.51	
	HT/VHT40 Beam Forming, M16 to M23	4	6	-6.7	-0.9	0.1	-1.6	0.1	4.5	30.0	25.51	
	HT/VHT40 Beam Forming, M24 to M31	4	5	-6.7	-0.9	0.1	-1.6	0.1	4.5	30.0	25.51	
	HT/VHT40 STBC, M0 to M7	2	5	-6.7	-0.9			0.1	0.2	30.0	29.78	
	HT/VHT40 STBC, M0 to M7	3	7	-6.7	-0.9	0.1		0.1	3.2	29.0	25.77	
	HT/VHT40 STBC, M0 to M7	4	8	-6.7	-0.9	0.1	-1.6	0.1	4.5	28.0	23.51	
	HE40, M0 to M9 1ss	1	5	-6.6					0.1	-6.5	30.0	36.47
	HE40, M0 to M9 1ss	2	8	-6.6	-0.6				0.1	0.5	28.0	27.50
	HE40, M0 to M9 2ss	2	5	-6.6	-0.6				0.1	0.5	30.0	29.50
	HE40, M0 to M9 1ss	3	10	-6.6	-0.6	0.1			0.1	3.4	26.0	22.63
	HE40, M0 to M9 2ss	3	7	-6.6	-0.6	0.1			0.1	3.4	29.0	25.63
	HE40, M0 to M9 3ss	3	5	-6.6	-0.6	0.1			0.1	3.4	30.0	26.63

	HE40, M0 to M9 1ss	4	11	-6.6	-0.6	0.1	-1.6	0.1	4.6	25.0	20.40
	HE40, M0 to M9 2ss	4	8	-6.6	-0.6	0.1	-1.6	0.1	4.6	28.0	23.40
	HE40, M0 to M9 3ss	4	6	-6.6	-0.6	0.1	-1.6	0.1	4.6	30.0	25.40
	HE40, M0 to M9 4ss	4	5	-6.6	-0.6	0.1	-1.6	0.1	4.6	30.0	25.40
	HE40 Beam Forming, M0 to M9 1ss	2	8	-6.6	-0.6			0.1	0.5	28.0	27.50
	HE40 Beam Forming, M0 to M9 2ss	2	5	-6.6	-0.6			0.1	0.5	30.0	29.50
	HE40 Beam Forming, M0 to M9 1ss	3	10	-6.6	-0.6	0.1		0.1	3.4	26.0	22.63
	HE40 Beam Forming, M0 to M9 2ss	3	7	-6.6	-0.6	0.1		0.1	3.4	29.0	25.63
	HE40 Beam Forming, M0 to M9 3ss	3	5	-6.6	-0.6	0.1		0.1	3.4	30.0	26.63
	HE40 Beam Forming, M0 to M9 1ss	4	11	-6.6	-0.6	0.1	-1.6	0.1	4.6	25.0	20.40
	HE40 Beam Forming, M0 to M9 2ss	4	8	-6.6	-0.6	0.1	-1.6	0.1	4.6	28.0	23.40
	HE40 Beam Forming, M0 to M9 3ss	4	6	-6.6	-0.6	0.1	-1.6	0.1	4.6	30.0	25.40
	HE40 Beam Forming, M0 to M9 4ss	4	5	-6.6	-0.6	0.1	-1.6	0.1	4.6	30.0	25.40
	HE40 STBC, M0 to M9 2ss	2	5	-6.6	-0.6			0.1	0.5	30.0	29.50
	HE40 STBC, M0 to M9 2ss	3	7	-6.6	-0.6	0.1		0.1	3.4	29.0	25.63
	HE40 STBC, M0 to M9 2ss	4	8	-6.6	-0.6	0.1	-1.6	0.1	4.6	28.0	23.40
5825	Non HT20, 6 to 54 Mbps	1	5	-2.1				0.1	-2.0	30.0	32.05
	Non HT20, 6 to 54 Mbps	2	8	-2.1	2.3			0.1	3.7	28.0	24.30
	Non HT20, 6 to 54 Mbps	3	10	-2.1	2.3	3.9		0.1	6.8	26.0	19.16
	Non HT20, 6 to 54 Mbps	4	11	-2.1	2.3	3.9	2.2	0.1	8.1	25.0	16.87
	Non HT20 Beam Forming, 6 to 54 Mbps	2	8	-2.1	2.3			0.1	3.7	28.0	24.30
	Non HT20 Beam Forming, 6 to 54 Mbps	3	10	-2.1	2.3	3.9		0.1	6.8	26.0	19.16
	Non HT20 Beam Forming, 6 to 54 Mbps	4	11	-2.1	2.3	3.9	2.2	0.1	8.1	25.0	16.87
	HT/VHT20, M0 to M7	1	5	-2.4				0.1	-2.3	30.0	32.35
	HT/VHT20, M0 to M7	2	8	-2.4	2.3			0.1	3.6	28.0	24.38
	HT/VHT20, M8 to M15	2	5	-2.4	2.3			0.1	3.6	30.0	26.38
	HT/VHT20, M0 to M7	3	10	-2.4	2.3	3.5		0.1	6.6	26.0	19.40
	HT/VHT20, M8 to M15	3	7	-2.4	2.3	3.5		0.1	6.6	29.0	22.40
	HT/VHT20, M16 to M23	3	5	-2.4	2.3	3.5		0.1	6.6	30.0	23.40
	HT/VHT20, M0 to M7	4	11	-2.4	2.3	3.5	1.9	0.1	7.9	25.0	17.12
	HT/VHT20, M8 to M15	4	8	-2.4	2.3	3.5	1.9	0.1	7.9	28.0	20.12
	HT/VHT20, M16 to M23	4	6	-2.4	2.3	3.5	1.9	0.1	7.9	30.0	22.12
	HT/VHT20, M24 to M31	4	5	-2.4	2.3	3.5	1.9	0.1	7.9	30.0	22.12
	HT/VHT20 Beam Forming, M0 to M7	2	8	-2.4	2.3			0.1	3.6	28.0	24.38
	HT/VHT20 Beam Forming, M8 to M15	2	5	-2.4	2.3			0.1	3.6	30.0	26.38
	HT/VHT20 Beam Forming, M0 to M7	3	10	-2.4	2.3	3.5		0.1	6.6	26.0	19.40
	HT/VHT20 Beam Forming, M8 to M15	3	7	-2.4	2.3	3.5		0.1	6.6	29.0	22.40
	HT/VHT20 Beam Forming, M16 to M23	3	5	-2.4	2.3	3.5		0.1	6.6	30.0	23.40
	HT/VHT20 Beam Forming, M0 to M7	4	11	-2.4	2.3	3.5	1.9	0.1	7.9	25.0	17.12
	HT/VHT20 Beam Forming, M8 to M15	4	8	-2.4	2.3	3.5	1.9	0.1	7.9	28.0	20.12
HT/VHT20 Beam Forming, M16 to M23	4	6	-2.4	2.3	3.5	1.9	0.1	7.9	30.0	22.12	
HT/VHT20 Beam Forming, M24 to M31	4	5	-2.4	2.3	3.5	1.9	0.1	7.9	30.0	22.12	



HT/VHT20 STBC, M0 to M7	2	5	-2.4	2.3				0.1	3.6	30.0	26.38
HT/VHT20 STBC, M0 to M7	3	7	-2.4	2.3	3.5			0.1	6.6	29.0	22.40
HT/VHT20 STBC, M0 to M7	4	8	-2.4	2.3	3.5	1.9		0.1	7.9	28.0	20.12
HE20, M0 to M9 1ss	1	5	-2.6					0.1	-2.5	30.0	32.53
HE20, M0 to M9 1ss	2	8	-2.6	2.0				0.1	3.4	28.0	24.64
HE20, M0 to M9 2ss	2	5	-2.6	2.0				0.1	3.4	30.0	26.64
HE20, M0 to M9 1ss	3	10	-2.6	2.0	3.8			0.1	6.6	26.0	19.37
HE20, M0 to M9 2ss	3	7	-2.6	2.0	3.8			0.1	6.6	29.0	22.37
HE20, M0 to M9 3ss	3	5	-2.6	2.0	3.8			0.1	6.6	30.0	23.37
HE20, M0 to M9 1ss	4	11	-2.6	2.0	3.8	2.0		0.1	7.9	25.0	17.07
HE20, M0 to M9 2ss	4	8	-2.6	2.0	3.8	2.0		0.1	7.9	28.0	20.07
HE20, M0 to M9 3ss	4	6	-2.6	2.0	3.8	2.0		0.1	7.9	30.0	22.07
HE20, M0 to M9 4ss	4	5	-2.6	2.0	3.8	2.0		0.1	7.9	30.0	22.07
HE20 Beam Forming, M0 to M9 1ss	2	8	-2.6	2.0				0.1	3.4	28.0	24.64
HE20 Beam Forming, M0 to M9 2ss	2	5	-2.6	2.0				0.1	3.4	30.0	26.64
HE20 Beam Forming, M0 to M9 1ss	3	10	-2.6	2.0	3.8			0.1	6.6	26.0	19.37
HE20 Beam Forming, M0 to M9 2ss	3	7	-2.6	2.0	3.8			0.1	6.6	29.0	22.37
HE20 Beam Forming, M0 to M9 3ss	3	5	-2.6	2.0	3.8			0.1	6.6	30.0	23.37
HE20 Beam Forming, M0 to M9 1ss	4	11	-2.6	2.0	3.8	2.0		0.1	7.9	25.0	17.07
HE20 Beam Forming, M0 to M9 2ss	4	8	-2.6	2.0	3.8	2.0		0.1	7.9	28.0	20.07
HE20 Beam Forming, M0 to M9 3ss	4	6	-2.6	2.0	3.8	2.0		0.1	7.9	30.0	22.07
HE20 Beam Forming, M0 to M9 4ss	4	5	-2.6	2.0	3.8	2.0		0.1	7.9	30.0	22.07
HE20 STBC, M0 to M9 2ss	2	5	-2.6	2.0				0.1	3.4	30.0	26.64
HE20 STBC, M0 to M9 2ss	3	7	-2.6	2.0	3.8			0.1	6.6	29.0	22.37
HE20 STBC, M0 to M9 2ss	4	8	-2.6	2.0	3.8	2.0		0.1	7.9	28.0	20.07

**Power Spectral Density, 5dBi**  
**5785 MHz, Non HT20, 6 to 54 Mbps**

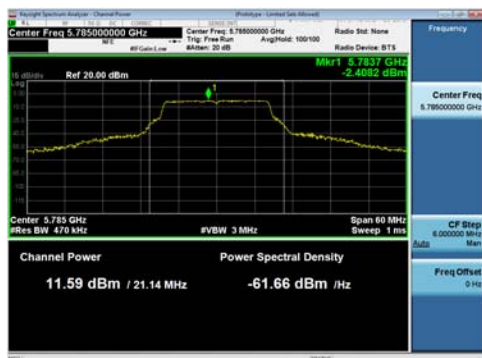

**Antenna A**

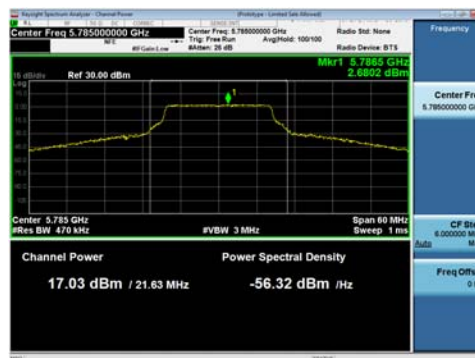

**Antenna B**

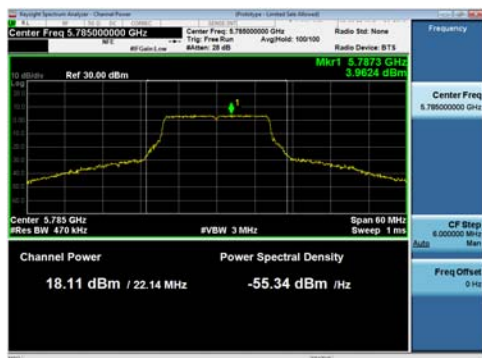

**Antenna C**

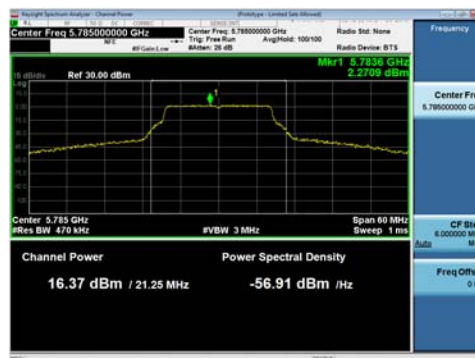

**Antenna D**



## Power Spectral Density, 6dBi

Frequency (MHz)	Mode	Tx Paths	Correlated Antenna Gain (dBi)	Tx 1 PSD (dBm/500kHz)	Tx 2 PSD (dBm/500kHz)	Tx 3 PSD (dBm/500kHz)	Tx 4 PSD (dBm/500kHz)	Duty Cycle Correction (dB)	Total PSD (dBm/500kHz)	Limit (dBm/500kHz)	Margin (dB)	
5720 <sup>14</sup>	Non HT20, 6 to 54 Mbps	1	6	-4.0				0.1	-3.9	30.0	33.95	
	Non HT20, 6 to 54 Mbps	2	9	-4.0	-0.4			0.1	1.2	27.0	25.78	
	Non HT20, 6 to 54 Mbps	3	11	-4.0	-0.4	0.2		0.1	3.8	25.0	21.23	
	Non HT20, 6 to 54 Mbps	4	12	-4.0	-0.4	0.2	0.0	0.1	5.3	24.0	18.69	
	Non HT20 Beam Forming, 6 to 54 Mbps	2	9	-4.0	-0.4			0.1	1.2	27.0	25.78	
	Non HT20 Beam Forming, 6 to 54 Mbps	3	11	-4.0	-3.4	-3.2		0.1	1.3	25.0	23.70	
	Non HT20 Beam Forming, 6 to 54 Mbps	4	12	-4.0	-5.5	-4.9	-5.4	0.1	1.2	24.0	22.84	
	HT/VHT20, M0 to M7	1	6	-4.0					0.1	-3.9	30.0	33.95
	HT/VHT20, M0 to M7	2	9	-4.0	-0.3				0.1	1.3	27.0	25.70
	HT/VHT20, M8 to M15	2	6	-4.0	-0.3				0.1	1.3	30.0	28.70
	HT/VHT20, M0 to M7	3	11	-4.0	-0.3	0.5			0.1	4.0	25.0	21.05
	HT/VHT20, M8 to M15	3	8	-4.0	-0.3	0.5			0.1	4.0	28.0	24.05
	HT/VHT20, M16 to M23	3	6	-4.0	-0.3	0.5			0.1	4.0	30.0	26.05
	HT/VHT20, M0 to M7	4	12	-4.0	-0.3	0.5	-0.1		0.1	5.4	24.0	18.59
	HT/VHT20, M8 to M15	4	9	-4.0	-0.3	0.5	-0.1		0.1	5.4	27.0	21.59
	HT/VHT20, M16 to M23	4	7	-4.0	-0.3	0.5	-0.1		0.1	5.4	29.0	23.59
	HT/VHT20, M24 to M31	4	6	-4.0	-0.3	0.5	-0.1		0.1	5.4	30.0	24.59
	HT/VHT20 Beam Forming, M0 to M7	2	9	-4.0	-0.3				0.1	1.3	27.0	25.70
	HT/VHT20 Beam Forming, M8 to M15	2	6	-4.0	-0.3				0.1	1.3	30.0	28.70
	HT/VHT20 Beam Forming, M0 to M7	3	11	-4.0	-3.7	-3.4			0.1	1.1	25.0	23.87
	HT/VHT20 Beam Forming, M8 to M15	3	8	-4.0	-0.3	0.5			0.1	4.0	28.0	24.05
	HT/VHT20 Beam Forming, M16 to M23	3	6	-4.0	-0.3	0.5			0.1	4.0	30.0	26.05
	HT/VHT20 Beam Forming, M0 to M7	4	12	-4.0	-5.8	-5.5	-5.6		0.1	0.9	24.0	23.09
	HT/VHT20 Beam Forming, M8 to M15	4	9	-4.0	-2.6	-2.3	-2.0		0.1	3.4	27.0	23.59
	HT/VHT20 Beam Forming, M16 to M23	4	7	-4.0	-0.3	0.5	-0.1		0.1	5.4	29.0	23.59
	HT/VHT20 Beam Forming, M24 to M31	4	6	-4.0	-0.3	0.5	-0.1		0.1	5.4	30.0	24.59
	HT/VHT20 STBC, M0 to M7	2	6	-4.0	-0.3				0.1	1.3	30.0	28.70
	HT/VHT20 STBC, M0 to M7	3	8	-4.0	-0.3	0.5			0.1	4.0	28.0	24.05
	HT/VHT20 STBC, M0 to M7	4	9	-4.0	-2.6	-2.3	-2.0		0.1	3.4	27.0	23.59

<sup>14</sup> 5720 (ch144) not supported for Canada.





	HE20, M0 to M9 1ss	1	6	-4.3				0.1	-4.2	30.0	34.23
	HE20, M0 to M9 1ss	2	9	-4.3	-0.6			0.1	1.0	27.0	25.99
	HE20, M0 to M9 2ss	2	6	-4.3	-0.6			0.1	1.0	30.0	28.99
	HE20, M0 to M9 1ss	3	11	-4.3	-0.6	0.0		0.1	3.6	25.0	21.42
	HE20, M0 to M9 2ss	3	8	-4.3	-0.6	0.0		0.1	3.6	28.0	24.42
	HE20, M0 to M9 3ss	3	6	-4.3	-0.6	0.0		0.1	3.6	30.0	26.42
	HE20, M0 to M9 1ss	4	12	-4.3	-0.6	0.0	-0.2	0.1	5.1	24.0	18.88
	HE20, M0 to M9 2ss	4	9	-4.3	-0.6	0.0	-0.2	0.1	5.1	27.0	21.88
	HE20, M0 to M9 3ss	4	7	-4.3	-0.6	0.0	-0.2	0.1	5.1	29.0	23.88
	HE20, M0 to M9 4ss	4	6	-4.3	-0.6	0.0	-0.2	0.1	5.1	30.0	24.88
	HE20 Beam Forming, M0 to M9 1ss	2	9	-4.3	-0.6			0.1	1.0	27.0	25.99
	HE20 Beam Forming, M0 to M9 2ss	2	6	-4.3	-0.6			0.1	1.0	30.0	28.99
	HE20 Beam Forming, M0 to M9 1ss	3	11	-4.3	-3.7	-3.3		0.1	1.1	25.0	23.91
	HE20 Beam Forming, M0 to M9 2ss	3	8	-4.3	-0.6	0.0		0.1	3.6	28.0	24.42
	HE20 Beam Forming, M0 to M9 3ss	3	6	-4.3	-0.6	0.0		0.1	3.6	30.0	26.42
	HE20 Beam Forming, M0 to M9 1ss	4	12	-4.3	-5.9	-5.5	-5.8	0.1	0.8	24.0	23.24
	HE20 Beam Forming, M0 to M9 2ss	4	9	-4.3	-2.7	-2.4	-2.5	0.1	3.2	27.0	23.82
	HE20 Beam Forming, M0 to M9 3ss	4	7	-4.3	-0.6	0.0	-0.2	0.1	5.1	29.0	23.88
	HE20 Beam Forming, M0 to M9 4ss	4	6	-4.3	-0.6	0.0	-0.2	0.1	5.1	30.0	24.88
	HE20 STBC, M0 to M9 2ss	2	6	-4.3	-0.6			0.1	1.0	30.0	28.99
	HE20 STBC, M0 to M9 2ss	3	8	-4.3	-0.6	0.0		0.1	3.6	28.0	24.42
	HE20 STBC, M0 to M9 2ss	4	9	-4.3	-2.7	-2.4	-2.5	0.1	3.2	27.0	23.82
5745	Non HT20, 6 to 54 Mbps	1	6	-3.0				0.1	-2.9	30.0	32.95
	Non HT20, 6 to 54 Mbps	2	9	-3.0	2.8			0.1	3.9	27.0	23.14
	Non HT20, 6 to 54 Mbps	3	11	-3.0	2.8	3.7		0.1	6.8	25.0	18.18
	Non HT20, 6 to 54 Mbps	4	12	-3.0	2.8	3.7	1.6	0.1	8.0	24.0	16.03
	Non HT20 Beam Forming, 6 to 54 Mbps	2	9	-3.0	2.8			0.1	3.9	27.0	23.14
	Non HT20 Beam Forming, 6 to 54 Mbps	3	11	-3.0	2.8	3.7		0.1	6.8	25.0	18.18
	Non HT20 Beam Forming, 6 to 54 Mbps	4	12	-3.0	2.8	3.7	1.6	0.1	8.0	24.0	16.03
	HT/VHT20, M0 to M7	1	6	-3.2				0.1	-3.1	30.0	33.15
	HT/VHT20, M0 to M7	2	9	-3.2	2.2			0.1	3.4	27.0	23.65
	HT/VHT20, M8 to M15	2	6	-3.2	2.2			0.1	3.4	30.0	26.65
	HT/VHT20, M0 to M7	3	11	-3.2	2.2	3.7		0.1	6.6	25.0	18.43
	HT/VHT20, M8 to M15	3	8	-3.2	2.2	3.7		0.1	6.6	28.0	21.43
	HT/VHT20, M16 to M23	3	6	-3.2	2.2	3.7		0.1	6.6	30.0	23.43
	HT/VHT20, M0 to M7	4	12	-3.2	2.2	3.7	1.4	0.1	7.7	24.0	16.27
	HT/VHT20, M8 to M15	4	9	-3.2	2.2	3.7	1.4	0.1	7.7	27.0	19.27
	HT/VHT20, M16 to M23	4	7	-3.2	2.2	3.7	1.4	0.1	7.7	29.0	21.27
	HT/VHT20, M24 to M31	4	6	-3.2	2.2	3.7	1.4	0.1	7.7	30.0	22.27
	HT/VHT20 Beam Forming, M0 to M7	2	9	-3.2	2.2			0.1	3.4	27.0	23.65
	HT/VHT20 Beam Forming, M8 to M15	2	6	-3.2	2.2			0.1	3.4	30.0	26.65
HT/VHT20 Beam Forming, M0 to M7	3	11	-3.2	2.2	3.7		0.1	6.6	25.0	18.43	

	HT/VHT20 Beam Forming, M8 to M15	3	8	-3.2	2.2	3.7		0.1	6.6	28.0	21.43
	HT/VHT20 Beam Forming, M16 to M23	3	6	-3.2	2.2	3.7		0.1	6.6	30.0	23.43
	HT/VHT20 Beam Forming, M0 to M7	4	12	-3.2	2.2	3.7	1.4	0.1	7.7	24.0	16.27
	HT/VHT20 Beam Forming, M8 to M15	4	9	-3.2	2.2	3.7	1.4	0.1	7.7	27.0	19.27
	HT/VHT20 Beam Forming, M16 to M23	4	7	-3.2	2.2	3.7	1.4	0.1	7.7	29.0	21.27
	HT/VHT20 Beam Forming, M24 to M31	4	6	-3.2	2.2	3.7	1.4	0.1	7.7	30.0	22.27
	HT/VHT20 STBC, M0 to M7	2	6	-3.2	2.2			0.1	3.4	30.0	26.65
	HT/VHT20 STBC, M0 to M7	3	8	-3.2	2.2	3.7		0.1	6.6	28.0	21.43
	HT/VHT20 STBC, M0 to M7	4	9	-3.2	2.2	3.7	1.4	0.1	7.7	27.0	19.27
	HE20, M0 to M9 1ss	1	6	-3.1				0.1	-3.0	30.0	33.03
	HE20, M0 to M9 1ss	2	9	-3.1	2.4			0.1	3.5	27.0	23.45
	HE20, M0 to M9 2ss	2	6	-3.1	2.4			0.1	3.5	30.0	26.45
	HE20, M0 to M9 1ss	3	11	-3.1	2.4	3.6		0.1	6.6	25.0	18.38
	HE20, M0 to M9 2ss	3	8	-3.1	2.4	3.6		0.1	6.6	28.0	21.38
	HE20, M0 to M9 3ss	3	6	-3.1	2.4	3.6		0.1	6.6	30.0	23.38
	HE20, M0 to M9 1ss	4	12	-3.1	2.4	3.6	2.3	0.1	8.0	24.0	16.00
	HE20, M0 to M9 2ss	4	9	-3.1	2.4	3.6	2.3	0.1	8.0	27.0	19.00
	HE20, M0 to M9 3ss	4	7	-3.1	2.4	3.6	2.3	0.1	8.0	29.0	21.00
	HE20, M0 to M9 4ss	4	6	-3.1	2.4	3.6	2.3	0.1	8.0	30.0	22.00
	HE20 Beam Forming, M0 to M9 1ss	2	9	-3.1	2.4			0.1	3.5	27.0	23.45
	HE20 Beam Forming, M0 to M9 2ss	2	6	-3.1	2.4			0.1	3.5	30.0	26.45
	HE20 Beam Forming, M0 to M9 1ss	3	11	-3.1	2.4	3.6		0.1	6.6	25.0	18.38
	HE20 Beam Forming, M0 to M9 2ss	3	8	-3.1	2.4	3.6		0.1	6.6	28.0	21.38
	HE20 Beam Forming, M0 to M9 3ss	3	6	-3.1	2.4	3.6		0.1	6.6	30.0	23.38
	HE20 Beam Forming, M0 to M9 1ss	4	12	-3.1	2.4	3.6	2.3	0.1	8.0	24.0	16.00
	HE20 Beam Forming, M0 to M9 2ss	4	9	-3.1	2.4	3.6	2.3	0.1	8.0	27.0	19.00
	HE20 Beam Forming, M0 to M9 3ss	4	7	-3.1	2.4	3.6	2.3	0.1	8.0	29.0	21.00
	HE20 Beam Forming, M0 to M9 4ss	4	6	-3.1	2.4	3.6	2.3	0.1	8.0	30.0	22.00
	HE20 STBC, M0 to M9 2ss	2	6	-3.1	2.4			0.1	3.5	30.0	26.45
	HE20 STBC, M0 to M9 2ss	3	8	-3.1	2.4	3.6		0.1	6.6	28.0	21.38
	HE20 STBC, M0 to M9 2ss	4	9	-3.1	2.4	3.6	2.3	0.1	8.0	27.0	19.00
5755	Non HT40, 6 to 54 Mbps	1	6	-6.8				0.1	-6.7	30.0	36.75
	Non HT40, 6 to 54 Mbps	2	9	-6.8	-0.5			0.1	0.5	27.0	26.53
	Non HT40, 6 to 54 Mbps	3	11	-6.8	-0.5	0.4		0.1	3.5	25.0	21.53
	Non HT40, 6 to 54 Mbps	4	12	-6.8	-0.5	0.4	-1.6	0.1	4.7	24.0	19.34
	HT/VHT40, M0 to M7	1	6	-6.8				0.1	-6.7	30.0	36.69
	HT/VHT40, M0 to M7	2	9	-6.8	-0.5			0.1	0.5	27.0	26.48
	HT/VHT40, M8 to M15	2	6	-6.8	-0.5			0.1	0.5	30.0	29.48
	HT/VHT40, M0 to M7	3	11	-6.8	-0.5	0.2		0.1	3.4	25.0	21.57
	HT/VHT40, M8 to M15	3	8	-6.8	-0.5	0.2		0.1	3.4	28.0	24.57
	HT/VHT40, M16 to M23	3	6	-6.8	-0.5	0.2		0.1	3.4	30.0	26.57
	HT/VHT40, M0 to M7	4	12	-6.8	-0.5	0.2	-1.8	0.1	4.6	24.0	19.41

	HT/VHT40, M8 to M15	4	9	-6.8	-0.5	0.2	-1.8	0.1	4.6	27.0	22.41
	HT/VHT40, M16 to M23	4	7	-6.8	-0.5	0.2	-1.8	0.1	4.6	29.0	24.41
	HT/VHT40, M24 to M31	4	6	-6.8	-0.5	0.2	-1.8	0.1	4.6	30.0	25.41
	HT/VHT40 Beam Forming, M0 to M7	2	9	-6.8	-0.5			0.1	0.5	27.0	26.48
	HT/VHT40 Beam Forming, M8 to M15	2	6	-6.8	-0.5			0.1	0.5	30.0	29.48
	HT/VHT40 Beam Forming, M0 to M7	3	11	-6.8	-0.5	0.2		0.1	3.4	25.0	21.57
	HT/VHT40 Beam Forming, M8 to M15	3	8	-6.8	-0.5	0.2		0.1	3.4	28.0	24.57
	HT/VHT40 Beam Forming, M16 to M23	3	6	-6.8	-0.5	0.2		0.1	3.4	30.0	26.57
	HT/VHT40 Beam Forming, M0 to M7	4	12	-6.8	-0.5	0.2	-1.8	0.1	4.6	24.0	19.41
	HT/VHT40 Beam Forming, M8 to M15	4	9	-6.8	-0.5	0.2	-1.8	0.1	4.6	27.0	22.41
	HT/VHT40 Beam Forming, M16 to M23	4	7	-6.8	-0.5	0.2	-1.8	0.1	4.6	29.0	24.41
	HT/VHT40 Beam Forming, M24 to M31	4	6	-6.8	-0.5	0.2	-1.8	0.1	4.6	30.0	25.41
	HT/VHT40 STBC, M0 to M7	2	6	-6.8	-0.5			0.1	0.5	30.0	29.48
	HT/VHT40 STBC, M0 to M7	3	8	-6.8	-0.5	0.2		0.1	3.4	28.0	24.57
	HT/VHT40 STBC, M0 to M7	4	9	-6.8	-0.5	0.2	-1.8	0.1	4.6	27.0	22.41
	HE40, M0 to M9 1ss	1	6	-6.8				0.1	-6.7	30.0	36.67
	HE40, M0 to M9 1ss	2	9	-6.8	-0.6			0.1	0.5	27.0	26.54
	HE40, M0 to M9 2ss	2	6	-6.8	-0.6			0.1	0.5	30.0	29.54
	HE40, M0 to M9 1ss	3	11	-6.8	-0.6	0.5		0.1	3.6	25.0	21.45
	HE40, M0 to M9 2ss	3	8	-6.8	-0.6	0.5		0.1	3.6	28.0	24.45
	HE40, M0 to M9 3ss	3	6	-6.8	-0.6	0.5		0.1	3.6	30.0	26.45
	HE40, M0 to M9 1ss	4	12	-6.8	-0.6	0.5	-2.0	0.1	4.6	24.0	19.35
	HE40, M0 to M9 2ss	4	9	-6.8	-0.6	0.5	-2.0	0.1	4.6	27.0	22.35
	HE40, M0 to M9 3ss	4	7	-6.8	-0.6	0.5	-2.0	0.1	4.6	29.0	24.35
	HE40, M0 to M9 4ss	4	6	-6.8	-0.6	0.5	-2.0	0.1	4.6	30.0	25.35
	HE40 Beam Forming, M0 to M9 1ss	2	9	-6.8	-0.6			0.1	0.5	27.0	26.54
	HE40 Beam Forming, M0 to M9 2ss	2	6	-6.8	-0.6			0.1	0.5	30.0	29.54
	HE40 Beam Forming, M0 to M9 1ss	3	11	-6.8	-0.6	0.5		0.1	3.6	25.0	21.45
	HE40 Beam Forming, M0 to M9 2ss	3	8	-6.8	-0.6	0.5		0.1	3.6	28.0	24.45
	HE40 Beam Forming, M0 to M9 3ss	3	6	-6.8	-0.6	0.5		0.1	3.6	30.0	26.45
	HE40 Beam Forming, M0 to M9 1ss	4	12	-6.8	-0.6	0.5	-2.0	0.1	4.6	24.0	19.35
	HE40 Beam Forming, M0 to M9 2ss	4	9	-6.8	-0.6	0.5	-2.0	0.1	4.6	27.0	22.35
	HE40 Beam Forming, M0 to M9 3ss	4	7	-6.8	-0.6	0.5	-2.0	0.1	4.6	29.0	24.35
	HE40 Beam Forming, M0 to M9 4ss	4	6	-6.8	-0.6	0.5	-2.0	0.1	4.6	30.0	25.35
	HE40 STBC, M0 to M9 2ss	2	6	-6.8	-0.6			0.1	0.5	30.0	29.54
	HE40 STBC, M0 to M9 2ss	3	8	-6.8	-0.6	0.5		0.1	3.6	28.0	24.45
	HE40 STBC, M0 to M9 2ss	4	9	-6.8	-0.6	0.5	-2.0	0.1	4.6	27.0	22.35
5775	Non HT80, 6 to 54 Mbps	1	6	-9.6				0.0	-9.6	30.0	39.55
	Non HT80, 6 to 54 Mbps	2	9	-9.6	-4.2			0.0	-3.1	27.0	30.05
	Non HT80, 6 to 54 Mbps	3	11	-9.6	-4.2	-3.2		0.0	-0.1	25.0	25.09
	Non HT80, 6 to 54 Mbps	4	12	-9.6	-4.2	-3.2	-4.8	0.0	1.2	24.0	22.81
	VHT80, M0 to M9 1ss	1	6	-9.8				0.2	-9.6	30.0	39.58

VHT80, M0 to M9 1ss	2	9	-9.8	-4.4			0.2	-3.1	27.0	30.08
VHT80, M0 to M9 2ss	2	6	-9.8	-4.4			0.2	-3.1	30.0	33.08
VHT80, M0 to M9 1ss	3	11	-9.8	-4.4	-3.6		0.2	-0.2	25.0	25.21
VHT80, M0 to M9 2ss	3	8	-9.8	-4.4	-3.6		0.2	-0.2	28.0	28.21
VHT80, M0 to M9 3ss	3	6	-9.8	-4.4	-3.6		0.2	-0.2	30.0	30.21
VHT80, M0 to M9 1ss	4	12	-9.8	-4.4	-3.6	-5.1	0.2	1.1	24.0	22.94
VHT80, M0 to M9 2ss	4	9	-9.8	-4.4	-3.6	-5.1	0.2	1.1	27.0	25.94
VHT80, M0 to M9 3ss	4	7	-9.8	-4.4	-3.6	-5.1	0.2	1.1	29.0	27.94
VHT80, M0 to M9 4ss	4	6	-9.8	-4.4	-3.6	-5.1	0.2	1.1	30.0	28.94
VHT80 Beam Forming, M0 to M9 1ss	2	9	-9.8	-4.4			0.2	-3.1	27.0	30.08
VHT80 Beam Forming, M0 to M9 2ss	2	6	-9.8	-4.4			0.2	-3.1	30.0	33.08
VHT80 Beam Forming, M0 to M9 1ss	3	11	-9.8	-4.4	-3.6		0.2	-0.2	25.0	25.21
VHT80 Beam Forming, M0 to M9 2ss	3	8	-9.8	-4.4	-3.6		0.2	-0.2	28.0	28.21
VHT80 Beam Forming, M0 to M9 3ss	3	6	-9.8	-4.4	-3.6		0.2	-0.2	30.0	30.21
VHT80 Beam Forming, M0 to M9 1ss	4	12	-9.8	-4.4	-3.6	-5.1	0.2	1.1	24.0	22.94
VHT80 Beam Forming, M0 to M9 2ss	4	9	-9.8	-4.4	-3.6	-5.1	0.2	1.1	27.0	25.94
VHT80 Beam Forming, M0 to M9 3ss	4	7	-9.8	-4.4	-3.6	-5.1	0.2	1.1	29.0	27.94
VHT80 Beam Forming, M0 to M9 4ss	4	6	-9.8	-4.4	-3.6	-5.1	0.2	1.1	30.0	28.94
VHT80 STBC, M0 to M9 1ss	2	6	-9.8	-4.4			0.2	-3.1	30.0	33.08
VHT80 STBC, M0 to M9 1ss	3	6	-9.8	-4.4	-3.6		0.2	-0.2	30.0	30.21
VHT80 STBC, M0 to M9 1ss	4	6	-9.8	-4.4	-3.6	-5.1	0.2	1.1	30.0	28.94
HE80, M0 to M9 1ss	1	6	-9.6				0.2	-9.4	30.0	39.35
HE80, M0 to M9 1ss	2	9	-9.6	-4.3			0.2	-2.9	27.0	29.93
HE80, M0 to M9 2ss	2	6	-9.6	-4.3			0.2	-2.9	30.0	32.93
HE80, M0 to M9 1ss	3	11	-9.6	-4.3	-3.0		0.2	0.2	25.0	24.83
HE80, M0 to M9 2ss	3	8	-9.6	-4.3	-3.0		0.2	0.2	28.0	27.83
HE80, M0 to M9 3ss	3	6	-9.6	-4.3	-3.0		0.2	0.2	30.0	29.83
HE80, M0 to M9 1ss	4	12	-9.6	-4.3	-3.0	-4.9	0.2	1.4	24.0	22.59
HE80, M0 to M9 2ss	4	9	-9.6	-4.3	-3.0	-4.9	0.2	1.4	27.0	25.59
HE80, M0 to M9 3ss	4	7	-9.6	-4.3	-3.0	-4.9	0.2	1.4	29.0	27.59
HE80, M0 to M9 4ss	4	6	-9.6	-4.3	-3.0	-4.9	0.2	1.4	30.0	28.59
HE80 Beam Forming, M0 to M9 1ss	2	9	-9.6	-4.3			0.2	-2.9	27.0	29.93
HE80 Beam Forming, M0 to M9 2ss	2	6	-9.6	-4.3			0.2	-2.9	30.0	32.93
HE80 Beam Forming, M0 to M9 1ss	3	11	-9.6	-4.3	-3.0		0.2	0.2	25.0	24.83
HE80 Beam Forming, M0 to M9 2ss	3	8	-9.6	-4.3	-3.0		0.2	0.2	28.0	27.83
HE80 Beam Forming, M0 to M9 3ss	3	6	-9.6	-4.3	-3.0		0.2	0.2	30.0	29.83
HE80 Beam Forming, M0 to M9 1ss	4	12	-9.6	-4.3	-3.0	-4.9	0.2	1.4	24.0	22.59
HE80 Beam Forming, M0 to M9 2ss	4	9	-9.6	-4.3	-3.0	-4.9	0.2	1.4	27.0	25.59
HE80 Beam Forming, M0 to M9 3ss	4	7	-9.6	-4.3	-3.0	-4.9	0.2	1.4	29.0	27.59
HE80 Beam Forming, M0 to M9 4ss	4	6	-9.6	-4.3	-3.0	-4.9	0.2	1.4	30.0	28.59
HE80 STBC, M0 to M9 1ss	2	6	-9.6	-4.3			0.2	-2.9	30.0	32.93
HE80 STBC, M0 to M9 1ss	3	6	-9.6	-4.3	-3.0		0.2	0.2	30.0	29.83
HE80 STBC, M0 to M9 1ss	4	6	-9.6	-4.3	-3.0	-4.9	0.2	1.4	30.0	28.59

5785	Non HT20, 6 to 54 Mbps	1	6	-2.4				0.1	-2.3	30.0	32.35
	Non HT20, 6 to 54 Mbps	2	9	-2.4	2.7			0.1	3.9	27.0	23.08
	Non HT20, 6 to 54 Mbps	3	11	-2.4	2.7	4.0		0.1	7.0	25.0	18.00
	<b>Non HT20, 6 to 54 Mbps</b>	<b>4</b>	<b>12</b>	<b>-2.4</b>	<b>2.7</b>	<b>4.0</b>	<b>2.3</b>	<b>0.1</b>	<b>8.3</b>	<b>24.0</b>	<b>15.72</b>
	Non HT20 Beam Forming, 6 to 54 Mbps	2	9	-2.4	2.7			0.1	3.9	27.0	23.08
	Non HT20 Beam Forming, 6 to 54 Mbps	3	11	-2.4	2.7	4.0		0.1	7.0	25.0	18.00
	Non HT20 Beam Forming, 6 to 54 Mbps	4	12	-2.4	2.7	4.0	2.3	0.1	8.3	24.0	15.72
	HT/VHT20, M0 to M7	1	6	-2.7				0.1	-2.6	30.0	32.65
	HT/VHT20, M0 to M7	2	9	-2.7	2.5			0.1	3.7	27.0	23.30
	HT/VHT20, M8 to M15	2	6	-2.7	2.5			0.1	3.7	30.0	26.30
	HT/VHT20, M0 to M7	3	11	-2.7	2.5	3.6		0.1	6.7	25.0	18.31
	HT/VHT20, M8 to M15	3	8	-2.7	2.5	3.6		0.1	6.7	28.0	21.31
	HT/VHT20, M16 to M23	3	6	-2.7	2.5	3.6		0.1	6.7	30.0	23.31
	HT/VHT20, M0 to M7	4	12	-2.7	2.5	3.6	1.7	0.1	7.9	24.0	16.10
	HT/VHT20, M8 to M15	4	9	-2.7	2.5	3.6	1.7	0.1	7.9	27.0	19.10
	HT/VHT20, M16 to M23	4	7	-2.7	2.5	3.6	1.7	0.1	7.9	29.0	21.10
	HT/VHT20, M24 to M31	4	6	-2.7	2.5	3.6	1.7	0.1	7.9	30.0	22.10
	HT/VHT20 Beam Forming, M0 to M7	2	9	-2.7	2.5			0.1	3.7	27.0	23.30
	HT/VHT20 Beam Forming, M8 to M15	2	6	-2.7	2.5			0.1	3.7	30.0	26.30
	HT/VHT20 Beam Forming, M0 to M7	3	11	-2.7	2.5	3.6		0.1	6.7	25.0	18.31
	HT/VHT20 Beam Forming, M8 to M15	3	8	-2.7	2.5	3.6		0.1	6.7	28.0	21.31
	HT/VHT20 Beam Forming, M16 to M23	3	6	-2.7	2.5	3.6		0.1	6.7	30.0	23.31
	HT/VHT20 Beam Forming, M0 to M7	4	12	-2.7	2.5	3.6	1.7	0.1	7.9	24.0	16.10
	HT/VHT20 Beam Forming, M8 to M15	4	9	-2.7	2.5	3.6	1.7	0.1	7.9	27.0	19.10
	HT/VHT20 Beam Forming, M16 to M23	4	7	-2.7	2.5	3.6	1.7	0.1	7.9	29.0	21.10
	HT/VHT20 Beam Forming, M24 to M31	4	6	-2.7	2.5	3.6	1.7	0.1	7.9	30.0	22.10
	HT/VHT20 STBC, M0 to M7	2	6	-2.7	2.5			0.1	3.7	30.0	26.30
	HT/VHT20 STBC, M0 to M7	3	8	-2.7	2.5	3.6		0.1	6.7	28.0	21.31
	HT/VHT20 STBC, M0 to M7	4	9	-2.7	2.5	3.6	1.7	0.1	7.9	27.0	19.10
	HE20, M0 to M9 1ss	1	6	-2.8				0.1	-2.7	30.0	32.73
	HE20, M0 to M9 1ss	2	9	-2.8	2.8			0.1	3.9	27.0	23.08
	HE20, M0 to M9 2ss	2	6	-2.8	2.8			0.1	3.9	30.0	26.08
	HE20, M0 to M9 1ss	3	11	-2.8	2.8	3.6		0.1	6.8	25.0	18.19
	HE20, M0 to M9 2ss	3	8	-2.8	2.8	3.6		0.1	6.8	28.0	21.19
	HE20, M0 to M9 3ss	3	6	-2.8	2.8	3.6		0.1	6.8	30.0	23.19
	HE20, M0 to M9 1ss	4	12	-2.8	2.8	3.6	1.8	0.1	8.0	24.0	15.98
	HE20, M0 to M9 2ss	4	9	-2.8	2.8	3.6	1.8	0.1	8.0	27.0	18.98
	HE20, M0 to M9 3ss	4	7	-2.8	2.8	3.6	1.8	0.1	8.0	29.0	20.98
	HE20, M0 to M9 4ss	4	6	-2.8	2.8	3.6	1.8	0.1	8.0	30.0	21.98
	HE20 Beam Forming, M0 to M9 1ss	2	9	-2.8	2.8			0.1	3.9	27.0	23.08
	HE20 Beam Forming, M0 to M9 2ss	2	6	-2.8	2.8			0.1	3.9	30.0	26.08

	HE20 Beam Forming, M0 to M9 1ss	3	11	-2.8	2.8	3.6		0.1	6.8	25.0	18.19	
	HE20 Beam Forming, M0 to M9 2ss	3	8	-2.8	2.8	3.6		0.1	6.8	28.0	21.19	
	HE20 Beam Forming, M0 to M9 3ss	3	6	-2.8	2.8	3.6		0.1	6.8	30.0	23.19	
	HE20 Beam Forming, M0 to M9 1ss	4	12	-2.8	2.8	3.6	1.8	0.1	8.0	24.0	15.98	
	HE20 Beam Forming, M0 to M9 2ss	4	9	-2.8	2.8	3.6	1.8	0.1	8.0	27.0	18.98	
	HE20 Beam Forming, M0 to M9 3ss	4	7	-2.8	2.8	3.6	1.8	0.1	8.0	29.0	20.98	
	HE20 Beam Forming, M0 to M9 4ss	4	6	-2.8	2.8	3.6	1.8	0.1	8.0	30.0	21.98	
	HE20 STBC, M0 to M9 2ss	2	6	-2.8	2.8			0.1	3.9	30.0	26.08	
	HE20 STBC, M0 to M9 2ss	3	8	-2.8	2.8	3.6		0.1	6.8	28.0	21.19	
	HE20 STBC, M0 to M9 2ss	4	9	-2.8	2.8	3.6	1.8	0.1	8.0	27.0	18.98	
5795	Non HT40, 6 to 54 Mbps	1	6	-6.2				0.1	-6.1	30.0	36.15	
	Non HT40, 6 to 54 Mbps	2	9	-6.2	-0.3			0.1	0.7	27.0	26.26	
	Non HT40, 6 to 54 Mbps	3	11	-6.2	-0.3	1.0		0.1	3.9	25.0	21.09	
	Non HT40, 6 to 54 Mbps	4	12	-6.2	-0.3	1.0	-1.3	0.1	5.1	24.0	18.93	
	HT/VHT40, M0 to M7	1	6	-6.7				0.1	-6.6	30.0	36.59	
	HT/VHT40, M0 to M7	2	9	-6.7	-0.9			0.1	0.2	27.0	26.78	
	HT/VHT40, M8 to M15	2	6	-6.7	-0.9			0.1	0.2	30.0	29.78	
	HT/VHT40, M0 to M7	3	11	-6.7	-0.9	0.1		0.1	3.2	25.0	21.77	
	HT/VHT40, M8 to M15	3	8	-6.7	-0.9	0.1		0.1	3.2	28.0	24.77	
	HT/VHT40, M16 to M23	3	6	-6.7	-0.9	0.1		0.1	3.2	30.0	26.77	
	HT/VHT40, M0 to M7	4	12	-6.7	-0.9	0.1	-1.6	0.1	4.5	24.0	19.51	
	HT/VHT40, M8 to M15	4	9	-6.7	-0.9	0.1	-1.6	0.1	4.5	27.0	22.51	
	HT/VHT40, M16 to M23	4	7	-6.7	-0.9	0.1	-1.6	0.1	4.5	29.0	24.51	
	HT/VHT40, M24 to M31	4	6	-6.7	-0.9	0.1	-1.6	0.1	4.5	30.0	25.51	
	HT/VHT40 Beam Forming, M0 to M7	2	9	-6.7	-0.9			0.1	0.2	27.0	26.78	
	HT/VHT40 Beam Forming, M8 to M15	2	6	-6.7	-0.9			0.1	0.2	30.0	29.78	
	HT/VHT40 Beam Forming, M0 to M7	3	11	-6.7	-0.9	0.1		0.1	3.2	25.0	21.77	
	HT/VHT40 Beam Forming, M8 to M15	3	8	-6.7	-0.9	0.1		0.1	3.2	28.0	24.77	
	HT/VHT40 Beam Forming, M16 to M23	3	6	-6.7	-0.9	0.1		0.1	3.2	30.0	26.77	
	HT/VHT40 Beam Forming, M0 to M7	4	12	-6.7	-0.9	0.1	-1.6	0.1	4.5	24.0	19.51	
	HT/VHT40 Beam Forming, M8 to M15	4	9	-6.7	-0.9	0.1	-1.6	0.1	4.5	27.0	22.51	
	HT/VHT40 Beam Forming, M16 to M23	4	7	-6.7	-0.9	0.1	-1.6	0.1	4.5	29.0	24.51	
	HT/VHT40 Beam Forming, M24 to M31	4	6	-6.7	-0.9	0.1	-1.6	0.1	4.5	30.0	25.51	
	HT/VHT40 STBC, M0 to M7	2	6	-6.7	-0.9			0.1	0.2	30.0	29.78	
	HT/VHT40 STBC, M0 to M7	3	8	-6.7	-0.9	0.1		0.1	3.2	28.0	24.77	
	HT/VHT40 STBC, M0 to M7	4	9	-6.7	-0.9	0.1	-1.6	0.1	4.5	27.0	22.51	
	HE40, M0 to M9 1ss	1	6	-6.6					0.1	-6.5	30.0	36.47
	HE40, M0 to M9 1ss	2	9	-6.6	-0.6				0.1	0.5	27.0	26.50
	HE40, M0 to M9 2ss	2	6	-6.6	-0.6				0.1	0.5	30.0	29.50
	HE40, M0 to M9 1ss	3	11	-6.6	-0.6	0.1			0.1	3.4	25.0	21.63
	HE40, M0 to M9 2ss	3	8	-6.6	-0.6	0.1			0.1	3.4	28.0	24.63
	HE40, M0 to M9 3ss	3	6	-6.6	-0.6	0.1			0.1	3.4	30.0	26.63



	HE40, M0 to M9 1ss	4	12	-6.6	-0.6	0.1	-1.6	0.1	4.6	24.0	19.40
	HE40, M0 to M9 2ss	4	9	-6.6	-0.6	0.1	-1.6	0.1	4.6	27.0	22.40
	HE40, M0 to M9 3ss	4	7	-6.6	-0.6	0.1	-1.6	0.1	4.6	29.0	24.40
	HE40, M0 to M9 4ss	4	6	-6.6	-0.6	0.1	-1.6	0.1	4.6	30.0	25.40
	HE40 Beam Forming, M0 to M9 1ss	2	9	-6.6	-0.6			0.1	0.5	27.0	26.50
	HE40 Beam Forming, M0 to M9 2ss	2	6	-6.6	-0.6			0.1	0.5	30.0	29.50
	HE40 Beam Forming, M0 to M9 1ss	3	11	-6.6	-0.6	0.1		0.1	3.4	25.0	21.63
	HE40 Beam Forming, M0 to M9 2ss	3	8	-6.6	-0.6	0.1		0.1	3.4	28.0	24.63
	HE40 Beam Forming, M0 to M9 3ss	3	6	-6.6	-0.6	0.1		0.1	3.4	30.0	26.63
	HE40 Beam Forming, M0 to M9 1ss	4	12	-6.6	-0.6	0.1	-1.6	0.1	4.6	24.0	19.40
	HE40 Beam Forming, M0 to M9 2ss	4	9	-6.6	-0.6	0.1	-1.6	0.1	4.6	27.0	22.40
	HE40 Beam Forming, M0 to M9 3ss	4	7	-6.6	-0.6	0.1	-1.6	0.1	4.6	29.0	24.40
	HE40 Beam Forming, M0 to M9 4ss	4	6	-6.6	-0.6	0.1	-1.6	0.1	4.6	30.0	25.40
	HE40 STBC, M0 to M9 2ss	2	6	-6.6	-0.6			0.1	0.5	30.0	29.50
	HE40 STBC, M0 to M9 2ss	3	8	-6.6	-0.6	0.1		0.1	3.4	28.0	24.63
	HE40 STBC, M0 to M9 2ss	4	9	-6.6	-0.6	0.1	-1.6	0.1	4.6	27.0	22.40
5825	Non HT20, 6 to 54 Mbps	1	6	-2.1				0.1	-2.0	30.0	32.05
	Non HT20, 6 to 54 Mbps	2	9	-2.1	2.3			0.1	3.7	27.0	23.30
	Non HT20, 6 to 54 Mbps	3	11	-2.1	2.3	3.9		0.1	6.8	25.0	18.16
	Non HT20, 6 to 54 Mbps	4	12	-2.1	2.3	3.9	2.2	0.1	8.1	24.0	15.87
	Non HT20 Beam Forming, 6 to 54 Mbps	2	9	-2.1	2.3			0.1	3.7	27.0	23.30
	Non HT20 Beam Forming, 6 to 54 Mbps	3	11	-2.1	2.3	3.9		0.1	6.8	25.0	18.16
	Non HT20 Beam Forming, 6 to 54 Mbps	4	12	-2.1	2.3	3.9	2.2	0.1	8.1	24.0	15.87
	HT/VHT20, M0 to M7	1	6	-2.4				0.1	-2.3	30.0	32.35
	HT/VHT20, M0 to M7	2	9	-2.4	2.3			0.1	3.6	27.0	23.38
	HT/VHT20, M8 to M15	2	6	-2.4	2.3			0.1	3.6	30.0	26.38
	HT/VHT20, M0 to M7	3	11	-2.4	2.3	3.5		0.1	6.6	25.0	18.40
	HT/VHT20, M8 to M15	3	8	-2.4	2.3	3.5		0.1	6.6	28.0	21.40
	HT/VHT20, M16 to M23	3	6	-2.4	2.3	3.5		0.1	6.6	30.0	23.40
	HT/VHT20, M0 to M7	4	12	-2.4	2.3	3.5	1.9	0.1	7.9	24.0	16.12
	HT/VHT20, M8 to M15	4	9	-2.4	2.3	3.5	1.9	0.1	7.9	27.0	19.12
	HT/VHT20, M16 to M23	4	7	-2.4	2.3	3.5	1.9	0.1	7.9	29.0	21.12
	HT/VHT20, M24 to M31	4	6	-2.4	2.3	3.5	1.9	0.1	7.9	30.0	22.12
	HT/VHT20 Beam Forming, M0 to M7	2	9	-2.4	2.3			0.1	3.6	27.0	23.38
	HT/VHT20 Beam Forming, M8 to M15	2	6	-2.4	2.3			0.1	3.6	30.0	26.38
	HT/VHT20 Beam Forming, M0 to M7	3	11	-2.4	2.3	3.5		0.1	6.6	25.0	18.40
	HT/VHT20 Beam Forming, M8 to M15	3	8	-2.4	2.3	3.5		0.1	6.6	28.0	21.40
	HT/VHT20 Beam Forming, M16 to M23	3	6	-2.4	2.3	3.5		0.1	6.6	30.0	23.40
	HT/VHT20 Beam Forming, M0 to M7	4	12	-2.4	2.3	3.5	1.9	0.1	7.9	24.0	16.12
HT/VHT20 Beam Forming, M8 to M15	4	9	-2.4	2.3	3.5	1.9	0.1	7.9	27.0	19.12	
HT/VHT20 Beam Forming, M16 to M23	4	7	-2.4	2.3	3.5	1.9	0.1	7.9	29.0	21.12	
HT/VHT20 Beam Forming, M24 to M31	4	6	-2.4	2.3	3.5	1.9	0.1	7.9	30.0	22.12	



HT/VHT20 STBC, M0 to M7	2	6	-2.4	2.3				0.1	3.6	30.0	26.38
HT/VHT20 STBC, M0 to M7	3	8	-2.4	2.3	3.5			0.1	6.6	28.0	21.40
HT/VHT20 STBC, M0 to M7	4	9	-2.4	2.3	3.5	1.9		0.1	7.9	27.0	19.12
HE20, M0 to M9 1ss	1	6	-2.6					0.1	-2.5	30.0	32.53
HE20, M0 to M9 1ss	2	9	-2.6	2.0				0.1	3.4	27.0	23.64
HE20, M0 to M9 2ss	2	6	-2.6	2.0				0.1	3.4	30.0	26.64
HE20, M0 to M9 1ss	3	11	-2.6	2.0	3.8			0.1	6.6	25.0	18.37
HE20, M0 to M9 2ss	3	8	-2.6	2.0	3.8			0.1	6.6	28.0	21.37
HE20, M0 to M9 3ss	3	6	-2.6	2.0	3.8			0.1	6.6	30.0	23.37
HE20, M0 to M9 1ss	4	12	-2.6	2.0	3.8	2.0		0.1	7.9	24.0	16.07
HE20, M0 to M9 2ss	4	9	-2.6	2.0	3.8	2.0		0.1	7.9	27.0	19.07
HE20, M0 to M9 3ss	4	7	-2.6	2.0	3.8	2.0		0.1	7.9	29.0	21.07
HE20, M0 to M9 4ss	4	6	-2.6	2.0	3.8	2.0		0.1	7.9	30.0	22.07
HE20 Beam Forming, M0 to M9 1ss	2	9	-2.6	2.0				0.1	3.4	27.0	23.64
HE20 Beam Forming, M0 to M9 2ss	2	6	-2.6	2.0				0.1	3.4	30.0	26.64
HE20 Beam Forming, M0 to M9 1ss	3	11	-2.6	2.0	3.8			0.1	6.6	25.0	18.37
HE20 Beam Forming, M0 to M9 2ss	3	8	-2.6	2.0	3.8			0.1	6.6	28.0	21.37
HE20 Beam Forming, M0 to M9 3ss	3	6	-2.6	2.0	3.8			0.1	6.6	30.0	23.37
HE20 Beam Forming, M0 to M9 1ss	4	12	-2.6	2.0	3.8	2.0		0.1	7.9	24.0	16.07
HE20 Beam Forming, M0 to M9 2ss	4	9	-2.6	2.0	3.8	2.0		0.1	7.9	27.0	19.07
HE20 Beam Forming, M0 to M9 3ss	4	7	-2.6	2.0	3.8	2.0		0.1	7.9	29.0	21.07
HE20 Beam Forming, M0 to M9 4ss	4	6	-2.6	2.0	3.8	2.0		0.1	7.9	30.0	22.07
HE20 STBC, M0 to M9 2ss	2	6	-2.6	2.0				0.1	3.4	30.0	26.64
HE20 STBC, M0 to M9 2ss	3	8	-2.6	2.0	3.8			0.1	6.6	28.0	21.37
HE20 STBC, M0 to M9 2ss	4	9	-2.6	2.0	3.8	2.0		0.1	7.9	27.0	19.07



**Power Spectral Density, 6dBi**  
**5785 MHz, Non HT20, 6 to 54 Mbps**

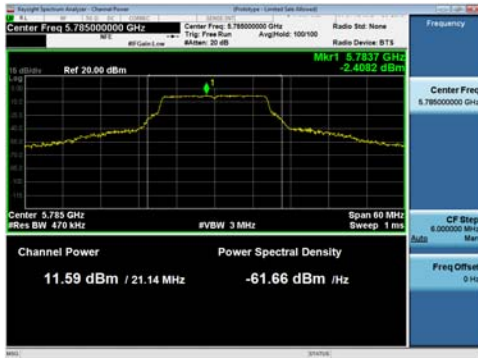

**Antenna A**

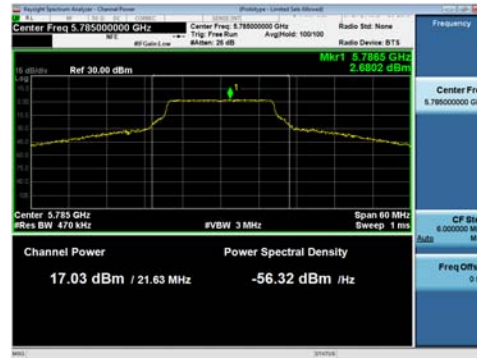

**Antenna B**

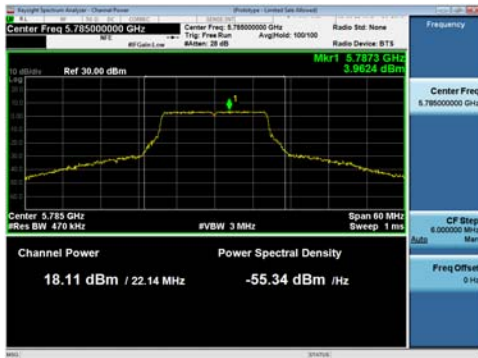

**Antenna C**

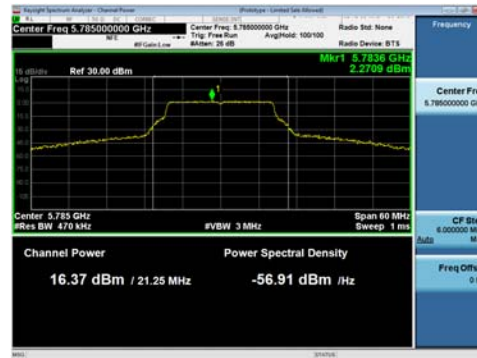

**Antenna D**

## A.6 Conducted Spurious Emissions

**15.205 / 15.209 / LP0002** - Radiated emissions which fall in the restricted bands, as defined in Section 15.205(a), must also comply with the radiated emission limits specified in Section 15.209(a) (see Section 15.205(c)).

**RSS-Gen 8.9:** Except when the requirements applicable to a given device state otherwise, emissions from licence-exempt transmitters shall comply with the field strength limits shown in Table 4 and Table 5 below. Additionally, the level of any transmitter emission shall not exceed the level of the transmitter's fundamental emission.

**RSS-Gen 8.10 (b)** Unwanted emissions that fall into restricted bands of Table 6 shall comply with the limits specified in RSS-Gen; and **(c)** Unwanted emissions that do not fall within the restricted frequency bands of Table 6 shall comply either with the limits specified in the applicable RSS or with those specified in this RSS-Gen.

Use formula below to substitute conducted measurements in place of radiated measurements

$$E[\text{dB}\mu\text{V}/\text{m}] = \text{EIRP}[\text{dBm}] - 20 \log(d[\text{meters}]) + 104.77, \text{ where } E = \text{field strength and } d = 3 \text{ meter}$$

- 1) Average Plot, Limit= -41.25 dBm eirp
- 2) Peak plot, Limit = -21.25 dBm eirp

### Test Procedure

**Ref.** KDB 789033 D02 General UNII Test Procedures New Rules v01r03  
ANSI C63.10: 2013

<b>Conducted Spurious Emissions</b> Test Procedure
<ol style="list-style-type: none"> <li>1. Connect the antenna port(s) to the spectrum analyzer input.</li> <li>2. Place the radio in continuous transmit mode. Use the procedures in KDB 789033 D02 General UNII Test Procedures New Rules v01r03 to substitute conducted measurements in place of radiated measurements.</li> <li>3. Configure Spectrum analyzer as per test parameters below (be sure to enter all losses between the transmitter output and the spectrum analyzer).</li> <li>4. Record the marker waveform peak to spur difference. Also measure any emissions in the restricted bands.</li> <li>5. The "measure-and-sum technique" is used for measuring in-band transmit power of a device. In the measure-and-sum approach, the conducted emission level is measured at each antenna port. The measured results at the various antenna ports are then summed mathematically to determine the total emission level from the device. Summing is performed in linear power units. The worst case output is recorded.</li> <li>6. Capture graphs and record pertinent measurement data.</li> </ol>

**Ref.** KDB 789033 D02 General UNII Test Procedures New Rules v01r03  
ANSI C63.10: 2013 section 12.7.7.3 (average) & 12.7.6 (peak)

<b>Conducted Spurious Emissions</b> Test parameters
Span = 30MHz to 18GHz / 18GHz to 40GHz RBW = 1 MHz VBW ≥ 3 x RBW for Peak, 1kHz for Average Sweep = Auto couple Detector = Peak Trace = Max Hold.

System Number	Description	Samples	System under test	Support equipment
1	EUT	S01+S02	<input checked="" type="checkbox"/>	<input type="checkbox"/>
	Support		<input type="checkbox"/>	<input checked="" type="checkbox"/>

<b>Tested By :</b> Chris Blair	<b>Date of testing:</b> 25-Sep-19 - 01-Oct-19
<b>Test Result : PASS</b>	

See Appendix C for list of test equipment

**Conducted Spurs Average Upper, 5745 MHz, Non HT20, 6 to 54 Mbps**



**Conducted Spurs Peak Upper, 5745 MHz, Non HT20, 6 to 54 Mbps**

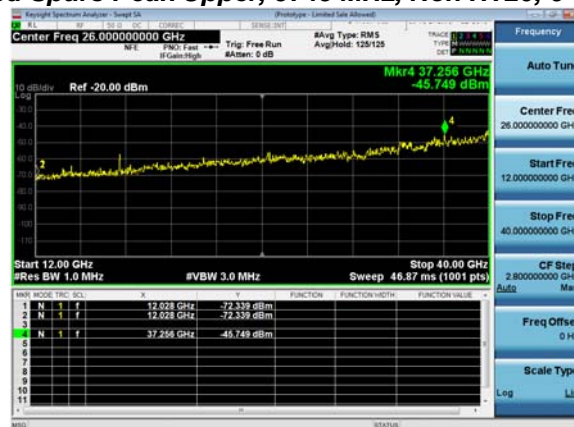

## Conducted Spurious Average Table, 4dBi

Frequency (MHz)	Mode	Tx Paths	Correlated Antenna Gain (dBi)	Tx 1 Spur Power (dBm)	Tx 2 Spur Power (dBm)	Tx 3 Spur Power (dBm)	Tx 4 Spur Power (dBm)	Duty Cycle Correction (dB)	Total Conducted Spur (dBm)	Limit (dBm)	Margin (dB)
5720 <sup>15</sup>	Non HT20, 6 to 54 Mbps	1	4	-63.7				0.1	-59.6	-41.25	18.40
	Non HT20, 6 to 54 Mbps	2	4	-63.7	-61.0			0.1	-55.1	-41.25	13.83
	Non HT20, 6 to 54 Mbps	3	4	-63.7	-61.0	-60.7		0.1	-52.8	-41.25	11.54
	Non HT20, 6 to 54 Mbps	4	4	-63.7	-61.0	-60.7	-60.5	0.1	-51.2	-41.25	9.98
	Non HT20 Beam Forming, 6 to 54 Mbps	2	7	-63.7	-61.0			0.1	-52.1	-41.25	10.83
	Non HT20 Beam Forming, 6 to 54 Mbps	3	9	-63.7	-61.3	-61.6		0.1	-48.3	-41.25	7.00
	Non HT20 Beam Forming, 6 to 54 Mbps	4	10	-63.7	-62.9	-63.3	-63.3	0.1	-47.2	-41.25	5.97
	HT/VHT20, M0 to M7	1	4	-63.6				0.1	-59.5	-41.25	18.30
	HT/VHT20, M0 to M7	2	4	-63.6	-61.0			0.1	-55.0	-41.25	13.80
	HT/VHT20, M8 to M15	2	4	-63.6	-61.0			0.1	-55.0	-41.25	13.80
	HT/VHT20, M0 to M7	3	4	-63.6	-61.0	-60.7		0.1	-52.8	-41.25	11.51
	HT/VHT20, M8 to M15	3	4	-63.6	-61.0	-60.7		0.1	-52.8	-41.25	11.51
	HT/VHT20, M16 to M23	3	4	-63.6	-61.0	-60.7		0.1	-52.8	-41.25	11.51
	HT/VHT20, M0 to M7	4	4	-63.6	-61.0	-60.7	-61.1	0.1	-51.4	-41.25	10.14
	HT/VHT20, M8 to M15	4	4	-63.6	-61.0	-60.7	-61.1	0.1	-51.4	-41.25	10.14
	HT/VHT20, M16 to M23	4	4	-63.6	-61.0	-60.7	-61.1	0.1	-51.4	-41.25	10.14
	HT/VHT20, M24 to M31	4	4	-63.6	-61.0	-60.7	-61.1	0.1	-51.4	-41.25	10.14
	HT/VHT20 Beam Forming, M0 to M7	2	7	-63.6	-61.0			0.1	-52.0	-41.25	10.80
	HT/VHT20 Beam Forming, M8 to M15	2	4	-63.6	-61.0			0.1	-55.0	-41.25	13.80
	HT/VHT20 Beam Forming, M0 to M7	3	9	-63.6	-61.6	-61.9		0.1	-48.5	-41.25	7.21
	HT/VHT20 Beam Forming, M8 to M15	3	6	-63.6	-61.0	-60.7		0.1	-50.8	-41.25	9.51
	HT/VHT20 Beam Forming, M16 to M23	3	4	-63.6	-61.0	-60.7		0.1	-52.8	-41.25	11.51
	HT/VHT20 Beam Forming, M0 to M7	4	10	-63.6	-62.9	-63.4	-63.3	0.1	-47.2	-41.25	5.97
	HT/VHT20 Beam Forming, M8 to M15	4	7	-63.6	-61.0	-60.7	-61.1	0.1	-48.4	-41.25	7.14
	HT/VHT20 Beam Forming, M16 to M23	4	5	-63.6	-61.0	-60.7	-61.1	0.1	-50.4	-41.25	9.14
	HT/VHT20 Beam Forming, M24 to M31	4	4	-63.6	-61.0	-60.7	-61.1	0.1	-51.4	-41.25	10.14
	HT/VHT20 STBC, M0 to M7	2	4	-63.6	-61.0			0.1	-55.0	-41.25	13.80
	HT/VHT20 STBC, M0 to M7	3	4	-63.6	-61.0	-60.7		0.1	-52.8	-41.25	11.51
HT/VHT20 STBC, M0 to M7	4	4	-63.6	-61.0	-60.7	-61.1	0.1	-51.4	-41.25	10.14	

<sup>15</sup> 5720 (ch144) not supported for Canada.



	HE20, M0 to M9 1ss	1	4	-63.9				0.1	-59.8	-41.25	18.58
	HE20, M0 to M9 1ss	2	4	-63.9	-60.9			0.1	-55.1	-41.25	13.82
	HE20, M0 to M9 2ss	2	4	-63.9	-60.9			0.1	-55.1	-41.25	13.82
	HE20, M0 to M9 1ss	3	4	-63.9	-60.9	-61.1		0.1	-52.9	-41.25	11.68
	HE20, M0 to M9 2ss	3	4	-63.9	-60.9	-61.1		0.1	-52.9	-41.25	11.68
	HE20, M0 to M9 3ss	3	4	-63.9	-60.9	-61.1		0.1	-52.9	-41.25	11.68
	HE20, M0 to M9 1ss	4	4	-63.9	-60.9	-61.1	-60.5	0.1	-51.3	-41.25	10.08
	HE20, M0 to M9 2ss	4	4	-63.9	-60.9	-61.1	-60.5	0.1	-51.3	-41.25	10.08
	HE20, M0 to M9 3ss	4	4	-63.9	-60.9	-61.1	-60.5	0.1	-51.3	-41.25	10.08
	HE20, M0 to M9 4ss	4	4	-63.9	-60.9	-61.1	-60.5	0.1	-51.3	-41.25	10.08
	HE20 Beam Forming, M0 to M9 1ss	2	7	-63.9	-60.9			0.1	-52.1	-41.25	10.82
	HE20 Beam Forming, M0 to M9 2ss	2	4	-63.9	-60.9			0.1	-55.1	-41.25	13.82
	HE20 Beam Forming, M0 to M9 1ss	3	9	-63.9	-61.8	-61.8		0.1	-48.6	-41.25	7.30
	HE20 Beam Forming, M0 to M9 2ss	3	6	-63.9	-60.9	-61.1		0.1	-50.9	-41.25	9.68
	HE20 Beam Forming, M0 to M9 3ss	3	4	-63.9	-60.9	-61.1		0.1	-52.9	-41.25	11.68
	HE20 Beam Forming, M0 to M9 1ss	4	10	-63.9	-63.2	-63.3	-63.6	0.1	-47.4	-41.25	6.15
	HE20 Beam Forming, M0 to M9 2ss	4	7	-63.9	-60.9	-61.1	-60.5	0.1	-48.3	-41.25	7.08
	HE20 Beam Forming, M0 to M9 3ss	4	5	-63.9	-60.9	-61.1	-60.5	0.1	-50.3	-41.25	9.08
	HE20 Beam Forming, M0 to M9 4ss	4	4	-63.9	-60.9	-61.1	-60.5	0.1	-51.3	-41.25	10.08
	HE20 STBC, M0 to M9 2ss	2	4	-63.9	-60.9			0.1	-55.1	-41.25	13.82
	HE20 STBC, M0 to M9 2ss	3	4	-63.9	-60.9	-61.1		0.1	-52.9	-41.25	11.68
	HE20 STBC, M0 to M9 2ss	4	4	-63.9	-60.9	-61.1	-60.5	0.1	-51.3	-41.25	10.08
5745	Non HT20, 6 to 54 Mbps	1	4	-65.2				0.1	-61.1	-41.25	19.90
	Non HT20, 6 to 54 Mbps	2	4	-65.2	-59.5			0.1	-54.4	-41.25	13.16
	Non HT20, 6 to 54 Mbps	3	4	-65.2	-59.5	-59.0		0.1	-51.7	-41.25	10.41
	Non HT20, 6 to 54 Mbps	4	4	-65.2	-59.5	-59.0	-60.2	0.1	-50.3	-41.25	9.09
	Non HT20 Beam Forming, 6 to 54 Mbps	2	7	-65.2	-59.5			0.1	-51.4	-41.25	10.16
	Non HT20 Beam Forming, 6 to 54 Mbps	3	9	-65.2	-59.5	-59.0		0.1	-46.7	-41.25	5.41
	Non HT20 Beam Forming, 6 to 54 Mbps	4	10	-65.2	-59.5	-59.0	-60.2	0.1	-44.3	-41.25	3.09
	HT/VHT20, M0 to M7	1	4	-66.0				0.1	-61.9	-41.25	20.70
	HT/VHT20, M0 to M7	2	4	-66.0	-59.5			0.1	-54.6	-41.25	13.32
	HT/VHT20, M8 to M15	2	4	-66.0	-59.5			0.1	-54.6	-41.25	13.32
	HT/VHT20, M0 to M7	3	4	-66.0	-59.5	-59.0		0.1	-51.7	-41.25	10.49
	HT/VHT20, M8 to M15	3	4	-66.0	-59.5	-59.0		0.1	-51.7	-41.25	10.49
	HT/VHT20, M16 to M23	3	4	-66.0	-59.5	-59.0		0.1	-51.7	-41.25	10.49
	HT/VHT20, M0 to M7	4	4	-66.0	-59.5	-59.0	-59.9	0.1	-50.3	-41.25	9.07
	HT/VHT20, M8 to M15	4	4	-66.0	-59.5	-59.0	-59.9	0.1	-50.3	-41.25	9.07
	HT/VHT20, M16 to M23	4	4	-66.0	-59.5	-59.0	-59.9	0.1	-50.3	-41.25	9.07
	HT/VHT20, M24 to M31	4	4	-66.0	-59.5	-59.0	-59.9	0.1	-50.3	-41.25	9.07
	HT/VHT20 Beam Forming, M0 to M7	2	7	-66.0	-59.5			0.1	-51.6	-41.25	10.32
HT/VHT20 Beam Forming, M8 to M15	2	4	-66.0	-59.5			0.1	-54.6	-41.25	13.32	
HT/VHT20 Beam Forming, M0 to M7	3	9	-66.0	-59.5	-59.0		0.1	-46.7	-41.25	5.49	

HT/VHT20 Beam Forming, M8 to M15	3	6	-66.0	-59.5	-59.0		0.1	-49.7	-41.25	8.49
HT/VHT20 Beam Forming, M16 to M23	3	4	-66.0	-59.5	-59.0		0.1	-51.7	-41.25	10.49
HT/VHT20 Beam Forming, M0 to M7	4	10	-66.0	-59.5	-59.0	-59.9	0.1	-44.3	-41.25	3.07
HT/VHT20 Beam Forming, M8 to M15	4	7	-66.0	-59.5	-59.0	-59.9	0.1	-47.3	-41.25	6.07
HT/VHT20 Beam Forming, M16 to M23	4	5	-66.0	-59.5	-59.0	-59.9	0.1	-49.3	-41.25	8.07
HT/VHT20 Beam Forming, M24 to M31	4	4	-66.0	-59.5	-59.0	-59.9	0.1	-50.3	-41.25	9.07
HT/VHT20 STBC, M0 to M7	2	4	-66.0	-59.5			0.1	-54.6	-41.25	13.32
HT/VHT20 STBC, M0 to M7	3	4	-66.0	-59.5	-59.0		0.1	-51.7	-41.25	10.49
HT/VHT20 STBC, M0 to M7	4	4	-66.0	-59.5	-59.0	-59.9	0.1	-50.3	-41.25	9.07
HE20, M0 to M9 1ss	1	4	-65.8				0.1	-61.7	-41.25	20.48
HE20, M0 to M9 1ss	2	4	-65.8	-59.6			0.1	-54.6	-41.25	13.35
HE20, M0 to M9 2ss	2	4	-65.8	-59.6			0.1	-54.6	-41.25	13.35
HE20, M0 to M9 1ss	3	4	-65.8	-59.6	-59.0		0.1	-51.8	-41.25	10.50
HE20, M0 to M9 2ss	3	4	-65.8	-59.6	-59.0		0.1	-51.8	-41.25	10.50
HE20, M0 to M9 3ss	3	4	-65.8	-59.6	-59.0		0.1	-51.8	-41.25	10.50
HE20, M0 to M9 1ss	4	4	-65.8	-59.6	-59.0	-59.8	0.1	-50.3	-41.25	9.04
HE20, M0 to M9 2ss	4	4	-65.8	-59.6	-59.0	-59.8	0.1	-50.3	-41.25	9.04
HE20, M0 to M9 3ss	4	4	-65.8	-59.6	-59.0	-59.8	0.1	-50.3	-41.25	9.04
HE20, M0 to M9 4ss	4	4	-65.8	-59.6	-59.0	-59.8	0.1	-50.3	-41.25	9.04
HE20 Beam Forming, M0 to M9 1ss	2	7	-65.8	-59.6			0.1	-51.6	-41.25	10.35
HE20 Beam Forming, M0 to M9 2ss	2	4	-65.8	-59.6			0.1	-54.6	-41.25	13.35
HE20 Beam Forming, M0 to M9 1ss	3	9	-65.8	-59.6	-59.0		0.1	-46.8	-41.25	5.50
HE20 Beam Forming, M0 to M9 2ss	3	6	-65.8	-59.6	-59.0		0.1	-49.8	-41.25	8.50
HE20 Beam Forming, M0 to M9 3ss	3	4	-65.8	-59.6	-59.0		0.1	-51.8	-41.25	10.50
HE20 Beam Forming, M0 to M9 1ss	4	10	-65.8	-59.6	-59.0	-59.8	0.1	-44.3	-41.25	3.04
HE20 Beam Forming, M0 to M9 2ss	4	7	-65.8	-59.6	-59.0	-59.8	0.1	-47.3	-41.25	6.04
HE20 Beam Forming, M0 to M9 3ss	4	5	-65.8	-59.6	-59.0	-59.8	0.1	-49.3	-41.25	8.04
HE20 Beam Forming, M0 to M9 4ss	4	4	-65.8	-59.6	-59.0	-59.8	0.1	-50.3	-41.25	9.04
HE20 STBC, M0 to M9 2ss	2	4	-65.8	-59.6			0.1	-54.6	-41.25	13.35
HE20 STBC, M0 to M9 2ss	3	4	-65.8	-59.6	-59.0		0.1	-51.8	-41.25	10.50
HE20 STBC, M0 to M9 2ss	4	4	-65.8	-59.6	-59.0	-59.8	0.1	-50.3	-41.25	9.04
5755										
Non HT40, 6 to 54 Mbps	1	4	-65.3				0.1	-61.2	-41.25	20.00
Non HT40, 6 to 54 Mbps	2	4	-65.3	-59.1			0.1	-54.1	-41.25	12.87
Non HT40, 6 to 54 Mbps	3	4	-65.3	-59.1	-58.8		0.1	-51.4	-41.25	10.16
Non HT40, 6 to 54 Mbps	4	4	-65.3	-59.1	-58.8	-60.0	0.1	-50.1	-41.25	8.85
HT/VHT40, M0 to M7	1	4	-66.0				0.1	-61.9	-41.25	20.64
HT/VHT40, M0 to M7	2	4	-66.0	-59.4			0.1	-54.4	-41.25	13.18
HT/VHT40, M8 to M15	2	4	-66.0	-59.4			0.1	-54.4	-41.25	13.18
HT/VHT40, M0 to M7	3	4	-66.0	-59.4	-59.3		0.1	-51.8	-41.25	10.53
HT/VHT40, M8 to M15	3	4	-66.0	-59.4	-59.3		0.1	-51.8	-41.25	10.53
HT/VHT40, M16 to M23	3	4	-66.0	-59.4	-59.3		0.1	-51.8	-41.25	10.53
HT/VHT40, M0 to M7	4	4	-66.0	-59.4	-59.3	-60.2	0.1	-50.4	-41.25	9.16

	HT/VHT40, M8 to M15	4	4	-66.0	-59.4	-59.3	-60.2	0.1	-50.4	-41.25	9.16
	HT/VHT40, M16 to M23	4	4	-66.0	-59.4	-59.3	-60.2	0.1	-50.4	-41.25	9.16
	HT/VHT40, M24 to M31	4	4	-66.0	-59.4	-59.3	-60.2	0.1	-50.4	-41.25	9.16
	HT/VHT40 Beam Forming, M0 to M7	2	7	-66.0	-59.4			0.1	-51.4	-41.25	10.18
	HT/VHT40 Beam Forming, M8 to M15	2	4	-66.0	-59.4			0.1	-54.4	-41.25	13.18
	HT/VHT40 Beam Forming, M0 to M7	3	9	-66.0	-59.4	-59.3		0.1	-46.8	-41.25	5.53
	HT/VHT40 Beam Forming, M8 to M15	3	6	-66.0	-59.4	-59.3		0.1	-49.8	-41.25	8.53
	HT/VHT40 Beam Forming, M16 to M23	3	4	-66.0	-59.4	-59.3		0.1	-51.8	-41.25	10.53
	HT/VHT40 Beam Forming, M0 to M7	4	10	-66.0	-59.4	-59.3	-60.2	0.1	-44.4	-41.25	3.16
	HT/VHT40 Beam Forming, M8 to M15	4	7	-66.0	-59.4	-59.3	-60.2	0.1	-47.4	-41.25	6.16
	HT/VHT40 Beam Forming, M16 to M23	4	5	-66.0	-59.4	-59.3	-60.2	0.1	-49.4	-41.25	8.16
	HT/VHT40 Beam Forming, M24 to M31	4	4	-66.0	-59.4	-59.3	-60.2	0.1	-50.4	-41.25	9.16
	HT/VHT40 STBC, M0 to M7	2	4	-66.0	-59.4			0.1	-54.4	-41.25	13.18
	HT/VHT40 STBC, M0 to M7	3	4	-66.0	-59.4	-59.3		0.1	-51.8	-41.25	10.53
	HT/VHT40 STBC, M0 to M7	4	4	-66.0	-59.4	-59.3	-60.2	0.1	-50.4	-41.25	9.16
	HE40, M0 to M9 1ss	1	4	-65.9				0.1	-61.8	-41.25	20.52
	HE40, M0 to M9 1ss	2	4	-65.9	-59.4			0.1	-54.4	-41.25	13.15
	HE40, M0 to M9 2ss	2	4	-65.9	-59.4			0.1	-54.4	-41.25	13.15
	HE40, M0 to M9 1ss	3	4	-65.9	-59.4	-59.1		0.1	-51.7	-41.25	10.42
	HE40, M0 to M9 2ss	3	4	-65.9	-59.4	-59.1		0.1	-51.7	-41.25	10.42
	HE40, M0 to M9 3ss	3	4	-65.9	-59.4	-59.1		0.1	-51.7	-41.25	10.42
	HE40, M0 to M9 1ss	4	4	-65.9	-59.4	-59.1	-60.1	0.1	-50.3	-41.25	9.05
	HE40, M0 to M9 2ss	4	4	-65.9	-59.4	-59.1	-60.1	0.1	-50.3	-41.25	9.05
	HE40, M0 to M9 3ss	4	4	-65.9	-59.4	-59.1	-60.1	0.1	-50.3	-41.25	9.05
	HE40, M0 to M9 4ss	4	4	-65.9	-59.4	-59.1	-60.1	0.1	-50.3	-41.25	9.05
	HE40 Beam Forming, M0 to M9 1ss	2	7	-65.9	-59.4			0.1	-51.4	-41.25	10.15
	HE40 Beam Forming, M0 to M9 2ss	2	4	-65.9	-59.4			0.1	-54.4	-41.25	13.15
	HE40 Beam Forming, M0 to M9 1ss	3	9	-65.9	-59.4	-59.1		0.1	-46.7	-41.25	5.42
	HE40 Beam Forming, M0 to M9 2ss	3	6	-65.9	-59.4	-59.1		0.1	-49.7	-41.25	8.42
	HE40 Beam Forming, M0 to M9 3ss	3	4	-65.9	-59.4	-59.1		0.1	-51.7	-41.25	10.42
	HE40 Beam Forming, M0 to M9 1ss	4	10	-65.9	-59.4	-59.1	-60.1	0.1	-44.3	-41.25	3.05
	HE40 Beam Forming, M0 to M9 2ss	4	7	-65.9	-59.4	-59.1	-60.1	0.1	-47.3	-41.25	6.05
	HE40 Beam Forming, M0 to M9 3ss	4	5	-65.9	-59.4	-59.1	-60.1	0.1	-49.3	-41.25	8.05
	HE40 Beam Forming, M0 to M9 4ss	4	4	-65.9	-59.4	-59.1	-60.1	0.1	-50.3	-41.25	9.05
	HE40 STBC, M0 to M9 2ss	2	4	-65.9	-59.4			0.1	-54.4	-41.25	13.15
	HE40 STBC, M0 to M9 2ss	3	4	-65.9	-59.4	-59.1		0.1	-51.7	-41.25	10.42
	HE40 STBC, M0 to M9 2ss	4	4	-65.9	-59.4	-59.1	-60.1	0.1	-50.3	-41.25	9.05
5775	Non HT80, 6 to 54 Mbps	1	4	-64.6				0.0	-60.6	-41.25	19.30
	Non HT80, 6 to 54 Mbps	2	4	-64.6	-58.9			0.0	-53.8	-41.25	12.57
	Non HT80, 6 to 54 Mbps	3	4	-64.6	-58.9	-58.0		0.0	-50.9	-41.25	9.62
	Non HT80, 6 to 54 Mbps	4	4	-64.6	-58.9	-58.0	-58.9	0.0	-49.4	-41.25	8.16
	VHT80, M0 to M9 1ss	1	4	-65.4				0.2	-61.2	-41.25	19.93



VHT80, M0 to M9 1ss	2	4	-65.4	-59.9			0.2	-54.6	-41.25	13.35
VHT80, M0 to M9 2ss	2	4	-65.4	-59.9			0.2	-54.6	-41.25	13.35
VHT80, M0 to M9 1ss	3	4	-65.4	-59.9	-58.5		0.2	-51.4	-41.25	10.17
VHT80, M0 to M9 2ss	3	4	-65.4	-59.9	-58.5		0.2	-51.4	-41.25	10.17
VHT80, M0 to M9 3ss	3	4	-65.4	-59.9	-58.5		0.2	-51.4	-41.25	10.17
VHT80, M0 to M9 1ss	4	4	-65.4	-59.9	-58.5	-59.7	0.2	-50.0	-41.25	8.73
VHT80, M0 to M9 2ss	4	4	-65.4	-59.9	-58.5	-59.7	0.2	-50.0	-41.25	8.73
VHT80, M0 to M9 3ss	4	4	-65.4	-59.9	-58.5	-59.7	0.2	-50.0	-41.25	8.73
VHT80, M0 to M9 4ss	4	4	-65.4	-59.9	-58.5	-59.7	0.2	-50.0	-41.25	8.73
VHT80 Beam Forming, M0 to M9 1ss	2	7	-65.4	-59.9			0.2	-51.6	-41.25	10.35
VHT80 Beam Forming, M0 to M9 2ss	2	4	-65.4	-59.9			0.2	-54.6	-41.25	13.35
VHT80 Beam Forming, M0 to M9 1ss	3	9	-65.4	-59.9	-58.5		0.2	-46.4	-41.25	5.17
VHT80 Beam Forming, M0 to M9 2ss	3	6	-65.4	-59.9	-58.5		0.2	-49.4	-41.25	8.17
VHT80 Beam Forming, M0 to M9 3ss	3	4	-65.4	-59.9	-58.5		0.2	-51.4	-41.25	10.17
VHT80 Beam Forming, M0 to M9 1ss	4	10	-65.4	-59.9	-58.5	-59.7	0.2	-44.0	-41.25	2.73
VHT80 Beam Forming, M0 to M9 2ss	4	7	-65.4	-59.9	-58.5	-59.7	0.2	-47.0	-41.25	5.73
VHT80 Beam Forming, M0 to M9 3ss	4	5	-65.4	-59.9	-58.5	-59.7	0.2	-49.0	-41.25	7.73
VHT80 Beam Forming, M0 to M9 4ss	4	4	-65.4	-59.9	-58.5	-59.7	0.2	-50.0	-41.25	8.73
VHT80 STBC, M0 to M9 1ss	2	4	-65.4	-59.9			0.2	-54.6	-41.25	13.35
VHT80 STBC, M0 to M9 1ss	3	4	-65.4	-59.9	-58.5		0.2	-51.4	-41.25	10.17
VHT80 STBC, M0 to M9 1ss	4	4	-65.4	-59.9	-58.5	-59.7	0.2	-50.0	-41.25	8.73
HE80, M0 to M9 1ss	1	4	-65.3				0.2	-61.1	-41.25	19.80
HE80, M0 to M9 1ss	2	4	-65.3	-59.1			0.2	-53.9	-41.25	12.67
HE80, M0 to M9 2ss	2	4	-65.3	-59.1			0.2	-53.9	-41.25	12.67
HE80, M0 to M9 1ss	3	4	-65.3	-59.1	-58.4		0.2	-51.0	-41.25	9.77
HE80, M0 to M9 2ss	3	4	-65.3	-59.1	-58.4		0.2	-51.0	-41.25	9.77
HE80, M0 to M9 3ss	3	4	-65.3	-59.1	-58.4		0.2	-51.0	-41.25	9.77
HE80, M0 to M9 1ss	4	4	-65.3	-59.1	-58.4	-59.3	0.2	-49.6	-41.25	8.32
HE80, M0 to M9 2ss	4	4	-65.3	-59.1	-58.4	-59.3	0.2	-49.6	-41.25	8.32
HE80, M0 to M9 3ss	4	4	-65.3	-59.1	-58.4	-59.3	0.2	-49.6	-41.25	8.32
HE80, M0 to M9 4ss	4	4	-65.3	-59.1	-58.4	-59.3	0.2	-49.6	-41.25	8.32
HE80 Beam Forming, M0 to M9 1ss	2	7	-65.3	-59.1			0.2	-50.9	-41.25	9.67
HE80 Beam Forming, M0 to M9 2ss	2	4	-65.3	-59.1			0.2	-53.9	-41.25	12.67
HE80 Beam Forming, M0 to M9 1ss	3	9	-65.3	-59.1	-58.4		0.2	-46.0	-41.25	4.77
HE80 Beam Forming, M0 to M9 2ss	3	6	-65.3	-59.1	-58.4		0.2	-49.0	-41.25	7.77
HE80 Beam Forming, M0 to M9 3ss	3	4	-65.3	-59.1	-58.4		0.2	-51.0	-41.25	9.77
<b>HE80 Beam Forming, M0 to M9 1ss</b>	<b>4</b>	<b>10</b>	<b>-65.3</b>	<b>-59.1</b>	<b>-58.4</b>	<b>-59.3</b>	<b>0.2</b>	<b>-43.6</b>	<b>-41.25</b>	<b>2.32</b>
HE80 Beam Forming, M0 to M9 2ss	4	7	-65.3	-59.1	-58.4	-59.3	0.2	-46.6	-41.25	5.32
HE80 Beam Forming, M0 to M9 3ss	4	5	-65.3	-59.1	-58.4	-59.3	0.2	-48.6	-41.25	7.32
HE80 Beam Forming, M0 to M9 4ss	4	4	-65.3	-59.1	-58.4	-59.3	0.2	-49.6	-41.25	8.32
HE80 STBC, M0 to M9 1ss	2	4	-65.3	-59.1			0.2	-53.9	-41.25	12.67
HE80 STBC, M0 to M9 1ss	3	4	-65.3	-59.1	-58.4		0.2	-51.0	-41.25	9.77
HE80 STBC, M0 to M9 1ss	4	4	-65.3	-59.1	-58.4	-59.3	0.2	-49.6	-41.25	8.32

5785	Non HT20, 6 to 54 Mbps	1	4	-64.7				0.1	-60.6	-41.25	19.40
	Non HT20, 6 to 54 Mbps	2	4	-64.7	-59.9			0.1	-54.6	-41.25	13.36
	Non HT20, 6 to 54 Mbps	3	4	-64.7	-59.9	-58.9		0.1	-51.7	-41.25	10.47
	Non HT20, 6 to 54 Mbps	4	4	-64.7	-59.9	-58.9	-59.5	0.1	-50.2	-41.25	8.93
	Non HT20 Beam Forming, 6 to 54 Mbps	2	7	-64.7	-59.9			0.1	-51.6	-41.25	10.36
	Non HT20 Beam Forming, 6 to 54 Mbps	3	9	-64.7	-59.9	-58.9		0.1	-46.7	-41.25	5.47
	Non HT20 Beam Forming, 6 to 54 Mbps	4	10	-64.7	-59.9	-58.9	-59.5	0.1	-44.2	-41.25	2.93
	HT/VHT20, M0 to M7	1	4	-64.9				0.1	-60.8	-41.25	19.60
	HT/VHT20, M0 to M7	2	4	-64.9	-60.1			0.1	-54.8	-41.25	13.56
	HT/VHT20, M8 to M15	2	4	-64.9	-60.1			0.1	-54.8	-41.25	13.56
	HT/VHT20, M0 to M7	3	4	-64.9	-60.1	-58.8		0.1	-51.8	-41.25	10.52
	HT/VHT20, M8 to M15	3	4	-64.9	-60.1	-58.8		0.1	-51.8	-41.25	10.52
	HT/VHT20, M16 to M23	3	4	-64.9	-60.1	-58.8		0.1	-51.8	-41.25	10.52
	HT/VHT20, M0 to M7	4	4	-64.9	-60.1	-58.8	-59.9	0.1	-50.3	-41.25	9.08
	HT/VHT20, M8 to M15	4	4	-64.9	-60.1	-58.8	-59.9	0.1	-50.3	-41.25	9.08
	HT/VHT20, M16 to M23	4	4	-64.9	-60.1	-58.8	-59.9	0.1	-50.3	-41.25	9.08
	HT/VHT20, M24 to M31	4	4	-64.9	-60.1	-58.8	-59.9	0.1	-50.3	-41.25	9.08
	HT/VHT20 Beam Forming, M0 to M7	2	7	-64.9	-60.1			0.1	-51.8	-41.25	10.56
	HT/VHT20 Beam Forming, M8 to M15	2	4	-64.9	-60.1			0.1	-54.8	-41.25	13.56
	HT/VHT20 Beam Forming, M0 to M7	3	9	-64.9	-60.1	-58.8		0.1	-46.8	-41.25	5.52
	HT/VHT20 Beam Forming, M8 to M15	3	6	-64.9	-60.1	-58.8		0.1	-49.8	-41.25	8.52
	HT/VHT20 Beam Forming, M16 to M23	3	4	-64.9	-60.1	-58.8		0.1	-51.8	-41.25	10.52
	HT/VHT20 Beam Forming, M0 to M7	4	10	-64.9	-60.1	-58.8	-59.9	0.1	-44.3	-41.25	3.08
	HT/VHT20 Beam Forming, M8 to M15	4	7	-64.9	-60.1	-58.8	-59.9	0.1	-47.3	-41.25	6.08
	HT/VHT20 Beam Forming, M16 to M23	4	5	-64.9	-60.1	-58.8	-59.9	0.1	-49.3	-41.25	8.08
	HT/VHT20 Beam Forming, M24 to M31	4	4	-64.9	-60.1	-58.8	-59.9	0.1	-50.3	-41.25	9.08
	HT/VHT20 STBC, M0 to M7	2	4	-64.9	-60.1			0.1	-54.8	-41.25	13.56
	HT/VHT20 STBC, M0 to M7	3	4	-64.9	-60.1	-58.8		0.1	-51.8	-41.25	10.52
	HT/VHT20 STBC, M0 to M7	4	4	-64.9	-60.1	-58.8	-59.9	0.1	-50.3	-41.25	9.08
	HE20, M0 to M9 1ss	1	4	-64.7				0.1	-60.6	-41.25	19.38
	HE20, M0 to M9 1ss	2	4	-64.7	-59.9			0.1	-54.6	-41.25	13.34
	HE20, M0 to M9 2ss	2	4	-64.7	-59.9			0.1	-54.6	-41.25	13.34
	HE20, M0 to M9 1ss	3	4	-64.7	-59.9	-59.0		0.1	-51.7	-41.25	10.50
	HE20, M0 to M9 2ss	3	4	-64.7	-59.9	-59.0		0.1	-51.7	-41.25	10.50
	HE20, M0 to M9 3ss	3	4	-64.7	-59.9	-59.0		0.1	-51.7	-41.25	10.50
	HE20, M0 to M9 1ss	4	4	-64.7	-59.9	-59.0	-59.7	0.1	-50.3	-41.25	9.01
	HE20, M0 to M9 2ss	4	4	-64.7	-59.9	-59.0	-59.7	0.1	-50.3	-41.25	9.01
	HE20, M0 to M9 3ss	4	4	-64.7	-59.9	-59.0	-59.7	0.1	-50.3	-41.25	9.01
	HE20, M0 to M9 4ss	4	4	-64.7	-59.9	-59.0	-59.7	0.1	-50.3	-41.25	9.01
	HE20 Beam Forming, M0 to M9 1ss	2	7	-64.7	-59.9			0.1	-51.6	-41.25	10.34
HE20 Beam Forming, M0 to M9 2ss	2	4	-64.7	-59.9			0.1	-54.6	-41.25	13.34	

	HE20 Beam Forming, M0 to M9 1ss	3	9	-64.7	-59.9	-59.0		0.1	-46.7	-41.25	5.50
	HE20 Beam Forming, M0 to M9 2ss	3	6	-64.7	-59.9	-59.0		0.1	-49.7	-41.25	8.50
	HE20 Beam Forming, M0 to M9 3ss	3	4	-64.7	-59.9	-59.0		0.1	-51.7	-41.25	10.50
	HE20 Beam Forming, M0 to M9 1ss	4	10	-64.7	-59.9	-59.0	-59.7	0.1	-44.3	-41.25	3.01
	HE20 Beam Forming, M0 to M9 2ss	4	7	-64.7	-59.9	-59.0	-59.7	0.1	-47.3	-41.25	6.01
	HE20 Beam Forming, M0 to M9 3ss	4	5	-64.7	-59.9	-59.0	-59.7	0.1	-49.3	-41.25	8.01
	HE20 Beam Forming, M0 to M9 4ss	4	4	-64.7	-59.9	-59.0	-59.7	0.1	-50.3	-41.25	9.01
	HE20 STBC, M0 to M9 2ss	2	4	-64.7	-59.9			0.1	-54.6	-41.25	13.34
	HE20 STBC, M0 to M9 2ss	3	4	-64.7	-59.9	-59.0		0.1	-51.7	-41.25	10.50
	HE20 STBC, M0 to M9 2ss	4	4	-64.7	-59.9	-59.0	-59.7	0.1	-50.3	-41.25	9.01
	Non HT40, 6 to 54 Mbps	1	4	-65.6				0.1	-61.5	-41.25	20.30
	Non HT40, 6 to 54 Mbps	2	4	-65.6	-59.4			0.1	-54.4	-41.25	13.17
	Non HT40, 6 to 54 Mbps	3	4	-65.6	-59.4	-59.1		0.1	-51.7	-41.25	10.46
	Non HT40, 6 to 54 Mbps	4	4	-65.6	-59.4	-59.1	-60.0	0.1	-50.3	-41.25	9.07
	HT/VHT40, M0 to M7	1	4	-65.9				0.1	-61.8	-41.25	20.54
	HT/VHT40, M0 to M7	2	4	-65.9	-60.1			0.1	-55.0	-41.25	13.73
	HT/VHT40, M8 to M15	2	4	-65.9	-60.1			0.1	-55.0	-41.25	13.73
	HT/VHT40, M0 to M7	3	4	-65.9	-60.1	-59.5		0.1	-52.2	-41.25	10.92
	HT/VHT40, M8 to M15	3	4	-65.9	-60.1	-59.5		0.1	-52.2	-41.25	10.92
	HT/VHT40, M16 to M23	3	4	-65.9	-60.1	-59.5		0.1	-52.2	-41.25	10.92
	HT/VHT40, M0 to M7	4	4	-65.9	-60.1	-59.5	-60.3	0.1	-50.7	-41.25	9.47
	HT/VHT40, M8 to M15	4	4	-65.9	-60.1	-59.5	-60.3	0.1	-50.7	-41.25	9.47
	HT/VHT40, M16 to M23	4	4	-65.9	-60.1	-59.5	-60.3	0.1	-50.7	-41.25	9.47
	HT/VHT40, M24 to M31	4	4	-65.9	-60.1	-59.5	-60.3	0.1	-50.7	-41.25	9.47
	HT/VHT40 Beam Forming, M0 to M7	2	7	-65.9	-60.1			0.1	-52.0	-41.25	10.73
	HT/VHT40 Beam Forming, M8 to M15	2	4	-65.9	-60.1			0.1	-55.0	-41.25	13.73
	HT/VHT40 Beam Forming, M0 to M7	3	9	-65.9	-60.1	-59.5		0.1	-47.2	-41.25	5.92
	HT/VHT40 Beam Forming, M8 to M15	3	6	-65.9	-60.1	-59.5		0.1	-50.2	-41.25	8.92
	HT/VHT40 Beam Forming, M16 to M23	3	4	-65.9	-60.1	-59.5		0.1	-52.2	-41.25	10.92
	HT/VHT40 Beam Forming, M0 to M7	4	10	-65.9	-60.1	-59.5	-60.3	0.1	-44.7	-41.25	3.47
	HT/VHT40 Beam Forming, M8 to M15	4	7	-65.9	-60.1	-59.5	-60.3	0.1	-47.7	-41.25	6.47
	HT/VHT40 Beam Forming, M16 to M23	4	5	-65.9	-60.1	-59.5	-60.3	0.1	-49.7	-41.25	8.47
	HT/VHT40 Beam Forming, M24 to M31	4	4	-65.9	-60.1	-59.5	-60.3	0.1	-50.7	-41.25	9.47
	HT/VHT40 STBC, M0 to M7	2	4	-65.9	-60.1			0.1	-55.0	-41.25	13.73
	HT/VHT40 STBC, M0 to M7	3	4	-65.9	-60.1	-59.5		0.1	-52.2	-41.25	10.92
	HT/VHT40 STBC, M0 to M7	4	4	-65.9	-60.1	-59.5	-60.3	0.1	-50.7	-41.25	9.47
	HE40, M0 to M9 1ss	1	4	-65.9				0.1	-61.8	-41.25	20.52
	HE40, M0 to M9 1ss	2	4	-65.9	-60.0			0.1	-54.9	-41.25	13.63
	HE40, M0 to M9 2ss	2	4	-65.9	-60.0			0.1	-54.9	-41.25	13.63
	HE40, M0 to M9 1ss	3	4	-65.9	-60.0	-59.6		0.1	-52.2	-41.25	10.91
	HE40, M0 to M9 2ss	3	4	-65.9	-60.0	-59.6		0.1	-52.2	-41.25	10.91
	HE40, M0 to M9 3ss	3	4	-65.9	-60.0	-59.6		0.1	-52.2	-41.25	10.91

	HE40, M0 to M9 1ss	4	4	-65.9	-60.0	-59.6	-60.5	0.1	-50.8	-41.25	9.51
	HE40, M0 to M9 2ss	4	4	-65.9	-60.0	-59.6	-60.5	0.1	-50.8	-41.25	9.51
	HE40, M0 to M9 3ss	4	4	-65.9	-60.0	-59.6	-60.5	0.1	-50.8	-41.25	9.51
	HE40, M0 to M9 4ss	4	4	-65.9	-60.0	-59.6	-60.5	0.1	-50.8	-41.25	9.51
	HE40 Beam Forming, M0 to M9 1ss	2	7	-65.9	-60.0			0.1	-51.9	-41.25	10.63
	HE40 Beam Forming, M0 to M9 2ss	2	4	-65.9	-60.0			0.1	-54.9	-41.25	13.63
	HE40 Beam Forming, M0 to M9 1ss	3	9	-65.9	-60.0	-59.6		0.1	-47.2	-41.25	5.91
	HE40 Beam Forming, M0 to M9 2ss	3	6	-65.9	-60.0	-59.6		0.1	-50.2	-41.25	8.91
	HE40 Beam Forming, M0 to M9 3ss	3	4	-65.9	-60.0	-59.6		0.1	-52.2	-41.25	10.91
	HE40 Beam Forming, M0 to M9 1ss	4	10	-65.9	-60.0	-59.6	-60.5	0.1	-44.8	-41.25	3.51
	HE40 Beam Forming, M0 to M9 2ss	4	7	-65.9	-60.0	-59.6	-60.5	0.1	-47.8	-41.25	6.51
	HE40 Beam Forming, M0 to M9 3ss	4	5	-65.9	-60.0	-59.6	-60.5	0.1	-49.8	-41.25	8.51
	HE40 Beam Forming, M0 to M9 4ss	4	4	-65.9	-60.0	-59.6	-60.5	0.1	-50.8	-41.25	9.51
	HE40 STBC, M0 to M9 2ss	2	4	-65.9	-60.0			0.1	-54.9	-41.25	13.63
	HE40 STBC, M0 to M9 2ss	3	4	-65.9	-60.0	-59.6		0.1	-52.2	-41.25	10.91
	HE40 STBC, M0 to M9 2ss	4	4	-65.9	-60.0	-59.6	-60.5	0.1	-50.8	-41.25	9.51
5825	Non HT20, 6 to 54 Mbps	1	4	-65.7				0.1	-61.6	-41.25	20.40
	Non HT20, 6 to 54 Mbps	2	4	-65.7	-59.9			0.1	-54.8	-41.25	13.59
	Non HT20, 6 to 54 Mbps	3	4	-65.7	-59.9	-59.2		0.1	-52.0	-41.25	10.73
	Non HT20, 6 to 54 Mbps	4	4	-65.7	-59.9	-59.2	-59.6	0.1	-50.4	-41.25	9.15
	Non HT20 Beam Forming, 6 to 54 Mbps	2	7	-65.7	-59.9			0.1	-51.8	-41.25	10.59
	Non HT20 Beam Forming, 6 to 54 Mbps	3	9	-65.7	-59.9	-59.2		0.1	-47.0	-41.25	5.73
	Non HT20 Beam Forming, 6 to 54 Mbps	4	10	-65.7	-59.9	-59.2	-59.6	0.1	-44.4	-41.25	3.15
	HT/VHT20, M0 to M7	1	4	-65.9				0.1	-61.8	-41.25	20.60
	HT/VHT20, M0 to M7	2	4	-65.9	-60.2			0.1	-55.1	-41.25	13.86
	HT/VHT20, M8 to M15	2	4	-65.9	-60.2			0.1	-55.1	-41.25	13.86
	HT/VHT20, M0 to M7	3	4	-65.9	-60.2	-59.3		0.1	-52.2	-41.25	10.92
	HT/VHT20, M8 to M15	3	4	-65.9	-60.2	-59.3		0.1	-52.2	-41.25	10.92
	HT/VHT20, M16 to M23	3	4	-65.9	-60.2	-59.3		0.1	-52.2	-41.25	10.92
	HT/VHT20, M0 to M7	4	4	-65.9	-60.2	-59.3	-60.0	0.1	-50.6	-41.25	9.40
	HT/VHT20, M8 to M15	4	4	-65.9	-60.2	-59.3	-60.0	0.1	-50.6	-41.25	9.40
	HT/VHT20, M16 to M23	4	4	-65.9	-60.2	-59.3	-60.0	0.1	-50.6	-41.25	9.40
	HT/VHT20, M24 to M31	4	4	-65.9	-60.2	-59.3	-60.0	0.1	-50.6	-41.25	9.40
	HT/VHT20 Beam Forming, M0 to M7	2	7	-65.9	-60.2			0.1	-52.1	-41.25	10.86
	HT/VHT20 Beam Forming, M8 to M15	2	4	-65.9	-60.2			0.1	-55.1	-41.25	13.86
	HT/VHT20 Beam Forming, M0 to M7	3	9	-65.9	-60.2	-59.3		0.1	-47.2	-41.25	5.92
	HT/VHT20 Beam Forming, M8 to M15	3	6	-65.9	-60.2	-59.3		0.1	-50.2	-41.25	8.92
	HT/VHT20 Beam Forming, M16 to M23	3	4	-65.9	-60.2	-59.3		0.1	-52.2	-41.25	10.92
	HT/VHT20 Beam Forming, M0 to M7	4	10	-65.9	-60.2	-59.3	-60.0	0.1	-44.6	-41.25	3.40
HT/VHT20 Beam Forming, M8 to M15	4	7	-65.9	-60.2	-59.3	-60.0	0.1	-47.6	-41.25	6.40	
HT/VHT20 Beam Forming, M16 to M23	4	5	-65.9	-60.2	-59.3	-60.0	0.1	-49.6	-41.25	8.40	
HT/VHT20 Beam Forming, M24 to M31	4	4	-65.9	-60.2	-59.3	-60.0	0.1	-50.6	-41.25	9.40	



HT/VHT20 STBC, M0 to M7	2	4	-65.9	-60.2			0.1	-55.1	-41.25	13.86
HT/VHT20 STBC, M0 to M7	3	4	-65.9	-60.2	-59.3		0.1	-52.2	-41.25	10.92
HT/VHT20 STBC, M0 to M7	4	4	-65.9	-60.2	-59.3	-60.0	0.1	-50.6	-41.25	9.40
HE20, M0 to M9 1ss	1	4	-65.9				0.1	-61.8	-41.25	20.58
HE20, M0 to M9 1ss	2	4	-65.9	-60.2			0.1	-55.1	-41.25	13.85
HE20, M0 to M9 2ss	2	4	-65.9	-60.2			0.1	-55.1	-41.25	13.85
HE20, M0 to M9 1ss	3	4	-65.9	-60.2	-59.3		0.1	-52.2	-41.25	10.90
HE20, M0 to M9 2ss	3	4	-65.9	-60.2	-59.3		0.1	-52.2	-41.25	10.90
HE20, M0 to M9 3ss	3	4	-65.9	-60.2	-59.3		0.1	-52.2	-41.25	10.90
HE20, M0 to M9 1ss	4	4	-65.9	-60.2	-59.3	-59.9	0.1	-50.6	-41.25	9.35
HE20, M0 to M9 2ss	4	4	-65.9	-60.2	-59.3	-59.9	0.1	-50.6	-41.25	9.35
HE20, M0 to M9 3ss	4	4	-65.9	-60.2	-59.3	-59.9	0.1	-50.6	-41.25	9.35
HE20, M0 to M9 4ss	4	4	-65.9	-60.2	-59.3	-59.9	0.1	-50.6	-41.25	9.35
HE20 Beam Forming, M0 to M9 1ss	2	7	-65.9	-60.2			0.1	-52.1	-41.25	10.85
HE20 Beam Forming, M0 to M9 2ss	2	4	-65.9	-60.2			0.1	-55.1	-41.25	13.85
HE20 Beam Forming, M0 to M9 1ss	3	9	-65.9	-60.2	-59.3		0.1	-47.2	-41.25	5.90
HE20 Beam Forming, M0 to M9 2ss	3	6	-65.9	-60.2	-59.3		0.1	-50.2	-41.25	8.90
HE20 Beam Forming, M0 to M9 3ss	3	4	-65.9	-60.2	-59.3		0.1	-52.2	-41.25	10.90
HE20 Beam Forming, M0 to M9 1ss	4	10	-65.9	-60.2	-59.3	-59.9	0.1	-44.6	-41.25	3.35
HE20 Beam Forming, M0 to M9 2ss	4	7	-65.9	-60.2	-59.3	-59.9	0.1	-47.6	-41.25	6.35
HE20 Beam Forming, M0 to M9 3ss	4	5	-65.9	-60.2	-59.3	-59.9	0.1	-49.6	-41.25	8.35
HE20 Beam Forming, M0 to M9 4ss	4	4	-65.9	-60.2	-59.3	-59.9	0.1	-50.6	-41.25	9.35
HE20 STBC, M0 to M9 2ss	2	4	-65.9	-60.2			0.1	-55.1	-41.25	13.85
HE20 STBC, M0 to M9 2ss	3	4	-65.9	-60.2	-59.3		0.1	-52.2	-41.25	10.90
HE20 STBC, M0 to M9 2ss	4	4	-65.9	-60.2	-59.3	-59.9	0.1	-50.6	-41.25	9.35

**Conducted Spurs Average, 4dBi  
5775 MHz, HE80 Beam Forming, M0 to M9 1ss**

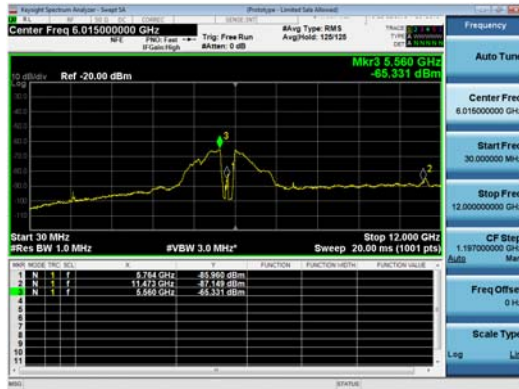

**Antenna A      Antenna B**

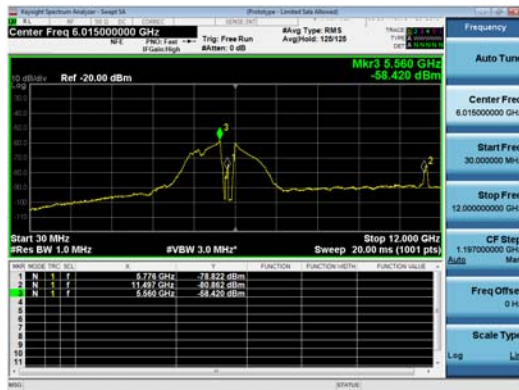
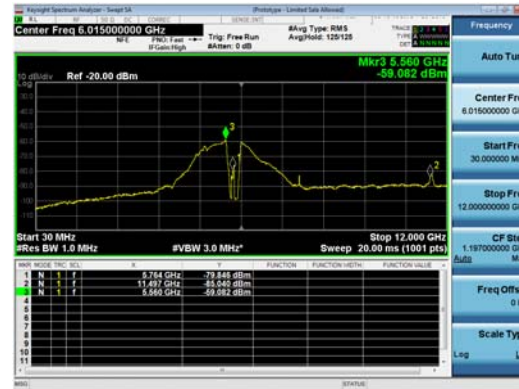

**Antenna C      Antenna D**

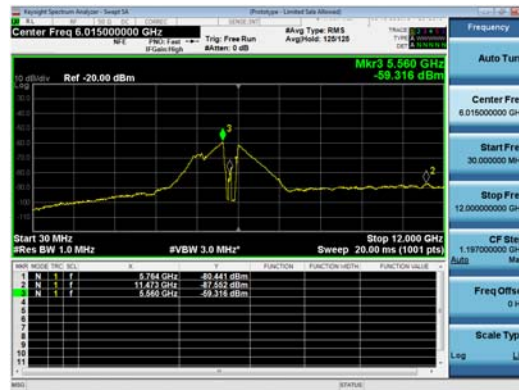



## Conducted Spurious Average Table, 5dBi

Frequency (MHz)	Mode	Tx Paths	Correlated Antenna Gain (dBi)	Tx 1 Spur Power (dBm)	Tx 2 Spur Power (dBm)	Tx 3 Spur Power (dBm)	Tx 4 Spur Power (dBm)	Duty Cycle Correction (dB)	Total Conducted Spur (dBm)	Limit (dBm)	Margin (dB)
5720 <sup>16</sup>	Non HT20, 6 to 54 Mbps	1	5	-63.7				0.1	-58.6	-41.25	17.40
	Non HT20, 6 to 54 Mbps	2	5	-63.7	-61.0			0.1	-54.1	-41.25	12.83
	Non HT20, 6 to 54 Mbps	3	5	-63.7	-61.0	-60.7		0.1	-51.8	-41.25	10.54
	Non HT20, 6 to 54 Mbps	4	5	-63.7	-61.0	-60.7	-60.5	0.1	-50.2	-41.25	8.98
	Non HT20 Beam Forming, 6 to 54 Mbps	2	8	-63.7	-61.0			0.1	-51.1	-41.25	9.83
	Non HT20 Beam Forming, 6 to 54 Mbps	3	10	-63.7	-62.5	-62.2		0.1	-47.9	-41.25	6.68
	Non HT20 Beam Forming, 6 to 54 Mbps	4	11	-63.7	-63.7	-65.1	-64.3	0.1	-47.1	-41.25	5.84
	HT/VHT20, M0 to M7	1	5	-63.6				0.1	-58.5	-41.25	17.30
	HT/VHT20, M0 to M7	2	5	-63.6	-61.0			0.1	-54.0	-41.25	12.80
	HT/VHT20, M8 to M15	2	5	-63.6	-61.0			0.1	-54.0	-41.25	12.80
	HT/VHT20, M0 to M7	3	5	-63.6	-61.0	-60.7		0.1	-51.8	-41.25	10.51
	HT/VHT20, M8 to M15	3	5	-63.6	-61.0	-60.7		0.1	-51.8	-41.25	10.51
	HT/VHT20, M16 to M23	3	5	-63.6	-61.0	-60.7		0.1	-51.8	-41.25	10.51
	HT/VHT20, M0 to M7	4	5	-63.6	-61.0	-60.7	-61.1	0.1	-50.4	-41.25	9.14
	HT/VHT20, M8 to M15	4	5	-63.6	-61.0	-60.7	-61.1	0.1	-50.4	-41.25	9.14
	HT/VHT20, M16 to M23	4	5	-63.6	-61.0	-60.7	-61.1	0.1	-50.4	-41.25	9.14
	HT/VHT20, M24 to M31	4	5	-63.6	-61.0	-60.7	-61.1	0.1	-50.4	-41.25	9.14
	HT/VHT20 Beam Forming, M0 to M7	2	8	-63.6	-61.0			0.1	-51.0	-41.25	9.80
	HT/VHT20 Beam Forming, M8 to M15	2	5	-63.6	-61.0			0.1	-54.0	-41.25	12.80
	HT/VHT20 Beam Forming, M0 to M7	3	10	-63.6	-62.4	-62.6		0.1	-48.0	-41.25	6.76
	HT/VHT20 Beam Forming, M8 to M15	3	7	-63.6	-61.0	-60.7		0.1	-49.8	-41.25	8.51
	HT/VHT20 Beam Forming, M16 to M23	3	5	-63.6	-61.0	-60.7		0.1	-51.8	-41.25	10.51
	HT/VHT20 Beam Forming, M0 to M7	4	11	-63.6	-63.6	-65.1	-64.4	0.1	-47.1	-41.25	5.81
	HT/VHT20 Beam Forming, M8 to M15	4	8	-63.6	-61.6	-61.9	-61.9	0.1	-48.1	-41.25	6.86
	HT/VHT20 Beam Forming, M16 to M23	4	6	-63.6	-61.0	-60.7	-61.1	0.1	-49.4	-41.25	8.14
	HT/VHT20 Beam Forming, M24 to M31	4	5	-63.6	-61.0	-60.7	-61.1	0.1	-50.4	-41.25	9.14
	HT/VHT20 STBC, M0 to M7	2	5	-63.6	-61.0			0.1	-54.0	-41.25	12.80

<sup>16</sup> 5720 (ch144) not supported for Canada.



	HT/VHT20 STBC, M0 to M7	3	5	-63.6	-61.0	-60.7		0.1	-51.8	-41.25	10.51
	HT/VHT20 STBC, M0 to M7	4	5	-63.6	-61.6	-61.9	-61.9	0.1	-51.1	-41.25	9.86
	HE20, M0 to M9 1ss	1	5	-63.9				0.1	-58.8	-41.25	17.58
	HE20, M0 to M9 1ss	2	5	-63.9	-60.9			0.1	-54.1	-41.25	12.82
	HE20, M0 to M9 2ss	2	5	-63.9	-60.9			0.1	-54.1	-41.25	12.82
	HE20, M0 to M9 1ss	3	5	-63.9	-60.9	-61.1		0.1	-51.9	-41.25	10.68
	HE20, M0 to M9 2ss	3	5	-63.9	-60.9	-61.1		0.1	-51.9	-41.25	10.68
	HE20, M0 to M9 3ss	3	5	-63.9	-60.9	-61.1		0.1	-51.9	-41.25	10.68
	HE20, M0 to M9 1ss	4	5	-63.9	-60.9	-61.1	-60.5	0.1	-50.3	-41.25	9.08
	HE20, M0 to M9 2ss	4	5	-63.9	-60.9	-61.1	-60.5	0.1	-50.3	-41.25	9.08
	HE20, M0 to M9 3ss	4	5	-63.9	-60.9	-61.1	-60.5	0.1	-50.3	-41.25	9.08
	HE20, M0 to M9 4ss	4	5	-63.9	-60.9	-61.1	-60.5	0.1	-50.3	-41.25	9.08
	HE20 Beam Forming, M0 to M9 1ss	2	8	-63.9	-60.9			0.1	-51.1	-41.25	9.82
	HE20 Beam Forming, M0 to M9 2ss	2	5	-63.9	-60.9			0.1	-54.1	-41.25	12.82
	HE20 Beam Forming, M0 to M9 1ss	3	10	-63.9	-62.5	-62.6		0.1	-48.1	-41.25	6.87
	HE20 Beam Forming, M0 to M9 2ss	3	7	-63.9	-60.9	-61.1		0.1	-49.9	-41.25	8.68
	HE20 Beam Forming, M0 to M9 3ss	3	5	-63.9	-60.9	-61.1		0.1	-51.9	-41.25	10.68
	HE20 Beam Forming, M0 to M9 1ss	4	11	-63.9	-63.7	-65.4	-64.5	0.1	-47.2	-41.25	5.99
	HE20 Beam Forming, M0 to M9 2ss	4	8	-63.9	-61.8	-61.8	-62.1	0.1	-48.2	-41.25	6.98
	HE20 Beam Forming, M0 to M9 3ss	4	6	-63.9	-60.9	-61.1	-60.5	0.1	-49.3	-41.25	8.08
	HE20 Beam Forming, M0 to M9 4ss	4	5	-63.9	-60.9	-61.1	-60.5	0.1	-50.3	-41.25	9.08
	HE20 STBC, M0 to M9 2ss	2	5	-63.9	-60.9			0.1	-54.1	-41.25	12.82
	HE20 STBC, M0 to M9 2ss	3	5	-63.9	-60.9	-61.1		0.1	-51.9	-41.25	10.68
	HE20 STBC, M0 to M9 2ss	4	5	-63.9	-61.8	-61.8	-62.1	0.1	-51.2	-41.25	9.98
5745	Non HT20, 6 to 54 Mbps	1	5	-65.2				0.1	-60.1	-41.25	18.90
	Non HT20, 6 to 54 Mbps	2	5	-65.2	-59.5			0.1	-53.4	-41.25	12.16
	Non HT20, 6 to 54 Mbps	3	5	-65.2	-59.5	-59.0		0.1	-50.7	-41.25	9.41
	Non HT20, 6 to 54 Mbps	4	5	-65.2	-59.5	-59.0	-60.2	0.1	-49.3	-41.25	8.09
	Non HT20 Beam Forming, 6 to 54 Mbps	2	8	-65.2	-59.5			0.1	-50.4	-41.25	9.16
	Non HT20 Beam Forming, 6 to 54 Mbps	3	10	-65.2	-59.5	-59.0		0.1	-45.7	-41.25	4.41
	Non HT20 Beam Forming, 6 to 54 Mbps	4	11	-65.2	-59.5	-59.0	-60.2	0.1	-43.3	-41.25	2.09
	HT/VHT20, M0 to M7	1	5	-66.0				0.1	-60.9	-41.25	19.70
	HT/VHT20, M0 to M7	2	5	-66.0	-59.5			0.1	-53.6	-41.25	12.32
	HT/VHT20, M8 to M15	2	5	-66.0	-59.5			0.1	-53.6	-41.25	12.32
	HT/VHT20, M0 to M7	3	5	-66.0	-59.5	-59.0		0.1	-50.7	-41.25	9.49
	HT/VHT20, M8 to M15	3	5	-66.0	-59.5	-59.0		0.1	-50.7	-41.25	9.49
	HT/VHT20, M16 to M23	3	5	-66.0	-59.5	-59.0		0.1	-50.7	-41.25	9.49
	HT/VHT20, M0 to M7	4	5	-66.0	-59.5	-59.0	-59.9	0.1	-49.3	-41.25	8.07
	HT/VHT20, M8 to M15	4	5	-66.0	-59.5	-59.0	-59.9	0.1	-49.3	-41.25	8.07
	HT/VHT20, M16 to M23	4	5	-66.0	-59.5	-59.0	-59.9	0.1	-49.3	-41.25	8.07
	HT/VHT20, M24 to M31	4	5	-66.0	-59.5	-59.0	-59.9	0.1	-49.3	-41.25	8.07
HT/VHT20 Beam Forming, M0 to M7	2	8	-66.0	-59.5			0.1	-50.6	-41.25	9.32	



	HT/VHT20 Beam Forming, M8 to M15	2	5	-66.0	-59.5			0.1	-53.6	-41.25	12.32
	HT/VHT20 Beam Forming, M0 to M7	3	10	-66.0	-59.5	-59.0		0.1	-45.7	-41.25	4.49
	HT/VHT20 Beam Forming, M8 to M15	3	7	-66.0	-59.5	-59.0		0.1	-48.7	-41.25	7.49
	HT/VHT20 Beam Forming, M16 to M23	3	5	-66.0	-59.5	-59.0		0.1	-50.7	-41.25	9.49
	HT/VHT20 Beam Forming, M0 to M7	4	11	-66.0	-59.5	-59.0	-59.9	0.1	-43.3	-41.25	2.07
	HT/VHT20 Beam Forming, M8 to M15	4	8	-66.0	-59.5	-59.0	-59.9	0.1	-46.3	-41.25	5.07
	HT/VHT20 Beam Forming, M16 to M23	4	6	-66.0	-59.5	-59.0	-59.9	0.1	-48.3	-41.25	7.07
	HT/VHT20 Beam Forming, M24 to M31	4	5	-66.0	-59.5	-59.0	-59.9	0.1	-49.3	-41.25	8.07
	HT/VHT20 STBC, M0 to M7	2	5	-66.0	-59.5			0.1	-53.6	-41.25	12.32
	HT/VHT20 STBC, M0 to M7	3	5	-66.0	-59.5	-59.0		0.1	-50.7	-41.25	9.49
	HT/VHT20 STBC, M0 to M7	4	5	-66.0	-59.5	-59.0	-59.9	0.1	-49.3	-41.25	8.07
	HE20, M0 to M9 1ss	1	5	-65.8				0.1	-60.7	-41.25	19.48
	HE20, M0 to M9 1ss	2	5	-65.8	-59.6			0.1	-53.6	-41.25	12.35
	HE20, M0 to M9 2ss	2	5	-65.8	-59.6			0.1	-53.6	-41.25	12.35
	HE20, M0 to M9 1ss	3	5	-65.8	-59.6	-59.0		0.1	-50.8	-41.25	9.50
	HE20, M0 to M9 2ss	3	5	-65.8	-59.6	-59.0		0.1	-50.8	-41.25	9.50
	HE20, M0 to M9 3ss	3	5	-65.8	-59.6	-59.0		0.1	-50.8	-41.25	9.50
	HE20, M0 to M9 1ss	4	5	-65.8	-59.6	-59.0	-59.8	0.1	-49.3	-41.25	8.04
	HE20, M0 to M9 2ss	4	5	-65.8	-59.6	-59.0	-59.8	0.1	-49.3	-41.25	8.04
	HE20, M0 to M9 3ss	4	5	-65.8	-59.6	-59.0	-59.8	0.1	-49.3	-41.25	8.04
	HE20, M0 to M9 4ss	4	5	-65.8	-59.6	-59.0	-59.8	0.1	-49.3	-41.25	8.04
	HE20 Beam Forming, M0 to M9 1ss	2	8	-65.8	-59.6			0.1	-50.6	-41.25	9.35
	HE20 Beam Forming, M0 to M9 2ss	2	5	-65.8	-59.6			0.1	-53.6	-41.25	12.35
	HE20 Beam Forming, M0 to M9 1ss	3	10	-65.8	-59.6	-59.0		0.1	-45.8	-41.25	4.50
	HE20 Beam Forming, M0 to M9 2ss	3	7	-65.8	-59.6	-59.0		0.1	-48.8	-41.25	7.50
	HE20 Beam Forming, M0 to M9 3ss	3	5	-65.8	-59.6	-59.0		0.1	-50.8	-41.25	9.50
	HE20 Beam Forming, M0 to M9 1ss	4	11	-65.8	-59.6	-59.0	-59.8	0.1	-43.3	-41.25	2.04
	HE20 Beam Forming, M0 to M9 2ss	4	8	-65.8	-59.6	-59.0	-59.8	0.1	-46.3	-41.25	5.04
	HE20 Beam Forming, M0 to M9 3ss	4	6	-65.8	-59.6	-59.0	-59.8	0.1	-48.3	-41.25	7.04
	HE20 Beam Forming, M0 to M9 4ss	4	5	-65.8	-59.6	-59.0	-59.8	0.1	-49.3	-41.25	8.04
	HE20 STBC, M0 to M9 2ss	2	5	-65.8	-59.6			0.1	-53.6	-41.25	12.35
	HE20 STBC, M0 to M9 2ss	3	5	-65.8	-59.6	-59.0		0.1	-50.8	-41.25	9.50
	HE20 STBC, M0 to M9 2ss	4	5	-65.8	-59.6	-59.0	-59.8	0.1	-49.3	-41.25	8.04
5755	Non HT40, 6 to 54 Mbps	1	5	-65.3				0.1	-60.2	-41.25	19.00
	Non HT40, 6 to 54 Mbps	2	5	-65.3	-59.1			0.1	-53.1	-41.25	11.87
	Non HT40, 6 to 54 Mbps	3	5	-65.3	-59.1	-58.8		0.1	-50.4	-41.25	9.16
	Non HT40, 6 to 54 Mbps	4	5	-65.3	-59.1	-58.8	-60.0	0.1	-49.1	-41.25	7.85
	HT/VHT40, M0 to M7	1	5	-66.0				0.1	-60.9	-41.25	19.64
	HT/VHT40, M0 to M7	2	5	-66.0	-59.4			0.1	-53.4	-41.25	12.18
	HT/VHT40, M8 to M15	2	5	-66.0	-59.4			0.1	-53.4	-41.25	12.18
	HT/VHT40, M0 to M7	3	5	-66.0	-59.4	-59.3		0.1	-50.8	-41.25	9.53
	HT/VHT40, M8 to M15	3	5	-66.0	-59.4	-59.3		0.1	-50.8	-41.25	9.53



HT/VHT40, M16 to M23	3	5	-66.0	-59.4	-59.3		0.1	-50.8	-41.25	9.53	
HT/VHT40, M0 to M7	4	5	-66.0	-59.4	-59.3	-60.2	0.1	-49.4	-41.25	8.16	
HT/VHT40, M8 to M15	4	5	-66.0	-59.4	-59.3	-60.2	0.1	-49.4	-41.25	8.16	
HT/VHT40, M16 to M23	4	5	-66.0	-59.4	-59.3	-60.2	0.1	-49.4	-41.25	8.16	
HT/VHT40, M24 to M31	4	5	-66.0	-59.4	-59.3	-60.2	0.1	-49.4	-41.25	8.16	
HT/VHT40 Beam Forming, M0 to M7	2	8	-66.0	-59.4			0.1	-50.4	-41.25	9.18	
HT/VHT40 Beam Forming, M8 to M15	2	5	-66.0	-59.4			0.1	-53.4	-41.25	12.18	
HT/VHT40 Beam Forming, M0 to M7	3	10	-66.0	-59.4	-59.3		0.1	-45.8	-41.25	4.53	
HT/VHT40 Beam Forming, M8 to M15	3	7	-66.0	-59.4	-59.3		0.1	-48.8	-41.25	7.53	
HT/VHT40 Beam Forming, M16 to M23	3	5	-66.0	-59.4	-59.3		0.1	-50.8	-41.25	9.53	
HT/VHT40 Beam Forming, M0 to M7	4	11	-66.0	-59.4	-59.3	-60.2	0.1	-43.4	-41.25	2.16	
HT/VHT40 Beam Forming, M8 to M15	4	8	-66.0	-59.4	-59.3	-60.2	0.1	-46.4	-41.25	5.16	
HT/VHT40 Beam Forming, M16 to M23	4	6	-66.0	-59.4	-59.3	-60.2	0.1	-48.4	-41.25	7.16	
HT/VHT40 Beam Forming, M24 to M31	4	5	-66.0	-59.4	-59.3	-60.2	0.1	-49.4	-41.25	8.16	
HT/VHT40 STBC, M0 to M7	2	5	-66.0	-59.4			0.1	-53.4	-41.25	12.18	
HT/VHT40 STBC, M0 to M7	3	5	-66.0	-59.4	-59.3		0.1	-50.8	-41.25	9.53	
HT/VHT40 STBC, M0 to M7	4	5	-66.0	-59.4	-59.3	-60.2	0.1	-49.4	-41.25	8.16	
HE40, M0 to M9 1ss	1	5	-65.9				0.1	-60.8	-41.25	19.52	
HE40, M0 to M9 1ss	2	5	-65.9	-59.4			0.1	-53.4	-41.25	12.15	
HE40, M0 to M9 2ss	2	5	-65.9	-59.4			0.1	-53.4	-41.25	12.15	
HE40, M0 to M9 1ss	3	5	-65.9	-59.4	-59.1		0.1	-50.7	-41.25	9.42	
HE40, M0 to M9 2ss	3	5	-65.9	-59.4	-59.1		0.1	-50.7	-41.25	9.42	
HE40, M0 to M9 3ss	3	5	-65.9	-59.4	-59.1		0.1	-50.7	-41.25	9.42	
HE40, M0 to M9 1ss	4	5	-65.9	-59.4	-59.1	-60.1	0.1	-49.3	-41.25	8.05	
HE40, M0 to M9 2ss	4	5	-65.9	-59.4	-59.1	-60.1	0.1	-49.3	-41.25	8.05	
HE40, M0 to M9 3ss	4	5	-65.9	-59.4	-59.1	-60.1	0.1	-49.3	-41.25	8.05	
HE40, M0 to M9 4ss	4	5	-65.9	-59.4	-59.1	-60.1	0.1	-49.3	-41.25	8.05	
HE40 Beam Forming, M0 to M9 1ss	2	8	-65.9	-59.4			0.1	-50.4	-41.25	9.15	
HE40 Beam Forming, M0 to M9 2ss	2	5	-65.9	-59.4			0.1	-53.4	-41.25	12.15	
HE40 Beam Forming, M0 to M9 1ss	3	10	-65.9	-59.4	-59.1		0.1	-45.7	-41.25	4.42	
HE40 Beam Forming, M0 to M9 2ss	3	7	-65.9	-59.4	-59.1		0.1	-48.7	-41.25	7.42	
HE40 Beam Forming, M0 to M9 3ss	3	5	-65.9	-59.4	-59.1		0.1	-50.7	-41.25	9.42	
HE40 Beam Forming, M0 to M9 1ss	4	11	-65.9	-59.4	-59.1	-60.1	0.1	-43.3	-41.25	2.05	
HE40 Beam Forming, M0 to M9 2ss	4	8	-65.9	-59.4	-59.1	-60.1	0.1	-46.3	-41.25	5.05	
HE40 Beam Forming, M0 to M9 3ss	4	6	-65.9	-59.4	-59.1	-60.1	0.1	-48.3	-41.25	7.05	
HE40 Beam Forming, M0 to M9 4ss	4	5	-65.9	-59.4	-59.1	-60.1	0.1	-49.3	-41.25	8.05	
HE40 STBC, M0 to M9 2ss	2	5	-65.9	-59.4			0.1	-53.4	-41.25	12.15	
HE40 STBC, M0 to M9 2ss	3	5	-65.9	-59.4	-59.1		0.1	-50.7	-41.25	9.42	
HE40 STBC, M0 to M9 2ss	4	5	-65.9	-59.4	-59.1	-60.1	0.1	-49.3	-41.25	8.05	
5775	Non HT80, 6 to 54 Mbps	1	5	-64.6				0.0	-59.6	-41.25	18.30
	Non HT80, 6 to 54 Mbps	2	5	-64.6	-58.9			0.0	-52.8	-41.25	11.57
	Non HT80, 6 to 54 Mbps	3	5	-64.6	-58.9	-58.0		0.0	-49.9	-41.25	8.62

Non HT80, 6 to 54 Mbps	4	5	-64.6	-58.9	-58.0	-58.9	0.0	-48.4	-41.25	7.16
VHT80, M0 to M9 1ss	1	5	-65.4				0.2	-60.2	-41.25	18.93
VHT80, M0 to M9 1ss	2	5	-65.4	-59.9			0.2	-53.6	-41.25	12.35
VHT80, M0 to M9 2ss	2	5	-65.4	-59.9			0.2	-53.6	-41.25	12.35
VHT80, M0 to M9 1ss	3	5	-65.4	-59.9	-58.5		0.2	-50.4	-41.25	9.17
VHT80, M0 to M9 2ss	3	5	-65.4	-59.9	-58.5		0.2	-50.4	-41.25	9.17
VHT80, M0 to M9 3ss	3	5	-65.4	-59.9	-58.5		0.2	-50.4	-41.25	9.17
VHT80, M0 to M9 1ss	4	5	-65.4	-59.9	-58.5	-59.7	0.2	-49.0	-41.25	7.73
VHT80, M0 to M9 2ss	4	5	-65.4	-59.9	-58.5	-59.7	0.2	-49.0	-41.25	7.73
VHT80, M0 to M9 3ss	4	5	-65.4	-59.9	-58.5	-59.7	0.2	-49.0	-41.25	7.73
VHT80, M0 to M9 4ss	4	5	-65.4	-59.9	-58.5	-59.7	0.2	-49.0	-41.25	7.73
VHT80 Beam Forming, M0 to M9 1ss	2	8	-65.4	-59.9			0.2	-50.6	-41.25	9.35
VHT80 Beam Forming, M0 to M9 2ss	2	5	-65.4	-59.9			0.2	-53.6	-41.25	12.35
VHT80 Beam Forming, M0 to M9 1ss	3	10	-65.4	-59.9	-58.5		0.2	-45.4	-41.25	4.17
VHT80 Beam Forming, M0 to M9 2ss	3	7	-65.4	-59.9	-58.5		0.2	-48.4	-41.25	7.17
VHT80 Beam Forming, M0 to M9 3ss	3	5	-65.4	-59.9	-58.5		0.2	-50.4	-41.25	9.17
VHT80 Beam Forming, M0 to M9 1ss	4	11	-65.4	-59.9	-58.5	-59.7	0.2	-43.0	-41.25	1.73
VHT80 Beam Forming, M0 to M9 2ss	4	8	-65.4	-59.9	-58.5	-59.7	0.2	-46.0	-41.25	4.73
VHT80 Beam Forming, M0 to M9 3ss	4	6	-65.4	-59.9	-58.5	-59.7	0.2	-48.0	-41.25	6.73
VHT80 Beam Forming, M0 to M9 4ss	4	5	-65.4	-59.9	-58.5	-59.7	0.2	-49.0	-41.25	7.73
VHT80 STBC, M0 to M9 1ss	2	5	-65.4	-59.9			0.2	-53.6	-41.25	12.35
VHT80 STBC, M0 to M9 1ss	3	5	-65.4	-59.9	-58.5		0.2	-50.4	-41.25	9.17
VHT80 STBC, M0 to M9 1ss	4	5	-65.4	-59.9	-58.5	-59.7	0.2	-49.0	-41.25	7.73
HE80, M0 to M9 1ss	1	5	-65.3				0.2	-60.1	-41.25	18.80
HE80, M0 to M9 1ss	2	5	-65.3	-59.1			0.2	-52.9	-41.25	11.67
HE80, M0 to M9 2ss	2	5	-65.3	-59.1			0.2	-52.9	-41.25	11.67
HE80, M0 to M9 1ss	3	5	-65.3	-59.1	-58.4		0.2	-50.0	-41.25	8.77
HE80, M0 to M9 2ss	3	5	-65.3	-59.1	-58.4		0.2	-50.0	-41.25	8.77
HE80, M0 to M9 3ss	3	5	-65.3	-59.1	-58.4		0.2	-50.0	-41.25	8.77
HE80, M0 to M9 1ss	4	5	-65.3	-59.1	-58.4	-59.3	0.2	-48.6	-41.25	7.32
HE80, M0 to M9 2ss	4	5	-65.3	-59.1	-58.4	-59.3	0.2	-48.6	-41.25	7.32
HE80, M0 to M9 3ss	4	5	-65.3	-59.1	-58.4	-59.3	0.2	-48.6	-41.25	7.32
HE80, M0 to M9 4ss	4	5	-65.3	-59.1	-58.4	-59.3	0.2	-48.6	-41.25	7.32
HE80 Beam Forming, M0 to M9 1ss	2	8	-65.3	-59.1			0.2	-49.9	-41.25	8.67
HE80 Beam Forming, M0 to M9 2ss	2	5	-65.3	-59.1			0.2	-52.9	-41.25	11.67
HE80 Beam Forming, M0 to M9 1ss	3	10	-65.3	-59.1	-58.4		0.2	-45.0	-41.25	3.77
HE80 Beam Forming, M0 to M9 2ss	3	7	-65.3	-59.1	-58.4		0.2	-48.0	-41.25	6.77
HE80 Beam Forming, M0 to M9 3ss	3	5	-65.3	-59.1	-58.4		0.2	-50.0	-41.25	8.77
<b>HE80 Beam Forming, M0 to M9 1ss</b>	<b>4</b>	<b>11</b>	<b>-65.3</b>	<b>-59.1</b>	<b>-58.4</b>	<b>-59.3</b>	<b>0.2</b>	<b>-42.6</b>	<b>-41.25</b>	<b>1.32</b>
HE80 Beam Forming, M0 to M9 2ss	4	8	-65.3	-59.1	-58.4	-59.3	0.2	-45.6	-41.25	4.32
HE80 Beam Forming, M0 to M9 3ss	4	6	-65.3	-59.1	-58.4	-59.3	0.2	-47.6	-41.25	6.32
HE80 Beam Forming, M0 to M9 4ss	4	5	-65.3	-59.1	-58.4	-59.3	0.2	-48.6	-41.25	7.32
HE80 STBC, M0 to M9 1ss	2	5	-65.3	-59.1			0.2	-52.9	-41.25	11.67

HE80 STBC, M0 to M9 1ss	3	5	-65.3	-59.1	-58.4		0.2	-50.0	-41.25	8.77
HE80 STBC, M0 to M9 1ss	4	5	-65.3	-59.1	-58.4	-59.3	0.2	-48.6	-41.25	7.32

5785	Non HT20, 6 to 54 Mbps	1	5	-64.7				0.1	-59.6	-41.25	18.40
	Non HT20, 6 to 54 Mbps	2	5	-64.7	-59.9			0.1	-53.6	-41.25	12.36
	Non HT20, 6 to 54 Mbps	3	5	-64.7	-59.9	-58.9		0.1	-50.7	-41.25	9.47
	Non HT20, 6 to 54 Mbps	4	5	-64.7	-59.9	-58.9	-59.5	0.1	-49.2	-41.25	7.93
	Non HT20 Beam Forming, 6 to 54 Mbps	2	8	-64.7	-59.9			0.1	-50.6	-41.25	9.36
	Non HT20 Beam Forming, 6 to 54 Mbps	3	10	-64.7	-59.9	-58.9		0.1	-45.7	-41.25	4.47
	Non HT20 Beam Forming, 6 to 54 Mbps	4	11	-64.7	-59.9	-58.9	-59.5	0.1	-43.2	-41.25	1.93
	HT/VHT20, M0 to M7	1	5	-64.9				0.1	-59.8	-41.25	18.60
	HT/VHT20, M0 to M7	2	5	-64.9	-60.1			0.1	-53.8	-41.25	12.56
	HT/VHT20, M8 to M15	2	5	-64.9	-60.1			0.1	-53.8	-41.25	12.56
	HT/VHT20, M0 to M7	3	5	-64.9	-60.1	-58.8		0.1	-50.8	-41.25	9.52
	HT/VHT20, M8 to M15	3	5	-64.9	-60.1	-58.8		0.1	-50.8	-41.25	9.52
	HT/VHT20, M16 to M23	3	5	-64.9	-60.1	-58.8		0.1	-50.8	-41.25	9.52
	HT/VHT20, M0 to M7	4	5	-64.9	-60.1	-58.8	-59.9	0.1	-49.3	-41.25	8.08
	HT/VHT20, M8 to M15	4	5	-64.9	-60.1	-58.8	-59.9	0.1	-49.3	-41.25	8.08
	HT/VHT20, M16 to M23	4	5	-64.9	-60.1	-58.8	-59.9	0.1	-49.3	-41.25	8.08
	HT/VHT20, M24 to M31	4	5	-64.9	-60.1	-58.8	-59.9	0.1	-49.3	-41.25	8.08
	HT/VHT20 Beam Forming, M0 to M7	2	8	-64.9	-60.1			0.1	-50.8	-41.25	9.56
	HT/VHT20 Beam Forming, M8 to M15	2	5	-64.9	-60.1			0.1	-53.8	-41.25	12.56
	HT/VHT20 Beam Forming, M0 to M7	3	10	-64.9	-60.1	-58.8		0.1	-45.8	-41.25	4.52
	HT/VHT20 Beam Forming, M8 to M15	3	7	-64.9	-60.1	-58.8		0.1	-48.8	-41.25	7.52
	HT/VHT20 Beam Forming, M16 to M23	3	5	-64.9	-60.1	-58.8		0.1	-50.8	-41.25	9.52
	HT/VHT20 Beam Forming, M0 to M7	4	11	-64.9	-60.1	-58.8	-59.9	0.1	-43.3	-41.25	2.08
	HT/VHT20 Beam Forming, M8 to M15	4	8	-64.9	-60.1	-58.8	-59.9	0.1	-46.3	-41.25	5.08
	HT/VHT20 Beam Forming, M16 to M23	4	6	-64.9	-60.1	-58.8	-59.9	0.1	-48.3	-41.25	7.08
	HT/VHT20 Beam Forming, M24 to M31	4	5	-64.9	-60.1	-58.8	-59.9	0.1	-49.3	-41.25	8.08
	HT/VHT20 STBC, M0 to M7	2	5	-64.9	-60.1			0.1	-53.8	-41.25	12.56
	HT/VHT20 STBC, M0 to M7	3	5	-64.9	-60.1	-58.8		0.1	-50.8	-41.25	9.52
	HT/VHT20 STBC, M0 to M7	4	5	-64.9	-60.1	-58.8	-59.9	0.1	-49.3	-41.25	8.08
	HE20, M0 to M9 1ss	1	5	-64.7				0.1	-59.6	-41.25	18.38
	HE20, M0 to M9 1ss	2	5	-64.7	-59.9			0.1	-53.6	-41.25	12.34
	HE20, M0 to M9 2ss	2	5	-64.7	-59.9			0.1	-53.6	-41.25	12.34
	HE20, M0 to M9 1ss	3	5	-64.7	-59.9	-59.0		0.1	-50.7	-41.25	9.50
	HE20, M0 to M9 2ss	3	5	-64.7	-59.9	-59.0		0.1	-50.7	-41.25	9.50
	HE20, M0 to M9 3ss	3	5	-64.7	-59.9	-59.0		0.1	-50.7	-41.25	9.50
	HE20, M0 to M9 1ss	4	5	-64.7	-59.9	-59.0	-59.7	0.1	-49.3	-41.25	8.01
HE20, M0 to M9 2ss	4	5	-64.7	-59.9	-59.0	-59.7	0.1	-49.3	-41.25	8.01	
HE20, M0 to M9 3ss	4	5	-64.7	-59.9	-59.0	-59.7	0.1	-49.3	-41.25	8.01	
HE20, M0 to M9 4ss	4	5	-64.7	-59.9	-59.0	-59.7	0.1	-49.3	-41.25	8.01	

	HE20 Beam Forming, M0 to M9 1ss	2	8	-64.7	-59.9			0.1	-50.6	-41.25	9.34
	HE20 Beam Forming, M0 to M9 2ss	2	5	-64.7	-59.9			0.1	-53.6	-41.25	12.34
	HE20 Beam Forming, M0 to M9 1ss	3	10	-64.7	-59.9	-59.0		0.1	-45.7	-41.25	4.50
	HE20 Beam Forming, M0 to M9 2ss	3	7	-64.7	-59.9	-59.0		0.1	-48.7	-41.25	7.50
	HE20 Beam Forming, M0 to M9 3ss	3	5	-64.7	-59.9	-59.0		0.1	-50.7	-41.25	9.50
	HE20 Beam Forming, M0 to M9 1ss	4	11	-64.7	-59.9	-59.0	-59.7	0.1	-43.3	-41.25	2.01
	HE20 Beam Forming, M0 to M9 2ss	4	8	-64.7	-59.9	-59.0	-59.7	0.1	-46.3	-41.25	5.01
	HE20 Beam Forming, M0 to M9 3ss	4	6	-64.7	-59.9	-59.0	-59.7	0.1	-48.3	-41.25	7.01
	HE20 Beam Forming, M0 to M9 4ss	4	5	-64.7	-59.9	-59.0	-59.7	0.1	-49.3	-41.25	8.01
	HE20 STBC, M0 to M9 2ss	2	5	-64.7	-59.9			0.1	-53.6	-41.25	12.34
	HE20 STBC, M0 to M9 2ss	3	5	-64.7	-59.9	-59.0		0.1	-50.7	-41.25	9.50
	HE20 STBC, M0 to M9 2ss	4	5	-64.7	-59.9	-59.0	-59.7	0.1	-49.3	-41.25	8.01
5795	Non HT40, 6 to 54 Mbps	1	5	-65.6				0.1	-60.5	-41.25	19.30
	Non HT40, 6 to 54 Mbps	2	5	-65.6	-59.4			0.1	-53.4	-41.25	12.17
	Non HT40, 6 to 54 Mbps	3	5	-65.6	-59.4	-59.1		0.1	-50.7	-41.25	9.46
	Non HT40, 6 to 54 Mbps	4	5	-65.6	-59.4	-59.1	-60.0	0.1	-49.3	-41.25	8.07
	HT/VHT40, M0 to M7	1	5	-65.9				0.1	-60.8	-41.25	19.54
	HT/VHT40, M0 to M7	2	5	-65.9	-60.1			0.1	-54.0	-41.25	12.73
	HT/VHT40, M8 to M15	2	5	-65.9	-60.1			0.1	-54.0	-41.25	12.73
	HT/VHT40, M0 to M7	3	5	-65.9	-60.1	-59.5		0.1	-51.2	-41.25	9.92
	HT/VHT40, M8 to M15	3	5	-65.9	-60.1	-59.5		0.1	-51.2	-41.25	9.92
	HT/VHT40, M16 to M23	3	5	-65.9	-60.1	-59.5		0.1	-51.2	-41.25	9.92
	HT/VHT40, M0 to M7	4	5	-65.9	-60.1	-59.5	-60.3	0.1	-49.7	-41.25	8.47
	HT/VHT40, M8 to M15	4	5	-65.9	-60.1	-59.5	-60.3	0.1	-49.7	-41.25	8.47
	HT/VHT40, M16 to M23	4	5	-65.9	-60.1	-59.5	-60.3	0.1	-49.7	-41.25	8.47
	HT/VHT40, M24 to M31	4	5	-65.9	-60.1	-59.5	-60.3	0.1	-49.7	-41.25	8.47
	HT/VHT40 Beam Forming, M0 to M7	2	8	-65.9	-60.1			0.1	-51.0	-41.25	9.73
	HT/VHT40 Beam Forming, M8 to M15	2	5	-65.9	-60.1			0.1	-54.0	-41.25	12.73
	HT/VHT40 Beam Forming, M0 to M7	3	10	-65.9	-60.1	-59.5		0.1	-46.2	-41.25	4.92
	HT/VHT40 Beam Forming, M8 to M15	3	7	-65.9	-60.1	-59.5		0.1	-49.2	-41.25	7.92
	HT/VHT40 Beam Forming, M16 to M23	3	5	-65.9	-60.1	-59.5		0.1	-51.2	-41.25	9.92
	HT/VHT40 Beam Forming, M0 to M7	4	11	-65.9	-60.1	-59.5	-60.3	0.1	-43.7	-41.25	2.47
	HT/VHT40 Beam Forming, M8 to M15	4	8	-65.9	-60.1	-59.5	-60.3	0.1	-46.7	-41.25	5.47
	HT/VHT40 Beam Forming, M16 to M23	4	6	-65.9	-60.1	-59.5	-60.3	0.1	-48.7	-41.25	7.47
	HT/VHT40 Beam Forming, M24 to M31	4	5	-65.9	-60.1	-59.5	-60.3	0.1	-49.7	-41.25	8.47
	HT/VHT40 STBC, M0 to M7	2	5	-65.9	-60.1			0.1	-54.0	-41.25	12.73
	HT/VHT40 STBC, M0 to M7	3	5	-65.9	-60.1	-59.5		0.1	-51.2	-41.25	9.92
	HT/VHT40 STBC, M0 to M7	4	5	-65.9	-60.1	-59.5	-60.3	0.1	-49.7	-41.25	8.47
	HE40, M0 to M9 1ss	1	5	-65.9				0.1	-60.8	-41.25	19.52
	HE40, M0 to M9 1ss	2	5	-65.9	-60.0			0.1	-53.9	-41.25	12.63
HE40, M0 to M9 2ss	2	5	-65.9	-60.0			0.1	-53.9	-41.25	12.63	
HE40, M0 to M9 1ss	3	5	-65.9	-60.0	-59.6		0.1	-51.2	-41.25	9.91	



	HE40, M0 to M9 2ss	3	5	-65.9	-60.0	-59.6		0.1	-51.2	-41.25	9.91
	HE40, M0 to M9 3ss	3	5	-65.9	-60.0	-59.6		0.1	-51.2	-41.25	9.91
	HE40, M0 to M9 1ss	4	5	-65.9	-60.0	-59.6	-60.5	0.1	-49.8	-41.25	8.51
	HE40, M0 to M9 2ss	4	5	-65.9	-60.0	-59.6	-60.5	0.1	-49.8	-41.25	8.51
	HE40, M0 to M9 3ss	4	5	-65.9	-60.0	-59.6	-60.5	0.1	-49.8	-41.25	8.51
	HE40, M0 to M9 4ss	4	5	-65.9	-60.0	-59.6	-60.5	0.1	-49.8	-41.25	8.51
	HE40 Beam Forming, M0 to M9 1ss	2	8	-65.9	-60.0			0.1	-50.9	-41.25	9.63
	HE40 Beam Forming, M0 to M9 2ss	2	5	-65.9	-60.0			0.1	-53.9	-41.25	12.63
	HE40 Beam Forming, M0 to M9 1ss	3	10	-65.9	-60.0	-59.6		0.1	-46.2	-41.25	4.91
	HE40 Beam Forming, M0 to M9 2ss	3	7	-65.9	-60.0	-59.6		0.1	-49.2	-41.25	7.91
	HE40 Beam Forming, M0 to M9 3ss	3	5	-65.9	-60.0	-59.6		0.1	-51.2	-41.25	9.91
	HE40 Beam Forming, M0 to M9 1ss	4	11	-65.9	-60.0	-59.6	-60.5	0.1	-43.8	-41.25	2.51
	HE40 Beam Forming, M0 to M9 2ss	4	8	-65.9	-60.0	-59.6	-60.5	0.1	-46.8	-41.25	5.51
	HE40 Beam Forming, M0 to M9 3ss	4	6	-65.9	-60.0	-59.6	-60.5	0.1	-48.8	-41.25	7.51
	HE40 Beam Forming, M0 to M9 4ss	4	5	-65.9	-60.0	-59.6	-60.5	0.1	-49.8	-41.25	8.51
	HE40 STBC, M0 to M9 2ss	2	5	-65.9	-60.0			0.1	-53.9	-41.25	12.63
	HE40 STBC, M0 to M9 2ss	3	5	-65.9	-60.0	-59.6		0.1	-51.2	-41.25	9.91
	HE40 STBC, M0 to M9 2ss	4	5	-65.9	-60.0	-59.6	-60.5	0.1	-49.8	-41.25	8.51
5825	Non HT20, 6 to 54 Mbps	1	5	-65.7				0.1	-60.6	-41.25	19.40
	Non HT20, 6 to 54 Mbps	2	5	-65.7	-59.9			0.1	-53.8	-41.25	12.59
	Non HT20, 6 to 54 Mbps	3	5	-65.7	-59.9	-59.2		0.1	-51.0	-41.25	9.73
	Non HT20, 6 to 54 Mbps	4	5	-65.7	-59.9	-59.2	-59.6	0.1	-49.4	-41.25	8.15
	Non HT20 Beam Forming, 6 to 54 Mbps	2	8	-65.7	-59.9			0.1	-50.8	-41.25	9.59
	Non HT20 Beam Forming, 6 to 54 Mbps	3	10	-65.7	-59.9	-59.2		0.1	-46.0	-41.25	4.73
	Non HT20 Beam Forming, 6 to 54 Mbps	4	11	-65.7	-59.9	-59.2	-59.6	0.1	-43.4	-41.25	2.15
	HT/VHT20, M0 to M7	1	5	-65.9				0.1	-60.8	-41.25	19.60
	HT/VHT20, M0 to M7	2	5	-65.9	-60.2			0.1	-54.1	-41.25	12.86
	HT/VHT20, M8 to M15	2	5	-65.9	-60.2			0.1	-54.1	-41.25	12.86
	HT/VHT20, M0 to M7	3	5	-65.9	-60.2	-59.3		0.1	-51.2	-41.25	9.92
	HT/VHT20, M8 to M15	3	5	-65.9	-60.2	-59.3		0.1	-51.2	-41.25	9.92
	HT/VHT20, M16 to M23	3	5	-65.9	-60.2	-59.3		0.1	-51.2	-41.25	9.92
	HT/VHT20, M0 to M7	4	5	-65.9	-60.2	-59.3	-60.0	0.1	-49.6	-41.25	8.40
	HT/VHT20, M8 to M15	4	5	-65.9	-60.2	-59.3	-60.0	0.1	-49.6	-41.25	8.40
	HT/VHT20, M16 to M23	4	5	-65.9	-60.2	-59.3	-60.0	0.1	-49.6	-41.25	8.40
	HT/VHT20, M24 to M31	4	5	-65.9	-60.2	-59.3	-60.0	0.1	-49.6	-41.25	8.40
	HT/VHT20 Beam Forming, M0 to M7	2	8	-65.9	-60.2			0.1	-51.1	-41.25	9.86
	HT/VHT20 Beam Forming, M8 to M15	2	5	-65.9	-60.2			0.1	-54.1	-41.25	12.86
	HT/VHT20 Beam Forming, M0 to M7	3	10	-65.9	-60.2	-59.3		0.1	-46.2	-41.25	4.92
HT/VHT20 Beam Forming, M8 to M15	3	7	-65.9	-60.2	-59.3		0.1	-49.2	-41.25	7.92	
HT/VHT20 Beam Forming, M16 to M23	3	5	-65.9	-60.2	-59.3		0.1	-51.2	-41.25	9.92	
HT/VHT20 Beam Forming, M0 to M7	4	11	-65.9	-60.2	-59.3	-60.0	0.1	-43.6	-41.25	2.40	
HT/VHT20 Beam Forming, M8 to M15	4	8	-65.9	-60.2	-59.3	-60.0	0.1	-46.6	-41.25	5.40	



HT/VHT20 Beam Forming, M16 to M23	4	6	-65.9	-60.2	-59.3	-60.0	0.1	-48.6	-41.25	7.40
HT/VHT20 Beam Forming, M24 to M31	4	5	-65.9	-60.2	-59.3	-60.0	0.1	-49.6	-41.25	8.40
HT/VHT20 STBC, M0 to M7	2	5	-65.9	-60.2			0.1	-54.1	-41.25	12.86
HT/VHT20 STBC, M0 to M7	3	5	-65.9	-60.2	-59.3		0.1	-51.2	-41.25	9.92
HT/VHT20 STBC, M0 to M7	4	5	-65.9	-60.2	-59.3	-60.0	0.1	-49.6	-41.25	8.40
HE20, M0 to M9 1ss	1	5	-65.9				0.1	-60.8	-41.25	19.58
HE20, M0 to M9 1ss	2	5	-65.9	-60.2			0.1	-54.1	-41.25	12.85
HE20, M0 to M9 2ss	2	5	-65.9	-60.2			0.1	-54.1	-41.25	12.85
HE20, M0 to M9 1ss	3	5	-65.9	-60.2	-59.3		0.1	-51.2	-41.25	9.90
HE20, M0 to M9 2ss	3	5	-65.9	-60.2	-59.3		0.1	-51.2	-41.25	9.90
HE20, M0 to M9 3ss	3	5	-65.9	-60.2	-59.3		0.1	-51.2	-41.25	9.90
HE20, M0 to M9 1ss	4	5	-65.9	-60.2	-59.3	-59.9	0.1	-49.6	-41.25	8.35
HE20, M0 to M9 2ss	4	5	-65.9	-60.2	-59.3	-59.9	0.1	-49.6	-41.25	8.35
HE20, M0 to M9 3ss	4	5	-65.9	-60.2	-59.3	-59.9	0.1	-49.6	-41.25	8.35
HE20, M0 to M9 4ss	4	5	-65.9	-60.2	-59.3	-59.9	0.1	-49.6	-41.25	8.35
HE20 Beam Forming, M0 to M9 1ss	2	8	-65.9	-60.2			0.1	-51.1	-41.25	9.85
HE20 Beam Forming, M0 to M9 2ss	2	5	-65.9	-60.2			0.1	-54.1	-41.25	12.85
HE20 Beam Forming, M0 to M9 1ss	3	10	-65.9	-60.2	-59.3		0.1	-46.2	-41.25	4.90
HE20 Beam Forming, M0 to M9 2ss	3	7	-65.9	-60.2	-59.3		0.1	-49.2	-41.25	7.90
HE20 Beam Forming, M0 to M9 3ss	3	5	-65.9	-60.2	-59.3		0.1	-51.2	-41.25	9.90
HE20 Beam Forming, M0 to M9 1ss	4	11	-65.9	-60.2	-59.3	-59.9	0.1	-43.6	-41.25	2.35
HE20 Beam Forming, M0 to M9 2ss	4	8	-65.9	-60.2	-59.3	-59.9	0.1	-46.6	-41.25	5.35
HE20 Beam Forming, M0 to M9 3ss	4	6	-65.9	-60.2	-59.3	-59.9	0.1	-48.6	-41.25	7.35
HE20 Beam Forming, M0 to M9 4ss	4	5	-65.9	-60.2	-59.3	-59.9	0.1	-49.6	-41.25	8.35
HE20 STBC, M0 to M9 2ss	2	5	-65.9	-60.2			0.1	-54.1	-41.25	12.85
HE20 STBC, M0 to M9 2ss	3	5	-65.9	-60.2	-59.3		0.1	-51.2	-41.25	9.90
HE20 STBC, M0 to M9 2ss	4	5	-65.9	-60.2	-59.3	-59.9	0.1	-49.6	-41.25	8.35

**Conducted Spurs Average, 5dBi  
5775 MHz, HE80 Beam Forming, M0 to M9 1ss**

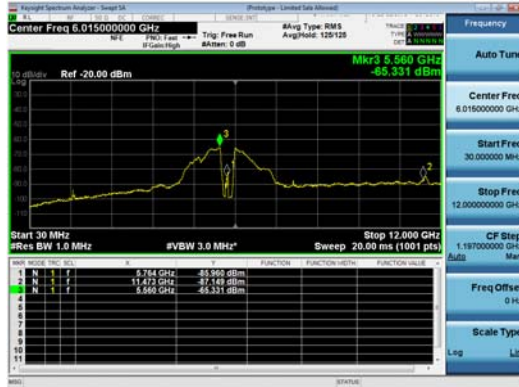

**Antenna A      Antenna B**

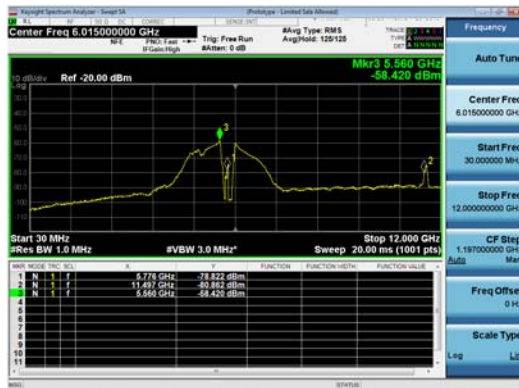
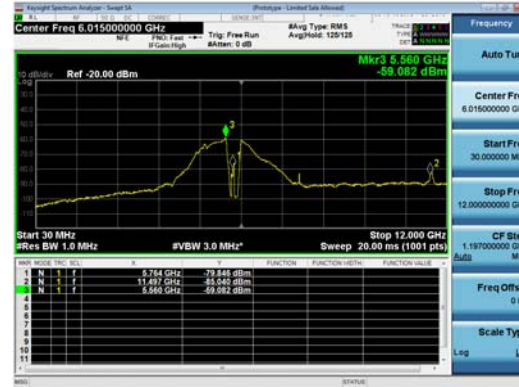

**Antenna C      Antenna D**

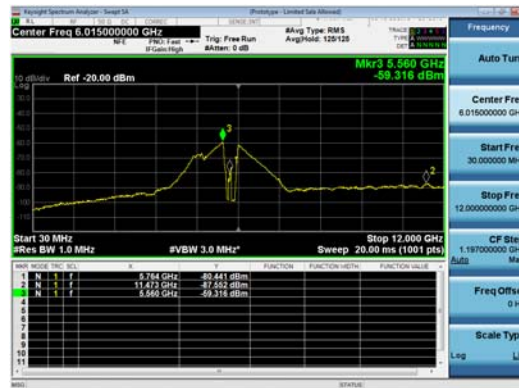



## Conducted Spurious Average Table, 6dBi

Frequency (MHz)	Mode	Tx Paths	Correlated Antenna Gain (dBi)	Tx 1 Spur Power (dBm)	Tx 2 Spur Power (dBm)	Tx 3 Spur Power (dBm)	Tx 4 Spur Power (dBm)	Duty Cycle Correction (dB)	Total Conducted Spur (dBm)	Limit (dBm)	Margin (dB)
5720 <sup>17</sup>	Non HT20, 6 to 54 Mbps	1	6	-63.7				0.1	-57.6	-41.25	16.40
	Non HT20, 6 to 54 Mbps	2	6	-63.7	-61.0			0.1	-53.1	-41.25	11.83
	Non HT20, 6 to 54 Mbps	3	6	-63.7	-61.0	-60.7		0.1	-50.8	-41.25	9.54
	Non HT20, 6 to 54 Mbps	4	6	-63.7	-61.0	-60.7	-60.5	0.1	-49.2	-41.25	7.98
	Non HT20 Beam Forming, 6 to 54 Mbps	2	9	-63.7	-61.0			0.1	-50.1	-41.25	8.83
	Non HT20 Beam Forming, 6 to 54 Mbps	3	11	-63.7	-62.9	-63.3		0.1	-47.5	-41.25	6.22
	Non HT20 Beam Forming, 6 to 54 Mbps	4	12	-63.7	-65.3	-65.9	-64.7	0.1	-46.8	-41.25	5.50
	HT/VHT20, M0 to M7	1	6	-63.6				0.1	-57.5	-41.25	16.30
	HT/VHT20, M0 to M7	2	6	-63.6	-61.0			0.1	-53.0	-41.25	11.80
	HT/VHT20, M8 to M15	2	6	-63.6	-61.0			0.1	-53.0	-41.25	11.80
	HT/VHT20, M0 to M7	3	6	-63.6	-61.0	-60.7		0.1	-50.8	-41.25	9.51
	HT/VHT20, M8 to M15	3	6	-63.6	-61.0	-60.7		0.1	-50.8	-41.25	9.51
	HT/VHT20, M16 to M23	3	6	-63.6	-61.0	-60.7		0.1	-50.8	-41.25	9.51
	HT/VHT20, M0 to M7	4	6	-63.6	-61.0	-60.7	-61.1	0.1	-49.4	-41.25	8.14
	HT/VHT20, M8 to M15	4	6	-63.6	-61.0	-60.7	-61.1	0.1	-49.4	-41.25	8.14
	HT/VHT20, M16 to M23	4	6	-63.6	-61.0	-60.7	-61.1	0.1	-49.4	-41.25	8.14
	HT/VHT20, M24 to M31	4	6	-63.6	-61.0	-60.7	-61.1	0.1	-49.4	-41.25	8.14
	HT/VHT20 Beam Forming, M0 to M7	2	9	-63.6	-61.0			0.1	-50.0	-41.25	8.80
	HT/VHT20 Beam Forming, M8 to M15	2	6	-63.6	-61.0			0.1	-53.0	-41.25	11.80
	HT/VHT20 Beam Forming, M0 to M7	3	11	-63.6	-62.9	-63.4		0.1	-47.5	-41.25	6.22
	HT/VHT20 Beam Forming, M8 to M15	3	8	-63.6	-61.0	-60.7		0.1	-48.8	-41.25	7.51
	HT/VHT20 Beam Forming, M16 to M23	3	6	-63.6	-61.0	-60.7		0.1	-50.8	-41.25	9.51
	HT/VHT20 Beam Forming, M0 to M7	4	12	-63.6	-65.2	-65.9	-65.5	0.1	-46.9	-41.25	5.63
	HT/VHT20 Beam Forming, M8 to M15	4	9	-63.6	-62.4	-62.6	-62.7	0.1	-47.7	-41.25	6.48
	HT/VHT20 Beam Forming, M16 to M23	4	7	-63.6	-61.0	-60.7	-61.1	0.1	-48.4	-41.25	7.14
	HT/VHT20 Beam Forming, M24 to M31	4	6	-63.6	-61.0	-60.7	-61.1	0.1	-49.4	-41.25	8.14
	HT/VHT20 STBC, M0 to M7	2	6	-63.6	-61.0			0.1	-53.0	-41.25	11.80
	HT/VHT20 STBC, M0 to M7	3	6	-63.6	-61.0	-60.7		0.1	-50.8	-41.25	9.51

<sup>17</sup> 5720 (ch144) not supported for Canada.



	HT/VHT20 STBC, M0 to M7	4	6	-63.6	-62.4	-62.6	-62.7	0.1	-50.7	-41.25	9.48
	HE20, M0 to M9 1ss	1	6	-63.9				0.1	-57.8	-41.25	16.58
	HE20, M0 to M9 1ss	2	6	-63.9	-60.9			0.1	-53.1	-41.25	11.82
	HE20, M0 to M9 2ss	2	6	-63.9	-60.9			0.1	-53.1	-41.25	11.82
	HE20, M0 to M9 1ss	3	6	-63.9	-60.9	-61.1		0.1	-50.9	-41.25	9.68
	HE20, M0 to M9 2ss	3	6	-63.9	-60.9	-61.1		0.1	-50.9	-41.25	9.68
	HE20, M0 to M9 3ss	3	6	-63.9	-60.9	-61.1		0.1	-50.9	-41.25	9.68
	HE20, M0 to M9 1ss	4	6	-63.9	-60.9	-61.1	-60.5	0.1	-49.3	-41.25	8.08
	HE20, M0 to M9 2ss	4	6	-63.9	-60.9	-61.1	-60.5	0.1	-49.3	-41.25	8.08
	HE20, M0 to M9 3ss	4	6	-63.9	-60.9	-61.1	-60.5	0.1	-49.3	-41.25	8.08
	HE20, M0 to M9 4ss	4	6	-63.9	-60.9	-61.1	-60.5	0.1	-49.3	-41.25	8.08
	HE20 Beam Forming, M0 to M9 1ss	2	9	-63.9	-60.9			0.1	-50.1	-41.25	8.82
	HE20 Beam Forming, M0 to M9 2ss	2	6	-63.9	-60.9			0.1	-53.1	-41.25	11.82
	HE20 Beam Forming, M0 to M9 1ss	3	11	-63.9	-63.2	-63.3		0.1	-47.6	-41.25	6.37
	HE20 Beam Forming, M0 to M9 2ss	3	8	-63.9	-60.9	-61.1		0.1	-48.9	-41.25	7.68
	HE20 Beam Forming, M0 to M9 3ss	3	6	-63.9	-60.9	-61.1		0.1	-50.9	-41.25	9.68
	HE20 Beam Forming, M0 to M9 1ss	4	12	-63.9	-65.0	-66.1	-65.8	0.1	-47.0	-41.25	5.78
	HE20 Beam Forming, M0 to M9 2ss	4	9	-63.9	-62.5	-62.6	-63.1	0.1	-47.9	-41.25	6.65
	HE20 Beam Forming, M0 to M9 3ss	4	7	-63.9	-60.9	-61.1	-60.5	0.1	-48.3	-41.25	7.08
	HE20 Beam Forming, M0 to M9 4ss	4	6	-63.9	-60.9	-61.1	-60.5	0.1	-49.3	-41.25	8.08
	HE20 STBC, M0 to M9 2ss	2	6	-63.9	-60.9			0.1	-53.1	-41.25	11.82
	HE20 STBC, M0 to M9 2ss	3	6	-63.9	-60.9	-61.1		0.1	-50.9	-41.25	9.68
	HE20 STBC, M0 to M9 2ss	4	6	-63.9	-62.5	-62.6	-63.1	0.1	-50.9	-41.25	9.65
5745	Non HT20, 6 to 54 Mbps	1	6	-65.2				0.1	-59.1	-41.25	17.90
	Non HT20, 6 to 54 Mbps	2	6	-65.2	-59.5			0.1	-52.4	-41.25	11.16
	Non HT20, 6 to 54 Mbps	3	6	-65.2	-59.5	-59.0		0.1	-49.7	-41.25	8.41
	Non HT20, 6 to 54 Mbps	4	6	-65.2	-59.5	-59.0	-60.2	0.1	-48.3	-41.25	7.09
	Non HT20 Beam Forming, 6 to 54 Mbps	2	9	-65.2	-59.5			0.1	-49.4	-41.25	8.16
	Non HT20 Beam Forming, 6 to 54 Mbps	3	11	-65.2	-59.5	-59.0		0.1	-44.7	-41.25	3.41
	Non HT20 Beam Forming, 6 to 54 Mbps	4	12	-65.2	-59.5	-59.0	-60.2	0.1	-42.3	-41.25	1.09
	HT/VHT20, M0 to M7	1	6	-66.0				0.1	-59.9	-41.25	18.70
	HT/VHT20, M0 to M7	2	6	-66.0	-59.5			0.1	-52.6	-41.25	11.32
	HT/VHT20, M8 to M15	2	6	-66.0	-59.5			0.1	-52.6	-41.25	11.32
	HT/VHT20, M0 to M7	3	6	-66.0	-59.5	-59.0		0.1	-49.7	-41.25	8.49
	HT/VHT20, M8 to M15	3	6	-66.0	-59.5	-59.0		0.1	-49.7	-41.25	8.49
	HT/VHT20, M16 to M23	3	6	-66.0	-59.5	-59.0		0.1	-49.7	-41.25	8.49
	HT/VHT20, M0 to M7	4	6	-66.0	-59.5	-59.0	-59.9	0.1	-48.3	-41.25	7.07
	HT/VHT20, M8 to M15	4	6	-66.0	-59.5	-59.0	-59.9	0.1	-48.3	-41.25	7.07
	HT/VHT20, M16 to M23	4	6	-66.0	-59.5	-59.0	-59.9	0.1	-48.3	-41.25	7.07
	HT/VHT20, M24 to M31	4	6	-66.0	-59.5	-59.0	-59.9	0.1	-48.3	-41.25	7.07
	HT/VHT20 Beam Forming, M0 to M7	2	9	-66.0	-59.5			0.1	-49.6	-41.25	8.32
HT/VHT20 Beam Forming, M8 to M15	2	6	-66.0	-59.5			0.1	-52.6	-41.25	11.32	

	HT/VHT20 Beam Forming, M0 to M7	3	11	-66.0	-59.5	-59.0		0.1	-44.7	-41.25	3.49
	HT/VHT20 Beam Forming, M8 to M15	3	8	-66.0	-59.5	-59.0		0.1	-47.7	-41.25	6.49
	HT/VHT20 Beam Forming, M16 to M23	3	6	-66.0	-59.5	-59.0		0.1	-49.7	-41.25	8.49
	HT/VHT20 Beam Forming, M0 to M7	4	12	-66.0	-59.5	-59.0	-59.9	0.1	-42.3	-41.25	1.07
	HT/VHT20 Beam Forming, M8 to M15	4	9	-66.0	-59.5	-59.0	-59.9	0.1	-45.3	-41.25	4.07
	HT/VHT20 Beam Forming, M16 to M23	4	7	-66.0	-59.5	-59.0	-59.9	0.1	-47.3	-41.25	6.07
	HT/VHT20 Beam Forming, M24 to M31	4	6	-66.0	-59.5	-59.0	-59.9	0.1	-48.3	-41.25	7.07
	HT/VHT20 STBC, M0 to M7	2	6	-66.0	-59.5			0.1	-52.6	-41.25	11.32
	HT/VHT20 STBC, M0 to M7	3	6	-66.0	-59.5	-59.0		0.1	-49.7	-41.25	8.49
	HT/VHT20 STBC, M0 to M7	4	6	-66.0	-59.5	-59.0	-59.9	0.1	-48.3	-41.25	7.07
	HE20, M0 to M9 1ss	1	6	-65.8				0.1	-59.7	-41.25	18.48
	HE20, M0 to M9 1ss	2	6	-65.8	-59.6			0.1	-52.6	-41.25	11.35
	HE20, M0 to M9 2ss	2	6	-65.8	-59.6			0.1	-52.6	-41.25	11.35
	HE20, M0 to M9 1ss	3	6	-65.8	-59.6	-59.0		0.1	-49.8	-41.25	8.50
	HE20, M0 to M9 2ss	3	6	-65.8	-59.6	-59.0		0.1	-49.8	-41.25	8.50
	HE20, M0 to M9 3ss	3	6	-65.8	-59.6	-59.0		0.1	-49.8	-41.25	8.50
	HE20, M0 to M9 1ss	4	6	-65.8	-59.6	-59.0	-59.8	0.1	-48.3	-41.25	7.04
	HE20, M0 to M9 2ss	4	6	-65.8	-59.6	-59.0	-59.8	0.1	-48.3	-41.25	7.04
	HE20, M0 to M9 3ss	4	6	-65.8	-59.6	-59.0	-59.8	0.1	-48.3	-41.25	7.04
	HE20, M0 to M9 4ss	4	6	-65.8	-59.6	-59.0	-59.8	0.1	-48.3	-41.25	7.04
	HE20 Beam Forming, M0 to M9 1ss	2	9	-65.8	-59.6			0.1	-49.6	-41.25	8.35
	HE20 Beam Forming, M0 to M9 2ss	2	6	-65.8	-59.6			0.1	-52.6	-41.25	11.35
	HE20 Beam Forming, M0 to M9 1ss	3	11	-65.8	-59.6	-59.0		0.1	-44.8	-41.25	3.50
	HE20 Beam Forming, M0 to M9 2ss	3	8	-65.8	-59.6	-59.0		0.1	-47.8	-41.25	6.50
	HE20 Beam Forming, M0 to M9 3ss	3	6	-65.8	-59.6	-59.0		0.1	-49.8	-41.25	8.50
	HE20 Beam Forming, M0 to M9 1ss	4	12	-65.8	-59.6	-59.0	-59.8	0.1	-42.3	-41.25	1.04
	HE20 Beam Forming, M0 to M9 2ss	4	9	-65.8	-59.6	-59.0	-59.8	0.1	-45.3	-41.25	4.04
	HE20 Beam Forming, M0 to M9 3ss	4	7	-65.8	-59.6	-59.0	-59.8	0.1	-47.3	-41.25	6.04
	HE20 Beam Forming, M0 to M9 4ss	4	6	-65.8	-59.6	-59.0	-59.8	0.1	-48.3	-41.25	7.04
	HE20 STBC, M0 to M9 2ss	2	6	-65.8	-59.6			0.1	-52.6	-41.25	11.35
	HE20 STBC, M0 to M9 2ss	3	6	-65.8	-59.6	-59.0		0.1	-49.8	-41.25	8.50
	HE20 STBC, M0 to M9 2ss	4	6	-65.8	-59.6	-59.0	-59.8	0.1	-48.3	-41.25	7.04
5755	Non HT40, 6 to 54 Mbps	1	6	-65.3				0.1	-59.2	-41.25	18.00
	Non HT40, 6 to 54 Mbps	2	6	-65.3	-59.1			0.1	-52.1	-41.25	10.87
	Non HT40, 6 to 54 Mbps	3	6	-65.3	-59.1	-58.8		0.1	-49.4	-41.25	8.16
	Non HT40, 6 to 54 Mbps	4	6	-65.3	-59.1	-58.8	-60.0	0.1	-48.1	-41.25	6.85
	HT/VHT40, M0 to M7	1	6	-66.0				0.1	-59.9	-41.25	18.64
	HT/VHT40, M0 to M7	2	6	-66.0	-59.4			0.1	-52.4	-41.25	11.18
	HT/VHT40, M8 to M15	2	6	-66.0	-59.4			0.1	-52.4	-41.25	11.18
	HT/VHT40, M0 to M7	3	6	-66.0	-59.4	-59.3		0.1	-49.8	-41.25	8.53
	HT/VHT40, M8 to M15	3	6	-66.0	-59.4	-59.3		0.1	-49.8	-41.25	8.53
	HT/VHT40, M16 to M23	3	6	-66.0	-59.4	-59.3		0.1	-49.8	-41.25	8.53

HT/VHT40, M0 to M7	4	6	-66.0	-59.4	-59.3	-60.2	0.1	-48.4	-41.25	7.16	
HT/VHT40, M8 to M15	4	6	-66.0	-59.4	-59.3	-60.2	0.1	-48.4	-41.25	7.16	
HT/VHT40, M16 to M23	4	6	-66.0	-59.4	-59.3	-60.2	0.1	-48.4	-41.25	7.16	
HT/VHT40, M24 to M31	4	6	-66.0	-59.4	-59.3	-60.2	0.1	-48.4	-41.25	7.16	
HT/VHT40 Beam Forming, M0 to M7	2	9	-66.0	-59.4			0.1	-49.4	-41.25	8.18	
HT/VHT40 Beam Forming, M8 to M15	2	6	-66.0	-59.4			0.1	-52.4	-41.25	11.18	
HT/VHT40 Beam Forming, M0 to M7	3	11	-66.0	-59.4	-59.3		0.1	-44.8	-41.25	3.53	
HT/VHT40 Beam Forming, M8 to M15	3	8	-66.0	-59.4	-59.3		0.1	-47.8	-41.25	6.53	
HT/VHT40 Beam Forming, M16 to M23	3	6	-66.0	-59.4	-59.3		0.1	-49.8	-41.25	8.53	
HT/VHT40 Beam Forming, M0 to M7	4	12	-66.0	-59.4	-59.3	-60.2	0.1	-42.4	-41.25	1.16	
HT/VHT40 Beam Forming, M8 to M15	4	9	-66.0	-59.4	-59.3	-60.2	0.1	-45.4	-41.25	4.16	
HT/VHT40 Beam Forming, M16 to M23	4	7	-66.0	-59.4	-59.3	-60.2	0.1	-47.4	-41.25	6.16	
HT/VHT40 Beam Forming, M24 to M31	4	6	-66.0	-59.4	-59.3	-60.2	0.1	-48.4	-41.25	7.16	
HT/VHT40 STBC, M0 to M7	2	6	-66.0	-59.4			0.1	-52.4	-41.25	11.18	
HT/VHT40 STBC, M0 to M7	3	6	-66.0	-59.4	-59.3		0.1	-49.8	-41.25	8.53	
HT/VHT40 STBC, M0 to M7	4	6	-66.0	-59.4	-59.3	-60.2	0.1	-48.4	-41.25	7.16	
HE40, M0 to M9 1ss	1	6	-65.9				0.1	-59.8	-41.25	18.52	
HE40, M0 to M9 1ss	2	6	-65.9	-59.4			0.1	-52.4	-41.25	11.15	
HE40, M0 to M9 2ss	2	6	-65.9	-59.4			0.1	-52.4	-41.25	11.15	
HE40, M0 to M9 1ss	3	6	-65.9	-59.4	-59.1		0.1	-49.7	-41.25	8.42	
HE40, M0 to M9 2ss	3	6	-65.9	-59.4	-59.1		0.1	-49.7	-41.25	8.42	
HE40, M0 to M9 3ss	3	6	-65.9	-59.4	-59.1		0.1	-49.7	-41.25	8.42	
HE40, M0 to M9 1ss	4	6	-65.9	-59.4	-59.1	-60.1	0.1	-48.3	-41.25	7.05	
HE40, M0 to M9 2ss	4	6	-65.9	-59.4	-59.1	-60.1	0.1	-48.3	-41.25	7.05	
HE40, M0 to M9 3ss	4	6	-65.9	-59.4	-59.1	-60.1	0.1	-48.3	-41.25	7.05	
HE40, M0 to M9 4ss	4	6	-65.9	-59.4	-59.1	-60.1	0.1	-48.3	-41.25	7.05	
HE40 Beam Forming, M0 to M9 1ss	2	9	-65.9	-59.4			0.1	-49.4	-41.25	8.15	
HE40 Beam Forming, M0 to M9 2ss	2	6	-65.9	-59.4			0.1	-52.4	-41.25	11.15	
HE40 Beam Forming, M0 to M9 1ss	3	11	-65.9	-59.4	-59.1		0.1	-44.7	-41.25	3.42	
HE40 Beam Forming, M0 to M9 2ss	3	8	-65.9	-59.4	-59.1		0.1	-47.7	-41.25	6.42	
HE40 Beam Forming, M0 to M9 3ss	3	6	-65.9	-59.4	-59.1		0.1	-49.7	-41.25	8.42	
HE40 Beam Forming, M0 to M9 1ss	4	12	-65.9	-59.4	-59.1	-60.1	0.1	-42.3	-41.25	1.05	
HE40 Beam Forming, M0 to M9 2ss	4	9	-65.9	-59.4	-59.1	-60.1	0.1	-45.3	-41.25	4.05	
HE40 Beam Forming, M0 to M9 3ss	4	7	-65.9	-59.4	-59.1	-60.1	0.1	-47.3	-41.25	6.05	
HE40 Beam Forming, M0 to M9 4ss	4	6	-65.9	-59.4	-59.1	-60.1	0.1	-48.3	-41.25	7.05	
HE40 STBC, M0 to M9 2ss	2	6	-65.9	-59.4			0.1	-52.4	-41.25	11.15	
HE40 STBC, M0 to M9 2ss	3	6	-65.9	-59.4	-59.1		0.1	-49.7	-41.25	8.42	
HE40 STBC, M0 to M9 2ss	4	6	-65.9	-59.4	-59.1	-60.1	0.1	-48.3	-41.25	7.05	
5775	Non HT80, 6 to 54 Mbps	1	6	-64.6				0.0	-58.6	-41.25	17.30
	Non HT80, 6 to 54 Mbps	2	6	-64.6	-58.9			0.0	-51.8	-41.25	10.57
	Non HT80, 6 to 54 Mbps	3	6	-64.6	-58.9	-58.0		0.0	-48.9	-41.25	7.62
	Non HT80, 6 to 54 Mbps	4	6	-64.6	-58.9	-58.0	-58.9	0.0	-47.4	-41.25	6.16

VHT80, M0 to M9 1ss	1	6	-65.4				0.2	-59.2	-41.25	17.93
VHT80, M0 to M9 1ss	2	6	-65.4	-59.9			0.2	-52.6	-41.25	11.35
VHT80, M0 to M9 2ss	2	6	-65.4	-59.9			0.2	-52.6	-41.25	11.35
VHT80, M0 to M9 1ss	3	6	-65.4	-59.9	-58.5		0.2	-49.4	-41.25	8.17
VHT80, M0 to M9 2ss	3	6	-65.4	-59.9	-58.5		0.2	-49.4	-41.25	8.17
VHT80, M0 to M9 3ss	3	6	-65.4	-59.9	-58.5		0.2	-49.4	-41.25	8.17
VHT80, M0 to M9 1ss	4	6	-65.4	-59.9	-58.5	-59.7	0.2	-48.0	-41.25	6.73
VHT80, M0 to M9 2ss	4	6	-65.4	-59.9	-58.5	-59.7	0.2	-48.0	-41.25	6.73
VHT80, M0 to M9 3ss	4	6	-65.4	-59.9	-58.5	-59.7	0.2	-48.0	-41.25	6.73
VHT80, M0 to M9 4ss	4	6	-65.4	-59.9	-58.5	-59.7	0.2	-48.0	-41.25	6.73
VHT80 Beam Forming, M0 to M9 1ss	2	9	-65.4	-59.9			0.2	-49.6	-41.25	8.35
VHT80 Beam Forming, M0 to M9 2ss	2	6	-65.4	-59.9			0.2	-52.6	-41.25	11.35
VHT80 Beam Forming, M0 to M9 1ss	3	11	-65.4	-59.9	-58.5		0.2	-44.4	-41.25	3.17
VHT80 Beam Forming, M0 to M9 2ss	3	8	-65.4	-59.9	-58.5		0.2	-47.4	-41.25	6.17
VHT80 Beam Forming, M0 to M9 3ss	3	6	-65.4	-59.9	-58.5		0.2	-49.4	-41.25	8.17
VHT80 Beam Forming, M0 to M9 1ss	4	12	-65.4	-59.9	-58.5	-59.7	0.2	-42.0	-41.25	0.73
VHT80 Beam Forming, M0 to M9 2ss	4	9	-65.4	-59.9	-58.5	-59.7	0.2	-45.0	-41.25	3.73
VHT80 Beam Forming, M0 to M9 3ss	4	7	-65.4	-59.9	-58.5	-59.7	0.2	-47.0	-41.25	5.73
VHT80 Beam Forming, M0 to M9 4ss	4	6	-65.4	-59.9	-58.5	-59.7	0.2	-48.0	-41.25	6.73
VHT80 STBC, M0 to M9 1ss	2	6	-65.4	-59.9			0.2	-52.6	-41.25	11.35
VHT80 STBC, M0 to M9 1ss	3	6	-65.4	-59.9	-58.5		0.2	-49.4	-41.25	8.17
VHT80 STBC, M0 to M9 1ss	4	6	-65.4	-59.9	-58.5	-59.7	0.2	-48.0	-41.25	6.73
HE80, M0 to M9 1ss	1	6	-65.3				0.2	-59.1	-41.25	17.80
HE80, M0 to M9 1ss	2	6	-65.3	-59.1			0.2	-51.9	-41.25	10.67
HE80, M0 to M9 2ss	2	6	-65.3	-59.1			0.2	-51.9	-41.25	10.67
HE80, M0 to M9 1ss	3	6	-65.3	-59.1	-58.4		0.2	-49.0	-41.25	7.77
HE80, M0 to M9 2ss	3	6	-65.3	-59.1	-58.4		0.2	-49.0	-41.25	7.77
HE80, M0 to M9 3ss	3	6	-65.3	-59.1	-58.4		0.2	-49.0	-41.25	7.77
HE80, M0 to M9 1ss	4	6	-65.3	-59.1	-58.4	-59.3	0.2	-47.6	-41.25	6.32
HE80, M0 to M9 2ss	4	6	-65.3	-59.1	-58.4	-59.3	0.2	-47.6	-41.25	6.32
HE80, M0 to M9 3ss	4	6	-65.3	-59.1	-58.4	-59.3	0.2	-47.6	-41.25	6.32
HE80, M0 to M9 4ss	4	6	-65.3	-59.1	-58.4	-59.3	0.2	-47.6	-41.25	6.32
HE80 Beam Forming, M0 to M9 1ss	2	9	-65.3	-59.1			0.2	-48.9	-41.25	7.67
HE80 Beam Forming, M0 to M9 2ss	2	6	-65.3	-59.1			0.2	-51.9	-41.25	10.67
HE80 Beam Forming, M0 to M9 1ss	3	11	-65.3	-59.1	-58.4		0.2	-44.0	-41.25	2.77
HE80 Beam Forming, M0 to M9 2ss	3	8	-65.3	-59.1	-58.4		0.2	-47.0	-41.25	5.77
HE80 Beam Forming, M0 to M9 3ss	3	6	-65.3	-59.1	-58.4		0.2	-49.0	-41.25	7.77
<b>HE80 Beam Forming, M0 to M9 1ss</b>	<b>4</b>	<b>12</b>	<b>-65.3</b>	<b>-59.1</b>	<b>-58.4</b>	<b>-59.3</b>	<b>0.2</b>	<b>-41.6</b>	<b>-41.25</b>	<b>0.32</b>
HE80 Beam Forming, M0 to M9 2ss	4	9	-65.3	-59.1	-58.4	-59.3	0.2	-44.6	-41.25	3.32
HE80 Beam Forming, M0 to M9 3ss	4	7	-65.3	-59.1	-58.4	-59.3	0.2	-46.6	-41.25	5.32
HE80 Beam Forming, M0 to M9 4ss	4	6	-65.3	-59.1	-58.4	-59.3	0.2	-47.6	-41.25	6.32
HE80 STBC, M0 to M9 1ss	2	6	-65.3	-59.1			0.2	-51.9	-41.25	10.67
HE80 STBC, M0 to M9 1ss	3	6	-65.3	-59.1	-58.4		0.2	-49.0	-41.25	7.77

HE80 STBC, M0 to M9 1ss	4	6	-65.3	-59.1	-58.4	-59.3	0.2	-47.6	-41.25	6.32
-------------------------	---	---	-------	-------	-------	-------	-----	-------	--------	------

5785	Non HT20, 6 to 54 Mbps	1	6	-64.7				0.1	-58.6	-41.25	17.40
	Non HT20, 6 to 54 Mbps	2	6	-64.7	-59.9			0.1	-52.6	-41.25	11.36
	Non HT20, 6 to 54 Mbps	3	6	-64.7	-59.9	-58.9		0.1	-49.7	-41.25	8.47
	Non HT20, 6 to 54 Mbps	4	6	-64.7	-59.9	-58.9	-59.5	0.1	-48.2	-41.25	6.93
	Non HT20 Beam Forming, 6 to 54 Mbps	2	9	-64.7	-59.9			0.1	-49.6	-41.25	8.36
	Non HT20 Beam Forming, 6 to 54 Mbps	3	11	-64.7	-59.9	-58.9		0.1	-44.7	-41.25	3.47
	Non HT20 Beam Forming, 6 to 54 Mbps	4	12	-64.7	-59.9	-58.9	-59.5	0.1	-42.2	-41.25	0.93
	HT/VHT20, M0 to M7	1	6	-64.9				0.1	-58.8	-41.25	17.60
	HT/VHT20, M0 to M7	2	6	-64.9	-60.1			0.1	-52.8	-41.25	11.56
	HT/VHT20, M8 to M15	2	6	-64.9	-60.1			0.1	-52.8	-41.25	11.56
	HT/VHT20, M0 to M7	3	6	-64.9	-60.1	-58.8		0.1	-49.8	-41.25	8.52
	HT/VHT20, M8 to M15	3	6	-64.9	-60.1	-58.8		0.1	-49.8	-41.25	8.52
	HT/VHT20, M16 to M23	3	6	-64.9	-60.1	-58.8		0.1	-49.8	-41.25	8.52
	HT/VHT20, M0 to M7	4	6	-64.9	-60.1	-58.8	-59.9	0.1	-48.3	-41.25	7.08
	HT/VHT20, M8 to M15	4	6	-64.9	-60.1	-58.8	-59.9	0.1	-48.3	-41.25	7.08
	HT/VHT20, M16 to M23	4	6	-64.9	-60.1	-58.8	-59.9	0.1	-48.3	-41.25	7.08
	HT/VHT20, M24 to M31	4	6	-64.9	-60.1	-58.8	-59.9	0.1	-48.3	-41.25	7.08
	HT/VHT20 Beam Forming, M0 to M7	2	9	-64.9	-60.1			0.1	-49.8	-41.25	8.56
	HT/VHT20 Beam Forming, M8 to M15	2	6	-64.9	-60.1			0.1	-52.8	-41.25	11.56
	HT/VHT20 Beam Forming, M0 to M7	3	11	-64.9	-60.1	-58.8		0.1	-44.8	-41.25	3.52
	HT/VHT20 Beam Forming, M8 to M15	3	8	-64.9	-60.1	-58.8		0.1	-47.8	-41.25	6.52
	HT/VHT20 Beam Forming, M16 to M23	3	6	-64.9	-60.1	-58.8		0.1	-49.8	-41.25	8.52
	HT/VHT20 Beam Forming, M0 to M7	4	12	-64.9	-60.1	-58.8	-59.9	0.1	-42.3	-41.25	1.08
	HT/VHT20 Beam Forming, M8 to M15	4	9	-64.9	-60.1	-58.8	-59.9	0.1	-45.3	-41.25	4.08
	HT/VHT20 Beam Forming, M16 to M23	4	7	-64.9	-60.1	-58.8	-59.9	0.1	-47.3	-41.25	6.08
	HT/VHT20 Beam Forming, M24 to M31	4	6	-64.9	-60.1	-58.8	-59.9	0.1	-48.3	-41.25	7.08
	HT/VHT20 STBC, M0 to M7	2	6	-64.9	-60.1			0.1	-52.8	-41.25	11.56
	HT/VHT20 STBC, M0 to M7	3	6	-64.9	-60.1	-58.8		0.1	-49.8	-41.25	8.52
	HT/VHT20 STBC, M0 to M7	4	6	-64.9	-60.1	-58.8	-59.9	0.1	-48.3	-41.25	7.08
	HE20, M0 to M9 1ss	1	6	-64.7				0.1	-58.6	-41.25	17.38
	HE20, M0 to M9 1ss	2	6	-64.7	-59.9			0.1	-52.6	-41.25	11.34
	HE20, M0 to M9 2ss	2	6	-64.7	-59.9			0.1	-52.6	-41.25	11.34
	HE20, M0 to M9 1ss	3	6	-64.7	-59.9	-59.0		0.1	-49.7	-41.25	8.50
	HE20, M0 to M9 2ss	3	6	-64.7	-59.9	-59.0		0.1	-49.7	-41.25	8.50
HE20, M0 to M9 3ss	3	6	-64.7	-59.9	-59.0		0.1	-49.7	-41.25	8.50	
HE20, M0 to M9 1ss	4	6	-64.7	-59.9	-59.0	-59.7	0.1	-48.3	-41.25	7.01	
HE20, M0 to M9 2ss	4	6	-64.7	-59.9	-59.0	-59.7	0.1	-48.3	-41.25	7.01	
HE20, M0 to M9 3ss	4	6	-64.7	-59.9	-59.0	-59.7	0.1	-48.3	-41.25	7.01	
HE20, M0 to M9 4ss	4	6	-64.7	-59.9	-59.0	-59.7	0.1	-48.3	-41.25	7.01	
HE20 Beam Forming, M0 to M9 1ss	2	9	-64.7	-59.9			0.1	-49.6	-41.25	8.34	



	HE20 Beam Forming, M0 to M9 2ss	2	6	-64.7	-59.9			0.1	-52.6	-41.25	11.34
	HE20 Beam Forming, M0 to M9 1ss	3	11	-64.7	-59.9	-59.0		0.1	-44.7	-41.25	3.50
	HE20 Beam Forming, M0 to M9 2ss	3	8	-64.7	-59.9	-59.0		0.1	-47.7	-41.25	6.50
	HE20 Beam Forming, M0 to M9 3ss	3	6	-64.7	-59.9	-59.0		0.1	-49.7	-41.25	8.50
	HE20 Beam Forming, M0 to M9 1ss	4	12	-64.7	-59.9	-59.0	-59.7	0.1	-42.3	-41.25	1.01
	HE20 Beam Forming, M0 to M9 2ss	4	9	-64.7	-59.9	-59.0	-59.7	0.1	-45.3	-41.25	4.01
	HE20 Beam Forming, M0 to M9 3ss	4	7	-64.7	-59.9	-59.0	-59.7	0.1	-47.3	-41.25	6.01
	HE20 Beam Forming, M0 to M9 4ss	4	6	-64.7	-59.9	-59.0	-59.7	0.1	-48.3	-41.25	7.01
	HE20 STBC, M0 to M9 2ss	2	6	-64.7	-59.9			0.1	-52.6	-41.25	11.34
	HE20 STBC, M0 to M9 2ss	3	6	-64.7	-59.9	-59.0		0.1	-49.7	-41.25	8.50
	HE20 STBC, M0 to M9 2ss	4	6	-64.7	-59.9	-59.0	-59.7	0.1	-48.3	-41.25	7.01
	Non HT40, 6 to 54 Mbps	1	6	-65.6				0.1	-59.5	-41.25	18.30
	Non HT40, 6 to 54 Mbps	2	6	-65.6	-59.4			0.1	-52.4	-41.25	11.17
	Non HT40, 6 to 54 Mbps	3	6	-65.6	-59.4	-59.1		0.1	-49.7	-41.25	8.46
	Non HT40, 6 to 54 Mbps	4	6	-65.6	-59.4	-59.1	-60.0	0.1	-48.3	-41.25	7.07
	HT/VHT40, M0 to M7	1	6	-65.9				0.1	-59.8	-41.25	18.54
	HT/VHT40, M0 to M7	2	6	-65.9	-60.1			0.1	-53.0	-41.25	11.73
	HT/VHT40, M8 to M15	2	6	-65.9	-60.1			0.1	-53.0	-41.25	11.73
	HT/VHT40, M0 to M7	3	6	-65.9	-60.1	-59.5		0.1	-50.2	-41.25	8.92
	HT/VHT40, M8 to M15	3	6	-65.9	-60.1	-59.5		0.1	-50.2	-41.25	8.92
	HT/VHT40, M16 to M23	3	6	-65.9	-60.1	-59.5		0.1	-50.2	-41.25	8.92
	HT/VHT40, M0 to M7	4	6	-65.9	-60.1	-59.5	-60.3	0.1	-48.7	-41.25	7.47
	HT/VHT40, M8 to M15	4	6	-65.9	-60.1	-59.5	-60.3	0.1	-48.7	-41.25	7.47
	HT/VHT40, M16 to M23	4	6	-65.9	-60.1	-59.5	-60.3	0.1	-48.7	-41.25	7.47
	HT/VHT40, M24 to M31	4	6	-65.9	-60.1	-59.5	-60.3	0.1	-48.7	-41.25	7.47
5795	HT/VHT40 Beam Forming, M0 to M7	2	9	-65.9	-60.1			0.1	-50.0	-41.25	8.73
	HT/VHT40 Beam Forming, M8 to M15	2	6	-65.9	-60.1			0.1	-53.0	-41.25	11.73
	HT/VHT40 Beam Forming, M0 to M7	3	11	-65.9	-60.1	-59.5		0.1	-45.2	-41.25	3.92
	HT/VHT40 Beam Forming, M8 to M15	3	8	-65.9	-60.1	-59.5		0.1	-48.2	-41.25	6.92
	HT/VHT40 Beam Forming, M16 to M23	3	6	-65.9	-60.1	-59.5		0.1	-50.2	-41.25	8.92
	HT/VHT40 Beam Forming, M0 to M7	4	12	-65.9	-60.1	-59.5	-60.3	0.1	-42.7	-41.25	1.47
	HT/VHT40 Beam Forming, M8 to M15	4	9	-65.9	-60.1	-59.5	-60.3	0.1	-45.7	-41.25	4.47
	HT/VHT40 Beam Forming, M16 to M23	4	7	-65.9	-60.1	-59.5	-60.3	0.1	-47.7	-41.25	6.47
	HT/VHT40 Beam Forming, M24 to M31	4	6	-65.9	-60.1	-59.5	-60.3	0.1	-48.7	-41.25	7.47
	HT/VHT40 STBC, M0 to M7	2	6	-65.9	-60.1			0.1	-53.0	-41.25	11.73
	HT/VHT40 STBC, M0 to M7	3	6	-65.9	-60.1	-59.5		0.1	-50.2	-41.25	8.92
	HT/VHT40 STBC, M0 to M7	4	6	-65.9	-60.1	-59.5	-60.3	0.1	-48.7	-41.25	7.47
	HE40, M0 to M9 1ss	1	6	-65.9				0.1	-59.8	-41.25	18.52
	HE40, M0 to M9 1ss	2	6	-65.9	-60.0			0.1	-52.9	-41.25	11.63
	HE40, M0 to M9 2ss	2	6	-65.9	-60.0			0.1	-52.9	-41.25	11.63
	HE40, M0 to M9 1ss	3	6	-65.9	-60.0	-59.6		0.1	-50.2	-41.25	8.91
	HE40, M0 to M9 2ss	3	6	-65.9	-60.0	-59.6		0.1	-50.2	-41.25	8.91

	HE40, M0 to M9 3ss	3	6	-65.9	-60.0	-59.6		0.1	-50.2	-41.25	8.91
	HE40, M0 to M9 1ss	4	6	-65.9	-60.0	-59.6	-60.5	0.1	-48.8	-41.25	7.51
	HE40, M0 to M9 2ss	4	6	-65.9	-60.0	-59.6	-60.5	0.1	-48.8	-41.25	7.51
	HE40, M0 to M9 3ss	4	6	-65.9	-60.0	-59.6	-60.5	0.1	-48.8	-41.25	7.51
	HE40, M0 to M9 4ss	4	6	-65.9	-60.0	-59.6	-60.5	0.1	-48.8	-41.25	7.51
	HE40 Beam Forming, M0 to M9 1ss	2	9	-65.9	-60.0			0.1	-49.9	-41.25	8.63
	HE40 Beam Forming, M0 to M9 2ss	2	6	-65.9	-60.0			0.1	-52.9	-41.25	11.63
	HE40 Beam Forming, M0 to M9 1ss	3	11	-65.9	-60.0	-59.6		0.1	-45.2	-41.25	3.91
	HE40 Beam Forming, M0 to M9 2ss	3	8	-65.9	-60.0	-59.6		0.1	-48.2	-41.25	6.91
	HE40 Beam Forming, M0 to M9 3ss	3	6	-65.9	-60.0	-59.6		0.1	-50.2	-41.25	8.91
	HE40 Beam Forming, M0 to M9 1ss	4	12	-65.9	-60.0	-59.6	-60.5	0.1	-42.8	-41.25	1.51
	HE40 Beam Forming, M0 to M9 2ss	4	9	-65.9	-60.0	-59.6	-60.5	0.1	-45.8	-41.25	4.51
	HE40 Beam Forming, M0 to M9 3ss	4	7	-65.9	-60.0	-59.6	-60.5	0.1	-47.8	-41.25	6.51
	HE40 Beam Forming, M0 to M9 4ss	4	6	-65.9	-60.0	-59.6	-60.5	0.1	-48.8	-41.25	7.51
	HE40 STBC, M0 to M9 2ss	2	6	-65.9	-60.0			0.1	-52.9	-41.25	11.63
	HE40 STBC, M0 to M9 2ss	3	6	-65.9	-60.0	-59.6		0.1	-50.2	-41.25	8.91
	HE40 STBC, M0 to M9 2ss	4	6	-65.9	-60.0	-59.6	-60.5	0.1	-48.8	-41.25	7.51
5825	Non HT20, 6 to 54 Mbps	1	6	-65.7				0.1	-59.6	-41.25	18.40
	Non HT20, 6 to 54 Mbps	2	6	-65.7	-59.9			0.1	-52.8	-41.25	11.59
	Non HT20, 6 to 54 Mbps	3	6	-65.7	-59.9	-59.2		0.1	-50.0	-41.25	8.73
	Non HT20, 6 to 54 Mbps	4	6	-65.7	-59.9	-59.2	-59.6	0.1	-48.4	-41.25	7.15
	Non HT20 Beam Forming, 6 to 54 Mbps	2	9	-65.7	-59.9			0.1	-49.8	-41.25	8.59
	Non HT20 Beam Forming, 6 to 54 Mbps	3	11	-65.7	-59.9	-59.2		0.1	-45.0	-41.25	3.73
	Non HT20 Beam Forming, 6 to 54 Mbps	4	12	-65.7	-59.9	-59.2	-59.6	0.1	-42.4	-41.25	1.15
	HT/VHT20, M0 to M7	1	6	-65.9				0.1	-59.8	-41.25	18.60
	HT/VHT20, M0 to M7	2	6	-65.9	-60.2			0.1	-53.1	-41.25	11.86
	HT/VHT20, M8 to M15	2	6	-65.9	-60.2			0.1	-53.1	-41.25	11.86
	HT/VHT20, M0 to M7	3	6	-65.9	-60.2	-59.3		0.1	-50.2	-41.25	8.92
	HT/VHT20, M8 to M15	3	6	-65.9	-60.2	-59.3		0.1	-50.2	-41.25	8.92
	HT/VHT20, M16 to M23	3	6	-65.9	-60.2	-59.3		0.1	-50.2	-41.25	8.92
	HT/VHT20, M0 to M7	4	6	-65.9	-60.2	-59.3	-60.0	0.1	-48.6	-41.25	7.40
	HT/VHT20, M8 to M15	4	6	-65.9	-60.2	-59.3	-60.0	0.1	-48.6	-41.25	7.40
	HT/VHT20, M16 to M23	4	6	-65.9	-60.2	-59.3	-60.0	0.1	-48.6	-41.25	7.40
	HT/VHT20, M24 to M31	4	6	-65.9	-60.2	-59.3	-60.0	0.1	-48.6	-41.25	7.40
	HT/VHT20 Beam Forming, M0 to M7	2	9	-65.9	-60.2			0.1	-50.1	-41.25	8.86
	HT/VHT20 Beam Forming, M8 to M15	2	6	-65.9	-60.2			0.1	-53.1	-41.25	11.86
	HT/VHT20 Beam Forming, M0 to M7	3	11	-65.9	-60.2	-59.3		0.1	-45.2	-41.25	3.92
	HT/VHT20 Beam Forming, M8 to M15	3	8	-65.9	-60.2	-59.3		0.1	-48.2	-41.25	6.92
	HT/VHT20 Beam Forming, M16 to M23	3	6	-65.9	-60.2	-59.3		0.1	-50.2	-41.25	8.92
	HT/VHT20 Beam Forming, M0 to M7	4	12	-65.9	-60.2	-59.3	-60.0	0.1	-42.6	-41.25	1.40
	HT/VHT20 Beam Forming, M8 to M15	4	9	-65.9	-60.2	-59.3	-60.0	0.1	-45.6	-41.25	4.40
HT/VHT20 Beam Forming, M16 to M23	4	7	-65.9	-60.2	-59.3	-60.0	0.1	-47.6	-41.25	6.40	



HT/VHT20 Beam Forming, M24 to M31	4	6	-65.9	-60.2	-59.3	-60.0	0.1	-48.6	-41.25	7.40
HT/VHT20 STBC, M0 to M7	2	6	-65.9	-60.2			0.1	-53.1	-41.25	11.86
HT/VHT20 STBC, M0 to M7	3	6	-65.9	-60.2	-59.3		0.1	-50.2	-41.25	8.92
HT/VHT20 STBC, M0 to M7	4	6	-65.9	-60.2	-59.3	-60.0	0.1	-48.6	-41.25	7.40
HE20, M0 to M9 1ss	1	6	-65.9				0.1	-59.8	-41.25	18.58
HE20, M0 to M9 1ss	2	6	-65.9	-60.2			0.1	-53.1	-41.25	11.85
HE20, M0 to M9 2ss	2	6	-65.9	-60.2			0.1	-53.1	-41.25	11.85
HE20, M0 to M9 1ss	3	6	-65.9	-60.2	-59.3		0.1	-50.2	-41.25	8.90
HE20, M0 to M9 2ss	3	6	-65.9	-60.2	-59.3		0.1	-50.2	-41.25	8.90
HE20, M0 to M9 3ss	3	6	-65.9	-60.2	-59.3		0.1	-50.2	-41.25	8.90
HE20, M0 to M9 1ss	4	6	-65.9	-60.2	-59.3	-59.9	0.1	-48.6	-41.25	7.35
HE20, M0 to M9 2ss	4	6	-65.9	-60.2	-59.3	-59.9	0.1	-48.6	-41.25	7.35
HE20, M0 to M9 3ss	4	6	-65.9	-60.2	-59.3	-59.9	0.1	-48.6	-41.25	7.35
HE20, M0 to M9 4ss	4	6	-65.9	-60.2	-59.3	-59.9	0.1	-48.6	-41.25	7.35
HE20 Beam Forming, M0 to M9 1ss	2	9	-65.9	-60.2			0.1	-50.1	-41.25	8.85
HE20 Beam Forming, M0 to M9 2ss	2	6	-65.9	-60.2			0.1	-53.1	-41.25	11.85
HE20 Beam Forming, M0 to M9 1ss	3	11	-65.9	-60.2	-59.3		0.1	-45.2	-41.25	3.90
HE20 Beam Forming, M0 to M9 2ss	3	8	-65.9	-60.2	-59.3		0.1	-48.2	-41.25	6.90
HE20 Beam Forming, M0 to M9 3ss	3	6	-65.9	-60.2	-59.3		0.1	-50.2	-41.25	8.90
HE20 Beam Forming, M0 to M9 1ss	4	12	-65.9	-60.2	-59.3	-59.9	0.1	-42.6	-41.25	1.35
HE20 Beam Forming, M0 to M9 2ss	4	9	-65.9	-60.2	-59.3	-59.9	0.1	-45.6	-41.25	4.35
HE20 Beam Forming, M0 to M9 3ss	4	7	-65.9	-60.2	-59.3	-59.9	0.1	-47.6	-41.25	6.35
HE20 Beam Forming, M0 to M9 4ss	4	6	-65.9	-60.2	-59.3	-59.9	0.1	-48.6	-41.25	7.35
HE20 STBC, M0 to M9 2ss	2	6	-65.9	-60.2			0.1	-53.1	-41.25	11.85
HE20 STBC, M0 to M9 2ss	3	6	-65.9	-60.2	-59.3		0.1	-50.2	-41.25	8.90
HE20 STBC, M0 to M9 2ss	4	6	-65.9	-60.2	-59.3	-59.9	0.1	-48.6	-41.25	7.35

**Conducted Spurs Average, 6dB<sub>i</sub>**  
**5775 MHz, HE80 Beam Forming, M0 to M9 1ss**

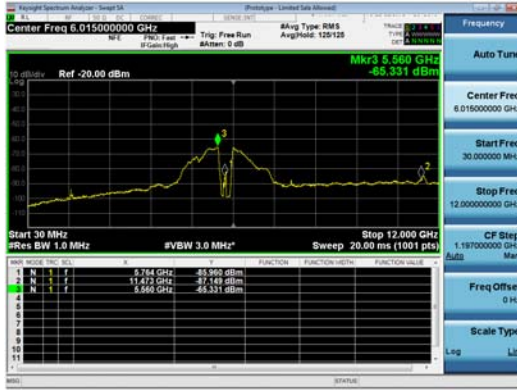

**Antenna A**

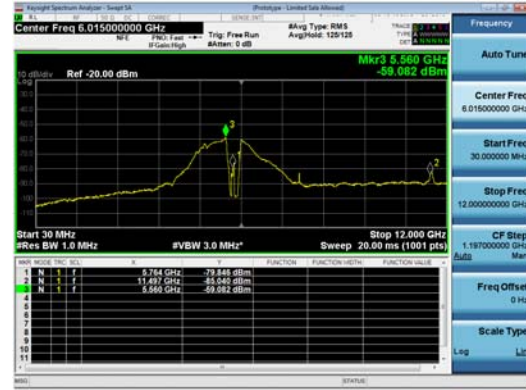

**Antenna B**

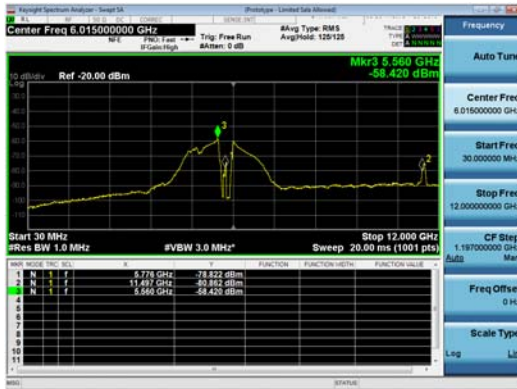

**Antenna C**

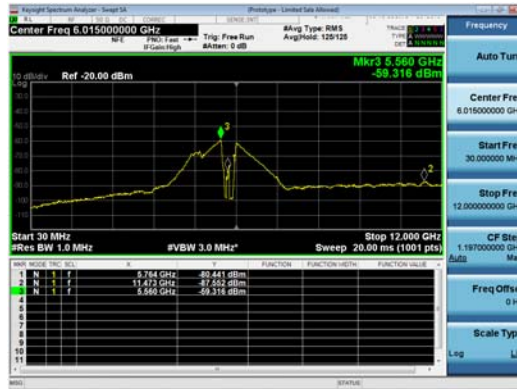

**Antenna D**

Conducted Spurious Peak, 4dBi

Frequency (MHz)	Mode	Tx Paths	Correlated Antenna Gain (dBi)	Tx 1 Spur Power (dBm)	Tx 2 Spur Power (dBm)	Tx 3 Spur Power (dBm)	Tx 4 Spur Power (dBm)	Duty Cycle Correction (dB)	Total Conducted Spur (dBm)	Limit (dBm)	Margin (dB)
5720 <sup>18</sup>	Non HT20, 6 to 54 Mbps	1	4	-58.5				0.1	-54.4	-21.25	33.20
	Non HT20, 6 to 54 Mbps	2	4	-58.5	-51.8			0.1	-46.9	-21.25	25.66
	Non HT20, 6 to 54 Mbps	3	4	-58.5	-51.8	-54.7		0.1	-45.4	-21.25	24.13
	Non HT20, 6 to 54 Mbps	4	4	-58.5	-51.8	-54.7	-56.2	0.1	-44.5	-21.25	23.30
	Non HT20 Beam Forming, 6 to 54 Mbps	2	7	-58.5	-51.8			0.1	-43.9	-21.25	22.66
	Non HT20 Beam Forming, 6 to 54 Mbps	3	9	-58.5	-52.7	-53.7		0.1	-40.5	-21.25	19.27
	Non HT20 Beam Forming, 6 to 54 Mbps	4	10	-58.5	-53.7	-55.7	-57.2	0.1	-39.8	-21.25	18.58
	HT/VHT20, M0 to M7	1	4	-58.7				0.1	-54.6	-21.25	33.40
	HT/VHT20, M0 to M7	2	4	-58.7	-52.2			0.1	-47.3	-21.25	26.02
	HT/VHT20, M8 to M15	2	4	-58.7	-52.2			0.1	-47.3	-21.25	26.02
	HT/VHT20, M0 to M7	3	4	-58.7	-52.2	-54.3		0.1	-45.5	-21.25	24.25
	HT/VHT20, M8 to M15	3	4	-58.7	-52.2	-54.3		0.1	-45.5	-21.25	24.25
	HT/VHT20, M16 to M23	3	4	-58.7	-52.2	-54.3		0.1	-45.5	-21.25	24.25
	HT/VHT20, M0 to M7	4	4	-58.7	-52.2	-54.3	-56.8	0.1	-44.7	-21.25	23.50
	HT/VHT20, M8 to M15	4	4	-58.7	-52.2	-54.3	-56.8	0.1	-44.7	-21.25	23.50
	HT/VHT20, M16 to M23	4	4	-58.7	-52.2	-54.3	-56.8	0.1	-44.7	-21.25	23.50
	HT/VHT20, M24 to M31	4	4	-58.7	-52.2	-54.3	-56.8	0.1	-44.7	-21.25	23.50
	HT/VHT20 Beam Forming, M0 to M7	2	7	-58.7	-52.2			0.1	-44.3	-21.25	23.02
	HT/VHT20 Beam Forming, M8 to M15	2	4	-58.7	-52.2			0.1	-47.3	-21.25	26.02
	HT/VHT20 Beam Forming, M0 to M7	3	9	-58.7	-52.3	-55.0		0.1	-40.8	-21.25	19.53
	HT/VHT20 Beam Forming, M8 to M15	3	6	-58.7	-52.2	-54.3		0.1	-43.5	-21.25	22.25
	HT/VHT20 Beam Forming, M16 to M23	3	4	-58.7	-52.2	-54.3		0.1	-45.5	-21.25	24.25
	HT/VHT20 Beam Forming, M0 to M7	4	10	-58.7	-53.3	-55.8	-57.9	0.1	-39.8	-21.25	18.58
	HT/VHT20 Beam Forming, M8 to M15	4	7	-58.7	-52.2	-54.3	-56.8	0.1	-41.7	-21.25	20.50
	HT/VHT20 Beam Forming, M16 to M23	4	5	-58.7	-52.2	-54.3	-56.8	0.1	-43.7	-21.25	22.50
	HT/VHT20 Beam Forming, M24 to M31	4	4	-58.7	-52.2	-54.3	-56.8	0.1	-44.7	-21.25	23.50
HT/VHT20 STBC, M0 to M7	2	4	-58.7	-52.2			0.1	-47.3	-21.25	26.02	

<sup>18</sup> 5720 (ch144) not supported for Canada.



	HT/VHT20 STBC, M0 to M7	3	4	-58.7	-52.2	-54.3		0.1	-45.5	-21.25	24.25
	HT/VHT20 STBC, M0 to M7	4	4	-58.7	-52.2	-54.3	-56.8	0.1	-44.7	-21.25	23.50
	HE20, M0 to M9 1ss	1	4	-58.9				0.1	-54.8	-21.25	33.58
	HE20, M0 to M9 1ss	2	4	-58.9	-51.6			0.1	-46.8	-21.25	25.54
	HE20, M0 to M9 2ss	2	4	-58.9	-51.6			0.1	-46.8	-21.25	25.54
	HE20, M0 to M9 1ss	3	4	-58.9	-51.6	-54.4		0.1	-45.2	-21.25	23.95
	HE20, M0 to M9 2ss	3	4	-58.9	-51.6	-54.4		0.1	-45.2	-21.25	23.95
	HE20, M0 to M9 3ss	3	4	-58.9	-51.6	-54.4		0.1	-45.2	-21.25	23.95
	HE20, M0 to M9 1ss	4	4	-58.9	-51.6	-54.4	-55.4	0.1	-44.3	-21.25	23.00
	HE20, M0 to M9 2ss	4	4	-58.9	-51.6	-54.4	-55.4	0.1	-44.3	-21.25	23.00
	HE20, M0 to M9 3ss	4	4	-58.9	-51.6	-54.4	-55.4	0.1	-44.3	-21.25	23.00
	HE20, M0 to M9 4ss	4	4	-58.9	-51.6	-54.4	-55.4	0.1	-44.3	-21.25	23.00
	HE20 Beam Forming, M0 to M9 1ss	2	7	-58.9	-51.6			0.1	-43.8	-21.25	22.54
	HE20 Beam Forming, M0 to M9 2ss	2	4	-58.9	-51.6			0.1	-46.8	-21.25	25.54
	HE20 Beam Forming, M0 to M9 1ss	3	9	-58.9	-53.7	-55.3		0.1	-41.6	-21.25	20.39
	HE20 Beam Forming, M0 to M9 2ss	3	6	-58.9	-51.6	-54.4		0.1	-43.2	-21.25	21.95
	HE20 Beam Forming, M0 to M9 3ss	3	4	-58.9	-51.6	-54.4		0.1	-45.2	-21.25	23.95
	HE20 Beam Forming, M0 to M9 1ss	4	10	-58.9	-53.7	-55.3	-58.0	0.1	-39.9	-21.25	18.64
	HE20 Beam Forming, M0 to M9 2ss	4	7	-58.9	-51.6	-54.4	-55.4	0.1	-41.3	-21.25	20.00
	HE20 Beam Forming, M0 to M9 3ss	4	5	-58.9	-51.6	-54.4	-55.4	0.1	-43.3	-21.25	22.00
	HE20 Beam Forming, M0 to M9 4ss	4	4	-58.9	-51.6	-54.4	-55.4	0.1	-44.3	-21.25	23.00
	HE20 STBC, M0 to M9 2ss	2	4	-58.9	-51.6			0.1	-46.8	-21.25	25.54
	HE20 STBC, M0 to M9 2ss	3	4	-58.9	-51.6	-54.4		0.1	-45.2	-21.25	23.95
	HE20 STBC, M0 to M9 2ss	4	4	-58.9	-51.6	-54.4	-55.4	0.1	-44.3	-21.25	23.00
5745	Non HT20, 6 to 54 Mbps	1	4	-54.6				0.1	-50.5	-21.25	29.30
	Non HT20, 6 to 54 Mbps	2	4	-54.6	-50.2			0.1	-44.8	-21.25	23.55
	Non HT20, 6 to 54 Mbps	3	4	-54.6	-50.2	-50.2		0.1	-42.4	-21.25	21.16
	Non HT20, 6 to 54 Mbps	4	4	-54.6	-50.2	-50.2	-51.8	0.1	-41.3	-21.25	20.05
	Non HT20 Beam Forming, 6 to 54 Mbps	2	7	-54.6	-50.2			0.1	-41.8	-21.25	20.55
	Non HT20 Beam Forming, 6 to 54 Mbps	3	9	-54.6	-50.2	-50.2		0.1	-37.4	-21.25	16.16
	Non HT20 Beam Forming, 6 to 54 Mbps	4	10	-54.6	-50.2	-50.2	-51.8	0.1	-35.3	-21.25	14.05
	HT/VHT20, M0 to M7	1	4	-55.0				0.1	-50.9	-21.25	29.70
	HT/VHT20, M0 to M7	2	4	-55.0	-50.9			0.1	-45.4	-21.25	24.17
	HT/VHT20, M8 to M15	2	4	-55.0	-50.9			0.1	-45.4	-21.25	24.17
	HT/VHT20, M0 to M7	3	4	-55.0	-50.9	-50.4		0.1	-42.8	-21.25	21.60
	HT/VHT20, M8 to M15	3	4	-55.0	-50.9	-50.4		0.1	-42.8	-21.25	21.60
	HT/VHT20, M16 to M23	3	4	-55.0	-50.9	-50.4		0.1	-42.8	-21.25	21.60
	HT/VHT20, M0 to M7	4	4	-55.0	-50.9	-50.4	-51.3	0.1	-41.5	-21.25	20.25
	HT/VHT20, M8 to M15	4	4	-55.0	-50.9	-50.4	-51.3	0.1	-41.5	-21.25	20.25
	HT/VHT20, M16 to M23	4	4	-55.0	-50.9	-50.4	-51.3	0.1	-41.5	-21.25	20.25
	HT/VHT20, M24 to M31	4	4	-55.0	-50.9	-50.4	-51.3	0.1	-41.5	-21.25	20.25
HT/VHT20 Beam Forming, M0 to M7	2	7	-55.0	-50.9			0.1	-42.4	-21.25	21.17	

	HT/VHT20 Beam Forming, M8 to M15	2	4	-55.0	-50.9			0.1	-45.4	-21.25	24.17
	HT/VHT20 Beam Forming, M0 to M7	3	9	-55.0	-50.9	-50.4		0.1	-37.8	-21.25	16.60
	HT/VHT20 Beam Forming, M8 to M15	3	6	-55.0	-50.9	-50.4		0.1	-40.8	-21.25	19.60
	HT/VHT20 Beam Forming, M16 to M23	3	4	-55.0	-50.9	-50.4		0.1	-42.8	-21.25	21.60
	HT/VHT20 Beam Forming, M0 to M7	4	10	-55.0	-50.9	-50.4	-51.3	0.1	-35.5	-21.25	14.25
	HT/VHT20 Beam Forming, M8 to M15	4	7	-55.0	-50.9	-50.4	-51.3	0.1	-38.5	-21.25	17.25
	HT/VHT20 Beam Forming, M16 to M23	4	5	-55.0	-50.9	-50.4	-51.3	0.1	-40.5	-21.25	19.25
	HT/VHT20 Beam Forming, M24 to M31	4	4	-55.0	-50.9	-50.4	-51.3	0.1	-41.5	-21.25	20.25
	HT/VHT20 STBC, M0 to M7	2	4	-55.0	-50.9			0.1	-45.4	-21.25	24.17
	HT/VHT20 STBC, M0 to M7	3	4	-55.0	-50.9	-50.4		0.1	-42.8	-21.25	21.60
	HT/VHT20 STBC, M0 to M7	4	4	-55.0	-50.9	-50.4	-51.3	0.1	-41.5	-21.25	20.25
	HE20, M0 to M9 1ss	1	4	-55.4				0.1	-51.3	-21.25	30.08
	HE20, M0 to M9 1ss	2	4	-55.4	-50.0			0.1	-44.8	-21.25	23.58
	HE20, M0 to M9 2ss	2	4	-55.4	-50.0			0.1	-44.8	-21.25	23.58
	HE20, M0 to M9 1ss	3	4	-55.4	-50.0	-49.7		0.1	-42.2	-21.25	20.95
	HE20, M0 to M9 2ss	3	4	-55.4	-50.0	-49.7		0.1	-42.2	-21.25	20.95
	HE20, M0 to M9 3ss	3	4	-55.4	-50.0	-49.7		0.1	-42.2	-21.25	20.95
	HE20, M0 to M9 1ss	4	4	-55.4	-50.0	-49.7	-51.0	0.1	-40.9	-21.25	19.69
	HE20, M0 to M9 2ss	4	4	-55.4	-50.0	-49.7	-51.0	0.1	-40.9	-21.25	19.69
	HE20, M0 to M9 3ss	4	4	-55.4	-50.0	-49.7	-51.0	0.1	-40.9	-21.25	19.69
	HE20, M0 to M9 4ss	4	4	-55.4	-50.0	-49.7	-51.0	0.1	-40.9	-21.25	19.69
	HE20 Beam Forming, M0 to M9 1ss	2	7	-55.4	-50.0			0.1	-41.8	-21.25	20.58
	HE20 Beam Forming, M0 to M9 2ss	2	4	-55.4	-50.0			0.1	-44.8	-21.25	23.58
	HE20 Beam Forming, M0 to M9 1ss	3	9	-55.4	-50.0	-49.7		0.1	-37.2	-21.25	15.95
	HE20 Beam Forming, M0 to M9 2ss	3	6	-55.4	-50.0	-49.7		0.1	-40.2	-21.25	18.95
	HE20 Beam Forming, M0 to M9 3ss	3	4	-55.4	-50.0	-49.7		0.1	-42.2	-21.25	20.95
	HE20 Beam Forming, M0 to M9 1ss	4	10	-55.4	-50.0	-49.7	-51.0	0.1	-34.9	-21.25	13.69
	HE20 Beam Forming, M0 to M9 2ss	4	7	-55.4	-50.0	-49.7	-51.0	0.1	-37.9	-21.25	16.69
	HE20 Beam Forming, M0 to M9 3ss	4	5	-55.4	-50.0	-49.7	-51.0	0.1	-39.9	-21.25	18.69
	HE20 Beam Forming, M0 to M9 4ss	4	4	-55.4	-50.0	-49.7	-51.0	0.1	-40.9	-21.25	19.69
	HE20 STBC, M0 to M9 2ss	2	4	-55.4	-50.0			0.1	-44.8	-21.25	23.58
	HE20 STBC, M0 to M9 2ss	3	4	-55.4	-50.0	-49.7		0.1	-42.2	-21.25	20.95
	HE20 STBC, M0 to M9 2ss	4	4	-55.4	-50.0	-49.7	-51.0	0.1	-40.9	-21.25	19.69
5755	Non HT40, 6 to 54 Mbps	1	4	-55.0				0.1	-50.9	-21.25	29.70
	Non HT40, 6 to 54 Mbps	2	4	-55.0	-50.2			0.1	-44.9	-21.25	23.66
	Non HT40, 6 to 54 Mbps	3	4	-55.0	-50.2	-49.9		0.1	-42.3	-21.25	21.09
	Non HT40, 6 to 54 Mbps	4	4	-55.0	-50.2	-49.9	-51.3	0.1	-41.1	-21.25	19.88
	HT/VHT40, M0 to M7	1	4	-56.2				0.1	-52.1	-21.25	30.84
	HT/VHT40, M0 to M7	2	4	-56.2	-49.8			0.1	-44.8	-21.25	23.54
	HT/VHT40, M8 to M15	2	4	-56.2	-49.8			0.1	-44.8	-21.25	23.54
	HT/VHT40, M0 to M7	3	4	-56.2	-49.8	-51.2		0.1	-42.8	-21.25	21.53
	HT/VHT40, M8 to M15	3	4	-56.2	-49.8	-51.2		0.1	-42.8	-21.25	21.53

	HT/VHT40, M16 to M23	3	4	-56.2	-49.8	-51.2		0.1	-42.8	-21.25	21.53
	HT/VHT40, M0 to M7	4	4	-56.2	-49.8	-51.2	-51.8	0.1	-41.6	-21.25	20.32
	HT/VHT40, M8 to M15	4	4	-56.2	-49.8	-51.2	-51.8	0.1	-41.6	-21.25	20.32
	HT/VHT40, M16 to M23	4	4	-56.2	-49.8	-51.2	-51.8	0.1	-41.6	-21.25	20.32
	HT/VHT40, M24 to M31	4	4	-56.2	-49.8	-51.2	-51.8	0.1	-41.6	-21.25	20.32
	HT/VHT40 Beam Forming, M0 to M7	2	7	-56.2	-49.8			0.1	-41.8	-21.25	20.54
	HT/VHT40 Beam Forming, M8 to M15	2	4	-56.2	-49.8			0.1	-44.8	-21.25	23.54
	HT/VHT40 Beam Forming, M0 to M7	3	9	-56.2	-49.8	-51.2		0.1	-37.8	-21.25	16.53
	HT/VHT40 Beam Forming, M8 to M15	3	6	-56.2	-49.8	-51.2		0.1	-40.8	-21.25	19.53
	HT/VHT40 Beam Forming, M16 to M23	3	4	-56.2	-49.8	-51.2		0.1	-42.8	-21.25	21.53
	HT/VHT40 Beam Forming, M0 to M7	4	10	-56.2	-49.8	-51.2	-51.8	0.1	-35.6	-21.25	14.32
	HT/VHT40 Beam Forming, M8 to M15	4	7	-56.2	-49.8	-51.2	-51.8	0.1	-38.6	-21.25	17.32
	HT/VHT40 Beam Forming, M16 to M23	4	5	-56.2	-49.8	-51.2	-51.8	0.1	-40.6	-21.25	19.32
	HT/VHT40 Beam Forming, M24 to M31	4	4	-56.2	-49.8	-51.2	-51.8	0.1	-41.6	-21.25	20.32
	HT/VHT40 STBC, M0 to M7	2	4	-56.2	-49.8			0.1	-44.8	-21.25	23.54
	HT/VHT40 STBC, M0 to M7	3	4	-56.2	-49.8	-51.2		0.1	-42.8	-21.25	21.53
	HT/VHT40 STBC, M0 to M7	4	4	-56.2	-49.8	-51.2	-51.8	0.1	-41.6	-21.25	20.32
	HE40, M0 to M9 1ss	1	4	-55.8				0.1	-51.7	-21.25	30.42
	HE40, M0 to M9 1ss	2	4	-55.8	-50.4			0.1	-45.2	-21.25	23.92
	HE40, M0 to M9 2ss	2	4	-55.8	-50.4			0.1	-45.2	-21.25	23.92
	HE40, M0 to M9 1ss	3	4	-55.8	-50.4	-50.6		0.1	-42.8	-21.25	21.52
	HE40, M0 to M9 2ss	3	4	-55.8	-50.4	-50.6		0.1	-42.8	-21.25	21.52
	HE40, M0 to M9 3ss	3	4	-55.8	-50.4	-50.6		0.1	-42.8	-21.25	21.52
	HE40, M0 to M9 1ss	4	4	-55.8	-50.4	-50.6	-51.7	0.1	-41.5	-21.25	20.28
	HE40, M0 to M9 2ss	4	4	-55.8	-50.4	-50.6	-51.7	0.1	-41.5	-21.25	20.28
	HE40, M0 to M9 3ss	4	4	-55.8	-50.4	-50.6	-51.7	0.1	-41.5	-21.25	20.28
	HE40, M0 to M9 4ss	4	4	-55.8	-50.4	-50.6	-51.7	0.1	-41.5	-21.25	20.28
	HE40 Beam Forming, M0 to M9 1ss	2	7	-55.8	-50.4			0.1	-42.2	-21.25	20.92
	HE40 Beam Forming, M0 to M9 2ss	2	4	-55.8	-50.4			0.1	-45.2	-21.25	23.92
	HE40 Beam Forming, M0 to M9 1ss	3	9	-55.8	-50.4	-50.6		0.1	-37.8	-21.25	16.52
	HE40 Beam Forming, M0 to M9 2ss	3	6	-55.8	-50.4	-50.6		0.1	-40.8	-21.25	19.52
	HE40 Beam Forming, M0 to M9 3ss	3	4	-55.8	-50.4	-50.6		0.1	-42.8	-21.25	21.52
	HE40 Beam Forming, M0 to M9 1ss	4	10	-55.8	-50.4	-50.6	-51.7	0.1	-35.5	-21.25	14.28
	HE40 Beam Forming, M0 to M9 2ss	4	7	-55.8	-50.4	-50.6	-51.7	0.1	-38.5	-21.25	17.28
	HE40 Beam Forming, M0 to M9 3ss	4	5	-55.8	-50.4	-50.6	-51.7	0.1	-40.5	-21.25	19.28
	HE40 Beam Forming, M0 to M9 4ss	4	4	-55.8	-50.4	-50.6	-51.7	0.1	-41.5	-21.25	20.28
	HE40 STBC, M0 to M9 2ss	2	4	-55.8	-50.4			0.1	-45.2	-21.25	23.92
	HE40 STBC, M0 to M9 2ss	3	4	-55.8	-50.4	-50.6		0.1	-42.8	-21.25	21.52
	HE40 STBC, M0 to M9 2ss	4	4	-55.8	-50.4	-50.6	-51.7	0.1	-41.5	-21.25	20.28
5775	Non HT80, 6 to 54 Mbps	1	4	-55.4				0.0	-51.4	-21.25	30.10
	Non HT80, 6 to 54 Mbps	2	4	-55.4	-51.1			0.0	-45.7	-21.25	24.43
	Non HT80, 6 to 54 Mbps	3	4	-55.4	-51.1	-50.7		0.0	-43.1	-21.25	21.88



Non HT80, 6 to 54 Mbps	4	4	-55.4	-51.1	-50.7	-51.3	0.0	-41.7	-21.25	20.46
VHT80, M0 to M9 1ss	1	4	-56.4				0.2	-52.2	-21.25	30.93
VHT80, M0 to M9 1ss	2	4	-56.4	-51.1			0.2	-45.8	-21.25	24.50
VHT80, M0 to M9 2ss	2	4	-56.4	-51.1			0.2	-45.8	-21.25	24.50
VHT80, M0 to M9 1ss	3	4	-56.4	-51.1	-51.0		0.2	-43.2	-21.25	21.97
VHT80, M0 to M9 2ss	3	4	-56.4	-51.1	-51.0		0.2	-43.2	-21.25	21.97
VHT80, M0 to M9 3ss	3	4	-56.4	-51.1	-51.0		0.2	-43.2	-21.25	21.97
VHT80, M0 to M9 1ss	4	4	-56.4	-51.1	-51.0	-52.4	0.2	-42.0	-21.25	20.77
VHT80, M0 to M9 2ss	4	4	-56.4	-51.1	-51.0	-52.4	0.2	-42.0	-21.25	20.77
VHT80, M0 to M9 3ss	4	4	-56.4	-51.1	-51.0	-52.4	0.2	-42.0	-21.25	20.77
VHT80, M0 to M9 4ss	4	4	-56.4	-51.1	-51.0	-52.4	0.2	-42.0	-21.25	20.77
VHT80 Beam Forming, M0 to M9 1ss	2	7	-56.4	-51.1			0.2	-42.8	-21.25	21.50
VHT80 Beam Forming, M0 to M9 2ss	2	4	-56.4	-51.1			0.2	-45.8	-21.25	24.50
VHT80 Beam Forming, M0 to M9 1ss	3	9	-56.4	-51.1	-51.0		0.2	-38.2	-21.25	16.97
VHT80 Beam Forming, M0 to M9 2ss	3	6	-56.4	-51.1	-51.0		0.2	-41.2	-21.25	19.97
VHT80 Beam Forming, M0 to M9 3ss	3	4	-56.4	-51.1	-51.0		0.2	-43.2	-21.25	21.97
VHT80 Beam Forming, M0 to M9 1ss	4	10	-56.4	-51.1	-51.0	-52.4	0.2	-36.0	-21.25	14.77
VHT80 Beam Forming, M0 to M9 2ss	4	7	-56.4	-51.1	-51.0	-52.4	0.2	-39.0	-21.25	17.77
VHT80 Beam Forming, M0 to M9 3ss	4	5	-56.4	-51.1	-51.0	-52.4	0.2	-41.0	-21.25	19.77
VHT80 Beam Forming, M0 to M9 4ss	4	4	-56.4	-51.1	-51.0	-52.4	0.2	-42.0	-21.25	20.77
VHT80 STBC, M0 to M9 1ss	2	4	-56.4	-51.1			0.2	-45.8	-21.25	24.50
VHT80 STBC, M0 to M9 1ss	3	4	-56.4	-51.1	-51.0		0.2	-43.2	-21.25	21.97
VHT80 STBC, M0 to M9 1ss	4	4	-56.4	-51.1	-51.0	-52.4	0.2	-42.0	-21.25	20.77
HE80, M0 to M9 1ss	1	4	-55.5				0.2	-51.3	-21.25	30.00
HE80, M0 to M9 1ss	2	4	-55.5	-48.9			0.2	-43.8	-21.25	22.54
HE80, M0 to M9 2ss	2	4	-55.5	-48.9			0.2	-43.8	-21.25	22.54
HE80, M0 to M9 1ss	3	4	-55.5	-48.9	-51.0		0.2	-42.0	-21.25	20.76
HE80, M0 to M9 2ss	3	4	-55.5	-48.9	-51.0		0.2	-42.0	-21.25	20.76
HE80, M0 to M9 3ss	3	4	-55.5	-48.9	-51.0		0.2	-42.0	-21.25	20.76
HE80, M0 to M9 1ss	4	4	-55.5	-48.9	-51.0	-51.6	0.2	-40.9	-21.25	19.65
HE80, M0 to M9 2ss	4	4	-55.5	-48.9	-51.0	-51.6	0.2	-40.9	-21.25	19.65
HE80, M0 to M9 3ss	4	4	-55.5	-48.9	-51.0	-51.6	0.2	-40.9	-21.25	19.65
HE80, M0 to M9 4ss	4	4	-55.5	-48.9	-51.0	-51.6	0.2	-40.9	-21.25	19.65
HE80 Beam Forming, M0 to M9 1ss	2	7	-55.5	-48.9			0.2	-40.8	-21.25	19.54
HE80 Beam Forming, M0 to M9 2ss	2	4	-55.5	-48.9			0.2	-43.8	-21.25	22.54
HE80 Beam Forming, M0 to M9 1ss	3	9	-55.5	-48.9	-51.0		0.2	-37.0	-21.25	15.76
HE80 Beam Forming, M0 to M9 2ss	3	6	-55.5	-48.9	-51.0		0.2	-40.0	-21.25	18.76
HE80 Beam Forming, M0 to M9 3ss	3	4	-55.5	-48.9	-51.0		0.2	-42.0	-21.25	20.76
<b>HE80 Beam Forming, M0 to M9 1ss</b>	<b>4</b>	<b>10</b>	<b>-55.5</b>	<b>-48.9</b>	<b>-51.0</b>	<b>-51.6</b>	<b>0.2</b>	<b>-34.9</b>	<b>-21.25</b>	<b>13.65</b>
HE80 Beam Forming, M0 to M9 2ss	4	7	-55.5	-48.9	-51.0	-51.6	0.2	-37.9	-21.25	16.65
HE80 Beam Forming, M0 to M9 3ss	4	5	-55.5	-48.9	-51.0	-51.6	0.2	-39.9	-21.25	18.65
HE80 Beam Forming, M0 to M9 4ss	4	4	-55.5	-48.9	-51.0	-51.6	0.2	-40.9	-21.25	19.65
HE80 STBC, M0 to M9 1ss	2	4	-55.5	-48.9			0.2	-43.8	-21.25	22.54

	HE80 STBC, M0 to M9 1ss	3	4	-55.5	-48.9	-51.0		0.2	-42.0	-21.25	20.76
	HE80 STBC, M0 to M9 1ss	4	4	-55.5	-48.9	-51.0	-51.6	0.2	-40.9	-21.25	19.65
5785	Non HT20, 6 to 54 Mbps	1	4	-55.7				0.1	-51.6	-21.25	30.40
	Non HT20, 6 to 54 Mbps	2	4	-55.7	-50.0			0.1	-44.9	-21.25	23.66
	Non HT20, 6 to 54 Mbps	3	4	-55.7	-50.0	-50.3		0.1	-42.5	-21.25	21.27
	Non HT20, 6 to 54 Mbps	4	4	-55.7	-50.0	-50.3	-50.8	0.1	-41.1	-21.25	19.88
	Non HT20 Beam Forming, 6 to 54 Mbps	2	7	-55.7	-50.0			0.1	-41.9	-21.25	20.66
	Non HT20 Beam Forming, 6 to 54 Mbps	3	9	-55.7	-50.0	-50.3		0.1	-37.5	-21.25	16.27
	Non HT20 Beam Forming, 6 to 54 Mbps	4	10	-55.7	-50.0	-50.3	-50.8	0.1	-35.1	-21.25	13.88
	HT/VHT20, M0 to M7	1	4	-54.7				0.1	-50.6	-21.25	29.40
	HT/VHT20, M0 to M7	2	4	-54.7	-50.1			0.1	-44.8	-21.25	23.50
	HT/VHT20, M8 to M15	2	4	-54.7	-50.1			0.1	-44.8	-21.25	23.50
	HT/VHT20, M0 to M7	3	4	-54.7	-50.1	-49.7		0.1	-42.2	-21.25	20.92
	HT/VHT20, M8 to M15	3	4	-54.7	-50.1	-49.7		0.1	-42.2	-21.25	20.92
	HT/VHT20, M16 to M23	3	4	-54.7	-50.1	-49.7		0.1	-42.2	-21.25	20.92
	HT/VHT20, M0 to M7	4	4	-54.7	-50.1	-49.7	-52.0	0.1	-41.1	-21.25	19.90
	HT/VHT20, M8 to M15	4	4	-54.7	-50.1	-49.7	-52.0	0.1	-41.1	-21.25	19.90
	HT/VHT20, M16 to M23	4	4	-54.7	-50.1	-49.7	-52.0	0.1	-41.1	-21.25	19.90
	HT/VHT20, M24 to M31	4	4	-54.7	-50.1	-49.7	-52.0	0.1	-41.1	-21.25	19.90
	HT/VHT20 Beam Forming, M0 to M7	2	7	-54.7	-50.1			0.1	-41.8	-21.25	20.50
	HT/VHT20 Beam Forming, M8 to M15	2	4	-54.7	-50.1			0.1	-44.8	-21.25	23.50
	HT/VHT20 Beam Forming, M0 to M7	3	9	-54.7	-50.1	-49.7		0.1	-37.2	-21.25	15.92
	HT/VHT20 Beam Forming, M8 to M15	3	6	-54.7	-50.1	-49.7		0.1	-40.2	-21.25	18.92
	HT/VHT20 Beam Forming, M16 to M23	3	4	-54.7	-50.1	-49.7		0.1	-42.2	-21.25	20.92
	HT/VHT20 Beam Forming, M0 to M7	4	10	-54.7	-50.1	-49.7	-52.0	0.1	-35.1	-21.25	13.90
	HT/VHT20 Beam Forming, M8 to M15	4	7	-54.7	-50.1	-49.7	-52.0	0.1	-38.1	-21.25	16.90
	HT/VHT20 Beam Forming, M16 to M23	4	5	-54.7	-50.1	-49.7	-52.0	0.1	-40.1	-21.25	18.90
	HT/VHT20 Beam Forming, M24 to M31	4	4	-54.7	-50.1	-49.7	-52.0	0.1	-41.1	-21.25	19.90
	HT/VHT20 STBC, M0 to M7	2	4	-54.7	-50.1			0.1	-44.8	-21.25	23.50
	HT/VHT20 STBC, M0 to M7	3	4	-54.7	-50.1	-49.7		0.1	-42.2	-21.25	20.92
	HT/VHT20 STBC, M0 to M7	4	4	-54.7	-50.1	-49.7	-52.0	0.1	-41.1	-21.25	19.90
	HE20, M0 to M9 1ss	1	4	-54.8				0.1	-50.7	-21.25	29.48
	HE20, M0 to M9 1ss	2	4	-54.8	-50.6			0.1	-45.1	-21.25	23.88
	HE20, M0 to M9 2ss	2	4	-54.8	-50.6			0.1	-45.1	-21.25	23.88
	HE20, M0 to M9 1ss	3	4	-54.8	-50.6	-50.2		0.1	-42.6	-21.25	21.34
	HE20, M0 to M9 2ss	3	4	-54.8	-50.6	-50.2		0.1	-42.6	-21.25	21.34
HE20, M0 to M9 3ss	3	4	-54.8	-50.6	-50.2		0.1	-42.6	-21.25	21.34	
HE20, M0 to M9 1ss	4	4	-54.8	-50.6	-50.2	-51.4	0.1	-41.3	-21.25	20.09	
HE20, M0 to M9 2ss	4	4	-54.8	-50.6	-50.2	-51.4	0.1	-41.3	-21.25	20.09	
HE20, M0 to M9 3ss	4	4	-54.8	-50.6	-50.2	-51.4	0.1	-41.3	-21.25	20.09	
HE20, M0 to M9 4ss	4	4	-54.8	-50.6	-50.2	-51.4	0.1	-41.3	-21.25	20.09	
HE20 Beam Forming, M0 to M9 1ss	2	7	-54.8	-50.6			0.1	-42.1	-21.25	20.88	





	HE20 Beam Forming, M0 to M9 2ss	2	4	-54.8	-50.6			0.1	-45.1	-21.25	23.88
	HE20 Beam Forming, M0 to M9 1ss	3	9	-54.8	-50.6	-50.2		0.1	-37.6	-21.25	16.34
	HE20 Beam Forming, M0 to M9 2ss	3	6	-54.8	-50.6	-50.2		0.1	-40.6	-21.25	19.34
	HE20 Beam Forming, M0 to M9 3ss	3	4	-54.8	-50.6	-50.2		0.1	-42.6	-21.25	21.34
	HE20 Beam Forming, M0 to M9 1ss	4	10	-54.8	-50.6	-50.2	-51.4	0.1	-35.3	-21.25	14.09
	HE20 Beam Forming, M0 to M9 2ss	4	7	-54.8	-50.6	-50.2	-51.4	0.1	-38.3	-21.25	17.09
	HE20 Beam Forming, M0 to M9 3ss	4	5	-54.8	-50.6	-50.2	-51.4	0.1	-40.3	-21.25	19.09
	HE20 Beam Forming, M0 to M9 4ss	4	4	-54.8	-50.6	-50.2	-51.4	0.1	-41.3	-21.25	20.09
	HE20 STBC, M0 to M9 2ss	2	4	-54.8	-50.6			0.1	-45.1	-21.25	23.88
	HE20 STBC, M0 to M9 2ss	3	4	-54.8	-50.6	-50.2		0.1	-42.6	-21.25	21.34
	HE20 STBC, M0 to M9 2ss	4	4	-54.8	-50.6	-50.2	-51.4	0.1	-41.3	-21.25	20.09
5795	Non HT40, 6 to 54 Mbps	1	4	-56.4				0.1	-52.3	-21.25	31.10
	Non HT40, 6 to 54 Mbps	2	4	-56.4	-50.6			0.1	-45.5	-21.25	24.29
	Non HT40, 6 to 54 Mbps	3	4	-56.4	-50.6	-50.8		0.1	-43.1	-21.25	21.84
	Non HT40, 6 to 54 Mbps	4	4	-56.4	-50.6	-50.8	-51.8	0.1	-41.8	-21.25	20.56
	HT/VHT40, M0 to M7	1	4	-55.4				0.1	-51.3	-21.25	30.04
	HT/VHT40, M0 to M7	2	4	-55.4	-50.5			0.1	-45.2	-21.25	23.92
	HT/VHT40, M8 to M15	2	4	-55.4	-50.5			0.1	-45.2	-21.25	23.92
	HT/VHT40, M0 to M7	3	4	-55.4	-50.5	-50.8		0.1	-42.9	-21.25	21.61
	HT/VHT40, M8 to M15	3	4	-55.4	-50.5	-50.8		0.1	-42.9	-21.25	21.61
	HT/VHT40, M16 to M23	3	4	-55.4	-50.5	-50.8		0.1	-42.9	-21.25	21.61
	HT/VHT40, M0 to M7	4	4	-55.4	-50.5	-50.8	-51.8	0.1	-41.6	-21.25	20.37
	HT/VHT40, M8 to M15	4	4	-55.4	-50.5	-50.8	-51.8	0.1	-41.6	-21.25	20.37
	HT/VHT40, M16 to M23	4	4	-55.4	-50.5	-50.8	-51.8	0.1	-41.6	-21.25	20.37
	HT/VHT40, M24 to M31	4	4	-55.4	-50.5	-50.8	-51.8	0.1	-41.6	-21.25	20.37
	HT/VHT40 Beam Forming, M0 to M7	2	7	-55.4	-50.5			0.1	-42.2	-21.25	20.92
	HT/VHT40 Beam Forming, M8 to M15	2	4	-55.4	-50.5			0.1	-45.2	-21.25	23.92
	HT/VHT40 Beam Forming, M0 to M7	3	9	-55.4	-50.5	-50.8		0.1	-37.9	-21.25	16.61
	HT/VHT40 Beam Forming, M8 to M15	3	6	-55.4	-50.5	-50.8		0.1	-40.9	-21.25	19.61
	HT/VHT40 Beam Forming, M16 to M23	3	4	-55.4	-50.5	-50.8		0.1	-42.9	-21.25	21.61
	HT/VHT40 Beam Forming, M0 to M7	4	10	-55.4	-50.5	-50.8	-51.8	0.1	-35.6	-21.25	14.37
	HT/VHT40 Beam Forming, M8 to M15	4	7	-55.4	-50.5	-50.8	-51.8	0.1	-38.6	-21.25	17.37
	HT/VHT40 Beam Forming, M16 to M23	4	5	-55.4	-50.5	-50.8	-51.8	0.1	-40.6	-21.25	19.37
	HT/VHT40 Beam Forming, M24 to M31	4	4	-55.4	-50.5	-50.8	-51.8	0.1	-41.6	-21.25	20.37
	HT/VHT40 STBC, M0 to M7	2	4	-55.4	-50.5			0.1	-45.2	-21.25	23.92
	HT/VHT40 STBC, M0 to M7	3	4	-55.4	-50.5	-50.8		0.1	-42.9	-21.25	21.61
	HT/VHT40 STBC, M0 to M7	4	4	-55.4	-50.5	-50.8	-51.8	0.1	-41.6	-21.25	20.37
	HE40, M0 to M9 1ss	1	4	-56.5				0.1	-52.4	-21.25	31.12
	HE40, M0 to M9 1ss	2	4	-56.5	-50.5			0.1	-45.4	-21.25	24.15
	HE40, M0 to M9 2ss	2	4	-56.5	-50.5			0.1	-45.4	-21.25	24.15
	HE40, M0 to M9 1ss	3	4	-56.5	-50.5	-51.2		0.1	-43.1	-21.25	21.90
HE40, M0 to M9 2ss	3	4	-56.5	-50.5	-51.2		0.1	-43.1	-21.25	21.90	



HE40, M0 to M9 3ss	3	4	-56.5	-50.5	-51.2			0.1	-43.1	-21.25	21.90
HE40, M0 to M9 1ss	4	4	-56.5	-50.5	-51.2	-52.2		0.1	-41.9	-21.25	20.69
HE40, M0 to M9 2ss	4	4	-56.5	-50.5	-51.2	-52.2		0.1	-41.9	-21.25	20.69
HE40, M0 to M9 3ss	4	4	-56.5	-50.5	-51.2	-52.2		0.1	-41.9	-21.25	20.69
HE40, M0 to M9 4ss	4	4	-56.5	-50.5	-51.2	-52.2		0.1	-41.9	-21.25	20.69
HE40 Beam Forming, M0 to M9 1ss	2	7	-56.5	-50.5				0.1	-42.4	-21.25	21.15
HE40 Beam Forming, M0 to M9 2ss	2	4	-56.5	-50.5				0.1	-45.4	-21.25	24.15
HE40 Beam Forming, M0 to M9 1ss	3	9	-56.5	-50.5	-51.2			0.1	-38.1	-21.25	16.90
HE40 Beam Forming, M0 to M9 2ss	3	6	-56.5	-50.5	-51.2			0.1	-41.1	-21.25	19.90
HE40 Beam Forming, M0 to M9 3ss	3	4	-56.5	-50.5	-51.2			0.1	-43.1	-21.25	21.90
HE40 Beam Forming, M0 to M9 1ss	4	10	-56.5	-50.5	-51.2	-52.2		0.1	-35.9	-21.25	14.69
HE40 Beam Forming, M0 to M9 2ss	4	7	-56.5	-50.5	-51.2	-52.2		0.1	-38.9	-21.25	17.69
HE40 Beam Forming, M0 to M9 3ss	4	5	-56.5	-50.5	-51.2	-52.2		0.1	-40.9	-21.25	19.69
HE40 Beam Forming, M0 to M9 4ss	4	4	-56.5	-50.5	-51.2	-52.2		0.1	-41.9	-21.25	20.69
HE40 STBC, M0 to M9 2ss	2	4	-56.5	-50.5				0.1	-45.4	-21.25	24.15
HE40 STBC, M0 to M9 2ss	3	4	-56.5	-50.5	-51.2			0.1	-43.1	-21.25	21.90
HE40 STBC, M0 to M9 2ss	4	4	-56.5	-50.5	-51.2	-52.2		0.1	-41.9	-21.25	20.69

Non HT20, 6 to 54 Mbps	1	4	-55.8					0.1	-51.7	-21.25	30.50
Non HT20, 6 to 54 Mbps	2	4	-55.8	-50.5				0.1	-45.3	-21.25	24.08
Non HT20, 6 to 54 Mbps	3	4	-55.8	-50.5	-50.5			0.1	-42.8	-21.25	21.59
Non HT20, 6 to 54 Mbps	4	4	-55.8	-50.5	-50.5	-51.1		0.1	-41.4	-21.25	20.19
Non HT20 Beam Forming, 6 to 54 Mbps	2	7	-55.8	-50.5				0.1	-42.3	-21.25	21.08
Non HT20 Beam Forming, 6 to 54 Mbps	3	9	-55.8	-50.5	-50.5			0.1	-37.8	-21.25	16.59
Non HT20 Beam Forming, 6 to 54 Mbps	4	10	-55.8	-50.5	-50.5	-51.1		0.1	-35.4	-21.25	14.19
HT/VHT20, M0 to M7	1	4	-56.7					0.1	-52.6	-21.25	31.40
HT/VHT20, M0 to M7	2	4	-56.7	-51.1				0.1	-46.0	-21.25	24.74
HT/VHT20, M8 to M15	2	4	-56.7	-51.1				0.1	-46.0	-21.25	24.74
HT/VHT20, M0 to M7	3	4	-56.7	-51.1	-50.6			0.1	-43.3	-21.25	22.00
HT/VHT20, M8 to M15	3	4	-56.7	-51.1	-50.6			0.1	-43.3	-21.25	22.00
HT/VHT20, M16 to M23	3	4	-56.7	-51.1	-50.6			0.1	-43.3	-21.25	22.00
HT/VHT20, M0 to M7	4	4	-56.7	-51.1	-50.6	-51.7		0.1	-41.9	-21.25	20.65
HT/VHT20, M8 to M15	4	4	-56.7	-51.1	-50.6	-51.7		0.1	-41.9	-21.25	20.65
HT/VHT20, M16 to M23	4	4	-56.7	-51.1	-50.6	-51.7		0.1	-41.9	-21.25	20.65
HT/VHT20, M24 to M31	4	4	-56.7	-51.1	-50.6	-51.7		0.1	-41.9	-21.25	20.65
HT/VHT20 Beam Forming, M0 to M7	2	7	-56.7	-51.1				0.1	-43.0	-21.25	21.74
HT/VHT20 Beam Forming, M8 to M15	2	4	-56.7	-51.1				0.1	-46.0	-21.25	24.74
HT/VHT20 Beam Forming, M0 to M7	3	9	-56.7	-51.1	-50.6			0.1	-38.3	-21.25	17.00
HT/VHT20 Beam Forming, M8 to M15	3	6	-56.7	-51.1	-50.6			0.1	-41.3	-21.25	20.00
HT/VHT20 Beam Forming, M16 to M23	3	4	-56.7	-51.1	-50.6			0.1	-43.3	-21.25	22.00
HT/VHT20 Beam Forming, M0 to M7	4	10	-56.7	-51.1	-50.6	-51.7		0.1	-35.9	-21.25	14.65
HT/VHT20 Beam Forming, M8 to M15	4	7	-56.7	-51.1	-50.6	-51.7		0.1	-38.9	-21.25	17.65
HT/VHT20 Beam Forming, M16 to M23	4	5	-56.7	-51.1	-50.6	-51.7		0.1	-40.9	-21.25	19.65

HT/VHT20 Beam Forming, M24 to M31	4	4	-56.7	-51.1	-50.6	-51.7	0.1	-41.9	-21.25	20.65
HT/VHT20 STBC, M0 to M7	2	4	-56.7	-51.1			0.1	-46.0	-21.25	24.74
HT/VHT20 STBC, M0 to M7	3	4	-56.7	-51.1	-50.6		0.1	-43.3	-21.25	22.00
HT/VHT20 STBC, M0 to M7	4	4	-56.7	-51.1	-50.6	-51.7	0.1	-41.9	-21.25	20.65
HE20, M0 to M9 1ss	1	4	-55.8				0.1	-51.7	-21.25	30.48
HE20, M0 to M9 1ss	2	4	-55.8	-51.1			0.1	-45.8	-21.25	24.51
HE20, M0 to M9 2ss	2	4	-55.8	-51.1			0.1	-45.8	-21.25	24.51
HE20, M0 to M9 1ss	3	4	-55.8	-51.1	-50.8		0.1	-43.2	-21.25	21.96
HE20, M0 to M9 2ss	3	4	-55.8	-51.1	-50.8		0.1	-43.2	-21.25	21.96
HE20, M0 to M9 3ss	3	4	-55.8	-51.1	-50.8		0.1	-43.2	-21.25	21.96
HE20, M0 to M9 1ss	4	4	-55.8	-51.1	-50.8	-51.0	0.1	-41.7	-21.25	20.42
HE20, M0 to M9 2ss	4	4	-55.8	-51.1	-50.8	-51.0	0.1	-41.7	-21.25	20.42
HE20, M0 to M9 3ss	4	4	-55.8	-51.1	-50.8	-51.0	0.1	-41.7	-21.25	20.42
HE20, M0 to M9 4ss	4	4	-55.8	-51.1	-50.8	-51.0	0.1	-41.7	-21.25	20.42
HE20 Beam Forming, M0 to M9 1ss	2	7	-55.8	-51.1			0.1	-42.8	-21.25	21.51
HE20 Beam Forming, M0 to M9 2ss	2	4	-55.8	-51.1			0.1	-45.8	-21.25	24.51
HE20 Beam Forming, M0 to M9 1ss	3	9	-55.8	-51.1	-50.8		0.1	-38.2	-21.25	16.96
HE20 Beam Forming, M0 to M9 2ss	3	6	-55.8	-51.1	-50.8		0.1	-41.2	-21.25	19.96
HE20 Beam Forming, M0 to M9 3ss	3	4	-55.8	-51.1	-50.8		0.1	-43.2	-21.25	21.96
HE20 Beam Forming, M0 to M9 1ss	4	10	-55.8	-51.1	-50.8	-51.0	0.1	-35.7	-21.25	14.42
HE20 Beam Forming, M0 to M9 2ss	4	7	-55.8	-51.1	-50.8	-51.0	0.1	-38.7	-21.25	17.42
HE20 Beam Forming, M0 to M9 3ss	4	5	-55.8	-51.1	-50.8	-51.0	0.1	-40.7	-21.25	19.42
HE20 Beam Forming, M0 to M9 4ss	4	4	-55.8	-51.1	-50.8	-51.0	0.1	-41.7	-21.25	20.42
HE20 STBC, M0 to M9 2ss	2	4	-55.8	-51.1			0.1	-45.8	-21.25	24.51
HE20 STBC, M0 to M9 2ss	3	4	-55.8	-51.1	-50.8		0.1	-43.2	-21.25	21.96
HE20 STBC, M0 to M9 2ss	4	4	-55.8	-51.1	-50.8	-51.0	0.1	-41.7	-21.25	20.42

**Conducted Spurs Peak, 4dBi  
5775 MHz, HE80 Beam Forming, M0 to M9 1ss**



**Antenna A**

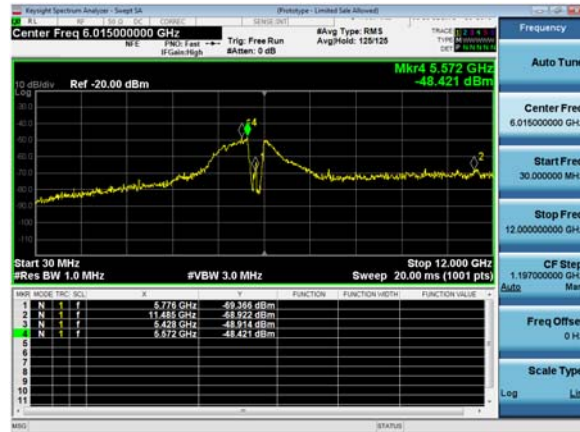

**Antenna B**



**Antenna C**

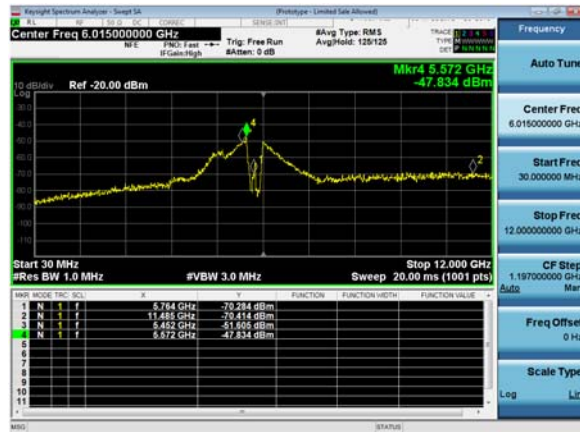

**Antenna D**

Conducted Spurious Peak, 5dBi

Frequency (MHz)	Mode	Tx Paths	Correlated Antenna Gain (dBi)	Tx 1 Spur Power (dBm)	Tx 2 Spur Power (dBm)	Tx 3 Spur Power (dBm)	Tx 4 Spur Power (dBm)	Duty Cycle Correction (dB)	Total Conducted Spur (dBm)	Limit (dBm)	Margin (dB)
5720 <sup>19</sup>	Non HT20, 6 to 54 Mbps	1	5	-58.5				0.1	-53.4	-21.25	32.20
	Non HT20, 6 to 54 Mbps	2	5	-58.5	-51.8			0.1	-45.9	-21.25	24.66
	Non HT20, 6 to 54 Mbps	3	5	-58.5	-51.8	-54.7		0.1	-44.4	-21.25	23.13
	Non HT20, 6 to 54 Mbps	4	5	-58.5	-51.8	-54.7	-56.2	0.1	-43.5	-21.25	22.30
	Non HT20 Beam Forming, 6 to 54 Mbps	2	8	-58.5	-51.8			0.1	-42.9	-21.25	21.66
	Non HT20 Beam Forming, 6 to 54 Mbps	3	10	-58.5	-52.7	-54.4		0.1	-39.8	-21.25	18.52
	Non HT20 Beam Forming, 6 to 54 Mbps	4	11	-58.5	-54.0	-56.6	-58.1	0.1	-39.3	-21.25	18.09
	HT/VHT20, M0 to M7	1	5	-58.7				0.1	-53.6	-21.25	32.40
	HT/VHT20, M0 to M7	2	5	-58.7	-52.2			0.1	-46.3	-21.25	25.02
	HT/VHT20, M8 to M15	2	5	-58.7	-52.2			0.1	-46.3	-21.25	25.02
	HT/VHT20, M0 to M7	3	5	-58.7	-52.2	-54.3		0.1	-44.5	-21.25	23.25
	HT/VHT20, M8 to M15	3	5	-58.7	-52.2	-54.3		0.1	-44.5	-21.25	23.25
	HT/VHT20, M16 to M23	3	5	-58.7	-52.2	-54.3		0.1	-44.5	-21.25	23.25
	HT/VHT20, M0 to M7	4	5	-58.7	-52.2	-54.3	-56.8	0.1	-43.7	-21.25	22.50
	HT/VHT20, M8 to M15	4	5	-58.7	-52.2	-54.3	-56.8	0.1	-43.7	-21.25	22.50
	HT/VHT20, M16 to M23	4	5	-58.7	-52.2	-54.3	-56.8	0.1	-43.7	-21.25	22.50
	HT/VHT20, M24 to M31	4	5	-58.7	-52.2	-54.3	-56.8	0.1	-43.7	-21.25	22.50
	HT/VHT20 Beam Forming, M0 to M7	2	8	-58.7	-52.2			0.1	-43.3	-21.25	22.02
	HT/VHT20 Beam Forming, M8 to M15	2	5	-58.7	-52.2			0.1	-46.3	-21.25	25.02
	HT/VHT20 Beam Forming, M0 to M7	3	10	-58.7	-54.1	-54.9		0.1	-40.7	-21.25	19.42
	HT/VHT20 Beam Forming, M8 to M15	3	7	-58.7	-52.2	-54.3		0.1	-42.5	-21.25	21.25
	HT/VHT20 Beam Forming, M16 to M23	3	5	-58.7	-52.2	-54.3		0.1	-44.5	-21.25	23.25
	HT/VHT20 Beam Forming, M0 to M7	4	11	-58.7	-53.8	-55.9	-58.0	0.1	-39.1	-21.25	17.84
	HT/VHT20 Beam Forming, M8 to M15	4	8	-58.7	-52.3	-55.0	-57.0	0.1	-41.0	-21.25	19.77
	HT/VHT20 Beam Forming, M16 to M23	4	6	-58.7	-52.2	-54.3	-56.8	0.1	-42.7	-21.25	21.50
	HT/VHT20 Beam Forming, M24 to M31	4	5	-58.7	-52.2	-54.3	-56.8	0.1	-43.7	-21.25	22.50
	HT/VHT20 STBC, M0 to M7	2	5	-58.7	-52.2			0.1	-46.3	-21.25	25.02

<sup>19</sup> 5720 (ch144) not supported for Canada.

	HT/VHT20 STBC, M0 to M7	3	5	-58.7	-52.2	-54.3		0.1	-44.5	-21.25	23.25
	HT/VHT20 STBC, M0 to M7	4	5	-58.7	-52.3	-55.0	-57.0	0.1	-44.0	-21.25	22.77
	HE20, M0 to M9 1ss	1	5	-58.9				0.1	-53.8	-21.25	32.58
	HE20, M0 to M9 1ss	2	5	-58.9	-51.6			0.1	-45.8	-21.25	24.54
	HE20, M0 to M9 2ss	2	5	-58.9	-51.6			0.1	-45.8	-21.25	24.54
	HE20, M0 to M9 1ss	3	5	-58.9	-51.6	-54.4		0.1	-44.2	-21.25	22.95
	HE20, M0 to M9 2ss	3	5	-58.9	-51.6	-54.4		0.1	-44.2	-21.25	22.95
	HE20, M0 to M9 3ss	3	5	-58.9	-51.6	-54.4		0.1	-44.2	-21.25	22.95
	HE20, M0 to M9 1ss	4	5	-58.9	-51.6	-54.4	-55.4	0.1	-43.3	-21.25	22.00
	HE20, M0 to M9 2ss	4	5	-58.9	-51.6	-54.4	-55.4	0.1	-43.3	-21.25	22.00
	HE20, M0 to M9 3ss	4	5	-58.9	-51.6	-54.4	-55.4	0.1	-43.3	-21.25	22.00
	HE20, M0 to M9 4ss	4	5	-58.9	-51.6	-54.4	-55.4	0.1	-43.3	-21.25	22.00
	HE20 Beam Forming, M0 to M9 1ss	2	8	-58.9	-51.6			0.1	-42.8	-21.25	21.54
	HE20 Beam Forming, M0 to M9 2ss	2	5	-58.9	-51.6			0.1	-45.8	-21.25	24.54
	HE20 Beam Forming, M0 to M9 1ss	3	10	-58.9	-54.2	-54.7		0.1	-40.6	-21.25	19.40
	HE20 Beam Forming, M0 to M9 2ss	3	7	-58.9	-51.6	-54.4		0.1	-42.2	-21.25	20.95
	HE20 Beam Forming, M0 to M9 3ss	3	5	-58.9	-51.6	-54.4		0.1	-44.2	-21.25	22.95
	HE20 Beam Forming, M0 to M9 1ss	4	11	-58.9	-54.1	-57.3	-58.0	0.1	-39.6	-21.25	18.32
	HE20 Beam Forming, M0 to M9 2ss	4	8	-58.9	-53.7	-55.3	-56.9	0.1	-41.7	-21.25	20.45
	HE20 Beam Forming, M0 to M9 3ss	4	6	-58.9	-51.6	-54.4	-55.4	0.1	-42.3	-21.25	21.00
	HE20 Beam Forming, M0 to M9 4ss	4	5	-58.9	-51.6	-54.4	-55.4	0.1	-43.3	-21.25	22.00
	HE20 STBC, M0 to M9 2ss	2	5	-58.9	-51.6			0.1	-45.8	-21.25	24.54
	HE20 STBC, M0 to M9 2ss	3	5	-58.9	-51.6	-54.4		0.1	-44.2	-21.25	22.95
	HE20 STBC, M0 to M9 2ss	4	5	-58.9	-53.7	-55.3	-56.9	0.1	-44.7	-21.25	23.45
5745	Non HT20, 6 to 54 Mbps	1	5	-54.6				0.1	-49.5	-21.25	28.30
	Non HT20, 6 to 54 Mbps	2	5	-54.6	-50.2			0.1	-43.8	-21.25	22.55
	Non HT20, 6 to 54 Mbps	3	5	-54.6	-50.2	-50.2		0.1	-41.4	-21.25	20.16
	Non HT20, 6 to 54 Mbps	4	5	-54.6	-50.2	-50.2	-51.8	0.1	-40.3	-21.25	19.05
	Non HT20 Beam Forming, 6 to 54 Mbps	2	8	-54.6	-50.2			0.1	-40.8	-21.25	19.55
	Non HT20 Beam Forming, 6 to 54 Mbps	3	10	-54.6	-50.2	-50.2		0.1	-36.4	-21.25	15.16
	Non HT20 Beam Forming, 6 to 54 Mbps	4	11	-54.6	-50.2	-50.2	-51.8	0.1	-34.3	-21.25	13.05
	HT/VHT20, M0 to M7	1	5	-55.0				0.1	-49.9	-21.25	28.70
	HT/VHT20, M0 to M7	2	5	-55.0	-50.9			0.1	-44.4	-21.25	23.17
	HT/VHT20, M8 to M15	2	5	-55.0	-50.9			0.1	-44.4	-21.25	23.17
	HT/VHT20, M0 to M7	3	5	-55.0	-50.9	-50.4		0.1	-41.8	-21.25	20.60
	HT/VHT20, M8 to M15	3	5	-55.0	-50.9	-50.4		0.1	-41.8	-21.25	20.60
	HT/VHT20, M16 to M23	3	5	-55.0	-50.9	-50.4		0.1	-41.8	-21.25	20.60
	HT/VHT20, M0 to M7	4	5	-55.0	-50.9	-50.4	-51.3	0.1	-40.5	-21.25	19.25
	HT/VHT20, M8 to M15	4	5	-55.0	-50.9	-50.4	-51.3	0.1	-40.5	-21.25	19.25
	HT/VHT20, M16 to M23	4	5	-55.0	-50.9	-50.4	-51.3	0.1	-40.5	-21.25	19.25
	HT/VHT20, M24 to M31	4	5	-55.0	-50.9	-50.4	-51.3	0.1	-40.5	-21.25	19.25
HT/VHT20 Beam Forming, M0 to M7	2	8	-55.0	-50.9			0.1	-41.4	-21.25	20.17	





	HT/VHT20 Beam Forming, M8 to M15	2	5	-55.0	-50.9			0.1	-44.4	-21.25	23.17
	HT/VHT20 Beam Forming, M0 to M7	3	10	-55.0	-50.9	-50.4		0.1	-36.8	-21.25	15.60
	HT/VHT20 Beam Forming, M8 to M15	3	7	-55.0	-50.9	-50.4		0.1	-39.8	-21.25	18.60
	HT/VHT20 Beam Forming, M16 to M23	3	5	-55.0	-50.9	-50.4		0.1	-41.8	-21.25	20.60
	HT/VHT20 Beam Forming, M0 to M7	4	11	-55.0	-50.9	-50.4	-51.3	0.1	-34.5	-21.25	13.25
	HT/VHT20 Beam Forming, M8 to M15	4	8	-55.0	-50.9	-50.4	-51.3	0.1	-37.5	-21.25	16.25
	HT/VHT20 Beam Forming, M16 to M23	4	6	-55.0	-50.9	-50.4	-51.3	0.1	-39.5	-21.25	18.25
	HT/VHT20 Beam Forming, M24 to M31	4	5	-55.0	-50.9	-50.4	-51.3	0.1	-40.5	-21.25	19.25
	HT/VHT20 STBC, M0 to M7	2	5	-55.0	-50.9			0.1	-44.4	-21.25	23.17
	HT/VHT20 STBC, M0 to M7	3	5	-55.0	-50.9	-50.4		0.1	-41.8	-21.25	20.60
	HT/VHT20 STBC, M0 to M7	4	5	-55.0	-50.9	-50.4	-51.3	0.1	-40.5	-21.25	19.25
	HE20, M0 to M9 1ss	1	5	-55.4				0.1	-50.3	-21.25	29.08
	HE20, M0 to M9 1ss	2	5	-55.4	-50.0			0.1	-43.8	-21.25	22.58
	HE20, M0 to M9 2ss	2	5	-55.4	-50.0			0.1	-43.8	-21.25	22.58
	HE20, M0 to M9 1ss	3	5	-55.4	-50.0	-49.7		0.1	-41.2	-21.25	19.95
	HE20, M0 to M9 2ss	3	5	-55.4	-50.0	-49.7		0.1	-41.2	-21.25	19.95
	HE20, M0 to M9 3ss	3	5	-55.4	-50.0	-49.7		0.1	-41.2	-21.25	19.95
	HE20, M0 to M9 1ss	4	5	-55.4	-50.0	-49.7	-51.0	0.1	-39.9	-21.25	18.69
	HE20, M0 to M9 2ss	4	5	-55.4	-50.0	-49.7	-51.0	0.1	-39.9	-21.25	18.69
	HE20, M0 to M9 3ss	4	5	-55.4	-50.0	-49.7	-51.0	0.1	-39.9	-21.25	18.69
	HE20, M0 to M9 4ss	4	5	-55.4	-50.0	-49.7	-51.0	0.1	-39.9	-21.25	18.69
	HE20 Beam Forming, M0 to M9 1ss	2	8	-55.4	-50.0			0.1	-40.8	-21.25	19.58
	HE20 Beam Forming, M0 to M9 2ss	2	5	-55.4	-50.0			0.1	-43.8	-21.25	22.58
	HE20 Beam Forming, M0 to M9 1ss	3	10	-55.4	-50.0	-49.7		0.1	-36.2	-21.25	14.95
	HE20 Beam Forming, M0 to M9 2ss	3	7	-55.4	-50.0	-49.7		0.1	-39.2	-21.25	17.95
	HE20 Beam Forming, M0 to M9 3ss	3	5	-55.4	-50.0	-49.7		0.1	-41.2	-21.25	19.95
	HE20 Beam Forming, M0 to M9 1ss	4	11	-55.4	-50.0	-49.7	-51.0	0.1	-33.9	-21.25	12.69
	HE20 Beam Forming, M0 to M9 2ss	4	8	-55.4	-50.0	-49.7	-51.0	0.1	-36.9	-21.25	15.69
	HE20 Beam Forming, M0 to M9 3ss	4	6	-55.4	-50.0	-49.7	-51.0	0.1	-38.9	-21.25	17.69
	HE20 Beam Forming, M0 to M9 4ss	4	5	-55.4	-50.0	-49.7	-51.0	0.1	-39.9	-21.25	18.69
	HE20 STBC, M0 to M9 2ss	2	5	-55.4	-50.0			0.1	-43.8	-21.25	22.58
	HE20 STBC, M0 to M9 2ss	3	5	-55.4	-50.0	-49.7		0.1	-41.2	-21.25	19.95
	HE20 STBC, M0 to M9 2ss	4	5	-55.4	-50.0	-49.7	-51.0	0.1	-39.9	-21.25	18.69
5755	Non HT40, 6 to 54 Mbps	1	5	-55.0				0.1	-49.9	-21.25	28.70
	Non HT40, 6 to 54 Mbps	2	5	-55.0	-50.2			0.1	-43.9	-21.25	22.66
	Non HT40, 6 to 54 Mbps	3	5	-55.0	-50.2	-49.9		0.1	-41.3	-21.25	20.09
	Non HT40, 6 to 54 Mbps	4	5	-55.0	-50.2	-49.9	-51.3	0.1	-40.1	-21.25	18.88
	HT/VHT40, M0 to M7	1	5	-56.2				0.1	-51.1	-21.25	29.84
	HT/VHT40, M0 to M7	2	5	-56.2	-49.8			0.1	-43.8	-21.25	22.54
	HT/VHT40, M8 to M15	2	5	-56.2	-49.8			0.1	-43.8	-21.25	22.54
	HT/VHT40, M0 to M7	3	5	-56.2	-49.8	-51.2		0.1	-41.8	-21.25	20.53
	HT/VHT40, M8 to M15	3	5	-56.2	-49.8	-51.2		0.1	-41.8	-21.25	20.53





	HT/VHT40, M16 to M23	3	5	-56.2	-49.8	-51.2		0.1	-41.8	-21.25	20.53
	HT/VHT40, M0 to M7	4	5	-56.2	-49.8	-51.2	-51.8	0.1	-40.6	-21.25	19.32
	HT/VHT40, M8 to M15	4	5	-56.2	-49.8	-51.2	-51.8	0.1	-40.6	-21.25	19.32
	HT/VHT40, M16 to M23	4	5	-56.2	-49.8	-51.2	-51.8	0.1	-40.6	-21.25	19.32
	HT/VHT40, M24 to M31	4	5	-56.2	-49.8	-51.2	-51.8	0.1	-40.6	-21.25	19.32
	HT/VHT40 Beam Forming, M0 to M7	2	8	-56.2	-49.8			0.1	-40.8	-21.25	19.54
	HT/VHT40 Beam Forming, M8 to M15	2	5	-56.2	-49.8			0.1	-43.8	-21.25	22.54
	HT/VHT40 Beam Forming, M0 to M7	3	10	-56.2	-49.8	-51.2		0.1	-36.8	-21.25	15.53
	HT/VHT40 Beam Forming, M8 to M15	3	7	-56.2	-49.8	-51.2		0.1	-39.8	-21.25	18.53
	HT/VHT40 Beam Forming, M16 to M23	3	5	-56.2	-49.8	-51.2		0.1	-41.8	-21.25	20.53
	HT/VHT40 Beam Forming, M0 to M7	4	11	-56.2	-49.8	-51.2	-51.8	0.1	-34.6	-21.25	13.32
	HT/VHT40 Beam Forming, M8 to M15	4	8	-56.2	-49.8	-51.2	-51.8	0.1	-37.6	-21.25	16.32
	HT/VHT40 Beam Forming, M16 to M23	4	6	-56.2	-49.8	-51.2	-51.8	0.1	-39.6	-21.25	18.32
	HT/VHT40 Beam Forming, M24 to M31	4	5	-56.2	-49.8	-51.2	-51.8	0.1	-40.6	-21.25	19.32
	HT/VHT40 STBC, M0 to M7	2	5	-56.2	-49.8			0.1	-43.8	-21.25	22.54
	HT/VHT40 STBC, M0 to M7	3	5	-56.2	-49.8	-51.2		0.1	-41.8	-21.25	20.53
	HT/VHT40 STBC, M0 to M7	4	5	-56.2	-49.8	-51.2	-51.8	0.1	-40.6	-21.25	19.32
	HE40, M0 to M9 1ss	1	5	-55.8				0.1	-50.7	-21.25	29.42
	HE40, M0 to M9 1ss	2	5	-55.8	-50.4			0.1	-44.2	-21.25	22.92
	HE40, M0 to M9 2ss	2	5	-55.8	-50.4			0.1	-44.2	-21.25	22.92
	HE40, M0 to M9 1ss	3	5	-55.8	-50.4	-50.6		0.1	-41.8	-21.25	20.52
	HE40, M0 to M9 2ss	3	5	-55.8	-50.4	-50.6		0.1	-41.8	-21.25	20.52
	HE40, M0 to M9 3ss	3	5	-55.8	-50.4	-50.6		0.1	-41.8	-21.25	20.52
	HE40, M0 to M9 1ss	4	5	-55.8	-50.4	-50.6	-51.7	0.1	-40.5	-21.25	19.28
	HE40, M0 to M9 2ss	4	5	-55.8	-50.4	-50.6	-51.7	0.1	-40.5	-21.25	19.28
	HE40, M0 to M9 3ss	4	5	-55.8	-50.4	-50.6	-51.7	0.1	-40.5	-21.25	19.28
	HE40, M0 to M9 4ss	4	5	-55.8	-50.4	-50.6	-51.7	0.1	-40.5	-21.25	19.28
	HE40 Beam Forming, M0 to M9 1ss	2	8	-55.8	-50.4			0.1	-41.2	-21.25	19.92
	HE40 Beam Forming, M0 to M9 2ss	2	5	-55.8	-50.4			0.1	-44.2	-21.25	22.92
	HE40 Beam Forming, M0 to M9 1ss	3	10	-55.8	-50.4	-50.6		0.1	-36.8	-21.25	15.52
	HE40 Beam Forming, M0 to M9 2ss	3	7	-55.8	-50.4	-50.6		0.1	-39.8	-21.25	18.52
	HE40 Beam Forming, M0 to M9 3ss	3	5	-55.8	-50.4	-50.6		0.1	-41.8	-21.25	20.52
	HE40 Beam Forming, M0 to M9 1ss	4	11	-55.8	-50.4	-50.6	-51.7	0.1	-34.5	-21.25	13.28
	HE40 Beam Forming, M0 to M9 2ss	4	8	-55.8	-50.4	-50.6	-51.7	0.1	-37.5	-21.25	16.28
	HE40 Beam Forming, M0 to M9 3ss	4	6	-55.8	-50.4	-50.6	-51.7	0.1	-39.5	-21.25	18.28
	HE40 Beam Forming, M0 to M9 4ss	4	5	-55.8	-50.4	-50.6	-51.7	0.1	-40.5	-21.25	19.28
	HE40 STBC, M0 to M9 2ss	2	5	-55.8	-50.4			0.1	-44.2	-21.25	22.92
	HE40 STBC, M0 to M9 2ss	3	5	-55.8	-50.4	-50.6		0.1	-41.8	-21.25	20.52
	HE40 STBC, M0 to M9 2ss	4	5	-55.8	-50.4	-50.6	-51.7	0.1	-40.5	-21.25	19.28
5775	Non HT80, 6 to 54 Mbps	1	5	-55.4				0.0	-50.4	-21.25	29.10
	Non HT80, 6 to 54 Mbps	2	5	-55.4	-51.1			0.0	-44.7	-21.25	23.43
	Non HT80, 6 to 54 Mbps	3	5	-55.4	-51.1	-50.7		0.0	-42.1	-21.25	20.88

Non HT80, 6 to 54 Mbps	4	5	-55.4	-51.1	-50.7	-51.3	0.0	-40.7	-21.25	19.46
VHT80, M0 to M9 1ss	1	5	-56.4				0.2	-51.2	-21.25	29.93
VHT80, M0 to M9 1ss	2	5	-56.4	-51.1			0.2	-44.8	-21.25	23.50
VHT80, M0 to M9 2ss	2	5	-56.4	-51.1			0.2	-44.8	-21.25	23.50
VHT80, M0 to M9 1ss	3	5	-56.4	-51.1	-51.0		0.2	-42.2	-21.25	20.97
VHT80, M0 to M9 2ss	3	5	-56.4	-51.1	-51.0		0.2	-42.2	-21.25	20.97
VHT80, M0 to M9 3ss	3	5	-56.4	-51.1	-51.0		0.2	-42.2	-21.25	20.97
VHT80, M0 to M9 1ss	4	5	-56.4	-51.1	-51.0	-52.4	0.2	-41.0	-21.25	19.77
VHT80, M0 to M9 2ss	4	5	-56.4	-51.1	-51.0	-52.4	0.2	-41.0	-21.25	19.77
VHT80, M0 to M9 3ss	4	5	-56.4	-51.1	-51.0	-52.4	0.2	-41.0	-21.25	19.77
VHT80, M0 to M9 4ss	4	5	-56.4	-51.1	-51.0	-52.4	0.2	-41.0	-21.25	19.77
VHT80 Beam Forming, M0 to M9 1ss	2	8	-56.4	-51.1			0.2	-41.8	-21.25	20.50
VHT80 Beam Forming, M0 to M9 2ss	2	5	-56.4	-51.1			0.2	-44.8	-21.25	23.50
VHT80 Beam Forming, M0 to M9 1ss	3	10	-56.4	-51.1	-51.0		0.2	-37.2	-21.25	15.97
VHT80 Beam Forming, M0 to M9 2ss	3	7	-56.4	-51.1	-51.0		0.2	-40.2	-21.25	18.97
VHT80 Beam Forming, M0 to M9 3ss	3	5	-56.4	-51.1	-51.0		0.2	-42.2	-21.25	20.97
VHT80 Beam Forming, M0 to M9 1ss	4	11	-56.4	-51.1	-51.0	-52.4	0.2	-35.0	-21.25	13.77
VHT80 Beam Forming, M0 to M9 2ss	4	8	-56.4	-51.1	-51.0	-52.4	0.2	-38.0	-21.25	16.77
VHT80 Beam Forming, M0 to M9 3ss	4	6	-56.4	-51.1	-51.0	-52.4	0.2	-40.0	-21.25	18.77
VHT80 Beam Forming, M0 to M9 4ss	4	5	-56.4	-51.1	-51.0	-52.4	0.2	-41.0	-21.25	19.77
VHT80 STBC, M0 to M9 1ss	2	5	-56.4	-51.1			0.2	-44.8	-21.25	23.50
VHT80 STBC, M0 to M9 1ss	3	5	-56.4	-51.1	-51.0		0.2	-42.2	-21.25	20.97
VHT80 STBC, M0 to M9 1ss	4	5	-56.4	-51.1	-51.0	-52.4	0.2	-41.0	-21.25	19.77
HE80, M0 to M9 1ss	1	5	-55.5				0.2	-50.3	-21.25	29.00
HE80, M0 to M9 1ss	2	5	-55.5	-48.9			0.2	-42.8	-21.25	21.54
HE80, M0 to M9 2ss	2	5	-55.5	-48.9			0.2	-42.8	-21.25	21.54
HE80, M0 to M9 1ss	3	5	-55.5	-48.9	-51.0		0.2	-41.0	-21.25	19.76
HE80, M0 to M9 2ss	3	5	-55.5	-48.9	-51.0		0.2	-41.0	-21.25	19.76
HE80, M0 to M9 3ss	3	5	-55.5	-48.9	-51.0		0.2	-41.0	-21.25	19.76
HE80, M0 to M9 1ss	4	5	-55.5	-48.9	-51.0	-51.6	0.2	-39.9	-21.25	18.65
HE80, M0 to M9 2ss	4	5	-55.5	-48.9	-51.0	-51.6	0.2	-39.9	-21.25	18.65
HE80, M0 to M9 3ss	4	5	-55.5	-48.9	-51.0	-51.6	0.2	-39.9	-21.25	18.65
HE80, M0 to M9 4ss	4	5	-55.5	-48.9	-51.0	-51.6	0.2	-39.9	-21.25	18.65
HE80 Beam Forming, M0 to M9 1ss	2	8	-55.5	-48.9			0.2	-39.8	-21.25	18.54
HE80 Beam Forming, M0 to M9 2ss	2	5	-55.5	-48.9			0.2	-42.8	-21.25	21.54
HE80 Beam Forming, M0 to M9 1ss	3	10	-55.5	-48.9	-51.0		0.2	-36.0	-21.25	14.76
HE80 Beam Forming, M0 to M9 2ss	3	7	-55.5	-48.9	-51.0		0.2	-39.0	-21.25	17.76
HE80 Beam Forming, M0 to M9 3ss	3	5	-55.5	-48.9	-51.0		0.2	-41.0	-21.25	19.76
<b>HE80 Beam Forming, M0 to M9 1ss</b>	<b>4</b>	<b>11</b>	<b>-55.5</b>	<b>-48.9</b>	<b>-51.0</b>	<b>-51.6</b>	<b>0.2</b>	<b>-33.9</b>	<b>-21.25</b>	<b>12.65</b>
HE80 Beam Forming, M0 to M9 2ss	4	8	-55.5	-48.9	-51.0	-51.6	0.2	-36.9	-21.25	15.65
HE80 Beam Forming, M0 to M9 3ss	4	6	-55.5	-48.9	-51.0	-51.6	0.2	-38.9	-21.25	17.65
HE80 Beam Forming, M0 to M9 4ss	4	5	-55.5	-48.9	-51.0	-51.6	0.2	-39.9	-21.25	18.65
HE80 STBC, M0 to M9 1ss	2	5	-55.5	-48.9			0.2	-42.8	-21.25	21.54

	HE80 STBC, M0 to M9 1ss	3	5	-55.5	-48.9	-51.0		0.2	-41.0	-21.25	19.76
	HE80 STBC, M0 to M9 1ss	4	5	-55.5	-48.9	-51.0	-51.6	0.2	-39.9	-21.25	18.65
5785	Non HT20, 6 to 54 Mbps	1	5	-55.7				0.1	-50.6	-21.25	29.40
	Non HT20, 6 to 54 Mbps	2	5	-55.7	-50.0			0.1	-43.9	-21.25	22.66
	Non HT20, 6 to 54 Mbps	3	5	-55.7	-50.0	-50.3		0.1	-41.5	-21.25	20.27
	Non HT20, 6 to 54 Mbps	4	5	-55.7	-50.0	-50.3	-50.8	0.1	-40.1	-21.25	18.88
	Non HT20 Beam Forming, 6 to 54 Mbps	2	8	-55.7	-50.0			0.1	-40.9	-21.25	19.66
	Non HT20 Beam Forming, 6 to 54 Mbps	3	10	-55.7	-50.0	-50.3		0.1	-36.5	-21.25	15.27
	Non HT20 Beam Forming, 6 to 54 Mbps	4	11	-55.7	-50.0	-50.3	-50.8	0.1	-34.1	-21.25	12.88
	HT/VHT20, M0 to M7	1	5	-54.7				0.1	-49.6	-21.25	28.40
	HT/VHT20, M0 to M7	2	5	-54.7	-50.1			0.1	-43.8	-21.25	22.50
	HT/VHT20, M8 to M15	2	5	-54.7	-50.1			0.1	-43.8	-21.25	22.50
	HT/VHT20, M0 to M7	3	5	-54.7	-50.1	-49.7		0.1	-41.2	-21.25	19.92
	HT/VHT20, M8 to M15	3	5	-54.7	-50.1	-49.7		0.1	-41.2	-21.25	19.92
	HT/VHT20, M16 to M23	3	5	-54.7	-50.1	-49.7		0.1	-41.2	-21.25	19.92
	HT/VHT20, M0 to M7	4	5	-54.7	-50.1	-49.7	-52.0	0.1	-40.1	-21.25	18.90
	HT/VHT20, M8 to M15	4	5	-54.7	-50.1	-49.7	-52.0	0.1	-40.1	-21.25	18.90
	HT/VHT20, M16 to M23	4	5	-54.7	-50.1	-49.7	-52.0	0.1	-40.1	-21.25	18.90
	HT/VHT20, M24 to M31	4	5	-54.7	-50.1	-49.7	-52.0	0.1	-40.1	-21.25	18.90
	HT/VHT20 Beam Forming, M0 to M7	2	8	-54.7	-50.1			0.1	-40.8	-21.25	19.50
	HT/VHT20 Beam Forming, M8 to M15	2	5	-54.7	-50.1			0.1	-43.8	-21.25	22.50
	HT/VHT20 Beam Forming, M0 to M7	3	10	-54.7	-50.1	-49.7		0.1	-36.2	-21.25	14.92
	HT/VHT20 Beam Forming, M8 to M15	3	7	-54.7	-50.1	-49.7		0.1	-39.2	-21.25	17.92
	HT/VHT20 Beam Forming, M16 to M23	3	5	-54.7	-50.1	-49.7		0.1	-41.2	-21.25	19.92
	HT/VHT20 Beam Forming, M0 to M7	4	11	-54.7	-50.1	-49.7	-52.0	0.1	-34.1	-21.25	12.90
	HT/VHT20 Beam Forming, M8 to M15	4	8	-54.7	-50.1	-49.7	-52.0	0.1	-37.1	-21.25	15.90
	HT/VHT20 Beam Forming, M16 to M23	4	6	-54.7	-50.1	-49.7	-52.0	0.1	-39.1	-21.25	17.90
	HT/VHT20 Beam Forming, M24 to M31	4	5	-54.7	-50.1	-49.7	-52.0	0.1	-40.1	-21.25	18.90
	HT/VHT20 STBC, M0 to M7	2	5	-54.7	-50.1			0.1	-43.8	-21.25	22.50
	HT/VHT20 STBC, M0 to M7	3	5	-54.7	-50.1	-49.7		0.1	-41.2	-21.25	19.92
	HT/VHT20 STBC, M0 to M7	4	5	-54.7	-50.1	-49.7	-52.0	0.1	-40.1	-21.25	18.90
	HE20, M0 to M9 1ss	1	5	-54.8				0.1	-49.7	-21.25	28.48
	HE20, M0 to M9 1ss	2	5	-54.8	-50.6			0.1	-44.1	-21.25	22.88
	HE20, M0 to M9 2ss	2	5	-54.8	-50.6			0.1	-44.1	-21.25	22.88
	HE20, M0 to M9 1ss	3	5	-54.8	-50.6	-50.2		0.1	-41.6	-21.25	20.34
	HE20, M0 to M9 2ss	3	5	-54.8	-50.6	-50.2		0.1	-41.6	-21.25	20.34
HE20, M0 to M9 3ss	3	5	-54.8	-50.6	-50.2		0.1	-41.6	-21.25	20.34	
HE20, M0 to M9 1ss	4	5	-54.8	-50.6	-50.2	-51.4	0.1	-40.3	-21.25	19.09	
HE20, M0 to M9 2ss	4	5	-54.8	-50.6	-50.2	-51.4	0.1	-40.3	-21.25	19.09	
HE20, M0 to M9 3ss	4	5	-54.8	-50.6	-50.2	-51.4	0.1	-40.3	-21.25	19.09	
HE20, M0 to M9 4ss	4	5	-54.8	-50.6	-50.2	-51.4	0.1	-40.3	-21.25	19.09	
HE20 Beam Forming, M0 to M9 1ss	2	8	-54.8	-50.6			0.1	-41.1	-21.25	19.88	



	HE20 Beam Forming, M0 to M9 2ss	2	5	-54.8	-50.6			0.1	-44.1	-21.25	22.88
	HE20 Beam Forming, M0 to M9 1ss	3	10	-54.8	-50.6	-50.2		0.1	-36.6	-21.25	15.34
	HE20 Beam Forming, M0 to M9 2ss	3	7	-54.8	-50.6	-50.2		0.1	-39.6	-21.25	18.34
	HE20 Beam Forming, M0 to M9 3ss	3	5	-54.8	-50.6	-50.2		0.1	-41.6	-21.25	20.34
	HE20 Beam Forming, M0 to M9 1ss	4	11	-54.8	-50.6	-50.2	-51.4	0.1	-34.3	-21.25	13.09
	HE20 Beam Forming, M0 to M9 2ss	4	8	-54.8	-50.6	-50.2	-51.4	0.1	-37.3	-21.25	16.09
	HE20 Beam Forming, M0 to M9 3ss	4	6	-54.8	-50.6	-50.2	-51.4	0.1	-39.3	-21.25	18.09
	HE20 Beam Forming, M0 to M9 4ss	4	5	-54.8	-50.6	-50.2	-51.4	0.1	-40.3	-21.25	19.09
	HE20 STBC, M0 to M9 2ss	2	5	-54.8	-50.6			0.1	-44.1	-21.25	22.88
	HE20 STBC, M0 to M9 2ss	3	5	-54.8	-50.6	-50.2		0.1	-41.6	-21.25	20.34
	HE20 STBC, M0 to M9 2ss	4	5	-54.8	-50.6	-50.2	-51.4	0.1	-40.3	-21.25	19.09
5795	Non HT40, 6 to 54 Mbps	1	5	-56.4				0.1	-51.3	-21.25	30.10
	Non HT40, 6 to 54 Mbps	2	5	-56.4	-50.6			0.1	-44.5	-21.25	23.29
	Non HT40, 6 to 54 Mbps	3	5	-56.4	-50.6	-50.8		0.1	-42.1	-21.25	20.84
	Non HT40, 6 to 54 Mbps	4	5	-56.4	-50.6	-50.8	-51.8	0.1	-40.8	-21.25	19.56
	HT/VHT40, M0 to M7	1	5	-55.4				0.1	-50.3	-21.25	29.04
	HT/VHT40, M0 to M7	2	5	-55.4	-50.5			0.1	-44.2	-21.25	22.92
	HT/VHT40, M8 to M15	2	5	-55.4	-50.5			0.1	-44.2	-21.25	22.92
	HT/VHT40, M0 to M7	3	5	-55.4	-50.5	-50.8		0.1	-41.9	-21.25	20.61
	HT/VHT40, M8 to M15	3	5	-55.4	-50.5	-50.8		0.1	-41.9	-21.25	20.61
	HT/VHT40, M16 to M23	3	5	-55.4	-50.5	-50.8		0.1	-41.9	-21.25	20.61
	HT/VHT40, M0 to M7	4	5	-55.4	-50.5	-50.8	-51.8	0.1	-40.6	-21.25	19.37
	HT/VHT40, M8 to M15	4	5	-55.4	-50.5	-50.8	-51.8	0.1	-40.6	-21.25	19.37
	HT/VHT40, M16 to M23	4	5	-55.4	-50.5	-50.8	-51.8	0.1	-40.6	-21.25	19.37
	HT/VHT40, M24 to M31	4	5	-55.4	-50.5	-50.8	-51.8	0.1	-40.6	-21.25	19.37
	HT/VHT40 Beam Forming, M0 to M7	2	8	-55.4	-50.5			0.1	-41.2	-21.25	19.92
	HT/VHT40 Beam Forming, M8 to M15	2	5	-55.4	-50.5			0.1	-44.2	-21.25	22.92
	HT/VHT40 Beam Forming, M0 to M7	3	10	-55.4	-50.5	-50.8		0.1	-36.9	-21.25	15.61
	HT/VHT40 Beam Forming, M8 to M15	3	7	-55.4	-50.5	-50.8		0.1	-39.9	-21.25	18.61
	HT/VHT40 Beam Forming, M16 to M23	3	5	-55.4	-50.5	-50.8		0.1	-41.9	-21.25	20.61
	HT/VHT40 Beam Forming, M0 to M7	4	11	-55.4	-50.5	-50.8	-51.8	0.1	-34.6	-21.25	13.37
	HT/VHT40 Beam Forming, M8 to M15	4	8	-55.4	-50.5	-50.8	-51.8	0.1	-37.6	-21.25	16.37
	HT/VHT40 Beam Forming, M16 to M23	4	6	-55.4	-50.5	-50.8	-51.8	0.1	-39.6	-21.25	18.37
	HT/VHT40 Beam Forming, M24 to M31	4	5	-55.4	-50.5	-50.8	-51.8	0.1	-40.6	-21.25	19.37
	HT/VHT40 STBC, M0 to M7	2	5	-55.4	-50.5			0.1	-44.2	-21.25	22.92
	HT/VHT40 STBC, M0 to M7	3	5	-55.4	-50.5	-50.8		0.1	-41.9	-21.25	20.61
	HT/VHT40 STBC, M0 to M7	4	5	-55.4	-50.5	-50.8	-51.8	0.1	-40.6	-21.25	19.37
	HE40, M0 to M9 1ss	1	5	-56.5				0.1	-51.4	-21.25	30.12
	HE40, M0 to M9 1ss	2	5	-56.5	-50.5			0.1	-44.4	-21.25	23.15
	HE40, M0 to M9 2ss	2	5	-56.5	-50.5			0.1	-44.4	-21.25	23.15
	HE40, M0 to M9 1ss	3	5	-56.5	-50.5	-51.2		0.1	-42.1	-21.25	20.90
	HE40, M0 to M9 2ss	3	5	-56.5	-50.5	-51.2		0.1	-42.1	-21.25	20.90



HE40, M0 to M9 3ss	3	5	-56.5	-50.5	-51.2		0.1	-42.1	-21.25	20.90
HE40, M0 to M9 1ss	4	5	-56.5	-50.5	-51.2	-52.2	0.1	-40.9	-21.25	19.69
HE40, M0 to M9 2ss	4	5	-56.5	-50.5	-51.2	-52.2	0.1	-40.9	-21.25	19.69
HE40, M0 to M9 3ss	4	5	-56.5	-50.5	-51.2	-52.2	0.1	-40.9	-21.25	19.69
HE40, M0 to M9 4ss	4	5	-56.5	-50.5	-51.2	-52.2	0.1	-40.9	-21.25	19.69
HE40 Beam Forming, M0 to M9 1ss	2	8	-56.5	-50.5			0.1	-41.4	-21.25	20.15
HE40 Beam Forming, M0 to M9 2ss	2	5	-56.5	-50.5			0.1	-44.4	-21.25	23.15
HE40 Beam Forming, M0 to M9 1ss	3	10	-56.5	-50.5	-51.2		0.1	-37.1	-21.25	15.90
HE40 Beam Forming, M0 to M9 2ss	3	7	-56.5	-50.5	-51.2		0.1	-40.1	-21.25	18.90
HE40 Beam Forming, M0 to M9 3ss	3	5	-56.5	-50.5	-51.2		0.1	-42.1	-21.25	20.90
HE40 Beam Forming, M0 to M9 1ss	4	11	-56.5	-50.5	-51.2	-52.2	0.1	-34.9	-21.25	13.69
HE40 Beam Forming, M0 to M9 2ss	4	8	-56.5	-50.5	-51.2	-52.2	0.1	-37.9	-21.25	16.69
HE40 Beam Forming, M0 to M9 3ss	4	6	-56.5	-50.5	-51.2	-52.2	0.1	-39.9	-21.25	18.69
HE40 Beam Forming, M0 to M9 4ss	4	5	-56.5	-50.5	-51.2	-52.2	0.1	-40.9	-21.25	19.69
HE40 STBC, M0 to M9 2ss	2	5	-56.5	-50.5			0.1	-44.4	-21.25	23.15
HE40 STBC, M0 to M9 2ss	3	5	-56.5	-50.5	-51.2		0.1	-42.1	-21.25	20.90
HE40 STBC, M0 to M9 2ss	4	5	-56.5	-50.5	-51.2	-52.2	0.1	-40.9	-21.25	19.69

Non HT20, 6 to 54 Mbps	1	5	-55.8				0.1	-50.7	-21.25	29.50
Non HT20, 6 to 54 Mbps	2	5	-55.8	-50.5			0.1	-44.3	-21.25	23.08
Non HT20, 6 to 54 Mbps	3	5	-55.8	-50.5	-50.5		0.1	-41.8	-21.25	20.59
Non HT20, 6 to 54 Mbps	4	5	-55.8	-50.5	-50.5	-51.1	0.1	-40.4	-21.25	19.19
Non HT20 Beam Forming, 6 to 54 Mbps	2	8	-55.8	-50.5			0.1	-41.3	-21.25	20.08
Non HT20 Beam Forming, 6 to 54 Mbps	3	10	-55.8	-50.5	-50.5		0.1	-36.8	-21.25	15.59
Non HT20 Beam Forming, 6 to 54 Mbps	4	11	-55.8	-50.5	-50.5	-51.1	0.1	-34.4	-21.25	13.19
HT/VHT20, M0 to M7	1	5	-56.7				0.1	-51.6	-21.25	30.40
HT/VHT20, M0 to M7	2	5	-56.7	-51.1			0.1	-45.0	-21.25	23.74
HT/VHT20, M8 to M15	2	5	-56.7	-51.1			0.1	-45.0	-21.25	23.74
HT/VHT20, M0 to M7	3	5	-56.7	-51.1	-50.6		0.1	-42.3	-21.25	21.00
HT/VHT20, M8 to M15	3	5	-56.7	-51.1	-50.6		0.1	-42.3	-21.25	21.00
HT/VHT20, M16 to M23	3	5	-56.7	-51.1	-50.6		0.1	-42.3	-21.25	21.00
HT/VHT20, M0 to M7	4	5	-56.7	-51.1	-50.6	-51.7	0.1	-40.9	-21.25	19.65
HT/VHT20, M8 to M15	4	5	-56.7	-51.1	-50.6	-51.7	0.1	-40.9	-21.25	19.65
HT/VHT20, M16 to M23	4	5	-56.7	-51.1	-50.6	-51.7	0.1	-40.9	-21.25	19.65
HT/VHT20, M24 to M31	4	5	-56.7	-51.1	-50.6	-51.7	0.1	-40.9	-21.25	19.65
HT/VHT20 Beam Forming, M0 to M7	2	8	-56.7	-51.1			0.1	-42.0	-21.25	20.74
HT/VHT20 Beam Forming, M8 to M15	2	5	-56.7	-51.1			0.1	-45.0	-21.25	23.74
HT/VHT20 Beam Forming, M0 to M7	3	10	-56.7	-51.1	-50.6		0.1	-37.3	-21.25	16.00
HT/VHT20 Beam Forming, M8 to M15	3	7	-56.7	-51.1	-50.6		0.1	-40.3	-21.25	19.00
HT/VHT20 Beam Forming, M16 to M23	3	5	-56.7	-51.1	-50.6		0.1	-42.3	-21.25	21.00



HT/VHT20 Beam Forming, M0 to M7	4	11	-56.7	-51.1	-50.6	-51.7	0.1	-34.9	-21.25	13.65
HT/VHT20 Beam Forming, M8 to M15	4	8	-56.7	-51.1	-50.6	-51.7	0.1	-37.9	-21.25	16.65
HT/VHT20 Beam Forming, M16 to M23	4	6	-56.7	-51.1	-50.6	-51.7	0.1	-39.9	-21.25	18.65
HT/VHT20 Beam Forming, M24 to M31	4	5	-56.7	-51.1	-50.6	-51.7	0.1	-40.9	-21.25	19.65
HT/VHT20 STBC, M0 to M7	2	5	-56.7	-51.1			0.1	-45.0	-21.25	23.74
HT/VHT20 STBC, M0 to M7	3	5	-56.7	-51.1	-50.6		0.1	-42.3	-21.25	21.00
HT/VHT20 STBC, M0 to M7	4	5	-56.7	-51.1	-50.6	-51.7	0.1	-40.9	-21.25	19.65
HE20, M0 to M9 1ss	1	5	-55.8				0.1	-50.7	-21.25	29.48
HE20, M0 to M9 1ss	2	5	-55.8	-51.1			0.1	-44.8	-21.25	23.51
HE20, M0 to M9 2ss	2	5	-55.8	-51.1			0.1	-44.8	-21.25	23.51
HE20, M0 to M9 1ss	3	5	-55.8	-51.1	-50.8		0.1	-42.2	-21.25	20.96
HE20, M0 to M9 2ss	3	5	-55.8	-51.1	-50.8		0.1	-42.2	-21.25	20.96
HE20, M0 to M9 3ss	3	5	-55.8	-51.1	-50.8		0.1	-42.2	-21.25	20.96
HE20, M0 to M9 1ss	4	5	-55.8	-51.1	-50.8	-51.0	0.1	-40.7	-21.25	19.42
HE20, M0 to M9 2ss	4	5	-55.8	-51.1	-50.8	-51.0	0.1	-40.7	-21.25	19.42
HE20, M0 to M9 3ss	4	5	-55.8	-51.1	-50.8	-51.0	0.1	-40.7	-21.25	19.42
HE20, M0 to M9 4ss	4	5	-55.8	-51.1	-50.8	-51.0	0.1	-40.7	-21.25	19.42
HE20 Beam Forming, M0 to M9 1ss	2	8	-55.8	-51.1			0.1	-41.8	-21.25	20.51
HE20 Beam Forming, M0 to M9 2ss	2	5	-55.8	-51.1			0.1	-44.8	-21.25	23.51
HE20 Beam Forming, M0 to M9 1ss	3	10	-55.8	-51.1	-50.8		0.1	-37.2	-21.25	15.96
HE20 Beam Forming, M0 to M9 2ss	3	7	-55.8	-51.1	-50.8		0.1	-40.2	-21.25	18.96
HE20 Beam Forming, M0 to M9 3ss	3	5	-55.8	-51.1	-50.8		0.1	-42.2	-21.25	20.96
HE20 Beam Forming, M0 to M9 1ss	4	11	-55.8	-51.1	-50.8	-51.0	0.1	-34.7	-21.25	13.42
HE20 Beam Forming, M0 to M9 2ss	4	8	-55.8	-51.1	-50.8	-51.0	0.1	-37.7	-21.25	16.42
HE20 Beam Forming, M0 to M9 3ss	4	6	-55.8	-51.1	-50.8	-51.0	0.1	-39.7	-21.25	18.42
HE20 Beam Forming, M0 to M9 4ss	4	5	-55.8	-51.1	-50.8	-51.0	0.1	-40.7	-21.25	19.42
HE20 STBC, M0 to M9 2ss	2	5	-55.8	-51.1			0.1	-44.8	-21.25	23.51
HE20 STBC, M0 to M9 2ss	3	5	-55.8	-51.1	-50.8		0.1	-42.2	-21.25	20.96
HE20 STBC, M0 to M9 2ss	4	5	-55.8	-51.1	-50.8	-51.0	0.1	-40.7	-21.25	19.42



**Conducted Spurs Peak, 5dBi  
5775 MHz, HE80 Beam Forming, M0 to M9 1ss**



**Antenna A**

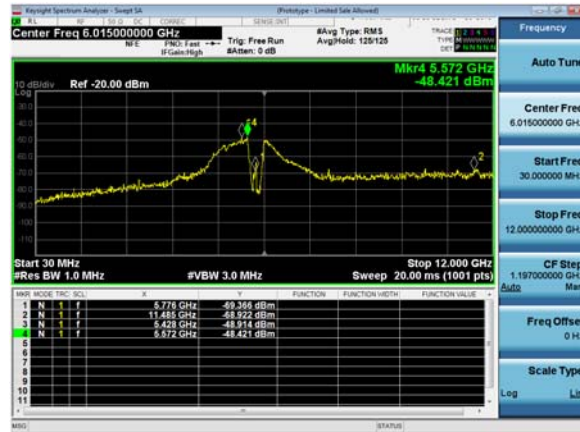

**Antenna B**



**Antenna C**

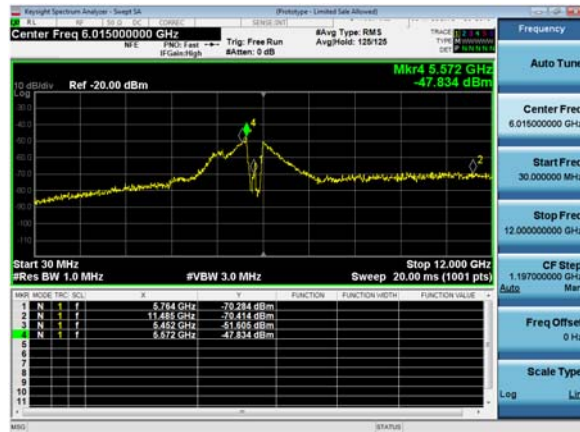

**Antenna D**



Conducted Spurious Peak, 6dBi

Frequency (MHz)	Mode	Tx Paths	Correlated Antenna Gain (dBi)	Tx 1 Spur Power (dBm)	Tx 2 Spur Power (dBm)	Tx 3 Spur Power (dBm)	Tx 4 Spur Power (dBm)	Duty Cycle Correction (dB)	Total Conducted Spur (dBm)	Limit (dBm)	Margin (dB)
5720 <sup>20</sup>	Non HT20, 6 to 54 Mbps	1	6	-58.5				0.1	-52.4	-21.25	31.20
	Non HT20, 6 to 54 Mbps	2	6	-58.5	-51.8			0.1	-44.9	-21.25	23.66
	Non HT20, 6 to 54 Mbps	3	6	-58.5	-51.8	-54.7		0.1	-43.4	-21.25	22.13
	Non HT20, 6 to 54 Mbps	4	6	-58.5	-51.8	-54.7	-56.2	0.1	-42.5	-21.25	21.30
	Non HT20 Beam Forming, 6 to 54 Mbps	2	9	-58.5	-51.8			0.1	-41.9	-21.25	20.66
	Non HT20 Beam Forming, 6 to 54 Mbps	3	11	-58.5	-53.7	-55.7		0.1	-39.7	-21.25	18.47
	Non HT20 Beam Forming, 6 to 54 Mbps	4	12	-58.5	-55.1	-57.7	-58.0	0.1	-39.0	-21.25	17.79
	HT/VHT20, M0 to M7	1	6	-58.7				0.1	-52.6	-21.25	31.40
	HT/VHT20, M0 to M7	2	6	-58.7	-52.2			0.1	-45.3	-21.25	24.02
	HT/VHT20, M8 to M15	2	6	-58.7	-52.2			0.1	-45.3	-21.25	24.02
	HT/VHT20, M0 to M7	3	6	-58.7	-52.2	-54.3		0.1	-43.5	-21.25	22.25
	HT/VHT20, M8 to M15	3	6	-58.7	-52.2	-54.3		0.1	-43.5	-21.25	22.25
	HT/VHT20, M16 to M23	3	6	-58.7	-52.2	-54.3		0.1	-43.5	-21.25	22.25
	HT/VHT20, M0 to M7	4	6	-58.7	-52.2	-54.3	-56.8	0.1	-42.7	-21.25	21.50
	HT/VHT20, M8 to M15	4	6	-58.7	-52.2	-54.3	-56.8	0.1	-42.7	-21.25	21.50
	HT/VHT20, M16 to M23	4	6	-58.7	-52.2	-54.3	-56.8	0.1	-42.7	-21.25	21.50
	HT/VHT20, M24 to M31	4	6	-58.7	-52.2	-54.3	-56.8	0.1	-42.7	-21.25	21.50
	HT/VHT20 Beam Forming, M0 to M7	2	9	-58.7	-52.2			0.1	-42.3	-21.25	21.02
	HT/VHT20 Beam Forming, M8 to M15	2	6	-58.7	-52.2			0.1	-45.3	-21.25	24.02
	HT/VHT20 Beam Forming, M0 to M7	3	11	-58.7	-53.3	-55.8		0.1	-39.6	-21.25	18.32
	HT/VHT20 Beam Forming, M8 to M15	3	8	-58.7	-52.2	-54.3		0.1	-41.5	-21.25	20.25
	HT/VHT20 Beam Forming, M16 to M23	3	6	-58.7	-52.2	-54.3		0.1	-43.5	-21.25	22.25
	HT/VHT20 Beam Forming, M0 to M7	4	12	-58.7	-55.1	-56.2	-58.1	0.1	-38.7	-21.25	17.46
	HT/VHT20 Beam Forming, M8 to M15	4	9	-58.7	-54.1	-54.9	-57.0	0.1	-40.7	-21.25	19.50
	HT/VHT20 Beam Forming, M16 to M23	4	7	-58.7	-52.2	-54.3	-56.8	0.1	-41.7	-21.25	20.50
	HT/VHT20 Beam Forming, M24 to M31	4	6	-58.7	-52.2	-54.3	-56.8	0.1	-42.7	-21.25	21.50
	HT/VHT20 STBC, M0 to M7	2	6	-58.7	-52.2			0.1	-45.3	-21.25	24.02

<sup>20</sup> 5720 (ch144) not supported for Canada.



	HT/VHT20 STBC, M0 to M7	3	6	-58.7	-52.2	-54.3		0.1	-43.5	-21.25	22.25
	HT/VHT20 STBC, M0 to M7	4	6	-58.7	-54.1	-54.9	-57.0	0.1	-43.7	-21.25	22.50
	HE20, M0 to M9 1ss	1	6	-58.9				0.1	-52.8	-21.25	31.58
	HE20, M0 to M9 1ss	2	6	-58.9	-51.6			0.1	-44.8	-21.25	23.54
	HE20, M0 to M9 2ss	2	6	-58.9	-51.6			0.1	-44.8	-21.25	23.54
	HE20, M0 to M9 1ss	3	6	-58.9	-51.6	-54.4		0.1	-43.2	-21.25	21.95
	HE20, M0 to M9 2ss	3	6	-58.9	-51.6	-54.4		0.1	-43.2	-21.25	21.95
	HE20, M0 to M9 3ss	3	6	-58.9	-51.6	-54.4		0.1	-43.2	-21.25	21.95
	HE20, M0 to M9 1ss	4	6	-58.9	-51.6	-54.4	-55.4	0.1	-42.3	-21.25	21.00
	HE20, M0 to M9 2ss	4	6	-58.9	-51.6	-54.4	-55.4	0.1	-42.3	-21.25	21.00
	HE20, M0 to M9 3ss	4	6	-58.9	-51.6	-54.4	-55.4	0.1	-42.3	-21.25	21.00
	HE20, M0 to M9 4ss	4	6	-58.9	-51.6	-54.4	-55.4	0.1	-42.3	-21.25	21.00
	HE20 Beam Forming, M0 to M9 1ss	2	9	-58.9	-51.6			0.1	-41.8	-21.25	20.54
	HE20 Beam Forming, M0 to M9 2ss	2	6	-58.9	-51.6			0.1	-44.8	-21.25	23.54
	HE20 Beam Forming, M0 to M9 1ss	3	11	-58.9	-53.7	-55.3		0.1	-39.6	-21.25	18.39
	HE20 Beam Forming, M0 to M9 2ss	3	8	-58.9	-51.6	-54.4		0.1	-41.2	-21.25	19.95
	HE20 Beam Forming, M0 to M9 3ss	3	6	-58.9	-51.6	-54.4		0.1	-43.2	-21.25	21.95
	HE20 Beam Forming, M0 to M9 1ss	4	12	-58.9	-55.6	-57.3	-58.4	0.1	-39.3	-21.25	18.02
	HE20 Beam Forming, M0 to M9 2ss	4	9	-58.9	-54.2	-54.7	-57.8	0.1	-40.9	-21.25	19.62
	HE20 Beam Forming, M0 to M9 3ss	4	7	-58.9	-51.6	-54.4	-55.4	0.1	-41.3	-21.25	20.00
	HE20 Beam Forming, M0 to M9 4ss	4	6	-58.9	-51.6	-54.4	-55.4	0.1	-42.3	-21.25	21.00
	HE20 STBC, M0 to M9 2ss	2	6	-58.9	-51.6			0.1	-44.8	-21.25	23.54
	HE20 STBC, M0 to M9 2ss	3	6	-58.9	-51.6	-54.4		0.1	-43.2	-21.25	21.95
	HE20 STBC, M0 to M9 2ss	4	6	-58.9	-54.2	-54.7	-57.8	0.1	-43.9	-21.25	22.62
5745	Non HT20, 6 to 54 Mbps	1	6	-54.6				0.1	-48.5	-21.25	27.30
	Non HT20, 6 to 54 Mbps	2	6	-54.6	-50.2			0.1	-42.8	-21.25	21.55
	Non HT20, 6 to 54 Mbps	3	6	-54.6	-50.2	-50.2		0.1	-40.4	-21.25	19.16
	Non HT20, 6 to 54 Mbps	4	6	-54.6	-50.2	-50.2	-51.8	0.1	-39.3	-21.25	18.05
	Non HT20 Beam Forming, 6 to 54 Mbps	2	9	-54.6	-50.2			0.1	-39.8	-21.25	18.55
	Non HT20 Beam Forming, 6 to 54 Mbps	3	11	-54.6	-50.2	-50.2		0.1	-35.4	-21.25	14.16
	Non HT20 Beam Forming, 6 to 54 Mbps	4	12	-54.6	-50.2	-50.2	-51.8	0.1	-33.3	-21.25	12.05
	HT/VHT20, M0 to M7	1	6	-55.0				0.1	-48.9	-21.25	27.70
	HT/VHT20, M0 to M7	2	6	-55.0	-50.9			0.1	-43.4	-21.25	22.17
	HT/VHT20, M8 to M15	2	6	-55.0	-50.9			0.1	-43.4	-21.25	22.17
	HT/VHT20, M0 to M7	3	6	-55.0	-50.9	-50.4		0.1	-40.8	-21.25	19.60
	HT/VHT20, M8 to M15	3	6	-55.0	-50.9	-50.4		0.1	-40.8	-21.25	19.60
	HT/VHT20, M16 to M23	3	6	-55.0	-50.9	-50.4		0.1	-40.8	-21.25	19.60
	HT/VHT20, M0 to M7	4	6	-55.0	-50.9	-50.4	-51.3	0.1	-39.5	-21.25	18.25
	HT/VHT20, M8 to M15	4	6	-55.0	-50.9	-50.4	-51.3	0.1	-39.5	-21.25	18.25
	HT/VHT20, M16 to M23	4	6	-55.0	-50.9	-50.4	-51.3	0.1	-39.5	-21.25	18.25
	HT/VHT20, M24 to M31	4	6	-55.0	-50.9	-50.4	-51.3	0.1	-39.5	-21.25	18.25
HT/VHT20 Beam Forming, M0 to M7	2	9	-55.0	-50.9			0.1	-40.4	-21.25	19.17	

	HT/VHT20 Beam Forming, M8 to M15	2	6	-55.0	-50.9			0.1	-43.4	-21.25	22.17
	HT/VHT20 Beam Forming, M0 to M7	3	11	-55.0	-50.9	-50.4		0.1	-35.8	-21.25	14.60
	HT/VHT20 Beam Forming, M8 to M15	3	8	-55.0	-50.9	-50.4		0.1	-38.8	-21.25	17.60
	HT/VHT20 Beam Forming, M16 to M23	3	6	-55.0	-50.9	-50.4		0.1	-40.8	-21.25	19.60
	HT/VHT20 Beam Forming, M0 to M7	4	12	-55.0	-50.9	-50.4	-51.3	0.1	-33.5	-21.25	12.25
	HT/VHT20 Beam Forming, M8 to M15	4	9	-55.0	-50.9	-50.4	-51.3	0.1	-36.5	-21.25	15.25
	HT/VHT20 Beam Forming, M16 to M23	4	7	-55.0	-50.9	-50.4	-51.3	0.1	-38.5	-21.25	17.25
	HT/VHT20 Beam Forming, M24 to M31	4	6	-55.0	-50.9	-50.4	-51.3	0.1	-39.5	-21.25	18.25
	HT/VHT20 STBC, M0 to M7	2	6	-55.0	-50.9			0.1	-43.4	-21.25	22.17
	HT/VHT20 STBC, M0 to M7	3	6	-55.0	-50.9	-50.4		0.1	-40.8	-21.25	19.60
	HT/VHT20 STBC, M0 to M7	4	6	-55.0	-50.9	-50.4	-51.3	0.1	-39.5	-21.25	18.25
	HE20, M0 to M9 1ss	1	6	-55.4				0.1	-49.3	-21.25	28.08
	HE20, M0 to M9 1ss	2	6	-55.4	-50.0			0.1	-42.8	-21.25	21.58
	HE20, M0 to M9 2ss	2	6	-55.4	-50.0			0.1	-42.8	-21.25	21.58
	HE20, M0 to M9 1ss	3	6	-55.4	-50.0	-49.7		0.1	-40.2	-21.25	18.95
	HE20, M0 to M9 2ss	3	6	-55.4	-50.0	-49.7		0.1	-40.2	-21.25	18.95
	HE20, M0 to M9 3ss	3	6	-55.4	-50.0	-49.7		0.1	-40.2	-21.25	18.95
	HE20, M0 to M9 1ss	4	6	-55.4	-50.0	-49.7	-51.0	0.1	-38.9	-21.25	17.69
	HE20, M0 to M9 2ss	4	6	-55.4	-50.0	-49.7	-51.0	0.1	-38.9	-21.25	17.69
	HE20, M0 to M9 3ss	4	6	-55.4	-50.0	-49.7	-51.0	0.1	-38.9	-21.25	17.69
	HE20, M0 to M9 4ss	4	6	-55.4	-50.0	-49.7	-51.0	0.1	-38.9	-21.25	17.69
	HE20 Beam Forming, M0 to M9 1ss	2	9	-55.4	-50.0			0.1	-39.8	-21.25	18.58
	HE20 Beam Forming, M0 to M9 2ss	2	6	-55.4	-50.0			0.1	-42.8	-21.25	21.58
	HE20 Beam Forming, M0 to M9 1ss	3	11	-55.4	-50.0	-49.7		0.1	-35.2	-21.25	13.95
	HE20 Beam Forming, M0 to M9 2ss	3	8	-55.4	-50.0	-49.7		0.1	-38.2	-21.25	16.95
	HE20 Beam Forming, M0 to M9 3ss	3	6	-55.4	-50.0	-49.7		0.1	-40.2	-21.25	18.95
	HE20 Beam Forming, M0 to M9 1ss	4	12	-55.4	-50.0	-49.7	-51.0	0.1	-32.9	-21.25	11.69
	HE20 Beam Forming, M0 to M9 2ss	4	9	-55.4	-50.0	-49.7	-51.0	0.1	-35.9	-21.25	14.69
	HE20 Beam Forming, M0 to M9 3ss	4	7	-55.4	-50.0	-49.7	-51.0	0.1	-37.9	-21.25	16.69
	HE20 Beam Forming, M0 to M9 4ss	4	6	-55.4	-50.0	-49.7	-51.0	0.1	-38.9	-21.25	17.69
	HE20 STBC, M0 to M9 2ss	2	6	-55.4	-50.0			0.1	-42.8	-21.25	21.58
	HE20 STBC, M0 to M9 2ss	3	6	-55.4	-50.0	-49.7		0.1	-40.2	-21.25	18.95
	HE20 STBC, M0 to M9 2ss	4	6	-55.4	-50.0	-49.7	-51.0	0.1	-38.9	-21.25	17.69
5755	Non HT40, 6 to 54 Mbps	1	6	-55.0				0.1	-48.9	-21.25	27.70
	Non HT40, 6 to 54 Mbps	2	6	-55.0	-50.2			0.1	-42.9	-21.25	21.66
	Non HT40, 6 to 54 Mbps	3	6	-55.0	-50.2	-49.9		0.1	-40.3	-21.25	19.09
	Non HT40, 6 to 54 Mbps	4	6	-55.0	-50.2	-49.9	-51.3	0.1	-39.1	-21.25	17.88
	HT/VHT40, M0 to M7	1	6	-56.2				0.1	-50.1	-21.25	28.84
	HT/VHT40, M0 to M7	2	6	-56.2	-49.8			0.1	-42.8	-21.25	21.54
	HT/VHT40, M8 to M15	2	6	-56.2	-49.8			0.1	-42.8	-21.25	21.54
	HT/VHT40, M0 to M7	3	6	-56.2	-49.8	-51.2		0.1	-40.8	-21.25	19.53
	HT/VHT40, M8 to M15	3	6	-56.2	-49.8	-51.2		0.1	-40.8	-21.25	19.53



HT/VHT40, M16 to M23	3	6	-56.2	-49.8	-51.2		0.1	-40.8	-21.25	19.53	
HT/VHT40, M0 to M7	4	6	-56.2	-49.8	-51.2	-51.8	0.1	-39.6	-21.25	18.32	
HT/VHT40, M8 to M15	4	6	-56.2	-49.8	-51.2	-51.8	0.1	-39.6	-21.25	18.32	
HT/VHT40, M16 to M23	4	6	-56.2	-49.8	-51.2	-51.8	0.1	-39.6	-21.25	18.32	
HT/VHT40, M24 to M31	4	6	-56.2	-49.8	-51.2	-51.8	0.1	-39.6	-21.25	18.32	
HT/VHT40 Beam Forming, M0 to M7	2	9	-56.2	-49.8			0.1	-39.8	-21.25	18.54	
HT/VHT40 Beam Forming, M8 to M15	2	6	-56.2	-49.8			0.1	-42.8	-21.25	21.54	
HT/VHT40 Beam Forming, M0 to M7	3	11	-56.2	-49.8	-51.2		0.1	-35.8	-21.25	14.53	
HT/VHT40 Beam Forming, M8 to M15	3	8	-56.2	-49.8	-51.2		0.1	-38.8	-21.25	17.53	
HT/VHT40 Beam Forming, M16 to M23	3	6	-56.2	-49.8	-51.2		0.1	-40.8	-21.25	19.53	
HT/VHT40 Beam Forming, M0 to M7	4	12	-56.2	-49.8	-51.2	-51.8	0.1	-33.6	-21.25	12.32	
HT/VHT40 Beam Forming, M8 to M15	4	9	-56.2	-49.8	-51.2	-51.8	0.1	-36.6	-21.25	15.32	
HT/VHT40 Beam Forming, M16 to M23	4	7	-56.2	-49.8	-51.2	-51.8	0.1	-38.6	-21.25	17.32	
HT/VHT40 Beam Forming, M24 to M31	4	6	-56.2	-49.8	-51.2	-51.8	0.1	-39.6	-21.25	18.32	
HT/VHT40 STBC, M0 to M7	2	6	-56.2	-49.8			0.1	-42.8	-21.25	21.54	
HT/VHT40 STBC, M0 to M7	3	6	-56.2	-49.8	-51.2		0.1	-40.8	-21.25	19.53	
HT/VHT40 STBC, M0 to M7	4	6	-56.2	-49.8	-51.2	-51.8	0.1	-39.6	-21.25	18.32	
HE40, M0 to M9 1ss	1	6	-55.8				0.1	-49.7	-21.25	28.42	
HE40, M0 to M9 1ss	2	6	-55.8	-50.4			0.1	-43.2	-21.25	21.92	
HE40, M0 to M9 2ss	2	6	-55.8	-50.4			0.1	-43.2	-21.25	21.92	
HE40, M0 to M9 1ss	3	6	-55.8	-50.4	-50.6		0.1	-40.8	-21.25	19.52	
HE40, M0 to M9 2ss	3	6	-55.8	-50.4	-50.6		0.1	-40.8	-21.25	19.52	
HE40, M0 to M9 3ss	3	6	-55.8	-50.4	-50.6		0.1	-40.8	-21.25	19.52	
HE40, M0 to M9 1ss	4	6	-55.8	-50.4	-50.6	-51.7	0.1	-39.5	-21.25	18.28	
HE40, M0 to M9 2ss	4	6	-55.8	-50.4	-50.6	-51.7	0.1	-39.5	-21.25	18.28	
HE40, M0 to M9 3ss	4	6	-55.8	-50.4	-50.6	-51.7	0.1	-39.5	-21.25	18.28	
HE40, M0 to M9 4ss	4	6	-55.8	-50.4	-50.6	-51.7	0.1	-39.5	-21.25	18.28	
HE40 Beam Forming, M0 to M9 1ss	2	9	-55.8	-50.4			0.1	-40.2	-21.25	18.92	
HE40 Beam Forming, M0 to M9 2ss	2	6	-55.8	-50.4			0.1	-43.2	-21.25	21.92	
HE40 Beam Forming, M0 to M9 1ss	3	11	-55.8	-50.4	-50.6		0.1	-35.8	-21.25	14.52	
HE40 Beam Forming, M0 to M9 2ss	3	8	-55.8	-50.4	-50.6		0.1	-38.8	-21.25	17.52	
HE40 Beam Forming, M0 to M9 3ss	3	6	-55.8	-50.4	-50.6		0.1	-40.8	-21.25	19.52	
HE40 Beam Forming, M0 to M9 1ss	4	12	-55.8	-50.4	-50.6	-51.7	0.1	-33.5	-21.25	12.28	
HE40 Beam Forming, M0 to M9 2ss	4	9	-55.8	-50.4	-50.6	-51.7	0.1	-36.5	-21.25	15.28	
HE40 Beam Forming, M0 to M9 3ss	4	7	-55.8	-50.4	-50.6	-51.7	0.1	-38.5	-21.25	17.28	
HE40 Beam Forming, M0 to M9 4ss	4	6	-55.8	-50.4	-50.6	-51.7	0.1	-39.5	-21.25	18.28	
HE40 STBC, M0 to M9 2ss	2	6	-55.8	-50.4			0.1	-43.2	-21.25	21.92	
HE40 STBC, M0 to M9 2ss	3	6	-55.8	-50.4	-50.6		0.1	-40.8	-21.25	19.52	
HE40 STBC, M0 to M9 2ss	4	6	-55.8	-50.4	-50.6	-51.7	0.1	-39.5	-21.25	18.28	
5775	Non HT80, 6 to 54 Mbps	1	6	-55.4				0.0	-49.4	-21.25	28.10
	Non HT80, 6 to 54 Mbps	2	6	-55.4	-51.1			0.0	-43.7	-21.25	22.43
	Non HT80, 6 to 54 Mbps	3	6	-55.4	-51.1	-50.7		0.0	-41.1	-21.25	19.88

Non HT80, 6 to 54 Mbps	4	6	-55.4	-51.1	-50.7	-51.3	0.0	-39.7	-21.25	18.46
VHT80, M0 to M9 1ss	1	6	-56.4				0.2	-50.2	-21.25	28.93
VHT80, M0 to M9 1ss	2	6	-56.4	-51.1			0.2	-43.8	-21.25	22.50
VHT80, M0 to M9 2ss	2	6	-56.4	-51.1			0.2	-43.8	-21.25	22.50
VHT80, M0 to M9 1ss	3	6	-56.4	-51.1	-51.0		0.2	-41.2	-21.25	19.97
VHT80, M0 to M9 2ss	3	6	-56.4	-51.1	-51.0		0.2	-41.2	-21.25	19.97
VHT80, M0 to M9 3ss	3	6	-56.4	-51.1	-51.0		0.2	-41.2	-21.25	19.97
VHT80, M0 to M9 1ss	4	6	-56.4	-51.1	-51.0	-52.4	0.2	-40.0	-21.25	18.77
VHT80, M0 to M9 2ss	4	6	-56.4	-51.1	-51.0	-52.4	0.2	-40.0	-21.25	18.77
VHT80, M0 to M9 3ss	4	6	-56.4	-51.1	-51.0	-52.4	0.2	-40.0	-21.25	18.77
VHT80, M0 to M9 4ss	4	6	-56.4	-51.1	-51.0	-52.4	0.2	-40.0	-21.25	18.77
VHT80 Beam Forming, M0 to M9 1ss	2	9	-56.4	-51.1			0.2	-40.8	-21.25	19.50
VHT80 Beam Forming, M0 to M9 2ss	2	6	-56.4	-51.1			0.2	-43.8	-21.25	22.50
VHT80 Beam Forming, M0 to M9 1ss	3	11	-56.4	-51.1	-51.0		0.2	-36.2	-21.25	14.97
VHT80 Beam Forming, M0 to M9 2ss	3	8	-56.4	-51.1	-51.0		0.2	-39.2	-21.25	17.97
VHT80 Beam Forming, M0 to M9 3ss	3	6	-56.4	-51.1	-51.0		0.2	-41.2	-21.25	19.97
VHT80 Beam Forming, M0 to M9 1ss	4	12	-56.4	-51.1	-51.0	-52.4	0.2	-34.0	-21.25	12.77
VHT80 Beam Forming, M0 to M9 2ss	4	9	-56.4	-51.1	-51.0	-52.4	0.2	-37.0	-21.25	15.77
VHT80 Beam Forming, M0 to M9 3ss	4	7	-56.4	-51.1	-51.0	-52.4	0.2	-39.0	-21.25	17.77
VHT80 Beam Forming, M0 to M9 4ss	4	6	-56.4	-51.1	-51.0	-52.4	0.2	-40.0	-21.25	18.77
VHT80 STBC, M0 to M9 1ss	2	6	-56.4	-51.1			0.2	-43.8	-21.25	22.50
VHT80 STBC, M0 to M9 1ss	3	6	-56.4	-51.1	-51.0		0.2	-41.2	-21.25	19.97
VHT80 STBC, M0 to M9 1ss	4	6	-56.4	-51.1	-51.0	-52.4	0.2	-40.0	-21.25	18.77
HE80, M0 to M9 1ss	1	6	-55.5				0.2	-49.3	-21.25	28.00
HE80, M0 to M9 1ss	2	6	-55.5	-48.9			0.2	-41.8	-21.25	20.54
HE80, M0 to M9 2ss	2	6	-55.5	-48.9			0.2	-41.8	-21.25	20.54
HE80, M0 to M9 1ss	3	6	-55.5	-48.9	-51.0		0.2	-40.0	-21.25	18.76
HE80, M0 to M9 2ss	3	6	-55.5	-48.9	-51.0		0.2	-40.0	-21.25	18.76
HE80, M0 to M9 3ss	3	6	-55.5	-48.9	-51.0		0.2	-40.0	-21.25	18.76
HE80, M0 to M9 1ss	4	6	-55.5	-48.9	-51.0	-51.6	0.2	-38.9	-21.25	17.65
HE80, M0 to M9 2ss	4	6	-55.5	-48.9	-51.0	-51.6	0.2	-38.9	-21.25	17.65
HE80, M0 to M9 3ss	4	6	-55.5	-48.9	-51.0	-51.6	0.2	-38.9	-21.25	17.65
HE80, M0 to M9 4ss	4	6	-55.5	-48.9	-51.0	-51.6	0.2	-38.9	-21.25	17.65
HE80 Beam Forming, M0 to M9 1ss	2	9	-55.5	-48.9			0.2	-38.8	-21.25	17.54
HE80 Beam Forming, M0 to M9 2ss	2	6	-55.5	-48.9			0.2	-41.8	-21.25	20.54
HE80 Beam Forming, M0 to M9 1ss	3	11	-55.5	-48.9	-51.0		0.2	-35.0	-21.25	13.76
HE80 Beam Forming, M0 to M9 2ss	3	8	-55.5	-48.9	-51.0		0.2	-38.0	-21.25	16.76
HE80 Beam Forming, M0 to M9 3ss	3	6	-55.5	-48.9	-51.0		0.2	-40.0	-21.25	18.76
<b>HE80 Beam Forming, M0 to M9 1ss</b>	<b>4</b>	<b>12</b>	<b>-55.5</b>	<b>-48.9</b>	<b>-51.0</b>	<b>-51.6</b>	<b>0.2</b>	<b>-32.9</b>	<b>-21.25</b>	<b>11.65</b>
HE80 Beam Forming, M0 to M9 2ss	4	9	-55.5	-48.9	-51.0	-51.6	0.2	-35.9	-21.25	14.65
HE80 Beam Forming, M0 to M9 3ss	4	7	-55.5	-48.9	-51.0	-51.6	0.2	-37.9	-21.25	16.65
HE80 Beam Forming, M0 to M9 4ss	4	6	-55.5	-48.9	-51.0	-51.6	0.2	-38.9	-21.25	17.65
HE80 STBC, M0 to M9 1ss	2	6	-55.5	-48.9			0.2	-41.8	-21.25	20.54

	HE80 STBC, M0 to M9 1ss	3	6	-55.5	-48.9	-51.0		0.2	-40.0	-21.25	18.76
	HE80 STBC, M0 to M9 1ss	4	6	-55.5	-48.9	-51.0	-51.6	0.2	-38.9	-21.25	17.65
5785	Non HT20, 6 to 54 Mbps	1	6	-55.7				0.1	-49.6	-21.25	28.40
	Non HT20, 6 to 54 Mbps	2	6	-55.7	-50.0			0.1	-42.9	-21.25	21.66
	Non HT20, 6 to 54 Mbps	3	6	-55.7	-50.0	-50.3		0.1	-40.5	-21.25	19.27
	Non HT20, 6 to 54 Mbps	4	6	-55.7	-50.0	-50.3	-50.8	0.1	-39.1	-21.25	17.88
	Non HT20 Beam Forming, 6 to 54 Mbps	2	9	-55.7	-50.0			0.1	-39.9	-21.25	18.66
	Non HT20 Beam Forming, 6 to 54 Mbps	3	11	-55.7	-50.0	-50.3		0.1	-35.5	-21.25	14.27
	Non HT20 Beam Forming, 6 to 54 Mbps	4	12	-55.7	-50.0	-50.3	-50.8	0.1	-33.1	-21.25	11.88
	HT/VHT20, M0 to M7	1	6	-54.7				0.1	-48.6	-21.25	27.40
	HT/VHT20, M0 to M7	2	6	-54.7	-50.1			0.1	-42.8	-21.25	21.50
	HT/VHT20, M8 to M15	2	6	-54.7	-50.1			0.1	-42.8	-21.25	21.50
	HT/VHT20, M0 to M7	3	6	-54.7	-50.1	-49.7		0.1	-40.2	-21.25	18.92
	HT/VHT20, M8 to M15	3	6	-54.7	-50.1	-49.7		0.1	-40.2	-21.25	18.92
	HT/VHT20, M16 to M23	3	6	-54.7	-50.1	-49.7		0.1	-40.2	-21.25	18.92
	HT/VHT20, M0 to M7	4	6	-54.7	-50.1	-49.7	-52.0	0.1	-39.1	-21.25	17.90
	HT/VHT20, M8 to M15	4	6	-54.7	-50.1	-49.7	-52.0	0.1	-39.1	-21.25	17.90
	HT/VHT20, M16 to M23	4	6	-54.7	-50.1	-49.7	-52.0	0.1	-39.1	-21.25	17.90
	HT/VHT20, M24 to M31	4	6	-54.7	-50.1	-49.7	-52.0	0.1	-39.1	-21.25	17.90
	HT/VHT20 Beam Forming, M0 to M7	2	9	-54.7	-50.1			0.1	-39.8	-21.25	18.50
	HT/VHT20 Beam Forming, M8 to M15	2	6	-54.7	-50.1			0.1	-42.8	-21.25	21.50
	HT/VHT20 Beam Forming, M0 to M7	3	11	-54.7	-50.1	-49.7		0.1	-35.2	-21.25	13.92
	HT/VHT20 Beam Forming, M8 to M15	3	8	-54.7	-50.1	-49.7		0.1	-38.2	-21.25	16.92
	HT/VHT20 Beam Forming, M16 to M23	3	6	-54.7	-50.1	-49.7		0.1	-40.2	-21.25	18.92
	HT/VHT20 Beam Forming, M0 to M7	4	12	-54.7	-50.1	-49.7	-52.0	0.1	-33.1	-21.25	11.90
	HT/VHT20 Beam Forming, M8 to M15	4	9	-54.7	-50.1	-49.7	-52.0	0.1	-36.1	-21.25	14.90
	HT/VHT20 Beam Forming, M16 to M23	4	7	-54.7	-50.1	-49.7	-52.0	0.1	-38.1	-21.25	16.90
	HT/VHT20 Beam Forming, M24 to M31	4	6	-54.7	-50.1	-49.7	-52.0	0.1	-39.1	-21.25	17.90
	HT/VHT20 STBC, M0 to M7	2	6	-54.7	-50.1			0.1	-42.8	-21.25	21.50
	HT/VHT20 STBC, M0 to M7	3	6	-54.7	-50.1	-49.7		0.1	-40.2	-21.25	18.92
	HT/VHT20 STBC, M0 to M7	4	6	-54.7	-50.1	-49.7	-52.0	0.1	-39.1	-21.25	17.90
	HE20, M0 to M9 1ss	1	6	-54.8				0.1	-48.7	-21.25	27.48
	HE20, M0 to M9 1ss	2	6	-54.8	-50.6			0.1	-43.1	-21.25	21.88
	HE20, M0 to M9 2ss	2	6	-54.8	-50.6			0.1	-43.1	-21.25	21.88
	HE20, M0 to M9 1ss	3	6	-54.8	-50.6	-50.2		0.1	-40.6	-21.25	19.34
	HE20, M0 to M9 2ss	3	6	-54.8	-50.6	-50.2		0.1	-40.6	-21.25	19.34
	HE20, M0 to M9 3ss	3	6	-54.8	-50.6	-50.2		0.1	-40.6	-21.25	19.34
	HE20, M0 to M9 1ss	4	6	-54.8	-50.6	-50.2	-51.4	0.1	-39.3	-21.25	18.09
HE20, M0 to M9 2ss	4	6	-54.8	-50.6	-50.2	-51.4	0.1	-39.3	-21.25	18.09	
HE20, M0 to M9 3ss	4	6	-54.8	-50.6	-50.2	-51.4	0.1	-39.3	-21.25	18.09	
HE20, M0 to M9 4ss	4	6	-54.8	-50.6	-50.2	-51.4	0.1	-39.3	-21.25	18.09	
HE20 Beam Forming, M0 to M9 1ss	2	9	-54.8	-50.6			0.1	-40.1	-21.25	18.88	



	HE20 Beam Forming, M0 to M9 2ss	2	6	-54.8	-50.6			0.1	-43.1	-21.25	21.88	
	HE20 Beam Forming, M0 to M9 1ss	3	11	-54.8	-50.6	-50.2		0.1	-35.6	-21.25	14.34	
	HE20 Beam Forming, M0 to M9 2ss	3	8	-54.8	-50.6	-50.2		0.1	-38.6	-21.25	17.34	
	HE20 Beam Forming, M0 to M9 3ss	3	6	-54.8	-50.6	-50.2		0.1	-40.6	-21.25	19.34	
	HE20 Beam Forming, M0 to M9 1ss	4	12	-54.8	-50.6	-50.2	-51.4	0.1	-33.3	-21.25	12.09	
	HE20 Beam Forming, M0 to M9 2ss	4	9	-54.8	-50.6	-50.2	-51.4	0.1	-36.3	-21.25	15.09	
	HE20 Beam Forming, M0 to M9 3ss	4	7	-54.8	-50.6	-50.2	-51.4	0.1	-38.3	-21.25	17.09	
	HE20 Beam Forming, M0 to M9 4ss	4	6	-54.8	-50.6	-50.2	-51.4	0.1	-39.3	-21.25	18.09	
	HE20 STBC, M0 to M9 2ss	2	6	-54.8	-50.6			0.1	-43.1	-21.25	21.88	
	HE20 STBC, M0 to M9 2ss	3	6	-54.8	-50.6	-50.2		0.1	-40.6	-21.25	19.34	
	HE20 STBC, M0 to M9 2ss	4	6	-54.8	-50.6	-50.2	-51.4	0.1	-39.3	-21.25	18.09	
	Non HT40, 6 to 54 Mbps	1	6	-56.4				0.1	-50.3	-21.25	29.10	
	Non HT40, 6 to 54 Mbps	2	6	-56.4	-50.6			0.1	-43.5	-21.25	22.29	
	Non HT40, 6 to 54 Mbps	3	6	-56.4	-50.6	-50.8		0.1	-41.1	-21.25	19.84	
	Non HT40, 6 to 54 Mbps	4	6	-56.4	-50.6	-50.8	-51.8	0.1	-39.8	-21.25	18.56	
	HT/VHT40, M0 to M7	1	6	-55.4				0.1	-49.3	-21.25	28.04	
	HT/VHT40, M0 to M7	2	6	-55.4	-50.5			0.1	-43.2	-21.25	21.92	
	HT/VHT40, M8 to M15	2	6	-55.4	-50.5			0.1	-43.2	-21.25	21.92	
	HT/VHT40, M0 to M7	3	6	-55.4	-50.5	-50.8		0.1	-40.9	-21.25	19.61	
	HT/VHT40, M8 to M15	3	6	-55.4	-50.5	-50.8		0.1	-40.9	-21.25	19.61	
	HT/VHT40, M16 to M23	3	6	-55.4	-50.5	-50.8		0.1	-40.9	-21.25	19.61	
	HT/VHT40, M0 to M7	4	6	-55.4	-50.5	-50.8	-51.8	0.1	-39.6	-21.25	18.37	
	HT/VHT40, M8 to M15	4	6	-55.4	-50.5	-50.8	-51.8	0.1	-39.6	-21.25	18.37	
	HT/VHT40, M16 to M23	4	6	-55.4	-50.5	-50.8	-51.8	0.1	-39.6	-21.25	18.37	
	HT/VHT40, M24 to M31	4	6	-55.4	-50.5	-50.8	-51.8	0.1	-39.6	-21.25	18.37	
5795	HT/VHT40 Beam Forming, M0 to M7	2	9	-55.4	-50.5			0.1	-40.2	-21.25	18.92	
	HT/VHT40 Beam Forming, M8 to M15	2	6	-55.4	-50.5			0.1	-43.2	-21.25	21.92	
	HT/VHT40 Beam Forming, M0 to M7	3	11	-55.4	-50.5	-50.8		0.1	-35.9	-21.25	14.61	
	HT/VHT40 Beam Forming, M8 to M15	3	8	-55.4	-50.5	-50.8		0.1	-38.9	-21.25	17.61	
	HT/VHT40 Beam Forming, M16 to M23	3	6	-55.4	-50.5	-50.8		0.1	-40.9	-21.25	19.61	
	HT/VHT40 Beam Forming, M0 to M7	4	12	-55.4	-50.5	-50.8	-51.8	0.1	-33.6	-21.25	12.37	
	HT/VHT40 Beam Forming, M8 to M15	4	9	-55.4	-50.5	-50.8	-51.8	0.1	-36.6	-21.25	15.37	
	HT/VHT40 Beam Forming, M16 to M23	4	7	-55.4	-50.5	-50.8	-51.8	0.1	-38.6	-21.25	17.37	
	HT/VHT40 Beam Forming, M24 to M31	4	6	-55.4	-50.5	-50.8	-51.8	0.1	-39.6	-21.25	18.37	
	HT/VHT40 STBC, M0 to M7	2	6	-55.4	-50.5			0.1	-43.2	-21.25	21.92	
	HT/VHT40 STBC, M0 to M7	3	6	-55.4	-50.5	-50.8		0.1	-40.9	-21.25	19.61	
	HT/VHT40 STBC, M0 to M7	4	6	-55.4	-50.5	-50.8	-51.8	0.1	-39.6	-21.25	18.37	
	HE40, M0 to M9 1ss	1	6	-56.5					0.1	-50.4	-21.25	29.12
	HE40, M0 to M9 1ss	2	6	-56.5	-50.5				0.1	-43.4	-21.25	22.15
	HE40, M0 to M9 2ss	2	6	-56.5	-50.5				0.1	-43.4	-21.25	22.15
	HE40, M0 to M9 1ss	3	6	-56.5	-50.5	-51.2			0.1	-41.1	-21.25	19.90
	HE40, M0 to M9 2ss	3	6	-56.5	-50.5	-51.2			0.1	-41.1	-21.25	19.90



HE40, M0 to M9 3ss	3	6	-56.5	-50.5	-51.2		0.1	-41.1	-21.25	19.90
HE40, M0 to M9 1ss	4	6	-56.5	-50.5	-51.2	-52.2	0.1	-39.9	-21.25	18.69
HE40, M0 to M9 2ss	4	6	-56.5	-50.5	-51.2	-52.2	0.1	-39.9	-21.25	18.69
HE40, M0 to M9 3ss	4	6	-56.5	-50.5	-51.2	-52.2	0.1	-39.9	-21.25	18.69
HE40, M0 to M9 4ss	4	6	-56.5	-50.5	-51.2	-52.2	0.1	-39.9	-21.25	18.69
HE40 Beam Forming, M0 to M9 1ss	2	9	-56.5	-50.5			0.1	-40.4	-21.25	19.15
HE40 Beam Forming, M0 to M9 2ss	2	6	-56.5	-50.5			0.1	-43.4	-21.25	22.15
HE40 Beam Forming, M0 to M9 1ss	3	11	-56.5	-50.5	-51.2		0.1	-36.1	-21.25	14.90
HE40 Beam Forming, M0 to M9 2ss	3	8	-56.5	-50.5	-51.2		0.1	-39.1	-21.25	17.90
HE40 Beam Forming, M0 to M9 3ss	3	6	-56.5	-50.5	-51.2		0.1	-41.1	-21.25	19.90
HE40 Beam Forming, M0 to M9 1ss	4	12	-56.5	-50.5	-51.2	-52.2	0.1	-33.9	-21.25	12.69
HE40 Beam Forming, M0 to M9 2ss	4	9	-56.5	-50.5	-51.2	-52.2	0.1	-36.9	-21.25	15.69
HE40 Beam Forming, M0 to M9 3ss	4	7	-56.5	-50.5	-51.2	-52.2	0.1	-38.9	-21.25	17.69
HE40 Beam Forming, M0 to M9 4ss	4	6	-56.5	-50.5	-51.2	-52.2	0.1	-39.9	-21.25	18.69
HE40 STBC, M0 to M9 2ss	2	6	-56.5	-50.5			0.1	-43.4	-21.25	22.15
HE40 STBC, M0 to M9 2ss	3	6	-56.5	-50.5	-51.2		0.1	-41.1	-21.25	19.90
HE40 STBC, M0 to M9 2ss	4	6	-56.5	-50.5	-51.2	-52.2	0.1	-39.9	-21.25	18.69

Non HT20, 6 to 54 Mbps	1	6	-55.8				0.1	-49.7	-21.25	28.50
Non HT20, 6 to 54 Mbps	2	6	-55.8	-50.5			0.1	-43.3	-21.25	22.08
Non HT20, 6 to 54 Mbps	3	6	-55.8	-50.5	-50.5		0.1	-40.8	-21.25	19.59
Non HT20, 6 to 54 Mbps	4	6	-55.8	-50.5	-50.5	-51.1	0.1	-39.4	-21.25	18.19
Non HT20 Beam Forming, 6 to 54 Mbps	2	9	-55.8	-50.5			0.1	-40.3	-21.25	19.08
Non HT20 Beam Forming, 6 to 54 Mbps	3	11	-55.8	-50.5	-50.5		0.1	-35.8	-21.25	14.59
Non HT20 Beam Forming, 6 to 54 Mbps	4	12	-55.8	-50.5	-50.5	-51.1	0.1	-33.4	-21.25	12.19
HT/VHT20, M0 to M7	1	6	-56.7				0.1	-50.6	-21.25	29.40
HT/VHT20, M0 to M7	2	6	-56.7	-51.1			0.1	-44.0	-21.25	22.74
HT/VHT20, M8 to M15	2	6	-56.7	-51.1			0.1	-44.0	-21.25	22.74
HT/VHT20, M0 to M7	3	6	-56.7	-51.1	-50.6		0.1	-41.3	-21.25	20.00
HT/VHT20, M8 to M15	3	6	-56.7	-51.1	-50.6		0.1	-41.3	-21.25	20.00
HT/VHT20, M16 to M23	3	6	-56.7	-51.1	-50.6		0.1	-41.3	-21.25	20.00
HT/VHT20, M0 to M7	4	6	-56.7	-51.1	-50.6	-51.7	0.1	-39.9	-21.25	18.65
HT/VHT20, M8 to M15	4	6	-56.7	-51.1	-50.6	-51.7	0.1	-39.9	-21.25	18.65
HT/VHT20, M16 to M23	4	6	-56.7	-51.1	-50.6	-51.7	0.1	-39.9	-21.25	18.65
HT/VHT20, M24 to M31	4	6	-56.7	-51.1	-50.6	-51.7	0.1	-39.9	-21.25	18.65
HT/VHT20 Beam Forming, M0 to M7	2	9	-56.7	-51.1			0.1	-41.0	-21.25	19.74
HT/VHT20 Beam Forming, M8 to M15	2	6	-56.7	-51.1			0.1	-44.0	-21.25	22.74
HT/VHT20 Beam Forming, M0 to M7	3	11	-56.7	-51.1	-50.6		0.1	-36.3	-21.25	15.00
HT/VHT20 Beam Forming, M8 to M15	3	8	-56.7	-51.1	-50.6		0.1	-39.3	-21.25	18.00
HT/VHT20 Beam Forming, M16 to M23	3	6	-56.7	-51.1	-50.6		0.1	-41.3	-21.25	20.00
HT/VHT20 Beam Forming, M0 to M7	4	12	-56.7	-51.1	-50.6	-51.7	0.1	-33.9	-21.25	12.65
HT/VHT20 Beam Forming, M8 to M15	4	9	-56.7	-51.1	-50.6	-51.7	0.1	-36.9	-21.25	15.65
HT/VHT20 Beam Forming, M16 to M23	4	7	-56.7	-51.1	-50.6	-51.7	0.1	-38.9	-21.25	17.65



HT/VHT20 Beam Forming, M24 to M31	4	6	-56.7	-51.1	-50.6	-51.7	0.1	-39.9	-21.25	18.65
HT/VHT20 STBC, M0 to M7	2	6	-56.7	-51.1			0.1	-44.0	-21.25	22.74
HT/VHT20 STBC, M0 to M7	3	6	-56.7	-51.1	-50.6		0.1	-41.3	-21.25	20.00
HT/VHT20 STBC, M0 to M7	4	6	-56.7	-51.1	-50.6	-51.7	0.1	-39.9	-21.25	18.65
HE20, M0 to M9 1ss	1	6	-55.8				0.1	-49.7	-21.25	28.48
HE20, M0 to M9 1ss	2	6	-55.8	-51.1			0.1	-43.8	-21.25	22.51
HE20, M0 to M9 2ss	2	6	-55.8	-51.1			0.1	-43.8	-21.25	22.51
HE20, M0 to M9 1ss	3	6	-55.8	-51.1	-50.8		0.1	-41.2	-21.25	19.96
HE20, M0 to M9 2ss	3	6	-55.8	-51.1	-50.8		0.1	-41.2	-21.25	19.96
HE20, M0 to M9 3ss	3	6	-55.8	-51.1	-50.8		0.1	-41.2	-21.25	19.96
HE20, M0 to M9 1ss	4	6	-55.8	-51.1	-50.8	-51.0	0.1	-39.7	-21.25	18.42
HE20, M0 to M9 2ss	4	6	-55.8	-51.1	-50.8	-51.0	0.1	-39.7	-21.25	18.42
HE20, M0 to M9 3ss	4	6	-55.8	-51.1	-50.8	-51.0	0.1	-39.7	-21.25	18.42
HE20, M0 to M9 4ss	4	6	-55.8	-51.1	-50.8	-51.0	0.1	-39.7	-21.25	18.42
HE20 Beam Forming, M0 to M9 1ss	2	9	-55.8	-51.1			0.1	-40.8	-21.25	19.51
HE20 Beam Forming, M0 to M9 2ss	2	6	-55.8	-51.1			0.1	-43.8	-21.25	22.51
HE20 Beam Forming, M0 to M9 1ss	3	11	-55.8	-51.1	-50.8		0.1	-36.2	-21.25	14.96
HE20 Beam Forming, M0 to M9 2ss	3	8	-55.8	-51.1	-50.8		0.1	-39.2	-21.25	17.96
HE20 Beam Forming, M0 to M9 3ss	3	6	-55.8	-51.1	-50.8		0.1	-41.2	-21.25	19.96
HE20 Beam Forming, M0 to M9 1ss	4	12	-55.8	-51.1	-50.8	-51.0	0.1	-33.7	-21.25	12.42
HE20 Beam Forming, M0 to M9 2ss	4	9	-55.8	-51.1	-50.8	-51.0	0.1	-36.7	-21.25	15.42
HE20 Beam Forming, M0 to M9 3ss	4	7	-55.8	-51.1	-50.8	-51.0	0.1	-38.7	-21.25	17.42
HE20 Beam Forming, M0 to M9 4ss	4	6	-55.8	-51.1	-50.8	-51.0	0.1	-39.7	-21.25	18.42
HE20 STBC, M0 to M9 2ss	2	6	-55.8	-51.1			0.1	-43.8	-21.25	22.51
HE20 STBC, M0 to M9 2ss	3	6	-55.8	-51.1	-50.8		0.1	-41.2	-21.25	19.96
HE20 STBC, M0 to M9 2ss	4	6	-55.8	-51.1	-50.8	-51.0	0.1	-39.7	-21.25	18.42

**Conducted Spurs Peak, 6dBi  
5775 MHz, HE80 Beam Forming, M0 to M9 1ss**

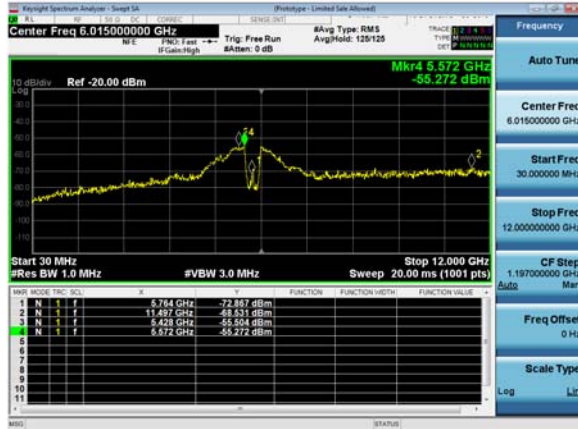

**Antenna A**

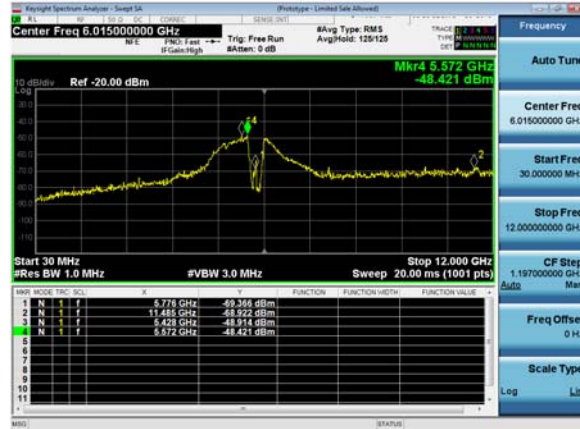

**Antenna B**

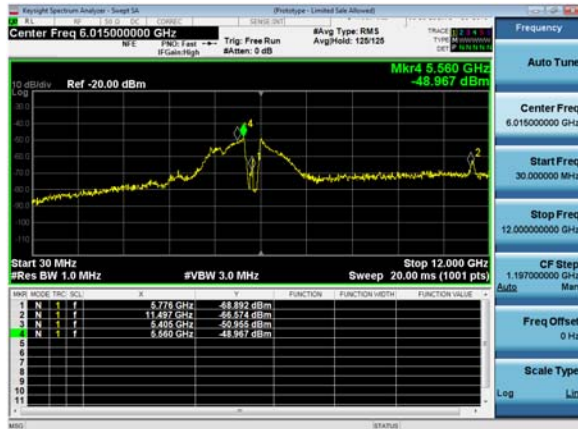

**Antenna C**

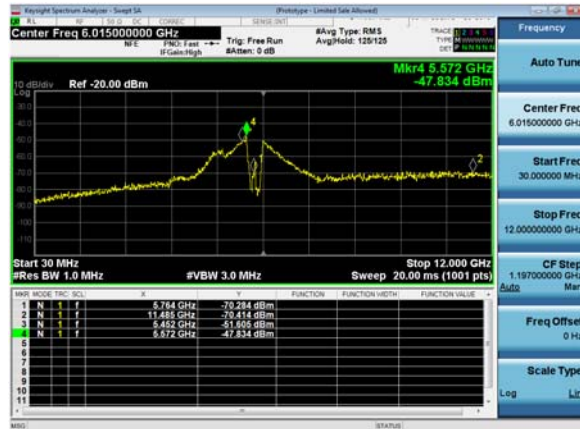

**Antenna D**

## A.7 Conducted Receiver Spurious Emissions

### Spurious Of Receive Average Upp, 5745 MHz, Non HT20, 6 to 54 Mbps



### Spurious Of Receive Peak Upper, 5745 MHz, Non HT20, 6 to 54 Mbps

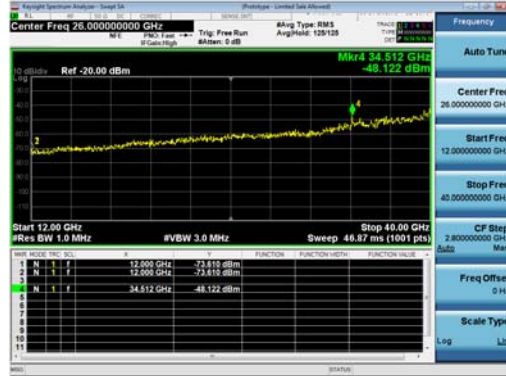

Conducted Receiver Spurious Average, 4dBi

Frequency (MHz)	Mode	Tx Paths	Correlated Antenna Gain (dBi)	Rx 1 Spur Power (dBm)	Rx 2 Spur Power (dBm)	Rx 3 Spur Power (dBm)	Rx 4 Spur Power (dBm)	Duty Cycle Correction (dB)	Total Conducted Spur (dBm)	Limit (dBm)	Margin (dB)
5720 <sup>21</sup>	Non HT20, 6 to 54 Mbps	4	4	-88.8	-89.2	-89.0	-88.7	0.1	-78.8	-41.25	37.60
	HT/VHT20, M0 to M7	4	4	-89.0	-89.4	-88.8	-89.2	0.1	-79.0	-41.25	37.77
	HE20, M0 to M9 1ss	4	4	-89.0	-89.4	-89.1	-89.6	0.1	-79.2	-41.25	37.93
5745	Non HT20, 6 to 54 Mbps	4	4	-88.6	-89.4	-89.0	-89.2	0.1	-79.0	-41.25	37.72
	HT/VHT20, M0 to M7	4	4	-88.3	-89.2	-89.0	-88.7	0.1	-78.7	-41.25	37.46
	HE20, M0 to M9 1ss	4	4	-88.4	-88.6	-88.4	-88.9	0.1	-78.5	-41.25	37.23
5755	Non HT40, 6 to 54 Mbps	4	4	-88.8	-89.3	-89.0	-88.7	0.1	-78.9	-41.25	37.62
	HT/VHT40, M0 to M7	4	4	-88.4	-88.7	-88.7	-89.1	0.1	-78.6	-41.25	37.34
	HE40, M0 to M9 1ss	4	4	-88.7	-89.2	-89.2	-88.5	0.1	-78.7	-41.25	37.49
5775	Non HT80, 6 to 54 Mbps	4	4	-89.0	-89.4	-88.8	-89.2	0.0	-79.0	-41.25	37.77
	<b>VHT80, M0 to M9 1ss</b>	4	4	<b>-88.5</b>	<b>-88.9</b>	<b>-88.6</b>	<b>-88.7</b>	<b>0.2</b>	<b>-78.4</b>	<b>-41.25</b>	<b>37.18</b>
	HE80, M0 to M9 1ss	4	4	-88.6	-88.9	-88.6	-88.7	0.2	-78.4	-41.25	37.18
5785	Non HT20, 6 to 54 Mbps	4	4	-88.5	-88.7	-89.1	-88.4	0.1	-78.6	-41.25	37.35
	HT/VHT20, M0 to M7	4	4	-88.5	-88.9	-88.9	-88.9	0.1	-78.7	-41.25	37.47
	HE20, M0 to M9 1ss	4	4	-88.2	-89.0	-88.8	-88.8	0.1	-78.6	-41.25	37.35
5795	Non HT40, 6 to 54 Mbps	4	4	-88.5	-88.8	-88.4	-89.0	0.1	-78.6	-41.25	37.35
	HT/VHT40, M0 to M7	4	4	-88.5	-88.9	-88.8	-88.8	0.1	-78.6	-41.25	37.37
	HE40, M0 to M9 1ss	4	4	-88.5	-89.2	-88.7	-88.8	0.1	-78.6	-41.25	37.40
5825	Non HT20, 6 to 54 Mbps	4	4	-88.3	-88.9	-88.6	-88.7	0.1	-78.5	-41.25	37.30
	HT/VHT20, M0 to M7	4	4	-88.5	-88.7	-88.8	-88.7	0.1	-78.6	-41.25	37.35
	HE20, M0 to M9 1ss	4	4	-88.7	-89.0	-88.5	-89.0	0.1	-78.7	-41.25	37.46

<sup>21</sup> 5720 (ch144) not supported for Canada.



Conducted Receiver Spurious Average, 5dBi

Frequency (MHz)	Mode	Tx Paths	Correlated Antenna Gain (dBi)	Rx 1 Spur Power (dBm)	Rx 2 Spur Power (dBm)	Rx 3 Spur Power (dBm)	Rx 4 Spur Power (dBm)	Duty Cycle Correction (dB)	Total Conducted Spur (dBm)	Limit (dBm)	Margin (dB)
5720 <sup>22</sup>	Non HT20, 6 to 54 Mbps	4	5	-88.8	-89.2	-89.0	-88.7	0.1	-77.8	-41.25	36.60
	HT/VHT20, M0 to M7	4	5	-89.0	-89.4	-88.8	-89.2	0.1	-78.0	-41.25	36.77
	HE20, M0 to M9 1ss	4	5	-89.0	-89.4	-89.1	-89.6	0.1	-78.2	-41.25	36.93
5745	Non HT20, 6 to 54 Mbps	4	5	-88.6	-89.4	-89.0	-89.2	0.1	-78.0	-41.25	36.72
	HT/VHT20, M0 to M7	4	5	-88.3	-89.2	-89.0	-88.7	0.1	-77.7	-41.25	36.46
	HE20, M0 to M9 1ss	4	5	-88.4	-88.6	-88.4	-88.9	0.1	-77.5	-41.25	36.23
5755	Non HT40, 6 to 54 Mbps	4	5	-88.8	-89.3	-89.0	-88.7	0.1	-77.9	-41.25	36.62
	HT/VHT40, M0 to M7	4	5	-88.4	-88.7	-88.7	-89.1	0.1	-77.6	-41.25	36.34
	HE40, M0 to M9 1ss	4	5	-88.7	-89.2	-89.2	-88.5	0.1	-77.7	-41.25	36.49
5775	Non HT80, 6 to 54 Mbps	4	5	-89.0	-89.4	-88.8	-89.2	0.0	-78.0	-41.25	36.77
	<b>VHT80, M0 to M9 1ss</b>	4	5	<b>-88.5</b>	<b>-88.9</b>	<b>-88.6</b>	<b>-88.7</b>	<b>0.2</b>	<b>-77.4</b>	<b>-41.25</b>	<b>36.18</b>
	HE80, M0 to M9 1ss	4	5	-88.6	-88.9	-88.6	-88.7	0.2	-77.4	-41.25	36.18
5785	Non HT20, 6 to 54 Mbps	4	5	-88.5	-88.7	-89.1	-88.4	0.1	-77.6	-41.25	36.35
	HT/VHT20, M0 to M7	4	5	-88.5	-88.9	-88.9	-88.9	0.1	-77.7	-41.25	36.47
	HE20, M0 to M9 1ss	4	5	-88.2	-89.0	-88.8	-88.8	0.1	-77.6	-41.25	36.35
5795	Non HT40, 6 to 54 Mbps	4	5	-88.5	-88.8	-88.4	-89.0	0.1	-77.6	-41.25	36.35
	HT/VHT40, M0 to M7	4	5	-88.5	-88.9	-88.8	-88.8	0.1	-77.6	-41.25	36.37
	HE40, M0 to M9 1ss	4	5	-88.5	-89.2	-88.7	-88.8	0.1	-77.6	-41.25	36.40
5825	Non HT20, 6 to 54 Mbps	4	5	-88.3	-88.9	-88.6	-88.7	0.1	-77.5	-41.25	36.30
	HT/VHT20, M0 to M7	4	5	-88.5	-88.7	-88.8	-88.7	0.1	-77.6	-41.25	36.35

<sup>22</sup> 5720 (ch144) not supported for Canada.





HE20, M0 to M9 1ss	4	5	-88.7	-89.0	-88.5	-89.0	0.1	-77.7	-41.25	36.46
--------------------	---	---	-------	-------	-------	-------	-----	-------	--------	-------

Conducted Receiver Spurious Average, 6dBi

Frequency (MHz)	Mode	Tx Paths	Correlated Antenna Gain (dBi)	Rx 1 Spur Power (dBm)	Rx 2 Spur Power (dBm)	Rx 3 Spur Power (dBm)	Rx 4 Spur Power (dBm)	Duty Cycle Correction (dB)	Total Conducted Spur (dBm)	Limit (dBm)	Margin (dB)
5720 <sup>23</sup>	Non HT20, 6 to 54 Mbps	4	6	-88.8	-89.2	-89.0	-88.7	0.1	-76.8	-41.25	35.60
	HT/VHT20, M0 to M7	4	6	-89.0	-89.4	-88.8	-89.2	0.1	-77.0	-41.25	35.77
	HE20, M0 to M9 1ss	4	6	-89.0	-89.4	-89.1	-89.6	0.1	-77.2	-41.25	35.93
5745	Non HT20, 6 to 54 Mbps	4	6	-88.6	-89.4	-89.0	-89.2	0.1	-77.0	-41.25	35.72
	HT/VHT20, M0 to M7	4	6	-88.3	-89.2	-89.0	-88.7	0.1	-76.7	-41.25	35.46
	HE20, M0 to M9 1ss	4	6	-88.4	-88.6	-88.4	-88.9	0.1	-76.5	-41.25	35.23
5755	Non HT40, 6 to 54 Mbps	4	6	-88.8	-89.3	-89.0	-88.7	0.1	-76.9	-41.25	35.62
	HT/VHT40, M0 to M7	4	6	-88.4	-88.7	-88.7	-89.1	0.1	-76.6	-41.25	35.34
	HE40, M0 to M9 1ss	4	6	-88.7	-89.2	-89.2	-88.5	0.1	-76.7	-41.25	35.49
5775	Non HT80, 6 to 54 Mbps	4	6	-89.0	-89.4	-88.8	-89.2	0.0	-77.0	-41.25	35.77
	<b>VHT80, M0 to M9 1ss</b>	<b>4</b>	<b>6</b>	<b>-88.5</b>	<b>-88.9</b>	<b>-88.6</b>	<b>-88.7</b>	<b>0.2</b>	<b>-76.4</b>	<b>-41.25</b>	<b>35.18</b>
	HE80, M0 to M9 1ss	4	6	-88.6	-88.9	-88.6	-88.7	0.2	-76.4	-41.25	35.18
5785	Non HT20, 6 to 54 Mbps	4	6	-88.5	-88.7	-89.1	-88.4	0.1	-76.6	-41.25	35.35
	HT/VHT20, M0 to M7	4	6	-88.5	-88.9	-88.9	-88.9	0.1	-76.7	-41.25	35.47
	HE20, M0 to M9 1ss	4	6	-88.2	-89.0	-88.8	-88.8	0.1	-76.6	-41.25	35.35
5795	Non HT40, 6 to 54 Mbps	4	6	-88.5	-88.8	-88.4	-89.0	0.1	-76.6	-41.25	35.35
	HT/VHT40, M0 to M7	4	6	-88.5	-88.9	-88.8	-88.8	0.1	-76.6	-41.25	35.37
	HE40, M0 to M9 1ss	4	6	-88.5	-89.2	-88.7	-88.8	0.1	-76.6	-41.25	35.40
5825	Non HT20, 6 to 54 Mbps	4	6	-88.3	-88.9	-88.6	-88.7	0.1	-76.5	-41.25	35.30
	HT/VHT20, M0 to M7	4	6	-88.5	-88.7	-88.8	-88.7	0.1	-76.6	-41.25	35.35
	HE20, M0 to M9 1ss	4	6	-88.7	-89.0	-88.5	-89.0	0.1	-76.7	-41.25	35.46

<sup>23</sup> 5720 (ch144) not supported for Canada.

**Spurious Of Receive Average, 4dBi, 5dBi, 6dBi  
5775 MHz, VHT80, M0 to M9 1ss**

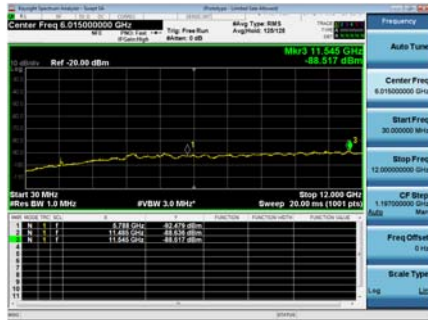

**Antenna A**



**Antenna B**



**Antenna C**

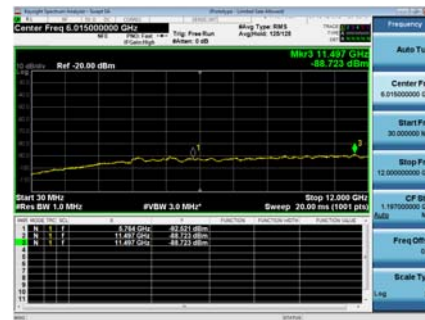

**Antenna D**

Conducted Receiver Spurious Peak, 4dBi

Frequency (MHz)	Mode	Tx Paths	Correlated Antenna Gain (dBi)	Rx 1 Spur Power (dBm)	Rx 2 Spur Power (dBm)	Rx 3 Spur Power (dBm)	Rx 4 Spur Power (dBm)	Total Conducted Spur (dBm)	Limit (dBm)	Margin (dB)
5720 <sup>24</sup>	Non HT20, 6 to 54 Mbps	4	4	-68.7	-69.4	-68.3	-69.2	-58.8	-21.25	37.56
	HT/VHT20, M0 to M7	4	4	-69.2	-68.7	-69.0	-69.8	-59.1	-21.25	37.83
	HE20, M0 to M9 1ss	4	4	-68.7	-69.8	-68.4	-70.0	-59.1	-21.25	37.83
5745	Non HT20, 6 to 54 Mbps	4	4	-68.8	-69.4	-69.0	-70.2	-59.2	-21.25	38.00
	HT/VHT20, M0 to M7	4	4	-69.4	-69.3	-69.6	-69.1	-59.3	-21.25	38.02
	HE20, M0 to M9 1ss	4	4	-68.8	-69.6	-69.8	-68.9	-59.2	-21.25	37.92
5755	Non HT40, 6 to 54 Mbps	4	4	-69.5	-68.8	-69.3	-69.7	-59.2	-21.25	37.99
	<b>HT/VHT40, M0 to M7</b>	<b>4</b>	<b>4</b>	<b>-69.1</b>	<b>-68.6</b>	<b>-68.6</b>	<b>-68.0</b>	<b>-58.4</b>	<b>-21.25</b>	<b>37.18</b>
	HE40, M0 to M9 1ss	4	4	-69.1	-69.7	-69.4	-69.4	-59.2	-21.25	38.00
5775	Non HT80, 6 to 54 Mbps	4	4	-69.7	-69.5	-69.2	-69.6	-59.4	-21.25	38.18
	VHT80, M0 to M9 1ss	4	4	-69.6	-68.9	-68.7	-69.4	-58.9	-21.25	37.64
	HE80, M0 to M9 1ss	4	4	-69.2	-69.5	-69.1	-68.2	-58.7	-21.25	37.45
5785	Non HT20, 6 to 54 Mbps	4	4	-68.7	-69.9	-69.7	-69.3	-59.3	-21.25	38.05
	HT/VHT20, M0 to M7	4	4	-69.2	-68.2	-69.7	-69.2	-59.0	-21.25	37.72
	HE20, M0 to M9 1ss	4	4	-69.0	-69.4	-69.4	-70.1	-59.4	-21.25	38.12
5795	Non HT40, 6 to 54 Mbps	4	4	-68.0	-68.5	-69.3	-68.8	-58.6	-21.25	37.30
	HT/VHT40, M0 to M7	4	4	-69.3	-68.8	-68.8	-69.6	-59.0	-21.25	37.73
	HE40, M0 to M9 1ss	4	4	-69.0	-69.6	-69.9	-69.2	-59.3	-21.25	38.02
5825	Non HT20, 6 to 54 Mbps	4	4	-69.4	-68.6	-69.4	-69.1	-59.0	-21.25	37.79
	HT/VHT20, M0 to M7	4	4	-69.3	-69.8	-69.1	-68.9	-59.2	-21.25	37.94

<sup>24</sup> 5720 (ch144) not supported for Canada.



HE20, M0 to M9 1ss	4	4	-69.0	-69.2	-69.4	-69.5	-59.2	-21.25	37.93
--------------------	---	---	-------	-------	-------	-------	-------	--------	-------

Conducted Receiver Spurious Peak, 5dBi

Frequency (MHz)	Mode	Tx Paths	Correlated Antenna Gain (dBi)	Rx 1 Spur Power (dBm)	Rx 2 Spur Power (dBm)	Rx 3 Spur Power (dBm)	Rx 4 Spur Power (dBm)	Total Conducted Spur (dBm)	Limit (dBm)	Margin (dB)
5720 <sup>25</sup>	Non HT20, 6 to 54 Mbps	4	5	-68.7	-69.4	-68.3	-69.2	-57.8	-21.25	36.56
	HT/VHT20, M0 to M7	4	5	-69.2	-68.7	-69.0	-69.8	-58.1	-21.25	36.83
	HE20, M0 to M9 1ss	4	5	-68.7	-69.8	-68.4	-70.0	-58.1	-21.25	36.83
5745	Non HT20, 6 to 54 Mbps	4	5	-68.8	-69.4	-69.0	-70.2	-58.2	-21.25	37.00
	HT/VHT20, M0 to M7	4	5	-69.4	-69.3	-69.6	-69.1	-58.3	-21.25	37.02
	HE20, M0 to M9 1ss	4	5	-68.8	-69.6	-69.8	-68.9	-58.2	-21.25	36.92
5755	Non HT40, 6 to 54 Mbps	4	5	-69.5	-68.8	-69.3	-69.7	-58.2	-21.25	36.99
	<b>HT/VHT40, M0 to M7</b>	<b>4</b>	<b>5</b>	<b>-69.1</b>	<b>-68.6</b>	<b>-68.6</b>	<b>-68.0</b>	<b>-57.4</b>	<b>-21.25</b>	<b>36.18</b>
	HE40, M0 to M9 1ss	4	5	-69.1	-69.7	-69.4	-69.4	-58.2	-21.25	37.00
5775	Non HT80, 6 to 54 Mbps	4	5	-69.7	-69.5	-69.2	-69.6	-58.4	-21.25	37.18
	VHT80, M0 to M9 1ss	4	5	-69.6	-68.9	-68.7	-69.4	-57.9	-21.25	36.64
	HE80, M0 to M9 1ss	4	5	-69.2	-69.5	-69.1	-68.2	-57.7	-21.25	36.45
5785	Non HT20, 6 to 54 Mbps	4	5	-68.7	-69.9	-69.7	-69.3	-58.3	-21.25	37.05
	HT/VHT20, M0 to M7	4	5	-69.2	-68.2	-69.7	-69.2	-58.0	-21.25	36.72
	HE20, M0 to M9 1ss	4	5	-69.0	-69.4	-69.4	-70.1	-58.4	-21.25	37.12
5795	Non HT40, 6 to 54 Mbps	4	5	-68.0	-68.5	-69.3	-68.8	-57.6	-21.25	36.30
	HT/VHT40, M0 to M7	4	5	-69.3	-68.8	-68.8	-69.6	-58.0	-21.25	36.73
	HE40, M0 to M9 1ss	4	5	-69.0	-69.6	-69.9	-69.2	-58.3	-21.25	37.02
5825	Non HT20, 6 to 54 Mbps	4	5	-69.4	-68.6	-69.4	-69.1	-58.0	-21.25	36.79
	HT/VHT20, M0 to M7	4	5	-69.3	-69.8	-69.1	-68.9	-58.2	-21.25	36.94
	HE20, M0 to M9 1ss	4	5	-69.0	-69.2	-69.4	-69.5	-58.2	-21.25	36.93

<sup>25</sup> 5720 (ch144) not supported for Canada.

Conducted Receiver Spurious Peak, 6dBi

Frequency (MHz)	Mode	Tx Paths	Correlated Antenna Gain (dBi)	Rx 1 Spur Power (dBm)	Rx 2 Spur Power (dBm)	Rx 3 Spur Power (dBm)	Rx 4 Spur Power (dBm)	Total Conducted Spur (dBm)	Limit (dBm)	Margin (dB)
5720 <sup>26</sup>	Non HT20, 6 to 54 Mbps	4	6	-68.7	-69.4	-68.3	-69.2	-56.8	-21.25	35.56
	HT/VHT20, M0 to M7	4	6	-69.2	-68.7	-69.0	-69.8	-57.1	-21.25	35.83
	HE20, M0 to M9 1ss	4	6	-68.7	-69.8	-68.4	-70.0	-57.1	-21.25	35.83
5745	Non HT20, 6 to 54 Mbps	4	6	-68.8	-69.4	-69.0	-70.2	-57.2	-21.25	36.00
	HT/VHT20, M0 to M7	4	6	-69.4	-69.3	-69.6	-69.1	-57.3	-21.25	36.02
	HE20, M0 to M9 1ss	4	6	-68.8	-69.6	-69.8	-68.9	-57.2	-21.25	35.92
5755	Non HT40, 6 to 54 Mbps	4	6	-69.5	-68.8	-69.3	-69.7	-57.2	-21.25	35.99
	<b>HT/VHT40, M0 to M7</b>	<b>4</b>	<b>6</b>	<b>-69.1</b>	<b>-68.6</b>	<b>-68.6</b>	<b>-68.0</b>	<b>-56.4</b>	<b>-21.25</b>	<b>35.18</b>
	HE40, M0 to M9 1ss	4	6	-69.1	-69.7	-69.4	-69.4	-57.2	-21.25	36.00
5775	Non HT80, 6 to 54 Mbps	4	6	-69.7	-69.5	-69.2	-69.6	-57.4	-21.25	36.18
	VHT80, M0 to M9 1ss	4	6	-69.6	-68.9	-68.7	-69.4	-56.9	-21.25	35.64
	HE80, M0 to M9 1ss	4	6	-69.2	-69.5	-69.1	-68.2	-56.7	-21.25	35.45
5785	Non HT20, 6 to 54 Mbps	4	6	-68.7	-69.9	-69.7	-69.3	-57.3	-21.25	36.05
	HT/VHT20, M0 to M7	4	6	-69.2	-68.2	-69.7	-69.2	-57.0	-21.25	35.72
	HE20, M0 to M9 1ss	4	6	-69.0	-69.4	-69.4	-70.1	-57.4	-21.25	36.12
5795	Non HT40, 6 to 54 Mbps	4	6	-68.0	-68.5	-69.3	-68.8	-56.6	-21.25	35.30
	HT/VHT40, M0 to M7	4	6	-69.3	-68.8	-68.8	-69.6	-57.0	-21.25	35.73
	HE40, M0 to M9 1ss	4	6	-69.0	-69.6	-69.9	-69.2	-57.3	-21.25	36.02
5825	Non HT20, 6 to 54 Mbps	4	6	-69.4	-68.6	-69.4	-69.1	-57.0	-21.25	35.79
	HT/VHT20, M0 to M7	4	6	-69.3	-69.8	-69.1	-68.9	-57.2	-21.25	35.94
	HE20, M0 to M9 1ss	4	6	-69.0	-69.2	-69.4	-69.5	-57.2	-21.25	35.93

<sup>26</sup> 5720 (ch144) not supported for Canada.



**Spurious Of Receive Peak, 4dB, 5dB, 6dB  
5755 MHz, HT/VHT40, M0 to M7**

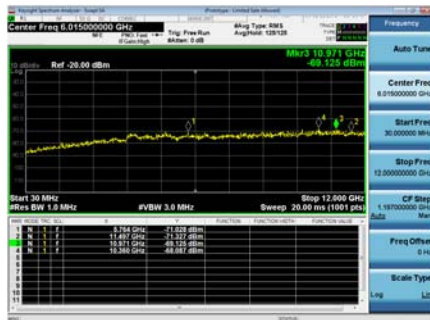

**Antenna A**



**Antenna B**



**Antenna C**

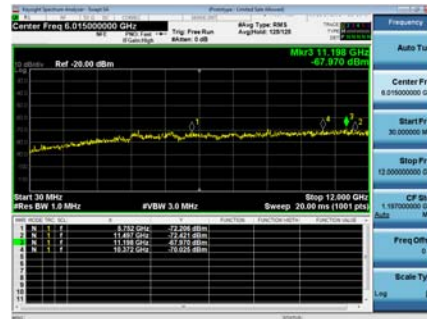

**Antenna D**

## A.8 Conducted Bandedge

**15.205 / 15.247 / LP0002 / RSS-247** In any 100 kHz bandwidth outside the frequency band in which the digitally modulated intentional radiator is operating, the radio frequency power that is produced by the intentional radiator shall be at least 30 dB below that in the 100 kHz bandwidth within the band that contains the highest level of the desired power.

Devices certified before March 2, 2018 with antenna gain of 10 dBi or less may demonstrate compliance with the emission limits in §15.247(d), but manufacturing, marketing and importing of devices certified under this alternative must cease before March 2, 2020.

### Test Procedure

Ref. KDB 558074 D01 DTS Meas Guidance v03r05  
ANSI C63.10: 2013

Conducted Band edge
Test Procedure
<ol style="list-style-type: none"> <li>1. Connect the antenna port(s) to the spectrum analyzer input.</li> <li>2. Place the radio in continuous transmit mode. Use the procedures in KDB 558074 D01 DTS Meas Guidance v03r05 to substitute conducted measurements in place of radiated measurements.</li> <li>3. Configure Spectrum analyzer as per test parameters below below (be sure to enter all losses between the transmitter output and the spectrum analyzer).</li> <li>4. Place a marker at the end of the restricted band closest to the transmit frequency to show compliance. Also measure any emissions in the restricted bands..</li> <li>5. The “measure-and-sum technique” is used for measuring in-band transmit power of a device. In the measure-and-sum approach, the conducted emission level is measured at each antenna port. The measured results at the various antenna ports are then summed mathematically to determine the total emission level from the device. Summing is performed in linear power units. The worst case output is recorded.</li> <li>6. Place a marker at the end of the restricted band closest to the transmit frequency to show compliance. Also measure any emissions in the restricted bands</li> <li>7. Capture graphs and record pertinent measurement data.</li> </ol>

Conducted Bandedge
Test parameters non-restricted Band KDB 558074 D01 v03r05 section 11.1b, 11.2-3, also see ANSI C63.10: 2013 section 11.10.3
RBW = 100 kHz VBW ≥ 3 x RBW Sweep = Auto couple Detector = Peak Trace = Max Hold.

System Number	Description	Samples	System under test	Support equipment
1	EUT	S01+S02	<input checked="" type="checkbox"/>	<input type="checkbox"/>
	Support		<input type="checkbox"/>	<input checked="" type="checkbox"/>

<b>Tested By :</b> Chris Blair	<b>Date of testing:</b> 25-Sep-19 - 01-Oct-19
-----------------------------------	--

**Test Result : PASS**

See Appendix C for list of test equipment

Conducted Bandedge Peak (Left Side), 4dBi

Frequency (MHz)	Mode	Tx Paths	Correlated Antenna Gain (dBi)	Tx 1 Bandedge Level (dBm)	Tx 2 Bandedge Level (dBm)	Tx 3 Bandedge Level (dBm)	Tx 4 Bandedge Level (dBm)	Total Tx Bandedge Level (dBm)	Limit (dBm)	Margin (dB)
5745	Non HT20, 6 to 54 Mbps	1	4	-59.3				-55.2	-27.00	28.25
	Non HT20, 6 to 54 Mbps	2	4	-59.3	-53.6			-48.5	-27.00	21.51
	Non HT20, 6 to 54 Mbps	3	4	-59.3	-53.6	-52.1		-45.3	-27.00	18.27
	Non HT20, 6 to 54 Mbps	4	4	-59.3	-53.6	-52.1	-54.0	-44.0	-27.00	16.99
	Non HT20 Beam Forming, 6 to 54 Mbps	2	7	-59.3	-53.6			-45.5	-27.00	18.51
	Non HT20 Beam Forming, 6 to 54 Mbps	3	9	-59.3	-53.6	-52.1		-40.3	-27.00	13.27
	Non HT20 Beam Forming, 6 to 54 Mbps	4	10	-59.3	-53.6	-52.1	-54.0	-38.0	-27.00	10.99
	HT/VHT20, M0 to M7	1	4	-59.1				-55.0	-27.00	28.05
	HT/VHT20, M0 to M7	2	4	-59.1	-53.4			-48.3	-27.00	21.31
	HT/VHT20, M8 to M15	2	4	-59.1	-53.4			-48.3	-27.00	21.31
	HT/VHT20, M0 to M7	3	4	-59.1	-53.4	-52.1		-45.2	-27.00	18.17
	HT/VHT20, M8 to M15	3	4	-59.1	-53.4	-52.1		-45.2	-27.00	18.17
	HT/VHT20, M16 to M23	3	4	-59.1	-53.4	-52.1		-45.2	-27.00	18.17
	HT/VHT20, M0 to M7	4	4	-59.1	-53.4	-52.1	-53.7	-43.8	-27.00	16.84
	HT/VHT20, M8 to M15	4	4	-59.1	-53.4	-52.1	-53.7	-43.8	-27.00	16.84
	HT/VHT20, M16 to M23	4	4	-59.1	-53.4	-52.1	-53.7	-43.8	-27.00	16.84
	HT/VHT20, M24 to M31	4	4	-59.1	-53.4	-52.1	-53.7	-43.8	-27.00	16.84
	HT/VHT20 Beam Forming, M0 to M7	2	7	-59.1	-53.4			-45.3	-27.00	18.31
	HT/VHT20 Beam Forming, M8 to M15	2	4	-59.1	-53.4			-48.3	-27.00	21.31
	HT/VHT20 Beam Forming, M0 to M7	3	9	-59.1	-53.4	-52.1		-40.2	-27.00	13.17
	HT/VHT20 Beam Forming, M8 to M15	3	6	-59.1	-53.4	-52.1		-43.2	-27.00	16.17
	HT/VHT20 Beam Forming, M16 to M23	3	4	-59.1	-53.4	-52.1		-45.2	-27.00	18.17
	HT/VHT20 Beam Forming, M0 to M7	4	10	-59.1	-53.4	-52.1	-53.7	-37.8	-27.00	10.84
	HT/VHT20 Beam Forming, M8 to M15	4	7	-59.1	-53.4	-52.1	-53.7	-40.8	-27.00	13.84
	HT/VHT20 Beam Forming, M16 to M23	4	5	-59.1	-53.4	-52.1	-53.7	-42.8	-27.00	15.84
	HT/VHT20 Beam Forming, M24 to M31	4	4	-59.1	-53.4	-52.1	-53.7	-43.8	-27.00	16.84
	HT/VHT20 STBC, M0 to M7	2	4	-59.1	-53.4			-48.3	-27.00	21.31
	HT/VHT20 STBC, M0 to M7	3	4	-59.1	-53.4	-52.1		-45.2	-27.00	18.17
	HT/VHT20 STBC, M0 to M7	4	4	-59.1	-53.4	-52.1	-53.7	-43.8	-27.00	16.84

	HE20, M0 to M9 1ss	1	4	-58.9				-54.8	-27.00	27.83
	HE20, M0 to M9 1ss	2	4	-58.9	-53.0			-47.9	-27.00	20.94
	HE20, M0 to M9 2ss	2	4	-58.9	-53.0			-47.9	-27.00	20.94
	HE20, M0 to M9 1ss	3	4	-58.9	-53.0	-52.1		-45.0	-27.00	17.97
	HE20, M0 to M9 2ss	3	4	-58.9	-53.0	-52.1		-45.0	-27.00	17.97
	HE20, M0 to M9 3ss	3	4	-58.9	-53.0	-52.1		-45.0	-27.00	17.97
	HE20, M0 to M9 1ss	4	4	-58.9	-53.0	-52.1	-53.2	-43.6	-27.00	16.56
	HE20, M0 to M9 2ss	4	4	-58.9	-53.0	-52.1	-53.2	-43.6	-27.00	16.56
	HE20, M0 to M9 3ss	4	4	-58.9	-53.0	-52.1	-53.2	-43.6	-27.00	16.56
	HE20, M0 to M9 4ss	4	4	-58.9	-53.0	-52.1	-53.2	-43.6	-27.00	16.56
	HE20 Beam Forming, M0 to M9 1ss	2	7	-58.9	-53.0			-44.9	-27.00	17.94
	HE20 Beam Forming, M0 to M9 2ss	2	4	-58.9	-53.0			-47.9	-27.00	20.94
	HE20 Beam Forming, M0 to M9 1ss	3	9	-58.9	-53.0	-52.1		-40.0	-27.00	12.97
	HE20 Beam Forming, M0 to M9 2ss	3	6	-58.9	-53.0	-52.1		-43.0	-27.00	15.97
	HE20 Beam Forming, M0 to M9 3ss	3	4	-58.9	-53.0	-52.1		-45.0	-27.00	17.97
	HE20 Beam Forming, M0 to M9 1ss	4	10	-58.9	-53.0	-52.1	-53.2	-37.6	-27.00	10.56
	HE20 Beam Forming, M0 to M9 2ss	4	7	-58.9	-53.0	-52.1	-53.2	-40.6	-27.00	13.56
	HE20 Beam Forming, M0 to M9 3ss	4	5	-58.9	-53.0	-52.1	-53.2	-42.6	-27.00	15.56
	HE20 Beam Forming, M0 to M9 4ss	4	4	-58.9	-53.0	-52.1	-53.2	-43.6	-27.00	16.56
	HE20 STBC, M0 to M9 2ss	2	4	-58.9	-53.0			-47.9	-27.00	20.94
	HE20 STBC, M0 to M9 2ss	3	4	-58.9	-53.0	-52.1		-45.0	-27.00	17.97
	HE20 STBC, M0 to M9 2ss	4	4	-58.9	-53.0	-52.1	-53.2	-43.6	-27.00	16.56
5755	Non HT40, 6 to 54 Mbps	1	4	-58.9				-54.8	-27.00	27.85
	Non HT40, 6 to 54 Mbps	2	4	-58.9	-52.3			-47.4	-27.00	20.39
	Non HT40, 6 to 54 Mbps	3	4	-58.9	-52.3	-51.2		-44.3	-27.00	17.26
	Non HT40, 6 to 54 Mbps	4	4	-58.9	-52.3	-51.2	-53.1	-43.0	-27.00	16.01
	HT/VHT40, M0 to M7	1	4	-59.5				-55.4	-27.00	28.39
	HT/VHT40, M0 to M7	2	4	-59.5	-52.3			-47.4	-27.00	20.43
	HT/VHT40, M8 to M15	2	4	-59.5	-52.3			-47.4	-27.00	20.43
	HT/VHT40, M0 to M7	3	4	-59.5	-52.3	-52.2		-44.7	-27.00	17.74
	HT/VHT40, M8 to M15	3	4	-59.5	-52.3	-52.2		-44.7	-27.00	17.74
	HT/VHT40, M16 to M23	3	4	-59.5	-52.3	-52.2		-44.7	-27.00	17.74
	HT/VHT40, M0 to M7	4	4	-59.5	-52.3	-52.2	-53.6	-43.5	-27.00	16.48
	HT/VHT40, M8 to M15	4	4	-59.5	-52.3	-52.2	-53.6	-43.5	-27.00	16.48
	HT/VHT40, M16 to M23	4	4	-59.5	-52.3	-52.2	-53.6	-43.5	-27.00	16.48
	HT/VHT40, M24 to M31	4	4	-59.5	-52.3	-52.2	-53.6	-43.5	-27.00	16.48
	HT/VHT40 Beam Forming, M0 to M7	2	7	-59.5	-52.3			-44.4	-27.00	17.43
	HT/VHT40 Beam Forming, M8 to M15	2	4	-59.5	-52.3			-47.4	-27.00	20.43
	HT/VHT40 Beam Forming, M0 to M7	3	9	-59.5	-52.3	-52.2		-39.7	-27.00	12.74
	HT/VHT40 Beam Forming, M8 to M15	3	6	-59.5	-52.3	-52.2		-42.7	-27.00	15.74
HT/VHT40 Beam Forming, M16 to M23	3	4	-59.5	-52.3	-52.2		-44.7	-27.00	17.74	
HT/VHT40 Beam Forming, M0 to M7	4	10	-59.5	-52.3	-52.2	-53.6	-37.5	-27.00	10.48	

	HT/VHT40 Beam Forming, M8 to M15	4	7	-59.5	-52.3	-52.2	-53.6	-40.5	-27.00	13.48
	HT/VHT40 Beam Forming, M16 to M23	4	5	-59.5	-52.3	-52.2	-53.6	-42.5	-27.00	15.48
	HT/VHT40 Beam Forming, M24 to M31	4	4	-59.5	-52.3	-52.2	-53.6	-43.5	-27.00	16.48
	HT/VHT40 STBC, M0 to M7	2	4	-59.5	-52.3			-47.4	-27.00	20.43
	HT/VHT40 STBC, M0 to M7	3	4	-59.5	-52.3	-52.2		-44.7	-27.00	17.74
	HT/VHT40 STBC, M0 to M7	4	4	-59.5	-52.3	-52.2	-53.6	-43.5	-27.00	16.48
	HE40, M0 to M9 1ss	1	4	-59.2				-55.1	-27.00	28.07
	HE40, M0 to M9 1ss	2	4	-59.2	-51.9			-47.0	-27.00	20.03
	HE40, M0 to M9 2ss	2	4	-59.2	-51.9			-47.0	-27.00	20.03
	HE40, M0 to M9 1ss	3	4	-59.2	-51.9	-51.7		-44.3	-27.00	17.29
	HE40, M0 to M9 2ss	3	4	-59.2	-51.9	-51.7		-44.3	-27.00	17.29
	HE40, M0 to M9 3ss	3	4	-59.2	-51.9	-51.7		-44.3	-27.00	17.29
	HE40, M0 to M9 1ss	4	4	-59.2	-51.9	-51.7	-53.6	-43.1	-27.00	16.14
	HE40, M0 to M9 2ss	4	4	-59.2	-51.9	-51.7	-53.6	-43.1	-27.00	16.14
	HE40, M0 to M9 3ss	4	4	-59.2	-51.9	-51.7	-53.6	-43.1	-27.00	16.14
	HE40, M0 to M9 4ss	4	4	-59.2	-51.9	-51.7	-53.6	-43.1	-27.00	16.14
	HE40 Beam Forming, M0 to M9 1ss	2	7	-59.2	-51.9			-44.0	-27.00	17.03
	HE40 Beam Forming, M0 to M9 2ss	2	4	-59.2	-51.9			-47.0	-27.00	20.03
	HE40 Beam Forming, M0 to M9 1ss	3	9	-59.2	-51.9	-51.7		-39.3	-27.00	12.29
	HE40 Beam Forming, M0 to M9 2ss	3	6	-59.2	-51.9	-51.7		-42.3	-27.00	15.29
	HE40 Beam Forming, M0 to M9 3ss	3	4	-59.2	-51.9	-51.7		-44.3	-27.00	17.29
	HE40 Beam Forming, M0 to M9 1ss	4	10	-59.2	-51.9	-51.7	-53.6	-37.1	-27.00	10.14
	HE40 Beam Forming, M0 to M9 2ss	4	7	-59.2	-51.9	-51.7	-53.6	-40.1	-27.00	13.14
	HE40 Beam Forming, M0 to M9 3ss	4	5	-59.2	-51.9	-51.7	-53.6	-42.1	-27.00	15.14
	HE40 Beam Forming, M0 to M9 4ss	4	4	-59.2	-51.9	-51.7	-53.6	-43.1	-27.00	16.14
	HE40 STBC, M0 to M9 2ss	2	4	-59.2	-51.9			-47.0	-27.00	20.03
	HE40 STBC, M0 to M9 2ss	3	4	-59.2	-51.9	-51.7		-44.3	-27.00	17.29
	HE40 STBC, M0 to M9 2ss	4	4	-59.2	-51.9	-51.7	-53.6	-43.1	-27.00	16.14
5775	Non HT80, 6 to 54 Mbps	1	4	-55.7				-51.7	-27.00	24.65
	Non HT80, 6 to 54 Mbps	2	4	-55.7	-46.3			-41.8	-27.00	14.78
	Non HT80, 6 to 54 Mbps	3	4	-55.7	-46.3	-43.9		-37.7	-27.00	10.70
	Non HT80, 6 to 54 Mbps	4	4	-55.7	-46.3	-43.9	-47.5	-36.7	-27.00	9.67
	VHT80, M0 to M9 1ss	1	4	-56.7				-52.5	-27.00	25.48
	VHT80, M0 to M9 1ss	2	4	-56.7	-47.7			-43.0	-27.00	15.96
	VHT80, M0 to M9 2ss	2	4	-56.7	-47.7			-43.0	-27.00	15.96
	VHT80, M0 to M9 1ss	3	4	-56.7	-47.7	-45.1		-38.8	-27.00	11.78
	VHT80, M0 to M9 2ss	3	4	-56.7	-47.7	-45.1		-38.8	-27.00	11.78
	VHT80, M0 to M9 3ss	3	4	-56.7	-47.7	-45.1		-38.8	-27.00	11.78
	VHT80, M0 to M9 1ss	4	4	-56.7	-47.7	-45.1	-48.8	-37.8	-27.00	10.77
	VHT80, M0 to M9 2ss	4	4	-56.7	-47.7	-45.1	-48.8	-37.8	-27.00	10.77
	VHT80, M0 to M9 3ss	4	4	-56.7	-47.7	-45.1	-48.8	-37.8	-27.00	10.77
	VHT80, M0 to M9 4ss	4	4	-56.7	-47.7	-45.1	-48.8	-37.8	-27.00	10.77

VHT80 Beam Forming, M0 to M9 1ss	2	7	-56.7	-47.7			-40.0	-27.00	12.96
VHT80 Beam Forming, M0 to M9 2ss	2	4	-56.7	-47.7			-43.0	-27.00	15.96
VHT80 Beam Forming, M0 to M9 1ss	3	9	-56.7	-47.7	-45.1		-33.8	-27.00	6.78
VHT80 Beam Forming, M0 to M9 2ss	3	6	-56.7	-47.7	-45.1		-36.8	-27.00	9.78
VHT80 Beam Forming, M0 to M9 3ss	3	4	-56.7	-47.7	-45.1		-38.8	-27.00	11.78
VHT80 Beam Forming, M0 to M9 1ss	4	10	-56.7	-47.7	-45.1	-48.8	-31.8	-27.00	4.77
VHT80 Beam Forming, M0 to M9 2ss	4	7	-56.7	-47.7	-45.1	-48.8	-34.8	-27.00	7.77
VHT80 Beam Forming, M0 to M9 3ss	4	5	-56.7	-47.7	-45.1	-48.8	-36.8	-27.00	9.77
VHT80 Beam Forming, M0 to M9 4ss	4	4	-56.7	-47.7	-45.1	-48.8	-37.8	-27.00	10.77
VHT80 STBC, M0 to M9 1ss	2	4	-56.7	-47.7			-43.0	-27.00	15.96
VHT80 STBC, M0 to M9 1ss	3	4	-56.7	-47.7	-45.1		-38.8	-27.00	11.78
VHT80 STBC, M0 to M9 1ss	4	4	-56.7	-47.7	-45.1	-48.8	-37.8	-27.00	10.77
HE80, M0 to M9 1ss	1	4	-56.5				-52.3	-27.00	25.25
HE80, M0 to M9 1ss	2	4	-56.5	-46.6			-41.9	-27.00	14.93
HE80, M0 to M9 2ss	2	4	-56.5	-46.6			-41.9	-27.00	14.93
HE80, M0 to M9 1ss	3	4	-56.5	-46.6	-44.3		-37.9	-27.00	10.88
HE80, M0 to M9 2ss	3	4	-56.5	-46.6	-44.3		-37.9	-27.00	10.88
HE80, M0 to M9 3ss	3	4	-56.5	-46.6	-44.3		-37.9	-27.00	10.88
HE80, M0 to M9 1ss	4	4	-56.5	-46.6	-44.3	-48.0	-36.9	-27.00	9.88
HE80, M0 to M9 2ss	4	4	-56.5	-46.6	-44.3	-48.0	-36.9	-27.00	9.88
HE80, M0 to M9 3ss	4	4	-56.5	-46.6	-44.3	-48.0	-36.9	-27.00	9.88
HE80, M0 to M9 4ss	4	4	-56.5	-46.6	-44.3	-48.0	-36.9	-27.00	9.88
HE80 Beam Forming, M0 to M9 1ss	2	7	-56.5	-46.6			-38.9	-27.00	11.93
HE80 Beam Forming, M0 to M9 2ss	2	4	-56.5	-46.6			-41.9	-27.00	14.93
HE80 Beam Forming, M0 to M9 1ss	3	9	-56.5	-46.6	-44.3		-32.9	-27.00	5.88
HE80 Beam Forming, M0 to M9 2ss	3	6	-56.5	-46.6	-44.3		-35.9	-27.00	8.88
HE80 Beam Forming, M0 to M9 3ss	3	4	-56.5	-46.6	-44.3		-37.9	-27.00	10.88
<b>HE80 Beam Forming, M0 to M9 1ss</b>	<b>4</b>	<b>10</b>	<b>-56.5</b>	<b>-46.6</b>	<b>-44.3</b>	<b>-48.0</b>	<b>-30.9</b>	<b>-27.00</b>	<b>3.88</b>
HE80 Beam Forming, M0 to M9 2ss	4	7	-56.5	-46.6	-44.3	-48.0	-33.9	-27.00	6.88
HE80 Beam Forming, M0 to M9 3ss	4	5	-56.5	-46.6	-44.3	-48.0	-35.9	-27.00	8.88
HE80 Beam Forming, M0 to M9 4ss	4	4	-56.5	-46.6	-44.3	-48.0	-36.9	-27.00	9.88
HE80 STBC, M0 to M9 1ss	2	4	-56.5	-46.6			-41.9	-27.00	14.93
HE80 STBC, M0 to M9 1ss	3	4	-56.5	-46.6	-44.3		-37.9	-27.00	10.88
HE80 STBC, M0 to M9 1ss	4	4	-56.5	-46.6	-44.3	-48.0	-36.9	-27.00	9.88

**Conducted Bandedge Peak 15407L, 4dBi  
5775 MHz, HE80 Beam Forming, M0 to M9 1ss**



Antenna A



Antenna B



Antenna C



Antenna D



Conducted Bandedge Peak (Left Side), 5dBi

Frequency (MHz)	Mode	Tx Paths	Correlated Antenna Gain (dBi)	Tx 1 Bandedge Level (dBm)	Tx 2 Bandedge Level (dBm)	Tx 3 Bandedge Level (dBm)	Tx 4 Bandedge Level (dBm)	Total Tx Bandedge Level (dBm)	Limit (dBm)	Margin (dB)
5745	Non HT20, 6 to 54 Mbps	1	5	-59.3				-54.2	-27.00	27.25
	Non HT20, 6 to 54 Mbps	2	5	-59.3	-53.6			-47.5	-27.00	20.51
	Non HT20, 6 to 54 Mbps	3	5	-59.3	-53.6	-52.1		-44.3	-27.00	17.27
	Non HT20, 6 to 54 Mbps	4	5	-59.3	-53.6	-52.1	-54.0	-43.0	-27.00	15.99
	Non HT20 Beam Forming, 6 to 54 Mbps	2	8	-59.3	-53.6			-44.5	-27.00	17.51
	Non HT20 Beam Forming, 6 to 54 Mbps	3	10	-59.3	-53.6	-52.1		-39.3	-27.00	12.27
	Non HT20 Beam Forming, 6 to 54 Mbps	4	11	-59.3	-53.6	-52.1	-54.0	-37.0	-27.00	9.99
	HT/VHT20, M0 to M7	1	5	-59.1				-54.0	-27.00	27.05
	HT/VHT20, M0 to M7	2	5	-59.1	-53.4			-47.3	-27.00	20.31
	HT/VHT20, M8 to M15	2	5	-59.1	-53.4			-47.3	-27.00	20.31
	HT/VHT20, M0 to M7	3	5	-59.1	-53.4	-52.1		-44.2	-27.00	17.17
	HT/VHT20, M8 to M15	3	5	-59.1	-53.4	-52.1		-44.2	-27.00	17.17
	HT/VHT20, M16 to M23	3	5	-59.1	-53.4	-52.1		-44.2	-27.00	17.17
	HT/VHT20, M0 to M7	4	5	-59.1	-53.4	-52.1	-53.7	-42.8	-27.00	15.84
	HT/VHT20, M8 to M15	4	5	-59.1	-53.4	-52.1	-53.7	-42.8	-27.00	15.84
	HT/VHT20, M16 to M23	4	5	-59.1	-53.4	-52.1	-53.7	-42.8	-27.00	15.84
	HT/VHT20, M24 to M31	4	5	-59.1	-53.4	-52.1	-53.7	-42.8	-27.00	15.84
	HT/VHT20 Beam Forming, M0 to M7	2	8	-59.1	-53.4			-44.3	-27.00	17.31
	HT/VHT20 Beam Forming, M8 to M15	2	5	-59.1	-53.4			-47.3	-27.00	20.31
	HT/VHT20 Beam Forming, M0 to M7	3	10	-59.1	-53.4	-52.1		-39.2	-27.00	12.17
	HT/VHT20 Beam Forming, M8 to M15	3	7	-59.1	-53.4	-52.1		-42.2	-27.00	15.17
	HT/VHT20 Beam Forming, M16 to M23	3	5	-59.1	-53.4	-52.1		-44.2	-27.00	17.17
	HT/VHT20 Beam Forming, M0 to M7	4	11	-59.1	-53.4	-52.1	-53.7	-36.8	-27.00	9.84
	HT/VHT20 Beam Forming, M8 to M15	4	8	-59.1	-53.4	-52.1	-53.7	-39.8	-27.00	12.84
	HT/VHT20 Beam Forming, M16 to M23	4	6	-59.1	-53.4	-52.1	-53.7	-41.8	-27.00	14.84
	HT/VHT20 Beam Forming, M24 to M31	4	5	-59.1	-53.4	-52.1	-53.7	-42.8	-27.00	15.84
	HT/VHT20 STBC, M0 to M7	2	5	-59.1	-53.4			-47.3	-27.00	20.31
	HT/VHT20 STBC, M0 to M7	3	5	-59.1	-53.4	-52.1		-44.2	-27.00	17.17

	HT/VHT20 STBC, M0 to M7	4	5	-59.1	-53.4	-52.1	-53.7	-42.8	-27.00	15.84
	HE20, M0 to M9 1ss	1	5	-58.9				-53.8	-27.00	26.83
	HE20, M0 to M9 1ss	2	5	-58.9	-53.0			-46.9	-27.00	19.94
	HE20, M0 to M9 2ss	2	5	-58.9	-53.0			-46.9	-27.00	19.94
	HE20, M0 to M9 1ss	3	5	-58.9	-53.0	-52.1		-44.0	-27.00	16.97
	HE20, M0 to M9 2ss	3	5	-58.9	-53.0	-52.1		-44.0	-27.00	16.97
	HE20, M0 to M9 3ss	3	5	-58.9	-53.0	-52.1		-44.0	-27.00	16.97
	HE20, M0 to M9 1ss	4	5	-58.9	-53.0	-52.1	-53.2	-42.6	-27.00	15.56
	HE20, M0 to M9 2ss	4	5	-58.9	-53.0	-52.1	-53.2	-42.6	-27.00	15.56
	HE20, M0 to M9 3ss	4	5	-58.9	-53.0	-52.1	-53.2	-42.6	-27.00	15.56
	HE20, M0 to M9 4ss	4	5	-58.9	-53.0	-52.1	-53.2	-42.6	-27.00	15.56
	HE20 Beam Forming, M0 to M9 1ss	2	8	-58.9	-53.0			-43.9	-27.00	16.94
	HE20 Beam Forming, M0 to M9 2ss	2	5	-58.9	-53.0			-46.9	-27.00	19.94
	HE20 Beam Forming, M0 to M9 1ss	3	10	-58.9	-53.0	-52.1		-39.0	-27.00	11.97
	HE20 Beam Forming, M0 to M9 2ss	3	7	-58.9	-53.0	-52.1		-42.0	-27.00	14.97
	HE20 Beam Forming, M0 to M9 3ss	3	5	-58.9	-53.0	-52.1		-44.0	-27.00	16.97
	HE20 Beam Forming, M0 to M9 1ss	4	11	-58.9	-53.0	-52.1	-53.2	-36.6	-27.00	9.56
	HE20 Beam Forming, M0 to M9 2ss	4	8	-58.9	-53.0	-52.1	-53.2	-39.6	-27.00	12.56
	HE20 Beam Forming, M0 to M9 3ss	4	6	-58.9	-53.0	-52.1	-53.2	-41.6	-27.00	14.56
	HE20 Beam Forming, M0 to M9 4ss	4	5	-58.9	-53.0	-52.1	-53.2	-42.6	-27.00	15.56
	HE20 STBC, M0 to M9 2ss	2	5	-58.9	-53.0			-46.9	-27.00	19.94
	HE20 STBC, M0 to M9 2ss	3	5	-58.9	-53.0	-52.1		-44.0	-27.00	16.97
	HE20 STBC, M0 to M9 2ss	4	5	-58.9	-53.0	-52.1	-53.2	-42.6	-27.00	15.56
5755	Non HT40, 6 to 54 Mbps	1	5	-58.9				-53.8	-27.00	26.85
	Non HT40, 6 to 54 Mbps	2	5	-58.9	-52.3			-46.4	-27.00	19.39
	Non HT40, 6 to 54 Mbps	3	5	-58.9	-52.3	-51.2		-43.3	-27.00	16.26
	Non HT40, 6 to 54 Mbps	4	5	-58.9	-52.3	-51.2	-53.1	-42.0	-27.00	15.01
	HT/VHT40, M0 to M7	1	5	-59.5				-54.4	-27.00	27.39
	HT/VHT40, M0 to M7	2	5	-59.5	-52.3			-46.4	-27.00	19.43
	HT/VHT40, M8 to M15	2	5	-59.5	-52.3			-46.4	-27.00	19.43
	HT/VHT40, M0 to M7	3	5	-59.5	-52.3	-52.2		-43.7	-27.00	16.74
	HT/VHT40, M8 to M15	3	5	-59.5	-52.3	-52.2		-43.7	-27.00	16.74
	HT/VHT40, M16 to M23	3	5	-59.5	-52.3	-52.2		-43.7	-27.00	16.74
	HT/VHT40, M0 to M7	4	5	-59.5	-52.3	-52.2	-53.6	-42.5	-27.00	15.48
	HT/VHT40, M8 to M15	4	5	-59.5	-52.3	-52.2	-53.6	-42.5	-27.00	15.48
	HT/VHT40, M16 to M23	4	5	-59.5	-52.3	-52.2	-53.6	-42.5	-27.00	15.48
	HT/VHT40, M24 to M31	4	5	-59.5	-52.3	-52.2	-53.6	-42.5	-27.00	15.48
	HT/VHT40 Beam Forming, M0 to M7	2	8	-59.5	-52.3			-43.4	-27.00	16.43
	HT/VHT40 Beam Forming, M8 to M15	2	5	-59.5	-52.3			-46.4	-27.00	19.43
	HT/VHT40 Beam Forming, M0 to M7	3	10	-59.5	-52.3	-52.2		-38.7	-27.00	11.74
HT/VHT40 Beam Forming, M8 to M15	3	7	-59.5	-52.3	-52.2		-41.7	-27.00	14.74	
HT/VHT40 Beam Forming, M16 to M23	3	5	-59.5	-52.3	-52.2		-43.7	-27.00	16.74	

	HT/VHT40 Beam Forming, M0 to M7	4	11	-59.5	-52.3	-52.2	-53.6	-36.5	-27.00	9.48
	HT/VHT40 Beam Forming, M8 to M15	4	8	-59.5	-52.3	-52.2	-53.6	-39.5	-27.00	12.48
	HT/VHT40 Beam Forming, M16 to M23	4	6	-59.5	-52.3	-52.2	-53.6	-41.5	-27.00	14.48
	HT/VHT40 Beam Forming, M24 to M31	4	5	-59.5	-52.3	-52.2	-53.6	-42.5	-27.00	15.48
	HT/VHT40 STBC, M0 to M7	2	5	-59.5	-52.3			-46.4	-27.00	19.43
	HT/VHT40 STBC, M0 to M7	3	5	-59.5	-52.3	-52.2		-43.7	-27.00	16.74
	HT/VHT40 STBC, M0 to M7	4	5	-59.5	-52.3	-52.2	-53.6	-42.5	-27.00	15.48
	HE40, M0 to M9 1ss	1	5	-59.2				-54.1	-27.00	27.07
	HE40, M0 to M9 1ss	2	5	-59.2	-51.9			-46.0	-27.00	19.03
	HE40, M0 to M9 2ss	2	5	-59.2	-51.9			-46.0	-27.00	19.03
	HE40, M0 to M9 1ss	3	5	-59.2	-51.9	-51.7		-43.3	-27.00	16.29
	HE40, M0 to M9 2ss	3	5	-59.2	-51.9	-51.7		-43.3	-27.00	16.29
	HE40, M0 to M9 3ss	3	5	-59.2	-51.9	-51.7		-43.3	-27.00	16.29
	HE40, M0 to M9 1ss	4	5	-59.2	-51.9	-51.7	-53.6	-42.1	-27.00	15.14
	HE40, M0 to M9 2ss	4	5	-59.2	-51.9	-51.7	-53.6	-42.1	-27.00	15.14
	HE40, M0 to M9 3ss	4	5	-59.2	-51.9	-51.7	-53.6	-42.1	-27.00	15.14
	HE40, M0 to M9 4ss	4	5	-59.2	-51.9	-51.7	-53.6	-42.1	-27.00	15.14
	HE40 Beam Forming, M0 to M9 1ss	2	8	-59.2	-51.9			-43.0	-27.00	16.03
	HE40 Beam Forming, M0 to M9 2ss	2	5	-59.2	-51.9			-46.0	-27.00	19.03
	HE40 Beam Forming, M0 to M9 1ss	3	10	-59.2	-51.9	-51.7		-38.3	-27.00	11.29
	HE40 Beam Forming, M0 to M9 2ss	3	7	-59.2	-51.9	-51.7		-41.3	-27.00	14.29
	HE40 Beam Forming, M0 to M9 3ss	3	5	-59.2	-51.9	-51.7		-43.3	-27.00	16.29
	HE40 Beam Forming, M0 to M9 1ss	4	11	-59.2	-51.9	-51.7	-53.6	-36.1	-27.00	9.14
	HE40 Beam Forming, M0 to M9 2ss	4	8	-59.2	-51.9	-51.7	-53.6	-39.1	-27.00	12.14
	HE40 Beam Forming, M0 to M9 3ss	4	6	-59.2	-51.9	-51.7	-53.6	-41.1	-27.00	14.14
	HE40 Beam Forming, M0 to M9 4ss	4	5	-59.2	-51.9	-51.7	-53.6	-42.1	-27.00	15.14
	HE40 STBC, M0 to M9 2ss	2	5	-59.2	-51.9			-46.0	-27.00	19.03
	HE40 STBC, M0 to M9 2ss	3	5	-59.2	-51.9	-51.7		-43.3	-27.00	16.29
	HE40 STBC, M0 to M9 2ss	4	5	-59.2	-51.9	-51.7	-53.6	-42.1	-27.00	15.14
5775	Non HT80, 6 to 54 Mbps	1	5	-55.7				-50.7	-27.00	23.65
	Non HT80, 6 to 54 Mbps	2	5	-55.7	-46.3			-40.8	-27.00	13.78
	Non HT80, 6 to 54 Mbps	3	5	-55.7	-46.3	-43.9		-36.7	-27.00	9.70
	Non HT80, 6 to 54 Mbps	4	5	-55.7	-46.3	-43.9	-47.5	-35.7	-27.00	8.67
	VHT80, M0 to M9 1ss	1	5	-56.7				-51.5	-27.00	24.48
	VHT80, M0 to M9 1ss	2	5	-56.7	-47.7			-42.0	-27.00	14.96
	VHT80, M0 to M9 2ss	2	5	-56.7	-47.7			-42.0	-27.00	14.96
	VHT80, M0 to M9 1ss	3	5	-56.7	-47.7	-45.1		-37.8	-27.00	10.78
	VHT80, M0 to M9 2ss	3	5	-56.7	-47.7	-45.1		-37.8	-27.00	10.78
	VHT80, M0 to M9 3ss	3	5	-56.7	-47.7	-45.1		-37.8	-27.00	10.78
	VHT80, M0 to M9 1ss	4	5	-56.7	-47.7	-45.1	-48.8	-36.8	-27.00	9.77
	VHT80, M0 to M9 2ss	4	5	-56.7	-47.7	-45.1	-48.8	-36.8	-27.00	9.77
VHT80, M0 to M9 3ss	4	5	-56.7	-47.7	-45.1	-48.8	-36.8	-27.00	9.77	

VHT80, M0 to M9 4ss	4	5	-56.7	-47.7	-45.1	-48.8	-36.8	-27.00	9.77
VHT80 Beam Forming, M0 to M9 1ss	2	8	-56.7	-47.7			-39.0	-27.00	11.96
VHT80 Beam Forming, M0 to M9 2ss	2	5	-56.7	-47.7			-42.0	-27.00	14.96
VHT80 Beam Forming, M0 to M9 1ss	3	10	-56.7	-47.7	-45.1		-32.8	-27.00	5.78
VHT80 Beam Forming, M0 to M9 2ss	3	7	-56.7	-47.7	-45.1		-35.8	-27.00	8.78
VHT80 Beam Forming, M0 to M9 3ss	3	5	-56.7	-47.7	-45.1		-37.8	-27.00	10.78
VHT80 Beam Forming, M0 to M9 1ss	4	11	-56.7	-47.7	-45.1	-48.8	-30.8	-27.00	3.77
VHT80 Beam Forming, M0 to M9 2ss	4	8	-56.7	-47.7	-45.1	-48.8	-33.8	-27.00	6.77
VHT80 Beam Forming, M0 to M9 3ss	4	6	-56.7	-47.7	-45.1	-48.8	-35.8	-27.00	8.77
VHT80 Beam Forming, M0 to M9 4ss	4	5	-56.7	-47.7	-45.1	-48.8	-36.8	-27.00	9.77
VHT80 STBC, M0 to M9 1ss	2	5	-56.7	-47.7			-42.0	-27.00	14.96
VHT80 STBC, M0 to M9 1ss	3	5	-56.7	-47.7	-45.1		-37.8	-27.00	10.78
VHT80 STBC, M0 to M9 1ss	4	5	-56.7	-47.7	-45.1	-48.8	-36.8	-27.00	9.77
HE80, M0 to M9 1ss	1	5	-56.5				-51.3	-27.00	24.25
HE80, M0 to M9 1ss	2	5	-56.5	-46.6			-40.9	-27.00	13.93
HE80, M0 to M9 2ss	2	5	-56.5	-46.6			-40.9	-27.00	13.93
HE80, M0 to M9 1ss	3	5	-56.5	-46.6	-44.3		-36.9	-27.00	9.88
HE80, M0 to M9 2ss	3	5	-56.5	-46.6	-44.3		-36.9	-27.00	9.88
HE80, M0 to M9 3ss	3	5	-56.5	-46.6	-44.3		-36.9	-27.00	9.88
HE80, M0 to M9 1ss	4	5	-56.5	-46.6	-44.3	-48.0	-35.9	-27.00	8.88
HE80, M0 to M9 2ss	4	5	-56.5	-46.6	-44.3	-48.0	-35.9	-27.00	8.88
HE80, M0 to M9 3ss	4	5	-56.5	-46.6	-44.3	-48.0	-35.9	-27.00	8.88
HE80, M0 to M9 4ss	4	5	-56.5	-46.6	-44.3	-48.0	-35.9	-27.00	8.88
HE80 Beam Forming, M0 to M9 1ss	2	8	-56.5	-46.6			-37.9	-27.00	10.93
HE80 Beam Forming, M0 to M9 2ss	2	5	-56.5	-46.6			-40.9	-27.00	13.93
HE80 Beam Forming, M0 to M9 1ss	3	10	-56.5	-46.6	-44.3		-31.9	-27.00	4.88
HE80 Beam Forming, M0 to M9 2ss	3	7	-56.5	-46.6	-44.3		-34.9	-27.00	7.88
HE80 Beam Forming, M0 to M9 3ss	3	5	-56.5	-46.6	-44.3		-36.9	-27.00	9.88
<b>HE80 Beam Forming, M0 to M9 1ss</b>	<b>4</b>	<b>11</b>	<b>-56.5</b>	<b>-46.6</b>	<b>-44.3</b>	<b>-48.0</b>	<b>-29.9</b>	<b>-27.00</b>	<b>2.88</b>
HE80 Beam Forming, M0 to M9 2ss	4	8	-56.5	-46.6	-44.3	-48.0	-32.9	-27.00	5.88
HE80 Beam Forming, M0 to M9 3ss	4	6	-56.5	-46.6	-44.3	-48.0	-34.9	-27.00	7.88
HE80 Beam Forming, M0 to M9 4ss	4	5	-56.5	-46.6	-44.3	-48.0	-35.9	-27.00	8.88
HE80 STBC, M0 to M9 1ss	2	5	-56.5	-46.6			-40.9	-27.00	13.93
HE80 STBC, M0 to M9 1ss	3	5	-56.5	-46.6	-44.3		-36.9	-27.00	9.88
HE80 STBC, M0 to M9 1ss	4	5	-56.5	-46.6	-44.3	-48.0	-35.9	-27.00	8.88

**Conducted Bandedge Peak 15407L, 5dBi  
5775 MHz, HE80 Beam Forming, M0 to M9 1ss**



**Antenna A**



**Antenna B**



**Antenna C**



**Antenna D**

Conducted Bandedge Peak (Left Side), 6dBi

Frequency (MHz)	Mode	Tx Paths	Correlated Antenna Gain (dBi)	Tx 1 Bandedge Level (dBm)	Tx 2 Bandedge Level (dBm)	Tx 3 Bandedge Level (dBm)	Tx 4 Bandedge Level (dBm)	Total Tx Bandedge Level (dBm)	Limit (dBm)	Margin (dB)
5745	Non HT20, 6 to 54 Mbps	1	6	-59.3				-53.2	-27.00	26.25
	Non HT20, 6 to 54 Mbps	2	6	-59.3	-53.6			-46.5	-27.00	19.51
	Non HT20, 6 to 54 Mbps	3	6	-59.3	-53.6	-52.1		-43.3	-27.00	16.27
	Non HT20, 6 to 54 Mbps	4	6	-59.3	-53.6	-52.1	-54.0	-42.0	-27.00	14.99
	Non HT20 Beam Forming, 6 to 54 Mbps	2	9	-59.3	-53.6			-43.5	-27.00	16.51
	Non HT20 Beam Forming, 6 to 54 Mbps	3	11	-59.3	-53.6	-52.1		-38.3	-27.00	11.27
	Non HT20 Beam Forming, 6 to 54 Mbps	4	12	-59.3	-53.6	-52.1	-54.0	-36.0	-27.00	8.99
	HT/VHT20, M0 to M7	1	6	-59.1				-53.0	-27.00	26.05
	HT/VHT20, M0 to M7	2	6	-59.1	-53.4			-46.3	-27.00	19.31
	HT/VHT20, M8 to M15	2	6	-59.1	-53.4			-46.3	-27.00	19.31
	HT/VHT20, M0 to M7	3	6	-59.1	-53.4	-52.1		-43.2	-27.00	16.17
	HT/VHT20, M8 to M15	3	6	-59.1	-53.4	-52.1		-43.2	-27.00	16.17
	HT/VHT20, M16 to M23	3	6	-59.1	-53.4	-52.1		-43.2	-27.00	16.17
	HT/VHT20, M0 to M7	4	6	-59.1	-53.4	-52.1	-53.7	-41.8	-27.00	14.84
	HT/VHT20, M8 to M15	4	6	-59.1	-53.4	-52.1	-53.7	-41.8	-27.00	14.84
	HT/VHT20, M16 to M23	4	6	-59.1	-53.4	-52.1	-53.7	-41.8	-27.00	14.84
	HT/VHT20, M24 to M31	4	6	-59.1	-53.4	-52.1	-53.7	-41.8	-27.00	14.84
	HT/VHT20 Beam Forming, M0 to M7	2	9	-59.1	-53.4			-43.3	-27.00	16.31
	HT/VHT20 Beam Forming, M8 to M15	2	6	-59.1	-53.4			-46.3	-27.00	19.31
	HT/VHT20 Beam Forming, M0 to M7	3	11	-59.1	-53.4	-52.1		-38.2	-27.00	11.17
	HT/VHT20 Beam Forming, M8 to M15	3	8	-59.1	-53.4	-52.1		-41.2	-27.00	14.17
	HT/VHT20 Beam Forming, M16 to M23	3	6	-59.1	-53.4	-52.1		-43.2	-27.00	16.17
	HT/VHT20 Beam Forming, M0 to M7	4	12	-59.1	-53.4	-52.1	-53.7	-35.8	-27.00	8.84
	HT/VHT20 Beam Forming, M8 to M15	4	9	-59.1	-53.4	-52.1	-53.7	-38.8	-27.00	11.84
	HT/VHT20 Beam Forming, M16 to M23	4	7	-59.1	-53.4	-52.1	-53.7	-40.8	-27.00	13.84
	HT/VHT20 Beam Forming, M24 to M31	4	6	-59.1	-53.4	-52.1	-53.7	-41.8	-27.00	14.84
	HT/VHT20 STBC, M0 to M7	2	6	-59.1	-53.4			-46.3	-27.00	19.31
	HT/VHT20 STBC, M0 to M7	3	6	-59.1	-53.4	-52.1		-43.2	-27.00	16.17
	HT/VHT20 STBC, M0 to M7	4	6	-59.1	-53.4	-52.1	-53.7	-41.8	-27.00	14.84



	HE20, M0 to M9 1ss	1	6	-58.9				-52.8	-27.00	25.83
	HE20, M0 to M9 1ss	2	6	-58.9	-53.0			-45.9	-27.00	18.94
	HE20, M0 to M9 2ss	2	6	-58.9	-53.0			-45.9	-27.00	18.94
	HE20, M0 to M9 1ss	3	6	-58.9	-53.0	-52.1		-43.0	-27.00	15.97
	HE20, M0 to M9 2ss	3	6	-58.9	-53.0	-52.1		-43.0	-27.00	15.97
	HE20, M0 to M9 3ss	3	6	-58.9	-53.0	-52.1		-43.0	-27.00	15.97
	HE20, M0 to M9 1ss	4	6	-58.9	-53.0	-52.1	-53.2	-41.6	-27.00	14.56
	HE20, M0 to M9 2ss	4	6	-58.9	-53.0	-52.1	-53.2	-41.6	-27.00	14.56
	HE20, M0 to M9 3ss	4	6	-58.9	-53.0	-52.1	-53.2	-41.6	-27.00	14.56
	HE20, M0 to M9 4ss	4	6	-58.9	-53.0	-52.1	-53.2	-41.6	-27.00	14.56
	HE20 Beam Forming, M0 to M9 1ss	2	9	-58.9	-53.0			-42.9	-27.00	15.94
	HE20 Beam Forming, M0 to M9 2ss	2	6	-58.9	-53.0			-45.9	-27.00	18.94
	HE20 Beam Forming, M0 to M9 1ss	3	11	-58.9	-53.0	-52.1		-38.0	-27.00	10.97
	HE20 Beam Forming, M0 to M9 2ss	3	8	-58.9	-53.0	-52.1		-41.0	-27.00	13.97
	HE20 Beam Forming, M0 to M9 3ss	3	6	-58.9	-53.0	-52.1		-43.0	-27.00	15.97
	HE20 Beam Forming, M0 to M9 1ss	4	12	-58.9	-53.0	-52.1	-53.2	-35.6	-27.00	8.56
	HE20 Beam Forming, M0 to M9 2ss	4	9	-58.9	-53.0	-52.1	-53.2	-38.6	-27.00	11.56
	HE20 Beam Forming, M0 to M9 3ss	4	7	-58.9	-53.0	-52.1	-53.2	-40.6	-27.00	13.56
	HE20 Beam Forming, M0 to M9 4ss	4	6	-58.9	-53.0	-52.1	-53.2	-41.6	-27.00	14.56
	HE20 STBC, M0 to M9 2ss	2	6	-58.9	-53.0			-45.9	-27.00	18.94
	HE20 STBC, M0 to M9 2ss	3	6	-58.9	-53.0	-52.1		-43.0	-27.00	15.97
	HE20 STBC, M0 to M9 2ss	4	6	-58.9	-53.0	-52.1	-53.2	-41.6	-27.00	14.56
5755	Non HT40, 6 to 54 Mbps	1	6	-58.9				-52.8	-27.00	25.85
	Non HT40, 6 to 54 Mbps	2	6	-58.9	-52.3			-45.4	-27.00	18.39
	Non HT40, 6 to 54 Mbps	3	6	-58.9	-52.3	-51.2		-42.3	-27.00	15.26
	Non HT40, 6 to 54 Mbps	4	6	-58.9	-52.3	-51.2	-53.1	-41.0	-27.00	14.01
	HT/VHT40, M0 to M7	1	6	-59.5				-53.4	-27.00	26.39
	HT/VHT40, M0 to M7	2	6	-59.5	-52.3			-45.4	-27.00	18.43
	HT/VHT40, M8 to M15	2	6	-59.5	-52.3			-45.4	-27.00	18.43
	HT/VHT40, M0 to M7	3	6	-59.5	-52.3	-52.2		-42.7	-27.00	15.74
	HT/VHT40, M8 to M15	3	6	-59.5	-52.3	-52.2		-42.7	-27.00	15.74
	HT/VHT40, M16 to M23	3	6	-59.5	-52.3	-52.2		-42.7	-27.00	15.74
	HT/VHT40, M0 to M7	4	6	-59.5	-52.3	-52.2	-53.6	-41.5	-27.00	14.48
	HT/VHT40, M8 to M15	4	6	-59.5	-52.3	-52.2	-53.6	-41.5	-27.00	14.48
	HT/VHT40, M16 to M23	4	6	-59.5	-52.3	-52.2	-53.6	-41.5	-27.00	14.48
	HT/VHT40, M24 to M31	4	6	-59.5	-52.3	-52.2	-53.6	-41.5	-27.00	14.48
	HT/VHT40 Beam Forming, M0 to M7	2	9	-59.5	-52.3			-42.4	-27.00	15.43
	HT/VHT40 Beam Forming, M8 to M15	2	6	-59.5	-52.3			-45.4	-27.00	18.43
	HT/VHT40 Beam Forming, M0 to M7	3	11	-59.5	-52.3	-52.2		-37.7	-27.00	10.74
	HT/VHT40 Beam Forming, M8 to M15	3	8	-59.5	-52.3	-52.2		-40.7	-27.00	13.74
HT/VHT40 Beam Forming, M16 to M23	3	6	-59.5	-52.3	-52.2		-42.7	-27.00	15.74	
HT/VHT40 Beam Forming, M0 to M7	4	12	-59.5	-52.3	-52.2	-53.6	-35.5	-27.00	8.48	



	HT/VHT40 Beam Forming, M8 to M15	4	9	-59.5	-52.3	-52.2	-53.6	-38.5	-27.00	11.48
	HT/VHT40 Beam Forming, M16 to M23	4	7	-59.5	-52.3	-52.2	-53.6	-40.5	-27.00	13.48
	HT/VHT40 Beam Forming, M24 to M31	4	6	-59.5	-52.3	-52.2	-53.6	-41.5	-27.00	14.48
	HT/VHT40 STBC, M0 to M7	2	6	-59.5	-52.3			-45.4	-27.00	18.43
	HT/VHT40 STBC, M0 to M7	3	6	-59.5	-52.3	-52.2		-42.7	-27.00	15.74
	HT/VHT40 STBC, M0 to M7	4	6	-59.5	-52.3	-52.2	-53.6	-41.5	-27.00	14.48
	HE40, M0 to M9 1ss	1	6	-59.2				-53.1	-27.00	26.07
	HE40, M0 to M9 1ss	2	6	-59.2	-51.9			-45.0	-27.00	18.03
	HE40, M0 to M9 2ss	2	6	-59.2	-51.9			-45.0	-27.00	18.03
	HE40, M0 to M9 1ss	3	6	-59.2	-51.9	-51.7		-42.3	-27.00	15.29
	HE40, M0 to M9 2ss	3	6	-59.2	-51.9	-51.7		-42.3	-27.00	15.29
	HE40, M0 to M9 3ss	3	6	-59.2	-51.9	-51.7		-42.3	-27.00	15.29
	HE40, M0 to M9 1ss	4	6	-59.2	-51.9	-51.7	-53.6	-41.1	-27.00	14.14
	HE40, M0 to M9 2ss	4	6	-59.2	-51.9	-51.7	-53.6	-41.1	-27.00	14.14
	HE40, M0 to M9 3ss	4	6	-59.2	-51.9	-51.7	-53.6	-41.1	-27.00	14.14
	HE40, M0 to M9 4ss	4	6	-59.2	-51.9	-51.7	-53.6	-41.1	-27.00	14.14
	HE40 Beam Forming, M0 to M9 1ss	2	9	-59.2	-51.9			-42.0	-27.00	15.03
	HE40 Beam Forming, M0 to M9 2ss	2	6	-59.2	-51.9			-45.0	-27.00	18.03
	HE40 Beam Forming, M0 to M9 1ss	3	11	-59.2	-51.9	-51.7		-37.3	-27.00	10.29
	HE40 Beam Forming, M0 to M9 2ss	3	8	-59.2	-51.9	-51.7		-40.3	-27.00	13.29
	HE40 Beam Forming, M0 to M9 3ss	3	6	-59.2	-51.9	-51.7		-42.3	-27.00	15.29
	HE40 Beam Forming, M0 to M9 1ss	4	12	-59.2	-51.9	-51.7	-53.6	-35.1	-27.00	8.14
	HE40 Beam Forming, M0 to M9 2ss	4	9	-59.2	-51.9	-51.7	-53.6	-38.1	-27.00	11.14
	HE40 Beam Forming, M0 to M9 3ss	4	7	-59.2	-51.9	-51.7	-53.6	-40.1	-27.00	13.14
	HE40 Beam Forming, M0 to M9 4ss	4	6	-59.2	-51.9	-51.7	-53.6	-41.1	-27.00	14.14
	HE40 STBC, M0 to M9 2ss	2	6	-59.2	-51.9			-45.0	-27.00	18.03
	HE40 STBC, M0 to M9 2ss	3	6	-59.2	-51.9	-51.7		-42.3	-27.00	15.29
	HE40 STBC, M0 to M9 2ss	4	6	-59.2	-51.9	-51.7	-53.6	-41.1	-27.00	14.14
5775	Non HT80, 6 to 54 Mbps	1	6	-55.7				-49.7	-27.00	22.65
	Non HT80, 6 to 54 Mbps	2	6	-55.7	-46.3			-39.8	-27.00	12.78
	Non HT80, 6 to 54 Mbps	3	6	-55.7	-46.3	-43.9		-35.7	-27.00	8.70
	Non HT80, 6 to 54 Mbps	4	6	-55.7	-46.3	-43.9	-47.5	-34.7	-27.00	7.67
	VHT80, M0 to M9 1ss	1	6	-56.7				-50.5	-27.00	23.48
	VHT80, M0 to M9 1ss	2	6	-56.7	-47.7			-41.0	-27.00	13.96
	VHT80, M0 to M9 2ss	2	6	-56.7	-47.7			-41.0	-27.00	13.96
	VHT80, M0 to M9 1ss	3	6	-56.7	-47.7	-45.1		-36.8	-27.00	9.78
	VHT80, M0 to M9 2ss	3	6	-56.7	-47.7	-45.1		-36.8	-27.00	9.78
	VHT80, M0 to M9 3ss	3	6	-56.7	-47.7	-45.1		-36.8	-27.00	9.78
	VHT80, M0 to M9 1ss	4	6	-56.7	-47.7	-45.1	-48.8	-35.8	-27.00	8.77
	VHT80, M0 to M9 2ss	4	6	-56.7	-47.7	-45.1	-48.8	-35.8	-27.00	8.77
	VHT80, M0 to M9 3ss	4	6	-56.7	-47.7	-45.1	-48.8	-35.8	-27.00	8.77
	VHT80, M0 to M9 4ss	4	6	-56.7	-47.7	-45.1	-48.8	-35.8	-27.00	8.77

VHT80 Beam Forming, M0 to M9 1ss	2	9	-56.7	-47.7			-38.0	-27.00	10.96
VHT80 Beam Forming, M0 to M9 2ss	2	6	-56.7	-47.7			-41.0	-27.00	13.96
VHT80 Beam Forming, M0 to M9 1ss	3	11	-56.7	-47.7	-45.1		-31.8	-27.00	4.78
VHT80 Beam Forming, M0 to M9 2ss	3	8	-56.7	-47.7	-45.1		-34.8	-27.00	7.78
VHT80 Beam Forming, M0 to M9 3ss	3	6	-56.7	-47.7	-45.1		-36.8	-27.00	9.78
VHT80 Beam Forming, M0 to M9 1ss	4	12	-56.7	-47.7	-45.1	-48.8	-29.8	-27.00	2.77
VHT80 Beam Forming, M0 to M9 2ss	4	9	-56.7	-47.7	-45.1	-48.8	-32.8	-27.00	5.77
VHT80 Beam Forming, M0 to M9 3ss	4	7	-56.7	-47.7	-45.1	-48.8	-34.8	-27.00	7.77
VHT80 Beam Forming, M0 to M9 4ss	4	6	-56.7	-47.7	-45.1	-48.8	-35.8	-27.00	8.77
VHT80 STBC, M0 to M9 1ss	2	6	-56.7	-47.7			-41.0	-27.00	13.96
VHT80 STBC, M0 to M9 1ss	3	6	-56.7	-47.7	-45.1		-36.8	-27.00	9.78
VHT80 STBC, M0 to M9 1ss	4	6	-56.7	-47.7	-45.1	-48.8	-35.8	-27.00	8.77
HE80, M0 to M9 1ss	1	6	-56.5				-50.3	-27.00	23.25
HE80, M0 to M9 1ss	2	6	-56.5	-46.6			-39.9	-27.00	12.93
HE80, M0 to M9 2ss	2	6	-56.5	-46.6			-39.9	-27.00	12.93
HE80, M0 to M9 1ss	3	6	-56.5	-46.6	-44.3		-35.9	-27.00	8.88
HE80, M0 to M9 2ss	3	6	-56.5	-46.6	-44.3		-35.9	-27.00	8.88
HE80, M0 to M9 3ss	3	6	-56.5	-46.6	-44.3		-35.9	-27.00	8.88
HE80, M0 to M9 1ss	4	6	-56.5	-46.6	-44.3	-48.0	-34.9	-27.00	7.88
HE80, M0 to M9 2ss	4	6	-56.5	-46.6	-44.3	-48.0	-34.9	-27.00	7.88
HE80, M0 to M9 3ss	4	6	-56.5	-46.6	-44.3	-48.0	-34.9	-27.00	7.88
HE80, M0 to M9 4ss	4	6	-56.5	-46.6	-44.3	-48.0	-34.9	-27.00	7.88
HE80 Beam Forming, M0 to M9 1ss	2	9	-56.5	-46.6			-36.9	-27.00	9.93
HE80 Beam Forming, M0 to M9 2ss	2	6	-56.5	-46.6			-39.9	-27.00	12.93
HE80 Beam Forming, M0 to M9 1ss	3	11	-56.5	-46.6	-44.3		-30.9	-27.00	3.88
HE80 Beam Forming, M0 to M9 2ss	3	8	-56.5	-46.6	-44.3		-33.9	-27.00	6.88
HE80 Beam Forming, M0 to M9 3ss	3	6	-56.5	-46.6	-44.3		-35.9	-27.00	8.88
<b>HE80 Beam Forming, M0 to M9 1ss</b>	<b>4</b>	<b>12</b>	<b>-56.5</b>	<b>-46.6</b>	<b>-44.3</b>	<b>-48.0</b>	<b>-28.9</b>	<b>-27.00</b>	<b>1.88</b>
HE80 Beam Forming, M0 to M9 2ss	4	9	-56.5	-46.6	-44.3	-48.0	-31.9	-27.00	4.88
HE80 Beam Forming, M0 to M9 3ss	4	7	-56.5	-46.6	-44.3	-48.0	-33.9	-27.00	6.88
HE80 Beam Forming, M0 to M9 4ss	4	6	-56.5	-46.6	-44.3	-48.0	-34.9	-27.00	7.88
HE80 STBC, M0 to M9 1ss	2	6	-56.5	-46.6			-39.9	-27.00	12.93
HE80 STBC, M0 to M9 1ss	3	6	-56.5	-46.6	-44.3		-35.9	-27.00	8.88
HE80 STBC, M0 to M9 1ss	4	6	-56.5	-46.6	-44.3	-48.0	-34.9	-27.00	7.88

**Conducted Bandedge Peak 15407L, 6dBi  
5775 MHz, HE80 Beam Forming, M0 to M9 1ss**



**Antenna A**



**Antenna B**



**Antenna C**



**Antenna D**

Conducted Bandedge Peak (Right Side), 4dBi

Frequency (MHz)	Mode	Tx Paths	Correlated Antenna Gain (dBi)	Tx 1 Bandedge Level (dBm)	Tx 2 Bandedge Level (dBm)	Tx 3 Bandedge Level (dBm)	Tx 4 Bandedge Level (dBm)	Total Tx Bandedge Level (dBm)	Limit (dBm)	Margin (dB)	
5775	Non HT80, 6 to 54 Mbps	1	4	-53.2				-49.2	-27.00	22.15	
	Non HT80, 6 to 54 Mbps	2	4	-53.2	-46.4			-41.5	-27.00	14.53	
	Non HT80, 6 to 54 Mbps	3	4	-53.2	-46.4	-44.7		-38.1	-27.00	11.06	
	Non HT80, 6 to 54 Mbps	4	4	-53.2	-46.4	-44.7	-49.4	-37.3	-27.00	10.31	
	VHT80, M0 to M9 1ss	1	4	-55.2				-51.0	-27.00	23.98	
	VHT80, M0 to M9 1ss	2	4	-55.2	-49.3			-44.1	-27.00	17.08	
	VHT80, M0 to M9 2ss	2	4	-55.2	-49.3			-44.1	-27.00	17.08	
	VHT80, M0 to M9 1ss	3	4	-55.2	-49.3	-48.0		-40.9	-27.00	13.92	
	VHT80, M0 to M9 2ss	3	4	-55.2	-49.3	-48.0		-40.9	-27.00	13.92	
	VHT80, M0 to M9 3ss	3	4	-55.2	-49.3	-48.0		-40.9	-27.00	13.92	
	VHT80, M0 to M9 1ss	4	4	-55.2	-49.3	-48.0	-51.0	-39.9	-27.00	12.91	
	VHT80, M0 to M9 2ss	4	4	-55.2	-49.3	-48.0	-51.0	-39.9	-27.00	12.91	
	VHT80, M0 to M9 3ss	4	4	-55.2	-49.3	-48.0	-51.0	-39.9	-27.00	12.91	
	VHT80, M0 to M9 4ss	4	4	-55.2	-49.3	-48.0	-51.0	-39.9	-27.00	12.91	
	VHT80 Beam Forming, M0 to M9 1ss	2	7	-55.2	-49.3				-41.1	-27.00	14.08
	VHT80 Beam Forming, M0 to M9 2ss	2	4	-55.2	-49.3				-44.1	-27.00	17.08
	VHT80 Beam Forming, M0 to M9 1ss	3	9	-55.2	-49.3	-48.0			-35.9	-27.00	8.92
	VHT80 Beam Forming, M0 to M9 2ss	3	6	-55.2	-49.3	-48.0			-38.9	-27.00	11.92
	VHT80 Beam Forming, M0 to M9 3ss	3	4	-55.2	-49.3	-48.0			-40.9	-27.00	13.92
	VHT80 Beam Forming, M0 to M9 1ss	4	10	-55.2	-49.3	-48.0	-51.0		-33.9	-27.00	6.91
	VHT80 Beam Forming, M0 to M9 2ss	4	7	-55.2	-49.3	-48.0	-51.0		-36.9	-27.00	9.91
	VHT80 Beam Forming, M0 to M9 3ss	4	5	-55.2	-49.3	-48.0	-51.0		-38.9	-27.00	11.91
	VHT80 Beam Forming, M0 to M9 4ss	4	4	-55.2	-49.3	-48.0	-51.0		-39.9	-27.00	12.91
	VHT80 STBC, M0 to M9 1ss	2	4	-55.2	-49.3				-44.1	-27.00	17.08
	VHT80 STBC, M0 to M9 1ss	3	4	-55.2	-49.3	-48.0			-40.9	-27.00	13.92
VHT80 STBC, M0 to M9 1ss	4	4	-55.2	-49.3	-48.0	-51.0		-39.9	-27.00	12.91	

	HE80, M0 to M9 1ss	1	4	-54.6				-50.4	-27.00	23.35
	HE80, M0 to M9 1ss	2	4	-54.6	-48.1			-43.0	-27.00	15.97
	HE80, M0 to M9 2ss	2	4	-54.6	-48.1			-43.0	-27.00	15.97
	HE80, M0 to M9 1ss	3	4	-54.6	-48.1	-46.4		-39.5	-27.00	12.53
	HE80, M0 to M9 2ss	3	4	-54.6	-48.1	-46.4		-39.5	-27.00	12.53
	HE80, M0 to M9 3ss	3	4	-54.6	-48.1	-46.4		-39.5	-27.00	12.53
	HE80, M0 to M9 1ss	4	4	-54.6	-48.1	-46.4	-50.4	-38.7	-27.00	11.68
	HE80, M0 to M9 2ss	4	4	-54.6	-48.1	-46.4	-50.4	-38.7	-27.00	11.68
	HE80, M0 to M9 3ss	4	4	-54.6	-48.1	-46.4	-50.4	-38.7	-27.00	11.68
	HE80, M0 to M9 4ss	4	4	-54.6	-48.1	-46.4	-50.4	-38.7	-27.00	11.68
	HE80 Beam Forming, M0 to M9 1ss	2	7	-54.6	-48.1			-40.0	-27.00	12.97
	HE80 Beam Forming, M0 to M9 2ss	2	4	-54.6	-48.1			-43.0	-27.00	15.97
	HE80 Beam Forming, M0 to M9 1ss	3	9	-54.6	-48.1	-46.4		-34.5	-27.00	7.53
	HE80 Beam Forming, M0 to M9 2ss	3	6	-54.6	-48.1	-46.4		-37.5	-27.00	10.53
	HE80 Beam Forming, M0 to M9 3ss	3	4	-54.6	-48.1	-46.4		-39.5	-27.00	12.53
	<b>HE80 Beam Forming, M0 to M9 1ss</b>	<b>4</b>	<b>10</b>	<b>-54.6</b>	<b>-48.1</b>	<b>-46.4</b>	<b>-50.4</b>	<b>-32.7</b>	<b>-27.00</b>	<b>5.68</b>
	HE80 Beam Forming, M0 to M9 2ss	4	7	-54.6	-48.1	-46.4	-50.4	-35.7	-27.00	8.68
	HE80 Beam Forming, M0 to M9 3ss	4	5	-54.6	-48.1	-46.4	-50.4	-37.7	-27.00	10.68
	HE80 Beam Forming, M0 to M9 4ss	4	4	-54.6	-48.1	-46.4	-50.4	-38.7	-27.00	11.68
	HE80 STBC, M0 to M9 1ss	2	4	-54.6	-48.1			-43.0	-27.00	15.97
	HE80 STBC, M0 to M9 1ss	3	4	-54.6	-48.1	-46.4		-39.5	-27.00	12.53
	HE80 STBC, M0 to M9 1ss	4	4	-54.6	-48.1	-46.4	-50.4	-38.7	-27.00	11.68
5785	Non HT20, 6 to 54 Mbps	1	4	-56.6				-52.5	-27.00	25.55
	Non HT20, 6 to 54 Mbps	2	4	-56.6	-53.8			-47.9	-27.00	20.92
	Non HT20, 6 to 54 Mbps	3	4	-56.6	-53.8	-52.6		-45.2	-27.00	18.21
	Non HT20, 6 to 54 Mbps	4	4	-56.6	-53.8	-52.6	-54.2	-44.0	-27.00	17.00
	Non HT20 Beam Forming, 6 to 54 Mbps	2	7	-56.6	-53.8			-44.9	-27.00	17.92
	Non HT20 Beam Forming, 6 to 54 Mbps	3	9	-56.6	-53.8	-52.6		-40.2	-27.00	13.21
	Non HT20 Beam Forming, 6 to 54 Mbps	4	10	-56.6	-53.8	-52.6	-54.2	-38.0	-27.00	11.00
	HT/VHT20, M0 to M7	1	4	-57.5				-53.4	-27.00	26.45
	HT/VHT20, M0 to M7	2	4	-57.5	-54.1			-48.4	-27.00	21.41
	HT/VHT20, M8 to M15	2	4	-57.5	-54.1			-48.4	-27.00	21.41
	HT/VHT20, M0 to M7	3	4	-57.5	-54.1	-52.8		-45.6	-27.00	18.57
	HT/VHT20, M8 to M15	3	4	-57.5	-54.1	-52.8		-45.6	-27.00	18.57
	HT/VHT20, M16 to M23	3	4	-57.5	-54.1	-52.8		-45.6	-27.00	18.57
	HT/VHT20, M0 to M7	4	4	-57.5	-54.1	-52.8	-53.8	-44.2	-27.00	17.16
	HT/VHT20, M8 to M15	4	4	-57.5	-54.1	-52.8	-53.8	-44.2	-27.00	17.16
	HT/VHT20, M16 to M23	4	4	-57.5	-54.1	-52.8	-53.8	-44.2	-27.00	17.16
	HT/VHT20, M24 to M31	4	4	-57.5	-54.1	-52.8	-53.8	-44.2	-27.00	17.16
	HT/VHT20 Beam Forming, M0 to M7	2	7	-57.5	-54.1			-45.4	-27.00	18.41
	HT/VHT20 Beam Forming, M8 to M15	2	4	-57.5	-54.1			-48.4	-27.00	21.41
HT/VHT20 Beam Forming, M0 to M7	3	9	-57.5	-54.1	-52.8		-40.6	-27.00	13.57	

	HT/VHT20 Beam Forming, M8 to M15	3	6	-57.5	-54.1	-52.8		-43.6	-27.00	16.57
	HT/VHT20 Beam Forming, M16 to M23	3	4	-57.5	-54.1	-52.8		-45.6	-27.00	18.57
	HT/VHT20 Beam Forming, M0 to M7	4	10	-57.5	-54.1	-52.8	-53.8	-38.2	-27.00	11.16
	HT/VHT20 Beam Forming, M8 to M15	4	7	-57.5	-54.1	-52.8	-53.8	-41.2	-27.00	14.16
	HT/VHT20 Beam Forming, M16 to M23	4	5	-57.5	-54.1	-52.8	-53.8	-43.2	-27.00	16.16
	HT/VHT20 Beam Forming, M24 to M31	4	4	-57.5	-54.1	-52.8	-53.8	-44.2	-27.00	17.16
	HT/VHT20 STBC, M0 to M7	2	4	-57.5	-54.1			-48.4	-27.00	21.41
	HT/VHT20 STBC, M0 to M7	3	4	-57.5	-54.1	-52.8		-45.6	-27.00	18.57
	HT/VHT20 STBC, M0 to M7	4	4	-57.5	-54.1	-52.8	-53.8	-44.2	-27.00	17.16
	HE20, M0 to M9 1ss	1	4	-57.1				-53.0	-27.00	26.03
	HE20, M0 to M9 1ss	2	4	-57.1	-53.8			-48.1	-27.00	21.07
	HE20, M0 to M9 2ss	2	4	-57.1	-53.8			-48.1	-27.00	21.07
	HE20, M0 to M9 1ss	3	4	-57.1	-53.8	-53.1		-45.5	-27.00	18.51
	HE20, M0 to M9 2ss	3	4	-57.1	-53.8	-53.1		-45.5	-27.00	18.51
	HE20, M0 to M9 3ss	3	4	-57.1	-53.8	-53.1		-45.5	-27.00	18.51
	HE20, M0 to M9 1ss	4	4	-57.1	-53.8	-53.1	-53.9	-44.1	-27.00	17.15
	HE20, M0 to M9 2ss	4	4	-57.1	-53.8	-53.1	-53.9	-44.1	-27.00	17.15
	HE20, M0 to M9 3ss	4	4	-57.1	-53.8	-53.1	-53.9	-44.1	-27.00	17.15
	HE20, M0 to M9 4ss	4	4	-57.1	-53.8	-53.1	-53.9	-44.1	-27.00	17.15
	HE20 Beam Forming, M0 to M9 1ss	2	7	-57.1	-53.8			-45.1	-27.00	18.07
	HE20 Beam Forming, M0 to M9 2ss	2	4	-57.1	-53.8			-48.1	-27.00	21.07
	HE20 Beam Forming, M0 to M9 1ss	3	9	-57.1	-53.8	-53.1		-40.5	-27.00	13.51
	HE20 Beam Forming, M0 to M9 2ss	3	6	-57.1	-53.8	-53.1		-43.5	-27.00	16.51
	HE20 Beam Forming, M0 to M9 3ss	3	4	-57.1	-53.8	-53.1		-45.5	-27.00	18.51
	HE20 Beam Forming, M0 to M9 1ss	4	10	-57.1	-53.8	-53.1	-53.9	-38.1	-27.00	11.15
	HE20 Beam Forming, M0 to M9 2ss	4	7	-57.1	-53.8	-53.1	-53.9	-41.1	-27.00	14.15
	HE20 Beam Forming, M0 to M9 3ss	4	5	-57.1	-53.8	-53.1	-53.9	-43.1	-27.00	16.15
	HE20 Beam Forming, M0 to M9 4ss	4	4	-57.1	-53.8	-53.1	-53.9	-44.1	-27.00	17.15
	HE20 STBC, M0 to M9 2ss	2	4	-57.1	-53.8			-48.1	-27.00	21.07
	HE20 STBC, M0 to M9 2ss	3	4	-57.1	-53.8	-53.1		-45.5	-27.00	18.51
	HE20 STBC, M0 to M9 2ss	4	4	-57.1	-53.8	-53.1	-53.9	-44.1	-27.00	17.15
5795	Non HT40, 6 to 54 Mbps	1	4	-56.7				-52.6	-27.00	25.65
	Non HT40, 6 to 54 Mbps	2	4	-56.7	-53.0			-47.4	-27.00	20.41
	Non HT40, 6 to 54 Mbps	3	4	-56.7	-53.0	-51.5		-44.4	-27.00	17.42
	Non HT40, 6 to 54 Mbps	4	4	-56.7	-53.0	-51.5	-53.3	-43.2	-27.00	16.18
	HT/VHT40, M0 to M7	1	4	-56.8				-52.7	-27.00	25.69
	HT/VHT40, M0 to M7	2	4	-56.8	-53.6			-47.8	-27.00	20.79
	HT/VHT40, M8 to M15	2	4	-56.8	-53.6			-47.8	-27.00	20.79
	HT/VHT40, M0 to M7	3	4	-56.8	-53.6	-52.2		-44.9	-27.00	17.93
	HT/VHT40, M8 to M15	3	4	-56.8	-53.6	-52.2		-44.9	-27.00	17.93
	HT/VHT40, M16 to M23	3	4	-56.8	-53.6	-52.2		-44.9	-27.00	17.93
	HT/VHT40, M0 to M7	4	4	-56.8	-53.6	-52.2	-53.8	-43.7	-27.00	16.68



	HT/VHT40, M8 to M15	4	4	-56.8	-53.6	-52.2	-53.8	-43.7	-27.00	16.68
	HT/VHT40, M16 to M23	4	4	-56.8	-53.6	-52.2	-53.8	-43.7	-27.00	16.68
	HT/VHT40, M24 to M31	4	4	-56.8	-53.6	-52.2	-53.8	-43.7	-27.00	16.68
	HT/VHT40 Beam Forming, M0 to M7	2	7	-56.8	-53.6			-44.8	-27.00	17.79
	HT/VHT40 Beam Forming, M8 to M15	2	4	-56.8	-53.6			-47.8	-27.00	20.79
	HT/VHT40 Beam Forming, M0 to M7	3	9	-56.8	-53.6	-52.2		-39.9	-27.00	12.93
	HT/VHT40 Beam Forming, M8 to M15	3	6	-56.8	-53.6	-52.2		-42.9	-27.00	15.93
	HT/VHT40 Beam Forming, M16 to M23	3	4	-56.8	-53.6	-52.2		-44.9	-27.00	17.93
	HT/VHT40 Beam Forming, M0 to M7	4	10	-56.8	-53.6	-52.2	-53.8	-37.7	-27.00	10.68
	HT/VHT40 Beam Forming, M8 to M15	4	7	-56.8	-53.6	-52.2	-53.8	-40.7	-27.00	13.68
	HT/VHT40 Beam Forming, M16 to M23	4	5	-56.8	-53.6	-52.2	-53.8	-42.7	-27.00	15.68
	HT/VHT40 Beam Forming, M24 to M31	4	4	-56.8	-53.6	-52.2	-53.8	-43.7	-27.00	16.68
	HT/VHT40 STBC, M0 to M7	2	4	-56.8	-53.6			-47.8	-27.00	20.79
	HT/VHT40 STBC, M0 to M7	3	4	-56.8	-53.6	-52.2		-44.9	-27.00	17.93
	HT/VHT40 STBC, M0 to M7	4	4	-56.8	-53.6	-52.2	-53.8	-43.7	-27.00	16.68
	HE40, M0 to M9 1ss	1	4	-57.0				-52.9	-27.00	25.87
	HE40, M0 to M9 1ss	2	4	-57.0	-53.2			-47.6	-27.00	20.56
	HE40, M0 to M9 2ss	2	4	-57.0	-53.2			-47.6	-27.00	20.56
	HE40, M0 to M9 1ss	3	4	-57.0	-53.2	-52.2		-44.8	-27.00	17.80
	HE40, M0 to M9 2ss	3	4	-57.0	-53.2	-52.2		-44.8	-27.00	17.80
	HE40, M0 to M9 3ss	3	4	-57.0	-53.2	-52.2		-44.8	-27.00	17.80
	HE40, M0 to M9 1ss	4	4	-57.0	-53.2	-52.2	-53.7	-43.6	-27.00	16.55
	HE40, M0 to M9 2ss	4	4	-57.0	-53.2	-52.2	-53.7	-43.6	-27.00	16.55
	HE40, M0 to M9 3ss	4	4	-57.0	-53.2	-52.2	-53.7	-43.6	-27.00	16.55
	HE40, M0 to M9 4ss	4	4	-57.0	-53.2	-52.2	-53.7	-43.6	-27.00	16.55
	HE40 Beam Forming, M0 to M9 1ss	2	7	-57.0	-53.2			-44.6	-27.00	17.56
	HE40 Beam Forming, M0 to M9 2ss	2	4	-57.0	-53.2			-47.6	-27.00	20.56
	HE40 Beam Forming, M0 to M9 1ss	3	9	-57.0	-53.2	-52.2		-39.8	-27.00	12.80
	HE40 Beam Forming, M0 to M9 2ss	3	6	-57.0	-53.2	-52.2		-42.8	-27.00	15.80
	HE40 Beam Forming, M0 to M9 3ss	3	4	-57.0	-53.2	-52.2		-44.8	-27.00	17.80
	HE40 Beam Forming, M0 to M9 1ss	4	10	-57.0	-53.2	-52.2	-53.7	-37.6	-27.00	10.55
	HE40 Beam Forming, M0 to M9 2ss	4	7	-57.0	-53.2	-52.2	-53.7	-40.6	-27.00	13.55
	HE40 Beam Forming, M0 to M9 3ss	4	5	-57.0	-53.2	-52.2	-53.7	-42.6	-27.00	15.55
	HE40 Beam Forming, M0 to M9 4ss	4	4	-57.0	-53.2	-52.2	-53.7	-43.6	-27.00	16.55
	HE40 STBC, M0 to M9 2ss	2	4	-57.0	-53.2			-47.6	-27.00	20.56
	HE40 STBC, M0 to M9 2ss	3	4	-57.0	-53.2	-52.2		-44.8	-27.00	17.80
	HE40 STBC, M0 to M9 2ss	4	4	-57.0	-53.2	-52.2	-53.7	-43.6	-27.00	16.55
5825	Non HT20, 6 to 54 Mbps	1	4	-56.6				-52.5	-27.00	25.55
	Non HT20, 6 to 54 Mbps	2	4	-56.6	-53.7			-47.9	-27.00	20.85
	Non HT20, 6 to 54 Mbps	3	4	-56.6	-53.7	-52.2		-45.0	-27.00	17.99
	Non HT20, 6 to 54 Mbps	4	4	-56.6	-53.7	-52.2	-53.3	-43.6	-27.00	16.61
	Non HT20 Beam Forming, 6 to 54 Mbps	2	7	-56.6	-53.7			-44.9	-27.00	17.85



Non HT20 Beam Forming, 6 to 54 Mbps	3	9	-56.6	-53.7	-52.2		-40.0	-27.00	12.99
Non HT20 Beam Forming, 6 to 54 Mbps	4	10	-56.6	-53.7	-52.2	-53.3	-37.6	-27.00	10.61
HT/VHT20, M0 to M7	1	4	-56.8				-52.7	-27.00	25.75
HT/VHT20, M0 to M7	2	4	-56.8	-53.9			-48.0	-27.00	21.05
HT/VHT20, M8 to M15	2	4	-56.8	-53.9			-48.0	-27.00	21.05
HT/VHT20, M0 to M7	3	4	-56.8	-53.9	-52.9		-45.4	-27.00	18.42
HT/VHT20, M8 to M15	3	4	-56.8	-53.9	-52.9		-45.4	-27.00	18.42
HT/VHT20, M16 to M23	3	4	-56.8	-53.9	-52.9		-45.4	-27.00	18.42
HT/VHT20, M0 to M7	4	4	-56.8	-53.9	-52.9	-53.8	-44.1	-27.00	17.06
HT/VHT20, M8 to M15	4	4	-56.8	-53.9	-52.9	-53.8	-44.1	-27.00	17.06
HT/VHT20, M16 to M23	4	4	-56.8	-53.9	-52.9	-53.8	-44.1	-27.00	17.06
HT/VHT20, M24 to M31	4	4	-56.8	-53.9	-52.9	-53.8	-44.1	-27.00	17.06
HT/VHT20 Beam Forming, M0 to M7	2	7	-56.8	-53.9			-45.0	-27.00	18.05
HT/VHT20 Beam Forming, M8 to M15	2	4	-56.8	-53.9			-48.0	-27.00	21.05
HT/VHT20 Beam Forming, M0 to M7	3	9	-56.8	-53.9	-52.9		-40.4	-27.00	13.42
HT/VHT20 Beam Forming, M8 to M15	3	6	-56.8	-53.9	-52.9		-43.4	-27.00	16.42
HT/VHT20 Beam Forming, M16 to M23	3	4	-56.8	-53.9	-52.9		-45.4	-27.00	18.42
HT/VHT20 Beam Forming, M0 to M7	4	10	-56.8	-53.9	-52.9	-53.8	-38.1	-27.00	11.06
HT/VHT20 Beam Forming, M8 to M15	4	7	-56.8	-53.9	-52.9	-53.8	-41.1	-27.00	14.06
HT/VHT20 Beam Forming, M16 to M23	4	5	-56.8	-53.9	-52.9	-53.8	-43.1	-27.00	16.06
HT/VHT20 Beam Forming, M24 to M31	4	4	-56.8	-53.9	-52.9	-53.8	-44.1	-27.00	17.06
HT/VHT20 STBC, M0 to M7	2	4	-56.8	-53.9			-48.0	-27.00	21.05
HT/VHT20 STBC, M0 to M7	3	4	-56.8	-53.9	-52.9		-45.4	-27.00	18.42
HT/VHT20 STBC, M0 to M7	4	4	-56.8	-53.9	-52.9	-53.8	-44.1	-27.00	17.06
HE20, M0 to M9 1ss	1	4	-57.1				-53.0	-27.00	26.03
HE20, M0 to M9 1ss	2	4	-57.1	-53.9			-48.1	-27.00	21.13
HE20, M0 to M9 2ss	2	4	-57.1	-53.9			-48.1	-27.00	21.13
HE20, M0 to M9 1ss	3	4	-57.1	-53.9	-52.6		-45.3	-27.00	18.32
HE20, M0 to M9 2ss	3	4	-57.1	-53.9	-52.6		-45.3	-27.00	18.32
HE20, M0 to M9 3ss	3	4	-57.1	-53.9	-52.6		-45.3	-27.00	18.32
HE20, M0 to M9 1ss	4	4	-57.1	-53.9	-52.6	-53.6	-43.9	-27.00	16.92
HE20, M0 to M9 2ss	4	4	-57.1	-53.9	-52.6	-53.6	-43.9	-27.00	16.92
HE20, M0 to M9 3ss	4	4	-57.1	-53.9	-52.6	-53.6	-43.9	-27.00	16.92
HE20, M0 to M9 4ss	4	4	-57.1	-53.9	-52.6	-53.6	-43.9	-27.00	16.92
HE20 Beam Forming, M0 to M9 1ss	2	7	-57.1	-53.9			-45.1	-27.00	18.13
HE20 Beam Forming, M0 to M9 2ss	2	4	-57.1	-53.9			-48.1	-27.00	21.13
HE20 Beam Forming, M0 to M9 1ss	3	9	-57.1	-53.9	-52.6		-40.3	-27.00	13.32
HE20 Beam Forming, M0 to M9 2ss	3	6	-57.1	-53.9	-52.6		-43.3	-27.00	16.32
HE20 Beam Forming, M0 to M9 3ss	3	4	-57.1	-53.9	-52.6		-45.3	-27.00	18.32
HE20 Beam Forming, M0 to M9 1ss	4	10	-57.1	-53.9	-52.6	-53.6	-37.9	-27.00	10.92
HE20 Beam Forming, M0 to M9 2ss	4	7	-57.1	-53.9	-52.6	-53.6	-40.9	-27.00	13.92
HE20 Beam Forming, M0 to M9 3ss	4	5	-57.1	-53.9	-52.6	-53.6	-42.9	-27.00	15.92
HE20 Beam Forming, M0 to M9 4ss	4	4	-57.1	-53.9	-52.6	-53.6	-43.9	-27.00	16.92



HE20 STBC, M0 to M9 2ss	2	4	-57.1	-53.9			-48.1	-27.00	21.13
HE20 STBC, M0 to M9 2ss	3	4	-57.1	-53.9	-52.6		-45.3	-27.00	18.32
HE20 STBC, M0 to M9 2ss	4	4	-57.1	-53.9	-52.6	-53.6	-43.9	-27.00	16.92

**Conducted Bandedge Peak 15407R, 4dBi  
5775 MHz, HE80 Beam Forming, M0 to M9 1ss**

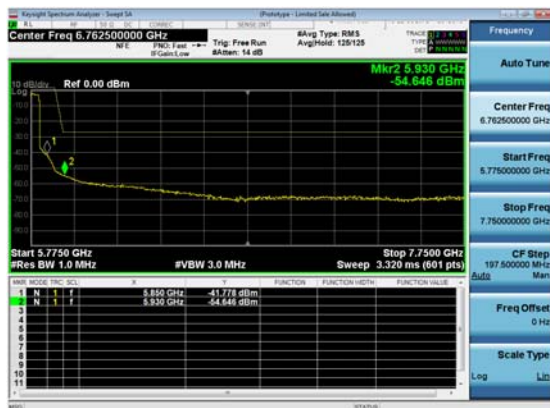

**Antenna A**

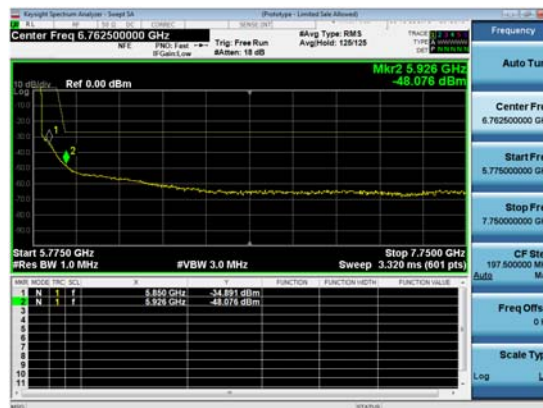

**Antenna B**

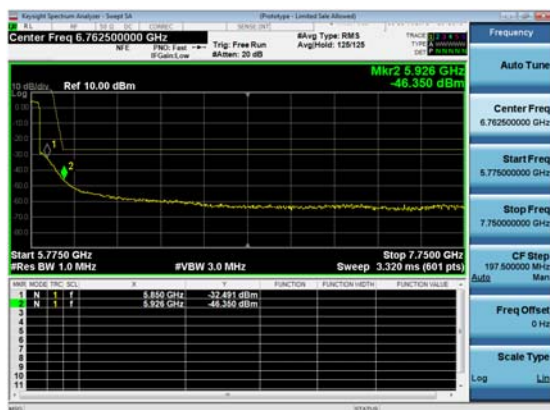

**Antenna C**

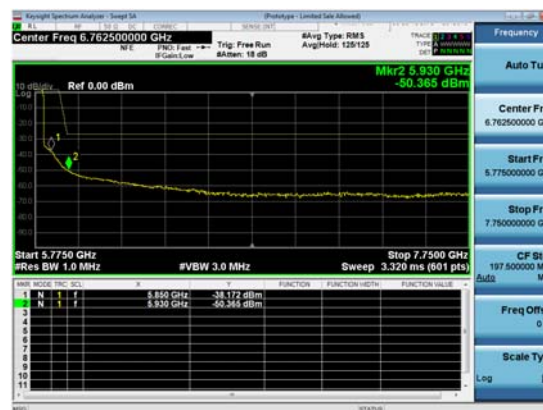

**Antenna D**

Conducted Bandedge Peak (Right Side), 5dBi

Frequency (MHz)	Mode	Tx Paths	Correlated Antenna Gain (dBi)	Tx 1 Bandedge Level (dBm)	Tx 2 Bandedge Level (dBm)	Tx 3 Bandedge Level (dBm)	Tx 4 Bandedge Level (dBm)	Total Tx Bandedge Level (dBm)	Limit (dBm)	Margin (dB)	
5775	Non HT80, 6 to 54 Mbps	1	5	-53.2				-48.2	-27.00	21.15	
	Non HT80, 6 to 54 Mbps	2	5	-53.2	-46.4			-40.5	-27.00	13.53	
	Non HT80, 6 to 54 Mbps	3	5	-53.2	-46.4	-44.7		-37.1	-27.00	10.06	
	Non HT80, 6 to 54 Mbps	4	5	-53.2	-46.4	-44.7	-49.4	-36.3	-27.00	9.31	
	VHT80, M0 to M9 1ss	1	5	-55.2				-50.0	-27.00	22.98	
	VHT80, M0 to M9 1ss	2	5	-55.2	-49.3			-43.1	-27.00	16.08	
	VHT80, M0 to M9 2ss	2	5	-55.2	-49.3			-43.1	-27.00	16.08	
	VHT80, M0 to M9 1ss	3	5	-55.2	-49.3	-48.0		-39.9	-27.00	12.92	
	VHT80, M0 to M9 2ss	3	5	-55.2	-49.3	-48.0		-39.9	-27.00	12.92	
	VHT80, M0 to M9 3ss	3	5	-55.2	-49.3	-48.0		-39.9	-27.00	12.92	
	VHT80, M0 to M9 1ss	4	5	-55.2	-49.3	-48.0	-51.0	-38.9	-27.00	11.91	
	VHT80, M0 to M9 2ss	4	5	-55.2	-49.3	-48.0	-51.0	-38.9	-27.00	11.91	
	VHT80, M0 to M9 3ss	4	5	-55.2	-49.3	-48.0	-51.0	-38.9	-27.00	11.91	
	VHT80, M0 to M9 4ss	4	5	-55.2	-49.3	-48.0	-51.0	-38.9	-27.00	11.91	
	VHT80 Beam Forming, M0 to M9 1ss	2	8	-55.2	-49.3				-40.1	-27.00	13.08
	VHT80 Beam Forming, M0 to M9 2ss	2	5	-55.2	-49.3				-43.1	-27.00	16.08
	VHT80 Beam Forming, M0 to M9 1ss	3	10	-55.2	-49.3	-48.0			-34.9	-27.00	7.92
	VHT80 Beam Forming, M0 to M9 2ss	3	7	-55.2	-49.3	-48.0			-37.9	-27.00	10.92
	VHT80 Beam Forming, M0 to M9 3ss	3	5	-55.2	-49.3	-48.0			-39.9	-27.00	12.92
	VHT80 Beam Forming, M0 to M9 1ss	4	11	-55.2	-49.3	-48.0	-51.0		-32.9	-27.00	5.91
	VHT80 Beam Forming, M0 to M9 2ss	4	8	-55.2	-49.3	-48.0	-51.0		-35.9	-27.00	8.91
	VHT80 Beam Forming, M0 to M9 3ss	4	6	-55.2	-49.3	-48.0	-51.0		-37.9	-27.00	10.91
	VHT80 Beam Forming, M0 to M9 4ss	4	5	-55.2	-49.3	-48.0	-51.0		-38.9	-27.00	11.91
	VHT80 STBC, M0 to M9 1ss	2	5	-55.2	-49.3				-43.1	-27.00	16.08
	VHT80 STBC, M0 to M9 1ss	3	5	-55.2	-49.3	-48.0			-39.9	-27.00	12.92
	VHT80 STBC, M0 to M9 1ss	4	5	-55.2	-49.3	-48.0	-51.0		-38.9	-27.00	11.91
	HE80, M0 to M9 1ss	1	5	-54.6					-49.4	-27.00	22.35
	HE80, M0 to M9 1ss	2	5	-54.6	-48.1				-42.0	-27.00	14.97

	HE80, M0 to M9 2ss	2	5	-54.6	-48.1			-42.0	-27.00	14.97
	HE80, M0 to M9 1ss	3	5	-54.6	-48.1	-46.4		-38.5	-27.00	11.53
	HE80, M0 to M9 2ss	3	5	-54.6	-48.1	-46.4		-38.5	-27.00	11.53
	HE80, M0 to M9 3ss	3	5	-54.6	-48.1	-46.4		-38.5	-27.00	11.53
	HE80, M0 to M9 1ss	4	5	-54.6	-48.1	-46.4	-50.4	-37.7	-27.00	10.68
	HE80, M0 to M9 2ss	4	5	-54.6	-48.1	-46.4	-50.4	-37.7	-27.00	10.68
	HE80, M0 to M9 3ss	4	5	-54.6	-48.1	-46.4	-50.4	-37.7	-27.00	10.68
	HE80, M0 to M9 4ss	4	5	-54.6	-48.1	-46.4	-50.4	-37.7	-27.00	10.68
	HE80 Beam Forming, M0 to M9 1ss	2	8	-54.6	-48.1			-39.0	-27.00	11.97
	HE80 Beam Forming, M0 to M9 2ss	2	5	-54.6	-48.1			-42.0	-27.00	14.97
	HE80 Beam Forming, M0 to M9 1ss	3	10	-54.6	-48.1	-46.4		-33.5	-27.00	6.53
	HE80 Beam Forming, M0 to M9 2ss	3	7	-54.6	-48.1	-46.4		-36.5	-27.00	9.53
	HE80 Beam Forming, M0 to M9 3ss	3	5	-54.6	-48.1	-46.4		-38.5	-27.00	11.53
	<b>HE80 Beam Forming, M0 to M9 1ss</b>	<b>4</b>	<b>11</b>	<b>-54.6</b>	<b>-48.1</b>	<b>-46.4</b>	<b>-50.4</b>	<b>-31.7</b>	<b>-27.00</b>	<b>4.68</b>
	HE80 Beam Forming, M0 to M9 2ss	4	8	-54.6	-48.1	-46.4	-50.4	-34.7	-27.00	7.68
	HE80 Beam Forming, M0 to M9 3ss	4	6	-54.6	-48.1	-46.4	-50.4	-36.7	-27.00	9.68
	HE80 Beam Forming, M0 to M9 4ss	4	5	-54.6	-48.1	-46.4	-50.4	-37.7	-27.00	10.68
	HE80 STBC, M0 to M9 1ss	2	5	-54.6	-48.1			-42.0	-27.00	14.97
	HE80 STBC, M0 to M9 1ss	3	5	-54.6	-48.1	-46.4		-38.5	-27.00	11.53
	HE80 STBC, M0 to M9 1ss	4	5	-54.6	-48.1	-46.4	-50.4	-37.7	-27.00	10.68
5785	Non HT20, 6 to 54 Mbps	1	5	-56.6				-51.5	-27.00	24.55
	Non HT20, 6 to 54 Mbps	2	5	-56.6	-53.8			-46.9	-27.00	19.92
	Non HT20, 6 to 54 Mbps	3	5	-56.6	-53.8	-52.6		-44.2	-27.00	17.21
	Non HT20, 6 to 54 Mbps	4	5	-56.6	-53.8	-52.6	-54.2	-43.0	-27.00	16.00
	Non HT20 Beam Forming, 6 to 54 Mbps	2	8	-56.6	-53.8			-43.9	-27.00	16.92
	Non HT20 Beam Forming, 6 to 54 Mbps	3	10	-56.6	-53.8	-52.6		-39.2	-27.00	12.21
	Non HT20 Beam Forming, 6 to 54 Mbps	4	11	-56.6	-53.8	-52.6	-54.2	-37.0	-27.00	10.00
	HT/VHT20, M0 to M7	1	5	-57.5				-52.4	-27.00	25.45
	HT/VHT20, M0 to M7	2	5	-57.5	-54.1			-47.4	-27.00	20.41
	HT/VHT20, M8 to M15	2	5	-57.5	-54.1			-47.4	-27.00	20.41
	HT/VHT20, M0 to M7	3	5	-57.5	-54.1	-52.8		-44.6	-27.00	17.57
	HT/VHT20, M8 to M15	3	5	-57.5	-54.1	-52.8		-44.6	-27.00	17.57
	HT/VHT20, M16 to M23	3	5	-57.5	-54.1	-52.8		-44.6	-27.00	17.57
	HT/VHT20, M0 to M7	4	5	-57.5	-54.1	-52.8	-53.8	-43.2	-27.00	16.16
	HT/VHT20, M8 to M15	4	5	-57.5	-54.1	-52.8	-53.8	-43.2	-27.00	16.16
	HT/VHT20, M16 to M23	4	5	-57.5	-54.1	-52.8	-53.8	-43.2	-27.00	16.16
	HT/VHT20, M24 to M31	4	5	-57.5	-54.1	-52.8	-53.8	-43.2	-27.00	16.16
	HT/VHT20 Beam Forming, M0 to M7	2	8	-57.5	-54.1			-44.4	-27.00	17.41
	HT/VHT20 Beam Forming, M8 to M15	2	5	-57.5	-54.1			-47.4	-27.00	20.41
	HT/VHT20 Beam Forming, M0 to M7	3	10	-57.5	-54.1	-52.8		-39.6	-27.00	12.57
HT/VHT20 Beam Forming, M8 to M15	3	7	-57.5	-54.1	-52.8		-42.6	-27.00	15.57	
HT/VHT20 Beam Forming, M16 to M23	3	5	-57.5	-54.1	-52.8		-44.6	-27.00	17.57	

	HT/VHT20 Beam Forming, M0 to M7	4	11	-57.5	-54.1	-52.8	-53.8	-37.2	-27.00	10.16
	HT/VHT20 Beam Forming, M8 to M15	4	8	-57.5	-54.1	-52.8	-53.8	-40.2	-27.00	13.16
	HT/VHT20 Beam Forming, M16 to M23	4	6	-57.5	-54.1	-52.8	-53.8	-42.2	-27.00	15.16
	HT/VHT20 Beam Forming, M24 to M31	4	5	-57.5	-54.1	-52.8	-53.8	-43.2	-27.00	16.16
	HT/VHT20 STBC, M0 to M7	2	5	-57.5	-54.1			-47.4	-27.00	20.41
	HT/VHT20 STBC, M0 to M7	3	5	-57.5	-54.1	-52.8		-44.6	-27.00	17.57
	HT/VHT20 STBC, M0 to M7	4	5	-57.5	-54.1	-52.8	-53.8	-43.2	-27.00	16.16
	HE20, M0 to M9 1ss	1	5	-57.1				-52.0	-27.00	25.03
	HE20, M0 to M9 1ss	2	5	-57.1	-53.8			-47.1	-27.00	20.07
	HE20, M0 to M9 2ss	2	5	-57.1	-53.8			-47.1	-27.00	20.07
	HE20, M0 to M9 1ss	3	5	-57.1	-53.8	-53.1		-44.5	-27.00	17.51
	HE20, M0 to M9 2ss	3	5	-57.1	-53.8	-53.1		-44.5	-27.00	17.51
	HE20, M0 to M9 3ss	3	5	-57.1	-53.8	-53.1		-44.5	-27.00	17.51
	HE20, M0 to M9 1ss	4	5	-57.1	-53.8	-53.1	-53.9	-43.1	-27.00	16.15
	HE20, M0 to M9 2ss	4	5	-57.1	-53.8	-53.1	-53.9	-43.1	-27.00	16.15
	HE20, M0 to M9 3ss	4	5	-57.1	-53.8	-53.1	-53.9	-43.1	-27.00	16.15
	HE20, M0 to M9 4ss	4	5	-57.1	-53.8	-53.1	-53.9	-43.1	-27.00	16.15
	HE20 Beam Forming, M0 to M9 1ss	2	8	-57.1	-53.8			-44.1	-27.00	17.07
	HE20 Beam Forming, M0 to M9 2ss	2	5	-57.1	-53.8			-47.1	-27.00	20.07
	HE20 Beam Forming, M0 to M9 1ss	3	10	-57.1	-53.8	-53.1		-39.5	-27.00	12.51
	HE20 Beam Forming, M0 to M9 2ss	3	7	-57.1	-53.8	-53.1		-42.5	-27.00	15.51
	HE20 Beam Forming, M0 to M9 3ss	3	5	-57.1	-53.8	-53.1		-44.5	-27.00	17.51
	HE20 Beam Forming, M0 to M9 1ss	4	11	-57.1	-53.8	-53.1	-53.9	-37.1	-27.00	10.15
	HE20 Beam Forming, M0 to M9 2ss	4	8	-57.1	-53.8	-53.1	-53.9	-40.1	-27.00	13.15
	HE20 Beam Forming, M0 to M9 3ss	4	6	-57.1	-53.8	-53.1	-53.9	-42.1	-27.00	15.15
	HE20 Beam Forming, M0 to M9 4ss	4	5	-57.1	-53.8	-53.1	-53.9	-43.1	-27.00	16.15
	HE20 STBC, M0 to M9 2ss	2	5	-57.1	-53.8			-47.1	-27.00	20.07
	HE20 STBC, M0 to M9 2ss	3	5	-57.1	-53.8	-53.1		-44.5	-27.00	17.51
	HE20 STBC, M0 to M9 2ss	4	5	-57.1	-53.8	-53.1	-53.9	-43.1	-27.00	16.15
5795	Non HT40, 6 to 54 Mbps	1	5	-56.7				-51.6	-27.00	24.65
	Non HT40, 6 to 54 Mbps	2	5	-56.7	-53.0			-46.4	-27.00	19.41
	Non HT40, 6 to 54 Mbps	3	5	-56.7	-53.0	-51.5		-43.4	-27.00	16.42
	Non HT40, 6 to 54 Mbps	4	5	-56.7	-53.0	-51.5	-53.3	-42.2	-27.00	15.18
	HT/VHT40, M0 to M7	1	5	-56.8				-51.7	-27.00	24.69
	HT/VHT40, M0 to M7	2	5	-56.8	-53.6			-46.8	-27.00	19.79
	HT/VHT40, M8 to M15	2	5	-56.8	-53.6			-46.8	-27.00	19.79
	HT/VHT40, M0 to M7	3	5	-56.8	-53.6	-52.2		-43.9	-27.00	16.93
	HT/VHT40, M8 to M15	3	5	-56.8	-53.6	-52.2		-43.9	-27.00	16.93
	HT/VHT40, M16 to M23	3	5	-56.8	-53.6	-52.2		-43.9	-27.00	16.93
	HT/VHT40, M0 to M7	4	5	-56.8	-53.6	-52.2	-53.8	-42.7	-27.00	15.68
	HT/VHT40, M8 to M15	4	5	-56.8	-53.6	-52.2	-53.8	-42.7	-27.00	15.68
	HT/VHT40, M16 to M23	4	5	-56.8	-53.6	-52.2	-53.8	-42.7	-27.00	15.68

	HT/VHT40, M24 to M31	4	5	-56.8	-53.6	-52.2	-53.8	-42.7	-27.00	15.68
	HT/VHT40 Beam Forming, M0 to M7	2	8	-56.8	-53.6			-43.8	-27.00	16.79
	HT/VHT40 Beam Forming, M8 to M15	2	5	-56.8	-53.6			-46.8	-27.00	19.79
	HT/VHT40 Beam Forming, M0 to M7	3	10	-56.8	-53.6	-52.2		-38.9	-27.00	11.93
	HT/VHT40 Beam Forming, M8 to M15	3	7	-56.8	-53.6	-52.2		-41.9	-27.00	14.93
	HT/VHT40 Beam Forming, M16 to M23	3	5	-56.8	-53.6	-52.2		-43.9	-27.00	16.93
	HT/VHT40 Beam Forming, M0 to M7	4	11	-56.8	-53.6	-52.2	-53.8	-36.7	-27.00	9.68
	HT/VHT40 Beam Forming, M8 to M15	4	8	-56.8	-53.6	-52.2	-53.8	-39.7	-27.00	12.68
	HT/VHT40 Beam Forming, M16 to M23	4	6	-56.8	-53.6	-52.2	-53.8	-41.7	-27.00	14.68
	HT/VHT40 Beam Forming, M24 to M31	4	5	-56.8	-53.6	-52.2	-53.8	-42.7	-27.00	15.68
	HT/VHT40 STBC, M0 to M7	2	5	-56.8	-53.6			-46.8	-27.00	19.79
	HT/VHT40 STBC, M0 to M7	3	5	-56.8	-53.6	-52.2		-43.9	-27.00	16.93
	HT/VHT40 STBC, M0 to M7	4	5	-56.8	-53.6	-52.2	-53.8	-42.7	-27.00	15.68
	HE40, M0 to M9 1ss	1	5	-57.0				-51.9	-27.00	24.87
	HE40, M0 to M9 1ss	2	5	-57.0	-53.2			-46.6	-27.00	19.56
	HE40, M0 to M9 2ss	2	5	-57.0	-53.2			-46.6	-27.00	19.56
	HE40, M0 to M9 1ss	3	5	-57.0	-53.2	-52.2		-43.8	-27.00	16.80
	HE40, M0 to M9 2ss	3	5	-57.0	-53.2	-52.2		-43.8	-27.00	16.80
	HE40, M0 to M9 3ss	3	5	-57.0	-53.2	-52.2		-43.8	-27.00	16.80
	HE40, M0 to M9 1ss	4	5	-57.0	-53.2	-52.2	-53.7	-42.6	-27.00	15.55
	HE40, M0 to M9 2ss	4	5	-57.0	-53.2	-52.2	-53.7	-42.6	-27.00	15.55
	HE40, M0 to M9 3ss	4	5	-57.0	-53.2	-52.2	-53.7	-42.6	-27.00	15.55
	HE40, M0 to M9 4ss	4	5	-57.0	-53.2	-52.2	-53.7	-42.6	-27.00	15.55
	HE40 Beam Forming, M0 to M9 1ss	2	8	-57.0	-53.2			-43.6	-27.00	16.56
	HE40 Beam Forming, M0 to M9 2ss	2	5	-57.0	-53.2			-46.6	-27.00	19.56
	HE40 Beam Forming, M0 to M9 1ss	3	10	-57.0	-53.2	-52.2		-38.8	-27.00	11.80
	HE40 Beam Forming, M0 to M9 2ss	3	7	-57.0	-53.2	-52.2		-41.8	-27.00	14.80
	HE40 Beam Forming, M0 to M9 3ss	3	5	-57.0	-53.2	-52.2		-43.8	-27.00	16.80
	HE40 Beam Forming, M0 to M9 1ss	4	11	-57.0	-53.2	-52.2	-53.7	-36.6	-27.00	9.55
	HE40 Beam Forming, M0 to M9 2ss	4	8	-57.0	-53.2	-52.2	-53.7	-39.6	-27.00	12.55
	HE40 Beam Forming, M0 to M9 3ss	4	6	-57.0	-53.2	-52.2	-53.7	-41.6	-27.00	14.55
	HE40 Beam Forming, M0 to M9 4ss	4	5	-57.0	-53.2	-52.2	-53.7	-42.6	-27.00	15.55
	HE40 STBC, M0 to M9 2ss	2	5	-57.0	-53.2			-46.6	-27.00	19.56
	HE40 STBC, M0 to M9 2ss	3	5	-57.0	-53.2	-52.2		-43.8	-27.00	16.80
	HE40 STBC, M0 to M9 2ss	4	5	-57.0	-53.2	-52.2	-53.7	-42.6	-27.00	15.55
5825	Non HT20, 6 to 54 Mbps	1	5	-56.6				-51.5	-27.00	24.55
	Non HT20, 6 to 54 Mbps	2	5	-56.6	-53.7			-46.9	-27.00	19.85
	Non HT20, 6 to 54 Mbps	3	5	-56.6	-53.7	-52.2		-44.0	-27.00	16.99
	Non HT20, 6 to 54 Mbps	4	5	-56.6	-53.7	-52.2	-53.3	-42.6	-27.00	15.61
	Non HT20 Beam Forming, 6 to 54 Mbps	2	8	-56.6	-53.7			-43.9	-27.00	16.85
	Non HT20 Beam Forming, 6 to 54 Mbps	3	10	-56.6	-53.7	-52.2		-39.0	-27.00	11.99
	Non HT20 Beam Forming, 6 to 54 Mbps	4	11	-56.6	-53.7	-52.2	-53.3	-36.6	-27.00	9.61



HT/VHT20, M0 to M7	1	5	-56.8				-51.7	-27.00	24.75
HT/VHT20, M0 to M7	2	5	-56.8	-53.9			-47.0	-27.00	20.05
HT/VHT20, M8 to M15	2	5	-56.8	-53.9			-47.0	-27.00	20.05
HT/VHT20, M0 to M7	3	5	-56.8	-53.9	-52.9		-44.4	-27.00	17.42
HT/VHT20, M8 to M15	3	5	-56.8	-53.9	-52.9		-44.4	-27.00	17.42
HT/VHT20, M16 to M23	3	5	-56.8	-53.9	-52.9		-44.4	-27.00	17.42
HT/VHT20, M0 to M7	4	5	-56.8	-53.9	-52.9	-53.8	-43.1	-27.00	16.06
HT/VHT20, M8 to M15	4	5	-56.8	-53.9	-52.9	-53.8	-43.1	-27.00	16.06
HT/VHT20, M16 to M23	4	5	-56.8	-53.9	-52.9	-53.8	-43.1	-27.00	16.06
HT/VHT20, M24 to M31	4	5	-56.8	-53.9	-52.9	-53.8	-43.1	-27.00	16.06
HT/VHT20 Beam Forming, M0 to M7	2	8	-56.8	-53.9			-44.0	-27.00	17.05
HT/VHT20 Beam Forming, M8 to M15	2	5	-56.8	-53.9			-47.0	-27.00	20.05
HT/VHT20 Beam Forming, M0 to M7	3	10	-56.8	-53.9	-52.9		-39.4	-27.00	12.42
HT/VHT20 Beam Forming, M8 to M15	3	7	-56.8	-53.9	-52.9		-42.4	-27.00	15.42
HT/VHT20 Beam Forming, M16 to M23	3	5	-56.8	-53.9	-52.9		-44.4	-27.00	17.42
HT/VHT20 Beam Forming, M0 to M7	4	11	-56.8	-53.9	-52.9	-53.8	-37.1	-27.00	10.06
HT/VHT20 Beam Forming, M8 to M15	4	8	-56.8	-53.9	-52.9	-53.8	-40.1	-27.00	13.06
HT/VHT20 Beam Forming, M16 to M23	4	6	-56.8	-53.9	-52.9	-53.8	-42.1	-27.00	15.06
HT/VHT20 Beam Forming, M24 to M31	4	5	-56.8	-53.9	-52.9	-53.8	-43.1	-27.00	16.06
HT/VHT20 STBC, M0 to M7	2	5	-56.8	-53.9			-47.0	-27.00	20.05
HT/VHT20 STBC, M0 to M7	3	5	-56.8	-53.9	-52.9		-44.4	-27.00	17.42
HT/VHT20 STBC, M0 to M7	4	5	-56.8	-53.9	-52.9	-53.8	-43.1	-27.00	16.06
HE20, M0 to M9 1ss	1	5	-57.1				-52.0	-27.00	25.03
HE20, M0 to M9 1ss	2	5	-57.1	-53.9			-47.1	-27.00	20.13
HE20, M0 to M9 2ss	2	5	-57.1	-53.9			-47.1	-27.00	20.13
HE20, M0 to M9 1ss	3	5	-57.1	-53.9	-52.6		-44.3	-27.00	17.32
HE20, M0 to M9 2ss	3	5	-57.1	-53.9	-52.6		-44.3	-27.00	17.32
HE20, M0 to M9 3ss	3	5	-57.1	-53.9	-52.6		-44.3	-27.00	17.32
HE20, M0 to M9 1ss	4	5	-57.1	-53.9	-52.6	-53.6	-42.9	-27.00	15.92
HE20, M0 to M9 2ss	4	5	-57.1	-53.9	-52.6	-53.6	-42.9	-27.00	15.92
HE20, M0 to M9 3ss	4	5	-57.1	-53.9	-52.6	-53.6	-42.9	-27.00	15.92
HE20, M0 to M9 4ss	4	5	-57.1	-53.9	-52.6	-53.6	-42.9	-27.00	15.92
HE20 Beam Forming, M0 to M9 1ss	2	8	-57.1	-53.9			-44.1	-27.00	17.13
HE20 Beam Forming, M0 to M9 2ss	2	5	-57.1	-53.9			-47.1	-27.00	20.13
HE20 Beam Forming, M0 to M9 1ss	3	10	-57.1	-53.9	-52.6		-39.3	-27.00	12.32
HE20 Beam Forming, M0 to M9 2ss	3	7	-57.1	-53.9	-52.6		-42.3	-27.00	15.32
HE20 Beam Forming, M0 to M9 3ss	3	5	-57.1	-53.9	-52.6		-44.3	-27.00	17.32
HE20 Beam Forming, M0 to M9 1ss	4	11	-57.1	-53.9	-52.6	-53.6	-36.9	-27.00	9.92
HE20 Beam Forming, M0 to M9 2ss	4	8	-57.1	-53.9	-52.6	-53.6	-39.9	-27.00	12.92
HE20 Beam Forming, M0 to M9 3ss	4	6	-57.1	-53.9	-52.6	-53.6	-41.9	-27.00	14.92
HE20 Beam Forming, M0 to M9 4ss	4	5	-57.1	-53.9	-52.6	-53.6	-42.9	-27.00	15.92
HE20 STBC, M0 to M9 2ss	2	5	-57.1	-53.9			-47.1	-27.00	20.13
HE20 STBC, M0 to M9 2ss	3	5	-57.1	-53.9	-52.6		-44.3	-27.00	17.32



HE20 STBC, M0 to M9 2ss	4	5	-57.1	-53.9	-52.6	-53.6	-42.9	-27.00	15.92
-------------------------	---	---	-------	-------	-------	-------	-------	--------	-------

**Conducted Bandedge Peak 15407R, 5dBi  
5775 MHz, HE80 Beam Forming, M0 to M9 1ss**

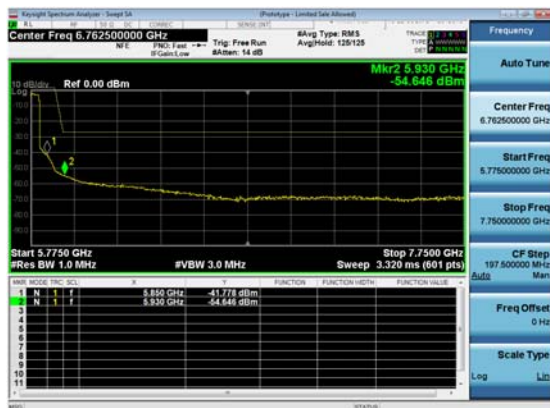

**Antenna A**

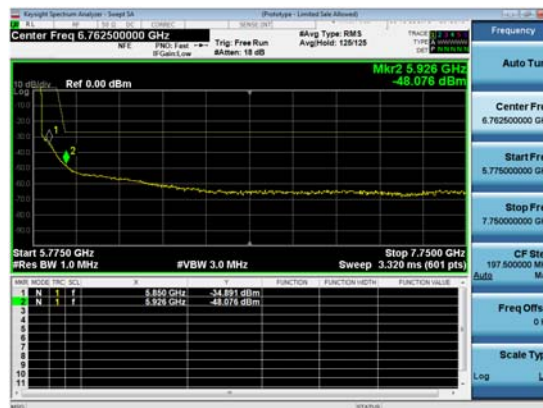

**Antenna B**

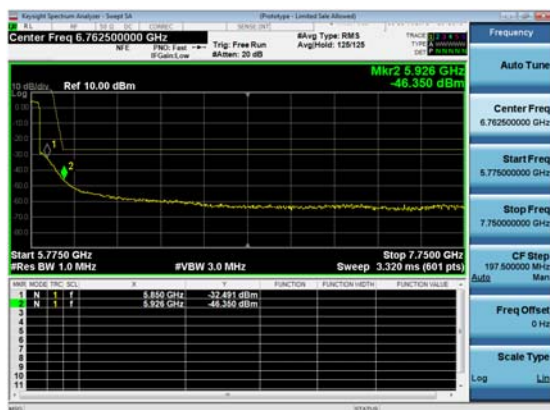

**Antenna C**

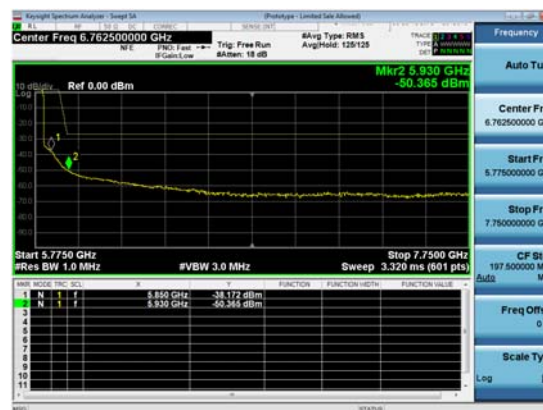

**Antenna D**

Conducted Bandedge Peak (Right Side), 6dBi

Frequency (MHz)	Mode	Tx Paths	Correlated Antenna Gain (dBi)	Tx 1 Bandedge Level (dBm)	Tx 2 Bandedge Level (dBm)	Tx 3 Bandedge Level (dBm)	Tx 4 Bandedge Level (dBm)	Total Tx Bandedge Level (dBm)	Limit (dBm)	Margin (dB)	
5775	Non HT80, 6 to 54 Mbps	1	6	-53.2				-47.2	-27.00	20.15	
	Non HT80, 6 to 54 Mbps	2	6	-53.2	-46.4			-39.5	-27.00	12.53	
	Non HT80, 6 to 54 Mbps	3	6	-53.2	-46.4	-44.7		-36.1	-27.00	9.06	
	Non HT80, 6 to 54 Mbps	4	6	-53.2	-46.4	-44.7	-49.4	-35.3	-27.00	8.31	
	VHT80, M0 to M9 1ss	1	6	-55.2				-49.0	-27.00	21.98	
	VHT80, M0 to M9 1ss	2	6	-55.2	-49.3			-42.1	-27.00	15.08	
	VHT80, M0 to M9 2ss	2	6	-55.2	-49.3			-42.1	-27.00	15.08	
	VHT80, M0 to M9 1ss	3	6	-55.2	-49.3	-48.0		-38.9	-27.00	11.92	
	VHT80, M0 to M9 2ss	3	6	-55.2	-49.3	-48.0		-38.9	-27.00	11.92	
	VHT80, M0 to M9 3ss	3	6	-55.2	-49.3	-48.0		-38.9	-27.00	11.92	
	VHT80, M0 to M9 1ss	4	6	-55.2	-49.3	-48.0	-51.0	-37.9	-27.00	10.91	
	VHT80, M0 to M9 2ss	4	6	-55.2	-49.3	-48.0	-51.0	-37.9	-27.00	10.91	
	VHT80, M0 to M9 3ss	4	6	-55.2	-49.3	-48.0	-51.0	-37.9	-27.00	10.91	
	VHT80, M0 to M9 4ss	4	6	-55.2	-49.3	-48.0	-51.0	-37.9	-27.00	10.91	
	VHT80 Beam Forming, M0 to M9 1ss	2	9	-55.2	-49.3				-39.1	-27.00	12.08
	VHT80 Beam Forming, M0 to M9 2ss	2	6	-55.2	-49.3				-42.1	-27.00	15.08
	VHT80 Beam Forming, M0 to M9 1ss	3	11	-55.2	-49.3	-48.0			-33.9	-27.00	6.92
	VHT80 Beam Forming, M0 to M9 2ss	3	8	-55.2	-49.3	-48.0			-36.9	-27.00	9.92
	VHT80 Beam Forming, M0 to M9 3ss	3	6	-55.2	-49.3	-48.0			-38.9	-27.00	11.92
	VHT80 Beam Forming, M0 to M9 1ss	4	12	-55.2	-49.3	-48.0	-51.0		-31.9	-27.00	4.91
	VHT80 Beam Forming, M0 to M9 2ss	4	9	-55.2	-49.3	-48.0	-51.0		-34.9	-27.00	7.91
	VHT80 Beam Forming, M0 to M9 3ss	4	7	-55.2	-49.3	-48.0	-51.0		-36.9	-27.00	9.91
	VHT80 Beam Forming, M0 to M9 4ss	4	6	-55.2	-49.3	-48.0	-51.0		-37.9	-27.00	10.91
	VHT80 STBC, M0 to M9 1ss	2	6	-55.2	-49.3				-42.1	-27.00	15.08
	VHT80 STBC, M0 to M9 1ss	3	6	-55.2	-49.3	-48.0			-38.9	-27.00	11.92
	VHT80 STBC, M0 to M9 1ss	4	6	-55.2	-49.3	-48.0	-51.0		-37.9	-27.00	10.91
	HE80, M0 to M9 1ss	1	6	-54.6					-48.4	-27.00	21.35
	HE80, M0 to M9 1ss	2	6	-54.6	-48.1				-41.0	-27.00	13.97

	HE80, M0 to M9 2ss	2	6	-54.6	-48.1			-41.0	-27.00	13.97
	HE80, M0 to M9 1ss	3	6	-54.6	-48.1	-46.4		-37.5	-27.00	10.53
	HE80, M0 to M9 2ss	3	6	-54.6	-48.1	-46.4		-37.5	-27.00	10.53
	HE80, M0 to M9 3ss	3	6	-54.6	-48.1	-46.4		-37.5	-27.00	10.53
	HE80, M0 to M9 1ss	4	6	-54.6	-48.1	-46.4	-50.4	-36.7	-27.00	9.68
	HE80, M0 to M9 2ss	4	6	-54.6	-48.1	-46.4	-50.4	-36.7	-27.00	9.68
	HE80, M0 to M9 3ss	4	6	-54.6	-48.1	-46.4	-50.4	-36.7	-27.00	9.68
	HE80, M0 to M9 4ss	4	6	-54.6	-48.1	-46.4	-50.4	-36.7	-27.00	9.68
	HE80 Beam Forming, M0 to M9 1ss	2	9	-54.6	-48.1			-38.0	-27.00	10.97
	HE80 Beam Forming, M0 to M9 2ss	2	6	-54.6	-48.1			-41.0	-27.00	13.97
	HE80 Beam Forming, M0 to M9 1ss	3	11	-54.6	-48.1	-46.4		-32.5	-27.00	5.53
	HE80 Beam Forming, M0 to M9 2ss	3	8	-54.6	-48.1	-46.4		-35.5	-27.00	8.53
	HE80 Beam Forming, M0 to M9 3ss	3	6	-54.6	-48.1	-46.4		-37.5	-27.00	10.53
	<b>HE80 Beam Forming, M0 to M9 1ss</b>	<b>4</b>	<b>12</b>	<b>-54.6</b>	<b>-48.1</b>	<b>-46.4</b>	<b>-50.4</b>	<b>-30.7</b>	<b>-27.00</b>	<b>3.68</b>
	HE80 Beam Forming, M0 to M9 2ss	4	9	-54.6	-48.1	-46.4	-50.4	-33.7	-27.00	6.68
	HE80 Beam Forming, M0 to M9 3ss	4	7	-54.6	-48.1	-46.4	-50.4	-35.7	-27.00	8.68
	HE80 Beam Forming, M0 to M9 4ss	4	6	-54.6	-48.1	-46.4	-50.4	-36.7	-27.00	9.68
	HE80 STBC, M0 to M9 1ss	2	6	-54.6	-48.1			-41.0	-27.00	13.97
	HE80 STBC, M0 to M9 1ss	3	6	-54.6	-48.1	-46.4		-37.5	-27.00	10.53
	HE80 STBC, M0 to M9 1ss	4	6	-54.6	-48.1	-46.4	-50.4	-36.7	-27.00	9.68
5785	Non HT20, 6 to 54 Mbps	1	6	-56.6				-50.5	-27.00	23.55
	Non HT20, 6 to 54 Mbps	2	6	-56.6	-53.8			-45.9	-27.00	18.92
	Non HT20, 6 to 54 Mbps	3	6	-56.6	-53.8	-52.6		-43.2	-27.00	16.21
	Non HT20, 6 to 54 Mbps	4	6	-56.6	-53.8	-52.6	-54.2	-42.0	-27.00	15.00
	Non HT20 Beam Forming, 6 to 54 Mbps	2	9	-56.6	-53.8			-42.9	-27.00	15.92
	Non HT20 Beam Forming, 6 to 54 Mbps	3	11	-56.6	-53.8	-52.6		-38.2	-27.00	11.21
	Non HT20 Beam Forming, 6 to 54 Mbps	4	12	-56.6	-53.8	-52.6	-54.2	-36.0	-27.00	9.00
	HT/VHT20, M0 to M7	1	6	-57.5				-51.4	-27.00	24.45
	HT/VHT20, M0 to M7	2	6	-57.5	-54.1			-46.4	-27.00	19.41
	HT/VHT20, M8 to M15	2	6	-57.5	-54.1			-46.4	-27.00	19.41
	HT/VHT20, M0 to M7	3	6	-57.5	-54.1	-52.8		-43.6	-27.00	16.57
	HT/VHT20, M8 to M15	3	6	-57.5	-54.1	-52.8		-43.6	-27.00	16.57
	HT/VHT20, M16 to M23	3	6	-57.5	-54.1	-52.8		-43.6	-27.00	16.57
	HT/VHT20, M0 to M7	4	6	-57.5	-54.1	-52.8	-53.8	-42.2	-27.00	15.16
	HT/VHT20, M8 to M15	4	6	-57.5	-54.1	-52.8	-53.8	-42.2	-27.00	15.16
	HT/VHT20, M16 to M23	4	6	-57.5	-54.1	-52.8	-53.8	-42.2	-27.00	15.16
	HT/VHT20, M24 to M31	4	6	-57.5	-54.1	-52.8	-53.8	-42.2	-27.00	15.16
	HT/VHT20 Beam Forming, M0 to M7	2	9	-57.5	-54.1			-43.4	-27.00	16.41
	HT/VHT20 Beam Forming, M8 to M15	2	6	-57.5	-54.1			-46.4	-27.00	19.41
	HT/VHT20 Beam Forming, M0 to M7	3	11	-57.5	-54.1	-52.8		-38.6	-27.00	11.57
HT/VHT20 Beam Forming, M8 to M15	3	8	-57.5	-54.1	-52.8		-41.6	-27.00	14.57	
HT/VHT20 Beam Forming, M16 to M23	3	6	-57.5	-54.1	-52.8		-43.6	-27.00	16.57	

	HT/VHT20 Beam Forming, M0 to M7	4	12	-57.5	-54.1	-52.8	-53.8	-36.2	-27.00	9.16
	HT/VHT20 Beam Forming, M8 to M15	4	9	-57.5	-54.1	-52.8	-53.8	-39.2	-27.00	12.16
	HT/VHT20 Beam Forming, M16 to M23	4	7	-57.5	-54.1	-52.8	-53.8	-41.2	-27.00	14.16
	HT/VHT20 Beam Forming, M24 to M31	4	6	-57.5	-54.1	-52.8	-53.8	-42.2	-27.00	15.16
	HT/VHT20 STBC, M0 to M7	2	6	-57.5	-54.1			-46.4	-27.00	19.41
	HT/VHT20 STBC, M0 to M7	3	6	-57.5	-54.1	-52.8		-43.6	-27.00	16.57
	HT/VHT20 STBC, M0 to M7	4	6	-57.5	-54.1	-52.8	-53.8	-42.2	-27.00	15.16
	HE20, M0 to M9 1ss	1	6	-57.1				-51.0	-27.00	24.03
	HE20, M0 to M9 1ss	2	6	-57.1	-53.8			-46.1	-27.00	19.07
	HE20, M0 to M9 2ss	2	6	-57.1	-53.8			-46.1	-27.00	19.07
	HE20, M0 to M9 1ss	3	6	-57.1	-53.8	-53.1		-43.5	-27.00	16.51
	HE20, M0 to M9 2ss	3	6	-57.1	-53.8	-53.1		-43.5	-27.00	16.51
	HE20, M0 to M9 3ss	3	6	-57.1	-53.8	-53.1		-43.5	-27.00	16.51
	HE20, M0 to M9 1ss	4	6	-57.1	-53.8	-53.1	-53.9	-42.1	-27.00	15.15
	HE20, M0 to M9 2ss	4	6	-57.1	-53.8	-53.1	-53.9	-42.1	-27.00	15.15
	HE20, M0 to M9 3ss	4	6	-57.1	-53.8	-53.1	-53.9	-42.1	-27.00	15.15
	HE20, M0 to M9 4ss	4	6	-57.1	-53.8	-53.1	-53.9	-42.1	-27.00	15.15
	HE20 Beam Forming, M0 to M9 1ss	2	9	-57.1	-53.8			-43.1	-27.00	16.07
	HE20 Beam Forming, M0 to M9 2ss	2	6	-57.1	-53.8			-46.1	-27.00	19.07
	HE20 Beam Forming, M0 to M9 1ss	3	11	-57.1	-53.8	-53.1		-38.5	-27.00	11.51
	HE20 Beam Forming, M0 to M9 2ss	3	8	-57.1	-53.8	-53.1		-41.5	-27.00	14.51
	HE20 Beam Forming, M0 to M9 3ss	3	6	-57.1	-53.8	-53.1		-43.5	-27.00	16.51
	HE20 Beam Forming, M0 to M9 1ss	4	12	-57.1	-53.8	-53.1	-53.9	-36.1	-27.00	9.15
	HE20 Beam Forming, M0 to M9 2ss	4	9	-57.1	-53.8	-53.1	-53.9	-39.1	-27.00	12.15
	HE20 Beam Forming, M0 to M9 3ss	4	7	-57.1	-53.8	-53.1	-53.9	-41.1	-27.00	14.15
	HE20 Beam Forming, M0 to M9 4ss	4	6	-57.1	-53.8	-53.1	-53.9	-42.1	-27.00	15.15
	HE20 STBC, M0 to M9 2ss	2	6	-57.1	-53.8			-46.1	-27.00	19.07
	HE20 STBC, M0 to M9 2ss	3	6	-57.1	-53.8	-53.1		-43.5	-27.00	16.51
	HE20 STBC, M0 to M9 2ss	4	6	-57.1	-53.8	-53.1	-53.9	-42.1	-27.00	15.15
5795	Non HT40, 6 to 54 Mbps	1	6	-56.7				-50.6	-27.00	23.65
	Non HT40, 6 to 54 Mbps	2	6	-56.7	-53.0			-45.4	-27.00	18.41
	Non HT40, 6 to 54 Mbps	3	6	-56.7	-53.0	-51.5		-42.4	-27.00	15.42
	Non HT40, 6 to 54 Mbps	4	6	-56.7	-53.0	-51.5	-53.3	-41.2	-27.00	14.18
	HT/VHT40, M0 to M7	1	6	-56.8				-50.7	-27.00	23.69
	HT/VHT40, M0 to M7	2	6	-56.8	-53.6			-45.8	-27.00	18.79
	HT/VHT40, M8 to M15	2	6	-56.8	-53.6			-45.8	-27.00	18.79
	HT/VHT40, M0 to M7	3	6	-56.8	-53.6	-52.2		-42.9	-27.00	15.93
	HT/VHT40, M8 to M15	3	6	-56.8	-53.6	-52.2		-42.9	-27.00	15.93
	HT/VHT40, M16 to M23	3	6	-56.8	-53.6	-52.2		-42.9	-27.00	15.93
	HT/VHT40, M0 to M7	4	6	-56.8	-53.6	-52.2	-53.8	-41.7	-27.00	14.68
	HT/VHT40, M8 to M15	4	6	-56.8	-53.6	-52.2	-53.8	-41.7	-27.00	14.68
	HT/VHT40, M16 to M23	4	6	-56.8	-53.6	-52.2	-53.8	-41.7	-27.00	14.68

	HT/VHT40, M24 to M31	4	6	-56.8	-53.6	-52.2	-53.8	-41.7	-27.00	14.68
	HT/VHT40 Beam Forming, M0 to M7	2	9	-56.8	-53.6			-42.8	-27.00	15.79
	HT/VHT40 Beam Forming, M8 to M15	2	6	-56.8	-53.6			-45.8	-27.00	18.79
	HT/VHT40 Beam Forming, M0 to M7	3	11	-56.8	-53.6	-52.2		-37.9	-27.00	10.93
	HT/VHT40 Beam Forming, M8 to M15	3	8	-56.8	-53.6	-52.2		-40.9	-27.00	13.93
	HT/VHT40 Beam Forming, M16 to M23	3	6	-56.8	-53.6	-52.2		-42.9	-27.00	15.93
	HT/VHT40 Beam Forming, M0 to M7	4	12	-56.8	-53.6	-52.2	-53.8	-35.7	-27.00	8.68
	HT/VHT40 Beam Forming, M8 to M15	4	9	-56.8	-53.6	-52.2	-53.8	-38.7	-27.00	11.68
	HT/VHT40 Beam Forming, M16 to M23	4	7	-56.8	-53.6	-52.2	-53.8	-40.7	-27.00	13.68
	HT/VHT40 Beam Forming, M24 to M31	4	6	-56.8	-53.6	-52.2	-53.8	-41.7	-27.00	14.68
	HT/VHT40 STBC, M0 to M7	2	6	-56.8	-53.6			-45.8	-27.00	18.79
	HT/VHT40 STBC, M0 to M7	3	6	-56.8	-53.6	-52.2		-42.9	-27.00	15.93
	HT/VHT40 STBC, M0 to M7	4	6	-56.8	-53.6	-52.2	-53.8	-41.7	-27.00	14.68
	HE40, M0 to M9 1ss	1	6	-57.0				-50.9	-27.00	23.87
	HE40, M0 to M9 1ss	2	6	-57.0	-53.2			-45.6	-27.00	18.56
	HE40, M0 to M9 2ss	2	6	-57.0	-53.2			-45.6	-27.00	18.56
	HE40, M0 to M9 1ss	3	6	-57.0	-53.2	-52.2		-42.8	-27.00	15.80
	HE40, M0 to M9 2ss	3	6	-57.0	-53.2	-52.2		-42.8	-27.00	15.80
	HE40, M0 to M9 3ss	3	6	-57.0	-53.2	-52.2		-42.8	-27.00	15.80
	HE40, M0 to M9 1ss	4	6	-57.0	-53.2	-52.2	-53.7	-41.6	-27.00	14.55
	HE40, M0 to M9 2ss	4	6	-57.0	-53.2	-52.2	-53.7	-41.6	-27.00	14.55
	HE40, M0 to M9 3ss	4	6	-57.0	-53.2	-52.2	-53.7	-41.6	-27.00	14.55
	HE40, M0 to M9 4ss	4	6	-57.0	-53.2	-52.2	-53.7	-41.6	-27.00	14.55
	HE40 Beam Forming, M0 to M9 1ss	2	9	-57.0	-53.2			-42.6	-27.00	15.56
	HE40 Beam Forming, M0 to M9 2ss	2	6	-57.0	-53.2			-45.6	-27.00	18.56
	HE40 Beam Forming, M0 to M9 1ss	3	11	-57.0	-53.2	-52.2		-37.8	-27.00	10.80
	HE40 Beam Forming, M0 to M9 2ss	3	8	-57.0	-53.2	-52.2		-40.8	-27.00	13.80
	HE40 Beam Forming, M0 to M9 3ss	3	6	-57.0	-53.2	-52.2		-42.8	-27.00	15.80
	HE40 Beam Forming, M0 to M9 1ss	4	12	-57.0	-53.2	-52.2	-53.7	-35.6	-27.00	8.55
	HE40 Beam Forming, M0 to M9 2ss	4	9	-57.0	-53.2	-52.2	-53.7	-38.6	-27.00	11.55
	HE40 Beam Forming, M0 to M9 3ss	4	7	-57.0	-53.2	-52.2	-53.7	-40.6	-27.00	13.55
	HE40 Beam Forming, M0 to M9 4ss	4	6	-57.0	-53.2	-52.2	-53.7	-41.6	-27.00	14.55
	HE40 STBC, M0 to M9 2ss	2	6	-57.0	-53.2			-45.6	-27.00	18.56
	HE40 STBC, M0 to M9 2ss	3	6	-57.0	-53.2	-52.2		-42.8	-27.00	15.80
	HE40 STBC, M0 to M9 2ss	4	6	-57.0	-53.2	-52.2	-53.7	-41.6	-27.00	14.55
5825	Non HT20, 6 to 54 Mbps	1	6	-56.6				-50.5	-27.00	23.55
	Non HT20, 6 to 54 Mbps	2	6	-56.6	-53.7			-45.9	-27.00	18.85
	Non HT20, 6 to 54 Mbps	3	6	-56.6	-53.7	-52.2		-43.0	-27.00	15.99
	Non HT20, 6 to 54 Mbps	4	6	-56.6	-53.7	-52.2	-53.3	-41.6	-27.00	14.61
	Non HT20 Beam Forming, 6 to 54 Mbps	2	9	-56.6	-53.7			-42.9	-27.00	15.85
	Non HT20 Beam Forming, 6 to 54 Mbps	3	11	-56.6	-53.7	-52.2		-38.0	-27.00	10.99
	Non HT20 Beam Forming, 6 to 54 Mbps	4	12	-56.6	-53.7	-52.2	-53.3	-35.6	-27.00	8.61



HT/VHT20, M0 to M7	1	6	-56.8				-50.7	-27.00	23.75
HT/VHT20, M0 to M7	2	6	-56.8	-53.9			-46.0	-27.00	19.05
HT/VHT20, M8 to M15	2	6	-56.8	-53.9			-46.0	-27.00	19.05
HT/VHT20, M0 to M7	3	6	-56.8	-53.9	-52.9		-43.4	-27.00	16.42
HT/VHT20, M8 to M15	3	6	-56.8	-53.9	-52.9		-43.4	-27.00	16.42
HT/VHT20, M16 to M23	3	6	-56.8	-53.9	-52.9		-43.4	-27.00	16.42
HT/VHT20, M0 to M7	4	6	-56.8	-53.9	-52.9	-53.8	-42.1	-27.00	15.06
HT/VHT20, M8 to M15	4	6	-56.8	-53.9	-52.9	-53.8	-42.1	-27.00	15.06
HT/VHT20, M16 to M23	4	6	-56.8	-53.9	-52.9	-53.8	-42.1	-27.00	15.06
HT/VHT20, M24 to M31	4	6	-56.8	-53.9	-52.9	-53.8	-42.1	-27.00	15.06
HT/VHT20 Beam Forming, M0 to M7	2	9	-56.8	-53.9			-43.0	-27.00	16.05
HT/VHT20 Beam Forming, M8 to M15	2	6	-56.8	-53.9			-46.0	-27.00	19.05
HT/VHT20 Beam Forming, M0 to M7	3	11	-56.8	-53.9	-52.9		-38.4	-27.00	11.42
HT/VHT20 Beam Forming, M8 to M15	3	8	-56.8	-53.9	-52.9		-41.4	-27.00	14.42
HT/VHT20 Beam Forming, M16 to M23	3	6	-56.8	-53.9	-52.9		-43.4	-27.00	16.42
HT/VHT20 Beam Forming, M0 to M7	4	12	-56.8	-53.9	-52.9	-53.8	-36.1	-27.00	9.06
HT/VHT20 Beam Forming, M8 to M15	4	9	-56.8	-53.9	-52.9	-53.8	-39.1	-27.00	12.06
HT/VHT20 Beam Forming, M16 to M23	4	7	-56.8	-53.9	-52.9	-53.8	-41.1	-27.00	14.06
HT/VHT20 Beam Forming, M24 to M31	4	6	-56.8	-53.9	-52.9	-53.8	-42.1	-27.00	15.06
HT/VHT20 STBC, M0 to M7	2	6	-56.8	-53.9			-46.0	-27.00	19.05
HT/VHT20 STBC, M0 to M7	3	6	-56.8	-53.9	-52.9		-43.4	-27.00	16.42
HT/VHT20 STBC, M0 to M7	4	6	-56.8	-53.9	-52.9	-53.8	-42.1	-27.00	15.06
HE20, M0 to M9 1ss	1	6	-57.1				-51.0	-27.00	24.03
HE20, M0 to M9 1ss	2	6	-57.1	-53.9			-46.1	-27.00	19.13
HE20, M0 to M9 2ss	2	6	-57.1	-53.9			-46.1	-27.00	19.13
HE20, M0 to M9 1ss	3	6	-57.1	-53.9	-52.6		-43.3	-27.00	16.32
HE20, M0 to M9 2ss	3	6	-57.1	-53.9	-52.6		-43.3	-27.00	16.32
HE20, M0 to M9 3ss	3	6	-57.1	-53.9	-52.6		-43.3	-27.00	16.32
HE20, M0 to M9 1ss	4	6	-57.1	-53.9	-52.6	-53.6	-41.9	-27.00	14.92
HE20, M0 to M9 2ss	4	6	-57.1	-53.9	-52.6	-53.6	-41.9	-27.00	14.92
HE20, M0 to M9 3ss	4	6	-57.1	-53.9	-52.6	-53.6	-41.9	-27.00	14.92
HE20, M0 to M9 4ss	4	6	-57.1	-53.9	-52.6	-53.6	-41.9	-27.00	14.92
HE20 Beam Forming, M0 to M9 1ss	2	9	-57.1	-53.9			-43.1	-27.00	16.13
HE20 Beam Forming, M0 to M9 2ss	2	6	-57.1	-53.9			-46.1	-27.00	19.13
HE20 Beam Forming, M0 to M9 1ss	3	11	-57.1	-53.9	-52.6		-38.3	-27.00	11.32
HE20 Beam Forming, M0 to M9 2ss	3	8	-57.1	-53.9	-52.6		-41.3	-27.00	14.32
HE20 Beam Forming, M0 to M9 3ss	3	6	-57.1	-53.9	-52.6		-43.3	-27.00	16.32
HE20 Beam Forming, M0 to M9 1ss	4	12	-57.1	-53.9	-52.6	-53.6	-35.9	-27.00	8.92
HE20 Beam Forming, M0 to M9 2ss	4	9	-57.1	-53.9	-52.6	-53.6	-38.9	-27.00	11.92
HE20 Beam Forming, M0 to M9 3ss	4	7	-57.1	-53.9	-52.6	-53.6	-40.9	-27.00	13.92
HE20 Beam Forming, M0 to M9 4ss	4	6	-57.1	-53.9	-52.6	-53.6	-41.9	-27.00	14.92
HE20 STBC, M0 to M9 2ss	2	6	-57.1	-53.9			-46.1	-27.00	19.13
HE20 STBC, M0 to M9 2ss	3	6	-57.1	-53.9	-52.6		-43.3	-27.00	16.32



HE20 STBC, M0 to M9 2ss	4	6	-57.1	-53.9	-52.6	-53.6	-41.9	-27.00	14.92
-------------------------	---	---	-------	-------	-------	-------	-------	--------	-------





**Appendix B: Radiated & AC Conducted Emissions Test Results**  
Testing done by outside laboratory.

## Appendix C: List of Test Equipment Used to perform the test

Test Equipment used for Radiated Emissions					
Equip#	Manufacturer/ Model	Description	Last Cal	Next Cal	Test Item
57477	Cisco	Automation Test Insertion Loss	NA	NA	A1-A7
55108	Keysight N9030A-550	PXA Signal Analyzer, 3Hz to 50GHz	23 Oct 2018	23 Oct 2019	A1-A7
55093	NI PXI-1042	CHASSIS, PXI	NA	NA	A1-A7
57238	NI PXI-8115	Embedded Controller	NA	NA	A1-A7
57247	NI PXI-2796	40 GHz Dual 6x1 Multiplexer (SP6T)	NA	NA	A1-A7
57248	NI PXI-2799	Switch 1x1	NA	NA	A1-A7
56092	NI PXI-2796	40 GHz Dual 6x1 Multiplexer (SP6T)	NA	NA	A1-A7
7329	Omega CT485B	Chart recorder	18 Feb 2019	18 Feb 2020	A1-A7
56328	Pasternack PE5019-1	Torque wrench	14 Feb 2019	14 Feb 2020	A1-A7
56329	Pasternack PE5019-1	Torque wrench	28 Feb 2019	28 Feb 2020	A1-A7
56330	Pasternack PE5019-1	Torque wrench	28 Feb 2019	28 Feb 2020	A1-A7

## Appendix D: Abbreviation Key and Definitions

The following table defines abbreviations used within this test report.

Abbreviation	Description	Abbreviation	Description
EMC	Electro Magnetic Compatibility	°F	Degrees Fahrenheit
EMI	Electro Magnetic Interference	°C	Degrees Celsius
EUT	Equipment Under Test	Temp	Temperature
ITE	Information Technology Equipment	S/N	Serial Number
TAP	Test Assessment Schedule	Qty	Quantity
ESD	Electro Static Discharge	emf	Electromotive force
EFT	Electric Fast Transient	RMS	Root mean square
EDCS	Engineering Document Control System	Qp	Quasi Peak
Config	Configuration	Av	Average
CIS#	Cisco Number (unique identification number for Cisco test equipment)	Pk	Peak
Cal	Calibration	kHz	Kilohertz (1x10 <sup>3</sup> )
EN	European Norm	MHz	MegaHertz (1x10 <sup>6</sup> )
IEC	International Electro technical Commission	GHz	Gigahertz (1x10 <sup>9</sup> )
CISPR	International Special Committee on Radio Interference	H	Horizontal
CDN	Coupling/Decoupling Network	V	Vertical
LISN	Line Impedance Stabilization Network	dB	decibel
PE	Protective Earth	V	Volt
GND	Ground	kV	Kilovolt (1x10 <sup>3</sup> )
L1	Line 1	μV	Microvolt (1x10 <sup>-6</sup> )
L2	Line2	A	Amp
L3	Line 3	μA	Micro Amp (1x10 <sup>-6</sup> )
DC	Direct Current	mS	Milli Second (1x10 <sup>-3</sup> )
RAW	Uncorrected measurement value, as indicated by the measuring device	μS	Micro Second (1x10 <sup>-6</sup> )
RF	Radio Frequency	μS	Micro Second (1x10 <sup>-6</sup> )
SLCE	Signal Line Conducted Emissions	m	Meter
Meas dist	Measurement distance	Spec dist	Specification distance
N/A or NA	Not Applicable	SL	Signal Line (or Telecom Line)
P	Power Line	L	Live Line
N	Neutral Line	R	Return
S	Supply	AC	Alternating Current

## **Appendix E: Photographs of Test Setups**

Please refer to the attachment



## Appendix F: Software Used to Perform Testing

Cisco Internal LabView Radio Test Automation Software rev57

## Appendix G: Test Procedures

Measurements were made in accordance with

- KDB Publication No. 789033 - D02 General UNII Test Procedures New Rules v02r01
- KDB Publication No. 662911 - MIMO
- ANSI C63.4 2014 Unintentional Radiators
- ANSI C63.10 2013 Intentional Radiators

Test procedures are summarized below:

FCC 5GHz Test Procedures	EDCS # 1445048
FCC 5GHz RSE Test Procedures	EDCS # 1511600

## Appendix H: Scope of Accreditation (A2LA certificate number 1178-01)

The scope of accreditation of Cisco Systems, Inc. can be found on the A2LA web page at:

<http://www.a2la.org/scopepdf/1178-01.pdf>

## Appendix I: Test Assessment Plan

Target Power Tables EDCS# 18087112.

## Appendix J: UUT Software Info

APA453.0E7B.CB48#  
APA453.0E7B.CB48#  
APA453.0E7B.CB48#test watchdog monitoring off  
APA453.0E7B.CB48#  
APA453.0E7B.CB48#  
APA453.0E7B.CB48#  
APA453.0E7B.CB48#show ver  
Restricted Rights Legend

Use, duplication, or disclosure by the Government is subject to restrictions as set forth in subparagraph (c) of the Commercial Computer Software - Restricted Rights clause at FAR sec. 52.227-19 and subparagraph (c) (1) (ii) of the Rights in Technical Data and Computer Software clause at DFARS sec. 252.227-7013.

Cisco Systems, Inc.  
170 West Tasman Drive  
San Jose, California 95134-1706

This product contains cryptographic features and is subject to United States and local country laws governing import, export, transfer and use. Delivery of Cisco cryptographic products does not imply third-party authority to import, export, distribute or use encryption. Importers, exporters, distributors and users are responsible for compliance with U.S. and local country laws. By using this product you agree to comply with applicable laws and regulations. If you are unable to comply with U.S. and local laws, return this product immediately.

A summary of U.S. laws governing Cisco cryptographic products may be found at:  
<http://www.cisco.com/www/export/crypto/tool/stqrg.html>

If you require further assistance please contact us by sending email to [export@cisco.com](mailto:export@cisco.com).

This product contains some software licensed under the "GNU General Public License, version 2" provided with ABSOLUTELY NO WARRANTY under the terms of "GNU General Public License, version 2", available here:  
<http://www.gnu.org/licenses/old-licenses/gpl-2.0.html>

This product contains some software licensed under the "GNU Library General Public License, version 2" provided with ABSOLUTELY NO WARRANTY under the terms of "GNU Library General Public License, version 2", available here:  
<http://www.gnu.org/licenses/old-licenses/lgpl-2.0.html>

This product contains some software licensed under the



"GNU Lesser General Public License, version 2.1" provided with ABSOLUTELY NO WARRANTY under the terms of "GNU Lesser General Public License, version 2.1", available here: <http://www.gnu.org/licenses/old-licenses/lgpl-2.1.html>

This product contains some software licensed under the "GNU General Public License, version 3" provided with ABSOLUTELY NO WARRANTY under the terms of "GNU General Public License, Version 3", available here: <http://www.gnu.org/licenses/gpl.html>.

This product contains some software licensed under the "GNU Affero General Public License, version 3" provided with ABSOLUTELY NO WARRANTY under the terms of "GNU Affero General Public License, version 3", available here: <http://www.gnu.org/licenses/agpl-3.0.html>.

Cisco AP Software, (ap1g7), [cheetah-build6:/san2/BUILD/workspace/Nightly-Cheetah-axel-bcm-mfg-c8\_10\_throttle]  
Technical Support: <http://www.cisco.com/techsupport>  
Copyright (c) 1986-2019 by Cisco Systems, Inc.  
Compiled Tue Aug 6 08:07:11 PDT 2019

ROM: Bootstrap program is U-Boot boot loader  
BOOTLDR: U-Boot boot loader Version

APA453.0E7B.CB48 uptime is 0 days, 0 hours, 4 minutes  
Last reload time : Tue Aug 6 09:41:25 UTC 2019  
Last reload reason : unknown

cisco C9120AXE-B with 1813676/1065756K bytes of memory.  
Processor board ID 0  
AP Running Image : 8.8.1.10  
Primary Boot Image : 8.8.1.10  
Backup Boot Image : 0.0.0.0  
Primary Boot Image Hash:  
Backup Boot Image Hash:  
1 Gigabit Ethernet interfaces  
2 802.11 Radios  
Radio Driver version : 17.10 RC77.13  
Radio FW version : 1268.14948.r146 146  
NSS FW version : NA

Base ethernet MAC Address : A4:53:0E:7B:CB:48  
Part Number : 0-000000-00  
PCA Assembly Number : 800-105708-01  
PCA Revision Number : 09  
PCB Serial Number : FOC23302F3B  
Top Assembly Part Number : 800-105708-01



Top Assembly Serial Number : 0  
Top Revision Number : 09  
Product/Model Number : C9120AXE-B

APA453.0E7B.CB48#  
APA453.0E7B.CB48#  
APA453.0E7B.CB48#  
APA453.0E7B.CB48#  
APA453.0E7B.CB48#  
APA453.0E7B.CB48#  
APA453.0E7B.CB48#  
APA453.0E7B.CB48#

APA453.0E7B.CB48#devs

EXITING CISCO SHELL. PLEASE EXECUTE EXIT IN DEVSHELL TO GET BACK TO CISCO SHELL.

BusyBox v1.29.3 () built-in shell (ash)

Welcome to Cisco.

Usage of this device is governed by Cisco's End User License Agreement, available at:

[http://www.cisco.com/c/en/us/td/docs/general/warranty/English/EU1KEN\\_.html](http://www.cisco.com/c/en/us/td/docs/general/warranty/English/EU1KEN_.html).

mA4530E7BCB48:##

mA4530E7BCB48:##

mA4530E7BCB48:##

mA4530E7BCB48:##

mA4530E7BCB48:##

mA4530E7BCB48:## cat MERAKI\_BUILD.extra

Tue Aug 6 08:07:11 PDT 2019

cheetah-build6

/san2/BUILD/workspace/Nightly-Cheetah-axel-bcm-mfg-c8\_10\_throttle

\* (HEAD detached at c9764ec05b)

svn base: c9764ec05b8c12d58c9be25326e8565279ce1a37

commit: c9764ec05b8c12d58c9be25326e8565279ce1a37

tree 91b17c0a6dff95efbab96749f9f008dd797f938

mA4530E7BCB48:##

mA4530E7BCB48:##

mA4530E7BCB48:##

mA4530E7BCB48:##

mA4530E7BCB48:## show\_cookie

Part Number : 0-000000-00

Board Revision : 00

PCB Serial Number : FOC23302F3B

PCB Fab Part Number : 0-000000-00  
Deviation Number : 0  
MAC Address : A4:53:0E:7B:CB:48  
MAC Address Block Size : 4  
Radio 0 MAC Address : D4:AD:BD:A2:0A:40  
Radio 0 MAC Address Block Size : 16  
Radio 1 MAC Address : D4:AD:BD:A2:0A:50  
Radio 1 MAC Address Block Size : 16  
PCA Assembly Number : 800-105708-01  
PCA Revision Number : 09  
Product/Model Number : C9120AXE-B  
Top Assembly Part Number : 800-105708-01  
Top Revision Number : 09  
Top Assembly Serial Number : 0  
RMA Test History : 00  
RMA History : 00  
RMA Number : 00-00-00-00  
Device Type : 4C  
Max Association Allowed : 2  
Radio(2.4G) Carrier Set : 0000  
Radio(2.4G) Max Transmit Power Level : 100  
Radio(2.4G) Antenna Diversity Support: 01  
Radio(2.4G) Encryption Ability : 0002  
Radio(5G) Carrier Set : 0029  
Radio(5G) Max Transmit Power Level : 100  
Radio(5G) Antenna Diversity Support : 01  
Radio(5G) Encryption Ability : 0002  
Radio(802.11g) Radio Mode : 255  
PEP Product Identifier (PID) : C9120AXE-B  
PEP Version Identifier (VID) : V01  
System Flags : 00  
Controller Type : 0000  
Host Controller Type : 0000  
Mfr Service Date : 2019.08.03-47:59:59  
Radio(49) Carrier Set : 0000  
Radio(49) Max Transmit Power Level : 0  
Radio(49) Antenna Diversity Support : 00  
Radio(49) Encryption Ability : 0000  
Radio(58) Carrier Set : 0029  
Radio(58) Max Transmit Power Level : 100  
Radio(58) Antenna Diversity Support : 01  
Radio(58) Encryption Ability : 0002  
ACT2 ID : C9120  
Static AP Mode : 0  
mA4530E7BCB48:##  
mA4530E7BCB48:##  
mA4530E7BCB48:##  
mA4530E7BCB48:##

```
mA4530E7BCB48:/#
mA4530E7BCB48:/#
mA4530E7BCB48:/# cat /storage/rxtx_mode
tx
mA4530E7BCB48:/#
mA4530E7BCB48:/#
mA4530E7BCB48:/#
mA4530E7BCB48:/# cd /usr/bin/bcm/mfg
mA4530E7BCB48:/usr/bin/bcm/mfg#
mA4530E7BCB48:/usr/bin/bcm/mfg#
mA4530E7BCB48:/usr/bin/bcm/mfg#
mA4530E7BCB48:/usr/bin/bcm/mfg#
mA4530E7BCB48:/usr/bin/bcm/mfg#
mA4530E7BCB48:/usr/bin/bcm/mfg#
mA4530E7BCB48:/usr/bin/bcm/mfg#
mA4530E7BCB48:/usr/bin/bcm/mfg#
mA4530E7BCB48:/usr/bin/bcm/mfg#
mA4530E7BCB48:/usr/bin/bcm/mfg# ./dfstool.lua
```

```
Vanc dfstool
BOARD: Axel BCM !!!!!
```

Display config:

```
wl -i apr0v0 status | head -3
"SSID: "MFG-2GTEST"
Mode: Managed  RSSI: 0 dBm  SNR: 0 dB  noise: -97 dBm  Channel: 1
BSSID: D4:AD:BD:A2:0A:40  Capability: ESS ShortSlot "
```

Display config:

```
wl -i apr1v0 status | head -3
"SSID: "MFG-5GTEST"
Mode: Managed  RSSI: 0 dBm  SNR: 0 dB  noise: -97 dBm  Channel: 36
BSSID: D4:AD:BD:A2:0A:4F  Capability: ESS "
```

```
show_carrier_cookies | grep -o '!\.$'
rc:result="41"
```

```
wl -i apr1v0 country US
wl -i apr0v0 country US
>
line=""
>
line=""
>
line=""
>
line=""
>
```