



**Test Report**

**C9120AXE-x**  
(x=B)

**Cisco Catalyst C9120AX Series 802.11ax Access Point**

**XOR 5GHz Radio**  
FCC ID: LDKEDAC92157

**5250-5350 MHz**

Against the following Specifications:

CFR47 Part 15.407



**Cisco Systems**  
170 West Tasman Drive  
San Jose, CA 95134

	
<b>Author:</b> Chris Blair <b>Tested By:</b> Chris Blair	<b>Approved By:</b> Gez Thorpe <b>Title:</b> Radio Compliance Manager <b>Revision:</b> See EDCS

This report replaces any previously entered test report under EDCS – **18315849**. This test report has been electronically authorized and archived using the CISCO Engineering Document Control system. Test Report Template EDCS# 11644123.



This test report has been electronically authorized and archived using the CISCO Engineering Document Control system.

<b>SECTION 1: OVERVIEW .....</b>	<b>3</b>
<b>SECTION 2: ASSESSMENT INFORMATION .....</b>	<b>4</b>
2.1 GENERAL .....	4
2.2 DATE OF TESTING.....	6
2.3 REPORT ISSUE DATE .....	6
2.4 TESTING FACILITIES .....	6
2.5 EQUIPMENT ASSESSED (EUT).....	7
2.6 EUT DESCRIPTION.....	7
<b>SECTION 3: RESULT SUMMARY.....</b>	<b>13</b>
3.1 RESULTS SUMMARY TABLE .....	13
<b>SECTION 4: SAMPLE DETAILS.....</b>	<b>15</b>
4.1 SAMPLE DETAILS.....	15
4.2 SYSTEM DETAILS.....	15
4.3 MODE OF OPERATION DETAILS.....	15
<b>APPENDIX A: EMISSION TEST RESULTS .....</b>	<b>16</b>
CONDUCTED TEST SETUP DIAGRAM.....	16
TARGET MAXIMUM CHANNEL POWER .....	16
A.1 DUTY CYCLE .....	20
A.2 99% AND 26DB BANDWIDTH.....	23
A.3 MAXIMUM CONDUCTED OUTPUT POWER .....	27
A.4 POWER SPECTRAL DENSITY .....	59
A.5 CONDUCTED SPURIOUS EMISSIONS.....	91
A.6 CONDUCTED RECEIVER SPURIOUS EMISSIONS.....	154
A.7 CONDUCTED BANDEDGE.....	163
<b>APPENDIX B: RADIATED &amp; AC CONDUCTED EMISSIONS TEST RESULTS .....</b>	<b>207</b>
<b>APPENDIX C: LIST OF TEST EQUIPMENT USED TO PERFORM THE TEST .....</b>	<b>208</b>
<b>APPENDIX D: ABBREVIATION KEY AND DEFINITIONS.....</b>	<b>209</b>
<b>APPENDIX E: PHOTOGRAPHS OF TEST SETUPS .....</b>	<b>210</b>
<b>APPENDIX F: SOFTWARE USED TO PERFORM TESTING .....</b>	<b>211</b>
<b>APPENDIX G: TEST PROCEDURES.....</b>	<b>211</b>
<b>APPENDIX H: SCOPE OF ACCREDITATION (A2LA CERTIFICATE NUMBER 1178-01).....</b>	<b>211</b>
<b>APPENDIX I: TEST ASSESSMENT PLAN .....</b>	<b>211</b>
<b>APPENDIX J: UUT SOFTWARE INFO .....</b>	<b>212</b>



**Section 1: Overview**

The samples were assessed against the tests detailed in section 3 under the requirements of the following specifications:

<b>Specifications:</b>
CFR47 Part 15.407



## Section 2: Assessment Information

### 2.1 General

This report contains an assessment of an apparatus against Electromagnetic Compatibility Standards based upon tests carried out on the samples submitted. The testing was performed by and for the use of Cisco systems Inc:

With regard to this assessment, the following points should be noted:

- a) The results contained in this report relate only to the items tested and were obtained in the period between the date of the initial assessment and the date of issue of the report. Manufactured products will not necessarily give identical results due to production and measurement tolerances.
- b) The apparatus was set up and exercised using the configuration and modes of operation defined in this report only.
- c) Where relevant, the apparatus was only assessed using the susceptibility criteria defined in this report and the Test Assessment Plan (TAP).
- d) All testing was performed under the following environmental conditions:

Temperature	15°C to 35°C (54°F to 95°F)
Atmospheric Pressure	860mbar to 1060mbar (25.4" to 31.3")
Humidity	10% to 75*%

### Units of Measurement

The units of measurements defined in the appendices are reported in specific terms, which are test dependent. Where radiated measurements are concerned these are defined at a particular distance. Basic voltage measurements are defined in units of [dBuV]

As an example, the basic calculation for all measurements is as follows:

$$\text{Emission level [dBuV]} = \text{Indicated voltage level [dBuV]} + \text{Cable Loss [dB]} + \text{Other correction factors [dB]}$$

The combinations of correction factors are dependent upon the exact test configurations [see test equipment lists for further details] and may include:-

Antenna Factors, Pre Amplifier Gain, LISN Loss, Pulse Limiter Loss and Filter Insertion Loss

Note: to convert the results from dBuV/m to uV/m use the following formula:-

$$\text{Level in uV/m} = \text{Common Antilogarithm} [(X \text{ dBuV/m})/20] = Y \text{ uV/m}$$



## Measurement Uncertainty Values

voltage and power measurements	± 2 dB
conducted EIRP measurements	± 1.4 dB
radiated measurements	± 3.2 dB
frequency measurements	± 2.4 10 <sup>-7</sup>
temperature measurements	± 0.54°
humidity measurements	± 2.3%
DC and low frequency measurements	± 2.5%

Where relevant measurement uncertainty levels have been estimated for tests performed on the apparatus. This uncertainty represents an expanded uncertainty expressed at approximately the 95% confidence level using a coverage factor of k=2.

## Radiated emissions (expanded uncertainty, confidence interval 95%)

30 MHz - 300 MHz	+/- 3.8 dB
300 MHz - 1000 MHz	+/- 4.3 dB
1 GHz - 10 GHz	+/- 4.0 dB
10 GHz - 18GHz	+/- 8.2 dB
18GHz - 26.5GHz	+/- 4.1 dB
26.5GHz - 40GHz	+/- 3.9 dB

## Conducted emissions (expanded uncertainty, confidence interval 95%)

30 MHz – 40GHz	+/- 0.38 dB
----------------	-------------

A product is considered to comply with a requirement if the nominal measured value is below the limit line. The product is considered to not be in compliance in case the nominal measured value is above the limit line.

**This report must not be reproduced except in full, without written approval of Cisco Systems.**

**2.2 Date of testing**

11-Sep-19 - 25-Sep-19

**2.3 Report Issue Date**

25-Oct-19

Cisco uses an electronic system to issue, store and control the revision of test reports. This system is called the Engineering Document Control System. The actual report issue date is embedded into the original file on EDCS. Any copies of this report, either electronic or paper, that are not on EDCS must be considered uncontrolled.

**2.4 Testing facilities**

This assessment was performed by: Chris Blair & Julian Land

**Testing Laboratory**

Cisco Systems, Inc.  
125 West Tasman Drive (Building P)  
San Jose, CA 95134  
USA

**Headquarters**

Cisco Systems, Inc.,  
170 West Tasman Drive  
San Jose, CA 95134,  
USA

**Registration Numbers for Industry Canada**

<b>Cisco System Site</b>	<b>Address</b>	<b>Site Identifier</b>
Building P, 10m Chamber	125 West Tasman Dr San Jose, CA 95134	Company #: 2461N-2
Building P, 5m Chamber	125 West Tasman Dr San Jose, CA 95134	Company #: 2461N-1
Building I, 5m Chamber	285 W. Tasman Drive San Jose, California 95134	Company #: 2461M-1
Building 7, 5m Chamber	425 E. Tasman Drive San Jose, California 95134	Company #: 2461N-3

**Test Engineers**

Chris Blair



## 2.5 Equipment Assessed (EUT)

C9120AXE-B

## 2.6 EUT Description

The radio supports the following modes of operation. The modes are further defined in the radio Theory of Operation. The modes included in this report represent the worst case data for all modes.

802.11a - Non HT20, One Antenna, 6 to 54 Mbps, 1ss  
802.11a - Non HT20, Two Antennas, 6 to 54 Mbps, 1ss  
802.11a - Non HT20, Three Antennas, 6 to 54 Mbps, 1ss  
802.11a - Non HT20, Four Antennas, 6 to 54 Mbps, 1ss

802.11a - Non HT20 Beam Forming, Two Antennas, 6 to 54 Mbps, 1ss  
802.11a - Non HT20 Beam Forming, Three Antennas, 6 to 54 Mbps, 1ss  
802.11a - Non HT20 Beam Forming, Four Antennas, 6 to 54 Mbps, 1ss

802.11n/ac - HT/VHT20, One Antenna, M0 to M7, 1ss  
802.11n/ac - HT/VHT20, Two Antennas, M0 to M7, 1ss  
802.11n/ac - HT/VHT20, Two Antennas, M8 to M15, 2ss  
802.11n/ac - HT/VHT20, Three Antennas, M0 to M7, 1ss  
802.11n/ac - HT/VHT20, Three Antennas, M8 to M15, 2ss  
802.11n/ac - HT/VHT20, Three Antennas, M16 to M23, 3ss  
802.11n/ac - HT/VHT20, Four Antennas, M0 to M7, 1ss  
802.11n/ac - HT/VHT20, Four Antennas, M8 to M15, 2ss  
802.11n/ac - HT/VHT20, Four Antennas, M16 to M23, 3ss  
802.11n/ac - HT/VHT20, Four Antennas, M24 to M31, 4ss

802.11n/ac - HT/VHT20 Beam Forming, Two Antennas, M0 to M7, 1ss  
802.11n/ac - HT/VHT20 Beam Forming, Two Antennas, M8 to M15, 2ss  
802.11n/ac - HT/VHT20 Beam Forming, Three Antennas, M0 to M7, 1ss  
802.11n/ac - HT/VHT20 Beam Forming, Three Antennas, M8 to M15, 2ss  
802.11n/ac - HT/VHT20 Beam Forming, Three Antennas, M16 to M23, 3ss  
802.11n/ac - HT/VHT20 Beam Forming, Four Antennas, M0 to M7, 1ss  
802.11n/ac - HT/VHT20 Beam Forming, Four Antennas, M8 to M15, 2ss  
802.11n/ac - HT/VHT20 Beam Forming, Four Antennas, M16 to M23, 3ss  
802.11n/ac - HT/VHT20 Beam Forming, Four Antennas, M24 to M31, 4ss

802.11n/ac - HT/VHT20 STBC, Two Antennas, M0 to M7, 2ss  
802.11n/ac - HT/VHT20 STBC, Three Antennas, M0 to M7, 2ss  
802.11n/ac - HT/VHT20 STBC, Four Antennas, M0 to M7, 2ss

802.11ax - HE20, One Antenna, M0 to M9 1ss  
802.11ax - HE20, Two Antennas, M0 to M9 1ss  
802.11ax - HE20, Two Antennas, M0 to M9 2ss  
802.11ax - HE20, Three Antennas, M0 to M9 1ss  
802.11ax - HE20, Three Antennas, M0 to M9 2ss



802.11ax - HE20, Three Antennas, M0 to M9 3ss  
802.11ax - HE20, Four Antennas, M0 to M9 1ss  
802.11ax - HE20, Four Antennas, M0 to M9 2ss  
802.11ax - HE20, Four Antennas, M0 to M9 3ss  
802.11ax - HE20, Four Antennas, M0 to M9 4ss

802.11ax - HE20 Beam Forming, Two Antennas, M0 to M9 1ss  
802.11ax - HE20 Beam Forming, Two Antennas, M0 to M9 2ss  
802.11ax - HE20 Beam Forming, Three Antennas, M0 to M9 1ss  
802.11ax - HE20 Beam Forming, Three Antennas, M0 to M9 2ss  
802.11ax - HE20 Beam Forming, Three Antennas, M0 to M9 3ss  
802.11ax - HE20 Beam Forming, Four Antennas, M0 to M9 1ss  
802.11ax - HE20 Beam Forming, Four Antennas, M0 to M9 2ss  
802.11ax - HE20 Beam Forming, Four Antennas, M0 to M9 3ss  
802.11ax - HE20 Beam Forming, Four Antennas, M0 to M9 4ss

802.11ax - HE20 STBC, Two Antennas, M0 to M9 2ss  
802.11ax - HE20 STBC, Three Antennas, M0 to M9 2ss  
802.11ax - HE20 STBC, Four Antennas, M0 to M9 2ss

802.11a - Non HT40, One Antenna, 6 to 54 Mbps, 1ss  
802.11a - Non HT40, Two Antennas, 6 to 54 Mbps, 1ss  
802.11a - Non HT40, Three Antennas, 6 to 54 Mbps, 1ss  
802.11a - Non HT40, Four Antennas, 6 to 54 Mbps, 1ss

802.11n/ac - HT/VHT40, One Antenna, M0 to M7, 1ss  
802.11n/ac - HT/VHT40, Two Antennas, M0 to M7, 1ss  
802.11n/ac - HT/VHT40, Two Antennas, M8 to M15, 2ss  
802.11n/ac - HT/VHT40, Three Antennas, M0 to M7, 1ss  
802.11n/ac - HT/VHT40, Three Antennas, M8 to M15, 2ss  
802.11n/ac - HT/VHT40, Three Antennas, M16 to M23, 3ss  
802.11n/ac - HT/VHT40, Four Antennas, M0 to M7, 1ss  
802.11n/ac - HT/VHT40, Four Antennas, M8 to M15, 2ss  
802.11n/ac - HT/VHT40, Four Antennas, M16 to M23, 3ss  
802.11n/ac - HT/VHT40, Four Antennas, M24 to M31, 4ss

802.11n/ac - HT/VHT40 Beam Forming, Two Antennas, M0 to M7, 1ss  
802.11n/ac - HT/VHT40 Beam Forming, Two Antennas, M8 to M15, 2ss  
802.11n/ac - HT/VHT40 Beam Forming, Three Antennas, M0 to M7, 1ss  
802.11n/ac - HT/VHT40 Beam Forming, Three Antennas, M8 to M15, 2ss  
802.11n/ac - HT/VHT40 Beam Forming, Three Antennas, M16 to M23, 3ss  
802.11n/ac - HT/VHT40 Beam Forming, Four Antennas, M0 to M7, 1ss  
802.11n/ac - HT/VHT40 Beam Forming, Four Antennas, M8 to M15, 2ss  
802.11n/ac - HT/VHT40 Beam Forming, Four Antennas, M16 to M23, 3ss  
802.11n/ac - HT/VHT40 Beam Forming, Four Antennas, M24 to M31, 4ss





802.11n/ac - HT/VHT40 STBC, Two Antennas, M0 to M7, 2ss  
802.11n/ac - HT/VHT40 STBC, Three Antennas, M0 to M7, 2ss  
802.11n/ac - HT/VHT40 STBC, Four Antennas, M0 to M7, 2ss

802.11ax - HE40, One Antenna, M0 to M9 1ss  
802.11ax - HE40, Two Antennas, M0 to M9 1ss  
802.11ax - HE40, Two Antennas, M0 to M9 2ss  
802.11ax - HE40, Three Antennas, M0 to M9 1ss  
802.11ax - HE40, Three Antennas, M0 to M9 2ss  
802.11ax - HE40, Three Antennas, M0 to M9 3ss  
802.11ax - HE40, Four Antennas, M0 to M9 1ss  
802.11ax - HE40, Four Antennas, M0 to M9 2ss  
802.11ax - HE40, Four Antennas, M0 to M9 3ss  
802.11ax - HE40, Four Antennas, M0 to M9 4ss

802.11ax - HE40 Beam Forming, Two Antennas, M0 to M9 1ss  
802.11ax - HE40 Beam Forming, Two Antennas, M0 to M9 2ss  
802.11ax - HE40 Beam Forming, Three Antennas, M0 to M9 1ss  
802.11ax - HE40 Beam Forming, Three Antennas, M0 to M9 2ss  
802.11ax - HE40 Beam Forming, Three Antennas, M0 to M9 3ss  
802.11ax - HE40 Beam Forming, Four Antennas, M0 to M9 1ss  
802.11ax - HE40 Beam Forming, Four Antennas, M0 to M9 2ss  
802.11ax - HE40 Beam Forming, Four Antennas, M0 to M9 3ss  
802.11ax - HE40 Beam Forming, Four Antennas, M0 to M9 4ss

802.11ax - HE40 STBC, Two Antennas, M0 to M9 2ss  
802.11ax - HE40 STBC, Three Antennas, M0 to M9 2ss  
802.11ax - HE40 STBC, Four Antennas, M0 to M9 2ss

802.11a - Non HT80, One Antenna, 6 to 54 Mbps, 1ss  
802.11a - Non HT80, Two Antennas, 6 to 54 Mbps, 1ss  
802.11a - Non HT80, Three Antennas, 6 to 54 Mbps, 1ss  
802.11a - Non HT80, Four Antennas, 6 to 54 Mbps, 1ss

802.11ac - VHT80, One Antenna, M0 to M9 1ss  
802.11ac - VHT80, Two Antennas, M0 to M9 1ss  
802.11ac - VHT80, Two Antennas, M0 to M9 2ss  
802.11ac - VHT80, Three Antennas, M0 to M9 1ss  
802.11ac - VHT80, Three Antennas, M0 to M9 2ss  
802.11ac - VHT80, Three Antennas, M0 to M9 3ss  
802.11ac - VHT80, Four Antennas, M0 to M9 1ss  
802.11ac - VHT80, Four Antennas, M0 to M9 2ss  
802.11ac - VHT80, Four Antennas, M0 to M9 3ss  
802.11ac - VHT80, Four Antennas, M0 to M9 4ss



802.11ac - VHT80 Beam Forming, Two Antennas, M0 to M9 1ss  
802.11ac - VHT80 Beam Forming, Two Antennas, M0 to M9 2ss  
802.11ac - VHT80 Beam Forming, Three Antennas, M0 to M9 1ss  
802.11ac - VHT80 Beam Forming, Three Antennas, M0 to M9 2ss  
802.11ac - VHT80 Beam Forming, Three Antennas, M0 to M9 3ss  
802.11ac - VHT80 Beam Forming, Four Antennas, M0 to M9 1ss  
802.11ac - VHT80 Beam Forming, Four Antennas, M0 to M9 2ss  
802.11ac - VHT80 Beam Forming, Four Antennas, M0 to M9 3ss  
802.11ac - VHT80 Beam Forming, Four Antennas, M0 to M9 4ss

802.11ac - VHT80 STBC, Two Antennas, M0 to M9 2ss  
802.11ac - VHT80 STBC, Three Antennas, M0 to M9 2ss  
802.11ac - VHT80 STBC, Four Antennas, M0 to M9 2ss

802.11ax - HE80, One Antenna, M0 to M9 1ss  
802.11ax - HE80, Two Antennas, M0 to M9 1ss  
802.11ax - HE80, Two Antennas, M0 to M9 2ss  
802.11ax - HE80, Three Antennas, M0 to M9 1ss  
802.11ax - HE80, Three Antennas, M0 to M9 2ss  
802.11ax - HE80, Three Antennas, M0 to M9 3ss  
802.11ax - HE80, Four Antennas, M0 to M9 1ss  
802.11ax - HE80, Four Antennas, M0 to M9 2ss  
802.11ax - HE80, Four Antennas, M0 to M9 3ss  
802.11ax - HE80, Four Antennas, M0 to M9 4ss

802.11ax - HE80 Beam Forming, Two Antennas, M0 to M9 1ss  
802.11ax - HE80 Beam Forming, Two Antennas, M0 to M9 2ss  
802.11ax - HE80 Beam Forming, Three Antennas, M0 to M9 1ss  
802.11ax - HE80 Beam Forming, Three Antennas, M0 to M9 2ss  
802.11ax - HE80 Beam Forming, Three Antennas, M0 to M9 3ss  
802.11ax - HE80 Beam Forming, Four Antennas, M0 to M9 1ss  
802.11ax - HE80 Beam Forming, Four Antennas, M0 to M9 2ss  
802.11ax - HE80 Beam Forming, Four Antennas, M0 to M9 3ss  
802.11ax - HE80 Beam Forming, Four Antennas, M0 to M9 4ss

802.11ax - HE80 STBC, Two Antennas, M0 to M9 2ss  
802.11ax - HE80 STBC, Three Antennas, M0 to M9 2ss  
802.11ax - HE80 STBC, Four Antennas, M0 to M9 2ss

802.11a - Non HT160, One Antenna, 6 to 54 Mbps, 1ss  
802.11a - Non HT160, Two Antennas, 6 to 54 Mbps, 1ss  
802.11a - Non HT160, Three Antennas, 6 to 54 Mbps, 1ss  
802.11a - Non HT160, Four Antennas, 6 to 54 Mbps, 1ss

802.11ac - VHT160, One Antenna, M0 to M9 1ss  
802.11ac - VHT160, Two Antennas, M0 to M9 1ss  
802.11ac - VHT160, Two Antennas, M0 to M9 2ss



802.11ac - VHT160, Three Antennas, M0 to M9 1ss  
802.11ac - VHT160, Three Antennas, M0 to M9 2ss  
802.11ac - VHT160, Three Antennas, M0 to M9 3ss  
802.11ac - VHT160, Four Antennas, M0 to M9 1ss  
802.11ac - VHT160, Four Antennas, M0 to M9 2ss  
802.11ac - VHT160, Four Antennas, M0 to M9 3ss  
802.11ac - VHT160, Four Antennas, M0 to M9 4ss

802.11ac - VHT160 Beam Forming, Two Antennas, M0 to M9 1ss  
802.11ac - VHT160 Beam Forming, Two Antennas, M0 to M9 2ss  
802.11ac - VHT160 Beam Forming, Three Antennas, M0 to M9 1ss  
802.11ac - VHT160 Beam Forming, Three Antennas, M0 to M9 2ss  
802.11ac - VHT160 Beam Forming, Three Antennas, M0 to M9 3ss  
802.11ac - VHT160 Beam Forming, Four Antennas, M0 to M9 1ss  
802.11ac - VHT160 Beam Forming, Four Antennas, M0 to M9 2ss  
802.11ac - VHT160 Beam Forming, Four Antennas, M0 to M9 3ss  
802.11ac - VHT160 Beam Forming, Four Antennas, M0 to M9 4ss

802.11ac - VHT160 STBC, Two Antennas, M0 to M9 2ss  
802.11ac - VHT160 STBC, Three Antennas, M0 to M9 2ss  
802.11ac - VHT160 STBC, Four Antennas, M0 to M9 2ss

802.11ax - HE160, One Antenna, M0 to M9 1ss  
802.11ax - HE160, Two Antennas, M0 to M9 1ss  
802.11ax - HE160, Two Antennas, M0 to M9 2ss  
802.11ax - HE160, Three Antennas, M0 to M9 1ss  
802.11ax - HE160, Three Antennas, M0 to M9 2ss  
802.11ax - HE160, Three Antennas, M0 to M9 3ss  
802.11ax - HE160, Four Antennas, M0 to M9 1ss  
802.11ax - HE160, Four Antennas, M0 to M9 2ss  
802.11ax - HE160, Four Antennas, M0 to M9 3ss  
802.11ax - HE160, Four Antennas, M0 to M9 4ss

802.11ax - HE160 Beam Forming, Two Antennas, M0 to M9 1ss  
802.11ax - HE160 Beam Forming, Two Antennas, M0 to M9 2ss  
802.11ax - HE160 Beam Forming, Three Antennas, M0 to M9 1ss  
802.11ax - HE160 Beam Forming, Three Antennas, M0 to M9 2ss  
802.11ax - HE160 Beam Forming, Three Antennas, M0 to M9 3ss  
802.11ax - HE160 Beam Forming, Four Antennas, M0 to M9 1ss  
802.11ax - HE160 Beam Forming, Four Antennas, M0 to M9 2ss  
802.11ax - HE160 Beam Forming, Four Antennas, M0 to M9 3ss  
802.11ax - HE160 Beam Forming, Four Antennas, M0 to M9 4ss

802.11ax - HE160 STBC, Two Antennas, M0 to M9 2ss  
802.11ax - HE160 STBC, Three Antennas, M0 to M9 2ss  
802.11ax - HE160 STBC, Four Antennas, M0 to M9 2ss



The following antennas are supported by this product series.

The data included in this report represent the worst case data for all antennas.

Frequency	Part Number	Antenna Type	Antenna Gain (dBi)
<b>-E SKU</b>			
2.4GHz&5GHz	AIR-ANT2524DB-R/=	2.4 GHz 2 dBi/5 GHz 4 dBi Dipole Ant., Black, connectors RP-TNC	2dBi@2.4GHz 4dBi@5GHz
2.4GHz&5GHz	AIR-ANT2524DG-R/=	2.4 GHz 2 dBi/5 GHz 4 dBi Dipole Ant., Gray, connectors RP-TNC	2dBi@2.4GHz 4dBi@5GHz
2.4GHz&5GHz	AIR-ANT2524DW-R/=	2.4 GHz 2 dBi/5 GHz 4 dBi Dipole Ant., White, connectors RP-TNC	2dBi@2.4GHz 4dBi@5GHz
2.4GHz&5GHz	AIR-ANT2535SDW-R	2.4 GHz 3dBi/5 GHz 5 dBi Low Profile Antenna, White, connectors RP-TNC	3dBi@2.4GHz 5dBi@5GHz
2.4GHz&5GHz	AIR-ANT2566P4W-R=	2.4 GHz 6 dBi/5 GHz 6 dBi Directionnel Ant., 4-port, connectors RP-TNC	6dBi@2.4GHz 6dBi@5GHz
2.4GHz&5GHz	AIR-ANT2524V4C-R=	2.4GHz 2 dBi/5GHz 4 dBi Ceiling Mount Omni Ant., 4-port, connectors RP-TNC	2dBi@2.4GHz 4dBi@5GHz
2.4GHz&5GHz	AIR-ANT2544V4M-R=	2.4GHz 4 dBi/5GHz 4 dBi Wall Mount Omni Ant., 4-port, connectors RP-TNC	4dBi@2.4GHz 4dBi@5GHz
2.4GHz&5GHz	AIR-ANT2566D4M-R=	2.4 GHz 6 dBi/5 GHz 6 dBi 60 Deg. Patch Ant., 4-port, RP-TNC	6dBi@2.4GHz 6dBi@5GHz

### Section 3: Result Summary

#### 3.1 Results Summary Table

##### Conducted emissions

Basic Standard	Technical Requirements / Details	Result
15.407	<p><b>99% &amp; 26 dB Bandwidth:</b> The 99% occupied bandwidth is the frequency bandwidth such that, below its lower and above its upper frequency limits, the mean powers are each equal to 0.5% of the total mean power of the given emission. There is no limit for 99% OBW.</p> <p>The 26 dB emission is the width of the emission that is constrained by the frequencies associated with the two outermost amplitude points (upper and lower frequencies) that are attenuated by 26 dB relative to the maximum level measured in the fundamental emission.</p>	Pass
15.407	<p><b>Output Power:</b> For the 5.25-5.35 GHz and 5.47-5.725 GHz bands, the maximum conducted output power over the frequency bands of operation shall not exceed the lesser of 250 mW or 11 dBm + 10 log B, where B is the 26 dB emission bandwidth in megahertz.</p> <p>If transmitting antennas of directional gain greater than 6 dBi are used, both the maximum conducted output power and the maximum power spectral density shall be reduced by the amount in dB that the directional gain of the antenna exceeds 6 dBi.</p>	Pass
15.407	<p><b>Power Spectral Density</b> The maximum power spectral density shall not exceed 11 dBm in any 1 megahertz band. If transmitting antennas of directional gain greater than 6 dBi are used, both the maximum conducted output power and the maximum power spectral density shall be reduced by the amount in dB that the directional gain of the antenna exceeds 6 dBi.</p>	Pass
15.407	<p><b>Conducted Spurious Emissions / Band-Edge:</b> 2) For transmitters operating in the 5.25-5.35 GHz band: All emissions outside of the 5.15-5.35 GHz band shall not exceed an e.i.r.p. of -27 dBm/MHz.</p>	Pass
15.407 15.205 15.209	<p><b>Restricted band:</b> Unwanted emissions must comply with the general field strength limits set forth in §15.209.</p>	Pass

**Radiated Emissions (General requirements)**

<b>Basic Standard</b>	<b>Technical Requirements / Details</b>	<b>Result</b>
15.407 15.205 15.209	<b>TX Spurious Emissions:</b> Except as provided elsewhere in this subpart, the emissions from an intentional radiator shall not exceed the field strength levels specified in the field strength limits table in this section.	Not Tested
15.207	<b>AC conducted Emissions:</b> U-NII devices using an AC power line are required to comply also with the conducted limits set forth in §15.207.	Not Tested



## Section 4: Sample Details

Note: Each sample was evaluated to ensure that its condition was suitable to be used as a test sample prior to the commencement of testing.

### 4.1 Sample Details

Sample No.	Equipment Details	Manufacturer	Hardware Rev.	Firmware Rev.	Software Rev.	Serial Number
S01	C9120AXE-B	Foxconn	P2-2	1268.14948.r1 46 146	Cisco AP Software, (ap1g7), [cheetah-build6:/san2/BUILD/workspace/Nightly-Cheetah-axel-bcm-mfg-c8_10_throttle] Compiled Tue Aug 6 08:07:11 PDT 2019	FOC23302F3B
S02	DART cable 37-100909-01	Amphenol	NA	NA	NA	NA

### 4.2 System Details

System #	Description	Samples
1	C9120AXE-B and DART cable	S01+S02

### 4.3 Mode of Operation Details

Mode#	Description	Comments
1	Continuously Transmitting	Constant duty cycle

**Appendix A: Emission Test Results**

**Conducted Test Setup Diagram**

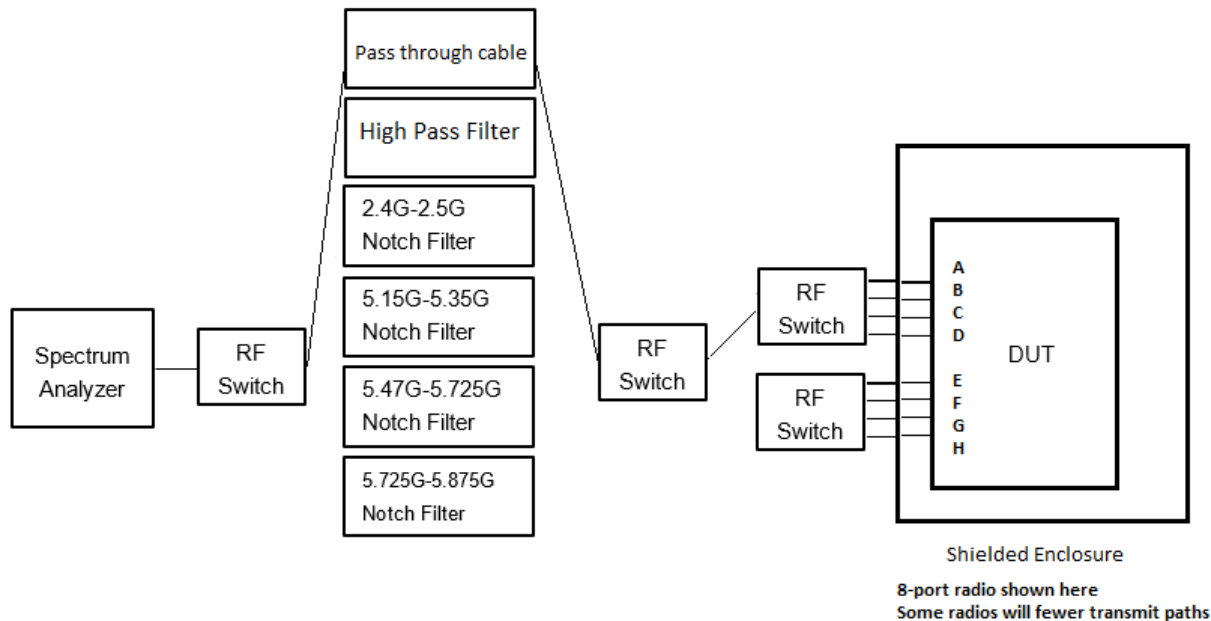

**Target Maximum Channel Power**

The following tables detail the maximum supported Total Channel Power for all operating modes.





Operating Mode	Maximum Channel Power, 4dBi (dBm)			
	Frequency (MHz)			
	5250			
Non HT160, 6 to 54 Mbps	13			
VHT160, M0 to M9, M0 to M9 1-2ss	15			
VHT160 Beam Forming, M0 to M9, M0 to M9 1-2ss	15			
VHT160 STBC, M0 to M9 1ss	15			
HE160, M0 to M9, M0 to M9 1-2ss	15			
HE160 Beam Forming, M0 to M9, M0 to M9 1-2ss	15			
HE160 STBC, M0 to M9 1ss	15			
	5260	5300	5320	
Non HT20, 6 to 54 Mbps	19	19	19	
Non HT20 Beam Forming, 6 to 54 Mbps	19	19	19	
HT/VHT20, M0 to M31	22	22	21	
HT/VHT20 Beam Forming, M0 to M31	22	22	21	
HT/VHT20 STBC, M0 to M7	21	21	21	
HE20, M0 to M9, M0 to M9 1-2ss	22	22	20	
HE20 Beam Forming, M0 to M9, M0 to M9 1-2ss	22	22	20	
HE20 STBC, M0 to M9 2ss	21	21	20	
	5270	5310		
Non HT40, 6 to 54 Mbps	21	16		
HT/VHT40, M0 to M31	22	16		
HT/VHT40 Beam Forming, M0 to M31	22	16		
HT/VHT40 STBC, M0 to M7	22	16		
HE40, M0 to M9, M0 to M9 1-2ss	22	16		
HE40 Beam Forming, M0 to M9, M0 to M9 1-2ss	22	16		
HE40 STBC, M0 to M9 2ss	22	16		
	5290			
Non HT80, 6 to 54 Mbps	15			
VHT80, M0 to M9, M0 to M9 1-2ss	16			
VHT80 Beam Forming, M0 to M9, M0 to M9 1-2ss	16			
VHT80 STBC, M0 to M9 1ss	16			
HE80, M0 to M9, M0 to M9 1-2ss	16			
HE80 Beam Forming, M0 to M9, M0 to M9 1-2ss	16			
HE80 STBC, M0 to M9 1ss	16			



Operating Mode	Maximum Channel Power, 5dBi (dBm)			
	Frequency (MHz)			
	5250			
Non HT160, 6 to 54 Mbps	12			
VHT160, M0 to M9, M0 to M9 1-2ss	15			
VHT160 Beam Forming, M0 to M9, M0 to M9 1-2ss	15			
VHT160 STBC, M0 to M9 1ss	15			
HE160, M0 to M9, M0 to M9 1-2ss	15			
HE160 Beam Forming, M0 to M9, M0 to M9 1-2ss	15			
HE160 STBC, M0 to M9 1ss	15			
	5260	5300	5320	
Non HT20, 6 to 54 Mbps	18	18	18	
Non HT20 Beam Forming, 6 to 54 Mbps	18	18	17	
HT/VHT20, M0 to M31	22	22	20	
HT/VHT20 Beam Forming, M0 to M31	22	22	20	
HT/VHT20 STBC, M0 to M7	20	20	20	
HE20, M0 to M9, M0 to M9 1-2ss	22	22	20	
HE20 Beam Forming, M0 to M9, M0 to M9 1-2ss	22	22	20	
HE20 STBC, M0 to M9 2ss	21	21	20	
	5270	5310		
Non HT40, 6 to 54 Mbps	20	16		
HT/VHT40, M0 to M31	22	16		
HT/VHT40 Beam Forming, M0 to M31	22	16		
HT/VHT40 STBC, M0 to M7	21	16		
HE40, M0 to M9, M0 to M9 1-2ss	22	15		
HE40 Beam Forming, M0 to M9, M0 to M9 1-2ss	22	15		
HE40 STBC, M0 to M9 2ss	21	15		
	5290			
Non HT80, 6 to 54 Mbps	15			
VHT80, M0 to M9, M0 to M9 1-2ss	16			
VHT80 Beam Forming, M0 to M9, M0 to M9 1-2ss	16			
VHT80 STBC, M0 to M9 1ss	16			
HE80, M0 to M9, M0 to M9 1-2ss	15			
HE80 Beam Forming, M0 to M9, M0 to M9 1-2ss	15			
HE80 STBC, M0 to M9 1ss	15			



Operating Mode	Maximum Channel Power, 6dBi (dBm)			
	Frequency (MHz)			
	5250			
Non HT160, 6 to 54 Mbps	12			
VHT160, M0 to M9, M0 to M9 1-2ss	14			
VHT160 Beam Forming, M0 to M9, M0 to M9 1-2ss	14			
VHT160 STBC, M0 to M9 1ss	14			
HE160, M0 to M9, M0 to M9 1-2ss	15			
HE160 Beam Forming, M0 to M9, M0 to M9 1-2ss	15			
HE160 STBC, M0 to M9 1ss	15			
	5260	5300	5320	
Non HT20, 6 to 54 Mbps	18	18	17	
Non HT20 Beam Forming, 6 to 54 Mbps	18	18	17	
HT/VHT20, M0 to M31	22	22	20	
HT/VHT20 Beam Forming, M0 to M31	22	22	20	
HT/VHT20 STBC, M0 to M7	19	19	19	
HE20, M0 to M9, M0 to M9 1-2ss	22	22	20	
HE20 Beam Forming, M0 to M9, M0 to M9 1-2ss	22	22	20	
HE20 STBC, M0 to M9 2ss	20	20	19	
	5270	5310		
Non HT40, 6 to 54 Mbps	19	15		
HT/VHT40, M0 to M31	22	16		
HT/VHT40 Beam Forming, M0 to M31	22	16		
HT/VHT40 STBC, M0 to M7	20	16		
HE40, M0 to M9, M0 to M9 1-2ss	22	15		
HE40 Beam Forming, M0 to M9, M0 to M9 1-2ss	22	15		
HE40 STBC, M0 to M9 2ss	20	15		
	5290			
Non HT80, 6 to 54 Mbps	15			
VHT80, M0 to M9, M0 to M9 1-2ss	15			
VHT80 Beam Forming, M0 to M9, M0 to M9 1-2ss	15			
VHT80 STBC, M0 to M9 1ss	15			
HE80, M0 to M9, M0 to M9 1-2ss	15			
HE80 Beam Forming, M0 to M9, M0 to M9 1-2ss	15			
HE80 STBC, M0 to M9 1ss	15			



## A.1 Duty Cycle

### Duty Cycle Test Requirement

From KDB 789033 D02 General UNII Test Procedures New Rules v02r01

#### B. Duty Cycle (x), Transmission Duration (T), and Maximum Power Control Level

1. All measurements are to be performed with the EUT transmitting at 100 percent duty cycle at its maximum power control level; however, if 100 percent duty cycle cannot be achieved, measurements of duty cycle, x, and maximum-power transmission duration, T, are required for each tested mode of operation.

### Duty Cycle Test Method

From KDB 789033 D02 General UNII Test Procedures New Rules v02r01:

#### B. Duty Cycle (x), Transmission Duration (T), and Maximum Power Control Level

The zero-span mode on a spectrum analyzer or EMI receiver, if the response time and spacing between bins on the sweep are sufficient to permit accurate measurements of the on and off times of the transmitted signal. Set the center frequency of the instrument to the center frequency of the transmission. Set  $RBW \geq EBW$  if possible; otherwise, set RBW to the largest available value. Set  $VBW \geq RBW$ . Set detector = peak or average. The zero-span measurement method shall not be used unless both RBW and VBW are  $> 50/T$ , where T is defined in section II.B.1.a), and the number of sweep points across duration T exceeds 100. (For example, if VBW and/or RBW are limited to 3 MHz, then the zero-span method of measuring duty cycle shall not be used if  $T \leq 16.7$  microseconds.)

### Duty Cycle Test Information

<b>Tested By :</b> Chris Blair	<b>Date of testing:</b> 11-Sep-19 - 25-Sep-19
<b>Test Result : PASS</b>	

#### Test Equipment

See Appendix C for list of test equipment

#### Samples, Systems, and Modes

System Number	Description	Samples	System under test	Support equipment
1	EUT	S01+S02	<input checked="" type="checkbox"/>	<input type="checkbox"/>
	Support		<input type="checkbox"/>	<input checked="" type="checkbox"/>



### Duty Cycle Data Table

Duty Cycle table and screen captures are shown below for power/psd modes.

Frequency	Mode	Data Rate	Duty Cycle correction (dB)
5260	Non HT20, 6 to 54 Mbps	6	0.0
	HT/VHT20, M0 to M31	m0	0.1
	HE20, M0 to M9, M0 to M9 1-2ss	m0h1	0.1
5270	Non HT40, 6 to 54 Mbps	6	0.0
	HT/VHT40, M0 to M31	m0	0.1
	HE40, M0 to M9, M0 to M9 1-2ss	m0h1	0.1
5290	Non HT80, 6 to 54 Mbps	6	0.1
	VHT80, M0 to M9, M0 to M9 1-2ss	m0x1	0.2
	HE80, M0 to M9, M0 to M9 1-2ss	m0h1	0.3
5300	Non HT20, 6 to 54 Mbps	6	0.0
	HT/VHT20, M0 to M31	m0	0.1
	HE20, M0 to M9, M0 to M9 1-2ss	m0h1	0.1
5310	Non HT40, 6 to 54 Mbps	6	0.0
	HT/VHT40, M0 to M31	m0	0.1
	HE40, M0 to M9, M0 to M9 1-2ss	m0h1	0.1
5320	Non HT20, 6 to 54 Mbps	6	0.0
	HT/VHT20, M0 to M31	m0	0.1
	HE20, M0 to M9, M0 to M9 1-2ss	m0h1	0.1
5250	Non HT160, 6 to 54 Mbps	6	0.0
	VHT160, M0 to M9, M0 to M9 1-2ss	m0x1	0.4
	<b>HE160, M0 to M9, M0 to M9 1-2ss</b>	<b>m0h1</b>	<b>0.4</b>



Duty Cycle, 5250 MHz, HE160, M0 to M9, M0 to M9 1-2ss

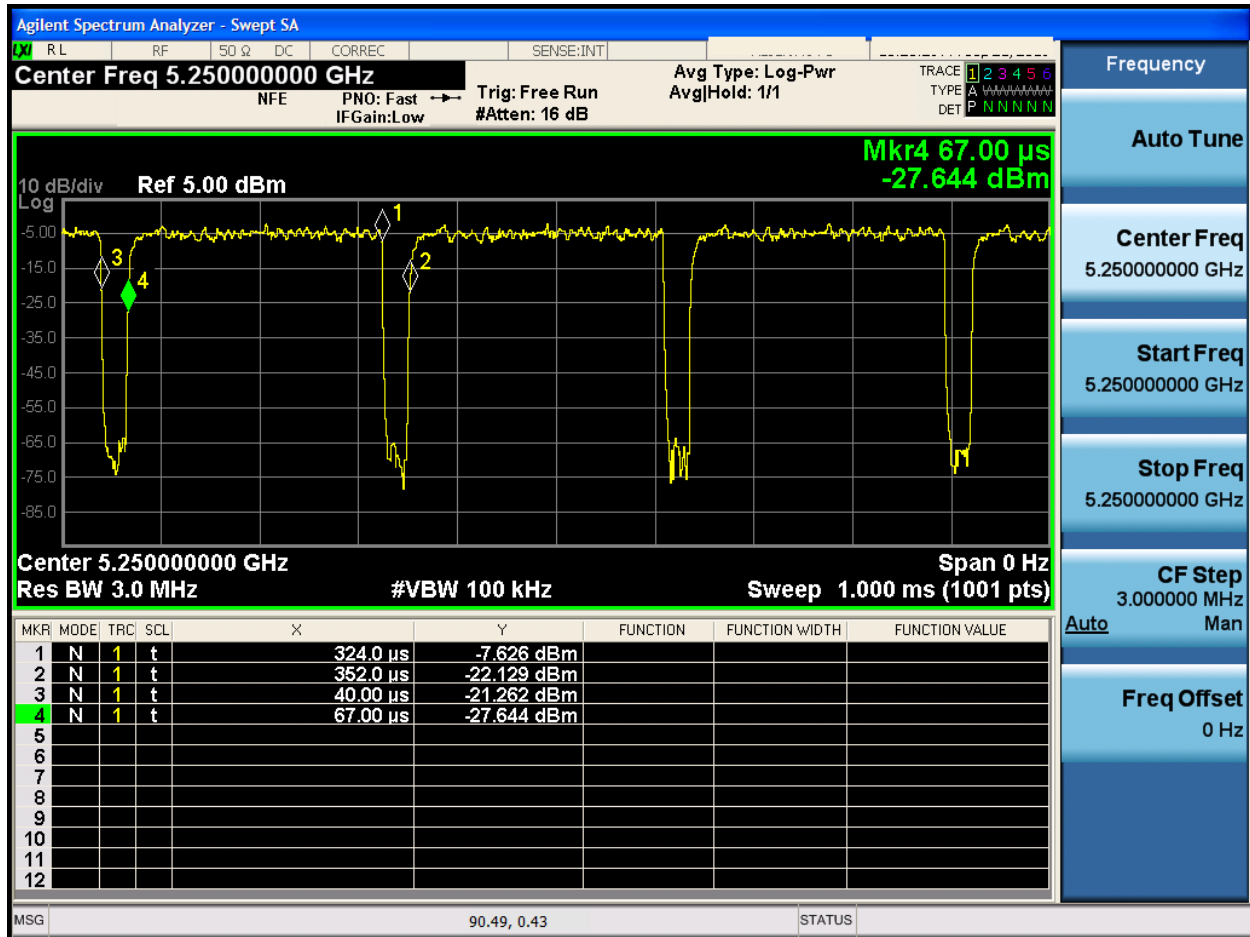



## A.2 99% and 26dB Bandwidth

### 99% and 26dB Bandwidth Test Requirement

There is no requirement for the value of bandwidth.

However, the 26dB BW (EBW) is used to calculate the power limits in 15.407 (a) (2). Power measurements are made using the 99% Bandwidth as the integration bandwidth.

### 99% and 26dB Bandwidth Test Procedure

The 99-percent occupied bandwidth is the frequency bandwidth such that, below its lower and above its upper frequency limits, the mean powers are each equal to 0.5 % of the total mean power of the given emission. Measurement of the 99-percent occupied bandwidth is required only as a condition for using the optional band-edge measurement techniques described in section II.G.3.d). Measurements of 99-percent occupied bandwidth may also optionally be used in lieu of the EBW to define the minimum frequency range over which the spectrum is integrated when measuring maximum conducted output power as described in section II.E. However, the EBW must be measured to determine bandwidth dependent limits on maximum conducted output power in accordance with 15.407(a).

#### Ref. KDB 789033 D02 General UNII Test Procedures New Rules v02r01

##### Section D. 99 Percent Occupied Bandwidth

###### ANSI C63.10: 2013

###### 99% BW

###### Test Parameters

1. Set center frequency to the nominal EUT channel center frequency.
2. Set span = 1.5 times to 5.0 times the OBW.
3. Set RBW = 1 % to 5 % of the OBW
4. Set VBW  $\geq 3 \cdot$  RBW
5. Video averaging is not permitted. Where practical, a sample detection and single sweep mode shall be used. Otherwise, peak detection and max hold mode (until the trace stabilizes) shall be used.
6. Use the 99 % power bandwidth function of the instrument (if available).

#### Ref KDB 789033 D02 General UNII Test Procedures New Rules v02r01

##### Section C. Measurement Bandwidth, Section 1

###### 26 BW

###### Test parameters

X dB BW = -26dB (using the OBW function of the spectrum analyzer)

###### Emission Bandwidth (EBW)

- a) Set RBW = approximately 1% of the emission bandwidth.
- b) Set the VBW > RBW.
- c) Detector = Peak.
- d) Trace mode = max hold.
- e) Measure the maximum width of the emission that is 26 dB down from the maximum of the emission. Compare this with the RBW setting of the analyzer. Readjust RBW and repeat measurement as needed until the RBW/EBW ratio is approximately 1%.

#### Samples, Systems, and Modes



System Number	Description	Samples	System under test	Support equipment
1	EUT	S01+S02	<input checked="" type="checkbox"/>	<input type="checkbox"/>
	Support		<input type="checkbox"/>	<input checked="" type="checkbox"/>

<b>Tested By :</b> Chris Blair	<b>Date of testing:</b> 11-Sep-19 - 25-Sep-19
<b>Test Result : PASS</b>	

**Test Equipment**

See Appendix C for list of test equipment





99% and 26dB Bandwidth

Frequency (MHz)	Mode	Data Rate (Mbps)	26dB BW (MHz)	99% BW (MHz)
5260	Non HT20, 6 to 54 Mbps	6	21.2	16.775
	HT/VHT20, M0 to M31	m0	21.8	18.056
	HE20, M0 to M9, M0 to M9 1-2ss	m0h1	21.4	19.131
5270	Non HT40, 6 to 54 Mbps	6	39.8	36.357
	HT/VHT40, M0 to M31	m0	40.1	36.410
	HE40, M0 to M9, M0 to M9 1-2ss	m0h1	39.8	37.632
5290	Non HT80, 6 to 54 Mbps	6	82.1	76.213
	VHT80, M0 to M9, M0 to M9 1-2ss	m0x1	82.2	76.040
	HE80, M0 to M9, M0 to M9 1-2ss	m0h1	81.8	76.979
5300	Non HT20, 6 to 54 Mbps	6	21.2	16.779
	HT/VHT20, M0 to M31	m0	21.8	18.042
	HE20, M0 to M9, M0 to M9 1-2ss	m0h1	21.5	19.136
5310	Non HT40, 6 to 54 Mbps	6	39.7	36.366
	HT/VHT40, M0 to M31	m0	40.1	36.421
	HE40, M0 to M9, M0 to M9 1-2ss	m0h1	39.8	37.558
5320	Non HT20, 6 to 54 Mbps	6	21.2	16.775
	HT/VHT20, M0 to M31	m0	21.8	18.064
	HE20, M0 to M9, M0 to M9 1-2ss	m0h1	21.5	19.136
5250	Non HT160, 6 to 54 Mbps	6	164.0	153.999
	VHT160, M0 to M9, M0 to M9 1-2ss	m0x1	164.6	154.582
	HE160, M0 to M9, M0 to M9 1-2ss	m0h1	163.4	154.658



**26dB / 99% Bandwidth, 5260 MHz, Non HT20, 6 to 54 Mbps**

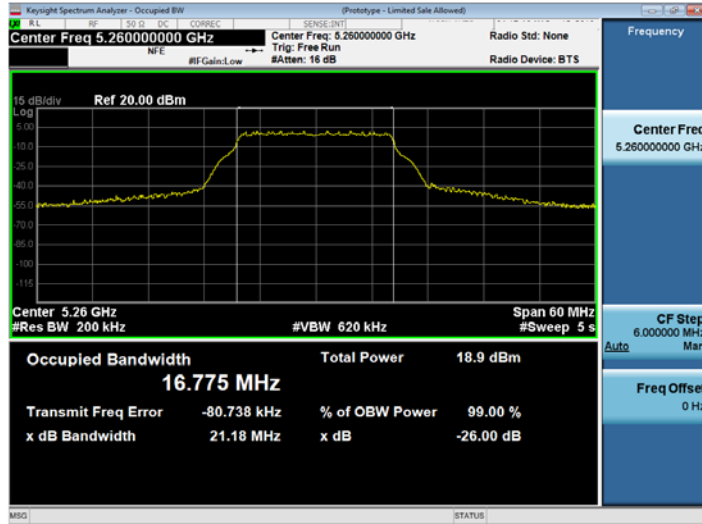



## A.3 Maximum Conducted Output Power

### Maximum Conducted Output Power Test Requirement

**15.407 (2)** For the 5.25-5.35 GHz and 5.47-5.725 GHz bands, the maximum conducted output power over the frequency bands of operation shall not exceed the lesser of 250 mW or  $11 \text{ dBm} + 10 \log B$ , where B is the 26 dB emission bandwidth in megahertz. ... If transmitting antennas of directional gain greater than 6 dBi are used, both the maximum conducted output power and the maximum power spectral density shall be reduced by the amount in dB that the directional gain of the antenna exceeds 6 dBi.

**15.407 (5)** The maximum power spectral density is measured as a conducted emission by direct connection of a calibrated test instrument to the equipment under test. If the device cannot be connected directly, alternative techniques acceptable to the Commission may be used. Measurements in the 5.15-5.25 GHz, 5.25-5.35 GHz, and the 5.47-5.725 GHz bands are made over a bandwidth of 1 MHz or the 26 dB emission bandwidth of the device, whichever is less. A narrower resolution bandwidth can be used, provided that the measured power is integrated over the full reference bandwidth.

Referencing “644545 D03 Guidance for IEEE 802.11ac v01”, covering signals that cross the boundary between two adjacent UNII bands, the FCC describes a procedure to measure EBW, power, and PSD in each UNII band. For the case of a 160MHz signal equally distributed between UNII-1 and UNII-2a, we apply the following alternate procedure.

Rather than measure:

- The half of the signal in UNII-1, measured against the 30dBm power / 17dBm/MHz PSD limits
- The half of the signal in UNII-2a, measured against the 24dBm power / 11dBm/MHz PSD limits

If a 160MHz signal (equally distributed between the two bands) produces a total power of 27dBm across the entire 160 MHz EBW, the total power in each band would be half of the total, or 24dBm (which meets both the UNII-1 and UNII-2a limits), and would have a PSD no greater than 11dBm/MHz in either sub-band.

Given these facts, we have measured the complete 160 MHz EBW (across both sub-bands) against 27dBm power and 11dBm/MHz PSD limits, rather than individual sub band measurements against the individual sub band limits.”

### Maximum Conducted Output Power Test Procedure

**Ref. KDB 789033 D02 General UNII Test Procedures New Rules v02r01**

**ANSI C63.10: 2013**

#### Maximum Conducted Output Power

Test Procedure

1. Set the radio in the continuous transmitting mode at full power
2. Compute power by integrating the spectrum across the EBW (or alternatively entire 99% OBW) of the signal using the instrument’s band power measurement function. The integration shall be performed using the spectrum analyzer band-power measurement function with band limits set equal to the EBW or the OBW band edges.
3. Capture graphs and record pertinent measurement data.

**Ref. KDB 789033 D02 General UNII Test Procedures New Rules v02r01**

**2. Measurement using a Spectrum Analyzer or EMI Receiver (SA), (d) Method SA-2**

#### Maximum Conducted Output Power

Test parameters



Method SA-2 (trace averaging across on and off times of the EUT transmissions, followed by duty cycle correction).

(i) Measure the duty cycle,  $x$ , of the transmitter output signal as described in section II.B.

(ii) Set span to encompass the EBW (or, alternatively, the entire 99% occupied bandwidth) of the signal.

(iii) Set RBW = 1 MHz.

(iv) Set VBW  $\geq$  3 MHz.

(v) Number of points in sweep  $\geq$  2 Span / RBW. (This ensures that bin-to-bin spacing is  $\leq$  RBW/2, so that narrowband signals are not lost between frequency bins.)

(vi) Sweep time = auto.

(vii) Detector = RMS (i.e., power averaging), if available. Otherwise, use sample detector mode.

(viii) Do not use sweep triggering. Allow the sweep to “free run”.

(ix) Trace average at least 100 traces in power averaging (i.e., RMS) mode; however, the number of traces to be averaged shall be increased above 100 as needed to ensure that the average accurately represents the true average over the on and off periods of the transmitter.

(x) Compute power by integrating the spectrum across the EBW (or, alternatively, the entire 99% occupied bandwidth) of the signal using the instrument’s band power measurement function with band limits set equal to the EBW (or occupied bandwidth)

The “measure-and-sum technique” is used for measuring in-band transmit power of a device. In the measure-and-sum approach, the conducted emission level is measured at each antenna port. The measured results at the various antenna ports are then summed mathematically to determine the total emission level from the device. Summing is performed in linear power units. ANSI C63.10 section 14.3.2.2

#### Samples, Systems, and Modes

System Number	Description	Samples	System under test	Support equipment
1	EUT	S01+S02	<input checked="" type="checkbox"/>	<input type="checkbox"/>
	Support		<input type="checkbox"/>	<input checked="" type="checkbox"/>

<b>Tested By :</b> Chris Blair	<b>Date of testing:</b> 11-Sep-19 - 25-Sep-19
<b>Test Result : PASS</b>	

#### Test Equipment

See Appendix C for list of test equipment



## Maximum Output Power, 4dBi

Frequency (MHz)	Mode	Tx Paths	Correlated Antenna Gain (dBi)	Tx 1 Max Power (dBm)	Tx 2 Max Power (dBm)	Tx 3 Max Power (dBm)	Tx 4 Max Power (dBm)	Duty Cycle Correction (dB)	Total Tx Channel Power (dBm)	Limit (dBm)	Margin (dB)
5260	Non HT20, 6 to 54 Mbps	1	4	10.9				0.0	10.9	24.0	13.06
	Non HT20, 6 to 54 Mbps	2	4	10.9	17.0			0.0	18.0	24.0	6.00
	Non HT20, 6 to 54 Mbps	3	4	10.9	15.1	14.3		0.0	18.6	24.0	5.41
	Non HT20, 6 to 54 Mbps	4	4	10.9	11.9	10.9	10.8	0.0	17.2	24.0	6.79
	Non HT20 Beam Forming, 6 to 54 Mbps	2	7	10.9	17.0			0.0	18.0	23.0	5.00
	Non HT20 Beam Forming, 6 to 54 Mbps	3	9	10.9	15.1	14.3		0.0	18.6	21.0	2.41
	Non HT20 Beam Forming, 6 to 54 Mbps	4	10	10.9	11.9	10.9	10.8	0.0	17.2	20.0	2.79
	HT/VHT20, M0 to M7	1	4	10.9				0.1	11.0	24.0	13.05
	HT/VHT20, M0 to M7	2	4	10.9	17.1			0.1	18.1	24.0	5.91
	HT/VHT20, M8 to M15	2	4	10.9	17.1			0.1	18.1	24.0	5.91
	HT/VHT20, M0 to M7	3	4	10.9	15.1	14.2		0.1	18.6	24.0	5.44
	HT/VHT20, M8 to M15	3	4	10.9	17.1	16.5		0.1	20.4	24.0	3.60
	HT/VHT20, M16 to M23	3	4	10.9	17.1	16.5		0.1	20.4	24.0	3.60
	HT/VHT20, M0 to M7	4	4	10.9	12.7	12.1	11.7	0.1	18.0	24.0	6.03
	HT/VHT20, M8 to M15	4	4	10.9	15.9	15.5	15.2	0.1	20.8	24.0	3.16
	HT/VHT20, M16 to M23	4	4	10.9	17.1	16.5	16.5	0.1	21.9	24.0	2.10
	HT/VHT20, M24 to M31	4	4	10.9	17.1	16.5	16.5	0.1	21.9	24.0	2.10
	HT/VHT20 Beam Forming, M0 to M7	2	7	10.9	17.1			0.1	18.1	23.0	4.91
	HT/VHT20 Beam Forming, M8 to M15	2	4	10.9	17.1			0.1	18.1	24.0	5.91
	HT/VHT20 Beam Forming, M0 to M7	3	9	10.9	15.1	14.2		0.1	18.6	21.0	2.44
	HT/VHT20 Beam Forming, M8 to M15	3	6	10.9	17.1	16.5		0.1	20.4	24.0	3.60
	HT/VHT20 Beam Forming, M16 to M23	3	4	10.9	17.1	16.5		0.1	20.4	24.0	3.60
	HT/VHT20 Beam Forming, M0 to M7	4	10	10.9	12.7	12.1	11.7	0.1	18.0	20.0	2.03
	HT/VHT20 Beam Forming, M8 to M15	4	7	10.9	15.9	15.5	15.2	0.1	20.8	23.0	2.16
	HT/VHT20 Beam Forming, M16 to M23	4	5	10.9	17.1	16.5	16.5	0.1	21.9	24.0	2.10
	HT/VHT20 Beam Forming, M24 to M31	4	4	10.9	17.1	16.5	16.5	0.1	21.9	24.0	2.10
	HT/VHT20 STBC, M0 to M7	2	4	10.9	17.1			0.1	18.1	24.0	5.91
	HT/VHT20 STBC, M0 to M7	3	4	10.9	17.1	16.5		0.1	20.4	24.0	3.60
	HT/VHT20 STBC, M0 to M7	4	4	10.9	15.9	15.5	15.2	0.1	20.8	24.0	3.16
	HE20, M0 to M9 1ss	1	4	11.1				0.1	11.2	24.0	12.83



	HE20, M0 to M9 1ss	2	4	11.1	17.4			0.1	18.4	24.0	5.61
	HE20, M0 to M9 2ss	2	4	11.1	17.4			0.1	18.4	24.0	5.61
	HE20, M0 to M9 1ss	3	4	11.1	15.3	14.6		0.1	18.9	24.0	5.14
	HE20, M0 to M9 2ss	3	4	11.1	17.4	16.9		0.1	20.7	24.0	3.25
	HE20, M0 to M9 3ss	3	4	11.1	17.4	16.9		0.1	20.7	24.0	3.25
	HE20, M0 to M9 1ss	4	4	11.1	12.1	11.3	11.0	0.1	17.5	24.0	6.51
	HE20, M0 to M9 2ss	4	4	11.1	16.3	15.8	15.5	0.1	21.2	24.0	2.82
	HE20, M0 to M9 3ss	4	4	11.1	17.4	16.9	16.8	0.1	22.2	24.0	1.76
	HE20, M0 to M9 4ss	4	4	11.1	17.4	16.9	16.8	0.1	22.2	24.0	1.76
	HE20 Beam Forming, M0 to M9 1ss	2	7	11.1	17.4			0.1	18.4	23.0	4.61
	HE20 Beam Forming, M0 to M9 2ss	2	4	11.1	17.4			0.1	18.4	24.0	5.61
	HE20 Beam Forming, M0 to M9 1ss	3	9	11.1	15.3	14.6		0.1	18.9	21.0	2.14
	HE20 Beam Forming, M0 to M9 2ss	3	6	11.1	17.4	16.9		0.1	20.7	24.0	3.25
	HE20 Beam Forming, M0 to M9 3ss	3	4	11.1	17.4	16.9		0.1	20.7	24.0	3.25
	HE20 Beam Forming, M0 to M9 1ss	4	10	11.1	12.1	11.3	11.0	0.1	17.5	20.0	2.51
	HE20 Beam Forming, M0 to M9 2ss	4	7	11.1	16.3	15.8	15.5	0.1	21.2	23.0	1.82
	HE20 Beam Forming, M0 to M9 3ss	4	5	11.1	17.4	16.9	16.8	0.1	22.2	24.0	1.76
	HE20 Beam Forming, M0 to M9 4ss	4	4	11.1	17.4	16.9	16.8	0.1	22.2	24.0	1.76
	HE20 STBC, M0 to M9 2ss	2	4	11.1	17.4			0.1	18.4	24.0	5.61
	HE20 STBC, M0 to M9 2ss	3	4	11.1	17.4	16.9		0.1	20.7	24.0	3.25
	HE20 STBC, M0 to M9 2ss	4	4	11.1	16.3	15.8	15.5	0.1	21.2	24.0	2.82
5270	Non HT40, 6 to 54 Mbps	1	4	10.7				0.0	10.7	24.0	13.26
	Non HT40, 6 to 54 Mbps	2	4	10.7	16.3			0.0	17.4	24.0	6.60
	Non HT40, 6 to 54 Mbps	3	4	10.7	16.3	16.7		0.0	20.1	24.0	3.91
	Non HT40, 6 to 54 Mbps	4	4	10.7	15.3	15.5	15.3	0.0	20.7	24.0	3.35
	HT/VHT40, M0 to M7	1	4	10.6				0.1	10.7	24.0	13.30
	HT/VHT40, M0 to M7	2	4	10.6	16.2			0.1	17.4	24.0	6.64
	HT/VHT40, M8 to M15	2	4	10.6	16.2			0.1	17.4	24.0	6.64
	HT/VHT40, M0 to M7	3	4	10.6	16.2	16.6		0.1	20.1	24.0	3.95
	HT/VHT40, M8 to M15	3	4	10.6	16.2	16.6		0.1	20.1	24.0	3.95
	HT/VHT40, M16 to M23	3	4	10.6	16.2	16.6		0.1	20.1	24.0	3.95
	HT/VHT40, M0 to M7	4	4	10.6	15.4	15.5	15.2	0.1	20.7	24.0	3.30
	HT/VHT40, M8 to M15	4	4	10.6	16.2	16.6	16.3	0.1	21.6	24.0	2.39
	HT/VHT40, M16 to M23	4	4	10.6	16.2	16.6	16.3	0.1	21.6	24.0	2.39
	HT/VHT40, M24 to M31	4	4	10.6	16.2	16.6	16.3	0.1	21.6	24.0	2.39
	HT/VHT40 Beam Forming, M0 to M7	2	7	10.6	16.2			0.1	17.4	23.0	5.64
	HT/VHT40 Beam Forming, M8 to M15	2	4	10.6	16.2			0.1	17.4	24.0	6.64
	HT/VHT40 Beam Forming, M0 to M7	3	9	10.6	15.4	15.5		0.1	19.2	21.0	1.78
	HT/VHT40 Beam Forming, M8 to M15	3	6	10.6	16.2	16.6		0.1	20.1	24.0	3.95
	HT/VHT40 Beam Forming, M16 to M23	3	4	10.6	16.2	16.6		0.1	20.1	24.0	3.95
HT/VHT40 Beam Forming, M0 to M7	4	10	10.6	13.1	13.3	12.9	0.1	18.7	20.0	1.28	



HT/VHT40 Beam Forming, M8 to M15	4	7	10.6	16.2	16.6	16.3	0.1	21.6	23.0	1.39
HT/VHT40 Beam Forming, M16 to M23	4	5	10.6	16.2	16.6	16.3	0.1	21.6	24.0	2.39
HT/VHT40 Beam Forming, M24 to M31	4	4	10.6	16.2	16.6	16.3	0.1	21.6	24.0	2.39
HT/VHT40 STBC, M0 to M7	2	4	10.6	16.2			0.1	17.4	24.0	6.64
HT/VHT40 STBC, M0 to M7	3	4	10.6	16.2	16.6		0.1	20.1	24.0	3.95
HT/VHT40 STBC, M0 to M7	4	4	10.6	16.2	16.6	16.3	0.1	21.6	24.0	2.39
HE40, M0 to M9 1ss	1	4	10.8				0.1	10.9	24.0	13.07
HE40, M0 to M9 1ss	2	4	10.8	16.7			0.1	17.8	24.0	6.18
HE40, M0 to M9 2ss	2	4	10.8	16.7			0.1	17.8	24.0	6.18
HE40, M0 to M9 1ss	3	4	10.8	16.7	16.8		0.1	20.4	24.0	3.59
HE40, M0 to M9 2ss	3	4	10.8	16.7	16.8		0.1	20.4	24.0	3.59
HE40, M0 to M9 3ss	3	4	10.8	16.7	16.8		0.1	20.4	24.0	3.59
HE40, M0 to M9 1ss	4	4	10.8	15.5	15.6	15.5	0.1	20.9	24.0	3.10
HE40, M0 to M9 2ss	4	4	10.8	16.7	16.8	16.6	0.1	22.0	24.0	2.04
HE40, M0 to M9 3ss	4	4	10.8	16.7	16.8	16.6	0.1	22.0	24.0	2.04
HE40, M0 to M9 4ss	4	4	10.8	16.7	16.8	16.6	0.1	22.0	24.0	2.04
HE40 Beam Forming, M0 to M9 1ss	2	7	10.8	16.7			0.1	17.8	23.0	5.18
HE40 Beam Forming, M0 to M9 2ss	2	4	10.8	16.7			0.1	17.8	24.0	6.18
HE40 Beam Forming, M0 to M9 1ss	3	9	10.8	15.5	15.6		0.1	19.4	21.0	1.64
HE40 Beam Forming, M0 to M9 2ss	3	6	10.8	16.7	16.8		0.1	20.4	24.0	3.59
HE40 Beam Forming, M0 to M9 3ss	3	4	10.8	16.7	16.8		0.1	20.4	24.0	3.59
<b>HE40 Beam Forming, M0 to M9 1ss</b>	<b>4</b>	<b>10</b>	<b>10.8</b>	<b>13.4</b>	<b>13.4</b>	<b>13.2</b>	<b>0.1</b>	<b>19.0</b>	<b>20.0</b>	<b>1.02</b>
HE40 Beam Forming, M0 to M9 2ss	4	7	10.8	16.7	16.8	16.6	0.1	22.0	23.0	1.04
HE40 Beam Forming, M0 to M9 3ss	4	5	10.8	16.7	16.8	16.6	0.1	22.0	24.0	2.04
HE40 Beam Forming, M0 to M9 4ss	4	4	10.8	16.7	16.8	16.6	0.1	22.0	24.0	2.04
HE40 STBC, M0 to M9 2ss	2	4	10.8	16.7			0.1	17.8	24.0	6.18
HE40 STBC, M0 to M9 2ss	3	4	10.8	16.7	16.8		0.1	20.4	24.0	3.59
HE40 STBC, M0 to M9 2ss	4	4	10.8	16.7	16.8	16.6	0.1	22.0	24.0	2.04
<b>5290</b>										
Non HT80, 6 to 54 Mbps	1	4	8.7				0.1	8.8	24.0	15.25
Non HT80, 6 to 54 Mbps	2	4	8.7	8.7			0.1	11.8	24.0	12.24
Non HT80, 6 to 54 Mbps	3	4	8.7	8.7	8.9		0.1	13.6	24.0	10.41
Non HT80, 6 to 54 Mbps	4	4	8.7	8.7	8.9	8.3	0.1	14.7	24.0	9.27
VHT80, M0 to M9 1ss	1	4	9.5				0.2	9.7	24.0	14.28
VHT80, M0 to M9 1ss	2	4	9.5	9.5			0.2	12.7	24.0	11.27
VHT80, M0 to M9 2ss	2	4	9.5	9.5			0.2	12.7	24.0	11.27
VHT80, M0 to M9 1ss	3	4	9.5	9.5	9.8		0.2	14.6	24.0	9.41
VHT80, M0 to M9 2ss	3	4	9.5	9.5	9.8		0.2	14.6	24.0	9.41
VHT80, M0 to M9 3ss	3	4	9.5	9.5	9.8		0.2	14.6	24.0	9.41
VHT80, M0 to M9 1ss	4	4	9.5	9.5	9.8	9.2	0.2	15.7	24.0	8.26
VHT80, M0 to M9 2ss	4	4	9.5	9.5	9.8	9.2	0.2	15.7	24.0	8.26
VHT80, M0 to M9 3ss	4	4	9.5	9.5	9.8	9.2	0.2	15.7	24.0	8.26



VHT80, M0 to M9 4ss	4	4	9.5	9.5	9.8	9.2	0.2	15.7	24.0	8.26	
VHT80 Beam Forming, M0 to M9 1ss	2	7	8.7	8.6			0.2	11.9	23.0	11.12	
VHT80 Beam Forming, M0 to M9 2ss	2	4	9.5	9.5			0.2	12.7	24.0	11.27	
VHT80 Beam Forming, M0 to M9 1ss	3	9	7.6	7.5	7.7		0.2	12.6	21.0	8.41	
VHT80 Beam Forming, M0 to M9 2ss	3	6	8.7	8.6	8.9		0.2	13.7	24.0	10.28	
VHT80 Beam Forming, M0 to M9 3ss	3	4	9.5	9.5	9.8		0.2	14.6	24.0	9.41	
VHT80 Beam Forming, M0 to M9 1ss	4	10	7.6	7.5	7.7	7.0	0.2	13.7	20.0	6.31	
VHT80 Beam Forming, M0 to M9 2ss	4	7	8.7	8.6	8.9	8.2	0.2	14.8	23.0	8.16	
VHT80 Beam Forming, M0 to M9 3ss	4	5	9.5	9.5	9.8	9.2	0.2	15.7	24.0	8.26	
VHT80 Beam Forming, M0 to M9 4ss	4	4	9.5	9.5	9.8	9.2	0.2	15.7	24.0	8.26	
VHT80 STBC, M0 to M9 1ss	2	4	9.5	9.5			0.2	12.7	24.0	11.27	
VHT80 STBC, M0 to M9 1ss	3	4	9.5	9.5	9.8		0.2	14.6	24.0	9.41	
VHT80 STBC, M0 to M9 1ss	4	4	9.5	9.5	9.8	9.2	0.2	15.7	24.0	8.26	
HE80, M0 to M9 1ss	1	4	9.6				0.3	9.9	24.0	14.14	
HE80, M0 to M9 1ss	2	4	9.6	9.5			0.3	12.8	24.0	11.18	
HE80, M0 to M9 2ss	2	4	9.6	9.5			0.3	12.8	24.0	11.18	
HE80, M0 to M9 1ss	3	4	9.6	9.5	9.7		0.3	14.6	24.0	9.37	
HE80, M0 to M9 2ss	3	4	9.6	9.5	9.7		0.3	14.6	24.0	9.37	
HE80, M0 to M9 3ss	3	4	9.6	9.5	9.7		0.3	14.6	24.0	9.37	
HE80, M0 to M9 1ss	4	4	9.6	9.5	9.7	9.1	0.3	15.8	24.0	8.24	
HE80, M0 to M9 2ss	4	4	9.6	9.5	9.7	9.1	0.3	15.8	24.0	8.24	
HE80, M0 to M9 3ss	4	4	9.6	9.5	9.7	9.1	0.3	15.8	24.0	8.24	
HE80, M0 to M9 4ss	4	4	9.6	9.5	9.7	9.1	0.3	15.8	24.0	8.24	
HE80 Beam Forming, M0 to M9 1ss	2	7	8.6	8.6			0.3	11.9	23.0	11.13	
HE80 Beam Forming, M0 to M9 2ss	2	4	9.6	9.5			0.3	12.8	24.0	11.18	
HE80 Beam Forming, M0 to M9 1ss	3	9	7.8	7.6	7.7		0.3	12.7	21.0	8.27	
HE80 Beam Forming, M0 to M9 2ss	3	6	8.6	8.6	8.8		0.3	13.7	24.0	10.30	
HE80 Beam Forming, M0 to M9 3ss	3	4	9.6	9.5	9.7		0.3	14.6	24.0	9.37	
HE80 Beam Forming, M0 to M9 1ss	4	10	6.8	6.5	6.7	6.2	0.3	12.8	20.0	7.16	
HE80 Beam Forming, M0 to M9 2ss	4	7	7.8	7.6	7.7	7.0	0.3	13.8	23.0	9.18	
HE80 Beam Forming, M0 to M9 3ss	4	5	8.6	8.6	8.8	8.3	0.3	14.9	24.0	9.14	
HE80 Beam Forming, M0 to M9 4ss	4	4	9.6	9.5	9.7	9.1	0.3	15.8	24.0	8.24	
HE80 STBC, M0 to M9 1ss	2	4	9.6	9.5			0.3	12.8	24.0	11.18	
HE80 STBC, M0 to M9 1ss	3	4	9.6	9.5	9.7		0.3	14.6	24.0	9.37	
HE80 STBC, M0 to M9 1ss	4	4	9.6	9.5	9.7	9.1	0.3	15.8	24.0	8.24	
5300	Non HT20, 6 to 54 Mbps	1	4	11.2				0.0	11.2	24.0	12.76
	Non HT20, 6 to 54 Mbps	2	4	11.2	16.9			0.0	18.0	24.0	6.02
	Non HT20, 6 to 54 Mbps	3	4	11.2	15.0	14.3		0.0	18.6	24.0	5.40
	Non HT20, 6 to 54 Mbps	4	4	11.2	11.8	11.2	10.3	0.0	17.2	24.0	6.78
	Non HT20 Beam Forming, 6 to 54 Mbps	2	7	11.2	16.9			0.0	18.0	23.0	5.02
	Non HT20 Beam Forming, 6 to 54 Mbps	3	9	11.2	15.0	14.3		0.0	18.6	21.0	2.40





Non HT20 Beam Forming, 6 to 54 Mbps	4	10	11.2	11.8	11.2	10.3	0.0	17.2	20.0	2.78
HT/VHT20, M0 to M7	1	4	11.2				0.1	11.3	24.0	12.75
HT/VHT20, M0 to M7	2	4	11.2	16.8			0.1	17.9	24.0	6.09
HT/VHT20, M8 to M15	2	4	11.2	16.8			0.1	17.9	24.0	6.09
HT/VHT20, M0 to M7	3	4	11.2	14.9	14.3		0.1	18.6	24.0	5.43
HT/VHT20, M8 to M15	3	4	11.2	16.8	16.7		0.1	20.4	24.0	3.62
HT/VHT20, M16 to M23	3	4	11.2	16.8	16.7		0.1	20.4	24.0	3.62
HT/VHT20, M0 to M7	4	4	11.2	12.7	12.3	11.4	0.1	18.0	24.0	5.98
HT/VHT20, M8 to M15	4	4	11.2	15.8	15.5	14.7	0.1	20.7	24.0	3.30
HT/VHT20, M16 to M23	4	4	11.2	16.8	16.7	16.1	0.1	21.8	24.0	2.23
HT/VHT20, M24 to M31	4	4	11.2	16.8	16.7	16.1	0.1	21.8	24.0	2.23
HT/VHT20 Beam Forming, M0 to M7	2	7	11.2	16.8			0.1	17.9	23.0	5.09
HT/VHT20 Beam Forming, M8 to M15	2	4	11.2	16.8			0.1	17.9	24.0	6.09
HT/VHT20 Beam Forming, M0 to M7	3	9	11.2	14.9	14.3		0.1	18.6	21.0	2.43
HT/VHT20 Beam Forming, M8 to M15	3	6	11.2	16.8	16.7		0.1	20.4	24.0	3.62
HT/VHT20 Beam Forming, M16 to M23	3	4	11.2	16.8	16.7		0.1	20.4	24.0	3.62
HT/VHT20 Beam Forming, M0 to M7	4	10	11.2	12.7	12.3	11.4	0.1	18.0	20.0	1.98
HT/VHT20 Beam Forming, M8 to M15	4	7	11.2	15.8	15.5	14.7	0.1	20.7	23.0	2.30
HT/VHT20 Beam Forming, M16 to M23	4	5	11.2	16.8	16.7	16.1	0.1	21.8	24.0	2.23
HT/VHT20 Beam Forming, M24 to M31	4	4	11.2	16.8	16.7	16.1	0.1	21.8	24.0	2.23
HT/VHT20 STBC, M0 to M7	2	4	11.2	16.8			0.1	17.9	24.0	6.09
HT/VHT20 STBC, M0 to M7	3	4	11.2	16.8	16.7		0.1	20.4	24.0	3.62
HT/VHT20 STBC, M0 to M7	4	4	11.2	15.8	15.5	14.7	0.1	20.7	24.0	3.30
HE20, M0 to M9 1ss	1	4	11.4				0.1	11.5	24.0	12.53
HE20, M0 to M9 1ss	2	4	11.4	17.2			0.1	18.3	24.0	5.72
HE20, M0 to M9 2ss	2	4	11.4	17.2			0.1	18.3	24.0	5.72
HE20, M0 to M9 1ss	3	4	11.4	15.2	14.7		0.1	18.9	24.0	5.10
HE20, M0 to M9 2ss	3	4	11.4	17.2	16.9		0.1	20.7	24.0	3.31
HE20, M0 to M9 3ss	3	4	11.4	17.2	16.9		0.1	20.7	24.0	3.31
HE20, M0 to M9 1ss	4	4	11.4	12.9	12.6	11.8	0.1	18.3	24.0	5.69
HE20, M0 to M9 2ss	4	4	11.4	16.0	15.7	15.1	0.1	21.0	24.0	3.03
HE20, M0 to M9 3ss	4	4	11.4	17.2	16.9	16.4	0.1	22.1	24.0	1.92
HE20, M0 to M9 4ss	4	4	11.4	17.2	16.9	16.4	0.1	22.1	24.0	1.92
HE20 Beam Forming, M0 to M9 1ss	2	7	11.4	17.2			0.1	18.3	23.0	4.72
HE20 Beam Forming, M0 to M9 2ss	2	4	11.4	17.2			0.1	18.3	24.0	5.72
HE20 Beam Forming, M0 to M9 1ss	3	9	11.4	15.2	14.7		0.1	18.9	21.0	2.10
HE20 Beam Forming, M0 to M9 2ss	3	6	11.4	17.2	16.9		0.1	20.7	24.0	3.31
HE20 Beam Forming, M0 to M9 3ss	3	4	11.4	17.2	16.9		0.1	20.7	24.0	3.31
HE20 Beam Forming, M0 to M9 1ss	4	10	11.4	12.9	12.6	11.8	0.1	18.3	20.0	1.69
HE20 Beam Forming, M0 to M9 2ss	4	7	11.4	16.0	15.7	15.1	0.1	21.0	23.0	2.03
HE20 Beam Forming, M0 to M9 3ss	4	5	11.4	17.2	16.9	16.4	0.1	22.1	24.0	1.92
HE20 Beam Forming, M0 to M9 4ss	4	4	11.4	17.2	16.9	16.4	0.1	22.1	24.0	1.92



	HE20 STBC, M0 to M9 2ss	2	4	11.4	17.2			0.1	18.3	24.0	5.72
	HE20 STBC, M0 to M9 2ss	3	4	11.4	17.2	16.9		0.1	20.7	24.0	3.31
	HE20 STBC, M0 to M9 2ss	4	4	11.4	16.0	15.7	15.1	0.1	21.0	24.0	3.03
5310	Non HT40, 6 to 54 Mbps	1	4	10.9				0.0	10.9	24.0	13.06
	Non HT40, 6 to 54 Mbps	2	4	9.9	10.1			0.0	13.1	24.0	10.94
	Non HT40, 6 to 54 Mbps	3	4	9.9	10.1	10.4		0.0	15.0	24.0	9.05
	Non HT40, 6 to 54 Mbps	4	4	9.9	10.1	10.4	9.4	0.0	16.0	24.0	7.97
	HT/VHT40, M0 to M7	1	4	10.6				0.1	10.7	24.0	13.30
	HT/VHT40, M0 to M7	2	4	10.6	11.9			0.1	14.4	24.0	9.59
	HT/VHT40, M8 to M15	2	4	10.6	11.9			0.1	14.4	24.0	9.59
	HT/VHT40, M0 to M7	3	4	10.6	11.0	11.3		0.1	15.8	24.0	8.15
	HT/VHT40, M8 to M15	3	4	10.6	11.0	11.3		0.1	15.8	24.0	8.15
	HT/VHT40, M16 to M23	3	4	10.6	11.0	11.3		0.1	15.8	24.0	8.15
	HT/VHT40, M0 to M7	4	4	9.8	10.0	9.9	9.2	0.1	15.9	24.0	8.14
	HT/VHT40, M8 to M15	4	4	9.8	10.0	9.9	9.2	0.1	15.9	24.0	8.14
	HT/VHT40, M16 to M23	4	4	9.8	10.0	9.9	9.2	0.1	15.9	24.0	8.14
	HT/VHT40, M24 to M31	4	4	9.8	10.0	9.9	9.2	0.1	15.9	24.0	8.14
	HT/VHT40 Beam Forming, M0 to M7	2	7	9.8	10.0			0.1	13.0	23.0	9.99
	HT/VHT40 Beam Forming, M8 to M15	2	4	10.6	11.9			0.1	14.4	24.0	9.59
	HT/VHT40 Beam Forming, M0 to M7	3	9	8.6	9.0	9.1		0.1	13.8	21.0	7.22
	HT/VHT40 Beam Forming, M8 to M15	3	6	9.8	10.0	9.9		0.1	14.8	24.0	9.23
	HT/VHT40 Beam Forming, M16 to M23	3	4	10.6	11.0	11.3		0.1	15.8	24.0	8.15
	HT/VHT40 Beam Forming, M0 to M7	4	10	7.7	7.7	8.0	7.1	0.1	13.8	20.0	6.24
	HT/VHT40 Beam Forming, M8 to M15	4	7	8.6	9.0	9.1	8.2	0.1	14.9	23.0	8.14
	HT/VHT40 Beam Forming, M16 to M23	4	5	9.8	10.0	9.9	9.2	0.1	15.9	24.0	8.14
	HT/VHT40 Beam Forming, M24 to M31	4	4	9.8	10.0	9.9	9.2	0.1	15.9	24.0	8.14
	HT/VHT40 STBC, M0 to M7	2	4	10.6	11.9			0.1	14.4	24.0	9.59
	HT/VHT40 STBC, M0 to M7	3	4	10.6	11.0	11.3		0.1	15.8	24.0	8.15
	HT/VHT40 STBC, M0 to M7	4	4	9.8	10.0	9.9	9.2	0.1	15.9	24.0	8.14
	HE40, M0 to M9 1ss	1	4	10.0				0.1	10.1	24.0	13.87
	HE40, M0 to M9 1ss	2	4	10.0	10.3			0.1	13.3	24.0	10.71
	HE40, M0 to M9 2ss	2	4	10.0	10.3			0.1	13.3	24.0	10.71
	HE40, M0 to M9 1ss	3	4	10.0	10.3	10.6		0.1	15.2	24.0	8.79
	HE40, M0 to M9 2ss	3	4	10.0	10.3	10.6		0.1	15.2	24.0	8.79
	HE40, M0 to M9 3ss	3	4	10.0	10.3	10.6		0.1	15.2	24.0	8.79
	HE40, M0 to M9 1ss	4	4	10.0	10.3	10.6	9.5	0.1	16.3	24.0	7.73
	HE40, M0 to M9 2ss	4	4	10.0	10.3	10.6	9.5	0.1	16.3	24.0	7.73
	HE40, M0 to M9 3ss	4	4	10.0	10.3	10.6	9.5	0.1	16.3	24.0	7.73
	HE40, M0 to M9 4ss	4	4	10.0	10.3	10.6	9.5	0.1	16.3	24.0	7.73
HE40 Beam Forming, M0 to M9 1ss	2	7	8.9	9.4			0.1	12.3	23.0	10.70	
HE40 Beam Forming, M0 to M9 2ss	2	4	10.0	10.3			0.1	13.3	24.0	10.71	



HE40 Beam Forming, M0 to M9 1ss	3	9	8.9	9.4	9.4		0.1	14.1	21.0	6.86	
HE40 Beam Forming, M0 to M9 2ss	3	6	8.9	9.4	9.4		0.1	14.1	24.0	9.86	
HE40 Beam Forming, M0 to M9 3ss	3	4	10.0	10.3	10.6		0.1	15.2	24.0	8.79	
HE40 Beam Forming, M0 to M9 1ss	4	10	8.1	8.3	8.2	7.4	0.1	14.2	20.0	5.84	
HE40 Beam Forming, M0 to M9 2ss	4	7	8.9	9.4	9.4	8.5	0.1	15.2	23.0	7.78	
HE40 Beam Forming, M0 to M9 3ss	4	5	8.9	9.4	9.4	8.5	0.1	15.2	24.0	8.78	
HE40 Beam Forming, M0 to M9 4ss	4	4	10.0	10.3	10.6	9.5	0.1	16.3	24.0	7.73	
HE40 STBC, M0 to M9 2ss	2	4	10.0	10.3			0.1	13.3	24.0	10.71	
HE40 STBC, M0 to M9 2ss	3	4	10.0	10.3	10.6		0.1	15.2	24.0	8.79	
HE40 STBC, M0 to M9 2ss	4	4	10.0	10.3	10.6	9.5	0.1	16.3	24.0	7.73	
5320	Non HT20, 6 to 54 Mbps	1	4	11.1				0.0	11.1	24.0	12.86
	Non HT20, 6 to 54 Mbps	2	4	11.1	16.9			0.0	18.0	24.0	6.04
	Non HT20, 6 to 54 Mbps	3	4	11.1	14.9	14.5		0.0	18.6	24.0	5.38
	Non HT20, 6 to 54 Mbps	4	4	11.1	12.6	12.3	11.4	0.0	18.0	24.0	6.04
	Non HT20 Beam Forming, 6 to 54 Mbps	2	7	11.1	15.8			0.0	17.1	23.0	5.89
	Non HT20 Beam Forming, 6 to 54 Mbps	3	9	11.1	14.9	14.5		0.0	18.6	21.0	2.38
	Non HT20 Beam Forming, 6 to 54 Mbps	4	10	11.1	12.6	12.3	11.4	0.0	18.0	20.0	2.04
	HT/VHT20, M0 to M7	1	4	10.9				0.1	11.0	24.0	13.05
	HT/VHT20, M0 to M7	2	4	10.9	15.7			0.1	17.0	24.0	7.01
	HT/VHT20, M8 to M15	2	4	10.9	15.7			0.1	17.0	24.0	7.01
	HT/VHT20, M0 to M7	3	4	10.9	14.9	14.4		0.1	18.5	24.0	5.45
	HT/VHT20, M8 to M15	3	4	10.9	15.7	15.6		0.1	19.4	24.0	4.61
	HT/VHT20, M16 to M23	3	4	10.9	15.7	15.6		0.1	19.4	24.0	4.61
	HT/VHT20, M0 to M7	4	4	10.9	12.7	12.4	11.3	0.1	18.0	24.0	6.04
	HT/VHT20, M8 to M15	4	4	10.9	15.7	15.6	14.7	0.1	20.7	24.0	3.33
	HT/VHT20, M16 to M23	4	4	10.9	15.7	15.6	14.7	0.1	20.7	24.0	3.33
	HT/VHT20, M24 to M31	4	4	10.9	15.7	15.6	14.7	0.1	20.7	24.0	3.33
	HT/VHT20 Beam Forming, M0 to M7	2	7	10.9	15.7			0.1	17.0	23.0	6.01
	HT/VHT20 Beam Forming, M8 to M15	2	4	10.9	15.7			0.1	17.0	24.0	7.01
	HT/VHT20 Beam Forming, M0 to M7	3	9	10.9	14.9	14.4		0.1	18.5	21.0	2.45
	HT/VHT20 Beam Forming, M8 to M15	3	6	10.9	15.7	15.6		0.1	19.4	24.0	4.61
	HT/VHT20 Beam Forming, M16 to M23	3	4	10.9	15.7	15.6		0.1	19.4	24.0	4.61
	HT/VHT20 Beam Forming, M0 to M7	4	10	10.9	12.7	12.4	11.3	0.1	18.0	20.0	2.04
	HT/VHT20 Beam Forming, M8 to M15	4	7	10.9	14.9	14.4	13.4	0.1	19.7	23.0	3.28
	HT/VHT20 Beam Forming, M16 to M23	4	5	10.9	14.9	14.4	13.4	0.1	19.7	24.0	4.28
	HT/VHT20 Beam Forming, M24 to M31	4	4	10.9	15.7	15.6	14.7	0.1	20.7	24.0	3.33
	HT/VHT20 STBC, M0 to M7	2	4	10.9	15.7			0.1	17.0	24.0	7.01
	HT/VHT20 STBC, M0 to M7	3	4	10.9	15.7	15.6		0.1	19.4	24.0	4.61
	HT/VHT20 STBC, M0 to M7	4	4	10.9	15.7	15.6	14.7	0.1	20.7	24.0	3.33
	HE20, M0 to M9 1ss	1	4	10.9				0.1	11.0	24.0	13.03
	HE20, M0 to M9 1ss	2	4	10.9	15.8			0.1	17.1	24.0	6.91



	HE20, M0 to M9 2ss	2	4	10.9	15.8			0.1	17.1	24.0	6.91	
	HE20, M0 to M9 1ss	3	4	10.9	14.9	14.5		0.1	18.6	24.0	5.39	
	HE20, M0 to M9 2ss	3	4	10.9	15.8	15.7		0.1	19.5	24.0	4.51	
	HE20, M0 to M9 3ss	3	4	10.9	15.8	15.7		0.1	19.5	24.0	4.51	
	HE20, M0 to M9 1ss	4	4	10.9	12.8	12.5	11.3	0.1	18.0	24.0	5.96	
	HE20, M0 to M9 2ss	4	4	10.9	14.9	14.5	13.5	0.1	19.8	24.0	4.21	
	HE20, M0 to M9 3ss	4	4	10.9	14.9	14.5	13.5	0.1	19.8	24.0	4.21	
	HE20, M0 to M9 4ss	4	4	10.9	14.9	14.5	13.5	0.1	19.8	24.0	4.21	
	HE20 Beam Forming, M0 to M9 1ss	2	7	10.9	14.9			0.1	16.4	23.0	6.57	
	HE20 Beam Forming, M0 to M9 2ss	2	4	10.9	15.8			0.1	17.1	24.0	6.91	
	HE20 Beam Forming, M0 to M9 1ss	3	9	10.9	13.9	13.6		0.1	17.8	21.0	3.17	
	HE20 Beam Forming, M0 to M9 2ss	3	6	10.9	14.9	14.5		0.1	18.6	24.0	5.39	
	HE20 Beam Forming, M0 to M9 3ss	3	4	10.9	15.8	15.7		0.1	19.5	24.0	4.51	
	HE20 Beam Forming, M0 to M9 1ss	4	10	10.9	12.8	12.5	11.3	0.1	18.0	20.0	1.96	
	HE20 Beam Forming, M0 to M9 2ss	4	7	10.9	13.9	13.6	12.5	0.1	19.0	23.0	4.03	
	HE20 Beam Forming, M0 to M9 3ss	4	5	10.9	14.9	14.5	13.5	0.1	19.8	24.0	4.21	
	HE20 Beam Forming, M0 to M9 4ss	4	4	10.9	14.9	14.5	13.5	0.1	19.8	24.0	4.21	
	HE20 STBC, M0 to M9 2ss	2	4	10.9	15.8			0.1	17.1	24.0	6.91	
	HE20 STBC, M0 to M9 2ss	3	4	10.9	15.8	15.7		0.1	19.5	24.0	4.51	
	HE20 STBC, M0 to M9 2ss	4	4	10.9	14.9	14.5	13.5	0.1	19.8	24.0	4.21	
5250	Non HT160, 6 to 54 Mbps	1	4	7.6				0.0	7.6	24.0	16.35	
	Non HT160, 6 to 54 Mbps	2	4	7.6	7.3			0.0	10.5	24.0	13.49	
	Non HT160, 6 to 54 Mbps	3	4	7.6	7.3	7.0		0.0	12.1	24.0	11.87	
	Non HT160, 6 to 54 Mbps	4	4	7.6	7.3	7.0	6.6	0.0	13.2	24.0	10.79	
	VHT160, M0 to M9 1ss	1	4	8.5				0.4	8.9	24.0	15.11	
	VHT160, M0 to M9 1ss	2	4	8.5	8.4			0.4	11.9	24.0	12.15	
	VHT160, M0 to M9 2ss	2	4	8.5	8.4			0.4	11.9	24.0	12.15	
	VHT160, M0 to M9 1ss	3	4	8.5	8.4	8.3		0.4	13.6	24.0	10.44	
	VHT160, M0 to M9 2ss	3	4	8.5	8.4	8.3		0.4	13.6	24.0	10.44	
	VHT160, M0 to M9 3ss	3	4	8.5	8.4	8.3		0.4	13.6	24.0	10.44	
	VHT160, M0 to M9 1ss	4	4	8.5	8.4	8.3	7.4	0.4	14.6	24.0	9.42	
	VHT160, M0 to M9 2ss	4	4	8.5	8.4	8.3	7.4	0.4	14.6	24.0	9.42	
	VHT160, M0 to M9 3ss	4	4	8.5	8.4	8.3	7.4	0.4	14.6	24.0	9.42	
	VHT160, M0 to M9 4ss	4	4	8.5	8.4	8.3	7.4	0.4	14.6	24.0	9.42	
	VHT160 Beam Forming, M0 to M9 1ss	2	7	7.6	7.5				0.4	11.0	23.0	12.05
	VHT160 Beam Forming, M0 to M9 2ss	2	4	8.5	8.4				0.4	11.9	24.0	12.15
	VHT160 Beam Forming, M0 to M9 1ss	3	9	6.7	6.2	6.1			0.4	11.5	21.0	9.50
	VHT160 Beam Forming, M0 to M9 2ss	3	6	8.5	8.4	8.3			0.4	13.6	24.0	10.44
	VHT160 Beam Forming, M0 to M9 3ss	3	4	8.5	8.4	8.3			0.4	13.6	24.0	10.44
	VHT160 Beam Forming, M0 to M9 1ss	4	10	6.7	6.2	6.1	5.4		0.4	12.5	20.0	7.46
VHT160 Beam Forming, M0 to M9 2ss	4	7	7.6	7.5	7.1	6.6		0.4	13.6	23.0	9.37	



VHT160 Beam Forming, M0 to M9 3ss	4	5	8.5	8.4	8.3	7.4	0.4	14.6	24.0	9.42
VHT160 Beam Forming, M0 to M9 4ss	4	4	8.5	8.4	8.3	7.4	0.4	14.6	24.0	9.42
VHT160 STBC, M0 to M9 1ss	2	4	8.5	8.4			0.4	11.9	24.0	12.15
VHT160 STBC, M0 to M9 1ss	3	4	8.5	8.4	8.3		0.4	13.6	24.0	10.44
VHT160 STBC, M0 to M9 1ss	4	4	8.5	8.4	8.3	7.4	0.4	14.6	24.0	9.42
HE160, M0 to M9 1ss	1	4	9.8				0.4	10.2	24.0	13.77
HE160, M0 to M9 1ss	2	4	9.8	9.9			0.4	13.3	24.0	10.71
HE160, M0 to M9 2ss	2	4	9.8	9.9			0.4	13.3	24.0	10.71
HE160, M0 to M9 1ss	3	4	8.9	8.6	8.6		0.4	13.9	24.0	10.09
HE160, M0 to M9 2ss	3	4	8.9	8.6	8.6		0.4	13.9	24.0	10.09
HE160, M0 to M9 3ss	3	4	8.9	8.6	8.6		0.4	13.9	24.0	10.09
HE160, M0 to M9 1ss	4	4	8.9	8.6	8.6	7.9	0.4	15.0	24.0	9.03
HE160, M0 to M9 2ss	4	4	8.9	8.6	8.6	7.9	0.4	15.0	24.0	9.03
HE160, M0 to M9 3ss	4	4	8.9	8.6	8.6	7.9	0.4	15.0	24.0	9.03
HE160, M0 to M9 4ss	4	4	8.9	8.6	8.6	7.9	0.4	15.0	24.0	9.03
HE160 Beam Forming, M0 to M9 1ss	2	7	8.9	8.6			0.4	12.2	23.0	10.80
HE160 Beam Forming, M0 to M9 2ss	2	4	9.8	9.9			0.4	13.3	24.0	10.71
HE160 Beam Forming, M0 to M9 1ss	3	9	7.9	7.7	7.4		0.4	12.9	21.0	8.12
HE160 Beam Forming, M0 to M9 2ss	3	6	8.9	8.6	8.6		0.4	13.9	24.0	10.09
HE160 Beam Forming, M0 to M9 3ss	3	4	8.9	8.6	8.6		0.4	13.9	24.0	10.09
HE160 Beam Forming, M0 to M9 1ss	4	10	6.9	6.5	6.2	5.7	0.4	12.8	20.0	7.20
HE160 Beam Forming, M0 to M9 2ss	4	7	7.9	7.7	7.4	7.0	0.4	14.0	23.0	9.03
HE160 Beam Forming, M0 to M9 3ss	4	5	8.9	8.6	8.6	7.9	0.4	15.0	24.0	9.03
HE160 Beam Forming, M0 to M9 4ss	4	4	8.9	8.6	8.6	7.9	0.4	15.0	24.0	9.03
HE160 STBC, M0 to M9 1ss	2	4	9.8	9.9			0.4	13.3	24.0	10.71
HE160 STBC, M0 to M9 1ss	3	4	8.9	8.6	8.6		0.4	13.9	24.0	10.09
HE160 STBC, M0 to M9 1ss	4	4	8.9	8.6	8.6	7.9	0.4	15.0	24.0	9.03



**Maximum Transmit Output Power, 4dBi  
5270 MHz, HE40 Beam Forming, M0 to M9 1ss**



**Antenna A**

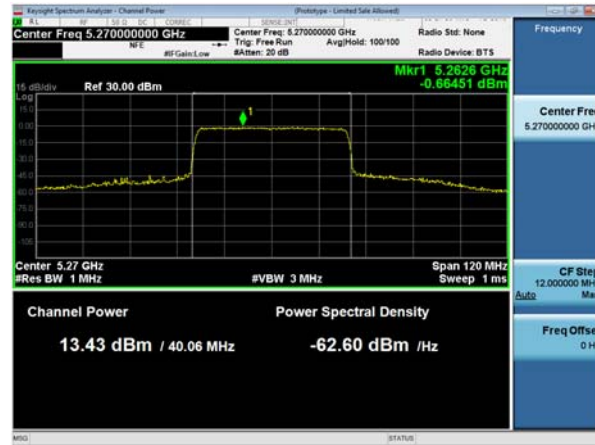

**Antenna B**

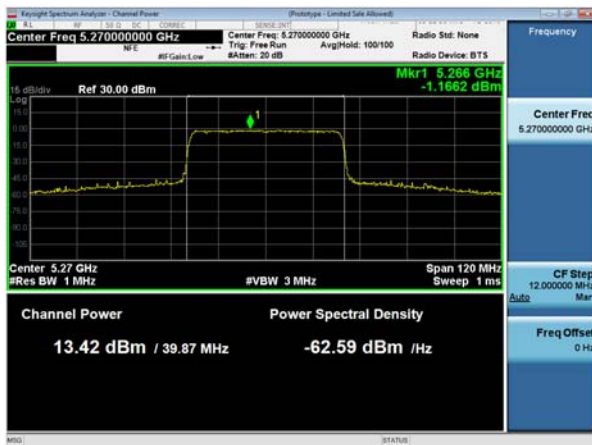

**Antenna C**

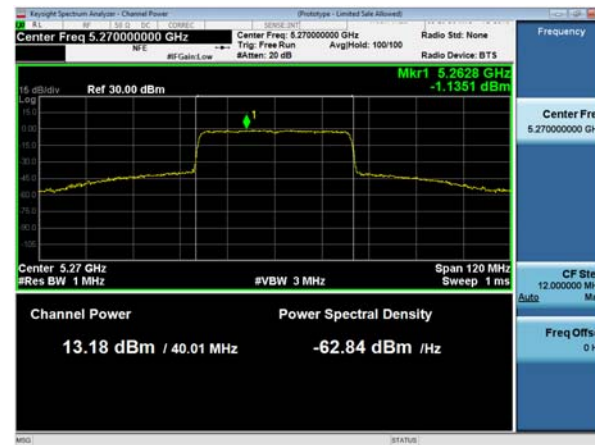

**Antenna D**



## Maximum Output Power, 5dBi

Frequency (MHz)	Mode	Tx Paths	Correlated Antenna Gain (dBi)	Tx 1 Max Power (dBm)	Tx 2 Max Power (dBm)	Tx 3 Max Power (dBm)	Tx 4 Max Power (dBm)	Duty Cycle Correction (dB)	Total Tx Channel Power (dBm)	Limit (dBm)	Margin (dB)
5260	Non HT20, 6 to 54 Mbps	1	5	10.9				0.0	10.9	24.0	13.06
	Non HT20, 6 to 54 Mbps	2	5	10.9	17.0			0.0	18.0	24.0	6.00
	Non HT20, 6 to 54 Mbps	3	5	10.9	14.0	13.2		0.0	17.7	24.0	6.30
	Non HT20, 6 to 54 Mbps	4	5	10.0	10.8	10.2	9.8	0.0	16.3	24.0	7.72
	Non HT20 Beam Forming, 6 to 54 Mbps	2	8	10.9	17.0			0.0	18.0	22.0	4.00
	Non HT20 Beam Forming, 6 to 54 Mbps	3	10	10.9	14.0	13.2		0.0	17.7	20.0	2.30
	Non HT20 Beam Forming, 6 to 54 Mbps	4	11	10.0	10.8	10.2	9.8	0.0	16.3	19.0	2.72
	HT/VHT20, M0 to M7	1	5	10.9				0.1	11.0	24.0	13.05
	HT/VHT20, M0 to M7	2	5	10.9	17.1			0.1	18.1	24.0	5.91
	HT/VHT20, M8 to M15	2	5	10.9	17.1			0.1	18.1	24.0	5.91
	HT/VHT20, M0 to M7	3	5	10.9	14.0	13.3		0.1	17.7	24.0	6.25
	HT/VHT20, M8 to M15	3	5	10.9	17.1	16.5		0.1	20.4	24.0	3.60
	HT/VHT20, M16 to M23	3	5	10.9	17.1	16.5		0.1	20.4	24.0	3.60
	HT/VHT20, M0 to M7	4	5	10.9	11.7	10.9	10.6	0.1	17.1	24.0	6.88
	HT/VHT20, M8 to M15	4	5	10.9	15.1	14.2	13.9	0.1	19.9	24.0	4.15
	HT/VHT20, M16 to M23	4	5	10.9	17.1	16.5	16.5	0.1	21.9	24.0	2.10
	HT/VHT20, M24 to M31	4	5	10.9	17.1	16.5	16.5	0.1	21.9	24.0	2.10
	HT/VHT20 Beam Forming, M0 to M7	2	8	10.9	17.1			0.1	18.1	22.0	3.91
	HT/VHT20 Beam Forming, M8 to M15	2	5	10.9	17.1			0.1	18.1	24.0	5.91
	HT/VHT20 Beam Forming, M0 to M7	3	10	10.9	14.0	13.3		0.1	17.7	20.0	2.25
	HT/VHT20 Beam Forming, M8 to M15	3	7	10.9	17.1	16.5		0.1	20.4	23.0	2.60
	HT/VHT20 Beam Forming, M16 to M23	3	5	10.9	17.1	16.5		0.1	20.4	24.0	3.60
	HT/VHT20 Beam Forming, M0 to M7	4	11	10.9	11.7	10.9	10.6	0.1	17.1	19.0	1.88
	HT/VHT20 Beam Forming, M8 to M15	4	8	10.9	15.1	14.2	13.9	0.1	19.9	22.0	2.15
	HT/VHT20 Beam Forming, M16 to M23	4	6	10.9	17.1	16.5	16.5	0.1	21.9	24.0	2.10
	HT/VHT20 Beam Forming, M24 to M31	4	5	10.9	17.1	16.5	16.5	0.1	21.9	24.0	2.10
	HT/VHT20 STBC, M0 to M7	2	5	10.9	17.1			0.1	18.1	24.0	5.91
	HT/VHT20 STBC, M0 to M7	3	5	10.9	17.1	16.5		0.1	20.4	24.0	3.60
	HT/VHT20 STBC, M0 to M7	4	5	10.9	15.1	14.2	13.9	0.1	19.9	24.0	4.15
	HE20, M0 to M9 1ss	1	5	11.1				0.1	11.2	24.0	12.83





	HE20, M0 to M9 1ss	2	5	11.1	17.4			0.1	18.4	24.0	5.61
	HE20, M0 to M9 2ss	2	5	11.1	17.4			0.1	18.4	24.0	5.61
	HE20, M0 to M9 1ss	3	5	11.1	14.1	13.7		0.1	18.0	24.0	6.00
	HE20, M0 to M9 2ss	3	5	11.1	17.4	16.9		0.1	20.7	24.0	3.25
	HE20, M0 to M9 3ss	3	5	11.1	17.4	16.9		0.1	20.7	24.0	3.25
	HE20, M0 to M9 1ss	4	5	10.2	11.1	10.5	10.0	0.1	16.6	24.0	7.44
	HE20, M0 to M9 2ss	4	5	11.1	15.3	14.6	14.2	0.1	20.2	24.0	3.85
	HE20, M0 to M9 3ss	4	5	11.1	17.4	16.9	16.8	0.1	22.2	24.0	1.76
	HE20, M0 to M9 4ss	4	5	11.1	17.4	16.9	16.8	0.1	22.2	24.0	1.76
	HE20 Beam Forming, M0 to M9 1ss	2	8	11.1	17.4			0.1	18.4	22.0	3.61
	HE20 Beam Forming, M0 to M9 2ss	2	5	11.1	17.4			0.1	18.4	24.0	5.61
	HE20 Beam Forming, M0 to M9 1ss	3	10	11.1	14.1	13.7		0.1	18.0	20.0	2.00
	HE20 Beam Forming, M0 to M9 2ss	3	7	11.1	17.4	16.9		0.1	20.7	23.0	2.25
	HE20 Beam Forming, M0 to M9 3ss	3	5	11.1	17.4	16.9		0.1	20.7	24.0	3.25
	HE20 Beam Forming, M0 to M9 1ss	4	11	10.2	11.1	10.5	10.0	0.1	16.6	19.0	2.44
	HE20 Beam Forming, M0 to M9 2ss	4	8	11.1	15.3	14.6	14.2	0.1	20.2	22.0	1.85
	HE20 Beam Forming, M0 to M9 3ss	4	6	11.1	17.4	16.9	16.8	0.1	22.2	24.0	1.76
	HE20 Beam Forming, M0 to M9 4ss	4	5	11.1	17.4	16.9	16.8	0.1	22.2	24.0	1.76
	HE20 STBC, M0 to M9 2ss	2	5	11.1	17.4			0.1	18.4	24.0	5.61
	HE20 STBC, M0 to M9 2ss	3	5	11.1	17.4	16.9		0.1	20.7	24.0	3.25
	HE20 STBC, M0 to M9 2ss	4	5	11.1	15.3	14.6	14.2	0.1	20.2	24.0	3.85
5270	Non HT40, 6 to 54 Mbps	1	5	10.7				0.0	10.7	24.0	13.26
	Non HT40, 6 to 54 Mbps	2	5	10.7	16.3			0.0	17.4	24.0	6.60
	Non HT40, 6 to 54 Mbps	3	5	10.7	16.3	16.7		0.0	20.1	24.0	3.91
	Non HT40, 6 to 54 Mbps	4	5	10.7	14.4	14.4	14.3	0.0	19.8	24.0	4.24
	HT/VHT40, M0 to M7	1	5	10.6				0.1	10.7	24.0	13.30
	HT/VHT40, M0 to M7	2	5	10.6	16.2			0.1	17.4	24.0	6.64
	HT/VHT40, M8 to M15	2	5	10.6	16.2			0.1	17.4	24.0	6.64
	HT/VHT40, M0 to M7	3	5	10.6	16.2	16.6		0.1	20.1	24.0	3.95
	HT/VHT40, M8 to M15	3	5	10.6	16.2	16.6		0.1	20.1	24.0	3.95
	HT/VHT40, M16 to M23	3	5	10.6	16.2	16.6		0.1	20.1	24.0	3.95
	HT/VHT40, M0 to M7	4	5	10.6	14.1	14.5	14.1	0.1	19.7	24.0	4.30
	HT/VHT40, M8 to M15	4	5	10.6	16.2	16.6	16.3	0.1	21.6	24.0	2.39
	HT/VHT40, M16 to M23	4	5	10.6	16.2	16.6	16.3	0.1	21.6	24.0	2.39
	HT/VHT40, M24 to M31	4	5	10.6	16.2	16.6	16.3	0.1	21.6	24.0	2.39
	HT/VHT40 Beam Forming, M0 to M7	2	8	10.6	16.2			0.1	17.4	22.0	4.64
	HT/VHT40 Beam Forming, M8 to M15	2	5	10.6	16.2			0.1	17.4	24.0	6.64
	HT/VHT40 Beam Forming, M0 to M7	3	10	10.6	14.1	14.5		0.1	18.3	20.0	1.74
	HT/VHT40 Beam Forming, M8 to M15	3	7	10.6	16.2	16.6		0.1	20.1	23.0	2.95
	HT/VHT40 Beam Forming, M16 to M23	3	5	10.6	16.2	16.6		0.1	20.1	24.0	3.95
	HT/VHT40 Beam Forming, M0 to M7	4	11	10.6	12.2	12.2	11.9	0.1	17.9	19.0	1.10





	HT/VHT40 Beam Forming, M8 to M15	4	8	10.6	15.4	15.5	15.2	0.1	20.7	22.0	1.30
	HT/VHT40 Beam Forming, M16 to M23	4	6	10.6	16.2	16.6	16.3	0.1	21.6	24.0	2.39
	HT/VHT40 Beam Forming, M24 to M31	4	5	10.6	16.2	16.6	16.3	0.1	21.6	24.0	2.39
	HT/VHT40 STBC, M0 to M7	2	5	10.6	16.2			0.1	17.4	24.0	6.64
	HT/VHT40 STBC, M0 to M7	3	5	10.6	16.2	16.6		0.1	20.1	24.0	3.95
	HT/VHT40 STBC, M0 to M7	4	5	10.6	15.4	15.5	15.2	0.1	20.7	24.0	3.30
	HE40, M0 to M9 1ss	1	5	10.8				0.1	10.9	24.0	13.07
	HE40, M0 to M9 1ss	2	5	10.8	16.7			0.1	17.8	24.0	6.18
	HE40, M0 to M9 2ss	2	5	10.8	16.7			0.1	17.8	24.0	6.18
	HE40, M0 to M9 1ss	3	5	10.8	16.7	16.8		0.1	20.4	24.0	3.59
	HE40, M0 to M9 2ss	3	5	10.8	16.7	16.8		0.1	20.4	24.0	3.59
	HE40, M0 to M9 3ss	3	5	10.8	16.7	16.8		0.1	20.4	24.0	3.59
	HE40, M0 to M9 1ss	4	5	10.8	14.4	14.4	14.4	0.1	19.9	24.0	4.11
	HE40, M0 to M9 2ss	4	5	10.8	16.7	16.8	16.6	0.1	22.0	24.0	2.04
	HE40, M0 to M9 3ss	4	5	10.8	16.7	16.8	16.6	0.1	22.0	24.0	2.04
	HE40, M0 to M9 4ss	4	5	10.8	16.7	16.8	16.6	0.1	22.0	24.0	2.04
	HE40 Beam Forming, M0 to M9 1ss	2	8	10.8	16.7			0.1	17.8	22.0	4.18
	HE40 Beam Forming, M0 to M9 2ss	2	5	10.8	16.7			0.1	17.8	24.0	6.18
	HE40 Beam Forming, M0 to M9 1ss	3	10	10.8	14.4	14.4		0.1	18.4	20.0	1.60
	HE40 Beam Forming, M0 to M9 2ss	3	7	10.8	16.7	16.8		0.1	20.4	23.0	2.59
	HE40 Beam Forming, M0 to M9 3ss	3	5	10.8	16.7	16.8		0.1	20.4	24.0	3.59
	<b>HE40 Beam Forming, M0 to M9 1ss</b>	<b>4</b>	<b>11</b>	<b>10.8</b>	<b>12.5</b>	<b>12.2</b>	<b>12.0</b>	<b>0.1</b>	<b>18.1</b>	<b>19.0</b>	<b>0.93</b>
	HE40 Beam Forming, M0 to M9 2ss	4	8	10.8	15.5	15.6	15.5	0.1	20.9	22.0	1.10
	HE40 Beam Forming, M0 to M9 3ss	4	6	10.8	16.7	16.8	16.6	0.1	22.0	24.0	2.04
	HE40 Beam Forming, M0 to M9 4ss	4	5	10.8	16.7	16.8	16.6	0.1	22.0	24.0	2.04
	HE40 STBC, M0 to M9 2ss	2	5	10.8	16.7			0.1	17.8	24.0	6.18
	HE40 STBC, M0 to M9 2ss	3	5	10.8	16.7	16.8		0.1	20.4	24.0	3.59
	HE40 STBC, M0 to M9 2ss	4	5	10.8	15.5	15.6	15.5	0.1	20.9	24.0	3.10
5290	Non HT80, 6 to 54 Mbps	1	5	8.7				0.1	8.8	24.0	15.25
	Non HT80, 6 to 54 Mbps	2	5	8.7	8.7			0.1	11.8	24.0	12.24
	Non HT80, 6 to 54 Mbps	3	5	8.7	8.7	8.9		0.1	13.6	24.0	10.41
	Non HT80, 6 to 54 Mbps	4	5	8.7	8.7	8.9	8.3	0.1	14.7	24.0	9.27
	VHT80, M0 to M9 1ss	1	5	9.5				0.2	9.7	24.0	14.28
	VHT80, M0 to M9 1ss	2	5	9.5	9.5			0.2	12.7	24.0	11.27
	VHT80, M0 to M9 2ss	2	5	9.5	9.5			0.2	12.7	24.0	11.27
	VHT80, M0 to M9 1ss	3	5	9.5	9.5	9.8		0.2	14.6	24.0	9.41
	VHT80, M0 to M9 2ss	3	5	9.5	9.5	9.8		0.2	14.6	24.0	9.41
	VHT80, M0 to M9 3ss	3	5	9.5	9.5	9.8		0.2	14.6	24.0	9.41
	VHT80, M0 to M9 1ss	4	5	9.5	9.5	9.8	9.2	0.2	15.7	24.0	8.26
	VHT80, M0 to M9 2ss	4	5	9.5	9.5	9.8	9.2	0.2	15.7	24.0	8.26
	VHT80, M0 to M9 3ss	4	5	9.5	9.5	9.8	9.2	0.2	15.7	24.0	8.26



	VHT80, M0 to M9 4ss	4	5	9.5	9.5	9.8	9.2	0.2	15.7	24.0	8.26
	VHT80 Beam Forming, M0 to M9 1ss	2	8	8.7	8.6			0.2	11.9	22.0	10.12
	VHT80 Beam Forming, M0 to M9 2ss	2	5	9.5	9.5			0.2	12.7	24.0	11.27
	VHT80 Beam Forming, M0 to M9 1ss	3	10	7.6	7.5	7.7		0.2	12.6	20.0	7.41
	VHT80 Beam Forming, M0 to M9 2ss	3	7	8.7	8.6	8.9		0.2	13.7	23.0	9.28
	VHT80 Beam Forming, M0 to M9 3ss	3	5	9.5	9.5	9.8		0.2	14.6	24.0	9.41
	VHT80 Beam Forming, M0 to M9 1ss	4	11	6.6	6.5	6.8	6.1	0.2	12.7	19.0	6.26
	VHT80 Beam Forming, M0 to M9 2ss	4	8	7.6	7.5	7.7	7.0	0.2	13.7	22.0	8.31
	VHT80 Beam Forming, M0 to M9 3ss	4	6	8.7	8.6	8.9	8.2	0.2	14.8	24.0	9.16
	VHT80 Beam Forming, M0 to M9 4ss	4	5	9.5	9.5	9.8	9.2	0.2	15.7	24.0	8.26
	VHT80 STBC, M0 to M9 1ss	2	5	9.5	9.5			0.2	12.7	24.0	11.27
	VHT80 STBC, M0 to M9 1ss	3	5	9.5	9.5	9.8		0.2	14.6	24.0	9.41
	VHT80 STBC, M0 to M9 1ss	4	5	9.5	9.5	9.8	9.2	0.2	15.7	24.0	8.26
	HE80, M0 to M9 1ss	1	5	9.6				0.3	9.9	24.0	14.14
	HE80, M0 to M9 1ss	2	5	9.6	9.5			0.3	12.8	24.0	11.18
	HE80, M0 to M9 2ss	2	5	9.6	9.5			0.3	12.8	24.0	11.18
	HE80, M0 to M9 1ss	3	5	8.6	8.6	8.8		0.3	13.7	24.0	10.30
	HE80, M0 to M9 2ss	3	5	8.6	8.6	8.8		0.3	13.7	24.0	10.30
	HE80, M0 to M9 3ss	3	5	8.6	8.6	8.8		0.3	13.7	24.0	10.30
	HE80, M0 to M9 1ss	4	5	8.6	8.6	8.8	8.3	0.3	14.9	24.0	9.14
	HE80, M0 to M9 2ss	4	5	8.6	8.6	8.8	8.3	0.3	14.9	24.0	9.14
	HE80, M0 to M9 3ss	4	5	8.6	8.6	8.8	8.3	0.3	14.9	24.0	9.14
	HE80, M0 to M9 4ss	4	5	8.6	8.6	8.8	8.3	0.3	14.9	24.0	9.14
	HE80 Beam Forming, M0 to M9 1ss	2	8	8.6	8.6			0.3	11.9	22.0	10.13
	HE80 Beam Forming, M0 to M9 2ss	2	5	9.6	9.5			0.3	12.8	24.0	11.18
	HE80 Beam Forming, M0 to M9 1ss	3	10	7.8	7.6	7.7		0.3	12.7	20.0	7.27
	HE80 Beam Forming, M0 to M9 2ss	3	7	8.6	8.6	8.8		0.3	13.7	23.0	9.30
	HE80 Beam Forming, M0 to M9 3ss	3	5	8.6	8.6	8.8		0.3	13.7	24.0	10.30
	HE80 Beam Forming, M0 to M9 1ss	4	11	6.8	6.5	6.7	6.2	0.3	12.8	19.0	6.16
	HE80 Beam Forming, M0 to M9 2ss	4	8	7.8	7.6	7.7	7.0	0.3	13.8	22.0	8.18
	HE80 Beam Forming, M0 to M9 3ss	4	6	8.6	8.6	8.8	8.3	0.3	14.9	24.0	9.14
	HE80 Beam Forming, M0 to M9 4ss	4	5	8.6	8.6	8.8	8.3	0.3	14.9	24.0	9.14
	HE80 STBC, M0 to M9 1ss	2	5	9.6	9.5			0.3	12.8	24.0	11.18
	HE80 STBC, M0 to M9 1ss	3	5	8.6	8.6	8.8		0.3	13.7	24.0	10.30
	HE80 STBC, M0 to M9 1ss	4	5	8.6	8.6	8.8	8.3	0.3	14.9	24.0	9.14
5300	Non HT20, 6 to 54 Mbps	1	5	11.2				0.0	11.2	24.0	12.76
	Non HT20, 6 to 54 Mbps	2	5	11.2	16.9			0.0	18.0	24.0	6.02
	Non HT20, 6 to 54 Mbps	3	5	11.2	13.8	13.6		0.0	17.8	24.0	6.17
	Non HT20, 6 to 54 Mbps	4	5	10.2	10.8	10.3	9.4	0.0	16.3	24.0	7.73
	Non HT20 Beam Forming, 6 to 54 Mbps	2	8	11.2	16.9			0.0	18.0	22.0	4.02
	Non HT20 Beam Forming, 6 to 54 Mbps	3	10	11.2	13.8	13.6		0.0	17.8	20.0	2.17



Non HT20 Beam Forming, 6 to 54 Mbps	4	11	10.2	10.8	10.3	9.4	0.0	16.3	19.0	2.73
HT/VHT20, M0 to M7	1	5	11.2				0.1	11.3	24.0	12.75
HT/VHT20, M0 to M7	2	5	11.2	16.8			0.1	17.9	24.0	6.09
HT/VHT20, M8 to M15	2	5	11.2	16.8			0.1	17.9	24.0	6.09
HT/VHT20, M0 to M7	3	5	11.2	13.7	13.6		0.1	17.8	24.0	6.20
HT/VHT20, M8 to M15	3	5	11.2	16.8	16.7		0.1	20.4	24.0	3.62
HT/VHT20, M16 to M23	3	5	11.2	16.8	16.7		0.1	20.4	24.0	3.62
HT/VHT20, M0 to M7	4	5	11.2	11.7	11.1	10.2	0.1	17.2	24.0	6.84
HT/VHT20, M8 to M15	4	5	11.2	14.9	14.3	13.7	0.1	19.8	24.0	4.20
HT/VHT20, M16 to M23	4	5	11.2	16.8	16.7	16.1	0.1	21.8	24.0	2.23
HT/VHT20, M24 to M31	4	5	11.2	16.8	16.7	16.1	0.1	21.8	24.0	2.23
HT/VHT20 Beam Forming, M0 to M7	2	8	11.2	16.8			0.1	17.9	22.0	4.09
HT/VHT20 Beam Forming, M8 to M15	2	5	11.2	16.8			0.1	17.9	24.0	6.09
HT/VHT20 Beam Forming, M0 to M7	3	10	11.2	13.7	13.6		0.1	17.8	20.0	2.20
HT/VHT20 Beam Forming, M8 to M15	3	7	11.2	16.8	16.7		0.1	20.4	23.0	2.62
HT/VHT20 Beam Forming, M16 to M23	3	5	11.2	16.8	16.7		0.1	20.4	24.0	3.62
HT/VHT20 Beam Forming, M0 to M7	4	11	11.2	11.7	11.1	10.2	0.1	17.2	19.0	1.84
HT/VHT20 Beam Forming, M8 to M15	4	8	11.2	14.9	14.3	13.7	0.1	19.8	22.0	2.20
HT/VHT20 Beam Forming, M16 to M23	4	6	11.2	16.8	16.7	16.1	0.1	21.8	24.0	2.23
HT/VHT20 Beam Forming, M24 to M31	4	5	11.2	16.8	16.7	16.1	0.1	21.8	24.0	2.23
HT/VHT20 STBC, M0 to M7	2	5	11.2	16.8			0.1	17.9	24.0	6.09
HT/VHT20 STBC, M0 to M7	3	5	11.2	16.8	16.7		0.1	20.4	24.0	3.62
HT/VHT20 STBC, M0 to M7	4	5	11.2	14.9	14.3	13.7	0.1	19.8	24.0	4.20
HE20, M0 to M9 1ss	1	5	11.4				0.1	11.5	24.0	12.53
HE20, M0 to M9 1ss	2	5	11.4	17.2			0.1	18.3	24.0	5.72
HE20, M0 to M9 2ss	2	5	11.4	17.2			0.1	18.3	24.0	5.72
HE20, M0 to M9 1ss	3	5	11.4	14.0	13.8		0.1	18.1	24.0	5.94
HE20, M0 to M9 2ss	3	5	11.4	17.2	16.9		0.1	20.7	24.0	3.31
HE20, M0 to M9 3ss	3	5	11.4	17.2	16.9		0.1	20.7	24.0	3.31
HE20, M0 to M9 1ss	4	5	10.4	11.0	10.6	9.6	0.1	16.5	24.0	7.48
HE20, M0 to M9 2ss	4	5	11.4	15.2	14.7	14.0	0.1	20.1	24.0	3.86
HE20, M0 to M9 3ss	4	5	11.4	17.2	16.9	16.4	0.1	22.1	24.0	1.92
HE20, M0 to M9 4ss	4	5	11.4	17.2	16.9	16.4	0.1	22.1	24.0	1.92
HE20 Beam Forming, M0 to M9 1ss	2	8	11.4	17.2			0.1	18.3	22.0	3.72
HE20 Beam Forming, M0 to M9 2ss	2	5	11.4	17.2			0.1	18.3	24.0	5.72
HE20 Beam Forming, M0 to M9 1ss	3	10	11.4	14.0	13.8		0.1	18.1	20.0	1.94
HE20 Beam Forming, M0 to M9 2ss	3	7	11.4	17.2	16.9		0.1	20.7	23.0	2.31
HE20 Beam Forming, M0 to M9 3ss	3	5	11.4	17.2	16.9		0.1	20.7	24.0	3.31
HE20 Beam Forming, M0 to M9 1ss	4	11	10.4	11.0	10.6	9.6	0.1	16.5	19.0	2.48
HE20 Beam Forming, M0 to M9 2ss	4	8	11.4	15.2	14.7	14.0	0.1	20.1	22.0	1.86
HE20 Beam Forming, M0 to M9 3ss	4	6	11.4	17.2	16.9	16.4	0.1	22.1	24.0	1.92
HE20 Beam Forming, M0 to M9 4ss	4	5	11.4	17.2	16.9	16.4	0.1	22.1	24.0	1.92



	HE20 STBC, M0 to M9 2ss	2	5	11.4	17.2			0.1	18.3	24.0	5.72
	HE20 STBC, M0 to M9 2ss	3	5	11.4	17.2	16.9		0.1	20.7	24.0	3.31
	HE20 STBC, M0 to M9 2ss	4	5	11.4	15.2	14.7	14.0	0.1	20.1	24.0	3.86
5310	Non HT40, 6 to 54 Mbps	1	5	9.9				0.0	9.9	24.0	14.06
	Non HT40, 6 to 54 Mbps	2	5	9.9	10.1			0.0	13.1	24.0	10.94
	Non HT40, 6 to 54 Mbps	3	5	9.9	10.1	10.4		0.0	15.0	24.0	9.05
	Non HT40, 6 to 54 Mbps	4	5	9.9	10.1	10.4	9.4	0.0	16.0	24.0	7.97
	HT/VHT40, M0 to M7	1	5	9.8				0.1	9.9	24.0	14.10
	HT/VHT40, M0 to M7	2	5	9.8	10.0			0.1	13.0	24.0	10.99
	HT/VHT40, M8 to M15	2	5	9.8	10.0			0.1	13.0	24.0	10.99
	HT/VHT40, M0 to M7	3	5	9.8	10.0	9.9		0.1	14.8	24.0	9.23
	HT/VHT40, M8 to M15	3	5	9.8	10.0	9.9		0.1	14.8	24.0	9.23
	HT/VHT40, M16 to M23	3	5	9.8	10.0	9.9		0.1	14.8	24.0	9.23
	HT/VHT40, M0 to M7	4	5	9.8	10.0	9.9	9.2	0.1	15.9	24.0	8.14
	HT/VHT40, M8 to M15	4	5	9.8	10.0	9.9	9.2	0.1	15.9	24.0	8.14
	HT/VHT40, M16 to M23	4	5	9.8	10.0	9.9	9.2	0.1	15.9	24.0	8.14
	HT/VHT40, M24 to M31	4	5	9.8	10.0	9.9	9.2	0.1	15.9	24.0	8.14
	HT/VHT40 Beam Forming, M0 to M7	2	8	9.8	10.0			0.1	13.0	22.0	8.99
	HT/VHT40 Beam Forming, M8 to M15	2	5	9.8	10.0			0.1	13.0	24.0	10.99
	HT/VHT40 Beam Forming, M0 to M7	3	10	8.6	9.0	9.1		0.1	13.8	20.0	6.22
	HT/VHT40 Beam Forming, M8 to M15	3	7	9.8	10.0	9.9		0.1	14.8	23.0	8.23
	HT/VHT40 Beam Forming, M16 to M23	3	5	9.8	10.0	9.9		0.1	14.8	24.0	9.23
	HT/VHT40 Beam Forming, M0 to M7	4	11	7.7	7.7	8.0	7.1	0.1	13.8	19.0	5.24
	HT/VHT40 Beam Forming, M8 to M15	4	8	8.6	9.0	9.1	8.2	0.1	14.9	22.0	7.14
	HT/VHT40 Beam Forming, M16 to M23	4	6	9.8	10.0	9.9	9.2	0.1	15.9	24.0	8.14
	HT/VHT40 Beam Forming, M24 to M31	4	5	9.8	10.0	9.9	9.2	0.1	15.9	24.0	8.14
	HT/VHT40 STBC, M0 to M7	2	5	9.8	10.0			0.1	13.0	24.0	10.99
	HT/VHT40 STBC, M0 to M7	3	5	9.8	10.0	9.9		0.1	14.8	24.0	9.23
	HT/VHT40 STBC, M0 to M7	4	5	9.8	10.0	9.9	9.2	0.1	15.9	24.0	8.14
	HE40, M0 to M9 1ss	1	5	10.0				0.1	10.1	24.0	13.87
	HE40, M0 to M9 1ss	2	5	10.0	10.3			0.1	13.3	24.0	10.71
	HE40, M0 to M9 2ss	2	5	10.0	10.3			0.1	13.3	24.0	10.71
	HE40, M0 to M9 1ss	3	5	10.0	10.3	10.6		0.1	15.2	24.0	8.79
	HE40, M0 to M9 2ss	3	5	10.0	10.3	10.6		0.1	15.2	24.0	8.79
	HE40, M0 to M9 3ss	3	5	10.0	10.3	10.6		0.1	15.2	24.0	8.79
	HE40, M0 to M9 1ss	4	5	8.9	9.4	9.4	8.5	0.1	15.2	24.0	8.78
HE40, M0 to M9 2ss	4	5	8.9	9.4	9.4	8.5	0.1	15.2	24.0	8.78	
HE40, M0 to M9 3ss	4	5	8.9	9.4	9.4	8.5	0.1	15.2	24.0	8.78	
HE40, M0 to M9 4ss	4	5	8.9	9.4	9.4	8.5	0.1	15.2	24.0	8.78	
HE40 Beam Forming, M0 to M9 1ss	2	8	8.9	9.4			0.1	12.3	22.0	9.70	
HE40 Beam Forming, M0 to M9 2ss	2	5	10.0	10.3			0.1	13.3	24.0	10.71	



	HE40 Beam Forming, M0 to M9 1ss	3	10	8.1	8.3	8.2		0.1	13.1	20.0	6.90
	HE40 Beam Forming, M0 to M9 2ss	3	7	8.9	9.4	9.4		0.1	14.1	23.0	8.86
	HE40 Beam Forming, M0 to M9 3ss	3	5	10.0	10.3	10.6		0.1	15.2	24.0	8.79
	HE40 Beam Forming, M0 to M9 1ss	4	11	7.3	7.2	7.4	6.5	0.1	13.3	19.0	5.74
	HE40 Beam Forming, M0 to M9 2ss	4	8	8.9	9.4	9.4	8.5	0.1	15.2	22.0	6.78
	HE40 Beam Forming, M0 to M9 3ss	4	6	8.9	9.4	9.4	8.5	0.1	15.2	24.0	8.78
	HE40 Beam Forming, M0 to M9 4ss	4	5	8.9	9.4	9.4	8.5	0.1	15.2	24.0	8.78
	HE40 STBC, M0 to M9 2ss	2	5	10.0	10.3			0.1	13.3	24.0	10.71
	HE40 STBC, M0 to M9 2ss	3	5	10.0	10.3	10.6		0.1	15.2	24.0	8.79
	HE40 STBC, M0 to M9 2ss	4	5	8.9	9.4	9.4	8.5	0.1	15.2	24.0	8.78
5320	Non HT20, 6 to 54 Mbps	1	5	11.1				0.0	11.1	24.0	12.86
	Non HT20, 6 to 54 Mbps	2	5	11.1	16.9			0.0	18.0	24.0	6.04
	Non HT20, 6 to 54 Mbps	3	5	11.1	12.6	12.3		0.0	16.9	24.0	7.14
	Non HT20, 6 to 54 Mbps	4	5	9.9	10.8	10.2	9.3	0.0	16.1	24.0	7.85
	Non HT20 Beam Forming, 6 to 54 Mbps	2	8	11.1	15.8			0.0	17.1	22.0	4.89
	Non HT20 Beam Forming, 6 to 54 Mbps	3	10	11.1	12.6	12.3		0.0	16.9	20.0	3.14
	Non HT20 Beam Forming, 6 to 54 Mbps	4	11	9.9	10.8	10.2	9.3	0.0	16.1	19.0	2.85
	HT/VHT20, M0 to M7	1	5	10.9				0.1	11.0	24.0	13.05
	HT/VHT20, M0 to M7	2	5	10.9	15.7			0.1	17.0	24.0	7.01
	HT/VHT20, M8 to M15	2	5	10.9	15.7			0.1	17.0	24.0	7.01
	HT/VHT20, M0 to M7	3	5	10.9	13.9	13.5		0.1	17.8	24.0	6.22
	HT/VHT20, M8 to M15	3	5	10.9	15.7	15.6		0.1	19.4	24.0	4.61
	HT/VHT20, M16 to M23	3	5	10.9	15.7	15.6		0.1	19.4	24.0	4.61
	HT/VHT20, M0 to M7	4	5	10.9	11.6	11.1	10.1	0.1	17.0	24.0	6.97
	HT/VHT20, M8 to M15	4	5	10.9	14.9	14.4	13.4	0.1	19.7	24.0	4.28
	HT/VHT20, M16 to M23	4	5	10.9	14.9	14.4	13.4	0.1	19.7	24.0	4.28
	HT/VHT20, M24 to M31	4	5	10.9	14.9	14.4	13.4	0.1	19.7	24.0	4.28
	HT/VHT20 Beam Forming, M0 to M7	2	8	10.9	15.7			0.1	17.0	22.0	5.01
	HT/VHT20 Beam Forming, M8 to M15	2	5	10.9	15.7			0.1	17.0	24.0	7.01
	HT/VHT20 Beam Forming, M0 to M7	3	10	10.9	13.9	13.5		0.1	17.8	20.0	2.22
	HT/VHT20 Beam Forming, M8 to M15	3	7	10.9	14.9	14.4		0.1	18.5	23.0	4.45
	HT/VHT20 Beam Forming, M16 to M23	3	5	10.9	15.7	15.6		0.1	19.4	24.0	4.61
	HT/VHT20 Beam Forming, M0 to M7	4	11	10.9	11.6	11.1	10.1	0.1	17.0	19.0	1.97
	HT/VHT20 Beam Forming, M8 to M15	4	8	10.9	14.9	14.4	13.4	0.1	19.7	22.0	2.28
	HT/VHT20 Beam Forming, M16 to M23	4	6	10.9	14.9	14.4	13.4	0.1	19.7	24.0	4.28
	HT/VHT20 Beam Forming, M24 to M31	4	5	10.9	14.9	14.4	13.4	0.1	19.7	24.0	4.28
	HT/VHT20 STBC, M0 to M7	2	5	10.9	15.7			0.1	17.0	24.0	7.01
	HT/VHT20 STBC, M0 to M7	3	5	10.9	15.7	15.6		0.1	19.4	24.0	4.61
	HT/VHT20 STBC, M0 to M7	4	5	10.9	14.9	14.4	13.4	0.1	19.7	24.0	4.28
	HE20, M0 to M9 1ss	1	5	10.9				0.1	11.0	24.0	13.03
	HE20, M0 to M9 1ss	2	5	10.9	15.8			0.1	17.1	24.0	6.91



	HE20, M0 to M9 2ss	2	5	10.9	15.8			0.1	17.1	24.0	6.91
	HE20, M0 to M9 1ss	3	5	10.9	13.9	13.6		0.1	17.8	24.0	6.17
	HE20, M0 to M9 2ss	3	5	10.9	15.8	15.7		0.1	19.5	24.0	4.51
	HE20, M0 to M9 3ss	3	5	10.9	15.8	15.7		0.1	19.5	24.0	4.51
	HE20, M0 to M9 1ss	4	5	10.9	11.8	11.2	10.1	0.1	17.1	24.0	6.87
	HE20, M0 to M9 2ss	4	5	10.9	14.9	14.5	13.5	0.1	19.8	24.0	4.21
	HE20, M0 to M9 3ss	4	5	10.9	14.9	14.5	13.5	0.1	19.8	24.0	4.21
	HE20, M0 to M9 4ss	4	5	10.9	14.9	14.5	13.5	0.1	19.8	24.0	4.21
	HE20 Beam Forming, M0 to M9 1ss	2	8	10.9	14.9			0.1	16.4	22.0	5.57
	HE20 Beam Forming, M0 to M9 2ss	2	5	10.9	15.8			0.1	17.1	24.0	6.91
	HE20 Beam Forming, M0 to M9 1ss	3	10	10.9	13.9	13.6		0.1	17.8	20.0	2.17
	HE20 Beam Forming, M0 to M9 2ss	3	7	10.9	14.9	14.5		0.1	18.6	23.0	4.39
	HE20 Beam Forming, M0 to M9 3ss	3	5	10.9	15.8	15.7		0.1	19.5	24.0	4.51
	HE20 Beam Forming, M0 to M9 1ss	4	11	10.9	11.8	11.2	10.1	0.1	17.1	19.0	1.87
	HE20 Beam Forming, M0 to M9 2ss	4	8	10.9	13.9	13.6	12.5	0.1	19.0	22.0	3.03
	HE20 Beam Forming, M0 to M9 3ss	4	6	10.9	14.9	14.5	13.5	0.1	19.8	24.0	4.21
	HE20 Beam Forming, M0 to M9 4ss	4	5	10.9	14.9	14.5	13.5	0.1	19.8	24.0	4.21
	HE20 STBC, M0 to M9 2ss	2	5	10.9	15.8			0.1	17.1	24.0	6.91
	HE20 STBC, M0 to M9 2ss	3	5	10.9	15.8	15.7		0.1	19.5	24.0	4.51
	HE20 STBC, M0 to M9 2ss	4	5	10.9	14.9	14.5	13.5	0.1	19.8	24.0	4.21
5250	Non HT160, 6 to 54 Mbps	1	5	7.6				0.0	7.6	24.0	16.35
	Non HT160, 6 to 54 Mbps	2	5	6.7	6.3			0.0	9.6	24.0	14.44
	Non HT160, 6 to 54 Mbps	3	5	6.7	6.3	6.1		0.0	11.2	24.0	12.81
	Non HT160, 6 to 54 Mbps	4	5	6.7	6.3	6.1	5.5	0.0	12.2	24.0	11.76
	VHT160, M0 to M9 1ss	1	5	8.5				0.4	8.9	24.0	15.11
	VHT160, M0 to M9 1ss	2	5	8.5	8.4			0.4	11.9	24.0	12.15
	VHT160, M0 to M9 2ss	2	5	8.5	8.4			0.4	11.9	24.0	12.15
	VHT160, M0 to M9 1ss	3	5	8.5	8.4	8.3		0.4	13.6	24.0	10.44
	VHT160, M0 to M9 2ss	3	5	8.5	8.4	8.3		0.4	13.6	24.0	10.44
	VHT160, M0 to M9 3ss	3	5	8.5	8.4	8.3		0.4	13.6	24.0	10.44
	VHT160, M0 to M9 1ss	4	5	8.5	8.4	8.3	7.4	0.4	14.6	24.0	9.42
	VHT160, M0 to M9 2ss	4	5	8.5	8.4	8.3	7.4	0.4	14.6	24.0	9.42
	VHT160, M0 to M9 3ss	4	5	8.5	8.4	8.3	7.4	0.4	14.6	24.0	9.42
	VHT160, M0 to M9 4ss	4	5	8.5	8.4	8.3	7.4	0.4	14.6	24.0	9.42
	VHT160 Beam Forming, M0 to M9 1ss	2	8	7.6	7.5			0.4	11.0	22.0	11.05
	VHT160 Beam Forming, M0 to M9 2ss	2	5	8.5	8.4			0.4	11.9	24.0	12.15
	VHT160 Beam Forming, M0 to M9 1ss	3	10	6.7	6.2	6.1		0.4	11.5	20.0	8.50
	VHT160 Beam Forming, M0 to M9 2ss	3	7	7.6	7.5	7.1		0.4	12.6	23.0	10.43
	VHT160 Beam Forming, M0 to M9 3ss	3	5	8.5	8.4	8.3		0.4	13.6	24.0	10.44
	VHT160 Beam Forming, M0 to M9 1ss	4	11	5.8	5.3	5.2	4.5	0.4	11.6	19.0	7.36
VHT160 Beam Forming, M0 to M9 2ss	4	8	7.6	7.5	7.1	6.6	0.4	13.6	22.0	8.37	



VHT160 Beam Forming, M0 to M9 3ss	4	6	7.6	7.5	7.1	6.6	0.4	13.6	24.0	10.37
VHT160 Beam Forming, M0 to M9 4ss	4	5	8.5	8.4	8.3	7.4	0.4	14.6	24.0	9.42
VHT160 STBC, M0 to M9 1ss	2	5	8.5	8.4			0.4	11.9	24.0	12.15
VHT160 STBC, M0 to M9 1ss	3	5	8.5	8.4	8.3		0.4	13.6	24.0	10.44
VHT160 STBC, M0 to M9 1ss	4	5	8.5	8.4	8.3	7.4	0.4	14.6	24.0	9.42
HE160, M0 to M9 1ss	1	5	8.9				0.4	9.3	24.0	14.67
HE160, M0 to M9 1ss	2	5	8.9	8.6			0.4	12.2	24.0	11.80
HE160, M0 to M9 2ss	2	5	8.9	8.6			0.4	12.2	24.0	11.80
HE160, M0 to M9 1ss	3	5	8.9	8.6	8.6		0.4	13.9	24.0	10.09
HE160, M0 to M9 2ss	3	5	8.9	8.6	8.6		0.4	13.9	24.0	10.09
HE160, M0 to M9 3ss	3	5	8.9	8.6	8.6		0.4	13.9	24.0	10.09
HE160, M0 to M9 1ss	4	5	8.9	8.6	8.6	7.9	0.4	15.0	24.0	9.03
HE160, M0 to M9 2ss	4	5	8.9	8.6	8.6	7.9	0.4	15.0	24.0	9.03
HE160, M0 to M9 3ss	4	5	8.9	8.6	8.6	7.9	0.4	15.0	24.0	9.03
HE160, M0 to M9 4ss	4	5	8.9	8.6	8.6	7.9	0.4	15.0	24.0	9.03
HE160 Beam Forming, M0 to M9 1ss	2	8	7.9	7.7			0.4	11.2	22.0	10.75
HE160 Beam Forming, M0 to M9 2ss	2	5	8.9	8.6			0.4	12.2	24.0	11.80
HE160 Beam Forming, M0 to M9 1ss	3	10	7.9	7.7	7.4		0.4	12.9	20.0	7.12
HE160 Beam Forming, M0 to M9 2ss	3	7	8.9	8.6	8.6		0.4	13.9	23.0	9.09
HE160 Beam Forming, M0 to M9 3ss	3	5	8.9	8.6	8.6		0.4	13.9	24.0	10.09
HE160 Beam Forming, M0 to M9 1ss	4	11	6.9	6.5	6.2	5.7	0.4	12.8	19.0	6.20
HE160 Beam Forming, M0 to M9 2ss	4	8	7.9	7.7	7.4	7.0	0.4	14.0	22.0	8.03
HE160 Beam Forming, M0 to M9 3ss	4	6	8.9	8.6	8.6	7.9	0.4	15.0	24.0	9.03
HE160 Beam Forming, M0 to M9 4ss	4	5	8.9	8.6	8.6	7.9	0.4	15.0	24.0	9.03
HE160 STBC, M0 to M9 1ss	2	5	8.9	8.6			0.4	12.2	24.0	11.80
HE160 STBC, M0 to M9 1ss	3	5	8.9	8.6	8.6		0.4	13.9	24.0	10.09
HE160 STBC, M0 to M9 1ss	4	5	8.9	8.6	8.6	7.9	0.4	15.0	24.0	9.03





**Maximum Transmit Output Power, 5dBi  
5270 MHz, HE40 Beam Forming, M0 to M9 1ss**



**Antenna A**

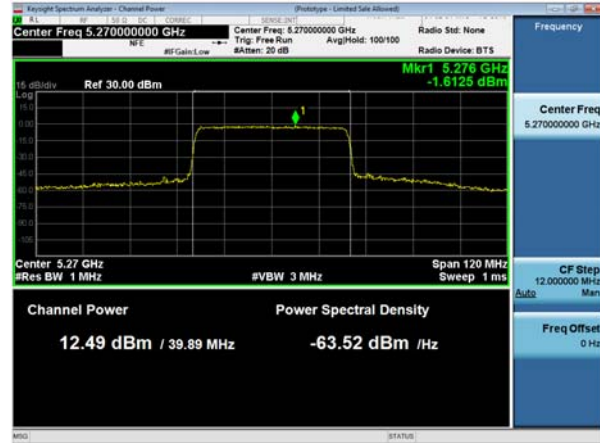

**Antenna B**

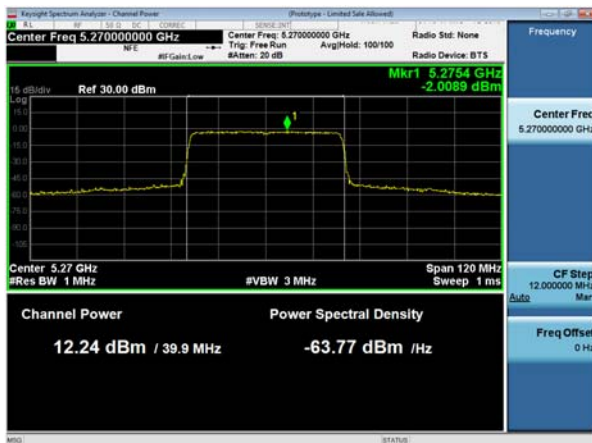

**Antenna C**



**Antenna D**





## Maximum Output Power, 6dBi

Frequency (MHz)	Mode	Tx Paths	Correlated Antenna Gain (dBi)	Tx 1 Max Power (dBm)	Tx 2 Max Power (dBm)	Tx 3 Max Power (dBm)	Tx 4 Max Power (dBm)	Duty Cycle Correction (dB)	Total Tx Channel Power (dBm)	Limit (dBm)	Margin (dB)
5260	Non HT20, 6 to 54 Mbps	1	6	10.9				0.0	10.9	24.0	13.06
	Non HT20, 6 to 54 Mbps	2	6	10.9	17.0			0.0	18.0	24.0	6.00
	Non HT20, 6 to 54 Mbps	3	6	10.9	12.9	12.1		0.0	16.9	24.0	7.14
	Non HT20, 6 to 54 Mbps	4	6	9.1	9.6	9.1	8.6	0.0	15.2	24.0	8.82
	Non HT20 Beam Forming, 6 to 54 Mbps	2	9	10.9	17.0			0.0	18.0	21.0	3.00
	Non HT20 Beam Forming, 6 to 54 Mbps	3	11	10.9	12.9	12.1		0.0	16.9	19.0	2.14
	Non HT20 Beam Forming, 6 to 54 Mbps	4	12	9.1	9.6	9.1	8.6	0.0	15.2	18.0	2.82
	HT/VHT20, M0 to M7	1	6	10.9				0.1	11.0	24.0	13.05
	HT/VHT20, M0 to M7	2	6	10.9	17.1			0.1	18.1	24.0	5.91
	HT/VHT20, M8 to M15	2	6	10.9	17.1			0.1	18.1	24.0	5.91
	HT/VHT20, M0 to M7	3	6	10.9	12.7	12.1		0.1	16.8	24.0	7.21
	HT/VHT20, M8 to M15	3	6	10.9	15.9	15.5		0.1	19.4	24.0	4.57
	HT/VHT20, M16 to M23	3	6	10.9	17.1	16.5		0.1	20.4	24.0	3.60
	HT/VHT20, M0 to M7	4	6	10.0	10.7	10.0	9.6	0.1	16.2	24.0	7.83
	HT/VHT20, M8 to M15	4	6	10.9	14.0	13.3	13.1	0.1	19.0	24.0	4.96
	HT/VHT20, M16 to M23	4	6	10.9	15.9	15.5	15.2	0.1	20.8	24.0	3.16
	HT/VHT20, M24 to M31	4	6	10.9	17.1	16.5	16.5	0.1	21.9	24.0	2.10
	HT/VHT20 Beam Forming, M0 to M7	2	9	10.9	17.1			0.1	18.1	21.0	2.91
	HT/VHT20 Beam Forming, M8 to M15	2	6	10.9	17.1			0.1	18.1	24.0	5.91
	HT/VHT20 Beam Forming, M0 to M7	3	11	10.9	12.7	12.1		0.1	16.8	19.0	2.21
	HT/VHT20 Beam Forming, M8 to M15	3	8	10.9	15.9	15.5		0.1	19.4	22.0	2.57
	HT/VHT20 Beam Forming, M16 to M23	3	6	10.9	17.1	16.5		0.1	20.4	24.0	3.60
	HT/VHT20 Beam Forming, M0 to M7	4	12	10.0	10.7	10.0	9.6	0.1	16.2	18.0	1.83
	HT/VHT20 Beam Forming, M8 to M15	4	9	10.9	14.0	13.3	13.1	0.1	19.0	21.0	1.96
	HT/VHT20 Beam Forming, M16 to M23	4	7	10.9	15.9	15.5	15.2	0.1	20.8	23.0	2.16
	HT/VHT20 Beam Forming, M24 to M31	4	6	10.9	17.1	16.5	16.5	0.1	21.9	24.0	2.10
	HT/VHT20 STBC, M0 to M7	2	6	10.9	17.1			0.1	18.1	24.0	5.91
	HT/VHT20 STBC, M0 to M7	3	6	10.9	15.9	15.5		0.1	19.4	24.0	4.57
	HT/VHT20 STBC, M0 to M7	4	6	10.9	14.0	13.3	13.1	0.1	19.0	24.0	4.96
	HE20, M0 to M9 1ss	1	6	11.1				0.1	11.2	24.0	12.83



	HE20, M0 to M9 1ss	2	6	11.1	17.4			0.1	18.4	24.0	5.61
	HE20, M0 to M9 2ss	2	6	11.1	17.4			0.1	18.4	24.0	5.61
	HE20, M0 to M9 1ss	3	6	11.1	13.1	12.4		0.1	17.1	24.0	6.88
	HE20, M0 to M9 2ss	3	6	11.1	16.3	15.8		0.1	19.8	24.0	4.22
	HE20, M0 to M9 3ss	3	6	11.1	17.4	16.9		0.1	20.7	24.0	3.25
	HE20, M0 to M9 1ss	4	6	9.4	10.1	9.3	8.8	0.1	15.5	24.0	8.48
	HE20, M0 to M9 2ss	4	6	11.1	13.1	12.4	12.2	0.1	18.3	24.0	5.65
	HE20, M0 to M9 3ss	4	6	11.1	16.3	15.8	15.5	0.1	21.2	24.0	2.82
	HE20, M0 to M9 4ss	4	6	11.1	17.4	16.9	16.8	0.1	22.2	24.0	1.76
	HE20 Beam Forming, M0 to M9 1ss	2	9	11.1	17.4			0.1	18.4	21.0	2.61
	HE20 Beam Forming, M0 to M9 2ss	2	6	11.1	17.4			0.1	18.4	24.0	5.61
	HE20 Beam Forming, M0 to M9 1ss	3	11	11.1	13.1	12.4		0.1	17.1	19.0	1.88
	HE20 Beam Forming, M0 to M9 2ss	3	8	11.1	16.3	15.8		0.1	19.8	22.0	2.22
	HE20 Beam Forming, M0 to M9 3ss	3	6	11.1	17.4	16.9		0.1	20.7	24.0	3.25
	HE20 Beam Forming, M0 to M9 1ss	4	12	9.4	10.1	9.3	8.8	0.1	15.5	18.0	2.48
	HE20 Beam Forming, M0 to M9 2ss	4	9	11.1	13.1	12.4	12.2	0.1	18.3	21.0	2.65
	HE20 Beam Forming, M0 to M9 3ss	4	7	11.1	16.3	15.8	15.5	0.1	21.2	23.0	1.82
	HE20 Beam Forming, M0 to M9 4ss	4	6	11.1	17.4	16.9	16.8	0.1	22.2	24.0	1.76
	HE20 STBC, M0 to M9 2ss	2	6	11.1	17.4			0.1	18.4	24.0	5.61
	HE20 STBC, M0 to M9 2ss	3	6	11.1	16.3	15.8		0.1	19.8	24.0	4.22
	HE20 STBC, M0 to M9 2ss	4	6	11.1	13.1	12.4	12.2	0.1	18.3	24.0	5.65
5270	Non HT40, 6 to 54 Mbps	1	6	10.7				0.0	10.7	24.0	13.26
	Non HT40, 6 to 54 Mbps	2	6	10.7	16.3			0.0	17.4	24.0	6.60
	Non HT40, 6 to 54 Mbps	3	6	10.7	15.3	15.5		0.0	19.1	24.0	4.87
	Non HT40, 6 to 54 Mbps	4	6	10.7	12.1	12.3	11.9	0.0	17.9	24.0	6.14
	HT/VHT40, M0 to M7	1	6	10.6				0.1	10.7	24.0	13.30
	HT/VHT40, M0 to M7	2	6	10.6	16.2			0.1	17.4	24.0	6.64
	HT/VHT40, M8 to M15	2	6	10.6	16.2			0.1	17.4	24.0	6.64
	HT/VHT40, M0 to M7	3	6	10.6	16.2	16.6		0.1	20.1	24.0	3.95
	HT/VHT40, M8 to M15	3	6	10.6	16.2	16.6		0.1	20.1	24.0	3.95
	HT/VHT40, M16 to M23	3	6	10.6	16.2	16.6		0.1	20.1	24.0	3.95
	HT/VHT40, M0 to M7	4	6	10.6	13.1	13.3	12.9	0.1	18.7	24.0	5.28
	HT/VHT40, M8 to M15	4	6	10.6	16.2	16.6	16.3	0.1	21.6	24.0	2.39
	HT/VHT40, M16 to M23	4	6	10.6	16.2	16.6	16.3	0.1	21.6	24.0	2.39
	HT/VHT40, M24 to M31	4	6	10.6	16.2	16.6	16.3	0.1	21.6	24.0	2.39
	HT/VHT40 Beam Forming, M0 to M7	2	9	10.6	16.2			0.1	17.4	21.0	3.64
	HT/VHT40 Beam Forming, M8 to M15	2	6	10.6	16.2			0.1	17.4	24.0	6.64
	HT/VHT40 Beam Forming, M0 to M7	3	11	10.6	13.1	13.3		0.1	17.4	19.0	1.63
	HT/VHT40 Beam Forming, M8 to M15	3	8	10.6	16.2	16.6		0.1	20.1	22.0	1.95
	HT/VHT40 Beam Forming, M16 to M23	3	6	10.6	16.2	16.6		0.1	20.1	24.0	3.95
HT/VHT40 Beam Forming, M0 to M7	4	12	10.6	11.3	11.2	10.7	0.1	17.1	18.0	0.92	



HT/VHT40 Beam Forming, M8 to M15	4	9	10.6	14.1	14.5	14.1	0.1	19.7	21.0	1.30
HT/VHT40 Beam Forming, M16 to M23	4	7	10.6	16.2	16.6	16.3	0.1	21.6	23.0	1.39
HT/VHT40 Beam Forming, M24 to M31	4	6	10.6	16.2	16.6	16.3	0.1	21.6	24.0	2.39
HT/VHT40 STBC, M0 to M7	2	6	10.6	16.2			0.1	17.4	24.0	6.64
HT/VHT40 STBC, M0 to M7	3	6	10.6	16.2	16.6		0.1	20.1	24.0	3.95
HT/VHT40 STBC, M0 to M7	4	6	10.6	14.1	14.5	14.1	0.1	19.7	24.0	4.30
HE40, M0 to M9 1ss	1	6	10.8				0.1	10.9	24.0	13.07
HE40, M0 to M9 1ss	2	6	10.8	16.7			0.1	17.8	24.0	6.18
HE40, M0 to M9 2ss	2	6	10.8	16.7			0.1	17.8	24.0	6.18
HE40, M0 to M9 1ss	3	6	10.8	15.5	15.6		0.1	19.4	24.0	4.64
HE40, M0 to M9 2ss	3	6	10.8	16.7	16.8		0.1	20.4	24.0	3.59
HE40, M0 to M9 3ss	3	6	10.8	16.7	16.8		0.1	20.4	24.0	3.59
HE40, M0 to M9 1ss	4	6	10.8	13.4	13.4	13.2	0.1	19.0	24.0	5.02
HE40, M0 to M9 2ss	4	6	10.8	16.7	16.8	16.6	0.1	22.0	24.0	2.04
HE40, M0 to M9 3ss	4	6	10.8	16.7	16.8	16.6	0.1	22.0	24.0	2.04
HE40, M0 to M9 4ss	4	6	10.8	16.7	16.8	16.6	0.1	22.0	24.0	2.04
HE40 Beam Forming, M0 to M9 1ss	2	9	10.8	16.7			0.1	17.8	21.0	3.18
HE40 Beam Forming, M0 to M9 2ss	2	6	10.8	16.7			0.1	17.8	24.0	6.18
HE40 Beam Forming, M0 to M9 1ss	3	11	10.8	13.4	13.4		0.1	17.6	19.0	1.41
HE40 Beam Forming, M0 to M9 2ss	3	8	10.8	16.7	16.8		0.1	20.4	22.0	1.59
HE40 Beam Forming, M0 to M9 3ss	3	6	10.8	16.7	16.8		0.1	20.4	24.0	3.59
<b>HE40 Beam Forming, M0 to M9 1ss</b>	<b>4</b>	<b>12</b>	<b>10.8</b>	<b>11.4</b>	<b>11.4</b>	<b>10.9</b>	<b>0.1</b>	<b>17.3</b>	<b>18.0</b>	<b>0.72</b>
HE40 Beam Forming, M0 to M9 2ss	4	9	10.8	14.4	14.4	14.4	0.1	19.9	21.0	1.11
HE40 Beam Forming, M0 to M9 3ss	4	7	10.8	16.7	16.8	16.6	0.1	22.0	23.0	1.04
HE40 Beam Forming, M0 to M9 4ss	4	6	10.8	16.7	16.8	16.6	0.1	22.0	24.0	2.04
HE40 STBC, M0 to M9 2ss	2	6	10.8	16.7			0.1	17.8	24.0	6.18
HE40 STBC, M0 to M9 2ss	3	6	10.8	16.7	16.8		0.1	20.4	24.0	3.59
HE40 STBC, M0 to M9 2ss	4	6	10.8	14.4	14.4	14.4	0.1	19.9	24.0	4.11
5290										
Non HT80, 6 to 54 Mbps	1	6	8.7				0.1	8.8	24.0	15.25
Non HT80, 6 to 54 Mbps	2	6	8.7	8.7			0.1	11.8	24.0	12.24
Non HT80, 6 to 54 Mbps	3	6	8.7	8.7	8.9		0.1	13.6	24.0	10.41
Non HT80, 6 to 54 Mbps	4	6	8.7	8.7	8.9	8.3	0.1	14.7	24.0	9.27
VHT80, M0 to M9 1ss	1	6	9.5				0.2	9.7	24.0	14.28
VHT80, M0 to M9 1ss	2	6	9.5	9.5			0.2	12.7	24.0	11.27
VHT80, M0 to M9 2ss	2	6	9.5	9.5			0.2	12.7	24.0	11.27
VHT80, M0 to M9 1ss	3	6	8.7	8.6	8.9		0.2	13.7	24.0	10.28
VHT80, M0 to M9 2ss	3	6	8.7	8.6	8.9		0.2	13.7	24.0	10.28
VHT80, M0 to M9 3ss	3	6	8.7	8.6	8.9		0.2	13.7	24.0	10.28
VHT80, M0 to M9 1ss	4	6	8.7	8.6	8.9	8.2	0.2	14.8	24.0	9.16
VHT80, M0 to M9 2ss	4	6	8.7	8.6	8.9	8.2	0.2	14.8	24.0	9.16
VHT80, M0 to M9 3ss	4	6	8.7	8.6	8.9	8.2	0.2	14.8	24.0	9.16



VHT80, M0 to M9 4ss	4	6	8.7	8.6	8.9	8.2	0.2	14.8	24.0	9.16	
VHT80 Beam Forming, M0 to M9 1ss	2	9	8.7	8.6			0.2	11.9	21.0	9.12	
VHT80 Beam Forming, M0 to M9 2ss	2	6	9.5	9.5			0.2	12.7	24.0	11.27	
VHT80 Beam Forming, M0 to M9 1ss	3	11	7.6	7.5	7.7		0.2	12.6	19.0	6.41	
VHT80 Beam Forming, M0 to M9 2ss	3	8	8.7	8.6	8.9		0.2	13.7	22.0	8.28	
VHT80 Beam Forming, M0 to M9 3ss	3	6	8.7	8.6	8.9		0.2	13.7	24.0	10.28	
VHT80 Beam Forming, M0 to M9 1ss	4	12	6.6	6.5	6.8	6.1	0.2	12.7	18.0	5.26	
VHT80 Beam Forming, M0 to M9 2ss	4	9	7.6	7.5	7.7	7.0	0.2	13.7	21.0	7.31	
VHT80 Beam Forming, M0 to M9 3ss	4	7	8.7	8.6	8.9	8.2	0.2	14.8	23.0	8.16	
VHT80 Beam Forming, M0 to M9 4ss	4	6	8.7	8.6	8.9	8.2	0.2	14.8	24.0	9.16	
VHT80 STBC, M0 to M9 1ss	2	6	9.5	9.5			0.2	12.7	24.0	11.27	
VHT80 STBC, M0 to M9 1ss	3	6	8.7	8.6	8.9		0.2	13.7	24.0	10.28	
VHT80 STBC, M0 to M9 1ss	4	6	8.7	8.6	8.9	8.2	0.2	14.8	24.0	9.16	
HE80, M0 to M9 1ss	1	6	8.6				0.3	8.9	24.0	15.14	
HE80, M0 to M9 1ss	2	6	8.6	8.6			0.3	11.9	24.0	12.13	
HE80, M0 to M9 2ss	2	6	8.6	8.6			0.3	11.9	24.0	12.13	
HE80, M0 to M9 1ss	3	6	8.6	8.6	8.8		0.3	13.7	24.0	10.30	
HE80, M0 to M9 2ss	3	6	8.6	8.6	8.8		0.3	13.7	24.0	10.30	
HE80, M0 to M9 3ss	3	6	8.6	8.6	8.8		0.3	13.7	24.0	10.30	
HE80, M0 to M9 1ss	4	6	8.6	8.6	8.8	8.3	0.3	14.9	24.0	9.14	
HE80, M0 to M9 2ss	4	6	8.6	8.6	8.8	8.3	0.3	14.9	24.0	9.14	
HE80, M0 to M9 3ss	4	6	8.6	8.6	8.8	8.3	0.3	14.9	24.0	9.14	
HE80, M0 to M9 4ss	4	6	8.6	8.6	8.8	8.3	0.3	14.9	24.0	9.14	
HE80 Beam Forming, M0 to M9 1ss	2	9	7.8	7.6			0.3	11.0	21.0	10.03	
HE80 Beam Forming, M0 to M9 2ss	2	6	8.6	8.6			0.3	11.9	24.0	12.13	
HE80 Beam Forming, M0 to M9 1ss	3	11	6.8	6.5	6.7		0.3	11.7	19.0	7.30	
HE80 Beam Forming, M0 to M9 2ss	3	8	7.8	7.6	7.7		0.3	12.7	22.0	9.27	
HE80 Beam Forming, M0 to M9 3ss	3	6	8.6	8.6	8.8		0.3	13.7	24.0	10.30	
HE80 Beam Forming, M0 to M9 1ss	4	12	5.9	5.6	5.8	4.9	0.3	11.8	18.0	6.15	
HE80 Beam Forming, M0 to M9 2ss	4	9	7.8	7.6	7.7	7.0	0.3	13.8	21.0	7.18	
HE80 Beam Forming, M0 to M9 3ss	4	7	7.8	7.6	7.7	7.0	0.3	13.8	23.0	9.18	
HE80 Beam Forming, M0 to M9 4ss	4	6	8.6	8.6	8.8	8.3	0.3	14.9	24.0	9.14	
HE80 STBC, M0 to M9 1ss	2	6	8.6	8.6			0.3	11.9	24.0	12.13	
HE80 STBC, M0 to M9 1ss	3	6	8.6	8.6	8.8		0.3	13.7	24.0	10.30	
HE80 STBC, M0 to M9 1ss	4	6	8.6	8.6	8.8	8.3	0.3	14.9	24.0	9.14	
5300	Non HT20, 6 to 54 Mbps	1	6	11.2				0.0	11.2	24.0	12.76
	Non HT20, 6 to 54 Mbps	2	6	11.2	16.9			0.0	18.0	24.0	6.02
	Non HT20, 6 to 54 Mbps	3	6	11.2	11.8	11.2		0.0	16.2	24.0	7.78
	Non HT20, 6 to 54 Mbps	4	6	9.4	9.5	9.1	8.3	0.0	15.2	24.0	8.84
	Non HT20 Beam Forming, 6 to 54 Mbps	2	9	11.2	16.9			0.0	18.0	21.0	3.02
	Non HT20 Beam Forming, 6 to 54 Mbps	3	11	11.2	11.8	11.2		0.0	16.2	19.0	2.78



Non HT20 Beam Forming, 6 to 54 Mbps	4	12	9.4	9.5	9.1	8.3	0.0	15.2	18.0	2.84
HT/VHT20, M0 to M7	1	6	11.2				0.1	11.3	24.0	12.75
HT/VHT20, M0 to M7	2	6	11.2	16.8			0.1	17.9	24.0	6.09
HT/VHT20, M8 to M15	2	6	11.2	16.8			0.1	17.9	24.0	6.09
HT/VHT20, M0 to M7	3	6	11.2	12.7	12.3		0.1	16.9	24.0	7.06
HT/VHT20, M8 to M15	3	6	11.2	15.8	15.5		0.1	19.4	24.0	4.57
HT/VHT20, M16 to M23	3	6	11.2	16.8	16.7		0.1	20.4	24.0	3.62
HT/VHT20, M0 to M7	4	6	9.4	9.6	9.2	8.3	0.1	15.2	24.0	8.77
HT/VHT20, M8 to M15	4	6	11.2	13.7	13.6	12.6	0.1	19.0	24.0	5.04
HT/VHT20, M16 to M23	4	6	11.2	15.8	15.5	14.7	0.1	20.7	24.0	3.30
HT/VHT20, M24 to M31	4	6	11.2	16.8	16.7	16.1	0.1	21.8	24.0	2.23
HT/VHT20 Beam Forming, M0 to M7	2	9	11.2	16.8			0.1	17.9	21.0	3.09
HT/VHT20 Beam Forming, M8 to M15	2	6	11.2	16.8			0.1	17.9	24.0	6.09
HT/VHT20 Beam Forming, M0 to M7	3	11	11.2	12.7	12.3		0.1	16.9	19.0	2.06
HT/VHT20 Beam Forming, M8 to M15	3	8	11.2	15.8	15.5		0.1	19.4	22.0	2.57
HT/VHT20 Beam Forming, M16 to M23	3	6	11.2	16.8	16.7		0.1	20.4	24.0	3.62
HT/VHT20 Beam Forming, M0 to M7	4	12	9.4	9.6	9.2	8.3	0.1	15.2	18.0	2.77
HT/VHT20 Beam Forming, M8 to M15	4	9	11.2	13.7	13.6	12.6	0.1	19.0	21.0	2.04
HT/VHT20 Beam Forming, M16 to M23	4	7	11.2	15.8	15.5	14.7	0.1	20.7	23.0	2.30
HT/VHT20 Beam Forming, M24 to M31	4	6	11.2	16.8	16.7	16.1	0.1	21.8	24.0	2.23
HT/VHT20 STBC, M0 to M7	2	6	11.2	16.8			0.1	17.9	24.0	6.09
HT/VHT20 STBC, M0 to M7	3	6	11.2	15.8	15.5		0.1	19.4	24.0	4.57
HT/VHT20 STBC, M0 to M7	4	6	11.2	13.7	13.6	12.6	0.1	19.0	24.0	5.04
HE20, M0 to M9 1ss	1	6	11.4				0.1	11.5	24.0	12.53
HE20, M0 to M9 1ss	2	6	11.4	17.2			0.1	18.3	24.0	5.72
HE20, M0 to M9 2ss	2	6	11.4	17.2			0.1	18.3	24.0	5.72
HE20, M0 to M9 1ss	3	6	11.4	12.9	12.6		0.1	17.2	24.0	6.81
HE20, M0 to M9 2ss	3	6	11.4	16.0	15.7		0.1	19.6	24.0	4.35
HE20, M0 to M9 3ss	3	6	11.4	17.2	16.9		0.1	20.7	24.0	3.31
HE20, M0 to M9 1ss	4	6	9.6	9.9	9.4	8.5	0.1	15.5	24.0	8.53
HE20, M0 to M9 2ss	4	6	11.4	14.0	13.8	12.9	0.1	19.2	24.0	4.77
HE20, M0 to M9 3ss	4	6	11.4	16.0	15.7	15.1	0.1	21.0	24.0	3.03
HE20, M0 to M9 4ss	4	6	11.4	17.2	16.9	16.4	0.1	22.1	24.0	1.92
HE20 Beam Forming, M0 to M9 1ss	2	9	11.4	17.2			0.1	18.3	21.0	2.72
HE20 Beam Forming, M0 to M9 2ss	2	6	11.4	17.2			0.1	18.3	24.0	5.72
HE20 Beam Forming, M0 to M9 1ss	3	11	11.4	12.9	12.6		0.1	17.2	19.0	1.81
HE20 Beam Forming, M0 to M9 2ss	3	8	11.4	16.0	15.7		0.1	19.6	22.0	2.35
HE20 Beam Forming, M0 to M9 3ss	3	6	11.4	17.2	16.9		0.1	20.7	24.0	3.31
HE20 Beam Forming, M0 to M9 1ss	4	12	9.6	9.9	9.4	8.5	0.1	15.5	18.0	2.53
HE20 Beam Forming, M0 to M9 2ss	4	9	11.4	14.0	13.8	12.9	0.1	19.2	21.0	1.77
HE20 Beam Forming, M0 to M9 3ss	4	7	11.4	16.0	15.7	15.1	0.1	21.0	23.0	2.03
HE20 Beam Forming, M0 to M9 4ss	4	6	11.4	17.2	16.9	16.4	0.1	22.1	24.0	1.92



	HE20 STBC, M0 to M9 2ss	2	6	11.4	17.2			0.1	18.3	24.0	5.72
	HE20 STBC, M0 to M9 2ss	3	6	11.4	16.0	15.7		0.1	19.6	24.0	4.35
	HE20 STBC, M0 to M9 2ss	4	6	11.4	14.0	13.8	12.9	0.1	19.2	24.0	4.77
5310	Non HT40, 6 to 54 Mbps	1	6	9.9				0.0	9.9	24.0	14.06
	Non HT40, 6 to 54 Mbps	2	6	9.9	10.1			0.0	13.1	24.0	10.94
	Non HT40, 6 to 54 Mbps	3	6	9.0	9.2	9.3		0.0	14.0	24.0	10.02
	Non HT40, 6 to 54 Mbps	4	6	9.0	9.2	9.3	8.6	0.0	15.1	24.0	8.90
	HT/VHT40, M0 to M7	1	6	9.8				0.1	9.9	24.0	14.10
	HT/VHT40, M0 to M7	2	6	9.8	10.0			0.1	13.0	24.0	10.99
	HT/VHT40, M8 to M15	2	6	9.8	10.0			0.1	13.0	24.0	10.99
	HT/VHT40, M0 to M7	3	6	9.8	10.0	9.9		0.1	14.8	24.0	9.23
	HT/VHT40, M8 to M15	3	6	9.8	10.0	9.9		0.1	14.8	24.0	9.23
	HT/VHT40, M16 to M23	3	6	9.8	10.0	9.9		0.1	14.8	24.0	9.23
	HT/VHT40, M0 to M7	4	6	9.8	10.0	9.9	9.2	0.1	15.9	24.0	8.14
	HT/VHT40, M8 to M15	4	6	9.8	10.0	9.9	9.2	0.1	15.9	24.0	8.14
	HT/VHT40, M16 to M23	4	6	9.8	10.0	9.9	9.2	0.1	15.9	24.0	8.14
	HT/VHT40, M24 to M31	4	6	9.8	10.0	9.9	9.2	0.1	15.9	24.0	8.14
	HT/VHT40 Beam Forming, M0 to M7	2	9	8.6	9.0			0.1	11.9	21.0	9.08
	HT/VHT40 Beam Forming, M8 to M15	2	6	9.8	10.0			0.1	13.0	24.0	10.99
	HT/VHT40 Beam Forming, M0 to M7	3	11	7.7	7.7	8.0		0.1	12.7	19.0	6.32
	HT/VHT40 Beam Forming, M8 to M15	3	8	8.6	9.0	9.1		0.1	13.8	22.0	8.22
	HT/VHT40 Beam Forming, M16 to M23	3	6	9.8	10.0	9.9		0.1	14.8	24.0	9.23
	HT/VHT40 Beam Forming, M0 to M7	4	12	7.7	7.7	8.0	7.1	0.1	13.8	18.0	4.24
	HT/VHT40 Beam Forming, M8 to M15	4	9	8.6	9.0	9.1	8.2	0.1	14.9	21.0	6.14
	HT/VHT40 Beam Forming, M16 to M23	4	7	8.6	9.0	9.1	8.2	0.1	14.9	23.0	8.14
	HT/VHT40 Beam Forming, M24 to M31	4	6	9.8	10.0	9.9	9.2	0.1	15.9	24.0	8.14
	HT/VHT40 STBC, M0 to M7	2	6	9.8	10.0			0.1	13.0	24.0	10.99
	HT/VHT40 STBC, M0 to M7	3	6	9.8	10.0	9.9		0.1	14.8	24.0	9.23
	HT/VHT40 STBC, M0 to M7	4	6	9.8	10.0	9.9	9.2	0.1	15.9	24.0	8.14
	HE40, M0 to M9 1ss	1	6	10.0				0.1	10.1	24.0	13.87
	HE40, M0 to M9 1ss	2	6	10.0	10.3			0.1	13.3	24.0	10.71
	HE40, M0 to M9 2ss	2	6	10.0	10.3			0.1	13.3	24.0	10.71
	HE40, M0 to M9 1ss	3	6	8.9	9.4	9.4		0.1	14.1	24.0	9.86
	HE40, M0 to M9 2ss	3	6	8.9	9.4	9.4		0.1	14.1	24.0	9.86
	HE40, M0 to M9 3ss	3	6	8.9	9.4	9.4		0.1	14.1	24.0	9.86
	HE40, M0 to M9 1ss	4	6	8.9	9.4	9.4	8.5	0.1	15.2	24.0	8.78
	HE40, M0 to M9 2ss	4	6	8.9	9.4	9.4	8.5	0.1	15.2	24.0	8.78
	HE40, M0 to M9 3ss	4	6	8.9	9.4	9.4	8.5	0.1	15.2	24.0	8.78
	HE40, M0 to M9 4ss	4	6	8.9	9.4	9.4	8.5	0.1	15.2	24.0	8.78
HE40 Beam Forming, M0 to M9 1ss	2	9	8.9	9.4			0.1	12.3	21.0	8.70	
HE40 Beam Forming, M0 to M9 2ss	2	6	10.0	10.3			0.1	13.3	24.0	10.71	



HE40 Beam Forming, M0 to M9 1ss	3	11	8.1	8.3	8.2		0.1	13.1	19.0	5.90
HE40 Beam Forming, M0 to M9 2ss	3	8	8.9	9.4	9.4		0.1	14.1	22.0	7.86
HE40 Beam Forming, M0 to M9 3ss	3	6	8.9	9.4	9.4		0.1	14.1	24.0	9.86
HE40 Beam Forming, M0 to M9 1ss	4	12	7.3	7.2	7.4	6.5	0.1	13.3	18.0	4.74
HE40 Beam Forming, M0 to M9 2ss	4	9	8.1	8.3	8.2	7.4	0.1	14.2	21.0	6.84
HE40 Beam Forming, M0 to M9 3ss	4	7	8.9	9.4	9.4	8.5	0.1	15.2	23.0	7.78
HE40 Beam Forming, M0 to M9 4ss	4	6	8.9	9.4	9.4	8.5	0.1	15.2	24.0	8.78
HE40 STBC, M0 to M9 2ss	2	6	10.0	10.3			0.1	13.3	24.0	10.71
HE40 STBC, M0 to M9 2ss	3	6	8.9	9.4	9.4		0.1	14.1	24.0	9.86
HE40 STBC, M0 to M9 2ss	4	6	8.9	9.4	9.4	8.5	0.1	15.2	24.0	8.78
5320										
Non HT20, 6 to 54 Mbps	1	6	11.1				0.0	11.1	24.0	12.86
Non HT20, 6 to 54 Mbps	2	6	11.1	15.8			0.0	17.1	24.0	6.89
Non HT20, 6 to 54 Mbps	3	6	11.1	12.6	12.3		0.0	16.9	24.0	7.14
Non HT20, 6 to 54 Mbps	4	6	9.1	9.6	9.0	8.2	0.0	15.1	24.0	8.93
Non HT20 Beam Forming, 6 to 54 Mbps	2	9	11.1	14.9			0.0	16.5	21.0	4.54
Non HT20 Beam Forming, 6 to 54 Mbps	3	11	11.1	12.6	12.3		0.0	16.9	19.0	2.14
Non HT20 Beam Forming, 6 to 54 Mbps	4	12	9.1	9.6	9.0	8.2	0.0	15.1	18.0	2.93
HT/VHT20, M0 to M7	1	6	10.9				0.1	11.0	24.0	13.05
HT/VHT20, M0 to M7	2	6	10.9	15.7			0.1	17.0	24.0	7.01
HT/VHT20, M8 to M15	2	6	10.9	15.7			0.1	17.0	24.0	7.01
HT/VHT20, M0 to M7	3	6	10.9	12.7	12.4		0.1	16.9	24.0	7.11
HT/VHT20, M8 to M15	3	6	10.9	15.7	15.6		0.1	19.4	24.0	4.61
HT/VHT20, M16 to M23	3	6	10.9	15.7	15.6		0.1	19.4	24.0	4.61
HT/VHT20, M0 to M7	4	6	10.1	10.7	10.2	9.2	0.1	16.2	24.0	7.84
HT/VHT20, M8 to M15	4	6	10.9	13.9	13.5	12.5	0.1	18.9	24.0	5.08
HT/VHT20, M16 to M23	4	6	10.9	14.9	14.4	13.4	0.1	19.7	24.0	4.28
HT/VHT20, M24 to M31	4	6	10.9	14.9	14.4	13.4	0.1	19.7	24.0	4.28
HT/VHT20 Beam Forming, M0 to M7	2	9	10.9	14.9			0.1	16.4	21.0	4.59
HT/VHT20 Beam Forming, M8 to M15	2	6	10.9	15.7			0.1	17.0	24.0	7.01
HT/VHT20 Beam Forming, M0 to M7	3	11	10.9	12.7	12.4		0.1	16.9	19.0	2.11
HT/VHT20 Beam Forming, M8 to M15	3	8	10.9	14.9	14.4		0.1	18.5	22.0	3.45
HT/VHT20 Beam Forming, M16 to M23	3	6	10.9	15.7	15.6		0.1	19.4	24.0	4.61
HT/VHT20 Beam Forming, M0 to M7	4	12	10.1	10.7	10.2	9.2	0.1	16.2	18.0	1.84
HT/VHT20 Beam Forming, M8 to M15	4	9	10.9	13.9	13.5	12.5	0.1	18.9	21.0	2.08
HT/VHT20 Beam Forming, M16 to M23	4	7	10.9	14.9	14.4	13.4	0.1	19.7	23.0	3.28
HT/VHT20 Beam Forming, M24 to M31	4	6	10.9	14.9	14.4	13.4	0.1	19.7	24.0	4.28
HT/VHT20 STBC, M0 to M7	2	6	10.9	15.7			0.1	17.0	24.0	7.01
HT/VHT20 STBC, M0 to M7	3	6	10.9	15.7	15.6		0.1	19.4	24.0	4.61
HT/VHT20 STBC, M0 to M7	4	6	10.9	13.9	13.5	12.5	0.1	18.9	24.0	5.08
HE20, M0 to M9 1ss	1	6	10.9				0.1	11.0	24.0	13.03
HE20, M0 to M9 1ss	2	6	10.9	15.8			0.1	17.1	24.0	6.91





	HE20, M0 to M9 2ss	2	6	10.9	15.8			0.1	17.1	24.0	6.91	
	HE20, M0 to M9 1ss	3	6	10.9	12.8	12.5		0.1	17.0	24.0	7.02	
	HE20, M0 to M9 2ss	3	6	10.9	14.9	14.5		0.1	18.6	24.0	5.39	
	HE20, M0 to M9 3ss	3	6	10.9	14.9	14.5		0.1	18.6	24.0	5.39	
	HE20, M0 to M9 1ss	4	6	10.0	10.7	10.3	9.3	0.1	16.2	24.0	7.80	
	HE20, M0 to M9 2ss	4	6	10.9	13.9	13.6	12.5	0.1	19.0	24.0	5.03	
	HE20, M0 to M9 3ss	4	6	10.9	14.9	14.5	13.5	0.1	19.8	24.0	4.21	
	HE20, M0 to M9 4ss	4	6	10.9	14.9	14.5	13.5	0.1	19.8	24.0	4.21	
	HE20 Beam Forming, M0 to M9 1ss	2	9	10.9	13.9			0.1	15.7	21.0	5.27	
	HE20 Beam Forming, M0 to M9 2ss	2	6	10.9	15.8			0.1	17.1	24.0	6.91	
	HE20 Beam Forming, M0 to M9 1ss	3	11	10.9	12.8	12.5		0.1	17.0	19.0	2.02	
	HE20 Beam Forming, M0 to M9 2ss	3	8	10.9	13.9	13.6		0.1	17.8	22.0	4.17	
	HE20 Beam Forming, M0 to M9 3ss	3	6	10.9	14.9	14.5		0.1	18.6	24.0	5.39	
	HE20 Beam Forming, M0 to M9 1ss	4	12	10.0	10.7	10.3	9.3	0.1	16.2	18.0	1.80	
	HE20 Beam Forming, M0 to M9 2ss	4	9	10.9	12.8	12.5	11.3	0.1	18.0	21.0	2.96	
	HE20 Beam Forming, M0 to M9 3ss	4	7	10.9	13.9	13.6	12.5	0.1	19.0	23.0	4.03	
	HE20 Beam Forming, M0 to M9 4ss	4	6	10.9	14.9	14.5	13.5	0.1	19.8	24.0	4.21	
	HE20 STBC, M0 to M9 2ss	2	6	10.9	15.8			0.1	17.1	24.0	6.91	
	HE20 STBC, M0 to M9 2ss	3	6	10.9	14.9	14.5		0.1	18.6	24.0	5.39	
	HE20 STBC, M0 to M9 2ss	4	6	10.9	13.9	13.6	12.5	0.1	19.0	24.0	5.03	
5250	Non HT160, 6 to 54 Mbps	1	6	6.7				0.0	6.7	24.0	17.25	
	Non HT160, 6 to 54 Mbps	2	6	6.7	6.3			0.0	9.6	24.0	14.44	
	Non HT160, 6 to 54 Mbps	3	6	6.7	6.3	6.1		0.0	11.2	24.0	12.81	
	Non HT160, 6 to 54 Mbps	4	6	6.7	6.3	6.1	5.5	0.0	12.2	24.0	11.76	
	VHT160, M0 to M9 1ss	1	6	8.5				0.4	8.9	24.0	15.11	
	VHT160, M0 to M9 1ss	2	6	8.5	8.4			0.4	11.9	24.0	12.15	
	VHT160, M0 to M9 2ss	2	6	8.5	8.4			0.4	11.9	24.0	12.15	
	VHT160, M0 to M9 1ss	3	6	8.5	8.4	8.3		0.4	13.6	24.0	10.44	
	VHT160, M0 to M9 2ss	3	6	8.5	8.4	8.3		0.4	13.6	24.0	10.44	
	VHT160, M0 to M9 3ss	3	6	8.5	8.4	8.3		0.4	13.6	24.0	10.44	
	VHT160, M0 to M9 1ss	4	6	7.6	7.5	7.1	6.6	0.4	13.6	24.0	10.37	
	VHT160, M0 to M9 2ss	4	6	7.6	7.5	7.1	6.6	0.4	13.6	24.0	10.37	
	VHT160, M0 to M9 3ss	4	6	7.6	7.5	7.1	6.6	0.4	13.6	24.0	10.37	
	VHT160, M0 to M9 4ss	4	6	7.6	7.5	7.1	6.6	0.4	13.6	24.0	10.37	
	VHT160 Beam Forming, M0 to M9 1ss	2	9	6.7	6.2				0.4	9.9	21.0	11.14
	VHT160 Beam Forming, M0 to M9 2ss	2	6	8.5	8.4				0.4	11.9	24.0	12.15
	VHT160 Beam Forming, M0 to M9 1ss	3	11	5.8	5.3	5.2			0.4	10.6	19.0	8.40
	VHT160 Beam Forming, M0 to M9 2ss	3	8	7.6	7.5	7.1			0.4	12.6	22.0	9.43
	VHT160 Beam Forming, M0 to M9 3ss	3	6	8.5	8.4	8.3			0.4	13.6	24.0	10.44
	VHT160 Beam Forming, M0 to M9 1ss	4	12	5.8	5.3	5.2	4.5		0.4	11.6	18.0	6.36
VHT160 Beam Forming, M0 to M9 2ss	4	9	6.7	6.2	6.1	5.4		0.4	12.5	21.0	8.46	





VHT160 Beam Forming, M0 to M9 3ss	4	7	7.6	7.5	7.1	6.6	0.4	13.6	23.0	9.37
VHT160 Beam Forming, M0 to M9 4ss	4	6	7.6	7.5	7.1	6.6	0.4	13.6	24.0	10.37
VHT160 STBC, M0 to M9 1ss	2	6	8.5	8.4			0.4	11.9	24.0	12.15
VHT160 STBC, M0 to M9 1ss	3	6	8.5	8.4	8.3		0.4	13.6	24.0	10.44
VHT160 STBC, M0 to M9 1ss	4	6	7.6	7.5	7.1	6.6	0.4	13.6	24.0	10.37
HE160, M0 to M9 1ss	1	6	8.9				0.4	9.3	24.0	14.67
HE160, M0 to M9 1ss	2	6	8.9	8.6			0.4	12.2	24.0	11.80
HE160, M0 to M9 2ss	2	6	8.9	8.6			0.4	12.2	24.0	11.80
HE160, M0 to M9 1ss	3	6	8.9	8.6	8.6		0.4	13.9	24.0	10.09
HE160, M0 to M9 2ss	3	6	8.9	8.6	8.6		0.4	13.9	24.0	10.09
HE160, M0 to M9 3ss	3	6	8.9	8.6	8.6		0.4	13.9	24.0	10.09
HE160, M0 to M9 1ss	4	6	8.9	8.6	8.6	7.9	0.4	15.0	24.0	9.03
HE160, M0 to M9 2ss	4	6	8.9	8.6	8.6	7.9	0.4	15.0	24.0	9.03
HE160, M0 to M9 3ss	4	6	8.9	8.6	8.6	7.9	0.4	15.0	24.0	9.03
HE160, M0 to M9 4ss	4	6	8.9	8.6	8.6	7.9	0.4	15.0	24.0	9.03
HE160 Beam Forming, M0 to M9 1ss	2	9	7.9	7.7			0.4	11.2	21.0	9.75
HE160 Beam Forming, M0 to M9 2ss	2	6	8.9	8.6			0.4	12.2	24.0	11.80
HE160 Beam Forming, M0 to M9 1ss	3	11	6.9	6.5	6.2		0.4	11.7	19.0	7.25
HE160 Beam Forming, M0 to M9 2ss	3	8	7.9	7.7	7.4		0.4	12.9	22.0	9.12
HE160 Beam Forming, M0 to M9 3ss	3	6	8.9	8.6	8.6		0.4	13.9	24.0	10.09
HE160 Beam Forming, M0 to M9 1ss	4	12	5.9	5.5	5.4	4.8	0.4	11.9	18.0	6.13
HE160 Beam Forming, M0 to M9 2ss	4	9	7.9	7.7	7.4	7.0	0.4	14.0	21.0	7.03
HE160 Beam Forming, M0 to M9 3ss	4	7	7.9	7.7	7.4	7.0	0.4	14.0	23.0	9.03
HE160 Beam Forming, M0 to M9 4ss	4	6	8.9	8.6	8.6	7.9	0.4	15.0	24.0	9.03
HE160 STBC, M0 to M9 1ss	2	6	8.9	8.6			0.4	12.2	24.0	11.80
HE160 STBC, M0 to M9 1ss	3	6	8.9	8.6	8.6		0.4	13.9	24.0	10.09
HE160 STBC, M0 to M9 1ss	4	6	8.9	8.6	8.6	7.9	0.4	15.0	24.0	9.03



**Maximum Transmit Output Power, 6dBi  
5270 MHz, HE40 Beam Forming, M0 to M9 1ss**



**Antenna A**

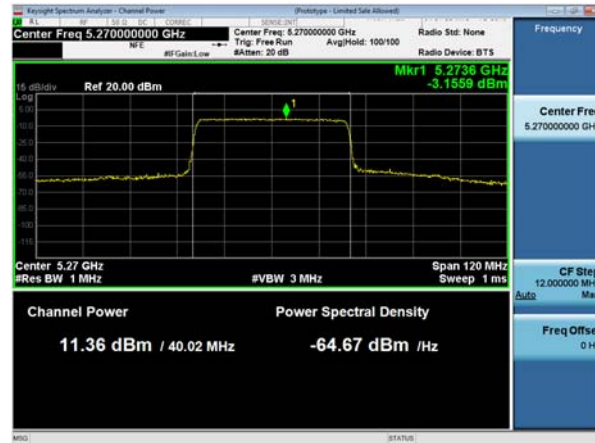

**Antenna B**

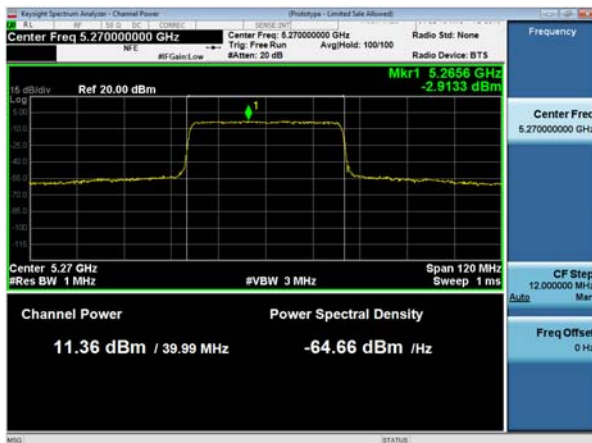

**Antenna C**

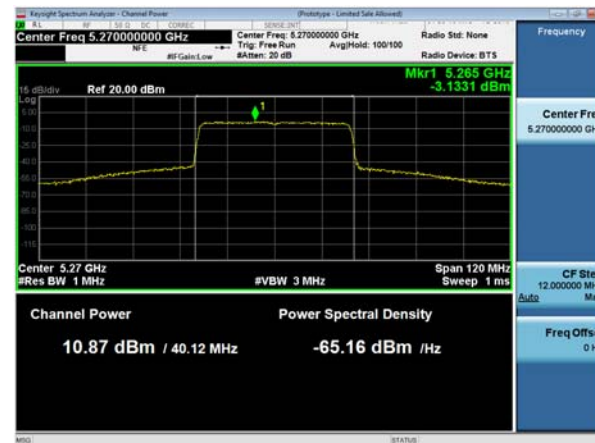

**Antenna D**



## A.4 Power Spectral Density

### Power Spectral Density Test Requirement

**15.407 (2)** For the 5.25-5.35 GHz and 5.47-5.725 GHz bands, the maximum conducted output power over the frequency bands of operation shall not exceed the lesser of 250 mW or 11 dBm + 10 log B, where B is the 26 dB emission bandwidth in megahertz. In addition, the maximum power spectral density shall not exceed 11 dBm in any 1 megahertz band. If transmitting antennas of directional gain greater than 6 dBi are used, both the maximum conducted output power and the maximum power spectral density shall be reduced by the amount in dB that the directional gain of the antenna exceeds 6 dBi.

**15.407 (5)** The maximum power spectral density is measured as a conducted emission by direct connection of a calibrated test instrument to the equipment under test. If the device cannot be connected directly, alternative techniques acceptable to the Commission may be used. Measurements in the 5.15-5.25 GHz, 5.25-5.35 GHz, and the 5.47-5.725 GHz bands are made over a bandwidth of 1 MHz or the 26 dB emission bandwidth of the device, whichever is less. A narrower resolution bandwidth can be used, provided that the measured power is integrated over the full reference bandwidth.

Referencing “644545 D03 Guidance for IEEE 802.11ac v01”, covering signals that cross the boundary between two adjacent UNII bands, the FCC describes a procedure to measure EBW, power, and PSD in each UNII band. For the case of a 160MHz signal equally distributed between UNII-1 and UNII-2a, we apply the following alternate procedure.

Rather than measure:

- The half of the signal in UNII-1, measured against the 30dBm power / 17dBm/MHz PSD limits
- The half of the signal in UNII-2a, measured against the 24dBm power / 11dBm/MHz PSD limits

If a 160MHz signal (equally distributed between the two bands) produces a total power of 27dBm across the entire 160 MHz EBW, the total power in each band would be half of the total, or 24dBm (which meets both the UNII-1 and UNII-2a limits), and would have a PSD no greater than 11dBm/MHz in either sub-band.

Given these facts, we have measured the complete 160 MHz EBW (across both sub-bands) against 27dBm power and 11dBm/MHz PSD limits, rather than individual sub band measurements against the individual sub band limits.”

### Power Spectral Density Test Procedure

**Ref. KDB 789033 D02 General UNII Test Procedures New Rules v02r01**

#### F. Maximum Power Spectral Density (PSD)

##### Power Spectral Density

##### Test Procedure

The rules requires “maximum power spectral density” measurements where the intent is to measure the maximum value of the time average of the power spectral density measured during a period of continuous transmission.

1. Create an average power spectrum for the EUT operating mode being tested by following the instructions in section II.E.2. for measuring maximum conducted output power using a spectrum analyzer or EMI receiver: select the appropriate test method (SA-1, SA-2, SA-3, or alternatives to each) and apply it up to, but not including, the step labeled, “Compute power...”. (This procedure is required even if the maximum conducted output power measurement was performed using a power meter, method PM.)

2. Use the peak search function on the instrument to find the peak of the spectrum and record its value.

3. Make the following adjustments to the peak value of the spectrum, if applicable: a) If Method SA-2 or SA-2 Alternative was used, add 10 log(1/x), where x is the duty cycle, to the peak of the spectrum.

b) If Method SA-3 Alternative was used and the linear mode was used in step II.E.2.g)(viii), add 1 dB to the final result to compensate for the difference between linear averaging and power averaging.

4. The result is the Maximum PSD over 1 MHz reference bandwidth.

**Ref. KDB 789033 D02 General UNII Test Procedures New Rules v02r01****2. Measurement using a Spectrum Analyzer or EMI Receiver (SA), (d) Method SA-2****Power Spectral Density**

## Test parameters

Method SA-2 (trace averaging across on and off times of the EUT transmissions, followed by duty cycle correction).

- (i) Measure the duty cycle,  $x$ , of the transmitter output signal as described in section II.B.
- (ii) Set span to encompass the EBW (or, alternatively, the entire 99% occupied bandwidth) of the signal.
- (iii) Set RBW = 1 MHz.
- (iv) Set VBW  $\geq$  3 MHz.
- (v) Number of points in sweep  $\geq$  2 Span / RBW. (This ensures that bin-to-bin spacing is  $\leq$  RBW/2, so that narrowband signals are not lost between frequency bins.)
- (vi) Sweep time = auto.
- (vii) Detector = RMS (i.e., power averaging), if available. Otherwise, use sample detector mode.
- (viii) Do not use sweep triggering. Allow the sweep to “free run”.
- (ix) Trace average at least 100 traces in power averaging (i.e., RMS) mode; however, the number of traces to be averaged shall be increased above 100 as needed to ensure that the average accurately represents the true average over the on and off periods of the transmitter.
- (x) Compute power by integrating the spectrum across the EBW (or, alternatively, the entire 99% occupied bandwidth) of the signal using the instrument’s band power measurement function with band limits set equal to the EBW (or occupied bandwidth)

**F. Maximum Power Spectral Density (PSD)**

- 2. Use the peak search function on the instrument to find the peak of the spectrum and record its value.
- 3. Make the following adjustments to the peak value of the spectrum, if applicable: a) If Method SA-2 or SA-2 Alternative was used, add  $10 \log(1/x)$ , where  $x$  is the duty cycle, to the peak of the spectrum.

The “measure-and-sum technique” is used for measuring in-band transmit power of a device. In the measure-and-sum approach, the conducted emission level is measured at each antenna port. The measured results at the various antenna ports are then summed mathematically to determine the total emission level from the device. Summing is performed in linear power units. (See ANSI C63.10 section 14.3.2.2)

**Samples, Systems, and Modes**

System Number	Description	Samples	System under test	Support equipment
1	EUT	S01+S02	<input checked="" type="checkbox"/>	<input type="checkbox"/>
	Support		<input type="checkbox"/>	<input checked="" type="checkbox"/>

**Tested By :**

Chris Blair

**Date of testing:**

11-Sep-19 - 25-Sep-19

**Test Result : PASS****Test Equipment**

See Appendix C for list of test equipment



## Power Spectral Density, 4dBi

Frequency (MHz)	Mode	Tx Paths	Correlated Antenna Gain (dBi)	Tx 1 PSD (dBm/MHz)	Tx 2 PSD (dBm/MHz)	Tx 3 PSD (dBm/MHz)	Tx 4 PSD (dBm/MHz)	Duty Cycle Correction (dB)	Total PSD (dBm/MHz)	Limit (dBm/MHz)	Margin (dB)	
5260	Non HT20, 6 to 54 Mbps	1	4	0.1				0.0	0.1	11.0	10.86	
	Non HT20, 6 to 54 Mbps	2	7	0.1	6.3			0.0	7.3	10.0	2.72	
	Non HT20, 6 to 54 Mbps	3	9	0.1	4.1	3.4		0.0	7.7	8.0	0.34	
	Non HT20, 6 to 54 Mbps	4	10	0.1	0.9	0.3	-0.2	0.0	6.4	7.0	0.64	
	Non HT20 Beam Forming, 6 to 54 Mbps	2	7	0.1	6.3			0.0	7.3	10.0	2.72	
	Non HT20 Beam Forming, 6 to 54 Mbps	3	9	0.1	4.1	3.4		0.0	7.7	8.0	0.34	
	Non HT20 Beam Forming, 6 to 54 Mbps	4	10	0.1	0.9	0.3	-0.2	0.0	6.4	7.0	0.64	
	HT/VHT20, M0 to M7	1	4	-0.5					0.1	-0.4	11.0	11.45
	HT/VHT20, M0 to M7	2	7	-0.5	5.9				0.1	6.8	10.0	3.15
	HT/VHT20, M8 to M15	2	4	-0.5	5.9				0.1	6.8	11.0	4.15
	HT/VHT20, M0 to M7	3	9	-0.5	4.0	3.1			0.1	7.4	8.0	0.59
	HT/VHT20, M8 to M15	3	6	-0.5	5.9	5.1			0.1	9.1	11.0	1.91
	HT/VHT20, M16 to M23	3	4	-0.5	5.9	5.1			0.1	9.1	11.0	1.91
	HT/VHT20, M0 to M7	4	10	-0.5	1.8	0.8	0.5		0.1	6.8	7.0	0.20
	HT/VHT20, M8 to M15	4	7	-0.5	4.8	4.4	4.3		0.1	9.8	10.0	0.24
	HT/VHT20, M16 to M23	4	5	-0.5	5.9	5.1	5.1		0.1	10.6	11.0	0.43
	HT/VHT20, M24 to M31	4	4	-0.5	5.9	5.1	5.1		0.1	10.6	11.0	0.43
	HT/VHT20 Beam Forming, M0 to M7	2	7	-0.5	5.9				0.1	6.8	10.0	3.15
	HT/VHT20 Beam Forming, M8 to M15	2	4	-0.5	5.9				0.1	6.8	11.0	4.15
	HT/VHT20 Beam Forming, M0 to M7	3	9	-0.5	4.0	3.1			0.1	7.4	8.0	0.59
	HT/VHT20 Beam Forming, M8 to M15	3	6	-0.5	5.9	5.1			0.1	9.1	11.0	1.91
	HT/VHT20 Beam Forming, M16 to M23	3	4	-0.5	5.9	5.1			0.1	9.1	11.0	1.91
	HT/VHT20 Beam Forming, M0 to M7	4	10	-0.5	1.8	0.8	0.5		0.1	6.8	7.0	0.20
	HT/VHT20 Beam Forming, M8 to M15	4	7	-0.5	4.8	4.4	4.3		0.1	9.8	10.0	0.24
	HT/VHT20 Beam Forming, M16 to M23	4	5	-0.5	5.9	5.1	5.1		0.1	10.6	11.0	0.43
	HT/VHT20 Beam Forming, M24 to M31	4	4	-0.5	5.9	5.1	5.1		0.1	10.6	11.0	0.43
	HT/VHT20 STBC, M0 to M7	2	4	-0.5	5.9				0.1	6.8	11.0	4.15
	HT/VHT20 STBC, M0 to M7	3	6	-0.5	5.9	5.1			0.1	9.1	11.0	1.91
	HT/VHT20 STBC, M0 to M7	4	7	-0.5	4.8	4.4	4.3		0.1	9.8	10.0	0.24
	HE20, M0 to M9 1ss	1	4	-0.3					0.1	-0.2	11.0	11.23



	HE20, M0 to M9 1ss	2	7	-0.3	5.7			0.1	6.7	10.0	3.26
	HE20, M0 to M9 2ss	2	4	-0.3	5.7			0.1	6.7	11.0	4.26
	HE20, M0 to M9 1ss	3	9	-0.3	3.8	3.3		0.1	7.5	8.0	0.55
	HE20, M0 to M9 2ss	3	6	-0.3	5.7	5.9		0.1	9.4	11.0	1.62
	HE20, M0 to M9 3ss	3	4	-0.3	5.7	5.9		0.1	9.4	11.0	1.62
	HE20, M0 to M9 1ss	4	10	-0.3	0.5	0.2	-0.3	0.1	6.1	7.0	0.87
	<b>HE20, M0 to M9 2ss</b>	<b>4</b>	<b>7</b>	<b>-0.3</b>	<b>5.2</b>	<b>4.7</b>	<b>4.2</b>	<b>0.1</b>	<b>10.0</b>	<b>10.0</b>	<b>0.01</b>
	HE20, M0 to M9 3ss	4	5	-0.3	5.7	5.9	5.4	0.1	10.9	11.0	0.14
	HE20, M0 to M9 4ss	4	4	-0.3	5.7	5.9	5.4	0.1	10.9	11.0	0.14
	HE20 Beam Forming, M0 to M9 1ss	2	7	-0.3	5.7			0.1	6.7	10.0	3.26
	HE20 Beam Forming, M0 to M9 2ss	2	4	-0.3	5.7			0.1	6.7	11.0	4.26
	HE20 Beam Forming, M0 to M9 1ss	3	9	-0.3	3.8	3.3		0.1	7.5	8.0	0.55
	HE20 Beam Forming, M0 to M9 2ss	3	6	-0.3	5.7	5.9		0.1	9.4	11.0	1.62
	HE20 Beam Forming, M0 to M9 3ss	3	4	-0.3	5.7	5.9		0.1	9.4	11.0	1.62
	HE20 Beam Forming, M0 to M9 1ss	4	10	-0.3	0.5	0.2	-0.3	0.1	6.1	7.0	0.87
	HE20 Beam Forming, M0 to M9 2ss	4	7	-0.3	5.2	4.7	4.2	0.1	10.0	10.0	0.01
	HE20 Beam Forming, M0 to M9 3ss	4	5	-0.3	5.7	5.9	5.4	0.1	10.9	11.0	0.14
	HE20 Beam Forming, M0 to M9 4ss	4	4	-0.3	5.7	5.9	5.4	0.1	10.9	11.0	0.14
	HE20 STBC, M0 to M9 2ss	2	4	-0.3	5.7			0.1	6.7	11.0	4.26
	HE20 STBC, M0 to M9 2ss	3	6	-0.3	5.7	5.9		0.1	9.4	11.0	1.62
	HE20 STBC, M0 to M9 2ss	4	7	-0.3	5.2	4.7	4.2	0.1	10.0	10.0	0.01
5270	Non HT40, 6 to 54 Mbps	1	4	-3.2				0.0	-3.2	11.0	14.16
	Non HT40, 6 to 54 Mbps	2	7	-3.2	2.4			0.0	3.5	10.0	6.50
	Non HT40, 6 to 54 Mbps	3	9	-3.2	2.4	3.0		0.0	6.3	8.0	1.71
	Non HT40, 6 to 54 Mbps	4	10	-3.2	1.4	1.9	1.7	0.0	6.9	7.0	0.07
	HT/VHT40, M0 to M7	1	4	-3.5				0.1	-3.4	11.0	14.40
	HT/VHT40, M0 to M7	2	7	-3.5	2.1			0.1	3.3	10.0	6.74
	HT/VHT40, M8 to M15	2	4	-3.5	2.1			0.1	3.3	11.0	7.74
	HT/VHT40, M0 to M7	3	9	-3.5	2.1	2.3		0.1	5.9	8.0	2.14
	HT/VHT40, M8 to M15	3	6	-3.5	2.1	2.3		0.1	5.9	11.0	5.14
	HT/VHT40, M16 to M23	3	4	-3.5	2.1	2.3		0.1	5.9	11.0	5.14
	HT/VHT40, M0 to M7	4	10	-3.5	1.2	1.2	1.0	0.1	6.5	7.0	0.52
	HT/VHT40, M8 to M15	4	7	-3.5	2.1	2.3	2.1	0.1	7.4	10.0	2.58
	HT/VHT40, M16 to M23	4	5	-3.5	2.1	2.3	2.1	0.1	7.4	11.0	3.58
	HT/VHT40, M24 to M31	4	4	-3.5	2.1	2.3	2.1	0.1	7.4	11.0	3.58
	HT/VHT40 Beam Forming, M0 to M7	2	7	-3.5	2.1			0.1	3.3	10.0	6.74
	HT/VHT40 Beam Forming, M8 to M15	2	4	-3.5	2.1			0.1	3.3	11.0	7.74
	HT/VHT40 Beam Forming, M0 to M7	3	9	-3.5	1.2	1.2		0.1	5.0	8.0	3.01
	HT/VHT40 Beam Forming, M8 to M15	3	6	-3.5	2.1	2.3		0.1	5.9	11.0	5.14
	HT/VHT40 Beam Forming, M16 to M23	3	4	-3.5	2.1	2.3		0.1	5.9	11.0	5.14
HT/VHT40 Beam Forming, M0 to M7	4	10	-3.5	-0.9	-1.0	-1.5	0.1	4.5	7.0	2.49	



	HT/VHT40 Beam Forming, M8 to M15	4	7	-3.5	2.1	2.3	2.1	0.1	7.4	10.0	2.58
	HT/VHT40 Beam Forming, M16 to M23	4	5	-3.5	2.1	2.3	2.1	0.1	7.4	11.0	3.58
	HT/VHT40 Beam Forming, M24 to M31	4	4	-3.5	2.1	2.3	2.1	0.1	7.4	11.0	3.58
	HT/VHT40 STBC, M0 to M7	2	4	-3.5	2.1			0.1	3.3	11.0	7.74
	HT/VHT40 STBC, M0 to M7	3	6	-3.5	2.1	2.3		0.1	5.9	11.0	5.14
	HT/VHT40 STBC, M0 to M7	4	7	-3.5	2.1	2.3	2.1	0.1	7.4	10.0	2.58
	HE40, M0 to M9 1ss	1	4	-3.2				0.1	-3.1	11.0	14.07
	HE40, M0 to M9 1ss	2	7	-3.2	2.4			0.1	3.6	10.0	6.41
	HE40, M0 to M9 2ss	2	4	-3.2	2.4			0.1	3.6	11.0	7.41
	HE40, M0 to M9 1ss	3	9	-3.2	2.4	2.5		0.1	6.1	8.0	1.86
	HE40, M0 to M9 2ss	3	6	-3.2	2.4	2.5		0.1	6.1	11.0	4.86
	HE40, M0 to M9 3ss	3	4	-3.2	2.4	2.5		0.1	6.1	11.0	4.86
	HE40, M0 to M9 1ss	4	10	-3.2	1.3	1.5	1.3	0.1	6.7	7.0	0.25
	HE40, M0 to M9 2ss	4	7	-3.2	2.4	2.5	2.6	0.1	7.8	10.0	2.22
	HE40, M0 to M9 3ss	4	5	-3.2	2.4	2.5	2.6	0.1	7.8	11.0	3.22
	HE40, M0 to M9 4ss	4	4	-3.2	2.4	2.5	2.6	0.1	7.8	11.0	3.22
	HE40 Beam Forming, M0 to M9 1ss	2	7	-3.2	2.4			0.1	3.6	10.0	6.41
	HE40 Beam Forming, M0 to M9 2ss	2	4	-3.2	2.4			0.1	3.6	11.0	7.41
	HE40 Beam Forming, M0 to M9 1ss	3	9	-3.2	1.3	1.5		0.1	5.2	8.0	2.76
	HE40 Beam Forming, M0 to M9 2ss	3	6	-3.2	2.4	2.5		0.1	6.1	11.0	4.86
	HE40 Beam Forming, M0 to M9 3ss	3	4	-3.2	2.4	2.5		0.1	6.1	11.0	4.86
	HE40 Beam Forming, M0 to M9 1ss	4	10	-3.2	-0.7	-1.2	-1.1	0.1	4.7	7.0	2.30
	HE40 Beam Forming, M0 to M9 2ss	4	7	-3.2	2.4	2.5	2.6	0.1	7.8	10.0	2.22
	HE40 Beam Forming, M0 to M9 3ss	4	5	-3.2	2.4	2.5	2.6	0.1	7.8	11.0	3.22
	HE40 Beam Forming, M0 to M9 4ss	4	4	-3.2	2.4	2.5	2.6	0.1	7.8	11.0	3.22
	HE40 STBC, M0 to M9 2ss	2	4	-3.2	2.4			0.1	3.6	11.0	7.41
	HE40 STBC, M0 to M9 2ss	3	6	-3.2	2.4	2.5		0.1	6.1	11.0	4.86
	HE40 STBC, M0 to M9 2ss	4	7	-3.2	2.4	2.5	2.6	0.1	7.8	10.0	2.22
5290	Non HT80, 6 to 54 Mbps	1	4	-7.9				0.1	-7.8	11.0	18.85
	Non HT80, 6 to 54 Mbps	2	7	-7.9	-7.9			0.1	-4.8	10.0	14.84
	Non HT80, 6 to 54 Mbps	3	9	-7.9	-7.9	-7.7		0.1	-3.0	8.0	11.01
	Non HT80, 6 to 54 Mbps	4	10	-7.9	-7.9	-7.7	-8.2	0.1	-1.9	7.0	8.85
	VHT80, M0 to M9 1ss	1	4	-7.6				0.2	-7.4	11.0	18.38
	VHT80, M0 to M9 1ss	2	7	-7.6	-7.4			0.2	-4.3	10.0	14.27
	VHT80, M0 to M9 2ss	2	4	-7.6	-7.4			0.2	-4.3	11.0	15.27
	VHT80, M0 to M9 1ss	3	9	-7.6	-7.4	-7.5		0.2	-2.5	8.0	10.51
	VHT80, M0 to M9 2ss	3	6	-7.6	-7.4	-7.5		0.2	-2.5	11.0	13.51
	VHT80, M0 to M9 3ss	3	4	-7.6	-7.4	-7.5		0.2	-2.5	11.0	13.51
	VHT80, M0 to M9 1ss	4	10	-7.6	-7.4	-7.5	-8.0	0.2	-1.4	7.0	8.38
	VHT80, M0 to M9 2ss	4	7	-7.6	-7.4	-7.5	-8.0	0.2	-1.4	10.0	11.38
	VHT80, M0 to M9 3ss	4	5	-7.6	-7.4	-7.5	-8.0	0.2	-1.4	11.0	12.38





	VHT80, M0 to M9 4ss	4	4	-7.6	-7.4	-7.5	-8.0	0.2	-1.4	11.0	12.38
	VHT80 Beam Forming, M0 to M9 1ss	2	7	-8.2	-8.4			0.2	-5.1	10.0	15.07
	VHT80 Beam Forming, M0 to M9 2ss	2	4	-7.6	-7.4			0.2	-4.3	11.0	15.27
	VHT80 Beam Forming, M0 to M9 1ss	3	9	-9.4	-9.8	-9.4		0.2	-4.5	8.0	12.54
	VHT80 Beam Forming, M0 to M9 2ss	3	6	-8.2	-8.4	-7.9		0.2	-3.2	11.0	14.17
	VHT80 Beam Forming, M0 to M9 3ss	3	4	-7.6	-7.4	-7.5		0.2	-2.5	11.0	13.51
	VHT80 Beam Forming, M0 to M9 1ss	4	10	-9.4	-9.8	-9.4	-10.2	0.2	-3.5	7.0	10.45
	VHT80 Beam Forming, M0 to M9 2ss	4	7	-8.2	-8.4	-7.9	-9.0	0.2	-2.1	10.0	12.12
	VHT80 Beam Forming, M0 to M9 3ss	4	5	-7.6	-7.4	-7.5	-8.0	0.2	-1.4	11.0	12.38
	VHT80 Beam Forming, M0 to M9 4ss	4	4	-7.6	-7.4	-7.5	-8.0	0.2	-1.4	11.0	12.38
	VHT80 STBC, M0 to M9 1ss	2	4	-7.6	-7.4			0.2	-4.3	11.0	15.27
	VHT80 STBC, M0 to M9 1ss	3	4	-7.6	-7.4	-7.5		0.2	-2.5	11.0	13.51
	VHT80 STBC, M0 to M9 1ss	4	4	-7.6	-7.4	-7.5	-8.0	0.2	-1.4	11.0	12.38
	HE80, M0 to M9 1ss	1	4	-7.6				0.3	-7.3	11.0	18.34
	HE80, M0 to M9 1ss	2	7	-7.6	-7.5			0.3	-4.3	10.0	14.28
	HE80, M0 to M9 2ss	2	4	-7.6	-7.5			0.3	-4.3	11.0	15.28
	HE80, M0 to M9 1ss	3	9	-7.6	-7.5	-7.1		0.3	-2.4	8.0	10.36
	HE80, M0 to M9 2ss	3	6	-7.6	-7.5	-7.1		0.3	-2.4	11.0	13.36
	HE80, M0 to M9 3ss	3	4	-7.6	-7.5	-7.1		0.3	-2.4	11.0	13.36
	HE80, M0 to M9 1ss	4	10	-7.6	-7.5	-7.1	-7.8	0.3	-1.2	7.0	8.21
	HE80, M0 to M9 2ss	4	7	-7.6	-7.5	-7.1	-7.8	0.3	-1.2	10.0	11.21
	HE80, M0 to M9 3ss	4	5	-7.6	-7.5	-7.1	-7.8	0.3	-1.2	11.0	12.21
	HE80, M0 to M9 4ss	4	4	-7.6	-7.5	-7.1	-7.8	0.3	-1.2	11.0	12.21
	HE80 Beam Forming, M0 to M9 1ss	2	7	-8.8	-8.4			0.3	-5.3	10.0	15.33
	HE80 Beam Forming, M0 to M9 2ss	2	4	-7.6	-7.5			0.3	-4.3	11.0	15.28
	HE80 Beam Forming, M0 to M9 1ss	3	9	-9.0	-9.2	-9.4		0.3	-4.2	8.0	12.17
	HE80 Beam Forming, M0 to M9 2ss	3	6	-8.8	-8.4	-8.2		0.3	-3.4	11.0	14.43
	HE80 Beam Forming, M0 to M9 3ss	3	4	-7.6	-7.5	-7.1		0.3	-2.4	11.0	13.36
	HE80 Beam Forming, M0 to M9 1ss	4	10	-10.0	-10.8	-10.5	-11.0	0.3	-4.3	7.0	11.28
	HE80 Beam Forming, M0 to M9 2ss	4	7	-9.0	-9.2	-9.4	-10.5	0.3	-3.2	10.0	13.21
	HE80 Beam Forming, M0 to M9 3ss	4	5	-8.8	-8.4	-8.2	-9.0	0.3	-2.3	11.0	13.31
	HE80 Beam Forming, M0 to M9 4ss	4	4	-7.6	-7.5	-7.1	-7.8	0.3	-1.2	11.0	12.21
	HE80 STBC, M0 to M9 1ss	2	4	-7.6	-7.5			0.3	-4.3	11.0	15.28
	HE80 STBC, M0 to M9 1ss	3	4	-7.6	-7.5	-7.1		0.3	-2.4	11.0	13.36
	HE80 STBC, M0 to M9 1ss	4	4	-7.6	-7.5	-7.1	-7.8	0.3	-1.2	11.0	12.21
5300	Non HT20, 6 to 54 Mbps	1	4	0.2				0.0	0.2	11.0	10.76
	Non HT20, 6 to 54 Mbps	2	7	0.2	5.9			0.0	7.0	10.0	3.02
	Non HT20, 6 to 54 Mbps	3	9	0.2	4.0	3.3		0.0	7.6	8.0	0.40
	Non HT20, 6 to 54 Mbps	4	10	0.2	1.0	0.6	-0.7	0.0	6.4	7.0	0.62
	Non HT20 Beam Forming, 6 to 54 Mbps	2	7	0.2	5.9			0.0	7.0	10.0	3.02
	Non HT20 Beam Forming, 6 to 54 Mbps	3	9	0.2	4.0	3.3		0.0	7.6	8.0	0.40





Non HT20 Beam Forming, 6 to 54 Mbps	4	10	0.2	1.0	0.6	-0.7	0.0	6.4	7.0	0.62
HT/VHT20, M0 to M7	1	4	-0.2				0.1	-0.1	11.0	11.15
HT/VHT20, M0 to M7	2	7	-0.2	5.6			0.1	6.7	10.0	3.33
HT/VHT20, M8 to M15	2	4	-0.2	5.6			0.1	6.7	11.0	4.33
HT/VHT20, M0 to M7	3	9	-0.2	3.7	2.9		0.1	7.3	8.0	0.75
HT/VHT20, M8 to M15	3	6	-0.2	5.6	5.5		0.1	9.2	11.0	1.84
HT/VHT20, M16 to M23	3	4	-0.2	5.6	5.5		0.1	9.2	11.0	1.84
HT/VHT20, M0 to M7	4	10	-0.2	1.4	1.1	0.1	0.1	6.7	7.0	0.28
HT/VHT20, M8 to M15	4	7	-0.2	4.7	4.4	3.6	0.1	9.6	10.0	0.43
HT/VHT20, M16 to M23	4	5	-0.2	5.6	5.5	4.9	0.1	10.6	11.0	0.45
HT/VHT20, M24 to M31	4	4	-0.2	5.6	5.5	4.9	0.1	10.6	11.0	0.45
HT/VHT20 Beam Forming, M0 to M7	2	7	-0.2	5.6			0.1	6.7	10.0	3.33
HT/VHT20 Beam Forming, M8 to M15	2	4	-0.2	5.6			0.1	6.7	11.0	4.33
HT/VHT20 Beam Forming, M0 to M7	3	9	-0.2	3.7	2.9		0.1	7.3	8.0	0.75
HT/VHT20 Beam Forming, M8 to M15	3	6	-0.2	5.6	5.5		0.1	9.2	11.0	1.84
HT/VHT20 Beam Forming, M16 to M23	3	4	-0.2	5.6	5.5		0.1	9.2	11.0	1.84
HT/VHT20 Beam Forming, M0 to M7	4	10	-0.2	1.4	1.1	0.1	0.1	6.7	7.0	0.28
HT/VHT20 Beam Forming, M8 to M15	4	7	-0.2	4.7	4.4	3.6	0.1	9.6	10.0	0.43
HT/VHT20 Beam Forming, M16 to M23	4	5	-0.2	5.6	5.5	4.9	0.1	10.6	11.0	0.45
HT/VHT20 Beam Forming, M24 to M31	4	4	-0.2	5.6	5.5	4.9	0.1	10.6	11.0	0.45
HT/VHT20 STBC, M0 to M7	2	4	-0.2	5.6			0.1	6.7	11.0	4.33
HT/VHT20 STBC, M0 to M7	3	6	-0.2	5.6	5.5		0.1	9.2	11.0	1.84
HT/VHT20 STBC, M0 to M7	4	7	-0.2	4.7	4.4	3.6	0.1	9.6	10.0	0.43
HE20, M0 to M9 1ss	1	4	0.1				0.1	0.2	11.0	10.83
HE20, M0 to M9 1ss	2	7	0.1	5.8			0.1	6.9	10.0	3.09
HE20, M0 to M9 2ss	2	4	0.1	5.8			0.1	6.9	11.0	4.09
HE20, M0 to M9 1ss	3	9	0.1	4.0	3.3		0.1	7.6	8.0	0.39
HE20, M0 to M9 2ss	3	6	0.1	5.8	5.5		0.1	9.3	11.0	1.70
HE20, M0 to M9 3ss	3	4	0.1	5.8	5.5		0.1	9.3	11.0	1.70
HE20, M0 to M9 1ss	4	10	0.1	1.4	1.2	0.4	0.1	6.9	7.0	0.10
HE20, M0 to M9 2ss	4	7	0.1	4.7	4.6	3.7	0.1	9.7	10.0	0.29
HE20, M0 to M9 3ss	4	5	0.1	5.8	5.5	5.0	0.1	10.7	11.0	0.31
HE20, M0 to M9 4ss	4	4	0.1	5.8	5.5	5.0	0.1	10.7	11.0	0.31
HE20 Beam Forming, M0 to M9 1ss	2	7	0.1	5.8			0.1	6.9	10.0	3.09
HE20 Beam Forming, M0 to M9 2ss	2	4	0.1	5.8			0.1	6.9	11.0	4.09
HE20 Beam Forming, M0 to M9 1ss	3	9	0.1	4.0	3.3		0.1	7.6	8.0	0.39
HE20 Beam Forming, M0 to M9 2ss	3	6	0.1	5.8	5.5		0.1	9.3	11.0	1.70
HE20 Beam Forming, M0 to M9 3ss	3	4	0.1	5.8	5.5		0.1	9.3	11.0	1.70
HE20 Beam Forming, M0 to M9 1ss	4	10	0.1	1.4	1.2	0.4	0.1	6.9	7.0	0.10
HE20 Beam Forming, M0 to M9 2ss	4	7	0.1	4.7	4.6	3.7	0.1	9.7	10.0	0.29
HE20 Beam Forming, M0 to M9 3ss	4	5	0.1	5.8	5.5	5.0	0.1	10.7	11.0	0.31
HE20 Beam Forming, M0 to M9 4ss	4	4	0.1	5.8	5.5	5.0	0.1	10.7	11.0	0.31



	HE20 STBC, M0 to M9 2ss	2	4	0.1	5.8			0.1	6.9	11.0	4.09
	HE20 STBC, M0 to M9 2ss	3	6	0.1	5.8	5.5		0.1	9.3	11.0	1.70
	HE20 STBC, M0 to M9 2ss	4	7	0.1	4.7	4.6	3.7	0.1	9.7	10.0	0.29
5310	Non HT40, 6 to 54 Mbps	1	4	-2.8				0.0	-2.8	11.0	13.76
	Non HT40, 6 to 54 Mbps	2	7	-3.8	-3.5			0.0	-0.6	10.0	10.59
	Non HT40, 6 to 54 Mbps	3	9	-3.8	-3.5	-3.1		0.0	1.4	8.0	6.64
	Non HT40, 6 to 54 Mbps	4	10	-3.8	-3.5	-3.1	-4.5	0.0	2.4	7.0	4.63
	HT/VHT40, M0 to M7	1	4	-2.8				0.1	-2.7	11.0	13.70
	HT/VHT40, M0 to M7	2	7	-2.8	-2.4			0.1	0.5	10.0	9.48
	HT/VHT40, M8 to M15	2	4	-2.8	-2.4			0.1	0.5	11.0	10.48
	HT/VHT40, M0 to M7	3	9	-2.8	-3.1	-3.0		0.1	1.9	8.0	6.09
	HT/VHT40, M8 to M15	3	6	-2.8	-3.1	-3.0		0.1	1.9	11.0	9.09
	HT/VHT40, M16 to M23	3	4	-2.8	-3.1	-3.0		0.1	1.9	11.0	9.09
	HT/VHT40, M0 to M7	4	10	-4.2	-4.3	-4.4	-5.1	0.1	1.6	7.0	5.36
	HT/VHT40, M8 to M15	4	7	-4.2	-4.3	-4.4	-5.1	0.1	1.6	10.0	8.36
	HT/VHT40, M16 to M23	4	5	-4.2	-4.3	-4.4	-5.1	0.1	1.6	11.0	9.36
	HT/VHT40, M24 to M31	4	4	-4.2	-4.3	-4.4	-5.1	0.1	1.6	11.0	9.36
	HT/VHT40 Beam Forming, M0 to M7	2	7	-4.2	-4.3			0.1	-1.1	10.0	11.14
	HT/VHT40 Beam Forming, M8 to M15	2	4	-2.8	-2.4			0.1	0.5	11.0	10.48
	HT/VHT40 Beam Forming, M0 to M7	3	9	-5.1	-4.8	-4.9		0.1	-0.1	8.0	8.06
	HT/VHT40 Beam Forming, M8 to M15	3	6	-4.2	-4.3	-4.4		0.1	0.6	11.0	10.43
	HT/VHT40 Beam Forming, M16 to M23	3	4	-2.8	-3.1	-3.0		0.1	1.9	11.0	9.09
	HT/VHT40 Beam Forming, M0 to M7	4	10	-6.1	-6.3	-6.1	-7.0	0.1	-0.2	7.0	7.24
	HT/VHT40 Beam Forming, M8 to M15	4	7	-5.1	-4.8	-4.9	-5.9	0.1	1.0	10.0	9.03
	HT/VHT40 Beam Forming, M16 to M23	4	5	-4.2	-4.3	-4.4	-5.1	0.1	1.6	11.0	9.36
	HT/VHT40 Beam Forming, M24 to M31	4	4	-4.2	-4.3	-4.4	-5.1	0.1	1.6	11.0	9.36
	HT/VHT40 STBC, M0 to M7	2	4	-2.8	-2.4			0.1	0.5	11.0	10.48
	HT/VHT40 STBC, M0 to M7	3	6	-2.8	-3.1	-3.0		0.1	1.9	11.0	9.09
	HT/VHT40 STBC, M0 to M7	4	7	-4.2	-4.3	-4.4	-5.1	0.1	1.6	10.0	8.36
	HE40, M0 to M9 1ss	1	4	-4.2				0.1	-4.1	11.0	15.07
	HE40, M0 to M9 1ss	2	7	-4.2	-3.9			0.1	-0.9	10.0	10.91
	HE40, M0 to M9 2ss	2	4	-4.2	-3.9			0.1	-0.9	11.0	11.91
	HE40, M0 to M9 1ss	3	9	-4.2	-3.9	-3.6		0.1	1.0	8.0	6.99
	HE40, M0 to M9 2ss	3	6	-4.2	-3.9	-3.6		0.1	1.0	11.0	9.99
	HE40, M0 to M9 3ss	3	4	-4.2	-3.9	-3.6		0.1	1.0	11.0	9.99
	HE40, M0 to M9 1ss	4	10	-4.2	-3.9	-3.6	-4.3	0.1	2.2	7.0	4.84
	HE40, M0 to M9 2ss	4	7	-4.2	-3.9	-3.6	-4.3	0.1	2.2	10.0	7.84
HE40, M0 to M9 3ss	4	5	-4.2	-3.9	-3.6	-4.3	0.1	2.2	11.0	8.84	
HE40, M0 to M9 4ss	4	4	-4.2	-3.9	-3.6	-4.3	0.1	2.2	11.0	8.84	
HE40 Beam Forming, M0 to M9 1ss	2	7	-5.3	-4.7			0.1	-1.8	10.0	11.85	
HE40 Beam Forming, M0 to M9 2ss	2	4	-4.2	-3.9			0.1	-0.9	11.0	11.91	



	HE40 Beam Forming, M0 to M9 1ss	3	9	-5.3	-4.7	-4.9		0.1	-0.1	8.0	8.06
	HE40 Beam Forming, M0 to M9 2ss	3	6	-5.3	-4.7	-4.9		0.1	-0.1	11.0	11.06
	HE40 Beam Forming, M0 to M9 3ss	3	4	-4.2	-3.9	-3.6		0.1	1.0	11.0	9.99
	HE40 Beam Forming, M0 to M9 1ss	4	10	-6.2	-5.7	-6.3	-6.9	0.1	-0.1	7.0	7.10
	HE40 Beam Forming, M0 to M9 2ss	4	7	-5.3	-4.7	-4.9	-5.6	0.1	1.0	10.0	8.96
	HE40 Beam Forming, M0 to M9 3ss	4	5	-5.3	-4.7	-4.9	-5.6	0.1	1.0	11.0	9.96
	HE40 Beam Forming, M0 to M9 4ss	4	4	-4.2	-3.9	-3.6	-4.3	0.1	2.2	11.0	8.84
	HE40 STBC, M0 to M9 2ss	2	4	-4.2	-3.9			0.1	-0.9	11.0	11.91
	HE40 STBC, M0 to M9 2ss	3	6	-4.2	-3.9	-3.6		0.1	1.0	11.0	9.99
	HE40 STBC, M0 to M9 2ss	4	7	-4.2	-3.9	-3.6	-4.3	0.1	2.2	10.0	7.84
	Non HT20, 6 to 54 Mbps	1	4	0.1				0.0	0.1	11.0	10.86
	Non HT20, 6 to 54 Mbps	2	7	0.1	6.0			0.0	7.0	10.0	2.96
	Non HT20, 6 to 54 Mbps	3	9	0.1	3.9	3.6		0.0	7.7	8.0	0.35
	Non HT20, 6 to 54 Mbps	4	10	0.1	1.6	1.3	0.4	0.0	7.0	7.0	0.04
	Non HT20 Beam Forming, 6 to 54 Mbps	2	7	0.1	4.9			0.0	6.2	10.0	3.81
	Non HT20 Beam Forming, 6 to 54 Mbps	3	9	0.1	3.9	3.6		0.0	7.7	8.0	0.35
	Non HT20 Beam Forming, 6 to 54 Mbps	4	10	0.1	1.6	1.3	0.4	0.0	7.0	7.0	0.04
	HT/VHT20, M0 to M7	1	4	-0.4				0.1	-0.3	11.0	11.35
	HT/VHT20, M0 to M7	2	7	-0.4	4.4			0.1	5.7	10.0	4.31
	HT/VHT20, M8 to M15	2	4	-0.4	4.4			0.1	5.7	11.0	5.31
	HT/VHT20, M0 to M7	3	9	-0.4	3.5	3.1		0.1	7.2	8.0	0.79
	HT/VHT20, M8 to M15	3	6	-0.4	4.4	4.4		0.1	8.1	11.0	2.87
	HT/VHT20, M16 to M23	3	4	-0.4	4.4	4.4		0.1	8.1	11.0	2.87
	HT/VHT20, M0 to M7	4	10	-0.4	1.3	1.4	0.0	0.1	6.7	7.0	0.28
	HT/VHT20, M8 to M15	4	7	-0.4	4.4	4.4	3.7	0.1	9.5	10.0	0.52
	HT/VHT20, M16 to M23	4	5	-0.4	4.4	4.4	3.7	0.1	9.5	11.0	1.52
	HT/VHT20, M24 to M31	4	4	-0.4	4.4	4.4	3.7	0.1	9.5	11.0	1.52
	HT/VHT20 Beam Forming, M0 to M7	2	7	-0.4	4.4			0.1	5.7	10.0	4.31
	HT/VHT20 Beam Forming, M8 to M15	2	4	-0.4	4.4			0.1	5.7	11.0	5.31
	HT/VHT20 Beam Forming, M0 to M7	3	9	-0.4	3.5	3.1		0.1	7.2	8.0	0.79
	HT/VHT20 Beam Forming, M8 to M15	3	6	-0.4	4.4	4.4		0.1	8.1	11.0	2.87
	HT/VHT20 Beam Forming, M16 to M23	3	4	-0.4	4.4	4.4		0.1	8.1	11.0	2.87
	HT/VHT20 Beam Forming, M0 to M7	4	10	-0.4	1.3	1.4	0.0	0.1	6.7	7.0	0.28
	HT/VHT20 Beam Forming, M8 to M15	4	7	-0.4	3.5	3.1	2.3	0.1	8.4	10.0	1.56
	HT/VHT20 Beam Forming, M16 to M23	4	5	-0.4	3.5	3.1	2.3	0.1	8.4	11.0	2.56
	HT/VHT20 Beam Forming, M24 to M31	4	4	-0.4	4.4	4.4	3.7	0.1	9.5	11.0	1.52
	HT/VHT20 STBC, M0 to M7	2	4	-0.4	4.4			0.1	5.7	11.0	5.31
	HT/VHT20 STBC, M0 to M7	3	6	-0.4	4.4	4.4		0.1	8.1	11.0	2.87
	HT/VHT20 STBC, M0 to M7	4	7	-0.4	4.4	4.4	3.7	0.1	9.5	10.0	0.52
	HE20, M0 to M9 1ss	1	4	-0.4				0.1	-0.3	11.0	11.33
	HE20, M0 to M9 1ss	2	7	-0.4	4.5			0.1	5.8	10.0	4.21



	HE20, M0 to M9 2ss	2	4	-0.4	4.5			0.1	5.8	11.0	5.21
	HE20, M0 to M9 1ss	3	9	-0.4	3.3	3.1		0.1	7.1	8.0	0.86
	HE20, M0 to M9 2ss	3	6	-0.4	4.5	4.1		0.1	8.1	11.0	2.94
	HE20, M0 to M9 3ss	3	4	-0.4	4.5	4.1		0.1	8.1	11.0	2.94
	HE20, M0 to M9 1ss	4	10	-0.4	1.4	1.0	0.1	0.1	6.7	7.0	0.33
	HE20, M0 to M9 2ss	4	7	-0.4	3.3	3.1	2.0	0.1	8.3	10.0	1.68
	HE20, M0 to M9 3ss	4	5	-0.4	3.3	3.1	2.0	0.1	8.3	11.0	2.68
	HE20, M0 to M9 4ss	4	4	-0.4	3.3	3.1	2.0	0.1	8.3	11.0	2.68
	HE20 Beam Forming, M0 to M9 1ss	2	7	-0.4	3.3			0.1	4.9	10.0	5.09
	HE20 Beam Forming, M0 to M9 2ss	2	4	-0.4	4.5			0.1	5.8	11.0	5.21
	HE20 Beam Forming, M0 to M9 1ss	3	9	-0.4	2.4	2.2		0.1	6.4	8.0	1.59
	HE20 Beam Forming, M0 to M9 2ss	3	6	-0.4	3.3	3.1		0.1	7.1	11.0	3.86
	HE20 Beam Forming, M0 to M9 3ss	3	4	-0.4	4.5	4.1		0.1	8.1	11.0	2.94
	HE20 Beam Forming, M0 to M9 1ss	4	10	-0.4	1.4	1.0	0.1	0.1	6.7	7.0	0.33
	HE20 Beam Forming, M0 to M9 2ss	4	7	-0.4	2.4	2.2	1.1	0.1	7.6	10.0	2.45
	HE20 Beam Forming, M0 to M9 3ss	4	5	-0.4	3.3	3.1	2.0	0.1	8.3	11.0	2.68
	HE20 Beam Forming, M0 to M9 4ss	4	4	-0.4	3.3	3.1	2.0	0.1	8.3	11.0	2.68
	HE20 STBC, M0 to M9 2ss	2	4	-0.4	4.5			0.1	5.8	11.0	5.21
	HE20 STBC, M0 to M9 2ss	3	6	-0.4	4.5	4.1		0.1	8.1	11.0	2.94
	HE20 STBC, M0 to M9 2ss	4	7	-0.4	3.3	3.1	2.0	0.1	8.3	10.0	1.68
5250	Non HT160, 6 to 54 Mbps	1	4	-11.2				0.0	-11.2	11.0	22.15
	Non HT160, 6 to 54 Mbps	2	7	-11.2	-10.2			0.0	-7.6	10.0	17.61
	Non HT160, 6 to 54 Mbps	3	9	-11.2	-10.2	-12.1		0.0	-6.3	8.0	14.28
	Non HT160, 6 to 54 Mbps	4	10	-11.2	-10.2	-12.1	-12.5	0.0	-5.3	7.0	12.34
	VHT160, M0 to M9 1ss	1	4	-10.9				0.4	-10.5	11.0	21.51
	VHT160, M0 to M9 1ss	2	7	-10.9	-11.4			0.4	-7.7	10.0	17.74
	VHT160, M0 to M9 2ss	2	4	-10.9	-11.4			0.4	-7.7	11.0	18.74
	VHT160, M0 to M9 1ss	3	9	-10.9	-11.4	-11.8		0.4	-6.2	8.0	14.19
	VHT160, M0 to M9 2ss	3	6	-10.9	-11.4	-11.8		0.4	-6.2	11.0	17.19
	VHT160, M0 to M9 3ss	3	4	-10.9	-11.4	-11.8		0.4	-6.2	11.0	17.19
	VHT160, M0 to M9 1ss	4	10	-10.9	-11.4	-11.8	-12.0	0.4	-5.1	7.0	12.09
	VHT160, M0 to M9 2ss	4	7	-10.9	-11.4	-11.8	-12.0	0.4	-5.1	10.0	15.09
	VHT160, M0 to M9 3ss	4	5	-10.9	-11.4	-11.8	-12.0	0.4	-5.1	11.0	16.09
	VHT160, M0 to M9 4ss	4	4	-10.9	-11.4	-11.8	-12.0	0.4	-5.1	11.0	16.09
	VHT160 Beam Forming, M0 to M9 1ss	2	7	-12.2	-12.2			0.4	-8.8	10.0	18.80
	VHT160 Beam Forming, M0 to M9 2ss	2	4	-10.9	-11.4			0.4	-7.7	11.0	18.74
	VHT160 Beam Forming, M0 to M9 1ss	3	9	-12.8	-13.2	-13.8		0.4	-8.1	8.0	16.08
	VHT160 Beam Forming, M0 to M9 2ss	3	6	-10.9	-11.4	-11.8		0.4	-6.2	11.0	17.19
	VHT160 Beam Forming, M0 to M9 3ss	3	4	-10.9	-11.4	-11.8		0.4	-6.2	11.0	17.19
	VHT160 Beam Forming, M0 to M9 1ss	4	10	-12.8	-13.2	-13.8	-14.3	0.4	-7.1	7.0	14.08
VHT160 Beam Forming, M0 to M9 2ss	4	7	-12.2	-12.2	-12.8	-13.0	0.4	-6.1	10.0	16.12	



VHT160 Beam Forming, M0 to M9 3ss	4	5	-10.9	-11.4	-11.8	-12.0	0.4	-5.1	11.0	16.09
VHT160 Beam Forming, M0 to M9 4ss	4	4	-10.9	-11.4	-11.8	-12.0	0.4	-5.1	11.0	16.09
VHT160 STBC, M0 to M9 1ss	2	4	-10.9	-11.4			0.4	-7.7	11.0	18.74
VHT160 STBC, M0 to M9 1ss	3	4	-10.9	-11.4	-11.8		0.4	-6.2	11.0	17.19
VHT160 STBC, M0 to M9 1ss	4	4	-10.9	-11.4	-11.8	-12.0	0.4	-5.1	11.0	16.09
HE160, M0 to M9 1ss	1	4	-9.7				0.4	-9.3	11.0	20.27
HE160, M0 to M9 1ss	2	7	-9.7	-10.2			0.4	-6.5	10.0	16.50
HE160, M0 to M9 2ss	2	4	-9.7	-10.2			0.4	-6.5	11.0	17.50
HE160, M0 to M9 1ss	3	9	-10.3	-11.0	-11.2		0.4	-5.6	8.0	13.61
HE160, M0 to M9 2ss	3	6	-10.3	-11.0	-11.2		0.4	-5.6	11.0	16.61
HE160, M0 to M9 3ss	3	4	-10.3	-11.0	-11.2		0.4	-5.6	11.0	16.61
HE160, M0 to M9 1ss	4	10	-10.3	-11.0	-11.2	-11.8	0.4	-4.6	7.0	11.59
HE160, M0 to M9 2ss	4	7	-10.3	-11.0	-11.2	-11.8	0.4	-4.6	10.0	14.59
HE160, M0 to M9 3ss	4	5	-10.3	-11.0	-11.2	-11.8	0.4	-4.6	11.0	15.59
HE160, M0 to M9 4ss	4	4	-10.3	-11.0	-11.2	-11.8	0.4	-4.6	11.0	15.59
HE160 Beam Forming, M0 to M9 1ss	2	7	-10.3	-11.0			0.4	-7.2	10.0	17.19
HE160 Beam Forming, M0 to M9 2ss	2	4	-9.7	-10.2			0.4	-6.5	11.0	17.50
HE160 Beam Forming, M0 to M9 1ss	3	9	-11.6	-12.1	-12.2		0.4	-6.8	8.0	14.75
HE160 Beam Forming, M0 to M9 2ss	3	6	-10.3	-11.0	-11.2		0.4	-5.6	11.0	16.61
HE160 Beam Forming, M0 to M9 3ss	3	4	-10.3	-11.0	-11.2		0.4	-5.6	11.0	16.61
HE160 Beam Forming, M0 to M9 1ss	4	10	-12.6	-13.4	-13.6	-13.7	0.4	-6.8	7.0	13.85
HE160 Beam Forming, M0 to M9 2ss	4	7	-11.6	-12.1	-12.2	-12.8	0.4	-5.7	10.0	15.70
HE160 Beam Forming, M0 to M9 3ss	4	5	-10.3	-11.0	-11.2	-11.8	0.4	-4.6	11.0	15.59
HE160 Beam Forming, M0 to M9 4ss	4	4	-10.3	-11.0	-11.2	-11.8	0.4	-4.6	11.0	15.59
HE160 STBC, M0 to M9 1ss	2	4	-9.7	-10.2			0.4	-6.5	11.0	17.50
HE160 STBC, M0 to M9 1ss	3	4	-10.3	-11.0	-11.2		0.4	-5.6	11.0	16.61
HE160 STBC, M0 to M9 1ss	4	4	-10.3	-11.0	-11.2	-11.8	0.4	-4.6	11.0	15.59



**Power Spectral Density, 4dBi**  
**5260 MHz, HE20, M0 to M9 2ss**

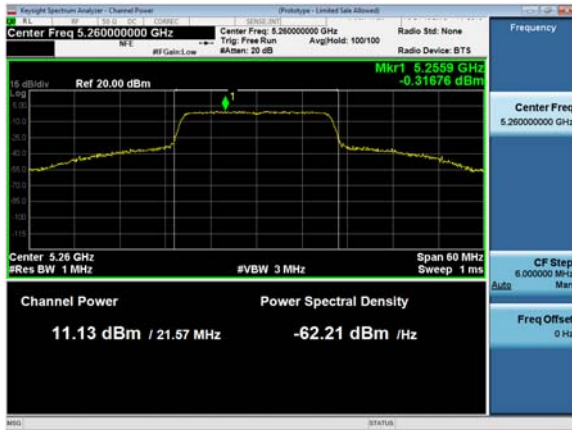

**Antenna A**

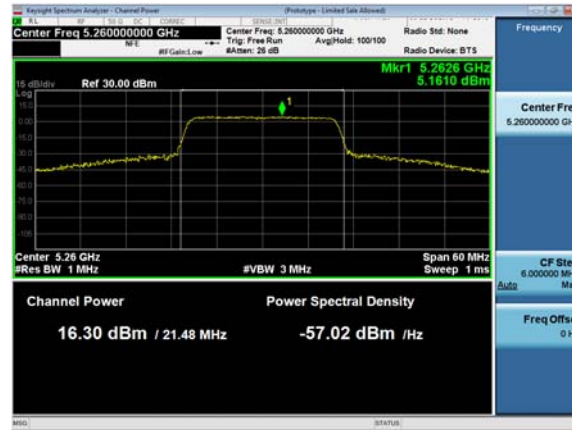

**Antenna B**

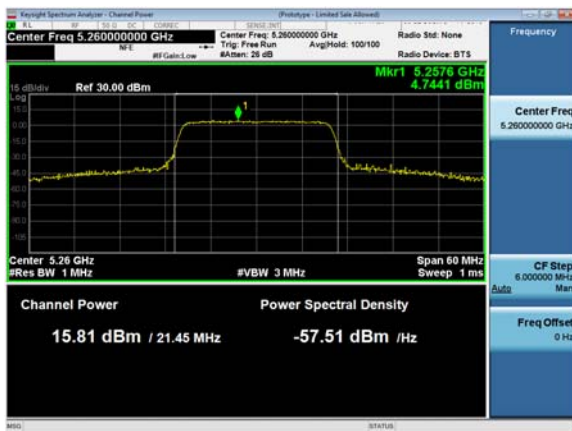

**Antenna C**

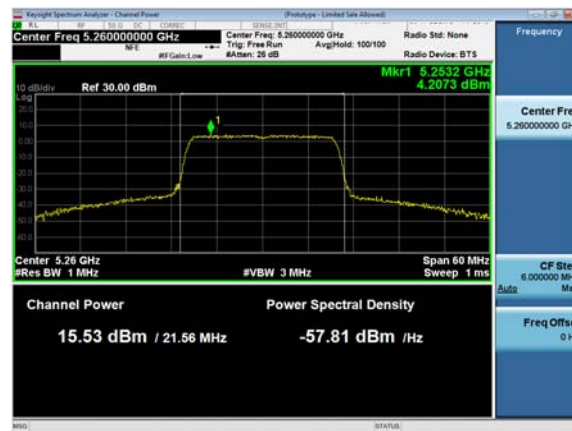

**Antenna D**



## Power Spectral Density, 5dBi

Frequency (MHz)	Mode	Tx Paths	Correlated Antenna Gain (dBi)	Tx 1 PSD (dBm/MHz)	Tx 2 PSD (dBm/MHz)	Tx 3 PSD (dBm/MHz)	Tx 4 PSD (dBm/MHz)	Duty Cycle Correction (dB)	Total PSD (dBm/MHz)	Limit (dBm/MHz)	Margin (dB)
5260	Non HT20, 6 to 54 Mbps	1	5	0.1				0.0	0.1	11.0	10.86
	Non HT20, 6 to 54 Mbps	2	8	0.1	6.3			0.0	7.3	9.0	1.72
	Non HT20, 6 to 54 Mbps	3	10	0.1	3.1	2.6		0.0	6.9	7.0	0.07
	Non HT20, 6 to 54 Mbps	4	11	-0.9	-0.3	-0.9	-1.2	0.0	5.3	6.0	0.75
	Non HT20 Beam Forming, 6 to 54 Mbps	2	8	0.1	6.3			0.0	7.3	9.0	1.72
	Non HT20 Beam Forming, 6 to 54 Mbps	3	10	0.1	3.1	2.6		0.0	6.9	7.0	0.07
	Non HT20 Beam Forming, 6 to 54 Mbps	4	11	-0.9	-0.3	-0.9	-1.2	0.0	5.3	6.0	0.75
	HT/VHT20, M0 to M7	1	5	-0.5				0.1	-0.4	11.0	11.45
	HT/VHT20, M0 to M7	2	8	-0.5	5.9			0.1	6.8	9.0	2.15
	HT/VHT20, M8 to M15	2	5	-0.5	5.9			0.1	6.8	11.0	4.15
	HT/VHT20, M0 to M7	3	10	-0.5	2.7	2.2		0.1	6.5	7.0	0.50
	HT/VHT20, M8 to M15	3	7	-0.5	5.9	5.1		0.1	9.1	10.0	0.91
	HT/VHT20, M16 to M23	3	5	-0.5	5.9	5.1		0.1	9.1	11.0	1.91
	HT/VHT20, M0 to M7	4	11	-0.5	0.4	-0.2	-0.3	0.1	5.9	6.0	0.06
	HT/VHT20, M8 to M15	4	8	-0.5	4.0	3.1	2.6	0.1	8.7	9.0	0.34
	HT/VHT20, M16 to M23	4	6	-0.5	5.9	5.1	5.1	0.1	10.6	11.0	0.43
	HT/VHT20, M24 to M31	4	5	-0.5	5.9	5.1	5.1	0.1	10.6	11.0	0.43
	HT/VHT20 Beam Forming, M0 to M7	2	8	-0.5	5.9			0.1	6.8	9.0	2.15
	HT/VHT20 Beam Forming, M8 to M15	2	5	-0.5	5.9			0.1	6.8	11.0	4.15
	HT/VHT20 Beam Forming, M0 to M7	3	10	-0.5	2.7	2.2		0.1	6.5	7.0	0.50
	HT/VHT20 Beam Forming, M8 to M15	3	7	-0.5	5.9	5.1		0.1	9.1	10.0	0.91
	HT/VHT20 Beam Forming, M16 to M23	3	5	-0.5	5.9	5.1		0.1	9.1	11.0	1.91
	HT/VHT20 Beam Forming, M0 to M7	4	11	-0.5	0.4	-0.2	-0.3	0.1	5.9	6.0	0.06
	HT/VHT20 Beam Forming, M8 to M15	4	8	-0.5	4.0	3.1	2.6	0.1	8.7	9.0	0.34
	HT/VHT20 Beam Forming, M16 to M23	4	6	-0.5	5.9	5.1	5.1	0.1	10.6	11.0	0.43
	HT/VHT20 Beam Forming, M24 to M31	4	5	-0.5	5.9	5.1	5.1	0.1	10.6	11.0	0.43
	HT/VHT20 STBC, M0 to M7	2	5	-0.5	5.9			0.1	6.8	11.0	4.15
	HT/VHT20 STBC, M0 to M7	3	7	-0.5	5.9	5.1		0.1	9.1	10.0	0.91
	HT/VHT20 STBC, M0 to M7	4	8	-0.5	4.0	3.1	2.6	0.1	8.7	9.0	0.34
	HE20, M0 to M9 1ss	1	5	-0.3				0.1	-0.2	11.0	11.23





	HE20, M0 to M9 1ss	2	8	-0.3	5.7			0.1	6.7	9.0	2.26
	HE20, M0 to M9 2ss	2	5	-0.3	5.7			0.1	6.7	11.0	4.26
	HE20, M0 to M9 1ss	3	10	-0.3	2.8	2.6		0.1	6.8	7.0	0.25
	HE20, M0 to M9 2ss	3	7	-0.3	5.7	5.9		0.1	9.4	10.0	0.62
	HE20, M0 to M9 3ss	3	5	-0.3	5.7	5.9		0.1	9.4	11.0	1.62
	HE20, M0 to M9 1ss	4	11	-1.3	-0.5	-0.7	-1.4	0.1	5.1	6.0	0.87
	HE20, M0 to M9 2ss	4	8	-0.3	3.8	3.3	2.9	0.1	8.8	9.0	0.23
	HE20, M0 to M9 3ss	4	6	-0.3	5.7	5.9	5.4	0.1	10.9	11.0	0.14
	HE20, M0 to M9 4ss	4	5	-0.3	5.7	5.9	5.4	0.1	10.9	11.0	0.14
	HE20 Beam Forming, M0 to M9 1ss	2	8	-0.3	5.7			0.1	6.7	9.0	2.26
	HE20 Beam Forming, M0 to M9 2ss	2	5	-0.3	5.7			0.1	6.7	11.0	4.26
	HE20 Beam Forming, M0 to M9 1ss	3	10	-0.3	2.8	2.6		0.1	6.8	7.0	0.25
	HE20 Beam Forming, M0 to M9 2ss	3	7	-0.3	5.7	5.9		0.1	9.4	10.0	0.62
	HE20 Beam Forming, M0 to M9 3ss	3	5	-0.3	5.7	5.9		0.1	9.4	11.0	1.62
	HE20 Beam Forming, M0 to M9 1ss	4	11	-1.3	-0.5	-0.7	-1.4	0.1	5.1	6.0	0.87
	HE20 Beam Forming, M0 to M9 2ss	4	8	-0.3	3.8	3.3	2.9	0.1	8.8	9.0	0.23
	HE20 Beam Forming, M0 to M9 3ss	4	6	-0.3	5.7	5.9	5.4	0.1	10.9	11.0	0.14
	HE20 Beam Forming, M0 to M9 4ss	4	5	-0.3	5.7	5.9	5.4	0.1	10.9	11.0	0.14
	HE20 STBC, M0 to M9 2ss	2	5	-0.3	5.7			0.1	6.7	11.0	4.26
	HE20 STBC, M0 to M9 2ss	3	7	-0.3	5.7	5.9		0.1	9.4	10.0	0.62
	HE20 STBC, M0 to M9 2ss	4	8	-0.3	3.8	3.3	2.9	0.1	8.8	9.0	0.23
5270	Non HT40, 6 to 54 Mbps	1	5	-3.2				0.0	-3.2	11.0	14.16
	Non HT40, 6 to 54 Mbps	2	8	-3.2	2.4			0.0	3.5	9.0	5.50
	Non HT40, 6 to 54 Mbps	3	10	-3.2	2.4	3.0		0.0	6.3	7.0	0.71
	Non HT40, 6 to 54 Mbps	4	11	-3.2	0.6	0.7	0.5	0.0	6.0	6.0	0.02
	HT/VHT40, M0 to M7	1	5	-3.5				0.1	-3.4	11.0	14.40
	HT/VHT40, M0 to M7	2	8	-3.5	2.1			0.1	3.3	9.0	5.74
	HT/VHT40, M8 to M15	2	5	-3.5	2.1			0.1	3.3	11.0	7.74
	HT/VHT40, M0 to M7	3	10	-3.5	2.1	2.3		0.1	5.9	7.0	1.14
	HT/VHT40, M8 to M15	3	7	-3.5	2.1	2.3		0.1	5.9	10.0	4.14
	HT/VHT40, M16 to M23	3	5	-3.5	2.1	2.3		0.1	5.9	11.0	5.14
	HT/VHT40, M0 to M7	4	11	-3.5	-0.1	0.1	-0.2	0.1	5.4	6.0	0.58
	HT/VHT40, M8 to M15	4	8	-3.5	2.1	2.3	2.1	0.1	7.4	9.0	1.58
	HT/VHT40, M16 to M23	4	6	-3.5	2.1	2.3	2.1	0.1	7.4	11.0	3.58
	HT/VHT40, M24 to M31	4	5	-3.5	2.1	2.3	2.1	0.1	7.4	11.0	3.58
	HT/VHT40 Beam Forming, M0 to M7	2	8	-3.5	2.1			0.1	3.3	9.0	5.74
	HT/VHT40 Beam Forming, M8 to M15	2	5	-3.5	2.1			0.1	3.3	11.0	7.74
	HT/VHT40 Beam Forming, M0 to M7	3	10	-3.5	-0.1	0.1		0.1	4.0	7.0	3.01
	HT/VHT40 Beam Forming, M8 to M15	3	7	-3.5	2.1	2.3		0.1	5.9	10.0	4.14
HT/VHT40 Beam Forming, M16 to M23	3	5	-3.5	2.1	2.3		0.1	5.9	11.0	5.14	
HT/VHT40 Beam Forming, M0 to M7	4	11	-3.5	-1.8	-2.1	-2.3	0.1	3.7	6.0	2.26	





	HT/VHT40 Beam Forming, M8 to M15	4	8	-3.5	1.2	1.2	1.0	0.1	6.5	9.0	2.52
	HT/VHT40 Beam Forming, M16 to M23	4	6	-3.5	2.1	2.3	2.1	0.1	7.4	11.0	3.58
	HT/VHT40 Beam Forming, M24 to M31	4	5	-3.5	2.1	2.3	2.1	0.1	7.4	11.0	3.58
	HT/VHT40 STBC, M0 to M7	2	5	-3.5	2.1			0.1	3.3	11.0	7.74
	HT/VHT40 STBC, M0 to M7	3	7	-3.5	2.1	2.3		0.1	5.9	10.0	4.14
	HT/VHT40 STBC, M0 to M7	4	8	-3.5	1.2	1.2	1.0	0.1	6.5	9.0	2.52
	HE40, M0 to M9 1ss	1	5	-3.2				0.1	-3.1	11.0	14.07
	HE40, M0 to M9 1ss	2	8	-3.2	2.4			0.1	3.6	9.0	5.41
	HE40, M0 to M9 2ss	2	5	-3.2	2.4			0.1	3.6	11.0	7.41
	HE40, M0 to M9 1ss	3	10	-3.2	2.4	2.5		0.1	6.1	7.0	0.86
	HE40, M0 to M9 2ss	3	7	-3.2	2.4	2.5		0.1	6.1	10.0	3.86
	HE40, M0 to M9 3ss	3	5	-3.2	2.4	2.5		0.1	6.1	11.0	4.86
	HE40, M0 to M9 1ss	4	11	-3.2	0.4	0.3	0.2	0.1	5.8	6.0	0.20
	HE40, M0 to M9 2ss	4	8	-3.2	2.4	2.5	2.6	0.1	7.8	9.0	1.22
	HE40, M0 to M9 3ss	4	6	-3.2	2.4	2.5	2.6	0.1	7.8	11.0	3.22
	HE40, M0 to M9 4ss	4	5	-3.2	2.4	2.5	2.6	0.1	7.8	11.0	3.22
	HE40 Beam Forming, M0 to M9 1ss	2	8	-3.2	2.4			0.1	3.6	9.0	5.41
	HE40 Beam Forming, M0 to M9 2ss	2	5	-3.2	2.4			0.1	3.6	11.0	7.41
	HE40 Beam Forming, M0 to M9 1ss	3	10	-3.2	0.4	0.3		0.1	4.4	7.0	2.64
	HE40 Beam Forming, M0 to M9 2ss	3	7	-3.2	2.4	2.5		0.1	6.1	10.0	3.86
	HE40 Beam Forming, M0 to M9 3ss	3	5	-3.2	2.4	2.5		0.1	6.1	11.0	4.86
	HE40 Beam Forming, M0 to M9 1ss	4	11	-3.2	-1.6	-2.0	-2.5	0.1	3.9	6.0	2.13
	HE40 Beam Forming, M0 to M9 2ss	4	8	-3.2	1.3	1.5	1.3	0.1	6.7	9.0	2.25
	HE40 Beam Forming, M0 to M9 3ss	4	6	-3.2	2.4	2.5	2.6	0.1	7.8	11.0	3.22
	HE40 Beam Forming, M0 to M9 4ss	4	5	-3.2	2.4	2.5	2.6	0.1	7.8	11.0	3.22
	HE40 STBC, M0 to M9 2ss	2	5	-3.2	2.4			0.1	3.6	11.0	7.41
	HE40 STBC, M0 to M9 2ss	3	7	-3.2	2.4	2.5		0.1	6.1	10.0	3.86
	HE40 STBC, M0 to M9 2ss	4	8	-3.2	1.3	1.5	1.3	0.1	6.7	9.0	2.25
5290	Non HT80, 6 to 54 Mbps	1	5	-7.9				0.1	-7.8	11.0	18.85
	Non HT80, 6 to 54 Mbps	2	8	-7.9	-7.9			0.1	-4.8	9.0	13.84
	Non HT80, 6 to 54 Mbps	3	10	-7.9	-7.9	-7.7		0.1	-3.0	7.0	10.01
	Non HT80, 6 to 54 Mbps	4	11	-7.9	-7.9	-7.7	-8.2	0.1	-1.9	6.0	7.85
	VHT80, M0 to M9 1ss	1	5	-7.6				0.2	-7.4	11.0	18.38
	VHT80, M0 to M9 1ss	2	8	-7.6	-7.4			0.2	-4.3	9.0	13.27
	VHT80, M0 to M9 2ss	2	5	-7.6	-7.4			0.2	-4.3	11.0	15.27
	VHT80, M0 to M9 1ss	3	10	-7.6	-7.4	-7.5		0.2	-2.5	7.0	9.51
	VHT80, M0 to M9 2ss	3	7	-7.6	-7.4	-7.5		0.2	-2.5	10.0	12.51
	VHT80, M0 to M9 3ss	3	5	-7.6	-7.4	-7.5		0.2	-2.5	11.0	13.51
	VHT80, M0 to M9 1ss	4	11	-7.6	-7.4	-7.5	-8.0	0.2	-1.4	6.0	7.38
	VHT80, M0 to M9 2ss	4	8	-7.6	-7.4	-7.5	-8.0	0.2	-1.4	9.0	10.38
	VHT80, M0 to M9 3ss	4	6	-7.6	-7.4	-7.5	-8.0	0.2	-1.4	11.0	12.38



	VHT80, M0 to M9 4ss	4	5	-7.6	-7.4	-7.5	-8.0	0.2	-1.4	11.0	12.38
	VHT80 Beam Forming, M0 to M9 1ss	2	8	-8.2	-8.4			0.2	-5.1	9.0	14.07
	VHT80 Beam Forming, M0 to M9 2ss	2	5	-7.6	-7.4			0.2	-4.3	11.0	15.27
	VHT80 Beam Forming, M0 to M9 1ss	3	10	-9.4	-9.8	-9.4		0.2	-4.5	7.0	11.54
	VHT80 Beam Forming, M0 to M9 2ss	3	7	-8.2	-8.4	-7.9		0.2	-3.2	10.0	13.17
	VHT80 Beam Forming, M0 to M9 3ss	3	5	-7.6	-7.4	-7.5		0.2	-2.5	11.0	13.51
	VHT80 Beam Forming, M0 to M9 1ss	4	11	-10.2	-10.8	-10.6	-11.1	0.2	-4.4	6.0	10.43
	VHT80 Beam Forming, M0 to M9 2ss	4	8	-9.4	-9.8	-9.4	-10.2	0.2	-3.5	9.0	12.45
	VHT80 Beam Forming, M0 to M9 3ss	4	6	-8.2	-8.4	-7.9	-9.0	0.2	-2.1	11.0	13.12
	VHT80 Beam Forming, M0 to M9 4ss	4	5	-7.6	-7.4	-7.5	-8.0	0.2	-1.4	11.0	12.38
	VHT80 STBC, M0 to M9 1ss	2	5	-7.6	-7.4			0.2	-4.3	11.0	15.27
	VHT80 STBC, M0 to M9 1ss	3	5	-7.6	-7.4	-7.5		0.2	-2.5	11.0	13.51
	VHT80 STBC, M0 to M9 1ss	4	5	-7.6	-7.4	-7.5	-8.0	0.2	-1.4	11.0	12.38
	HE80, M0 to M9 1ss	1	5	-7.6				0.3	-7.3	11.0	18.34
	HE80, M0 to M9 1ss	2	8	-7.6	-7.5			0.3	-4.3	9.0	13.28
	HE80, M0 to M9 2ss	2	5	-7.6	-7.5			0.3	-4.3	11.0	15.28
	HE80, M0 to M9 1ss	3	10	-8.8	-8.4	-8.2		0.3	-3.4	7.0	10.43
	HE80, M0 to M9 2ss	3	7	-8.8	-8.4	-8.2		0.3	-3.4	10.0	13.43
	HE80, M0 to M9 3ss	3	5	-8.8	-8.4	-8.2		0.3	-3.4	11.0	14.43
	HE80, M0 to M9 1ss	4	11	-8.8	-8.4	-8.2	-9.0	0.3	-2.3	6.0	8.31
	HE80, M0 to M9 2ss	4	8	-8.8	-8.4	-8.2	-9.0	0.3	-2.3	9.0	11.31
	HE80, M0 to M9 3ss	4	6	-8.8	-8.4	-8.2	-9.0	0.3	-2.3	11.0	13.31
	HE80, M0 to M9 4ss	4	5	-8.8	-8.4	-8.2	-9.0	0.3	-2.3	11.0	13.31
	HE80 Beam Forming, M0 to M9 1ss	2	8	-8.8	-8.4			0.3	-5.3	9.0	14.33
	HE80 Beam Forming, M0 to M9 2ss	2	5	-7.6	-7.5			0.3	-4.3	11.0	15.28
	HE80 Beam Forming, M0 to M9 1ss	3	10	-9.0	-9.2	-9.4		0.3	-4.2	7.0	11.17
	HE80 Beam Forming, M0 to M9 2ss	3	7	-8.8	-8.4	-8.2		0.3	-3.4	10.0	13.43
	HE80 Beam Forming, M0 to M9 3ss	3	5	-8.8	-8.4	-8.2		0.3	-3.4	11.0	14.43
	HE80 Beam Forming, M0 to M9 1ss	4	11	-10.0	-10.8	-10.5	-11.0	0.3	-4.3	6.0	10.28
	HE80 Beam Forming, M0 to M9 2ss	4	8	-9.0	-9.2	-9.4	-10.5	0.3	-3.2	9.0	12.21
	HE80 Beam Forming, M0 to M9 3ss	4	6	-8.8	-8.4	-8.2	-9.0	0.3	-2.3	11.0	13.31
	HE80 Beam Forming, M0 to M9 4ss	4	5	-8.8	-8.4	-8.2	-9.0	0.3	-2.3	11.0	13.31
	HE80 STBC, M0 to M9 1ss	2	5	-7.6	-7.5			0.3	-4.3	11.0	15.28
	HE80 STBC, M0 to M9 1ss	3	5	-8.8	-8.4	-8.2		0.3	-3.4	11.0	14.43
	HE80 STBC, M0 to M9 1ss	4	5	-8.8	-8.4	-8.2	-9.0	0.3	-2.3	11.0	13.31
5300	Non HT20, 6 to 54 Mbps	1	5	0.2				0.0	0.2	11.0	10.76
	Non HT20, 6 to 54 Mbps	2	8	0.2	5.9			0.0	7.0	9.0	2.02
	<b>Non HT20, 6 to 54 Mbps</b>	<b>3</b>	<b>10</b>	<b>0.2</b>	<b>3.1</b>	<b>2.7</b>		<b>0.0</b>	<b>7.0</b>	<b>7.0</b>	<b>0.01</b>
	Non HT20, 6 to 54 Mbps	4	11	-0.8	0.0	-0.8	-1.6	0.0	5.3	6.0	0.70
	Non HT20 Beam Forming, 6 to 54 Mbps	2	8	0.2	5.9			0.0	7.0	9.0	2.02
	Non HT20 Beam Forming, 6 to 54 Mbps	3	10	0.2	3.1	2.7		0.0	7.0	7.0	0.01



Non HT20 Beam Forming, 6 to 54 Mbps	4	11	-0.8	0.0	-0.8	-1.6	0.0	5.3	6.0	0.70
HT/VHT20, M0 to M7	1	5	-0.2				0.1	-0.1	11.0	11.15
HT/VHT20, M0 to M7	2	8	-0.2	5.6			0.1	6.7	9.0	2.33
HT/VHT20, M8 to M15	2	5	-0.2	5.6			0.1	6.7	11.0	4.33
HT/VHT20, M0 to M7	3	10	-0.2	2.4	2.5		0.1	6.6	7.0	0.44
HT/VHT20, M8 to M15	3	7	-0.2	5.6	5.5		0.1	9.2	10.0	0.84
HT/VHT20, M16 to M23	3	5	-0.2	5.6	5.5		0.1	9.2	11.0	1.84
HT/VHT20, M0 to M7	4	11	-0.2	0.5	-0.1	-0.9	0.1	5.9	6.0	0.07
HT/VHT20, M8 to M15	4	8	-0.2	3.7	2.9	2.3	0.1	8.5	9.0	0.53
HT/VHT20, M16 to M23	4	6	-0.2	5.6	5.5	4.9	0.1	10.6	11.0	0.45
HT/VHT20, M24 to M31	4	5	-0.2	5.6	5.5	4.9	0.1	10.6	11.0	0.45
HT/VHT20 Beam Forming, M0 to M7	2	8	-0.2	5.6			0.1	6.7	9.0	2.33
HT/VHT20 Beam Forming, M8 to M15	2	5	-0.2	5.6			0.1	6.7	11.0	4.33
HT/VHT20 Beam Forming, M0 to M7	3	10	-0.2	2.4	2.5		0.1	6.6	7.0	0.44
HT/VHT20 Beam Forming, M8 to M15	3	7	-0.2	5.6	5.5		0.1	9.2	10.0	0.84
HT/VHT20 Beam Forming, M16 to M23	3	5	-0.2	5.6	5.5		0.1	9.2	11.0	1.84
HT/VHT20 Beam Forming, M0 to M7	4	11	-0.2	0.5	-0.1	-0.9	0.1	5.9	6.0	0.07
HT/VHT20 Beam Forming, M8 to M15	4	8	-0.2	3.7	2.9	2.3	0.1	8.5	9.0	0.53
HT/VHT20 Beam Forming, M16 to M23	4	6	-0.2	5.6	5.5	4.9	0.1	10.6	11.0	0.45
HT/VHT20 Beam Forming, M24 to M31	4	5	-0.2	5.6	5.5	4.9	0.1	10.6	11.0	0.45
HT/VHT20 STBC, M0 to M7	2	5	-0.2	5.6			0.1	6.7	11.0	4.33
HT/VHT20 STBC, M0 to M7	3	7	-0.2	5.6	5.5		0.1	9.2	10.0	0.84
HT/VHT20 STBC, M0 to M7	4	8	-0.2	3.7	2.9	2.3	0.1	8.5	9.0	0.53
HE20, M0 to M9 1ss	1	5	0.1				0.1	0.2	11.0	10.83
HE20, M0 to M9 1ss	2	8	0.1	5.8			0.1	6.9	9.0	2.09
HE20, M0 to M9 2ss	2	5	0.1	5.8			0.1	6.9	11.0	4.09
HE20, M0 to M9 1ss	3	10	0.1	2.6	2.7		0.1	6.8	7.0	0.20
HE20, M0 to M9 2ss	3	7	0.1	5.8	5.5		0.1	9.3	10.0	0.70
HE20, M0 to M9 3ss	3	5	0.1	5.8	5.5		0.1	9.3	11.0	1.70
HE20, M0 to M9 1ss	4	11	-0.6	-0.7	-0.8	-1.7	0.1	5.2	6.0	0.84
HE20, M0 to M9 2ss	4	8	0.1	4.0	3.3	2.6	0.1	8.8	9.0	0.18
HE20, M0 to M9 3ss	4	6	0.1	5.8	5.5	5.0	0.1	10.7	11.0	0.31
HE20, M0 to M9 4ss	4	5	0.1	5.8	5.5	5.0	0.1	10.7	11.0	0.31
HE20 Beam Forming, M0 to M9 1ss	2	8	0.1	5.8			0.1	6.9	9.0	2.09
HE20 Beam Forming, M0 to M9 2ss	2	5	0.1	5.8			0.1	6.9	11.0	4.09
HE20 Beam Forming, M0 to M9 1ss	3	10	0.1	2.6	2.7		0.1	6.8	7.0	0.20
HE20 Beam Forming, M0 to M9 2ss	3	7	0.1	5.8	5.5		0.1	9.3	10.0	0.70
HE20 Beam Forming, M0 to M9 3ss	3	5	0.1	5.8	5.5		0.1	9.3	11.0	1.70
HE20 Beam Forming, M0 to M9 1ss	4	11	-0.6	-0.7	-0.8	-1.7	0.1	5.2	6.0	0.84
HE20 Beam Forming, M0 to M9 2ss	4	8	0.1	4.0	3.3	2.6	0.1	8.8	9.0	0.18
HE20 Beam Forming, M0 to M9 3ss	4	6	0.1	5.8	5.5	5.0	0.1	10.7	11.0	0.31
HE20 Beam Forming, M0 to M9 4ss	4	5	0.1	5.8	5.5	5.0	0.1	10.7	11.0	0.31



	HE20 STBC, M0 to M9 2ss	2	5	0.1	5.8			0.1	6.9	11.0	4.09
	HE20 STBC, M0 to M9 2ss	3	7	0.1	5.8	5.5		0.1	9.3	10.0	0.70
	HE20 STBC, M0 to M9 2ss	4	8	0.1	4.0	3.3	2.6	0.1	8.8	9.0	0.18
5310	Non HT40, 6 to 54 Mbps	1	5	-3.8				0.0	-3.8	11.0	14.76
	Non HT40, 6 to 54 Mbps	2	8	-3.8	-3.5			0.0	-0.6	9.0	9.59
	Non HT40, 6 to 54 Mbps	3	10	-3.8	-3.5	-3.1		0.0	1.4	7.0	5.64
	Non HT40, 6 to 54 Mbps	4	11	-3.8	-3.5	-3.1	-4.5	0.0	2.4	6.0	3.63
	HT/VHT40, M0 to M7	1	5	-4.2				0.1	-4.1	11.0	15.10
	HT/VHT40, M0 to M7	2	8	-4.2	-4.3			0.1	-1.1	9.0	10.14
	HT/VHT40, M8 to M15	2	5	-4.2	-4.3			0.1	-1.1	11.0	12.14
	HT/VHT40, M0 to M7	3	10	-4.2	-4.3	-4.4		0.1	0.6	7.0	6.43
	HT/VHT40, M8 to M15	3	7	-4.2	-4.3	-4.4		0.1	0.6	10.0	9.43
	HT/VHT40, M16 to M23	3	5	-4.2	-4.3	-4.4		0.1	0.6	11.0	10.43
	HT/VHT40, M0 to M7	4	11	-4.2	-4.3	-4.4	-5.1	0.1	1.6	6.0	4.36
	HT/VHT40, M8 to M15	4	8	-4.2	-4.3	-4.4	-5.1	0.1	1.6	9.0	7.36
	HT/VHT40, M16 to M23	4	6	-4.2	-4.3	-4.4	-5.1	0.1	1.6	11.0	9.36
	HT/VHT40, M24 to M31	4	5	-4.2	-4.3	-4.4	-5.1	0.1	1.6	11.0	9.36
	HT/VHT40 Beam Forming, M0 to M7	2	8	-4.2	-4.3			0.1	-1.1	9.0	10.14
	HT/VHT40 Beam Forming, M8 to M15	2	5	-4.2	-4.3			0.1	-1.1	11.0	12.14
	HT/VHT40 Beam Forming, M0 to M7	3	10	-5.1	-4.8	-4.9		0.1	-0.1	7.0	7.06
	HT/VHT40 Beam Forming, M8 to M15	3	7	-4.2	-4.3	-4.4		0.1	0.6	10.0	9.43
	HT/VHT40 Beam Forming, M16 to M23	3	5	-4.2	-4.3	-4.4		0.1	0.6	11.0	10.43
	HT/VHT40 Beam Forming, M0 to M7	4	11	-6.1	-6.3	-6.1	-7.0	0.1	-0.2	6.0	6.24
	HT/VHT40 Beam Forming, M8 to M15	4	8	-5.1	-4.8	-4.9	-5.9	0.1	1.0	9.0	8.03
	HT/VHT40 Beam Forming, M16 to M23	4	6	-4.2	-4.3	-4.4	-5.1	0.1	1.6	11.0	9.36
	HT/VHT40 Beam Forming, M24 to M31	4	5	-4.2	-4.3	-4.4	-5.1	0.1	1.6	11.0	9.36
	HT/VHT40 STBC, M0 to M7	2	5	-4.2	-4.3			0.1	-1.1	11.0	12.14
	HT/VHT40 STBC, M0 to M7	3	7	-4.2	-4.3	-4.4		0.1	0.6	10.0	9.43
	HT/VHT40 STBC, M0 to M7	4	8	-4.2	-4.3	-4.4	-5.1	0.1	1.6	9.0	7.36
	HE40, M0 to M9 1ss	1	5	-4.2				0.1	-4.1	11.0	15.07
	HE40, M0 to M9 1ss	2	8	-4.2	-3.9			0.1	-0.9	9.0	9.91
	HE40, M0 to M9 2ss	2	5	-4.2	-3.9			0.1	-0.9	11.0	11.91
	HE40, M0 to M9 1ss	3	10	-4.2	-3.9	-3.6		0.1	1.0	7.0	5.99
	HE40, M0 to M9 2ss	3	7	-4.2	-3.9	-3.6		0.1	1.0	10.0	8.99
	HE40, M0 to M9 3ss	3	5	-4.2	-3.9	-3.6		0.1	1.0	11.0	9.99
	HE40, M0 to M9 1ss	4	11	-5.3	-4.7	-4.9	-5.6	0.1	1.0	6.0	4.96
	HE40, M0 to M9 2ss	4	8	-5.3	-4.7	-4.9	-5.6	0.1	1.0	9.0	7.96
	HE40, M0 to M9 3ss	4	6	-5.3	-4.7	-4.9	-5.6	0.1	1.0	11.0	9.96
HE40, M0 to M9 4ss	4	5	-5.3	-4.7	-4.9	-5.6	0.1	1.0	11.0	9.96	
HE40 Beam Forming, M0 to M9 1ss	2	8	-5.3	-4.7			0.1	-1.8	9.0	10.85	
HE40 Beam Forming, M0 to M9 2ss	2	5	-4.2	-3.9			0.1	-0.9	11.0	11.91	



	HE40 Beam Forming, M0 to M9 1ss	3	10	-6.2	-5.7	-6.3		0.1	-1.2	7.0	8.16
	HE40 Beam Forming, M0 to M9 2ss	3	7	-5.3	-4.7	-4.9		0.1	-0.1	10.0	10.06
	HE40 Beam Forming, M0 to M9 3ss	3	5	-4.2	-3.9	-3.6		0.1	1.0	11.0	9.99
	HE40 Beam Forming, M0 to M9 1ss	4	11	-6.9	-6.8	-7.0	-7.9	0.1	-1.0	6.0	6.98
	HE40 Beam Forming, M0 to M9 2ss	4	8	-5.3	-4.7	-4.9	-5.6	0.1	1.0	9.0	7.96
	HE40 Beam Forming, M0 to M9 3ss	4	6	-5.3	-4.7	-4.9	-5.6	0.1	1.0	11.0	9.96
	HE40 Beam Forming, M0 to M9 4ss	4	5	-5.3	-4.7	-4.9	-5.6	0.1	1.0	11.0	9.96
	HE40 STBC, M0 to M9 2ss	2	5	-4.2	-3.9			0.1	-0.9	11.0	11.91
	HE40 STBC, M0 to M9 2ss	3	7	-4.2	-3.9	-3.6		0.1	1.0	10.0	8.99
	HE40 STBC, M0 to M9 2ss	4	8	-5.3	-4.7	-4.9	-5.6	0.1	1.0	9.0	7.96
5320	Non HT20, 6 to 54 Mbps	1	5	0.1				0.0	0.1	11.0	10.86
	Non HT20, 6 to 54 Mbps	2	8	0.1	6.0			0.0	7.0	9.0	1.96
	Non HT20, 6 to 54 Mbps	3	10	0.1	1.6	1.3		0.0	5.9	7.0	1.14
	Non HT20, 6 to 54 Mbps	4	11	-0.7	0.1	-0.8	-1.8	0.0	5.3	6.0	0.68
	Non HT20 Beam Forming, 6 to 54 Mbps	2	8	0.1	4.9			0.0	6.2	9.0	2.81
	Non HT20 Beam Forming, 6 to 54 Mbps	3	10	0.1	1.6	1.3		0.0	5.9	7.0	1.14
	Non HT20 Beam Forming, 6 to 54 Mbps	4	11	-0.7	0.1	-0.8	-1.8	0.0	5.3	6.0	0.68
	HT/VHT20, M0 to M7	1	5	-0.4				0.1	-0.3	11.0	11.35
	HT/VHT20, M0 to M7	2	8	-0.4	4.4			0.1	5.7	9.0	3.31
	HT/VHT20, M8 to M15	2	5	-0.4	4.4			0.1	5.7	11.0	5.31
	HT/VHT20, M0 to M7	3	10	-0.4	2.5	2.4		0.1	6.5	7.0	0.49
	HT/VHT20, M8 to M15	3	7	-0.4	4.4	4.4		0.1	8.1	10.0	1.87
	HT/VHT20, M16 to M23	3	5	-0.4	4.4	4.4		0.1	8.1	11.0	2.87
	HT/VHT20, M0 to M7	4	11	-0.4	0.3	0.0	-1.1	0.1	5.8	6.0	0.20
	HT/VHT20, M8 to M15	4	8	-0.4	3.5	3.1	2.3	0.1	8.4	9.0	0.56
	HT/VHT20, M16 to M23	4	6	-0.4	3.5	3.1	2.3	0.1	8.4	11.0	2.56
	HT/VHT20, M24 to M31	4	5	-0.4	3.5	3.1	2.3	0.1	8.4	11.0	2.56
	HT/VHT20 Beam Forming, M0 to M7	2	8	-0.4	4.4			0.1	5.7	9.0	3.31
	HT/VHT20 Beam Forming, M8 to M15	2	5	-0.4	4.4			0.1	5.7	11.0	5.31
	HT/VHT20 Beam Forming, M0 to M7	3	10	-0.4	2.5	2.4		0.1	6.5	7.0	0.49
	HT/VHT20 Beam Forming, M8 to M15	3	7	-0.4	3.5	3.1		0.1	7.2	10.0	2.79
	HT/VHT20 Beam Forming, M16 to M23	3	5	-0.4	4.4	4.4		0.1	8.1	11.0	2.87
	HT/VHT20 Beam Forming, M0 to M7	4	11	-0.4	0.3	0.0	-1.1	0.1	5.8	6.0	0.20
	HT/VHT20 Beam Forming, M8 to M15	4	8	-0.4	3.5	3.1	2.3	0.1	8.4	9.0	0.56
	HT/VHT20 Beam Forming, M16 to M23	4	6	-0.4	3.5	3.1	2.3	0.1	8.4	11.0	2.56
	HT/VHT20 Beam Forming, M24 to M31	4	5	-0.4	3.5	3.1	2.3	0.1	8.4	11.0	2.56
	HT/VHT20 STBC, M0 to M7	2	5	-0.4	4.4			0.1	5.7	11.0	5.31
	HT/VHT20 STBC, M0 to M7	3	7	-0.4	4.4	4.4		0.1	8.1	10.0	1.87
	HT/VHT20 STBC, M0 to M7	4	8	-0.4	3.5	3.1	2.3	0.1	8.4	9.0	0.56
	HE20, M0 to M9 1ss	1	5	-0.4				0.1	-0.3	11.0	11.33
	HE20, M0 to M9 1ss	2	8	-0.4	4.5			0.1	5.8	9.0	3.21



	HE20, M0 to M9 2ss	2	5	-0.4	4.5			0.1	5.8	11.0	5.21
	HE20, M0 to M9 1ss	3	10	-0.4	2.4	2.2		0.1	6.4	7.0	0.59
	HE20, M0 to M9 2ss	3	7	-0.4	4.5	4.1		0.1	8.1	10.0	1.94
	HE20, M0 to M9 3ss	3	5	-0.4	4.5	4.1		0.1	8.1	11.0	2.94
	HE20, M0 to M9 1ss	4	11	-0.4	0.4	0.2	-1.2	0.1	5.9	6.0	0.12
	HE20, M0 to M9 2ss	4	8	-0.4	3.3	3.1	2.0	0.1	8.3	9.0	0.68
	HE20, M0 to M9 3ss	4	6	-0.4	3.3	3.1	2.0	0.1	8.3	11.0	2.68
	HE20, M0 to M9 4ss	4	5	-0.4	3.3	3.1	2.0	0.1	8.3	11.0	2.68
	HE20 Beam Forming, M0 to M9 1ss	2	8	-0.4	3.3			0.1	4.9	9.0	4.09
	HE20 Beam Forming, M0 to M9 2ss	2	5	-0.4	4.5			0.1	5.8	11.0	5.21
	HE20 Beam Forming, M0 to M9 1ss	3	10	-0.4	2.4	2.2		0.1	6.4	7.0	0.59
	HE20 Beam Forming, M0 to M9 2ss	3	7	-0.4	3.3	3.1		0.1	7.1	10.0	2.86
	HE20 Beam Forming, M0 to M9 3ss	3	5	-0.4	4.5	4.1		0.1	8.1	11.0	2.94
	HE20 Beam Forming, M0 to M9 1ss	4	11	-0.4	0.4	0.2	-1.2	0.1	5.9	6.0	0.12
	HE20 Beam Forming, M0 to M9 2ss	4	8	-0.4	2.4	2.2	1.1	0.1	7.6	9.0	1.45
	HE20 Beam Forming, M0 to M9 3ss	4	6	-0.4	3.3	3.1	2.0	0.1	8.3	11.0	2.68
	HE20 Beam Forming, M0 to M9 4ss	4	5	-0.4	3.3	3.1	2.0	0.1	8.3	11.0	2.68
	HE20 STBC, M0 to M9 2ss	2	5	-0.4	4.5			0.1	5.8	11.0	5.21
	HE20 STBC, M0 to M9 2ss	3	7	-0.4	4.5	4.1		0.1	8.1	10.0	1.94
	HE20 STBC, M0 to M9 2ss	4	8	-0.4	3.3	3.1	2.0	0.1	8.3	9.0	0.68
5250	Non HT160, 6 to 54 Mbps	1	5	-11.2				0.0	-11.2	11.0	22.15
	Non HT160, 6 to 54 Mbps	2	8	-11.8	-11.0			0.0	-8.3	9.0	17.32
	Non HT160, 6 to 54 Mbps	3	10	-11.8	-11.0	-12.6		0.0	-6.9	7.0	13.93
	Non HT160, 6 to 54 Mbps	4	11	-11.8	-11.0	-12.6	-13.3	0.0	-6.0	6.0	12.02
	VHT160, M0 to M9 1ss	1	5	-10.9				0.4	-10.5	11.0	21.51
	VHT160, M0 to M9 1ss	2	8	-10.9	-11.4			0.4	-7.7	9.0	16.74
	VHT160, M0 to M9 2ss	2	5	-10.9	-11.4			0.4	-7.7	11.0	18.74
	VHT160, M0 to M9 1ss	3	10	-10.9	-11.4	-11.8		0.4	-6.2	7.0	13.19
	VHT160, M0 to M9 2ss	3	7	-10.9	-11.4	-11.8		0.4	-6.2	10.0	16.19
	VHT160, M0 to M9 3ss	3	5	-10.9	-11.4	-11.8		0.4	-6.2	11.0	17.19
	VHT160, M0 to M9 1ss	4	11	-10.9	-11.4	-11.8	-12.0	0.4	-5.1	6.0	11.09
	VHT160, M0 to M9 2ss	4	8	-10.9	-11.4	-11.8	-12.0	0.4	-5.1	9.0	14.09
	VHT160, M0 to M9 3ss	4	6	-10.9	-11.4	-11.8	-12.0	0.4	-5.1	11.0	16.09
	VHT160, M0 to M9 4ss	4	5	-10.9	-11.4	-11.8	-12.0	0.4	-5.1	11.0	16.09
	VHT160 Beam Forming, M0 to M9 1ss	2	8	-12.2	-12.2			0.4	-8.8	9.0	17.80
	VHT160 Beam Forming, M0 to M9 2ss	2	5	-10.9	-11.4			0.4	-7.7	11.0	18.74
	VHT160 Beam Forming, M0 to M9 1ss	3	10	-12.8	-13.2	-13.8		0.4	-8.1	7.0	15.08
	VHT160 Beam Forming, M0 to M9 2ss	3	7	-12.2	-12.2	-12.8		0.4	-7.2	10.0	17.23
	VHT160 Beam Forming, M0 to M9 3ss	3	5	-10.9	-11.4	-11.8		0.4	-6.2	11.0	17.19
	VHT160 Beam Forming, M0 to M9 1ss	4	11	-13.5	-14.1	-14.8	-14.9	0.4	-7.9	6.0	13.87
VHT160 Beam Forming, M0 to M9 2ss	4	8	-12.2	-12.2	-12.8	-13.0	0.4	-6.1	9.0	15.12	



VHT160 Beam Forming, M0 to M9 3ss	4	6	-12.2	-12.2	-12.8	-13.0	0.4	-6.1	11.0	17.12
VHT160 Beam Forming, M0 to M9 4ss	4	5	-10.9	-11.4	-11.8	-12.0	0.4	-5.1	11.0	16.09
VHT160 STBC, M0 to M9 1ss	2	5	-10.9	-11.4			0.4	-7.7	11.0	18.74
VHT160 STBC, M0 to M9 1ss	3	5	-10.9	-11.4	-11.8		0.4	-6.2	11.0	17.19
VHT160 STBC, M0 to M9 1ss	4	5	-10.9	-11.4	-11.8	-12.0	0.4	-5.1	11.0	16.09
HE160, M0 to M9 1ss	1	5	-10.3				0.4	-9.9	11.0	20.87
HE160, M0 to M9 1ss	2	8	-10.3	-11.0			0.4	-7.2	9.0	16.19
HE160, M0 to M9 2ss	2	5	-10.3	-11.0			0.4	-7.2	11.0	18.19
HE160, M0 to M9 1ss	3	10	-10.3	-11.0	-11.2		0.4	-5.6	7.0	12.61
HE160, M0 to M9 2ss	3	7	-10.3	-11.0	-11.2		0.4	-5.6	10.0	15.61
HE160, M0 to M9 3ss	3	5	-10.3	-11.0	-11.2		0.4	-5.6	11.0	16.61
HE160, M0 to M9 1ss	4	11	-10.3	-11.0	-11.2	-11.8	0.4	-4.6	6.0	10.59
HE160, M0 to M9 2ss	4	8	-10.3	-11.0	-11.2	-11.8	0.4	-4.6	9.0	13.59
HE160, M0 to M9 3ss	4	6	-10.3	-11.0	-11.2	-11.8	0.4	-4.6	11.0	15.59
HE160, M0 to M9 4ss	4	5	-10.3	-11.0	-11.2	-11.8	0.4	-4.6	11.0	15.59
HE160 Beam Forming, M0 to M9 1ss	2	8	-11.6	-12.1			0.4	-8.4	9.0	17.40
HE160 Beam Forming, M0 to M9 2ss	2	5	-10.3	-11.0			0.4	-7.2	11.0	18.19
HE160 Beam Forming, M0 to M9 1ss	3	10	-11.6	-12.1	-12.2		0.4	-6.8	7.0	13.75
HE160 Beam Forming, M0 to M9 2ss	3	7	-10.3	-11.0	-11.2		0.4	-5.6	10.0	15.61
HE160 Beam Forming, M0 to M9 3ss	3	5	-10.3	-11.0	-11.2		0.4	-5.6	11.0	16.61
HE160 Beam Forming, M0 to M9 1ss	4	11	-12.6	-13.4	-13.6	-13.7	0.4	-6.8	6.0	12.85
HE160 Beam Forming, M0 to M9 2ss	4	8	-11.6	-12.1	-12.2	-12.8	0.4	-5.7	9.0	14.70
HE160 Beam Forming, M0 to M9 3ss	4	6	-10.3	-11.0	-11.2	-11.8	0.4	-4.6	11.0	15.59
HE160 Beam Forming, M0 to M9 4ss	4	5	-10.3	-11.0	-11.2	-11.8	0.4	-4.6	11.0	15.59
HE160 STBC, M0 to M9 1ss	2	5	-10.3	-11.0			0.4	-7.2	11.0	18.19
HE160 STBC, M0 to M9 1ss	3	5	-10.3	-11.0	-11.2		0.4	-5.6	11.0	16.61
HE160 STBC, M0 to M9 1ss	4	5	-10.3	-11.0	-11.2	-11.8	0.4	-4.6	11.0	15.59





**Power Spectral Density, 5dBi  
5300 MHz, Non HT20, 6 to 54 Mbps**

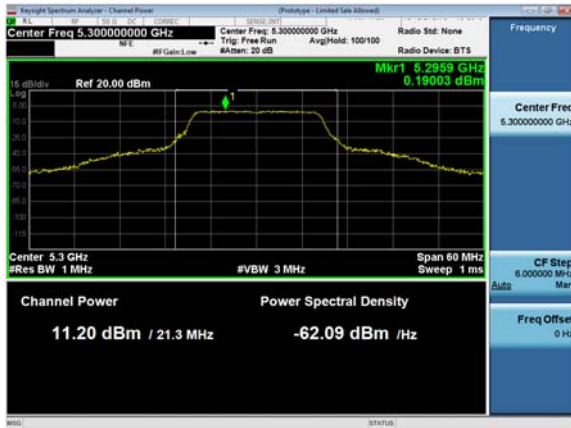

**Antenna A**



**Antenna B**

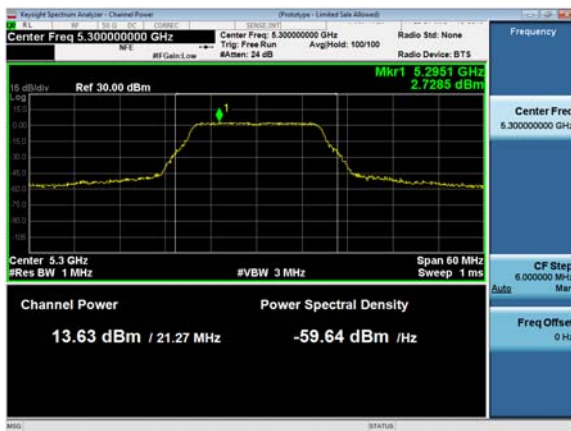

**Antenna C**





## Power Spectral Density, 6dBi

Frequency (MHz)	Mode	Tx Paths	Correlated Antenna Gain (dBi)	Tx 1 PSD (dBm/MHz)	Tx 2 PSD (dBm/MHz)	Tx 3 PSD (dBm/MHz)	Tx 4 PSD (dBm/MHz)	Duty Cycle Correction (dB)	Total PSD (dBm/MHz)	Limit (dBm/MHz)	Margin (dB)	
5260	Non HT20, 6 to 54 Mbps	1	6	0.1				0.0	0.1	11.0	10.86	
	Non HT20, 6 to 54 Mbps	2	9	0.1	6.3			0.0	7.3	8.0	0.72	
	Non HT20, 6 to 54 Mbps	3	11	0.1	2.0	1.2		0.0	6.0	6.0	0.02	
	Non HT20, 6 to 54 Mbps	4	12	-1.8	-1.3	-1.8	-2.4	0.0	4.3	5.0	0.74	
	Non HT20 Beam Forming, 6 to 54 Mbps	2	9	0.1	6.3			0.0	7.3	8.0	0.72	
	Non HT20 Beam Forming, 6 to 54 Mbps	3	11	0.1	2.0	1.2		0.0	6.0	6.0	0.02	
	Non HT20 Beam Forming, 6 to 54 Mbps	4	12	-1.8	-1.3	-1.8	-2.4	0.0	4.3	5.0	0.74	
	HT/VHT20, M0 to M7	1	6	-0.5				0.1	-0.4	11.0	11.45	
	HT/VHT20, M0 to M7	2	9	-0.5	5.9			0.1	6.8	8.0	1.15	
	HT/VHT20, M8 to M15	2	6	-0.5	5.9			0.1	6.8	11.0	4.15	
	HT/VHT20, M0 to M7	3	11	-0.5	1.8	0.8		0.1	5.6	6.0	0.38	
	HT/VHT20, M8 to M15	3	8	-0.5	4.8	4.4		0.1	8.3	9.0	0.71	
	HT/VHT20, M16 to M23	3	6	-0.5	5.9	5.1		0.1	9.1	11.0	1.91	
	HT/VHT20, M0 to M7	4	12	-1.3	-0.6	-1.0	-1.5	0.1	5.0	5.0	0.01	
	HT/VHT20, M8 to M15	4	9	-0.5	2.7	2.2	1.7	0.1	7.8	8.0	0.24	
	HT/VHT20, M16 to M23	4	7	-0.5	4.8	4.4	4.3	0.1	9.8	10.0	0.24	
	HT/VHT20, M24 to M31	4	6	-0.5	5.9	5.1	5.1	0.1	10.6	11.0	0.43	
	HT/VHT20 Beam Forming, M0 to M7	2	9	-0.5	5.9			0.1	6.8	8.0	1.15	
	HT/VHT20 Beam Forming, M8 to M15	2	6	-0.5	5.9			0.1	6.8	11.0	4.15	
	HT/VHT20 Beam Forming, M0 to M7	3	11	-0.5	1.8	0.8		0.1	5.6	6.0	0.38	
	HT/VHT20 Beam Forming, M8 to M15	3	8	-0.5	4.8	4.4		0.1	8.3	9.0	0.71	
	HT/VHT20 Beam Forming, M16 to M23	3	6	-0.5	5.9	5.1		0.1	9.1	11.0	1.91	
	HT/VHT20 Beam Forming, M0 to M7	4	12	-1.3	-0.6	-1.0	-1.5	0.1	5.0	5.0	0.01	
	HT/VHT20 Beam Forming, M8 to M15	4	9	-0.5	2.7	2.2	1.7	0.1	7.8	8.0	0.24	
	HT/VHT20 Beam Forming, M16 to M23	4	7	-0.5	4.8	4.4	4.3	0.1	9.8	10.0	0.24	
	HT/VHT20 Beam Forming, M24 to M31	4	6	-0.5	5.9	5.1	5.1	0.1	10.6	11.0	0.43	
	HT/VHT20 STBC, M0 to M7	2	6	-0.5	5.9			0.1	6.8	11.0	4.15	
	HT/VHT20 STBC, M0 to M7	3	8	-0.5	4.8	4.4		0.1	8.3	9.0	0.71	
	HT/VHT20 STBC, M0 to M7	4	9	-0.5	2.7	2.2	1.7	0.1	7.8	8.0	0.24	
	HE20, M0 to M9 1ss	1	6	-0.3					0.1	-0.2	11.0	11.23



	HE20, M0 to M9 1ss	2	9	-0.3	5.7			0.1	6.7	8.0	1.26
	HE20, M0 to M9 2ss	2	6	-0.3	5.7			0.1	6.7	11.0	4.26
	HE20, M0 to M9 1ss	3	11	-0.3	1.9	1.1		0.1	5.8	6.0	0.17
	HE20, M0 to M9 2ss	3	8	-0.3	5.2	4.7		0.1	8.6	9.0	0.36
	HE20, M0 to M9 3ss	3	6	-0.3	5.7	5.9		0.1	9.4	11.0	1.62
	HE20, M0 to M9 1ss	4	12	-2.1	-1.3	-2.2	-2.3	0.1	4.1	5.0	0.87
	HE20, M0 to M9 2ss	4	9	-0.3	1.9	1.1	0.7	0.1	7.0	8.0	0.99
	<b>HE20, M0 to M9 3ss</b>	<b>4</b>	<b>7</b>	<b>-0.3</b>	<b>5.2</b>	<b>4.7</b>	<b>4.2</b>	<b>0.1</b>	<b>10.0</b>	<b>10.0</b>	<b>0.01</b>
	HE20, M0 to M9 4ss	4	6	-0.3	5.7	5.9	5.4	0.1	10.9	11.0	0.14
	HE20 Beam Forming, M0 to M9 1ss	2	9	-0.3	5.7			0.1	6.7	8.0	1.26
	HE20 Beam Forming, M0 to M9 2ss	2	6	-0.3	5.7			0.1	6.7	11.0	4.26
	HE20 Beam Forming, M0 to M9 1ss	3	11	-0.3	1.9	1.1		0.1	5.8	6.0	0.17
	HE20 Beam Forming, M0 to M9 2ss	3	8	-0.3	5.2	4.7		0.1	8.6	9.0	0.36
	HE20 Beam Forming, M0 to M9 3ss	3	6	-0.3	5.7	5.9		0.1	9.4	11.0	1.62
	HE20 Beam Forming, M0 to M9 1ss	4	12	-2.1	-1.3	-2.2	-2.3	0.1	4.1	5.0	0.87
	HE20 Beam Forming, M0 to M9 2ss	4	9	-0.3	1.9	1.1	0.7	0.1	7.0	8.0	0.99
	HE20 Beam Forming, M0 to M9 3ss	4	7	-0.3	5.2	4.7	4.2	0.1	10.0	10.0	0.01
	HE20 Beam Forming, M0 to M9 4ss	4	6	-0.3	5.7	5.9	5.4	0.1	10.9	11.0	0.14
	HE20 STBC, M0 to M9 2ss	2	6	-0.3	5.7			0.1	6.7	11.0	4.26
	HE20 STBC, M0 to M9 2ss	3	8	-0.3	5.2	4.7		0.1	8.6	9.0	0.36
	HE20 STBC, M0 to M9 2ss	4	9	-0.3	1.9	1.1	0.7	0.1	7.0	8.0	0.99
5270	Non HT40, 6 to 54 Mbps	1	6	-3.2				0.0	-3.2	11.0	14.16
	Non HT40, 6 to 54 Mbps	2	9	-3.2	2.4			0.0	3.5	8.0	4.50
	Non HT40, 6 to 54 Mbps	3	11	-3.2	1.4	1.9		0.0	5.4	6.0	0.63
	Non HT40, 6 to 54 Mbps	4	12	-3.2	-1.5	-1.5	-2.0	0.0	4.1	5.0	0.93
	HT/VHT40, M0 to M7	1	6	-3.5				0.1	-3.4	11.0	14.40
	HT/VHT40, M0 to M7	2	9	-3.5	2.1			0.1	3.3	8.0	4.74
	HT/VHT40, M8 to M15	2	6	-3.5	2.1			0.1	3.3	11.0	7.74
	HT/VHT40, M0 to M7	3	11	-3.5	2.1	2.3		0.1	5.9	6.0	0.14
	HT/VHT40, M8 to M15	3	8	-3.5	2.1	2.3		0.1	5.9	9.0	3.14
	HT/VHT40, M16 to M23	3	6	-3.5	2.1	2.3		0.1	5.9	11.0	5.14
	HT/VHT40, M0 to M7	4	12	-3.5	-0.9	-1.0	-1.5	0.1	4.5	5.0	0.49
	HT/VHT40, M8 to M15	4	9	-3.5	2.1	2.3	2.1	0.1	7.4	8.0	0.58
	HT/VHT40, M16 to M23	4	7	-3.5	2.1	2.3	2.1	0.1	7.4	10.0	2.58
	HT/VHT40, M24 to M31	4	6	-3.5	2.1	2.3	2.1	0.1	7.4	11.0	3.58
	HT/VHT40 Beam Forming, M0 to M7	2	9	-3.5	2.1			0.1	3.3	8.0	4.74
	HT/VHT40 Beam Forming, M8 to M15	2	6	-3.5	2.1			0.1	3.3	11.0	7.74
	HT/VHT40 Beam Forming, M0 to M7	3	11	-3.5	-0.9	-1.0		0.1	3.2	6.0	2.77
	HT/VHT40 Beam Forming, M8 to M15	3	8	-3.5	2.1	2.3		0.1	5.9	9.0	3.14
HT/VHT40 Beam Forming, M16 to M23	3	6	-3.5	2.1	2.3		0.1	5.9	11.0	5.14	
HT/VHT40 Beam Forming, M0 to M7	4	12	-3.5	-2.6	-2.6	-3.6	0.1	3.1	5.0	1.93	



	HT/VHT40 Beam Forming, M8 to M15	4	9	-3.5	-0.1	0.1	-0.2	0.1	5.4	8.0	2.58
	HT/VHT40 Beam Forming, M16 to M23	4	7	-3.5	2.1	2.3	2.1	0.1	7.4	10.0	2.58
	HT/VHT40 Beam Forming, M24 to M31	4	6	-3.5	2.1	2.3	2.1	0.1	7.4	11.0	3.58
	HT/VHT40 STBC, M0 to M7	2	6	-3.5	2.1			0.1	3.3	11.0	7.74
	HT/VHT40 STBC, M0 to M7	3	8	-3.5	2.1	2.3		0.1	5.9	9.0	3.14
	HT/VHT40 STBC, M0 to M7	4	9	-3.5	-0.1	0.1	-0.2	0.1	5.4	8.0	2.58
	HE40, M0 to M9 1ss	1	6	-3.2				0.1	-3.1	11.0	14.07
	HE40, M0 to M9 1ss	2	9	-3.2	2.4			0.1	3.6	8.0	4.41
	HE40, M0 to M9 2ss	2	6	-3.2	2.4			0.1	3.6	11.0	7.41
	HE40, M0 to M9 1ss	3	11	-3.2	1.3	1.5		0.1	5.2	6.0	0.76
	HE40, M0 to M9 2ss	3	8	-3.2	2.4	2.5		0.1	6.1	9.0	2.86
	HE40, M0 to M9 3ss	3	6	-3.2	2.4	2.5		0.1	6.1	11.0	4.86
	HE40, M0 to M9 1ss	4	12	-3.2	-0.7	-1.2	-1.1	0.1	4.7	5.0	0.30
	HE40, M0 to M9 2ss	4	9	-3.2	2.4	2.5	2.6	0.1	7.8	8.0	0.22
	HE40, M0 to M9 3ss	4	7	-3.2	2.4	2.5	2.6	0.1	7.8	10.0	2.22
	HE40, M0 to M9 4ss	4	6	-3.2	2.4	2.5	2.6	0.1	7.8	11.0	3.22
	HE40 Beam Forming, M0 to M9 1ss	2	9	-3.2	2.4			0.1	3.6	8.0	4.41
	HE40 Beam Forming, M0 to M9 2ss	2	6	-3.2	2.4			0.1	3.6	11.0	7.41
	HE40 Beam Forming, M0 to M9 1ss	3	11	-3.2	-0.7	-1.2		0.1	3.3	6.0	2.67
	HE40 Beam Forming, M0 to M9 2ss	3	8	-3.2	2.4	2.5		0.1	6.1	9.0	2.86
	HE40 Beam Forming, M0 to M9 3ss	3	6	-3.2	2.4	2.5		0.1	6.1	11.0	4.86
	HE40 Beam Forming, M0 to M9 1ss	4	12	-3.2	-3.2	-2.9	-3.1	0.1	3.1	5.0	1.95
	HE40 Beam Forming, M0 to M9 2ss	4	9	-3.2	0.4	0.3	0.2	0.1	5.8	8.0	2.20
	HE40 Beam Forming, M0 to M9 3ss	4	7	-3.2	2.4	2.5	2.6	0.1	7.8	10.0	2.22
	HE40 Beam Forming, M0 to M9 4ss	4	6	-3.2	2.4	2.5	2.6	0.1	7.8	11.0	3.22
	HE40 STBC, M0 to M9 2ss	2	6	-3.2	2.4			0.1	3.6	11.0	7.41
	HE40 STBC, M0 to M9 2ss	3	8	-3.2	2.4	2.5		0.1	6.1	9.0	2.86
	HE40 STBC, M0 to M9 2ss	4	9	-3.2	0.4	0.3	0.2	0.1	5.8	8.0	2.20
5290	Non HT80, 6 to 54 Mbps	1	6	-7.9				0.1	-7.8	11.0	18.85
	Non HT80, 6 to 54 Mbps	2	9	-7.9	-7.9			0.1	-4.8	8.0	12.84
	Non HT80, 6 to 54 Mbps	3	11	-7.9	-7.9	-7.7		0.1	-3.0	6.0	9.01
	Non HT80, 6 to 54 Mbps	4	12	-7.9	-7.9	-7.7	-8.2	0.1	-1.9	5.0	6.85
	VHT80, M0 to M9 1ss	1	6	-7.6				0.2	-7.4	11.0	18.38
	VHT80, M0 to M9 1ss	2	9	-7.6	-7.4			0.2	-4.3	8.0	12.27
	VHT80, M0 to M9 2ss	2	6	-7.6	-7.4			0.2	-4.3	11.0	15.27
	VHT80, M0 to M9 1ss	3	11	-8.2	-8.4	-7.9		0.2	-3.2	6.0	9.17
	VHT80, M0 to M9 2ss	3	8	-8.2	-8.4	-7.9		0.2	-3.2	9.0	12.17
	VHT80, M0 to M9 3ss	3	6	-8.2	-8.4	-7.9		0.2	-3.2	11.0	14.17
	VHT80, M0 to M9 1ss	4	12	-8.2	-8.4	-7.9	-9.0	0.2	-2.1	5.0	7.12
	VHT80, M0 to M9 2ss	4	9	-8.2	-8.4	-7.9	-9.0	0.2	-2.1	8.0	10.12
	VHT80, M0 to M9 3ss	4	7	-8.2	-8.4	-7.9	-9.0	0.2	-2.1	10.0	12.12



	VHT80, M0 to M9 4ss	4	6	-8.2	-8.4	-7.9	-9.0	0.2	-2.1	11.0	13.12
	VHT80 Beam Forming, M0 to M9 1ss	2	9	-8.2	-8.4			0.2	-5.1	8.0	13.07
	VHT80 Beam Forming, M0 to M9 2ss	2	6	-7.6	-7.4			0.2	-4.3	11.0	15.27
	VHT80 Beam Forming, M0 to M9 1ss	3	11	-9.4	-9.8	-9.4		0.2	-4.5	6.0	10.54
	VHT80 Beam Forming, M0 to M9 2ss	3	8	-8.2	-8.4	-7.9		0.2	-3.2	9.0	12.17
	VHT80 Beam Forming, M0 to M9 3ss	3	6	-8.2	-8.4	-7.9		0.2	-3.2	11.0	14.17
	VHT80 Beam Forming, M0 to M9 1ss	4	12	-10.2	-10.8	-10.6	-11.1	0.2	-4.4	5.0	9.43
	VHT80 Beam Forming, M0 to M9 2ss	4	9	-9.4	-9.8	-9.4	-10.2	0.2	-3.5	8.0	11.45
	VHT80 Beam Forming, M0 to M9 3ss	4	7	-8.2	-8.4	-7.9	-9.0	0.2	-2.1	10.0	12.12
	VHT80 Beam Forming, M0 to M9 4ss	4	6	-8.2	-8.4	-7.9	-9.0	0.2	-2.1	11.0	13.12
	VHT80 STBC, M0 to M9 1ss	2	6	-7.6	-7.4			0.2	-4.3	11.0	15.27
	VHT80 STBC, M0 to M9 1ss	3	6	-8.2	-8.4	-7.9		0.2	-3.2	11.0	14.17
	VHT80 STBC, M0 to M9 1ss	4	6	-8.2	-8.4	-7.9	-9.0	0.2	-2.1	11.0	13.12
	HE80, M0 to M9 1ss	1	6	-8.8				0.3	-8.5	11.0	19.54
	HE80, M0 to M9 1ss	2	9	-8.8	-8.4			0.3	-5.3	8.0	13.33
	HE80, M0 to M9 2ss	2	6	-8.8	-8.4			0.3	-5.3	11.0	16.33
	HE80, M0 to M9 1ss	3	11	-8.8	-8.4	-8.2		0.3	-3.4	6.0	9.43
	HE80, M0 to M9 2ss	3	8	-8.8	-8.4	-8.2		0.3	-3.4	9.0	12.43
	HE80, M0 to M9 3ss	3	6	-8.8	-8.4	-8.2		0.3	-3.4	11.0	14.43
	HE80, M0 to M9 1ss	4	12	-8.8	-8.4	-8.2	-9.0	0.3	-2.3	5.0	7.31
	HE80, M0 to M9 2ss	4	9	-8.8	-8.4	-8.2	-9.0	0.3	-2.3	8.0	10.31
	HE80, M0 to M9 3ss	4	7	-8.8	-8.4	-8.2	-9.0	0.3	-2.3	10.0	12.31
	HE80, M0 to M9 4ss	4	6	-8.8	-8.4	-8.2	-9.0	0.3	-2.3	11.0	13.31
	HE80 Beam Forming, M0 to M9 1ss	2	9	-9.0	-9.2			0.3	-5.8	8.0	13.83
	HE80 Beam Forming, M0 to M9 2ss	2	6	-8.8	-8.4			0.3	-5.3	11.0	16.33
	HE80 Beam Forming, M0 to M9 1ss	3	11	-10.0	-10.8	-10.5		0.3	-5.4	6.0	11.39
	HE80 Beam Forming, M0 to M9 2ss	3	8	-9.0	-9.2	-9.4		0.3	-4.2	9.0	13.17
	HE80 Beam Forming, M0 to M9 3ss	3	6	-8.8	-8.4	-8.2		0.3	-3.4	11.0	14.43
	HE80 Beam Forming, M0 to M9 1ss	4	12	-11.0	-11.5	-11.4	-12.3	0.3	-5.2	5.0	10.24
	HE80 Beam Forming, M0 to M9 2ss	4	9	-9.0	-9.2	-9.4	-10.5	0.3	-3.2	8.0	11.21
	HE80 Beam Forming, M0 to M9 3ss	4	7	-9.0	-9.2	-9.4	-10.5	0.3	-3.2	10.0	13.21
	HE80 Beam Forming, M0 to M9 4ss	4	6	-8.8	-8.4	-8.2	-9.0	0.3	-2.3	11.0	13.31
	HE80 STBC, M0 to M9 1ss	2	6	-8.8	-8.4			0.3	-5.3	11.0	16.33
	HE80 STBC, M0 to M9 1ss	3	6	-8.8	-8.4	-8.2		0.3	-3.4	11.0	14.43
	HE80 STBC, M0 to M9 1ss	4	6	-8.8	-8.4	-8.2	-9.0	0.3	-2.3	11.0	13.31
5300	Non HT20, 6 to 54 Mbps	1	6	0.2				0.0	0.2	11.0	10.76
	Non HT20, 6 to 54 Mbps	2	9	0.2	5.9			0.0	7.0	8.0	1.02
	Non HT20, 6 to 54 Mbps	3	11	0.2	1.0	0.6		0.0	5.4	6.0	0.57
	Non HT20, 6 to 54 Mbps	4	12	-1.3	-1.4	-1.7	-2.6	0.0	4.3	5.0	0.66
	Non HT20 Beam Forming, 6 to 54 Mbps	2	9	0.2	5.9			0.0	7.0	8.0	1.02
	Non HT20 Beam Forming, 6 to 54 Mbps	3	11	0.2	1.0	0.6		0.0	5.4	6.0	0.57



Non HT20 Beam Forming, 6 to 54 Mbps	4	12	-1.3	-1.4	-1.7	-2.6	0.0	4.3	5.0	0.66
HT/VHT20, M0 to M7	1	6	-0.2				0.1	-0.1	11.0	11.15
HT/VHT20, M0 to M7	2	9	-0.2	5.6			0.1	6.7	8.0	1.33
HT/VHT20, M8 to M15	2	6	-0.2	5.6			0.1	6.7	11.0	4.33
HT/VHT20, M0 to M7	3	11	-0.2	1.4	1.1		0.1	5.6	6.0	0.36
HT/VHT20, M8 to M15	3	8	-0.2	4.7	4.4		0.1	8.3	9.0	0.71
HT/VHT20, M16 to M23	3	6	-0.2	5.6	5.5		0.1	9.2	11.0	1.84
HT/VHT20, M0 to M7	4	12	-1.7	-1.3	-2.0	-3.0	0.1	4.1	5.0	0.88
HT/VHT20, M8 to M15	4	9	-0.2	2.4	2.5	1.5	0.1	7.7	8.0	0.25
HT/VHT20, M16 to M23	4	7	-0.2	4.7	4.4	3.6	0.1	9.6	10.0	0.43
HT/VHT20, M24 to M31	4	6	-0.2	5.6	5.5	4.9	0.1	10.6	11.0	0.45
HT/VHT20 Beam Forming, M0 to M7	2	9	-0.2	5.6			0.1	6.7	8.0	1.33
HT/VHT20 Beam Forming, M8 to M15	2	6	-0.2	5.6			0.1	6.7	11.0	4.33
HT/VHT20 Beam Forming, M0 to M7	3	11	-0.2	1.4	1.1		0.1	5.6	6.0	0.36
HT/VHT20 Beam Forming, M8 to M15	3	8	-0.2	4.7	4.4		0.1	8.3	9.0	0.71
HT/VHT20 Beam Forming, M16 to M23	3	6	-0.2	5.6	5.5		0.1	9.2	11.0	1.84
HT/VHT20 Beam Forming, M0 to M7	4	12	-1.7	-1.3	-2.0	-3.0	0.1	4.1	5.0	0.88
HT/VHT20 Beam Forming, M8 to M15	4	9	-0.2	2.4	2.5	1.5	0.1	7.7	8.0	0.25
HT/VHT20 Beam Forming, M16 to M23	4	7	-0.2	4.7	4.4	3.6	0.1	9.6	10.0	0.43
HT/VHT20 Beam Forming, M24 to M31	4	6	-0.2	5.6	5.5	4.9	0.1	10.6	11.0	0.45
HT/VHT20 STBC, M0 to M7	2	6	-0.2	5.6			0.1	6.7	11.0	4.33
HT/VHT20 STBC, M0 to M7	3	8	-0.2	4.7	4.4		0.1	8.3	9.0	0.71
HT/VHT20 STBC, M0 to M7	4	9	-0.2	2.4	2.5	1.5	0.1	7.7	8.0	0.25
HE20, M0 to M9 1ss	1	6	0.1				0.1	0.2	11.0	10.83
HE20, M0 to M9 1ss	2	9	0.1	5.8			0.1	6.9	8.0	1.09
HE20, M0 to M9 2ss	2	6	0.1	5.8			0.1	6.9	11.0	4.09
HE20, M0 to M9 1ss	3	11	0.1	1.4	1.2		0.1	5.8	6.0	0.22
HE20, M0 to M9 2ss	3	8	0.1	4.7	4.6		0.1	8.4	9.0	0.57
HE20, M0 to M9 3ss	3	6	0.1	5.8	5.5		0.1	9.3	11.0	1.70
HE20, M0 to M9 1ss	4	12	-1.8	-1.6	-2.1	-2.7	0.1	4.1	5.0	0.94
HE20, M0 to M9 2ss	4	9	0.1	2.6	2.7	1.7	0.1	8.0	8.0	0.02
HE20, M0 to M9 3ss	4	7	0.1	4.7	4.6	3.7	0.1	9.7	10.0	0.29
HE20, M0 to M9 4ss	4	6	0.1	5.8	5.5	5.0	0.1	10.7	11.0	0.31
HE20 Beam Forming, M0 to M9 1ss	2	9	0.1	5.8			0.1	6.9	8.0	1.09
HE20 Beam Forming, M0 to M9 2ss	2	6	0.1	5.8			0.1	6.9	11.0	4.09
HE20 Beam Forming, M0 to M9 1ss	3	11	0.1	1.4	1.2		0.1	5.8	6.0	0.22
HE20 Beam Forming, M0 to M9 2ss	3	8	0.1	4.7	4.6		0.1	8.4	9.0	0.57
HE20 Beam Forming, M0 to M9 3ss	3	6	0.1	5.8	5.5		0.1	9.3	11.0	1.70
HE20 Beam Forming, M0 to M9 1ss	4	12	-1.8	-1.6	-2.1	-2.7	0.1	4.1	5.0	0.94
HE20 Beam Forming, M0 to M9 2ss	4	9	0.1	2.6	2.7	1.7	0.1	8.0	8.0	0.02
HE20 Beam Forming, M0 to M9 3ss	4	7	0.1	4.7	4.6	3.7	0.1	9.7	10.0	0.29
HE20 Beam Forming, M0 to M9 4ss	4	6	0.1	5.8	5.5	5.0	0.1	10.7	11.0	0.31



	HE20 STBC, M0 to M9 2ss	2	6	0.1	5.8			0.1	6.9	11.0	4.09
	HE20 STBC, M0 to M9 2ss	3	8	0.1	4.7	4.6		0.1	8.4	9.0	0.57
	HE20 STBC, M0 to M9 2ss	4	9	0.1	2.6	2.7	1.7	0.1	8.0	8.0	0.02
5310	Non HT40, 6 to 54 Mbps	1	6	-3.8				0.0	-3.8	11.0	14.76
	Non HT40, 6 to 54 Mbps	2	9	-3.8	-3.5			0.0	-0.6	8.0	8.59
	Non HT40, 6 to 54 Mbps	3	11	-4.5	-4.5	-4.5		0.0	0.3	6.0	5.69
	Non HT40, 6 to 54 Mbps	4	12	-4.5	-4.5	-4.5	-5.2	0.0	1.4	5.0	3.60
	HT/VHT40, M0 to M7	1	6	-4.2				0.1	-4.1	11.0	15.10
	HT/VHT40, M0 to M7	2	9	-4.2	-4.3			0.1	-1.1	8.0	9.14
	HT/VHT40, M8 to M15	2	6	-4.2	-4.3			0.1	-1.1	11.0	12.14
	HT/VHT40, M0 to M7	3	11	-4.2	-4.3	-4.4		0.1	0.6	6.0	5.43
	HT/VHT40, M8 to M15	3	8	-4.2	-4.3	-4.4		0.1	0.6	9.0	8.43
	HT/VHT40, M16 to M23	3	6	-4.2	-4.3	-4.4		0.1	0.6	11.0	10.43
	HT/VHT40, M0 to M7	4	12	-4.2	-4.3	-4.4	-5.1	0.1	1.6	5.0	3.36
	HT/VHT40, M8 to M15	4	9	-4.2	-4.3	-4.4	-5.1	0.1	1.6	8.0	6.36
	HT/VHT40, M16 to M23	4	7	-4.2	-4.3	-4.4	-5.1	0.1	1.6	10.0	8.36
	HT/VHT40, M24 to M31	4	6	-4.2	-4.3	-4.4	-5.1	0.1	1.6	11.0	9.36
	HT/VHT40 Beam Forming, M0 to M7	2	9	-5.1	-4.8			0.1	-1.8	8.0	9.83
	HT/VHT40 Beam Forming, M8 to M15	2	6	-4.2	-4.3			0.1	-1.1	11.0	12.14
	HT/VHT40 Beam Forming, M0 to M7	3	11	-6.1	-6.3	-6.1		0.1	-1.3	6.0	7.29
	HT/VHT40 Beam Forming, M8 to M15	3	8	-5.1	-4.8	-4.9		0.1	-0.1	9.0	9.06
	HT/VHT40 Beam Forming, M16 to M23	3	6	-4.2	-4.3	-4.4		0.1	0.6	11.0	10.43
	HT/VHT40 Beam Forming, M0 to M7	4	12	-6.1	-6.3	-6.1	-7.0	0.1	-0.2	5.0	5.24
	HT/VHT40 Beam Forming, M8 to M15	4	9	-5.1	-4.8	-4.9	-5.9	0.1	1.0	8.0	7.03
	HT/VHT40 Beam Forming, M16 to M23	4	7	-5.1	-4.8	-4.9	-5.9	0.1	1.0	10.0	9.03
	HT/VHT40 Beam Forming, M24 to M31	4	6	-4.2	-4.3	-4.4	-5.1	0.1	1.6	11.0	9.36
	HT/VHT40 STBC, M0 to M7	2	6	-4.2	-4.3			0.1	-1.1	11.0	12.14
	HT/VHT40 STBC, M0 to M7	3	8	-4.2	-4.3	-4.4		0.1	0.6	9.0	8.43
	HT/VHT40 STBC, M0 to M7	4	9	-4.2	-4.3	-4.4	-5.1	0.1	1.6	8.0	6.36
	HE40, M0 to M9 1ss	1	6	-4.2				0.1	-4.1	11.0	15.07
	HE40, M0 to M9 1ss	2	9	-4.2	-3.9			0.1	-0.9	8.0	8.91
	HE40, M0 to M9 2ss	2	6	-4.2	-3.9			0.1	-0.9	11.0	11.91
	HE40, M0 to M9 1ss	3	11	-5.3	-4.7	-4.9		0.1	-0.1	6.0	6.06
	HE40, M0 to M9 2ss	3	8	-5.3	-4.7	-4.9		0.1	-0.1	9.0	9.06
	HE40, M0 to M9 3ss	3	6	-5.3	-4.7	-4.9		0.1	-0.1	11.0	11.06
	HE40, M0 to M9 1ss	4	12	-5.3	-4.7	-4.9	-5.6	0.1	1.0	5.0	3.96
	HE40, M0 to M9 2ss	4	9	-5.3	-4.7	-4.9	-5.6	0.1	1.0	8.0	6.96
HE40, M0 to M9 3ss	4	7	-5.3	-4.7	-4.9	-5.6	0.1	1.0	10.0	8.96	
HE40, M0 to M9 4ss	4	6	-5.3	-4.7	-4.9	-5.6	0.1	1.0	11.0	9.96	
HE40 Beam Forming, M0 to M9 1ss	2	9	-5.3	-4.7			0.1	-1.8	8.0	9.85	
HE40 Beam Forming, M0 to M9 2ss	2	6	-4.2	-3.9			0.1	-0.9	11.0	11.91	



	HE40 Beam Forming, M0 to M9 1ss	3	11	-6.2	-5.7	-6.3		0.1	-1.2	6.0	7.16	
	HE40 Beam Forming, M0 to M9 2ss	3	8	-5.3	-4.7	-4.9		0.1	-0.1	9.0	9.06	
	HE40 Beam Forming, M0 to M9 3ss	3	6	-5.3	-4.7	-4.9		0.1	-0.1	11.0	11.06	
	HE40 Beam Forming, M0 to M9 1ss	4	12	-6.9	-6.8	-7.0	-7.9	0.1	-1.0	5.0	5.98	
	HE40 Beam Forming, M0 to M9 2ss	4	9	-6.2	-5.7	-6.3	-6.9	0.1	-0.1	8.0	8.10	
	HE40 Beam Forming, M0 to M9 3ss	4	7	-5.3	-4.7	-4.9	-5.6	0.1	1.0	10.0	8.96	
	HE40 Beam Forming, M0 to M9 4ss	4	6	-5.3	-4.7	-4.9	-5.6	0.1	1.0	11.0	9.96	
	HE40 STBC, M0 to M9 2ss	2	6	-4.2	-3.9			0.1	-0.9	11.0	11.91	
	HE40 STBC, M0 to M9 2ss	3	8	-5.3	-4.7	-4.9		0.1	-0.1	9.0	9.06	
	HE40 STBC, M0 to M9 2ss	4	9	-5.3	-4.7	-4.9	-5.6	0.1	1.0	8.0	6.96	
5320	Non HT20, 6 to 54 Mbps	1	6	0.1				0.0	0.1	11.0	10.86	
	Non HT20, 6 to 54 Mbps	2	9	0.1	4.9			0.0	6.2	8.0	1.81	
	Non HT20, 6 to 54 Mbps	3	11	0.1	1.6	1.3		0.0	5.9	6.0	0.14	
	Non HT20, 6 to 54 Mbps	4	12	-1.6	-1.4	-1.8	-2.7	0.0	4.2	5.0	0.78	
	Non HT20 Beam Forming, 6 to 54 Mbps	2	9	0.1	3.9			0.0	5.5	8.0	2.54	
	Non HT20 Beam Forming, 6 to 54 Mbps	3	11	0.1	1.6	1.3		0.0	5.9	6.0	0.14	
	Non HT20 Beam Forming, 6 to 54 Mbps	4	12	-1.6	-1.4	-1.8	-2.7	0.0	4.2	5.0	0.78	
	HT/VHT20, M0 to M7	1	6	-0.4					0.1	-0.3	11.0	11.35
	HT/VHT20, M0 to M7	2	9	-0.4	4.4				0.1	5.7	8.0	2.31
	HT/VHT20, M8 to M15	2	6	-0.4	4.4				0.1	5.7	11.0	5.31
	HT/VHT20, M0 to M7	3	11	-0.4	1.3	1.4			0.1	5.7	6.0	0.33
	HT/VHT20, M8 to M15	3	8	-0.4	4.4	4.4			0.1	8.1	9.0	0.87
	HT/VHT20, M16 to M23	3	6	-0.4	4.4	4.4			0.1	8.1	11.0	2.87
	HT/VHT20, M0 to M7	4	12	-1.3	-0.5	-1.1	-2.1		0.1	4.9	5.0	0.14
	HT/VHT20, M8 to M15	4	9	-0.4	2.5	2.4	1.2		0.1	7.6	8.0	0.35
	HT/VHT20, M16 to M23	4	7	-0.4	3.5	3.1	2.3		0.1	8.4	10.0	1.56
	HT/VHT20, M24 to M31	4	6	-0.4	3.5	3.1	2.3		0.1	8.4	11.0	2.56
	HT/VHT20 Beam Forming, M0 to M7	2	9	-0.4	3.5				0.1	5.0	8.0	2.96
	HT/VHT20 Beam Forming, M8 to M15	2	6	-0.4	4.4				0.1	5.7	11.0	5.31
	HT/VHT20 Beam Forming, M0 to M7	3	11	-0.4	1.3	1.4			0.1	5.7	6.0	0.33
	HT/VHT20 Beam Forming, M8 to M15	3	8	-0.4	3.5	3.1			0.1	7.2	9.0	1.79
	HT/VHT20 Beam Forming, M16 to M23	3	6	-0.4	4.4	4.4			0.1	8.1	11.0	2.87
	HT/VHT20 Beam Forming, M0 to M7	4	12	-1.3	-0.5	-1.1	-2.1		0.1	4.9	5.0	0.14
	HT/VHT20 Beam Forming, M8 to M15	4	9	-0.4	2.5	2.4	1.2		0.1	7.6	8.0	0.35
	HT/VHT20 Beam Forming, M16 to M23	4	7	-0.4	3.5	3.1	2.3		0.1	8.4	10.0	1.56
	HT/VHT20 Beam Forming, M24 to M31	4	6	-0.4	3.5	3.1	2.3		0.1	8.4	11.0	2.56
	HT/VHT20 STBC, M0 to M7	2	6	-0.4	4.4				0.1	5.7	11.0	5.31
	HT/VHT20 STBC, M0 to M7	3	8	-0.4	4.4	4.4			0.1	8.1	9.0	0.87
	HT/VHT20 STBC, M0 to M7	4	9	-0.4	2.5	2.4	1.2		0.1	7.6	8.0	0.35
	HE20, M0 to M9 1ss	1	6	-0.4					0.1	-0.3	11.0	11.33
	HE20, M0 to M9 1ss	2	9	-0.4	4.5				0.1	5.8	8.0	2.21





	HE20, M0 to M9 2ss	2	6	-0.4	4.5			0.1	5.8	11.0	5.21
	HE20, M0 to M9 1ss	3	11	-0.4	1.4	1.0		0.1	5.6	6.0	0.43
	HE20, M0 to M9 2ss	3	8	-0.4	3.3	3.1		0.1	7.1	9.0	1.86
	HE20, M0 to M9 3ss	3	6	-0.4	3.3	3.1		0.1	7.1	11.0	3.86
	HE20, M0 to M9 1ss	4	12	-1.3	-0.7	-0.8	-2.2	0.1	4.9	5.0	0.12
	HE20, M0 to M9 2ss	4	9	-0.4	2.4	2.2	1.1	0.1	7.6	8.0	0.45
	HE20, M0 to M9 3ss	4	7	-0.4	3.3	3.1	2.0	0.1	8.3	10.0	1.68
	HE20, M0 to M9 4ss	4	6	-0.4	3.3	3.1	2.0	0.1	8.3	11.0	2.68
	HE20 Beam Forming, M0 to M9 1ss	2	9	-0.4	2.4			0.1	4.3	8.0	3.70
	HE20 Beam Forming, M0 to M9 2ss	2	6	-0.4	4.5			0.1	5.8	11.0	5.21
	HE20 Beam Forming, M0 to M9 1ss	3	11	-0.4	1.4	1.0		0.1	5.6	6.0	0.43
	HE20 Beam Forming, M0 to M9 2ss	3	8	-0.4	2.4	2.2		0.1	6.4	9.0	2.59
	HE20 Beam Forming, M0 to M9 3ss	3	6	-0.4	3.3	3.1		0.1	7.1	11.0	3.86
	HE20 Beam Forming, M0 to M9 1ss	4	12	-1.3	-0.7	-0.8	-2.2	0.1	4.9	5.0	0.12
	HE20 Beam Forming, M0 to M9 2ss	4	9	-0.4	1.4	1.0	0.1	0.1	6.7	8.0	1.33
	HE20 Beam Forming, M0 to M9 3ss	4	7	-0.4	2.4	2.2	1.1	0.1	7.6	10.0	2.45
	HE20 Beam Forming, M0 to M9 4ss	4	6	-0.4	3.3	3.1	2.0	0.1	8.3	11.0	2.68
	HE20 STBC, M0 to M9 2ss	2	6	-0.4	4.5			0.1	5.8	11.0	5.21
	HE20 STBC, M0 to M9 2ss	3	8	-0.4	3.3	3.1		0.1	7.1	9.0	1.86
	HE20 STBC, M0 to M9 2ss	4	9	-0.4	2.4	2.2	1.1	0.1	7.6	8.0	0.45
5250	Non HT160, 6 to 54 Mbps	1	6	-11.8				0.0	-11.8	11.0	22.75
	Non HT160, 6 to 54 Mbps	2	9	-11.8	-11.0			0.0	-8.3	8.0	16.32
	Non HT160, 6 to 54 Mbps	3	11	-11.8	-11.0	-12.6		0.0	-6.9	6.0	12.93
	Non HT160, 6 to 54 Mbps	4	12	-11.8	-11.0	-12.6	-13.3	0.0	-6.0	5.0	11.02
	VHT160, M0 to M9 1ss	1	6	-10.9				0.4	-10.5	11.0	21.51
	VHT160, M0 to M9 1ss	2	9	-10.9	-11.4			0.4	-7.7	8.0	15.74
	VHT160, M0 to M9 2ss	2	6	-10.9	-11.4			0.4	-7.7	11.0	18.74
	VHT160, M0 to M9 1ss	3	11	-10.9	-11.4	-11.8		0.4	-6.2	6.0	12.19
	VHT160, M0 to M9 2ss	3	8	-10.9	-11.4	-11.8		0.4	-6.2	9.0	15.19
	VHT160, M0 to M9 3ss	3	6	-10.9	-11.4	-11.8		0.4	-6.2	11.0	17.19
	VHT160, M0 to M9 1ss	4	12	-12.2	-12.2	-12.8	-13.0	0.4	-6.1	5.0	11.12
	VHT160, M0 to M9 2ss	4	9	-12.2	-12.2	-12.8	-13.0	0.4	-6.1	8.0	14.12
	VHT160, M0 to M9 3ss	4	7	-12.2	-12.2	-12.8	-13.0	0.4	-6.1	10.0	16.12
	VHT160, M0 to M9 4ss	4	6	-12.2	-12.2	-12.8	-13.0	0.4	-6.1	11.0	17.12
	VHT160 Beam Forming, M0 to M9 1ss	2	9	-12.8	-13.2			0.4	-9.6	8.0	17.59
	VHT160 Beam Forming, M0 to M9 2ss	2	6	-10.9	-11.4			0.4	-7.7	11.0	18.74
	VHT160 Beam Forming, M0 to M9 1ss	3	11	-13.5	-14.1	-14.8		0.4	-8.9	6.0	14.94
	VHT160 Beam Forming, M0 to M9 2ss	3	8	-12.2	-12.2	-12.8		0.4	-7.2	9.0	16.23
	VHT160 Beam Forming, M0 to M9 3ss	3	6	-10.9	-11.4	-11.8		0.4	-6.2	11.0	17.19
	VHT160 Beam Forming, M0 to M9 1ss	4	12	-13.5	-14.1	-14.8	-14.9	0.4	-7.9	5.0	12.87
VHT160 Beam Forming, M0 to M9 2ss	4	9	-12.8	-13.2	-13.8	-14.3	0.4	-7.1	8.0	15.08	





VHT160 Beam Forming, M0 to M9 3ss	4	7	-12.2	-12.2	-12.8	-13.0	0.4	-6.1	10.0	16.12
VHT160 Beam Forming, M0 to M9 4ss	4	6	-12.2	-12.2	-12.8	-13.0	0.4	-6.1	11.0	17.12
VHT160 STBC, M0 to M9 1ss	2	6	-10.9	-11.4			0.4	-7.7	11.0	18.74
VHT160 STBC, M0 to M9 1ss	3	6	-10.9	-11.4	-11.8		0.4	-6.2	11.0	17.19
VHT160 STBC, M0 to M9 1ss	4	6	-12.2	-12.2	-12.8	-13.0	0.4	-6.1	11.0	17.12
HE160, M0 to M9 1ss	1	6	-10.3				0.4	-9.9	11.0	20.87
HE160, M0 to M9 1ss	2	9	-10.3	-11.0			0.4	-7.2	8.0	15.19
HE160, M0 to M9 2ss	2	6	-10.3	-11.0			0.4	-7.2	11.0	18.19
HE160, M0 to M9 1ss	3	11	-10.3	-11.0	-11.2		0.4	-5.6	6.0	11.61
HE160, M0 to M9 2ss	3	8	-10.3	-11.0	-11.2		0.4	-5.6	9.0	14.61
HE160, M0 to M9 3ss	3	6	-10.3	-11.0	-11.2		0.4	-5.6	11.0	16.61
HE160, M0 to M9 1ss	4	12	-10.3	-11.0	-11.2	-11.8	0.4	-4.6	5.0	9.59
HE160, M0 to M9 2ss	4	9	-10.3	-11.0	-11.2	-11.8	0.4	-4.6	8.0	12.59
HE160, M0 to M9 3ss	4	7	-10.3	-11.0	-11.2	-11.8	0.4	-4.6	10.0	14.59
HE160, M0 to M9 4ss	4	6	-10.3	-11.0	-11.2	-11.8	0.4	-4.6	11.0	15.59
HE160 Beam Forming, M0 to M9 1ss	2	9	-11.6	-12.1			0.4	-8.4	8.0	16.40
HE160 Beam Forming, M0 to M9 2ss	2	6	-10.3	-11.0			0.4	-7.2	11.0	18.19
HE160 Beam Forming, M0 to M9 1ss	3	11	-12.6	-13.4	-13.6		0.4	-8.0	6.0	13.97
HE160 Beam Forming, M0 to M9 2ss	3	8	-11.6	-12.1	-12.2		0.4	-6.8	9.0	15.75
HE160 Beam Forming, M0 to M9 3ss	3	6	-10.3	-11.0	-11.2		0.4	-5.6	11.0	16.61
HE160 Beam Forming, M0 to M9 1ss	4	12	-13.5	-13.9	-14.3	-14.8	0.4	-7.6	5.0	12.64
HE160 Beam Forming, M0 to M9 2ss	4	9	-11.6	-12.1	-12.2	-12.8	0.4	-5.7	8.0	13.70
HE160 Beam Forming, M0 to M9 3ss	4	7	-11.6	-12.1	-12.2	-12.8	0.4	-5.7	10.0	15.70
HE160 Beam Forming, M0 to M9 4ss	4	6	-10.3	-11.0	-11.2	-11.8	0.4	-4.6	11.0	15.59
HE160 STBC, M0 to M9 1ss	2	6	-10.3	-11.0			0.4	-7.2	11.0	18.19
HE160 STBC, M0 to M9 1ss	3	6	-10.3	-11.0	-11.2		0.4	-5.6	11.0	16.61
HE160 STBC, M0 to M9 1ss	4	6	-10.3	-11.0	-11.2	-11.8	0.4	-4.6	11.0	15.59



**Power Spectral Density, 6dBi  
5260 MHz, HE20, M0 to M9 3ss**

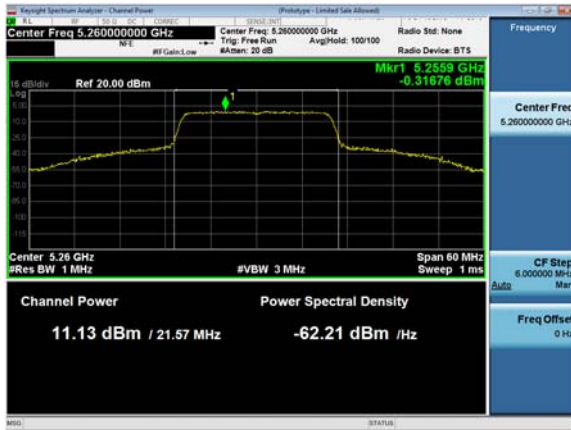

**Antenna A**

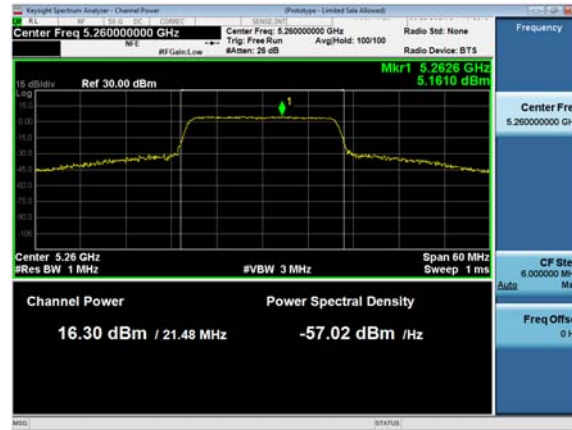

**Antenna B**

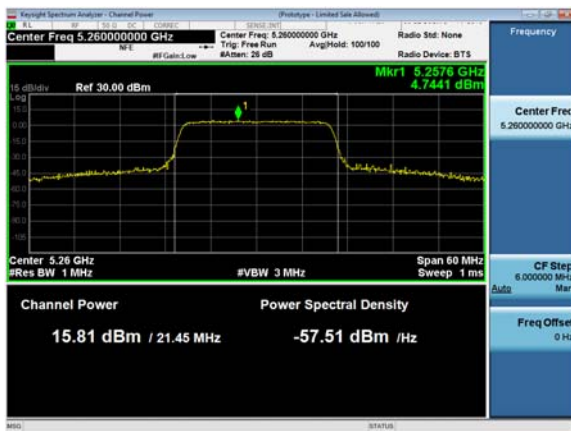

**Antenna C**

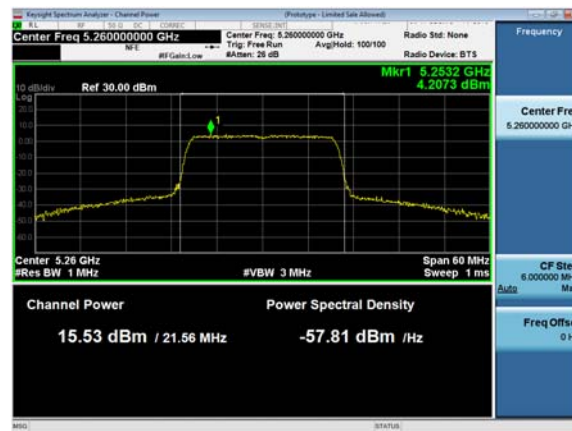

**Antenna D**



## A.5 Conducted Spurious Emissions

### Conducted Spurious Emissions Test Requirement

**15.407(b) Undesirable emission limits.** Except as shown in paragraph (b)(7) of this section, the maximum emissions outside of the frequency bands of operation shall be attenuated in accordance with the following limits:

- (2) For transmitters operating in the 5.25-5.35 GHz band: All emissions outside of the 5.15-5.35 GHz band shall not exceed an e.i.r.p. of -27 dBm/MHz.
- (6) Unwanted emissions below 1 GHz must comply with the general field strength limits set forth in §15.209.
- (7) The provisions of §15.205 apply to intentional radiators operating under this section.

Use formula below to substitute conducted measurements in place of radiated measurements

$$E[\text{dB}\mu\text{V/m}] = \text{EIRP}[\text{dBm}] - 20 \log(d[\text{meters}]) + 104.77, \text{ where } E = \text{field strength and } d = 3 \text{ meter}$$

- 1) Average Plot, Limit= -41.25 dBm eirp
- 2) Peak plot, Limit = -21.25 dBm eirp

### Conducted Spurious Emissions Test Procedure

**KDB 789033 D02 General UNII Test Procedures New Rules v02r01**

**Ref. ANSI C63.10: 2013**

<b>Conducted Spurious Emissions</b>
Test Procedure
<ol style="list-style-type: none"> <li>1. Connect the antenna port(s) to the spectrum analyzer input.</li> <li>2. Place the radio in continuous transmit mode</li> <li>3. Configure Spectrum analyzer as per test parameters below (be sure to enter all losses between the transmitter output and the spectrum analyzer).</li> <li>4. Use the peak marker function to determine the maximum spurs amplitude level.</li> <li>5. The “measure-and-sum technique” is used for measuring in-band transmit power of a device. In the measure-and-sum approach, the conducted emission level is measured at each antenna port. The measured results at the various antenna ports are then summed mathematically to determine the total emission level from the device. Summing is performed in linear power units. The worst case output is recorded. (see ANSI C63.10:2013 section 14.3.2.2)</li> <li>6. Capture graphs and record pertinent measurement data.</li> </ol>

**Ref. ANSI C63.10: 2013 section 12.7.6 (Peak) and 12.7.7.2 (Average)**

**KDB 789033 D02 General UNII Test Procedures New Rules v02r01, Sec. 5 (Peak), Sec. 6 (Average Method AD)**

<b>Conducted Spurious Emissions</b>	
Test parameters	
<b>Peak</b>	<b>Average</b>
RBW = 1 MHz	RBW = 1 MHz
VBW ≥ 3 MHz	VBW ≥ 3 MHz
Sweep = Auto	Sweep = Auto



Detector = Peak Trace = Max Hold.	Detector = RMS Power Averaging
--------------------------------------	-----------------------------------

Add the max antenna gain + ground reflection factor (4.7 dB for frequencies between 30 MHz and 1000 MHz, and 0 dB for frequencies > 1000 MHz).

**Samples, Systems, and Modes**

System Number	Description	Samples	System under test	Support equipment
1	EUT	S01+S02	<input checked="" type="checkbox"/>	<input type="checkbox"/>
	Support		<input type="checkbox"/>	<input checked="" type="checkbox"/>

<b>Tested By :</b> Chris Blair	<b>Date of testing:</b> 11-Sep-19 - 25-Sep-19
<b>Test Result : PASS</b>	

**Test Equipment**

See Appendix C for list of test equipment



**Conducted Spurs Average Upper, 5260 MHz, Non HT20, 6 to 54 Mbps**



**Conducted Spurs Peak Upper, 5260 MHz, Non HT20, 6 to 54 Mbps**

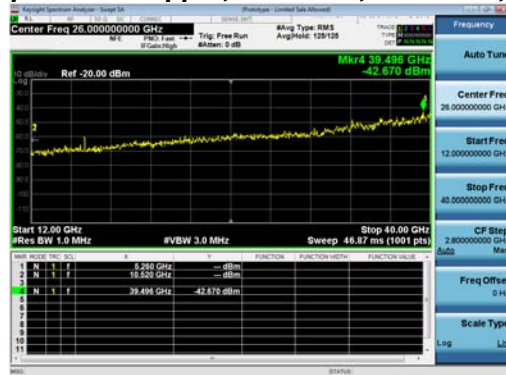

Conducted Spurious Emissions Average Table, 4dB



Frequency (MHz)	Mode	Tx Paths	Correlated Antenna Gain (dBi)	Tx 1 Spur Power (dBm)	Tx 2 Spur Power (dBm)	Tx 3 Spur Power (dBm)	Tx 4 Spur Power (dBm)	Duty Cycle Correction (dB)	Total Conducted Spur (dBm)	Limit (dBm)	Margin (dB)
5260	Non HT20, 6 to 54 Mbps	1	4	-64.9				0.0	-60.9	-41.25	19.61
	Non HT20, 6 to 54 Mbps	2	4	-64.9	-56.0			0.0	-51.4	-41.25	10.18
	Non HT20, 6 to 54 Mbps	3	4	-64.9	-57.4	-58.4		0.0	-50.4	-41.25	9.16
	Non HT20, 6 to 54 Mbps	4	4	-64.9	-59.3	-60.7	-63.1	0.0	-51.4	-41.25	10.17
	Non HT20 Beam Forming, 6 to 54 Mbps	2	7	-64.9	-56.0			0.0	-48.4	-41.25	7.18
	Non HT20 Beam Forming, 6 to 54 Mbps	3	9	-64.9	-57.4	-58.4		0.0	-45.4	-41.25	4.16
	Non HT20 Beam Forming, 6 to 54 Mbps	4	10	-64.9	-59.3	-60.7	-63.1	0.0	-45.4	-41.25	4.17
	HT/VHT20, M0 to M7	1	4	-65.4				0.1	-61.3	-41.25	20.10
	HT/VHT20, M0 to M7	2	4	-65.4	-55.9			0.1	-51.4	-41.25	10.14
	HT/VHT20, M8 to M15	2	4	-65.4	-55.9			0.1	-51.4	-41.25	10.14
	HT/VHT20, M0 to M7	3	4	-65.4	-57.4	-58.8		0.1	-50.6	-41.25	9.35
	HT/VHT20, M8 to M15	3	4	-65.4	-55.9	-56.6		0.1	-48.9	-41.25	7.67
	HT/VHT20, M16 to M23	3	4	-65.4	-55.9	-56.6		0.1	-48.9	-41.25	7.67
	HT/VHT20, M0 to M7	4	4	-65.4	-58.9	-60.2	-62.9	0.1	-51.1	-41.25	9.86
	HT/VHT20, M8 to M15	4	4	-65.4	-56.9	-57.7	-60.3	0.1	-49.0	-41.25	7.74
	HT/VHT20, M16 to M23	4	4	-65.4	-55.9	-56.6	-59.2	0.1	-48.0	-41.25	6.74
	HT/VHT20, M24 to M31	4	4	-65.4	-55.9	-56.6	-59.2	0.1	-48.0	-41.25	6.74
	HT/VHT20 Beam Forming, M0 to M7	2	7	-65.4	-55.9			0.1	-48.4	-41.25	7.14
	HT/VHT20 Beam Forming, M8 to M15	2	4	-65.4	-55.9			0.1	-51.4	-41.25	10.14
	HT/VHT20 Beam Forming, M0 to M7	3	9	-65.4	-57.4	-58.8		0.1	-45.6	-41.25	4.35
	HT/VHT20 Beam Forming, M8 to M15	3	6	-65.4	-55.9	-56.6		0.1	-46.9	-41.25	5.67
	HT/VHT20 Beam Forming, M16 to M23	3	4	-65.4	-55.9	-56.6		0.1	-48.9	-41.25	7.67
	HT/VHT20 Beam Forming, M0 to M7	4	10	-65.4	-58.9	-60.2	-62.9	0.1	-45.1	-41.25	3.86
	HT/VHT20 Beam Forming, M8 to M15	4	7	-65.4	-56.9	-57.7	-60.3	0.1	-46.0	-41.25	4.74
	HT/VHT20 Beam Forming, M16 to M23	4	5	-65.4	-55.9	-56.6	-59.2	0.1	-47.0	-41.25	5.74
	HT/VHT20 Beam Forming, M24 to M31	4	4	-65.4	-55.9	-56.6	-59.2	0.1	-48.0	-41.25	6.74
	HT/VHT20 STBC, M0 to M7	2	4	-65.4	-55.9			0.1	-51.4	-41.25	10.14
	HT/VHT20 STBC, M0 to M7	3	4	-65.4	-55.9	-56.6		0.1	-48.9	-41.25	7.67
	HT/VHT20 STBC, M0 to M7	4	4	-65.4	-56.9	-57.7	-60.3	0.1	-49.0	-41.25	7.74



HE20, M0 to M9 1ss	1	4	-65.0				0.1	-60.9	-41.25	19.68
HE20, M0 to M9 1ss	2	4	-65.0	-55.8			0.1	-51.2	-41.25	9.99
HE20, M0 to M9 2ss	2	4	-65.0	-55.8			0.1	-51.2	-41.25	9.99
HE20, M0 to M9 1ss	3	4	-65.0	-57.4	-58.7		0.1	-50.5	-41.25	9.26
HE20, M0 to M9 2ss	3	4	-65.0	-55.8	-56.7		0.1	-48.9	-41.25	7.62
HE20, M0 to M9 3ss	3	4	-65.0	-55.8	-56.7		0.1	-48.9	-41.25	7.62
HE20, M0 to M9 1ss	4	4	-65.0	-59.7	-61.2	-63.1	0.1	-51.7	-41.25	10.47
HE20, M0 to M9 2ss	4	4	-65.0	-56.8	-57.4	-60.0	0.1	-48.7	-41.25	7.50
HE20, M0 to M9 3ss	4	4	-65.0	-55.8	-56.7	-59.1	0.1	-47.9	-41.25	6.68
HE20, M0 to M9 4ss	4	4	-65.0	-55.8	-56.7	-59.1	0.1	-47.9	-41.25	6.68
HE20 Beam Forming, M0 to M9 1ss	2	7	-65.0	-55.8			0.1	-48.2	-41.25	6.99
HE20 Beam Forming, M0 to M9 2ss	2	4	-65.0	-55.8			0.1	-51.2	-41.25	9.99
HE20 Beam Forming, M0 to M9 1ss	3	9	-65.0	-57.4	-58.7		0.1	-45.5	-41.25	4.26
HE20 Beam Forming, M0 to M9 2ss	3	6	-65.0	-55.8	-56.7		0.1	-46.9	-41.25	5.62
HE20 Beam Forming, M0 to M9 3ss	3	4	-65.0	-55.8	-56.7		0.1	-48.9	-41.25	7.62
HE20 Beam Forming, M0 to M9 1ss	4	10	-65.0	-59.7	-61.2	-63.1	0.1	-45.7	-41.25	4.47
HE20 Beam Forming, M0 to M9 2ss	4	7	-65.0	-56.8	-57.4	-60.0	0.1	-45.7	-41.25	4.50
HE20 Beam Forming, M0 to M9 3ss	4	5	-65.0	-55.8	-56.7	-59.1	0.1	-46.9	-41.25	5.68
HE20 Beam Forming, M0 to M9 4ss	4	4	-65.0	-55.8	-56.7	-59.1	0.1	-47.9	-41.25	6.68
HE20 STBC, M0 to M9 2ss	2	4	-65.0	-55.8			0.1	-51.2	-41.25	9.99
HE20 STBC, M0 to M9 2ss	3	4	-65.0	-55.8	-56.7		0.1	-48.9	-41.25	7.62
HE20 STBC, M0 to M9 2ss	4	4	-65.0	-56.8	-57.4	-60.0	0.1	-48.7	-41.25	7.50
5270										
Non HT40, 6 to 54 Mbps	1	4	-65.2				0.0	-61.2	-41.25	19.91
Non HT40, 6 to 54 Mbps	2	4	-65.2	-56.3			0.0	-51.7	-41.25	10.48
Non HT40, 6 to 54 Mbps	3	4	-65.2	-56.3	-56.7		0.0	-49.2	-41.25	7.91
Non HT40, 6 to 54 Mbps	4	4	-65.2	-57.1	-57.4	-59.9	0.0	-48.9	-41.25	7.64
HT/VHT40, M0 to M7	1	4	-65.6				0.1	-61.5	-41.25	20.25
HT/VHT40, M0 to M7	2	4	-65.6	-56.8			0.1	-52.2	-41.25	10.91
HT/VHT40, M8 to M15	2	4	-65.6	-56.8			0.1	-52.2	-41.25	10.91
HT/VHT40, M0 to M7	3	4	-65.6	-56.8	-57.0		0.1	-49.5	-41.25	8.25
HT/VHT40, M8 to M15	3	4	-65.6	-56.8	-57.0		0.1	-49.5	-41.25	8.25
HT/VHT40, M16 to M23	3	4	-65.6	-56.8	-57.0		0.1	-49.5	-41.25	8.25
HT/VHT40, M0 to M7	4	4	-65.6	-57.2	-57.9	-60.1	0.1	-49.1	-41.25	7.85
HT/VHT40, M8 to M15	4	4	-65.6	-56.8	-57.0	-59.6	0.1	-48.5	-41.25	7.28
HT/VHT40, M16 to M23	4	4	-65.6	-56.8	-57.0	-59.6	0.1	-48.5	-41.25	7.28
HT/VHT40, M24 to M31	4	4	-65.6	-56.8	-57.0	-59.6	0.1	-48.5	-41.25	7.28
HT/VHT40 Beam Forming, M0 to M7	2	7	-65.6	-56.8			0.1	-49.2	-41.25	7.91
HT/VHT40 Beam Forming, M8 to M15	2	4	-65.6	-56.8			0.1	-52.2	-41.25	10.91
HT/VHT40 Beam Forming, M0 to M7	3	9	-65.6	-57.2	-57.9		0.1	-45.1	-41.25	3.85
HT/VHT40 Beam Forming, M8 to M15	3	6	-65.6	-56.8	-57.0		0.1	-47.5	-41.25	6.25
HT/VHT40 Beam Forming, M16 to M23	3	4	-65.6	-56.8	-57.0		0.1	-49.5	-41.25	8.25



	<b>HT/VHT40 Beam Forming, M0 to M7</b>	<b>4</b>	<b>10</b>	<b>-65.6</b>	<b>-58.7</b>	<b>-59.7</b>	<b>-61.9</b>	<b>0.1</b>	<b>-44.7</b>	<b>-41.25</b>	<b>3.41</b>
	HT/VHT40 Beam Forming, M8 to M15	4	7	-65.6	-56.8	-57.0	-59.6	0.1	-45.5	-41.25	4.28
	HT/VHT40 Beam Forming, M16 to M23	4	5	-65.6	-56.8	-57.0	-59.6	0.1	-47.5	-41.25	6.28
	HT/VHT40 Beam Forming, M24 to M31	4	4	-65.6	-56.8	-57.0	-59.6	0.1	-48.5	-41.25	7.28
	HT/VHT40 STBC, M0 to M7	2	4	-65.6	-56.8			0.1	-52.2	-41.25	10.91
	HT/VHT40 STBC, M0 to M7	3	4	-65.6	-56.8	-57.0		0.1	-49.5	-41.25	8.25
	HT/VHT40 STBC, M0 to M7	4	4	-65.6	-56.8	-57.0	-59.6	0.1	-48.5	-41.25	7.28
	HE40, M0 to M9 1ss	1	4	-65.7				0.1	-61.6	-41.25	20.32
	HE40, M0 to M9 1ss	2	4	-65.7	-56.5			0.1	-51.9	-41.25	10.63
	HE40, M0 to M9 2ss	2	4	-65.7	-56.5			0.1	-51.9	-41.25	10.63
	HE40, M0 to M9 1ss	3	4	-65.7	-56.5	-56.8		0.1	-49.2	-41.25	8.00
	HE40, M0 to M9 2ss	3	4	-65.7	-56.5	-56.8		0.1	-49.2	-41.25	8.00
	HE40, M0 to M9 3ss	3	4	-65.7	-56.5	-56.8		0.1	-49.2	-41.25	8.00
	HE40, M0 to M9 1ss	4	4	-65.7	-57.5	-57.9	-60.4	0.1	-49.3	-41.25	8.01
	HE40, M0 to M9 2ss	4	4	-65.7	-56.5	-56.8	-59.6	0.1	-48.3	-41.25	7.07
	HE40, M0 to M9 3ss	4	4	-65.7	-56.5	-56.8	-59.6	0.1	-48.3	-41.25	7.07
	HE40, M0 to M9 4ss	4	4	-65.7	-56.5	-56.8	-59.6	0.1	-48.3	-41.25	7.07
	HE40 Beam Forming, M0 to M9 1ss	2	7	-65.7	-56.5			0.1	-48.9	-41.25	7.63
	HE40 Beam Forming, M0 to M9 2ss	2	4	-65.7	-56.5			0.1	-51.9	-41.25	10.63
	HE40 Beam Forming, M0 to M9 1ss	3	9	-65.7	-57.5	-57.9		0.1	-45.2	-41.25	3.97
	HE40 Beam Forming, M0 to M9 2ss	3	6	-65.7	-56.5	-56.8		0.1	-47.2	-41.25	6.00
	HE40 Beam Forming, M0 to M9 3ss	3	4	-65.7	-56.5	-56.8		0.1	-49.2	-41.25	8.00
	HE40 Beam Forming, M0 to M9 1ss	4	10	-65.7	-59.1	-59.7	-62.1	0.1	-44.8	-41.25	3.59
	HE40 Beam Forming, M0 to M9 2ss	4	7	-65.7	-56.5	-56.8	-59.6	0.1	-45.3	-41.25	4.07
	HE40 Beam Forming, M0 to M9 3ss	4	5	-65.7	-56.5	-56.8	-59.6	0.1	-47.3	-41.25	6.07
	HE40 Beam Forming, M0 to M9 4ss	4	4	-65.7	-56.5	-56.8	-59.6	0.1	-48.3	-41.25	7.07
	HE40 STBC, M0 to M9 2ss	2	4	-65.7	-56.5			0.1	-51.9	-41.25	10.63
	HE40 STBC, M0 to M9 2ss	3	4	-65.7	-56.5	-56.8		0.1	-49.2	-41.25	8.00
	HE40 STBC, M0 to M9 2ss	4	4	-65.7	-56.5	-56.8	-59.6	0.1	-48.3	-41.25	7.07
5290	Non HT80, 6 to 54 Mbps	1	4	-66.0				0.1	-61.9	-41.25	20.70
	Non HT80, 6 to 54 Mbps	2	4	-66.0	-61.9			0.1	-56.4	-41.25	15.17
	Non HT80, 6 to 54 Mbps	3	4	-66.0	-61.9	-62.7		0.1	-54.4	-41.25	13.13
	Non HT80, 6 to 54 Mbps	4	4	-66.0	-61.9	-62.7	-65.3	0.1	-53.6	-41.25	12.32
	VHT80, M0 to M9 1ss	1	4	-65.8				0.2	-61.6	-41.25	20.33
	VHT80, M0 to M9 1ss	2	4	-65.8	-61.6			0.2	-56.0	-41.25	14.73
	VHT80, M0 to M9 2ss	2	4	-65.8	-61.6			0.2	-56.0	-41.25	14.73
	VHT80, M0 to M9 1ss	3	4	-65.8	-61.6	-62.6		0.2	-54.0	-41.25	12.76
	VHT80, M0 to M9 2ss	3	4	-65.8	-61.6	-62.6		0.2	-54.0	-41.25	12.76
	VHT80, M0 to M9 3ss	3	4	-65.8	-61.6	-62.6		0.2	-54.0	-41.25	12.76
	VHT80, M0 to M9 1ss	4	4	-65.8	-61.6	-62.6	-64.5	0.2	-53.1	-41.25	11.84
	VHT80, M0 to M9 2ss	4	4	-65.8	-61.6	-62.6	-64.5	0.2	-53.1	-41.25	11.84





VHT80, M0 to M9 3ss	4	4	-65.8	-61.6	-62.6	-64.5	0.2	-53.1	-41.25	11.84
VHT80, M0 to M9 4ss	4	4	-65.8	-61.6	-62.6	-64.5	0.2	-53.1	-41.25	11.84
VHT80 Beam Forming, M0 to M9 1ss	2	7	-66.5	-62.1			0.2	-53.5	-41.25	12.29
VHT80 Beam Forming, M0 to M9 2ss	2	4	-65.8	-61.6			0.2	-56.0	-41.25	14.73
VHT80 Beam Forming, M0 to M9 1ss	3	9	-67.2	-62.7	-64.1		0.2	-50.3	-41.25	9.06
VHT80 Beam Forming, M0 to M9 2ss	3	6	-66.5	-62.1	-63.2		0.2	-52.6	-41.25	11.33
VHT80 Beam Forming, M0 to M9 3ss	3	4	-65.8	-61.6	-62.6		0.2	-54.0	-41.25	12.76
VHT80 Beam Forming, M0 to M9 1ss	4	10	-67.2	-62.7	-64.1	-66.7	0.2	-48.5	-41.25	7.29
VHT80 Beam Forming, M0 to M9 2ss	4	7	-66.5	-62.1	-63.2	-65.8	0.2	-50.8	-41.25	9.54
VHT80 Beam Forming, M0 to M9 3ss	4	5	-65.8	-61.6	-62.6	-64.5	0.2	-52.1	-41.25	10.84
VHT80 Beam Forming, M0 to M9 4ss	4	4	-65.8	-61.6	-62.6	-64.5	0.2	-53.1	-41.25	11.84
VHT80 STBC, M0 to M9 1ss	2	4	-65.8	-61.6			0.2	-56.0	-41.25	14.73
VHT80 STBC, M0 to M9 1ss	3	4	-65.8	-61.6	-62.6		0.2	-54.0	-41.25	12.76
VHT80 STBC, M0 to M9 1ss	4	4	-65.8	-61.6	-62.6	-64.5	0.2	-53.1	-41.25	11.84
HE80, M0 to M9 1ss	1	4	-65.9				0.3	-61.6	-41.25	20.39
HE80, M0 to M9 1ss	2	4	-65.9	-62.0			0.3	-56.3	-41.25	15.01
HE80, M0 to M9 2ss	2	4	-65.9	-62.0			0.3	-56.3	-41.25	15.01
HE80, M0 to M9 1ss	3	4	-65.9	-62.0	-63.1		0.3	-54.3	-41.25	13.10
HE80, M0 to M9 2ss	3	4	-65.9	-62.0	-63.1		0.3	-54.3	-41.25	13.10
HE80, M0 to M9 3ss	3	4	-65.9	-62.0	-63.1		0.3	-54.3	-41.25	13.10
HE80, M0 to M9 1ss	4	4	-65.9	-62.0	-63.1	-64.5	0.3	-53.4	-41.25	12.10
HE80, M0 to M9 2ss	4	4	-65.9	-62.0	-63.1	-64.5	0.3	-53.4	-41.25	12.10
HE80, M0 to M9 3ss	4	4	-65.9	-62.0	-63.1	-64.5	0.3	-53.4	-41.25	12.10
HE80, M0 to M9 4ss	4	4	-65.9	-62.0	-63.1	-64.5	0.3	-53.4	-41.25	12.10
HE80 Beam Forming, M0 to M9 1ss	2	7	-66.6	-62.3			0.3	-53.7	-41.25	12.42
HE80 Beam Forming, M0 to M9 2ss	2	4	-65.9	-62.0			0.3	-56.3	-41.25	15.01
HE80 Beam Forming, M0 to M9 1ss	3	9	-67.1	-63.0	-64.2		0.3	-50.4	-41.25	9.17
HE80 Beam Forming, M0 to M9 2ss	3	6	-66.6	-62.3	-63.1		0.3	-52.6	-41.25	11.36
HE80 Beam Forming, M0 to M9 3ss	3	4	-65.9	-62.0	-63.1		0.3	-54.3	-41.25	13.10
HE80 Beam Forming, M0 to M9 1ss	4	10	-68.5	-63.6	-64.6	-67.2	0.3	-49.3	-41.25	8.02
HE80 Beam Forming, M0 to M9 2ss	4	7	-67.1	-63.0	-64.2	-66.6	0.3	-51.6	-41.25	10.37
HE80 Beam Forming, M0 to M9 3ss	4	5	-66.6	-62.3	-63.1	-66.1	0.3	-52.9	-41.25	11.61
HE80 Beam Forming, M0 to M9 4ss	4	4	-65.9	-62.0	-63.1	-64.5	0.3	-53.4	-41.25	12.10
HE80 STBC, M0 to M9 1ss	2	4	-65.9	-62.0			0.3	-56.3	-41.25	15.01
HE80 STBC, M0 to M9 1ss	3	4	-65.9	-62.0	-63.1		0.3	-54.3	-41.25	13.10
HE80 STBC, M0 to M9 1ss	4	4	-65.9	-62.0	-63.1	-64.5	0.3	-53.4	-41.25	12.10

30 Non HT20, 6 to 54 Mbps	1	4	-65.1				0.0	-61.1	-41.25	19.81
---------------------------	---	---	-------	--	--	--	-----	-------	--------	-------



Non HT20, 6 to 54 Mbps	2	4	-65.1	-56.2			0.0	-51.6	-41.25	10.38
Non HT20, 6 to 54 Mbps	3	4	-65.1	-58.0	-59.2		0.0	-51.0	-41.25	9.80
Non HT20, 6 to 54 Mbps	4	4	-65.1	-60.0	-61.0	-63.8	0.0	-51.9	-41.25	10.69
Non HT20 Beam Forming, 6 to 54 Mbps	2	7	-65.1	-56.2			0.0	-48.6	-41.25	7.38
Non HT20 Beam Forming, 6 to 54 Mbps	3	9	-65.1	-58.0	-59.2		0.0	-46.0	-41.25	4.80
Non HT20 Beam Forming, 6 to 54 Mbps	4	10	-65.1	-60.0	-61.0	-63.8	0.0	-45.9	-41.25	4.69
HT/VHT20, M0 to M7	1	4	-65.0				0.1	-60.9	-41.25	19.70
HT/VHT20, M0 to M7	2	4	-65.0	-56.7			0.1	-52.0	-41.25	10.80
HT/VHT20, M8 to M15	2	4	-65.0	-56.7			0.1	-52.0	-41.25	10.80
HT/VHT20, M0 to M7	3	4	-65.0	-57.7	-59.3		0.1	-50.9	-41.25	9.66
HT/VHT20, M8 to M15	3	4	-65.0	-56.7	-57.1		0.1	-49.5	-41.25	8.26
HT/VHT20, M16 to M23	3	4	-65.0	-56.7	-57.1		0.1	-49.5	-41.25	8.26
HT/VHT20, M0 to M7	4	4	-65.0	-59.1	-60.6	-63.0	0.1	-51.3	-41.25	10.05
HT/VHT20, M8 to M15	4	4	-65.0	-57.3	-58.5	-61.0	0.1	-49.5	-41.25	8.28
HT/VHT20, M16 to M23	4	4	-65.0	-56.7	-57.1	-60.1	0.1	-48.6	-41.25	7.39
HT/VHT20, M24 to M31	4	4	-65.0	-56.7	-57.1	-60.1	0.1	-48.6	-41.25	7.39
HT/VHT20 Beam Forming, M0 to M7	2	7	-65.0	-56.7			0.1	-49.0	-41.25	7.80
HT/VHT20 Beam Forming, M8 to M15	2	4	-65.0	-56.7			0.1	-52.0	-41.25	10.80
HT/VHT20 Beam Forming, M0 to M7	3	9	-65.0	-57.7	-59.3		0.1	-45.9	-41.25	4.66
HT/VHT20 Beam Forming, M8 to M15	3	6	-65.0	-56.7	-57.1		0.1	-47.5	-41.25	6.26
HT/VHT20 Beam Forming, M16 to M23	3	4	-65.0	-56.7	-57.1		0.1	-49.5	-41.25	8.26
HT/VHT20 Beam Forming, M0 to M7	4	10	-65.0	-59.1	-60.6	-63.0	0.1	-45.3	-41.25	4.05
HT/VHT20 Beam Forming, M8 to M15	4	7	-65.0	-57.3	-58.5	-61.0	0.1	-46.5	-41.25	5.28
HT/VHT20 Beam Forming, M16 to M23	4	5	-65.0	-56.7	-57.1	-60.1	0.1	-47.6	-41.25	6.39
HT/VHT20 Beam Forming, M24 to M31	4	4	-65.0	-56.7	-57.1	-60.1	0.1	-48.6	-41.25	7.39
HT/VHT20 STBC, M0 to M7	2	4	-65.0	-56.7			0.1	-52.0	-41.25	10.80
HT/VHT20 STBC, M0 to M7	3	4	-65.0	-56.7	-57.1		0.1	-49.5	-41.25	8.26
HT/VHT20 STBC, M0 to M7	4	4	-65.0	-57.3	-58.5	-61.0	0.1	-49.5	-41.25	8.28
HE20, M0 to M9 1ss	1	4	-65.2				0.1	-61.1	-41.25	19.88
HE20, M0 to M9 1ss	2	4	-65.2	-56.2			0.1	-51.6	-41.25	10.36
HE20, M0 to M9 2ss	2	4	-65.2	-56.2			0.1	-51.6	-41.25	10.36
HE20, M0 to M9 1ss	3	4	-65.2	-58.0	-59.1		0.1	-51.0	-41.25	9.74
HE20, M0 to M9 2ss	3	4	-65.2	-56.2	-57.1		0.1	-49.3	-41.25	8.00
HE20, M0 to M9 3ss	3	4	-65.2	-56.2	-57.1		0.1	-49.3	-41.25	8.00
HE20, M0 to M9 1ss	4	4	-65.2	-59.0	-60.5	-63.1	0.1	-51.2	-41.25	9.99
HE20, M0 to M9 2ss	4	4	-65.2	-57.2	-58.4	-61.0	0.1	-49.4	-41.25	8.20
HE20, M0 to M9 3ss	4	4	-65.2	-56.2	-57.1	-60.2	0.1	-48.4	-41.25	7.19
HE20, M0 to M9 4ss	4	4	-65.2	-56.2	-57.1	-60.2	0.1	-48.4	-41.25	7.19
HE20 Beam Forming, M0 to M9 1ss	2	7	-65.2	-56.2			0.1	-48.6	-41.25	7.36
HE20 Beam Forming, M0 to M9 2ss	2	4	-65.2	-56.2			0.1	-51.6	-41.25	10.36
HE20 Beam Forming, M0 to M9 1ss	3	9	-65.2	-58.0	-59.1		0.1	-46.0	-41.25	4.74
HE20 Beam Forming, M0 to M9 2ss	3	6	-65.2	-56.2	-57.1		0.1	-47.3	-41.25	6.00



	HE20 Beam Forming, M0 to M9 3ss	3	4	-65.2	-56.2	-57.1		0.1	-49.3	-41.25	8.00
	HE20 Beam Forming, M0 to M9 1ss	4	10	-65.2	-59.0	-60.5	-63.1	0.1	-45.2	-41.25	3.99
	HE20 Beam Forming, M0 to M9 2ss	4	7	-65.2	-57.2	-58.4	-61.0	0.1	-46.4	-41.25	5.20
	HE20 Beam Forming, M0 to M9 3ss	4	5	-65.2	-56.2	-57.1	-60.2	0.1	-47.4	-41.25	6.19
	HE20 Beam Forming, M0 to M9 4ss	4	4	-65.2	-56.2	-57.1	-60.2	0.1	-48.4	-41.25	7.19
	HE20 STBC, M0 to M9 2ss	2	4	-65.2	-56.2			0.1	-51.6	-41.25	10.36
	HE20 STBC, M0 to M9 2ss	3	4	-65.2	-56.2	-57.1		0.1	-49.3	-41.25	8.00
	HE20 STBC, M0 to M9 2ss	4	4	-65.2	-57.2	-58.4	-61.0	0.1	-49.4	-41.25	8.20
5310	Non HT40, 6 to 54 Mbps	1	4	-65.0				0.0	-61.0	-41.25	19.71
	Non HT40, 6 to 54 Mbps	2	4	-65.5	-61.6			0.0	-56.1	-41.25	14.82
	Non HT40, 6 to 54 Mbps	3	4	-65.5	-61.6	-62.3		0.0	-54.0	-41.25	12.77
	Non HT40, 6 to 54 Mbps	4	4	-65.5	-61.6	-62.3	-64.4	0.0	-53.1	-41.25	11.86
	HT/VHT40, M0 to M7	1	4	-65.1				0.1	-61.0	-41.25	19.75
	HT/VHT40, M0 to M7	2	4	-65.1	-59.6			0.1	-54.4	-41.25	13.17
	HT/VHT40, M8 to M15	2	4	-65.1	-59.6			0.1	-54.4	-41.25	13.17
	HT/VHT40, M0 to M7	3	4	-65.1	-60.5	-61.3		0.1	-53.0	-41.25	11.77
	HT/VHT40, M8 to M15	3	4	-65.1	-60.5	-61.3		0.1	-53.0	-41.25	11.77
	HT/VHT40, M16 to M23	3	4	-65.1	-60.5	-61.3		0.1	-53.0	-41.25	11.77
	HT/VHT40, M0 to M7	4	4	-65.8	-61.7	-63.0	-64.9	0.1	-53.4	-41.25	12.18
	HT/VHT40, M8 to M15	4	4	-65.8	-61.7	-63.0	-64.9	0.1	-53.4	-41.25	12.18
	HT/VHT40, M16 to M23	4	4	-65.8	-61.7	-63.0	-64.9	0.1	-53.4	-41.25	12.18
	HT/VHT40, M24 to M31	4	4	-65.8	-61.7	-63.0	-64.9	0.1	-53.4	-41.25	12.18
	HT/VHT40 Beam Forming, M0 to M7	2	7	-65.8	-61.7			0.1	-53.2	-41.25	11.92
	HT/VHT40 Beam Forming, M8 to M15	2	4	-65.1	-59.6			0.1	-54.4	-41.25	13.17
	HT/VHT40 Beam Forming, M0 to M7	3	9	-66.6	-62.2	-63.4		0.1	-49.8	-41.25	8.58
	HT/VHT40 Beam Forming, M8 to M15	3	6	-65.8	-61.7	-63.0		0.1	-52.3	-41.25	11.06
	HT/VHT40 Beam Forming, M16 to M23	3	4	-65.1	-60.5	-61.3		0.1	-53.0	-41.25	11.77
	HT/VHT40 Beam Forming, M0 to M7	4	10	-67.1	-63.0	-64.2	-67.0	0.1	-48.8	-41.25	7.59
	HT/VHT40 Beam Forming, M8 to M15	4	7	-66.6	-62.2	-63.4	-66.1	0.1	-51.1	-41.25	9.82
	HT/VHT40 Beam Forming, M16 to M23	4	5	-65.8	-61.7	-63.0	-64.9	0.1	-52.4	-41.25	11.18
	HT/VHT40 Beam Forming, M24 to M31	4	4	-65.8	-61.7	-63.0	-64.9	0.1	-53.4	-41.25	12.18
	HT/VHT40 STBC, M0 to M7	2	4	-65.1	-59.6			0.1	-54.4	-41.25	13.17
	HT/VHT40 STBC, M0 to M7	3	4	-65.1	-60.5	-61.3		0.1	-53.0	-41.25	11.77
	HT/VHT40 STBC, M0 to M7	4	4	-65.8	-61.7	-63.0	-64.9	0.1	-53.4	-41.25	12.18
	HE40, M0 to M9 1ss	1	4	-65.8				0.1	-61.7	-41.25	20.42
	HE40, M0 to M9 1ss	2	4	-65.8	-61.5			0.1	-56.0	-41.25	14.75
	HE40, M0 to M9 2ss	2	4	-65.8	-61.5			0.1	-56.0	-41.25	14.75
	HE40, M0 to M9 1ss	3	4	-65.8	-61.5	-62.7		0.1	-54.1	-41.25	12.84
	HE40, M0 to M9 2ss	3	4	-65.8	-61.5	-62.7		0.1	-54.1	-41.25	12.84
HE40, M0 to M9 3ss	3	4	-65.8	-61.5	-62.7		0.1	-54.1	-41.25	12.84	
HE40, M0 to M9 1ss	4	4	-65.8	-61.5	-62.7	-65.0	0.1	-53.3	-41.25	12.01	



	HE40, M0 to M9 2ss	4	4	-65.8	-61.5	-62.7	-65.0	0.1	-53.3	-41.25	12.01
	HE40, M0 to M9 3ss	4	4	-65.8	-61.5	-62.7	-65.0	0.1	-53.3	-41.25	12.01
	HE40, M0 to M9 4ss	4	4	-65.8	-61.5	-62.7	-65.0	0.1	-53.3	-41.25	12.01
	HE40 Beam Forming, M0 to M9 1ss	2	7	-66.4	-62.2			0.1	-53.7	-41.25	12.42
	HE40 Beam Forming, M0 to M9 2ss	2	4	-65.8	-61.5			0.1	-56.0	-41.25	14.75
	HE40 Beam Forming, M0 to M9 1ss	3	9	-66.4	-62.2	-63.6		0.1	-49.8	-41.25	8.59
	HE40 Beam Forming, M0 to M9 2ss	3	6	-66.4	-62.2	-63.6		0.1	-52.8	-41.25	11.59
	HE40 Beam Forming, M0 to M9 3ss	3	4	-65.8	-61.5	-62.7		0.1	-54.1	-41.25	12.84
	HE40 Beam Forming, M0 to M9 1ss	4	10	-67.0	-62.8	-64.2	-66.6	0.1	-48.7	-41.25	7.40
	HE40 Beam Forming, M0 to M9 2ss	4	7	-66.4	-62.2	-63.6	-66.0	0.1	-51.1	-41.25	9.80
	HE40 Beam Forming, M0 to M9 3ss	4	5	-66.4	-62.2	-63.6	-66.0	0.1	-53.1	-41.25	11.80
	HE40 Beam Forming, M0 to M9 4ss	4	4	-65.8	-61.5	-62.7	-65.0	0.1	-53.3	-41.25	12.01
	HE40 STBC, M0 to M9 2ss	2	4	-65.8	-61.5			0.1	-56.0	-41.25	14.75
	HE40 STBC, M0 to M9 2ss	3	4	-65.8	-61.5	-62.7		0.1	-54.1	-41.25	12.84
	HE40 STBC, M0 to M9 2ss	4	4	-65.8	-61.5	-62.7	-65.0	0.1	-53.3	-41.25	12.01
5320	Non HT20, 6 to 54 Mbps	1	4	-65.6				0.0	-61.6	-41.25	20.31
	Non HT20, 6 to 54 Mbps	2	4	-65.6	-57.1			0.0	-52.5	-41.25	11.23
	Non HT20, 6 to 54 Mbps	3	4	-65.6	-58.5	-60.0		0.0	-51.7	-41.25	10.41
	Non HT20, 6 to 54 Mbps	4	4	-65.6	-59.7	-61.1	-64.0	0.0	-51.9	-41.25	10.69
	Non HT20 Beam Forming, 6 to 54 Mbps	2	7	-65.6	-57.9			0.0	-50.2	-41.25	8.93
	Non HT20 Beam Forming, 6 to 54 Mbps	3	9	-65.6	-58.5	-60.0		0.0	-46.7	-41.25	5.41
	Non HT20 Beam Forming, 6 to 54 Mbps	4	10	-65.6	-59.7	-61.1	-64.0	0.0	-45.9	-41.25	4.69
	HT/VHT20, M0 to M7	1	4	-65.9				0.1	-61.8	-41.25	20.60
	HT/VHT20, M0 to M7	2	4	-65.9	-58.1			0.1	-53.4	-41.25	12.13
	HT/VHT20, M8 to M15	2	4	-65.9	-58.1			0.1	-53.4	-41.25	12.13
	HT/VHT20, M0 to M7	3	4	-65.9	-58.6	-59.7		0.1	-51.6	-41.25	10.37
	HT/VHT20, M8 to M15	3	4	-65.9	-58.1	-59.1		0.1	-51.1	-41.25	9.87
	HT/VHT20, M16 to M23	3	4	-65.9	-58.1	-59.1		0.1	-51.1	-41.25	9.87
	HT/VHT20, M0 to M7	4	4	-65.9	-60.2	-61.3	-64.1	0.1	-52.3	-41.25	11.00
	HT/VHT20, M8 to M15	4	4	-65.9	-58.1	-59.1	-61.8	0.1	-50.3	-41.25	9.02
	HT/VHT20, M16 to M23	4	4	-65.9	-58.1	-59.1	-61.8	0.1	-50.3	-41.25	9.02
	HT/VHT20, M24 to M31	4	4	-65.9	-58.1	-59.1	-61.8	0.1	-50.3	-41.25	9.02
	HT/VHT20 Beam Forming, M0 to M7	2	7	-65.9	-58.1			0.1	-50.4	-41.25	9.13
	HT/VHT20 Beam Forming, M8 to M15	2	4	-65.9	-58.1			0.1	-53.4	-41.25	12.13
	HT/VHT20 Beam Forming, M0 to M7	3	9	-65.9	-58.6	-59.7		0.1	-46.6	-41.25	5.37
	HT/VHT20 Beam Forming, M8 to M15	3	6	-65.9	-58.1	-59.1		0.1	-49.1	-41.25	7.87
	HT/VHT20 Beam Forming, M16 to M23	3	4	-65.9	-58.1	-59.1		0.1	-51.1	-41.25	9.87
	HT/VHT20 Beam Forming, M0 to M7	4	10	-65.9	-60.2	-61.3	-64.1	0.1	-46.3	-41.25	5.00
	HT/VHT20 Beam Forming, M8 to M15	4	7	-65.9	-58.6	-59.7	-62.9	0.1	-47.9	-41.25	6.62
HT/VHT20 Beam Forming, M16 to M23	4	5	-65.9	-58.6	-59.7	-62.9	0.1	-49.9	-41.25	8.62	
HT/VHT20 Beam Forming, M24 to M31	4	4	-65.9	-58.1	-59.1	-61.8	0.1	-50.3	-41.25	9.02	



HT/VHT20 STBC, M0 to M7	2	4	-65.9	-58.1				0.1	-53.4	-41.25	12.13	
HT/VHT20 STBC, M0 to M7	3	4	-65.9	-58.1	-59.1			0.1	-51.1	-41.25	9.87	
HT/VHT20 STBC, M0 to M7	4	4	-65.9	-58.1	-59.1	-61.8		0.1	-50.3	-41.25	9.02	
HE20, M0 to M9 1ss	1	4	-65.4					0.1	-61.3	-41.25	20.08	
HE20, M0 to M9 1ss	2	4	-65.4	-57.8				0.1	-53.0	-41.25	11.78	
HE20, M0 to M9 2ss	2	4	-65.4	-57.8				0.1	-53.0	-41.25	11.78	
HE20, M0 to M9 1ss	3	4	-65.4	-58.5	-59.3			0.1	-51.3	-41.25	10.09	
HE20, M0 to M9 2ss	3	4	-65.4	-57.8	-58.6			0.1	-50.7	-41.25	9.46	
HE20, M0 to M9 3ss	3	4	-65.4	-57.8	-58.6			0.1	-50.7	-41.25	9.46	
HE20, M0 to M9 1ss	4	4	-65.4	-59.8	-60.7	-63.8		0.1	-51.8	-41.25	10.52	
HE20, M0 to M9 2ss	4	4	-65.4	-58.5	-59.3	-62.4		0.1	-50.5	-41.25	9.30	
HE20, M0 to M9 3ss	4	4	-65.4	-58.5	-59.3	-62.4		0.1	-50.5	-41.25	9.30	
HE20, M0 to M9 4ss	4	4	-65.4	-58.5	-59.3	-62.4		0.1	-50.5	-41.25	9.30	
HE20 Beam Forming, M0 to M9 1ss	2	7	-65.4	-58.5				0.1	-50.6	-41.25	9.37	
HE20 Beam Forming, M0 to M9 2ss	2	4	-65.4	-57.8				0.1	-53.0	-41.25	11.78	
HE20 Beam Forming, M0 to M9 1ss	3	9	-65.4	-59.0	-60.0			0.1	-46.9	-41.25	5.62	
HE20 Beam Forming, M0 to M9 2ss	3	6	-65.4	-58.5	-59.3			0.1	-49.3	-41.25	8.09	
HE20 Beam Forming, M0 to M9 3ss	3	4	-65.4	-57.8	-58.6			0.1	-50.7	-41.25	9.46	
HE20 Beam Forming, M0 to M9 1ss	4	10	-65.4	-59.8	-60.7	-63.8		0.1	-45.8	-41.25	4.52	
HE20 Beam Forming, M0 to M9 2ss	4	7	-65.4	-59.0	-60.0	-62.8		0.1	-48.1	-41.25	6.81	
HE20 Beam Forming, M0 to M9 3ss	4	5	-65.4	-58.5	-59.3	-62.4		0.1	-49.5	-41.25	8.30	
HE20 Beam Forming, M0 to M9 4ss	4	4	-65.4	-58.5	-59.3	-62.4		0.1	-50.5	-41.25	9.30	
HE20 STBC, M0 to M9 2ss	2	4	-65.4	-57.8				0.1	-53.0	-41.25	11.78	
HE20 STBC, M0 to M9 2ss	3	4	-65.4	-57.8	-58.6			0.1	-50.7	-41.25	9.46	
HE20 STBC, M0 to M9 2ss	4	4	-65.4	-58.5	-59.3	-62.4		0.1	-50.5	-41.25	9.30	
5250	Non HT160, 6 to 54 Mbps	1	4	-62.3				0.0	-58.3	-41.25	17.00	
	Non HT160, 6 to 54 Mbps	2	4	-62.3	-59.7			0.0	-53.7	-41.25	12.50	
	Non HT160, 6 to 54 Mbps	3	4	-62.3	-59.7	-60.5		0.0	-51.9	-41.25	10.63	
	Non HT160, 6 to 54 Mbps	4	4	-62.3	-59.7	-60.5	-62.3	0.0	-51.0	-41.25	9.73	
	VHT160, M0 to M9 1ss	1	4	-63.9				0.4	-59.5	-41.25	18.26	
	VHT160, M0 to M9 1ss	2	4	-63.9	-60.8			0.4	-54.7	-41.25	13.43	
	VHT160, M0 to M9 2ss	2	4	-63.9	-60.8			0.4	-54.7	-41.25	13.43	
	VHT160, M0 to M9 1ss	3	4	-63.9	-60.8	-61.4		0.4	-52.7	-41.25	11.43	
	VHT160, M0 to M9 2ss	3	4	-63.9	-60.8	-61.4		0.4	-52.7	-41.25	11.43	
	VHT160, M0 to M9 3ss	3	4	-63.9	-60.8	-61.4		0.4	-52.7	-41.25	11.43	
	VHT160, M0 to M9 1ss	4	4	-63.9	-60.8	-61.4	-63.8	0.4	-51.8	-41.25	10.59	
	VHT160, M0 to M9 2ss	4	4	-63.9	-60.8	-61.4	-63.8	0.4	-51.8	-41.25	10.59	
	VHT160, M0 to M9 3ss	4	4	-63.9	-60.8	-61.4	-63.8	0.4	-51.8	-41.25	10.59	
	VHT160, M0 to M9 4ss	4	4	-63.9	-60.8	-61.4	-63.8	0.4	-51.8	-41.25	10.59	
	VHT160 Beam Forming, M0 to M9 1ss	2	7	-64.9	-61.4				0.4	-52.4	-41.25	11.15
	VHT160 Beam Forming, M0 to M9 2ss	2	4	-63.9	-60.8				0.4	-54.7	-41.25	13.43



VHT160 Beam Forming, M0 to M9 1ss	3	9	-65.5	-61.9	-62.9		0.4	-49.0	-41.25	7.77
VHT160 Beam Forming, M0 to M9 2ss	3	6	-63.9	-60.8	-61.4		0.4	-50.7	-41.25	9.43
VHT160 Beam Forming, M0 to M9 3ss	3	4	-63.9	-60.8	-61.4		0.4	-52.7	-41.25	11.43
VHT160 Beam Forming, M0 to M9 1ss	4	10	-65.5	-61.9	-62.9	-65.5	0.4	-47.2	-41.25	6.00
VHT160 Beam Forming, M0 to M9 2ss	4	7	-64.9	-61.4	-62.4	-64.6	0.4	-49.7	-41.25	8.41
VHT160 Beam Forming, M0 to M9 3ss	4	5	-63.9	-60.8	-61.4	-63.8	0.4	-50.8	-41.25	9.59
VHT160 Beam Forming, M0 to M9 4ss	4	4	-63.9	-60.8	-61.4	-63.8	0.4	-51.8	-41.25	10.59
VHT160 STBC, M0 to M9 1ss	2	4	-63.9	-60.8			0.4	-54.7	-41.25	13.43
VHT160 STBC, M0 to M9 1ss	3	4	-63.9	-60.8	-61.4		0.4	-52.7	-41.25	11.43
VHT160 STBC, M0 to M9 1ss	4	4	-63.9	-60.8	-61.4	-63.8	0.4	-51.8	-41.25	10.59
HE160, M0 to M9 1ss	1	4	-62.2				0.4	-57.8	-41.25	16.52
HE160, M0 to M9 1ss	2	4	-62.2	-59.6			0.4	-53.3	-41.25	12.01
HE160, M0 to M9 2ss	2	4	-62.2	-59.6			0.4	-53.3	-41.25	12.01
HE160, M0 to M9 1ss	3	4	-63.9	-60.3	-61.2		0.4	-52.3	-41.25	11.10
HE160, M0 to M9 2ss	3	4	-63.9	-60.3	-61.2		0.4	-52.3	-41.25	11.10
HE160, M0 to M9 3ss	3	4	-63.9	-60.3	-61.2		0.4	-52.3	-41.25	11.10
HE160, M0 to M9 1ss	4	4	-63.9	-60.3	-61.2	-63.9	0.4	-51.6	-41.25	10.33
HE160, M0 to M9 2ss	4	4	-63.9	-60.3	-61.2	-63.9	0.4	-51.6	-41.25	10.33
HE160, M0 to M9 3ss	4	4	-63.9	-60.3	-61.2	-63.9	0.4	-51.6	-41.25	10.33
HE160, M0 to M9 4ss	4	4	-63.9	-60.3	-61.2	-63.9	0.4	-51.6	-41.25	10.33
HE160 Beam Forming, M0 to M9 1ss	2	7	-63.9	-60.3			0.4	-51.3	-41.25	10.04
HE160 Beam Forming, M0 to M9 2ss	2	4	-62.2	-59.6			0.4	-53.3	-41.25	12.01
HE160 Beam Forming, M0 to M9 1ss	3	9	-64.8	-61.2	-62.0		0.4	-48.2	-41.25	6.96
HE160 Beam Forming, M0 to M9 2ss	3	6	-63.9	-60.3	-61.2		0.4	-50.3	-41.25	9.10
HE160 Beam Forming, M0 to M9 3ss	3	4	-63.9	-60.3	-61.2		0.4	-52.3	-41.25	11.10
HE160 Beam Forming, M0 to M9 1ss	4	10	-65.3	-61.8	-62.9	-65.5	0.4	-47.1	-41.25	5.88
HE160 Beam Forming, M0 to M9 2ss	4	7	-64.8	-61.2	-62.0	-64.5	0.4	-49.4	-41.25	8.14
HE160 Beam Forming, M0 to M9 3ss	4	5	-63.9	-60.3	-61.2	-63.9	0.4	-50.6	-41.25	9.33
HE160 Beam Forming, M0 to M9 4ss	4	4	-63.9	-60.3	-61.2	-63.9	0.4	-51.6	-41.25	10.33
HE160 STBC, M0 to M9 1ss	2	4	-62.2	-59.6			0.4	-53.3	-41.25	12.01
HE160 STBC, M0 to M9 1ss	3	4	-63.9	-60.3	-61.2		0.4	-52.3	-41.25	11.10
HE160 STBC, M0 to M9 1ss	4	4	-63.9	-60.3	-61.2	-63.9	0.4	-51.6	-41.25	10.33





**Conducted Spurs Average, 4dBi  
5270 MHz, HT/VHT40 Beam Forming, M0 to M7**

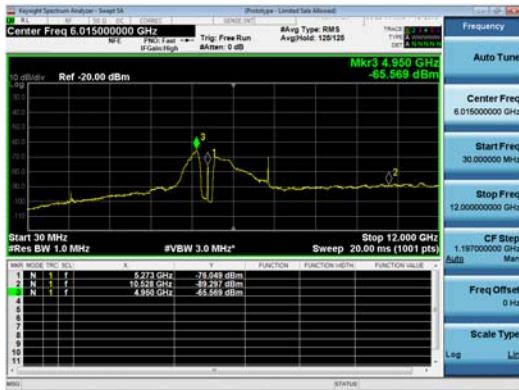

**Antenna A**

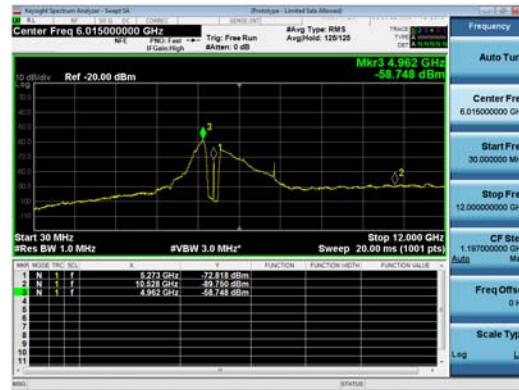

**Antenna B**

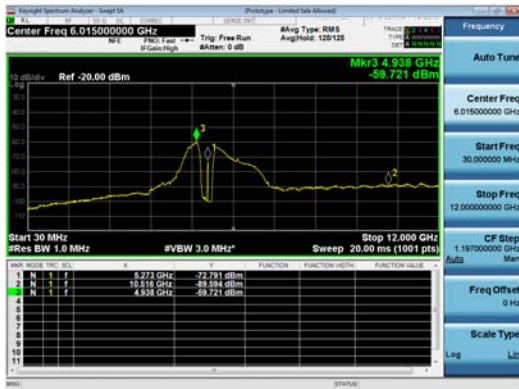

**Antenna C**

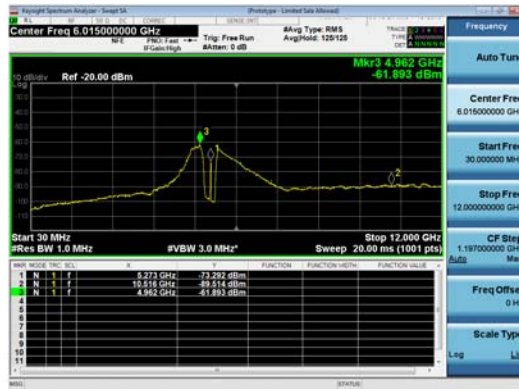

**Antenna D**



## Conducted Spurious Emissions Average Table, 5dBi

Frequency (MHz)	Mode	Tx Paths	Correlated Antenna Gain (dBi)	Tx 1 Spur Power (dBm)	Tx 2 Spur Power (dBm)	Tx 3 Spur Power (dBm)	Tx 4 Spur Power (dBm)	Duty Cycle Correction (dB)	Total Conducted Spur (dBm)	Limit (dBm)	Margin (dB)
5260	Non HT20, 6 to 54 Mbps	1	5	-64.9				0.0	-59.9	-41.25	18.61
	Non HT20, 6 to 54 Mbps	2	5	-64.9	-56.0			0.0	-50.4	-41.25	9.18
	Non HT20, 6 to 54 Mbps	3	5	-64.9	-58.1	-59.1		0.0	-50.0	-41.25	8.79
	Non HT20, 6 to 54 Mbps	4	5	-65.7	-60.7	-62.2	-63.7	0.0	-51.6	-41.25	10.38
	Non HT20 Beam Forming, 6 to 54 Mbps	2	8	-64.9	-56.0			0.0	-47.4	-41.25	6.18
	Non HT20 Beam Forming, 6 to 54 Mbps	3	10	-64.9	-58.1	-59.1		0.0	-45.0	-41.25	3.79
	Non HT20 Beam Forming, 6 to 54 Mbps	4	11	-65.7	-60.7	-62.2	-63.7	0.0	-45.6	-41.25	4.38
	HT/VHT20, M0 to M7	1	5	-65.4				0.1	-60.3	-41.25	19.10
	HT/VHT20, M0 to M7	2	5	-65.4	-55.9			0.1	-50.4	-41.25	9.14
	HT/VHT20, M8 to M15	2	5	-65.4	-55.9			0.1	-50.4	-41.25	9.14
	HT/VHT20, M0 to M7	3	5	-65.4	-58.5	-59.4		0.1	-50.4	-41.25	9.15
	HT/VHT20, M8 to M15	3	5	-65.4	-55.9	-56.6		0.1	-47.9	-41.25	6.67
	HT/VHT20, M16 to M23	3	5	-65.4	-55.9	-56.6		0.1	-47.9	-41.25	6.67
	HT/VHT20, M0 to M7	4	5	-65.4	-59.7	-61.3	-63.6	0.1	-50.9	-41.25	9.65
	HT/VHT20, M8 to M15	4	5	-65.4	-57.4	-58.8	-61.1	0.1	-48.7	-41.25	7.46
	HT/VHT20, M16 to M23	4	5	-65.4	-55.9	-56.6	-59.2	0.1	-47.0	-41.25	5.74
	HT/VHT20, M24 to M31	4	5	-65.4	-55.9	-56.6	-59.2	0.1	-47.0	-41.25	5.74
	HT/VHT20 Beam Forming, M0 to M7	2	8	-65.4	-55.9			0.1	-47.4	-41.25	6.14
	HT/VHT20 Beam Forming, M8 to M15	2	5	-65.4	-55.9			0.1	-50.4	-41.25	9.14
	HT/VHT20 Beam Forming, M0 to M7	3	10	-65.4	-58.5	-59.4		0.1	-45.4	-41.25	4.15
	HT/VHT20 Beam Forming, M8 to M15	3	7	-65.4	-55.9	-56.6		0.1	-45.9	-41.25	4.67
	HT/VHT20 Beam Forming, M16 to M23	3	5	-65.4	-55.9	-56.6		0.1	-47.9	-41.25	6.67
	HT/VHT20 Beam Forming, M0 to M7	4	11	-65.4	-59.7	-61.3	-63.6	0.1	-44.9	-41.25	3.65
	HT/VHT20 Beam Forming, M8 to M15	4	8	-65.4	-57.4	-58.8	-61.1	0.1	-45.7	-41.25	4.46
	HT/VHT20 Beam Forming, M16 to M23	4	6	-65.4	-55.9	-56.6	-59.2	0.1	-46.0	-41.25	4.74
	HT/VHT20 Beam Forming, M24 to M31	4	5	-65.4	-55.9	-56.6	-59.2	0.1	-47.0	-41.25	5.74
	HT/VHT20 STBC, M0 to M7	2	5	-65.4	-55.9			0.1	-50.4	-41.25	9.14
	HT/VHT20 STBC, M0 to M7	3	5	-65.4	-55.9	-56.6		0.1	-47.9	-41.25	6.67





	HT/VHT20 STBC, M0 to M7	4	5	-65.4	-57.4	-58.8	-61.1	0.1	-48.7	-41.25	7.46
	HE20, M0 to M9 1ss	1	5	-65.0				0.1	-59.9	-41.25	18.68
	HE20, M0 to M9 1ss	2	5	-65.0	-55.8			0.1	-50.2	-41.25	8.99
	HE20, M0 to M9 2ss	2	5	-65.0	-55.8			0.1	-50.2	-41.25	8.99
	HE20, M0 to M9 1ss	3	5	-65.0	-58.1	-59.2		0.1	-50.1	-41.25	8.81
	HE20, M0 to M9 2ss	3	5	-65.0	-55.8	-56.7		0.1	-47.9	-41.25	6.62
	HE20, M0 to M9 3ss	3	5	-65.0	-55.8	-56.7		0.1	-47.9	-41.25	6.62
	HE20, M0 to M9 1ss	4	5	-66.0	-60.7	-62.4	-64.1	0.1	-51.8	-41.25	10.53
	HE20, M0 to M9 2ss	4	5	-65.0	-57.4	-58.7	-60.9	0.1	-48.6	-41.25	7.35
	HE20, M0 to M9 3ss	4	5	-65.0	-55.8	-56.7	-59.1	0.1	-46.9	-41.25	5.68
	HE20, M0 to M9 4ss	4	5	-65.0	-55.8	-56.7	-59.1	0.1	-46.9	-41.25	5.68
	HE20 Beam Forming, M0 to M9 1ss	2	8	-65.0	-55.8			0.1	-47.2	-41.25	5.99
	HE20 Beam Forming, M0 to M9 2ss	2	5	-65.0	-55.8			0.1	-50.2	-41.25	8.99
	HE20 Beam Forming, M0 to M9 1ss	3	10	-65.0	-58.1	-59.2		0.1	-45.1	-41.25	3.81
	HE20 Beam Forming, M0 to M9 2ss	3	7	-65.0	-55.8	-56.7		0.1	-45.9	-41.25	4.62
	HE20 Beam Forming, M0 to M9 3ss	3	5	-65.0	-55.8	-56.7		0.1	-47.9	-41.25	6.62
	HE20 Beam Forming, M0 to M9 1ss	4	11	-66.0	-60.7	-62.4	-64.1	0.1	-45.8	-41.25	4.53
	HE20 Beam Forming, M0 to M9 2ss	4	8	-65.0	-57.4	-58.7	-60.9	0.1	-45.6	-41.25	4.35
	HE20 Beam Forming, M0 to M9 3ss	4	6	-65.0	-55.8	-56.7	-59.1	0.1	-45.9	-41.25	4.68
	HE20 Beam Forming, M0 to M9 4ss	4	5	-65.0	-55.8	-56.7	-59.1	0.1	-46.9	-41.25	5.68
	HE20 STBC, M0 to M9 2ss	2	5	-65.0	-55.8			0.1	-50.2	-41.25	8.99
	HE20 STBC, M0 to M9 2ss	3	5	-65.0	-55.8	-56.7		0.1	-47.9	-41.25	6.62
	HE20 STBC, M0 to M9 2ss	4	5	-65.0	-57.4	-58.7	-60.9	0.1	-48.6	-41.25	7.35
5270	Non HT40, 6 to 54 Mbps	1	5	-65.2				0.0	-60.2	-41.25	18.91
	Non HT40, 6 to 54 Mbps	2	5	-65.2	-56.3			0.0	-50.7	-41.25	9.48
	Non HT40, 6 to 54 Mbps	3	5	-65.2	-56.3	-56.7		0.0	-48.2	-41.25	6.91
	Non HT40, 6 to 54 Mbps	4	5	-65.2	-57.9	-58.7	-61.0	0.0	-48.9	-41.25	7.61
	HT/VHT40, M0 to M7	1	5	-65.6				0.1	-60.5	-41.25	19.25
	HT/VHT40, M0 to M7	2	5	-65.6	-56.8			0.1	-51.2	-41.25	9.91
	HT/VHT40, M8 to M15	2	5	-65.6	-56.8			0.1	-51.2	-41.25	9.91
	HT/VHT40, M0 to M7	3	5	-65.6	-56.8	-57.0		0.1	-48.5	-41.25	7.25
	HT/VHT40, M8 to M15	3	5	-65.6	-56.8	-57.0		0.1	-48.5	-41.25	7.25
	HT/VHT40, M16 to M23	3	5	-65.6	-56.8	-57.0		0.1	-48.5	-41.25	7.25
	HT/VHT40, M0 to M7	4	5	-65.6	-58.1	-58.8	-61.3	0.1	-49.0	-41.25	7.76
	HT/VHT40, M8 to M15	4	5	-65.6	-56.8	-57.0	-59.6	0.1	-47.5	-41.25	6.28
	HT/VHT40, M16 to M23	4	5	-65.6	-56.8	-57.0	-59.6	0.1	-47.5	-41.25	6.28
	HT/VHT40, M24 to M31	4	5	-65.6	-56.8	-57.0	-59.6	0.1	-47.5	-41.25	6.28
	HT/VHT40 Beam Forming, M0 to M7	2	8	-65.6	-56.8			0.1	-48.2	-41.25	6.91
	HT/VHT40 Beam Forming, M8 to M15	2	5	-65.6	-56.8			0.1	-51.2	-41.25	9.91
	HT/VHT40 Beam Forming, M0 to M7	3	10	-65.6	-58.1	-58.8		0.1	-44.9	-41.25	3.67
HT/VHT40 Beam Forming, M8 to M15	3	7	-65.6	-56.8	-57.0		0.1	-46.5	-41.25	5.25	



HT/VHT40 Beam Forming, M16 to M23	3	5	-65.6	-56.8	-57.0		0.1	-48.5	-41.25	7.25	
<b>HT/VHT40 Beam Forming, M0 to M7</b>	<b>4</b>	<b>11</b>	<b>-65.6</b>	<b>-59.4</b>	<b>-60.2</b>	<b>-62.9</b>	<b>0.1</b>	<b>-44.3</b>	<b>-41.25</b>	<b>3.04</b>	
HT/VHT40 Beam Forming, M8 to M15	4	8	-65.6	-57.2	-57.9	-60.1	0.1	-45.1	-41.25	3.85	
HT/VHT40 Beam Forming, M16 to M23	4	6	-65.6	-56.8	-57.0	-59.6	0.1	-46.5	-41.25	5.28	
HT/VHT40 Beam Forming, M24 to M31	4	5	-65.6	-56.8	-57.0	-59.6	0.1	-47.5	-41.25	6.28	
HT/VHT40 STBC, M0 to M7	2	5	-65.6	-56.8			0.1	-51.2	-41.25	9.91	
HT/VHT40 STBC, M0 to M7	3	5	-65.6	-56.8	-57.0		0.1	-48.5	-41.25	7.25	
HT/VHT40 STBC, M0 to M7	4	5	-65.6	-57.2	-57.9	-60.1	0.1	-48.1	-41.25	6.85	
HE40, M0 to M9 1ss	1	5	-65.7				0.1	-60.6	-41.25	19.32	
HE40, M0 to M9 1ss	2	5	-65.7	-56.5			0.1	-50.9	-41.25	9.63	
HE40, M0 to M9 2ss	2	5	-65.7	-56.5			0.1	-50.9	-41.25	9.63	
HE40, M0 to M9 1ss	3	5	-65.7	-56.5	-56.8		0.1	-48.2	-41.25	7.00	
HE40, M0 to M9 2ss	3	5	-65.7	-56.5	-56.8		0.1	-48.2	-41.25	7.00	
HE40, M0 to M9 3ss	3	5	-65.7	-56.5	-56.8		0.1	-48.2	-41.25	7.00	
HE40, M0 to M9 1ss	4	5	-65.7	-58.1	-58.8	-61.3	0.1	-49.0	-41.25	7.73	
HE40, M0 to M9 2ss	4	5	-65.7	-56.5	-56.8	-59.6	0.1	-47.3	-41.25	6.07	
HE40, M0 to M9 3ss	4	5	-65.7	-56.5	-56.8	-59.6	0.1	-47.3	-41.25	6.07	
HE40, M0 to M9 4ss	4	5	-65.7	-56.5	-56.8	-59.6	0.1	-47.3	-41.25	6.07	
HE40 Beam Forming, M0 to M9 1ss	2	8	-65.7	-56.5			0.1	-47.9	-41.25	6.63	
HE40 Beam Forming, M0 to M9 2ss	2	5	-65.7	-56.5			0.1	-50.9	-41.25	9.63	
HE40 Beam Forming, M0 to M9 1ss	3	10	-65.7	-58.1	-58.8		0.1	-44.9	-41.25	3.66	
HE40 Beam Forming, M0 to M9 2ss	3	7	-65.7	-56.5	-56.8		0.1	-46.2	-41.25	5.00	
HE40 Beam Forming, M0 to M9 3ss	3	5	-65.7	-56.5	-56.8		0.1	-48.2	-41.25	7.00	
HE40 Beam Forming, M0 to M9 1ss	4	11	-65.7	-59.4	-60.4	-62.8	0.1	-44.3	-41.25	3.07	
HE40 Beam Forming, M0 to M9 2ss	4	8	-65.7	-57.5	-57.9	-60.4	0.1	-45.3	-41.25	4.01	
HE40 Beam Forming, M0 to M9 3ss	4	6	-65.7	-56.5	-56.8	-59.6	0.1	-46.3	-41.25	5.07	
HE40 Beam Forming, M0 to M9 4ss	4	5	-65.7	-56.5	-56.8	-59.6	0.1	-47.3	-41.25	6.07	
HE40 STBC, M0 to M9 2ss	2	5	-65.7	-56.5			0.1	-50.9	-41.25	9.63	
HE40 STBC, M0 to M9 2ss	3	5	-65.7	-56.5	-56.8		0.1	-48.2	-41.25	7.00	
HE40 STBC, M0 to M9 2ss	4	5	-65.7	-57.5	-57.9	-60.4	0.1	-48.3	-41.25	7.01	
5290	Non HT80, 6 to 54 Mbps	1	5	-66.0				0.1	-60.9	-41.25	19.70
	Non HT80, 6 to 54 Mbps	2	5	-66.0	-61.9			0.1	-55.4	-41.25	14.17
	Non HT80, 6 to 54 Mbps	3	5	-66.0	-61.9	-62.7		0.1	-53.4	-41.25	12.13
	Non HT80, 6 to 54 Mbps	4	5	-66.0	-61.9	-62.7	-65.3	0.1	-52.6	-41.25	11.32
	VHT80, M0 to M9 1ss	1	5	-65.8				0.2	-60.6	-41.25	19.33
	VHT80, M0 to M9 1ss	2	5	-65.8	-61.6			0.2	-55.0	-41.25	13.73
	VHT80, M0 to M9 2ss	2	5	-65.8	-61.6			0.2	-55.0	-41.25	13.73
	VHT80, M0 to M9 1ss	3	5	-65.8	-61.6	-62.6		0.2	-53.0	-41.25	11.76
	VHT80, M0 to M9 2ss	3	5	-65.8	-61.6	-62.6		0.2	-53.0	-41.25	11.76
	VHT80, M0 to M9 3ss	3	5	-65.8	-61.6	-62.6		0.2	-53.0	-41.25	11.76
VHT80, M0 to M9 1ss	4	5	-65.8	-61.6	-62.6	-64.5	0.2	-52.1	-41.25	10.84	



VHT80, M0 to M9 2ss	4	5	-65.8	-61.6	-62.6	-64.5	0.2	-52.1	-41.25	10.84
VHT80, M0 to M9 3ss	4	5	-65.8	-61.6	-62.6	-64.5	0.2	-52.1	-41.25	10.84
VHT80, M0 to M9 4ss	4	5	-65.8	-61.6	-62.6	-64.5	0.2	-52.1	-41.25	10.84
VHT80 Beam Forming, M0 to M9 1ss	2	8	-66.5	-62.1			0.2	-52.5	-41.25	11.29
VHT80 Beam Forming, M0 to M9 2ss	2	5	-65.8	-61.6			0.2	-55.0	-41.25	13.73
VHT80 Beam Forming, M0 to M9 1ss	3	10	-67.2	-62.7	-64.1		0.2	-49.3	-41.25	8.06
VHT80 Beam Forming, M0 to M9 2ss	3	7	-66.5	-62.1	-63.2		0.2	-51.6	-41.25	10.33
VHT80 Beam Forming, M0 to M9 3ss	3	5	-65.8	-61.6	-62.6		0.2	-53.0	-41.25	11.76
VHT80 Beam Forming, M0 to M9 1ss	4	11	-68.4	-63.2	-64.4	-67.0	0.2	-48.0	-41.25	6.79
VHT80 Beam Forming, M0 to M9 2ss	4	8	-67.2	-62.7	-64.1	-66.7	0.2	-50.5	-41.25	9.29
VHT80 Beam Forming, M0 to M9 3ss	4	6	-66.5	-62.1	-63.2	-65.8	0.2	-51.8	-41.25	10.54
VHT80 Beam Forming, M0 to M9 4ss	4	5	-65.8	-61.6	-62.6	-64.5	0.2	-52.1	-41.25	10.84
VHT80 STBC, M0 to M9 1ss	2	5	-65.8	-61.6			0.2	-55.0	-41.25	13.73
VHT80 STBC, M0 to M9 1ss	3	5	-65.8	-61.6	-62.6		0.2	-53.0	-41.25	11.76
VHT80 STBC, M0 to M9 1ss	4	5	-65.8	-61.6	-62.6	-64.5	0.2	-52.1	-41.25	10.84
HE80, M0 to M9 1ss	1	5	-65.9				0.3	-60.6	-41.25	19.39
HE80, M0 to M9 1ss	2	5	-65.9	-62.0			0.3	-55.3	-41.25	14.01
HE80, M0 to M9 2ss	2	5	-65.9	-62.0			0.3	-55.3	-41.25	14.01
HE80, M0 to M9 1ss	3	5	-66.6	-62.3	-63.1		0.3	-53.6	-41.25	12.36
HE80, M0 to M9 2ss	3	5	-66.6	-62.3	-63.1		0.3	-53.6	-41.25	12.36
HE80, M0 to M9 3ss	3	5	-66.6	-62.3	-63.1		0.3	-53.6	-41.25	12.36
HE80, M0 to M9 1ss	4	5	-66.6	-62.3	-63.1	-66.1	0.3	-52.9	-41.25	11.61
HE80, M0 to M9 2ss	4	5	-66.6	-62.3	-63.1	-66.1	0.3	-52.9	-41.25	11.61
HE80, M0 to M9 3ss	4	5	-66.6	-62.3	-63.1	-66.1	0.3	-52.9	-41.25	11.61
HE80, M0 to M9 4ss	4	5	-66.6	-62.3	-63.1	-66.1	0.3	-52.9	-41.25	11.61
HE80 Beam Forming, M0 to M9 1ss	2	8	-66.6	-62.3			0.3	-52.7	-41.25	11.42
HE80 Beam Forming, M0 to M9 2ss	2	5	-65.9	-62.0			0.3	-55.3	-41.25	14.01
HE80 Beam Forming, M0 to M9 1ss	3	10	-67.1	-63.0	-64.2		0.3	-49.4	-41.25	8.17
HE80 Beam Forming, M0 to M9 2ss	3	7	-66.6	-62.3	-63.1		0.3	-51.6	-41.25	10.36
HE80 Beam Forming, M0 to M9 3ss	3	5	-66.6	-62.3	-63.1		0.3	-53.6	-41.25	12.36
HE80 Beam Forming, M0 to M9 1ss	4	11	-68.5	-63.6	-64.6	-67.2	0.3	-48.3	-41.25	7.02
HE80 Beam Forming, M0 to M9 2ss	4	8	-67.1	-63.0	-64.2	-66.6	0.3	-50.6	-41.25	9.37
HE80 Beam Forming, M0 to M9 3ss	4	6	-66.6	-62.3	-63.1	-66.1	0.3	-51.9	-41.25	10.61
HE80 Beam Forming, M0 to M9 4ss	4	5	-66.6	-62.3	-63.1	-66.1	0.3	-52.9	-41.25	11.61
HE80 STBC, M0 to M9 1ss	2	5	-65.9	-62.0			0.3	-55.3	-41.25	14.01
HE80 STBC, M0 to M9 1ss	3	5	-66.6	-62.3	-63.1		0.3	-53.6	-41.25	12.36
HE80 STBC, M0 to M9 1ss	4	5	-66.6	-62.3	-63.1	-66.1	0.3	-52.9	-41.25	11.61



5300	Non HT20, 6 to 54 Mbps	1	5	-65.1				0.0	-60.1	-41.25	18.81
	Non HT20, 6 to 54 Mbps	2	5	-65.1	-56.2			0.0	-50.6	-41.25	9.38
	Non HT20, 6 to 54 Mbps	3	5	-65.1	-58.6	-59.7		0.0	-50.5	-41.25	9.30
	Non HT20, 6 to 54 Mbps	4	5	-65.7	-61.3	-62.7	-64.8	0.0	-52.2	-41.25	10.97
	Non HT20 Beam Forming, 6 to 54 Mbps	2	8	-65.1	-56.2			0.0	-47.6	-41.25	6.38
	Non HT20 Beam Forming, 6 to 54 Mbps	3	10	-65.1	-58.6	-59.7		0.0	-45.5	-41.25	4.30
	Non HT20 Beam Forming, 6 to 54 Mbps	4	11	-65.7	-61.3	-62.7	-64.8	0.0	-46.2	-41.25	4.97
	HT/VHT20, M0 to M7	1	5	-65.0				0.1	-59.9	-41.25	18.70
	HT/VHT20, M0 to M7	2	5	-65.0	-56.7			0.1	-51.0	-41.25	9.80
	HT/VHT20, M8 to M15	2	5	-65.0	-56.7			0.1	-51.0	-41.25	9.80
	HT/VHT20, M0 to M7	3	5	-65.0	-58.2	-59.8		0.1	-50.4	-41.25	9.11
	HT/VHT20, M8 to M15	3	5	-65.0	-56.7	-57.1		0.1	-48.5	-41.25	7.26
	HT/VHT20, M16 to M23	3	5	-65.0	-56.7	-57.1		0.1	-48.5	-41.25	7.26
	HT/VHT20, M0 to M7	4	5	-65.0	-60.3	-62.2	-63.8	0.1	-51.4	-41.25	10.14
	HT/VHT20, M8 to M15	4	5	-65.0	-57.7	-59.3	-61.9	0.1	-49.1	-41.25	7.86
	HT/VHT20, M16 to M23	4	5	-65.0	-56.7	-57.1	-60.1	0.1	-47.6	-41.25	6.39
	HT/VHT20, M24 to M31	4	5	-65.0	-56.7	-57.1	-60.1	0.1	-47.6	-41.25	6.39
	HT/VHT20 Beam Forming, M0 to M7	2	8	-65.0	-56.7			0.1	-48.0	-41.25	6.80
	HT/VHT20 Beam Forming, M8 to M15	2	5	-65.0	-56.7			0.1	-51.0	-41.25	9.80
	HT/VHT20 Beam Forming, M0 to M7	3	10	-65.0	-58.2	-59.8		0.1	-45.4	-41.25	4.11
	HT/VHT20 Beam Forming, M8 to M15	3	7	-65.0	-56.7	-57.1		0.1	-46.5	-41.25	5.26
	HT/VHT20 Beam Forming, M16 to M23	3	5	-65.0	-56.7	-57.1		0.1	-48.5	-41.25	7.26
	HT/VHT20 Beam Forming, M0 to M7	4	11	-65.0	-60.3	-62.2	-63.8	0.1	-45.4	-41.25	4.14
	HT/VHT20 Beam Forming, M8 to M15	4	8	-65.0	-57.7	-59.3	-61.9	0.1	-46.1	-41.25	4.86
	HT/VHT20 Beam Forming, M16 to M23	4	6	-65.0	-56.7	-57.1	-60.1	0.1	-46.6	-41.25	5.39
	HT/VHT20 Beam Forming, M24 to M31	4	5	-65.0	-56.7	-57.1	-60.1	0.1	-47.6	-41.25	6.39
	HT/VHT20 STBC, M0 to M7	2	5	-65.0	-56.7			0.1	-51.0	-41.25	9.80
	HT/VHT20 STBC, M0 to M7	3	5	-65.0	-56.7	-57.1		0.1	-48.5	-41.25	7.26
	HT/VHT20 STBC, M0 to M7	4	5	-65.0	-57.7	-59.3	-61.9	0.1	-49.1	-41.25	7.86
	HE20, M0 to M9 1ss	1	5	-65.2				0.1	-60.1	-41.25	18.88
	HE20, M0 to M9 1ss	2	5	-65.2	-56.2			0.1	-50.6	-41.25	9.36
	HE20, M0 to M9 2ss	2	5	-65.2	-56.2			0.1	-50.6	-41.25	9.36
	HE20, M0 to M9 1ss	3	5	-65.2	-58.5	-59.8		0.1	-50.5	-41.25	9.27
	HE20, M0 to M9 2ss	3	5	-65.2	-56.2	-57.1		0.1	-48.3	-41.25	7.00
	HE20, M0 to M9 3ss	3	5	-65.2	-56.2	-57.1		0.1	-48.3	-41.25	7.00
	HE20, M0 to M9 1ss	4	5	-65.8	-61.2	-63.0	-65.5	0.1	-52.4	-41.25	11.12
	HE20, M0 to M9 2ss	4	5	-65.2	-58.0	-59.1	-61.8	0.1	-49.2	-41.25	7.91
	HE20, M0 to M9 3ss	4	5	-65.2	-56.2	-57.1	-60.2	0.1	-47.4	-41.25	6.19
	HE20, M0 to M9 4ss	4	5	-65.2	-56.2	-57.1	-60.2	0.1	-47.4	-41.25	6.19
	HE20 Beam Forming, M0 to M9 1ss	2	8	-65.2	-56.2			0.1	-47.6	-41.25	6.36
HE20 Beam Forming, M0 to M9 2ss	2	5	-65.2	-56.2			0.1	-50.6	-41.25	9.36	
HE20 Beam Forming, M0 to M9 1ss	3	10	-65.2	-58.5	-59.8		0.1	-45.5	-41.25	4.27	



	HE20 Beam Forming, M0 to M9 2ss	3	7	-65.2	-56.2	-57.1		0.1	-46.3	-41.25	5.00
	HE20 Beam Forming, M0 to M9 3ss	3	5	-65.2	-56.2	-57.1		0.1	-48.3	-41.25	7.00
	HE20 Beam Forming, M0 to M9 1ss	4	11	-65.8	-61.2	-63.0	-65.5	0.1	-46.4	-41.25	5.12
	HE20 Beam Forming, M0 to M9 2ss	4	8	-65.2	-58.0	-59.1	-61.8	0.1	-46.2	-41.25	4.91
	HE20 Beam Forming, M0 to M9 3ss	4	6	-65.2	-56.2	-57.1	-60.2	0.1	-46.4	-41.25	5.19
	HE20 Beam Forming, M0 to M9 4ss	4	5	-65.2	-56.2	-57.1	-60.2	0.1	-47.4	-41.25	6.19
	HE20 STBC, M0 to M9 2ss	2	5	-65.2	-56.2			0.1	-50.6	-41.25	9.36
	HE20 STBC, M0 to M9 2ss	3	5	-65.2	-56.2	-57.1		0.1	-48.3	-41.25	7.00
	HE20 STBC, M0 to M9 2ss	4	5	-65.2	-58.0	-59.1	-61.8	0.1	-49.2	-41.25	7.91
5310	Non HT40, 6 to 54 Mbps	1	5	-65.5				0.0	-60.5	-41.25	19.21
	Non HT40, 6 to 54 Mbps	2	5	-65.5	-61.6			0.0	-55.1	-41.25	13.82
	Non HT40, 6 to 54 Mbps	3	5	-65.5	-61.6	-62.3		0.0	-53.0	-41.25	11.77
	Non HT40, 6 to 54 Mbps	4	5	-65.5	-61.6	-62.3	-64.4	0.0	-52.1	-41.25	10.86
	HT/VHT40, M0 to M7	1	5	-65.8				0.1	-60.7	-41.25	19.45
	HT/VHT40, M0 to M7	2	5	-65.8	-61.7			0.1	-55.2	-41.25	13.92
	HT/VHT40, M8 to M15	2	5	-65.8	-61.7			0.1	-55.2	-41.25	13.92
	HT/VHT40, M0 to M7	3	5	-65.8	-61.7	-63.0		0.1	-53.3	-41.25	12.06
	HT/VHT40, M8 to M15	3	5	-65.8	-61.7	-63.0		0.1	-53.3	-41.25	12.06
	HT/VHT40, M16 to M23	3	5	-65.8	-61.7	-63.0		0.1	-53.3	-41.25	12.06
	HT/VHT40, M0 to M7	4	5	-65.8	-61.7	-63.0	-64.9	0.1	-52.4	-41.25	11.18
	HT/VHT40, M8 to M15	4	5	-65.8	-61.7	-63.0	-64.9	0.1	-52.4	-41.25	11.18
	HT/VHT40, M16 to M23	4	5	-65.8	-61.7	-63.0	-64.9	0.1	-52.4	-41.25	11.18
	HT/VHT40, M24 to M31	4	5	-65.8	-61.7	-63.0	-64.9	0.1	-52.4	-41.25	11.18
	HT/VHT40 Beam Forming, M0 to M7	2	8	-65.8	-61.7			0.1	-52.2	-41.25	10.92
	HT/VHT40 Beam Forming, M8 to M15	2	5	-65.8	-61.7			0.1	-55.2	-41.25	13.92
	HT/VHT40 Beam Forming, M0 to M7	3	10	-66.6	-62.2	-63.4		0.1	-48.8	-41.25	7.58
	HT/VHT40 Beam Forming, M8 to M15	3	7	-65.8	-61.7	-63.0		0.1	-51.3	-41.25	10.06
	HT/VHT40 Beam Forming, M16 to M23	3	5	-65.8	-61.7	-63.0		0.1	-53.3	-41.25	12.06
	HT/VHT40 Beam Forming, M0 to M7	4	11	-67.1	-63.0	-64.2	-67.0	0.1	-47.8	-41.25	6.59
	HT/VHT40 Beam Forming, M8 to M15	4	8	-66.6	-62.2	-63.4	-66.1	0.1	-50.1	-41.25	8.82
	HT/VHT40 Beam Forming, M16 to M23	4	6	-65.8	-61.7	-63.0	-64.9	0.1	-51.4	-41.25	10.18
	HT/VHT40 Beam Forming, M24 to M31	4	5	-65.8	-61.7	-63.0	-64.9	0.1	-52.4	-41.25	11.18
	HT/VHT40 STBC, M0 to M7	2	5	-65.8	-61.7			0.1	-55.2	-41.25	13.92
	HT/VHT40 STBC, M0 to M7	3	5	-65.8	-61.7	-63.0		0.1	-53.3	-41.25	12.06
	HT/VHT40 STBC, M0 to M7	4	5	-65.8	-61.7	-63.0	-64.9	0.1	-52.4	-41.25	11.18
	HE40, M0 to M9 1ss	1	5	-65.8				0.1	-60.7	-41.25	19.42
	HE40, M0 to M9 1ss	2	5	-65.8	-61.5			0.1	-55.0	-41.25	13.75
	HE40, M0 to M9 2ss	2	5	-65.8	-61.5			0.1	-55.0	-41.25	13.75
	HE40, M0 to M9 1ss	3	5	-65.8	-61.5	-62.7		0.1	-53.1	-41.25	11.84
	HE40, M0 to M9 2ss	3	5	-65.8	-61.5	-62.7		0.1	-53.1	-41.25	11.84
	HE40, M0 to M9 3ss	3	5	-65.8	-61.5	-62.7		0.1	-53.1	-41.25	11.84



HE40, M0 to M9 1ss	4	5	-66.4	-62.2	-63.6	-66.0	0.1	-53.1	-41.25	11.80
HE40, M0 to M9 2ss	4	5	-66.4	-62.2	-63.6	-66.0	0.1	-53.1	-41.25	11.80
HE40, M0 to M9 3ss	4	5	-66.4	-62.2	-63.6	-66.0	0.1	-53.1	-41.25	11.80
HE40, M0 to M9 4ss	4	5	-66.4	-62.2	-63.6	-66.0	0.1	-53.1	-41.25	11.80
HE40 Beam Forming, M0 to M9 1ss	2	8	-66.4	-62.2			0.1	-52.7	-41.25	11.42
HE40 Beam Forming, M0 to M9 2ss	2	5	-65.8	-61.5			0.1	-55.0	-41.25	13.75
HE40 Beam Forming, M0 to M9 1ss	3	10	-67.0	-62.8	-64.2		0.1	-49.4	-41.25	8.19
HE40 Beam Forming, M0 to M9 2ss	3	7	-66.4	-62.2	-63.6		0.1	-51.8	-41.25	10.59
HE40 Beam Forming, M0 to M9 3ss	3	5	-65.8	-61.5	-62.7		0.1	-53.1	-41.25	11.84
HE40 Beam Forming, M0 to M9 1ss	4	11	-67.9	-63.2	-64.4	-67.1	0.1	-48.1	-41.25	6.83
HE40 Beam Forming, M0 to M9 2ss	4	8	-66.4	-62.2	-63.6	-66.0	0.1	-50.1	-41.25	8.80
HE40 Beam Forming, M0 to M9 3ss	4	6	-66.4	-62.2	-63.6	-66.0	0.1	-52.1	-41.25	10.80
HE40 Beam Forming, M0 to M9 4ss	4	5	-66.4	-62.2	-63.6	-66.0	0.1	-53.1	-41.25	11.80
HE40 STBC, M0 to M9 2ss	2	5	-65.8	-61.5			0.1	-55.0	-41.25	13.75
HE40 STBC, M0 to M9 2ss	3	5	-65.8	-61.5	-62.7		0.1	-53.1	-41.25	11.84
HE40 STBC, M0 to M9 2ss	4	5	-66.4	-62.2	-63.6	-66.0	0.1	-53.1	-41.25	11.80
5320										
Non HT20, 6 to 54 Mbps	1	5	-65.6				0.0	-60.6	-41.25	19.31
Non HT20, 6 to 54 Mbps	2	5	-65.6	-57.1			0.0	-51.5	-41.25	10.23
Non HT20, 6 to 54 Mbps	3	5	-65.6	-59.7	-61.1		0.0	-51.7	-41.25	10.44
Non HT20, 6 to 54 Mbps	4	5	-66.4	-61.6	-63.3	-66.1	0.0	-52.8	-41.25	11.57
Non HT20 Beam Forming, 6 to 54 Mbps	2	8	-65.6	-57.9			0.0	-49.2	-41.25	7.93
Non HT20 Beam Forming, 6 to 54 Mbps	3	10	-65.6	-59.7	-61.1		0.0	-46.7	-41.25	5.44
Non HT20 Beam Forming, 6 to 54 Mbps	4	11	-66.4	-61.6	-63.3	-66.1	0.0	-46.8	-41.25	5.57
HT/VHT20, M0 to M7	1	5	-65.9				0.1	-60.8	-41.25	19.60
HT/VHT20, M0 to M7	2	5	-65.9	-58.1			0.1	-52.4	-41.25	11.13
HT/VHT20, M8 to M15	2	5	-65.9	-58.1			0.1	-52.4	-41.25	11.13
HT/VHT20, M0 to M7	3	5	-65.9	-59.4	-60.4		0.1	-51.3	-41.25	10.05
HT/VHT20, M8 to M15	3	5	-65.9	-58.1	-59.1		0.1	-50.1	-41.25	8.87
HT/VHT20, M16 to M23	3	5	-65.9	-58.1	-59.1		0.1	-50.1	-41.25	8.87
HT/VHT20, M0 to M7	4	5	-65.9	-61.0	-62.8	-64.8	0.1	-52.1	-41.25	10.89
HT/VHT20, M8 to M15	4	5	-65.9	-58.6	-59.7	-62.9	0.1	-49.9	-41.25	8.62
HT/VHT20, M16 to M23	4	5	-65.9	-58.6	-59.7	-62.9	0.1	-49.9	-41.25	8.62
HT/VHT20, M24 to M31	4	5	-65.9	-58.6	-59.7	-62.9	0.1	-49.9	-41.25	8.62
HT/VHT20 Beam Forming, M0 to M7	2	8	-65.9	-58.1			0.1	-49.4	-41.25	8.13
HT/VHT20 Beam Forming, M8 to M15	2	5	-65.9	-58.1			0.1	-52.4	-41.25	11.13
HT/VHT20 Beam Forming, M0 to M7	3	10	-65.9	-59.4	-60.4		0.1	-46.3	-41.25	5.05
HT/VHT20 Beam Forming, M8 to M15	3	7	-65.9	-58.6	-59.7		0.1	-48.6	-41.25	7.37
HT/VHT20 Beam Forming, M16 to M23	3	5	-65.9	-58.1	-59.1		0.1	-50.1	-41.25	8.87
HT/VHT20 Beam Forming, M0 to M7	4	11	-65.9	-61.0	-62.8	-64.8	0.1	-46.1	-41.25	4.89
HT/VHT20 Beam Forming, M8 to M15	4	8	-65.9	-58.6	-59.7	-62.9	0.1	-46.9	-41.25	5.62
HT/VHT20 Beam Forming, M16 to M23	4	6	-65.9	-58.6	-59.7	-62.9	0.1	-48.9	-41.25	7.62





	HT/VHT20 Beam Forming, M24 to M31	4	5	-65.9	-58.6	-59.7	-62.9	0.1	-49.9	-41.25	8.62
	HT/VHT20 STBC, M0 to M7	2	5	-65.9	-58.1			0.1	-52.4	-41.25	11.13
	HT/VHT20 STBC, M0 to M7	3	5	-65.9	-58.1	-59.1		0.1	-50.1	-41.25	8.87
	HT/VHT20 STBC, M0 to M7	4	5	-65.9	-58.6	-59.7	-62.9	0.1	-49.9	-41.25	8.62
	HE20, M0 to M9 1ss	1	5	-65.4				0.1	-60.3	-41.25	19.08
	HE20, M0 to M9 1ss	2	5	-65.4	-57.8			0.1	-52.0	-41.25	10.78
	HE20, M0 to M9 2ss	2	5	-65.4	-57.8			0.1	-52.0	-41.25	10.78
	HE20, M0 to M9 1ss	3	5	-65.4	-59.0	-60.0		0.1	-50.9	-41.25	9.62
	HE20, M0 to M9 2ss	3	5	-65.4	-57.8	-58.6		0.1	-49.7	-41.25	8.46
	HE20, M0 to M9 3ss	3	5	-65.4	-57.8	-58.6		0.1	-49.7	-41.25	8.46
	HE20, M0 to M9 1ss	4	5	-65.4	-60.8	-62.3	-64.5	0.1	-51.8	-41.25	10.53
	HE20, M0 to M9 2ss	4	5	-65.4	-58.5	-59.3	-62.4	0.1	-49.5	-41.25	8.30
	HE20, M0 to M9 3ss	4	5	-65.4	-58.5	-59.3	-62.4	0.1	-49.5	-41.25	8.30
	HE20, M0 to M9 4ss	4	5	-65.4	-58.5	-59.3	-62.4	0.1	-49.5	-41.25	8.30
	HE20 Beam Forming, M0 to M9 1ss	2	8	-65.4	-58.5			0.1	-49.6	-41.25	8.37
	HE20 Beam Forming, M0 to M9 2ss	2	5	-65.4	-57.8			0.1	-52.0	-41.25	10.78
	HE20 Beam Forming, M0 to M9 1ss	3	10	-65.4	-59.0	-60.0		0.1	-45.9	-41.25	4.62
	HE20 Beam Forming, M0 to M9 2ss	3	7	-65.4	-58.5	-59.3		0.1	-48.3	-41.25	7.09
	HE20 Beam Forming, M0 to M9 3ss	3	5	-65.4	-57.8	-58.6		0.1	-49.7	-41.25	8.46
	HE20 Beam Forming, M0 to M9 1ss	4	11	-65.4	-60.8	-62.3	-64.5	0.1	-45.8	-41.25	4.53
	HE20 Beam Forming, M0 to M9 2ss	4	8	-65.4	-59.0	-60.0	-62.8	0.1	-47.1	-41.25	5.81
	HE20 Beam Forming, M0 to M9 3ss	4	6	-65.4	-58.5	-59.3	-62.4	0.1	-48.5	-41.25	7.30
	HE20 Beam Forming, M0 to M9 4ss	4	5	-65.4	-58.5	-59.3	-62.4	0.1	-49.5	-41.25	8.30
	HE20 STBC, M0 to M9 2ss	2	5	-65.4	-57.8			0.1	-52.0	-41.25	10.78
	HE20 STBC, M0 to M9 2ss	3	5	-65.4	-57.8	-58.6		0.1	-49.7	-41.25	8.46
	HE20 STBC, M0 to M9 2ss	4	5	-65.4	-58.5	-59.3	-62.4	0.1	-49.5	-41.25	8.30
5250	Non HT160, 6 to 54 Mbps	1	5	-62.3				0.0	-57.3	-41.25	16.00
	Non HT160, 6 to 54 Mbps	2	5	-63.8	-60.4			0.0	-53.7	-41.25	12.47
	Non HT160, 6 to 54 Mbps	3	5	-63.8	-60.4	-61.8		0.0	-52.0	-41.25	10.71
	Non HT160, 6 to 54 Mbps	4	5	-63.8	-60.4	-61.8	-63.8	0.0	-51.1	-41.25	9.89
	VHT160, M0 to M9 1ss	1	5	-63.9				0.4	-58.5	-41.25	17.26
	VHT160, M0 to M9 1ss	2	5	-63.9	-60.8			0.4	-53.7	-41.25	12.43
	VHT160, M0 to M9 2ss	2	5	-63.9	-60.8			0.4	-53.7	-41.25	12.43
	VHT160, M0 to M9 1ss	3	5	-63.9	-60.8	-61.4		0.4	-51.7	-41.25	10.43
	VHT160, M0 to M9 2ss	3	5	-63.9	-60.8	-61.4		0.4	-51.7	-41.25	10.43
	VHT160, M0 to M9 3ss	3	5	-63.9	-60.8	-61.4		0.4	-51.7	-41.25	10.43
	VHT160, M0 to M9 1ss	4	5	-63.9	-60.8	-61.4	-63.8	0.4	-50.8	-41.25	9.59
	VHT160, M0 to M9 2ss	4	5	-63.9	-60.8	-61.4	-63.8	0.4	-50.8	-41.25	9.59
	VHT160, M0 to M9 3ss	4	5	-63.9	-60.8	-61.4	-63.8	0.4	-50.8	-41.25	9.59
	VHT160, M0 to M9 4ss	4	5	-63.9	-60.8	-61.4	-63.8	0.4	-50.8	-41.25	9.59
	VHT160 Beam Forming, M0 to M9 1ss	2	8	-64.9	-61.4			0.4	-51.4	-41.25	10.15



VHT160 Beam Forming, M0 to M9 2ss	2	5	-63.9	-60.8			0.4	-53.7	-41.25	12.43
VHT160 Beam Forming, M0 to M9 1ss	3	10	-65.5	-61.9	-62.9		0.4	-48.0	-41.25	6.77
VHT160 Beam Forming, M0 to M9 2ss	3	7	-64.9	-61.4	-62.4		0.4	-50.5	-41.25	9.25
VHT160 Beam Forming, M0 to M9 3ss	3	5	-63.9	-60.8	-61.4		0.4	-51.7	-41.25	10.43
VHT160 Beam Forming, M0 to M9 1ss	4	11	-66.9	-62.7	-63.5	-66.3	0.4	-47.1	-41.25	5.83
VHT160 Beam Forming, M0 to M9 2ss	4	8	-64.9	-61.4	-62.4	-64.6	0.4	-48.7	-41.25	7.41
VHT160 Beam Forming, M0 to M9 3ss	4	6	-64.9	-61.4	-62.4	-64.6	0.4	-50.7	-41.25	9.41
VHT160 Beam Forming, M0 to M9 4ss	4	5	-63.9	-60.8	-61.4	-63.8	0.4	-50.8	-41.25	9.59
VHT160 STBC, M0 to M9 1ss	2	5	-63.9	-60.8			0.4	-53.7	-41.25	12.43
VHT160 STBC, M0 to M9 1ss	3	5	-63.9	-60.8	-61.4		0.4	-51.7	-41.25	10.43
VHT160 STBC, M0 to M9 1ss	4	5	-63.9	-60.8	-61.4	-63.8	0.4	-50.8	-41.25	9.59
HE160, M0 to M9 1ss	1	5	-63.9				0.4	-58.5	-41.25	17.22
HE160, M0 to M9 1ss	2	5	-63.9	-60.3			0.4	-53.3	-41.25	12.04
HE160, M0 to M9 2ss	2	5	-63.9	-60.3			0.4	-53.3	-41.25	12.04
HE160, M0 to M9 1ss	3	5	-63.9	-60.3	-61.2		0.4	-51.3	-41.25	10.10
HE160, M0 to M9 2ss	3	5	-63.9	-60.3	-61.2		0.4	-51.3	-41.25	10.10
HE160, M0 to M9 3ss	3	5	-63.9	-60.3	-61.2		0.4	-51.3	-41.25	10.10
HE160, M0 to M9 1ss	4	5	-63.9	-60.3	-61.2	-63.9	0.4	-50.6	-41.25	9.33
HE160, M0 to M9 2ss	4	5	-63.9	-60.3	-61.2	-63.9	0.4	-50.6	-41.25	9.33
HE160, M0 to M9 3ss	4	5	-63.9	-60.3	-61.2	-63.9	0.4	-50.6	-41.25	9.33
HE160, M0 to M9 4ss	4	5	-63.9	-60.3	-61.2	-63.9	0.4	-50.6	-41.25	9.33
HE160 Beam Forming, M0 to M9 1ss	2	8	-64.8	-61.2			0.4	-51.2	-41.25	9.94
HE160 Beam Forming, M0 to M9 2ss	2	5	-63.9	-60.3			0.4	-53.3	-41.25	12.04
HE160 Beam Forming, M0 to M9 1ss	3	10	-64.8	-61.2	-62.0		0.4	-47.2	-41.25	5.96
HE160 Beam Forming, M0 to M9 2ss	3	7	-63.9	-60.3	-61.2		0.4	-49.3	-41.25	8.10
HE160 Beam Forming, M0 to M9 3ss	3	5	-63.9	-60.3	-61.2		0.4	-51.3	-41.25	10.10
HE160 Beam Forming, M0 to M9 1ss	4	11	-65.3	-61.8	-62.9	-65.5	0.4	-46.1	-41.25	4.88
HE160 Beam Forming, M0 to M9 2ss	4	8	-64.8	-61.2	-62.0	-64.5	0.4	-48.4	-41.25	7.14
HE160 Beam Forming, M0 to M9 3ss	4	6	-63.9	-60.3	-61.2	-63.9	0.4	-49.6	-41.25	8.33
HE160 Beam Forming, M0 to M9 4ss	4	5	-63.9	-60.3	-61.2	-63.9	0.4	-50.6	-41.25	9.33
HE160 STBC, M0 to M9 1ss	2	5	-63.9	-60.3			0.4	-53.3	-41.25	12.04
HE160 STBC, M0 to M9 1ss	3	5	-63.9	-60.3	-61.2		0.4	-51.3	-41.25	10.10
HE160 STBC, M0 to M9 1ss	4	5	-63.9	-60.3	-61.2	-63.9	0.4	-50.6	-41.25	9.33





**Conducted Spurs Average, 5dBi  
5270 MHz, HT/VHT40 Beam Forming, M0 to M7**

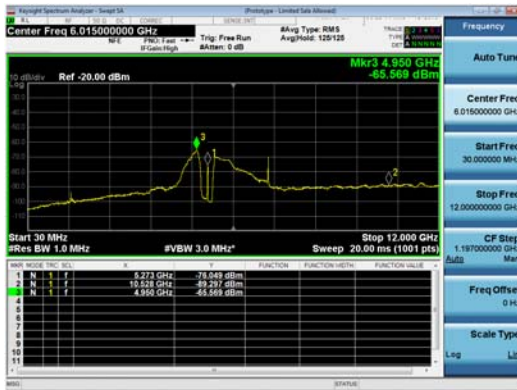

**Antenna A**

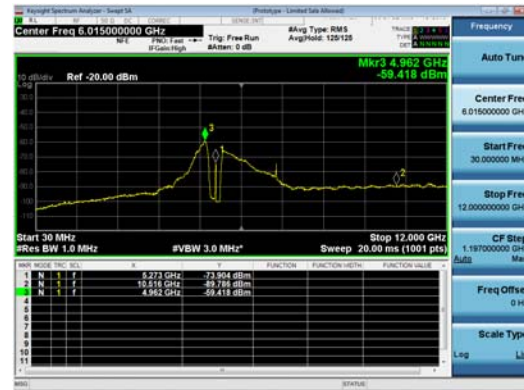

**Antenna B**

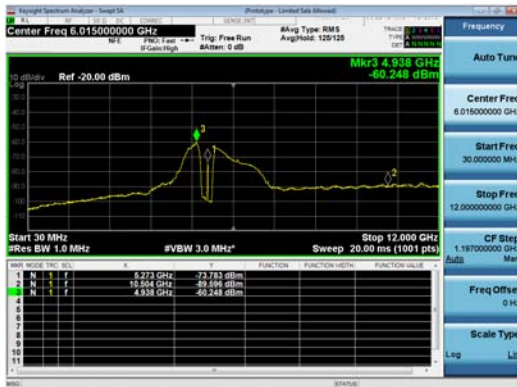

**Antenna C**

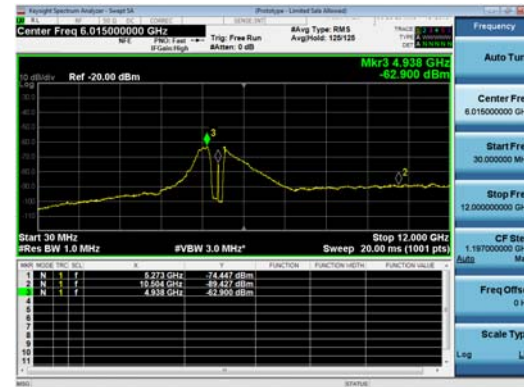

**Antenna D**



## Conducted Spurious Emissions Average Table, 6dBi

Frequency (MHz)	Mode	Tx Paths	Correlated Antenna Gain (dBi)	Tx 1 Spur Power (dBm)	Tx 2 Spur Power (dBm)	Tx 3 Spur Power (dBm)	Tx 4 Spur Power (dBm)	Duty Cycle Correction (dB)	Total Conducted Spur (dBm)	Limit (dBm)	Margin (dB)
5260	Non HT20, 6 to 54 Mbps	1	6	-64.9				0.0	-58.9	-41.25	17.61
	Non HT20, 6 to 54 Mbps	2	6	-64.9	-56.0			0.0	-49.4	-41.25	8.18
	Non HT20, 6 to 54 Mbps	3	6	-64.9	-58.7	-60.1		0.0	-49.7	-41.25	8.47
	Non HT20, 6 to 54 Mbps	4	6	-66.3	-61.7	-63.1	-65.4	0.0	-51.7	-41.25	10.43
	Non HT20 Beam Forming, 6 to 54 Mbps	2	9	-64.9	-56.0			0.0	-46.4	-41.25	5.18
	Non HT20 Beam Forming, 6 to 54 Mbps	3	11	-64.9	-58.7	-60.1		0.0	-44.7	-41.25	3.47
	Non HT20 Beam Forming, 6 to 54 Mbps	4	12	-66.3	-61.7	-63.1	-65.4	0.0	-45.7	-41.25	4.43
	HT/VHT20, M0 to M7	1	6	-65.4				0.1	-59.3	-41.25	18.10
	HT/VHT20, M0 to M7	2	6	-65.4	-55.9			0.1	-49.4	-41.25	8.14
	HT/VHT20, M8 to M15	2	6	-65.4	-55.9			0.1	-49.4	-41.25	8.14
	HT/VHT20, M0 to M7	3	6	-65.4	-58.9	-60.2		0.1	-49.9	-41.25	8.66
	HT/VHT20, M8 to M15	3	6	-65.4	-56.9	-57.7		0.1	-47.9	-41.25	6.65
	HT/VHT20, M16 to M23	3	6	-65.4	-55.9	-56.6		0.1	-46.9	-41.25	5.67
	HT/VHT20, M0 to M7	4	6	-66.2	-61.3	-62.4	-64.5	0.1	-51.1	-41.25	9.88
	HT/VHT20, M8 to M15	4	6	-65.4	-58.5	-59.4	-61.9	0.1	-48.5	-41.25	7.26
	HT/VHT20, M16 to M23	4	6	-65.4	-56.9	-57.7	-60.3	0.1	-47.0	-41.25	5.74
	HT/VHT20, M24 to M31	4	6	-65.4	-55.9	-56.6	-59.2	0.1	-46.0	-41.25	4.74
	HT/VHT20 Beam Forming, M0 to M7	2	9	-65.4	-55.9			0.1	-46.4	-41.25	5.14
	HT/VHT20 Beam Forming, M8 to M15	2	6	-65.4	-55.9			0.1	-49.4	-41.25	8.14
	HT/VHT20 Beam Forming, M0 to M7	3	11	-65.4	-58.9	-60.2		0.1	-44.9	-41.25	3.66
	HT/VHT20 Beam Forming, M8 to M15	3	8	-65.4	-56.9	-57.7		0.1	-45.9	-41.25	4.65
	HT/VHT20 Beam Forming, M16 to M23	3	6	-65.4	-55.9	-56.6		0.1	-46.9	-41.25	5.67
	HT/VHT20 Beam Forming, M0 to M7	4	12	-66.2	-61.3	-62.4	-64.5	0.1	-45.1	-41.25	3.88
	HT/VHT20 Beam Forming, M8 to M15	4	9	-65.4	-58.5	-59.4	-61.9	0.1	-45.5	-41.25	4.26
	HT/VHT20 Beam Forming, M16 to M23	4	7	-65.4	-56.9	-57.7	-60.3	0.1	-46.0	-41.25	4.74
	HT/VHT20 Beam Forming, M24 to M31	4	6	-65.4	-55.9	-56.6	-59.2	0.1	-46.0	-41.25	4.74
	HT/VHT20 STBC, M0 to M7	2	6	-65.4	-55.9			0.1	-49.4	-41.25	8.14
	HT/VHT20 STBC, M0 to M7	3	6	-65.4	-56.9	-57.7		0.1	-47.9	-41.25	6.65



	HT/VHT20 STBC, M0 to M7	4	6	-65.4	-58.5	-59.4	-61.9	0.1	-48.5	-41.25	7.26
	HE20, M0 to M9 1ss	1	6	-65.0				0.1	-58.9	-41.25	17.68
	HE20, M0 to M9 1ss	2	6	-65.0	-55.8			0.1	-49.2	-41.25	7.99
	HE20, M0 to M9 2ss	2	6	-65.0	-55.8			0.1	-49.2	-41.25	7.99
	HE20, M0 to M9 1ss	3	6	-65.0	-58.8	-59.9		0.1	-49.7	-41.25	8.43
	HE20, M0 to M9 2ss	3	6	-65.0	-56.8	-57.4		0.1	-47.7	-41.25	6.42
	HE20, M0 to M9 3ss	3	6	-65.0	-55.8	-56.7		0.1	-46.9	-41.25	5.62
	HE20, M0 to M9 1ss	4	6	-66.3	-61.6	-63.1	-65.4	0.1	-51.6	-41.25	10.36
	HE20, M0 to M9 2ss	4	6	-65.0	-58.8	-59.9	-62.6	0.1	-48.9	-41.25	7.62
	HE20, M0 to M9 3ss	4	6	-65.0	-56.8	-57.4	-60.0	0.1	-46.7	-41.25	5.50
	HE20, M0 to M9 4ss	4	6	-65.0	-55.8	-56.7	-59.1	0.1	-45.9	-41.25	4.68
	HE20 Beam Forming, M0 to M9 1ss	2	9	-65.0	-55.8			0.1	-46.2	-41.25	4.99
	HE20 Beam Forming, M0 to M9 2ss	2	6	-65.0	-55.8			0.1	-49.2	-41.25	7.99
	HE20 Beam Forming, M0 to M9 1ss	3	11	-65.0	-58.8	-59.9		0.1	-44.7	-41.25	3.43
	HE20 Beam Forming, M0 to M9 2ss	3	8	-65.0	-56.8	-57.4		0.1	-45.7	-41.25	4.42
	HE20 Beam Forming, M0 to M9 3ss	3	6	-65.0	-55.8	-56.7		0.1	-46.9	-41.25	5.62
	HE20 Beam Forming, M0 to M9 1ss	4	12	-66.3	-61.6	-63.1	-65.4	0.1	-45.6	-41.25	4.36
	HE20 Beam Forming, M0 to M9 2ss	4	9	-65.0	-58.8	-59.9	-62.6	0.1	-45.9	-41.25	4.62
	HE20 Beam Forming, M0 to M9 3ss	4	7	-65.0	-56.8	-57.4	-60.0	0.1	-45.7	-41.25	4.50
	HE20 Beam Forming, M0 to M9 4ss	4	6	-65.0	-55.8	-56.7	-59.1	0.1	-45.9	-41.25	4.68
	HE20 STBC, M0 to M9 2ss	2	6	-65.0	-55.8			0.1	-49.2	-41.25	7.99
	HE20 STBC, M0 to M9 2ss	3	6	-65.0	-56.8	-57.4		0.1	-47.7	-41.25	6.42
	HE20 STBC, M0 to M9 2ss	4	6	-65.0	-58.8	-59.9	-62.6	0.1	-48.9	-41.25	7.62
5270	Non HT40, 6 to 54 Mbps	1	6	-65.2				0.0	-59.2	-41.25	17.91
	Non HT40, 6 to 54 Mbps	2	6	-65.2	-56.3			0.0	-49.7	-41.25	8.48
	Non HT40, 6 to 54 Mbps	3	6	-65.2	-57.1	-57.4		0.0	-47.9	-41.25	6.61
	Non HT40, 6 to 54 Mbps	4	6	-65.2	-59.3	-60.1	-62.8	0.0	-49.2	-41.25	7.97
	HT/VHT40, M0 to M7	1	6	-65.6				0.1	-59.5	-41.25	18.25
	HT/VHT40, M0 to M7	2	6	-65.6	-56.8			0.1	-50.2	-41.25	8.91
	HT/VHT40, M8 to M15	2	6	-65.6	-56.8			0.1	-50.2	-41.25	8.91
	HT/VHT40, M0 to M7	3	6	-65.6	-56.8	-57.0		0.1	-47.5	-41.25	6.25
	HT/VHT40, M8 to M15	3	6	-65.6	-56.8	-57.0		0.1	-47.5	-41.25	6.25
	HT/VHT40, M16 to M23	3	6	-65.6	-56.8	-57.0		0.1	-47.5	-41.25	6.25
	HT/VHT40, M0 to M7	4	6	-65.6	-58.7	-59.7	-61.9	0.1	-48.7	-41.25	7.41
	HT/VHT40, M8 to M15	4	6	-65.6	-56.8	-57.0	-59.6	0.1	-46.5	-41.25	5.28
	HT/VHT40, M16 to M23	4	6	-65.6	-56.8	-57.0	-59.6	0.1	-46.5	-41.25	5.28
	HT/VHT40, M24 to M31	4	6	-65.6	-56.8	-57.0	-59.6	0.1	-46.5	-41.25	5.28
	HT/VHT40 Beam Forming, M0 to M7	2	9	-65.6	-56.8			0.1	-47.2	-41.25	5.91
	HT/VHT40 Beam Forming, M8 to M15	2	6	-65.6	-56.8			0.1	-50.2	-41.25	8.91
	HT/VHT40 Beam Forming, M0 to M7	3	11	-65.6	-58.7	-59.7		0.1	-44.6	-41.25	3.34
HT/VHT40 Beam Forming, M8 to M15	3	8	-65.6	-56.8	-57.0		0.1	-45.5	-41.25	4.25	



HT/VHT40 Beam Forming, M16 to M23	3	6	-65.6	-56.8	-57.0		0.1	-47.5	-41.25	6.25
<b>HT/VHT40 Beam Forming, M0 to M7</b>	<b>4</b>	<b>12</b>	<b>-65.6</b>	<b>-60.3</b>	<b>-60.7</b>	<b>-63.5</b>	<b>0.1</b>	<b>-43.9</b>	<b>-41.25</b>	<b>2.66</b>
HT/VHT40 Beam Forming, M8 to M15	4	9	-65.6	-58.1	-58.8	-61.3	0.1	-45.0	-41.25	3.76
HT/VHT40 Beam Forming, M16 to M23	4	7	-65.6	-56.8	-57.0	-59.6	0.1	-45.5	-41.25	4.28
HT/VHT40 Beam Forming, M24 to M31	4	6	-65.6	-56.8	-57.0	-59.6	0.1	-46.5	-41.25	5.28
HT/VHT40 STBC, M0 to M7	2	6	-65.6	-56.8			0.1	-50.2	-41.25	8.91
HT/VHT40 STBC, M0 to M7	3	6	-65.6	-56.8	-57.0		0.1	-47.5	-41.25	6.25
HT/VHT40 STBC, M0 to M7	4	6	-65.6	-58.1	-58.8	-61.3	0.1	-48.0	-41.25	6.76
HE40, M0 to M9 1ss	1	6	-65.7				0.1	-59.6	-41.25	18.32
HE40, M0 to M9 1ss	2	6	-65.7	-56.5			0.1	-49.9	-41.25	8.63
HE40, M0 to M9 2ss	2	6	-65.7	-56.5			0.1	-49.9	-41.25	8.63
HE40, M0 to M9 1ss	3	6	-65.7	-57.5	-57.9		0.1	-48.2	-41.25	6.97
HE40, M0 to M9 2ss	3	6	-65.7	-56.5	-56.8		0.1	-47.2	-41.25	6.00
HE40, M0 to M9 3ss	3	6	-65.7	-56.5	-56.8		0.1	-47.2	-41.25	6.00
HE40, M0 to M9 1ss	4	6	-65.7	-59.1	-59.7	-62.1	0.1	-48.8	-41.25	7.59
HE40, M0 to M9 2ss	4	6	-65.7	-56.5	-56.8	-59.6	0.1	-46.3	-41.25	5.07
HE40, M0 to M9 3ss	4	6	-65.7	-56.5	-56.8	-59.6	0.1	-46.3	-41.25	5.07
HE40, M0 to M9 4ss	4	6	-65.7	-56.5	-56.8	-59.6	0.1	-46.3	-41.25	5.07
HE40 Beam Forming, M0 to M9 1ss	2	9	-65.7	-56.5			0.1	-46.9	-41.25	5.63
HE40 Beam Forming, M0 to M9 2ss	2	6	-65.7	-56.5			0.1	-49.9	-41.25	8.63
HE40 Beam Forming, M0 to M9 1ss	3	11	-65.7	-59.1	-59.7		0.1	-44.8	-41.25	3.52
HE40 Beam Forming, M0 to M9 2ss	3	8	-65.7	-56.5	-56.8		0.1	-45.2	-41.25	4.00
HE40 Beam Forming, M0 to M9 3ss	3	6	-65.7	-56.5	-56.8		0.1	-47.2	-41.25	6.00
HE40 Beam Forming, M0 to M9 1ss	4	12	-65.7	-60.5	-61.0	-63.5	0.1	-44.1	-41.25	2.82
HE40 Beam Forming, M0 to M9 2ss	4	9	-65.7	-58.1	-58.8	-61.3	0.1	-45.0	-41.25	3.73
HE40 Beam Forming, M0 to M9 3ss	4	7	-65.7	-56.5	-56.8	-59.6	0.1	-45.3	-41.25	4.07
HE40 Beam Forming, M0 to M9 4ss	4	6	-65.7	-56.5	-56.8	-59.6	0.1	-46.3	-41.25	5.07
HE40 STBC, M0 to M9 2ss	2	6	-65.7	-56.5			0.1	-49.9	-41.25	8.63
HE40 STBC, M0 to M9 2ss	3	6	-65.7	-56.5	-56.8		0.1	-47.2	-41.25	6.00
HE40 STBC, M0 to M9 2ss	4	6	-65.7	-58.1	-58.8	-61.3	0.1	-48.0	-41.25	6.73
<b>5290</b>										
Non HT80, 6 to 54 Mbps	1	6	-66.0				0.1	-59.9	-41.25	18.70
Non HT80, 6 to 54 Mbps	2	6	-66.0	-61.9			0.1	-54.4	-41.25	13.17
Non HT80, 6 to 54 Mbps	3	6	-66.0	-61.9	-62.7		0.1	-52.4	-41.25	11.13
Non HT80, 6 to 54 Mbps	4	6	-66.0	-61.9	-62.7	-65.3	0.1	-51.6	-41.25	10.32
VHT80, M0 to M9 1ss	1	6	-65.8				0.2	-59.6	-41.25	18.33
VHT80, M0 to M9 1ss	2	6	-65.8	-61.6			0.2	-54.0	-41.25	12.73
VHT80, M0 to M9 2ss	2	6	-65.8	-61.6			0.2	-54.0	-41.25	12.73
VHT80, M0 to M9 1ss	3	6	-66.5	-62.1	-63.2		0.2	-52.6	-41.25	11.33
VHT80, M0 to M9 2ss	3	6	-66.5	-62.1	-63.2		0.2	-52.6	-41.25	11.33
VHT80, M0 to M9 3ss	3	6	-66.5	-62.1	-63.2		0.2	-52.6	-41.25	11.33
VHT80, M0 to M9 1ss	4	6	-66.5	-62.1	-63.2	-65.8	0.2	-51.8	-41.25	10.54



VHT80, M0 to M9 2ss	4	6	-66.5	-62.1	-63.2	-65.8	0.2	-51.8	-41.25	10.54	
VHT80, M0 to M9 3ss	4	6	-66.5	-62.1	-63.2	-65.8	0.2	-51.8	-41.25	10.54	
VHT80, M0 to M9 4ss	4	6	-66.5	-62.1	-63.2	-65.8	0.2	-51.8	-41.25	10.54	
VHT80 Beam Forming, M0 to M9 1ss	2	9	-66.5	-62.1			0.2	-51.5	-41.25	10.29	
VHT80 Beam Forming, M0 to M9 2ss	2	6	-65.8	-61.6			0.2	-54.0	-41.25	12.73	
VHT80 Beam Forming, M0 to M9 1ss	3	11	-67.2	-62.7	-64.1		0.2	-48.3	-41.25	7.06	
VHT80 Beam Forming, M0 to M9 2ss	3	8	-66.5	-62.1	-63.2		0.2	-50.6	-41.25	9.33	
VHT80 Beam Forming, M0 to M9 3ss	3	6	-66.5	-62.1	-63.2		0.2	-52.6	-41.25	11.33	
VHT80 Beam Forming, M0 to M9 1ss	4	12	-68.4	-63.2	-64.4	-67.0	0.2	-47.0	-41.25	5.79	
VHT80 Beam Forming, M0 to M9 2ss	4	9	-67.2	-62.7	-64.1	-66.7	0.2	-49.5	-41.25	8.29	
VHT80 Beam Forming, M0 to M9 3ss	4	7	-66.5	-62.1	-63.2	-65.8	0.2	-50.8	-41.25	9.54	
VHT80 Beam Forming, M0 to M9 4ss	4	6	-66.5	-62.1	-63.2	-65.8	0.2	-51.8	-41.25	10.54	
VHT80 STBC, M0 to M9 1ss	2	6	-65.8	-61.6			0.2	-54.0	-41.25	12.73	
VHT80 STBC, M0 to M9 1ss	3	6	-66.5	-62.1	-63.2		0.2	-52.6	-41.25	11.33	
VHT80 STBC, M0 to M9 1ss	4	6	-66.5	-62.1	-63.2	-65.8	0.2	-51.8	-41.25	10.54	
HE80, M0 to M9 1ss	1	6	-66.6				0.3	-60.3	-41.25	19.09	
HE80, M0 to M9 1ss	2	6	-66.6	-62.3			0.3	-54.7	-41.25	13.42	
HE80, M0 to M9 2ss	2	6	-66.6	-62.3			0.3	-54.7	-41.25	13.42	
HE80, M0 to M9 1ss	3	6	-66.6	-62.3	-63.1		0.3	-52.6	-41.25	11.36	
HE80, M0 to M9 2ss	3	6	-66.6	-62.3	-63.1		0.3	-52.6	-41.25	11.36	
HE80, M0 to M9 3ss	3	6	-66.6	-62.3	-63.1		0.3	-52.6	-41.25	11.36	
HE80, M0 to M9 1ss	4	6	-66.6	-62.3	-63.1	-66.1	0.3	-51.9	-41.25	10.61	
HE80, M0 to M9 2ss	4	6	-66.6	-62.3	-63.1	-66.1	0.3	-51.9	-41.25	10.61	
HE80, M0 to M9 3ss	4	6	-66.6	-62.3	-63.1	-66.1	0.3	-51.9	-41.25	10.61	
HE80, M0 to M9 4ss	4	6	-66.6	-62.3	-63.1	-66.1	0.3	-51.9	-41.25	10.61	
HE80 Beam Forming, M0 to M9 1ss	2	9	-67.1	-63.0			0.3	-52.3	-41.25	11.06	
HE80 Beam Forming, M0 to M9 2ss	2	6	-66.6	-62.3			0.3	-54.7	-41.25	13.42	
HE80 Beam Forming, M0 to M9 1ss	3	11	-68.5	-63.6	-64.6		0.3	-49.1	-41.25	7.83	
HE80 Beam Forming, M0 to M9 2ss	3	8	-67.1	-63.0	-64.2		0.3	-51.4	-41.25	10.17	
HE80 Beam Forming, M0 to M9 3ss	3	6	-66.6	-62.3	-63.1		0.3	-52.6	-41.25	11.36	
HE80 Beam Forming, M0 to M9 1ss	4	12	-69.3	-64.0	-64.9	-67.8	0.3	-47.7	-41.25	6.47	
HE80 Beam Forming, M0 to M9 2ss	4	9	-67.1	-63.0	-64.2	-66.6	0.3	-49.6	-41.25	8.37	
HE80 Beam Forming, M0 to M9 3ss	4	7	-67.1	-63.0	-64.2	-66.6	0.3	-51.6	-41.25	10.37	
HE80 Beam Forming, M0 to M9 4ss	4	6	-66.6	-62.3	-63.1	-66.1	0.3	-51.9	-41.25	10.61	
HE80 STBC, M0 to M9 1ss	2	6	-66.6	-62.3			0.3	-54.7	-41.25	13.42	
HE80 STBC, M0 to M9 1ss	3	6	-66.6	-62.3	-63.1		0.3	-52.6	-41.25	11.36	
HE80 STBC, M0 to M9 1ss	4	6	-66.6	-62.3	-63.1	-66.1	0.3	-51.9	-41.25	10.61	
5300	Non HT20, 6 to 54 Mbps	1	6	-65.1				0.0	-59.1	-41.25	17.81
	Non HT20, 6 to 54 Mbps	2	6	-65.1	-56.2			0.0	-49.6	-41.25	8.38
	Non HT20, 6 to 54 Mbps	3	6	-65.1	-60.0	-61.0		0.0	-50.7	-41.25	9.48
	Non HT20, 6 to 54 Mbps	4	6	-66.2	-61.9	-63.3	-66.1	0.0	-51.9	-41.25	10.67



Non HT20 Beam Forming, 6 to 54 Mbps	2	9	-65.1	-56.2			0.0	-46.6	-41.25	5.38
Non HT20 Beam Forming, 6 to 54 Mbps	3	11	-65.1	-60.0	-61.0		0.0	-45.7	-41.25	4.48
Non HT20 Beam Forming, 6 to 54 Mbps	4	12	-66.2	-61.9	-63.3	-66.1	0.0	-45.9	-41.25	4.67
HT/VHT20, M0 to M7	1	6	-65.0				0.1	-58.9	-41.25	17.70
HT/VHT20, M0 to M7	2	6	-65.0	-56.7			0.1	-50.0	-41.25	8.80
HT/VHT20, M8 to M15	2	6	-65.0	-56.7			0.1	-50.0	-41.25	8.80
HT/VHT20, M0 to M7	3	6	-65.0	-59.1	-60.6		0.1	-50.1	-41.25	8.86
HT/VHT20, M8 to M15	3	6	-65.0	-57.3	-58.5		0.1	-48.4	-41.25	7.15
HT/VHT20, M16 to M23	3	6	-65.0	-56.7	-57.1		0.1	-47.5	-41.25	6.26
HT/VHT20, M0 to M7	4	6	-66.3	-61.8	-63.4	-66.0	0.1	-51.9	-41.25	10.65
HT/VHT20, M8 to M15	4	6	-65.0	-58.2	-59.8	-62.4	0.1	-48.6	-41.25	7.32
HT/VHT20, M16 to M23	4	6	-65.0	-57.3	-58.5	-61.0	0.1	-47.5	-41.25	6.28
HT/VHT20, M24 to M31	4	6	-65.0	-56.7	-57.1	-60.1	0.1	-46.6	-41.25	5.39
HT/VHT20 Beam Forming, M0 to M7	2	9	-65.0	-56.7			0.1	-47.0	-41.25	5.80
HT/VHT20 Beam Forming, M8 to M15	2	6	-65.0	-56.7			0.1	-50.0	-41.25	8.80
HT/VHT20 Beam Forming, M0 to M7	3	11	-65.0	-59.1	-60.6		0.1	-45.1	-41.25	3.86
HT/VHT20 Beam Forming, M8 to M15	3	8	-65.0	-57.3	-58.5		0.1	-46.4	-41.25	5.15
HT/VHT20 Beam Forming, M16 to M23	3	6	-65.0	-56.7	-57.1		0.1	-47.5	-41.25	6.26
HT/VHT20 Beam Forming, M0 to M7	4	12	-66.3	-61.8	-63.4	-66.0	0.1	-45.9	-41.25	4.65
HT/VHT20 Beam Forming, M8 to M15	4	9	-65.0	-58.2	-59.8	-62.4	0.1	-45.6	-41.25	4.32
HT/VHT20 Beam Forming, M16 to M23	4	7	-65.0	-57.3	-58.5	-61.0	0.1	-46.5	-41.25	5.28
HT/VHT20 Beam Forming, M24 to M31	4	6	-65.0	-56.7	-57.1	-60.1	0.1	-46.6	-41.25	5.39
HT/VHT20 STBC, M0 to M7	2	6	-65.0	-56.7			0.1	-50.0	-41.25	8.80
HT/VHT20 STBC, M0 to M7	3	6	-65.0	-57.3	-58.5		0.1	-48.4	-41.25	7.15
HT/VHT20 STBC, M0 to M7	4	6	-65.0	-58.2	-59.8	-62.4	0.1	-48.6	-41.25	7.32
HE20, M0 to M9 1ss	1	6	-65.2				0.1	-59.1	-41.25	17.88
HE20, M0 to M9 1ss	2	6	-65.2	-56.2			0.1	-49.6	-41.25	8.36
HE20, M0 to M9 2ss	2	6	-65.2	-56.2			0.1	-49.6	-41.25	8.36
HE20, M0 to M9 1ss	3	6	-65.2	-59.0	-60.5		0.1	-50.0	-41.25	8.78
HE20, M0 to M9 2ss	3	6	-65.2	-57.2	-58.4		0.1	-48.3	-41.25	7.05
HE20, M0 to M9 3ss	3	6	-65.2	-56.2	-57.1		0.1	-47.3	-41.25	6.00
HE20, M0 to M9 1ss	4	6	-66.4	-61.8	-63.6	-66.2	0.1	-52.0	-41.25	10.73
HE20, M0 to M9 2ss	4	6	-65.2	-58.5	-59.8	-62.5	0.1	-48.7	-41.25	7.46
HE20, M0 to M9 3ss	4	6	-65.2	-57.2	-58.4	-61.0	0.1	-47.4	-41.25	6.20
HE20, M0 to M9 4ss	4	6	-65.2	-56.2	-57.1	-60.2	0.1	-46.4	-41.25	5.19
HE20 Beam Forming, M0 to M9 1ss	2	9	-65.2	-56.2			0.1	-46.6	-41.25	5.36
HE20 Beam Forming, M0 to M9 2ss	2	6	-65.2	-56.2			0.1	-49.6	-41.25	8.36
HE20 Beam Forming, M0 to M9 1ss	3	11	-65.2	-59.0	-60.5		0.1	-45.0	-41.25	3.78
HE20 Beam Forming, M0 to M9 2ss	3	8	-65.2	-57.2	-58.4		0.1	-46.3	-41.25	5.05
HE20 Beam Forming, M0 to M9 3ss	3	6	-65.2	-56.2	-57.1		0.1	-47.3	-41.25	6.00
HE20 Beam Forming, M0 to M9 1ss	4	12	-66.4	-61.8	-63.6	-66.2	0.1	-46.0	-41.25	4.73
HE20 Beam Forming, M0 to M9 2ss	4	9	-65.2	-58.5	-59.8	-62.5	0.1	-45.7	-41.25	4.46





	HE20 Beam Forming, M0 to M9 3ss	4	7	-65.2	-57.2	-58.4	-61.0	0.1	-46.4	-41.25	5.20
	HE20 Beam Forming, M0 to M9 4ss	4	6	-65.2	-56.2	-57.1	-60.2	0.1	-46.4	-41.25	5.19
	HE20 STBC, M0 to M9 2ss	2	6	-65.2	-56.2			0.1	-49.6	-41.25	8.36
	HE20 STBC, M0 to M9 2ss	3	6	-65.2	-57.2	-58.4		0.1	-48.3	-41.25	7.05
	HE20 STBC, M0 to M9 2ss	4	6	-65.2	-58.5	-59.8	-62.5	0.1	-48.7	-41.25	7.46
5310	Non HT40, 6 to 54 Mbps	1	6	-65.5				0.0	-59.5	-41.25	18.21
	Non HT40, 6 to 54 Mbps	2	6	-65.5	-61.6			0.0	-54.1	-41.25	12.82
	Non HT40, 6 to 54 Mbps	3	6	-66.0	-62.1	-62.9		0.0	-52.6	-41.25	11.31
	Non HT40, 6 to 54 Mbps	4	6	-66.0	-62.1	-62.9	-65.6	0.0	-51.8	-41.25	10.52
	HT/VHT40, M0 to M7	1	6	-65.8				0.1	-59.7	-41.25	18.45
	HT/VHT40, M0 to M7	2	6	-65.8	-61.7			0.1	-54.2	-41.25	12.92
	HT/VHT40, M8 to M15	2	6	-65.8	-61.7			0.1	-54.2	-41.25	12.92
	HT/VHT40, M0 to M7	3	6	-65.8	-61.7	-63.0		0.1	-52.3	-41.25	11.06
	HT/VHT40, M8 to M15	3	6	-65.8	-61.7	-63.0		0.1	-52.3	-41.25	11.06
	HT/VHT40, M16 to M23	3	6	-65.8	-61.7	-63.0		0.1	-52.3	-41.25	11.06
	HT/VHT40, M0 to M7	4	6	-65.8	-61.7	-63.0	-64.9	0.1	-51.4	-41.25	10.18
	HT/VHT40, M8 to M15	4	6	-65.8	-61.7	-63.0	-64.9	0.1	-51.4	-41.25	10.18
	HT/VHT40, M16 to M23	4	6	-65.8	-61.7	-63.0	-64.9	0.1	-51.4	-41.25	10.18
	HT/VHT40, M24 to M31	4	6	-65.8	-61.7	-63.0	-64.9	0.1	-51.4	-41.25	10.18
	HT/VHT40 Beam Forming, M0 to M7	2	9	-66.6	-62.2			0.1	-51.8	-41.25	10.50
	HT/VHT40 Beam Forming, M8 to M15	2	6	-65.8	-61.7			0.1	-54.2	-41.25	12.92
	HT/VHT40 Beam Forming, M0 to M7	3	11	-67.1	-63.0	-64.2		0.1	-48.6	-41.25	7.33
	HT/VHT40 Beam Forming, M8 to M15	3	8	-66.6	-62.2	-63.4		0.1	-50.8	-41.25	9.58
	HT/VHT40 Beam Forming, M16 to M23	3	6	-65.8	-61.7	-63.0		0.1	-52.3	-41.25	11.06
	HT/VHT40 Beam Forming, M0 to M7	4	12	-67.1	-63.0	-64.2	-67.0	0.1	-46.8	-41.25	5.59
	HT/VHT40 Beam Forming, M8 to M15	4	9	-66.6	-62.2	-63.4	-66.1	0.1	-49.1	-41.25	7.82
	HT/VHT40 Beam Forming, M16 to M23	4	7	-66.6	-62.2	-63.4	-66.1	0.1	-51.1	-41.25	9.82
	HT/VHT40 Beam Forming, M24 to M31	4	6	-65.8	-61.7	-63.0	-64.9	0.1	-51.4	-41.25	10.18
	HT/VHT40 STBC, M0 to M7	2	6	-65.8	-61.7			0.1	-54.2	-41.25	12.92
	HT/VHT40 STBC, M0 to M7	3	6	-65.8	-61.7	-63.0		0.1	-52.3	-41.25	11.06
	HT/VHT40 STBC, M0 to M7	4	6	-65.8	-61.7	-63.0	-64.9	0.1	-51.4	-41.25	10.18
	HE40, M0 to M9 1ss	1	6	-65.8				0.1	-59.7	-41.25	18.42
	HE40, M0 to M9 1ss	2	6	-65.8	-61.5			0.1	-54.0	-41.25	12.75
	HE40, M0 to M9 2ss	2	6	-65.8	-61.5			0.1	-54.0	-41.25	12.75
	HE40, M0 to M9 1ss	3	6	-66.4	-62.2	-63.6		0.1	-52.8	-41.25	11.59
	HE40, M0 to M9 2ss	3	6	-66.4	-62.2	-63.6		0.1	-52.8	-41.25	11.59
	HE40, M0 to M9 3ss	3	6	-66.4	-62.2	-63.6		0.1	-52.8	-41.25	11.59
	HE40, M0 to M9 1ss	4	6	-66.4	-62.2	-63.6	-66.0	0.1	-52.1	-41.25	10.80
HE40, M0 to M9 2ss	4	6	-66.4	-62.2	-63.6	-66.0	0.1	-52.1	-41.25	10.80	
HE40, M0 to M9 3ss	4	6	-66.4	-62.2	-63.6	-66.0	0.1	-52.1	-41.25	10.80	
HE40, M0 to M9 4ss	4	6	-66.4	-62.2	-63.6	-66.0	0.1	-52.1	-41.25	10.80	



	HE40 Beam Forming, M0 to M9 1ss	2	9	-66.4	-62.2			0.1	-51.7	-41.25	10.42
	HE40 Beam Forming, M0 to M9 2ss	2	6	-65.8	-61.5			0.1	-54.0	-41.25	12.75
	HE40 Beam Forming, M0 to M9 1ss	3	11	-67.0	-62.8	-64.2		0.1	-48.4	-41.25	7.19
	HE40 Beam Forming, M0 to M9 2ss	3	8	-66.4	-62.2	-63.6		0.1	-50.8	-41.25	9.59
	HE40 Beam Forming, M0 to M9 3ss	3	6	-66.4	-62.2	-63.6		0.1	-52.8	-41.25	11.59
	HE40 Beam Forming, M0 to M9 1ss	4	12	-67.9	-63.2	-64.4	-67.1	0.1	-47.1	-41.25	5.83
	HE40 Beam Forming, M0 to M9 2ss	4	9	-67.0	-62.8	-64.2	-66.6	0.1	-49.7	-41.25	8.40
	HE40 Beam Forming, M0 to M9 3ss	4	7	-66.4	-62.2	-63.6	-66.0	0.1	-51.1	-41.25	9.80
	HE40 Beam Forming, M0 to M9 4ss	4	6	-66.4	-62.2	-63.6	-66.0	0.1	-52.1	-41.25	10.80
	HE40 STBC, M0 to M9 2ss	2	6	-65.8	-61.5			0.1	-54.0	-41.25	12.75
	HE40 STBC, M0 to M9 2ss	3	6	-66.4	-62.2	-63.6		0.1	-52.8	-41.25	11.59
	HE40 STBC, M0 to M9 2ss	4	6	-66.4	-62.2	-63.6	-66.0	0.1	-52.1	-41.25	10.80
5320	Non HT20, 6 to 54 Mbps	1	6	-65.6				0.0	-59.6	-41.25	18.31
	Non HT20, 6 to 54 Mbps	2	6	-65.6	-57.9			0.0	-51.2	-41.25	9.93
	Non HT20, 6 to 54 Mbps	3	6	-65.6	-59.7	-61.1		0.0	-50.7	-41.25	9.44
	Non HT20, 6 to 54 Mbps	4	6	-66.7	-62.5	-64.2	-66.7	0.0	-52.6	-41.25	11.34
	Non HT20 Beam Forming, 6 to 54 Mbps	2	9	-65.6	-58.5			0.0	-48.7	-41.25	7.43
	Non HT20 Beam Forming, 6 to 54 Mbps	3	11	-65.6	-59.7	-61.1		0.0	-45.7	-41.25	4.44
	Non HT20 Beam Forming, 6 to 54 Mbps	4	12	-66.7	-62.5	-64.2	-66.7	0.0	-46.6	-41.25	5.34
	HT/VHT20, M0 to M7	1	6	-65.9				0.1	-59.8	-41.25	18.60
	HT/VHT20, M0 to M7	2	6	-65.9	-58.1			0.1	-51.4	-41.25	10.13
	HT/VHT20, M8 to M15	2	6	-65.9	-58.1			0.1	-51.4	-41.25	10.13
	HT/VHT20, M0 to M7	3	6	-65.9	-60.2	-61.3		0.1	-51.0	-41.25	9.79
	HT/VHT20, M8 to M15	3	6	-65.9	-58.1	-59.1		0.1	-49.1	-41.25	7.87
	HT/VHT20, M16 to M23	3	6	-65.9	-58.1	-59.1		0.1	-49.1	-41.25	7.87
	HT/VHT20, M0 to M7	4	6	-66.6	-62.1	-63.5	-66.3	0.1	-52.1	-41.25	10.89
	HT/VHT20, M8 to M15	4	6	-65.9	-59.4	-60.4	-63.5	0.1	-49.5	-41.25	8.28
	HT/VHT20, M16 to M23	4	6	-65.9	-58.6	-59.7	-62.9	0.1	-48.9	-41.25	7.62
	HT/VHT20, M24 to M31	4	6	-65.9	-58.6	-59.7	-62.9	0.1	-48.9	-41.25	7.62
	HT/VHT20 Beam Forming, M0 to M7	2	9	-65.9	-58.6			0.1	-48.8	-41.25	7.56
	HT/VHT20 Beam Forming, M8 to M15	2	6	-65.9	-58.1			0.1	-51.4	-41.25	10.13
	HT/VHT20 Beam Forming, M0 to M7	3	11	-65.9	-60.2	-61.3		0.1	-46.0	-41.25	4.79
	HT/VHT20 Beam Forming, M8 to M15	3	8	-65.9	-58.6	-59.7		0.1	-47.6	-41.25	6.37
	HT/VHT20 Beam Forming, M16 to M23	3	6	-65.9	-58.1	-59.1		0.1	-49.1	-41.25	7.87
	HT/VHT20 Beam Forming, M0 to M7	4	12	-66.6	-62.1	-63.5	-66.3	0.1	-46.1	-41.25	4.89
	HT/VHT20 Beam Forming, M8 to M15	4	9	-65.9	-59.4	-60.4	-63.5	0.1	-46.5	-41.25	5.28
	HT/VHT20 Beam Forming, M16 to M23	4	7	-65.9	-58.6	-59.7	-62.9	0.1	-47.9	-41.25	6.62
	HT/VHT20 Beam Forming, M24 to M31	4	6	-65.9	-58.6	-59.7	-62.9	0.1	-48.9	-41.25	7.62
	HT/VHT20 STBC, M0 to M7	2	6	-65.9	-58.1			0.1	-51.4	-41.25	10.13
	HT/VHT20 STBC, M0 to M7	3	6	-65.9	-58.1	-59.1		0.1	-49.1	-41.25	7.87
HT/VHT20 STBC, M0 to M7	4	6	-65.9	-59.4	-60.4	-63.5	0.1	-49.5	-41.25	8.28	





	HE20, M0 to M9 1ss	1	6	-65.4				0.1	-59.3	-41.25	18.08
	HE20, M0 to M9 1ss	2	6	-65.4	-57.8			0.1	-51.0	-41.25	9.78
	HE20, M0 to M9 2ss	2	6	-65.4	-57.8			0.1	-51.0	-41.25	9.78
	HE20, M0 to M9 1ss	3	6	-65.4	-59.8	-60.7		0.1	-50.5	-41.25	9.28
	HE20, M0 to M9 2ss	3	6	-65.4	-58.5	-59.3		0.1	-49.3	-41.25	8.09
	HE20, M0 to M9 3ss	3	6	-65.4	-58.5	-59.3		0.1	-49.3	-41.25	8.09
	HE20, M0 to M9 1ss	4	6	-65.9	-61.7	-63.2	-66.0	0.1	-51.7	-41.25	10.47
	HE20, M0 to M9 2ss	4	6	-65.4	-59.0	-60.0	-62.8	0.1	-49.1	-41.25	7.81
	HE20, M0 to M9 3ss	4	6	-65.4	-58.5	-59.3	-62.4	0.1	-48.5	-41.25	7.30
	HE20, M0 to M9 4ss	4	6	-65.4	-58.5	-59.3	-62.4	0.1	-48.5	-41.25	7.30
	HE20 Beam Forming, M0 to M9 1ss	2	9	-65.4	-59.0			0.1	-49.0	-41.25	7.78
	HE20 Beam Forming, M0 to M9 2ss	2	6	-65.4	-57.8			0.1	-51.0	-41.25	9.78
	HE20 Beam Forming, M0 to M9 1ss	3	11	-65.4	-59.8	-60.7		0.1	-45.5	-41.25	4.28
	HE20 Beam Forming, M0 to M9 2ss	3	8	-65.4	-59.0	-60.0		0.1	-47.9	-41.25	6.62
	HE20 Beam Forming, M0 to M9 3ss	3	6	-65.4	-58.5	-59.3		0.1	-49.3	-41.25	8.09
	HE20 Beam Forming, M0 to M9 1ss	4	12	-65.9	-61.7	-63.2	-66.0	0.1	-45.7	-41.25	4.47
	HE20 Beam Forming, M0 to M9 2ss	4	9	-65.4	-59.8	-60.7	-63.8	0.1	-46.8	-41.25	5.52
	HE20 Beam Forming, M0 to M9 3ss	4	7	-65.4	-59.0	-60.0	-62.8	0.1	-48.1	-41.25	6.81
	HE20 Beam Forming, M0 to M9 4ss	4	6	-65.4	-58.5	-59.3	-62.4	0.1	-48.5	-41.25	7.30
	HE20 STBC, M0 to M9 2ss	2	6	-65.4	-57.8			0.1	-51.0	-41.25	9.78
	HE20 STBC, M0 to M9 2ss	3	6	-65.4	-58.5	-59.3		0.1	-49.3	-41.25	8.09
	HE20 STBC, M0 to M9 2ss	4	6	-65.4	-59.0	-60.0	-62.8	0.1	-49.1	-41.25	7.81
5250	Non HT160, 6 to 54 Mbps	1	6	-63.8				0.0	-57.8	-41.25	16.50
	Non HT160, 6 to 54 Mbps	2	6	-63.8	-60.4			0.0	-52.7	-41.25	11.47
	Non HT160, 6 to 54 Mbps	3	6	-63.8	-60.4	-61.8		0.0	-51.0	-41.25	9.71
	Non HT160, 6 to 54 Mbps	4	6	-63.8	-60.4	-61.8	-63.8	0.0	-50.1	-41.25	8.89
	VHT160, M0 to M9 1ss	1	6	-63.9				0.4	-57.5	-41.25	16.26
	VHT160, M0 to M9 1ss	2	6	-63.9	-60.8			0.4	-52.7	-41.25	11.43
	VHT160, M0 to M9 2ss	2	6	-63.9	-60.8			0.4	-52.7	-41.25	11.43
	VHT160, M0 to M9 1ss	3	6	-63.9	-60.8	-61.4		0.4	-50.7	-41.25	9.43
	VHT160, M0 to M9 2ss	3	6	-63.9	-60.8	-61.4		0.4	-50.7	-41.25	9.43
	VHT160, M0 to M9 3ss	3	6	-63.9	-60.8	-61.4		0.4	-50.7	-41.25	9.43
	VHT160, M0 to M9 1ss	4	6	-64.9	-61.4	-62.4	-64.6	0.4	-50.7	-41.25	9.41
	VHT160, M0 to M9 2ss	4	6	-64.9	-61.4	-62.4	-64.6	0.4	-50.7	-41.25	9.41
	VHT160, M0 to M9 3ss	4	6	-64.9	-61.4	-62.4	-64.6	0.4	-50.7	-41.25	9.41
	VHT160, M0 to M9 4ss	4	6	-64.9	-61.4	-62.4	-64.6	0.4	-50.7	-41.25	9.41
	VHT160 Beam Forming, M0 to M9 1ss	2	9	-65.5	-61.9			0.4	-50.9	-41.25	9.68
	VHT160 Beam Forming, M0 to M9 2ss	2	6	-63.9	-60.8			0.4	-52.7	-41.25	11.43
	VHT160 Beam Forming, M0 to M9 1ss	3	11	-66.9	-62.7	-63.5		0.4	-47.9	-41.25	6.61
	VHT160 Beam Forming, M0 to M9 2ss	3	8	-64.9	-61.4	-62.4		0.4	-49.5	-41.25	8.25
VHT160 Beam Forming, M0 to M9 3ss	3	6	-63.9	-60.8	-61.4		0.4	-50.7	-41.25	9.43	



VHT160 Beam Forming, M0 to M9 1ss	4	12	-66.9	-62.7	-63.5	-66.3	0.4	-46.1	-41.25	4.83
VHT160 Beam Forming, M0 to M9 2ss	4	9	-65.5	-61.9	-62.9	-65.5	0.4	-48.2	-41.25	7.00
VHT160 Beam Forming, M0 to M9 3ss	4	7	-64.9	-61.4	-62.4	-64.6	0.4	-49.7	-41.25	8.41
VHT160 Beam Forming, M0 to M9 4ss	4	6	-64.9	-61.4	-62.4	-64.6	0.4	-50.7	-41.25	9.41
VHT160 STBC, M0 to M9 1ss	2	6	-63.9	-60.8			0.4	-52.7	-41.25	11.43
VHT160 STBC, M0 to M9 1ss	3	6	-63.9	-60.8	-61.4		0.4	-50.7	-41.25	9.43
VHT160 STBC, M0 to M9 1ss	4	6	-64.9	-61.4	-62.4	-64.6	0.4	-50.7	-41.25	9.41
HE160, M0 to M9 1ss	1	6	-63.9				0.4	-57.5	-41.25	16.22
HE160, M0 to M9 1ss	2	6	-63.9	-60.3			0.4	-52.3	-41.25	11.04
HE160, M0 to M9 2ss	2	6	-63.9	-60.3			0.4	-52.3	-41.25	11.04
HE160, M0 to M9 1ss	3	6	-63.9	-60.3	-61.2		0.4	-50.3	-41.25	9.10
HE160, M0 to M9 2ss	3	6	-63.9	-60.3	-61.2		0.4	-50.3	-41.25	9.10
HE160, M0 to M9 3ss	3	6	-63.9	-60.3	-61.2		0.4	-50.3	-41.25	9.10
HE160, M0 to M9 1ss	4	6	-63.9	-60.3	-61.2	-63.9	0.4	-49.6	-41.25	8.33
HE160, M0 to M9 2ss	4	6	-63.9	-60.3	-61.2	-63.9	0.4	-49.6	-41.25	8.33
HE160, M0 to M9 3ss	4	6	-63.9	-60.3	-61.2	-63.9	0.4	-49.6	-41.25	8.33
HE160, M0 to M9 4ss	4	6	-63.9	-60.3	-61.2	-63.9	0.4	-49.6	-41.25	8.33
HE160 Beam Forming, M0 to M9 1ss	2	9	-64.8	-61.2			0.4	-50.2	-41.25	8.94
HE160 Beam Forming, M0 to M9 2ss	2	6	-63.9	-60.3			0.4	-52.3	-41.25	11.04
HE160 Beam Forming, M0 to M9 1ss	3	11	-65.3	-61.8	-62.9		0.4	-46.9	-41.25	5.65
HE160 Beam Forming, M0 to M9 2ss	3	8	-64.8	-61.2	-62.0		0.4	-49.2	-41.25	7.96
HE160 Beam Forming, M0 to M9 3ss	3	6	-63.9	-60.3	-61.2		0.4	-50.3	-41.25	9.10
HE160 Beam Forming, M0 to M9 1ss	4	12	-66.8	-62.5	-63.2	-66.0	0.4	-45.8	-41.25	4.55
HE160 Beam Forming, M0 to M9 2ss	4	9	-64.8	-61.2	-62.0	-64.5	0.4	-47.4	-41.25	6.14
HE160 Beam Forming, M0 to M9 3ss	4	7	-64.8	-61.2	-62.0	-64.5	0.4	-49.4	-41.25	8.14
HE160 Beam Forming, M0 to M9 4ss	4	6	-63.9	-60.3	-61.2	-63.9	0.4	-49.6	-41.25	8.33
HE160 STBC, M0 to M9 1ss	2	6	-63.9	-60.3			0.4	-52.3	-41.25	11.04
HE160 STBC, M0 to M9 1ss	3	6	-63.9	-60.3	-61.2		0.4	-50.3	-41.25	9.10
HE160 STBC, M0 to M9 1ss	4	6	-63.9	-60.3	-61.2	-63.9	0.4	-49.6	-41.25	8.33



**Conducted Spurs Average, 6dBi  
5270 MHz, HT/VHT40 Beam Forming, M0 to M7**

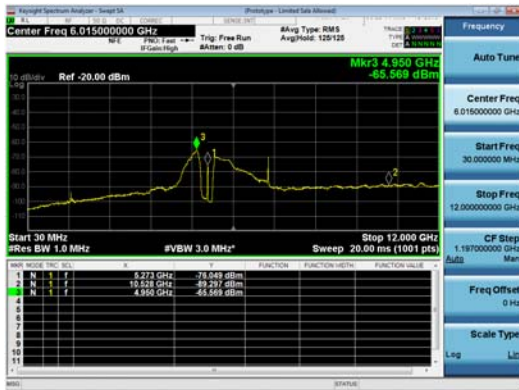

Antenna A

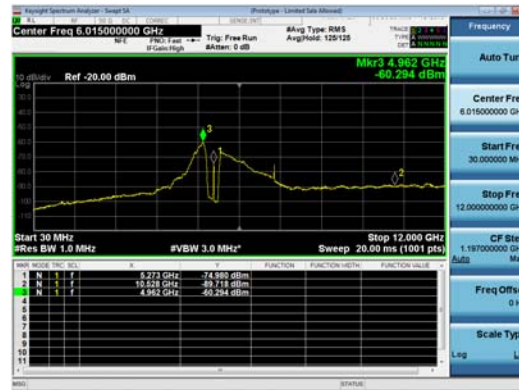

Antenna B

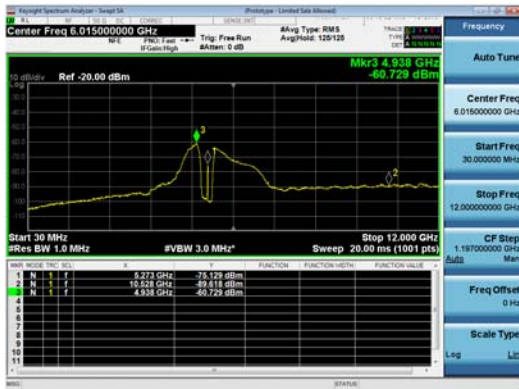

Antenna C

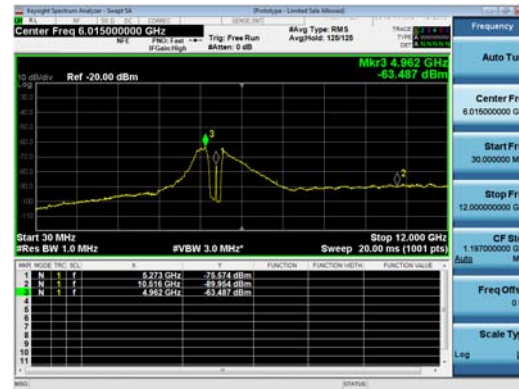

Antenna D



## Conducted Spurious Emissions Peak Table, 4dBi

Frequency (MHz)	Mode	Tx Paths	Correlated Antenna Gain (dBi)	Tx 1 Spur Power (dBm)	Tx 2 Spur Power (dBm)	Tx 3 Spur Power (dBm)	Tx 4 Spur Power (dBm)	Tx 5 Spur Power (dBm)	Total Conducted Spur (dBm)	Limit (dBm)	Margin (dB)
5260	Non HT20, 6 to 54 Mbps	1	4	-54.2				0.0	-50.2	-21.25	28.91
	Non HT20, 6 to 54 Mbps	2	4	-54.2	-45.4			0.0	-40.8	-21.25	19.57
	Non HT20, 6 to 54 Mbps	3	4	-54.2	-45.3	-48.2		0.0	-39.1	-21.25	17.85
	Non HT20, 6 to 54 Mbps	4	4	-54.2	-49.2	-49.9	-52.6	0.0	-41.0	-21.25	19.72
	Non HT20 Beam Forming, 6 to 54 Mbps	2	7	-54.2	-45.4			0.0	-37.8	-21.25	16.57
	Non HT20 Beam Forming, 6 to 54 Mbps	3	9	-54.2	-45.3	-48.2		0.0	-34.1	-21.25	12.85
	Non HT20 Beam Forming, 6 to 54 Mbps	4	10	-54.2	-49.2	-49.9	-52.6	0.0	-35.0	-21.25	13.72
	HT/VHT20, M0 to M7	1	4	-54.2				0.1	-50.1	-21.25	28.90
	HT/VHT20, M0 to M7	2	4	-54.2	-45.8			0.1	-41.2	-21.25	19.91
	HT/VHT20, M8 to M15	2	4	-54.2	-45.8			0.1	-41.2	-21.25	19.91
	HT/VHT20, M0 to M7	3	4	-54.2	-46.9	-47.4		0.1	-39.7	-21.25	18.42
	HT/VHT20, M8 to M15	3	4	-54.2	-45.8	-46.1		0.1	-38.6	-21.25	17.32
	HT/VHT20, M16 to M23	3	4	-54.2	-45.8	-46.1		0.1	-38.6	-21.25	17.32
	HT/VHT20, M0 to M7	4	4	-54.2	-48.3	-49.9	-52.2	0.1	-40.5	-21.25	19.28
	HT/VHT20, M8 to M15	4	4	-54.2	-46.7	-47.5	-49.4	0.1	-38.6	-21.25	17.34
	HT/VHT20, M16 to M23	4	4	-54.2	-45.8	-46.1	-48.8	0.1	-37.6	-21.25	16.38
	HT/VHT20, M24 to M31	4	4	-54.2	-45.8	-46.1	-48.8	0.1	-37.6	-21.25	16.38
	HT/VHT20 Beam Forming, M0 to M7	2	7	-54.2	-45.8			0.1	-38.2	-21.25	16.91
	HT/VHT20 Beam Forming, M8 to M15	2	4	-54.2	-45.8			0.1	-41.2	-21.25	19.91
	HT/VHT20 Beam Forming, M0 to M7	3	9	-54.2	-46.9	-47.4		0.1	-34.7	-21.25	13.42
	HT/VHT20 Beam Forming, M8 to M15	3	6	-54.2	-45.8	-46.1		0.1	-36.6	-21.25	15.32
	HT/VHT20 Beam Forming, M16 to M23	3	4	-54.2	-45.8	-46.1		0.1	-38.6	-21.25	17.32
	HT/VHT20 Beam Forming, M0 to M7	4	10	-54.2	-48.3	-49.9	-52.2	0.1	-34.5	-21.25	13.28
	HT/VHT20 Beam Forming, M8 to M15	4	7	-54.2	-46.7	-47.5	-49.4	0.1	-35.6	-21.25	14.34
	HT/VHT20 Beam Forming, M16 to M23	4	5	-54.2	-45.8	-46.1	-48.8	0.1	-36.6	-21.25	15.38
	HT/VHT20 Beam Forming, M24 to M31	4	4	-54.2	-45.8	-46.1	-48.8	0.1	-37.6	-21.25	16.38
	HT/VHT20 STBC, M0 to M7	2	4	-54.2	-45.8			0.1	-41.2	-21.25	19.91
	HT/VHT20 STBC, M0 to M7	3	4	-54.2	-45.8	-46.1		0.1	-38.6	-21.25	17.32
	HT/VHT20 STBC, M0 to M7	4	4	-54.2	-46.7	-47.5	-49.4	0.1	-38.6	-21.25	17.34
	HE20, M0 to M9 1ss	1	4	-54.5				0.1	-50.4	-21.25	29.18



	HE20, M0 to M9 1ss	2	4	-54.5	-45.3			0.1	-40.7	-21.25	19.49
	HE20, M0 to M9 2ss	2	4	-54.5	-45.3			0.1	-40.7	-21.25	19.49
	HE20, M0 to M9 1ss	3	4	-54.5	-47.2	-48.5		0.1	-40.3	-21.25	19.03
	HE20, M0 to M9 2ss	3	4	-54.5	-45.3	-46.6		0.1	-38.5	-21.25	17.28
	HE20, M0 to M9 3ss	3	4	-54.5	-45.3	-46.6		0.1	-38.5	-21.25	17.28
	HE20, M0 to M9 1ss	4	4	-54.5	-48.9	-49.3	-52.6	0.1	-40.7	-21.25	19.41
	HE20, M0 to M9 2ss	4	4	-54.5	-45.6	-47.3	-49.4	0.1	-38.1	-21.25	16.81
	HE20, M0 to M9 3ss	4	4	-54.5	-45.3	-46.6	-48.4	0.1	-37.5	-21.25	16.27
	HE20, M0 to M9 4ss	4	4	-54.5	-45.3	-46.6	-48.4	0.1	-37.5	-21.25	16.27
	HE20 Beam Forming, M0 to M9 1ss	2	7	-54.5	-45.3			0.1	-37.7	-21.25	16.49
	HE20 Beam Forming, M0 to M9 2ss	2	4	-54.5	-45.3			0.1	-40.7	-21.25	19.49
	HE20 Beam Forming, M0 to M9 1ss	3	9	-54.5	-47.2	-48.5		0.1	-35.3	-21.25	14.03
	HE20 Beam Forming, M0 to M9 2ss	3	6	-54.5	-45.3	-46.6		0.1	-36.5	-21.25	15.28
	HE20 Beam Forming, M0 to M9 3ss	3	4	-54.5	-45.3	-46.6		0.1	-38.5	-21.25	17.28
	HE20 Beam Forming, M0 to M9 1ss	4	10	-54.5	-48.9	-49.3	-52.6	0.1	-34.7	-21.25	13.41
	HE20 Beam Forming, M0 to M9 2ss	4	7	-54.5	-45.6	-47.3	-49.4	0.1	-35.1	-21.25	13.81
	HE20 Beam Forming, M0 to M9 3ss	4	5	-54.5	-45.3	-46.6	-48.4	0.1	-36.5	-21.25	15.27
	HE20 Beam Forming, M0 to M9 4ss	4	4	-54.5	-45.3	-46.6	-48.4	0.1	-37.5	-21.25	16.27
	HE20 STBC, M0 to M9 2ss	2	4	-54.5	-45.3			0.1	-40.7	-21.25	19.49
	HE20 STBC, M0 to M9 2ss	3	4	-54.5	-45.3	-46.6		0.1	-38.5	-21.25	17.28
	HE20 STBC, M0 to M9 2ss	4	4	-54.5	-45.6	-47.3	-49.4	0.1	-38.1	-21.25	16.81
5270	Non HT40, 6 to 54 Mbps	1	4	-54.8				0.0	-50.8	-21.25	29.51
	Non HT40, 6 to 54 Mbps	2	4	-54.8	-46.1			0.0	-41.5	-21.25	20.26
	Non HT40, 6 to 54 Mbps	3	4	-54.8	-46.1	-44.6		0.0	-38.0	-21.25	16.75
	Non HT40, 6 to 54 Mbps	4	4	-54.8	-46.3	-46.9	-49.0	0.0	-38.2	-21.25	16.94
	HT/VHT40, M0 to M7	1	4	-54.7				0.1	-50.6	-21.25	29.35
	HT/VHT40, M0 to M7	2	4	-54.7	-46.5			0.1	-41.8	-21.25	20.54
	HT/VHT40, M8 to M15	2	4	-54.7	-46.5			0.1	-41.8	-21.25	20.54
	HT/VHT40, M0 to M7	3	4	-54.7	-46.5	-46.4		0.1	-39.0	-21.25	17.77
	HT/VHT40, M8 to M15	3	4	-54.7	-46.5	-46.4		0.1	-39.0	-21.25	17.77
	HT/VHT40, M16 to M23	3	4	-54.7	-46.5	-46.4		0.1	-39.0	-21.25	17.77
	HT/VHT40, M0 to M7	4	4	-54.7	-46.7	-47.7	-48.9	0.1	-38.5	-21.25	17.27
	HT/VHT40, M8 to M15	4	4	-54.7	-46.5	-46.4	-49.5	0.1	-38.1	-21.25	16.87
	HT/VHT40, M16 to M23	4	4	-54.7	-46.5	-46.4	-49.5	0.1	-38.1	-21.25	16.87
	HT/VHT40, M24 to M31	4	4	-54.7	-46.5	-46.4	-49.5	0.1	-38.1	-21.25	16.87
	HT/VHT40 Beam Forming, M0 to M7	2	7	-54.7	-46.5			0.1	-38.8	-21.25	17.54
	HT/VHT40 Beam Forming, M8 to M15	2	4	-54.7	-46.5			0.1	-41.8	-21.25	20.54
	HT/VHT40 Beam Forming, M0 to M7	3	9	-54.7	-46.7	-47.7		0.1	-34.7	-21.25	13.44
	HT/VHT40 Beam Forming, M8 to M15	3	6	-54.7	-46.5	-46.4		0.1	-37.0	-21.25	15.77
HT/VHT40 Beam Forming, M16 to M23	3	4	-54.7	-46.5	-46.4		0.1	-39.0	-21.25	17.77	
HT/VHT40 Beam Forming, M0 to M7	4	10	-54.7	-47.7	-49.0	-51.5	0.1	-33.9	-21.25	12.62	



	HT/VHT40 Beam Forming, M8 to M15	4	7	-54.7	-46.5	-46.4	-49.5	0.1	-35.1	-21.25	13.87
	HT/VHT40 Beam Forming, M16 to M23	4	5	-54.7	-46.5	-46.4	-49.5	0.1	-37.1	-21.25	15.87
	HT/VHT40 Beam Forming, M24 to M31	4	4	-54.7	-46.5	-46.4	-49.5	0.1	-38.1	-21.25	16.87
	HT/VHT40 STBC, M0 to M7	2	4	-54.7	-46.5			0.1	-41.8	-21.25	20.54
	HT/VHT40 STBC, M0 to M7	3	4	-54.7	-46.5	-46.4		0.1	-39.0	-21.25	17.77
	HT/VHT40 STBC, M0 to M7	4	4	-54.7	-46.5	-46.4	-49.5	0.1	-38.1	-21.25	16.87
	HE40, M0 to M9 1ss	1	4	-54.1				0.1	-50.0	-21.25	28.72
	HE40, M0 to M9 1ss	2	4	-54.1	-45.4			0.1	-40.7	-21.25	19.47
	HE40, M0 to M9 2ss	2	4	-54.1	-45.4			0.1	-40.7	-21.25	19.47
	HE40, M0 to M9 1ss	3	4	-54.1	-45.4	-46.0		0.1	-38.2	-21.25	17.00
	HE40, M0 to M9 2ss	3	4	-54.1	-45.4	-46.0		0.1	-38.2	-21.25	17.00
	HE40, M0 to M9 3ss	3	4	-54.1	-45.4	-46.0		0.1	-38.2	-21.25	17.00
	HE40, M0 to M9 1ss	4	4	-54.1	-45.9	-47.5	-49.3	0.1	-38.2	-21.25	16.90
	HE40, M0 to M9 2ss	4	4	-54.1	-45.4	-46.0	-50.0	0.1	-37.6	-21.25	16.30
	HE40, M0 to M9 3ss	4	4	-54.1	-45.4	-46.0	-50.0	0.1	-37.6	-21.25	16.30
	HE40, M0 to M9 4ss	4	4	-54.1	-45.4	-46.0	-50.0	0.1	-37.6	-21.25	16.30
	HE40 Beam Forming, M0 to M9 1ss	2	7	-54.1	-45.4			0.1	-37.7	-21.25	16.47
	HE40 Beam Forming, M0 to M9 2ss	2	4	-54.1	-45.4			0.1	-40.7	-21.25	19.47
	HE40 Beam Forming, M0 to M9 1ss	3	9	-54.1	-45.9	-47.5		0.1	-34.1	-21.25	12.86
	HE40 Beam Forming, M0 to M9 2ss	3	6	-54.1	-45.4	-46.0		0.1	-36.2	-21.25	15.00
	HE40 Beam Forming, M0 to M9 3ss	3	4	-54.1	-45.4	-46.0		0.1	-38.2	-21.25	17.00
	<b>HE40 Beam Forming, M0 to M9 1ss</b>	<b>4</b>	<b>10</b>	<b>-54.1</b>	<b>-47.8</b>	<b>-48.1</b>	<b>-51.9</b>	<b>0.1</b>	<b>-33.6</b>	<b>-21.25</b>	<b>12.34</b>
	HE40 Beam Forming, M0 to M9 2ss	4	7	-54.1	-45.4	-46.0	-50.0	0.1	-34.6	-21.25	13.30
	HE40 Beam Forming, M0 to M9 3ss	4	5	-54.1	-45.4	-46.0	-50.0	0.1	-36.6	-21.25	15.30
	HE40 Beam Forming, M0 to M9 4ss	4	4	-54.1	-45.4	-46.0	-50.0	0.1	-37.6	-21.25	16.30
	HE40 STBC, M0 to M9 2ss	2	4	-54.1	-45.4			0.1	-40.7	-21.25	19.47
	HE40 STBC, M0 to M9 2ss	3	4	-54.1	-45.4	-46.0		0.1	-38.2	-21.25	17.00
	HE40 STBC, M0 to M9 2ss	4	4	-54.1	-45.4	-46.0	-50.0	0.1	-37.6	-21.25	16.30
5290	Non HT80, 6 to 54 Mbps	1	4	-56.0				0.1	-51.9	-21.25	30.70
	Non HT80, 6 to 54 Mbps	2	4	-56.0	-50.3			0.1	-45.2	-21.25	23.96
	Non HT80, 6 to 54 Mbps	3	4	-56.0	-50.3	-53.2		0.1	-43.7	-21.25	22.49
	Non HT80, 6 to 54 Mbps	4	4	-56.0	-50.3	-53.2	-54.4	0.1	-42.9	-21.25	21.63
	VHT80, M0 to M9 1ss	1	4	-55.5				0.2	-51.3	-21.25	30.03
	VHT80, M0 to M9 1ss	2	4	-55.5	-51.8			0.2	-46.0	-21.25	24.79
	VHT80, M0 to M9 2ss	2	4	-55.5	-51.8			0.2	-46.0	-21.25	24.79
	VHT80, M0 to M9 1ss	3	4	-55.5	-51.8	-51.7		0.2	-43.7	-21.25	22.44
	VHT80, M0 to M9 2ss	3	4	-55.5	-51.8	-51.7		0.2	-43.7	-21.25	22.44
	VHT80, M0 to M9 3ss	3	4	-55.5	-51.8	-51.7		0.2	-43.7	-21.25	22.44
	VHT80, M0 to M9 1ss	4	4	-55.5	-51.8	-51.7	-53.3	0.2	-42.6	-21.25	21.34
	VHT80, M0 to M9 2ss	4	4	-55.5	-51.8	-51.7	-53.3	0.2	-42.6	-21.25	21.34
	VHT80, M0 to M9 3ss	4	4	-55.5	-51.8	-51.7	-53.3	0.2	-42.6	-21.25	21.34





	VHT80, M0 to M9 4ss	4	4	-55.5	-51.8	-51.7	-53.3	0.2	-42.6	-21.25	21.34
	VHT80 Beam Forming, M0 to M9 1ss	2	7	-55.5	-52.1			0.2	-43.2	-21.25	22.00
	VHT80 Beam Forming, M0 to M9 2ss	2	4	-55.5	-51.8			0.2	-46.0	-21.25	24.79
	VHT80 Beam Forming, M0 to M9 1ss	3	9	-57.0	-52.2	-53.4		0.2	-39.8	-21.25	18.53
	VHT80 Beam Forming, M0 to M9 2ss	3	6	-55.5	-52.1	-52.9		0.2	-42.3	-21.25	21.04
	VHT80 Beam Forming, M0 to M9 3ss	3	4	-55.5	-51.8	-51.7		0.2	-43.7	-21.25	22.44
	VHT80 Beam Forming, M0 to M9 1ss	4	10	-57.0	-52.2	-53.4	-55.8	0.2	-38.0	-21.25	16.71
	VHT80 Beam Forming, M0 to M9 2ss	4	7	-55.5	-52.1	-52.9	-55.5	0.2	-40.5	-21.25	19.25
	VHT80 Beam Forming, M0 to M9 3ss	4	5	-55.5	-51.8	-51.7	-53.3	0.2	-41.6	-21.25	20.34
	VHT80 Beam Forming, M0 to M9 4ss	4	4	-55.5	-51.8	-51.7	-53.3	0.2	-42.6	-21.25	21.34
	VHT80 STBC, M0 to M9 1ss	2	4	-55.5	-51.8			0.2	-46.0	-21.25	24.79
	VHT80 STBC, M0 to M9 1ss	3	4	-55.5	-51.8	-51.7		0.2	-43.7	-21.25	22.44
	VHT80 STBC, M0 to M9 1ss	4	4	-55.5	-51.8	-51.7	-53.3	0.2	-42.6	-21.25	21.34
	HE80, M0 to M9 1ss	1	4	-55.1				0.3	-50.8	-21.25	29.59
	HE80, M0 to M9 1ss	2	4	-55.1	-51.1			0.3	-45.4	-21.25	24.14
	HE80, M0 to M9 2ss	2	4	-55.1	-51.1			0.3	-45.4	-21.25	24.14
	HE80, M0 to M9 1ss	3	4	-55.1	-51.1	-52.0		0.3	-43.4	-21.25	22.14
	HE80, M0 to M9 2ss	3	4	-55.1	-51.1	-52.0		0.3	-43.4	-21.25	22.14
	HE80, M0 to M9 3ss	3	4	-55.1	-51.1	-52.0		0.3	-43.4	-21.25	22.14
	HE80, M0 to M9 1ss	4	4	-55.1	-51.1	-52.0	-53.5	0.3	-42.4	-21.25	21.14
	HE80, M0 to M9 2ss	4	4	-55.1	-51.1	-52.0	-53.5	0.3	-42.4	-21.25	21.14
	HE80, M0 to M9 3ss	4	4	-55.1	-51.1	-52.0	-53.5	0.3	-42.4	-21.25	21.14
	HE80, M0 to M9 4ss	4	4	-55.1	-51.1	-52.0	-53.5	0.3	-42.4	-21.25	21.14
	HE80 Beam Forming, M0 to M9 1ss	2	7	-56.3	-52.1			0.3	-43.4	-21.25	22.19
	HE80 Beam Forming, M0 to M9 2ss	2	4	-55.1	-51.1			0.3	-45.4	-21.25	24.14
	HE80 Beam Forming, M0 to M9 1ss	3	9	-56.4	-51.8	-53.1		0.3	-39.3	-21.25	18.09
	HE80 Beam Forming, M0 to M9 2ss	3	6	-56.3	-52.1	-52.1		0.3	-42.1	-21.25	20.82
	HE80 Beam Forming, M0 to M9 3ss	3	4	-55.1	-51.1	-52.0		0.3	-43.4	-21.25	22.14
	HE80 Beam Forming, M0 to M9 1ss	4	10	-57.6	-52.7	-54.1	-56.5	0.3	-38.5	-21.25	17.27
	HE80 Beam Forming, M0 to M9 2ss	4	7	-56.4	-51.8	-53.1	-54.4	0.3	-40.3	-21.25	19.08
	HE80 Beam Forming, M0 to M9 3ss	4	5	-56.3	-52.1	-52.1	-55.7	0.3	-42.3	-21.25	21.09
	HE80 Beam Forming, M0 to M9 4ss	4	4	-55.1	-51.1	-52.0	-53.5	0.3	-42.4	-21.25	21.14
	HE80 STBC, M0 to M9 1ss	2	4	-55.1	-51.1			0.3	-45.4	-21.25	24.14
	HE80 STBC, M0 to M9 1ss	3	4	-55.1	-51.1	-52.0		0.3	-43.4	-21.25	22.14
	HE80 STBC, M0 to M9 1ss	4	4	-55.1	-51.1	-52.0	-53.5	0.3	-42.4	-21.25	21.14
5300	Non HT20, 6 to 54 Mbps	1	4	-54.3				0.0	-50.3	-21.25	29.01
	Non HT20, 6 to 54 Mbps	2	4	-54.3	-46.4			0.0	-41.7	-21.25	20.45
	Non HT20, 6 to 54 Mbps	3	4	-54.3	-47.1	-48.3		0.0	-40.2	-21.25	18.91
	Non HT20, 6 to 54 Mbps	4	4	-54.3	-49.7	-50.4	-53.0	0.0	-41.4	-21.25	20.15
	Non HT20 Beam Forming, 6 to 54 Mbps	2	7	-54.3	-46.4			0.0	-38.7	-21.25	17.45
	Non HT20 Beam Forming, 6 to 54 Mbps	3	9	-54.3	-47.1	-48.3		0.0	-35.2	-21.25	13.91



Non HT20 Beam Forming, 6 to 54 Mbps	4	10	-54.3	-49.7	-50.4	-53.0	0.0	-35.4	-21.25	14.15
HT/VHT20, M0 to M7	1	4	-54.5				0.1	-50.4	-21.25	29.20
HT/VHT20, M0 to M7	2	4	-54.5	-46.2			0.1	-41.5	-21.25	20.30
HT/VHT20, M8 to M15	2	4	-54.5	-46.2			0.1	-41.5	-21.25	20.30
HT/VHT20, M0 to M7	3	4	-54.5	-47.5	-48.5		0.1	-40.5	-21.25	19.20
HT/VHT20, M8 to M15	3	4	-54.5	-46.2	-47.4		0.1	-39.3	-21.25	18.10
HT/VHT20, M16 to M23	3	4	-54.5	-46.2	-47.4		0.1	-39.3	-21.25	18.10
HT/VHT20, M0 to M7	4	4	-54.5	-49.1	-50.0	-52.8	0.1	-41.0	-21.25	19.77
HT/VHT20, M8 to M15	4	4	-54.5	-46.7	-47.9	-49.1	0.1	-38.7	-21.25	17.42
HT/VHT20, M16 to M23	4	4	-54.5	-46.2	-47.4	-48.8	0.1	-38.2	-21.25	17.00
HT/VHT20, M24 to M31	4	4	-54.5	-46.2	-47.4	-48.8	0.1	-38.2	-21.25	17.00
HT/VHT20 Beam Forming, M0 to M7	2	7	-54.5	-46.2			0.1	-38.5	-21.25	17.30
HT/VHT20 Beam Forming, M8 to M15	2	4	-54.5	-46.2			0.1	-41.5	-21.25	20.30
HT/VHT20 Beam Forming, M0 to M7	3	9	-54.5	-47.5	-48.5		0.1	-35.5	-21.25	14.20
HT/VHT20 Beam Forming, M8 to M15	3	6	-54.5	-46.2	-47.4		0.1	-37.3	-21.25	16.10
HT/VHT20 Beam Forming, M16 to M23	3	4	-54.5	-46.2	-47.4		0.1	-39.3	-21.25	18.10
HT/VHT20 Beam Forming, M0 to M7	4	10	-54.5	-49.1	-50.0	-52.8	0.1	-35.0	-21.25	13.77
HT/VHT20 Beam Forming, M8 to M15	4	7	-54.5	-46.7	-47.9	-49.1	0.1	-35.7	-21.25	14.42
HT/VHT20 Beam Forming, M16 to M23	4	5	-54.5	-46.2	-47.4	-48.8	0.1	-37.2	-21.25	16.00
HT/VHT20 Beam Forming, M24 to M31	4	4	-54.5	-46.2	-47.4	-48.8	0.1	-38.2	-21.25	17.00
HT/VHT20 STBC, M0 to M7	2	4	-54.5	-46.2			0.1	-41.5	-21.25	20.30
HT/VHT20 STBC, M0 to M7	3	4	-54.5	-46.2	-47.4		0.1	-39.3	-21.25	18.10
HT/VHT20 STBC, M0 to M7	4	4	-54.5	-46.7	-47.9	-49.1	0.1	-38.7	-21.25	17.42
HE20, M0 to M9 1ss	1	4	-54.2				0.1	-50.1	-21.25	28.88
HE20, M0 to M9 1ss	2	4	-54.2	-44.7			0.1	-40.2	-21.25	18.92
HE20, M0 to M9 2ss	2	4	-54.2	-44.7			0.1	-40.2	-21.25	18.92
HE20, M0 to M9 1ss	3	4	-54.2	-47.8	-47.5		0.1	-40.1	-21.25	18.86
HE20, M0 to M9 2ss	3	4	-54.2	-44.7	-46.6		0.1	-38.2	-21.25	16.93
HE20, M0 to M9 3ss	3	4	-54.2	-44.7	-46.6		0.1	-38.2	-21.25	16.93
HE20, M0 to M9 1ss	4	4	-54.2	-48.2	-50.2	-51.8	0.1	-40.5	-21.25	19.23
HE20, M0 to M9 2ss	4	4	-54.2	-47.3	-47.8	-50.0	0.1	-39.0	-21.25	17.78
HE20, M0 to M9 3ss	4	4	-54.2	-44.7	-46.6	-49.8	0.1	-37.5	-21.25	16.23
HE20, M0 to M9 4ss	4	4	-54.2	-44.7	-46.6	-49.8	0.1	-37.5	-21.25	16.23
HE20 Beam Forming, M0 to M9 1ss	2	7	-54.2	-44.7			0.1	-37.2	-21.25	15.92
HE20 Beam Forming, M0 to M9 2ss	2	4	-54.2	-44.7			0.1	-40.2	-21.25	18.92
HE20 Beam Forming, M0 to M9 1ss	3	9	-54.2	-47.8	-47.5		0.1	-35.1	-21.25	13.86
HE20 Beam Forming, M0 to M9 2ss	3	6	-54.2	-44.7	-46.6		0.1	-36.2	-21.25	14.93
HE20 Beam Forming, M0 to M9 3ss	3	4	-54.2	-44.7	-46.6		0.1	-38.2	-21.25	16.93
HE20 Beam Forming, M0 to M9 1ss	4	10	-54.2	-48.2	-50.2	-51.8	0.1	-34.5	-21.25	13.23
HE20 Beam Forming, M0 to M9 2ss	4	7	-54.2	-47.3	-47.8	-50.0	0.1	-36.0	-21.25	14.78
HE20 Beam Forming, M0 to M9 3ss	4	5	-54.2	-44.7	-46.6	-49.8	0.1	-36.5	-21.25	15.23
HE20 Beam Forming, M0 to M9 4ss	4	4	-54.2	-44.7	-46.6	-49.8	0.1	-37.5	-21.25	16.23





	HE20 STBC, M0 to M9 2ss	2	4	-54.2	-44.7			0.1	-40.2	-21.25	18.92
	HE20 STBC, M0 to M9 2ss	3	4	-54.2	-44.7	-46.6		0.1	-38.2	-21.25	16.93
	HE20 STBC, M0 to M9 2ss	4	4	-54.2	-47.3	-47.8	-50.0	0.1	-39.0	-21.25	17.78
5310	Non HT40, 6 to 54 Mbps	1	4	-54.0				0.0	-50.0	-21.25	28.71
	Non HT40, 6 to 54 Mbps	2	4	-55.1	-51.0			0.0	-45.5	-21.25	24.28
	Non HT40, 6 to 54 Mbps	3	4	-55.1	-51.0	-52.1		0.0	-43.6	-21.25	22.35
	Non HT40, 6 to 54 Mbps	4	4	-55.1	-51.0	-52.1	-53.1	0.0	-42.5	-21.25	21.26
	HT/VHT40, M0 to M7	1	4	-54.3				0.1	-50.2	-21.25	28.95
	HT/VHT40, M0 to M7	2	4	-54.3	-47.8			0.1	-42.8	-21.25	21.57
	HT/VHT40, M8 to M15	2	4	-54.3	-47.8			0.1	-42.8	-21.25	21.57
	HT/VHT40, M0 to M7	3	4	-54.3	-50.3	-50.3		0.1	-42.4	-21.25	21.15
	HT/VHT40, M8 to M15	3	4	-54.3	-50.3	-50.3		0.1	-42.4	-21.25	21.15
	HT/VHT40, M16 to M23	3	4	-54.3	-50.3	-50.3		0.1	-42.4	-21.25	21.15
	HT/VHT40, M0 to M7	4	4	-54.4	-51.5	-52.3	-54.6	0.1	-42.9	-21.25	21.62
	HT/VHT40, M8 to M15	4	4	-54.4	-51.5	-52.3	-54.6	0.1	-42.9	-21.25	21.62
	HT/VHT40, M16 to M23	4	4	-54.4	-51.5	-52.3	-54.6	0.1	-42.9	-21.25	21.62
	HT/VHT40, M24 to M31	4	4	-54.4	-51.5	-52.3	-54.6	0.1	-42.9	-21.25	21.62
	HT/VHT40 Beam Forming, M0 to M7	2	7	-54.4	-51.5			0.1	-42.6	-21.25	21.35
	HT/VHT40 Beam Forming, M8 to M15	2	4	-54.3	-47.8			0.1	-42.8	-21.25	21.57
	HT/VHT40 Beam Forming, M0 to M7	3	9	-55.7	-51.9	-53.6		0.1	-39.6	-21.25	18.34
	HT/VHT40 Beam Forming, M8 to M15	3	6	-54.4	-51.5	-52.3		0.1	-41.7	-21.25	20.45
	HT/VHT40 Beam Forming, M16 to M23	3	4	-54.3	-50.3	-50.3		0.1	-42.4	-21.25	21.15
	HT/VHT40 Beam Forming, M0 to M7	4	10	-56.3	-52.2	-52.9	-56.0	0.1	-37.9	-21.25	16.60
	HT/VHT40 Beam Forming, M8 to M15	4	7	-55.7	-51.9	-53.6	-55.6	0.1	-40.8	-21.25	19.53
	HT/VHT40 Beam Forming, M16 to M23	4	5	-54.4	-51.5	-52.3	-54.6	0.1	-41.9	-21.25	20.62
	HT/VHT40 Beam Forming, M24 to M31	4	4	-54.4	-51.5	-52.3	-54.6	0.1	-42.9	-21.25	21.62
	HT/VHT40 STBC, M0 to M7	2	4	-54.3	-47.8			0.1	-42.8	-21.25	21.57
	HT/VHT40 STBC, M0 to M7	3	4	-54.3	-50.3	-50.3		0.1	-42.4	-21.25	21.15
	HT/VHT40 STBC, M0 to M7	4	4	-54.4	-51.5	-52.3	-54.6	0.1	-42.9	-21.25	21.62
	HE40, M0 to M9 1ss	1	4	-54.9				0.1	-50.8	-21.25	29.52
	HE40, M0 to M9 1ss	2	4	-54.9	-50.9			0.1	-45.3	-21.25	24.06
	HE40, M0 to M9 2ss	2	4	-54.9	-50.9			0.1	-45.3	-21.25	24.06
	HE40, M0 to M9 1ss	3	4	-54.9	-50.9	-52.5		0.1	-43.6	-21.25	22.32
	HE40, M0 to M9 2ss	3	4	-54.9	-50.9	-52.5		0.1	-43.6	-21.25	22.32
	HE40, M0 to M9 3ss	3	4	-54.9	-50.9	-52.5		0.1	-43.6	-21.25	22.32
	HE40, M0 to M9 1ss	4	4	-54.9	-50.9	-52.5	-53.9	0.1	-42.6	-21.25	21.39
HE40, M0 to M9 2ss	4	4	-54.9	-50.9	-52.5	-53.9	0.1	-42.6	-21.25	21.39	
HE40, M0 to M9 3ss	4	4	-54.9	-50.9	-52.5	-53.9	0.1	-42.6	-21.25	21.39	
HE40, M0 to M9 4ss	4	4	-54.9	-50.9	-52.5	-53.9	0.1	-42.6	-21.25	21.39	
HE40 Beam Forming, M0 to M9 1ss	2	7	-56.1	-51.9			0.1	-43.4	-21.25	22.12	
HE40 Beam Forming, M0 to M9 2ss	2	4	-54.9	-50.9			0.1	-45.3	-21.25	24.06	



	HE40 Beam Forming, M0 to M9 1ss	3	9	-56.1	-51.9	-52.6		0.1	-39.3	-21.25	18.03
	HE40 Beam Forming, M0 to M9 2ss	3	6	-56.1	-51.9	-52.6		0.1	-42.3	-21.25	21.03
	HE40 Beam Forming, M0 to M9 3ss	3	4	-54.9	-50.9	-52.5		0.1	-43.6	-21.25	22.32
	HE40 Beam Forming, M0 to M9 1ss	4	10	-56.4	-52.3	-53.2	-55.6	0.1	-37.9	-21.25	16.66
	HE40 Beam Forming, M0 to M9 2ss	4	7	-56.1	-51.9	-52.6	-55.3	0.1	-40.5	-21.25	19.22
	HE40 Beam Forming, M0 to M9 3ss	4	5	-56.1	-51.9	-52.6	-55.3	0.1	-42.5	-21.25	21.22
	HE40 Beam Forming, M0 to M9 4ss	4	4	-54.9	-50.9	-52.5	-53.9	0.1	-42.6	-21.25	21.39
	HE40 STBC, M0 to M9 2ss	2	4	-54.9	-50.9			0.1	-45.3	-21.25	24.06
	HE40 STBC, M0 to M9 2ss	3	4	-54.9	-50.9	-52.5		0.1	-43.6	-21.25	22.32
	HE40 STBC, M0 to M9 2ss	4	4	-54.9	-50.9	-52.5	-53.9	0.1	-42.6	-21.25	21.39
5320	Non HT20, 6 to 54 Mbps	1	4	-55.1				0.0	-51.1	-21.25	29.81
	Non HT20, 6 to 54 Mbps	2	4	-55.1	-47.0			0.0	-42.3	-21.25	21.08
	Non HT20, 6 to 54 Mbps	3	4	-55.1	-47.6	-49.7		0.0	-41.0	-21.25	19.77
	Non HT20, 6 to 54 Mbps	4	4	-55.1	-49.5	-50.2	-53.7	0.0	-41.5	-21.25	20.22
	Non HT20 Beam Forming, 6 to 54 Mbps	2	7	-55.1	-47.3			0.0	-39.6	-21.25	18.34
	Non HT20 Beam Forming, 6 to 54 Mbps	3	9	-55.1	-47.6	-49.7		0.0	-36.0	-21.25	14.77
	Non HT20 Beam Forming, 6 to 54 Mbps	4	10	-55.1	-49.5	-50.2	-53.7	0.0	-35.5	-21.25	14.22
	HT/VHT20, M0 to M7	1	4	-55.1				0.1	-51.0	-21.25	29.80
	HT/VHT20, M0 to M7	2	4	-55.1	-48.3			0.1	-43.4	-21.25	22.17
	HT/VHT20, M8 to M15	2	4	-55.1	-48.3			0.1	-43.4	-21.25	22.17
	HT/VHT20, M0 to M7	3	4	-55.1	-48.4	-49.8		0.1	-41.5	-21.25	20.22
	HT/VHT20, M8 to M15	3	4	-55.1	-48.3	-48.3		0.1	-40.8	-21.25	19.56
	HT/VHT20, M16 to M23	3	4	-55.1	-48.3	-48.3		0.1	-40.8	-21.25	19.56
	HT/VHT20, M0 to M7	4	4	-55.1	-49.1	-50.5	-54.2	0.1	-41.5	-21.25	20.21
	HT/VHT20, M8 to M15	4	4	-55.1	-48.3	-48.3	-50.4	0.1	-39.7	-21.25	18.49
	HT/VHT20, M16 to M23	4	4	-55.1	-48.3	-48.3	-50.4	0.1	-39.7	-21.25	18.49
	HT/VHT20, M24 to M31	4	4	-55.1	-48.3	-48.3	-50.4	0.1	-39.7	-21.25	18.49
	HT/VHT20 Beam Forming, M0 to M7	2	7	-55.1	-48.3			0.1	-40.4	-21.25	19.17
	HT/VHT20 Beam Forming, M8 to M15	2	4	-55.1	-48.3			0.1	-43.4	-21.25	22.17
	HT/VHT20 Beam Forming, M0 to M7	3	9	-55.1	-48.4	-49.8		0.1	-36.5	-21.25	15.22
	HT/VHT20 Beam Forming, M8 to M15	3	6	-55.1	-48.3	-48.3		0.1	-38.8	-21.25	17.56
	HT/VHT20 Beam Forming, M16 to M23	3	4	-55.1	-48.3	-48.3		0.1	-40.8	-21.25	19.56
	HT/VHT20 Beam Forming, M0 to M7	4	10	-55.1	-49.1	-50.5	-54.2	0.1	-35.5	-21.25	14.21
	HT/VHT20 Beam Forming, M8 to M15	4	7	-55.1	-48.4	-49.8	-53.0	0.1	-37.8	-21.25	16.51
	HT/VHT20 Beam Forming, M16 to M23	4	5	-55.1	-48.4	-49.8	-53.0	0.1	-39.8	-21.25	18.51
	HT/VHT20 Beam Forming, M24 to M31	4	4	-55.1	-48.3	-48.3	-50.4	0.1	-39.7	-21.25	18.49
	HT/VHT20 STBC, M0 to M7	2	4	-55.1	-48.3			0.1	-43.4	-21.25	22.17
	HT/VHT20 STBC, M0 to M7	3	4	-55.1	-48.3	-48.3		0.1	-40.8	-21.25	19.56
	HT/VHT20 STBC, M0 to M7	4	4	-55.1	-48.3	-48.3	-50.4	0.1	-39.7	-21.25	18.49
	HE20, M0 to M9 1ss	1	4	-54.5				0.1	-50.4	-21.25	29.18
	HE20, M0 to M9 1ss	2	4	-54.5	-47.1			0.1	-42.3	-21.25	21.05



	HE20, M0 to M9 2ss	2	4	-54.5	-47.1			0.1	-42.3	-21.25	21.05
	HE20, M0 to M9 1ss	3	4	-54.5	-48.4	-48.7		0.1	-40.9	-21.25	19.70
	HE20, M0 to M9 2ss	3	4	-54.5	-47.1	-48.4		0.1	-40.2	-21.25	18.94
	HE20, M0 to M9 3ss	3	4	-54.5	-47.1	-48.4		0.1	-40.2	-21.25	18.94
	HE20, M0 to M9 1ss	4	4	-54.5	-49.0	-50.7	-52.7	0.1	-41.2	-21.25	19.91
	HE20, M0 to M9 2ss	4	4	-54.5	-48.4	-48.7	-52.1	0.1	-40.2	-21.25	18.92
	HE20, M0 to M9 3ss	4	4	-54.5	-48.4	-48.7	-52.1	0.1	-40.2	-21.25	18.92
	HE20, M0 to M9 4ss	4	4	-54.5	-48.4	-48.7	-52.1	0.1	-40.2	-21.25	18.92
	HE20 Beam Forming, M0 to M9 1ss	2	7	-54.5	-48.4			0.1	-40.4	-21.25	19.13
	HE20 Beam Forming, M0 to M9 2ss	2	4	-54.5	-47.1			0.1	-42.3	-21.25	21.05
	HE20 Beam Forming, M0 to M9 1ss	3	9	-54.5	-49.3	-48.5		0.1	-36.2	-21.25	14.99
	HE20 Beam Forming, M0 to M9 2ss	3	6	-54.5	-48.4	-48.7		0.1	-38.9	-21.25	17.70
	HE20 Beam Forming, M0 to M9 3ss	3	4	-54.5	-47.1	-48.4		0.1	-40.2	-21.25	18.94
	HE20 Beam Forming, M0 to M9 1ss	4	10	-54.5	-49.0	-50.7	-52.7	0.1	-35.2	-21.25	13.91
	HE20 Beam Forming, M0 to M9 2ss	4	7	-54.5	-49.3	-48.5	-52.5	0.1	-37.5	-21.25	16.23
	HE20 Beam Forming, M0 to M9 3ss	4	5	-54.5	-48.4	-48.7	-52.1	0.1	-39.2	-21.25	17.92
	HE20 Beam Forming, M0 to M9 4ss	4	4	-54.5	-48.4	-48.7	-52.1	0.1	-40.2	-21.25	18.92
	HE20 STBC, M0 to M9 2ss	2	4	-54.5	-47.1			0.1	-42.3	-21.25	21.05
	HE20 STBC, M0 to M9 2ss	3	4	-54.5	-47.1	-48.4		0.1	-40.2	-21.25	18.94
	HE20 STBC, M0 to M9 2ss	4	4	-54.5	-48.4	-48.7	-52.1	0.1	-40.2	-21.25	18.92
5250	Non HT160, 6 to 54 Mbps	1	4	-50.4				0.0	-46.4	-21.25	25.10
	Non HT160, 6 to 54 Mbps	2	4	-50.4	-49.5			0.0	-42.9	-21.25	21.62
	Non HT160, 6 to 54 Mbps	3	4	-50.4	-49.5	-50.2		0.0	-41.2	-21.25	19.95
	Non HT160, 6 to 54 Mbps	4	4	-50.4	-49.5	-50.2	-52.0	0.0	-40.4	-21.25	19.11
	VHT160, M0 to M9 1ss	1	4	-48.7				0.4	-44.3	-21.25	23.06
	VHT160, M0 to M9 1ss	2	4	-48.7	-49.5			0.4	-41.7	-21.25	20.43
	VHT160, M0 to M9 2ss	2	4	-48.7	-49.5			0.4	-41.7	-21.25	20.43
	VHT160, M0 to M9 1ss	3	4	-48.7	-49.5	-51.2		0.4	-40.5	-21.25	19.27
	VHT160, M0 to M9 2ss	3	4	-48.7	-49.5	-51.2		0.4	-40.5	-21.25	19.27
	VHT160, M0 to M9 3ss	3	4	-48.7	-49.5	-51.2		0.4	-40.5	-21.25	19.27
	VHT160, M0 to M9 1ss	4	4	-48.7	-49.5	-51.2	-53.0	0.4	-39.9	-21.25	18.64
	VHT160, M0 to M9 2ss	4	4	-48.7	-49.5	-51.2	-53.0	0.4	-39.9	-21.25	18.64
	VHT160, M0 to M9 3ss	4	4	-48.7	-49.5	-51.2	-53.0	0.4	-39.9	-21.25	18.64
	VHT160, M0 to M9 4ss	4	4	-48.7	-49.5	-51.2	-53.0	0.4	-39.9	-21.25	18.64
	VHT160 Beam Forming, M0 to M9 1ss	2	7	-51.7	-50.7			0.4	-40.8	-21.25	19.52
	VHT160 Beam Forming, M0 to M9 2ss	2	4	-48.7	-49.5			0.4	-41.7	-21.25	20.43
	VHT160 Beam Forming, M0 to M9 1ss	3	9	-52.9	-51.8	-52.2		0.4	-38.1	-21.25	16.86
	VHT160 Beam Forming, M0 to M9 2ss	3	6	-48.7	-49.5	-51.2		0.4	-38.5	-21.25	17.27
	VHT160 Beam Forming, M0 to M9 3ss	3	4	-48.7	-49.5	-51.2		0.4	-40.5	-21.25	19.27
	VHT160 Beam Forming, M0 to M9 1ss	4	10	-52.9	-51.8	-52.2	-54.5	0.4	-36.3	-21.25	15.07
VHT160 Beam Forming, M0 to M9 2ss	4	7	-51.7	-50.7	-51.2	-54.5	0.4	-38.4	-21.25	17.14	



VHT160 Beam Forming, M0 to M9 3ss	4	5	-48.7	-49.5	-51.2	-53.0	0.4	-38.9	-21.25	17.64
VHT160 Beam Forming, M0 to M9 4ss	4	4	-48.7	-49.5	-51.2	-53.0	0.4	-39.9	-21.25	18.64
VHT160 STBC, M0 to M9 1ss	2	4	-48.7	-49.5			0.4	-41.7	-21.25	20.43
VHT160 STBC, M0 to M9 1ss	3	4	-48.7	-49.5	-51.2		0.4	-40.5	-21.25	19.27
VHT160 STBC, M0 to M9 1ss	4	4	-48.7	-49.5	-51.2	-53.0	0.4	-39.9	-21.25	18.64
HE160, M0 to M9 1ss	1	4	-50.2				0.4	-45.8	-21.25	24.52
HE160, M0 to M9 1ss	2	4	-50.2	-49.1			0.4	-42.2	-21.25	20.92
HE160, M0 to M9 2ss	2	4	-50.2	-49.1			0.4	-42.2	-21.25	20.92
HE160, M0 to M9 1ss	3	4	-50.8	-49.3	-50.4		0.4	-40.9	-21.25	19.66
HE160, M0 to M9 2ss	3	4	-50.8	-49.3	-50.4		0.4	-40.9	-21.25	19.66
HE160, M0 to M9 3ss	3	4	-50.8	-49.3	-50.4		0.4	-40.9	-21.25	19.66
HE160, M0 to M9 1ss	4	4	-50.8	-49.3	-50.4	-53.3	0.4	-40.3	-21.25	19.02
HE160, M0 to M9 2ss	4	4	-50.8	-49.3	-50.4	-53.3	0.4	-40.3	-21.25	19.02
HE160, M0 to M9 3ss	4	4	-50.8	-49.3	-50.4	-53.3	0.4	-40.3	-21.25	19.02
HE160, M0 to M9 4ss	4	4	-50.8	-49.3	-50.4	-53.3	0.4	-40.3	-21.25	19.02
HE160 Beam Forming, M0 to M9 1ss	2	7	-50.8	-49.3			0.4	-39.5	-21.25	18.29
HE160 Beam Forming, M0 to M9 2ss	2	4	-50.2	-49.1			0.4	-42.2	-21.25	20.92
HE160 Beam Forming, M0 to M9 1ss	3	9	-54.3	-50.6	-52.0		0.4	-37.8	-21.25	16.59
HE160 Beam Forming, M0 to M9 2ss	3	6	-50.8	-49.3	-50.4		0.4	-38.9	-21.25	17.66
HE160 Beam Forming, M0 to M9 3ss	3	4	-50.8	-49.3	-50.4		0.4	-40.9	-21.25	19.66
HE160 Beam Forming, M0 to M9 1ss	4	10	-54.3	-50.5	-52.9	-54.4	0.4	-36.3	-21.25	15.01
HE160 Beam Forming, M0 to M9 2ss	4	7	-54.3	-50.6	-52.0	-54.4	0.4	-39.1	-21.25	17.82
HE160 Beam Forming, M0 to M9 3ss	4	5	-50.8	-49.3	-50.4	-53.3	0.4	-39.3	-21.25	18.02
HE160 Beam Forming, M0 to M9 4ss	4	4	-50.8	-49.3	-50.4	-53.3	0.4	-40.3	-21.25	19.02
HE160 STBC, M0 to M9 1ss	2	4	-50.2	-49.1			0.4	-42.2	-21.25	20.92
HE160 STBC, M0 to M9 1ss	3	4	-50.8	-49.3	-50.4		0.4	-40.9	-21.25	19.66
HE160 STBC, M0 to M9 1ss	4	4	-50.8	-49.3	-50.4	-53.3	0.4	-40.3	-21.25	19.02



**Conducted Spurs Peak, 4dBi  
5270 MHz, HE40 Beam Forming, M0 to M9 1ss**



**Antenna A**

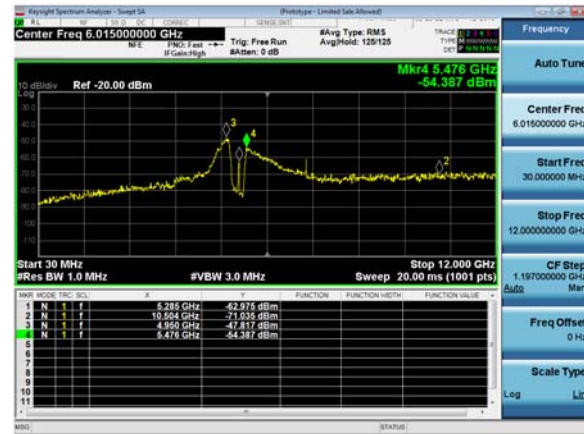

**Antenna B**



**Antenna C**

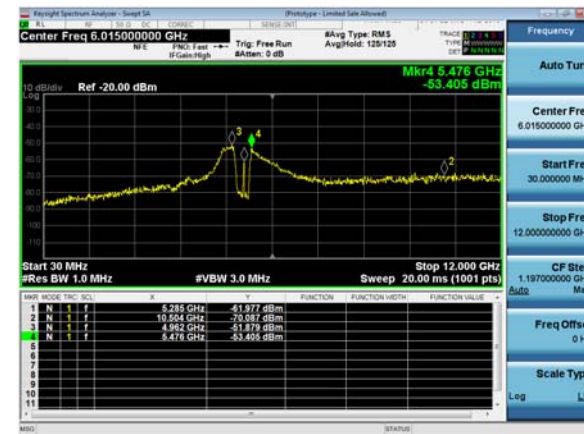

**Antenna D**



## Conducted Spurious Emissions Peak Table, 5dBi

Frequency (MHz)	Mode	Tx Paths	Correlated Antenna Gain (dBi)	Tx 1 Spur Power (dBm)	Tx 2 Spur Power (dBm)	Tx 3 Spur Power (dBm)	Tx 4 Spur Power (dBm)	Tx 5 Spur Power (dBm)	Total Conducted Spur (dBm)	Limit (dBm)	Margin (dB)
5260	Non HT20, 6 to 54 Mbps	1	5	-54.2				0.0	-49.2	-21.25	27.91
	Non HT20, 6 to 54 Mbps	2	5	-54.2	-45.4			0.0	-39.8	-21.25	18.57
	Non HT20, 6 to 54 Mbps	3	5	-54.2	-46.4	-48.5		0.0	-38.8	-21.25	17.60
	Non HT20, 6 to 54 Mbps	4	5	-55.7	-50.2	-51.4	-53.3	0.0	-41.1	-21.25	19.87
	Non HT20 Beam Forming, 6 to 54 Mbps	2	8	-54.2	-45.4			0.0	-36.8	-21.25	15.57
	Non HT20 Beam Forming, 6 to 54 Mbps	3	10	-54.2	-46.4	-48.5		0.0	-33.8	-21.25	12.60
	Non HT20 Beam Forming, 6 to 54 Mbps	4	11	-55.7	-50.2	-51.4	-53.3	0.0	-35.1	-21.25	13.87
	HT/VHT20, M0 to M7	1	5	-54.2				0.1	-49.1	-21.25	27.90
	HT/VHT20, M0 to M7	2	5	-54.2	-45.8			0.1	-40.2	-21.25	18.91
	HT/VHT20, M8 to M15	2	5	-54.2	-45.8			0.1	-40.2	-21.25	18.91
	HT/VHT20, M0 to M7	3	5	-54.2	-47.6	-48.9		0.1	-39.6	-21.25	18.37
	HT/VHT20, M8 to M15	3	5	-54.2	-45.8	-46.1		0.1	-37.6	-21.25	16.32
	HT/VHT20, M16 to M23	3	5	-54.2	-45.8	-46.1		0.1	-37.6	-21.25	16.32
	HT/VHT20, M0 to M7	4	5	-54.2	-48.9	-51.0	-51.9	0.1	-40.0	-21.25	18.77
	HT/VHT20, M8 to M15	4	5	-54.2	-46.9	-47.4	-50.6	0.1	-37.9	-21.25	16.61
	HT/VHT20, M16 to M23	4	5	-54.2	-45.8	-46.1	-48.8	0.1	-36.6	-21.25	15.38
	HT/VHT20, M24 to M31	4	5	-54.2	-45.8	-46.1	-48.8	0.1	-36.6	-21.25	15.38
	HT/VHT20 Beam Forming, M0 to M7	2	8	-54.2	-45.8			0.1	-37.2	-21.25	15.91
	HT/VHT20 Beam Forming, M8 to M15	2	5	-54.2	-45.8			0.1	-40.2	-21.25	18.91
	HT/VHT20 Beam Forming, M0 to M7	3	10	-54.2	-47.6	-48.9		0.1	-34.6	-21.25	13.37
	HT/VHT20 Beam Forming, M8 to M15	3	7	-54.2	-45.8	-46.1		0.1	-35.6	-21.25	14.32
	HT/VHT20 Beam Forming, M16 to M23	3	5	-54.2	-45.8	-46.1		0.1	-37.6	-21.25	16.32
	HT/VHT20 Beam Forming, M0 to M7	4	11	-54.2	-48.9	-51.0	-51.9	0.1	-34.0	-21.25	12.77
	HT/VHT20 Beam Forming, M8 to M15	4	8	-54.2	-46.9	-47.4	-50.6	0.1	-34.9	-21.25	13.61
	HT/VHT20 Beam Forming, M16 to M23	4	6	-54.2	-45.8	-46.1	-48.8	0.1	-35.6	-21.25	14.38
	HT/VHT20 Beam Forming, M24 to M31	4	5	-54.2	-45.8	-46.1	-48.8	0.1	-36.6	-21.25	15.38
	HT/VHT20 STBC, M0 to M7	2	5	-54.2	-45.8			0.1	-40.2	-21.25	18.91
	HT/VHT20 STBC, M0 to M7	3	5	-54.2	-45.8	-46.1		0.1	-37.6	-21.25	16.32
	HT/VHT20 STBC, M0 to M7	4	5	-54.2	-46.9	-47.4	-50.6	0.1	-37.9	-21.25	16.61





	HE20, M0 to M9 1ss	1	5	-54.5				0.1	-49.4	-21.25	28.18
	HE20, M0 to M9 1ss	2	5	-54.5	-45.3			0.1	-39.7	-21.25	18.49
	HE20, M0 to M9 2ss	2	5	-54.5	-45.3			0.1	-39.7	-21.25	18.49
	HE20, M0 to M9 1ss	3	5	-54.5	-47.5	-47.1		0.1	-38.8	-21.25	17.57
	HE20, M0 to M9 2ss	3	5	-54.5	-45.3	-46.6		0.1	-37.5	-21.25	16.28
	HE20, M0 to M9 3ss	3	5	-54.5	-45.3	-46.6		0.1	-37.5	-21.25	16.28
	HE20, M0 to M9 1ss	4	5	-54.4	-50.0	-51.9	-53.5	0.1	-41.0	-21.25	19.78
	HE20, M0 to M9 2ss	4	5	-54.5	-47.2	-48.5	-50.4	0.1	-38.3	-21.25	17.07
	HE20, M0 to M9 3ss	4	5	-54.5	-45.3	-46.6	-48.4	0.1	-36.5	-21.25	15.27
	HE20, M0 to M9 4ss	4	5	-54.5	-45.3	-46.6	-48.4	0.1	-36.5	-21.25	15.27
	HE20 Beam Forming, M0 to M9 1ss	2	8	-54.5	-45.3			0.1	-36.7	-21.25	15.49
	HE20 Beam Forming, M0 to M9 2ss	2	5	-54.5	-45.3			0.1	-39.7	-21.25	18.49
	HE20 Beam Forming, M0 to M9 1ss	3	10	-54.5	-47.5	-47.1		0.1	-33.8	-21.25	12.57
	HE20 Beam Forming, M0 to M9 2ss	3	7	-54.5	-45.3	-46.6		0.1	-35.5	-21.25	14.28
	HE20 Beam Forming, M0 to M9 3ss	3	5	-54.5	-45.3	-46.6		0.1	-37.5	-21.25	16.28
	HE20 Beam Forming, M0 to M9 1ss	4	11	-54.4	-50.0	-51.9	-53.5	0.1	-35.0	-21.25	13.78
	HE20 Beam Forming, M0 to M9 2ss	4	8	-54.5	-47.2	-48.5	-50.4	0.1	-35.3	-21.25	14.07
	HE20 Beam Forming, M0 to M9 3ss	4	6	-54.5	-45.3	-46.6	-48.4	0.1	-35.5	-21.25	14.27
	HE20 Beam Forming, M0 to M9 4ss	4	5	-54.5	-45.3	-46.6	-48.4	0.1	-36.5	-21.25	15.27
	HE20 STBC, M0 to M9 2ss	2	5	-54.5	-45.3			0.1	-39.7	-21.25	18.49
	HE20 STBC, M0 to M9 2ss	3	5	-54.5	-45.3	-46.6		0.1	-37.5	-21.25	16.28
	HE20 STBC, M0 to M9 2ss	4	5	-54.5	-47.2	-48.5	-50.4	0.1	-38.3	-21.25	17.07
5270	Non HT40, 6 to 54 Mbps	1	5	-54.8				0.0	-49.8	-21.25	28.51
	Non HT40, 6 to 54 Mbps	2	5	-54.8	-46.1			0.0	-40.5	-21.25	19.26
	Non HT40, 6 to 54 Mbps	3	5	-54.8	-46.1	-44.6		0.0	-37.0	-21.25	15.75
	Non HT40, 6 to 54 Mbps	4	5	-54.8	-47.2	-48.4	-49.5	0.0	-38.1	-21.25	16.89
	HT/VHT40, M0 to M7	1	5	-54.7				0.1	-49.6	-21.25	28.35
	HT/VHT40, M0 to M7	2	5	-54.7	-46.5			0.1	-40.8	-21.25	19.54
	HT/VHT40, M8 to M15	2	5	-54.7	-46.5			0.1	-40.8	-21.25	19.54
	HT/VHT40, M0 to M7	3	5	-54.7	-46.5	-46.4		0.1	-38.0	-21.25	16.77
	HT/VHT40, M8 to M15	3	5	-54.7	-46.5	-46.4		0.1	-38.0	-21.25	16.77
	HT/VHT40, M16 to M23	3	5	-54.7	-46.5	-46.4		0.1	-38.0	-21.25	16.77
	HT/VHT40, M0 to M7	4	5	-54.7	-47.7	-49.0	-51.2	0.1	-38.8	-21.25	17.57
	HT/VHT40, M8 to M15	4	5	-54.7	-46.5	-46.4	-49.5	0.1	-37.1	-21.25	15.87
	HT/VHT40, M16 to M23	4	5	-54.7	-46.5	-46.4	-49.5	0.1	-37.1	-21.25	15.87
	HT/VHT40, M24 to M31	4	5	-54.7	-46.5	-46.4	-49.5	0.1	-37.1	-21.25	15.87
	HT/VHT40 Beam Forming, M0 to M7	2	8	-54.7	-46.5			0.1	-37.8	-21.25	16.54
	HT/VHT40 Beam Forming, M8 to M15	2	5	-54.7	-46.5			0.1	-40.8	-21.25	19.54
	HT/VHT40 Beam Forming, M0 to M7	3	10	-54.7	-47.7	-49.0		0.1	-34.7	-21.25	13.47
	HT/VHT40 Beam Forming, M8 to M15	3	7	-54.7	-46.5	-46.4		0.1	-36.0	-21.25	14.77
HT/VHT40 Beam Forming, M16 to M23	3	5	-54.7	-46.5	-46.4		0.1	-38.0	-21.25	16.77	





	<b>HT/VHT40 Beam Forming, M0 to M7</b>	<b>4</b>	<b>11</b>	<b>-54.7</b>	<b>-47.9</b>	<b>-49.8</b>	<b>-52.5</b>	<b>0.1</b>	<b>-33.4</b>	<b>-21.25</b>	<b>12.12</b>
	HT/VHT40 Beam Forming, M8 to M15	4	8	-54.7	-46.7	-47.7	-48.9	0.1	-34.5	-21.25	13.27
	HT/VHT40 Beam Forming, M16 to M23	4	6	-54.7	-46.5	-46.4	-49.5	0.1	-36.1	-21.25	14.87
	HT/VHT40 Beam Forming, M24 to M31	4	5	-54.7	-46.5	-46.4	-49.5	0.1	-37.1	-21.25	15.87
	HT/VHT40 STBC, M0 to M7	2	5	-54.7	-46.5			0.1	-40.8	-21.25	19.54
	HT/VHT40 STBC, M0 to M7	3	5	-54.7	-46.5	-46.4		0.1	-38.0	-21.25	16.77
	HT/VHT40 STBC, M0 to M7	4	5	-54.7	-46.7	-47.7	-48.9	0.1	-37.5	-21.25	16.27
	HE40, M0 to M9 1ss	1	5	-54.1				0.1	-49.0	-21.25	27.72
	HE40, M0 to M9 1ss	2	5	-54.1	-45.4			0.1	-39.7	-21.25	18.47
	HE40, M0 to M9 2ss	2	5	-54.1	-45.4			0.1	-39.7	-21.25	18.47
	HE40, M0 to M9 1ss	3	5	-54.1	-45.4	-46.0		0.1	-37.2	-21.25	16.00
	HE40, M0 to M9 2ss	3	5	-54.1	-45.4	-46.0		0.1	-37.2	-21.25	16.00
	HE40, M0 to M9 3ss	3	5	-54.1	-45.4	-46.0		0.1	-37.2	-21.25	16.00
	HE40, M0 to M9 1ss	4	5	-54.1	-48.0	-48.2	-50.8	0.1	-38.5	-21.25	17.27
	HE40, M0 to M9 2ss	4	5	-54.1	-45.4	-46.0	-50.0	0.1	-36.6	-21.25	15.30
	HE40, M0 to M9 3ss	4	5	-54.1	-45.4	-46.0	-50.0	0.1	-36.6	-21.25	15.30
	HE40, M0 to M9 4ss	4	5	-54.1	-45.4	-46.0	-50.0	0.1	-36.6	-21.25	15.30
	HE40 Beam Forming, M0 to M9 1ss	2	8	-54.1	-45.4			0.1	-36.7	-21.25	15.47
	HE40 Beam Forming, M0 to M9 2ss	2	5	-54.1	-45.4			0.1	-39.7	-21.25	18.47
	HE40 Beam Forming, M0 to M9 1ss	3	10	-54.1	-48.0	-48.2		0.1	-34.4	-21.25	13.19
	HE40 Beam Forming, M0 to M9 2ss	3	7	-54.1	-45.4	-46.0		0.1	-35.2	-21.25	14.00
	HE40 Beam Forming, M0 to M9 3ss	3	5	-54.1	-45.4	-46.0		0.1	-37.2	-21.25	16.00
	HE40 Beam Forming, M0 to M9 1ss	4	11	-54.1	-49.1	-50.0	-52.6	0.1	-33.9	-21.25	12.61
	HE40 Beam Forming, M0 to M9 2ss	4	8	-54.1	-45.9	-47.5	-49.3	0.1	-34.2	-21.25	12.90
	HE40 Beam Forming, M0 to M9 3ss	4	6	-54.1	-45.4	-46.0	-50.0	0.1	-35.6	-21.25	14.30
	HE40 Beam Forming, M0 to M9 4ss	4	5	-54.1	-45.4	-46.0	-50.0	0.1	-36.6	-21.25	15.30
	HE40 STBC, M0 to M9 2ss	2	5	-54.1	-45.4			0.1	-39.7	-21.25	18.47
	HE40 STBC, M0 to M9 2ss	3	5	-54.1	-45.4	-46.0		0.1	-37.2	-21.25	16.00
	HE40 STBC, M0 to M9 2ss	4	5	-54.1	-45.9	-47.5	-49.3	0.1	-37.2	-21.25	15.90
5290	Non HT80, 6 to 54 Mbps	1	5	-56.0				0.1	-50.9	-21.25	29.70
	Non HT80, 6 to 54 Mbps	2	5	-56.0	-50.3			0.1	-44.2	-21.25	22.96
	Non HT80, 6 to 54 Mbps	3	5	-56.0	-50.3	-53.2		0.1	-42.7	-21.25	21.49
	Non HT80, 6 to 54 Mbps	4	5	-56.0	-50.3	-53.2	-54.4	0.1	-41.9	-21.25	20.63
	VHT80, M0 to M9 1ss	1	5	-55.5				0.2	-50.3	-21.25	29.03
	VHT80, M0 to M9 1ss	2	5	-55.5	-51.8			0.2	-45.0	-21.25	23.79
	VHT80, M0 to M9 2ss	2	5	-55.5	-51.8			0.2	-45.0	-21.25	23.79
	VHT80, M0 to M9 1ss	3	5	-55.5	-51.8	-51.7		0.2	-42.7	-21.25	21.44
	VHT80, M0 to M9 2ss	3	5	-55.5	-51.8	-51.7		0.2	-42.7	-21.25	21.44
	VHT80, M0 to M9 3ss	3	5	-55.5	-51.8	-51.7		0.2	-42.7	-21.25	21.44
	VHT80, M0 to M9 1ss	4	5	-55.5	-51.8	-51.7	-53.3	0.2	-41.6	-21.25	20.34
	VHT80, M0 to M9 2ss	4	5	-55.5	-51.8	-51.7	-53.3	0.2	-41.6	-21.25	20.34



	VHT80, M0 to M9 3ss	4	5	-55.5	-51.8	-51.7	-53.3	0.2	-41.6	-21.25	20.34
	VHT80, M0 to M9 4ss	4	5	-55.5	-51.8	-51.7	-53.3	0.2	-41.6	-21.25	20.34
	VHT80 Beam Forming, M0 to M9 1ss	2	8	-55.5	-52.1			0.2	-42.2	-21.25	21.00
	VHT80 Beam Forming, M0 to M9 2ss	2	5	-55.5	-51.8			0.2	-45.0	-21.25	23.79
	VHT80 Beam Forming, M0 to M9 1ss	3	10	-57.0	-52.2	-53.4		0.2	-38.8	-21.25	17.53
	VHT80 Beam Forming, M0 to M9 2ss	3	7	-55.5	-52.1	-52.9		0.2	-41.3	-21.25	20.04
	VHT80 Beam Forming, M0 to M9 3ss	3	5	-55.5	-51.8	-51.7		0.2	-42.7	-21.25	21.44
	VHT80 Beam Forming, M0 to M9 1ss	4	11	-57.2	-52.8	-54.0	-55.6	0.2	-37.4	-21.25	16.11
	VHT80 Beam Forming, M0 to M9 2ss	4	8	-57.0	-52.2	-53.4	-55.8	0.2	-40.0	-21.25	18.71
	VHT80 Beam Forming, M0 to M9 3ss	4	6	-55.5	-52.1	-52.9	-55.5	0.2	-41.5	-21.25	20.25
	VHT80 Beam Forming, M0 to M9 4ss	4	5	-55.5	-51.8	-51.7	-53.3	0.2	-41.6	-21.25	20.34
	VHT80 STBC, M0 to M9 1ss	2	5	-55.5	-51.8			0.2	-45.0	-21.25	23.79
	VHT80 STBC, M0 to M9 1ss	3	5	-55.5	-51.8	-51.7		0.2	-42.7	-21.25	21.44
	VHT80 STBC, M0 to M9 1ss	4	5	-55.5	-51.8	-51.7	-53.3	0.2	-41.6	-21.25	20.34
	HE80, M0 to M9 1ss	1	5	-55.1				0.3	-49.8	-21.25	28.59
	HE80, M0 to M9 1ss	2	5	-55.1	-51.1			0.3	-44.4	-21.25	23.14
	HE80, M0 to M9 2ss	2	5	-55.1	-51.1			0.3	-44.4	-21.25	23.14
	HE80, M0 to M9 1ss	3	5	-56.3	-52.1	-52.1		0.3	-43.1	-21.25	21.82
	HE80, M0 to M9 2ss	3	5	-56.3	-52.1	-52.1		0.3	-43.1	-21.25	21.82
	HE80, M0 to M9 3ss	3	5	-56.3	-52.1	-52.1		0.3	-43.1	-21.25	21.82
	HE80, M0 to M9 1ss	4	5	-56.3	-52.1	-52.1	-55.7	0.3	-42.3	-21.25	21.09
	HE80, M0 to M9 2ss	4	5	-56.3	-52.1	-52.1	-55.7	0.3	-42.3	-21.25	21.09
	HE80, M0 to M9 3ss	4	5	-56.3	-52.1	-52.1	-55.7	0.3	-42.3	-21.25	21.09
	HE80, M0 to M9 4ss	4	5	-56.3	-52.1	-52.1	-55.7	0.3	-42.3	-21.25	21.09
	HE80 Beam Forming, M0 to M9 1ss	2	8	-56.3	-52.1			0.3	-42.4	-21.25	21.19
	HE80 Beam Forming, M0 to M9 2ss	2	5	-55.1	-51.1			0.3	-44.4	-21.25	23.14
	HE80 Beam Forming, M0 to M9 1ss	3	10	-56.4	-51.8	-53.1		0.3	-38.3	-21.25	17.09
	HE80 Beam Forming, M0 to M9 2ss	3	7	-56.3	-52.1	-52.1		0.3	-41.1	-21.25	19.82
	HE80 Beam Forming, M0 to M9 3ss	3	5	-56.3	-52.1	-52.1		0.3	-43.1	-21.25	21.82
	HE80 Beam Forming, M0 to M9 1ss	4	11	-57.6	-52.7	-54.1	-56.5	0.3	-37.5	-21.25	16.27
	HE80 Beam Forming, M0 to M9 2ss	4	8	-56.4	-51.8	-53.1	-54.4	0.3	-39.3	-21.25	18.08
	HE80 Beam Forming, M0 to M9 3ss	4	6	-56.3	-52.1	-52.1	-55.7	0.3	-41.3	-21.25	20.09
	HE80 Beam Forming, M0 to M9 4ss	4	5	-56.3	-52.1	-52.1	-55.7	0.3	-42.3	-21.25	21.09
	HE80 STBC, M0 to M9 1ss	2	5	-55.1	-51.1			0.3	-44.4	-21.25	23.14
	HE80 STBC, M0 to M9 1ss	3	5	-56.3	-52.1	-52.1		0.3	-43.1	-21.25	21.82
	HE80 STBC, M0 to M9 1ss	4	5	-56.3	-52.1	-52.1	-55.7	0.3	-42.3	-21.25	21.09
5300	Non HT20, 6 to 54 Mbps	1	5	-54.3				0.0	-49.3	-21.25	28.01
	Non HT20, 6 to 54 Mbps	2	5	-54.3	-46.4			0.0	-40.7	-21.25	19.45
	Non HT20, 6 to 54 Mbps	3	5	-54.3	-47.8	-48.3		0.0	-39.5	-21.25	18.25
	Non HT20, 6 to 54 Mbps	4	5	-55.3	-50.5	-52.6	-53.9	0.0	-41.6	-21.25	20.40
	Non HT20 Beam Forming, 6 to 54 Mbps	2	8	-54.3	-46.4			0.0	-37.7	-21.25	16.45



Non HT20 Beam Forming, 6 to 54 Mbps	3	10	-54.3	-47.8	-48.3		0.0	-34.5	-21.25	13.25
Non HT20 Beam Forming, 6 to 54 Mbps	4	11	-55.3	-50.5	-52.6	-53.9	0.0	-35.6	-21.25	14.40
HT/VHT20, M0 to M7	1	5	-54.5				0.1	-49.4	-21.25	28.20
HT/VHT20, M0 to M7	2	5	-54.5	-46.2			0.1	-40.5	-21.25	19.30
HT/VHT20, M8 to M15	2	5	-54.5	-46.2			0.1	-40.5	-21.25	19.30
HT/VHT20, M0 to M7	3	5	-54.5	-48.0	-49.3		0.1	-40.0	-21.25	18.76
HT/VHT20, M8 to M15	3	5	-54.5	-46.2	-47.4		0.1	-38.3	-21.25	17.10
HT/VHT20, M16 to M23	3	5	-54.5	-46.2	-47.4		0.1	-38.3	-21.25	17.10
HT/VHT20, M0 to M7	4	5	-54.5	-48.4	-52.0	-53.6	0.1	-40.4	-21.25	19.12
HT/VHT20, M8 to M15	4	5	-54.5	-47.5	-48.5	-49.8	0.1	-38.3	-21.25	17.08
HT/VHT20, M16 to M23	4	5	-54.5	-46.2	-47.4	-48.8	0.1	-37.2	-21.25	16.00
HT/VHT20, M24 to M31	4	5	-54.5	-46.2	-47.4	-48.8	0.1	-37.2	-21.25	16.00
HT/VHT20 Beam Forming, M0 to M7	2	8	-54.5	-46.2			0.1	-37.5	-21.25	16.30
HT/VHT20 Beam Forming, M8 to M15	2	5	-54.5	-46.2			0.1	-40.5	-21.25	19.30
HT/VHT20 Beam Forming, M0 to M7	3	10	-54.5	-48.0	-49.3		0.1	-35.0	-21.25	13.76
HT/VHT20 Beam Forming, M8 to M15	3	7	-54.5	-46.2	-47.4		0.1	-36.3	-21.25	15.10
HT/VHT20 Beam Forming, M16 to M23	3	5	-54.5	-46.2	-47.4		0.1	-38.3	-21.25	17.10
HT/VHT20 Beam Forming, M0 to M7	4	11	-54.5	-48.4	-52.0	-53.6	0.1	-34.4	-21.25	13.12
HT/VHT20 Beam Forming, M8 to M15	4	8	-54.5	-47.5	-48.5	-49.8	0.1	-35.3	-21.25	14.08
HT/VHT20 Beam Forming, M16 to M23	4	6	-54.5	-46.2	-47.4	-48.8	0.1	-36.2	-21.25	15.00
HT/VHT20 Beam Forming, M24 to M31	4	5	-54.5	-46.2	-47.4	-48.8	0.1	-37.2	-21.25	16.00
HT/VHT20 STBC, M0 to M7	2	5	-54.5	-46.2			0.1	-40.5	-21.25	19.30
HT/VHT20 STBC, M0 to M7	3	5	-54.5	-46.2	-47.4		0.1	-38.3	-21.25	17.10
HT/VHT20 STBC, M0 to M7	4	5	-54.5	-47.5	-48.5	-49.8	0.1	-38.3	-21.25	17.08
HE20, M0 to M9 1ss	1	5	-54.2				0.1	-49.1	-21.25	27.88
HE20, M0 to M9 1ss	2	5	-54.2	-44.7			0.1	-39.2	-21.25	17.92
HE20, M0 to M9 2ss	2	5	-54.2	-44.7			0.1	-39.2	-21.25	17.92
HE20, M0 to M9 1ss	3	5	-54.2	-47.8	-49.8		0.1	-40.0	-21.25	18.78
HE20, M0 to M9 2ss	3	5	-54.2	-44.7	-46.6		0.1	-37.2	-21.25	15.93
HE20, M0 to M9 3ss	3	5	-54.2	-44.7	-46.6		0.1	-37.2	-21.25	15.93
HE20, M0 to M9 1ss	4	5	-55.7	-50.2	-51.7	-54.5	0.1	-41.4	-21.25	20.15
HE20, M0 to M9 2ss	4	5	-54.2	-47.8	-47.5	-51.3	0.1	-38.3	-21.25	17.09
HE20, M0 to M9 3ss	4	5	-54.2	-44.7	-46.6	-49.8	0.1	-36.5	-21.25	15.23
HE20, M0 to M9 4ss	4	5	-54.2	-44.7	-46.6	-49.8	0.1	-36.5	-21.25	15.23
HE20 Beam Forming, M0 to M9 1ss	2	8	-54.2	-44.7			0.1	-36.2	-21.25	14.92
HE20 Beam Forming, M0 to M9 2ss	2	5	-54.2	-44.7			0.1	-39.2	-21.25	17.92
HE20 Beam Forming, M0 to M9 1ss	3	10	-54.2	-47.8	-49.8		0.1	-35.0	-21.25	13.78
HE20 Beam Forming, M0 to M9 2ss	3	7	-54.2	-44.7	-46.6		0.1	-35.2	-21.25	13.93
HE20 Beam Forming, M0 to M9 3ss	3	5	-54.2	-44.7	-46.6		0.1	-37.2	-21.25	15.93
HE20 Beam Forming, M0 to M9 1ss	4	11	-55.7	-50.2	-51.7	-54.5	0.1	-35.4	-21.25	14.15
HE20 Beam Forming, M0 to M9 2ss	4	8	-54.2	-47.8	-47.5	-51.3	0.1	-35.3	-21.25	14.09
HE20 Beam Forming, M0 to M9 3ss	4	6	-54.2	-44.7	-46.6	-49.8	0.1	-35.5	-21.25	14.23



	HE20 Beam Forming, M0 to M9 4ss	4	5	-54.2	-44.7	-46.6	-49.8	0.1	-36.5	-21.25	15.23
	HE20 STBC, M0 to M9 2ss	2	5	-54.2	-44.7			0.1	-39.2	-21.25	17.92
	HE20 STBC, M0 to M9 2ss	3	5	-54.2	-44.7	-46.6		0.1	-37.2	-21.25	15.93
	HE20 STBC, M0 to M9 2ss	4	5	-54.2	-47.8	-47.5	-51.3	0.1	-38.3	-21.25	17.09
5310	Non HT40, 6 to 54 Mbps	1	5	-55.1				0.0	-50.1	-21.25	28.81
	Non HT40, 6 to 54 Mbps	2	5	-55.1	-51.0			0.0	-44.5	-21.25	23.28
	Non HT40, 6 to 54 Mbps	3	5	-55.1	-51.0	-52.1		0.0	-42.6	-21.25	21.35
	Non HT40, 6 to 54 Mbps	4	5	-55.1	-51.0	-52.1	-53.1	0.0	-41.5	-21.25	20.26
	HT/VHT40, M0 to M7	1	5	-54.4				0.1	-49.3	-21.25	28.05
	HT/VHT40, M0 to M7	2	5	-54.4	-51.5			0.1	-44.6	-21.25	23.35
	HT/VHT40, M8 to M15	2	5	-54.4	-51.5			0.1	-44.6	-21.25	23.35
	HT/VHT40, M0 to M7	3	5	-54.4	-51.5	-52.3		0.1	-42.7	-21.25	21.45
	HT/VHT40, M8 to M15	3	5	-54.4	-51.5	-52.3		0.1	-42.7	-21.25	21.45
	HT/VHT40, M16 to M23	3	5	-54.4	-51.5	-52.3		0.1	-42.7	-21.25	21.45
	HT/VHT40, M0 to M7	4	5	-54.4	-51.5	-52.3	-54.6	0.1	-41.9	-21.25	20.62
	HT/VHT40, M8 to M15	4	5	-54.4	-51.5	-52.3	-54.6	0.1	-41.9	-21.25	20.62
	HT/VHT40, M16 to M23	4	5	-54.4	-51.5	-52.3	-54.6	0.1	-41.9	-21.25	20.62
	HT/VHT40, M24 to M31	4	5	-54.4	-51.5	-52.3	-54.6	0.1	-41.9	-21.25	20.62
	HT/VHT40 Beam Forming, M0 to M7	2	8	-54.4	-51.5			0.1	-41.6	-21.25	20.35
	HT/VHT40 Beam Forming, M8 to M15	2	5	-54.4	-51.5			0.1	-44.6	-21.25	23.35
	HT/VHT40 Beam Forming, M0 to M7	3	10	-55.7	-51.9	-53.6		0.1	-38.6	-21.25	17.34
	HT/VHT40 Beam Forming, M8 to M15	3	7	-54.4	-51.5	-52.3		0.1	-40.7	-21.25	19.45
	HT/VHT40 Beam Forming, M16 to M23	3	5	-54.4	-51.5	-52.3		0.1	-42.7	-21.25	21.45
	HT/VHT40 Beam Forming, M0 to M7	4	11	-56.3	-52.2	-52.9	-56.0	0.1	-36.9	-21.25	15.60
	HT/VHT40 Beam Forming, M8 to M15	4	8	-55.7	-51.9	-53.6	-55.6	0.1	-39.8	-21.25	18.53
	HT/VHT40 Beam Forming, M16 to M23	4	6	-54.4	-51.5	-52.3	-54.6	0.1	-40.9	-21.25	19.62
	HT/VHT40 Beam Forming, M24 to M31	4	5	-54.4	-51.5	-52.3	-54.6	0.1	-41.9	-21.25	20.62
	HT/VHT40 STBC, M0 to M7	2	5	-54.4	-51.5			0.1	-44.6	-21.25	23.35
	HT/VHT40 STBC, M0 to M7	3	5	-54.4	-51.5	-52.3		0.1	-42.7	-21.25	21.45
	HT/VHT40 STBC, M0 to M7	4	5	-54.4	-51.5	-52.3	-54.6	0.1	-41.9	-21.25	20.62
	HE40, M0 to M9 1ss	1	5	-54.9				0.1	-49.8	-21.25	28.52
	HE40, M0 to M9 1ss	2	5	-54.9	-50.9			0.1	-44.3	-21.25	23.06
	HE40, M0 to M9 2ss	2	5	-54.9	-50.9			0.1	-44.3	-21.25	23.06
	HE40, M0 to M9 1ss	3	5	-54.9	-50.9	-52.5		0.1	-42.6	-21.25	21.32
	HE40, M0 to M9 2ss	3	5	-54.9	-50.9	-52.5		0.1	-42.6	-21.25	21.32
	HE40, M0 to M9 3ss	3	5	-54.9	-50.9	-52.5		0.1	-42.6	-21.25	21.32
	HE40, M0 to M9 1ss	4	5	-56.1	-51.9	-52.6	-55.3	0.1	-42.5	-21.25	21.22
HE40, M0 to M9 2ss	4	5	-56.1	-51.9	-52.6	-55.3	0.1	-42.5	-21.25	21.22	
HE40, M0 to M9 3ss	4	5	-56.1	-51.9	-52.6	-55.3	0.1	-42.5	-21.25	21.22	
HE40, M0 to M9 4ss	4	5	-56.1	-51.9	-52.6	-55.3	0.1	-42.5	-21.25	21.22	
HE40 Beam Forming, M0 to M9 1ss	2	8	-56.1	-51.9			0.1	-42.4	-21.25	21.12	



	HE40 Beam Forming, M0 to M9 2ss	2	5	-54.9	-50.9			0.1	-44.3	-21.25	23.06
	HE40 Beam Forming, M0 to M9 1ss	3	10	-56.4	-52.3	-53.2		0.1	-38.7	-21.25	17.49
	HE40 Beam Forming, M0 to M9 2ss	3	7	-56.1	-51.9	-52.6		0.1	-41.3	-21.25	20.03
	HE40 Beam Forming, M0 to M9 3ss	3	5	-54.9	-50.9	-52.5		0.1	-42.6	-21.25	21.32
	HE40 Beam Forming, M0 to M9 1ss	4	11	-55.2	-51.9	-53.8	-56.3	0.1	-36.8	-21.25	15.58
	HE40 Beam Forming, M0 to M9 2ss	4	8	-56.1	-51.9	-52.6	-55.3	0.1	-39.5	-21.25	18.22
	HE40 Beam Forming, M0 to M9 3ss	4	6	-56.1	-51.9	-52.6	-55.3	0.1	-41.5	-21.25	20.22
	HE40 Beam Forming, M0 to M9 4ss	4	5	-56.1	-51.9	-52.6	-55.3	0.1	-42.5	-21.25	21.22
	HE40 STBC, M0 to M9 2ss	2	5	-54.9	-50.9			0.1	-44.3	-21.25	23.06
	HE40 STBC, M0 to M9 2ss	3	5	-54.9	-50.9	-52.5		0.1	-42.6	-21.25	21.32
	HE40 STBC, M0 to M9 2ss	4	5	-56.1	-51.9	-52.6	-55.3	0.1	-42.5	-21.25	21.22
5320	Non HT20, 6 to 54 Mbps	1	5	-55.1				0.0	-50.1	-21.25	28.81
	Non HT20, 6 to 54 Mbps	2	5	-55.1	-47.0			0.0	-41.3	-21.25	20.08
	Non HT20, 6 to 54 Mbps	3	5	-55.1	-49.5	-50.2		0.0	-41.2	-21.25	19.93
	Non HT20, 6 to 54 Mbps	4	5	-55.8	-51.1	-52.6	-55.8	0.0	-42.3	-21.25	21.03
	Non HT20 Beam Forming, 6 to 54 Mbps	2	8	-55.1	-47.3			0.0	-38.6	-21.25	17.34
	Non HT20 Beam Forming, 6 to 54 Mbps	3	10	-55.1	-49.5	-50.2		0.0	-36.2	-21.25	14.93
	Non HT20 Beam Forming, 6 to 54 Mbps	4	11	-55.8	-51.1	-52.6	-55.8	0.0	-36.3	-21.25	15.03
	HT/VHT20, M0 to M7	1	5	-55.1				0.1	-50.0	-21.25	28.80
	HT/VHT20, M0 to M7	2	5	-55.1	-48.3			0.1	-42.4	-21.25	21.17
	HT/VHT20, M8 to M15	2	5	-55.1	-48.3			0.1	-42.4	-21.25	21.17
	HT/VHT20, M0 to M7	3	5	-55.1	-47.9	-49.9		0.1	-40.2	-21.25	18.99
	HT/VHT20, M8 to M15	3	5	-55.1	-48.3	-48.3		0.1	-39.8	-21.25	18.56
	HT/VHT20, M16 to M23	3	5	-55.1	-48.3	-48.3		0.1	-39.8	-21.25	18.56
	HT/VHT20, M0 to M7	4	5	-55.1	-50.0	-52.6	-54.1	0.1	-41.4	-21.25	20.18
	HT/VHT20, M8 to M15	4	5	-55.1	-48.4	-49.8	-53.0	0.1	-39.8	-21.25	18.51
	HT/VHT20, M16 to M23	4	5	-55.1	-48.4	-49.8	-53.0	0.1	-39.8	-21.25	18.51
	HT/VHT20, M24 to M31	4	5	-55.1	-48.4	-49.8	-53.0	0.1	-39.8	-21.25	18.51
	HT/VHT20 Beam Forming, M0 to M7	2	8	-55.1	-48.3			0.1	-39.4	-21.25	18.17
	HT/VHT20 Beam Forming, M8 to M15	2	5	-55.1	-48.3			0.1	-42.4	-21.25	21.17
	HT/VHT20 Beam Forming, M0 to M7	3	10	-55.1	-47.9	-49.9		0.1	-35.2	-21.25	13.99
	HT/VHT20 Beam Forming, M8 to M15	3	7	-55.1	-48.4	-49.8		0.1	-38.5	-21.25	17.22
	HT/VHT20 Beam Forming, M16 to M23	3	5	-55.1	-48.3	-48.3		0.1	-39.8	-21.25	18.56
	HT/VHT20 Beam Forming, M0 to M7	4	11	-55.1	-50.0	-52.6	-54.1	0.1	-35.4	-21.25	14.18
	HT/VHT20 Beam Forming, M8 to M15	4	8	-55.1	-48.4	-49.8	-53.0	0.1	-36.8	-21.25	15.51
	HT/VHT20 Beam Forming, M16 to M23	4	6	-55.1	-48.4	-49.8	-53.0	0.1	-38.8	-21.25	17.51
	HT/VHT20 Beam Forming, M24 to M31	4	5	-55.1	-48.4	-49.8	-53.0	0.1	-39.8	-21.25	18.51
	HT/VHT20 STBC, M0 to M7	2	5	-55.1	-48.3			0.1	-42.4	-21.25	21.17
	HT/VHT20 STBC, M0 to M7	3	5	-55.1	-48.3	-48.3		0.1	-39.8	-21.25	18.56
	HT/VHT20 STBC, M0 to M7	4	5	-55.1	-48.4	-49.8	-53.0	0.1	-39.8	-21.25	18.51
	HE20, M0 to M9 1ss	1	5	-54.5				0.1	-49.4	-21.25	28.18



	HE20, M0 to M9 1ss	2	5	-54.5	-47.1			0.1	-41.3	-21.25	20.05
	HE20, M0 to M9 2ss	2	5	-54.5	-47.1			0.1	-41.3	-21.25	20.05
	HE20, M0 to M9 1ss	3	5	-54.5	-49.3	-48.5		0.1	-40.2	-21.25	18.99
	HE20, M0 to M9 2ss	3	5	-54.5	-47.1	-48.4		0.1	-39.2	-21.25	17.94
	HE20, M0 to M9 3ss	3	5	-54.5	-47.1	-48.4		0.1	-39.2	-21.25	17.94
	HE20, M0 to M9 1ss	4	5	-54.5	-50.2	-51.9	-53.7	0.1	-41.2	-21.25	19.91
	HE20, M0 to M9 2ss	4	5	-54.5	-48.4	-48.7	-52.1	0.1	-39.2	-21.25	17.92
	HE20, M0 to M9 3ss	4	5	-54.5	-48.4	-48.7	-52.1	0.1	-39.2	-21.25	17.92
	HE20, M0 to M9 4ss	4	5	-54.5	-48.4	-48.7	-52.1	0.1	-39.2	-21.25	17.92
	HE20 Beam Forming, M0 to M9 1ss	2	8	-54.5	-48.4			0.1	-39.4	-21.25	18.13
	HE20 Beam Forming, M0 to M9 2ss	2	5	-54.5	-47.1			0.1	-41.3	-21.25	20.05
	HE20 Beam Forming, M0 to M9 1ss	3	10	-54.5	-49.3	-48.5		0.1	-35.2	-21.25	13.99
	HE20 Beam Forming, M0 to M9 2ss	3	7	-54.5	-48.4	-48.7		0.1	-37.9	-21.25	16.70
	HE20 Beam Forming, M0 to M9 3ss	3	5	-54.5	-47.1	-48.4		0.1	-39.2	-21.25	17.94
	HE20 Beam Forming, M0 to M9 1ss	4	11	-54.5	-50.2	-51.9	-53.7	0.1	-35.2	-21.25	13.91
	HE20 Beam Forming, M0 to M9 2ss	4	8	-54.5	-49.3	-48.5	-52.5	0.1	-36.5	-21.25	15.23
	HE20 Beam Forming, M0 to M9 3ss	4	6	-54.5	-48.4	-48.7	-52.1	0.1	-38.2	-21.25	16.92
	HE20 Beam Forming, M0 to M9 4ss	4	5	-54.5	-48.4	-48.7	-52.1	0.1	-39.2	-21.25	17.92
	HE20 STBC, M0 to M9 2ss	2	5	-54.5	-47.1			0.1	-41.3	-21.25	20.05
	HE20 STBC, M0 to M9 2ss	3	5	-54.5	-47.1	-48.4		0.1	-39.2	-21.25	17.94
	HE20 STBC, M0 to M9 2ss	4	5	-54.5	-48.4	-48.7	-52.1	0.1	-39.2	-21.25	17.92
5250	Non HT160, 6 to 54 Mbps	1	5	-50.4				0.0	-45.4	-21.25	24.10
	Non HT160, 6 to 54 Mbps	2	5	-52.3	-51.0			0.0	-43.5	-21.25	22.29
	Non HT160, 6 to 54 Mbps	3	5	-52.3	-51.0	-50.9		0.0	-41.5	-21.25	20.28
	Non HT160, 6 to 54 Mbps	4	5	-52.3	-51.0	-50.9	-53.6	0.0	-40.7	-21.25	19.50
	VHT160, M0 to M9 1ss	1	5	-48.7				0.4	-43.3	-21.25	22.06
	VHT160, M0 to M9 1ss	2	5	-48.7	-49.5			0.4	-40.7	-21.25	19.43
	VHT160, M0 to M9 2ss	2	5	-48.7	-49.5			0.4	-40.7	-21.25	19.43
	VHT160, M0 to M9 1ss	3	5	-48.7	-49.5	-51.2		0.4	-39.5	-21.25	18.27
	VHT160, M0 to M9 2ss	3	5	-48.7	-49.5	-51.2		0.4	-39.5	-21.25	18.27
	VHT160, M0 to M9 3ss	3	5	-48.7	-49.5	-51.2		0.4	-39.5	-21.25	18.27
	VHT160, M0 to M9 1ss	4	5	-48.7	-49.5	-51.2	-53.0	0.4	-38.9	-21.25	17.64
	VHT160, M0 to M9 2ss	4	5	-48.7	-49.5	-51.2	-53.0	0.4	-38.9	-21.25	17.64
	VHT160, M0 to M9 3ss	4	5	-48.7	-49.5	-51.2	-53.0	0.4	-38.9	-21.25	17.64
	VHT160, M0 to M9 4ss	4	5	-48.7	-49.5	-51.2	-53.0	0.4	-38.9	-21.25	17.64
	VHT160 Beam Forming, M0 to M9 1ss	2	8	-51.7	-50.7			0.4	-39.8	-21.25	18.52
	VHT160 Beam Forming, M0 to M9 2ss	2	5	-48.7	-49.5			0.4	-40.7	-21.25	19.43
	VHT160 Beam Forming, M0 to M9 1ss	3	10	-52.9	-51.8	-52.2		0.4	-37.1	-21.25	15.86
	VHT160 Beam Forming, M0 to M9 2ss	3	7	-51.7	-50.7	-51.2		0.4	-39.0	-21.25	17.77
	VHT160 Beam Forming, M0 to M9 3ss	3	5	-48.7	-49.5	-51.2		0.4	-39.5	-21.25	18.27
VHT160 Beam Forming, M0 to M9 1ss	4	11	-55.5	-52.5	-53.2	-55.5	0.4	-36.6	-21.25	15.30	





VHT160 Beam Forming, M0 to M9 2ss	4	8	-51.7	-50.7	-51.2	-54.5	0.4	-37.4	-21.25	16.14
VHT160 Beam Forming, M0 to M9 3ss	4	6	-51.7	-50.7	-51.2	-54.5	0.4	-39.4	-21.25	18.14
VHT160 Beam Forming, M0 to M9 4ss	4	5	-48.7	-49.5	-51.2	-53.0	0.4	-38.9	-21.25	17.64
VHT160 STBC, M0 to M9 1ss	2	5	-48.7	-49.5			0.4	-40.7	-21.25	19.43
VHT160 STBC, M0 to M9 1ss	3	5	-48.7	-49.5	-51.2		0.4	-39.5	-21.25	18.27
VHT160 STBC, M0 to M9 1ss	4	5	-48.7	-49.5	-51.2	-53.0	0.4	-38.9	-21.25	17.64
HE160, M0 to M9 1ss	1	5	-50.8				0.4	-45.4	-21.25	24.12
HE160, M0 to M9 1ss	2	5	-50.8	-49.3			0.4	-41.5	-21.25	20.29
HE160, M0 to M9 2ss	2	5	-50.8	-49.3			0.4	-41.5	-21.25	20.29
HE160, M0 to M9 1ss	3	5	-50.8	-49.3	-50.4		0.4	-39.9	-21.25	18.66
HE160, M0 to M9 2ss	3	5	-50.8	-49.3	-50.4		0.4	-39.9	-21.25	18.66
HE160, M0 to M9 3ss	3	5	-50.8	-49.3	-50.4		0.4	-39.9	-21.25	18.66
HE160, M0 to M9 1ss	4	5	-50.8	-49.3	-50.4	-53.3	0.4	-39.3	-21.25	18.02
HE160, M0 to M9 2ss	4	5	-50.8	-49.3	-50.4	-53.3	0.4	-39.3	-21.25	18.02
HE160, M0 to M9 3ss	4	5	-50.8	-49.3	-50.4	-53.3	0.4	-39.3	-21.25	18.02
HE160, M0 to M9 4ss	4	5	-50.8	-49.3	-50.4	-53.3	0.4	-39.3	-21.25	18.02
HE160 Beam Forming, M0 to M9 1ss	2	8	-54.3	-50.6			0.4	-40.6	-21.25	19.37
HE160 Beam Forming, M0 to M9 2ss	2	5	-50.8	-49.3			0.4	-41.5	-21.25	20.29
HE160 Beam Forming, M0 to M9 1ss	3	10	-54.3	-50.6	-52.0		0.4	-36.8	-21.25	15.59
HE160 Beam Forming, M0 to M9 2ss	3	7	-50.8	-49.3	-50.4		0.4	-37.9	-21.25	16.66
HE160 Beam Forming, M0 to M9 3ss	3	5	-50.8	-49.3	-50.4		0.4	-39.9	-21.25	18.66
HE160 Beam Forming, M0 to M9 1ss	4	11	-54.3	-50.5	-52.9	-54.4	0.4	-35.3	-21.25	14.01
HE160 Beam Forming, M0 to M9 2ss	4	8	-54.3	-50.6	-52.0	-54.4	0.4	-38.1	-21.25	16.82
HE160 Beam Forming, M0 to M9 3ss	4	6	-50.8	-49.3	-50.4	-53.3	0.4	-38.3	-21.25	17.02
HE160 Beam Forming, M0 to M9 4ss	4	5	-50.8	-49.3	-50.4	-53.3	0.4	-39.3	-21.25	18.02
HE160 STBC, M0 to M9 1ss	2	5	-50.8	-49.3			0.4	-41.5	-21.25	20.29
HE160 STBC, M0 to M9 1ss	3	5	-50.8	-49.3	-50.4		0.4	-39.9	-21.25	18.66
HE160 STBC, M0 to M9 1ss	4	5	-50.8	-49.3	-50.4	-53.3	0.4	-39.3	-21.25	18.02





**Conducted Spurs Peak, 5dBi  
5270 MHz, HT/VHT40 Beam Forming, M0 to M7**

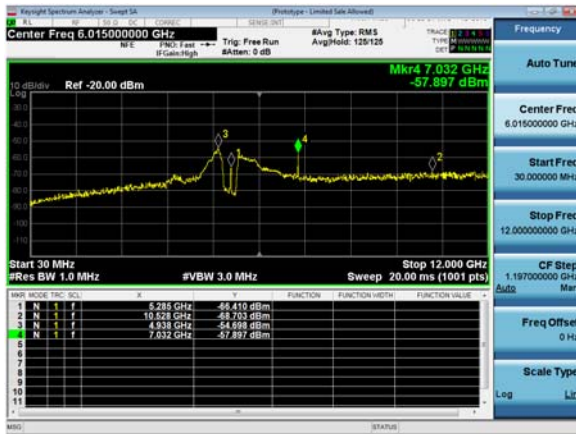

Antenna A

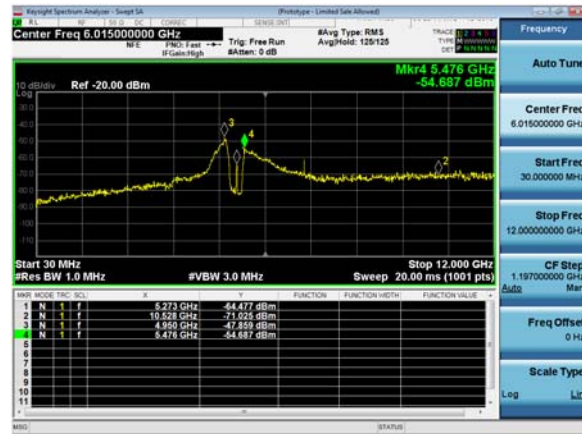

Antenna B



Antenna C

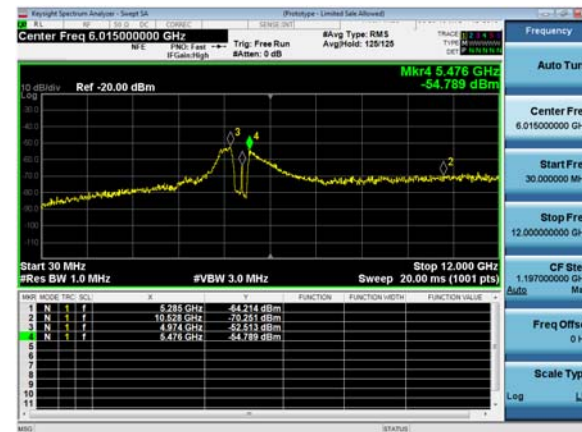

Antenna D



## Conducted Spurious Emissions Peak Table, 6dBi

Frequency (MHz)	Mode	Tx Paths	Correlated Antenna Gain (dBi)	Tx 1 Spur Power (dBm)	Tx 2 Spur Power (dBm)	Tx 3 Spur Power (dBm)	Tx 4 Spur Power (dBm)	Tx 5 Spur Power (dBm)	Total Conducted Spur (dBm)	Limit (dBm)	Margin (dB)
5260	Non HT20, 6 to 54 Mbps	1	6	-54.2				0.0	-48.2	-21.25	26.91
	Non HT20, 6 to 54 Mbps	2	6	-54.2	-45.4			0.0	-38.8	-21.25	17.57
	Non HT20, 6 to 54 Mbps	3	6	-54.2	-47.5	-49.6		0.0	-38.8	-21.25	17.58
	Non HT20, 6 to 54 Mbps	4	6	-56.1	-51.1	-53.2	-55.0	0.0	-41.4	-21.25	20.11
	Non HT20 Beam Forming, 6 to 54 Mbps	2	9	-54.2	-45.4			0.0	-35.8	-21.25	14.57
	Non HT20 Beam Forming, 6 to 54 Mbps	3	11	-54.2	-47.5	-49.6		0.0	-33.8	-21.25	12.58
	Non HT20 Beam Forming, 6 to 54 Mbps	4	12	-56.1	-51.1	-53.2	-55.0	0.0	-35.4	-21.25	14.11
	HT/VHT20, M0 to M7	1	6	-54.2				0.1	-48.1	-21.25	26.90
	HT/VHT20, M0 to M7	2	6	-54.2	-45.8			0.1	-39.2	-21.25	17.91
	HT/VHT20, M8 to M15	2	6	-54.2	-45.8			0.1	-39.2	-21.25	17.91
	HT/VHT20, M0 to M7	3	6	-54.2	-48.3	-49.9		0.1	-39.3	-21.25	18.10
	HT/VHT20, M8 to M15	3	6	-54.2	-46.7	-47.5		0.1	-37.6	-21.25	16.37
	HT/VHT20, M16 to M23	3	6	-54.2	-45.8	-46.1		0.1	-36.6	-21.25	15.32
	HT/VHT20, M0 to M7	4	6	-54.1	-51.2	-52.5	-53.5	0.1	-40.6	-21.25	19.36
	HT/VHT20, M8 to M15	4	6	-54.2	-47.6	-48.9	-51.0	0.1	-37.7	-21.25	16.46
	HT/VHT20, M16 to M23	4	6	-54.2	-46.7	-47.5	-49.4	0.1	-36.6	-21.25	15.34
	HT/VHT20, M24 to M31	4	6	-54.2	-45.8	-46.1	-48.8	0.1	-35.6	-21.25	14.38
	HT/VHT20 Beam Forming, M0 to M7	2	9	-54.2	-45.8			0.1	-36.2	-21.25	14.91
	HT/VHT20 Beam Forming, M8 to M15	2	6	-54.2	-45.8			0.1	-39.2	-21.25	17.91
	HT/VHT20 Beam Forming, M0 to M7	3	11	-54.2	-48.3	-49.9		0.1	-34.3	-21.25	13.10
	HT/VHT20 Beam Forming, M8 to M15	3	8	-54.2	-46.7	-47.5		0.1	-35.6	-21.25	14.37
	HT/VHT20 Beam Forming, M16 to M23	3	6	-54.2	-45.8	-46.1		0.1	-36.6	-21.25	15.32
	HT/VHT20 Beam Forming, M0 to M7	4	12	-54.1	-51.2	-52.5	-53.5	0.1	-34.6	-21.25	13.36
	HT/VHT20 Beam Forming, M8 to M15	4	9	-54.2	-47.6	-48.9	-51.0	0.1	-34.7	-21.25	13.46
	HT/VHT20 Beam Forming, M16 to M23	4	7	-54.2	-46.7	-47.5	-49.4	0.1	-35.6	-21.25	14.34
	HT/VHT20 Beam Forming, M24 to M31	4	6	-54.2	-45.8	-46.1	-48.8	0.1	-35.6	-21.25	14.38
	HT/VHT20 STBC, M0 to M7	2	6	-54.2	-45.8			0.1	-39.2	-21.25	17.91
	HT/VHT20 STBC, M0 to M7	3	6	-54.2	-46.7	-47.5		0.1	-37.6	-21.25	16.37
	HT/VHT20 STBC, M0 to M7	4	6	-54.2	-47.6	-48.9	-51.0	0.1	-37.7	-21.25	16.46



	HE20, M0 to M9 1ss	1	6	-54.5				0.1	-48.4	-21.25	27.18
	HE20, M0 to M9 1ss	2	6	-54.5	-45.3			0.1	-38.7	-21.25	17.49
	HE20, M0 to M9 2ss	2	6	-54.5	-45.3			0.1	-38.7	-21.25	17.49
	HE20, M0 to M9 1ss	3	6	-54.5	-48.4	-49.5		0.1	-39.3	-21.25	18.02
	HE20, M0 to M9 2ss	3	6	-54.5	-45.6	-47.3		0.1	-37.0	-21.25	15.71
	HE20, M0 to M9 3ss	3	6	-54.5	-45.3	-46.6		0.1	-36.5	-21.25	15.28
	HE20, M0 to M9 1ss	4	6	-55.3	-50.7	-52.0	-54.8	0.1	-40.7	-21.25	19.44
	HE20, M0 to M9 2ss	4	6	-54.5	-48.4	-49.5	-51.6	0.1	-38.3	-21.25	17.10
	HE20, M0 to M9 3ss	4	6	-54.5	-45.6	-47.3	-49.4	0.1	-36.1	-21.25	14.81
	HE20, M0 to M9 4ss	4	6	-54.5	-45.3	-46.6	-48.4	0.1	-35.5	-21.25	14.27
	HE20 Beam Forming, M0 to M9 1ss	2	9	-54.5	-45.3			0.1	-35.7	-21.25	14.49
	HE20 Beam Forming, M0 to M9 2ss	2	6	-54.5	-45.3			0.1	-38.7	-21.25	17.49
	HE20 Beam Forming, M0 to M9 1ss	3	11	-54.5	-48.4	-49.5		0.1	-34.3	-21.25	13.02
	HE20 Beam Forming, M0 to M9 2ss	3	8	-54.5	-45.6	-47.3		0.1	-35.0	-21.25	13.71
	HE20 Beam Forming, M0 to M9 3ss	3	6	-54.5	-45.3	-46.6		0.1	-36.5	-21.25	15.28
	HE20 Beam Forming, M0 to M9 1ss	4	12	-55.3	-50.7	-52.0	-54.8	0.1	-34.7	-21.25	13.44
	HE20 Beam Forming, M0 to M9 2ss	4	9	-54.5	-48.4	-49.5	-51.6	0.1	-35.3	-21.25	14.10
	HE20 Beam Forming, M0 to M9 3ss	4	7	-54.5	-45.6	-47.3	-49.4	0.1	-35.1	-21.25	13.81
	HE20 Beam Forming, M0 to M9 4ss	4	6	-54.5	-45.3	-46.6	-48.4	0.1	-35.5	-21.25	14.27
	HE20 STBC, M0 to M9 2ss	2	6	-54.5	-45.3			0.1	-38.7	-21.25	17.49
	HE20 STBC, M0 to M9 2ss	3	6	-54.5	-45.6	-47.3		0.1	-37.0	-21.25	15.71
	HE20 STBC, M0 to M9 2ss	4	6	-54.5	-48.4	-49.5	-51.6	0.1	-38.3	-21.25	17.10
5270	Non HT40, 6 to 54 Mbps	1	6	-54.8				0.0	-48.8	-21.25	27.51
	Non HT40, 6 to 54 Mbps	2	6	-54.8	-46.1			0.0	-39.5	-21.25	18.26
	Non HT40, 6 to 54 Mbps	3	6	-54.8	-46.3	-46.9		0.0	-37.2	-21.25	15.97
	Non HT40, 6 to 54 Mbps	4	6	-54.8	-49.0	-49.0	-51.6	0.0	-38.5	-21.25	17.22
	HT/VHT40, M0 to M7	1	6	-54.7				0.1	-48.6	-21.25	27.35
	HT/VHT40, M0 to M7	2	6	-54.7	-46.5			0.1	-39.8	-21.25	18.54
	HT/VHT40, M8 to M15	2	6	-54.7	-46.5			0.1	-39.8	-21.25	18.54
	HT/VHT40, M0 to M7	3	6	-54.7	-46.5	-46.4		0.1	-37.0	-21.25	15.77
	HT/VHT40, M8 to M15	3	6	-54.7	-46.5	-46.4		0.1	-37.0	-21.25	15.77
	HT/VHT40, M16 to M23	3	6	-54.7	-46.5	-46.4		0.1	-37.0	-21.25	15.77
	HT/VHT40, M0 to M7	4	6	-54.7	-47.7	-49.0	-51.5	0.1	-37.9	-21.25	16.62
	HT/VHT40, M8 to M15	4	6	-54.7	-46.5	-46.4	-49.5	0.1	-36.1	-21.25	14.87
	HT/VHT40, M16 to M23	4	6	-54.7	-46.5	-46.4	-49.5	0.1	-36.1	-21.25	14.87
	HT/VHT40, M24 to M31	4	6	-54.7	-46.5	-46.4	-49.5	0.1	-36.1	-21.25	14.87
	HT/VHT40 Beam Forming, M0 to M7	2	9	-54.7	-46.5			0.1	-36.8	-21.25	15.54
	HT/VHT40 Beam Forming, M8 to M15	2	6	-54.7	-46.5			0.1	-39.8	-21.25	18.54
	HT/VHT40 Beam Forming, M0 to M7	3	11	-54.7	-47.7	-49.0		0.1	-33.7	-21.25	12.47
	HT/VHT40 Beam Forming, M8 to M15	3	8	-54.7	-46.5	-46.4		0.1	-35.0	-21.25	13.77
HT/VHT40 Beam Forming, M16 to M23	3	6	-54.7	-46.5	-46.4		0.1	-37.0	-21.25	15.77	



	<b>HT/VHT40 Beam Forming, M0 to M7</b>	<b>4</b>	<b>12</b>	<b>-54.7</b>	<b>-49.0</b>	<b>-50.6</b>	<b>-53.5</b>	<b>0.1</b>	<b>-33.3</b>	<b>-21.25</b>	<b>12.00</b>
	HT/VHT40 Beam Forming, M8 to M15	4	9	-54.7	-47.7	-49.0	-51.2	0.1	-34.8	-21.25	13.57
	HT/VHT40 Beam Forming, M16 to M23	4	7	-54.7	-46.5	-46.4	-49.5	0.1	-35.1	-21.25	13.87
	HT/VHT40 Beam Forming, M24 to M31	4	6	-54.7	-46.5	-46.4	-49.5	0.1	-36.1	-21.25	14.87
	HT/VHT40 STBC, M0 to M7	2	6	-54.7	-46.5			0.1	-39.8	-21.25	18.54
	HT/VHT40 STBC, M0 to M7	3	6	-54.7	-46.5	-46.4		0.1	-37.0	-21.25	15.77
	HT/VHT40 STBC, M0 to M7	4	6	-54.7	-47.7	-49.0	-51.2	0.1	-37.8	-21.25	16.57
	HE40, M0 to M9 1ss	1	6	-54.1				0.1	-48.0	-21.25	26.72
	HE40, M0 to M9 1ss	2	6	-54.1	-45.4			0.1	-38.7	-21.25	17.47
	HE40, M0 to M9 2ss	2	6	-54.1	-45.4			0.1	-38.7	-21.25	17.47
	HE40, M0 to M9 1ss	3	6	-54.1	-45.9	-47.5		0.1	-37.1	-21.25	15.86
	HE40, M0 to M9 2ss	3	6	-54.1	-45.4	-46.0		0.1	-36.2	-21.25	15.00
	HE40, M0 to M9 3ss	3	6	-54.1	-45.4	-46.0		0.1	-36.2	-21.25	15.00
	HE40, M0 to M9 1ss	4	6	-54.1	-47.8	-48.1	-51.9	0.1	-37.6	-21.25	16.34
	HE40, M0 to M9 2ss	4	6	-54.1	-45.4	-46.0	-50.0	0.1	-35.6	-21.25	14.30
	HE40, M0 to M9 3ss	4	6	-54.1	-45.4	-46.0	-50.0	0.1	-35.6	-21.25	14.30
	HE40, M0 to M9 4ss	4	6	-54.1	-45.4	-46.0	-50.0	0.1	-35.6	-21.25	14.30
	HE40 Beam Forming, M0 to M9 1ss	2	9	-54.1	-45.4			0.1	-35.7	-21.25	14.47
	HE40 Beam Forming, M0 to M9 2ss	2	6	-54.1	-45.4			0.1	-38.7	-21.25	17.47
	HE40 Beam Forming, M0 to M9 1ss	3	11	-54.1	-47.8	-48.1		0.1	-33.3	-21.25	12.06
	HE40 Beam Forming, M0 to M9 2ss	3	8	-54.1	-45.4	-46.0		0.1	-34.2	-21.25	13.00
	HE40 Beam Forming, M0 to M9 3ss	3	6	-54.1	-45.4	-46.0		0.1	-36.2	-21.25	15.00
	HE40 Beam Forming, M0 to M9 1ss	4	12	-54.1	-50.6	-50.2	-53.2	0.1	-33.6	-21.25	12.32
	HE40 Beam Forming, M0 to M9 2ss	4	9	-54.1	-48.0	-48.2	-50.8	0.1	-34.5	-21.25	13.27
	HE40 Beam Forming, M0 to M9 3ss	4	7	-54.1	-45.4	-46.0	-50.0	0.1	-34.6	-21.25	13.30
	HE40 Beam Forming, M0 to M9 4ss	4	6	-54.1	-45.4	-46.0	-50.0	0.1	-35.6	-21.25	14.30
	HE40 STBC, M0 to M9 2ss	2	6	-54.1	-45.4			0.1	-38.7	-21.25	17.47
	HE40 STBC, M0 to M9 2ss	3	6	-54.1	-45.4	-46.0		0.1	-36.2	-21.25	15.00
	HE40 STBC, M0 to M9 2ss	4	6	-54.1	-48.0	-48.2	-50.8	0.1	-37.5	-21.25	16.27
5290	Non HT80, 6 to 54 Mbps	1	6	-56.0				0.1	-49.9	-21.25	28.70
	Non HT80, 6 to 54 Mbps	2	6	-56.0	-50.3			0.1	-43.2	-21.25	21.96
	Non HT80, 6 to 54 Mbps	3	6	-56.0	-50.3	-53.2		0.1	-41.7	-21.25	20.49
	Non HT80, 6 to 54 Mbps	4	6	-56.0	-50.3	-53.2	-54.4	0.1	-40.9	-21.25	19.63
	VHT80, M0 to M9 1ss	1	6	-55.5				0.2	-49.3	-21.25	28.03
	VHT80, M0 to M9 1ss	2	6	-55.5	-51.8			0.2	-44.0	-21.25	22.79
	VHT80, M0 to M9 2ss	2	6	-55.5	-51.8			0.2	-44.0	-21.25	22.79
	VHT80, M0 to M9 1ss	3	6	-55.5	-52.1	-52.9		0.2	-42.3	-21.25	21.04
	VHT80, M0 to M9 2ss	3	6	-55.5	-52.1	-52.9		0.2	-42.3	-21.25	21.04
	VHT80, M0 to M9 3ss	3	6	-55.5	-52.1	-52.9		0.2	-42.3	-21.25	21.04
	VHT80, M0 to M9 1ss	4	6	-55.5	-52.1	-52.9	-55.5	0.2	-41.5	-21.25	20.25
	VHT80, M0 to M9 2ss	4	6	-55.5	-52.1	-52.9	-55.5	0.2	-41.5	-21.25	20.25



	VHT80, M0 to M9 3ss	4	6	-55.5	-52.1	-52.9	-55.5	0.2	-41.5	-21.25	20.25
	VHT80, M0 to M9 4ss	4	6	-55.5	-52.1	-52.9	-55.5	0.2	-41.5	-21.25	20.25
	VHT80 Beam Forming, M0 to M9 1ss	2	9	-55.5	-52.1			0.2	-41.2	-21.25	20.00
	VHT80 Beam Forming, M0 to M9 2ss	2	6	-55.5	-51.8			0.2	-44.0	-21.25	22.79
	VHT80 Beam Forming, M0 to M9 1ss	3	11	-57.0	-52.2	-53.4		0.2	-37.8	-21.25	16.53
	VHT80 Beam Forming, M0 to M9 2ss	3	8	-55.5	-52.1	-52.9		0.2	-40.3	-21.25	19.04
	VHT80 Beam Forming, M0 to M9 3ss	3	6	-55.5	-52.1	-52.9		0.2	-42.3	-21.25	21.04
	VHT80 Beam Forming, M0 to M9 1ss	4	12	-57.2	-52.8	-54.0	-55.6	0.2	-36.4	-21.25	15.11
	VHT80 Beam Forming, M0 to M9 2ss	4	9	-57.0	-52.2	-53.4	-55.8	0.2	-39.0	-21.25	17.71
	VHT80 Beam Forming, M0 to M9 3ss	4	7	-55.5	-52.1	-52.9	-55.5	0.2	-40.5	-21.25	19.25
	VHT80 Beam Forming, M0 to M9 4ss	4	6	-55.5	-52.1	-52.9	-55.5	0.2	-41.5	-21.25	20.25
	VHT80 STBC, M0 to M9 1ss	2	6	-55.5	-51.8			0.2	-44.0	-21.25	22.79
	VHT80 STBC, M0 to M9 1ss	3	6	-55.5	-52.1	-52.9		0.2	-42.3	-21.25	21.04
	VHT80 STBC, M0 to M9 1ss	4	6	-55.5	-52.1	-52.9	-55.5	0.2	-41.5	-21.25	20.25
	HE80, M0 to M9 1ss	1	6	-56.3				0.3	-50.0	-21.25	28.79
	HE80, M0 to M9 1ss	2	6	-56.3	-52.1			0.3	-44.4	-21.25	23.19
	HE80, M0 to M9 2ss	2	6	-56.3	-52.1			0.3	-44.4	-21.25	23.19
	HE80, M0 to M9 1ss	3	6	-56.3	-52.1	-52.1		0.3	-42.1	-21.25	20.82
	HE80, M0 to M9 2ss	3	6	-56.3	-52.1	-52.1		0.3	-42.1	-21.25	20.82
	HE80, M0 to M9 3ss	3	6	-56.3	-52.1	-52.1		0.3	-42.1	-21.25	20.82
	HE80, M0 to M9 1ss	4	6	-56.3	-52.1	-52.1	-55.7	0.3	-41.3	-21.25	20.09
	HE80, M0 to M9 2ss	4	6	-56.3	-52.1	-52.1	-55.7	0.3	-41.3	-21.25	20.09
	HE80, M0 to M9 3ss	4	6	-56.3	-52.1	-52.1	-55.7	0.3	-41.3	-21.25	20.09
	HE80, M0 to M9 4ss	4	6	-56.3	-52.1	-52.1	-55.7	0.3	-41.3	-21.25	20.09
	HE80 Beam Forming, M0 to M9 1ss	2	9	-56.4	-51.8			0.3	-41.2	-21.25	20.00
	HE80 Beam Forming, M0 to M9 2ss	2	6	-56.3	-52.1			0.3	-44.4	-21.25	23.19
	HE80 Beam Forming, M0 to M9 1ss	3	11	-57.6	-52.7	-54.1		0.3	-38.3	-21.25	17.08
	HE80 Beam Forming, M0 to M9 2ss	3	8	-56.4	-51.8	-53.1		0.3	-40.3	-21.25	19.09
	HE80 Beam Forming, M0 to M9 3ss	3	6	-56.3	-52.1	-52.1		0.3	-42.1	-21.25	20.82
	HE80 Beam Forming, M0 to M9 1ss	4	12	-57.9	-53.0	-54.9	-57.2	0.3	-37.0	-21.25	15.78
	HE80 Beam Forming, M0 to M9 2ss	4	9	-56.4	-51.8	-53.1	-54.4	0.3	-38.3	-21.25	17.08
	HE80 Beam Forming, M0 to M9 3ss	4	7	-56.4	-51.8	-53.1	-54.4	0.3	-40.3	-21.25	19.08
	HE80 Beam Forming, M0 to M9 4ss	4	6	-56.3	-52.1	-52.1	-55.7	0.3	-41.3	-21.25	20.09
	HE80 STBC, M0 to M9 1ss	2	6	-56.3	-52.1			0.3	-44.4	-21.25	23.19
	HE80 STBC, M0 to M9 1ss	3	6	-56.3	-52.1	-52.1		0.3	-42.1	-21.25	20.82
	HE80 STBC, M0 to M9 1ss	4	6	-56.3	-52.1	-52.1	-55.7	0.3	-41.3	-21.25	20.09
5300	Non HT20, 6 to 54 Mbps	1	6	-54.3				0.0	-48.3	-21.25	27.01
	Non HT20, 6 to 54 Mbps	2	6	-54.3	-46.4			0.0	-39.7	-21.25	18.45
	Non HT20, 6 to 54 Mbps	3	6	-54.3	-49.7	-50.4		0.0	-40.2	-21.25	18.99
	Non HT20, 6 to 54 Mbps	4	6	-55.0	-52.0	-52.6	-55.3	0.0	-41.4	-21.25	20.17
	Non HT20 Beam Forming, 6 to 54 Mbps	2	9	-54.3	-46.4			0.0	-36.7	-21.25	15.45



Non HT20 Beam Forming, 6 to 54 Mbps	3	11	-54.3	-49.7	-50.4		0.0	-35.2	-21.25	13.99
Non HT20 Beam Forming, 6 to 54 Mbps	4	12	-55.0	-52.0	-52.6	-55.3	0.0	-35.4	-21.25	14.17
HT/VHT20, M0 to M7	1	6	-54.5				0.1	-48.4	-21.25	27.20
HT/VHT20, M0 to M7	2	6	-54.5	-46.2			0.1	-39.5	-21.25	18.30
HT/VHT20, M8 to M15	2	6	-54.5	-46.2			0.1	-39.5	-21.25	18.30
HT/VHT20, M0 to M7	3	6	-54.5	-49.1	-50.0		0.1	-39.8	-21.25	18.57
HT/VHT20, M8 to M15	3	6	-54.5	-46.7	-47.9		0.1	-37.8	-21.25	16.55
HT/VHT20, M16 to M23	3	6	-54.5	-46.2	-47.4		0.1	-37.3	-21.25	16.10
HT/VHT20, M0 to M7	4	6	-54.9	-50.8	-52.9	-55.8	0.1	-41.1	-21.25	19.84
HT/VHT20, M8 to M15	4	6	-54.5	-48.0	-49.3	-52.4	0.1	-38.3	-21.25	17.03
HT/VHT20, M16 to M23	4	6	-54.5	-46.7	-47.9	-49.1	0.1	-36.7	-21.25	15.42
HT/VHT20, M24 to M31	4	6	-54.5	-46.2	-47.4	-48.8	0.1	-36.2	-21.25	15.00
HT/VHT20 Beam Forming, M0 to M7	2	9	-54.5	-46.2			0.1	-36.5	-21.25	15.30
HT/VHT20 Beam Forming, M8 to M15	2	6	-54.5	-46.2			0.1	-39.5	-21.25	18.30
HT/VHT20 Beam Forming, M0 to M7	3	11	-54.5	-49.1	-50.0		0.1	-34.8	-21.25	13.57
HT/VHT20 Beam Forming, M8 to M15	3	8	-54.5	-46.7	-47.9		0.1	-35.8	-21.25	14.55
HT/VHT20 Beam Forming, M16 to M23	3	6	-54.5	-46.2	-47.4		0.1	-37.3	-21.25	16.10
HT/VHT20 Beam Forming, M0 to M7	4	12	-54.9	-50.8	-52.9	-55.8	0.1	-35.1	-21.25	13.84
HT/VHT20 Beam Forming, M8 to M15	4	9	-54.5	-48.0	-49.3	-52.4	0.1	-35.3	-21.25	14.03
HT/VHT20 Beam Forming, M16 to M23	4	7	-54.5	-46.7	-47.9	-49.1	0.1	-35.7	-21.25	14.42
HT/VHT20 Beam Forming, M24 to M31	4	6	-54.5	-46.2	-47.4	-48.8	0.1	-36.2	-21.25	15.00
HT/VHT20 STBC, M0 to M7	2	6	-54.5	-46.2			0.1	-39.5	-21.25	18.30
HT/VHT20 STBC, M0 to M7	3	6	-54.5	-46.7	-47.9		0.1	-37.8	-21.25	16.55
HT/VHT20 STBC, M0 to M7	4	6	-54.5	-48.0	-49.3	-52.4	0.1	-38.3	-21.25	17.03
HE20, M0 to M9 1ss	1	6	-54.2				0.1	-48.1	-21.25	26.88
HE20, M0 to M9 1ss	2	6	-54.2	-44.7			0.1	-38.2	-21.25	16.92
HE20, M0 to M9 2ss	2	6	-54.2	-44.7			0.1	-38.2	-21.25	16.92
HE20, M0 to M9 1ss	3	6	-54.2	-48.2	-50.2		0.1	-39.4	-21.25	18.13
HE20, M0 to M9 2ss	3	6	-54.2	-47.3	-47.8		0.1	-38.0	-21.25	16.77
HE20, M0 to M9 3ss	3	6	-54.2	-44.7	-46.6		0.1	-36.2	-21.25	14.93
HE20, M0 to M9 1ss	4	6	-56.0	-52.0	-52.9	-55.8	0.1	-41.7	-21.25	20.48
HE20, M0 to M9 2ss	4	6	-54.2	-47.8	-49.8	-52.0	0.1	-38.2	-21.25	16.98
HE20, M0 to M9 3ss	4	6	-54.2	-47.3	-47.8	-50.0	0.1	-37.0	-21.25	15.78
HE20, M0 to M9 4ss	4	6	-54.2	-44.7	-46.6	-49.8	0.1	-35.5	-21.25	14.23
HE20 Beam Forming, M0 to M9 1ss	2	9	-54.2	-44.7			0.1	-35.2	-21.25	13.92
HE20 Beam Forming, M0 to M9 2ss	2	6	-54.2	-44.7			0.1	-38.2	-21.25	16.92
HE20 Beam Forming, M0 to M9 1ss	3	11	-54.2	-48.2	-50.2		0.1	-34.4	-21.25	13.13
HE20 Beam Forming, M0 to M9 2ss	3	8	-54.2	-47.3	-47.8		0.1	-36.0	-21.25	14.77
HE20 Beam Forming, M0 to M9 3ss	3	6	-54.2	-44.7	-46.6		0.1	-36.2	-21.25	14.93
HE20 Beam Forming, M0 to M9 1ss	4	12	-56.0	-52.0	-52.9	-55.8	0.1	-35.7	-21.25	14.48
HE20 Beam Forming, M0 to M9 2ss	4	9	-54.2	-47.8	-49.8	-52.0	0.1	-35.2	-21.25	13.98
HE20 Beam Forming, M0 to M9 3ss	4	7	-54.2	-47.3	-47.8	-50.0	0.1	-36.0	-21.25	14.78





	HE20 Beam Forming, M0 to M9 4ss	4	6	-54.2	-44.7	-46.6	-49.8	0.1	-35.5	-21.25	14.23
	HE20 STBC, M0 to M9 2ss	2	6	-54.2	-44.7			0.1	-38.2	-21.25	16.92
	HE20 STBC, M0 to M9 2ss	3	6	-54.2	-47.3	-47.8		0.1	-38.0	-21.25	16.77
	HE20 STBC, M0 to M9 2ss	4	6	-54.2	-47.8	-49.8	-52.0	0.1	-38.2	-21.25	16.98
5310	Non HT40, 6 to 54 Mbps	1	6	-55.1				0.0	-49.1	-21.25	27.81
	Non HT40, 6 to 54 Mbps	2	6	-55.1	-51.0			0.0	-43.5	-21.25	22.28
	Non HT40, 6 to 54 Mbps	3	6	-56.0	-51.8	-52.5		0.0	-42.3	-21.25	21.02
	Non HT40, 6 to 54 Mbps	4	6	-56.0	-51.8	-52.5	-55.5	0.0	-41.5	-21.25	20.26
	HT/VHT40, M0 to M7	1	6	-54.4				0.1	-48.3	-21.25	27.05
	HT/VHT40, M0 to M7	2	6	-54.4	-51.5			0.1	-43.6	-21.25	22.35
	HT/VHT40, M8 to M15	2	6	-54.4	-51.5			0.1	-43.6	-21.25	22.35
	HT/VHT40, M0 to M7	3	6	-54.4	-51.5	-52.3		0.1	-41.7	-21.25	20.45
	HT/VHT40, M8 to M15	3	6	-54.4	-51.5	-52.3		0.1	-41.7	-21.25	20.45
	HT/VHT40, M16 to M23	3	6	-54.4	-51.5	-52.3		0.1	-41.7	-21.25	20.45
	HT/VHT40, M0 to M7	4	6	-54.4	-51.5	-52.3	-54.6	0.1	-40.9	-21.25	19.62
	HT/VHT40, M8 to M15	4	6	-54.4	-51.5	-52.3	-54.6	0.1	-40.9	-21.25	19.62
	HT/VHT40, M16 to M23	4	6	-54.4	-51.5	-52.3	-54.6	0.1	-40.9	-21.25	19.62
	HT/VHT40, M24 to M31	4	6	-54.4	-51.5	-52.3	-54.6	0.1	-40.9	-21.25	19.62
	HT/VHT40 Beam Forming, M0 to M7	2	9	-55.7	-51.9			0.1	-41.3	-21.25	20.03
	HT/VHT40 Beam Forming, M8 to M15	2	6	-54.4	-51.5			0.1	-43.6	-21.25	22.35
	HT/VHT40 Beam Forming, M0 to M7	3	11	-56.3	-52.2	-52.9		0.1	-37.6	-21.25	16.34
	HT/VHT40 Beam Forming, M8 to M15	3	8	-55.7	-51.9	-53.6		0.1	-40.6	-21.25	19.34
	HT/VHT40 Beam Forming, M16 to M23	3	6	-54.4	-51.5	-52.3		0.1	-41.7	-21.25	20.45
	HT/VHT40 Beam Forming, M0 to M7	4	12	-56.3	-52.2	-52.9	-56.0	0.1	-35.9	-21.25	14.60
	HT/VHT40 Beam Forming, M8 to M15	4	9	-55.7	-51.9	-53.6	-55.6	0.1	-38.8	-21.25	17.53
	HT/VHT40 Beam Forming, M16 to M23	4	7	-55.7	-51.9	-53.6	-55.6	0.1	-40.8	-21.25	19.53
	HT/VHT40 Beam Forming, M24 to M31	4	6	-54.4	-51.5	-52.3	-54.6	0.1	-40.9	-21.25	19.62
	HT/VHT40 STBC, M0 to M7	2	6	-54.4	-51.5			0.1	-43.6	-21.25	22.35
	HT/VHT40 STBC, M0 to M7	3	6	-54.4	-51.5	-52.3		0.1	-41.7	-21.25	20.45
	HT/VHT40 STBC, M0 to M7	4	6	-54.4	-51.5	-52.3	-54.6	0.1	-40.9	-21.25	19.62
	HE40, M0 to M9 1ss	1	6	-54.9				0.1	-48.8	-21.25	27.52
	HE40, M0 to M9 1ss	2	6	-54.9	-50.9			0.1	-43.3	-21.25	22.06
	HE40, M0 to M9 2ss	2	6	-54.9	-50.9			0.1	-43.3	-21.25	22.06
	HE40, M0 to M9 1ss	3	6	-56.1	-51.9	-52.6		0.1	-42.3	-21.25	21.03
	HE40, M0 to M9 2ss	3	6	-56.1	-51.9	-52.6		0.1	-42.3	-21.25	21.03
	HE40, M0 to M9 3ss	3	6	-56.1	-51.9	-52.6		0.1	-42.3	-21.25	21.03
	HE40, M0 to M9 1ss	4	6	-56.1	-51.9	-52.6	-55.3	0.1	-41.5	-21.25	20.22
HE40, M0 to M9 2ss	4	6	-56.1	-51.9	-52.6	-55.3	0.1	-41.5	-21.25	20.22	
HE40, M0 to M9 3ss	4	6	-56.1	-51.9	-52.6	-55.3	0.1	-41.5	-21.25	20.22	
HE40, M0 to M9 4ss	4	6	-56.1	-51.9	-52.6	-55.3	0.1	-41.5	-21.25	20.22	
HE40 Beam Forming, M0 to M9 1ss	2	9	-56.1	-51.9			0.1	-41.4	-21.25	20.12	





	HE40 Beam Forming, M0 to M9 2ss	2	6	-54.9	-50.9			0.1	-43.3	-21.25	22.06
	HE40 Beam Forming, M0 to M9 1ss	3	11	-56.4	-52.3	-53.2		0.1	-37.7	-21.25	16.49
	HE40 Beam Forming, M0 to M9 2ss	3	8	-56.1	-51.9	-52.6		0.1	-40.3	-21.25	19.03
	HE40 Beam Forming, M0 to M9 3ss	3	6	-56.1	-51.9	-52.6		0.1	-42.3	-21.25	21.03
	HE40 Beam Forming, M0 to M9 1ss	4	12	-55.2	-51.9	-53.8	-56.3	0.1	-35.8	-21.25	14.58
	HE40 Beam Forming, M0 to M9 2ss	4	9	-56.4	-52.3	-53.2	-55.6	0.1	-38.9	-21.25	17.66
	HE40 Beam Forming, M0 to M9 3ss	4	7	-56.1	-51.9	-52.6	-55.3	0.1	-40.5	-21.25	19.22
	HE40 Beam Forming, M0 to M9 4ss	4	6	-56.1	-51.9	-52.6	-55.3	0.1	-41.5	-21.25	20.22
	HE40 STBC, M0 to M9 2ss	2	6	-54.9	-50.9			0.1	-43.3	-21.25	22.06
	HE40 STBC, M0 to M9 2ss	3	6	-56.1	-51.9	-52.6		0.1	-42.3	-21.25	21.03
	HE40 STBC, M0 to M9 2ss	4	6	-56.1	-51.9	-52.6	-55.3	0.1	-41.5	-21.25	20.22
5320	Non HT20, 6 to 54 Mbps	1	6	-55.1				0.0	-49.1	-21.25	27.81
	Non HT20, 6 to 54 Mbps	2	6	-55.1	-47.3			0.0	-40.6	-21.25	19.34
	Non HT20, 6 to 54 Mbps	3	6	-55.1	-49.5	-50.2		0.0	-40.2	-21.25	18.93
	Non HT20, 6 to 54 Mbps	4	6	-56.4	-51.5	-53.3	-55.5	0.0	-41.7	-21.25	20.44
	Non HT20 Beam Forming, 6 to 54 Mbps	2	9	-55.1	-47.6			0.0	-37.8	-21.25	16.60
	Non HT20 Beam Forming, 6 to 54 Mbps	3	11	-55.1	-49.5	-50.2		0.0	-35.2	-21.25	13.93
	Non HT20 Beam Forming, 6 to 54 Mbps	4	12	-56.4	-51.5	-53.3	-55.5	0.0	-35.7	-21.25	14.44
	HT/VHT20, M0 to M7	1	6	-55.1				0.1	-49.0	-21.25	27.80
	HT/VHT20, M0 to M7	2	6	-55.1	-48.3			0.1	-41.4	-21.25	20.17
	HT/VHT20, M8 to M15	2	6	-55.1	-48.3			0.1	-41.4	-21.25	20.17
	HT/VHT20, M0 to M7	3	6	-55.1	-49.1	-50.5		0.1	-40.1	-21.25	18.84
	HT/VHT20, M8 to M15	3	6	-55.1	-48.3	-48.3		0.1	-38.8	-21.25	17.56
	HT/VHT20, M16 to M23	3	6	-55.1	-48.3	-48.3		0.1	-38.8	-21.25	17.56
	HT/VHT20, M0 to M7	4	6	-56.3	-50.5	-52.7	-55.4	0.1	-41.0	-21.25	19.79
	HT/VHT20, M8 to M15	4	6	-55.1	-47.9	-49.9	-52.0	0.1	-38.4	-21.25	17.15
	HT/VHT20, M16 to M23	4	6	-55.1	-48.4	-49.8	-53.0	0.1	-38.8	-21.25	17.51
	HT/VHT20, M24 to M31	4	6	-55.1	-48.4	-49.8	-53.0	0.1	-38.8	-21.25	17.51
	HT/VHT20 Beam Forming, M0 to M7	2	9	-55.1	-48.4			0.1	-38.5	-21.25	17.26
	HT/VHT20 Beam Forming, M8 to M15	2	6	-55.1	-48.3			0.1	-41.4	-21.25	20.17
	HT/VHT20 Beam Forming, M0 to M7	3	11	-55.1	-49.1	-50.5		0.1	-35.1	-21.25	13.84
	HT/VHT20 Beam Forming, M8 to M15	3	8	-55.1	-48.4	-49.8		0.1	-37.5	-21.25	16.22
	HT/VHT20 Beam Forming, M16 to M23	3	6	-55.1	-48.3	-48.3		0.1	-38.8	-21.25	17.56
	HT/VHT20 Beam Forming, M0 to M7	4	12	-56.3	-50.5	-52.7	-55.4	0.1	-35.0	-21.25	13.79
	HT/VHT20 Beam Forming, M8 to M15	4	9	-55.1	-47.9	-49.9	-52.0	0.1	-35.4	-21.25	14.15
	HT/VHT20 Beam Forming, M16 to M23	4	7	-55.1	-48.4	-49.8	-53.0	0.1	-37.8	-21.25	16.51
	HT/VHT20 Beam Forming, M24 to M31	4	6	-55.1	-48.4	-49.8	-53.0	0.1	-38.8	-21.25	17.51
	HT/VHT20 STBC, M0 to M7	2	6	-55.1	-48.3			0.1	-41.4	-21.25	20.17
	HT/VHT20 STBC, M0 to M7	3	6	-55.1	-48.3	-48.3		0.1	-38.8	-21.25	17.56
	HT/VHT20 STBC, M0 to M7	4	6	-55.1	-47.9	-49.9	-52.0	0.1	-38.4	-21.25	17.15
	HE20, M0 to M9 1ss	1	6	-54.5				0.1	-48.4	-21.25	27.18



	HE20, M0 to M9 1ss	2	6	-54.5	-47.1			0.1	-40.3	-21.25	19.05	
	HE20, M0 to M9 2ss	2	6	-54.5	-47.1			0.1	-40.3	-21.25	19.05	
	HE20, M0 to M9 1ss	3	6	-54.5	-49.0	-50.7		0.1	-40.0	-21.25	18.76	
	HE20, M0 to M9 2ss	3	6	-54.5	-48.4	-48.7		0.1	-38.9	-21.25	17.70	
	HE20, M0 to M9 3ss	3	6	-54.5	-48.4	-48.7		0.1	-38.9	-21.25	17.70	
	HE20, M0 to M9 1ss	4	6	-54.6	-51.8	-52.3	-55.1	0.1	-41.1	-21.25	19.88	
	HE20, M0 to M9 2ss	4	6	-54.5	-49.3	-48.5	-52.5	0.1	-38.5	-21.25	17.23	
	HE20, M0 to M9 3ss	4	6	-54.5	-48.4	-48.7	-52.1	0.1	-38.2	-21.25	16.92	
	HE20, M0 to M9 4ss	4	6	-54.5	-48.4	-48.7	-52.1	0.1	-38.2	-21.25	16.92	
	HE20 Beam Forming, M0 to M9 1ss	2	9	-54.5	-49.3			0.1	-39.1	-21.25	17.83	
	HE20 Beam Forming, M0 to M9 2ss	2	6	-54.5	-47.1			0.1	-40.3	-21.25	19.05	
	HE20 Beam Forming, M0 to M9 1ss	3	11	-54.5	-49.0	-50.7		0.1	-35.0	-21.25	13.76	
	HE20 Beam Forming, M0 to M9 2ss	3	8	-54.5	-49.3	-48.5		0.1	-37.2	-21.25	15.99	
	HE20 Beam Forming, M0 to M9 3ss	3	6	-54.5	-48.4	-48.7		0.1	-38.9	-21.25	17.70	
	HE20 Beam Forming, M0 to M9 1ss	4	12	-54.6	-51.8	-52.3	-55.1	0.1	-35.1	-21.25	13.88	
	HE20 Beam Forming, M0 to M9 2ss	4	9	-54.5	-49.0	-50.7	-52.7	0.1	-36.2	-21.25	14.91	
	HE20 Beam Forming, M0 to M9 3ss	4	7	-54.5	-49.3	-48.5	-52.5	0.1	-37.5	-21.25	16.23	
	HE20 Beam Forming, M0 to M9 4ss	4	6	-54.5	-48.4	-48.7	-52.1	0.1	-38.2	-21.25	16.92	
	HE20 STBC, M0 to M9 2ss	2	6	-54.5	-47.1			0.1	-40.3	-21.25	19.05	
	HE20 STBC, M0 to M9 2ss	3	6	-54.5	-48.4	-48.7		0.1	-38.9	-21.25	17.70	
	HE20 STBC, M0 to M9 2ss	4	6	-54.5	-49.3	-48.5	-52.5	0.1	-38.5	-21.25	17.23	
5250	Non HT160, 6 to 54 Mbps	1	6	-52.3				0.0	-46.3	-21.25	25.00	
	Non HT160, 6 to 54 Mbps	2	6	-52.3	-51.0			0.0	-42.5	-21.25	21.29	
	Non HT160, 6 to 54 Mbps	3	6	-52.3	-51.0	-50.9		0.0	-40.5	-21.25	19.28	
	Non HT160, 6 to 54 Mbps	4	6	-52.3	-51.0	-50.9	-53.6	0.0	-39.7	-21.25	18.50	
	VHT160, M0 to M9 1ss	1	6	-48.7				0.4	-42.3	-21.25	21.06	
	VHT160, M0 to M9 1ss	2	6	-48.7	-49.5			0.4	-39.7	-21.25	18.43	
	VHT160, M0 to M9 2ss	2	6	-48.7	-49.5			0.4	-39.7	-21.25	18.43	
	VHT160, M0 to M9 1ss	3	6	-48.7	-49.5	-51.2		0.4	-38.5	-21.25	17.27	
	VHT160, M0 to M9 2ss	3	6	-48.7	-49.5	-51.2		0.4	-38.5	-21.25	17.27	
	VHT160, M0 to M9 3ss	3	6	-48.7	-49.5	-51.2		0.4	-38.5	-21.25	17.27	
	VHT160, M0 to M9 1ss	4	6	-51.7	-50.7	-51.2	-54.5	0.4	-39.4	-21.25	18.14	
	VHT160, M0 to M9 2ss	4	6	-51.7	-50.7	-51.2	-54.5	0.4	-39.4	-21.25	18.14	
	VHT160, M0 to M9 3ss	4	6	-51.7	-50.7	-51.2	-54.5	0.4	-39.4	-21.25	18.14	
	VHT160, M0 to M9 4ss	4	6	-51.7	-50.7	-51.2	-54.5	0.4	-39.4	-21.25	18.14	
	VHT160 Beam Forming, M0 to M9 1ss	2	9	-52.9	-51.8				0.4	-39.9	-21.25	18.66
	VHT160 Beam Forming, M0 to M9 2ss	2	6	-48.7	-49.5				0.4	-39.7	-21.25	18.43
	VHT160 Beam Forming, M0 to M9 1ss	3	11	-55.5	-52.5	-53.2			0.4	-37.4	-21.25	16.14
	VHT160 Beam Forming, M0 to M9 2ss	3	8	-51.7	-50.7	-51.2			0.4	-38.0	-21.25	16.77
	VHT160 Beam Forming, M0 to M9 3ss	3	6	-48.7	-49.5	-51.2			0.4	-38.5	-21.25	17.27
VHT160 Beam Forming, M0 to M9 1ss	4	12	-55.5	-52.5	-53.2	-55.5		0.4	-35.6	-21.25	14.30	



VHT160 Beam Forming, M0 to M9 2ss	4	9	-52.9	-51.8	-52.2	-54.5	0.4	-37.3	-21.25	16.07
VHT160 Beam Forming, M0 to M9 3ss	4	7	-51.7	-50.7	-51.2	-54.5	0.4	-38.4	-21.25	17.14
VHT160 Beam Forming, M0 to M9 4ss	4	6	-51.7	-50.7	-51.2	-54.5	0.4	-39.4	-21.25	18.14
VHT160 STBC, M0 to M9 1ss	2	6	-48.7	-49.5			0.4	-39.7	-21.25	18.43
VHT160 STBC, M0 to M9 1ss	3	6	-48.7	-49.5	-51.2		0.4	-38.5	-21.25	17.27
VHT160 STBC, M0 to M9 1ss	4	6	-51.7	-50.7	-51.2	-54.5	0.4	-39.4	-21.25	18.14
HE160, M0 to M9 1ss	1	6	-50.8				0.4	-44.4	-21.25	23.12
HE160, M0 to M9 1ss	2	6	-50.8	-49.3			0.4	-40.5	-21.25	19.29
HE160, M0 to M9 2ss	2	6	-50.8	-49.3			0.4	-40.5	-21.25	19.29
HE160, M0 to M9 1ss	3	6	-50.8	-49.3	-50.4		0.4	-38.9	-21.25	17.66
HE160, M0 to M9 2ss	3	6	-50.8	-49.3	-50.4		0.4	-38.9	-21.25	17.66
HE160, M0 to M9 3ss	3	6	-50.8	-49.3	-50.4		0.4	-38.9	-21.25	17.66
HE160, M0 to M9 1ss	4	6	-50.8	-49.3	-50.4	-53.3	0.4	-38.3	-21.25	17.02
HE160, M0 to M9 2ss	4	6	-50.8	-49.3	-50.4	-53.3	0.4	-38.3	-21.25	17.02
HE160, M0 to M9 3ss	4	6	-50.8	-49.3	-50.4	-53.3	0.4	-38.3	-21.25	17.02
HE160, M0 to M9 4ss	4	6	-50.8	-49.3	-50.4	-53.3	0.4	-38.3	-21.25	17.02
HE160 Beam Forming, M0 to M9 1ss	2	9	-54.3	-50.6			0.4	-39.6	-21.25	18.37
HE160 Beam Forming, M0 to M9 2ss	2	6	-50.8	-49.3			0.4	-40.5	-21.25	19.29
HE160 Beam Forming, M0 to M9 1ss	3	11	-54.3	-50.5	-52.9		0.4	-36.1	-21.25	14.82
HE160 Beam Forming, M0 to M9 2ss	3	8	-54.3	-50.6	-52.0		0.4	-38.8	-21.25	17.59
HE160 Beam Forming, M0 to M9 3ss	3	6	-50.8	-49.3	-50.4		0.4	-38.9	-21.25	17.66
HE160 Beam Forming, M0 to M9 1ss	4	12	-55.6	-51.2	-52.5	-55.2	0.4	-34.8	-21.25	13.53
HE160 Beam Forming, M0 to M9 2ss	4	9	-54.3	-50.6	-52.0	-54.4	0.4	-37.1	-21.25	15.82
HE160 Beam Forming, M0 to M9 3ss	4	7	-54.3	-50.6	-52.0	-54.4	0.4	-39.1	-21.25	17.82
HE160 Beam Forming, M0 to M9 4ss	4	6	-50.8	-49.3	-50.4	-53.3	0.4	-38.3	-21.25	17.02
HE160 STBC, M0 to M9 1ss	2	6	-50.8	-49.3			0.4	-40.5	-21.25	19.29
HE160 STBC, M0 to M9 1ss	3	6	-50.8	-49.3	-50.4		0.4	-38.9	-21.25	17.66
HE160 STBC, M0 to M9 1ss	4	6	-50.8	-49.3	-50.4	-53.3	0.4	-38.3	-21.25	17.02



**Conducted Spurs Peak, 6dBi  
5270 MHz, HT/VHT40 Beam Forming, M0 to M7**

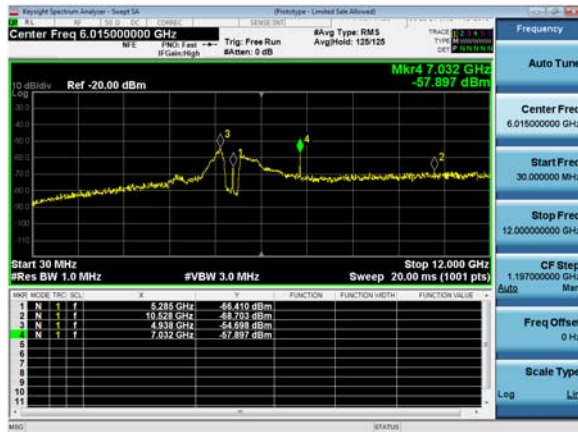

**Antenna A**

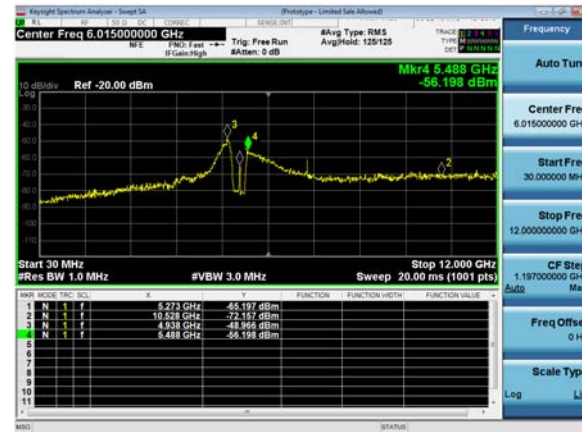

**Antenna B**



**Antenna C**



**Antenna D**



## A.6 Conducted Receiver Spurious Emissions

### Spurious Of Receive Average Upp, 5260 MHz, Non HT20, 6 to 54 Mbps

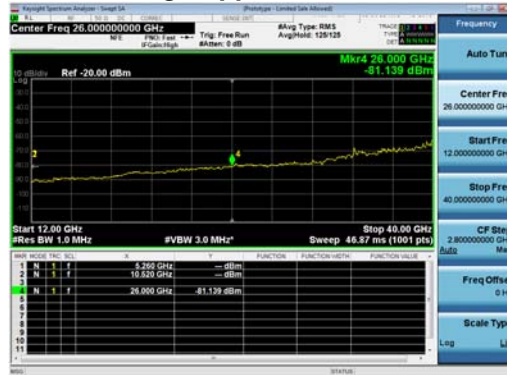

### Spurious Of Receive Peak Upper, 5260 MHz, Non HT20, 6 to 54 Mbps

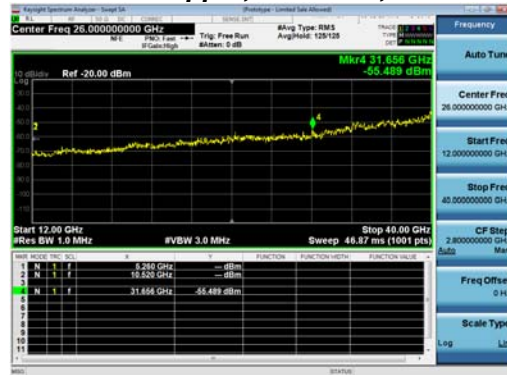



## Conducted Spurious of Receive Average Table, 4dBi

Frequency (MHz)	Mode	Tx Paths	Correlated Antenna Gain (dBi)	Rx 1 Spur Power (dBm)	Rx 2 Spur Power (dBm)	Rx 3 Spur Power (dBm)	Rx 4 Spur Power (dBm)	Duty Cycle Correction (dB)	Total Conducted Spur (dBm)	Limit (dBm)	Margin (dB)
5260	Non HT20, 6 to 54 Mbps	4	4	-88.8	-89.1	-89.2	-88.7	0.0	-78.9	-41.25	37.63
	HT/VHT20, M0 to M7	4	4	-88.3	-89.1	-89.0	-89.0	0.1	-78.8	-41.25	37.51
	HE20, M0 to M9 1ss	4	4	-88.6	-88.9	-88.9	-89.1	0.1	-78.8	-41.25	37.53
5270	Non HT40, 6 to 54 Mbps	4	4	-88.8	-89.1	-89.2	-89.2	0.0	-79.0	-41.25	37.76
	HT/VHT40, M0 to M7	4	4	-89.0	-89.6	-89.4	-89.3	0.1	-79.2	-41.25	37.95
	HE40, M0 to M9 1ss	4	4	-88.6	-89.3	-89.2	-89.2	0.1	-78.9	-41.25	37.67
5290	Non HT80, 6 to 54 Mbps	4	4	-88.4	-89.3	-88.7	-89.1	0.1	-78.8	-41.25	37.54
	VHT80, M0 to M9 1ss	4	4	-88.6	-89.3	-89.3	-88.8	0.2	-78.8	-41.25	37.50
	HE80, M0 to M9 1ss	4	4	-89.0	-89.1	-89.3	-89.0	0.3	-78.8	-41.25	37.57
5300	Non HT20, 6 to 54 Mbps	4	4	-88.8	-89.1	-88.8	-88.8	0.0	-78.8	-41.25	37.56
	HT/VHT20, M0 to M7	4	4	-88.7	-89.2	-89.1	-89.3	0.1	-79.0	-41.25	37.75
	HE20, M0 to M9 1ss	4	4	-89.0	-89.2	-88.8	-88.9	0.1	-78.9	-41.25	37.63
5310	Non HT40, 6 to 54 Mbps	4	4	-88.4	-88.9	-88.6	-88.5	0.0	-78.5	-41.25	37.28
	HT/VHT40, M0 to M7	4	4	-88.7	-89.5	-88.6	-89.5	0.1	-78.9	-41.25	37.68
	HE40, M0 to M9 1ss	4	4	-89.4	-89.5	-89.4	-89.6	0.1	-79.3	-41.25	38.07
5320	Non HT20, 6 to 54 Mbps	4	4	-88.2	-89.3	-88.8	-88.4	0.0	-78.6	-41.25	37.34
	HT/VHT20, M0 to M7	4	4	-88.5	-89.0	-88.9	-89.1	0.1	-78.8	-41.25	37.55
	HE20, M0 to M9 1ss	4	4	-88.4	-89.0	-88.6	-88.7	0.1	-78.6	-41.25	37.33
5250	Non HT160, 6 to 54 Mbps	4	4	-88.4	-88.7	-88.8	-88.8	0.0	-78.6	-41.25	37.35
	VHT160, M0 to M9 1ss	4	4	-88.7	-88.8	-88.5	-88.9	0.4	-78.3	-41.25	37.06
	<b>HE160, M0 to M9 1ss</b>	<b>4</b>	<b>4</b>	<b>-88.4</b>	<b>-89.1</b>	<b>-88.5</b>	<b>-88.9</b>	<b>0.4</b>	<b>-78.3</b>	<b>-41.25</b>	<b>37.01</b>



## Conducted Spurious of Receive Average Table, 5dBi

Frequency (MHz)	Mode	Tx Paths	Correlated Antenna Gain (dBi)	Rx 1 Spur Power (dBm)	Tx 2 Spur Power (dBm)	Tx 3 Spur Power (dBm)	Tx 4 Spur Power (dBm)	Duty Cycle Correction (dB)	Total Conducted Spur (dBm)	Limit (dBm)	Margin (dB)
5260	Non HT20, 6 to 54 Mbps	4	5	-88.8	-89.1	-89.2	-88.7	0.0	-77.9	-41.25	36.63
	HT/VHT20, M0 to M7	4	5	-88.3	-89.1	-89.0	-89.0	0.1	-77.8	-41.25	36.51
	HE20, M0 to M9 1ss	4	5	-88.6	-88.9	-88.9	-89.1	0.1	-77.8	-41.25	36.53
5270	Non HT40, 6 to 54 Mbps	4	5	-88.8	-89.1	-89.2	-89.2	0.0	-78.0	-41.25	36.76
	HT/VHT40, M0 to M7	4	5	-89.0	-89.6	-89.4	-89.3	0.1	-78.2	-41.25	36.95
	HE40, M0 to M9 1ss	4	5	-88.6	-89.3	-89.2	-89.2	0.1	-77.9	-41.25	36.67
5290	Non HT80, 6 to 54 Mbps	4	5	-88.4	-89.3	-88.7	-89.1	0.1	-77.8	-41.25	36.54
	VHT80, M0 to M9 1ss	4	5	-88.6	-89.3	-89.3	-88.8	0.2	-77.8	-41.25	36.50
	HE80, M0 to M9 1ss	4	5	-89.0	-89.1	-89.3	-89.0	0.3	-77.8	-41.25	36.57
5300	Non HT20, 6 to 54 Mbps	4	5	-88.8	-89.1	-88.8	-88.8	0.0	-77.8	-41.25	36.56
	HT/VHT20, M0 to M7	4	5	-88.7	-89.2	-89.1	-89.3	0.1	-78.0	-41.25	36.75
	HE20, M0 to M9 1ss	4	5	-89.0	-89.2	-88.8	-88.9	0.1	-77.9	-41.25	36.63
5310	Non HT40, 6 to 54 Mbps	4	5	-88.4	-88.9	-88.6	-88.5	0.0	-77.5	-41.25	36.28
	HT/VHT40, M0 to M7	4	5	-88.7	-89.5	-88.6	-89.5	0.1	-77.9	-41.25	36.68
	HE40, M0 to M9 1ss	4	5	-89.4	-89.5	-89.4	-89.6	0.1	-78.3	-41.25	37.07
5320	Non HT20, 6 to 54 Mbps	4	5	-88.2	-89.3	-88.8	-88.4	0.0	-77.6	-41.25	36.34
	HT/VHT20, M0 to M7	4	5	-88.5	-89.0	-88.9	-89.1	0.1	-77.8	-41.25	36.55
	HE20, M0 to M9 1ss	4	5	-88.4	-89.0	-88.6	-88.7	0.1	-77.6	-41.25	36.33
5250	Non HT160, 6 to 54 Mbps	4	5	-88.4	-88.7	-88.8	-88.8	0.0	-77.6	-41.25	36.35
	VHT160, M0 to M9 1ss	4	5	-88.7	-88.8	-88.5	-88.9	0.4	-77.3	-41.25	36.06
	<b>HE160, M0 to M9 1ss</b>	<b>4</b>	<b>5</b>	<b>-88.4</b>	<b>-89.1</b>	<b>-88.5</b>	<b>-88.9</b>	<b>0.4</b>	<b>-77.3</b>	<b>-41.25</b>	<b>36.01</b>





## Conducted Spurious of Receive Average Table, 6dBi

Frequency (MHz)	Mode	Tx Paths	Correlated Antenna Gain (dBi)	Rx 1 Spur Power (dBm)	Rx 2 Spur Power (dBm)	Rx 3 Spur Power (dBm)	Rx 4 Spur Power (dBm)	Duty Cycle Correction (dB)	Total Conducted Spur (dBm)	Limit (dBm)	Margin (dB)
5260	Non HT20, 6 to 54 Mbps	4	6	-88.8	-89.1	-89.2	-88.7	0.0	-76.9	-41.25	35.63
	HT/VHT20, M0 to M7	4	6	-88.3	-89.1	-89.0	-89.0	0.1	-76.8	-41.25	35.51
	HE20, M0 to M9 1ss	4	6	-88.6	-88.9	-88.9	-89.1	0.1	-76.8	-41.25	35.53
5270	Non HT40, 6 to 54 Mbps	4	6	-88.8	-89.1	-89.2	-89.2	0.0	-77.0	-41.25	35.76
	HT/VHT40, M0 to M7	4	6	-89.0	-89.6	-89.4	-89.3	0.1	-77.2	-41.25	35.95
	HE40, M0 to M9 1ss	4	6	-88.6	-89.3	-89.2	-89.2	0.1	-76.9	-41.25	35.67
5290	Non HT80, 6 to 54 Mbps	4	6	-88.4	-89.3	-88.7	-89.1	0.1	-76.8	-41.25	35.54
	VHT80, M0 to M9 1ss	4	6	-88.6	-89.3	-89.3	-88.8	0.2	-76.8	-41.25	35.50
	HE80, M0 to M9 1ss	4	6	-89.0	-89.1	-89.3	-89.0	0.3	-76.8	-41.25	35.57
5300	Non HT20, 6 to 54 Mbps	4	6	-88.8	-89.1	-88.8	-88.8	0.0	-76.8	-41.25	35.56
	HT/VHT20, M0 to M7	4	6	-88.7	-89.2	-89.1	-89.3	0.1	-77.0	-41.25	35.75
	HE20, M0 to M9 1ss	4	6	-89.0	-89.2	-88.8	-88.9	0.1	-76.9	-41.25	35.63
5310	Non HT40, 6 to 54 Mbps	4	6	-88.4	-88.9	-88.6	-88.5	0.0	-76.5	-41.25	35.28
	HT/VHT40, M0 to M7	4	6	-88.7	-89.5	-88.6	-89.5	0.1	-76.9	-41.25	35.68
	HE40, M0 to M9 1ss	4	6	-89.4	-89.5	-89.4	-89.6	0.1	-77.3	-41.25	36.07
5320	Non HT20, 6 to 54 Mbps	4	6	-88.2	-89.3	-88.8	-88.4	0.0	-76.6	-41.25	35.34
	HT/VHT20, M0 to M7	4	6	-88.5	-89.0	-88.9	-89.1	0.1	-76.8	-41.25	35.55
	HE20, M0 to M9 1ss	4	6	-88.4	-89.0	-88.6	-88.7	0.1	-76.6	-41.25	35.33
5250	Non HT160, 6 to 54 Mbps	4	6	-88.4	-88.7	-88.8	-88.8	0.0	-76.6	-41.25	35.35
	VHT160, M0 to M9 1ss	4	6	-88.7	-88.8	-88.5	-88.9	0.4	-76.3	-41.25	35.06
	<b>HE160, M0 to M9 1ss</b>	<b>4</b>	<b>6</b>	<b>-88.4</b>	<b>-89.1</b>	<b>-88.5</b>	<b>-88.9</b>	<b>0.4</b>	<b>-76.3</b>	<b>-41.25</b>	<b>35.01</b>



**Spurious Of Receive Average, 5250 MHz, HE160, M0 to M9 1ss**

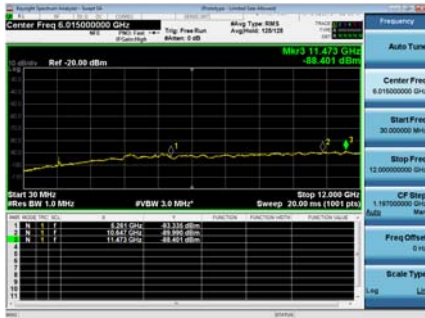

**Antenna A**

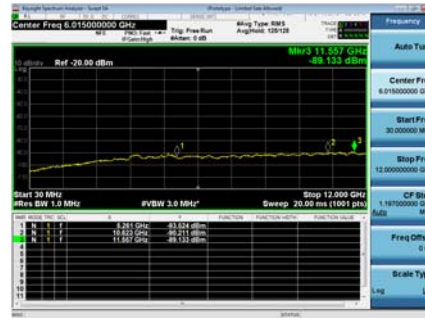

**Antenna B**

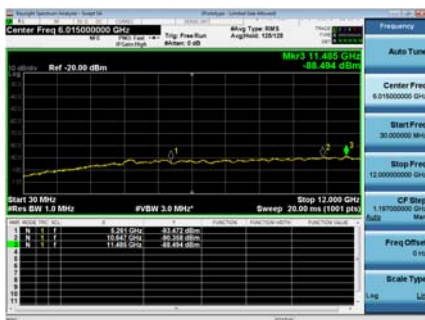

**Antenna C**

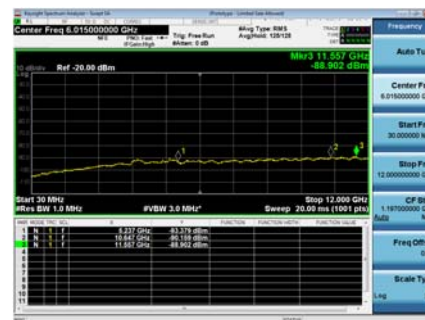

**Antenna D**



## Conducted Spurious of Receive Peak Table, 4dBi

Frequency (MHz)	Mode	Tx Paths	Correlated Antenna Gain (dBi)	Rx 1 Spur Power (dBm)	Rx 2 Spur Power (dBm)	Rx 3 Spur Power (dBm)	Rx 4 Spur Power (dBm)	Total Conducted Spur (dBm)	Limit (dBm)	Margin (dB)
5260	Non HT20, 6 to 54 Mbps	4	4	-68.3	-69.4	-68.4	-69.2	-58.7	-21.25	37.48
	HT/VHT20, M0 to M7	4	4	-69.2	-68.9	-69.4	-68.8	-59.0	-21.25	37.75
	HE20, M0 to M9 1ss	4	4	-69.0	-69.6	-68.4	-69.3	-59.0	-21.25	37.71
5270	Non HT40, 6 to 54 Mbps	4	4	-69.5	-70.0	-68.8	-69.5	-59.4	-21.25	38.11
	HT/VHT40, M0 to M7	4	4	-69.9	-69.1	-69.3	-69.2	-59.2	-21.25	37.99
	HE40, M0 to M9 1ss	4	4	-68.0	-69.9	-68.1	-69.9	-58.7	-21.25	37.48
5290	Non HT80, 6 to 54 Mbps	4	4	-69.4	-69.5	-69.3	-69.5	-59.4	-21.25	38.10
	VHT80, M0 to M9 1ss	4	4	-69.4	-69.4	-69.0	-69.3	-59.0	-21.25	37.79
	HE80, M0 to M9 1ss	4	4	-68.6	-69.8	-69.1	-69.4	-58.9	-21.25	37.67
5300	Non HT20, 6 to 54 Mbps	4	4	-68.6	-69.2	-68.3	-69.2	-58.7	-21.25	37.49
	HT/VHT20, M0 to M7	4	4	-69.0	-69.3	-69.6	-69.7	-59.3	-21.25	38.07
	HE20, M0 to M9 1ss	4	4	-69.6	-69.8	-68.8	-68.7	-59.1	-21.25	37.86
5310	Non HT40, 6 to 54 Mbps	4	4	-69.0	-70.1	-69.5	-69.0	-59.3	-21.25	38.06
	HT/VHT40, M0 to M7	4	4	-69.4	-68.3	-69.4	-69.6	-59.0	-21.25	37.77
	HE40, M0 to M9 1ss	4	4	-69.3	-70.1	-68.9	-69.2	-59.2	-21.25	37.95
5320	Non HT20, 6 to 54 Mbps	4	4	-68.9	-69.8	-69.6	-69.1	-59.3	-21.25	38.02
	HT/VHT20, M0 to M7	4	4	-69.0	-69.3	-69.9	-69.4	-59.3	-21.25	38.07
	HE20, M0 to M9 1ss	4	4	-69.1	-69.0	-69.2	-69.0	-59.0	-21.25	37.73
5250	Non HT160, 6 to 54 Mbps	4	4	-68.1	-69.1	-69.0	-69.8	-58.9	-21.25	37.64
	<b>VHT160, M0 to M9 1ss</b>	<b>4</b>	<b>4</b>	<b>-68.4</b>	<b>-69.7</b>	<b>-68.8</b>	<b>-69.3</b>	<b>-58.6</b>	<b>-21.25</b>	<b>37.36</b>
	HE160, M0 to M9 1ss	4	4	-68.8	-68.9	-69.5	-69.2	-58.6	-21.25	37.39



## Conducted Spurious of Receive Peak Table, 5dBi

Frequency (MHz)	Mode	Tx Paths	Correlated Antenna Gain (dBi)	Rx 1 Spur Power (dBm)	Rx 2 Spur Power (dBm)	Rx 3 Spur Power (dBm)	Rx 4 Spur Power (dBm)	Total Conducted Spur (dBm)	Limit (dBm)	Margin (dB)
5260	Non HT20, 6 to 54 Mbps	4	5	-68.3	-69.4	-68.4	-69.2	-57.7	-21.25	36.48
	HT/VHT20, M0 to M7	4	5	-69.2	-68.9	-69.4	-68.8	-58.0	-21.25	36.75
	HE20, M0 to M9 1ss	4	5	-69.0	-69.6	-68.4	-69.3	-58.0	-21.25	36.71
5270	Non HT40, 6 to 54 Mbps	4	5	-69.5	-70.0	-68.8	-69.5	-58.4	-21.25	37.11
	HT/VHT40, M0 to M7	4	5	-69.9	-69.1	-69.3	-69.2	-58.2	-21.25	36.99
	HE40, M0 to M9 1ss	4	5	-68.0	-69.9	-68.1	-69.9	-57.7	-21.25	36.48
5290	Non HT80, 6 to 54 Mbps	4	5	-69.4	-69.5	-69.3	-69.5	-58.4	-21.25	37.10
	VHT80, M0 to M9 1ss	4	5	-69.4	-69.4	-69.0	-69.3	-58.0	-21.25	36.79
	HE80, M0 to M9 1ss	4	5	-68.6	-69.8	-69.1	-69.4	-57.9	-21.25	36.67
5300	Non HT20, 6 to 54 Mbps	4	5	-68.6	-69.2	-68.3	-69.2	-57.7	-21.25	36.49
	HT/VHT20, M0 to M7	4	5	-69.0	-69.3	-69.6	-69.7	-58.3	-21.25	37.07
	HE20, M0 to M9 1ss	4	5	-69.6	-69.8	-68.8	-68.7	-58.1	-21.25	36.86
5310	Non HT40, 6 to 54 Mbps	4	5	-69.0	-70.1	-69.5	-69.0	-58.3	-21.25	37.06
	HT/VHT40, M0 to M7	4	5	-69.4	-68.3	-69.4	-69.6	-58.0	-21.25	36.77
	HE40, M0 to M9 1ss	4	5	-69.3	-70.1	-68.9	-69.2	-58.2	-21.25	36.95
5320	Non HT20, 6 to 54 Mbps	4	5	-68.9	-69.8	-69.6	-69.1	-58.3	-21.25	37.02
	HT/VHT20, M0 to M7	4	5	-69.0	-69.3	-69.9	-69.4	-58.3	-21.25	37.07
	HE20, M0 to M9 1ss	4	5	-69.1	-69.0	-69.2	-69.0	-58.0	-21.25	36.73
5250	Non HT160, 6 to 54 Mbps	4	5	-68.1	-69.1	-69.0	-69.8	-57.9	-21.25	36.64
	<b>VHT160, M0 to M9 1ss</b>	<b>4</b>	<b>5</b>	<b>-68.4</b>	<b>-69.7</b>	<b>-68.8</b>	<b>-69.3</b>	<b>-57.6</b>	<b>-21.25</b>	<b>36.36</b>
	HE160, M0 to M9 1ss	4	5	-68.8	-68.9	-69.5	-69.2	-57.6	-21.25	36.39



## Conducted Spurious of Receive Peak Table, 6dBi

Frequency (MHz)	Mode	Tx Paths	Correlated Antenna Gain (dBi)	Rx 1 Spur Power (dBm)	Rx 2 Spur Power (dBm)	Rx 3 Spur Power (dBm)	Rx 4 Spur Power (dBm)	Total Conducted Spur (dBm)	Limit (dBm)	Margin (dB)
5260	Non HT20, 6 to 54 Mbps	4	6	-68.3	-69.4	-68.4	-69.2	-56.7	-21.25	35.48
	HT/VHT20, M0 to M7	4	6	-69.2	-68.9	-69.4	-68.8	-57.0	-21.25	35.75
	HE20, M0 to M9 1ss	4	6	-69.0	-69.6	-68.4	-69.3	-57.0	-21.25	35.71
5270	Non HT40, 6 to 54 Mbps	4	6	-69.5	-70.0	-68.8	-69.5	-57.4	-21.25	36.11
	HT/VHT40, M0 to M7	4	6	-69.9	-69.1	-69.3	-69.2	-57.2	-21.25	35.99
	HE40, M0 to M9 1ss	4	6	-68.0	-69.9	-68.1	-69.9	-56.7	-21.25	35.48
5290	Non HT80, 6 to 54 Mbps	4	6	-69.4	-69.5	-69.3	-69.5	-57.4	-21.25	36.10
	VHT80, M0 to M9 1ss	4	6	-69.4	-69.4	-69.0	-69.3	-57.0	-21.25	35.79
	HE80, M0 to M9 1ss	4	6	-68.6	-69.8	-69.1	-69.4	-56.9	-21.25	35.67
5300	Non HT20, 6 to 54 Mbps	4	6	-68.6	-69.2	-68.3	-69.2	-56.7	-21.25	35.49
	HT/VHT20, M0 to M7	4	6	-69.0	-69.3	-69.6	-69.7	-57.3	-21.25	36.07
	HE20, M0 to M9 1ss	4	6	-69.6	-69.8	-68.8	-68.7	-57.1	-21.25	35.86
5310	Non HT40, 6 to 54 Mbps	4	6	-69.0	-70.1	-69.5	-69.0	-57.3	-21.25	36.06
	HT/VHT40, M0 to M7	4	6	-69.4	-68.3	-69.4	-69.6	-57.0	-21.25	35.77
	HE40, M0 to M9 1ss	4	6	-69.3	-70.1	-68.9	-69.2	-57.2	-21.25	35.95
5320	Non HT20, 6 to 54 Mbps	4	6	-68.9	-69.8	-69.6	-69.1	-57.3	-21.25	36.02
	HT/VHT20, M0 to M7	4	6	-69.0	-69.3	-69.9	-69.4	-57.3	-21.25	36.07
	HE20, M0 to M9 1ss	4	6	-69.1	-69.0	-69.2	-69.0	-57.0	-21.25	35.73
5250	Non HT160, 6 to 54 Mbps	4	6	-68.1	-69.1	-69.0	-69.8	-56.9	-21.25	35.64
	<b>VHT160, M0 to M9 1ss</b>	<b>4</b>	<b>6</b>	<b>-68.4</b>	<b>-69.7</b>	<b>-68.8</b>	<b>-69.3</b>	<b>-56.6</b>	<b>-21.25</b>	<b>35.36</b>
	HE160, M0 to M9 1ss	4	6	-68.8	-68.9	-69.5	-69.2	-56.6	-21.25	35.39



**Spurious Of Receive Peak, 5250 MHz, VHT160, M0 to M9 1ss**

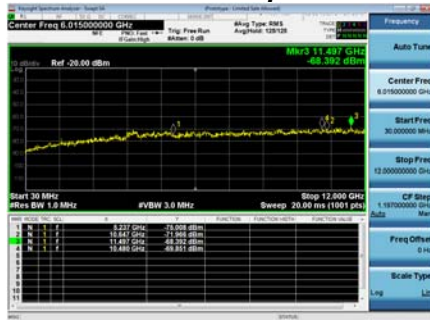

**Antenna A**

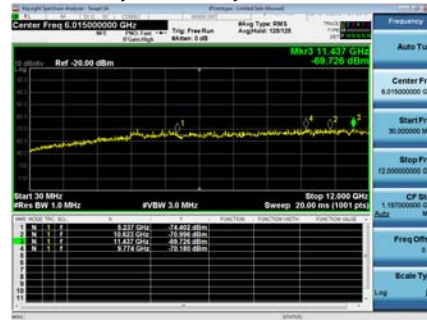

**Antenna B**



**Antenna C**

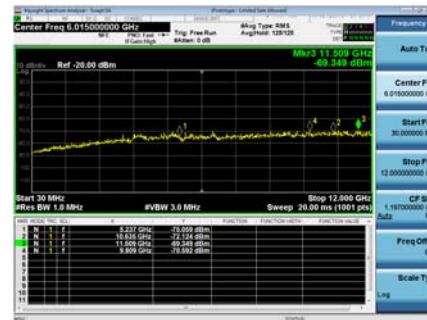

**Antenna D**



## A.7 Conducted Bandedge

### Conducted Band Edge Test Requirement

**15.407(b) Undesirable emission limits.** Except as shown in paragraph (b)(7) of this section, the maximum emissions outside of the frequency bands of operation shall be attenuated in accordance with the following limits:

(2) For transmitters operating in the 5.25-5.35 GHz band: All emissions outside of the 5.15-5.35 GHz band shall not exceed an e.i.r.p. of  $-27$  dBm/MHz.

(6) Unwanted emissions below 1 GHz must comply with the general field strength limits set forth in §15.209.

(7) The provisions of §15.205 apply to intentional radiators operating under this section.

(8) When measuring the emission limits, the nominal carrier frequency shall be adjusted as close to the upper and lower frequency band edges as the design of the equipment permits.

#### KDB 789033 D02 General UNII Test Procedures New Rules v02r01

##### 2. Unwanted Emissions that fall Outside of the Restricted Bands

a) For all measurements, follow the requirements in II.G.3. *“General Requirements for Unwanted Emissions Measurements.”*

b) At frequencies below 1000 MHz, use the procedure described in II.G.4. *“Procedure for Unwanted Emissions Measurements Below 1000 MHz.”*

c) At frequencies above 1000 MHz, use the procedure for maximum emissions described in II.G.5., *“Procedure for Unwanted Emissions Measurements Above 1000 MHz.”*

(i) Sections 15.407(b)(1-3) specifies the unwanted emissions limit for the U-NII-1 and U-NII-2 bands. As specified, emissions above 1000 MHz that are outside of the restricted bands are subject to a peak emission limit of  $-27$  dBm/MHz.<sup>3</sup>

### Conducted Band Edge Test Procedure

#### KDB 789033 D02 General UNII Test Procedures New Rules v02r01

Ref. ANSI C63.10: 2013

##### Conducted Spurious Emissions

###### Test Procedure

1. Connect the antenna port(s) to the spectrum analyzer input.
2. Place the radio in continuous transmit mode
3. Configure Spectrum analyzer as per test parameters below (be sure to enter all losses between the transmitter output and the spectrum analyzer).
4. Use the peak marker function to determine the maximum spurs amplitude level.
5. The “measure-and-sum technique” is used for measuring in-band transmit power of a device. In the measure-and-sum approach, the conducted emission level is measured at each antenna port. The measured results at the various antenna ports are then summed mathematically to determine the total emission level from the device. Summing is performed in linear power units. The worst case output is recorded. (see ANSI C63.10:2013 section 14.3.2.2)
6. Capture graphs and record pertinent measurement data.

Ref. ANSI C63.10: 2013 section 12.7.6 (Peak) and 12.7.7.2 (Average)

KDB 789033 D02 General UNII Test Procedures New Rules v02r01, Sec. 5 (Peak), Sec. 6 (Average Method AD)

##### Conducted Spurious Emissions

###### Test parameters





<b>Peak</b> RBW = 1 MHz VBW $\geq$ 3 MHz Sweep = Auto Detector = Peak Trace = Max Hold.	<b>Average</b> RBW = 1 MHz VBW $\geq$ 3 MHz Sweep = Auto Detector = RMS Power Averaging
--------------------------------------------------------------------------------------------------------	--------------------------------------------------------------------------------------------------------

**Samples, Systems, and Modes**

System Number	Description	Samples	System under test	Support equipment
1	EUT	S01+S02	<input checked="" type="checkbox"/>	<input type="checkbox"/>
	Support		<input type="checkbox"/>	<input checked="" type="checkbox"/>

<b>Tested By :</b> Chris Blair	<b>Date of testing:</b> 11-Sep-19 - 25-Sep-19
<b>Test Result : PASS</b>	

**Test Equipment**

See Appendix C for list of test equipment

Conducted Bandedge Average Table, 4dBi



Frequency (MHz)	Mode	Tx Paths	Correlated Antenna Gain (dBi)	Tx 1 Bandedge Level (dBm)	Tx 2 Bandedge Level (dBm)	Tx 3 Bandedge Level (dBm)	Tx 4 Bandedge Level (dBm)	Duty Cycle Correction (dB)	Total Tx Bandedge Level (dBm)	Limit (dBm)	Margin (dB)
5290	Non HT80, 6 to 54 Mbps	1	4	-50.7				0.1	-46.6	-41.25	5.40
	Non HT80, 6 to 54 Mbps	2	4	-50.7	-59.6			0.1	-46.1	-41.25	4.87
	Non HT80, 6 to 54 Mbps	3	4	-50.7	-59.6	-57.4		0.1	-45.4	-41.25	4.12
	Non HT80, 6 to 54 Mbps	4	4	-50.7	-59.6	-57.4	-56.8	0.1	-44.6	-41.25	3.39
	VHT80, M0 to M9 1ss	1	4	-48.4				0.2	-44.2	-41.25	2.93
	VHT80, M0 to M9 1ss	2	4	-48.4	-57.6			0.2	-43.7	-41.25	2.44
	VHT80, M0 to M9 2ss	2	4	-48.4	-57.6			0.2	-43.7	-41.25	2.44
	VHT80, M0 to M9 1ss	3	4	-48.4	-57.6	-57.6		0.2	-43.2	-41.25	2.00
	VHT80, M0 to M9 2ss	3	4	-48.4	-57.6	-57.6		0.2	-43.2	-41.25	2.00
	VHT80, M0 to M9 3ss	3	4	-48.4	-57.6	-57.6		0.2	-43.2	-41.25	2.00
	VHT80, M0 to M9 1ss	4	4	-48.4	-57.6	-57.6	-55.0	0.2	-42.5	-41.25	1.29
	VHT80, M0 to M9 2ss	4	4	-48.4	-57.6	-57.6	-55.0	0.2	-42.5	-41.25	1.29
	VHT80, M0 to M9 3ss	4	4	-48.4	-57.6	-57.6	-55.0	0.2	-42.5	-41.25	1.29
	VHT80, M0 to M9 4ss	4	4	-48.4	-57.6	-57.6	-55.0	0.2	-42.5	-41.25	1.29
	VHT80 Beam Forming, M0 to M9 1ss	2	7	-51.1	-59.2			0.2	-43.3	-41.25	2.01
	VHT80 Beam Forming, M0 to M9 2ss	2	4	-48.4	-57.6			0.2	-43.7	-41.25	2.44
	VHT80 Beam Forming, M0 to M9 1ss	3	9	-54.6	-60.5	-59.3		0.2	-43.4	-41.25	2.10
	VHT80 Beam Forming, M0 to M9 2ss	3	6	-51.1	-59.2	-58.8		0.2	-43.7	-41.25	2.41
	VHT80 Beam Forming, M0 to M9 3ss	3	4	-48.4	-57.6	-57.6		0.2	-43.2	-41.25	2.00
	VHT80 Beam Forming, M0 to M9 1ss	4	10	-54.6	-60.5	-59.3	-60.0	0.2	-41.6	-41.25	0.38
	VHT80 Beam Forming, M0 to M9 2ss	4	7	-51.1	-59.2	-58.8	-57.4	0.2	-42.0	-41.25	0.71
	VHT80 Beam Forming, M0 to M9 3ss	4	5	-48.4	-57.6	-57.6	-55.0	0.2	-41.5	-41.25	0.29
	VHT80 Beam Forming, M0 to M9 4ss	4	4	-48.4	-57.6	-57.6	-55.0	0.2	-42.5	-41.25	1.29
	VHT80 STBC, M0 to M9 1ss	2	4	-48.4	-57.6			0.2	-43.7	-41.25	2.44
	VHT80 STBC, M0 to M9 1ss	3	4	-48.4	-57.6	-57.6		0.2	-43.2	-41.25	2.00
	VHT80 STBC, M0 to M9 1ss	4	4	-48.4	-57.6	-57.6	-55.0	0.2	-42.5	-41.25	1.29
	HE80, M0 to M9 1ss	1	4	-47.0				0.3	-42.7	-41.25	1.49
	HE80, M0 to M9 1ss	2	4	-47.0	-57.1			0.3	-42.3	-41.25	1.09
	HE80, M0 to M9 2ss	2	4	-47.0	-57.1			0.3	-42.3	-41.25	1.09
	HE80, M0 to M9 1ss	3	4	-47.0	-57.1	-57.7		0.3	-42.0	-41.25	0.76



	HE80, M0 to M9 2ss	3	4	-47.0	-57.1	-57.7		0.3	-42.0	-41.25	0.76
	HE80, M0 to M9 3ss	3	4	-47.0	-57.1	-57.7		0.3	-42.0	-41.25	0.76
	HE80, M0 to M9 1ss	4	4	-47.0	-57.1	-57.7	-54.8	0.3	-41.4	-41.25	0.19
	HE80, M0 to M9 2ss	4	4	-47.0	-57.1	-57.7	-54.8	0.3	-41.4	-41.25	0.19
	HE80, M0 to M9 3ss	4	4	-47.0	-57.1	-57.7	-54.8	0.3	-41.4	-41.25	0.19
	HE80, M0 to M9 4ss	4	4	-47.0	-57.1	-57.7	-54.8	0.3	-41.4	-41.25	0.19
	HE80 Beam Forming, M0 to M9 1ss	2	7	-50.2	-58.4			0.3	-42.3	-41.25	1.08
	HE80 Beam Forming, M0 to M9 2ss	2	4	-47.0	-57.1			0.3	-42.3	-41.25	1.09
	HE80 Beam Forming, M0 to M9 1ss	3	9	-53.8	-59.8	-59.6		0.3	-42.7	-41.25	1.49
	HE80 Beam Forming, M0 to M9 2ss	3	6	-50.2	-58.4	-58.7		0.3	-42.8	-41.25	1.58
	HE80 Beam Forming, M0 to M9 3ss	3	4	-47.0	-57.1	-57.7		0.3	-42.0	-41.25	0.76
	HE80 Beam Forming, M0 to M9 1ss	4	10	-57.1	-61.6	-60.3	-60.5	0.3	-43.2	-41.25	1.99
	HE80 Beam Forming, M0 to M9 2ss	4	7	-53.8	-59.8	-59.6	-58.7	0.3	-43.9	-41.25	2.65
	HE80 Beam Forming, M0 to M9 3ss	4	5	-50.2	-58.4	-58.7	-56.4	0.3	-43.1	-41.25	1.84
	HE80 Beam Forming, M0 to M9 4ss	4	4	-47.0	-57.1	-57.7	-54.8	0.3	-41.4	-41.25	0.19
	HE80 STBC, M0 to M9 1ss	2	4	-47.0	-57.1			0.3	-42.3	-41.25	1.09
	HE80 STBC, M0 to M9 1ss	3	4	-47.0	-57.1	-57.7		0.3	-42.0	-41.25	0.76
	HE80 STBC, M0 to M9 1ss	4	4	-47.0	-57.1	-57.7	-54.8	0.3	-41.4	-41.25	0.19
5310	Non HT40, 6 to 54 Mbps	1	4	-45.4				0.0	-41.4	-41.25	0.11
	Non HT40, 6 to 54 Mbps	2	4	-47.9	-57.6			0.0	-43.4	-41.25	2.16
	Non HT40, 6 to 54 Mbps	3	4	-47.9	-57.6	-58.5		0.0	-43.1	-41.25	1.84
	Non HT40, 6 to 54 Mbps	4	4	-47.9	-57.6	-58.5	-55.2	0.0	-42.5	-41.25	1.21
	HT/VHT40, M0 to M7	1	4	-46.3				0.1	-42.2	-41.25	0.95
	HT/VHT40, M0 to M7	2	4	-46.3	-54.6			0.1	-41.6	-41.25	0.35
	HT/VHT40, M8 to M15	2	4	-46.3	-54.6			0.1	-41.6	-41.25	0.35
	HT/VHT40, M0 to M7	3	4	-46.3	-56.1	-57.6		0.1	-41.5	-41.25	0.23
	HT/VHT40, M8 to M15	3	4	-46.3	-56.1	-57.6		0.1	-41.5	-41.25	0.23
	HT/VHT40, M16 to M23	3	4	-46.3	-56.1	-57.6		0.1	-41.5	-41.25	0.23
	HT/VHT40, M0 to M7	4	4	-50.3	-58.2	-58.6	-55.4	0.1	-44.1	-41.25	2.85
	HT/VHT40, M8 to M15	4	4	-50.3	-58.2	-58.6	-55.4	0.1	-44.1	-41.25	2.85
	HT/VHT40, M16 to M23	4	4	-50.3	-58.2	-58.6	-55.4	0.1	-44.1	-41.25	2.85
	HT/VHT40, M24 to M31	4	4	-50.3	-58.2	-58.6	-55.4	0.1	-44.1	-41.25	2.85
	HT/VHT40 Beam Forming, M0 to M7	2	7	-50.3	-58.2			0.1	-42.5	-41.25	1.29
	HT/VHT40 Beam Forming, M8 to M15	2	4	-46.3	-54.6			0.1	-41.6	-41.25	0.35
	HT/VHT40 Beam Forming, M0 to M7	3	9	-53.4	-60.0	-59.6		0.1	-42.7	-41.25	1.41
	HT/VHT40 Beam Forming, M8 to M15	3	6	-50.3	-58.2	-58.6		0.1	-43.0	-41.25	1.77
	HT/VHT40 Beam Forming, M16 to M23	3	4	-46.3	-56.1	-57.6		0.1	-41.5	-41.25	0.23
	HT/VHT40 Beam Forming, M0 to M7	4	10	-56.8	-60.9	-61.0	-60.6	0.1	-43.3	-41.25	2.05
	HT/VHT40 Beam Forming, M8 to M15	4	7	-53.4	-60.0	-59.6	-58.6	0.1	-43.8	-41.25	2.59
HT/VHT40 Beam Forming, M16 to M23	4	5	-50.3	-58.2	-58.6	-55.4	0.1	-43.1	-41.25	1.85	
HT/VHT40 Beam Forming, M24 to M31	4	4	-50.3	-58.2	-58.6	-55.4	0.1	-44.1	-41.25	2.85	



	HT/VHT40 STBC, M0 to M7	2	4	-46.3	-54.6			0.1	-41.6	-41.25	0.35
	HT/VHT40 STBC, M0 to M7	3	4	-46.3	-56.1	-57.6		0.1	-41.5	-41.25	0.23
	HT/VHT40 STBC, M0 to M7	4	4	-50.3	-58.2	-58.6	-55.4	0.1	-44.1	-41.25	2.85
	HE40, M0 to M9 1ss	1	4	-47.9				0.1	-43.8	-41.25	2.52
	HE40, M0 to M9 1ss	2	4	-47.9	-57.2			0.1	-43.3	-41.25	2.04
	HE40, M0 to M9 2ss	2	4	-47.9	-57.2			0.1	-43.3	-41.25	2.04
	HE40, M0 to M9 1ss	3	4	-47.9	-57.2	-58.0		0.1	-42.9	-41.25	1.67
	HE40, M0 to M9 2ss	3	4	-47.9	-57.2	-58.0		0.1	-42.9	-41.25	1.67
	HE40, M0 to M9 3ss	3	4	-47.9	-57.2	-58.0		0.1	-42.9	-41.25	1.67
	HE40, M0 to M9 1ss	4	4	-47.9	-57.2	-58.0	-54.3	0.1	-42.2	-41.25	0.92
	HE40, M0 to M9 2ss	4	4	-47.9	-57.2	-58.0	-54.3	0.1	-42.2	-41.25	0.92
	HE40, M0 to M9 3ss	4	4	-47.9	-57.2	-58.0	-54.3	0.1	-42.2	-41.25	0.92
	HE40, M0 to M9 4ss	4	4	-47.9	-57.2	-58.0	-54.3	0.1	-42.2	-41.25	0.92
	HE40 Beam Forming, M0 to M9 1ss	2	7	-51.9	-58.9			0.1	-44.0	-41.25	2.73
	HE40 Beam Forming, M0 to M9 2ss	2	4	-47.9	-57.2			0.1	-43.3	-41.25	2.04
	<b>HE40 Beam Forming, M0 to M9 1ss</b>	<b>3</b>	<b>9</b>	<b>-51.9</b>	<b>-58.9</b>	<b>-58.8</b>		<b>0.1</b>	<b>-41.3</b>	<b>-41.25</b>	<b>0.05</b>
	HE40 Beam Forming, M0 to M9 2ss	3	6	-51.9	-58.9	-58.8		0.1	-44.3	-41.25	3.05
	HE40 Beam Forming, M0 to M9 3ss	3	4	-47.9	-57.2	-58.0		0.1	-42.9	-41.25	1.67
	HE40 Beam Forming, M0 to M9 1ss	4	10	-54.7	-60.5	-60.4	-59.9	0.1	-41.9	-41.25	0.69
	HE40 Beam Forming, M0 to M9 2ss	4	7	-51.9	-58.9	-58.8	-57.1	0.1	-42.5	-41.25	1.20
	HE40 Beam Forming, M0 to M9 3ss	4	5	-51.9	-58.9	-58.8	-57.1	0.1	-44.5	-41.25	3.20
	HE40 Beam Forming, M0 to M9 4ss	4	4	-47.9	-57.2	-58.0	-54.3	0.1	-42.2	-41.25	0.92
	HE40 STBC, M0 to M9 2ss	2	4	-47.9	-57.2			0.1	-43.3	-41.25	2.04
	HE40 STBC, M0 to M9 2ss	3	4	-47.9	-57.2	-58.0		0.1	-42.9	-41.25	1.67
	HE40 STBC, M0 to M9 2ss	4	4	-47.9	-57.2	-58.0	-54.3	0.1	-42.2	-41.25	0.92
5320	Non HT20, 6 to 54 Mbps	1	4	-58.2				0.0	-54.2	-41.25	12.91
	Non HT20, 6 to 54 Mbps	2	4	-58.2	-47.5			0.0	-43.1	-41.25	1.85
	Non HT20, 6 to 54 Mbps	3	4	-58.2	-53.4	-55.6		0.0	-46.5	-41.25	5.24
	Non HT20, 6 to 54 Mbps	4	4	-58.2	-58.4	-58.3	-58.8	0.0	-48.4	-41.25	7.10
	Non HT20 Beam Forming, 6 to 54 Mbps	2	7	-58.2	-50.9			0.0	-43.1	-41.25	1.86
	Non HT20 Beam Forming, 6 to 54 Mbps	3	9	-58.2	-53.4	-55.6		0.0	-41.5	-41.25	0.24
	Non HT20 Beam Forming, 6 to 54 Mbps	4	10	-58.2	-58.4	-58.3	-58.8	0.0	-42.4	-41.25	1.10
	HT/VHT20, M0 to M7	1	4	-59.5				0.1	-55.4	-41.25	14.20
	HT/VHT20, M0 to M7	2	4	-59.5	-49.8			0.1	-45.3	-41.25	4.06
	HT/VHT20, M8 to M15	2	4	-59.5	-49.8			0.1	-45.3	-41.25	4.06
	HT/VHT20, M0 to M7	3	4	-59.5	-53.8	-56.0		0.1	-47.0	-41.25	5.78
	HT/VHT20, M8 to M15	3	4	-59.5	-49.8	-52.4		0.1	-43.6	-41.25	2.31
	HT/VHT20, M16 to M23	3	4	-59.5	-49.8	-52.4		0.1	-43.6	-41.25	2.31
	HT/VHT20, M0 to M7	4	4	-59.5	-58.0	-58.5	-59.1	0.1	-48.7	-41.25	7.41
	HT/VHT20, M8 to M15	4	4	-59.5	-49.8	-52.4	-51.1	0.1	-41.9	-41.25	0.70
	HT/VHT20, M16 to M23	4	4	-59.5	-49.8	-52.4	-51.1	0.1	-41.9	-41.25	0.70



HT/VHT20, M24 to M31	4	4	-59.5	-49.8	-52.4	-51.1	0.1	-41.9	-41.25	0.70
HT/VHT20 Beam Forming, M0 to M7	2	7	-59.5	-49.8			0.1	-42.3	-41.25	1.06
HT/VHT20 Beam Forming, M8 to M15	2	4	-59.5	-49.8			0.1	-45.3	-41.25	4.06
HT/VHT20 Beam Forming, M0 to M7	3	9	-59.5	-53.8	-56.0		0.1	-42.0	-41.25	0.78
HT/VHT20 Beam Forming, M8 to M15	3	6	-59.5	-49.8	-52.4		0.1	-41.6	-41.25	0.31
HT/VHT20 Beam Forming, M16 to M23	3	4	-59.5	-49.8	-52.4		0.1	-43.6	-41.25	2.31
HT/VHT20 Beam Forming, M0 to M7	4	10	-59.5	-58.0	-58.5	-59.1	0.1	-42.7	-41.25	1.41
HT/VHT20 Beam Forming, M8 to M15	4	7	-59.5	-53.8	-56.0	-54.7	0.1	-42.5	-41.25	1.21
HT/VHT20 Beam Forming, M16 to M23	4	5	-59.5	-53.8	-56.0	-54.7	0.1	-44.5	-41.25	3.21
HT/VHT20 Beam Forming, M24 to M31	4	4	-59.5	-49.8	-52.4	-51.1	0.1	-41.9	-41.25	0.70
HT/VHT20 STBC, M0 to M7	2	4	-59.5	-49.8			0.1	-45.3	-41.25	4.06
HT/VHT20 STBC, M0 to M7	3	4	-59.5	-49.8	-52.4		0.1	-43.6	-41.25	2.31
HT/VHT20 STBC, M0 to M7	4	4	-59.5	-49.8	-52.4	-51.1	0.1	-41.9	-41.25	0.70
HE20, M0 to M9 1ss	1	4	-56.9				0.1	-52.8	-41.25	11.58
HE20, M0 to M9 1ss	2	4	-56.9	-48.5			0.1	-43.8	-41.25	2.59
HE20, M0 to M9 2ss	2	4	-56.9	-48.5			0.1	-43.8	-41.25	2.59
HE20, M0 to M9 1ss	3	4	-56.9	-51.3	-54.7		0.1	-44.8	-41.25	3.59
HE20, M0 to M9 2ss	3	4	-56.9	-48.5	-52.0		0.1	-42.4	-41.25	1.16
HE20, M0 to M9 3ss	3	4	-56.9	-48.5	-52.0		0.1	-42.4	-41.25	1.16
HE20, M0 to M9 1ss	4	4	-56.9	-58.2	-57.6	-57.4	0.1	-47.4	-41.25	6.16
HE20, M0 to M9 2ss	4	4	-56.9	-51.3	-54.7	-53.8	0.1	-43.6	-41.25	2.37
HE20, M0 to M9 3ss	4	4	-56.9	-51.3	-54.7	-53.8	0.1	-43.6	-41.25	2.37
HE20, M0 to M9 4ss	4	4	-56.9	-51.3	-54.7	-53.8	0.1	-43.6	-41.25	2.37
HE20 Beam Forming, M0 to M9 1ss	2	7	-56.9	-51.3			0.1	-43.2	-41.25	1.92
HE20 Beam Forming, M0 to M9 2ss	2	4	-56.9	-48.5			0.1	-43.8	-41.25	2.59
HE20 Beam Forming, M0 to M9 1ss	3	9	-56.9	-55.1	-57.1		0.1	-42.4	-41.25	1.18
HE20 Beam Forming, M0 to M9 2ss	3	6	-56.9	-51.3	-54.7		0.1	-42.8	-41.25	1.59
HE20 Beam Forming, M0 to M9 3ss	3	4	-56.9	-48.5	-52.0		0.1	-42.4	-41.25	1.16
HE20 Beam Forming, M0 to M9 1ss	4	10	-56.9	-58.2	-57.6	-57.4	0.1	-41.4	-41.25	0.16
HE20 Beam Forming, M0 to M9 2ss	4	7	-56.9	-55.1	-57.1	-56.3	0.1	-43.2	-41.25	1.94
HE20 Beam Forming, M0 to M9 3ss	4	5	-56.9	-51.3	-54.7	-53.8	0.1	-42.6	-41.25	1.37
HE20 Beam Forming, M0 to M9 4ss	4	4	-56.9	-51.3	-54.7	-53.8	0.1	-43.6	-41.25	2.37
HE20 STBC, M0 to M9 2ss	2	4	-56.9	-48.5			0.1	-43.8	-41.25	2.59
HE20 STBC, M0 to M9 2ss	3	4	-56.9	-48.5	-52.0		0.1	-42.4	-41.25	1.16
HE20 STBC, M0 to M9 2ss	4	4	-56.9	-51.3	-54.7	-53.8	0.1	-43.6	-41.25	2.37

52	Non HT160, 6 to 54 Mbps	1	4	-46.4				0.0	-42.4	-41.25	1.10
50	Non HT160, 6 to 54 Mbps	2	4	-46.4	-58.3			0.0	-42.1	-41.25	0.83



Non HT160, 6 to 54 Mbps	3	4	-46.4	-58.3	-59.1		0.0	-41.9	-41.25	0.62
Non HT160, 6 to 54 Mbps	4	4	-46.4	-58.3	-59.1	-54.6	0.0	-41.3	-41.25	0.06
VHT160, M0 to M9 1ss	1	4	-49.8				0.4	-45.4	-41.25	4.16
VHT160, M0 to M9 1ss	2	4	-49.8	-57.6			0.4	-44.7	-41.25	3.49
VHT160, M0 to M9 2ss	2	4	-49.8	-57.6			0.4	-44.7	-41.25	3.49
VHT160, M0 to M9 1ss	3	4	-49.8	-57.6	-60.6		0.4	-44.4	-41.25	3.19
VHT160, M0 to M9 2ss	3	4	-49.8	-57.6	-60.6		0.4	-44.4	-41.25	3.19
VHT160, M0 to M9 3ss	3	4	-49.8	-57.6	-60.6		0.4	-44.4	-41.25	3.19
VHT160, M0 to M9 1ss	4	4	-49.8	-57.6	-60.6	-58.9	0.4	-44.0	-41.25	2.78
VHT160, M0 to M9 2ss	4	4	-49.8	-57.6	-60.6	-58.9	0.4	-44.0	-41.25	2.78
VHT160, M0 to M9 3ss	4	4	-49.8	-57.6	-60.6	-58.9	0.4	-44.0	-41.25	2.78
VHT160, M0 to M9 4ss	4	4	-49.8	-57.6	-60.6	-58.9	0.4	-44.0	-41.25	2.78
VHT160 Beam Forming, M0 to M9 1ss	2	7	-51.5	-59.7			0.4	-43.5	-41.25	2.25
VHT160 Beam Forming, M0 to M9 2ss	2	4	-49.8	-57.6			0.4	-44.7	-41.25	3.49
VHT160 Beam Forming, M0 to M9 1ss	3	9	-54.8	-63.4	-62.8		0.4	-44.3	-41.25	3.03
VHT160 Beam Forming, M0 to M9 2ss	3	6	-49.8	-57.6	-60.6		0.4	-42.4	-41.25	1.19
VHT160 Beam Forming, M0 to M9 3ss	3	4	-49.8	-57.6	-60.6		0.4	-44.4	-41.25	3.19
VHT160 Beam Forming, M0 to M9 1ss	4	10	-54.8	-63.4	-62.8	-62.4	0.4	-42.7	-41.25	1.48
VHT160 Beam Forming, M0 to M9 2ss	4	7	-51.5	-59.7	-61.8	-61.1	0.4	-42.8	-41.25	1.54
VHT160 Beam Forming, M0 to M9 3ss	4	5	-49.8	-57.6	-60.6	-58.9	0.4	-43.0	-41.25	1.78
VHT160 Beam Forming, M0 to M9 4ss	4	4	-49.8	-57.6	-60.6	-58.9	0.4	-44.0	-41.25	2.78
VHT160 STBC, M0 to M9 1ss	2	4	-49.8	-57.6			0.4	-44.7	-41.25	3.49
VHT160 STBC, M0 to M9 1ss	3	4	-49.8	-57.6	-60.6		0.4	-44.4	-41.25	3.19
VHT160 STBC, M0 to M9 1ss	4	4	-49.8	-57.6	-60.6	-58.9	0.4	-44.0	-41.25	2.78
HE160, M0 to M9 1ss	1	4	-46.0				0.4	-41.6	-41.25	0.32
HE160, M0 to M9 1ss	2	4	-46.0	-58.4			0.4	-41.3	-41.25	0.07
HE160, M0 to M9 2ss	2	4	-46.0	-58.4			0.4	-41.3	-41.25	0.07
HE160, M0 to M9 1ss	3	4	-49.7	-60.6	-60.2		0.4	-44.6	-41.25	3.33
HE160, M0 to M9 2ss	3	4	-49.7	-60.6	-60.2		0.4	-44.6	-41.25	3.33
HE160, M0 to M9 3ss	3	4	-49.7	-60.6	-60.2		0.4	-44.6	-41.25	3.33
HE160, M0 to M9 1ss	4	4	-49.7	-60.6	-60.2	-58.1	0.4	-44.1	-41.25	2.83
HE160, M0 to M9 2ss	4	4	-49.7	-60.6	-60.2	-58.1	0.4	-44.1	-41.25	2.83
HE160, M0 to M9 3ss	4	4	-49.7	-60.6	-60.2	-58.1	0.4	-44.1	-41.25	2.83
HE160, M0 to M9 4ss	4	4	-49.7	-60.6	-60.2	-58.1	0.4	-44.1	-41.25	2.83
HE160 Beam Forming, M0 to M9 1ss	2	7	-49.7	-60.6			0.4	-41.9	-41.25	0.68
HE160 Beam Forming, M0 to M9 2ss	2	4	-46.0	-58.4			0.4	-41.3	-41.25	0.07
HE160 Beam Forming, M0 to M9 1ss	3	9	-52.9	-61.4	-61.5		0.4	-42.4	-41.25	1.15
HE160 Beam Forming, M0 to M9 2ss	3	6	-49.7	-60.6	-60.2		0.4	-42.6	-41.25	1.33
HE160 Beam Forming, M0 to M9 3ss	3	4	-49.7	-60.6	-60.2		0.4	-44.6	-41.25	3.33
HE160 Beam Forming, M0 to M9 1ss	4	10	-55.9	-63.1	-62.2	-61.7	0.4	-43.2	-41.25	1.94
HE160 Beam Forming, M0 to M9 2ss	4	7	-52.9	-61.4	-61.5	-60.4	0.4	-43.8	-41.25	2.58
HE160 Beam Forming, M0 to M9 3ss	4	5	-49.7	-60.6	-60.2	-58.1	0.4	-43.1	-41.25	1.83



HE160 Beam Forming, M0 to M9 4ss	4	4	-49.7	-60.6	-60.2	-58.1	0.4	-44.1	-41.25	2.83
HE160 STBC, M0 to M9 1ss	2	4	-46.0	-58.4			0.4	-41.3	-41.25	0.07
HE160 STBC, M0 to M9 1ss	3	4	-49.7	-60.6	-60.2		0.4	-44.6	-41.25	3.33
HE160 STBC, M0 to M9 1ss	4	4	-49.7	-60.6	-60.2	-58.1	0.4	-44.1	-41.25	2.83





**Conducted Bandedge Average, 4dBi**  
**5**  
**310 MHz, HE40 Beam Forming, M0 to M9 1ss**



**Antenna A**

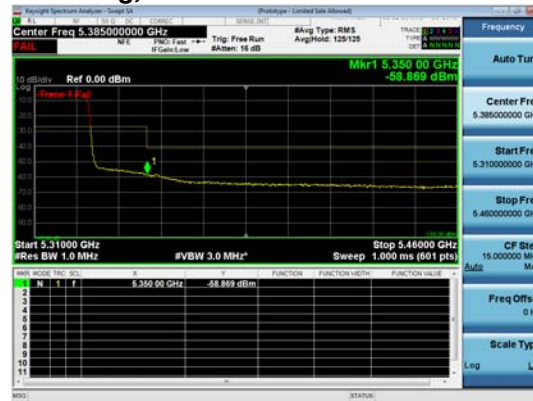

**Antenna B**



**Antenna C**



Conducted Bandedge Average Table, 5dBi

Frequency (MHz)	Mode	Tx Paths	Correlated Antenna Gain (dBi)	Tx 1 Bandedge Level (dBm)	Tx 2 Bandedge Level (dBm)	Tx 3 Bandedge Level (dBm)	Tx 4 Bandedge Level (dBm)	Duty Cycle Correction (dB)	Total Tx Bandedge Level (dBm)	Limit (dBm)	Margin (dB)
5290	Non HT80, 6 to 54 Mbps	1	5	-50.7				0.1	-45.6	-41.25	4.40
	Non HT80, 6 to 54 Mbps	2	5	-50.7	-59.6			0.1	-45.1	-41.25	3.87
	Non HT80, 6 to 54 Mbps	3	5	-50.7	-59.6	-57.4		0.1	-44.4	-41.25	3.12
	Non HT80, 6 to 54 Mbps	4	5	-50.7	-59.6	-57.4	-56.8	0.1	-43.6	-41.25	2.39
	VHT80, M0 to M9 1ss	1	5	-48.4				0.2	-43.2	-41.25	1.93
	VHT80, M0 to M9 1ss	2	5	-48.4	-57.6			0.2	-42.7	-41.25	1.44
	VHT80, M0 to M9 2ss	2	5	-48.4	-57.6			0.2	-42.7	-41.25	1.44
	VHT80, M0 to M9 1ss	3	5	-48.4	-57.6	-57.6		0.2	-42.2	-41.25	1.00
	VHT80, M0 to M9 2ss	3	5	-48.4	-57.6	-57.6		0.2	-42.2	-41.25	1.00
	VHT80, M0 to M9 3ss	3	5	-48.4	-57.6	-57.6		0.2	-42.2	-41.25	1.00
	VHT80, M0 to M9 1ss	4	5	-48.4	-57.6	-57.6	-55.0	0.2	-41.5	-41.25	0.29
	VHT80, M0 to M9 2ss	4	5	-48.4	-57.6	-57.6	-55.0	0.2	-41.5	-41.25	0.29
	VHT80, M0 to M9 3ss	4	5	-48.4	-57.6	-57.6	-55.0	0.2	-41.5	-41.25	0.29
	VHT80, M0 to M9 4ss	4	5	-48.4	-57.6	-57.6	-55.0	0.2	-41.5	-41.25	0.29
	VHT80 Beam Forming, M0 to M9 1ss	2	8	-51.1	-59.2			0.2	-42.3	-41.25	1.01
	VHT80 Beam Forming, M0 to M9 2ss	2	5	-48.4	-57.6			0.2	-42.7	-41.25	1.44
	VHT80 Beam Forming, M0 to M9 1ss	3	10	-54.6	-60.5	-59.3		0.2	-42.4	-41.25	1.10
	VHT80 Beam Forming, M0 to M9 2ss	3	7	-51.1	-59.2	-58.8		0.2	-42.7	-41.25	1.41
	VHT80 Beam Forming, M0 to M9 3ss	3	5	-48.4	-57.6	-57.6		0.2	-42.2	-41.25	1.00
	VHT80 Beam Forming, M0 to M9 1ss	4	11	-57.2	-62.0	-60.9	-60.7	0.2	-42.6	-41.25	1.30
	VHT80 Beam Forming, M0 to M9 2ss	4	8	-54.6	-60.5	-59.3	-60.0	0.2	-43.6	-41.25	2.38
	VHT80 Beam Forming, M0 to M9 3ss	4	6	-51.1	-59.2	-58.8	-57.4	0.2	-43.0	-41.25	1.71
	VHT80 Beam Forming, M0 to M9 4ss	4	5	-48.4	-57.6	-57.6	-55.0	0.2	-41.5	-41.25	0.29
	VHT80 STBC, M0 to M9 1ss	2	5	-48.4	-57.6			0.2	-42.7	-41.25	1.44
	VHT80 STBC, M0 to M9 1ss	3	5	-48.4	-57.6	-57.6		0.2	-42.2	-41.25	1.00
	VHT80 STBC, M0 to M9 1ss	4	5	-48.4	-57.6	-57.6	-55.0	0.2	-41.5	-41.25	0.29
	HE80, M0 to M9 1ss	1	5	-47.0				0.3	-41.7	-41.25	0.49
	HE80, M0 to M9 1ss	2	5	-47.0	-57.1			0.3	-41.3	-41.25	0.09



	HE80, M0 to M9 2ss	2	5	-47.0	-57.1			0.3	-41.3	-41.25	0.09
	HE80, M0 to M9 1ss	3	5	-50.2	-58.4	-58.7		0.3	-43.8	-41.25	2.58
	HE80, M0 to M9 2ss	3	5	-50.2	-58.4	-58.7		0.3	-43.8	-41.25	2.58
	HE80, M0 to M9 3ss	3	5	-50.2	-58.4	-58.7		0.3	-43.8	-41.25	2.58
	HE80, M0 to M9 1ss	4	5	-50.2	-58.4	-58.7	-56.4	0.3	-43.1	-41.25	1.84
	HE80, M0 to M9 2ss	4	5	-50.2	-58.4	-58.7	-56.4	0.3	-43.1	-41.25	1.84
	HE80, M0 to M9 3ss	4	5	-50.2	-58.4	-58.7	-56.4	0.3	-43.1	-41.25	1.84
	HE80, M0 to M9 4ss	4	5	-50.2	-58.4	-58.7	-56.4	0.3	-43.1	-41.25	1.84
	HE80 Beam Forming, M0 to M9 1ss	2	8	-50.2	-58.4			0.3	-41.3	-41.25	0.08
	HE80 Beam Forming, M0 to M9 2ss	2	5	-47.0	-57.1			0.3	-41.3	-41.25	0.09
	HE80 Beam Forming, M0 to M9 1ss	3	10	-53.8	-59.8	-59.6		0.3	-41.7	-41.25	0.49
	HE80 Beam Forming, M0 to M9 2ss	3	7	-50.2	-58.4	-58.7		0.3	-41.8	-41.25	0.58
	HE80 Beam Forming, M0 to M9 3ss	3	5	-50.2	-58.4	-58.7		0.3	-43.8	-41.25	2.58
	HE80 Beam Forming, M0 to M9 1ss	4	11	-57.1	-61.6	-60.3	-60.5	0.3	-42.2	-41.25	0.99
	HE80 Beam Forming, M0 to M9 2ss	4	8	-53.8	-59.8	-59.6	-58.7	0.3	-42.9	-41.25	1.65
	HE80 Beam Forming, M0 to M9 3ss	4	6	-50.2	-58.4	-58.7	-56.4	0.3	-42.1	-41.25	0.84
	HE80 Beam Forming, M0 to M9 4ss	4	5	-50.2	-58.4	-58.7	-56.4	0.3	-43.1	-41.25	1.84
	HE80 STBC, M0 to M9 1ss	2	5	-47.0	-57.1			0.3	-41.3	-41.25	0.09
	HE80 STBC, M0 to M9 1ss	3	5	-50.2	-58.4	-58.7		0.3	-43.8	-41.25	2.58
	HE80 STBC, M0 to M9 1ss	4	5	-50.2	-58.4	-58.7	-56.4	0.3	-43.1	-41.25	1.84
5310	Non HT40, 6 to 54 Mbps	1	5	-47.9				0.0	-42.9	-41.25	1.61
	Non HT40, 6 to 54 Mbps	2	5	-47.9	-57.6			0.0	-42.4	-41.25	1.16
	Non HT40, 6 to 54 Mbps	3	5	-47.9	-57.6	-58.5		0.0	-42.1	-41.25	0.84
	Non HT40, 6 to 54 Mbps	4	5	-47.9	-57.6	-58.5	-55.2	0.0	-41.5	-41.25	0.21
	HT/VHT40, M0 to M7	1	5	-50.3				0.1	-45.2	-41.25	3.95
	HT/VHT40, M0 to M7	2	5	-50.3	-58.2			0.1	-44.5	-41.25	3.29
	HT/VHT40, M8 to M15	2	5	-50.3	-58.2			0.1	-44.5	-41.25	3.29
	HT/VHT40, M0 to M7	3	5	-50.3	-58.2	-58.6		0.1	-44.0	-41.25	2.77
	HT/VHT40, M8 to M15	3	5	-50.3	-58.2	-58.6		0.1	-44.0	-41.25	2.77
	HT/VHT40, M16 to M23	3	5	-50.3	-58.2	-58.6		0.1	-44.0	-41.25	2.77
	HT/VHT40, M0 to M7	4	5	-50.3	-58.2	-58.6	-55.4	0.1	-43.1	-41.25	1.85
	HT/VHT40, M8 to M15	4	5	-50.3	-58.2	-58.6	-55.4	0.1	-43.1	-41.25	1.85
	HT/VHT40, M16 to M23	4	5	-50.3	-58.2	-58.6	-55.4	0.1	-43.1	-41.25	1.85
	HT/VHT40, M24 to M31	4	5	-50.3	-58.2	-58.6	-55.4	0.1	-43.1	-41.25	1.85
	HT/VHT40 Beam Forming, M0 to M7	2	8	-50.3	-58.2			0.1	-41.5	-41.25	0.29
	HT/VHT40 Beam Forming, M8 to M15	2	5	-50.3	-58.2			0.1	-44.5	-41.25	3.29
	HT/VHT40 Beam Forming, M0 to M7	3	10	-53.4	-60.0	-59.6		0.1	-41.7	-41.25	0.41
	HT/VHT40 Beam Forming, M8 to M15	3	7	-50.3	-58.2	-58.6		0.1	-42.0	-41.25	0.77
	HT/VHT40 Beam Forming, M16 to M23	3	5	-50.3	-58.2	-58.6		0.1	-44.0	-41.25	2.77
	HT/VHT40 Beam Forming, M0 to M7	4	11	-56.8	-60.9	-61.0	-60.6	0.1	-42.3	-41.25	1.05
HT/VHT40 Beam Forming, M8 to M15	4	8	-53.4	-60.0	-59.6	-58.6	0.1	-42.8	-41.25	1.59	



	HT/VHT40 Beam Forming, M16 to M23	4	6	-50.3	-58.2	-58.6	-55.4	0.1	-42.1	-41.25	0.85
	HT/VHT40 Beam Forming, M24 to M31	4	5	-50.3	-58.2	-58.6	-55.4	0.1	-43.1	-41.25	1.85
	HT/VHT40 STBC, M0 to M7	2	5	-50.3	-58.2			0.1	-44.5	-41.25	3.29
	HT/VHT40 STBC, M0 to M7	3	5	-50.3	-58.2	-58.6		0.1	-44.0	-41.25	2.77
	HT/VHT40 STBC, M0 to M7	4	5	-50.3	-58.2	-58.6	-55.4	0.1	-43.1	-41.25	1.85
	HE40, M0 to M9 1ss	1	5	-47.9				0.1	-42.8	-41.25	1.52
	HE40, M0 to M9 1ss	2	5	-47.9	-57.2			0.1	-42.3	-41.25	1.04
	HE40, M0 to M9 2ss	2	5	-47.9	-57.2			0.1	-42.3	-41.25	1.04
	HE40, M0 to M9 1ss	3	5	-47.9	-57.2	-58.0		0.1	-41.9	-41.25	0.67
	HE40, M0 to M9 2ss	3	5	-47.9	-57.2	-58.0		0.1	-41.9	-41.25	0.67
	HE40, M0 to M9 3ss	3	5	-47.9	-57.2	-58.0		0.1	-41.9	-41.25	0.67
	HE40, M0 to M9 1ss	4	5	-51.9	-58.9	-58.8	-57.1	0.1	-44.5	-41.25	3.20
	HE40, M0 to M9 2ss	4	5	-51.9	-58.9	-58.8	-57.1	0.1	-44.5	-41.25	3.20
	HE40, M0 to M9 3ss	4	5	-51.9	-58.9	-58.8	-57.1	0.1	-44.5	-41.25	3.20
	HE40, M0 to M9 4ss	4	5	-51.9	-58.9	-58.8	-57.1	0.1	-44.5	-41.25	3.20
	HE40 Beam Forming, M0 to M9 1ss	2	8	-51.9	-58.9			0.1	-43.0	-41.25	1.73
	HE40 Beam Forming, M0 to M9 2ss	2	5	-47.9	-57.2			0.1	-42.3	-41.25	1.04
	HE40 Beam Forming, M0 to M9 1ss	3	10	-54.7	-60.5	-60.4		0.1	-42.7	-41.25	1.47
	HE40 Beam Forming, M0 to M9 2ss	3	7	-51.9	-58.9	-58.8		0.1	-43.3	-41.25	2.05
	HE40 Beam Forming, M0 to M9 3ss	3	5	-47.9	-57.2	-58.0		0.1	-41.9	-41.25	0.67
	HE40 Beam Forming, M0 to M9 1ss	4	11	-56.8	-61.2	-61.4	-61.6	0.1	-42.6	-41.25	1.32
	HE40 Beam Forming, M0 to M9 2ss	4	8	-51.9	-58.9	-58.8	-57.1	0.1	-41.5	-41.25	0.20
	HE40 Beam Forming, M0 to M9 3ss	4	6	-51.9	-58.9	-58.8	-57.1	0.1	-43.5	-41.25	2.20
	HE40 Beam Forming, M0 to M9 4ss	4	5	-51.9	-58.9	-58.8	-57.1	0.1	-44.5	-41.25	3.20
	HE40 STBC, M0 to M9 2ss	2	5	-47.9	-57.2			0.1	-42.3	-41.25	1.04
	HE40 STBC, M0 to M9 2ss	3	5	-47.9	-57.2	-58.0		0.1	-41.9	-41.25	0.67
	HE40 STBC, M0 to M9 2ss	4	5	-51.9	-58.9	-58.8	-57.1	0.1	-44.5	-41.25	3.20
5320	Non HT20, 6 to 54 Mbps	1	5	-58.2				0.0	-53.2	-41.25	11.91
	Non HT20, 6 to 54 Mbps	2	5	-58.2	-47.5			0.0	-42.1	-41.25	0.85
	Non HT20, 6 to 54 Mbps	3	5	-58.2	-58.4	-58.3		0.0	-48.5	-41.25	7.23
	Non HT20, 6 to 54 Mbps	4	5	-61.3	-61.0	-61.7	-61.3	0.0	-50.3	-41.25	9.00
	Non HT20 Beam Forming, 6 to 54 Mbps	2	8	-58.2	-50.9			0.0	-42.1	-41.25	0.86
	Non HT20 Beam Forming, 6 to 54 Mbps	3	10	-58.2	-58.4	-58.3		0.0	-43.5	-41.25	2.23
	Non HT20 Beam Forming, 6 to 54 Mbps	4	11	-61.3	-61.0	-61.7	-61.3	0.0	-44.3	-41.25	3.00
	HT/VHT20, M0 to M7	1	5	-59.5				0.1	-54.4	-41.25	13.20
	HT/VHT20, M0 to M7	2	5	-59.5	-49.8			0.1	-44.3	-41.25	3.06
	HT/VHT20, M8 to M15	2	5	-59.5	-49.8			0.1	-44.3	-41.25	3.06
	HT/VHT20, M0 to M7	3	5	-59.5	-55.8	-57.4		0.1	-47.5	-41.25	6.24
	HT/VHT20, M8 to M15	3	5	-59.5	-49.8	-52.4		0.1	-42.6	-41.25	1.31
	HT/VHT20, M16 to M23	3	5	-59.5	-49.8	-52.4		0.1	-42.6	-41.25	1.31
HT/VHT20, M0 to M7	4	5	-59.5	-59.9	-60.3	-60.1	0.1	-48.9	-41.25	7.62	



HT/VHT20, M8 to M15	4	5	-59.5	-53.8	-56.0	-54.7	0.1	-44.5	-41.25	3.21
HT/VHT20, M16 to M23	4	5	-59.5	-53.8	-56.0	-54.7	0.1	-44.5	-41.25	3.21
HT/VHT20, M24 to M31	4	5	-59.5	-53.8	-56.0	-54.7	0.1	-44.5	-41.25	3.21
<b>HT/VHT20 Beam Forming, M0 to M7</b>	<b>2</b>	<b>8</b>	<b>-59.5</b>	<b>-49.8</b>			<b>0.1</b>	<b>-41.3</b>	<b>-41.25</b>	<b>0.06</b>
HT/VHT20 Beam Forming, M8 to M15	2	5	-59.5	-49.8			0.1	-44.3	-41.25	3.06
HT/VHT20 Beam Forming, M0 to M7	3	10	-59.5	-55.8	-57.4		0.1	-42.5	-41.25	1.24
HT/VHT20 Beam Forming, M8 to M15	3	7	-59.5	-53.8	-56.0		0.1	-44.0	-41.25	2.78
HT/VHT20 Beam Forming, M16 to M23	3	5	-59.5	-49.8	-52.4		0.1	-42.6	-41.25	1.31
HT/VHT20 Beam Forming, M0 to M7	4	11	-59.5	-59.9	-60.3	-60.1	0.1	-42.9	-41.25	1.62
HT/VHT20 Beam Forming, M8 to M15	4	8	-59.5	-53.8	-56.0	-54.7	0.1	-41.5	-41.25	0.21
HT/VHT20 Beam Forming, M16 to M23	4	6	-59.5	-53.8	-56.0	-54.7	0.1	-43.5	-41.25	2.21
HT/VHT20 Beam Forming, M24 to M31	4	5	-59.5	-53.8	-56.0	-54.7	0.1	-44.5	-41.25	3.21
HT/VHT20 STBC, M0 to M7	2	5	-59.5	-49.8			0.1	-44.3	-41.25	3.06
HT/VHT20 STBC, M0 to M7	3	5	-59.5	-49.8	-52.4		0.1	-42.6	-41.25	1.31
HT/VHT20 STBC, M0 to M7	4	5	-59.5	-53.8	-56.0	-54.7	0.1	-44.5	-41.25	3.21
HE20, M0 to M9 1ss	1	5	-56.9				0.1	-51.8	-41.25	10.58
HE20, M0 to M9 1ss	2	5	-56.9	-48.5			0.1	-42.8	-41.25	1.59
HE20, M0 to M9 2ss	2	5	-56.9	-48.5			0.1	-42.8	-41.25	1.59
HE20, M0 to M9 1ss	3	5	-56.9	-55.1	-57.1		0.1	-46.4	-41.25	5.18
HE20, M0 to M9 2ss	3	5	-56.9	-48.5	-52.0		0.1	-41.4	-41.25	0.16
HE20, M0 to M9 3ss	3	5	-56.9	-48.5	-52.0		0.1	-41.4	-41.25	0.16
HE20, M0 to M9 1ss	4	5	-56.9	-59.1	-59.5	-59.2	0.1	-47.5	-41.25	6.20
HE20, M0 to M9 2ss	4	5	-56.9	-51.3	-54.7	-53.8	0.1	-42.6	-41.25	1.37
HE20, M0 to M9 3ss	4	5	-56.9	-51.3	-54.7	-53.8	0.1	-42.6	-41.25	1.37
HE20, M0 to M9 4ss	4	5	-56.9	-51.3	-54.7	-53.8	0.1	-42.6	-41.25	1.37
HE20 Beam Forming, M0 to M9 1ss	2	8	-56.9	-51.3			0.1	-42.2	-41.25	0.92
HE20 Beam Forming, M0 to M9 2ss	2	5	-56.9	-48.5			0.1	-42.8	-41.25	1.59
HE20 Beam Forming, M0 to M9 1ss	3	10	-56.9	-55.1	-57.1		0.1	-41.4	-41.25	0.18
HE20 Beam Forming, M0 to M9 2ss	3	7	-56.9	-51.3	-54.7		0.1	-41.8	-41.25	0.59
HE20 Beam Forming, M0 to M9 3ss	3	5	-56.9	-48.5	-52.0		0.1	-41.4	-41.25	0.16
HE20 Beam Forming, M0 to M9 1ss	4	11	-56.9	-59.1	-59.5	-59.2	0.1	-41.5	-41.25	0.20
HE20 Beam Forming, M0 to M9 2ss	4	8	-56.9	-55.1	-57.1	-56.3	0.1	-42.2	-41.25	0.94
HE20 Beam Forming, M0 to M9 3ss	4	6	-56.9	-51.3	-54.7	-53.8	0.1	-41.6	-41.25	0.37
HE20 Beam Forming, M0 to M9 4ss	4	5	-56.9	-51.3	-54.7	-53.8	0.1	-42.6	-41.25	1.37
HE20 STBC, M0 to M9 2ss	2	5	-56.9	-48.5			0.1	-42.8	-41.25	1.59
HE20 STBC, M0 to M9 2ss	3	5	-56.9	-48.5	-52.0		0.1	-41.4	-41.25	0.16
HE20 STBC, M0 to M9 2ss	4	5	-56.9	-51.3	-54.7	-53.8	0.1	-42.6	-41.25	1.37



5250	Non HT160, 6 to 54 Mbps	1	5	-46.4				0.0	-41.4	-41.25	0.10
	Non HT160, 6 to 54 Mbps	2	5	-50.2	-60.0			0.0	-44.7	-41.25	3.47
	Non HT160, 6 to 54 Mbps	3	5	-50.2	-60.0	-60.3		0.0	-44.4	-41.25	3.10
	Non HT160, 6 to 54 Mbps	4	5	-50.2	-60.0	-60.3	-57.0	0.0	-43.7	-41.25	2.40
	VHT160, M0 to M9 1ss	1	5	-49.8				0.4	-44.4	-41.25	3.16
	VHT160, M0 to M9 1ss	2	5	-49.8	-57.6			0.4	-43.7	-41.25	2.49
	VHT160, M0 to M9 2ss	2	5	-49.8	-57.6			0.4	-43.7	-41.25	2.49
	VHT160, M0 to M9 1ss	3	5	-49.8	-57.6	-60.6		0.4	-43.4	-41.25	2.19
	VHT160, M0 to M9 2ss	3	5	-49.8	-57.6	-60.6		0.4	-43.4	-41.25	2.19
	VHT160, M0 to M9 3ss	3	5	-49.8	-57.6	-60.6		0.4	-43.4	-41.25	2.19
	VHT160, M0 to M9 1ss	4	5	-49.8	-57.6	-60.6	-58.9	0.4	-43.0	-41.25	1.78
	VHT160, M0 to M9 2ss	4	5	-49.8	-57.6	-60.6	-58.9	0.4	-43.0	-41.25	1.78
	VHT160, M0 to M9 3ss	4	5	-49.8	-57.6	-60.6	-58.9	0.4	-43.0	-41.25	1.78
	VHT160, M0 to M9 4ss	4	5	-49.8	-57.6	-60.6	-58.9	0.4	-43.0	-41.25	1.78
	VHT160 Beam Forming, M0 to M9 1ss	2	8	-51.5	-59.7			0.4	-42.5	-41.25	1.25
	VHT160 Beam Forming, M0 to M9 2ss	2	5	-49.8	-57.6			0.4	-43.7	-41.25	2.49
	VHT160 Beam Forming, M0 to M9 1ss	3	10	-54.8	-63.4	-62.8		0.4	-43.3	-41.25	2.03
	VHT160 Beam Forming, M0 to M9 2ss	3	7	-51.5	-59.7	-61.8		0.4	-43.2	-41.25	1.91
	VHT160 Beam Forming, M0 to M9 3ss	3	5	-49.8	-57.6	-60.6		0.4	-43.4	-41.25	2.19
	VHT160 Beam Forming, M0 to M9 1ss	4	11	-56.5	-62.3	-63.4	-63.2	0.4	-42.9	-41.25	1.60
	VHT160 Beam Forming, M0 to M9 2ss	4	8	-51.5	-59.7	-61.8	-61.1	0.4	-41.8	-41.25	0.54
	VHT160 Beam Forming, M0 to M9 3ss	4	6	-51.5	-59.7	-61.8	-61.1	0.4	-43.8	-41.25	2.54
	VHT160 Beam Forming, M0 to M9 4ss	4	5	-49.8	-57.6	-60.6	-58.9	0.4	-43.0	-41.25	1.78
	VHT160 STBC, M0 to M9 1ss	2	5	-49.8	-57.6			0.4	-43.7	-41.25	2.49
	VHT160 STBC, M0 to M9 1ss	3	5	-49.8	-57.6	-60.6		0.4	-43.4	-41.25	2.19
	VHT160 STBC, M0 to M9 1ss	4	5	-49.8	-57.6	-60.6	-58.9	0.4	-43.0	-41.25	1.78
	HE160, M0 to M9 1ss	1	5	-49.7				0.4	-44.3	-41.25	3.02
	HE160, M0 to M9 1ss	2	5	-49.7	-60.6			0.4	-43.9	-41.25	2.68
	HE160, M0 to M9 2ss	2	5	-49.7	-60.6			0.4	-43.9	-41.25	2.68
	HE160, M0 to M9 1ss	3	5	-49.7	-60.6	-60.2		0.4	-43.6	-41.25	2.33
	HE160, M0 to M9 2ss	3	5	-49.7	-60.6	-60.2		0.4	-43.6	-41.25	2.33
	HE160, M0 to M9 3ss	3	5	-49.7	-60.6	-60.2		0.4	-43.6	-41.25	2.33
	HE160, M0 to M9 1ss	4	5	-49.7	-60.6	-60.2	-58.1	0.4	-43.1	-41.25	1.83
	HE160, M0 to M9 2ss	4	5	-49.7	-60.6	-60.2	-58.1	0.4	-43.1	-41.25	1.83
	HE160, M0 to M9 3ss	4	5	-49.7	-60.6	-60.2	-58.1	0.4	-43.1	-41.25	1.83
	HE160, M0 to M9 4ss	4	5	-49.7	-60.6	-60.2	-58.1	0.4	-43.1	-41.25	1.83
	HE160 Beam Forming, M0 to M9 1ss	2	8	-52.9	-61.4			0.4	-43.9	-41.25	2.64
	HE160 Beam Forming, M0 to M9 2ss	2	5	-49.7	-60.6			0.4	-43.9	-41.25	2.68
	HE160 Beam Forming, M0 to M9 1ss	3	10	-52.9	-61.4	-61.5		0.4	-41.4	-41.25	0.15
	HE160 Beam Forming, M0 to M9 2ss	3	7	-49.7	-60.6	-60.2		0.4	-41.6	-41.25	0.33
HE160 Beam Forming, M0 to M9 3ss	3	5	-49.7	-60.6	-60.2		0.4	-43.6	-41.25	2.33	
HE160 Beam Forming, M0 to M9 1ss	4	11	-55.9	-63.1	-62.2	-61.7	0.4	-42.2	-41.25	0.94	



HE160 Beam Forming, M0 to M9 2ss	4	8	-52.9	-61.4	-61.5	-60.4	0.4	-42.8	-41.25	1.58
HE160 Beam Forming, M0 to M9 3ss	4	6	-49.7	-60.6	-60.2	-58.1	0.4	-42.1	-41.25	0.83
HE160 Beam Forming, M0 to M9 4ss	4	5	-49.7	-60.6	-60.2	-58.1	0.4	-43.1	-41.25	1.83
HE160 STBC, M0 to M9 1ss	2	5	-49.7	-60.6			0.4	-43.9	-41.25	2.68
HE160 STBC, M0 to M9 1ss	3	5	-49.7	-60.6	-60.2		0.4	-43.6	-41.25	2.33
HE160 STBC, M0 to M9 1ss	4	5	-49.7	-60.6	-60.2	-58.1	0.4	-43.1	-41.25	1.83





**Conducted Bandedge Average, 5dBi  
5320 MHz, HT/VHT20 Beam Forming, M0 to M7**



**Antenna A**

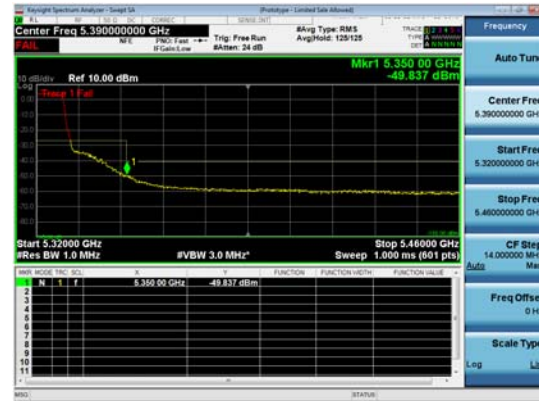

**Antenna B**



## Conducted Bandedge Average Table, 6dBi

Frequency (MHz)	Mode	Tx Paths	Correlated Antenna Gain (dBi)	Tx 1 Bandedge Level (dBm)	Tx 2 Bandedge Level (dBm)	Tx 3 Bandedge Level (dBm)	Tx 4 Bandedge Level (dBm)	Duty Cycle Correction (dB)	Total Tx Bandedge Level (dBm)	Limit (dBm)	Margin (dB)	
5290	Non HT80, 6 to 54 Mbps	1	6	-50.7				0.1	-44.6	-41.25	3.40	
	Non HT80, 6 to 54 Mbps	2	6	-50.7	-59.6			0.1	-44.1	-41.25	2.87	
	Non HT80, 6 to 54 Mbps	3	6	-50.7	-59.6	-57.4		0.1	-43.4	-41.25	2.12	
	Non HT80, 6 to 54 Mbps	4	6	-50.7	-59.6	-57.4	-56.8	0.1	-42.6	-41.25	1.39	
	VHT80, M0 to M9 1ss	1	6	-48.4				0.2	-42.2	-41.25	0.93	
	VHT80, M0 to M9 1ss	2	6	-48.4	-57.6			0.2	-41.7	-41.25	0.44	
	VHT80, M0 to M9 2ss	2	6	-48.4	-57.6			0.2	-41.7	-41.25	0.44	
	VHT80, M0 to M9 1ss	3	6	-51.1	-59.2	-58.8		0.2	-43.7	-41.25	2.41	
	VHT80, M0 to M9 2ss	3	6	-51.1	-59.2	-58.8		0.2	-43.7	-41.25	2.41	
	VHT80, M0 to M9 3ss	3	6	-51.1	-59.2	-58.8		0.2	-43.7	-41.25	2.41	
	VHT80, M0 to M9 1ss	4	6	-51.1	-59.2	-58.8	-57.4	0.2	-43.0	-41.25	1.71	
	VHT80, M0 to M9 2ss	4	6	-51.1	-59.2	-58.8	-57.4	0.2	-43.0	-41.25	1.71	
	VHT80, M0 to M9 3ss	4	6	-51.1	-59.2	-58.8	-57.4	0.2	-43.0	-41.25	1.71	
	VHT80, M0 to M9 4ss	4	6	-51.1	-59.2	-58.8	-57.4	0.2	-43.0	-41.25	1.71	
	<b>VHT80 Beam Forming, M0 to M9 1ss</b>	<b>2</b>	<b>9</b>	<b>-51.1</b>	<b>-59.2</b>				<b>0.2</b>	<b>-41.3</b>	<b>-41.25</b>	<b>0.01</b>
	VHT80 Beam Forming, M0 to M9 2ss	2	6	-48.4	-57.6				0.2	-41.7	-41.25	0.44
	VHT80 Beam Forming, M0 to M9 1ss	3	11	-54.6	-60.5	-59.3			0.2	-41.4	-41.25	0.10
	VHT80 Beam Forming, M0 to M9 2ss	3	8	-51.1	-59.2	-58.8			0.2	-41.7	-41.25	0.41
	VHT80 Beam Forming, M0 to M9 3ss	3	6	-51.1	-59.2	-58.8			0.2	-43.7	-41.25	2.41
	VHT80 Beam Forming, M0 to M9 1ss	4	12	-57.2	-62.0	-60.9	-60.7		0.2	-41.6	-41.25	0.30
	VHT80 Beam Forming, M0 to M9 2ss	4	9	-54.6	-60.5	-59.3	-60.0		0.2	-42.6	-41.25	1.38
	VHT80 Beam Forming, M0 to M9 3ss	4	7	-51.1	-59.2	-58.8	-57.4		0.2	-42.0	-41.25	0.71
	VHT80 Beam Forming, M0 to M9 4ss	4	6	-51.1	-59.2	-58.8	-57.4		0.2	-43.0	-41.25	1.71
	VHT80 STBC, M0 to M9 1ss	2	6	-48.4	-57.6				0.2	-41.7	-41.25	0.44
	VHT80 STBC, M0 to M9 1ss	3	6	-51.1	-59.2	-58.8			0.2	-43.7	-41.25	2.41
	VHT80 STBC, M0 to M9 1ss	4	6	-51.1	-59.2	-58.8	-57.4		0.2	-43.0	-41.25	1.71
	HE80, M0 to M9 1ss	1	6	-50.2					0.3	-43.9	-41.25	2.69



	HE80, M0 to M9 1ss	2	6	-50.2	-58.4			0.3	-43.3	-41.25	2.08
	HE80, M0 to M9 2ss	2	6	-50.2	-58.4			0.3	-43.3	-41.25	2.08
	HE80, M0 to M9 1ss	3	6	-50.2	-58.4	-58.7		0.3	-42.8	-41.25	1.58
	HE80, M0 to M9 2ss	3	6	-50.2	-58.4	-58.7		0.3	-42.8	-41.25	1.58
	HE80, M0 to M9 3ss	3	6	-50.2	-58.4	-58.7		0.3	-42.8	-41.25	1.58
	HE80, M0 to M9 1ss	4	6	-50.2	-58.4	-58.7	-56.4	0.3	-42.1	-41.25	0.84
	HE80, M0 to M9 2ss	4	6	-50.2	-58.4	-58.7	-56.4	0.3	-42.1	-41.25	0.84
	HE80, M0 to M9 3ss	4	6	-50.2	-58.4	-58.7	-56.4	0.3	-42.1	-41.25	0.84
	HE80, M0 to M9 4ss	4	6	-50.2	-58.4	-58.7	-56.4	0.3	-42.1	-41.25	0.84
	HE80 Beam Forming, M0 to M9 1ss	2	9	-53.8	-59.8			0.3	-43.6	-41.25	2.32
	HE80 Beam Forming, M0 to M9 2ss	2	6	-50.2	-58.4			0.3	-43.3	-41.25	2.08
	HE80 Beam Forming, M0 to M9 1ss	3	11	-57.1	-61.6	-60.3		0.3	-43.2	-41.25	1.96
	HE80 Beam Forming, M0 to M9 2ss	3	8	-53.8	-59.8	-59.6		0.3	-43.7	-41.25	2.49
	HE80 Beam Forming, M0 to M9 3ss	3	6	-50.2	-58.4	-58.7		0.3	-42.8	-41.25	1.58
	HE80 Beam Forming, M0 to M9 1ss	4	12	-58.4	-62.4	-61.3	-62.2	0.3	-42.5	-41.25	1.22
	HE80 Beam Forming, M0 to M9 2ss	4	9	-53.8	-59.8	-59.6	-58.7	0.3	-41.9	-41.25	0.65
	HE80 Beam Forming, M0 to M9 3ss	4	7	-53.8	-59.8	-59.6	-58.7	0.3	-43.9	-41.25	2.65
	HE80 Beam Forming, M0 to M9 4ss	4	6	-50.2	-58.4	-58.7	-56.4	0.3	-42.1	-41.25	0.84
	HE80 STBC, M0 to M9 1ss	2	6	-50.2	-58.4			0.3	-43.3	-41.25	2.08
	HE80 STBC, M0 to M9 1ss	3	6	-50.2	-58.4	-58.7		0.3	-42.8	-41.25	1.58
	HE80 STBC, M0 to M9 1ss	4	6	-50.2	-58.4	-58.7	-56.4	0.3	-42.1	-41.25	0.84
5310	Non HT40, 6 to 54 Mbps	1	6	-47.9				0.0	-41.9	-41.25	0.61
	Non HT40, 6 to 54 Mbps	2	6	-47.9	-57.6			0.0	-41.4	-41.25	0.16
	Non HT40, 6 to 54 Mbps	3	6	-51.6	-58.2	-58.7		0.0	-44.1	-41.25	2.80
	Non HT40, 6 to 54 Mbps	4	6	-51.6	-58.2	-58.7	-57.6	0.0	-43.3	-41.25	2.09
	HT/VHT40, M0 to M7	1	6	-50.3				0.1	-44.2	-41.25	2.95
	HT/VHT40, M0 to M7	2	6	-50.3	-58.2			0.1	-43.5	-41.25	2.29
	HT/VHT40, M8 to M15	2	6	-50.3	-58.2			0.1	-43.5	-41.25	2.29
	HT/VHT40, M0 to M7	3	6	-50.3	-58.2	-58.6		0.1	-43.0	-41.25	1.77
	HT/VHT40, M8 to M15	3	6	-50.3	-58.2	-58.6		0.1	-43.0	-41.25	1.77
	HT/VHT40, M16 to M23	3	6	-50.3	-58.2	-58.6		0.1	-43.0	-41.25	1.77
	HT/VHT40, M0 to M7	4	6	-50.3	-58.2	-58.6	-55.4	0.1	-42.1	-41.25	0.85
	HT/VHT40, M8 to M15	4	6	-50.3	-58.2	-58.6	-55.4	0.1	-42.1	-41.25	0.85
	HT/VHT40, M16 to M23	4	6	-50.3	-58.2	-58.6	-55.4	0.1	-42.1	-41.25	0.85
	HT/VHT40, M24 to M31	4	6	-50.3	-58.2	-58.6	-55.4	0.1	-42.1	-41.25	0.85
	HT/VHT40 Beam Forming, M0 to M7	2	9	-53.4	-60.0			0.1	-43.4	-41.25	2.19
	HT/VHT40 Beam Forming, M8 to M15	2	6	-50.3	-58.2			0.1	-43.5	-41.25	2.29
	HT/VHT40 Beam Forming, M0 to M7	3	11	-56.8	-60.9	-61.0		0.1	-43.2	-41.25	1.97
	HT/VHT40 Beam Forming, M8 to M15	3	8	-53.4	-60.0	-59.6		0.1	-43.7	-41.25	2.41
	HT/VHT40 Beam Forming, M16 to M23	3	6	-50.3	-58.2	-58.6		0.1	-43.0	-41.25	1.77
	HT/VHT40 Beam Forming, M0 to M7	4	12	-56.8	-60.9	-61.0	-60.6	0.1	-41.3	-41.25	0.05



	HT/VHT40 Beam Forming, M8 to M15	4	9	-53.4	-60.0	-59.6	-58.6	0.1	-41.8	-41.25	0.59
	HT/VHT40 Beam Forming, M16 to M23	4	7	-53.4	-60.0	-59.6	-58.6	0.1	-43.8	-41.25	2.59
	HT/VHT40 Beam Forming, M24 to M31	4	6	-50.3	-58.2	-58.6	-55.4	0.1	-42.1	-41.25	0.85
	HT/VHT40 STBC, M0 to M7	2	6	-50.3	-58.2			0.1	-43.5	-41.25	2.29
	HT/VHT40 STBC, M0 to M7	3	6	-50.3	-58.2	-58.6		0.1	-43.0	-41.25	1.77
	HT/VHT40 STBC, M0 to M7	4	6	-50.3	-58.2	-58.6	-55.4	0.1	-42.1	-41.25	0.85
	HE40, M0 to M9 1ss	1	6	-47.9				0.1	-41.8	-41.25	0.52
	HE40, M0 to M9 1ss	2	6	-47.9	-57.2			0.1	-41.3	-41.25	0.04
	HE40, M0 to M9 2ss	2	6	-47.9	-57.2			0.1	-41.3	-41.25	0.04
	HE40, M0 to M9 1ss	3	6	-51.9	-58.9	-58.8		0.1	-44.3	-41.25	3.05
	HE40, M0 to M9 2ss	3	6	-51.9	-58.9	-58.8		0.1	-44.3	-41.25	3.05
	HE40, M0 to M9 3ss	3	6	-51.9	-58.9	-58.8		0.1	-44.3	-41.25	3.05
	HE40, M0 to M9 1ss	4	6	-51.9	-58.9	-58.8	-57.1	0.1	-43.5	-41.25	2.20
	HE40, M0 to M9 2ss	4	6	-51.9	-58.9	-58.8	-57.1	0.1	-43.5	-41.25	2.20
	HE40, M0 to M9 3ss	4	6	-51.9	-58.9	-58.8	-57.1	0.1	-43.5	-41.25	2.20
	HE40, M0 to M9 4ss	4	6	-51.9	-58.9	-58.8	-57.1	0.1	-43.5	-41.25	2.20
	HE40 Beam Forming, M0 to M9 1ss	2	9	-51.9	-58.9			0.1	-42.0	-41.25	0.73
	HE40 Beam Forming, M0 to M9 2ss	2	6	-47.9	-57.2			0.1	-41.3	-41.25	0.04
	HE40 Beam Forming, M0 to M9 1ss	3	11	-54.7	-60.5	-60.4		0.1	-41.7	-41.25	0.47
	HE40 Beam Forming, M0 to M9 2ss	3	8	-51.9	-58.9	-58.8		0.1	-42.3	-41.25	1.05
	HE40 Beam Forming, M0 to M9 3ss	3	6	-51.9	-58.9	-58.8		0.1	-44.3	-41.25	3.05
	HE40 Beam Forming, M0 to M9 1ss	4	12	-56.8	-61.2	-61.4	-61.6	0.1	-41.6	-41.25	0.32
	HE40 Beam Forming, M0 to M9 2ss	4	9	-54.7	-60.5	-60.4	-59.9	0.1	-42.9	-41.25	1.69
	HE40 Beam Forming, M0 to M9 3ss	4	7	-51.9	-58.9	-58.8	-57.1	0.1	-42.5	-41.25	1.20
	HE40 Beam Forming, M0 to M9 4ss	4	6	-51.9	-58.9	-58.8	-57.1	0.1	-43.5	-41.25	2.20
	HE40 STBC, M0 to M9 2ss	2	6	-47.9	-57.2			0.1	-41.3	-41.25	0.04
	HE40 STBC, M0 to M9 2ss	3	6	-51.9	-58.9	-58.8		0.1	-44.3	-41.25	3.05
	HE40 STBC, M0 to M9 2ss	4	6	-51.9	-58.9	-58.8	-57.1	0.1	-43.5	-41.25	2.20
5320	Non HT20, 6 to 54 Mbps	1	6	-58.2				0.0	-52.2	-41.25	10.91
	Non HT20, 6 to 54 Mbps	2	6	-58.2	-50.9			0.0	-44.1	-41.25	2.86
	Non HT20, 6 to 54 Mbps	3	6	-58.2	-58.4	-58.3		0.0	-47.5	-41.25	6.23
	Non HT20, 6 to 54 Mbps	4	6	-62.3	-62.7	-62.4	-62.2	0.0	-50.3	-41.25	9.08
	Non HT20 Beam Forming, 6 to 54 Mbps	2	9	-58.2	-53.4			0.0	-43.1	-41.25	1.86
	Non HT20 Beam Forming, 6 to 54 Mbps	3	11	-58.2	-58.4	-58.3		0.0	-42.5	-41.25	1.23
	Non HT20 Beam Forming, 6 to 54 Mbps	4	12	-62.3	-62.7	-62.4	-62.2	0.0	-44.3	-41.25	3.08
	HT/VHT20, M0 to M7	1	6	-59.5				0.1	-53.4	-41.25	12.20
	HT/VHT20, M0 to M7	2	6	-59.5	-49.8			0.1	-43.3	-41.25	2.06
	HT/VHT20, M8 to M15	2	6	-59.5	-49.8			0.1	-43.3	-41.25	2.06
	HT/VHT20, M0 to M7	3	6	-59.5	-58.0	-58.5		0.1	-47.8	-41.25	6.55
	HT/VHT20, M8 to M15	3	6	-59.5	-49.8	-52.4		0.1	-41.6	-41.25	0.31
	HT/VHT20, M16 to M23	3	6	-59.5	-49.8	-52.4		0.1	-41.6	-41.25	0.31



HT/VHT20, M0 to M7	4	6	-60.5	-61.4	-61.4	-61.3	0.1	-49.1	-41.25	7.81
HT/VHT20, M8 to M15	4	6	-59.5	-55.8	-57.4	-57.1	0.1	-45.2	-41.25	3.93
HT/VHT20, M16 to M23	4	6	-59.5	-53.8	-56.0	-54.7	0.1	-43.5	-41.25	2.21
HT/VHT20, M24 to M31	4	6	-59.5	-53.8	-56.0	-54.7	0.1	-43.5	-41.25	2.21
HT/VHT20 Beam Forming, M0 to M7	2	9	-59.5	-53.8			0.1	-43.7	-41.25	2.46
HT/VHT20 Beam Forming, M8 to M15	2	6	-59.5	-49.8			0.1	-43.3	-41.25	2.06
HT/VHT20 Beam Forming, M0 to M7	3	11	-59.5	-58.0	-58.5		0.1	-42.8	-41.25	1.55
HT/VHT20 Beam Forming, M8 to M15	3	8	-59.5	-53.8	-56.0		0.1	-43.0	-41.25	1.78
HT/VHT20 Beam Forming, M16 to M23	3	6	-59.5	-49.8	-52.4		0.1	-41.6	-41.25	0.31
HT/VHT20 Beam Forming, M0 to M7	4	12	-60.5	-61.4	-61.4	-61.3	0.1	-43.1	-41.25	1.81
HT/VHT20 Beam Forming, M8 to M15	4	9	-59.5	-55.8	-57.4	-57.1	0.1	-42.2	-41.25	0.93
HT/VHT20 Beam Forming, M16 to M23	4	7	-59.5	-53.8	-56.0	-54.7	0.1	-42.5	-41.25	1.21
HT/VHT20 Beam Forming, M24 to M31	4	6	-59.5	-53.8	-56.0	-54.7	0.1	-43.5	-41.25	2.21
HT/VHT20 STBC, M0 to M7	2	6	-59.5	-49.8			0.1	-43.3	-41.25	2.06
HT/VHT20 STBC, M0 to M7	3	6	-59.5	-49.8	-52.4		0.1	-41.6	-41.25	0.31
HT/VHT20 STBC, M0 to M7	4	6	-59.5	-55.8	-57.4	-57.1	0.1	-45.2	-41.25	3.93
HE20, M0 to M9 1ss	1	6	-56.9				0.1	-50.8	-41.25	9.58
HE20, M0 to M9 1ss	2	6	-56.9	-48.5			0.1	-41.8	-41.25	0.59
HE20, M0 to M9 2ss	2	6	-56.9	-48.5			0.1	-41.8	-41.25	0.59
HE20, M0 to M9 1ss	3	6	-56.9	-58.2	-57.6		0.1	-46.7	-41.25	5.44
HE20, M0 to M9 2ss	3	6	-56.9	-51.3	-54.7		0.1	-42.8	-41.25	1.59
HE20, M0 to M9 3ss	3	6	-56.9	-51.3	-54.7		0.1	-42.8	-41.25	1.59
HE20, M0 to M9 1ss	4	6	-59.7	-60.7	-60.3	-60.8	0.1	-48.3	-41.25	7.01
HE20, M0 to M9 2ss	4	6	-56.9	-55.1	-57.1	-56.3	0.1	-44.2	-41.25	2.94
HE20, M0 to M9 3ss	4	6	-56.9	-51.3	-54.7	-53.8	0.1	-41.6	-41.25	0.37
HE20, M0 to M9 4ss	4	6	-56.9	-51.3	-54.7	-53.8	0.1	-41.6	-41.25	0.37
HE20 Beam Forming, M0 to M9 1ss	2	9	-56.9	-55.1			0.1	-43.8	-41.25	2.58
HE20 Beam Forming, M0 to M9 2ss	2	6	-56.9	-48.5			0.1	-41.8	-41.25	0.59
HE20 Beam Forming, M0 to M9 1ss	3	11	-56.9	-58.2	-57.6		0.1	-41.7	-41.25	0.44
HE20 Beam Forming, M0 to M9 2ss	3	8	-56.9	-55.1	-57.1		0.1	-43.4	-41.25	2.18
HE20 Beam Forming, M0 to M9 3ss	3	6	-56.9	-51.3	-54.7		0.1	-42.8	-41.25	1.59
HE20 Beam Forming, M0 to M9 1ss	4	12	-59.7	-60.7	-60.3	-60.8	0.1	-42.3	-41.25	1.01
HE20 Beam Forming, M0 to M9 2ss	4	9	-56.9	-58.2	-57.6	-57.4	0.1	-42.4	-41.25	1.16
HE20 Beam Forming, M0 to M9 3ss	4	7	-56.9	-55.1	-57.1	-56.3	0.1	-43.2	-41.25	1.94
HE20 Beam Forming, M0 to M9 4ss	4	6	-56.9	-51.3	-54.7	-53.8	0.1	-41.6	-41.25	0.37
HE20 STBC, M0 to M9 2ss	2	6	-56.9	-48.5			0.1	-41.8	-41.25	0.59
HE20 STBC, M0 to M9 2ss	3	6	-56.9	-51.3	-54.7		0.1	-42.8	-41.25	1.59
HE20 STBC, M0 to M9 2ss	4	6	-56.9	-55.1	-57.1	-56.3	0.1	-44.2	-41.25	2.94



5250	Non HT160, 6 to 54 Mbps	1	6	-50.2				0.0	-44.2	-41.25	2.90
	Non HT160, 6 to 54 Mbps	2	6	-50.2	-60.0			0.0	-43.7	-41.25	2.47
	Non HT160, 6 to 54 Mbps	3	6	-50.2	-60.0	-60.3		0.0	-43.4	-41.25	2.10
	Non HT160, 6 to 54 Mbps	4	6	-50.2	-60.0	-60.3	-57.0	0.0	-42.7	-41.25	1.40
	VHT160, M0 to M9 1ss	1	6	-49.8				0.4	-43.4	-41.25	2.16
	VHT160, M0 to M9 1ss	2	6	-49.8	-57.6			0.4	-42.7	-41.25	1.49
	VHT160, M0 to M9 2ss	2	6	-49.8	-57.6			0.4	-42.7	-41.25	1.49
	VHT160, M0 to M9 1ss	3	6	-49.8	-57.6	-60.6		0.4	-42.4	-41.25	1.19
	VHT160, M0 to M9 2ss	3	6	-49.8	-57.6	-60.6		0.4	-42.4	-41.25	1.19
	VHT160, M0 to M9 3ss	3	6	-49.8	-57.6	-60.6		0.4	-42.4	-41.25	1.19
	VHT160, M0 to M9 1ss	4	6	-51.5	-59.7	-61.8	-61.1	0.4	-43.8	-41.25	2.54
	VHT160, M0 to M9 2ss	4	6	-51.5	-59.7	-61.8	-61.1	0.4	-43.8	-41.25	2.54
	VHT160, M0 to M9 3ss	4	6	-51.5	-59.7	-61.8	-61.1	0.4	-43.8	-41.25	2.54
	VHT160, M0 to M9 4ss	4	6	-51.5	-59.7	-61.8	-61.1	0.4	-43.8	-41.25	2.54
	VHT160 Beam Forming, M0 to M9 1ss	2	9	-54.8	-63.4			0.4	-44.8	-41.25	3.60
	VHT160 Beam Forming, M0 to M9 2ss	2	6	-49.8	-57.6			0.4	-42.7	-41.25	1.49
	VHT160 Beam Forming, M0 to M9 1ss	3	11	-56.5	-62.3	-63.4		0.4	-43.4	-41.25	2.19
	VHT160 Beam Forming, M0 to M9 2ss	3	8	-51.5	-59.7	-61.8		0.4	-42.2	-41.25	0.91
	VHT160 Beam Forming, M0 to M9 3ss	3	6	-49.8	-57.6	-60.6		0.4	-42.4	-41.25	1.19
	VHT160 Beam Forming, M0 to M9 1ss	4	12	-56.5	-62.3	-63.4	-63.2	0.4	-41.9	-41.25	0.60
	VHT160 Beam Forming, M0 to M9 2ss	4	9	-54.8	-63.4	-62.8	-62.4	0.4	-43.7	-41.25	2.48
	VHT160 Beam Forming, M0 to M9 3ss	4	7	-51.5	-59.7	-61.8	-61.1	0.4	-42.8	-41.25	1.54
	VHT160 Beam Forming, M0 to M9 4ss	4	6	-51.5	-59.7	-61.8	-61.1	0.4	-43.8	-41.25	2.54
	VHT160 STBC, M0 to M9 1ss	2	6	-49.8	-57.6			0.4	-42.7	-41.25	1.49
	VHT160 STBC, M0 to M9 1ss	3	6	-49.8	-57.6	-60.6		0.4	-42.4	-41.25	1.19
	VHT160 STBC, M0 to M9 1ss	4	6	-51.5	-59.7	-61.8	-61.1	0.4	-43.8	-41.25	2.54
	HE160, M0 to M9 1ss	1	6	-49.7				0.4	-43.3	-41.25	2.02
	HE160, M0 to M9 1ss	2	6	-49.7	-60.6			0.4	-42.9	-41.25	1.68
	HE160, M0 to M9 2ss	2	6	-49.7	-60.6			0.4	-42.9	-41.25	1.68
	HE160, M0 to M9 1ss	3	6	-49.7	-60.6	-60.2		0.4	-42.6	-41.25	1.33
	HE160, M0 to M9 2ss	3	6	-49.7	-60.6	-60.2		0.4	-42.6	-41.25	1.33
	HE160, M0 to M9 3ss	3	6	-49.7	-60.6	-60.2		0.4	-42.6	-41.25	1.33
	HE160, M0 to M9 1ss	4	6	-49.7	-60.6	-60.2	-58.1	0.4	-42.1	-41.25	0.83
	HE160, M0 to M9 2ss	4	6	-49.7	-60.6	-60.2	-58.1	0.4	-42.1	-41.25	0.83
	HE160, M0 to M9 3ss	4	6	-49.7	-60.6	-60.2	-58.1	0.4	-42.1	-41.25	0.83
	HE160, M0 to M9 4ss	4	6	-49.7	-60.6	-60.2	-58.1	0.4	-42.1	-41.25	0.83
	HE160 Beam Forming, M0 to M9 1ss	2	9	-52.9	-61.4			0.4	-42.9	-41.25	1.64
	HE160 Beam Forming, M0 to M9 2ss	2	6	-49.7	-60.6			0.4	-42.9	-41.25	1.68
	HE160 Beam Forming, M0 to M9 1ss	3	11	-55.9	-63.1	-62.2		0.4	-42.9	-41.25	1.68
	HE160 Beam Forming, M0 to M9 2ss	3	8	-52.9	-61.4	-61.5		0.4	-43.4	-41.25	2.15
HE160 Beam Forming, M0 to M9 3ss	3	6	-49.7	-60.6	-60.2		0.4	-42.6	-41.25	1.33	



HE160 Beam Forming, M0 to M9 1ss	4	12	-59.2	-63.8	-63.3	-63.2	0.4	-43.5	-41.25	2.22
HE160 Beam Forming, M0 to M9 2ss	4	9	-52.9	-61.4	-61.5	-60.4	0.4	-41.8	-41.25	0.58
HE160 Beam Forming, M0 to M9 3ss	4	7	-52.9	-61.4	-61.5	-60.4	0.4	-43.8	-41.25	2.58
HE160 Beam Forming, M0 to M9 4ss	4	6	-49.7	-60.6	-60.2	-58.1	0.4	-42.1	-41.25	0.83
HE160 STBC, M0 to M9 1ss	2	6	-49.7	-60.6			0.4	-42.9	-41.25	1.68
HE160 STBC, M0 to M9 1ss	3	6	-49.7	-60.6	-60.2		0.4	-42.6	-41.25	1.33
HE160 STBC, M0 to M9 1ss	4	6	-49.7	-60.6	-60.2	-58.1	0.4	-42.1	-41.25	0.83





**Conducted Bandedge Average, 6dBi  
5290 MHz, VHT80 Beam Forming, M0 to M9 1ss**



**Antenna A**

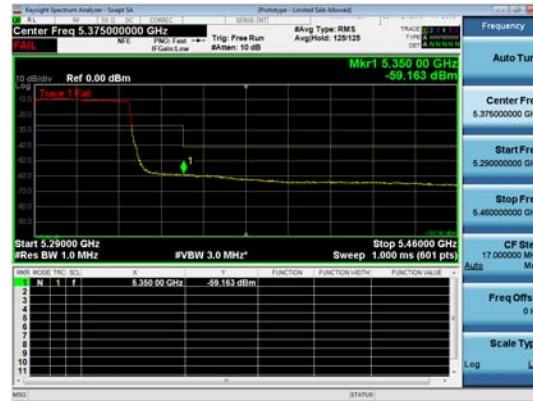

**Antenna B**



## Conducted Bandedge Peak Table, 4dBi

Frequency (MHz)	Mode	Tx Paths	Correlated Antenna Gain (dBi)	Tx 1 Bandedge Level (dBm)	Tx 2 Bandedge Level (dBm)	Tx 3 Bandedge Level (dBm)	Tx 4 Bandedge Level (dBm)	Total Tx Bandedge Level (dBm)	Limit (dBm)	Margin (dB)
5290	Non HT80, 6 to 54 Mbps	1	4	-32.9				-28.8	-21.25	7.60
	Non HT80, 6 to 54 Mbps	2	4	-32.9	-44.4			-28.6	-21.25	7.30
	Non HT80, 6 to 54 Mbps	3	4	-32.9	-44.4	-47.2		-28.4	-21.25	7.15
	Non HT80, 6 to 54 Mbps	4	4	-32.9	-44.4	-47.2	-38.2	-27.4	-21.25	6.13
	VHT80, M0 to M9 1ss	1	4	-33.0				-28.8	-21.25	7.53
	VHT80, M0 to M9 1ss	2	4	-33.0	-45.8			-28.6	-21.25	7.31
	VHT80, M0 to M9 2ss	2	4	-33.0	-45.8			-28.6	-21.25	7.31
	VHT80, M0 to M9 1ss	3	4	-33.0	-45.8	-47.4		-28.4	-21.25	7.16
	VHT80, M0 to M9 2ss	3	4	-33.0	-45.8	-47.4		-28.4	-21.25	7.16
	VHT80, M0 to M9 3ss	3	4	-33.0	-45.8	-47.4		-28.4	-21.25	7.16
	VHT80, M0 to M9 1ss	4	4	-33.0	-45.8	-47.4	-43.7	-28.1	-21.25	6.84
	VHT80, M0 to M9 2ss	4	4	-33.0	-45.8	-47.4	-43.7	-28.1	-21.25	6.84
	VHT80, M0 to M9 3ss	4	4	-33.0	-45.8	-47.4	-43.7	-28.1	-21.25	6.84
	VHT80, M0 to M9 4ss	4	4	-33.0	-45.8	-47.4	-43.7	-28.1	-21.25	6.84
	VHT80 Beam Forming, M0 to M9 1ss	2	7	-36.3	-46.6			-28.7	-21.25	7.45
	VHT80 Beam Forming, M0 to M9 2ss	2	4	-33.0	-45.8			-28.6	-21.25	7.31
	VHT80 Beam Forming, M0 to M9 1ss	3	9	-39.3	-48.8	-50.6		-29.3	-21.25	8.09
	VHT80 Beam Forming, M0 to M9 2ss	3	6	-36.3	-46.6	-47.0		-29.4	-21.25	8.12
	VHT80 Beam Forming, M0 to M9 3ss	3	4	-33.0	-45.8	-47.4		-28.4	-21.25	7.16
	VHT80 Beam Forming, M0 to M9 1ss	4	10	-39.3	-48.8	-50.6	-47.8	-27.9	-21.25	6.60
	VHT80 Beam Forming, M0 to M9 2ss	4	7	-36.3	-46.6	-47.0	-46.6	-28.0	-21.25	6.79
	VHT80 Beam Forming, M0 to M9 3ss	4	5	-33.0	-45.8	-47.4	-43.7	-27.1	-21.25	5.84
	VHT80 Beam Forming, M0 to M9 4ss	4	4	-33.0	-45.8	-47.4	-43.7	-28.1	-21.25	6.84
	VHT80 STBC, M0 to M9 1ss	2	4	-33.0	-45.8			-28.6	-21.25	7.31
	VHT80 STBC, M0 to M9 1ss	3	4	-33.0	-45.8	-47.4		-28.4	-21.25	7.16
	VHT80 STBC, M0 to M9 1ss	4	4	-33.0	-45.8	-47.4	-43.7	-28.1	-21.25	6.84
	HE80, M0 to M9 1ss	1	4	-33.5				-29.2	-21.25	7.99



	HE80, M0 to M9 1ss	2	4	-33.5	-46.7			-29.0	-21.25	7.79
	HE80, M0 to M9 2ss	2	4	-33.5	-46.7			-29.0	-21.25	7.79
	HE80, M0 to M9 1ss	3	4	-33.5	-46.7	-47.0		-28.9	-21.25	7.61
	HE80, M0 to M9 2ss	3	4	-33.5	-46.7	-47.0		-28.9	-21.25	7.61
	HE80, M0 to M9 3ss	3	4	-33.5	-46.7	-47.0		-28.9	-21.25	7.61
	HE80, M0 to M9 1ss	4	4	-33.5	-46.7	-47.0	-43.6	-28.5	-21.25	7.23
	HE80, M0 to M9 2ss	4	4	-33.5	-46.7	-47.0	-43.6	-28.5	-21.25	7.23
	HE80, M0 to M9 3ss	4	4	-33.5	-46.7	-47.0	-43.6	-28.5	-21.25	7.23
	HE80, M0 to M9 4ss	4	4	-33.5	-46.7	-47.0	-43.6	-28.5	-21.25	7.23
	HE80 Beam Forming, M0 to M9 1ss	2	7	-39.1	-46.6			-31.1	-21.25	9.88
	HE80 Beam Forming, M0 to M9 2ss	2	4	-33.5	-46.7			-29.0	-21.25	7.79
	HE80 Beam Forming, M0 to M9 1ss	3	9	-41.5	-50.7	-50.0		-31.2	-21.25	9.98
	HE80 Beam Forming, M0 to M9 2ss	3	6	-39.1	-46.6	-47.7		-31.6	-21.25	10.40
	HE80 Beam Forming, M0 to M9 3ss	3	4	-33.5	-46.7	-47.0		-28.9	-21.25	7.61
	HE80 Beam Forming, M0 to M9 1ss	4	10	-45.6	-50.7	-49.7	-49.4	-32.1	-21.25	10.84
	HE80 Beam Forming, M0 to M9 2ss	4	7	-41.5	-50.7	-50.0	-49.1	-32.7	-21.25	11.42
	HE80 Beam Forming, M0 to M9 3ss	4	5	-39.1	-46.6	-47.7	-45.8	-32.0	-21.25	10.74
	HE80 Beam Forming, M0 to M9 4ss	4	4	-33.5	-46.7	-47.0	-43.6	-28.5	-21.25	7.23
	HE80 STBC, M0 to M9 1ss	2	4	-33.5	-46.7			-29.0	-21.25	7.79
	HE80 STBC, M0 to M9 1ss	3	4	-33.5	-46.7	-47.0		-28.9	-21.25	7.61
	HE80 STBC, M0 to M9 1ss	4	4	-33.5	-46.7	-47.0	-43.6	-28.5	-21.25	7.23
5310	Non HT40, 6 to 54 Mbps	1	4	-32.6				-28.6	-21.25	7.31
	Non HT40, 6 to 54 Mbps	2	4	-33.7	-44.6			-29.3	-21.25	8.07
	Non HT40, 6 to 54 Mbps	3	4	-33.7	-44.6	-46.8		-29.1	-21.25	7.87
	Non HT40, 6 to 54 Mbps	4	4	-33.7	-44.6	-46.8	-44.0	-28.8	-21.25	7.53
	HT/VHT40, M0 to M7	1	4	-34.2				-30.1	-21.25	8.85
	HT/VHT40, M0 to M7	2	4	-34.2	-40.3			-29.1	-21.25	7.89
	HT/VHT40, M8 to M15	2	4	-34.2	-40.3			-29.1	-21.25	7.89
	HT/VHT40, M0 to M7	3	4	-34.2	-43.9	-48.1		-29.5	-21.25	8.25
	HT/VHT40, M8 to M15	3	4	-34.2	-43.9	-48.1		-29.5	-21.25	8.25
	HT/VHT40, M16 to M23	3	4	-34.2	-43.9	-48.1		-29.5	-21.25	8.25
	HT/VHT40, M0 to M7	4	4	-36.4	-46.0	-48.8	-43.4	-30.9	-21.25	9.69
	HT/VHT40, M8 to M15	4	4	-36.4	-46.0	-48.8	-43.4	-30.9	-21.25	9.69
	HT/VHT40, M16 to M23	4	4	-36.4	-46.0	-48.8	-43.4	-30.9	-21.25	9.69
	HT/VHT40, M24 to M31	4	4	-36.4	-46.0	-48.8	-43.4	-30.9	-21.25	9.69
	HT/VHT40 Beam Forming, M0 to M7	2	7	-36.4	-46.0			-28.8	-21.25	7.60
	HT/VHT40 Beam Forming, M8 to M15	2	4	-34.2	-40.3			-29.1	-21.25	7.89
	HT/VHT40 Beam Forming, M0 to M7	3	9	-39.6	-48.3	-48.9		-29.5	-21.25	8.27
	HT/VHT40 Beam Forming, M8 to M15	3	6	-36.4	-46.0	-48.8		-29.6	-21.25	8.38
	HT/VHT40 Beam Forming, M16 to M23	3	4	-34.2	-43.9	-48.1		-29.5	-21.25	8.25
	HT/VHT40 Beam Forming, M0 to M7	4	10	-44.2	-49.2	-49.7	-49.7	-31.4	-21.25	10.11



	HT/VHT40 Beam Forming, M8 to M15	4	7	-39.6	-48.3	-48.9	-46.9	-30.9	-21.25	9.67
	HT/VHT40 Beam Forming, M16 to M23	4	5	-36.4	-46.0	-48.8	-43.4	-29.9	-21.25	8.69
	HT/VHT40 Beam Forming, M24 to M31	4	4	-36.4	-46.0	-48.8	-43.4	-30.9	-21.25	9.69
	HT/VHT40 STBC, M0 to M7	2	4	-34.2	-40.3			-29.1	-21.25	7.89
	HT/VHT40 STBC, M0 to M7	3	4	-34.2	-43.9	-48.1		-29.5	-21.25	8.25
	HT/VHT40 STBC, M0 to M7	4	4	-36.4	-46.0	-48.8	-43.4	-30.9	-21.25	9.69
	HE40, M0 to M9 1ss	1	4	-34.0				-29.9	-21.25	8.62
	HE40, M0 to M9 1ss	2	4	-34.0	-44.0			-29.5	-21.25	8.21
	HE40, M0 to M9 2ss	2	4	-34.0	-44.0			-29.5	-21.25	8.21
	HE40, M0 to M9 1ss	3	4	-34.0	-44.0	-46.6		-29.2	-21.25	7.99
	HE40, M0 to M9 2ss	3	4	-34.0	-44.0	-46.6		-29.2	-21.25	7.99
	HE40, M0 to M9 3ss	3	4	-34.0	-44.0	-46.6		-29.2	-21.25	7.99
	HE40, M0 to M9 1ss	4	4	-34.0	-44.0	-46.6	-41.5	-28.6	-21.25	7.37
	HE40, M0 to M9 2ss	4	4	-34.0	-44.0	-46.6	-41.5	-28.6	-21.25	7.37
	HE40, M0 to M9 3ss	4	4	-34.0	-44.0	-46.6	-41.5	-28.6	-21.25	7.37
	HE40, M0 to M9 4ss	4	4	-34.0	-44.0	-46.6	-41.5	-28.6	-21.25	7.37
	HE40 Beam Forming, M0 to M9 1ss	2	7	-36.5	-47.2			-29.0	-21.25	7.77
	HE40 Beam Forming, M0 to M9 2ss	2	4	-34.0	-44.0			-29.5	-21.25	8.21
	HE40 Beam Forming, M0 to M9 1ss	3	9	-36.5	-47.2	-50.9		-26.9	-21.25	5.62
	HE40 Beam Forming, M0 to M9 2ss	3	6	-36.5	-47.2	-50.9		-29.9	-21.25	8.62
	HE40 Beam Forming, M0 to M9 3ss	3	4	-34.0	-44.0	-46.6		-29.2	-21.25	7.99
	HE40 Beam Forming, M0 to M9 1ss	4	10	-39.4	-48.7	-50.1	-50.4	-28.2	-21.25	6.94
	HE40 Beam Forming, M0 to M9 2ss	4	7	-36.5	-47.2	-50.9	-43.0	-28.1	-21.25	6.83
	HE40 Beam Forming, M0 to M9 3ss	4	5	-36.5	-47.2	-50.9	-43.0	-30.1	-21.25	8.83
	HE40 Beam Forming, M0 to M9 4ss	4	4	-34.0	-44.0	-46.6	-41.5	-28.6	-21.25	7.37
	HE40 STBC, M0 to M9 2ss	2	4	-34.0	-44.0			-29.5	-21.25	8.21
	HE40 STBC, M0 to M9 2ss	3	4	-34.0	-44.0	-46.6		-29.2	-21.25	7.99
	HE40 STBC, M0 to M9 2ss	4	4	-34.0	-44.0	-46.6	-41.5	-28.6	-21.25	7.37
5320	Non HT20, 6 to 54 Mbps	1	4	-42.2				-38.2	-21.25	16.91
	Non HT20, 6 to 54 Mbps	2	4	-42.2	-32.9			-28.4	-21.25	7.12
	Non HT20, 6 to 54 Mbps	3	4	-42.2	-36.9	-45.8		-31.3	-21.25	10.07
	Non HT20, 6 to 54 Mbps	4	4	-42.2	-45.7	-47.2	-47.0	-34.9	-21.25	13.70
	Non HT20 Beam Forming, 6 to 54 Mbps	2	7	-42.2	-34.7			-26.9	-21.25	5.70
	Non HT20 Beam Forming, 6 to 54 Mbps	3	9	-42.2	-36.9	-45.8		-26.3	-21.25	5.07
	Non HT20 Beam Forming, 6 to 54 Mbps	4	10	-42.2	-45.7	-47.2	-47.0	-28.9	-21.25	7.70
	HT/VHT20, M0 to M7	1	4	-43.2				-39.1	-21.25	17.90
	HT/VHT20, M0 to M7	2	4	-43.2	-34.1			-29.5	-21.25	8.29
	HT/VHT20, M8 to M15	2	4	-43.2	-34.1			-29.5	-21.25	8.29
	HT/VHT20, M0 to M7	3	4	-43.2	-39.7	-40.4		-32.0	-21.25	10.78
	HT/VHT20, M8 to M15	3	4	-43.2	-34.1	-35.9		-27.5	-21.25	6.28
	HT/VHT20, M16 to M23	3	4	-43.2	-34.1	-35.9		-27.5	-21.25	6.28



	HT/VHT20, M0 to M7	4	4	-43.2	-43.3	-46.8	-47.0	-34.6	-21.25	13.38
	HT/VHT20, M8 to M15	4	4	-43.2	-34.1	-35.9	-35.1	-25.9	-21.25	4.68
	HT/VHT20, M16 to M23	4	4	-43.2	-34.1	-35.9	-35.1	-25.9	-21.25	4.68
	HT/VHT20, M24 to M31	4	4	-43.2	-34.1	-35.9	-35.1	-25.9	-21.25	4.68
	HT/VHT20 Beam Forming, M0 to M7	2	7	-43.2	-34.1			-26.5	-21.25	5.29
	HT/VHT20 Beam Forming, M8 to M15	2	4	-43.2	-34.1			-29.5	-21.25	8.29
	HT/VHT20 Beam Forming, M0 to M7	3	9	-43.2	-39.7	-40.4		-27.0	-21.25	5.78
	HT/VHT20 Beam Forming, M8 to M15	3	6	-43.2	-34.1	-35.9		-25.5	-21.25	4.28
	HT/VHT20 Beam Forming, M16 to M23	3	4	-43.2	-34.1	-35.9		-27.5	-21.25	6.28
	HT/VHT20 Beam Forming, M0 to M7	4	10	-43.2	-43.3	-46.8	-47.0	-28.6	-21.25	7.38
	HT/VHT20 Beam Forming, M8 to M15	4	7	-43.2	-39.7	-40.4	-39.5	-27.4	-21.25	6.15
	HT/VHT20 Beam Forming, M16 to M23	4	5	-43.2	-39.7	-40.4	-39.5	-29.4	-21.25	8.15
	HT/VHT20 Beam Forming, M24 to M31	4	4	-43.2	-34.1	-35.9	-35.1	-25.9	-21.25	4.68
	HT/VHT20 STBC, M0 to M7	2	4	-43.2	-34.1			-29.5	-21.25	8.29
	HT/VHT20 STBC, M0 to M7	3	4	-43.2	-34.1	-35.9		-27.5	-21.25	6.28
	HT/VHT20 STBC, M0 to M7	4	4	-43.2	-34.1	-35.9	-35.1	-25.9	-21.25	4.68
	HE20, M0 to M9 1ss	1	4	-42.3				-38.2	-21.25	16.98
	HE20, M0 to M9 1ss	2	4	-42.3	-33.2			-28.6	-21.25	7.38
	HE20, M0 to M9 2ss	2	4	-42.3	-33.2			-28.6	-21.25	7.38
	HE20, M0 to M9 1ss	3	4	-42.3	-36.1	-37.8		-29.2	-21.25	7.96
	HE20, M0 to M9 2ss	3	4	-42.3	-33.2	-37.1		-27.3	-21.25	6.03
	HE20, M0 to M9 3ss	3	4	-42.3	-33.2	-37.1		-27.3	-21.25	6.03
	HE20, M0 to M9 1ss	4	4	-42.3	-42.4	-45.0	-41.7	-32.6	-21.25	11.34
	HE20, M0 to M9 2ss	4	4	-42.3	-36.1	-37.8	-35.6	-27.2	-21.25	5.95
	HE20, M0 to M9 3ss	4	4	-42.3	-36.1	-37.8	-35.6	-27.2	-21.25	5.95
	HE20, M0 to M9 4ss	4	4	-42.3	-36.1	-37.8	-35.6	-27.2	-21.25	5.95
	HE20 Beam Forming, M0 to M9 1ss	2	7	-42.3	-36.1			-28.1	-21.25	6.85
	HE20 Beam Forming, M0 to M9 2ss	2	4	-42.3	-33.2			-28.6	-21.25	7.38
	HE20 Beam Forming, M0 to M9 1ss	3	9	-42.3	-40.3	-40.3		-27.0	-21.25	5.78
	HE20 Beam Forming, M0 to M9 2ss	3	6	-42.3	-36.1	-37.8		-27.2	-21.25	5.96
	HE20 Beam Forming, M0 to M9 3ss	3	4	-42.3	-33.2	-37.1		-27.3	-21.25	6.03
	HE20 Beam Forming, M0 to M9 1ss	4	10	-42.3	-42.4	-45.0	-41.7	-26.6	-21.25	5.34
	HE20 Beam Forming, M0 to M9 2ss	4	7	-42.3	-40.3	-40.3	-38.6	-27.1	-21.25	5.84
	HE20 Beam Forming, M0 to M9 3ss	4	5	-42.3	-36.1	-37.8	-35.6	-26.2	-21.25	4.95
	HE20 Beam Forming, M0 to M9 4ss	4	4	-42.3	-36.1	-37.8	-35.6	-27.2	-21.25	5.95
	HE20 STBC, M0 to M9 2ss	2	4	-42.3	-33.2			-28.6	-21.25	7.38
	HE20 STBC, M0 to M9 2ss	3	4	-42.3	-33.2	-37.1		-27.3	-21.25	6.03
	HE20 STBC, M0 to M9 2ss	4	4	-42.3	-36.1	-37.8	-35.6	-27.2	-21.25	5.95
5250	Non HT160, 6 to 54 Mbps	1	4	-32.0				-28.0	-21.25	6.70
	Non HT160, 6 to 54 Mbps	2	4	-32.0	-45.9			-27.8	-21.25	6.53
	Non HT160, 6 to 54 Mbps	3	4	-32.0	-45.9	-47.0		-27.6	-21.25	6.40



Non HT160, 6 to 54 Mbps	4	4	-32.0	-45.9	-47.0	-42.8	-27.3	-21.25	6.07
VHT160, M0 to M9 1ss	1	4	-28.2				-23.8	-21.25	2.56
VHT160, M0 to M9 1ss	2	4	-28.2	-39.2			-23.5	-21.25	2.23
VHT160, M0 to M9 2ss	2	4	-28.2	-39.2			-23.5	-21.25	2.23
VHT160, M0 to M9 1ss	3	4	-28.2	-39.2	-42.0		-23.3	-21.25	2.06
VHT160, M0 to M9 2ss	3	4	-28.2	-39.2	-42.0		-23.3	-21.25	2.06
VHT160, M0 to M9 3ss	3	4	-28.2	-39.2	-42.0		-23.3	-21.25	2.06
VHT160, M0 to M9 1ss	4	4	-28.2	-39.2	-42.0	-41.6	-23.1	-21.25	1.89
VHT160, M0 to M9 2ss	4	4	-28.2	-39.2	-42.0	-41.6	-23.1	-21.25	1.89
VHT160, M0 to M9 3ss	4	4	-28.2	-39.2	-42.0	-41.6	-23.1	-21.25	1.89
VHT160, M0 to M9 4ss	4	4	-28.2	-39.2	-42.0	-41.6	-23.1	-21.25	1.89
VHT160 Beam Forming, M0 to M9 1ss	2	7	-30.9	-40.0			-23.0	-21.25	1.75
VHT160 Beam Forming, M0 to M9 2ss	2	4	-28.2	-39.2			-23.5	-21.25	2.23
VHT160 Beam Forming, M0 to M9 1ss	3	9	-33.1	-43.0	-44.1		-23.0	-21.25	1.73
<b>VHT160 Beam Forming, M0 to M9 2ss</b>	<b>3</b>	<b>6</b>	<b>-28.2</b>	<b>-39.2</b>	<b>-42.0</b>		<b>-21.3</b>	<b>-21.25</b>	<b>0.06</b>
VHT160 Beam Forming, M0 to M9 3ss	3	4	-28.2	-39.2	-42.0		-23.3	-21.25	2.06
VHT160 Beam Forming, M0 to M9 1ss	4	10	-33.1	-43.0	-44.1	-43.3	-21.6	-21.25	0.40
VHT160 Beam Forming, M0 to M9 2ss	4	7	-30.9	-40.0	-42.3	-42.4	-22.5	-21.25	1.23
VHT160 Beam Forming, M0 to M9 3ss	4	5	-28.2	-39.2	-42.0	-41.6	-22.1	-21.25	0.89
VHT160 Beam Forming, M0 to M9 4ss	4	4	-28.2	-39.2	-42.0	-41.6	-23.1	-21.25	1.89
VHT160 STBC, M0 to M9 1ss	2	4	-28.2	-39.2			-23.5	-21.25	2.23
VHT160 STBC, M0 to M9 1ss	3	4	-28.2	-39.2	-42.0		-23.3	-21.25	2.06
VHT160 STBC, M0 to M9 1ss	4	4	-28.2	-39.2	-42.0	-41.6	-23.1	-21.25	1.89
HE160, M0 to M9 1ss	1	4	-30.4				-26.0	-21.25	4.72
HE160, M0 to M9 1ss	2	4	-30.4	-44.5			-25.8	-21.25	4.55
HE160, M0 to M9 2ss	2	4	-30.4	-44.5			-25.8	-21.25	4.55
HE160, M0 to M9 1ss	3	4	-34.6	-47.1	-48.7		-29.8	-21.25	8.52
HE160, M0 to M9 2ss	3	4	-34.6	-47.1	-48.7		-29.8	-21.25	8.52
HE160, M0 to M9 3ss	3	4	-34.6	-47.1	-48.7		-29.8	-21.25	8.52
HE160, M0 to M9 1ss	4	4	-34.6	-47.1	-48.7	-44.2	-29.4	-21.25	8.11
HE160, M0 to M9 2ss	4	4	-34.6	-47.1	-48.7	-44.2	-29.4	-21.25	8.11
HE160, M0 to M9 3ss	4	4	-34.6	-47.1	-48.7	-44.2	-29.4	-21.25	8.11
HE160, M0 to M9 4ss	4	4	-34.6	-47.1	-48.7	-44.2	-29.4	-21.25	8.11
HE160 Beam Forming, M0 to M9 1ss	2	7	-34.6	-47.1			-26.9	-21.25	5.68
HE160 Beam Forming, M0 to M9 2ss	2	4	-30.4	-44.5			-25.8	-21.25	4.55
HE160 Beam Forming, M0 to M9 1ss	3	9	-37.9	-44.0	-50.6		-27.3	-21.25	6.08
HE160 Beam Forming, M0 to M9 2ss	3	6	-34.6	-47.1	-48.7		-27.8	-21.25	6.52
HE160 Beam Forming, M0 to M9 3ss	3	4	-34.6	-47.1	-48.7		-29.8	-21.25	8.52
HE160 Beam Forming, M0 to M9 1ss	4	10	-42.0	-50.4	-49.6	-48.7	-29.7	-21.25	8.46
HE160 Beam Forming, M0 to M9 2ss	4	7	-37.9	-44.0	-50.6	-45.8	-28.8	-21.25	7.57
HE160 Beam Forming, M0 to M9 3ss	4	5	-34.6	-47.1	-48.7	-44.2	-28.4	-21.25	7.11
HE160 Beam Forming, M0 to M9 4ss	4	4	-34.6	-47.1	-48.7	-44.2	-29.4	-21.25	8.11



HE160 STBC, M0 to M9 1ss	2	4	-30.4	-44.5			-25.8	-21.25	4.55
HE160 STBC, M0 to M9 1ss	3	4	-34.6	-47.1	-48.7		-29.8	-21.25	8.52
HE160 STBC, M0 to M9 1ss	4	4	-34.6	-47.1	-48.7	-44.2	-29.4	-21.25	8.11





**Conducted Bandedge Peak, 4dBi  
5250 MHz, VHT160 Beam Forming, M0 to M9 2ss**



**Antenna A**

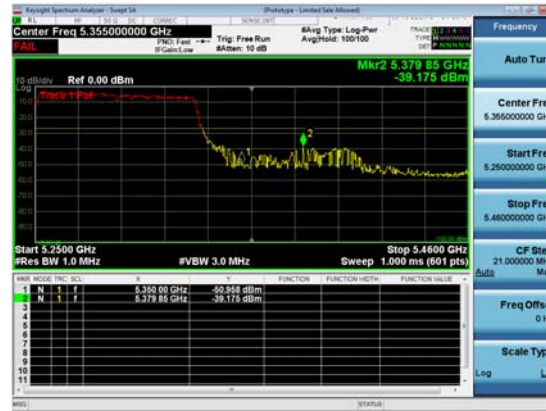

**Antenna B**



**Antenna C**



## Conducted Bandedge Peak Table, 5dBi

Frequency (MHz)	Mode	Tx Paths	Correlated Antenna Gain (dBi)	Tx 1 Bandedge Level (dBm)	Tx 2 Bandedge Level (dBm)	Tx 3 Bandedge Level (dBm)	Tx 4 Bandedge Level (dBm)	Total Tx Bandedge Level (dBm)	Limit (dBm)	Margin (dB)
5290	Non HT80, 6 to 54 Mbps	1	5	-32.9				-27.8	-21.25	6.60
	Non HT80, 6 to 54 Mbps	2	5	-32.9	-44.4			-27.6	-21.25	6.30
	Non HT80, 6 to 54 Mbps	3	5	-32.9	-44.4	-47.2		-27.4	-21.25	6.15
	Non HT80, 6 to 54 Mbps	4	5	-32.9	-44.4	-47.2	-38.2	-26.4	-21.25	5.13
	VHT80, M0 to M9 1ss	1	5	-33.0				-27.8	-21.25	6.53
	VHT80, M0 to M9 1ss	2	5	-33.0	-45.8			-27.6	-21.25	6.31
	VHT80, M0 to M9 2ss	2	5	-33.0	-45.8			-27.6	-21.25	6.31
	VHT80, M0 to M9 1ss	3	5	-33.0	-45.8	-47.4		-27.4	-21.25	6.16
	VHT80, M0 to M9 2ss	3	5	-33.0	-45.8	-47.4		-27.4	-21.25	6.16
	VHT80, M0 to M9 3ss	3	5	-33.0	-45.8	-47.4		-27.4	-21.25	6.16
	VHT80, M0 to M9 1ss	4	5	-33.0	-45.8	-47.4	-43.7	-27.1	-21.25	5.84
	VHT80, M0 to M9 2ss	4	5	-33.0	-45.8	-47.4	-43.7	-27.1	-21.25	5.84
	VHT80, M0 to M9 3ss	4	5	-33.0	-45.8	-47.4	-43.7	-27.1	-21.25	5.84
	VHT80, M0 to M9 4ss	4	5	-33.0	-45.8	-47.4	-43.7	-27.1	-21.25	5.84
	VHT80 Beam Forming, M0 to M9 1ss	2	8	-36.3	-46.6			-27.7	-21.25	6.45
	VHT80 Beam Forming, M0 to M9 2ss	2	5	-33.0	-45.8			-27.6	-21.25	6.31
	VHT80 Beam Forming, M0 to M9 1ss	3	10	-39.3	-48.8	-50.6		-28.3	-21.25	7.09
	VHT80 Beam Forming, M0 to M9 2ss	3	7	-36.3	-46.6	-47.0		-28.4	-21.25	7.12
	VHT80 Beam Forming, M0 to M9 3ss	3	5	-33.0	-45.8	-47.4		-27.4	-21.25	6.16
	VHT80 Beam Forming, M0 to M9 1ss	4	11	-43.1	-50.3	-49.2	-49.5	-29.7	-21.25	8.42
	VHT80 Beam Forming, M0 to M9 2ss	4	8	-39.3	-48.8	-50.6	-47.8	-29.9	-21.25	8.60
	VHT80 Beam Forming, M0 to M9 3ss	4	6	-36.3	-46.6	-47.0	-46.6	-29.0	-21.25	7.79
	VHT80 Beam Forming, M0 to M9 4ss	4	5	-33.0	-45.8	-47.4	-43.7	-27.1	-21.25	5.84
	VHT80 STBC, M0 to M9 1ss	2	5	-33.0	-45.8			-27.6	-21.25	6.31
	VHT80 STBC, M0 to M9 1ss	3	5	-33.0	-45.8	-47.4		-27.4	-21.25	6.16
	VHT80 STBC, M0 to M9 1ss	4	5	-33.0	-45.8	-47.4	-43.7	-27.1	-21.25	5.84
	HE80, M0 to M9 1ss	1	5	-33.5				-28.2	-21.25	6.99



	HE80, M0 to M9 1ss	2	5	-33.5	-46.7			-28.0	-21.25	6.79
	HE80, M0 to M9 2ss	2	5	-33.5	-46.7			-28.0	-21.25	6.79
	HE80, M0 to M9 1ss	3	5	-39.1	-46.6	-47.7		-32.6	-21.25	11.40
	HE80, M0 to M9 2ss	3	5	-39.1	-46.6	-47.7		-32.6	-21.25	11.40
	HE80, M0 to M9 3ss	3	5	-39.1	-46.6	-47.7		-32.6	-21.25	11.40
	HE80, M0 to M9 1ss	4	5	-39.1	-46.6	-47.7	-45.8	-32.0	-21.25	10.74
	HE80, M0 to M9 2ss	4	5	-39.1	-46.6	-47.7	-45.8	-32.0	-21.25	10.74
	HE80, M0 to M9 3ss	4	5	-39.1	-46.6	-47.7	-45.8	-32.0	-21.25	10.74
	HE80, M0 to M9 4ss	4	5	-39.1	-46.6	-47.7	-45.8	-32.0	-21.25	10.74
	HE80 Beam Forming, M0 to M9 1ss	2	8	-39.1	-46.6			-30.1	-21.25	8.88
	HE80 Beam Forming, M0 to M9 2ss	2	5	-33.5	-46.7			-28.0	-21.25	6.79
	HE80 Beam Forming, M0 to M9 1ss	3	10	-41.5	-50.7	-50.0		-30.2	-21.25	8.98
	HE80 Beam Forming, M0 to M9 2ss	3	7	-39.1	-46.6	-47.7		-30.6	-21.25	9.40
	HE80 Beam Forming, M0 to M9 3ss	3	5	-39.1	-46.6	-47.7		-32.6	-21.25	11.40
	HE80 Beam Forming, M0 to M9 1ss	4	11	-45.6	-50.7	-49.7	-49.4	-31.1	-21.25	9.84
	HE80 Beam Forming, M0 to M9 2ss	4	8	-41.5	-50.7	-50.0	-49.1	-31.7	-21.25	10.42
	HE80 Beam Forming, M0 to M9 3ss	4	6	-39.1	-46.6	-47.7	-45.8	-31.0	-21.25	9.74
	HE80 Beam Forming, M0 to M9 4ss	4	5	-39.1	-46.6	-47.7	-45.8	-32.0	-21.25	10.74
	HE80 STBC, M0 to M9 1ss	2	5	-33.5	-46.7			-28.0	-21.25	6.79
	HE80 STBC, M0 to M9 1ss	3	5	-39.1	-46.6	-47.7		-32.6	-21.25	11.40
	HE80 STBC, M0 to M9 1ss	4	5	-39.1	-46.6	-47.7	-45.8	-32.0	-21.25	10.74
5310	Non HT40, 6 to 54 Mbps	1	5	-33.7				-28.7	-21.25	7.41
	Non HT40, 6 to 54 Mbps	2	5	-33.7	-44.6			-28.3	-21.25	7.07
	Non HT40, 6 to 54 Mbps	3	5	-33.7	-44.6	-46.8		-28.1	-21.25	6.87
	Non HT40, 6 to 54 Mbps	4	5	-33.7	-44.6	-46.8	-44.0	-27.8	-21.25	6.53
	HT/VHT40, M0 to M7	1	5	-36.4				-31.3	-21.25	10.05
	HT/VHT40, M0 to M7	2	5	-36.4	-46.0			-30.8	-21.25	9.60
	HT/VHT40, M8 to M15	2	5	-36.4	-46.0			-30.8	-21.25	9.60
	HT/VHT40, M0 to M7	3	5	-36.4	-46.0	-48.8		-30.6	-21.25	9.38
	HT/VHT40, M8 to M15	3	5	-36.4	-46.0	-48.8		-30.6	-21.25	9.38
	HT/VHT40, M16 to M23	3	5	-36.4	-46.0	-48.8		-30.6	-21.25	9.38
	HT/VHT40, M0 to M7	4	5	-36.4	-46.0	-48.8	-43.4	-29.9	-21.25	8.69
	HT/VHT40, M8 to M15	4	5	-36.4	-46.0	-48.8	-43.4	-29.9	-21.25	8.69
	HT/VHT40, M16 to M23	4	5	-36.4	-46.0	-48.8	-43.4	-29.9	-21.25	8.69
	HT/VHT40, M24 to M31	4	5	-36.4	-46.0	-48.8	-43.4	-29.9	-21.25	8.69
	HT/VHT40 Beam Forming, M0 to M7	2	8	-36.4	-46.0			-27.8	-21.25	6.60
	HT/VHT40 Beam Forming, M8 to M15	2	5	-36.4	-46.0			-30.8	-21.25	9.60
	HT/VHT40 Beam Forming, M0 to M7	3	10	-39.6	-48.3	-48.9		-28.5	-21.25	7.27
	HT/VHT40 Beam Forming, M8 to M15	3	7	-36.4	-46.0	-48.8		-28.6	-21.25	7.38
	HT/VHT40 Beam Forming, M16 to M23	3	5	-36.4	-46.0	-48.8		-30.6	-21.25	9.38
HT/VHT40 Beam Forming, M0 to M7	4	11	-44.2	-49.2	-49.7	-49.7	-30.4	-21.25	9.11	



	HT/VHT40 Beam Forming, M8 to M15	4	8	-39.6	-48.3	-48.9	-46.9	-29.9	-21.25	8.67
	HT/VHT40 Beam Forming, M16 to M23	4	6	-36.4	-46.0	-48.8	-43.4	-28.9	-21.25	7.69
	HT/VHT40 Beam Forming, M24 to M31	4	5	-36.4	-46.0	-48.8	-43.4	-29.9	-21.25	8.69
	HT/VHT40 STBC, M0 to M7	2	5	-36.4	-46.0			-30.8	-21.25	9.60
	HT/VHT40 STBC, M0 to M7	3	5	-36.4	-46.0	-48.8		-30.6	-21.25	9.38
	HT/VHT40 STBC, M0 to M7	4	5	-36.4	-46.0	-48.8	-43.4	-29.9	-21.25	8.69
	HE40, M0 to M9 1ss	1	5	-34.0				-28.9	-21.25	7.62
	HE40, M0 to M9 1ss	2	5	-34.0	-44.0			-28.5	-21.25	7.21
	HE40, M0 to M9 2ss	2	5	-34.0	-44.0			-28.5	-21.25	7.21
	HE40, M0 to M9 1ss	3	5	-34.0	-44.0	-46.6		-28.2	-21.25	6.99
	HE40, M0 to M9 2ss	3	5	-34.0	-44.0	-46.6		-28.2	-21.25	6.99
	HE40, M0 to M9 3ss	3	5	-34.0	-44.0	-46.6		-28.2	-21.25	6.99
	HE40, M0 to M9 1ss	4	5	-36.5	-47.2	-50.9	-43.0	-30.1	-21.25	8.83
	HE40, M0 to M9 2ss	4	5	-36.5	-47.2	-50.9	-43.0	-30.1	-21.25	8.83
	HE40, M0 to M9 3ss	4	5	-36.5	-47.2	-50.9	-43.0	-30.1	-21.25	8.83
	HE40, M0 to M9 4ss	4	5	-36.5	-47.2	-50.9	-43.0	-30.1	-21.25	8.83
	HE40 Beam Forming, M0 to M9 1ss	2	8	-36.5	-47.2			-28.0	-21.25	6.77
	HE40 Beam Forming, M0 to M9 2ss	2	5	-34.0	-44.0			-28.5	-21.25	7.21
	HE40 Beam Forming, M0 to M9 1ss	3	10	-39.4	-48.7	-50.1		-28.5	-21.25	7.22
	HE40 Beam Forming, M0 to M9 2ss	3	7	-36.5	-47.2	-50.9		-28.9	-21.25	7.62
	HE40 Beam Forming, M0 to M9 3ss	3	5	-34.0	-44.0	-46.6		-28.2	-21.25	6.99
	HE40 Beam Forming, M0 to M9 1ss	4	11	-43.6	-50.9	-49.2	-49.8	-30.2	-21.25	8.91
	HE40 Beam Forming, M0 to M9 2ss	4	8	-36.5	-47.2	-50.9	-43.0	-27.1	-21.25	5.83
	HE40 Beam Forming, M0 to M9 3ss	4	6	-36.5	-47.2	-50.9	-43.0	-29.1	-21.25	7.83
	HE40 Beam Forming, M0 to M9 4ss	4	5	-36.5	-47.2	-50.9	-43.0	-30.1	-21.25	8.83
	HE40 STBC, M0 to M9 2ss	2	5	-34.0	-44.0			-28.5	-21.25	7.21
	HE40 STBC, M0 to M9 2ss	3	5	-34.0	-44.0	-46.6		-28.2	-21.25	6.99
	HE40 STBC, M0 to M9 2ss	4	5	-36.5	-47.2	-50.9	-43.0	-30.1	-21.25	8.83
5320	Non HT20, 6 to 54 Mbps	1	5	-42.2				-37.2	-21.25	15.91
	Non HT20, 6 to 54 Mbps	2	5	-42.2	-32.9			-27.4	-21.25	6.12
	Non HT20, 6 to 54 Mbps	3	5	-42.2	-45.7	-47.2		-34.7	-21.25	13.44
	Non HT20, 6 to 54 Mbps	4	5	-47.9	-49.0	-48.2	-49.8	-37.6	-21.25	16.35
	Non HT20 Beam Forming, 6 to 54 Mbps	2	8	-42.2	-34.7			-25.9	-21.25	4.70
	Non HT20 Beam Forming, 6 to 54 Mbps	3	10	-42.2	-45.7	-47.2		-29.7	-21.25	8.44
	Non HT20 Beam Forming, 6 to 54 Mbps	4	11	-47.9	-49.0	-48.2	-49.8	-31.6	-21.25	10.35
	HT/VHT20, M0 to M7	1	5	-43.2				-38.1	-21.25	16.90
	HT/VHT20, M0 to M7	2	5	-43.2	-34.1			-28.5	-21.25	7.29
	HT/VHT20, M8 to M15	2	5	-43.2	-34.1			-28.5	-21.25	7.29
	HT/VHT20, M0 to M7	3	5	-43.2	-43.7	-42.6		-33.3	-21.25	12.07
	HT/VHT20, M8 to M15	3	5	-43.2	-34.1	-35.9		-26.5	-21.25	5.28
	HT/VHT20, M16 to M23	3	5	-43.2	-34.1	-35.9		-26.5	-21.25	5.28



	HT/VHT20, M0 to M7	4	5	-43.2	-48.5	-48.7	-48.3	-35.4	-21.25	14.14
	HT/VHT20, M8 to M15	4	5	-43.2	-39.7	-40.4	-39.5	-29.4	-21.25	8.15
	HT/VHT20, M16 to M23	4	5	-43.2	-39.7	-40.4	-39.5	-29.4	-21.25	8.15
	HT/VHT20, M24 to M31	4	5	-43.2	-39.7	-40.4	-39.5	-29.4	-21.25	8.15
	HT/VHT20 Beam Forming, M0 to M7	2	8	-43.2	-34.1			-25.5	-21.25	4.29
	HT/VHT20 Beam Forming, M8 to M15	2	5	-43.2	-34.1			-28.5	-21.25	7.29
	HT/VHT20 Beam Forming, M0 to M7	3	10	-43.2	-43.7	-42.6		-28.3	-21.25	7.07
	HT/VHT20 Beam Forming, M8 to M15	3	7	-43.2	-39.7	-40.4		-29.0	-21.25	7.78
	HT/VHT20 Beam Forming, M16 to M23	3	5	-43.2	-34.1	-35.9		-26.5	-21.25	5.28
	HT/VHT20 Beam Forming, M0 to M7	4	11	-43.2	-48.5	-48.7	-48.3	-29.4	-21.25	8.14
	HT/VHT20 Beam Forming, M8 to M15	4	8	-43.2	-39.7	-40.4	-39.5	-26.4	-21.25	5.15
	HT/VHT20 Beam Forming, M16 to M23	4	6	-43.2	-39.7	-40.4	-39.5	-28.4	-21.25	7.15
	HT/VHT20 Beam Forming, M24 to M31	4	5	-43.2	-39.7	-40.4	-39.5	-29.4	-21.25	8.15
	HT/VHT20 STBC, M0 to M7	2	5	-43.2	-34.1			-28.5	-21.25	7.29
	HT/VHT20 STBC, M0 to M7	3	5	-43.2	-34.1	-35.9		-26.5	-21.25	5.28
	HT/VHT20 STBC, M0 to M7	4	5	-43.2	-39.7	-40.4	-39.5	-29.4	-21.25	8.15
	HE20, M0 to M9 1ss	1	5	-42.3				-37.2	-21.25	15.98
	HE20, M0 to M9 1ss	2	5	-42.3	-33.2			-27.6	-21.25	6.38
	HE20, M0 to M9 2ss	2	5	-42.3	-33.2			-27.6	-21.25	6.38
	HE20, M0 to M9 1ss	3	5	-42.3	-40.3	-40.3		-31.0	-21.25	9.78
	HE20, M0 to M9 2ss	3	5	-42.3	-33.2	-37.1		-26.3	-21.25	5.03
	HE20, M0 to M9 3ss	3	5	-42.3	-33.2	-37.1		-26.3	-21.25	5.03
	HE20, M0 to M9 1ss	4	5	-42.3	-46.8	-47.4	-48.1	-34.4	-21.25	13.13
	HE20, M0 to M9 2ss	4	5	-42.3	-36.1	-37.8	-35.6	-26.2	-21.25	4.95
	HE20, M0 to M9 3ss	4	5	-42.3	-36.1	-37.8	-35.6	-26.2	-21.25	4.95
	HE20, M0 to M9 4ss	4	5	-42.3	-36.1	-37.8	-35.6	-26.2	-21.25	4.95
	HE20 Beam Forming, M0 to M9 1ss	2	8	-42.3	-36.1			-27.1	-21.25	5.85
	HE20 Beam Forming, M0 to M9 2ss	2	5	-42.3	-33.2			-27.6	-21.25	6.38
	HE20 Beam Forming, M0 to M9 1ss	3	10	-42.3	-40.3	-40.3		-26.0	-21.25	4.78
	HE20 Beam Forming, M0 to M9 2ss	3	7	-42.3	-36.1	-37.8		-26.2	-21.25	4.96
	HE20 Beam Forming, M0 to M9 3ss	3	5	-42.3	-33.2	-37.1		-26.3	-21.25	5.03
	HE20 Beam Forming, M0 to M9 1ss	4	11	-42.3	-46.8	-47.4	-48.1	-28.4	-21.25	7.13
	HE20 Beam Forming, M0 to M9 2ss	4	8	-42.3	-40.3	-40.3	-38.6	-26.1	-21.25	4.84
	HE20 Beam Forming, M0 to M9 3ss	4	6	-42.3	-36.1	-37.8	-35.6	-25.2	-21.25	3.95
	HE20 Beam Forming, M0 to M9 4ss	4	5	-42.3	-36.1	-37.8	-35.6	-26.2	-21.25	4.95
	HE20 STBC, M0 to M9 2ss	2	5	-42.3	-33.2			-27.6	-21.25	6.38
	HE20 STBC, M0 to M9 2ss	3	5	-42.3	-33.2	-37.1		-26.3	-21.25	5.03
	HE20 STBC, M0 to M9 2ss	4	5	-42.3	-36.1	-37.8	-35.6	-26.2	-21.25	4.95
5250	Non HT160, 6 to 54 Mbps	1	5	-32.0				-27.0	-21.25	5.70
	Non HT160, 6 to 54 Mbps	2	5	-34.5	-47.9			-29.3	-21.25	8.01
	Non HT160, 6 to 54 Mbps	3	5	-34.5	-47.9	-50.0		-29.1	-21.25	7.89



Non HT160, 6 to 54 Mbps	4	5	-34.5	-47.9	-50.0	-44.6	-28.8	-21.25	7.51
VHT160, M0 to M9 1ss	1	5	-28.2				-22.8	-21.25	1.56
VHT160, M0 to M9 1ss	2	5	-28.2	-39.2			-22.5	-21.25	1.23
VHT160, M0 to M9 2ss	2	5	-28.2	-39.2			-22.5	-21.25	1.23
VHT160, M0 to M9 1ss	3	5	-28.2	-39.2	-42.0		-22.3	-21.25	1.06
VHT160, M0 to M9 2ss	3	5	-28.2	-39.2	-42.0		-22.3	-21.25	1.06
VHT160, M0 to M9 3ss	3	5	-28.2	-39.2	-42.0		-22.3	-21.25	1.06
VHT160, M0 to M9 1ss	4	5	-28.2	-39.2	-42.0	-41.6	-22.1	-21.25	0.89
VHT160, M0 to M9 2ss	4	5	-28.2	-39.2	-42.0	-41.6	-22.1	-21.25	0.89
VHT160, M0 to M9 3ss	4	5	-28.2	-39.2	-42.0	-41.6	-22.1	-21.25	0.89
VHT160, M0 to M9 4ss	4	5	-28.2	-39.2	-42.0	-41.6	-22.1	-21.25	0.89
VHT160 Beam Forming, M0 to M9 1ss	2	8	-30.9	-40.0			-22.0	-21.25	0.75
VHT160 Beam Forming, M0 to M9 2ss	2	5	-28.2	-39.2			-22.5	-21.25	1.23
VHT160 Beam Forming, M0 to M9 1ss	3	10	-33.1	-43.0	-44.1		-22.0	-21.25	0.73
VHT160 Beam Forming, M0 to M9 2ss	3	7	-30.9	-40.0	-42.3		-22.7	-21.25	1.48
VHT160 Beam Forming, M0 to M9 3ss	3	5	-28.2	-39.2	-42.0		-22.3	-21.25	1.06
VHT160 Beam Forming, M0 to M9 1ss	4	11	-36.1	-44.5	-44.6	-44.7	-23.2	-21.25	1.92
<b>VHT160 Beam Forming, M0 to M9 2ss</b>	<b>4</b>	<b>8</b>	<b>-30.9</b>	<b>-40.0</b>	<b>-42.3</b>	<b>-42.4</b>	<b>-21.5</b>	<b>-21.25</b>	<b>0.23</b>
VHT160 Beam Forming, M0 to M9 3ss	4	6	-30.9	-40.0	-42.3	-42.4	-23.5	-21.25	2.23
VHT160 Beam Forming, M0 to M9 4ss	4	5	-28.2	-39.2	-42.0	-41.6	-22.1	-21.25	0.89
VHT160 STBC, M0 to M9 1ss	2	5	-28.2	-39.2			-22.5	-21.25	1.23
VHT160 STBC, M0 to M9 1ss	3	5	-28.2	-39.2	-42.0		-22.3	-21.25	1.06
VHT160 STBC, M0 to M9 1ss	4	5	-28.2	-39.2	-42.0	-41.6	-22.1	-21.25	0.89
HE160, M0 to M9 1ss	1	5	-34.6				-29.2	-21.25	7.92
HE160, M0 to M9 1ss	2	5	-34.6	-47.1			-28.9	-21.25	7.68
HE160, M0 to M9 2ss	2	5	-34.6	-47.1			-28.9	-21.25	7.68
HE160, M0 to M9 1ss	3	5	-34.6	-47.1	-48.7		-28.8	-21.25	7.52
HE160, M0 to M9 2ss	3	5	-34.6	-47.1	-48.7		-28.8	-21.25	7.52
HE160, M0 to M9 3ss	3	5	-34.6	-47.1	-48.7		-28.8	-21.25	7.52
HE160, M0 to M9 1ss	4	5	-34.6	-47.1	-48.7	-44.2	-28.4	-21.25	7.11
HE160, M0 to M9 2ss	4	5	-34.6	-47.1	-48.7	-44.2	-28.4	-21.25	7.11
HE160, M0 to M9 3ss	4	5	-34.6	-47.1	-48.7	-44.2	-28.4	-21.25	7.11
HE160, M0 to M9 4ss	4	5	-34.6	-47.1	-48.7	-44.2	-28.4	-21.25	7.11
HE160 Beam Forming, M0 to M9 1ss	2	8	-37.9	-44.0			-28.5	-21.25	7.26
HE160 Beam Forming, M0 to M9 2ss	2	5	-34.6	-47.1			-28.9	-21.25	7.68
HE160 Beam Forming, M0 to M9 1ss	3	10	-37.9	-44.0	-50.6		-26.3	-21.25	5.08
HE160 Beam Forming, M0 to M9 2ss	3	7	-34.6	-47.1	-48.7		-26.8	-21.25	5.52
HE160 Beam Forming, M0 to M9 3ss	3	5	-34.6	-47.1	-48.7		-28.8	-21.25	7.52
HE160 Beam Forming, M0 to M9 1ss	4	11	-42.0	-50.4	-49.6	-48.7	-28.7	-21.25	7.46
HE160 Beam Forming, M0 to M9 2ss	4	8	-37.9	-44.0	-50.6	-45.8	-27.8	-21.25	6.57
HE160 Beam Forming, M0 to M9 3ss	4	6	-34.6	-47.1	-48.7	-44.2	-27.4	-21.25	6.11
HE160 Beam Forming, M0 to M9 4ss	4	5	-34.6	-47.1	-48.7	-44.2	-28.4	-21.25	7.11



HE160 STBC, M0 to M9 1ss	2	5	-34.6	-47.1			-28.9	-21.25	7.68
HE160 STBC, M0 to M9 1ss	3	5	-34.6	-47.1	-48.7		-28.8	-21.25	7.52
HE160 STBC, M0 to M9 1ss	4	5	-34.6	-47.1	-48.7	-44.2	-28.4	-21.25	7.11





**Conducted Bandedge Peak, 5dBi  
5250 MHz, VHT160 Beam Forming, M0 to M9 2ss**



**Antenna A**

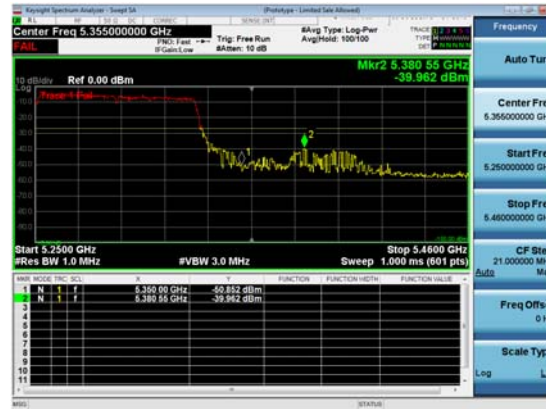

**Antenna B**



**Antenna C**



**Antenna D**



## Conducted Bandedge Peak Table, 6dBi

Frequency (MHz)	Mode	Tx Paths	Correlated Antenna Gain (dBi)	Tx 1 Bandedge Level (dBm)	Tx 2 Bandedge Level (dBm)	Tx 3 Bandedge Level (dBm)	Tx 4 Bandedge Level (dBm)	Total Tx Bandedge Level (dBm)	Limit (dBm)	Margin (dB)
5290	Non HT80, 6 to 54 Mbps	1	6	-32.9				-26.8	-21.25	5.60
	Non HT80, 6 to 54 Mbps	2	6	-32.9	-44.4			-26.6	-21.25	5.30
	Non HT80, 6 to 54 Mbps	3	6	-32.9	-44.4	-47.2		-26.4	-21.25	5.15
	Non HT80, 6 to 54 Mbps	4	6	-32.9	-44.4	-47.2	-38.2	-25.4	-21.25	4.13
	VHT80, M0 to M9 1ss	1	6	-33.0				-26.8	-21.25	5.53
	VHT80, M0 to M9 1ss	2	6	-33.0	-45.8			-26.6	-21.25	5.31
	VHT80, M0 to M9 2ss	2	6	-33.0	-45.8			-26.6	-21.25	5.31
	VHT80, M0 to M9 1ss	3	6	-36.3	-46.6	-47.0		-29.4	-21.25	8.12
	VHT80, M0 to M9 2ss	3	6	-36.3	-46.6	-47.0		-29.4	-21.25	8.12
	VHT80, M0 to M9 3ss	3	6	-36.3	-46.6	-47.0		-29.4	-21.25	8.12
	VHT80, M0 to M9 1ss	4	6	-36.3	-46.6	-47.0	-46.6	-29.0	-21.25	7.79
	VHT80, M0 to M9 2ss	4	6	-36.3	-46.6	-47.0	-46.6	-29.0	-21.25	7.79
	VHT80, M0 to M9 3ss	4	6	-36.3	-46.6	-47.0	-46.6	-29.0	-21.25	7.79
	VHT80, M0 to M9 4ss	4	6	-36.3	-46.6	-47.0	-46.6	-29.0	-21.25	7.79
	VHT80 Beam Forming, M0 to M9 1ss	2	9	-36.3	-46.6			-26.7	-21.25	5.45
	VHT80 Beam Forming, M0 to M9 2ss	2	6	-33.0	-45.8			-26.6	-21.25	5.31
	VHT80 Beam Forming, M0 to M9 1ss	3	11	-39.3	-48.8	-50.6		-27.3	-21.25	6.09
	VHT80 Beam Forming, M0 to M9 2ss	3	8	-36.3	-46.6	-47.0		-27.4	-21.25	6.12
	VHT80 Beam Forming, M0 to M9 3ss	3	6	-36.3	-46.6	-47.0		-29.4	-21.25	8.12
	VHT80 Beam Forming, M0 to M9 1ss	4	12	-43.1	-50.3	-49.2	-49.5	-28.7	-21.25	7.42
	VHT80 Beam Forming, M0 to M9 2ss	4	9	-39.3	-48.8	-50.6	-47.8	-28.9	-21.25	7.60
	VHT80 Beam Forming, M0 to M9 3ss	4	7	-36.3	-46.6	-47.0	-46.6	-28.0	-21.25	6.79
	VHT80 Beam Forming, M0 to M9 4ss	4	6	-36.3	-46.6	-47.0	-46.6	-29.0	-21.25	7.79
	VHT80 STBC, M0 to M9 1ss	2	6	-33.0	-45.8			-26.6	-21.25	5.31
	VHT80 STBC, M0 to M9 1ss	3	6	-36.3	-46.6	-47.0		-29.4	-21.25	8.12
	VHT80 STBC, M0 to M9 1ss	4	6	-36.3	-46.6	-47.0	-46.6	-29.0	-21.25	7.79
	HE80, M0 to M9 1ss	1	6	-39.1				-32.8	-21.25	11.59



	HE80, M0 to M9 1ss	2	6	-39.1	-46.6			-32.1	-21.25	10.88
	HE80, M0 to M9 2ss	2	6	-39.1	-46.6			-32.1	-21.25	10.88
	HE80, M0 to M9 1ss	3	6	-39.1	-46.6	-47.7		-31.6	-21.25	10.40
	HE80, M0 to M9 2ss	3	6	-39.1	-46.6	-47.7		-31.6	-21.25	10.40
	HE80, M0 to M9 3ss	3	6	-39.1	-46.6	-47.7		-31.6	-21.25	10.40
	HE80, M0 to M9 1ss	4	6	-39.1	-46.6	-47.7	-45.8	-31.0	-21.25	9.74
	HE80, M0 to M9 2ss	4	6	-39.1	-46.6	-47.7	-45.8	-31.0	-21.25	9.74
	HE80, M0 to M9 3ss	4	6	-39.1	-46.6	-47.7	-45.8	-31.0	-21.25	9.74
	HE80, M0 to M9 4ss	4	6	-39.1	-46.6	-47.7	-45.8	-31.0	-21.25	9.74
	HE80 Beam Forming, M0 to M9 1ss	2	9	-41.5	-50.7			-31.7	-21.25	10.50
	HE80 Beam Forming, M0 to M9 2ss	2	6	-39.1	-46.6			-32.1	-21.25	10.88
	HE80 Beam Forming, M0 to M9 1ss	3	11	-45.6	-50.7	-49.7		-32.0	-21.25	10.79
	HE80 Beam Forming, M0 to M9 2ss	3	8	-41.5	-50.7	-50.0		-32.2	-21.25	10.98
	HE80 Beam Forming, M0 to M9 3ss	3	6	-39.1	-46.6	-47.7		-31.6	-21.25	10.40
	HE80 Beam Forming, M0 to M9 1ss	4	12	-45.1	-52.0	-52.1	-51.3	-30.7	-21.25	9.43
	HE80 Beam Forming, M0 to M9 2ss	4	9	-41.5	-50.7	-50.0	-49.1	-30.7	-21.25	9.42
	HE80 Beam Forming, M0 to M9 3ss	4	7	-41.5	-50.7	-50.0	-49.1	-32.7	-21.25	11.42
	HE80 Beam Forming, M0 to M9 4ss	4	6	-39.1	-46.6	-47.7	-45.8	-31.0	-21.25	9.74
	HE80 STBC, M0 to M9 1ss	2	6	-39.1	-46.6			-32.1	-21.25	10.88
	HE80 STBC, M0 to M9 1ss	3	6	-39.1	-46.6	-47.7		-31.6	-21.25	10.40
	HE80 STBC, M0 to M9 1ss	4	6	-39.1	-46.6	-47.7	-45.8	-31.0	-21.25	9.74
5310	Non HT40, 6 to 54 Mbps	1	6	-33.7				-27.7	-21.25	6.41
	Non HT40, 6 to 54 Mbps	2	6	-33.7	-44.6			-27.3	-21.25	6.07
	Non HT40, 6 to 54 Mbps	3	6	-37.1	-46.8	-48.0		-30.3	-21.25	9.06
	Non HT40, 6 to 54 Mbps	4	6	-37.1	-46.8	-48.0	-44.7	-29.7	-21.25	8.46
	HT/VHT40, M0 to M7	1	6	-36.4				-30.3	-21.25	9.05
	HT/VHT40, M0 to M7	2	6	-36.4	-46.0			-29.8	-21.25	8.60
	HT/VHT40, M8 to M15	2	6	-36.4	-46.0			-29.8	-21.25	8.60
	HT/VHT40, M0 to M7	3	6	-36.4	-46.0	-48.8		-29.6	-21.25	8.38
	HT/VHT40, M8 to M15	3	6	-36.4	-46.0	-48.8		-29.6	-21.25	8.38
	HT/VHT40, M16 to M23	3	6	-36.4	-46.0	-48.8		-29.6	-21.25	8.38
	HT/VHT40, M0 to M7	4	6	-36.4	-46.0	-48.8	-43.4	-28.9	-21.25	7.69
	HT/VHT40, M8 to M15	4	6	-36.4	-46.0	-48.8	-43.4	-28.9	-21.25	7.69
	HT/VHT40, M16 to M23	4	6	-36.4	-46.0	-48.8	-43.4	-28.9	-21.25	7.69
	HT/VHT40, M24 to M31	4	6	-36.4	-46.0	-48.8	-43.4	-28.9	-21.25	7.69
	HT/VHT40 Beam Forming, M0 to M7	2	9	-39.6	-48.3			-29.9	-21.25	8.70
	HT/VHT40 Beam Forming, M8 to M15	2	6	-36.4	-46.0			-29.8	-21.25	8.60
	HT/VHT40 Beam Forming, M0 to M7	3	11	-44.2	-49.2	-49.7		-31.1	-21.25	9.81
	HT/VHT40 Beam Forming, M8 to M15	3	8	-39.6	-48.3	-48.9		-30.5	-21.25	9.27
	HT/VHT40 Beam Forming, M16 to M23	3	6	-36.4	-46.0	-48.8		-29.6	-21.25	8.38
	HT/VHT40 Beam Forming, M0 to M7	4	12	-44.2	-49.2	-49.7	-49.7	-29.4	-21.25	8.11



	HT/VHT40 Beam Forming, M8 to M15	4	9	-39.6	-48.3	-48.9	-46.9	-28.9	-21.25	7.67
	HT/VHT40 Beam Forming, M16 to M23	4	7	-39.6	-48.3	-48.9	-46.9	-30.9	-21.25	9.67
	HT/VHT40 Beam Forming, M24 to M31	4	6	-36.4	-46.0	-48.8	-43.4	-28.9	-21.25	7.69
	HT/VHT40 STBC, M0 to M7	2	6	-36.4	-46.0			-29.8	-21.25	8.60
	HT/VHT40 STBC, M0 to M7	3	6	-36.4	-46.0	-48.8		-29.6	-21.25	8.38
	HT/VHT40 STBC, M0 to M7	4	6	-36.4	-46.0	-48.8	-43.4	-28.9	-21.25	7.69
	HE40, M0 to M9 1ss	1	6	-34.0				-27.9	-21.25	6.62
	HE40, M0 to M9 1ss	2	6	-34.0	-44.0			-27.5	-21.25	6.21
	HE40, M0 to M9 2ss	2	6	-34.0	-44.0			-27.5	-21.25	6.21
	HE40, M0 to M9 1ss	3	6	-36.5	-47.2	-50.9		-29.9	-21.25	8.62
	HE40, M0 to M9 2ss	3	6	-36.5	-47.2	-50.9		-29.9	-21.25	8.62
	HE40, M0 to M9 3ss	3	6	-36.5	-47.2	-50.9		-29.9	-21.25	8.62
	HE40, M0 to M9 1ss	4	6	-36.5	-47.2	-50.9	-43.0	-29.1	-21.25	7.83
	HE40, M0 to M9 2ss	4	6	-36.5	-47.2	-50.9	-43.0	-29.1	-21.25	7.83
	HE40, M0 to M9 3ss	4	6	-36.5	-47.2	-50.9	-43.0	-29.1	-21.25	7.83
	HE40, M0 to M9 4ss	4	6	-36.5	-47.2	-50.9	-43.0	-29.1	-21.25	7.83
	HE40 Beam Forming, M0 to M9 1ss	2	9	-36.5	-47.2			-27.0	-21.25	5.77
	HE40 Beam Forming, M0 to M9 2ss	2	6	-34.0	-44.0			-27.5	-21.25	6.21
	HE40 Beam Forming, M0 to M9 1ss	3	11	-39.4	-48.7	-50.1		-27.5	-21.25	6.22
	HE40 Beam Forming, M0 to M9 2ss	3	8	-36.5	-47.2	-50.9		-27.9	-21.25	6.62
	HE40 Beam Forming, M0 to M9 3ss	3	6	-36.5	-47.2	-50.9		-29.9	-21.25	8.62
	HE40 Beam Forming, M0 to M9 1ss	4	12	-43.6	-50.9	-49.2	-49.8	-29.2	-21.25	7.91
	HE40 Beam Forming, M0 to M9 2ss	4	9	-39.4	-48.7	-50.1	-50.4	-29.2	-21.25	7.94
	HE40 Beam Forming, M0 to M9 3ss	4	7	-36.5	-47.2	-50.9	-43.0	-28.1	-21.25	6.83
	HE40 Beam Forming, M0 to M9 4ss	4	6	-36.5	-47.2	-50.9	-43.0	-29.1	-21.25	7.83
	HE40 STBC, M0 to M9 2ss	2	6	-34.0	-44.0			-27.5	-21.25	6.21
	HE40 STBC, M0 to M9 2ss	3	6	-36.5	-47.2	-50.9		-29.9	-21.25	8.62
	HE40 STBC, M0 to M9 2ss	4	6	-36.5	-47.2	-50.9	-43.0	-29.1	-21.25	7.83
5320	Non HT20, 6 to 54 Mbps	1	6	-42.2				-36.2	-21.25	14.91
	Non HT20, 6 to 54 Mbps	2	6	-42.2	-34.7			-27.9	-21.25	6.70
	Non HT20, 6 to 54 Mbps	3	6	-42.2	-45.7	-47.2		-33.7	-21.25	12.44
	Non HT20, 6 to 54 Mbps	4	6	-49.3	-50.5	-50.5	-49.9	-38.0	-21.25	16.71
	Non HT20 Beam Forming, 6 to 54 Mbps	2	9	-42.2	-36.9			-26.7	-21.25	5.48
	Non HT20 Beam Forming, 6 to 54 Mbps	3	11	-42.2	-45.7	-47.2		-28.7	-21.25	7.44
	Non HT20 Beam Forming, 6 to 54 Mbps	4	12	-49.3	-50.5	-50.5	-49.9	-32.0	-21.25	10.71
	HT/VHT20, M0 to M7	1	6	-43.2				-37.1	-21.25	15.90
	HT/VHT20, M0 to M7	2	6	-43.2	-34.1			-27.5	-21.25	6.29
	HT/VHT20, M8 to M15	2	6	-43.2	-34.1			-27.5	-21.25	6.29
	HT/VHT20, M0 to M7	3	6	-43.2	-43.3	-46.8		-33.3	-21.25	12.07
	HT/VHT20, M8 to M15	3	6	-43.2	-34.1	-35.9		-25.5	-21.25	4.28
	HT/VHT20, M16 to M23	3	6	-43.2	-34.1	-35.9		-25.5	-21.25	4.28



	HT/VHT20, M0 to M7	4	6	-45.8	-49.2	-50.4	-47.7	-35.9	-21.25	14.61
	HT/VHT20, M8 to M15	4	6	-43.2	-43.7	-42.6	-43.3	-31.1	-21.25	9.86
	HT/VHT20, M16 to M23	4	6	-43.2	-39.7	-40.4	-39.5	-28.4	-21.25	7.15
	HT/VHT20, M24 to M31	4	6	-43.2	-39.7	-40.4	-39.5	-28.4	-21.25	7.15
	HT/VHT20 Beam Forming, M0 to M7	2	9	-43.2	-39.7			-29.0	-21.25	7.79
	HT/VHT20 Beam Forming, M8 to M15	2	6	-43.2	-34.1			-27.5	-21.25	6.29
	HT/VHT20 Beam Forming, M0 to M7	3	11	-43.2	-43.3	-46.8		-28.3	-21.25	7.07
	HT/VHT20 Beam Forming, M8 to M15	3	8	-43.2	-39.7	-40.4		-28.0	-21.25	6.78
	HT/VHT20 Beam Forming, M16 to M23	3	6	-43.2	-34.1	-35.9		-25.5	-21.25	4.28
	HT/VHT20 Beam Forming, M0 to M7	4	12	-45.8	-49.2	-50.4	-47.7	-29.9	-21.25	8.61
	HT/VHT20 Beam Forming, M8 to M15	4	9	-43.2	-43.7	-42.6	-43.3	-28.1	-21.25	6.86
	HT/VHT20 Beam Forming, M16 to M23	4	7	-43.2	-39.7	-40.4	-39.5	-27.4	-21.25	6.15
	HT/VHT20 Beam Forming, M24 to M31	4	6	-43.2	-39.7	-40.4	-39.5	-28.4	-21.25	7.15
	HT/VHT20 STBC, M0 to M7	2	6	-43.2	-34.1			-27.5	-21.25	6.29
	HT/VHT20 STBC, M0 to M7	3	6	-43.2	-34.1	-35.9		-25.5	-21.25	4.28
	HT/VHT20 STBC, M0 to M7	4	6	-43.2	-43.7	-42.6	-43.3	-31.1	-21.25	9.86
	HE20, M0 to M9 1ss	1	6	-42.3				-36.2	-21.25	14.98
	HE20, M0 to M9 1ss	2	6	-42.3	-33.2			-26.6	-21.25	5.38
	HE20, M0 to M9 2ss	2	6	-42.3	-33.2			-26.6	-21.25	5.38
	HE20, M0 to M9 1ss	3	6	-42.3	-42.4	-45.0		-32.2	-21.25	10.98
	HE20, M0 to M9 2ss	3	6	-42.3	-36.1	-37.8		-27.2	-21.25	5.96
	HE20, M0 to M9 3ss	3	6	-42.3	-36.1	-37.8		-27.2	-21.25	5.96
	HE20, M0 to M9 1ss	4	6	-45.0	-49.8	-49.2	-47.9	-35.5	-21.25	14.21
	HE20, M0 to M9 2ss	4	6	-42.3	-40.3	-40.3	-38.6	-28.1	-21.25	6.84
	HE20, M0 to M9 3ss	4	6	-42.3	-36.1	-37.8	-35.6	-25.2	-21.25	3.95
	HE20, M0 to M9 4ss	4	6	-42.3	-36.1	-37.8	-35.6	-25.2	-21.25	3.95
	HE20 Beam Forming, M0 to M9 1ss	2	9	-42.3	-40.3			-29.1	-21.25	7.86
	HE20 Beam Forming, M0 to M9 2ss	2	6	-42.3	-33.2			-26.6	-21.25	5.38
	HE20 Beam Forming, M0 to M9 1ss	3	11	-42.3	-42.4	-45.0		-27.2	-21.25	5.98
	HE20 Beam Forming, M0 to M9 2ss	3	8	-42.3	-40.3	-40.3		-28.0	-21.25	6.78
	HE20 Beam Forming, M0 to M9 3ss	3	6	-42.3	-36.1	-37.8		-27.2	-21.25	5.96
	HE20 Beam Forming, M0 to M9 1ss	4	12	-45.0	-49.8	-49.2	-47.9	-29.5	-21.25	8.21
	HE20 Beam Forming, M0 to M9 2ss	4	9	-42.3	-42.4	-45.0	-41.7	-27.6	-21.25	6.34
	HE20 Beam Forming, M0 to M9 3ss	4	7	-42.3	-40.3	-40.3	-38.6	-27.1	-21.25	5.84
	HE20 Beam Forming, M0 to M9 4ss	4	6	-42.3	-36.1	-37.8	-35.6	-25.2	-21.25	3.95
	HE20 STBC, M0 to M9 2ss	2	6	-42.3	-33.2			-26.6	-21.25	5.38
	HE20 STBC, M0 to M9 2ss	3	6	-42.3	-36.1	-37.8		-27.2	-21.25	5.96
	HE20 STBC, M0 to M9 2ss	4	6	-42.3	-40.3	-40.3	-38.6	-28.1	-21.25	6.84
5250	Non HT160, 6 to 54 Mbps	1	6	-34.5				-28.5	-21.25	7.20
	Non HT160, 6 to 54 Mbps	2	6	-34.5	-47.9			-28.3	-21.25	7.01
	Non HT160, 6 to 54 Mbps	3	6	-34.5	-47.9	-50.0		-28.1	-21.25	6.89



Non HT160, 6 to 54 Mbps	4	6	-34.5	-47.9	-50.0	-44.6	-27.8	-21.25	6.51
VHT160, M0 to M9 1ss	1	6	-28.2				-21.8	-21.25	0.56
VHT160, M0 to M9 1ss	2	6	-28.2	-39.2			-21.5	-21.25	0.23
VHT160, M0 to M9 2ss	2	6	-28.2	-39.2			-21.5	-21.25	0.23
<b>VHT160, M0 to M9 1ss</b>	<b>3</b>	<b>6</b>	<b>-28.2</b>	<b>-39.2</b>	<b>-42.0</b>		<b>-21.3</b>	<b>-21.25</b>	<b>0.06</b>
VHT160, M0 to M9 2ss	3	6	-28.2	-39.2	-42.0		-21.3	-21.25	0.06
VHT160, M0 to M9 3ss	3	6	-28.2	-39.2	-42.0		-21.3	-21.25	0.06
VHT160, M0 to M9 1ss	4	6	-30.9	-40.0	-42.3	-42.4	-23.5	-21.25	2.23
VHT160, M0 to M9 2ss	4	6	-30.9	-40.0	-42.3	-42.4	-23.5	-21.25	2.23
VHT160, M0 to M9 3ss	4	6	-30.9	-40.0	-42.3	-42.4	-23.5	-21.25	2.23
VHT160, M0 to M9 4ss	4	6	-30.9	-40.0	-42.3	-42.4	-23.5	-21.25	2.23
VHT160 Beam Forming, M0 to M9 1ss	2	9	-33.1	-43.0			-23.3	-21.25	2.03
VHT160 Beam Forming, M0 to M9 2ss	2	6	-28.2	-39.2			-21.5	-21.25	0.23
VHT160 Beam Forming, M0 to M9 1ss	3	11	-36.1	-44.5	-44.6		-23.6	-21.25	2.37
VHT160 Beam Forming, M0 to M9 2ss	3	8	-30.9	-40.0	-42.3		-21.7	-21.25	0.48
VHT160 Beam Forming, M0 to M9 3ss	3	6	-28.2	-39.2	-42.0		-21.3	-21.25	0.06
VHT160 Beam Forming, M0 to M9 1ss	4	12	-36.1	-44.5	-44.6	-44.7	-22.2	-21.25	0.92
VHT160 Beam Forming, M0 to M9 2ss	4	9	-33.1	-43.0	-44.1	-43.3	-22.6	-21.25	1.40
VHT160 Beam Forming, M0 to M9 3ss	4	7	-30.9	-40.0	-42.3	-42.4	-22.5	-21.25	1.23
VHT160 Beam Forming, M0 to M9 4ss	4	6	-30.9	-40.0	-42.3	-42.4	-23.5	-21.25	2.23
VHT160 STBC, M0 to M9 1ss	2	6	-28.2	-39.2			-21.5	-21.25	0.23
VHT160 STBC, M0 to M9 1ss	3	6	-28.2	-39.2	-42.0		-21.3	-21.25	0.06
VHT160 STBC, M0 to M9 1ss	4	6	-30.9	-40.0	-42.3	-42.4	-23.5	-21.25	2.23
HE160, M0 to M9 1ss	1	6	-34.6				-28.2	-21.25	6.92
HE160, M0 to M9 1ss	2	6	-34.6	-47.1			-27.9	-21.25	6.68
HE160, M0 to M9 2ss	2	6	-34.6	-47.1			-27.9	-21.25	6.68
HE160, M0 to M9 1ss	3	6	-34.6	-47.1	-48.7		-27.8	-21.25	6.52
HE160, M0 to M9 2ss	3	6	-34.6	-47.1	-48.7		-27.8	-21.25	6.52
HE160, M0 to M9 3ss	3	6	-34.6	-47.1	-48.7		-27.8	-21.25	6.52
HE160, M0 to M9 1ss	4	6	-34.6	-47.1	-48.7	-44.2	-27.4	-21.25	6.11
HE160, M0 to M9 2ss	4	6	-34.6	-47.1	-48.7	-44.2	-27.4	-21.25	6.11
HE160, M0 to M9 3ss	4	6	-34.6	-47.1	-48.7	-44.2	-27.4	-21.25	6.11
HE160, M0 to M9 4ss	4	6	-34.6	-47.1	-48.7	-44.2	-27.4	-21.25	6.11
HE160 Beam Forming, M0 to M9 1ss	2	9	-37.9	-44.0			-27.5	-21.25	6.26
HE160 Beam Forming, M0 to M9 2ss	2	6	-34.6	-47.1			-27.9	-21.25	6.68
HE160 Beam Forming, M0 to M9 1ss	3	11	-42.0	-50.4	-49.6		-29.4	-21.25	8.12
HE160 Beam Forming, M0 to M9 2ss	3	8	-37.9	-44.0	-50.6		-28.3	-21.25	7.08
HE160 Beam Forming, M0 to M9 3ss	3	6	-34.6	-47.1	-48.7		-27.8	-21.25	6.52
HE160 Beam Forming, M0 to M9 1ss	4	12	-45.0	-51.9	-51.5	-50.1	-30.2	-21.25	8.92
HE160 Beam Forming, M0 to M9 2ss	4	9	-37.9	-44.0	-50.6	-45.8	-26.8	-21.25	5.57
HE160 Beam Forming, M0 to M9 3ss	4	7	-37.9	-44.0	-50.6	-45.8	-28.8	-21.25	7.57
HE160 Beam Forming, M0 to M9 4ss	4	6	-34.6	-47.1	-48.7	-44.2	-27.4	-21.25	6.11



HE160 STBC, M0 to M9 1ss	2	6	-34.6	-47.1			-27.9	-21.25	6.68
HE160 STBC, M0 to M9 1ss	3	6	-34.6	-47.1	-48.7		-27.8	-21.25	6.52
HE160 STBC, M0 to M9 1ss	4	6	-34.6	-47.1	-48.7	-44.2	-27.4	-21.25	6.11





**Conducted Bandedge Peak, 6dBi  
5250 MHz, VHT160, M0 to M9 1ss**



**Antenna A**

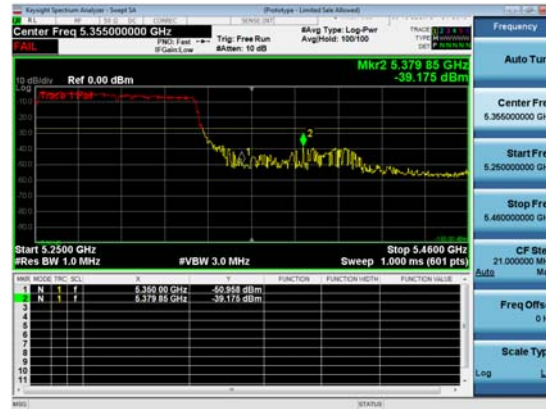

**Antenna B**



**Antenna C**



**Appendix B: Radiated & AC Conducted Emissions Test Results**  
Testing done by outside laboratory.





## Appendix D: Abbreviation Key and Definitions

The following table defines abbreviations used within this test report.

Abbreviation	Description	Abbreviation	Description
EMC	Electro Magnetic Compatibility	°F	Degrees Fahrenheit
EMI	Electro Magnetic Interference	°C	Degrees Celsius
EUT	Equipment Under Test	Temp	Temperature
ITE	Information Technology Equipment	S/N	Serial Number
TAP	Test Assessment Schedule	Qty	Quantity
ESD	Electro Static Discharge	emf	Electromotive force
EFT	Electric Fast Transient	RMS	Root mean square
EDCS	Engineering Document Control System	Qp	Quasi Peak
Config	Configuration	Av	Average
CIS#	Cisco Number (unique identification number for Cisco test equipment)	Pk	Peak
Cal	Calibration	kHz	Kilohertz ( $1 \times 10^3$ )
EN	European Norm	MHz	MegaHertz ( $1 \times 10^6$ )
IEC	International Electro technical Commission	GHz	Gigahertz ( $1 \times 10^9$ )
CISPR	International Special Committee on Radio Interference	H	Horizontal
CDN	Coupling/Decoupling Network	V	Vertical
LISN	Line Impedance Stabilization Network	dB	decibel
PE	Protective Earth	V	Volt
GND	Ground	kV	Kilovolt ( $1 \times 10^3$ )
L1	Line 1	$\mu$ V	Microvolt ( $1 \times 10^{-6}$ )
L2	Line2	A	Amp
L3	Line 3	$\mu$ A	Micro Amp ( $1 \times 10^{-6}$ )
DC	Direct Current	mS	Milli Second ( $1 \times 10^{-3}$ )
RAW	Uncorrected measurement value, as indicated by the measuring device	$\mu$ S	Micro Second ( $1 \times 10^{-6}$ )
RF	Radio Frequency	$\mu$ S	Micro Second ( $1 \times 10^{-6}$ )
SLCE	Signal Line Conducted Emissions	m	Meter
Meas dist	Measurement distance	Spec dist	Specification distance
N/A or NA	Not Applicable	SL	Signal Line (or Telecom Line)
P	Power Line	L	Live Line
N	Neutral Line	R	Return
S	Supply	AC	Alternating Current



## **Appendix E: Photographs of Test Setups**

Please refer to the attachment



## **Appendix F: Software Used to Perform Testing**

Cisco Internal LabView Radio Test Automation Software rev57

## **Appendix G: Test Procedures**

Measurements were made in accordance with

- KDB 789033 - D02 General UNII Test Procedures New Rules v02r01
- KDB 662911 - MIMO
- ANSI C63.4 2014 Unintentional Radiators
- ANSI C63.10 2013 Intentional Radiators

Test procedures are summarized below:

FCC 5GHz Test Procedures	EDCS # 1445048
FCC 5GHz RSE Test Procedures	EDCS # 1511600

## **Appendix H: Scope of Accreditation (A2LA certificate number 1178-01)**

The scope of accreditation of Cisco Systems, Inc. can be found on the A2LA web page at:

<http://www.a2la.org/scopepdf/1178-01.pdf>

## **Appendix I: Test Assessment Plan**

Target Power Tables EDCS# 18087112



## Appendix J: UUT Software Info

```
APA453.0E7B.CB48#  
APA453.0E7B.CB48#  
APA453.0E7B.CB48#test watchdog monitoring off  
APA453.0E7B.CB48#  
APA453.0E7B.CB48#  
APA453.0E7B.CB48#  
APA453.0E7B.CB48#show ver  
Restricted Rights Legend
```

Use, duplication, or disclosure by the Government is subject to restrictions as set forth in subparagraph (c) of the Commercial Computer Software - Restricted Rights clause at FAR sec. 52.227-19 and subparagraph (c) (1) (ii) of the Rights in Technical Data and Computer Software clause at DFARS sec. 252.227-7013.

Cisco Systems, Inc.  
170 West Tasman Drive  
San Jose, California 95134-1706

This product contains cryptographic features and is subject to United States and local country laws governing import, export, transfer and use. Delivery of Cisco cryptographic products does not imply third-party authority to import, export, distribute or use encryption. Importers, exporters, distributors and users are responsible for compliance with U.S. and local country laws. By using this product you agree to comply with applicable laws and regulations. If you are unable to comply with U.S. and local laws, return this product immediately.

A summary of U.S. laws governing Cisco cryptographic products may be found at:  
<http://www.cisco.com/wwl/export/crypto/tool/stqrg.html>

If you require further assistance please contact us by sending email to [export@cisco.com](mailto:export@cisco.com).

This product contains some software licensed under the "GNU General Public License, version 2" provided with ABSOLUTELY NO WARRANTY under the terms of "GNU General Public License, version 2", available here:  
<http://www.gnu.org/licenses/old-licenses/gpl-2.0.html>

This product contains some software licensed under the "GNU Library General Public License, version 2" provided with ABSOLUTELY NO WARRANTY under the terms of "GNU Library General Public License, version 2", available here:





<http://www.gnu.org/licenses/old-licenses/lgpl-2.0.html>

This product contains some software licensed under the "GNU Lesser General Public License, version 2.1" provided with ABSOLUTELY NO WARRANTY under the terms of "GNU Lesser General Public License, version 2.1", available here: <http://www.gnu.org/licenses/old-licenses/lgpl-2.1.html>

This product contains some software licensed under the "GNU General Public License, version 3" provided with ABSOLUTELY NO WARRANTY under the terms of "GNU General Public License, Version 3", available here: <http://www.gnu.org/licenses/gpl.html>.

This product contains some software licensed under the "GNU Affero General Public License, version 3" provided with ABSOLUTELY NO WARRANTY under the terms of "GNU Affero General Public License, version 3", available here: <http://www.gnu.org/licenses/agpl-3.0.html>.

Cisco AP Software, (ap1g7), [cheetah-build6:/san2/BUILD/workspace/Nightly-Cheetah-axel-bcm-mfg-c8\_10\_throttle]  
Technical Support: <http://www.cisco.com/techsupport>  
Copyright (c) 1986-2019 by Cisco Systems, Inc.  
Compiled Tue Aug 6 08:07:11 PDT 2019

ROM: Bootstrap program is U-Boot boot loader  
BOOTLDR: U-Boot boot loader Version

APA453.0E7B.CB48 uptime is 0 days, 0 hours, 4 minutes  
Last reload time : Tue Aug 6 09:41:25 UTC 2019  
Last reload reason : unknown

cisco C9120AXE-B with 1813676/1065756K bytes of memory.  
Processor board ID 0  
AP Running Image : 8.8.1.10  
Primary Boot Image : 8.8.1.10  
Backup Boot Image : 0.0.0.0  
Primary Boot Image Hash:  
Backup Boot Image Hash:  
1 Gigabit Ethernet interfaces  
2 802.11 Radios  
Radio Driver version : 17.10 RC77.13  
Radio FW version : 1268.14948.r146 146  
NSS FW version : NA

Base ethernet MAC Address : A4:53:0E:7B:CB:48  
Part Number : 0-000000-00



PCA Assembly Number : 800-105708-01  
PCA Revision Number : 09  
PCB Serial Number : FOC23302F3B  
Top Assembly Part Number : 800-105708-01  
Top Assembly Serial Number : 0  
Top Revision Number : 09  
Product/Model Number : C9120AXE-B

APA453.0E7B.CB48#

APA453.0E7B.CB48#

APA453.0E7B.CB48#

APA453.0E7B.CB48#

APA453.0E7B.CB48#

APA453.0E7B.CB48#

APA453.0E7B.CB48#

APA453.0E7B.CB48#

APA453.0E7B.CB48#devs

EXITING CISCO SHELL. PLEASE EXECUTE EXIT IN DEVSHELL TO GET BACK TO CISCO SHELL.

BusyBox v1.29.3 () built-in shell (ash)

Welcome to Cisco.

Usage of this device is governed by Cisco's End User License Agreement,  
available at:

[http://www.cisco.com/c/en/us/td/docs/general/warranty/English/EU1KEN\\_.html](http://www.cisco.com/c/en/us/td/docs/general/warranty/English/EU1KEN_.html).

mA4530E7BCB48:##

mA4530E7BCB48:##

mA4530E7BCB48:##

mA4530E7BCB48:##

mA4530E7BCB48:##

mA4530E7BCB48:## cat MERAKI\_BUILD.extra

Tue Aug 6 08:07:11 PDT 2019

cheetah-build6

/san2/BUILD/workspace/Nightly-Cheetah-axel-bcm-mfg-c8\_10\_throttle

\* (HEAD detached at c9764ec05b)

svn base: c9764ec05b8c12d58c9be25326e8565279ce1a37

commit: c9764ec05b8c12d58c9be25326e8565279ce1a37

tree 91b17c0a6dff95efbab96749f9f008dd797f938

mA4530E7BCB48:##

mA4530E7BCB48:##

mA4530E7BCB48:##



mA4530E7BCB48:/#  
mA4530E7BCB48:/# show\_cookie  
Part Number : 0-000000-00  
Board Revision : 00  
PCB Serial Number : FOC23302F3B  
PCB Fab Part Number : 0-000000-00  
Deviation Number : 0  
MAC Address : A4:53:0E:7B:CB:48  
MAC Address Block Size : 4  
Radio 0 MAC Address : D4:AD:BD:A2:0A:40  
Radio 0 MAC Address Block Size : 16  
Radio 1 MAC Address : D4:AD:BD:A2:0A:50  
Radio 1 MAC Address Block Size : 16  
PCA Assembly Number : 800-105708-01  
PCA Revision Number : 09  
Product/Model Number : C9120AXE-B  
Top Assembly Part Number : 800-105708-01  
Top Revision Number : 09  
Top Assembly Serial Number : 0  
RMA Test History : 00  
RMA History : 00  
RMA Number : 00-00-00-00  
Device Type : 4C  
Max Association Allowed : 2  
Radio(2.4G) Carrier Set : 0000  
Radio(2.4G) Max Transmit Power Level : 100  
Radio(2.4G) Antenna Diversity Support: 01  
Radio(2.4G) Encryption Ability : 0002  
Radio(5G) Carrier Set : 0029  
Radio(5G) Max Transmit Power Level : 100  
Radio(5G) Antenna Diversity Support : 01  
Radio(5G) Encryption Ability : 0002  
Radio(802.11g) Radio Mode : 255  
PEP Product Identifier (PID) : C9120AXE-B  
PEP Version Identifier (VID) : V01  
System Flags : 00  
Controller Type : 0000  
Host Controller Type : 0000  
Mfr Service Date : 2019.08.03-47:59:59  
Radio(49) Carrier Set : 0000  
Radio(49) Max Transmit Power Level : 0  
Radio(49) Antenna Diversity Support : 00  
Radio(49) Encryption Ability : 0000  
Radio(58) Carrier Set : 0029  
Radio(58) Max Transmit Power Level : 100  
Radio(58) Antenna Diversity Support : 01  
Radio(58) Encryption Ability : 0002



```
ACT2 ID           : C9120
Static AP Mode    : 0
mA4530E7BCB48:/#
mA4530E7BCB48:/#
mA4530E7BCB48:/#
mA4530E7BCB48:/#
mA4530E7BCB48:/#
mA4530E7BCB48:/#
mA4530E7BCB48:/#
mA4530E7BCB48:/# cat /storage/rxtx_mode
tx
mA4530E7BCB48:/#
mA4530E7BCB48:/#
mA4530E7BCB48:/#
mA4530E7BCB48:/# cd /usr/bin/bcm/mfg
mA4530E7BCB48:/usr/bin/bcm/mfg#
mA4530E7BCB48:/usr/bin/bcm/mfg#
mA4530E7BCB48:/usr/bin/bcm/mfg#
mA4530E7BCB48:/usr/bin/bcm/mfg#
mA4530E7BCB48:/usr/bin/bcm/mfg#
mA4530E7BCB48:/usr/bin/bcm/mfg#
mA4530E7BCB48:/usr/bin/bcm/mfg#
mA4530E7BCB48:/usr/bin/bcm/mfg#
mA4530E7BCB48:/usr/bin/bcm/mfg#
mA4530E7BCB48:/usr/bin/bcm/mfg#
mA4530E7BCB48:/usr/bin/bcm/mfg#
```

```
Vanc dfstool
BOARD: Axel BCM !!!!!
```

```
Display config:
wl -i apr0v0 status | head -3
"SSID: "MFG-2GTEST"
Mode: Managed  RSSI: 0 dBm    SNR: 0 dB    noise: -97 dBm  Channel: 1
BSSID: D4:AD:BD:A2:0A:40    Capability: ESS ShortSlot "
```

```
Display config:
wl -i apr1v0 status | head -3
"SSID: "MFG-5GTEST"
Mode: Managed  RSSI: 0 dBm    SNR: 0 dB    noise: -97 dBm  Channel: 36
BSSID: D4:AD:BD:A2:0A:4F    Capability: ESS "
```

```
show_carrier_cookies | grep -o '..$'
rc:result="41"
```

```
wl -i apr1v0 country US
wl -i apr0v0 country US
>
line=""
>
```



```
line=""  
>  
line=""  
>  
line=""  
>
```

**End**