

Test Report

C9120AXE-x (x=B)

Cisco Catalyst C9120AX Series 802.11ax Access Point

XOR 5GHz Radio

FCC ID: LDKEDAC92157

5150-5250 MHz

Against the following Specifications:

CFR47 Part 15.407



Cisco Systems

170 West Tasman Drive

San Jose, CA 95134

	
<p>Author: Chris Blair Tested By: Chris Blair</p>	<p>Approved By: Gez Thorpe Title: Radio Compliance Manager Revision: See EDCS</p>

This report replaces any previously entered test report under EDCS – **18295598**. This test report has been electronically authorized and archived using the CISCO Engineering Document Control system. Test Report Template EDCS# 11644122.

This test report has been electronically authorized and archived using the CISCO Engineering Document Control system.

SECTION 1: OVERVIEW	3
SECTION 2: ASSESSMENT INFORMATION	4
2.1 GENERAL	4
2.2 DATE OF TESTING.....	6
2.3 REPORT ISSUE DATE	6
2.4 TESTING FACILITIES	6
2.5 EQUIPMENT ASSESSED (EUT).....	6
2.6 EUT DESCRIPTION.....	7
SECTION 3: RESULT SUMMARY	13
3.1 RESULTS SUMMARY TABLE	13
SECTION 4: SAMPLE DETAILS.....	17
4.1 SAMPLE DETAILS	17
4.2 SYSTEM DETAILS	17
4.3 MODE OF OPERATION DETAILS.....	17
APPENDIX A: EMISSION TEST RESULTS	18
CONDUCTED TEST SETUP DIAGRAM.....	18
TARGET MAXIMUM CHANNEL POWER	18
A.1 DUTY CYCLE	22
A.2 99% AND 26DB BANDWIDTH.....	25
A.3 MAXIMUM CONDUCTED OUTPUT POWER	29
A.4 POWER SPECTRAL DENSITY	61
A.5 CONDUCTED SPURIOUS EMISSIONS.....	93
A.6 CONDUCTED RECEIVER SPURIOUS EMISSIONS	156
A.7 CONDUCTED BAND EDGE	166
APPENDIX B: RADIATED & AC CONDUCTED EMISSIONS TEST RESULTS	204
APPENDIX C: LIST OF TEST EQUIPMENT USED TO PERFORM THE TEST.....	205
APPENDIX D: ABBREVIATION KEY AND DEFINITIONS	206
APPENDIX E: PHOTOGRAPHS OF TEST SETUPS	207
APPENDIX F: SOFTWARE USED TO PERFORM TESTING.....	208
APPENDIX G: TEST PROCEDURES	208
APPENDIX H: SCOPE OF ACCREDITATION (A2LA CERTIFICATE NUMBER 1178-01)	208
APPENDIX I: TEST ASSESSMENT PLAN	208
APPENDIX J: UUT SOFTWARE INFO.....	209



Section 1: Overview

The samples were assessed against the tests detailed in section 3 under the requirements of the following specifications:

Specifications:
CFR47 Part 15.407

Section 2: Assessment Information

2.1 General

This report contains an assessment of an apparatus against Electromagnetic Compatibility Standards based upon tests carried out on the samples submitted. The testing was performed by and for the use of Cisco systems Inc:

With regard to this assessment, the following points should be noted:

- a) The results contained in this report relate only to the items tested and were obtained in the period between the date of the initial assessment and the date of issue of the report. Manufactured products will not necessarily give identical results due to production and measurement tolerances.
- b) The apparatus was set up and exercised using the configuration and modes of operation defined in this report only.
- c) Where relevant, the apparatus was only assessed using the susceptibility criteria defined in this report and the Test Assessment Plan (TAP).
- d) All testing was performed under the following environmental conditions:

Temperature	15°C to 35°C (54°F to 95°F)
Atmospheric Pressure	860mbar to 1060mbar (25.4" to 31.3")
Humidity	10% to 75*%

Units of Measurement

The units of measurements defined in the appendices are reported in specific terms, which are test dependent. Where radiated measurements are concerned these are defined at a particular distance. Basic voltage measurements are defined in units of [dBuV]

As an example, the basic calculation for all measurements is as follows:

$$\text{Emission level [dBuV]} = \text{Indicated voltage level [dBuV]} + \text{Cable Loss [dB]} + \text{Other correction factors [dB]}$$

The combinations of correction factors are dependent upon the exact test configurations [see test equipment lists for further details] and may include:-

Antenna Factors, Pre Amplifier Gain, LISN Loss, Pulse Limiter Loss and Filter Insertion Loss..

Note: to convert the results from dBuV/m to uV/m use the following formula:-

$$\text{Level in uV/m} = \text{Common Antilogarithm } [(X \text{ dBuV/m})/20] = Y \text{ uV/m}$$

Measurement Uncertainty Values

voltage and power measurements	± 2 dB
conducted EIRP measurements	± 1.4 dB
radiated measurements	± 3.2 dB
frequency measurements	± 2.4 10 ⁻⁷
temperature measurements	± 0.54°
humidity measurements	± 2.3%
DC and low frequency measurements	± 2.5%

Where relevant measurement uncertainty levels have been estimated for tests performed on the apparatus. This uncertainty represents an expanded uncertainty expressed at approximately the 95% confidence level using a coverage factor of k=2.

Radiated emissions (expanded uncertainty, confidence interval 95%)

30 MHz - 300 MHz	+/- 3.8 dB
300 MHz - 1000 MHz	+/- 4.3 dB
1 GHz - 10 GHz	+/- 4.0 dB
10 GHz - 18GHz	+/- 8.2 dB
18GHz - 26.5GHz	+/- 4.1 dB
26.5GHz - 40GHz	+/- 3.9 dB

Conducted emissions (expanded uncertainty, confidence interval 95%)

30 MHz – 40GHz	+/- 0.38 dB
----------------	-------------

A product is considered to comply with a requirement if the nominal measured value is below the limit line. The product is considered to not be in compliance in case the nominal measured value is above the limit line.

This report must not be reproduced except in full, without written approval of Cisco Systems.

2.2 Date of testing

16-Sep-19 - 26-Sep-19

2.3 Report Issue Date

24-Oct-2019

Cisco uses an electronic system to issue, store and control the revision of test reports. This system is called the Engineering Document Control System. The actual report issue date is embedded into the original file on EDCS. Any copies of this report, either electronic or paper, that are not on EDCS must be considered uncontrolled.

2.4 Testing facilities

This assessment was performed by: Chris Blair & Julian Land

Testing Laboratory

Cisco Systems, Inc.
125 West Tasman Drive (Building P)
San Jose, CA 95134
USA

Headquarters

Cisco Systems, Inc.,
170 West Tasman Drive
San Jose, CA 95134,
USA

Registration Numbers for Industry Canada

Cisco System Site	Address	Site Identifier
Building P, 10m Chamber	125 West Tasman Dr San Jose, CA 95134	Company #: 2461N-2
Building P, 5m Chamber	125 West Tasman Dr San Jose, CA 95134	Company #: 2461N-1
Building I, 5m Chamber	285 W. Tasman Drive San Jose, California 95134	Company #: 2461M-1
Building 7, 5m Chamber	425 E. Tasman Drive San Jose, California 95134	Company #: 2461N-3

Test Engineers

Chris Blair

2.5 Equipment Assessed (EUT)

C9120AXE-B

2.6 EUT Description

The radio supports the following modes of operation. The modes are further defined in the radio Theory of Operation. The modes included in this report represent the worst case data for all modes.

802.11a - Non HT20, One Antenna, 6 to 54 Mbps, 1ss
802.11a - Non HT20, Two Antennas, 6 to 54 Mbps, 1ss
802.11a - Non HT20, Three Antennas, 6 to 54 Mbps, 1ss
802.11a - Non HT20, Four Antennas, 6 to 54 Mbps, 1ss

802.11a - Non HT20 Beam Forming, Two Antennas, 6 to 54 Mbps, 1ss
802.11a - Non HT20 Beam Forming, Three Antennas, 6 to 54 Mbps, 1ss
802.11a - Non HT20 Beam Forming, Four Antennas, 6 to 54 Mbps, 1ss

802.11n/ac - HT/VHT20, One Antenna, M0 to M7, 1ss
802.11n/ac - HT/VHT20, Two Antennas, M0 to M7, 1ss
802.11n/ac - HT/VHT20, Two Antennas, M8 to M15, 2ss
802.11n/ac - HT/VHT20, Three Antennas, M0 to M7, 1ss
802.11n/ac - HT/VHT20, Three Antennas, M8 to M15, 2ss
802.11n/ac - HT/VHT20, Three Antennas, M16 to M23, 3ss
802.11n/ac - HT/VHT20, Four Antennas, M0 to M7, 1ss
802.11n/ac - HT/VHT20, Four Antennas, M8 to M15, 2ss
802.11n/ac - HT/VHT20, Four Antennas, M16 to M23, 3ss
802.11n/ac - HT/VHT20, Four Antennas, M24 to M31, 4ss

802.11n/ac - HT/VHT20 Beam Forming, Two Antennas, M0 to M7, 1ss
802.11n/ac - HT/VHT20 Beam Forming, Two Antennas, M8 to M15, 2ss
802.11n/ac - HT/VHT20 Beam Forming, Three Antennas, M0 to M7, 1ss
802.11n/ac - HT/VHT20 Beam Forming, Three Antennas, M8 to M15, 2ss
802.11n/ac - HT/VHT20 Beam Forming, Three Antennas, M16 to M23, 3ss
802.11n/ac - HT/VHT20 Beam Forming, Four Antennas, M0 to M7, 1ss
802.11n/ac - HT/VHT20 Beam Forming, Four Antennas, M8 to M15, 2ss
802.11n/ac - HT/VHT20 Beam Forming, Four Antennas, M16 to M23, 3ss
802.11n/ac - HT/VHT20 Beam Forming, Four Antennas, M24 to M31, 4ss

802.11n/ac - HT/VHT20 STBC, Two Antennas, M0 to M7, 2ss
802.11n/ac - HT/VHT20 STBC, Three Antennas, M0 to M7, 2ss
802.11n/ac - HT/VHT20 STBC, Four Antennas, M0 to M7, 2ss

802.11ax - HE20, One Antenna, M0 to M9 1ss
802.11ax - HE20, Two Antennas, M0 to M9 1ss
802.11ax - HE20, Two Antennas, M0 to M9 2ss
802.11ax - HE20, Three Antennas, M0 to M9 1ss
802.11ax - HE20, Three Antennas, M0 to M9 2ss
802.11ax - HE20, Three Antennas, M0 to M9 3ss
802.11ax - HE20, Four Antennas, M0 to M9 1ss
802.11ax - HE20, Four Antennas, M0 to M9 2ss
802.11ax - HE20, Four Antennas, M0 to M9 3ss
802.11ax - HE20, Four Antennas, M0 to M9 4ss

802.11ax - HE20 Beam Forming, Two Antennas, M0 to M9 1ss
802.11ax - HE20 Beam Forming, Two Antennas, M0 to M9 2ss
802.11ax - HE20 Beam Forming, Three Antennas, M0 to M9 1ss
802.11ax - HE20 Beam Forming, Three Antennas, M0 to M9 2ss
802.11ax - HE20 Beam Forming, Three Antennas, M0 to M9 3ss
802.11ax - HE20 Beam Forming, Four Antennas, M0 to M9 1ss
802.11ax - HE20 Beam Forming, Four Antennas, M0 to M9 2ss
802.11ax - HE20 Beam Forming, Four Antennas, M0 to M9 3ss
802.11ax - HE20 Beam Forming, Four Antennas, M0 to M9 4ss

802.11ax - HE20 STBC, Two Antennas, M0 to M9 2ss
802.11ax - HE20 STBC, Three Antennas, M0 to M9 2ss
802.11ax - HE20 STBC, Four Antennas, M0 to M9 2ss

802.11a - Non HT40, One Antenna, 6 to 54 Mbps, 1ss
802.11a - Non HT40, Two Antennas, 6 to 54 Mbps, 1ss
802.11a - Non HT40, Three Antennas, 6 to 54 Mbps, 1ss
802.11a - Non HT40, Four Antennas, 6 to 54 Mbps, 1ss

802.11n/ac - HT/VHT40, One Antenna, M0 to M7, 1ss
802.11n/ac - HT/VHT40, Two Antennas, M0 to M7, 1ss
802.11n/ac - HT/VHT40, Two Antennas, M8 to M15, 2ss
802.11n/ac - HT/VHT40, Three Antennas, M0 to M7, 1ss
802.11n/ac - HT/VHT40, Three Antennas, M8 to M15, 2ss
802.11n/ac - HT/VHT40, Three Antennas, M16 to M23, 3ss
802.11n/ac - HT/VHT40, Four Antennas, M0 to M7, 1ss
802.11n/ac - HT/VHT40, Four Antennas, M8 to M15, 2ss
802.11n/ac - HT/VHT40, Four Antennas, M16 to M23, 3ss
802.11n/ac - HT/VHT40, Four Antennas, M24 to M31, 4ss

802.11n/ac - HT/VHT40 Beam Forming, Two Antennas, M0 to M7, 1ss
802.11n/ac - HT/VHT40 Beam Forming, Two Antennas, M8 to M15, 2ss
802.11n/ac - HT/VHT40 Beam Forming, Three Antennas, M0 to M7, 1ss
802.11n/ac - HT/VHT40 Beam Forming, Three Antennas, M8 to M15, 2ss
802.11n/ac - HT/VHT40 Beam Forming, Three Antennas, M16 to M23, 3ss
802.11n/ac - HT/VHT40 Beam Forming, Four Antennas, M0 to M7, 1ss
802.11n/ac - HT/VHT40 Beam Forming, Four Antennas, M8 to M15, 2ss
802.11n/ac - HT/VHT40 Beam Forming, Four Antennas, M16 to M23, 3ss
802.11n/ac - HT/VHT40 Beam Forming, Four Antennas, M24 to M31, 4ss

802.11n/ac - HT/VHT40 STBC, Two Antennas, M0 to M7, 2ss
802.11n/ac - HT/VHT40 STBC, Three Antennas, M0 to M7, 2ss
802.11n/ac - HT/VHT40 STBC, Four Antennas, M0 to M7, 2ss

802.11ax - HE40, One Antenna, M0 to M9 1ss
802.11ax - HE40, Two Antennas, M0 to M9 1ss

802.11ax - HE40, Two Antennas, M0 to M9 2ss
802.11ax - HE40, Three Antennas, M0 to M9 1ss
802.11ax - HE40, Three Antennas, M0 to M9 2ss
802.11ax - HE40, Three Antennas, M0 to M9 3ss
802.11ax - HE40, Four Antennas, M0 to M9 1ss
802.11ax - HE40, Four Antennas, M0 to M9 2ss
802.11ax - HE40, Four Antennas, M0 to M9 3ss
802.11ax - HE40, Four Antennas, M0 to M9 4ss

802.11ax - HE40 Beam Forming, Two Antennas, M0 to M9 1ss
802.11ax - HE40 Beam Forming, Two Antennas, M0 to M9 2ss
802.11ax - HE40 Beam Forming, Three Antennas, M0 to M9 1ss
802.11ax - HE40 Beam Forming, Three Antennas, M0 to M9 2ss
802.11ax - HE40 Beam Forming, Three Antennas, M0 to M9 3ss
802.11ax - HE40 Beam Forming, Four Antennas, M0 to M9 1ss
802.11ax - HE40 Beam Forming, Four Antennas, M0 to M9 2ss
802.11ax - HE40 Beam Forming, Four Antennas, M0 to M9 3ss
802.11ax - HE40 Beam Forming, Four Antennas, M0 to M9 4ss

802.11ax - HE40 STBC, Two Antennas, M0 to M9 2ss
802.11ax - HE40 STBC, Three Antennas, M0 to M9 2ss
802.11ax - HE40 STBC, Four Antennas, M0 to M9 2ss

802.11a - Non HT80, One Antenna, 6 to 54 Mbps, 1ss
802.11a - Non HT80, Two Antennas, 6 to 54 Mbps, 1ss
802.11a - Non HT80, Three Antennas, 6 to 54 Mbps, 1ss
802.11a - Non HT80, Four Antennas, 6 to 54 Mbps, 1ss

802.11ac - VHT80, One Antenna, M0 to M9 1ss
802.11ac - VHT80, Two Antennas, M0 to M9 1ss
802.11ac - VHT80, Two Antennas, M0 to M9 2ss
802.11ac - VHT80, Three Antennas, M0 to M9 1ss
802.11ac - VHT80, Three Antennas, M0 to M9 2ss
802.11ac - VHT80, Three Antennas, M0 to M9 3ss
802.11ac - VHT80, Four Antennas, M0 to M9 1ss
802.11ac - VHT80, Four Antennas, M0 to M9 2ss
802.11ac - VHT80, Four Antennas, M0 to M9 3ss
802.11ac - VHT80, Four Antennas, M0 to M9 4ss

802.11ac - VHT80 Beam Forming, Two Antennas, M0 to M9 1ss
802.11ac - VHT80 Beam Forming, Two Antennas, M0 to M9 2ss
802.11ac - VHT80 Beam Forming, Three Antennas, M0 to M9 1ss
802.11ac - VHT80 Beam Forming, Three Antennas, M0 to M9 2ss
802.11ac - VHT80 Beam Forming, Three Antennas, M0 to M9 3ss
802.11ac - VHT80 Beam Forming, Four Antennas, M0 to M9 1ss
802.11ac - VHT80 Beam Forming, Four Antennas, M0 to M9 2ss
802.11ac - VHT80 Beam Forming, Four Antennas, M0 to M9 3ss
802.11ac - VHT80 Beam Forming, Four Antennas, M0 to M9 4ss

802.11ac - VHT80 STBC, Two Antennas, M0 to M9 2ss
802.11ac - VHT80 STBC, Three Antennas, M0 to M9 2ss
802.11ac - VHT80 STBC, Four Antennas, M0 to M9 2ss

802.11ax - HE80, One Antenna, M0 to M9 1ss
802.11ax - HE80, Two Antennas, M0 to M9 1ss
802.11ax - HE80, Two Antennas, M0 to M9 2ss
802.11ax - HE80, Three Antennas, M0 to M9 1ss
802.11ax - HE80, Three Antennas, M0 to M9 2ss
802.11ax - HE80, Three Antennas, M0 to M9 3ss
802.11ax - HE80, Four Antennas, M0 to M9 1ss
802.11ax - HE80, Four Antennas, M0 to M9 2ss
802.11ax - HE80, Four Antennas, M0 to M9 3ss
802.11ax - HE80, Four Antennas, M0 to M9 4ss

802.11ax - HE80 Beam Forming, Two Antennas, M0 to M9 1ss
802.11ax - HE80 Beam Forming, Two Antennas, M0 to M9 2ss
802.11ax - HE80 Beam Forming, Three Antennas, M0 to M9 1ss
802.11ax - HE80 Beam Forming, Three Antennas, M0 to M9 2ss
802.11ax - HE80 Beam Forming, Three Antennas, M0 to M9 3ss
802.11ax - HE80 Beam Forming, Four Antennas, M0 to M9 1ss
802.11ax - HE80 Beam Forming, Four Antennas, M0 to M9 2ss
802.11ax - HE80 Beam Forming, Four Antennas, M0 to M9 3ss
802.11ax - HE80 Beam Forming, Four Antennas, M0 to M9 4ss

802.11ax - HE80 STBC, Two Antennas, M0 to M9 2ss
802.11ax - HE80 STBC, Three Antennas, M0 to M9 2ss
802.11ax - HE80 STBC, Four Antennas, M0 to M9 2ss

802.11a - Non HT160, One Antenna, 6 to 54 Mbps, 1ss
802.11a - Non HT160, Two Antennas, 6 to 54 Mbps, 1ss
802.11a - Non HT160, Three Antennas, 6 to 54 Mbps, 1ss
802.11a - Non HT160, Four Antennas, 6 to 54 Mbps, 1ss

802.11ac - VHT160, One Antenna, M0 to M9 1ss
802.11ac - VHT160, Two Antennas, M0 to M9 1ss
802.11ac - VHT160, Two Antennas, M0 to M9 2ss
802.11ac - VHT160, Three Antennas, M0 to M9 1ss
802.11ac - VHT160, Three Antennas, M0 to M9 2ss
802.11ac - VHT160, Three Antennas, M0 to M9 3ss
802.11ac - VHT160, Four Antennas, M0 to M9 1ss
802.11ac - VHT160, Four Antennas, M0 to M9 2ss
802.11ac - VHT160, Four Antennas, M0 to M9 3ss
802.11ac - VHT160, Four Antennas, M0 to M9 4ss

802.11ac - VHT160 Beam Forming, Two Antennas, M0 to M9 1ss
802.11ac - VHT160 Beam Forming, Two Antennas, M0 to M9 2ss

802.11ac - VHT160 Beam Forming, Three Antennas, M0 to M9 1ss
802.11ac - VHT160 Beam Forming, Three Antennas, M0 to M9 2ss
802.11ac - VHT160 Beam Forming, Three Antennas, M0 to M9 3ss
802.11ac - VHT160 Beam Forming, Four Antennas, M0 to M9 1ss
802.11ac - VHT160 Beam Forming, Four Antennas, M0 to M9 2ss
802.11ac - VHT160 Beam Forming, Four Antennas, M0 to M9 3ss
802.11ac - VHT160 Beam Forming, Four Antennas, M0 to M9 4ss

802.11ac - VHT160 STBC, Two Antennas, M0 to M9 2ss
802.11ac - VHT160 STBC, Three Antennas, M0 to M9 2ss
802.11ac - VHT160 STBC, Four Antennas, M0 to M9 2ss

802.11ax - HE160, One Antenna, M0 to M9 1ss
802.11ax - HE160, Two Antennas, M0 to M9 1ss
802.11ax - HE160, Two Antennas, M0 to M9 2ss
802.11ax - HE160, Three Antennas, M0 to M9 1ss
802.11ax - HE160, Three Antennas, M0 to M9 2ss
802.11ax - HE160, Three Antennas, M0 to M9 3ss
802.11ax - HE160, Four Antennas, M0 to M9 1ss
802.11ax - HE160, Four Antennas, M0 to M9 2ss
802.11ax - HE160, Four Antennas, M0 to M9 3ss
802.11ax - HE160, Four Antennas, M0 to M9 4ss

802.11ax - HE160 Beam Forming, Two Antennas, M0 to M9 1ss
802.11ax - HE160 Beam Forming, Two Antennas, M0 to M9 2ss
802.11ax - HE160 Beam Forming, Three Antennas, M0 to M9 1ss
802.11ax - HE160 Beam Forming, Three Antennas, M0 to M9 2ss
802.11ax - HE160 Beam Forming, Three Antennas, M0 to M9 3ss
802.11ax - HE160 Beam Forming, Four Antennas, M0 to M9 1ss
802.11ax - HE160 Beam Forming, Four Antennas, M0 to M9 2ss
802.11ax - HE160 Beam Forming, Four Antennas, M0 to M9 3ss
802.11ax - HE160 Beam Forming, Four Antennas, M0 to M9 4ss

802.11ax - HE160 STBC, Two Antennas, M0 to M9 2ss
802.11ax - HE160 STBC, Three Antennas, M0 to M9 2ss
802.11ax - HE160 STBC, Four Antennas, M0 to M9 2ss

The following antennas are supported by this product series.

The data included in this report represent the worst case data for all antennas.

Frequency	Part Number	Antenna Type	Antenna Gain (dBi)
-E SKU			
2.4GHz&5GHz	AIR-ANT2524DB-R/=	2.4 GHz 2 dBi/5 GHz 4 dBi Dipole Ant., Black, connectors RP-TNC	2dBi@2.4GHz 4dBi@5GHz
2.4GHz&5GHz	AIR-ANT2524DG-R/=	2.4 GHz 2 dBi/5 GHz 4 dBi Dipole Ant., Gray, connectors RP-TNC	2dBi@2.4GHz 4dBi@5GHz
2.4GHz&5GHz	AIR-ANT2524DW-R/=	2.4 GHz 2 dBi/5 GHz 4 dBi Dipole Ant., White, connectors RP-TNC	2dBi@2.4GHz 4dBi@5GHz
2.4GHz&5GHz	AIR-ANT2535SDW-R	2.4 GHz 3dBi/5 GHz 5 dBi Low Profile Antenna, White, connectors RP-TNC	3dBi@2.4GHz 5dBi@5GHz
2.4GHz&5GHz	AIR-ANT2566P4W-R=	2.4 GHz 6 dBi/5 GHz 6 dBi Directionnel Ant., 4-port, connectors RP-TNC	6dBi@2.4GHz 6dBi@5GHz
2.4GHz&5GHz	AIR-ANT2524V4C-R=	2.4GHz 2 dBi/5GHz 4 dBi Ceiling Mount Omni Ant., 4-port, connectors RP-TNC	2dBi@2.4GHz 4dBi@5GHz
2.4GHz&5GHz	AIR-ANT2544V4M-R=	2.4GHz 4 dBi/5GHz 4 dBi Wall Mount Omni Ant., 4-port, connectors RP-TNC	4dBi@2.4GHz 4dBi@5GHz
2.4GHz&5GHz	AIR-ANT2566D4M-R=	2.4 GHz 6 dBi/5 GHz 6 dBi 60 Deg. Patch Ant., 4-port, RP-TNC	6dBi@2.4GHz 6dBi@5GHz

Section 3: Result Summary

3.1 Results Summary Table

Conducted emissions

Basic Standard	Technical Requirements / Details	Result
FCC 15.407	<p>99% & 26 dB Bandwidth:</p> <p>The 99% occupied bandwidth is the frequency bandwidth such that, below its lower and above its upper frequency limits, the mean powers are each equal to 0.5% of the total mean power of the given emission. There is no limit for 99% OBW.</p> <p>The 26 dB emission is the width of the emission that is constrained by the frequencies associated with the two outermost amplitude points (upper and lower frequencies) that are attenuated by 26 dB relative to the maximum level measured in the fundamental emission.</p>	Pass

FCC 15.407	<p>Output Power: (1) For the band 5.15-5.25 GHz.</p> <p>(i) For an outdoor access point operating in the band 5.15-5.25 GHz, the maximum conducted output power over the frequency band of operation shall not exceed 1 W provided the maximum antenna gain does not exceed 6 dBi. ... If transmitting antennas of directional gain greater than 6 dBi are used, both the maximum conducted output power ... shall be reduced by the amount in dB that the directional gain of the antenna exceeds 6 dBi. The maximum e.i.r.p. at any elevation angle above 30 degrees as measured from the horizon must not exceed 125 mW (21 dBm).</p> <p>(ii) For an indoor access point operating in the band 5.15-5.25 GHz, the maximum conducted output power over the frequency band of operation shall not exceed 1 W provided the maximum antenna gain does not exceed 6 dBi. ... If transmitting antennas of directional gain greater than 6 dBi are used, both the maximum conducted output power and the maximum power spectral density shall be reduced by the amount in dB that the directional gain of the antenna exceeds 6 dBi.</p> <p>(iii) For fixed point-to-point access points operating in the band 5.15-5.25 GHz, the maximum conducted output power over the frequency band of operation shall not exceed 1 W. ... Fixed point-to-point U-NII devices may employ antennas with directional gain up to 23 dBi without any corresponding reduction in the maximum conducted output power or maximum power spectral density. For fixed point-to-point transmitters that employ a directional antenna gain greater than 23 dBi, a 1 dB reduction in maximum conducted output power and maximum power spectral density is required for each 1 dB of antenna gain in excess of 23 dBi. Fixed, point-to-point operations exclude the use of point-to-multipoint systems, omnidirectional applications, and multiple collocated transmitters transmitting the same information. The operator of the U-NII device, or if the equipment is professionally installed, the installer, is responsible for ensuring that systems employing high gain directional antennas are used exclusively for fixed, point-to-point operations.</p> <p>(iv) For mobile and portable client devices in the 5.15-5.25 GHz band, the maximum conducted output power over the frequency band of operation shall not exceed 250 mW provided the maximum antenna gain does not exceed 6 dBi. In addition, the maximum power spectral density shall not exceed 11 dBm in any 1 megahertz band. If transmitting antennas of directional gain greater than 6 dBi are used, both the maximum conducted output power and the maximum power spectral density shall be reduced by the amount in dB that the directional gain of the antenna exceeds 6 dBi.</p>	Pass
------------	--	------

FCC 15.407	<p>Power Spectral Density</p> <p>(i) For an outdoor access point operating in the band 5.15-5.25 GHz...the maximum power spectral density shall not exceed 17 dBm in any 1 megahertz band. If transmitting antennas of directional gain greater than 6 dBi are used, both the maximum conducted output power and the maximum power spectral density shall be reduced by the amount in dB that the directional gain of the antenna exceeds 6 dBi. The maximum e.i.r.p. at any elevation angle above 30 degrees as measured from the horizon must not exceed 125 mW (21 dBm).</p> <p>(ii) For an indoor access point operating in the band 5.15-5.25 GHz... the maximum power spectral density shall not exceed 17 dBm in any 1 megahertz band. If transmitting antennas of directional gain greater than 6 dBi are used, both the maximum conducted output power and the maximum power spectral density shall be reduced by the amount in dB that the directional gain of the antenna exceeds 6 dBi.</p> <p>(iii) For fixed point-to-point access points operating in the band 5.15-5.25 GHz ...the maximum power spectral density shall not exceed 17 dBm in any 1 megahertz band. Fixed point-to-point U-NII devices may employ antennas with directional gain up to 23 dBi without any corresponding reduction in the ... maximum power spectral density. For fixed point-to-point transmitters that employ a directional antenna gain greater than 23 dBi, a 1 dB reduction in maximum conducted output power and maximum power spectral density is required for each 1 dB of antenna gain in excess of 23 dBi. Fixed, point-to-point operations exclude the use of point-to-multipoint systems, omnidirectional applications, and multiple collocated transmitters transmitting the same information. The operator of the U-NII device, or if the equipment is professionally installed, the installer, is responsible for ensuring that systems employing high gain directional antennas are used exclusively for fixed, point-to-point operations.</p> <p>(iv) For mobile and portable client devices in the 5.15-5.25 GHz band...the maximum power spectral density shall not exceed 11 dBm in any 1 megahertz band. If transmitting antennas of directional gain greater than 6 dBi are used... the maximum power spectral density shall be reduced by the amount in dB that the directional gain of the antenna exceeds 6 dBi.</p>	Pass
FCC 15.407	<p>Conducted Spurious Emissions / Band-Edge: For transmitters operating in the 5.15-5.25 GHz band: all emissions outside of the 5.15-5.35 GHz band shall not exceed an EIRP of -27dBm/MHz.</p>	Pass
FCC 15.407 FCC 15.209 FCC 15.205	<p>Restricted band: Unwanted emissions falling within the restricted bands, as defined in FCC 15.205 (a) must also comply with the radiated emission limits specified in FCC 15.209 (a)</p>	Pass

Radiated Emissions (General requirements)

Basic Standard	Technical Requirements / Details	Result
FCC 15.209 FCC 15.205	TX Spurious Emissions: Except as provided elsewhere in this subpart, the emissions from an intentional radiator shall not exceed the field strength levels specified in the field strength limits table in this section.	Not Tested
FCC 15.207	AC Conducted Emissions: Except when the requirements applicable to a given device state otherwise, for any radio apparatus equipped to operate from the public utility AC power supply, either directly or indirectly (such as with a battery charger), the radio frequency voltage of emissions conducted back onto the AC power lines in the frequency range of 0.15 MHz to 30 MHz shall not exceed the limits shown in the table in these sections. The more stringent limit applies at the frequency range boundaries.	Not Tested

Section 4: Sample Details

Note: Each sample was evaluated to ensure that its condition was suitable to be used as a test sample prior to the commencement of testing.

4.1 Sample Details

Sample No.	Equipment Details	Manufacturer	Hardware Rev.	Firmware Rev.	Software Rev.	Serial Number
S01	C9120AXE-B	Foxconn	P2-2	1268.14948.r 14702 14702	Cisco AP Software, (ap1g7), [cheetah-build6:/san2/ BUILD/workspace/Nig htly-Cheetah-axel-bcm -mfg-c8_10_throttle] Compiled Fri Sep 6 08:06:05 PDT 2019	FOC23302F2B
S02	DART cable 37-100909-01	Amphenol	NA	NA	NA	NA

4.2 System Details

System #	Description	Samples
1	C9120AXE-B	S01+S02

4.3 Mode of Operation Details

Mode#	Description	Comments
1	Continuously Transmitting	Constant duty cycle

Appendix A: Emission Test Results

Conducted Test Setup Diagram

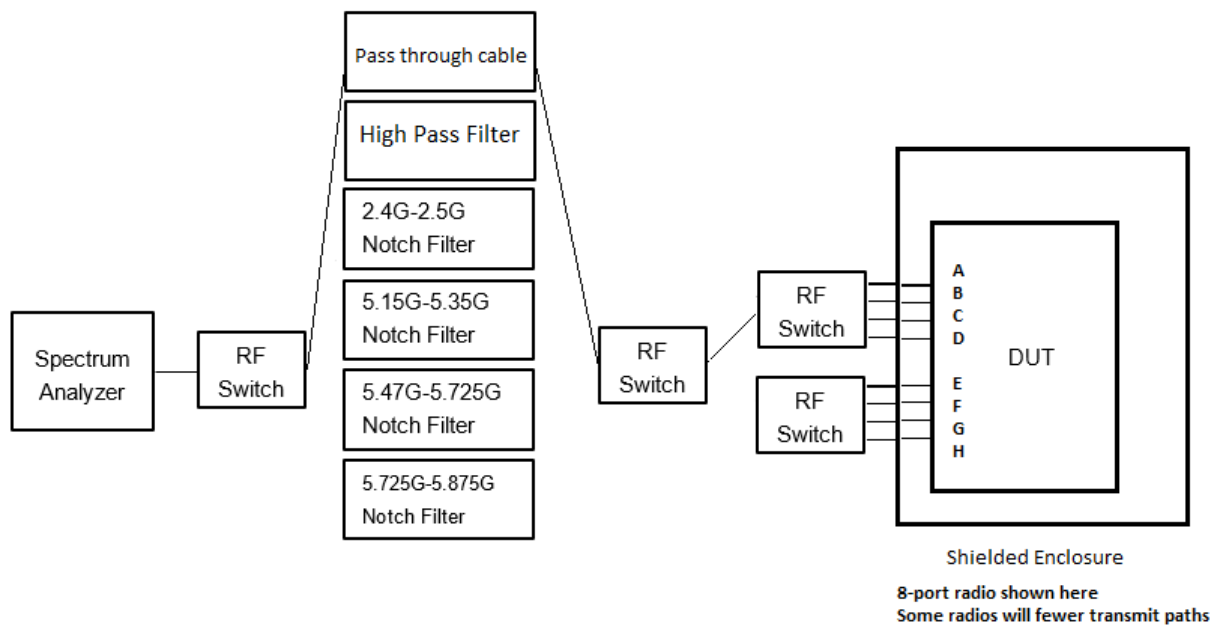

Target Maximum Channel Power

The following tables detail the maximum supported Total Channel Power for all operating modes.

Operating Mode	Maximum Channel Power, 4dBi (dBm)		
	Frequency (MHz)		
	5250		
Non HT160, 6 to 54 Mbps	15		
VHT160, M0 to M9, M0 to M9 1-2ss	16		
VHT160 Beam Forming, M0 to M9, M0 to M9 1-2ss	16		
VHT160 STBC, M0 to M9 1ss	16		
HE160, M0 to M9, M0 to M9 1-2ss	15		
HE160 Beam Forming, M0 to M9, M0 to M9 1-2ss	15		
HE160 STBC, M0 to M9 1ss	15		
	5180	5220	5240
Non HT20, 6 to 54 Mbps	20	21	21
Non HT20 Beam Forming, 6 to 54 Mbps	17	21	21
HT/VHT20, M0 to M31	21	21	21
HT/VHT20 Beam Forming, M0 to M31	21	21	21
HT/VHT20 STBC, M0 to M7	21	21	21
HE20, M0 to M9, M0 to M9 1-2ss	19	21	21
HE20 Beam Forming, M0 to M9, M0 to M9 1-2ss	19	21	21
HE20 STBC, M0 to M9 2ss	19	21	21
	5190	5230	
Non HT40, 6 to 54 Mbps	15	21	
HT/VHT40, M0 to M31	16	21	
HT/VHT40 Beam Forming, M0 to M31	16	21	
HT/VHT40 STBC, M0 to M7	16	21	
HE40, M0 to M9, M0 to M9 1-2ss	14	21	
HE40 Beam Forming, M0 to M9, M0 to M9 1-2ss	14	21	
HE40 STBC, M0 to M9 2ss	14	21	
	5210		
Non HT80, 6 to 54 Mbps	16		
VHT80, M0 to M9, M0 to M9 1-2ss	16		
VHT80 Beam Forming, M0 to M9, M0 to M9 1-2ss	16		
VHT80 STBC, M0 to M9 1ss	16		
HE80, M0 to M9, M0 to M9 1-2ss	15		
HE80 Beam Forming, M0 to M9, M0 to M9 1-2ss	15		
HE80 STBC, M0 to M9 1ss	15		

Operating Mode	Maximum Channel Power, 5dBi (dBm)		
	Frequency (MHz)		
	5250		
Non HT160, 6 to 54 Mbps	15		
VHT160, M0 to M9, M0 to M9 1-2ss	15		
VHT160 Beam Forming, M0 to M9, M0 to M9 1-2ss	15		
VHT160 STBC, M0 to M9 1ss	15		
HE160, M0 to M9, M0 to M9 1-2ss	15		
HE160 Beam Forming, M0 to M9, M0 to M9 1-2ss	15		
HE160 STBC, M0 to M9 1ss	15		
	5180	5220	5240
Non HT20, 6 to 54 Mbps	20	21	21
Non HT20 Beam Forming, 6 to 54 Mbps	16	21	21
HT/VHT20, M0 to M31	20	21	21
HT/VHT20 Beam Forming, M0 to M31	20	21	21
HT/VHT20 STBC, M0 to M7	20	21	21
HE20, M0 to M9, M0 to M9 1-2ss	19	21	21
HE20 Beam Forming, M0 to M9, M0 to M9 1-2ss	19	21	21
HE20 STBC, M0 to M9 2ss	19	21	21
	5190	5230	
Non HT40, 6 to 54 Mbps	15	21	
HT/VHT40, M0 to M31	15	21	
HT/VHT40 Beam Forming, M0 to M31	15	21	
HT/VHT40 STBC, M0 to M7	15	21	
HE40, M0 to M9, M0 to M9 1-2ss	14	21	
HE40 Beam Forming, M0 to M9, M0 to M9 1-2ss	14	21	
HE40 STBC, M0 to M9 2ss	14	21	
	5210		
Non HT80, 6 to 54 Mbps	15		
VHT80, M0 to M9, M0 to M9 1-2ss	16		
VHT80 Beam Forming, M0 to M9, M0 to M9 1-2ss	16		
VHT80 STBC, M0 to M9 1ss	16		
HE80, M0 to M9, M0 to M9 1-2ss	15		
HE80 Beam Forming, M0 to M9, M0 to M9 1-2ss	15		
HE80 STBC, M0 to M9 1ss	15		

Operating Mode	Maximum Channel Power, 6dBi (dBm)		
	Frequency (MHz)		
	5250		
Non HT160, 6 to 54 Mbps	14		
VHT160, M0 to M9, M0 to M9 1-2ss	15		
VHT160 Beam Forming, M0 to M9, M0 to M9 1-2ss	15		
VHT160 STBC, M0 to M9 1ss	15		
HE160, M0 to M9, M0 to M9 1-2ss	15		
HE160 Beam Forming, M0 to M9, M0 to M9 1-2ss	15		
HE160 STBC, M0 to M9 1ss	15		
	5180	5220	5240
Non HT20, 6 to 54 Mbps	19	21	21
Non HT20 Beam Forming, 6 to 54 Mbps	16	21	21
HT/VHT20, M0 to M31	20	21	21
HT/VHT20 Beam Forming, M0 to M31	20	21	21
HT/VHT20 STBC, M0 to M7	20	21	21
HE20, M0 to M9, M0 to M9 1-2ss	18	21	21
HE20 Beam Forming, M0 to M9, M0 to M9 1-2ss	18	21	21
HE20 STBC, M0 to M9 2ss	18	21	21
	5190	5230	
Non HT40, 6 to 54 Mbps	15	21	
HT/VHT40, M0 to M31	15	21	
HT/VHT40 Beam Forming, M0 to M31	15	21	
HT/VHT40 STBC, M0 to M7	15	21	
HE40, M0 to M9, M0 to M9 1-2ss	14	21	
HE40 Beam Forming, M0 to M9, M0 to M9 1-2ss	14	21	
HE40 STBC, M0 to M9 2ss	14	21	
	5210		
Non HT80, 6 to 54 Mbps	15		
VHT80, M0 to M9, M0 to M9 1-2ss	15		
VHT80 Beam Forming, M0 to M9, M0 to M9 1-2ss	15		
VHT80 STBC, M0 to M9 1ss	15		
HE80, M0 to M9, M0 to M9 1-2ss	14		
HE80 Beam Forming, M0 to M9, M0 to M9 1-2ss	14		
HE80 STBC, M0 to M9 1ss	14		

A.1 Duty Cycle

Duty Cycle Test Requirement

From KDB 789033 D02 General UNII Test Procedures New Rules v02r01

B. Duty Cycle (x), Transmission Duration (T), and Maximum Power Control Level

1. All measurements are to be performed with the EUT transmitting at 100 percent duty cycle at its maximum power control level; however, if 100 percent duty cycle cannot be achieved, measurements of duty cycle, x, and maximum-power transmission duration, T, are required for each tested mode of operation.

Duty Cycle Test Method

From KDB 789033 D02 General UNII Test Procedures New Rules v02r01:

B. Duty Cycle (x), Transmission Duration (T), and Maximum Power Control Level

The zero-span mode on a spectrum analyzer or EMI receiver, if the response time and spacing between bins on the sweep are sufficient to permit accurate measurements of the on and off times of the transmitted signal. Set the center frequency of the instrument to the center frequency of the transmission. Set RBW \geq EBW if possible; otherwise, set RBW to the largest available value. Set VBW \geq RBW. Set detector = peak or average. The zero-span measurement method shall not be used unless both RBW and VBW are $> 50/T$, where T is defined in section II.B.1.a), and the number of sweep points across duration T exceeds 100. (For example, if VBW and/or RBW are limited to 3 MHz, then the zero-span method of measuring duty cycle shall not be used if $T \leq 16.7$ microseconds.)

Duty Cycle Test Information

Tested By : Chris Blair	Date of testing: 16-Sep-19 - 26-Sep-19
Test Result : PASS	

Test Equipment

See Appendix C for list of test equipment

Samples, Systems, and Modes

System Number	Description	Samples	System under test	Support equipment
1	EUT	S01 + S02	<input checked="" type="checkbox"/>	<input type="checkbox"/>
	Support		<input type="checkbox"/>	<input checked="" type="checkbox"/>

Duty Cycle Data Table

Duty Cycle table and screen captures are shown below for power/psd modes.

Frequency	Mode	Data Rate	Duty Cycle correction (dB)
5180	Non HT20, 6 to 54 Mbps	6	0.1
	HT/VHT20, M0 to M31	m0	0.1
	HE20, M0 to M9, M0 to M9 1-2ss	m0h1	0.1
5190	Non HT40, 6 to 54 Mbps	6	0.0
	HT/VHT40, M0 to M31	m0	0.1
	HE40, M0 to M9, M0 to M9 1-2ss	m0h1	0.1
5210	Non HT80, 6 to 54 Mbps	6	0.1
	VHT80, M0 to M9, M0 to M9 1-2ss	m0x1	0.2
	HE80, M0 to M9, M0 to M9 1-2ss	m0h1	0.3
5220	Non HT20, 6 to 54 Mbps	6	0.1
	HT/VHT20, M0 to M31	m0	0.1
	HE20, M0 to M9, M0 to M9 1-2ss	m0h1	0.1
5230	Non HT40, 6 to 54 Mbps	6	0.0
	HT/VHT40, M0 to M31	m0	0.1
	HE40, M0 to M9, M0 to M9 1-2ss	m0h1	0.1
5240	Non HT20, 6 to 54 Mbps	6	0.1
	HT/VHT20, M0 to M31	m0	0.1
	HE20, M0 to M9, M0 to M9 1-2ss	m0h1	0.1
5250	Non HT160, 6 to 54 Mbps	6	0.0
	VHT160, M0 to M9, M0 to M9 1-2ss	m0x1	0.4
	HE160, M0 to M9, M0 to M9 1-2ss	m0h1	0.4



Duty Cycle, 5190 MHz, HE160, M0 to M9, M0 to M9 1-2ss

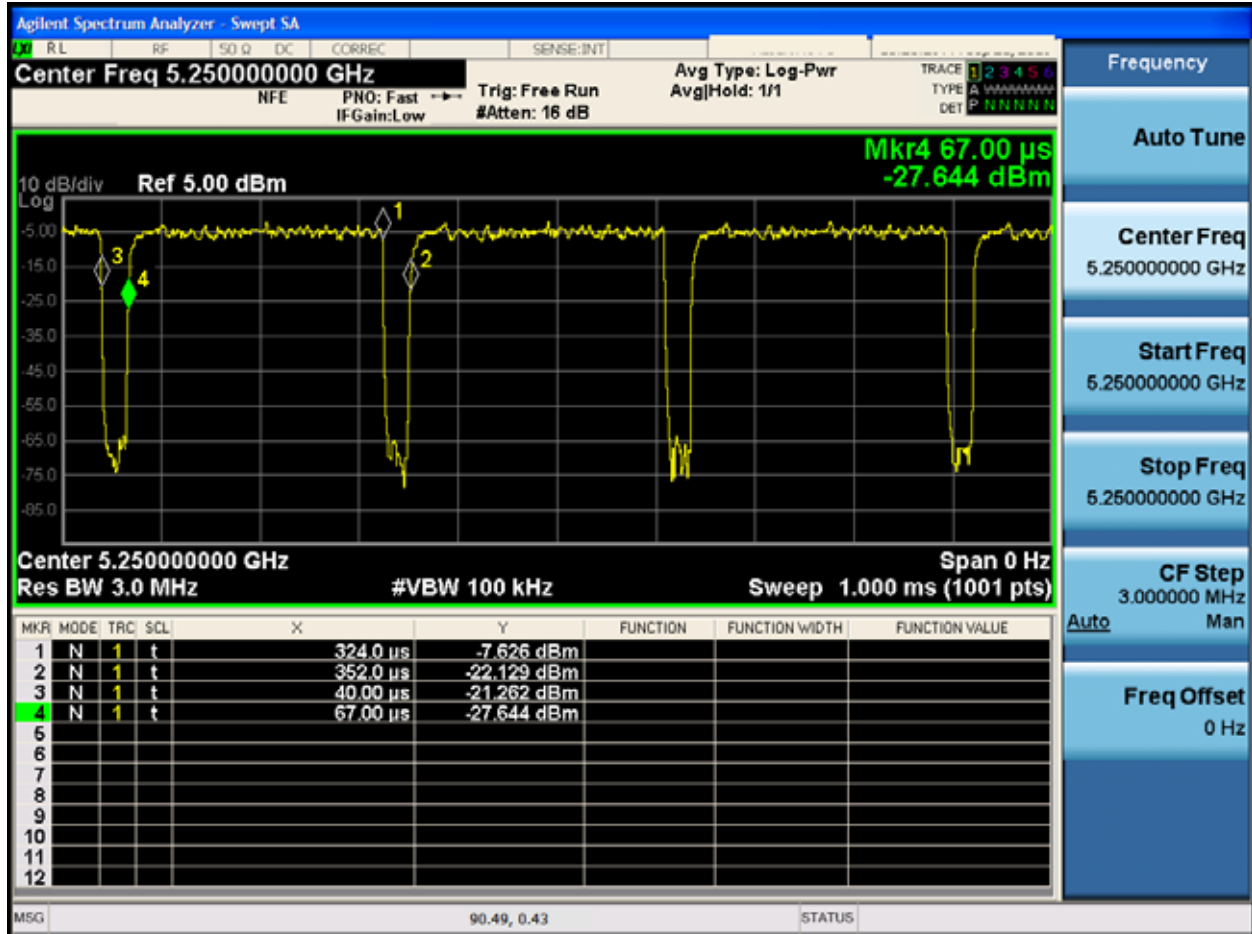

A.2 99% and 26dB Bandwidth

99% and 26dB Bandwidth Test Requirement

For the FCC:

There is no requirement for the value of bandwidth.

Power measurements are made using the 99% Bandwidth as the integration bandwidth.

99% and 26dB Bandwidth Test Procedure

The 99-percent occupied bandwidth is the frequency bandwidth such that, below its lower and above its upper frequency limits, the mean powers are each equal to 0.5 % of the total mean power of the given emission. Measurement of the 99-percent occupied bandwidth is required only as a condition for using the optional band-edge measurement techniques described in section II.G.3.d). Measurements of 99-percent occupied bandwidth may also optionally be used in lieu of the EBW to define the minimum frequency range over which the spectrum is integrated when measuring maximum conducted output power as described in section II.E. However, the EBW must be measured to determine bandwidth dependent limits on maximum conducted output power in accordance with 15.407(a).

Ref. KDB 789033 Section D. 99 Percent Occupied Bandwidth

99% BW
Test Parameters
<ol style="list-style-type: none"> 1. Set center frequency to the nominal EUT channel center frequency. 2. Set span = 1.5 times to 5.0 times the OBW. 3. Set RBW = 1 % to 5 % of the OBW 4. Set VBW $\geq 3 \cdot$ RBW 5. Video averaging is not permitted. Where practical, a sample detection and single sweep mode shall be used. Otherwise, peak detection and max hold mode (until the trace stabilizes) shall be used. 6. Use the 99 % power bandwidth function of the instrument (if available).

Ref KDB 789033 in Section C. Measurement Bandwidth, Section 1

26 BW
Test parameters
X dB BW = -26dB (using the OBW function of the spectrum analyzer)
Emission Bandwidth (EBW)
<ol style="list-style-type: none"> a) Set RBW = approximately 1% of the emission bandwidth. b) Set the VBW > RBW. c) Detector = Peak. d) Trace mode = max hold. e) Measure the maximum width of the emission that is 26 dB down from the maximum of the emission. Compare this with the RBW setting of the analyzer. Readjust RBW and repeat measurement as needed until the RBW/EBW ratio is approximately 1%.

Samples, Systems, and Modes

System Number	Description	Samples	System under test	Support equipment
1	EUT	S01 + S02	<input checked="" type="checkbox"/>	<input type="checkbox"/>
	Support		<input type="checkbox"/>	<input checked="" type="checkbox"/>



Tested By : Chris Blair	Date of testing: 16-Sep-19 - 26-Sep-19
Test Result : PASS	

Test Equipment

See Appendix C for list of test equipment

Frequency (MHz)	Mode	Data Rate (Mbps)	26dB BW (MHz)	99% BW (MHz)
5180	Non HT20, 6 to 54 Mbps	6	21.2	16.782
	HT/VHT20, M0 to M31	m0	21.7	18.011
	HE20, M0 to M9, M0 to M9 1-2ss	m0h1	21.4	19.117
5190	Non HT40, 6 to 54 Mbps	6	39.7	36.334
	HT/VHT40, M0 to M31	m0	40.1	36.436
	HE40, M0 to M9, M0 to M9 1-2ss	m0h1	39.9	37.564
5210	Non HT80, 6 to 54 Mbps	6	81.8	76.131
	VHT80, M0 to M9, M0 to M9 1-2ss	m0x1	82.2	75.941
	HE80, M0 to M9, M0 to M9 1-2ss	m0h1	81.9	77.020
5220	Non HT20, 6 to 54 Mbps	6	21.2	16.783
	HT/VHT20, M0 to M31	m0	21.8	18.063
	HE20, M0 to M9, M0 to M9 1-2ss	m0h1	21.5	19.154
5230	Non HT40, 6 to 54 Mbps	6	39.9	36.394
	HT/VHT40, M0 to M31	m0	40.2	36.469
	HE40, M0 to M9, M0 to M9 1-2ss	m0h1	40.0	37.660
5240	Non HT20, 6 to 54 Mbps	6	21.2	16.790
	HT/VHT20, M0 to M31	m0	21.8	18.063
	HE20, M0 to M9, M0 to M9 1-2ss	m0h1	21.5	19.147
5250	Non HT160, 6 to 54 Mbps	6	163.6	153.999
	VHT160, M0 to M9, M0 to M9 1-2ss	m0x1	164.6	154.660
	HE160, M0 to M9, M0 to M9 1-2ss	m0h1	163.0	155.091

26dB / 99% Bandwidth, 5180 MHz, Non HT20, 6 to 54 Mbps

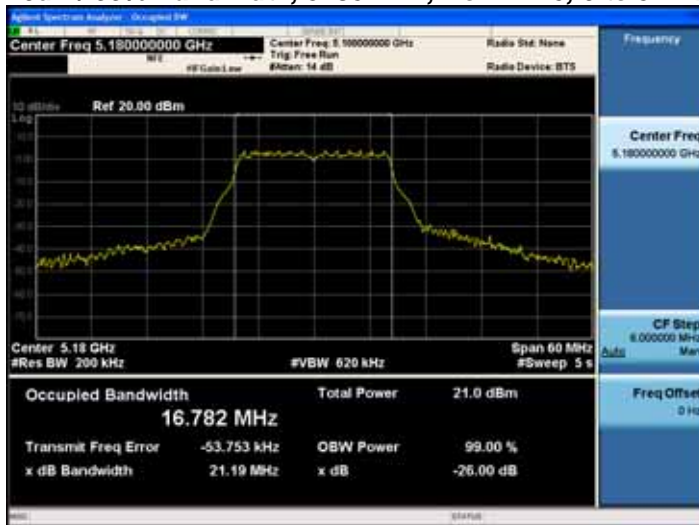

A.3 Maximum Conducted Output Power

Maximum Conducted Output Power Test Requirement

15.407 General technical requirements, (a) *Power limits: (1) For the band 5.15-5.25 GHz.*

(i) For an outdoor access point operating in the band 5.15-5.25 GHz, the maximum conducted output power over the frequency band of operation shall not exceed 1 W provided the maximum antenna gain does not exceed 6 dBi.If transmitting antennas of directional gain greater than 6 dBi are used, both the maximum conducted output power and the maximum power spectral density shall be reduced by the amount in dB that the directional gain of the antenna exceeds 6 dBi. The maximum e.i.r.p. at any elevation angle above 30 degrees as measured from the horizon must not exceed 125 mW (21 dBm).

(ii) For an indoor access point operating in the band 5.15-5.25 GHz, the maximum conducted output power over the frequency band of operation shall not exceed 1 W provided the maximum antenna gain does not exceed 6 dBi. ...If transmitting antennas of directional gain greater than 6 dBi are used, both the maximum conducted output power and the maximum power spectral density shall be reduced by the amount in dB that the directional gain of the antenna exceeds 6 dBi.

(iii) For fixed point-to-point access points operating in the band 5.15-5.25 GHz, the maximum conducted output power over the frequency band of operation shall not exceed 1 W. ...Fixed point-to-point U-NII devices may employ antennas with directional gain up to 23 dBi without any corresponding reduction in the maximum conducted output power or maximum power spectral density. For fixed point-to-point transmitters that employ a directional antenna gain greater than 23 dBi, a 1 dB reduction in maximum conducted output power and maximum power spectral density is required for each 1 dB of antenna gain in excess of 23 dBi. Fixed, point-to-point operations exclude the use of point-to-multipoint systems, omnidirectional applications, and multiple collocated transmitters transmitting the same information. The operator of the U-NII device, or if the equipment is professionally installed, the installer, is responsible for ensuring that systems employing high gain directional antennas are used exclusively for fixed, point-to-point operations.

(iv) For client devices in the 5.15-5.25 GHz band, the maximum conducted output power over the frequency band of operation shall not exceed 250 mW provided the maximum antenna gain does not exceed 6 dBi. In addition, the maximum power spectral density shall not exceed 11 dBm in any 1 megahertz band. If transmitting antennas of directional gain greater than 6 dBi are used, both the maximum conducted output power and the maximum power spectral density shall be reduced by the amount in dB that the directional gain of the antenna exceeds 6 dBi.

Maximum Conducted Output Power Test Procedure

Ref. KDB 789033 D02 General UNII Test Procedures New Rules v02r01
ANSI C63.10: 2013

Maximum Conducted Output Power Test Procedure
--

- | |
|---|
| <ol style="list-style-type: none"> 1. Set the radio in the continuous transmitting mode at full power 2. Compute power by integrating the spectrum across the EBW (or alternatively entire 99% OBW) of the signal using the instrument's band power measurement function. The integration shall be performed using the spectrum analyzer band-power measurement function with band limits set equal to the EBW or the OBW band edges. 3. Capture graphs and record pertinent measurement data. |
|---|

Ref. KDB 789033 D02 General UNII Test Procedures New Rules v02r01

2. Measurement using a Spectrum Analyzer or EMI Receiver (SA), (d) Method SA-2

Maximum Conducted Output Power
Test parameters

Method SA-2 (trace averaging across on and off times of the EUT transmissions, followed by duty cycle correction).

(i) Measure the duty cycle, x , of the transmitter output signal as described in section II.B.

(ii) Set span to encompass the EBW (or, alternatively, the entire 99% occupied bandwidth) of the signal.

(iii) Set RBW = 1 MHz.

(iv) Set VBW \geq 3 MHz.

(v) Number of points in sweep \geq 2 Span / RBW. (This ensures that bin-to-bin spacing is \leq RBW/2, so that narrowband signals are not lost between frequency bins.)

(vi) Sweep time = auto.

(vii) Detector = RMS (i.e., power averaging), if available. Otherwise, use sample detector mode.

(viii) Do not use sweep triggering. Allow the sweep to “free run”.

(ix) Trace average at least 100 traces in power averaging (i.e., RMS) mode; however, the number of traces to be averaged shall be increased above 100 as needed to ensure that the average accurately represents the true average over the on and off periods of the transmitter.

(x) Compute power by integrating the spectrum across the EBW (or, alternatively, the entire 99% occupied bandwidth) of the signal using the instrument’s band power measurement function with band limits set equal to the EBW (or occupied bandwidth)

The “measure-and-sum technique” is used for measuring in-band transmit power of a device. In the measure-and-sum approach, the conducted emission level is measured at each antenna port. The measured results at the various antenna ports are then summed mathematically to determine the total emission level from the device. Summing is performed in linear power units. ANSI C63.10 section 14.3.2.2

Samples, Systems, and Modes

System Number	Description	Samples	System under test	Support equipment
1	EUT	S01 + S02	<input checked="" type="checkbox"/>	<input type="checkbox"/>
	Support		<input type="checkbox"/>	<input checked="" type="checkbox"/>

Tested By : Chris Blair	Date of testing: 16-Sep-19 - 26-Sep-19
Test Result : PASS	

Test Equipment

See Appendix C for list of test equipment

Maximum Output Power, 4dBi

Frequency (MHz)	Mode	Tx Paths	Correlated Antenna Gain (dBi)	Tx 1 Max Power (dBm)	Tx 2 Max Power (dBm)	Tx 3 Max Power (dBm)	Tx 4 Max Power (dBm)	Duty Cycle Correction (dB)	Total Tx Channel Power (dBm)	Limit (dBm)	Margin (dB)	
5180	Non HT20, 6 to 54 Mbps	1	4	9.6				0.1	9.7	30.0	20.35	
	Non HT20, 6 to 54 Mbps	2	4	9.6	15.8			0.1	16.8	30.0	13.21	
	Non HT20, 6 to 54 Mbps	3	4	9.6	15.8	16.7		0.1	19.8	30.0	10.22	
	Non HT20, 6 to 54 Mbps	4	4	9.6	14.7	15.6	14.5	0.1	20.2	30.0	9.81	
	Non HT20 Beam Forming, 6 to 54 Mbps	2	7	9.6	14.7			0.1	15.9	29.0	13.08	
	Non HT20 Beam Forming, 6 to 54 Mbps	3	9	9.6	12.3	13.4		0.1	16.9	27.0	10.14	
	Non HT20 Beam Forming, 6 to 54 Mbps	4	10	9.6	11.3	12.3	11.2	0.1	17.3	26.0	8.72	
	HT/VHT20, M0 to M7	1	4	10.2					0.1	10.3	30.0	19.75
	HT/VHT20, M0 to M7	2	4	10.2	15.8				0.1	16.9	30.0	13.09
	HT/VHT20, M8 to M15	2	4	10.2	15.8				0.1	16.9	30.0	13.09
	HT/VHT20, M0 to M7	3	4	10.2	15.1	15.8			0.1	19.1	30.0	10.87
	HT/VHT20, M8 to M15	3	4	10.2	15.1	15.8			0.1	19.1	30.0	10.87
	HT/VHT20, M16 to M23	3	4	10.2	15.1	15.8			0.1	19.1	30.0	10.87
	HT/VHT20, M0 to M7	4	4	10.2	15.1	15.8	15.0		0.1	20.6	30.0	9.44
	HT/VHT20, M8 to M15	4	4	10.2	15.1	15.8	15.0		0.1	20.6	30.0	9.44
	HT/VHT20, M16 to M23	4	4	10.2	15.1	15.8	15.0		0.1	20.6	30.0	9.44
	HT/VHT20, M24 to M31	4	4	10.2	15.1	15.8	15.0		0.1	20.6	30.0	9.44
	HT/VHT20 Beam Forming, M0 to M7	2	7	10.2	15.1				0.1	16.4	29.0	12.63
	HT/VHT20 Beam Forming, M8 to M15	2	4	10.2	15.8				0.1	16.9	30.0	13.09
	HT/VHT20 Beam Forming, M0 to M7	3	9	10.2	12.9	13.7			0.1	17.3	27.0	9.67
	HT/VHT20 Beam Forming, M8 to M15	3	6	10.2	13.9	14.7			0.1	18.2	30.0	11.85
	HT/VHT20 Beam Forming, M16 to M23	3	4	10.2	15.1	15.8			0.1	19.1	30.0	10.87
	HT/VHT20 Beam Forming, M0 to M7	4	10	9.2	9.7	10.6	9.9		0.1	16.0	26.0	10.05
	HT/VHT20 Beam Forming, M8 to M15	4	7	10.2	13.9	14.7	13.9		0.1	19.6	29.0	9.45
	HT/VHT20 Beam Forming, M16 to M23	4	5	10.2	13.9	14.7	13.9		0.1	19.6	30.0	10.45
	HT/VHT20 Beam Forming, M24 to M31	4	4	10.2	15.1	15.8	15.0		0.1	20.6	30.0	9.44
	HT/VHT20 STBC, M0 to M7	2	4	10.2	15.8				0.1	16.9	30.0	13.09
	HT/VHT20 STBC, M0 to M7	3	4	10.2	15.1	15.8			0.1	19.1	30.0	10.87
	HT/VHT20 STBC, M0 to M7	4	4	10.2	15.1	15.8	15.0		0.1	20.6	30.0	9.44
	HE20, M0 to M9 1ss	1	4	9.3					0.1	9.4	30.0	20.63
	HE20, M0 to M9 1ss	2	4	9.3	14.0				0.1	15.3	30.0	14.66
	HE20, M0 to M9 2ss	2	4	9.3	14.0				0.1	15.3	30.0	14.66



	HE20, M0 to M9 1ss	3	4	9.3	14.0	14.7		0.1	18.1	30.0	11.93	
	HE20, M0 to M9 2ss	3	4	9.3	14.0	14.7		0.1	18.1	30.0	11.93	
	HE20, M0 to M9 3ss	3	4	9.3	14.0	14.7		0.1	18.1	30.0	11.93	
	HE20, M0 to M9 1ss	4	4	9.3	13.1	14.0	13.2	0.1	18.8	30.0	11.18	
	HE20, M0 to M9 2ss	4	4	9.3	13.1	14.0	13.2	0.1	18.8	30.0	11.18	
	HE20, M0 to M9 3ss	4	4	9.3	13.1	14.0	13.2	0.1	18.8	30.0	11.18	
	HE20, M0 to M9 4ss	4	4	9.3	13.1	14.0	13.2	0.1	18.8	30.0	11.18	
	HE20 Beam Forming, M0 to M9 1ss	2	7	9.3	13.1			0.1	14.7	29.0	14.32	
	HE20 Beam Forming, M0 to M9 2ss	2	4	9.3	14.0			0.1	15.3	30.0	14.66	
	HE20 Beam Forming, M0 to M9 1ss	3	9	8.3	8.8	9.7		0.1	13.8	27.0	13.19	
	HE20 Beam Forming, M0 to M9 2ss	3	6	9.3	13.1	14.0		0.1	17.4	30.0	12.60	
	HE20 Beam Forming, M0 to M9 3ss	3	4	9.3	14.0	14.7		0.1	18.1	30.0	11.93	
	HE20 Beam Forming, M0 to M9 1ss	4	10	8.3	8.8	9.7	8.8	0.1	15.0	26.0	10.98	
	HE20 Beam Forming, M0 to M9 2ss	4	7	9.3	10.9	11.7	10.9	0.1	16.9	29.0	12.13	
	HE20 Beam Forming, M0 to M9 3ss	4	5	9.3	13.1	14.0	13.2	0.1	18.8	30.0	11.18	
	HE20 Beam Forming, M0 to M9 4ss	4	4	9.3	13.1	14.0	13.2	0.1	18.8	30.0	11.18	
	HE20 STBC, M0 to M9 2ss	2	4	9.3	14.0			0.1	15.3	30.0	14.66	
	HE20 STBC, M0 to M9 2ss	3	4	9.3	14.0	14.7		0.1	18.1	30.0	11.93	
	HE20 STBC, M0 to M9 2ss	4	4	9.3	13.1	14.0	13.2	0.1	18.8	30.0	11.18	
5190	Non HT40, 6 to 54 Mbps	1	4	8.3				0.0	8.3	30.0	21.65	
	Non HT40, 6 to 54 Mbps	2	4	8.3	8.9			0.0	11.7	30.0	18.33	
	Non HT40, 6 to 54 Mbps	3	4	8.3	8.9	9.4		0.0	13.7	30.0	16.29	
	Non HT40, 6 to 54 Mbps	4	4	8.3	8.9	9.4	8.8	0.0	14.9	30.0	15.06	
	HT/VHT40, M0 to M7	1	4	9.5				0.1	9.6	30.0	20.40	
	HT/VHT40, M0 to M7	2	4	9.5	10.0			0.1	12.9	30.0	17.13	
	HT/VHT40, M8 to M15	2	4	9.5	10.0			0.1	12.9	30.0	17.13	
	HT/VHT40, M0 to M7	3	4	9.5	10.0	10.9		0.1	15.0	30.0	14.95	
	HT/VHT40, M8 to M15	3	4	9.5	10.0	10.9		0.1	15.0	30.0	14.95	
	HT/VHT40, M16 to M23	3	4	9.5	10.0	10.9		0.1	15.0	30.0	14.95	
	HT/VHT40, M0 to M7	4	4	9.5	10.0	10.9	10.0	0.1	16.3	30.0	13.75	
	HT/VHT40, M8 to M15	4	4	9.5	10.0	10.9	10.0	0.1	16.3	30.0	13.75	
	HT/VHT40, M16 to M23	4	4	9.5	10.0	10.9	10.0	0.1	16.3	30.0	13.75	
	HT/VHT40, M24 to M31	4	4	9.5	10.0	10.9	10.0	0.1	16.3	30.0	13.75	
	HT/VHT40 Beam Forming, M0 to M7	2	7	8.5	9.0				0.1	11.9	29.0	17.13
	HT/VHT40 Beam Forming, M8 to M15	2	4	9.5	10.0				0.1	12.9	30.0	17.13
	HT/VHT40 Beam Forming, M0 to M7	3	9	7.4	8.0	8.9			0.1	13.0	27.0	13.98
	HT/VHT40 Beam Forming, M8 to M15	3	6	8.5	9.0	9.7			0.1	14.0	30.0	16.03
	HT/VHT40 Beam Forming, M16 to M23	3	4	9.5	10.0	10.9			0.1	15.0	30.0	14.95
	HT/VHT40 Beam Forming, M0 to M7	4	10	7.4	8.0	8.9	7.9		0.1	14.2	26.0	11.79
HT/VHT40 Beam Forming, M8 to M15	4	7	8.5	9.0	9.7	9.0		0.1	15.2	29.0	13.81	
HT/VHT40 Beam Forming, M16 to M23	4	5	8.5	9.0	9.7	9.0		0.1	15.2	30.0	14.81	
HT/VHT40 Beam Forming, M24 to M31	4	4	9.5	10.0	10.9	10.0		0.1	16.3	30.0	13.75	

	HT/VHT40 STBC, M0 to M7	2	4	9.5	10.0			0.1	12.9	30.0	17.13	
	HT/VHT40 STBC, M0 to M7	3	4	9.5	10.0	10.9		0.1	15.0	30.0	14.95	
	HT/VHT40 STBC, M0 to M7	4	4	9.5	10.0	10.9	10.0	0.1	16.3	30.0	13.75	
	HE40, M0 to M9 1ss	1	4	7.6				0.1	7.7	30.0	22.27	
	HE40, M0 to M9 1ss	2	4	7.6	8.2			0.1	11.0	30.0	18.95	
	HE40, M0 to M9 2ss	2	4	7.6	8.2			0.1	11.0	30.0	18.95	
	HE40, M0 to M9 1ss	3	4	7.6	8.2	8.9		0.1	13.2	30.0	16.84	
	HE40, M0 to M9 2ss	3	4	7.6	8.2	8.9		0.1	13.2	30.0	16.84	
	HE40, M0 to M9 3ss	3	4	7.6	8.2	8.9		0.1	13.2	30.0	16.84	
	HE40, M0 to M9 1ss	4	4	7.6	8.2	8.9	8.1	0.1	14.4	30.0	15.63	
	HE40, M0 to M9 2ss	4	4	7.6	8.2	8.9	8.1	0.1	14.4	30.0	15.63	
	HE40, M0 to M9 3ss	4	4	7.6	8.2	8.9	8.1	0.1	14.4	30.0	15.63	
	HE40, M0 to M9 4ss	4	4	7.6	8.2	8.9	8.1	0.1	14.4	30.0	15.63	
	HE40 Beam Forming, M0 to M9 1ss	2	7	7.6	8.2			0.1	11.0	29.0	17.95	
	HE40 Beam Forming, M0 to M9 2ss	2	4	7.6	8.2			0.1	11.0	30.0	18.95	
	HE40 Beam Forming, M0 to M9 1ss	3	9	6.6	7.2	7.8		0.1	12.1	27.0	14.88	
	HE40 Beam Forming, M0 to M9 2ss	3	6	7.6	8.2	8.9		0.1	13.2	30.0	16.84	
	HE40 Beam Forming, M0 to M9 3ss	3	4	7.6	8.2	8.9		0.1	13.2	30.0	16.84	
	HE40 Beam Forming, M0 to M9 1ss	4	10	5.5	6.2	6.7	5.9	0.1	12.2	26.0	13.76	
	HE40 Beam Forming, M0 to M9 2ss	4	7	6.6	7.2	7.8	7.1	0.1	13.3	29.0	15.66	
	HE40 Beam Forming, M0 to M9 3ss	4	5	7.6	8.2	8.9	8.1	0.1	14.4	30.0	15.63	
	HE40 Beam Forming, M0 to M9 4ss	4	4	7.6	8.2	8.9	8.1	0.1	14.4	30.0	15.63	
	HE40 STBC, M0 to M9 2ss	2	4	7.6	8.2			0.1	11.0	30.0	18.95	
	HE40 STBC, M0 to M9 2ss	3	4	7.6	8.2	8.9		0.1	13.2	30.0	16.84	
	HE40 STBC, M0 to M9 2ss	4	4	7.6	8.2	8.9	8.1	0.1	14.4	30.0	15.63	
5210	Non HT80, 6 to 54 Mbps	1	4	9.3				0.1	9.4	30.0	20.65	
	Non HT80, 6 to 54 Mbps	2	4	9.3	9.7			0.1	12.6	30.0	17.43	
	Non HT80, 6 to 54 Mbps	3	4	9.3	9.7	9.9		0.1	14.5	30.0	15.53	
	Non HT80, 6 to 54 Mbps	4	4	9.3	9.7	9.9	9.4	0.1	15.7	30.0	14.34	
	VHT80, M0 to M9 1ss	1	4	9.2				0.2	9.4	30.0	20.58	
	VHT80, M0 to M9 1ss	2	4	9.2	9.6			0.2	12.6	30.0	17.36	
	VHT80, M0 to M9 2ss	2	4	9.2	9.6			0.2	12.6	30.0	17.36	
	VHT80, M0 to M9 1ss	3	4	9.2	9.6	9.8		0.2	14.5	30.0	15.46	
	VHT80, M0 to M9 2ss	3	4	9.2	9.6	9.8		0.2	14.5	30.0	15.46	
	VHT80, M0 to M9 3ss	3	4	9.2	9.6	9.8		0.2	14.5	30.0	15.46	
	VHT80, M0 to M9 1ss	4	4	9.2	9.6	9.8	9.3	0.2	15.7	30.0	14.27	
	VHT80, M0 to M9 2ss	4	4	9.2	9.6	9.8	9.3	0.2	15.7	30.0	14.27	
	VHT80, M0 to M9 3ss	4	4	9.2	9.6	9.8	9.3	0.2	15.7	30.0	14.27	
	VHT80, M0 to M9 4ss	4	4	9.2	9.6	9.8	9.3	0.2	15.7	30.0	14.27	
	VHT80 Beam Forming, M0 to M9 1ss	2	7	7.9	8.3				0.2	11.3	29.0	17.66
	VHT80 Beam Forming, M0 to M9 2ss	2	4	9.2	9.6				0.2	12.6	30.0	17.36
	VHT80 Beam Forming, M0 to M9 1ss	3	9	7.9	8.3	8.6			0.2	13.3	27.0	13.73

VHT80 Beam Forming, M0 to M9 2ss	3	6	7.9	8.3	8.6		0.2	13.3	30.0	16.73	
VHT80 Beam Forming, M0 to M9 3ss	3	4	9.2	9.6	9.8		0.2	14.5	30.0	15.46	
VHT80 Beam Forming, M0 to M9 1ss	4	10	7.0	7.7	7.9	7.5	0.2	13.8	26.0	12.22	
VHT80 Beam Forming, M0 to M9 2ss	4	7	7.9	8.3	8.6	8.3	0.2	14.5	29.0	14.47	
VHT80 Beam Forming, M0 to M9 3ss	4	5	9.2	9.6	9.8	9.3	0.2	15.7	30.0	14.27	
VHT80 Beam Forming, M0 to M9 4ss	4	4	9.2	9.6	9.8	9.3	0.2	15.7	30.0	14.27	
VHT80 STBC, M0 to M9 1ss	2	4	9.2	9.6			0.2	12.6	30.0	17.36	
VHT80 STBC, M0 to M9 1ss	3	4	9.2	9.6	9.8		0.2	14.5	30.0	15.46	
VHT80 STBC, M0 to M9 1ss	4	4	9.2	9.6	9.8	9.3	0.2	15.7	30.0	14.27	
HE80, M0 to M9 1ss	1	4	8.1				0.3	8.4	30.0	21.65	
HE80, M0 to M9 1ss	2	4	8.1	8.6			0.3	11.6	30.0	18.38	
HE80, M0 to M9 2ss	2	4	8.1	8.6			0.3	11.6	30.0	18.38	
HE80, M0 to M9 1ss	3	4	8.1	8.6	8.6		0.3	13.5	30.0	16.54	
HE80, M0 to M9 2ss	3	4	8.1	8.6	8.6		0.3	13.5	30.0	16.54	
HE80, M0 to M9 3ss	3	4	8.1	8.6	8.6		0.3	13.5	30.0	16.54	
HE80, M0 to M9 1ss	4	4	8.1	8.6	8.6	8.3	0.3	14.7	30.0	15.32	
HE80, M0 to M9 2ss	4	4	8.1	8.6	8.6	8.3	0.3	14.7	30.0	15.32	
HE80, M0 to M9 3ss	4	4	8.1	8.6	8.6	8.3	0.3	14.7	30.0	15.32	
HE80, M0 to M9 4ss	4	4	8.1	8.6	8.6	8.3	0.3	14.7	30.0	15.32	
HE80 Beam Forming, M0 to M9 1ss	2	7	6.9	7.4			0.3	10.4	29.0	18.58	
HE80 Beam Forming, M0 to M9 2ss	2	4	8.1	8.6			0.3	11.6	30.0	18.38	
HE80 Beam Forming, M0 to M9 1ss	3	9	6.9	7.4	7.8		0.3	12.4	27.0	14.60	
HE80 Beam Forming, M0 to M9 2ss	3	6	6.9	7.4	7.8		0.3	12.4	30.0	17.60	
HE80 Beam Forming, M0 to M9 3ss	3	4	8.1	8.6	8.6		0.3	13.5	30.0	16.54	
HE80 Beam Forming, M0 to M9 1ss	4	10	6.3	6.7	6.7	6.3	0.3	12.8	26.0	13.22	
HE80 Beam Forming, M0 to M9 2ss	4	7	6.9	7.4	7.8	7.2	0.3	13.6	29.0	15.39	
HE80 Beam Forming, M0 to M9 3ss	4	5	8.1	8.6	8.6	8.3	0.3	14.7	30.0	15.32	
HE80 Beam Forming, M0 to M9 4ss	4	4	8.1	8.6	8.6	8.3	0.3	14.7	30.0	15.32	
HE80 STBC, M0 to M9 1ss	2	4	8.1	8.6			0.3	11.6	30.0	18.38	
HE80 STBC, M0 to M9 1ss	3	4	8.1	8.6	8.6		0.3	13.5	30.0	16.54	
HE80 STBC, M0 to M9 1ss	4	4	8.1	8.6	8.6	8.3	0.3	14.7	30.0	15.32	
5220	Non HT20, 6 to 54 Mbps	1	4	9.6				0.1	9.7	30.0	20.35
	Non HT20, 6 to 54 Mbps	2	4	9.6	15.5			0.1	16.5	30.0	13.45
	Non HT20, 6 to 54 Mbps	3	4	9.6	15.5	16.0		0.1	19.3	30.0	10.68
	Non HT20, 6 to 54 Mbps	4	4	9.6	15.5	16.0	15.9	0.1	21.0	30.0	9.04
	Non HT20 Beam Forming, 6 to 54 Mbps	2	7	9.6	15.5			0.1	16.5	29.0	12.45
	Non HT20 Beam Forming, 6 to 54 Mbps	3	9	9.6	15.5	16.0		0.1	19.3	27.0	7.68
	Non HT20 Beam Forming, 6 to 54 Mbps	4	10	9.6	15.5	16.0	15.9	0.1	21.0	26.0	5.04
	HT/VHT20, M0 to M7	1	4	9.8				0.1	9.9	30.0	20.15
	HT/VHT20, M0 to M7	2	4	9.8	15.5			0.1	16.6	30.0	13.41
	HT/VHT20, M8 to M15	2	4	9.8	15.5			0.1	16.6	30.0	13.41
HT/VHT20, M0 to M7	3	4	9.8	15.5	16.0		0.1	19.3	30.0	10.66	

HT/VHT20, M8 to M15	3	4	9.8	15.5	16.0		0.1	19.3	30.0	10.66
HT/VHT20, M16 to M23	3	4	9.8	15.5	16.0		0.1	19.3	30.0	10.66
HT/VHT20, M0 to M7	4	4	9.8	15.5	16.0	15.9	0.1	21.0	30.0	9.02
HT/VHT20, M8 to M15	4	4	9.8	15.5	16.0	15.9	0.1	21.0	30.0	9.02
HT/VHT20, M16 to M23	4	4	9.8	15.5	16.0	15.9	0.1	21.0	30.0	9.02
HT/VHT20, M24 to M31	4	4	9.8	15.5	16.0	15.9	0.1	21.0	30.0	9.02
HT/VHT20 Beam Forming, M0 to M7	2	7	9.8	15.5			0.1	16.6	29.0	12.41
HT/VHT20 Beam Forming, M8 to M15	2	4	9.8	15.5			0.1	16.6	30.0	13.41
HT/VHT20 Beam Forming, M0 to M7	3	9	9.8	15.5	16.0		0.1	19.3	27.0	7.66
HT/VHT20 Beam Forming, M8 to M15	3	6	9.8	15.5	16.0		0.1	19.3	30.0	10.66
HT/VHT20 Beam Forming, M16 to M23	3	4	9.8	15.5	16.0		0.1	19.3	30.0	10.66
HT/VHT20 Beam Forming, M0 to M7	4	10	9.8	15.5	16.0	15.9	0.1	21.0	26.0	5.02
HT/VHT20 Beam Forming, M8 to M15	4	7	9.8	15.5	16.0	15.9	0.1	21.0	29.0	8.02
HT/VHT20 Beam Forming, M16 to M23	4	5	9.8	15.5	16.0	15.9	0.1	21.0	30.0	9.02
HT/VHT20 Beam Forming, M24 to M31	4	4	9.8	15.5	16.0	15.9	0.1	21.0	30.0	9.02
HT/VHT20 STBC, M0 to M7	2	4	9.8	15.5			0.1	16.6	30.0	13.41
HT/VHT20 STBC, M0 to M7	3	4	9.8	15.5	16.0		0.1	19.3	30.0	10.66
HT/VHT20 STBC, M0 to M7	4	4	9.8	15.5	16.0	15.9	0.1	21.0	30.0	9.02
HE20, M0 to M9 1ss	1	4	9.9				0.1	10.0	30.0	20.03
HE20, M0 to M9 1ss	2	4	9.9	15.8			0.1	16.9	30.0	13.14
HE20, M0 to M9 2ss	2	4	9.9	15.8			0.1	16.9	30.0	13.14
HE20, M0 to M9 1ss	3	4	9.9	15.8	16.3		0.1	19.6	30.0	10.37
HE20, M0 to M9 2ss	3	4	9.9	15.8	16.3		0.1	19.6	30.0	10.37
HE20, M0 to M9 3ss	3	4	9.9	15.8	16.3		0.1	19.6	30.0	10.37
HE20, M0 to M9 1ss	4	4	9.9	15.8	16.3	16.0	0.1	21.2	30.0	8.78
HE20, M0 to M9 2ss	4	4	9.9	15.8	16.3	16.0	0.1	21.2	30.0	8.78
HE20, M0 to M9 3ss	4	4	9.9	15.8	16.3	16.0	0.1	21.2	30.0	8.78
HE20, M0 to M9 4ss	4	4	9.9	15.8	16.3	16.0	0.1	21.2	30.0	8.78
HE20 Beam Forming, M0 to M9 1ss	2	7	9.9	15.8			0.1	16.9	29.0	12.14
HE20 Beam Forming, M0 to M9 2ss	2	4	9.9	15.8			0.1	16.9	30.0	13.14
HE20 Beam Forming, M0 to M9 1ss	3	9	9.9	15.8	16.3		0.1	19.6	27.0	7.37
HE20 Beam Forming, M0 to M9 2ss	3	6	9.9	15.8	16.3		0.1	19.6	30.0	10.37
HE20 Beam Forming, M0 to M9 3ss	3	4	9.9	15.8	16.3		0.1	19.6	30.0	10.37
HE20 Beam Forming, M0 to M9 1ss	4	10	9.9	15.8	16.3	16.0	0.1	21.2	26.0	4.78
HE20 Beam Forming, M0 to M9 2ss	4	7	9.9	15.8	16.3	16.0	0.1	21.2	29.0	7.78
HE20 Beam Forming, M0 to M9 3ss	4	5	9.9	15.8	16.3	16.0	0.1	21.2	30.0	8.78
HE20 Beam Forming, M0 to M9 4ss	4	4	9.9	15.8	16.3	16.0	0.1	21.2	30.0	8.78
HE20 STBC, M0 to M9 2ss	2	4	9.9	15.8			0.1	16.9	30.0	13.14
HE20 STBC, M0 to M9 2ss	3	4	9.9	15.8	16.3		0.1	19.6	30.0	10.37
HE20 STBC, M0 to M9 2ss	4	4	9.9	15.8	16.3	16.0	0.1	21.2	30.0	8.78



5230	Non HT40, 6 to 54 Mbps	1	4	10.0				0.0	10.0	30.0	19.95
	Non HT40, 6 to 54 Mbps	2	4	10.0	15.6			0.0	16.7	30.0	13.29
	Non HT40, 6 to 54 Mbps	3	4	10.0	15.6	16.0		0.0	19.4	30.0	10.60
	Non HT40, 6 to 54 Mbps	4	4	10.0	15.6	16.0	15.7	0.0	21.0	30.0	9.04
	HT/VHT40, M0 to M7	1	4	10.0				0.1	10.1	30.0	19.90
	HT/VHT40, M0 to M7	2	4	10.0	15.6			0.1	16.8	30.0	13.24
	HT/VHT40, M8 to M15	2	4	10.0	15.6			0.1	16.8	30.0	13.24
	HT/VHT40, M0 to M7	3	4	10.0	15.6	16.0		0.1	19.5	30.0	10.55
	HT/VHT40, M8 to M15	3	4	10.0	15.6	16.0		0.1	19.5	30.0	10.55
	HT/VHT40, M16 to M23	3	4	10.0	15.6	16.0		0.1	19.5	30.0	10.55
	HT/VHT40, M0 to M7	4	4	10.0	15.6	16.0	15.5	0.1	21.0	30.0	9.05
	HT/VHT40, M8 to M15	4	4	10.0	15.6	16.0	15.5	0.1	21.0	30.0	9.05
	HT/VHT40, M16 to M23	4	4	10.0	15.6	16.0	15.5	0.1	21.0	30.0	9.05
	HT/VHT40, M24 to M31	4	4	10.0	15.6	16.0	15.5	0.1	21.0	30.0	9.05
	HT/VHT40 Beam Forming, M0 to M7	2	7	10.0	15.6			0.1	16.8	29.0	12.24
	HT/VHT40 Beam Forming, M8 to M15	2	4	10.0	15.6			0.1	16.8	30.0	13.24
	HT/VHT40 Beam Forming, M0 to M7	3	9	10.0	15.6	16.0		0.1	19.5	27.0	7.55
	HT/VHT40 Beam Forming, M8 to M15	3	6	10.0	15.6	16.0		0.1	19.5	30.0	10.55
	HT/VHT40 Beam Forming, M16 to M23	3	4	10.0	15.6	16.0		0.1	19.5	30.0	10.55
	HT/VHT40 Beam Forming, M0 to M7	4	10	10.0	15.6	16.0	15.5	0.1	21.0	26.0	5.05
	HT/VHT40 Beam Forming, M8 to M15	4	7	10.0	15.6	16.0	15.5	0.1	21.0	29.0	8.05
	HT/VHT40 Beam Forming, M16 to M23	4	5	10.0	15.6	16.0	15.5	0.1	21.0	30.0	9.05
	HT/VHT40 Beam Forming, M24 to M31	4	4	10.0	15.6	16.0	15.5	0.1	21.0	30.0	9.05
	HT/VHT40 STBC, M0 to M7	2	4	10.0	15.6			0.1	16.8	30.0	13.24
	HT/VHT40 STBC, M0 to M7	3	4	10.0	15.6	16.0		0.1	19.5	30.0	10.55
	HT/VHT40 STBC, M0 to M7	4	4	10.0	15.6	16.0	15.5	0.1	21.0	30.0	9.05
	HE40, M0 to M9 1ss	1	4	10.0				0.1	10.1	30.0	19.87
	HE40, M0 to M9 1ss	2	4	10.0	15.9			0.1	17.0	30.0	12.98
	HE40, M0 to M9 2ss	2	4	10.0	15.9			0.1	17.0	30.0	12.98
	HE40, M0 to M9 1ss	3	4	10.0	15.9	16.3		0.1	19.7	30.0	10.26
	HE40, M0 to M9 2ss	3	4	10.0	15.9	16.3		0.1	19.7	30.0	10.26
	HE40, M0 to M9 3ss	3	4	10.0	15.9	16.3		0.1	19.7	30.0	10.26
	HE40, M0 to M9 1ss	4	4	10.0	15.9	16.3	15.8	0.1	21.3	30.0	8.75
	HE40, M0 to M9 2ss	4	4	10.0	15.9	16.3	15.8	0.1	21.3	30.0	8.75
	HE40, M0 to M9 3ss	4	4	10.0	15.9	16.3	15.8	0.1	21.3	30.0	8.75
	HE40, M0 to M9 4ss	4	4	10.0	15.9	16.3	15.8	0.1	21.3	30.0	8.75
	HE40 Beam Forming, M0 to M9 1ss	2	7	10.0	15.9			0.1	17.0	29.0	11.98
	HE40 Beam Forming, M0 to M9 2ss	2	4	10.0	15.9			0.1	17.0	30.0	12.98
	HE40 Beam Forming, M0 to M9 1ss	3	9	10.0	15.9	16.3		0.1	19.7	27.0	7.26
	HE40 Beam Forming, M0 to M9 2ss	3	6	10.0	15.9	16.3		0.1	19.7	30.0	10.26
	HE40 Beam Forming, M0 to M9 3ss	3	4	10.0	15.9	16.3		0.1	19.7	30.0	10.26
	HE40 Beam Forming, M0 to M9 1ss	4	10	10.0	15.9	16.3	15.8	0.1	21.3	26.0	4.75
	HE40 Beam Forming, M0 to M9 2ss	4	7	10.0	15.9	16.3	15.8	0.1	21.3	29.0	7.75

	HE40 Beam Forming, M0 to M9 3ss	4	5	10.0	15.9	16.3	15.8	0.1	21.3	30.0	8.75	
	HE40 Beam Forming, M0 to M9 4ss	4	4	10.0	15.9	16.3	15.8	0.1	21.3	30.0	8.75	
	HE40 STBC, M0 to M9 2ss	2	4	10.0	15.9			0.1	17.0	30.0	12.98	
	HE40 STBC, M0 to M9 2ss	3	4	10.0	15.9	16.3		0.1	19.7	30.0	10.26	
	HE40 STBC, M0 to M9 2ss	4	4	10.0	15.9	16.3	15.8	0.1	21.3	30.0	8.75	
5240	Non HT20, 6 to 54 Mbps	1	4	10.1				0.1	10.2	30.0	19.85	
	Non HT20, 6 to 54 Mbps	2	4	10.1	15.7			0.1	16.8	30.0	13.19	
	Non HT20, 6 to 54 Mbps	3	4	10.1	15.7	16.1		0.1	19.5	30.0	10.49	
	Non HT20, 6 to 54 Mbps	4	4	10.1	15.7	16.1	15.5	0.1	21.0	30.0	9.03	
	Non HT20 Beam Forming, 6 to 54 Mbps	2	7	10.1	15.7			0.1	16.8	29.0	12.19	
	Non HT20 Beam Forming, 6 to 54 Mbps	3	9	10.1	15.7	16.1		0.1	19.5	27.0	7.49	
	Non HT20 Beam Forming, 6 to 54 Mbps	4	10	10.1	15.7	16.1	15.5	0.1	21.0	26.0	5.03	
	HT/VHT20, M0 to M7	1	4	10.0					0.1	10.1	30.0	19.95
	HT/VHT20, M0 to M7	2	4	10.0	15.6				0.1	16.7	30.0	13.29
	HT/VHT20, M8 to M15	2	4	10.0	15.6				0.1	16.7	30.0	13.29
	HT/VHT20, M0 to M7	3	4	10.0	15.6	16.0			0.1	19.4	30.0	10.60
	HT/VHT20, M8 to M15	3	4	10.0	15.6	16.0			0.1	19.4	30.0	10.60
	HT/VHT20, M16 to M23	3	4	10.0	15.6	16.0			0.1	19.4	30.0	10.60
	HT/VHT20, M0 to M7	4	4	10.0	15.6	16.0	15.3		0.1	20.8	30.0	9.16
	HT/VHT20, M8 to M15	4	4	10.0	15.6	16.0	15.3		0.1	20.8	30.0	9.16
	HT/VHT20, M16 to M23	4	4	10.0	15.6	16.0	15.3		0.1	20.8	30.0	9.16
	HT/VHT20, M24 to M31	4	4	10.0	15.6	16.0	15.3		0.1	20.8	30.0	9.16
	HT/VHT20 Beam Forming, M0 to M7	2	7	10.0	15.6				0.1	16.7	29.0	12.29
	HT/VHT20 Beam Forming, M8 to M15	2	4	10.0	15.6				0.1	16.7	30.0	13.29
	HT/VHT20 Beam Forming, M0 to M7	3	9	10.0	15.6	16.0			0.1	19.4	27.0	7.60
	HT/VHT20 Beam Forming, M8 to M15	3	6	10.0	15.6	16.0			0.1	19.4	30.0	10.60
	HT/VHT20 Beam Forming, M16 to M23	3	4	10.0	15.6	16.0			0.1	19.4	30.0	10.60
	HT/VHT20 Beam Forming, M0 to M7	4	10	10.0	15.6	16.0	15.3		0.1	20.8	26.0	5.16
	HT/VHT20 Beam Forming, M8 to M15	4	7	10.0	15.6	16.0	15.3		0.1	20.8	29.0	8.16
	HT/VHT20 Beam Forming, M16 to M23	4	5	10.0	15.6	16.0	15.3		0.1	20.8	30.0	9.16
	HT/VHT20 Beam Forming, M24 to M31	4	4	10.0	15.6	16.0	15.3		0.1	20.8	30.0	9.16
	HT/VHT20 STBC, M0 to M7	2	4	10.0	15.6				0.1	16.7	30.0	13.29
	HT/VHT20 STBC, M0 to M7	3	4	10.0	15.6	16.0			0.1	19.4	30.0	10.60
	HT/VHT20 STBC, M0 to M7	4	4	10.0	15.6	16.0	15.3		0.1	20.8	30.0	9.16
	HE20, M0 to M9 1ss	1	4	10.3					0.1	10.4	30.0	19.63
	HE20, M0 to M9 1ss	2	4	10.3	15.7				0.1	16.9	30.0	13.13
	HE20, M0 to M9 2ss	2	4	10.3	15.7				0.1	16.9	30.0	13.13
	HE20, M0 to M9 1ss	3	4	10.3	15.7	16.3			0.1	19.6	30.0	10.36
	HE20, M0 to M9 2ss	3	4	10.3	15.7	16.3			0.1	19.6	30.0	10.36
HE20, M0 to M9 3ss	3	4	10.3	15.7	16.3			0.1	19.6	30.0	10.36	
HE20, M0 to M9 1ss	4	4	10.3	15.7	16.3	15.7		0.1	21.1	30.0	8.87	
HE20, M0 to M9 2ss	4	4	10.3	15.7	16.3	15.7		0.1	21.1	30.0	8.87	



	HE20, M0 to M9 3ss	4	4	10.3	15.7	16.3	15.7	0.1	21.1	30.0	8.87
	HE20, M0 to M9 4ss	4	4	10.3	15.7	16.3	15.7	0.1	21.1	30.0	8.87
	HE20 Beam Forming, M0 to M9 1ss	2	7	10.3	15.7			0.1	16.9	29.0	12.13
	HE20 Beam Forming, M0 to M9 2ss	2	4	10.3	15.7			0.1	16.9	30.0	13.13
	HE20 Beam Forming, M0 to M9 1ss	3	9	10.3	15.7	16.3		0.1	19.6	27.0	7.36
	HE20 Beam Forming, M0 to M9 2ss	3	6	10.3	15.7	16.3		0.1	19.6	30.0	10.36
	HE20 Beam Forming, M0 to M9 3ss	3	4	10.3	15.7	16.3		0.1	19.6	30.0	10.36
	HE20 Beam Forming, M0 to M9 1ss	4	10	10.3	15.7	16.3	15.7	0.1	21.1	26.0	4.87
	HE20 Beam Forming, M0 to M9 2ss	4	7	10.3	15.7	16.3	15.7	0.1	21.1	29.0	7.87
	HE20 Beam Forming, M0 to M9 3ss	4	5	10.3	15.7	16.3	15.7	0.1	21.1	30.0	8.87
	HE20 Beam Forming, M0 to M9 4ss	4	4	10.3	15.7	16.3	15.7	0.1	21.1	30.0	8.87
	HE20 STBC, M0 to M9 2ss	2	4	10.3	15.7			0.1	16.9	30.0	13.13
	HE20 STBC, M0 to M9 2ss	3	4	10.3	15.7	16.3		0.1	19.6	30.0	10.36
	HE20 STBC, M0 to M9 2ss	4	4	10.3	15.7	16.3	15.7	0.1	21.1	30.0	8.87
5250	Non HT160, 6 to 54 Mbps	1	4	8.3				0.0	8.3	30.0	21.65
	Non HT160, 6 to 54 Mbps	2	4	8.3	8.5			0.0	11.5	30.0	18.54
	Non HT160, 6 to 54 Mbps	3	4	8.3	8.5	8.9		0.0	13.4	30.0	16.61
	Non HT160, 6 to 54 Mbps	4	4	8.3	8.5	8.9	8.4	0.0	14.6	30.0	15.40
	VHT160, M0 to M9 1ss	1	4	9.4				0.4	9.8	30.0	20.21
	VHT160, M0 to M9 1ss	2	4	9.4	9.3			0.4	12.8	30.0	17.25
	VHT160, M0 to M9 2ss	2	4	9.4	9.3			0.4	12.8	30.0	17.25
	VHT160, M0 to M9 1ss	3	4	9.4	9.3	9.6		0.4	14.6	30.0	15.40
	VHT160, M0 to M9 2ss	3	4	9.4	9.3	9.6		0.4	14.6	30.0	15.40
	VHT160, M0 to M9 3ss	3	4	9.4	9.3	9.6		0.4	14.6	30.0	15.40
	VHT160, M0 to M9 1ss	4	4	9.4	9.3	9.6	9.4	0.4	15.8	30.0	14.16
	VHT160, M0 to M9 2ss	4	4	9.4	9.3	9.6	9.4	0.4	15.8	30.0	14.16
	VHT160, M0 to M9 3ss	4	4	9.4	9.3	9.6	9.4	0.4	15.8	30.0	14.16
	VHT160, M0 to M9 4ss	4	4	9.4	9.3	9.6	9.4	0.4	15.8	30.0	14.16
	VHT160 Beam Forming, M0 to M9 1ss	2	7	8.0	8.4			0.4	11.6	29.0	17.39
	VHT160 Beam Forming, M0 to M9 2ss	2	4	9.4	9.3			0.4	12.8	30.0	17.25
	VHT160 Beam Forming, M0 to M9 1ss	3	9	7.1	7.2	7.5		0.4	12.4	27.0	14.57
	VHT160 Beam Forming, M0 to M9 2ss	3	6	8.0	8.4	8.6		0.4	13.5	30.0	16.50
	VHT160 Beam Forming, M0 to M9 3ss	3	4	9.4	9.3	9.6		0.4	14.6	30.0	15.40
	VHT160 Beam Forming, M0 to M9 1ss	4	10	7.1	7.2	7.5	7.3	0.4	13.7	26.0	12.31
	VHT160 Beam Forming, M0 to M9 2ss	4	7	8.0	8.4	8.6	8.1	0.4	14.7	29.0	14.31
	VHT160 Beam Forming, M0 to M9 3ss	4	5	8.0	8.4	8.6	8.1	0.4	14.7	30.0	15.31
	VHT160 Beam Forming, M0 to M9 4ss	4	4	9.4	9.3	9.6	9.4	0.4	15.8	30.0	14.16
	VHT160 STBC, M0 to M9 1ss	2	4	9.4	9.3			0.4	12.8	30.0	17.25
	VHT160 STBC, M0 to M9 1ss	3	4	9.4	9.3	9.6		0.4	14.6	30.0	15.40
	VHT160 STBC, M0 to M9 1ss	4	4	9.4	9.3	9.6	9.4	0.4	15.8	30.0	14.16
	HE160, M0 to M9 1ss	1	4	9.2				0.4	9.6	30.0	20.37
	HE160, M0 to M9 1ss	2	4	9.2	9.2			0.4	12.6	30.0	17.36



HE160, M0 to M9 2ss	2	4	9.2	9.2			0.4	12.6	30.0	17.36
HE160, M0 to M9 1ss	3	4	8.3	8.5	8.6		0.4	13.7	30.0	16.33
HE160, M0 to M9 2ss	3	4	8.3	8.5	8.6		0.4	13.7	30.0	16.33
HE160, M0 to M9 3ss	3	4	8.3	8.5	8.6		0.4	13.7	30.0	16.33
HE160, M0 to M9 1ss	4	4	8.3	8.5	8.6	8.5	0.4	14.9	30.0	15.07
HE160, M0 to M9 2ss	4	4	8.3	8.5	8.6	8.5	0.4	14.9	30.0	15.07
HE160, M0 to M9 3ss	4	4	8.3	8.5	8.6	8.5	0.4	14.9	30.0	15.07
HE160, M0 to M9 4ss	4	4	8.3	8.5	8.6	8.5	0.4	14.9	30.0	15.07
HE160 Beam Forming, M0 to M9 1ss	2	7	8.3	8.5			0.4	11.8	29.0	17.15
HE160 Beam Forming, M0 to M9 2ss	2	4	9.2	9.2			0.4	12.6	30.0	17.36
HE160 Beam Forming, M0 to M9 1ss	3	9	7.2	7.2	7.6		0.4	12.5	27.0	14.46
HE160 Beam Forming, M0 to M9 2ss	3	6	8.3	8.5	8.6		0.4	13.7	30.0	16.33
HE160 Beam Forming, M0 to M9 3ss	3	4	8.3	8.5	8.6		0.4	13.7	30.0	16.33
HE160 Beam Forming, M0 to M9 1ss	4	10	7.2	7.2	7.6	6.9	0.4	13.7	26.0	12.31
HE160 Beam Forming, M0 to M9 2ss	4	7	7.2	7.2	7.6	6.9	0.4	13.7	29.0	15.31
HE160 Beam Forming, M0 to M9 3ss	4	5	8.3	8.5	8.6	8.5	0.4	14.9	30.0	15.07
HE160 Beam Forming, M0 to M9 4ss	4	4	8.3	8.5	8.6	8.5	0.4	14.9	30.0	15.07
HE160 STBC, M0 to M9 1ss	2	4	9.2	9.2			0.4	12.6	30.0	17.36
HE160 STBC, M0 to M9 1ss	3	4	8.3	8.5	8.6		0.4	13.7	30.0	16.33
HE160 STBC, M0 to M9 1ss	4	4	8.3	8.5	8.6	8.5	0.4	14.9	30.0	15.07

**Maximum Transmit Output Power, 4dBi
5230 MHz, HE40 Beam Forming, M0 to M9 1ss**



Antenna A

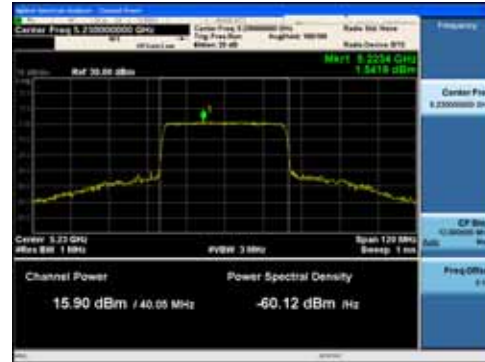

Antenna B



Antenna C



Antenna D

Maximum Output Power, 5dBi

Frequency (MHz)	Mode	Tx Paths	Correlated Antenna Gain (dBi)	Tx 1 Max Power (dBm)	Tx 2 Max Power (dBm)	Tx 3 Max Power (dBm)	Tx 4 Max Power (dBm)	Duty Cycle Correction (dB)	Total Tx Channel Power (dBm)	Limit (dBm)	Margin (dB)
5180	Non HT20, 6 to 54 Mbps	1	5	9.6				0.1	9.7	30.0	20.35
	Non HT20, 6 to 54 Mbps	2	5	9.6	15.8			0.1	16.8	30.0	13.21
	Non HT20, 6 to 54 Mbps	3	5	9.6	14.7	15.6		0.1	18.8	30.0	11.20
	Non HT20, 6 to 54 Mbps	4	5	9.6	14.7	15.6	14.5	0.1	20.2	30.0	9.81
	Non HT20 Beam Forming, 6 to 54 Mbps	2	8	9.6	14.7			0.1	15.9	28.0	12.08
	Non HT20 Beam Forming, 6 to 54 Mbps	3	10	9.6	11.3	12.3		0.1	16.0	26.0	9.97
	Non HT20 Beam Forming, 6 to 54 Mbps	4	11	8.8	9.4	10.4	9.6	0.1	15.7	25.0	9.34
	HT/VHT20, M0 to M7	1	5	10.2				0.1	10.3	30.0	19.75
	HT/VHT20, M0 to M7	2	5	10.2	15.8			0.1	16.9	30.0	13.09
	HT/VHT20, M8 to M15	2	5	10.2	15.8			0.1	16.9	30.0	13.09
	HT/VHT20, M0 to M7	3	5	10.2	15.1	15.8		0.1	19.1	30.0	10.87
	HT/VHT20, M8 to M15	3	5	10.2	15.1	15.8		0.1	19.1	30.0	10.87
	HT/VHT20, M16 to M23	3	5	10.2	15.1	15.8		0.1	19.1	30.0	10.87
	HT/VHT20, M0 to M7	4	5	10.2	13.9	14.7	13.9	0.1	19.6	30.0	10.45
	HT/VHT20, M8 to M15	4	5	10.2	13.9	14.7	13.9	0.1	19.6	30.0	10.45
	HT/VHT20, M16 to M23	4	5	10.2	13.9	14.7	13.9	0.1	19.6	30.0	10.45
	HT/VHT20, M24 to M31	4	5	10.2	13.9	14.7	13.9	0.1	19.6	30.0	10.45
	HT/VHT20 Beam Forming, M0 to M7	2	8	10.2	13.9			0.1	15.5	28.0	12.50
	HT/VHT20 Beam Forming, M8 to M15	2	5	10.2	15.8			0.1	16.9	30.0	13.09
	HT/VHT20 Beam Forming, M0 to M7	3	10	10.2	10.8	11.7		0.1	15.8	26.0	10.23
	HT/VHT20 Beam Forming, M8 to M15	3	7	10.2	13.9	14.7		0.1	18.2	29.0	10.85
	HT/VHT20 Beam Forming, M16 to M23	3	5	10.2	15.1	15.8		0.1	19.1	30.0	10.87
	HT/VHT20 Beam Forming, M0 to M7	4	11	9.2	9.7	10.6	9.9	0.1	16.0	25.0	9.05
	HT/VHT20 Beam Forming, M8 to M15	4	8	10.2	12.9	13.7	13.0	0.1	18.7	28.0	9.29
	HT/VHT20 Beam Forming, M16 to M23	4	6	10.2	13.9	14.7	13.9	0.1	19.6	30.0	10.45
	HT/VHT20 Beam Forming, M24 to M31	4	5	10.2	13.9	14.7	13.9	0.1	19.6	30.0	10.45
	HT/VHT20 STBC, M0 to M7	2	5	10.2	15.8			0.1	16.9	30.0	13.09
	HT/VHT20 STBC, M0 to M7	3	5	10.2	15.1	15.8		0.1	19.1	30.0	10.87
	HT/VHT20 STBC, M0 to M7	4	5	10.2	13.9	14.7	13.9	0.1	19.6	30.0	10.45
	HE20, M0 to M9 1ss	1	5	9.3				0.1	9.4	30.0	20.63

	HE20, M0 to M9 1ss	2	5	9.3	14.0			0.1	15.3	30.0	14.66	
	HE20, M0 to M9 2ss	2	5	9.3	14.0			0.1	15.3	30.0	14.66	
	HE20, M0 to M9 1ss	3	5	9.3	13.1	14.0		0.1	17.4	30.0	12.60	
	HE20, M0 to M9 2ss	3	5	9.3	13.1	14.0		0.1	17.4	30.0	12.60	
	HE20, M0 to M9 3ss	3	5	9.3	13.1	14.0		0.1	17.4	30.0	12.60	
	HE20, M0 to M9 1ss	4	5	9.3	13.1	14.0	13.2	0.1	18.8	30.0	11.18	
	HE20, M0 to M9 2ss	4	5	9.3	13.1	14.0	13.2	0.1	18.8	30.0	11.18	
	HE20, M0 to M9 3ss	4	5	9.3	13.1	14.0	13.2	0.1	18.8	30.0	11.18	
	HE20, M0 to M9 4ss	4	5	9.3	13.1	14.0	13.2	0.1	18.8	30.0	11.18	
	HE20 Beam Forming, M0 to M9 1ss	2	8	9.3	12.2			0.1	14.1	28.0	13.93	
	HE20 Beam Forming, M0 to M9 2ss	2	5	9.3	14.0			0.1	15.3	30.0	14.66	
	HE20 Beam Forming, M0 to M9 1ss	3	10	8.3	8.8	9.7		0.1	13.8	26.0	12.19	
	HE20 Beam Forming, M0 to M9 2ss	3	7	9.3	12.2	13.0		0.1	16.6	29.0	12.39	
	HE20 Beam Forming, M0 to M9 3ss	3	5	9.3	13.1	14.0		0.1	17.4	30.0	12.60	
	HE20 Beam Forming, M0 to M9 1ss	4	11	7.2	7.7	8.5	7.8	0.1	13.9	25.0	11.09	
	HE20 Beam Forming, M0 to M9 2ss	4	8	9.3	9.8	10.7	10.0	0.1	16.1	28.0	11.93	
	HE20 Beam Forming, M0 to M9 3ss	4	6	9.3	12.2	13.0	12.5	0.1	18.1	30.0	11.95	
	HE20 Beam Forming, M0 to M9 4ss	4	5	9.3	13.1	14.0	13.2	0.1	18.8	30.0	11.18	
	HE20 STBC, M0 to M9 2ss	2	5	9.3	14.0			0.1	15.3	30.0	14.66	
	HE20 STBC, M0 to M9 2ss	3	5	9.3	13.1	14.0		0.1	17.4	30.0	12.60	
	HE20 STBC, M0 to M9 2ss	4	5	9.3	13.1	14.0	13.2	0.1	18.8	30.0	11.18	
5190	Non HT40, 6 to 54 Mbps	1	5	8.3				0.0	8.3	30.0	21.65	
	Non HT40, 6 to 54 Mbps	2	5	8.3	8.9			0.0	11.7	30.0	18.33	
	Non HT40, 6 to 54 Mbps	3	5	8.3	8.9	9.4		0.0	13.7	30.0	16.29	
	Non HT40, 6 to 54 Mbps	4	5	8.3	8.9	9.4	8.8	0.0	14.9	30.0	15.06	
	HT/VHT40, M0 to M7	1	5	9.5				0.1	9.6	30.0	20.40	
	HT/VHT40, M0 to M7	2	5	8.5	9.0			0.1	11.9	30.0	18.13	
	HT/VHT40, M8 to M15	2	5	8.5	9.0			0.1	11.9	30.0	18.13	
	HT/VHT40, M0 to M7	3	5	8.5	9.0	9.7		0.1	14.0	30.0	16.03	
	HT/VHT40, M8 to M15	3	5	8.5	9.0	9.7		0.1	14.0	30.0	16.03	
	HT/VHT40, M16 to M23	3	5	8.5	9.0	9.7		0.1	14.0	30.0	16.03	
	HT/VHT40, M0 to M7	4	5	8.5	9.0	9.7	9.0	0.1	15.2	30.0	14.81	
	HT/VHT40, M8 to M15	4	5	8.5	9.0	9.7	9.0	0.1	15.2	30.0	14.81	
	HT/VHT40, M16 to M23	4	5	8.5	9.0	9.7	9.0	0.1	15.2	30.0	14.81	
	HT/VHT40, M24 to M31	4	5	8.5	9.0	9.7	9.0	0.1	15.2	30.0	14.81	
	HT/VHT40 Beam Forming, M0 to M7	2	8	8.5	9.0				0.1	11.9	28.0	16.13
	HT/VHT40 Beam Forming, M8 to M15	2	5	8.5	9.0				0.1	11.9	30.0	18.13
	HT/VHT40 Beam Forming, M0 to M7	3	10	7.4	8.0	8.9			0.1	13.0	26.0	12.98
	HT/VHT40 Beam Forming, M8 to M15	3	7	8.5	9.0	9.7			0.1	14.0	29.0	15.03
	HT/VHT40 Beam Forming, M16 to M23	3	5	8.5	9.0	9.7			0.1	14.0	30.0	16.03
	HT/VHT40 Beam Forming, M0 to M7	4	11	6.3	7.1	7.8	7.1		0.1	13.2	25.0	11.77
HT/VHT40 Beam Forming, M8 to M15	4	8	7.4	8.0	8.9	7.9		0.1	14.2	28.0	13.79	

	HT/VHT40 Beam Forming, M16 to M23	4	6	8.5	9.0	9.7	9.0	0.1	15.2	30.0	14.81
	HT/VHT40 Beam Forming, M24 to M31	4	5	8.5	9.0	9.7	9.0	0.1	15.2	30.0	14.81
	HT/VHT40 STBC, M0 to M7	2	5	8.5	9.0			0.1	11.9	30.0	18.13
	HT/VHT40 STBC, M0 to M7	3	5	8.5	9.0	9.7		0.1	14.0	30.0	16.03
	HT/VHT40 STBC, M0 to M7	4	5	8.5	9.0	9.7	9.0	0.1	15.2	30.0	14.81
	HE40, M0 to M9 1ss	1	5	7.6				0.1	7.7	30.0	22.27
	HE40, M0 to M9 1ss	2	5	7.6	8.2			0.1	11.0	30.0	18.95
	HE40, M0 to M9 2ss	2	5	7.6	8.2			0.1	11.0	30.0	18.95
	HE40, M0 to M9 1ss	3	5	7.6	8.2	8.9		0.1	13.2	30.0	16.84
	HE40, M0 to M9 2ss	3	5	7.6	8.2	8.9		0.1	13.2	30.0	16.84
	HE40, M0 to M9 3ss	3	5	7.6	8.2	8.9		0.1	13.2	30.0	16.84
	HE40, M0 to M9 1ss	4	5	7.6	8.2	8.9	8.1	0.1	14.4	30.0	15.63
	HE40, M0 to M9 2ss	4	5	7.6	8.2	8.9	8.1	0.1	14.4	30.0	15.63
	HE40, M0 to M9 3ss	4	5	7.6	8.2	8.9	8.1	0.1	14.4	30.0	15.63
	HE40, M0 to M9 4ss	4	5	7.6	8.2	8.9	8.1	0.1	14.4	30.0	15.63
	HE40 Beam Forming, M0 to M9 1ss	2	8	6.6	7.2			0.1	10.0	28.0	17.95
	HE40 Beam Forming, M0 to M9 2ss	2	5	7.6	8.2			0.1	11.0	30.0	18.95
	HE40 Beam Forming, M0 to M9 1ss	3	10	6.6	7.2	7.8		0.1	12.1	26.0	13.88
	HE40 Beam Forming, M0 to M9 2ss	3	7	7.6	8.2	8.9		0.1	13.2	29.0	15.84
	HE40 Beam Forming, M0 to M9 3ss	3	5	7.6	8.2	8.9		0.1	13.2	30.0	16.84
	HE40 Beam Forming, M0 to M9 1ss	4	11	5.5	6.2	6.7	5.9	0.1	12.2	25.0	12.76
	HE40 Beam Forming, M0 to M9 2ss	4	8	6.6	7.2	7.8	7.1	0.1	13.3	28.0	14.66
	HE40 Beam Forming, M0 to M9 3ss	4	6	7.6	8.2	8.9	8.1	0.1	14.4	30.0	15.63
	HE40 Beam Forming, M0 to M9 4ss	4	5	7.6	8.2	8.9	8.1	0.1	14.4	30.0	15.63
	HE40 STBC, M0 to M9 2ss	2	5	7.6	8.2			0.1	11.0	30.0	18.95
	HE40 STBC, M0 to M9 2ss	3	5	7.6	8.2	8.9		0.1	13.2	30.0	16.84
	HE40 STBC, M0 to M9 2ss	4	5	7.6	8.2	8.9	8.1	0.1	14.4	30.0	15.63
5210	Non HT80, 6 to 54 Mbps	1	5	9.3				0.1	9.4	30.0	20.65
	Non HT80, 6 to 54 Mbps	2	5	9.3	9.7			0.1	12.6	30.0	17.43
	Non HT80, 6 to 54 Mbps	3	5	9.3	9.7	9.9		0.1	14.5	30.0	15.53
	Non HT80, 6 to 54 Mbps	4	5	8.0	8.6	8.9	8.6	0.1	14.6	30.0	15.39
	VHT80, M0 to M9 1ss	1	5	9.2				0.2	9.4	30.0	20.58
	VHT80, M0 to M9 1ss	2	5	9.2	9.6			0.2	12.6	30.0	17.36
	VHT80, M0 to M9 2ss	2	5	9.2	9.6			0.2	12.6	30.0	17.36
	VHT80, M0 to M9 1ss	3	5	9.2	9.6	9.8		0.2	14.5	30.0	15.46
	VHT80, M0 to M9 2ss	3	5	9.2	9.6	9.8		0.2	14.5	30.0	15.46
	VHT80, M0 to M9 3ss	3	5	9.2	9.6	9.8		0.2	14.5	30.0	15.46
	VHT80, M0 to M9 1ss	4	5	9.2	9.6	9.8	9.3	0.2	15.7	30.0	14.27
	VHT80, M0 to M9 2ss	4	5	9.2	9.6	9.8	9.3	0.2	15.7	30.0	14.27
	VHT80, M0 to M9 3ss	4	5	9.2	9.6	9.8	9.3	0.2	15.7	30.0	14.27
	VHT80, M0 to M9 4ss	4	5	9.2	9.6	9.8	9.3	0.2	15.7	30.0	14.27
	VHT80 Beam Forming, M0 to M9 1ss	2	8	7.9	8.3			0.2	11.3	28.0	16.66

	VHT80 Beam Forming, M0 to M9 2ss	2	5	9.2	9.6			0.2	12.6	30.0	17.36	
	VHT80 Beam Forming, M0 to M9 1ss	3	10	7.9	8.3	8.6		0.2	13.3	26.0	12.73	
	VHT80 Beam Forming, M0 to M9 2ss	3	7	7.9	8.3	8.6		0.2	13.3	29.0	15.73	
	VHT80 Beam Forming, M0 to M9 3ss	3	5	9.2	9.6	9.8		0.2	14.5	30.0	15.46	
	VHT80 Beam Forming, M0 to M9 1ss	4	11	7.0	7.7	7.9	7.5	0.2	13.8	25.0	11.22	
	VHT80 Beam Forming, M0 to M9 2ss	4	8	7.9	8.3	8.6	8.3	0.2	14.5	28.0	13.47	
	VHT80 Beam Forming, M0 to M9 3ss	4	6	7.9	8.3	8.6	8.3	0.2	14.5	30.0	15.47	
	VHT80 Beam Forming, M0 to M9 4ss	4	5	9.2	9.6	9.8	9.3	0.2	15.7	30.0	14.27	
	VHT80 STBC, M0 to M9 1ss	2	5	9.2	9.6			0.2	12.6	30.0	17.36	
	VHT80 STBC, M0 to M9 1ss	3	5	9.2	9.6	9.8		0.2	14.5	30.0	15.46	
	VHT80 STBC, M0 to M9 1ss	4	5	9.2	9.6	9.8	9.3	0.2	15.7	30.0	14.27	
	HE80, M0 to M9 1ss	1	5	8.1				0.3	8.4	30.0	21.65	
	HE80, M0 to M9 1ss	2	5	8.1	8.6			0.3	11.6	30.0	18.38	
	HE80, M0 to M9 2ss	2	5	8.1	8.6			0.3	11.6	30.0	18.38	
	HE80, M0 to M9 1ss	3	5	8.1	8.6	8.6		0.3	13.5	30.0	16.54	
	HE80, M0 to M9 2ss	3	5	8.1	8.6	8.6		0.3	13.5	30.0	16.54	
	HE80, M0 to M9 3ss	3	5	8.1	8.6	8.6		0.3	13.5	30.0	16.54	
	HE80, M0 to M9 1ss	4	5	8.1	8.6	8.6	8.3	0.3	14.7	30.0	15.32	
	HE80, M0 to M9 2ss	4	5	8.1	8.6	8.6	8.3	0.3	14.7	30.0	15.32	
	HE80, M0 to M9 3ss	4	5	8.1	8.6	8.6	8.3	0.3	14.7	30.0	15.32	
	HE80, M0 to M9 4ss	4	5	8.1	8.6	8.6	8.3	0.3	14.7	30.0	15.32	
	HE80 Beam Forming, M0 to M9 1ss	2	8	6.9	7.4			0.3	10.4	28.0	17.58	
	HE80 Beam Forming, M0 to M9 2ss	2	5	8.1	8.6			0.3	11.6	30.0	18.38	
	HE80 Beam Forming, M0 to M9 1ss	3	10	6.9	7.4	7.8		0.3	12.4	26.0	13.60	
	HE80 Beam Forming, M0 to M9 2ss	3	7	6.9	7.4	7.8		0.3	12.4	29.0	16.60	
	HE80 Beam Forming, M0 to M9 3ss	3	5	8.1	8.6	8.6		0.3	13.5	30.0	16.54	
	HE80 Beam Forming, M0 to M9 1ss	4	11	6.3	6.7	6.7	6.3	0.3	12.8	25.0	12.22	
	HE80 Beam Forming, M0 to M9 2ss	4	8	6.9	7.4	7.8	7.2	0.3	13.6	28.0	14.39	
	HE80 Beam Forming, M0 to M9 3ss	4	6	6.9	7.4	7.8	7.2	0.3	13.6	30.0	16.39	
	HE80 Beam Forming, M0 to M9 4ss	4	5	8.1	8.6	8.6	8.3	0.3	14.7	30.0	15.32	
	HE80 STBC, M0 to M9 1ss	2	5	8.1	8.6			0.3	11.6	30.0	18.38	
	HE80 STBC, M0 to M9 1ss	3	5	8.1	8.6	8.6		0.3	13.5	30.0	16.54	
	HE80 STBC, M0 to M9 1ss	4	5	8.1	8.6	8.6	8.3	0.3	14.7	30.0	15.32	
	5220	Non HT20, 6 to 54 Mbps	1	5	9.6				0.1	9.7	30.0	20.35
		Non HT20, 6 to 54 Mbps	2	5	9.6	15.5			0.1	16.5	30.0	13.45
Non HT20, 6 to 54 Mbps		3	5	9.6	15.5	16.0		0.1	19.3	30.0	10.68	
Non HT20, 6 to 54 Mbps		4	5	9.6	15.5	16.0	15.9	0.1	21.0	30.0	9.04	
Non HT20 Beam Forming, 6 to 54 Mbps		2	8	9.6	15.5			0.1	16.5	28.0	11.45	
Non HT20 Beam Forming, 6 to 54 Mbps		3	10	9.6	15.5	16.0		0.1	19.3	26.0	6.68	
Non HT20 Beam Forming, 6 to 54 Mbps		4	11	9.6	15.5	16.0	15.9	0.1	21.0	25.0	4.04	
HT/VHT20, M0 to M7		1	5	9.8				0.1	9.9	30.0	20.15	
HT/VHT20, M0 to M7		2	5	9.8	15.5			0.1	16.6	30.0	13.41	

HT/VHT20, M8 to M15	2	5	9.8	15.5			0.1	16.6	30.0	13.41
HT/VHT20, M0 to M7	3	5	9.8	15.5	16.0		0.1	19.3	30.0	10.66
HT/VHT20, M8 to M15	3	5	9.8	15.5	16.0		0.1	19.3	30.0	10.66
HT/VHT20, M16 to M23	3	5	9.8	15.5	16.0		0.1	19.3	30.0	10.66
HT/VHT20, M0 to M7	4	5	9.8	15.5	16.0	15.9	0.1	21.0	30.0	9.02
HT/VHT20, M8 to M15	4	5	9.8	15.5	16.0	15.9	0.1	21.0	30.0	9.02
HT/VHT20, M16 to M23	4	5	9.8	15.5	16.0	15.9	0.1	21.0	30.0	9.02
HT/VHT20, M24 to M31	4	5	9.8	15.5	16.0	15.9	0.1	21.0	30.0	9.02
HT/VHT20 Beam Forming, M0 to M7	2	8	9.8	15.5			0.1	16.6	28.0	11.41
HT/VHT20 Beam Forming, M8 to M15	2	5	9.8	15.5			0.1	16.6	30.0	13.41
HT/VHT20 Beam Forming, M0 to M7	3	10	9.8	15.5	16.0		0.1	19.3	26.0	6.66
HT/VHT20 Beam Forming, M8 to M15	3	7	9.8	15.5	16.0		0.1	19.3	29.0	9.66
HT/VHT20 Beam Forming, M16 to M23	3	5	9.8	15.5	16.0		0.1	19.3	30.0	10.66
HT/VHT20 Beam Forming, M0 to M7	4	11	9.8	15.5	16.0	15.9	0.1	21.0	25.0	4.02
HT/VHT20 Beam Forming, M8 to M15	4	8	9.8	15.5	16.0	15.9	0.1	21.0	28.0	7.02
HT/VHT20 Beam Forming, M16 to M23	4	6	9.8	15.5	16.0	15.9	0.1	21.0	30.0	9.02
HT/VHT20 Beam Forming, M24 to M31	4	5	9.8	15.5	16.0	15.9	0.1	21.0	30.0	9.02
HT/VHT20 STBC, M0 to M7	2	5	9.8	15.5			0.1	16.6	30.0	13.41
HT/VHT20 STBC, M0 to M7	3	5	9.8	15.5	16.0		0.1	19.3	30.0	10.66
HT/VHT20 STBC, M0 to M7	4	5	9.8	15.5	16.0	15.9	0.1	21.0	30.0	9.02
HE20, M0 to M9 1ss	1	5	9.9				0.1	10.0	30.0	20.03
HE20, M0 to M9 1ss	2	5	9.9	15.8			0.1	16.9	30.0	13.14
HE20, M0 to M9 2ss	2	5	9.9	15.8			0.1	16.9	30.0	13.14
HE20, M0 to M9 1ss	3	5	9.9	15.8	16.3		0.1	19.6	30.0	10.37
HE20, M0 to M9 2ss	3	5	9.9	15.8	16.3		0.1	19.6	30.0	10.37
HE20, M0 to M9 3ss	3	5	9.9	15.8	16.3		0.1	19.6	30.0	10.37
HE20, M0 to M9 1ss	4	5	9.9	15.8	16.3	16.0	0.1	21.2	30.0	8.78
HE20, M0 to M9 2ss	4	5	9.9	15.8	16.3	16.0	0.1	21.2	30.0	8.78
HE20, M0 to M9 3ss	4	5	9.9	15.8	16.3	16.0	0.1	21.2	30.0	8.78
HE20, M0 to M9 4ss	4	5	9.9	15.8	16.3	16.0	0.1	21.2	30.0	8.78
HE20 Beam Forming, M0 to M9 1ss	2	8	9.9	15.8			0.1	16.9	28.0	11.14
HE20 Beam Forming, M0 to M9 2ss	2	5	9.9	15.8			0.1	16.9	30.0	13.14
HE20 Beam Forming, M0 to M9 1ss	3	10	9.9	15.8	16.3		0.1	19.6	26.0	6.37
HE20 Beam Forming, M0 to M9 2ss	3	7	9.9	15.8	16.3		0.1	19.6	29.0	9.37
HE20 Beam Forming, M0 to M9 3ss	3	5	9.9	15.8	16.3		0.1	19.6	30.0	10.37
HE20 Beam Forming, M0 to M9 1ss	4	11	9.9	15.8	16.3	16.0	0.1	21.2	25.0	3.78
HE20 Beam Forming, M0 to M9 2ss	4	8	9.9	15.8	16.3	16.0	0.1	21.2	28.0	6.78
HE20 Beam Forming, M0 to M9 3ss	4	6	9.9	15.8	16.3	16.0	0.1	21.2	30.0	8.78
HE20 Beam Forming, M0 to M9 4ss	4	5	9.9	15.8	16.3	16.0	0.1	21.2	30.0	8.78
HE20 STBC, M0 to M9 2ss	2	5	9.9	15.8			0.1	16.9	30.0	13.14
HE20 STBC, M0 to M9 2ss	3	5	9.9	15.8	16.3		0.1	19.6	30.0	10.37
HE20 STBC, M0 to M9 2ss	4	5	9.9	15.8	16.3	16.0	0.1	21.2	30.0	8.78

5230	Non HT40, 6 to 54 Mbps	1	5	10.0				0.0	10.0	30.0	19.95
	Non HT40, 6 to 54 Mbps	2	5	10.0	15.6			0.0	16.7	30.0	13.29
	Non HT40, 6 to 54 Mbps	3	5	10.0	15.6	16.0		0.0	19.4	30.0	10.60
	Non HT40, 6 to 54 Mbps	4	5	10.0	15.6	16.0	15.7	0.0	21.0	30.0	9.04
	HT/VHT40, M0 to M7	1	5	10.0				0.1	10.1	30.0	19.90
	HT/VHT40, M0 to M7	2	5	10.0	15.6			0.1	16.8	30.0	13.24
	HT/VHT40, M8 to M15	2	5	10.0	15.6			0.1	16.8	30.0	13.24
	HT/VHT40, M0 to M7	3	5	10.0	15.6	16.0		0.1	19.5	30.0	10.55
	HT/VHT40, M8 to M15	3	5	10.0	15.6	16.0		0.1	19.5	30.0	10.55
	HT/VHT40, M16 to M23	3	5	10.0	15.6	16.0		0.1	19.5	30.0	10.55
	HT/VHT40, M0 to M7	4	5	10.0	15.6	16.0	15.5	0.1	21.0	30.0	9.05
	HT/VHT40, M8 to M15	4	5	10.0	15.6	16.0	15.5	0.1	21.0	30.0	9.05
	HT/VHT40, M16 to M23	4	5	10.0	15.6	16.0	15.5	0.1	21.0	30.0	9.05
	HT/VHT40, M24 to M31	4	5	10.0	15.6	16.0	15.5	0.1	21.0	30.0	9.05
	HT/VHT40 Beam Forming, M0 to M7	2	8	10.0	15.6			0.1	16.8	28.0	11.24
	HT/VHT40 Beam Forming, M8 to M15	2	5	10.0	15.6			0.1	16.8	30.0	13.24
	HT/VHT40 Beam Forming, M0 to M7	3	10	10.0	15.6	16.0		0.1	19.5	26.0	6.55
	HT/VHT40 Beam Forming, M8 to M15	3	7	10.0	15.6	16.0		0.1	19.5	29.0	9.55
	HT/VHT40 Beam Forming, M16 to M23	3	5	10.0	15.6	16.0		0.1	19.5	30.0	10.55
	HT/VHT40 Beam Forming, M0 to M7	4	11	10.0	15.6	16.0	15.5	0.1	21.0	25.0	4.05
	HT/VHT40 Beam Forming, M8 to M15	4	8	10.0	15.6	16.0	15.5	0.1	21.0	28.0	7.05
	HT/VHT40 Beam Forming, M16 to M23	4	6	10.0	15.6	16.0	15.5	0.1	21.0	30.0	9.05
	HT/VHT40 Beam Forming, M24 to M31	4	5	10.0	15.6	16.0	15.5	0.1	21.0	30.0	9.05
	HT/VHT40 STBC, M0 to M7	2	5	10.0	15.6			0.1	16.8	30.0	13.24
	HT/VHT40 STBC, M0 to M7	3	5	10.0	15.6	16.0		0.1	19.5	30.0	10.55
	HT/VHT40 STBC, M0 to M7	4	5	10.0	15.6	16.0	15.5	0.1	21.0	30.0	9.05
	HE40, M0 to M9 1ss	1	5	10.0				0.1	10.1	30.0	19.87
	HE40, M0 to M9 1ss	2	5	10.0	15.9			0.1	17.0	30.0	12.98
	HE40, M0 to M9 2ss	2	5	10.0	15.9			0.1	17.0	30.0	12.98
	HE40, M0 to M9 1ss	3	5	10.0	15.9	16.3		0.1	19.7	30.0	10.26
	HE40, M0 to M9 2ss	3	5	10.0	15.9	16.3		0.1	19.7	30.0	10.26
	HE40, M0 to M9 3ss	3	5	10.0	15.9	16.3		0.1	19.7	30.0	10.26
	HE40, M0 to M9 1ss	4	5	10.0	15.9	16.3	15.8	0.1	21.3	30.0	8.75
	HE40, M0 to M9 2ss	4	5	10.0	15.9	16.3	15.8	0.1	21.3	30.0	8.75
	HE40, M0 to M9 3ss	4	5	10.0	15.9	16.3	15.8	0.1	21.3	30.0	8.75
	HE40, M0 to M9 4ss	4	5	10.0	15.9	16.3	15.8	0.1	21.3	30.0	8.75
	HE40 Beam Forming, M0 to M9 1ss	2	8	10.0	15.9			0.1	17.0	28.0	10.98
	HE40 Beam Forming, M0 to M9 2ss	2	5	10.0	15.9			0.1	17.0	30.0	12.98
	HE40 Beam Forming, M0 to M9 1ss	3	10	10.0	15.9	16.3		0.1	19.7	26.0	6.26
	HE40 Beam Forming, M0 to M9 2ss	3	7	10.0	15.9	16.3		0.1	19.7	29.0	9.26
HE40 Beam Forming, M0 to M9 3ss	3	5	10.0	15.9	16.3		0.1	19.7	30.0	10.26	

	HE40 Beam Forming, M0 to M9 1ss	4	11	10.0	15.9	16.3	15.8	0.1	21.3	25.0	3.75
	HE40 Beam Forming, M0 to M9 2ss	4	8	10.0	15.9	16.3	15.8	0.1	21.3	28.0	6.75
	HE40 Beam Forming, M0 to M9 3ss	4	6	10.0	15.9	16.3	15.8	0.1	21.3	30.0	8.75
	HE40 Beam Forming, M0 to M9 4ss	4	5	10.0	15.9	16.3	15.8	0.1	21.3	30.0	8.75
	HE40 STBC, M0 to M9 2ss	2	5	10.0	15.9			0.1	17.0	30.0	12.98
	HE40 STBC, M0 to M9 2ss	3	5	10.0	15.9	16.3		0.1	19.7	30.0	10.26
	HE40 STBC, M0 to M9 2ss	4	5	10.0	15.9	16.3	15.8	0.1	21.3	30.0	8.75
5240	Non HT20, 6 to 54 Mbps	1	5	10.1				0.1	10.2	30.0	19.85
	Non HT20, 6 to 54 Mbps	2	5	10.1	15.7			0.1	16.8	30.0	13.19
	Non HT20, 6 to 54 Mbps	3	5	10.1	15.7	16.1		0.1	19.5	30.0	10.49
	Non HT20, 6 to 54 Mbps	4	5	10.1	15.7	16.1	15.5	0.1	21.0	30.0	9.03
	Non HT20 Beam Forming, 6 to 54 Mbps	2	8	10.1	15.7			0.1	16.8	28.0	11.19
	Non HT20 Beam Forming, 6 to 54 Mbps	3	10	10.1	15.7	16.1		0.1	19.5	26.0	6.49
	Non HT20 Beam Forming, 6 to 54 Mbps	4	11	10.1	15.7	16.1	15.5	0.1	21.0	25.0	4.03
	HT/VHT20, M0 to M7	1	5	10.0				0.1	10.1	30.0	19.95
	HT/VHT20, M0 to M7	2	5	10.0	15.6			0.1	16.7	30.0	13.29
	HT/VHT20, M8 to M15	2	5	10.0	15.6			0.1	16.7	30.0	13.29
	HT/VHT20, M0 to M7	3	5	10.0	15.6	16.0		0.1	19.4	30.0	10.60
	HT/VHT20, M8 to M15	3	5	10.0	15.6	16.0		0.1	19.4	30.0	10.60
	HT/VHT20, M16 to M23	3	5	10.0	15.6	16.0		0.1	19.4	30.0	10.60
	HT/VHT20, M0 to M7	4	5	10.0	15.6	16.0	15.3	0.1	20.8	30.0	9.16
	HT/VHT20, M8 to M15	4	5	10.0	15.6	16.0	15.3	0.1	20.8	30.0	9.16
	HT/VHT20, M16 to M23	4	5	10.0	15.6	16.0	15.3	0.1	20.8	30.0	9.16
	HT/VHT20, M24 to M31	4	5	10.0	15.6	16.0	15.3	0.1	20.8	30.0	9.16
	HT/VHT20 Beam Forming, M0 to M7	2	8	10.0	15.6			0.1	16.7	28.0	11.29
	HT/VHT20 Beam Forming, M8 to M15	2	5	10.0	15.6			0.1	16.7	30.0	13.29
	HT/VHT20 Beam Forming, M0 to M7	3	10	10.0	15.6	16.0		0.1	19.4	26.0	6.60
	HT/VHT20 Beam Forming, M8 to M15	3	7	10.0	15.6	16.0		0.1	19.4	29.0	9.60
	HT/VHT20 Beam Forming, M16 to M23	3	5	10.0	15.6	16.0		0.1	19.4	30.0	10.60
	HT/VHT20 Beam Forming, M0 to M7	4	11	10.0	15.6	16.0	15.3	0.1	20.8	25.0	4.16
	HT/VHT20 Beam Forming, M8 to M15	4	8	10.0	15.6	16.0	15.3	0.1	20.8	28.0	7.16
	HT/VHT20 Beam Forming, M16 to M23	4	6	10.0	15.6	16.0	15.3	0.1	20.8	30.0	9.16
	HT/VHT20 Beam Forming, M24 to M31	4	5	10.0	15.6	16.0	15.3	0.1	20.8	30.0	9.16
	HT/VHT20 STBC, M0 to M7	2	5	10.0	15.6			0.1	16.7	30.0	13.29
	HT/VHT20 STBC, M0 to M7	3	5	10.0	15.6	16.0		0.1	19.4	30.0	10.60
	HT/VHT20 STBC, M0 to M7	4	5	10.0	15.6	16.0	15.3	0.1	20.8	30.0	9.16
	HE20, M0 to M9 1ss	1	5	10.3				0.1	10.4	30.0	19.63
	HE20, M0 to M9 1ss	2	5	10.3	15.7			0.1	16.9	30.0	13.13
	HE20, M0 to M9 2ss	2	5	10.3	15.7			0.1	16.9	30.0	13.13
	HE20, M0 to M9 1ss	3	5	10.3	15.7	16.3		0.1	19.6	30.0	10.36
	HE20, M0 to M9 2ss	3	5	10.3	15.7	16.3		0.1	19.6	30.0	10.36
HE20, M0 to M9 3ss	3	5	10.3	15.7	16.3		0.1	19.6	30.0	10.36	

	HE20, M0 to M9 1ss	4	5	10.3	15.7	16.3	15.7	0.1	21.1	30.0	8.87
	HE20, M0 to M9 2ss	4	5	10.3	15.7	16.3	15.7	0.1	21.1	30.0	8.87
	HE20, M0 to M9 3ss	4	5	10.3	15.7	16.3	15.7	0.1	21.1	30.0	8.87
	HE20, M0 to M9 4ss	4	5	10.3	15.7	16.3	15.7	0.1	21.1	30.0	8.87
	HE20 Beam Forming, M0 to M9 1ss	2	8	10.3	15.7			0.1	16.9	28.0	11.13
	HE20 Beam Forming, M0 to M9 2ss	2	5	10.3	15.7			0.1	16.9	30.0	13.13
	HE20 Beam Forming, M0 to M9 1ss	3	10	10.3	15.7	16.3		0.1	19.6	26.0	6.36
	HE20 Beam Forming, M0 to M9 2ss	3	7	10.3	15.7	16.3		0.1	19.6	29.0	9.36
	HE20 Beam Forming, M0 to M9 3ss	3	5	10.3	15.7	16.3		0.1	19.6	30.0	10.36
	HE20 Beam Forming, M0 to M9 1ss	4	11	10.3	15.7	16.3	15.7	0.1	21.1	25.0	3.87
	HE20 Beam Forming, M0 to M9 2ss	4	8	10.3	15.7	16.3	15.7	0.1	21.1	28.0	6.87
	HE20 Beam Forming, M0 to M9 3ss	4	6	10.3	15.7	16.3	15.7	0.1	21.1	30.0	8.87
	HE20 Beam Forming, M0 to M9 4ss	4	5	10.3	15.7	16.3	15.7	0.1	21.1	30.0	8.87
	HE20 STBC, M0 to M9 2ss	2	5	10.3	15.7			0.1	16.9	30.0	13.13
	HE20 STBC, M0 to M9 2ss	3	5	10.3	15.7	16.3		0.1	19.6	30.0	10.36
	HE20 STBC, M0 to M9 2ss	4	5	10.3	15.7	16.3	15.7	0.1	21.1	30.0	8.87
	Non HT160, 6 to 54 Mbps	1	5	8.3				0.0	8.3	30.0	21.65
	Non HT160, 6 to 54 Mbps	2	5	8.3	8.5			0.0	11.5	30.0	18.54
	Non HT160, 6 to 54 Mbps	3	5	8.3	8.5	8.9		0.0	13.4	30.0	16.61
	Non HT160, 6 to 54 Mbps	4	5	8.3	8.5	8.9	8.4	0.0	14.6	30.0	15.40
	VHT160, M0 to M9 1ss	1	5	9.4				0.4	9.8	30.0	20.21
	VHT160, M0 to M9 1ss	2	5	9.4	9.3			0.4	12.8	30.0	17.25
	VHT160, M0 to M9 2ss	2	5	9.4	9.3			0.4	12.8	30.0	17.25
	VHT160, M0 to M9 1ss	3	5	8.0	8.4	8.6		0.4	13.5	30.0	16.50
	VHT160, M0 to M9 2ss	3	5	8.0	8.4	8.6		0.4	13.5	30.0	16.50
	VHT160, M0 to M9 3ss	3	5	8.0	8.4	8.6		0.4	13.5	30.0	16.50
	VHT160, M0 to M9 1ss	4	5	8.0	8.4	8.6	8.1	0.4	14.7	30.0	15.31
	VHT160, M0 to M9 2ss	4	5	8.0	8.4	8.6	8.1	0.4	14.7	30.0	15.31
	VHT160, M0 to M9 3ss	4	5	8.0	8.4	8.6	8.1	0.4	14.7	30.0	15.31
	VHT160, M0 to M9 4ss	4	5	8.0	8.4	8.6	8.1	0.4	14.7	30.0	15.31
	VHT160 Beam Forming, M0 to M9 1ss	2	8	8.0	8.4			0.4	11.6	28.0	16.39
	VHT160 Beam Forming, M0 to M9 2ss	2	5	9.4	9.3			0.4	12.8	30.0	17.25
	VHT160 Beam Forming, M0 to M9 1ss	3	10	7.1	7.2	7.5		0.4	12.4	26.0	13.57
	VHT160 Beam Forming, M0 to M9 2ss	3	7	8.0	8.4	8.6		0.4	13.5	29.0	15.50
	VHT160 Beam Forming, M0 to M9 3ss	3	5	8.0	8.4	8.6		0.4	13.5	30.0	16.50
	VHT160 Beam Forming, M0 to M9 1ss	4	11	6.0	6.2	6.8	6.0	0.4	12.7	25.0	12.32
	VHT160 Beam Forming, M0 to M9 2ss	4	8	8.0	8.4	8.6	8.1	0.4	14.7	28.0	13.31
	VHT160 Beam Forming, M0 to M9 3ss	4	6	8.0	8.4	8.6	8.1	0.4	14.7	30.0	15.31
	VHT160 Beam Forming, M0 to M9 4ss	4	5	8.0	8.4	8.6	8.1	0.4	14.7	30.0	15.31
	VHT160 STBC, M0 to M9 1ss	2	5	9.4	9.3			0.4	12.8	30.0	17.25
	VHT160 STBC, M0 to M9 1ss	3	5	8.0	8.4	8.6		0.4	13.5	30.0	16.50
	VHT160 STBC, M0 to M9 1ss	4	5	8.0	8.4	8.6	8.1	0.4	14.7	30.0	15.31



HE160, M0 to M9 1ss	1	5	8.3				0.4	8.7	30.0	21.27
HE160, M0 to M9 1ss	2	5	8.3	8.5			0.4	11.8	30.0	18.15
HE160, M0 to M9 2ss	2	5	8.3	8.5			0.4	11.8	30.0	18.15
HE160, M0 to M9 1ss	3	5	8.3	8.5	8.6		0.4	13.7	30.0	16.33
HE160, M0 to M9 2ss	3	5	8.3	8.5	8.6		0.4	13.7	30.0	16.33
HE160, M0 to M9 3ss	3	5	8.3	8.5	8.6		0.4	13.7	30.0	16.33
HE160, M0 to M9 1ss	4	5	8.3	8.5	8.6	8.5	0.4	14.9	30.0	15.07
HE160, M0 to M9 2ss	4	5	8.3	8.5	8.6	8.5	0.4	14.9	30.0	15.07
HE160, M0 to M9 3ss	4	5	8.3	8.5	8.6	8.5	0.4	14.9	30.0	15.07
HE160, M0 to M9 4ss	4	5	8.3	8.5	8.6	8.5	0.4	14.9	30.0	15.07
HE160 Beam Forming, M0 to M9 1ss	2	8	8.3	8.5			0.4	11.8	28.0	16.15
HE160 Beam Forming, M0 to M9 2ss	2	5	8.3	8.5			0.4	11.8	30.0	18.15
HE160 Beam Forming, M0 to M9 1ss	3	10	7.2	7.2	7.6		0.4	12.5	26.0	13.46
HE160 Beam Forming, M0 to M9 2ss	3	7	8.3	8.5	8.6		0.4	13.7	29.0	15.33
HE160 Beam Forming, M0 to M9 3ss	3	5	8.3	8.5	8.6		0.4	13.7	30.0	16.33
HE160 Beam Forming, M0 to M9 1ss	4	11	6.4	6.4	6.6	6.1	0.4	12.8	25.0	12.17
HE160 Beam Forming, M0 to M9 2ss	4	8	7.2	7.2	7.6	6.9	0.4	13.7	28.0	14.31
HE160 Beam Forming, M0 to M9 3ss	4	6	8.3	8.5	8.6	8.5	0.4	14.9	30.0	15.07
HE160 Beam Forming, M0 to M9 4ss	4	5	8.3	8.5	8.6	8.5	0.4	14.9	30.0	15.07
HE160 STBC, M0 to M9 1ss	2	5	8.3	8.5			0.4	11.8	30.0	18.15
HE160 STBC, M0 to M9 1ss	3	5	8.3	8.5	8.6		0.4	13.7	30.0	16.33
HE160 STBC, M0 to M9 1ss	4	5	8.3	8.5	8.6	8.5	0.4	14.9	30.0	15.07

**Maximum Transmit Output Power, 5dBi
5230 MHz, HE40 Beam Forming, M0 to M9 1ss**



Antenna A

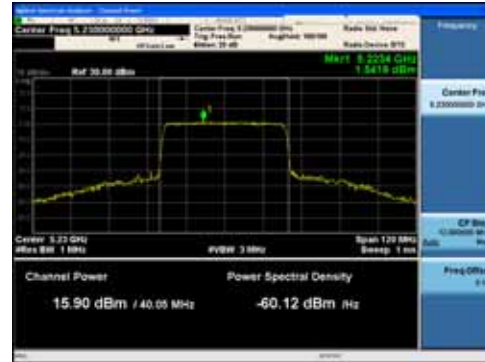

Antenna B



Antenna C



Antenna D

Maximum Output Power, 6dBi

Frequency (MHz)	Mode	Tx Paths	Correlated Antenna Gain (dBi)	Tx 1 Max Power (dBm)	Tx 2 Max Power (dBm)	Tx 3 Max Power (dBm)	Tx 4 Max Power (dBm)	Duty Cycle Correction (dB)	Total Tx Channel Power (dBm)	Limit (dBm)	Margin (dB)
5180	Non HT20, 6 to 54 Mbps	1	6	9.6				0.1	9.7	30.0	20.35
	Non HT20, 6 to 54 Mbps	2	6	9.6	15.8			0.1	16.8	30.0	13.21
	Non HT20, 6 to 54 Mbps	3	6	9.6	14.7	15.6		0.1	18.8	30.0	11.20
	Non HT20, 6 to 54 Mbps	4	6	9.6	13.5	14.4	13.5	0.1	19.2	30.0	10.84
	Non HT20 Beam Forming, 6 to 54 Mbps	2	9	9.6	14.7			0.1	15.9	27.0	11.08
	Non HT20 Beam Forming, 6 to 54 Mbps	3	11	9.6	11.3	12.3		0.1	16.0	25.0	8.97
	Non HT20 Beam Forming, 6 to 54 Mbps	4	12	8.8	9.4	10.4	9.6	0.1	15.7	24.0	8.34
	HT/VHT20, M0 to M7	1	6	10.2				0.1	10.3	30.0	19.75
	HT/VHT20, M0 to M7	2	6	10.2	15.1			0.1	16.4	30.0	13.63
	HT/VHT20, M8 to M15	2	6	10.2	15.1			0.1	16.4	30.0	13.63
	HT/VHT20, M0 to M7	3	6	10.2	13.9	14.7		0.1	18.2	30.0	11.85
	HT/VHT20, M8 to M15	3	6	10.2	13.9	14.7		0.1	18.2	30.0	11.85
	HT/VHT20, M16 to M23	3	6	10.2	13.9	14.7		0.1	18.2	30.0	11.85
	HT/VHT20, M0 to M7	4	6	10.2	13.9	14.7	13.9	0.1	19.6	30.0	10.45
	HT/VHT20, M8 to M15	4	6	10.2	13.9	14.7	13.9	0.1	19.6	30.0	10.45
	HT/VHT20, M16 to M23	4	6	10.2	13.9	14.7	13.9	0.1	19.6	30.0	10.45
	HT/VHT20, M24 to M31	4	6	10.2	13.9	14.7	13.9	0.1	19.6	30.0	10.45
	HT/VHT20 Beam Forming, M0 to M7	2	9	10.2	13.9			0.1	15.5	27.0	11.50
	HT/VHT20 Beam Forming, M8 to M15	2	6	10.2	15.1			0.1	16.4	30.0	13.63
	HT/VHT20 Beam Forming, M0 to M7	3	11	9.2	9.7	10.6		0.1	14.7	25.0	10.30
	HT/VHT20 Beam Forming, M8 to M15	3	8	10.2	12.9	13.7		0.1	17.3	28.0	10.67
	HT/VHT20 Beam Forming, M16 to M23	3	6	10.2	13.9	14.7		0.1	18.2	30.0	11.85
	HT/VHT20 Beam Forming, M0 to M7	4	12	9.2	9.7	10.6	9.9	0.1	16.0	24.0	8.05
	HT/VHT20 Beam Forming, M8 to M15	4	9	10.2	11.7	12.6	12.2	0.1	17.8	27.0	9.16
	HT/VHT20 Beam Forming, M16 to M23	4	7	10.2	13.9	14.7	13.9	0.1	19.6	29.0	9.45
	HT/VHT20 Beam Forming, M24 to M31	4	6	10.2	13.9	14.7	13.9	0.1	19.6	30.0	10.45
	HT/VHT20 STBC, M0 to M7	2	6	10.2	15.1			0.1	16.4	30.0	13.63
	HT/VHT20 STBC, M0 to M7	3	6	10.2	13.9	14.7		0.1	18.2	30.0	11.85
	HT/VHT20 STBC, M0 to M7	4	6	10.2	13.9	14.7	13.9	0.1	19.6	30.0	10.45
	HE20, M0 to M9 1ss	1	6	9.3				0.1	9.4	30.0	20.63
	HE20, M0 to M9 1ss	2	6	9.3	14.0			0.1	15.3	30.0	14.66

	HE20, M0 to M9 2ss	2	6	9.3	14.0			0.1	15.3	30.0	14.66
	HE20, M0 to M9 1ss	3	6	9.3	13.1	14.0		0.1	17.4	30.0	12.60
	HE20, M0 to M9 2ss	3	6	9.3	13.1	14.0		0.1	17.4	30.0	12.60
	HE20, M0 to M9 3ss	3	6	9.3	13.1	14.0		0.1	17.4	30.0	12.60
	HE20, M0 to M9 1ss	4	6	9.3	12.2	13.0	12.5	0.1	18.1	30.0	11.95
	HE20, M0 to M9 2ss	4	6	9.3	12.2	13.0	12.5	0.1	18.1	30.0	11.95
	HE20, M0 to M9 3ss	4	6	9.3	12.2	13.0	12.5	0.1	18.1	30.0	11.95
	HE20, M0 to M9 4ss	4	6	9.3	12.2	13.0	12.5	0.1	18.1	30.0	11.95
	HE20 Beam Forming, M0 to M9 1ss	2	9	8.3	8.8			0.1	11.6	27.0	15.36
	HE20 Beam Forming, M0 to M9 2ss	2	6	9.3	14.0			0.1	15.3	30.0	14.66
	HE20 Beam Forming, M0 to M9 1ss	3	11	7.2	7.7	8.5		0.1	12.7	25.0	12.33
	HE20 Beam Forming, M0 to M9 2ss	3	8	9.3	10.9	11.7		0.1	15.6	28.0	12.42
	HE20 Beam Forming, M0 to M9 3ss	3	6	9.3	13.1	14.0		0.1	17.4	30.0	12.60
	HE20 Beam Forming, M0 to M9 1ss	4	12	7.2	7.7	8.5	7.8	0.1	13.9	24.0	10.09
	HE20 Beam Forming, M0 to M9 2ss	4	9	8.3	8.8	9.7	8.8	0.1	15.0	27.0	11.98
	HE20 Beam Forming, M0 to M9 3ss	4	7	9.3	10.9	11.7	10.9	0.1	16.9	29.0	12.13
	HE20 Beam Forming, M0 to M9 4ss	4	6	9.3	12.2	13.0	12.5	0.1	18.1	30.0	11.95
	HE20 STBC, M0 to M9 2ss	2	6	9.3	14.0			0.1	15.3	30.0	14.66
	HE20 STBC, M0 to M9 2ss	3	6	9.3	13.1	14.0		0.1	17.4	30.0	12.60
	HE20 STBC, M0 to M9 2ss	4	6	9.3	12.2	13.0	12.5	0.1	18.1	30.0	11.95
5190	Non HT40, 6 to 54 Mbps	1	6	8.3				0.0	8.3	30.0	21.65
	Non HT40, 6 to 54 Mbps	2	6	8.3	8.9			0.0	11.7	30.0	18.33
	Non HT40, 6 to 54 Mbps	3	6	8.3	8.9	9.4		0.0	13.7	30.0	16.29
	Non HT40, 6 to 54 Mbps	4	6	8.3	8.9	9.4	8.8	0.0	14.9	30.0	15.06
	HT/VHT40, M0 to M7	1	6	8.5				0.1	8.6	30.0	21.40
	HT/VHT40, M0 to M7	2	6	8.5	9.0			0.1	11.9	30.0	18.13
	HT/VHT40, M8 to M15	2	6	8.5	9.0			0.1	11.9	30.0	18.13
	HT/VHT40, M0 to M7	3	6	8.5	9.0	9.7		0.1	14.0	30.0	16.03
	HT/VHT40, M8 to M15	3	6	8.5	9.0	9.7		0.1	14.0	30.0	16.03
	HT/VHT40, M16 to M23	3	6	8.5	9.0	9.7		0.1	14.0	30.0	16.03
	HT/VHT40, M0 to M7	4	6	8.5	9.0	9.7	9.0	0.1	15.2	30.0	14.81
	HT/VHT40, M8 to M15	4	6	8.5	9.0	9.7	9.0	0.1	15.2	30.0	14.81
	HT/VHT40, M16 to M23	4	6	8.5	9.0	9.7	9.0	0.1	15.2	30.0	14.81
	HT/VHT40, M24 to M31	4	6	8.5	9.0	9.7	9.0	0.1	15.2	30.0	14.81
	HT/VHT40 Beam Forming, M0 to M7	2	9	7.4	8.0			0.1	10.8	27.0	16.18
	HT/VHT40 Beam Forming, M8 to M15	2	6	8.5	9.0			0.1	11.9	30.0	18.13
	HT/VHT40 Beam Forming, M0 to M7	3	11	7.4	8.0	8.9		0.1	13.0	25.0	11.98
	HT/VHT40 Beam Forming, M8 to M15	3	8	8.5	9.0	9.7		0.1	14.0	28.0	14.03
	HT/VHT40 Beam Forming, M16 to M23	3	6	8.5	9.0	9.7		0.1	14.0	30.0	16.03
	HT/VHT40 Beam Forming, M0 to M7	4	12	6.3	7.1	7.8	7.1	0.1	13.2	24.0	10.77
HT/VHT40 Beam Forming, M8 to M15	4	9	7.4	8.0	8.9	7.9	0.1	14.2	27.0	12.79	
HT/VHT40 Beam Forming, M16 to M23	4	7	8.5	9.0	9.7	9.0	0.1	15.2	29.0	13.81	

	HT/VHT40 Beam Forming, M24 to M31	4	6	8.5	9.0	9.7	9.0	0.1	15.2	30.0	14.81	
	HT/VHT40 STBC, M0 to M7	2	6	8.5	9.0			0.1	11.9	30.0	18.13	
	HT/VHT40 STBC, M0 to M7	3	6	8.5	9.0	9.7		0.1	14.0	30.0	16.03	
	HT/VHT40 STBC, M0 to M7	4	6	8.5	9.0	9.7	9.0	0.1	15.2	30.0	14.81	
	HE40, M0 to M9 1ss	1	6	7.6				0.1	7.7	30.0	22.27	
	HE40, M0 to M9 1ss	2	6	7.6	8.2			0.1	11.0	30.0	18.95	
	HE40, M0 to M9 2ss	2	6	7.6	8.2			0.1	11.0	30.0	18.95	
	HE40, M0 to M9 1ss	3	6	7.6	8.2	8.9		0.1	13.2	30.0	16.84	
	HE40, M0 to M9 2ss	3	6	7.6	8.2	8.9		0.1	13.2	30.0	16.84	
	HE40, M0 to M9 3ss	3	6	7.6	8.2	8.9		0.1	13.2	30.0	16.84	
	HE40, M0 to M9 1ss	4	6	7.6	8.2	8.9	8.1	0.1	14.4	30.0	15.63	
	HE40, M0 to M9 2ss	4	6	7.6	8.2	8.9	8.1	0.1	14.4	30.0	15.63	
	HE40, M0 to M9 3ss	4	6	7.6	8.2	8.9	8.1	0.1	14.4	30.0	15.63	
	HE40, M0 to M9 4ss	4	6	7.6	8.2	8.9	8.1	0.1	14.4	30.0	15.63	
	HE40 Beam Forming, M0 to M9 1ss	2	9	6.6	7.2			0.1	10.0	27.0	16.95	
	HE40 Beam Forming, M0 to M9 2ss	2	6	7.6	8.2			0.1	11.0	30.0	18.95	
	HE40 Beam Forming, M0 to M9 1ss	3	11	5.5	6.2	6.7		0.1	11.1	25.0	13.94	
	HE40 Beam Forming, M0 to M9 2ss	3	8	6.6	7.2	7.8		0.1	12.1	28.0	15.88	
	HE40 Beam Forming, M0 to M9 3ss	3	6	7.6	8.2	8.9		0.1	13.2	30.0	16.84	
	HE40 Beam Forming, M0 to M9 1ss	4	12	5.5	6.2	6.7	5.9	0.1	12.2	24.0	11.76	
	HE40 Beam Forming, M0 to M9 2ss	4	9	6.6	7.2	7.8	7.1	0.1	13.3	27.0	13.66	
	HE40 Beam Forming, M0 to M9 3ss	4	7	6.6	7.2	7.8	7.1	0.1	13.3	29.0	15.66	
	HE40 Beam Forming, M0 to M9 4ss	4	6	7.6	8.2	8.9	8.1	0.1	14.4	30.0	15.63	
	HE40 STBC, M0 to M9 2ss	2	6	7.6	8.2			0.1	11.0	30.0	18.95	
	HE40 STBC, M0 to M9 2ss	3	6	7.6	8.2	8.9		0.1	13.2	30.0	16.84	
	HE40 STBC, M0 to M9 2ss	4	6	7.6	8.2	8.9	8.1	0.1	14.4	30.0	15.63	
5210	Non HT80, 6 to 54 Mbps	1	6	8.0				0.1	8.1	30.0	21.95	
	Non HT80, 6 to 54 Mbps	2	6	8.0	8.6			0.1	11.4	30.0	18.63	
	Non HT80, 6 to 54 Mbps	3	6	8.0	8.6	8.9		0.1	13.3	30.0	16.66	
	Non HT80, 6 to 54 Mbps	4	6	8.0	8.6	8.9	8.6	0.1	14.6	30.0	15.39	
	VHT80, M0 to M9 1ss	1	6	9.2				0.2	9.4	30.0	20.58	
	VHT80, M0 to M9 1ss	2	6	7.9	8.3			0.2	11.3	30.0	18.66	
	VHT80, M0 to M9 2ss	2	6	7.9	8.3			0.2	11.3	30.0	18.66	
	VHT80, M0 to M9 1ss	3	6	7.9	8.3	8.6		0.2	13.3	30.0	16.73	
	VHT80, M0 to M9 2ss	3	6	7.9	8.3	8.6		0.2	13.3	30.0	16.73	
	VHT80, M0 to M9 3ss	3	6	7.9	8.3	8.6		0.2	13.3	30.0	16.73	
	VHT80, M0 to M9 1ss	4	6	7.9	8.3	8.6	8.3	0.2	14.5	30.0	15.47	
	VHT80, M0 to M9 2ss	4	6	7.9	8.3	8.6	8.3	0.2	14.5	30.0	15.47	
	VHT80, M0 to M9 3ss	4	6	7.9	8.3	8.6	8.3	0.2	14.5	30.0	15.47	
	VHT80, M0 to M9 4ss	4	6	7.9	8.3	8.6	8.3	0.2	14.5	30.0	15.47	
	VHT80 Beam Forming, M0 to M9 1ss	2	9	7.9	8.3				0.2	11.3	27.0	15.66
	VHT80 Beam Forming, M0 to M9 2ss	2	6	7.9	8.3				0.2	11.3	30.0	18.66

	VHT80 Beam Forming, M0 to M9 1ss	3	11	7.0	7.7	7.9		0.2	12.5	25.0	12.45	
	VHT80 Beam Forming, M0 to M9 2ss	3	8	7.9	8.3	8.6		0.2	13.3	28.0	14.73	
	VHT80 Beam Forming, M0 to M9 3ss	3	6	7.9	8.3	8.6		0.2	13.3	30.0	16.73	
	VHT80 Beam Forming, M0 to M9 1ss	4	12	7.0	7.7	7.9	7.5	0.2	13.8	24.0	10.22	
	VHT80 Beam Forming, M0 to M9 2ss	4	9	7.9	8.3	8.6	8.3	0.2	14.5	27.0	12.47	
	VHT80 Beam Forming, M0 to M9 3ss	4	7	7.9	8.3	8.6	8.3	0.2	14.5	29.0	14.47	
	VHT80 Beam Forming, M0 to M9 4ss	4	6	7.9	8.3	8.6	8.3	0.2	14.5	30.0	15.47	
	VHT80 STBC, M0 to M9 1ss	2	6	7.9	8.3			0.2	11.3	30.0	18.66	
	VHT80 STBC, M0 to M9 1ss	3	6	7.9	8.3	8.6		0.2	13.3	30.0	16.73	
	VHT80 STBC, M0 to M9 1ss	4	6	7.9	8.3	8.6	8.3	0.2	14.5	30.0	15.47	
	HE80, M0 to M9 1ss	1	6	8.1				0.3	8.4	30.0	21.65	
	HE80, M0 to M9 1ss	2	6	8.1	8.6			0.3	11.6	30.0	18.38	
	HE80, M0 to M9 2ss	2	6	8.1	8.6			0.3	11.6	30.0	18.38	
	HE80, M0 to M9 1ss	3	6	6.9	7.4	7.8		0.3	12.4	30.0	17.60	
	HE80, M0 to M9 2ss	3	6	6.9	7.4	7.8		0.3	12.4	30.0	17.60	
	HE80, M0 to M9 3ss	3	6	6.9	7.4	7.8		0.3	12.4	30.0	17.60	
	HE80, M0 to M9 1ss	4	6	6.9	7.4	7.8	7.2	0.3	13.6	30.0	16.39	
	HE80, M0 to M9 2ss	4	6	6.9	7.4	7.8	7.2	0.3	13.6	30.0	16.39	
	HE80, M0 to M9 3ss	4	6	6.9	7.4	7.8	7.2	0.3	13.6	30.0	16.39	
	HE80, M0 to M9 4ss	4	6	6.9	7.4	7.8	7.2	0.3	13.6	30.0	16.39	
	HE80 Beam Forming, M0 to M9 1ss	2	9	6.9	7.4			0.3	10.4	27.0	16.58	
	HE80 Beam Forming, M0 to M9 2ss	2	6	8.1	8.6			0.3	11.6	30.0	18.38	
	HE80 Beam Forming, M0 to M9 1ss	3	11	6.3	6.7	6.7		0.3	11.6	25.0	13.41	
	HE80 Beam Forming, M0 to M9 2ss	3	8	6.9	7.4	7.8		0.3	12.4	28.0	15.60	
	HE80 Beam Forming, M0 to M9 3ss	3	6	6.9	7.4	7.8		0.3	12.4	30.0	17.60	
	HE80 Beam Forming, M0 to M9 1ss	4	12	6.3	6.7	6.7	6.3	0.3	12.8	24.0	11.22	
	HE80 Beam Forming, M0 to M9 2ss	4	9	6.9	7.4	7.8	7.2	0.3	13.6	27.0	13.39	
	HE80 Beam Forming, M0 to M9 3ss	4	7	6.9	7.4	7.8	7.2	0.3	13.6	29.0	15.39	
	HE80 Beam Forming, M0 to M9 4ss	4	6	6.9	7.4	7.8	7.2	0.3	13.6	30.0	16.39	
	HE80 STBC, M0 to M9 1ss	2	6	8.1	8.6			0.3	11.6	30.0	18.38	
	HE80 STBC, M0 to M9 1ss	3	6	6.9	7.4	7.8		0.3	12.4	30.0	17.60	
	HE80 STBC, M0 to M9 1ss	4	6	6.9	7.4	7.8	7.2	0.3	13.6	30.0	16.39	
	5220	Non HT20, 6 to 54 Mbps	1	6	9.6				0.1	9.7	30.0	20.35
		Non HT20, 6 to 54 Mbps	2	6	9.6	15.5			0.1	16.5	30.0	13.45
Non HT20, 6 to 54 Mbps		3	6	9.6	15.5	16.0		0.1	19.3	30.0	10.68	
Non HT20, 6 to 54 Mbps		4	6	9.6	15.5	16.0	15.9	0.1	21.0	30.0	9.04	
Non HT20 Beam Forming, 6 to 54 Mbps		2	9	9.6	15.5			0.1	16.5	27.0	10.45	
Non HT20 Beam Forming, 6 to 54 Mbps		3	11	9.6	15.5	16.0		0.1	19.3	25.0	5.68	
Non HT20 Beam Forming, 6 to 54 Mbps		4	12	9.6	15.5	16.0	15.9	0.1	21.0	24.0	3.04	
HT/VHT20, M0 to M7		1	6	9.8				0.1	9.9	30.0	20.15	
HT/VHT20, M0 to M7		2	6	9.8	15.5			0.1	16.6	30.0	13.41	
HT/VHT20, M8 to M15	2	6	9.8	15.5			0.1	16.6	30.0	13.41		

HT/VHT20, M0 to M7	3	6	9.8	15.5	16.0		0.1	19.3	30.0	10.66
HT/VHT20, M8 to M15	3	6	9.8	15.5	16.0		0.1	19.3	30.0	10.66
HT/VHT20, M16 to M23	3	6	9.8	15.5	16.0		0.1	19.3	30.0	10.66
HT/VHT20, M0 to M7	4	6	9.8	15.5	16.0	15.9	0.1	21.0	30.0	9.02
HT/VHT20, M8 to M15	4	6	9.8	15.5	16.0	15.9	0.1	21.0	30.0	9.02
HT/VHT20, M16 to M23	4	6	9.8	15.5	16.0	15.9	0.1	21.0	30.0	9.02
HT/VHT20, M24 to M31	4	6	9.8	15.5	16.0	15.9	0.1	21.0	30.0	9.02
HT/VHT20 Beam Forming, M0 to M7	2	9	9.8	15.5			0.1	16.6	27.0	10.41
HT/VHT20 Beam Forming, M8 to M15	2	6	9.8	15.5			0.1	16.6	30.0	13.41
HT/VHT20 Beam Forming, M0 to M7	3	11	9.8	15.5	16.0		0.1	19.3	25.0	5.66
HT/VHT20 Beam Forming, M8 to M15	3	8	9.8	15.5	16.0		0.1	19.3	28.0	8.66
HT/VHT20 Beam Forming, M16 to M23	3	6	9.8	15.5	16.0		0.1	19.3	30.0	10.66
HT/VHT20 Beam Forming, M0 to M7	4	12	9.8	15.5	16.0	15.9	0.1	21.0	24.0	3.02
HT/VHT20 Beam Forming, M8 to M15	4	9	9.8	15.5	16.0	15.9	0.1	21.0	27.0	6.02
HT/VHT20 Beam Forming, M16 to M23	4	7	9.8	15.5	16.0	15.9	0.1	21.0	29.0	8.02
HT/VHT20 Beam Forming, M24 to M31	4	6	9.8	15.5	16.0	15.9	0.1	21.0	30.0	9.02
HT/VHT20 STBC, M0 to M7	2	6	9.8	15.5			0.1	16.6	30.0	13.41
HT/VHT20 STBC, M0 to M7	3	6	9.8	15.5	16.0		0.1	19.3	30.0	10.66
HT/VHT20 STBC, M0 to M7	4	6	9.8	15.5	16.0	15.9	0.1	21.0	30.0	9.02
HE20, M0 to M9 1ss	1	6	9.9				0.1	10.0	30.0	20.03
HE20, M0 to M9 1ss	2	6	9.9	15.8			0.1	16.9	30.0	13.14
HE20, M0 to M9 2ss	2	6	9.9	15.8			0.1	16.9	30.0	13.14
HE20, M0 to M9 1ss	3	6	9.9	15.8	16.3		0.1	19.6	30.0	10.37
HE20, M0 to M9 2ss	3	6	9.9	15.8	16.3		0.1	19.6	30.0	10.37
HE20, M0 to M9 3ss	3	6	9.9	15.8	16.3		0.1	19.6	30.0	10.37
HE20, M0 to M9 1ss	4	6	9.9	15.8	16.3	16.0	0.1	21.2	30.0	8.78
HE20, M0 to M9 2ss	4	6	9.9	15.8	16.3	16.0	0.1	21.2	30.0	8.78
HE20, M0 to M9 3ss	4	6	9.9	15.8	16.3	16.0	0.1	21.2	30.0	8.78
HE20, M0 to M9 4ss	4	6	9.9	15.8	16.3	16.0	0.1	21.2	30.0	8.78
HE20 Beam Forming, M0 to M9 1ss	2	9	9.9	15.8			0.1	16.9	27.0	10.14
HE20 Beam Forming, M0 to M9 2ss	2	6	9.9	15.8			0.1	16.9	30.0	13.14
HE20 Beam Forming, M0 to M9 1ss	3	11	9.9	15.8	16.3		0.1	19.6	25.0	5.37
HE20 Beam Forming, M0 to M9 2ss	3	8	9.9	15.8	16.3		0.1	19.6	28.0	8.37
HE20 Beam Forming, M0 to M9 3ss	3	6	9.9	15.8	16.3		0.1	19.6	30.0	10.37
HE20 Beam Forming, M0 to M9 1ss	4	12	9.9	15.8	16.3	16.0	0.1	21.2	24.0	2.78
HE20 Beam Forming, M0 to M9 2ss	4	9	9.9	15.8	16.3	16.0	0.1	21.2	27.0	5.78
HE20 Beam Forming, M0 to M9 3ss	4	7	9.9	15.8	16.3	16.0	0.1	21.2	29.0	7.78
HE20 Beam Forming, M0 to M9 4ss	4	6	9.9	15.8	16.3	16.0	0.1	21.2	30.0	8.78
HE20 STBC, M0 to M9 2ss	2	6	9.9	15.8			0.1	16.9	30.0	13.14
HE20 STBC, M0 to M9 2ss	3	6	9.9	15.8	16.3		0.1	19.6	30.0	10.37
HE20 STBC, M0 to M9 2ss	4	6	9.9	15.8	16.3	16.0	0.1	21.2	30.0	8.78

5230	Non HT40, 6 to 54 Mbps	1	6	10.0				0.0	10.0	30.0	19.95
	Non HT40, 6 to 54 Mbps	2	6	10.0	15.6			0.0	16.7	30.0	13.29
	Non HT40, 6 to 54 Mbps	3	6	10.0	15.6	16.0		0.0	19.4	30.0	10.60
	Non HT40, 6 to 54 Mbps	4	6	10.0	15.6	16.0	15.7	0.0	21.0	30.0	9.04
	HT/VHT40, M0 to M7	1	6	10.0				0.1	10.1	30.0	19.90
	HT/VHT40, M0 to M7	2	6	10.0	15.6			0.1	16.8	30.0	13.24
	HT/VHT40, M8 to M15	2	6	10.0	15.6			0.1	16.8	30.0	13.24
	HT/VHT40, M0 to M7	3	6	10.0	15.6	16.0		0.1	19.5	30.0	10.55
	HT/VHT40, M8 to M15	3	6	10.0	15.6	16.0		0.1	19.5	30.0	10.55
	HT/VHT40, M16 to M23	3	6	10.0	15.6	16.0		0.1	19.5	30.0	10.55
	HT/VHT40, M0 to M7	4	6	10.0	15.6	16.0	15.5	0.1	21.0	30.0	9.05
	HT/VHT40, M8 to M15	4	6	10.0	15.6	16.0	15.5	0.1	21.0	30.0	9.05
	HT/VHT40, M16 to M23	4	6	10.0	15.6	16.0	15.5	0.1	21.0	30.0	9.05
	HT/VHT40, M24 to M31	4	6	10.0	15.6	16.0	15.5	0.1	21.0	30.0	9.05
	HT/VHT40 Beam Forming, M0 to M7	2	9	10.0	15.6			0.1	16.8	27.0	10.24
	HT/VHT40 Beam Forming, M8 to M15	2	6	10.0	15.6			0.1	16.8	30.0	13.24
	HT/VHT40 Beam Forming, M0 to M7	3	11	10.0	15.6	16.0		0.1	19.5	25.0	5.55
	HT/VHT40 Beam Forming, M8 to M15	3	8	10.0	15.6	16.0		0.1	19.5	28.0	8.55
	HT/VHT40 Beam Forming, M16 to M23	3	6	10.0	15.6	16.0		0.1	19.5	30.0	10.55
	HT/VHT40 Beam Forming, M0 to M7	4	12	10.0	15.6	16.0	15.5	0.1	21.0	24.0	3.05
	HT/VHT40 Beam Forming, M8 to M15	4	9	10.0	15.6	16.0	15.5	0.1	21.0	27.0	6.05
	HT/VHT40 Beam Forming, M16 to M23	4	7	10.0	15.6	16.0	15.5	0.1	21.0	29.0	8.05
	HT/VHT40 Beam Forming, M24 to M31	4	6	10.0	15.6	16.0	15.5	0.1	21.0	30.0	9.05
	HT/VHT40 STBC, M0 to M7	2	6	10.0	15.6			0.1	16.8	30.0	13.24
	HT/VHT40 STBC, M0 to M7	3	6	10.0	15.6	16.0		0.1	19.5	30.0	10.55
	HT/VHT40 STBC, M0 to M7	4	6	10.0	15.6	16.0	15.5	0.1	21.0	30.0	9.05
	HE40, M0 to M9 1ss	1	6	10.0				0.1	10.1	30.0	19.87
	HE40, M0 to M9 1ss	2	6	10.0	15.9			0.1	17.0	30.0	12.98
	HE40, M0 to M9 2ss	2	6	10.0	15.9			0.1	17.0	30.0	12.98
	HE40, M0 to M9 1ss	3	6	10.0	15.9	16.3		0.1	19.7	30.0	10.26
	HE40, M0 to M9 2ss	3	6	10.0	15.9	16.3		0.1	19.7	30.0	10.26
	HE40, M0 to M9 3ss	3	6	10.0	15.9	16.3		0.1	19.7	30.0	10.26
	HE40, M0 to M9 1ss	4	6	10.0	15.9	16.3	15.8	0.1	21.3	30.0	8.75
	HE40, M0 to M9 2ss	4	6	10.0	15.9	16.3	15.8	0.1	21.3	30.0	8.75
	HE40, M0 to M9 3ss	4	6	10.0	15.9	16.3	15.8	0.1	21.3	30.0	8.75
	HE40, M0 to M9 4ss	4	6	10.0	15.9	16.3	15.8	0.1	21.3	30.0	8.75
	HE40 Beam Forming, M0 to M9 1ss	2	9	10.0	15.9			0.1	17.0	27.0	9.98
	HE40 Beam Forming, M0 to M9 2ss	2	6	10.0	15.9			0.1	17.0	30.0	12.98
	HE40 Beam Forming, M0 to M9 1ss	3	11	10.0	15.9	16.3		0.1	19.7	25.0	5.26
	HE40 Beam Forming, M0 to M9 2ss	3	8	10.0	15.9	16.3		0.1	19.7	28.0	8.26
	HE40 Beam Forming, M0 to M9 3ss	3	6	10.0	15.9	16.3		0.1	19.7	30.0	10.26
	HE40 Beam Forming, M0 to M9 1ss	4	12	10.0	15.9	16.3	15.8	0.1	21.3	24.0	2.75

	HE40 Beam Forming, M0 to M9 2ss	4	9	10.0	15.9	16.3	15.8	0.1	21.3	27.0	5.75	
	HE40 Beam Forming, M0 to M9 3ss	4	7	10.0	15.9	16.3	15.8	0.1	21.3	29.0	7.75	
	HE40 Beam Forming, M0 to M9 4ss	4	6	10.0	15.9	16.3	15.8	0.1	21.3	30.0	8.75	
	HE40 STBC, M0 to M9 2ss	2	6	10.0	15.9			0.1	17.0	30.0	12.98	
	HE40 STBC, M0 to M9 2ss	3	6	10.0	15.9	16.3		0.1	19.7	30.0	10.26	
	HE40 STBC, M0 to M9 2ss	4	6	10.0	15.9	16.3	15.8	0.1	21.3	30.0	8.75	
5240	Non HT20, 6 to 54 Mbps	1	6	10.1				0.1	10.2	30.0	19.85	
	Non HT20, 6 to 54 Mbps	2	6	10.1	15.7			0.1	16.8	30.0	13.19	
	Non HT20, 6 to 54 Mbps	3	6	10.1	15.7	16.1		0.1	19.5	30.0	10.49	
	Non HT20, 6 to 54 Mbps	4	6	10.1	15.7	16.1	15.5	0.1	21.0	30.0	9.03	
	Non HT20 Beam Forming, 6 to 54 Mbps	2	9	10.1	15.7			0.1	16.8	27.0	10.19	
	Non HT20 Beam Forming, 6 to 54 Mbps	3	11	10.1	15.7	16.1		0.1	19.5	25.0	5.49	
	Non HT20 Beam Forming, 6 to 54 Mbps	4	12	10.1	15.7	16.1	15.5	0.1	21.0	24.0	3.03	
	HT/VHT20, M0 to M7	1	6	10.0					0.1	10.1	30.0	19.95
	HT/VHT20, M0 to M7	2	6	10.0	15.6				0.1	16.7	30.0	13.29
	HT/VHT20, M8 to M15	2	6	10.0	15.6				0.1	16.7	30.0	13.29
	HT/VHT20, M0 to M7	3	6	10.0	15.6	16.0			0.1	19.4	30.0	10.60
	HT/VHT20, M8 to M15	3	6	10.0	15.6	16.0			0.1	19.4	30.0	10.60
	HT/VHT20, M16 to M23	3	6	10.0	15.6	16.0			0.1	19.4	30.0	10.60
	HT/VHT20, M0 to M7	4	6	10.0	15.6	16.0	15.3		0.1	20.8	30.0	9.16
	HT/VHT20, M8 to M15	4	6	10.0	15.6	16.0	15.3		0.1	20.8	30.0	9.16
	HT/VHT20, M16 to M23	4	6	10.0	15.6	16.0	15.3		0.1	20.8	30.0	9.16
	HT/VHT20, M24 to M31	4	6	10.0	15.6	16.0	15.3		0.1	20.8	30.0	9.16
	HT/VHT20 Beam Forming, M0 to M7	2	9	10.0	15.6				0.1	16.7	27.0	10.29
	HT/VHT20 Beam Forming, M8 to M15	2	6	10.0	15.6				0.1	16.7	30.0	13.29
	HT/VHT20 Beam Forming, M0 to M7	3	11	10.0	15.6	16.0			0.1	19.4	25.0	5.60
	HT/VHT20 Beam Forming, M8 to M15	3	8	10.0	15.6	16.0			0.1	19.4	28.0	8.60
	HT/VHT20 Beam Forming, M16 to M23	3	6	10.0	15.6	16.0			0.1	19.4	30.0	10.60
	HT/VHT20 Beam Forming, M0 to M7	4	12	10.0	15.6	16.0	15.3		0.1	20.8	24.0	3.16
	HT/VHT20 Beam Forming, M8 to M15	4	9	10.0	15.6	16.0	15.3		0.1	20.8	27.0	6.16
	HT/VHT20 Beam Forming, M16 to M23	4	7	10.0	15.6	16.0	15.3		0.1	20.8	29.0	8.16
	HT/VHT20 Beam Forming, M24 to M31	4	6	10.0	15.6	16.0	15.3		0.1	20.8	30.0	9.16
	HT/VHT20 STBC, M0 to M7	2	6	10.0	15.6				0.1	16.7	30.0	13.29
	HT/VHT20 STBC, M0 to M7	3	6	10.0	15.6	16.0			0.1	19.4	30.0	10.60
	HT/VHT20 STBC, M0 to M7	4	6	10.0	15.6	16.0	15.3		0.1	20.8	30.0	9.16
	HE20, M0 to M9 1ss	1	6	10.3					0.1	10.4	30.0	19.63
	HE20, M0 to M9 1ss	2	6	10.3	15.7				0.1	16.9	30.0	13.13
	HE20, M0 to M9 2ss	2	6	10.3	15.7				0.1	16.9	30.0	13.13
	HE20, M0 to M9 1ss	3	6	10.3	15.7	16.3			0.1	19.6	30.0	10.36
	HE20, M0 to M9 2ss	3	6	10.3	15.7	16.3			0.1	19.6	30.0	10.36
HE20, M0 to M9 3ss	3	6	10.3	15.7	16.3			0.1	19.6	30.0	10.36	
HE20, M0 to M9 1ss	4	6	10.3	15.7	16.3	15.7		0.1	21.1	30.0	8.87	

	HE20, M0 to M9 2ss	4	6	10.3	15.7	16.3	15.7	0.1	21.1	30.0	8.87
	HE20, M0 to M9 3ss	4	6	10.3	15.7	16.3	15.7	0.1	21.1	30.0	8.87
	HE20, M0 to M9 4ss	4	6	10.3	15.7	16.3	15.7	0.1	21.1	30.0	8.87
	HE20 Beam Forming, M0 to M9 1ss	2	9	10.3	15.7			0.1	16.9	27.0	10.13
	HE20 Beam Forming, M0 to M9 2ss	2	6	10.3	15.7			0.1	16.9	30.0	13.13
	HE20 Beam Forming, M0 to M9 1ss	3	11	10.3	15.7	16.3		0.1	19.6	25.0	5.36
	HE20 Beam Forming, M0 to M9 2ss	3	8	10.3	15.7	16.3		0.1	19.6	28.0	8.36
	HE20 Beam Forming, M0 to M9 3ss	3	6	10.3	15.7	16.3		0.1	19.6	30.0	10.36
	HE20 Beam Forming, M0 to M9 1ss	4	12	10.3	15.7	16.3	15.7	0.1	21.1	24.0	2.87
	HE20 Beam Forming, M0 to M9 2ss	4	9	10.3	15.7	16.3	15.7	0.1	21.1	27.0	5.87
	HE20 Beam Forming, M0 to M9 3ss	4	7	10.3	15.7	16.3	15.7	0.1	21.1	29.0	7.87
	HE20 Beam Forming, M0 to M9 4ss	4	6	10.3	15.7	16.3	15.7	0.1	21.1	30.0	8.87
	HE20 STBC, M0 to M9 2ss	2	6	10.3	15.7			0.1	16.9	30.0	13.13
	HE20 STBC, M0 to M9 2ss	3	6	10.3	15.7	16.3		0.1	19.6	30.0	10.36
	HE20 STBC, M0 to M9 2ss	4	6	10.3	15.7	16.3	15.7	0.1	21.1	30.0	8.87
5250	Non HT160, 6 to 54 Mbps	1	6	8.3				0.0	8.3	30.0	21.65
	Non HT160, 6 to 54 Mbps	2	6	8.3	8.5			0.0	11.5	30.0	18.54
	Non HT160, 6 to 54 Mbps	3	6	8.3	8.5	8.9		0.0	13.4	30.0	16.61
	Non HT160, 6 to 54 Mbps	4	6	7.5	7.6	7.9	7.4	0.0	13.7	30.0	16.33
	VHT160, M0 to M9 1ss	1	6	8.0				0.4	8.4	30.0	21.61
	VHT160, M0 to M9 1ss	2	6	8.0	8.4			0.4	11.6	30.0	18.39
	VHT160, M0 to M9 2ss	2	6	8.0	8.4			0.4	11.6	30.0	18.39
	VHT160, M0 to M9 1ss	3	6	8.0	8.4	8.6		0.4	13.5	30.0	16.50
	VHT160, M0 to M9 2ss	3	6	8.0	8.4	8.6		0.4	13.5	30.0	16.50
	VHT160, M0 to M9 3ss	3	6	8.0	8.4	8.6		0.4	13.5	30.0	16.50
	VHT160, M0 to M9 1ss	4	6	8.0	8.4	8.6	8.1	0.4	14.7	30.0	15.31
	VHT160, M0 to M9 2ss	4	6	8.0	8.4	8.6	8.1	0.4	14.7	30.0	15.31
	VHT160, M0 to M9 3ss	4	6	8.0	8.4	8.6	8.1	0.4	14.7	30.0	15.31
	VHT160, M0 to M9 4ss	4	6	8.0	8.4	8.6	8.1	0.4	14.7	30.0	15.31
	VHT160 Beam Forming, M0 to M9 1ss	2	9	7.1	7.2			0.4	10.6	27.0	16.45
	VHT160 Beam Forming, M0 to M9 2ss	2	6	8.0	8.4			0.4	11.6	30.0	18.39
	VHT160 Beam Forming, M0 to M9 1ss	3	11	6.0	6.2	6.8		0.4	11.5	25.0	13.49
	VHT160 Beam Forming, M0 to M9 2ss	3	8	8.0	8.4	8.6		0.4	13.5	28.0	14.50
	VHT160 Beam Forming, M0 to M9 3ss	3	6	8.0	8.4	8.6		0.4	13.5	30.0	16.50
	VHT160 Beam Forming, M0 to M9 1ss	4	12	6.0	6.2	6.8	6.0	0.4	12.7	24.0	11.32
	VHT160 Beam Forming, M0 to M9 2ss	4	9	7.1	7.2	7.5	7.3	0.4	13.7	27.0	13.31
	VHT160 Beam Forming, M0 to M9 3ss	4	7	8.0	8.4	8.6	8.1	0.4	14.7	29.0	14.31
	VHT160 Beam Forming, M0 to M9 4ss	4	6	8.0	8.4	8.6	8.1	0.4	14.7	30.0	15.31
	VHT160 STBC, M0 to M9 1ss	2	6	8.0	8.4			0.4	11.6	30.0	18.39
	VHT160 STBC, M0 to M9 1ss	3	6	8.0	8.4	8.6		0.4	13.5	30.0	16.50
	VHT160 STBC, M0 to M9 1ss	4	6	8.0	8.4	8.6	8.1	0.4	14.7	30.0	15.31
	HE160, M0 to M9 1ss	1	6	8.3				0.4	8.7	30.0	21.27



HE160, M0 to M9 1ss	2	6	8.3	8.5			0.4	11.8	30.0	18.15
HE160, M0 to M9 2ss	2	6	8.3	8.5			0.4	11.8	30.0	18.15
HE160, M0 to M9 1ss	3	6	8.3	8.5	8.6		0.4	13.7	30.0	16.33
HE160, M0 to M9 2ss	3	6	8.3	8.5	8.6		0.4	13.7	30.0	16.33
HE160, M0 to M9 3ss	3	6	8.3	8.5	8.6		0.4	13.7	30.0	16.33
HE160, M0 to M9 1ss	4	6	8.3	8.5	8.6	8.5	0.4	14.9	30.0	15.07
HE160, M0 to M9 2ss	4	6	8.3	8.5	8.6	8.5	0.4	14.9	30.0	15.07
HE160, M0 to M9 3ss	4	6	8.3	8.5	8.6	8.5	0.4	14.9	30.0	15.07
HE160, M0 to M9 4ss	4	6	8.3	8.5	8.6	8.5	0.4	14.9	30.0	15.07
HE160 Beam Forming, M0 to M9 1ss	2	9	7.2	7.2			0.4	10.6	27.0	16.36
HE160 Beam Forming, M0 to M9 2ss	2	6	8.3	8.5			0.4	11.8	30.0	18.15
HE160 Beam Forming, M0 to M9 1ss	3	11	7.2	7.2	7.6		0.4	12.5	25.0	12.46
HE160 Beam Forming, M0 to M9 2ss	3	8	7.2	7.2	7.6		0.4	12.5	28.0	15.46
HE160 Beam Forming, M0 to M9 3ss	3	6	8.3	8.5	8.6		0.4	13.7	30.0	16.33
HE160 Beam Forming, M0 to M9 1ss	4	12	6.4	6.4	6.6	6.1	0.4	12.8	24.0	11.17
HE160 Beam Forming, M0 to M9 2ss	4	9	7.2	7.2	7.6	6.9	0.4	13.7	27.0	13.31
HE160 Beam Forming, M0 to M9 3ss	4	7	7.2	7.2	7.6	6.9	0.4	13.7	29.0	15.31
HE160 Beam Forming, M0 to M9 4ss	4	6	8.3	8.5	8.6	8.5	0.4	14.9	30.0	15.07
HE160 STBC, M0 to M9 1ss	2	6	8.3	8.5			0.4	11.8	30.0	18.15
HE160 STBC, M0 to M9 1ss	3	6	8.3	8.5	8.6		0.4	13.7	30.0	16.33
HE160 STBC, M0 to M9 1ss	4	6	8.3	8.5	8.6	8.5	0.4	14.9	30.0	15.07

**Maximum Transmit Output Power, 6dBi
5230 MHz, HE40 Beam Forming, M0 to M9 1ss**

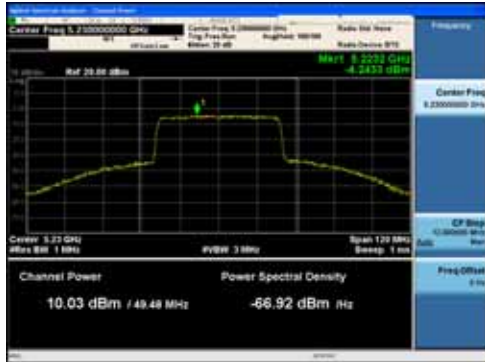

Antenna A

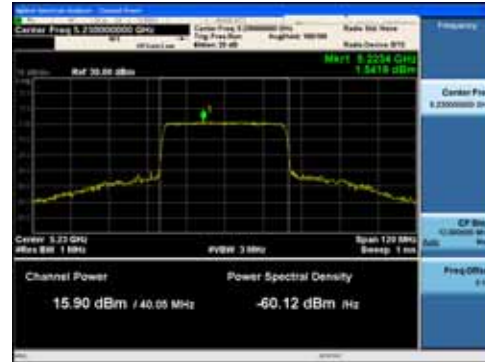

Antenna B



Antenna C



Antenna D

A.4 Power Spectral Density

Power Spectral Density Test Requirement

15.407 General technical requirements, (a) Power limits: (1) For the band 5.15-5.25 GHz.

(i) For an outdoor access point operating in the band 5.15-5.25 GHz ... the maximum power spectral density shall not exceed 17 dBm in any 1 megahertz band. If transmitting antennas of directional gain greater than 6 dBi are used, both the maximum conducted output power and the maximum power spectral density shall be reduced by the amount in dB that the directional gain of the antenna exceeds 6 dBi.

(ii) For an indoor access point operating in the band 5.15-5.25 GHz... the maximum power spectral density shall not exceed 17 dBm in any 1 megahertz band. If transmitting antennas of directional gain greater than 6 dBi are used, both the maximum conducted output power and the maximum power spectral density shall be reduced by the amount in dB that the directional gain of the antenna exceeds 6 dBi.

(iii) For fixed point-to-point access points operating in the band 5.15-5.25 GHz...the maximum power spectral density shall not exceed 17 dBm in any 1 megahertz band. Fixed point-to-point U-NII devices may employ antennas with directional gain up to 23 dBi without any corresponding reduction in the maximum conducted output power or maximum power spectral density. For fixed point-to-point transmitters that employ a directional antenna gain greater than 23 dBi, a 1 dB reduction in maximum conducted output power and maximum power spectral density is required for each 1 dB of antenna gain in excess of 23 dBi. Fixed, point-to-point operations exclude the use of point-to-multipoint systems, omnidirectional applications, and multiple collocated transmitters transmitting the same information. The operator of the U-NII device, or if the equipment is professionally installed, the installer, is responsible for ensuring that systems employing high gain directional antennas are used exclusively for fixed, point-to-point operations.

(iv) For client devices in the 5.15-5.25 GHz band, the maximum power spectral density shall not exceed 11 dBm in any 1 megahertz band. If transmitting antennas of directional gain greater than 6 dBi are used, both the maximum conducted output power and the maximum power spectral density shall be reduced by the amount in dB that the directional gain of the antenna exceeds 6 dBi.

Power Spectral Density Test Procedure

Ref. KDB 789033 D02 General UNII Test Procedures New Rules v02r01

F. Maximum Power Spectral Density (PSD)

Power Spectral Density

Test Procedure

The rules requires “maximum power spectral density” measurements where the intent is to measure the maximum value of the time average of the power spectral density measured during a period of continuous transmission.

1. Create an average power spectrum for the EUT operating mode being tested by following the instructions in section II.E.2. for measuring maximum conducted output power using a spectrum analyzer or EMI receiver: select the appropriate test method (SA-1, SA-2, SA-3, or alternatives to each) and apply it up to, but not including, the step labeled, “Compute power...”. (This procedure is required even if the maximum conducted output power measurement was performed using a power meter, method PM.)

2. Use the peak search function on the instrument to find the peak of the spectrum and record its value.

3. Make the following adjustments to the peak value of the spectrum, if applicable: a) If Method SA-2 or SA-2 Alternative was used, add $10 \log(1/x)$, where x is the duty cycle, to the peak of the spectrum.

b) If Method SA-3 Alternative was used and the linear mode was used in step II.E.2.g)(viii), add 1 dB to the final result to compensate for the difference between linear averaging and power averaging.

4. The result is the Maximum PSD over 1 MHz reference bandwidth.

Ref. KDB 789033 D02 General UNII Test Procedures New Rules v02r01

2. Measurement using a Spectrum Analyzer or EMI Receiver (SA), (d) Method SA-2

Power Spectral Density

Test parameters

Method SA-2 (trace averaging across on and off times of the EUT transmissions, followed by duty cycle correction).

(i) Measure the duty cycle, x , of the transmitter output signal as described in section II.B.

(ii) Set span to encompass the EBW (or, alternatively, the entire 99% occupied bandwidth) of the signal.

(iii) Set RBW = 1 MHz.

(iv) Set VBW \geq 3 MHz.

(v) Number of points in sweep \geq 2 Span / RBW. (This ensures that bin-to-bin spacing is \leq RBW/2, so that narrowband signals are not lost between frequency bins.)

(vi) Sweep time = auto.

(vii) Detector = RMS (i.e., power averaging), if available. Otherwise, use sample detector mode.

(viii) Do not use sweep triggering. Allow the sweep to “free run”.

(ix) Trace average at least 100 traces in power averaging (i.e., RMS) mode; however, the number of traces to be averaged shall be increased above 100 as needed to ensure that the average accurately represents the true average over the on and off periods of the transmitter.

(x) Compute power by integrating the spectrum across the EBW (or, alternatively, the entire 99% occupied bandwidth) of the signal using the instrument’s band power measurement function with band limits set equal to the EBW (or occupied bandwidth)

F. Maximum Power Spectral Density (PSD)

2. Use the peak search function on the instrument to find the peak of the spectrum and record its value.

3. Make the following adjustments to the peak value of the spectrum, if applicable: a) If Method SA-2 or SA-2 Alternative was used, add $10 \log(1/x)$, where x is the duty cycle, to the peak of the spectrum.

The “measure-and-sum technique” is used for measuring in-band transmit power of a device. In the measure-and-sum approach, the conducted emission level is measured at each antenna port. The measured results at the various antenna ports are then summed mathematically to determine the total emission level from the device. Summing is performed in linear power units. ANSI C63.10 section 14.3.2.2

Samples, Systems, and Modes

System Number	Description	Samples	System under test	Support equipment
1	EUT	S01 + S02	<input checked="" type="checkbox"/>	<input type="checkbox"/>
	Support		<input type="checkbox"/>	<input checked="" type="checkbox"/>

Tested By :

Chris Blair

Date of testing:

16-Sep-19 - 26-Sep-19

Test Result : PASS

Test Equipment

See Appendix C for list of test equipment

Power Spectral Density, 4dBi

Frequency (MHz)	Mode	Tx Paths	Correlated Antenna Gain (dBi)	Tx 1 PSD (dBm/MHz)	Tx 2 PSD (dBm/MHz)	Tx 3 PSD (dBm/MHz)	Tx 4 PSD (dBm/MHz)	Duty Cycle Correction (dB)	Total PSD (dBm/MHz)	Limit (dBm/MHz)	Margin (dB)	
5180	Non HT20, 6 to 54 Mbps	1	4	-1.3				0.1	-1.2	17.0	18.25	
	Non HT20, 6 to 54 Mbps	2	7	-1.3	4.9			0.1	5.9	16.0	10.11	
	Non HT20, 6 to 54 Mbps	3	9	-1.3	4.9	5.9		0.1	8.9	14.0	5.07	
	Non HT20, 6 to 54 Mbps	4	10	-1.3	3.9	4.5	3.6	0.1	9.2	13.0	3.75	
	Non HT20 Beam Forming, 6 to 54 Mbps	2	7	-1.3	3.9			0.1	5.1	16.0	10.90	
	Non HT20 Beam Forming, 6 to 54 Mbps	3	9	-1.3	1.4	2.2		0.1	5.8	14.0	8.17	
	Non HT20 Beam Forming, 6 to 54 Mbps	4	10	-1.3	0.3	1.4	0.4	0.1	6.4	13.0	6.62	
	HT/VHT20, M0 to M7	1	4	-1.0					0.1	-0.9	17.0	17.95
	HT/VHT20, M0 to M7	2	7	-1.0	4.6				0.1	5.7	16.0	10.29
	HT/VHT20, M8 to M15	2	4	-1.0	4.6				0.1	5.7	17.0	11.29
	HT/VHT20, M0 to M7	3	9	-1.0	4.1	4.7			0.1	8.1	14.0	5.94
	HT/VHT20, M8 to M15	3	6	-1.0	4.1	4.7			0.1	8.1	17.0	8.94
	HT/VHT20, M16 to M23	3	4	-1.0	4.1	4.7			0.1	8.1	17.0	8.94
	HT/VHT20, M0 to M7	4	10	-1.0	4.1	4.7	4.1		0.1	9.5	13.0	3.46
	HT/VHT20, M8 to M15	4	7	-1.0	4.1	4.7	4.1		0.1	9.5	16.0	6.46
	HT/VHT20, M16 to M23	4	5	-1.0	4.1	4.7	4.1		0.1	9.5	17.0	7.46
	HT/VHT20, M24 to M31	4	4	-1.0	4.1	4.7	4.1		0.1	9.5	17.0	7.46
	HT/VHT20 Beam Forming, M0 to M7	2	7	-1.0	4.1				0.1	5.3	16.0	10.68
	HT/VHT20 Beam Forming, M8 to M15	2	4	-1.0	4.6				0.1	5.7	17.0	11.29
	HT/VHT20 Beam Forming, M0 to M7	3	9	-1.0	1.7	2.6			0.1	6.2	14.0	7.83
	HT/VHT20 Beam Forming, M8 to M15	3	6	-1.0	2.5	3.5			0.1	6.9	17.0	10.12
	HT/VHT20 Beam Forming, M16 to M23	3	4	-1.0	4.1	4.7			0.1	8.1	17.0	8.94
	HT/VHT20 Beam Forming, M0 to M7	4	10	-2.2	-1.6	-0.6	-1.3		0.1	4.7	13.0	8.31
	HT/VHT20 Beam Forming, M8 to M15	4	7	-1.0	2.5	3.5	2.9		0.1	8.4	16.0	7.65
	HT/VHT20 Beam Forming, M16 to M23	4	5	-1.0	2.5	3.5	2.9		0.1	8.4	17.0	8.65
	HT/VHT20 Beam Forming, M24 to M31	4	4	-1.0	4.1	4.7	4.1		0.1	9.5	17.0	7.46
	HT/VHT20 STBC, M0 to M7	2	4	-1.0	4.6				0.1	5.7	17.0	11.29
	HT/VHT20 STBC, M0 to M7	3	6	-1.0	4.1	4.7			0.1	8.1	17.0	8.94
	HT/VHT20 STBC, M0 to M7	4	7	-1.0	4.1	4.7	4.1		0.1	9.5	16.0	6.46
	HE20, M0 to M9 1ss	1	4	-2.2					0.1	-2.1	17.0	19.13
	HE20, M0 to M9 1ss	2	7	-2.2	2.7				0.1	4.0	16.0	12.01
	HE20, M0 to M9 2ss	2	4	-2.2	2.7				0.1	4.0	17.0	13.01



	HE20, M0 to M9 1ss	3	9	-2.2	2.7	3.4		0.1	6.7	14.0	7.26
	HE20, M0 to M9 2ss	3	6	-2.2	2.7	3.4		0.1	6.7	17.0	10.26
	HE20, M0 to M9 3ss	3	4	-2.2	2.7	3.4		0.1	6.7	17.0	10.26
	HE20, M0 to M9 1ss	4	10	-2.2	1.8	2.9	1.9	0.1	7.6	13.0	5.44
	HE20, M0 to M9 2ss	4	7	-2.2	1.8	2.9	1.9	0.1	7.6	16.0	8.44
	HE20, M0 to M9 3ss	4	5	-2.2	1.8	2.9	1.9	0.1	7.6	17.0	9.44
	HE20, M0 to M9 4ss	4	4	-2.2	1.8	2.9	1.9	0.1	7.6	17.0	9.44
	HE20 Beam Forming, M0 to M9 1ss	2	7	-2.2	1.8			0.1	3.3	16.0	12.68
	HE20 Beam Forming, M0 to M9 2ss	2	4	-2.2	2.7			0.1	4.0	17.0	13.01
	HE20 Beam Forming, M0 to M9 1ss	3	9	-2.9	-2.5	-1.9		0.1	2.4	14.0	11.57
	HE20 Beam Forming, M0 to M9 2ss	3	6	-2.2	1.8	2.9		0.1	6.2	17.0	10.84
	HE20 Beam Forming, M0 to M9 3ss	3	4	-2.2	2.7	3.4		0.1	6.7	17.0	10.26
	HE20 Beam Forming, M0 to M9 1ss	4	10	-2.9	-2.5	-1.9	-2.2	0.1	3.7	13.0	9.27
	HE20 Beam Forming, M0 to M9 2ss	4	7	-2.2	-0.3	0.5	-0.6	0.1	5.5	16.0	10.46
	HE20 Beam Forming, M0 to M9 3ss	4	5	-2.2	1.8	2.9	1.9	0.1	7.6	17.0	9.44
	HE20 Beam Forming, M0 to M9 4ss	4	4	-2.2	1.8	2.9	1.9	0.1	7.6	17.0	9.44
	HE20 STBC, M0 to M9 2ss	2	4	-2.2	2.7			0.1	4.0	17.0	13.01
	HE20 STBC, M0 to M9 2ss	3	6	-2.2	2.7	3.4		0.1	6.7	17.0	10.26
	HE20 STBC, M0 to M9 2ss	4	7	-2.2	1.8	2.9	1.9	0.1	7.6	16.0	8.44
5190	Non HT40, 6 to 54 Mbps	1	4	-5.4				0.0	-5.4	17.0	22.35
	Non HT40, 6 to 54 Mbps	2	7	-5.4	-5.0			0.0	-2.1	16.0	18.14
	Non HT40, 6 to 54 Mbps	3	9	-5.4	-5.0	-4.6		0.0	-0.2	14.0	14.17
	Non HT40, 6 to 54 Mbps	4	10	-5.4	-5.0	-4.6	-4.9	0.0	1.1	13.0	11.90
	HT/VHT40, M0 to M7	1	4	-4.6				0.1	-4.5	17.0	21.50
	HT/VHT40, M0 to M7	2	7	-4.6	-4.2			0.1	-1.3	16.0	17.28
	HT/VHT40, M8 to M15	2	4	-4.6	-4.2			0.1	-1.3	17.0	18.28
	HT/VHT40, M0 to M7	3	9	-4.6	-4.2	-3.4		0.1	0.8	14.0	13.16
	HT/VHT40, M8 to M15	3	6	-4.6	-4.2	-3.4		0.1	0.8	17.0	16.16
	HT/VHT40, M16 to M23	3	4	-4.6	-4.2	-3.4		0.1	0.8	17.0	16.16
	HT/VHT40, M0 to M7	4	10	-4.6	-4.2	-3.4	-4.1	0.1	2.1	13.0	10.93
	HT/VHT40, M8 to M15	4	7	-4.6	-4.2	-3.4	-4.1	0.1	2.1	16.0	13.93
	HT/VHT40, M16 to M23	4	5	-4.6	-4.2	-3.4	-4.1	0.1	2.1	17.0	14.93
	HT/VHT40, M24 to M31	4	4	-4.6	-4.2	-3.4	-4.1	0.1	2.1	17.0	14.93
	HT/VHT40 Beam Forming, M0 to M7	2	7	-5.1	-5.0			0.1	-1.9	16.0	17.94
	HT/VHT40 Beam Forming, M8 to M15	2	4	-4.6	-4.2			0.1	-1.3	17.0	18.28
	HT/VHT40 Beam Forming, M0 to M7	3	9	-6.7	-6.2	-5.3		0.1	-1.2	14.0	15.15
	HT/VHT40 Beam Forming, M8 to M15	3	6	-5.1	-5.0	-4.2		0.1	0.1	17.0	16.87
	HT/VHT40 Beam Forming, M16 to M23	3	4	-4.6	-4.2	-3.4		0.1	0.8	17.0	16.16
	HT/VHT40 Beam Forming, M0 to M7	4	10	-6.7	-6.2	-5.3	-6.1	0.1	0.1	13.0	12.92
HT/VHT40 Beam Forming, M8 to M15	4	7	-5.1	-5.0	-4.2	-5.2	0.1	1.3	16.0	14.73	
HT/VHT40 Beam Forming, M16 to M23	4	5	-5.1	-5.0	-4.2	-5.2	0.1	1.3	17.0	15.73	
HT/VHT40 Beam Forming, M24 to M31	4	4	-4.6	-4.2	-3.4	-4.1	0.1	2.1	17.0	14.93	

	HT/VHT40 STBC, M0 to M7	2	4	-4.6	-4.2			0.1	-1.3	17.0	18.28
	HT/VHT40 STBC, M0 to M7	3	6	-4.6	-4.2	-3.4		0.1	0.8	17.0	16.16
	HT/VHT40 STBC, M0 to M7	4	7	-4.6	-4.2	-3.4	-4.1	0.1	2.1	16.0	13.93
	HE40, M0 to M9 1ss	1	4	-6.8				0.1	-6.7	17.0	23.67
	HE40, M0 to M9 1ss	2	7	-6.8	-5.9			0.1	-3.2	16.0	19.19
	HE40, M0 to M9 2ss	2	4	-6.8	-5.9			0.1	-3.2	17.0	20.19
	HE40, M0 to M9 1ss	3	9	-6.8	-5.9	-5.4		0.1	-1.1	14.0	15.10
	HE40, M0 to M9 2ss	3	6	-6.8	-5.9	-5.4		0.1	-1.1	17.0	18.10
	HE40, M0 to M9 3ss	3	4	-6.8	-5.9	-5.4		0.1	-1.1	17.0	18.10
	HE40, M0 to M9 1ss	4	10	-6.8	-5.9	-5.4	-5.7	0.1	0.2	13.0	12.77
	HE40, M0 to M9 2ss	4	7	-6.8	-5.9	-5.4	-5.7	0.1	0.2	16.0	15.77
	HE40, M0 to M9 3ss	4	5	-6.8	-5.9	-5.4	-5.7	0.1	0.2	17.0	16.77
	HE40, M0 to M9 4ss	4	4	-6.8	-5.9	-5.4	-5.7	0.1	0.2	17.0	16.77
	HE40 Beam Forming, M0 to M9 1ss	2	7	-6.8	-5.9			0.1	-3.2	16.0	19.19
	HE40 Beam Forming, M0 to M9 2ss	2	4	-6.8	-5.9			0.1	-3.2	17.0	20.19
	HE40 Beam Forming, M0 to M9 1ss	3	9	-7.7	-7.0	-6.4		0.1	-2.1	14.0	16.10
	HE40 Beam Forming, M0 to M9 2ss	3	6	-6.8	-5.9	-5.4		0.1	-1.1	17.0	18.10
	HE40 Beam Forming, M0 to M9 3ss	3	4	-6.8	-5.9	-5.4		0.1	-1.1	17.0	18.10
	HE40 Beam Forming, M0 to M9 1ss	4	10	-8.8	-7.8	-7.5	-8.4	0.1	-1.9	13.0	14.95
	HE40 Beam Forming, M0 to M9 2ss	4	7	-7.7	-7.0	-6.4	-7.0	0.1	-0.9	16.0	16.86
	HE40 Beam Forming, M0 to M9 3ss	4	5	-6.8	-5.9	-5.4	-5.7	0.1	0.2	17.0	16.77
	HE40 Beam Forming, M0 to M9 4ss	4	4	-6.8	-5.9	-5.4	-5.7	0.1	0.2	17.0	16.77
	HE40 STBC, M0 to M9 2ss	2	4	-6.8	-5.9			0.1	-3.2	17.0	20.19
	HE40 STBC, M0 to M9 2ss	3	6	-6.8	-5.9	-5.4		0.1	-1.1	17.0	18.10
	HE40 STBC, M0 to M9 2ss	4	7	-6.8	-5.9	-5.4	-5.7	0.1	0.2	16.0	15.77
5210	Non HT80, 6 to 54 Mbps	1	4	-7.2				0.1	-7.1	17.0	24.15
	Non HT80, 6 to 54 Mbps	2	7	-7.2	-6.8			0.1	-3.9	16.0	19.93
	Non HT80, 6 to 54 Mbps	3	9	-7.2	-6.8	-6.3		0.1	-1.9	14.0	15.93
	Non HT80, 6 to 54 Mbps	4	10	-7.2	-6.8	-6.3	-7.1	0.1	-0.8	13.0	13.76
	VHT80, M0 to M9 1ss	1	4	-8.0				0.2	-7.8	17.0	24.78
	VHT80, M0 to M9 1ss	2	7	-8.0	-7.6			0.2	-4.6	16.0	20.56
	VHT80, M0 to M9 2ss	2	4	-8.0	-7.6			0.2	-4.6	17.0	21.56
	VHT80, M0 to M9 1ss	3	9	-8.0	-7.6	-7.3		0.2	-2.6	14.0	16.63
	VHT80, M0 to M9 2ss	3	6	-8.0	-7.6	-7.3		0.2	-2.6	17.0	19.63
	VHT80, M0 to M9 3ss	3	4	-8.0	-7.6	-7.3		0.2	-2.6	17.0	19.63
	VHT80, M0 to M9 1ss	4	10	-8.0	-7.6	-7.3	-7.6	0.2	-1.4	13.0	14.37
	VHT80, M0 to M9 2ss	4	7	-8.0	-7.6	-7.3	-7.6	0.2	-1.4	16.0	17.37
	VHT80, M0 to M9 3ss	4	5	-8.0	-7.6	-7.3	-7.6	0.2	-1.4	17.0	18.37
	VHT80, M0 to M9 4ss	4	4	-8.0	-7.6	-7.3	-7.6	0.2	-1.4	17.0	18.37
	VHT80 Beam Forming, M0 to M9 1ss	2	7	-9.2	-8.7			0.2	-5.7	16.0	21.71
	VHT80 Beam Forming, M0 to M9 2ss	2	4	-8.0	-7.6			0.2	-4.6	17.0	21.56
VHT80 Beam Forming, M0 to M9 1ss	3	9	-9.2	-8.7	-8.3		0.2	-3.7	14.0	17.72	

VHT80 Beam Forming, M0 to M9 2ss	3	6	-9.2	-8.7	-8.3			0.2	-3.7	17.0	20.72	
VHT80 Beam Forming, M0 to M9 3ss	3	4	-8.0	-7.6	-7.3			0.2	-2.6	17.0	19.63	
VHT80 Beam Forming, M0 to M9 1ss	4	10	-10.1	-9.2	-9.2	-9.5		0.2	-3.2	13.0	16.24	
VHT80 Beam Forming, M0 to M9 2ss	4	7	-9.2	-8.7	-8.3	-8.7		0.2	-2.5	16.0	18.47	
VHT80 Beam Forming, M0 to M9 3ss	4	5	-8.0	-7.6	-7.3	-7.6		0.2	-1.4	17.0	18.37	
VHT80 Beam Forming, M0 to M9 4ss	4	4	-8.0	-7.6	-7.3	-7.6		0.2	-1.4	17.0	18.37	
VHT80 STBC, M0 to M9 1ss	2	4	-8.0	-7.6				0.2	-4.6	17.0	21.56	
VHT80 STBC, M0 to M9 1ss	3	4	-8.0	-7.6	-7.3			0.2	-2.6	17.0	19.63	
VHT80 STBC, M0 to M9 1ss	4	4	-8.0	-7.6	-7.3	-7.6		0.2	-1.4	17.0	18.37	
HE80, M0 to M9 1ss	1	4	-9.0					0.3	-8.7	17.0	25.75	
HE80, M0 to M9 1ss	2	7	-9.0	-8.6				0.3	-5.5	16.0	21.53	
HE80, M0 to M9 2ss	2	4	-9.0	-8.6				0.3	-5.5	17.0	22.53	
HE80, M0 to M9 1ss	3	9	-9.0	-8.6	-8.0			0.3	-3.5	14.0	17.49	
HE80, M0 to M9 2ss	3	6	-9.0	-8.6	-8.0			0.3	-3.5	17.0	20.49	
HE80, M0 to M9 3ss	3	4	-9.0	-8.6	-8.0			0.3	-3.5	17.0	20.49	
HE80, M0 to M9 1ss	4	10	-9.0	-8.6	-8.0	-8.9		0.3	-2.3	13.0	15.34	
HE80, M0 to M9 2ss	4	7	-9.0	-8.6	-8.0	-8.9		0.3	-2.3	16.0	18.34	
HE80, M0 to M9 3ss	4	5	-9.0	-8.6	-8.0	-8.9		0.3	-2.3	17.0	19.34	
HE80, M0 to M9 4ss	4	4	-9.0	-8.6	-8.0	-8.9		0.3	-2.3	17.0	19.34	
HE80 Beam Forming, M0 to M9 1ss	2	7	-10.1	-9.7				0.3	-6.6	16.0	22.63	
HE80 Beam Forming, M0 to M9 2ss	2	4	-9.0	-8.6				0.3	-5.5	17.0	22.53	
HE80 Beam Forming, M0 to M9 1ss	3	9	-10.1	-9.7	-9.5			0.3	-4.7	14.0	18.74	
HE80 Beam Forming, M0 to M9 2ss	3	6	-10.1	-9.7	-9.5			0.3	-4.7	17.0	21.74	
HE80 Beam Forming, M0 to M9 3ss	3	4	-9.0	-8.6	-8.0			0.3	-3.5	17.0	20.49	
HE80 Beam Forming, M0 to M9 1ss	4	10	-10.5	-10.1	-10.3	-10.7		0.3	-4.1	13.0	17.12	
HE80 Beam Forming, M0 to M9 2ss	4	7	-10.1	-9.7	-9.5	-10.0		0.3	-3.5	16.0	19.55	
HE80 Beam Forming, M0 to M9 3ss	4	5	-9.0	-8.6	-8.0	-8.9		0.3	-2.3	17.0	19.34	
HE80 Beam Forming, M0 to M9 4ss	4	4	-9.0	-8.6	-8.0	-8.9		0.3	-2.3	17.0	19.34	
HE80 STBC, M0 to M9 1ss	2	4	-9.0	-8.6				0.3	-5.5	17.0	22.53	
HE80 STBC, M0 to M9 1ss	3	4	-9.0	-8.6	-8.0			0.3	-3.5	17.0	20.49	
HE80 STBC, M0 to M9 1ss	4	4	-9.0	-8.6	-8.0	-8.9		0.3	-2.3	17.0	19.34	
5220	Non HT20, 6 to 54 Mbps	1	4	-1.1				0.1	-1.0	17.0	18.05	
	Non HT20, 6 to 54 Mbps	2	7	-1.1	4.6			0.1	5.7	16.0	10.31	
	Non HT20, 6 to 54 Mbps	3	9	-1.1	4.6	4.9		0.1	8.3	14.0	5.65	
	Non HT20, 6 to 54 Mbps	4	10	-1.1	4.6	4.9	5.1	0.1	10.0	13.0	2.95	
	Non HT20 Beam Forming, 6 to 54 Mbps	2	7	-1.1	4.6			0.1	5.7	16.0	10.31	
	Non HT20 Beam Forming, 6 to 54 Mbps	3	9	-1.1	4.6	4.9		0.1	8.3	14.0	5.65	
	Non HT20 Beam Forming, 6 to 54 Mbps	4	10	-1.1	4.6	4.9	5.1	0.1	10.0	13.0	2.95	
	HT/VHT20, M0 to M7	1	4	-1.5					0.1	-1.4	17.0	18.45
	HT/VHT20, M0 to M7	2	7	-1.5	4.2				0.1	5.3	16.0	10.71
	HT/VHT20, M8 to M15	2	4	-1.5	4.2				0.1	5.3	17.0	11.71
HT/VHT20, M0 to M7	3	9	-1.5	4.2	4.9			0.1	8.1	14.0	5.87	



HT/VHT20, M8 to M15	3	6	-1.5	4.2	4.9		0.1	8.1	17.0	8.87
HT/VHT20, M16 to M23	3	4	-1.5	4.2	4.9		0.1	8.1	17.0	8.87
HT/VHT20, M0 to M7	4	10	-1.5	4.2	4.9	4.6	0.1	9.7	13.0	3.26
HT/VHT20, M8 to M15	4	7	-1.5	4.2	4.9	4.6	0.1	9.7	16.0	6.26
HT/VHT20, M16 to M23	4	5	-1.5	4.2	4.9	4.6	0.1	9.7	17.0	7.26
HT/VHT20, M24 to M31	4	4	-1.5	4.2	4.9	4.6	0.1	9.7	17.0	7.26
HT/VHT20 Beam Forming, M0 to M7	2	7	-1.5	4.2			0.1	5.3	16.0	10.71
HT/VHT20 Beam Forming, M8 to M15	2	4	-1.5	4.2			0.1	5.3	17.0	11.71
HT/VHT20 Beam Forming, M0 to M7	3	9	-1.5	4.2	4.9		0.1	8.1	14.0	5.87
HT/VHT20 Beam Forming, M8 to M15	3	6	-1.5	4.2	4.9		0.1	8.1	17.0	8.87
HT/VHT20 Beam Forming, M16 to M23	3	4	-1.5	4.2	4.9		0.1	8.1	17.0	8.87
HT/VHT20 Beam Forming, M0 to M7	4	10	-1.5	4.2	4.9	4.6	0.1	9.7	13.0	3.26
HT/VHT20 Beam Forming, M8 to M15	4	7	-1.5	4.2	4.9	4.6	0.1	9.7	16.0	6.26
HT/VHT20 Beam Forming, M16 to M23	4	5	-1.5	4.2	4.9	4.6	0.1	9.7	17.0	7.26
HT/VHT20 Beam Forming, M24 to M31	4	4	-1.5	4.2	4.9	4.6	0.1	9.7	17.0	7.26
HT/VHT20 STBC, M0 to M7	2	4	-1.5	4.2			0.1	5.3	17.0	11.71
HT/VHT20 STBC, M0 to M7	3	6	-1.5	4.2	4.9		0.1	8.1	17.0	8.87
HT/VHT20 STBC, M0 to M7	4	7	-1.5	4.2	4.9	4.6	0.1	9.7	16.0	6.26
HE20, M0 to M9 1ss	1	4	-1.3				0.1	-1.2	17.0	18.23
HE20, M0 to M9 1ss	2	7	-1.3	4.4			0.1	5.5	16.0	10.50
HE20, M0 to M9 2ss	2	4	-1.3	4.4			0.1	5.5	17.0	11.50
HE20, M0 to M9 1ss	3	9	-1.3	4.4	5.0		0.1	8.3	14.0	5.70
HE20, M0 to M9 2ss	3	6	-1.3	4.4	5.0		0.1	8.3	17.0	8.70
HE20, M0 to M9 3ss	3	4	-1.3	4.4	5.0		0.1	8.3	17.0	8.70
HE20, M0 to M9 1ss	4	10	-1.3	4.4	5.0	4.9	0.1	10.0	13.0	3.04
HE20, M0 to M9 2ss	4	7	-1.3	4.4	5.0	4.9	0.1	10.0	16.0	6.04
HE20, M0 to M9 3ss	4	5	-1.3	4.4	5.0	4.9	0.1	10.0	17.0	7.04
HE20, M0 to M9 4ss	4	4	-1.3	4.4	5.0	4.9	0.1	10.0	17.0	7.04
HE20 Beam Forming, M0 to M9 1ss	2	7	-1.3	4.4			0.1	5.5	16.0	10.50
HE20 Beam Forming, M0 to M9 2ss	2	4	-1.3	4.4			0.1	5.5	17.0	11.50
HE20 Beam Forming, M0 to M9 1ss	3	9	-1.3	4.4	5.0		0.1	8.3	14.0	5.70
HE20 Beam Forming, M0 to M9 2ss	3	6	-1.3	4.4	5.0		0.1	8.3	17.0	8.70
HE20 Beam Forming, M0 to M9 3ss	3	4	-1.3	4.4	5.0		0.1	8.3	17.0	8.70
HE20 Beam Forming, M0 to M9 1ss	4	10	-1.3	4.4	5.0	4.9	0.1	10.0	13.0	3.04
HE20 Beam Forming, M0 to M9 2ss	4	7	-1.3	4.4	5.0	4.9	0.1	10.0	16.0	6.04
HE20 Beam Forming, M0 to M9 3ss	4	5	-1.3	4.4	5.0	4.9	0.1	10.0	17.0	7.04
HE20 Beam Forming, M0 to M9 4ss	4	4	-1.3	4.4	5.0	4.9	0.1	10.0	17.0	7.04
HE20 STBC, M0 to M9 2ss	2	4	-1.3	4.4			0.1	5.5	17.0	11.50
HE20 STBC, M0 to M9 2ss	3	6	-1.3	4.4	5.0		0.1	8.3	17.0	8.70
HE20 STBC, M0 to M9 2ss	4	7	-1.3	4.4	5.0	4.9	0.1	10.0	16.0	6.04

5230	Non HT40, 6 to 54 Mbps	1	4	-3.6				0.0	-3.6	17.0	20.55
	Non HT40, 6 to 54 Mbps	2	7	-3.6	1.8			0.0	2.9	16.0	13.05
	Non HT40, 6 to 54 Mbps	3	9	-3.6	1.8	2.6		0.0	5.8	14.0	8.19
	Non HT40, 6 to 54 Mbps	4	10	-3.6	1.8	2.6	1.9	0.0	7.3	13.0	5.69
	HT/VHT40, M0 to M7	1	4	-4.1				0.1	-4.0	17.0	21.00
	HT/VHT40, M0 to M7	2	7	-4.1	1.3			0.1	2.5	16.0	13.50
	HT/VHT40, M8 to M15	2	4	-4.1	1.3			0.1	2.5	17.0	14.50
	HT/VHT40, M0 to M7	3	9	-4.1	1.3	1.8		0.1	5.2	14.0	8.78
	HT/VHT40, M8 to M15	3	6	-4.1	1.3	1.8		0.1	5.2	17.0	11.78
	HT/VHT40, M16 to M23	3	4	-4.1	1.3	1.8		0.1	5.2	17.0	11.78
	HT/VHT40, M0 to M7	4	10	-4.1	1.3	1.8	1.5	0.1	6.8	13.0	6.21
	HT/VHT40, M8 to M15	4	7	-4.1	1.3	1.8	1.5	0.1	6.8	16.0	9.21
	HT/VHT40, M16 to M23	4	5	-4.1	1.3	1.8	1.5	0.1	6.8	17.0	10.21
	HT/VHT40, M24 to M31	4	4	-4.1	1.3	1.8	1.5	0.1	6.8	17.0	10.21
	HT/VHT40 Beam Forming, M0 to M7	2	7	-4.1	1.3			0.1	2.5	16.0	13.50
	HT/VHT40 Beam Forming, M8 to M15	2	4	-4.1	1.3			0.1	2.5	17.0	14.50
	HT/VHT40 Beam Forming, M0 to M7	3	9	-4.1	1.3	1.8		0.1	5.2	14.0	8.78
	HT/VHT40 Beam Forming, M8 to M15	3	6	-4.1	1.3	1.8		0.1	5.2	17.0	11.78
	HT/VHT40 Beam Forming, M16 to M23	3	4	-4.1	1.3	1.8		0.1	5.2	17.0	11.78
	HT/VHT40 Beam Forming, M0 to M7	4	10	-4.1	1.3	1.8	1.5	0.1	6.8	13.0	6.21
	HT/VHT40 Beam Forming, M8 to M15	4	7	-4.1	1.3	1.8	1.5	0.1	6.8	16.0	9.21
	HT/VHT40 Beam Forming, M16 to M23	4	5	-4.1	1.3	1.8	1.5	0.1	6.8	17.0	10.21
	HT/VHT40 Beam Forming, M24 to M31	4	4	-4.1	1.3	1.8	1.5	0.1	6.8	17.0	10.21
	HT/VHT40 STBC, M0 to M7	2	4	-4.1	1.3			0.1	2.5	17.0	14.50
	HT/VHT40 STBC, M0 to M7	3	6	-4.1	1.3	1.8		0.1	5.2	17.0	11.78
	HT/VHT40 STBC, M0 to M7	4	7	-4.1	1.3	1.8	1.5	0.1	6.8	16.0	9.21
	HE40, M0 to M9 1ss	1	4	-4.2				0.1	-4.1	17.0	21.07
	HE40, M0 to M9 1ss	2	7	-4.2	1.5			0.1	2.7	16.0	13.34
	HE40, M0 to M9 2ss	2	4	-4.2	1.5			0.1	2.7	17.0	14.34
	HE40, M0 to M9 1ss	3	9	-4.2	1.5	2.2		0.1	5.5	14.0	8.49
	HE40, M0 to M9 2ss	3	6	-4.2	1.5	2.2		0.1	5.5	17.0	11.49
	HE40, M0 to M9 3ss	3	4	-4.2	1.5	2.2		0.1	5.5	17.0	11.49
	HE40, M0 to M9 1ss	4	10	-4.2	1.5	2.2	1.8	0.1	7.1	13.0	5.91
	HE40, M0 to M9 2ss	4	7	-4.2	1.5	2.2	1.8	0.1	7.1	16.0	8.91
	HE40, M0 to M9 3ss	4	5	-4.2	1.5	2.2	1.8	0.1	7.1	17.0	9.91
	HE40, M0 to M9 4ss	4	4	-4.2	1.5	2.2	1.8	0.1	7.1	17.0	9.91
	HE40 Beam Forming, M0 to M9 1ss	2	7	-4.2	1.5			0.1	2.7	16.0	13.34
	HE40 Beam Forming, M0 to M9 2ss	2	4	-4.2	1.5			0.1	2.7	17.0	14.34
	HE40 Beam Forming, M0 to M9 1ss	3	9	-4.2	1.5	2.2		0.1	5.5	14.0	8.49
	HE40 Beam Forming, M0 to M9 2ss	3	6	-4.2	1.5	2.2		0.1	5.5	17.0	11.49
	HE40 Beam Forming, M0 to M9 3ss	3	4	-4.2	1.5	2.2		0.1	5.5	17.0	11.49
	HE40 Beam Forming, M0 to M9 1ss	4	10	-4.2	1.5	2.2	1.8	0.1	7.1	13.0	5.91
HE40 Beam Forming, M0 to M9 2ss	4	7	-4.2	1.5	2.2	1.8	0.1	7.1	16.0	8.91	

	HE40 Beam Forming, M0 to M9 3ss	4	5	-4.2	1.5	2.2	1.8	0.1	7.1	17.0	9.91	
	HE40 Beam Forming, M0 to M9 4ss	4	4	-4.2	1.5	2.2	1.8	0.1	7.1	17.0	9.91	
	HE40 STBC, M0 to M9 2ss	2	4	-4.2	1.5			0.1	2.7	17.0	14.34	
	HE40 STBC, M0 to M9 2ss	3	6	-4.2	1.5	2.2		0.1	5.5	17.0	11.49	
	HE40 STBC, M0 to M9 2ss	4	7	-4.2	1.5	2.2	1.8	0.1	7.1	16.0	8.91	
5240	Non HT20, 6 to 54 Mbps	1	4	-0.8				0.1	-0.7	17.0	17.75	
	Non HT20, 6 to 54 Mbps	2	7	-0.8	4.9			0.1	6.0	16.0	10.01	
	Non HT20, 6 to 54 Mbps	3	9	-0.8	4.9	5.1		0.1	8.6	14.0	5.40	
	Non HT20, 6 to 54 Mbps	4	10	-0.8	4.9	5.1	4.5	0.1	10.0	13.0	2.96	
	Non HT20 Beam Forming, 6 to 54 Mbps	2	7	-0.8	4.9			0.1	6.0	16.0	10.01	
	Non HT20 Beam Forming, 6 to 54 Mbps	3	9	-0.8	4.9	5.1		0.1	8.6	14.0	5.40	
	Non HT20 Beam Forming, 6 to 54 Mbps	4	10	-0.8	4.9	5.1	4.5	0.1	10.0	13.0	2.96	
	HT/VHT20, M0 to M7	1	4	-1.0					0.1	-0.9	17.0	17.95
	HT/VHT20, M0 to M7	2	7	-1.0	4.3				0.1	5.5	16.0	10.52
	HT/VHT20, M8 to M15	2	4	-1.0	4.3				0.1	5.5	17.0	11.52
	HT/VHT20, M0 to M7	3	9	-1.0	4.3	4.8			0.1	8.2	14.0	5.81
	HT/VHT20, M8 to M15	3	6	-1.0	4.3	4.8			0.1	8.2	17.0	8.81
	HT/VHT20, M16 to M23	3	4	-1.0	4.3	4.8			0.1	8.2	17.0	8.81
	HT/VHT20, M0 to M7	4	10	-1.0	4.3	4.8	4.4		0.1	9.7	13.0	3.28
	HT/VHT20, M8 to M15	4	7	-1.0	4.3	4.8	4.4		0.1	9.7	16.0	6.28
	HT/VHT20, M16 to M23	4	5	-1.0	4.3	4.8	4.4		0.1	9.7	17.0	7.28
	HT/VHT20, M24 to M31	4	4	-1.0	4.3	4.8	4.4		0.1	9.7	17.0	7.28
	HT/VHT20 Beam Forming, M0 to M7	2	7	-1.0	4.3				0.1	5.5	16.0	10.52
	HT/VHT20 Beam Forming, M8 to M15	2	4	-1.0	4.3				0.1	5.5	17.0	11.52
	HT/VHT20 Beam Forming, M0 to M7	3	9	-1.0	4.3	4.8			0.1	8.2	14.0	5.81
	HT/VHT20 Beam Forming, M8 to M15	3	6	-1.0	4.3	4.8			0.1	8.2	17.0	8.81
	HT/VHT20 Beam Forming, M16 to M23	3	4	-1.0	4.3	4.8			0.1	8.2	17.0	8.81
	HT/VHT20 Beam Forming, M0 to M7	4	10	-1.0	4.3	4.8	4.4		0.1	9.7	13.0	3.28
	HT/VHT20 Beam Forming, M8 to M15	4	7	-1.0	4.3	4.8	4.4		0.1	9.7	16.0	6.28
	HT/VHT20 Beam Forming, M16 to M23	4	5	-1.0	4.3	4.8	4.4		0.1	9.7	17.0	7.28
	HT/VHT20 Beam Forming, M24 to M31	4	4	-1.0	4.3	4.8	4.4		0.1	9.7	17.0	7.28
	HT/VHT20 STBC, M0 to M7	2	4	-1.0	4.3				0.1	5.5	17.0	11.52
	HT/VHT20 STBC, M0 to M7	3	6	-1.0	4.3	4.8			0.1	8.2	17.0	8.81
	HT/VHT20 STBC, M0 to M7	4	7	-1.0	4.3	4.8	4.4		0.1	9.7	16.0	6.28
	HE20, M0 to M9 1ss	1	4	-1.2					0.1	-1.1	17.0	18.13
	HE20, M0 to M9 1ss	2	7	-1.2	4.4				0.1	5.5	16.0	10.48
	HE20, M0 to M9 2ss	2	4	-1.2	4.4				0.1	5.5	17.0	11.48
	HE20, M0 to M9 1ss	3	9	-1.2	4.4	5.1			0.1	8.4	14.0	5.64
	HE20, M0 to M9 2ss	3	6	-1.2	4.4	5.1			0.1	8.4	17.0	8.64
HE20, M0 to M9 3ss	3	4	-1.2	4.4	5.1			0.1	8.4	17.0	8.64	
HE20, M0 to M9 1ss	4	10	-1.2	4.4	5.1	4.2		0.1	9.8	13.0	3.21	
HE20, M0 to M9 2ss	4	7	-1.2	4.4	5.1	4.2		0.1	9.8	16.0	6.21	

	HE20, M0 to M9 3ss	4	5	-1.2	4.4	5.1	4.2	0.1	9.8	17.0	7.21
	HE20, M0 to M9 4ss	4	4	-1.2	4.4	5.1	4.2	0.1	9.8	17.0	7.21
	HE20 Beam Forming, M0 to M9 1ss	2	7	-1.2	4.4			0.1	5.5	16.0	10.48
	HE20 Beam Forming, M0 to M9 2ss	2	4	-1.2	4.4			0.1	5.5	17.0	11.48
	HE20 Beam Forming, M0 to M9 1ss	3	9	-1.2	4.4	5.1		0.1	8.4	14.0	5.64
	HE20 Beam Forming, M0 to M9 2ss	3	6	-1.2	4.4	5.1		0.1	8.4	17.0	8.64
	HE20 Beam Forming, M0 to M9 3ss	3	4	-1.2	4.4	5.1		0.1	8.4	17.0	8.64
	HE20 Beam Forming, M0 to M9 1ss	4	10	-1.2	4.4	5.1	4.2	0.1	9.8	13.0	3.21
	HE20 Beam Forming, M0 to M9 2ss	4	7	-1.2	4.4	5.1	4.2	0.1	9.8	16.0	6.21
	HE20 Beam Forming, M0 to M9 3ss	4	5	-1.2	4.4	5.1	4.2	0.1	9.8	17.0	7.21
	HE20 Beam Forming, M0 to M9 4ss	4	4	-1.2	4.4	5.1	4.2	0.1	9.8	17.0	7.21
	HE20 STBC, M0 to M9 2ss	2	4	-1.2	4.4			0.1	5.5	17.0	11.48
	HE20 STBC, M0 to M9 2ss	3	6	-1.2	4.4	5.1		0.1	8.4	17.0	8.64
	HE20 STBC, M0 to M9 2ss	4	7	-1.2	4.4	5.1	4.2	0.1	9.8	16.0	6.21
5250	Non HT160, 6 to 54 Mbps	1	4	-10.8				0.0	-10.8	17.0	27.75
	Non HT160, 6 to 54 Mbps	2	7	-10.8	-10.7			0.0	-7.7	16.0	23.69
	Non HT160, 6 to 54 Mbps	3	9	-10.8	-10.7	-9.4		0.0	-5.4	14.0	19.43
	Non HT160, 6 to 54 Mbps	4	10	-10.8	-10.7	-9.4	-10.6	0.0	-4.3	13.0	17.27
	VHT160, M0 to M9 1ss	1	4	-10.1				0.4	-9.7	17.0	26.71
	VHT160, M0 to M9 1ss	2	7	-10.1	-10.5			0.4	-6.9	16.0	22.89
	VHT160, M0 to M9 2ss	2	4	-10.1	-10.5			0.4	-6.9	17.0	23.89
	VHT160, M0 to M9 1ss	3	9	-10.1	-10.5	-10.0		0.4	-5.0	14.0	19.03
	VHT160, M0 to M9 2ss	3	6	-10.1	-10.5	-10.0		0.4	-5.0	17.0	22.03
	VHT160, M0 to M9 3ss	3	4	-10.1	-10.5	-10.0		0.4	-5.0	17.0	22.03
	VHT160, M0 to M9 1ss	4	10	-10.1	-10.5	-10.0	-9.8	0.4	-3.7	13.0	16.68
	VHT160, M0 to M9 2ss	4	7	-10.1	-10.5	-10.0	-9.8	0.4	-3.7	16.0	19.68
	VHT160, M0 to M9 3ss	4	5	-10.1	-10.5	-10.0	-9.8	0.4	-3.7	17.0	20.68
	VHT160, M0 to M9 4ss	4	4	-10.1	-10.5	-10.0	-9.8	0.4	-3.7	17.0	20.68
	VHT160 Beam Forming, M0 to M9 1ss	2	7	-11.3	-11.3			0.4	-7.9	16.0	23.90
	VHT160 Beam Forming, M0 to M9 2ss	2	4	-10.1	-10.5			0.4	-6.9	17.0	23.89
	VHT160 Beam Forming, M0 to M9 1ss	3	9	-12.3	-12.6	-12.5		0.4	-7.3	14.0	21.30
	VHT160 Beam Forming, M0 to M9 2ss	3	6	-11.3	-11.3	-11.4		0.4	-6.2	17.0	23.17
	VHT160 Beam Forming, M0 to M9 3ss	3	4	-10.1	-10.5	-10.0		0.4	-5.0	17.0	22.03
	VHT160 Beam Forming, M0 to M9 1ss	4	10	-12.3	-12.6	-12.5	-12.6	0.4	-6.1	13.0	19.09
	VHT160 Beam Forming, M0 to M9 2ss	4	7	-11.3	-11.3	-11.4	-11.2	0.4	-4.9	16.0	20.89
	VHT160 Beam Forming, M0 to M9 3ss	4	5	-11.3	-11.3	-11.4	-11.2	0.4	-4.9	17.0	21.89
	VHT160 Beam Forming, M0 to M9 4ss	4	4	-10.1	-10.5	-10.0	-9.8	0.4	-3.7	17.0	20.68
	VHT160 STBC, M0 to M9 1ss	2	4	-10.1	-10.5			0.4	-6.9	17.0	23.89
	VHT160 STBC, M0 to M9 1ss	3	4	-10.1	-10.5	-10.0		0.4	-5.0	17.0	22.03
	VHT160 STBC, M0 to M9 1ss	4	4	-10.1	-10.5	-10.0	-9.8	0.4	-3.7	17.0	20.68
	HE160, M0 to M9 1ss	1	4	-10.4				0.4	-10.0	17.0	26.97
	HE160, M0 to M9 1ss	2	7	-10.4	-10.4			0.4	-7.0	16.0	22.96



HE160, M0 to M9 2ss	2	4	-10.4	-10.4			0.4	-7.0	17.0	23.96
HE160, M0 to M9 1ss	3	9	-10.5	-11.5	-11.3		0.4	-5.9	14.0	19.87
HE160, M0 to M9 2ss	3	6	-10.5	-11.5	-11.3		0.4	-5.9	17.0	22.87
HE160, M0 to M9 3ss	3	4	-10.5	-11.5	-11.3		0.4	-5.9	17.0	22.87
HE160, M0 to M9 1ss	4	10	-10.5	-11.5	-11.3	-11.3	0.4	-4.7	13.0	17.68
HE160, M0 to M9 2ss	4	7	-10.5	-11.5	-11.3	-11.3	0.4	-4.7	16.0	20.68
HE160, M0 to M9 3ss	4	5	-10.5	-11.5	-11.3	-11.3	0.4	-4.7	17.0	21.68
HE160, M0 to M9 4ss	4	4	-10.5	-11.5	-11.3	-11.3	0.4	-4.7	17.0	21.68
HE160 Beam Forming, M0 to M9 1ss	2	7	-10.5	-11.5			0.4	-7.5	16.0	23.53
HE160 Beam Forming, M0 to M9 2ss	2	4	-10.4	-10.4			0.4	-7.0	17.0	23.96
HE160 Beam Forming, M0 to M9 1ss	3	9	-12.3	-12.8	-12.4		0.4	-7.3	14.0	21.29
HE160 Beam Forming, M0 to M9 2ss	3	6	-10.5	-11.5	-11.3		0.4	-5.9	17.0	22.87
HE160 Beam Forming, M0 to M9 3ss	3	4	-10.5	-11.5	-11.3		0.4	-5.9	17.0	22.87
HE160 Beam Forming, M0 to M9 1ss	4	10	-12.3	-12.8	-12.4	-12.8	0.4	-6.1	13.0	19.11
HE160 Beam Forming, M0 to M9 2ss	4	7	-12.3	-12.8	-12.4	-12.8	0.4	-6.1	16.0	22.11
HE160 Beam Forming, M0 to M9 3ss	4	5	-10.5	-11.5	-11.3	-11.3	0.4	-4.7	17.0	21.68
HE160 Beam Forming, M0 to M9 4ss	4	4	-10.5	-11.5	-11.3	-11.3	0.4	-4.7	17.0	21.68
HE160 STBC, M0 to M9 1ss	2	4	-10.4	-10.4			0.4	-7.0	17.0	23.96
HE160 STBC, M0 to M9 1ss	3	4	-10.5	-11.5	-11.3		0.4	-5.9	17.0	22.87
HE160 STBC, M0 to M9 1ss	4	4	-10.5	-11.5	-11.3	-11.3	0.4	-4.7	17.0	21.68

Power Spectral Density, 4dBi
5220 MHz, Non HT20, 6 to 54 Mbps



Antenna A

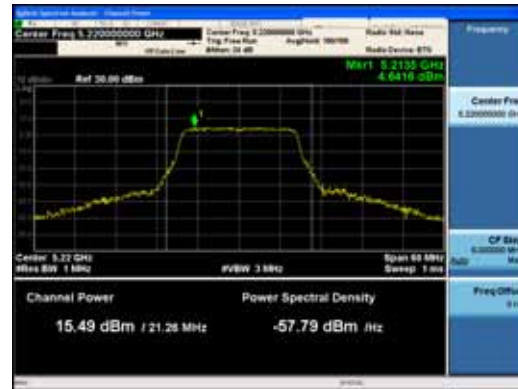

Antenna B

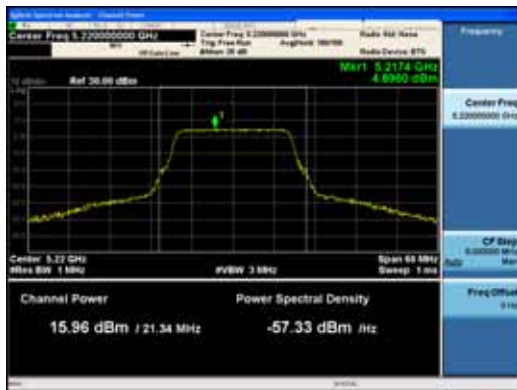

Antenna C

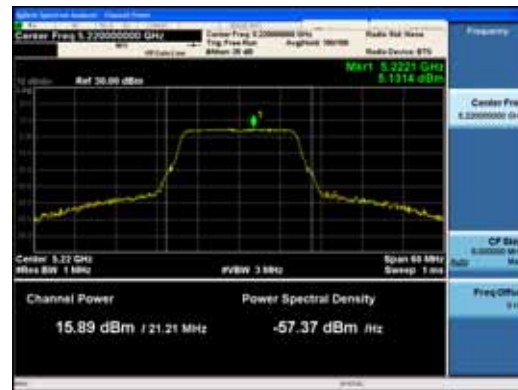

Antenna D

Power Spectral Density, 5dBi

Frequency (MHz)	Mode	Tx Paths	Correlated Antenna Gain (dBi)	Tx 1 PSD (dBm/MHz)	Tx 2 PSD (dBm/MHz)	Tx 3 PSD (dBm/MHz)	Tx 4 PSD (dBm/MHz)	Duty Cycle Correction (dB)	Total PSD (dBm/MHz)	Limit (dBm/MHz)	Margin (dB)
5180	Non HT20, 6 to 54 Mbps	1	5	-1.3				0.1	-1.2	17.0	18.25
	Non HT20, 6 to 54 Mbps	2	8	-1.3	4.9			0.1	5.9	15.0	9.11
	Non HT20, 6 to 54 Mbps	3	10	-1.3	3.9	4.5		0.1	7.8	13.0	5.15
	Non HT20, 6 to 54 Mbps	4	11	-1.3	3.9	4.5	3.6	0.1	9.2	12.0	2.75
	Non HT20 Beam Forming, 6 to 54 Mbps	2	8	-1.3	3.9			0.1	5.1	15.0	9.90
	Non HT20 Beam Forming, 6 to 54 Mbps	3	10	-1.3	0.3	1.4		0.1	5.1	13.0	7.90
	Non HT20 Beam Forming, 6 to 54 Mbps	4	11	-2.2	-1.5	-0.3	-1.3	0.1	4.8	12.0	7.20
	HT/VHT20, M0 to M7	1	5	-1.0				0.1	-0.9	17.0	17.95
	HT/VHT20, M0 to M7	2	8	-1.0	4.6			0.1	5.7	15.0	9.29
	HT/VHT20, M8 to M15	2	5	-1.0	4.6			0.1	5.7	17.0	11.29
	HT/VHT20, M0 to M7	3	10	-1.0	4.1	4.7		0.1	8.1	13.0	4.94
	HT/VHT20, M8 to M15	3	7	-1.0	4.1	4.7		0.1	8.1	16.0	7.94
	HT/VHT20, M16 to M23	3	5	-1.0	4.1	4.7		0.1	8.1	17.0	8.94
	HT/VHT20, M0 to M7	4	11	-1.0	2.5	3.5	2.9	0.1	8.4	12.0	3.65
	HT/VHT20, M8 to M15	4	8	-1.0	2.5	3.5	2.9	0.1	8.4	15.0	6.65
	HT/VHT20, M16 to M23	4	6	-1.0	2.5	3.5	2.9	0.1	8.4	17.0	8.65
	HT/VHT20, M24 to M31	4	5	-1.0	2.5	3.5	2.9	0.1	8.4	17.0	8.65
	HT/VHT20 Beam Forming, M0 to M7	2	8	-1.0	2.5			0.1	4.2	15.0	10.84
	HT/VHT20 Beam Forming, M8 to M15	2	5	-1.0	4.6			0.1	5.7	17.0	11.29
	HT/VHT20 Beam Forming, M0 to M7	3	10	-1.0	-0.2	0.5		0.1	4.6	13.0	8.37
	HT/VHT20 Beam Forming, M8 to M15	3	7	-1.0	2.5	3.5		0.1	6.9	16.0	9.12
	HT/VHT20 Beam Forming, M16 to M23	3	5	-1.0	4.1	4.7		0.1	8.1	17.0	8.94
	HT/VHT20 Beam Forming, M0 to M7	4	11	-2.2	-1.6	-0.6	-1.3	0.1	4.7	12.0	7.31
	HT/VHT20 Beam Forming, M8 to M15	4	8	-1.0	1.7	2.6	2.0	0.1	7.6	15.0	7.41
	HT/VHT20 Beam Forming, M16 to M23	4	6	-1.0	2.5	3.5	2.9	0.1	8.4	17.0	8.65
	HT/VHT20 Beam Forming, M24 to M31	4	5	-1.0	2.5	3.5	2.9	0.1	8.4	17.0	8.65
	HT/VHT20 STBC, M0 to M7	2	5	-1.0	4.6			0.1	5.7	17.0	11.29
	HT/VHT20 STBC, M0 to M7	3	7	-1.0	4.1	4.7		0.1	8.1	16.0	7.94
	HT/VHT20 STBC, M0 to M7	4	8	-1.0	2.5	3.5	2.9	0.1	8.4	15.0	6.65
	HE20, M0 to M9 1ss	1	5	-2.2				0.1	-2.1	17.0	19.13
	HE20, M0 to M9 1ss	2	8	-2.2	2.7			0.1	4.0	15.0	11.01
	HE20, M0 to M9 2ss	2	5	-2.2	2.7			0.1	4.0	17.0	13.01



	HE20, M0 to M9 1ss	3	10	-2.2	1.8	2.9		0.1	6.2	13.0	6.84
	HE20, M0 to M9 2ss	3	7	-2.2	1.8	2.9		0.1	6.2	16.0	9.84
	HE20, M0 to M9 3ss	3	5	-2.2	1.8	2.9		0.1	6.2	17.0	10.84
	HE20, M0 to M9 1ss	4	11	-2.2	1.8	2.9	1.9	0.1	7.6	12.0	4.44
	HE20, M0 to M9 2ss	4	8	-2.2	1.8	2.9	1.9	0.1	7.6	15.0	7.44
	HE20, M0 to M9 3ss	4	6	-2.2	1.8	2.9	1.9	0.1	7.6	17.0	9.44
	HE20, M0 to M9 4ss	4	5	-2.2	1.8	2.9	1.9	0.1	7.6	17.0	9.44
	HE20 Beam Forming, M0 to M9 1ss	2	8	-2.2	1.1			0.1	2.8	15.0	12.17
	HE20 Beam Forming, M0 to M9 2ss	2	5	-2.2	2.7			0.1	4.0	17.0	13.01
	HE20 Beam Forming, M0 to M9 1ss	3	10	-2.9	-2.5	-1.9		0.1	2.4	13.0	10.57
	HE20 Beam Forming, M0 to M9 2ss	3	7	-2.2	1.1	1.3		0.1	5.2	16.0	10.83
	HE20 Beam Forming, M0 to M9 3ss	3	5	-2.2	1.8	2.9		0.1	6.2	17.0	10.84
	HE20 Beam Forming, M0 to M9 1ss	4	11	-4.2	-3.6	-2.9	-3.6	0.1	2.5	12.0	9.46
	HE20 Beam Forming, M0 to M9 2ss	4	8	-2.2	-1.5	-0.6	-1.4	0.1	4.7	15.0	10.30
	HE20 Beam Forming, M0 to M9 3ss	4	6	-2.2	1.1	1.3	1.2	0.1	6.7	17.0	10.34
	HE20 Beam Forming, M0 to M9 4ss	4	5	-2.2	1.8	2.9	1.9	0.1	7.6	17.0	9.44
	HE20 STBC, M0 to M9 2ss	2	5	-2.2	2.7			0.1	4.0	17.0	13.01
	HE20 STBC, M0 to M9 2ss	3	7	-2.2	1.8	2.9		0.1	6.2	16.0	9.84
	HE20 STBC, M0 to M9 2ss	4	8	-2.2	1.8	2.9	1.9	0.1	7.6	15.0	7.44
5190	Non HT40, 6 to 54 Mbps	1	5	-5.4				0.0	-5.4	17.0	22.35
	Non HT40, 6 to 54 Mbps	2	8	-5.4	-5.0			0.0	-2.1	15.0	17.14
	Non HT40, 6 to 54 Mbps	3	10	-5.4	-5.0	-4.6		0.0	-0.2	13.0	13.17
	Non HT40, 6 to 54 Mbps	4	11	-5.4	-5.0	-4.6	-4.9	0.0	1.1	12.0	10.90
	HT/VHT40, M0 to M7	1	5	-4.6				0.1	-4.5	17.0	21.50
	HT/VHT40, M0 to M7	2	8	-5.1	-5.0			0.1	-1.9	15.0	16.94
	HT/VHT40, M8 to M15	2	5	-5.1	-5.0			0.1	-1.9	17.0	18.94
	HT/VHT40, M0 to M7	3	10	-5.1	-5.0	-4.2		0.1	0.1	13.0	12.87
	HT/VHT40, M8 to M15	3	7	-5.1	-5.0	-4.2		0.1	0.1	16.0	15.87
	HT/VHT40, M16 to M23	3	5	-5.1	-5.0	-4.2		0.1	0.1	17.0	16.87
	HT/VHT40, M0 to M7	4	11	-5.1	-5.0	-4.2	-5.2	0.1	1.3	12.0	10.73
	HT/VHT40, M8 to M15	4	8	-5.1	-5.0	-4.2	-5.2	0.1	1.3	15.0	13.73
	HT/VHT40, M16 to M23	4	6	-5.1	-5.0	-4.2	-5.2	0.1	1.3	17.0	15.73
	HT/VHT40, M24 to M31	4	5	-5.1	-5.0	-4.2	-5.2	0.1	1.3	17.0	15.73
	HT/VHT40 Beam Forming, M0 to M7	2	8	-5.1	-5.0			0.1	-1.9	15.0	16.94
	HT/VHT40 Beam Forming, M8 to M15	2	5	-5.1	-5.0			0.1	-1.9	17.0	18.94
	HT/VHT40 Beam Forming, M0 to M7	3	10	-6.7	-6.2	-5.3		0.1	-1.2	13.0	14.15
	HT/VHT40 Beam Forming, M8 to M15	3	7	-5.1	-5.0	-4.2		0.1	0.1	16.0	15.87
	HT/VHT40 Beam Forming, M16 to M23	3	5	-5.1	-5.0	-4.2		0.1	0.1	17.0	16.87
	HT/VHT40 Beam Forming, M0 to M7	4	11	-7.9	-7.0	-6.3	-7.1	0.1	-0.9	12.0	12.92
HT/VHT40 Beam Forming, M8 to M15	4	8	-6.7	-6.2	-5.3	-6.1	0.1	0.1	15.0	14.92	
HT/VHT40 Beam Forming, M16 to M23	4	6	-5.1	-5.0	-4.2	-5.2	0.1	1.3	17.0	15.73	
HT/VHT40 Beam Forming, M24 to M31	4	5	-5.1	-5.0	-4.2	-5.2	0.1	1.3	17.0	15.73	

	HT/VHT40 STBC, M0 to M7	2	5	-5.1	-5.0			0.1	-1.9	17.0	18.94
	HT/VHT40 STBC, M0 to M7	3	7	-5.1	-5.0	-4.2		0.1	0.1	16.0	15.87
	HT/VHT40 STBC, M0 to M7	4	8	-5.1	-5.0	-4.2	-5.2	0.1	1.3	15.0	13.73
	HE40, M0 to M9 1ss	1	5	-6.8				0.1	-6.7	17.0	23.67
	HE40, M0 to M9 1ss	2	8	-6.8	-5.9			0.1	-3.2	15.0	18.19
	HE40, M0 to M9 2ss	2	5	-6.8	-5.9			0.1	-3.2	17.0	20.19
	HE40, M0 to M9 1ss	3	10	-6.8	-5.9	-5.4		0.1	-1.1	13.0	14.10
	HE40, M0 to M9 2ss	3	7	-6.8	-5.9	-5.4		0.1	-1.1	16.0	17.10
	HE40, M0 to M9 3ss	3	5	-6.8	-5.9	-5.4		0.1	-1.1	17.0	18.10
	HE40, M0 to M9 1ss	4	11	-6.8	-5.9	-5.4	-5.7	0.1	0.2	12.0	11.77
	HE40, M0 to M9 2ss	4	8	-6.8	-5.9	-5.4	-5.7	0.1	0.2	15.0	14.77
	HE40, M0 to M9 3ss	4	6	-6.8	-5.9	-5.4	-5.7	0.1	0.2	17.0	16.77
	HE40, M0 to M9 4ss	4	5	-6.8	-5.9	-5.4	-5.7	0.1	0.2	17.0	16.77
	HE40 Beam Forming, M0 to M9 1ss	2	8	-7.7	-7.0			0.1	-4.2	15.0	19.20
	HE40 Beam Forming, M0 to M9 2ss	2	5	-6.8	-5.9			0.1	-3.2	17.0	20.19
	HE40 Beam Forming, M0 to M9 1ss	3	10	-7.7	-7.0	-6.4		0.1	-2.1	13.0	15.10
	HE40 Beam Forming, M0 to M9 2ss	3	7	-6.8	-5.9	-5.4		0.1	-1.1	16.0	17.10
	HE40 Beam Forming, M0 to M9 3ss	3	5	-6.8	-5.9	-5.4		0.1	-1.1	17.0	18.10
	HE40 Beam Forming, M0 to M9 1ss	4	11	-8.8	-7.8	-7.5	-8.4	0.1	-1.9	12.0	13.95
	HE40 Beam Forming, M0 to M9 2ss	4	8	-7.7	-7.0	-6.4	-7.0	0.1	-0.9	15.0	15.86
	HE40 Beam Forming, M0 to M9 3ss	4	6	-6.8	-5.9	-5.4	-5.7	0.1	0.2	17.0	16.77
	HE40 Beam Forming, M0 to M9 4ss	4	5	-6.8	-5.9	-5.4	-5.7	0.1	0.2	17.0	16.77
	HE40 STBC, M0 to M9 2ss	2	5	-6.8	-5.9			0.1	-3.2	17.0	20.19
	HE40 STBC, M0 to M9 2ss	3	7	-6.8	-5.9	-5.4		0.1	-1.1	16.0	17.10
	HE40 STBC, M0 to M9 2ss	4	8	-6.8	-5.9	-5.4	-5.7	0.1	0.2	15.0	14.77
5210	Non HT80, 6 to 54 Mbps	1	5	-7.2				0.1	-7.1	17.0	24.15
	Non HT80, 6 to 54 Mbps	2	8	-7.2	-6.8			0.1	-3.9	15.0	18.93
	Non HT80, 6 to 54 Mbps	3	10	-7.2	-6.8	-6.3		0.1	-1.9	13.0	14.93
	Non HT80, 6 to 54 Mbps	4	11	-8.5	-8.0	-7.7	-7.9	0.1	-1.9	12.0	13.94
	VHT80, M0 to M9 1ss	1	5	-8.0				0.2	-7.8	17.0	24.78
	VHT80, M0 to M9 1ss	2	8	-8.0	-7.6			0.2	-4.6	15.0	19.56
	VHT80, M0 to M9 2ss	2	5	-8.0	-7.6			0.2	-4.6	17.0	21.56
	VHT80, M0 to M9 1ss	3	10	-8.0	-7.6	-7.3		0.2	-2.6	13.0	15.63
	VHT80, M0 to M9 2ss	3	7	-8.0	-7.6	-7.3		0.2	-2.6	16.0	18.63
	VHT80, M0 to M9 3ss	3	5	-8.0	-7.6	-7.3		0.2	-2.6	17.0	19.63
	VHT80, M0 to M9 1ss	4	11	-8.0	-7.6	-7.3	-7.6	0.2	-1.4	12.0	13.37
	VHT80, M0 to M9 2ss	4	8	-8.0	-7.6	-7.3	-7.6	0.2	-1.4	15.0	16.37
	VHT80, M0 to M9 3ss	4	6	-8.0	-7.6	-7.3	-7.6	0.2	-1.4	17.0	18.37
	VHT80, M0 to M9 4ss	4	5	-8.0	-7.6	-7.3	-7.6	0.2	-1.4	17.0	18.37
	VHT80 Beam Forming, M0 to M9 1ss	2	8	-9.2	-8.7			0.2	-5.7	15.0	20.71
	VHT80 Beam Forming, M0 to M9 2ss	2	5	-8.0	-7.6			0.2	-4.6	17.0	21.56
VHT80 Beam Forming, M0 to M9 1ss	3	10	-9.2	-8.7	-8.3		0.2	-3.7	13.0	16.72	

VHT80 Beam Forming, M0 to M9 2ss	3	7	-9.2	-8.7	-8.3			0.2	-3.7	16.0	19.72		
VHT80 Beam Forming, M0 to M9 3ss	3	5	-8.0	-7.6	-7.3			0.2	-2.6	17.0	19.63		
VHT80 Beam Forming, M0 to M9 1ss	4	11	-10.1	-9.2	-9.2	-9.5		0.2	-3.2	12.0	15.24		
VHT80 Beam Forming, M0 to M9 2ss	4	8	-9.2	-8.7	-8.3	-8.7		0.2	-2.5	15.0	17.47		
VHT80 Beam Forming, M0 to M9 3ss	4	6	-9.2	-8.7	-8.3	-8.7		0.2	-2.5	17.0	19.47		
VHT80 Beam Forming, M0 to M9 4ss	4	5	-8.0	-7.6	-7.3	-7.6		0.2	-1.4	17.0	18.37		
VHT80 STBC, M0 to M9 1ss	2	5	-8.0	-7.6				0.2	-4.6	17.0	21.56		
VHT80 STBC, M0 to M9 1ss	3	5	-8.0	-7.6	-7.3			0.2	-2.6	17.0	19.63		
VHT80 STBC, M0 to M9 1ss	4	5	-8.0	-7.6	-7.3	-7.6		0.2	-1.4	17.0	18.37		
HE80, M0 to M9 1ss	1	5	-9.0					0.3	-8.7	17.0	25.75		
HE80, M0 to M9 1ss	2	8	-9.0	-8.6				0.3	-5.5	15.0	20.53		
HE80, M0 to M9 2ss	2	5	-9.0	-8.6				0.3	-5.5	17.0	22.53		
HE80, M0 to M9 1ss	3	10	-9.0	-8.6	-8.0			0.3	-3.5	13.0	16.49		
HE80, M0 to M9 2ss	3	7	-9.0	-8.6	-8.0			0.3	-3.5	16.0	19.49		
HE80, M0 to M9 3ss	3	5	-9.0	-8.6	-8.0			0.3	-3.5	17.0	20.49		
HE80, M0 to M9 1ss	4	11	-9.0	-8.6	-8.0	-8.9		0.3	-2.3	12.0	14.34		
HE80, M0 to M9 2ss	4	8	-9.0	-8.6	-8.0	-8.9		0.3	-2.3	15.0	17.34		
HE80, M0 to M9 3ss	4	6	-9.0	-8.6	-8.0	-8.9		0.3	-2.3	17.0	19.34		
HE80, M0 to M9 4ss	4	5	-9.0	-8.6	-8.0	-8.9		0.3	-2.3	17.0	19.34		
HE80 Beam Forming, M0 to M9 1ss	2	8	-10.1	-9.7				0.3	-6.6	15.0	21.63		
HE80 Beam Forming, M0 to M9 2ss	2	5	-9.0	-8.6				0.3	-5.5	17.0	22.53		
HE80 Beam Forming, M0 to M9 1ss	3	10	-10.1	-9.7	-9.5			0.3	-4.7	13.0	17.74		
HE80 Beam Forming, M0 to M9 2ss	3	7	-10.1	-9.7	-9.5			0.3	-4.7	16.0	20.74		
HE80 Beam Forming, M0 to M9 3ss	3	5	-9.0	-8.6	-8.0			0.3	-3.5	17.0	20.49		
HE80 Beam Forming, M0 to M9 1ss	4	11	-10.5	-10.1	-10.3	-10.7		0.3	-4.1	12.0	16.12		
HE80 Beam Forming, M0 to M9 2ss	4	8	-10.1	-9.7	-9.5	-10.0		0.3	-3.5	15.0	18.55		
HE80 Beam Forming, M0 to M9 3ss	4	6	-10.1	-9.7	-9.5	-10.0		0.3	-3.5	17.0	20.55		
HE80 Beam Forming, M0 to M9 4ss	4	5	-9.0	-8.6	-8.0	-8.9		0.3	-2.3	17.0	19.34		
HE80 STBC, M0 to M9 1ss	2	5	-9.0	-8.6				0.3	-5.5	17.0	22.53		
HE80 STBC, M0 to M9 1ss	3	5	-9.0	-8.6	-8.0			0.3	-3.5	17.0	20.49		
HE80 STBC, M0 to M9 1ss	4	5	-9.0	-8.6	-8.0	-8.9		0.3	-2.3	17.0	19.34		
5220	Non HT20, 6 to 54 Mbps	1	5	-1.1					0.1	-1.0	17.0	18.05	
	Non HT20, 6 to 54 Mbps	2	8	-1.1	4.6				0.1	5.7	15.0	9.31	
	Non HT20, 6 to 54 Mbps	3	10	-1.1	4.6	4.9			0.1	8.3	13.0	4.65	
	Non HT20, 6 to 54 Mbps	4	11	-1.1	4.6	4.9	5.1		0.1	10.0	12.0	1.95	
	Non HT20 Beam Forming, 6 to 54 Mbps	2	8	-1.1	4.6				0.1	5.7	15.0	9.31	
	Non HT20 Beam Forming, 6 to 54 Mbps	3	10	-1.1	4.6	4.9			0.1	8.3	13.0	4.65	
	Non HT20 Beam Forming, 6 to 54 Mbps	4	11	-1.1	4.6	4.9	5.1		0.1	10.0	12.0	1.95	
	HT/VHT20, M0 to M7	1	5	-1.5						0.1	-1.4	17.0	18.45
	HT/VHT20, M0 to M7	2	8	-1.5	4.2					0.1	5.3	15.0	9.71
	HT/VHT20, M8 to M15	2	5	-1.5	4.2					0.1	5.3	17.0	11.71
HT/VHT20, M0 to M7	3	10	-1.5	4.2	4.9				0.1	8.1	13.0	4.87	

HT/VHT20, M8 to M15	3	7	-1.5	4.2	4.9		0.1	8.1	16.0	7.87
HT/VHT20, M16 to M23	3	5	-1.5	4.2	4.9		0.1	8.1	17.0	8.87
HT/VHT20, M0 to M7	4	11	-1.5	4.2	4.9	4.6	0.1	9.7	12.0	2.26
HT/VHT20, M8 to M15	4	8	-1.5	4.2	4.9	4.6	0.1	9.7	15.0	5.26
HT/VHT20, M16 to M23	4	6	-1.5	4.2	4.9	4.6	0.1	9.7	17.0	7.26
HT/VHT20, M24 to M31	4	5	-1.5	4.2	4.9	4.6	0.1	9.7	17.0	7.26
HT/VHT20 Beam Forming, M0 to M7	2	8	-1.5	4.2			0.1	5.3	15.0	9.71
HT/VHT20 Beam Forming, M8 to M15	2	5	-1.5	4.2			0.1	5.3	17.0	11.71
HT/VHT20 Beam Forming, M0 to M7	3	10	-1.5	4.2	4.9		0.1	8.1	13.0	4.87
HT/VHT20 Beam Forming, M8 to M15	3	7	-1.5	4.2	4.9		0.1	8.1	16.0	7.87
HT/VHT20 Beam Forming, M16 to M23	3	5	-1.5	4.2	4.9		0.1	8.1	17.0	8.87
HT/VHT20 Beam Forming, M0 to M7	4	11	-1.5	4.2	4.9	4.6	0.1	9.7	12.0	2.26
HT/VHT20 Beam Forming, M8 to M15	4	8	-1.5	4.2	4.9	4.6	0.1	9.7	15.0	5.26
HT/VHT20 Beam Forming, M16 to M23	4	6	-1.5	4.2	4.9	4.6	0.1	9.7	17.0	7.26
HT/VHT20 Beam Forming, M24 to M31	4	5	-1.5	4.2	4.9	4.6	0.1	9.7	17.0	7.26
HT/VHT20 STBC, M0 to M7	2	5	-1.5	4.2			0.1	5.3	17.0	11.71
HT/VHT20 STBC, M0 to M7	3	7	-1.5	4.2	4.9		0.1	8.1	16.0	7.87
HT/VHT20 STBC, M0 to M7	4	8	-1.5	4.2	4.9	4.6	0.1	9.7	15.0	5.26
HE20, M0 to M9 1ss	1	5	-1.3				0.1	-1.2	17.0	18.23
HE20, M0 to M9 1ss	2	8	-1.3	4.4			0.1	5.5	15.0	9.50
HE20, M0 to M9 2ss	2	5	-1.3	4.4			0.1	5.5	17.0	11.50
HE20, M0 to M9 1ss	3	10	-1.3	4.4	5.0		0.1	8.3	13.0	4.70
HE20, M0 to M9 2ss	3	7	-1.3	4.4	5.0		0.1	8.3	16.0	7.70
HE20, M0 to M9 3ss	3	5	-1.3	4.4	5.0		0.1	8.3	17.0	8.70
HE20, M0 to M9 1ss	4	11	-1.3	4.4	5.0	4.9	0.1	10.0	12.0	2.04
HE20, M0 to M9 2ss	4	8	-1.3	4.4	5.0	4.9	0.1	10.0	15.0	5.04
HE20, M0 to M9 3ss	4	6	-1.3	4.4	5.0	4.9	0.1	10.0	17.0	7.04
HE20, M0 to M9 4ss	4	5	-1.3	4.4	5.0	4.9	0.1	10.0	17.0	7.04
HE20 Beam Forming, M0 to M9 1ss	2	8	-1.3	4.4			0.1	5.5	15.0	9.50
HE20 Beam Forming, M0 to M9 2ss	2	5	-1.3	4.4			0.1	5.5	17.0	11.50
HE20 Beam Forming, M0 to M9 1ss	3	10	-1.3	4.4	5.0		0.1	8.3	13.0	4.70
HE20 Beam Forming, M0 to M9 2ss	3	7	-1.3	4.4	5.0		0.1	8.3	16.0	7.70
HE20 Beam Forming, M0 to M9 3ss	3	5	-1.3	4.4	5.0		0.1	8.3	17.0	8.70
HE20 Beam Forming, M0 to M9 1ss	4	11	-1.3	4.4	5.0	4.9	0.1	10.0	12.0	2.04
HE20 Beam Forming, M0 to M9 2ss	4	8	-1.3	4.4	5.0	4.9	0.1	10.0	15.0	5.04
HE20 Beam Forming, M0 to M9 3ss	4	6	-1.3	4.4	5.0	4.9	0.1	10.0	17.0	7.04
HE20 Beam Forming, M0 to M9 4ss	4	5	-1.3	4.4	5.0	4.9	0.1	10.0	17.0	7.04
HE20 STBC, M0 to M9 2ss	2	5	-1.3	4.4			0.1	5.5	17.0	11.50
HE20 STBC, M0 to M9 2ss	3	7	-1.3	4.4	5.0		0.1	8.3	16.0	7.70
HE20 STBC, M0 to M9 2ss	4	8	-1.3	4.4	5.0	4.9	0.1	10.0	15.0	5.04

5230	Non HT40, 6 to 54 Mbps	1	5	-3.6				0.0	-3.6	17.0	20.55
	Non HT40, 6 to 54 Mbps	2	8	-3.6	1.8			0.0	2.9	15.0	12.05
	Non HT40, 6 to 54 Mbps	3	10	-3.6	1.8	2.6		0.0	5.8	13.0	7.19
	Non HT40, 6 to 54 Mbps	4	11	-3.6	1.8	2.6	1.9	0.0	7.3	12.0	4.69
	HT/VHT40, M0 to M7	1	5	-4.1				0.1	-4.0	17.0	21.00
	HT/VHT40, M0 to M7	2	8	-4.1	1.3			0.1	2.5	15.0	12.50
	HT/VHT40, M8 to M15	2	5	-4.1	1.3			0.1	2.5	17.0	14.50
	HT/VHT40, M0 to M7	3	10	-4.1	1.3	1.8		0.1	5.2	13.0	7.78
	HT/VHT40, M8 to M15	3	7	-4.1	1.3	1.8		0.1	5.2	16.0	10.78
	HT/VHT40, M16 to M23	3	5	-4.1	1.3	1.8		0.1	5.2	17.0	11.78
	HT/VHT40, M0 to M7	4	11	-4.1	1.3	1.8	1.5	0.1	6.8	12.0	5.21
	HT/VHT40, M8 to M15	4	8	-4.1	1.3	1.8	1.5	0.1	6.8	15.0	8.21
	HT/VHT40, M16 to M23	4	6	-4.1	1.3	1.8	1.5	0.1	6.8	17.0	10.21
	HT/VHT40, M24 to M31	4	5	-4.1	1.3	1.8	1.5	0.1	6.8	17.0	10.21
	HT/VHT40 Beam Forming, M0 to M7	2	8	-4.1	1.3			0.1	2.5	15.0	12.50
	HT/VHT40 Beam Forming, M8 to M15	2	5	-4.1	1.3			0.1	2.5	17.0	14.50
	HT/VHT40 Beam Forming, M0 to M7	3	10	-4.1	1.3	1.8		0.1	5.2	13.0	7.78
	HT/VHT40 Beam Forming, M8 to M15	3	7	-4.1	1.3	1.8		0.1	5.2	16.0	10.78
	HT/VHT40 Beam Forming, M16 to M23	3	5	-4.1	1.3	1.8		0.1	5.2	17.0	11.78
	HT/VHT40 Beam Forming, M0 to M7	4	11	-4.1	1.3	1.8	1.5	0.1	6.8	12.0	5.21
	HT/VHT40 Beam Forming, M8 to M15	4	8	-4.1	1.3	1.8	1.5	0.1	6.8	15.0	8.21
	HT/VHT40 Beam Forming, M16 to M23	4	6	-4.1	1.3	1.8	1.5	0.1	6.8	17.0	10.21
	HT/VHT40 Beam Forming, M24 to M31	4	5	-4.1	1.3	1.8	1.5	0.1	6.8	17.0	10.21
	HT/VHT40 STBC, M0 to M7	2	5	-4.1	1.3			0.1	2.5	17.0	14.50
	HT/VHT40 STBC, M0 to M7	3	7	-4.1	1.3	1.8		0.1	5.2	16.0	10.78
	HT/VHT40 STBC, M0 to M7	4	8	-4.1	1.3	1.8	1.5	0.1	6.8	15.0	8.21
	HE40, M0 to M9 1ss	1	5	-4.2				0.1	-4.1	17.0	21.07
	HE40, M0 to M9 1ss	2	8	-4.2	1.5			0.1	2.7	15.0	12.34
	HE40, M0 to M9 2ss	2	5	-4.2	1.5			0.1	2.7	17.0	14.34
	HE40, M0 to M9 1ss	3	10	-4.2	1.5	2.2		0.1	5.5	13.0	7.49
	HE40, M0 to M9 2ss	3	7	-4.2	1.5	2.2		0.1	5.5	16.0	10.49
	HE40, M0 to M9 3ss	3	5	-4.2	1.5	2.2		0.1	5.5	17.0	11.49
	HE40, M0 to M9 1ss	4	11	-4.2	1.5	2.2	1.8	0.1	7.1	12.0	4.91
	HE40, M0 to M9 2ss	4	8	-4.2	1.5	2.2	1.8	0.1	7.1	15.0	7.91
	HE40, M0 to M9 3ss	4	6	-4.2	1.5	2.2	1.8	0.1	7.1	17.0	9.91
	HE40, M0 to M9 4ss	4	5	-4.2	1.5	2.2	1.8	0.1	7.1	17.0	9.91
	HE40 Beam Forming, M0 to M9 1ss	2	8	-4.2	1.5			0.1	2.7	15.0	12.34
	HE40 Beam Forming, M0 to M9 2ss	2	5	-4.2	1.5			0.1	2.7	17.0	14.34
	HE40 Beam Forming, M0 to M9 1ss	3	10	-4.2	1.5	2.2		0.1	5.5	13.0	7.49
	HE40 Beam Forming, M0 to M9 2ss	3	7	-4.2	1.5	2.2		0.1	5.5	16.0	10.49
	HE40 Beam Forming, M0 to M9 3ss	3	5	-4.2	1.5	2.2		0.1	5.5	17.0	11.49
	HE40 Beam Forming, M0 to M9 1ss	4	11	-4.2	1.5	2.2	1.8	0.1	7.1	12.0	4.91
	HE40 Beam Forming, M0 to M9 2ss	4	8	-4.2	1.5	2.2	1.8	0.1	7.1	15.0	7.91

	HE40 Beam Forming, M0 to M9 3ss	4	6	-4.2	1.5	2.2	1.8	0.1	7.1	17.0	9.91	
	HE40 Beam Forming, M0 to M9 4ss	4	5	-4.2	1.5	2.2	1.8	0.1	7.1	17.0	9.91	
	HE40 STBC, M0 to M9 2ss	2	5	-4.2	1.5			0.1	2.7	17.0	14.34	
	HE40 STBC, M0 to M9 2ss	3	7	-4.2	1.5	2.2		0.1	5.5	16.0	10.49	
	HE40 STBC, M0 to M9 2ss	4	8	-4.2	1.5	2.2	1.8	0.1	7.1	15.0	7.91	
5240	Non HT20, 6 to 54 Mbps	1	5	-0.8				0.1	-0.7	17.0	17.75	
	Non HT20, 6 to 54 Mbps	2	8	-0.8	4.9			0.1	6.0	15.0	9.01	
	Non HT20, 6 to 54 Mbps	3	10	-0.8	4.9	5.1		0.1	8.6	13.0	4.40	
	Non HT20, 6 to 54 Mbps	4	11	-0.8	4.9	5.1	4.5	0.1	10.0	12.0	1.96	
	Non HT20 Beam Forming, 6 to 54 Mbps	2	8	-0.8	4.9			0.1	6.0	15.0	9.01	
	Non HT20 Beam Forming, 6 to 54 Mbps	3	10	-0.8	4.9	5.1		0.1	8.6	13.0	4.40	
	Non HT20 Beam Forming, 6 to 54 Mbps	4	11	-0.8	4.9	5.1	4.5	0.1	10.0	12.0	1.96	
	HT/VHT20, M0 to M7	1	5	-1.0					0.1	-0.9	17.0	17.95
	HT/VHT20, M0 to M7	2	8	-1.0	4.3				0.1	5.5	15.0	9.52
	HT/VHT20, M8 to M15	2	5	-1.0	4.3				0.1	5.5	17.0	11.52
	HT/VHT20, M0 to M7	3	10	-1.0	4.3	4.8			0.1	8.2	13.0	4.81
	HT/VHT20, M8 to M15	3	7	-1.0	4.3	4.8			0.1	8.2	16.0	7.81
	HT/VHT20, M16 to M23	3	5	-1.0	4.3	4.8			0.1	8.2	17.0	8.81
	HT/VHT20, M0 to M7	4	11	-1.0	4.3	4.8	4.4		0.1	9.7	12.0	2.28
	HT/VHT20, M8 to M15	4	8	-1.0	4.3	4.8	4.4		0.1	9.7	15.0	5.28
	HT/VHT20, M16 to M23	4	6	-1.0	4.3	4.8	4.4		0.1	9.7	17.0	7.28
	HT/VHT20, M24 to M31	4	5	-1.0	4.3	4.8	4.4		0.1	9.7	17.0	7.28
	HT/VHT20 Beam Forming, M0 to M7	2	8	-1.0	4.3				0.1	5.5	15.0	9.52
	HT/VHT20 Beam Forming, M8 to M15	2	5	-1.0	4.3				0.1	5.5	17.0	11.52
	HT/VHT20 Beam Forming, M0 to M7	3	10	-1.0	4.3	4.8			0.1	8.2	13.0	4.81
	HT/VHT20 Beam Forming, M8 to M15	3	7	-1.0	4.3	4.8			0.1	8.2	16.0	7.81
	HT/VHT20 Beam Forming, M16 to M23	3	5	-1.0	4.3	4.8			0.1	8.2	17.0	8.81
	HT/VHT20 Beam Forming, M0 to M7	4	11	-1.0	4.3	4.8	4.4		0.1	9.7	12.0	2.28
	HT/VHT20 Beam Forming, M8 to M15	4	8	-1.0	4.3	4.8	4.4		0.1	9.7	15.0	5.28
	HT/VHT20 Beam Forming, M16 to M23	4	6	-1.0	4.3	4.8	4.4		0.1	9.7	17.0	7.28
	HT/VHT20 Beam Forming, M24 to M31	4	5	-1.0	4.3	4.8	4.4		0.1	9.7	17.0	7.28
	HT/VHT20 STBC, M0 to M7	2	5	-1.0	4.3				0.1	5.5	17.0	11.52
	HT/VHT20 STBC, M0 to M7	3	7	-1.0	4.3	4.8			0.1	8.2	16.0	7.81
	HT/VHT20 STBC, M0 to M7	4	8	-1.0	4.3	4.8	4.4		0.1	9.7	15.0	5.28
	HE20, M0 to M9 1ss	1	5	-1.2					0.1	-1.1	17.0	18.13
	HE20, M0 to M9 1ss	2	8	-1.2	4.4				0.1	5.5	15.0	9.48
	HE20, M0 to M9 2ss	2	5	-1.2	4.4				0.1	5.5	17.0	11.48
	HE20, M0 to M9 1ss	3	10	-1.2	4.4	5.1			0.1	8.4	13.0	4.64
	HE20, M0 to M9 2ss	3	7	-1.2	4.4	5.1			0.1	8.4	16.0	7.64
HE20, M0 to M9 3ss	3	5	-1.2	4.4	5.1			0.1	8.4	17.0	8.64	
HE20, M0 to M9 1ss	4	11	-1.2	4.4	5.1	4.2		0.1	9.8	12.0	2.21	
HE20, M0 to M9 2ss	4	8	-1.2	4.4	5.1	4.2		0.1	9.8	15.0	5.21	

	HE20, M0 to M9 3ss	4	6	-1.2	4.4	5.1	4.2	0.1	9.8	17.0	7.21
	HE20, M0 to M9 4ss	4	5	-1.2	4.4	5.1	4.2	0.1	9.8	17.0	7.21
	HE20 Beam Forming, M0 to M9 1ss	2	8	-1.2	4.4			0.1	5.5	15.0	9.48
	HE20 Beam Forming, M0 to M9 2ss	2	5	-1.2	4.4			0.1	5.5	17.0	11.48
	HE20 Beam Forming, M0 to M9 1ss	3	10	-1.2	4.4	5.1		0.1	8.4	13.0	4.64
	HE20 Beam Forming, M0 to M9 2ss	3	7	-1.2	4.4	5.1		0.1	8.4	16.0	7.64
	HE20 Beam Forming, M0 to M9 3ss	3	5	-1.2	4.4	5.1		0.1	8.4	17.0	8.64
	HE20 Beam Forming, M0 to M9 1ss	4	11	-1.2	4.4	5.1	4.2	0.1	9.8	12.0	2.21
	HE20 Beam Forming, M0 to M9 2ss	4	8	-1.2	4.4	5.1	4.2	0.1	9.8	15.0	5.21
	HE20 Beam Forming, M0 to M9 3ss	4	6	-1.2	4.4	5.1	4.2	0.1	9.8	17.0	7.21
	HE20 Beam Forming, M0 to M9 4ss	4	5	-1.2	4.4	5.1	4.2	0.1	9.8	17.0	7.21
	HE20 STBC, M0 to M9 2ss	2	5	-1.2	4.4			0.1	5.5	17.0	11.48
	HE20 STBC, M0 to M9 2ss	3	7	-1.2	4.4	5.1		0.1	8.4	16.0	7.64
	HE20 STBC, M0 to M9 2ss	4	8	-1.2	4.4	5.1	4.2	0.1	9.8	15.0	5.21
5250	Non HT160, 6 to 54 Mbps	1	5	-10.8				0.0	-10.8	17.0	27.75
	Non HT160, 6 to 54 Mbps	2	8	-10.8	-10.7			0.0	-7.7	15.0	22.69
	Non HT160, 6 to 54 Mbps	3	10	-10.8	-10.7	-9.4		0.0	-5.4	13.0	18.43
	Non HT160, 6 to 54 Mbps	4	11	-10.8	-10.7	-9.4	-10.6	0.0	-4.3	12.0	16.27
	VHT160, M0 to M9 1ss	1	5	-10.1				0.4	-9.7	17.0	26.71
	VHT160, M0 to M9 1ss	2	8	-10.1	-10.5			0.4	-6.9	15.0	21.89
	VHT160, M0 to M9 2ss	2	5	-10.1	-10.5			0.4	-6.9	17.0	23.89
	VHT160, M0 to M9 1ss	3	10	-11.3	-11.3	-11.4		0.4	-6.2	13.0	19.17
	VHT160, M0 to M9 2ss	3	7	-11.3	-11.3	-11.4		0.4	-6.2	16.0	22.17
	VHT160, M0 to M9 3ss	3	5	-11.3	-11.3	-11.4		0.4	-6.2	17.0	23.17
	VHT160, M0 to M9 1ss	4	11	-11.3	-11.3	-11.4	-11.2	0.4	-4.9	12.0	16.89
	VHT160, M0 to M9 2ss	4	8	-11.3	-11.3	-11.4	-11.2	0.4	-4.9	15.0	19.89
	VHT160, M0 to M9 3ss	4	6	-11.3	-11.3	-11.4	-11.2	0.4	-4.9	17.0	21.89
	VHT160, M0 to M9 4ss	4	5	-11.3	-11.3	-11.4	-11.2	0.4	-4.9	17.0	21.89
	VHT160 Beam Forming, M0 to M9 1ss	2	8	-11.3	-11.3			0.4	-7.9	15.0	22.90
	VHT160 Beam Forming, M0 to M9 2ss	2	5	-10.1	-10.5			0.4	-6.9	17.0	23.89
	VHT160 Beam Forming, M0 to M9 1ss	3	10	-12.3	-12.6	-12.5		0.4	-7.3	13.0	20.30
	VHT160 Beam Forming, M0 to M9 2ss	3	7	-11.3	-11.3	-11.4		0.4	-6.2	16.0	22.17
	VHT160 Beam Forming, M0 to M9 3ss	3	5	-11.3	-11.3	-11.4		0.4	-6.2	17.0	23.17
	VHT160 Beam Forming, M0 to M9 1ss	4	11	-12.9	-13.2	-13.2	-13.7	0.4	-6.8	12.0	18.83
	VHT160 Beam Forming, M0 to M9 2ss	4	8	-11.3	-11.3	-11.4	-11.2	0.4	-4.9	15.0	19.89
	VHT160 Beam Forming, M0 to M9 3ss	4	6	-11.3	-11.3	-11.4	-11.2	0.4	-4.9	17.0	21.89
	VHT160 Beam Forming, M0 to M9 4ss	4	5	-11.3	-11.3	-11.4	-11.2	0.4	-4.9	17.0	21.89
	VHT160 STBC, M0 to M9 1ss	2	5	-10.1	-10.5			0.4	-6.9	17.0	23.89
	VHT160 STBC, M0 to M9 1ss	3	5	-11.3	-11.3	-11.4		0.4	-6.2	17.0	23.17
	VHT160 STBC, M0 to M9 1ss	4	5	-11.3	-11.3	-11.4	-11.2	0.4	-4.9	17.0	21.89
	HE160, M0 to M9 1ss	1	5	-10.5				0.4	-10.1	17.0	27.07
	HE160, M0 to M9 1ss	2	8	-10.5	-11.5			0.4	-7.5	15.0	22.53



HE160, M0 to M9 2ss	2	5	-10.5	-11.5			0.4	-7.5	17.0	24.53
HE160, M0 to M9 1ss	3	10	-10.5	-11.5	-11.3		0.4	-5.9	13.0	18.87
HE160, M0 to M9 2ss	3	7	-10.5	-11.5	-11.3		0.4	-5.9	16.0	21.87
HE160, M0 to M9 3ss	3	5	-10.5	-11.5	-11.3		0.4	-5.9	17.0	22.87
HE160, M0 to M9 1ss	4	11	-10.5	-11.5	-11.3	-11.3	0.4	-4.7	12.0	16.68
HE160, M0 to M9 2ss	4	8	-10.5	-11.5	-11.3	-11.3	0.4	-4.7	15.0	19.68
HE160, M0 to M9 3ss	4	6	-10.5	-11.5	-11.3	-11.3	0.4	-4.7	17.0	21.68
HE160, M0 to M9 4ss	4	5	-10.5	-11.5	-11.3	-11.3	0.4	-4.7	17.0	21.68
HE160 Beam Forming, M0 to M9 1ss	2	8	-10.5	-11.5			0.4	-7.5	15.0	22.53
HE160 Beam Forming, M0 to M9 2ss	2	5	-10.5	-11.5			0.4	-7.5	17.0	24.53
HE160 Beam Forming, M0 to M9 1ss	3	10	-12.3	-12.8	-12.4		0.4	-7.3	13.0	20.29
HE160 Beam Forming, M0 to M9 2ss	3	7	-10.5	-11.5	-11.3		0.4	-5.9	16.0	21.87
HE160 Beam Forming, M0 to M9 3ss	3	5	-10.5	-11.5	-11.3		0.4	-5.9	17.0	22.87
HE160 Beam Forming, M0 to M9 1ss	4	11	-13.2	-13.3	-12.8	-13.5	0.4	-6.7	12.0	18.74
HE160 Beam Forming, M0 to M9 2ss	4	8	-12.3	-12.8	-12.4	-12.8	0.4	-6.1	15.0	21.11
HE160 Beam Forming, M0 to M9 3ss	4	6	-10.5	-11.5	-11.3	-11.3	0.4	-4.7	17.0	21.68
HE160 Beam Forming, M0 to M9 4ss	4	5	-10.5	-11.5	-11.3	-11.3	0.4	-4.7	17.0	21.68
HE160 STBC, M0 to M9 1ss	2	5	-10.5	-11.5			0.4	-7.5	17.0	24.53
HE160 STBC, M0 to M9 1ss	3	5	-10.5	-11.5	-11.3		0.4	-5.9	17.0	22.87
HE160 STBC, M0 to M9 1ss	4	5	-10.5	-11.5	-11.3	-11.3	0.4	-4.7	17.0	21.68

**Power Spectral Density, 5dBi
5220 MHz, Non HT20, 6 to 54 Mbps**



Antenna A

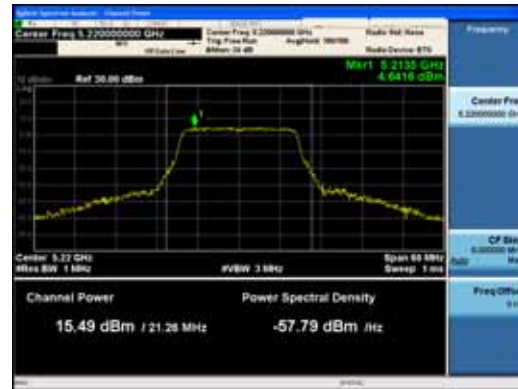

Antenna B



Antenna C



Antenna D

Power Spectral Density, 6dBi

Frequency (MHz)	Mode	Tx Paths	Correlated Antenna Gain (dBi)	Tx 1 PSD (dBm/MHz)	Tx 2 PSD (dBm/MHz)	Tx 3 PSD (dBm/MHz)	Tx 4 PSD (dBm/MHz)	Duty Cycle Correction (dB)	Total PSD (dBm/MHz)	Limit (dBm/MHz)	Margin (dB)
5180	Non HT20, 6 to 54 Mbps	1	6	-1.3				0.1	-1.2	17.0	18.25
	Non HT20, 6 to 54 Mbps	2	9	-1.3	4.9			0.1	5.9	14.0	8.11
	Non HT20, 6 to 54 Mbps	3	11	-1.3	3.9	4.5		0.1	7.8	12.0	4.15
	Non HT20, 6 to 54 Mbps	4	12	-1.3	2.6	3.4	2.6	0.1	8.2	11.0	2.77
	Non HT20 Beam Forming, 6 to 54 Mbps	2	9	-1.3	3.9			0.1	5.1	14.0	8.90
	Non HT20 Beam Forming, 6 to 54 Mbps	3	11	-1.3	0.3	1.4		0.1	5.1	12.0	6.90
	Non HT20 Beam Forming, 6 to 54 Mbps	4	12	-2.2	-1.5	-0.3	-1.3	0.1	4.8	11.0	6.20
	HT/VHT20, M0 to M7	1	6	-1.0				0.1	-0.9	17.0	17.95
	HT/VHT20, M0 to M7	2	9	-1.0	4.1			0.1	5.3	14.0	8.68
	HT/VHT20, M8 to M15	2	6	-1.0	4.1			0.1	5.3	17.0	11.68
	HT/VHT20, M0 to M7	3	11	-1.0	2.5	3.5		0.1	6.9	12.0	5.12
	HT/VHT20, M8 to M15	3	8	-1.0	2.5	3.5		0.1	6.9	15.0	8.12
	HT/VHT20, M16 to M23	3	6	-1.0	2.5	3.5		0.1	6.9	17.0	10.12
	HT/VHT20, M0 to M7	4	12	-1.0	2.5	3.5	2.9	0.1	8.4	11.0	2.65
	HT/VHT20, M8 to M15	4	9	-1.0	2.5	3.5	2.9	0.1	8.4	14.0	5.65
	HT/VHT20, M16 to M23	4	7	-1.0	2.5	3.5	2.9	0.1	8.4	16.0	7.65
	HT/VHT20, M24 to M31	4	6	-1.0	2.5	3.5	2.9	0.1	8.4	17.0	8.65
	HT/VHT20 Beam Forming, M0 to M7	2	9	-1.0	2.5			0.1	4.2	14.0	9.84
	HT/VHT20 Beam Forming, M8 to M15	2	6	-1.0	4.1			0.1	5.3	17.0	11.68
	HT/VHT20 Beam Forming, M0 to M7	3	11	-2.2	-1.6	-0.6		0.1	3.4	12.0	8.59
	HT/VHT20 Beam Forming, M8 to M15	3	8	-1.0	1.7	2.6		0.1	6.2	15.0	8.83
	HT/VHT20 Beam Forming, M16 to M23	3	6	-1.0	2.5	3.5		0.1	6.9	17.0	10.12
	HT/VHT20 Beam Forming, M0 to M7	4	12	-2.2	-1.6	-0.6	-1.3	0.1	4.7	11.0	6.31
	HT/VHT20 Beam Forming, M8 to M15	4	9	-1.0	0.4	1.6	1.2	0.1	6.7	14.0	7.27
	HT/VHT20 Beam Forming, M16 to M23	4	7	-1.0	2.5	3.5	2.9	0.1	8.4	16.0	7.65
	HT/VHT20 Beam Forming, M24 to M31	4	6	-1.0	2.5	3.5	2.9	0.1	8.4	17.0	8.65
	HT/VHT20 STBC, M0 to M7	2	6	-1.0	4.1			0.1	5.3	17.0	11.68
	HT/VHT20 STBC, M0 to M7	3	8	-1.0	2.5	3.5		0.1	6.9	15.0	8.12
	HT/VHT20 STBC, M0 to M7	4	9	-1.0	2.5	3.5	2.9	0.1	8.4	14.0	5.65
	HE20, M0 to M9 1ss	1	6	-2.2				0.1	-2.1	17.0	19.13
	HE20, M0 to M9 1ss	2	9	-2.2	2.7			0.1	4.0	14.0	10.01
	HE20, M0 to M9 2ss	2	6	-2.2	2.7			0.1	4.0	17.0	13.01



	HE20, M0 to M9 1ss	3	11	-2.2	1.8	2.9		0.1	6.2	12.0	5.84
	HE20, M0 to M9 2ss	3	8	-2.2	1.8	2.9		0.1	6.2	15.0	8.84
	HE20, M0 to M9 3ss	3	6	-2.2	1.8	2.9		0.1	6.2	17.0	10.84
	HE20, M0 to M9 1ss	4	12	-2.2	1.1	1.3	1.2	0.1	6.7	11.0	4.34
	HE20, M0 to M9 2ss	4	9	-2.2	1.1	1.3	1.2	0.1	6.7	14.0	7.34
	HE20, M0 to M9 3ss	4	7	-2.2	1.1	1.3	1.2	0.1	6.7	16.0	9.34
	HE20, M0 to M9 4ss	4	6	-2.2	1.1	1.3	1.2	0.1	6.7	17.0	10.34
	HE20 Beam Forming, M0 to M9 1ss	2	9	-2.9	-2.5			0.1	0.4	14.0	13.62
	HE20 Beam Forming, M0 to M9 2ss	2	6	-2.2	2.7			0.1	4.0	17.0	13.01
	HE20 Beam Forming, M0 to M9 1ss	3	11	-4.2	-3.6	-2.9		0.1	1.3	12.0	10.70
	HE20 Beam Forming, M0 to M9 2ss	3	8	-2.2	-0.3	0.5		0.1	4.3	15.0	10.69
	HE20 Beam Forming, M0 to M9 3ss	3	6	-2.2	1.8	2.9		0.1	6.2	17.0	10.84
	HE20 Beam Forming, M0 to M9 1ss	4	12	-4.2	-3.6	-2.9	-3.6	0.1	2.5	11.0	8.46
	HE20 Beam Forming, M0 to M9 2ss	4	9	-2.9	-2.5	-1.9	-2.2	0.1	3.7	14.0	10.27
	HE20 Beam Forming, M0 to M9 3ss	4	7	-2.2	-0.3	0.5	-0.6	0.1	5.5	16.0	10.46
	HE20 Beam Forming, M0 to M9 4ss	4	6	-2.2	1.1	1.3	1.2	0.1	6.7	17.0	10.34
	HE20 STBC, M0 to M9 2ss	2	6	-2.2	2.7			0.1	4.0	17.0	13.01
	HE20 STBC, M0 to M9 2ss	3	8	-2.2	1.8	2.9		0.1	6.2	15.0	8.84
	HE20 STBC, M0 to M9 2ss	4	9	-2.2	1.1	1.3	1.2	0.1	6.7	14.0	7.34
5190	Non HT40, 6 to 54 Mbps	1	6	-5.4				0.0	-5.4	17.0	22.35
	Non HT40, 6 to 54 Mbps	2	9	-5.4	-5.0			0.0	-2.1	14.0	16.14
	Non HT40, 6 to 54 Mbps	3	11	-5.4	-5.0	-4.6		0.0	-0.2	12.0	12.17
	Non HT40, 6 to 54 Mbps	4	12	-5.4	-5.0	-4.6	-4.9	0.0	1.1	11.0	9.90
	HT/VHT40, M0 to M7	1	6	-5.1				0.1	-5.0	17.0	22.00
	HT/VHT40, M0 to M7	2	9	-5.1	-5.0			0.1	-1.9	14.0	15.94
	HT/VHT40, M8 to M15	2	6	-5.1	-5.0			0.1	-1.9	17.0	18.94
	HT/VHT40, M0 to M7	3	11	-5.1	-5.0	-4.2		0.1	0.1	12.0	11.87
	HT/VHT40, M8 to M15	3	8	-5.1	-5.0	-4.2		0.1	0.1	15.0	14.87
	HT/VHT40, M16 to M23	3	6	-5.1	-5.0	-4.2		0.1	0.1	17.0	16.87
	HT/VHT40, M0 to M7	4	12	-5.1	-5.0	-4.2	-5.2	0.1	1.3	11.0	9.73
	HT/VHT40, M8 to M15	4	9	-5.1	-5.0	-4.2	-5.2	0.1	1.3	14.0	12.73
	HT/VHT40, M16 to M23	4	7	-5.1	-5.0	-4.2	-5.2	0.1	1.3	16.0	14.73
	HT/VHT40, M24 to M31	4	6	-5.1	-5.0	-4.2	-5.2	0.1	1.3	17.0	15.73
	HT/VHT40 Beam Forming, M0 to M7	2	9	-6.7	-6.2			0.1	-3.3	14.0	17.33
	HT/VHT40 Beam Forming, M8 to M15	2	6	-5.1	-5.0			0.1	-1.9	17.0	18.94
	HT/VHT40 Beam Forming, M0 to M7	3	11	-6.7	-6.2	-5.3		0.1	-1.2	12.0	13.15
	HT/VHT40 Beam Forming, M8 to M15	3	8	-5.1	-5.0	-4.2		0.1	0.1	15.0	14.87
	HT/VHT40 Beam Forming, M16 to M23	3	6	-5.1	-5.0	-4.2		0.1	0.1	17.0	16.87
	HT/VHT40 Beam Forming, M0 to M7	4	12	-7.9	-7.0	-6.3	-7.1	0.1	-0.9	11.0	11.92
HT/VHT40 Beam Forming, M8 to M15	4	9	-6.7	-6.2	-5.3	-6.1	0.1	0.1	14.0	13.92	
HT/VHT40 Beam Forming, M16 to M23	4	7	-5.1	-5.0	-4.2	-5.2	0.1	1.3	16.0	14.73	
HT/VHT40 Beam Forming, M24 to M31	4	6	-5.1	-5.0	-4.2	-5.2	0.1	1.3	17.0	15.73	

	HT/VHT40 STBC, M0 to M7	2	6	-5.1	-5.0			0.1	-1.9	17.0	18.94
	HT/VHT40 STBC, M0 to M7	3	8	-5.1	-5.0	-4.2		0.1	0.1	15.0	14.87
	HT/VHT40 STBC, M0 to M7	4	9	-5.1	-5.0	-4.2	-5.2	0.1	1.3	14.0	12.73
	HE40, M0 to M9 1ss	1	6	-6.8				0.1	-6.7	17.0	23.67
	HE40, M0 to M9 1ss	2	9	-6.8	-5.9			0.1	-3.2	14.0	17.19
	HE40, M0 to M9 2ss	2	6	-6.8	-5.9			0.1	-3.2	17.0	20.19
	HE40, M0 to M9 1ss	3	11	-6.8	-5.9	-5.4		0.1	-1.1	12.0	13.10
	HE40, M0 to M9 2ss	3	8	-6.8	-5.9	-5.4		0.1	-1.1	15.0	16.10
	HE40, M0 to M9 3ss	3	6	-6.8	-5.9	-5.4		0.1	-1.1	17.0	18.10
	HE40, M0 to M9 1ss	4	12	-6.8	-5.9	-5.4	-5.7	0.1	0.2	11.0	10.77
	HE40, M0 to M9 2ss	4	9	-6.8	-5.9	-5.4	-5.7	0.1	0.2	14.0	13.77
	HE40, M0 to M9 3ss	4	7	-6.8	-5.9	-5.4	-5.7	0.1	0.2	16.0	15.77
	HE40, M0 to M9 4ss	4	6	-6.8	-5.9	-5.4	-5.7	0.1	0.2	17.0	16.77
	HE40 Beam Forming, M0 to M9 1ss	2	9	-7.7	-7.0			0.1	-4.2	14.0	18.20
	HE40 Beam Forming, M0 to M9 2ss	2	6	-6.8	-5.9			0.1	-3.2	17.0	20.19
	HE40 Beam Forming, M0 to M9 1ss	3	11	-8.8	-7.8	-7.5		0.1	-3.1	12.0	15.10
	HE40 Beam Forming, M0 to M9 2ss	3	8	-7.7	-7.0	-6.4		0.1	-2.1	15.0	17.10
	HE40 Beam Forming, M0 to M9 3ss	3	6	-6.8	-5.9	-5.4		0.1	-1.1	17.0	18.10
	HE40 Beam Forming, M0 to M9 1ss	4	12	-8.8	-7.8	-7.5	-8.4	0.1	-1.9	11.0	12.95
	HE40 Beam Forming, M0 to M9 2ss	4	9	-7.7	-7.0	-6.4	-7.0	0.1	-0.9	14.0	14.86
	HE40 Beam Forming, M0 to M9 3ss	4	7	-7.7	-7.0	-6.4	-7.0	0.1	-0.9	16.0	16.86
	HE40 Beam Forming, M0 to M9 4ss	4	6	-6.8	-5.9	-5.4	-5.7	0.1	0.2	17.0	16.77
	HE40 STBC, M0 to M9 2ss	2	6	-6.8	-5.9			0.1	-3.2	17.0	20.19
	HE40 STBC, M0 to M9 2ss	3	8	-6.8	-5.9	-5.4		0.1	-1.1	15.0	16.10
	HE40 STBC, M0 to M9 2ss	4	9	-6.8	-5.9	-5.4	-5.7	0.1	0.2	14.0	13.77
5210	Non HT80, 6 to 54 Mbps	1	6	-8.5				0.1	-8.4	17.0	25.45
	Non HT80, 6 to 54 Mbps	2	9	-8.5	-8.0			0.1	-5.2	14.0	19.18
	Non HT80, 6 to 54 Mbps	3	11	-8.5	-8.0	-7.7		0.1	-3.2	12.0	15.23
	Non HT80, 6 to 54 Mbps	4	12	-8.5	-8.0	-7.7	-7.9	0.1	-1.9	11.0	12.94
	VHT80, M0 to M9 1ss	1	6	-8.0				0.2	-7.8	17.0	24.78
	VHT80, M0 to M9 1ss	2	9	-9.2	-8.7			0.2	-5.7	14.0	19.71
	VHT80, M0 to M9 2ss	2	6	-9.2	-8.7			0.2	-5.7	17.0	22.71
	VHT80, M0 to M9 1ss	3	11	-9.2	-8.7	-8.3		0.2	-3.7	12.0	15.72
	VHT80, M0 to M9 2ss	3	8	-9.2	-8.7	-8.3		0.2	-3.7	15.0	18.72
	VHT80, M0 to M9 3ss	3	6	-9.2	-8.7	-8.3		0.2	-3.7	17.0	20.72
	VHT80, M0 to M9 1ss	4	12	-9.2	-8.7	-8.3	-8.7	0.2	-2.5	11.0	13.47
	VHT80, M0 to M9 2ss	4	9	-9.2	-8.7	-8.3	-8.7	0.2	-2.5	14.0	16.47
	VHT80, M0 to M9 3ss	4	7	-9.2	-8.7	-8.3	-8.7	0.2	-2.5	16.0	18.47
	VHT80, M0 to M9 4ss	4	6	-9.2	-8.7	-8.3	-8.7	0.2	-2.5	17.0	19.47
	VHT80 Beam Forming, M0 to M9 1ss	2	9	-9.2	-8.7			0.2	-5.7	14.0	19.71
	VHT80 Beam Forming, M0 to M9 2ss	2	6	-9.2	-8.7			0.2	-5.7	17.0	22.71
VHT80 Beam Forming, M0 to M9 1ss	3	11	-10.1	-9.2	-9.2		0.2	-4.5	12.0	16.48	

	VHT80 Beam Forming, M0 to M9 2ss	3	8	-9.2	-8.7	-8.3		0.2	-3.7	15.0	18.72
	VHT80 Beam Forming, M0 to M9 3ss	3	6	-9.2	-8.7	-8.3		0.2	-3.7	17.0	20.72
	VHT80 Beam Forming, M0 to M9 1ss	4	12	-10.1	-9.2	-9.2	-9.5	0.2	-3.2	11.0	14.24
	VHT80 Beam Forming, M0 to M9 2ss	4	9	-9.2	-8.7	-8.3	-8.7	0.2	-2.5	14.0	16.47
	VHT80 Beam Forming, M0 to M9 3ss	4	7	-9.2	-8.7	-8.3	-8.7	0.2	-2.5	16.0	18.47
	VHT80 Beam Forming, M0 to M9 4ss	4	6	-9.2	-8.7	-8.3	-8.7	0.2	-2.5	17.0	19.47
	VHT80 STBC, M0 to M9 1ss	2	6	-9.2	-8.7			0.2	-5.7	17.0	22.71
	VHT80 STBC, M0 to M9 1ss	3	6	-9.2	-8.7	-8.3		0.2	-3.7	17.0	20.72
	VHT80 STBC, M0 to M9 1ss	4	6	-9.2	-8.7	-8.3	-8.7	0.2	-2.5	17.0	19.47
	HE80, M0 to M9 1ss	1	6	-9.0				0.3	-8.7	17.0	25.75
	HE80, M0 to M9 1ss	2	9	-9.0	-8.6			0.3	-5.5	14.0	19.53
	HE80, M0 to M9 2ss	2	6	-9.0	-8.6			0.3	-5.5	17.0	22.53
	HE80, M0 to M9 1ss	3	11	-10.1	-9.7	-9.5		0.3	-4.7	12.0	16.74
	HE80, M0 to M9 2ss	3	8	-10.1	-9.7	-9.5		0.3	-4.7	15.0	19.74
	HE80, M0 to M9 3ss	3	6	-10.1	-9.7	-9.5		0.3	-4.7	17.0	21.74
	HE80, M0 to M9 1ss	4	12	-10.1	-9.7	-9.5	-10.0	0.3	-3.5	11.0	14.55
	HE80, M0 to M9 2ss	4	9	-10.1	-9.7	-9.5	-10.0	0.3	-3.5	14.0	17.55
	HE80, M0 to M9 3ss	4	7	-10.1	-9.7	-9.5	-10.0	0.3	-3.5	16.0	19.55
	HE80, M0 to M9 4ss	4	6	-10.1	-9.7	-9.5	-10.0	0.3	-3.5	17.0	20.55
	HE80 Beam Forming, M0 to M9 1ss	2	9	-10.1	-9.7			0.3	-6.6	14.0	20.63
	HE80 Beam Forming, M0 to M9 2ss	2	6	-9.0	-8.6			0.3	-5.5	17.0	22.53
	HE80 Beam Forming, M0 to M9 1ss	3	11	-10.5	-10.1	-10.3		0.3	-5.3	12.0	17.28
	HE80 Beam Forming, M0 to M9 2ss	3	8	-10.1	-9.7	-9.5		0.3	-4.7	15.0	19.74
	HE80 Beam Forming, M0 to M9 3ss	3	6	-10.1	-9.7	-9.5		0.3	-4.7	17.0	21.74
	HE80 Beam Forming, M0 to M9 1ss	4	12	-10.5	-10.1	-10.3	-10.7	0.3	-4.1	11.0	15.12
	HE80 Beam Forming, M0 to M9 2ss	4	9	-10.1	-9.7	-9.5	-10.0	0.3	-3.5	14.0	17.55
	HE80 Beam Forming, M0 to M9 3ss	4	7	-10.1	-9.7	-9.5	-10.0	0.3	-3.5	16.0	19.55
	HE80 Beam Forming, M0 to M9 4ss	4	6	-10.1	-9.7	-9.5	-10.0	0.3	-3.5	17.0	20.55
	HE80 STBC, M0 to M9 1ss	2	6	-9.0	-8.6			0.3	-5.5	17.0	22.53
	HE80 STBC, M0 to M9 1ss	3	6	-10.1	-9.7	-9.5		0.3	-4.7	17.0	21.74
	HE80 STBC, M0 to M9 1ss	4	6	-10.1	-9.7	-9.5	-10.0	0.3	-3.5	17.0	20.55
5220	Non HT20, 6 to 54 Mbps	1	6	-1.1				0.1	-1.0	17.0	18.05
	Non HT20, 6 to 54 Mbps	2	9	-1.1	4.6			0.1	5.7	14.0	8.31
	Non HT20, 6 to 54 Mbps	3	11	-1.1	4.6	4.9		0.1	8.3	12.0	3.65
	Non HT20, 6 to 54 Mbps	4	12	-1.1	4.6	4.9	5.1	0.1	10.0	11.0	0.95
	Non HT20 Beam Forming, 6 to 54 Mbps	2	9	-1.1	4.6			0.1	5.7	14.0	8.31
	Non HT20 Beam Forming, 6 to 54 Mbps	3	11	-1.1	4.6	4.9		0.1	8.3	12.0	3.65
	Non HT20 Beam Forming, 6 to 54 Mbps	4	12	-1.1	4.6	4.9	5.1	0.1	10.0	11.0	0.95
	HT/VHT20, M0 to M7	1	6	-1.5				0.1	-1.4	17.0	18.45
	HT/VHT20, M0 to M7	2	9	-1.5	4.2			0.1	5.3	14.0	8.71
	HT/VHT20, M8 to M15	2	6	-1.5	4.2			0.1	5.3	17.0	11.71
HT/VHT20, M0 to M7	3	11	-1.5	4.2	4.9		0.1	8.1	12.0	3.87	



HT/VHT20, M8 to M15	3	8	-1.5	4.2	4.9		0.1	8.1	15.0	6.87
HT/VHT20, M16 to M23	3	6	-1.5	4.2	4.9		0.1	8.1	17.0	8.87
HT/VHT20, M0 to M7	4	12	-1.5	4.2	4.9	4.6	0.1	9.7	11.0	1.26
HT/VHT20, M8 to M15	4	9	-1.5	4.2	4.9	4.6	0.1	9.7	14.0	4.26
HT/VHT20, M16 to M23	4	7	-1.5	4.2	4.9	4.6	0.1	9.7	16.0	6.26
HT/VHT20, M24 to M31	4	6	-1.5	4.2	4.9	4.6	0.1	9.7	17.0	7.26
HT/VHT20 Beam Forming, M0 to M7	2	9	-1.5	4.2			0.1	5.3	14.0	8.71
HT/VHT20 Beam Forming, M8 to M15	2	6	-1.5	4.2			0.1	5.3	17.0	11.71
HT/VHT20 Beam Forming, M0 to M7	3	11	-1.5	4.2	4.9		0.1	8.1	12.0	3.87
HT/VHT20 Beam Forming, M8 to M15	3	8	-1.5	4.2	4.9		0.1	8.1	15.0	6.87
HT/VHT20 Beam Forming, M16 to M23	3	6	-1.5	4.2	4.9		0.1	8.1	17.0	8.87
HT/VHT20 Beam Forming, M0 to M7	4	12	-1.5	4.2	4.9	4.6	0.1	9.7	11.0	1.26
HT/VHT20 Beam Forming, M8 to M15	4	9	-1.5	4.2	4.9	4.6	0.1	9.7	14.0	4.26
HT/VHT20 Beam Forming, M16 to M23	4	7	-1.5	4.2	4.9	4.6	0.1	9.7	16.0	6.26
HT/VHT20 Beam Forming, M24 to M31	4	6	-1.5	4.2	4.9	4.6	0.1	9.7	17.0	7.26
HT/VHT20 STBC, M0 to M7	2	6	-1.5	4.2			0.1	5.3	17.0	11.71
HT/VHT20 STBC, M0 to M7	3	8	-1.5	4.2	4.9		0.1	8.1	15.0	6.87
HT/VHT20 STBC, M0 to M7	4	9	-1.5	4.2	4.9	4.6	0.1	9.7	14.0	4.26
HE20, M0 to M9 1ss	1	6	-1.3				0.1	-1.2	17.0	18.23
HE20, M0 to M9 1ss	2	9	-1.3	4.4			0.1	5.5	14.0	8.50
HE20, M0 to M9 2ss	2	6	-1.3	4.4			0.1	5.5	17.0	11.50
HE20, M0 to M9 1ss	3	11	-1.3	4.4	5.0		0.1	8.3	12.0	3.70
HE20, M0 to M9 2ss	3	8	-1.3	4.4	5.0		0.1	8.3	15.0	6.70
HE20, M0 to M9 3ss	3	6	-1.3	4.4	5.0		0.1	8.3	17.0	8.70
HE20, M0 to M9 1ss	4	12	-1.3	4.4	5.0	4.9	0.1	10.0	11.0	1.04
HE20, M0 to M9 2ss	4	9	-1.3	4.4	5.0	4.9	0.1	10.0	14.0	4.04
HE20, M0 to M9 3ss	4	7	-1.3	4.4	5.0	4.9	0.1	10.0	16.0	6.04
HE20, M0 to M9 4ss	4	6	-1.3	4.4	5.0	4.9	0.1	10.0	17.0	7.04
HE20 Beam Forming, M0 to M9 1ss	2	9	-1.3	4.4			0.1	5.5	14.0	8.50
HE20 Beam Forming, M0 to M9 2ss	2	6	-1.3	4.4			0.1	5.5	17.0	11.50
HE20 Beam Forming, M0 to M9 1ss	3	11	-1.3	4.4	5.0		0.1	8.3	12.0	3.70
HE20 Beam Forming, M0 to M9 2ss	3	8	-1.3	4.4	5.0		0.1	8.3	15.0	6.70
HE20 Beam Forming, M0 to M9 3ss	3	6	-1.3	4.4	5.0		0.1	8.3	17.0	8.70
HE20 Beam Forming, M0 to M9 1ss	4	12	-1.3	4.4	5.0	4.9	0.1	10.0	11.0	1.04
HE20 Beam Forming, M0 to M9 2ss	4	9	-1.3	4.4	5.0	4.9	0.1	10.0	14.0	4.04
HE20 Beam Forming, M0 to M9 3ss	4	7	-1.3	4.4	5.0	4.9	0.1	10.0	16.0	6.04
HE20 Beam Forming, M0 to M9 4ss	4	6	-1.3	4.4	5.0	4.9	0.1	10.0	17.0	7.04
HE20 STBC, M0 to M9 2ss	2	6	-1.3	4.4			0.1	5.5	17.0	11.50
HE20 STBC, M0 to M9 2ss	3	8	-1.3	4.4	5.0		0.1	8.3	15.0	6.70
HE20 STBC, M0 to M9 2ss	4	9	-1.3	4.4	5.0	4.9	0.1	10.0	14.0	4.04

5230	Non HT40, 6 to 54 Mbps	1	6	-3.6				0.0	-3.6	17.0	20.55
	Non HT40, 6 to 54 Mbps	2	9	-3.6	1.8			0.0	2.9	14.0	11.05
	Non HT40, 6 to 54 Mbps	3	11	-3.6	1.8	2.6		0.0	5.8	12.0	6.19
	Non HT40, 6 to 54 Mbps	4	12	-3.6	1.8	2.6	1.9	0.0	7.3	11.0	3.69
	HT/VHT40, M0 to M7	1	6	-4.1				0.1	-4.0	17.0	21.00
	HT/VHT40, M0 to M7	2	9	-4.1	1.3			0.1	2.5	14.0	11.50
	HT/VHT40, M8 to M15	2	6	-4.1	1.3			0.1	2.5	17.0	14.50
	HT/VHT40, M0 to M7	3	11	-4.1	1.3	1.8		0.1	5.2	12.0	6.78
	HT/VHT40, M8 to M15	3	8	-4.1	1.3	1.8		0.1	5.2	15.0	9.78
	HT/VHT40, M16 to M23	3	6	-4.1	1.3	1.8		0.1	5.2	17.0	11.78
	HT/VHT40, M0 to M7	4	12	-4.1	1.3	1.8	1.5	0.1	6.8	11.0	4.21
	HT/VHT40, M8 to M15	4	9	-4.1	1.3	1.8	1.5	0.1	6.8	14.0	7.21
	HT/VHT40, M16 to M23	4	7	-4.1	1.3	1.8	1.5	0.1	6.8	16.0	9.21
	HT/VHT40, M24 to M31	4	6	-4.1	1.3	1.8	1.5	0.1	6.8	17.0	10.21
	HT/VHT40 Beam Forming, M0 to M7	2	9	-4.1	1.3			0.1	2.5	14.0	11.50
	HT/VHT40 Beam Forming, M8 to M15	2	6	-4.1	1.3			0.1	2.5	17.0	14.50
	HT/VHT40 Beam Forming, M0 to M7	3	11	-4.1	1.3	1.8		0.1	5.2	12.0	6.78
	HT/VHT40 Beam Forming, M8 to M15	3	8	-4.1	1.3	1.8		0.1	5.2	15.0	9.78
	HT/VHT40 Beam Forming, M16 to M23	3	6	-4.1	1.3	1.8		0.1	5.2	17.0	11.78
	HT/VHT40 Beam Forming, M0 to M7	4	12	-4.1	1.3	1.8	1.5	0.1	6.8	11.0	4.21
	HT/VHT40 Beam Forming, M8 to M15	4	9	-4.1	1.3	1.8	1.5	0.1	6.8	14.0	7.21
	HT/VHT40 Beam Forming, M16 to M23	4	7	-4.1	1.3	1.8	1.5	0.1	6.8	16.0	9.21
	HT/VHT40 Beam Forming, M24 to M31	4	6	-4.1	1.3	1.8	1.5	0.1	6.8	17.0	10.21
	HT/VHT40 STBC, M0 to M7	2	6	-4.1	1.3			0.1	2.5	17.0	14.50
	HT/VHT40 STBC, M0 to M7	3	8	-4.1	1.3	1.8		0.1	5.2	15.0	9.78
	HT/VHT40 STBC, M0 to M7	4	9	-4.1	1.3	1.8	1.5	0.1	6.8	14.0	7.21
	HE40, M0 to M9 1ss	1	6	-4.2				0.1	-4.1	17.0	21.07
	HE40, M0 to M9 1ss	2	9	-4.2	1.5			0.1	2.7	14.0	11.34
	HE40, M0 to M9 2ss	2	6	-4.2	1.5			0.1	2.7	17.0	14.34
	HE40, M0 to M9 1ss	3	11	-4.2	1.5	2.2		0.1	5.5	12.0	6.49
	HE40, M0 to M9 2ss	3	8	-4.2	1.5	2.2		0.1	5.5	15.0	9.49
	HE40, M0 to M9 3ss	3	6	-4.2	1.5	2.2		0.1	5.5	17.0	11.49
	HE40, M0 to M9 1ss	4	12	-4.2	1.5	2.2	1.8	0.1	7.1	11.0	3.91
	HE40, M0 to M9 2ss	4	9	-4.2	1.5	2.2	1.8	0.1	7.1	14.0	6.91
	HE40, M0 to M9 3ss	4	7	-4.2	1.5	2.2	1.8	0.1	7.1	16.0	8.91
	HE40, M0 to M9 4ss	4	6	-4.2	1.5	2.2	1.8	0.1	7.1	17.0	9.91
	HE40 Beam Forming, M0 to M9 1ss	2	9	-4.2	1.5			0.1	2.7	14.0	11.34
	HE40 Beam Forming, M0 to M9 2ss	2	6	-4.2	1.5			0.1	2.7	17.0	14.34
	HE40 Beam Forming, M0 to M9 1ss	3	11	-4.2	1.5	2.2		0.1	5.5	12.0	6.49
	HE40 Beam Forming, M0 to M9 2ss	3	8	-4.2	1.5	2.2		0.1	5.5	15.0	9.49
HE40 Beam Forming, M0 to M9 3ss	3	6	-4.2	1.5	2.2		0.1	5.5	17.0	11.49	
HE40 Beam Forming, M0 to M9 1ss	4	12	-4.2	1.5	2.2	1.8	0.1	7.1	11.0	3.91	
HE40 Beam Forming, M0 to M9 2ss	4	9	-4.2	1.5	2.2	1.8	0.1	7.1	14.0	6.91	

	HE40 Beam Forming, M0 to M9 3ss	4	7	-4.2	1.5	2.2	1.8	0.1	7.1	16.0	8.91	
	HE40 Beam Forming, M0 to M9 4ss	4	6	-4.2	1.5	2.2	1.8	0.1	7.1	17.0	9.91	
	HE40 STBC, M0 to M9 2ss	2	6	-4.2	1.5			0.1	2.7	17.0	14.34	
	HE40 STBC, M0 to M9 2ss	3	8	-4.2	1.5	2.2		0.1	5.5	15.0	9.49	
	HE40 STBC, M0 to M9 2ss	4	9	-4.2	1.5	2.2	1.8	0.1	7.1	14.0	6.91	
5240	Non HT20, 6 to 54 Mbps	1	6	-0.8				0.1	-0.7	17.0	17.75	
	Non HT20, 6 to 54 Mbps	2	9	-0.8	4.9			0.1	6.0	14.0	8.01	
	Non HT20, 6 to 54 Mbps	3	11	-0.8	4.9	5.1		0.1	8.6	12.0	3.40	
	Non HT20, 6 to 54 Mbps	4	12	-0.8	4.9	5.1	4.5	0.1	10.0	11.0	0.96	
	Non HT20 Beam Forming, 6 to 54 Mbps	2	9	-0.8	4.9			0.1	6.0	14.0	8.01	
	Non HT20 Beam Forming, 6 to 54 Mbps	3	11	-0.8	4.9	5.1		0.1	8.6	12.0	3.40	
	Non HT20 Beam Forming, 6 to 54 Mbps	4	12	-0.8	4.9	5.1	4.5	0.1	10.0	11.0	0.96	
	HT/VHT20, M0 to M7	1	6	-1.0					0.1	-0.9	17.0	17.95
	HT/VHT20, M0 to M7	2	9	-1.0	4.3				0.1	5.5	14.0	8.52
	HT/VHT20, M8 to M15	2	6	-1.0	4.3				0.1	5.5	17.0	11.52
	HT/VHT20, M0 to M7	3	11	-1.0	4.3	4.8			0.1	8.2	12.0	3.81
	HT/VHT20, M8 to M15	3	8	-1.0	4.3	4.8			0.1	8.2	15.0	6.81
	HT/VHT20, M16 to M23	3	6	-1.0	4.3	4.8			0.1	8.2	17.0	8.81
	HT/VHT20, M0 to M7	4	12	-1.0	4.3	4.8	4.4		0.1	9.7	11.0	1.28
	HT/VHT20, M8 to M15	4	9	-1.0	4.3	4.8	4.4		0.1	9.7	14.0	4.28
	HT/VHT20, M16 to M23	4	7	-1.0	4.3	4.8	4.4		0.1	9.7	16.0	6.28
	HT/VHT20, M24 to M31	4	6	-1.0	4.3	4.8	4.4		0.1	9.7	17.0	7.28
	HT/VHT20 Beam Forming, M0 to M7	2	9	-1.0	4.3				0.1	5.5	14.0	8.52
	HT/VHT20 Beam Forming, M8 to M15	2	6	-1.0	4.3				0.1	5.5	17.0	11.52
	HT/VHT20 Beam Forming, M0 to M7	3	11	-1.0	4.3	4.8			0.1	8.2	12.0	3.81
	HT/VHT20 Beam Forming, M8 to M15	3	8	-1.0	4.3	4.8			0.1	8.2	15.0	6.81
	HT/VHT20 Beam Forming, M16 to M23	3	6	-1.0	4.3	4.8			0.1	8.2	17.0	8.81
	HT/VHT20 Beam Forming, M0 to M7	4	12	-1.0	4.3	4.8	4.4		0.1	9.7	11.0	1.28
	HT/VHT20 Beam Forming, M8 to M15	4	9	-1.0	4.3	4.8	4.4		0.1	9.7	14.0	4.28
	HT/VHT20 Beam Forming, M16 to M23	4	7	-1.0	4.3	4.8	4.4		0.1	9.7	16.0	6.28
	HT/VHT20 Beam Forming, M24 to M31	4	6	-1.0	4.3	4.8	4.4		0.1	9.7	17.0	7.28
	HT/VHT20 STBC, M0 to M7	2	6	-1.0	4.3				0.1	5.5	17.0	11.52
	HT/VHT20 STBC, M0 to M7	3	8	-1.0	4.3	4.8			0.1	8.2	15.0	6.81
	HT/VHT20 STBC, M0 to M7	4	9	-1.0	4.3	4.8	4.4		0.1	9.7	14.0	4.28
	HE20, M0 to M9 1ss	1	6	-1.2					0.1	-1.1	17.0	18.13
	HE20, M0 to M9 1ss	2	9	-1.2	4.4				0.1	5.5	14.0	8.48
	HE20, M0 to M9 2ss	2	6	-1.2	4.4				0.1	5.5	17.0	11.48
	HE20, M0 to M9 1ss	3	11	-1.2	4.4	5.1			0.1	8.4	12.0	3.64
	HE20, M0 to M9 2ss	3	8	-1.2	4.4	5.1			0.1	8.4	15.0	6.64
HE20, M0 to M9 3ss	3	6	-1.2	4.4	5.1			0.1	8.4	17.0	8.64	
HE20, M0 to M9 1ss	4	12	-1.2	4.4	5.1	4.2		0.1	9.8	11.0	1.21	
HE20, M0 to M9 2ss	4	9	-1.2	4.4	5.1	4.2		0.1	9.8	14.0	4.21	

	HE20, M0 to M9 3ss	4	7	-1.2	4.4	5.1	4.2	0.1	9.8	16.0	6.21
	HE20, M0 to M9 4ss	4	6	-1.2	4.4	5.1	4.2	0.1	9.8	17.0	7.21
	HE20 Beam Forming, M0 to M9 1ss	2	9	-1.2	4.4			0.1	5.5	14.0	8.48
	HE20 Beam Forming, M0 to M9 2ss	2	6	-1.2	4.4			0.1	5.5	17.0	11.48
	HE20 Beam Forming, M0 to M9 1ss	3	11	-1.2	4.4	5.1		0.1	8.4	12.0	3.64
	HE20 Beam Forming, M0 to M9 2ss	3	8	-1.2	4.4	5.1		0.1	8.4	15.0	6.64
	HE20 Beam Forming, M0 to M9 3ss	3	6	-1.2	4.4	5.1		0.1	8.4	17.0	8.64
	HE20 Beam Forming, M0 to M9 1ss	4	12	-1.2	4.4	5.1	4.2	0.1	9.8	11.0	1.21
	HE20 Beam Forming, M0 to M9 2ss	4	9	-1.2	4.4	5.1	4.2	0.1	9.8	14.0	4.21
	HE20 Beam Forming, M0 to M9 3ss	4	7	-1.2	4.4	5.1	4.2	0.1	9.8	16.0	6.21
	HE20 Beam Forming, M0 to M9 4ss	4	6	-1.2	4.4	5.1	4.2	0.1	9.8	17.0	7.21
	HE20 STBC, M0 to M9 2ss	2	6	-1.2	4.4			0.1	5.5	17.0	11.48
	HE20 STBC, M0 to M9 2ss	3	8	-1.2	4.4	5.1		0.1	8.4	15.0	6.64
	HE20 STBC, M0 to M9 2ss	4	9	-1.2	4.4	5.1	4.2	0.1	9.8	14.0	4.21
5250	Non HT160, 6 to 54 Mbps	1	6	-10.8				0.0	-10.8	17.0	27.75
	Non HT160, 6 to 54 Mbps	2	9	-10.8	-10.7			0.0	-7.7	14.0	21.69
	Non HT160, 6 to 54 Mbps	3	11	-10.8	-10.7	-9.4		0.0	-5.4	12.0	17.43
	Non HT160, 6 to 54 Mbps	4	12	-11.6	-11.4	-10.2	-11.5	0.0	-5.1	11.0	16.07
	VHT160, M0 to M9 1ss	1	6	-11.3				0.4	-10.9	17.0	27.91
	VHT160, M0 to M9 1ss	2	9	-11.3	-11.3			0.4	-7.9	14.0	21.90
	VHT160, M0 to M9 2ss	2	6	-11.3	-11.3			0.4	-7.9	17.0	24.90
	VHT160, M0 to M9 1ss	3	11	-11.3	-11.3	-11.4		0.4	-6.2	12.0	18.17
	VHT160, M0 to M9 2ss	3	8	-11.3	-11.3	-11.4		0.4	-6.2	15.0	21.17
	VHT160, M0 to M9 3ss	3	6	-11.3	-11.3	-11.4		0.4	-6.2	17.0	23.17
	VHT160, M0 to M9 1ss	4	12	-11.3	-11.3	-11.4	-11.2	0.4	-4.9	11.0	15.89
	VHT160, M0 to M9 2ss	4	9	-11.3	-11.3	-11.4	-11.2	0.4	-4.9	14.0	18.89
	VHT160, M0 to M9 3ss	4	7	-11.3	-11.3	-11.4	-11.2	0.4	-4.9	16.0	20.89
	VHT160, M0 to M9 4ss	4	6	-11.3	-11.3	-11.4	-11.2	0.4	-4.9	17.0	21.89
	VHT160 Beam Forming, M0 to M9 1ss	2	9	-12.3	-12.6			0.4	-9.0	14.0	23.05
	VHT160 Beam Forming, M0 to M9 2ss	2	6	-11.3	-11.3			0.4	-7.9	17.0	24.90
	VHT160 Beam Forming, M0 to M9 1ss	3	11	-12.9	-13.2	-13.2		0.4	-7.9	12.0	19.93
	VHT160 Beam Forming, M0 to M9 2ss	3	8	-11.3	-11.3	-11.4		0.4	-6.2	15.0	21.17
	VHT160 Beam Forming, M0 to M9 3ss	3	6	-11.3	-11.3	-11.4		0.4	-6.2	17.0	23.17
	VHT160 Beam Forming, M0 to M9 1ss	4	12	-12.9	-13.2	-13.2	-13.7	0.4	-6.8	11.0	17.83
	VHT160 Beam Forming, M0 to M9 2ss	4	9	-12.3	-12.6	-12.5	-12.6	0.4	-6.1	14.0	20.09
	VHT160 Beam Forming, M0 to M9 3ss	4	7	-11.3	-11.3	-11.4	-11.2	0.4	-4.9	16.0	20.89
	VHT160 Beam Forming, M0 to M9 4ss	4	6	-11.3	-11.3	-11.4	-11.2	0.4	-4.9	17.0	21.89
	VHT160 STBC, M0 to M9 1ss	2	6	-11.3	-11.3			0.4	-7.9	17.0	24.90
	VHT160 STBC, M0 to M9 1ss	3	6	-11.3	-11.3	-11.4		0.4	-6.2	17.0	23.17
	VHT160 STBC, M0 to M9 1ss	4	6	-11.3	-11.3	-11.4	-11.2	0.4	-4.9	17.0	21.89
	HE160, M0 to M9 1ss	1	6	-10.5				0.4	-10.1	17.0	27.07
	HE160, M0 to M9 1ss	2	9	-10.5	-11.5			0.4	-7.5	14.0	21.53



HE160, M0 to M9 2ss	2	6	-10.5	-11.5			0.4	-7.5	17.0	24.53
HE160, M0 to M9 1ss	3	11	-10.5	-11.5	-11.3		0.4	-5.9	12.0	17.87
HE160, M0 to M9 2ss	3	8	-10.5	-11.5	-11.3		0.4	-5.9	15.0	20.87
HE160, M0 to M9 3ss	3	6	-10.5	-11.5	-11.3		0.4	-5.9	17.0	22.87
HE160, M0 to M9 1ss	4	12	-10.5	-11.5	-11.3	-11.3	0.4	-4.7	11.0	15.68
HE160, M0 to M9 2ss	4	9	-10.5	-11.5	-11.3	-11.3	0.4	-4.7	14.0	18.68
HE160, M0 to M9 3ss	4	7	-10.5	-11.5	-11.3	-11.3	0.4	-4.7	16.0	20.68
HE160, M0 to M9 4ss	4	6	-10.5	-11.5	-11.3	-11.3	0.4	-4.7	17.0	21.68
HE160 Beam Forming, M0 to M9 1ss	2	9	-12.3	-12.8			0.4	-9.1	14.0	23.10
HE160 Beam Forming, M0 to M9 2ss	2	6	-10.5	-11.5			0.4	-7.5	17.0	24.53
HE160 Beam Forming, M0 to M9 1ss	3	11	-12.3	-12.8	-12.4		0.4	-7.3	12.0	19.29
HE160 Beam Forming, M0 to M9 2ss	3	8	-12.3	-12.8	-12.4		0.4	-7.3	15.0	22.29
HE160 Beam Forming, M0 to M9 3ss	3	6	-10.5	-11.5	-11.3		0.4	-5.9	17.0	22.87
HE160 Beam Forming, M0 to M9 1ss	4	12	-13.2	-13.3	-12.8	-13.5	0.4	-6.7	11.0	17.74
HE160 Beam Forming, M0 to M9 2ss	4	9	-12.3	-12.8	-12.4	-12.8	0.4	-6.1	14.0	20.11
HE160 Beam Forming, M0 to M9 3ss	4	7	-12.3	-12.8	-12.4	-12.8	0.4	-6.1	16.0	22.11
HE160 Beam Forming, M0 to M9 4ss	4	6	-10.5	-11.5	-11.3	-11.3	0.4	-4.7	17.0	21.68
HE160 STBC, M0 to M9 1ss	2	6	-10.5	-11.5			0.4	-7.5	17.0	24.53
HE160 STBC, M0 to M9 1ss	3	6	-10.5	-11.5	-11.3		0.4	-5.9	17.0	22.87
HE160 STBC, M0 to M9 1ss	4	6	-10.5	-11.5	-11.3	-11.3	0.4	-4.7	17.0	21.68

**Power Spectral Density, 6dBi
5220 MHz, Non HT20, 6 to 54 Mbps**



Antenna A

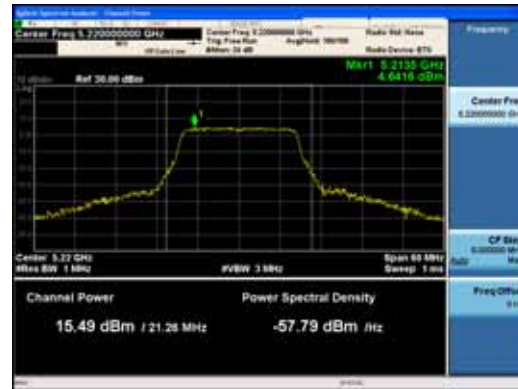

Antenna B

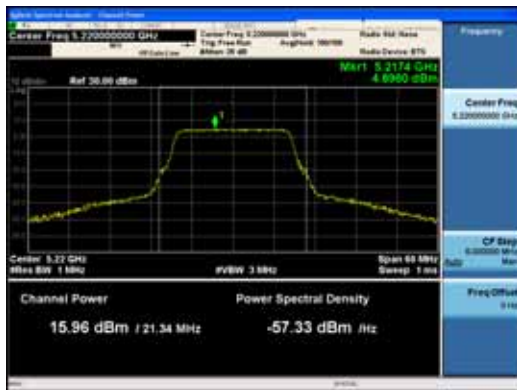

Antenna C

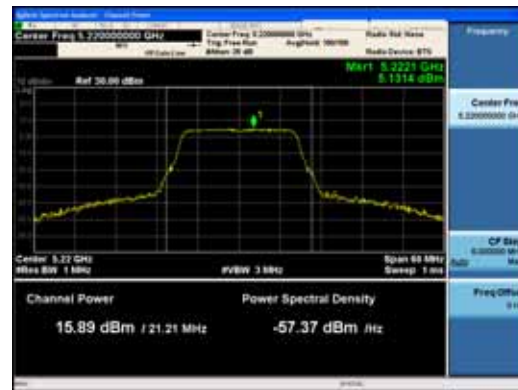

Antenna D

A.5 Conducted Spurious Emissions

Conducted Spurious Emissions Test Requirement

15.407(b) Undesirable emission limits. Except as shown in paragraph (b)(7) of this section, the maximum emissions outside of the frequency bands of operation shall be attenuated in accordance with the following limits:

- (1) For transmitters operating in the 5.15-5.25 GHz band: All emissions outside of the 5.15-5.35 GHz band shall not exceed an e.i.r.p. of -27 dBm/MHz.
- (5) The emission measurements shall be performed using a minimum resolution bandwidth of 1 MHz. A lower resolution bandwidth may be employed near the band edge, when necessary, provided the measured energy is integrated to show the total power over 1 MHz.
- (6) Unwanted emissions below 1 GHz must comply with the general field strength limits set forth in §15.209.
- (7) The provisions of §15.205 apply to intentional radiators operating under this section.
- (8) When measuring the emission limits, the nominal carrier frequency shall be adjusted as close to the upper and lower frequency band edges as the design of the equipment permits.

Radiated emissions which fall in the restricted bands, as defined in Section 15.205(a), must also comply with the radiated emission limits specified in Section 15.209(a) (see Section 15.205(c)).

Use formula below to substitute conducted measurements in place of radiated measurements

$$E[\text{dB}\mu\text{V}/\text{m}] = \text{EIRP}[\text{dBm}] - 20 \log(d[\text{meters}]) + 104.77, \text{ where } E = \text{field strength and } d = 3 \text{ meter}$$

- 1) Average Plot, Limit= -41.25 dBm eirp
- 2) Peak plot, Limit = -21.25 dBm eirp

KDB 789033 D02 General UNII Test Procedures New Rules v02r01

2. Unwanted Emissions that fall Outside of the Restricted Bands

- a) For all measurements, follow the requirements in II.G.3. “*General Requirements for Unwanted Emissions Measurements.*”
- b) At frequencies below 1000 MHz, use the procedure described in II.G.4. “*Procedure for Unwanted Emissions Measurements Below 1000 MHz.*”
- c) At frequencies above 1000 MHz, use the procedure for maximum emissions described in II.G.5., “*Procedure for Unwanted Emissions Measurements Above 1000 MHz.*”
- (i) Sections 15.407(b)(1-3) specifies the unwanted emissions limit for the U-NII-1 and U-NII-2 bands. As specified, emissions above 1000 MHz that are outside of the restricted bands are subject to a peak emission limit of -27 dBm/MHz.³

Conducted Spurious Emissions Test Procedure

KDB 789033 D02 General UNII Test Procedures New Rules v02r01

Ref. ANSI C63.10: 2013

Conducted Spurious Emissions

Test Procedure

1. Connect the antenna port(s) to the spectrum analyzer input.
2. Place the radio in continuous transmit mode
3. Configure Spectrum analyzer as per test parameters below (be sure to enter all losses between the transmitter output and the spectrum analyzer).
4. Use the peak marker function to determine the maximum spurs amplitude level.
5. The “measure-and-sum technique” is used for measuring in-band transmit power of a device. In the measure-and-sum approach, the conducted emission level is measured at each antenna port. The measured



results at the various antenna ports are then summed mathematically to determine the total emission level from the device. Summing is performed in linear power units. The worst case output is recorded. (see ANSI C63.10:2013 section 14.3.2.2)

6. Capture graphs and record pertinent measurement data.

Ref. ANSI C63.10: 2013 section 12.7.6 (Peak) and 12.7.7.2 (Average)

KDB 789033 D02 General UNII Test Procedures New Rules v02r01, Sec. 5 (Peak), Sec. 6 (Average Method AD)

Conducted Spurious Emissions

Test parameters

Peak	Average
RBW = 1 MHz	RBW = 1 MHz
VBW ≥ 3 MHz	VBW ≥ 3 MHz
Sweep = Auto	Sweep = Auto
Detector = Peak	Detector = RMS
Trace = Max Hold.	Power Averaging

Add the max antenna gain + ground reflection factor (4.7 dB for frequencies between 30 MHz and 1000 MHz, and 0 dB for frequencies > 1000 MHz).

Samples, Systems, and Modes

System Number	Description	Samples	System under test	Support equipment
1	EUT	S01 + S02	<input checked="" type="checkbox"/>	<input type="checkbox"/>
	Support		<input type="checkbox"/>	<input checked="" type="checkbox"/>

Tested By : Chris Blair	Date of testing: 16-Sep-19 - 26-Sep-19
Test Result : PASS	

Test Equipment

See Appendix C for list of test equipment

Conducted Spurs Average Upper, 5180 MHz, Non HT20, 6 to 54 Mbps



Conducted Spurs Peak Upper, 5180 MHz, Non HT20, 6 to 54 Mbps



Conducted Spurious Average Table, 4dBi

Frequency (MHz)	Mode	Tx Paths	Correlated Antenna Gain (dBi)	Tx 1 Spur Power (dBm)	Tx 2 Spur Power (dBm)	Tx 3 Spur Power (dBm)	Tx 4 Spur Power (dBm)	Duty Cycle Correction (dB)	Total Conducted Spur (dBm)	Limit (dBm)	Margin (dB)
5180	Non HT20, 6 to 54 Mbps	1	4	-65.7				0.1	-61.6	-41.25	20.40
	Non HT20, 6 to 54 Mbps	2	4	-65.7	-58.8			0.1	-53.9	-41.25	12.69
	Non HT20, 6 to 54 Mbps	3	4	-65.7	-58.8	-57.4		0.1	-50.6	-41.25	9.37
	Non HT20, 6 to 54 Mbps	4	4	-65.7	-59.9	-58.9	-61.3	0.1	-50.7	-41.25	9.48
	Non HT20 Beam Forming, 6 to 54 Mbps	2	7	-65.7	-59.9			0.1	-51.8	-41.25	10.58
	Non HT20 Beam Forming, 6 to 54 Mbps	3	9	-65.7	-62.0	-59.7		0.1	-48.0	-41.25	6.75
	Non HT20 Beam Forming, 6 to 54 Mbps	4	10	-65.7	-61.4	-60.8	-63.4	0.1	-46.4	-41.25	5.11
	HT/VHT20, M0 to M7	1	4	-65.5				0.1	-61.4	-41.25	20.20
	HT/VHT20, M0 to M7	2	4	-65.5	-58.0			0.1	-53.2	-41.25	11.99
	HT/VHT20, M8 to M15	2	4	-65.5	-58.0			0.1	-53.2	-41.25	11.99
	HT/VHT20, M0 to M7	3	4	-65.5	-59.2	-57.8		0.1	-51.0	-41.25	9.72
	HT/VHT20, M8 to M15	3	4	-65.5	-59.2	-57.8		0.1	-51.0	-41.25	9.72
	HT/VHT20, M16 to M23	3	4	-65.5	-59.2	-57.8		0.1	-51.0	-41.25	9.72
	HT/VHT20, M0 to M7	4	4	-65.5	-59.2	-57.8	-59.8	0.1	-49.7	-41.25	8.47
	HT/VHT20, M8 to M15	4	4	-65.5	-59.2	-57.8	-59.8	0.1	-49.7	-41.25	8.47
	HT/VHT20, M16 to M23	4	4	-65.5	-59.2	-57.8	-59.8	0.1	-49.7	-41.25	8.47
	HT/VHT20, M24 to M31	4	4	-65.5	-59.2	-57.8	-59.8	0.1	-49.7	-41.25	8.47
	HT/VHT20 Beam Forming, M0 to M7	2	7	-65.5	-59.2			0.1	-51.2	-41.25	9.98
	HT/VHT20 Beam Forming, M8 to M15	2	4	-65.5	-58.0			0.1	-53.2	-41.25	11.99
	HT/VHT20 Beam Forming, M0 to M7	3	9	-65.5	-60.6	-59.1		0.1	-47.2	-41.25	5.93
	HT/VHT20 Beam Forming, M8 to M15	3	6	-65.5	-60.0	-58.6		0.1	-49.7	-41.25	8.45
	HT/VHT20 Beam Forming, M16 to M23	3	4	-65.5	-59.2	-57.8		0.1	-51.0	-41.25	9.72
	HT/VHT20 Beam Forming, M0 to M7	4	10	-66.2	-63.2	-62.1	-64.2	0.1	-47.6	-41.25	6.35
	HT/VHT20 Beam Forming, M8 to M15	4	7	-65.5	-60.0	-58.6	-60.7	0.1	-47.5	-41.25	6.24
	HT/VHT20 Beam Forming, M16 to M23	4	5	-65.5	-60.0	-58.6	-60.7	0.1	-49.5	-41.25	8.24
	HT/VHT20 Beam Forming, M24 to M31	4	4	-65.5	-59.2	-57.8	-59.8	0.1	-49.7	-41.25	8.47
	HT/VHT20 STBC, M0 to M7	2	4	-65.5	-58.0			0.1	-53.2	-41.25	11.99
	HT/VHT20 STBC, M0 to M7	3	4	-65.5	-59.2	-57.8		0.1	-51.0	-41.25	9.72
	HT/VHT20 STBC, M0 to M7	4	4	-65.5	-59.2	-57.8	-59.8	0.1	-49.7	-41.25	8.47
	HE20, M0 to M9 1ss	1	4	-65.7				0.1	-61.6	-41.25	20.38
HE20, M0 to M9 1ss	2	4	-65.7	-59.7			0.1	-54.7	-41.25	13.41	

HE20, M0 to M9 2ss	2	4	-65.7	-59.7			0.1	-54.7	-41.25	13.41
HE20, M0 to M9 1ss	3	4	-65.7	-59.7	-58.0		0.1	-51.3	-41.25	10.02
HE20, M0 to M9 2ss	3	4	-65.7	-59.7	-58.0		0.1	-51.3	-41.25	10.02
HE20, M0 to M9 3ss	3	4	-65.7	-59.7	-58.0		0.1	-51.3	-41.25	10.02
HE20, M0 to M9 1ss	4	4	-65.7	-60.0	-58.6	-60.5	0.1	-50.4	-41.25	9.19
HE20, M0 to M9 2ss	4	4	-65.7	-60.0	-58.6	-60.5	0.1	-50.4	-41.25	9.19
HE20, M0 to M9 3ss	4	4	-65.7	-60.0	-58.6	-60.5	0.1	-50.4	-41.25	9.19
HE20, M0 to M9 4ss	4	4	-65.7	-60.0	-58.6	-60.5	0.1	-50.4	-41.25	9.19
HE20 Beam Forming, M0 to M9 1ss	2	7	-65.7	-60.0			0.1	-51.9	-41.25	10.65
HE20 Beam Forming, M0 to M9 2ss	2	4	-65.7	-59.7			0.1	-54.7	-41.25	13.41
HE20 Beam Forming, M0 to M9 1ss	3	9	-66.3	-63.6	-62.1		0.1	-49.8	-41.25	8.58
HE20 Beam Forming, M0 to M9 2ss	3	6	-65.7	-60.0	-58.6		0.1	-49.7	-41.25	8.45
HE20 Beam Forming, M0 to M9 3ss	3	4	-65.7	-59.7	-58.0		0.1	-51.3	-41.25	10.02
HE20 Beam Forming, M0 to M9 1ss	4	10	-66.3	-63.6	-62.1	-64.0	0.1	-47.7	-41.25	6.41
HE20 Beam Forming, M0 to M9 2ss	4	7	-65.7	-61.4	-60.8	-61.8	0.1	-49.0	-41.25	7.73
HE20 Beam Forming, M0 to M9 3ss	4	5	-65.7	-60.0	-58.6	-60.5	0.1	-49.4	-41.25	8.19
HE20 Beam Forming, M0 to M9 4ss	4	4	-65.7	-60.0	-58.6	-60.5	0.1	-50.4	-41.25	9.19
HE20 STBC, M0 to M9 2ss	2	4	-65.7	-59.7			0.1	-54.7	-41.25	13.41
HE20 STBC, M0 to M9 2ss	3	4	-65.7	-59.7	-58.0		0.1	-51.3	-41.25	10.02
HE20 STBC, M0 to M9 2ss	4	4	-65.7	-60.0	-58.6	-60.5	0.1	-50.4	-41.25	9.19

Non HT40, 6 to 54 Mbps	1	4	-66.0				0.0	-62.0	-41.25	20.70
Non HT40, 6 to 54 Mbps	2	4	-66.0	-63.6			0.0	-57.6	-41.25	16.33
Non HT40, 6 to 54 Mbps	3	4	-66.0	-63.6	-62.6		0.0	-55.0	-41.25	13.78
Non HT40, 6 to 54 Mbps	4	4	-66.0	-63.6	-62.6	-64.6	0.0	-54.0	-41.25	12.70
HT/VHT40, M0 to M7	1	4	-65.6				0.1	-61.5	-41.25	20.25
HT/VHT40, M0 to M7	2	4	-65.6	-63.1			0.1	-57.1	-41.25	15.81
HT/VHT40, M8 to M15	2	4	-65.6	-63.1			0.1	-57.1	-41.25	15.81
HT/VHT40, M0 to M7	3	4	-65.6	-63.1	-62.0		0.1	-54.4	-41.25	13.20
HT/VHT40, M8 to M15	3	4	-65.6	-63.1	-62.0		0.1	-54.4	-41.25	13.20
HT/VHT40, M16 to M23	3	4	-65.6	-63.1	-62.0		0.1	-54.4	-41.25	13.20
HT/VHT40, M0 to M7	4	4	-65.6	-63.1	-62.0	-64.1	0.1	-53.4	-41.25	12.13
HT/VHT40, M8 to M15	4	4	-65.6	-63.1	-62.0	-64.1	0.1	-53.4	-41.25	12.13
HT/VHT40, M16 to M23	4	4	-65.6	-63.1	-62.0	-64.1	0.1	-53.4	-41.25	12.13
HT/VHT40, M24 to M31	4	4	-65.6	-63.1	-62.0	-64.1	0.1	-53.4	-41.25	12.13
HT/VHT40 Beam Forming, M0 to M7	2	7	-66.2	-63.7			0.1	-54.7	-41.25	13.41
HT/VHT40 Beam Forming, M8 to M15	2	4	-65.6	-63.1			0.1	-57.1	-41.25	15.81
HT/VHT40 Beam Forming, M0 to M7	3	9	-66.7	-64.2	-63.1		0.1	-50.5	-41.25	9.30
HT/VHT40 Beam Forming, M8 to M15	3	6	-66.2	-63.7	-62.7		0.1	-53.1	-41.25	11.84
HT/VHT40 Beam Forming, M16 to M23	3	4	-65.6	-63.1	-62.0		0.1	-54.4	-41.25	13.20
HT/VHT40 Beam Forming, M0 to M7	4	10	-66.7	-64.2	-63.1	-65.3	0.1	-48.5	-41.25	7.25
HT/VHT40 Beam Forming, M8 to M15	4	7	-66.2	-63.7	-62.7	-64.8	0.1	-51.0	-41.25	9.79
HT/VHT40 Beam Forming, M16 to M23	4	5	-66.2	-63.7	-62.7	-64.8	0.1	-53.0	-41.25	11.79

	HT/VHT40 Beam Forming, M24 to M31	4	4	-65.6	-63.1	-62.0	-64.1	0.1	-53.4	-41.25	12.13
	HT/VHT40 STBC, M0 to M7	2	4	-65.6	-63.1			0.1	-57.1	-41.25	15.81
	HT/VHT40 STBC, M0 to M7	3	4	-65.6	-63.1	-62.0		0.1	-54.4	-41.25	13.20
	HT/VHT40 STBC, M0 to M7	4	4	-65.6	-63.1	-62.0	-64.1	0.1	-53.4	-41.25	12.13
	HE40, M0 to M9 1ss	1	4	-66.2				0.1	-62.1	-41.25	20.82
	HE40, M0 to M9 1ss	2	4	-66.2	-63.8			0.1	-57.7	-41.25	16.45
	HE40, M0 to M9 2ss	2	4	-66.2	-63.8			0.1	-57.7	-41.25	16.45
	HE40, M0 to M9 1ss	3	4	-66.2	-63.8	-62.5		0.1	-55.0	-41.25	13.76
	HE40, M0 to M9 2ss	3	4	-66.2	-63.8	-62.5		0.1	-55.0	-41.25	13.76
	HE40, M0 to M9 3ss	3	4	-66.2	-63.8	-62.5		0.1	-55.0	-41.25	13.76
	HE40, M0 to M9 1ss	4	4	-66.2	-63.8	-62.5	-64.7	0.1	-53.9	-41.25	12.70
	HE40, M0 to M9 2ss	4	4	-66.2	-63.8	-62.5	-64.7	0.1	-53.9	-41.25	12.70
	HE40, M0 to M9 3ss	4	4	-66.2	-63.8	-62.5	-64.7	0.1	-53.9	-41.25	12.70
	HE40, M0 to M9 4ss	4	4	-66.2	-63.8	-62.5	-64.7	0.1	-53.9	-41.25	12.70
	HE40 Beam Forming, M0 to M9 1ss	2	7	-66.2	-63.8			0.1	-54.7	-41.25	13.45
	HE40 Beam Forming, M0 to M9 2ss	2	4	-66.2	-63.8			0.1	-57.7	-41.25	16.45
	HE40 Beam Forming, M0 to M9 1ss	3	9	-66.8	-64.3	-63.2		0.1	-50.6	-41.25	9.38
	HE40 Beam Forming, M0 to M9 2ss	3	6	-66.2	-63.8	-62.5		0.1	-53.0	-41.25	11.76
	HE40 Beam Forming, M0 to M9 3ss	3	4	-66.2	-63.8	-62.5		0.1	-55.0	-41.25	13.76
	HE40 Beam Forming, M0 to M9 1ss	4	10	-68.1	-64.8	-63.9	-65.9	0.1	-49.3	-41.25	8.02
	HE40 Beam Forming, M0 to M9 2ss	4	7	-66.8	-64.3	-63.2	-65.4	0.1	-51.6	-41.25	10.33
	HE40 Beam Forming, M0 to M9 3ss	4	5	-66.2	-63.8	-62.5	-64.7	0.1	-52.9	-41.25	11.70
	HE40 Beam Forming, M0 to M9 4ss	4	4	-66.2	-63.8	-62.5	-64.7	0.1	-53.9	-41.25	12.70
	HE40 STBC, M0 to M9 2ss	2	4	-66.2	-63.8			0.1	-57.7	-41.25	16.45
	HE40 STBC, M0 to M9 2ss	3	4	-66.2	-63.8	-62.5		0.1	-55.0	-41.25	13.76
	HE40 STBC, M0 to M9 2ss	4	4	-66.2	-63.8	-62.5	-64.7	0.1	-53.9	-41.25	12.70
5210	Non HT80, 6 to 54 Mbps	1	4	-65.0				0.1	-60.9	-41.25	19.70
	Non HT80, 6 to 54 Mbps	2	4	-65.0	-63.0			0.1	-56.8	-41.25	15.57
	Non HT80, 6 to 54 Mbps	3	4	-65.0	-63.0	-62.6		0.1	-54.6	-41.25	13.34
	Non HT80, 6 to 54 Mbps	4	4	-65.0	-63.0	-62.6	-64.5	0.1	-53.6	-41.25	12.34
	VHT80, M0 to M9 1ss	1	4	-65.1				0.2	-60.9	-41.25	19.63
	VHT80, M0 to M9 1ss	2	4	-65.1	-63.4			0.2	-56.9	-41.25	15.68
	VHT80, M0 to M9 2ss	2	4	-65.1	-63.4			0.2	-56.9	-41.25	15.68
	VHT80, M0 to M9 1ss	3	4	-65.1	-63.4	-63.2		0.2	-54.8	-41.25	13.58
	VHT80, M0 to M9 2ss	3	4	-65.1	-63.4	-63.2		0.2	-54.8	-41.25	13.58
	VHT80, M0 to M9 3ss	3	4	-65.1	-63.4	-63.2		0.2	-54.8	-41.25	13.58
	VHT80, M0 to M9 1ss	4	4	-65.1	-63.4	-63.2	-64.9	0.2	-53.8	-41.25	12.57
	VHT80, M0 to M9 2ss	4	4	-65.1	-63.4	-63.2	-64.9	0.2	-53.8	-41.25	12.57
	VHT80, M0 to M9 3ss	4	4	-65.1	-63.4	-63.2	-64.9	0.2	-53.8	-41.25	12.57
	VHT80, M0 to M9 4ss	4	4	-65.1	-63.4	-63.2	-64.9	0.2	-53.8	-41.25	12.57
	VHT80 Beam Forming, M0 to M9 1ss	2	7	-66.2	-64.4			0.2	-55.0	-41.25	13.72
VHT80 Beam Forming, M0 to M9 2ss	2	4	-65.1	-63.4			0.2	-56.9	-41.25	15.68	

VHT80 Beam Forming, M0 to M9 1ss	3	9	-66.2	-64.4	-63.5		0.2	-50.6	-41.25	9.32	
VHT80 Beam Forming, M0 to M9 2ss	3	6	-66.2	-64.4	-63.5		0.2	-53.6	-41.25	12.32	
VHT80 Beam Forming, M0 to M9 3ss	3	4	-65.1	-63.4	-63.2		0.2	-54.8	-41.25	13.58	
VHT80 Beam Forming, M0 to M9 1ss	4	10	-66.5	-64.3	-63.8	-65.9	0.2	-48.7	-41.25	7.49	
VHT80 Beam Forming, M0 to M9 2ss	4	7	-66.2	-64.4	-63.5	-65.5	0.2	-51.5	-41.25	10.28	
VHT80 Beam Forming, M0 to M9 3ss	4	5	-65.1	-63.4	-63.2	-64.9	0.2	-52.8	-41.25	11.57	
VHT80 Beam Forming, M0 to M9 4ss	4	4	-65.1	-63.4	-63.2	-64.9	0.2	-53.8	-41.25	12.57	
VHT80 STBC, M0 to M9 1ss	2	4	-65.1	-63.4			0.2	-56.9	-41.25	15.68	
VHT80 STBC, M0 to M9 1ss	3	4	-65.1	-63.4	-63.2		0.2	-54.8	-41.25	13.58	
VHT80 STBC, M0 to M9 1ss	4	4	-65.1	-63.4	-63.2	-64.9	0.2	-53.8	-41.25	12.57	
HE80, M0 to M9 1ss	1	4	-65.5				0.3	-61.2	-41.25	20.00	
HE80, M0 to M9 1ss	2	4	-65.5	-63.7			0.3	-57.2	-41.25	16.00	
HE80, M0 to M9 2ss	2	4	-65.5	-63.7			0.3	-57.2	-41.25	16.00	
HE80, M0 to M9 1ss	3	4	-65.5	-63.7	-63.0		0.3	-54.9	-41.25	13.67	
HE80, M0 to M9 2ss	3	4	-65.5	-63.7	-63.0		0.3	-54.9	-41.25	13.67	
HE80, M0 to M9 3ss	3	4	-65.5	-63.7	-63.0		0.3	-54.9	-41.25	13.67	
HE80, M0 to M9 1ss	4	4	-65.5	-63.7	-63.0	-65.1	0.3	-53.9	-41.25	12.69	
HE80, M0 to M9 2ss	4	4	-65.5	-63.7	-63.0	-65.1	0.3	-53.9	-41.25	12.69	
HE80, M0 to M9 3ss	4	4	-65.5	-63.7	-63.0	-65.1	0.3	-53.9	-41.25	12.69	
HE80, M0 to M9 4ss	4	4	-65.5	-63.7	-63.0	-65.1	0.3	-53.9	-41.25	12.69	
HE80 Beam Forming, M0 to M9 1ss	2	7	-66.2	-64.4			0.3	-54.9	-41.25	13.70	
HE80 Beam Forming, M0 to M9 2ss	2	4	-65.5	-63.7			0.3	-57.2	-41.25	16.00	
HE80 Beam Forming, M0 to M9 1ss	3	9	-66.2	-64.4	-63.6		0.3	-50.6	-41.25	9.33	
HE80 Beam Forming, M0 to M9 2ss	3	6	-66.2	-64.4	-63.6		0.3	-53.6	-41.25	12.33	
HE80 Beam Forming, M0 to M9 3ss	3	4	-65.5	-63.7	-63.0		0.3	-54.9	-41.25	13.67	
HE80 Beam Forming, M0 to M9 1ss	4	10	-66.7	-64.7	-64.0	-66.2	0.3	-49.0	-41.25	7.74	
HE80 Beam Forming, M0 to M9 2ss	4	7	-66.2	-64.4	-63.6	-65.8	0.3	-51.6	-41.25	10.35	
HE80 Beam Forming, M0 to M9 3ss	4	5	-65.5	-63.7	-63.0	-65.1	0.3	-52.9	-41.25	11.69	
HE80 Beam Forming, M0 to M9 4ss	4	4	-65.5	-63.7	-63.0	-65.1	0.3	-53.9	-41.25	12.69	
HE80 STBC, M0 to M9 1ss	2	4	-65.5	-63.7			0.3	-57.2	-41.25	16.00	
HE80 STBC, M0 to M9 1ss	3	4	-65.5	-63.7	-63.0		0.3	-54.9	-41.25	13.67	
HE80 STBC, M0 to M9 1ss	4	4	-65.5	-63.7	-63.0	-65.1	0.3	-53.9	-41.25	12.69	
5220	Non HT20, 6 to 54 Mbps	1	4	-65.5				0.1	-61.4	-41.25	20.20
	Non HT20, 6 to 54 Mbps	2	4	-65.5	-59.1			0.1	-54.1	-41.25	12.90
	Non HT20, 6 to 54 Mbps	3	4	-65.5	-59.1	-58.3		0.1	-51.2	-41.25	9.94
	Non HT20, 6 to 54 Mbps	4	4	-65.5	-59.1	-58.3	-59.4	0.1	-49.8	-41.25	8.53
	Non HT20 Beam Forming, 6 to 54 Mbps	2	7	-65.5	-59.1			0.1	-51.1	-41.25	9.90
	Non HT20 Beam Forming, 6 to 54 Mbps	3	9	-65.5	-59.1	-58.3		0.1	-46.2	-41.25	4.94
	Non HT20 Beam Forming, 6 to 54 Mbps	4	10	-65.5	-59.1	-58.3	-59.4	0.1	-43.8	-41.25	2.53
	HT/VHT20, M0 to M7	1	4	-65.8				0.1	-61.7	-41.25	20.50
	HT/VHT20, M0 to M7	2	4	-65.8	-59.3			0.1	-54.4	-41.25	13.12
HT/VHT20, M8 to M15	2	4	-65.8	-59.3			0.1	-54.4	-41.25	13.12	



HT/VHT20, M0 to M7	3	4	-65.8	-59.3	-58.3		0.1	-51.3	-41.25	10.05
HT/VHT20, M8 to M15	3	4	-65.8	-59.3	-58.3		0.1	-51.3	-41.25	10.05
HT/VHT20, M16 to M23	3	4	-65.8	-59.3	-58.3		0.1	-51.3	-41.25	10.05
HT/VHT20, M0 to M7	4	4	-65.8	-59.3	-58.3	-60.1	0.1	-50.0	-41.25	8.79
HT/VHT20, M8 to M15	4	4	-65.8	-59.3	-58.3	-60.1	0.1	-50.0	-41.25	8.79
HT/VHT20, M16 to M23	4	4	-65.8	-59.3	-58.3	-60.1	0.1	-50.0	-41.25	8.79
HT/VHT20, M24 to M31	4	4	-65.8	-59.3	-58.3	-60.1	0.1	-50.0	-41.25	8.79
HT/VHT20 Beam Forming, M0 to M7	2	7	-65.8	-59.3			0.1	-51.4	-41.25	10.12
HT/VHT20 Beam Forming, M8 to M15	2	4	-65.8	-59.3			0.1	-54.4	-41.25	13.12
HT/VHT20 Beam Forming, M0 to M7	3	9	-65.8	-59.3	-58.3		0.1	-46.3	-41.25	5.05
HT/VHT20 Beam Forming, M8 to M15	3	6	-65.8	-59.3	-58.3		0.1	-49.3	-41.25	8.05
HT/VHT20 Beam Forming, M16 to M23	3	4	-65.8	-59.3	-58.3		0.1	-51.3	-41.25	10.05
HT/VHT20 Beam Forming, M0 to M7	4	10	-65.8	-59.3	-58.3	-60.1	0.1	-44.0	-41.25	2.79
HT/VHT20 Beam Forming, M8 to M15	4	7	-65.8	-59.3	-58.3	-60.1	0.1	-47.0	-41.25	5.79
HT/VHT20 Beam Forming, M16 to M23	4	5	-65.8	-59.3	-58.3	-60.1	0.1	-49.0	-41.25	7.79
HT/VHT20 Beam Forming, M24 to M31	4	4	-65.8	-59.3	-58.3	-60.1	0.1	-50.0	-41.25	8.79
HT/VHT20 STBC, M0 to M7	2	4	-65.8	-59.3			0.1	-54.4	-41.25	13.12
HT/VHT20 STBC, M0 to M7	3	4	-65.8	-59.3	-58.3		0.1	-51.3	-41.25	10.05
HT/VHT20 STBC, M0 to M7	4	4	-65.8	-59.3	-58.3	-60.1	0.1	-50.0	-41.25	8.79
HE20, M0 to M9 1ss	1	4	-65.7				0.1	-61.6	-41.25	20.38
HE20, M0 to M9 1ss	2	4	-65.7	-59.2			0.1	-54.3	-41.25	13.00
HE20, M0 to M9 2ss	2	4	-65.7	-59.2			0.1	-54.3	-41.25	13.00
HE20, M0 to M9 1ss	3	4	-65.7	-59.2	-58.2		0.1	-51.2	-41.25	9.93
HE20, M0 to M9 2ss	3	4	-65.7	-59.2	-58.2		0.1	-51.2	-41.25	9.93
HE20, M0 to M9 3ss	3	4	-65.7	-59.2	-58.2		0.1	-51.2	-41.25	9.93
HE20, M0 to M9 1ss	4	4	-65.7	-59.2	-58.2	-60.0	0.1	-49.9	-41.25	8.68
HE20, M0 to M9 2ss	4	4	-65.7	-59.2	-58.2	-60.0	0.1	-49.9	-41.25	8.68
HE20, M0 to M9 3ss	4	4	-65.7	-59.2	-58.2	-60.0	0.1	-49.9	-41.25	8.68
HE20, M0 to M9 4ss	4	4	-65.7	-59.2	-58.2	-60.0	0.1	-49.9	-41.25	8.68
HE20 Beam Forming, M0 to M9 1ss	2	7	-65.7	-59.2			0.1	-51.3	-41.25	10.00
HE20 Beam Forming, M0 to M9 2ss	2	4	-65.7	-59.2			0.1	-54.3	-41.25	13.00
HE20 Beam Forming, M0 to M9 1ss	3	9	-65.7	-59.2	-58.2		0.1	-46.2	-41.25	4.93
HE20 Beam Forming, M0 to M9 2ss	3	6	-65.7	-59.2	-58.2		0.1	-49.2	-41.25	7.93
HE20 Beam Forming, M0 to M9 3ss	3	4	-65.7	-59.2	-58.2		0.1	-51.2	-41.25	9.93
HE20 Beam Forming, M0 to M9 1ss	4	10	-65.7	-59.2	-58.2	-60.0	0.1	-43.9	-41.25	2.68
HE20 Beam Forming, M0 to M9 2ss	4	7	-65.7	-59.2	-58.2	-60.0	0.1	-46.9	-41.25	5.68
HE20 Beam Forming, M0 to M9 3ss	4	5	-65.7	-59.2	-58.2	-60.0	0.1	-48.9	-41.25	7.68
HE20 Beam Forming, M0 to M9 4ss	4	4	-65.7	-59.2	-58.2	-60.0	0.1	-49.9	-41.25	8.68
HE20 STBC, M0 to M9 2ss	2	4	-65.7	-59.2			0.1	-54.3	-41.25	13.00
HE20 STBC, M0 to M9 2ss	3	4	-65.7	-59.2	-58.2		0.1	-51.2	-41.25	9.93
HE20 STBC, M0 to M9 2ss	4	4	-65.7	-59.2	-58.2	-60.0	0.1	-49.9	-41.25	8.68
Non HT40, 6 to 54 Mbps	1	4	-65.5				0.0	-61.5	-41.25	20.20

Non HT40, 6 to 54 Mbps	2	4	-65.5	-58.6			0.0	-53.7	-41.25	12.49
Non HT40, 6 to 54 Mbps	3	4	-65.5	-58.6	-58.1		0.0	-50.9	-41.25	9.63
Non HT40, 6 to 54 Mbps	4	4	-65.5	-58.6	-58.1	-59.4	0.0	-49.6	-41.25	8.31
HT/VHT40, M0 to M7	1	4	-65.8				0.1	-61.7	-41.25	20.45
HT/VHT40, M0 to M7	2	4	-65.8	-59.2			0.1	-54.2	-41.25	12.99
HT/VHT40, M8 to M15	2	4	-65.8	-59.2			0.1	-54.2	-41.25	12.99
HT/VHT40, M0 to M7	3	4	-65.8	-59.2	-58.3		0.1	-51.2	-41.25	9.96
HT/VHT40, M8 to M15	3	4	-65.8	-59.2	-58.3		0.1	-51.2	-41.25	9.96
HT/VHT40, M16 to M23	3	4	-65.8	-59.2	-58.3		0.1	-51.2	-41.25	9.96
HT/VHT40, M0 to M7	4	4	-65.8	-59.2	-58.3	-59.7	0.1	-49.9	-41.25	8.61
HT/VHT40, M8 to M15	4	4	-65.8	-59.2	-58.3	-59.7	0.1	-49.9	-41.25	8.61
HT/VHT40, M16 to M23	4	4	-65.8	-59.2	-58.3	-59.7	0.1	-49.9	-41.25	8.61
HT/VHT40, M24 to M31	4	4	-65.8	-59.2	-58.3	-59.7	0.1	-49.9	-41.25	8.61
HT/VHT40 Beam Forming, M0 to M7	2	7	-65.8	-59.2			0.1	-51.2	-41.25	9.99
HT/VHT40 Beam Forming, M8 to M15	2	4	-65.8	-59.2			0.1	-54.2	-41.25	12.99
HT/VHT40 Beam Forming, M0 to M7	3	9	-65.8	-59.2	-58.3		0.1	-46.2	-41.25	4.96
HT/VHT40 Beam Forming, M8 to M15	3	6	-65.8	-59.2	-58.3		0.1	-49.2	-41.25	7.96
HT/VHT40 Beam Forming, M16 to M23	3	4	-65.8	-59.2	-58.3		0.1	-51.2	-41.25	9.96
HT/VHT40 Beam Forming, M0 to M7	4	10	-65.8	-59.2	-58.3	-59.7	0.1	-43.9	-41.25	2.61
HT/VHT40 Beam Forming, M8 to M15	4	7	-65.8	-59.2	-58.3	-59.7	0.1	-46.9	-41.25	5.61
HT/VHT40 Beam Forming, M16 to M23	4	5	-65.8	-59.2	-58.3	-59.7	0.1	-48.9	-41.25	7.61
HT/VHT40 Beam Forming, M24 to M31	4	4	-65.8	-59.2	-58.3	-59.7	0.1	-49.9	-41.25	8.61
HT/VHT40 STBC, M0 to M7	2	4	-65.8	-59.2			0.1	-54.2	-41.25	12.99
HT/VHT40 STBC, M0 to M7	3	4	-65.8	-59.2	-58.3		0.1	-51.2	-41.25	9.96
HT/VHT40 STBC, M0 to M7	4	4	-65.8	-59.2	-58.3	-59.7	0.1	-49.9	-41.25	8.61
HE40, M0 to M9 1ss	1	4	-65.6				0.1	-61.5	-41.25	20.22
HE40, M0 to M9 1ss	2	4	-65.6	-59.2			0.1	-54.2	-41.25	12.93
HE40, M0 to M9 2ss	2	4	-65.6	-59.2			0.1	-54.2	-41.25	12.93
HE40, M0 to M9 1ss	3	4	-65.6	-59.2	-58.2		0.1	-51.1	-41.25	9.87
HE40, M0 to M9 2ss	3	4	-65.6	-59.2	-58.2		0.1	-51.1	-41.25	9.87
HE40, M0 to M9 3ss	3	4	-65.6	-59.2	-58.2		0.1	-51.1	-41.25	9.87
HE40, M0 to M9 1ss	4	4	-65.6	-59.2	-58.2	-59.8	0.1	-49.8	-41.25	8.56
HE40, M0 to M9 2ss	4	4	-65.6	-59.2	-58.2	-59.8	0.1	-49.8	-41.25	8.56
HE40, M0 to M9 3ss	4	4	-65.6	-59.2	-58.2	-59.8	0.1	-49.8	-41.25	8.56
HE40, M0 to M9 4ss	4	4	-65.6	-59.2	-58.2	-59.8	0.1	-49.8	-41.25	8.56
HE40 Beam Forming, M0 to M9 1ss	2	7	-65.6	-59.2			0.1	-51.2	-41.25	9.93
HE40 Beam Forming, M0 to M9 2ss	2	4	-65.6	-59.2			0.1	-54.2	-41.25	12.93
HE40 Beam Forming, M0 to M9 1ss	3	9	-65.6	-59.2	-58.2		0.1	-46.1	-41.25	4.87
HE40 Beam Forming, M0 to M9 2ss	3	6	-65.6	-59.2	-58.2		0.1	-49.1	-41.25	7.87
HE40 Beam Forming, M0 to M9 3ss	3	4	-65.6	-59.2	-58.2		0.1	-51.1	-41.25	9.87
HE40 Beam Forming, M0 to M9 1ss	4	10	-65.6	-59.2	-58.2	-59.8	0.1	-43.8	-41.25	2.56
HE40 Beam Forming, M0 to M9 2ss	4	7	-65.6	-59.2	-58.2	-59.8	0.1	-46.8	-41.25	5.56
HE40 Beam Forming, M0 to M9 3ss	4	5	-65.6	-59.2	-58.2	-59.8	0.1	-48.8	-41.25	7.56

	HE40 Beam Forming, M0 to M9 4ss	4	4	-65.6	-59.2	-58.2	-59.8	0.1	-49.8	-41.25	8.56
	HE40 STBC, M0 to M9 2ss	2	4	-65.6	-59.2			0.1	-54.2	-41.25	12.93
	HE40 STBC, M0 to M9 2ss	3	4	-65.6	-59.2	-58.2		0.1	-51.1	-41.25	9.87
	HE40 STBC, M0 to M9 2ss	4	4	-65.6	-59.2	-58.2	-59.8	0.1	-49.8	-41.25	8.56
5240	Non HT20, 6 to 54 Mbps	1	4	-65.8				0.1	-61.7	-41.25	20.50
	Non HT20, 6 to 54 Mbps	2	4	-65.8	-58.6			0.1	-53.8	-41.25	12.54
	Non HT20, 6 to 54 Mbps	3	4	-65.8	-58.6	-57.9		0.1	-50.8	-41.25	9.56
	Non HT20, 6 to 54 Mbps	4	4	-65.8	-58.6	-57.9	-59.0	0.1	-49.4	-41.25	8.14
	Non HT20 Beam Forming, 6 to 54 Mbps	2	7	-65.8	-58.6			0.1	-50.8	-41.25	9.54
	Non HT20 Beam Forming, 6 to 54 Mbps	3	9	-65.8	-58.6	-57.9		0.1	-45.8	-41.25	4.56
	Non HT20 Beam Forming, 6 to 54 Mbps	4	10	-65.8	-58.6	-57.9	-59.0	0.1	-43.4	-41.25	2.14
	HT/VHT20, M0 to M7	1	4	-65.9				0.1	-61.8	-41.25	20.60
	HT/VHT20, M0 to M7	2	4	-65.9	-59.4			0.1	-54.5	-41.25	13.22
	HT/VHT20, M8 to M15	2	4	-65.9	-59.4			0.1	-54.5	-41.25	13.22
	HT/VHT20, M0 to M7	3	4	-65.9	-59.4	-58.0		0.1	-51.2	-41.25	9.94
	HT/VHT20, M8 to M15	3	4	-65.9	-59.4	-58.0		0.1	-51.2	-41.25	9.94
	HT/VHT20, M16 to M23	3	4	-65.9	-59.4	-58.0		0.1	-51.2	-41.25	9.94
	HT/VHT20, M0 to M7	4	4	-65.9	-59.4	-58.0	-59.6	0.1	-49.8	-41.25	8.58
	HT/VHT20, M8 to M15	4	4	-65.9	-59.4	-58.0	-59.6	0.1	-49.8	-41.25	8.58
	HT/VHT20, M16 to M23	4	4	-65.9	-59.4	-58.0	-59.6	0.1	-49.8	-41.25	8.58
	HT/VHT20, M24 to M31	4	4	-65.9	-59.4	-58.0	-59.6	0.1	-49.8	-41.25	8.58
	HT/VHT20 Beam Forming, M0 to M7	2	7	-65.9	-59.4			0.1	-51.5	-41.25	10.22
	HT/VHT20 Beam Forming, M8 to M15	2	4	-65.9	-59.4			0.1	-54.5	-41.25	13.22
	HT/VHT20 Beam Forming, M0 to M7	3	9	-65.9	-59.4	-58.0		0.1	-46.2	-41.25	4.94
	HT/VHT20 Beam Forming, M8 to M15	3	6	-65.9	-59.4	-58.0		0.1	-49.2	-41.25	7.94
	HT/VHT20 Beam Forming, M16 to M23	3	4	-65.9	-59.4	-58.0		0.1	-51.2	-41.25	9.94
	HT/VHT20 Beam Forming, M0 to M7	4	10	-65.9	-59.4	-58.0	-59.6	0.1	-43.8	-41.25	2.58
	HT/VHT20 Beam Forming, M8 to M15	4	7	-65.9	-59.4	-58.0	-59.6	0.1	-46.8	-41.25	5.58
	HT/VHT20 Beam Forming, M16 to M23	4	5	-65.9	-59.4	-58.0	-59.6	0.1	-48.8	-41.25	7.58
	HT/VHT20 Beam Forming, M24 to M31	4	4	-65.9	-59.4	-58.0	-59.6	0.1	-49.8	-41.25	8.58
	HT/VHT20 STBC, M0 to M7	2	4	-65.9	-59.4			0.1	-54.5	-41.25	13.22
	HT/VHT20 STBC, M0 to M7	3	4	-65.9	-59.4	-58.0		0.1	-51.2	-41.25	9.94
	HT/VHT20 STBC, M0 to M7	4	4	-65.9	-59.4	-58.0	-59.6	0.1	-49.8	-41.25	8.58
	HE20, M0 to M9 1ss	1	4	-65.9				0.1	-61.8	-41.25	20.58
	HE20, M0 to M9 1ss	2	4	-65.9	-59.2			0.1	-54.3	-41.25	13.04
	HE20, M0 to M9 2ss	2	4	-65.9	-59.2			0.1	-54.3	-41.25	13.04
	HE20, M0 to M9 1ss	3	4	-65.9	-59.2	-58.0		0.1	-51.1	-41.25	9.85
HE20, M0 to M9 2ss	3	4	-65.9	-59.2	-58.0		0.1	-51.1	-41.25	9.85	
HE20, M0 to M9 3ss	3	4	-65.9	-59.2	-58.0		0.1	-51.1	-41.25	9.85	
HE20, M0 to M9 1ss	4	4	-65.9	-59.2	-58.0	-59.6	0.1	-49.8	-41.25	8.51	
HE20, M0 to M9 2ss	4	4	-65.9	-59.2	-58.0	-59.6	0.1	-49.8	-41.25	8.51	
HE20, M0 to M9 3ss	4	4	-65.9	-59.2	-58.0	-59.6	0.1	-49.8	-41.25	8.51	

	HE20, M0 to M9 4ss	4	4	-65.9	-59.2	-58.0	-59.6	0.1	-49.8	-41.25	8.51
	HE20 Beam Forming, M0 to M9 1ss	2	7	-65.9	-59.2			0.1	-51.3	-41.25	10.04
	HE20 Beam Forming, M0 to M9 2ss	2	4	-65.9	-59.2			0.1	-54.3	-41.25	13.04
	HE20 Beam Forming, M0 to M9 1ss	3	9	-65.9	-59.2	-58.0		0.1	-46.1	-41.25	4.85
	HE20 Beam Forming, M0 to M9 2ss	3	6	-65.9	-59.2	-58.0		0.1	-49.1	-41.25	7.85
	HE20 Beam Forming, M0 to M9 3ss	3	4	-65.9	-59.2	-58.0		0.1	-51.1	-41.25	9.85
	HE20 Beam Forming, M0 to M9 1ss	4	10	-65.9	-59.2	-58.0	-59.6	0.1	-43.8	-41.25	2.51
	HE20 Beam Forming, M0 to M9 2ss	4	7	-65.9	-59.2	-58.0	-59.6	0.1	-46.8	-41.25	5.51
	HE20 Beam Forming, M0 to M9 3ss	4	5	-65.9	-59.2	-58.0	-59.6	0.1	-48.8	-41.25	7.51
	HE20 Beam Forming, M0 to M9 4ss	4	4	-65.9	-59.2	-58.0	-59.6	0.1	-49.8	-41.25	8.51
	HE20 STBC, M0 to M9 2ss	2	4	-65.9	-59.2			0.1	-54.3	-41.25	13.04
	HE20 STBC, M0 to M9 2ss	3	4	-65.9	-59.2	-58.0		0.1	-51.1	-41.25	9.85
	HE20 STBC, M0 to M9 2ss	4	4	-65.9	-59.2	-58.0	-59.6	0.1	-49.8	-41.25	8.51
5250	Non HT160, 6 to 54 Mbps	1	4	-59.6				0.0	-55.6	-41.25	14.30
	Non HT160, 6 to 54 Mbps	2	4	-59.6	-60.8			0.0	-53.1	-41.25	11.85
	Non HT160, 6 to 54 Mbps	3	4	-59.6	-60.8	-61.6		0.0	-51.8	-41.25	10.52
	Non HT160, 6 to 54 Mbps	4	4	-59.6	-60.8	-61.6	-63.0	0.0	-51.0	-41.25	9.76
	VHT160, M0 to M9 1ss	1	4	-61.0				0.4	-56.6	-41.25	15.36
	VHT160, M0 to M9 1ss	2	4	-61.0	-62.1			0.4	-54.1	-41.25	12.86
	VHT160, M0 to M9 2ss	2	4	-61.0	-62.1			0.4	-54.1	-41.25	12.86
	VHT160, M0 to M9 1ss	3	4	-61.0	-62.1	-62.5		0.4	-52.7	-41.25	11.41
	VHT160, M0 to M9 2ss	3	4	-61.0	-62.1	-62.5		0.4	-52.7	-41.25	11.41
	VHT160, M0 to M9 3ss	3	4	-61.0	-62.1	-62.5		0.4	-52.7	-41.25	11.41
	VHT160, M0 to M9 1ss	4	4	-61.0	-62.1	-62.5	-64.4	0.4	-51.9	-41.25	10.67
	VHT160, M0 to M9 2ss	4	4	-61.0	-62.1	-62.5	-64.4	0.4	-51.9	-41.25	10.67
	VHT160, M0 to M9 3ss	4	4	-61.0	-62.1	-62.5	-64.4	0.4	-51.9	-41.25	10.67
	VHT160, M0 to M9 4ss	4	4	-61.0	-62.1	-62.5	-64.4	0.4	-51.9	-41.25	10.67
	VHT160 Beam Forming, M0 to M9 1ss	2	7	-63.2	-63.3			0.4	-52.8	-41.25	11.60
	VHT160 Beam Forming, M0 to M9 2ss	2	4	-61.0	-62.1			0.4	-54.1	-41.25	12.86
	VHT160 Beam Forming, M0 to M9 1ss	3	9	-64.6	-63.9	-63.7		0.4	-49.9	-41.25	8.64
	VHT160 Beam Forming, M0 to M9 2ss	3	6	-63.2	-63.3	-63.5		0.4	-52.2	-41.25	10.92
	VHT160 Beam Forming, M0 to M9 3ss	3	4	-61.0	-62.1	-62.5		0.4	-52.7	-41.25	11.41
	VHT160 Beam Forming, M0 to M9 1ss	4	10	-64.6	-63.9	-63.7	-66.2	0.4	-48.1	-41.25	6.83
	VHT160 Beam Forming, M0 to M9 2ss	4	7	-63.2	-63.3	-63.5	-65.5	0.4	-50.4	-41.25	9.12
	VHT160 Beam Forming, M0 to M9 3ss	4	5	-63.2	-63.3	-63.5	-65.5	0.4	-52.4	-41.25	11.12
	VHT160 Beam Forming, M0 to M9 4ss	4	4	-61.0	-62.1	-62.5	-64.4	0.4	-51.9	-41.25	10.67
	VHT160 STBC, M0 to M9 1ss	2	4	-61.0	-62.1			0.4	-54.1	-41.25	12.86
	VHT160 STBC, M0 to M9 1ss	3	4	-61.0	-62.1	-62.5		0.4	-52.7	-41.25	11.41
	VHT160 STBC, M0 to M9 1ss	4	4	-61.0	-62.1	-62.5	-64.4	0.4	-51.9	-41.25	10.67
	HE160, M0 to M9 1ss	1	4	-57.9				0.4	-53.5	-41.25	12.22
	HE160, M0 to M9 1ss	2	4	-57.9	-61.9			0.4	-52.0	-41.25	10.76
HE160, M0 to M9 2ss	2	4	-57.9	-61.9			0.4	-52.0	-41.25	10.76	



HE160, M0 to M9 1ss	3	4	-60.6	-62.4	-62.3		0.4	-52.5	-41.25	11.23
HE160, M0 to M9 2ss	3	4	-60.6	-62.4	-62.3		0.4	-52.5	-41.25	11.23
HE160, M0 to M9 3ss	3	4	-60.6	-62.4	-62.3		0.4	-52.5	-41.25	11.23
HE160, M0 to M9 1ss	4	4	-60.6	-62.4	-62.3	-64.1	0.4	-51.7	-41.25	10.47
HE160, M0 to M9 2ss	4	4	-60.6	-62.4	-62.3	-64.1	0.4	-51.7	-41.25	10.47
HE160, M0 to M9 3ss	4	4	-60.6	-62.4	-62.3	-64.1	0.4	-51.7	-41.25	10.47
HE160, M0 to M9 4ss	4	4	-60.6	-62.4	-62.3	-64.1	0.4	-51.7	-41.25	10.47
HE160 Beam Forming, M0 to M9 1ss	2	7	-60.6	-62.4			0.4	-51.0	-41.25	9.71
HE160 Beam Forming, M0 to M9 2ss	2	4	-57.9	-61.9			0.4	-52.0	-41.25	10.76
HE160 Beam Forming, M0 to M9 1ss	3	9	-63.2	-63.5	-63.3		0.4	-49.1	-41.25	7.88
HE160 Beam Forming, M0 to M9 2ss	3	6	-60.6	-62.4	-62.3		0.4	-50.5	-41.25	9.23
HE160 Beam Forming, M0 to M9 3ss	3	4	-60.6	-62.4	-62.3		0.4	-52.5	-41.25	11.23
HE160 Beam Forming, M0 to M9 1ss	4	10	-63.2	-63.5	-63.3	-65.4	0.4	-47.3	-41.25	6.06
HE160 Beam Forming, M0 to M9 2ss	4	7	-63.2	-63.5	-63.3	-65.4	0.4	-50.3	-41.25	9.06
HE160 Beam Forming, M0 to M9 3ss	4	5	-60.6	-62.4	-62.3	-64.1	0.4	-50.7	-41.25	9.47
HE160 Beam Forming, M0 to M9 4ss	4	4	-60.6	-62.4	-62.3	-64.1	0.4	-51.7	-41.25	10.47
HE160 STBC, M0 to M9 1ss	2	4	-57.9	-61.9			0.4	-52.0	-41.25	10.76
HE160 STBC, M0 to M9 1ss	3	4	-60.6	-62.4	-62.3		0.4	-52.5	-41.25	11.23
HE160 STBC, M0 to M9 1ss	4	4	-60.6	-62.4	-62.3	-64.1	0.4	-51.7	-41.25	10.47

**Conducted Spurs Average, 4dBi
5240 MHz, Non HT20 Beam Forming, 6 to 54 Mbps**



Antenna A



Antenna B



Antenna C



Antenna D

Conducted Spurious Average Table, 5dBi

Frequency (MHz)	Mode	Tx Paths	Correlated Antenna Gain (dBi)	Tx 1 Spur Power (dBm)	Tx 2 Spur Power (dBm)	Tx 3 Spur Power (dBm)	Tx 4 Spur Power (dBm)	Duty Cycle Correction (dB)	Total Conducted Spur (dBm)	Limit (dBm)	Margin (dB)
5180	Non HT20, 6 to 54 Mbps	1	5	-65.7				0.1	-60.6	-41.25	19.40
	Non HT20, 6 to 54 Mbps	2	5	-65.7	-58.8			0.1	-52.9	-41.25	11.69
	Non HT20, 6 to 54 Mbps	3	5	-65.7	-59.9	-58.9		0.1	-50.8	-41.25	9.58
	Non HT20, 6 to 54 Mbps	4	5	-65.7	-59.9	-58.9	-61.3	0.1	-49.7	-41.25	8.48
	Non HT20 Beam Forming, 6 to 54 Mbps	2	8	-65.7	-59.9			0.1	-50.8	-41.25	9.58
	Non HT20 Beam Forming, 6 to 54 Mbps	3	10	-65.7	-61.4	-60.8		0.1	-47.3	-41.25	6.08
	Non HT20 Beam Forming, 6 to 54 Mbps	4	11	-66.2	-63.4	-62.1	-64.1	0.1	-46.6	-41.25	5.38
	HT/VHT20, M0 to M7	1	5	-65.5				0.1	-60.4	-41.25	19.20
	HT/VHT20, M0 to M7	2	5	-65.5	-58.0			0.1	-52.2	-41.25	10.99
	HT/VHT20, M8 to M15	2	5	-65.5	-58.0			0.1	-52.2	-41.25	10.99
	HT/VHT20, M0 to M7	3	5	-65.5	-59.2	-57.8		0.1	-50.0	-41.25	8.72
	HT/VHT20, M8 to M15	3	5	-65.5	-59.2	-57.8		0.1	-50.0	-41.25	8.72
	HT/VHT20, M16 to M23	3	5	-65.5	-59.2	-57.8		0.1	-50.0	-41.25	8.72
	HT/VHT20, M0 to M7	4	5	-65.5	-60.0	-58.6	-60.7	0.1	-49.5	-41.25	8.24
	HT/VHT20, M8 to M15	4	5	-65.5	-60.0	-58.6	-60.7	0.1	-49.5	-41.25	8.24
	HT/VHT20, M16 to M23	4	5	-65.5	-60.0	-58.6	-60.7	0.1	-49.5	-41.25	8.24
	HT/VHT20, M24 to M31	4	5	-65.5	-60.0	-58.6	-60.7	0.1	-49.5	-41.25	8.24
	HT/VHT20 Beam Forming, M0 to M7	2	8	-65.5	-60.0			0.1	-50.9	-41.25	9.62
	HT/VHT20 Beam Forming, M8 to M15	2	5	-65.5	-58.0			0.1	-52.2	-41.25	10.99
	HT/VHT20 Beam Forming, M0 to M7	3	10	-65.5	-62.4	-61.5		0.1	-48.0	-41.25	6.75
	HT/VHT20 Beam Forming, M8 to M15	3	7	-65.5	-60.0	-58.6		0.1	-48.7	-41.25	7.45
	HT/VHT20 Beam Forming, M16 to M23	3	5	-65.5	-59.2	-57.8		0.1	-50.0	-41.25	8.72
	HT/VHT20 Beam Forming, M0 to M7	4	11	-66.2	-63.2	-62.1	-64.2	0.1	-46.6	-41.25	5.35
	HT/VHT20 Beam Forming, M8 to M15	4	8	-65.5	-60.6	-59.1	-61.2	0.1	-47.0	-41.25	5.73
	HT/VHT20 Beam Forming, M16 to M23	4	6	-65.5	-60.0	-58.6	-60.7	0.1	-48.5	-41.25	7.24
	HT/VHT20 Beam Forming, M24 to M31	4	5	-65.5	-60.0	-58.6	-60.7	0.1	-49.5	-41.25	8.24
	HT/VHT20 STBC, M0 to M7	2	5	-65.5	-58.0			0.1	-52.2	-41.25	10.99
	HT/VHT20 STBC, M0 to M7	3	5	-65.5	-59.2	-57.8		0.1	-50.0	-41.25	8.72
	HT/VHT20 STBC, M0 to M7	4	5	-65.5	-60.0	-58.6	-60.7	0.1	-49.5	-41.25	8.24
	HE20, M0 to M9 1ss	1	5	-65.7				0.1	-60.6	-41.25	19.38
	HE20, M0 to M9 1ss	2	5	-65.7	-59.7			0.1	-53.7	-41.25	12.41

HE20, M0 to M9 2ss	2	5	-65.7	-59.7				0.1	-53.7	-41.25	12.41
HE20, M0 to M9 1ss	3	5	-65.7	-60.0	-58.6			0.1	-50.7	-41.25	9.45
HE20, M0 to M9 2ss	3	5	-65.7	-60.0	-58.6			0.1	-50.7	-41.25	9.45
HE20, M0 to M9 3ss	3	5	-65.7	-60.0	-58.6			0.1	-50.7	-41.25	9.45
HE20, M0 to M9 1ss	4	5	-65.7	-60.0	-58.6	-60.5		0.1	-49.4	-41.25	8.19
HE20, M0 to M9 2ss	4	5	-65.7	-60.0	-58.6	-60.5		0.1	-49.4	-41.25	8.19
HE20, M0 to M9 3ss	4	5	-65.7	-60.0	-58.6	-60.5		0.1	-49.4	-41.25	8.19
HE20, M0 to M9 4ss	4	5	-65.7	-60.0	-58.6	-60.5		0.1	-49.4	-41.25	8.19
HE20 Beam Forming, M0 to M9 1ss	2	8	-65.7	-60.5				0.1	-51.3	-41.25	10.04
HE20 Beam Forming, M0 to M9 2ss	2	5	-65.7	-59.7				0.1	-53.7	-41.25	12.41
HE20 Beam Forming, M0 to M9 1ss	3	10	-66.3	-63.6	-62.1			0.1	-48.8	-41.25	7.58
HE20 Beam Forming, M0 to M9 2ss	3	7	-65.7	-60.5	-59.1			0.1	-49.1	-41.25	7.90
HE20 Beam Forming, M0 to M9 3ss	3	5	-65.7	-60.0	-58.6			0.1	-50.7	-41.25	9.45
HE20 Beam Forming, M0 to M9 1ss	4	11	-67.0	-64.2	-63.0	-65.1		0.1	-47.5	-41.25	6.25
HE20 Beam Forming, M0 to M9 2ss	4	8	-65.7	-62.8	-61.6	-63.1		0.1	-49.0	-41.25	7.73
HE20 Beam Forming, M0 to M9 3ss	4	6	-65.7	-60.5	-59.1	-61.0		0.1	-48.9	-41.25	7.65
HE20 Beam Forming, M0 to M9 4ss	4	5	-65.7	-60.0	-58.6	-60.5		0.1	-49.4	-41.25	8.19
HE20 STBC, M0 to M9 2ss	2	5	-65.7	-59.7				0.1	-53.7	-41.25	12.41
HE20 STBC, M0 to M9 2ss	3	5	-65.7	-60.0	-58.6			0.1	-50.7	-41.25	9.45
HE20 STBC, M0 to M9 2ss	4	5	-65.7	-60.0	-58.6	-60.5		0.1	-49.4	-41.25	8.19

Non HT40, 6 to 54 Mbps	1	5	-66.0					0.0	-61.0	-41.25	19.70
Non HT40, 6 to 54 Mbps	2	5	-66.0	-63.6				0.0	-56.6	-41.25	15.33
Non HT40, 6 to 54 Mbps	3	5	-66.0	-63.6	-62.6			0.0	-54.0	-41.25	12.78
Non HT40, 6 to 54 Mbps	4	5	-66.0	-63.6	-62.6	-64.6		0.0	-53.0	-41.25	11.70
HT/VHT40, M0 to M7	1	5	-65.6					0.1	-60.5	-41.25	19.25
HT/VHT40, M0 to M7	2	5	-66.2	-63.7				0.1	-56.7	-41.25	15.41
HT/VHT40, M8 to M15	2	5	-66.2	-63.7				0.1	-56.7	-41.25	15.41
HT/VHT40, M0 to M7	3	5	-66.2	-63.7	-62.7			0.1	-54.1	-41.25	12.84
HT/VHT40, M8 to M15	3	5	-66.2	-63.7	-62.7			0.1	-54.1	-41.25	12.84
HT/VHT40, M16 to M23	3	5	-66.2	-63.7	-62.7			0.1	-54.1	-41.25	12.84
HT/VHT40, M0 to M7	4	5	-66.2	-63.7	-62.7	-64.8		0.1	-53.0	-41.25	11.79
HT/VHT40, M8 to M15	4	5	-66.2	-63.7	-62.7	-64.8		0.1	-53.0	-41.25	11.79
HT/VHT40, M16 to M23	4	5	-66.2	-63.7	-62.7	-64.8		0.1	-53.0	-41.25	11.79
HT/VHT40, M24 to M31	4	5	-66.2	-63.7	-62.7	-64.8		0.1	-53.0	-41.25	11.79
HT/VHT40 Beam Forming, M0 to M7	2	8	-66.2	-63.7				0.1	-53.7	-41.25	12.41
HT/VHT40 Beam Forming, M8 to M15	2	5	-66.2	-63.7				0.1	-56.7	-41.25	15.41
HT/VHT40 Beam Forming, M0 to M7	3	10	-66.7	-64.2	-63.1			0.1	-49.5	-41.25	8.30
HT/VHT40 Beam Forming, M8 to M15	3	7	-66.2	-63.7	-62.7			0.1	-52.1	-41.25	10.84
HT/VHT40 Beam Forming, M16 to M23	3	5	-66.2	-63.7	-62.7			0.1	-54.1	-41.25	12.84
HT/VHT40 Beam Forming, M0 to M7	4	11	-67.9	-64.7	-63.6	-65.9		0.1	-48.1	-41.25	6.88
HT/VHT40 Beam Forming, M8 to M15	4	8	-66.7	-64.2	-63.1	-65.3		0.1	-50.5	-41.25	9.25
HT/VHT40 Beam Forming, M16 to M23	4	6	-66.2	-63.7	-62.7	-64.8		0.1	-52.0	-41.25	10.79

	HT/VHT40 Beam Forming, M24 to M31	4	5	-66.2	-63.7	-62.7	-64.8	0.1	-53.0	-41.25	11.79
	HT/VHT40 STBC, M0 to M7	2	5	-66.2	-63.7			0.1	-56.7	-41.25	15.41
	HT/VHT40 STBC, M0 to M7	3	5	-66.2	-63.7	-62.7		0.1	-54.1	-41.25	12.84
	HT/VHT40 STBC, M0 to M7	4	5	-66.2	-63.7	-62.7	-64.8	0.1	-53.0	-41.25	11.79
	HE40, M0 to M9 1ss	1	5	-66.2				0.1	-61.1	-41.25	19.82
	HE40, M0 to M9 1ss	2	5	-66.2	-63.8			0.1	-56.7	-41.25	15.45
	HE40, M0 to M9 2ss	2	5	-66.2	-63.8			0.1	-56.7	-41.25	15.45
	HE40, M0 to M9 1ss	3	5	-66.2	-63.8	-62.5		0.1	-54.0	-41.25	12.76
	HE40, M0 to M9 2ss	3	5	-66.2	-63.8	-62.5		0.1	-54.0	-41.25	12.76
	HE40, M0 to M9 3ss	3	5	-66.2	-63.8	-62.5		0.1	-54.0	-41.25	12.76
	HE40, M0 to M9 1ss	4	5	-66.2	-63.8	-62.5	-64.7	0.1	-52.9	-41.25	11.70
	HE40, M0 to M9 2ss	4	5	-66.2	-63.8	-62.5	-64.7	0.1	-52.9	-41.25	11.70
	HE40, M0 to M9 3ss	4	5	-66.2	-63.8	-62.5	-64.7	0.1	-52.9	-41.25	11.70
	HE40, M0 to M9 4ss	4	5	-66.2	-63.8	-62.5	-64.7	0.1	-52.9	-41.25	11.70
	HE40 Beam Forming, M0 to M9 1ss	2	8	-66.8	-64.3			0.1	-54.2	-41.25	12.99
	HE40 Beam Forming, M0 to M9 2ss	2	5	-66.2	-63.8			0.1	-56.7	-41.25	15.45
	HE40 Beam Forming, M0 to M9 1ss	3	10	-66.8	-64.3	-63.2		0.1	-49.6	-41.25	8.38
	HE40 Beam Forming, M0 to M9 2ss	3	7	-66.2	-63.8	-62.5		0.1	-52.0	-41.25	10.76
	HE40 Beam Forming, M0 to M9 3ss	3	5	-66.2	-63.8	-62.5		0.1	-54.0	-41.25	12.76
	HE40 Beam Forming, M0 to M9 1ss	4	11	-68.1	-64.8	-63.9	-65.9	0.1	-48.3	-41.25	7.02
	HE40 Beam Forming, M0 to M9 2ss	4	8	-66.8	-64.3	-63.2	-65.4	0.1	-50.6	-41.25	9.33
	HE40 Beam Forming, M0 to M9 3ss	4	6	-66.2	-63.8	-62.5	-64.7	0.1	-51.9	-41.25	10.70
	HE40 Beam Forming, M0 to M9 4ss	4	5	-66.2	-63.8	-62.5	-64.7	0.1	-52.9	-41.25	11.70
	HE40 STBC, M0 to M9 2ss	2	5	-66.2	-63.8			0.1	-56.7	-41.25	15.45
	HE40 STBC, M0 to M9 2ss	3	5	-66.2	-63.8	-62.5		0.1	-54.0	-41.25	12.76
	HE40 STBC, M0 to M9 2ss	4	5	-66.2	-63.8	-62.5	-64.7	0.1	-52.9	-41.25	11.70
5210	Non HT80, 6 to 54 Mbps	1	5	-65.0				0.1	-59.9	-41.25	18.70
	Non HT80, 6 to 54 Mbps	2	5	-65.0	-63.0			0.1	-55.8	-41.25	14.57
	Non HT80, 6 to 54 Mbps	3	5	-65.0	-63.0	-62.6		0.1	-53.6	-41.25	12.34
	Non HT80, 6 to 54 Mbps	4	5	-65.5	-63.7	-63.2	-65.0	0.1	-53.2	-41.25	11.93
	VHT80, M0 to M9 1ss	1	5	-65.1				0.2	-59.9	-41.25	18.63
	VHT80, M0 to M9 1ss	2	5	-65.1	-63.4			0.2	-55.9	-41.25	14.68
	VHT80, M0 to M9 2ss	2	5	-65.1	-63.4			0.2	-55.9	-41.25	14.68
	VHT80, M0 to M9 1ss	3	5	-65.1	-63.4	-63.2		0.2	-53.8	-41.25	12.58
	VHT80, M0 to M9 2ss	3	5	-65.1	-63.4	-63.2		0.2	-53.8	-41.25	12.58
	VHT80, M0 to M9 3ss	3	5	-65.1	-63.4	-63.2		0.2	-53.8	-41.25	12.58
	VHT80, M0 to M9 1ss	4	5	-65.1	-63.4	-63.2	-64.9	0.2	-52.8	-41.25	11.57
	VHT80, M0 to M9 2ss	4	5	-65.1	-63.4	-63.2	-64.9	0.2	-52.8	-41.25	11.57
	VHT80, M0 to M9 3ss	4	5	-65.1	-63.4	-63.2	-64.9	0.2	-52.8	-41.25	11.57
	VHT80, M0 to M9 4ss	4	5	-65.1	-63.4	-63.2	-64.9	0.2	-52.8	-41.25	11.57
	VHT80 Beam Forming, M0 to M9 1ss	2	8	-66.2	-64.4			0.2	-54.0	-41.25	12.72
VHT80 Beam Forming, M0 to M9 2ss	2	5	-65.1	-63.4			0.2	-55.9	-41.25	14.68	

VHT80 Beam Forming, M0 to M9 1ss	3	10	-66.2	-64.4	-63.5		0.2	-49.6	-41.25	8.32
VHT80 Beam Forming, M0 to M9 2ss	3	7	-66.2	-64.4	-63.5		0.2	-52.6	-41.25	11.32
VHT80 Beam Forming, M0 to M9 3ss	3	5	-65.1	-63.4	-63.2		0.2	-53.8	-41.25	12.58
VHT80 Beam Forming, M0 to M9 1ss	4	11	-66.5	-64.3	-63.8	-65.9	0.2	-47.7	-41.25	6.49
VHT80 Beam Forming, M0 to M9 2ss	4	8	-66.2	-64.4	-63.5	-65.5	0.2	-50.5	-41.25	9.28
VHT80 Beam Forming, M0 to M9 3ss	4	6	-66.2	-64.4	-63.5	-65.5	0.2	-52.5	-41.25	11.28
VHT80 Beam Forming, M0 to M9 4ss	4	5	-65.1	-63.4	-63.2	-64.9	0.2	-52.8	-41.25	11.57
VHT80 STBC, M0 to M9 1ss	2	5	-65.1	-63.4			0.2	-55.9	-41.25	14.68
VHT80 STBC, M0 to M9 1ss	3	5	-65.1	-63.4	-63.2		0.2	-53.8	-41.25	12.58
VHT80 STBC, M0 to M9 1ss	4	5	-65.1	-63.4	-63.2	-64.9	0.2	-52.8	-41.25	11.57
HE80, M0 to M9 1ss	1	5	-65.5				0.3	-60.2	-41.25	19.00
HE80, M0 to M9 1ss	2	5	-65.5	-63.7			0.3	-56.2	-41.25	15.00
HE80, M0 to M9 2ss	2	5	-65.5	-63.7			0.3	-56.2	-41.25	15.00
HE80, M0 to M9 1ss	3	5	-65.5	-63.7	-63.0		0.3	-53.9	-41.25	12.67
HE80, M0 to M9 2ss	3	5	-65.5	-63.7	-63.0		0.3	-53.9	-41.25	12.67
HE80, M0 to M9 3ss	3	5	-65.5	-63.7	-63.0		0.3	-53.9	-41.25	12.67
HE80, M0 to M9 1ss	4	5	-65.5	-63.7	-63.0	-65.1	0.3	-52.9	-41.25	11.69
HE80, M0 to M9 2ss	4	5	-65.5	-63.7	-63.0	-65.1	0.3	-52.9	-41.25	11.69
HE80, M0 to M9 3ss	4	5	-65.5	-63.7	-63.0	-65.1	0.3	-52.9	-41.25	11.69
HE80, M0 to M9 4ss	4	5	-65.5	-63.7	-63.0	-65.1	0.3	-52.9	-41.25	11.69
HE80 Beam Forming, M0 to M9 1ss	2	8	-66.2	-64.4			0.3	-53.9	-41.25	12.70
HE80 Beam Forming, M0 to M9 2ss	2	5	-65.5	-63.7			0.3	-56.2	-41.25	15.00
HE80 Beam Forming, M0 to M9 1ss	3	10	-66.2	-64.4	-63.6		0.3	-49.6	-41.25	8.33
HE80 Beam Forming, M0 to M9 2ss	3	7	-66.2	-64.4	-63.6		0.3	-52.6	-41.25	11.33
HE80 Beam Forming, M0 to M9 3ss	3	5	-65.5	-63.7	-63.0		0.3	-53.9	-41.25	12.67
HE80 Beam Forming, M0 to M9 1ss	4	11	-66.7	-64.7	-64.0	-66.2	0.3	-48.0	-41.25	6.74
HE80 Beam Forming, M0 to M9 2ss	4	8	-66.2	-64.4	-63.6	-65.8	0.3	-50.6	-41.25	9.35
HE80 Beam Forming, M0 to M9 3ss	4	6	-66.2	-64.4	-63.6	-65.8	0.3	-52.6	-41.25	11.35
HE80 Beam Forming, M0 to M9 4ss	4	5	-65.5	-63.7	-63.0	-65.1	0.3	-52.9	-41.25	11.69
HE80 STBC, M0 to M9 1ss	2	5	-65.5	-63.7			0.3	-56.2	-41.25	15.00
HE80 STBC, M0 to M9 1ss	3	5	-65.5	-63.7	-63.0		0.3	-53.9	-41.25	12.67
HE80 STBC, M0 to M9 1ss	4	5	-65.5	-63.7	-63.0	-65.1	0.3	-52.9	-41.25	11.69
5220										
Non HT20, 6 to 54 Mbps	1	5	-65.5				0.1	-60.4	-41.25	19.20
Non HT20, 6 to 54 Mbps	2	5	-65.5	-59.1			0.1	-53.1	-41.25	11.90
Non HT20, 6 to 54 Mbps	3	5	-65.5	-59.1	-58.3		0.1	-50.2	-41.25	8.94
Non HT20, 6 to 54 Mbps	4	5	-65.5	-59.1	-58.3	-59.4	0.1	-48.8	-41.25	7.53
Non HT20 Beam Forming, 6 to 54 Mbps	2	8	-65.5	-59.1			0.1	-50.1	-41.25	8.90
Non HT20 Beam Forming, 6 to 54 Mbps	3	10	-65.5	-59.1	-58.3		0.1	-45.2	-41.25	3.94
Non HT20 Beam Forming, 6 to 54 Mbps	4	11	-65.5	-59.1	-58.3	-59.4	0.1	-42.8	-41.25	1.53
HT/VHT20, M0 to M7	1	5	-65.8				0.1	-60.7	-41.25	19.50
HT/VHT20, M0 to M7	2	5	-65.8	-59.3			0.1	-53.4	-41.25	12.12
HT/VHT20, M8 to M15	2	5	-65.8	-59.3			0.1	-53.4	-41.25	12.12

HT/VHT20, M0 to M7	3	5	-65.8	-59.3	-58.3		0.1	-50.3	-41.25	9.05
HT/VHT20, M8 to M15	3	5	-65.8	-59.3	-58.3		0.1	-50.3	-41.25	9.05
HT/VHT20, M16 to M23	3	5	-65.8	-59.3	-58.3		0.1	-50.3	-41.25	9.05
HT/VHT20, M0 to M7	4	5	-65.8	-59.3	-58.3	-60.1	0.1	-49.0	-41.25	7.79
HT/VHT20, M8 to M15	4	5	-65.8	-59.3	-58.3	-60.1	0.1	-49.0	-41.25	7.79
HT/VHT20, M16 to M23	4	5	-65.8	-59.3	-58.3	-60.1	0.1	-49.0	-41.25	7.79
HT/VHT20, M24 to M31	4	5	-65.8	-59.3	-58.3	-60.1	0.1	-49.0	-41.25	7.79
HT/VHT20 Beam Forming, M0 to M7	2	8	-65.8	-59.3			0.1	-50.4	-41.25	9.12
HT/VHT20 Beam Forming, M8 to M15	2	5	-65.8	-59.3			0.1	-53.4	-41.25	12.12
HT/VHT20 Beam Forming, M0 to M7	3	10	-65.8	-59.3	-58.3		0.1	-45.3	-41.25	4.05
HT/VHT20 Beam Forming, M8 to M15	3	7	-65.8	-59.3	-58.3		0.1	-48.3	-41.25	7.05
HT/VHT20 Beam Forming, M16 to M23	3	5	-65.8	-59.3	-58.3		0.1	-50.3	-41.25	9.05
HT/VHT20 Beam Forming, M0 to M7	4	11	-65.8	-59.3	-58.3	-60.1	0.1	-43.0	-41.25	1.79
HT/VHT20 Beam Forming, M8 to M15	4	8	-65.8	-59.3	-58.3	-60.1	0.1	-46.0	-41.25	4.79
HT/VHT20 Beam Forming, M16 to M23	4	6	-65.8	-59.3	-58.3	-60.1	0.1	-48.0	-41.25	6.79
HT/VHT20 Beam Forming, M24 to M31	4	5	-65.8	-59.3	-58.3	-60.1	0.1	-49.0	-41.25	7.79
HT/VHT20 STBC, M0 to M7	2	5	-65.8	-59.3			0.1	-53.4	-41.25	12.12
HT/VHT20 STBC, M0 to M7	3	5	-65.8	-59.3	-58.3		0.1	-50.3	-41.25	9.05
HT/VHT20 STBC, M0 to M7	4	5	-65.8	-59.3	-58.3	-60.1	0.1	-49.0	-41.25	7.79
HE20, M0 to M9 1ss	1	5	-65.7				0.1	-60.6	-41.25	19.38
HE20, M0 to M9 1ss	2	5	-65.7	-59.2			0.1	-53.3	-41.25	12.00
HE20, M0 to M9 2ss	2	5	-65.7	-59.2			0.1	-53.3	-41.25	12.00
HE20, M0 to M9 1ss	3	5	-65.7	-59.2	-58.2		0.1	-50.2	-41.25	8.93
HE20, M0 to M9 2ss	3	5	-65.7	-59.2	-58.2		0.1	-50.2	-41.25	8.93
HE20, M0 to M9 3ss	3	5	-65.7	-59.2	-58.2		0.1	-50.2	-41.25	8.93
HE20, M0 to M9 1ss	4	5	-65.7	-59.2	-58.2	-60.0	0.1	-48.9	-41.25	7.68
HE20, M0 to M9 2ss	4	5	-65.7	-59.2	-58.2	-60.0	0.1	-48.9	-41.25	7.68
HE20, M0 to M9 3ss	4	5	-65.7	-59.2	-58.2	-60.0	0.1	-48.9	-41.25	7.68
HE20, M0 to M9 4ss	4	5	-65.7	-59.2	-58.2	-60.0	0.1	-48.9	-41.25	7.68
HE20 Beam Forming, M0 to M9 1ss	2	8	-65.7	-59.2			0.1	-50.3	-41.25	9.00
HE20 Beam Forming, M0 to M9 2ss	2	5	-65.7	-59.2			0.1	-53.3	-41.25	12.00
HE20 Beam Forming, M0 to M9 1ss	3	10	-65.7	-59.2	-58.2		0.1	-45.2	-41.25	3.93
HE20 Beam Forming, M0 to M9 2ss	3	7	-65.7	-59.2	-58.2		0.1	-48.2	-41.25	6.93
HE20 Beam Forming, M0 to M9 3ss	3	5	-65.7	-59.2	-58.2		0.1	-50.2	-41.25	8.93
HE20 Beam Forming, M0 to M9 1ss	4	11	-65.7	-59.2	-58.2	-60.0	0.1	-42.9	-41.25	1.68
HE20 Beam Forming, M0 to M9 2ss	4	8	-65.7	-59.2	-58.2	-60.0	0.1	-45.9	-41.25	4.68
HE20 Beam Forming, M0 to M9 3ss	4	6	-65.7	-59.2	-58.2	-60.0	0.1	-47.9	-41.25	6.68
HE20 Beam Forming, M0 to M9 4ss	4	5	-65.7	-59.2	-58.2	-60.0	0.1	-48.9	-41.25	7.68
HE20 STBC, M0 to M9 2ss	2	5	-65.7	-59.2			0.1	-53.3	-41.25	12.00
HE20 STBC, M0 to M9 2ss	3	5	-65.7	-59.2	-58.2		0.1	-50.2	-41.25	8.93
HE20 STBC, M0 to M9 2ss	4	5	-65.7	-59.2	-58.2	-60.0	0.1	-48.9	-41.25	7.68
Non HT40, 6 to 54 Mbps	1	5	-65.5				0.0	-60.5	-41.25	19.20

Non HT40, 6 to 54 Mbps	2	5	-65.5	-58.6			0.0	-52.7	-41.25	11.49
Non HT40, 6 to 54 Mbps	3	5	-65.5	-58.6	-58.1		0.0	-49.9	-41.25	8.63
Non HT40, 6 to 54 Mbps	4	5	-65.5	-58.6	-58.1	-59.4	0.0	-48.6	-41.25	7.31
HT/VHT40, M0 to M7	1	5	-65.8				0.1	-60.7	-41.25	19.45
HT/VHT40, M0 to M7	2	5	-65.8	-59.2			0.1	-53.2	-41.25	11.99
HT/VHT40, M8 to M15	2	5	-65.8	-59.2			0.1	-53.2	-41.25	11.99
HT/VHT40, M0 to M7	3	5	-65.8	-59.2	-58.3		0.1	-50.2	-41.25	8.96
HT/VHT40, M8 to M15	3	5	-65.8	-59.2	-58.3		0.1	-50.2	-41.25	8.96
HT/VHT40, M16 to M23	3	5	-65.8	-59.2	-58.3		0.1	-50.2	-41.25	8.96
HT/VHT40, M0 to M7	4	5	-65.8	-59.2	-58.3	-59.7	0.1	-48.9	-41.25	7.61
HT/VHT40, M8 to M15	4	5	-65.8	-59.2	-58.3	-59.7	0.1	-48.9	-41.25	7.61
HT/VHT40, M16 to M23	4	5	-65.8	-59.2	-58.3	-59.7	0.1	-48.9	-41.25	7.61
HT/VHT40, M24 to M31	4	5	-65.8	-59.2	-58.3	-59.7	0.1	-48.9	-41.25	7.61
HT/VHT40 Beam Forming, M0 to M7	2	8	-65.8	-59.2			0.1	-50.2	-41.25	8.99
HT/VHT40 Beam Forming, M8 to M15	2	5	-65.8	-59.2			0.1	-53.2	-41.25	11.99
HT/VHT40 Beam Forming, M0 to M7	3	10	-65.8	-59.2	-58.3		0.1	-45.2	-41.25	3.96
HT/VHT40 Beam Forming, M8 to M15	3	7	-65.8	-59.2	-58.3		0.1	-48.2	-41.25	6.96
HT/VHT40 Beam Forming, M16 to M23	3	5	-65.8	-59.2	-58.3		0.1	-50.2	-41.25	8.96
HT/VHT40 Beam Forming, M0 to M7	4	11	-65.8	-59.2	-58.3	-59.7	0.1	-42.9	-41.25	1.61
HT/VHT40 Beam Forming, M8 to M15	4	8	-65.8	-59.2	-58.3	-59.7	0.1	-45.9	-41.25	4.61
HT/VHT40 Beam Forming, M16 to M23	4	6	-65.8	-59.2	-58.3	-59.7	0.1	-47.9	-41.25	6.61
HT/VHT40 Beam Forming, M24 to M31	4	5	-65.8	-59.2	-58.3	-59.7	0.1	-48.9	-41.25	7.61
HT/VHT40 STBC, M0 to M7	2	5	-65.8	-59.2			0.1	-53.2	-41.25	11.99
HT/VHT40 STBC, M0 to M7	3	5	-65.8	-59.2	-58.3		0.1	-50.2	-41.25	8.96
HT/VHT40 STBC, M0 to M7	4	5	-65.8	-59.2	-58.3	-59.7	0.1	-48.9	-41.25	7.61
HE40, M0 to M9 1ss	1	5	-65.6				0.1	-60.5	-41.25	19.22
HE40, M0 to M9 1ss	2	5	-65.6	-59.2			0.1	-53.2	-41.25	11.93
HE40, M0 to M9 2ss	2	5	-65.6	-59.2			0.1	-53.2	-41.25	11.93
HE40, M0 to M9 1ss	3	5	-65.6	-59.2	-58.2		0.1	-50.1	-41.25	8.87
HE40, M0 to M9 2ss	3	5	-65.6	-59.2	-58.2		0.1	-50.1	-41.25	8.87
HE40, M0 to M9 3ss	3	5	-65.6	-59.2	-58.2		0.1	-50.1	-41.25	8.87
HE40, M0 to M9 1ss	4	5	-65.6	-59.2	-58.2	-59.8	0.1	-48.8	-41.25	7.56
HE40, M0 to M9 2ss	4	5	-65.6	-59.2	-58.2	-59.8	0.1	-48.8	-41.25	7.56
HE40, M0 to M9 3ss	4	5	-65.6	-59.2	-58.2	-59.8	0.1	-48.8	-41.25	7.56
HE40, M0 to M9 4ss	4	5	-65.6	-59.2	-58.2	-59.8	0.1	-48.8	-41.25	7.56
HE40 Beam Forming, M0 to M9 1ss	2	8	-65.6	-59.2			0.1	-50.2	-41.25	8.93
HE40 Beam Forming, M0 to M9 2ss	2	5	-65.6	-59.2			0.1	-53.2	-41.25	11.93
HE40 Beam Forming, M0 to M9 1ss	3	10	-65.6	-59.2	-58.2		0.1	-45.1	-41.25	3.87
HE40 Beam Forming, M0 to M9 2ss	3	7	-65.6	-59.2	-58.2		0.1	-48.1	-41.25	6.87
HE40 Beam Forming, M0 to M9 3ss	3	5	-65.6	-59.2	-58.2		0.1	-50.1	-41.25	8.87
HE40 Beam Forming, M0 to M9 1ss	4	11	-65.6	-59.2	-58.2	-59.8	0.1	-42.8	-41.25	1.56
HE40 Beam Forming, M0 to M9 2ss	4	8	-65.6	-59.2	-58.2	-59.8	0.1	-45.8	-41.25	4.56
HE40 Beam Forming, M0 to M9 3ss	4	6	-65.6	-59.2	-58.2	-59.8	0.1	-47.8	-41.25	6.56

	HE40 Beam Forming, M0 to M9 4ss	4	5	-65.6	-59.2	-58.2	-59.8	0.1	-48.8	-41.25	7.56
	HE40 STBC, M0 to M9 2ss	2	5	-65.6	-59.2			0.1	-53.2	-41.25	11.93
	HE40 STBC, M0 to M9 2ss	3	5	-65.6	-59.2	-58.2		0.1	-50.1	-41.25	8.87
	HE40 STBC, M0 to M9 2ss	4	5	-65.6	-59.2	-58.2	-59.8	0.1	-48.8	-41.25	7.56
5240	Non HT20, 6 to 54 Mbps	1	5	-65.8				0.1	-60.7	-41.25	19.50
	Non HT20, 6 to 54 Mbps	2	5	-65.8	-58.6			0.1	-52.8	-41.25	11.54
	Non HT20, 6 to 54 Mbps	3	5	-65.8	-58.6	-57.9		0.1	-49.8	-41.25	8.56
	Non HT20, 6 to 54 Mbps	4	5	-65.8	-58.6	-57.9	-59.0	0.1	-48.4	-41.25	7.14
	Non HT20 Beam Forming, 6 to 54 Mbps	2	8	-65.8	-58.6			0.1	-49.8	-41.25	8.54
	Non HT20 Beam Forming, 6 to 54 Mbps	3	10	-65.8	-58.6	-57.9		0.1	-44.8	-41.25	3.56
	Non HT20 Beam Forming, 6 to 54 Mbps	4	11	-65.8	-58.6	-57.9	-59.0	0.1	-42.4	-41.25	1.14
	HT/VHT20, M0 to M7	1	5	-65.9				0.1	-60.8	-41.25	19.60
	HT/VHT20, M0 to M7	2	5	-65.9	-59.4			0.1	-53.5	-41.25	12.22
	HT/VHT20, M8 to M15	2	5	-65.9	-59.4			0.1	-53.5	-41.25	12.22
	HT/VHT20, M0 to M7	3	5	-65.9	-59.4	-58.0		0.1	-50.2	-41.25	8.94
	HT/VHT20, M8 to M15	3	5	-65.9	-59.4	-58.0		0.1	-50.2	-41.25	8.94
	HT/VHT20, M16 to M23	3	5	-65.9	-59.4	-58.0		0.1	-50.2	-41.25	8.94
	HT/VHT20, M0 to M7	4	5	-65.9	-59.4	-58.0	-59.6	0.1	-48.8	-41.25	7.58
	HT/VHT20, M8 to M15	4	5	-65.9	-59.4	-58.0	-59.6	0.1	-48.8	-41.25	7.58
	HT/VHT20, M16 to M23	4	5	-65.9	-59.4	-58.0	-59.6	0.1	-48.8	-41.25	7.58
	HT/VHT20, M24 to M31	4	5	-65.9	-59.4	-58.0	-59.6	0.1	-48.8	-41.25	7.58
	HT/VHT20 Beam Forming, M0 to M7	2	8	-65.9	-59.4			0.1	-50.5	-41.25	9.22
	HT/VHT20 Beam Forming, M8 to M15	2	5	-65.9	-59.4			0.1	-53.5	-41.25	12.22
	HT/VHT20 Beam Forming, M0 to M7	3	10	-65.9	-59.4	-58.0		0.1	-45.2	-41.25	3.94
	HT/VHT20 Beam Forming, M8 to M15	3	7	-65.9	-59.4	-58.0		0.1	-48.2	-41.25	6.94
	HT/VHT20 Beam Forming, M16 to M23	3	5	-65.9	-59.4	-58.0		0.1	-50.2	-41.25	8.94
	HT/VHT20 Beam Forming, M0 to M7	4	11	-65.9	-59.4	-58.0	-59.6	0.1	-42.8	-41.25	1.58
	HT/VHT20 Beam Forming, M8 to M15	4	8	-65.9	-59.4	-58.0	-59.6	0.1	-45.8	-41.25	4.58
	HT/VHT20 Beam Forming, M16 to M23	4	6	-65.9	-59.4	-58.0	-59.6	0.1	-47.8	-41.25	6.58
	HT/VHT20 Beam Forming, M24 to M31	4	5	-65.9	-59.4	-58.0	-59.6	0.1	-48.8	-41.25	7.58
	HT/VHT20 STBC, M0 to M7	2	5	-65.9	-59.4			0.1	-53.5	-41.25	12.22
	HT/VHT20 STBC, M0 to M7	3	5	-65.9	-59.4	-58.0		0.1	-50.2	-41.25	8.94
	HT/VHT20 STBC, M0 to M7	4	5	-65.9	-59.4	-58.0	-59.6	0.1	-48.8	-41.25	7.58
	HE20, M0 to M9 1ss	1	5	-65.9				0.1	-60.8	-41.25	19.58
	HE20, M0 to M9 1ss	2	5	-65.9	-59.2			0.1	-53.3	-41.25	12.04
	HE20, M0 to M9 2ss	2	5	-65.9	-59.2			0.1	-53.3	-41.25	12.04
	HE20, M0 to M9 1ss	3	5	-65.9	-59.2	-58.0		0.1	-50.1	-41.25	8.85
	HE20, M0 to M9 2ss	3	5	-65.9	-59.2	-58.0		0.1	-50.1	-41.25	8.85
HE20, M0 to M9 3ss	3	5	-65.9	-59.2	-58.0		0.1	-50.1	-41.25	8.85	
HE20, M0 to M9 1ss	4	5	-65.9	-59.2	-58.0	-59.6	0.1	-48.8	-41.25	7.51	
HE20, M0 to M9 2ss	4	5	-65.9	-59.2	-58.0	-59.6	0.1	-48.8	-41.25	7.51	
HE20, M0 to M9 3ss	4	5	-65.9	-59.2	-58.0	-59.6	0.1	-48.8	-41.25	7.51	

	HE20, M0 to M9 4ss	4	5	-65.9	-59.2	-58.0	-59.6	0.1	-48.8	-41.25	7.51
	HE20 Beam Forming, M0 to M9 1ss	2	8	-65.9	-59.2			0.1	-50.3	-41.25	9.04
	HE20 Beam Forming, M0 to M9 2ss	2	5	-65.9	-59.2			0.1	-53.3	-41.25	12.04
	HE20 Beam Forming, M0 to M9 1ss	3	10	-65.9	-59.2	-58.0		0.1	-45.1	-41.25	3.85
	HE20 Beam Forming, M0 to M9 2ss	3	7	-65.9	-59.2	-58.0		0.1	-48.1	-41.25	6.85
	HE20 Beam Forming, M0 to M9 3ss	3	5	-65.9	-59.2	-58.0		0.1	-50.1	-41.25	8.85
	HE20 Beam Forming, M0 to M9 1ss	4	11	-65.9	-59.2	-58.0	-59.6	0.1	-42.8	-41.25	1.51
	HE20 Beam Forming, M0 to M9 2ss	4	8	-65.9	-59.2	-58.0	-59.6	0.1	-45.8	-41.25	4.51
	HE20 Beam Forming, M0 to M9 3ss	4	6	-65.9	-59.2	-58.0	-59.6	0.1	-47.8	-41.25	6.51
	HE20 Beam Forming, M0 to M9 4ss	4	5	-65.9	-59.2	-58.0	-59.6	0.1	-48.8	-41.25	7.51
	HE20 STBC, M0 to M9 2ss	2	5	-65.9	-59.2			0.1	-53.3	-41.25	12.04
	HE20 STBC, M0 to M9 2ss	3	5	-65.9	-59.2	-58.0		0.1	-50.1	-41.25	8.85
	HE20 STBC, M0 to M9 2ss	4	5	-65.9	-59.2	-58.0	-59.6	0.1	-48.8	-41.25	7.51
5250	Non HT160, 6 to 54 Mbps	1	5	-59.6				0.0	-54.6	-41.25	13.30
	Non HT160, 6 to 54 Mbps	2	5	-59.6	-60.8			0.0	-52.1	-41.25	10.85
	Non HT160, 6 to 54 Mbps	3	5	-59.6	-60.8	-61.6		0.0	-50.8	-41.25	9.52
	Non HT160, 6 to 54 Mbps	4	5	-59.6	-60.8	-61.6	-63.0	0.0	-50.0	-41.25	8.76
	VHT160, M0 to M9 1ss	1	5	-61.0				0.4	-55.6	-41.25	14.36
	VHT160, M0 to M9 1ss	2	5	-61.0	-62.1			0.4	-53.1	-41.25	11.86
	VHT160, M0 to M9 2ss	2	5	-61.0	-62.1			0.4	-53.1	-41.25	11.86
	VHT160, M0 to M9 1ss	3	5	-63.2	-63.3	-63.5		0.4	-53.2	-41.25	11.92
	VHT160, M0 to M9 2ss	3	5	-63.2	-63.3	-63.5		0.4	-53.2	-41.25	11.92
	VHT160, M0 to M9 3ss	3	5	-63.2	-63.3	-63.5		0.4	-53.2	-41.25	11.92
	VHT160, M0 to M9 1ss	4	5	-63.2	-63.3	-63.5	-65.5	0.4	-52.4	-41.25	11.12
	VHT160, M0 to M9 2ss	4	5	-63.2	-63.3	-63.5	-65.5	0.4	-52.4	-41.25	11.12
	VHT160, M0 to M9 3ss	4	5	-63.2	-63.3	-63.5	-65.5	0.4	-52.4	-41.25	11.12
	VHT160, M0 to M9 4ss	4	5	-63.2	-63.3	-63.5	-65.5	0.4	-52.4	-41.25	11.12
	VHT160 Beam Forming, M0 to M9 1ss	2	8	-63.2	-63.3			0.4	-51.8	-41.25	10.60
	VHT160 Beam Forming, M0 to M9 2ss	2	5	-61.0	-62.1			0.4	-53.1	-41.25	11.86
	VHT160 Beam Forming, M0 to M9 1ss	3	10	-64.6	-63.9	-63.7		0.4	-48.9	-41.25	7.64
	VHT160 Beam Forming, M0 to M9 2ss	3	7	-63.2	-63.3	-63.5		0.4	-51.2	-41.25	9.92
	VHT160 Beam Forming, M0 to M9 3ss	3	5	-63.2	-63.3	-63.5		0.4	-53.2	-41.25	11.92
	VHT160 Beam Forming, M0 to M9 1ss	4	11	-66.5	-64.5	-64.7	-67.0	0.4	-48.1	-41.25	6.88
	VHT160 Beam Forming, M0 to M9 2ss	4	8	-63.2	-63.3	-63.5	-65.5	0.4	-49.4	-41.25	8.12
	VHT160 Beam Forming, M0 to M9 3ss	4	6	-63.2	-63.3	-63.5	-65.5	0.4	-51.4	-41.25	10.12
	VHT160 Beam Forming, M0 to M9 4ss	4	5	-63.2	-63.3	-63.5	-65.5	0.4	-52.4	-41.25	11.12
	VHT160 STBC, M0 to M9 1ss	2	5	-61.0	-62.1			0.4	-53.1	-41.25	11.86
	VHT160 STBC, M0 to M9 1ss	3	5	-63.2	-63.3	-63.5		0.4	-53.2	-41.25	11.92
	VHT160 STBC, M0 to M9 1ss	4	5	-63.2	-63.3	-63.5	-65.5	0.4	-52.4	-41.25	11.12
	HE160, M0 to M9 1ss	1	5	-60.6				0.4	-55.2	-41.25	13.92
	HE160, M0 to M9 1ss	2	5	-60.6	-62.4			0.4	-53.0	-41.25	11.71
HE160, M0 to M9 2ss	2	5	-60.6	-62.4			0.4	-53.0	-41.25	11.71	



HE160, M0 to M9 1ss	3	5	-60.6	-62.4	-62.3		0.4	-51.5	-41.25	10.23
HE160, M0 to M9 2ss	3	5	-60.6	-62.4	-62.3		0.4	-51.5	-41.25	10.23
HE160, M0 to M9 3ss	3	5	-60.6	-62.4	-62.3		0.4	-51.5	-41.25	10.23
HE160, M0 to M9 1ss	4	5	-60.6	-62.4	-62.3	-64.1	0.4	-50.7	-41.25	9.47
HE160, M0 to M9 2ss	4	5	-60.6	-62.4	-62.3	-64.1	0.4	-50.7	-41.25	9.47
HE160, M0 to M9 3ss	4	5	-60.6	-62.4	-62.3	-64.1	0.4	-50.7	-41.25	9.47
HE160, M0 to M9 4ss	4	5	-60.6	-62.4	-62.3	-64.1	0.4	-50.7	-41.25	9.47
HE160 Beam Forming, M0 to M9 1ss	2	8	-60.6	-62.4			0.4	-50.0	-41.25	8.71
HE160 Beam Forming, M0 to M9 2ss	2	5	-60.6	-62.4			0.4	-53.0	-41.25	11.71
HE160 Beam Forming, M0 to M9 1ss	3	10	-63.2	-63.5	-63.3		0.4	-48.1	-41.25	6.88
HE160 Beam Forming, M0 to M9 2ss	3	7	-60.6	-62.4	-62.3		0.4	-49.5	-41.25	8.23
HE160 Beam Forming, M0 to M9 3ss	3	5	-60.6	-62.4	-62.3		0.4	-51.5	-41.25	10.23
HE160 Beam Forming, M0 to M9 1ss	4	11	-64.9	-63.9	-64.1	-66.6	0.4	-47.3	-41.25	6.05
HE160 Beam Forming, M0 to M9 2ss	4	8	-63.2	-63.5	-63.3	-65.4	0.4	-49.3	-41.25	8.06
HE160 Beam Forming, M0 to M9 3ss	4	6	-60.6	-62.4	-62.3	-64.1	0.4	-49.7	-41.25	8.47
HE160 Beam Forming, M0 to M9 4ss	4	5	-60.6	-62.4	-62.3	-64.1	0.4	-50.7	-41.25	9.47
HE160 STBC, M0 to M9 1ss	2	5	-60.6	-62.4			0.4	-53.0	-41.25	11.71
HE160 STBC, M0 to M9 1ss	3	5	-60.6	-62.4	-62.3		0.4	-51.5	-41.25	10.23
HE160 STBC, M0 to M9 1ss	4	5	-60.6	-62.4	-62.3	-64.1	0.4	-50.7	-41.25	9.47

**Conducted Spurs Average, 5dBi
5240 MHz, Non HT20 Beam Forming, 6 to 54 Mbps**



Antenna A



Antenna B



Antenna C



Antenna D

Conducted Spurious Average Table, 6dBi

Frequency (MHz)	Mode	Tx Paths	Correlated Antenna Gain (dBi)	Tx 1 Spur Power (dBm)	Tx 2 Spur Power (dBm)	Tx 3 Spur Power (dBm)	Tx 4 Spur Power (dBm)	Duty Cycle Correction (dB)	Total Conducted Spur (dBm)	Limit (dBm)	Margin (dB)
5180	Non HT20, 6 to 54 Mbps	1	6	-65.7				0.1	-59.6	-41.25	18.40
	Non HT20, 6 to 54 Mbps	2	6	-65.7	-58.8			0.1	-51.9	-41.25	10.69
	Non HT20, 6 to 54 Mbps	3	6	-65.7	-59.9	-58.9		0.1	-49.8	-41.25	8.58
	Non HT20, 6 to 54 Mbps	4	6	-65.7	-61.4	-59.2	-61.2	0.1	-49.2	-41.25	7.99
	Non HT20 Beam Forming, 6 to 54 Mbps	2	9	-65.7	-59.9			0.1	-49.8	-41.25	8.58
	Non HT20 Beam Forming, 6 to 54 Mbps	3	11	-65.7	-61.4	-60.8		0.1	-46.3	-41.25	5.08
	Non HT20 Beam Forming, 6 to 54 Mbps	4	12	-66.2	-63.4	-62.1	-64.1	0.1	-45.6	-41.25	4.38
	HT/VHT20, M0 to M7	1	6	-65.5				0.1	-59.4	-41.25	18.20
	HT/VHT20, M0 to M7	2	6	-65.5	-59.2			0.1	-52.2	-41.25	10.98
	HT/VHT20, M8 to M15	2	6	-65.5	-59.2			0.1	-52.2	-41.25	10.98
	HT/VHT20, M0 to M7	3	6	-65.5	-60.0	-58.6		0.1	-49.7	-41.25	8.45
	HT/VHT20, M8 to M15	3	6	-65.5	-60.0	-58.6		0.1	-49.7	-41.25	8.45
	HT/VHT20, M16 to M23	3	6	-65.5	-60.0	-58.6		0.1	-49.7	-41.25	8.45
	HT/VHT20, M0 to M7	4	6	-65.5	-60.0	-58.6	-60.7	0.1	-48.5	-41.25	7.24
	HT/VHT20, M8 to M15	4	6	-65.5	-60.0	-58.6	-60.7	0.1	-48.5	-41.25	7.24
	HT/VHT20, M16 to M23	4	6	-65.5	-60.0	-58.6	-60.7	0.1	-48.5	-41.25	7.24
	HT/VHT20, M24 to M31	4	6	-65.5	-60.0	-58.6	-60.7	0.1	-48.5	-41.25	7.24
	HT/VHT20 Beam Forming, M0 to M7	2	9	-65.5	-60.0			0.1	-49.9	-41.25	8.62
	HT/VHT20 Beam Forming, M8 to M15	2	6	-65.5	-59.2			0.1	-52.2	-41.25	10.98
	HT/VHT20 Beam Forming, M0 to M7	3	11	-66.2	-63.2	-62.1		0.1	-47.7	-41.25	6.44
	HT/VHT20 Beam Forming, M8 to M15	3	8	-65.5	-60.6	-59.1		0.1	-48.2	-41.25	6.93
	HT/VHT20 Beam Forming, M16 to M23	3	6	-65.5	-60.0	-58.6		0.1	-49.7	-41.25	8.45
	HT/VHT20 Beam Forming, M0 to M7	4	12	-66.2	-63.2	-62.1	-64.2	0.1	-45.6	-41.25	4.35
	HT/VHT20 Beam Forming, M8 to M15	4	9	-65.5	-61.3	-60.5	-61.6	0.1	-46.8	-41.25	5.54
	HT/VHT20 Beam Forming, M16 to M23	4	7	-65.5	-60.0	-58.6	-60.7	0.1	-47.5	-41.25	6.24
	HT/VHT20 Beam Forming, M24 to M31	4	6	-65.5	-60.0	-58.6	-60.7	0.1	-48.5	-41.25	7.24
	HT/VHT20 STBC, M0 to M7	2	6	-65.5	-59.2			0.1	-52.2	-41.25	10.98
	HT/VHT20 STBC, M0 to M7	3	6	-65.5	-60.0	-58.6		0.1	-49.7	-41.25	8.45
	HT/VHT20 STBC, M0 to M7	4	6	-65.5	-60.0	-58.6	-60.7	0.1	-48.5	-41.25	7.24
	HE20, M0 to M9 1ss	1	6	-65.7				0.1	-59.6	-41.25	18.38
HE20, M0 to M9 1ss	2	6	-65.7	-59.7			0.1	-52.7	-41.25	11.41	

HE20, M0 to M9 2ss	2	6	-65.7	-59.7			0.1	-52.7	-41.25	11.41
HE20, M0 to M9 1ss	3	6	-65.7	-60.0	-58.6		0.1	-49.7	-41.25	8.45
HE20, M0 to M9 2ss	3	6	-65.7	-60.0	-58.6		0.1	-49.7	-41.25	8.45
HE20, M0 to M9 3ss	3	6	-65.7	-60.0	-58.6		0.1	-49.7	-41.25	8.45
HE20, M0 to M9 1ss	4	6	-65.7	-60.5	-59.1	-61.0	0.1	-48.9	-41.25	7.65
HE20, M0 to M9 2ss	4	6	-65.7	-60.5	-59.1	-61.0	0.1	-48.9	-41.25	7.65
HE20, M0 to M9 3ss	4	6	-65.7	-60.5	-59.1	-61.0	0.1	-48.9	-41.25	7.65
HE20, M0 to M9 4ss	4	6	-65.7	-60.5	-59.1	-61.0	0.1	-48.9	-41.25	7.65
HE20 Beam Forming, M0 to M9 1ss	2	9	-66.3	-63.6			0.1	-52.7	-41.25	11.42
HE20 Beam Forming, M0 to M9 2ss	2	6	-65.7	-59.7			0.1	-52.7	-41.25	11.41
HE20 Beam Forming, M0 to M9 1ss	3	11	-67.0	-64.2	-63.0		0.1	-48.6	-41.25	7.34
HE20 Beam Forming, M0 to M9 2ss	3	8	-65.7	-61.4	-60.8		0.1	-49.3	-41.25	8.07
HE20 Beam Forming, M0 to M9 3ss	3	6	-65.7	-60.0	-58.6		0.1	-49.7	-41.25	8.45
HE20 Beam Forming, M0 to M9 1ss	4	12	-67.0	-64.2	-63.0	-65.1	0.1	-46.5	-41.25	5.25
HE20 Beam Forming, M0 to M9 2ss	4	9	-66.3	-63.6	-62.1	-64.0	0.1	-48.7	-41.25	7.41
HE20 Beam Forming, M0 to M9 3ss	4	7	-65.7	-61.4	-60.8	-61.8	0.1	-49.0	-41.25	7.73
HE20 Beam Forming, M0 to M9 4ss	4	6	-65.7	-60.5	-59.1	-61.0	0.1	-48.9	-41.25	7.65
HE20 STBC, M0 to M9 2ss	2	6	-65.7	-59.7			0.1	-52.7	-41.25	11.41
HE20 STBC, M0 to M9 2ss	3	6	-65.7	-60.0	-58.6		0.1	-49.7	-41.25	8.45
HE20 STBC, M0 to M9 2ss	4	6	-65.7	-60.5	-59.1	-61.0	0.1	-48.9	-41.25	7.65

Non HT40, 6 to 54 Mbps	1	6	-66.0				0.0	-60.0	-41.25	18.70
Non HT40, 6 to 54 Mbps	2	6	-66.0	-63.6			0.0	-55.6	-41.25	14.33
Non HT40, 6 to 54 Mbps	3	6	-66.0	-63.6	-62.6		0.0	-53.0	-41.25	11.78
Non HT40, 6 to 54 Mbps	4	6	-66.0	-63.6	-62.6	-64.6	0.0	-52.0	-41.25	10.70
HT/VHT40, M0 to M7	1	6	-66.2				0.1	-60.1	-41.25	18.85
HT/VHT40, M0 to M7	2	6	-66.2	-63.7			0.1	-55.7	-41.25	14.41
HT/VHT40, M8 to M15	2	6	-66.2	-63.7			0.1	-55.7	-41.25	14.41
HT/VHT40, M0 to M7	3	6	-66.2	-63.7	-62.7		0.1	-53.1	-41.25	11.84
HT/VHT40, M8 to M15	3	6	-66.2	-63.7	-62.7		0.1	-53.1	-41.25	11.84
HT/VHT40, M16 to M23	3	6	-66.2	-63.7	-62.7		0.1	-53.1	-41.25	11.84
HT/VHT40, M0 to M7	4	6	-66.2	-63.7	-62.7	-64.8	0.1	-52.0	-41.25	10.79
HT/VHT40, M8 to M15	4	6	-66.2	-63.7	-62.7	-64.8	0.1	-52.0	-41.25	10.79
HT/VHT40, M16 to M23	4	6	-66.2	-63.7	-62.7	-64.8	0.1	-52.0	-41.25	10.79
HT/VHT40 Beam Forming, M0 to M7	2	9	-66.7	-64.2			0.1	-53.2	-41.25	11.91
HT/VHT40 Beam Forming, M8 to M15	2	6	-66.2	-63.7			0.1	-55.7	-41.25	14.41
HT/VHT40 Beam Forming, M0 to M7	3	11	-66.7	-64.2	-63.1		0.1	-48.5	-41.25	7.30
HT/VHT40 Beam Forming, M8 to M15	3	8	-66.2	-63.7	-62.7		0.1	-51.1	-41.25	9.84
HT/VHT40 Beam Forming, M16 to M23	3	6	-66.2	-63.7	-62.7		0.1	-53.1	-41.25	11.84
HT/VHT40 Beam Forming, M0 to M7	4	12	-67.9	-64.7	-63.6	-65.9	0.1	-47.1	-41.25	5.88
HT/VHT40 Beam Forming, M8 to M15	4	9	-66.7	-64.2	-63.1	-65.3	0.1	-49.5	-41.25	8.25
HT/VHT40 Beam Forming, M16 to M23	4	7	-66.2	-63.7	-62.7	-64.8	0.1	-51.0	-41.25	9.79



	HT/VHT40 Beam Forming, M24 to M31	4	6	-66.2	-63.7	-62.7	-64.8	0.1	-52.0	-41.25	10.79
	HT/VHT40 STBC, M0 to M7	2	6	-66.2	-63.7			0.1	-55.7	-41.25	14.41
	HT/VHT40 STBC, M0 to M7	3	6	-66.2	-63.7	-62.7		0.1	-53.1	-41.25	11.84
	HT/VHT40 STBC, M0 to M7	4	6	-66.2	-63.7	-62.7	-64.8	0.1	-52.0	-41.25	10.79
	HE40, M0 to M9 1ss	1	6	-66.2				0.1	-60.1	-41.25	18.82
	HE40, M0 to M9 1ss	2	6	-66.2	-63.8			0.1	-55.7	-41.25	14.45
	HE40, M0 to M9 2ss	2	6	-66.2	-63.8			0.1	-55.7	-41.25	14.45
	HE40, M0 to M9 1ss	3	6	-66.2	-63.8	-62.5		0.1	-53.0	-41.25	11.76
	HE40, M0 to M9 2ss	3	6	-66.2	-63.8	-62.5		0.1	-53.0	-41.25	11.76
	HE40, M0 to M9 3ss	3	6	-66.2	-63.8	-62.5		0.1	-53.0	-41.25	11.76
	HE40, M0 to M9 1ss	4	6	-66.2	-63.8	-62.5	-64.7	0.1	-51.9	-41.25	10.70
	HE40, M0 to M9 2ss	4	6	-66.2	-63.8	-62.5	-64.7	0.1	-51.9	-41.25	10.70
	HE40, M0 to M9 3ss	4	6	-66.2	-63.8	-62.5	-64.7	0.1	-51.9	-41.25	10.70
	HE40, M0 to M9 4ss	4	6	-66.2	-63.8	-62.5	-64.7	0.1	-51.9	-41.25	10.70
	HE40 Beam Forming, M0 to M9 1ss	2	9	-66.8	-64.3			0.1	-53.2	-41.25	11.99
	HE40 Beam Forming, M0 to M9 2ss	2	6	-66.2	-63.8			0.1	-55.7	-41.25	14.45
	HE40 Beam Forming, M0 to M9 1ss	3	11	-68.1	-64.8	-63.9		0.1	-49.4	-41.25	8.11
	HE40 Beam Forming, M0 to M9 2ss	3	8	-66.8	-64.3	-63.2		0.1	-51.6	-41.25	10.38
	HE40 Beam Forming, M0 to M9 3ss	3	6	-66.2	-63.8	-62.5		0.1	-53.0	-41.25	11.76
	HE40 Beam Forming, M0 to M9 1ss	4	12	-68.1	-64.8	-63.9	-65.9	0.1	-47.3	-41.25	6.02
	HE40 Beam Forming, M0 to M9 2ss	4	9	-66.8	-64.3	-63.2	-65.4	0.1	-49.6	-41.25	8.33
	HE40 Beam Forming, M0 to M9 3ss	4	7	-66.8	-64.3	-63.2	-65.4	0.1	-51.6	-41.25	10.33
	HE40 Beam Forming, M0 to M9 4ss	4	6	-66.2	-63.8	-62.5	-64.7	0.1	-51.9	-41.25	10.70
	HE40 STBC, M0 to M9 2ss	2	6	-66.2	-63.8			0.1	-55.7	-41.25	14.45
	HE40 STBC, M0 to M9 2ss	3	6	-66.2	-63.8	-62.5		0.1	-53.0	-41.25	11.76
	HE40 STBC, M0 to M9 2ss	4	6	-66.2	-63.8	-62.5	-64.7	0.1	-51.9	-41.25	10.70
5210	Non HT80, 6 to 54 Mbps	1	6	-65.5				0.1	-59.4	-41.25	18.20
	Non HT80, 6 to 54 Mbps	2	6	-65.5	-63.7			0.1	-55.4	-41.25	14.19
	Non HT80, 6 to 54 Mbps	3	6	-65.5	-63.7	-63.2		0.1	-53.2	-41.25	11.95
	Non HT80, 6 to 54 Mbps	4	6	-65.5	-63.7	-63.2	-65.0	0.1	-52.2	-41.25	10.93
	VHT80, M0 to M9 1ss	1	6	-65.1				0.2	-58.9	-41.25	17.63
	VHT80, M0 to M9 1ss	2	6	-66.2	-64.4			0.2	-56.0	-41.25	14.72
	VHT80, M0 to M9 2ss	2	6	-66.2	-64.4			0.2	-56.0	-41.25	14.72
	VHT80, M0 to M9 1ss	3	6	-66.2	-64.4	-63.5		0.2	-53.6	-41.25	12.32
	VHT80, M0 to M9 2ss	3	6	-66.2	-64.4	-63.5		0.2	-53.6	-41.25	12.32
	VHT80, M0 to M9 3ss	3	6	-66.2	-64.4	-63.5		0.2	-53.6	-41.25	12.32
	VHT80, M0 to M9 1ss	4	6	-66.2	-64.4	-63.5	-65.5	0.2	-52.5	-41.25	11.28
	VHT80, M0 to M9 2ss	4	6	-66.2	-64.4	-63.5	-65.5	0.2	-52.5	-41.25	11.28
	VHT80, M0 to M9 3ss	4	6	-66.2	-64.4	-63.5	-65.5	0.2	-52.5	-41.25	11.28
	VHT80, M0 to M9 4ss	4	6	-66.2	-64.4	-63.5	-65.5	0.2	-52.5	-41.25	11.28
	VHT80 Beam Forming, M0 to M9 1ss	2	9	-66.2	-64.4			0.2	-53.0	-41.25	11.72
VHT80 Beam Forming, M0 to M9 2ss	2	6	-66.2	-64.4			0.2	-56.0	-41.25	14.72	

VHT80 Beam Forming, M0 to M9 1ss	3	11	-66.5	-64.3	-63.8		0.2	-48.7	-41.25	7.47
VHT80 Beam Forming, M0 to M9 2ss	3	8	-66.2	-64.4	-63.5		0.2	-51.6	-41.25	10.32
VHT80 Beam Forming, M0 to M9 3ss	3	6	-66.2	-64.4	-63.5		0.2	-53.6	-41.25	12.32
VHT80 Beam Forming, M0 to M9 1ss	4	12	-66.5	-64.3	-63.8	-65.9	0.2	-46.7	-41.25	5.49
VHT80 Beam Forming, M0 to M9 2ss	4	9	-66.2	-64.4	-63.5	-65.5	0.2	-49.5	-41.25	8.28
VHT80 Beam Forming, M0 to M9 3ss	4	7	-66.2	-64.4	-63.5	-65.5	0.2	-51.5	-41.25	10.28
VHT80 Beam Forming, M0 to M9 4ss	4	6	-66.2	-64.4	-63.5	-65.5	0.2	-52.5	-41.25	11.28
VHT80 STBC, M0 to M9 1ss	2	6	-66.2	-64.4			0.2	-56.0	-41.25	14.72
VHT80 STBC, M0 to M9 1ss	3	6	-66.2	-64.4	-63.5		0.2	-53.6	-41.25	12.32
VHT80 STBC, M0 to M9 1ss	4	6	-66.2	-64.4	-63.5	-65.5	0.2	-52.5	-41.25	11.28
HE80, M0 to M9 1ss	1	6	-65.5				0.3	-59.2	-41.25	18.00
HE80, M0 to M9 1ss	2	6	-65.5	-63.7			0.3	-55.2	-41.25	14.00
HE80, M0 to M9 2ss	2	6	-65.5	-63.7			0.3	-55.2	-41.25	14.00
HE80, M0 to M9 1ss	3	6	-66.2	-64.4	-63.6		0.3	-53.6	-41.25	12.33
HE80, M0 to M9 2ss	3	6	-66.2	-64.4	-63.6		0.3	-53.6	-41.25	12.33
HE80, M0 to M9 3ss	3	6	-66.2	-64.4	-63.6		0.3	-53.6	-41.25	12.33
HE80, M0 to M9 1ss	4	6	-66.2	-64.4	-63.6	-65.8	0.3	-52.6	-41.25	11.35
HE80, M0 to M9 2ss	4	6	-66.2	-64.4	-63.6	-65.8	0.3	-52.6	-41.25	11.35
HE80, M0 to M9 3ss	4	6	-66.2	-64.4	-63.6	-65.8	0.3	-52.6	-41.25	11.35
HE80, M0 to M9 4ss	4	6	-66.2	-64.4	-63.6	-65.8	0.3	-52.6	-41.25	11.35
HE80 Beam Forming, M0 to M9 1ss	2	9	-66.2	-64.4			0.3	-52.9	-41.25	11.70
HE80 Beam Forming, M0 to M9 2ss	2	6	-65.5	-63.7			0.3	-55.2	-41.25	14.00
HE80 Beam Forming, M0 to M9 1ss	3	11	-66.7	-64.7	-64.0		0.3	-49.0	-41.25	7.72
HE80 Beam Forming, M0 to M9 2ss	3	8	-66.2	-64.4	-63.6		0.3	-51.6	-41.25	10.33
HE80 Beam Forming, M0 to M9 3ss	3	6	-66.2	-64.4	-63.6		0.3	-53.6	-41.25	12.33
HE80 Beam Forming, M0 to M9 1ss	4	12	-66.7	-64.7	-64.0	-66.2	0.3	-47.0	-41.25	5.74
HE80 Beam Forming, M0 to M9 2ss	4	9	-66.2	-64.4	-63.6	-65.8	0.3	-49.6	-41.25	8.35
HE80 Beam Forming, M0 to M9 3ss	4	7	-66.2	-64.4	-63.6	-65.8	0.3	-51.6	-41.25	10.35
HE80 Beam Forming, M0 to M9 4ss	4	6	-66.2	-64.4	-63.6	-65.8	0.3	-52.6	-41.25	11.35
HE80 STBC, M0 to M9 1ss	2	6	-65.5	-63.7			0.3	-55.2	-41.25	14.00
HE80 STBC, M0 to M9 1ss	3	6	-66.2	-64.4	-63.6		0.3	-53.6	-41.25	12.33
HE80 STBC, M0 to M9 1ss	4	6	-66.2	-64.4	-63.6	-65.8	0.3	-52.6	-41.25	11.35
5220										
Non HT20, 6 to 54 Mbps	1	6	-65.5				0.1	-59.4	-41.25	18.20
Non HT20, 6 to 54 Mbps	2	6	-65.5	-59.1			0.1	-52.1	-41.25	10.90
Non HT20, 6 to 54 Mbps	3	6	-65.5	-59.1	-58.3		0.1	-49.2	-41.25	7.94
Non HT20, 6 to 54 Mbps	4	6	-65.5	-59.1	-58.3	-59.4	0.1	-47.8	-41.25	6.53
Non HT20 Beam Forming, 6 to 54 Mbps	2	9	-65.5	-59.1			0.1	-49.1	-41.25	7.90
Non HT20 Beam Forming, 6 to 54 Mbps	3	11	-65.5	-59.1	-58.3		0.1	-44.2	-41.25	2.94
Non HT20 Beam Forming, 6 to 54 Mbps	4	12	-65.5	-59.1	-58.3	-59.4	0.1	-41.8	-41.25	0.53
HT/VHT20, M0 to M7	1	6	-65.8				0.1	-59.7	-41.25	18.50
HT/VHT20, M0 to M7	2	6	-65.8	-59.3			0.1	-52.4	-41.25	11.12
HT/VHT20, M8 to M15	2	6	-65.8	-59.3			0.1	-52.4	-41.25	11.12

HT/VHT20, M0 to M7	3	6	-65.8	-59.3	-58.3		0.1	-49.3	-41.25	8.05
HT/VHT20, M8 to M15	3	6	-65.8	-59.3	-58.3		0.1	-49.3	-41.25	8.05
HT/VHT20, M16 to M23	3	6	-65.8	-59.3	-58.3		0.1	-49.3	-41.25	8.05
HT/VHT20, M0 to M7	4	6	-65.8	-59.3	-58.3	-60.1	0.1	-48.0	-41.25	6.79
HT/VHT20, M8 to M15	4	6	-65.8	-59.3	-58.3	-60.1	0.1	-48.0	-41.25	6.79
HT/VHT20, M16 to M23	4	6	-65.8	-59.3	-58.3	-60.1	0.1	-48.0	-41.25	6.79
HT/VHT20, M24 to M31	4	6	-65.8	-59.3	-58.3	-60.1	0.1	-48.0	-41.25	6.79
HT/VHT20 Beam Forming, M0 to M7	2	9	-65.8	-59.3			0.1	-49.4	-41.25	8.12
HT/VHT20 Beam Forming, M8 to M15	2	6	-65.8	-59.3			0.1	-52.4	-41.25	11.12
HT/VHT20 Beam Forming, M0 to M7	3	11	-65.8	-59.3	-58.3		0.1	-44.3	-41.25	3.05
HT/VHT20 Beam Forming, M8 to M15	3	8	-65.8	-59.3	-58.3		0.1	-47.3	-41.25	6.05
HT/VHT20 Beam Forming, M16 to M23	3	6	-65.8	-59.3	-58.3		0.1	-49.3	-41.25	8.05
HT/VHT20 Beam Forming, M0 to M7	4	12	-65.8	-59.3	-58.3	-60.1	0.1	-42.0	-41.25	0.79
HT/VHT20 Beam Forming, M8 to M15	4	9	-65.8	-59.3	-58.3	-60.1	0.1	-45.0	-41.25	3.79
HT/VHT20 Beam Forming, M16 to M23	4	7	-65.8	-59.3	-58.3	-60.1	0.1	-47.0	-41.25	5.79
HT/VHT20 Beam Forming, M24 to M31	4	6	-65.8	-59.3	-58.3	-60.1	0.1	-48.0	-41.25	6.79
HT/VHT20 STBC, M0 to M7	2	6	-65.8	-59.3			0.1	-52.4	-41.25	11.12
HT/VHT20 STBC, M0 to M7	3	6	-65.8	-59.3	-58.3		0.1	-49.3	-41.25	8.05
HT/VHT20 STBC, M0 to M7	4	6	-65.8	-59.3	-58.3	-60.1	0.1	-48.0	-41.25	6.79
HE20, M0 to M9 1ss	1	6	-65.7				0.1	-59.6	-41.25	18.38
HE20, M0 to M9 1ss	2	6	-65.7	-59.2			0.1	-52.3	-41.25	11.00
HE20, M0 to M9 2ss	2	6	-65.7	-59.2			0.1	-52.3	-41.25	11.00
HE20, M0 to M9 1ss	3	6	-65.7	-59.2	-58.2		0.1	-49.2	-41.25	7.93
HE20, M0 to M9 2ss	3	6	-65.7	-59.2	-58.2		0.1	-49.2	-41.25	7.93
HE20, M0 to M9 3ss	3	6	-65.7	-59.2	-58.2		0.1	-49.2	-41.25	7.93
HE20, M0 to M9 1ss	4	6	-65.7	-59.2	-58.2	-60.0	0.1	-47.9	-41.25	6.68
HE20, M0 to M9 2ss	4	6	-65.7	-59.2	-58.2	-60.0	0.1	-47.9	-41.25	6.68
HE20, M0 to M9 3ss	4	6	-65.7	-59.2	-58.2	-60.0	0.1	-47.9	-41.25	6.68
HE20, M0 to M9 4ss	4	6	-65.7	-59.2	-58.2	-60.0	0.1	-47.9	-41.25	6.68
HE20 Beam Forming, M0 to M9 1ss	2	9	-65.7	-59.2			0.1	-49.3	-41.25	8.00
HE20 Beam Forming, M0 to M9 2ss	2	6	-65.7	-59.2			0.1	-52.3	-41.25	11.00
HE20 Beam Forming, M0 to M9 1ss	3	11	-65.7	-59.2	-58.2		0.1	-44.2	-41.25	2.93
HE20 Beam Forming, M0 to M9 2ss	3	8	-65.7	-59.2	-58.2		0.1	-47.2	-41.25	5.93
HE20 Beam Forming, M0 to M9 3ss	3	6	-65.7	-59.2	-58.2		0.1	-49.2	-41.25	7.93
HE20 Beam Forming, M0 to M9 1ss	4	12	-65.7	-59.2	-58.2	-60.0	0.1	-41.9	-41.25	0.68
HE20 Beam Forming, M0 to M9 2ss	4	9	-65.7	-59.2	-58.2	-60.0	0.1	-44.9	-41.25	3.68
HE20 Beam Forming, M0 to M9 3ss	4	7	-65.7	-59.2	-58.2	-60.0	0.1	-46.9	-41.25	5.68
HE20 Beam Forming, M0 to M9 4ss	4	6	-65.7	-59.2	-58.2	-60.0	0.1	-47.9	-41.25	6.68
HE20 STBC, M0 to M9 2ss	2	6	-65.7	-59.2			0.1	-52.3	-41.25	11.00
HE20 STBC, M0 to M9 2ss	3	6	-65.7	-59.2	-58.2		0.1	-49.2	-41.25	7.93
HE20 STBC, M0 to M9 2ss	4	6	-65.7	-59.2	-58.2	-60.0	0.1	-47.9	-41.25	6.68
Non HT40, 6 to 54 Mbps	1	6	-65.5				0.0	-59.5	-41.25	18.20

Non HT40, 6 to 54 Mbps	2	6	-65.5	-58.6			0.0	-51.7	-41.25	10.49
Non HT40, 6 to 54 Mbps	3	6	-65.5	-58.6	-58.1		0.0	-48.9	-41.25	7.63
Non HT40, 6 to 54 Mbps	4	6	-65.5	-58.6	-58.1	-59.4	0.0	-47.6	-41.25	6.31
HT/VHT40, M0 to M7	1	6	-65.8				0.1	-59.7	-41.25	18.45
HT/VHT40, M0 to M7	2	6	-65.8	-59.2			0.1	-52.2	-41.25	10.99
HT/VHT40, M8 to M15	2	6	-65.8	-59.2			0.1	-52.2	-41.25	10.99
HT/VHT40, M0 to M7	3	6	-65.8	-59.2	-58.3		0.1	-49.2	-41.25	7.96
HT/VHT40, M8 to M15	3	6	-65.8	-59.2	-58.3		0.1	-49.2	-41.25	7.96
HT/VHT40, M16 to M23	3	6	-65.8	-59.2	-58.3		0.1	-49.2	-41.25	7.96
HT/VHT40, M0 to M7	4	6	-65.8	-59.2	-58.3	-59.7	0.1	-47.9	-41.25	6.61
HT/VHT40, M8 to M15	4	6	-65.8	-59.2	-58.3	-59.7	0.1	-47.9	-41.25	6.61
HT/VHT40, M16 to M23	4	6	-65.8	-59.2	-58.3	-59.7	0.1	-47.9	-41.25	6.61
HT/VHT40, M24 to M31	4	6	-65.8	-59.2	-58.3	-59.7	0.1	-47.9	-41.25	6.61
HT/VHT40 Beam Forming, M0 to M7	2	9	-65.8	-59.2			0.1	-49.2	-41.25	7.99
HT/VHT40 Beam Forming, M8 to M15	2	6	-65.8	-59.2			0.1	-52.2	-41.25	10.99
HT/VHT40 Beam Forming, M0 to M7	3	11	-65.8	-59.2	-58.3		0.1	-44.2	-41.25	2.96
HT/VHT40 Beam Forming, M8 to M15	3	8	-65.8	-59.2	-58.3		0.1	-47.2	-41.25	5.96
HT/VHT40 Beam Forming, M16 to M23	3	6	-65.8	-59.2	-58.3		0.1	-49.2	-41.25	7.96
HT/VHT40 Beam Forming, M0 to M7	4	12	-65.8	-59.2	-58.3	-59.7	0.1	-41.9	-41.25	0.61
HT/VHT40 Beam Forming, M8 to M15	4	9	-65.8	-59.2	-58.3	-59.7	0.1	-44.9	-41.25	3.61
HT/VHT40 Beam Forming, M16 to M23	4	7	-65.8	-59.2	-58.3	-59.7	0.1	-46.9	-41.25	5.61
HT/VHT40 Beam Forming, M24 to M31	4	6	-65.8	-59.2	-58.3	-59.7	0.1	-47.9	-41.25	6.61
HT/VHT40 STBC, M0 to M7	2	6	-65.8	-59.2			0.1	-52.2	-41.25	10.99
HT/VHT40 STBC, M0 to M7	3	6	-65.8	-59.2	-58.3		0.1	-49.2	-41.25	7.96
HT/VHT40 STBC, M0 to M7	4	6	-65.8	-59.2	-58.3	-59.7	0.1	-47.9	-41.25	6.61
HE40, M0 to M9 1ss	1	6	-65.6				0.1	-59.5	-41.25	18.22
HE40, M0 to M9 1ss	2	6	-65.6	-59.2			0.1	-52.2	-41.25	10.93
HE40, M0 to M9 2ss	2	6	-65.6	-59.2			0.1	-52.2	-41.25	10.93
HE40, M0 to M9 1ss	3	6	-65.6	-59.2	-58.2		0.1	-49.1	-41.25	7.87
HE40, M0 to M9 2ss	3	6	-65.6	-59.2	-58.2		0.1	-49.1	-41.25	7.87
HE40, M0 to M9 3ss	3	6	-65.6	-59.2	-58.2		0.1	-49.1	-41.25	7.87
HE40, M0 to M9 1ss	4	6	-65.6	-59.2	-58.2	-59.8	0.1	-47.8	-41.25	6.56
HE40, M0 to M9 2ss	4	6	-65.6	-59.2	-58.2	-59.8	0.1	-47.8	-41.25	6.56
HE40, M0 to M9 3ss	4	6	-65.6	-59.2	-58.2	-59.8	0.1	-47.8	-41.25	6.56
HE40, M0 to M9 4ss	4	6	-65.6	-59.2	-58.2	-59.8	0.1	-47.8	-41.25	6.56
HE40 Beam Forming, M0 to M9 1ss	2	9	-65.6	-59.2			0.1	-49.2	-41.25	7.93
HE40 Beam Forming, M0 to M9 2ss	2	6	-65.6	-59.2			0.1	-52.2	-41.25	10.93
HE40 Beam Forming, M0 to M9 1ss	3	11	-65.6	-59.2	-58.2		0.1	-44.1	-41.25	2.87
HE40 Beam Forming, M0 to M9 2ss	3	8	-65.6	-59.2	-58.2		0.1	-47.1	-41.25	5.87
HE40 Beam Forming, M0 to M9 3ss	3	6	-65.6	-59.2	-58.2		0.1	-49.1	-41.25	7.87
HE40 Beam Forming, M0 to M9 1ss	4	12	-65.6	-59.2	-58.2	-59.8	0.1	-41.8	-41.25	0.56
HE40 Beam Forming, M0 to M9 2ss	4	9	-65.6	-59.2	-58.2	-59.8	0.1	-44.8	-41.25	3.56
HE40 Beam Forming, M0 to M9 3ss	4	7	-65.6	-59.2	-58.2	-59.8	0.1	-46.8	-41.25	5.56

	HE40 Beam Forming, M0 to M9 4ss	4	6	-65.6	-59.2	-58.2	-59.8	0.1	-47.8	-41.25	6.56
	HE40 STBC, M0 to M9 2ss	2	6	-65.6	-59.2			0.1	-52.2	-41.25	10.93
	HE40 STBC, M0 to M9 2ss	3	6	-65.6	-59.2	-58.2		0.1	-49.1	-41.25	7.87
	HE40 STBC, M0 to M9 2ss	4	6	-65.6	-59.2	-58.2	-59.8	0.1	-47.8	-41.25	6.56
	Non HT20, 6 to 54 Mbps	1	6	-65.8				0.1	-59.7	-41.25	18.50
	Non HT20, 6 to 54 Mbps	2	6	-65.8	-58.6			0.1	-51.8	-41.25	10.54
	Non HT20, 6 to 54 Mbps	3	6	-65.8	-58.6	-57.9		0.1	-48.8	-41.25	7.56
	Non HT20, 6 to 54 Mbps	4	6	-65.8	-58.6	-57.9	-59.0	0.1	-47.4	-41.25	6.14
	Non HT20 Beam Forming, 6 to 54 Mbps	2	9	-65.8	-58.6			0.1	-48.8	-41.25	7.54
	Non HT20 Beam Forming, 6 to 54 Mbps	3	11	-65.8	-58.6	-57.9		0.1	-43.8	-41.25	2.56
	Non HT20 Beam Forming, 6 to 54 Mbps	4	12	-65.8	-58.6	-57.9	-59.0	0.1	-41.4	-41.25	0.14
	HT/VHT20, M0 to M7	1	6	-65.9				0.1	-59.8	-41.25	18.60
	HT/VHT20, M0 to M7	2	6	-65.9	-59.4			0.1	-52.5	-41.25	11.22
	HT/VHT20, M8 to M15	2	6	-65.9	-59.4			0.1	-52.5	-41.25	11.22
	HT/VHT20, M0 to M7	3	6	-65.9	-59.4	-58.0		0.1	-49.2	-41.25	7.94
	HT/VHT20, M8 to M15	3	6	-65.9	-59.4	-58.0		0.1	-49.2	-41.25	7.94
	HT/VHT20, M16 to M23	3	6	-65.9	-59.4	-58.0		0.1	-49.2	-41.25	7.94
	HT/VHT20, M0 to M7	4	6	-65.9	-59.4	-58.0	-59.6	0.1	-47.8	-41.25	6.58
	HT/VHT20, M8 to M15	4	6	-65.9	-59.4	-58.0	-59.6	0.1	-47.8	-41.25	6.58
	HT/VHT20, M16 to M23	4	6	-65.9	-59.4	-58.0	-59.6	0.1	-47.8	-41.25	6.58
	HT/VHT20, M24 to M31	4	6	-65.9	-59.4	-58.0	-59.6	0.1	-47.8	-41.25	6.58
	HT/VHT20 Beam Forming, M0 to M7	2	9	-65.9	-59.4			0.1	-49.5	-41.25	8.22
	HT/VHT20 Beam Forming, M8 to M15	2	6	-65.9	-59.4			0.1	-52.5	-41.25	11.22
	HT/VHT20 Beam Forming, M0 to M7	3	11	-65.9	-59.4	-58.0		0.1	-44.2	-41.25	2.94
	HT/VHT20 Beam Forming, M8 to M15	3	8	-65.9	-59.4	-58.0		0.1	-47.2	-41.25	5.94
	HT/VHT20 Beam Forming, M16 to M23	3	6	-65.9	-59.4	-58.0		0.1	-49.2	-41.25	7.94
	HT/VHT20 Beam Forming, M0 to M7	4	12	-65.9	-59.4	-58.0	-59.6	0.1	-41.8	-41.25	0.58
	HT/VHT20 Beam Forming, M8 to M15	4	9	-65.9	-59.4	-58.0	-59.6	0.1	-44.8	-41.25	3.58
	HT/VHT20 Beam Forming, M16 to M23	4	7	-65.9	-59.4	-58.0	-59.6	0.1	-46.8	-41.25	5.58
	HT/VHT20 Beam Forming, M24 to M31	4	6	-65.9	-59.4	-58.0	-59.6	0.1	-47.8	-41.25	6.58
	HT/VHT20 STBC, M0 to M7	2	6	-65.9	-59.4			0.1	-52.5	-41.25	11.22
	HT/VHT20 STBC, M0 to M7	3	6	-65.9	-59.4	-58.0		0.1	-49.2	-41.25	7.94
	HT/VHT20 STBC, M0 to M7	4	6	-65.9	-59.4	-58.0	-59.6	0.1	-47.8	-41.25	6.58
	HE20, M0 to M9 1ss	1	6	-65.9				0.1	-59.8	-41.25	18.58
	HE20, M0 to M9 1ss	2	6	-65.9	-59.2			0.1	-52.3	-41.25	11.04
	HE20, M0 to M9 2ss	2	6	-65.9	-59.2			0.1	-52.3	-41.25	11.04
	HE20, M0 to M9 1ss	3	6	-65.9	-59.2	-58.0		0.1	-49.1	-41.25	7.85
	HE20, M0 to M9 2ss	3	6	-65.9	-59.2	-58.0		0.1	-49.1	-41.25	7.85
	HE20, M0 to M9 3ss	3	6	-65.9	-59.2	-58.0		0.1	-49.1	-41.25	7.85
	HE20, M0 to M9 1ss	4	6	-65.9	-59.2	-58.0	-59.6	0.1	-47.8	-41.25	6.51
	HE20, M0 to M9 2ss	4	6	-65.9	-59.2	-58.0	-59.6	0.1	-47.8	-41.25	6.51
	HE20, M0 to M9 3ss	4	6	-65.9	-59.2	-58.0	-59.6	0.1	-47.8	-41.25	6.51

5240

	HE20, M0 to M9 4ss	4	6	-65.9	-59.2	-58.0	-59.6	0.1	-47.8	-41.25	6.51
	HE20 Beam Forming, M0 to M9 1ss	2	9	-65.9	-59.2			0.1	-49.3	-41.25	8.04
	HE20 Beam Forming, M0 to M9 2ss	2	6	-65.9	-59.2			0.1	-52.3	-41.25	11.04
	HE20 Beam Forming, M0 to M9 1ss	3	11	-65.9	-59.2	-58.0		0.1	-44.1	-41.25	2.85
	HE20 Beam Forming, M0 to M9 2ss	3	8	-65.9	-59.2	-58.0		0.1	-47.1	-41.25	5.85
	HE20 Beam Forming, M0 to M9 3ss	3	6	-65.9	-59.2	-58.0		0.1	-49.1	-41.25	7.85
	HE20 Beam Forming, M0 to M9 1ss	4	12	-65.9	-59.2	-58.0	-59.6	0.1	-41.8	-41.25	0.51
	HE20 Beam Forming, M0 to M9 2ss	4	9	-65.9	-59.2	-58.0	-59.6	0.1	-44.8	-41.25	3.51
	HE20 Beam Forming, M0 to M9 3ss	4	7	-65.9	-59.2	-58.0	-59.6	0.1	-46.8	-41.25	5.51
	HE20 Beam Forming, M0 to M9 4ss	4	6	-65.9	-59.2	-58.0	-59.6	0.1	-47.8	-41.25	6.51
	HE20 STBC, M0 to M9 2ss	2	6	-65.9	-59.2			0.1	-52.3	-41.25	11.04
	HE20 STBC, M0 to M9 2ss	3	6	-65.9	-59.2	-58.0		0.1	-49.1	-41.25	7.85
	HE20 STBC, M0 to M9 2ss	4	6	-65.9	-59.2	-58.0	-59.6	0.1	-47.8	-41.25	6.51
5250	Non HT160, 6 to 54 Mbps	1	6	-59.6				0.0	-53.6	-41.25	12.30
	Non HT160, 6 to 54 Mbps	2	6	-59.6	-60.8			0.0	-51.1	-41.25	9.85
	Non HT160, 6 to 54 Mbps	3	6	-59.6	-60.8	-61.6		0.0	-49.8	-41.25	8.52
	Non HT160, 6 to 54 Mbps	4	6	-61.1	-62.3	-62.3	-64.3	0.0	-50.3	-41.25	9.04
	VHT160, M0 to M9 1ss	1	6	-63.2				0.4	-56.8	-41.25	15.56
	VHT160, M0 to M9 1ss	2	6	-63.2	-63.3			0.4	-53.8	-41.25	12.60
	VHT160, M0 to M9 2ss	2	6	-63.2	-63.3			0.4	-53.8	-41.25	12.60
	VHT160, M0 to M9 1ss	3	6	-63.2	-63.3	-63.5		0.4	-52.2	-41.25	10.92
	VHT160, M0 to M9 2ss	3	6	-63.2	-63.3	-63.5		0.4	-52.2	-41.25	10.92
	VHT160, M0 to M9 3ss	3	6	-63.2	-63.3	-63.5		0.4	-52.2	-41.25	10.92
	VHT160, M0 to M9 1ss	4	6	-63.2	-63.3	-63.5	-65.5	0.4	-51.4	-41.25	10.12
	VHT160, M0 to M9 2ss	4	6	-63.2	-63.3	-63.5	-65.5	0.4	-51.4	-41.25	10.12
	VHT160, M0 to M9 3ss	4	6	-63.2	-63.3	-63.5	-65.5	0.4	-51.4	-41.25	10.12
	VHT160, M0 to M9 4ss	4	6	-63.2	-63.3	-63.5	-65.5	0.4	-51.4	-41.25	10.12
	VHT160 Beam Forming, M0 to M9 1ss	2	9	-64.6	-63.9			0.4	-51.8	-41.25	10.58
	VHT160 Beam Forming, M0 to M9 2ss	2	6	-63.2	-63.3			0.4	-53.8	-41.25	12.60
	VHT160 Beam Forming, M0 to M9 1ss	3	11	-66.5	-64.5	-64.7		0.4	-49.0	-41.25	7.73
	VHT160 Beam Forming, M0 to M9 2ss	3	8	-63.2	-63.3	-63.5		0.4	-50.2	-41.25	8.92
	VHT160 Beam Forming, M0 to M9 3ss	3	6	-63.2	-63.3	-63.5		0.4	-52.2	-41.25	10.92
	VHT160 Beam Forming, M0 to M9 1ss	4	12	-66.5	-64.5	-64.7	-67.0	0.4	-47.1	-41.25	5.88
	VHT160 Beam Forming, M0 to M9 2ss	4	9	-64.6	-63.9	-63.7	-66.2	0.4	-49.1	-41.25	7.83
	VHT160 Beam Forming, M0 to M9 3ss	4	7	-63.2	-63.3	-63.5	-65.5	0.4	-50.4	-41.25	9.12
	VHT160 Beam Forming, M0 to M9 4ss	4	6	-63.2	-63.3	-63.5	-65.5	0.4	-51.4	-41.25	10.12
	VHT160 STBC, M0 to M9 1ss	2	6	-63.2	-63.3			0.4	-53.8	-41.25	12.60
	VHT160 STBC, M0 to M9 1ss	3	6	-63.2	-63.3	-63.5		0.4	-52.2	-41.25	10.92
	VHT160 STBC, M0 to M9 1ss	4	6	-63.2	-63.3	-63.5	-65.5	0.4	-51.4	-41.25	10.12
	HE160, M0 to M9 1ss	1	6	-60.6				0.4	-54.2	-41.25	12.92
	HE160, M0 to M9 1ss	2	6	-60.6	-62.4			0.4	-52.0	-41.25	10.71
HE160, M0 to M9 2ss	2	6	-60.6	-62.4			0.4	-52.0	-41.25	10.71	



HE160, M0 to M9 1ss	3	6	-60.6	-62.4	-62.3		0.4	-50.5	-41.25	9.23
HE160, M0 to M9 2ss	3	6	-60.6	-62.4	-62.3		0.4	-50.5	-41.25	9.23
HE160, M0 to M9 3ss	3	6	-60.6	-62.4	-62.3		0.4	-50.5	-41.25	9.23
HE160, M0 to M9 1ss	4	6	-60.6	-62.4	-62.3	-64.1	0.4	-49.7	-41.25	8.47
HE160, M0 to M9 2ss	4	6	-60.6	-62.4	-62.3	-64.1	0.4	-49.7	-41.25	8.47
HE160, M0 to M9 3ss	4	6	-60.6	-62.4	-62.3	-64.1	0.4	-49.7	-41.25	8.47
HE160, M0 to M9 4ss	4	6	-60.6	-62.4	-62.3	-64.1	0.4	-49.7	-41.25	8.47
HE160 Beam Forming, M0 to M9 1ss	2	9	-63.2	-63.5			0.4	-50.9	-41.25	9.65
HE160 Beam Forming, M0 to M9 2ss	2	6	-60.6	-62.4			0.4	-52.0	-41.25	10.71
HE160 Beam Forming, M0 to M9 1ss	3	11	-63.2	-63.5	-63.3		0.4	-47.1	-41.25	5.88
HE160 Beam Forming, M0 to M9 2ss	3	8	-63.2	-63.5	-63.3		0.4	-50.1	-41.25	8.88
HE160 Beam Forming, M0 to M9 3ss	3	6	-60.6	-62.4	-62.3		0.4	-50.5	-41.25	9.23
HE160 Beam Forming, M0 to M9 1ss	4	12	-64.9	-63.9	-64.1	-66.6	0.4	-46.3	-41.25	5.05
HE160 Beam Forming, M0 to M9 2ss	4	9	-63.2	-63.5	-63.3	-65.4	0.4	-48.3	-41.25	7.06
HE160 Beam Forming, M0 to M9 3ss	4	7	-63.2	-63.5	-63.3	-65.4	0.4	-50.3	-41.25	9.06
HE160 Beam Forming, M0 to M9 4ss	4	6	-60.6	-62.4	-62.3	-64.1	0.4	-49.7	-41.25	8.47
HE160 STBC, M0 to M9 1ss	2	6	-60.6	-62.4			0.4	-52.0	-41.25	10.71
HE160 STBC, M0 to M9 1ss	3	6	-60.6	-62.4	-62.3		0.4	-50.5	-41.25	9.23
HE160 STBC, M0 to M9 1ss	4	6	-60.6	-62.4	-62.3	-64.1	0.4	-49.7	-41.25	8.47

**Conducted Spurs Average, 6dBi
5240 MHz, Non HT20 Beam Forming, 6 to 54 Mbps**



Antenna A

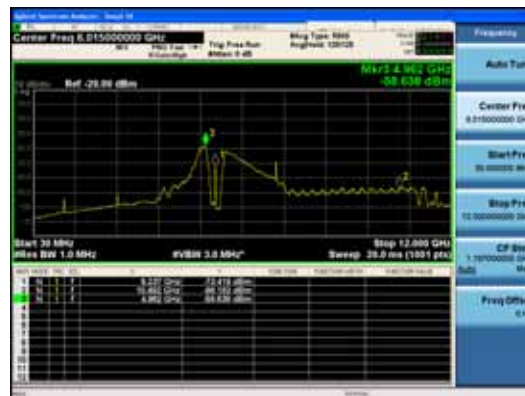

Antenna B

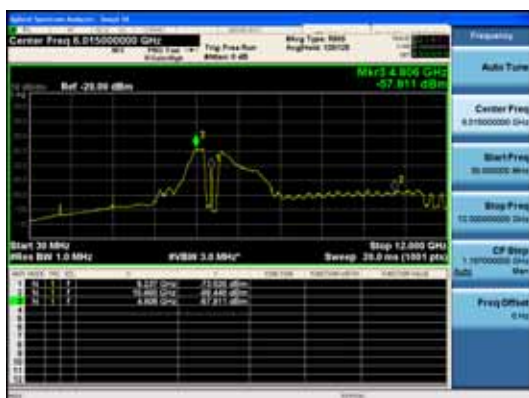

Antenna C

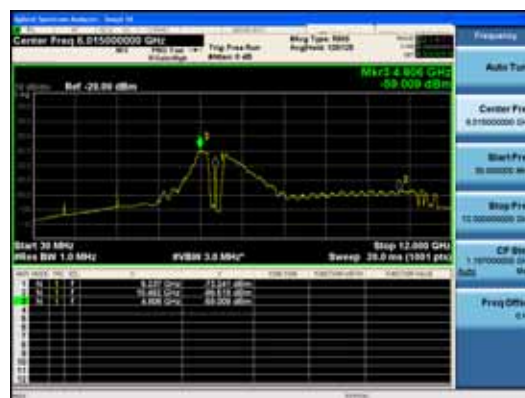

Antenna D

Conducted Spurious Peak Table, 4dBi

Frequency (MHz)	Mode	Tx Paths	Correlated Antenna Gain (dBi)	Spur Power (dBm)					Total Conducted Spur (dBm)	Limit (dBm)	Margin (dB)
				Tx 1 Spur Power (dBm)	Tx 2 Spur Power (dBm)	Tx 3 Spur Power (dBm)	Tx 4 Spur Power (dBm)	Tx 5 Spur Power (dBm)			
5180	Non HT20, 6 to 54 Mbps	1	4	-54.9				0.1	-50.8	-21.25	29.60
	Non HT20, 6 to 54 Mbps	2	4	-54.9	-48.2			0.1	-43.3	-21.25	22.05
	Non HT20, 6 to 54 Mbps	3	4	-54.9	-48.2	-47.2		0.1	-40.2	-21.25	18.96
	Non HT20, 6 to 54 Mbps	4	4	-54.9	-49.4	-46.7	-50.4	0.1	-39.4	-21.25	18.14
	Non HT20 Beam Forming, 6 to 54 Mbps	2	7	-54.9	-49.4			0.1	-41.3	-21.25	20.02
	Non HT20 Beam Forming, 6 to 54 Mbps	3	9	-54.9	-51.6	-50.4		0.1	-38.1	-21.25	16.85
	Non HT20 Beam Forming, 6 to 54 Mbps	4	10	-54.9	-51.4	-49.7	-52.4	0.1	-35.6	-21.25	14.39
	HT/VHT20, M0 to M7	1	4	-54.2				0.1	-50.1	-21.25	28.90
	HT/VHT20, M0 to M7	2	4	-54.2	-47.4			0.1	-42.5	-21.25	21.27
	HT/VHT20, M8 to M15	2	4	-54.2	-47.4			0.1	-42.5	-21.25	21.27
	HT/VHT20, M0 to M7	3	4	-54.2	-48.9	-46.9		0.1	-40.3	-21.25	19.00
	HT/VHT20, M8 to M15	3	4	-54.2	-48.9	-46.9		0.1	-40.3	-21.25	19.00
	HT/VHT20, M16 to M23	3	4	-54.2	-48.9	-46.9		0.1	-40.3	-21.25	19.00
	HT/VHT20, M0 to M7	4	4	-54.2	-48.9	-46.9	-49.4	0.1	-39.1	-21.25	17.83
	HT/VHT20, M8 to M15	4	4	-54.2	-48.9	-46.9	-49.4	0.1	-39.1	-21.25	17.83
	HT/VHT20, M16 to M23	4	4	-54.2	-48.9	-46.9	-49.4	0.1	-39.1	-21.25	17.83
	HT/VHT20, M24 to M31	4	4	-54.2	-48.9	-46.9	-49.4	0.1	-39.1	-21.25	17.83
	HT/VHT20 Beam Forming, M0 to M7	2	7	-54.2	-48.9			0.1	-40.7	-21.25	19.47
	HT/VHT20 Beam Forming, M8 to M15	2	4	-54.2	-47.4			0.1	-42.5	-21.25	21.27
	HT/VHT20 Beam Forming, M0 to M7	3	9	-54.2	-50.3	-48.4		0.1	-36.5	-21.25	15.29
	HT/VHT20 Beam Forming, M8 to M15	3	6	-54.2	-49.8	-47.7		0.1	-39.0	-21.25	17.75
	HT/VHT20 Beam Forming, M16 to M23	3	4	-54.2	-48.9	-46.9		0.1	-40.3	-21.25	19.00
	HT/VHT20 Beam Forming, M0 to M7	4	10	-54.8	-52.7	-50.3	-53.1	0.1	-36.3	-21.25	15.10
	HT/VHT20 Beam Forming, M8 to M15	4	7	-54.2	-49.8	-47.7	-49.3	0.1	-36.6	-21.25	15.36
	HT/VHT20 Beam Forming, M16 to M23	4	5	-54.2	-49.8	-47.7	-49.3	0.1	-38.6	-21.25	17.36
	HT/VHT20 Beam Forming, M24 to M31	4	4	-54.2	-48.9	-46.9	-49.4	0.1	-39.1	-21.25	17.83
	HT/VHT20 STBC, M0 to M7	2	4	-54.2	-47.4			0.1	-42.5	-21.25	21.27
	HT/VHT20 STBC, M0 to M7	3	4	-54.2	-48.9	-46.9		0.1	-40.3	-21.25	19.00
	HT/VHT20 STBC, M0 to M7	4	4	-54.2	-48.9	-46.9	-49.4	0.1	-39.1	-21.25	17.83
	HE20, M0 to M9 1ss	1	4	-54.7				0.1	-50.6	-21.25	29.38
	HE20, M0 to M9 1ss	2	4	-54.7	-49.0			0.1	-43.9	-21.25	22.65



	HE20, M0 to M9 2ss	2	4	-54.7	-49.0			0.1	-43.9	-21.25	22.65
	HE20, M0 to M9 1ss	3	4	-54.7	-49.0	-46.7		0.1	-40.2	-21.25	18.96
	HE20, M0 to M9 2ss	3	4	-54.7	-49.0	-46.7		0.1	-40.2	-21.25	18.96
	HE20, M0 to M9 3ss	3	4	-54.7	-49.0	-46.7		0.1	-40.2	-21.25	18.96
	HE20, M0 to M9 1ss	4	4	-54.7	-48.5	-47.4	-49.2	0.1	-39.1	-21.25	17.89
	HE20, M0 to M9 2ss	4	4	-54.7	-48.5	-47.4	-49.2	0.1	-39.1	-21.25	17.89
	HE20, M0 to M9 3ss	4	4	-54.7	-48.5	-47.4	-49.2	0.1	-39.1	-21.25	17.89
	HE20, M0 to M9 4ss	4	4	-54.7	-48.5	-47.4	-49.2	0.1	-39.1	-21.25	17.89
	HE20 Beam Forming, M0 to M9 1ss	2	7	-54.7	-48.5			0.1	-40.5	-21.25	19.25
	HE20 Beam Forming, M0 to M9 2ss	2	4	-54.7	-49.0			0.1	-43.9	-21.25	22.65
	HE20 Beam Forming, M0 to M9 1ss	3	9	-55.4	-52.3	-51.4		0.1	-38.9	-21.25	17.64
	HE20 Beam Forming, M0 to M9 2ss	3	6	-54.7	-48.5	-47.4		0.1	-38.4	-21.25	17.15
	HE20 Beam Forming, M0 to M9 3ss	3	4	-54.7	-49.0	-46.7		0.1	-40.2	-21.25	18.96
	HE20 Beam Forming, M0 to M9 1ss	4	10	-55.4	-52.3	-51.4	-53.2	0.1	-36.8	-21.25	15.50
	HE20 Beam Forming, M0 to M9 2ss	4	7	-54.7	-50.4	-50.6	-50.8	0.1	-38.2	-21.25	16.98
	HE20 Beam Forming, M0 to M9 3ss	4	5	-54.7	-48.5	-47.4	-49.2	0.1	-38.1	-21.25	16.89
	HE20 Beam Forming, M0 to M9 4ss	4	4	-54.7	-48.5	-47.4	-49.2	0.1	-39.1	-21.25	17.89
	HE20 STBC, M0 to M9 2ss	2	4	-54.7	-49.0			0.1	-43.9	-21.25	22.65
	HE20 STBC, M0 to M9 2ss	3	4	-54.7	-49.0	-46.7		0.1	-40.2	-21.25	18.96
	HE20 STBC, M0 to M9 2ss	4	4	-54.7	-48.5	-47.4	-49.2	0.1	-39.1	-21.25	17.89
5190	Non HT40, 6 to 54 Mbps	1	4	-55.2				0.0	-51.2	-21.25	29.90
	Non HT40, 6 to 54 Mbps	2	4	-55.2	-53.3			0.0	-47.1	-21.25	25.84
	Non HT40, 6 to 54 Mbps	3	4	-55.2	-53.3	-51.1		0.0	-44.1	-21.25	22.81
	Non HT40, 6 to 54 Mbps	4	4	-55.2	-53.3	-51.1	-52.9	0.0	-42.8	-21.25	21.56
	HT/VHT40, M0 to M7	1	4	-54.1				0.1	-50.0	-21.25	28.75
	HT/VHT40, M0 to M7	2	4	-54.1	-52.9			0.1	-46.3	-21.25	25.10
	HT/VHT40, M8 to M15	2	4	-54.1	-52.9			0.1	-46.3	-21.25	25.10
	HT/VHT40, M0 to M7	3	4	-54.1	-52.9	-51.4		0.1	-43.8	-21.25	22.54
	HT/VHT40, M8 to M15	3	4	-54.1	-52.9	-51.4		0.1	-43.8	-21.25	22.54
	HT/VHT40, M16 to M23	3	4	-54.1	-52.9	-51.4		0.1	-43.8	-21.25	22.54
	HT/VHT40, M0 to M7	4	4	-54.1	-52.9	-51.4	-52.8	0.1	-42.6	-21.25	21.32
	HT/VHT40, M8 to M15	4	4	-54.1	-52.9	-51.4	-52.8	0.1	-42.6	-21.25	21.32
	HT/VHT40, M16 to M23	4	4	-54.1	-52.9	-51.4	-52.8	0.1	-42.6	-21.25	21.32
	HT/VHT40, M24 to M31	4	4	-54.1	-52.9	-51.4	-52.8	0.1	-42.6	-21.25	21.32
	HT/VHT40 Beam Forming, M0 to M7	2	7	-54.7	-53.2			0.1	-43.8	-21.25	22.52
	HT/VHT40 Beam Forming, M8 to M15	2	4	-54.1	-52.9			0.1	-46.3	-21.25	25.10
	HT/VHT40 Beam Forming, M0 to M7	3	9	-55.9	-53.6	-52.9		0.1	-40.1	-21.25	18.83
	HT/VHT40 Beam Forming, M8 to M15	3	6	-54.7	-53.2	-51.7		0.1	-42.2	-21.25	20.91
	HT/VHT40 Beam Forming, M16 to M23	3	4	-54.1	-52.9	-51.4		0.1	-43.8	-21.25	22.54
	HT/VHT40 Beam Forming, M0 to M7	4	10	-55.9	-53.6	-52.9	-54.4	0.1	-37.9	-21.25	16.69
HT/VHT40 Beam Forming, M8 to M15	4	7	-54.7	-53.2	-51.7	-53.9	0.1	-40.1	-21.25	18.86	
HT/VHT40 Beam Forming, M16 to M23	4	5	-54.7	-53.2	-51.7	-53.9	0.1	-42.1	-21.25	20.86	



	HT/VHT40 Beam Forming, M24 to M31	4	4	-54.1	-52.9	-51.4	-52.8	0.1	-42.6	-21.25	21.32
	HT/VHT40 STBC, M0 to M7	2	4	-54.1	-52.9			0.1	-46.3	-21.25	25.10
	HT/VHT40 STBC, M0 to M7	3	4	-54.1	-52.9	-51.4		0.1	-43.8	-21.25	22.54
	HT/VHT40 STBC, M0 to M7	4	4	-54.1	-52.9	-51.4	-52.8	0.1	-42.6	-21.25	21.32
	HE40, M0 to M9 1ss	1	4	-55.7				0.1	-51.6	-21.25	30.32
	HE40, M0 to M9 1ss	2	4	-55.7	-53.4			0.1	-47.3	-21.25	26.01
	HE40, M0 to M9 2ss	2	4	-55.7	-53.4			0.1	-47.3	-21.25	26.01
	HE40, M0 to M9 1ss	3	4	-55.7	-53.4	-51.1		0.1	-44.1	-21.25	22.86
	HE40, M0 to M9 2ss	3	4	-55.7	-53.4	-51.1		0.1	-44.1	-21.25	22.86
	HE40, M0 to M9 3ss	3	4	-55.7	-53.4	-51.1		0.1	-44.1	-21.25	22.86
	HE40, M0 to M9 1ss	4	4	-55.7	-53.4	-51.1	-54.4	0.1	-43.2	-21.25	21.92
	HE40, M0 to M9 2ss	4	4	-55.7	-53.4	-51.1	-54.4	0.1	-43.2	-21.25	21.92
	HE40, M0 to M9 3ss	4	4	-55.7	-53.4	-51.1	-54.4	0.1	-43.2	-21.25	21.92
	HE40, M0 to M9 4ss	4	4	-55.7	-53.4	-51.1	-54.4	0.1	-43.2	-21.25	21.92
	HE40 Beam Forming, M0 to M9 1ss	2	7	-55.7	-53.4			0.1	-44.3	-21.25	23.01
	HE40 Beam Forming, M0 to M9 2ss	2	4	-55.7	-53.4			0.1	-47.3	-21.25	26.01
	HE40 Beam Forming, M0 to M9 1ss	3	9	-55.6	-53.7	-52.4		0.1	-39.8	-21.25	18.56
	HE40 Beam Forming, M0 to M9 2ss	3	6	-55.7	-53.4	-51.1		0.1	-42.1	-21.25	20.86
	HE40 Beam Forming, M0 to M9 3ss	3	4	-55.7	-53.4	-51.1		0.1	-44.1	-21.25	22.86
	HE40 Beam Forming, M0 to M9 1ss	4	10	-57.0	-53.0	-52.8	-54.6	0.1	-37.9	-21.25	16.66
	HE40 Beam Forming, M0 to M9 2ss	4	7	-55.6	-53.7	-52.4	-54.2	0.1	-40.7	-21.25	19.43
	HE40 Beam Forming, M0 to M9 3ss	4	5	-55.7	-53.4	-51.1	-54.4	0.1	-42.2	-21.25	20.92
	HE40 Beam Forming, M0 to M9 4ss	4	4	-55.7	-53.4	-51.1	-54.4	0.1	-43.2	-21.25	21.92
	HE40 STBC, M0 to M9 2ss	2	4	-55.7	-53.4			0.1	-47.3	-21.25	26.01
	HE40 STBC, M0 to M9 2ss	3	4	-55.7	-53.4	-51.1		0.1	-44.1	-21.25	22.86
	HE40 STBC, M0 to M9 2ss	4	4	-55.7	-53.4	-51.1	-54.4	0.1	-43.2	-21.25	21.92
5210	Non HT80, 6 to 54 Mbps	1	4	-54.0				0.1	-49.9	-21.25	28.70
	Non HT80, 6 to 54 Mbps	2	4	-54.0	-52.9			0.1	-46.4	-21.25	25.10
	Non HT80, 6 to 54 Mbps	3	4	-54.0	-52.9	-50.8		0.1	-43.5	-21.25	22.28
	Non HT80, 6 to 54 Mbps	4	4	-54.0	-52.9	-50.8	-54.3	0.1	-42.7	-21.25	21.44
	VHT80, M0 to M9 1ss	1	4	-54.2				0.2	-50.0	-21.25	28.73
	VHT80, M0 to M9 1ss	2	4	-54.2	-52.7			0.2	-46.2	-21.25	24.90
	VHT80, M0 to M9 2ss	2	4	-54.2	-52.7			0.2	-46.2	-21.25	24.90
	VHT80, M0 to M9 1ss	3	4	-54.2	-52.7	-52.1		0.2	-43.9	-21.25	22.67
	VHT80, M0 to M9 2ss	3	4	-54.2	-52.7	-52.1		0.2	-43.9	-21.25	22.67
	VHT80, M0 to M9 3ss	3	4	-54.2	-52.7	-52.1		0.2	-43.9	-21.25	22.67
	VHT80, M0 to M9 1ss	4	4	-54.2	-52.7	-52.1	-53.4	0.2	-42.8	-21.25	21.54
	VHT80, M0 to M9 2ss	4	4	-54.2	-52.7	-52.1	-53.4	0.2	-42.8	-21.25	21.54
	VHT80, M0 to M9 3ss	4	4	-54.2	-52.7	-52.1	-53.4	0.2	-42.8	-21.25	21.54
	VHT80, M0 to M9 4ss	4	4	-54.2	-52.7	-52.1	-53.4	0.2	-42.8	-21.25	21.54
	VHT80 Beam Forming, M0 to M9 1ss	2	7	-56.1	-52.5			0.2	-43.7	-21.25	22.45
	VHT80 Beam Forming, M0 to M9 2ss	2	4	-54.2	-52.7			0.2	-46.2	-21.25	24.90

VHT80 Beam Forming, M0 to M9 1ss	3	9	-56.1	-52.5	-51.9		0.2	-39.2	-21.25	17.90	
VHT80 Beam Forming, M0 to M9 2ss	3	6	-56.1	-52.5	-51.9		0.2	-42.2	-21.25	20.90	
VHT80 Beam Forming, M0 to M9 3ss	3	4	-54.2	-52.7	-52.1		0.2	-43.9	-21.25	22.67	
VHT80 Beam Forming, M0 to M9 1ss	4	10	-55.5	-52.9	-53.0	-55.3	0.2	-37.8	-21.25	16.51	
VHT80 Beam Forming, M0 to M9 2ss	4	7	-56.1	-52.5	-51.9	-55.0	0.2	-40.3	-21.25	19.05	
VHT80 Beam Forming, M0 to M9 3ss	4	5	-54.2	-52.7	-52.1	-53.4	0.2	-41.8	-21.25	20.54	
VHT80 Beam Forming, M0 to M9 4ss	4	4	-54.2	-52.7	-52.1	-53.4	0.2	-42.8	-21.25	21.54	
VHT80 STBC, M0 to M9 1ss	2	4	-54.2	-52.7			0.2	-46.2	-21.25	24.90	
VHT80 STBC, M0 to M9 1ss	3	4	-54.2	-52.7	-52.1		0.2	-43.9	-21.25	22.67	
VHT80 STBC, M0 to M9 1ss	4	4	-54.2	-52.7	-52.1	-53.4	0.2	-42.8	-21.25	21.54	
HE80, M0 to M9 1ss	1	4	-54.9				0.3	-50.6	-21.25	29.40	
HE80, M0 to M9 1ss	2	4	-54.9	-52.3			0.3	-46.1	-21.25	24.90	
HE80, M0 to M9 2ss	2	4	-54.9	-52.3			0.3	-46.1	-21.25	24.90	
HE80, M0 to M9 1ss	3	4	-54.9	-52.3	-52.1		0.3	-43.9	-21.25	22.66	
HE80, M0 to M9 2ss	3	4	-54.9	-52.3	-52.1		0.3	-43.9	-21.25	22.66	
HE80, M0 to M9 3ss	3	4	-54.9	-52.3	-52.1		0.3	-43.9	-21.25	22.66	
HE80, M0 to M9 1ss	4	4	-54.9	-52.3	-52.1	-54.3	0.3	-43.0	-21.25	21.71	
HE80, M0 to M9 2ss	4	4	-54.9	-52.3	-52.1	-54.3	0.3	-43.0	-21.25	21.71	
HE80, M0 to M9 3ss	4	4	-54.9	-52.3	-52.1	-54.3	0.3	-43.0	-21.25	21.71	
HE80, M0 to M9 4ss	4	4	-54.9	-52.3	-52.1	-54.3	0.3	-43.0	-21.25	21.71	
HE80 Beam Forming, M0 to M9 1ss	2	7	-55.5	-52.9			0.3	-43.7	-21.25	22.50	
HE80 Beam Forming, M0 to M9 2ss	2	4	-54.9	-52.3			0.3	-46.1	-21.25	24.90	
HE80 Beam Forming, M0 to M9 1ss	3	9	-55.5	-52.9	-52.2		0.3	-39.3	-21.25	18.05	
HE80 Beam Forming, M0 to M9 2ss	3	6	-55.5	-52.9	-52.2		0.3	-42.3	-21.25	21.05	
HE80 Beam Forming, M0 to M9 3ss	3	4	-54.9	-52.3	-52.1		0.3	-43.9	-21.25	22.66	
HE80 Beam Forming, M0 to M9 1ss	4	10	-55.7	-53.9	-53.6	-55.3	0.3	-38.3	-21.25	17.01	
HE80 Beam Forming, M0 to M9 2ss	4	7	-55.5	-52.9	-52.2	-54.8	0.3	-40.4	-21.25	19.12	
HE80 Beam Forming, M0 to M9 3ss	4	5	-54.9	-52.3	-52.1	-54.3	0.3	-42.0	-21.25	20.71	
HE80 Beam Forming, M0 to M9 4ss	4	4	-54.9	-52.3	-52.1	-54.3	0.3	-43.0	-21.25	21.71	
HE80 STBC, M0 to M9 1ss	2	4	-54.9	-52.3			0.3	-46.1	-21.25	24.90	
HE80 STBC, M0 to M9 1ss	3	4	-54.9	-52.3	-52.1		0.3	-43.9	-21.25	22.66	
HE80 STBC, M0 to M9 1ss	4	4	-54.9	-52.3	-52.1	-54.3	0.3	-43.0	-21.25	21.71	
5220	Non HT20, 6 to 54 Mbps	1	4	-54.8				0.1	-50.7	-21.25	29.50
	Non HT20, 6 to 54 Mbps	2	4	-54.8	-47.4			0.1	-42.6	-21.25	21.37
	Non HT20, 6 to 54 Mbps	3	4	-54.8	-47.4	-47.8		0.1	-40.1	-21.25	18.89
	Non HT20, 6 to 54 Mbps	4	4	-54.8	-47.4	-47.8	-48.9	0.1	-38.9	-21.25	17.62
	Non HT20 Beam Forming, 6 to 54 Mbps	2	7	-54.8	-47.4			0.1	-39.6	-21.25	18.37
	Non HT20 Beam Forming, 6 to 54 Mbps	3	9	-54.8	-47.4	-47.8		0.1	-35.1	-21.25	13.89
	Non HT20 Beam Forming, 6 to 54 Mbps	4	10	-54.8	-47.4	-47.8	-48.9	0.1	-32.9	-21.25	11.62
	HT/VHT20, M0 to M7	1	4	-54.8				0.1	-50.7	-21.25	29.50
	HT/VHT20, M0 to M7	2	4	-54.8	-48.8			0.1	-43.8	-21.25	22.52
	HT/VHT20, M8 to M15	2	4	-54.8	-48.8			0.1	-43.8	-21.25	22.52

HT/VHT20, M0 to M7	3	4	-54.8	-48.8	-47.9		0.1	-40.8	-21.25	19.55
HT/VHT20, M8 to M15	3	4	-54.8	-48.8	-47.9		0.1	-40.8	-21.25	19.55
HT/VHT20, M16 to M23	3	4	-54.8	-48.8	-47.9		0.1	-40.8	-21.25	19.55
HT/VHT20, M0 to M7	4	4	-54.8	-48.8	-47.9	-48.3	0.1	-39.2	-21.25	17.93
HT/VHT20, M8 to M15	4	4	-54.8	-48.8	-47.9	-48.3	0.1	-39.2	-21.25	17.93
HT/VHT20, M16 to M23	4	4	-54.8	-48.8	-47.9	-48.3	0.1	-39.2	-21.25	17.93
HT/VHT20, M24 to M31	4	4	-54.8	-48.8	-47.9	-48.3	0.1	-39.2	-21.25	17.93
HT/VHT20 Beam Forming, M0 to M7	2	7	-54.8	-48.8			0.1	-40.8	-21.25	19.52
HT/VHT20 Beam Forming, M8 to M15	2	4	-54.8	-48.8			0.1	-43.8	-21.25	22.52
HT/VHT20 Beam Forming, M0 to M7	3	9	-54.8	-48.8	-47.9		0.1	-35.8	-21.25	14.55
HT/VHT20 Beam Forming, M8 to M15	3	6	-54.8	-48.8	-47.9		0.1	-38.8	-21.25	17.55
HT/VHT20 Beam Forming, M16 to M23	3	4	-54.8	-48.8	-47.9		0.1	-40.8	-21.25	19.55
HT/VHT20 Beam Forming, M0 to M7	4	10	-54.8	-48.8	-47.9	-48.3	0.1	-33.2	-21.25	11.93
HT/VHT20 Beam Forming, M8 to M15	4	7	-54.8	-48.8	-47.9	-48.3	0.1	-36.2	-21.25	14.93
HT/VHT20 Beam Forming, M16 to M23	4	5	-54.8	-48.8	-47.9	-48.3	0.1	-38.2	-21.25	16.93
HT/VHT20 Beam Forming, M24 to M31	4	4	-54.8	-48.8	-47.9	-48.3	0.1	-39.2	-21.25	17.93
HT/VHT20 STBC, M0 to M7	2	4	-54.8	-48.8			0.1	-43.8	-21.25	22.52
HT/VHT20 STBC, M0 to M7	3	4	-54.8	-48.8	-47.9		0.1	-40.8	-21.25	19.55
HT/VHT20 STBC, M0 to M7	4	4	-54.8	-48.8	-47.9	-48.3	0.1	-39.2	-21.25	17.93
HE20, M0 to M9 1ss	1	4	-54.4				0.1	-50.3	-21.25	29.08
HE20, M0 to M9 1ss	2	4	-54.4	-49.1			0.1	-43.9	-21.25	22.66
HE20, M0 to M9 2ss	2	4	-54.4	-49.1			0.1	-43.9	-21.25	22.66
HE20, M0 to M9 1ss	3	4	-54.4	-49.1	-47.5		0.1	-40.7	-21.25	19.40
HE20, M0 to M9 2ss	3	4	-54.4	-49.1	-47.5		0.1	-40.7	-21.25	19.40
HE20, M0 to M9 3ss	3	4	-54.4	-49.1	-47.5		0.1	-40.7	-21.25	19.40
HE20, M0 to M9 1ss	4	4	-54.4	-49.1	-47.5	-49.3	0.1	-39.4	-21.25	18.11
HE20, M0 to M9 2ss	4	4	-54.4	-49.1	-47.5	-49.3	0.1	-39.4	-21.25	18.11
HE20, M0 to M9 3ss	4	4	-54.4	-49.1	-47.5	-49.3	0.1	-39.4	-21.25	18.11
HE20, M0 to M9 4ss	4	4	-54.4	-49.1	-47.5	-49.3	0.1	-39.4	-21.25	18.11
HE20 Beam Forming, M0 to M9 1ss	2	7	-54.4	-49.1			0.1	-40.9	-21.25	19.66
HE20 Beam Forming, M0 to M9 2ss	2	4	-54.4	-49.1			0.1	-43.9	-21.25	22.66
HE20 Beam Forming, M0 to M9 1ss	3	9	-54.4	-49.1	-47.5		0.1	-35.7	-21.25	14.40
HE20 Beam Forming, M0 to M9 2ss	3	6	-54.4	-49.1	-47.5		0.1	-38.7	-21.25	17.40
HE20 Beam Forming, M0 to M9 3ss	3	4	-54.4	-49.1	-47.5		0.1	-40.7	-21.25	19.40
HE20 Beam Forming, M0 to M9 1ss	4	10	-54.4	-49.1	-47.5	-49.3	0.1	-33.4	-21.25	12.11
HE20 Beam Forming, M0 to M9 2ss	4	7	-54.4	-49.1	-47.5	-49.3	0.1	-36.4	-21.25	15.11
HE20 Beam Forming, M0 to M9 3ss	4	5	-54.4	-49.1	-47.5	-49.3	0.1	-38.4	-21.25	17.11
HE20 Beam Forming, M0 to M9 4ss	4	4	-54.4	-49.1	-47.5	-49.3	0.1	-39.4	-21.25	18.11
HE20 STBC, M0 to M9 2ss	2	4	-54.4	-49.1			0.1	-43.9	-21.25	22.66
HE20 STBC, M0 to M9 2ss	3	4	-54.4	-49.1	-47.5		0.1	-40.7	-21.25	19.40
HE20 STBC, M0 to M9 2ss	4	4	-54.4	-49.1	-47.5	-49.3	0.1	-39.4	-21.25	18.11

5230	Non HT40, 6 to 54 Mbps	1	4	-54.9				0.0	-50.9	-21.25	29.60
	Non HT40, 6 to 54 Mbps	2	4	-54.9	-47.8			0.0	-43.0	-21.25	21.73
	Non HT40, 6 to 54 Mbps	3	4	-54.9	-47.8	-48.1		0.0	-40.5	-21.25	19.22
	Non HT40, 6 to 54 Mbps	4	4	-54.9	-47.8	-48.1	-48.8	0.0	-39.1	-21.25	17.84
	HT/VHT40, M0 to M7	1	4	-54.7				0.1	-50.6	-21.25	29.35
	HT/VHT40, M0 to M7	2	4	-54.7	-48.5			0.1	-43.5	-21.25	22.21
	HT/VHT40, M8 to M15	2	4	-54.7	-48.5			0.1	-43.5	-21.25	22.21
	HT/VHT40, M0 to M7	3	4	-54.7	-48.5	-47.6		0.1	-40.5	-21.25	19.22
	HT/VHT40, M8 to M15	3	4	-54.7	-48.5	-47.6		0.1	-40.5	-21.25	19.22
	HT/VHT40, M16 to M23	3	4	-54.7	-48.5	-47.6		0.1	-40.5	-21.25	19.22
	HT/VHT40, M0 to M7	4	4	-54.7	-48.5	-47.6	-49.4	0.1	-39.2	-21.25	17.98
	HT/VHT40, M8 to M15	4	4	-54.7	-48.5	-47.6	-49.4	0.1	-39.2	-21.25	17.98
	HT/VHT40, M16 to M23	4	4	-54.7	-48.5	-47.6	-49.4	0.1	-39.2	-21.25	17.98
	HT/VHT40, M24 to M31	4	4	-54.7	-48.5	-47.6	-49.4	0.1	-39.2	-21.25	17.98
	HT/VHT40 Beam Forming, M0 to M7	2	7	-54.7	-48.5			0.1	-40.5	-21.25	19.21
	HT/VHT40 Beam Forming, M8 to M15	2	4	-54.7	-48.5			0.1	-43.5	-21.25	22.21
	HT/VHT40 Beam Forming, M0 to M7	3	9	-54.7	-48.5	-47.6		0.1	-35.5	-21.25	14.22
	HT/VHT40 Beam Forming, M8 to M15	3	6	-54.7	-48.5	-47.6		0.1	-38.5	-21.25	17.22
	HT/VHT40 Beam Forming, M16 to M23	3	4	-54.7	-48.5	-47.6		0.1	-40.5	-21.25	19.22
	HT/VHT40 Beam Forming, M0 to M7	4	10	-54.7	-48.5	-47.6	-49.4	0.1	-33.2	-21.25	11.98
	HT/VHT40 Beam Forming, M8 to M15	4	7	-54.7	-48.5	-47.6	-49.4	0.1	-36.2	-21.25	14.98
	HT/VHT40 Beam Forming, M16 to M23	4	5	-54.7	-48.5	-47.6	-49.4	0.1	-38.2	-21.25	16.98
	HT/VHT40 Beam Forming, M24 to M31	4	4	-54.7	-48.5	-47.6	-49.4	0.1	-39.2	-21.25	17.98
	HT/VHT40 STBC, M0 to M7	2	4	-54.7	-48.5			0.1	-43.5	-21.25	22.21
	HT/VHT40 STBC, M0 to M7	3	4	-54.7	-48.5	-47.6		0.1	-40.5	-21.25	19.22
	HT/VHT40 STBC, M0 to M7	4	4	-54.7	-48.5	-47.6	-49.4	0.1	-39.2	-21.25	17.98
	HE40, M0 to M9 1ss	1	4	-54.3				0.1	-50.2	-21.25	28.92
	HE40, M0 to M9 1ss	2	4	-54.3	-48.7			0.1	-43.5	-21.25	22.27
	HE40, M0 to M9 2ss	2	4	-54.3	-48.7			0.1	-43.5	-21.25	22.27
	HE40, M0 to M9 1ss	3	4	-54.3	-48.7	-47.7		0.1	-40.5	-21.25	19.29
	HE40, M0 to M9 2ss	3	4	-54.3	-48.7	-47.7		0.1	-40.5	-21.25	19.29
	HE40, M0 to M9 3ss	3	4	-54.3	-48.7	-47.7		0.1	-40.5	-21.25	19.29
	HE40, M0 to M9 1ss	4	4	-54.3	-48.7	-47.7	-48.9	0.1	-39.1	-21.25	17.90
	HE40, M0 to M9 2ss	4	4	-54.3	-48.7	-47.7	-48.9	0.1	-39.1	-21.25	17.90
	HE40, M0 to M9 3ss	4	4	-54.3	-48.7	-47.7	-48.9	0.1	-39.1	-21.25	17.90
	HE40, M0 to M9 4ss	4	4	-54.3	-48.7	-47.7	-48.9	0.1	-39.1	-21.25	17.90
	HE40 Beam Forming, M0 to M9 1ss	2	7	-54.3	-48.7			0.1	-40.5	-21.25	19.27
	HE40 Beam Forming, M0 to M9 2ss	2	4	-54.3	-48.7			0.1	-43.5	-21.25	22.27
	HE40 Beam Forming, M0 to M9 1ss	3	9	-54.3	-48.7	-47.7		0.1	-35.5	-21.25	14.29
	HE40 Beam Forming, M0 to M9 2ss	3	6	-54.3	-48.7	-47.7		0.1	-38.5	-21.25	17.29
HE40 Beam Forming, M0 to M9 3ss	3	4	-54.3	-48.7	-47.7		0.1	-40.5	-21.25	19.29	

	HE40 Beam Forming, M0 to M9 1ss	4	10	-54.3	-48.7	-47.7	-48.9	0.1	-33.1	-21.25	11.90
	HE40 Beam Forming, M0 to M9 2ss	4	7	-54.3	-48.7	-47.7	-48.9	0.1	-36.1	-21.25	14.90
	HE40 Beam Forming, M0 to M9 3ss	4	5	-54.3	-48.7	-47.7	-48.9	0.1	-38.1	-21.25	16.90
	HE40 Beam Forming, M0 to M9 4ss	4	4	-54.3	-48.7	-47.7	-48.9	0.1	-39.1	-21.25	17.90
	HE40 STBC, M0 to M9 2ss	2	4	-54.3	-48.7			0.1	-43.5	-21.25	22.27
	HE40 STBC, M0 to M9 2ss	3	4	-54.3	-48.7	-47.7		0.1	-40.5	-21.25	19.29
	HE40 STBC, M0 to M9 2ss	4	4	-54.3	-48.7	-47.7	-48.9	0.1	-39.1	-21.25	17.90
5240	Non HT20, 6 to 54 Mbps	1	4	-53.8				0.1	-49.7	-21.25	28.50
	Non HT20, 6 to 54 Mbps	2	4	-53.8	-48.4			0.1	-43.2	-21.25	22.00
	Non HT20, 6 to 54 Mbps	3	4	-53.8	-48.4	-46.4		0.1	-39.8	-21.25	18.51
	Non HT20, 6 to 54 Mbps	4	4	-53.8	-48.4	-46.4	-48.1	0.1	-38.4	-21.25	17.14
	Non HT20 Beam Forming, 6 to 54 Mbps	2	7	-53.8	-48.4			0.1	-40.2	-21.25	19.00
	Non HT20 Beam Forming, 6 to 54 Mbps	3	9	-53.8	-48.4	-46.4		0.1	-34.8	-21.25	13.51
	Non HT20 Beam Forming, 6 to 54 Mbps	4	10	-53.8	-48.4	-46.4	-48.1	0.1	-32.4	-21.25	11.14
	HT/VHT20, M0 to M7	1	4	-53.6				0.1	-49.5	-21.25	28.30
	HT/VHT20, M0 to M7	2	4	-53.6	-48.9			0.1	-43.6	-21.25	22.33
	HT/VHT20, M8 to M15	2	4	-53.6	-48.9			0.1	-43.6	-21.25	22.33
	HT/VHT20, M0 to M7	3	4	-53.6	-48.9	-47.6		0.1	-40.6	-21.25	19.30
	HT/VHT20, M8 to M15	3	4	-53.6	-48.9	-47.6		0.1	-40.6	-21.25	19.30
	HT/VHT20, M16 to M23	3	4	-53.6	-48.9	-47.6		0.1	-40.6	-21.25	19.30
	HT/VHT20, M0 to M7	4	4	-53.6	-48.9	-47.6	-49.1	0.1	-39.2	-21.25	17.98
	HT/VHT20, M8 to M15	4	4	-53.6	-48.9	-47.6	-49.1	0.1	-39.2	-21.25	17.98
	HT/VHT20, M16 to M23	4	4	-53.6	-48.9	-47.6	-49.1	0.1	-39.2	-21.25	17.98
	HT/VHT20, M24 to M31	4	4	-53.6	-48.9	-47.6	-49.1	0.1	-39.2	-21.25	17.98
	HT/VHT20 Beam Forming, M0 to M7	2	7	-53.6	-48.9			0.1	-40.6	-21.25	19.33
	HT/VHT20 Beam Forming, M8 to M15	2	4	-53.6	-48.9			0.1	-43.6	-21.25	22.33
	HT/VHT20 Beam Forming, M0 to M7	3	9	-53.6	-48.9	-47.6		0.1	-35.6	-21.25	14.30
	HT/VHT20 Beam Forming, M8 to M15	3	6	-53.6	-48.9	-47.6		0.1	-38.6	-21.25	17.30
	HT/VHT20 Beam Forming, M16 to M23	3	4	-53.6	-48.9	-47.6		0.1	-40.6	-21.25	19.30
	HT/VHT20 Beam Forming, M0 to M7	4	10	-53.6	-48.9	-47.6	-49.1	0.1	-33.2	-21.25	11.98
	HT/VHT20 Beam Forming, M8 to M15	4	7	-53.6	-48.9	-47.6	-49.1	0.1	-36.2	-21.25	14.98
	HT/VHT20 Beam Forming, M16 to M23	4	5	-53.6	-48.9	-47.6	-49.1	0.1	-38.2	-21.25	16.98
	HT/VHT20 Beam Forming, M24 to M31	4	4	-53.6	-48.9	-47.6	-49.1	0.1	-39.2	-21.25	17.98
	HT/VHT20 STBC, M0 to M7	2	4	-53.6	-48.9			0.1	-43.6	-21.25	22.33
	HT/VHT20 STBC, M0 to M7	3	4	-53.6	-48.9	-47.6		0.1	-40.6	-21.25	19.30
	HT/VHT20 STBC, M0 to M7	4	4	-53.6	-48.9	-47.6	-49.1	0.1	-39.2	-21.25	17.98
	HE20, M0 to M9 1ss	1	4	-54.8				0.1	-50.7	-21.25	29.48
	HE20, M0 to M9 1ss	2	4	-54.8	-48.7			0.1	-43.7	-21.25	22.43
	HE20, M0 to M9 2ss	2	4	-54.8	-48.7			0.1	-43.7	-21.25	22.43
	HE20, M0 to M9 1ss	3	4	-54.8	-48.7	-47.5		0.1	-40.5	-21.25	19.29
HE20, M0 to M9 2ss	3	4	-54.8	-48.7	-47.5		0.1	-40.5	-21.25	19.29	
HE20, M0 to M9 3ss	3	4	-54.8	-48.7	-47.5		0.1	-40.5	-21.25	19.29	

	HE20, M0 to M9 1ss	4	4	-54.8	-48.7	-47.5	-48.2	0.1	-39.0	-21.25	17.72
	HE20, M0 to M9 2ss	4	4	-54.8	-48.7	-47.5	-48.2	0.1	-39.0	-21.25	17.72
	HE20, M0 to M9 3ss	4	4	-54.8	-48.7	-47.5	-48.2	0.1	-39.0	-21.25	17.72
	HE20, M0 to M9 4ss	4	4	-54.8	-48.7	-47.5	-48.2	0.1	-39.0	-21.25	17.72
	HE20 Beam Forming, M0 to M9 1ss	2	7	-54.8	-48.7			0.1	-40.7	-21.25	19.43
	HE20 Beam Forming, M0 to M9 2ss	2	4	-54.8	-48.7			0.1	-43.7	-21.25	22.43
	HE20 Beam Forming, M0 to M9 1ss	3	9	-54.8	-48.7	-47.5		0.1	-35.5	-21.25	14.29
	HE20 Beam Forming, M0 to M9 2ss	3	6	-54.8	-48.7	-47.5		0.1	-38.5	-21.25	17.29
	HE20 Beam Forming, M0 to M9 3ss	3	4	-54.8	-48.7	-47.5		0.1	-40.5	-21.25	19.29
	HE20 Beam Forming, M0 to M9 1ss	4	10	-54.8	-48.7	-47.5	-48.2	0.1	-33.0	-21.25	11.72
	HE20 Beam Forming, M0 to M9 2ss	4	7	-54.8	-48.7	-47.5	-48.2	0.1	-36.0	-21.25	14.72
	HE20 Beam Forming, M0 to M9 3ss	4	5	-54.8	-48.7	-47.5	-48.2	0.1	-38.0	-21.25	16.72
	HE20 Beam Forming, M0 to M9 4ss	4	4	-54.8	-48.7	-47.5	-48.2	0.1	-39.0	-21.25	17.72
	HE20 STBC, M0 to M9 2ss	2	4	-54.8	-48.7			0.1	-43.7	-21.25	22.43
	HE20 STBC, M0 to M9 2ss	3	4	-54.8	-48.7	-47.5		0.1	-40.5	-21.25	19.29
	HE20 STBC, M0 to M9 2ss	4	4	-54.8	-48.7	-47.5	-48.2	0.1	-39.0	-21.25	17.72
5250	Non HT160, 6 to 54 Mbps	1	4	-46.6				0.0	-42.6	-21.25	21.30
	Non HT160, 6 to 54 Mbps	2	4	-46.6	-51.5			0.0	-41.3	-21.25	20.08
	Non HT160, 6 to 54 Mbps	3	4	-46.6	-51.5	-51.7		0.0	-40.4	-21.25	19.17
	Non HT160, 6 to 54 Mbps	4	4	-46.6	-51.5	-51.7	-51.8	0.0	-39.7	-21.25	18.44
	VHT160, M0 to M9 1ss	1	4	-43.6				0.4	-39.2	-21.25	17.96
	VHT160, M0 to M9 1ss	2	4	-43.6	-51.7			0.4	-38.6	-21.25	17.33
	VHT160, M0 to M9 2ss	2	4	-43.6	-51.7			0.4	-38.6	-21.25	17.33
	VHT160, M0 to M9 1ss	3	4	-43.6	-51.7	-50.6		0.4	-37.9	-21.25	16.64
	VHT160, M0 to M9 2ss	3	4	-43.6	-51.7	-50.6		0.4	-37.9	-21.25	16.64
	VHT160, M0 to M9 3ss	3	4	-43.6	-51.7	-50.6		0.4	-37.9	-21.25	16.64
	VHT160, M0 to M9 1ss	4	4	-43.6	-51.7	-50.6	-50.8	0.4	-37.3	-21.25	16.07
	VHT160, M0 to M9 2ss	4	4	-43.6	-51.7	-50.6	-50.8	0.4	-37.3	-21.25	16.07
	VHT160, M0 to M9 3ss	4	4	-43.6	-51.7	-50.6	-50.8	0.4	-37.3	-21.25	16.07
	VHT160, M0 to M9 4ss	4	4	-43.6	-51.7	-50.6	-50.8	0.4	-37.3	-21.25	16.07
	VHT160 Beam Forming, M0 to M9 1ss	2	7	-47.5	-52.0			0.4	-38.8	-21.25	17.54
	VHT160 Beam Forming, M0 to M9 2ss	2	4	-43.6	-51.7			0.4	-38.6	-21.25	17.33
	VHT160 Beam Forming, M0 to M9 1ss	3	9	-49.5	-53.4	-52.1		0.4	-37.2	-21.25	15.94
	VHT160 Beam Forming, M0 to M9 2ss	3	6	-47.5	-52.0	-51.6		0.4	-38.7	-21.25	17.44
	VHT160 Beam Forming, M0 to M9 3ss	3	4	-43.6	-51.7	-50.6		0.4	-37.9	-21.25	16.64
	VHT160 Beam Forming, M0 to M9 1ss	4	10	-49.5	-53.4	-52.1	-54.7	0.4	-35.6	-21.25	14.32
	VHT160 Beam Forming, M0 to M9 2ss	4	7	-47.5	-52.0	-51.6	-53.8	0.4	-37.1	-21.25	15.90
	VHT160 Beam Forming, M0 to M9 3ss	4	5	-47.5	-52.0	-51.6	-53.8	0.4	-39.1	-21.25	17.90
	VHT160 Beam Forming, M0 to M9 4ss	4	4	-43.6	-51.7	-50.6	-50.8	0.4	-37.3	-21.25	16.07
VHT160 STBC, M0 to M9 1ss	2	4	-43.6	-51.7			0.4	-38.6	-21.25	17.33	
VHT160 STBC, M0 to M9 1ss	3	4	-43.6	-51.7	-50.6		0.4	-37.9	-21.25	16.64	
VHT160 STBC, M0 to M9 1ss	4	4	-43.6	-51.7	-50.6	-50.8	0.4	-37.3	-21.25	16.07	



HE160, M0 to M9 1ss	1	4	-45.5				0.4	-41.1	-21.25	19.82
HE160, M0 to M9 1ss	2	4	-45.5	-49.5			0.4	-39.6	-21.25	18.36
HE160, M0 to M9 2ss	2	4	-45.5	-49.5			0.4	-39.6	-21.25	18.36
HE160, M0 to M9 1ss	3	4	-47.5	-51.6	-51.3		0.4	-40.5	-21.25	19.25
HE160, M0 to M9 2ss	3	4	-47.5	-51.6	-51.3		0.4	-40.5	-21.25	19.25
HE160, M0 to M9 3ss	3	4	-47.5	-51.6	-51.3		0.4	-40.5	-21.25	19.25
HE160, M0 to M9 1ss	4	4	-47.5	-51.6	-51.3	-53.4	0.4	-39.9	-21.25	18.67
HE160, M0 to M9 2ss	4	4	-47.5	-51.6	-51.3	-53.4	0.4	-39.9	-21.25	18.67
HE160, M0 to M9 3ss	4	4	-47.5	-51.6	-51.3	-53.4	0.4	-39.9	-21.25	18.67
HE160, M0 to M9 4ss	4	4	-47.5	-51.6	-51.3	-53.4	0.4	-39.9	-21.25	18.67
HE160 Beam Forming, M0 to M9 1ss	2	7	-47.5	-51.6			0.4	-38.6	-21.25	17.39
HE160 Beam Forming, M0 to M9 2ss	2	4	-45.5	-49.5			0.4	-39.6	-21.25	18.36
HE160 Beam Forming, M0 to M9 1ss	3	9	-48.6	-52.9	-51.1		0.4	-36.3	-21.25	15.05
HE160 Beam Forming, M0 to M9 2ss	3	6	-47.5	-51.6	-51.3		0.4	-38.5	-21.25	17.25
HE160 Beam Forming, M0 to M9 3ss	3	4	-47.5	-51.6	-51.3		0.4	-40.5	-21.25	19.25
HE160 Beam Forming, M0 to M9 1ss	4	10	-48.6	-52.9	-51.1	-54.7	0.4	-34.8	-21.25	13.53
HE160 Beam Forming, M0 to M9 2ss	4	7	-48.6	-52.9	-51.1	-54.7	0.4	-37.8	-21.25	16.53
HE160 Beam Forming, M0 to M9 3ss	4	5	-47.5	-51.6	-51.3	-53.4	0.4	-38.9	-21.25	17.67
HE160 Beam Forming, M0 to M9 4ss	4	4	-47.5	-51.6	-51.3	-53.4	0.4	-39.9	-21.25	18.67
HE160 STBC, M0 to M9 1ss	2	4	-45.5	-49.5			0.4	-39.6	-21.25	18.36
HE160 STBC, M0 to M9 1ss	3	4	-47.5	-51.6	-51.3		0.4	-40.5	-21.25	19.25
HE160 STBC, M0 to M9 1ss	4	4	-47.5	-51.6	-51.3	-53.4	0.4	-39.9	-21.25	18.67

**Conducted Spurs Peak, 4dBi
5240 MHz, Non HT20 Beam Forming, 6 to 54 Mbps**



Antenna A



Antenna B



Antenna C



Antenna D

Conducted Spurious Peak Table, 5dBi

Frequency (MHz)	Mode	Tx Paths	Correlated Antenna Gain (dBi)	Tx 1 Spur Power (dBm)	Tx 2 Spur Power (dBm)	Tx 3 Spur Power (dBm)	Tx 4 Spur Power (dBm)	Tx 5 Spur Power (dBm)	Total Conducted Spur (dBm)	Limit (dBm)	Margin (dB)
5180	Non HT20, 6 to 54 Mbps	1	5	-54.9				0.1	-49.8	-21.25	28.60
	Non HT20, 6 to 54 Mbps	2	5	-54.9	-48.2			0.1	-42.3	-21.25	21.05
	Non HT20, 6 to 54 Mbps	3	5	-54.9	-49.4	-46.7		0.1	-39.4	-21.25	18.12
	Non HT20, 6 to 54 Mbps	4	5	-54.9	-49.4	-46.7	-50.4	0.1	-38.4	-21.25	17.14
	Non HT20 Beam Forming, 6 to 54 Mbps	2	8	-54.9	-49.4			0.1	-40.3	-21.25	19.02
	Non HT20 Beam Forming, 6 to 54 Mbps	3	10	-54.9	-51.4	-49.7		0.1	-36.7	-21.25	15.43
	Non HT20 Beam Forming, 6 to 54 Mbps	4	11	-55.3	-52.4	-52.1	-53.8	0.1	-36.1	-21.25	14.90
	HT/VHT20, M0 to M7	1	5	-54.2				0.1	-49.1	-21.25	27.90
	HT/VHT20, M0 to M7	2	5	-54.2	-47.4			0.1	-41.5	-21.25	20.27
	HT/VHT20, M8 to M15	2	5	-54.2	-47.4			0.1	-41.5	-21.25	20.27
	HT/VHT20, M0 to M7	3	5	-54.2	-48.9	-46.9		0.1	-39.3	-21.25	18.00
	HT/VHT20, M8 to M15	3	5	-54.2	-48.9	-46.9		0.1	-39.3	-21.25	18.00
	HT/VHT20, M16 to M23	3	5	-54.2	-48.9	-46.9		0.1	-39.3	-21.25	18.00
	HT/VHT20, M0 to M7	4	5	-54.2	-49.8	-47.7	-49.3	0.1	-38.6	-21.25	17.36
	HT/VHT20, M8 to M15	4	5	-54.2	-49.8	-47.7	-49.3	0.1	-38.6	-21.25	17.36
	HT/VHT20, M16 to M23	4	5	-54.2	-49.8	-47.7	-49.3	0.1	-38.6	-21.25	17.36
	HT/VHT20, M24 to M31	4	5	-54.2	-49.8	-47.7	-49.3	0.1	-38.6	-21.25	17.36
	HT/VHT20 Beam Forming, M0 to M7	2	8	-54.2	-49.8			0.1	-40.4	-21.25	19.15
	HT/VHT20 Beam Forming, M8 to M15	2	5	-54.2	-47.4			0.1	-41.5	-21.25	20.27
	HT/VHT20 Beam Forming, M0 to M7	3	10	-54.2	-52.4	-51.2		0.1	-37.6	-21.25	16.36
	HT/VHT20 Beam Forming, M8 to M15	3	7	-54.2	-49.8	-47.7		0.1	-38.0	-21.25	16.75
	HT/VHT20 Beam Forming, M16 to M23	3	5	-54.2	-48.9	-46.9		0.1	-39.3	-21.25	18.00
	HT/VHT20 Beam Forming, M0 to M7	4	11	-54.8	-52.7	-50.3	-53.1	0.1	-35.3	-21.25	14.10
	HT/VHT20 Beam Forming, M8 to M15	4	8	-54.2	-50.3	-48.4	-50.4	0.1	-36.3	-21.25	15.05
	HT/VHT20 Beam Forming, M16 to M23	4	6	-54.2	-49.8	-47.7	-49.3	0.1	-37.6	-21.25	16.36
	HT/VHT20 Beam Forming, M24 to M31	4	5	-54.2	-49.8	-47.7	-49.3	0.1	-38.6	-21.25	17.36
	HT/VHT20 STBC, M0 to M7	2	5	-54.2	-47.4			0.1	-41.5	-21.25	20.27
	HT/VHT20 STBC, M0 to M7	3	5	-54.2	-48.9	-46.9		0.1	-39.3	-21.25	18.00
	HT/VHT20 STBC, M0 to M7	4	5	-54.2	-49.8	-47.7	-49.3	0.1	-38.6	-21.25	17.36
	HE20, M0 to M9 1ss	1	5	-54.7				0.1	-49.6	-21.25	28.38
	HE20, M0 to M9 1ss	2	5	-54.7	-49.0			0.1	-42.9	-21.25	21.65



	HE20, M0 to M9 2ss	2	5	-54.7	-49.0			0.1	-42.9	-21.25	21.65
	HE20, M0 to M9 1ss	3	5	-54.7	-48.5	-47.4		0.1	-39.4	-21.25	18.15
	HE20, M0 to M9 2ss	3	5	-54.7	-48.5	-47.4		0.1	-39.4	-21.25	18.15
	HE20, M0 to M9 3ss	3	5	-54.7	-48.5	-47.4		0.1	-39.4	-21.25	18.15
	HE20, M0 to M9 1ss	4	5	-54.7	-48.5	-47.4	-49.2	0.1	-38.1	-21.25	16.89
	HE20, M0 to M9 2ss	4	5	-54.7	-48.5	-47.4	-49.2	0.1	-38.1	-21.25	16.89
	HE20, M0 to M9 3ss	4	5	-54.7	-48.5	-47.4	-49.2	0.1	-38.1	-21.25	16.89
	HE20, M0 to M9 4ss	4	5	-54.7	-48.5	-47.4	-49.2	0.1	-38.1	-21.25	16.89
	HE20 Beam Forming, M0 to M9 1ss	2	8	-54.7	-50.6			0.1	-41.1	-21.25	19.85
	HE20 Beam Forming, M0 to M9 2ss	2	5	-54.7	-49.0			0.1	-42.9	-21.25	21.65
	HE20 Beam Forming, M0 to M9 1ss	3	10	-55.4	-52.3	-51.4		0.1	-37.9	-21.25	16.64
	HE20 Beam Forming, M0 to M9 2ss	3	7	-54.7	-50.6	-48.7		0.1	-38.9	-21.25	17.60
	HE20 Beam Forming, M0 to M9 3ss	3	5	-54.7	-48.5	-47.4		0.1	-39.4	-21.25	18.15
	HE20 Beam Forming, M0 to M9 1ss	4	11	-55.5	-54.1	-51.4	-53.7	0.1	-36.3	-21.25	15.08
	HE20 Beam Forming, M0 to M9 2ss	4	8	-54.7	-51.3	-49.5	-51.9	0.1	-37.4	-21.25	16.14
	HE20 Beam Forming, M0 to M9 3ss	4	6	-54.7	-50.6	-48.7	-49.5	0.1	-38.3	-21.25	17.02
	HE20 Beam Forming, M0 to M9 4ss	4	5	-54.7	-48.5	-47.4	-49.2	0.1	-38.1	-21.25	16.89
	HE20 STBC, M0 to M9 2ss	2	5	-54.7	-49.0			0.1	-42.9	-21.25	21.65
	HE20 STBC, M0 to M9 2ss	3	5	-54.7	-48.5	-47.4		0.1	-39.4	-21.25	18.15
	HE20 STBC, M0 to M9 2ss	4	5	-54.7	-48.5	-47.4	-49.2	0.1	-38.1	-21.25	16.89
5190	Non HT40, 6 to 54 Mbps	1	5	-55.2				0.0	-50.2	-21.25	28.90
	Non HT40, 6 to 54 Mbps	2	5	-55.2	-53.3			0.0	-46.1	-21.25	24.84
	Non HT40, 6 to 54 Mbps	3	5	-55.2	-53.3	-51.1		0.0	-43.1	-21.25	21.81
	Non HT40, 6 to 54 Mbps	4	5	-55.2	-53.3	-51.1	-52.9	0.0	-41.8	-21.25	20.56
	HT/VHT40, M0 to M7	1	5	-54.1				0.1	-49.0	-21.25	27.75
	HT/VHT40, M0 to M7	2	5	-54.7	-53.2			0.1	-45.8	-21.25	24.52
	HT/VHT40, M8 to M15	2	5	-54.7	-53.2			0.1	-45.8	-21.25	24.52
	HT/VHT40, M0 to M7	3	5	-54.7	-53.2	-51.7		0.1	-43.2	-21.25	21.91
	HT/VHT40, M8 to M15	3	5	-54.7	-53.2	-51.7		0.1	-43.2	-21.25	21.91
	HT/VHT40, M16 to M23	3	5	-54.7	-53.2	-51.7		0.1	-43.2	-21.25	21.91
	HT/VHT40, M0 to M7	4	5	-54.7	-53.2	-51.7	-53.9	0.1	-42.1	-21.25	20.86
	HT/VHT40, M8 to M15	4	5	-54.7	-53.2	-51.7	-53.9	0.1	-42.1	-21.25	20.86
	HT/VHT40, M16 to M23	4	5	-54.7	-53.2	-51.7	-53.9	0.1	-42.1	-21.25	20.86
	HT/VHT40, M24 to M31	4	5	-54.7	-53.2	-51.7	-53.9	0.1	-42.1	-21.25	20.86
	HT/VHT40 Beam Forming, M0 to M7	2	8	-54.7	-53.2			0.1	-42.8	-21.25	21.52
	HT/VHT40 Beam Forming, M8 to M15	2	5	-54.7	-53.2			0.1	-45.8	-21.25	24.52
	HT/VHT40 Beam Forming, M0 to M7	3	10	-55.9	-53.6	-52.9		0.1	-39.1	-21.25	17.83
	HT/VHT40 Beam Forming, M8 to M15	3	7	-54.7	-53.2	-51.7		0.1	-41.2	-21.25	19.91
	HT/VHT40 Beam Forming, M16 to M23	3	5	-54.7	-53.2	-51.7		0.1	-43.2	-21.25	21.91
	HT/VHT40 Beam Forming, M0 to M7	4	11	-55.8	-52.9	-53.3	-54.6	0.1	-36.9	-21.25	15.63
HT/VHT40 Beam Forming, M8 to M15	4	8	-55.9	-53.6	-52.9	-54.4	0.1	-39.9	-21.25	18.69	
HT/VHT40 Beam Forming, M16 to M23	4	6	-54.7	-53.2	-51.7	-53.9	0.1	-41.1	-21.25	19.86	



	HT/VHT40 Beam Forming, M24 to M31	4	5	-54.7	-53.2	-51.7	-53.9	0.1	-42.1	-21.25	20.86
	HT/VHT40 STBC, M0 to M7	2	5	-54.7	-53.2			0.1	-45.8	-21.25	24.52
	HT/VHT40 STBC, M0 to M7	3	5	-54.7	-53.2	-51.7		0.1	-43.2	-21.25	21.91
	HT/VHT40 STBC, M0 to M7	4	5	-54.7	-53.2	-51.7	-53.9	0.1	-42.1	-21.25	20.86
	HE40, M0 to M9 1ss	1	5	-55.7				0.1	-50.6	-21.25	29.32
	HE40, M0 to M9 1ss	2	5	-55.7	-53.4			0.1	-46.3	-21.25	25.01
	HE40, M0 to M9 2ss	2	5	-55.7	-53.4			0.1	-46.3	-21.25	25.01
	HE40, M0 to M9 1ss	3	5	-55.7	-53.4	-51.1		0.1	-43.1	-21.25	21.86
	HE40, M0 to M9 2ss	3	5	-55.7	-53.4	-51.1		0.1	-43.1	-21.25	21.86
	HE40, M0 to M9 3ss	3	5	-55.7	-53.4	-51.1		0.1	-43.1	-21.25	21.86
	HE40, M0 to M9 1ss	4	5	-55.7	-53.4	-51.1	-54.4	0.1	-42.2	-21.25	20.92
	HE40, M0 to M9 2ss	4	5	-55.7	-53.4	-51.1	-54.4	0.1	-42.2	-21.25	20.92
	HE40, M0 to M9 3ss	4	5	-55.7	-53.4	-51.1	-54.4	0.1	-42.2	-21.25	20.92
	HE40, M0 to M9 4ss	4	5	-55.7	-53.4	-51.1	-54.4	0.1	-42.2	-21.25	20.92
	HE40 Beam Forming, M0 to M9 1ss	2	8	-55.6	-53.7			0.1	-43.4	-21.25	22.16
	HE40 Beam Forming, M0 to M9 2ss	2	5	-55.7	-53.4			0.1	-46.3	-21.25	25.01
	HE40 Beam Forming, M0 to M9 1ss	3	10	-55.6	-53.7	-52.4		0.1	-38.8	-21.25	17.56
	HE40 Beam Forming, M0 to M9 2ss	3	7	-55.7	-53.4	-51.1		0.1	-41.1	-21.25	19.86
	HE40 Beam Forming, M0 to M9 3ss	3	5	-55.7	-53.4	-51.1		0.1	-43.1	-21.25	21.86
	HE40 Beam Forming, M0 to M9 1ss	4	11	-57.0	-53.0	-52.8	-54.6	0.1	-36.9	-21.25	15.66
	HE40 Beam Forming, M0 to M9 2ss	4	8	-55.6	-53.7	-52.4	-54.2	0.1	-39.7	-21.25	18.43
	HE40 Beam Forming, M0 to M9 3ss	4	6	-55.7	-53.4	-51.1	-54.4	0.1	-41.2	-21.25	19.92
	HE40 Beam Forming, M0 to M9 4ss	4	5	-55.7	-53.4	-51.1	-54.4	0.1	-42.2	-21.25	20.92
	HE40 STBC, M0 to M9 2ss	2	5	-55.7	-53.4			0.1	-46.3	-21.25	25.01
	HE40 STBC, M0 to M9 2ss	3	5	-55.7	-53.4	-51.1		0.1	-43.1	-21.25	21.86
	HE40 STBC, M0 to M9 2ss	4	5	-55.7	-53.4	-51.1	-54.4	0.1	-42.2	-21.25	20.92
5210	Non HT80, 6 to 54 Mbps	1	5	-54.0				0.1	-48.9	-21.25	27.70
	Non HT80, 6 to 54 Mbps	2	5	-54.0	-52.9			0.1	-45.4	-21.25	24.10
	Non HT80, 6 to 54 Mbps	3	5	-54.0	-52.9	-50.8		0.1	-42.5	-21.25	21.28
	Non HT80, 6 to 54 Mbps	4	5	-54.1	-53.2	-53.1	-54.6	0.1	-42.6	-21.25	21.38
	VHT80, M0 to M9 1ss	1	5	-54.2				0.2	-49.0	-21.25	27.73
	VHT80, M0 to M9 1ss	2	5	-54.2	-52.7			0.2	-45.2	-21.25	23.90
	VHT80, M0 to M9 2ss	2	5	-54.2	-52.7			0.2	-45.2	-21.25	23.90
	VHT80, M0 to M9 1ss	3	5	-54.2	-52.7	-52.1		0.2	-42.9	-21.25	21.67
	VHT80, M0 to M9 2ss	3	5	-54.2	-52.7	-52.1		0.2	-42.9	-21.25	21.67
	VHT80, M0 to M9 3ss	3	5	-54.2	-52.7	-52.1		0.2	-42.9	-21.25	21.67
	VHT80, M0 to M9 1ss	4	5	-54.2	-52.7	-52.1	-53.4	0.2	-41.8	-21.25	20.54
	VHT80, M0 to M9 2ss	4	5	-54.2	-52.7	-52.1	-53.4	0.2	-41.8	-21.25	20.54
	VHT80, M0 to M9 3ss	4	5	-54.2	-52.7	-52.1	-53.4	0.2	-41.8	-21.25	20.54
	VHT80, M0 to M9 4ss	4	5	-54.2	-52.7	-52.1	-53.4	0.2	-41.8	-21.25	20.54
	VHT80 Beam Forming, M0 to M9 1ss	2	8	-56.1	-52.5			0.2	-42.7	-21.25	21.45
	VHT80 Beam Forming, M0 to M9 2ss	2	5	-54.2	-52.7			0.2	-45.2	-21.25	23.90

	VHT80 Beam Forming, M0 to M9 1ss	3	10	-56.1	-52.5	-51.9		0.2	-38.2	-21.25	16.90
	VHT80 Beam Forming, M0 to M9 2ss	3	7	-56.1	-52.5	-51.9		0.2	-41.2	-21.25	19.90
	VHT80 Beam Forming, M0 to M9 3ss	3	5	-54.2	-52.7	-52.1		0.2	-42.9	-21.25	21.67
	VHT80 Beam Forming, M0 to M9 1ss	4	11	-55.5	-52.9	-53.0	-55.3	0.2	-36.8	-21.25	15.51
	VHT80 Beam Forming, M0 to M9 2ss	4	8	-56.1	-52.5	-51.9	-55.0	0.2	-39.3	-21.25	18.05
	VHT80 Beam Forming, M0 to M9 3ss	4	6	-56.1	-52.5	-51.9	-55.0	0.2	-41.3	-21.25	20.05
	VHT80 Beam Forming, M0 to M9 4ss	4	5	-54.2	-52.7	-52.1	-53.4	0.2	-41.8	-21.25	20.54
	VHT80 STBC, M0 to M9 1ss	2	5	-54.2	-52.7			0.2	-45.2	-21.25	23.90
	VHT80 STBC, M0 to M9 1ss	3	5	-54.2	-52.7	-52.1		0.2	-42.9	-21.25	21.67
	VHT80 STBC, M0 to M9 1ss	4	5	-54.2	-52.7	-52.1	-53.4	0.2	-41.8	-21.25	20.54
	HE80, M0 to M9 1ss	1	5	-54.9				0.3	-49.6	-21.25	28.40
	HE80, M0 to M9 1ss	2	5	-54.9	-52.3			0.3	-45.1	-21.25	23.90
	HE80, M0 to M9 2ss	2	5	-54.9	-52.3			0.3	-45.1	-21.25	23.90
	HE80, M0 to M9 1ss	3	5	-54.9	-52.3	-52.1		0.3	-42.9	-21.25	21.66
	HE80, M0 to M9 2ss	3	5	-54.9	-52.3	-52.1		0.3	-42.9	-21.25	21.66
	HE80, M0 to M9 3ss	3	5	-54.9	-52.3	-52.1		0.3	-42.9	-21.25	21.66
	HE80, M0 to M9 1ss	4	5	-54.9	-52.3	-52.1	-54.3	0.3	-42.0	-21.25	20.71
	HE80, M0 to M9 2ss	4	5	-54.9	-52.3	-52.1	-54.3	0.3	-42.0	-21.25	20.71
	HE80, M0 to M9 3ss	4	5	-54.9	-52.3	-52.1	-54.3	0.3	-42.0	-21.25	20.71
	HE80, M0 to M9 4ss	4	5	-54.9	-52.3	-52.1	-54.3	0.3	-42.0	-21.25	20.71
	HE80 Beam Forming, M0 to M9 1ss	2	8	-55.5	-52.9			0.3	-42.7	-21.25	21.50
	HE80 Beam Forming, M0 to M9 2ss	2	5	-54.9	-52.3			0.3	-45.1	-21.25	23.90
	HE80 Beam Forming, M0 to M9 1ss	3	10	-55.5	-52.9	-52.2		0.3	-38.3	-21.25	17.05
	HE80 Beam Forming, M0 to M9 2ss	3	7	-55.5	-52.9	-52.2		0.3	-41.3	-21.25	20.05
	HE80 Beam Forming, M0 to M9 3ss	3	5	-54.9	-52.3	-52.1		0.3	-42.9	-21.25	21.66
	HE80 Beam Forming, M0 to M9 1ss	4	11	-55.7	-53.9	-53.6	-55.3	0.3	-37.3	-21.25	16.01
	HE80 Beam Forming, M0 to M9 2ss	4	8	-55.5	-52.9	-52.2	-54.8	0.3	-39.4	-21.25	18.12
	HE80 Beam Forming, M0 to M9 3ss	4	6	-55.5	-52.9	-52.2	-54.8	0.3	-41.4	-21.25	20.12
	HE80 Beam Forming, M0 to M9 4ss	4	5	-54.9	-52.3	-52.1	-54.3	0.3	-42.0	-21.25	20.71
	HE80 STBC, M0 to M9 1ss	2	5	-54.9	-52.3			0.3	-45.1	-21.25	23.90
	HE80 STBC, M0 to M9 1ss	3	5	-54.9	-52.3	-52.1		0.3	-42.9	-21.25	21.66
	HE80 STBC, M0 to M9 1ss	4	5	-54.9	-52.3	-52.1	-54.3	0.3	-42.0	-21.25	20.71
5220	Non HT20, 6 to 54 Mbps	1	5	-54.8				0.1	-49.7	-21.25	28.50
	Non HT20, 6 to 54 Mbps	2	5	-54.8	-47.4			0.1	-41.6	-21.25	20.37
	Non HT20, 6 to 54 Mbps	3	5	-54.8	-47.4	-47.8		0.1	-39.1	-21.25	17.89
	Non HT20, 6 to 54 Mbps	4	5	-54.8	-47.4	-47.8	-48.9	0.1	-37.9	-21.25	16.62
	Non HT20 Beam Forming, 6 to 54 Mbps	2	8	-54.8	-47.4			0.1	-38.6	-21.25	17.37
	Non HT20 Beam Forming, 6 to 54 Mbps	3	10	-54.8	-47.4	-47.8		0.1	-34.1	-21.25	12.89
	Non HT20 Beam Forming, 6 to 54 Mbps	4	11	-54.8	-47.4	-47.8	-48.9	0.1	-31.9	-21.25	10.62
	HT/VHT20, M0 to M7	1	5	-54.8				0.1	-49.7	-21.25	28.50
	HT/VHT20, M0 to M7	2	5	-54.8	-48.8			0.1	-42.8	-21.25	21.52
	HT/VHT20, M8 to M15	2	5	-54.8	-48.8			0.1	-42.8	-21.25	21.52

HT/VHT20, M0 to M7	3	5	-54.8	-48.8	-47.9		0.1	-39.8	-21.25	18.55
HT/VHT20, M8 to M15	3	5	-54.8	-48.8	-47.9		0.1	-39.8	-21.25	18.55
HT/VHT20, M16 to M23	3	5	-54.8	-48.8	-47.9		0.1	-39.8	-21.25	18.55
HT/VHT20, M0 to M7	4	5	-54.8	-48.8	-47.9	-48.3	0.1	-38.2	-21.25	16.93
HT/VHT20, M8 to M15	4	5	-54.8	-48.8	-47.9	-48.3	0.1	-38.2	-21.25	16.93
HT/VHT20, M16 to M23	4	5	-54.8	-48.8	-47.9	-48.3	0.1	-38.2	-21.25	16.93
HT/VHT20, M24 to M31	4	5	-54.8	-48.8	-47.9	-48.3	0.1	-38.2	-21.25	16.93
HT/VHT20 Beam Forming, M0 to M7	2	8	-54.8	-48.8			0.1	-39.8	-21.25	18.52
HT/VHT20 Beam Forming, M8 to M15	2	5	-54.8	-48.8			0.1	-42.8	-21.25	21.52
HT/VHT20 Beam Forming, M0 to M7	3	10	-54.8	-48.8	-47.9		0.1	-34.8	-21.25	13.55
HT/VHT20 Beam Forming, M8 to M15	3	7	-54.8	-48.8	-47.9		0.1	-37.8	-21.25	16.55
HT/VHT20 Beam Forming, M16 to M23	3	5	-54.8	-48.8	-47.9		0.1	-39.8	-21.25	18.55
HT/VHT20 Beam Forming, M0 to M7	4	11	-54.8	-48.8	-47.9	-48.3	0.1	-32.2	-21.25	10.93
HT/VHT20 Beam Forming, M8 to M15	4	8	-54.8	-48.8	-47.9	-48.3	0.1	-35.2	-21.25	13.93
HT/VHT20 Beam Forming, M16 to M23	4	6	-54.8	-48.8	-47.9	-48.3	0.1	-37.2	-21.25	15.93
HT/VHT20 Beam Forming, M24 to M31	4	5	-54.8	-48.8	-47.9	-48.3	0.1	-38.2	-21.25	16.93
HT/VHT20 STBC, M0 to M7	2	5	-54.8	-48.8			0.1	-42.8	-21.25	21.52
HT/VHT20 STBC, M0 to M7	3	5	-54.8	-48.8	-47.9		0.1	-39.8	-21.25	18.55
HT/VHT20 STBC, M0 to M7	4	5	-54.8	-48.8	-47.9	-48.3	0.1	-38.2	-21.25	16.93
HE20, M0 to M9 1ss	1	5	-54.4				0.1	-49.3	-21.25	28.08
HE20, M0 to M9 1ss	2	5	-54.4	-49.1			0.1	-42.9	-21.25	21.66
HE20, M0 to M9 2ss	2	5	-54.4	-49.1			0.1	-42.9	-21.25	21.66
HE20, M0 to M9 1ss	3	5	-54.4	-49.1	-47.5		0.1	-39.7	-21.25	18.40
HE20, M0 to M9 2ss	3	5	-54.4	-49.1	-47.5		0.1	-39.7	-21.25	18.40
HE20, M0 to M9 3ss	3	5	-54.4	-49.1	-47.5		0.1	-39.7	-21.25	18.40
HE20, M0 to M9 1ss	4	5	-54.4	-49.1	-47.5	-49.3	0.1	-38.4	-21.25	17.11
HE20, M0 to M9 2ss	4	5	-54.4	-49.1	-47.5	-49.3	0.1	-38.4	-21.25	17.11
HE20, M0 to M9 3ss	4	5	-54.4	-49.1	-47.5	-49.3	0.1	-38.4	-21.25	17.11
HE20, M0 to M9 4ss	4	5	-54.4	-49.1	-47.5	-49.3	0.1	-38.4	-21.25	17.11
HE20 Beam Forming, M0 to M9 1ss	2	8	-54.4	-49.1			0.1	-39.9	-21.25	18.66
HE20 Beam Forming, M0 to M9 2ss	2	5	-54.4	-49.1			0.1	-42.9	-21.25	21.66
HE20 Beam Forming, M0 to M9 1ss	3	10	-54.4	-49.1	-47.5		0.1	-34.7	-21.25	13.40
HE20 Beam Forming, M0 to M9 2ss	3	7	-54.4	-49.1	-47.5		0.1	-37.7	-21.25	16.40
HE20 Beam Forming, M0 to M9 3ss	3	5	-54.4	-49.1	-47.5		0.1	-39.7	-21.25	18.40
HE20 Beam Forming, M0 to M9 1ss	4	11	-54.4	-49.1	-47.5	-49.3	0.1	-32.4	-21.25	11.11
HE20 Beam Forming, M0 to M9 2ss	4	8	-54.4	-49.1	-47.5	-49.3	0.1	-35.4	-21.25	14.11
HE20 Beam Forming, M0 to M9 3ss	4	6	-54.4	-49.1	-47.5	-49.3	0.1	-37.4	-21.25	16.11
HE20 Beam Forming, M0 to M9 4ss	4	5	-54.4	-49.1	-47.5	-49.3	0.1	-38.4	-21.25	17.11
HE20 STBC, M0 to M9 2ss	2	5	-54.4	-49.1			0.1	-42.9	-21.25	21.66
HE20 STBC, M0 to M9 2ss	3	5	-54.4	-49.1	-47.5		0.1	-39.7	-21.25	18.40
HE20 STBC, M0 to M9 2ss	4	5	-54.4	-49.1	-47.5	-49.3	0.1	-38.4	-21.25	17.11

5230	Non HT40, 6 to 54 Mbps	1	5	-54.9				0.0	-49.9	-21.25	28.60
	Non HT40, 6 to 54 Mbps	2	5	-54.9	-47.8			0.0	-42.0	-21.25	20.73
	Non HT40, 6 to 54 Mbps	3	5	-54.9	-47.8	-48.1		0.0	-39.5	-21.25	18.22
	Non HT40, 6 to 54 Mbps	4	5	-54.9	-47.8	-48.1	-48.8	0.0	-38.1	-21.25	16.84
	HT/VHT40, M0 to M7	1	5	-54.7				0.1	-49.6	-21.25	28.35
	HT/VHT40, M0 to M7	2	5	-54.7	-48.5			0.1	-42.5	-21.25	21.21
	HT/VHT40, M8 to M15	2	5	-54.7	-48.5			0.1	-42.5	-21.25	21.21
	HT/VHT40, M0 to M7	3	5	-54.7	-48.5	-47.6		0.1	-39.5	-21.25	18.22
	HT/VHT40, M8 to M15	3	5	-54.7	-48.5	-47.6		0.1	-39.5	-21.25	18.22
	HT/VHT40, M16 to M23	3	5	-54.7	-48.5	-47.6		0.1	-39.5	-21.25	18.22
	HT/VHT40, M0 to M7	4	5	-54.7	-48.5	-47.6	-49.4	0.1	-38.2	-21.25	16.98
	HT/VHT40, M8 to M15	4	5	-54.7	-48.5	-47.6	-49.4	0.1	-38.2	-21.25	16.98
	HT/VHT40, M16 to M23	4	5	-54.7	-48.5	-47.6	-49.4	0.1	-38.2	-21.25	16.98
	HT/VHT40, M24 to M31	4	5	-54.7	-48.5	-47.6	-49.4	0.1	-38.2	-21.25	16.98
	HT/VHT40 Beam Forming, M0 to M7	2	8	-54.7	-48.5			0.1	-39.5	-21.25	18.21
	HT/VHT40 Beam Forming, M8 to M15	2	5	-54.7	-48.5			0.1	-42.5	-21.25	21.21
	HT/VHT40 Beam Forming, M0 to M7	3	10	-54.7	-48.5	-47.6		0.1	-34.5	-21.25	13.22
	HT/VHT40 Beam Forming, M8 to M15	3	7	-54.7	-48.5	-47.6		0.1	-37.5	-21.25	16.22
	HT/VHT40 Beam Forming, M16 to M23	3	5	-54.7	-48.5	-47.6		0.1	-39.5	-21.25	18.22
	HT/VHT40 Beam Forming, M0 to M7	4	11	-54.7	-48.5	-47.6	-49.4	0.1	-32.2	-21.25	10.98
	HT/VHT40 Beam Forming, M8 to M15	4	8	-54.7	-48.5	-47.6	-49.4	0.1	-35.2	-21.25	13.98
	HT/VHT40 Beam Forming, M16 to M23	4	6	-54.7	-48.5	-47.6	-49.4	0.1	-37.2	-21.25	15.98
	HT/VHT40 Beam Forming, M24 to M31	4	5	-54.7	-48.5	-47.6	-49.4	0.1	-38.2	-21.25	16.98
	HT/VHT40 STBC, M0 to M7	2	5	-54.7	-48.5			0.1	-42.5	-21.25	21.21
	HT/VHT40 STBC, M0 to M7	3	5	-54.7	-48.5	-47.6		0.1	-39.5	-21.25	18.22
	HT/VHT40 STBC, M0 to M7	4	5	-54.7	-48.5	-47.6	-49.4	0.1	-38.2	-21.25	16.98
	HE40, M0 to M9 1ss	1	5	-54.3				0.1	-49.2	-21.25	27.92
	HE40, M0 to M9 1ss	2	5	-54.3	-48.7			0.1	-42.5	-21.25	21.27
	HE40, M0 to M9 2ss	2	5	-54.3	-48.7			0.1	-42.5	-21.25	21.27
	HE40, M0 to M9 1ss	3	5	-54.3	-48.7	-47.7		0.1	-39.5	-21.25	18.29
	HE40, M0 to M9 2ss	3	5	-54.3	-48.7	-47.7		0.1	-39.5	-21.25	18.29
	HE40, M0 to M9 3ss	3	5	-54.3	-48.7	-47.7		0.1	-39.5	-21.25	18.29
	HE40, M0 to M9 1ss	4	5	-54.3	-48.7	-47.7	-48.9	0.1	-38.1	-21.25	16.90
	HE40, M0 to M9 2ss	4	5	-54.3	-48.7	-47.7	-48.9	0.1	-38.1	-21.25	16.90
	HE40, M0 to M9 3ss	4	5	-54.3	-48.7	-47.7	-48.9	0.1	-38.1	-21.25	16.90
	HE40, M0 to M9 4ss	4	5	-54.3	-48.7	-47.7	-48.9	0.1	-38.1	-21.25	16.90
	HE40 Beam Forming, M0 to M9 1ss	2	8	-54.3	-48.7			0.1	-39.5	-21.25	18.27
	HE40 Beam Forming, M0 to M9 2ss	2	5	-54.3	-48.7			0.1	-42.5	-21.25	21.27
	HE40 Beam Forming, M0 to M9 1ss	3	10	-54.3	-48.7	-47.7		0.1	-34.5	-21.25	13.29
	HE40 Beam Forming, M0 to M9 2ss	3	7	-54.3	-48.7	-47.7		0.1	-37.5	-21.25	16.29
HE40 Beam Forming, M0 to M9 3ss	3	5	-54.3	-48.7	-47.7		0.1	-39.5	-21.25	18.29	



	HE40 Beam Forming, M0 to M9 1ss	4	11	-54.3	-48.7	-47.7	-48.9	0.1	-32.1	-21.25	10.90
	HE40 Beam Forming, M0 to M9 2ss	4	8	-54.3	-48.7	-47.7	-48.9	0.1	-35.1	-21.25	13.90
	HE40 Beam Forming, M0 to M9 3ss	4	6	-54.3	-48.7	-47.7	-48.9	0.1	-37.1	-21.25	15.90
	HE40 Beam Forming, M0 to M9 4ss	4	5	-54.3	-48.7	-47.7	-48.9	0.1	-38.1	-21.25	16.90
	HE40 STBC, M0 to M9 2ss	2	5	-54.3	-48.7			0.1	-42.5	-21.25	21.27
	HE40 STBC, M0 to M9 2ss	3	5	-54.3	-48.7	-47.7		0.1	-39.5	-21.25	18.29
	HE40 STBC, M0 to M9 2ss	4	5	-54.3	-48.7	-47.7	-48.9	0.1	-38.1	-21.25	16.90
5240	Non HT20, 6 to 54 Mbps	1	5	-53.8				0.1	-48.7	-21.25	27.50
	Non HT20, 6 to 54 Mbps	2	5	-53.8	-48.4			0.1	-42.2	-21.25	21.00
	Non HT20, 6 to 54 Mbps	3	5	-53.8	-48.4	-46.4		0.1	-38.8	-21.25	17.51
	Non HT20, 6 to 54 Mbps	4	5	-53.8	-48.4	-46.4	-48.1	0.1	-37.4	-21.25	16.14
	Non HT20 Beam Forming, 6 to 54 Mbps	2	8	-53.8	-48.4			0.1	-39.2	-21.25	18.00
	Non HT20 Beam Forming, 6 to 54 Mbps	3	10	-53.8	-48.4	-46.4		0.1	-33.8	-21.25	12.51
	Non HT20 Beam Forming, 6 to 54 Mbps	4	11	-53.8	-48.4	-46.4	-48.1	0.1	-31.4	-21.25	10.14
	HT/VHT20, M0 to M7	1	5	-53.6				0.1	-48.5	-21.25	27.30
	HT/VHT20, M0 to M7	2	5	-53.6	-48.9			0.1	-42.6	-21.25	21.33
	HT/VHT20, M8 to M15	2	5	-53.6	-48.9			0.1	-42.6	-21.25	21.33
	HT/VHT20, M0 to M7	3	5	-53.6	-48.9	-47.6		0.1	-39.6	-21.25	18.30
	HT/VHT20, M8 to M15	3	5	-53.6	-48.9	-47.6		0.1	-39.6	-21.25	18.30
	HT/VHT20, M16 to M23	3	5	-53.6	-48.9	-47.6		0.1	-39.6	-21.25	18.30
	HT/VHT20, M0 to M7	4	5	-53.6	-48.9	-47.6	-49.1	0.1	-38.2	-21.25	16.98
	HT/VHT20, M8 to M15	4	5	-53.6	-48.9	-47.6	-49.1	0.1	-38.2	-21.25	16.98
	HT/VHT20, M16 to M23	4	5	-53.6	-48.9	-47.6	-49.1	0.1	-38.2	-21.25	16.98
	HT/VHT20, M24 to M31	4	5	-53.6	-48.9	-47.6	-49.1	0.1	-38.2	-21.25	16.98
	HT/VHT20 Beam Forming, M0 to M7	2	8	-53.6	-48.9			0.1	-39.6	-21.25	18.33
	HT/VHT20 Beam Forming, M8 to M15	2	5	-53.6	-48.9			0.1	-42.6	-21.25	21.33
	HT/VHT20 Beam Forming, M0 to M7	3	10	-53.6	-48.9	-47.6		0.1	-34.6	-21.25	13.30
	HT/VHT20 Beam Forming, M8 to M15	3	7	-53.6	-48.9	-47.6		0.1	-37.6	-21.25	16.30
	HT/VHT20 Beam Forming, M16 to M23	3	5	-53.6	-48.9	-47.6		0.1	-39.6	-21.25	18.30
	HT/VHT20 Beam Forming, M0 to M7	4	11	-53.6	-48.9	-47.6	-49.1	0.1	-32.2	-21.25	10.98
	HT/VHT20 Beam Forming, M8 to M15	4	8	-53.6	-48.9	-47.6	-49.1	0.1	-35.2	-21.25	13.98
	HT/VHT20 Beam Forming, M16 to M23	4	6	-53.6	-48.9	-47.6	-49.1	0.1	-37.2	-21.25	15.98
	HT/VHT20 Beam Forming, M24 to M31	4	5	-53.6	-48.9	-47.6	-49.1	0.1	-38.2	-21.25	16.98
	HT/VHT20 STBC, M0 to M7	2	5	-53.6	-48.9			0.1	-42.6	-21.25	21.33
	HT/VHT20 STBC, M0 to M7	3	5	-53.6	-48.9	-47.6		0.1	-39.6	-21.25	18.30
	HT/VHT20 STBC, M0 to M7	4	5	-53.6	-48.9	-47.6	-49.1	0.1	-38.2	-21.25	16.98
	HE20, M0 to M9 1ss	1	5	-54.8				0.1	-49.7	-21.25	28.48
	HE20, M0 to M9 1ss	2	5	-54.8	-48.7			0.1	-42.7	-21.25	21.43
	HE20, M0 to M9 2ss	2	5	-54.8	-48.7			0.1	-42.7	-21.25	21.43
	HE20, M0 to M9 1ss	3	5	-54.8	-48.7	-47.5		0.1	-39.5	-21.25	18.29
HE20, M0 to M9 2ss	3	5	-54.8	-48.7	-47.5		0.1	-39.5	-21.25	18.29	
HE20, M0 to M9 3ss	3	5	-54.8	-48.7	-47.5		0.1	-39.5	-21.25	18.29	



	HE20, M0 to M9 1ss	4	5	-54.8	-48.7	-47.5	-48.2	0.1	-38.0	-21.25	16.72
	HE20, M0 to M9 2ss	4	5	-54.8	-48.7	-47.5	-48.2	0.1	-38.0	-21.25	16.72
	HE20, M0 to M9 3ss	4	5	-54.8	-48.7	-47.5	-48.2	0.1	-38.0	-21.25	16.72
	HE20, M0 to M9 4ss	4	5	-54.8	-48.7	-47.5	-48.2	0.1	-38.0	-21.25	16.72
	HE20 Beam Forming, M0 to M9 1ss	2	8	-54.8	-48.7			0.1	-39.7	-21.25	18.43
	HE20 Beam Forming, M0 to M9 2ss	2	5	-54.8	-48.7			0.1	-42.7	-21.25	21.43
	HE20 Beam Forming, M0 to M9 1ss	3	10	-54.8	-48.7	-47.5		0.1	-34.5	-21.25	13.29
	HE20 Beam Forming, M0 to M9 2ss	3	7	-54.8	-48.7	-47.5		0.1	-37.5	-21.25	16.29
	HE20 Beam Forming, M0 to M9 3ss	3	5	-54.8	-48.7	-47.5		0.1	-39.5	-21.25	18.29
	HE20 Beam Forming, M0 to M9 1ss	4	11	-54.8	-48.7	-47.5	-48.2	0.1	-32.0	-21.25	10.72
	HE20 Beam Forming, M0 to M9 2ss	4	8	-54.8	-48.7	-47.5	-48.2	0.1	-35.0	-21.25	13.72
	HE20 Beam Forming, M0 to M9 3ss	4	6	-54.8	-48.7	-47.5	-48.2	0.1	-37.0	-21.25	15.72
	HE20 Beam Forming, M0 to M9 4ss	4	5	-54.8	-48.7	-47.5	-48.2	0.1	-38.0	-21.25	16.72
	HE20 STBC, M0 to M9 2ss	2	5	-54.8	-48.7			0.1	-42.7	-21.25	21.43
	HE20 STBC, M0 to M9 2ss	3	5	-54.8	-48.7	-47.5		0.1	-39.5	-21.25	18.29
	HE20 STBC, M0 to M9 2ss	4	5	-54.8	-48.7	-47.5	-48.2	0.1	-38.0	-21.25	16.72
5250	Non HT160, 6 to 54 Mbps	1	5	-46.6				0.0	-41.6	-21.25	20.30
	Non HT160, 6 to 54 Mbps	2	5	-46.6	-51.5			0.0	-40.3	-21.25	19.08
	Non HT160, 6 to 54 Mbps	3	5	-46.6	-51.5	-51.7		0.0	-39.4	-21.25	18.17
	Non HT160, 6 to 54 Mbps	4	5	-46.6	-51.5	-51.7	-51.8	0.0	-38.7	-21.25	17.44
	VHT160, M0 to M9 1ss	1	5	-43.6				0.4	-38.2	-21.25	16.96
	VHT160, M0 to M9 1ss	2	5	-43.6	-51.7			0.4	-37.6	-21.25	16.33
	VHT160, M0 to M9 2ss	2	5	-43.6	-51.7			0.4	-37.6	-21.25	16.33
	VHT160, M0 to M9 1ss	3	5	-47.5	-52.0	-51.6		0.4	-39.7	-21.25	18.44
	VHT160, M0 to M9 2ss	3	5	-47.5	-52.0	-51.6		0.4	-39.7	-21.25	18.44
	VHT160, M0 to M9 3ss	3	5	-47.5	-52.0	-51.6		0.4	-39.7	-21.25	18.44
	VHT160, M0 to M9 1ss	4	5	-47.5	-52.0	-51.6	-53.8	0.4	-39.1	-21.25	17.90
	VHT160, M0 to M9 2ss	4	5	-47.5	-52.0	-51.6	-53.8	0.4	-39.1	-21.25	17.90
	VHT160, M0 to M9 3ss	4	5	-47.5	-52.0	-51.6	-53.8	0.4	-39.1	-21.25	17.90
	VHT160, M0 to M9 4ss	4	5	-47.5	-52.0	-51.6	-53.8	0.4	-39.1	-21.25	17.90
	VHT160 Beam Forming, M0 to M9 1ss	2	8	-47.5	-52.0			0.4	-37.8	-21.25	16.54
	VHT160 Beam Forming, M0 to M9 2ss	2	5	-43.6	-51.7			0.4	-37.6	-21.25	16.33
	VHT160 Beam Forming, M0 to M9 1ss	3	10	-49.5	-53.4	-52.1		0.4	-36.2	-21.25	14.94
	VHT160 Beam Forming, M0 to M9 2ss	3	7	-47.5	-52.0	-51.6		0.4	-37.7	-21.25	16.44
	VHT160 Beam Forming, M0 to M9 3ss	3	5	-47.5	-52.0	-51.6		0.4	-39.7	-21.25	18.44
	VHT160 Beam Forming, M0 to M9 1ss	4	11	-51.5	-53.4	-53.9	-56.3	0.4	-36.0	-21.25	14.79
	VHT160 Beam Forming, M0 to M9 2ss	4	8	-47.5	-52.0	-51.6	-53.8	0.4	-36.1	-21.25	14.90
	VHT160 Beam Forming, M0 to M9 3ss	4	6	-47.5	-52.0	-51.6	-53.8	0.4	-38.1	-21.25	16.90
	VHT160 Beam Forming, M0 to M9 4ss	4	5	-47.5	-52.0	-51.6	-53.8	0.4	-39.1	-21.25	17.90
	VHT160 STBC, M0 to M9 1ss	2	5	-43.6	-51.7			0.4	-37.6	-21.25	16.33
	VHT160 STBC, M0 to M9 1ss	3	5	-47.5	-52.0	-51.6		0.4	-39.7	-21.25	18.44
	VHT160 STBC, M0 to M9 1ss	4	5	-47.5	-52.0	-51.6	-53.8	0.4	-39.1	-21.25	17.90



HE160, M0 to M9 1ss	1	5	-47.5					0.4	-42.1	-21.25	20.82
HE160, M0 to M9 1ss	2	5	-47.5	-51.6				0.4	-40.6	-21.25	19.39
HE160, M0 to M9 2ss	2	5	-47.5	-51.6				0.4	-40.6	-21.25	19.39
HE160, M0 to M9 1ss	3	5	-47.5	-51.6	-51.3			0.4	-39.5	-21.25	18.25
HE160, M0 to M9 2ss	3	5	-47.5	-51.6	-51.3			0.4	-39.5	-21.25	18.25
HE160, M0 to M9 3ss	3	5	-47.5	-51.6	-51.3			0.4	-39.5	-21.25	18.25
HE160, M0 to M9 1ss	4	5	-47.5	-51.6	-51.3	-53.4		0.4	-38.9	-21.25	17.67
HE160, M0 to M9 2ss	4	5	-47.5	-51.6	-51.3	-53.4		0.4	-38.9	-21.25	17.67
HE160, M0 to M9 3ss	4	5	-47.5	-51.6	-51.3	-53.4		0.4	-38.9	-21.25	17.67
HE160, M0 to M9 4ss	4	5	-47.5	-51.6	-51.3	-53.4		0.4	-38.9	-21.25	17.67
HE160 Beam Forming, M0 to M9 1ss	2	8	-47.5	-51.6				0.4	-37.6	-21.25	16.39
HE160 Beam Forming, M0 to M9 2ss	2	5	-47.5	-51.6				0.4	-40.6	-21.25	19.39
HE160 Beam Forming, M0 to M9 1ss	3	10	-48.6	-52.9	-51.1			0.4	-35.3	-21.25	14.05
HE160 Beam Forming, M0 to M9 2ss	3	7	-47.5	-51.6	-51.3			0.4	-37.5	-21.25	16.25
HE160 Beam Forming, M0 to M9 3ss	3	5	-47.5	-51.6	-51.3			0.4	-39.5	-21.25	18.25
HE160 Beam Forming, M0 to M9 1ss	4	11	-50.5	-52.6	-53.4	-55.5		0.4	-35.2	-21.25	13.93
HE160 Beam Forming, M0 to M9 2ss	4	8	-48.6	-52.9	-51.1	-54.7		0.4	-36.8	-21.25	15.53
HE160 Beam Forming, M0 to M9 3ss	4	6	-47.5	-51.6	-51.3	-53.4		0.4	-37.9	-21.25	16.67
HE160 Beam Forming, M0 to M9 4ss	4	5	-47.5	-51.6	-51.3	-53.4		0.4	-38.9	-21.25	17.67
HE160 STBC, M0 to M9 1ss	2	5	-47.5	-51.6				0.4	-40.6	-21.25	19.39
HE160 STBC, M0 to M9 1ss	3	5	-47.5	-51.6	-51.3			0.4	-39.5	-21.25	18.25
HE160 STBC, M0 to M9 1ss	4	5	-47.5	-51.6	-51.3	-53.4		0.4	-38.9	-21.25	17.67

**Conducted Spurs Peak, 5dBi
5240 MHz, Non HT20 Beam Forming, 6 to 54 Mbps**



Antenna A



Antenna B



Antenna C



Antenna D

Conducted Spurious Peak Table, 6dBi

Frequency (MHz)	Mode	Tx Paths	Correlated Antenna Gain (dBi)	Tx 1 Spur Power (dBm)	Tx 2 Spur Power (dBm)	Tx 3 Spur Power (dBm)	Tx 4 Spur Power (dBm)	Tx 5 Spur Power (dBm)	Total Conducted Spur (dBm)	Limit (dBm)	Margin (dB)
5180	Non HT20, 6 to 54 Mbps	1	6	-54.9				0.1	-48.8	-21.25	27.60
	Non HT20, 6 to 54 Mbps	2	6	-54.9	-48.2			0.1	-41.3	-21.25	20.05
	Non HT20, 6 to 54 Mbps	3	6	-54.9	-49.4	-46.7		0.1	-38.4	-21.25	17.12
	Non HT20, 6 to 54 Mbps	4	6	-54.9	-50.9	-48.2	-50.9	0.1	-38.6	-21.25	17.30
	Non HT20 Beam Forming, 6 to 54 Mbps	2	9	-54.9	-49.4			0.1	-39.3	-21.25	18.02
	Non HT20 Beam Forming, 6 to 54 Mbps	3	11	-54.9	-51.4	-49.7		0.1	-35.7	-21.25	14.43
	Non HT20 Beam Forming, 6 to 54 Mbps	4	12	-55.3	-52.4	-52.1	-53.8	0.1	-35.1	-21.25	13.90
	HT/VHT20, M0 to M7	1	6	-54.2				0.1	-48.1	-21.25	26.90
	HT/VHT20, M0 to M7	2	6	-54.2	-48.9			0.1	-41.7	-21.25	20.47
	HT/VHT20, M8 to M15	2	6	-54.2	-48.9			0.1	-41.7	-21.25	20.47
	HT/VHT20, M0 to M7	3	6	-54.2	-49.8	-47.7		0.1	-39.0	-21.25	17.75
	HT/VHT20, M8 to M15	3	6	-54.2	-49.8	-47.7		0.1	-39.0	-21.25	17.75
	HT/VHT20, M16 to M23	3	6	-54.2	-49.8	-47.7		0.1	-39.0	-21.25	17.75
	HT/VHT20, M0 to M7	4	6	-54.2	-49.8	-47.7	-49.3	0.1	-37.6	-21.25	16.36
	HT/VHT20, M8 to M15	4	6	-54.2	-49.8	-47.7	-49.3	0.1	-37.6	-21.25	16.36
	HT/VHT20, M16 to M23	4	6	-54.2	-49.8	-47.7	-49.3	0.1	-37.6	-21.25	16.36
	HT/VHT20, M24 to M31	4	6	-54.2	-49.8	-47.7	-49.3	0.1	-37.6	-21.25	16.36
	HT/VHT20 Beam Forming, M0 to M7	2	9	-54.2	-49.8			0.1	-39.4	-21.25	18.15
	HT/VHT20 Beam Forming, M8 to M15	2	6	-54.2	-48.9			0.1	-41.7	-21.25	20.47
	HT/VHT20 Beam Forming, M0 to M7	3	11	-54.8	-52.7	-50.3		0.1	-36.4	-21.25	15.14
	HT/VHT20 Beam Forming, M8 to M15	3	8	-54.2	-50.3	-48.4		0.1	-37.5	-21.25	16.29
	HT/VHT20 Beam Forming, M16 to M23	3	6	-54.2	-49.8	-47.7		0.1	-39.0	-21.25	17.75
	HT/VHT20 Beam Forming, M0 to M7	4	12	-54.8	-52.7	-50.3	-53.1	0.1	-34.3	-21.25	13.10
	HT/VHT20 Beam Forming, M8 to M15	4	9	-54.2	-51.4	-50.1	-50.8	0.1	-36.3	-21.25	15.05
	HT/VHT20 Beam Forming, M16 to M23	4	7	-54.2	-49.8	-47.7	-49.3	0.1	-36.6	-21.25	15.36
	HT/VHT20 Beam Forming, M24 to M31	4	6	-54.2	-49.8	-47.7	-49.3	0.1	-37.6	-21.25	16.36
	HT/VHT20 STBC, M0 to M7	2	6	-54.2	-48.9			0.1	-41.7	-21.25	20.47
	HT/VHT20 STBC, M0 to M7	3	6	-54.2	-49.8	-47.7		0.1	-39.0	-21.25	17.75
	HT/VHT20 STBC, M0 to M7	4	6	-54.2	-49.8	-47.7	-49.3	0.1	-37.6	-21.25	16.36
	HE20, M0 to M9 1ss	1	6	-54.7				0.1	-48.6	-21.25	27.38
	HE20, M0 to M9 1ss	2	6	-54.7	-49.0			0.1	-41.9	-21.25	20.65

	HE20, M0 to M9 2ss	2	6	-54.7	-49.0			0.1	-41.9	-21.25	20.65
	HE20, M0 to M9 1ss	3	6	-54.7	-48.5	-47.4		0.1	-38.4	-21.25	17.15
	HE20, M0 to M9 2ss	3	6	-54.7	-48.5	-47.4		0.1	-38.4	-21.25	17.15
	HE20, M0 to M9 3ss	3	6	-54.7	-48.5	-47.4		0.1	-38.4	-21.25	17.15
	HE20, M0 to M9 1ss	4	6	-54.7	-50.6	-48.7	-49.5	0.1	-38.3	-21.25	17.02
	HE20, M0 to M9 2ss	4	6	-54.7	-50.6	-48.7	-49.5	0.1	-38.3	-21.25	17.02
	HE20, M0 to M9 3ss	4	6	-54.7	-50.6	-48.7	-49.5	0.1	-38.3	-21.25	17.02
	HE20, M0 to M9 4ss	4	6	-54.7	-50.6	-48.7	-49.5	0.1	-38.3	-21.25	17.02
	HE20 Beam Forming, M0 to M9 1ss	2	9	-55.4	-52.3			0.1	-41.5	-21.25	20.25
	HE20 Beam Forming, M0 to M9 2ss	2	6	-54.7	-49.0			0.1	-41.9	-21.25	20.65
	HE20 Beam Forming, M0 to M9 1ss	3	11	-55.5	-54.1	-51.4		0.1	-37.5	-21.25	16.24
	HE20 Beam Forming, M0 to M9 2ss	3	8	-54.7	-50.4	-50.6		0.1	-38.7	-21.25	17.42
	HE20 Beam Forming, M0 to M9 3ss	3	6	-54.7	-48.5	-47.4		0.1	-38.4	-21.25	17.15
	HE20 Beam Forming, M0 to M9 1ss	4	12	-55.5	-54.1	-51.4	-53.7	0.1	-35.3	-21.25	14.08
	HE20 Beam Forming, M0 to M9 2ss	4	9	-55.4	-52.3	-51.4	-53.2	0.1	-37.8	-21.25	16.50
	HE20 Beam Forming, M0 to M9 3ss	4	7	-54.7	-50.4	-50.6	-50.8	0.1	-38.2	-21.25	16.98
	HE20 Beam Forming, M0 to M9 4ss	4	6	-54.7	-50.6	-48.7	-49.5	0.1	-38.3	-21.25	17.02
	HE20 STBC, M0 to M9 2ss	2	6	-54.7	-49.0			0.1	-41.9	-21.25	20.65
	HE20 STBC, M0 to M9 2ss	3	6	-54.7	-48.5	-47.4		0.1	-38.4	-21.25	17.15
	HE20 STBC, M0 to M9 2ss	4	6	-54.7	-50.6	-48.7	-49.5	0.1	-38.3	-21.25	17.02
5160	Non HT40, 6 to 54 Mbps	1	6	-55.2				0.0	-49.2	-21.25	27.90
	Non HT40, 6 to 54 Mbps	2	6	-55.2	-53.3			0.0	-45.1	-21.25	23.84
	Non HT40, 6 to 54 Mbps	3	6	-55.2	-53.3	-51.1		0.0	-42.1	-21.25	20.81
	Non HT40, 6 to 54 Mbps	4	6	-55.2	-53.3	-51.1	-52.9	0.0	-40.8	-21.25	19.56
	HT/VHT40, M0 to M7	1	6	-54.7				0.1	-48.6	-21.25	27.35
	HT/VHT40, M0 to M7	2	6	-54.7	-53.2			0.1	-44.8	-21.25	23.52
	HT/VHT40, M8 to M15	2	6	-54.7	-53.2			0.1	-44.8	-21.25	23.52
	HT/VHT40, M0 to M7	3	6	-54.7	-53.2	-51.7		0.1	-42.2	-21.25	20.91
	HT/VHT40, M8 to M15	3	6	-54.7	-53.2	-51.7		0.1	-42.2	-21.25	20.91
	HT/VHT40, M16 to M23	3	6	-54.7	-53.2	-51.7		0.1	-42.2	-21.25	20.91
	HT/VHT40, M0 to M7	4	6	-54.7	-53.2	-51.7	-53.9	0.1	-41.1	-21.25	19.86
	HT/VHT40, M8 to M15	4	6	-54.7	-53.2	-51.7	-53.9	0.1	-41.1	-21.25	19.86
	HT/VHT40, M16 to M23	4	6	-54.7	-53.2	-51.7	-53.9	0.1	-41.1	-21.25	19.86
	HT/VHT40, M24 to M31	4	6	-54.7	-53.2	-51.7	-53.9	0.1	-41.1	-21.25	19.86
	HT/VHT40 Beam Forming, M0 to M7	2	9	-55.9	-53.6			0.1	-42.5	-21.25	21.24
	HT/VHT40 Beam Forming, M8 to M15	2	6	-54.7	-53.2			0.1	-44.8	-21.25	23.52
	HT/VHT40 Beam Forming, M0 to M7	3	11	-55.9	-53.6	-52.9		0.1	-38.1	-21.25	16.83
	HT/VHT40 Beam Forming, M8 to M15	3	8	-54.7	-53.2	-51.7		0.1	-40.2	-21.25	18.91
	HT/VHT40 Beam Forming, M16 to M23	3	6	-54.7	-53.2	-51.7		0.1	-42.2	-21.25	20.91
	HT/VHT40 Beam Forming, M0 to M7	4	12	-55.8	-52.9	-53.3	-54.6	0.1	-35.9	-21.25	14.63
HT/VHT40 Beam Forming, M8 to M15	4	9	-55.9	-53.6	-52.9	-54.4	0.1	-38.9	-21.25	17.69	
HT/VHT40 Beam Forming, M16 to M23	4	7	-54.7	-53.2	-51.7	-53.9	0.1	-40.1	-21.25	18.86	

	HT/VHT40 Beam Forming, M24 to M31	4	6	-54.7	-53.2	-51.7	-53.9	0.1	-41.1	-21.25	19.86
	HT/VHT40 STBC, M0 to M7	2	6	-54.7	-53.2			0.1	-44.8	-21.25	23.52
	HT/VHT40 STBC, M0 to M7	3	6	-54.7	-53.2	-51.7		0.1	-42.2	-21.25	20.91
	HT/VHT40 STBC, M0 to M7	4	6	-54.7	-53.2	-51.7	-53.9	0.1	-41.1	-21.25	19.86
	HE40, M0 to M9 1ss	1	6	-55.7				0.1	-49.6	-21.25	28.32
	HE40, M0 to M9 1ss	2	6	-55.7	-53.4			0.1	-45.3	-21.25	24.01
	HE40, M0 to M9 2ss	2	6	-55.7	-53.4			0.1	-45.3	-21.25	24.01
	HE40, M0 to M9 1ss	3	6	-55.7	-53.4	-51.1		0.1	-42.1	-21.25	20.86
	HE40, M0 to M9 2ss	3	6	-55.7	-53.4	-51.1		0.1	-42.1	-21.25	20.86
	HE40, M0 to M9 3ss	3	6	-55.7	-53.4	-51.1		0.1	-42.1	-21.25	20.86
	HE40, M0 to M9 1ss	4	6	-55.7	-53.4	-51.1	-54.4	0.1	-41.2	-21.25	19.92
	HE40, M0 to M9 2ss	4	6	-55.7	-53.4	-51.1	-54.4	0.1	-41.2	-21.25	19.92
	HE40, M0 to M9 3ss	4	6	-55.7	-53.4	-51.1	-54.4	0.1	-41.2	-21.25	19.92
	HE40, M0 to M9 4ss	4	6	-55.7	-53.4	-51.1	-54.4	0.1	-41.2	-21.25	19.92
	HE40 Beam Forming, M0 to M9 1ss	2	9	-55.6	-53.7			0.1	-42.4	-21.25	21.16
	HE40 Beam Forming, M0 to M9 2ss	2	6	-55.7	-53.4			0.1	-45.3	-21.25	24.01
	HE40 Beam Forming, M0 to M9 1ss	3	11	-57.0	-53.0	-52.8		0.1	-38.0	-21.25	16.74
	HE40 Beam Forming, M0 to M9 2ss	3	8	-55.6	-53.7	-52.4		0.1	-40.8	-21.25	19.56
	HE40 Beam Forming, M0 to M9 3ss	3	6	-55.7	-53.4	-51.1		0.1	-42.1	-21.25	20.86
	HE40 Beam Forming, M0 to M9 1ss	4	12	-57.0	-53.0	-52.8	-54.6	0.1	-35.9	-21.25	14.66
	HE40 Beam Forming, M0 to M9 2ss	4	9	-55.6	-53.7	-52.4	-54.2	0.1	-38.7	-21.25	17.43
	HE40 Beam Forming, M0 to M9 3ss	4	7	-55.6	-53.7	-52.4	-54.2	0.1	-40.7	-21.25	19.43
	HE40 Beam Forming, M0 to M9 4ss	4	6	-55.7	-53.4	-51.1	-54.4	0.1	-41.2	-21.25	19.92
	HE40 STBC, M0 to M9 2ss	2	6	-55.7	-53.4			0.1	-45.3	-21.25	24.01
	HE40 STBC, M0 to M9 2ss	3	6	-55.7	-53.4	-51.1		0.1	-42.1	-21.25	20.86
	HE40 STBC, M0 to M9 2ss	4	6	-55.7	-53.4	-51.1	-54.4	0.1	-41.2	-21.25	19.92
5210	Non HT80, 6 to 54 Mbps	1	6	-54.1				0.1	-48.0	-21.25	26.80
	Non HT80, 6 to 54 Mbps	2	6	-54.1	-53.2			0.1	-44.6	-21.25	23.31
	Non HT80, 6 to 54 Mbps	3	6	-54.1	-53.2	-53.1		0.1	-42.6	-21.25	21.37
	Non HT80, 6 to 54 Mbps	4	6	-54.1	-53.2	-53.1	-54.6	0.1	-41.6	-21.25	20.38
	VHT80, M0 to M9 1ss	1	6	-54.2				0.2	-48.0	-21.25	26.73
	VHT80, M0 to M9 1ss	2	6	-56.1	-52.5			0.2	-44.7	-21.25	23.45
	VHT80, M0 to M9 2ss	2	6	-56.1	-52.5			0.2	-44.7	-21.25	23.45
	VHT80, M0 to M9 1ss	3	6	-56.1	-52.5	-51.9		0.2	-42.2	-21.25	20.90
	VHT80, M0 to M9 2ss	3	6	-56.1	-52.5	-51.9		0.2	-42.2	-21.25	20.90
	VHT80, M0 to M9 3ss	3	6	-56.1	-52.5	-51.9		0.2	-42.2	-21.25	20.90
	VHT80, M0 to M9 1ss	4	6	-56.1	-52.5	-51.9	-55.0	0.2	-41.3	-21.25	20.05
	VHT80, M0 to M9 2ss	4	6	-56.1	-52.5	-51.9	-55.0	0.2	-41.3	-21.25	20.05
	VHT80, M0 to M9 3ss	4	6	-56.1	-52.5	-51.9	-55.0	0.2	-41.3	-21.25	20.05
	VHT80, M0 to M9 4ss	4	6	-56.1	-52.5	-51.9	-55.0	0.2	-41.3	-21.25	20.05
	VHT80 Beam Forming, M0 to M9 1ss	2	9	-56.1	-52.5			0.2	-41.7	-21.25	20.45
	VHT80 Beam Forming, M0 to M9 2ss	2	6	-56.1	-52.5			0.2	-44.7	-21.25	23.45

	VHT80 Beam Forming, M0 to M9 1ss	3	11	-55.5	-52.9	-53.0		0.2	-37.7	-21.25	16.40
	VHT80 Beam Forming, M0 to M9 2ss	3	8	-56.1	-52.5	-51.9		0.2	-40.2	-21.25	18.90
	VHT80 Beam Forming, M0 to M9 3ss	3	6	-56.1	-52.5	-51.9		0.2	-42.2	-21.25	20.90
	VHT80 Beam Forming, M0 to M9 1ss	4	12	-55.5	-52.9	-53.0	-55.3	0.2	-35.8	-21.25	14.51
	VHT80 Beam Forming, M0 to M9 2ss	4	9	-56.1	-52.5	-51.9	-55.0	0.2	-38.3	-21.25	17.05
	VHT80 Beam Forming, M0 to M9 3ss	4	7	-56.1	-52.5	-51.9	-55.0	0.2	-40.3	-21.25	19.05
	VHT80 Beam Forming, M0 to M9 4ss	4	6	-56.1	-52.5	-51.9	-55.0	0.2	-41.3	-21.25	20.05
	VHT80 STBC, M0 to M9 1ss	2	6	-56.1	-52.5			0.2	-44.7	-21.25	23.45
	VHT80 STBC, M0 to M9 1ss	3	6	-56.1	-52.5	-51.9		0.2	-42.2	-21.25	20.90
	VHT80 STBC, M0 to M9 1ss	4	6	-56.1	-52.5	-51.9	-55.0	0.2	-41.3	-21.25	20.05
	HE80, M0 to M9 1ss	1	6	-54.9				0.3	-48.6	-21.25	27.40
	HE80, M0 to M9 1ss	2	6	-54.9	-52.3			0.3	-44.1	-21.25	22.90
	HE80, M0 to M9 2ss	2	6	-54.9	-52.3			0.3	-44.1	-21.25	22.90
	HE80, M0 to M9 1ss	3	6	-55.5	-52.9	-52.2		0.3	-42.3	-21.25	21.05
	HE80, M0 to M9 2ss	3	6	-55.5	-52.9	-52.2		0.3	-42.3	-21.25	21.05
	HE80, M0 to M9 3ss	3	6	-55.5	-52.9	-52.2		0.3	-42.3	-21.25	21.05
	HE80, M0 to M9 1ss	4	6	-55.5	-52.9	-52.2	-54.8	0.3	-41.4	-21.25	20.12
	HE80, M0 to M9 2ss	4	6	-55.5	-52.9	-52.2	-54.8	0.3	-41.4	-21.25	20.12
	HE80, M0 to M9 3ss	4	6	-55.5	-52.9	-52.2	-54.8	0.3	-41.4	-21.25	20.12
	HE80, M0 to M9 4ss	4	6	-55.5	-52.9	-52.2	-54.8	0.3	-41.4	-21.25	20.12
	HE80 Beam Forming, M0 to M9 1ss	2	9	-55.5	-52.9			0.3	-41.7	-21.25	20.50
	HE80 Beam Forming, M0 to M9 2ss	2	6	-54.9	-52.3			0.3	-44.1	-21.25	22.90
	HE80 Beam Forming, M0 to M9 1ss	3	11	-55.7	-53.9	-53.6		0.3	-38.3	-21.25	17.03
	HE80 Beam Forming, M0 to M9 2ss	3	8	-55.5	-52.9	-52.2		0.3	-40.3	-21.25	19.05
	HE80 Beam Forming, M0 to M9 3ss	3	6	-55.5	-52.9	-52.2		0.3	-42.3	-21.25	21.05
	HE80 Beam Forming, M0 to M9 1ss	4	12	-55.7	-53.9	-53.6	-55.3	0.3	-36.3	-21.25	15.01
	HE80 Beam Forming, M0 to M9 2ss	4	9	-55.5	-52.9	-52.2	-54.8	0.3	-38.4	-21.25	17.12
	HE80 Beam Forming, M0 to M9 3ss	4	7	-55.5	-52.9	-52.2	-54.8	0.3	-40.4	-21.25	19.12
	HE80 Beam Forming, M0 to M9 4ss	4	6	-55.5	-52.9	-52.2	-54.8	0.3	-41.4	-21.25	20.12
	HE80 STBC, M0 to M9 1ss	2	6	-54.9	-52.3			0.3	-44.1	-21.25	22.90
	HE80 STBC, M0 to M9 1ss	3	6	-55.5	-52.9	-52.2		0.3	-42.3	-21.25	21.05
	HE80 STBC, M0 to M9 1ss	4	6	-55.5	-52.9	-52.2	-54.8	0.3	-41.4	-21.25	20.12
	5220	Non HT20, 6 to 54 Mbps	1	6	-54.8				0.1	-48.7	-21.25
Non HT20, 6 to 54 Mbps		2	6	-54.8	-47.4			0.1	-40.6	-21.25	19.37
Non HT20, 6 to 54 Mbps		3	6	-54.8	-47.4	-47.8		0.1	-38.1	-21.25	16.89
Non HT20, 6 to 54 Mbps		4	6	-54.8	-47.4	-47.8	-48.9	0.1	-36.9	-21.25	15.62
Non HT20 Beam Forming, 6 to 54 Mbps		2	9	-54.8	-47.4			0.1	-37.6	-21.25	16.37
Non HT20 Beam Forming, 6 to 54 Mbps		3	11	-54.8	-47.4	-47.8		0.1	-33.1	-21.25	11.89
Non HT20 Beam Forming, 6 to 54 Mbps		4	12	-54.8	-47.4	-47.8	-48.9	0.1	-30.9	-21.25	9.62
HT/VHT20, M0 to M7		1	6	-54.8				0.1	-48.7	-21.25	27.50
HT/VHT20, M0 to M7		2	6	-54.8	-48.8			0.1	-41.8	-21.25	20.52
HT/VHT20, M8 to M15	2	6	-54.8	-48.8			0.1	-41.8	-21.25	20.52	

HT/VHT20, M0 to M7	3	6	-54.8	-48.8	-47.9		0.1	-38.8	-21.25	17.55
HT/VHT20, M8 to M15	3	6	-54.8	-48.8	-47.9		0.1	-38.8	-21.25	17.55
HT/VHT20, M16 to M23	3	6	-54.8	-48.8	-47.9		0.1	-38.8	-21.25	17.55
HT/VHT20, M0 to M7	4	6	-54.8	-48.8	-47.9	-48.3	0.1	-37.2	-21.25	15.93
HT/VHT20, M8 to M15	4	6	-54.8	-48.8	-47.9	-48.3	0.1	-37.2	-21.25	15.93
HT/VHT20, M16 to M23	4	6	-54.8	-48.8	-47.9	-48.3	0.1	-37.2	-21.25	15.93
HT/VHT20, M24 to M31	4	6	-54.8	-48.8	-47.9	-48.3	0.1	-37.2	-21.25	15.93
HT/VHT20 Beam Forming, M0 to M7	2	9	-54.8	-48.8			0.1	-38.8	-21.25	17.52
HT/VHT20 Beam Forming, M8 to M15	2	6	-54.8	-48.8			0.1	-41.8	-21.25	20.52
HT/VHT20 Beam Forming, M0 to M7	3	11	-54.8	-48.8	-47.9		0.1	-33.8	-21.25	12.55
HT/VHT20 Beam Forming, M8 to M15	3	8	-54.8	-48.8	-47.9		0.1	-36.8	-21.25	15.55
HT/VHT20 Beam Forming, M16 to M23	3	6	-54.8	-48.8	-47.9		0.1	-38.8	-21.25	17.55
HT/VHT20 Beam Forming, M0 to M7	4	12	-54.8	-48.8	-47.9	-48.3	0.1	-31.2	-21.25	9.93
HT/VHT20 Beam Forming, M8 to M15	4	9	-54.8	-48.8	-47.9	-48.3	0.1	-34.2	-21.25	12.93
HT/VHT20 Beam Forming, M16 to M23	4	7	-54.8	-48.8	-47.9	-48.3	0.1	-36.2	-21.25	14.93
HT/VHT20 Beam Forming, M24 to M31	4	6	-54.8	-48.8	-47.9	-48.3	0.1	-37.2	-21.25	15.93
HT/VHT20 STBC, M0 to M7	2	6	-54.8	-48.8			0.1	-41.8	-21.25	20.52
HT/VHT20 STBC, M0 to M7	3	6	-54.8	-48.8	-47.9		0.1	-38.8	-21.25	17.55
HT/VHT20 STBC, M0 to M7	4	6	-54.8	-48.8	-47.9	-48.3	0.1	-37.2	-21.25	15.93
HE20, M0 to M9 1ss	1	6	-54.4				0.1	-48.3	-21.25	27.08
HE20, M0 to M9 1ss	2	6	-54.4	-49.1			0.1	-41.9	-21.25	20.66
HE20, M0 to M9 2ss	2	6	-54.4	-49.1			0.1	-41.9	-21.25	20.66
HE20, M0 to M9 1ss	3	6	-54.4	-49.1	-47.5		0.1	-38.7	-21.25	17.40
HE20, M0 to M9 2ss	3	6	-54.4	-49.1	-47.5		0.1	-38.7	-21.25	17.40
HE20, M0 to M9 3ss	3	6	-54.4	-49.1	-47.5		0.1	-38.7	-21.25	17.40
HE20, M0 to M9 1ss	4	6	-54.4	-49.1	-47.5	-49.3	0.1	-37.4	-21.25	16.11
HE20, M0 to M9 2ss	4	6	-54.4	-49.1	-47.5	-49.3	0.1	-37.4	-21.25	16.11
HE20, M0 to M9 3ss	4	6	-54.4	-49.1	-47.5	-49.3	0.1	-37.4	-21.25	16.11
HE20, M0 to M9 4ss	4	6	-54.4	-49.1	-47.5	-49.3	0.1	-37.4	-21.25	16.11
HE20 Beam Forming, M0 to M9 1ss	2	9	-54.4	-49.1			0.1	-38.9	-21.25	17.66
HE20 Beam Forming, M0 to M9 2ss	2	6	-54.4	-49.1			0.1	-41.9	-21.25	20.66
HE20 Beam Forming, M0 to M9 1ss	3	11	-54.4	-49.1	-47.5		0.1	-33.7	-21.25	12.40
HE20 Beam Forming, M0 to M9 2ss	3	8	-54.4	-49.1	-47.5		0.1	-36.7	-21.25	15.40
HE20 Beam Forming, M0 to M9 3ss	3	6	-54.4	-49.1	-47.5		0.1	-38.7	-21.25	17.40
HE20 Beam Forming, M0 to M9 1ss	4	12	-54.4	-49.1	-47.5	-49.3	0.1	-31.4	-21.25	10.11
HE20 Beam Forming, M0 to M9 2ss	4	9	-54.4	-49.1	-47.5	-49.3	0.1	-34.4	-21.25	13.11
HE20 Beam Forming, M0 to M9 3ss	4	7	-54.4	-49.1	-47.5	-49.3	0.1	-36.4	-21.25	15.11
HE20 Beam Forming, M0 to M9 4ss	4	6	-54.4	-49.1	-47.5	-49.3	0.1	-37.4	-21.25	16.11
HE20 STBC, M0 to M9 2ss	2	6	-54.4	-49.1			0.1	-41.9	-21.25	20.66
HE20 STBC, M0 to M9 2ss	3	6	-54.4	-49.1	-47.5		0.1	-38.7	-21.25	17.40
HE20 STBC, M0 to M9 2ss	4	6	-54.4	-49.1	-47.5	-49.3	0.1	-37.4	-21.25	16.11

5230	Non HT40, 6 to 54 Mbps	1	6	-54.9				0.0	-48.9	-21.25	27.60
	Non HT40, 6 to 54 Mbps	2	6	-54.9	-47.8			0.0	-41.0	-21.25	19.73
	Non HT40, 6 to 54 Mbps	3	6	-54.9	-47.8	-48.1		0.0	-38.5	-21.25	17.22
	Non HT40, 6 to 54 Mbps	4	6	-54.9	-47.8	-48.1	-48.8	0.0	-37.1	-21.25	15.84
	HT/VHT40, M0 to M7	1	6	-54.7				0.1	-48.6	-21.25	27.35
	HT/VHT40, M0 to M7	2	6	-54.7	-48.5			0.1	-41.5	-21.25	20.21
	HT/VHT40, M8 to M15	2	6	-54.7	-48.5			0.1	-41.5	-21.25	20.21
	HT/VHT40, M0 to M7	3	6	-54.7	-48.5	-47.6		0.1	-38.5	-21.25	17.22
	HT/VHT40, M8 to M15	3	6	-54.7	-48.5	-47.6		0.1	-38.5	-21.25	17.22
	HT/VHT40, M16 to M23	3	6	-54.7	-48.5	-47.6		0.1	-38.5	-21.25	17.22
	HT/VHT40, M0 to M7	4	6	-54.7	-48.5	-47.6	-49.4	0.1	-37.2	-21.25	15.98
	HT/VHT40, M8 to M15	4	6	-54.7	-48.5	-47.6	-49.4	0.1	-37.2	-21.25	15.98
	HT/VHT40, M16 to M23	4	6	-54.7	-48.5	-47.6	-49.4	0.1	-37.2	-21.25	15.98
	HT/VHT40, M24 to M31	4	6	-54.7	-48.5	-47.6	-49.4	0.1	-37.2	-21.25	15.98
	HT/VHT40 Beam Forming, M0 to M7	2	9	-54.7	-48.5			0.1	-38.5	-21.25	17.21
	HT/VHT40 Beam Forming, M8 to M15	2	6	-54.7	-48.5			0.1	-41.5	-21.25	20.21
	HT/VHT40 Beam Forming, M0 to M7	3	11	-54.7	-48.5	-47.6		0.1	-33.5	-21.25	12.22
	HT/VHT40 Beam Forming, M8 to M15	3	8	-54.7	-48.5	-47.6		0.1	-36.5	-21.25	15.22
	HT/VHT40 Beam Forming, M16 to M23	3	6	-54.7	-48.5	-47.6		0.1	-38.5	-21.25	17.22
	HT/VHT40 Beam Forming, M0 to M7	4	12	-54.7	-48.5	-47.6	-49.4	0.1	-31.2	-21.25	9.98
	HT/VHT40 Beam Forming, M8 to M15	4	9	-54.7	-48.5	-47.6	-49.4	0.1	-34.2	-21.25	12.98
	HT/VHT40 Beam Forming, M16 to M23	4	7	-54.7	-48.5	-47.6	-49.4	0.1	-36.2	-21.25	14.98
	HT/VHT40 Beam Forming, M24 to M31	4	6	-54.7	-48.5	-47.6	-49.4	0.1	-37.2	-21.25	15.98
	HT/VHT40 STBC, M0 to M7	2	6	-54.7	-48.5			0.1	-41.5	-21.25	20.21
	HT/VHT40 STBC, M0 to M7	3	6	-54.7	-48.5	-47.6		0.1	-38.5	-21.25	17.22
	HT/VHT40 STBC, M0 to M7	4	6	-54.7	-48.5	-47.6	-49.4	0.1	-37.2	-21.25	15.98
	HE40, M0 to M9 1ss	1	6	-54.3				0.1	-48.2	-21.25	26.92
	HE40, M0 to M9 1ss	2	6	-54.3	-48.7			0.1	-41.5	-21.25	20.27
	HE40, M0 to M9 2ss	2	6	-54.3	-48.7			0.1	-41.5	-21.25	20.27
	HE40, M0 to M9 1ss	3	6	-54.3	-48.7	-47.7		0.1	-38.5	-21.25	17.29
	HE40, M0 to M9 2ss	3	6	-54.3	-48.7	-47.7		0.1	-38.5	-21.25	17.29
	HE40, M0 to M9 3ss	3	6	-54.3	-48.7	-47.7		0.1	-38.5	-21.25	17.29
	HE40, M0 to M9 1ss	4	6	-54.3	-48.7	-47.7	-48.9	0.1	-37.1	-21.25	15.90
	HE40, M0 to M9 2ss	4	6	-54.3	-48.7	-47.7	-48.9	0.1	-37.1	-21.25	15.90
	HE40, M0 to M9 3ss	4	6	-54.3	-48.7	-47.7	-48.9	0.1	-37.1	-21.25	15.90
	HE40, M0 to M9 4ss	4	6	-54.3	-48.7	-47.7	-48.9	0.1	-37.1	-21.25	15.90
	HE40 Beam Forming, M0 to M9 1ss	2	9	-54.3	-48.7			0.1	-38.5	-21.25	17.27
	HE40 Beam Forming, M0 to M9 2ss	2	6	-54.3	-48.7			0.1	-41.5	-21.25	20.27
	HE40 Beam Forming, M0 to M9 1ss	3	11	-54.3	-48.7	-47.7		0.1	-33.5	-21.25	12.29
	HE40 Beam Forming, M0 to M9 2ss	3	8	-54.3	-48.7	-47.7		0.1	-36.5	-21.25	15.29
HE40 Beam Forming, M0 to M9 3ss	3	6	-54.3	-48.7	-47.7		0.1	-38.5	-21.25	17.29	

	HE40 Beam Forming, M0 to M9 1ss	4	12	-54.3	-48.7	-47.7	-48.9	0.1	-31.1	-21.25	9.90
	HE40 Beam Forming, M0 to M9 2ss	4	9	-54.3	-48.7	-47.7	-48.9	0.1	-34.1	-21.25	12.90
	HE40 Beam Forming, M0 to M9 3ss	4	7	-54.3	-48.7	-47.7	-48.9	0.1	-36.1	-21.25	14.90
	HE40 Beam Forming, M0 to M9 4ss	4	6	-54.3	-48.7	-47.7	-48.9	0.1	-37.1	-21.25	15.90
	HE40 STBC, M0 to M9 2ss	2	6	-54.3	-48.7			0.1	-41.5	-21.25	20.27
	HE40 STBC, M0 to M9 2ss	3	6	-54.3	-48.7	-47.7		0.1	-38.5	-21.25	17.29
	HE40 STBC, M0 to M9 2ss	4	6	-54.3	-48.7	-47.7	-48.9	0.1	-37.1	-21.25	15.90
5240	Non HT20, 6 to 54 Mbps	1	6	-53.8				0.1	-47.7	-21.25	26.50
	Non HT20, 6 to 54 Mbps	2	6	-53.8	-48.4			0.1	-41.2	-21.25	20.00
	Non HT20, 6 to 54 Mbps	3	6	-53.8	-48.4	-46.4		0.1	-37.8	-21.25	16.51
	Non HT20, 6 to 54 Mbps	4	6	-53.8	-48.4	-46.4	-48.1	0.1	-36.4	-21.25	15.14
	Non HT20 Beam Forming, 6 to 54 Mbps	2	9	-53.8	-48.4			0.1	-38.2	-21.25	17.00
	Non HT20 Beam Forming, 6 to 54 Mbps	3	11	-53.8	-48.4	-46.4		0.1	-32.8	-21.25	11.51
	Non HT20 Beam Forming, 6 to 54 Mbps	4	12	-53.8	-48.4	-46.4	-48.1	0.1	-30.4	-21.25	9.14
	HT/VHT20, M0 to M7	1	6	-53.6				0.1	-47.5	-21.25	26.30
	HT/VHT20, M0 to M7	2	6	-53.6	-48.9			0.1	-41.6	-21.25	20.33
	HT/VHT20, M8 to M15	2	6	-53.6	-48.9			0.1	-41.6	-21.25	20.33
	HT/VHT20, M0 to M7	3	6	-53.6	-48.9	-47.6		0.1	-38.6	-21.25	17.30
	HT/VHT20, M8 to M15	3	6	-53.6	-48.9	-47.6		0.1	-38.6	-21.25	17.30
	HT/VHT20, M16 to M23	3	6	-53.6	-48.9	-47.6		0.1	-38.6	-21.25	17.30
	HT/VHT20, M0 to M7	4	6	-53.6	-48.9	-47.6	-49.1	0.1	-37.2	-21.25	15.98
	HT/VHT20, M8 to M15	4	6	-53.6	-48.9	-47.6	-49.1	0.1	-37.2	-21.25	15.98
	HT/VHT20, M16 to M23	4	6	-53.6	-48.9	-47.6	-49.1	0.1	-37.2	-21.25	15.98
	HT/VHT20, M24 to M31	4	6	-53.6	-48.9	-47.6	-49.1	0.1	-37.2	-21.25	15.98
	HT/VHT20 Beam Forming, M0 to M7	2	9	-53.6	-48.9			0.1	-38.6	-21.25	17.33
	HT/VHT20 Beam Forming, M8 to M15	2	6	-53.6	-48.9			0.1	-41.6	-21.25	20.33
	HT/VHT20 Beam Forming, M0 to M7	3	11	-53.6	-48.9	-47.6		0.1	-33.6	-21.25	12.30
	HT/VHT20 Beam Forming, M8 to M15	3	8	-53.6	-48.9	-47.6		0.1	-36.6	-21.25	15.30
	HT/VHT20 Beam Forming, M16 to M23	3	6	-53.6	-48.9	-47.6		0.1	-38.6	-21.25	17.30
	HT/VHT20 Beam Forming, M0 to M7	4	12	-53.6	-48.9	-47.6	-49.1	0.1	-31.2	-21.25	9.98
	HT/VHT20 Beam Forming, M8 to M15	4	9	-53.6	-48.9	-47.6	-49.1	0.1	-34.2	-21.25	12.98
	HT/VHT20 Beam Forming, M16 to M23	4	7	-53.6	-48.9	-47.6	-49.1	0.1	-36.2	-21.25	14.98
	HT/VHT20 Beam Forming, M24 to M31	4	6	-53.6	-48.9	-47.6	-49.1	0.1	-37.2	-21.25	15.98
	HT/VHT20 STBC, M0 to M7	2	6	-53.6	-48.9			0.1	-41.6	-21.25	20.33
	HT/VHT20 STBC, M0 to M7	3	6	-53.6	-48.9	-47.6		0.1	-38.6	-21.25	17.30
	HT/VHT20 STBC, M0 to M7	4	6	-53.6	-48.9	-47.6	-49.1	0.1	-37.2	-21.25	15.98
	HE20, M0 to M9 1ss	1	6	-54.8				0.1	-48.7	-21.25	27.48
	HE20, M0 to M9 1ss	2	6	-54.8	-48.7			0.1	-41.7	-21.25	20.43
	HE20, M0 to M9 2ss	2	6	-54.8	-48.7			0.1	-41.7	-21.25	20.43
	HE20, M0 to M9 1ss	3	6	-54.8	-48.7	-47.5		0.1	-38.5	-21.25	17.29
	HE20, M0 to M9 2ss	3	6	-54.8	-48.7	-47.5		0.1	-38.5	-21.25	17.29
	HE20, M0 to M9 3ss	3	6	-54.8	-48.7	-47.5		0.1	-38.5	-21.25	17.29

	HE20, M0 to M9 1ss	4	6	-54.8	-48.7	-47.5	-48.2	0.1	-37.0	-21.25	15.72
	HE20, M0 to M9 2ss	4	6	-54.8	-48.7	-47.5	-48.2	0.1	-37.0	-21.25	15.72
	HE20, M0 to M9 3ss	4	6	-54.8	-48.7	-47.5	-48.2	0.1	-37.0	-21.25	15.72
	HE20, M0 to M9 4ss	4	6	-54.8	-48.7	-47.5	-48.2	0.1	-37.0	-21.25	15.72
	HE20 Beam Forming, M0 to M9 1ss	2	9	-54.8	-48.7			0.1	-38.7	-21.25	17.43
	HE20 Beam Forming, M0 to M9 2ss	2	6	-54.8	-48.7			0.1	-41.7	-21.25	20.43
	HE20 Beam Forming, M0 to M9 1ss	3	11	-54.8	-48.7	-47.5		0.1	-33.5	-21.25	12.29
	HE20 Beam Forming, M0 to M9 2ss	3	8	-54.8	-48.7	-47.5		0.1	-36.5	-21.25	15.29
	HE20 Beam Forming, M0 to M9 3ss	3	6	-54.8	-48.7	-47.5		0.1	-38.5	-21.25	17.29
	HE20 Beam Forming, M0 to M9 1ss	4	12	-54.8	-48.7	-47.5	-48.2	0.1	-31.0	-21.25	9.72
	HE20 Beam Forming, M0 to M9 2ss	4	9	-54.8	-48.7	-47.5	-48.2	0.1	-34.0	-21.25	12.72
	HE20 Beam Forming, M0 to M9 3ss	4	7	-54.8	-48.7	-47.5	-48.2	0.1	-36.0	-21.25	14.72
	HE20 Beam Forming, M0 to M9 4ss	4	6	-54.8	-48.7	-47.5	-48.2	0.1	-37.0	-21.25	15.72
	HE20 STBC, M0 to M9 2ss	2	6	-54.8	-48.7			0.1	-41.7	-21.25	20.43
	HE20 STBC, M0 to M9 2ss	3	6	-54.8	-48.7	-47.5		0.1	-38.5	-21.25	17.29
	HE20 STBC, M0 to M9 2ss	4	6	-54.8	-48.7	-47.5	-48.2	0.1	-37.0	-21.25	15.72
5250	Non HT160, 6 to 54 Mbps	1	6	-46.6				0.0	-40.6	-21.25	19.30
	Non HT160, 6 to 54 Mbps	2	6	-46.6	-51.5			0.0	-39.3	-21.25	18.08
	Non HT160, 6 to 54 Mbps	3	6	-46.6	-51.5	-51.7		0.0	-38.4	-21.25	17.17
	Non HT160, 6 to 54 Mbps	4	6	-47.0	-51.2	-51.6	-54.5	0.0	-38.2	-21.25	16.90
	VHT160, M0 to M9 1ss	1	6	-47.5				0.4	-41.1	-21.25	19.86
	VHT160, M0 to M9 1ss	2	6	-47.5	-52.0			0.4	-39.8	-21.25	18.54
	VHT160, M0 to M9 2ss	2	6	-47.5	-52.0			0.4	-39.8	-21.25	18.54
	VHT160, M0 to M9 1ss	3	6	-47.5	-52.0	-51.6		0.4	-38.7	-21.25	17.44
	VHT160, M0 to M9 2ss	3	6	-47.5	-52.0	-51.6		0.4	-38.7	-21.25	17.44
	VHT160, M0 to M9 3ss	3	6	-47.5	-52.0	-51.6		0.4	-38.7	-21.25	17.44
	VHT160, M0 to M9 1ss	4	6	-47.5	-52.0	-51.6	-53.8	0.4	-38.1	-21.25	16.90
	VHT160, M0 to M9 2ss	4	6	-47.5	-52.0	-51.6	-53.8	0.4	-38.1	-21.25	16.90
	VHT160, M0 to M9 3ss	4	6	-47.5	-52.0	-51.6	-53.8	0.4	-38.1	-21.25	16.90
	VHT160, M0 to M9 4ss	4	6	-47.5	-52.0	-51.6	-53.8	0.4	-38.1	-21.25	16.90
	VHT160 Beam Forming, M0 to M9 1ss	2	9	-49.5	-53.4			0.4	-38.6	-21.25	17.37
	VHT160 Beam Forming, M0 to M9 2ss	2	6	-47.5	-52.0			0.4	-39.8	-21.25	18.54
	VHT160 Beam Forming, M0 to M9 1ss	3	11	-51.5	-53.4	-53.9		0.4	-36.6	-21.25	15.39
	VHT160 Beam Forming, M0 to M9 2ss	3	8	-47.5	-52.0	-51.6		0.4	-36.7	-21.25	15.44
	VHT160 Beam Forming, M0 to M9 3ss	3	6	-47.5	-52.0	-51.6		0.4	-38.7	-21.25	17.44
	VHT160 Beam Forming, M0 to M9 1ss	4	12	-51.5	-53.4	-53.9	-56.3	0.4	-35.0	-21.25	13.79
	VHT160 Beam Forming, M0 to M9 2ss	4	9	-49.5	-53.4	-52.1	-54.7	0.4	-36.6	-21.25	15.32
	VHT160 Beam Forming, M0 to M9 3ss	4	7	-47.5	-52.0	-51.6	-53.8	0.4	-37.1	-21.25	15.90
	VHT160 Beam Forming, M0 to M9 4ss	4	6	-47.5	-52.0	-51.6	-53.8	0.4	-38.1	-21.25	16.90
	VHT160 STBC, M0 to M9 1ss	2	6	-47.5	-52.0			0.4	-39.8	-21.25	18.54
VHT160 STBC, M0 to M9 1ss	3	6	-47.5	-52.0	-51.6		0.4	-38.7	-21.25	17.44	
VHT160 STBC, M0 to M9 1ss	4	6	-47.5	-52.0	-51.6	-53.8	0.4	-38.1	-21.25	16.90	



HE160, M0 to M9 1ss	1	6	-47.5				0.4	-41.1	-21.25	19.82
HE160, M0 to M9 1ss	2	6	-47.5	-51.6			0.4	-39.6	-21.25	18.39
HE160, M0 to M9 2ss	2	6	-47.5	-51.6			0.4	-39.6	-21.25	18.39
HE160, M0 to M9 1ss	3	6	-47.5	-51.6	-51.3		0.4	-38.5	-21.25	17.25
HE160, M0 to M9 2ss	3	6	-47.5	-51.6	-51.3		0.4	-38.5	-21.25	17.25
HE160, M0 to M9 3ss	3	6	-47.5	-51.6	-51.3		0.4	-38.5	-21.25	17.25
HE160, M0 to M9 1ss	4	6	-47.5	-51.6	-51.3	-53.4	0.4	-37.9	-21.25	16.67
HE160, M0 to M9 2ss	4	6	-47.5	-51.6	-51.3	-53.4	0.4	-37.9	-21.25	16.67
HE160, M0 to M9 3ss	4	6	-47.5	-51.6	-51.3	-53.4	0.4	-37.9	-21.25	16.67
HE160, M0 to M9 4ss	4	6	-47.5	-51.6	-51.3	-53.4	0.4	-37.9	-21.25	16.67
HE160 Beam Forming, M0 to M9 1ss	2	9	-48.6	-52.9			0.4	-37.8	-21.25	16.54
HE160 Beam Forming, M0 to M9 2ss	2	6	-47.5	-51.6			0.4	-39.6	-21.25	18.39
HE160 Beam Forming, M0 to M9 1ss	3	11	-48.6	-52.9	-51.1		0.4	-34.3	-21.25	13.05
HE160 Beam Forming, M0 to M9 2ss	3	8	-48.6	-52.9	-51.1		0.4	-37.3	-21.25	16.05
HE160 Beam Forming, M0 to M9 3ss	3	6	-47.5	-51.6	-51.3		0.4	-38.5	-21.25	17.25
HE160 Beam Forming, M0 to M9 1ss	4	12	-50.5	-52.6	-53.4	-55.5	0.4	-34.2	-21.25	12.93
HE160 Beam Forming, M0 to M9 2ss	4	9	-48.6	-52.9	-51.1	-54.7	0.4	-35.8	-21.25	14.53
HE160 Beam Forming, M0 to M9 3ss	4	7	-48.6	-52.9	-51.1	-54.7	0.4	-37.8	-21.25	16.53
HE160 Beam Forming, M0 to M9 4ss	4	6	-47.5	-51.6	-51.3	-53.4	0.4	-37.9	-21.25	16.67
HE160 STBC, M0 to M9 1ss	2	6	-47.5	-51.6			0.4	-39.6	-21.25	18.39
HE160 STBC, M0 to M9 1ss	3	6	-47.5	-51.6	-51.3		0.4	-38.5	-21.25	17.25
HE160 STBC, M0 to M9 1ss	4	6	-47.5	-51.6	-51.3	-53.4	0.4	-37.9	-21.25	16.67

**Conducted Spurs Peak, 6dBi,
5240 MHz, Non HT20 Beam Forming, 6 to 54 Mbps**



Antenna A



Antenna B



Antenna C



Antenna D

A.6 Conducted Receiver Spurious Emissions

Spurious Of Receive Average Upp, 5180 MHz, Non HT20, 6 to 54 Mbps



Spurious Of Receive Peak Upper, 5180 MHz, Non HT20, 6 to 54 Mbps



Conducted Receiver Spurious Average Table, 4dBi

Frequency (MHz)	Mode	Tx Paths	Correlated Antenna Gain (dBi)	Rx 1 Spur Power (dBm)	Rx 2 Spur Power (dBm)	Rx 3 Spur Power (dBm)	Rx 4 Spur Power (dBm)	Duty Cycle (dB)	Total Conducted Spur (dBm)	Limit (dB)	Margin (dB)
5180	Non HT20, 6 to 54 Mbps	4	4	-86.5	-86.2	-86.1	-86.0	0.1	-76.1	-41.25	34.87
	HT/VHT20, M0 to M7	4	4	-86.3	-86.3	-85.7	-85.6	0.1	-75.9	-41.25	34.64
	HE20, M0 to M9 1ss	4	4	-86.0	-86.6	-85.8	-85.9	0.1	-77.0	-41.25	35.73
5190	Non HT40, 6 to 54 Mbps	4	4	-85.8	-86.4	-85.8	-86.0	0.0	-75.9	-41.25	34.67
	HT/VHT40, M0 to M7	4	4	-86.2	-85.0	-85.9	-83.8	0.1	-75.0	-41.25	33.75
	HE40, M0 to M9 1ss	4	4	-86.6	-86.4	-86.6	-85.6	0.1	-76.1	-41.25	34.88
5210	Non HT80, 6 to 54 Mbps	4	4	-86.4	-85.2	-85.7	-84.5	0.1	-73.3	-41.25	32.07
	VHT80, M0 to M9 1ss	4	4	-86.1	-86.6	-85.9	-85.9	0.2	-73.9	-41.25	32.62
	HE80, M0 to M9 1ss	4	4	-86.3	-86.6	-86.2	-86.0	0.3	-74.0	-41.25	32.75
5220	Non HT20, 6 to 54 Mbps	4	4	-86.7	-86.6	-86.3	-86.1	0.1	-74.3	-41.25	33.09
	HT/VHT20, M0 to M7	4	4	-86.2	-86.4	-86.2	-86.2	0.1	-74.2	-41.25	32.93
	HE20, M0 to M9 1ss	4	4	-86.6	-86.5	-86.3	-86.1	0.1	-74.3	-41.25	33.03
5230	Non HT40, 6 to 54 Mbps	4	4	-86.1	-86.1	-86.4	-85.7	0.0	-74.0	-41.25	32.75
	HT/VHT40, M0 to M7	4	4	-86.7	-86.9	-85.8	-82.7	0.1	-73.0	-41.25	31.79
	HE40, M0 to M9 1ss	4	4	-86.5	-86.2	-86.3	-85.9	0.1	-74.1	-41.25	32.82
5240	Non HT20, 6 to 54 Mbps	4	4	-86.3	-86.3	-86.3	-86.3	0.1	-74.2	-41.25	32.98
	HT/VHT20, M0 to M7	4	4	-86.6	-86.5	-86.8	-85.7	0.1	-74.3	-41.25	33.06
	HE20, M0 to M9 1ss	4	4	-87.1	-86.9	-86.0	-85.8	0.1	-74.3	-41.25	33.08
5250	Non HT160, 6 to 54 Mbps	4	4	-86.5	-86.1	-85.9	-86.0	0.0	-74.0	-41.25	32.80
	VHT160, M0 to M9 1ss	4	4	-86.4	-86.5	-86.3	-85.8	0.4	-73.8	-41.25	32.58
	HE160, M0 to M9 1ss	4	4	-86.4	-86.3	-86.2	-82.3	0.4	-72.5	-41.25	31.20

Conducted Receiver Spurious Average Table, 5dBi

Frequency (MHz)	Mode	Tx Paths	Correlated Antenna Gain (dBi)	Rx 1 Spur Power (dBm)	Rx 2 Spur Power (dBm)	Rx 3 Spur Power (dBm)	Rx 4 Spur Power (dBm)	Duty Cycle Correction (dB)	Total Conducted Spur (dBm)	Limit (dBm)	Margin (dB)
5180	Non HT20, 6 to 54 Mbps	4	5	-86.5	-86.2	-86.1	-86.0	0.1	-75.1	-41.25	33.87
	HT/VHT20, M0 to M7	4	5	-86.3	-86.3	-85.7	-85.6	0.1	-74.9	-41.25	33.64
	HE20, M0 to M9 1ss	4	5	-86.0	-86.6	-85.8	-85.9	0.1	-75.0	-41.25	33.73
5190	Non HT40, 6 to 54 Mbps	4	5	-85.8	-86.4	-85.8	-86.0	0.0	-74.9	-41.25	33.67
	HT/VHT40, M0 to M7	4	5	-86.2	-85.0	-85.9	-83.8	0.1	-74.0	-41.25	32.75
	HE40, M0 to M9 1ss	4	5	-86.6	-86.4	-86.6	-85.6	0.1	-75.1	-41.25	33.88
5210	Non HT80, 6 to 54 Mbps	4	5	-86.4	-85.2	-85.7	-84.5	0.1	-74.3	-41.25	33.07
	VHT80, M0 to M9 1ss	4	5	-86.1	-86.6	-85.9	-85.9	0.2	-74.9	-41.25	33.62
	HE80, M0 to M9 1ss	4	5	-86.3	-86.6	-86.2	-86.0	0.3	-75.0	-41.25	33.75
5220	Non HT20, 6 to 54 Mbps	4	5	-86.7	-86.6	-86.3	-86.1	0.1	-75.3	-41.25	34.09
	HT/VHT20, M0 to M7	4	5	-86.2	-86.4	-86.2	-86.2	0.1	-75.2	-41.25	33.93
	HE20, M0 to M9 1ss	4	5	-86.6	-86.5	-86.3	-86.1	0.1	-75.3	-41.25	34.03
5230	Non HT40, 6 to 54 Mbps	4	5	-86.1	-86.1	-86.4	-85.7	0.0	-75.0	-41.25	33.75
	HT/VHT40, M0 to M7	4	5	-86.7	-86.9	-85.8	-82.7	0.1	-74.0	-41.25	32.79
	HE40, M0 to M9 1ss	4	5	-86.5	-86.2	-86.3	-85.9	0.1	-75.1	-41.25	33.82
5240	Non HT20, 6 to 54 Mbps	4	5	-86.3	-86.3	-86.3	-86.3	0.1	-75.2	-41.25	33.98
	HT/VHT20, M0 to M7	4	5	-86.6	-86.5	-86.8	-85.7	0.1	-75.3	-41.25	34.06
	HE20, M0 to M9 1ss	4	5	-87.1	-86.9	-86.0	-85.8	0.1	-75.3	-41.25	34.08
5250	Non HT160, 6 to 54 Mbps	4	5	-86.5	-86.1	-85.9	-86.0	0.0	-75.0	-41.25	33.80
	VHT160, M0 to M9 1ss	4	5	-86.4	-86.5	-86.3	-85.8	0.4	-74.8	-41.25	33.58
	HE160, M0 to M9 1ss	4	5	-86.4	-86.3	-86.2	-82.3	0.4	-73.5	-41.25	32.20

Conducted Receiver Spurious Average Table, 6dB

Frequency (MHz)	Mode	Tx Paths	Correlated Antenna Gain (dBi)	Rx 1 Spur Power (dBm)	Rx 2 Spur Power (dBm)	Rx 3 Spur Power (dBm)	Rx 4 Spur Power (dBm)	Duty Cycle Correction (dB)	Total Conducted Spur (dBm)	Limit (dBm)	Margin (dB)
5180	Non HT20, 6 to 54 Mbps	4	6	-86.5	-86.2	-86.1	-86.0	0.1	-74.1	-41.25	32.87
	HT/VHT20, M0 to M7	4	6	-86.3	-86.3	-85.7	-85.6	0.1	-73.9	-41.25	32.64
	HE20, M0 to M9 1ss	4	6	-86.0	-86.6	-85.8	-85.9	0.1	-74.0	-41.25	32.73
5190	Non HT40, 6 to 54 Mbps	4	6	-85.8	-86.4	-85.8	-86.0	0.0	-73.9	-41.25	32.67
	HT/VHT40, M0 to M7	4	6	-86.2	-85.0	-85.9	-83.8	0.1	-73.0	-41.25	31.75
	HE40, M0 to M9 1ss	4	6	-86.6	-86.4	-86.6	-85.6	0.1	-74.1	-41.25	32.88
5210	Non HT80, 6 to 54 Mbps	4	6	-86.4	-85.2	-85.7	-84.5	0.1	-73.3	-41.25	32.07
	VHT80, M0 to M9 1ss	4	6	-86.1	-86.6	-85.9	-85.9	0.2	-73.9	-41.25	32.62
	HE80, M0 to M9 1ss	4	6	-86.3	-86.6	-86.2	-86.0	0.3	-74.0	-41.25	32.75
5220	Non HT20, 6 to 54 Mbps	4	6	-86.7	-86.6	-86.3	-86.1	0.1	-74.3	-41.25	33.09
	HT/VHT20, M0 to M7	4	6	-86.2	-86.4	-86.2	-86.2	0.1	-74.2	-41.25	32.93
	HE20, M0 to M9 1ss	4	6	-86.6	-86.5	-86.3	-86.1	0.1	-74.3	-41.25	33.03
5230	Non HT40, 6 to 54 Mbps	4	6	-86.1	-86.1	-86.4	-85.7	0.0	-74.0	-41.25	32.75
	HT/VHT40, M0 to M7	4	6	-86.7	-86.9	-85.8	-82.7	0.1	-73.0	-41.25	31.79
	HE40, M0 to M9 1ss	4	6	-86.5	-86.2	-86.3	-85.9	0.1	-74.1	-41.25	32.82
5240	Non HT20, 6 to 54 Mbps	4	6	-86.3	-86.3	-86.3	-86.3	0.1	-74.2	-41.25	32.98
	HT/VHT20, M0 to M7	4	6	-86.6	-86.5	-86.8	-85.7	0.1	-74.3	-41.25	33.06
	HE20, M0 to M9 1ss	4	6	-87.1	-86.9	-86.0	-85.8	0.1	-74.3	-41.25	33.08
5250	Non HT160, 6 to 54 Mbps	4	6	-86.5	-86.1	-85.9	-86.0	0.0	-74.0	-41.25	32.80
	VHT160, M0 to M9 1ss	4	6	-86.4	-86.5	-86.3	-85.8	0.4	-73.8	-41.25	32.58
	HE160, M0 to M9 1ss	4	6	-86.4	-86.3	-86.2	-82.3	0.4	-72.5	-41.25	31.20

Spurious Of Receive Average, 5250 MHz, HE160, M0 to M9 1ss



Antenna A



Antenna B



Antenna C

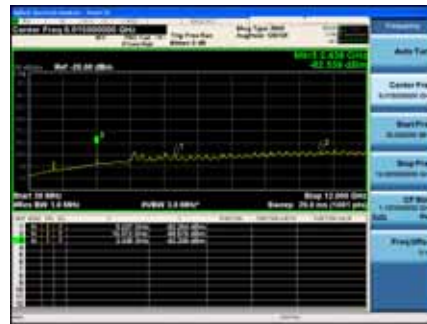

Antenna D

Conducted Receiver Spurious Peak Table, 4dBi

Frequency (MHz)	Mode	Tx Paths	Correlated Antenna Gain (dBi)	Rx 1 Spur Power (dBm)	Rx 2 Spur Power (dBm)	Rx 3 Spur Power (dBm)	Rx 4 Spur Power (dBm)	Total Conducted Spur (dBm)	Limit (dB)	Margin (dB)
5180	Non HT20, 6 to 54 Mbps	4	4	-66.7	-67.0	-67.3	-66.3	-56.7	-21.25	35.48
	HT/VHT20, M0 to M7	4	4	-67.5	-67.0	-65.9	-65.1	-56.2	-21.25	34.95
	HE20, M0 to M9 1ss	4	4	-67.6	-66.9	-67.2	-66.8	-57.0	-21.25	35.78
5190	Non HT40, 6 to 54 Mbps	4	4	-65.9	-67.6	-66.6	-66.3	-56.5	-21.25	35.24
	HT/VHT40, M0 to M7	4	4	-67.0	-65.7	-66.2	-66.5	-56.2	-21.25	34.95
	HE40, M0 to M9 1ss	4	4	-67.2	-68.2	-66.6	-66.8	-57.0	-21.25	35.76
5210	Non HT80, 6 to 54 Mbps	4	4	-67.3	-65.6	-66.5	-67.1	-56.5	-21.25	35.25
	VHT80, M0 to M9 1ss	4	4	-67.6	-66.6	-66.5	-66.6	-56.6	-21.25	35.31
	HE80, M0 to M9 1ss	4	4	-67.7	-67.3	-66.0	-66.7	-56.6	-21.25	35.36
5220	Non HT20, 6 to 54 Mbps	4	4	-67.8	-67.6	-66.9	-66.6	-57.1	-21.25	35.87
	HT/VHT20, M0 to M7	4	4	-66.9	-67.1	-66.6	-67.0	-56.8	-21.25	35.57
	HE20, M0 to M9 1ss	4	4	-67.7	-66.0	-66.6	-67.3	-56.8	-21.25	35.51
5230	Non HT40, 6 to 54 Mbps	4	4	-67.8	-66.8	-67.7	-67.0	-57.2	-21.25	35.98
	HT/VHT40, M0 to M7	4	4	-66.8	-67.6	-66.1	-67.8	-56.9	-21.25	35.65
	HE40, M0 to M9 1ss	4	4	-66.4	-66.8	-67.0	-67.6	-56.8	-21.25	35.53
5240	Non HT20, 6 to 54 Mbps	4	4	-66.7	-67.5	-67.4	-66.9	-57.0	-21.25	35.79
	HT/VHT20, M0 to M7	4	4	-67.2	-66.6	-67.4	-66.2	-56.8	-21.25	35.50
	HE20, M0 to M9 1ss	4	4	-67.0	-67.9	-65.8	-67.3	-56.8	-21.25	35.59
5250	Non HT160, 6 to 54 Mbps	4	4	-66.9	-67.5	-67.3	-67.6	-57.2	-21.25	36.00
	VHT160, M0 to M9 1ss	4	4	-67.3	-66.0	-66.3	-66.3	-56.0	-21.25	34.79
	HE160, M0 to M9 1ss	4	4	-67.4	-67.5	-67.4	-66.9	-56.8	-21.25	35.59



Conducted Receiver Spurious Peak Table, 5dBi

Frequency (MHz)	Mode	Tx Paths	Correlated Antenna Gain (dBi)	Rx 1 Spur Power (dBm)	Rx 2 Spur Power (dBm)	Rx 3 Spur Power (dBm)	Rx 4 Spur Power (dBm)	Total Conducted Spur (dBm)	Limit (dBm)	Margin (dB)
5180	Non HT20, 6 to 54 Mbps	4	5	-66.7	-67.0	-67.3	-66.3	-55.7	-21.25	34.48
	HT/VHT20, M0 to M7	4	5	-67.5	-67.0	-65.9	-65.1	-55.2	-21.25	33.95
	HE20, M0 to M9 1ss	4	5	-67.6	-66.9	-67.2	-66.8	-56.0	-21.25	34.78
5190	Non HT40, 6 to 54 Mbps	4	5	-65.9	-67.6	-66.6	-66.3	-55.5	-21.25	34.24
	HT/VHT40, M0 to M7	4	5	-67.0	-65.7	-66.2	-66.5	-55.2	-21.25	33.95
	HE40, M0 to M9 1ss	4	5	-67.2	-68.2	-66.6	-66.8	-56.0	-21.25	34.76
5210	Non HT80, 6 to 54 Mbps	4	5	-67.3	-65.6	-66.5	-67.1	-55.5	-21.25	34.25
	VHT80, M0 to M9 1ss	4	5	-67.6	-66.6	-66.5	-66.6	-55.6	-21.25	34.31
	HE80, M0 to M9 1ss	4	5	-67.7	-67.3	-66.0	-66.7	-55.6	-21.25	34.36
5220	Non HT20, 6 to 54 Mbps	4	5	-67.8	-67.6	-66.9	-66.6	-56.1	-21.25	34.87
	HT/VHT20, M0 to M7	4	5	-66.9	-67.1	-66.6	-67.0	-55.8	-21.25	34.57
	HE20, M0 to M9 1ss	4	5	-67.7	-66.0	-66.6	-67.3	-55.8	-21.25	34.51
5230	Non HT40, 6 to 54 Mbps	4	5	-67.8	-66.8	-67.7	-67.0	-56.2	-21.25	34.98
	HT/VHT40, M0 to M7	4	5	-66.8	-67.6	-66.1	-67.8	-55.9	-21.25	34.65
	HE40, M0 to M9 1ss	4	5	-66.4	-66.8	-67.0	-67.6	-55.8	-21.25	34.53
5240	Non HT20, 6 to 54 Mbps	4	5	-66.7	-67.5	-67.4	-66.9	-56.0	-21.25	34.79
	HT/VHT20, M0 to M7	4	5	-67.2	-66.6	-67.4	-66.2	-55.8	-21.25	34.50
	HE20, M0 to M9 1ss	4	5	-67.0	-67.9	-65.8	-67.3	-55.8	-21.25	34.59
5250	Non HT160, 6 to 54 Mbps	4	5	-66.9	-67.5	-67.3	-67.6	-56.2	-21.25	35.00
	VHT160, M0 to M9 1ss	4	5	-67.3	-66.0	-66.3	-66.3	-55.0	-21.25	33.79
	HE160, M0 to M9 1ss	4	5	-67.4	-67.5	-67.4	-66.9	-55.8	-21.25	34.59

Conducted Receiver Spurious Peak Table, 6dBi

Frequency (MHz)	Mode	Tx Paths	Correlated Antenna Gain (dBi)	Rx 1 Spur Power (dBm)	Rx 2 Spur Power (dBm)	Rx 3 Spur Power (dBm)	Rx 4 Spur Power (dBm)	Total Conducted Spur (dBm)	Limit (dBm)	Margin (dB)
5180	Non HT20, 6 to 54 Mbps	4	6	-66.7	-67.0	-67.3	-66.3	-54.7	-21.25	33.48
	HT/VHT20, M0 to M7	4	6	-67.5	-67.0	-65.9	-65.1	-54.2	-21.25	32.95
	HE20, M0 to M9 1ss	4	6	-67.6	-66.9	-67.2	-66.8	-55.0	-21.25	33.78
5190	Non HT40, 6 to 54 Mbps	4	6	-65.9	-67.6	-66.6	-66.3	-54.5	-21.25	33.24
	HT/VHT40, M0 to M7	4	6	-67.0	-65.7	-66.2	-66.5	-54.2	-21.25	32.95
	HE40, M0 to M9 1ss	4	6	-67.2	-68.2	-66.6	-66.8	-55.0	-21.25	33.76
5210	Non HT80, 6 to 54 Mbps	4	6	-67.3	-65.6	-66.5	-67.1	-54.5	-21.25	33.25
	VHT80, M0 to M9 1ss	4	6	-67.6	-66.6	-66.5	-66.6	-54.6	-21.25	33.31
	HE80, M0 to M9 1ss	4	6	-67.7	-67.3	-66.0	-66.7	-54.6	-21.25	33.36
5220	Non HT20, 6 to 54 Mbps	4	6	-67.8	-67.6	-66.9	-66.6	-55.1	-21.25	33.87
	HT/VHT20, M0 to M7	4	6	-66.9	-67.1	-66.6	-67.0	-54.8	-21.25	33.57
	HE20, M0 to M9 1ss	4	6	-67.7	-66.0	-66.6	-67.3	-54.8	-21.25	33.51
5230	Non HT40, 6 to 54 Mbps	4	6	-67.8	-66.8	-67.7	-67.0	-55.2	-21.25	33.98
	HT/VHT40, M0 to M7	4	6	-66.8	-67.6	-66.1	-67.8	-54.9	-21.25	33.65
	HE40, M0 to M9 1ss	4	6	-66.4	-66.8	-67.0	-67.6	-54.8	-21.25	33.53
5240	Non HT20, 6 to 54 Mbps	4	6	-66.7	-67.5	-67.4	-66.9	-55.0	-21.25	33.79
	HT/VHT20, M0 to M7	4	6	-67.2	-66.6	-67.4	-66.2	-54.8	-21.25	33.50
	HE20, M0 to M9 1ss	4	6	-67.0	-67.9	-65.8	-67.3	-54.8	-21.25	33.59
5250	Non HT160, 6 to 54 Mbps	4	6	-66.9	-67.5	-67.3	-67.6	-55.2	-21.25	34.00
	VHT160, M0 to M9 1ss	4	6	-67.3	-66.0	-66.3	-66.3	-54.0	-21.25	32.79
	HE160, M0 to M9 1ss	4	6	-67.4	-67.5	-67.4	-66.9	-54.8	-21.25	33.59

Spurious Of Receive Peak, 5250 MHz, VHT160, M0 to M9 1ss



Antenna A



Antenna B



Antenna C

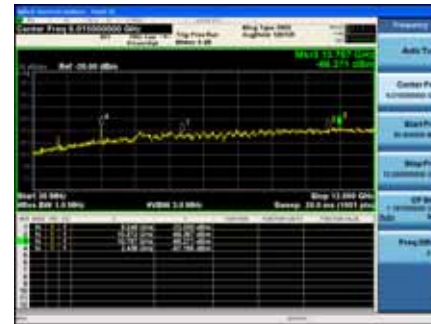

Antenna D

A.7 Conducted Band Edge

Conducted Band Edge Test Requirement

15.407(b) Undesirable emission limits. Except as shown in paragraph (b)(7) of this section, the maximum emissions outside of the frequency bands of operation shall be attenuated in accordance with the following limits:

- (1) For transmitters operating in the 5.15-5.25 GHz band: All emissions outside of the 5.15-5.35 GHz band shall not exceed an e.i.r.p. of -27 dBm/MHz.
- (5) The emission measurements shall be performed using a minimum resolution bandwidth of 1 MHz. A lower resolution bandwidth may be employed near the band edge, when necessary, provided the measured energy is integrated to show the total power over 1 MHz.
- (6) Unwanted emissions below 1 GHz must comply with the general field strength limits set forth in §15.209.
- (7) The provisions of §15.205 apply to intentional radiators operating under this section.
- (8) When measuring the emission limits, the nominal carrier frequency shall be adjusted as close to the upper and lower frequency band edges as the design of the equipment permits.

Radiated emissions which fall in the restricted bands, as defined in Section 15.205(a), must also comply with the radiated emission limits specified in Section 15.209(a) (see Section 15.205(c)).

Use formula below to substitute conducted measurements in place of radiated measurements

$$E[\text{dB}\mu\text{V}/\text{m}] = \text{EIRP}[\text{dBm}] - 20 \log(d[\text{meters}]) + 104.77, \text{ where } E = \text{field strength and } d = 3 \text{ meter}$$

- 1) Average Plot, Limit= -41.25 dBm eirp
- 2) Peak plot, Limit = -21.25 dBm eirp

KDB 789033 D02 General UNII Test Procedures New Rules v02r01

2. Unwanted Emissions that fall Outside of the Restricted Bands

- a) For all measurements, follow the requirements in II.G.3. “*General Requirements for Unwanted Emissions Measurements.*”
- b) At frequencies below 1000 MHz, use the procedure described in II.G.4. “*Procedure for Unwanted Emissions Measurements Below 1000 MHz.*”
- c) At frequencies above 1000 MHz, use the procedure for maximum emissions described in II.G.5., “*Procedure for Unwanted Emissions Measurements Above 1000 MHz.*”
- (i) Sections 15.407(b)(1-3) specifies the unwanted emissions limit for the U-NII-1 and U-NII-2 bands. As specified, emissions above 1000 MHz that are outside of the restricted bands are subject to a peak emission limit of -27 dBm/MHz.³

Conducted Band Edge Test Procedure

KDB 789033 D02 General UNII Test Procedures New Rules v02r01

Ref. ANSI C63.10: 2013

Conducted Spurious Emissions

Test Procedure

1. Connect the antenna port(s) to the spectrum analyzer input.
2. Place the radio in continuous transmit mode
3. Configure Spectrum analyzer as per test parameters below (be sure to enter all losses between the transmitter output and the spectrum analyzer).
4. Use the peak marker function to determine the maximum spurs amplitude level.
5. The “measure-and-sum technique” is used for measuring in-band transmit power of a device. In the

measure-and-sum approach, the conducted emission level is measured at each antenna port. The measured results at the various antenna ports are then summed mathematically to determine the total emission level from the device. Summing is performed in linear power units. The worst case output is recorded. (see ANSI C63.10:2013 section 14.3.2.2)

6. Capture graphs and record pertinent measurement data.

Ref. ANSI C63.10: 2013 section 12.7.6 (Peak) and 12.7.7.2 (Average)

KDB 789033 D02 General UNII Test Procedures New Rules v02r01, Sec. 5 (Peak), Sec. 6 (Average Method AD)

Conducted Spurious Emissions

Test parameters

Peak

RBW = 1 MHz

VBW \geq 3 MHz

Sweep = Auto

Detector = Peak

Trace = Max Hold.

Average

RBW = 1 MHz

VBW \geq 3 MHz

Sweep = Auto

Detector = RMS

Power Averaging

Samples, Systems, and Modes

System Number	Description	Samples	System under test	Support equipment
1	EUT	S01+S02	<input checked="" type="checkbox"/>	<input type="checkbox"/>
	Support		<input type="checkbox"/>	<input checked="" type="checkbox"/>

Tested By :

Chris Blair

Date of testing:

16-Sep-19 - 26-Sep-19

Test Result : PASS

Test Equipment

See Appendix C for list of test equipment

Conducted Band Edge, Average Table, 4dBi

Frequency (MHz)	Mode	Tx Paths	Correlated Antenna Gain (dBi)	Tx 1 Bandedge Level (dBm)	Tx 2 Bandedge Level (dBm)	Tx 3 Bandedge Level (dBm)	Tx 4 Bandedge Level (dBm)	Duty Cycle Correction (dB)	Total Tx Bandedge Level (dBm)	Limit (dBm)	Margin (dB)
5180	Non HT20, 6 to 54 Mbps	1	4	-55.1				0.1	-51.0	-41.25	9.80
	Non HT20, 6 to 54 Mbps	2	4	-55.1	-48.9			0.1	-43.9	-41.25	2.66
	Non HT20, 6 to 54 Mbps	3	4	-55.1	-48.9	-49.5		0.1	-41.6	-41.25	0.35
	Non HT20, 6 to 54 Mbps	4	4	-55.1	-52.9	-51.5	-53.1	0.1	-42.9	-41.25	1.64
	Non HT20 Beam Forming, 6 to 54 Mbps	2	7	-55.1	-52.9			0.1	-43.8	-41.25	2.55
	Non HT20 Beam Forming, 6 to 54 Mbps	3	9	-55.1	-56.4	-56.7		0.1	-42.2	-41.25	0.93
	Non HT20 Beam Forming, 6 to 54 Mbps	4	10	-55.1	-58.8	-58.9	-58.0	0.1	-41.3	-41.25	0.07
	HT/VHT20, M0 to M7	1	4	-53.1				0.1	-49.0	-41.25	7.80
	HT/VHT20, M0 to M7	2	4	-53.1	-47.5			0.1	-42.4	-41.25	1.14
	HT/VHT20, M8 to M15	2	4	-53.1	-47.5			0.1	-42.4	-41.25	1.14
	HT/VHT20, M0 to M7	3	4	-53.1	-50.7	-51.7		0.1	-42.9	-41.25	1.65
	HT/VHT20, M8 to M15	3	4	-53.1	-50.7	-51.7		0.1	-42.9	-41.25	1.65
	HT/VHT20, M16 to M23	3	4	-53.1	-50.7	-51.7		0.1	-42.9	-41.25	1.65
	HT/VHT20, M0 to M7	4	4	-53.1	-50.7	-51.7	-51.3	0.1	-41.5	-41.25	0.29
	HT/VHT20, M8 to M15	4	4	-53.1	-50.7	-51.7	-51.3	0.1	-41.5	-41.25	0.29
	HT/VHT20, M16 to M23	4	4	-53.1	-50.7	-51.7	-51.3	0.1	-41.5	-41.25	0.29
	HT/VHT20, M24 to M31	4	4	-53.1	-50.7	-51.7	-51.3	0.1	-41.5	-41.25	0.29
	HT/VHT20 Beam Forming, M0 to M7	2	7	-53.1	-50.7			0.1	-41.7	-41.25	0.42
	HT/VHT20 Beam Forming, M8 to M15	2	4	-53.1	-47.5			0.1	-42.4	-41.25	1.14
	HT/VHT20 Beam Forming, M0 to M7	3	9	-53.1	-57.1	-56.5		0.1	-41.4	-41.25	0.11
	HT/VHT20 Beam Forming, M8 to M15	3	6	-53.1	-55.0	-54.3		0.1	-43.2	-41.25	1.99
	HT/VHT20 Beam Forming, M16 to M23	3	4	-53.1	-50.7	-51.7		0.1	-42.9	-41.25	1.65
	HT/VHT20 Beam Forming, M0 to M7	4	10	-56.4	-61.4	-60.5	-62.3	0.1	-43.4	-41.25	2.17
	HT/VHT20 Beam Forming, M8 to M15	4	7	-53.1	-55.0	-54.3	-55.9	0.1	-41.4	-41.25	0.13
	HT/VHT20 Beam Forming, M16 to M23	4	5	-53.1	-55.0	-54.3	-55.9	0.1	-43.4	-41.25	2.13
	HT/VHT20 Beam Forming, M24 to M31	4	4	-53.1	-50.7	-51.7	-51.3	0.1	-41.5	-41.25	0.29
	HT/VHT20 STBC, M0 to M7	2	4	-53.1	-47.5			0.1	-42.4	-41.25	1.14
	HT/VHT20 STBC, M0 to M7	3	4	-53.1	-50.7	-51.7		0.1	-42.9	-41.25	1.65
	HT/VHT20 STBC, M0 to M7	4	4	-53.1	-50.7	-51.7	-51.3	0.1	-41.5	-41.25	0.29
	HE20, M0 to M9 1ss	1	4	-50.9				0.1	-46.8	-41.25	5.58



	HE20, M0 to M9 1ss	2	4	-50.9	-51.1			0.1	-43.9	-41.25	2.67
	HE20, M0 to M9 2ss	2	4	-50.9	-51.1			0.1	-43.9	-41.25	2.67
	HE20, M0 to M9 1ss	3	4	-50.9	-51.1	-51.1		0.1	-42.2	-41.25	0.94
	HE20, M0 to M9 2ss	3	4	-50.9	-51.1	-51.1		0.1	-42.2	-41.25	0.94
	HE20, M0 to M9 3ss	3	4	-50.9	-51.1	-51.1		0.1	-42.2	-41.25	0.94
	HE20, M0 to M9 1ss	4	4	-50.9	-53.5	-53.9	-53.5	0.1	-42.7	-41.25	1.43
	HE20, M0 to M9 2ss	4	4	-50.9	-53.5	-53.9	-53.5	0.1	-42.7	-41.25	1.43
	HE20, M0 to M9 3ss	4	4	-50.9	-53.5	-53.9	-53.5	0.1	-42.7	-41.25	1.43
	HE20, M0 to M9 4ss	4	4	-50.9	-53.5	-53.9	-53.5	0.1	-42.7	-41.25	1.43
	HE20 Beam Forming, M0 to M9 1ss	2	7	-50.9	-53.5			0.1	-41.9	-41.25	0.68
	HE20 Beam Forming, M0 to M9 2ss	2	4	-50.9	-51.1			0.1	-43.9	-41.25	2.67
	HE20 Beam Forming, M0 to M9 1ss	3	9	-53.6	-60.2	-60.0		0.1	-42.9	-41.25	1.67
	HE20 Beam Forming, M0 to M9 2ss	3	6	-50.9	-53.5	-53.9		0.1	-41.7	-41.25	0.46
	HE20 Beam Forming, M0 to M9 3ss	3	4	-50.9	-51.1	-51.1		0.1	-42.2	-41.25	0.94
	HE20 Beam Forming, M0 to M9 1ss	4	10	-53.6	-60.2	-60.0	-60.8	0.1	-41.4	-41.25	0.14
	HE20 Beam Forming, M0 to M9 2ss	4	7	-50.9	-57.8	-58.0	-58.3	0.1	-41.8	-41.25	0.59
	HE20 Beam Forming, M0 to M9 3ss	4	5	-50.9	-53.5	-53.9	-53.5	0.1	-41.7	-41.25	0.43
	HE20 Beam Forming, M0 to M9 4ss	4	4	-50.9	-53.5	-53.9	-53.5	0.1	-42.7	-41.25	1.43
	HE20 STBC, M0 to M9 2ss	2	4	-50.9	-51.1			0.1	-43.9	-41.25	2.67
	HE20 STBC, M0 to M9 2ss	3	4	-50.9	-51.1	-51.1		0.1	-42.2	-41.25	0.94
	HE20 STBC, M0 to M9 2ss	4	4	-50.9	-53.5	-53.9	-53.5	0.1	-42.7	-41.25	1.43
5190	Non HT40, 6 to 54 Mbps	1	4	-49.3				0.0	-45.3	-41.25	4.00
	Non HT40, 6 to 54 Mbps	2	4	-49.3	-59.7			0.0	-44.9	-41.25	3.62
	Non HT40, 6 to 54 Mbps	3	4	-49.3	-59.7	-58.7		0.0	-44.4	-41.25	3.19
	Non HT40, 6 to 54 Mbps	4	4	-49.3	-59.7	-58.7	-58.9	0.0	-44.1	-41.25	2.81
	HT/VHT40, M0 to M7	1	4	-46.4				0.1	-42.3	-41.25	1.05
	HT/VHT40, M0 to M7	2	4	-46.4	-58.7			0.1	-42.0	-41.25	0.80
	HT/VHT40, M8 to M15	2	4	-46.4	-58.7			0.1	-42.0	-41.25	0.80
	HT/VHT40, M0 to M7	3	4	-46.4	-58.7	-57.2		0.1	-41.7	-41.25	0.47
	HT/VHT40, M8 to M15	3	4	-46.4	-58.7	-57.2		0.1	-41.7	-41.25	0.47
	HT/VHT40, M16 to M23	3	4	-46.4	-58.7	-57.2		0.1	-41.7	-41.25	0.47
	HT/VHT40, M0 to M7	4	4	-46.4	-58.7	-57.2	-58.0	0.1	-41.5	-41.25	0.22
	HT/VHT40, M8 to M15	4	4	-46.4	-58.7	-57.2	-58.0	0.1	-41.5	-41.25	0.22
	HT/VHT40, M16 to M23	4	4	-46.4	-58.7	-57.2	-58.0	0.1	-41.5	-41.25	0.22
	HT/VHT40, M24 to M31	4	4	-46.4	-58.7	-57.2	-58.0	0.1	-41.5	-41.25	0.22
	HT/VHT40 Beam Forming, M0 to M7	2	7	-50.7	-59.3			0.1	-43.0	-41.25	1.79
	HT/VHT40 Beam Forming, M8 to M15	2	4	-46.4	-58.7			0.1	-42.0	-41.25	0.80
	HT/VHT40 Beam Forming, M0 to M7	3	9	-54.7	-61.0	-60.8		0.1	-43.9	-41.25	2.65
	HT/VHT40 Beam Forming, M8 to M15	3	6	-50.7	-59.3	-59.3		0.1	-43.5	-41.25	2.29
	HT/VHT40 Beam Forming, M16 to M23	3	4	-46.4	-58.7	-57.2		0.1	-41.7	-41.25	0.47
	HT/VHT40 Beam Forming, M0 to M7	4	10	-54.7	-61.0	-60.8	-60.7	0.1	-42.2	-41.25	0.96
HT/VHT40 Beam Forming, M8 to M15	4	7	-50.7	-59.3	-59.3	-59.2	0.1	-42.1	-41.25	0.83	



	HT/VHT40 Beam Forming, M16 to M23	4	5	-50.7	-59.3	-59.3	-59.2	0.1	-44.1	-41.25	2.83
	HT/VHT40 Beam Forming, M24 to M31	4	4	-46.4	-58.7	-57.2	-58.0	0.1	-41.5	-41.25	0.22
	HT/VHT40 STBC, M0 to M7	2	4	-46.4	-58.7			0.1	-42.0	-41.25	0.80
	HT/VHT40 STBC, M0 to M7	3	4	-46.4	-58.7	-57.2		0.1	-41.7	-41.25	0.47
	HT/VHT40 STBC, M0 to M7	4	4	-46.4	-58.7	-57.2	-58.0	0.1	-41.5	-41.25	0.22
	HE40, M0 to M9 1ss	1	4	-49.2				0.1	-45.1	-41.25	3.82
	HE40, M0 to M9 1ss	2	4	-49.2	-59.6			0.1	-44.7	-41.25	3.45
	HE40, M0 to M9 2ss	2	4	-49.2	-59.6			0.1	-44.7	-41.25	3.45
	HE40, M0 to M9 1ss	3	4	-49.2	-59.6	-58.8		0.1	-44.3	-41.25	3.03
	HE40, M0 to M9 2ss	3	4	-49.2	-59.6	-58.8		0.1	-44.3	-41.25	3.03
	HE40, M0 to M9 3ss	3	4	-49.2	-59.6	-58.8		0.1	-44.3	-41.25	3.03
	HE40, M0 to M9 1ss	4	4	-49.2	-59.6	-58.8	-59.1	0.1	-43.9	-41.25	2.67
	HE40, M0 to M9 2ss	4	4	-49.2	-59.6	-58.8	-59.1	0.1	-43.9	-41.25	2.67
	HE40, M0 to M9 3ss	4	4	-49.2	-59.6	-58.8	-59.1	0.1	-43.9	-41.25	2.67
	HE40, M0 to M9 4ss	4	4	-49.2	-59.6	-58.8	-59.1	0.1	-43.9	-41.25	2.67
	HE40 Beam Forming, M0 to M9 1ss	2	7	-49.2	-59.6			0.1	-41.7	-41.25	0.45
	HE40 Beam Forming, M0 to M9 2ss	2	4	-49.2	-59.6			0.1	-44.7	-41.25	3.45
	HE40 Beam Forming, M0 to M9 1ss	3	9	-52.9	-60.0	-60.2		0.1	-42.4	-41.25	1.12
	HE40 Beam Forming, M0 to M9 2ss	3	6	-49.2	-59.6	-58.8		0.1	-42.3	-41.25	1.03
	HE40 Beam Forming, M0 to M9 3ss	3	4	-49.2	-59.6	-58.8		0.1	-44.3	-41.25	3.03
	HE40 Beam Forming, M0 to M9 1ss	4	10	-57.4	-61.3	-61.2	-61.3	0.1	-43.8	-41.25	2.54
	HE40 Beam Forming, M0 to M9 2ss	4	7	-52.9	-60.0	-60.2	-60.1	0.1	-43.8	-41.25	2.56
	HE40 Beam Forming, M0 to M9 3ss	4	5	-49.2	-59.6	-58.8	-59.1	0.1	-42.9	-41.25	1.67
	HE40 Beam Forming, M0 to M9 4ss	4	4	-49.2	-59.6	-58.8	-59.1	0.1	-43.9	-41.25	2.67
	HE40 STBC, M0 to M9 2ss	2	4	-49.2	-59.6			0.1	-44.7	-41.25	3.45
	HE40 STBC, M0 to M9 2ss	3	4	-49.2	-59.6	-58.8		0.1	-44.3	-41.25	3.03
	HE40 STBC, M0 to M9 2ss	4	4	-49.2	-59.6	-58.8	-59.1	0.1	-43.9	-41.25	2.67
5210	Non HT80, 6 to 54 Mbps	1	4	-47.0				0.1	-42.9	-41.25	1.70
	Non HT80, 6 to 54 Mbps	2	4	-47.0	-59.3			0.1	-42.7	-41.25	1.45
	Non HT80, 6 to 54 Mbps	3	4	-47.0	-59.3	-57.7		0.1	-42.4	-41.25	1.11
	Non HT80, 6 to 54 Mbps	4	4	-47.0	-59.3	-57.7	-57.3	0.1	-42.0	-41.25	0.77
	VHT80, M0 to M9 1ss	1	4	-47.6				0.2	-43.4	-41.25	2.13
	VHT80, M0 to M9 1ss	2	4	-47.6	-60.4			0.2	-43.2	-41.25	1.90
	VHT80, M0 to M9 2ss	2	4	-47.6	-60.4			0.2	-43.2	-41.25	1.90
	VHT80, M0 to M9 1ss	3	4	-47.6	-60.4	-58.7		0.2	-42.8	-41.25	1.60
	VHT80, M0 to M9 2ss	3	4	-47.6	-60.4	-58.7		0.2	-42.8	-41.25	1.60
	VHT80, M0 to M9 3ss	3	4	-47.6	-60.4	-58.7		0.2	-42.8	-41.25	1.60
	VHT80, M0 to M9 1ss	4	4	-47.6	-60.4	-58.7	-58.5	0.2	-42.5	-41.25	1.29
	VHT80, M0 to M9 2ss	4	4	-47.6	-60.4	-58.7	-58.5	0.2	-42.5	-41.25	1.29
	VHT80, M0 to M9 3ss	4	4	-47.6	-60.4	-58.7	-58.5	0.2	-42.5	-41.25	1.29
	VHT80, M0 to M9 4ss	4	4	-47.6	-60.4	-58.7	-58.5	0.2	-42.5	-41.25	1.29
	VHT80 Beam Forming, M0 to M9 1ss	2	7	-53.4	-61.3			0.2	-45.5	-41.25	4.27

	VHT80 Beam Forming, M0 to M9 2ss	2	4	-47.6	-60.4			0.2	-43.2	-41.25	1.90
	VHT80 Beam Forming, M0 to M9 1ss	3	9	-53.4	-61.3	-61.0		0.2	-42.9	-41.25	1.67
	VHT80 Beam Forming, M0 to M9 2ss	3	6	-53.4	-61.3	-61.0		0.2	-45.9	-41.25	4.67
	VHT80 Beam Forming, M0 to M9 3ss	3	4	-47.6	-60.4	-58.7		0.2	-42.8	-41.25	1.60
	VHT80 Beam Forming, M0 to M9 1ss	4	10	-56.9	-62.2	-62.2	-61.9	0.2	-43.9	-41.25	2.62
	VHT80 Beam Forming, M0 to M9 2ss	4	7	-53.4	-61.3	-61.0	-59.9	0.2	-44.2	-41.25	3.00
	VHT80 Beam Forming, M0 to M9 3ss	4	5	-47.6	-60.4	-58.7	-58.5	0.2	-41.5	-41.25	0.29
	VHT80 Beam Forming, M0 to M9 4ss	4	4	-47.6	-60.4	-58.7	-58.5	0.2	-42.5	-41.25	1.29
	VHT80 STBC, M0 to M9 1ss	2	4	-47.6	-60.4			0.2	-43.2	-41.25	1.90
	VHT80 STBC, M0 to M9 1ss	3	4	-47.6	-60.4	-58.7		0.2	-42.8	-41.25	1.60
	VHT80 STBC, M0 to M9 1ss	4	4	-47.6	-60.4	-58.7	-58.5	0.2	-42.5	-41.25	1.29
	HE80, M0 to M9 1ss	1	4	-47.8				0.3	-43.5	-41.25	2.30
	HE80, M0 to M9 1ss	2	4	-47.8	-60.4			0.3	-43.3	-41.25	2.07
	HE80, M0 to M9 2ss	2	4	-47.8	-60.4			0.3	-43.3	-41.25	2.07
	HE80, M0 to M9 1ss	3	4	-47.8	-60.4	-59.3		0.3	-43.0	-41.25	1.79
	HE80, M0 to M9 2ss	3	4	-47.8	-60.4	-59.3		0.3	-43.0	-41.25	1.79
	HE80, M0 to M9 3ss	3	4	-47.8	-60.4	-59.3		0.3	-43.0	-41.25	1.79
	HE80, M0 to M9 1ss	4	4	-47.8	-60.4	-59.3	-59.0	0.3	-42.8	-41.25	1.50
	HE80, M0 to M9 2ss	4	4	-47.8	-60.4	-59.3	-59.0	0.3	-42.8	-41.25	1.50
	HE80, M0 to M9 3ss	4	4	-47.8	-60.4	-59.3	-59.0	0.3	-42.8	-41.25	1.50
	HE80, M0 to M9 4ss	4	4	-47.8	-60.4	-59.3	-59.0	0.3	-42.8	-41.25	1.50
	HE80 Beam Forming, M0 to M9 1ss	2	7	-53.0	-61.5			0.3	-45.2	-41.25	3.93
	HE80 Beam Forming, M0 to M9 2ss	2	4	-47.8	-60.4			0.3	-43.3	-41.25	2.07
	HE80 Beam Forming, M0 to M9 1ss	3	9	-53.0	-61.5	-60.9		0.3	-42.6	-41.25	1.35
	HE80 Beam Forming, M0 to M9 2ss	3	6	-53.0	-61.5	-60.9		0.3	-45.6	-41.25	4.35
	HE80 Beam Forming, M0 to M9 3ss	3	4	-47.8	-60.4	-59.3		0.3	-43.0	-41.25	1.79
	HE80 Beam Forming, M0 to M9 1ss	4	10	-56.1	-62.2	-62.1	-62.2	0.3	-43.4	-41.25	2.19
	HE80 Beam Forming, M0 to M9 2ss	4	7	-53.0	-61.5	-60.9	-60.6	0.3	-44.1	-41.25	2.81
	HE80 Beam Forming, M0 to M9 3ss	4	5	-47.8	-60.4	-59.3	-59.0	0.3	-41.8	-41.25	0.50
	HE80 Beam Forming, M0 to M9 4ss	4	4	-47.8	-60.4	-59.3	-59.0	0.3	-42.8	-41.25	1.50
	HE80 STBC, M0 to M9 1ss	2	4	-47.8	-60.4			0.3	-43.3	-41.25	2.07
	HE80 STBC, M0 to M9 1ss	3	4	-47.8	-60.4	-59.3		0.3	-43.0	-41.25	1.79
	HE80 STBC, M0 to M9 1ss	4	4	-47.8	-60.4	-59.3	-59.0	0.3	-42.8	-41.25	1.50
	5250	Non HT160, 6 to 54 Mbps	1	4	-50.0				0.0	-46.0	-41.25
Non HT160, 6 to 54 Mbps		2	4	-50.0	-59.8			0.0	-45.5	-41.25	4.27
Non HT160, 6 to 54 Mbps		3	4	-50.0	-59.8	-55.7		0.0	-44.6	-41.25	3.32
Non HT160, 6 to 54 Mbps		4	4	-50.0	-59.8	-55.7	-53.1	0.0	-43.2	-41.25	2.00
VHT160, M0 to M9 1ss		1	4	-48.4				0.4	-44.0	-41.25	2.76
VHT160, M0 to M9 1ss		2	4	-48.4	-60.1			0.4	-43.7	-41.25	2.47
VHT160, M0 to M9 2ss		2	4	-48.4	-60.1			0.4	-43.7	-41.25	2.47
VHT160, M0 to M9 1ss		3	4	-48.4	-60.1	-59.3		0.4	-43.4	-41.25	2.16
VHT160, M0 to M9 2ss		3	4	-48.4	-60.1	-59.3		0.4	-43.4	-41.25	2.16

VHT160, M0 to M9 3ss	3	4	-48.4	-60.1	-59.3		0.4	-43.4	-41.25	2.16
VHT160, M0 to M9 1ss	4	4	-48.4	-60.1	-59.3	-56.8	0.4	-42.9	-41.25	1.64
VHT160, M0 to M9 2ss	4	4	-48.4	-60.1	-59.3	-56.8	0.4	-42.9	-41.25	1.64
VHT160, M0 to M9 3ss	4	4	-48.4	-60.1	-59.3	-56.8	0.4	-42.9	-41.25	1.64
VHT160, M0 to M9 4ss	4	4	-48.4	-60.1	-59.3	-56.8	0.4	-42.9	-41.25	1.64
VHT160 Beam Forming, M0 to M9 1ss	2	7	-52.4	-60.3			0.4	-44.4	-41.25	3.11
VHT160 Beam Forming, M0 to M9 2ss	2	4	-48.4	-60.1			0.4	-43.7	-41.25	2.47
VHT160 Beam Forming, M0 to M9 1ss	3	9	-54.8	-61.6	-62.6		0.4	-44.0	-41.25	2.78
VHT160 Beam Forming, M0 to M9 2ss	3	6	-52.4	-60.3	-60.7		0.4	-44.8	-41.25	3.59
VHT160 Beam Forming, M0 to M9 3ss	3	4	-48.4	-60.1	-59.3		0.4	-43.4	-41.25	2.16
VHT160 Beam Forming, M0 to M9 1ss	4	10	-54.8	-61.6	-62.6	-60.8	0.4	-42.3	-41.25	1.05
VHT160 Beam Forming, M0 to M9 2ss	4	7	-52.4	-60.3	-60.7	-59.4	0.4	-43.2	-41.25	1.97
VHT160 Beam Forming, M0 to M9 3ss	4	5	-52.4	-60.3	-60.7	-59.4	0.4	-45.2	-41.25	3.97
VHT160 Beam Forming, M0 to M9 4ss	4	4	-48.4	-60.1	-59.3	-56.8	0.4	-42.9	-41.25	1.64
VHT160 STBC, M0 to M9 1ss	2	4	-48.4	-60.1			0.4	-43.7	-41.25	2.47
VHT160 STBC, M0 to M9 1ss	3	4	-48.4	-60.1	-59.3		0.4	-43.4	-41.25	2.16
VHT160 STBC, M0 to M9 1ss	4	4	-48.4	-60.1	-59.3	-56.8	0.4	-42.9	-41.25	1.64
HE160, M0 to M9 1ss	1	4	-46.0				0.4	-41.6	-41.25	0.32
HE160, M0 to M9 1ss	2	4	-46.0	-57.8			0.4	-41.3	-41.25	0.04
HE160, M0 to M9 2ss	2	4	-46.0	-57.8			0.4	-41.3	-41.25	0.04
HE160, M0 to M9 1ss	3	4	-50.4	-59.9	-58.7		0.4	-45.0	-41.25	3.71
HE160, M0 to M9 2ss	3	4	-50.4	-59.9	-58.7		0.4	-45.0	-41.25	3.71
HE160, M0 to M9 3ss	3	4	-50.4	-59.9	-58.7		0.4	-45.0	-41.25	3.71
HE160, M0 to M9 1ss	4	4	-50.4	-59.9	-58.7	-56.2	0.4	-44.1	-41.25	2.89
HE160, M0 to M9 2ss	4	4	-50.4	-59.9	-58.7	-56.2	0.4	-44.1	-41.25	2.89
HE160, M0 to M9 3ss	4	4	-50.4	-59.9	-58.7	-56.2	0.4	-44.1	-41.25	2.89
HE160, M0 to M9 4ss	4	4	-50.4	-59.9	-58.7	-56.2	0.4	-44.1	-41.25	2.89
HE160 Beam Forming, M0 to M9 1ss	2	7	-50.4	-59.9			0.4	-42.5	-41.25	1.25
HE160 Beam Forming, M0 to M9 2ss	2	4	-46.0	-57.8			0.4	-41.3	-41.25	0.04
HE160 Beam Forming, M0 to M9 1ss	3	9	-54.9	-61.5	-60.7		0.4	-43.8	-41.25	2.51
HE160 Beam Forming, M0 to M9 2ss	3	6	-50.4	-59.9	-58.7		0.4	-43.0	-41.25	1.71
HE160 Beam Forming, M0 to M9 3ss	3	4	-50.4	-59.9	-58.7		0.4	-45.0	-41.25	3.71
HE160 Beam Forming, M0 to M9 1ss	4	10	-54.9	-61.5	-60.7	-59.1	0.4	-41.8	-41.25	0.52
HE160 Beam Forming, M0 to M9 2ss	4	7	-54.9	-61.5	-60.7	-59.1	0.4	-44.8	-41.25	3.52
HE160 Beam Forming, M0 to M9 3ss	4	5	-50.4	-59.9	-58.7	-56.2	0.4	-43.1	-41.25	1.89
HE160 Beam Forming, M0 to M9 4ss	4	4	-50.4	-59.9	-58.7	-56.2	0.4	-44.1	-41.25	2.89
HE160 STBC, M0 to M9 1ss	2	4	-46.0	-57.8			0.4	-41.3	-41.25	0.04
HE160 STBC, M0 to M9 1ss	3	4	-50.4	-59.9	-58.7		0.4	-45.0	-41.25	3.71
HE160 STBC, M0 to M9 1ss	4	4	-50.4	-59.9	-58.7	-56.2	0.4	-44.1	-41.25	2.89

**Conducted Bandedge Average, 4dBi
5250 MHz, HE160, M0 to M9 1ss**



Antenna A



Antenna B

Conducted Band Edge, Average Table, 5dBi

Frequency (MHz)	Mode	Tx Paths	Correlated Antenna Gain (dBi)	Tx 1 Bandedge Level (dBm)	Tx 2 Bandedge Level (dBm)	Tx 3 Bandedge Level (dBm)	Tx 4 Bandedge Level (dBm)	Duty Cycle Correction (dB)	Total Tx Bandedge Level (dBm)	Limit (dBm)	Margin (dB)
5180	Non HT20, 6 to 54 Mbps	1	5	-55.1				0.1	-50.0	-41.25	8.80
	Non HT20, 6 to 54 Mbps	2	5	-55.1	-48.9			0.1	-42.9	-41.25	1.66
	Non HT20, 6 to 54 Mbps	3	5	-55.1	-52.9	-51.5		0.1	-43.1	-41.25	1.85
	Non HT20, 6 to 54 Mbps	4	5	-55.1	-52.9	-51.5	-53.1	0.1	-41.9	-41.25	0.64
	Non HT20 Beam Forming, 6 to 54 Mbps	2	8	-55.1	-52.9			0.1	-42.8	-41.25	1.55
	Non HT20 Beam Forming, 6 to 54 Mbps	3	10	-55.1	-58.8	-58.9		0.1	-42.4	-41.25	1.14
	Non HT20 Beam Forming, 6 to 54 Mbps	4	11	-57.3	-61.1	-60.8	-61.4	0.1	-42.7	-41.25	1.47
	HT/VHT20, M0 to M7	1	5	-53.1				0.1	-48.0	-41.25	6.80
	HT/VHT20, M0 to M7	2	5	-53.1	-47.5			0.1	-41.4	-41.25	0.14
	HT/VHT20, M8 to M15	2	5	-53.1	-47.5			0.1	-41.4	-41.25	0.14
	HT/VHT20, M0 to M7	3	5	-53.1	-50.7	-51.7		0.1	-41.9	-41.25	0.65
	HT/VHT20, M8 to M15	3	5	-53.1	-50.7	-51.7		0.1	-41.9	-41.25	0.65
	HT/VHT20, M16 to M23	3	5	-53.1	-50.7	-51.7		0.1	-41.9	-41.25	0.65
	HT/VHT20, M0 to M7	4	5	-53.1	-55.0	-54.3	-55.9	0.1	-43.4	-41.25	2.13
	HT/VHT20, M8 to M15	4	5	-53.1	-55.0	-54.3	-55.9	0.1	-43.4	-41.25	2.13
	HT/VHT20, M16 to M23	4	5	-53.1	-55.0	-54.3	-55.9	0.1	-43.4	-41.25	2.13
	HT/VHT20, M24 to M31	4	5	-53.1	-55.0	-54.3	-55.9	0.1	-43.4	-41.25	2.13
	HT/VHT20 Beam Forming, M0 to M7	2	8	-53.1	-55.0			0.1	-42.9	-41.25	1.63
	HT/VHT20 Beam Forming, M8 to M15	2	5	-53.1	-47.5			0.1	-41.4	-41.25	0.14
	HT/VHT20 Beam Forming, M0 to M7	3	10	-53.1	-60.6	-59.4		0.1	-41.5	-41.25	0.30
	HT/VHT20 Beam Forming, M8 to M15	3	7	-53.1	-55.0	-54.3		0.1	-42.2	-41.25	0.99
	HT/VHT20 Beam Forming, M16 to M23	3	5	-53.1	-50.7	-51.7		0.1	-41.9	-41.25	0.65
	HT/VHT20 Beam Forming, M0 to M7	4	11	-56.4	-61.4	-60.5	-62.3	0.1	-42.4	-41.25	1.17
	HT/VHT20 Beam Forming, M8 to M15	4	8	-53.1	-57.1	-56.5	-57.0	0.1	-41.5	-41.25	0.25
	HT/VHT20 Beam Forming, M16 to M23	4	6	-53.1	-55.0	-54.3	-55.9	0.1	-42.4	-41.25	1.13
	HT/VHT20 Beam Forming, M24 to M31	4	5	-53.1	-55.0	-54.3	-55.9	0.1	-43.4	-41.25	2.13
	HT/VHT20 STBC, M0 to M7	2	5	-53.1	-47.5			0.1	-41.4	-41.25	0.14
	HT/VHT20 STBC, M0 to M7	3	5	-53.1	-50.7	-51.7		0.1	-41.9	-41.25	0.65
	HT/VHT20 STBC, M0 to M7	4	5	-53.1	-55.0	-54.3	-55.9	0.1	-43.4	-41.25	2.13
	HE20, M0 to M9 1ss	1	5	-50.9				0.1	-45.8	-41.25	4.58

	HE20, M0 to M9 1ss	2	5	-50.9	-51.1			0.1	-42.9	-41.25	1.67
	HE20, M0 to M9 2ss	2	5	-50.9	-51.1			0.1	-42.9	-41.25	1.67
	HE20, M0 to M9 1ss	3	5	-50.9	-53.5	-53.9		0.1	-42.7	-41.25	1.46
	HE20, M0 to M9 2ss	3	5	-50.9	-53.5	-53.9		0.1	-42.7	-41.25	1.46
	HE20, M0 to M9 3ss	3	5	-50.9	-53.5	-53.9		0.1	-42.7	-41.25	1.46
	HE20, M0 to M9 1ss	4	5	-50.9	-53.5	-53.9	-53.5	0.1	-41.7	-41.25	0.43
	HE20, M0 to M9 2ss	4	5	-50.9	-53.5	-53.9	-53.5	0.1	-41.7	-41.25	0.43
	HE20, M0 to M9 3ss	4	5	-50.9	-53.5	-53.9	-53.5	0.1	-41.7	-41.25	0.43
	HE20, M0 to M9 4ss	4	5	-50.9	-53.5	-53.9	-53.5	0.1	-41.7	-41.25	0.43
	HE20 Beam Forming, M0 to M9 1ss	2	8	-50.9	-55.9			0.1	-41.6	-41.25	0.39
	HE20 Beam Forming, M0 to M9 2ss	2	5	-50.9	-51.1			0.1	-42.9	-41.25	1.67
	HE20 Beam Forming, M0 to M9 1ss	3	10	-53.6	-60.2	-60.0		0.1	-41.9	-41.25	0.67
	HE20 Beam Forming, M0 to M9 2ss	3	7	-50.9	-55.9	-55.8		0.1	-41.7	-41.25	0.43
	HE20 Beam Forming, M0 to M9 3ss	3	5	-50.9	-53.5	-53.9		0.1	-42.7	-41.25	1.46
	HE20 Beam Forming, M0 to M9 1ss	4	11	-58.2	-62.0	-61.2	-62.9	0.1	-43.6	-41.25	2.35
	HE20 Beam Forming, M0 to M9 2ss	4	8	-50.9	-59.3	-59.4	-59.5	0.1	-41.3	-41.25	0.05
	HE20 Beam Forming, M0 to M9 3ss	4	6	-50.9	-55.9	-55.8	-56.1	0.1	-42.0	-41.25	0.70
	HE20 Beam Forming, M0 to M9 4ss	4	5	-50.9	-53.5	-53.9	-53.5	0.1	-41.7	-41.25	0.43
	HE20 STBC, M0 to M9 2ss	2	5	-50.9	-51.1			0.1	-42.9	-41.25	1.67
	HE20 STBC, M0 to M9 2ss	3	5	-50.9	-53.5	-53.9		0.1	-42.7	-41.25	1.46
	HE20 STBC, M0 to M9 2ss	4	5	-50.9	-53.5	-53.9	-53.5	0.1	-41.7	-41.25	0.43
5190	Non HT40, 6 to 54 Mbps	1	5	-49.3				0.0	-44.3	-41.25	3.00
	Non HT40, 6 to 54 Mbps	2	5	-49.3	-59.7			0.0	-43.9	-41.25	2.62
	Non HT40, 6 to 54 Mbps	3	5	-49.3	-59.7	-58.7		0.0	-43.4	-41.25	2.19
	Non HT40, 6 to 54 Mbps	4	5	-49.3	-59.7	-58.7	-58.9	0.0	-43.1	-41.25	1.81
	HT/VHT40, M0 to M7	1	5	-46.4				0.1	-41.3	-41.25	0.05
	HT/VHT40, M0 to M7	2	5	-50.7	-59.3			0.1	-45.0	-41.25	3.79
	HT/VHT40, M8 to M15	2	5	-50.7	-59.3			0.1	-45.0	-41.25	3.79
	HT/VHT40, M0 to M7	3	5	-50.7	-59.3	-59.3		0.1	-44.5	-41.25	3.29
	HT/VHT40, M8 to M15	3	5	-50.7	-59.3	-59.3		0.1	-44.5	-41.25	3.29
	HT/VHT40, M16 to M23	3	5	-50.7	-59.3	-59.3		0.1	-44.5	-41.25	3.29
	HT/VHT40, M0 to M7	4	5	-50.7	-59.3	-59.3	-59.2	0.1	-44.1	-41.25	2.83
	HT/VHT40, M8 to M15	4	5	-50.7	-59.3	-59.3	-59.2	0.1	-44.1	-41.25	2.83
	HT/VHT40, M16 to M23	4	5	-50.7	-59.3	-59.3	-59.2	0.1	-44.1	-41.25	2.83
	HT/VHT40, M24 to M31	4	5	-50.7	-59.3	-59.3	-59.2	0.1	-44.1	-41.25	2.83
	HT/VHT40 Beam Forming, M0 to M7	2	8	-50.7	-59.3			0.1	-42.0	-41.25	0.79
	HT/VHT40 Beam Forming, M8 to M15	2	5	-50.7	-59.3			0.1	-45.0	-41.25	3.79
	HT/VHT40 Beam Forming, M0 to M7	3	10	-54.7	-61.0	-60.8		0.1	-42.9	-41.25	1.65
	HT/VHT40 Beam Forming, M8 to M15	3	7	-50.7	-59.3	-59.3		0.1	-42.5	-41.25	1.29
	HT/VHT40 Beam Forming, M16 to M23	3	5	-50.7	-59.3	-59.3		0.1	-44.5	-41.25	3.29
	HT/VHT40 Beam Forming, M0 to M7	4	11	-58.6	-61.2	-61.9	-61.2	0.1	-43.4	-41.25	2.15
HT/VHT40 Beam Forming, M8 to M15	4	8	-54.7	-61.0	-60.8	-60.7	0.1	-44.2	-41.25	2.96	

	HT/VHT40 Beam Forming, M16 to M23	4	6	-50.7	-59.3	-59.3	-59.2	0.1	-43.1	-41.25	1.83
	HT/VHT40 Beam Forming, M24 to M31	4	5	-50.7	-59.3	-59.3	-59.2	0.1	-44.1	-41.25	2.83
	HT/VHT40 STBC, M0 to M7	2	5	-50.7	-59.3			0.1	-45.0	-41.25	3.79
	HT/VHT40 STBC, M0 to M7	3	5	-50.7	-59.3	-59.3		0.1	-44.5	-41.25	3.29
	HT/VHT40 STBC, M0 to M7	4	5	-50.7	-59.3	-59.3	-59.2	0.1	-44.1	-41.25	2.83
	HE40, M0 to M9 1ss	1	5	-49.2				0.1	-44.1	-41.25	2.82
	HE40, M0 to M9 1ss	2	5	-49.2	-59.6			0.1	-43.7	-41.25	2.45
	HE40, M0 to M9 2ss	2	5	-49.2	-59.6			0.1	-43.7	-41.25	2.45
	HE40, M0 to M9 1ss	3	5	-49.2	-59.6	-58.8		0.1	-43.3	-41.25	2.03
	HE40, M0 to M9 2ss	3	5	-49.2	-59.6	-58.8		0.1	-43.3	-41.25	2.03
	HE40, M0 to M9 3ss	3	5	-49.2	-59.6	-58.8		0.1	-43.3	-41.25	2.03
	HE40, M0 to M9 1ss	4	5	-49.2	-59.6	-58.8	-59.1	0.1	-42.9	-41.25	1.67
	HE40, M0 to M9 2ss	4	5	-49.2	-59.6	-58.8	-59.1	0.1	-42.9	-41.25	1.67
	HE40, M0 to M9 3ss	4	5	-49.2	-59.6	-58.8	-59.1	0.1	-42.9	-41.25	1.67
	HE40, M0 to M9 4ss	4	5	-49.2	-59.6	-58.8	-59.1	0.1	-42.9	-41.25	1.67
	HE40 Beam Forming, M0 to M9 1ss	2	8	-52.9	-60.0			0.1	-44.0	-41.25	2.75
	HE40 Beam Forming, M0 to M9 2ss	2	5	-49.2	-59.6			0.1	-43.7	-41.25	2.45
	HE40 Beam Forming, M0 to M9 1ss	3	10	-52.9	-60.0	-60.2		0.1	-41.4	-41.25	0.12
	HE40 Beam Forming, M0 to M9 2ss	3	7	-49.2	-59.6	-58.8		0.1	-41.3	-41.25	0.03
	HE40 Beam Forming, M0 to M9 3ss	3	5	-49.2	-59.6	-58.8		0.1	-43.3	-41.25	2.03
	HE40 Beam Forming, M0 to M9 1ss	4	11	-57.4	-61.3	-61.2	-61.3	0.1	-42.8	-41.25	1.54
	HE40 Beam Forming, M0 to M9 2ss	4	8	-52.9	-60.0	-60.2	-60.1	0.1	-42.8	-41.25	1.56
	HE40 Beam Forming, M0 to M9 3ss	4	6	-49.2	-59.6	-58.8	-59.1	0.1	-41.9	-41.25	0.67
	HE40 Beam Forming, M0 to M9 4ss	4	5	-49.2	-59.6	-58.8	-59.1	0.1	-42.9	-41.25	1.67
	HE40 STBC, M0 to M9 2ss	2	5	-49.2	-59.6			0.1	-43.7	-41.25	2.45
	HE40 STBC, M0 to M9 2ss	3	5	-49.2	-59.6	-58.8		0.1	-43.3	-41.25	2.03
	HE40 STBC, M0 to M9 2ss	4	5	-49.2	-59.6	-58.8	-59.1	0.1	-42.9	-41.25	1.67
	<hr/>										
5210	Non HT80, 6 to 54 Mbps	1	5	-47.0				0.1	-41.9	-41.25	0.70
	Non HT80, 6 to 54 Mbps	2	5	-47.0	-59.3			0.1	-41.7	-41.25	0.45
	Non HT80, 6 to 54 Mbps	3	5	-47.0	-59.3	-57.7		0.1	-41.4	-41.25	0.11
	Non HT80, 6 to 54 Mbps	4	5	-51.8	-60.6	-59.4	-59.4	0.1	-45.0	-41.25	3.79
	VHT80, M0 to M9 1ss	1	5	-47.6				0.2	-42.4	-41.25	1.13
	VHT80, M0 to M9 1ss	2	5	-47.6	-60.4			0.2	-42.2	-41.25	0.90
	VHT80, M0 to M9 2ss	2	5	-47.6	-60.4			0.2	-42.2	-41.25	0.90
	VHT80, M0 to M9 1ss	3	5	-47.6	-60.4	-58.7		0.2	-41.8	-41.25	0.60
	VHT80, M0 to M9 2ss	3	5	-47.6	-60.4	-58.7		0.2	-41.8	-41.25	0.60
	VHT80, M0 to M9 3ss	3	5	-47.6	-60.4	-58.7		0.2	-41.8	-41.25	0.60
	VHT80, M0 to M9 1ss	4	5	-47.6	-60.4	-58.7	-58.5	0.2	-41.5	-41.25	0.29
	VHT80, M0 to M9 2ss	4	5	-47.6	-60.4	-58.7	-58.5	0.2	-41.5	-41.25	0.29
	VHT80, M0 to M9 3ss	4	5	-47.6	-60.4	-58.7	-58.5	0.2	-41.5	-41.25	0.29
	VHT80, M0 to M9 4ss	4	5	-47.6	-60.4	-58.7	-58.5	0.2	-41.5	-41.25	0.29
	VHT80 Beam Forming, M0 to M9 1ss	2	8	-53.4	-61.3			0.2	-44.5	-41.25	3.27

	VHT80 Beam Forming, M0 to M9 2ss	2	5	-47.6	-60.4			0.2	-42.2	-41.25	0.90
	VHT80 Beam Forming, M0 to M9 1ss	3	10	-53.4	-61.3	-61.0		0.2	-41.9	-41.25	0.67
	VHT80 Beam Forming, M0 to M9 2ss	3	7	-53.4	-61.3	-61.0		0.2	-44.9	-41.25	3.67
	VHT80 Beam Forming, M0 to M9 3ss	3	5	-47.6	-60.4	-58.7		0.2	-41.8	-41.25	0.60
	VHT80 Beam Forming, M0 to M9 1ss	4	11	-56.9	-62.2	-62.2	-61.9	0.2	-42.9	-41.25	1.62
	VHT80 Beam Forming, M0 to M9 2ss	4	8	-53.4	-61.3	-61.0	-59.9	0.2	-43.2	-41.25	2.00
	VHT80 Beam Forming, M0 to M9 3ss	4	6	-53.4	-61.3	-61.0	-59.9	0.2	-45.2	-41.25	4.00
	VHT80 Beam Forming, M0 to M9 4ss	4	5	-47.6	-60.4	-58.7	-58.5	0.2	-41.5	-41.25	0.29
	VHT80 STBC, M0 to M9 1ss	2	5	-47.6	-60.4			0.2	-42.2	-41.25	0.90
	VHT80 STBC, M0 to M9 1ss	3	5	-47.6	-60.4	-58.7		0.2	-41.8	-41.25	0.60
	VHT80 STBC, M0 to M9 1ss	4	5	-47.6	-60.4	-58.7	-58.5	0.2	-41.5	-41.25	0.29
	HE80, M0 to M9 1ss	1	5	-47.8				0.3	-42.5	-41.25	1.30
	HE80, M0 to M9 1ss	2	5	-47.8	-60.4			0.3	-42.3	-41.25	1.07
	HE80, M0 to M9 2ss	2	5	-47.8	-60.4			0.3	-42.3	-41.25	1.07
	HE80, M0 to M9 1ss	3	5	-47.8	-60.4	-59.3		0.3	-42.0	-41.25	0.79
	HE80, M0 to M9 2ss	3	5	-47.8	-60.4	-59.3		0.3	-42.0	-41.25	0.79
	HE80, M0 to M9 3ss	3	5	-47.8	-60.4	-59.3		0.3	-42.0	-41.25	0.79
	HE80, M0 to M9 1ss	4	5	-47.8	-60.4	-59.3	-59.0	0.3	-41.8	-41.25	0.50
	HE80, M0 to M9 2ss	4	5	-47.8	-60.4	-59.3	-59.0	0.3	-41.8	-41.25	0.50
	HE80, M0 to M9 3ss	4	5	-47.8	-60.4	-59.3	-59.0	0.3	-41.8	-41.25	0.50
	HE80, M0 to M9 4ss	4	5	-47.8	-60.4	-59.3	-59.0	0.3	-41.8	-41.25	0.50
	HE80 Beam Forming, M0 to M9 1ss	2	8	-53.0	-61.5			0.3	-44.2	-41.25	2.93
	HE80 Beam Forming, M0 to M9 2ss	2	5	-47.8	-60.4			0.3	-42.3	-41.25	1.07
	HE80 Beam Forming, M0 to M9 1ss	3	10	-53.0	-61.5	-60.9		0.3	-41.6	-41.25	0.35
	HE80 Beam Forming, M0 to M9 2ss	3	7	-53.0	-61.5	-60.9		0.3	-44.6	-41.25	3.35
	HE80 Beam Forming, M0 to M9 3ss	3	5	-47.8	-60.4	-59.3		0.3	-42.0	-41.25	0.79
	HE80 Beam Forming, M0 to M9 1ss	4	11	-56.1	-62.2	-62.1	-62.2	0.3	-42.4	-41.25	1.19
	HE80 Beam Forming, M0 to M9 2ss	4	8	-53.0	-61.5	-60.9	-60.6	0.3	-43.1	-41.25	1.81
	HE80 Beam Forming, M0 to M9 3ss	4	6	-53.0	-61.5	-60.9	-60.6	0.3	-45.1	-41.25	3.81
	HE80 Beam Forming, M0 to M9 4ss	4	5	-47.8	-60.4	-59.3	-59.0	0.3	-41.8	-41.25	0.50
	HE80 STBC, M0 to M9 1ss	2	5	-47.8	-60.4			0.3	-42.3	-41.25	1.07
	HE80 STBC, M0 to M9 1ss	3	5	-47.8	-60.4	-59.3		0.3	-42.0	-41.25	0.79
	HE80 STBC, M0 to M9 1ss	4	5	-47.8	-60.4	-59.3	-59.0	0.3	-41.8	-41.25	0.50
	5250	Non HT160, 6 to 54 Mbps	1	5	-50.0				0.0	-45.0	-41.25
Non HT160, 6 to 54 Mbps		2	5	-50.0	-59.8			0.0	-44.5	-41.25	3.27
Non HT160, 6 to 54 Mbps		3	5	-50.0	-59.8	-55.7		0.0	-43.6	-41.25	2.32
Non HT160, 6 to 54 Mbps		4	5	-50.0	-59.8	-55.7	-53.1	0.0	-42.2	-41.25	1.00
VHT160, M0 to M9 1ss		1	5	-48.4				0.4	-43.0	-41.25	1.76
VHT160, M0 to M9 1ss		2	5	-48.4	-60.1			0.4	-42.7	-41.25	1.47
VHT160, M0 to M9 2ss		2	5	-48.4	-60.1			0.4	-42.7	-41.25	1.47
VHT160, M0 to M9 1ss		3	5	-52.4	-60.3	-60.7		0.4	-45.8	-41.25	4.59
VHT160, M0 to M9 2ss		3	5	-52.4	-60.3	-60.7		0.4	-45.8	-41.25	4.59

VHT160, M0 to M9 3ss	3	5	-52.4	-60.3	-60.7		0.4	-45.8	-41.25	4.59
VHT160, M0 to M9 1ss	4	5	-52.4	-60.3	-60.7	-59.4	0.4	-45.2	-41.25	3.97
VHT160, M0 to M9 2ss	4	5	-52.4	-60.3	-60.7	-59.4	0.4	-45.2	-41.25	3.97
VHT160, M0 to M9 3ss	4	5	-52.4	-60.3	-60.7	-59.4	0.4	-45.2	-41.25	3.97
VHT160, M0 to M9 4ss	4	5	-52.4	-60.3	-60.7	-59.4	0.4	-45.2	-41.25	3.97
VHT160 Beam Forming, M0 to M9 1ss	2	8	-52.4	-60.3			0.4	-43.4	-41.25	2.11
VHT160 Beam Forming, M0 to M9 2ss	2	5	-48.4	-60.1			0.4	-42.7	-41.25	1.47
VHT160 Beam Forming, M0 to M9 1ss	3	10	-54.8	-61.6	-62.6		0.4	-43.0	-41.25	1.78
VHT160 Beam Forming, M0 to M9 2ss	3	7	-52.4	-60.3	-60.7		0.4	-43.8	-41.25	2.59
VHT160 Beam Forming, M0 to M9 3ss	3	5	-52.4	-60.3	-60.7		0.4	-45.8	-41.25	4.59
VHT160 Beam Forming, M0 to M9 1ss	4	11	-59.3	-63.6	-63.4	-62.9	0.4	-44.5	-41.25	3.24
VHT160 Beam Forming, M0 to M9 2ss	4	8	-52.4	-60.3	-60.7	-59.4	0.4	-42.2	-41.25	0.97
VHT160 Beam Forming, M0 to M9 3ss	4	6	-52.4	-60.3	-60.7	-59.4	0.4	-44.2	-41.25	2.97
VHT160 Beam Forming, M0 to M9 4ss	4	5	-52.4	-60.3	-60.7	-59.4	0.4	-45.2	-41.25	3.97
VHT160 STBC, M0 to M9 1ss	2	5	-48.4	-60.1			0.4	-42.7	-41.25	1.47
VHT160 STBC, M0 to M9 1ss	3	5	-52.4	-60.3	-60.7		0.4	-45.8	-41.25	4.59
VHT160 STBC, M0 to M9 1ss	4	5	-52.4	-60.3	-60.7	-59.4	0.4	-45.2	-41.25	3.97
HE160, M0 to M9 1ss	1	5	-50.4				0.4	-45.0	-41.25	3.72
HE160, M0 to M9 1ss	2	5	-50.4	-59.9			0.4	-44.5	-41.25	3.25
HE160, M0 to M9 2ss	2	5	-50.4	-59.9			0.4	-44.5	-41.25	3.25
HE160, M0 to M9 1ss	3	5	-50.4	-59.9	-58.7		0.4	-44.0	-41.25	2.71
HE160, M0 to M9 2ss	3	5	-50.4	-59.9	-58.7		0.4	-44.0	-41.25	2.71
HE160, M0 to M9 3ss	3	5	-50.4	-59.9	-58.7		0.4	-44.0	-41.25	2.71
HE160, M0 to M9 1ss	4	5	-50.4	-59.9	-58.7	-56.2	0.4	-43.1	-41.25	1.89
HE160, M0 to M9 2ss	4	5	-50.4	-59.9	-58.7	-56.2	0.4	-43.1	-41.25	1.89
HE160, M0 to M9 3ss	4	5	-50.4	-59.9	-58.7	-56.2	0.4	-43.1	-41.25	1.89
HE160, M0 to M9 4ss	4	5	-50.4	-59.9	-58.7	-56.2	0.4	-43.1	-41.25	1.89
HE160 Beam Forming, M0 to M9 1ss	2	8	-50.4	-59.9			0.4	-41.5	-41.25	0.25
HE160 Beam Forming, M0 to M9 2ss	2	5	-50.4	-59.9			0.4	-44.5	-41.25	3.25
HE160 Beam Forming, M0 to M9 1ss	3	10	-54.9	-61.5	-60.7		0.4	-42.8	-41.25	1.51
HE160 Beam Forming, M0 to M9 2ss	3	7	-50.4	-59.9	-58.7		0.4	-42.0	-41.25	0.71
HE160 Beam Forming, M0 to M9 3ss	3	5	-50.4	-59.9	-58.7		0.4	-44.0	-41.25	2.71
HE160 Beam Forming, M0 to M9 1ss	4	11	-58.0	-62.2	-62.2	-60.9	0.4	-43.0	-41.25	1.75
HE160 Beam Forming, M0 to M9 2ss	4	8	-54.9	-61.5	-60.7	-59.1	0.4	-43.8	-41.25	2.52
HE160 Beam Forming, M0 to M9 3ss	4	6	-50.4	-59.9	-58.7	-56.2	0.4	-42.1	-41.25	0.89
HE160 Beam Forming, M0 to M9 4ss	4	5	-50.4	-59.9	-58.7	-56.2	0.4	-43.1	-41.25	1.89
HE160 STBC, M0 to M9 1ss	2	5	-50.4	-59.9			0.4	-44.5	-41.25	3.25
HE160 STBC, M0 to M9 1ss	3	5	-50.4	-59.9	-58.7		0.4	-44.0	-41.25	2.71
HE160 STBC, M0 to M9 1ss	4	5	-50.4	-59.9	-58.7	-56.2	0.4	-43.1	-41.25	1.89

**Conducted Bandedge Average, 5dBi
5190 MHz, HE40 Beam Forming, M0 to M9 2ss**



Antenna A



Antenna B



Antenna C

Conducted Band Edge, Average Table, 6dBi

Frequency (MHz)	Mode	Tx Paths	Correlated Antenna Gain (dBi)	Tx 1 Bandedge Level (dBm)	Tx 2 Bandedge Level (dBm)	Tx 3 Bandedge Level (dBm)	Tx 4 Bandedge Level (dBm)	Duty Cycle Correction (dB)	Total Tx Bandedge Level (dBm)	Limit (dBm)	Margin (dB)
5180	Non HT20, 6 to 54 Mbps	1	6	-55.1				0.1	-49.0	-41.25	7.80
	Non HT20, 6 to 54 Mbps	2	6	-55.1	-48.9			0.1	-41.9	-41.25	0.66
	Non HT20, 6 to 54 Mbps	3	6	-55.1	-52.9	-51.5		0.1	-42.1	-41.25	0.85
	Non HT20, 6 to 54 Mbps	4	6	-55.1	-54.9	-55.2	-55.8	0.1	-43.2	-41.25	1.91
	Non HT20 Beam Forming, 6 to 54 Mbps	2	9	-55.1	-52.9			0.1	-41.8	-41.25	0.55
	Non HT20 Beam Forming, 6 to 54 Mbps	3	11	-55.1	-58.8	-58.9		0.1	-41.4	-41.25	0.14
	Non HT20 Beam Forming, 6 to 54 Mbps	4	12	-57.3	-61.1	-60.8	-61.4	0.1	-41.7	-41.25	0.47
	HT/VHT20, M0 to M7	1	6	-53.1				0.1	-47.0	-41.25	5.80
	HT/VHT20, M0 to M7	2	6	-53.1	-50.7			0.1	-42.7	-41.25	1.42
	HT/VHT20, M8 to M15	2	6	-53.1	-50.7			0.1	-42.7	-41.25	1.42
	HT/VHT20, M0 to M7	3	6	-53.1	-55.0	-54.3		0.1	-43.2	-41.25	1.99
	HT/VHT20, M8 to M15	3	6	-53.1	-55.0	-54.3		0.1	-43.2	-41.25	1.99
	HT/VHT20, M16 to M23	3	6	-53.1	-55.0	-54.3		0.1	-43.2	-41.25	1.99
	HT/VHT20, M0 to M7	4	6	-53.1	-55.0	-54.3	-55.9	0.1	-42.4	-41.25	1.13
	HT/VHT20, M8 to M15	4	6	-53.1	-55.0	-54.3	-55.9	0.1	-42.4	-41.25	1.13
	HT/VHT20, M16 to M23	4	6	-53.1	-55.0	-54.3	-55.9	0.1	-42.4	-41.25	1.13
	HT/VHT20, M24 to M31	4	6	-53.1	-55.0	-54.3	-55.9	0.1	-42.4	-41.25	1.13
	HT/VHT20 Beam Forming, M0 to M7	2	9	-53.1	-55.0			0.1	-41.9	-41.25	0.63
	HT/VHT20 Beam Forming, M8 to M15	2	6	-53.1	-50.7			0.1	-42.7	-41.25	1.42
	HT/VHT20 Beam Forming, M0 to M7	3	11	-56.4	-61.4	-60.5		0.1	-43.0	-41.25	1.78
	HT/VHT20 Beam Forming, M8 to M15	3	8	-53.1	-57.1	-56.5		0.1	-42.4	-41.25	1.11
	HT/VHT20 Beam Forming, M16 to M23	3	6	-53.1	-55.0	-54.3		0.1	-43.2	-41.25	1.99
	HT/VHT20 Beam Forming, M0 to M7	4	12	-56.4	-61.4	-60.5	-62.3	0.1	-41.4	-41.25	0.17
	HT/VHT20 Beam Forming, M8 to M15	4	9	-53.1	-58.6	-59.3	-58.5	0.1	-41.5	-41.25	0.22
	HT/VHT20 Beam Forming, M16 to M23	4	7	-53.1	-55.0	-54.3	-55.9	0.1	-41.4	-41.25	0.13
	HT/VHT20 Beam Forming, M24 to M31	4	6	-53.1	-55.0	-54.3	-55.9	0.1	-42.4	-41.25	1.13
	HT/VHT20 STBC, M0 to M7	2	6	-53.1	-50.7			0.1	-42.7	-41.25	1.42
	HT/VHT20 STBC, M0 to M7	3	6	-53.1	-55.0	-54.3		0.1	-43.2	-41.25	1.99
	HT/VHT20 STBC, M0 to M7	4	6	-53.1	-55.0	-54.3	-55.9	0.1	-42.4	-41.25	1.13
	HE20, M0 to M9 1ss	1	6	-50.9				0.1	-44.8	-41.25	3.58



	HE20, M0 to M9 1ss	2	6	-50.9	-51.1			0.1	-41.9	-41.25	0.67
	HE20, M0 to M9 2ss	2	6	-50.9	-51.1			0.1	-41.9	-41.25	0.67
	HE20, M0 to M9 1ss	3	6	-50.9	-53.5	-53.9		0.1	-41.7	-41.25	0.46
	HE20, M0 to M9 2ss	3	6	-50.9	-53.5	-53.9		0.1	-41.7	-41.25	0.46
	HE20, M0 to M9 3ss	3	6	-50.9	-53.5	-53.9		0.1	-41.7	-41.25	0.46
	HE20, M0 to M9 1ss	4	6	-50.9	-55.9	-55.8	-56.1	0.1	-42.0	-41.25	0.70
	HE20, M0 to M9 2ss	4	6	-50.9	-55.9	-55.8	-56.1	0.1	-42.0	-41.25	0.70
	HE20, M0 to M9 3ss	4	6	-50.9	-55.9	-55.8	-56.1	0.1	-42.0	-41.25	0.70
	HE20, M0 to M9 4ss	4	6	-50.9	-55.9	-55.8	-56.1	0.1	-42.0	-41.25	0.70
	HE20 Beam Forming, M0 to M9 1ss	2	9	-53.6	-60.2			0.1	-43.7	-41.25	2.42
	HE20 Beam Forming, M0 to M9 2ss	2	6	-50.9	-51.1			0.1	-41.9	-41.25	0.67
	HE20 Beam Forming, M0 to M9 1ss	3	11	-58.2	-62.0	-61.2		0.1	-44.3	-41.25	3.05
	HE20 Beam Forming, M0 to M9 2ss	3	8	-50.9	-57.8	-58.0		0.1	-41.4	-41.25	0.12
	HE20 Beam Forming, M0 to M9 3ss	3	6	-50.9	-53.5	-53.9		0.1	-41.7	-41.25	0.46
	HE20 Beam Forming, M0 to M9 1ss	4	12	-58.2	-62.0	-61.2	-62.9	0.1	-42.6	-41.25	1.35
	HE20 Beam Forming, M0 to M9 2ss	4	9	-53.6	-60.2	-60.0	-60.8	0.1	-42.4	-41.25	1.14
	HE20 Beam Forming, M0 to M9 3ss	4	7	-50.9	-57.8	-58.0	-58.3	0.1	-41.8	-41.25	0.59
	HE20 Beam Forming, M0 to M9 4ss	4	6	-50.9	-55.9	-55.8	-56.1	0.1	-42.0	-41.25	0.70
	HE20 STBC, M0 to M9 2ss	2	6	-50.9	-51.1			0.1	-41.9	-41.25	0.67
	HE20 STBC, M0 to M9 2ss	3	6	-50.9	-53.5	-53.9		0.1	-41.7	-41.25	0.46
	HE20 STBC, M0 to M9 2ss	4	6	-50.9	-55.9	-55.8	-56.1	0.1	-42.0	-41.25	0.70
5190	Non HT40, 6 to 54 Mbps	1	6	-49.3				0.0	-43.3	-41.25	2.00
	Non HT40, 6 to 54 Mbps	2	6	-49.3	-59.7			0.0	-42.9	-41.25	1.62
	Non HT40, 6 to 54 Mbps	3	6	-49.3	-59.7	-58.7		0.0	-42.4	-41.25	1.19
	Non HT40, 6 to 54 Mbps	4	6	-49.3	-59.7	-58.7	-58.9	0.0	-42.1	-41.25	0.81
	HT/VHT40, M0 to M7	1	6	-50.7				0.1	-44.6	-41.25	3.35
	HT/VHT40, M0 to M7	2	6	-50.7	-59.3			0.1	-44.0	-41.25	2.79
	HT/VHT40, M8 to M15	2	6	-50.7	-59.3			0.1	-44.0	-41.25	2.79
	HT/VHT40, M0 to M7	3	6	-50.7	-59.3	-59.3		0.1	-43.5	-41.25	2.29
	HT/VHT40, M8 to M15	3	6	-50.7	-59.3	-59.3		0.1	-43.5	-41.25	2.29
	HT/VHT40, M16 to M23	3	6	-50.7	-59.3	-59.3		0.1	-43.5	-41.25	2.29
	HT/VHT40, M0 to M7	4	6	-50.7	-59.3	-59.3	-59.2	0.1	-43.1	-41.25	1.83
	HT/VHT40, M8 to M15	4	6	-50.7	-59.3	-59.3	-59.2	0.1	-43.1	-41.25	1.83
	HT/VHT40, M16 to M23	4	6	-50.7	-59.3	-59.3	-59.2	0.1	-43.1	-41.25	1.83
	HT/VHT40, M24 to M31	4	6	-50.7	-59.3	-59.3	-59.2	0.1	-43.1	-41.25	1.83
	HT/VHT40 Beam Forming, M0 to M7	2	9	-54.7	-61.0			0.1	-44.7	-41.25	3.43
	HT/VHT40 Beam Forming, M8 to M15	2	6	-50.7	-59.3			0.1	-44.0	-41.25	2.79
	HT/VHT40 Beam Forming, M0 to M7	3	11	-54.7	-61.0	-60.8		0.1	-41.9	-41.25	0.65
	HT/VHT40 Beam Forming, M8 to M15	3	8	-50.7	-59.3	-59.3		0.1	-41.5	-41.25	0.29
	HT/VHT40 Beam Forming, M16 to M23	3	6	-50.7	-59.3	-59.3		0.1	-43.5	-41.25	2.29
	HT/VHT40 Beam Forming, M0 to M7	4	12	-58.6	-61.2	-61.9	-61.2	0.1	-42.4	-41.25	1.15
HT/VHT40 Beam Forming, M8 to M15	4	9	-54.7	-61.0	-60.8	-60.7	0.1	-43.2	-41.25	1.96	



	HT/VHT40 Beam Forming, M16 to M23	4	7	-50.7	-59.3	-59.3	-59.2	0.1	-42.1	-41.25	0.83
	HT/VHT40 Beam Forming, M24 to M31	4	6	-50.7	-59.3	-59.3	-59.2	0.1	-43.1	-41.25	1.83
	HT/VHT40 STBC, M0 to M7	2	6	-50.7	-59.3			0.1	-44.0	-41.25	2.79
	HT/VHT40 STBC, M0 to M7	3	6	-50.7	-59.3	-59.3		0.1	-43.5	-41.25	2.29
	HT/VHT40 STBC, M0 to M7	4	6	-50.7	-59.3	-59.3	-59.2	0.1	-43.1	-41.25	1.83
	HE40, M0 to M9 1ss	1	6	-49.2				0.1	-43.1	-41.25	1.82
	HE40, M0 to M9 1ss	2	6	-49.2	-59.6			0.1	-42.7	-41.25	1.45
	HE40, M0 to M9 2ss	2	6	-49.2	-59.6			0.1	-42.7	-41.25	1.45
	HE40, M0 to M9 1ss	3	6	-49.2	-59.6	-58.8		0.1	-42.3	-41.25	1.03
	HE40, M0 to M9 2ss	3	6	-49.2	-59.6	-58.8		0.1	-42.3	-41.25	1.03
	HE40, M0 to M9 3ss	3	6	-49.2	-59.6	-58.8		0.1	-42.3	-41.25	1.03
	HE40, M0 to M9 1ss	4	6	-49.2	-59.6	-58.8	-59.1	0.1	-41.9	-41.25	0.67
	HE40, M0 to M9 2ss	4	6	-49.2	-59.6	-58.8	-59.1	0.1	-41.9	-41.25	0.67
	HE40, M0 to M9 3ss	4	6	-49.2	-59.6	-58.8	-59.1	0.1	-41.9	-41.25	0.67
	HE40, M0 to M9 4ss	4	6	-49.2	-59.6	-58.8	-59.1	0.1	-41.9	-41.25	0.67
	HE40 Beam Forming, M0 to M9 1ss	2	9	-52.9	-60.0			0.1	-43.0	-41.25	1.75
	HE40 Beam Forming, M0 to M9 2ss	2	6	-49.2	-59.6			0.1	-42.7	-41.25	1.45
	HE40 Beam Forming, M0 to M9 1ss	3	11	-57.4	-61.3	-61.2		0.1	-43.7	-41.25	2.41
	HE40 Beam Forming, M0 to M9 2ss	3	8	-52.9	-60.0	-60.2		0.1	-43.4	-41.25	2.12
	HE40 Beam Forming, M0 to M9 3ss	3	6	-49.2	-59.6	-58.8		0.1	-42.3	-41.25	1.03
	HE40 Beam Forming, M0 to M9 1ss	4	12	-57.4	-61.3	-61.2	-61.3	0.1	-41.8	-41.25	0.54
	HE40 Beam Forming, M0 to M9 2ss	4	9	-52.9	-60.0	-60.2	-60.1	0.1	-41.8	-41.25	0.56
	HE40 Beam Forming, M0 to M9 3ss	4	7	-52.9	-60.0	-60.2	-60.1	0.1	-43.8	-41.25	2.56
	HE40 Beam Forming, M0 to M9 4ss	4	6	-49.2	-59.6	-58.8	-59.1	0.1	-41.9	-41.25	0.67
	HE40 STBC, M0 to M9 2ss	2	6	-49.2	-59.6			0.1	-42.7	-41.25	1.45
	HE40 STBC, M0 to M9 2ss	3	6	-49.2	-59.6	-58.8		0.1	-42.3	-41.25	1.03
	HE40 STBC, M0 to M9 2ss	4	6	-49.2	-59.6	-58.8	-59.1	0.1	-41.9	-41.25	0.67
5210	Non HT80, 6 to 54 Mbps	1	6	-51.8				0.1	-45.7	-41.25	4.50
	Non HT80, 6 to 54 Mbps	2	6	-51.8	-60.6			0.1	-45.2	-41.25	3.96
	Non HT80, 6 to 54 Mbps	3	6	-51.8	-60.6	-59.4		0.1	-44.6	-41.25	3.34
	Non HT80, 6 to 54 Mbps	4	6	-51.8	-60.6	-59.4	-59.4	0.1	-44.0	-41.25	2.79
	VHT80, M0 to M9 1ss	1	6	-47.6				0.2	-41.4	-41.25	0.13
	VHT80, M0 to M9 1ss	2	6	-53.4	-61.3			0.2	-46.5	-41.25	5.27
	VHT80, M0 to M9 2ss	2	6	-53.4	-61.3			0.2	-46.5	-41.25	5.27
	VHT80, M0 to M9 1ss	3	6	-53.4	-61.3	-61.0		0.2	-45.9	-41.25	4.67
	VHT80, M0 to M9 2ss	3	6	-53.4	-61.3	-61.0		0.2	-45.9	-41.25	4.67
	VHT80, M0 to M9 3ss	3	6	-53.4	-61.3	-61.0		0.2	-45.9	-41.25	4.67
	VHT80, M0 to M9 1ss	4	6	-53.4	-61.3	-61.0	-59.9	0.2	-45.2	-41.25	4.00
	VHT80, M0 to M9 2ss	4	6	-53.4	-61.3	-61.0	-59.9	0.2	-45.2	-41.25	4.00
	VHT80, M0 to M9 3ss	4	6	-53.4	-61.3	-61.0	-59.9	0.2	-45.2	-41.25	4.00
	VHT80, M0 to M9 4ss	4	6	-53.4	-61.3	-61.0	-59.9	0.2	-45.2	-41.25	4.00
	VHT80 Beam Forming, M0 to M9 1ss	2	9	-53.4	-61.3			0.2	-43.5	-41.25	2.27

	VHT80 Beam Forming, M0 to M9 2ss	2	6	-53.4	-61.3			0.2	-46.5	-41.25	5.27
	VHT80 Beam Forming, M0 to M9 1ss	3	11	-56.9	-62.2	-62.2		0.2	-43.7	-41.25	2.41
	VHT80 Beam Forming, M0 to M9 2ss	3	8	-53.4	-61.3	-61.0		0.2	-43.9	-41.25	2.67
	VHT80 Beam Forming, M0 to M9 3ss	3	6	-53.4	-61.3	-61.0		0.2	-45.9	-41.25	4.67
	VHT80 Beam Forming, M0 to M9 1ss	4	12	-56.9	-62.2	-62.2	-61.9	0.2	-41.9	-41.25	0.62
	VHT80 Beam Forming, M0 to M9 2ss	4	9	-53.4	-61.3	-61.0	-59.9	0.2	-42.2	-41.25	1.00
	VHT80 Beam Forming, M0 to M9 3ss	4	7	-53.4	-61.3	-61.0	-59.9	0.2	-44.2	-41.25	3.00
	VHT80 Beam Forming, M0 to M9 4ss	4	6	-53.4	-61.3	-61.0	-59.9	0.2	-45.2	-41.25	4.00
	VHT80 STBC, M0 to M9 1ss	2	6	-53.4	-61.3			0.2	-46.5	-41.25	5.27
	VHT80 STBC, M0 to M9 1ss	3	6	-53.4	-61.3	-61.0		0.2	-45.9	-41.25	4.67
	VHT80 STBC, M0 to M9 1ss	4	6	-53.4	-61.3	-61.0	-59.9	0.2	-45.2	-41.25	4.00
	HE80, M0 to M9 1ss	1	6	-47.8				0.3	-41.5	-41.25	0.30
	HE80, M0 to M9 1ss	2	6	-47.8	-60.4			0.3	-41.3	-41.25	0.07
	HE80, M0 to M9 2ss	2	6	-47.8	-60.4			0.3	-41.3	-41.25	0.07
	HE80, M0 to M9 1ss	3	6	-53.0	-61.5	-60.9		0.3	-45.6	-41.25	4.35
	HE80, M0 to M9 2ss	3	6	-53.0	-61.5	-60.9		0.3	-45.6	-41.25	4.35
	HE80, M0 to M9 3ss	3	6	-53.0	-61.5	-60.9		0.3	-45.6	-41.25	4.35
	HE80, M0 to M9 1ss	4	6	-53.0	-61.5	-60.9	-60.6	0.3	-45.1	-41.25	3.81
	HE80, M0 to M9 2ss	4	6	-53.0	-61.5	-60.9	-60.6	0.3	-45.1	-41.25	3.81
	HE80, M0 to M9 3ss	4	6	-53.0	-61.5	-60.9	-60.6	0.3	-45.1	-41.25	3.81
	HE80, M0 to M9 4ss	4	6	-53.0	-61.5	-60.9	-60.6	0.3	-45.1	-41.25	3.81
	HE80 Beam Forming, M0 to M9 1ss	2	9	-53.0	-61.5			0.3	-43.2	-41.25	1.93
	HE80 Beam Forming, M0 to M9 2ss	2	6	-47.8	-60.4			0.3	-41.3	-41.25	0.07
	HE80 Beam Forming, M0 to M9 1ss	3	11	-56.1	-62.2	-62.1		0.3	-43.1	-41.25	1.85
	HE80 Beam Forming, M0 to M9 2ss	3	8	-53.0	-61.5	-60.9		0.3	-43.6	-41.25	2.35
	HE80 Beam Forming, M0 to M9 3ss	3	6	-53.0	-61.5	-60.9		0.3	-45.6	-41.25	4.35
	HE80 Beam Forming, M0 to M9 1ss	4	12	-56.1	-62.2	-62.1	-62.2	0.3	-41.4	-41.25	0.19
	HE80 Beam Forming, M0 to M9 2ss	4	9	-53.0	-61.5	-60.9	-60.6	0.3	-42.1	-41.25	0.81
	HE80 Beam Forming, M0 to M9 3ss	4	7	-53.0	-61.5	-60.9	-60.6	0.3	-44.1	-41.25	2.81
	HE80 Beam Forming, M0 to M9 4ss	4	6	-53.0	-61.5	-60.9	-60.6	0.3	-45.1	-41.25	3.81
	HE80 STBC, M0 to M9 1ss	2	6	-47.8	-60.4			0.3	-41.3	-41.25	0.07
	HE80 STBC, M0 to M9 1ss	3	6	-53.0	-61.5	-60.9		0.3	-45.6	-41.25	4.35
	HE80 STBC, M0 to M9 1ss	4	6	-53.0	-61.5	-60.9	-60.6	0.3	-45.1	-41.25	3.81
5250	Non HT160, 6 to 54 Mbps	1	6	-50.0				0.0	-44.0	-41.25	2.70
	Non HT160, 6 to 54 Mbps	2	6	-50.0	-59.8			0.0	-43.5	-41.25	2.27
	Non HT160, 6 to 54 Mbps	3	6	-50.0	-59.8	-55.7		0.0	-42.6	-41.25	1.32
	Non HT160, 6 to 54 Mbps	4	6	-53.6	-61.8	-57.7	-55.6	0.0	-44.2	-41.25	2.93
	VHT160, M0 to M9 1ss	1	6	-52.4				0.4	-46.0	-41.25	4.76
	VHT160, M0 to M9 1ss	2	6	-52.4	-60.3			0.4	-45.4	-41.25	4.11
	VHT160, M0 to M9 2ss	2	6	-52.4	-60.3			0.4	-45.4	-41.25	4.11
	VHT160, M0 to M9 1ss	3	6	-52.4	-60.3	-60.7		0.4	-44.8	-41.25	3.59
	VHT160, M0 to M9 2ss	3	6	-52.4	-60.3	-60.7		0.4	-44.8	-41.25	3.59

VHT160, M0 to M9 3ss	3	6	-52.4	-60.3	-60.7		0.4	-44.8	-41.25	3.59
VHT160, M0 to M9 1ss	4	6	-52.4	-60.3	-60.7	-59.4	0.4	-44.2	-41.25	2.97
VHT160, M0 to M9 2ss	4	6	-52.4	-60.3	-60.7	-59.4	0.4	-44.2	-41.25	2.97
VHT160, M0 to M9 3ss	4	6	-52.4	-60.3	-60.7	-59.4	0.4	-44.2	-41.25	2.97
VHT160, M0 to M9 4ss	4	6	-52.4	-60.3	-60.7	-59.4	0.4	-44.2	-41.25	2.97
VHT160 Beam Forming, M0 to M9 1ss	2	9	-54.8	-61.6			0.4	-44.6	-41.25	3.33
VHT160 Beam Forming, M0 to M9 2ss	2	6	-52.4	-60.3			0.4	-45.4	-41.25	4.11
VHT160 Beam Forming, M0 to M9 1ss	3	11	-59.3	-63.6	-63.4		0.4	-45.5	-41.25	4.20
VHT160 Beam Forming, M0 to M9 2ss	3	8	-52.4	-60.3	-60.7		0.4	-42.8	-41.25	1.59
VHT160 Beam Forming, M0 to M9 3ss	3	6	-52.4	-60.3	-60.7		0.4	-44.8	-41.25	3.59
VHT160 Beam Forming, M0 to M9 1ss	4	12	-59.3	-63.6	-63.4	-62.9	0.4	-43.5	-41.25	2.24
VHT160 Beam Forming, M0 to M9 2ss	4	9	-54.8	-61.6	-62.6	-60.8	0.4	-43.3	-41.25	2.05
VHT160 Beam Forming, M0 to M9 3ss	4	7	-52.4	-60.3	-60.7	-59.4	0.4	-43.2	-41.25	1.97
VHT160 Beam Forming, M0 to M9 4ss	4	6	-52.4	-60.3	-60.7	-59.4	0.4	-44.2	-41.25	2.97
VHT160 STBC, M0 to M9 1ss	2	6	-52.4	-60.3			0.4	-45.4	-41.25	4.11
VHT160 STBC, M0 to M9 1ss	3	6	-52.4	-60.3	-60.7		0.4	-44.8	-41.25	3.59
VHT160 STBC, M0 to M9 1ss	4	6	-52.4	-60.3	-60.7	-59.4	0.4	-44.2	-41.25	2.97
HE160, M0 to M9 1ss	1	6	-50.4				0.4	-44.0	-41.25	2.72
HE160, M0 to M9 1ss	2	6	-50.4	-59.9			0.4	-43.5	-41.25	2.25
HE160, M0 to M9 2ss	2	6	-50.4	-59.9			0.4	-43.5	-41.25	2.25
HE160, M0 to M9 1ss	3	6	-50.4	-59.9	-58.7		0.4	-43.0	-41.25	1.71
HE160, M0 to M9 2ss	3	6	-50.4	-59.9	-58.7		0.4	-43.0	-41.25	1.71
HE160, M0 to M9 3ss	3	6	-50.4	-59.9	-58.7		0.4	-43.0	-41.25	1.71
HE160, M0 to M9 1ss	4	6	-50.4	-59.9	-58.7	-56.2	0.4	-42.1	-41.25	0.89
HE160, M0 to M9 2ss	4	6	-50.4	-59.9	-58.7	-56.2	0.4	-42.1	-41.25	0.89
HE160, M0 to M9 3ss	4	6	-50.4	-59.9	-58.7	-56.2	0.4	-42.1	-41.25	0.89
HE160, M0 to M9 4ss	4	6	-50.4	-59.9	-58.7	-56.2	0.4	-42.1	-41.25	0.89
HE160 Beam Forming, M0 to M9 1ss	2	9	-54.9	-61.5			0.4	-44.6	-41.25	3.36
HE160 Beam Forming, M0 to M9 2ss	2	6	-50.4	-59.9			0.4	-43.5	-41.25	2.25
HE160 Beam Forming, M0 to M9 1ss	3	11	-54.9	-61.5	-60.7		0.4	-41.8	-41.25	0.51
HE160 Beam Forming, M0 to M9 2ss	3	8	-54.9	-61.5	-60.7		0.4	-44.8	-41.25	3.51
HE160 Beam Forming, M0 to M9 3ss	3	6	-50.4	-59.9	-58.7		0.4	-43.0	-41.25	1.71
HE160 Beam Forming, M0 to M9 1ss	4	12	-58.0	-62.2	-62.2	-60.9	0.4	-42.0	-41.25	0.75
HE160 Beam Forming, M0 to M9 2ss	4	9	-54.9	-61.5	-60.7	-59.1	0.4	-42.8	-41.25	1.52
HE160 Beam Forming, M0 to M9 3ss	4	7	-54.9	-61.5	-60.7	-59.1	0.4	-44.8	-41.25	3.52
HE160 Beam Forming, M0 to M9 4ss	4	6	-50.4	-59.9	-58.7	-56.2	0.4	-42.1	-41.25	0.89
HE160 STBC, M0 to M9 1ss	2	6	-50.4	-59.9			0.4	-43.5	-41.25	2.25
HE160 STBC, M0 to M9 1ss	3	6	-50.4	-59.9	-58.7		0.4	-43.0	-41.25	1.71
HE160 STBC, M0 to M9 1ss	4	6	-50.4	-59.9	-58.7	-56.2	0.4	-42.1	-41.25	0.89

**Conducted Bandedge Average, 6dBi
5210 MHz, HE80, M0 to M9 1ss**



Antenna A



Antenna B

Conducted Band Edge, Peak Table, 4dBi

Frequency (MHz)	Mode	Tx Paths	Correlated Antenna Gain (dBi)	Tx 1 Bandedge Level (dBm)	Tx 2 Bandedge Level (dBm)	Tx 3 Bandedge Level (dBm)	Tx 4 Bandedge Level (dBm)	Total Tx Bandedge Level (dBm)	Limit (dBm)	Margin (dB)
5180	Non HT20, 6 to 54 Mbps	1	4	-40.9				-36.8	-21.25	15.60
	Non HT20, 6 to 54 Mbps	2	4	-40.9	-31.3			-26.8	-21.25	5.54
	Non HT20, 6 to 54 Mbps	3	4	-40.9	-31.3	-35.8		-25.6	-21.25	4.34
	Non HT20, 6 to 54 Mbps	4	4	-40.9	-37.7	-35.2	-36.5	-27.0	-21.25	5.79
	Non HT20 Beam Forming, 6 to 54 Mbps	2	7	-40.9	-37.7			-28.9	-21.25	7.70
	Non HT20 Beam Forming, 6 to 54 Mbps	3	9	-40.9	-46.2	-45.5		-29.7	-21.25	8.44
	Non HT20 Beam Forming, 6 to 54 Mbps	4	10	-40.9	-47.3	-47.5	-46.4	-28.5	-21.25	7.22
	HT/VHT20, M0 to M7	1	4	-41.1				-37.0	-21.25	15.80
	HT/VHT20, M0 to M7	2	4	-41.1	-31.3			-26.8	-21.25	5.57
	HT/VHT20, M8 to M15	2	4	-41.1	-31.3			-26.8	-21.25	5.57
	HT/VHT20, M0 to M7	3	4	-41.1	-37.7	-36.8		-29.4	-21.25	8.10
	HT/VHT20, M8 to M15	3	4	-41.1	-37.7	-36.8		-29.4	-21.25	8.10
	HT/VHT20, M16 to M23	3	4	-41.1	-37.7	-36.8		-29.4	-21.25	8.10
	HT/VHT20, M0 to M7	4	4	-41.1	-37.7	-36.8	-37.2	-27.8	-21.25	6.59
	HT/VHT20, M8 to M15	4	4	-41.1	-37.7	-36.8	-37.2	-27.8	-21.25	6.59
	HT/VHT20, M16 to M23	4	4	-41.1	-37.7	-36.8	-37.2	-27.8	-21.25	6.59
	HT/VHT20, M24 to M31	4	4	-41.1	-37.7	-36.8	-37.2	-27.8	-21.25	6.59
	HT/VHT20 Beam Forming, M0 to M7	2	7	-41.1	-37.7			-29.0	-21.25	7.76
	HT/VHT20 Beam Forming, M8 to M15	2	4	-41.1	-31.3			-26.8	-21.25	5.57
	HT/VHT20 Beam Forming, M0 to M7	3	9	-41.1	-45.5	-44.9		-29.5	-21.25	8.29
	HT/VHT20 Beam Forming, M8 to M15	3	6	-41.1	-46.3	-41.5		-31.6	-21.25	10.35
	HT/VHT20 Beam Forming, M16 to M23	3	4	-41.1	-37.7	-36.8		-29.4	-21.25	8.10
	HT/VHT20 Beam Forming, M0 to M7	4	10	-43.7	-49.5	-47.8	-50.5	-31.0	-21.25	9.70
	HT/VHT20 Beam Forming, M8 to M15	4	7	-41.1	-46.3	-41.5	-41.5	-29.1	-21.25	7.85
	HT/VHT20 Beam Forming, M16 to M23	4	5	-41.1	-46.3	-41.5	-41.5	-31.1	-21.25	9.85
	HT/VHT20 Beam Forming, M24 to M31	4	4	-41.1	-37.7	-36.8	-37.2	-27.8	-21.25	6.59
	HT/VHT20 STBC, M0 to M7	2	4	-41.1	-31.3			-26.8	-21.25	5.57
	HT/VHT20 STBC, M0 to M7	3	4	-41.1	-37.7	-36.8		-29.4	-21.25	8.10
	HT/VHT20 STBC, M0 to M7	4	4	-41.1	-37.7	-36.8	-37.2	-27.8	-21.25	6.59

	HE20, M0 to M9 1ss	1	4	-36.3				-32.2	-21.25	10.98
	HE20, M0 to M9 1ss	2	4	-36.3	-36.1			-29.1	-21.25	7.87
	HE20, M0 to M9 2ss	2	4	-36.3	-36.1			-29.1	-21.25	7.87
	HE20, M0 to M9 1ss	3	4	-36.3	-36.1	-36.6		-27.5	-21.25	6.24
	HE20, M0 to M9 2ss	3	4	-36.3	-36.1	-36.6		-27.5	-21.25	6.24
	HE20, M0 to M9 3ss	3	4	-36.3	-36.1	-36.6		-27.5	-21.25	6.24
	HE20, M0 to M9 1ss	4	4	-36.3	-41.1	-38.2	-37.9	-28.0	-21.25	6.72
	HE20, M0 to M9 2ss	4	4	-36.3	-41.1	-38.2	-37.9	-28.0	-21.25	6.72
	HE20, M0 to M9 3ss	4	4	-36.3	-41.1	-38.2	-37.9	-28.0	-21.25	6.72
	HE20, M0 to M9 4ss	4	4	-36.3	-41.1	-38.2	-37.9	-28.0	-21.25	6.72
	HE20 Beam Forming, M0 to M9 1ss	2	7	-36.3	-41.1			-28.0	-21.25	6.74
	HE20 Beam Forming, M0 to M9 2ss	2	4	-36.3	-36.1			-29.1	-21.25	7.87
	HE20 Beam Forming, M0 to M9 1ss	3	9	-41.4	-49.9	-48.4		-31.1	-21.25	9.81
	HE20 Beam Forming, M0 to M9 2ss	3	6	-36.3	-41.1	-38.2		-27.3	-21.25	6.02
	HE20 Beam Forming, M0 to M9 3ss	3	4	-36.3	-36.1	-36.6		-27.5	-21.25	6.24
	HE20 Beam Forming, M0 to M9 1ss	4	10	-41.4	-49.9	-48.4	-47.6	-29.3	-21.25	8.09
	HE20 Beam Forming, M0 to M9 2ss	4	7	-36.3	-45.0	-47.5	-48.3	-28.2	-21.25	6.93
	HE20 Beam Forming, M0 to M9 3ss	4	5	-36.3	-41.1	-38.2	-37.9	-27.0	-21.25	5.72
	HE20 Beam Forming, M0 to M9 4ss	4	4	-36.3	-41.1	-38.2	-37.9	-28.0	-21.25	6.72
	HE20 STBC, M0 to M9 2ss	2	4	-36.3	-36.1			-29.1	-21.25	7.87
	HE20 STBC, M0 to M9 2ss	3	4	-36.3	-36.1	-36.6		-27.5	-21.25	6.24
	HE20 STBC, M0 to M9 2ss	4	4	-36.3	-41.1	-38.2	-37.9	-28.0	-21.25	6.72
5190	Non HT40, 6 to 54 Mbps	1	4	-35.1				-31.1	-21.25	9.80
	Non HT40, 6 to 54 Mbps	2	4	-35.1	-49.5			-30.9	-21.25	9.65
	Non HT40, 6 to 54 Mbps	3	4	-35.1	-49.5	-49.3		-30.7	-21.25	9.49
	Non HT40, 6 to 54 Mbps	4	4	-35.1	-49.5	-49.3	-48.8	-30.6	-21.25	9.32
	HT/VHT40, M0 to M7	1	4	-32.5				-28.4	-21.25	7.15
	HT/VHT40, M0 to M7	2	4	-32.5	-49.8			-28.3	-21.25	7.07
	HT/VHT40, M8 to M15	2	4	-32.5	-49.8			-28.3	-21.25	7.07
	HT/VHT40, M0 to M7	3	4	-32.5	-49.8	-45.3		-28.1	-21.25	6.85
	HT/VHT40, M8 to M15	3	4	-32.5	-49.8	-45.3		-28.1	-21.25	6.85
	HT/VHT40, M16 to M23	3	4	-32.5	-49.8	-45.3		-28.1	-21.25	6.85
	HT/VHT40, M0 to M7	4	4	-32.5	-49.8	-45.3	-48.8	-28.0	-21.25	6.76
	HT/VHT40, M8 to M15	4	4	-32.5	-49.8	-45.3	-48.8	-28.0	-21.25	6.76
	HT/VHT40, M16 to M23	4	4	-32.5	-49.8	-45.3	-48.8	-28.0	-21.25	6.76
	HT/VHT40, M24 to M31	4	4	-32.5	-49.8	-45.3	-48.8	-28.0	-21.25	6.76
	HT/VHT40 Beam Forming, M0 to M7	2	7	-35.8	-50.6			-28.6	-21.25	7.31
	HT/VHT40 Beam Forming, M8 to M15	2	4	-32.5	-49.8			-28.3	-21.25	7.07
	HT/VHT40 Beam Forming, M0 to M7	3	9	-43.0	-50.9	-50.2		-32.6	-21.25	11.34
	HT/VHT40 Beam Forming, M8 to M15	3	6	-35.8	-50.6	-48.8		-29.4	-21.25	8.10
HT/VHT40 Beam Forming, M16 to M23	3	4	-32.5	-49.8	-45.3		-28.1	-21.25	6.85	
HT/VHT40 Beam Forming, M0 to M7	4	10	-43.0	-50.9	-50.2	-52.2	-31.2	-21.25	9.97	

	HT/VHT40 Beam Forming, M8 to M15	4	7	-35.8	-50.6	-48.8	-50.4	-28.2	-21.25	6.96
	HT/VHT40 Beam Forming, M16 to M23	4	5	-35.8	-50.6	-48.8	-50.4	-30.2	-21.25	8.96
	HT/VHT40 Beam Forming, M24 to M31	4	4	-32.5	-49.8	-45.3	-48.8	-28.0	-21.25	6.76
	HT/VHT40 STBC, M0 to M7	2	4	-32.5	-49.8			-28.3	-21.25	7.07
	HT/VHT40 STBC, M0 to M7	3	4	-32.5	-49.8	-45.3		-28.1	-21.25	6.85
	HT/VHT40 STBC, M0 to M7	4	4	-32.5	-49.8	-45.3	-48.8	-28.0	-21.25	6.76
	HE40, M0 to M9 1ss	1	4	-37.2				-33.1	-21.25	11.82
	HE40, M0 to M9 1ss	2	4	-37.2	-49.6			-32.8	-21.25	11.58
	HE40, M0 to M9 2ss	2	4	-37.2	-49.6			-32.8	-21.25	11.58
	HE40, M0 to M9 1ss	3	4	-37.2	-49.6	-48.6		-32.5	-21.25	11.29
	HE40, M0 to M9 2ss	3	4	-37.2	-49.6	-48.6		-32.5	-21.25	11.29
	HE40, M0 to M9 3ss	3	4	-37.2	-49.6	-48.6		-32.5	-21.25	11.29
	HE40, M0 to M9 1ss	4	4	-37.2	-49.6	-48.6	-49.2	-32.3	-21.25	11.06
	HE40, M0 to M9 2ss	4	4	-37.2	-49.6	-48.6	-49.2	-32.3	-21.25	11.06
	HE40, M0 to M9 3ss	4	4	-37.2	-49.6	-48.6	-49.2	-32.3	-21.25	11.06
	HE40, M0 to M9 4ss	4	4	-37.2	-49.6	-48.6	-49.2	-32.3	-21.25	11.06
	HE40 Beam Forming, M0 to M9 1ss	2	7	-37.2	-49.6			-29.8	-21.25	8.58
	HE40 Beam Forming, M0 to M9 2ss	2	4	-37.2	-49.6			-32.8	-21.25	11.58
	HE40 Beam Forming, M0 to M9 1ss	3	9	-40.6	-51.0	-50.4		-30.7	-21.25	9.45
	HE40 Beam Forming, M0 to M9 2ss	3	6	-37.2	-49.6	-48.6		-30.5	-21.25	9.29
	HE40 Beam Forming, M0 to M9 3ss	3	4	-37.2	-49.6	-48.6		-32.5	-21.25	11.29
	HE40 Beam Forming, M0 to M9 1ss	4	10	-37.9	-51.5	-52.1	-50.3	-27.2	-21.25	5.96
	HE40 Beam Forming, M0 to M9 2ss	4	7	-40.6	-51.0	-50.4	-51.9	-32.4	-21.25	11.19
	HE40 Beam Forming, M0 to M9 3ss	4	5	-37.2	-49.6	-48.6	-49.2	-31.3	-21.25	10.06
	HE40 Beam Forming, M0 to M9 4ss	4	4	-37.2	-49.6	-48.6	-49.2	-32.3	-21.25	11.06
	HE40 STBC, M0 to M9 2ss	2	4	-37.2	-49.6			-32.8	-21.25	11.58
	HE40 STBC, M0 to M9 2ss	3	4	-37.2	-49.6	-48.6		-32.5	-21.25	11.29
	HE40 STBC, M0 to M9 2ss	4	4	-37.2	-49.6	-48.6	-49.2	-32.3	-21.25	11.06
5210	Non HT80, 6 to 54 Mbps	1	4	-32.1				-28.0	-21.25	6.80
	Non HT80, 6 to 54 Mbps	2	4	-32.1	-48.2			-27.9	-21.25	6.69
	Non HT80, 6 to 54 Mbps	3	4	-32.1	-48.2	-44.2		-27.7	-21.25	6.44
	Non HT80, 6 to 54 Mbps	4	4	-32.1	-48.2	-44.2	-45.8	-27.5	-21.25	6.27
	VHT80, M0 to M9 1ss	1	4	-35.4				-31.2	-21.25	9.93
	VHT80, M0 to M9 1ss	2	4	-35.4	-49.6			-31.0	-21.25	9.76
	VHT80, M0 to M9 2ss	2	4	-35.4	-49.6			-31.0	-21.25	9.76
	VHT80, M0 to M9 1ss	3	4	-35.4	-49.6	-47.8		-30.8	-21.25	9.53
	VHT80, M0 to M9 2ss	3	4	-35.4	-49.6	-47.8		-30.8	-21.25	9.53
	VHT80, M0 to M9 3ss	3	4	-35.4	-49.6	-47.8		-30.8	-21.25	9.53
	VHT80, M0 to M9 1ss	4	4	-35.4	-49.6	-47.8	-48.2	-30.6	-21.25	9.33
	VHT80, M0 to M9 2ss	4	4	-35.4	-49.6	-47.8	-48.2	-30.6	-21.25	9.33
	VHT80, M0 to M9 3ss	4	4	-35.4	-49.6	-47.8	-48.2	-30.6	-21.25	9.33
	VHT80, M0 to M9 4ss	4	4	-35.4	-49.6	-47.8	-48.2	-30.6	-21.25	9.33

	VHT80 Beam Forming, M0 to M9 1ss	2	7	-36.0	-50.7			-28.6	-21.25	7.38
	VHT80 Beam Forming, M0 to M9 2ss	2	4	-35.4	-49.6			-31.0	-21.25	9.76
	VHT80 Beam Forming, M0 to M9 1ss	3	9	-36.0	-50.7	-51.1		-26.5	-21.25	5.25
	VHT80 Beam Forming, M0 to M9 2ss	3	6	-36.0	-50.7	-51.1		-29.5	-21.25	8.25
	VHT80 Beam Forming, M0 to M9 3ss	3	4	-35.4	-49.6	-47.8		-30.8	-21.25	9.53
	VHT80 Beam Forming, M0 to M9 1ss	4	10	-39.3	-51.6	-50.9	-53.0	-28.4	-21.25	7.14
	VHT80 Beam Forming, M0 to M9 2ss	4	7	-36.0	-50.7	-51.1	-49.3	-28.3	-21.25	7.07
	VHT80 Beam Forming, M0 to M9 3ss	4	5	-35.4	-49.6	-47.8	-48.2	-29.6	-21.25	8.33
	VHT80 Beam Forming, M0 to M9 4ss	4	4	-35.4	-49.6	-47.8	-48.2	-30.6	-21.25	9.33
	VHT80 STBC, M0 to M9 1ss	2	4	-35.4	-49.6			-31.0	-21.25	9.76
	VHT80 STBC, M0 to M9 1ss	3	4	-35.4	-49.6	-47.8		-30.8	-21.25	9.53
	VHT80 STBC, M0 to M9 1ss	4	4	-35.4	-49.6	-47.8	-48.2	-30.6	-21.25	9.33
	HE80, M0 to M9 1ss	1	4	-37.9				-33.6	-21.25	12.40
	HE80, M0 to M9 1ss	2	4	-37.9	-49.8			-33.4	-21.25	12.13
	HE80, M0 to M9 2ss	2	4	-37.9	-49.8			-33.4	-21.25	12.13
	HE80, M0 to M9 1ss	3	4	-37.9	-49.8	-50.6		-33.2	-21.25	11.91
	HE80, M0 to M9 2ss	3	4	-37.9	-49.8	-50.6		-33.2	-21.25	11.91
	HE80, M0 to M9 3ss	3	4	-37.9	-49.8	-50.6		-33.2	-21.25	11.91
	HE80, M0 to M9 1ss	4	4	-37.9	-49.8	-50.6	-46.9	-32.7	-21.25	11.45
	HE80, M0 to M9 2ss	4	4	-37.9	-49.8	-50.6	-46.9	-32.7	-21.25	11.45
	HE80, M0 to M9 3ss	4	4	-37.9	-49.8	-50.6	-46.9	-32.7	-21.25	11.45
	HE80, M0 to M9 4ss	4	4	-37.9	-49.8	-50.6	-46.9	-32.7	-21.25	11.45
	HE80 Beam Forming, M0 to M9 1ss	2	7	-40.6	-50.1			-32.9	-21.25	11.64
	HE80 Beam Forming, M0 to M9 2ss	2	4	-37.9	-49.8			-33.4	-21.25	12.13
	HE80 Beam Forming, M0 to M9 1ss	3	9	-40.6	-50.1	-49.0		-30.4	-21.25	9.11
	HE80 Beam Forming, M0 to M9 2ss	3	6	-40.6	-50.1	-49.0		-33.4	-21.25	12.11
	HE80 Beam Forming, M0 to M9 3ss	3	4	-37.9	-49.8	-50.6		-33.2	-21.25	11.91
	HE80 Beam Forming, M0 to M9 1ss	4	10	-42.9	-50.1	-50.7	-51.0	-30.9	-21.25	9.61
	HE80 Beam Forming, M0 to M9 2ss	4	7	-40.6	-50.1	-49.0	-49.1	-31.9	-21.25	10.64
	HE80 Beam Forming, M0 to M9 3ss	4	5	-37.9	-49.8	-50.6	-46.9	-31.7	-21.25	10.45
	HE80 Beam Forming, M0 to M9 4ss	4	4	-37.9	-49.8	-50.6	-46.9	-32.7	-21.25	11.45
	HE80 STBC, M0 to M9 1ss	2	4	-37.9	-49.8			-33.4	-21.25	12.13
	HE80 STBC, M0 to M9 1ss	3	4	-37.9	-49.8	-50.6		-33.2	-21.25	11.91
	HE80 STBC, M0 to M9 1ss	4	4	-37.9	-49.8	-50.6	-46.9	-32.7	-21.25	11.45
5250	Non HT160, 6 to 54 Mbps	1	4	-31.2				-27.2	-21.25	5.90
	Non HT160, 6 to 54 Mbps	2	4	-31.2	-46.5			-27.0	-21.25	5.77
	Non HT160, 6 to 54 Mbps	3	4	-31.2	-46.5	-44.6		-26.8	-21.25	5.59
	Non HT160, 6 to 54 Mbps	4	4	-31.2	-46.5	-44.6	-41.1	-26.4	-21.25	5.19
	VHT160, M0 to M9 1ss	1	4	-26.9				-22.5	-21.25	1.26
	VHT160, M0 to M9 1ss	2	4	-26.9	-41.6			-22.4	-21.25	1.11
	VHT160, M0 to M9 2ss	2	4	-26.9	-41.6			-22.4	-21.25	1.11
	VHT160, M0 to M9 1ss	3	4	-26.9	-41.6	-39.8		-22.2	-21.25	0.90

VHT160, M0 to M9 2ss	3	4	-26.9	-41.6	-39.8		-22.2	-21.25	0.90
VHT160, M0 to M9 3ss	3	4	-26.9	-41.6	-39.8		-22.2	-21.25	0.90
VHT160, M0 to M9 1ss	4	4	-26.9	-41.6	-39.8	-40.8	-22.0	-21.25	0.74
VHT160, M0 to M9 2ss	4	4	-26.9	-41.6	-39.8	-40.8	-22.0	-21.25	0.74
VHT160, M0 to M9 3ss	4	4	-26.9	-41.6	-39.8	-40.8	-22.0	-21.25	0.74
VHT160, M0 to M9 4ss	4	4	-26.9	-41.6	-39.8	-40.8	-22.0	-21.25	0.74
VHT160 Beam Forming, M0 to M9 1ss	2	7	-30.8	-42.4			-23.1	-21.25	1.87
VHT160 Beam Forming, M0 to M9 2ss	2	4	-26.9	-41.6			-22.4	-21.25	1.11
VHT160 Beam Forming, M0 to M9 1ss	3	9	-33.0	-42.6	-48.3		-23.0	-21.25	1.79
VHT160 Beam Forming, M0 to M9 2ss	3	6	-30.8	-42.4	-46.9		-24.0	-21.25	2.77
VHT160 Beam Forming, M0 to M9 3ss	3	4	-26.9	-41.6	-39.8		-22.2	-21.25	0.90
VHT160 Beam Forming, M0 to M9 1ss	4	10	-33.0	-42.6	-48.3	-42.7	-21.7	-21.25	0.40
VHT160 Beam Forming, M0 to M9 2ss	4	7	-30.8	-42.4	-46.9	-44.2	-22.8	-21.25	1.59
VHT160 Beam Forming, M0 to M9 3ss	4	5	-30.8	-42.4	-46.9	-44.2	-24.8	-21.25	3.59
VHT160 Beam Forming, M0 to M9 4ss	4	4	-26.9	-41.6	-39.8	-40.8	-22.0	-21.25	0.74
VHT160 STBC, M0 to M9 1ss	2	4	-26.9	-41.6			-22.4	-21.25	1.11
VHT160 STBC, M0 to M9 1ss	3	4	-26.9	-41.6	-39.8		-22.2	-21.25	0.90
VHT160 STBC, M0 to M9 1ss	4	4	-26.9	-41.6	-39.8	-40.8	-22.0	-21.25	0.74
HE160, M0 to M9 1ss	1	4	-30.8				-26.4	-21.25	5.12
HE160, M0 to M9 1ss	2	4	-30.8	-47.1			-26.3	-21.25	5.02
HE160, M0 to M9 2ss	2	4	-30.8	-47.1			-26.3	-21.25	5.02
HE160, M0 to M9 1ss	3	4	-33.3	-48.3	-45.8		-28.5	-21.25	7.25
HE160, M0 to M9 2ss	3	4	-33.3	-48.3	-45.8		-28.5	-21.25	7.25
HE160, M0 to M9 3ss	3	4	-33.3	-48.3	-45.8		-28.5	-21.25	7.25
HE160, M0 to M9 1ss	4	4	-33.3	-48.3	-45.8	-44.4	-28.2	-21.25	6.95
HE160, M0 to M9 2ss	4	4	-33.3	-48.3	-45.8	-44.4	-28.2	-21.25	6.95
HE160, M0 to M9 3ss	4	4	-33.3	-48.3	-45.8	-44.4	-28.2	-21.25	6.95
HE160, M0 to M9 4ss	4	4	-33.3	-48.3	-45.8	-44.4	-28.2	-21.25	6.95
HE160 Beam Forming, M0 to M9 1ss	2	7	-33.3	-48.3			-25.7	-21.25	4.48
HE160 Beam Forming, M0 to M9 2ss	2	4	-30.8	-47.1			-26.3	-21.25	5.02
HE160 Beam Forming, M0 to M9 1ss	3	9	-37.8	-48.7	-46.0		-27.5	-21.25	6.21
HE160 Beam Forming, M0 to M9 2ss	3	6	-33.3	-48.3	-45.8		-26.5	-21.25	5.25
HE160 Beam Forming, M0 to M9 3ss	3	4	-33.3	-48.3	-45.8		-28.5	-21.25	7.25
HE160 Beam Forming, M0 to M9 1ss	4	10	-37.8	-48.7	-46.0	-47.4	-26.1	-21.25	4.84
HE160 Beam Forming, M0 to M9 2ss	4	7	-37.8	-48.7	-46.0	-47.4	-29.1	-21.25	7.84
HE160 Beam Forming, M0 to M9 3ss	4	5	-33.3	-48.3	-45.8	-44.4	-27.2	-21.25	5.95
HE160 Beam Forming, M0 to M9 4ss	4	4	-33.3	-48.3	-45.8	-44.4	-28.2	-21.25	6.95
HE160 STBC, M0 to M9 1ss	2	4	-30.8	-47.1			-26.3	-21.25	5.02
HE160 STBC, M0 to M9 1ss	3	4	-33.3	-48.3	-45.8		-28.5	-21.25	7.25
HE160 STBC, M0 to M9 1ss	4	4	-33.3	-48.3	-45.8	-44.4	-28.2	-21.25	6.95

**Conducted Bandedge Peak, 4dBi
5250 MHz, VHT160 Beam Forming, M0 to M9 1ss**



Antenna A



Antenna B



Antenna C



Antenna D

Conducted Band Edge, Peak Table, 5dBi

Frequency (MHz)	Mode	Tx Paths	Correlated Antenna Gain (dBi)	Tx 1 Bandedge Level (dBm)	Tx 2 Bandedge Level (dBm)	Tx 3 Bandedge Level (dBm)	Tx 4 Bandedge Level (dBm)	Total Tx Bandedge Level (dBm)	Limit (dBm)	Margin (dB)
5180	Non HT20, 6 to 54 Mbps	1	5	-40.9				-35.8	-21.25	14.60
	Non HT20, 6 to 54 Mbps	2	5	-40.9	-31.3			-25.8	-21.25	4.54
	Non HT20, 6 to 54 Mbps	3	5	-40.9	-37.7	-35.2		-27.5	-21.25	6.27
	Non HT20, 6 to 54 Mbps	4	5	-40.9	-37.7	-35.2	-36.5	-26.0	-21.25	4.79
	Non HT20 Beam Forming, 6 to 54 Mbps	2	8	-40.9	-37.7			-27.9	-21.25	6.70
	Non HT20 Beam Forming, 6 to 54 Mbps	3	10	-40.9	-47.3	-47.5		-29.2	-21.25	7.99
	Non HT20 Beam Forming, 6 to 54 Mbps	4	11	-42.1	-49.0	-49.1	-50.3	-29.1	-21.25	7.88
	HT/VHT20, M0 to M7	1	5	-41.1				-36.0	-21.25	14.80
	HT/VHT20, M0 to M7	2	5	-41.1	-31.3			-25.8	-21.25	4.57
	HT/VHT20, M8 to M15	2	5	-41.1	-31.3			-25.8	-21.25	4.57
	HT/VHT20, M0 to M7	3	5	-41.1	-37.7	-36.8		-28.4	-21.25	7.10
	HT/VHT20, M8 to M15	3	5	-41.1	-37.7	-36.8		-28.4	-21.25	7.10
	HT/VHT20, M16 to M23	3	5	-41.1	-37.7	-36.8		-28.4	-21.25	7.10
	HT/VHT20, M0 to M7	4	5	-41.1	-46.3	-41.5	-41.5	-31.1	-21.25	9.85
	HT/VHT20, M8 to M15	4	5	-41.1	-46.3	-41.5	-41.5	-31.1	-21.25	9.85
	HT/VHT20, M16 to M23	4	5	-41.1	-46.3	-41.5	-41.5	-31.1	-21.25	9.85
	HT/VHT20, M24 to M31	4	5	-41.1	-46.3	-41.5	-41.5	-31.1	-21.25	9.85
	HT/VHT20 Beam Forming, M0 to M7	2	8	-41.1	-46.3			-31.9	-21.25	10.65
	HT/VHT20 Beam Forming, M8 to M15	2	5	-41.1	-31.3			-25.8	-21.25	4.57
	HT/VHT20 Beam Forming, M0 to M7	3	10	-41.1	-49.0	-49.0		-29.8	-21.25	8.58
	HT/VHT20 Beam Forming, M8 to M15	3	7	-41.1	-46.3	-41.5		-30.6	-21.25	9.35
	HT/VHT20 Beam Forming, M16 to M23	3	5	-41.1	-37.7	-36.8		-28.4	-21.25	7.10
	HT/VHT20 Beam Forming, M0 to M7	4	11	-43.7	-49.5	-47.8	-50.5	-30.0	-21.25	8.70
	HT/VHT20 Beam Forming, M8 to M15	4	8	-41.1	-45.5	-44.9	-43.3	-29.3	-21.25	8.03
	HT/VHT20 Beam Forming, M16 to M23	4	6	-41.1	-46.3	-41.5	-41.5	-30.1	-21.25	8.85
	HT/VHT20 Beam Forming, M24 to M31	4	5	-41.1	-46.3	-41.5	-41.5	-31.1	-21.25	9.85
	HT/VHT20 STBC, M0 to M7	2	5	-41.1	-31.3			-25.8	-21.25	4.57
	HT/VHT20 STBC, M0 to M7	3	5	-41.1	-37.7	-36.8		-28.4	-21.25	7.10
	HT/VHT20 STBC, M0 to M7	4	5	-41.1	-46.3	-41.5	-41.5	-31.1	-21.25	9.85

	HE20, M0 to M9 1ss	1	5	-36.3				-31.2	-21.25	9.98
	HE20, M0 to M9 1ss	2	5	-36.3	-36.1			-28.1	-21.25	6.87
	HE20, M0 to M9 2ss	2	5	-36.3	-36.1			-28.1	-21.25	6.87
	HE20, M0 to M9 1ss	3	5	-36.3	-41.1	-38.2		-28.3	-21.25	7.02
	HE20, M0 to M9 2ss	3	5	-36.3	-41.1	-38.2		-28.3	-21.25	7.02
	HE20, M0 to M9 3ss	3	5	-36.3	-41.1	-38.2		-28.3	-21.25	7.02
	HE20, M0 to M9 1ss	4	5	-36.3	-41.1	-38.2	-37.9	-27.0	-21.25	5.72
	HE20, M0 to M9 2ss	4	5	-36.3	-41.1	-38.2	-37.9	-27.0	-21.25	5.72
	HE20, M0 to M9 3ss	4	5	-36.3	-41.1	-38.2	-37.9	-27.0	-21.25	5.72
	HE20, M0 to M9 4ss	4	5	-36.3	-41.1	-38.2	-37.9	-27.0	-21.25	5.72
	HE20 Beam Forming, M0 to M9 1ss	2	8	-36.3	-46.0			-27.8	-21.25	6.54
	HE20 Beam Forming, M0 to M9 2ss	2	5	-36.3	-36.1			-28.1	-21.25	6.87
	HE20 Beam Forming, M0 to M9 1ss	3	10	-41.4	-49.9	-48.4		-30.1	-21.25	8.81
	HE20 Beam Forming, M0 to M9 2ss	3	7	-36.3	-46.0	-43.3		-28.1	-21.25	6.82
	HE20 Beam Forming, M0 to M9 3ss	3	5	-36.3	-41.1	-38.2		-28.3	-21.25	7.02
	HE20 Beam Forming, M0 to M9 1ss	4	11	-45.0	-50.8	-49.4	-49.4	-30.9	-21.25	9.70
	HE20 Beam Forming, M0 to M9 2ss	4	8	-36.3	-49.3	-47.2	-48.4	-27.5	-21.25	6.22
	HE20 Beam Forming, M0 to M9 3ss	4	6	-36.3	-46.0	-43.3	-45.2	-28.7	-21.25	7.41
	HE20 Beam Forming, M0 to M9 4ss	4	5	-36.3	-41.1	-38.2	-37.9	-27.0	-21.25	5.72
	HE20 STBC, M0 to M9 2ss	2	5	-36.3	-36.1			-28.1	-21.25	6.87
	HE20 STBC, M0 to M9 2ss	3	5	-36.3	-41.1	-38.2		-28.3	-21.25	7.02
	HE20 STBC, M0 to M9 2ss	4	5	-36.3	-41.1	-38.2	-37.9	-27.0	-21.25	5.72
5190	Non HT40, 6 to 54 Mbps	1	5	-35.1				-30.1	-21.25	8.80
	Non HT40, 6 to 54 Mbps	2	5	-35.1	-49.5			-29.9	-21.25	8.65
	Non HT40, 6 to 54 Mbps	3	5	-35.1	-49.5	-49.3		-29.7	-21.25	8.49
	Non HT40, 6 to 54 Mbps	4	5	-35.1	-49.5	-49.3	-48.8	-29.6	-21.25	8.32
	HT/VHT40, M0 to M7	1	5	-32.5				-27.4	-21.25	6.15
	HT/VHT40, M0 to M7	2	5	-35.8	-50.6			-30.6	-21.25	9.31
	HT/VHT40, M8 to M15	2	5	-35.8	-50.6			-30.6	-21.25	9.31
	HT/VHT40, M0 to M7	3	5	-35.8	-50.6	-48.8		-30.4	-21.25	9.10
	HT/VHT40, M8 to M15	3	5	-35.8	-50.6	-48.8		-30.4	-21.25	9.10
	HT/VHT40, M16 to M23	3	5	-35.8	-50.6	-48.8		-30.4	-21.25	9.10
	HT/VHT40, M0 to M7	4	5	-35.8	-50.6	-48.8	-50.4	-30.2	-21.25	8.96
	HT/VHT40, M8 to M15	4	5	-35.8	-50.6	-48.8	-50.4	-30.2	-21.25	8.96
	HT/VHT40, M16 to M23	4	5	-35.8	-50.6	-48.8	-50.4	-30.2	-21.25	8.96
	HT/VHT40, M24 to M31	4	5	-35.8	-50.6	-48.8	-50.4	-30.2	-21.25	8.96
	HT/VHT40 Beam Forming, M0 to M7	2	8	-35.8	-50.6			-27.6	-21.25	6.31
	HT/VHT40 Beam Forming, M8 to M15	2	5	-35.8	-50.6			-30.6	-21.25	9.31
	HT/VHT40 Beam Forming, M0 to M7	3	10	-43.0	-50.9	-50.2		-31.6	-21.25	10.34
	HT/VHT40 Beam Forming, M8 to M15	3	7	-35.8	-50.6	-48.8		-28.4	-21.25	7.10
	HT/VHT40 Beam Forming, M16 to M23	3	5	-35.8	-50.6	-48.8		-30.4	-21.25	9.10
	HT/VHT40 Beam Forming, M0 to M7	4	11	-45.3	-52.0	-52.0	-53.1	-32.2	-21.25	10.92

	HT/VHT40 Beam Forming, M8 to M15	4	8	-43.0	-50.9	-50.2	-52.2	-33.2	-21.25	11.97
	HT/VHT40 Beam Forming, M16 to M23	4	6	-35.8	-50.6	-48.8	-50.4	-29.2	-21.25	7.96
	HT/VHT40 Beam Forming, M24 to M31	4	5	-35.8	-50.6	-48.8	-50.4	-30.2	-21.25	8.96
	HT/VHT40 STBC, M0 to M7	2	5	-35.8	-50.6			-30.6	-21.25	9.31
	HT/VHT40 STBC, M0 to M7	3	5	-35.8	-50.6	-48.8		-30.4	-21.25	9.10
	HT/VHT40 STBC, M0 to M7	4	5	-35.8	-50.6	-48.8	-50.4	-30.2	-21.25	8.96
	HE40, M0 to M9 1ss	1	5	-37.2				-32.1	-21.25	10.82
	HE40, M0 to M9 1ss	2	5	-37.2	-49.6			-31.8	-21.25	10.58
	HE40, M0 to M9 2ss	2	5	-37.2	-49.6			-31.8	-21.25	10.58
	HE40, M0 to M9 1ss	3	5	-37.2	-49.6	-48.6		-31.5	-21.25	10.29
	HE40, M0 to M9 2ss	3	5	-37.2	-49.6	-48.6		-31.5	-21.25	10.29
	HE40, M0 to M9 3ss	3	5	-37.2	-49.6	-48.6		-31.5	-21.25	10.29
	HE40, M0 to M9 1ss	4	5	-37.2	-49.6	-48.6	-49.2	-31.3	-21.25	10.06
	HE40, M0 to M9 2ss	4	5	-37.2	-49.6	-48.6	-49.2	-31.3	-21.25	10.06
	HE40, M0 to M9 3ss	4	5	-37.2	-49.6	-48.6	-49.2	-31.3	-21.25	10.06
	HE40, M0 to M9 4ss	4	5	-37.2	-49.6	-48.6	-49.2	-31.3	-21.25	10.06
	HE40 Beam Forming, M0 to M9 1ss	2	8	-40.6	-51.0			-32.1	-21.25	10.85
	HE40 Beam Forming, M0 to M9 2ss	2	5	-37.2	-49.6			-31.8	-21.25	10.58
	HE40 Beam Forming, M0 to M9 1ss	3	10	-40.6	-51.0	-50.4		-29.7	-21.25	8.45
	HE40 Beam Forming, M0 to M9 2ss	3	7	-37.2	-49.6	-48.6		-29.5	-21.25	8.29
	HE40 Beam Forming, M0 to M9 3ss	3	5	-37.2	-49.6	-48.6		-31.5	-21.25	10.29
	HE40 Beam Forming, M0 to M9 1ss	4	11	-37.9	-51.5	-52.1	-50.3	-26.2	-21.25	4.96
	HE40 Beam Forming, M0 to M9 2ss	4	8	-40.6	-51.0	-50.4	-51.9	-31.4	-21.25	10.19
	HE40 Beam Forming, M0 to M9 3ss	4	6	-37.2	-49.6	-48.6	-49.2	-30.3	-21.25	9.06
	HE40 Beam Forming, M0 to M9 4ss	4	5	-37.2	-49.6	-48.6	-49.2	-31.3	-21.25	10.06
	HE40 STBC, M0 to M9 2ss	2	5	-37.2	-49.6			-31.8	-21.25	10.58
	HE40 STBC, M0 to M9 2ss	3	5	-37.2	-49.6	-48.6		-31.5	-21.25	10.29
	HE40 STBC, M0 to M9 2ss	4	5	-37.2	-49.6	-48.6	-49.2	-31.3	-21.25	10.06
5210	Non HT80, 6 to 54 Mbps	1	5	-32.1				-27.0	-21.25	5.80
	Non HT80, 6 to 54 Mbps	2	5	-32.1	-48.2			-26.9	-21.25	5.69
	Non HT80, 6 to 54 Mbps	3	5	-32.1	-48.2	-44.2		-26.7	-21.25	5.44
	Non HT80, 6 to 54 Mbps	4	5	-34.9	-49.0	-45.3	-45.8	-29.0	-21.25	7.76
	VHT80, M0 to M9 1ss	1	5	-35.4				-30.2	-21.25	8.93
	VHT80, M0 to M9 1ss	2	5	-35.4	-49.6			-30.0	-21.25	8.76
	VHT80, M0 to M9 2ss	2	5	-35.4	-49.6			-30.0	-21.25	8.76
	VHT80, M0 to M9 1ss	3	5	-35.4	-49.6	-47.8		-29.8	-21.25	8.53
	VHT80, M0 to M9 2ss	3	5	-35.4	-49.6	-47.8		-29.8	-21.25	8.53
	VHT80, M0 to M9 3ss	3	5	-35.4	-49.6	-47.8		-29.8	-21.25	8.53
	VHT80, M0 to M9 1ss	4	5	-35.4	-49.6	-47.8	-48.2	-29.6	-21.25	8.33
	VHT80, M0 to M9 2ss	4	5	-35.4	-49.6	-47.8	-48.2	-29.6	-21.25	8.33
	VHT80, M0 to M9 3ss	4	5	-35.4	-49.6	-47.8	-48.2	-29.6	-21.25	8.33
	VHT80, M0 to M9 4ss	4	5	-35.4	-49.6	-47.8	-48.2	-29.6	-21.25	8.33

VHT80 Beam Forming, M0 to M9 1ss	2	8	-36.0	-50.7			-27.6	-21.25	6.38
VHT80 Beam Forming, M0 to M9 2ss	2	5	-35.4	-49.6			-30.0	-21.25	8.76
VHT80 Beam Forming, M0 to M9 1ss	3	10	-36.0	-50.7	-51.1		-25.5	-21.25	4.25
VHT80 Beam Forming, M0 to M9 2ss	3	7	-36.0	-50.7	-51.1		-28.5	-21.25	7.25
VHT80 Beam Forming, M0 to M9 3ss	3	5	-35.4	-49.6	-47.8		-29.8	-21.25	8.53
VHT80 Beam Forming, M0 to M9 1ss	4	11	-39.3	-51.6	-50.9	-53.0	-27.4	-21.25	6.14
VHT80 Beam Forming, M0 to M9 2ss	4	8	-36.0	-50.7	-51.1	-49.3	-27.3	-21.25	6.07
VHT80 Beam Forming, M0 to M9 3ss	4	6	-36.0	-50.7	-51.1	-49.3	-29.3	-21.25	8.07
VHT80 Beam Forming, M0 to M9 4ss	4	5	-35.4	-49.6	-47.8	-48.2	-29.6	-21.25	8.33
VHT80 STBC, M0 to M9 1ss	2	5	-35.4	-49.6			-30.0	-21.25	8.76
VHT80 STBC, M0 to M9 1ss	3	5	-35.4	-49.6	-47.8		-29.8	-21.25	8.53
VHT80 STBC, M0 to M9 1ss	4	5	-35.4	-49.6	-47.8	-48.2	-29.6	-21.25	8.33
HE80, M0 to M9 1ss	1	5	-37.9				-32.6	-21.25	11.40
HE80, M0 to M9 1ss	2	5	-37.9	-49.8			-32.4	-21.25	11.13
HE80, M0 to M9 2ss	2	5	-37.9	-49.8			-32.4	-21.25	11.13
HE80, M0 to M9 1ss	3	5	-37.9	-49.8	-50.6		-32.2	-21.25	10.91
HE80, M0 to M9 2ss	3	5	-37.9	-49.8	-50.6		-32.2	-21.25	10.91
HE80, M0 to M9 3ss	3	5	-37.9	-49.8	-50.6		-32.2	-21.25	10.91
HE80, M0 to M9 1ss	4	5	-37.9	-49.8	-50.6	-46.9	-31.7	-21.25	10.45
HE80, M0 to M9 2ss	4	5	-37.9	-49.8	-50.6	-46.9	-31.7	-21.25	10.45
HE80, M0 to M9 3ss	4	5	-37.9	-49.8	-50.6	-46.9	-31.7	-21.25	10.45
HE80, M0 to M9 4ss	4	5	-37.9	-49.8	-50.6	-46.9	-31.7	-21.25	10.45
HE80 Beam Forming, M0 to M9 1ss	2	8	-40.6	-50.1			-31.9	-21.25	10.64
HE80 Beam Forming, M0 to M9 2ss	2	5	-37.9	-49.8			-32.4	-21.25	11.13
HE80 Beam Forming, M0 to M9 1ss	3	10	-40.6	-50.1	-49.0		-29.4	-21.25	8.11
HE80 Beam Forming, M0 to M9 2ss	3	7	-40.6	-50.1	-49.0		-32.4	-21.25	11.11
HE80 Beam Forming, M0 to M9 3ss	3	5	-37.9	-49.8	-50.6		-32.2	-21.25	10.91
HE80 Beam Forming, M0 to M9 1ss	4	11	-42.9	-50.1	-50.7	-51.0	-29.9	-21.25	8.61
HE80 Beam Forming, M0 to M9 2ss	4	8	-40.6	-50.1	-49.0	-49.1	-30.9	-21.25	9.64
HE80 Beam Forming, M0 to M9 3ss	4	6	-40.6	-50.1	-49.0	-49.1	-32.9	-21.25	11.64
HE80 Beam Forming, M0 to M9 4ss	4	5	-37.9	-49.8	-50.6	-46.9	-31.7	-21.25	10.45
HE80 STBC, M0 to M9 1ss	2	5	-37.9	-49.8			-32.4	-21.25	11.13
HE80 STBC, M0 to M9 1ss	3	5	-37.9	-49.8	-50.6		-32.2	-21.25	10.91
HE80 STBC, M0 to M9 1ss	4	5	-37.9	-49.8	-50.6	-46.9	-31.7	-21.25	10.45
Non HT160, 6 to 54 Mbps	1	5	-31.2				-26.2	-21.25	4.90
Non HT160, 6 to 54 Mbps	2	5	-31.2	-46.5			-26.0	-21.25	4.77
Non HT160, 6 to 54 Mbps	3	5	-31.2	-46.5	-44.6		-25.8	-21.25	4.59
Non HT160, 6 to 54 Mbps	4	5	-31.2	-46.5	-44.6	-41.1	-25.4	-21.25	4.19
VHT160, M0 to M9 1ss	1	5	-26.9				-21.5	-21.25	0.26
VHT160, M0 to M9 1ss	2	5	-26.9	-41.6			-21.4	-21.25	0.11
VHT160, M0 to M9 2ss	2	5	-26.9	-41.6			-21.4	-21.25	0.11
VHT160, M0 to M9 1ss	3	5	-30.8	-42.4	-46.9		-25.0	-21.25	3.77

VHT160, M0 to M9 2ss	3	5	-30.8	-42.4	-46.9		-25.0	-21.25	3.77
VHT160, M0 to M9 3ss	3	5	-30.8	-42.4	-46.9		-25.0	-21.25	3.77
VHT160, M0 to M9 1ss	4	5	-30.8	-42.4	-46.9	-44.2	-24.8	-21.25	3.59
VHT160, M0 to M9 2ss	4	5	-30.8	-42.4	-46.9	-44.2	-24.8	-21.25	3.59
VHT160, M0 to M9 3ss	4	5	-30.8	-42.4	-46.9	-44.2	-24.8	-21.25	3.59
VHT160, M0 to M9 4ss	4	5	-30.8	-42.4	-46.9	-44.2	-24.8	-21.25	3.59
VHT160 Beam Forming, M0 to M9 1ss	2	8	-30.8	-42.4			-22.1	-21.25	0.87
VHT160 Beam Forming, M0 to M9 2ss	2	5	-26.9	-41.6			-21.4	-21.25	0.11
VHT160 Beam Forming, M0 to M9 1ss	3	10	-33.0	-42.6	-48.3		-22.0	-21.25	0.79
VHT160 Beam Forming, M0 to M9 2ss	3	7	-30.8	-42.4	-46.9		-23.0	-21.25	1.77
VHT160 Beam Forming, M0 to M9 3ss	3	5	-30.8	-42.4	-46.9		-25.0	-21.25	3.77
VHT160 Beam Forming, M0 to M9 1ss	4	11	-36.8	-46.0	-43.5	-48.1	-23.9	-21.25	2.67
VHT160 Beam Forming, M0 to M9 2ss	4	8	-30.8	-42.4	-46.9	-44.2	-21.8	-21.25	0.59
VHT160 Beam Forming, M0 to M9 3ss	4	6	-30.8	-42.4	-46.9	-44.2	-23.8	-21.25	2.59
VHT160 Beam Forming, M0 to M9 4ss	4	5	-30.8	-42.4	-46.9	-44.2	-24.8	-21.25	3.59
VHT160 STBC, M0 to M9 1ss	2	5	-26.9	-41.6			-21.4	-21.25	0.11
VHT160 STBC, M0 to M9 1ss	3	5	-30.8	-42.4	-46.9		-25.0	-21.25	3.77
VHT160 STBC, M0 to M9 1ss	4	5	-30.8	-42.4	-46.9	-44.2	-24.8	-21.25	3.59
HE160, M0 to M9 1ss	1	5	-33.3				-27.9	-21.25	6.62
HE160, M0 to M9 1ss	2	5	-33.3	-48.3			-27.7	-21.25	6.48
HE160, M0 to M9 2ss	2	5	-33.3	-48.3			-27.7	-21.25	6.48
HE160, M0 to M9 1ss	3	5	-33.3	-48.3	-45.8		-27.5	-21.25	6.25
HE160, M0 to M9 2ss	3	5	-33.3	-48.3	-45.8		-27.5	-21.25	6.25
HE160, M0 to M9 3ss	3	5	-33.3	-48.3	-45.8		-27.5	-21.25	6.25
HE160, M0 to M9 1ss	4	5	-33.3	-48.3	-45.8	-44.4	-27.2	-21.25	5.95
HE160, M0 to M9 2ss	4	5	-33.3	-48.3	-45.8	-44.4	-27.2	-21.25	5.95
HE160, M0 to M9 3ss	4	5	-33.3	-48.3	-45.8	-44.4	-27.2	-21.25	5.95
HE160, M0 to M9 4ss	4	5	-33.3	-48.3	-45.8	-44.4	-27.2	-21.25	5.95
HE160 Beam Forming, M0 to M9 1ss	2	8	-33.3	-48.3			-24.7	-21.25	3.48
HE160 Beam Forming, M0 to M9 2ss	2	5	-33.3	-48.3			-27.7	-21.25	6.48
HE160 Beam Forming, M0 to M9 1ss	3	10	-37.8	-48.7	-46.0		-26.5	-21.25	5.21
HE160 Beam Forming, M0 to M9 2ss	3	7	-33.3	-48.3	-45.8		-25.5	-21.25	4.25
HE160 Beam Forming, M0 to M9 3ss	3	5	-33.3	-48.3	-45.8		-27.5	-21.25	6.25
HE160 Beam Forming, M0 to M9 1ss	4	11	-42.4	-50.9	-50.3	-47.9	-29.0	-21.25	7.71
HE160 Beam Forming, M0 to M9 2ss	4	8	-37.8	-48.7	-46.0	-47.4	-28.1	-21.25	6.84
HE160 Beam Forming, M0 to M9 3ss	4	6	-33.3	-48.3	-45.8	-44.4	-26.2	-21.25	4.95
HE160 Beam Forming, M0 to M9 4ss	4	5	-33.3	-48.3	-45.8	-44.4	-27.2	-21.25	5.95
HE160 STBC, M0 to M9 1ss	2	5	-33.3	-48.3			-27.7	-21.25	6.48
HE160 STBC, M0 to M9 1ss	3	5	-33.3	-48.3	-45.8		-27.5	-21.25	6.25
HE160 STBC, M0 to M9 1ss	4	5	-33.3	-48.3	-45.8	-44.4	-27.2	-21.25	5.95

**Conducted Bandedge Peak, 5dBi
5250 MHz, VHT160, M0 to M9 1ss**



Antenna A



Antenna B

Conducted Band Edge, Peak Table, 6dBi

Frequency (MHz)	Mode	Tx Paths	Correlated Antenna Gain (dBi)	Tx 1 Bandedge Level (dBm)	Tx 2 Bandedge Level (dBm)	Tx 3 Bandedge Level (dBm)	Tx 4 Bandedge Level (dBm)	Total Tx Bandedge Level (dBm)	Limit (dBm)	Margin (dB)
5180	Non HT20, 6 to 54 Mbps	1	6	-40.9				-34.8	-21.25	13.60
	Non HT20, 6 to 54 Mbps	2	6	-40.9	-31.3			-24.8	-21.25	3.54
	Non HT20, 6 to 54 Mbps	3	6	-40.9	-37.7	-35.2		-26.5	-21.25	5.27
	Non HT20, 6 to 54 Mbps	4	6	-40.9	-41.3	-42.4	-41.3	-29.4	-21.25	8.12
	Non HT20 Beam Forming, 6 to 54 Mbps	2	9	-40.9	-37.7			-26.9	-21.25	5.70
	Non HT20 Beam Forming, 6 to 54 Mbps	3	11	-40.9	-47.3	-47.5		-28.2	-21.25	6.99
	Non HT20 Beam Forming, 6 to 54 Mbps	4	12	-42.1	-49.0	-49.1	-50.3	-28.1	-21.25	6.88
	HT/VHT20, M0 to M7	1	6	-41.1				-35.0	-21.25	13.80
	HT/VHT20, M0 to M7	2	6	-41.1	-37.7			-30.0	-21.25	8.76
	HT/VHT20, M8 to M15	2	6	-41.1	-37.7			-30.0	-21.25	8.76
	HT/VHT20, M0 to M7	3	6	-41.1	-46.3	-41.5		-31.6	-21.25	10.35
	HT/VHT20, M8 to M15	3	6	-41.1	-46.3	-41.5		-31.6	-21.25	10.35
	HT/VHT20, M16 to M23	3	6	-41.1	-46.3	-41.5		-31.6	-21.25	10.35
	HT/VHT20, M0 to M7	4	6	-41.1	-46.3	-41.5	-41.5	-30.1	-21.25	8.85
	HT/VHT20, M8 to M15	4	6	-41.1	-46.3	-41.5	-41.5	-30.1	-21.25	8.85
	HT/VHT20, M16 to M23	4	6	-41.1	-46.3	-41.5	-41.5	-30.1	-21.25	8.85
	HT/VHT20, M24 to M31	4	6	-41.1	-46.3	-41.5	-41.5	-30.1	-21.25	8.85
	HT/VHT20 Beam Forming, M0 to M7	2	9	-41.1	-46.3			-30.9	-21.25	9.65
	HT/VHT20 Beam Forming, M8 to M15	2	6	-41.1	-37.7			-30.0	-21.25	8.76
	HT/VHT20 Beam Forming, M0 to M7	3	11	-43.7	-49.5	-47.8		-30.5	-21.25	9.22
	HT/VHT20 Beam Forming, M8 to M15	3	8	-41.1	-45.5	-44.9		-30.5	-21.25	9.29
	HT/VHT20 Beam Forming, M16 to M23	3	6	-41.1	-46.3	-41.5		-31.6	-21.25	10.35
	HT/VHT20 Beam Forming, M0 to M7	4	12	-43.7	-49.5	-47.8	-50.5	-29.0	-21.25	7.70
	HT/VHT20 Beam Forming, M8 to M15	4	9	-41.1	-48.1	-47.4	-45.2	-29.4	-21.25	8.19
	HT/VHT20 Beam Forming, M16 to M23	4	7	-41.1	-46.3	-41.5	-41.5	-29.1	-21.25	7.85
	HT/VHT20 Beam Forming, M24 to M31	4	6	-41.1	-46.3	-41.5	-41.5	-30.1	-21.25	8.85
	HT/VHT20 STBC, M0 to M7	2	6	-41.1	-37.7			-30.0	-21.25	8.76
	HT/VHT20 STBC, M0 to M7	3	6	-41.1	-46.3	-41.5		-31.6	-21.25	10.35
	HT/VHT20 STBC, M0 to M7	4	6	-41.1	-46.3	-41.5	-41.5	-30.1	-21.25	8.85

	HE20, M0 to M9 1ss	1	6	-36.3				-30.2	-21.25	8.98
	HE20, M0 to M9 1ss	2	6	-36.3	-36.1			-27.1	-21.25	5.87
	HE20, M0 to M9 2ss	2	6	-36.3	-36.1			-27.1	-21.25	5.87
	HE20, M0 to M9 1ss	3	6	-36.3	-41.1	-38.2		-27.3	-21.25	6.02
	HE20, M0 to M9 2ss	3	6	-36.3	-41.1	-38.2		-27.3	-21.25	6.02
	HE20, M0 to M9 3ss	3	6	-36.3	-41.1	-38.2		-27.3	-21.25	6.02
	HE20, M0 to M9 1ss	4	6	-36.3	-46.0	-43.3	-45.2	-28.7	-21.25	7.41
	HE20, M0 to M9 2ss	4	6	-36.3	-46.0	-43.3	-45.2	-28.7	-21.25	7.41
	HE20, M0 to M9 3ss	4	6	-36.3	-46.0	-43.3	-45.2	-28.7	-21.25	7.41
	HE20, M0 to M9 4ss	4	6	-36.3	-46.0	-43.3	-45.2	-28.7	-21.25	7.41
	HE20 Beam Forming, M0 to M9 1ss	2	9	-41.4	-49.9			-31.8	-21.25	10.51
	HE20 Beam Forming, M0 to M9 2ss	2	6	-36.3	-36.1			-27.1	-21.25	5.87
	HE20 Beam Forming, M0 to M9 1ss	3	11	-45.0	-50.8	-49.4		-31.8	-21.25	10.57
	HE20 Beam Forming, M0 to M9 2ss	3	8	-36.3	-45.0	-47.5		-27.4	-21.25	6.15
	HE20 Beam Forming, M0 to M9 3ss	3	6	-36.3	-41.1	-38.2		-27.3	-21.25	6.02
	HE20 Beam Forming, M0 to M9 1ss	4	12	-45.0	-50.8	-49.4	-49.4	-29.9	-21.25	8.70
	HE20 Beam Forming, M0 to M9 2ss	4	9	-41.4	-49.9	-48.4	-47.6	-30.3	-21.25	9.09
	HE20 Beam Forming, M0 to M9 3ss	4	7	-36.3	-45.0	-47.5	-48.3	-28.2	-21.25	6.93
	HE20 Beam Forming, M0 to M9 4ss	4	6	-36.3	-46.0	-43.3	-45.2	-28.7	-21.25	7.41
	HE20 STBC, M0 to M9 2ss	2	6	-36.3	-36.1			-27.1	-21.25	5.87
	HE20 STBC, M0 to M9 2ss	3	6	-36.3	-41.1	-38.2		-27.3	-21.25	6.02
	HE20 STBC, M0 to M9 2ss	4	6	-36.3	-46.0	-43.3	-45.2	-28.7	-21.25	7.41
5190	Non HT40, 6 to 54 Mbps	1	6	-35.1				-29.1	-21.25	7.80
	Non HT40, 6 to 54 Mbps	2	6	-35.1	-49.5			-28.9	-21.25	7.65
	Non HT40, 6 to 54 Mbps	3	6	-35.1	-49.5	-49.3		-28.7	-21.25	7.49
	Non HT40, 6 to 54 Mbps	4	6	-35.1	-49.5	-49.3	-48.8	-28.6	-21.25	7.32
	HT/VHT40, M0 to M7	1	6	-35.8				-29.7	-21.25	8.45
	HT/VHT40, M0 to M7	2	6	-35.8	-50.6			-29.6	-21.25	8.31
	HT/VHT40, M8 to M15	2	6	-35.8	-50.6			-29.6	-21.25	8.31
	HT/VHT40, M0 to M7	3	6	-35.8	-50.6	-48.8		-29.4	-21.25	8.10
	HT/VHT40, M8 to M15	3	6	-35.8	-50.6	-48.8		-29.4	-21.25	8.10
	HT/VHT40, M16 to M23	3	6	-35.8	-50.6	-48.8		-29.4	-21.25	8.10
	HT/VHT40, M0 to M7	4	6	-35.8	-50.6	-48.8	-50.4	-29.2	-21.25	7.96
	HT/VHT40, M8 to M15	4	6	-35.8	-50.6	-48.8	-50.4	-29.2	-21.25	7.96
	HT/VHT40, M16 to M23	4	6	-35.8	-50.6	-48.8	-50.4	-29.2	-21.25	7.96
	HT/VHT40, M24 to M31	4	6	-35.8	-50.6	-48.8	-50.4	-29.2	-21.25	7.96
	HT/VHT40 Beam Forming, M0 to M7	2	9	-43.0	-50.9			-33.2	-21.25	11.99
	HT/VHT40 Beam Forming, M8 to M15	2	6	-35.8	-50.6			-29.6	-21.25	8.31
	HT/VHT40 Beam Forming, M0 to M7	3	11	-43.0	-50.9	-50.2		-30.6	-21.25	9.34
	HT/VHT40 Beam Forming, M8 to M15	3	8	-35.8	-50.6	-48.8		-27.4	-21.25	6.10
HT/VHT40 Beam Forming, M16 to M23	3	6	-35.8	-50.6	-48.8		-29.4	-21.25	8.10	
HT/VHT40 Beam Forming, M0 to M7	4	12	-45.3	-52.0	-52.0	-53.1	-31.2	-21.25	9.92	

	HT/VHT40 Beam Forming, M8 to M15	4	9	-43.0	-50.9	-50.2	-52.2	-32.2	-21.25	10.97
	HT/VHT40 Beam Forming, M16 to M23	4	7	-35.8	-50.6	-48.8	-50.4	-28.2	-21.25	6.96
	HT/VHT40 Beam Forming, M24 to M31	4	6	-35.8	-50.6	-48.8	-50.4	-29.2	-21.25	7.96
	HT/VHT40 STBC, M0 to M7	2	6	-35.8	-50.6			-29.6	-21.25	8.31
	HT/VHT40 STBC, M0 to M7	3	6	-35.8	-50.6	-48.8		-29.4	-21.25	8.10
	HT/VHT40 STBC, M0 to M7	4	6	-35.8	-50.6	-48.8	-50.4	-29.2	-21.25	7.96
	HE40, M0 to M9 1ss	1	6	-37.2				-31.1	-21.25	9.82
	HE40, M0 to M9 1ss	2	6	-37.2	-49.6			-30.8	-21.25	9.58
	HE40, M0 to M9 2ss	2	6	-37.2	-49.6			-30.8	-21.25	9.58
	HE40, M0 to M9 1ss	3	6	-37.2	-49.6	-48.6		-30.5	-21.25	9.29
	HE40, M0 to M9 2ss	3	6	-37.2	-49.6	-48.6		-30.5	-21.25	9.29
	HE40, M0 to M9 3ss	3	6	-37.2	-49.6	-48.6		-30.5	-21.25	9.29
	HE40, M0 to M9 1ss	4	6	-37.2	-49.6	-48.6	-49.2	-30.3	-21.25	9.06
	HE40, M0 to M9 2ss	4	6	-37.2	-49.6	-48.6	-49.2	-30.3	-21.25	9.06
	HE40, M0 to M9 3ss	4	6	-37.2	-49.6	-48.6	-49.2	-30.3	-21.25	9.06
	HE40, M0 to M9 4ss	4	6	-37.2	-49.6	-48.6	-49.2	-30.3	-21.25	9.06
	HE40 Beam Forming, M0 to M9 1ss	2	9	-40.6	-51.0			-31.1	-21.25	9.85
	HE40 Beam Forming, M0 to M9 2ss	2	6	-37.2	-49.6			-30.8	-21.25	9.58
	HE40 Beam Forming, M0 to M9 1ss	3	11	-37.9	-51.5	-52.1		-26.4	-21.25	5.18
	HE40 Beam Forming, M0 to M9 2ss	3	8	-40.6	-51.0	-50.4		-31.7	-21.25	10.45
	HE40 Beam Forming, M0 to M9 3ss	3	6	-37.2	-49.6	-48.6		-30.5	-21.25	9.29
	HE40 Beam Forming, M0 to M9 1ss	4	12	-37.9	-51.5	-52.1	-50.3	-25.2	-21.25	3.96
	HE40 Beam Forming, M0 to M9 2ss	4	9	-40.6	-51.0	-50.4	-51.9	-30.4	-21.25	9.19
	HE40 Beam Forming, M0 to M9 3ss	4	7	-40.6	-51.0	-50.4	-51.9	-32.4	-21.25	11.19
	HE40 Beam Forming, M0 to M9 4ss	4	6	-37.2	-49.6	-48.6	-49.2	-30.3	-21.25	9.06
	HE40 STBC, M0 to M9 2ss	2	6	-37.2	-49.6			-30.8	-21.25	9.58
	HE40 STBC, M0 to M9 2ss	3	6	-37.2	-49.6	-48.6		-30.5	-21.25	9.29
	HE40 STBC, M0 to M9 2ss	4	6	-37.2	-49.6	-48.6	-49.2	-30.3	-21.25	9.06
5210	Non HT80, 6 to 54 Mbps	1	6	-34.9				-28.8	-21.25	7.60
	Non HT80, 6 to 54 Mbps	2	6	-34.9	-49.0			-28.7	-21.25	7.43
	Non HT80, 6 to 54 Mbps	3	6	-34.9	-49.0	-45.3		-28.3	-21.25	7.06
	Non HT80, 6 to 54 Mbps	4	6	-34.9	-49.0	-45.3	-45.8	-28.0	-21.25	6.76
	VHT80, M0 to M9 1ss	1	6	-35.4				-29.2	-21.25	7.93
	VHT80, M0 to M9 1ss	2	6	-36.0	-50.7			-29.6	-21.25	8.38
	VHT80, M0 to M9 2ss	2	6	-36.0	-50.7			-29.6	-21.25	8.38
	VHT80, M0 to M9 1ss	3	6	-36.0	-50.7	-51.1		-29.5	-21.25	8.25
	VHT80, M0 to M9 2ss	3	6	-36.0	-50.7	-51.1		-29.5	-21.25	8.25
	VHT80, M0 to M9 3ss	3	6	-36.0	-50.7	-51.1		-29.5	-21.25	8.25
	VHT80, M0 to M9 1ss	4	6	-36.0	-50.7	-51.1	-49.3	-29.3	-21.25	8.07
	VHT80, M0 to M9 2ss	4	6	-36.0	-50.7	-51.1	-49.3	-29.3	-21.25	8.07
	VHT80, M0 to M9 3ss	4	6	-36.0	-50.7	-51.1	-49.3	-29.3	-21.25	8.07
	VHT80, M0 to M9 4ss	4	6	-36.0	-50.7	-51.1	-49.3	-29.3	-21.25	8.07

	VHT80 Beam Forming, M0 to M9 1ss	2	9	-36.0	-50.7			-26.6	-21.25	5.38
	VHT80 Beam Forming, M0 to M9 2ss	2	6	-36.0	-50.7			-29.6	-21.25	8.38
	VHT80 Beam Forming, M0 to M9 1ss	3	11	-39.3	-51.6	-50.9		-27.6	-21.25	6.30
	VHT80 Beam Forming, M0 to M9 2ss	3	8	-36.0	-50.7	-51.1		-27.5	-21.25	6.25
	VHT80 Beam Forming, M0 to M9 3ss	3	6	-36.0	-50.7	-51.1		-29.5	-21.25	8.25
	VHT80 Beam Forming, M0 to M9 1ss	4	12	-39.3	-51.6	-50.9	-53.0	-26.4	-21.25	5.14
	VHT80 Beam Forming, M0 to M9 2ss	4	9	-36.0	-50.7	-51.1	-49.3	-26.3	-21.25	5.07
	VHT80 Beam Forming, M0 to M9 3ss	4	7	-36.0	-50.7	-51.1	-49.3	-28.3	-21.25	7.07
	VHT80 Beam Forming, M0 to M9 4ss	4	6	-36.0	-50.7	-51.1	-49.3	-29.3	-21.25	8.07
	VHT80 STBC, M0 to M9 1ss	2	6	-36.0	-50.7			-29.6	-21.25	8.38
	VHT80 STBC, M0 to M9 1ss	3	6	-36.0	-50.7	-51.1		-29.5	-21.25	8.25
	VHT80 STBC, M0 to M9 1ss	4	6	-36.0	-50.7	-51.1	-49.3	-29.3	-21.25	8.07
	HE80, M0 to M9 1ss	1	6	-37.9				-31.6	-21.25	10.40
	HE80, M0 to M9 1ss	2	6	-37.9	-49.8			-31.4	-21.25	10.13
	HE80, M0 to M9 2ss	2	6	-37.9	-49.8			-31.4	-21.25	10.13
	HE80, M0 to M9 1ss	3	6	-40.6	-50.1	-49.0		-33.4	-21.25	12.11
	HE80, M0 to M9 2ss	3	6	-40.6	-50.1	-49.0		-33.4	-21.25	12.11
	HE80, M0 to M9 3ss	3	6	-40.6	-50.1	-49.0		-33.4	-21.25	12.11
	HE80, M0 to M9 1ss	4	6	-40.6	-50.1	-49.0	-49.1	-32.9	-21.25	11.64
	HE80, M0 to M9 2ss	4	6	-40.6	-50.1	-49.0	-49.1	-32.9	-21.25	11.64
	HE80, M0 to M9 3ss	4	6	-40.6	-50.1	-49.0	-49.1	-32.9	-21.25	11.64
	HE80, M0 to M9 4ss	4	6	-40.6	-50.1	-49.0	-49.1	-32.9	-21.25	11.64
	HE80 Beam Forming, M0 to M9 1ss	2	9	-40.6	-50.1			-30.9	-21.25	9.64
	HE80 Beam Forming, M0 to M9 2ss	2	6	-37.9	-49.8			-31.4	-21.25	10.13
	HE80 Beam Forming, M0 to M9 1ss	3	11	-42.9	-50.1	-50.7		-30.3	-21.25	9.08
	HE80 Beam Forming, M0 to M9 2ss	3	8	-40.6	-50.1	-49.0		-31.4	-21.25	10.11
	HE80 Beam Forming, M0 to M9 3ss	3	6	-40.6	-50.1	-49.0		-33.4	-21.25	12.11
	HE80 Beam Forming, M0 to M9 1ss	4	12	-42.9	-50.1	-50.7	-51.0	-28.9	-21.25	7.61
	HE80 Beam Forming, M0 to M9 2ss	4	9	-40.6	-50.1	-49.0	-49.1	-29.9	-21.25	8.64
	HE80 Beam Forming, M0 to M9 3ss	4	7	-40.6	-50.1	-49.0	-49.1	-31.9	-21.25	10.64
	HE80 Beam Forming, M0 to M9 4ss	4	6	-40.6	-50.1	-49.0	-49.1	-32.9	-21.25	11.64
	HE80 STBC, M0 to M9 1ss	2	6	-37.9	-49.8			-31.4	-21.25	10.13
	HE80 STBC, M0 to M9 1ss	3	6	-40.6	-50.1	-49.0		-33.4	-21.25	12.11
HE80 STBC, M0 to M9 1ss	4	6	-40.6	-50.1	-49.0	-49.1	-32.9	-21.25	11.64	
5250	Non HT160, 6 to 54 Mbps	1	6	-31.2				-25.2	-21.25	3.90
	Non HT160, 6 to 54 Mbps	2	6	-31.2	-46.5			-25.0	-21.25	3.77
	Non HT160, 6 to 54 Mbps	3	6	-31.2	-46.5	-44.6		-24.8	-21.25	3.59
	Non HT160, 6 to 54 Mbps	4	6	-33.1	-49.6	-47.0	-45.5	-26.6	-21.25	5.31
	VHT160, M0 to M9 1ss	1	6	-30.8				-24.4	-21.25	3.16
	VHT160, M0 to M9 1ss	2	6	-30.8	-42.4			-24.1	-21.25	2.87
	VHT160, M0 to M9 2ss	2	6	-30.8	-42.4			-24.1	-21.25	2.87
	VHT160, M0 to M9 1ss	3	6	-30.8	-42.4	-46.9		-24.0	-21.25	2.77

VHT160, M0 to M9 2ss	3	6	-30.8	-42.4	-46.9		-24.0	-21.25	2.77
VHT160, M0 to M9 3ss	3	6	-30.8	-42.4	-46.9		-24.0	-21.25	2.77
VHT160, M0 to M9 1ss	4	6	-30.8	-42.4	-46.9	-44.2	-23.8	-21.25	2.59
VHT160, M0 to M9 2ss	4	6	-30.8	-42.4	-46.9	-44.2	-23.8	-21.25	2.59
VHT160, M0 to M9 3ss	4	6	-30.8	-42.4	-46.9	-44.2	-23.8	-21.25	2.59
VHT160, M0 to M9 4ss	4	6	-30.8	-42.4	-46.9	-44.2	-23.8	-21.25	2.59
VHT160 Beam Forming, M0 to M9 1ss	2	9	-33.0	-42.6			-23.2	-21.25	1.91
VHT160 Beam Forming, M0 to M9 2ss	2	6	-30.8	-42.4			-24.1	-21.25	2.87
VHT160 Beam Forming, M0 to M9 1ss	3	11	-36.8	-46.0	-43.5		-24.2	-21.25	2.91
VHT160 Beam Forming, M0 to M9 2ss	3	8	-30.8	-42.4	-46.9		-22.0	-21.25	0.77
VHT160 Beam Forming, M0 to M9 3ss	3	6	-30.8	-42.4	-46.9		-24.0	-21.25	2.77
VHT160 Beam Forming, M0 to M9 1ss	4	12	-36.8	-46.0	-43.5	-48.1	-22.9	-21.25	1.67
VHT160 Beam Forming, M0 to M9 2ss	4	9	-33.0	-42.6	-48.3	-42.7	-22.7	-21.25	1.40
VHT160 Beam Forming, M0 to M9 3ss	4	7	-30.8	-42.4	-46.9	-44.2	-22.8	-21.25	1.59
VHT160 Beam Forming, M0 to M9 4ss	4	6	-30.8	-42.4	-46.9	-44.2	-23.8	-21.25	2.59
VHT160 STBC, M0 to M9 1ss	2	6	-30.8	-42.4			-24.1	-21.25	2.87
VHT160 STBC, M0 to M9 1ss	3	6	-30.8	-42.4	-46.9		-24.0	-21.25	2.77
VHT160 STBC, M0 to M9 1ss	4	6	-30.8	-42.4	-46.9	-44.2	-23.8	-21.25	2.59
HE160, M0 to M9 1ss	1	6	-33.3				-26.9	-21.25	5.62
HE160, M0 to M9 1ss	2	6	-33.3	-48.3			-26.7	-21.25	5.48
HE160, M0 to M9 2ss	2	6	-33.3	-48.3			-26.7	-21.25	5.48
HE160, M0 to M9 1ss	3	6	-33.3	-48.3	-45.8		-26.5	-21.25	5.25
HE160, M0 to M9 2ss	3	6	-33.3	-48.3	-45.8		-26.5	-21.25	5.25
HE160, M0 to M9 3ss	3	6	-33.3	-48.3	-45.8		-26.5	-21.25	5.25
HE160, M0 to M9 1ss	4	6	-33.3	-48.3	-45.8	-44.4	-26.2	-21.25	4.95
HE160, M0 to M9 2ss	4	6	-33.3	-48.3	-45.8	-44.4	-26.2	-21.25	4.95
HE160, M0 to M9 3ss	4	6	-33.3	-48.3	-45.8	-44.4	-26.2	-21.25	4.95
HE160, M0 to M9 4ss	4	6	-33.3	-48.3	-45.8	-44.4	-26.2	-21.25	4.95
HE160 Beam Forming, M0 to M9 1ss	2	9	-37.8	-48.7			-28.0	-21.25	6.78
HE160 Beam Forming, M0 to M9 2ss	2	6	-33.3	-48.3			-26.7	-21.25	5.48
HE160 Beam Forming, M0 to M9 1ss	3	11	-37.8	-48.7	-46.0		-25.5	-21.25	4.21
HE160 Beam Forming, M0 to M9 2ss	3	8	-37.8	-48.7	-46.0		-28.5	-21.25	7.21
HE160 Beam Forming, M0 to M9 3ss	3	6	-33.3	-48.3	-45.8		-26.5	-21.25	5.25
HE160 Beam Forming, M0 to M9 1ss	4	12	-42.4	-50.9	-50.3	-47.9	-28.0	-21.25	6.71
HE160 Beam Forming, M0 to M9 2ss	4	9	-37.8	-48.7	-46.0	-47.4	-27.1	-21.25	5.84
HE160 Beam Forming, M0 to M9 3ss	4	7	-37.8	-48.7	-46.0	-47.4	-29.1	-21.25	7.84
HE160 Beam Forming, M0 to M9 4ss	4	6	-33.3	-48.3	-45.8	-44.4	-26.2	-21.25	4.95
HE160 STBC, M0 to M9 1ss	2	6	-33.3	-48.3			-26.7	-21.25	5.48
HE160 STBC, M0 to M9 1ss	3	6	-33.3	-48.3	-45.8		-26.5	-21.25	5.25
HE160 STBC, M0 to M9 1ss	4	6	-33.3	-48.3	-45.8	-44.4	-26.2	-21.25	4.95

**Conducted Bandedge Peak, 6dBi
5250 MHz, VHT160 Beam Forming, M0 to M9 2ss**



Antenna A



Antenna B



Antenna C



Appendix B: Radiated & AC Conducted Emissions Test Results
Testing done by outside laboratory.

Appendix C: List of Test Equipment Used to perform the test

Test Equipment used for Radiated Emissions					
Equip#	Manufacturer/ Model	Description	Last Cal	Next Cal	Test Item
57479	Cisco	Automation Test Insertion Loss	NA	NA	A1-A7
49516	Keysight N9030A-550	PXA Signal Analyzer, 3Hz to 50GHz	29 Nov 2018	29 Nov 2019	A1-A7
55097	NI PXI-1042	CHASSIS, PXI	NA	NA	A1-A7
57233	NI PXI-8115	Embedded Controller	NA	NA	A1-A7
57253	NI PXI-2796	40 GHz Dual 6x1 Multiplexer (SP6T)	NA	NA	A1-A7
57254	NI PXI-2799	Switch 1x1	NA	NA	A1-A7
56089	NI PXI-2796	40 GHz Dual 6x1 Multiplexer (SP6T)	NA	NA	A1-A7
7329	Omega CT485B	Chart recorder	18 Feb 2019	18 Feb 2020	A1-A7
56328	Pasternack PE5019-1	Torque wrench	14 Feb 2019	14 Feb 2020	A1-A7
56329	Pasternack PE5019-1	Torque wrench	28 Feb 2019	28 Feb 2020	A1-A7
56330	Pasternack PE5019-1	Torque wrench	28 Feb 2019	28 Feb 2020	A1-A7

Appendix D: Abbreviation Key and Definitions

The following table defines abbreviations used within this test report.

Abbreviation	Description	Abbreviation	Description
EMC	Electro Magnetic Compatibility	°F	Degrees Fahrenheit
EMI	Electro Magnetic Interference	°C	Degrees Celsius
EUT	Equipment Under Test	Temp	Temperature
ITE	Information Technology Equipment	S/N	Serial Number
TAP	Test Assessment Schedule	Qty	Quantity
ESD	Electro Static Discharge	emf	Electromotive force
EFT	Electric Fast Transient	RMS	Root mean square
EDCS	Engineering Document Control System	Qp	Quasi Peak
Config	Configuration	Av	Average
CIS#	Cisco Number (unique identification number for Cisco test equipment)	Pk	Peak
Cal	Calibration	kHz	Kilohertz (1×10^3)
EN	European Norm	MHz	MegaHertz (1×10^6)
IEC	International Electro technical Commission	GHz	Gigahertz (1×10^9)
CISPR	International Special Committee on Radio Interference	H	Horizontal
CDN	Coupling/Decoupling Network	V	Vertical
LISN	Line Impedance Stabilization Network	dB	decibel
PE	Protective Earth	V	Volt
GND	Ground	kV	Kilovolt (1×10^3)
L1	Line 1	μ V	Microvolt (1×10^{-6})
L2	Line2	A	Amp
L3	Line 3	μ A	Micro Amp (1×10^{-6})
DC	Direct Current	mS	Milli Second (1×10^{-3})
RAW	Uncorrected measurement value, as indicated by the measuring device	μ S	Micro Second (1×10^{-6})
RF	Radio Frequency	μ S	Micro Second (1×10^{-6})
SLCE	Signal Line Conducted Emissions	m	Meter
Meas dist	Measurement distance	Spec dist	Specification distance
N/A or NA	Not Applicable	SL	Signal Line (or Telecom Line)
P	Power Line	L	Live Line
N	Neutral Line	R	Return
S	Supply	AC	Alternating Current

Appendix E: Photographs of Test Setups

Please refer to the attachement

Appendix F: Software Used to Perform Testing

Cisco Internal LabView Radio Test Automation Software rev57

Appendix G: Test Procedures

Measurements were made in accordance with

- KDB 789033 - D02 General UNII Test Procedures New Rules v02r01
- KDB 662911 - MIMO
- ANSI C63.4 2014 Unintentional Radiators
- ANSI C63.10 2013 Intentional Radiators

Test procedures are summarized below:

FCC 5GHz Test Procedures	EDCS # 1445048
FCC 5GHz RSE Test Procedures	EDCS # 1511600

Appendix H: Scope of Accreditation (A2LA certificate number 1178-01)

The scope of accreditation of Cisco Systems, Inc. can be found on the A2LA web page at:

<http://www.a2la.org/scopepdf/1178-01.pdf>

Appendix I: Test Assessment Plan

Target Power Tables EDCS# 18087112

Appendix J: UUT Software Info

```
APA453.0E7B.CD64#test watchdog monitoring off
APA453.0E7B.CD64#
APA453.0E7B.CD64#
APA453.0E7B.CD64#
APA453.0E7B.CD64#
APA453.0E7B.CD64#show ver
    Restricted Rights Legend
```

Use, duplication, or disclosure by the Government is subject to restrictions as set forth in subparagraph (c) of the Commercial Computer Software - Restricted Rights clause at FAR sec. 52.227-19 and subparagraph (c) (1) (ii) of the Rights in Technical Data and Computer Software clause at DFARS sec. 252.227-7013.

Cisco Systems, Inc.
170 West Tasman Drive
San Jose, California 95134-1706

This product contains cryptographic features and is subject to United States and local country laws governing import, export, transfer and use. Delivery of Cisco cryptographic products does not imply third-party authority to import, export, distribute or use encryption. Importers, exporters, distributors and users are responsible for compliance with U.S. and local country laws. By using this product you agree to comply with applicable laws and regulations. If you are unable to comply with U.S. and local laws, return this product immediately.

A summary of U.S. laws governing Cisco cryptographic products may be found at:
<http://www.cisco.com/www/export/crypto/tool/stqrg.html>

If you require further assistance please contact us by sending email to export@cisco.com.

This product contains some software licensed under the "GNU General Public License, version 2" provided with ABSOLUTELY NO WARRANTY under the terms of "GNU General Public License, version 2", available here:
<http://www.gnu.org/licenses/old-licenses/gpl-2.0.html>

This product contains some software licensed under the "GNU Library General Public License, version 2" provided with ABSOLUTELY NO WARRANTY under the terms of "GNU Library General Public License, version 2", available here:
<http://www.gnu.org/licenses/old-licenses/lgpl-2.0.html>

This product contains some software licensed under the



"GNU Lesser General Public License, version 2.1" provided with ABSOLUTELY NO WARRANTY under the terms of "GNU Lesser General Public License, version 2.1", available here: <http://www.gnu.org/licenses/old-licenses/lgpl-2.1.html>

This product contains some software licensed under the "GNU General Public License, version 3" provided with ABSOLUTELY NO WARRANTY under the terms of "GNU General Public License, Version 3", available here: <http://www.gnu.org/licenses/gpl.html>.

This product contains some software licensed under the "GNU Affero General Public License, version 3" provided with ABSOLUTELY NO WARRANTY under the terms of "GNU Affero General Public License, version 3", available here: <http://www.gnu.org/licenses/agpl-3.0.html>.

Cisco AP Software, (ap1g7), [cheetah-build6:/san2/BUILD/workspace/Nightly-Cheetah-axel-bcm-mfg-c8_10_throttle]
Technical Support: <http://www.cisco.com/techsupport>
Copyright (c) 1986-2019 by Cisco Systems, Inc.
Compiled Fri Sep 6 08:06:05 PDT 2019

ROM: Bootstrap program is U-Boot boot loader
BOOTLDR: U-Boot boot loader Version

APA453.0E7B.CD64 uptime is 0 days, 1 hours, 28 minutes
Last reload time : Fri Sep 6 08:07:16 UTC 2019
Last reload reason : unknown

cisco C9120AXE-B with 1809824/1062900K bytes of memory.
Processor board ID 0
AP Running Image : 8.8.1.10
Primary Boot Image : 8.8.1.10
Backup Boot Image : 0.0.0.0
Primary Boot Image Hash:
Backup Boot Image Hash:
1 Gigabit Ethernet interfaces
2 802.11 Radios
Radio Driver version : 17.10 RC77.13
Radio FW version : 1268.14948.r14702 14702
NSS FW version : NA

Base ethernet MAC Address : A4:53:0E:7B:CD:64
Part Number : 0-000000-00
PCA Assembly Number : 800-105708-01
PCA Revision Number : 09
PCB Serial Number : FOC23302F2B
Top Assembly Part Number : 800-105708-01



Top Assembly Serial Number : 0
Top Revision Number : 09
Product/Model Number : C9120AXE-B

```
APA453.0E7B.CD64#  
APA453.0E7B.CD64#  
APA453.0E7B.CD64#  
APA453.0E7B.CD64#  
APA453.0E7B.CD64#devs  
EXITING CISCO SHELL. PLEASE EXECUTE EXIT IN DEVSHELL TO GET BACK TO CISCO SHELL.
```

BusyBox v1.29.3 () built-in shell (ash)

Welcome to Cisco.

Usage of this device is governed by Cisco's End User License Agreement,
available at:

http://www.cisco.com/c/en/us/td/docs/general/warranty/English/EU1KEN_.html.

```
mA4530E7BCD64:##  
mA4530E7BCD64:##  
mA4530E7BCD64:##  
mA4530E7BCD64:## echo 0 > /meraki_gpio/RF_2G_ble  
mA4530E7BCD64:## echo 0 > /meraki_gpio/2g_dart_sw  
mA4530E7BCD64:##  
mA4530E7BCD64:##  
mA4530E7BCD64:## cat MERAKE_BUILD.extra  
Fri Sep 6 08:06:05 PDT 2019  
cheetah-build6  
/san2/BUILD/workspace/Nightly-Cheetah-axel-bcm-mfg-c8_10_throttle
```

* (HEAD detached at fb31ca5b6a)

svn base: fb31ca5b6ab1468794221acdd081bea192921139

commit: fb31ca5b6ab1468794221acdd081bea192921139

tree 9933345a372cf5493649162765b52efdf4ff9219

```
mA4530E7BCD64:##  
mA4530E7BCD64:##  
mA4530E7BCD64:##  
mA4530E7BCD64:## show_cookie
```

```
Part Number : 0-000000-00  
Board Revision : 00  
PCB Serial Number : FOC23302F2B  
PCB Fab Part Number : 0-000000-00  
Deviation Number : 0  
MAC Address : A4:53:0E:7B:CD:64
```

MAC Address Block Size : 4
Radio 0 MAC Address : D4:AD:BD:A2:1B:20
Radio 0 MAC Address Block Size : 16
Radio 1 MAC Address : D4:AD:BD:A2:1B:30
Radio 1 MAC Address Block Size : 16
PCA Assembly Number : 800-105708-01
PCA Revision Number : 09
Product/Model Number : C9120AXE-B
Top Assembly Part Number : 800-105708-01
Top Revision Number : 09
Top Assembly Serial Number : 0
RMA Test History : 00
RMA History : 00
RMA Number : 00-00-00-00
Device Type : 4C
Max Association Allowed : 2
Radio(2.4G) Carrier Set : 0000
Radio(2.4G) Max Transmit Power Level : 100
Radio(2.4G) Antenna Diversity Support: 01
Radio(2.4G) Encryption Ability : 0002
Radio(5G) Carrier Set : 0029
Radio(5G) Max Transmit Power Level : 100
Radio(5G) Antenna Diversity Support : 01
Radio(5G) Encryption Ability : 0002
Radio(802.11g) Radio Mode : 255
PEP Product Identifier (PID) : C9120AXE-B
PEP Version Identifier (VID) : V01
System Flags : 00
Controller Type : 0000
Host Controller Type : 0000
Mfr Service Date : 2019.08.03-47:59:59
Radio(49) Carrier Set : 0000
Radio(49) Max Transmit Power Level : 0
Radio(49) Antenna Diversity Support : 00
Radio(49) Encryption Ability : 0000
Radio(58) Carrier Set : 0029
Radio(58) Max Transmit Power Level : 100
Radio(58) Antenna Diversity Support : 01
Radio(58) Encryption Ability : 0002
ACT2 ID : C9120
Static AP Mode : 0
mA4530E7BCD64:/#
mA4530E7BCD64:/#
mA4530E7BCD64:/#
mA4530E7BCD64:/#
mA4530E7BCD64:/# cat /storage/rxtx_mode
tx
mA4530E7BCD64:/#

```
mA4530E7BCD64:/#
mA4530E7BCD64:/#
mA4530E7BCD64:/# cd /usr/bin/bcm/mfg
mA4530E7BCD64:/usr/bin/bcm/mfg#
mA4530E7BCD64:/usr/bin/bcm/mfg#
mA4530E7BCD64:/usr/bin/bcm/mfg#
mA4530E7BCD64:/usr/bin/bcm/mfg# ./init_config.sh
show_carrier_cookies | grep -o '..$'
41
wl -i apr1v0 country US
wl -i apr0v0 country US
Chanspec set to 0x1001
[*09/06/2019 09:37:43.5720] wlc_ucose_download: wl1: Loading 129 MU ucode
Chanspec set to 0xd024
[*09/06/2019 09:37:43.6510] wlc_ucose_download: wl0: Loading 129 MU ucode
mA4530E7BCD64:/usr/bin/bcm/mfg#
mA4530E7BCD64:/usr/bin/bcm/mfg#
mA4530E7BCD64:/usr/bin/bcm/mfg#
mA4530E7BCD64:/usr/bin/bcm/mfg#
mA4530E7BCD64:/usr/bin/bcm/mfg#
mA4530E7BCD64:/usr/bin/bcm/mfg#
mA4530E7BCD64:/usr/bin/bcm/mfg# ./dfstool.lua
```

```
Vanc dfstool
BOARD: Axel BCM !!!!!
```

```
Display config:
wl -i apr0v0 status | head -3
"Not associated. Last associated with SSID: ""
```

```
Display config:
wl -i apr1v0 status | head -3
"Not associated. Last associated with SSID: ""
```

```
show_carrier_cookies | grep -o '..$'
rc:result="41"
```

```
wl -i apr1v0 country US
wl -i apr0v0 country US
>
line=""
>
line=""
>
line=""
>do0 stop
line="do0 stop"
```

```
DEBUG: compliance stop command matched.
```

INFO: subcommand="compliance off".

execution section for compliance stop command.

```
line="do0 stop"
interface="0"
stop_option="stop"
wl -i apr0v0 pkteng_status | awk -F'[ , ]' '{print $3}'
main:result="0"
```

1601792112 (0x5f796870)

>

line=""

>do1 stop

line="do1 stop"

DEBUG: compliance stop command matched.

INFO: subcommand="compliance off".

execution section for compliance stop command.

```
line="do1 stop"
interface="1"
stop_option="stop"
wl -i apr1v0 pkteng_status | awk -F'[ , ]' '{print $3}'
main:result="0"
```

1601792112 (0x5f796870)

>

line=""

>do4 stop

line="do4 stop"

DEBUG: compliance stop command matched.

INFO: subcommand="compliance off".

execution section for compliance stop command.

```
line="do4 stop"
interface="4"
stop_option="stop"
[09/06/2019 09:38:02.8090] NXP-RHL-Driver 0001:01:00.0: xcvr[0], swcmd 0x23 done
[09/06/2019 09:38:02.9910] NXP-RHL-Driver 0001:01:00.0: xcvr[0], swcmd 0x4 done
[09/06/2019 09:38:03.0740] NXP-RHL-Driver 0001:01:00.0: VSPA FW :: FN = dcr.eld
>
line=""
>
line=""
>
```

End