

Test Report

C1920AXE-x

(x = A, B, N, T)

Cisco Catalyst C9120AX Series 802.11ax Access Point

2.4GHz Chillwave Radio

FCC ID: LDKEDAC92157

IC: 2461N-EDAC92157

2400-2483.5 MHz

Against the following Specifications:

CFR47 Part 15.247

RSS-247

RSS-Gen Issue 5

LP0002 (2018-01-10)



Cisco Systems

170 West Tasman Drive

San Jose, CA 95134

	
<p>Author: Chris Blair Tested By: Chris Blair</p>	<p>Approved By: Gez Thorpe Title: Radio Compliance Manager Revision: See EDCS</p>

This report replaces any previously entered test report under EDCS – **18351925**. This test report has been electronically authorized and archived using the CISCO Engineering Document Control system. Test Report Template EDCS# 11644121.



SECTION 1: OVERVIEW3

SECTION 2: ASSESSMENT INFORMATION4

 2.1 GENERAL4

 2.2 DATE OF TESTING6

 2.3 REPORT ISSUE DATE6

 2.4 TESTING FACILITIES6

 2.5 EQUIPMENT ASSESSED (EUT)6

 2.6 EUT DESCRIPTION7

SECTION 3: RESULT SUMMARY8

 3.1 RESULTS SUMMARY TABLE8

SECTION 4: SAMPLE DETAILS11

 4.1 SAMPLE DETAILS11

 4.2 SYSTEM DETAILS11

 4.3 MODE OF OPERATION DETAILS11

APPENDIX A: EMISSION TEST RESULTS12

 CONDUCTED TEST SETUP DIAGRAM12

 TARGET MAXIMUM CHANNEL POWER12

 A.1 DUTY CYCLE13

 A.2 DTS BANDWIDTH (6dB BANDWIDTH)15

 A.3 OCCUPIED BANDWIDTH18

 A.4 MAXIMUM CONDUCTED OUTPUT POWER21

 A.5 POWER SPECTRAL DENSITY27

 A.6 CONDUCTED SPURIOUS EMISSIONS32

 A.7 CONDUCTED RECEIVER SPURIOUS EMISSIONS42

 A.8 CONDUCTED BANDEGE (RESTRICTED BAND)45

 A.9 CONDUCTED BANDEGE (NON-RESTRICTED BAND)63

APPENDIX B: RADIATED AND AC CONDUCTED EMISSION TEST RESULTS69

APPENDIX C: LIST OF TEST EQUIPMENT USED TO PERFORM THE TEST70

APPENDIX D: ABBREVIATION KEY AND DEFINITIONS71

APPENDIX E: PHOTOGRAPHS OF TEST SETUPS72

APPENDIX F: SOFTWARE USED TO PERFORM TESTING73

APPENDIX G: TEST PROCEDURES73

APPENDIX H: SCOPE OF ACCREDITATION (A2LA CERTIFICATE NUMBER 1178-01)73

APPENDIX I: TEST ASSESSMENT PLAN73

APPENDIX J: UUT SOFTWARE INFO74



Section 1: Overview

The samples were assessed against the tests under the requirements of the following specifications:

Emission
CFR47 Part 15.247 RSS-247 Issue 2: Feb 2017 RSS-Gen Issue 5: Apr 2018 LP0002 (2018-01-10)

Section 2: Assessment Information

2.1 General

This report contains an assessment of an apparatus against Electromagnetic Compatibility Standards based upon tests carried out on the samples submitted. The testing was performed by and for the use of Cisco systems Inc:

With regard to this assessment, the following points should be noted:

- a) The results contained in this report relate only to the items tested and were obtained in the period between the date of the initial assessment and the date of issue of the report. Manufactured products will not necessarily give identical results due to production and measurement tolerances.
- b) The apparatus was set up and exercised using the configuration and modes of operation defined in this report only.
- c) Where relevant, the apparatus was only assessed using the susceptibility criteria defined in this report and the Test Assessment Plan (TAP).
- d) All testing was performed under the following environmental conditions:

Temperature	15°C to 35°C (54°F to 95°F)
Atmospheric Pressure	860mbar to 1060mbar (25.4" to 31.3")
Humidity	10% to 75*%

Units of Measurement

The units of measurements defined in the appendices are reported in specific terms, which are test dependent. Where radiated measurements are concerned these are defined at a particular distance. Basic voltage measurements are defined in units of [dBuV]

As an example, the basic calculation for all measurements is as follows:

$$\text{Emission level [dBuV]} = \text{Indicated voltage level [dBuV]} + \text{Cable Loss [dB]} + \text{Other correction factors [dB]}$$

The combinations of correction factors are dependent upon the exact test configurations [see test equipment lists for further details] and may include:-

Antenna Factors, Pre Amplifier Gain, LISN Loss, Pulse Limiter Loss and Filter Insertion Loss..

Note: to convert the results from dBuV/m to uV/m use the following formula:-

$$\text{Level in uV/m} = \text{Common Antilogarithm} [(X \text{ dBuV/m})/20] = Y \text{ uV/m}$$



Measurement Uncertainty Values

voltage and power measurements	± 2 dB
conducted EIRP measurements	± 1.4 dB
radiated measurements	± 3.2 dB
frequency measurements	± 2.4 10 ⁻⁷
temperature measurements	± 0.54°
humidity measurements	± 2.3%
DC and low frequency measurements	± 2.5%

Where relevant measurement uncertainty levels have been estimated for tests performed on the apparatus. This uncertainty represents an expanded uncertainty expressed at approximately the 95% confidence level using a coverage factor of k=2.

Radiated emissions (expanded uncertainty, confidence interval 95%)

30 MHz - 300 MHz	+/- 3.8 dB
300 MHz - 1000 MHz	+/- 4.3 dB
1 GHz - 10 GHz	+/- 4.0 dB
10 GHz - 18GHz	+/- 8.2 dB
18GHz - 26.5GHz	+/- 4.1 dB
26.5GHz - 40GHz	+/- 3.9 dB

Conducted emissions (expanded uncertainty, confidence interval 95%)

30 MHz – 40GHz	+/- 0.38 dB
----------------	-------------

A product is considered to comply with a requirement if the nominal measured value is below the limit line. The product is considered to not be in compliance in case the nominal measured value is above the limit line.

This report must not be reproduced except in full, without written approval of Cisco Systems.

2.2 Date of testing

15-Sep-19 - 16-Sep-19

2.3 Report Issue Date

15-Oct-19

Cisco uses an electronic system to issue, store and control the revision of test reports. This system is called the Engineering Document Control System. The actual report issue date is embedded into the original file on EDCS. Any copies of this report, either electronic or paper, that are not on EDCS must be considered uncontrolled.

2.4 Testing facilities

This assessment was performed by: Chris Blair & Julian Land

Testing Laboratory

Cisco Systems, Inc.
125 West Tasman Drive (Building P)
San Jose, CA 95134
USA

Headquarters

Cisco Systems, Inc.,
170 West Tasman Drive
San Jose, CA 95134,
USA

Registration Numbers for Industry Canada

Cisco System Site	Address	Site Identifier
Building P, 10m Chamber	125 West Tasman Dr San Jose, CA 95134	Company #: 2461N-2
Building P, 5m Chamber	125 West Tasman Dr San Jose, CA 95134	Company #: 2461N-1
Building I, 5m Chamber	285 W. Tasman Drive San Jose, California 95134	Company #: 2461M-1
Building 7, 5m Chamber	425 E. Tasman Drive San Jose, California 95134	Company #: 2461N-3

Test Engineers

Chris Blair

2.5 Equipment Assessed (EUT)

C9120AXE-x

2.6 EUT Description

The radio supports the following modes of operation. The modes are further defined in the radio Theory of Operation. The modes included in this report represent the worst case data for all modes. Data is recorded at the lowest supported data rate for each mode. This report covers operation on channel 1-11.

802.11g - Non HT20, One Antenna, 6 to 54 Mbps, 1ss

The following antennas are supported by this product series.

The data included in this report represent the worst case data for all antennas.

Frequency	Part Number	Antenna Type	Antenna Gain (dBi)
-E SKU			
2.4GHz&5GHz	AIR-ANT2524DB-R/=	2.4 GHz 2 dBi/5 GHz 4 dBi Dipole Ant., Black, connectors RP-TNC	2dBi@2.4GHz 4dBi@5GHz
2.4GHz&5GHz	AIR-ANT2524DG-R/=	2.4 GHz 2 dBi/5 GHz 4 dBi Dipole Ant., Gray, connectors RP-TNC	2dBi@2.4GHz 4dBi@5GHz
2.4GHz&5GHz	AIR-ANT2524DW-R/=	2.4 GHz 2 dBi/5 GHz 4 dBi Dipole Ant., White, connectors RP-TNC	2dBi@2.4GHz 4dBi@5GHz
2.4GHz&5GHz	AIR-ANT2535SDW-R	2.4 GHz 3dBi/5 GHz 5 dBi Low Profile Antenna, White, connectors RP-TNC	3dBi@2.4GHz 5dBi@5GHz
2.4GHz&5GHz	AIR-ANT2566P4W-R=	2.4 GHz 6 dBi/5 GHz 6 dBi Directionnel Ant., 4-port, connectors RP-TNC	6dBi@2.4GHz 6dBi@5GHz
2.4GHz&5GHz	AIR-ANT2524V4C-R=	2.4GHz 2 dBi/5GHz 4 dBi Ceiling Mount Omni Ant., 4-port, connectors RP-TNC	2dBi@2.4GHz 4dBi@5GHz
2.4GHz&5GHz	AIR-ANT2544V4M-R=	2.4GHz 4 dBi/5GHz 4 dBi Wall Mount Omni Ant., 4-port, connectors RP-TNC	4dBi@2.4GHz 4dBi@5GHz
2.4GHz&5GHz	AIR-ANT2566D4M-R=	2.4 GHz 6 dBi/5 GHz 6 dBi 60 Deg. Patch Ant., 4-port, RP-TNC	6dBi@2.4GHz 6dBi@5GHz

Section 3: Result Summary

3.1 Results Summary Table

Conducted emissions

Basic Standard	Technical Requirements / Details	Result
FCC 15.247 RSS-247 LP0002:3.10.1(6.2.1)	6dB Bandwidth Systems using digital modulation techniques may operate in the 2400-2483.5MHz band. The minimum 6dB bandwidth shall be at least 500 kHz	Pass
FCC 15.247 RSS-247	99% & 26 dB Bandwidth: The 99% occupied bandwidth is the frequency bandwidth such that, below its lower and above its upper frequency limits, the mean powers are each equal to 0.5% of the total mean power of the given emission. There is no limit for 99% OBW. The 26 dB emission is the width of the emission that is constrained by the frequencies associated with the two outermost amplitude points (upper and lower frequencies) that are attenuated by 26 dB relative to the maximum level measured in the fundamental emission.	Pass
FCC 15.247 RSS-247 LP0002:3.10.1(2.3)	Output Power: 15.247 The maximum conducted output power of the intentional radiator for systems using digital modulation in the 2400-2483.5 MHz band shall not exceed 1 Watt (30dBm). If transmitting antennas of directional gain greater than 6 dBi are used, the maximum conducted output power shall be reduced by the amount in dB that the directional gain of the antenna exceeds 6 dBi. RSS-247 For DTSs employing digital modulation techniques operating in the band 2400-2483.5 MHz, the maximum peak conducted output power shall not exceed 1W. Except as provided in Section 5.4(e), the e.i.r.p. shall not exceed 4 W.	Pass
FCC 15.247 RSS-247 LP0002:3.10.1(6.2.2)	Power Spectral Density For digitally modulated systems, the power spectral density conducted from the intentional radiator to the antenna shall not be greater than 8 dBm in any 3 kHz band during any time interval of continuous transmission.	Pass



<p>FCC 15.247 RSS-247 LP0002:3.10.1(5)/2.8</p>	<p>Conducted Spurious Emissions / Band-Edge: In any 100 kHz bandwidth outside the frequency band in which the spread spectrum or digitally modulated device is operating, the RF power that is produced shall be at least 20 dB below that in the 100 kHz bandwidth within the band that contains the highest level of the desired power, based on either an RF conducted or a radiated measurement, provided that the transmitter demonstrates compliance with the peak conducted power limits. If the transmitter complies with the conducted power limits based on the use of root-mean-square averaging over a time interval, as permitted under section 5.4(d), the attenuation required shall be 30 dB instead of 20 dB. Attenuation below the general field strength limits specified in RSS-Gen is not required.</p>	<p>Pass</p>
<p>FCC 15.247 RSS-247 FCC 15.205 RSS-Gen</p>	<p>Restricted band: Unwanted emissions falling within the restricted bands, as defined in FCC 15.205 (a) and RSS-Gen 8.10 must also comply with the radiated emission limits specified in FCC 15.209 (a) and RSS-Gen 8.9</p>	<p>Pass</p>

Radiated Emissions (General requirements)

Basic Standard	Technical Requirements / Details	Result
FCC 15.209 RSS-Gen LP0002:3.10.1(5)/2.8	TX Spurious Emissions: Except as provided elsewhere in this subpart, the emissions from an intentional radiator shall not exceed the field strength levels specified in the filed strength limits table in this section. Unwanted emissions falling within the restricted bands, as defined in FCC 15.205 (a) and RSS-Gen 8.10 must also comply with the radiated emission limits specified in FCC 15.209 (a) and RSS-Gen 8.9	Not Tested
RSS-Gen LP0002:3.10.1(5)/2.8	RX Spurious Emissions: RSS-Gen 8.9 Except when the requirements applicable to a given device state otherwise, emissions from licence-exempt transmitters shall comply with the field strength limits shown in Table 4 and Table 5 below. Additionally, the level of any transmitter emission shall not exceed the level of the transmitter's fundamental emission. RSS-Gen 8.10 Restricted Bands Unwanted emissions that fall into restricted bands of Table 6 shall comply with the limits specified in RSS-Gen; and (c) Unwanted emissions that do not fall within the restricted frequency bands of Table 6 shall comply either with the limits specified in the applicable RSS or with those specified in this RSS-Gen.	Not Tested
FCC 15.207 RSS-Gen LP0002:2.3	AC conducted Emissions: Except when the requirements applicable to a given device state otherwise, for any radio apparatus equipped to operate from the public utility AC power supply, either directly or indirectly (such as with a battery charger), the radio frequency voltage of emissions conducted back onto the AC power lines in the frequency range of 0.15 MHz to 30 MHz shall not exceed the limits shown in the table in these sections. The more stringent limit applies at the frequency range boundaries.	Not Tested



Section 4: Sample Details

Note: Each sample was evaluated to ensure that its condition was suitable to be used as a test sample prior to the commencement of testing.

4.1 Sample Details

Sample No.	Equipment Details	Manufacturer	Hardware Rev.	Firmware Rev.	Software Rev.	Serial Number
S01	C1920AXE-x	Foxconn	P2-2	1268.149 48.r1470 2 14702	Cisco AP Software, (ap1g7), [cheetah-build6:/san2/BUILD/ workspace/Nightly-Cheetah-a xel-bcm-mfg-c8_10_throttle] Compiled Fri Sep 6 08:06:05 PDT 2019	FOC23302F0Q

4.2 System Details

System #	Description	Samples
1	C1920AXE-x	S01

4.3 Mode of Operation Details

Mode#	Description	Comments
1	Continuously Transmitting	Constant duty cycle

Appendix A: Emission Test Results

Conducted Test Setup Diagram

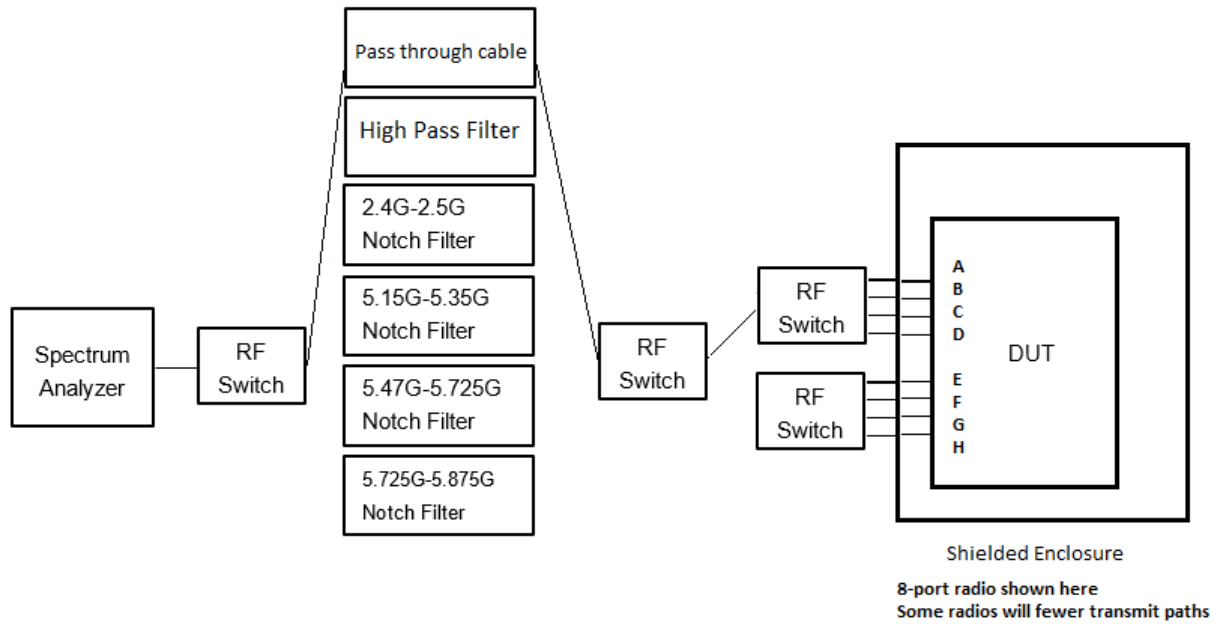

Target Maximum Channel Power

The following table details the maximum supported Total Channel Power for all operating modes.

Antenna	Operating Mode	Maximum Channel Power (dBm)		
		Frequency (MHz)		
		2412	2462	
2dBi	Non HT20, 6 to 54 Mbps	12	13	
3dBi	Non HT20, 6 to 54 Mbps	12	13	
4dBi	Non HT20, 6 to 54 Mbps	12	13	
6dBi	Non HT20, 6 to 54 Mbps	10	13	

A.1 Duty Cycle

Duty Cycle Test Requirement

From KDB 558074, Section 6

6.0 Duty cycle, transmission duration and maximum power control level

Preferably, all measurements of maximum conducted (average) output power will be performed with the EUT transmitting continuously (*i.e.*, with a duty cycle of greater than or equal to 98%). When continuous operation cannot be realized, then the use of sweep triggering/signal gating techniques can be utilized to ensure that measurements are made only during transmissions at the maximum power control level. ...

When continuous transmission cannot be achieved and sweep triggering/signal gating cannot be implemented, alternate procedures are provided that can be used to measure the average power; however, they will require an additional measurement of the transmitter duty cycle. Within this guidance document, the duty cycle refers to the fraction of time over which the transmitter is on and is transmitting at its maximum power control level. The duty cycle is considered to be constant if variations are less than ± 2 percent, otherwise the duty cycle is considered to be non-constant.

Duty Cycle Test Method

From KDB 558074, Section 6:

The zero-span mode on a spectrum analyzer or EMI receiver if the response time and spacing between bins on the sweep are sufficient to permit accurate measurements of the on and off times of the transmitted signal. Set the center frequency of the instrument to the center frequency of the transmission. Set RBW \geq OBW if possible; otherwise, set RBW to the largest available value. Set VBW \geq RBW. Set detector = peak or average. The zero-span measurement method shall not be used unless both RBW and VBW are $> 50/T$ and the number of sweep points across duration T exceeds 100. (For example, if VBW and/or RBW are limited to 3 MHz, then the zero-span method of measuring duty cycle shall not be used if $T \leq 16.7$ microseconds.)

Duty Cycle Test Information

Samples, Systems, and Modes

System Number	Description	Samples	System under test	Support equipment
1	EUT	S01	<input checked="" type="checkbox"/>	<input type="checkbox"/>
	Support		<input type="checkbox"/>	<input checked="" type="checkbox"/>

Tested By : Chris Blair	Date of testing: 15-Sep-19 - 16-Sep-19
Test Result : PASS	

Test Equipment

See Appendix C for list of test equipment

Duty Cycle Data Table

Duty Cycle table and screen captures are shown below for power/psd modes.

Frequency	Mode	Data Rate	Duty Cycle correction (dB)
2412	Non HT20, 6 to 54 Mbps	6	0.1
2437	Non HT20, 6 to 54 Mbps	6	0.1
2462	Non HT20, 6 to 54 Mbps	6	0.1

Duty Cycle Data Screenshots

Duty Cycle, 2412 MHz, Non HT20, 6 to 54 Mbps

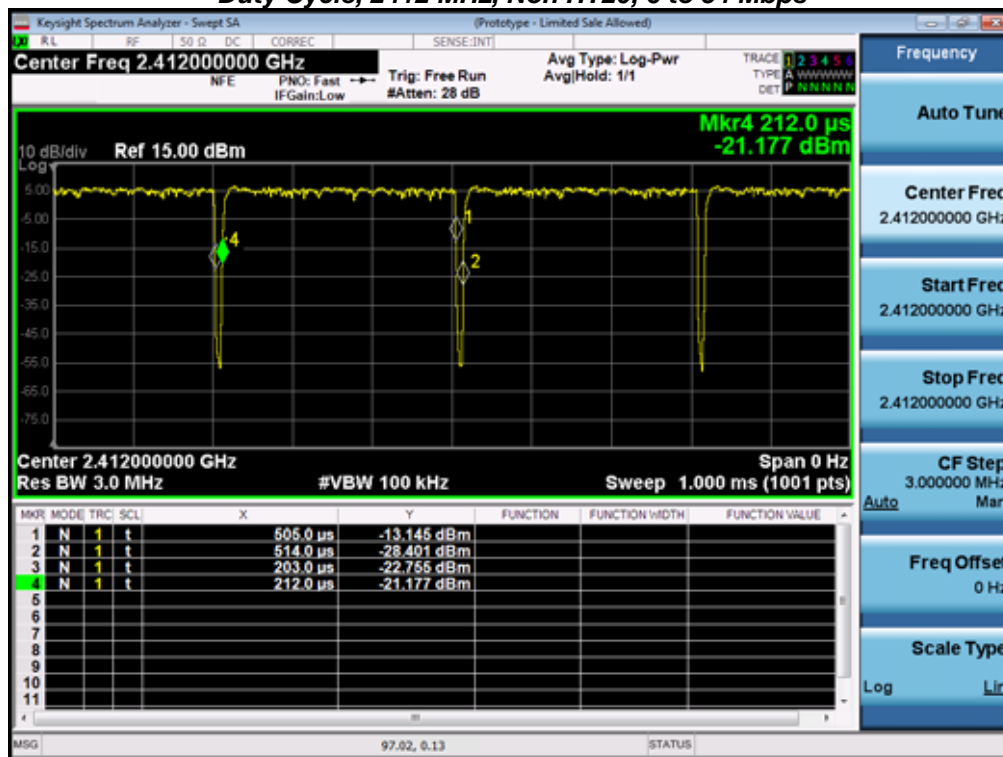

A.2 DTS Bandwidth (6dB Bandwidth)

DTS Bandwidth Test Requirement

For the FCC/ LP0002:3.10.1(6.2.1):
15.247 (2)

Systems using digital modulation techniques may operate in the 902–928 MHz, 2400–2483.5 MHz, and 5725–5850 MHz bands. The minimum 6 dB bandwidth shall be at least 500 kHz.

For Industry Canada:
RSS-247 5.2 (a)

5.2 Digital transmission systems

DTSs include systems that employ digital modulation techniques resulting in spectral characteristics similar to direct sequence systems. The following applies to the bands 902-928 MHz and 2400-2483.5 MHz:

- a) The minimum 6 dB bandwidth shall be 500 kHz.

DTS Bandwidth/ 6dB Bandwidth Test Procedure

Ref. KDB 558074 D01 DTS Meas Guidance v05, Section 8.2
ANSI C63.10: 2013, Clause 11.8.2 Option 2

6 BW

Test Procedure

- | |
|--|
| <ol style="list-style-type: none"> 1. Set the radio in the continuous transmitting mode. 2. Allow the trace to stabilize. 3. Setting the x-dB bandwidth mode to -6dB within the measurement set up function. 4. Select the automatic OBW measurement function of an instrument to perform bandwidth measurement. 5. Capture graphs and record pertinent measurement data. |
|--|

Ref. KDB 558074 D01 DTS Meas Guidance v05, Section 8.2
ANSI C63.10: 2013, Clause 11.8.2 Option 2

6 BW

Test parameters



11.8 DTS bandwidth

One of the following procedures may be used to determine the modulated DTS bandwidth.

11.8.1 Option 1

The steps for the first option are as follows:

- a) Set RBW = 100 kHz.
- b) Set the VBW $\geq [3 \times \text{RBW}]$.
- c) Detector = peak.
- d) Trace mode = max hold.
- e) Sweep = auto couple.
- f) Allow the trace to stabilize.
- g) Measure the maximum width of the emission that is constrained by the frequencies associated with the two outermost amplitude points (upper and lower frequencies) that are attenuated by 6 dB relative to the maximum level measured in the fundamental emission.

11.8.2 Option 2

The automatic bandwidth measurement capability of an instrument may be employed using the *X* dB bandwidth mode with *X* set to 6 dB, if the functionality described in 11.8.1 (i.e., RBW = 100 kHz, VBW $\geq 3 \times \text{RBW}$, and peak detector with maximum hold) is implemented by the instrumentation function. When using this capability, care shall be taken so that the bandwidth measurement is not influenced by any intermediate power nulls in the fundamental emission that might be ≥ 6 dB.

Samples, Systems, and Modes

System Number	Description	Samples	System under test	Support equipment
1	EUT	S01	<input checked="" type="checkbox"/>	<input type="checkbox"/>
	Support		<input type="checkbox"/>	<input checked="" type="checkbox"/>

Tested By : Chris Blair	Date of testing: 15-Sep-19 - 16-Sep-19
Test Result : PASS	

Test Equipment

See Appendix C for list of test equipment

DTS BW Table

Frequency (MHz)	Mode	Data Rate (Mbps)	6dB BW (MHz)	Limit (kHz)	Margin (MHz)
2412	Non HT20, 6 to 54 Mbps	6	16.4	>500	15.90
2437	Non HT20, 6 to 54 Mbps	6	16.4	>500	15.90
2462	Non HT20, 6 to 54 Mbps	6	16.4	>500	15.90

DTS Bandwidth Screenshots

6dB Bandwidth, 2412 MHz, Non HT20, 6 to 54 Mbps

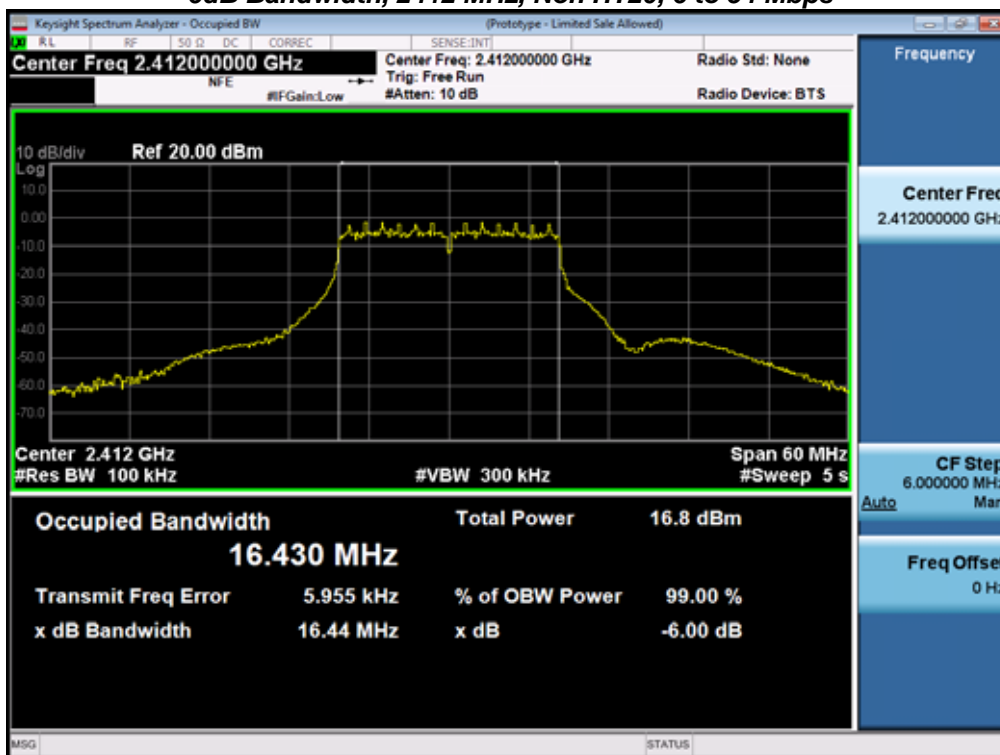

A.3 Occupied Bandwidth

Occupied Bandwidth Test Requirement

The 99% occupied bandwidth is the frequency bandwidth such that, below its lower and above its upper frequency limits, the mean powers are each equal to 0.5% of the total mean power of the given emission. There is no limit for 99% OBW.

The 26 dB emission is the width of the emission that is constrained by the frequencies associated with the two outermost amplitude points (upper and lower frequencies) that are attenuated by 26 dB relative to the maximum level measured in the fundamental emission.

Occupied Bandwidth Test Method

Ref. ANSI C63.10: 2013

Occupied Bandwidth

Test Procedure

1. Set the radio in the continuous transmitting mode.
2. Allow the trace to stabilize.
3. Setting the x-dB bandwidth mode to -26dB & OBW to 99% within the measurement set up function.
4. Select the automatic OBW measurement function of an instrument to perform bandwidth measurement.
5. Capture graphs and record pertinent measurement data.

Ref. ANSI C63.10: 2013 section 6.9.3

Occupied Bandwidth

Test parameters

6.9.3 Occupied bandwidth—power bandwidth (99%) measurement procedure

The occupied bandwidth is the frequency bandwidth such that, below its lower and above its upper frequency limits, the mean powers are each equal to 0.5% of the total mean power of the given emission. The following procedure shall be used for measuring 99% power bandwidth:

- a) The instrument center frequency is set to the nominal EUT channel center frequency. The frequency span for the spectrum analyzer shall be between 1.5 times and 5.0 times the OBW.
- b) The nominal IF filter bandwidth (3 dB RBW) shall be in the range of 1% to 5% of the OBW, and VBW shall be approximately three times the RBW, unless otherwise specified by the applicable requirement.
- c) Set the reference level of the instrument as required, keeping the signal from exceeding the maximum input mixer level for linear operation. In general, the peak of the spectral envelope shall be more than $[10 \log (OBW/RBW)]$ below the reference level. Specific guidance is given in 4.1.5.2.
- d) Step a) through step c) might require iteration to adjust within the specified range.
- e) Video averaging is not permitted. Where practical, a sample detection and single sweep mode shall be used. Otherwise, peak detection and max hold mode (until the trace stabilizes) shall be used.
- f) Use the 99% power bandwidth function of the instrument (if available) and report the measured bandwidth.
- g) If the instrument does not have a 99% power bandwidth function, then the trace data points are recovered and directly summed in linear power terms. The recovered amplitude data points, beginning at the lowest frequency, are placed in a running sum until 0.5% of the total is reached; that frequency is recorded as the lower frequency. The process is repeated until 99.5% of the total is reached; that frequency is recorded as the upper frequency. The 99% power bandwidth is the difference between these two frequencies.
- h) The occupied bandwidth shall be reported by providing plot(s) of the measuring instrument display; the plot axes and the scale units per division shall be clearly labeled. Tabular data may be reported in addition to the plot(s).



Samples, Systems, and Modes

System Number	Description	Samples	System under test	Support equipment
1	EUT	S01	<input checked="" type="checkbox"/>	<input type="checkbox"/>
	Support		<input type="checkbox"/>	<input checked="" type="checkbox"/>

Tested By : Chris Blair	Date of testing: 15-Sep-19 - 16-Sep-19
Test Result : PASS	

Test Equipment

See Appendix C for list of test equipment



Occupied Bandwidth

Frequency (MHz)	Mode	Data Rate (Mbps)	26dB BW (MHz)	99% BW (MHz)
2412	Non HT20, 6 to 54 Mbps	6	21.0	16.514
2437	Non HT20, 6 to 54 Mbps	6	20.6	16.537
2462	Non HT20, 6 to 54 Mbps	6	21.4	16.555

26dB / 99% Bandwidth, 2412 MHz, Non HT20, 6 to 54 Mbps

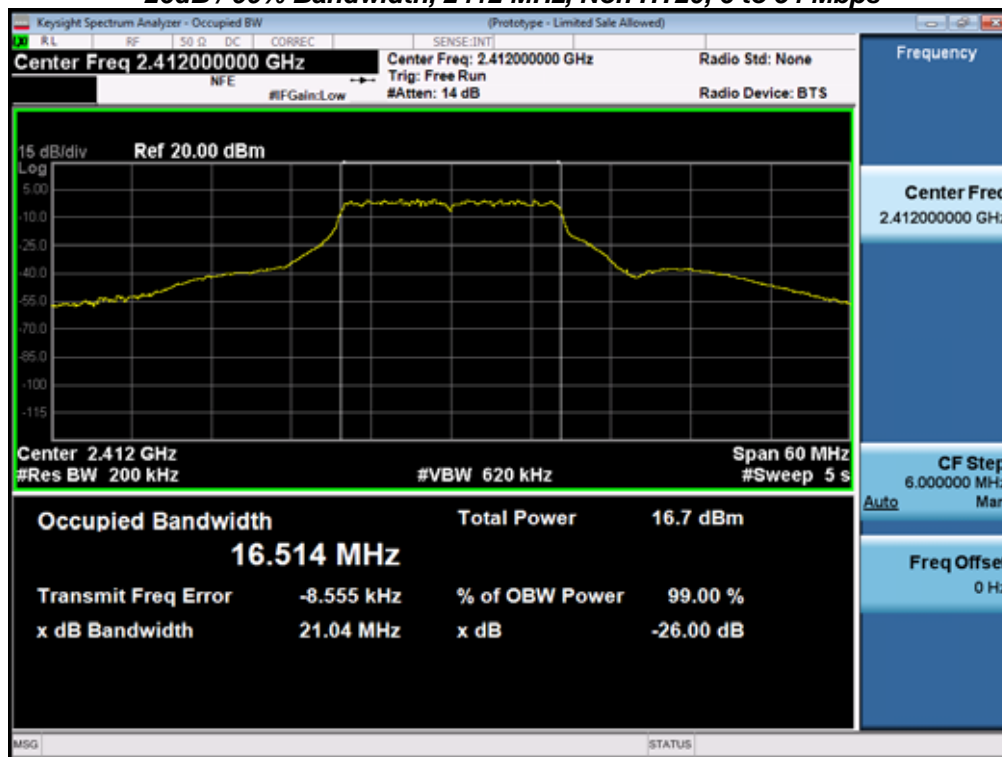

A.4 Maximum Conducted Output Power

Maximum Conducted Output Power Test Requirement

FCC, 15.247/ LP0002:3.10.1(2.3):

(b) The maximum peak conducted output power of the intentional radiator shall not exceed the following: (3) For systems using digital modulation in the 902-928 MHz, **2400-2483.5 MHz**, and 5725-5850 MHz bands: **1 Watt**. As an alternative to a peak power measurement, compliance with the one Watt limit can be based on a measurement of the maximum conducted output power. Maximum Conducted Output Power is defined as the total transmit power delivered to all antennas and antenna elements averaged across all symbols in the signaling alphabet when the transmitter is operating at its maximum power control level. Power must be summed across all antennas and antenna elements. The average must not include any time intervals during which the transmitter is off or is transmitting at a reduced power level. If multiple modes of operation are possible (e.g., alternative modulation methods), the maximum conducted output power is the highest total transmit power occurring in any mode.

(4) The conducted output power limit specified in paragraph (b) of this section is based on the use of antennas with directional gains that do not exceed 6 dBi. Except as shown in paragraph (c) of this section, if transmitting antennas of directional gain greater than 6 dBi are used, the conducted output power from the intentional radiator shall be reduced below the stated values in paragraphs (b)(1), (b)(2), and (b)(3) of this section, as appropriate, by the amount in dB that the directional gain of the antenna exceeds 6 dBi.

Industry Canada, RSS-247:

5.4 Transmitter output power and equivalent isotropically radiated power (e.i.r.p.) requirements

d) For DTSs employing digital modulation techniques operating in the bands 902-928 MHz and 2400-2483.5 MHz, the maximum peak conducted output power shall not exceed 1W. The e.i.r.p. shall not exceed 4 W, except as provided in section 5.4(e).

As an alternative to a peak power measurement, compliance can be based on a measurement of the maximum conducted output power. The maximum conducted output power is the total transmit power delivered to all antennas and antenna elements, averaged across all symbols in the signalling alphabet when the transmitter is operating at its maximum power control level. Power must be summed across all antennas and antenna elements. The average must not include any time intervals during which the transmitter is off or transmitting at a reduced power level. If multiple modes of operation are implemented, the maximum conducted output power is the highest total transmit power occurring in any mode.

The maximum supported antenna gain is (GAIN_MAX_TRANSMIT_POWER)dBi. The peak correlated gain for each mode is listed in the table below.

Maximum Conducted Output Power Test Method

Ref. KDB 558074 D01 DTS Meas Guidance v05

ANSI C63.10: 2013

Maximum Conducted Output power
Test Procedure
<ol style="list-style-type: none"> 1. Set the radio in the continuous transmitting mode at full power 2. Compute power by integrating the spectrum across the EBW (or alternatively entire 99% OBW) of the signal using the instrument's band power measurement function. The integration shall be performed using the spectrum analyzer band-power measurement function with band limits set equal to the EBW or the OBW band edges. 3. Capture graphs and record pertinent measurement data.

Ref. 558074 D01 DTS Meas Guidance v05, 8.3.2.2 Measurement using a spectrum analyzer (SA)

ANSI C63.10: 2013, section 11.9.2.2.4 Method AVGSA-2

Maximum Conducted Output power
Test parameters



11.9.2.2.4 Method AVGSA-2

Method AVGSA-2 uses trace averaging across ON and OFF times of the EUT transmissions, followed by duty cycle correction. The procedure for this method is as follows:

- a) Measure the duty cycle *D* of the transmitter output signal as described in 11.6.
- b) Set span to at least 1.5 times the OBW.
- c) Set RBW = 1% to 5% of the OBW, not to exceed 1 MHz.
- d) Set VBW $\geq [3 \times \text{RBW}]$.
- e) Number of points in sweep $\geq [2 \times \text{span} / \text{RBW}]$. (This gives bin-to-bin spacing $\leq \text{RBW} / 2$, so that narrowband signals are not lost between frequency bins.)
- f) Sweep time = auto.
- g) Detector = RMS (i.e., power averaging), if available. Otherwise, use the sample detector mode.
- h) Do not use sweep triggering. Allow the sweep to “free run.”
- i) Trace average at least 100 traces in power averaging (rms) mode; however, the number of traces to be averaged shall be increased above 100 as needed such that the average accurately represents the true average over the ON and OFF periods of the transmitter.
- j) Compute power by integrating the spectrum across the OBW of the signal using the instrument’s band power measurement function with band limits set equal to the OBW band edges. If the instrument does not have a band power function, then sum the spectrum levels (in power units) at intervals equal to the RBW extending across the entire OBW of the spectrum.
- k) Add $[10 \log (1 / D)]$, where *D* is the duty cycle, to the measured power to compute the average power during the actual transmission times (because the measurement represents an average over both the ON and OFF times of the transmission). For example, add $[10 \log (1/0.25)] = 6 \text{ dB}$ if the duty cycle is 25%.

The “measure-and-sum technique” is used for measuring in-band transmit power of a device. In the measure-and-sum approach, the conducted emission level is measured at each antenna port. The measured results at the various antenna ports are then summed mathematically to determine the total emission level from the device. Summing is performed in linear power units. (See ANSI C63.10 section 14.3 for Guidance)

Samples, Systems, and Modes

System Number	Description	Samples	System under test	Support equipment
1	EUT	S01	<input checked="" type="checkbox"/>	<input type="checkbox"/>
	Support		<input type="checkbox"/>	<input checked="" type="checkbox"/>

Tested By : Chris Blair	Date of testing: 15-Sep-19 - 16-Sep-19
Test Result : PASS	

Test Equipment

See Appendix C for list of test equipment

Note: Limit is modified to ensure complying with both conducted power limit of 30dBm and eirp limit of 36 dBm



Maximum Output Power, 2dBi

Frequency (MHz)	Mode	Tx Paths	Correlated Antenna Gain (dBi)	Tx 1 Max Power (dBm)	Duty Cycle Correction (dB)	Total Tx Channel Power (dBm)	Limit (dBm)	Margin (dB)
2412	Non HT20, 6 to 54 Mbps	1	2	12.3	0.1	12.4	30.0	17.57
2437	Non HT20, 6 to 54 Mbps	1	2	13.3	0.1	13.4	30.0	16.57
2462	Non HT20, 6 to 54 Mbps	1	2	12.7	0.1	12.8	30.0	17.17



Maximum Output Power, 3dBi

Frequency (MHz)	Mode	Tx Paths	Correlated Antenna Gain (dBi)	Tx 1 Max Power (dBm)	Duty Cycle Correction (dB)	Total Tx Channel Power (dBm)	Limit (dBm)	Margin (dB)
2412	Non HT20, 6 to 54 Mbps	1	3	12.3	0.1	12.4	30.0	17.57
2437	Non HT20, 6 to 54 Mbps	1	3	13.3	0.1	13.4	30.0	16.57
2462	Non HT20, 6 to 54 Mbps	1	3	12.7	0.1	12.8	30.0	17.17



Maximum Output Power, 4dBi

Frequency (MHz)	Mode	Tx Paths	Correlated Antenna Gain (dBi)	Tx 1 Max Power (dBm)	Duty Cycle Correction (dB)	Total Tx Channel Power (dBm)	Limit (dBm)	Margin (dB)
2412	Non HT20, 6 to 54 Mbps	1	4	12.3	0.1	12.4	30.0	17.57
2437	Non HT20, 6 to 54 Mbps	1	4	13.3	0.1	13.4	30.0	16.57
2462	Non HT20, 6 to 54 Mbps	1	4	11.6	0.1	11.7	30.0	18.27

Maximum Output Power, 6dBi

Frequency (MHz)	Mode	Tx Paths	Correlated Antenna Gain (dBi)	Tx 1 Max Power (dBm)	Duty Cycle Correction (dB)	Total Tx Channel Power (dBm)	Limit (dBm)	Margin (dB)
2412	Non HT20, 6 to 54 Mbps	1	6	9.9	0.1	10.0	30.0	19.97
2437	Non HT20, 6 to 54 Mbps	1	6	13.3	0.1	13.4	30.0	16.57
2462	Non HT20, 6 to 54 Mbps	1	6	9.2	0.1	9.3	30.0	20.67

Maximum Transmit Output Power, 2437 MHz, Non HT20, 6 to 54 Mbps, all antennas



Antenna A

A.5 Power Spectral Density

Power Spectral Density Test Requirement

15.247 (e) / RSS-247 5.2 (b) / LP0002:3.10.1(6.2.2)

5.2 Digital transmission systems

DTSs include systems that employ digital modulation techniques resulting in spectral characteristics similar to direct sequence systems. The following applies to the bands 902-928 MHz and 2400-2483.5 MHz:

b) The transmitter power spectral density conducted from the transmitter to the antenna shall not be greater than 8 dBm in any 3 kHz band during any time interval of continuous transmission. This power spectral density shall be determined in accordance with the provisions of section 5.4(d), (i.e. the power spectral density shall be determined using the same method as is used to determine the conducted output power).

Power Spectral Density Test Method

Ref. KDB 558074 D01 DTS Meas Guidance v05

ANSI C63.10: 2013

Power Spectral Density

Test Procedure

1. Set the radio in the continuous transmitting mode at full power
2. Configure Spectrum analyzer as per test parameters below and Peak search marker
3. Capture graphs and record pertinent measurement data.

Ref. KDB 558074 D01 DTS Meas Guidance v05, section 8.4 DTS maximum power spectral density level in the fundamental emission

ANSI C63.10: 2013, section 11.10.5 Average PSD

Power Spectral Density

Test parameters

11.10.5 Method AVGPSD-2

Method AVGPSD-2 uses trace averaging across ON and OFF times of the EUT transmissions, followed by duty cycle correction.

The following procedure is applicable when the EUT cannot be configured to transmit continuously (i.e., $D < 98\%$), when sweep triggering/signal gating cannot be used to measure only when the EUT is transmitting at its maximum power control level, and when the transmission duty cycle is constant (i.e., duty cycle variations are less than $\pm 2\%$):

- a) Measure the duty cycle (D) of the transmitter output signal as described in 11.6.
- b) Set instrument center frequency to DTS channel center frequency.
- c) Set span to at least 1.5 times the OBW.
- d) Set RBW to: $3 \text{ kHz} \leq \text{RBW} \leq 100 \text{ kHz}$.
- e) Set $\sqrt{\text{VBW}} \geq [3 \times \text{RBW}]$.
- f) Detector = power averaging (rms) or sample detector (when rms not available).
- g) Ensure that the number of measurement points in the sweep $\geq [2 \times \text{span} / \text{RBW}]$.
- h) Sweep time = auto couple.
- i) Do not use sweep triggering; allow sweep to "free run."
- j) Employ trace averaging (rms) mode over a minimum of 100 traces.
- k) Use the peak marker function to determine the maximum amplitude level.
- l) Add $[10 \log (1 / D)]$, where D is the duty cycle measured in step a), to the measured PSD to compute the average PSD during the actual transmission time.
- m) If measured value exceeds requirement specified by regulatory agency, then reduce RBW (but no less than 3 kHz) and repeat (note that this may require zooming in on the emission of interest and reducing the span to meet the minimum measurement point requirement as the RBW is reduced).



The “Measure and add 10 log(N) dB technique”, where N is the number of outputs, is used for measuring in-band Power Spectral Density. (See ANSI C63.10 section 14.3.2.3)

Samples, Systems, and Modes

System Number	Description	Samples	System under test	Support equipment
1	EUT	S01	<input checked="" type="checkbox"/>	<input type="checkbox"/>
	Support		<input type="checkbox"/>	<input checked="" type="checkbox"/>

Tested By : Chris Blair	Date of testing: 15-Sep-19 - 16-Sep-19
Test Result : PASS	

Test Equipment

See Appendix C for list of test equipment



Power Spectral Density, 2dBi

Frequency (MHz)	Mode	Tx Paths	Correlated Antenna Gain (dBi)	Tx 1 PSD (dBm/3kHz)	Duty Cycle Correction (dB)	Total PSD (dBm/3kHz)	Limit (dBm/3kHz)	Margin (dB)
2412	Non HT20, 6 to 54 Mbps	1	2	-14.0	0.1	-13.9	8.0	21.87
2437	Non HT20, 6 to 54 Mbps	1	2	-13.0	0.1	-12.9	8.0	20.87
2462	Non HT20, 6 to 54 Mbps	1	2	-13.9	0.1	-13.8	8.0	21.77

Power Spectral Density, 3dBi

Frequency (MHz)	Mode	Tx Paths	Correlated Antenna Gain (dBi)	Tx 1 PSD (dBm/3kHz)	Duty Cycle Correction (dB)	Total PSD (dBm/3kHz)	Limit (dBm/3kHz)	Margin (dB)
2412	Non HT20, 6 to 54 Mbps	1	3	-14.0	0.1	-13.9	8.0	21.87
2437	Non HT20, 6 to 54 Mbps	1	3	-13.0	0.1	-12.9	8.0	20.87
2462	Non HT20, 6 to 54 Mbps	1	3	-13.9	0.1	-13.8	8.0	21.77



Power Spectral Density, 4dBi

Frequency (MHz)	Mode	Tx Paths	Correlated Antenna Gain (dBi)	Tx 1 PSD (dBm/3kHz)	Duty Cycle Correction (dB)	Total PSD (dBm/3kHz)	Limit (dBm/3kHz)	Margin (dB)
2412	Non HT20, 6 to 54 Mbps	1	4	-14.0	0.1	-13.9	8.0	21.87
2437	Non HT20, 6 to 54 Mbps	1	4	-13.0	0.1	-12.9	8.0	20.87
2462	Non HT20, 6 to 54 Mbps	1	4	-15.0	0.1	-14.9	8.0	22.87

Power Spectral Density, 6dBi

Frequency (MHz)	Mode	Tx Paths	Correlated Antenna Gain (dBi)	Tx 1 PSD (dBm/3kHz)	Duty Cycle Correction (dB)	Total PSD (dBm/3kHz)	Limit (dBm/3kHz)	Margin (dB)
2412	Non HT20, 6 to 54 Mbps	1	6	-16.5	0.1	-16.4	8.0	24.37
2437	Non HT20, 6 to 54 Mbps	1	6	-13.0	0.1	-12.9	8.0	20.87
2462	Non HT20, 6 to 54 Mbps	1	6	-17.6	0.1	-17.5	8.0	25.47

Power Spectral Density, 2437 MHz, Non HT20, 6 to 54 Mbps, all antennas





A.6 Conducted Spurious Emissions

Conducted Spurious Emissions Test Requirement

15.205 / RSS-Gen / LP0002

Radiated emissions which fall in the restricted bands, as defined in Section 15.205(a) and RSS-GEN section 8.10, must also comply with the radiated emission limits specified in Section 15.209(a) (see Section 15.205(c)) and RSS-Gen section 8.9

RSS-Gen 8.9 Except when the requirements applicable to a given device state otherwise, emissions from licence-exempt transmitters shall comply with the field strength limits shown in Table 4 and Table 5 below. Additionally, the level of any transmitter emission shall not exceed the level of the transmitter’s fundamental emission.

RSS-Gen 8.10 (b) Unwanted emissions that fall into restricted bands of Table 6 shall comply with the limits specified in RSS-Gen; and (c) Unwanted emissions that do not fall within the restricted frequency bands of Table 6 shall comply either with the limits specified in the applicable RSS or with those specified in this RSS-Gen.

Use formula below to substitute conducted measurements in place of radiated measurements

$$E[\text{dB}\mu\text{V/m}] = \text{EIRP}[\text{dBm}] - 20 \log(d[\text{meters}]) + 104.77, \text{ where } E = \text{field strength and } d = 3 \text{ meter}$$

- 1) Average Plot, Limit= -41.25 dBm eirp
- 2) Peak plot, Limit = -21.25 dBm eirp

Conducted Spurious Emissions Test Method

**Ref. KDB 558074 D01 DTS Meas Guidance v05
ANSI C63.10: 2013**

<p>Conducted Spurious Emissions Test Procedure</p> <ol style="list-style-type: none"> 1. Connect the antenna port(s) to the spectrum analyzer input. 2. Place the radio in continuous transmit mode 3. Configure Spectrum analyzer as per test parameters below (be sure to enter all losses between the transmitter output and the spectrum analyzer). 4. Use the peak marker function to determine the maximum spurs amplitude level. 5. The “measure-and-sum technique” is used for measuring in-band transmit power of a device. In the measure-and-sum approach, the conducted emission level is measured at each antenna port. The measured results at the various antenna ports are then summed mathematically to determine the total emission level from the device. Summing is performed in linear power units. The worst case output is recorded. (see ANSI C63.10 2013 section 14.3.2.2) 6. Capture graphs and record pertinent measurement data.

**Ref. KDB 558074 D01 DTS Meas Guidance v05, section 8.1 c) 3, section 8.6 DTS emissions in restricted frequency bands
ANSI C63.10: 2013 section 11.12.2.4 (Peak) & 11.12.2.5.2 (Average)**

<p>Conducted Spurious Emissions Test parameters</p>	
<p>Peak Span = 30MHz to 26.5GHz / 26.5GHz to 40GHz RBW = 1 MHz</p>	<p>Average Span = 30MHz to 26.5GHz / 26.5GHz to 40GHz RBW = 1 MHz</p>



VBW ≥ 3 MHz Sweep = Auto Detector = Peak Trace = Max Hold.	VBW ≥ 3 MHz Sweep = Auto Detector = RMS Power Averaging
---	--

ANSI C63.10: 2013 section 11.12.2.2 c) add the max antenna gain + ground reflection factor (4.7 dB for frequencies between 30 MHz and 1000 MHz, and 0 dB for frequencies > 1000 MHz).

Samples, Systems, and Modes

System Number	Description	Samples	System under test	Support equipment
1	EUT	S01	<input checked="" type="checkbox"/>	<input type="checkbox"/>
	Support		<input type="checkbox"/>	<input checked="" type="checkbox"/>

Tested By : Chris Blair	Date of testing: 15-Sep-19 - 16-Sep-19
Test Result : PASS	

Test Equipment

See Appendix C for list of test equipment

Conducted Spurs Average, 2412 MHz, Non HT20, 6 to 54 Mbps



Conducted Spurs Peak Upper, 2412 MHz, Non HT20, 6 to 54 Mbps

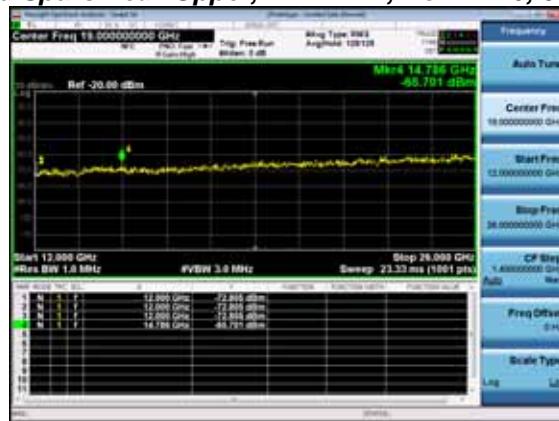



Conducted Spurious Average Table, 2dBi

Frequency (MHz)	Mode	Tx Paths	Correlated Antenna Gain (dBi)	Tx 1 Spur Power (dBm)	Duty Cycle Correction (dB)	Total Conducted Spur (dBm)	Limit (dBm)	Margin (dB)
2412	Non HT20, 6 to 54 Mbps	1	2	-67.8	0.1	-65.7	-41.25	24.42
2437	Non HT20, 6 to 54 Mbps	1	2	-66.6	0.1	-64.5	-41.25	23.22
2462	Non HT20, 6 to 54 Mbps	1	2	-68.0	0.1	-65.9	-41.25	24.62

Conducted Spurious Average Table, 3dBi

Frequency (MHz)	Mode	Tx Paths	Correlated Antenna Gain (dBi)	Tx 1 Spur Power (dBm)	Duty Cycle Correction (dB)	Total Conducted Spur (dBm)	Limit (dBm)	Margin (dB)
2412	Non HT20, 6 to 54 Mbps	1	3	-67.8	0.1	-64.7	-41.25	23.42
2437	Non HT20, 6 to 54 Mbps	1	3	-66.6	0.1	-63.5	-41.25	22.22
2462	Non HT20, 6 to 54 Mbps	1	3	-68.0	0.1	-64.9	-41.25	23.62



Conducted Spurious Average Table, 4dBi

Frequency (MHz)	Mode	Tx Paths	Correlated Antenna Gain (dBi)	Tx 1 Spur Power (dBm)	Duty Cycle Correction (dB)	Total Conducted Spur (dBm)	Limit (dBm)	Margin (dB)
2412	Non HT20, 6 to 54 Mbps	1	4	-67.8	0.1	-63.7	-41.25	22.42
2437	Non HT20, 6 to 54 Mbps	1	4	-66.6	0.1	-62.5	-41.25	21.22
2462	Non HT20, 6 to 54 Mbps	1	4	-69.2	0.1	-65.1	-41.25	23.82

Conducted Spurious Average Table, 6dBi

Frequency (MHz)	Mode	Tx Paths	Correlated Antenna Gain (dBi)	Tx 1 Spur Power (dBm)	Duty Cycle Correction (dB)	Total Conducted Spur (dBm)	Limit (dBm)	Margin (dB)
2412	Non HT20, 6 to 54 Mbps	1	6	-68.1	0.1	-62.0	-41.25	20.72
2437	Non HT20, 6 to 54 Mbps	1	6	-66.6	0.1	-60.5	-41.25	19.22
2462	Non HT20, 6 to 54 Mbps	1	6	-68.6	0.1	-62.5	-41.25	21.22

Conducted Spurs Average, 2437 MHz, Non HT20, 6 to 54 Mbps, all antennas

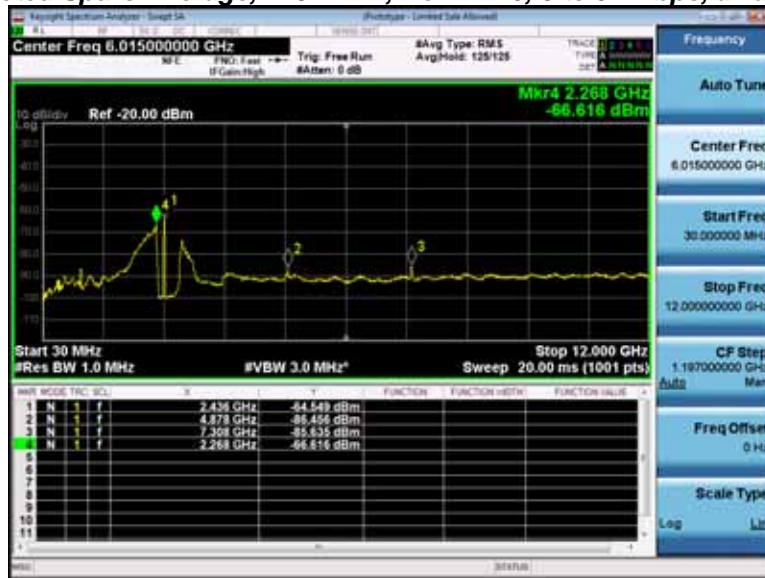

Antenna A

Conducted Spurious Peak, 2dBi

Frequency (MHz)	Mode	Tx Paths	Correlated Antenna Gain (dBi)	Tx 1 Spur Power (dBm)	Duty Cycle Correction (dB)	Total Conducted Spur (dBm)	Limit (dBm)	Margin (dB)
2412	Non HT20, 6 to 54 Mbps	1	2	-69.2	0.1	-67.1	-21.25	45.82
2437	Non HT20, 6 to 54 Mbps	1	2	-69.6	0.1	-67.5	-21.25	46.22
2462	Non HT20, 6 to 54 Mbps	1	2	-66.1	0.1	-64.0	-21.25	42.72

Conducted Spurs Peak, 2462 MHz, Non HT20, 6 to 54 Mbps

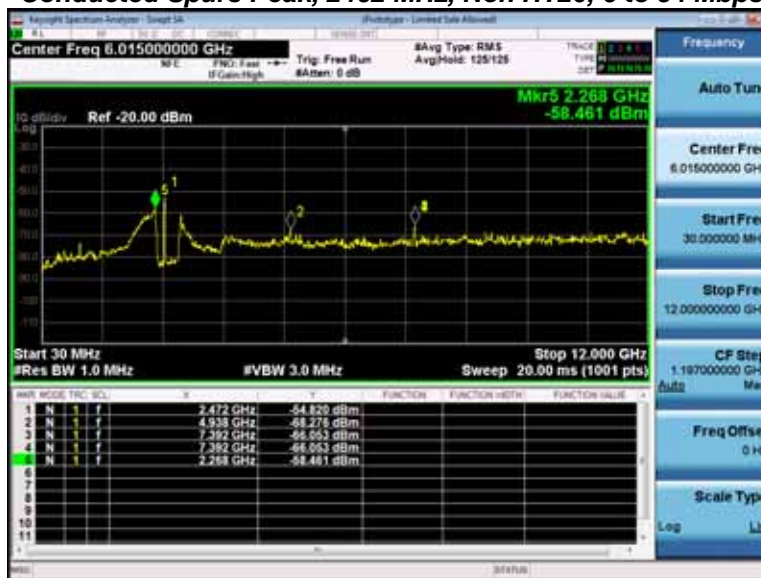

Antenna A

Conducted Spurious Peak, 3dBi

Frequency (MHz)	Mode	Tx Paths	Correlated Antenna Gain (dBi)	Tx 1 Spur Power (dBm)	Duty Cycle Correction (dB)	Total Conducted Spur (dBm)	Limit (dBm)	Margin (dB)
2412	Non HT20, 6 to 54 Mbps	1	3	-69.2	0.1	-66.1	-21.25	44.82
2437	Non HT20, 6 to 54 Mbps	1	3	-69.6	0.1	-66.5	-21.25	45.22
2462	Non HT20, 6 to 54 Mbps	1	3	-66.1	0.1	-63.0	-21.25	41.72

Conducted Spurs Peak, 2462 MHz, Non HT20, 6 to 54 Mbps

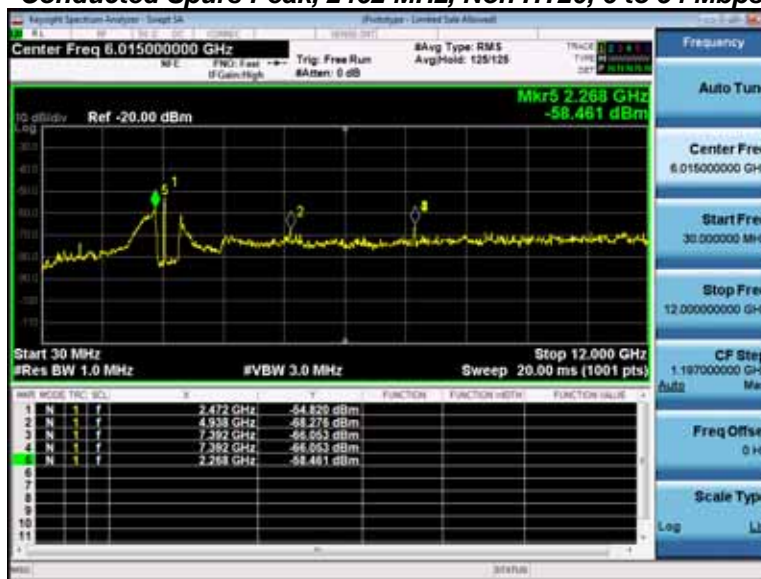

Antenna A

Conducted Spurious Peak, 4dBi

Frequency (MHz)	Mode	Tx Paths	Correlated Antenna Gain (dBi)	Tx 1 Spur Power (dBm)	Duty Cycle Correction (dB)	Total Conducted Spur (dBm)	Limit (dBm)	Margin (dB)
2412	Non HT20, 6 to 54 Mbps	1	4	-69.2	0.1	-65.1	-21.25	43.82
2437	Non HT20, 6 to 54 Mbps	1	4	-69.6	0.1	-65.5	-21.25	44.22
2462	Non HT20, 6 to 54 Mbps	1	4	-68.9	0.1	-64.8	-21.25	43.52

Conducted Spurs Peak, 2462 MHz, Non HT20, 6 to 54 Mbps

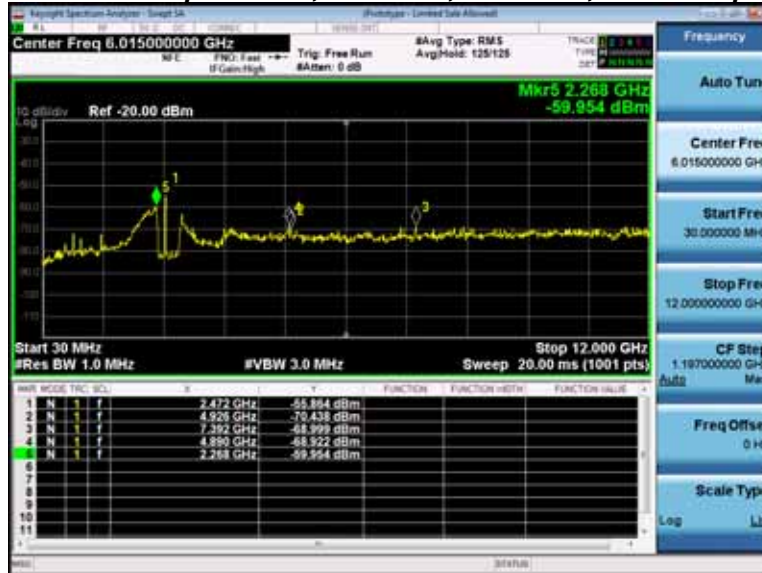

Antenna A

Conducted Spurious Peak, 6dBi

Frequency (MHz)	Mode	Tx Paths	Correlated Antenna Gain (dBi)	Tx 1 Spur Power (dBm)	Duty Cycle Correction (dB)	Total Conducted Spur (dBm)	Limit (dBm)	Margin (dB)
2412	Non HT20, 6 to 54 Mbps	1	6	-69.3	0.1	-63.2	-21.25	41.92
2437	Non HT20, 6 to 54 Mbps	1	6	-69.6	0.1	-63.5	-21.25	42.22
2462	Non HT20, 6 to 54 Mbps	1	6	-69.0	0.1	-62.9	-21.25	41.62

Conducted Spurs Peak, 2462 MHz, Non HT20, 6 to 54 Mbps

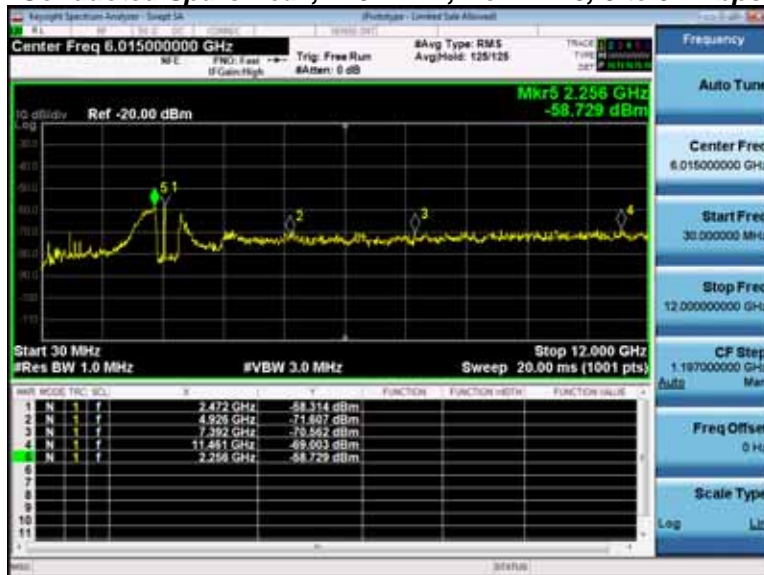

Antenna A

A.7 Conducted Receiver Spurious Emissions

Spurious Of Receive Average Upp, 2412 MHz, Non HT20, 6 to 54 Mbps

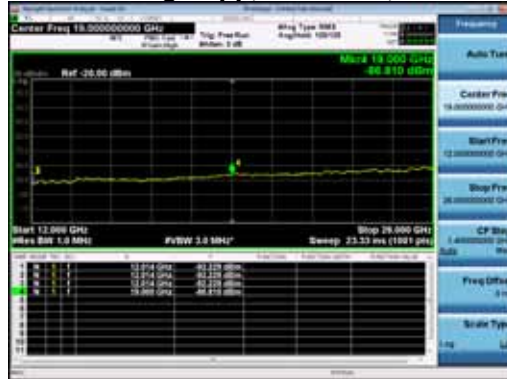

Spurious Of Receive Peak Upper, 2412 MHz, Non HT20, 6 to 54 Mbps



Conducted Receiver Spurious Average, all antennas

Frequency (MHz)	Mode	Tx Paths	Correlated Antenna Gain (dBi)	Rx 1 Spur Power (dBm)	Duty Cycle Correction (dB)	Total Conducted Spur (dBm)	Limit (dBm)	Margin (dB)
2412	Non HT20, 6 to 54 Mbps	1	6	-87.0	0.1	-80.9	-41.25	39.62
2437	Non HT20, 6 to 54 Mbps	1	6	-87.1	0.1	-81.0	-41.25	39.72
2462	Non HT20, 6 to 54 Mbps	1	6	-86.4	0.1	-80.3	-41.25	39.02

Spurious Of Receive Average, 2462 MHz, Non HT20, 6 to 54 Mbps, all antennas

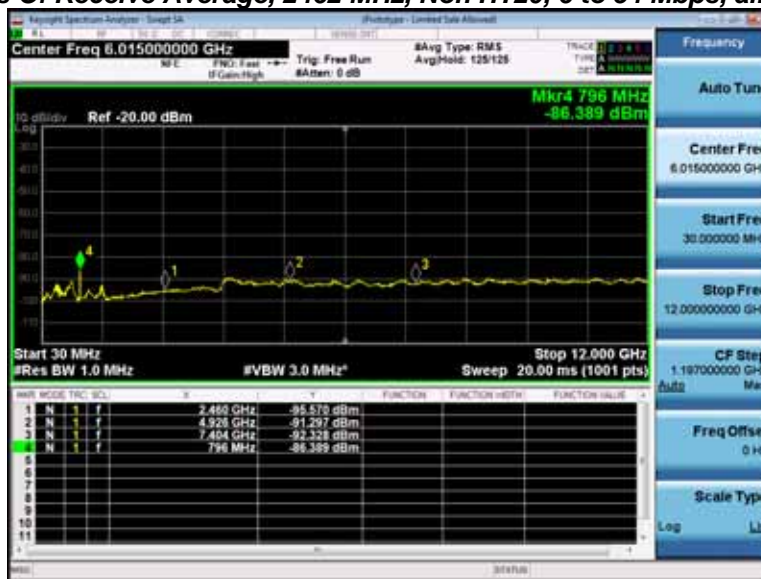

Antenna A

Conducted Receiver Spurious Peak, all antennas

Frequency (MHz)	Mode	Tx Paths	Correlated Antenna Gain (dBi)	Rx 1 Spur Power (dBm)	Total Conducted Spur (dBm)	Limit (dBm)	Margin (dB)
2412	Non HT20, 6 to 54 Mbps	1	6	-69.8	-63.7	-21.25	42.42
2437	Non HT20, 6 to 54 Mbps	1	6	-69.1	-63.0	-21.25	41.72
2462	Non HT20, 6 to 54 Mbps	1	6	-69.6	-63.5	-21.25	42.22

Spurious Of Receive Peak, 2437 MHz, Non HT20, 6 to 54 Mbps



Antenna A

A.8 Conducted Bandedge (Restricted Band)

Conducted Band Edge Test Requirement

15.247 / LP0002:3.10.1(5) & 2.8

(d) In any 100 kHz bandwidth outside the frequency band in which the spread spectrum or digitally modulated intentional radiator is operating, the radio frequency power that is produced by the intentional radiator shall be at least 20 dB below that in the 100 kHz bandwidth within the band that contains the highest level of the desired power, based on either an RF conducted or a radiated measurement, provided the transmitter demonstrates compliance with the peak conducted power limits. If the transmitter complies with the conducted power limits based on the use of RMS averaging over a time interval, as permitted under paragraph (b)(3) of this section, the attenuation required under this paragraph shall be 30 dB instead of 20 dB. Attenuation below the general limits specified in §15.209(a) is not required. In addition, radiated emissions which fall in the restricted bands, as defined in §15.205(a), must also comply with the radiated emission limits specified in §15.209(a) (see §15.205(c)).

RSS-247

5.5 Unwanted emissions

In any 100 kHz bandwidth outside the frequency band in which the spread spectrum or digitally modulated device is operating, the RF power that is produced shall be at least 20 dB below that in the 100 kHz bandwidth within the band that contains the highest level of the desired power, based on either an RF conducted or a radiated measurement, provided that the transmitter demonstrates compliance with the peak conducted power limits. If the transmitter complies with the conducted power limits based on the use of root-mean-square averaging over a time interval, as permitted under section 5.4(d), the attenuation required shall be 30 dB instead of 20 dB. Attenuation below the general field strength limits specified in RSS-Gen is not required.

15.205 / RSS-Gen

Radiated emissions which fall in the restricted bands, as defined in Section 15.205(a), and RSS-Gen 8.10 must also comply with the radiated emission limits specified in Section 15.209(a) (see Section 15.205(c)) and RSS-Gen 8.9.

Conducted Bandedge Test Method

Ref. KDB 558074 D01 DTS Meas Guidance v05

ANSI C63.10: 2013

Conducted Band edge

Test Procedure

1. Connect the antenna port(s) to the spectrum analyzer input.
2. Place the radio in continuous transmit mode. Use the procedures in KDB 558074 D01 DTS Meas Guidance v04 to substitute conducted measurements in place of radiated measurements.
3. Configure Spectrum analyzer as per test parameters below (be sure to enter all losses between the transmitter output and the spectrum analyzer).
4. Place a marker at the end of the restricted band closest to the transmit frequency to show compliance. Also measure any emissions in the restricted bands.
5. The “measure-and-sum technique” is used for measuring in-band transmit power of a device. In the measure-and-sum approach, the conducted emission level is measured at each antenna port. The measured results at the various antenna ports are then summed mathematically to determine the total emission level from the device. Summing is performed in linear power units. The worst case output is recorded.
6. Place a marker at the end of the restricted band closest to the transmit frequency to show compliance. Also measure any emissions in the restricted bands
7. Capture graphs and record pertinent measurement data.

Ref. KDB 558074 D01 DTS Meas Guidance v05, section 8.1 c) 3, section 8.6 DTS emissions in restricted frequency bands

ANSI C63.10: 2013 section 11.12.2.4 (Peak) & 11.12.2.5.2 (Average)



Conducted Spurious Emissions	
Test parameters	
Peak RBW = 1 MHz VBW ≥ 3 MHz Sweep = Auto Detector = Peak Trace = Max Hold.	Average RBW = 1 MHz VBW ≥ 3 MHz Sweep = Auto Detector = RMS Power Averaging

Samples, Systems, and Modes

System Number	Description	Samples	System under test	Support equipment
1	EUT	S01	<input checked="" type="checkbox"/>	<input type="checkbox"/>
	Support		<input type="checkbox"/>	<input checked="" type="checkbox"/>

Tested By : Chris Blair	Date of testing: 15-Sep-19 - 16-Sep-19
Test Result : PASS	

Test Equipment

See Appendix C for list of test equipment



Restricted Band

Conducted Bandedge Average Table, 2dBi

Frequency (MHz)	Mode	Tx Paths	Correlated Antenna Gain (dBi)	Tx 1 Bandedge Level (dBm)	Duty Cycle Correction (dB)	Total Tx Bandedge Level (dBm)	Limit (dBm)	Margin (dB)
2412	Non HT20, 6 to 54 Mbps	1	2	-47.1	0.1	-45.0	-41.25	3.72
2462	Non HT20, 6 to 54 Mbps	1	2	-44.9	0.1	-42.8	-41.25	1.52

Conducted Bandedge Average, 2412 MHz, Non HT20, 6 to 54 Mbps



Antenna A

Conducted Bandedge Average, 2462 MHz, Non HT20, 6 to 54 Mbps



Antenna A



Conducted Bandedge Average Table, 3dBi

Frequency (MHz)	Mode	Tx Paths	Correlated Antenna Gain (dBi)	Tx 1 Bandedge Level (dBm)	Duty Cycle Correction (dB)	Total Tx Bandedge Level (dBm)	Limit (dBm)	Margin (dB)
2412	Non HT20, 6 to 54 Mbps	1	3	-47.1	0.1	-44.0	-41.25	2.72
2462	Non HT20, 6 to 54 Mbps	1	3	-44.9	0.1	-41.8	-41.25	0.52

Conducted Bandedge Average, 2412 MHz, Non HT20, 6 to 54 Mbps



Antenna A

Conducted Bandedge Average, 2462 MHz, Non HT20, 6 to 54 Mbps



Antenna A



Conducted Bandedge Average Table, 4dBi

Frequency (MHz)	Mode	Tx Paths	Correlated Antenna Gain (dBi)	Tx 1 Bandedge Level (dBm)	Duty Cycle Correction (dB)	Total Tx Bandedge Level (dBm)	Limit (dBm)	Margin (dB)
2412	Non HT20, 6 to 54 Mbps	1	4	-47.1	0.1	-43.0	-41.25	1.72
2462	Non HT20, 6 to 54 Mbps	1	4	-47.3	0.1	-43.2	-41.25	1.92

Conducted Bandedge Average, 2412 MHz, Non HT20, 6 to 54 Mbps

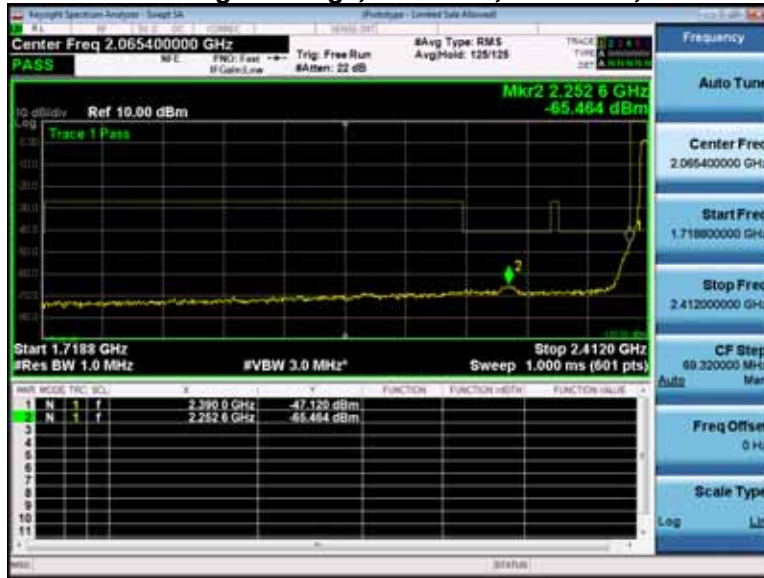

Antenna A

Conducted Bandedge Average, 2462 MHz, Non HT20, 6 to 54 Mbps

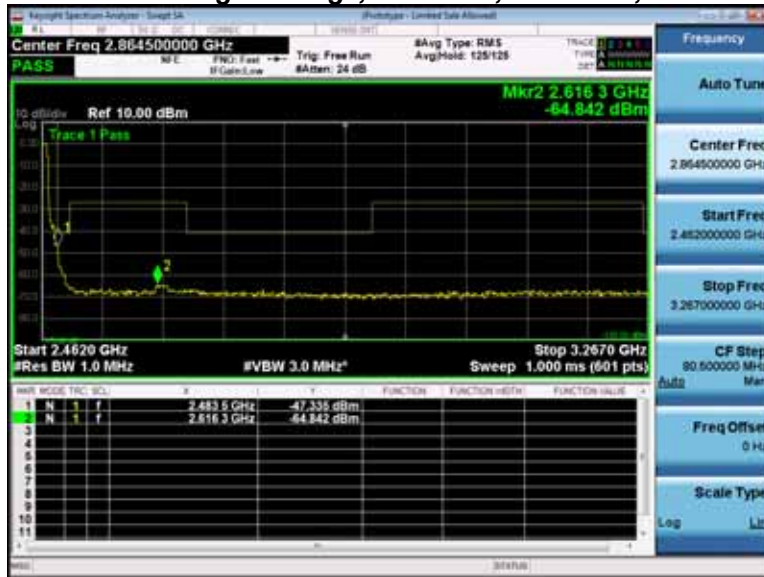

Antenna A



Conducted Bandedge Average Table, 6dBi

Frequency (MHz)	Mode	Tx Paths	Correlated Antenna Gain (dBi)	Tx 1 Bandedge Level (dBm)	Duty Cycle Correction (dB)	Total Tx Bandedge Level (dBm)	Limit (dBm)	Margin (dB)
2412	Non HT20, 6 to 54 Mbps	1	6	-55.4	0.1	-49.3	-41.25	8.02
2462	Non HT20, 6 to 54 Mbps	1	6	-53.6	0.1	-47.5	-41.25	6.22

Conducted Bandedge Average, 2412 MHz, Non HT20, 6 to 54 Mbps

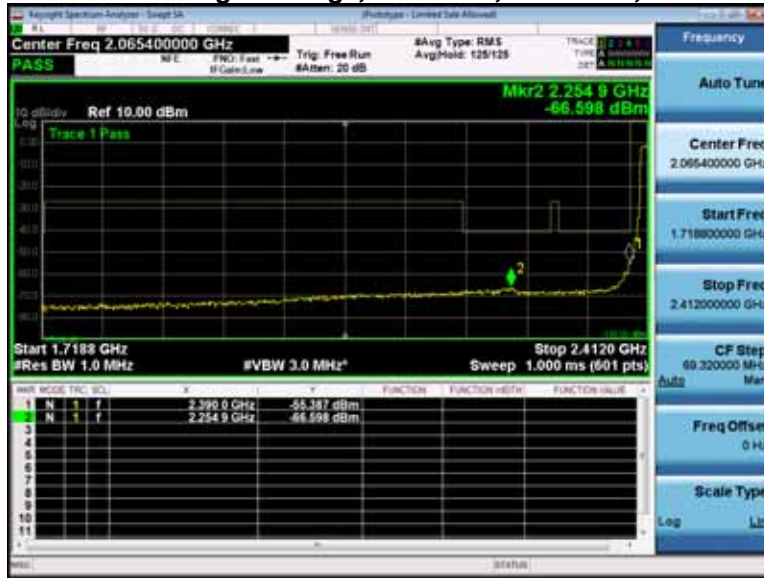

Antenna A

Conducted Bandedge Average, 2462 MHz, Non HT20, 6 to 54 Mbps



Antenna A



Conducted Bandedge Peak Table, 2dBi

Frequency (MHz)	Mode	Tx Paths	Correlated Antenna Gain (dBi)	Tx 1 Bandedge Level (dBm)	Total Tx Bandedge Level (dBm)	Limit (dBm)	Margin (dB)
2412	Non HT20, 6 to 54 Mbps	1	2	-32.4	-30.3	-21.25	9.02
2462	Non HT20, 6 to 54 Mbps	1	2	-26.4	-24.3	-21.25	3.02

Conducted Bandedge Peak, 2412 MHz, Non HT20, 6 to 54 Mbps



Antenna A

Conducted Bandedge Peak, 2462 MHz, Non HT20, 6 to 54 Mbps



Antenna A



Conducted Bandedge Peak Table, 3dBi

Frequency (MHz)	Mode	Tx Paths	Correlated Antenna Gain (dBi)	Tx 1 Bandedge Level (dBm)	Total Tx Bandedge Level (dBm)	Limit (dBm)	Margin (dB)
2412	Non HT20, 6 to 54 Mbps	1	3	-32.4	-29.3	-21.25	8.02
2462	Non HT20, 6 to 54 Mbps	1	3	-26.4	-23.3	-21.25	2.02

Conducted Bandedge Peak, 2412 MHz, Non HT20, 6 to 54 Mbps



Antenna A

Conducted Bandedge Peak, 2462 MHz, Non HT20, 6 to 54 Mbps



Antenna A



Conducted Bandedge Peak Table, 4dBi

Frequency (MHz)	Mode	Tx Paths	Correlated Antenna Gain (dBi)	Tx 1 Bandedge Level (dBm)	Total Tx Bandedge Level (dBm)	Limit (dBm)	Margin (dB)
2412	Non HT20, 6 to 54 Mbps	1	4	-32.4	-28.3	-21.25	7.02
2462	Non HT20, 6 to 54 Mbps	1	4	-27.3	-23.2	-21.25	1.92

Conducted Bandedge Peak, 2412 MHz, Non HT20, 6 to 54 Mbps



Antenna A

Conducted Bandedge Peak, 2462 MHz, Non HT20, 6 to 54 Mbps



Antenna A



Conducted Bandedge Peak Table, 6dBi

Frequency (MHz)	Mode	Tx Paths	Correlated Antenna Gain (dBi)	Tx 1 Bandedge Level (dBm)	Total Tx Bandedge Level (dBm)	Limit (dBm)	Margin (dB)
2412	Non HT20, 6 to 54 Mbps	1	6	-37.2	-31.1	-21.25	9.82
2462	Non HT20, 6 to 54 Mbps	1	6	-30.1	-24.0	-21.25	2.72

Conducted Bandedge Peak, 2412 MHz, Non HT20, 6 to 54 Mbps

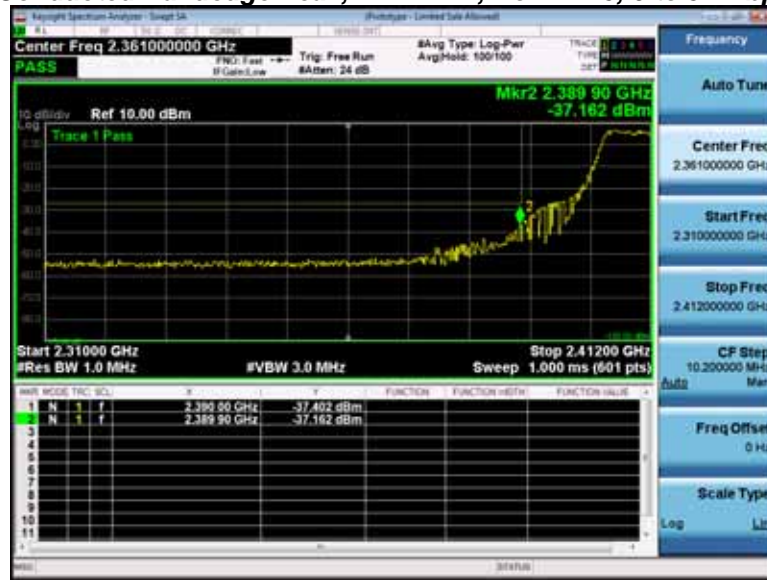

Antenna A

Conducted Bandedge Peak, 2462 MHz, Non HT20, 6 to 54 Mbps

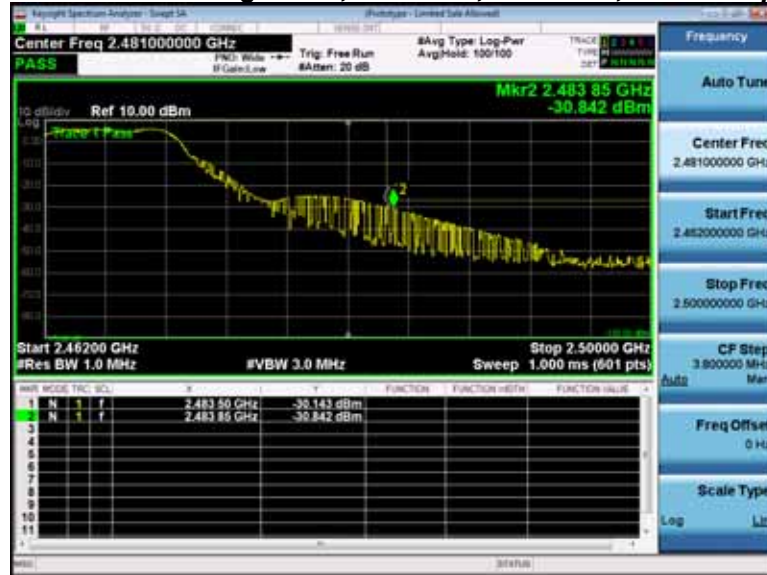

Antenna A

A.9 Conducted Bandedge (Non-Restricted Band)

Emissions in non-restricted frequency bands - Test Requirement

15.247 / LP0002:3.10.1(5) & 2.8

(d) In any 100 kHz bandwidth outside the frequency band in which the spread spectrum or digitally modulated intentional radiator is operating, the radio frequency power that is produced by the intentional radiator shall be at least 20 dB below that in the 100 kHz bandwidth within the band that contains the highest level of the desired power, based on either an RF conducted or a radiated measurement, provided the transmitter demonstrates compliance with the peak conducted power limits. If the transmitter complies with the conducted power limits based on the use of RMS averaging over a time interval, as permitted under paragraph (b)(3) of this section, the attenuation required under this paragraph shall be 30 dB instead of 20 dB. Attenuation below the general limits specified in §15.209(a) is not required. In addition, radiated emissions which fall in the restricted bands, as defined in §15.205(a), must also comply with the radiated emission limits specified in §15.209(a) (see §15.205(c)).

RSS-Gen 8.9 Except when the requirements applicable to a given device state otherwise, emissions from licence-exempt transmitters shall comply with the field strength limits shown in Table 4 and Table 5 below. Additionally, the level of any transmitter emission shall not exceed the level of the transmitter’s fundamental emission.

RSS-Gen 8.10 (b) Unwanted emissions that fall into restricted bands of Table 6 shall comply with the limits specified in RSS-Gen; and (c) Unwanted emissions that do not fall within the restricted frequency bands of Table 6 shall comply either with the limits specified in the applicable RSS or with those specified in this RSS-Gen.

Emissions in non-restricted frequency bands - Test Method

Ref. KDB 558074 D01 DTS Meas Guidance v05

ANSI C63.10: 2013

<p>Emissions in non-restricted frequency bands - Conducted Test Procedure</p> <ol style="list-style-type: none"> 1. Connect the antenna port(s) to the spectrum analyzer input. 2. Place the radio in continuous transmit mode 3. Configure Spectrum analyzer as per test parameters below (be sure to enter all losses between the transmitter output and the spectrum analyzer). 4. Use the marker function to determine the maximum spurs amplitude level. 5. Capture graphs and record pertinent measurement data.
--

Ref. KDB 558074 D01 DTS Meas Guidance v05 section, 8.5 DTS emissions in non-restricted frequency bands, 8.7 DTS band-edge measurements

ANSI C63.10: 2013 section 11.11.2, 11.11.3

<p>Emissions in non-restricted frequency bands - Conducted Test parameters</p>	
<p>11.11.2 Reference Level measurement Establish a reference level by using the following procedure:</p> <ol style="list-style-type: none"> a) Set instrument center frequency to DTS channel center frequency. b) Set the span to $\geq 1.5 \times DTS \text{ bandwidth}$. c) Set the RBW = 100 kHz. d) Set the VBW $\geq 3 \times RBW$. e) Detector = peak. f) Sweep time = auto couple. g) Trace mode = max hold. h) Allow trace to fully stabilize. i) Use the peak marker function to determine the maximum PSD level. 	<p>11.11.3 Emission Level Measurement</p> <ol style="list-style-type: none"> a) Set the center frequency and span to encompass frequency range to be measured. b) Set the RBW = 100 kHz. c) Set the VBW $\geq 3 \times RBW$. d) Detector = peak. e) Sweep time = auto couple. f) Trace mode = max hold. g) Allow trace to fully stabilize. h) Use the peak marker function to determine the maximum amplitude level.



Samples, Systems, and Modes

System Number	Description	Samples	System under test	Support equipment
1	EUT	S01	<input checked="" type="checkbox"/>	<input type="checkbox"/>
	Support		<input type="checkbox"/>	<input checked="" type="checkbox"/>

Tested By : Chris Blair	Date of testing: 15-Sep-19 - 16-Sep-19
Test Result : PASS	

Test Equipment

See Appendix C for list of test equipment

Non-Restricted Band

2dBi

Frequency (MHz)	Mode	Data Rate (Mbps)	Conducted Bandedge Delta (dB)	Limit (dBc)	Duty Cycle Correction (dB)	Margin (dB)
2412	Non HT20, 6 to 54 Mbps	6	37.3	>30	0.1	7.17
2462	Non HT20, 6 to 54 Mbps	6	45.4	>30	0.1	15.27

Conducted Bandedge Delta, 2412 MHz, Non HT20, 6 to 54 Mbps



3dBi

Frequency (MHz)	Mode	Data Rate (Mbps)	Conducted Bandedge Delta (dB)	Limit (dBc)	Duty Cycle Correction (dB)	Margin (dB)
2412	Non HT20, 6 to 54 Mbps	6	37.3	>30	0.1	7.17
2462	Non HT20, 6 to 54 Mbps	6	45.4	>30	0.1	15.27

Conducted Bandedge Delta, 2412 MHz, Non HT20, 6 to 54 Mbps



4dBi

Frequency (MHz)	Mode	Data Rate (Mbps)	Conducted Bandedge Delta (dB)	Limit (dBc)	Duty Cycle Correction (dB)	Margin (dB)
2412	Non HT20, 6 to 54 Mbps	6	37.3	>30	0.1	7.17
2462	Non HT20, 6 to 54 Mbps	6	46.3	>30	0.1	16.17

Conducted Bandedge Delta, 2412 MHz, Non HT20, 6 to 54 Mbps



6dBi

Frequency (MHz)	Mode	Data Rate (Mbps)	Conducted Bandedge Delta (dB)	Limit (dBc)	Duty Cycle Correction (dB)	Margin (dB)
2412	Non HT20, 6 to 54 Mbps	6	40.0	>30	0.1	9.87
2462	Non HT20, 6 to 54 Mbps	6	47.6	>30	0.1	17.47

Conducted Bandedge Delta, 2412 MHz, Non HT20, 6 to 54 Mbps



Appendix B: Radiated and AC Conducted Emission Test Results

Testing done by outside laboratory, not included in the scope of this report.



Appendix C: List of Test Equipment Used to perform the test

Equip#	Manufacturer/ Model	Description	Last Cal	Next Due	Test Item
57475	Cisco	Automation Test Insertion Loss	NA	NA	A1-A9
53614	Keysight N9030A-550	PXA Signal Analyzer, 3Hz to 50GHz	16 Jul 2019	16 Jul 2020	A1-A9
55095	NI PXI-1042	CHASSIS, PXI	NA	NA	A1-A9
57236	NI PXI-8115	Embedded Controller	NA	NA	A1-A9
57242	NI PXI-2796	40 GHz Dual 6x1 Multiplexer (SP6T)	NA	NA	A1-A9
57243	NI PXI-2799	Switch 1x1	NA	NA	A1-A9
56090	NI PXI-2796	40 GHz Dual 6x1 Multiplexer (SP6T)	NA	NA	A1-A9
7329	Omega CT485B	Chart recorder	18 Feb 2019	18 Feb 2020	A1-A9
56328	Pasternack PE5019-1	Torque wrench	14 Feb 2019	14 Feb 2020	A1-A9
56329	Pasternack PE5019-1	Torque wrench	28 Feb 2019	28 Feb 2020	A1-A9
56330	Pasternack PE5019-1	Torque wrench	28 Feb 2019	28 Feb 2020	A1-A9

Appendix D: Abbreviation Key and Definitions

The following table defines abbreviations used within this test report.

Abbreviation	Description	Abbreviation	Description
EMC	Electro Magnetic Compatibility	°F	Degrees Fahrenheit
EMI	Electro Magnetic Interference	°C	Degrees Celsius
EUT	Equipment Under Test	Temp	Temperature
ITE	Information Technology Equipment	S/N	Serial Number
TAP	Test Assessment Schedule	Qty	Quantity
ESD	Electro Static Discharge	emf	Electromotive force
EFT	Electric Fast Transient	RMS	Root mean square
EDCS	Engineering Document Control System	Qp	Quasi Peak
Config	Configuration	Av	Average
CIS#	Cisco Number (unique identification number for Cisco test equipment)	Pk	Peak
Cal	Calibration	kHz	Kilohertz (1×10^3)
EN	European Norm	MHz	MegaHertz (1×10^6)
IEC	International Electro technical Commission	GHz	Gigahertz (1×10^9)
CISPR	International Special Committee on Radio Interference	H	Horizontal
CDN	Coupling/Decoupling Network	V	Vertical
LISN	Line Impedance Stabilization Network	dB	decibel
PE	Protective Earth	V	Volt
GND	Ground	kV	Kilovolt (1×10^3)
L1	Line 1	μ V	Microvolt (1×10^{-6})
L2	Line2	A	Amp
L3	Line 3	μ A	Micro Amp (1×10^{-6})
DC	Direct Current	mS	Milli Second (1×10^{-3})
RAW	Uncorrected measurement value, as indicated by the measuring device	μ S	Micro Second (1×10^{-6})
RF	Radio Frequency	μ S	Micro Second (1×10^{-6})
SLCE	Signal Line Conducted Emissions	m	Meter
Meas dist	Measurement distance	Spec dist	Specification distance
N/A or NA	Not Applicable	SL	Signal Line (or Telecom Line)
P	Power Line	L	Live Line
N	Neutral Line	R	Return
S	Supply	AC	Alternating Current

Appendix E: Photographs of Test Setups

Please refer to the attachment



Appendix F: Software Used to Perform Testing

Cisco Internal LabView Radio Test Automation Software rev57

Appendix G: Test Procedures

Measurements were made in accordance with

- KDB 558074 - D01 DTS Meas Guidance v05
- KDB 662911 - MIMO
- ANSI C63.4 2014 Unintentional Radiators
- ANSI C63.10 2013 Intentional Radiators

Test procedures are summarized below

FCC 2.4GHz Test Procedures	EDCS # 1445042
FCC 2.4GHz RSE Test Procedures	EDCS # 1480386

Appendix H: Scope of Accreditation (A2LA certificate number 1178-01)

The scope of accreditation of Cisco Systems, Inc. can be found on the A2LA web page at:

<http://www.a2la.org/scopepdf/1178-01.pdf>

Appendix I: Test Assessment Plan

Target Power Tables EDCS# 18087112

Appendix J: UUT Software Info

```
APA453.0E7B.CCD0#  
APA453.0E7B.CCD0#test watchdog monitoring off  
APA453.0E7B.CCD0#  
APA453.0E7B.CCD0#  
APA453.0E7B.CCD0#  
APA453.0E7B.CCD0#  
APA453.0E7B.CCD0#show ver  
    Restricted Rights Legend
```

Use, duplication, or disclosure by the Government is subject to restrictions as set forth in subparagraph (c) of the Commercial Computer Software - Restricted Rights clause at FAR sec. 52.227-19 and subparagraph (c) (1) (ii) of the Rights in Technical Data and Computer Software clause at DFARS sec. 252.227-7013.

Cisco Systems, Inc.
170 West Tasman Drive
San Jose, California 95134-1706

This product contains cryptographic features and is subject to United States and local country laws governing import, export, transfer and use. Delivery of Cisco cryptographic products does not imply third-party authority to import, export, distribute or use encryption. Importers, exporters, distributors and users are responsible for compliance with U.S. and local country laws. By using this product you agree to comply with applicable laws and regulations. If you are unable to comply with U.S. and local laws, return this product immediately.

A summary of U.S. laws governing Cisco cryptographic products may be found at:
<http://www.cisco.com/wwl/export/crypto/tool/stqrg.html>

If you require further assistance please contact us by sending email to export@cisco.com.

This product contains some software licensed under the "GNU General Public License, version 2" provided with ABSOLUTELY NO WARRANTY under the terms of "GNU General Public License, version 2", available here:
<http://www.gnu.org/licenses/old-licenses/gpl-2.0.html>

This product contains some software licensed under the "GNU Library General Public License, version 2" provided with ABSOLUTELY NO WARRANTY under the terms of "GNU Library General Public License, version 2", available here:
<http://www.gnu.org/licenses/old-licenses/lgpl-2.0.html>

This product contains some software licensed under the "GNU Lesser General Public License, version 2.1" provided with ABSOLUTELY NO WARRANTY under the terms of "GNU Lesser General Public License, version 2.1", available here: <http://www.gnu.org/licenses/old-licenses/lgpl-2.1.html>

This product contains some software licensed under the "GNU General Public License, version 3" provided with ABSOLUTELY NO WARRANTY under the terms of "GNU General Public License, Version 3", available here: <http://www.gnu.org/licenses/gpl.html>.

This product contains some software licensed under the "GNU Affero General Public License, version 3" provided with ABSOLUTELY NO WARRANTY under the terms of "GNU Affero General Public License, version 3", available here: <http://www.gnu.org/licenses/agpl-3.0.html>.

Cisco AP Software, (ap1g7), [cheetah-build6:/san2/BUILD/workspace/Nightly-Cheetah-axel-bcm-mfg-c8_10_throttle]
Technical Support: <http://www.cisco.com/techsupport>
Copyright (c) 1986-2019 by Cisco Systems, Inc.
Compiled Fri Sep 6 08:06:05 PDT 2019

ROM: Bootstrap program is U-Boot boot loader
BOOTLDR: U-Boot boot loader Version

APA453.0E7B.CCD0 uptime is 0 days, 0 hours, 4 minutes
Last reload time : Fri Sep 6 08:22:50 UTC 2019
Last reload reason : unknown

cisco C9120AXE-B with 1809824/1062468K bytes of memory.
Processor board ID 0
AP Running Image : 8.8.1.10
Primary Boot Image : 8.8.1.10
Backup Boot Image : 0.0.0.0
Primary Boot Image Hash:
Backup Boot Image Hash:
1 Gigabit Ethernet interfaces
2 802.11 Radios
Radio Driver version : 17.10 RC77.13
Radio FW version : 1268.14948.r14702 14702
NSS FW version : NA

Base ethernet MAC Address : A4:53:0E:7B:CC:D0
Part Number : 0-000000-00
PCA Assembly Number : 800-105708-01
PCA Revision Number : 09
PCB Serial Number : FOC23302F0Q



Top Assembly Part Number : 800-105708-01
Top Assembly Serial Number : 0
Top Revision Number : 09
Product/Model Number : C9120AXE-B

APA453.0E7B.CCD0#
APA453.0E7B.CCD0#
APA453.0E7B.CCD0#
APA453.0E7B.CCD0#
APA453.0E7B.CCD0#
APA453.0E7B.CCD0#
Read timed out

User Access Verification
Username: Cisco
Password:
Lock out for 4 seconds in release image

% Authentication failed

User Access Verification
Username: Cisco
Password:
APA453.0E7B.CCD0>en
Password:
APA453.0E7B.CCD0#
APA453.0E7B.CCD0#
APA453.0E7B.CCD0#
APA453.0E7B.CCD0#
APA453.0E7B.CCD0#
APA453.0E7B.CCD0#
APA453.0E7B.CCD0#
APA453.0E7B.CCD0#devs
EXITING CISCO SHELL. PLEASE EXECUTE EXIT IN DEVSHELL TO GET BACK TO CISCO SHELL.

BusyBox v1.29.3 () built-in shell (ash)

Welcome to Cisco.

Usage of this device is governed by Cisco's End User License Agreement,
available at:
http://www.cisco.com/c/en/us/td/docs/general/warranty/English/EU1KEN_.html.

```
mA4530E7BCCD0:##
mA4530E7BCCD0:##
mA4530E7BCCD0:## echo 0 > /meraki_gpio/RF_2G_ble
mA4530E7BCCD0:##
mA4530E7BCCD0:##
mA4530E7BCCD0:##
mA4530E7BCCD0:## cat MERAKI_BUILD.extra
Fri Sep 6 08:06:05 PDT 2019
cheetah-build6
/san2/BUILD/workspace/Nightly-Cheetah-axel-bcm-mfg-c8_10_throttle
```

* (HEAD detached at fb31ca5b6a)

```
svn base: fb31ca5b6ab1468794221acdd081bea192921139
commit: fb31ca5b6ab1468794221acdd081bea192921139
tree 9933345a372cf5493649162765b52efdf4ff9219
mA4530E7BCCD0:##
mA4530E7BCCD0:##
mA4530E7BCCD0:##
mA4530E7BCCD0:## show_cookie
Part Number           : 0-000000-00
Board Revision        : 00
PCB Serial Number     : FOC23302F0Q
PCB Fab Part Number   : 0-000000-00
Deviation Number     : 0
MAC Address           : A4:53:0E:7B:CC:D0
MAC Address Block Size : 4
Radio 0 MAC Address   : D4:AD:BD:A2:16:80
Radio 0 MAC Address Block Size : 16
Radio 1 MAC Address   : D4:AD:BD:A2:16:90
Radio 1 MAC Address Block Size : 16
PCA Assembly Number   : 800-105708-01
PCA Revision Number   : 09
Product/Model Number  : C9120AXE-B
Top Assembly Part Number : 800-105708-01
Top Revision Number   : 09
Top Assembly Serial Number : 0
RMA Test History      : 00
RMA History           : 00
RMA Number            : 00-00-00-00
Device Type           : 4C
Max Association Allowed : 2
Radio(2.4G) Carrier Set : 0000
Radio(2.4G) Max Transmit Power Level : 100
Radio(2.4G) Antenna Diversity Support: 01
Radio(2.4G) Encryption Ability : 0002
Radio(5G) Carrier Set : 0029
Radio(5G) Max Transmit Power Level : 100
```

```
Radio(5G) Antenna Diversity Support : 01
Radio(5G) Encryption Ability       : 0002
Radio(802.11g) Radio Mode         : 255
PEP Product Identifier (PID)      : C9120AXE-B
PEP Version Identifier (VID)      : V01
System Flags                      : 00
Controller Type                   : 0000
Host Controller Type              : 0000
Mfr Service Date                  : 2019.08.03-47:59:59
Radio(49) Carrier Set            : 0000
Radio(49) Max Transmit Power Level : 0
Radio(49) Antenna Diversity Support : 00
Radio(49) Encryption Ability      : 0000
Radio(58) Carrier Set            : 0029
Radio(58) Max Transmit Power Level : 100
Radio(58) Antenna Diversity Support : 01
Radio(58) Encryption Ability      : 0002
ACT2 ID                          : C9120
Static AP Mode                    : 0
mA4530E7BCCD0:/#
mA4530E7BCCD0:/#
mA4530E7BCCD0:/#
mA4530E7BCCD0:/#
mA4530E7BCCD0:/# cat /storage/rxtx_mode
tx
mA4530E7BCCD0:/#
mA4530E7BCCD0:/#
mA4530E7BCCD0:/#
mA4530E7BCCD0:/# cd /usr/bin/bcm/mfg
mA4530E7BCCD0:/usr/bin/bcm/mfg#
mA4530E7BCCD0:/usr/bin/bcm/mfg#
mA4530E7BCCD0:/usr/bin/bcm/mfg#
mA4530E7BCCD0:/usr/bin/bcm/mfg# ./init_config.sh broadcast_ssids
show_carrier_cookies | grep -o '..$'
41
wl -i apr1v0 country US
wl -i apr0v0 country US
Chanspec set to 0x1001
[*09/06/2019 08:42:38.7040] wlc_ucose_download: wl1: Loading 129 MU ucode
Chanspec set to 0xd024
[*09/06/2019 08:42:38.7870] wlc_ucose_download: wl0: Loading 129 MU ucode
mA4530E7BCCD0:/usr/bin/bcm/mfg#
mA4530E7BCCD0:/usr/bin/bcm/mfg#
mA4530E7BCCD0:/usr/bin/bcm/mfg#
mA4530E7BCCD0:/usr/bin/bcm/mfg# ./dfstool.lua

Vanc dfstool
BOARD: Axel BCM !!!!!
```

Display config:

```
wl -i apr0v0 status | head -3
"Not associated. Last associated with SSID: ""
```

Display config:

```
wl -i apr1v0 status | head -3
"Not associated. Last associated with SSID: ""
```

```
show_carrier_cookies | grep -o '..$'
rc:result="41"
```

```
wl -i apr1v0 country US
wl -i apr0v0 country US
>
line=""
```

```
>do0 stop
line="do0 stop"
```

```
DEBUG: compliance stop command matched.
INFO: subcommand="compliance off".
```

```
execution section for compliance stop command.
line="do0 stop"
interface="0"
stop_option="stop"
wl -i apr0v0 pkteng_status | awk -F'[ , ]' '{print $3}'
main:result="0"
```

```
1601792112 (0x5f796870)
>
line=""
>do1 stop
line="do1 stop"
```

```
DEBUG: compliance stop command matched.
INFO: subcommand="compliance off".
```

```
execution section for compliance stop command.
line="do1 stop"
interface="1"
stop_option="stop"
wl -i apr1v0 pkteng_status | awk -F'[ , ]' '{print $3}'
main:result="0"
```

```
1601792112 (0x5f796870)
```

```
>  
line=""  
>do4 stop  
line="do4 stop"
```

```
DEBUG: compliance stop command matched.  
INFO: subcommand="compliance off".
```

```
execution section for compliance stop command.  
line="do4 stop"  
interface="4"  
stop_option="stop"  
[09/06/2019 08:44:03.9220] NXP-RHL-Driver 0001:01:00.0: xcvr[0], swcmd 0x23 done  
[09/06/2019 08:44:04.1030] NXP-RHL-Driver 0001:01:00.0: xcvr[0], swcmd 0x4 done  
[09/06/2019 08:44:04.1870] NXP-RHL-Driver 0001:01:00.0: VSPA FW :: FN = dcr.eld  
>  
line=""  
>
```