



Dynamic Frequency Selection (DFS) Test Report

C9130AXI-(X)

Cisco Catalyst C9130AX Series (x=A,B)



FCC ID: LDKAX5122118
IC: 2461N- AX5122118

5250-5350, 5470-5725 MHz

Against the following Specifications:

**CFR47 Part 15.407
RSS247**

Cisco Systems
170 West Tasman Drive
San Jose, CA 95134

	
Author: Johanna Knudsen Tested By: Johanna Knudsen	Approved By: Gerard Thorpe Title: Manager – Radio Compliance & Certifications Revision: Controlled by Doc Central

This report replaces any previously entered test report under EDCS – **18179347**. This test report has been electronically authorized and archived using the CISCO Engineering Document Control system.



SECTION 1: OVERVIEW3

SECTION 2: ASSESSMENT INFORMATION4

2.1 GENERAL4

2.2 DATE OF TESTING6

2.3 REPORT ISSUE DATE6

2.4 TESTING FACILITIES6

2.5 EQUIPMENT ASSESSED (EUT)6

SECTION 3: RESULT SUMMARY7

3.1 RESULTS SUMMARY TABLE7

SECTION 4: SAMPLE DETAILS8

4.1 SAMPLE DETAILS8

4.2 SYSTEM DETAILS8

4.3 MODE OF OPERATION DETAILS8

APPENDIX A: DYNAMIC FREQUENCY SELECTION (DFS)9

A.1 UNII DEVICE DESCRIPTION9

A.2 DFS DETECTION THRESHOLDS10

A.3 RADAR TEST WAVEFORMS11

APPENDIX B: DYNAMIC FREQUENCY SELECTION / TEST RESULTS15

CALIBRATION PLOTS17

B.1 TEST PROCEDURE/RESULTS33

B.2 UNII DETECTION BANDWIDTH34

B.3 INITIAL CHANNEL AVAILABILITY CHECK TIME51

B.4 RADAR BURST AT THE BEGINNING OF THE CHANNEL AVAILABILITY CHECK TIME52

B.5 RADAR BURST AT THE END OF THE CHANNEL AVAILABILITY CHECK TIME53

B.6 IN-SERVICE MONITORING FOR CHANNEL MOVE TIME, CHANNEL CLOSING TRANSMISSION TIME AND
NON-OCCUPANCY PERIOD54

B.7 STATISTICAL PERFORMANCE CHECK57

APPENDIX C: LIST OF TEST EQUIPMENT USED TO PERFORM THE TEST244

APPENDIX D: PHOTOGRAPHS OF TEST SETUPS245

APPENDIX E: SOFTWARE USED TO PERFORM TESTING245

APPENDIX F: TEST PROCEDURES245

APPENDIX G: SCOPE OF ACCREDITATION (A2LA CERTIFICATE NUMBER 1178-01)245

APPENDIX H: TEST ASSESSMENT PLAN245

APPENDIX I: WORST CASE JUSTIFICATION245

APPENDIX J: UUT SOFTWARE INFO245



Section 1: Overview

The samples were assessed against the tests detailed in section 3 under the requirements of the following specifications:

Specifications:
CFR47 Part 15.407 RSS-247

Section 2: Assessment Information

2.1 General

This report contains an assessment of an apparatus against Electromagnetic Compatibility Standards based upon tests carried out on the samples submitted. The testing was performed by and for the use of Cisco systems Inc:

With regard to this assessment, the following points should be noted:

- a) The results contained in this report relate only to the items tested and were obtained in the period between the date of the initial assessment and the date of issue of the report. Manufactured products will not necessarily give identical results due to production and measurement tolerances.
- b) The apparatus was set up and exercised using the configuration and modes of operation defined in this report only.
- c) Where relevant, the apparatus was only assessed using the susceptibility criteria defined in this report and the Test Assessment Plan (TAP).
- d) All testing was performed under the following environmental conditions:

Temperature	15°C to 35°C (54°F to 95°F)
Atmospheric Pressure	860mbar to 1060mbar (25.4" to 31.3")
Humidity	10% to 75*%
- e) All AC testing was performed at one or more of the following supply voltages:
110V 60 Hz (+/-20%)

Units of Measurement

The units of measurements defined in the appendices are reported in specific terms, which are test dependent. Where radiated measurements are concerned these are defined at a particular distance. Basic voltage measurements are defined in units of [dBuV]

As an example, the basic calculation for all measurements is as follows:

$$\text{Emission level [dBuV]} = \text{Indicated voltage level [dBuV]} + \text{Cable Loss [dB]} + \text{Other correction factors [dB]}$$

The combinations of correction factors are dependent upon the exact test configurations [see test equipment lists for further details] and may include:-

Antenna Factors, Pre Amplifier Gain, LISN Loss, Pulse Limiter Loss and Filter Insertion Loss..

Note: to convert the results from dBuV/m to uV/m use the following formula:-

$$\text{Level in uV/m} = \text{Common Antilogarithm} [(X \text{ dBuV/m})/20] = Y \text{ uV/m}$$

Measurement Uncertainty Values

voltage and power measurements	± 2 dB
conducted EIRP measurements	± 1.4 dB
radiated measurements	± 3.2 dB
frequency measurements	± 2.4 10 ⁻⁷
temperature measurements	± 0.54°
humidity measurements	± 2.3%
DC and low frequency measurements	± 2.5%

Where relevant measurement uncertainty levels have been estimated for tests performed on the apparatus. This uncertainty represents an expanded uncertainty expressed at approximately the 95% confidence level using a coverage factor of k=2.

Radiated emissions (expanded uncertainty, confidence interval 95%)

30 MHz - 300 MHz	+/- 3.8 dB
300 MHz - 1000 MHz	+/- 4.3 dB
1 GHz - 10 GHz	+/- 4.0 dB
10 GHz - 18GHz	+/- 8.2 dB
18GHz - 26.5GHz	+/- 4.1 dB
26.5GHz - 40GHz	+/- 3.9 dB

Conducted emissions (expanded uncertainty, confidence interval 95%)

30 MHz – 40GHz	+/- 0.38 dB
----------------	-------------

A product is considered to comply with a requirement if the nominal measured value is below the limit line. The product is considered to not be in compliance in case the nominal measured value is above the limit line.

This report must not be reproduced except in full, without written approval of Cisco Systems.

**2.2 Date of testing**

28-AUG-19 - 13-SEP-19

2.3 Report Issue Date

13-SEP-19

Cisco uses an electronic system to issue, store and control the revision of test reports. This system is called the Engineering Document Control System 13253354. The actual report issue date is embedded into the original file on EDCS. Any copies of this report, either electronic or paper, that are not on EDCS must be considered uncontrolled.

2.4 Testing facilities

This assessment was performed by:

Testing Laboratory

Cisco Systems, Inc.,
125 West Tasman Drive
San Jose, CA 95134, USA

Registration Numbers for Industry Canada

Cisco System Site	Address	Site Identifier
Building P, 10m Chamber	125 West Tasman Dr San Jose, CA 95134	Company #: 2461N-2
Building P, 5m Chamber	125 West Tasman Dr San Jose, CA 95134	Company #: 2461N-1
Building I, 5m Chamber	285 W. Tasman Drive San Jose, California 95134	Company #: 2461M-1

Test Engineers

Johanna Knudsen

2.5 Equipment Assessed (EUT)

C9130AXI-B



Section 3: Result Summary

3.1 Results Summary Table

Basic Standard	Technical Requirements / Details	Result
FCC 15.407 RSS-247	Dynamic Frequency Selection (DFS) Detection Threshold	Pass
FCC 15.407 RSS-247	Channel Availability Check Time	Pass
FCC 15.407 RSS-247	Channel Move Time	Pass
FCC 15.407 RSS-247	Channel Closing Time	Pass
FCC 15.407 RSS-247	Non-Occupancy Period	Pass
FCC 15.407 RSS-247	U-NII Detection Bandwidth	Pass



Section 4: Sample Details

Note: Each sample was evaluated to ensure that its condition was suitable to be used as a test sample prior to the commencement of testing.

4.1 Sample Details

Sample No.	Equipment Details	Manufacturer	Hardware Rev.	Firmware Rev.	Software Rev.	Serial Number
S01	C9130AXI-B	Cisco Systems, Inc	800-105662-01 , P6B-1	NA	NA	KWC2325001A
S02	Support Laptop	Asus	FX504G	NA	NA	JANRCX002576412

4.2 System Details

System Number	Description	Sample Description	Samples	System under test	Support equipment
1	Used for 20, 40, 80MHz, and 160MHz testing	C9130AXI-B	S01	<input checked="" type="checkbox"/>	<input type="checkbox"/>
		Support Laptop	S02	<input type="checkbox"/>	<input checked="" type="checkbox"/>

4.3 Mode of Operation Details

Mode#	Description	Comments
1	20MHz BW DFS Tests	20MHz BW DFS Tests with traffic: 24% Traffic Loading using IPERF
2	40MHz BW DFS Tests	40MHz BW DFS Tests with traffic: 20% Traffic Loading using IPERF
3	80MHz BW DFS Tests	80MHz BW DFS Tests with traffic: 17% Traffic Loading using IPERF
4	160MHz BW DFS Tests	160MHz BW DFS tests with traffic: 17% Traffic Loading using IPERF



Appendix A: Dynamic Frequency Selection (DFS)

15.407: U-NII devices operating in the 5.25-5.35 GHz band and the 5.47-5.725 GHz band shall employ a TPC mechanism. The U-NII device is required to have the capability to operate at least 6 dB below the mean EIRP value of 30 dBm. A TPC mechanism is not required for systems with an e.i.r.p. of less than 500 mW.

U-NII devices operating in the 5.25-5.35 GHz and 5.47-5.725 GHz bands shall employ a DFS radar detection mechanism to detect the presence of radar systems and to avoid co-channel operation with radar systems.

A.1 UNII Device Description

Refer to the Radio Theory of Operation for supported modes. The modes included in this report represent the worst case data for all modes.

The following antennas are supported by this product series.

The data included in this report represent the worst case data for all antennas.

Frequency	Part Number	Antenna Type	Antenna Gain (dBi)
5GHz	NA	Internal, Dual-band Omni-directional	6

1. The maximum EIRP of the 5GHz equipment is 29 dBm, and the minimum possible EIRP is 10 dBm.

Below are the available 50 ohm antenna assemblies and their corresponding gains. 0dBi gain was used to set the -63 dBm threshold level (-64dBm +1 dB) during calibration of the test setup.

2. System testing was performed with IPERF traffic that streams continuously from the Master to the Client IP based system.
3. The Master requires 116.7s seconds to complete its power-on cycle.
4. Information regarding the parameters of the detected Radar Waveforms is not available to the end user.
5. For the 5250-5350 MHz and 5470-5725 MHz bands, the Master device provides, on aggregate, uniform loading of the spectrum across all devices by selecting an operating channel among the available channels using a random algorithm.

A.2 DFS Detection Thresholds

1. Interference Threshold values, Master or Client incorporating In-Service Monitoring

Maximum Transmit Power	Value (See Notes 1, 2, and 3)
EIRP \geq 200 milliwatt	-64 dBm
EIRP < 200 milliwatt and power spectral density < 10 dBm/MHz	-62 dBm
EIRP < 200 milliwatt that do not meet the power spectral density requirement	-64 dBm
<p>Note 1: This is the level at the input of the receiver assuming a 0 dBi receive antenna.</p> <p>Note 2: Throughout these test procedures an additional 1 dB has been added to the amplitude of the test transmission waveforms to account for variations in measurement equipment. This will ensure that the test signal is at or above the detection threshold level to trigger a DFS response.</p> <p>Note3: EIRP is based on the highest antenna gain. For MIMO devices refer to KDB Publication 662911 D01 v02r01.</p>	

2. DFS Response requirement values

Parameter	Value
<i>Non-occupancy period</i>	Minimum 30 minutes
<i>Channel Availability Check Time</i>	60 seconds
<i>Channel Move Time</i>	10 seconds See Note 1.
<i>Channel Closing Transmission Time</i>	200 milliseconds + an aggregate of 60 milliseconds over remaining 10 second period. See Notes 1 and 2.
<i>U-NII Detection Bandwidth</i>	Minimum 100% of the U-NII 99% transmission power bandwidth. See Note 3.
<p>Note 1: <i>Channel Move Time</i> and the <i>Channel Closing Transmission Time</i> should be performed with Radar Type 0. The measurement timing begins at the end of the Radar Type 0 burst.</p> <p>Note 2: The <i>Channel Closing Transmission Time</i> is comprised of 200 milliseconds starting at the beginning of the <i>Channel Move Time</i> plus any additional intermittent control signals required to facilitate a <i>Channel</i> move (an aggregate of 60 milliseconds) during the remainder of the 10 second period. The aggregate duration of control signals will not count quiet periods in between transmissions.</p> <p>Note 3: During the <i>U-NII Detection Bandwidth</i> detection test, radar type 0 should be used. For each frequency step the minimum percentage of detection is 90 percent. Measurements are performed with no data traffic.</p>	

A.3 Radar Test Waveforms

This section provides the parameters for required test waveforms, minimum percentage of successful detections, and the minimum number of trials that must be used for determining DFS conformance. Step intervals of 0.1 microsecond for Pulse Width, 1 microsecond for PRI, 1 MHz for chirp width and 1 for the number of pulses will be utilized for the random determination of specific test waveforms.

1. Short Pulse Radar Test Waveforms

Radar Type	Pulse Width (μsec)	PRI (μsec)	Number of Pulses	Minimum Percentage of Successful Detection	Minimum Numbers of Trials
0	1	1428	18	See Note 1	See Note 1
1	1	Test A: 15 unique PRI values randomly selected from the list of 23 PRI values in Table 5a	Roundup $\left\{ \begin{array}{l} \left(\frac{1}{360} \right) \cdot \\ \left(\frac{19 \cdot 10^6}{PRI_{\mu sec}} \right) \end{array} \right\}$	60%	30
		Test B: 15 unique PRI values randomly selected within the range of 518-3066 μsec, with a minimum increment of 1 μsec, excluding PRI values selected in Test A			
2	1-5	150-230	23-29	60%	30
3	6-10	200-500	16-18	60%	30
4	11-20	200-500	12-16	60%	30
Aggregate (Radar Types 1-4)				80%	120
Note 1: Short Pulse Radar Type 0 shall only be used for the channel availability and detection bandwidth tests. It should be noted that any of the radar test waveforms 0 – 4 can be used for the channel availability and detection bandwidth tests.					

A minimum of 30 unique waveforms are required for each of the Short Pulse Radar Types 2 through 4. If more than 30 waveforms are used for Short Pulse Radar Types 2 through 4, then each additional waveform must also be unique and not repeated from the previous waveforms. If more than 30 waveforms are used for Short Pulse Radar Type 1, then each additional waveform is generated with Test B and must also be unique and not repeated from the previous waveforms in Tests A or B.



For example if in Short Pulse Radar Type 1 Test B a PRI of 3066 μ sec is selected, the number of pulses would be $\text{Roundup}\left\{\left(\frac{1}{360}\right) \cdot \left(\frac{19 \cdot 10^6}{3066}\right)\right\} = \text{Roundup}\{17.2\} = 18$

Table 5a – Pulse Repetition Intervals Values for Test A

Pulse Repetition Frequency Number	Pulse Repetition Frequency (Pulses Per Second)	Pulse Repetition Interval (Microseconds)
1	1930.5	518
2	1858.7	538
3	1792.1	558
4	1730.1	578
5	1672.2	598
6	1618.1	618
7	1567.4	638
8	1519.8	658
9	1474.9	678
10	1432.7	698
11	1392.8	718
12	1355.0	738
13	1319.3	758
14	1285.3	778
15	1253.1	798
16	1222.5	818
17	1193.3	838
18	1165.6	858
19	1139.0	878
20	1113.6	898
21	1089.3	918
22	1066.1	938
23	326.2	3066

The aggregate is the average of the percentage of successful detections of Short Pulse Radar Types 1-4. For example, the following table indicates how to compute the aggregate of percentage of successful detections.

Radar Type	Number of Trials	Number of Successful Detections	Minimum Percentage of Successful Detection
1	35	29	82.9%
2	30	18	60%
3	30	27	90%
4	50	44	88%
Aggregate $(82.9\% + 60\% + 90\% + 88\%)/4 = 80.2\%$			

2. Long Pulse Radar Test Waveform

Radar Type	Pulse Width (µsec)	Chirp Width (MHz)	PRI (µsec)	Number of Pulses per Burst	Number of Bursts	Minimum Percentage of Successful Detection	Minimum Trials
5	50-100	5-20	1000- 2000	1-3	8-20	80%	30

The parameters for this waveform are randomly chosen. Thirty unique waveforms are required for the Long Pulse radar test signal. If more than 30 waveforms are used for the Long Pulse radar test signal, then each additional waveform must also be unique and not repeated from the previous waveforms.

Each waveform is defined as follows:

- 1) The transmission period for the Long Pulse Radar test signal is 12 seconds.
- 2) There are a total of 8 to 20 Bursts in the 12 second period, with the number of Bursts being randomly chosen. This number is Burst Count.
- 3) Each Burst consists of 1 to 3 pulses, with the number of pulses being randomly chosen. Each Burst within the 12 second sequence may have a different number of pulses.
- 4) The pulse width is between 50 and 100 microseconds, with the pulse width being randomly chosen. Each pulse within a Burst will have the same pulse width. Pulses in different Bursts may have different pulse widths.
- 5) Each pulse has a linear FM chirp between 5 and 20 MHz, with the chirp width being randomly chosen. Each pulse within a Burst will have the same chirp width. Each pulse within a transmission period will have the same chirp width. The chirp is centered on the pulse. For example, with a radar frequency of 5300 MHz and a 20 MHz chirped signal, the chirp starts at 5290 MHz and ends at 5310 MHz.
- 6) If more than one pulse is present in a Burst, the time between the pulses will be between 1000 and 2000 microseconds, with the time being randomly chosen. If three pulses are present in a Burst, the time between the first and second pulses is chosen independently of the time between the second and third pulses.
- 7) The 12 second transmission period is divided into even intervals. The number of intervals is equal to Burst Count. Each interval is of length $(12,000,000 / \text{Burst Count})$ microseconds. Each interval contains one Burst. The start time for the Burst, relative to the beginning of the interval, is between 1 and $[(12,000,000 / \text{Burst Count}) - (\text{Total Burst Length}) + (\text{One Random PRI Interval})]$ microseconds, with the start time being randomly chosen. The step interval for the start time is 1 microsecond. The start time for each Burst is chosen randomly.

A representative example of a Long Pulse radar test waveform:

- 1) The total test signal length is 12 seconds.
- 2) 8 Bursts are randomly generated for the Burst Count.
- 3) Burst 1 has 2 randomly generated pulses.
- 4) The pulse width (for both pulses) is randomly selected to be 75 microseconds.
- 5) The PRI is randomly selected to be at 1213 microseconds.
- 6) Bursts 2 through 8 are generated using steps 3 – 5.
- 7) Each Burst is contained in even intervals of 1,500,000 microseconds. The starting location for Pulse 1, Burst 1 is randomly generated (1 to 1,500,000 minus the total Burst 1 length + 1 random PRI interval) at the 325,001 microsecond step. Bursts 2 through 8 randomly fall in successive 1,500,000 microsecond intervals (i.e. Burst 2 falls in the 1,500,001 – 3,000,000 microsecond range).

Graphical Representation of a Long Pulse radar Test Waveform

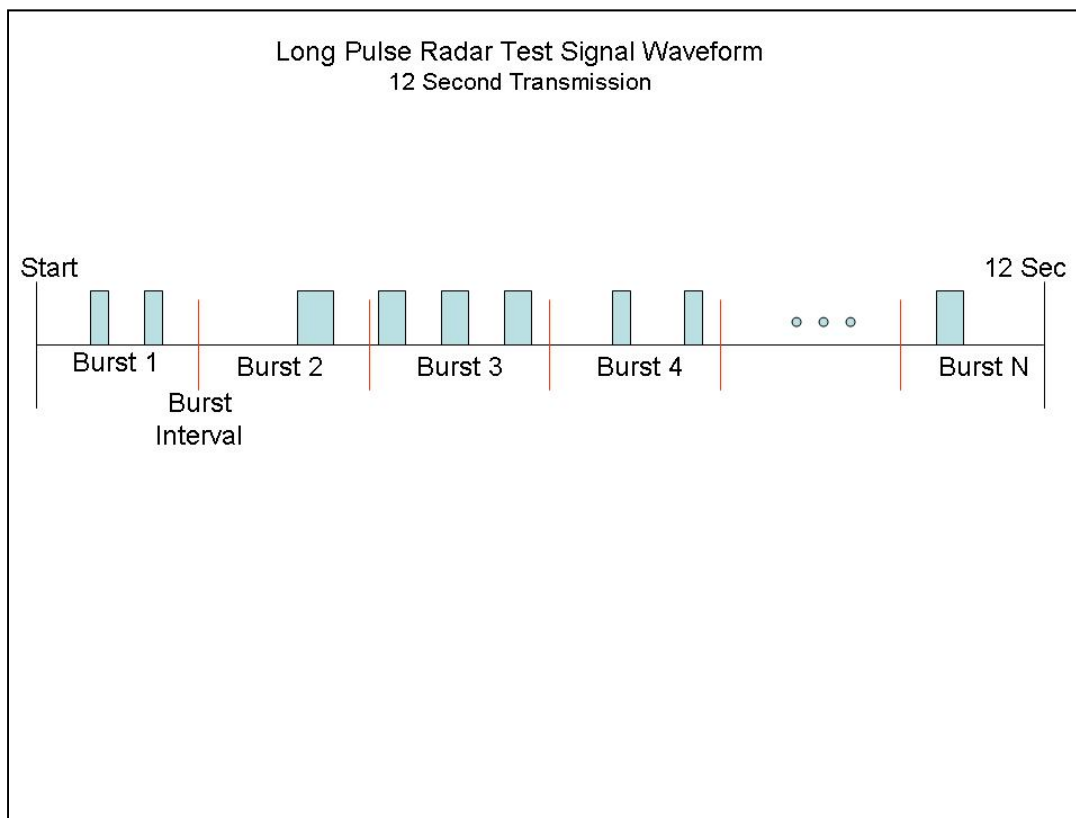

3. Long Pulse Radar Test Waveform

Radars Type	Pulse Width (µsec)	PRI (µsec)	Pulses per Hop	Hopping Rate (kHz)	Hopping Sequence Length (msec)	Minimum Percentage of Successful Detection	Minimum Trials
6	1	333	9	.333	300	70%	30

For the Frequency Hopping Radar Type, the same *Burst* parameters are used for each waveform. The hopping sequence is different for each waveform and a 100-length segment is selected¹ from the hopping sequence defined by the following algorithm:

The first frequency in a hopping sequence is selected randomly from the group of 475 integer frequencies from 5250 – 5724 MHz. Next, the frequency that was just chosen is removed from the group and a frequency is randomly selected from the remaining 474 frequencies in the group. This process continues until all 475 frequencies are chosen for the set. For selection of a random frequency, the frequencies remaining within the group are always treated as equally likely.



Appendix B: Dynamic Frequency Selection / Test Results

Standards Reference

FCC 15.407 / RSS-247

Test Procedure

Ref. KDB 905462 D02 UNII DFS Compliance Procedures New Rules v02

DFS Test parameters
Span = 0 Hz
RBW ≥ 3 MHz
VBW ≥ 3 MHz
Detector = Peak
Trace = Single Sweep

Samples, Systems, and Modes

System Number	Description	Samples	System under test	Support equipment
1	EUT	S01	<input checked="" type="checkbox"/>	<input type="checkbox"/>
	Support	S02	<input type="checkbox"/>	<input checked="" type="checkbox"/>

Tested By : Johanna Knudsen	Date of testing: 24-Aug-19 - 13-Sep-19
Test Result : PASS	

Test Equipment

See Appendix C for list of test equipment

The following equipment setup was used to calibrate the conducted Radar Waveform. A spectrum analyzer was used to establish the test signal level for each radar type. During this process there were no transmissions by either the Master or Client Device. The spectrum analyzer was switched to the zero span (Time Domain) mode at the frequency of the Radar Waveform generator. Peak detection was utilized. The spectrum analyzer resolution bandwidth (RBW) and video bandwidth (VBW) were set to 3 MHz.

The signal generator amplitude was set so that the power level measured at the spectrum analyzer was -63dBm.

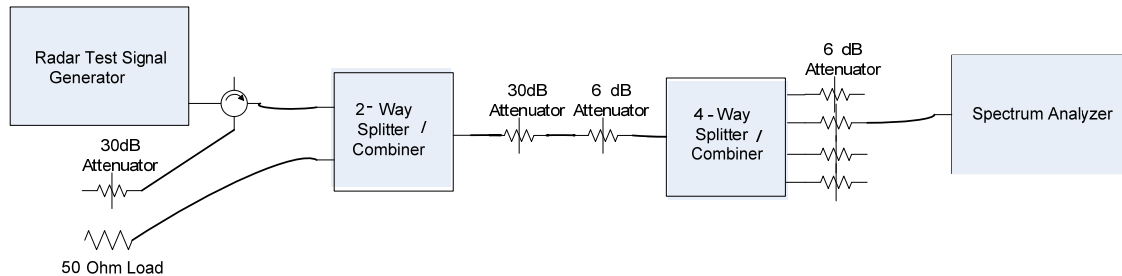

Conducted Calibration Setup



Calibration Plots

Following are the calibration plots for each of the required radar waveforms.

Calibration Plots – Bandwidth 20

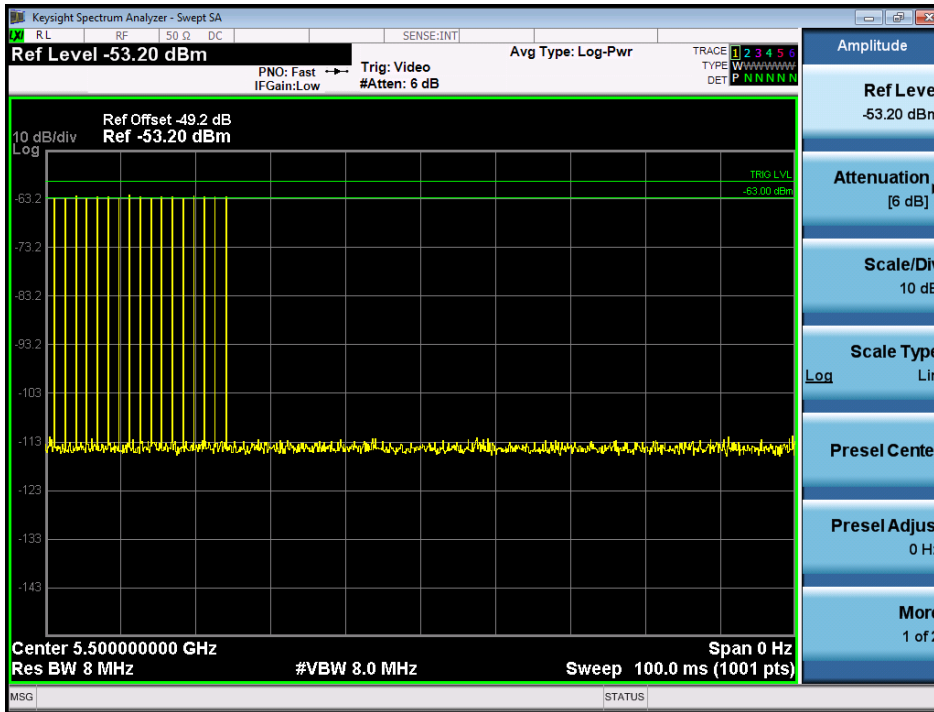

USA Bin 0 Radar Calibration BW20

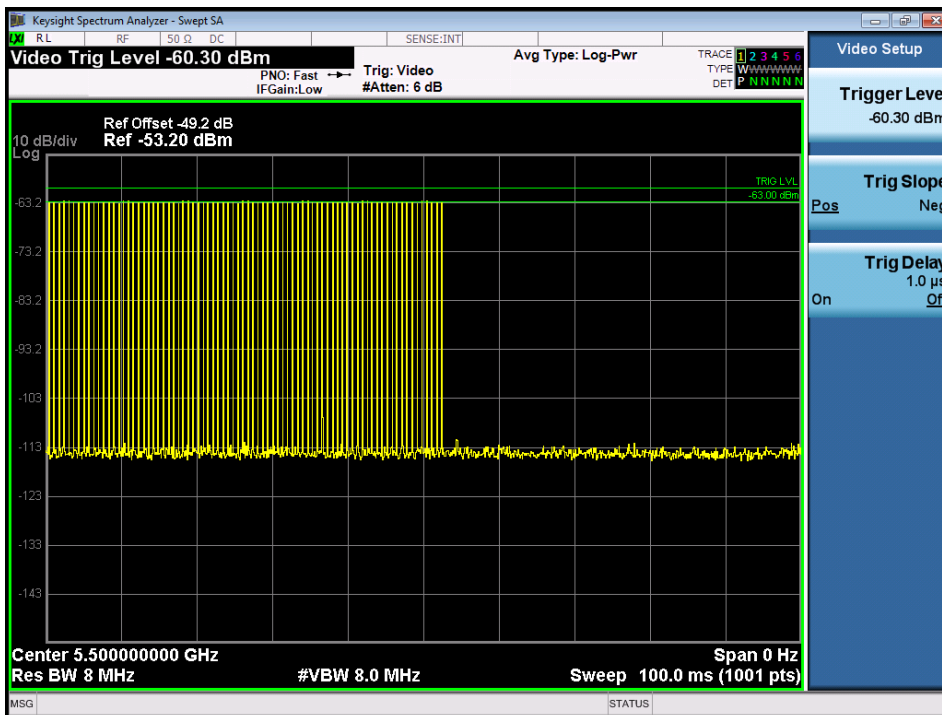

USA Bin 1A Radar Calibration BW20

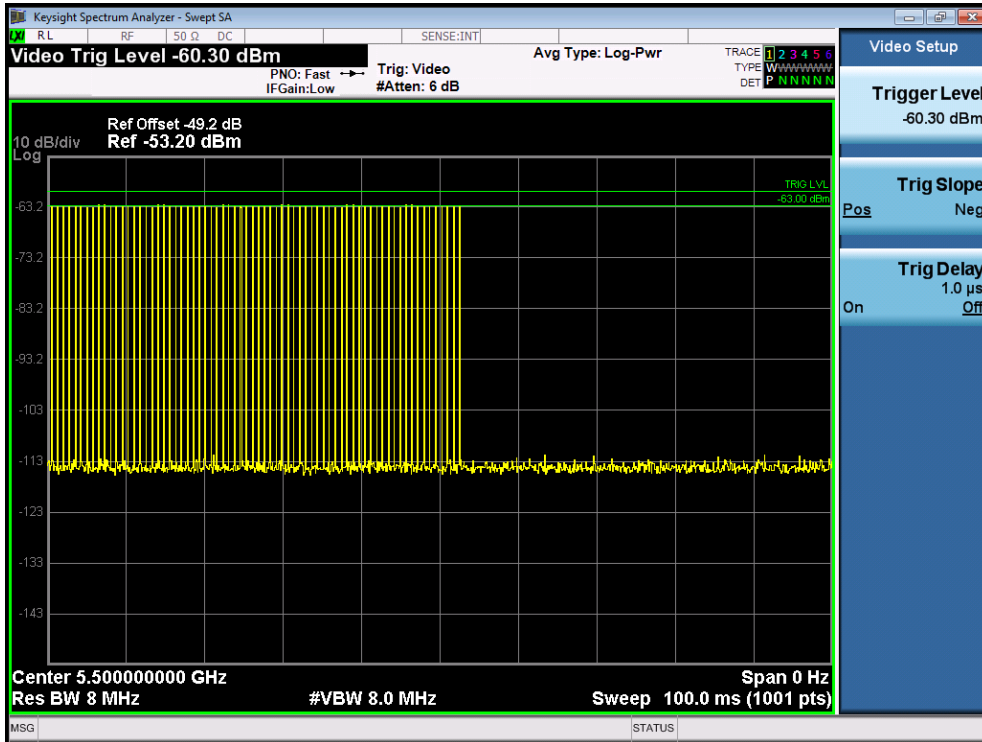

USA Bin 1B Radar Calibration BW20

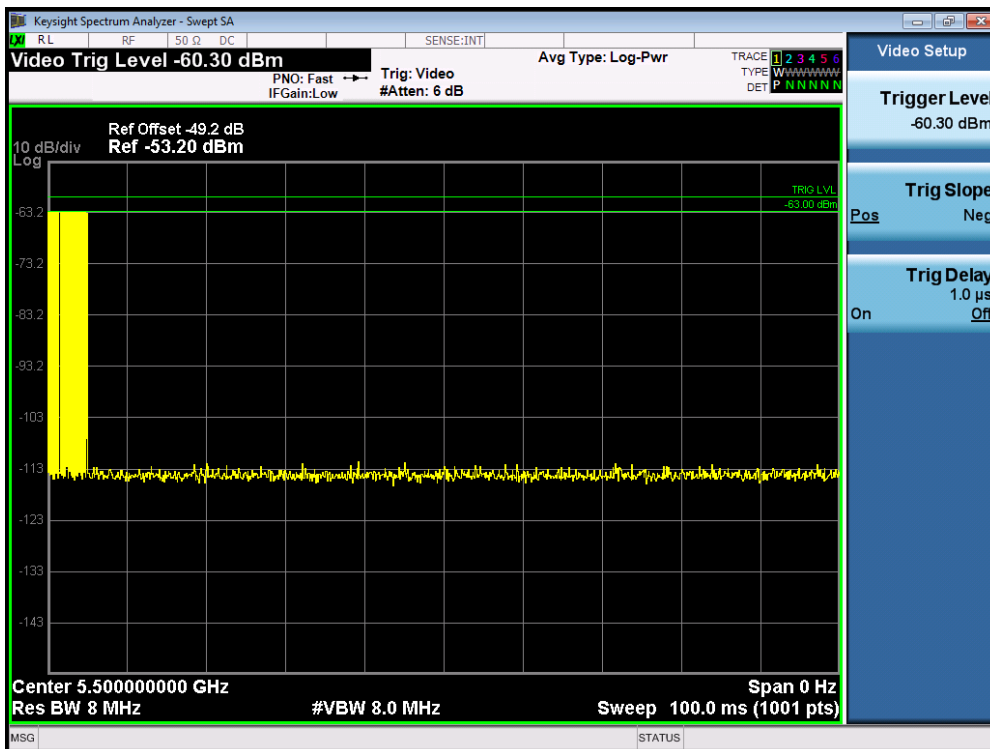

USA Bin 2 Radar Calibration BW20

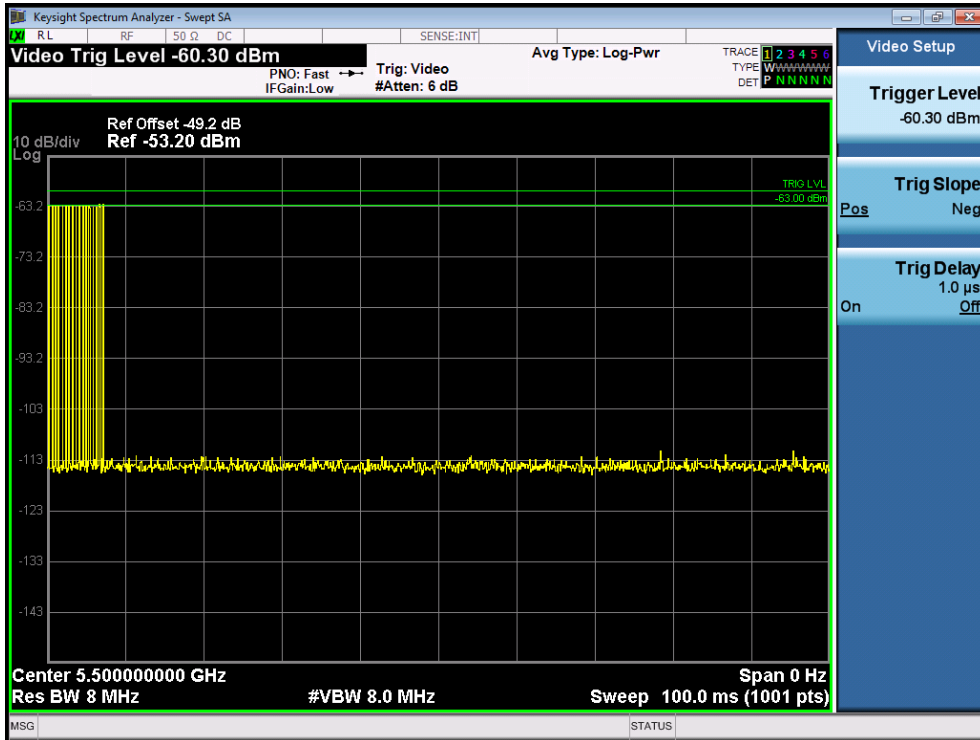

USA Bin 3 Radar Calibration BW20

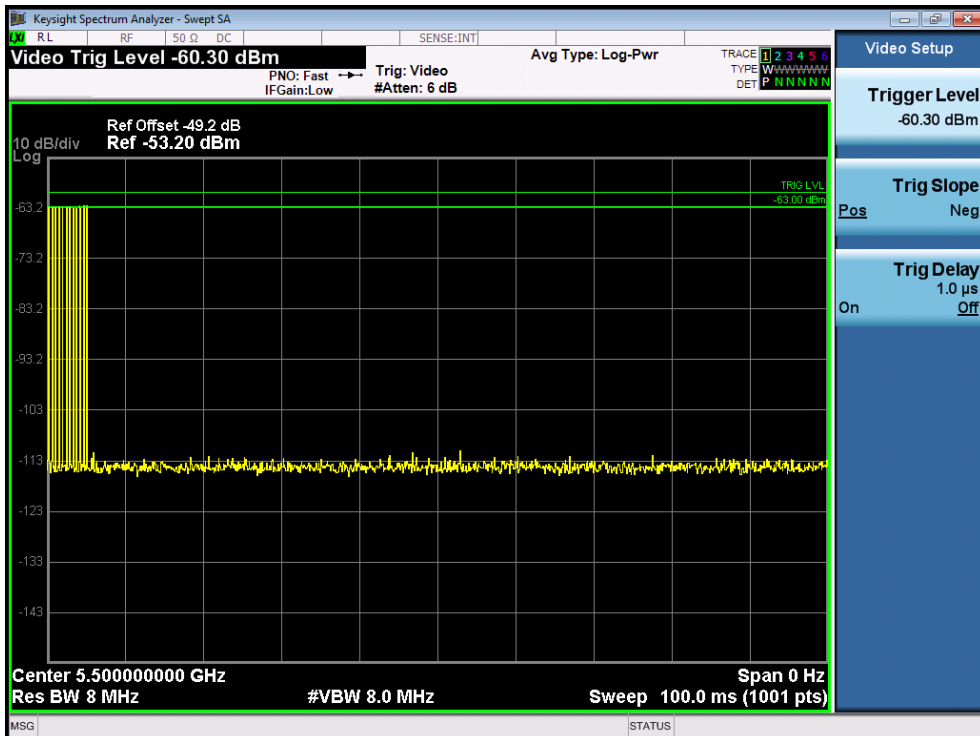

USA Bin 4 Radar Calibration BW20

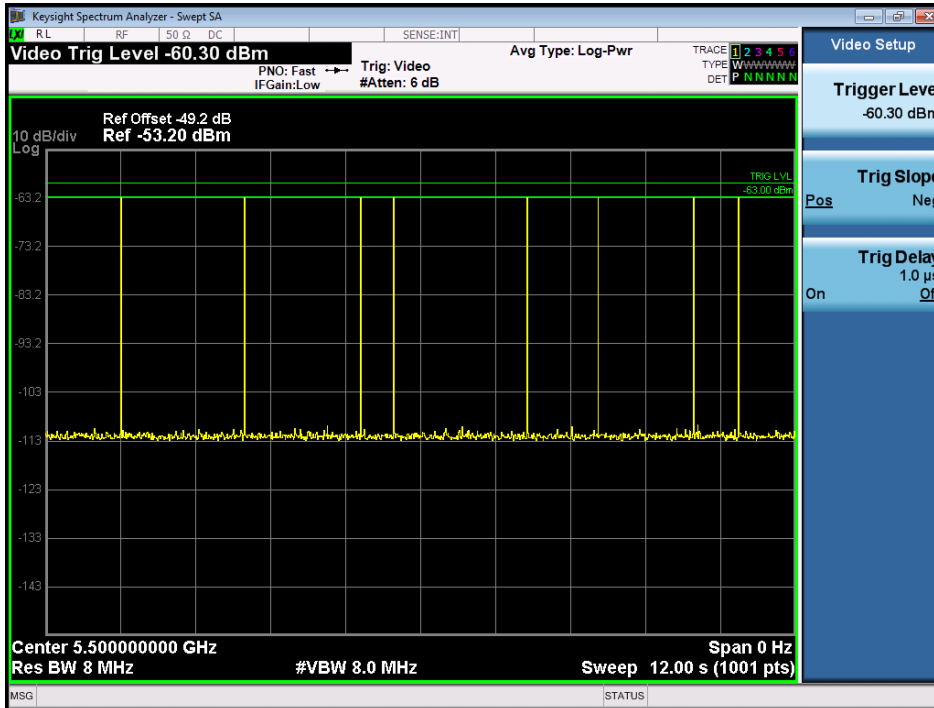

USA Bin 5 Radar Calibration BW20

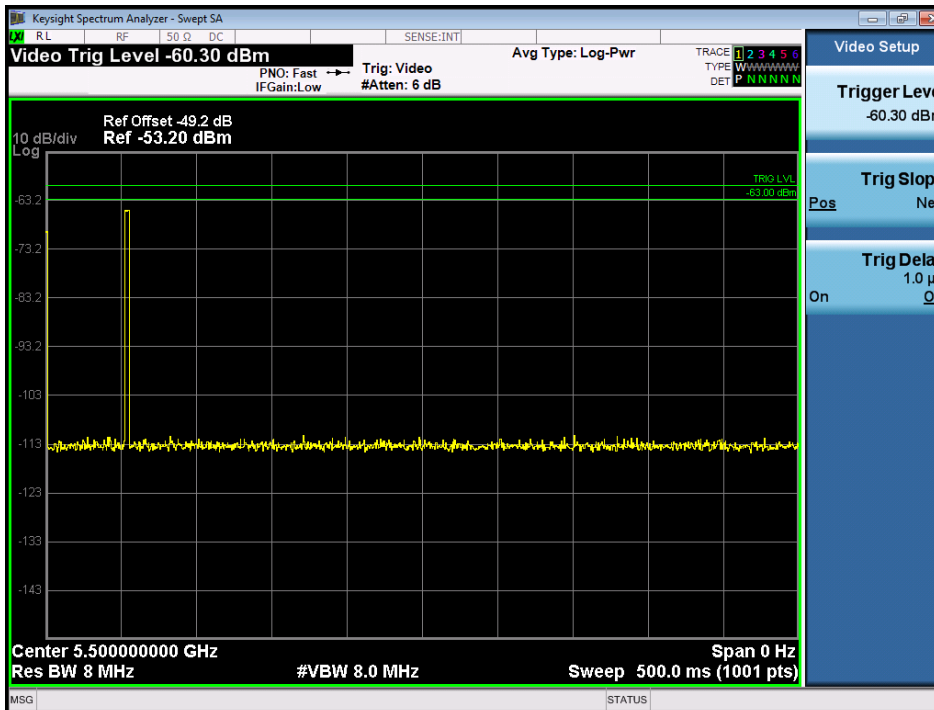

USA Frequency Hopping Radar Calibration BW20



Calibration Plots – Bandwidth 40

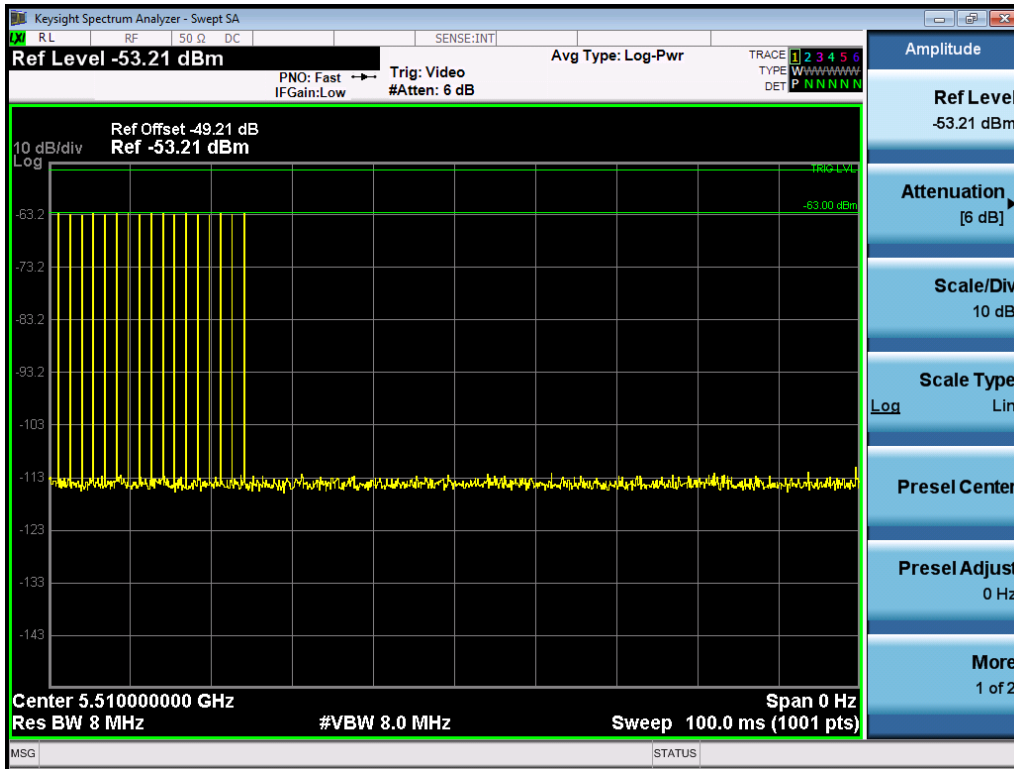

USA Bin 0 Radar Calibration BW40

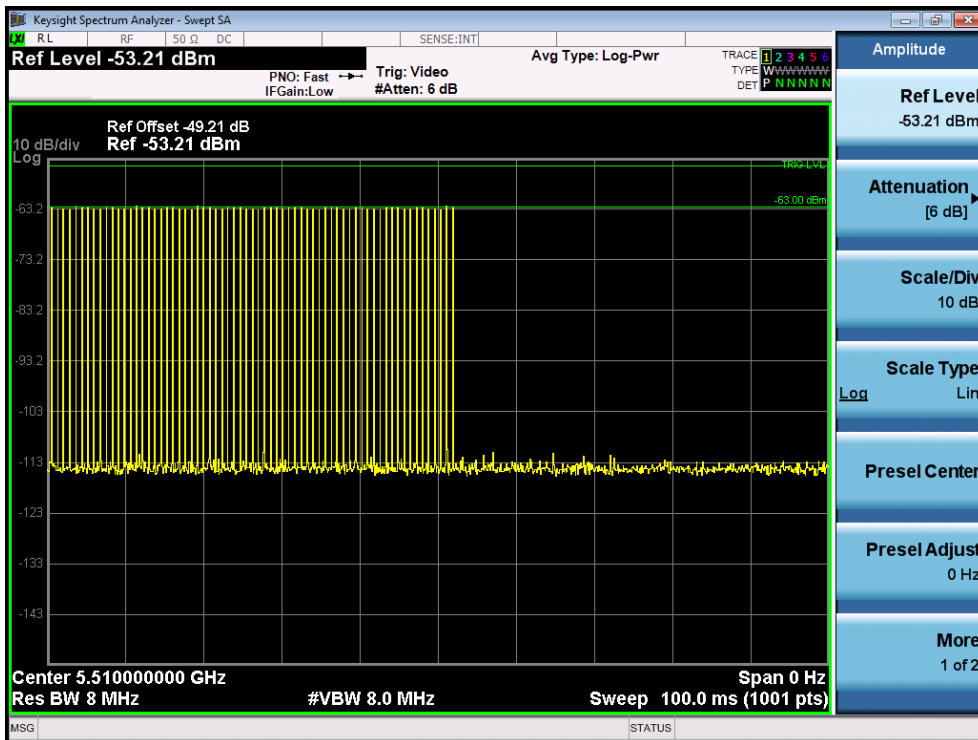

USA Bin 1A Radar Calibration BW40

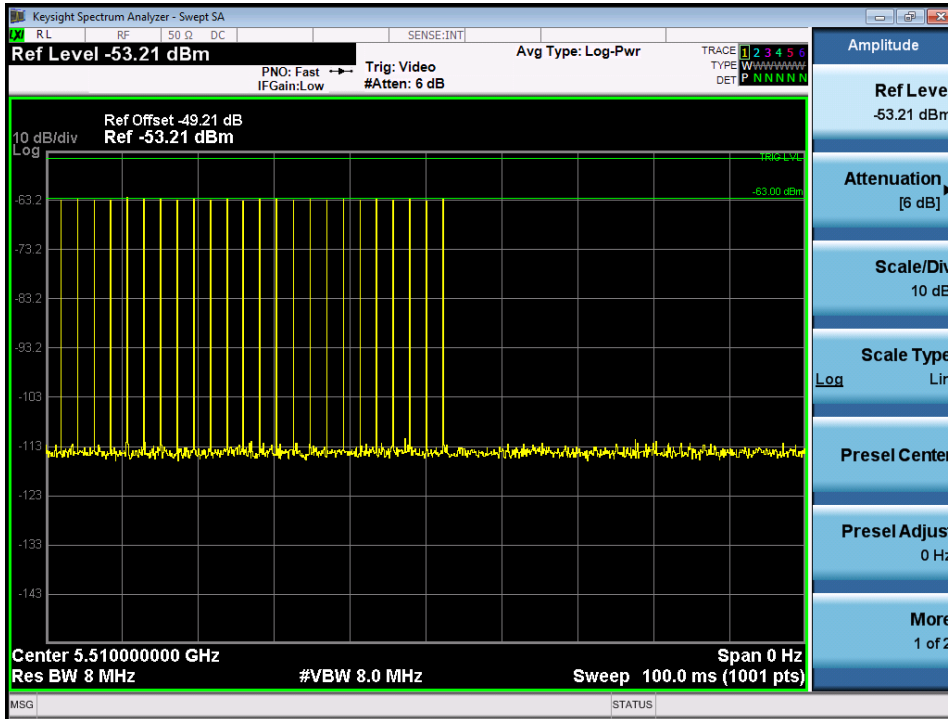

USA Bin 1B Radar Calibration BW40

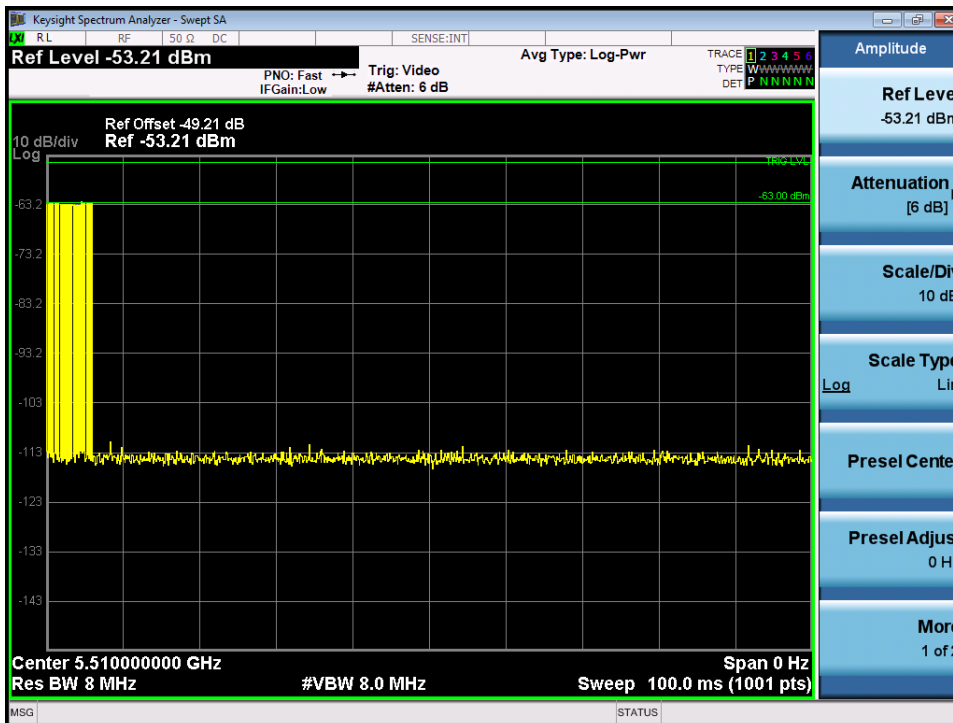

USA Bin 2 Radar Calibration BW40

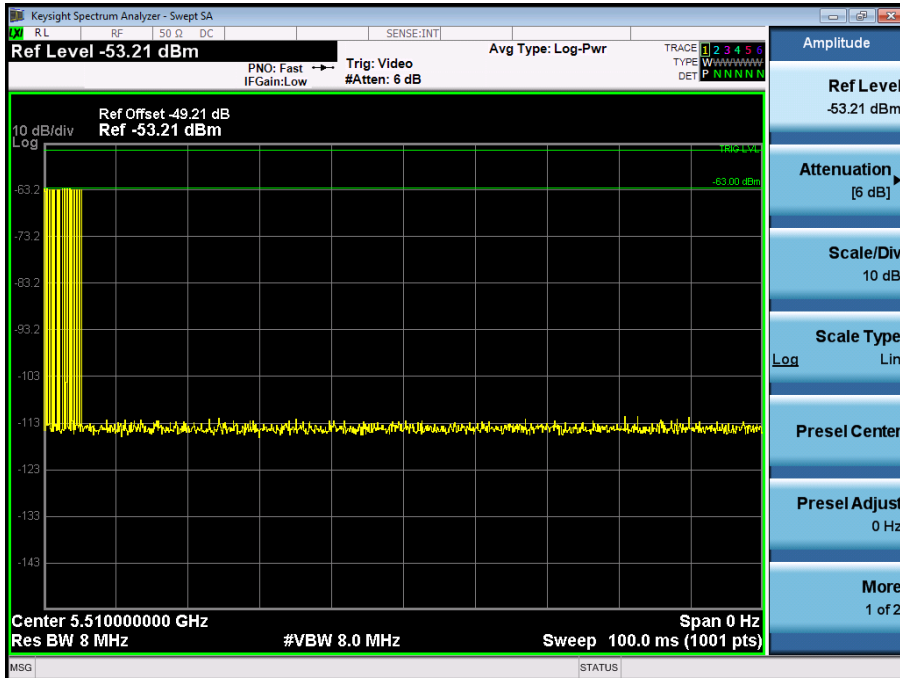

USA Bin 3 Radar Calibration BW40

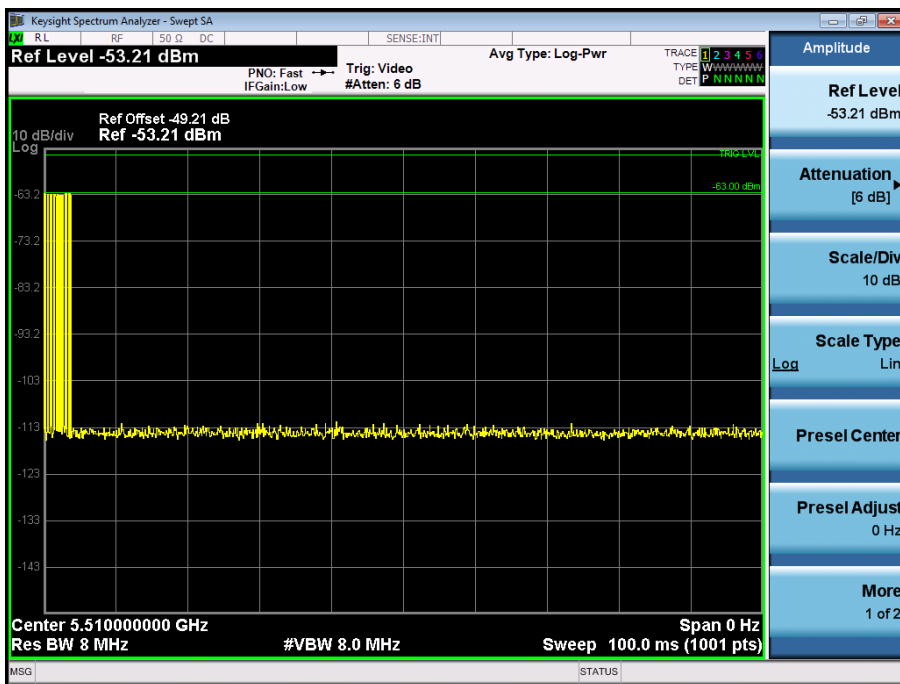

USA Bin 4 Radar Calibration BW40

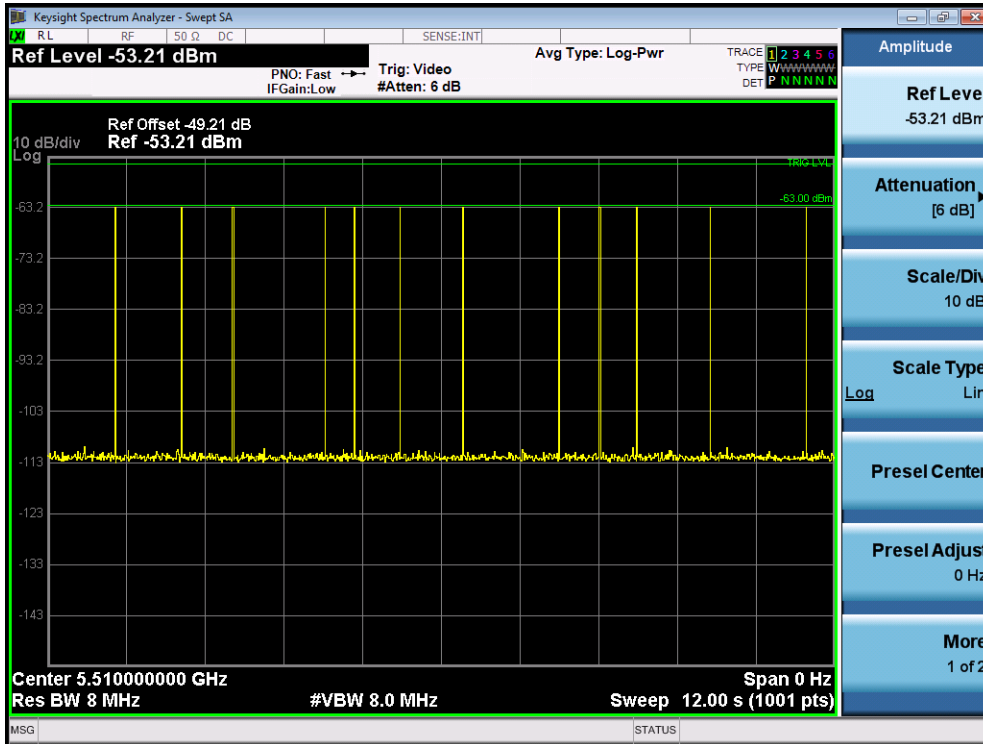

USA Bin 5 Radar Calibration BW40

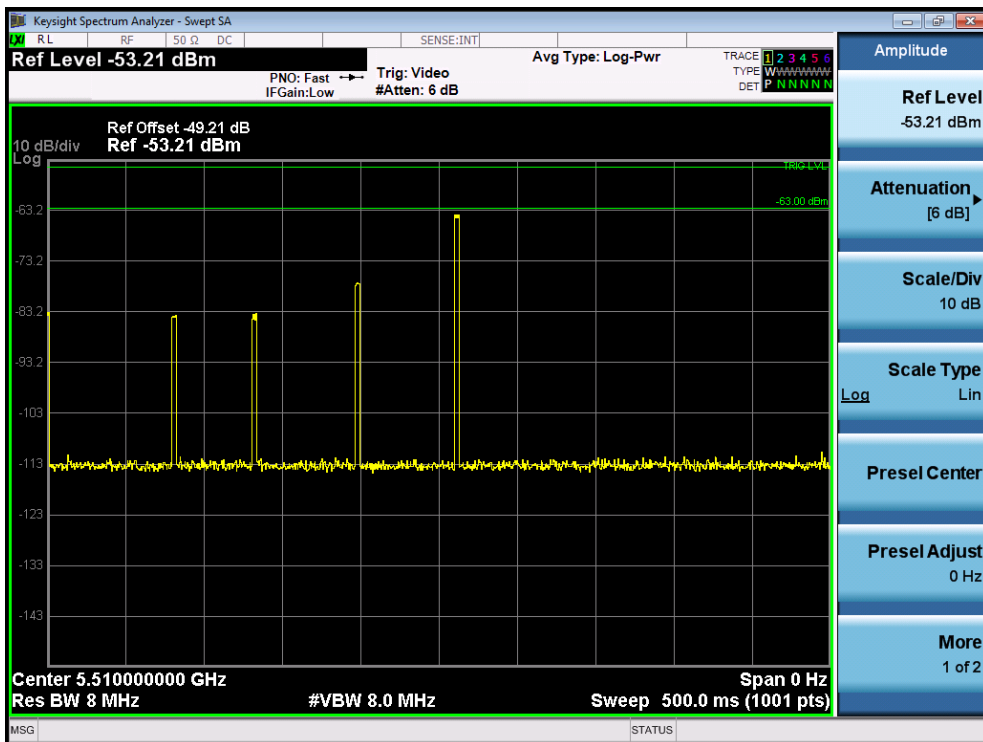

USA Frequency Hopping Radar Calibration BW40



Calibration Plots – Bandwidth 80

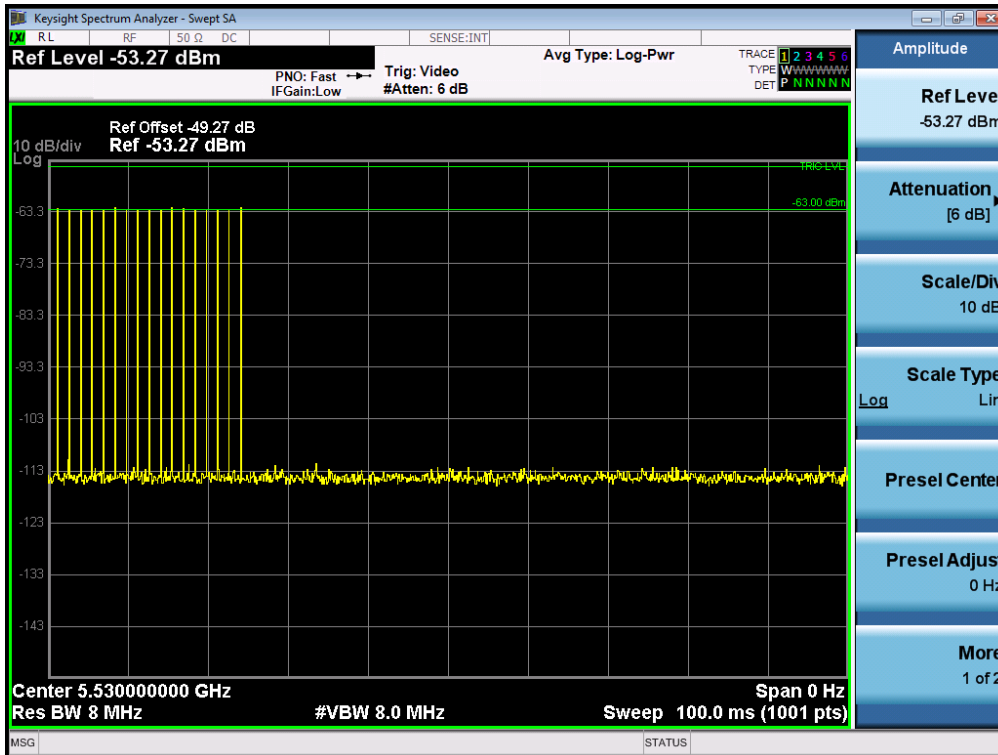

USA Bin 0 Radar Calibration BW80

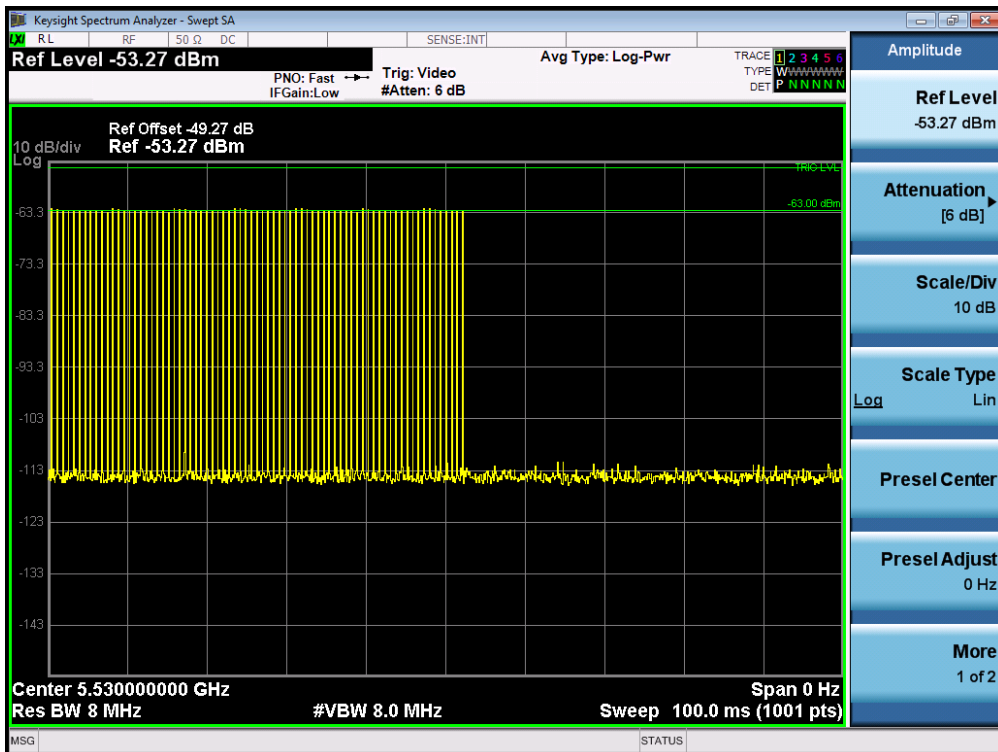

USA Bin 1A Radar Calibration BW80

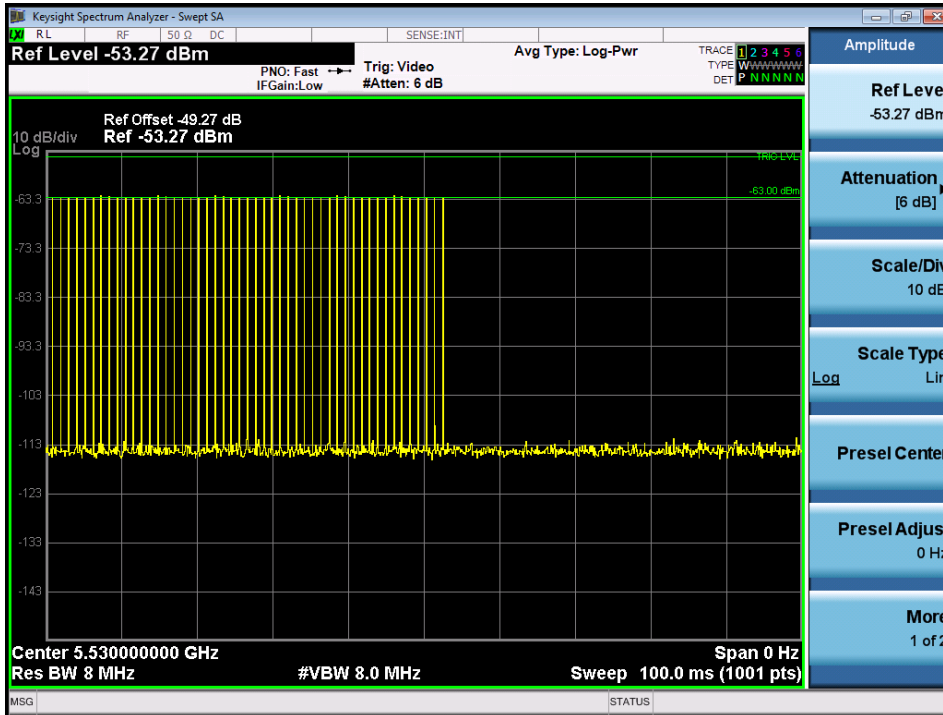

USA Bin 1B Radar Calibration BW80

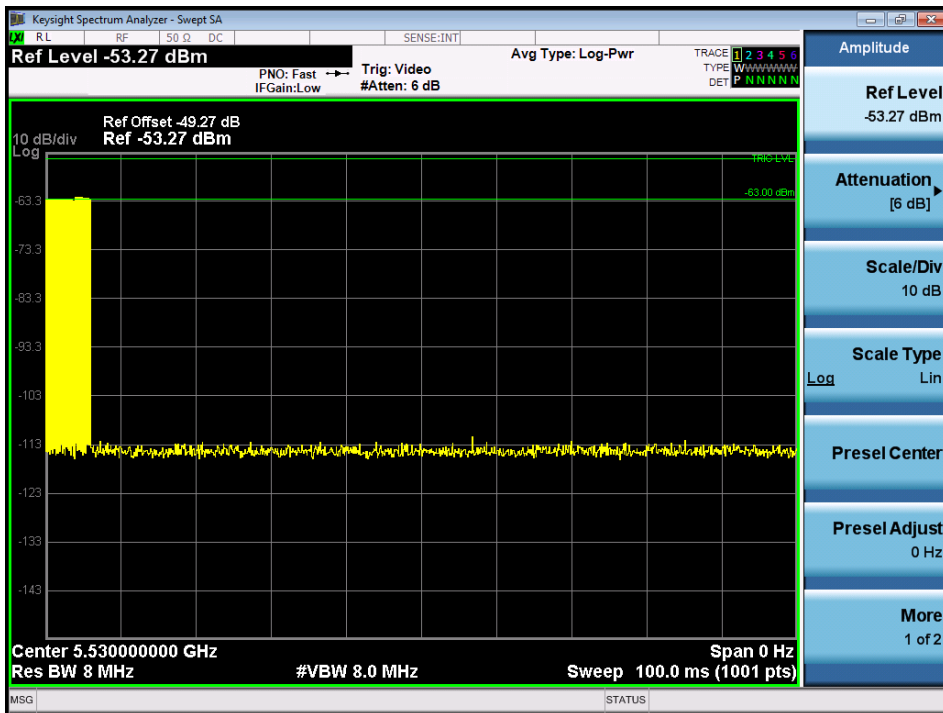

USA Bin 2 Radar Calibration BW80

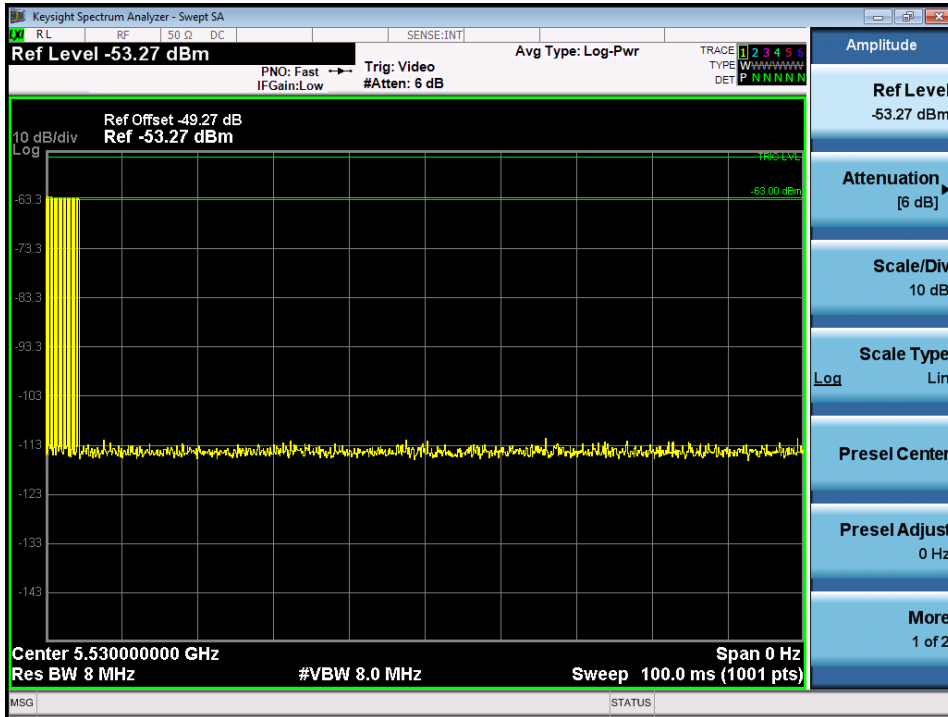

USA Bin 3 Radar Calibration BW80

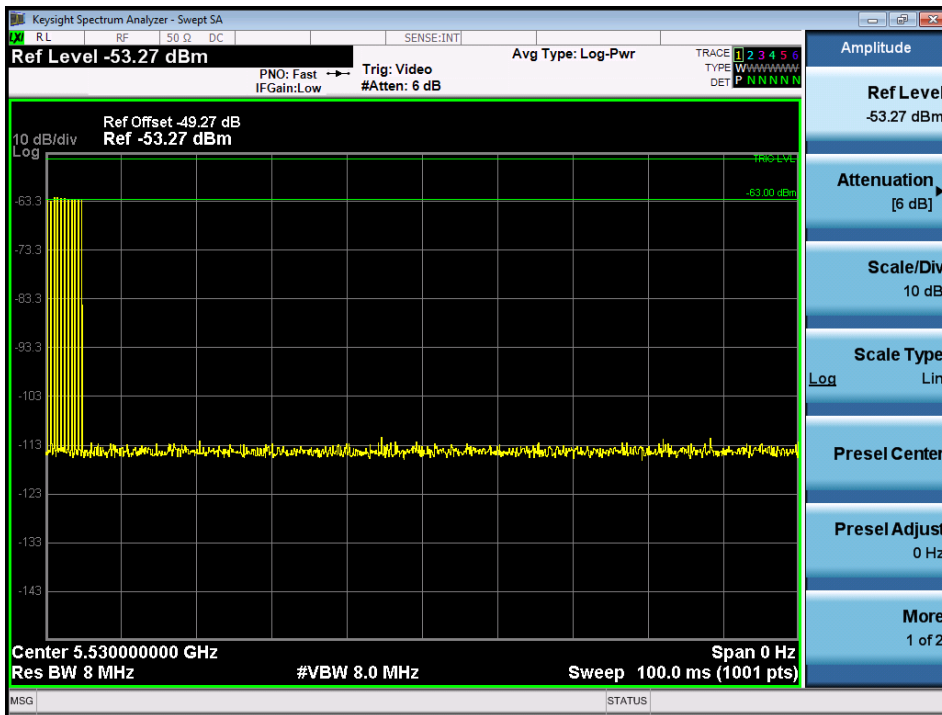

USA Bin 4 Radar Calibration BW80

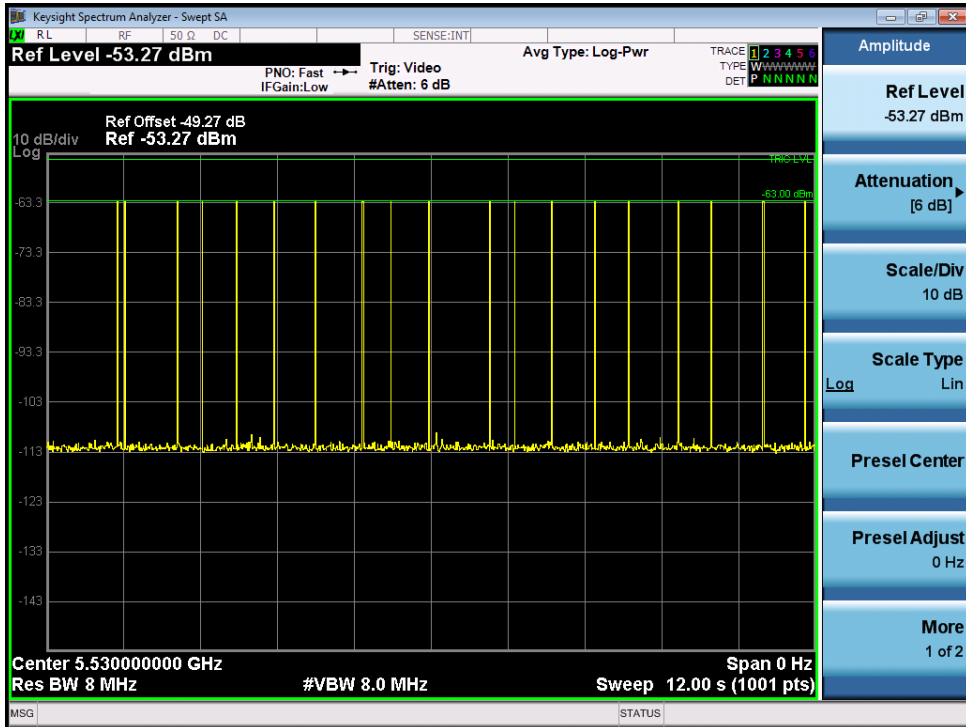

USA Bin 5 Radar Calibration BW80

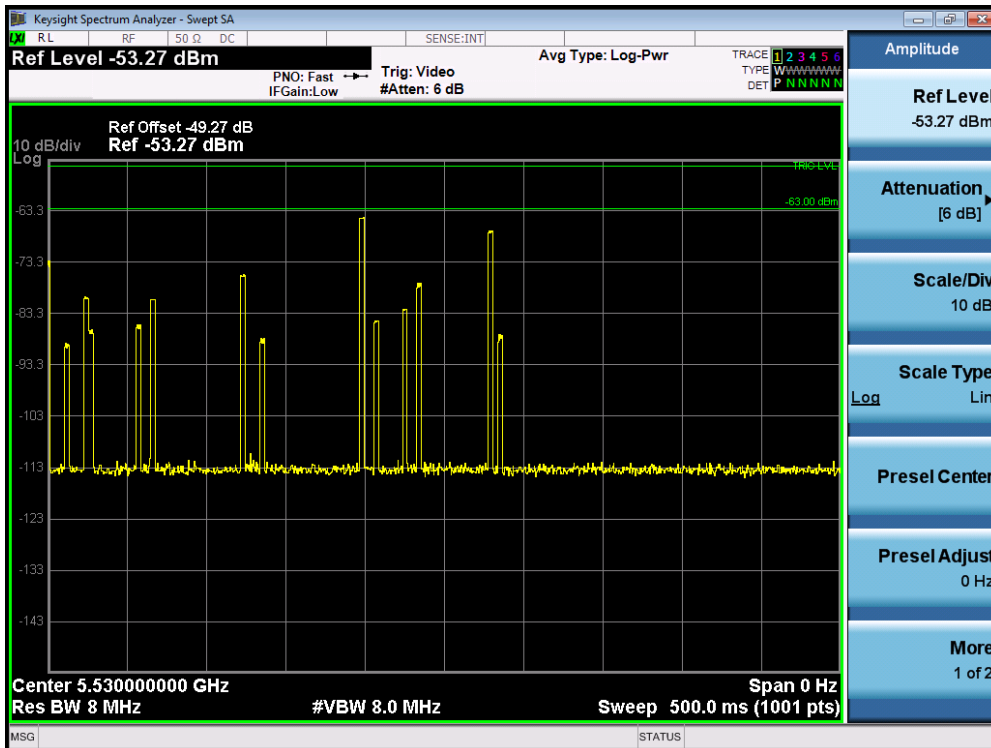

USA Frequency Hopping Radar Calibration BW80



Calibration Plots – Bandwidth 160

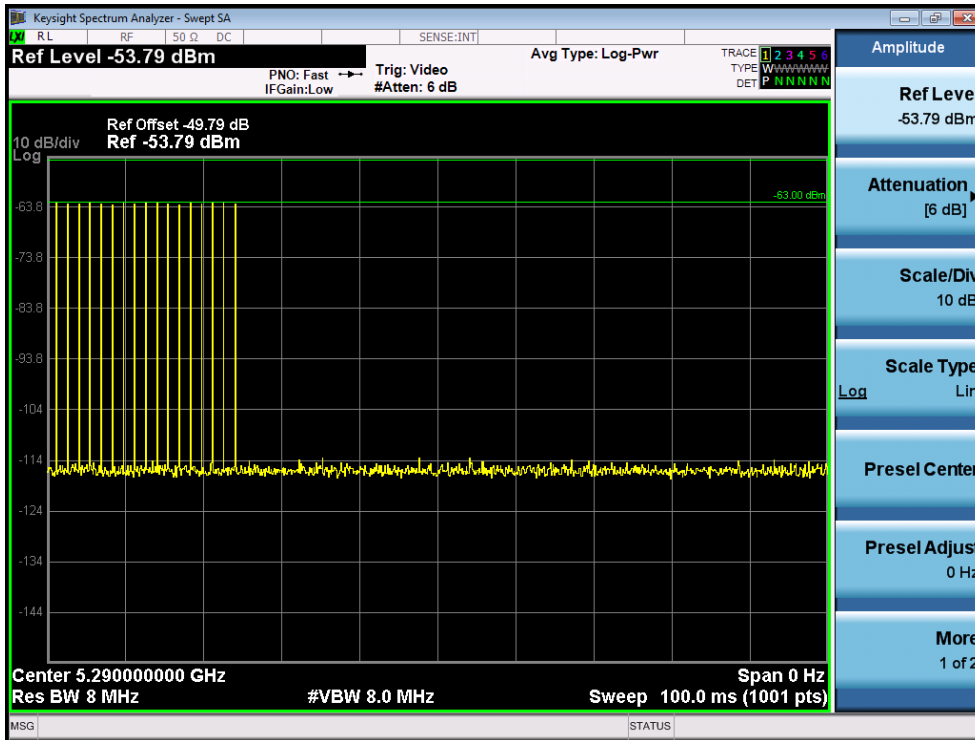

USA Bin 0 Radar Calibration BW160

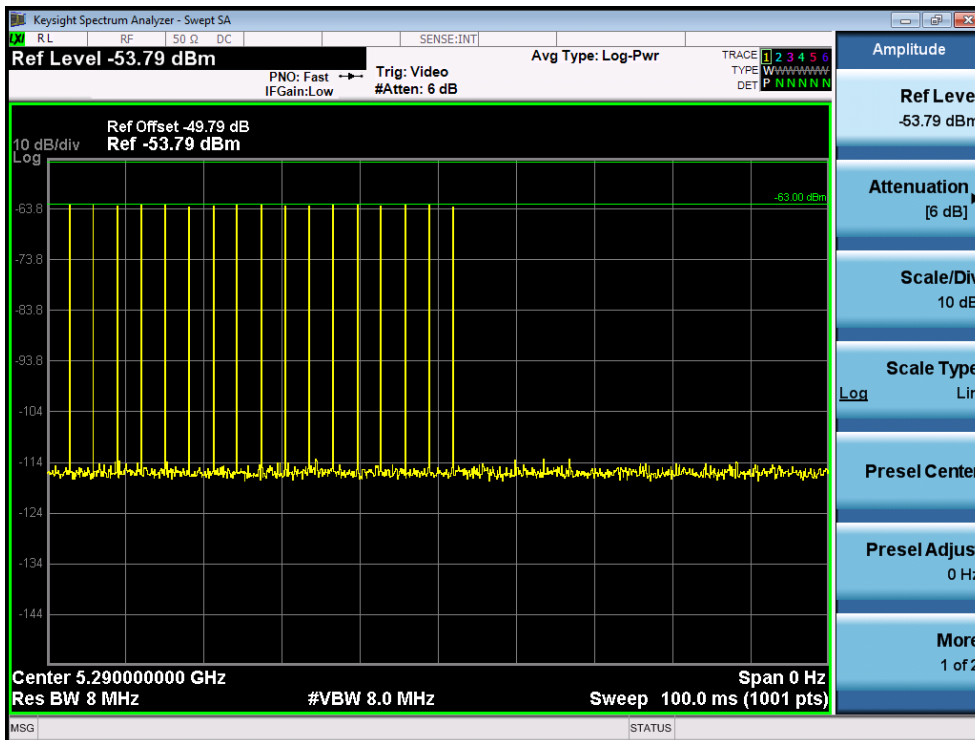

USA Bin 1A Radar Calibration BW160

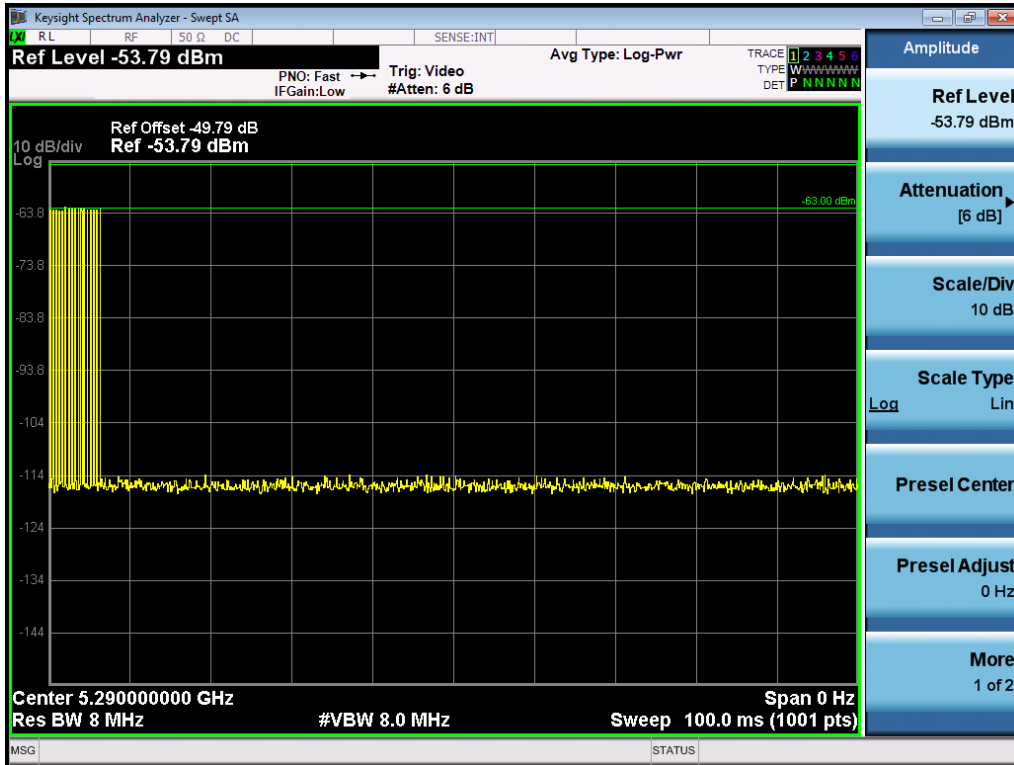

USA Bin 3 Radar Calibration BW160

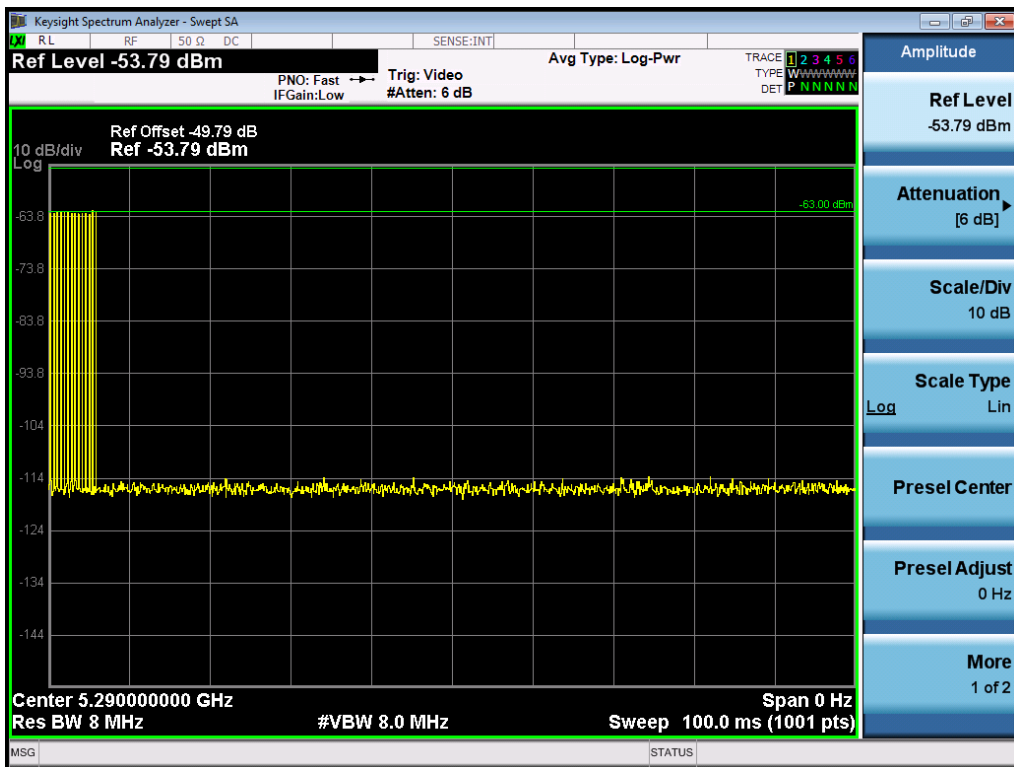

USA Bin 4 Radar Calibration BW160

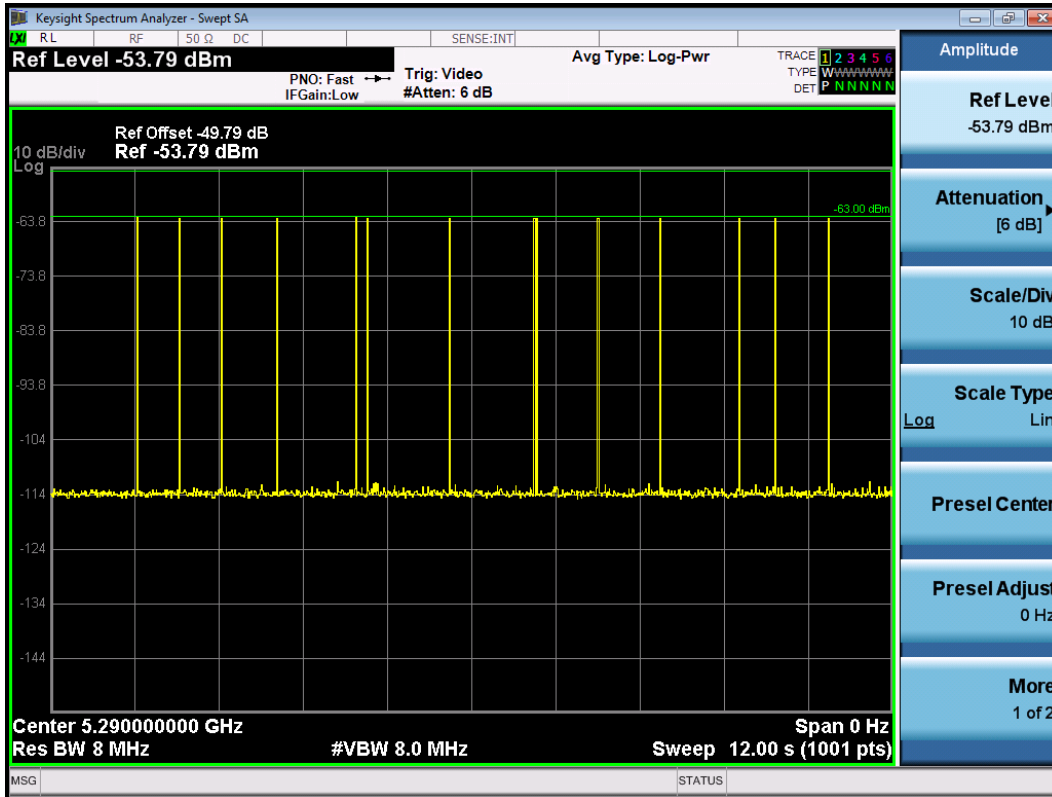

USA Bin 5 Radar Calibration BW160

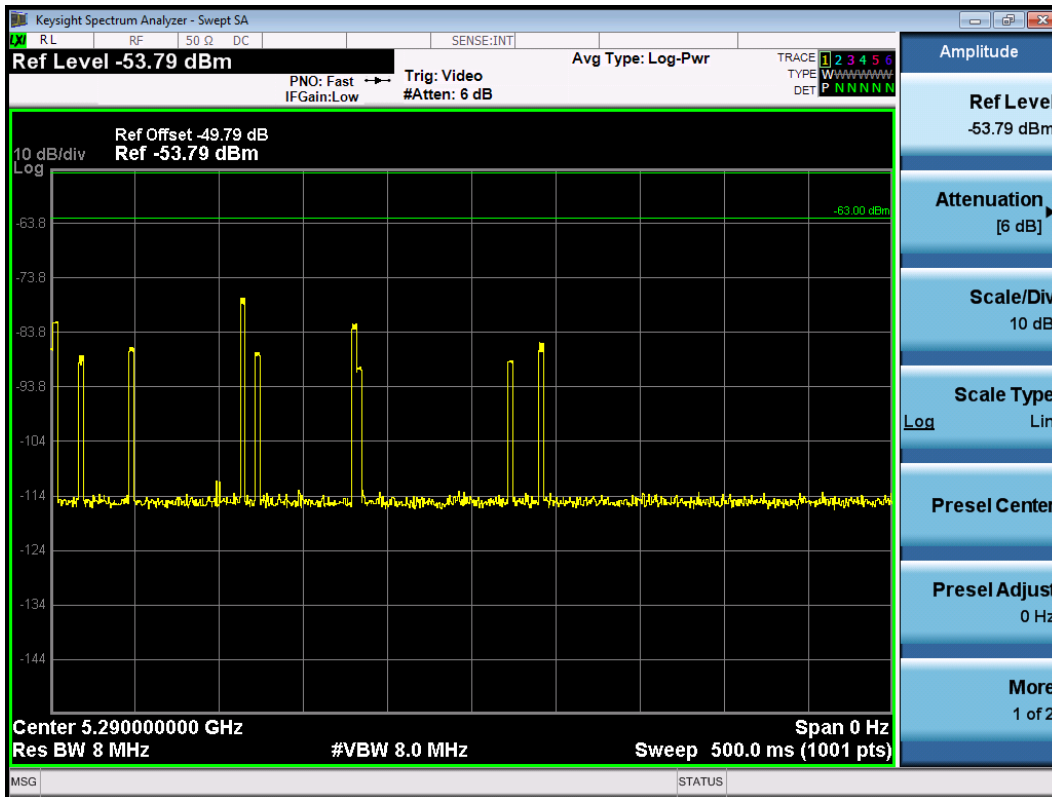

USA Frequency Hopping Radar Calibration BW160

B.1 Test Procedure/Results

A spectrum analyzer is used as a monitor to verify that the UUT has vacated the Channel within the (Channel Closing Transmission Time and Channel Move Time) and does not transmit on a Channel during the Non-Occupancy Period after the detection and Channel move. It is also used to monitor UUT transmissions during the Channel Availability Check Time.

Following is the test setup used to generate the Radar Waveforms, and for all DFS tests described herein.

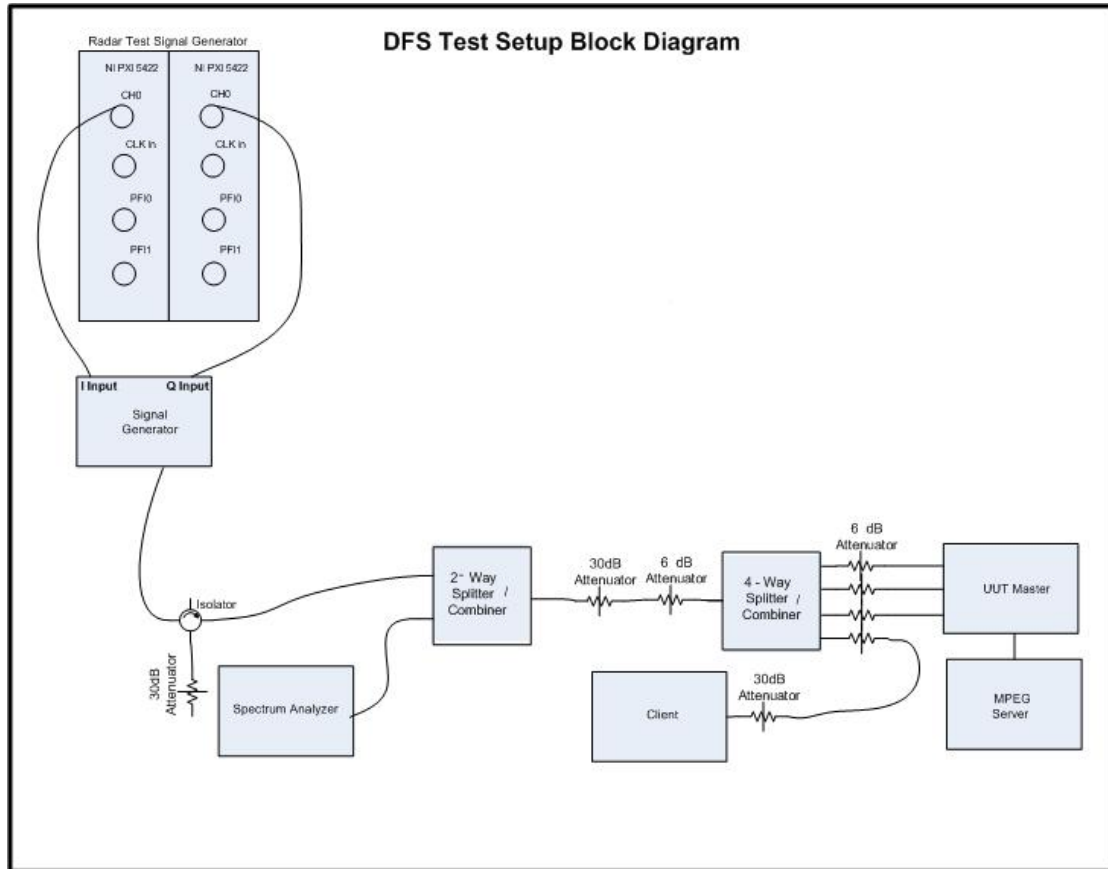

Conducted Setup: Radar Test Waveforms are injected into the Master

B.2 UNII Detection Bandwidth

Test Procedure

Ref. KDB 905462 D02 UNII section 7.8.1

All DFS testing was done at 5500 MHz, except for 160MHz with center frequency of 5250 MHz. The 99% channel bandwidth for 20MHz signals is 16 MHz, the the 99% channel bandwidth for 40MHz signals is 36 MHz, the 99% channel bandwidth for 80MHz signals is 76, and the 99% channel bandwidth for 160MHz signals is 76MHz per 80MHz section. See the 99% OBW section included below.

The generating equipment is configured as shown in the Conducted Test Setup above. A single *Burst* of the desired radar profile is produced at 5500MHz at a -63dBm level. The UUT is set up as a standalone device (no associated Client and no traffic).

A single radar Burst is generated for a minimum of 10 trials, and the response of the UUT is noted. The UUT must detect the Radar Waveform 90% or more of the time.

The radar frequency is increased in 1 MHz steps, repeating the above test sequence, until the detection rate falls below 90%. The highest frequency at which detection is greater than or equal to 90% is denoted as F_H .

The radar frequency is decreased in 1 MHz steps, repeating the above test sequence, until the detection rate falls below 90%. The lowest frequency at which detection is greater than or equal to 90% is denoted as F_L .

The U-NII Detection Bandwidth is calculated as follows:

$$\text{U-NII Detection Bandwidth} = F_H - F_L$$

The U-NII Detection Bandwidth must be at least 100% of the UUT transmitter 99% power bandwidth (16 MHz for 20MHz signals, 36 MHz for 40 MHz signals, 76 MHz for 80 MHz and 160MHz signals otherwise, the UUT does not comply with DFS requirements).

**99% Occupied Bandwidth**

Frequency (MHz)	Mode	Data Rate (Mbps)	99% BW (MHz)
5250	HE160, m0h1	m0h1	75.5*
5500	Non HT20, 6Mbps	6	16.4
5510	HT/VHT40, M0	m0	36.2
5530	VHT80, M0x1	m0x1	75.5

*160MHz channel is split between different antenna paths. The lower 80MHz portion of the channel is transmitted on the ABCD antenna ports while the upper 80MHz portion is transmitted on the EFGH ports. Each 80MHz section was tested individually. 99% BW therefore shows a value of 75.5%.



20MHz UNII Detection Bandwidth

USA Bin 0

power=-60dB

Radar Frequency	DFS Detection Trials (1=Detection, Blank= No Detection)											Detection Rate (%)	Detection Bandwidth (MHz)	Limit (MHz)
	1	2	3	4	5	6	7	8	9	10				
5490	1	1	1	1	1	1	1	1	1	1	1	100	20	18
5491	1	1	1	1	1	1	1	1	1	1	1	100		
5492	1	1	1	1	1	1	1	1	1	1	1	100		
5493	1	1	1	1	1	1	1	1	1	1	1	100		
5494	1	1	1	1	1	1	1	1	1	1	1	100		
5495	1	1	1	1	1	1	1	1	1	1	1	100		
5496	1	1	1	1	1	1	1	1	1	1	1	100		
5497	1	1	1	1	1	1	1	1	1	1	1	100		
5498	1	1	1	1	1	1	1	1	1	1	1	100		
5499	1	1	1	1	1	1	1	1	1	1	1	100		
5500	1	1	1	1	1	1	1	1	1	1	1	100		
5501	1	1	1	1	1	1	1	1	1	1	1	100		
5502	1	1	1	1	1	1	1	1	1	1	1	100		
5503	1	1	1	1	1	1	1	1	1	1	1	100		
5504	1	1	1	1	1	1	1	1	1	1	1	100		
5505	1	1	1	1	1	1	1	1	1	1	1	100		
5506	1	1	1	1	1	1	1	1	1	1	1	100		
5507	1	1	1	1	1	1	1	1	1	1	1	100		
5508	1	1	1	1	1	1	1	1	1	1	1	100		
5509	1	1	1	1	1	1	1	1	1	1	1	100		
5510	1	1	1	1	1	1	1	1	1	1	1	100		



40MHz UNII Detection Bandwidth

USA Bin 0

power=-60dB

Radar Frequency	DFS Detection Trials (1=Detection, Blank= No Detection)										Detection Rate (%)	Detection Bandwidth (MHz)	Limit (MHz)
	1	2	3	4	5	6	7	8	9	10			
5490	1	1	1	1	1	1	1	1	1	1	100	40	36
5491	1	1	1	1	1	1	1	1	1	1	100		
5492	1	1	1	1	1	1	1	1	1	1	100		
5493	1	1	1	1	1	1	1	1	1	1	100		
5494	1	1	1	1	1	1	1	1	1	1	100		
5495	1	1	1	1	1	1	1	1	1	1	100		
5496	1	1	1	1	1	1	1	1	1	1	100		
5497	1	1	1	1	1	1	1	1	1	1	100		
5498	1	1	1	1	1	1	1	1	1	1	100		
5499	1	1	1	1	1	1	1	1	1	1	100		
5500	1	1	1	1	1	1	1	1	1	1	100		
5501	1	1	1	1	1	1	1	1	1	1	100		
5502	1	1	1	1	1	1	1	1	1	1	100		
5503	1	1	1	1	1	1	1	1	1	1	100		
5504	1	1	1	1	1	1	1	1	1	1	100		
5505	1	1	1	1	1	1	1	1	1	1	100		
5506	1	1	1	1	1	1	1	1	1	1	100		
5507	1	1	1	1	1	1	1	1	1	1	100		
5508	1	1	1	1	1	1	1	1	1	1	100		
5509	1	1	1	1	1	1	1	1	1	1	100		
5510	1	1	1	1	1	1	1	1	1	1	100		
5511	1	1	1	1	1	1	1	1	1	1	100		
5512	1	1	1	1	1	1	1	1	1	1	100		
5513	1	1	1	1	1	1	1	1	1	1	100		
5514	1	1	1	1	1	1	1	1	1	1	100		
5515	1	1	1	1	1	1	1	1	1	1	100		
5516	1	1	1	1	1	1	1	1	1	1	100		
5517	1	1	1	1	1	1	1	1	1	1	100		
5518	1	1	1	1	1	1	1	1	1	1	100		
5519	1	1	1	1	1	1	1	1	1	1	100		
5520	1	1	1	1	1	1	1	1	1	1	100		
5521	1	1	1	1	1	1	1	1	1	1	100		
5522	1	1	1	1	1	1	1	1	1	1	100		
5523	1	1	1	1	1	1	1	1	1	1	100		
5524	1	1	1	1	1	1	1	1	1	1	100		
5525	1	1	1	1	1	1	1	1	1	1	100		



5526	1	1	1	1	1	1	1	1	1	1	100		
5527	1	1	1	1	1	1	1	1	1	1	100		
5528	1	1	1	1	1	1	1	1	1	1	100		
5529	1	1	1	1	1	1	1	1	1	1	100		
5530	1	1	1	1	1	1	1	1	1	1	100		



80MHz UNII Detection Bandwidth

USA Bin 0												power=-60dB		
Radar Frequency	DFS Detection Trials (1=Detection, Blank= No Detection)											Detection Rate (%)	Detection Bandwidth (MHz)	Limit (MHz)
	1	2	3	4	5	6	7	8	9	10				
5490	1	1	1	1	1	1	1	1	1	1	1	100	80	76
5491	1	1	1	1	1	1	1	1	1	1	1	100		
5492	1	1	1	1	1	1	1	1	1	1	1	100		
5493	1	1	1	1	1	1	1	1	1	1	1	100		
5494	1	1	1	1	1	1	1	1	1	1	1	100		
5495	1	1	1	1	1	1	1	1	1	1	1	100		
5496	1	1	1	1	1	1	1	1	1	1	1	100		
5497	1	1	1	1	1	1	1	1	1	1	1	100		
5498	1	1	1	1	1	1	1	1	1	1	1	100		
5499	1	1	1	1	1	1	1	1	1	1	1	100		
5500	1	1	1	1	1	1	1	1	1	1	1	100		
5501	1	1	1	1	1	1	1	1	1	1	1	100		
5502	1	1	1	1	1	1	1	1	1	1	1	100		
5503	1	1	1	1	1	1	1	1	1	1	1	100		
5504	1	1	1	1	1	1	1	1	1	1	1	100		
5505	1	1	1	1	1	1	1	1	1	1	1	100		
5506	1	1	1	1	1	1	1	1	1	1	1	100		
5507	1	1	1	1	1	1	1	1	1	1	1	100		
5508	1	1	1	1	1	1	1	1	1	1	1	100		
5509	1	1	1	1	1	1	1	1	1	1	1	100		
5510	1	1	1	1	1	1	1	1	1	1	1	100		
5511	1	1	1	1	1	1	1	1	1	1	1	100		
5512	1	1	1	1	1	1	1	1	1	1	1	100		
5513	1	1	1	1	1	1	1	1	1	1	1	100		
5514	1	1	1	1	1	1	1	1	1	1	1	100		
5515	1	1	1	1	1	1	1	1	1	1	1	100		
5516	1	1	1	1	1	1	1	1	1	1	1	100		
5517	1	1	1	1	1	1	1	1	1	1	1	100		
5518	1	1	1	1	1	1	1	1	1	1	1	100		
5519	1	1	1	1	1	1	1	1	1	1	1	100		
5520	1	1	1	1	1	1	1	1	1	1	1	100		
5521	1	1	1	1	1	1	1	1	1	1	1	100		
5522	1	1	1	1	1	1	1	1	1	1	1	100		
5523	1	1	1	1	1	1	1	1	1	1	1	100		
5524	1	1	1	1	1	1	1	1	1	1	1	100		
5525	1	1	1	1	1	1	1	1	1	1	1	100		



5526	1	1	1	1	1	1	1	1	1	1	100
5527	1	1	1	1	1	1	1	1	1	1	100
5528	1	1	1	1	1	1	1	1	1	1	100
5529	1	1	1	1	1	1	1	1	1	1	100
5530	1	1	1	1	1	1	1	1	1	1	100
5531	1	1	1	1	1	1	1	1	1	1	100
5532	1	1	1	1	1	1	1	1	1	1	100
5533	1	1	1	1	1	1	1	1	1	1	100
5534	1	1	1	1	1	1	1	1	1	1	100
5535	1	1	1	1	1	1	1	1	1	1	100
5536	1	1	1	1	1	1	1	1	1	1	100
5537	1	1	1	1	1	1	1	1	1	1	100
5538	1	1	1	1	1	1	1	1	1	1	100
5539	1	1	1	1	1	1	1	1	1	1	100
5540	1	1	1	1	1	1	1	1	1	1	100
5541	1	1	1	1	1	1	1	1	1	1	100
5542	1	1	1	1	1	1	1	1	1	1	100
5543	1	1	1	1	1	1	1	1	1	1	100
5544	1	1	1	1	1	1	1	1	1	1	100
5545	1	1	1	1	1	1	1	1	1	1	100
5546	1	1	1	1	1	1	1	1	1	1	100
5547	1	1	1	1	1	1	1	1	1	1	100
5548	1	1	1	1	1	1	1	1	1	1	100
5549	1	1	1	1	1	1	1	1	1	1	100
5550	1	1	1	1	1	1	1	1	1	1	100
5551	1	1	1	1	1	1	1	1	1	1	100
5552	1	1	1	1	1	1	1	1	1	1	100
5553	1	1	1	1	1	1	1	1	1	1	100
5554	1	1	1	1	1	1	1	1	1	1	100
5555	1	1	1	1	1	1	1	1	1	1	100
5556	1	1	1	1	1	1	1	1	1	1	100
5557	1	1	1	1	1	1	1	1	1	1	100
5558	1	1	1	1	1	1	1	1	1	1	100
5559	1	1	1	1	1	1	1	1	1	1	100
5560	1	1	1	1	1	1	1	1	1	1	100
5561	1	1	1	1	1	1	1	1	1	1	100
5562	1	1	1	1	1	1	1	1	1	1	100
5563	1	1	1	1	1	1	1	1	1	1	100
5564	1	1	1	1	1	1	1	1	1	1	100
5565	1	1	1	1	1	1	1	1	1	1	100
5566	1	1	1	1	1	1	1	1	1	1	100
5567	1	1	1	1	1	1	1	1	1	1	100
5568	1	1	1	1	1	1	1	1	1	1	100



5569	1	1	1	1	1	1	1	1	1	1	100		
5570	1	1	1	1	1	1	1	1	1	1	100		



160MHz UNII Detection Bandwidth (upper portion of 80+80)

USA Bin 0

power=-60dB

Radar Frequency	DFS Detection Trials (1=Detection, Blank= No Detection)											Detection Bandwidth (MHz)	Limit (MHz)	
	1	2	3	4	5	6	7	8	9	10	Detection Rate (%)			
5250	1	1	1	1	1	1	1	1	1	1	1	100	80	76
5251	1	1	1	1	1	1	1	1	1	1	1	100		
5252	1	1	1	1	1	1	1	1	1	1	1	100		
5253	1	1	1	1	1	1	1	1	1	1	1	100		
5254	1	1	1	1	1	1	1	1	1	1	1	100		
5255	1	1	1	1	1	1	1	1	1	1	1	100		
5256	1	1	1	1	1	1	1	1	1	1	1	100		
5257	1	1	1	1	1	1	1	1	1	1	1	100		
5258	1	1	1	1	1	1	1	1	1	1	1	100		
5259	1	1	1	1	1	1	1	1	1	1	1	100		
5260	1	1	1	1	1	1	1	1	1	1	1	100		
5261	1	1	1	1	1	1	1	1	1	1	1	100		
5262	1	1	1	1	1	1	1	1	1	1	1	100		
5263	1	1	1	1	1	1	1	1	1	1	1	100		
5264	1	1	1	1	1	1	1	1	1	1	1	100		
5265	1	1	1	1	1	1	1	1	1	1	1	100		
5266	1	1	1	1	1	1	1	1	1	1	1	100		
5267	1	1	1	1	1	1	1	1	1	1	1	100		
5268	1	1	1	1	1	1	1	1	1	1	1	100		
5269	1	1	1	1	1	1	1	1	1	1	1	100		
5270	1	1	1	1	1	1	1	1	1	1	1	100		
5271	1	1	1	1	1	1	1	1	1	1	1	100		
5272	1	1	1	1	1	1	1	1	1	1	1	100		
5273	1	1	1	1	1	1	1	1	1	1	1	100		
5274	1	1	1	1	1	1	1	1	1	1	1	100		
5275	1	1	1	1	1	1	1	1	1	1	1	100		
5276	1	1	1	1	1	1	1	1	1	1	1	100		
5277	1	1	1	1	1	1	1	1	1	1	1	100		
5278	1	1	1	1	1	1	1	1	1	1	1	100		
5279	1	1	1	1	1	1	1	1	1	1	1	100		
5280	1	1	1	1	1	1	1	1	1	1	1	100		
5281	1	1	1	1	1	1	1	1	1	1	1	100		
5282	1	1	1	1	1	1	1	1	1	1	1	100		
5283	1	1	1	1	1	1	1	1	1	1	1	100		
5284	1	1	1	1	1	1	1	1	1	1	1	100		
5285	1	1	1	1	1	1	1	1	1	1	1	100		



5286	1	1	1	1	1	1	1	1	1	1	100
5287	1	1	1	1	1	1	1	1	1	1	100
5288	1	1	1	1	1	1	1	1	1	1	100
5289	1	1	1	1	1	1	1	1	1	1	100
5290	1	1	1	1	1	1	1	1	1	1	100
5291	1	1	1	1	1	1	1	1	1	1	100
5292	1	1	1	1	1	1	1	1	1	1	100
5293	1	1	1	1	1	1	1	1	1	1	100
5294	1	1	1	1	1	1	1	1	1	1	100
5295	1	1	1	1	1	1	1	1	1	1	100
5296	1	1	1	1	1	1	1	1	1	1	100
5297	1	1	1	1	1	1	1	1	1	1	100
5298	1	1	1	1	1	1	1	1	1	1	100
5299	1	1	1	1	1	1	1	1	1	1	100
5300	1	1	1	1	1	1	1	1	1	1	100
5301	1	1	1	1	1	1	1	1	1	1	100
5302	1	1	1	1	1	1	1	1	1	1	100
5303	1	1	1	1	1	1	1	1	1	1	100
5304	1	1	1	1	1	1	1	1	1	1	100
5305	1	1	1	1	1	1	1	1	1	1	100
5306	1	1	1	1	1	1	1	1	1	1	100
5307	1	1	1	1	1	1	1	1	1	1	100
5308	1	1	1	1	1	1	1	1	1	1	100
5309	1	1	1	1	1	1	1	1	1	1	100
5310	1	1	1	1	1	1	1	1	1	1	100
5311	1	1	1	1	1	1	1	1	1	1	100
5312	1	1	1	1	1	1	1	1	1	1	100
5313	1	1	1	1	1	1	1	1	1	1	100
5314	1	1	1	1	1	1	1	1	1	1	100
5315	1	1	1	1	1	1	1	1	1	1	100
5316	1	1	1	1	1	1	1	1	1	1	100
5317	1	1	1	1	1	1	1	1	1	1	100
5318	1	1	1	1	1	1	1	1	1	1	100
5319	1	1	1	1	1	1	1	1	1	1	100
5320	1	1	1	1	1	1	1	1	1	1	100
5321	1	1	1	1	1	1	1	1	1	1	100
5322	1	1	1	1	1	1	1	1	1	1	100
5323	1	1	1	1	1	1	1	1	1	1	100
5324	1	1	1	1	1	1	1	1	1	1	100
5325	1	1	1	1	1	1	1	1	1	1	100
5326	1	1	1	1	1	1	1	1	1	1	100
5327	1	1	1	1	1	1	1	1	1	1	100
5328	1	1	1	1	1	1	1	1	1	1	100



5329	1	1	1	1	1	1	1	1	1	1	100		
5330	1	1	1	1	1	1	1	1	1	1	100		



160MHz UNII Detection Bandwidth (lower portion of 80+80)

USA Bin 0

power=-60dB

Radar Frequency	DFS Detection Trials (1=Detection, Blank= No Detection)											Detection Rate (%)	Detection Bandwidth (MHz)	Limit (MHz)
	1	2	3	4	5	6	7	8	9	10				
5490	1	1	1	1	1	1	1	1	1	1	1	100	80	76
5491	1	1	1	1	1	1	1	1	1	1	1	100		
5492	1	1	1	1	1	1	1	1	1	1	1	100		
5493	1	1	1	1	1	1	1	1	1	1	1	100		
5494	1	1	1	1	1	1	1	1	1	1	1	100		
5495	1	1	1	1	1	1	1	1	1	1	1	100		
5496	1	1	1	1	1	1	1	1	1	1	1	100		
5497	1	1	1	1	1	1	1	1	1	1	1	100		
5498	1	1	1	1	1	1	1	1	1	1	1	100		
5499	1	1	1	1	1	1	1	1	1	1	1	100		
5500	1	1	1	1	1	1	1	1	1	1	1	100		
5501	1	1	1	1	1	1	1	1	1	1	1	100		
5502	1	1	1	1	1	1	1	1	1	1	1	100		
5503	1	1	1	1	1	1	1	1	1	1	1	100		
5504	1	1	1	1	1	1	1	1	1	1	1	100		
5505	1	1	1	1	1	1	1	1	1	1	1	100		
5506	1	1	1	1	1	1	1	1	1	1	1	100		
5507	1	1	1	1	1	1	1	1	1	1	1	100		
5508	1	1	1	1	1	1	1	1	1	1	1	100		
5509	1	1	1	1	1	1	1	1	1	1	1	100		
5510	1	1	1	1	1	1	1	1	1	1	1	100		
5511	1	1	1	1	1	1	1	1	1	1	1	100		
5512	1	1	1	1	1	1	1	1	1	1	1	100		
5513	1	1	1	1	1	1	1	1	1	1	1	100		
5514	1	1	1	1	1	1	1	1	1	1	1	100		
5515	1	1	1	1	1	1	1	1	1	1	1	100		
5516	1	1	1	1	1	1	1	1	1	1	1	100		
5517	1	1	1	1	1	1	1	1	1	1	1	100		
5518	1	1	1	1	1	1	1	1	1	1	1	100		
5519	1	1	1	1	1	1	1	1	1	1	1	100		
5520	1	1	1	1	1	1	1	1	1	1	1	100		
5521	1	1	1	1	1	1	1	1	1	1	1	100		
5522	1	1	1	1	1	1	1	1	1	1	1	100		
5523	1	1	1	1	1	1	1	1	1	1	1	100		
5524	1	1	1	1	1	1	1	1	1	1	1	100		
5525	1	1	1	1	1	1	1	1	1	1	1	100		



5526	1	1	1	1	1	1	1	1	1	1	100
5527	1	1	1	1	1	1	1	1	1	1	100
5528	1	1	1	1	1	1	1	1	1	1	100
5529	1	1	1	1	1	1	1	1	1	1	100
5530	1	1	1	1	1	1	1	1	1	1	100
5531	1	1	1	1	1	1	1	1	1	1	100
5532	1	1	1	1	1	1	1	1	1	1	100
5533	1	1	1	1	1	1	1	1	1	1	100
5534	1	1	1	1	1	1	1	1	1	1	100
5535	1	1	1	1	1	1	1	1	1	1	100
5536	1	1	1	1	1	1	1	1	1	1	100
5537	1	1	1	1	1	1	1	1	1	1	100
5538	1	1	1	1	1	1	1	1	1	1	100
5539	1	1	1	1	1	1	1	1	1	1	100
5540	1	1	1	1	1	1	1	1	1	1	100
5541	1	1	1	1	1	1	1	1	1	1	100
5542	1	1	1	1	1	1	1	1	1	1	100
5543	1	1	1	1	1	1	1	1	1	1	100
5544	1	1	1	1	1	1	1	1	1	1	100
5545	1	1	1	1	1	1	1	1	1	1	100
5546	1	1	1	1	1	1	1	1	1	1	100
5547	1	1	1	1	1	1	1	1	1	1	100
5548	1	1	1	1	1	1	1	1	1	1	100
5549	1	1	1	1	1	1	1	1	1	1	100
5550	1	1	1	1	1	1	1	1	1	1	100
5551	1	1	1	1	1	1	1	1	1	1	100
5552	1	1	1	1	1	1	1	1	1	1	100
5553	1	1	1	1	1	1	1	1	1	1	100
5554	1	1	1	1	1	1	1	1	1	1	100
5555	1	1	1	1	1	1	1	1	1	1	100
5556	1	1	1	1	1	1	1	1	1	1	100
5557	1	1	1	1	1	1	1	1	1	1	100
5558	1	1	1	1	1	1	1	1	1	1	100
5559	1	1	1	1	1	1	1	1	1	1	100
5560	1	1	1	1	1	1	1	1	1	1	100
5561	1	1	1	1	1	1	1	1	1	1	100
5562	1	1	1	1	1	1	1	1	1	1	100
5563	1	1	1	1	1	1	1	1	1	1	100
5564	1	1	1	1	1	1	1	1	1	1	100
5565	1	1	1	1	1	1	1	1	1	1	100
5566	1	1	1	1	1	1	1	1	1	1	100
5567	1	1	1	1	1	1	1	1	1	1	100
5568	1	1	1	1	1	1	1	1	1	1	100



5569	1	1	1	1	1	1	1	1	1	1	100		
5570	1	1	1	1	1	1	1	1	1	1	100		



160MHz UNII Detection Bandwidth (upper portion of 80+80)

USA Bin 0												power=-60dB		
Radar Frequency	DFS Detection Trials (1=Detection, Blank= No Detection)											Detection Bandwidth (MHz)	Limit (MHz)	
	1	2	3	4	5	6	7	8	9	10	Detection Rate (%)			
5570	1	1	1	1	1	1	1	1	1	1	1	100	80	76
5571	1	1	1	1	1	1	1	1	1	1	1	100		
5572	1	1	1	1	1	1	1	1	1	1	1	100		
5573	1	1	1	1	1	1	1	1	1	1	1	100		
5574	1	1	1	1	1	1	1	1	1	1	1	100		
5575	1	1	1	1	1	1	1	1	1	1	1	100		
5576	1	1	1	1	1	1	1	1	1	1	1	100		
5577	1	1	1	1	1	1	1	1	1	1	1	100		
5578	1	1	1	1	1	1	1	1	1	1	1	100		
5579	1	1	1	1	1	1	1	1	1	1	1	100		
5580	1	1	1	1	1	1	1	1	1	1	1	100		
5581	1	1	1	1	1	1	1	1	1	1	1	100		
5582	1	1	1	1	1	1	1	1	1	1	1	100		
5583	1	1	1	1	1	1	1	1	1	1	1	100		
5584	1	1	1	1	1	1	1	1	1	1	1	100		
5585	1	1	1	1	1	1	1	1	1	1	1	100		
5586	1	1	1	1	1	1	1	1	1	1	1	100		
5587	1	1	1	1	1	1	1	1	1	1	1	100		
5588	1	1	1	1	1	1	1	1	1	1	1	100		
5589	1	1	1	1	1	1	1	1	1	1	1	100		
5590	1	1	1	1	1	1	1	1	1	1	1	100		
5591	1	1	1	1	1	1	1	1	1	1	1	100		
5592	1	1	1	1	1	1	1	1	1	1	1	100		
5593	1	1	1	1	1	1	1	1	1	1	1	100		
5594	1	1	1	1	1	1	1	1	1	1	1	100		
5595	1	1	1	1	1	1	1	1	1	1	1	100		
5596	1	1	1	1	1	1	1	1	1	1	1	100		
5597	1	1	1	1	1	1	1	1	1	1	1	100		
5598	1	1	1	1	1	1	1	1	1	1	1	100		
5599	1	1	1	1	1	1	1	1	1	1	1	100		
5600	1	1	1	1	1	1	1	1	1	1	1	100		
5601	1	1	1	1	1	1	1	1	1	1	1	100		
5602	1	1	1	1	1	1	1	1	1	1	1	100		
5603	1	1	1	1	1	1	1	1	1	1	1	100		
5604	1	1	1	1	1	1	1	1	1	1	1	100		
5605	1	1	1	1	1	1	1	1	1	1	1	100		



5606	1	1	1	1	1	1	1	1	1	1	100
5607	1	1	1	1	1	1	1	1	1	1	100
5608	1	1	1	1	1	1	1	1	1	1	100
5609	1	1	1	1	1	1	1	1	1	1	100
5610	1	1	1	1	1	1	1	1	1	1	100
5611	1	1	1	1	1	1	1	1	1	1	100
5612	1	1	1	1	1	1	1	1	1	1	100
5613	1	1	1	1	1	1	1	1	1	1	100
5614	1	1	1	1	1	1	1	1	1	1	100
5615	1	1	1	1	1	1	1	1	1	1	100
5616	1	1	1	1	1	1	1	1	1	1	100
5617	1	1	1	1	1	1	1	1	1	1	100
5618	1	1	1	1	1	1	1	1	1	1	100
5619	1	1	1	1	1	1	1	1	1	1	100
5620	1	1	1	1	1	1	1	1	1	1	100
5621	1	1	1	1	1	1	1	1	1	1	100
5622	1	1	1	1	1	1	1	1	1	1	100
5623	1	1	1	1	1	1	1	1	1	1	100
5624	1	1	1	1	1	1	1	1	1	1	100
5625	1	1	1	1	1	1	1	1	1	1	100
5626	1	1	1	1	1	1	1	1	1	1	100
5627	1	1	1	1	1	1	1	1	1	1	100
5628	1	1	1	1	1	1	1	1	1	1	100
5629	1	1	1	1	1	1	1	1	1	1	100
5630	1	1	1	1	1	1	1	1	1	1	100
5631	1	1	1	1	1	1	1	1	1	1	100
5632	1	1	1	1	1	1	1	1	1	1	100
5633	1	1	1	1	1	1	1	1	1	1	100
5634	1	1	1	1	1	1	1	1	1	1	100
5635	1	1	1	1	1	1	1	1	1	1	100
5636	1	1	1	1	1	1	1	1	1	1	100
5637	1	1	1	1	1	1	1	1	1	1	100
5638	1	1	1	1	1	1	1	1	1	1	100
5639	1	1	1	1	1	1	1	1	1	1	100
5640	1	1	1	1	1	1	1	1	1	1	100
5641	1	1	1	1	1	1	1	1	1	1	100
5642	1	1	1	1	1	1	1	1	1	1	100
5643	1	1	1	1	1	1	1	1	1	1	100
5644	1	1	1	1	1	1	1	1	1	1	100
5645	1	1	1	1	1	1	1	1	1	1	100
5646	1	1	1	1	1	1	1	1	1	1	100
5647	1	1	1	1	1	1	1	1	1	1	100
5648	1	1	1	1	1	1	1	1	1	1	100



5649	1	1	1	1	1	1	1	1	1	1	100		
5650	1	1	1	1	1	1	1	1	1	1	100		



B.3 Initial Channel Availability Check Time

The tests that the UUT does not emit beacon, control, or data signals on the test Channel until the power-up sequence has been completed and the U-NII device checks for Radar Waveforms for one minute on the test Channel. This test does not use any Radar Waveforms.

The U-NII device is powered on and instructed to operate at 5500 MHz. At the same time the UUT is powered on, the spectrum analyzer is set to zero span mode with a 3 MHz resolution bandwidth at 5500MHz with a 2.5 minute sweep time. The analyzer's sweep will be started the same time power is applied to the U-NII device.

The UUT should not transmit any beacon or data transmissions until at least 1 minute after the completion of the power-on cycle.

The initial power up time of the UUT is indicated by marker 1 in the plot. Initial beacons/data transmissions are indicated by marker 2.

Initial Channel Availability Check Time

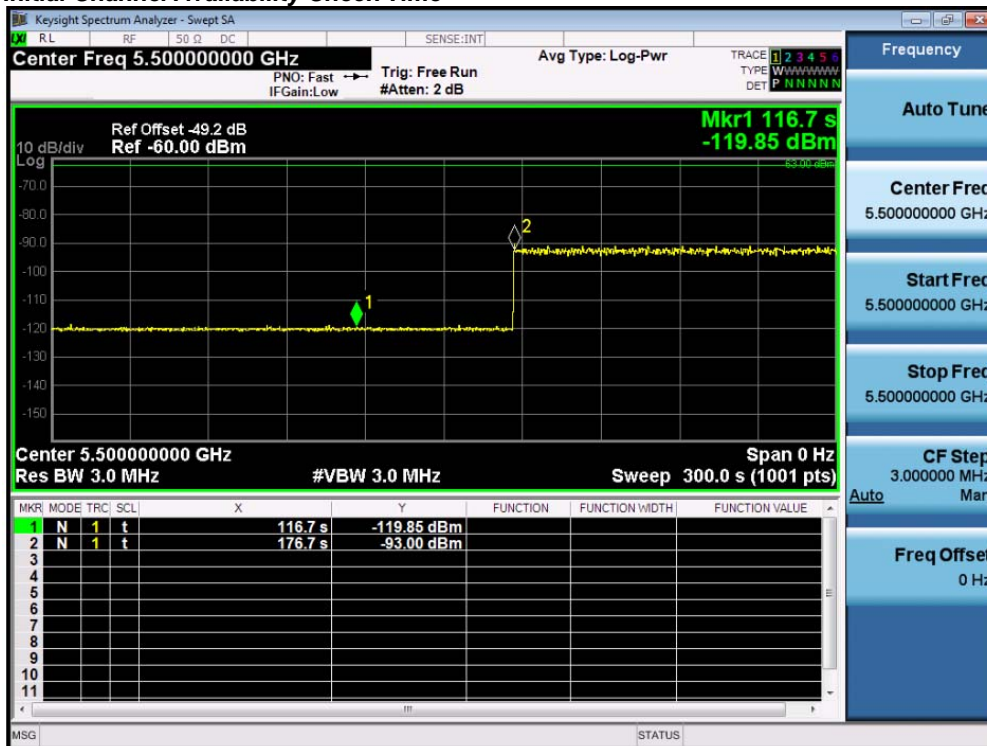

BW20



B.4 Radar Burst at the Beginning of the Channel Availability Check Time

The steps below define the procedure to verify successful radar detection on the selected Channel during a period equal to the Channel Availability Check Time and avoidance of operation on that Channel when a radar Burst with a level equal to the DFS Detection Threshold + 1 dB (-63dBm) occurs at the beginning of the Channel Availability Check Time.

The UUT is powered on at T_0 . T_1 denotes the instant when the UUT has completed its power-up sequence. The Channel Availability Check Time commences at instant T_1 and will end no sooner than $T_1 + 60$ seconds.

A single Burst of short pulse of radar type 0 at -63 dBm will commence within a 6 second window starting at T_1 .

Visual indication on the UUT of successful detection of the radar Burst will be recorded and reported. Observation of emissions at 5500MHz will continue for 2.5 minutes after the radar Burst has been generated.

Verify that during the 2.5 minute measurement window no UUT transmissions occurred at 5500MHz.

Radar Burst at the Beginning of the Channel Availability Check Time

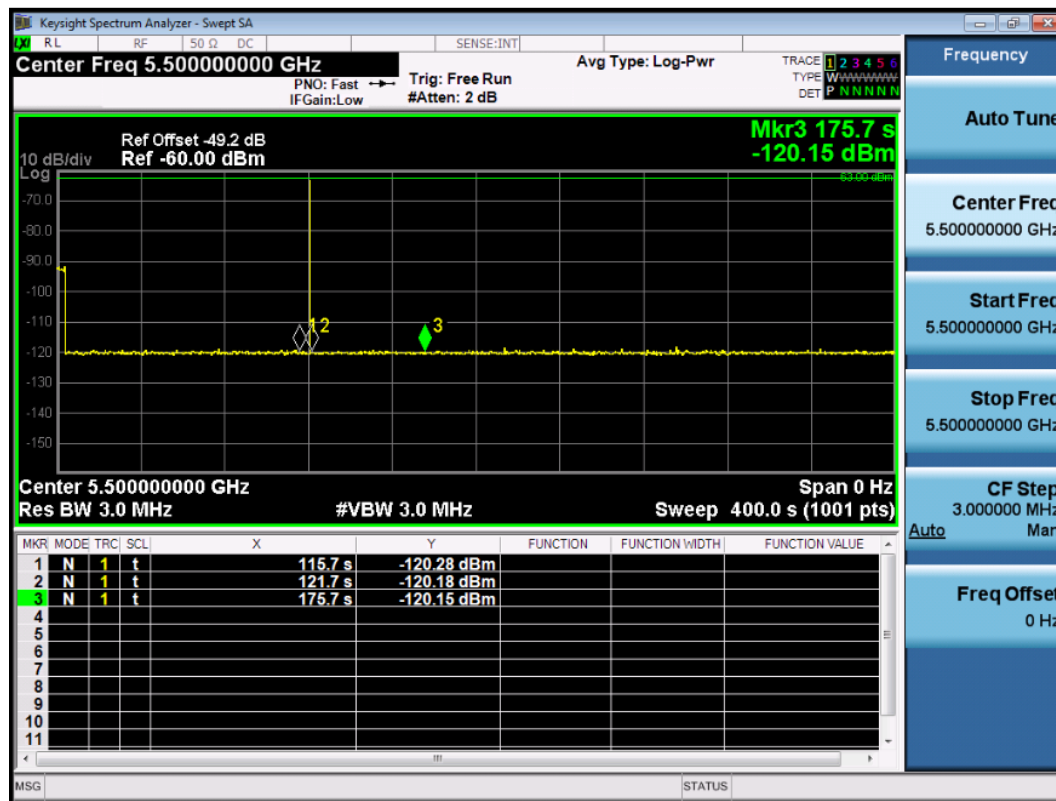

BW20



B.5 Radar Burst at the End of the Channel Availability Check Time

The steps below define the procedure to verify successful radar detection on the selected Channel during a period equal to the Channel Availability Check Time and avoidance of operation on that Channel when a radar Burst with a level equal to the DFS Detection Threshold + 1 dB (-63dBm) occurs at the end of the Channel Availability Check Time.

The UUT is powered on at T_0 . T_1 denotes the instant when the UUT has completed its power-up sequence. The Channel Availability Check Time commences at instant T_1 and will end no sooner than $T_1 + 60$ seconds.

A single Burst of short pulse of radar type 0 at -63 dBm will commence within a 6 second window starting at $T_1 + 54$ seconds.

Visual indication on the UUT of successful detection of the radar Burst will be recorded and reported. Observation of emissions at 5500MHz will continue for 2.5 minutes after the radar Burst has been generated.

Verify that during the 2.5 minute measurement window no UUT transmissions occurred at 5500MHz.

Radar Burst at the End of the Channel Availability Check Time

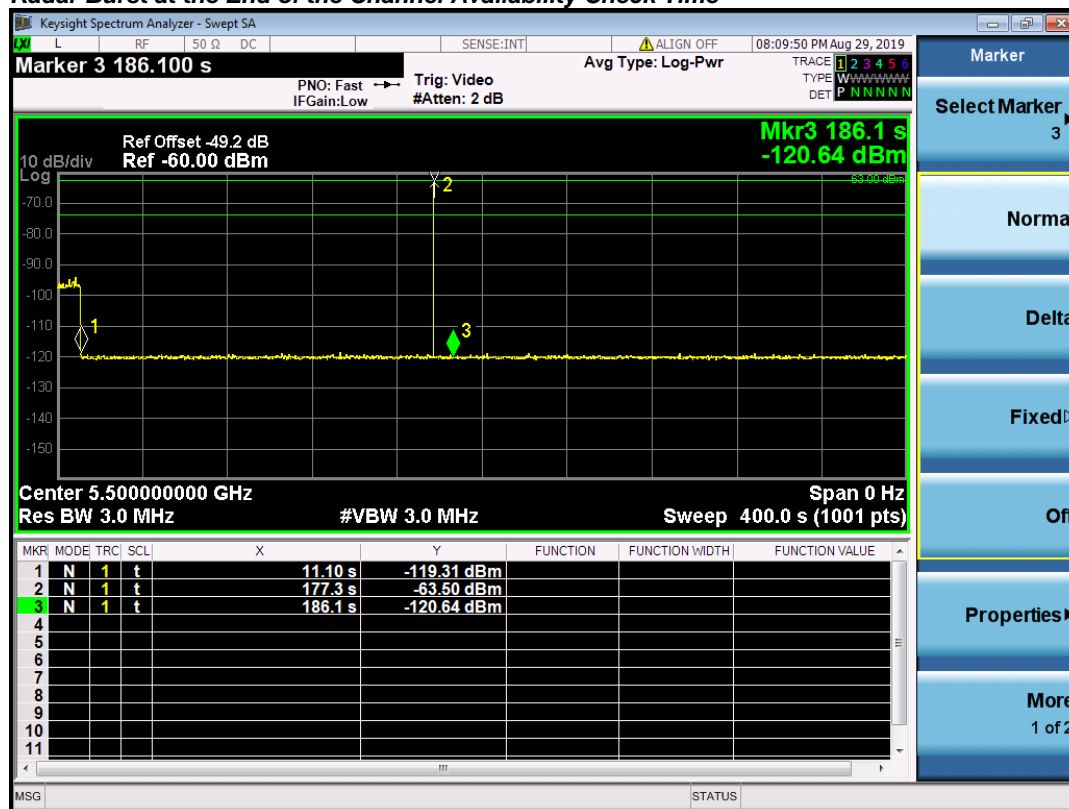

BW20



B.6 In-Service Monitoring for Channel Move Time, Channel Closing Transmission Time and Non-Occupancy Period

These tests define how the following DFS parameters are verified during In-Service Monitoring; Channel Closing Transmission Time, Channel Move Time, and Non-Occupancy Period.

The steps below define the procedure to determine the above mentioned parameters when a radar Burst with a level equal to the DFS Detection Threshold + 1dB (-63dBm) is generated on the Operating Channel of the U-NII device.

A U-NII device operating as a Client Device will associate with the UUT (Master) at 5500 MHz. Stream the MPEG test file from the Master Device to the Client Device on the selected Channel for the entire period of the test.

At time T_0 the Radar Waveform generator sends a Burst of pulses for radar type 0 at -63dBm.

Observe the transmissions of the UUT at the end of the radar Burst on the Operating Channel for duration greater than 10 seconds. Measure and record the transmissions from the UUT during the observation time (Channel Move Time). Compare the Channel Move Time and Channel Closing Transmission Time results to the limits defined in the *DFS Response requirement values table*.

The following plot demonstrates a channel close time of 50ms, with an aggregate of no more than 60 ms. Type 0 radar was used for this data.

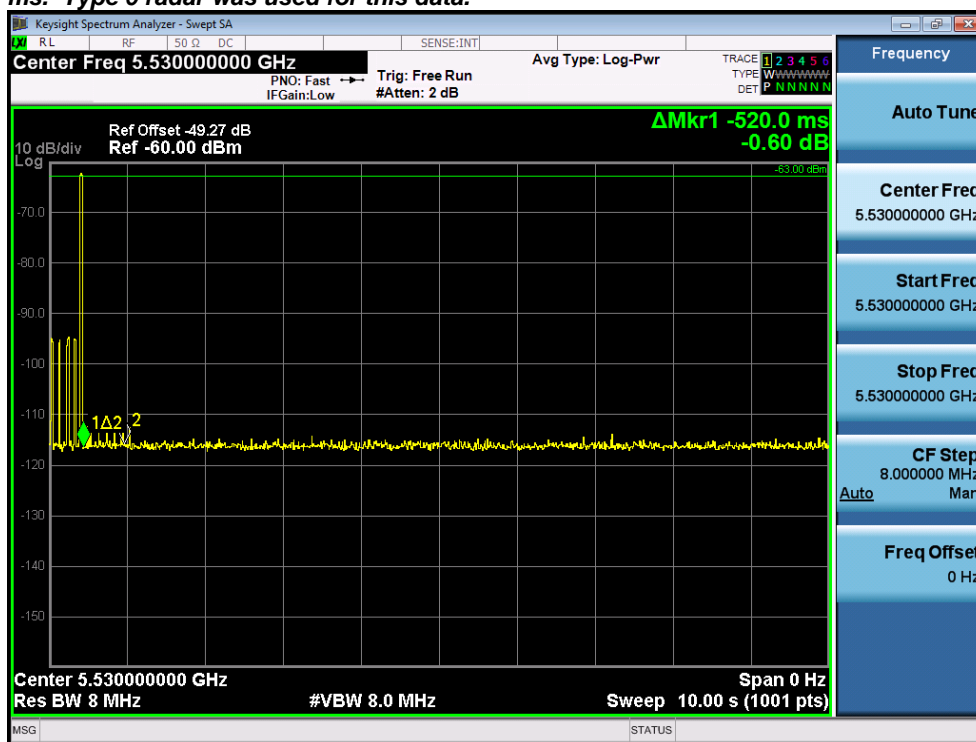



Channel Move Time, Channel Closing Transmission Time for Type 0 radar

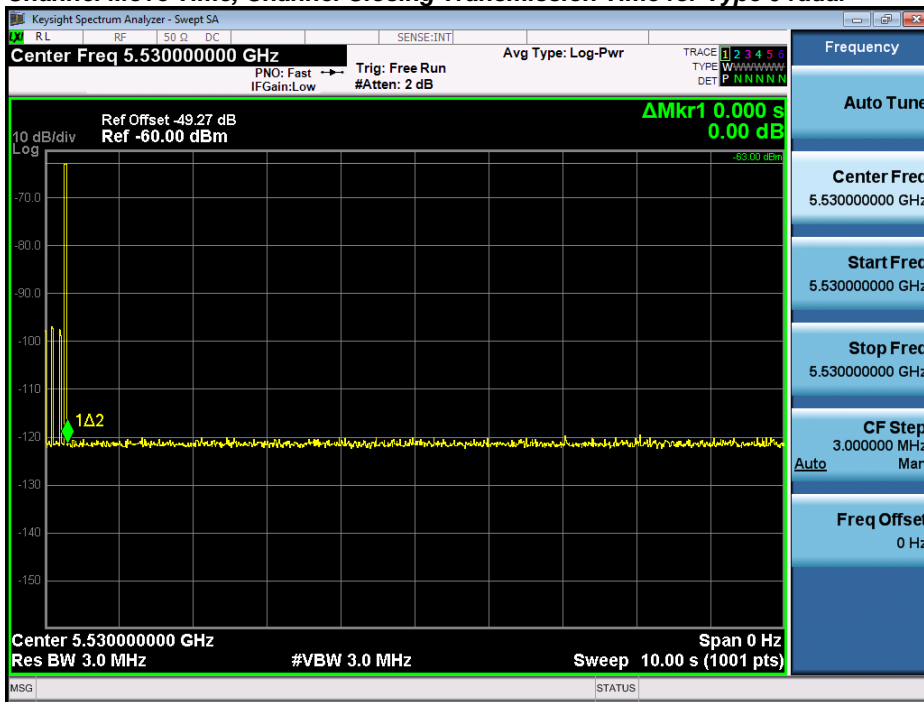

BW80



Measure the UUT for more than 30 minutes following the channel close/move time to verify that the UUT does not resume any transmissions on this Channel.

30 Minute Non-Occupancy Period (using Type 0 radar)

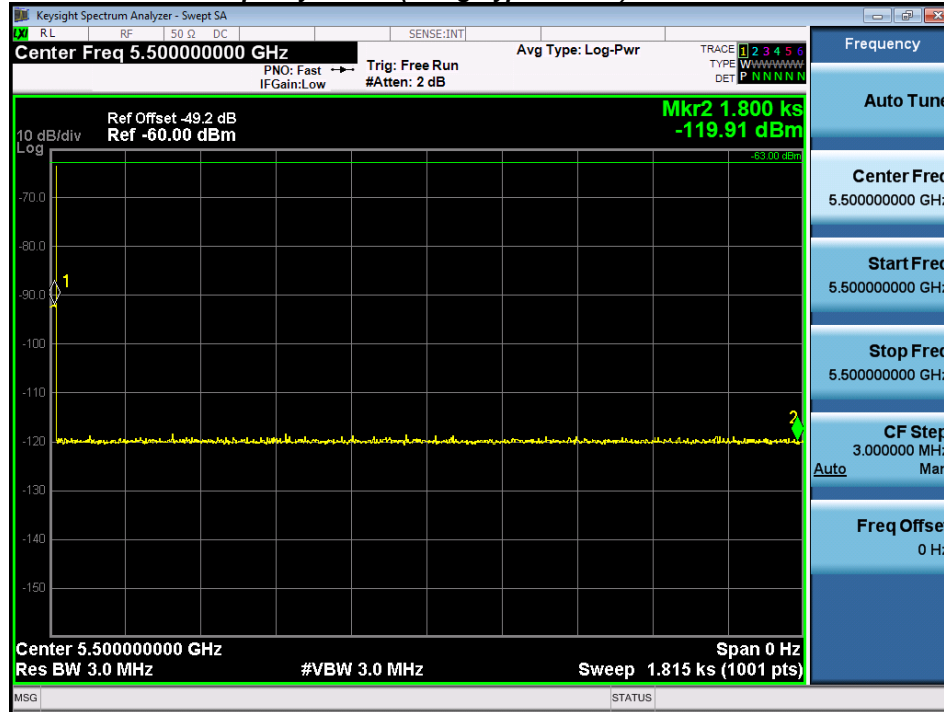

BW20

B.7 Statistical Performance Check

The steps below define the procedure to determine the minimum percentage of detection when a radar burst with a level equal to the DFS Detection Threshold + 1dB (-63dBm) is generated on the Operating Channel of the U-NII device.

A U-NII device operating as a Client Device will associate with the UUT (Master) at 5500 MHz. Stream the MPEG test file from the Master Device to the Client Device on the selected Channel for the entire period of the test.

The Radar Waveform generator sends the individual waveform for each of the radar types 1-6 at -63dbm. Statistical data will be gathered to determine the ability of the device to detect the radar test waveforms. The device can utilize a test mode to demonstrate when detection occurs to prevent the need to reset the device between trial runs. The percentage of successful detection is calculated by:

$$\frac{\textit{TotalWaveformDetections}}{\textit{TotalWaveformTrials}} \times 100 = \textit{Probability of Detection Radar Waveform}$$

The Minimum number of trails, minimum percentage of successful detection and the average minimum percentage of successful detection are found in the *Radar Test Waveforms* section. The data represents the worst case detection for 20 MHz, 40 MHz, and 80 MHz signal bandwidths.

Channel 5500 MHz, 20MHz BW, Statistical Performance

 freq=5500, rate=m0., traffic=97,
 bw=18.0

USA Bin 1A/1B

Trial	Frequency	Pulses	PW (uS)	PRI (uS)	1=Detection 0=No Detection	Detection Percentage	Limit
1	5494	70	1	758	1	86.7%	60.0%
2	5494	81	1	658	1		
3	5494	86	1	618	1		
4	5492	70	1	758	1		
5	5492	83	1	638	1		
6	5492	62	1	858	1		
7	5493	65	1	818	1		
8	5493	74	1	718	0		
9	5493	70	1	758	0		
10	5495	68	1	778	1		
11	5495	86	1	618	1		
12	5495	83	1	638	1		
13	5497	86	1	618	1		
14	5497	102	1	518	1		
15	5497	63	1	838	1		
16	5500	33	1	1645	0		
17	5500	24	1	2236	0		
18	5500	21	1	2584	1		
19	5503	31	1	1734	1		
20	5503	26	1	2076	1		
21	5503	51	1	1037	1		
22	5505	33	1	1617	1		
23	5505	30	1	1777	1		
24	5505	35	1	1512	1		
25	5507	72	1	743	1		
26	5507	23	1	2324	1		
27	5507	20	1	2713	1		
28	5506	24	1	2230	1		
29	5506	88	1	601	1		
30	5506	26	1	2080	1		



freq=5500, rate=m0., traffic=97,
bw=18.0

USA Bin 1A/1B

Trial	Frequency	Pulses	PW (uS)	PRI (uS)	1=Detection 0=No Detection	Detection Percentage	Limit
1	5494	78	1	678	1	90.0%	60.0%
2	5494	102	1	518	1		
3	5494	67	1	798	1		
4	5492	59	1	898	1		
5	5492	102	1	518	1		
6	5492	70	1	758	1		
7	5493	70	1	758	1		
8	5493	65	1	818	1		
9	5493	18	1	3066	1		
10	5495	76	1	698	1		
11	5495	81	1	658	1		
12	5495	83	1	638	1		
13	5497	74	1	718	0		
14	5497	74	1	718	0		
15	5497	92	1	578	1		
16	5500	61	1	873	1		
17	5500	31	1	1709	1		
18	5500	20	1	2658	0		
19	5503	54	1	995	1		
20	5503	20	1	2753	1		
21	5503	40	1	1339	1		
22	5505	26	1	2049	1		
23	5505	38	1	1394	1		
24	5505	75	1	706	1		
25	5507	45	1	1182	1		
26	5507	54	1	991	1		
27	5507	35	1	1551	1		
28	5506	24	1	2213	1		
29	5506	30	1	1816	1		
30	5506	81	1	656	1		



**USA Bin
2**

freq=5500, rate=m0., traffic=97,
bw=18.0

Trial	Frequency	Pulses	PW (uS)	PRI (uS)	1=Detection 0=No Detection	Detection Percentage	Limit
1	5494	23	1.2	221	1	70.0%	60.0%
2	5494	23	4	215	1		
3	5494	23	1.9	205	1		
4	5492	25	2.7	205	1		
5	5492	27	1.7	153	1		
6	5492	27	5	187	0		
7	5493	29	2.3	215	1		
8	5493	25	3	159	1		
9	5493	25	3.1	224	0		
10	5495	28	1	179	1		
11	5495	24	4.1	197	1		
12	5495	26	3.7	161	0		
13	5497	29	3.4	191	1		
14	5497	24	3	183	1		
15	5497	24	3.1	202	0		
16	5500	23	4.8	181	1		
17	5500	28	4.3	162	1		
18	5500	27	1	150	1		
19	5503	28	3.8	158	0		
20	5503	26	3.2	190	1		
21	5503	28	5	230	1		
22	5505	25	4.6	181	0		
23	5505	23	1.7	172	1		
24	5505	27	3.9	162	1		
25	5507	26	1.8	196	0		
26	5507	24	3.8	201	1		
27	5507	25	4.8	213	1		
28	5506	27	3.4	197	0		
29	5506	29	4.5	167	1		
30	5506	28	1.3	174	0		



freq=5500, rate=m0., traffic=97,
bw=18.0

USA Bin 3

Trial	Frequency	Pulses	PW (uS)	PRI (uS)	1=Detection 0=No Detection	Detection Percentage	Limit
1	5494	18	6.5	446	1	73.3%	60.0%
2	5494	18	10	435	0		
3	5494	16	8	343	1		
4	5492	16	6.9	433	0		
5	5492	17	9.2	399	1		
6	5492	18	6.3	225	1		
7	5493	17	10	392	0		
8	5493	17	9.8	226	1		
9	5493	18	7	463	1		
10	5495	18	7.1	415	0		
11	5495	18	6.1	473	1		
12	5495	16	7.4	239	1		
13	5497	18	6.4	276	0		
14	5497	18	7.5	487	1		
15	5497	16	8	411	1		
16	5500	17	7.3	284	1		
17	5500	18	9.7	306	1		
18	5500	17	9.5	275	1		
19	5503	17	9	200	1		
20	5503	17	9.7	330	1		
21	5503	18	9.2	232	1		
22	5505	18	6	486	0		
23	5505	17	8.3	200	1		
24	5505	16	6.3	275	1		
25	5507	17	9.9	411	0		
26	5507	16	6.1	351	1		
27	5507	18	8.2	306	1		
28	5506	17	6.5	258	1		
29	5506	16	9.9	316	1		
30	5506	16	6	370	0		



freq=5500, rate=m0., traffic=97,
bw=18.0

USA Bin 4

Trial	Frequency	Pulses	PW (uS)	PRI (uS)	1=Detection 0=No Detection	Detection Percentage	Limit
1	5494	15	19.4	440	1	80.0%	60.0%
2	5494	16	14	413	1		
3	5494	12	14.9	469	1		
4	5492	14	14.6	253	1		
5	5492	13	11.8	349	1		
6	5492	12	18.9	425	0		
7	5493	15	19.4	218	1		
8	5493	13	18.6	446	1		
9	5493	15	18.7	216	0		
10	5495	15	18.4	275	1		
11	5495	15	13.6	246	1		
12	5495	15	12.5	229	1		
13	5497	15	14.7	357	1		
14	5497	15	17.9	347	1		
15	5497	16	11.7	394	0		
16	5500	12	14.3	418	1		
17	5500	15	15.5	288	1		
18	5500	16	11.4	418	1		
19	5503	15	19.7	370	1		
20	5503	14	16.7	280	1		
21	5503	14	17.9	389	0		
22	5505	12	16.8	352	1		
23	5505	15	18.9	320	1		
24	5505	13	13.3	455	0		
25	5507	14	16.9	300	1		
26	5507	15	13.6	221	1		
27	5507	15	14.8	282	1		
28	5506	14	12.6	203	1		
29	5506	16	13.1	256	1		
30	5506	13	19	416	0		



USA
Bin
5

freq=5500, rate=m0., traffic=97,
bw=18.0

Trial	Burst #	Pulses	Frequency (MHz)	Chirp (MHz)	PW (uS)	Inter-pulse spacing (uS)	Inter-pulse spacing (uS)	Pulse Start (S)	1=Detection 0=No Detection	Detection Percentage	Limit
1	1	1	5495	10	85			0.289311	1	96.7%	80.0%
2	1	3	5499	20	55	1750	1316	0.00492	1		
3	1	2	5497	15	75	1537		0.577444	1		
4	1	3	5494.6	9	55	1289	1081	0.282532	1		
5	1	3	5496.2	13	90	1915	1499	0.742938	1		
6	1	1	5493.4	6	75			0.232642	1		
7	1	3	5495	10	100	1475	1281	0.148341	1		
8	1	1	5496.2	13	85			0.805975	1		
9	1	3	5498.6	19	95	1377	1362	0.340387	1		
10	1	1	5497.4	16	100			0.169819	1		
11	1	1	5500	14	85			0.697213	1		
12	1	1	5500	9	100			0.377944	1		
13	1	3	5500	7	100	1082	1480	0.013818	1		
14	1	1	5500	17	60			0.623072	1		
15	1	1	5500	5	65			0.254095	1		
16	1	2	5500	10	100	1142		0.417877	1		
17	1	2	5500	15	65	1699		0.318989	1		
18	1	1	5500	14	55			0.452909	1		
19	1	2	5500	15	55	1785		0.738644	1		
20	1	1	5500	20	60			0.15653	1		
21	1	1	5501.4	19	55			0.521969	0		
22	1	1	5505	10	60			0.013432	1		
23	1	1	5503.4	14	60			0.622423	1		
24	1	3	5501	20	90	1372	1496	0.476045	1		
25	1	2	5501	20	50	1651		0.142796	1		
26	1	3	5504.2	12	75	1172	1667	0.094498	1		
27	1	2	5504.2	12	90	1390		0.405031	1		
28	1	1	5502.2	17	85			0.182051	1		
29	1	2	5502.2	17	65	1456		0.339055	1		
30	1	1	5503	15	60			0.376402	1		



freq=5500, rate=m0., traffic=97,
bw=18.0

USA Frequency Hopping

Trial	Hop #	Freq (GHz)	Pulse Start (mS)	1=Detection 0=No Detection	Detection Percentage	Limit
1	68	5492	204	1	93.3%	70.0%
2	38	5502	114	1		
3	3	5505	9	1		
4	1	5502	3	1		
5	14	5499	42	1		
6	2	5495	6	1		
7	0	5492	0	1		
8	1	5495	3	1		
9	34	5497	102	1		
10	26	5509	78	1		
11	37	5502	111	1		
12	17	5504	51	0		
13	16	5502	48	1		
14	37	5491	111	1		
15	33	5493	99	1		
16	63	5506	189	1		
17	50	5502	150	1		
18	1	5507	3	1		
19	89	5501	267	1		
20	6	5499	18	1		
21	30	5492	90	1		
22	14	5505	42	1		
23	28	5500	84	1		
24	15	5493	45	1		
25	19	5503	57	1		
26	16	5495	48	1		
27	11	5504	33	1		
28	27	5491	81	1		
29	7	5500	21	0		
30	10	5497	30	1		

In addition an average minimum percentage of successful detection across all four Short pulse radar test waveforms is required and is calculated as follows:

$$\frac{P_d 1 + P_d 2 + P_d 3 + P_d 4}{4} = (86.7\% + 90.0\% + 70.0\% + 73.3\% + 80)/5 = 98.0\% (>80\%)$$



USA Bin 5 Trial #1

Burst #	Pulses	Frequency (MHz)	Chirp (MHz)	PW (uS)	Inter-pulse spacing (uS)	Inter-pulse spacing (uS)	Pulse Start (S)
1	1	5495	10	85			0.289311
2	1	5495	10	75			1.35813
3	2	5495	10	75	1215		1.664435
4	3	5495	10	50	1397	1983	2.320581
5	1	5495	10	70			3.39069
6	3	5495	10	55	1949	1056	4.211052
7	1	5495	10	100			4.922825
8	1	5495	10	85			5.820105
9	3	5495	10	85	1046	1914	6.595622
10	2	5495	10	60	1224		7.113445
11	3	5495	10	50	1021	1832	7.976771
12	1	5495	10	65			8.5762
13	3	5495	10	100	1621	1699	9.719943
14	3	5495	10	75	1980	1976	10.366779
15	3	5495	10	70	1994	1834	11.015453
16	1	5495	10	70			11.465684

USA Bin 5 Trial #2

Burst #	Pulses	Frequency (MHz)	Chirp (MHz)	PW (uS)	Inter-pulse spacing (uS)	Inter-pulse spacing (uS)	Pulse Start (S)
1	3	5499	20	55	1750	1316	0.00492
2	2	5499	20	90	1293		1.468343
3	3	5499	20	95	1250	1532	3.8311
4	2	5499	20	85	1877		4.74327
5	3	5499	20	85	1244	1169	5.638145
6	2	5499	20	100	1571		7.661947
7	1	5499	20	60			8.226609
8	3	5499	20	55	1971	1612	9.885224
9	2	5499	20	50	1027		11.176951

USA Bin 5 Trial #3

Burst #	Pulses	Frequency (MHz)	Chirp (MHz)	PW (uS)	Inter-pulse spacing (uS)	Inter-pulse spacing (uS)	Pulse Start (S)
1	2	5497	15	75	1537		0.577444
2	1	5497	15	75			1.192156
3	2	5497	15	95	1493		1.79442
4	3	5497	15	85	1018	1712	2.252004
5	2	5497	15	80	1128		3.120186
6	3	5497	15	85	1575	1855	3.669321
7	3	5497	15	85	1302	1392	4.277058



8	2	5497	15	85	1478		4.557885
9	2	5497	15	70	1640		5.088834
10	2	5497	15	50	1771		6.006077
11	1	5497	15	65			6.376654
12	2	5497	15	100	1381		7.340166
13	1	5497	15	100			8.17366
14	2	5497	15	55	1488		8.619828
15	1	5497	15	85			9.068605
16	3	5497	15	85	1934	1267	9.786896
17	3	5497	15	80	1113	1170	10.566238
18	2	5497	15	80	1782		11.113104
19	3	5497	15	90	1052	1018	11.430496

USA Bin 5 Trial #4

Burst #	Pulses	Frequency (MHz)	Chirp (MHz)	PW (uS)	Inter-pulse spacing (uS)	Inter-pulse spacing (uS)	Pulse Start (S)
1	3	5494.6	9	55	1289	1081	0.282532
2	1	5494.6	9	85			1.353559
3	2	5494.6	9	80	1354		2.22325
4	2	5494.6	9	65	1107		3.788979
5	2	5494.6	9	80	1452		4.422612
6	1	5494.6	9	90			5.411267
7	3	5494.6	9	95	1824	1644	6.956679
8	3	5494.6	9	90	1348	1348	7.343545
9	3	5494.6	9	50	1072	1024	8.301378
10	1	5494.6	9	100			9.462729
11	2	5494.6	9	75	1616		10.095924
12	3	5494.6	9	55	1422	1743	11.55452

USA Bin 5 Trial #5

Burst #	Pulses	Frequency (MHz)	Chirp (MHz)	PW (uS)	Inter-pulse spacing (uS)	Inter-pulse spacing (uS)	Pulse Start (S)
1	3	5496.2	13	90	1915	1499	0.742938
2	1	5496.2	13	55			1.621919
3	1	5496.2	13	65			3.144535
4	3	5496.2	13	95	1412	1627	5.006336
5	2	5496.2	13	70	1581		6.604032
6	3	5496.2	13	95	1259	1755	8.808863
7	1	5496.2	13	50			10.286152
8	2	5496.2	13	70	1826		11.228081

USA Bin 5 Trial #6

Burst #	Pulses	Frequency (MHz)	Chirp (MHz)	PW (uS)	Inter-pulse spacing (uS)	Inter-pulse spacing (uS)	Pulse Start (S)
---------	--------	-----------------	-------------	---------	--------------------------	--------------------------	-----------------



1	1	5493.4	6	75			0.232642
2	3	5493.4	6	55	1442	1448	0.932195
3	3	5493.4	6	60	1733	1222	2.46765
4	2	5493.4	6	65	1514		3.390664
5	2	5493.4	6	80	1871		4.479004
6	1	5493.4	6	85			5.511075
7	3	5493.4	6	50	1498	1151	5.916145
8	3	5493.4	6	60	1543	1142	6.586495
9	2	5493.4	6	50	1236		7.469855
10	3	5493.4	6	60	1751	1300	8.702736
11	1	5493.4	6	50			9.709253
12	3	5493.4	6	100	1533	1012	10.541767
13	2	5493.4	6	65	1126		11.506253

USA Bin 5 Trial #7

Burst #	Pulses	Frequency (MHz)	Chirp (MHz)	PW (uS)	Inter-pulse spacing (uS)	Inter-pulse spacing (uS)	Pulse Start (S)
1	3	5495	10	100	1475	1281	0.148341
2	3	5495	10	70	1945	1279	1.023225
3	3	5495	10	95	1021	1910	1.901853
4	1	5495	10	100			2.773262
5	1	5495	10	90			3.610295
6	1	5495	10	50			3.922691
7	3	5495	10	75	1194	1603	4.515269
8	3	5495	10	100	1075	1162	5.324602
9	2	5495	10	55	1338		6.558776
10	1	5495	10	70			6.9069
11	3	5495	10	95	1951	1546	7.774002
12	3	5495	10	75	1200	1786	8.872448
13	2	5495	10	70	1001		9.748826
14	3	5495	10	50	1614	1437	10.491199
15	1	5495	10	85			10.880947
16	2	5495	10	80	1927		11.81078

USA Bin 5 Trial #8

Burst #	Pulses	Frequency (MHz)	Chirp (MHz)	PW (uS)	Inter-pulse spacing (uS)	Inter-pulse spacing (uS)	Pulse Start (S)
1	1	5496.2	13	85			0.805975
2	3	5496.2	13	70	1632	1938	1.064812
3	1	5496.2	13	100			2.108617
4	2	5496.2	13	80	1713		2.915631
5	2	5496.2	13	70	1329		4.2174
6	2	5496.2	13	100	1533		4.401845
7	3	5496.2	13	75	1698	1803	5.385432



8	3	5496.2	13	100	1121	1602	6.004124
9	3	5496.2	13	95	1883	1116	7.456477
10	2	5496.2	13	90	1779		8.112903
11	3	5496.2	13	90	1292	1628	9.021598
12	1	5496.2	13	50			10.076645
13	3	5496.2	13	65	1267	1057	10.813386
14	1	5496.2	13	80			11.21333

USA Bin 5 Trial #9

Burst #	Pulses	Frequency (MHz)	Chirp (MHz)	PW (uS)	Inter-pulse spacing (uS)	Inter-pulse spacing (uS)	Pulse Start (S)
1	3	5498.6	19	95	1377	1362	0.340387
2	2	5498.6	19	50	1152		1.564897
3	2	5498.6	19	80	1901		2.34124
4	2	5498.6	19	65	1726		3.170525
5	2	5498.6	19	65	1447		4.661096
6	3	5498.6	19	90	1782	1802	5.039932
7	1	5498.6	19	75			6.43745
8	1	5498.6	19	65			7.417023
9	2	5498.6	19	90	1039		8.872895
10	1	5498.6	19	80			9.745183
11	3	5498.6	19	95	1956	1685	10.337644
12	3	5498.6	19	75	1308	1604	11.515495

USA Bin 5 Trial #10

Burst #	Pulses	Frequency (MHz)	Chirp (MHz)	PW (uS)	Inter-pulse spacing (uS)	Inter-pulse spacing (uS)	Pulse Start (S)
1	1	5497.4	16	100			0.169819
2	1	5497.4	16	70			0.850238
3	3	5497.4	16	85	1118	1632	1.819966
4	1	5497.4	16	60			3.024087
5	3	5497.4	16	90	1132	1769	3.901736
6	2	5497.4	16	100	1441		4.711764
7	2	5497.4	16	55	1075		5.042755
8	1	5497.4	16	80			5.745241
9	2	5497.4	16	65	1822		6.707292
10	2	5497.4	16	75	1275		7.598871
11	1	5497.4	16	65			8.149644
12	3	5497.4	16	55	1166	1219	9.415025
13	1	5497.4	16	100			10.330861
14	2	5497.4	16	95	1595		10.702949
15	3	5497.4	16	75	1255	1733	11.989939

USA Bin 5 Trial #11



Burst #	Pulses	Frequency (MHz)	Chirp (MHz)	PW (uS)	Inter-pulse spacing (uS)	Inter-pulse spacing (uS)	Pulse Start (S)
1	1	5500	14	85			0.697213
2	2	5500	14	60	1055		1.132705
3	2	5500	14	65	1472		2.125913
4	1	5500	14	65			3.969352
5	1	5500	14	65			4.49531
6	1	5500	14	95			5.060591
7	1	5500	14	55			6.94877
8	3	5500	14	85	1433	1935	7.427427
9	1	5500	14	75			8.968229
10	3	5500	14	60	1368	1556	9.214461
11	3	5500	14	60	1378	1514	10.368656
12	3	5500	14	100	1900	1161	11.47698

USA Bin 5 Trial #12

Burst #	Pulses	Frequency (MHz)	Chirp (MHz)	PW (uS)	Inter-pulse spacing (uS)	Inter-pulse spacing (uS)	Pulse Start (S)
1	1	5500	9	100			0.377944
2	2	5500	9	55	1015		0.90085
3	1	5500	9	70			1.295684
4	2	5500	9	70	1486		2.286101
5	1	5500	9	85			2.969862
6	1	5500	9	50			3.262598
7	1	5500	9	100			4.115447
8	1	5500	9	55			4.59268
9	3	5500	9	80	1863	1299	5.251957
10	3	5500	9	50	1032	1203	6.053687
11	3	5500	9	55	1582	1722	6.505543
12	3	5500	9	50	1488	1281	7.107612
13	2	5500	9	85	1134		7.778056
14	2	5500	9	100	1400		8.692588
15	3	5500	9	80	1479	1473	9.429483
16	2	5500	9	75	1876		10.078691
17	3	5500	9	95	1190	1925	10.370284
18	1	5500	9	80			10.913866
19	1	5500	9	80			11.469682

USA Bin 5 Trial #13

Burst #	Pulses	Frequency (MHz)	Chirp (MHz)	PW (uS)	Inter-pulse spacing (uS)	Inter-pulse spacing (uS)	Pulse Start (S)
1	3	5500	7	100	1082	1480	0.013818
2	3	5500	7	50	1052	1705	1.964456



3	3	5500	7	50	1158	1930	3.379748
4	2	5500	7	75	1079		5.218168
5	2	5500	7	60	1093		6.55195
6	1	5500	7	80			7.969271
7	2	5500	7	80	1770		8.72667
8	3	5500	7	50	1579	1089	9.978838
9	1	5500	7	100			11.395272

USA Bin 5 Trial #14

Burst #	Pulses	Frequency (MHz)	Chirp (MHz)	PW (uS)	Inter-pulse spacing (uS)	Inter-pulse spacing (uS)	Pulse Start (S)
1	1	5500	17	60			0.623072
2	1	5500	17	90			1.127743
3	1	5500	17	75			1.404956
4	1	5500	17	85			2.28608
5	1	5500	17	95			2.693051
6	1	5500	17	55			3.692386
7	1	5500	17	50			4.152831
8	1	5500	17	55			5.031611
9	3	5500	17	100	1903	1467	5.529816
10	1	5500	17	55			5.790935
11	2	5500	17	90	1914		6.440916
12	2	5500	17	80	1169		7.264701
13	2	5500	17	65	1928		8.03071
14	1	5500	17	80			8.695994
15	3	5500	17	55	1679	1213	9.022365
16	3	5500	17	80	1958	1810	10.093177
17	1	5500	17	75			10.652546
18	1	5500	17	85			11.300061
19	1	5500	17	75			11.402974

USA Bin 5 Trial #15

Burst #	Pulses	Frequency (MHz)	Chirp (MHz)	PW (uS)	Inter-pulse spacing (uS)	Inter-pulse spacing (uS)	Pulse Start (S)
1	1	5500	5	65			0.254095
2	1	5500	5	100			0.960905
3	1	5500	5	65			1.888705
4	2	5500	5	80	1477		2.094656
5	2	5500	5	85	1510		2.567631
6	3	5500	5	75	1258	1880	3.284682
7	3	5500	5	55	1357	1458	4.367754
8	2	5500	5	90	1927		4.672544
9	3	5500	5	100	1339	1314	5.417626
10	3	5500	5	65	1038	1861	5.819572



11	1	5500	5	80			6.525106
12	1	5500	5	95			7.414221
13	3	5500	5	85	1097	1529	7.794759
14	2	5500	5	50	1235		8.511403
15	1	5500	5	100			9.10916
16	3	5500	5	90	1139	1677	9.900079
17	3	5500	5	60	1833	1861	10.576096
18	3	5500	5	85	1936	1587	11.364279
19	3	5500	5	95	1247	1459	11.438731

USA Bin 5 Trial #16

Burst #	Pulses	Frequency (MHz)	Chirp (MHz)	PW (uS)	Inter-pulse spacing (uS)	Inter-pulse spacing (uS)	Pulse Start (S)
1	2	5500	10	100	1142		0.417877
2	2	5500	10	70	1460		1.013874
3	2	5500	10	55	1224		1.635734
4	2	5500	10	80	1061		2.499135
5	1	5500	10	65			2.672838
6	2	5500	10	75	1477		3.719277
7	2	5500	10	100	1656		3.916029
8	3	5500	10	70	1849	1230	4.546746
9	2	5500	10	75	1038		5.505616
10	3	5500	10	55	1164	1941	5.698659
11	3	5500	10	50	1167	1229	6.514557
12	1	5500	10	65			7.359305
13	2	5500	10	100	1180		7.860179
14	1	5500	10	65			8.367871
15	1	5500	10	60			9.129017
16	2	5500	10	75	1618		9.806028
17	3	5500	10	100	1845	1690	10.176886
18	1	5500	10	50			10.780916
19	1	5500	10	60			11.578229

USA Bin 5 Trial #17

Burst #	Pulses	Frequency (MHz)	Chirp (MHz)	PW (uS)	Inter-pulse spacing (uS)	Inter-pulse spacing (uS)	Pulse Start (S)
1	2	5500	15	65	1699		0.318989
2	1	5500	15	50			1.151829
3	3	5500	15	65	1506	1858	1.817992
4	3	5500	15	70	1648	1980	2.58607
5	2	5500	15	90	1355		3.702192
6	2	5500	15	95	1161		4.261523
7	2	5500	15	100	1554		5.033409
8	2	5500	15	65	1447		5.597478



9	2	5500	15	80	1466		6.097545
10	3	5500	15	85	1100	1833	7.234313
11	2	5500	15	85	1978		8.137705
12	2	5500	15	70	1383		8.259271
13	1	5500	15	90			9.221401
14	3	5500	15	95	1269	1359	10.144608
15	3	5500	15	100	1490	1914	10.735475
16	1	5500	15	85			11.695446

USA Bin 5 Trial #18

Burst #	Pulses	Frequency (MHz)	Chirp (MHz)	PW (uS)	Inter-pulse spacing (uS)	Inter-pulse spacing (uS)	Pulse Start (S)
1	1	5500	14	55			0.452909
2	2	5500	14	50	1293		0.601705
3	3	5500	14	60	1455	1743	1.667186
4	2	5500	14	100	1882		1.877662
5	3	5500	14	70	1626	1419	2.522067
6	3	5500	14	85	1369	1223	3.118448
7	2	5500	14	75	1299		3.869085
8	1	5500	14	70			4.201085
9	1	5500	14	55			5.371306
10	3	5500	14	90	1323	1689	5.861751
11	3	5500	14	65	1224	1484	6.322786
12	3	5500	14	55	1670	1433	6.99833
13	3	5500	14	50	1649	1462	7.676227
14	1	5500	14	95			8.208302
15	3	5500	14	90	1410	1191	8.695874
16	3	5500	14	65	1280	1811	9.221746
17	2	5500	14	50	1260		9.900071
18	3	5500	14	75	1869	1583	10.706919
19	2	5500	14	60	1946		10.994295
20	2	5500	14	80	1802		11.775753

USA Bin 5 Trial #19

Burst #	Pulses	Frequency (MHz)	Chirp (MHz)	PW (uS)	Inter-pulse spacing (uS)	Inter-pulse spacing (uS)	Pulse Start (S)
1	2	5500	15	55	1785		0.738644
2	2	5500	15	60	1404		1.059508
3	2	5500	15	65	1251		2.235014
4	2	5500	15	85	1645		2.818826
5	2	5500	15	60	1675		3.211018
6	3	5500	15	75	1161	1211	4.085825
7	2	5500	15	100	1194		5.343742
8	3	5500	15	65	1609	1650	5.696246



9	2	5500	15	95	1608		6.658222
10	1	5500	15	50			7.493193
11	3	5500	15	55	1423	1774	8.116366
12	3	5500	15	75	1980	1096	9.133681
13	2	5500	15	100	1933		9.7711
14	3	5500	15	60	1736	1929	10.73621
15	3	5500	15	60	1540	1127	11.631035

USA Bin 5 Trial #20

Burst #	Pulses	Frequency (MHz)	Chirp (MHz)	PW (uS)	Inter-pulse spacing (uS)	Inter-pulse spacing (uS)	Pulse Start (S)
1	1	5500	20	60			0.15653
2	3	5500	20	50	1072	1655	1.364072
3	2	5500	20	55	1777		1.89588
4	1	5500	20	50			2.209491
5	2	5500	20	70	1362		3.40332
6	2	5500	20	60	1991		4.007637
7	3	5500	20	85	1196	1617	4.700726
8	2	5500	20	100	1217		5.545956
9	1	5500	20	95			6.242708
10	3	5500	20	55	1369	1781	6.537488
11	1	5500	20	90			7.089794
12	3	5500	20	60	1134	1051	7.885396
13	2	5500	20	90	1210		9.119623
14	3	5500	20	90	1258	1045	9.439845
15	1	5500	20	70			9.887159
16	1	5500	20	65			10.624849
17	3	5500	20	75	1420	1653	11.98248

USA Bin 5 Trial #21

Burst #	Pulses	Frequency (MHz)	Chirp (MHz)	PW (uS)	Inter-pulse spacing (uS)	Inter-pulse spacing (uS)	Pulse Start (S)
1	1	5501.4	19	55			0.521969
2	3	5501.4	19	80	1752	1291	2.065623
3	2	5501.4	19	85	1305		3.377994
4	3	5501.4	19	50	1452	1591	4.855639
5	1	5501.4	19	65			6.660112
6	1	5501.4	19	95			8.292197
7	2	5501.4	19	55	1603		10.097822
8	3	5501.4	19	50	1928	1406	11.812148

USA Bin 5 Trial #22

Burst #	Pulses	Frequency (MHz)	Chirp (MHz)	PW (uS)	Inter-pulse spacing (uS)	Inter-pulse spacing (uS)	Pulse Start (S)
---------	--------	-----------------	-------------	---------	--------------------------	--------------------------	-----------------



1	1	5505	10	60			0.013432
2	1	5505	10	90			1.392835
3	2	5505	10	60	1750		2.174405
4	3	5505	10	80	1017	1542	3.59038
5	3	5505	10	70	1961	1358	4.46521
6	1	5505	10	70			5.404193
7	3	5505	10	65	1569	1405	5.986508
8	2	5505	10	65	1856		6.642706
9	3	5505	10	60	1637	1737	7.846517
10	3	5505	10	65	1876	1164	8.482478
11	1	5505	10	50			9.857422
12	3	5505	10	70	1848	1531	10.453975
13	1	5505	10	80			11.683771

USA Bin 5 Trial #23

Burst #	Pulses	Frequency (MHz)	Chirp (MHz)	PW (uS)	Inter-pulse spacing (uS)	Inter-pulse spacing (uS)	Pulse Start (S)
1	1	5503.4	14	60			0.622423
2	2	5503.4	14	85	1406		1.132812
3	1	5503.4	14	95			1.364833
4	2	5503.4	14	85	1565		2.348636
5	2	5503.4	14	65	1006		2.79928
6	3	5503.4	14	60	1647	1184	3.241168
7	2	5503.4	14	70	1727		4.001725
8	2	5503.4	14	55	1854		4.507974
9	2	5503.4	14	75	1210		5.120576
10	3	5503.4	14	75	1227	1890	6.295417
11	1	5503.4	14	85			6.93447
12	2	5503.4	14	55	1478		7.110506
13	2	5503.4	14	85	1609		8.203245
14	2	5503.4	14	60	1209		8.304427
15	2	5503.4	14	80	1821		8.850208
16	1	5503.4	14	70			9.498439
17	1	5503.4	14	85			10.634253
18	2	5503.4	14	65	1044		11.165176
19	1	5503.4	14	60			11.603837

USA Bin 5 Trial #24

Burst #	Pulses	Frequency (MHz)	Chirp (MHz)	PW (uS)	Inter-pulse spacing (uS)	Inter-pulse spacing (uS)	Pulse Start (S)
1	3	5501	20	90	1372	1496	0.476045
2	2	5501	20	85	1373		0.721292
3	2	5501	20	55	1765		1.322317
4	3	5501	20	70	1324	1912	2.016161



5	1	5501	20	50			2.947756
6	3	5501	20	65	1406	1049	3.188817
7	2	5501	20	75	1026		3.679579
8	3	5501	20	55	1935	1921	4.451584
9	3	5501	20	60	1036	1882	5.052736
10	1	5501	20	85			5.679425
11	1	5501	20	70			6.518349
12	2	5501	20	75	1634		6.622514
13	3	5501	20	70	1353	1041	7.488083
14	1	5501	20	80			8.163664
15	3	5501	20	75	1274	1215	8.649848
16	1	5501	20	80			9.166066
17	2	5501	20	60	1876		9.761717
18	1	5501	20	50			10.496123
19	2	5501	20	85	1963		10.890193
20	2	5501	20	85	1538		11.859638

USA Bin 5 Trial #25

Burst #	Pulses	Frequency (MHz)	Chirp (MHz)	PW (uS)	Inter-pulse spacing (uS)	Inter-pulse spacing (uS)	Pulse Start (S)
1	2	5501	20	50	1651		0.142796
2	2	5501	20	55	1986		1.783104
3	1	5501	20	60			2.305937
4	1	5501	20	80			3.802395
5	1	5501	20	55			4.409546
6	3	5501	20	60	1412	1886	5.716685
7	1	5501	20	85			6.652908
8	2	5501	20	100	1184		7.921174
9	1	5501	20	90			8.527709
10	2	5501	20	50	1560		9.918747
11	3	5501	20	60	1754	1033	10.450402
12	1	5501	20	75			11.703129

USA Bin 5 Trial #26

Burst #	Pulses	Frequency (MHz)	Chirp (MHz)	PW (uS)	Inter-pulse spacing (uS)	Inter-pulse spacing (uS)	Pulse Start (S)
1	3	5504.2	12	75	1172	1667	0.094498
2	1	5504.2	12	60			1.117205
3	1	5504.2	12	65			1.663643
4	1	5504.2	12	70			2.21395
5	3	5504.2	12	80	1515	1719	2.987894
6	3	5504.2	12	95	1043	1670	3.601498
7	2	5504.2	12	55	1833		4.011352
8	3	5504.2	12	100	1377	1844	4.443041



9	3	5504.2	12	50	1192	1083	5.371831
10	2	5504.2	12	55	1040		6.026426
11	2	5504.2	12	85	1697		6.409462
12	1	5504.2	12	75			7.543546
13	1	5504.2	12	60			8.031656
14	1	5504.2	12	80			8.673971
15	1	5504.2	12	55			9.179818
16	2	5504.2	12	55	1941		10.101089
17	2	5504.2	12	55	1468		10.512951
18	1	5504.2	12	95			11.123348
19	2	5504.2	12	90	1125		11.690558

USA Bin 5 Trial #27

Burst #	Pulses	Frequency (MHz)	Chirp (MHz)	PW (uS)	Inter-pulse spacing (uS)	Inter-pulse spacing (uS)	Pulse Start (S)
1	2	5504.2	12	90	1390		0.405031
2	2	5504.2	12	75	1275		1.356525
3	2	5504.2	12	65	1514		2.663756
4	3	5504.2	12	85	1224	1106	3.643814
5	1	5504.2	12	50			3.739336
6	2	5504.2	12	90	1727		5.272019
7	1	5504.2	12	65			6.099117
8	3	5504.2	12	95	1159	1795	6.996306
9	1	5504.2	12	90			7.868967
10	1	5504.2	12	50			8.790441
11	3	5504.2	12	55	1699	1381	10.071595
12	2	5504.2	12	70	1015		10.581831
13	2	5504.2	12	90	1967		11.863831

USA Bin 5 Trial #28

Burst #	Pulses	Frequency (MHz)	Chirp (MHz)	PW (uS)	Inter-pulse spacing (uS)	Inter-pulse spacing (uS)	Pulse Start (S)
1	1	5502.2	17	85			0.182051
2	1	5502.2	17	70			1.628064
3	1	5502.2	17	50			2.745063
4	3	5502.2	17	95	1670	1419	3.252536
5	3	5502.2	17	55	1912	1094	4.127923
6	3	5502.2	17	100	1152	1723	4.945249
7	3	5502.2	17	75	1648	1685	6.203439
8	1	5502.2	17	85			7.3453
9	3	5502.2	17	55	1822	1699	7.849537
10	2	5502.2	17	55	1594		8.625972
11	3	5502.2	17	80	1291	1740	9.444311
12	3	5502.2	17	65	1918	1764	11.047134



13 2 5502.2 17 55 1653 11.923949
 USA Bin 5 Trial #29

Burst #	Pulses	Frequency (MHz)	Chirp (MHz)	PW (uS)	Inter-pulse spacing (uS)	Inter-pulse spacing (uS)	Pulse Start (S)
1	2	5502.2	17	65	1456		0.339055
2	3	5502.2	17	90	1565	1588	1.566038
3	3	5502.2	17	65	1700	1625	3.418725
4	2	5502.2	17	90	1738		4.469122
5	2	5502.2	17	60	1980		5.379955
6	2	5502.2	17	100	1140		7.565229
7	3	5502.2	17	90	1145	1454	9.214659
8	3	5502.2	17	100	1177	1402	9.824031
9	2	5502.2	17	75	1555		11.241045

USA Bin 5 Trial #30

Burst #	Pulses	Frequency (MHz)	Chirp (MHz)	PW (uS)	Inter-pulse spacing (uS)	Inter-pulse spacing (uS)	Pulse Start (S)
1	1	5503	15	60			0.376402
2	2	5503	15	65	1629		0.957341
3	1	5503	15	60			1.603687
4	2	5503	15	95	1877		2.578578
5	3	5503	15	100	1027	1634	3.329186
6	3	5503	15	60	1419	1923	3.932655
7	2	5503	15	90	1198		4.34307
8	2	5503	15	55	1694		5.495775
9	2	5503	15	80	1481		5.914532
10	2	5503	15	100	1819		6.424438
11	1	5503	15	100			7.365255
12	1	5503	15	80			7.850208
13	2	5503	15	75	1071		8.639841
14	2	5503	15	65	1957		9.251466
15	1	5503	15	60			10.261908
16	1	5503	15	50			11.271559
17	2	5503	15	80	1363		11.522591

USA Frequency Hopping Trial #1

	Freq	Pulse Start
Hop #	(GHz)	(mS)
68	5492	204
76	5491	228

USA Frequency Hopping Trial #2

	Freq	Pulse Start
Hop #	(GHz)	(mS)
38	5502	114
60	5507	180
97	5508	291

USA Frequency Hopping Trial #3

	Freq	Pulse Start
Hop #	(GHz)	(mS)
3	5505	9
78	5503	234

USA Frequency Hopping Trial #4

	Freq	Pulse Start
Hop #	(GHz)	(mS)
1	5502	3
63	5500	189
90	5509	270
93	5491	279

USA Frequency Hopping Trial #5

	Freq	Pulse Start
Hop #	(GHz)	(mS)
14	5499	42
37	5506	111
41	5493	123
43	5503	129
86	5491	258
91	5494	273
98	5504	294

USA Frequency Hopping Trial #6

	Freq	Pulse Start
Hop #	(GHz)	(mS)
2	5495	6
14	5491	42
19	5496	57
99	5494	297

USA Frequency Hopping Trial #7

	Freq	Pulse Start
Hop #	(GHz)	(mS)
0	5492	0



20	5499	60
54	5494	162
61	5498	183
69	5504	207
75	5506	225
84	5495	252

USA Frequency Hopping Trial #8

Hop #	Freq (GHz)	Pulse Start (mS)
1	5495	3
31	5492	93

USA Frequency Hopping Trial #9

Hop #	Freq (GHz)	Pulse Start (mS)
34	5497	102
68	5507	204
79	5495	237
89	5498	267
93	5493	279

USA Frequency Hopping Trial #10

Hop #	Freq (GHz)	Pulse Start (mS)
26	5509	78
55	5503	165
70	5505	210
81	5491	243
90	5500	270

USA Frequency Hopping Trial #11

Hop #	Freq (GHz)	Pulse Start (mS)
37	5502	111
60	5495	180
96	5498	288

USA Frequency Hopping Trial #12

Hop #	Freq (GHz)	Pulse Start (mS)
17	5504	51
57	5503	171

USA Frequency Hopping Trial #13

Hop #	Freq (GHz)	Pulse Start (mS)
16	5502	48
35	5500	105
42	5496	126

78	5492	234
88	5507	264

USA Frequency Hopping Trial #14

Hop #	Freq (GHz)	Pulse Start (mS)
37	5491	111
39	5505	117
50	5500	150
54	5506	162

USA Frequency Hopping Trial #15

Hop #	Freq (GHz)	Pulse Start (mS)
33	5493	99
56	5495	168

USA Frequency Hopping Trial #16

Hop #	Freq (GHz)	Pulse Start (mS)
63	5506	189
80	5502	240
92	5500	276

USA Frequency Hopping Trial #17

Hop #	Freq (GHz)	Pulse Start (mS)
50	5502	150
56	5498	168
73	5500	219
74	5491	222
95	5492	285

USA Frequency Hopping Trial #18

Hop #	Freq (GHz)	Pulse Start (mS)
1	5507	3
4	5502	12
38	5492	114
89	5500	267

USA Frequency Hopping Trial #19

Hop #	Freq (GHz)	Pulse Start (mS)
89	5501	267

USA Frequency Hopping Trial #20

Hop #	Freq (GHz)	Pulse Start (mS)
6	5499	18
19	5496	57



87	5495	261
USA Frequency Hopping Trial #21		
	Freq	Pulse Start
Hop #	(GHz)	(mS)
30	5492	90
60	5497	180
61	5491	183
78	5509	234
91	5499	273

USA Frequency Hopping Trial #22		
	Freq	Pulse Start
Hop #	(GHz)	(mS)
14	5505	42
30	5495	90
69	5506	207
96	5504	288

USA Frequency Hopping Trial #23		
	Freq	Pulse Start
Hop #	(GHz)	(mS)
28	5500	84
36	5504	108
63	5508	189
95	5498	285

USA Frequency Hopping Trial #24		
	Freq	Pulse Start
Hop #	(GHz)	(mS)
15	5493	45
54	5502	162
57	5499	171
89	5503	267

USA Frequency Hopping Trial #25		
	Freq	Pulse Start
Hop #	(GHz)	(mS)
19	5503	57
72	5506	216

USA Frequency Hopping Trial #26		
	Freq	Pulse Start
Hop #	(GHz)	(mS)
16	5495	48
60	5502	180
74	5492	222
78	5496	234
96	5499	288
98	5500	294



USA Frequency Hopping Trial #27

Hop #	Freq (GHz)	Pulse Start (mS)
11	5504	33
37	5495	111
47	5493	141

USA Frequency Hopping Trial #28

Hop #	Freq (GHz)	Pulse Start (mS)
27	5491	81
79	5493	237
88	5509	264

USA Frequency Hopping Trial #29

Hop #	Freq (GHz)	Pulse Start (mS)
7	5500	21
61	5495	183

USA Frequency Hopping Trial #30

Hop #	Freq (GHz)	Pulse Start (mS)
10	5497	30
13	5508	39



Channel 5510 MHz, 40MHz BW, Statistical Performance

freq=5510, rate=m0., traffic=200,
bw=36.0

USA Bin 1A/1B					1=Detection 0=No Detection	Detection Percentage	Limit
Trial	Frequency	Pulses	PW (uS)	PRI (uS)			
1	5495	70	1	758	1	93.3%	60.0%
2	5495	59	1	898	1		
3	5495	59	1	898	1		
4	5497	59	1	898	0		
5	5497	81	1	658	1		
6	5497	83	1	638	1		
7	5501	67	1	798	1		
8	5501	61	1	878	1		
9	5501	81	1	658	1		
10	5505	78	1	678	1		
11	5505	62	1	858	1		
12	5507	18	1	3066	1		
13	5507	59	1	898	1		
14	5507	61	1	878	1		
15	5510	74	1	718	0		
16	5510	39	1	1366	1		
17	5510	83	1	640	1		
18	5512	27	1	1970	1		
19	5512	25	1	2170	1		
20	5512	19	1	2814	1		
21	5515	58	1	912	1		
22	5515	37	1	1437	1		
23	5519	71	1	744	1		
24	5519	21	1	2544	1		
25	5519	38	1	1419	1		
26	5523	39	1	1362	1		
27	5523	33	1	1603	1		
28	5523	28	1	1902	1		
29	5525	41	1	1299	1		
30	5525	28	1	1950	1		

freq=5510, rate=m0., traffic=200,
bw=36.0

USA Bin 1A/1B					1=Detection 0=No Detection	Detection Percentage	Limit
Trial	Frequency	Pulses	PW (uS)	PRI (uS)			



					Detection		
1	5495	58	1	918	1	96.7%	60.0%
2	5495	18	1	3066	1		
3	5495	65	1	818	1		
4	5497	63	1	838	1		
5	5497	61	1	878	1		
6	5497	81	1	658	1		
7	5501	70	1	758	1		
8	5501	74	1	718	0		
9	5501	81	1	658	1		
10	5505	57	1	938	1		
11	5505	72	1	738	1		
12	5507	72	1	738	1		
13	5507	99	1	538	1		
14	5507	92	1	578	1		
15	5510	18	1	3066	1		
16	5510	53	1	1012	1		
17	5510	26	1	2093	1		
18	5512	76	1	703	1		
19	5512	29	1	1867	1		
20	5512	27	1	1977	1		
21	5515	25	1	2128	1		
22	5515	48	1	1104	1		
23	5519	23	1	2340	1		
24	5519	64	1	825	1		
25	5519	30	1	1767	1		
26	5523	30	1	1796	1		
27	5523	23	1	2391	1		
28	5523	32	1	1692	1		
29	5525	39	1	1383	1		
30	5525	64	1	831	1		

freq=5510, rate=m0., traffic=200, bw=36.0

USA Bin 2

Trial	Frequency	Pulses	PW (uS)	PRI (uS)	1=Detection 0=No Detection	Detection Percentage	Limit
1	5495	29	3.7	197	1	86.7%	60.0%
2	5495	24	1	165	1		
3	5495	25	2.3	158	1		



4	5497	27	3.8	153	1
5	5497	23	1.8	158	1
6	5497	26	1.1	174	1
7	5501	24	4.5	219	0
8	5501	29	2.8	160	1
9	5501	24	2.8	172	1
10	5505	28	3.6	190	1
11	5505	28	1.1	198	1
12	5507	25	2.4	165	1
13	5507	27	1.9	153	1
14	5507	28	1.4	176	1
15	5510	24	4.5	195	0
16	5510	23	2	158	1
17	5510	24	5	190	1
18	5512	29	3.2	176	1
19	5512	26	2.9	182	1
20	5512	28	2.8	192	1
21	5515	26	4.7	186	1
22	5515	29	3.3	211	0
23	5519	26	5	204	1
24	5519	25	1	182	1
25	5519	23	1.6	174	1
26	5523	24	5	225	1
27	5523	28	4.5	180	1
28	5523	26	2.1	207	1
29	5525	29	4.8	154	0
30	5525	24	2.3	179	1

freq=5510, rate=m0., traffic=200,
bw=36.0

USA Bin 3

Trial	Frequency	Pulses	PW (uS)	PRI (uS)	1=Detection 0=No Detection	Detection Percentage	Limit
1	5495	18	8.1	381	0	73.3%	60.0%
2	5495	16	6.9	481	1		
3	5495	18	7.3	423	1		
4	5497	16	8.7	370	0		
5	5497	16	7.3	309	1		
6	5497	18	6.8	272	1		
7	5501	18	9	326	1		
8	5501	17	9.3	228	1		
9	5501	16	8.6	322	1		



10	5505	16	7.9	434	1
11	5505	17	7	260	1
12	5507	16	9.7	316	0
13	5507	18	6.3	261	1
14	5507	17	6.9	377	1
15	5510	18	6.9	229	0
16	5510	17	8.3	425	1
17	5510	18	8.8	350	1
18	5512	18	8.7	487	0
19	5512	18	6.6	229	1
20	5512	17	7.4	231	1
21	5515	16	8.2	250	0
22	5515	18	6.3	425	1
23	5519	18	8.6	411	1
24	5519	18	8.8	226	0
25	5519	17	6	219	1
26	5523	18	8.4	461	1
27	5523	18	6.5	483	1
28	5523	17	9.7	460	1
29	5525	17	6.9	283	0
30	5525	17	6.2	340	1

freq=5510, rate=m0., traffic=200,
bw=36.0

USA Bin 4

Trial	Frequency	Pulses	PW (uS)	PRI (uS)	1=Detection 0=No Detection	Detection Percentage	Limit
1	5495	13	16.3	453	1	76.7%	60.0%
2	5495	13	13.7	363	1		
3	5495	13	16.8	379	0		
4	5497	16	12	219	1		
5	5497	12	15.4	271	1		
6	5497	16	17.1	235	1		
7	5501	12	16.7	445	1		
8	5501	12	16.5	380	1		
9	5501	15	13.6	458	0		
10	5505	15	16.6	416	1		
11	5505	15	11.3	376	1		
12	5507	13	15.3	382	1		
13	5507	15	15.1	465	1		
14	5507	13	17.1	371	0		
15	5510	15	17.1	200	1		

16	5510	14	18.2	361	0
17	5510	14	15.5	319	1
18	5512	13	19.8	241	1
19	5512	16	17.3	303	0
20	5512	13	11.4	467	1
21	5515	16	18	308	1
22	5515	14	16.6	498	1
23	5519	13	11.1	352	1
24	5519	13	18.8	214	1
25	5519	14	12.3	256	0
26	5523	16	16.7	386	1
27	5523	15	18.9	300	1
28	5523	14	18.7	465	0
29	5525	12	16.5	339	1
30	5525	12	19.3	223	1



**USA
Bin
5**

freq=5510, rate=m0., traffic=200,
bw=36.0

Trial	Burst #	Pulses	Frequency (MHz)	Chirp (MHz)	PW (uS)	Inter-pulse spacing (uS)	Inter-pulse spacing (uS)	Pulse Start (S)	1=Detection 0=No Detection	Detection Percentage	Limit
1	1	1	5494	5	75			0.628908	1	96.7%	80.0%
2	1	1	5495.2	8	80			0.519582	1		
3	1	1	5500	20	80			0.327006	1		
4	1	2	5497.2	13	80	1698		0.470553	1		
5	1	1	5494	5	60			0.353864	1		
6	1	2	5497.2	13	60	1045		0.997878	1		
7	1	2	5499.6	19	70	1490		0.221206	1		
8	1	2	5500	20	50	1661		0.313617	1		
9	1	3	5499.2	18	95	1382	1879	0.159693	1		
10	1	2	5499.6	19	55	1781		0.094907	1		
11	1	2	5510	16	55	1369		0.600065	1		
12	1	3	5510	12	100	1062	1170	0.597835	1		
13	1	1	5510	14	90			0.088558	1		
14	1	3	5510	19	100	1822	1465	0.701595	1		
15	1	1	5510	5	95			0.962694	1		
16	1	2	5510	8	90	1809		0.920482	1		
17	1	2	5510	10	50	1848		0.076445	1		
18	1	2	5510	9	55	1889		0.693135	1		
19	1	2	5510	14	90	1277		0.758853	1		
20	1	1	5510	8	100			0.614666	1		
21	1	1	5520	20	100			0.292999	1		
22	1	2	5524.8	8	65	1085		0.327407	1		
23	1	1	5524	10	70			0.889201	0		
24	1	1	5525.6	6	65			0.218071	1		
25	1	3	5524	10	95	1651	1594	0.597572	1		
26	1	1	5522.4	14	55			0.342015	1		
27	1	3	5521.2	17	75	1012	1651	0.416672	1		
28	1	2	5520.8	18	50	1350		0.938475	1		
29	1	2	5522.4	14	60	1070		0.258812	1		
30	1	3	5521.6	16	75	1600	1898	0.048106	1		

USA Frequency Hopping

 freq=5510, rate=m0., traffic=200,
 bw=36.0

Trial	Hop #	Freq (GHz)	Pulse Start (mS)	1=Detection 0=No Detection	Detection Percentage	Limit
1	8	5497	24	1	100.0%	70.0%
2	0	5510	0	1		
3	50	5505	150	1		
4	8	5518	24	1		
5	28	5513	84	1		
6	51	5514	153	1		
7	13	5512	39	1		
8	4	5525	12	1		
9	2	5513	6	1		
10	8	5521	24	1		
11	0	5503	0	1		
12	20	5502	60	1		
13	16	5525	48	1		
14	9	5513	27	1		
15	0	5510	0	1		
16	1	5504	3	1		
17	11	5500	33	1		
18	43	5492	129	1		
19	13	5496	39	1		
20	8	5510	24	1		
21	14	5526	42	1		
22	24	5515	72	1		
23	2	5501	6	1		
24	7	5501	21	1		
25	0	5494	0	1		
26	3	5509	9	1		
27	12	5519	36	1		
28	1	5520	3	1		
29	23	5494	69	1		
30	1	5517	3	1		

Channel 5510 MHz, 40MHz BW, Statistical Performance

In addition an average minimum percentage of successful detection across all four Short pulse radar test waveforms is required and is calculated as follows:

$$\frac{P_d 1 + P_d 2 + P_d 3 + P_d 4}{4} = (93.3\% + 96.7\% + 86.7\% + 73.3\% + 76.7)/5 = 85.3\% (>80\%)$$



USA Bin 5 Trial #1

Burst #	Pulses	Frequency (MHz)	Chirp (MHz)	PW (uS)	Inter-pulse spacing (uS)	Inter-pulse spacing (uS)	Pulse Start (S)
1	1	5494	5	75			0.628908
2	3	5494	5	95	1529	1480	0.89447
3	1	5494	5	80			1.593384
4	1	5494	5	95			2.356163
5	2	5494	5	55	1084		2.814423
6	1	5494	5	55			3.345405
7	2	5494	5	90	1930		3.879769
8	3	5494	5	70	1393	1891	4.458468
9	3	5494	5	50	1154	1196	5.400663
10	2	5494	5	100	1320		6.042185
11	3	5494	5	55	1197	1709	6.395502
12	2	5494	5	70	1339		7.533863
13	2	5494	5	100	1205		7.885727
14	3	5494	5	90	1147	1228	8.406726
15	2	5494	5	55	1440		9.094529
16	1	5494	5	100			10.018897
17	3	5494	5	90	1050	1180	10.180919
18	3	5494	5	60	1375	1171	11.023501
19	1	5494	5	50			11.69999

USA Bin 5 Trial #2

Burst #	Pulses	Frequency (MHz)	Chirp (MHz)	PW (uS)	Inter-pulse spacing (uS)	Inter-pulse spacing (uS)	Pulse Start (S)
1	1	5495.2	8	80			0.519582
2	2	5495.2	8	100	1215		0.684285
3	1	5495.2	8	50			1.978288
4	1	5495.2	8	70			2.183656
5	3	5495.2	8	70	1037	1655	2.998388
6	3	5495.2	8	85	1486	1565	3.699955
7	3	5495.2	8	90	1472	1021	4.274069
8	3	5495.2	8	70	1664	1016	5.118695
9	1	5495.2	8	75			5.635678
10	2	5495.2	8	85	1100		6.480516
11	2	5495.2	8	95	1815		6.999152
12	3	5495.2	8	100	1384	1700	7.401616
13	3	5495.2	8	85	1680	1794	8.497362
14	2	5495.2	8	95	1245		9.304964
15	3	5495.2	8	65	1512	1981	9.536456
16	3	5495.2	8	80	1946	1094	10.001932
17	2	5495.2	8	60	1869		10.787705



18 2 5495.2 8 70 1754 11.763335
 USA Bin 5 Trial #3

Burst #	Pulses	Frequency (MHz)	Chirp (MHz)	PW (uS)	Inter-pulse spacing (uS)	Inter-pulse spacing (uS)	Pulse Start (S)
1	1	5500	20	80			0.327006
2	3	5500	20	65	1993	1322	1.974185
3	3	5500	20	65	1292	1267	2.773739
4	2	5500	20	50	1979		4.03888
5	2	5500	20	65	1557		5.49248
6	1	5500	20	100			6.855948
7	1	5500	20	50			8.3269
8	2	5500	20	55	1753		10.500495
9	2	5500	20	95	1272		10.76792

USA Bin 5 Trial #4

Burst #	Pulses	Frequency (MHz)	Chirp (MHz)	PW (uS)	Inter-pulse spacing (uS)	Inter-pulse spacing (uS)	Pulse Start (S)
1	2	5497.2	13	80	1698		0.470553
2	3	5497.2	13	80	1327	1750	1.947811
3	1	5497.2	13	85			2.582038
4	3	5497.2	13	95	1203	1665	3.121014
5	3	5497.2	13	85	1921	1381	4.218004
6	3	5497.2	13	65	1669	1291	5.361137
7	2	5497.2	13	65	1179		6.210926
8	3	5497.2	13	70	1620	1896	7.69346
9	3	5497.2	13	70	1636	1675	8.520697
10	3	5497.2	13	65	1049	1379	9.865555
11	3	5497.2	13	70	1561	1629	10.546922
12	3	5497.2	13	50	1493	1941	11.447498

USA Bin 5 Trial #5

Burst #	Pulses	Frequency (MHz)	Chirp (MHz)	PW (uS)	Inter-pulse spacing (uS)	Inter-pulse spacing (uS)	Pulse Start (S)
1	1	5494	5	60			0.353864
2	3	5494	5	75	1687	1862	1.255405
3	1	5494	5	60			1.889181
4	2	5494	5	100	1804		3.12152
5	2	5494	5	80	1027		3.49597
6	2	5494	5	55	1182		4.54302
7	2	5494	5	100	1445		5.314642
8	2	5494	5	50	1727		6.010468
9	3	5494	5	55	1812	1199	6.458493
10	1	5494	5	95			7.589938



11	3	5494	5	70	1756	1576	8.782868
12	2	5494	5	50	1875		8.874213
13	3	5494	5	55	1499	1143	9.969217
14	1	5494	5	60			10.687176
15	3	5494	5	95	1587	1232	11.577735

USA Bin 5 Trial #6

Burst #	Pulses	Frequency (MHz)	Chirp (MHz)	PW (uS)	Inter-pulse spacing (uS)	Inter-pulse spacing (uS)	Pulse Start (S)
1	2	5497.2	13	60	1045		0.997878
2	3	5497.2	13	70	1975	1531	1.388857
3	2	5497.2	13	100	1949		2.825507
4	3	5497.2	13	80	1478	1782	3.666995
5	2	5497.2	13	55	1510		5.216687
6	2	5497.2	13	80	1790		6.337329
7	3	5497.2	13	70	1571	1472	6.922506
8	2	5497.2	13	95	1402		8.478287
9	1	5497.2	13	100			9.503275
10	3	5497.2	13	75	1764	1785	10.877647
11	3	5497.2	13	75	1643	1352	10.999654

USA Bin 5 Trial #7

Burst #	Pulses	Frequency (MHz)	Chirp (MHz)	PW (uS)	Inter-pulse spacing (uS)	Inter-pulse spacing (uS)	Pulse Start (S)
1	2	5499.6	19	70	1490		0.221206
2	2	5499.6	19	75	1438		1.281275
3	1	5499.6	19	90			2.127763
4	1	5499.6	19	70			3.816834
5	3	5499.6	19	50	1139	1413	4.647643
6	2	5499.6	19	80	1803		5.951172
7	1	5499.6	19	85			6.102526
8	1	5499.6	19	55			7.010391
9	3	5499.6	19	60	1502	1877	8.780187
10	3	5499.6	19	60	1365	1209	9.081969
11	1	5499.6	19	90			10.195421
12	3	5499.6	19	95	1505	1933	11.133261

USA Bin 5 Trial #8

Burst #	Pulses	Frequency (MHz)	Chirp (MHz)	PW (uS)	Inter-pulse spacing (uS)	Inter-pulse spacing (uS)	Pulse Start (S)
1	2	5500	20	50	1661		0.313617
2	2	5500	20	85	1200		1.551757
3	2	5500	20	55	1283		3.238653
4	3	5500	20	100	1552	1210	3.504937



5	3	5500	20	60	1870	1281	4.54761
6	2	5500	20	75	1111		6.38679
7	3	5500	20	80	1903	1625	6.991595
8	2	5500	20	90	1777		8.183775
9	1	5500	20	75			9.243194
10	2	5500	20	65	1475		10.104371
11	1	5500	20	85			11.186742

USA Bin 5 Trial #9

Burst #	Pulses	Frequency (MHz)	Chirp (MHz)	PW (uS)	Inter-pulse spacing (uS)	Inter-pulse spacing (uS)	Pulse Start (S)
1	3	5499.2	18	95	1382	1879	0.159693
2	2	5499.2	18	65	1341		0.942451
3	1	5499.2	18	60			1.728191
4	2	5499.2	18	80	1691		2.260832
5	1	5499.2	18	85			2.550455
6	1	5499.2	18	100			3.336086
7	1	5499.2	18	50			3.909183
8	1	5499.2	18	100			4.709659
9	2	5499.2	18	55	1939		5.514868
10	2	5499.2	18	80	1292		6.088142
11	2	5499.2	18	75	1211		6.454489
12	1	5499.2	18	95			7.570567
13	2	5499.2	18	80	1455		7.617862
14	3	5499.2	18	70	1995	1191	8.512494
15	2	5499.2	18	55	1472		9.235022
16	1	5499.2	18	75			10.096751
17	2	5499.2	18	90	1079		10.16836
18	1	5499.2	18	75			10.783131
19	1	5499.2	18	55			11.706263

USA Bin 5 Trial #10

Burst #	Pulses	Frequency (MHz)	Chirp (MHz)	PW (uS)	Inter-pulse spacing (uS)	Inter-pulse spacing (uS)	Pulse Start (S)
1	2	5499.6	19	55	1781		0.094907
2	1	5499.6	19	70			0.885698
3	1	5499.6	19	70			1.885454
4	3	5499.6	19	80	1301	1874	2.659747
5	2	5499.6	19	75	1227		3.119228
6	3	5499.6	19	60	1011	1808	3.726061
7	2	5499.6	19	85	1349		4.895977
8	2	5499.6	19	100	1849		5.211591
9	1	5499.6	19	75			5.701418
10	3	5499.6	19	95	1999	1655	6.867222



11	1	5499.6	19	85			7.424758
12	2	5499.6	19	50	1907		7.851392
13	3	5499.6	19	85	1848	1414	8.840765
14	1	5499.6	19	70			9.757437
15	3	5499.6	19	55	1141	1697	10.110603
16	3	5499.6	19	100	1075	1649	11.077642
17	3	5499.6	19	90	1912	1696	11.38827

USA Bin 5 Trial #11

Burst #	Pulses	Frequency (MHz)	Chirp (MHz)	PW (uS)	Inter-pulse spacing (uS)	Inter-pulse spacing (uS)	Pulse Start (S)
1	2	5510	16	55	1369		0.600065
2	2	5510	16	50	1243		1.690598
3	2	5510	16	85	1823		2.387028
4	3	5510	16	95	1368	1148	2.674673
5	3	5510	16	95	1350	1387	3.811536
6	2	5510	16	80	1854		4.908149
7	1	5510	16	95			5.591726
8	1	5510	16	60			6.717283
9	2	5510	16	90	1498		7.645659
10	2	5510	16	70	1917		8.109911
11	2	5510	16	75	1335		9.367102
12	1	5510	16	65			9.592734
13	2	5510	16	100	1211		10.691547
14	2	5510	16	60	1939		11.255617

USA Bin 5 Trial #12

Burst #	Pulses	Frequency (MHz)	Chirp (MHz)	PW (uS)	Inter-pulse spacing (uS)	Inter-pulse spacing (uS)	Pulse Start (S)
1	3	5510	12	100	1062	1170	0.597835
2	2	5510	12	60	1341		1.094144
3	2	5510	12	70	1874		2.804007
4	1	5510	12	85			3.201419
5	2	5510	12	95	1616		4.128947
6	3	5510	12	80	1023	1808	5.202529
7	3	5510	12	60	1241	1676	6.466043
8	2	5510	12	55	1436		7.058309
9	1	5510	12	85			8.04363
10	3	5510	12	55	1656	1792	9.64327
11	2	5510	12	55	1349		10.47404
12	2	5510	12	80	1973		11.781436

USA Bin 5 Trial #13



Burst #	Pulses	Frequency (MHz)	Chirp (MHz)	PW (uS)	Inter-pulse spacing (uS)	Inter-pulse spacing (uS)	Pulse Start (S)
1	1	5510	14	90			0.088558
2	3	5510	14	55	1048	1382	1.196585
3	3	5510	14	60	1099	1401	1.587672
4	2	5510	14	90	1592		2.529056
5	3	5510	14	70	1032	1757	3.429645
6	1	5510	14	90			3.841627
7	1	5510	14	55			4.750987
8	1	5510	14	100			5.486524
9	3	5510	14	95	1542	1721	6.267101
10	2	5510	14	100	1480		6.93828
11	1	5510	14	50			7.468732
12	1	5510	14	65			7.918925
13	1	5510	14	90			9.109348
14	1	5510	14	100			9.419177
15	3	5510	14	60	1613	1708	10.058275
16	1	5510	14	85			10.77073
17	2	5510	14	60	1291		11.815619

USA Bin 5 Trial #14

Burst #	Pulses	Frequency (MHz)	Chirp (MHz)	PW (uS)	Inter-pulse spacing (uS)	Inter-pulse spacing (uS)	Pulse Start (S)
1	3	5510	19	100	1822	1465	0.701595
2	1	5510	19	65			1.210661
3	3	5510	19	95	1811	1018	2.125153
4	3	5510	19	70	1070	1985	2.64702
5	2	5510	19	95	1965		3.806166
6	1	5510	19	80			4.732431
7	1	5510	19	90			4.879716
8	1	5510	19	65			6.279031
9	1	5510	19	55			6.910868
10	2	5510	19	85	1208		7.55201
11	3	5510	19	50	1299	1479	8.248822
12	1	5510	19	55			9.558993
13	2	5510	19	70	1543		10.217937
14	2	5510	19	70	1159		10.97057
15	1	5510	19	50			11.796943

USA Bin 5 Trial #15

Burst #	Pulses	Frequency (MHz)	Chirp (MHz)	PW (uS)	Inter-pulse spacing (uS)	Inter-pulse spacing (uS)	Pulse Start (S)
1	1	5510	5	95			0.962694



2	2	5510	5	50	1239		1.267397
3	3	5510	5	65	1327	1968	3.23937
4	3	5510	5	55	1565	1015	3.834674
5	3	5510	5	55	1034	1484	5.279075
6	1	5510	5	85			7.040808
7	1	5510	5	80			7.835931
8	2	5510	5	90	1954		9.524202
9	3	5510	5	80	1706	1582	10.754968
10	2	5510	5	55	1023		10.978443

USA Bin 5 Trial #16

Burst #	Pulses	Frequency (MHz)	Chirp (MHz)	PW (uS)	Inter-pulse spacing (uS)	Inter-pulse spacing (uS)	Pulse Start (S)
1	2	5510	8	90	1809		0.920482
2	1	5510	8	60			1.216948
3	1	5510	8	90			2.262723
4	1	5510	8	75			4.35247
5	3	5510	8	85	1880	1727	4.90454
6	3	5510	8	60	1581	1245	5.871635
7	1	5510	8	95			7.037367
8	3	5510	8	70	1653	1876	8.677902
9	2	5510	8	85	1643		9.395882
10	2	5510	8	100	1790		9.997632
11	2	5510	8	85	1051		11.468405

USA Bin 5 Trial #17

Burst #	Pulses	Frequency (MHz)	Chirp (MHz)	PW (uS)	Inter-pulse spacing (uS)	Inter-pulse spacing (uS)	Pulse Start (S)
1	2	5510	10	50	1848		0.076445
2	1	5510	10	65			1.811629
3	3	5510	10	50	1724	1950	2.425459
4	2	5510	10	85	1691		3.322479
5	1	5510	10	65			4.755238
6	1	5510	10	75			5.697314
7	1	5510	10	90			6.626136
8	3	5510	10	95	1798	1137	8.435566
9	1	5510	10	80			9.736438
10	3	5510	10	75	1346	1463	10.092789
11	1	5510	10	95			11.397661

USA Bin 5 Trial #18

Burst #	Pulses	Frequency (MHz)	Chirp (MHz)	PW (uS)	Inter-pulse spacing (uS)	Inter-pulse spacing (uS)	Pulse Start (S)
1	2	5510	9	55	1889		0.693135



2	3	5510	9	55	1885	1138	1.343484
3	2	5510	9	55	1402		1.923749
4	3	5510	9	90	1258	1260	2.990325
5	2	5510	9	90	1879		4.456122
6	2	5510	9	100	1447		4.989925
7	1	5510	9	100			5.77915
8	1	5510	9	50			6.764768
9	3	5510	9	75	1128	1327	7.493165
10	2	5510	9	85	1572		8.339392
11	3	5510	9	55	1792	1461	9.510646
12	2	5510	9	60	1443		11.029389
13	2	5510	9	80	1643		11.41424

USA Bin 5 Trial #19

Burst #	Pulses	Frequency (MHz)	Chirp (MHz)	PW (uS)	Inter-pulse spacing (uS)	Inter-pulse spacing (uS)	Pulse Start (S)
1	2	5510	14	90	1277		0.758853
2	1	5510	14	75			1.554421
3	3	5510	14	75	1914	1418	2.858199
4	3	5510	14	65	1203	1309	3.630918
5	3	5510	14	95	1493	1936	4.634613
6	2	5510	14	55	1860		5.929558
7	1	5510	14	60			6.910599
8	3	5510	14	65	1602	1416	8.100594
9	2	5510	14	60	1061		9.650672
10	2	5510	14	85	1287		9.972307
11	1	5510	14	50			11.467561

USA Bin 5 Trial #20

Burst #	Pulses	Frequency (MHz)	Chirp (MHz)	PW (uS)	Inter-pulse spacing (uS)	Inter-pulse spacing (uS)	Pulse Start (S)
1	1	5510	8	100			0.614666
2	1	5510	8	95			1.370096
3	1	5510	8	70			2.159009
4	1	5510	8	60			2.757384
5	3	5510	8	70	1442	1170	3.647825
6	2	5510	8	85	1843		3.92747
7	3	5510	8	70	1577	1191	4.844875
8	1	5510	8	95			5.556949
9	2	5510	8	95	1737		6.526428
10	1	5510	8	50			6.921957
11	2	5510	8	75	1775		7.780107
12	3	5510	8	80	1831	1512	8.947237
13	2	5510	8	75	1046		9.482567



14	2	5510	8	100	1993		10.485369
15	3	5510	8	100	1515	1681	10.839175
16	2	5510	8	50	1039		11.835316

USA Bin 5 Trial #21

Burst #	Pulses	Frequency (MHz)	Chirp (MHz)	PW (uS)	Inter-pulse spacing (uS)	Inter-pulse spacing (uS)	Pulse Start (S)
1	1	5520	20	100			0.292999
2	3	5520	20	55	1283	1479	0.752039
3	3	5520	20	60	1215	1078	1.529281
4	2	5520	20	90	1208		2.37607
5	1	5520	20	100			2.76727
6	1	5520	20	90			3.31414
7	2	5520	20	55	1239		3.658426
8	1	5520	20	80			4.718596
9	2	5520	20	85	1690		5.368295
10	2	5520	20	90	1479		5.811283
11	2	5520	20	70	1090		6.389358
12	2	5520	20	90	1902		6.726806
13	2	5520	20	85	1862		7.555749
14	2	5520	20	70	1516		8.020537
15	2	5520	20	75	1259		8.531176
16	3	5520	20	95	1015	1089	9.209014
17	2	5520	20	70	1524		9.750906
18	1	5520	20	55			10.415927
19	3	5520	20	65	1378	1392	10.972557
20	3	5520	20	70	1121	1464	11.504437

USA Bin 5 Trial #22

Burst #	Pulses	Frequency (MHz)	Chirp (MHz)	PW (uS)	Inter-pulse spacing (uS)	Inter-pulse spacing (uS)	Pulse Start (S)
1	2	5524.8	8	65	1085		0.327407
2	1	5524.8	8	55			1.192329
3	1	5524.8	8	70			1.352778
4	2	5524.8	8	85	1872		2.189697
5	3	5524.8	8	95	1629	1401	2.874426
6	2	5524.8	8	95	1720		3.817387
7	1	5524.8	8	60			4.066342
8	1	5524.8	8	50			4.828989
9	3	5524.8	8	85	1375	1648	5.611612
10	2	5524.8	8	55	1567		6.590551
11	2	5524.8	8	100	1261		6.973217
12	2	5524.8	8	55	1023		7.576227
13	3	5524.8	8	65	1122	1147	8.093012



14	3	5524.8	8	100	1716	1082	8.866822
15	1	5524.8	8	80			9.926019
16	2	5524.8	8	75	1443		10.166859
17	1	5524.8	8	80			11.166143
18	1	5524.8	8	55			11.66606

USA Bin 5 Trial #23

Burst #	Pulses	Frequency (MHz)	Chirp (MHz)	PW (uS)	Inter-pulse spacing (uS)	Inter-pulse spacing (uS)	Pulse Start (S)
1	1	5524	10	70			0.889201
2	3	5524	10	60	1509	1762	1.801903
3	3	5524	10	100	1271	1363	2.802066
4	1	5524	10	95			3.792499
5	3	5524	10	60	1861	1412	4.697654
6	2	5524	10	70	1103		5.892114
7	3	5524	10	60	1258	1318	6.292148
8	1	5524	10	80			7.971146
9	1	5524	10	95			8.192369
10	1	5524	10	50			9.223706
11	1	5524	10	50			10.157983
12	2	5524	10	70	1621		11.202559

USA Bin 5 Trial #24

Burst #	Pulses	Frequency (MHz)	Chirp (MHz)	PW (uS)	Inter-pulse spacing (uS)	Inter-pulse spacing (uS)	Pulse Start (S)
1	1	5525.6	6	65			0.218071
2	2	5525.6	6	80	1690		1.318295
3	1	5525.6	6	95			1.460252
4	2	5525.6	6	75	1207		2.144281
5	1	5525.6	6	60			3.202029
6	2	5525.6	6	55	1350		3.612171
7	2	5525.6	6	65	1012		4.46124
8	3	5525.6	6	90	1382	1547	4.803384
9	3	5525.6	6	85	1622	1234	5.383773
10	2	5525.6	6	65	1349		6.251966
11	2	5525.6	6	90	1014		6.77539
12	2	5525.6	6	85	1335		7.834621
13	1	5525.6	6	65			8.236796
14	3	5525.6	6	55	1614	1109	9.239579
15	1	5525.6	6	80			9.801475
16	1	5525.6	6	55			10.269647
17	2	5525.6	6	95	1920		10.868426
18	1	5525.6	6	100			11.712447

USA Bin 5 Trial #25



Burst #	Pulses	Frequency (MHz)	Chirp (MHz)	PW (uS)	Inter-pulse spacing (uS)	Inter-pulse spacing (uS)	Pulse Start (S)
1	3	5524	10	95	1651	1594	0.597572
2	3	5524	10	95	1154	1780	1.70411
3	2	5524	10	85	1733		2.023473
4	3	5524	10	50	1602	1975	2.591971
5	1	5524	10	100			3.702358
6	2	5524	10	80	1949		4.384262
7	3	5524	10	55	1283	1362	5.988497
8	3	5524	10	60	1483	1892	6.406196
9	1	5524	10	60			7.420483
10	2	5524	10	90	1936		8.021213
11	2	5524	10	65	1459		8.913352
12	1	5524	10	80			9.6513
13	1	5524	10	95			10.641637
14	3	5524	10	90	1017	1099	11.374844

USA Bin 5 Trial #26

Burst #	Pulses	Frequency (MHz)	Chirp (MHz)	PW (uS)	Inter-pulse spacing (uS)	Inter-pulse spacing (uS)	Pulse Start (S)
1	1	5522.4	14	55			0.342015
2	2	5522.4	14	95	1200		0.675757
3	2	5522.4	14	90	1513		1.456907
4	1	5522.4	14	95			2.570355
5	2	5522.4	14	75	1168		2.812307
6	1	5522.4	14	90			3.489433
7	1	5522.4	14	100			4.355245
8	2	5522.4	14	75	1700		4.75967
9	1	5522.4	14	60			5.360535
10	2	5522.4	14	50	1898		6.212471
11	1	5522.4	14	75			7.284251
12	2	5522.4	14	85	1945		7.360549
13	3	5522.4	14	50	1460	1672	8.129138
14	1	5522.4	14	100			9.218866
15	3	5522.4	14	80	1376	1659	9.703777
16	3	5522.4	14	55	1548	1173	10.211623
17	2	5522.4	14	70	1181		10.845431
18	1	5522.4	14	85			11.786265

USA Bin 5 Trial #27

Burst #	Pulses	Frequency (MHz)	Chirp (MHz)	PW (uS)	Inter-pulse spacing (uS)	Inter-pulse spacing (uS)	Pulse Start (S)
1	3	5521.2	17	75	1012	1651	0.416672



2	2	5521.2	17	50	1424		1.235946
3	1	5521.2	17	75			2.060678
4	2	5521.2	17	90	1033		2.708958
5	2	5521.2	17	70	1276		3.154202
6	2	5521.2	17	65	1711		3.651621
7	1	5521.2	17	95			4.889352
8	1	5521.2	17	50			5.402558
9	2	5521.2	17	75	1183		6.110629
10	3	5521.2	17	65	1032	1149	6.504754
11	2	5521.2	17	50	1510		7.331939
12	3	5521.2	17	85	1659	1619	8.287662
13	2	5521.2	17	60	1457		8.6548
14	1	5521.2	17	60			9.871907
15	3	5521.2	17	65	1799	1054	10.120947
16	2	5521.2	17	55	1156		10.730517
17	1	5521.2	17	60			11.582926

USA Bin 5 Trial #28

Burst #	Pulses	Frequency (MHz)	Chirp (MHz)	PW (uS)	Inter-pulse spacing (uS)	Inter-pulse spacing (uS)	Pulse Start (S)
1	2	5520.8	18	50	1350		0.938475
2	2	5520.8	18	75	1449		2.260914
3	3	5520.8	18	95	1448	1494	3.181842
4	3	5520.8	18	80	1391	1253	4.623889
5	3	5520.8	18	90	1312	1575	6.063925
6	3	5520.8	18	95	1176	1470	7.19702
7	1	5520.8	18	75			8.900201
8	2	5520.8	18	90	1555		10.193989
9	2	5520.8	18	100	1254		11.34447

USA Bin 5 Trial #29

Burst #	Pulses	Frequency (MHz)	Chirp (MHz)	PW (uS)	Inter-pulse spacing (uS)	Inter-pulse spacing (uS)	Pulse Start (S)
1	2	5522.4	14	60	1070		0.258812
2	1	5522.4	14	65			0.820727
3	3	5522.4	14	75	1336	1219	2.060193
4	2	5522.4	14	60	1507		2.550239
5	2	5522.4	14	100	1125		3.498733
6	1	5522.4	14	50			3.685406
7	2	5522.4	14	50	1597		4.595408
8	2	5522.4	14	90	1962		5.151838
9	3	5522.4	14	95	1941	1515	5.94924
10	3	5522.4	14	55	1909	1949	6.424828
11	3	5522.4	14	60	1806	1392	7.429865



12	1	5522.4	14	50			8.252682
13	3	5522.4	14	80	1176	1497	8.982051
14	1	5522.4	14	80			9.506142
15	1	5522.4	14	80			9.987146
16	1	5522.4	14	75			10.91055
17	3	5522.4	14	60	1686	1715	11.442209

USA Bin 5 Trial #30

Burst #	Pulses	Frequency (MHz)	Chirp (MHz)	PW (uS)	Inter-pulse spacing (uS)	Inter-pulse spacing (uS)	Pulse Start (S)
1	3	5521.6	16	75	1600	1898	0.048106
2	1	5521.6	16	65			1.292112
3	1	5521.6	16	50			2.016831
4	2	5521.6	16	55	1615		3.107902
5	1	5521.6	16	70			4.614802
6	3	5521.6	16	55	1128	1170	4.805916
7	2	5521.6	16	50	1220		5.586926
8	1	5521.6	16	60			7.077856
9	2	5521.6	16	100	1140		8.021983
10	3	5521.6	16	60	1788	1808	8.652097
11	1	5521.6	16	70			9.454664
12	1	5521.6	16	85			10.969231
13	3	5521.6	16	75	1299	1979	11.671934



USA Frequency Hopping Trial #1

Hop #	Freq (GHz)	Pulse Start (mS)
8	5497	24
13	5506	39
23	5500	69
25	5525	75
45	5528	135
60	5510	180
83	5526	249
85	5498	255
86	5502	258

USA Frequency Hopping Trial #2

Hop #	Freq (GHz)	Pulse Start (mS)
0	5510	0
26	5506	78
40	5515	120
72	5513	216
93	5499	279

USA Frequency Hopping Trial #3

Hop #	Freq (GHz)	Pulse Start (mS)
50	5505	150
61	5496	183
62	5520	186
72	5494	216
76	5506	228
85	5498	255

USA Frequency Hopping Trial #4

Hop #	Freq (GHz)	Pulse Start (mS)
8	5518	24
17	5528	51
26	5522	78
28	5525	84
39	5521	117
45	5493	135
81	5492	243
84	5502	252
85	5511	255

USA Frequency Hopping Trial #5

Hop #	Freq (GHz)	Pulse Start (mS)
-------	------------	------------------



28	5513	84
33	5511	99
35	5522	105
48	5502	144
82	5508	246
89	5500	267

USA Frequency Hopping Trial #6

Hop #	Freq (GHz)	Pulse Start (mS)
51	5514	153
55	5518	165
60	5524	180
80	5492	240

USA Frequency Hopping Trial #7

Hop #	Freq (GHz)	Pulse Start (mS)
13	5512	39
16	5514	48
26	5500	78
27	5499	81
35	5496	105
37	5503	111
40	5509	120
44	5517	132
47	5505	141
54	5519	162
65	5521	195
66	5498	198
93	5502	279

USA Frequency Hopping Trial #8

Hop #	Freq (GHz)	Pulse Start (mS)
4	5525	12
44	5521	132
61	5498	183
63	5492	189
67	5513	201
75	5500	225
76	5505	228
79	5494	237

USA Frequency Hopping Trial #9

Hop #	Freq (GHz)	Pulse Start (mS)
2	5513	6



18	5527	54
27	5497	81
29	5521	87
36	5523	108
42	5510	126
59	5518	177
67	5525	201
83	5499	249

USA Frequency Hopping Trial #10

Hop #	Freq (GHz)	Pulse Start (mS)
8	5521	24
12	5507	36
13	5503	39
34	5499	102
36	5510	108
43	5501	129
44	5511	132
61	5497	183
71	5516	213
87	5517	261

USA Frequency Hopping Trial #11

Hop #	Freq (GHz)	Pulse Start (mS)
0	5503	0
22	5499	66
36	5519	108
55	5505	165
60	5508	180
83	5520	249

USA Frequency Hopping Trial #12

Hop #	Freq (GHz)	Pulse Start (mS)
20	5502	60
36	5494	108
40	5521	120
54	5511	162
57	5492	171
66	5507	198
77	5524	231
93	5528	279

USA Frequency Hopping Trial #13

Hop #	Freq (GHz)	Pulse Start (mS)
-------	------------	------------------



16	5525	48
33	5512	99
40	5518	120
49	5513	147
50	5493	150
52	5516	156
55	5511	165
82	5524	246

USA Frequency Hopping Trial #14

Hop #	Freq (GHz)	Pulse Start (mS)
9	5513	27
15	5515	45
41	5505	123
54	5525	162
81	5524	243
96	5521	288
99	5509	297

USA Frequency Hopping Trial #15

Hop #	Freq (GHz)	Pulse Start (mS)
0	5510	0
12	5505	36
18	5526	54
25	5521	75
26	5502	78
40	5498	120
63	5528	189
82	5496	246
94	5506	282

USA Frequency Hopping Trial #16

Hop #	Freq (GHz)	Pulse Start (mS)
1	5504	3
9	5510	27
12	5503	36
26	5516	78
42	5508	126
54	5527	162
63	5494	189
91	5518	273

USA Frequency Hopping Trial #17

Hop #	Freq (GHz)	Pulse Start (mS)
-------	------------	------------------



11	5500	33
26	5518	78
62	5503	186
75	5506	225
83	5501	249
84	5515	252
99	5496	297

USA Frequency Hopping Trial #18

Hop #	Freq (GHz)	Pulse Start (mS)
43	5492	129
50	5504	150
53	5516	159
60	5517	180
79	5494	237

USA Frequency Hopping Trial #19

Hop #	Freq (GHz)	Pulse Start (mS)
13	5496	39
16	5504	48
26	5516	78
38	5507	114
59	5498	177
61	5506	183
63	5524	189
73	5495	219
76	5501	228
79	5505	237
83	5519	249
85	5492	255
95	5521	285

USA Frequency Hopping Trial #20

Hop #	Freq (GHz)	Pulse Start (mS)
8	5510	24
10	5499	30
21	5496	63
39	5512	117
66	5511	198
67	5520	201
82	5525	246
90	5507	270

USA Frequency Hopping Trial #21



Hop #	Freq (GHz)	Pulse Start (mS)
14	5526	42
25	5507	75
37	5508	111
52	5498	156
65	5497	195
83	5502	249

USA Frequency Hopping Trial #22

Hop #	Freq (GHz)	Pulse Start (mS)
24	5515	72
28	5495	84
70	5504	210
82	5516	246
88	5512	264
93	5503	279

USA Frequency Hopping Trial #23

Hop #	Freq (GHz)	Pulse Start (mS)
2	5501	6
8	5507	24
10	5518	30
29	5525	87
35	5521	105
55	5494	165
57	5513	171
89	5495	267
93	5514	279

USA Frequency Hopping Trial #24

Hop #	Freq (GHz)	Pulse Start (mS)
7	5501	21
16	5495	48
54	5522	162
55	5496	165
65	5518	195
76	5514	228
82	5510	246
84	5504	252
99	5493	297

USA Frequency Hopping Trial #25

Hop #	Freq (GHz)	Pulse Start (mS)
-------	------------	------------------



0	5494	0
7	5505	21
13	5507	39
24	5516	72
38	5522	114
71	5492	213
75	5525	225
86	5524	258

USA Frequency Hopping Trial #26

Hop #	Freq (GHz)	Pulse Start (mS)
3	5509	9
11	5514	33
12	5492	36
13	5512	39
17	5501	51
49	5500	147
52	5497	156
54	5519	162
65	5524	195
72	5528	216
87	5494	261

USA Frequency Hopping Trial #27

Hop #	Freq (GHz)	Pulse Start (mS)
12	5519	36
14	5510	42
28	5499	84
35	5515	105
36	5501	108
41	5500	123
50	5506	150
69	5502	207
90	5521	270

USA Frequency Hopping Trial #28

Hop #	Freq (GHz)	Pulse Start (mS)
1	5520	3
3	5506	9
20	5504	60
28	5498	84
56	5512	168
67	5495	201
73	5493	219



USA Frequency Hopping Trial #29

Hop #	Freq (GHz)	Pulse Start (mS)
23	5494	69
39	5501	117
50	5525	150
51	5505	153
52	5499	156
58	5502	174
59	5504	177
65	5513	195
90	5496	270
93	5518	279

USA Frequency Hopping Trial #30

Hop #	Freq (GHz)	Pulse Start (mS)
1	5517	3
3	5523	9
14	5505	42
51	5501	153
64	5503	192
72	5516	216
76	5498	228
94	5527	282

Channel 5530 MHz, 80MHz BW, Statistical Performance

 freq=5530, rate=m0x1, traffic=420,
 bw=76.0

USA Bin 1A/1B

Trial	Frequency	Pulses	PW (uS)	PRI (uS)	1=Detection 0=No Detection	Detection Percentage	Limit
1	5495	61	1	878	1	100.0%	60.0%
2	5495	86	1	618	1		
3	5495	68	1	778	1		
4	5503	95	1	558	1		
5	5503	99	1	538	1		
6	5503	81	1	658	1		
7	5510	63	1	838	1		
8	5510	92	1	578	1		
9	5510	92	1	578	1		
10	5515	59	1	898	1		
11	5515	72	1	738	1		
12	5525	59	1	898	1		
13	5525	86	1	618	1		
14	5525	102	1	518	1		
15	5530	86	1	618	1		
16	5530	65	1	816	1		
17	5530	24	1	2280	1		
18	5535	65	1	820	1		
19	5535	73	1	733	1		
20	5535	31	1	1757	1		
21	5545	51	1	1055	1		
22	5545	24	1	2275	1		
23	5553	38	1	1403	1		
24	5553	54	1	979	1		
25	5553	21	1	2562	1		
26	5562	22	1	2399	1		
27	5562	80	1	660	1		
28	5562	25	1	2187	1		
29	5565	22	1	2428	1		
30	5565	19	1	2871	1		



freq=5530, rate=m0x1, traffic=420,
bw=76.0

USA Bin 1A/1B

Trial	Frequency	Pulses	PW (uS)	PRI (uS)	1=Detection 0=No Detection	Detection Percentage	Limit
1	5495	57	1	938	1	96.7%	60.0%
2	5495	68	1	778	1		
3	5495	62	1	858	1		
4	5503	86	1	618	1		
5	5503	63	1	838	1		
6	5503	95	1	558	1		
7	5510	102	1	518	1		
8	5510	95	1	558	1		
9	5510	99	1	538	1		
10	5515	74	1	718	0		
11	5515	99	1	538	1		
12	5525	76	1	698	1		
13	5525	83	1	638	1		
14	5525	59	1	898	1		
15	5530	68	1	778	1		
16	5530	18	1	2993	1		
17	5530	18	1	2997	1		
18	5535	28	1	1923	1		
19	5535	24	1	2224	1		
20	5535	62	1	865	1		
21	5545	30	1	1798	1		
22	5545	21	1	2596	1		
23	5553	25	1	2123	1		
24	5553	25	1	2178	1		
25	5553	23	1	2341	1		
26	5562	24	1	2274	1		
27	5562	60	1	886	1		
28	5562	27	1	1984	1		
29	5565	41	1	1318	1		
30	5565	23	1	2351	1		



**USA
Bin
2**

freq=5530, rate=m0x1, traffic=420,
bw=76.0

Trial	Frequency	Pulses	PW (uS)	PRI (uS)	1=Detection 0=No Detection	Detection Percentage	Limit
1	5495	28	1.5	169	1	80.0%	60.0%
2	5495	26	1.7	226	1		
3	5495	26	4.8	198	1		
4	5503	26	4.9	173	1		
5	5503	29	4.3	161	1		
6	5503	24	3.4	175	1		
7	5510	28	3	218	0		
8	5510	25	1.4	182	1		
9	5510	24	2.8	227	1		
10	5515	28	2.9	188	0		
11	5515	27	1.5	230	1		
12	5525	23	2.9	176	1		
13	5525	25	4	160	1		
14	5525	26	4.1	218	1		
15	5530	24	3	166	1		
16	5530	28	4	201	1		
17	5530	23	4	153	0		
18	5535	24	2.6	227	1		
19	5535	26	2.1	150	0		
20	5535	28	1.1	178	1		
21	5545	29	2.4	191	1		
22	5545	24	1.1	162	0		
23	5553	29	2.7	183	1		
24	5553	28	2.2	206	0		
25	5553	23	4.2	211	1		
26	5562	29	4.7	222	1		
27	5562	25	4	190	1		
28	5562	28	2.6	212	1		
29	5565	25	2.6	197	1		
30	5565	24	4.2	190	1		



**USA
Bin
3**

freq=5530, rate=m0x1, traffic=420,
bw=76.0

Trial	Frequency	Pulses	PW (uS)	PRI (uS)	1=Detection 0=No Detection	Detection Percentage	Limit
1	5495	18	8.8	494	1	80.0%	60.0%
2	5495	18	7.2	365	1		
3	5495	18	6.1	279	0		
4	5503	18	9.3	238	1		
5	5503	18	7	326	1		
6	5503	17	6.2	369	0		
7	5510	16	8.2	274	1		
8	5510	17	7.3	305	1		
9	5510	16	7.5	304	0		
10	5515	16	8.9	498	1		
11	5515	18	8.2	398	1		
12	5525	16	7.5	202	1		
13	5525	18	8.4	240	1		
14	5525	17	8.1	305	1		
15	5530	16	7.2	377	1		
16	5530	18	7.8	447	1		
17	5530	18	6.4	319	1		
18	5535	17	7.9	325	1		
19	5535	18	6.3	432	1		
20	5535	18	6.5	494	1		
21	5545	18	6.1	235	1		
22	5545	16	8.2	353	1		
23	5553	16	8.6	423	1		
24	5553	17	6.7	430	0		
25	5553	17	7.5	471	1		
26	5562	18	8.1	254	1		
27	5562	17	6.3	474	1		
28	5562	18	8.1	216	0		
29	5565	16	6.6	431	1		
30	5565	17	9.1	384	0		



**USA
Bin
4**

freq=5530, rate=m0x1, traffic=420,
bw=76.0

Trial	Frequency	Pulses	PW (uS)	PRI (uS)	1=Detection 0=No Detection	Detection Percentage	Limit
1	5495	12	13.7	281	1	83.3%	60.0%
2	5495	15	18.1	467	1		
3	5495	15	15.2	457	1		
4	5503	14	13.5	451	1		
5	5503	16	18	406	1		
6	5503	14	19.6	398	1		
7	5510	14	17.8	298	1		
8	5510	14	11.4	325	1		
9	5510	14	11.8	322	1		
10	5515	13	18.1	282	0		
11	5515	13	19.5	204	1		
12	5525	16	19.9	242	0		
13	5525	14	15.4	434	1		
14	5525	13	15.8	407	1		
15	5530	14	15.6	253	1		
16	5530	13	14.4	442	0		
17	5530	13	15.8	331	1		
18	5535	16	15.8	409	0		
19	5535	16	17.9	255	1		
20	5535	14	11.5	225	1		
21	5545	15	16.2	490	1		
22	5545	12	13.8	360	0		
23	5553	12	11.7	483	1		
24	5553	14	13.2	297	1		
25	5553	13	14.9	365	1		
26	5562	16	18.8	363	1		
27	5562	12	18.2	369	1		
28	5562	14	18.2	332	1		
29	5565	13	17.2	415	1		
30	5565	15	13	204	1		



USA
Bin
5

freq=5530, rate=m0x1, traffic=420, bw=76.0

Trial	Burst #	Pulses	Frequency (MHz)	Chirp (MHz)	PW (uS)	Inter-pulse spacing (uS)	Inter-pulse spacing (uS)	Pulse Start (S)	1=Detection 0=No Detection	Detection Percentage	Limit
1	1	3	5497.6	14	70	1117	1716	0.57818	1	100.0%	80.0 %
2	1	1	5494.4	6	75			0.494905	1		
3	1	1	5497.6	14	85			0.803481	1		
4	1	1	5494	5	50			0.14975	1		
5	1	1	5498	15	75			0.070075	1		
6	1	2	5494.8	7	100	1501		0.961004	1		
7	1	3	5495.6	9	90	1277	1320	0.088833	1		
8	1	1	5498	15	60			0.066653	1		
9	1	2	5497.6	14	50	1191		0.688731	1		
10	1	2	5497.2	13	60	1522		0.763438	1		
11	1	2	5530	13	90	1924		0.034894	1		
12	1	3	5530	17	95	1426	1975	0.117049	1		
13	1	1	5530	20	95			0.743161	1		
14	1	1	5530	11	95			0.077575	1		
15	1	3	5530	20	80	1777	1568	0.634235	1		
16	1	2	5530	12	90	1348		0.377414	1		
17	1	1	5530	18	95			0.316613	1		
18	1	1	5530	18	90			1.043482	1		
19	1	1	5530	16	80			0.030553	1		
20	1	2	5530	19	75	1385		0.019826	1		
21	1	2	5563.2	12	50	1899		0.788933	1		
22	1	1	5561.6	16	60			0.688377	1		
23	1	1	5564	10	50			0.332418	1		
24	1	2	5564.8	8	75	1911		0.486443	1		
25	1	2	5564	10	75	1115		0.427931	1		
26	1	2	5565.2	7	100	1903		0.471341	1		
27	1	3	5564	10	100	1138	1244	0.430188	1		
28	1	2	5564.4	9	85	1230		0.79506	1		
29	1	2	5565.6	6	95	1431		0.349525	1		
30	1	2	5564.4	9	50	1867		0.548808	1		



USA Frequency Hopping

freq=5530, rate=m0x1, traffic=420, bw=76.0

Trial	Hop #	Freq (GHz)	Pulse Start (mS)	1=Detection 0=No Detection	Detection Percentage	Limit
1	12	5507	36	1	100.0%	70.0%
2	17	5566	51	1		
3	4	5501	12	1		
4	4	5544	12	1		
5	0	5492	0	1		
6	5	5567	15	1		
7	3	5502	9	1		
8	21	5546	63	1		
9	12	5554	36	1		
10	3	5563	9	1		
11	2	5505	6	1		
12	5	5507	15	1		
13	9	5522	27	1		
14	9	5561	27	1		
15	3	5559	9	1		
16	11	5505	33	1		
17	3	5495	9	1		
18	14	5509	42	1		
19	1	5559	3	1		
20	1	5519	3	1		
21	2	5496	6	1		
22	0	5534	0	1		
23	1	5508	3	1		
24	8	5540	24	1		
25	1	5566	3	1		
26	5	5502	15	1		
27	2	5527	6	1		
28	1	5552	3	1		
29	5	5528	15	1		
30	10	5542	30	1		

In addition an average minimum percentage of successful detection across all four Short pulse radar test waveforms is required and is calculated as follows:

$$\frac{P_d 1 + P_d 2 + P_d 3 + P_d 4}{4} = (100.0\% + 96.7\% + 80.0\% + 83.3)/5 = 88.0\% (>80\%)$$



USA Bin 5 Trial #1

Burst #	Pulses	Frequency (MHz)	Chirp (MHz)	PW (uS)	Inter-pulse spacing (uS)	Inter-pulse spacing (uS)	Pulse Start (S)
1	3	5497.6	14	70	1117	1716	0.57818
2	2	5497.6	14	90	1031		0.974065
3	1	5497.6	14	90			1.859476
4	1	5497.6	14	50			2.797954
5	2	5497.6	14	100	1449		3.087496
6	1	5497.6	14	80			4.210869
7	3	5497.6	14	60	1060	1329	4.460461
8	1	5497.6	14	90			5.238391
9	3	5497.6	14	75	1594	1040	5.691528
10	1	5497.6	14	60			6.819674
11	2	5497.6	14	85	1702		7.407864
12	2	5497.6	14	100	1566		8.431062
13	2	5497.6	14	70	1913		9.020028
14	1	5497.6	14	95			9.357346
15	1	5497.6	14	85			10.367414
16	1	5497.6	14	95			10.877
17	1	5497.6	14	100			11.996202

USA Bin 5 Trial #2

Burst #	Pulses	Frequency (MHz)	Chirp (MHz)	PW (uS)	Inter-pulse spacing (uS)	Inter-pulse spacing (uS)	Pulse Start (S)
1	1	5494.4	6	75			0.494905
2	2	5494.4	6	50	1865		0.71743
3	1	5494.4	6	80			1.601908
4	2	5494.4	6	75	1003		2.430369
5	3	5494.4	6	100	1506	1008	2.767867
6	1	5494.4	6	50			3.357123
7	3	5494.4	6	100	1808	1899	4.357812
8	1	5494.4	6	65			4.75997
9	2	5494.4	6	70	1786		5.413016
10	2	5494.4	6	95	1488		6.483291
11	3	5494.4	6	75	1101	1984	7.090885
12	3	5494.4	6	90	1543	1684	7.865634
13	2	5494.4	6	80	1174		8.491977
14	1	5494.4	6	90			9.261432
15	3	5494.4	6	80	1115	1471	9.34182
16	1	5494.4	6	75			10.426568
17	1	5494.4	6	65			10.67394
18	1	5494.4	6	55			11.972975

USA Bin 5 Trial #3



Burst #	Pulses	Frequency (MHz)	Chirp (MHz)	PW (uS)	Inter-pulse spacing (uS)	Inter-pulse spacing (uS)	Pulse Start (S)
1	1	5497.6	14	85			0.803481
2	1	5497.6	14	90			1.561453
3	3	5497.6	14	50	1917	1745	2.018277
4	2	5497.6	14	60	1103		3.218558
5	2	5497.6	14	55	1059		4.191414
6	1	5497.6	14	60			4.756042
7	3	5497.6	14	55	1829	1717	5.830774
8	2	5497.6	14	85	1023		6.315424
9	1	5497.6	14	90			7.392158
10	2	5497.6	14	50	1092		7.907309
11	1	5497.6	14	95			9.218706
12	3	5497.6	14	95	1349	1222	9.803529
13	1	5497.6	14	50			10.88147
14	2	5497.6	14	85	1827		11.812014

USA Bin 5 Trial #4

Burst #	Pulses	Frequency (MHz)	Chirp (MHz)	PW (uS)	Inter-pulse spacing (uS)	Inter-pulse spacing (uS)	Pulse Start (S)
1	1	5494	5	50			0.14975
2	3	5494	5	85	1777	1686	0.834635
3	2	5494	5	75	1121		1.822817
4	2	5494	5	90	1367		2.385047
5	2	5494	5	60	1410		3.177601
6	2	5494	5	55	1484		3.550705
7	3	5494	5	90	1286	1177	4.51761
8	1	5494	5	50			4.895403
9	2	5494	5	70	1861		5.94465
10	1	5494	5	95			6.587338
11	1	5494	5	90			7.31255
12	3	5494	5	50	1354	1055	7.817226
13	2	5494	5	70	1439		8.558512
14	1	5494	5	80			8.668982
15	3	5494	5	65	1742	1383	9.623534
16	2	5494	5	65	1439		10.409745
17	1	5494	5	70			11.139349
18	1	5494	5	90			11.978929

USA Bin 5 Trial #5

Burst #	Pulses	Frequency (MHz)	Chirp (MHz)	PW (uS)	Inter-pulse spacing (uS)	Inter-pulse spacing (uS)	Pulse Start (S)
1	1	5498	15	75			0.070075



2	2	5498	15	75	1203		1.340763
3	2	5498	15	90	1667		2.367398
4	3	5498	15	70	1280	1433	3.58935
5	3	5498	15	70	1863	1971	4.425925
6	1	5498	15	100			5.952
7	2	5498	15	95	1899		6.721102
8	1	5498	15	50			7.757886
9	2	5498	15	90	1374		9.248393
10	2	5498	15	100	1371		10.380281
11	1	5498	15	60			11.179521

USA Bin 5 Trial #6

Burst #	Pulses	Frequency (MHz)	Chirp (MHz)	PW (uS)	Inter-pulse spacing (uS)	Inter-pulse spacing (uS)	Pulse Start (S)
1	2	5494.8	7	100	1501		0.961004
2	1	5494.8	7	95			2.42512
3	3	5494.8	7	100	1597	1235	2.731466
4	3	5494.8	7	85	1676	1600	5.16076
5	2	5494.8	7	90	1264		5.985206
6	3	5494.8	7	85	1907	1921	7.135168
7	3	5494.8	7	55	1738	1415	8.649409
8	2	5494.8	7	90	1771		10.007435
9	2	5494.8	7	85	1184		11.771066

USA Bin 5 Trial #7

Burst #	Pulses	Frequency (MHz)	Chirp (MHz)	PW (uS)	Inter-pulse spacing (uS)	Inter-pulse spacing (uS)	Pulse Start (S)
1	3	5495.6	9	90	1277	1320	0.088833
2	2	5495.6	9	60	1660		0.963131
3	2	5495.6	9	80	1376		1.274231
4	3	5495.6	9	65	1118	1393	2.255143
5	1	5495.6	9	50			2.736081
6	3	5495.6	9	55	1767	1299	3.69213
7	3	5495.6	9	60	1812	1480	4.152008
8	3	5495.6	9	95	1869	1709	4.57491
9	3	5495.6	9	100	1437	1350	5.370158
10	3	5495.6	9	65	1722	1248	6.159999
11	3	5495.6	9	60	1213	1182	6.763919
12	3	5495.6	9	50	1436	1330	7.124717
13	2	5495.6	9	55	1753		8.154454
14	1	5495.6	9	95			8.456232
15	2	5495.6	9	55	1126		8.990694
16	2	5495.6	9	95	1144		9.518837
17	1	5495.6	9	55			10.131436



18	3	5495.6	9	55	1010	1001	10.790291
19	3	5495.6	9	50	1340	1786	11.632782

USA Bin 5 Trial #8

Burst #	Pulses	Frequency (MHz)	Chirp (MHz)	PW (uS)	Inter-pulse spacing (uS)	Inter-pulse spacing (uS)	Pulse Start (S)
1	1	5498	15	60			0.066653
2	3	5498	15	70	1798	1553	1.991492
3	2	5498	15	80	1470		2.958144
4	1	5498	15	70			3.406492
5	2	5498	15	60	1421		5.452495
6	2	5498	15	80	1285		6.163367
7	1	5498	15	85			6.654725
8	2	5498	15	50	1478		7.809216
9	1	5498	15	90			9.546841
10	2	5498	15	60	1547		9.879673
11	1	5498	15	80			11.663248

USA Bin 5 Trial #9

Burst #	Pulses	Frequency (MHz)	Chirp (MHz)	PW (uS)	Inter-pulse spacing (uS)	Inter-pulse spacing (uS)	Pulse Start (S)
1	2	5497.6	14	50	1191		0.688731
2	1	5497.6	14	65			0.958014
3	1	5497.6	14	85			1.898231
4	1	5497.6	14	95			2.942761
5	3	5497.6	14	50	1269	1688	4.021424
6	1	5497.6	14	65			4.460015
7	3	5497.6	14	75	1510	1964	5.539362
8	3	5497.6	14	85	1181	1466	6.352523
9	3	5497.6	14	50	1419	1196	7.172028
10	2	5497.6	14	50	1977		8.066881
11	2	5497.6	14	75	1914		8.673446
12	2	5497.6	14	90	1403		10.049058
13	1	5497.6	14	85			10.469372
14	2	5497.6	14	65	1582		11.723679

USA Bin 5 Trial #10

Burst #	Pulses	Frequency (MHz)	Chirp (MHz)	PW (uS)	Inter-pulse spacing (uS)	Inter-pulse spacing (uS)	Pulse Start (S)
1	2	5497.2	13	60	1522		0.763438
2	1	5497.2	13	95			1.508867
3	3	5497.2	13	90	1594	1767	2.040228
4	1	5497.2	13	85			3.981019
5	3	5497.2	13	70	1604	1593	4.51356



6	3	5497.2	13	100	1911	1478	5.832807
7	1	5497.2	13	90			6.803668
8	3	5497.2	13	65	1004	1798	7.299261
9	2	5497.2	13	60	1847		8.231473
10	3	5497.2	13	90	1491	1347	9.166017
11	1	5497.2	13	80			10.834098
12	3	5497.2	13	55	1076	1337	11.111326

USA Bin 5 Trial #11

Burst #	Pulses	Frequency (MHz)	Chirp (MHz)	PW (uS)	Inter-pulse spacing (uS)	Inter-pulse spacing (uS)	Pulse Start (S)
1	2	5530	13	90	1924		0.034894
2	1	5530	13	80			0.867036
3	2	5530	13	75	1495		1.696797
4	2	5530	13	95	1042		2.051443
5	1	5530	13	100			2.656826
6	2	5530	13	65	1000		3.536189
7	2	5530	13	60	1301		3.958525
8	3	5530	13	90	1302	1131	4.720864
9	2	5530	13	65	2000		5.576477
10	1	5530	13	70			5.810331
11	1	5530	13	100			6.722081
12	3	5530	13	50	1265	1535	7.259453
13	3	5530	13	75	1195	1098	7.930542
14	3	5530	13	60	1679	1855	8.241731
15	2	5530	13	85	1923		9.470365
16	2	5530	13	95	1605		9.480249
17	2	5530	13	75	1083		10.315378
18	3	5530	13	65	1031	1261	10.772739
19	3	5530	13	80	1097	1020	11.647849

USA Bin 5 Trial #12

Burst #	Pulses	Frequency (MHz)	Chirp (MHz)	PW (uS)	Inter-pulse spacing (uS)	Inter-pulse spacing (uS)	Pulse Start (S)
1	3	5530	17	95	1426	1975	0.117049
2	3	5530	17	85	1385	1016	0.992022
3	3	5530	17	90	1886	1276	2.385102
4	3	5530	17	75	1669	1142	3.061728
5	3	5530	17	65	1476	1835	3.778495
6	1	5530	17	50			4.323119
7	2	5530	17	95	1012		5.18453
8	2	5530	17	90	1062		6.311255
9	2	5530	17	65	1903		6.893439
10	1	5530	17	50			7.206608



11	3	5530	17	50	1830	1925	8.231646
12	1	5530	17	80			9.219234
13	2	5530	17	70	1469		9.864621
14	2	5530	17	90	1005		10.455929
15	3	5530	17	100	1764	1540	11.607584

USA Bin 5 Trial #13

Burst #	Pulses	Frequency (MHz)	Chirp (MHz)	PW (uS)	Inter-pulse spacing (uS)	Inter-pulse spacing (uS)	Pulse Start (S)
1	1	5530	20	95			0.743161
2	1	5530	20	50			1.504215
3	2	5530	20	100	1170		2.043567
4	1	5530	20	70			3.525466
5	2	5530	20	65	1860		4.343937
6	3	5530	20	80	1540	1250	5.337785
7	2	5530	20	60	1487		6.827859
8	1	5530	20	80			7.482839
9	1	5530	20	85			8.734853
10	2	5530	20	75	1697		9.982621
11	1	5530	20	50			10.869624
12	2	5530	20	95	1635		11.370149

USA Bin 5 Trial #14

Burst #	Pulses	Frequency (MHz)	Chirp (MHz)	PW (uS)	Inter-pulse spacing (uS)	Inter-pulse spacing (uS)	Pulse Start (S)
1	1	5530	11	95			0.077575
2	1	5530	11	80			1.178697
3	3	5530	11	50	1989	1829	2.413198
4	2	5530	11	55	1850		2.996365
5	1	5530	11	95			3.988298
6	3	5530	11	55	1130	1404	5.06425
7	3	5530	11	75	1641	1014	5.274687
8	2	5530	11	90	1861		6.55783
9	2	5530	11	60	1049		6.945602
10	3	5530	11	95	1526	1327	7.75455
11	3	5530	11	75	1193	1359	9.384821
12	1	5530	11	90			10.22609
13	3	5530	11	65	1332	1276	10.552575
14	1	5530	11	100			11.24642

USA Bin 5 Trial #15

Burst #	Pulses	Frequency (MHz)	Chirp (MHz)	PW (uS)	Inter-pulse spacing (uS)	Inter-pulse spacing (uS)	Pulse Start (S)
1	3	5530	20	80	1777	1568	0.634235



2	2	5530	20	80	1544		0.836808
3	3	5530	20	60	1267	1090	1.687414
4	1	5530	20	65			2.940598
5	1	5530	20	60			3.934746
6	1	5530	20	95			4.204513
7	3	5530	20	60	1475	1613	4.909298
8	2	5530	20	75	1741		5.927672
9	3	5530	20	65	1727	1676	6.84419
10	3	5530	20	80	1070	1619	7.517056
11	1	5530	20	70			8.416396
12	1	5530	20	95			9.457412
13	2	5530	20	55	1611		10.028908
14	3	5530	20	85	1915	1553	10.819222
15	2	5530	20	65	1304		11.5425

USA Bin 5 Trial #16

Burst #	Pulses	Frequency (MHz)	Chirp (MHz)	PW (uS)	Inter-pulse spacing (uS)	Inter-pulse spacing (uS)	Pulse Start (S)
1	2	5530	12	90	1348		0.377414
2	2	5530	12	65	1595		0.995678
3	1	5530	12	75			1.614679
4	1	5530	12	55			2.316768
5	2	5530	12	85	1276		2.977387
6	1	5530	12	100			3.986974
7	1	5530	12	95			4.904634
8	1	5530	12	75			5.546296
9	3	5530	12	50	1546	1099	6.204212
10	2	5530	12	65	1451		6.722114
11	3	5530	12	80	1914	1851	7.659946
12	1	5530	12	65			8.372852
13	3	5530	12	60	1487	1450	8.682323
14	1	5530	12	65			9.741558
15	1	5530	12	80			10.471398
16	3	5530	12	80	1115	1668	10.836964
17	3	5530	12	85	1405	1753	11.427946

USA Bin 5 Trial #17

Burst #	Pulses	Frequency (MHz)	Chirp (MHz)	PW (uS)	Inter-pulse spacing (uS)	Inter-pulse spacing (uS)	Pulse Start (S)
1	1	5530	18	95			0.316613
2	3	5530	18	60	1647	1586	0.768667
3	1	5530	18	80			1.791017
4	2	5530	18	70	1341		2.468701
5	3	5530	18	60	1568	1594	3.03089



6	1	5530	18	75			3.645297
7	2	5530	18	85	1372		4.061045
8	2	5530	18	95	1701		4.720035
9	2	5530	18	65	1595		5.413123
10	1	5530	18	75			5.832982
11	2	5530	18	50	1699		6.493548
12	3	5530	18	65	1281	1386	7.366545
13	1	5530	18	70			7.775994
14	1	5530	18	55			8.212231
15	1	5530	18	85			9.450925
16	3	5530	18	90	1344	1604	9.649934
17	2	5530	18	85	1407		10.537357
18	1	5530	18	90			10.928057
19	1	5530	18	60			11.631942

USA Bin 5 Trial #18

Burst #	Pulses	Frequency (MHz)	Chirp (MHz)	PW (uS)	Inter-pulse spacing (uS)	Inter-pulse spacing (uS)	Pulse Start (S)
1	1	5530	18	90			1.043482
2	1	5530	18	90			1.657544
3	3	5530	18	60	1120	1188	3.238639
4	3	5530	18	65	1954	1243	4.264445
5	2	5530	18	75	1017		5.422298
6	1	5530	18	90			6.831122
7	2	5530	18	90	1474		8.024305
8	3	5530	18	65	1062	1532	8.581248
9	3	5530	18	60	1811	1427	10.487316
10	2	5530	18	55	1012		11.044519

USA Bin 5 Trial #19

Burst #	Pulses	Frequency (MHz)	Chirp (MHz)	PW (uS)	Inter-pulse spacing (uS)	Inter-pulse spacing (uS)	Pulse Start (S)
1	1	5530	16	80			0.030553
2	3	5530	16	90	1927	1452	1.527586
3	2	5530	16	75	1745		1.817386
4	1	5530	16	55			3.389529
5	1	5530	16	75			3.76602
6	3	5530	16	50	1912	1989	4.998361
7	3	5530	16	80	1896	1933	5.389629
8	3	5530	16	90	1778	1111	6.659174
9	2	5530	16	60	1008		7.109093
10	1	5530	16	75			7.768297
11	2	5530	16	50	1215		8.659956
12	2	5530	16	75	1557		9.786047



13	1	5530	16	50			10.857065
14	1	5530	16	50			11.999903

USA Bin 5 Trial #20

Burst #	Pulses	Frequency (MHz)	Chirp (MHz)	PW (uS)	Inter-pulse spacing (uS)	Inter-pulse spacing (uS)	Pulse Start (S)
1	2	5530	19	75	1385		0.019826
2	1	5530	19	65			1.132094
3	1	5530	19	70			1.866546
4	2	5530	19	60	2000		2.843416
5	1	5530	19	50			3.356574
6	1	5530	19	85			4.041129
7	3	5530	19	85	1829	1155	4.535272
8	3	5530	19	90	1992	1697	5.482614
9	1	5530	19	80			6.05069
10	3	5530	19	85	1466	1352	6.830897
11	3	5530	19	95	1697	1458	7.695568
12	2	5530	19	90	1657		8.490999
13	2	5530	19	100	1216		9.226812
14	1	5530	19	70			10.482131
15	3	5530	19	85	1255	1711	10.894586
16	2	5530	19	80	1714		11.307354

USA Bin 5 Trial #21

Burst #	Pulses	Frequency (MHz)	Chirp (MHz)	PW (uS)	Inter-pulse spacing (uS)	Inter-pulse spacing (uS)	Pulse Start (S)
1	2	5563.2	12	50	1899		0.788933
2	3	5563.2	12	85	1521	1078	1.349194
3	1	5563.2	12	75			2.405782
4	3	5563.2	12	60	1516	1406	3.89063
5	2	5563.2	12	55	1673		4.6853
6	3	5563.2	12	85	1634	1848	5.499199
7	3	5563.2	12	75	1978	1007	6.686179
8	1	5563.2	12	85			8.638597
9	1	5563.2	12	60			9.391931
10	1	5563.2	12	60			9.988638
11	1	5563.2	12	60			11.306648

USA Bin 5 Trial #22

Burst #	Pulses	Frequency (MHz)	Chirp (MHz)	PW (uS)	Inter-pulse spacing (uS)	Inter-pulse spacing (uS)	Pulse Start (S)
1	1	5561.6	16	60			0.688377
2	2	5561.6	16	75	1252		1.026773
3	1	5561.6	16	70			2.928998



4	3	5561.6	16	75	1013	1586	3.650895
5	1	5561.6	16	85			4.442416
6	2	5561.6	16	65	1570		5.420294
7	2	5561.6	16	95	1173		6.667023
8	1	5561.6	16	80			7.628655
9	2	5561.6	16	65	1668		8.497534
10	2	5561.6	16	55	1595		9.014095
11	1	5561.6	16	65			10.711943
12	1	5561.6	16	70			11.835234

USA Bin 5 Trial #23

Burst #	Pulses	Frequency (MHz)	Chirp (MHz)	PW (uS)	Inter-pulse spacing (uS)	Inter-pulse spacing (uS)	Pulse Start (S)
1	1	5564	10	50			0.332418
2	1	5564	10	100			0.98314
3	3	5564	10	100	1215	1056	1.834843
4	2	5564	10	90	1645		2.524302
5	3	5564	10	100	1350	1079	3.477107
6	3	5564	10	95	1840	1978	4.483383
7	1	5564	10	80			5.244551
8	1	5564	10	100			5.714407
9	1	5564	10	65			6.189434
10	2	5564	10	90	1029		6.93968
11	1	5564	10	80			7.561241
12	1	5564	10	65			8.466787
13	2	5564	10	80	1600		9.484706
14	3	5564	10	65	1269	1667	9.975901
15	3	5564	10	80	1338	1025	10.849197
16	2	5564	10	65	1727		11.335037

USA Bin 5 Trial #24

Burst #	Pulses	Frequency (MHz)	Chirp (MHz)	PW (uS)	Inter-pulse spacing (uS)	Inter-pulse spacing (uS)	Pulse Start (S)
1	2	5564.8	8	75	1911		0.486443
2	3	5564.8	8	95	1708	1279	0.877034
3	3	5564.8	8	90	1696	1921	1.886981
4	1	5564.8	8	95			2.163295
5	2	5564.8	8	95	1433		3.177835
6	2	5564.8	8	65	1095		3.47006
7	3	5564.8	8	80	1546	1225	4.549825
8	2	5564.8	8	50	1237		5.169668
9	1	5564.8	8	70			5.836409
10	3	5564.8	8	100	1788	1590	6.216455
11	3	5564.8	8	50	1380	1752	6.74747



12	1	5564.8	8	80			7.389209
13	2	5564.8	8	65	1946		8.606697
14	3	5564.8	8	85	1661	1592	9.247361
15	3	5564.8	8	70	1391	1069	9.788918
16	2	5564.8	8	100	1748		10.21577
17	2	5564.8	8	50	1480		11.078839
18	3	5564.8	8	95	1092	1651	11.603906

USA Bin 5 Trial #25

Burst #	Pulses	Frequency (MHz)	Chirp (MHz)	PW (uS)	Inter-pulse spacing (uS)	Inter-pulse spacing (uS)	Pulse Start (S)
1	2	5564	10	75	1115		0.427931
2	3	5564	10	95	1478	1361	1.562884
3	2	5564	10	100	1494		4.384555
4	3	5564	10	100	1928	1429	5.171836
5	3	5564	10	95	1633	1467	6.38036
6	1	5564	10	65			8.266882
7	2	5564	10	55	1545		9.13941
8	3	5564	10	65	1959	1938	10.540459

USA Bin 5 Trial #26

Burst #	Pulses	Frequency (MHz)	Chirp (MHz)	PW (uS)	Inter-pulse spacing (uS)	Inter-pulse spacing (uS)	Pulse Start (S)
1	2	5565.2	7	100	1903		0.471341
2	1	5565.2	7	65			1.194056
3	3	5565.2	7	65	1501	1006	2.523866
4	2	5565.2	7	60	1443		3.50511
5	1	5565.2	7	60			4.501378
6	1	5565.2	7	55			5.665671
7	1	5565.2	7	70			7.347401
8	3	5565.2	7	55	1909	1805	8.533876
9	3	5565.2	7	80	1999	1008	9.291544
10	3	5565.2	7	70	1346	1452	10.491578
11	3	5565.2	7	90	1119	1755	11.185849

USA Bin 5 Trial #27

Burst #	Pulses	Frequency (MHz)	Chirp (MHz)	PW (uS)	Inter-pulse spacing (uS)	Inter-pulse spacing (uS)	Pulse Start (S)
1	3	5564	10	100	1138	1244	0.430188
2	3	5564	10	70	1352	1272	1.693251
3	3	5564	10	95	1204	1852	2.244323
4	2	5564	10	55	1618		3.271009
5	2	5564	10	90	1129		3.826587
6	1	5564	10	50			5.271063



7	1	5564	10	80			5.819908
8	3	5564	10	90	1591	1519	6.916992
9	2	5564	10	85	1957		7.690776
10	2	5564	10	50	1970		8.623253
11	3	5564	10	70	1933	1233	9.369324
12	3	5564	10	55	1306	1472	10.624437
13	2	5564	10	85	1145		11.505593

USA Bin 5 Trial #28

Burst #	Pulses	Frequency (MHz)	Chirp (MHz)	PW (uS)	Inter-pulse spacing (uS)	Inter-pulse spacing (uS)	Pulse Start (S)
1	2	5564.4	9	85	1230		0.79506
2	2	5564.4	9	100	1145		1.603491
3	3	5564.4	9	60	1595	1062	2.439457
4	2	5564.4	9	70	1581		3.65674
5	2	5564.4	9	65	1926		4.531941
6	2	5564.4	9	65	1411		6.415071
7	3	5564.4	9	60	1265	1932	6.776526
8	1	5564.4	9	90			8.103551
9	1	5564.4	9	85			8.762346
10	3	5564.4	9	70	1438	1501	10.273428
11	1	5564.4	9	95			11.715316

USA Bin 5 Trial #29

Burst #	Pulses	Frequency (MHz)	Chirp (MHz)	PW (uS)	Inter-pulse spacing (uS)	Inter-pulse spacing (uS)	Pulse Start (S)
1	2	5565.6	6	95	1431		0.349525
2	2	5565.6	6	55	1638		2.720234
3	2	5565.6	6	50	1054		4.049001
4	2	5565.6	6	70	1807		5.617104
5	1	5565.6	6	90			6.433856
6	2	5565.6	6	90	1638		8.136485
7	3	5565.6	6	100	1443	1135	9.390395
8	2	5565.6	6	55	1130		11.082919

USA Bin 5 Trial #30

Burst #	Pulses	Frequency (MHz)	Chirp (MHz)	PW (uS)	Inter-pulse spacing (uS)	Inter-pulse spacing (uS)	Pulse Start (S)
1	2	5564.4	9	50	1867		0.548808
2	3	5564.4	9	60	1798	1335	1.022027
3	1	5564.4	9	75			1.987257
4	3	5564.4	9	50	1592	1383	2.413692
5	1	5564.4	9	55			3.789807
6	3	5564.4	9	65	1407	1961	4.578005



7	3	5564.4	9	100	1740	1895	5.391804
8	1	5564.4	9	65			6.233621
9	1	5564.4	9	90			6.439122
10	1	5564.4	9	50			7.267925
11	2	5564.4	9	55	1233		8.764544
12	2	5564.4	9	85	1312		9.393318
13	3	5564.4	9	85	1904	1757	10.366061
14	2	5564.4	9	60	1254		11.161833
15	3	5564.4	9	90	1449	1167	11.544941

USA Frequency Hopping Trial #1

Hop #	Freq (GHz)	Pulse Start (mS)
12	5507	36
17	5529	51
19	5516	57
20	5542	60
22	5519	66
32	5531	96
39	5520	117
40	5504	120
44	5502	132
45	5561	135
51	5530	153
71	5494	213
79	5563	237
80	5539	240
90	5512	270

USA Frequency Hopping Trial #2

Hop #	Freq (GHz)	Pulse Start (mS)
17	5566	51
19	5544	57
24	5493	72
25	5545	75
28	5514	84
35	5523	105
74	5535	222
75	5496	225
76	5562	228
80	5543	240
81	5567	243
82	5538	246
83	5524	249



93	5516	279
96	5511	288
99	5503	297

USA Frequency Hopping Trial #3

Hop #	Freq (GHz)	Pulse Start (mS)
4	5501	12
19	5547	57
30	5550	90
31	5554	93
32	5498	96
35	5523	105
38	5509	114
41	5552	123
47	5492	141
49	5533	147
68	5502	204
76	5504	228
81	5503	243
84	5500	252
86	5560	258
96	5559	288
99	5525	297

USA Frequency Hopping Trial #4

Hop #	Freq (GHz)	Pulse Start (mS)
4	5544	12
12	5547	36
17	5492	51
32	5564	96
33	5532	99
43	5506	129
45	5499	135
53	5536	159
57	5511	171
74	5496	222
76	5503	228
82	5527	246
89	5501	267
98	5555	294

USA Frequency Hopping Trial #5

Hop #	Freq (GHz)	Pulse Start (mS)
0	5492	0



4	5508	12
9	5548	27
10	5525	30
11	5529	33
21	5510	63
25	5501	75
29	5519	87
32	5494	96
36	5539	108
42	5543	126
45	5536	135
46	5568	138
55	5509	165
60	5550	180
65	5541	195
71	5556	213
83	5503	249
84	5542	252
90	5551	270

USA Frequency Hopping Trial #6

Hop #	Freq (GHz)	Pulse Start (mS)
5	5567	15
12	5519	36
19	5546	57
25	5548	75
26	5547	78
39	5533	117
43	5556	129
45	5566	135
52	5520	156
60	5564	180
76	5515	228
81	5507	243
86	5498	258
94	5549	282
95	5504	285

USA Frequency Hopping Trial #7

Hop #	Freq (GHz)	Pulse Start (mS)
3	5502	9
12	5547	36
16	5548	48
20	5527	60



24	5539	72
39	5503	117
49	5531	147
51	5514	153
56	5543	168
57	5560	171
67	5517	201
73	5529	219
75	5561	225
77	5509	231
78	5541	234
98	5515	294

USA Frequency Hopping Trial #8

Hop #	Freq (GHz)	Pulse Start (mS)
21	5546	63
24	5524	72
32	5499	96
44	5537	132
54	5504	162
59	5556	177
73	5558	219
89	5554	267

USA Frequency Hopping Trial #9

Hop #	Freq (GHz)	Pulse Start (mS)
12	5554	36
22	5523	66
27	5538	81
41	5564	123
43	5551	129
51	5529	153
54	5541	162
62	5509	186
70	5560	210
73	5498	219
74	5536	222
77	5527	231
80	5506	240
81	5542	243
88	5568	264

USA Frequency Hopping Trial #10

Hop #	Freq (GHz)	Pulse Start (mS)
-------	---------------	---------------------



3	5563	9
4	5517	12
20	5531	60
39	5500	117
49	5546	147
53	5511	159
58	5541	174
59	5556	177
75	5494	225
78	5519	234
79	5557	237

USA Frequency Hopping Trial #11

Hop #	Freq (GHz)	Pulse Start (mS)
2	5505	6
4	5550	12
7	5536	21
18	5537	54
27	5504	81
30	5507	90
31	5535	93
37	5501	111
42	5538	126
51	5559	153
58	5529	174
65	5517	195
68	5509	204

USA Frequency Hopping Trial #12

Hop #	Freq (GHz)	Pulse Start (mS)
5	5507	15
9	5531	27
15	5533	45
16	5532	48
17	5510	51
20	5494	60
23	5499	69
37	5519	111
51	5560	153
56	5565	168
75	5497	225
79	5554	237
83	5495	249
95	5553	285



USA Frequency Hopping Trial #13

Hop #	Freq (GHz)	Pulse Start (mS)
9	5522	27
12	5531	36
15	5515	45
18	5505	54
22	5556	66
24	5503	72
49	5498	147
61	5511	183
65	5493	195
77	5548	231
81	5559	243

USA Frequency Hopping Trial #14

Hop #	Freq (GHz)	Pulse Start (mS)
9	5561	27
12	5494	36
15	5507	45
19	5551	57
37	5554	111
42	5559	126
64	5523	192
70	5539	210
72	5510	216
74	5505	222
76	5534	228
79	5540	237
84	5527	252
88	5564	264
89	5516	267
95	5550	285
98	5547	294

USA Frequency Hopping Trial #15

Hop #	Freq (GHz)	Pulse Start (mS)
3	5559	9
5	5525	15
9	5561	27
11	5498	33
14	5543	42
19	5527	57
20	5541	60



26	5515	78
28	5523	84
56	5518	168
62	5568	186
63	5509	189
69	5542	207
70	5512	210
74	5565	222
79	5535	237
99	5531	297

USA Frequency Hopping Trial #16

Hop #	Freq (GHz)	Pulse Start (mS)
11	5505	33
16	5554	48
21	5521	63
24	5546	72
36	5528	108
38	5555	114
40	5515	120
58	5567	174
66	5553	198
70	5517	210
87	5568	261
88	5503	264
96	5539	288

USA Frequency Hopping Trial #17

Hop #	Freq (GHz)	Pulse Start (mS)
3	5495	9
4	5551	12
6	5548	18
16	5560	48
49	5547	147
53	5563	159
55	5499	165
60	5526	180
64	5520	192
68	5566	204
81	5494	243
84	5524	252
85	5552	255
95	5561	285

USA Frequency Hopping Trial #18



Hop #	Freq (GHz)	Pulse Start (mS)
14	5509	42
15	5549	45
16	5502	48
24	5526	72
25	5548	75
26	5533	78
35	5559	105
41	5568	123
54	5516	162
57	5492	171
60	5554	180
71	5563	213
76	5512	228
78	5542	234
84	5547	252
88	5560	264

USA Frequency Hopping Trial #19

Hop #	Freq (GHz)	Pulse Start (mS)
1	5559	3
7	5553	21
29	5564	87
39	5509	117
45	5521	135
52	5526	156
65	5505	195
71	5497	213
85	5515	255
95	5492	285

USA Frequency Hopping Trial #20

Hop #	Freq (GHz)	Pulse Start (mS)
1	5519	3
2	5520	6
13	5529	39
20	5543	60
21	5556	63
26	5513	78
43	5507	129
44	5509	132
45	5533	135
46	5567	138



47	5510	141
48	5550	144
49	5523	147
58	5563	174
59	5515	177
60	5541	180
63	5534	189
66	5544	198
67	5554	201
69	5542	207
72	5562	216
85	5557	255
92	5536	276

USA Frequency Hopping Trial #21

Hop #	Freq (GHz)	Pulse Start (mS)
2	5496	6
19	5509	57
28	5532	84
30	5543	90
34	5527	102
35	5554	105
42	5529	126
51	5548	153
53	5522	159
60	5536	180
68	5506	204
70	5517	210
71	5513	213
79	5512	237
85	5520	255
86	5521	258
87	5545	261
93	5524	279
97	5516	291
99	5560	297

USA Frequency Hopping Trial #22

Hop #	Freq (GHz)	Pulse Start (mS)
0	5534	0
3	5526	9
8	5494	24
15	5515	45
21	5565	63



25	5554	75
27	5525	81
45	5559	135
46	5535	138
47	5555	141
49	5516	147
51	5536	153
52	5523	156
55	5517	165
58	5508	174
64	5556	192
66	5553	198
67	5548	201
70	5563	210
75	5496	225
76	5512	228
84	5540	252
96	5521	288

USA Frequency Hopping Trial #23

Hop #	Freq (GHz)	Pulse Start (mS)
1	5508	3
4	5555	12
8	5531	24
18	5525	54
27	5515	81
40	5512	120
43	5558	129
45	5564	135
46	5545	138
48	5566	144
49	5568	147
68	5559	204
72	5497	216
73	5539	219
78	5543	234
81	5492	243
92	5553	276
99	5501	297

USA Frequency Hopping Trial #24

Hop #	Freq (GHz)	Pulse Start (mS)
8	5540	24
11	5528	33



12	5508	36
15	5548	45
20	5522	60
26	5495	78
27	5517	81
28	5492	84
32	5511	96
38	5555	114
56	5556	168
68	5531	204
73	5521	219
82	5543	246
83	5558	249
87	5506	261
91	5504	273
97	5539	291

USA Frequency Hopping Trial #25

Hop #	Freq (GHz)	Pulse Start (mS)
1	5566	3
18	5505	54
33	5535	99
40	5506	120
49	5531	147
50	5538	150
67	5558	201
78	5524	234
83	5565	249
91	5543	273

USA Frequency Hopping Trial #26

Hop #	Freq (GHz)	Pulse Start (mS)
5	5502	15
8	5528	24
45	5519	135
49	5526	147
65	5543	195
69	5532	207
75	5565	225
77	5552	231
84	5538	252
87	5542	261

USA Frequency Hopping Trial #27



Hop #	Freq (GHz)	Pulse Start (mS)
2	5527	6
12	5504	36
13	5543	39
19	5516	57
32	5498	96
34	5517	102
41	5538	123
49	5536	147
55	5529	165
71	5524	213
74	5519	222
98	5496	294

USA Frequency Hopping Trial #28

Hop #	Freq (GHz)	Pulse Start (mS)
1	5552	3
14	5529	42
29	5537	87
30	5516	90
35	5545	105
37	5514	111
48	5510	144
51	5540	153
55	5561	165
63	5560	189
71	5519	213
73	5520	219
78	5523	234
79	5504	237
89	5530	267
92	5555	276
96	5500	288

USA Frequency Hopping Trial #29

Hop #	Freq (GHz)	Pulse Start (mS)
5	5528	15
10	5534	30
17	5510	51
19	5564	57
22	5519	66
26	5505	78
38	5545	114



43	5553	129
57	5548	171
59	5522	177
60	5529	180
69	5565	207
71	5524	213
81	5527	243
92	5541	276
97	5525	291

USA Frequency Hopping Trial #30

Hop #	Freq (GHz)	Pulse Start (mS)
10	5542	30
11	5518	33
29	5509	87
34	5501	102
62	5496	186
66	5539	198
68	5516	204
70	5559	210
71	5495	213
83	5545	249
99	5565	297

Channel 5250 MHz, 160MHz BW, Statistical Performance
USA Bin 1A/1B

freq=5290, rate=m0x1, traffic=420, bw=76.0

Trial	Frequency	Pulses	PW (uS)	PRI (uS)	1=Detection 0=No Detection	Detection Percentage	Limit
1	5255	65	1	818	1	96.7%	60.0%
2	5255	68	1	778	1		
3	5255	78	1	678	1		
4	5263	61	1	878	1		
5	5263	72	1	738	1		
6	5263	70	1	758	1		
7	5270	76	1	698	1		
8	5270	89	1	598	1		
9	5270	63	1	838	1		
10	5275	81	1	658	1		
11	5275	81	1	658	1		
12	5285	57	1	938	1		
13	5285	83	1	638	1		
14	5285	61	1	878	1		
15	5290	68	1	778	1		
16	5290	26	1	2062	1		
17	5290	80	1	665	1		
18	5295	41	1	1317	1		
19	5295	29	1	1844	1		
20	5295	51	1	1047	1		
21	5305	34	1	1563	1		
22	5305	28	1	1917	1		
23	5313	20	1	2751	1		
24	5313	18	1	2941	1		
25	5313	30	1	1782	1		
26	5322	20	1	2669	1		
27	5322	67	1	794	1		
28	5322	36	1	1467	1		
29	5325	66	1	802	1		
30	5325	22	1	2405	0		



USA Bin 1A/1B

freq=5290, rate=m0x1, traffic=420, bw=76.0

Trial	Frequency	Pulses	PW (uS)	PRI (uS)	1=Detection 0=No Detection	Detection Percentage	Limit
1	5255	57	1	938	1	93.3%	60.0%
2	5255	78	1	678	1		
3	5255	59	1	898	1		
4	5263	62	1	858	1		
5	5263	81	1	658	1		
6	5263	63	1	838	1		
7	5270	63	1	838	1		
8	5270	83	1	638	1		
9	5270	65	1	818	1		
10	5275	78	1	678	1		
11	5275	70	1	758	1		
12	5285	78	1	678	1		
13	5285	57	1	938	1		
14	5285	74	1	718	0		
15	5290	59	1	898	1		
16	5290	18	1	3007	1		
17	5290	20	1	2645	0		
18	5295	19	1	2849	1		
19	5295	21	1	2561	1		
20	5295	36	1	1470	1		
21	5305	100	1	533	1		
22	5305	26	1	2102	1		
23	5313	22	1	2420	1		
24	5313	51	1	1054	1		
25	5313	64	1	834	1		
26	5322	24	1	2277	1		
27	5322	20	1	2723	1		
28	5322	62	1	862	1		
29	5325	35	1	1521	1		
30	5325	19	1	2832	1		



USA Bin 2

freq=5290, rate=m0x1, traffic=420, bw=76.0

Trial	Frequency	Pulses	PW (uS)	PRI (uS)	1=Detection 0=No Detection	Detection Percentage	Limit
1	5255	24	2.7	224	0	86.7%	60.0%
2	5255	29	3.4	203	1		
3	5255	24	2.3	213	1		
4	5263	29	2.3	160	1		
5	5263	26	2	212	1		
6	5263	25	1.1	223	1		
7	5270	28	3.8	176	1		
8	5270	23	3.3	193	1		
9	5270	24	1.4	221	1		
10	5275	25	5	210	1		
11	5275	28	4.8	172	1		
12	5285	28	2.8	178	1		
13	5285	27	1.5	161	1		
14	5285	25	3.4	208	1		
15	5290	24	4.7	209	0		
16	5290	24	3.4	194	1		
17	5290	25	2.1	159	1		
18	5295	27	4.7	226	0		
19	5295	24	4.1	206	1		
20	5295	28	1.6	187	0		
21	5305	25	1.3	190	1		
22	5305	27	1.2	178	1		
23	5313	23	3.6	217	1		
24	5313	29	1.9	197	1		
25	5313	24	3	200	1		
26	5322	23	3.9	211	1		
27	5322	25	4.7	191	1		
28	5322	24	1.4	212	1		
29	5325	29	2	173	1		
30	5325	25	5	181	1		



USA Bin 3

freq=5290, rate=m0x1, traffic=420, bw=76.0

Trial	Frequency	Pulses	PW (uS)	PRI (uS)	1=Detection 0=No Detection	Detection Percentage	Limit
1	5255	16	7.3	480	1	73.3%	60.0%
2	5255	18	8.9	486	1		
3	5255	16	7.8	241	0		
4	5263	17	8.2	254	1		
5	5263	18	6.9	407	1		
6	5263	16	6.6	359	0		
7	5270	16	8.9	326	1		
8	5270	16	8.1	411	1		
9	5270	17	7.7	436	0		
10	5275	17	7.3	430	1		
11	5275	16	6.9	374	0		
12	5285	17	6	201	1		
13	5285	18	6.3	237	1		
14	5285	16	7.7	245	1		
15	5290	18	9.8	216	1		
16	5290	17	8.8	234	1		
17	5290	16	8	269	0		
18	5295	17	7.9	312	1		
19	5295	18	9.8	491	1		
20	5295	17	9.4	277	1		
21	5305	16	7.6	490	1		
22	5305	16	8.1	368	1		
23	5313	16	6.3	304	1		
24	5313	18	6.3	309	1		
25	5313	18	6.3	209	0		
26	5322	18	9.9	322	1		
27	5322	16	6.5	294	0		
28	5322	17	6.8	426	1		
29	5325	17	7	315	0		
30	5325	18	8.9	217	1		



USA Bin 4

freq=5290, rate=m0x1, traffic=420, bw=76.0

Trial	Frequency	Pulses	PW (uS)	PRI (uS)	1=Detection 0=No Detection	Detection Percentage	Limit
1	5255	16	18.3	232	1	80.0%	60.0%
2	5255	16	13.6	440	1		
3	5255	13	19	200	0		
4	5263	14	18.9	307	1		
5	5263	15	18.2	256	1		
6	5263	15	14.6	345	0		
7	5270	13	19.1	286	1		
8	5270	16	16.7	485	0		
9	5270	12	18	442	1		
10	5275	14	13.4	312	0		
11	5275	13	11.9	459	1		
12	5285	12	12	220	1		
13	5285	15	11.7	216	0		
14	5285	16	13	411	1		
15	5290	12	11.6	402	1		
16	5290	14	13.7	493	1		
17	5290	12	18.2	463	1		
18	5295	13	18.7	454	1		
19	5295	12	18.8	336	1		
20	5295	15	13.9	231	1		
21	5305	12	18.7	465	1		
22	5305	16	11.4	204	1		
23	5313	12	19.2	319	0		
24	5313	12	13.1	387	1		
25	5313	12	11.1	270	1		
26	5322	12	15.7	384	1		
27	5322	16	18.3	347	1		
28	5322	16	14.6	325	1		
29	5325	16	15.8	352	1		
30	5325	16	16.9	224	1		



USA
Bin
5

freq=5290, rate=m0x1, traffic=420,
bw=76.0

Trial	Burst #	Pulses	Frequency (MHz)	Chirp (MHz)	PW (uS)	Inter-pulse spacing (uS)	Inter-pulse spacing (uS)	Pulse Start (S)	1=Detection 0=No Detection	Detection Percentage	Limit
1	1	2	5255.6	9	85	1233		0.584511	1	100.0%	80.0%
2	1	2	5256.4	11	100	1674		0.37948	1		
3	1	3	5258.4	16	60	1937	1194	0.992216	1		
4	1	1	5257.2	13	85			0.073771	1		
5	1	3	5256	10	70	1006	1118	0.127458	1		
6	1	1	5259.2	18	65			0.633978	1		
7	1	1	5258.8	17	70			0.370153	1		
8	1	1	5254.4	6	65			1.000568	1		
9	1	1	5257.2	13	95			0.402009	1		
10	1	1	5257.2	13	90			0.014983	1		
11	1	2	5290	11	70	1080		0.688681	1		
12	1	2	5290	16	90	1620		0.702058	1		
13	1	2	5290	6	80	1528		0.216932	1		
14	1	2	5290	9	85	1282		0.079763	1		
15	1	3	5290	16	75	1756	1797	0.739789	1		
16	1	2	5290	17	65	1072		0.548225	1		
17	1	1	5290	7	65			0.652638	1		
18	1	2	5290	19	80	1803		0.349415	1		
19	1	3	5290	7	100	1287	1074	0.633239	1		
20	1	3	5290	14	70	1858	1016	0.597337	1		
21	1	1	5323.2	12	90			0.374285	1		
22	1	3	5320	20	80	1330	1857	0.06665	1		
23	1	2	5321.2	17	55	1156		0.054522	1		
24	1	1	5322.8	13	50			0.09317	1		
25	1	3	5324.8	8	100	1656	1623	0.580919	1		
26	1	3	5320	20	100	1605	1752	0.367312	1		
27	1	2	5323.2	12	50	1573		0.502527	1		
28	1	3	5326	5	90	1513	1337	0.390902	1		
29	1	1	5320.8	18	75			0.102507	1		
30	1	3	5325.6	6	60	1211	1676	0.892232	1		



USA Frequency Hopping

freq=5290, rate=m0x1, traffic=420, bw=76.0

Trial	Hop #	Freq (GHz)	Pulse Start (mS)	1=Detection 0=No Detection	Detection Percentage	Limit
1	6	5286	18	1	100.0%	70.0%
2	0	5312	0	1		
3	2	5315	6	1		
4	0	5264	0	1		
5	2	5255	6	1		
6	4	5319	12	1		
7	5	5326	15	1		
8	2	5293	6	1		
9	2	5291	6	1		
10	3	5296	9	1		
11	3	5328	9	1		
12	4	5322	12	1		
13	1	5285	3	1		
14	3	5317	9	1		
15	7	5299	21	1		
16	20	5307	60	1		
17	2	5309	6	1		
18	0	5258	0	1		
19	1	5267	3	1		
20	1	5311	3	1		
21	0	5268	0	1		
22	5	5297	15	1		
23	1	5266	3	1		
24	0	5320	0	1		
25	7	5256	21	1		
26	0	5292	0	1		
27	26	5314	78	1		
28	5	5315	15	1		
29	0	5300	0	1		
30	2	5253	6	1		

In addition an average minimum percentage of successful detection across all four Short pulse radar test waveforms is required and is calculated as follows:

$$\frac{P_d 1 + P_d 2 + P_d 3 + P_d 4}{4} = (96.7\% + 93.3\% + 86.7\% + 73.3\% + 80.0\%) / 5 = 86.0\% (>80\%)$$



USA Bin 5 Trial #1

Burst #	Pulses	Frequency (MHz)	Chirp (MHz)	PW (uS)	Inter-pulse spacing (uS)	Inter-pulse spacing (uS)	Pulse Start (S)
1	2	5255.6	9	85	1233		0.584511
2	3	5255.6	9	90	1097	1365	1.160477
3	3	5255.6	9	50	1992	1187	1.766321
4	2	5255.6	9	90	1349		2.262641
5	2	5255.6	9	90	1971		3.171433
6	2	5255.6	9	80	1065		3.47166
7	2	5255.6	9	75	1677		4.557151
8	2	5255.6	9	95	1394		4.738684
9	3	5255.6	9	100	1753	1577	5.741228
10	2	5255.6	9	100	1629		6.144279
11	1	5255.6	9	60			6.856615
12	1	5255.6	9	75			7.50786
13	2	5255.6	9	95	1722		8.292029
14	3	5255.6	9	85	1338	1401	8.820497
15	3	5255.6	9	80	1663	1066	9.960795
16	2	5255.6	9	90	1104		10.530438
17	1	5255.6	9	85			11.053371
18	3	5255.6	9	85	1125	1778	11.961269

USA Bin 5 Trial #2

Burst #	Pulses	Frequency (MHz)	Chirp (MHz)	PW (uS)	Inter-pulse spacing (uS)	Inter-pulse spacing (uS)	Pulse Start (S)
1	2	5256.4	11	100	1674		0.37948
2	3	5256.4	11	55	1099	1358	1.100162
3	3	5256.4	11	70	1153	1945	1.817292
4	2	5256.4	11	85	1537		2.490518
5	1	5256.4	11	80			2.548788
6	3	5256.4	11	65	1383	1804	3.266843
7	1	5256.4	11	60			3.936598
8	2	5256.4	11	90	1888		5.010202
9	3	5256.4	11	100	1473	1273	5.568483
10	2	5256.4	11	65	1761		5.941871
11	1	5256.4	11	55			6.919106
12	1	5256.4	11	65			7.127638
13	1	5256.4	11	85			8.199274
14	2	5256.4	11	60	1268		8.626385
15	2	5256.4	11	85	1839		9.214034
16	2	5256.4	11	50	1660		9.583255
17	2	5256.4	11	65	1624		10.172943
18	2	5256.4	11	65	1203		10.867741



19 1 5256.4 11 80 11.907698
 USA Bin 5 Trial #3

Burst #	Pulses	Frequency (MHz)	Chirp (MHz)	PW (uS)	Inter-pulse spacing (uS)	Inter-pulse spacing (uS)	Pulse Start (S)
1	3	5258.4	16	60	1937	1194	0.992216
2	2	5258.4	16	75	1469		1.871972
3	3	5258.4	16	60	1972	1520	3.03425
4	1	5258.4	16	100			3.903209
5	3	5258.4	16	70	1263	1568	4.910493
6	1	5258.4	16	75			5.567704
7	3	5258.4	16	100	1763	1027	7.282233
8	2	5258.4	16	65	1370		8.211002
9	1	5258.4	16	50			9.692276
10	1	5258.4	16	95			10.494552
11	3	5258.4	16	50	1397	1095	11.734977

USA Bin 5 Trial #4

Burst #	Pulses	Frequency (MHz)	Chirp (MHz)	PW (uS)	Inter-pulse spacing (uS)	Inter-pulse spacing (uS)	Pulse Start (S)
1	1	5257.2	13	85			0.073771
2	1	5257.2	13	85			0.976363
3	2	5257.2	13	55	1878		1.611982
4	2	5257.2	13	55	1430		1.98744
5	2	5257.2	13	50	1062		2.494855
6	1	5257.2	13	55			3.557998
7	1	5257.2	13	55			3.862814
8	3	5257.2	13	100	1648	1955	4.375758
9	2	5257.2	13	65	1533		4.847409
10	2	5257.2	13	60	1244		5.648049
11	3	5257.2	13	80	1451	1163	6.566784
12	2	5257.2	13	95	1454		6.826293
13	2	5257.2	13	85	1398		7.21643
14	1	5257.2	13	85			7.950301
15	3	5257.2	13	50	1065	1519	8.405223
16	2	5257.2	13	85	1881		9.576459
17	1	5257.2	13	60			10.153066
18	1	5257.2	13	50			10.424552
19	3	5257.2	13	90	1995	1483	10.88605
20	3	5257.2	13	95	1511	1766	11.889616

USA Bin 5 Trial #5

Burst #	Pulses	Frequency (MHz)	Chirp (MHz)	PW (uS)	Inter-pulse spacing (uS)	Inter-pulse spacing (uS)	Pulse Start (S)
---------	--------	-----------------	-------------	---------	--------------------------	--------------------------	-----------------



1	3	5256	10	70	1006	1118	0.127458
2	3	5256	10	70	1603	1186	1.372108
3	3	5256	10	95	1115	1590	1.830742
4	3	5256	10	65	1604	1856	2.783657
5	3	5256	10	100	1223	1528	3.434578
6	2	5256	10	80	1769		4.472015
7	1	5256	10	85			5.413038
8	2	5256	10	65	1581		6.442333
9	1	5256	10	95			7.059858
10	3	5256	10	95	1199	1998	7.843677
11	3	5256	10	65	1151	1178	8.881732
12	1	5256	10	85			9.84628
13	1	5256	10	85			10.385604
14	2	5256	10	70	1840		11.638569

USA Bin 5 Trial #6

Burst #	Pulses	Frequency (MHz)	Chirp (MHz)	PW (uS)	Inter-pulse spacing (uS)	Inter-pulse spacing (uS)	Pulse Start (S)
1	1	5259.2	18	65			0.633978
2	1	5259.2	18	70			0.784633
3	2	5259.2	18	70	1835		1.720175
4	1	5259.2	18	85			2.288603
5	3	5259.2	18	75	1793	1909	2.992018
6	3	5259.2	18	90	1467	1028	3.821355
7	3	5259.2	18	80	1258	1957	4.628613
8	1	5259.2	18	65			4.978314
9	2	5259.2	18	95	1320		5.858211
10	1	5259.2	18	75			6.053802
11	3	5259.2	18	70	1526	1655	6.732578
12	2	5259.2	18	100	1574		7.621778
13	3	5259.2	18	50	1801	1369	8.493005
14	2	5259.2	18	80	1109		9.272469
15	3	5259.2	18	90	1683	1683	9.641199
16	3	5259.2	18	70	1932	1688	10.473663
17	2	5259.2	18	60	1859		11.203881
18	2	5259.2	18	65	1741		11.8835

USA Bin 5 Trial #7

Burst #	Pulses	Frequency (MHz)	Chirp (MHz)	PW (uS)	Inter-pulse spacing (uS)	Inter-pulse spacing (uS)	Pulse Start (S)
1	1	5258.8	17	70			0.370153
2	3	5258.8	17	50	1032	1718	2.1278
3	3	5258.8	17	90	1582	1215	3.40385
4	2	5258.8	17	70	1953		3.75252



5	1	5258.8	17	60		5.25204
6	2	5258.8	17	70	1555	6.155286
7	1	5258.8	17	90		7.333513
8	2	5258.8	17	95	1124	8.951092
9	2	5258.8	17	85	1201	9.74853
10	1	5258.8	17	70		11.171271

USA Bin 5 Trial #8

Burst #	Pulses	Frequency (MHz)	Chirp (MHz)	PW (uS)	Inter-pulse spacing (uS)	Inter-pulse spacing (uS)	Pulse Start (S)
1	1	5254.4	6	65			1.000568
2	1	5254.4	6	100			1.326148
3	2	5254.4	6	85	1171		2.462655
4	1	5254.4	6	50			3.717997
5	2	5254.4	6	70	1922		4.486247
6	1	5254.4	6	85			5.475149
7	2	5254.4	6	100	1347		7.63377
8	2	5254.4	6	65	1758		8.185528
9	1	5254.4	6	90			9.276278
10	1	5254.4	6	70			9.821159
11	1	5254.4	6	55			11.036318

USA Bin 5 Trial #9

Burst #	Pulses	Frequency (MHz)	Chirp (MHz)	PW (uS)	Inter-pulse spacing (uS)	Inter-pulse spacing (uS)	Pulse Start (S)
1	1	5257.2	13	95			0.402009
2	3	5257.2	13	95	1341	1269	0.937273
3	2	5257.2	13	70	1977		1.869167
4	2	5257.2	13	75	1941		2.682438
5	3	5257.2	13	70	1459	1499	3.493702
6	1	5257.2	13	95			3.547374
7	1	5257.2	13	100			4.800003
8	3	5257.2	13	50	1993	1291	5.61204
9	3	5257.2	13	75	1837	1530	6.154096
10	3	5257.2	13	80	1863	1076	6.720855
11	1	5257.2	13	50			7.404433
12	3	5257.2	13	55	1344	1699	8.43718
13	1	5257.2	13	75			8.475853
14	2	5257.2	13	95	1651		9.430662
15	2	5257.2	13	55	1372		10.507003
16	3	5257.2	13	50	1767	1677	10.648979
17	3	5257.2	13	80	1012	1849	11.602959

USA Bin 5 Trial #10



Burst #	Pulses	Frequency (MHz)	Chirp (MHz)	PW (uS)	Inter-pulse spacing (uS)	Inter-pulse spacing (uS)	Pulse Start (S)
1	1	5257.2	13	90			0.014983
2	1	5257.2	13	60			0.842512
3	2	5257.2	13	70	1299		1.848597
4	1	5257.2	13	65			2.205444
5	2	5257.2	13	90	1483		2.978759
6	1	5257.2	13	65			3.890827
7	3	5257.2	13	65	1040	1937	4.120199
8	1	5257.2	13	55			4.934873
9	2	5257.2	13	85	1379		5.9929
10	3	5257.2	13	90	1502	1773	6.395103
11	3	5257.2	13	80	1130	1016	6.818792
12	2	5257.2	13	65	1780		7.916599
13	2	5257.2	13	95	1025		8.175661
14	1	5257.2	13	75			8.772819
15	3	5257.2	13	75	1393	1767	9.755125
16	2	5257.2	13	95	1537		10.308501
17	3	5257.2	13	70	1203	1666	10.83629
18	1	5257.2	13	80			11.642335

USA Bin 5 Trial #11

Burst #	Pulses	Frequency (MHz)	Chirp (MHz)	PW (uS)	Inter-pulse spacing (uS)	Inter-pulse spacing (uS)	Pulse Start (S)
1	2	5290	11	70	1080		0.688681
2	1	5290	11	80			1.220385
3	3	5290	11	100	1842	1404	1.70983
4	2	5290	11	80	1333		2.475848
5	3	5290	11	85	1141	1954	3.44871
6	3	5290	11	100	1754	1174	3.702417
7	2	5290	11	70	1503		4.823306
8	2	5290	11	100	1851		5.297956
9	2	5290	11	50	1628		5.866293
10	2	5290	11	90	1117		6.356468
11	2	5290	11	60	1446		7.700672
12	1	5290	11	50			7.902533
13	1	5290	11	85			9.148538
14	2	5290	11	60	1004		9.827322
15	3	5290	11	90	1390	1731	10.082332
16	2	5290	11	50	1587		10.741846
17	3	5290	11	100	1036	1479	11.344057

USA Bin 5 Trial #12



Burst #	Pulses	Frequency (MHz)	Chirp (MHz)	PW (uS)	Inter-pulse spacing (uS)	Inter-pulse spacing (uS)	Pulse Start (S)
1	2	5290	16	90	1620		0.702058
2	3	5290	16	70	1474	1586	1.376277
3	2	5290	16	60	1985		2.207923
4	3	5290	16	75	1564	1036	3.680699
5	1	5290	16	70			4.182956
6	3	5290	16	70	1775	1105	5.894419
7	1	5290	16	65			6.674124
8	1	5290	16	100			7.811242
9	3	5290	16	65	1649	1710	8.39267
10	2	5290	16	75	1388		9.761202
11	2	5290	16	80	1562		10.57845
12	3	5290	16	85	1435	1443	11.877817

USA Bin 5 Trial #13

Burst #	Pulses	Frequency (MHz)	Chirp (MHz)	PW (uS)	Inter-pulse spacing (uS)	Inter-pulse spacing (uS)	Pulse Start (S)
1	2	5290	6	80	1528		0.216932
2	2	5290	6	95	1697		1.477236
3	2	5290	6	80	1428		2.908757
4	3	5290	6	75	1628	1161	3.973275
5	1	5290	6	100			4.803368
6	3	5290	6	95	1629	1715	6.000882
7	2	5290	6	85	1665		6.630283
8	2	5290	6	60	1278		8.719933
9	2	5290	6	95	1579		9.654185
10	2	5290	6	70	1989		10.006516
11	1	5290	6	55			11.611629

USA Bin 5 Trial #14

Burst #	Pulses	Frequency (MHz)	Chirp (MHz)	PW (uS)	Inter-pulse spacing (uS)	Inter-pulse spacing (uS)	Pulse Start (S)
1	2	5290	9	85	1282		0.079763
2	3	5290	9	90	1232	1541	0.78949
3	3	5290	9	85	1773	1532	1.568181
4	2	5290	9	100	1124		2.191207
5	1	5290	9	85			2.528129
6	3	5290	9	90	1911	1814	3.180654
7	2	5290	9	95	1657		3.732983
8	2	5290	9	50	1589		4.358238
9	2	5290	9	100	1752		5.32581
10	1	5290	9	95			5.558973



11	1	5290	9	50			6.173679
12	3	5290	9	70	1348	1143	7.056206
13	3	5290	9	55	1006	1360	7.215524
14	3	5290	9	85	1941	1668	8.117765
15	2	5290	9	50	1572		8.679646
16	2	5290	9	50	1368		9.330955
17	2	5290	9	70	1878		10.021486
18	3	5290	9	85	1139	1441	10.528924
19	2	5290	9	55	1535		10.987471
20	2	5290	9	90	1591		11.542535

USA Bin 5 Trial #15

Burst #	Pulses	Frequency (MHz)	Chirp (MHz)	PW (uS)	Inter-pulse spacing (uS)	Inter-pulse spacing (uS)	Pulse Start (S)
1	3	5290	16	75	1756	1797	0.739789
2	1	5290	16	80			1.620192
3	1	5290	16	100			1.721434
4	2	5290	16	90	1967		2.719225
5	2	5290	16	80	1778		4.121477
6	3	5290	16	65	1444	1376	5.039733
7	2	5290	16	80	1668		5.319688
8	3	5290	16	95	1256	1776	6.62821
9	2	5290	16	80	1972		7.41986
10	1	5290	16	85			8.267072
11	2	5290	16	50	1899		8.755576
12	1	5290	16	95			9.765113
13	3	5290	16	50	1217	1508	10.323776
14	3	5290	16	50	1219	1499	11.928195

USA Bin 5 Trial #16

Burst #	Pulses	Frequency (MHz)	Chirp (MHz)	PW (uS)	Inter-pulse spacing (uS)	Inter-pulse spacing (uS)	Pulse Start (S)
1	2	5290	17	65	1072		0.548225
2	3	5290	17	95	1095	1930	0.905384
3	2	5290	17	60	1720		1.744541
4	2	5290	17	95	1723		2.95214
5	2	5290	17	50	1347		3.317008
6	2	5290	17	70	1813		4.227566
7	2	5290	17	95	1640		5.168926
8	1	5290	17	80			5.608967
9	2	5290	17	85	1051		6.13991
10	1	5290	17	60			7.268435
11	2	5290	17	60	1003		8.196402
12	2	5290	17	100	1154		8.786055



13	1	5290	17	60		9.063974
14	1	5290	17	60		10.335491
15	2	5290	17	65	1560	11.241709
16	2	5290	17	100	1811	11.724626

USA Bin 5 Trial #17

Burst #	Pulses	Frequency (MHz)	Chirp (MHz)	PW (uS)	Inter-pulse spacing (uS)	Inter-pulse spacing (uS)	Pulse Start (S)
1	1	5290	7	65			0.652638
2	1	5290	7	85			1.556075
3	2	5290	7	70	1460		2.298384
4	1	5290	7	65			2.718197
5	3	5290	7	95	1969	1722	3.623261
6	3	5290	7	95	1742	1888	4.39052
7	2	5290	7	50	1619		5.504717
8	2	5290	7	75	1266		6.275489
9	3	5290	7	70	1420	1325	6.44203
10	3	5290	7	65	1063	1749	7.9809
11	1	5290	7	50			8.745316
12	3	5290	7	70	1761	1802	9.136294
13	2	5290	7	50	1222		9.659454
14	3	5290	7	80	1121	1411	10.821667
15	1	5290	7	55			11.362713

USA Bin 5 Trial #18

Burst #	Pulses	Frequency (MHz)	Chirp (MHz)	PW (uS)	Inter-pulse spacing (uS)	Inter-pulse spacing (uS)	Pulse Start (S)
1	2	5290	19	80	1803		0.349415
2	2	5290	19	50	1726		1.354476
3	2	5290	19	85	1821		2.334975
4	1	5290	19	65			4.237183
5	1	5290	19	60			4.669129
6	1	5290	19	50			6.408321
7	3	5290	19	80	1538	1569	7.36925
8	3	5290	19	85	1205	1507	8.166967
9	3	5290	19	95	1371	1742	9.264386
10	1	5290	19	70			10.328579
11	1	5290	19	65			11.26352

USA Bin 5 Trial #19

Burst #	Pulses	Frequency (MHz)	Chirp (MHz)	PW (uS)	Inter-pulse spacing (uS)	Inter-pulse spacing (uS)	Pulse Start (S)
1	3	5290	7	100	1287	1074	0.633239
2	2	5290	7	100	1497		0.841262



3	1	5290	7	60			2.180539
4	3	5290	7	100	1675	1759	2.902479
5	3	5290	7	100	1982	1084	3.673101
6	3	5290	7	95	1982	1115	4.068983
7	2	5290	7	95	1311		4.666654
8	3	5290	7	60	1734	1692	5.73712
9	1	5290	7	75			6.487615
10	2	5290	7	55	1909		7.141401
11	1	5290	7	60			7.829625
12	2	5290	7	75	1046		8.934921
13	2	5290	7	90	1648		9.120767
14	3	5290	7	60	1741	1729	10.369577
15	2	5290	7	50	1785		10.783133
16	3	5290	7	85	1922	1852	11.545842

USA Bin 5 Trial #20

Burst #	Pulses	Frequency (MHz)	Chirp (MHz)	PW (uS)	Inter-pulse spacing (uS)	Inter-pulse spacing (uS)	Pulse Start (S)
1	3	5290	14	70	1858	1016	0.597337
2	1	5290	14	85			0.769038
3	2	5290	14	60	1319		2.052775
4	2	5290	14	85	1566		2.720603
5	3	5290	14	90	1585	1914	3.515308
6	2	5290	14	90	1526		4.193664
7	1	5290	14	70			5.134782
8	2	5290	14	50	1108		5.578536
9	2	5290	14	90	1655		6.033281
10	3	5290	14	85	1982	1762	7.071221
11	2	5290	14	60	1840		8.05763
12	2	5290	14	65	1967		8.358185
13	3	5290	14	65	1457	1767	9.370166
14	2	5290	14	95	1010		10.336356
15	2	5290	14	100	1071		10.780167
16	3	5290	14	90	1702	1391	11.875816

USA Bin 5 Trial #21

Burst #	Pulses	Frequency (MHz)	Chirp (MHz)	PW (uS)	Inter-pulse spacing (uS)	Inter-pulse spacing (uS)	Pulse Start (S)
1	1	5323.2	12	90			0.374285
2	3	5323.2	12	50	1617	1945	0.711052
3	1	5323.2	12	65			1.673468
4	1	5323.2	12	85			2.084274
5	2	5323.2	12	75	1217		3.094869
6	3	5323.2	12	95	1736	1084	3.242343



7	1	5323.2	12	50			4.083036
8	1	5323.2	12	65			4.851095
9	3	5323.2	12	85	1872	1132	5.676109
10	2	5323.2	12	80	1511		6.198807
11	1	5323.2	12	70			6.482251
12	3	5323.2	12	80	1566	1693	7.40326
13	3	5323.2	12	60	1143	1937	7.670978
14	2	5323.2	12	65	1764		8.524343
15	1	5323.2	12	90			9.464144
16	1	5323.2	12	70			9.539797
17	1	5323.2	12	55			10.440977
18	3	5323.2	12	85	1872	1115	11.212788
19	1	5323.2	12	65			11.395186

USA Bin 5 Trial #22

Burst #	Pulses	Frequency (MHz)	Chirp (MHz)	PW (uS)	Inter-pulse spacing (uS)	Inter-pulse spacing (uS)	Pulse Start (S)
1	3	5320	20	80	1330	1857	0.06665
2	2	5320	20	55	1244		0.967207
3	2	5320	20	95	1985		1.613624
4	2	5320	20	60	1005		2.46602
5	3	5320	20	100	1582	1407	2.70382
6	1	5320	20	50			3.333605
7	3	5320	20	50	1307	1394	3.801163
8	2	5320	20	50	1659		4.94015
9	2	5320	20	65	1196		5.341779
10	3	5320	20	100	1181	1317	5.72997
11	3	5320	20	90	1894	1166	6.514287
12	3	5320	20	100	1842	1711	7.207057
13	2	5320	20	90	1849		7.864529
14	1	5320	20	80			8.451619
15	3	5320	20	90	1396	1816	9.114996
16	3	5320	20	65	1515	1029	9.825869
17	2	5320	20	55	1711		10.547927
18	1	5320	20	85			11.095497
19	1	5320	20	55			11.48915

USA Bin 5 Trial #23

Burst #	Pulses	Frequency (MHz)	Chirp (MHz)	PW (uS)	Inter-pulse spacing (uS)	Inter-pulse spacing (uS)	Pulse Start (S)
1	2	5321.2	17	55	1156		0.054522
2	2	5321.2	17	65	1113		1.222954
3	3	5321.2	17	55	1731	1886	2.343278
4	2	5321.2	17	95	1516		3.474968



5	1	5321.2	17	75			3.939405
6	3	5321.2	17	50	1207	1013	5.434538
7	2	5321.2	17	100	1869		6.225841
8	2	5321.2	17	70	1977		7.1683
9	1	5321.2	17	95			7.647865
10	3	5321.2	17	95	1665	1402	8.377231
11	2	5321.2	17	55	1273		9.492543
12	3	5321.2	17	80	1128	1212	10.192058
13	3	5321.2	17	85	1946	1251	11.194254

USA Bin 5 Trial #24

Burst #	Pulses	Frequency (MHz)	Chirp (MHz)	PW (uS)	Inter-pulse spacing (uS)	Inter-pulse spacing (uS)	Pulse Start (S)
1	1	5322.8	13	50			0.09317
2	3	5322.8	13	80	1630	1256	1.152051
3	2	5322.8	13	60	1269		1.238171
4	2	5322.8	13	70	1587		2.11346
5	3	5322.8	13	90	1165	1041	2.456487
6	2	5322.8	13	75	1403		3.299258
7	1	5322.8	13	95			3.808288
8	1	5322.8	13	50			4.412334
9	2	5322.8	13	80	1729		5.042954
10	2	5322.8	13	60	1690		5.912667
11	1	5322.8	13	85			6.241044
12	3	5322.8	13	90	1381	1894	6.60798
13	3	5322.8	13	50	1942	1966	7.55902
14	3	5322.8	13	85	1544	1458	8.197018
15	2	5322.8	13	50	1498		8.969156
16	1	5322.8	13	60			9.088999
17	3	5322.8	13	60	1028	1820	9.988067
18	1	5322.8	13	95			10.207089
19	3	5322.8	13	90	1086	1210	11.011176
20	1	5322.8	13	65			11.713607

USA Bin 5 Trial #25

Burst #	Pulses	Frequency (MHz)	Chirp (MHz)	PW (uS)	Inter-pulse spacing (uS)	Inter-pulse spacing (uS)	Pulse Start (S)
1	3	5324.8	8	100	1656	1623	0.580919
2	3	5324.8	8	60	1482	1394	0.904096
3	1	5324.8	8	60			1.866073
4	3	5324.8	8	95	1701	1977	2.437148
5	2	5324.8	8	90	1640		3.16712
6	3	5324.8	8	65	1113	1355	3.564016
7	3	5324.8	8	80	1143	1636	4.538551



8	1	5324.8	8	80			5.040409
9	3	5324.8	8	60	1132	1326	5.869985
10	2	5324.8	8	50	1367		6.538184
11	3	5324.8	8	100	1736	1013	7.392784
12	2	5324.8	8	95	1387		7.807864
13	1	5324.8	8	75			8.705517
14	3	5324.8	8	55	1638	1180	9.80637
15	2	5324.8	8	75	1931		10.129203
16	3	5324.8	8	70	1022	1186	10.675841
17	3	5324.8	8	60	1478	1992	11.425924

USA Bin 5 Trial #26

Burst #	Pulses	Frequency (MHz)	Chirp (MHz)	PW (uS)	Inter-pulse spacing (uS)	Inter-pulse spacing (uS)	Pulse Start (S)
1	3	5320	20	100	1605	1752	0.367312
2	3	5320	20	75	1010	1299	1.458974
3	2	5320	20	100	1983		1.666898
4	3	5320	20	95	1795	1093	2.819089
5	2	5320	20	65	1715		3.064045
6	2	5320	20	85	1053		4.334021
7	2	5320	20	55	1946		5.094637
8	2	5320	20	65	1748		5.428781
9	3	5320	20	50	1037	1106	6.641649
10	2	5320	20	80	1446		7.151325
11	3	5320	20	55	1910	1533	8.130491
12	1	5320	20	80			8.820331
13	1	5320	20	70			9.526869
14	1	5320	20	70			9.827461
15	2	5320	20	60	1550		10.628337
16	1	5320	20	75			11.392102

USA Bin 5 Trial #27

Burst #	Pulses	Frequency (MHz)	Chirp (MHz)	PW (uS)	Inter-pulse spacing (uS)	Inter-pulse spacing (uS)	Pulse Start (S)
1	2	5323.2	12	50	1573		0.502527
2	3	5323.2	12	80	1096	1219	1.239359
3	1	5323.2	12	100			1.772532
4	3	5323.2	12	85	1830	1473	2.221065
5	1	5323.2	12	85			3.105017
6	1	5323.2	12	80			3.706919
7	2	5323.2	12	60	1579		3.851499
8	3	5323.2	12	80	1093	1783	4.87602
9	3	5323.2	12	95	1035	1409	5.132371
10	2	5323.2	12	80	1371		5.780187



11	1	5323.2	12	95			6.944031
12	3	5323.2	12	70	1544	1089	7.292238
13	2	5323.2	12	55	1459		8.187066
14	3	5323.2	12	70	1593	1175	8.266651
15	1	5323.2	12	90			9.459109
16	3	5323.2	12	100	1175	1017	9.514866
17	1	5323.2	12	100			10.663267
18	3	5323.2	12	85	1382	1628	11.261199
19	2	5323.2	12	55	1062		11.745475

USA Bin 5 Trial #28

Burst #	Pulses	Frequency (MHz)	Chirp (MHz)	PW (uS)	Inter-pulse spacing (uS)	Inter-pulse spacing (uS)	Pulse Start (S)
1	3	5326	5	90	1513	1337	0.390902
2	3	5326	5	70	1479	1733	1.696819
3	3	5326	5	75	1550	1785	2.131786
4	2	5326	5	75	1455		3.114837
5	1	5326	5	85			3.699194
6	1	5326	5	80			4.767565
7	2	5326	5	80	1550		5.783666
8	2	5326	5	60	1965		7.221045
9	2	5326	5	100	1270		8.093661
10	1	5326	5	85			8.940277
11	3	5326	5	100	1763	1925	9.406064
12	1	5326	5	90			10.414037
13	1	5326	5	60			11.356091

USA Bin 5 Trial #29

Burst #	Pulses	Frequency (MHz)	Chirp (MHz)	PW (uS)	Inter-pulse spacing (uS)	Inter-pulse spacing (uS)	Pulse Start (S)
1	1	5320.8	18	75			0.102507
2	2	5320.8	18	80	1538		1.516822
3	2	5320.8	18	75	1098		3.178288
4	3	5320.8	18	75	1361	1086	3.946059
5	3	5320.8	18	95	1862	1774	5.754028
6	3	5320.8	18	60	1439	1923	6.93954
7	2	5320.8	18	95	1078		8.33327
8	3	5320.8	18	65	1088	1767	8.911878
9	2	5320.8	18	75	1584		10.618486
10	1	5320.8	18	80			11.260483

USA Bin 5 Trial #30

Burst #	Pulses	Frequency (MHz)	Chirp (MHz)	PW (uS)	Inter-pulse spacing (uS)	Inter-pulse spacing (uS)	Pulse Start (S)
---------	--------	-----------------	-------------	---------	--------------------------	--------------------------	-----------------



1	3	5325.6	6	60	1211	1676	0.892232
2	1	5325.6	6	55			1.809414
3	1	5325.6	6	50			2.303074
4	3	5325.6	6	100	1187	1291	3.11149
5	2	5325.6	6	60	1355		4.569146
6	1	5325.6	6	95			5.237833
7	3	5325.6	6	95	1728	1077	6.245397
8	1	5325.6	6	60			7.475191
9	1	5325.6	6	50			8.641061
10	2	5325.6	6	90	1034		9.629633
11	3	5325.6	6	100	1867	1740	10.355978
12	3	5325.6	6	55	1309	1740	11.939093



USA Frequency Hopping Trial #1

Hop #	Freq (GHz)	Pulse Start (mS)
6	5286	18
18	5261	54
20	5253	60
28	5314	84
32	5272	96
33	5316	99
39	5263	117
44	5294	132
49	5283	147
66	5299	198
79	5284	237
83	5273	249
84	5315	252
91	5305	273
95	5313	285

USA Frequency Hopping Trial #2

Hop #	Freq (GHz)	Pulse Start (mS)
0	5312	0
1	5280	3
4	5288	12
9	5253	27
17	5298	51
24	5328	72
34	5287	102
44	5278	132
50	5302	150
56	5264	168
57	5276	171
58	5259	174
63	5279	189
72	5325	216
80	5294	240
81	5296	243
87	5290	261
98	5309	294

USA Frequency Hopping Trial #3

Hop #	Freq (GHz)	Pulse Start (mS)
2	5315	6
20	5271	60



36	5256	108
38	5328	114
40	5320	120
48	5292	144
49	5294	147
57	5290	171
59	5311	177
62	5318	186
65	5258	195
69	5326	207
75	5327	225
77	5283	231
88	5312	264
94	5304	282
97	5295	291

USA Frequency Hopping Trial #4

Hop #	Freq (GHz)	Pulse Start (mS)
0	5264	0
15	5293	45
19	5318	57
33	5258	99
37	5278	111
42	5257	126
45	5274	135
51	5290	153
52	5287	156
56	5261	168
66	5306	198
76	5267	228
84	5317	252
85	5322	255
92	5327	276
95	5271	285

USA Frequency Hopping Trial #5

Hop #	Freq (GHz)	Pulse Start (mS)
2	5255	6
7	5307	21
14	5311	42
47	5281	141
49	5304	147
53	5292	159
55	5300	165



59	5282	177
75	5258	225
78	5275	234
86	5314	258
87	5323	261
88	5299	264
93	5301	279
94	5284	282
98	5328	294

USA Frequency Hopping Trial #6

Hop #	Freq (GHz)	Pulse Start (mS)
4	5319	12
7	5323	21
15	5285	45
25	5318	75
36	5311	108
53	5297	159
58	5313	174
65	5296	195
68	5287	204
86	5258	258
88	5309	264
90	5278	270
95	5299	285
99	5292	297

USA Frequency Hopping Trial #7

Hop #	Freq (GHz)	Pulse Start (mS)
5	5326	15
9	5281	27
21	5328	63
30	5280	90
42	5282	126
43	5325	129
46	5275	138
48	5311	144
52	5316	156
55	5283	165
65	5254	195
72	5305	216
76	5310	228
78	5285	234
81	5268	243



86	5300	258
88	5301	264
89	5262	267

USA Frequency Hopping Trial #8

Hop #	Freq (GHz)	Pulse Start (mS)
2	5293	6
4	5269	12
8	5311	24
10	5284	30
29	5321	87
33	5324	99
40	5265	120
53	5260	159
54	5297	162
66	5281	198
78	5274	234
83	5300	249
85	5328	255
98	5312	294

USA Frequency Hopping Trial #9

Hop #	Freq (GHz)	Pulse Start (mS)
2	5291	6
14	5267	42
19	5285	57
21	5256	63
39	5273	117
48	5286	144
50	5268	150
52	5297	156
65	5319	195
69	5271	207
72	5310	216
80	5293	240
84	5320	252
91	5324	273

USA Frequency Hopping Trial #10

Hop #	Freq (GHz)	Pulse Start (mS)
3	5296	9
6	5261	18
8	5321	24
12	5257	36



24	5284	72
25	5293	75
31	5312	93
36	5319	108
41	5265	123
48	5310	144
53	5283	159
59	5316	177
63	5288	189
67	5295	201
70	5268	210
78	5290	234
79	5305	237
88	5274	264
97	5252	291
99	5286	297

USA Frequency Hopping Trial #11

Hop #	Freq (GHz)	Pulse Start (mS)
3	5328	9
4	5310	12
7	5264	21
9	5263	27
12	5318	36
17	5268	51
31	5275	93
34	5283	102
38	5317	114
42	5315	126
50	5302	150
57	5305	171
58	5300	174
59	5282	177
62	5273	186
75	5322	225
77	5314	231
84	5299	252
86	5266	258
89	5307	267
94	5257	282

USA Frequency Hopping Trial #12

Hop #	Freq (GHz)	Pulse Start (mS)
4	5322	12



11	5270	33
19	5259	57
28	5288	84
36	5257	108
50	5302	150
54	5299	162
55	5316	165
65	5271	195
73	5296	219
79	5323	237
82	5254	246
90	5268	270
95	5286	285
96	5293	288

USA Frequency Hopping Trial #13

Hop #	Freq (GHz)	Pulse Start (mS)
1	5285	3
3	5261	9
4	5268	12
11	5252	33
12	5271	36
14	5282	42
17	5259	51
18	5288	54
26	5270	78
32	5290	96
38	5321	114
53	5286	159
54	5305	162
55	5274	165
56	5306	168
65	5253	195
71	5328	213
79	5295	237
82	5281	246
86	5324	258
88	5322	264
96	5255	288

USA Frequency Hopping Trial #14

Hop #	Freq (GHz)	Pulse Start (mS)
3	5317	9
7	5328	21



8	5299	24
18	5303	54
21	5280	63
24	5259	72
30	5267	90
34	5286	102
38	5272	114
48	5321	144
67	5326	201
69	5255	207
73	5283	219
74	5295	222
94	5296	282
95	5264	285
99	5261	297

USA Frequency Hopping Trial #15

Hop #	Freq (GHz)	Pulse Start (mS)
7	5299	21
8	5290	24
20	5297	60
30	5294	90
36	5270	108
44	5298	132
64	5286	192
69	5328	207
71	5271	213
72	5313	216
79	5273	237
83	5267	249
95	5295	285

USA Frequency Hopping Trial #16

Hop #	Freq (GHz)	Pulse Start (mS)
20	5307	60
30	5267	90
33	5324	99
36	5272	108
48	5311	144
54	5260	162
55	5318	165
64	5317	192
79	5283	237
91	5293	273



USA Frequency Hopping Trial #17

Hop #	Freq (GHz)	Pulse Start (mS)
2	5309	6
10	5287	30
13	5295	39
52	5318	156
54	5320	162
59	5276	177
72	5292	216
75	5293	225
84	5264	252
85	5322	255
93	5285	279
97	5324	291

USA Frequency Hopping Trial #18

Hop #	Freq (GHz)	Pulse Start (mS)
0	5258	0
2	5324	6
8	5294	24
11	5278	33
16	5311	48
26	5297	78
40	5309	120
49	5298	147
51	5299	153
52	5322	156
69	5270	207
83	5254	249
84	5264	252
87	5286	261
96	5303	288
98	5257	294

USA Frequency Hopping Trial #19

Hop #	Freq (GHz)	Pulse Start (mS)
1	5267	3
4	5295	12
5	5273	15
8	5326	24
12	5328	36
16	5310	48
22	5296	66



24	5253	72
25	5317	75
32	5312	96
39	5277	117
40	5294	120
41	5260	123
42	5272	126
46	5278	138
48	5306	144
54	5318	162
56	5270	168
76	5280	228
80	5281	240
83	5301	249
87	5264	261
89	5303	267
94	5307	282
95	5320	285

USA Frequency Hopping Trial #20

Hop #	Freq (GHz)	Pulse Start (mS)
1	5311	3
3	5287	9
8	5315	24
12	5260	36
28	5294	84
32	5292	96
37	5304	111
46	5261	138
47	5297	141
69	5264	207
75	5281	225
79	5263	237
86	5322	258
89	5327	267
95	5302	285

USA Frequency Hopping Trial #21

Hop #	Freq (GHz)	Pulse Start (mS)
0	5268	0
1	5252	3
6	5302	18
14	5253	42
21	5294	63



34	5279	102
35	5297	105
45	5319	135
46	5322	138
57	5303	171
66	5277	198
73	5282	219
83	5285	249
84	5327	252
90	5292	270
95	5306	285

USA Frequency Hopping Trial #22

Hop #	Freq (GHz)	Pulse Start (mS)
5	5297	15
6	5289	18
9	5290	27
10	5328	30
14	5291	42
15	5322	45
21	5295	63
27	5303	81
40	5299	120
41	5327	123
42	5305	126
43	5315	129
44	5324	132
45	5326	135
50	5267	150
61	5314	183
67	5272	201
75	5268	225
82	5309	246
88	5266	264
95	5261	285

USA Frequency Hopping Trial #23

Hop #	Freq (GHz)	Pulse Start (mS)
1	5266	3
9	5255	27
11	5327	33
12	5272	36
19	5298	57
21	5259	63



22	5289	66
31	5280	93
42	5254	126
55	5274	165
60	5314	180
77	5317	231
78	5260	234
79	5308	237
86	5326	258
94	5284	282

USA Frequency Hopping Trial #24

Hop #	Freq (GHz)	Pulse Start (mS)
0	5320	0
4	5315	12
7	5319	21
14	5258	42
28	5289	84
30	5306	90
34	5263	102
48	5324	144
50	5307	150
51	5285	153
55	5297	165
73	5266	219
77	5305	231
78	5295	234
80	5252	240
96	5254	288
97	5272	291

USA Frequency Hopping Trial #25

Hop #	Freq (GHz)	Pulse Start (mS)
7	5256	21
9	5254	27
29	5328	87
33	5280	99
34	5286	102
40	5253	120
42	5272	126
43	5268	129
46	5301	138
50	5282	150
51	5318	153



67	5283	201
68	5311	204
72	5274	216
76	5259	228
85	5271	255
86	5316	258
88	5273	264
93	5277	279
96	5290	288
98	5307	294

USA Frequency Hopping Trial #26

Hop #	Freq (GHz)	Pulse Start (mS)
0	5292	0
36	5268	108
42	5321	126
43	5261	129
53	5269	159
58	5319	174
63	5298	189
64	5280	192
71	5288	213
74	5295	222
80	5302	240
88	5305	264
94	5320	282
97	5311	291
99	5328	297

USA Frequency Hopping Trial #27

Hop #	Freq (GHz)	Pulse Start (mS)
26	5314	78
45	5283	135
47	5308	141
50	5327	150
60	5253	180
63	5274	189
65	5263	195
72	5319	216
73	5320	219
75	5292	225
88	5281	264
92	5306	276
97	5252	291



USA Frequency Hopping Trial #28

Hop #	Freq (GHz)	Pulse Start (mS)
5	5315	15
13	5298	39
27	5262	81
30	5327	90
42	5309	126
53	5253	159
54	5273	162
58	5284	174
69	5303	207
70	5261	210
76	5301	228
77	5267	231
82	5317	246
83	5290	249
86	5263	258

USA Frequency Hopping Trial #29

Hop #	Freq (GHz)	Pulse Start (mS)
0	5300	0
4	5313	12
29	5306	87
35	5286	105
37	5315	111
41	5324	123
47	5265	141
51	5259	153
59	5256	177
60	5284	180
66	5302	198
71	5274	213
77	5317	231
79	5325	237
86	5294	258
99	5283	297

USA Frequency Hopping Trial #30

Hop #	Freq (GHz)	Pulse Start (mS)
2	5253	6
8	5324	24
9	5316	27
12	5283	36



15	5318	45
18	5299	54
30	5311	90
35	5297	105
40	5255	120
61	5312	183
65	5306	195
68	5254	204
73	5273	219
89	5296	267
94	5302	282



Channel 5570 MHz, 160MHz BW, Statistical Performance (lower section of 80+80)

USA Bin 1A/1B

freq=5530, rate=m0x1, traffic=420, bw=76.0

Trial	Frequency	Pulses	PW (uS)	PRI (uS)	1=Detection 0=No Detection	Detection Percentage	Limit
1	5495	58	1	918	1	93.3%	60.0%
2	5495	81	1	658	1		
3	5495	72	1	738	1		
4	5503	57	1	938	1		
5	5503	18	1	3066	1		
6	5503	89	1	598	1		
7	5510	58	1	918	1		
8	5510	102	1	518	1		
9	5510	78	1	678	1		
10	5515	67	1	798	1		
11	5515	58	1	918	1		
12	5525	61	1	878	1		
13	5525	68	1	778	1		
14	5525	70	1	758	1		
15	5530	95	1	558	1		
16	5530	28	1	1908	1		
17	5530	27	1	2027	1		
18	5535	28	1	1903	1		
19	5535	91	1	585	1		
20	5535	21	1	2533	1		
21	5545	90	1	592	1		
22	5545	40	1	1323	1		
23	5553	19	1	2801	1		
24	5553	25	1	2117	1		
25	5553	48	1	1114	1		
26	5562	29	1	1881	1		
27	5562	21	1	2617	1		
28	5562	62	1	859	1		
29	5565	25	1	2120	0		
30	5565	24	1	2200	0		



USA Bin 1A/1B

freq=5530, rate=m0x1, traffic=420, bw=76.0

Trial	Frequency	Pulses	PW (uS)	PRI (uS)	1=Detection 0=No Detection	Detection Percentage	Limit
1	5495	81	1	658	1	90.0%	60.0%
2	5495	18	1	3066	1		
3	5495	81	1	658	1		
4	5503	63	1	838	1		
5	5503	18	1	3066	1		
6	5503	92	1	578	1		
7	5510	81	1	658	1		
8	5510	89	1	598	1		
9	5510	83	1	638	1		
10	5515	99	1	538	1		
11	5515	70	1	758	1		
12	5525	70	1	758	1		
13	5525	74	1	718	0		
14	5525	61	1	878	1		
15	5530	61	1	878	1		
16	5530	30	1	1778	1		
17	5530	32	1	1653	1		
18	5535	42	1	1279	1		
19	5535	21	1	2609	1		
20	5535	24	1	2237	1		
21	5545	43	1	1239	1		
22	5545	24	1	2259	1		
23	5553	19	1	2807	1		
24	5553	26	1	2062	1		
25	5553	21	1	2596	1		
26	5562	53	1	997	1		
27	5562	24	1	2263	1		
28	5562	20	1	2658	1		
29	5565	57	1	931	0		
30	5565	30	1	1764	0		



USA Bin 2

freq=5530, rate=m0x1, traffic=420, bw=76.0

Trial	Frequency	Pulses	PW (uS)	PRI (uS)	1=Detection 0=No Detection	Detection Percentage	Limit
1	5495	27	4.2	206	1	90.0%	60.0%
2	5495	23	1.8	173	1		
3	5495	29	4.7	150	1		
4	5503	29	3.4	155	1		
5	5503	27	3.4	218	1		
6	5503	25	2.1	197	0		
7	5510	29	2.8	219	1		
8	5510	25	4.7	172	1		
9	5510	27	3	213	1		
10	5515	26	4.4	182	1		
11	5515	23	2.6	174	1		
12	5525	27	4.7	174	1		
13	5525	26	2.3	186	1		
14	5525	29	3	203	1		
15	5530	24	2.2	199	0		
16	5530	27	3.4	215	1		
17	5530	29	3.4	223	1		
18	5535	29	2	195	1		
19	5535	29	2.1	182	1		
20	5535	29	3.1	166	1		
21	5545	29	1.6	175	1		
22	5545	24	4.6	173	1		
23	5553	27	3.9	177	1		
24	5553	28	3.9	182	1		
25	5553	29	3	224	1		
26	5562	27	3.5	169	1		
27	5562	26	2.3	189	1		
28	5562	27	4.5	224	1		
29	5565	27	4	216	1		
30	5565	24	4.4	207	0		



USA Bin 3

freq=5530, rate=m0x1, traffic=420, bw=76.0

Trial	Frequency	Pulses	PW (uS)	PRI (uS)	1=Detection 0=No Detection	Detection Percentage	Limit
1	5495	18	8	367	1	80.0%	60.0%
2	5495	17	9.1	483	1		
3	5495	16	9.7	350	1		
4	5503	16	8.6	335	1		
5	5503	16	9.5	500	1		
6	5503	16	9.5	252	1		
7	5510	16	6.5	488	1		
8	5510	18	6.7	313	1		
9	5510	16	9.5	420	1		
10	5515	16	9.7	265	1		
11	5515	16	8.1	337	1		
12	5525	17	8.6	450	1		
13	5525	17	9.6	400	0		
14	5525	17	7.9	263	1		
15	5530	17	7.8	469	0		
16	5530	16	8.1	448	0		
17	5530	16	6.1	422	1		
18	5535	16	8.4	384	0		
19	5535	16	8.7	459	1		
20	5535	17	8	265	1		
21	5545	18	8.9	414	1		
22	5545	17	7.2	243	1		
23	5553	16	7.2	254	1		
24	5553	17	6.4	403	1		
25	5553	18	7.9	244	1		
26	5562	16	8.1	496	1		
27	5562	17	6.8	220	1		
28	5562	18	8.8	486	1		
29	5565	18	6.3	427	0		
30	5565	17	7.9	270	0		



USA Bin 4

freq=5530, rate=m0x1, traffic=420, bw=76.0

Trial	Frequency	Pulses	PW (uS)	PRI (uS)	1=Detection 0=No Detection	Detection Percentage	Limit
1	5495	16	16.7	202	1	70.0%	60.0%
2	5495	15	15.5	393	1		
3	5495	14	11.4	351	1		
4	5503	13	15.1	209	0		
5	5503	16	14	425	1		
6	5503	13	18.5	425	1		
7	5510	13	17.4	386	1		
8	5510	15	17.5	285	1		
9	5510	14	19.3	314	0		
10	5515	16	14	346	1		
11	5515	13	19.8	455	1		
12	5525	13	15.4	263	0		
13	5525	15	19.8	324	1		
14	5525	14	14	311	1		
15	5530	12	11.6	484	1		
16	5530	12	14.3	213	1		
17	5530	16	15.6	418	0		
18	5535	16	13.8	333	1		
19	5535	14	13.4	339	1		
20	5535	16	11.6	262	0		
21	5545	15	17	256	1		
22	5545	16	17.6	356	0		
23	5553	13	17.5	482	1		
24	5553	14	12	430	1		
25	5553	15	18.4	479	0		
26	5562	12	13.4	211	1		
27	5562	16	11.7	278	1		
28	5562	16	12.9	418	1		
29	5565	13	17.8	244	0		
30	5565	14	17.6	246	0		

In addition an average minimum percentage of successful detection across all four Short pulse radar test waveforms is required and is calculated as follows:

$$\frac{P_d 1 + P_d 2 + P_d 3 + P_d 4}{4} = (93.3\% + 90.0\% + 90.0\% + 80.0\% + 70.0)/5 = 84.7\% (>80\%)$$



USA
Bin
5

freq=5530, rate=m0x1, traffic=420, bw=76.0

Trial	Burst #	Pulses	Frequency (MHz)	Chirp (MHz)	PW (uS)	Inter-pulse spacing (uS)	Inter-pulse spacing (uS)	Pulse Start (S)	1=Detection 0=No Detection	Detection Percentage	Limit
1	1	1	5500	20	95			0.179002	1	100.0%	80.0%
2	1	2	5497.2	13	55	1001		0.635526	1		
3	1	2	5497.6	14	50	1389		0.222035	1		
4	1	2	5496.8	12	65	1509		1.403791	1		
5	1	3	5495.6	9	50	1949	1024	0.847446	1		
6	1	3	5498.8	17	75	1544	1396	0.360153	1		
7	1	2	5495.2	8	55	1734		0.316574	1		
8	1	1	5494.8	7	65			0.839249	1		
9	1	2	5496.8	12	50	1784		0.390607	1		
10	1	2	5500	20	65	1705		0.488182	1		
11	1	1	5530	8	55			1.272782	1		
12	1	1	5530	5	60			0.115233	1		
13	1	3	5530	8	100	1597	1864	0.208018	1		
14	1	3	5530	9	55	1550	1226	0.568279	1		
15	1	3	5530	11	100	1572	1101	0.326804	1		
16	1	1	5530	9	60			0.044689	1		
17	1	2	5530	14	65	1903		0.597612	1		
18	1	3	5530	5	95	1318	1777	0.034915	1		
19	1	1	5530	14	80			0.382841	1		
20	1	2	5530	5	80	1223		0.605322	1		
21	1	3	5561.6	16	85	1082	1498	0.619181	1		
22	1	2	5560.4	19	50	1753		0.213264	1		
23	1	1	5563.6	11	95			0.999418	1		
24	1	2	5564	10	100	1162		0.289791	1		
25	1	2	5561.6	16	50	1382		0.851521	1		
26	1	3	5560.8	18	60	1971	1488	0.366738	1		
27	1	1	5565.2	7	75			0.314872	1		
28	1	2	5560	20	90	1188		0.28764	1		
29	1	2	5564.4	9	50	1560		0.400975	1		
30	1	2	5564.4	9	70	1859		0.189757	1		



freq=5530, rate=m0x1,
traffic=420, bw=76.0

USA Frequency Hopping

Trial	Hop #	Freq (GHz)	Pulse Start (mS)	1=Detection 0=No Detection	Detection Percentage	Limit
1	6	5508	18	1	100.0%	70.0%
2	2	5505	6	1		
3	12	5564	36	1		
4	26	5509	78	1		
5	1	5499	3	1		
6	0	5521	0	1		
7	3	5514	9	1		
8	3	5550	9	1		
9	2	5525	6	1		
10	9	5507	27	1		
11	5	5510	15	1		
12	11	5528	33	1		
13	1	5550	3	1		
14	11	5500	33	1		
15	0	5519	0	1		
16	8	5520	24	1		
17	0	5551	0	1		
18	2	5496	6	1		
19	2	5520	6	1		
20	11	5537	33	1		
21	3	5554	9	1		
22	0	5543	0	1		
23	3	5494	9	1		
24	3	5502	9	1		
25	4	5535	12	1		
26	22	5493	66	1		
27	3	5556	9	1		
28	10	5536	30	1		
29	7	5547	21	1		
30	1	5518	3	1		



USA Bin 5 Trial #1

Burst #	Pulses	Frequency (MHz)	Chirp (MHz)	PW (uS)	Inter-pulse spacing (uS)	Inter-pulse spacing (uS)	Pulse Start (S)
1	1	5500	20	95			0.179002
2	2	5500	20	90	1239		0.75539
3	1	5500	20	70			1.642128
4	1	5500	20	95			2.242444
5	2	5500	20	50	1724		2.759521
6	2	5500	20	50	1351		3.04601
7	1	5500	20	60			4.063606
8	1	5500	20	50			4.464266
9	3	5500	20	95	1193	1130	5.328119
10	1	5500	20	70			5.800855
11	2	5500	20	55	1723		6.346758
12	3	5500	20	100	1968	1608	7.049271
13	1	5500	20	90			7.658417
14	1	5500	20	95			8.012975
15	3	5500	20	50	1881	1676	8.669826
16	1	5500	20	70			9.001652
17	2	5500	20	70	1074		10.139798
18	2	5500	20	55	2000		10.620272
19	3	5500	20	90	1293	1328	10.931089
20	2	5500	20	100	1692		11.476842

USA Bin 5 Trial #2

Burst #	Pulses	Frequency (MHz)	Chirp (MHz)	PW (uS)	Inter-pulse spacing (uS)	Inter-pulse spacing (uS)	Pulse Start (S)
1	2	5497.2	13	55	1001		0.635526
2	2	5497.2	13	80	1755		1.580062
3	3	5497.2	13	85	1466	1419	3.07382
4	1	5497.2	13	70			5.131113
5	2	5497.2	13	60	1573		6.779307
6	1	5497.2	13	85			7.832805
7	3	5497.2	13	70	1365	1047	9.442571
8	3	5497.2	13	75	1149	1381	11.880372

USA Bin 5 Trial #3

Burst #	Pulses	Frequency (MHz)	Chirp (MHz)	PW (uS)	Inter-pulse spacing (uS)	Inter-pulse spacing (uS)	Pulse Start (S)
1	2	5497.6	14	50	1389		0.222035
2	1	5497.6	14	60			1.411966
3	2	5497.6	14	80	1219		1.849696
4	3	5497.6	14	95	1298	1672	2.471243



5	3	5497.6	14	95	1503	1228	3.114819
6	3	5497.6	14	65	1226	1480	3.901505
7	3	5497.6	14	50	1446	1465	4.60648
8	3	5497.6	14	95	1763	1472	5.862446
9	1	5497.6	14	100			6.72578
10	3	5497.6	14	90	1437	1598	7.487168
11	2	5497.6	14	75	1141		7.726934
12	2	5497.6	14	60	1717		8.269447
13	1	5497.6	14	95			9.625634
14	3	5497.6	14	100	1466	1273	10.279955
15	2	5497.6	14	95	1427		10.86831
16	2	5497.6	14	65	1237		11.284663

USA Bin 5 Trial #4

Burst #	Pulses	Frequency (MHz)	Chirp (MHz)	PW (uS)	Inter-pulse spacing (uS)	Inter-pulse spacing (uS)	Pulse Start (S)
1	2	5496.8	12	65	1509		1.403791
2	3	5496.8	12	65	1606	1177	2.687637
3	3	5496.8	12	50	1978	1338	4.381115
4	3	5496.8	12	60	1566	1531	4.574346
5	3	5496.8	12	55	1999	1053	6.51777
6	3	5496.8	12	50	1630	1511	8.872887
7	3	5496.8	12	90	1075	1578	9.286737
8	3	5496.8	12	95	1661	1275	11.451263

USA Bin 5 Trial #5

Burst #	Pulses	Frequency (MHz)	Chirp (MHz)	PW (uS)	Inter-pulse spacing (uS)	Inter-pulse spacing (uS)	Pulse Start (S)
1	3	5495.6	9	50	1949	1024	0.847446
2	3	5495.6	9	80	1483	1224	1.517161
3	1	5495.6	9	55			2.783673
4	3	5495.6	9	60	1837	1059	4.029379
5	2	5495.6	9	95	1898		5.32708
6	2	5495.6	9	85	1482		6.604282
7	3	5495.6	9	75	1492	1921	7.31093
8	1	5495.6	9	95			9.280512
9	2	5495.6	9	75	1003		10.318396
10	1	5495.6	9	85			10.896451

USA Bin 5 Trial #6

Burst #	Pulses	Frequency (MHz)	Chirp (MHz)	PW (uS)	Inter-pulse spacing (uS)	Inter-pulse spacing (uS)	Pulse Start (S)
1	3	5498.8	17	75	1544	1396	0.360153
2	2	5498.8	17	65	1701		1.146736



3	3	5498.8	17	70	1081	1765	1.280455
4	2	5498.8	17	90	1660		2.34128
5	3	5498.8	17	80	1209	1479	2.687371
6	2	5498.8	17	65	1439		3.280618
7	2	5498.8	17	75	1441		3.798408
8	2	5498.8	17	80	1506		4.690311
9	2	5498.8	17	80	1814		5.371168
10	3	5498.8	17	95	1349	1636	6.086156
11	3	5498.8	17	55	1678	1357	6.414169
12	3	5498.8	17	55	1690	1538	7.398583
13	2	5498.8	17	90	1993		8.181273
14	2	5498.8	17	70	1642		8.234226
15	1	5498.8	17	55			9.33934
16	3	5498.8	17	85	1670	1754	10.02469
17	1	5498.8	17	60			10.17504
18	3	5498.8	17	95	1790	1127	11.063154
19	3	5498.8	17	95	1170	1614	11.934451

USA Bin 5 Trial #7

Burst #	Pulses	Frequency (MHz)	Chirp (MHz)	PW (uS)	Inter-pulse spacing (uS)	Inter-pulse spacing (uS)	Pulse Start (S)
1	2	5495.2	8	55	1734		0.316574
2	2	5495.2	8	50	1518		1.804893
3	3	5495.2	8	75	1599	1891	3.028584
4	3	5495.2	8	75	1235	1579	4.609394
5	2	5495.2	8	80	1730		6.97802
6	1	5495.2	8	55			8.603996
7	1	5495.2	8	90			9.862382
8	1	5495.2	8	80			11.393133

USA Bin 5 Trial #8

Burst #	Pulses	Frequency (MHz)	Chirp (MHz)	PW (uS)	Inter-pulse spacing (uS)	Inter-pulse spacing (uS)	Pulse Start (S)
1	1	5494.8	7	65			0.839249
2	2	5494.8	7	65	1584		0.91526
3	2	5494.8	7	70	1796		2.302932
4	1	5494.8	7	90			3.07085
5	3	5494.8	7	95	1001	1921	3.513089
6	2	5494.8	7	65	1000		4.325547
7	2	5494.8	7	90	1146		5.610218
8	2	5494.8	7	95	1148		6.077048
9	1	5494.8	7	95			7.03016
10	2	5494.8	7	65	1511		7.721846
11	2	5494.8	7	90	1437		8.767405



12	3	5494.8	7	65	1153	1521	9.960993
13	2	5494.8	7	85	1194		10.659311
14	2	5494.8	7	95	1560		11.589172

USA Bin 5 Trial #9

Burst #	Pulses	Frequency (MHz)	Chirp (MHz)	PW (uS)	Inter-pulse spacing (uS)	Inter-pulse spacing (uS)	Pulse Start (S)
1	2	5496.8	12	50	1784		0.390607
2	1	5496.8	12	60			0.990175
3	3	5496.8	12	80	1716	1028	1.507363
4	3	5496.8	12	70	1589	1503	2.079555
5	1	5496.8	12	70			2.842311
6	2	5496.8	12	50	1831		3.04578
7	2	5496.8	12	85	1317		3.976904
8	1	5496.8	12	65			4.437328
9	2	5496.8	12	55	1006		4.838962
10	1	5496.8	12	60			5.768022
11	2	5496.8	12	75	1787		6.05809
12	1	5496.8	12	60			7.119783
13	3	5496.8	12	75	1095	1430	7.43155
14	1	5496.8	12	50			8.27144
15	1	5496.8	12	80			8.905579
16	3	5496.8	12	50	1236	1781	9.439841
17	1	5496.8	12	80			9.729853
18	2	5496.8	12	90	1785		10.39821
19	1	5496.8	12	75			11.116435
20	2	5496.8	12	85	1630		11.529217

USA Bin 5 Trial #10

Burst #	Pulses	Frequency (MHz)	Chirp (MHz)	PW (uS)	Inter-pulse spacing (uS)	Inter-pulse spacing (uS)	Pulse Start (S)
1	2	5500	20	65	1705		0.488182
2	3	5500	20	85	1962	1443	1.295126
3	3	5500	20	55	1938	1495	2.628519
4	2	5500	20	55	1390		3.341299
5	1	5500	20	70			3.874004
6	2	5500	20	70	1720		5.252429
7	1	5500	20	80			6.135049
8	2	5500	20	100	1922		6.559628
9	1	5500	20	75			7.97137
10	3	5500	20	100	1811	1391	8.452566
11	1	5500	20	80			9.568866
12	2	5500	20	60	1088		10.956192
13	3	5500	20	100	1459	1120	11.275299



USA Bin 5 Trial #11

Burst #	Pulses	Frequency (MHz)	Chirp (MHz)	PW (uS)	Inter-pulse spacing (uS)	Inter-pulse spacing (uS)	Pulse Start (S)
1	1	5530	8	55			1.272782
2	2	5530	8	90	1173		2.623236
3	3	5530	8	85	1991	1222	3.503356
4	2	5530	8	50	1852		5.969055
5	3	5530	8	75	1153	1515	6.227248
6	2	5530	8	55	1121		7.742774
7	1	5530	8	80			10.468799
8	3	5530	8	80	1754	1492	11.234205

USA Bin 5 Trial #12

Burst #	Pulses	Frequency (MHz)	Chirp (MHz)	PW (uS)	Inter-pulse spacing (uS)	Inter-pulse spacing (uS)	Pulse Start (S)
1	1	5530	5	60			0.115233
2	1	5530	5	90			1.146768
3	1	5530	5	95			2.679125
4	2	5530	5	90	1911		3.052665
5	2	5530	5	50	1198		4.689978
6	3	5530	5	60	1512	1696	5.497323
7	1	5530	5	60			6.822676
8	3	5530	5	85	1167	1066	7.440539
9	1	5530	5	65			8.006809
10	2	5530	5	65	1503		9.974579
11	3	5530	5	55	1978	1852	10.253022
12	2	5530	5	65	1375		11.425326

USA Bin 5 Trial #13

Burst #	Pulses	Frequency (MHz)	Chirp (MHz)	PW (uS)	Inter-pulse spacing (uS)	Inter-pulse spacing (uS)	Pulse Start (S)
1	3	5530	8	100	1597	1864	0.208018
2	3	5530	8	90	1779	1049	0.637981
3	3	5530	8	70	1716	1707	1.490058
4	2	5530	8	50	1935		2.30644
5	3	5530	8	60	1477	1769	2.458426
6	3	5530	8	50	1759	1074	3.224176
7	3	5530	8	65	1852	1275	3.831608
8	1	5530	8	80			4.766188
9	2	5530	8	50	1835		5.281402
10	2	5530	8	65	1946		5.708509
11	3	5530	8	75	1188	1551	6.024086
12	1	5530	8	75			6.855



13	3	5530	8	90	1781	1007	7.328377
14	1	5530	8	55			8.374568
15	1	5530	8	65			8.836191
16	3	5530	8	50	1478	1484	9.145907
17	1	5530	8	85			10.115167
18	2	5530	8	50	1525		10.407639
19	1	5530	8	65			10.813355
20	2	5530	8	60	1716		11.855143

USA Bin 5 Trial #14

Burst #	Pulses	Frequency (MHz)	Chirp (MHz)	PW (uS)	Inter-pulse spacing (uS)	Inter-pulse spacing (uS)	Pulse Start (S)
1	3	5530	9	55	1550	1226	0.568279
2	1	5530	9	55			1.012056
3	3	5530	9	50	1842	1756	2.112218
4	1	5530	9	55			3.392805
5	2	5530	9	75	1828		4.196511
6	2	5530	9	60	1097		5.498065
7	1	5530	9	75			6.05998
8	3	5530	9	70	1392	1593	6.57624
9	3	5530	9	60	1515	1591	7.404879
10	1	5530	9	90			8.383984
11	3	5530	9	100	1996	1534	9.647383
12	2	5530	9	60	1249		10.601718
13	1	5530	9	65			11.959853

USA Bin 5 Trial #15

Burst #	Pulses	Frequency (MHz)	Chirp (MHz)	PW (uS)	Inter-pulse spacing (uS)	Inter-pulse spacing (uS)	Pulse Start (S)
1	3	5530	11	100	1572	1101	0.326804
2	2	5530	11	80	1582		1.937495
3	3	5530	11	85	1971	1143	3.729545
4	2	5530	11	75	1811		5.678923
5	1	5530	11	50			6.811587
6	3	5530	11	85	1449	1791	8.210331
7	2	5530	11	60	1538		9.916984
8	2	5530	11	95	1722		11.299163

USA Bin 5 Trial #16

Burst #	Pulses	Frequency (MHz)	Chirp (MHz)	PW (uS)	Inter-pulse spacing (uS)	Inter-pulse spacing (uS)	Pulse Start (S)
1	1	5530	9	60			0.044689
2	3	5530	9	60	1024	1397	0.66787
3	2	5530	9	60	1588		1.319333



4	1	5530	9	95			2.52265
5	3	5530	9	65	1774	1924	2.90948
6	1	5530	9	70			3.159257
7	3	5530	9	100	1523	1006	4.182389
8	3	5530	9	85	1738	1662	4.683395
9	1	5530	9	60			5.41223
10	1	5530	9	85			6.075116
11	1	5530	9	65			6.703423
12	2	5530	9	95	1676		7.283183
13	2	5530	9	90	1838		8.074683
14	3	5530	9	65	1971	1568	8.465338
15	1	5530	9	60			9.0129
16	1	5530	9	80			9.765131
17	3	5530	9	75	1832	1310	10.67576
18	2	5530	9	60	1929		10.803136
19	3	5530	9	80	1614	1957	11.371463

USA Bin 5 Trial #17

Burst #	Pulses	Frequency (MHz)	Chirp (MHz)	PW (uS)	Inter-pulse spacing (uS)	Inter-pulse spacing (uS)	Pulse Start (S)
1	2	5530	14	65	1903		0.597612
2	1	5530	14	95			1.575911
3	1	5530	14	90			2.328944
4	1	5530	14	100			2.990156
5	2	5530	14	85	1673		3.979407
6	2	5530	14	85	1018		5.005792
7	2	5530	14	65	1984		5.177037
8	2	5530	14	75	1552		6.726217
9	1	5530	14	55			6.961824
10	1	5530	14	85			8.110375
11	1	5530	14	80			9.025975
12	2	5530	14	70	1425		9.460299
13	1	5530	14	85			10.783865
14	2	5530	14	95	1685		11.30087

USA Bin 5 Trial #18

Burst #	Pulses	Frequency (MHz)	Chirp (MHz)	PW (uS)	Inter-pulse spacing (uS)	Inter-pulse spacing (uS)	Pulse Start (S)
1	3	5530	5	95	1318	1777	0.034915
2	2	5530	5	90	1886		1.62943
3	3	5530	5	70	1009	1741	1.8711
4	2	5530	5	55	1000		3.026576
5	2	5530	5	55	1674		3.624465
6	3	5530	5	55	1129	1210	4.508702



7	3	5530	5	85	1524	1975	5.473286
8	1	5530	5	90			6.134333
9	2	5530	5	70	1081		7.609733
10	2	5530	5	65	1013		8.345276
11	3	5530	5	90	1719	1682	9.166229
12	2	5530	5	75	1547		9.496176
13	1	5530	5	60			10.949521
14	3	5530	5	80	1293	1715	11.234405

USA Bin 5 Trial #19

Burst #	Pulses	Frequency (MHz)	Chirp (MHz)	PW (uS)	Inter-pulse spacing (uS)	Inter-pulse spacing (uS)	Pulse Start (S)
1	1	5530	14	80			0.382841
2	1	5530	14	90			1.069048
3	2	5530	14	100	1170		1.407405
4	3	5530	14	100	1744	1034	2.123137
5	3	5530	14	60	1778	1997	2.989168
6	1	5530	14	95			3.46291
7	1	5530	14	50			3.953701
8	2	5530	14	65	1868		4.262302
9	3	5530	14	75	1473	1574	4.978861
10	3	5530	14	55	1155	1811	5.995474
11	1	5530	14	60			6.314295
12	1	5530	14	100			6.889527
13	1	5530	14	70			7.20086
14	2	5530	14	95	1763		8.322462
15	1	5530	14	90			8.967674
16	1	5530	14	55			9.220528
17	3	5530	14	75	1257	1261	9.832496
18	2	5530	14	65	1172		10.244494
19	2	5530	14	50	1371		10.808131
20	2	5530	14	80	1417		11.835019

USA Bin 5 Trial #20

Burst #	Pulses	Frequency (MHz)	Chirp (MHz)	PW (uS)	Inter-pulse spacing (uS)	Inter-pulse spacing (uS)	Pulse Start (S)
1	2	5530	5	80	1223		0.605322
2	1	5530	5	65			1.555465
3	1	5530	5	70			3.262103
4	2	5530	5	75	1580		4.226374
5	1	5530	5	65			5.55904
6	2	5530	5	70	1033		7.282069
7	3	5530	5	50	1804	1709	9.311685
8	1	5530	5	75			9.791318



9 2 5530 5 70 1394 11.056136
 USA Bin 5 Trial #21

Burst #	Pulses	Frequency (MHz)	Chirp (MHz)	PW (uS)	Inter-pulse spacing (uS)	Inter-pulse spacing (uS)	Pulse Start (S)
1	3	5561.6	16	85	1082	1498	0.619181
2	2	5561.6	16	50	1506		1.692997
3	3	5561.6	16	85	1380	1646	2.513307
4	2	5561.6	16	75	1018		3.460219
5	2	5561.6	16	60	1338		4.32575
6	1	5561.6	16	70			5.534045
7	3	5561.6	16	100	1510	1549	6.128223
8	2	5561.6	16	80	1241		7.053538
9	3	5561.6	16	85	1191	1894	7.77913
10	1	5561.6	16	55			9.100302
11	1	5561.6	16	60			9.697896
12	2	5561.6	16	80	1193		11.057075
13	1	5561.6	16	100			11.156824

USA Bin 5 Trial #22

Burst #	Pulses	Frequency (MHz)	Chirp (MHz)	PW (uS)	Inter-pulse spacing (uS)	Inter-pulse spacing (uS)	Pulse Start (S)
1	2	5560.4	19	50	1753		0.213264
2	3	5560.4	19	55	1328	1479	1.377609
3	1	5560.4	19	75			2.088466
4	2	5560.4	19	70	1845		2.176315
5	1	5560.4	19	65			2.953267
6	3	5560.4	19	50	1365	1880	3.819202
7	2	5560.4	19	100	1626		4.382546
8	2	5560.4	19	55	1174		5.40233
9	3	5560.4	19	50	1125	1974	6.045198
10	1	5560.4	19	60			6.42347
11	3	5560.4	19	55	1544	1897	7.13303
12	3	5560.4	19	75	1001	1188	7.898418
13	1	5560.4	19	50			8.910236
14	3	5560.4	19	85	1463	1204	9.267859
15	2	5560.4	19	95	1510		10.413161
16	1	5560.4	19	95			10.976703
17	2	5560.4	19	55	1337		11.527819

USA Bin 5 Trial #23

Burst #	Pulses	Frequency (MHz)	Chirp (MHz)	PW (uS)	Inter-pulse spacing (uS)	Inter-pulse spacing (uS)	Pulse Start (S)
1	1	5563.6	11	95			0.999418



2	3	5563.6	11	60	1450	1770	1.916345
3	1	5563.6	11	55			4.105193
4	3	5563.6	11	85	1912	1596	4.544353
5	2	5563.6	11	90	1398		6.728751
6	1	5563.6	11	80			8.636353
7	1	5563.6	11	85			9.562899
8	3	5563.6	11	60	1974	1346	11.19059

USA Bin 5 Trial #24

Burst #	Pulses	Frequency (MHz)	Chirp (MHz)	PW (uS)	Inter-pulse spacing (uS)	Inter-pulse spacing (uS)	Pulse Start (S)
1	2	5564	10	100	1162		0.289791
2	3	5564	10	50	1331	1845	1.677234
3	3	5564	10	75	1495	1006	2.162059
4	2	5564	10	85	1953		3.92064
5	1	5564	10	60			4.796631
6	2	5564	10	50	1076		5.092004
7	2	5564	10	60	1316		6.39936
8	2	5564	10	55	1938		7.28646
9	3	5564	10	85	1280	1293	8.401613
10	1	5564	10	100			9.808612
11	2	5564	10	70	1390		10.099081
12	1	5564	10	90			11.574639

USA Bin 5 Trial #25

Burst #	Pulses	Frequency (MHz)	Chirp (MHz)	PW (uS)	Inter-pulse spacing (uS)	Inter-pulse spacing (uS)	Pulse Start (S)
1	2	5561.6	16	50	1382		0.851521
2	2	5561.6	16	80	1339		1.025221
3	3	5561.6	16	80	1656	1055	2.404036
4	2	5561.6	16	100	1427		3.325609
5	2	5561.6	16	90	1227		3.715018
6	1	5561.6	16	70			4.745938
7	2	5561.6	16	95	1100		5.754675
8	3	5561.6	16	95	1855	1466	7.155966
9	3	5561.6	16	100	1331	1450	7.570433
10	1	5561.6	16	55			8.531817
11	1	5561.6	16	50			9.913773
12	3	5561.6	16	95	1622	1513	10.173564
13	2	5561.6	16	60	1668		11.919586

USA Bin 5 Trial #26

Burst #	Pulses	Frequency (MHz)	Chirp (MHz)	PW (uS)	Inter-pulse spacing (uS)	Inter-pulse spacing (uS)	Pulse Start (S)
---------	--------	-----------------	-------------	---------	--------------------------	--------------------------	-----------------



1	3	5560.8	18	60	1971	1488	0.366738
2	3	5560.8	18	50	1035	1744	0.681957
3	1	5560.8	18	65			1.435328
4	3	5560.8	18	60	1721	1911	2.112146
5	2	5560.8	18	95	1003		3.140523
6	3	5560.8	18	55	1269	1564	3.522046
7	2	5560.8	18	50	1905		4.546946
8	2	5560.8	18	65	1538		4.842446
9	3	5560.8	18	70	1280	1200	5.794174
10	1	5560.8	18	70			6.212974
11	1	5560.8	18	60			7.189264
12	1	5560.8	18	100			7.786221
13	2	5560.8	18	75	1018		8.22837
14	1	5560.8	18	60			9.236556
15	1	5560.8	18	100			9.813522
16	1	5560.8	18	90			10.042099
17	2	5560.8	18	55	1993		10.92758
18	2	5560.8	18	75	1142		11.996343

USA Bin 5 Trial #27

Burst #	Pulses	Frequency (MHz)	Chirp (MHz)	PW (uS)	Inter-pulse spacing (uS)	Inter-pulse spacing (uS)	Pulse Start (S)
1	1	5565.2	7	75			0.314872
2	3	5565.2	7	80	1354	1958	2.18212
3	3	5565.2	7	55	1406	1806	3.537248
4	1	5565.2	7	70			4.834312
5	2	5565.2	7	60	1238		6.332736
6	1	5565.2	7	85			7.416205
7	1	5565.2	7	50			8.815838
8	3	5565.2	7	70	1367	1625	9.404798
9	3	5565.2	7	65	1444	1145	10.865344

USA Bin 5 Trial #28

Burst #	Pulses	Frequency (MHz)	Chirp (MHz)	PW (uS)	Inter-pulse spacing (uS)	Inter-pulse spacing (uS)	Pulse Start (S)
1	2	5560	20	90	1188		0.28764
2	1	5560	20	70			1.220706
3	2	5560	20	65	1253		1.808548
4	2	5560	20	100	1532		2.824914
5	1	5560	20	95			3.885288
6	2	5560	20	70	1909		5.031508
7	1	5560	20	100			5.972573
8	1	5560	20	90			6.112906
9	2	5560	20	100	1035		7.595642



10	2	5560	20	55	1345		7.826357
11	1	5560	20	90			8.752059
12	3	5560	20	70	1900	1198	10.258523
13	3	5560	20	90	1856	1158	10.480314
14	1	5560	20	70			11.400179

USA Bin 5 Trial #29

Burst #	Pulses	Frequency (MHz)	Chirp (MHz)	PW (uS)	Inter-pulse spacing (uS)	Inter-pulse spacing (uS)	Pulse Start (S)
1	2	5564.4	9	50	1560		0.400975
2	3	5564.4	9	75	1859	1491	2.053629
3	2	5564.4	9	95	1703		2.690516
4	1	5564.4	9	100			4.025517
5	2	5564.4	9	65	1293		5.33427
6	1	5564.4	9	75			6.969636
7	3	5564.4	9	70	1600	1974	8.29788
8	2	5564.4	9	75	1332		9.192764
9	3	5564.4	9	60	1714	1790	9.668618
10	2	5564.4	9	60	1398		11.902288

USA Bin 5 Trial #30

Burst #	Pulses	Frequency (MHz)	Chirp (MHz)	PW (uS)	Inter-pulse spacing (uS)	Inter-pulse spacing (uS)	Pulse Start (S)
1	2	5564.4	9	70	1859		0.189757
2	2	5564.4	9	65	1953		0.985994
3	2	5564.4	9	80	1136		1.437539
4	2	5564.4	9	75	1135		2.260268
5	3	5564.4	9	80	1807	1323	2.537832
6	3	5564.4	9	100	1690	1501	3.079137
7	2	5564.4	9	85	1300		3.83632
8	2	5564.4	9	90	1655		4.538972
9	2	5564.4	9	70	1425		5.367221
10	3	5564.4	9	90	1884	1423	5.840457
11	2	5564.4	9	90	1317		6.145058
12	3	5564.4	9	80	1277	1024	6.941439
13	1	5564.4	9	75			7.501864
14	1	5564.4	9	100			8.17809
15	3	5564.4	9	100	1120	1990	8.447729
16	2	5564.4	9	80	1768		9.56593
17	2	5564.4	9	75	1549		10.087348
18	1	5564.4	9	70			10.656924
19	2	5564.4	9	95	1756		10.997819
20	1	5564.4	9	85			11.808947



USA Frequency Hopping Trial #1

Hop #	Freq (GHz)	Pulse Start (mS)
6	5508	18
14	5533	42
17	5559	51
18	5544	54
21	5561	63
31	5565	93
37	5529	111
53	5501	159
56	5497	168
59	5558	177
61	5540	183
77	5527	231
79	5548	237
81	5516	243
84	5528	252
97	5513	291

USA Frequency Hopping Trial #2

Hop #	Freq (GHz)	Pulse Start (mS)
2	5505	6
3	5558	9
7	5540	21
8	5563	24
36	5551	108
37	5501	111
39	5520	117
41	5503	123
43	5568	129
64	5553	192
65	5494	195
69	5538	207
71	5521	213
72	5564	216
77	5532	231
80	5492	240
83	5567	249
84	5560	252

USA Frequency Hopping Trial #3

Hop #	Freq (GHz)	Pulse Start (mS)
12	5564	36



17	5555	51
25	5517	75
37	5525	111
47	5516	141
48	5530	144
53	5513	159
57	5504	171
60	5533	180
91	5557	273

USA Frequency Hopping Trial #4

Hop #	Freq (GHz)	Pulse Start (mS)
26	5509	78
27	5524	81
39	5510	117
41	5562	123
47	5551	141
52	5517	156
54	5560	162
59	5493	177
66	5521	198
67	5523	201
71	5537	213
81	5516	243
87	5566	261
89	5496	267
97	5542	291

USA Frequency Hopping Trial #5

Hop #	Freq (GHz)	Pulse Start (mS)
1	5499	3
4	5530	12
18	5528	54
20	5565	60
28	5536	84
37	5508	111
49	5538	147
51	5559	153
58	5500	174
62	5547	186
64	5524	192
70	5503	210
74	5553	222
78	5511	234



88	5550	264
93	5535	279
96	5558	288

USA Frequency Hopping Trial #6

Hop #	Freq (GHz)	Pulse Start (mS)
0	5521	0
5	5551	15
29	5495	87
40	5559	120
53	5507	159
55	5531	165
62	5515	186
70	5535	210
74	5545	222
84	5502	252
96	5505	288

USA Frequency Hopping Trial #7

Hop #	Freq (GHz)	Pulse Start (mS)
3	5514	9
21	5526	63
28	5529	84
33	5513	99
35	5500	105
36	5538	108
48	5552	144
49	5532	147
53	5507	159
69	5503	207
73	5545	219
74	5515	222
93	5553	279

USA Frequency Hopping Trial #8

Hop #	Freq (GHz)	Pulse Start (mS)
3	5550	9
6	5509	18
24	5498	72
27	5533	81
38	5543	114
41	5511	123
43	5547	129
56	5567	168



60	5494	180
62	5555	186
69	5521	207
72	5535	216
79	5539	237
93	5505	279
95	5559	285

USA Frequency Hopping Trial #9

Hop #	Freq (GHz)	Pulse Start (mS)
2	5525	6
5	5563	15
17	5507	51
18	5510	54
19	5542	57
28	5559	84
30	5509	90
32	5503	96
45	5492	135
52	5545	156
57	5522	171
70	5551	210
78	5524	234
90	5526	270
93	5554	279
95	5567	285
97	5564	291
98	5518	294

USA Frequency Hopping Trial #10

Hop #	Freq (GHz)	Pulse Start (mS)
9	5507	27
13	5518	39
15	5504	45
18	5548	54
30	5494	90
49	5498	147
55	5547	165
61	5497	183
63	5525	189
68	5543	204
78	5526	234
80	5501	240
85	5561	255



88	5513	264
93	5502	279

USA Frequency Hopping Trial #11

Hop #	Freq (GHz)	Pulse Start (mS)
5	5510	15
6	5523	18
8	5502	24
12	5518	36
17	5549	51
21	5529	63
24	5522	72
28	5528	84
33	5506	99
36	5537	108
38	5498	114
47	5514	141
59	5496	177
67	5568	201
68	5524	204
69	5562	207
75	5552	225
82	5527	246
85	5521	255
91	5497	273
97	5567	291
99	5509	297

USA Frequency Hopping Trial #12

Hop #	Freq (GHz)	Pulse Start (mS)
11	5528	33
12	5556	36
17	5544	51
21	5533	63
25	5560	75
38	5518	114
43	5548	129
44	5549	132
46	5561	138
47	5547	141
53	5500	159
56	5568	168
57	5543	171
61	5494	183



69	5506	207
77	5502	231
88	5508	264
93	5539	279
94	5530	282

USA Frequency Hopping Trial #13

Hop #	Freq (GHz)	Pulse Start (mS)
1	5550	3
5	5515	15
11	5566	33
14	5545	42
16	5533	48
22	5520	66
25	5543	75
31	5555	93
34	5494	102
37	5541	111
40	5539	120
44	5524	132
45	5552	135
53	5498	159
66	5531	198
74	5521	222
83	5514	249
97	5526	291

USA Frequency Hopping Trial #14

Hop #	Freq (GHz)	Pulse Start (mS)
11	5500	33
15	5503	45
20	5560	60
40	5553	120
52	5532	156
54	5502	162
58	5542	174
62	5507	186
66	5552	198
68	5537	204
69	5518	207
89	5522	267
90	5549	270
91	5565	273
92	5534	276



Hop #	Freq (GHz)	Pulse Start (mS)
99	5516	297
USA Frequency Hopping Trial #15		
Hop #	Freq (GHz)	Pulse Start (mS)
0	5519	0
13	5506	39
21	5551	63
22	5531	66
27	5505	81
32	5542	96
37	5549	111
39	5534	117
48	5528	144
51	5515	153
56	5504	168
61	5526	183
70	5500	210
71	5548	213
75	5498	225
84	5493	252
89	5522	267
94	5497	282

Hop #	Freq (GHz)	Pulse Start (mS)
USA Frequency Hopping Trial #16		
Hop #	Freq (GHz)	Pulse Start (mS)
8	5520	24
11	5537	33
16	5566	48
17	5494	51
27	5513	81
43	5550	129
49	5512	147
53	5561	159
65	5507	195
78	5496	234

Hop #	Freq (GHz)	Pulse Start (mS)
USA Frequency Hopping Trial #17		
Hop #	Freq (GHz)	Pulse Start (mS)
0	5551	0
4	5563	12
8	5550	24
10	5513	30
12	5562	36
15	5492	45



26	5501	78
27	5565	81
29	5548	87
31	5519	93
33	5547	99
48	5498	144
52	5496	156
63	5568	189
64	5512	192
69	5537	207
70	5506	210
75	5526	225
79	5515	237
83	5525	249
96	5556	288

USA Frequency Hopping Trial #18

Hop #	Freq (GHz)	Pulse Start (mS)
2	5496	6
3	5523	9
10	5509	30
23	5494	69
24	5501	72
33	5512	99
38	5524	114
46	5499	138
49	5530	147
87	5515	261
91	5538	273
92	5548	276
98	5507	294

USA Frequency Hopping Trial #19

Hop #	Freq (GHz)	Pulse Start (mS)
2	5520	6
10	5514	30
11	5548	33
16	5500	48
17	5549	51
20	5533	60
28	5494	84
36	5560	108
39	5566	117
42	5509	126



47	5565	141
51	5534	153
52	5516	156
63	5535	189
64	5502	192
65	5532	195
68	5492	204
70	5552	210
86	5545	258
87	5493	261
90	5562	270

USA Frequency Hopping Trial #20

Hop #	Freq (GHz)	Pulse Start (mS)
11	5537	33
17	5497	51
33	5520	99
34	5546	102
35	5553	105
37	5544	111
48	5527	144
53	5493	159
58	5502	174
59	5519	177
67	5533	201
70	5559	210
73	5501	219
75	5566	225
83	5548	249
85	5524	255
88	5511	264
89	5549	267

USA Frequency Hopping Trial #21

Hop #	Freq (GHz)	Pulse Start (mS)
3	5554	9
9	5541	27
13	5502	39
17	5529	51
22	5509	66
26	5520	78
40	5559	120
43	5495	129
47	5563	141



56	5567	168
65	5516	195
73	5564	219
74	5515	222
84	5500	252
93	5558	279
94	5548	282

USA Frequency Hopping Trial #22

Hop #	Freq (GHz)	Pulse Start (mS)
0	5543	0
3	5565	9
4	5503	12
8	5508	24
10	5507	30
17	5526	51
18	5535	54
24	5529	72
25	5559	75
32	5495	96
40	5562	120
50	5500	150
51	5518	153
54	5545	162
70	5542	210
71	5493	213
76	5536	228
81	5517	243
88	5556	264

USA Frequency Hopping Trial #23

Hop #	Freq (GHz)	Pulse Start (mS)
3	5494	9
4	5525	12
6	5532	18
14	5509	42
23	5512	69
27	5562	81
36	5564	108
42	5558	126
43	5550	129
44	5560	132
45	5506	135
46	5547	138



49	5568	147
51	5566	153
52	5536	156
53	5546	159
55	5527	165
64	5542	192
66	5551	198
76	5502	228
93	5545	279
95	5497	285
97	5565	291

USA Frequency Hopping Trial #24

Hop #	Freq (GHz)	Pulse Start (mS)
3	5502	9
5	5510	15
6	5493	18
7	5542	21
9	5511	27
14	5564	42
19	5530	57
29	5520	87
44	5544	132
59	5516	177
65	5503	195
68	5567	204
72	5512	216
77	5560	231
85	5499	255
91	5494	273
94	5497	282

USA Frequency Hopping Trial #25

Hop #	Freq (GHz)	Pulse Start (mS)
4	5535	12
7	5548	21
11	5509	33
12	5516	36
43	5567	129
46	5522	138
54	5566	162
57	5550	171
61	5499	183
70	5527	210

72	5533	216
77	5526	231
85	5551	255
88	5502	264
90	5492	270
94	5525	282

USA Frequency Hopping Trial #26

Hop #	Freq (GHz)	Pulse Start (mS)
22	5493	66
28	5562	84
34	5527	102
53	5536	159
57	5503	171
66	5551	198
67	5515	201
71	5498	213
76	5560	228
79	5508	237
84	5525	252
85	5564	255
93	5538	279

USA Frequency Hopping Trial #27

Hop #	Freq (GHz)	Pulse Start (mS)
3	5556	9
9	5527	27
13	5511	39
17	5532	51
26	5492	78
29	5517	87
35	5558	105
41	5562	123
45	5554	135
48	5542	144
52	5548	156
68	5512	204
75	5525	225
86	5499	258
89	5522	267
96	5553	288
98	5519	294
99	5559	297

USA Frequency Hopping Trial #28



Hop #	Freq (GHz)	Pulse Start (mS)
10	5536	30
17	5558	51
19	5515	57
42	5513	126
44	5529	132
46	5545	138
47	5540	141
57	5560	171
61	5522	183
74	5539	222
78	5510	234
79	5508	237
85	5530	255
87	5523	261
92	5543	276
96	5533	288
99	5504	297

USA Frequency Hopping Trial #29

Hop #	Freq (GHz)	Pulse Start (mS)
7	5547	21
11	5537	33
13	5514	39
18	5540	54
30	5549	90
39	5553	117
52	5557	156
54	5533	162
59	5535	177
60	5534	180
66	5548	198
70	5526	210
71	5507	213
73	5522	219
74	5496	222
82	5543	246
88	5561	264
91	5552	273
96	5538	288
97	5539	291

USA Frequency Hopping Trial #30



Hop #	Freq (GHz)	Pulse Start (mS)
1	5518	3
25	5499	75
26	5505	78
28	5515	84
50	5553	150
54	5564	162
65	5567	195
67	5501	201
85	5544	255
91	5539	273
92	5525	276

Channel 5570 MHz, 160MHz BW, Statistical Performance (upper section of 80+80)
USA Bin 1A/1B

freq=5610, rate=m0x1, traffic=420, bw=76.0

Trial	Frequency	Pulses	PW (uS)	PRI (uS)	1=Detection 0=No Detection	Detection Percentage	Limit
1	5575	67	1	798	1	93.3%	60.0%
2	5575	92	1	578	1		
3	5575	99	1	538	1		
4	5583	76	1	698	1		
5	5583	68	1	778	1		
6	5583	18	1	3066	1		
7	5590	62	1	858	1		
8	5590	63	1	838	1		
9	5590	89	1	598	1		
10	5595	61	1	878	1		
11	5595	57	1	938	1		
12	5605	76	1	698	1		
13	5605	74	1	718	0		
14	5605	78	1	678	1		
15	5610	57	1	938	1		
16	5610	20	1	2663	0		
17	5610	43	1	1231	1		
18	5615	34	1	1570	1		
19	5615	30	1	1801	1		
20	5615	26	1	2111	1		
21	5625	70	1	764	1		
22	5625	28	1	1901	1		
23	5633	43	1	1231	1		
24	5633	27	1	1988	1		
25	5633	20	1	2721	1		
26	5642	27	1	2022	1		
27	5642	57	1	936	1		
28	5642	23	1	2328	1		
29	5645	26	1	2100	1		
30	5645	87	1	608	1		



USA Bin 1A/1B

freq=5610, rate=m0x1, traffic=420, bw=76.0

Trial	Frequency	Pulses	PW (uS)	PRI (uS)	1=Detection 0=No Detection	Detection Percentage	Limit
1	5575	99	1	538	1	96.7%	60.0%
2	5575	57	1	938	1		
3	5575	102	1	518	1		
4	5583	67	1	798	1		
5	5583	57	1	938	1		
6	5583	102	1	518	1		
7	5590	89	1	598	1		
8	5590	81	1	658	1		
9	5590	63	1	838	1		
10	5595	86	1	618	1		
11	5595	72	1	738	1		
12	5605	18	1	3066	1		
13	5605	57	1	938	1		
14	5605	58	1	918	1		
15	5610	95	1	558	1		
16	5610	57	1	934	1		
17	5610	32	1	1654	1		
18	5615	30	1	1764	1		
19	5615	34	1	1589	1		
20	5615	87	1	613	1		
21	5625	22	1	2407	1		
22	5625	29	1	1851	0		
23	5633	18	1	3032	1		
24	5633	52	1	1022	1		
25	5633	36	1	1480	1		
26	5642	82	1	648	1		
27	5642	19	1	2903	1		
28	5642	88	1	602	1		
29	5645	35	1	1526	1		
30	5645	19	1	2896	1		



USA Bin 2

freq=5610, rate=m0x1, traffic=420, bw=76.0

Trial	Frequency	Pulses	PW (uS)	PRI (uS)	1=Detection 0=No Detection	Detection Percentage	Limit
1	5575	23	1.8	210	1	90.0%	60.0%
2	5575	29	2.8	188	1		
3	5575	23	3.9	156	1		
4	5583	24	3.6	179	1		
5	5583	27	3	159	1		
6	5583	25	2.6	154	1		
7	5590	28	4.7	150	1		
8	5590	28	1.6	230	1		
9	5590	23	2.5	186	1		
10	5595	24	1.9	165	1		
11	5595	28	3.5	182	0		
12	5605	29	1.2	189	1		
13	5605	27	4	191	0		
14	5605	29	1.8	192	1		
15	5610	24	4.1	163	1		
16	5610	23	4.2	179	1		
17	5610	29	1	213	1		
18	5615	28	2	181	1		
19	5615	28	2.5	179	1		
20	5615	23	1.8	217	1		
21	5625	24	4.8	157	1		
22	5625	25	4.5	171	1		
23	5633	28	2.2	189	0		
24	5633	24	3.1	175	1		
25	5633	24	3.3	188	1		
26	5642	28	2.8	188	1		
27	5642	28	2.2	167	1		
28	5642	28	4	183	1		
29	5645	26	3	218	1		
30	5645	23	3	222	1		



USA Bin 3

freq=5610, rate=m0x1, traffic=420, bw=76.0

Trial	Frequency	Pulses	PW (uS)	PRI (uS)	1=Detection 0=No Detection	Detection Percentage	Limit
1	5575	17	7.9	224	1	96.7%	60.0%
2	5575	18	8	398	1		
3	5575	17	8	416	1		
4	5583	17	7	279	1		
5	5583	16	7.9	322	1		
6	5583	18	7.2	265	1		
7	5590	18	8.3	242	1		
8	5590	17	7.2	276	1		
9	5590	16	6.8	425	1		
10	5595	17	8.8	380	1		
11	5595	16	9.6	226	1		
12	5605	16	8.6	408	1		
13	5605	17	8.5	264	1		
14	5605	16	8.6	413	1		
15	5610	18	6.1	275	0		
16	5610	18	6.2	384	1		
17	5610	16	9.2	457	1		
18	5615	16	9.3	276	1		
19	5615	17	9.6	484	1		
20	5615	17	9.8	429	1		
21	5625	16	9.9	391	1		
22	5625	16	9	401	1		
23	5633	18	6	307	1		
24	5633	16	9.8	330	1		
25	5633	16	8	444	1		
26	5642	16	7	481	1		
27	5642	16	8.2	455	1		
28	5642	17	8.1	407	1		
29	5645	18	7.9	492	1		
30	5645	18	6.2	496	1		



USA Bin 4

freq=5610, rate=m0x1, traffic=420, bw=76.0

Trial	Frequency	Pulses	PW (uS)	PRI (uS)	1=Detection 0=No Detection	Detection Percentage	Limit
1	5575	15	15.2	249	1	83.3%	60.0%
2	5575	13	19.6	463	1		
3	5575	12	12.4	297	1		
4	5583	16	13.2	376	0		
5	5583	14	18.8	491	1		
6	5583	13	19.8	385	1		
7	5590	15	15.6	384	0		
8	5590	16	13.3	276	1		
9	5590	16	14	402	1		
10	5595	15	15.2	318	1		
11	5595	12	17.5	232	1		
12	5605	12	11.8	402	0		
13	5605	16	17.5	343	1		
14	5605	16	16.3	308	1		
15	5610	14	11.8	464	1		
16	5610	16	12.7	399	1		
17	5610	15	17.3	433	1		
18	5615	12	14.9	467	1		
19	5615	15	19.4	237	1		
20	5615	16	18.4	402	1		
21	5625	13	19.4	305	1		
22	5625	12	14.6	239	1		
23	5633	14	17.9	347	1		
24	5633	13	17.2	485	0		
25	5633	15	18.1	457	1		
26	5642	15	12.5	263	1		
27	5642	15	17.7	227	1		
28	5642	12	13	319	1		
29	5645	15	14.9	496	0		
30	5645	13	11.6	234	1		

In addition an average minimum percentage of successful detection across all four Short pulse radar test waveforms is required and is calculated as follows:

$$\frac{P_d 1 + P_d 2 + P_d 3 + P_d 4}{4} = (93.3\% + 96.7\% + 90.0\% + 96.7\% + 83.3)/5 = 92.0\% (>80\%)$$



USA
Bin
5

freq=5610, rate=m0x1, traffic=420, bw=76.0

Trial	Burst #	Pulses	Frequency (MHz)	Chirp (MHz)	PW (uS)	Inter-pulse spacing (uS)	Inter-pulse spacing (uS)	Pulse Start (S)	1=Detection 0=No Detection	Detection Percentage	Limit
1	1	3	5579.6	19	65	1522	1139	0.601461	1	100.0%	80.0%
2	1	1	5574.8	7	90			0.685632	1		
3	1	1	5575.2	8	95			0.207413	1		
4	1	2	5577.6	14	80	1091		0.704671	1		
5	1	1	5578.8	17	50			0.333692	1		
6	1	3	5579.2	18	70	1784	1713	0.76861	1		
7	1	2	5579.6	19	80	1285		0.706246	1		
8	1	3	5576.4	11	65	1654	1136	0.414435	1		
9	1	3	5579.2	18	95	1374	1213	0.619149	1		
10	1	2	5578	15	75	1061		0.124991	1		
11	1	3	5610	6	100	1146	1850	1.084623	1		
12	1	1	5610	14	60			0.804736	1		
13	1	1	5610	18	55			0.678234	1		
14	1	3	5610	15	95	1463	1236	0.369526	1		
15	1	3	5610	15	50	1442	1743	0.524681	1		
16	1	1	5610	16	50			0.569	1		
17	1	3	5610	7	90	1702	1374	0.581892	1		
18	1	3	5610	13	70	1066	1699	0.564378	1		
19	1	2	5610	18	100	1230		0.322386	1		
20	1	3	5610	13	60	1805	1769	0.291032	1		
21	1	1	5642	15	75			0.205922	1		
22	1	3	5644.8	8	95	1021	1693	0.005047	1		
23	1	2	5640.8	18	85	1437		0.536836	1		
24	1	1	5642	15	75			0.021862	1		
25	1	3	5642.8	13	55	1776	1020	0.550769	1		
26	1	1	5642.4	14	55			0.109667	1		
27	1	2	5644	10	50	1232		0.601424	1		
28	1	2	5640.4	19	65	1338		0.285068	1		
29	1	3	5644.8	8	60	1652	1393	0.298502	1		
30	1	1	5646	5	55			0.080989	1		



USA Frequency Hopping

freq=5610, rate=m0x1, traffic=420, bw=76.0

Trial	Hop #	Freq (GHz)	Pulse Start (mS)	1=Detection 0=No Detection	Detection Percentage	Limit
1	0	5584	0	1	100.0%	70.0%
2	3	5636	9	1		
3	3	5608	9	1		
4	36	5592	108	1		
5	0	5623	0	1		
6	2	5632	6	1		
7	23	5606	69	1		
8	2	5574	6	1		
9	3	5635	9	1		
10	14	5621	42	1		
11	3	5646	9	1		
12	8	5629	24	1		
13	6	5627	18	1		
14	4	5609	12	1		
15	5	5598	15	1		
16	3	5622	9	1		
17	0	5636	0	1		
18	0	5642	0	1		
19	4	5612	12	1		
20	3	5582	9	1		
21	32	5607	96	1		
22	8	5607	24	1		
23	8	5576	24	1		
24	12	5637	36	1		
25	14	5586	42	1		
26	4	5643	12	1		
27	4	5648	12	1		
28	0	5612	0	1		
29	2	5596	6	1		
30	8	5607	24	1		



USA Bin 5 Trial #1

Burst #	Pulses	Frequency (MHz)	Chirp (MHz)	PW (uS)	Inter-pulse spacing (uS)	Inter-pulse spacing (uS)	Pulse Start (S)
1	3	5579.6	19	65	1522	1139	0.601461
2	1	5579.6	19	100			1.040227
3	2	5579.6	19	95	1396		2.326756
4	1	5579.6	19	80			3.693722
5	3	5579.6	19	55	1214	1090	4.623897
6	1	5579.6	19	100			5.006225
7	3	5579.6	19	95	1683	1281	6.105396
8	2	5579.6	19	65	1267		7.556881
9	2	5579.6	19	65	1130		8.968709
10	2	5579.6	19	60	1952		9.061627
11	2	5579.6	19	50	1708		10.997764
12	3	5579.6	19	75	1428	1355	11.638292

USA Bin 5 Trial #2

Burst #	Pulses	Frequency (MHz)	Chirp (MHz)	PW (uS)	Inter-pulse spacing (uS)	Inter-pulse spacing (uS)	Pulse Start (S)
1	1	5574.8	7	90			0.685632
2	1	5574.8	7	50			1.542906
3	3	5574.8	7	50	1329	1655	2.177532
4	2	5574.8	7	50	1273		3.406256
5	1	5574.8	7	100			4.275283
6	2	5574.8	7	60	1238		5.5331
7	2	5574.8	7	55	1212		6.171486
8	2	5574.8	7	60	1983		7.196078
9	2	5574.8	7	100	1397		7.457002
10	1	5574.8	7	100			8.737616
11	3	5574.8	7	85	1503	1301	9.577553
12	1	5574.8	7	95			10.659097
13	3	5574.8	7	100	1750	1450	11.745187

USA Bin 5 Trial #3

Burst #	Pulses	Frequency (MHz)	Chirp (MHz)	PW (uS)	Inter-pulse spacing (uS)	Inter-pulse spacing (uS)	Pulse Start (S)
1	1	5575.2	8	95			0.207413
2	2	5575.2	8	95	1785		0.722506
3	2	5575.2	8	90	1078		1.761836
4	3	5575.2	8	90	1437	1996	2.033842
5	2	5575.2	8	85	1277		3.125016
6	3	5575.2	8	60	1255	1923	3.545564
7	3	5575.2	8	50	1141	1352	4.567857



8	2	5575.2	8	75	1141		5.115317
9	1	5575.2	8	50			5.919416
10	1	5575.2	8	95			6.370544
11	3	5575.2	8	90	1528	1755	6.803685
12	1	5575.2	8	90			7.972351
13	2	5575.2	8	90	1300		8.028922
14	1	5575.2	8	95			9.09581
15	2	5575.2	8	85	1277		9.535641
16	2	5575.2	8	75	1130		10.331508
17	3	5575.2	8	100	1624	1623	10.675231
18	2	5575.2	8	75	1542		11.655178

USA Bin 5 Trial #4

Burst #	Pulses	Frequency (MHz)	Chirp (MHz)	PW (uS)	Inter-pulse spacing (uS)	Inter-pulse spacing (uS)	Pulse Start (S)
1	2	5577.6	14	80	1091		0.704671
2	3	5577.6	14	60	1474	1534	1.337143
3	2	5577.6	14	80	1867		2.51808
4	2	5577.6	14	70	1850		3.362486
5	2	5577.6	14	80	1188		4.519952
6	3	5577.6	14	60	1430	1998	5.170452
7	3	5577.6	14	50	1634	1533	5.681825
8	1	5577.6	14	85			6.526695
9	2	5577.6	14	100	1555		8.261265
10	1	5577.6	14	50			8.339236
11	3	5577.6	14	65	1306	1302	9.371635
12	2	5577.6	14	80	1058		10.216278
13	3	5577.6	14	50	1972	1304	11.568107

USA Bin 5 Trial #5

Burst #	Pulses	Frequency (MHz)	Chirp (MHz)	PW (uS)	Inter-pulse spacing (uS)	Inter-pulse spacing (uS)	Pulse Start (S)
1	1	5578.8	17	50			0.333692
2	2	5578.8	17	75	1331		1.119103
3	1	5578.8	17	70			1.466529
4	1	5578.8	17	50			1.970823
5	3	5578.8	17	100	1191	1988	2.743525
6	2	5578.8	17	95	1341		3.323506
7	2	5578.8	17	85	1451		4.185561
8	3	5578.8	17	95	1914	1308	4.495188
9	1	5578.8	17	75			5.223325
10	3	5578.8	17	95	1792	1502	5.615098
11	1	5578.8	17	65			6.549718
12	3	5578.8	17	50	1413	1628	6.76667



13	3	5578.8	17	85	1732	1258	7.593713
14	1	5578.8	17	65			8.212586
15	3	5578.8	17	75	1938	1052	8.402625
16	2	5578.8	17	70	1164		9.580961
17	3	5578.8	17	90	1668	1534	10.059484
18	1	5578.8	17	90			10.645149
19	3	5578.8	17	90	1686	1265	10.969127
20	3	5578.8	17	70	1263	1894	11.550346

USA Bin 5 Trial #6

Burst #	Pulses	Frequency (MHz)	Chirp (MHz)	PW (uS)	Inter-pulse spacing (uS)	Inter-pulse spacing (uS)	Pulse Start (S)
1	3	5579.2	18	70	1784	1713	0.76861
2	2	5579.2	18	50	1341		1.204938
3	2	5579.2	18	55	1133		1.852041
4	2	5579.2	18	90	1915		3.472594
5	3	5579.2	18	70	1235	1165	3.825751
6	2	5579.2	18	90	1681		5.19042
7	3	5579.2	18	60	1470	1181	5.560622
8	3	5579.2	18	65	1425	1474	6.83216
9	3	5579.2	18	70	1030	1186	8.060618
10	1	5579.2	18	60			9.183753
11	2	5579.2	18	75	1641		9.419108
12	3	5579.2	18	65	1897	1198	10.926349
13	3	5579.2	18	50	1855	1729	11.415269

USA Bin 5 Trial #7

Burst #	Pulses	Frequency (MHz)	Chirp (MHz)	PW (uS)	Inter-pulse spacing (uS)	Inter-pulse spacing (uS)	Pulse Start (S)
1	2	5579.6	19	80	1285		0.706246
2	1	5579.6	19	100			1.713287
3	3	5579.6	19	85	1652	1827	2.166405
4	3	5579.6	19	75	1435	1371	3.079181
5	3	5579.6	19	80	1484	1763	3.651475
6	2	5579.6	19	60	1045		4.681113
7	2	5579.6	19	80	1403		5.166902
8	1	5579.6	19	95			6.694973
9	2	5579.6	19	95	1932		7.391753
10	2	5579.6	19	55	1166		8.139373
11	1	5579.6	19	60			8.756858
12	3	5579.6	19	55	1952	1029	10.161832
13	3	5579.6	19	75	1280	1642	10.495482
14	3	5579.6	19	75	1369	1723	11.247207

USA Bin 5 Trial #8



Burst #	Pulses	Frequency (MHz)	Chirp (MHz)	PW (uS)	Inter-pulse spacing (uS)	Inter-pulse spacing (uS)	Pulse Start (S)
1	3	5576.4	11	65	1654	1136	0.414435
2	1	5576.4	11	80			2.314794
3	3	5576.4	11	70	1990	1085	3.706341
4	3	5576.4	11	95	1047	1260	4.57135
5	1	5576.4	11	60			7.184483
6	1	5576.4	11	50			7.887204
7	3	5576.4	11	75	1820	1810	10.055
8	1	5576.4	11	65			11.872819

USA Bin 5 Trial #9

Burst #	Pulses	Frequency (MHz)	Chirp (MHz)	PW (uS)	Inter-pulse spacing (uS)	Inter-pulse spacing (uS)	Pulse Start (S)
1	3	5579.2	18	95	1374	1213	0.619149
2	2	5579.2	18	70	1184		1.975803
3	2	5579.2	18	70	1709		2.910311
4	3	5579.2	18	55	1254	1533	3.207411
5	3	5579.2	18	90	1971	1167	4.884349
6	2	5579.2	18	50	1006		5.143936
7	2	5579.2	18	90	1390		6.941019
8	1	5579.2	18	60			7.48121
9	2	5579.2	18	55	1563		8.175648
10	3	5579.2	18	80	1398	1483	9.868416
11	3	5579.2	18	50	1294	1285	10.597962
12	2	5579.2	18	80	1918		11.180898

USA Bin 5 Trial #10

Burst #	Pulses	Frequency (MHz)	Chirp (MHz)	PW (uS)	Inter-pulse spacing (uS)	Inter-pulse spacing (uS)	Pulse Start (S)
1	2	5578	15	75	1061		0.124991
2	3	5578	15	70	1894	1808	1.471926
3	1	5578	15	70			3.481242
4	2	5578	15	70	1943		3.903045
5	2	5578	15	85	1924		5.723871
6	3	5578	15	60	1104	1739	6.811122
7	2	5578	15	55	1262		8.017495
8	2	5578	15	55	1810		8.446228
9	1	5578	15	75			10.755858
10	1	5578	15	80			11.455463

USA Bin 5 Trial #11



Burst #	Pulses	Frequency (MHz)	Chirp (MHz)	PW (uS)	Inter-pulse spacing (uS)	Inter-pulse spacing (uS)	Pulse Start (S)
1	3	5610	6	100	1146	1850	1.084623
2	3	5610	6	95	1359	1423	1.585757
3	3	5610	6	75	1873	1230	2.659441
4	1	5610	6	80			3.556015
5	2	5610	6	80	1508		5.448883
6	2	5610	6	65	1480		5.50999
7	3	5610	6	60	1096	1240	6.816092
8	2	5610	6	80	1738		8.03286
9	2	5610	6	65	1715		9.435128
10	3	5610	6	65	1916	1947	10.188198
11	2	5610	6	65	1635		11.435432

USA Bin 5 Trial #12

Burst #	Pulses	Frequency (MHz)	Chirp (MHz)	PW (uS)	Inter-pulse spacing (uS)	Inter-pulse spacing (uS)	Pulse Start (S)
1	1	5610	14	60			0.804736
2	3	5610	14	95	1208	1248	2.06419
3	3	5610	14	50	1730	1740	3.138568
4	3	5610	14	90	1584	1562	4.591746
5	2	5610	14	100	1201		6.275416
6	1	5610	14	80			6.890876
7	2	5610	14	85	1216		9.109207
8	3	5610	14	100	1795	1771	10.074371
9	2	5610	14	60	1344		10.845942

USA Bin 5 Trial #13

Burst #	Pulses	Frequency (MHz)	Chirp (MHz)	PW (uS)	Inter-pulse spacing (uS)	Inter-pulse spacing (uS)	Pulse Start (S)
1	1	5610	18	55			0.678234
2	2	5610	18	85	1568		1.592941
3	1	5610	18	95			2.143905
4	3	5610	18	85	1400	1619	3.136928
5	1	5610	18	55			4.345829
6	3	5610	18	75	1246	1942	5.186179
7	3	5610	18	85	1818	1572	6.030784
8	3	5610	18	70	1799	1268	6.826993
9	3	5610	18	100	1907	1101	7.482659
10	3	5610	18	75	1872	1559	8.634997
11	1	5610	18	100			9.603827
12	1	5610	18	50			10.478365
13	3	5610	18	65	1846	1263	11.124253



USA Bin 5 Trial #14

Burst #	Pulses	Frequency (MHz)	Chirp (MHz)	PW (uS)	Inter-pulse spacing (uS)	Inter-pulse spacing (uS)	Pulse Start (S)
1	3	5610	15	95	1463	1236	0.369526
2	3	5610	15	100	1332	1429	2.657794
3	1	5610	15	100			3.442602
4	2	5610	15	65	1788		5.096717
5	2	5610	15	70	1406		6.491438
6	2	5610	15	85	1662		7.988193
7	1	5610	15	55			8.419766
8	3	5610	15	65	1379	1906	9.418337
9	1	5610	15	100			10.706646

USA Bin 5 Trial #15

Burst #	Pulses	Frequency (MHz)	Chirp (MHz)	PW (uS)	Inter-pulse spacing (uS)	Inter-pulse spacing (uS)	Pulse Start (S)
1	3	5610	15	50	1442	1743	0.524681
2	3	5610	15	75	1765	1941	1.001757
3	2	5610	15	70	1514		2.211876
4	2	5610	15	75	1457		3.15868
5	2	5610	15	50	1990		3.456728
6	1	5610	15	55			4.747858
7	1	5610	15	50			5.996674
8	2	5610	15	90	1012		6.643006
9	1	5610	15	65			7.534347
10	1	5610	15	85			8.378787
11	2	5610	15	95	1883		9.405532
12	1	5610	15	80			10.050879
13	2	5610	15	80	1744		10.573536
14	3	5610	15	50	1062	1836	11.404253

USA Bin 5 Trial #16

Burst #	Pulses	Frequency (MHz)	Chirp (MHz)	PW (uS)	Inter-pulse spacing (uS)	Inter-pulse spacing (uS)	Pulse Start (S)
1	1	5610	16	50			0.569
2	1	5610	16	70			1.009036
3	1	5610	16	55			1.993923
4	1	5610	16	70			2.463321
5	2	5610	16	50	1820		2.76052
6	2	5610	16	70	1403		3.829544
7	1	5610	16	60			4.518963
8	3	5610	16	80	1730	1918	5.160092
9	1	5610	16	65			5.718785



10	2	5610	16	90	1630		6.044709
11	2	5610	16	60	1702		6.707145
12	2	5610	16	90	1004		7.391974
13	3	5610	16	60	1532	1872	8.127375
14	2	5610	16	95	1212		9.155604
15	2	5610	16	65	1573		9.546444
16	3	5610	16	60	1947	1461	10.291102
17	2	5610	16	75	1236		10.838881
18	3	5610	16	85	1996	1850	11.643319

USA Bin 5 Trial #17

Burst #	Pulses	Frequency (MHz)	Chirp (MHz)	PW (uS)	Inter-pulse spacing (uS)	Inter-pulse spacing (uS)	Pulse Start (S)
1	3	5610	7	90	1702	1374	0.581892
2	1	5610	7	70			1.097224
3	3	5610	7	50	1008	1087	1.706186
4	2	5610	7	65	1373		2.461295
5	3	5610	7	85	1824	1546	2.960905
6	1	5610	7	85			3.832966
7	2	5610	7	60	1881		4.46753
8	3	5610	7	55	1291	1311	4.828235
9	2	5610	7	55	1352		5.615541
10	2	5610	7	85	1458		6.306331
11	1	5610	7	60			6.699215
12	2	5610	7	90	1742		7.661906
13	1	5610	7	85			8.605861
14	3	5610	7	50	1630	1811	8.764672
15	1	5610	7	85			9.970716
16	3	5610	7	80	1543	1946	10.517365
17	1	5610	7	80			10.960163
18	3	5610	7	85	1731	1735	11.354764

USA Bin 5 Trial #18

Burst #	Pulses	Frequency (MHz)	Chirp (MHz)	PW (uS)	Inter-pulse spacing (uS)	Inter-pulse spacing (uS)	Pulse Start (S)
1	3	5610	13	70	1066	1699	0.564378
2	1	5610	13	90			1.814319
3	1	5610	13	85			2.255492
4	1	5610	13	55			2.978034
5	3	5610	13	55	1793	1220	4.519661
6	2	5610	13	100	1567		5.289984
7	1	5610	13	100			5.980058
8	1	5610	13	65			6.861854
9	3	5610	13	85	1409	1660	7.860364



10	2	5610	13	70	1656	9.105001
11	2	5610	13	70	1810	9.588966
12	2	5610	13	70	1574	10.291457
13	1	5610	13	80		11.12031

USA Bin 5 Trial #19

Burst #	Pulses	Frequency (MHz)	Chirp (MHz)	PW (uS)	Inter-pulse spacing (uS)	Inter-pulse spacing (uS)	Pulse Start (S)
1	2	5610	18	100	1230		0.322386
2	1	5610	18	95			1.911489
3	1	5610	18	80			2.98945
4	1	5610	18	65			3.380522
5	1	5610	18	90			5.244054
6	3	5610	18	80	1578	1645	6.28005
7	1	5610	18	55			6.966948
8	1	5610	18	70			7.759831
9	3	5610	18	95	1240	1497	8.830176
10	2	5610	18	60	1912		10.647594
11	1	5610	18	75			11.019492

USA Bin 5 Trial #20

Burst #	Pulses	Frequency (MHz)	Chirp (MHz)	PW (uS)	Inter-pulse spacing (uS)	Inter-pulse spacing (uS)	Pulse Start (S)
1	3	5610	13	60	1805	1769	0.291032
2	1	5610	13	75			0.850347
3	3	5610	13	90	1825	1103	1.698492
4	3	5610	13	55	1623	1114	2.194453
5	2	5610	13	75	1087		3.149287
6	1	5610	13	50			3.592182
7	3	5610	13	50	1492	1554	3.934429
8	1	5610	13	60			4.587379
9	2	5610	13	55	1734		5.460867
10	2	5610	13	85	1325		6.227882
11	1	5610	13	85			6.45678
12	3	5610	13	75	1260	1261	7.371865
13	1	5610	13	60			7.881042
14	1	5610	13	100			8.340206
15	3	5610	13	75	1337	1317	8.896479
16	3	5610	13	90	1764	1113	9.895164
17	3	5610	13	75	1513	1083	10.232908
18	1	5610	13	60			10.907463
19	1	5610	13	70			11.369112

USA Bin 5 Trial #21



Burst #	Pulses	Frequency (MHz)	Chirp (MHz)	PW (uS)	Inter-pulse spacing (uS)	Inter-pulse spacing (uS)	Pulse Start (S)
1	1	5642	15	75			0.205922
2	3	5642	15	55	1262	1301	2.802537
3	2	5642	15	65	1773		3.418416
4	3	5642	15	90	1843	1025	4.670431
5	2	5642	15	60	1613		6.378443
6	3	5642	15	90	1291	1198	8.326513
7	3	5642	15	95	1310	1045	10.214462
8	2	5642	15	100	1942		10.785114

USA Bin 5 Trial #22

Burst #	Pulses	Frequency (MHz)	Chirp (MHz)	PW (uS)	Inter-pulse spacing (uS)	Inter-pulse spacing (uS)	Pulse Start (S)
1	3	5644.8	8	95	1021	1693	0.005047
2	1	5644.8	8	100			1.265014
3	1	5644.8	8	65			1.753096
4	1	5644.8	8	85			2.388093
5	1	5644.8	8	75			3.696359
6	2	5644.8	8	100	1390		4.475932
7	1	5644.8	8	65			5.025353
8	2	5644.8	8	75	1207		5.636302
9	3	5644.8	8	95	1788	1170	6.537562
10	2	5644.8	8	100	1350		7.297766
11	3	5644.8	8	65	1129	1834	7.922023
12	1	5644.8	8	65			8.475932
13	1	5644.8	8	65			9.052911
14	3	5644.8	8	65	1570	1612	9.833893
15	3	5644.8	8	70	1768	1386	11.105807
16	1	5644.8	8	55			11.782973

USA Bin 5 Trial #23

Burst #	Pulses	Frequency (MHz)	Chirp (MHz)	PW (uS)	Inter-pulse spacing (uS)	Inter-pulse spacing (uS)	Pulse Start (S)
1	2	5640.8	18	85	1437		0.536836
2	3	5640.8	18	95	1928	1283	0.818552
3	3	5640.8	18	70	1925	1092	2.128138
4	1	5640.8	18	80			2.791115
5	2	5640.8	18	60	1456		3.012826
6	1	5640.8	18	65			4.051872
7	3	5640.8	18	70	1912	1399	4.620385
8	2	5640.8	18	100	1053		5.633245
9	1	5640.8	18	60			6.260335



10	2	5640.8	18	95	1757		7.386754
11	3	5640.8	18	85	1182	1563	8.211032
12	3	5640.8	18	60	1892	1947	8.50849
13	1	5640.8	18	75			9.025773
14	1	5640.8	18	95			9.780606
15	2	5640.8	18	95	1773		10.866308
16	1	5640.8	18	90			11.405206

USA Bin 5 Trial #24

Burst #	Pulses	Frequency (MHz)	Chirp (MHz)	PW (uS)	Inter-pulse spacing (uS)	Inter-pulse spacing (uS)	Pulse Start (S)
1	1	5642	15	75			0.021862
2	2	5642	15	65	1768		0.933375
3	1	5642	15	90			1.49251
4	3	5642	15	85	1408	1042	2.155227
5	1	5642	15	55			2.779277
6	1	5642	15	80			3.568571
7	3	5642	15	75	1409	1219	3.796644
8	2	5642	15	75	1168		4.494034
9	1	5642	15	55			5.487683
10	1	5642	15	60			6.044575
11	2	5642	15	90	1041		6.451449
12	3	5642	15	70	1346	1199	7.108665
13	2	5642	15	95	1089		7.671467
14	3	5642	15	70	1825	1211	8.600117
15	3	5642	15	100	1668	1007	9.350733
16	2	5642	15	95	1229		9.593518
17	1	5642	15	90			10.201032
18	3	5642	15	75	1455	1640	10.800871
19	3	5642	15	90	1965	1463	11.889576

USA Bin 5 Trial #25

Burst #	Pulses	Frequency (MHz)	Chirp (MHz)	PW (uS)	Inter-pulse spacing (uS)	Inter-pulse spacing (uS)	Pulse Start (S)
1	3	5642.8	13	55	1776	1020	0.550769
2	1	5642.8	13	90			1.080815
3	1	5642.8	13	95			1.662001
4	2	5642.8	13	65	1215		3.041706
5	2	5642.8	13	60	1161		3.846212
6	1	5642.8	13	80			4.69349
7	3	5642.8	13	50	1088	1583	5.31191
8	3	5642.8	13	50	1898	1365	5.989139
9	2	5642.8	13	95	1855		7.023266
10	1	5642.8	13	65			7.530754



11	3	5642.8	13	90	1619	1867	8.694997
12	2	5642.8	13	55	1945		9.448878
13	1	5642.8	13	70			9.714444
14	1	5642.8	13	100			10.448473
15	3	5642.8	13	50	1372	1909	11.527195

USA Bin 5 Trial #26

Burst #	Pulses	Frequency (MHz)	Chirp (MHz)	PW (uS)	Inter-pulse spacing (uS)	Inter-pulse spacing (uS)	Pulse Start (S)
1	1	5642.4	14	55			0.109667
2	1	5642.4	14	70			0.665593
3	3	5642.4	14	50	1520	1257	1.50687
4	1	5642.4	14	55			2.06667
5	2	5642.4	14	70	1191		2.617081
6	2	5642.4	14	50	1469		3.469463
7	2	5642.4	14	100	1549		4.372755
8	1	5642.4	14	90			4.885457
9	2	5642.4	14	100	1666		5.280463
10	3	5642.4	14	60	1848	1108	6.305282
11	3	5642.4	14	90	1829	1626	6.675497
12	3	5642.4	14	85	1842	1201	7.391889
13	2	5642.4	14	85	1715		7.827277
14	1	5642.4	14	100			8.588633
15	1	5642.4	14	80			8.956628
16	2	5642.4	14	100	1370		9.961226
17	3	5642.4	14	55	1264	1932	10.215945
18	3	5642.4	14	75	1228	1400	11.028261
19	3	5642.4	14	65	1513	1272	11.73725

USA Bin 5 Trial #27

Burst #	Pulses	Frequency (MHz)	Chirp (MHz)	PW (uS)	Inter-pulse spacing (uS)	Inter-pulse spacing (uS)	Pulse Start (S)
1	2	5644	10	50	1232		0.601424
2	2	5644	10	85	1828		0.954217
3	2	5644	10	100	1403		2.178224
4	1	5644	10	80			2.932842
5	3	5644	10	65	1128	1334	3.970658
6	2	5644	10	85	1126		4.394046
7	1	5644	10	95			4.871092
8	1	5644	10	70			6.101479
9	2	5644	10	80	1052		6.781968
10	2	5644	10	100	1204		7.26629
11	1	5644	10	95			8.34271
12	3	5644	10	95	1692	1139	9.037795



13	2	5644	10	95	1947	9.863878
14	1	5644	10	90		10.546983
15	2	5644	10	85	1761	11.336777

USA Bin 5 Trial #28

Burst #	Pulses	Frequency (MHz)	Chirp (MHz)	PW (uS)	Inter-pulse spacing (uS)	Inter-pulse spacing (uS)	Pulse Start (S)
1	2	5640.4	19	65	1338		0.285068
2	2	5640.4	19	95	1437		1.703717
3	3	5640.4	19	55	1728	1795	2.287957
4	2	5640.4	19	100	1676		2.644761
5	2	5640.4	19	95	1943		3.809359
6	2	5640.4	19	95	1184		4.667527
7	2	5640.4	19	75	1877		5.39372
8	3	5640.4	19	90	1172	1854	6.677641
9	2	5640.4	19	95	1066		7.160357
10	3	5640.4	19	75	1610	1946	8.552338
11	3	5640.4	19	60	1300	1155	9.340069
12	3	5640.4	19	65	1985	1330	10.229665
13	1	5640.4	19	80			10.350941
14	2	5640.4	19	100	1172		11.399006

USA Bin 5 Trial #29

Burst #	Pulses	Frequency (MHz)	Chirp (MHz)	PW (uS)	Inter-pulse spacing (uS)	Inter-pulse spacing (uS)	Pulse Start (S)
1	3	5644.8	8	60	1652	1393	0.298502
2	2	5644.8	8	50	1773		1.020373
3	3	5644.8	8	100	1540	1126	1.58179
4	1	5644.8	8	65			2.358506
5	3	5644.8	8	85	1672	1673	2.8223
6	2	5644.8	8	50	1994		3.623394
7	3	5644.8	8	55	1896	1655	4.488621
8	2	5644.8	8	65	1679		5.202086
9	3	5644.8	8	70	1508	1647	5.616085
10	2	5644.8	8	55	1895		6.661785
11	2	5644.8	8	70	1830		6.832223
12	1	5644.8	8	80			7.522114
13	2	5644.8	8	80	1444		8.080635
14	3	5644.8	8	50	1069	1056	9.188021
15	1	5644.8	8	100			9.575722
16	2	5644.8	8	60	1365		10.356482
17	3	5644.8	8	75	1485	1421	11.118084
18	3	5644.8	8	60	1384	1142	11.422466

USA Bin 5 Trial #30



Burst #	Pulses	Frequency (MHz)	Chirp (MHz)	PW (uS)	Inter-pulse spacing (uS)	Inter-pulse spacing (uS)	Pulse Start (S)
1	1	5646	5	55			0.080989
2	2	5646	5	70	1929		1.266928
3	3	5646	5	100	1312	1521	2.476119
4	3	5646	5	85	1449	1172	4.796561
5	2	5646	5	95	1200		5.513371
6	3	5646	5	90	1267	1881	6.196258
7	1	5646	5	60			7.833113
8	1	5646	5	80			9.104803
9	2	5646	5	55	1050		10.047688
10	1	5646	5	75			11.468638



USA Frequency Hopping Trial #1

Hop #	Freq (GHz)	Pulse Start (mS)
0	5584	0
2	5618	6
4	5636	12
5	5619	15
6	5623	18
8	5642	24
26	5630	78
43	5600	129
51	5617	153
53	5631	159
62	5633	186
68	5577	204
79	5612	237
80	5578	240
82	5599	246
83	5595	249
85	5611	255

USA Frequency Hopping Trial #2

Hop #	Freq (GHz)	Pulse Start (mS)
3	5636	9
13	5580	39
15	5645	45
20	5642	60
21	5577	63
24	5647	72
28	5626	84
41	5589	123
46	5623	138
47	5572	141
52	5608	156
53	5603	159
54	5596	162
56	5641	168
58	5591	174
71	5634	213
75	5573	225
78	5611	234
81	5606	243
92	5612	276
93	5614	279



96	5585	288
USA Frequency Hopping Trial #3		
	Freq	Pulse Start
Hop #	(GHz)	(mS)
3	5608	9
12	5606	36
16	5590	48
19	5607	57
23	5632	69
35	5594	105
37	5648	111
49	5578	147
65	5587	195
71	5627	213
76	5600	228
87	5592	261
94	5595	282

USA Frequency Hopping Trial #4		
	Freq	Pulse Start
Hop #	(GHz)	(mS)
36	5592	108
68	5620	204
72	5637	216
90	5646	270
96	5609	288

USA Frequency Hopping Trial #5		
	Freq	Pulse Start
Hop #	(GHz)	(mS)
0	5623	0
5	5598	15
8	5633	24
10	5596	30
14	5577	42
17	5617	51
25	5645	75
33	5572	99
38	5611	114
44	5580	132
46	5642	138
47	5647	141
49	5610	147
57	5586	171
73	5579	219
89	5628	267

92	5639	276
USA Frequency Hopping Trial #6		
	Freq	Pulse Start
Hop #	(GHz)	(mS)
2	5632	6
3	5638	9
8	5591	24
23	5634	69
33	5592	99
42	5648	126
50	5642	150
57	5616	171
74	5595	222
75	5635	225
85	5598	255
86	5585	258
89	5610	267
96	5639	288

USA Frequency Hopping Trial #7		
	Freq	Pulse Start
Hop #	(GHz)	(mS)
23	5606	69
27	5624	81
34	5627	102
35	5587	105
36	5601	108
50	5635	150
51	5597	153
54	5621	162
94	5613	282
97	5583	291
99	5594	297

USA Frequency Hopping Trial #8		
	Freq	Pulse Start
Hop #	(GHz)	(mS)
2	5574	6
7	5646	21
8	5587	24
14	5618	42
16	5620	48
18	5585	54
19	5640	57
20	5635	60
21	5586	63



25	5621	75
28	5603	84
31	5600	93
43	5572	129
58	5583	174
60	5602	180
62	5590	186
63	5609	189
70	5575	210
76	5647	228
92	5594	276
97	5632	291
98	5623	294

USA Frequency Hopping Trial #9

Hop #	Freq (GHz)	Pulse Start (mS)
3	5635	9
21	5639	63
22	5574	66
26	5647	78
38	5595	114
39	5573	117
48	5610	144
51	5616	153
61	5633	183
63	5640	189
64	5631	192
76	5598	228
79	5628	237
86	5581	258
90	5623	270
99	5600	297

USA Frequency Hopping Trial #10

Hop #	Freq (GHz)	Pulse Start (mS)
14	5621	42
20	5620	60
22	5608	66
25	5640	75
26	5610	78
30	5612	90
33	5619	99
34	5592	102
37	5613	111



41	5607	123
49	5604	147
61	5614	183
63	5576	189
64	5591	192
79	5633	237
95	5580	285

USA Frequency Hopping Trial #11

Hop #	Freq (GHz)	Pulse Start (mS)
3	5646	9
4	5585	12
8	5616	24
28	5584	84
31	5628	93
33	5640	99
39	5648	117
55	5583	165
57	5591	171
64	5622	192
65	5594	195
66	5592	198
68	5614	204
72	5630	216
73	5618	219
75	5601	225
78	5573	234
79	5578	237
81	5623	243
85	5619	255
90	5633	270

USA Frequency Hopping Trial #12

Hop #	Freq (GHz)	Pulse Start (mS)
8	5629	24
17	5608	51
21	5610	63
36	5640	108
37	5637	111
39	5577	117
40	5621	120
53	5573	159
54	5617	162
55	5620	165



60	5601	180
63	5616	189
75	5591	225
77	5578	231
79	5635	237
87	5589	261

USA Frequency Hopping Trial #13

Hop #	Freq (GHz)	Pulse Start (mS)
6	5627	18
8	5618	24
12	5596	36
14	5576	42
20	5639	60
34	5580	102
35	5648	105
37	5617	111
45	5589	135
46	5646	138
52	5593	156
62	5605	186
69	5640	207
73	5645	219
74	5624	222
76	5631	228
80	5619	240
97	5634	291
98	5630	294

USA Frequency Hopping Trial #14

Hop #	Freq (GHz)	Pulse Start (mS)
4	5609	12
11	5611	33
15	5587	45
16	5590	48
28	5573	84
29	5574	87
31	5579	93
36	5597	108
46	5594	138
50	5608	150
54	5605	162
55	5642	165
61	5581	183



USA Frequency Hopping Trial #15

Hop #	Freq (GHz)	Pulse Start (mS)
5	5598	15
8	5592	24
10	5603	30
15	5648	45
17	5609	51
30	5600	90
36	5589	108
48	5637	144
50	5578	150
54	5582	162
67	5629	201
75	5634	225
80	5586	240
83	5579	249
92	5601	276
93	5599	279
95	5632	285

USA Frequency Hopping Trial #16

Hop #	Freq (GHz)	Pulse Start (mS)
3	5622	9
4	5611	12
20	5644	60
22	5602	66
36	5574	108
39	5587	117
49	5584	147
50	5630	150
52	5578	156
71	5590	213
72	5645	216
83	5626	249
84	5598	252
90	5595	270
97	5631	291
99	5599	297

USA Frequency Hopping Trial #17

Hop #	Freq (GHz)	Pulse Start (mS)
0	5636	0
6	5580	18



26	5599	78
29	5596	87
34	5642	102
49	5616	147
51	5645	153
61	5648	183
68	5608	204
73	5606	219
79	5597	237
85	5621	255
89	5630	267
90	5601	270
94	5633	282

USA Frequency Hopping Trial #18

Hop #	Freq (GHz)	Pulse Start (mS)
0	5642	0
19	5591	57
24	5605	72
26	5593	78
27	5617	81
31	5599	93
34	5594	102
36	5629	108
38	5584	114
39	5640	117
43	5586	129
46	5585	138
64	5639	192
86	5646	258
88	5595	264
91	5588	273

USA Frequency Hopping Trial #19

Hop #	Freq (GHz)	Pulse Start (mS)
4	5612	12
5	5645	15
31	5647	93
37	5621	111
47	5597	141
51	5634	153
54	5587	162
55	5578	165
81	5610	243



84	5619	252
85	5613	255
88	5633	264
93	5641	279
94	5590	282
98	5614	294
99	5591	297

USA Frequency Hopping Trial #20

Hop #	Freq (GHz)	Pulse Start (mS)
3	5582	9
4	5585	12
22	5581	66
25	5625	75
43	5576	129
44	5595	132
46	5608	138
50	5647	150
68	5593	204
85	5618	255
88	5621	264
92	5613	276
94	5574	282
95	5584	285

USA Frequency Hopping Trial #21

Hop #	Freq (GHz)	Pulse Start (mS)
32	5607	96
35	5595	105
37	5611	111
40	5600	120
42	5631	126
45	5609	135
53	5576	159
61	5648	183
63	5647	189
69	5620	207
70	5588	210
82	5608	246
83	5628	249
95	5584	285
96	5610	288

USA Frequency Hopping Trial #22



Hop #	Freq (GHz)	Pulse Start (mS)
8	5607	24
11	5622	33
20	5592	60
25	5625	75
26	5618	78
27	5601	81
31	5585	93
33	5583	99
34	5584	102
45	5595	135
58	5620	174
68	5582	204
70	5606	210
82	5632	246
85	5605	255
86	5628	258
96	5645	288
98	5621	294

USA Frequency Hopping Trial #23

Hop #	Freq (GHz)	Pulse Start (mS)
8	5576	24
14	5578	42
19	5615	57
27	5630	81
29	5601	87
61	5597	183
66	5646	198
68	5641	204
69	5596	207
80	5604	240
87	5620	261

USA Frequency Hopping Trial #24

Hop #	Freq (GHz)	Pulse Start (mS)
12	5637	36
16	5624	48
19	5615	57
21	5603	63
23	5602	69
27	5591	81
37	5612	111



44	5590	132
50	5635	150
53	5606	159
62	5586	186
70	5611	210
73	5638	219
79	5644	237
90	5599	270

USA Frequency Hopping Trial #25

Hop #	Freq (GHz)	Pulse Start (mS)
14	5586	42
15	5597	45
32	5645	96
35	5617	105
44	5638	132
53	5639	159
54	5616	162
63	5615	189
65	5599	195
71	5577	213
82	5625	246
85	5604	255
90	5591	270
97	5634	291

USA Frequency Hopping Trial #26

Hop #	Freq (GHz)	Pulse Start (mS)
4	5643	12
7	5646	21
9	5610	27
17	5606	51
21	5613	63
22	5601	66
26	5589	78
37	5647	111
44	5584	132
47	5575	141
48	5605	144
52	5630	156
53	5616	159
61	5590	183
68	5594	204
86	5639	258



USA Frequency Hopping Trial #27

Hop #	Freq (GHz)	Pulse Start (mS)
4	5648	12
5	5637	15
25	5609	75
27	5614	81
37	5630	111
48	5615	144
50	5594	150
60	5639	180
61	5632	183
83	5572	249
89	5591	267
93	5607	279

USA Frequency Hopping Trial #28

Hop #	Freq (GHz)	Pulse Start (mS)
0	5612	0
4	5640	12
9	5606	27
11	5574	33
29	5596	87
32	5641	96
36	5616	108
46	5607	138
51	5572	153
66	5599	198
78	5615	234
89	5632	267
92	5597	276
97	5618	291
99	5623	297

USA Frequency Hopping Trial #29

Hop #	Freq (GHz)	Pulse Start (mS)
2	5596	6
5	5634	15
12	5580	36
14	5637	42
18	5644	54
19	5597	57
22	5573	66
25	5590	75



26	5610	78
29	5624	87
37	5620	111
41	5611	123
42	5589	126
44	5613	132
47	5642	141
48	5606	144
54	5636	162
55	5621	165
66	5583	198
85	5582	255
93	5603	279
97	5586	291
98	5575	294

USA Frequency Hopping Trial #30

Hop #	Freq (GHz)	Pulse Start (mS)
8	5607	24
29	5590	87
30	5634	90
36	5609	108
39	5586	117
40	5638	120
46	5601	138
49	5592	147
50	5577	150
51	5647	153
55	5618	165
62	5574	186
66	5593	198
69	5621	207
74	5596	222
76	5576	228
84	5580	252



Appendix C: List of Test Equipment Used to perform the test

Equip#	Manufacturer/ Model	Description	Last Cal	Next Cal
57478	Cisco ATIL	Automation Test Insertion Loss	Cal Not Required	
55096	National Instruments PXI-1042Q	Chassis	Cal Not Required	
57239	National Instruments PXI-8115	Embedded Controller	Cal Not Required	
57225	National Instruments PXI-5422	200 MS/s, 16-bit Arbitrary Waveform Generator	28-Sep-18	28-Sep-19
57226	National Instruments PXI-5422	200 MS/s, 16-bit Arbitrary Waveform Generator	28-Sep-18	28-Sep-19
57250	National Instruments PXI-2796	40 GHz Dual 6x1 Multiplexer (SP6T)	Cal Not Required	
57251	National Instruments PXI-2796	40 GHz Dual 6x1 Multiplexer (SP6T)	Cal Not Required	
56093	National Instruments PXI-2799	Switch 1x1	Cal Not Required	
53615	Agilent N9030A-550	PXA Signal Analyzer, 3Hz to 50GHz	3-Apr-19	3-Apr-20
54303	Keysight N5182B	MXG X-Series RF Vector Signal Generator	9-Oct-18	9-Oct-19
6322	Lufft 5063-33W	Dial hygrometer	27-Dec-18	27-Dec-19
56329	Pasternack PE5019-1	Torque wrench	28-Feb-19	28-Feb-20
54397	HUBER + SUHNER Sucoflex 102	RF Cable 2.4mm - N Type 18GHz	24-Apr-19	24-Apr-20
47283	HUBER + SUHNER Sucoflex 102E	40GHz Cable K Connector	20-Jun-19	20-Jun-20
54695	DITOM D3C2060	Splitter	15-Nov-18	15-Nov-19
56128	Pasternack PE6072	SMA 50 Ohm Termination	19-Dec-18	19-Dec-19
49428	Mini-Circuits ZFSC-2-10G	SPLITTER, 2-10GHZ	15-Nov-18	15-Nov-19
55585	AEROFLEX BWS30-W2	30dB SMA Attenuator	13-Aug-19	13-Aug-20
56127	Pasternack PE6072	SMA 50 Ohm Termination	30-Jan-19	30-Jan-20
42637	Pasternack PE6072	SMA 50 Ohm Termination	6-Mar-19	6-Mar-20
42630	Pasternack PE6072	SMA 50 Ohm Termination	10-May-19	10-May-20
56115	Pasternack PE6072	SMA 50 Ohm Termination	3-Dec-18	3-Dec-19
42624	Pasternack PE6072	SMA 50 Ohm Termination	6-Mar-19	6-Mar-20
56129	Pasternack PE6072	SMA 50 Ohm Termination	3-Dec-18	3-Dec-19
42634	Pasternack PE6072	SMA 50 Ohm Termination	10-May-19	10-May-20
56133	Pasternack PE6072	SMA 50 Ohm Termination	3-Dec-18	3-Dec-19
54392	HUBER + SUHNER Sucoflex 102	RF Cable 2.4mm - N Type 18GHz	24-Apr-19	24-Apr-20
49429	Mini-Circuits ZFSC-2-10G	SPLITTER, 2-10GHZ	25-Jan-19	25-Jan-20
54623	Megaphase RA08-S1S1-18	SMA Cable	2-Aug-19	2-Aug-20
54674	Megaphase RA08-S1S1-12	SMA Cable	2-Aug-19	2-Aug-20
54607	Pulsar PS4-09-452/4S	Splitter	15-Nov-18	15-Nov-19
55559	Mini-Circuits ZFSC-2-10G	SPLITTER, 2-10GHZ	27-Jun-19	27-Jun-20
55366	Pulsar PS4-09-452/4S	Splitter	12-Apr-19	12-Apr-20
54620	Megaphase RA08-S1S1-12	SMA Cable	2-Aug-19	2-Aug-20
54616	Megaphase RA08-S1S1-12	SMA Cable	2-Aug-19	2-Aug-20
54614	Megaphase RA08-S1S1-12	SMA Cable	2-Aug-19	2-Aug-20
54617	Megaphase RA08-S1S1-12	SMA Cable	2-Aug-19	2-Aug-20
45162	KRYTAR 1850	500MHz to 18.5 GHz SMA Directional Coupler	30-Apr-19	30-Apr-20



Appendix D: Photographs of Test Setups

EUT Photos have been omitted from this test report. Photos can be found in the supplementary exhibit included in the submission and EDCS# 17887798.

Appendix E: Software Used to Perform Testing

Cisco Internal LabView Radio Test Automation Software – DFS Automation Main rev27

Appendix F: Test Procedures

Measurements were made in accordance with

- KDB 905462 D02 UNII DFS Compliance Procedures New Rules v02
- RSS-247 section A9.3a allows the use of applicable FCC KDBs

Test procedures are summarized below:

FCC DFS Test Procedures	EDCS # 1445052
-------------------------	----------------

Appendix G: Scope of Accreditation (A2LA certificate number 1178-01)

The scope of accreditation of Cisco Systems, Inc. can be found on the A2LA web page at:

<http://www.a2la.org/scopepdf/1178-01.pdf>

Appendix H: Test Assessment Plan

Compliance Test Plan (Excel) EDCS# 17883750

Radio Test Plan: EDCS# 18098256

Appendix I: Worst Case Justification

N/A

Appendix J: UUT Software Info

Cisco AP Software, (ap1g6a), [build-lnx-059:/san2/BUILD/workspace/Nightly-Cheetah-ap1g6a-mfg-c8_10_throttle]

Technical Support: <http://www.cisco.com/techsupport>

Copyright (c) 1986-2019 by Cisco Systems, Inc.

Compiled Mon Sep 2 07:02:05 PDT 2019

ROM: Bootstrap program is U-Boot boot loader

BOOTLDR: U-Boot boot loader Version 113