

Test Report
Model: C9130AXE-B
Cisco Catalyst C9130AXE Series

FCC ID: LDK948342197

5725-5850 MHz

Against the following Specifications:

CFR47 Part 15.407

RSS-247



Cisco Systems

170 West Tasman Drive

San Jose, CA 95134

	
<p>Author: Chris Blair Tested By: Chris Blair</p>	<p>Approved By: Gez Thorpe Title: Radio Compliance Manager Revision: See EDCS</p>

This report replaces any previously entered test report under EDCS – 18726859. This test report has been electronically authorized and archived using the CISCO Engineering Document Control system.

This test report has been electronically authorized and archived using the CISCO Engineering Document Control system.

SECTION 1: OVERVIEW	3
SECTION 2: ASSESSMENT INFORMATION	4
2.1 GENERAL	4
2.2 DATE OF TESTING.....	6
2.3 REPORT ISSUE DATE	6
2.4 TESTING FACILITIES	6
2.5 EQUIPMENT ASSESSED (EUT).....	6
2.6 EUT DESCRIPTION.....	7
SECTION 3: RESULT SUMMARY	9
3.1 RESULTS SUMMARY TABLE	9
SECTION 4: SAMPLE DETAILS.....	10
4.1 SAMPLE DETAILS	10
4.2 SYSTEM DETAILS	10
4.3 MODE OF OPERATION DETAILS.....	10
APPENDIX A: RF CONDUCTED EMISSION TEST RESULTS	11
CONDUCTED TEST SETUP DIAGRAM.....	11
A.1 DUTY CYCLE	12
A.2 6dB BANDWIDTH.....	15
A.3 99% AND 26dB BANDWIDTH	18
A.4 MAXIMUM CONDUCTED OUTPUT POWER	21
A.5 POWER SPECTRAL DENSITY	30
A.6 CONDUCTED SPURIOUS EMISSIONS	39
A.7 CONDUCTED RECEIVER SPURIOUS EMISSIONS	39
A.8 CONDUCTED BANDEDGE.....	40
APPENDIX B: RADIATED & AC CONDUCTED EMISSION TEST RESULTS.....	49
APPENDIX C: LIST OF TEST EQUIPMENT USED TO PERFORM THE TEST.....	49
APPENDIX D: ABBREVIATION KEY AND DEFINITIONS.....	50
APPENDIX E: PHOTOGRAPHS OF TEST SETUPS.....	51
APPENDIX F: SOFTWARE USED TO PERFORM TESTING.....	52
APPENDIX G: TEST PROCEDURES.....	52
APPENDIX H: SCOPE OF ACCREDITATION (A2LA CERTIFICATE NUMBER 1178-01).....	52
APPENDIX I: TEST ASSESSMENT PLAN	52

Section 1: Overview

The samples were assessed against the tests detailed in section 3 under the requirements of the following specifications:

Specifications:
CFR47 Part 15.407 RSS-247

Measurements were made in accordance with

- ANSI C63.10:2013
- KDB 789033 D02 General UNII Test Procedures New Rules v01r03
- KDB 662911 D01 Multiple Transmitter Output v02r01

Section 2: Assessment Information

2.1 General

This report contains an assessment of an apparatus against Electromagnetic Compatibility Standards based upon tests carried out on the samples submitted. The testing was performed by and for the use of Cisco systems Inc:

With regard to this assessment, the following points should be noted:

- a) The results contained in this report relate only to the items tested and were obtained in the period between the date of the initial assessment and the date of issue of the report. Manufactured products will not necessarily give identical results due to production and measurement tolerances.
- b) The apparatus was set up and exercised using the configuration and modes of operation defined in this report only.
- c) Where relevant, the apparatus was only assessed using the susceptibility criteria defined in this report and the Test Assessment Plan (TAP).
- d) All testing was performed under the following environmental conditions:

Temperature	15°C to 35°C (54°F to 95°F)
Atmospheric Pressure	860mbar to 1060mbar (25.4" to 31.3")
Humidity	10% to 75*%

Units of Measurement

The units of measurements defined in the appendices are reported in specific terms, which are test dependent. Where radiated measurements are concerned these are defined at a particular distance. Basic voltage measurements are defined in units of [dBuV]

As an example, the basic calculation for all measurements is as follows:

$$\text{Emission level [dBuV]} = \text{Indicated voltage level [dBuV]} + \text{Cable Loss [dB]} + \text{Other correction factors [dB]}$$

The combinations of correction factors are dependent upon the exact test configurations [see test equipment lists for further details] and may include:-

Antenna Factors, Pre Amplifier Gain, LISN Loss, Pulse Limiter Loss and Filter Insertion Loss

Note: to convert the results from dBuV/m to uV/m use the following formula:-

$$\text{Level in uV/m} = \text{Common Antilogarithm} [(X \text{ dBuV/m})/20] = Y \text{ uV/m}$$

Measurement Uncertainty Values

voltage and power measurements	± 2 dB
conducted EIRP measurements	± 1.4 dB
radiated measurements	± 3.2 dB
frequency measurements	± 2.4 10 ⁻⁷
temperature measurements	± 0.54°
humidity measurements	± 2.3%
DC and low frequency measurements	± 2.5%

Where relevant measurement uncertainty levels have been estimated for tests performed on the apparatus. This uncertainty represents an expanded uncertainty expressed at approximately the 95% confidence level using a coverage factor of k=2.

Radiated emissions (expanded uncertainty, confidence interval 95%)

30 MHz - 300 MHz	+/- 3.8 dB
300 MHz - 1000 MHz	+/- 4.3 dB
1 GHz - 10 GHz	+/- 4.0 dB
10 GHz - 18GHz	+/- 8.2 dB
18GHz - 26.5GHz	+/- 4.1 dB
26.5GHz - 40GHz	+/- 3.9 dB

Conducted emissions (expanded uncertainty, confidence interval 95%)

30 MHz – 40GHz	+/- 0.38 dB
----------------	-------------

A product is considered to comply with a requirement if the nominal measured value is below the limit line. The product is considered to not be in compliance in case the nominal measured value is above the limit line.

This report must not be reproduced except in full, without written approval of Cisco Systems.

2.2 Date of testing

22-Jan-2020 - 29-Jan-2020

2.3 Report Issue Date

31-Jan-2020

Cisco uses an electronic system to issue, store and control the revision of test reports. This system is called the Engineering Document Control System (EDCS). The actual report issue date is embedded into the original file on EDCS. Any copies of this report, either electronic or paper, that are not on EDCS must be considered uncontrolled.

2.4 Testing facilities

This assessment was performed by:

Testing Laboratory

Cisco Systems, Inc.,
125 West Tasman Drive
San Jose, CA 95134, USA

Registration Numbers for Industry Canada

Cisco System Site	Address	Site Identifier
Building P, 10m Chamber	125 West Tasman Dr San Jose, CA 95134	Company #: 2461N-2
Building P, 5m Chamber	125 West Tasman Dr San Jose, CA 95134	Company #: 2461N-1
Building I, 5m Chamber	285 W. Tasman Drive San Jose, California 95134	Company #: 2461M-1

Test Engineers

Chris Blair

2.5 Equipment Assessed (EUT)

C9130AXE-x

2.6 EUT Description

The modes are further defined in the radio Theory of Operation.

The modes included in this report represent the worst case data for all modes.

The following antennas are supported by this product series.

The data included in this report represent the worst case data for the 13dBi antennas.

Table 1 List of External Antennas Supported on C9130AXE









Part Number	Description	Gain
C-ANT9101-	Ceiling Mount Omni Self-Identifying Antenna with Bluetooth, 8-port, with DART connectors.	2 dBi (2.4 GHz) 6 dBi (5 GHz) 3 dBi (BLE)
C-ANT9102-	Pole or Wall Mount Omni Self-Identifying Antenna with Bluetooth, 8-port, with DART connectors.	4 dBi (2.4 GHz) 4 dBi (5 GHz) 4 dBi (BLE)
C-ANT9103-	Pole or Wall mount 75° Directional Self-Identifying Antenna with Bluetooth, 8-port, with DART connectors.	6 dBi (2.4 GHz) 6 dBi (5 GHz) 6 dBi (BLE)
AIR-ANT2513P4M-N-	Patch Antenna, 4-port, with N connectors.  Note <u>Connect to AP using AIR-CAB003-D8-N=.</u>	13 dBi (2.4 GHz) 13 dBi (5 GHz) 13 dBi (BLE)
AIR-ANT2524V4C-R-	Ceiling Mount Omni Antenna, 4-port, with RP-TNC connectors.  Note <u>Connect to AP using AIR-CAB002-D8-R=.</u>	2 dBi (2.4 GHz) 4 dBi (5 GHz)
AIR-ANT2524V4C-RS-	Ceiling Mount Omni Self-Identifying Antenna, 4-port, with RP-TNC connectors.  Note <u>Connect to AP using AIR-CAB002-D8-R=.</u>	2 dBi (2.4 GHz) 4 dBi (5 GHz)
AIR-ANT2544V4M-R-	Wall Mount Omni Antenna, 4-port, with RP-TNC connectors.  Note <u>Connect to AP using AIR-CAB002-D8-R=.</u>	4 dBi (2.4 GHz) 4 dBi (5 GHz)
AIR-ANT2544V4M-RS-	Wall Mount Omni Self-Identifying Antenna, 4-port, with RP-TNC connectors.  Note <u>Connect to AP using AIR-CAB002-D8-R=.</u>	4 dBi (2.4 GHz) 4 dBi (5 GHz)
AIR-ANT2566D4M-R-	60° Patch Antenna, 4-port, with RP-TNC connectors. ¹  Note <u>Connect to AP using AIR-CAB002-D8-R=.</u>	6 dBi (2.4 GHz) 6 dBi (5 GHz)
AIR-ANT2566D4M-RS-	60° Patch Self-Identifying Antenna, 4-port, with RP-TNC connectors.  Note <u>Connect to AP using AIR-CAB002-D8-R=.</u>	6 dBi (2.4 GHz) 6 dBi (5 GHz)

Table 1 *List of External Antennas Supported on C9130AXE*

Part Number	Description	Gain
AIR-ANT2566P4W-R-	Directional Antenna, 4-port, with RP-TNC connectors.  Note Connect to AP using AIR-CAB002-D8-R=.	6 dBi (2.4 GHz) 6 dBi (5 GHz)
AIR-ANT2566P4W-RS-	Directional Self-Identifying Antenna, 4-port, with RP-TNC connectors.  Note Connect to AP using AIR-CAB002-D8-R=.	6 dBi (2.4 GHz) 6 dBi (5 GHz)

1. For the USA, the UNII-1 channels can be used only indoors.

Section 3: Result Summary

3.1 Results Summary Table

Conducted emissions

Basic Standard	Technical Requirements / Details	Result
FCC 15.407 RSS-247	6dB Bandwidth: Systems using digital modulation techniques may operate in the 2400-2483.5MHz band. The minimum 6dB bandwidth shall be at least 500 kHz.	Pass
FCC 15.407 RSS-GEN	99% & 26 dB Bandwidth: The 99% occupied bandwidth is the frequency bandwidth such that, below its lower and above its upper frequency limits, the mean powers are each equal to 0.5% of the total mean power of the given emission. There is no limit for 99% OBW. The 26 dB emission is the width of the emission that is constrained by the frequencies associated with the two outermost amplitude points (upper and lower frequencies) that are attenuated by 26 dB relative to the maximum level measured in the fundamental emission.	Pass
FCC 15.407 RSS-247	Output Power: For the band 5.725-5.85 GHz, the maximum conducted output power over the frequency band of operation shall not exceed 1 W.	Pass
FCC 15.407 RSS-247	Power Spectral Density: 15.407 The maximum power spectral density shall not exceed 30 dBm in any 500-kHz band.	Pass
FCC 15.407 RSS-247	Conducted Spurious Emissions / Band-Edge: For transmitters operating in the 5.725-5.85 GHz band: All emissions within the frequency range from the band edge to 10 MHz above or below the band edge shall not exceed an e.i.r.p. of -17 dBm/MHz; for frequencies 10 MHz or greater above or below the band edge, emissions shall not exceed an e.i.r.p. of -27 dBm/MHz.	Band-Edge: Pass*
FCC 15.209 FCC 152.05 RSS-GEN	Restricted band: Unwanted emissions falling within the restricted bands, as defined in FCC 15.205 (a) must also comply with the radiated emission limits specified in FCC 15.209 (a).	Band-Edge: Pass*

* This report covers Conducted Band-Edge only. CSE calculation is covered in a separate report.

Radiated Emissions (General requirements)

Basic Standard	Technical Requirements / Details	Result
FCC 15.209 FCC 15.205 RSS-GEN	TX Spurious Emissions: Except as provided elsewhere in this subpart, the emissions from an intentional radiator shall not exceed the field strength levels specified in the filed strength limits table in this section.	Not covered by this report
FCC 15.207 RSS-GEN	AC conducted Emissions: Except when the requirements applicable to a given device state otherwise, for any radio apparatus equipped to operate from the public utility AC power supply, either directly or indirectly (such as with a battery charger), the radio frequency voltage of emissions conducted back onto the AC power lines in the frequency range of 0.15 MHz to 30 MHz shall not exceed the limits shown in the table in these sections. The more stringent limit applies at the frequency range boundaries.	Not covered by this report

** MPE calculation is recorded in a separate report

Section 4: Sample Details

Note: Each sample was evaluated to ensure that its condition was suitable to be used as a test sample prior to the commencement of testing.

4.1 Sample Details

Sample No.	Equipment Details	Manufacturer	Hardware Rev.	Firmware Rev.	Software Rev.	Serial Number
S01	C9130AXE-x	Cisco	800-106171-01	Radio FW version : QC_IMAGE_VERSION_STRING=WLAN.HK.2.0-01620-QCAHKSWPL_SILICONZ-1 NSS FW version : NSS.HK.J.CS-18-E_custC-sba1-redzone	Cisco AP Software, (ap1g6a), [build-Inx-059:/san2/BUILD/workspace/Nightly-Cheetah-ap1g6a-mfg-c171_throttle] Compiled Wed Nov 13 07:45:59 PST 2019 build-Inx-059 /san2/BUILD/workspace/Nightly-Cheetah-ap1g6a-mfg-c171_throttle * (HEAD detached at ff2b0938ed) svn base: ff2b0938eddb0b247d7fd1754e56eeb27f8c846 commit: ff2b0938eddb0b247d7fd1754e56eeb27f8c846 tree 96435cbc5cfe09eef8fca23f0a2286f010f8cb14	KWC233200X5

4.2 System Details

System #	Description	Samples
1	EUT for RF conducted measurements	S01

4.3 Mode of Operation Details

Mode#	Description	Comments
1	Continuously Transmitting	Continuously Transmitting ≥ 90% duty cycle

Appendix A: RF Conducted Emission Test Results

Conducted Test Setup Diagram

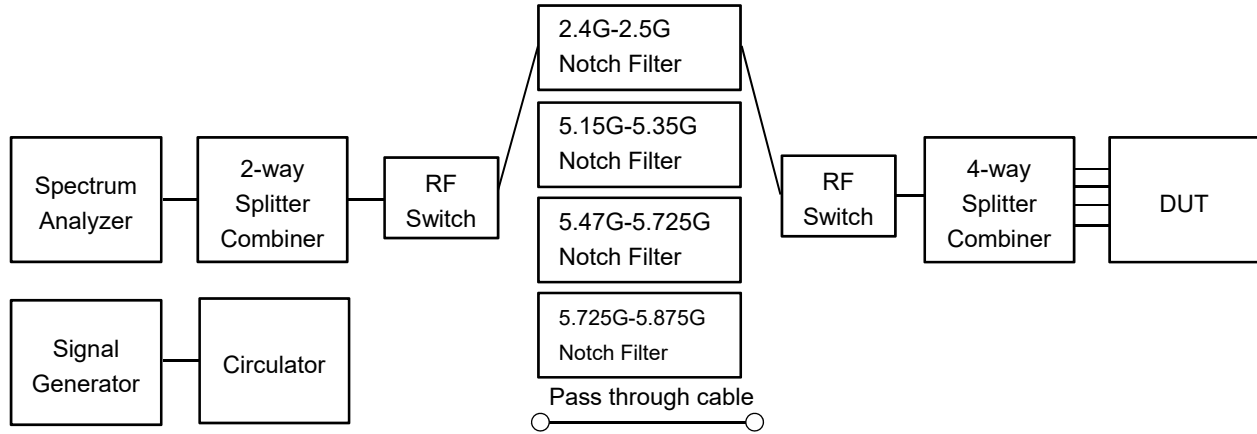

A.1 Duty Cycle

Duty Cycle Test Requirement

From KDB 789033 D02 General UNII Test Procedures New Rules v02r01

B. Duty Cycle (x), Transmission Duration (T), and Maximum Power Control Level

1. All measurements are to be performed with the EUT transmitting at 100 percent duty cycle at its maximum power control level; however, if 100 percent duty cycle cannot be achieved, measurements of duty cycle, x, and maximum-power transmission duration, T, are required for each tested mode of operation.

Duty Cycle Test Method

From KDB 789033 D02 General UNII Test Procedures New Rules v02r01:

B. Duty Cycle (x), Transmission Duration (T), and Maximum Power Control Level

The zero-span mode on a spectrum analyzer or EMI receiver, if the response time and spacing between bins on the sweep are sufficient to permit accurate measurements of the on and off times of the transmitted signal. Set the center frequency of the instrument to the center frequency of the transmission. Set $RBW \geq EBW$ if possible; otherwise, set RBW to the largest available value. Set $VBW \geq RBW$. Set detector = peak or average. The zero-span measurement method shall not be used unless both RBW and VBW are $> 50/T$, where T is defined in section II.B.1.a), and the number of sweep points across duration T exceeds 100. (For example, if VBW and/or RBW are limited to 3 MHz, then the zero-span method of measuring duty cycle shall not be used if $T \leq 16.7$ microseconds.)

Duty Cycle Test Information

Tested By : Chris Blair	Date of testing: 22-Jan-2020 - 29-Jan-2020
-----------------------------------	--

Test Equipment

See Appendix C for list of test equipment

Samples, Systems, and Modes

System Number	Description	Samples	System under test	Support equipment
1	EUT	S01	<input checked="" type="checkbox"/>	<input type="checkbox"/>
	Support		<input type="checkbox"/>	<input checked="" type="checkbox"/>

Duty Cycle Data Table

Duty Cycle table and screen captures are shown below for power/psd modes.

Frequency	Mode	Data Rate	Duty Cycle correction (dB)
5690	Non HT80, 6 to 54 Mbps	6	0.3
	HE80, M0 to M9, M0 to M9 1-2ss	m0h1	0.2
5710	Non HT40, 6 to 54 Mbps	6	0.3
	HE40, M0 to M9, M0 to M9 1-2ss	m0h1	0.2
5720	Non HT20, 6 to 54 Mbps	6	0.3
	HE20, M0 to M9, M0 to M9 1-2ss	m0h1	0.2
5745	Non HT20, 6 to 54 Mbps	6	0.3
	HE20, M0 to M9, M0 to M9 1-2ss	m0h1	0.2
5755	Non HT40, 6 to 54 Mbps	6	0.3
	HE40, M0 to M9, M0 to M9 1-2ss	m0h1	0.2
5775	Non HT80, 6 to 54 Mbps	6	0.3
	HE80, M0 to M9, M0 to M9 1-2ss	m0h1	0.2
5785	Non HT20, 6 to 54 Mbps	6	0.3
	HE20, M0 to M9, M0 to M9 1-2ss	m0h1	0.2
5795	Non HT40, 6 to 54 Mbps	6	0.3
	HE40, M0 to M9, M0 to M9 1-2ss	m0h1	0.2
5825	Non HT20, 6 to 54 Mbps	6	0.3
	HE20, M0 to M9, M0 to M9 1-2ss	m0h1	0.2



Duty Cycle, 5775 MHz, Non HT80, 6 to 54 Mbps

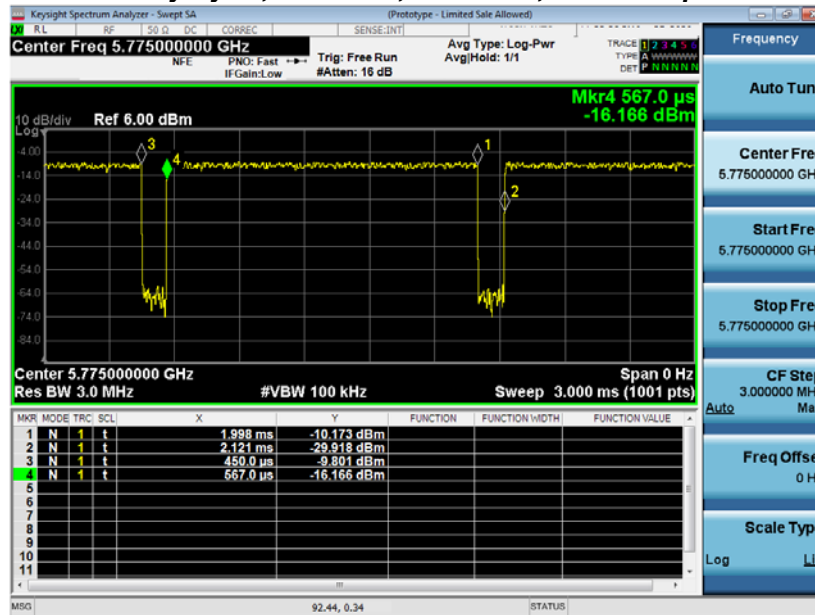

A.2 6dB Bandwidth

15.407 / RSS-247 Within the 5.725-5.85 GHz band, the minimum 6 dB bandwidth of U-NII devices shall be at least 500 KHz.

Test Procedure

Ref. KDB 789033 D02 General UNII Test Procedures New Rules v01r03
ANSI C63.10: 2013

6 BW Test Procedure
<ol style="list-style-type: none"> 1. Set the radio in the continuous transmitting mode. 2. Allow the trace to stabilize. 3. Setting the x-dB bandwidth mode to -6dB within the measurement set up function. 4. Select the automatic OBW measurement function of an instrument to perform bandwidth measurement. 5. Capture graphs and record pertinent measurement data.

Ref. KDB 789033 D02 General UNII Test Procedures New Rules v01r03
ANSI C63.10: 2013 section 11.8.2 Option 2

6 BW Test parameters
X dB BW = 6dB (using the OBW function of the spectrum analyzer) Span = Large enough to capture the entire EBW RBW = 100 KHz VBW ≥ 3 x RBW Sweep = Auto couple Detector = Peak or where practical sample shall be used Trace = Max. Hold

System Number	Description	Samples	System under test	Support equipment
1	EUT	S01	<input checked="" type="checkbox"/>	<input type="checkbox"/>
	Support		<input type="checkbox"/>	<input checked="" type="checkbox"/>

Tested By : Chris Blair	Date of testing: 22-Jan-2020 - 29-Jan-2020
Test Result : PASS	

See Appendix C for list of test equipment

6dB Bandwidth Table

Frequency (MHz)	Mode	Data Rate (Mbps)	6dB BW (MHz)	Limit (kHz)	Margin (MHz)
5690	Non HT80, 6 to 54 Mbps	6	3.1	>500	2.60
	HE80, M0 to M9, M0 to M9 1-2ss	m0h1	4.0	>500	3.50
5710	Non HT40, 6 to 54 Mbps	6	3.1	>500	2.60
	HE40, M0 to M9, M0 to M9 1-2ss	m0h1	4.0	>500	3.50
5720	Non HT20, 6 to 54 Mbps	6	3.1	>500	2.60
	HE20, M0 to M9, M0 to M9 1-2ss	m0h1	4.5	>500	4.00
5745	Non HT20, 6 to 54 Mbps	6	16.0	>500	15.50
	HE20, M0 to M9, M0 to M9 1-2ss	m0h1	18.7	>500	18.20
5755	Non HT40, 6 to 54 Mbps	6	35.3	>500	34.80
	HE40, M0 to M9, M0 to M9 1-2ss	m0h1	37.5	>500	37.00
5775	Non HT80, 6 to 54 Mbps	6	75.2	>500	74.70
	HE80, M0 to M9, M0 to M9 1-2ss	m0h1	76.2	>500	75.70
5785	Non HT20, 6 to 54 Mbps	6	16.3	>500	15.80
	HE20, M0 to M9, M0 to M9 1-2ss	m0h1	18.7	>500	18.20
5795	Non HT40, 6 to 54 Mbps	6	35.3	>500	34.80
	HE40, M0 to M9, M0 to M9 1-2ss	m0h1	37.5	>500	37.00
5825	Non HT20, 6 to 54 Mbps	6	16.3	>500	15.80
	HE20, M0 to M9, M0 to M9 1-2ss	m0h1	18.6	>500	18.10

6dB Bandwidth, 5690 MHz, Non HT80, 6 to 54 Mbps

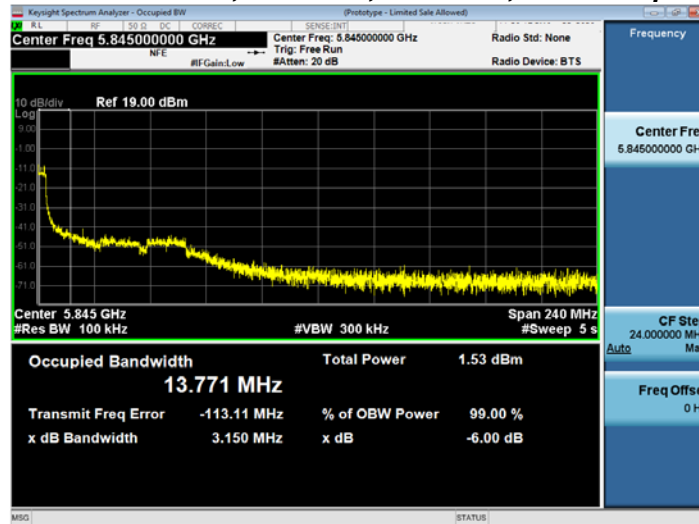

A.3 99% and 26dB Bandwidth

FCC 15.407 / RSS-GEN The 99% occupied bandwidth is the frequency bandwidth such that, below its lower and above its upper frequency limits, the mean powers are each equal to 0.5% of the total mean power of the given emission. There is no limit for 99% OBW.

The 26 dB emission is the width of the emission that is constrained by the frequencies associated with the two outermost amplitude points (upper and lower frequencies) that are attenuated by 26 dB relative to the maximum level measured in the fundamental emission.

Test Procedure

Ref. ANSI C63.10: 2013 Section 6.9.3

99% BW and EBW (-26dB)

Test Procedure

1. Set the radio in the continuous transmitting mode.
2. Allow the trace to stabilize.
3. Setting the x-dB bandwidth mode to -26dB and OBW power function to 99% within the measurement set up function.
4. Select the automatic OBW measurement function of an instrument to perform bandwidth measurement.
5. Capture graphs and record pertinent measurement data.

Ref. ANSI C63.10: 2013 Section 6.9.3

99% BW and EBW (-26dB)

Test parameters

Span = 1.5 x to 5.0 times OBW
 RBW = approx. 1% to 5% of the OBW
 VBW ≥ 3 x RBW
 Detector = Peak or where practical sample shall be used
 Trace = Max. Hold

System Number	Description	Samples	System under test	Support equipment
1	EUT	S01	<input checked="" type="checkbox"/>	<input type="checkbox"/>
	Support		<input type="checkbox"/>	<input checked="" type="checkbox"/>

Tested By :

Chris Blair

Date of testing:

22-Jan-2020 - 29-Jan-2020

Test Result : PASS

See Appendix C for list of test equipment

99% and 26dB Bandwidth Table

Frequency (MHz)	Mode	Data Rate (Mbps)	26dB BW (MHz)	99% BW (MHz)
5690	Non HT80, 6 to 54 Mbps	6	5.4	10.1
	HE80, M0 to M9, M0 to M9 1-2ss	m0h1	5.8	11.7
5710	Non HT40, 6 to 54 Mbps	6	7.2	16.4
	HE40, M0 to M9, M0 to M9 1-2ss	m0h1	6.0	4.6
5720	Non HT20, 6 to 54 Mbps	6	5.0	3.8
	HE20, M0 to M9, M0 to M9 1-2ss	m0h1	5.7	4.8
5745	Non HT20, 6 to 54 Mbps	6	19.3	16.3
	HE20, M0 to M9, M0 to M9 1-2ss	m0h1	21.7	18.9
5755	Non HT40, 6 to 54 Mbps	6	42.7	36.1
	HE40, M0 to M9, M0 to M9 1-2ss	m0h1	40.7	37.7
5775	Non HT80, 6 to 54 Mbps	6	80.4	75.5
	HE80, M0 to M9, M0 to M9 1-2ss	m0h1	80.7	77.1
5785	Non HT20, 6 to 54 Mbps	6	19.2	16.3
	HE20, M0 to M9, M0 to M9 1-2ss	m0h1	21.0	18.9
5795	Non HT40, 6 to 54 Mbps	6	44.8	36.2
	HE40, M0 to M9, M0 to M9 1-2ss	m0h1	40.6	37.7
5825	Non HT20, 6 to 54 Mbps	6	19.0	16.3
	HE20, M0 to M9, M0 to M9 1-2ss	m0h1	21.0	18.9

26dB-99% BW, 5720 MHz, Non HT20, 6 to 54 Mbps



A.4 Maximum Conducted Output Power

15.407 / RSS-247 For the band 5.725-5.85 GHz, the maximum conducted output power over the frequency band of operation shall not exceed 1 W. If transmitting antennas of directional gain greater than 6 dBi are used, both the maximum conducted output power and the maximum power spectral density shall be reduced by the amount in dB that the directional gain of the antenna exceeds 6 dBi. However, fixed point-to-point U-NII devices operating in this band may employ transmitting antennas with directional gain greater than 6 dBi without any corresponding reduction in transmitter conducted power. Fixed, point-to-point operations exclude the use of point-to-multipoint systems, omnidirectional applications, and multiple collocated transmitters transmitting the same information. The operator of the U-NII device, or if the equipment is professionally installed, the installer, is responsible for ensuring that systems employing high gain directional antennas are used exclusively for fixed, point-to-point operations.

The peak correlated gain for each mode is listed in the table below. See the Theory of Operation for details on the correlated gain for each mode.

Test Procedure

Ref. KDB 789033 D02 General UNII Test Procedures New Rules v01r03
ANSI C63.10: 2013

Output Power Test Procedure
<ol style="list-style-type: none"> 1. Set the radio in the continuous transmitting mode at full power 2. Compute power by integrating the spectrum across the EBW (or alternatively entire 99% OBW) of the signal using the instrument's band power measurement function. The integration shall be performed using the spectrum analyzer band-power measurement function with band limits set equal to the EBW or the OBW band edges. 3. Capture graphs and record pertinent measurement data.

Ref. KDB 789033 D02 General UNII Test Procedures New Rules v01r03
ANSI C63.10: 2013 section 12.3.2.2 Method SA-1

Output Power Test parameters
Span = >1.5 times the OBW RBW = 1MHz VBW ≥ 3 x RBW Sweep = Auto couple Detector = sample Trace = Trace Average 100

The "measure-and-sum technique" is used for measuring in-band transmit power of a device. In the measure-and-sum approach, the conducted emission level is measured at each antenna port. The measured results at the various antenna ports are then summed mathematically to determine the total emission level from the device. Summing is performed in linear power units. (See ANSI C63.10 section 14.3.2.2)

System Number	Description	Samples	System under test	Support equipment
1	EUT	S01	<input checked="" type="checkbox"/>	<input type="checkbox"/>
	Support		<input type="checkbox"/>	<input checked="" type="checkbox"/>

Tested By : Chris Blair	Date of testing: 22-Jan-2020 - 29-Jan-2020
Test Result : PASS	

See Appendix C for list of test equipment

Maximum Output Power

Frequency (MHz)	Mode	Tx Paths	Correlated Antenna Gain (dBi)	Tx 1 Max Power (dBm)	Tx 2 Max Power (dBm)	Tx 3 Max Power (dBm)	Tx 4 Max Power (dBm)	Duty Cycle Correction (dB)	Total Tx Channel Power (dBm)	Limit (dBm)	Margin (dB)
5690	Non HT80, 6 to 54 Mbps	1	13	-4.5				0.3	-4.2	23.0	27.16
	Non HT80, 6 to 54 Mbps	2	13	-4.5	-0.7			0.3	1.2	23.0	21.85
	Non HT80, 6 to 54 Mbps	3	13	-4.5	-0.7	0.1		0.3	3.8	23.0	19.18
	Non HT80, 6 to 54 Mbps	4	13	-4.5	-0.7	0.1	-1.1	0.3	5.1	23.0	17.88
	HE80, M0 to M9 1ss	1	13	-3.8				0.2	-3.6	23.0	26.56
	HE80, M0 to M9 1ss	2	13	-3.8	-0.4			0.2	1.5	23.0	21.53
	HE80, M0 to M9 2ss	2	13	-3.8	-0.4			0.2	1.5	23.0	21.53
	HE80, M0 to M9 1ss	3	13	-3.8	-0.4	0.9		0.2	4.3	23.0	18.68
	HE80, M0 to M9 2ss	3	13	-3.8	-0.4	0.9		0.2	4.3	23.0	18.68
	HE80, M0 to M9 3ss	3	13	-3.8	-0.4	0.9		0.2	4.3	23.0	18.68
	HE80, M0 to M9 1ss	4	13	-3.8	-0.4	0.9	-0.6	0.2	5.6	23.0	17.41
	HE80, M0 to M9 2ss	4	13	-3.8	-0.4	0.9	-0.6	0.2	5.6	23.0	17.41
	HE80, M0 to M9 3ss	4	13	-3.8	-0.4	0.9	-0.6	0.2	5.6	23.0	17.41
	HE80, M0 to M9 4ss	4	13	-3.8	-0.4	0.9	-0.6	0.2	5.6	23.0	17.41
	HE80 Beam Forming, M0 to M9 1ss	2	16	-3.8	-0.4			0.2	1.5	20.0	18.53
	HE80 Beam Forming, M0 to M9 2ss	2	13	-3.8	-0.4			0.2	1.5	23.0	21.53
	HE80 Beam Forming, M0 to M9 1ss	3	18	-3.8	-0.4	0.9		0.2	4.3	18.0	13.68
	HE80 Beam Forming, M0 to M9 2ss	3	15	-3.8	-0.4	0.9		0.2	4.3	21.0	16.68
	HE80 Beam Forming, M0 to M9 3ss	3	13	-3.8	-0.4	0.9		0.2	4.3	23.0	18.68
	HE80 Beam Forming, M0 to M9 1ss	4	19	-3.8	-0.4	0.9	-0.6	0.2	5.6	17.0	11.41
	HE80 Beam Forming, M0 to M9 2ss	4	16	-3.8	-0.4	0.9	-0.6	0.2	5.6	20.0	14.41
	HE80 Beam Forming, M0 to M9 3ss	4	14	-3.8	-0.4	0.9	-0.6	0.2	5.6	22.0	16.41
	HE80 Beam Forming, M0 to M9 4ss	4	13	-3.8	-0.4	0.9	-0.6	0.2	5.6	23.0	17.41
	HE80 STBC, M0 to M9 1ss	2	13	-3.8	-0.4			0.2	1.5	23.0	21.53
	HE80 STBC, M0 to M9 1ss	3	13	-3.8	-0.4	0.9		0.2	4.3	23.0	18.68
	HE80 STBC, M0 to M9 1ss	4	13	-3.8	-0.4	0.9	-0.6	0.2	5.6	23.0	17.41

Non HT40, 6 to 54 Mbps	1	13	0.2					0.3	0.5	23.0	22.47
------------------------	---	----	-----	--	--	--	--	-----	-----	------	-------

	Non HT40, 6 to 54 Mbps	2	13	0.2	3.5			0.3	5.5	23.0	17.50
	Non HT40, 6 to 54 Mbps	3	13	0.2	3.5	4.9		0.3	8.4	23.0	14.62
	Non HT40, 6 to 54 Mbps	4	13	0.2	3.5	4.9	3.7	0.3	9.7	23.0	13.26
	HE40, M0 to M9 1ss	1	13	0.7				0.2	0.9	23.0	22.07
	HE40, M0 to M9 1ss	2	13	0.7	3.9			0.2	5.8	23.0	17.17
	HE40, M0 to M9 2ss	2	13	0.7	3.9			0.2	5.8	23.0	17.17
	HE40, M0 to M9 1ss	3	13	0.7	3.9	5.4		0.2	8.7	23.0	14.26
	HE40, M0 to M9 2ss	3	13	0.7	3.9	5.4		0.2	8.7	23.0	14.26
	HE40, M0 to M9 3ss	3	13	0.7	3.9	5.4		0.2	8.7	23.0	14.26
	HE40, M0 to M9 1ss	4	13	0.7	3.9	5.4	4.4	0.2	10.2	23.0	12.84
	HE40, M0 to M9 2ss	4	13	0.7	3.9	5.4	4.4	0.2	10.2	23.0	12.84
	HE40, M0 to M9 3ss	4	13	0.7	3.9	5.4	4.4	0.2	10.2	23.0	12.84
	HE40, M0 to M9 4ss	4	13	0.7	3.9	5.4	4.4	0.2	10.2	23.0	12.84
	HE40 Beam Forming, M0 to M9 1ss	2	16	0.7	3.9			0.2	5.8	20.0	14.17
	HE40 Beam Forming, M0 to M9 2ss	2	13	0.7	3.9			0.2	5.8	23.0	17.17
	HE40 Beam Forming, M0 to M9 1ss	3	18	0.7	3.9	5.4		0.2	8.7	18.0	9.26
	HE40 Beam Forming, M0 to M9 2ss	3	15	0.7	3.9	5.4		0.2	8.7	21.0	12.26
	HE40 Beam Forming, M0 to M9 3ss	3	13	0.7	3.9	5.4		0.2	8.7	23.0	14.26
	HE40 Beam Forming, M0 to M9 1ss	4	19	0.7	3.9	5.4	4.4	0.2	10.2	17.0	6.84
	HE40 Beam Forming, M0 to M9 2ss	4	16	0.7	3.9	5.4	4.4	0.2	10.2	20.0	9.84
	HE40 Beam Forming, M0 to M9 3ss	4	14	0.7	3.9	5.4	4.4	0.2	10.2	22.0	11.84
	HE40 Beam Forming, M0 to M9 4ss	4	13	0.7	3.9	5.4	4.4	0.2	10.2	23.0	12.84
	HE40 STBC, M0 to M9 2ss	2	13	0.7	3.9			0.2	5.8	23.0	17.17
	HE40 STBC, M0 to M9 2ss	3	13	0.7	3.9	5.4		0.2	8.7	23.0	14.26
	HE40 STBC, M0 to M9 2ss	4	13	0.7	3.9	5.4	4.4	0.2	10.2	23.0	12.84
5720	Non HT20, 6 to 54 Mbps	1	13	4.2				0.3	4.5	23.0	18.48
	Non HT20, 6 to 54 Mbps	2	13	4.2	7.7			0.3	9.6	23.0	13.37
	Non HT20, 6 to 54 Mbps	3	13	4.2	7.7	9.3		0.3	12.6	23.0	10.36
	Non HT20, 6 to 54 Mbps	4	13	4.2	7.7	9.3	8.0	0.3	14.0	23.0	9.00
	Non HT20 Beam Forming, 6 to 54 Mbps	2	16	4.2	7.7			0.3	9.6	20.0	10.37
	Non HT20 Beam Forming, 6 to 54 Mbps	3	18	4.2	7.7	9.3		0.3	12.6	18.0	5.36
	Non HT20 Beam Forming, 6 to 54 Mbps	4	19	4.2	7.7	9.3	8.0	0.3	14.0	17.0	3.00
	HE20, M0 to M9 1ss	1	13	5.0				0.2	5.2	23.0	17.78
	HE20, M0 to M9 1ss	2	13	5.0	8.1			0.2	10.0	23.0	12.95
	HE20, M0 to M9 2ss	2	13	5.0	8.1			0.2	10.0	23.0	12.95
	HE20, M0 to M9 1ss	3	13	5.0	8.1	9.7		0.2	13.0	23.0	10.01
	HE20, M0 to M9 2ss	3	13	5.0	8.1	9.7		0.2	13.0	23.0	10.01
	HE20, M0 to M9 3ss	3	13	5.0	8.1	9.7		0.2	13.0	23.0	10.01
	HE20, M0 to M9 1ss	4	13	5.0	8.1	9.7	8.7	0.2	14.4	23.0	8.57
	HE20, M0 to M9 2ss	4	13	5.0	8.1	9.7	8.7	0.2	14.4	23.0	8.57
	HE20, M0 to M9 3ss	4	13	5.0	8.1	9.7	8.7	0.2	14.4	23.0	8.57
HE20, M0 to M9 4ss	4	13	5.0	8.1	9.7	8.7	0.2	14.4	23.0	8.57	

	HE20 Beam Forming, M0 to M9 1ss	2	16	5.0	8.1			0.2	10.0	20.0	9.95	
	HE20 Beam Forming, M0 to M9 2ss	2	13	5.0	8.1			0.2	10.0	23.0	12.95	
	HE20 Beam Forming, M0 to M9 1ss	3	18	5.0	8.1	9.7		0.2	13.0	18.0	5.01	
	HE20 Beam Forming, M0 to M9 2ss	3	15	5.0	8.1	9.7		0.2	13.0	21.0	8.01	
	HE20 Beam Forming, M0 to M9 3ss	3	13	5.0	8.1	9.7		0.2	13.0	23.0	10.01	
	HE20 Beam Forming, M0 to M9 1ss	4	19	5.0	8.1	9.7	8.7	0.2	14.4	17.0	2.57	
	HE20 Beam Forming, M0 to M9 2ss	4	16	5.0	8.1	9.7	8.7	0.2	14.4	20.0	5.57	
	HE20 Beam Forming, M0 to M9 3ss	4	14	5.0	8.1	9.7	8.7	0.2	14.4	22.0	7.57	
	HE20 Beam Forming, M0 to M9 4ss	4	13	5.0	8.1	9.7	8.7	0.2	14.4	23.0	8.57	
	HE20 STBC, M0 to M9 2ss	2	13	5.0	8.1			0.2	10.0	23.0	12.95	
	HE20 STBC, M0 to M9 2ss	3	13	5.0	8.1	9.7		0.2	13.0	23.0	10.01	
	HE20 STBC, M0 to M9 2ss	4	13	5.0	8.1	9.7	8.7	0.2	14.4	23.0	8.57	
5745	Non HT20, 6 to 54 Mbps	1	13	11.3				0.3	11.6	23.0	11.38	
	Non HT20, 6 to 54 Mbps	2	13	11.3	14.4			0.3	16.5	23.0	6.55	
	Non HT20, 6 to 54 Mbps	3	13	11.3	14.4	15.7		0.3	19.3	23.0	3.75	
	Non HT20, 6 to 54 Mbps	4	13	11.3	14.4	15.7	15.3	0.3	20.8	23.0	2.18	
	Non HT20 Beam Forming, 6 to 54 Mbps	2	16	11.3	14.4			0.3	16.5	20.0	3.55	
	Non HT20 Beam Forming, 6 to 54 Mbps	3	18	9.2	12.2	13.7		0.3	17.2	18.0	0.83	
	Non HT20 Beam Forming, 6 to 54 Mbps	4	19	7.4	10.5	11.9	11.4	0.3	17.0	17.0	0.05	
	HE20, M0 to M9 1ss	1	13	11.5					0.2	11.7	23.0	11.28
	HE20, M0 to M9 1ss	2	13	11.5	14.6				0.2	16.5	23.0	6.45
	HE20, M0 to M9 2ss	2	13	11.5	14.6				0.2	16.5	23.0	6.45
	HE20, M0 to M9 1ss	3	13	11.5	14.6	15.9			0.2	19.3	23.0	3.65
	HE20, M0 to M9 2ss	3	13	11.5	14.6	15.9			0.2	19.3	23.0	3.65
	HE20, M0 to M9 3ss	3	13	11.5	14.6	15.9			0.2	19.3	23.0	3.65
	HE20, M0 to M9 1ss	4	13	11.5	14.6	15.9	15.4		0.2	20.9	23.0	2.12
	HE20, M0 to M9 2ss	4	13	11.5	14.6	15.9	15.4		0.2	20.9	23.0	2.12
	HE20, M0 to M9 3ss	4	13	11.5	14.6	15.9	15.4		0.2	20.9	23.0	2.12
	HE20, M0 to M9 4ss	4	13	11.5	14.6	15.9	15.4		0.2	20.9	23.0	2.12
	HE20 Beam Forming, M0 to M9 1ss	2	16	11.5	14.6				0.2	16.5	20.0	3.45
	HE20 Beam Forming, M0 to M9 2ss	2	13	11.5	14.6				0.2	16.5	23.0	6.45
	HE20 Beam Forming, M0 to M9 1ss	3	18	9.5	12.4	13.7			0.2	17.2	18.0	0.82
	HE20 Beam Forming, M0 to M9 2ss	3	15	11.5	14.6	15.9			0.2	19.3	21.0	1.65
	HE20 Beam Forming, M0 to M9 3ss	3	13	11.5	14.6	15.9			0.2	19.3	23.0	3.65
	HE20 Beam Forming, M0 to M9 1ss	4	19	6.5	9.7	10.9	10.5		0.2	15.9	17.0	1.06
	HE20 Beam Forming, M0 to M9 2ss	4	16	10.5	13.5	14.9	14.4		0.2	19.9	20.0	0.14
	HE20 Beam Forming, M0 to M9 3ss	4	14	11.5	14.6	15.9	15.4		0.2	20.9	22.0	1.12
	HE20 Beam Forming, M0 to M9 4ss	4	13	11.5	14.6	15.9	15.4		0.2	20.9	23.0	2.12
	HE20 STBC, M0 to M9 2ss	2	13	11.5	14.6				0.2	16.5	23.0	6.45
	HE20 STBC, M0 to M9 2ss	3	13	11.5	14.6	15.9			0.2	19.3	23.0	3.65
	HE20 STBC, M0 to M9 2ss	4	13	11.5	14.6	15.9	15.4		0.2	20.9	23.0	2.12

5755	Non HT40, 6 to 54 Mbps	1	13	10.6				0.3	10.9	23.0	12.07
	Non HT40, 6 to 54 Mbps	2	13	10.6	13.8			0.3	15.8	23.0	7.17
	Non HT40, 6 to 54 Mbps	3	13	10.6	13.8	15.1		0.3	18.6	23.0	4.35
	Non HT40, 6 to 54 Mbps	4	13	10.6	13.8	15.1	14.8	0.3	20.2	23.0	2.75
	HE40, M0 to M9 1ss	1	13	11.5				0.2	11.7	23.0	11.27
	HE40, M0 to M9 1ss	2	13	11.5	14.3			0.2	16.4	23.0	6.64
	HE40, M0 to M9 2ss	2	13	11.5	14.3			0.2	16.4	23.0	6.64
	HE40, M0 to M9 1ss	3	13	11.5	14.3	15.8		0.2	19.2	23.0	3.79
	HE40, M0 to M9 2ss	3	13	11.5	14.3	15.8		0.2	19.2	23.0	3.79
	HE40, M0 to M9 3ss	3	13	11.5	14.3	15.8		0.2	19.2	23.0	3.79
	HE40, M0 to M9 1ss	4	13	11.5	14.3	15.8	15.3	0.2	20.8	23.0	2.24
	HE40, M0 to M9 2ss	4	13	11.5	14.3	15.8	15.3	0.2	20.8	23.0	2.24
	HE40, M0 to M9 3ss	4	13	11.5	14.3	15.8	15.3	0.2	20.8	23.0	2.24
	HE40, M0 to M9 4ss	4	13	11.5	14.3	15.8	15.3	0.2	20.8	23.0	2.24
	HE40 Beam Forming, M0 to M9 1ss	2	16	11.5	14.3			0.2	16.4	20.0	3.64
	HE40 Beam Forming, M0 to M9 2ss	2	13	11.5	14.3			0.2	16.4	23.0	6.64
	HE40 Beam Forming, M0 to M9 1ss	3	18	9.4	12.3	13.6		0.2	17.1	18.0	0.91
	HE40 Beam Forming, M0 to M9 2ss	3	15	11.5	14.3	15.8		0.2	19.2	21.0	1.79
	HE40 Beam Forming, M0 to M9 3ss	3	13	11.5	14.3	15.8		0.2	19.2	23.0	3.79
	HE40 Beam Forming, M0 to M9 1ss	4	19	7.6	10.7	11.8	11.3	0.2	16.9	17.0	0.13
	HE40 Beam Forming, M0 to M9 2ss	4	16	10.4	13.5	14.7	14.4	0.2	19.8	20.0	0.21
	HE40 Beam Forming, M0 to M9 3ss	4	14	11.5	14.3	15.8	15.3	0.2	20.8	22.0	1.24
	HE40 Beam Forming, M0 to M9 4ss	4	13	11.5	14.3	15.8	15.3	0.2	20.8	23.0	2.24
	HE40 STBC, M0 to M9 2ss	2	13	11.5	14.3			0.2	16.4	23.0	6.64
HE40 STBC, M0 to M9 2ss	3	13	11.5	14.3	15.8		0.2	19.2	23.0	3.79	
HE40 STBC, M0 to M9 2ss	4	13	11.5	14.3	15.8	15.3	0.2	20.8	23.0	2.24	
5775	Non HT80, 6 to 54 Mbps	1	13	10.4				0.3	10.7	23.0	12.26
	Non HT80, 6 to 54 Mbps	2	13	10.4	13.4			0.3	15.5	23.0	7.49
	Non HT80, 6 to 54 Mbps	3	13	10.4	13.4	14.6		0.3	18.2	23.0	4.76
	Non HT80, 6 to 54 Mbps	4	13	10.4	13.4	14.6	14.5	0.3	19.9	23.0	3.12
	HE80, M0 to M9 1ss	1	13	11.2				0.2	11.4	23.0	11.56
	HE80, M0 to M9 1ss	2	13	11.2	13.9			0.2	16.0	23.0	6.99
	HE80, M0 to M9 2ss	2	13	11.2	13.9			0.2	16.0	23.0	6.99
	HE80, M0 to M9 1ss	3	13	11.2	13.9	14.9		0.2	18.6	23.0	4.40
	HE80, M0 to M9 2ss	3	13	11.2	13.9	14.9		0.2	18.6	23.0	4.40
	HE80, M0 to M9 3ss	3	13	11.2	13.9	14.9		0.2	18.6	23.0	4.40
	HE80, M0 to M9 1ss	4	13	11.2	13.9	14.9	14.9	0.2	20.2	23.0	2.78
	HE80, M0 to M9 2ss	4	13	11.2	13.9	14.9	14.9	0.2	20.2	23.0	2.78
	HE80, M0 to M9 3ss	4	13	11.2	13.9	14.9	14.9	0.2	20.2	23.0	2.78
	HE80, M0 to M9 4ss	4	13	11.2	13.9	14.9	14.9	0.2	20.2	23.0	2.78
HE80 Beam Forming, M0 to M9 1ss	2	16	11.2	13.9			0.2	16.0	20.0	3.99	
HE80 Beam Forming, M0 to M9 2ss	2	13	11.2	13.9			0.2	16.0	23.0	6.99	

	HE80 Beam Forming, M0 to M9 1ss	3	18	10.0	12.8	14.0		0.2	17.6	18.0	0.42
	HE80 Beam Forming, M0 to M9 2ss	3	15	11.2	13.9	14.9		0.2	18.6	21.0	2.40
	HE80 Beam Forming, M0 to M9 3ss	3	13	11.2	13.9	14.9		0.2	18.6	23.0	4.40
	HE80 Beam Forming, M0 to M9 1ss	4	19	7.5	10.2	11.1	10.9	0.2	16.4	17.0	0.60
	HE80 Beam Forming, M0 to M9 2ss	4	16	10.0	12.8	14.0	14.1	0.2	19.3	20.0	0.74
	HE80 Beam Forming, M0 to M9 3ss	4	14	11.2	13.9	14.9	14.9	0.2	20.2	22.0	1.78
	HE80 Beam Forming, M0 to M9 4ss	4	13	11.2	13.9	14.9	14.9	0.2	20.2	23.0	2.78
	HE80 STBC, M0 to M9 1ss	2	13	11.2	13.9			0.2	16.0	23.0	6.99
	HE80 STBC, M0 to M9 1ss	3	13	11.2	13.9	14.9		0.2	18.6	23.0	4.40
	HE80 STBC, M0 to M9 1ss	4	13	11.2	13.9	14.9	14.9	0.2	20.2	23.0	2.78
	Non HT20, 6 to 54 Mbps	1	13	11.7				0.3	12.0	23.0	10.98
	Non HT20, 6 to 54 Mbps	2	13	11.7	14.3			0.3	16.5	23.0	6.47
	Non HT20, 6 to 54 Mbps	3	13	11.7	14.3	15.5		0.3	19.2	23.0	3.80
	Non HT20, 6 to 54 Mbps	4	13	11.7	14.3	15.5	15.4	0.3	20.8	23.0	2.19
	Non HT20 Beam Forming, 6 to 54 Mbps	2	16	11.7	14.3			0.3	16.5	20.0	3.47
	Non HT20 Beam Forming, 6 to 54 Mbps	3	18	9.6	12.2	13.3		0.3	17.1	18.0	0.95
	Non HT20 Beam Forming, 6 to 54 Mbps	4	19	7.6	10.1	11.3	11.1	0.3	16.6	17.0	0.41
	HE20, M0 to M9 1ss	1	13	12.0				0.2	12.2	23.0	10.78
	HE20, M0 to M9 1ss	2	13	12.0	14.5			0.2	16.7	23.0	6.35
	HE20, M0 to M9 2ss	2	13	12.0	14.5			0.2	16.7	23.0	6.35
	HE20, M0 to M9 1ss	3	13	12.0	14.5	15.6		0.2	19.3	23.0	3.73
	HE20, M0 to M9 2ss	3	13	12.0	14.5	15.6		0.2	19.3	23.0	3.73
	HE20, M0 to M9 3ss	3	13	12.0	14.5	15.6		0.2	19.3	23.0	3.73
	HE20, M0 to M9 1ss	4	13	12.0	14.5	15.6	15.7	0.2	20.9	23.0	2.08
	HE20, M0 to M9 2ss	4	13	12.0	14.5	15.6	15.7	0.2	20.9	23.0	2.08
	HE20, M0 to M9 3ss	4	13	12.0	14.5	15.6	15.7	0.2	20.9	23.0	2.08
	HE20, M0 to M9 4ss	4	13	12.0	14.5	15.6	15.7	0.2	20.9	23.0	2.08
	HE20 Beam Forming, M0 to M9 1ss	2	16	12.0	14.5			0.2	16.7	20.0	3.35
	HE20 Beam Forming, M0 to M9 2ss	2	13	12.0	14.5			0.2	16.7	23.0	6.35
	HE20 Beam Forming, M0 to M9 1ss	3	18	9.8	12.3	13.3		0.2	17.0	18.0	0.98
	HE20 Beam Forming, M0 to M9 2ss	3	15	12.0	14.5	15.6		0.2	19.3	21.0	1.73
	HE20 Beam Forming, M0 to M9 3ss	3	13	12.0	14.5	15.6		0.2	19.3	23.0	3.73
	HE20 Beam Forming, M0 to M9 1ss	4	19	8.0	10.4	11.6	11.5	0.2	16.8	17.0	0.17
	HE20 Beam Forming, M0 to M9 2ss	4	16	11.0	13.6	14.5	14.5	0.2	19.8	20.0	0.15
	HE20 Beam Forming, M0 to M9 3ss	4	14	12.0	14.5	15.6	15.7	0.2	20.9	22.0	1.08
	HE20 Beam Forming, M0 to M9 4ss	4	13	12.0	14.5	15.6	15.7	0.2	20.9	23.0	2.08
	HE20 STBC, M0 to M9 2ss	2	13	12.0	14.5			0.2	16.7	23.0	6.35
	HE20 STBC, M0 to M9 2ss	3	13	12.0	14.5	15.6		0.2	19.3	23.0	3.73
	HE20 STBC, M0 to M9 2ss	4	13	12.0	14.5	15.6	15.7	0.2	20.9	23.0	2.08
5785	Non HT40, 6 to 54 Mbps	1	13	11.3				0.3	11.6	23.0	11.37

	Non HT40, 6 to 54 Mbps	2	13	11.3	13.7			0.3	16.0	23.0	6.99	
	Non HT40, 6 to 54 Mbps	3	13	11.3	13.7	14.9		0.3	18.6	23.0	4.35	
	Non HT40, 6 to 54 Mbps	4	13	11.3	13.7	14.9	15.0	0.3	20.3	23.0	2.69	
	HE40, M0 to M9 1ss	1	13	11.9				0.2	12.1	23.0	10.87	
	HE40, M0 to M9 1ss	2	13	11.9	14.1			0.2	16.4	23.0	6.62	
	HE40, M0 to M9 2ss	2	13	11.9	14.1			0.2	16.4	23.0	6.62	
	HE40, M0 to M9 1ss	3	13	11.9	14.1	15.4		0.2	19.0	23.0	3.97	
	HE40, M0 to M9 2ss	3	13	11.9	14.1	15.4		0.2	19.0	23.0	3.97	
	HE40, M0 to M9 3ss	3	13	11.9	14.1	15.4		0.2	19.0	23.0	3.97	
	HE40, M0 to M9 1ss	4	13	11.9	14.1	15.4	15.7	0.2	20.8	23.0	2.24	
	HE40, M0 to M9 2ss	4	13	11.9	14.1	15.4	15.7	0.2	20.8	23.0	2.24	
	HE40, M0 to M9 3ss	4	13	11.9	14.1	15.4	15.7	0.2	20.8	23.0	2.24	
	HE40, M0 to M9 4ss	4	13	11.9	14.1	15.4	15.7	0.2	20.8	23.0	2.24	
	HE40 Beam Forming, M0 to M9 1ss	2	16	11.9	14.1			0.2	16.4	20.0	3.62	
	HE40 Beam Forming, M0 to M9 2ss	2	13	11.9	14.1			0.2	16.4	23.0	6.62	
	HE40 Beam Forming, M0 to M9 1ss	3	18	10.0	12.2	13.6		0.2	17.2	18.0	0.83	
	HE40 Beam Forming, M0 to M9 2ss	3	15	11.9	14.1	15.4		0.2	19.0	21.0	1.97	
	HE40 Beam Forming, M0 to M9 3ss	3	13	11.9	14.1	15.4		0.2	19.0	23.0	3.97	
	HE40 Beam Forming, M0 to M9 1ss	4	19	8.0	10.2	11.5	11.4	0.2	16.7	17.0	0.27	
	HE40 Beam Forming, M0 to M9 2ss	4	16	10.7	13.3	14.5	14.8	0.2	19.8	20.0	0.16	
	HE40 Beam Forming, M0 to M9 3ss	4	14	11.9	14.1	15.4	15.7	0.2	20.8	22.0	1.24	
	HE40 Beam Forming, M0 to M9 4ss	4	13	11.9	14.1	15.4	15.7	0.2	20.8	23.0	2.24	
	HE40 STBC, M0 to M9 2ss	2	13	11.9	14.1			0.2	16.4	23.0	6.62	
	HE40 STBC, M0 to M9 2ss	3	13	11.9	14.1	15.4		0.2	19.0	23.0	3.97	
	HE40 STBC, M0 to M9 2ss	4	13	11.9	14.1	15.4	15.7	0.2	20.8	23.0	2.24	
5825	Non HT20, 6 to 54 Mbps	1	13	11.5				0.3	11.8	23.0	11.18	
	Non HT20, 6 to 54 Mbps	2	13	11.5	13.3			0.3	15.8	23.0	7.17	
	Non HT20, 6 to 54 Mbps	3	13	11.5	13.3	15.2		0.3	18.7	23.0	4.31	
	Non HT20, 6 to 54 Mbps	4	13	11.5	13.3	15.2	15.4	0.3	20.5	23.0	2.54	
	Non HT20 Beam Forming, 6 to 54 Mbps	2	16	11.5	13.3			0.3	15.8	20.0	4.17	
	Non HT20 Beam Forming, 6 to 54 Mbps	3	18	10.6	12.2	14.1		0.3	17.6	18.0	0.37	
	Non HT20 Beam Forming, 6 to 54 Mbps	4	19	7.8	9.4	11.2	11.3	0.3	16.5	17.0	0.51	
	HE20, M0 to M9 1ss	1	13	11.8					0.2	12.0	23.0	10.98
	HE20, M0 to M9 1ss	2	13	11.8	13.3				0.2	15.8	23.0	7.16
	HE20, M0 to M9 2ss	2	13	11.8	13.3				0.2	15.8	23.0	7.16
	HE20, M0 to M9 1ss	3	13	11.8	13.3	15.2			0.2	18.6	23.0	4.36
	HE20, M0 to M9 2ss	3	13	11.8	13.3	15.2			0.2	18.6	23.0	4.36
	HE20, M0 to M9 3ss	3	13	11.8	13.3	15.2			0.2	18.6	23.0	4.36
	HE20, M0 to M9 1ss	4	13	11.8	13.3	15.2	15.5		0.2	20.4	23.0	2.57
	HE20, M0 to M9 2ss	4	13	11.8	13.3	15.2	15.5		0.2	20.4	23.0	2.57
	HE20, M0 to M9 3ss	4	13	11.8	13.3	15.2	15.5		0.2	20.4	23.0	2.57
HE20, M0 to M9 4ss	4	13	11.8	13.3	15.2	15.5		0.2	20.4	23.0	2.57	



HE20 Beam Forming, M0 to M9 1ss	2	16	11.8	13.3			0.2	15.8	20.0	4.16
HE20 Beam Forming, M0 to M9 2ss	2	13	11.8	13.3			0.2	15.8	23.0	7.16
HE20 Beam Forming, M0 to M9 1ss	3	18	10.6	12.1	14.2		0.2	17.5	18.0	0.46
HE20 Beam Forming, M0 to M9 2ss	3	15	11.8	13.3	15.2		0.2	18.6	21.0	2.36
HE20 Beam Forming, M0 to M9 3ss	3	13	11.8	13.3	15.2		0.2	18.6	23.0	4.36
HE20 Beam Forming, M0 to M9 1ss	4	19	7.9	9.4	11.2	11.3	0.2	16.4	17.0	0.60
HE20 Beam Forming, M0 to M9 2ss	4	16	10.6	12.1	14.2	14.4	0.2	19.3	20.0	0.67
HE20 Beam Forming, M0 to M9 3ss	4	14	11.8	13.3	15.2	15.5	0.2	20.4	22.0	1.57
HE20 Beam Forming, M0 to M9 4ss	4	13	11.8	13.3	15.2	15.5	0.2	20.4	23.0	2.57
HE20 STBC, M0 to M9 2ss	2	13	11.8	13.3			0.2	15.8	23.0	7.16
HE20 STBC, M0 to M9 2ss	3	13	11.8	13.3	15.2		0.2	18.6	23.0	4.36
HE20 STBC, M0 to M9 2ss	4	13	11.8	13.3	15.2	15.5	0.2	20.4	23.0	2.57

Maximum Transmit Power, 5745 MHz, Non HT20 Beam Forming, 6 to 54 Mbps

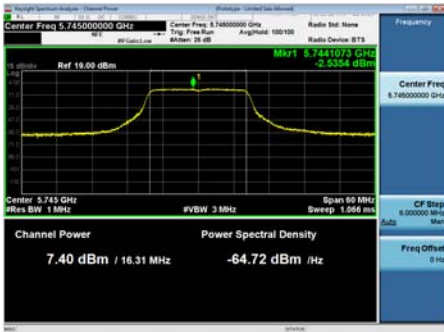

Antenna A

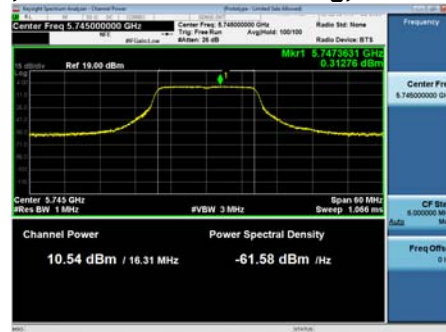

Antenna B

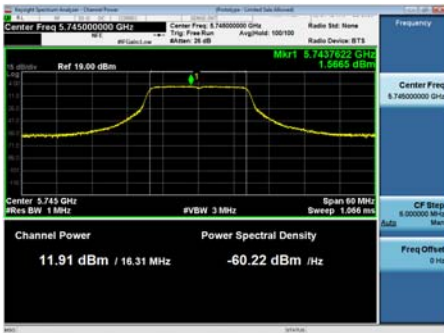

Antenna C

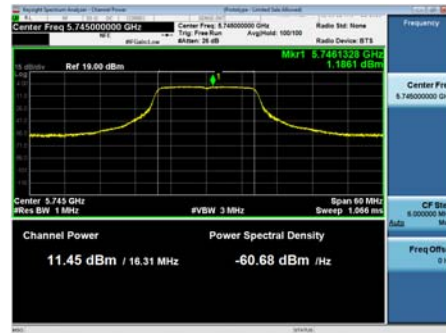

Antenna D

A.5 Power Spectral Density

15.407 / RSS-247 The power spectral density shall not exceed 30 dBm in any 500 kHz band. If transmitting antennas of directional gain greater than 6 dBi are used, both the maximum conducted output power and the power spectral density shall be reduced by the amount in dB that the directional gain of the antenna exceeds 6 dBi.

Test Procedure

Ref. KDB 789033 D02 General UNII Test Procedures New Rules v01

Power Spectral Density Test Procedure
<ol style="list-style-type: none"> 1. Connect the antenna port(s) to the spectrum analyzer input. 2. Set the radio in the continuous transmitting mode at full power 3. Configure Spectrum analyzer as per test parameters below and Peak search marker 4. Capture graphs and record pertinent measurement data.

Ref. KDB 789033 D02 v01 section F.5

Power Spectral Density Test parameters
Span = >1.5 times the OBW RBW = 500 kHz. VBW ≥ 3 x RBW Sweep = 10s Detector = Peak Trace = Single Sweep Marker = Peak Search

The "Measure and add 10 log(N) dB technique", where N is the number of outputs, is used for measuring in-band Power Spectral Density. With this technique, spectrum measurements are performed at each output of the device, and the quantity 10 log(4) (or 6dB) is added to the worst case spectrum value before comparing to the emission limit. (ANSI C63.10 2013 section 14.3.2.3)

System Number	Description	Samples	System under test	Support equipment
1	EUT	S01	<input checked="" type="checkbox"/>	<input type="checkbox"/>
	Support		<input type="checkbox"/>	<input checked="" type="checkbox"/>

Tested By : Chris Blair	Date of testing: 22-Jan-2020 - 29-Jan-2020
Test Result : PASS	

See Appendix C for list of test equipment

Power Spectral Density

Frequency (MHz)	Mode	Tx Paths	Correlated Antenna Gain (dBi)	Tx 1 PSD (dBm/500kHz)	Tx 2 PSD (dBm/500kHz)	Tx 3 PSD (dBm/500kHz)	Tx 4 PSD (dBm/500kHz)	Duty Cycle Correction (dB)	Total PSD (dBm/500kHz)	Limit (dBm/500kHz)	Margin (dB)
5690	Non HT80, 6 to 54 Mbps	1	13	-11.4				0.3	-11.1	23.0	34.06
	Non HT80, 6 to 54 Mbps	2	16	-11.4	-8.1			0.3	-6.1	20.0	26.09
	Non HT80, 6 to 54 Mbps	3	18	-11.4	-8.1	-6.8		0.3	-3.3	18.0	21.26
	Non HT80, 6 to 54 Mbps	4	19	-11.4	-8.1	-6.8	-8.2	0.3	-2.0	17.0	18.97
	HE80, M0 to M9 1ss	1	13	-11.6				0.2	-11.4	23.0	34.36
	HE80, M0 to M9 1ss	2	16	-11.6	-7.9			0.2	-6.1	20.0	26.12
	HE80, M0 to M9 2ss	2	13	-11.6	-7.9			0.2	-6.1	23.0	29.12
	HE80, M0 to M9 1ss	3	18	-11.6	-7.9	-7.0		0.2	-3.4	18.0	21.42
	HE80, M0 to M9 2ss	3	15	-11.6	-7.9	-7.0		0.2	-3.4	21.0	24.42
	HE80, M0 to M9 3ss	3	13	-11.6	-7.9	-7.0		0.2	-3.4	23.0	26.42
	HE80, M0 to M9 1ss	4	19	-11.6	-7.9	-7.0	-7.8	0.2	-2.0	17.0	19.00
	HE80, M0 to M9 2ss	4	16	-11.6	-7.9	-7.0	-7.8	0.2	-2.0	20.0	22.00
	HE80, M0 to M9 3ss	4	14	-11.6	-7.9	-7.0	-7.8	0.2	-2.0	22.0	24.00
	HE80, M0 to M9 4ss	4	13	-11.6	-7.9	-7.0	-7.8	0.2	-2.0	23.0	25.00
	HE80 Beam Forming, M0 to M9 1ss	2	16	-11.6	-7.9			0.2	-6.1	20.0	26.12
	HE80 Beam Forming, M0 to M9 2ss	2	13	-11.6	-7.9			0.2	-6.1	23.0	29.12
	HE80 Beam Forming, M0 to M9 1ss	3	18	-11.6	-7.9	-7.0		0.2	-3.4	18.0	21.42
	HE80 Beam Forming, M0 to M9 2ss	3	15	-11.6	-7.9	-7.0		0.2	-3.4	21.0	24.42
	HE80 Beam Forming, M0 to M9 3ss	3	13	-11.6	-7.9	-7.0		0.2	-3.4	23.0	26.42
	HE80 Beam Forming, M0 to M9 1ss	4	19	-11.6	-7.9	-7.0	-7.8	0.2	-2.0	17.0	19.00
	HE80 Beam Forming, M0 to M9 2ss	4	16	-11.6	-7.9	-7.0	-7.8	0.2	-2.0	20.0	22.00
	HE80 Beam Forming, M0 to M9 3ss	4	14	-11.6	-7.9	-7.0	-7.8	0.2	-2.0	22.0	24.00
	HE80 Beam Forming, M0 to M9 4ss	4	13	-11.6	-7.9	-7.0	-7.8	0.2	-2.0	23.0	25.00
	HE80 STBC, M0 to M9 1ss	2	13	-11.6	-7.9			0.2	-6.1	23.0	29.12
	HE80 STBC, M0 to M9 1ss	3	13	-11.6	-7.9	-7.0		0.2	-3.4	23.0	26.42
	HE80 STBC, M0 to M9 1ss	4	13	-11.6	-7.9	-7.0	-7.8	0.2	-2.0	23.0	25.00

5710	Non HT40, 6 to 54 Mbps	1	13	-6.6				0.3	-6.3	23.0	29.27
	Non HT40, 6 to 54 Mbps	2	16	-6.6	-3.5			0.3	-1.4	20.0	21.44
	Non HT40, 6 to 54 Mbps	3	18	-6.6	-3.5	-2.2		0.3	1.4	18.0	16.64
	Non HT40, 6 to 54 Mbps	4	19	-6.6	-3.5	-2.2	-3.0	0.3	2.8	17.0	14.19
	HE40, M0 to M9 1ss	1	13	-6.8				0.2	-6.6	23.0	29.57
	HE40, M0 to M9 1ss	2	16	-6.8	-4.2			0.2	-2.1	20.0	22.07
	HE40, M0 to M9 2ss	2	13	-6.8	-4.2			0.2	-2.1	23.0	25.07
	HE40, M0 to M9 1ss	3	18	-6.8	-4.2	-2.7		0.2	0.7	18.0	17.26
	HE40, M0 to M9 2ss	3	15	-6.8	-4.2	-2.7		0.2	0.7	21.0	20.26
	HE40, M0 to M9 3ss	3	13	-6.8	-4.2	-2.7		0.2	0.7	23.0	22.26
	HE40, M0 to M9 1ss	4	19	-6.8	-4.2	-2.7	-3.4	0.2	2.2	17.0	14.78
	HE40, M0 to M9 2ss	4	16	-6.8	-4.2	-2.7	-3.4	0.2	2.2	20.0	17.78
	HE40, M0 to M9 3ss	4	14	-6.8	-4.2	-2.7	-3.4	0.2	2.2	22.0	19.78
	HE40, M0 to M9 4ss	4	13	-6.8	-4.2	-2.7	-3.4	0.2	2.2	23.0	20.78
	HE40 Beam Forming, M0 to M9 1ss	2	16	-6.8	-4.2			0.2	-2.1	20.0	22.07
	HE40 Beam Forming, M0 to M9 2ss	2	13	-6.8	-4.2			0.2	-2.1	23.0	25.07
	HE40 Beam Forming, M0 to M9 1ss	3	18	-6.8	-4.2	-2.7		0.2	0.7	18.0	17.26
	HE40 Beam Forming, M0 to M9 2ss	3	15	-6.8	-4.2	-2.7		0.2	0.7	21.0	20.26
	HE40 Beam Forming, M0 to M9 3ss	3	13	-6.8	-4.2	-2.7		0.2	0.7	23.0	22.26
	HE40 Beam Forming, M0 to M9 1ss	4	19	-6.8	-4.2	-2.7	-3.4	0.2	2.2	17.0	14.78
	HE40 Beam Forming, M0 to M9 2ss	4	16	-6.8	-4.2	-2.7	-3.4	0.2	2.2	20.0	17.78
	HE40 Beam Forming, M0 to M9 3ss	4	14	-6.8	-4.2	-2.7	-3.4	0.2	2.2	22.0	19.78
	HE40 Beam Forming, M0 to M9 4ss	4	13	-6.8	-4.2	-2.7	-3.4	0.2	2.2	23.0	20.78
	HE40 STBC, M0 to M9 2ss	2	13	-6.8	-4.2			0.2	-2.1	23.0	25.07
HE40 STBC, M0 to M9 2ss	3	15	-6.8	-4.2	-2.7		0.2	0.7	21.0	20.26	
HE40 STBC, M0 to M9 2ss	4	16	-6.8	-4.2	-2.7	-3.4	0.2	2.2	20.0	17.78	
5720	Non HT20, 6 to 54 Mbps	1	13	-2.0				0.3	-1.7	23.0	24.68
	Non HT20, 6 to 54 Mbps	2	16	-2.0	0.7			0.3	2.9	20.0	17.11
	Non HT20, 6 to 54 Mbps	3	18	-2.0	0.7	2.3		0.3	5.8	18.0	12.23
	Non HT20, 6 to 54 Mbps	4	19	-2.0	0.7	2.3	1.0	0.3	7.1	17.0	9.90
	Non HT20 Beam Forming, 6 to 54 Mbps	2	16	-2.0	0.7			0.3	2.9	20.0	17.11
	Non HT20 Beam Forming, 6 to 54 Mbps	3	18	-2.0	0.7	2.3		0.3	5.8	18.0	12.23
	Non HT20 Beam Forming, 6 to 54 Mbps	4	19	-2.0	0.7	2.3	1.0	0.3	7.1	17.0	9.90
	HE20, M0 to M9 1ss	1	13	-2.9				0.2	-2.7	23.0	25.68
	HE20, M0 to M9 1ss	2	16	-2.9	0.5			0.2	2.4	20.0	17.65
	HE20, M0 to M9 2ss	2	13	-2.9	0.5			0.2	2.4	23.0	20.65
	HE20, M0 to M9 1ss	3	18	-2.9	0.5	1.7		0.2	5.1	18.0	12.85
	HE20, M0 to M9 2ss	3	15	-2.9	0.5	1.7		0.2	5.1	21.0	15.85
	HE20, M0 to M9 3ss	3	13	-2.9	0.5	1.7		0.2	5.1	23.0	17.85
	HE20, M0 to M9 1ss	4	19	-2.9	0.5	1.7	1.0	0.2	6.6	17.0	10.38
HE20, M0 to M9 2ss	4	16	-2.9	0.5	1.7	1.0	0.2	6.6	20.0	13.38	
HE20, M0 to M9 3ss	4	14	-2.9	0.5	1.7	1.0	0.2	6.6	22.0	15.38	

	HE20, M0 to M9 4ss	4	13	-2.9	0.5	1.7	1.0	0.2	6.6	23.0	16.38
	HE20 Beam Forming, M0 to M9 1ss	2	16	-2.9	0.5			0.2	2.4	20.0	17.65
	HE20 Beam Forming, M0 to M9 2ss	2	13	-2.9	0.5			0.2	2.4	23.0	20.65
	HE20 Beam Forming, M0 to M9 1ss	3	18	-2.9	0.5	1.7		0.2	5.1	18.0	12.85
	HE20 Beam Forming, M0 to M9 2ss	3	15	-2.9	0.5	1.7		0.2	5.1	21.0	15.85
	HE20 Beam Forming, M0 to M9 3ss	3	13	-2.9	0.5	1.7		0.2	5.1	23.0	17.85
	HE20 Beam Forming, M0 to M9 1ss	4	19	-2.9	0.5	1.7	1.0	0.2	6.6	17.0	10.38
	HE20 Beam Forming, M0 to M9 2ss	4	16	-2.9	0.5	1.7	1.0	0.2	6.6	20.0	13.38
	HE20 Beam Forming, M0 to M9 3ss	4	14	-2.9	0.5	1.7	1.0	0.2	6.6	22.0	15.38
	HE20 Beam Forming, M0 to M9 4ss	4	13	-2.9	0.5	1.7	1.0	0.2	6.6	23.0	16.38
	HE20 STBC, M0 to M9 2ss	2	13	-2.9	0.5			0.2	2.4	23.0	20.65
	HE20 STBC, M0 to M9 2ss	3	15	-2.9	0.5	1.7		0.2	5.1	21.0	15.85
	HE20 STBC, M0 to M9 2ss	4	16	-2.9	0.5	1.7	1.0	0.2	6.6	20.0	13.38
	Non HT20, 6 to 54 Mbps	1	13	-2.0				0.3	-1.7	23.0	24.68
	Non HT20, 6 to 54 Mbps	2	16	-2.0	0.7			0.3	2.9	20.0	17.11
	Non HT20, 6 to 54 Mbps	3	18	-2.0	0.7	2.4		0.3	5.8	18.0	12.18
	Non HT20, 6 to 54 Mbps	4	19	-2.0	0.7	2.4	1.9	0.3	7.4	17.0	9.61
	Non HT20 Beam Forming, 6 to 54 Mbps	2	16	-2.0	0.7			0.3	2.9	20.0	17.11
	Non HT20 Beam Forming, 6 to 54 Mbps	3	18	-3.9	-1.0	0.4		0.3	3.9	18.0	14.06
	Non HT20 Beam Forming, 6 to 54 Mbps	4	19	-5.6	-3.2	-1.7	-1.8	0.3	3.5	17.0	13.47
	HE20, M0 to M9 1ss	1	13	-2.5				0.2	-2.3	23.0	25.28
	HE20, M0 to M9 1ss	2	16	-2.5	0.6			0.2	2.5	20.0	17.45
	HE20, M0 to M9 2ss	2	13	-2.5	0.6			0.2	2.5	23.0	20.45
	HE20, M0 to M9 1ss	3	18	-2.5	0.6	1.7		0.2	5.3	18.0	12.75
	HE20, M0 to M9 2ss	3	15	-2.5	0.6	1.7		0.2	5.3	21.0	15.75
	HE20, M0 to M9 3ss	3	13	-2.5	0.6	1.7		0.2	5.3	23.0	17.75
	HE20, M0 to M9 1ss	4	19	-2.5	0.6	1.7	1.4	0.2	6.8	17.0	10.18
	HE20, M0 to M9 2ss	4	16	-2.5	0.6	1.7	1.4	0.2	6.8	20.0	13.18
	HE20, M0 to M9 3ss	4	14	-2.5	0.6	1.7	1.4	0.2	6.8	22.0	15.18
	HE20, M0 to M9 4ss	4	13	-2.5	0.6	1.7	1.4	0.2	6.8	23.0	16.18
	HE20 Beam Forming, M0 to M9 1ss	2	16	-2.5	0.6			0.2	2.5	20.0	17.45
	HE20 Beam Forming, M0 to M9 2ss	2	13	-2.5	0.6			0.2	2.5	23.0	20.45
	HE20 Beam Forming, M0 to M9 1ss	3	18	-4.5	-1.4	-0.1		0.2	3.3	18.0	14.65
	HE20 Beam Forming, M0 to M9 2ss	3	15	-2.5	0.6	1.7		0.2	5.3	21.0	15.75
	HE20 Beam Forming, M0 to M9 3ss	3	13	-2.5	0.6	1.7		0.2	5.3	23.0	17.75
	HE20 Beam Forming, M0 to M9 1ss	4	19	-7.0	-3.8	-2.8	-3.3	0.2	2.3	17.0	14.72
	HE20 Beam Forming, M0 to M9 2ss	4	16	-3.6	-0.2	1.3	0.7	0.2	6.1	20.0	13.86
	HE20 Beam Forming, M0 to M9 3ss	4	14	-2.5	0.6	1.7	1.4	0.2	6.8	22.0	15.18
	HE20 Beam Forming, M0 to M9 4ss	4	13	-2.5	0.6	1.7	1.4	0.2	6.8	23.0	16.18
	HE20 STBC, M0 to M9 2ss	2	13	-2.5	0.6			0.2	2.5	23.0	20.45
	HE20 STBC, M0 to M9 2ss	3	15	-2.5	0.6	1.7		0.2	5.3	21.0	15.75
	HE20 STBC, M0 to M9 2ss	4	16	-2.5	0.6	1.7	1.4	0.2	6.8	20.0	13.18

5755	Non HT40, 6 to 54 Mbps	1	13	-5.6				0.3	-5.3	23.0	28.27
	Non HT40, 6 to 54 Mbps	2	16	-5.6	-2.4			0.3	-0.4	20.0	20.37
	Non HT40, 6 to 54 Mbps	3	18	-5.6	-2.4	-1.0		0.3	2.5	18.0	15.50
	Non HT40, 6 to 54 Mbps	4	19	-5.6	-2.4	-1.0	-1.5	0.3	4.0	17.0	12.95
	HE40, M0 to M9 1ss	1	13	-5.3				0.2	-5.1	23.0	28.07
	HE40, M0 to M9 1ss	2	16	-5.3	-2.1			0.2	-0.2	20.0	20.17
	HE40, M0 to M9 2ss	2	13	-5.3	-2.1			0.2	-0.2	23.0	23.17
	HE40, M0 to M9 1ss	3	18	-5.3	-2.1	-0.7		0.2	2.7	18.0	15.31
	HE40, M0 to M9 2ss	3	15	-5.3	-2.1	-0.7		0.2	2.7	21.0	18.31
	HE40, M0 to M9 3ss	3	13	-5.3	-2.1	-0.7		0.2	2.7	23.0	20.31
	HE40, M0 to M9 1ss	4	19	-5.3	-2.1	-0.7	-1.2	0.2	4.2	17.0	12.76
	HE40, M0 to M9 2ss	4	16	-5.3	-2.1	-0.7	-1.2	0.2	4.2	20.0	15.76
	HE40, M0 to M9 3ss	4	14	-5.3	-2.1	-0.7	-1.2	0.2	4.2	22.0	17.76
	HE40, M0 to M9 4ss	4	13	-5.3	-2.1	-0.7	-1.2	0.2	4.2	23.0	18.76
	HE40 Beam Forming, M0 to M9 1ss	2	16	-5.3	-2.1			0.2	-0.2	20.0	20.17
	HE40 Beam Forming, M0 to M9 2ss	2	13	-5.3	-2.1			0.2	-0.2	23.0	23.17
	HE40 Beam Forming, M0 to M9 1ss	3	18	-7.5	-4.3	-2.9		0.2	0.5	18.0	17.51
	HE40 Beam Forming, M0 to M9 2ss	3	15	-5.3	-2.1	-0.7		0.2	2.7	21.0	18.31
	HE40 Beam Forming, M0 to M9 3ss	3	13	-5.3	-2.1	-0.7		0.2	2.7	23.0	20.31
	HE40 Beam Forming, M0 to M9 1ss	4	19	-9.4	-5.9	-5.0	-5.3	0.2	0.2	17.0	16.85
	HE40 Beam Forming, M0 to M9 2ss	4	16	-6.2	-2.8	-1.9	-2.6	0.2	3.2	20.0	16.85
	HE40 Beam Forming, M0 to M9 3ss	4	14	-5.3	-2.1	-0.7	-1.2	0.2	4.2	22.0	17.76
	HE40 Beam Forming, M0 to M9 4ss	4	13	-5.3	-2.1	-0.7	-1.2	0.2	4.2	23.0	18.76
	HE40 STBC, M0 to M9 2ss	2	13	-5.3	-2.1			0.2	-0.2	23.0	23.17
HE40 STBC, M0 to M9 2ss	3	15	-5.3	-2.1	-0.7		0.2	2.7	21.0	18.31	
HE40 STBC, M0 to M9 2ss	4	16	-5.3	-2.1	-0.7	-1.2	0.2	4.2	20.0	15.76	
5775	Non HT80, 6 to 54 Mbps	1	13	-8.1				0.3	-7.8	23.0	30.76
	Non HT80, 6 to 54 Mbps	2	16	-8.1	-5.3			0.3	-3.1	20.0	23.13
	Non HT80, 6 to 54 Mbps	3	18	-8.1	-5.3	-4.0		0.3	-0.4	18.0	18.37
	Non HT80, 6 to 54 Mbps	4	19	-8.1	-5.3	-4.0	-4.0	0.3	1.3	17.0	15.70
	HE80, M0 to M9 1ss	1	13	-8.2				0.2	-8.0	23.0	30.96
	HE80, M0 to M9 1ss	2	16	-8.2	-5.5			0.2	-3.4	20.0	23.39
	HE80, M0 to M9 2ss	2	13	-8.2	-5.5			0.2	-3.4	23.0	26.39
	HE80, M0 to M9 1ss	3	18	-8.2	-5.5	-4.1		0.2	-0.6	18.0	18.61
	HE80, M0 to M9 2ss	3	15	-8.2	-5.5	-4.1		0.2	-0.6	21.0	21.61
	HE80, M0 to M9 3ss	3	13	-8.2	-5.5	-4.1		0.2	-0.6	23.0	23.61
	HE80, M0 to M9 1ss	4	19	-8.2	-5.5	-4.1	-4.6	0.2	0.9	17.0	16.08
	HE80, M0 to M9 2ss	4	16	-8.2	-5.5	-4.1	-4.6	0.2	0.9	20.0	19.08
	HE80, M0 to M9 3ss	4	14	-8.2	-5.5	-4.1	-4.6	0.2	0.9	22.0	21.08
	HE80, M0 to M9 4ss	4	13	-8.2	-5.5	-4.1	-4.6	0.2	0.9	23.0	22.08
	HE80 Beam Forming, M0 to M9 1ss	2	16	-8.2	-5.5			0.2	-3.4	20.0	23.39

	HE80 Beam Forming, M0 to M9 2ss	2	13	-8.2	-5.5			0.2	-3.4	23.0	26.39
	HE80 Beam Forming, M0 to M9 1ss	3	18	-8.9	-6.3	-5.2		0.2	-1.5	18.0	19.53
	HE80 Beam Forming, M0 to M9 2ss	3	15	-8.2	-5.5	-4.1		0.2	-0.6	21.0	21.61
	HE80 Beam Forming, M0 to M9 3ss	3	13	-8.2	-5.5	-4.1		0.2	-0.6	23.0	23.61
	HE80 Beam Forming, M0 to M9 1ss	4	19	-11.7	-9.0	-8.3	-8.5	0.2	-2.9	17.0	19.92
	HE80 Beam Forming, M0 to M9 2ss	4	16	-8.9	-6.3	-5.2	-5.2	0.2	0.1	20.0	19.91
	HE80 Beam Forming, M0 to M9 3ss	4	14	-8.2	-5.5	-4.1	-4.6	0.2	0.9	22.0	21.08
	HE80 Beam Forming, M0 to M9 4ss	4	13	-8.2	-5.5	-4.1	-4.6	0.2	0.9	23.0	22.08
	HE80 STBC, M0 to M9 1ss	2	13	-8.2	-5.5			0.2	-3.4	23.0	26.39
	HE80 STBC, M0 to M9 1ss	3	13	-8.2	-5.5	-4.1		0.2	-0.6	23.0	23.61
	HE80 STBC, M0 to M9 1ss	4	13	-8.2	-5.5	-4.1	-4.6	0.2	0.9	23.0	22.08
5785	Non HT20, 6 to 54 Mbps	1	13	-1.9				0.3	-1.6	23.0	24.58
	Non HT20, 6 to 54 Mbps	2	16	-1.9	0.9			0.3	3.1	20.0	16.94
	Non HT20, 6 to 54 Mbps	3	18	-1.9	0.9	2.3		0.3	5.9	18.0	12.14
	Non HT20, 6 to 54 Mbps	4	19	-1.9	0.9	2.3	1.9	0.3	7.4	17.0	9.58
	Non HT20 Beam Forming, 6 to 54 Mbps	2	16	-1.9	0.9			0.3	3.1	20.0	16.94
	Non HT20 Beam Forming, 6 to 54 Mbps	3	18	-3.3	-1.3	0.0		0.3	3.8	18.0	14.23
	Non HT20 Beam Forming, 6 to 54 Mbps	4	19	-5.8	-3.5	-2.3	-2.2	0.3	3.1	17.0	13.89
	HE20, M0 to M9 1ss	1	13	-1.7				0.2	-1.5	23.0	24.48
	HE20, M0 to M9 1ss	2	16	-1.7	0.6			0.2	2.8	20.0	17.17
	HE20, M0 to M9 2ss	2	13	-1.7	0.6			0.2	2.8	23.0	20.17
	HE20, M0 to M9 1ss	3	18	-1.7	0.6	2.0		0.2	5.5	18.0	12.46
	HE20, M0 to M9 2ss	3	15	-1.7	0.6	2.0		0.2	5.5	21.0	15.46
	HE20, M0 to M9 3ss	3	13	-1.7	0.6	2.0		0.2	5.5	23.0	17.46
	HE20, M0 to M9 1ss	4	19	-1.7	0.6	2.0	1.8	0.2	7.1	17.0	9.86
	HE20, M0 to M9 2ss	4	16	-1.7	0.6	2.0	1.8	0.2	7.1	20.0	12.86
	HE20, M0 to M9 3ss	4	14	-1.7	0.6	2.0	1.8	0.2	7.1	22.0	14.86
	HE20, M0 to M9 4ss	4	13	-1.7	0.6	2.0	1.8	0.2	7.1	23.0	15.86
	HE20 Beam Forming, M0 to M9 1ss	2	16	-1.7	0.6			0.2	2.8	20.0	17.17
	HE20 Beam Forming, M0 to M9 2ss	2	13	-1.7	0.6			0.2	2.8	23.0	20.17
	HE20 Beam Forming, M0 to M9 1ss	3	18	-4.2	-1.5	-0.2		0.2	3.3	18.0	14.68
	HE20 Beam Forming, M0 to M9 2ss	3	15	-1.7	0.6	2.0		0.2	5.5	21.0	15.46
	HE20 Beam Forming, M0 to M9 3ss	3	13	-1.7	0.6	2.0		0.2	5.5	23.0	17.46
	HE20 Beam Forming, M0 to M9 1ss	4	19	-5.8	-3.4	-2.5	-2.4	0.2	2.9	17.0	14.09
	HE20 Beam Forming, M0 to M9 2ss	4	16	-2.9	0.1	0.9	0.6	0.2	6.1	20.0	13.86
	HE20 Beam Forming, M0 to M9 3ss	4	14	-1.7	0.6	2.0	1.8	0.2	7.1	22.0	14.86
	HE20 Beam Forming, M0 to M9 4ss	4	13	-1.7	0.6	2.0	1.8	0.2	7.1	23.0	15.86
	HE20 STBC, M0 to M9 2ss	2	13	-1.7	0.6			0.2	2.8	23.0	20.17
	HE20 STBC, M0 to M9 2ss	3	15	-1.7	0.6	2.0		0.2	5.5	21.0	15.46
	HE20 STBC, M0 to M9 2ss	4	16	-1.7	0.6	2.0	1.8	0.2	7.1	20.0	12.86

5795	Non HT40, 6 to 54 Mbps	1	13	-5.0				0.3	-4.7	23.0	27.67
	Non HT40, 6 to 54 Mbps	2	16	-5.0	-2.6			0.3	-0.3	20.0	20.29
	Non HT40, 6 to 54 Mbps	3	18	-5.0	-2.6	-1.1		0.3	2.5	18.0	15.51
	Non HT40, 6 to 54 Mbps	4	19	-5.0	-2.6	-1.1	-1.0	0.3	4.2	17.0	12.80
	HE40, M0 to M9 1ss	1	13	-4.8				0.2	-4.6	23.0	27.57
	HE40, M0 to M9 1ss	2	16	-4.8	-2.5			0.2	-0.3	20.0	20.26
	HE40, M0 to M9 2ss	2	13	-4.8	-2.5			0.2	-0.3	23.0	23.26
	HE40, M0 to M9 1ss	3	18	-4.8	-2.5	-0.9		0.2	2.5	18.0	15.45
	HE40, M0 to M9 2ss	3	15	-4.8	-2.5	-0.9		0.2	2.5	21.0	18.45
	HE40, M0 to M9 3ss	3	13	-4.8	-2.5	-0.9		0.2	2.5	23.0	20.45
	HE40, M0 to M9 1ss	4	19	-4.8	-2.5	-0.9	-1.0	0.2	4.2	17.0	12.79
	HE40, M0 to M9 2ss	4	16	-4.8	-2.5	-0.9	-1.0	0.2	4.2	20.0	15.79
	HE40, M0 to M9 3ss	4	14	-4.8	-2.5	-0.9	-1.0	0.2	4.2	22.0	17.79
	HE40, M0 to M9 4ss	4	13	-4.8	-2.5	-0.9	-1.0	0.2	4.2	23.0	18.79
	HE40 Beam Forming, M0 to M9 1ss	2	16	-4.8	-2.5			0.2	-0.3	20.0	20.26
	HE40 Beam Forming, M0 to M9 2ss	2	13	-4.8	-2.5			0.2	-0.3	23.0	23.26
	HE40 Beam Forming, M0 to M9 1ss	3	18	-6.9	-4.4	-2.8		0.2	0.6	18.0	17.39
	HE40 Beam Forming, M0 to M9 2ss	3	15	-4.8	-2.5	-0.9		0.2	2.5	21.0	18.45
	HE40 Beam Forming, M0 to M9 3ss	3	13	-4.8	-2.5	-0.9		0.2	2.5	23.0	20.45
	HE40 Beam Forming, M0 to M9 1ss	4	19	-8.6	-6.3	-5.0	-5.5	0.2	0.1	17.0	16.90
	HE40 Beam Forming, M0 to M9 2ss	4	16	-5.7	-3.6	-2.1	-2.0	0.2	3.1	20.0	16.86
	HE40 Beam Forming, M0 to M9 3ss	4	14	-4.8	-2.5	-0.9	-1.0	0.2	4.2	22.0	17.79
	HE40 Beam Forming, M0 to M9 4ss	4	13	-4.8	-2.5	-0.9	-1.0	0.2	4.2	23.0	18.79
HE40 STBC, M0 to M9 2ss	2	13	-4.8	-2.5			0.2	-0.3	23.0	23.26	
HE40 STBC, M0 to M9 2ss	3	15	-4.8	-2.5	-0.9		0.2	2.5	21.0	18.45	
HE40 STBC, M0 to M9 2ss	4	16	-4.8	-2.5	-0.9	-1.0	0.2	4.2	20.0	15.79	
5825	Non HT20, 6 to 54 Mbps	1	13	-1.8				0.3	-1.5	23.0	24.48
	Non HT20, 6 to 54 Mbps	2	16	-1.8	0.1			0.3	2.6	20.0	17.41
	Non HT20, 6 to 54 Mbps	3	18	-1.8	0.1	1.7		0.3	5.3	18.0	12.68
	Non HT20, 6 to 54 Mbps	4	19	-1.8	0.1	1.7	1.9	0.3	7.1	17.0	9.94
	Non HT20 Beam Forming, 6 to 54 Mbps	2	16	-1.8	0.1			0.3	2.6	20.0	17.41
	Non HT20 Beam Forming, 6 to 54 Mbps	3	18	-3.0	-1.0	0.6		0.3	4.2	18.0	13.80
	Non HT20 Beam Forming, 6 to 54 Mbps	4	19	-5.4	-4.0	-2.1	-2.0	0.3	3.2	17.0	13.81
	HE20, M0 to M9 1ss	1	13	-2.4				0.2	-2.2	23.0	25.18
	HE20, M0 to M9 1ss	2	16	-2.4	-0.4			0.2	1.9	20.0	18.06
	HE20, M0 to M9 2ss	2	13	-2.4	-0.4			0.2	1.9	23.0	21.06
	HE20, M0 to M9 1ss	3	18	-2.4	-0.4	1.4		0.2	4.8	18.0	13.21
	HE20, M0 to M9 2ss	3	15	-2.4	-0.4	1.4		0.2	4.8	21.0	16.21
	HE20, M0 to M9 3ss	3	13	-2.4	-0.4	1.4		0.2	4.8	23.0	18.21
	HE20, M0 to M9 1ss	4	19	-2.4	-0.4	1.4	1.4	0.2	6.5	17.0	10.50
	HE20, M0 to M9 2ss	4	16	-2.4	-0.4	1.4	1.4	0.2	6.5	20.0	13.50
HE20, M0 to M9 3ss	4	14	-2.4	-0.4	1.4	1.4	0.2	6.5	22.0	15.50	



HE20, M0 to M9 4ss	4	13	-2.4	-0.4	1.4	1.4	0.2	6.5	23.0	16.50
HE20 Beam Forming, M0 to M9 1ss	2	16	-2.4	-0.4			0.2	1.9	20.0	18.06
HE20 Beam Forming, M0 to M9 2ss	2	13	-2.4	-0.4			0.2	1.9	23.0	21.06
HE20 Beam Forming, M0 to M9 1ss	3	18	-3.1	-1.6	0.2		0.2	3.7	18.0	14.30
HE20 Beam Forming, M0 to M9 2ss	3	15	-2.4	-0.4	1.4		0.2	4.8	21.0	16.21
HE20 Beam Forming, M0 to M9 3ss	3	13	-2.4	-0.4	1.4		0.2	4.8	23.0	18.21
HE20 Beam Forming, M0 to M9 1ss	4	19	-5.8	-4.5	-2.7	-2.5	0.2	2.6	17.0	14.43
HE20 Beam Forming, M0 to M9 2ss	4	16	-3.1	-1.6	0.2	0.5	0.2	5.5	20.0	14.53
HE20 Beam Forming, M0 to M9 3ss	4	14	-2.4	-0.4	1.4	1.4	0.2	6.5	22.0	15.50
HE20 Beam Forming, M0 to M9 4ss	4	13	-2.4	-0.4	1.4	1.4	0.2	6.5	23.0	16.50
HE20 STBC, M0 to M9 2ss	2	13	-2.4	-0.4			0.2	1.9	23.0	21.06
HE20 STBC, M0 to M9 2ss	3	15	-2.4	-0.4	1.4		0.2	4.8	21.0	16.21
HE20 STBC, M0 to M9 2ss	4	16	-2.4	-0.4	1.4	1.4	0.2	6.5	20.0	13.50

Power Spectral Density 15.407, 5785 MHz, Non HT20, 6 to 54 Mbps

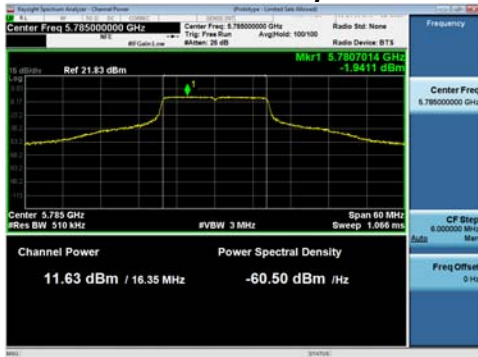

Antenna A

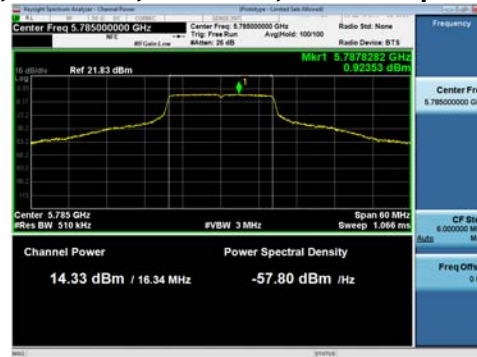

Antenna B

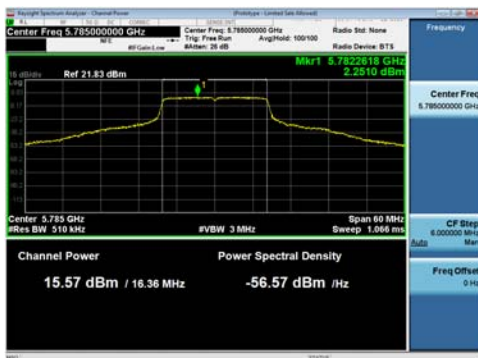

Antenna C

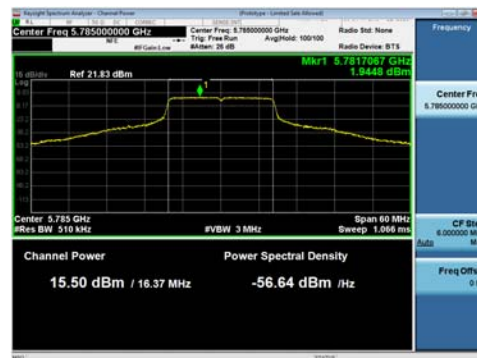

Antenna D

A.6 Conducted Spurious Emissions

Not covered by this report.

A.7 Conducted Receiver Spurious Emissions

Not covered by this report.

A.8 Conducted Bandedge

15.205 / 15.247 / LP0002 / RSS-247 In any 100 kHz bandwidth outside the frequency band in which the digitally modulated intentional radiator is operating, the radio frequency power that is produced by the intentional radiator shall be at least 30 dB below that in the 100 kHz bandwidth within the band that contains the highest level of the desired power.

Devices certified before March 2, 2018 with antenna gain of 10 dBi or less may demonstrate compliance with the emission limits in §15.247(d), but manufacturing, marketing and importing of devices certified under this alternative must cease before March 2, 2020.

Test Procedure

Ref. KDB 558074 D01 DTS Meas Guidance v03r05
ANSI C63.10: 2013

Conducted Band edge
Test Procedure
<ol style="list-style-type: none"> 1. Connect the antenna port(s) to the spectrum analyzer input. 2. Place the radio in continuous transmit mode. Use the procedures in KDB 558074 D01 DTS Meas Guidance v03r05 to substitute conducted measurements in place of radiated measurements. 3. Configure Spectrum analyzer as per test parameters below below (be sure to enter all losses between the transmitter output and the spectrum analyzer). 4. Place a marker at the end of the restricted band closest to the transmit frequency to show compliance. Also measure any emissions in the restricted bands.. 5. The “measure-and-sum technique” is used for measuring in-band transmit power of a device. In the measure-and-sum approach, the conducted emission level is measured at each antenna port. The measured results at the various antenna ports are then summed mathematically to determine the total emission level from the device. Summing is performed in linear power units. The worst case output is recorded. 6. Place a marker at the end of the restricted band closest to the transmit frequency to show compliance. Also measure any emissions in the restricted bands 7. Capture graphs and record pertinent measurement data.

Conducted Bandedge
Test parameters non-restricted Band KDB 558074 D01 v03r05 section 11.1b, 11.2-3, also see ANSI C63.10: 2013 section 11.10.3
RBW = 100 kHz VBW ≥ 3 x RBW Sweep = Auto couple Detector = Peak Trace = Max Hold.

System Number	Description	Samples	System under test	Support equipment
1	EUT	S01	<input checked="" type="checkbox"/>	<input type="checkbox"/>
	Support		<input type="checkbox"/>	<input checked="" type="checkbox"/>

Tested By : Chris Blair	Date of testing: 22-Jan-2020 - 29-Jan-2020
Test Result : PASS	

See Appendix C for list of test equipment

Conducted Bandedge Peak (Left Side)

Frequency (MHz)	Mode	Tx Paths	Correlated Antenna Gain (dBi)	Tx 1 Bandedge Level (dBm)	Tx 2 Bandedge Level (dBm)	Tx 3 Bandedge Level (dBm)	Tx 4 Bandedge Level (dBm)	Total Tx Bandedge Level (dBm)	Limit (dBm)	Margin (dB)
5745	Non HT20, 6 to 54 Mbps	1	13	-58.8				-45.5	-27.0	18.48
	Non HT20, 6 to 54 Mbps	2	13	-58.8	-56.1			-40.9	-27.0	13.91
	Non HT20, 6 to 54 Mbps	3	13	-58.8	-56.1	-56.8		-39.0	-27.0	12.00
	Non HT20, 6 to 54 Mbps	4	13	-58.8	-56.1	-56.8	-57.1	-37.7	-27.0	10.75
	Non HT20 Beam Forming, 6 to 54 Mbps	2	16	-58.8	-56.1			-37.9	-27.0	10.91
	Non HT20 Beam Forming, 6 to 54 Mbps	3	18	-61.1	-59.1	-59.0		-36.5	-27.0	9.54
	Non HT20 Beam Forming, 6 to 54 Mbps	4	19	-62.5	-59.7	-59.5	-59.6	-34.8	-27.0	7.82
	HE20, M0 to M9 1ss	1	13	-58.6				-45.4	-27.0	18.38
	HE20, M0 to M9 1ss	2	13	-58.6	-56.6			-41.3	-27.0	14.26
	HE20, M0 to M9 2ss	2	13	-58.6	-56.6			-41.3	-27.0	14.26
	HE20, M0 to M9 1ss	3	13	-58.6	-56.6	-56.9		-39.3	-27.0	12.29
	HE20, M0 to M9 2ss	3	13	-58.6	-56.6	-56.9		-39.3	-27.0	12.29
	HE20, M0 to M9 3ss	3	13	-58.6	-56.6	-56.9		-39.3	-27.0	12.29
	HE20, M0 to M9 1ss	4	13	-58.6	-56.6	-56.9	-57.0	-38.0	-27.0	10.97
	HE20, M0 to M9 2ss	4	13	-58.6	-56.6	-56.9	-57.0	-38.0	-27.0	10.97
	HE20, M0 to M9 3ss	4	13	-58.6	-56.6	-56.9	-57.0	-38.0	-27.0	10.97
	HE20, M0 to M9 4ss	4	13	-58.6	-56.6	-56.9	-57.0	-38.0	-27.0	10.97
	HE20 Beam Forming, M0 to M9 1ss	2	16	-58.6	-56.6			-38.3	-27.0	11.26
	HE20 Beam Forming, M0 to M9 2ss	2	13	-58.6	-56.6			-41.3	-27.0	14.26
	HE20 Beam Forming, M0 to M9 1ss	3	18	-61.1	-57.6	-58.9		-36.0	-27.0	8.98
	HE20 Beam Forming, M0 to M9 2ss	3	15	-58.6	-56.6	-56.9		-37.3	-27.0	10.29
	HE20 Beam Forming, M0 to M9 3ss	3	13	-58.6	-56.6	-56.9		-39.3	-27.0	12.29
	HE20 Beam Forming, M0 to M9 1ss	4	19	-64.7	-60.0	-62.5	-62.5	-36.9	-27.0	9.87
	HE20 Beam Forming, M0 to M9 2ss	4	16	-59.9	-57.2	-57.6	-57.6	-35.7	-27.0	8.72
	HE20 Beam Forming, M0 to M9 3ss	4	14	-58.6	-56.6	-56.9	-57.0	-37.0	-27.0	9.97
	HE20 Beam Forming, M0 to M9 4ss	4	13	-58.6	-56.6	-56.9	-57.0	-38.0	-27.0	10.97
	HE20 STBC, M0 to M9 2ss	2	13	-58.6	-56.6			-41.3	-27.0	14.26
	HE20 STBC, M0 to M9 2ss	3	13	-58.6	-56.6	-56.9		-39.3	-27.0	12.29
	HE20 STBC, M0 to M9 2ss	4	13	-58.6	-56.6	-56.9	-57.0	-38.0	-27.0	10.97

5755	Non HT40, 6 to 54 Mbps	1	13	-57.8				-44.5	-27.0	17.47
	Non HT40, 6 to 54 Mbps	2	13	-57.8	-56.1			-40.5	-27.0	13.52
	Non HT40, 6 to 54 Mbps	3	13	-57.8	-56.1	-54.6		-37.9	-27.0	10.87
	Non HT40, 6 to 54 Mbps	4	13	-57.8	-56.1	-54.6	-54.8	-36.3	-27.0	9.30
	HE40, M0 to M9 1ss	1	13	-58.8				-45.6	-27.0	18.57
	HE40, M0 to M9 1ss	2	13	-58.8	-57.1			-41.6	-27.0	14.63
	HE40, M0 to M9 2ss	2	13	-58.8	-57.1			-41.6	-27.0	14.63
	HE40, M0 to M9 1ss	3	13	-58.8	-57.1	-56.6		-39.4	-27.0	12.40
	HE40, M0 to M9 2ss	3	13	-58.8	-57.1	-56.6		-39.4	-27.0	12.40
	HE40, M0 to M9 3ss	3	13	-58.8	-57.1	-56.6		-39.4	-27.0	12.40
	HE40, M0 to M9 1ss	4	13	-58.8	-57.1	-56.6	-56.7	-38.0	-27.0	10.97
	HE40, M0 to M9 2ss	4	13	-58.8	-57.1	-56.6	-56.7	-38.0	-27.0	10.97
	HE40, M0 to M9 3ss	4	13	-58.8	-57.1	-56.6	-56.7	-38.0	-27.0	10.97
	HE40, M0 to M9 4ss	4	13	-58.8	-57.1	-56.6	-56.7	-38.0	-27.0	10.97
	HE40 Beam Forming, M0 to M9 1ss	2	16	-58.8	-57.1			-38.6	-27.0	11.63
	HE40 Beam Forming, M0 to M9 2ss	2	13	-58.8	-57.1			-41.6	-27.0	14.63
	HE40 Beam Forming, M0 to M9 1ss	3	18	-60.7	-57.8	-59.0		-36.0	-27.0	9.01
	HE40 Beam Forming, M0 to M9 2ss	3	15	-58.8	-57.1	-56.6		-37.4	-27.0	10.40
	HE40 Beam Forming, M0 to M9 3ss	3	13	-58.8	-57.1	-56.6		-39.4	-27.0	12.40
	HE40 Beam Forming, M0 to M9 1ss	4	19	-62.3	-59.7	-60.0	-60.1	-35.2	-27.0	8.16
	HE40 Beam Forming, M0 to M9 2ss	4	16	-59.5	-57.7	-57.6	-57.8	-35.8	-27.0	8.84
	HE40 Beam Forming, M0 to M9 3ss	4	14	-58.8	-57.1	-56.6	-56.7	-37.0	-27.0	9.97
	HE40 Beam Forming, M0 to M9 4ss	4	13	-58.8	-57.1	-56.6	-56.7	-38.0	-27.0	10.97
	HE40 STBC, M0 to M9 2ss	2	13	-58.8	-57.1			-41.6	-27.0	14.63
	HE40 STBC, M0 to M9 2ss	3	13	-58.8	-57.1	-56.6		-39.4	-27.0	12.40
HE40 STBC, M0 to M9 2ss	4	13	-58.8	-57.1	-56.6	-56.7	-38.0	-27.0	10.97	
5775	Non HT80, 6 to 54 Mbps	1	13	-46.9				-33.6	-27.0	6.56
	Non HT80, 6 to 54 Mbps	2	13	-46.9	-45.0			-29.5	-27.0	2.50
	Non HT80, 6 to 54 Mbps	3	13	-46.9	-45.0	-49.2		-28.6	-27.0	1.59
	Non HT80, 6 to 54 Mbps	4	13	-46.9	-45.0	-49.2	-49.5	-27.9	-27.0	0.89
	HE80, M0 to M9 1ss	1	13	-51.6				-38.4	-27.0	11.36
	HE80, M0 to M9 1ss	2	13	-51.6	-49.4			-34.1	-27.0	7.11
	HE80, M0 to M9 2ss	2	13	-51.6	-49.4			-34.1	-27.0	7.11
	HE80, M0 to M9 1ss	3	13	-51.6	-49.4	-47.0		-30.9	-27.0	3.92
	HE80, M0 to M9 2ss	3	13	-51.6	-49.4	-47.0		-30.9	-27.0	3.92
	HE80, M0 to M9 3ss	3	13	-51.6	-49.4	-47.0		-30.9	-27.0	3.92
	HE80, M0 to M9 1ss	4	13	-51.6	-49.4	-47.0	-47.5	-29.3	-27.0	2.27
	HE80, M0 to M9 2ss	4	13	-51.6	-49.4	-47.0	-47.5	-29.3	-27.0	2.27
	HE80, M0 to M9 3ss	4	13	-51.6	-49.4	-47.0	-47.5	-29.3	-27.0	2.27
HE80, M0 to M9 4ss	4	13	-51.6	-49.4	-47.0	-47.5	-29.3	-27.0	2.27	

HE80 Beam Forming, M0 to M9 1ss	2	16	-51.6	-49.4			-31.1	-27.0	4.11
HE80 Beam Forming, M0 to M9 2ss	2	13	-51.6	-49.4			-34.1	-27.0	7.11
HE80 Beam Forming, M0 to M9 1ss	3	18	-54.1	-52.3	-50.5		-29.0	-27.0	2.04
HE80 Beam Forming, M0 to M9 2ss	3	15	-51.6	-49.4	-47.0		-28.9	-27.0	1.92
HE80 Beam Forming, M0 to M9 3ss	3	13	-51.6	-49.4	-47.0		-30.9	-27.0	3.92
HE80 Beam Forming, M0 to M9 1ss	4	19	-61.7	-59.4	-59.2	-59.0	-34.4	-27.0	7.44
HE80 Beam Forming, M0 to M9 2ss	4	16	-54.1	-52.3	-50.5	-50.6	-29.4	-27.0	2.38
HE80 Beam Forming, M0 to M9 3ss	4	14	-51.6	-49.4	-47.0	-47.5	-28.3	-27.0	1.27
HE80 Beam Forming, M0 to M9 4ss	4	13	-51.6	-49.4	-47.0	-47.5	-29.3	-27.0	2.27
HE80 STBC, M0 to M9 1ss	2	13	-51.6	-49.4			-34.1	-27.0	7.11
HE80 STBC, M0 to M9 1ss	3	13	-51.6	-49.4	-47.0		-30.9	-27.0	3.92
HE80 STBC, M0 to M9 1ss	4	13	-51.6	-49.4	-47.0	-47.5	-29.3	-27.0	2.27



Conducted Bandedge 15407L, 5775 MHz, Non HT80, 6 to 54 Mbps

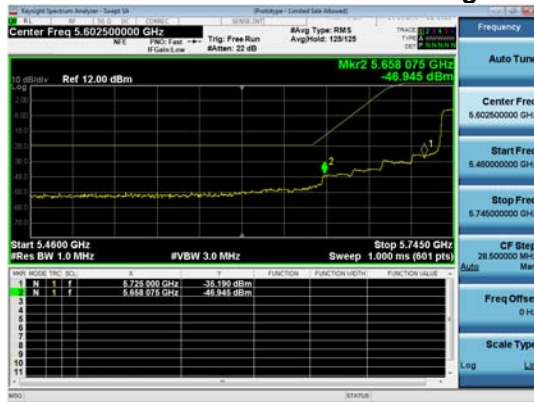

Antenna A



Antenna B



Antenna C



Antenna D

Conducted Bandedge Peak (Right Side)

Frequency (MHz)	Mode	Tx Paths	Correlated Antenna Gain (dBi)	Tx 1 Bandedge Level (dBm)	Tx 2 Bandedge Level (dBm)	Tx 3 Bandedge Level (dBm)	Tx 4 Bandedge Level (dBm)	Total Tx Bandedge Level (dBm)	Limit (dBm)	Margin (dB)
5785	Non HT20, 6 to 54 Mbps	1	13	-57.9				-44.6	-27.0	17.58
	Non HT20, 6 to 54 Mbps	2	13	-57.9	-57.9			-41.6	-27.0	14.57
	Non HT20, 6 to 54 Mbps	3	13	-57.9	-57.9	-56.6		-39.3	-27.0	12.33
	Non HT20, 6 to 54 Mbps	4	13	-57.9	-57.9	-56.6	-57.2	-38.0	-27.0	11.02
	Non HT20 Beam Forming, 6 to 54 Mbps	2	16	-57.9	-57.9			-38.6	-27.0	11.57
	Non HT20 Beam Forming, 6 to 54 Mbps	3	18	-59.0	-59.6	-59.4		-36.2	-27.0	9.23
	Non HT20 Beam Forming, 6 to 54 Mbps	4	19	-61.0	-61.7	-60.0	-60.8	-35.5	-27.0	8.49
	HE20, M0 to M9 1ss	1	13	-57.9				-44.7	-27.0	17.68
	HE20, M0 to M9 1ss	2	13	-57.9	-57.1			-41.3	-27.0	14.25
	HE20, M0 to M9 2ss	2	13	-57.9	-57.1			-41.3	-27.0	14.25
	HE20, M0 to M9 1ss	3	13	-57.9	-57.1	-56.5		-39.1	-27.0	12.14
	HE20, M0 to M9 2ss	3	13	-57.9	-57.1	-56.5		-39.1	-27.0	12.14
	HE20, M0 to M9 3ss	3	13	-57.9	-57.1	-56.5		-39.1	-27.0	12.14
	HE20, M0 to M9 1ss	4	13	-57.9	-57.1	-56.5	-56.9	-37.8	-27.0	10.83
	HE20, M0 to M9 2ss	4	13	-57.9	-57.1	-56.5	-56.9	-37.8	-27.0	10.83
	HE20, M0 to M9 3ss	4	13	-57.9	-57.1	-56.5	-56.9	-37.8	-27.0	10.83
	HE20, M0 to M9 4ss	4	13	-57.9	-57.1	-56.5	-56.9	-37.8	-27.0	10.83
	HE20 Beam Forming, M0 to M9 1ss	2	16	-57.9	-57.1			-38.3	-27.0	11.25
	HE20 Beam Forming, M0 to M9 2ss	2	13	-57.9	-57.1			-41.3	-27.0	14.25
	HE20 Beam Forming, M0 to M9 1ss	3	18	-59.4	-58.7	-59.5		-36.2	-27.0	9.20
	HE20 Beam Forming, M0 to M9 2ss	3	15	-57.9	-57.1	-56.5		-37.1	-27.0	10.14
	HE20 Beam Forming, M0 to M9 3ss	3	13	-57.9	-57.1	-56.5		-39.1	-27.0	12.14
	HE20 Beam Forming, M0 to M9 1ss	4	19	-61.6	-61.0	-59.9	-60.8	-35.5	-27.0	8.54
	HE20 Beam Forming, M0 to M9 2ss	4	16	-59.5	-59.3	-58.1	-58.8	-36.7	-27.0	9.65
	HE20 Beam Forming, M0 to M9 3ss	4	14	-57.9	-57.1	-56.5	-56.9	-36.8	-27.0	9.83
	HE20 Beam Forming, M0 to M9 4ss	4	13	-57.9	-57.1	-56.5	-56.9	-37.8	-27.0	10.83
	HE20 STBC, M0 to M9 2ss	2	13	-57.9	-57.1			-41.3	-27.0	14.25
	HE20 STBC, M0 to M9 2ss	3	13	-57.9	-57.1	-56.5		-39.1	-27.0	12.14

	HE20 STBC, M0 to M9 2ss	4	13	-57.9	-57.1	-56.5	-56.9	-37.8	-27.0	10.83
5795	Non HT40, 6 to 54 Mbps	1	13	-57.7				-44.4	-27.0	17.37
	Non HT40, 6 to 54 Mbps	2	13	-57.7	-58.0			-41.5	-27.0	14.50
	Non HT40, 6 to 54 Mbps	3	13	-57.7	-58.0	-56.5		-39.2	-27.0	12.25
	Non HT40, 6 to 54 Mbps	4	13	-57.7	-58.0	-56.5	-56.6	-37.8	-27.0	10.80
	HE40, M0 to M9 1ss	1	13	-57.4				-44.2	-27.0	17.17
	HE40, M0 to M9 1ss	2	13	-57.4	-58.0			-41.5	-27.0	14.45
	HE40, M0 to M9 2ss	2	13	-57.4	-58.0			-41.5	-27.0	14.45
	HE40, M0 to M9 1ss	3	13	-57.4	-58.0	-57.3		-39.6	-27.0	12.56
	HE40, M0 to M9 2ss	3	13	-57.4	-58.0	-57.3		-39.6	-27.0	12.56
	HE40, M0 to M9 3ss	3	13	-57.4	-58.0	-57.3		-39.6	-27.0	12.56
	HE40, M0 to M9 1ss	4	13	-57.4	-58.0	-57.3	-57.4	-38.3	-27.0	11.27
	HE40, M0 to M9 2ss	4	13	-57.4	-58.0	-57.3	-57.4	-38.3	-27.0	11.27
	HE40, M0 to M9 3ss	4	13	-57.4	-58.0	-57.3	-57.4	-38.3	-27.0	11.27
	HE40, M0 to M9 4ss	4	13	-57.4	-58.0	-57.3	-57.4	-38.3	-27.0	11.27
	HE40 Beam Forming, M0 to M9 1ss	2	16	-57.4	-58.0			-38.5	-27.0	11.45
	HE40 Beam Forming, M0 to M9 2ss	2	13	-57.4	-58.0			-41.5	-27.0	14.45
	HE40 Beam Forming, M0 to M9 1ss	3	18	-59.7	-58.4	-59.1		-36.0	-27.0	9.03
	HE40 Beam Forming, M0 to M9 2ss	3	15	-57.4	-58.0	-57.3		-37.6	-27.0	10.56
	HE40 Beam Forming, M0 to M9 3ss	3	13	-57.4	-58.0	-57.3		-39.6	-27.0	12.56
	HE40 Beam Forming, M0 to M9 1ss	4	19	-61.6	-61.9	-60.2	-61.1	-35.9	-27.0	8.90
	HE40 Beam Forming, M0 to M9 2ss	4	16	-59.4	-59.5	-58.1	-58.6	-36.6	-27.0	9.61
HE40 Beam Forming, M0 to M9 3ss	4	14	-57.4	-58.0	-57.3	-57.4	-37.3	-27.0	10.27	
HE40 Beam Forming, M0 to M9 4ss	4	13	-57.4	-58.0	-57.3	-57.4	-38.3	-27.0	11.27	
HE40 STBC, M0 to M9 2ss	2	13	-57.4	-58.0			-41.5	-27.0	14.45	
HE40 STBC, M0 to M9 2ss	3	13	-57.4	-58.0	-57.3		-39.6	-27.0	12.56	
HE40 STBC, M0 to M9 2ss	4	13	-57.4	-58.0	-57.3	-57.4	-38.3	-27.0	11.27	
5825	Non HT20, 6 to 54 Mbps	1	13	-57.2				-43.9	-27.0	16.88
	Non HT20, 6 to 54 Mbps	2	13	-57.2	-57.7			-41.1	-27.0	14.11
	Non HT20, 6 to 54 Mbps	3	13	-57.2	-57.7	-57.2		-39.3	-27.0	12.27
	Non HT20, 6 to 54 Mbps	4	13	-57.2	-57.7	-57.2	-56.9	-37.9	-27.0	10.90
	Non HT20 Beam Forming, 6 to 54 Mbps	2	16	-57.2	-57.7			-38.1	-27.0	11.11
	Non HT20 Beam Forming, 6 to 54 Mbps	3	18	-59.6	-59.4	-57.6		-35.7	-27.0	8.67
	Non HT20 Beam Forming, 6 to 54 Mbps	4	19	-61.6	-61.2	-60.2	-60.4	-35.5	-27.0	8.47
	HE20, M0 to M9 1ss	1	13	-58.1				-44.9	-27.0	17.88
	HE20, M0 to M9 1ss	2	13	-58.1	-57.7			-41.7	-27.0	14.67
	HE20, M0 to M9 2ss	2	13	-58.1	-57.7			-41.7	-27.0	14.67
	HE20, M0 to M9 1ss	3	13	-58.1	-57.7	-57.1		-39.6	-27.0	12.63
	HE20, M0 to M9 2ss	3	13	-58.1	-57.7	-57.1		-39.6	-27.0	12.63
	HE20, M0 to M9 3ss	3	13	-58.1	-57.7	-57.1		-39.6	-27.0	12.63
HE20, M0 to M9 1ss	4	13	-58.1	-57.7	-57.1	-57.2	-38.3	-27.0	11.27	

HE20, M0 to M9 2ss	4	13	-58.1	-57.7	-57.1	-57.2	-38.3	-27.0	11.27
HE20, M0 to M9 3ss	4	13	-58.1	-57.7	-57.1	-57.2	-38.3	-27.0	11.27
HE20, M0 to M9 4ss	4	13	-58.1	-57.7	-57.1	-57.2	-38.3	-27.0	11.27
HE20 Beam Forming, M0 to M9 1ss	2	16	-58.1	-57.7			-38.7	-27.0	11.67
HE20 Beam Forming, M0 to M9 2ss	2	13	-58.1	-57.7			-41.7	-27.0	14.67
HE20 Beam Forming, M0 to M9 1ss	3	18	-59.7	-59.1	-56.9		-35.4	-27.0	8.40
HE20 Beam Forming, M0 to M9 2ss	3	15	-58.1	-57.7	-57.1		-37.6	-27.0	10.63
HE20 Beam Forming, M0 to M9 3ss	3	13	-58.1	-57.7	-57.1		-39.6	-27.0	12.63
HE20 Beam Forming, M0 to M9 1ss	4	19	-61.7	-61.0	-60.1	-61.1	-35.7	-27.0	8.70
HE20 Beam Forming, M0 to M9 2ss	4	16	-59.7	-59.1	-56.9	-57.5	-35.9	-27.0	8.91
HE20 Beam Forming, M0 to M9 3ss	4	14	-58.1	-57.7	-57.1	-57.2	-37.3	-27.0	10.27
HE20 Beam Forming, M0 to M9 4ss	4	13	-58.1	-57.7	-57.1	-57.2	-38.3	-27.0	11.27
HE20 STBC, M0 to M9 2ss	2	13	-58.1	-57.7			-41.7	-27.0	14.67
HE20 STBC, M0 to M9 2ss	3	13	-58.1	-57.7	-57.1		-39.6	-27.0	12.63
HE20 STBC, M0 to M9 2ss	4	13	-58.1	-57.7	-57.1	-57.2	-38.3	-27.0	11.27

Conducted Bandedge 15407R, 5825 MHz, HE20 Beam Forming, M0 to M9 1ss

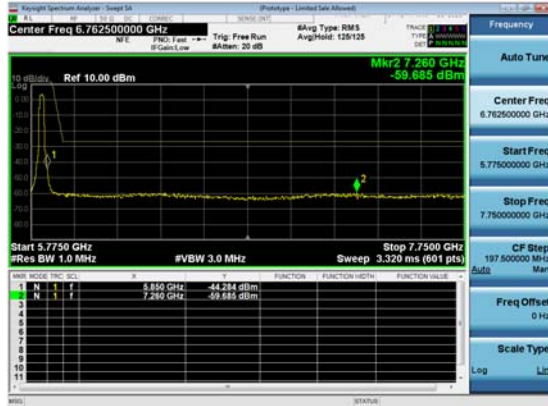

Antenna A

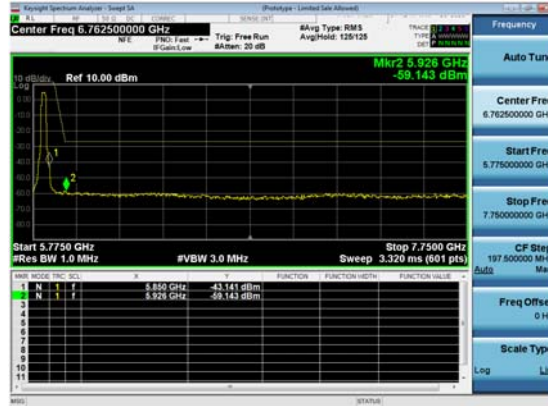

Antenna B

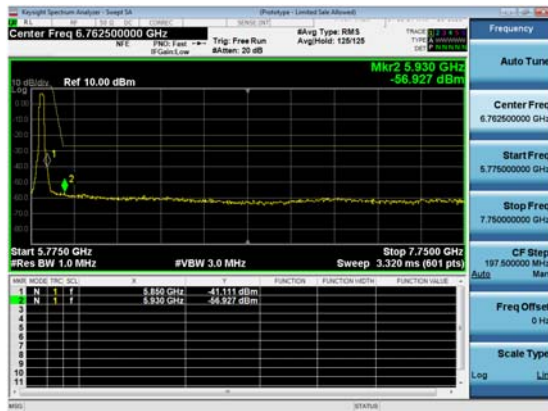

Antenna C

Appendix B: Radiated & AC Conducted Emission Test Results

Not covered by this report.

Appendix C: List of Test Equipment Used to perform the test

Equip#	Manufacturer/ Model	Description	Last Cal	Next Cal	Test Item
57477	Cisco	Automation Test Insertion Loss	NA	NA	A1-A8
55109	Keysight N9030A-550	PXA Signal Analyzer, 3Hz to 50GHz	18 Jul 2019	18 Jul 2020	A1-A8
55093	NI PXI-1042	CHASSIS, PXI	NA	NA	A1-A8
57238	NI PXI-8115	Embedded Controller	NA	NA	A1-A8
57247	NI PXI-2796	40 GHz Dual 6x1 Multiplexer (SP6T)	NA	NA	A1-A8
57248	NI PXI-2799	Switch 1x1	NA	NA	A1-A8
56092	NI PXI-2796	40 GHz Dual 6x1 Multiplexer (SP6T)	NA	NA	A1-A8
6695	Lufft 5063-33W	Dial hygrometer	06 Nov 2019	06 Nov 2020	A1-A8
56328	Pasternack PE5019-1	Torque wrench	14 Feb 2019	14 Feb 2020	A1-A8

Appendix D: Abbreviation Key and Definitions

The following table defines abbreviations used within this test report.

Abbreviation	Description	Abbreviation	Description
EMC	Electro Magnetic Compatibility	°F	Degrees Fahrenheit
EMI	Electro Magnetic Interference	°C	Degrees Celsius
EUT	Equipment Under Test	Temp	Temperature
ITE	Information Technology Equipment	S/N	Serial Number
TAP	Test Assessment Schedule	Qty	Quantity
ESD	Electro Static Discharge	emf	Electromotive force
EFT	Electric Fast Transient	RMS	Root mean square
EDCS	Engineering Document Control System	Qp	Quasi Peak
Config	Configuration	Av	Average
CIS#	Cisco Number (unique identification number for Cisco test equipment)	Pk	Peak
Cal	Calibration	kHz	Kilohertz (1x10 ³)
EN	European Norm	MHz	MegaHertz (1x10 ⁶)
IEC	International Electro technical Commission	GHz	Gigahertz (1x10 ⁹)
CISPR	International Special Committee on Radio Interference	H	Horizontal
CDN	Coupling/Decoupling Network	V	Vertical
LISN	Line Impedance Stabilization Network	dB	decibel
PE	Protective Earth	V	Volt
GND	Ground	kV	Kilovolt (1x10 ³)
L1	Line 1	μV	Microvolt (1x10 ⁻⁶)
L2	Line2	A	Amp
L3	Line 3	μA	Micro Amp (1x10 ⁻⁶)
DC	Direct Current	mS	Milli Second (1x10 ⁻³)
RAW	Uncorrected measurement value, as indicated by the measuring device	μS	Micro Second (1x10 ⁻⁶)
RF	Radio Frequency	μS	Micro Second (1x10 ⁻⁶)
SLCE	Signal Line Conducted Emissions	m	Meter
Meas dist	Measurement distance	Spec dist	Specification distance
N/A or NA	Not Applicable	SL	Signal Line (or Telecom Line)
P	Power Line	L	Live Line
N	Neutral Line	R	Return
S	Supply	AC	Alternating Current

Appendix E: Photographs of Test Setups

Please refer to the attachment

Appendix F: Software Used to Perform Testing

Cisco Internal LabView Radio Test Automation Software rev 133

Appendix G: Test Procedures

Measurements were made in accordance with

- KDB 789033 - D02 General UNII Test Procedures New Rules v02r01
- KDB 662911 - MIMO
- ANSI C63.4 2014 Unintentional Radiators
- ANSI C63.10 2013 Intentional Radiators

Test procedures are summarized below:

FCC 5GHz Test Procedures	EDCS # 1445048
FCC 5GHz RSE Test Procedures	EDCS # 1511600

Appendix H: Scope of Accreditation (A2LA certificate number 1178-01)

The scope of accreditation of Cisco Systems, Inc. can be found on the A2LA web page at:

<http://www.a2la.org/scopepdf/1178-01.pdf>

Appendix I: Test Assessment Plan

Compliance Test Plan (Excel) EDCS# 18216607

Radio Test Plan: EDCS# 18486508

End