

Test Report
Model: C9130AXE-(X)
Cisco Catalyst C9130AXE Series
(x= B)
Auxiliary Radio

FCC ID: LDK948342197



5470-5725 MHz

Against the following Specifications:

CFR47 Part 15.407



Cisco Systems
170 West Tasman Drive
San Jose, CA 95134

	
Author: Johanna Knudsen Tested By: Johanna Knudsen	Approved By: Gerard Thorpe Title: Manager Revision: 4

This report replaces any previously entered test report under EDCS – 18337242. This test report has been electronically authorized and archived using the CISCO Engineering Document Control system. Test Report Template EDCS# 11644124.

SECTION 1: OVERVIEW	3
SECTION2: ASSESSMENT INFORMATION	4
2.1 GENERAL	4
2.2 DATE OF TESTING.....	6
2.3 REPORT ISSUE DATE	6
2.4 TESTING FACILITIES	6
2.5 EQUIPMENT ASSESSED (EUT).....	6
2.6 EUT DESCRIPTION.....	7
SECTION 3: RESULT SUMMARY	9
3.1 RESULTS SUMMARY TABLE	9
SECTION 4: SAMPLE DETAILS.....	10
4.1 SAMPLE DETAILS	10
4.2 SYSTEM DETAILS	10
4.3 MODE OF OPERATION DETAILS.....	10
APPENDIX A: EMISSION TEST RESULTS	11
CONDUCTED TEST SETUP DIAGRAM.....	11
TARGET MAXIMUM CHANNEL POWER	11
A.1 DUTY CYCLE	12
A.2 99% AND 26DB BANDWIDTH.....	15
A.3 MAXIMUM CONDUCTED OUTPUT POWER	18
A.4 POWER SPECTRAL DENSITY	24
A.5 CONDUCTED SPURIOUS EMISSIONS	31
A.6 CONDUCTED BANDEDGE.....	42
APPENDIX B: EMISSION TEST RESULTS	49
RADIATED EMISSION SETUP DIAGRAM-BELOW 1G.....	49
B.1 RADIATED SPURIOUS EMISSIONS	50
B.2 RECEIVER SPURIOUS EMISSIONS	51
B.3 RADIATED EMISSIONS 30MHZ TO 1GHZ	52
B.4 AC CONDUCTED EMISSIONS	53
APPENDIX C: LIST OF TEST EQUIPMENT USED TO PERFORM THE TEST	54
APPENDIX D: ABBREVIATION KEY AND DEFINITIONS.....	55
APPENDIX E: PHOTOGRAPHS OF TEST SETUPS	56
APPENDIX F: SOFTWARE USED TO PERFORM TESTING.....	56
APPENDIX G: TEST PROCEDURES	56
APPENDIX H: SCOPE OF ACCREDITATION (A2LA CERTIFICATE NUMBER 1178-01)	56
APPENDIX I: TEST ASSESSMENT PLAN	56
APPENDIX J: WORST CASE JUSTIFICATION.....	56
APPENDIX K: UUT SOFTWARE INFO	56



Section 1: Overview

The samples were assessed against the tests detailed in section 3 under the requirements of the following specifications:

Specifications:
CFR47 Part 15.407

Section2: Assessment Information

2.1 General

This report contains an assessment of an apparatus against Electromagnetic Compatibility Standards based upon tests carried out on the samples submitted. The testing was performed by and for the use of Cisco systems Inc:

With regard to this assessment, the following points should be noted:

- a) The results contained in this report relate only to the items tested and were obtained in the period between the date of the initial assessment and the date of issue of the report. Manufactured products will not necessarily give identical results due to production and measurement tolerances.
- b) The apparatus was set up and exercised using the configuration and modes of operation defined in this report only.
- c) Where relevant, the apparatus was only assessed using the susceptibility criteria defined in this report and the Test Assessment Plan (TAP).
- d) All testing was performed under the following environmental conditions:

Temperature	15°C to 35°C (54°F to 95°F)
Atmospheric Pressure	860mbar to 1060mbar (25.4" to 31.3")
Humidity	10% to 75*%
- e) All AC testing was performed at one or more of the following supply voltages:
110V 60 Hz (+/-20%)

Units of Measurement

The units of measurements defined in the appendices are reported in specific terms, which are test dependent. Where radiated measurements are concerned these are defined at a particular distance. Basic voltage measurements are defined in units of [dBuV]

As an example, the basic calculation for all measurements is as follows:

$$\text{Emission level [dBuV]} = \text{Indicated voltage level [dBuV]} + \text{Cable Loss [dB]} + \text{Other correction factors [dB]}$$

The combinations of correction factors are dependent upon the exact test configurations [see test equipment lists for further details] and may include:-

Antenna Factors, Pre Amplifier Gain, LISN Loss, Pulse Limiter Loss and Filter Insertion Loss

Note: to convert the results from dBuV/m to uV/m use the following formula:-

$$\text{Level in uV/m} = \text{Common Antilogarithm} [(X \text{ dBuV/m})/20] = Y \text{ uV/m}$$

Measurement Uncertainty Values

voltage and power measurements	± 2 dB
conducted EIRP measurements	± 1.4 dB
radiated measurements	± 3.2 dB
frequency measurements	± 2.4 10 ⁻⁷
temperature measurements	± 0.54°
humidity measurements	± 2.3%
DC and low frequency measurements	± 2.5%

Where relevant measurement uncertainty levels have been estimated for tests performed on the apparatus. This uncertainty represents an expanded uncertainty expressed at approximately the 95% confidence level using a coverage factor of k=2.

Radiated emissions (expanded uncertainty, confidence interval 95%)

30 MHz - 300 MHz	+/- 3.8 dB
300 MHz - 1000 MHz	+/- 4.3 dB
1 GHz - 10 GHz	+/- 4.0 dB
10 GHz - 18GHz	+/- 8.2 dB
18GHz - 26.5GHz	+/- 4.1 dB
26.5GHz - 40GHz	+/- 3.9 dB

Conducted emissions (expanded uncertainty, confidence interval 95%)

30 MHz – 40GHz	+/- 0.38 dB
----------------	-------------

A product is considered to comply with a requirement if the nominal measured value is below the limit line. The product is considered to not be in compliance in case the nominal measured value is above the limit line.

This report must not be reproduced except in full, without written approval of Cisco Systems.

2.2 Date of testing

22-Nov-19 to 22-Nov-19

2.3 Report Issue Date

30-JAN-20

Cisco uses an electronic system to issue, store and control the revision of test reports. This system is called the Engineering Document Control System (EDCS). The actual report issue date is embedded into the original file on EDCS. Any copies of this report, either electronic or paper, that are not on EDCS must be considered uncontrolled.

2.4 Testing facilities

This assessment was performed by:

Testing Laboratory

Cisco Systems, Inc.
125 West Tasman Drive (Building P)
San Jose, CA 95134
USA

Headquarters

Cisco Systems, Inc.,
170 West Tasman Drive
San Jose, CA 95134,
USA

Registration Numbers for Industry Canada

Cisco System Site	Address	Site Identifier
Building P, 10m Chamber	125 West Tasman Dr San Jose, CA 95134	Company #: 2461N-2
Building P, 5m Chamber	125 West Tasman Dr San Jose, CA 95134	Company #: 2461N-1
Building I, 5m Chamber	285 W. Tasman Drive San Jose, California 95134	Company #: 2461M-1
Building 7, 5m Chamber	425 E. Tasman Drive San Jose, California 95134	Company #: 2461N-3

Test Engineers

Johanna Knudsen

2.5 Equipment Assessed (EUT)

C9130AXE-B









2.6 EUT Description

The radio supports the following modes of operation. The modes are further defined in the radio Theory of Operation. The modes included in this report represent the worst case data for all modes.

802.11a - Non HT20, One Antenna, 6 to 54 Mbps, 1ss

The following antennas are supported by this product series. The data included in this report represent the worst case data for all antennas.

List of External Antennas Supported on C9130AXE

Part Number	Description	Gain
C-ANT9101=	Ceiling Mount Omni Self-Identifying Antenna with Bluetooth, 8-port, with DART connectors.	2 dBi (2.4 GHz) 6 dBi (5 GHz) 3 dBi (BLE)
C-ANT9102=	Pole or Wall Mount Omni Self-Identifying Antenna with Bluetooth, 8-port, with DART connectors.	4 dBi (2.4 GHz) 4 dBi (5 GHz) 4 dBi (BLE)
C-ANT9103=	Pole or Wall mount 75° Directional Self-Identifying Antenna with Bluetooth, 8-port, with DART connectors.	6 dBi (2.4 GHz) 6 dBi (5 GHz) 6 dBi (BLE)
AIR-ANT2513P4M-N=	Patch Antenna, 4-port, with N connectors.  Note <u>Connect to AP using AIR-CAB003-D8-N=.</u>	13 dBi (2.4 GHz) 13 dBi (5 GHz) 13 dBi (BLE)
AIR-ANT2524V4C-R=	Ceiling Mount Omni Antenna, 4-port, with RP-TNC connectors.  Note <u>Connect to AP using AIR-CAB002-D8-R=.</u>	2 dBi (2.4 GHz) 4 dBi (5 GHz)
AIR-ANT2524V4C-RS=	Ceiling Mount Omni Self-Identifying Antenna, 4-port, with RP-TNC connectors.  Note <u>Connect to AP using AIR-CAB002-D8-R=.</u>	2 dBi (2.4 GHz) 4 dBi (5 GHz)
AIR-ANT2544V4M-R=	Wall Mount Omni Antenna, 4-port, with RP-TNC connectors.  Note <u>Connect to AP using AIR-CAB002-D8-R=.</u>	4 dBi (2.4 GHz) 4 dBi (5 GHz)
AIR-ANT2544V4M-RS=	Wall Mount Omni Self-Identifying Antenna, 4-port, with RP-TNC connectors.  Note <u>Connect to AP using AIR-CAB002-D8-R=.</u>	4 dBi (2.4 GHz) 4 dBi (5 GHz)
AIR-ANT2566D4M-R=	60° Patch Antenna, 4-port, with RP-TNC connectors. ¹  Note <u>Connect to AP using AIR-CAB002-D8-R=.</u>	6 dBi (2.4 GHz) 6 dBi (5 GHz)
AIR-ANT2566D4M-RS=	60° Patch Self-Identifying Antenna, 4-port, with RP-TNC connectors.  Note <u>Connect to AP using AIR-CAB002-D8-R=.</u>	6 dBi (2.4 GHz) 6 dBi (5 GHz)
AIR-ANT2566P4W-R=	Directional Antenna, 4-port, with RP-TNC connectors.  Note <u>Connect to AP using AIR-CAB002-D8-R=.</u>	6 dBi (2.4 GHz) 6 dBi (5 GHz)
AIR-ANT2566P4W-RS=	Directional Self-Identifying Antenna, 4-port, with RP-TNC connectors.  Note <u>Connect to AP using AIR-CAB002-D8-R=.</u>	6 dBi (2.4 GHz) 6 dBi (5 GHz)

Section 3: Result Summary

3.1 Results Summary Table

Conducted emissions

Basic Standard	Technical Requirements / Details	Result
FCC 15.407	<p>99% & 26 dB Bandwidth: The 99% occupied bandwidth is the frequency bandwidth such that, below its lower and above its upper frequency limits, the mean powers are each equal to 0.5% of the total mean power of the given emission. There is no limit for 99% OBW.</p> <p>The 26 dB emission is the width of the emission that is constrained by the frequencies associated with the two outermost amplitude points (upper and lower frequencies) that are attenuated by 26 dB relative to the maximum level measured in the fundamental emission.</p>	Pass
FCC 15.407	<p>Output Power: 15.407 (2) For the 5.25-5.35 GHz and 5.47-5.725 GHz bands, the maximum conducted output power over the frequency bands of operation shall not exceed the lesser of 250 mW or 11 dBm + 10 log B, where B is the 26 dB emission bandwidth in megahertz. In addition, the maximum power spectral density shall not exceed 11 dBm in any 1 megahertz band. If transmitting antennas of directional gain greater than 6 dBi are used, both the maximum conducted output power and the maximum power spectral density shall be reduced by the amount in dB that the directional gain of the antenna exceeds 6 dBi.</p>	Pass
FCC 15.407	<p>Power Spectral Density: 15.407 (2) For the 5.25-5.35 GHz and 5.47-5.725 GHz bands...the maximum power spectral density shall not exceed 11 dBm in any 1 megahertz band. If transmitting antennas of directional gain greater than 6 dBi are used, both the maximum conducted output power and the maximum power spectral density shall be reduced by the amount in dB that the directional gain of the antenna exceeds 6 dBi.</p>	Pass
FCC 15.407	<p>Conducted Spurious Emissions / Band-Edge: 15.407 (3) For transmitters operating in the 5.47-5.725 GHz band: All emissions outside of the 5.47-5.725 GHz band shall not exceed an e.i.r.p. of -27 dBm/MHz.</p>	Pass
FCC 15.407 FCC 15.209 FCC 15.205	<p>Restricted band: Unwanted emissions falling within the restricted bands, as defined in FCC 15.205 (a) must also comply with the radiated emission limits specified in FCC 15.209 (a).</p>	Pass

Radiated Emissions (General requirements)

Basic Standard	Technical Requirements / Details	Result
FCC 15.209 FCC 15.205	<p>TX Spurious Emissions: Except as provided elsewhere in this subpart, the emissions from an intentional radiator shall not exceed the field strength levels specified in the filed strength limits table in this section.</p>	Not covered by this test report
FCC 15.207	<p>AC conducted Emissions: Except when the requirements applicable to a given device state otherwise, for any radio apparatus equipped to operate from the public utility AC power supply, either directly or indirectly (such as with a battery charger), the radio frequency voltage of emissions conducted back onto the AC power lines in the frequency range of 0.15 MHz to 30 MHz shall not exceed the limits shown in the table in these sections. The more stringent limit applies at the frequency range boundaries.</p>	Not covered by this test report

Section 4: Sample Details

Note: Each sample was evaluated to ensure that its condition was suitable to be used as a test sample prior to the commencement of testing.

4.1 Sample Details

Sample No.	Equipment Details	Manufacturer	Hardware Rev.	Firmware Rev.	Software Rev.	Serial Number
S01	C9130AXE-B	Cisco	800-106171-01, P1A-2	NA	NA	KWC233200X5

4.2 System Details

System #	Description	Samples
1	EUT for RF conducted measurements	S01

4.3 Mode of Operation Details

Mode#	Description	Comments
1	Continuous Transmitting, RF conducted measurements	Continuously transmitting, constant high duty cycle Cisco AP Software, (ap1g6a), [build-lnx-059:/san2/BUILD/workspace/Nightly-Cheetah-ap1g6a-mfg-c171_ throttle] Compiled Wed Nov 13 07:45:59 PST 2019

Appendix A: Emission Test Results

Conducted Test Setup Diagram

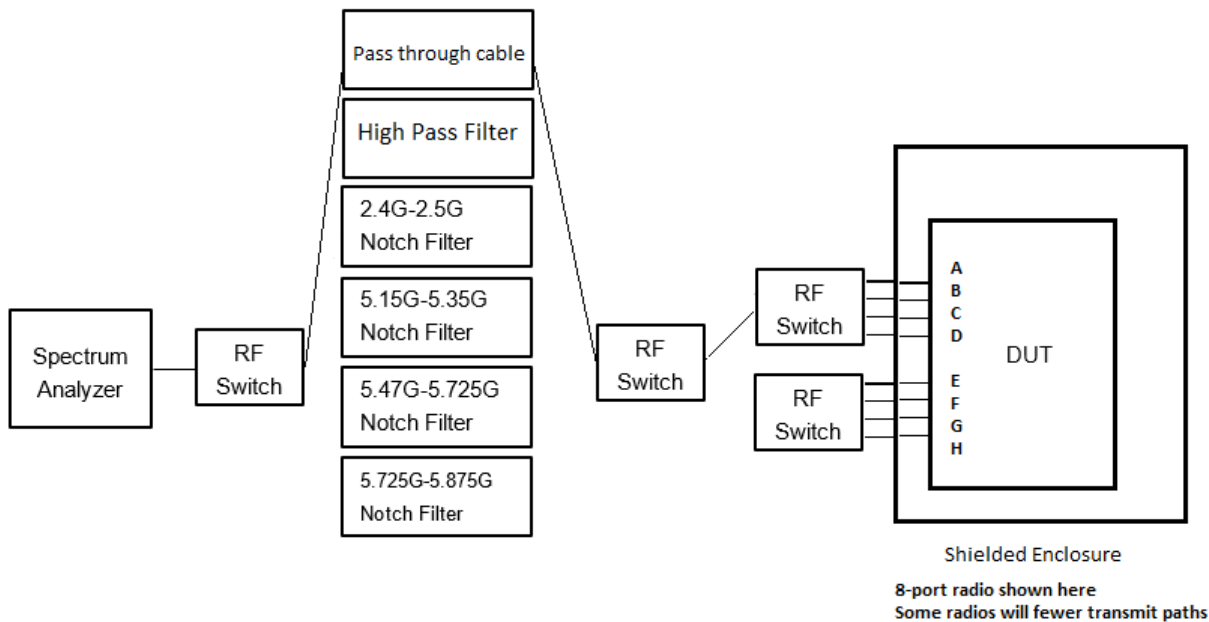

Target Maximum Channel Power

The following table details the maximum supported Total Channel Power for all operating modes.

Operating Mode	Maximum Channel Power (dBm)			
	Frequency (MHz)			
	5500	5560	5700	5720
Non HT20, 6 to 54 Mbps	9	10	7	6

A.1 Duty Cycle

Duty Cycle Test Requirement

From KDB 789033 D02 General UNII Test Procedures New Rules v02r01

B. Duty Cycle (x), Transmission Duration (T), and Maximum Power Control Level

1. All measurements are to be performed with the EUT transmitting at 100 percent duty cycle at its maximum power control level; however, if 100 percent duty cycle cannot be achieved, measurements of duty cycle, x, and maximum-power transmission duration, T, are required for each tested mode of operation.

Duty Cycle Test Method

From KDB 789033 D02 General UNII Test Procedures New Rules v02r01:

B. Duty Cycle (x), Transmission Duration (T), and Maximum Power Control Level

The zero-span mode on a spectrum analyzer or EMI receiver, if the response time and spacing between bins on the sweep are sufficient to permit accurate measurements of the on and off times of the transmitted signal. Set the center frequency of the instrument to the center frequency of the transmission. Set RBW \geq EBW if possible; otherwise, set RBW to the largest available value. Set VBW \geq RBW. Set detector = peak or average. The zero-span measurement method shall not be used unless both RBW and VBW are $> 50/T$, where T is defined in section II.B.1.a), and the number of sweep points across duration T exceeds 100. (For example, if VBW and/or RBW are limited to 3 MHz, then the zero-span method of measuring duty cycle shall not be used if $T \leq 16.7$ microseconds.)

Duty Cycle Test Information

Samples, Systems, and Modes

System Number	Description	Samples	System under test	Support equipment
1	EUT	S01	<input checked="" type="checkbox"/>	<input type="checkbox"/>
	Support	NA	<input type="checkbox"/>	<input checked="" type="checkbox"/>

Tested By : Johanna Knudsen	Date of testing: 22-Nov-19 to 22-Nov-19
Test Result : PASS	

Test Equipment

See Appendix C for list of test equipment

Duty Cycle Data Table

Duty Cycle table and screen captures are shown below for power/psd modes.

Frequency	Mode	Data Rate	Duty Cycle correction (dB)
5500	Non HT20, 6 to 54 Mbps	6	0.1
5560	Non HT20, 6 to 54 Mbps	6	0.1
5700	Non HT20, 6 to 54 Mbps	6	0.1
5720	Non HT20, 6 to 54 Mbps	6	0.1



Duty Cycle, 5500 MHz, Non HT20, 6 to 54 Mbps

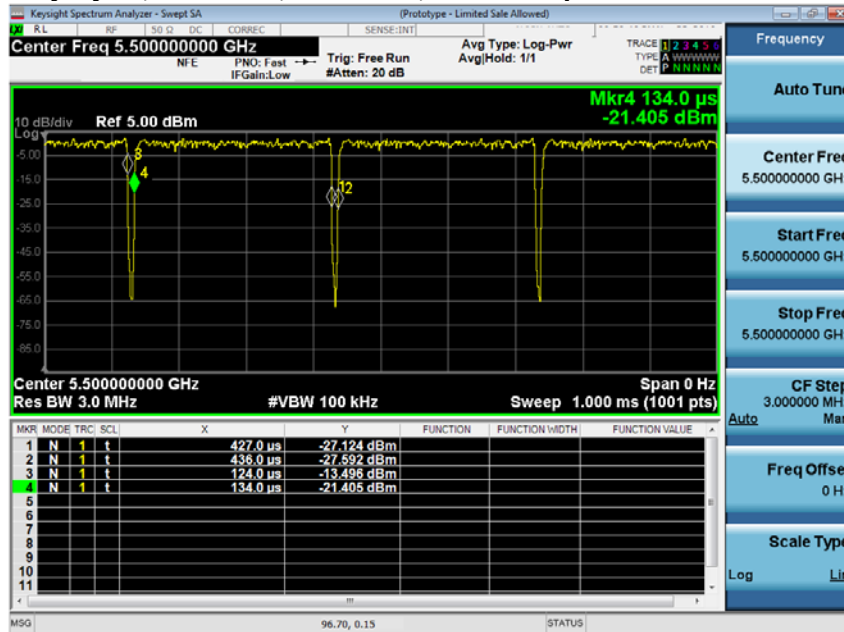

A.2 99% and 26dB Bandwidth

99% and 26dB Bandwidth Test Requirement

There is no requirement for the value of bandwidth. However, the 26dB BW (EBW) is used to calculate the power limits in 15.407 (a) (2). Power measurements are made using the 99% Bandwidth as the integration bandwidth.

Band-crossing emissions: For an emission that crosses the boundary between two adjacent U-NII bands, the boundary frequency between the bands serves as one edge for defining the portion of the EBW that falls within a particular U-NII band. However, the -26 dB points are measured relative to the highest point on the contiguous segment—regardless of which band contains that highest point (Figure4).

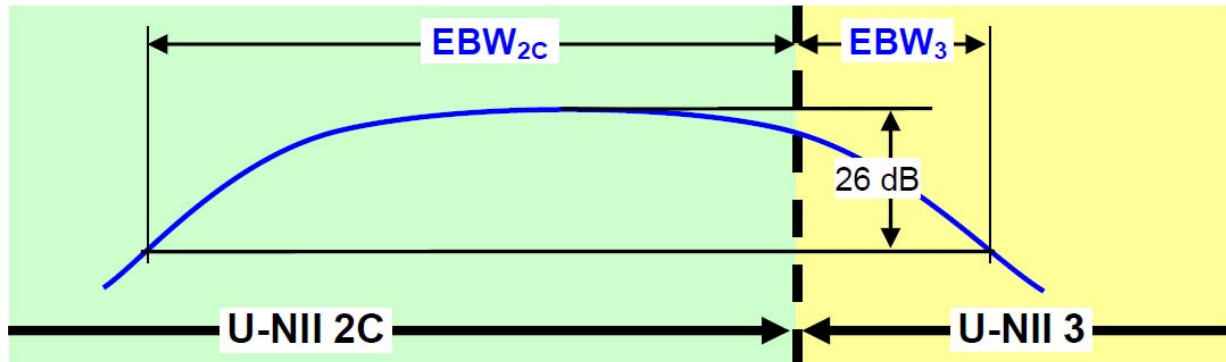

Figure 3. Emission Bandwidth (EBW) within a Band for Band-Crossing Signals

99% and 26dB Bandwidth Test Procedure

Ref. KDB 789033 Section D. 99 Percent Occupied Bandwidth
ANSI C63.10: 2013 Section 6.9.3
KDB 662911

99% BW

Test Parameters

1. Set center frequency to the nominal EUT channel center frequency.
2. Set span = 1.5 times to 5.0 times the OBW.
3. Set RBW = 1 % to 5 % of the OBW
4. Set VBW $\geq 3 \cdot$ RBW
5. Video averaging is not permitted. Where practical, a sample detection and single sweep mode shall be used. Otherwise, peak detection and max hold mode (until the trace stabilizes) shall be used.
6. Use the 99 % power bandwidth function of the instrument (if available).

Ref KDB 789033 in Section C. Measurement Bandwidth, Section 1

26 BW

Test parameters

X dB BW = -26dB (using the OBW function of the spectrum analyzer)

Emission Bandwidth (EBW)

- a) Set RBW = approximately 1% of the emission bandwidth.
- b) Set the VBW > RBW.
- c) Detector = Peak.
- d) Trace mode = max hold.
- e) Measure the maximum width of the emission that is 26 dB down from the maximum of the emission.

Compare this with the RBW setting of the analyzer. Readjust RBW and repeat measurement as needed until the RBW/EBW ratio is approximately 1%.

Samples, Systems, and Modes

System Number	Description	Samples	System under test	Support equipment
1	EUT	S01	<input checked="" type="checkbox"/>	<input type="checkbox"/>
	Support	NA	<input type="checkbox"/>	<input checked="" type="checkbox"/>

Tested By : Johanna Knudsen	Date of testing: 22-Nov-19 to 22-Nov-19
Test Result : PASS	

Test Equipment

See Appendix C for list of test equipment



99% and 26dB Bandwidth Table

Frequency (MHz)	Mode	Data Rate (Mbps)	26dB BW (MHz)	99% BW (MHz)
5500	Non HT20, 6 to 54 Mbps	6	22.0	16.570
5560	Non HT20, 6 to 54 Mbps	6	33.4	16.799
5700	Non HT20, 6 to 54 Mbps	6	21.5	16.556
5720	Non HT20, 6 to 54 Mbps	6	16.5	13.355

26dB / 99% Bandwidth, 5720 MHz, Non HT20, 6 to 54 Mbps



A.3 Maximum Conducted Output Power

Maximum Conducted Output Power Test Requirement

15.407 (2) For the 5.25-5.35 GHz and 5.47-5.725 GHz bands, the maximum conducted output power over the frequency bands of operation shall not exceed the lesser of 250 mW or $11 \text{ dBm} + 10 \log B$, where B is the 26 dB emission bandwidth in megahertz. ... If transmitting antennas of directional gain greater than 6 dBi are used, both the maximum conducted output power and the maximum power spectral density shall be reduced by the amount in dB that the directional gain of the antenna exceeds 6 dBi.

Band-Crossing Signals When measuring the portion of the maximum conducted output power within a single U-NII band, the power shall be integrated across only the portion of the EBW that falls within that band. That is, if an EBW extends across the boundary between two adjacent bands, the boundary frequency between the bands serves as one edge of the frequency range to be integrated. Integration across an entire U-NII band without regard to 26 dB points is also acceptable for determining conducted output power within that band.

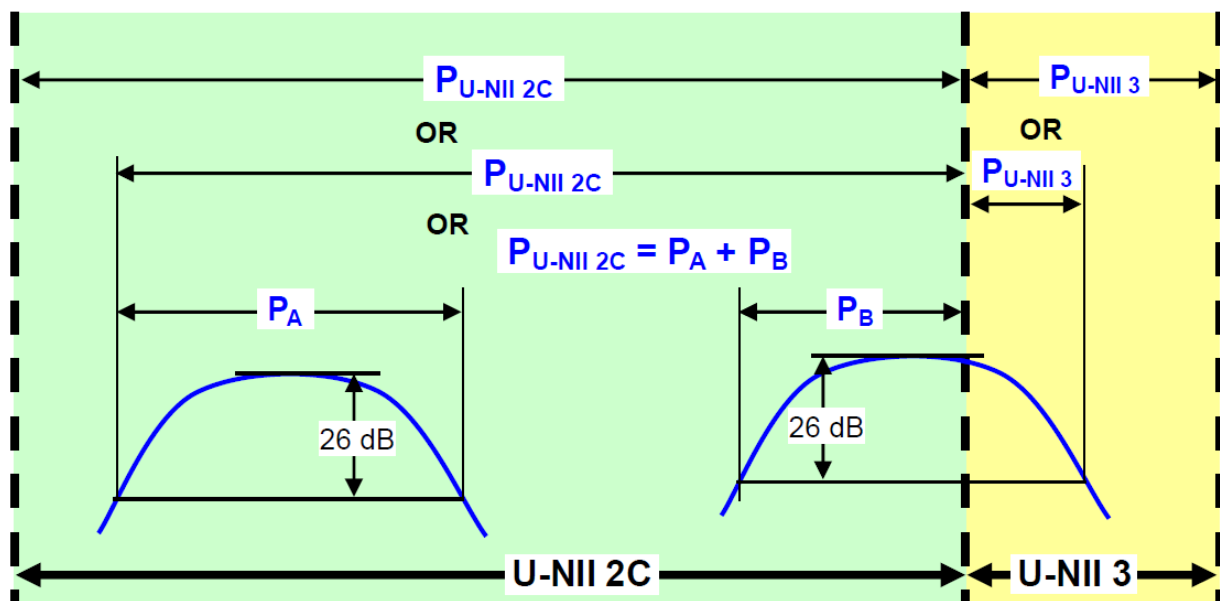

Conducted output power within a U-NII band: Integrate over the band or integrate over a span including the 26 dB EBWs of transmission segments within the band or integrate over 26 dB EBW of each transmission segment in the band and sum.

Figure 4. Conducted Output Power Measurement Examples

Maximum Conducted Output Power Test Procedure

Ref. KDB 789033 D02 General UNII Test Procedures New Rules v02r01
ANSI C63.10: 2013

Maximum Conducted Output Power

Test Procedure

1. Set the radio in the continuous transmitting mode at full power
2. Compute power by integrating the spectrum across the EBW (or alternatively entire 99% OBW) of the signal using the instrument's band power measurement function. The integration shall be performed using the spectrum analyzer band-power measurement function with band limits set equal to the EBW or the OBW band edges.

3. Capture graphs and record pertinent measurement data.

Ref. KDB 789033 D02 General UNII Test Procedures New Rules v02r01

2. Measurement using a Spectrum Analyzer or EMI Receiver (SA), (d) Method SA-2

Maximum Conducted Output Power

Test parameters

Method SA-2 (trace averaging across on and off times of the EUT transmissions, followed by duty cycle correction).

- (i) Measure the duty cycle, x , of the transmitter output signal as described in section II.B.
- (ii) Set span to encompass the EBW (or, alternatively, the entire 99% occupied bandwidth) of the signal.
- (iii) Set RBW = 1 MHz.
- (iv) Set VBW \geq 3 MHz.
- (v) Number of points in sweep \geq 2 Span / RBW. (This ensures that bin-to-bin spacing is \leq RBW/2, so that narrowband signals are not lost between frequency bins.)
- (vi) Sweep time = auto.
- (vii) Detector = RMS (i.e., power averaging), if available. Otherwise, use sample detector mode.
- (viii) Do not use sweep triggering. Allow the sweep to “free run”.
- (ix) Trace average at least 100 traces in power averaging (i.e., RMS) mode; however, the number of traces to be averaged shall be increased above 100 as needed to ensure that the average accurately represents the true average over the on and off periods of the transmitter.
- (x) Compute power by integrating the spectrum across the EBW (or, alternatively, the entire 99% occupied bandwidth) of the signal using the instrument’s band power measurement function with band limits set equal to the EBW (or occupied bandwidth)

The “measure-and-sum technique” is used for measuring in-band transmit power of a device. In the measure-and-sum approach, the conducted emission level is measured at each antenna port. The measured results at the various antenna ports are then summed mathematically to determine the total emission level from the device. Summing is performed in linear power units. ANSI C63.10 section 14.3.2.2

Samples, Systems, and Modes

System Number	Description	Samples	System under test	Support equipment
1	EUT	S01	<input checked="" type="checkbox"/>	<input type="checkbox"/>
	Support	NA	<input type="checkbox"/>	<input checked="" type="checkbox"/>

Tested By : Johanna Knudsen	Date of testing: 22-Nov-19 to 22-Nov-19
Test Result : PASS	

Test Equipment

See Appendix C for list of test equipment

Maximum Output Power

4dBi Antenna Gain

Frequency (MHz)	Mode	Tx Paths	Correlated Antenna Gain (dBi)	Tx 1 Max Power (dBm)	Duty Cycle Correction (dB)	Total Tx Channel Power (dBm)	Limit (dBm) EIRP	Margin (dB)
5500	Non HT20, 6 to 54 Mbps	1	4	9.0	0.1	9.1	24.0	14.85
5560	Non HT20, 6 to 54 Mbps	1	4	9.7	0.1	9.8	24.0	14.15
5700	Non HT20, 6 to 54 Mbps	1	4	7.0	0.1	7.1	24.0	16.85
5720	Non HT20, 6 to 54 Mbps	1	4	6.0	0.1	6.1	24.0	17.85

6dBi Antenna Gain

Frequency (MHz)	Mode	Tx Paths	Correlated Antenna Gain (dBi)	Tx 1 Max Power (dBm)	Duty Cycle Correction (dB)	Total Tx Channel Power (dBm)	Limit (dBm) EIRP	Margin (dB)
5500	Non HT20, 6 to 54 Mbps	1	6	9.0	0.1	9.1	24.0	14.85
5560	Non HT20, 6 to 54 Mbps	1	6	9.7	0.1	9.8	24.0	14.15
5700	Non HT20, 6 to 54 Mbps	1	6	7.0	0.1	7.1	24.0	16.85
5720	Non HT20, 6 to 54 Mbps	1	6	6.0	0.1	6.1	24.0	17.85

13dBi Antenna Gain

Frequency (MHz)	Mode	Tx Paths	Correlated Antenna Gain (dBi)	Tx 1 Max Power (dBm)	Duty Cycle Correction (dB)	Total Tx Channel Power (dBm)	Limit (dBm) EIRP	Margin (dB)
5500	Non HT20, 6 to 54 Mbps	1	13	9.0	0.1	9.1	17.0	7.85
5560	Non HT20, 6 to 54 Mbps	1	13	9.7	0.1	9.8	17.0	7.15
5700	Non HT20, 6 to 54 Mbps	1	13	4.6	0.1	4.7	17.0	12.25
5720	Non HT20, 6 to 54 Mbps	1	13	6.0	0.1	6.1	17.0	10.85

Maximum Transmit Output Power, 5560 MHz, Non HT20, 6 to 54 Mbps

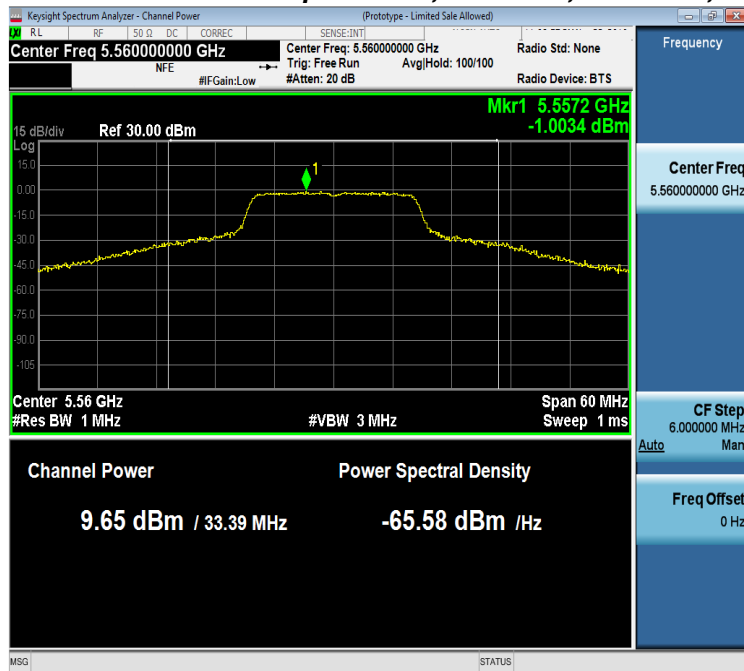

Antenna A

A.4 Power Spectral Density

Power Spectral Density Test Requirement

15.407 (2) For the 5.25-5.35 GHz and 5.47-5.725 GHz bands, the maximum conducted output power over the frequency bands of operation shall not exceed the lesser of 250 mW or 11 dBm + 10 log B, where B is the 26 dB emission bandwidth in megahertz. In addition, the maximum power spectral density shall not exceed 11 dBm in any 1 megahertz band. If transmitting antennas of directional gain greater than 6 dBi are used, both the maximum conducted output power and the maximum power spectral density shall be reduced by the amount in dB that the directional gain of the antenna exceeds 6 dBi.

Band-Crossing Signals

When measuring the portion of the maximum conducted output power within a single U-NII band, the power shall be integrated across only the portion of the EBW that falls within that band. That is, if an EBW extends across the boundary between two adjacent bands, the boundary frequency between the bands serves as one edge of the frequency range to be integrated. Integration across an entire U-NII band without regard to 26 dB points is also acceptable for determining conducted output power within that band.

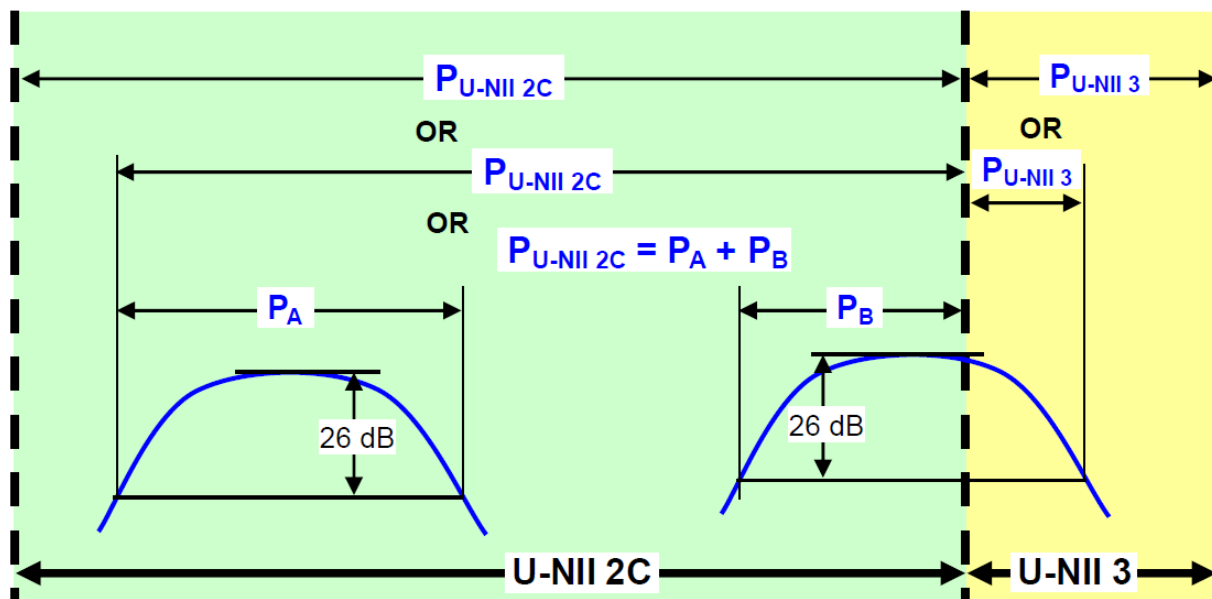

Conducted output power within a U-NII band: Integrate over the band or integrate over a span including the 26 dB EBWs of transmission segments within the band or integrate over 26 dB EBW of each transmission segment in the band and sum.

Figure 4. Conducted Output Power Measurement Examples

Power Spectral Density Test Procedure

Ref. KDB 789033 D02 General UNII Test Procedures New Rules v02r01, F. Maximum Power Spectral Density
ANSI C63.10: 2013 Peak Power Spectral Density 12.5, 12.3.2.4 Method SA-2

Power Spectral Density

Test Procedure

The rules requires “maximum power spectral density” measurements where the intent is to measure the maximum value of the time average of the power spectral density measured during a period of continuous transmission.

1. Create an average power spectrum for the EUT operating mode being tested by following the instructions in section II.E.2. for measuring maximum conducted output power using a spectrum analyzer or EMI receiver: select the

appropriate test method (SA-1, SA-2, SA-3, or alternatives to each) and apply it up to, but not including, the step labeled, “Compute power...”. (This procedure is required even if the maximum conducted output power measurement was performed using a power meter, method PM.)

2. Use the peak search function on the instrument to find the peak of the spectrum and record its value.
3. Make the following adjustments to the peak value of the spectrum, if applicable: a) If Method SA-2 or SA-2 Alternative was used, add $10 \log(1/x)$, where x is the duty cycle, to the peak of the spectrum.
b) If Method SA-3 Alternative was used and the linear mode was used in step II.E.2.g)(viii), add 1 dB to the final result to compensate for the difference between linear averaging and power averaging.
4. The result is the Maximum PSD over 1 MHz reference bandwidth.

Ref. KDB 789033 D02 General UNII Test Procedures New Rules v02r01, F. Maximum Power Spectral Density ANSI C63.10: 2013 Peak Power Spectral Density 12.5, 12.3.2.4 Method SA-2

Power Spectral Density

Test parameters

Method SA-2 (trace averaging across on and off times of the EUT transmissions, followed by duty cycle correction).

- (i) Measure the duty cycle, x , of the transmitter output signal as described in section II.B.
- (ii) Set span to encompass the EBW (or, alternatively, the entire 99% occupied bandwidth) of the signal.
- (iii) Set RBW = 1 MHz.
- (iv) Set VBW \geq 3 MHz.
- (v) Number of points in sweep \geq 2 Span / RBW. (This ensures that bin-to-bin spacing is \leq RBW/2, so that narrowband signals are not lost between frequency bins.)
- (vi) Sweep time = auto.
- (vii) Detector = RMS (i.e., power averaging), if available. Otherwise, use sample detector mode.
- (viii) Do not use sweep triggering. Allow the sweep to “free run”.
- (ix) Trace average at least 100 traces in power averaging (i.e., RMS) mode; however, the number of traces to be averaged shall be increased above 100 as needed to ensure that the average accurately represents the true average over the on and off periods of the transmitter.
- (x) Compute power by integrating the spectrum across the EBW (or, alternatively, the entire 99% occupied bandwidth) of the signal using the instrument’s band power measurement function with band limits set equal to the EBW (or occupied bandwidth)

F. Maximum Power Spectral Density (PSD)

2. Use the peak search function on the instrument to find the peak of the spectrum and record its value.
3. Make the following adjustments to the peak value of the spectrum, if applicable: a) If Method SA-2 or SA-2 Alternative was used, add $10 \log(1/x)$, where x is the duty cycle, to the peak of the spectrum.

The “measure-and-sum technique” is used for measuring in-band transmit power of a device. In the measure-and-sum approach, the conducted emission level is measured at each antenna port. The measured results at the various antenna ports are then summed mathematically to determine the total emission level from the device. Summing is performed in linear power units. ANSI C63.10 section 14.3.2.2

Samples, Systems, and Modes

System Number	Description	Samples	System under test	Support equipment
1	EUT	S01	<input checked="" type="checkbox"/>	<input type="checkbox"/>
	Support	NA	<input type="checkbox"/>	<input checked="" type="checkbox"/>



Tested By : Johanna Knudsen	Date of testing: 22-Nov-19 to 22-Nov-19
Test Result : PASS	

Test Equipment

See Appendix C for list of test equipment

Power Spectral Density

4dBi Antenna Gain

Frequency (MHz)	Mode	Tx Paths	Correlated Antenna Gain (dBi)	Tx 1 PSD (dBm/MHz)	Duty Cycle Correction (dB)	Total PSD (dBm/MHz)	Limit (dBm/MHz) EIRP	Margin (dB)
5500	Non HT20, 6 to 54 Mbps	1	4	-1.6	0.1	-1.5	11.0	12.45
5560	Non HT20, 6 to 54 Mbps	1	4	-1.0	0.1	-0.9	11.0	11.85
5700	Non HT20, 6 to 54 Mbps	1	4	-4.0	0.1	-3.9	11.0	14.85
5720	Non HT20, 6 to 54 Mbps	1	4	-3.6	0.1	-3.5	11.0	14.45

6dBi Antenna Gain

Frequency (MHz)	Mode	Tx Paths	Correlated Antenna Gain (dBi)	Tx 1 PSD (dBm/MHz)	Duty Cycle Correction (dB)	Total PSD (dBm/MHz)	Limit (dBm/MHz) EIRP	Margin (dB)
5500	Non HT20, 6 to 54 Mbps	1	6	-1.6	0.1	-1.5	11.0	12.45
5560	Non HT20, 6 to 54 Mbps	1	6	-1.0	0.1	-0.9	11.0	11.85
5700	Non HT20, 6 to 54 Mbps	1	6	-4.0	0.1	-3.9	11.0	14.85
5720	Non HT20, 6 to 54 Mbps	1	6	-3.6	0.1	-3.5	11.0	14.45

13dBi Antenna Gain

Frequency (MHz)	Mode	Tx Paths	Correlated Antenna Gain (dBi)	Tx 1 PSD (dBm/MHz)	Duty Cycle Correction (dB)	Total PSD (dBm/MHz)	Limit (dBm/MHz) EIRP	Margin (dB)
5500	Non HT20, 6 to 54 Mbps	1	13	-1.6	0.1	-1.5	4.0	5.45
5560	Non HT20, 6 to 54 Mbps	1	13	-1.0	0.1	-0.9	4.0	4.85
5700	Non HT20, 6 to 54 Mbps	1	13	-6.3	0.1	-6.2	4.0	10.15
5720	Non HT20, 6 to 54 Mbps	1	13	-3.6	0.1	-3.5	4.0	7.45

Power Spectral Density, 5560 MHz, Non HT20, 6 to 54 Mbps



Antenna A

A.5 Conducted Spurious Emissions

Conducted Spurious Emissions Test Requirement

15.407(b) Undesirable emission limits. Except as shown in paragraph (b)(7) of this section, the maximum emissions outside of the frequency bands of operation shall be attenuated in accordance with the following limits:

- (3) For transmitters operating in the 5.47-5.725 GHz band: All emissions outside of the 5.47-5.725 GHz band shall not exceed an e.i.r.p. of -27 dBm/MHz..
- (6) Unwanted emissions below 1 GHz must comply with the general field strength limits set forth in §15.209.
- (7) The provisions of §15.205 apply to intentional radiators operating under this section.
- (8) When measuring the emission limits, the nominal carrier frequency shall be adjusted as close to the upper and lower frequency band edges as the design of the equipment permits

15.205 / 15.209 - Radiated emissions which fall in the restricted bands, as defined in Section 15.205(a), must also comply with the radiated emission limits specified in Section 15.209(a) (see Section 15.205(c)).

Use formula below to substitute conducted measurements in place of radiated measurements

$$E[\text{dB}\mu\text{V}/\text{m}] = \text{EIRP}[\text{dBm}] - 20 \log(d[\text{meters}]) + 104.77, \text{ where } E = \text{field strength and } d = 3 \text{ meter}$$

- 1) Average Plot, Limit= -41.25 dBm eirp
- 2) Peak plot, Limit = -21.25 dBm eirp

KDB 789033 D02 General UNII Test Procedures New Rules v02r01

2. Unwanted Emissions that fall Outside of the Restricted Bands

- a) For all measurements, follow the requirements in II.G.3. “*General Requirements for Unwanted Emissions Measurements.*”
- b) At frequencies below 1000 MHz, use the procedure described in II.G.4. “*Procedure for Unwanted Emissions Measurements Below 1000 MHz.*”
- c) At frequencies above 1000 MHz, use the procedure for maximum emissions described in II.G.5., “*Procedure for Unwanted Emissions Measurements Above 1000 MHz.*”
- (i) Sections 15.407(b)(1-3) specifies the unwanted emissions limit for the U-NII-1 and U-NII-2 bands. As specified, emissions above 1000 MHz that are outside of the restricted bands are subject to a peak emission limit of -27 dBm/MHz.³

Conducted Spurious Emissions Test Procedure

KDB 789033 D02 General UNII Test Procedures New Rules v02r01

Ref. ANSI C63.10: 2013

Conducted Spurious Emissions

Test Procedure

1. Connect the antenna port(s) to the spectrum analyzer input.
2. Place the radio in continuous transmit mode
3. Configure Spectrum analyzer as per test parameters below (be sure to enter all losses between the transmitter output and the spectrum analyzer).
4. Use the peak marker function to determine the maximum spurs amplitude level.
5. The “measure-and-sum technique” is used for measuring in-band transmit power of a device. In the measure-and-sum approach, the conducted emission level is measured at each antenna port. The measured results at the various antenna ports are then summed mathematically to determine the total emission level from the device. Summing is performed in linear power units. The worst case output is recorded. (see ANSI C63.10:2013 section 14.3.2.2)

6. Capture graphs and record pertinent measurement data.
--

Ref. ANSI C63.10: 2013 section 12.7.6 (Peak) and 12.7.7.2 (Average)

KDB 789033 D02 General UNII Test Procedures New Rules v02r01, Sec. 5 (Peak), Sec. 6 (Average Method AD)

Conducted Spurious Emissions

Test parameters

Peak

RBW = 1 MHz

VBW \geq 3 MHz

Sweep = Auto

Detector = Peak

Trace = Max Hold.

Average

RBW = 1 MHz

VBW \geq 3 MHz

Sweep = Auto

Detector = RMS

Power Averaging

Add the max antenna gain + ground reflection factor (4.7 dB for frequencies between 30 MHz and 1000 MHz, and 0 dB for frequencies > 1000 MHz).

Samples, Systems, and Modes

System Number	Description	Samples	System under test	Support equipment
1	EUT	S01	<input checked="" type="checkbox"/>	<input type="checkbox"/>
	Support	NA	<input type="checkbox"/>	<input checked="" type="checkbox"/>

Tested By :

Johanna Knudsen

Date of testing:

22-Nov-19 to 22-Nov-19

Test Result : PASS

Test Equipment

See Appendix C for list of test equipment



Conducted Spurs Average Upper, 5500 MHz, Non HT20, 6 to 54 Mbps

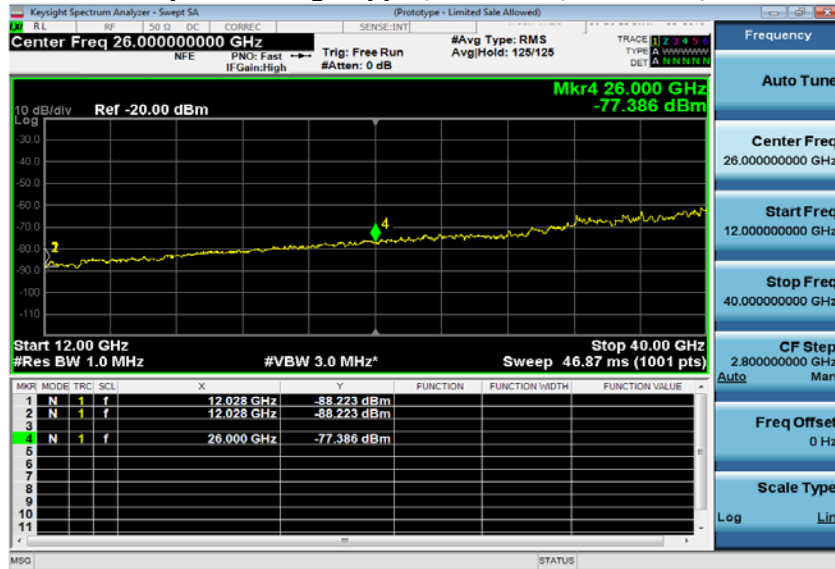

Conducted Spurs Peak Upper, 5500 MHz, Non HT20, 6 to 54 Mbps

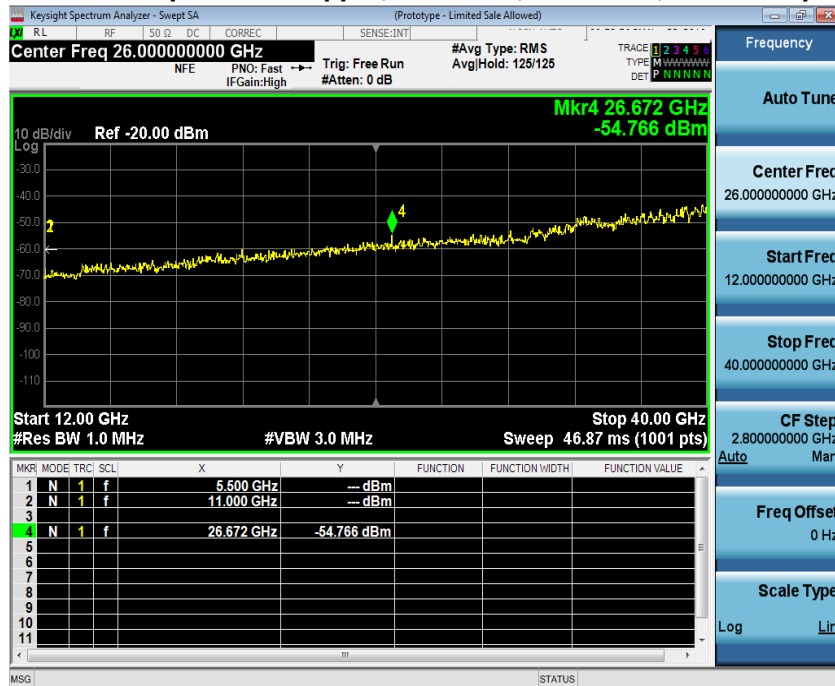

Conducted Spurious Average Table

4dBi Antenna Gain

Frequency (MHz)	Mode	Tx Paths	Correlated Antenna Gain (dBi)	Tx 1 Spur Power (dBm)	Duty Cycle Correction (dB)	Total Conducted Spur (dBm)	Limit (dBm)	Margin (dB)
5500	Non HT20, 6 to 54 Mbps	1	4	-66.9	0.1	-62.8	-41.25	21.50
5560	Non HT20, 6 to 54 Mbps	1	4	-66.6	0.1	-62.5	-41.25	21.20
5700	Non HT20, 6 to 54 Mbps	1	4	-59.1	0.1	-55.0	-41.25	13.70
5720	Non HT20, 6 to 54 Mbps	1	4	-56.7	0.1	-52.6	-41.25	11.30

6dBi Antenna Gain

Frequency (MHz)	Mode	Tx Paths	Correlated Antenna Gain (dBi)	Tx 1 Spur Power (dBm)	Duty Cycle Correction (dB)	Total Conducted Spur (dBm)	Limit (dBm)	Margin (dB)
5500	Non HT20, 6 to 54 Mbps	1	6	-66.9	0.1	-60.8	-41.25	19.50
5560	Non HT20, 6 to 54 Mbps	1	6	-66.6	0.1	-60.5	-41.25	19.20
5700	Non HT20, 6 to 54 Mbps	1	6	-59.1	0.1	-53.0	-41.25	11.70
5720	Non HT20, 6 to 54 Mbps	1	6	-56.7	0.1	-50.6	-41.25	9.30

13dBi Antenna Gain

Frequency (MHz)	Mode	Tx Paths	Correlated Antenna Gain (dBi)	Tx 1 Spur Power (dBm)	Duty Cycle Correction (dB)	Total Conducted Spur (dBm)	Limit (dBm)	Margin (dB)
5500	Non HT20, 6 to 54 Mbps	1	13	-66.9	0.1	-53.8	-41.25	12.50
5560	Non HT20, 6 to 54 Mbps	1	13	-66.6	0.1	-53.5	-41.25	12.20
5700	Non HT20, 6 to 54 Mbps	1	13	-68.5	0.1	-55.4	-41.25	14.10
5720	Non HT20, 6 to 54 Mbps	1	13	-56.7	0.1	-43.6	-41.25	2.30



Conducted Spurs Average, 5720 MHz, Non HT20, 6 to 54 Mbps

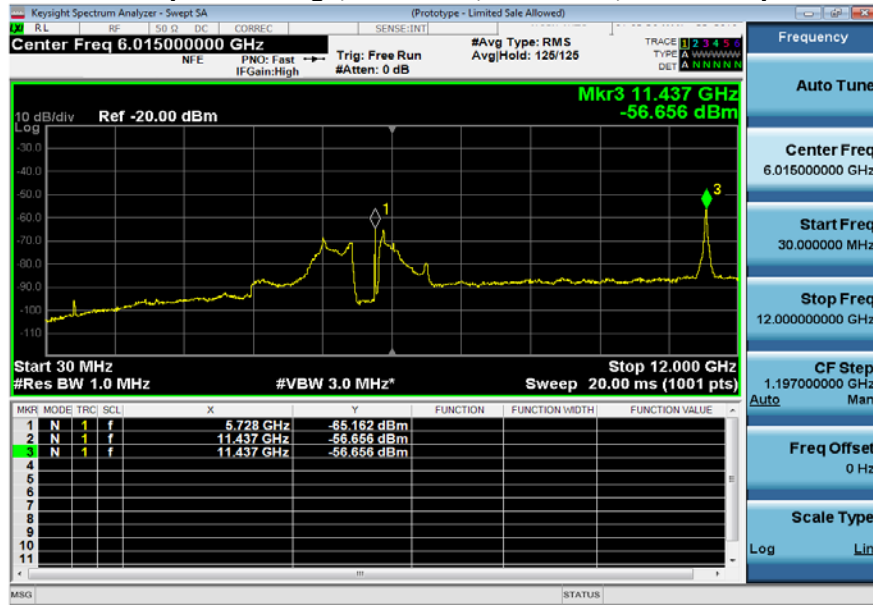

Antenna A

Conducted Spurious Emissions Peak Table**4dBi Antenna Gain**

Frequency (MHz)	Mode	Tx Paths	Correlated Antenna Gain (dBi)	Tx 1 Spur Power (dBm)	Tx 2 Spur Power (dBm)	Total Conducted Spur (dBm)	Limit (dBm)	Margin (dB)
5500	Non HT20, 6 to 54 Mbps	1	4	-58.2	0.1	-54.1	-21.25	32.80
5560	Non HT20, 6 to 54 Mbps	1	4	-57.2	0.1	-53.1	-21.25	31.80
5700	Non HT20, 6 to 54 Mbps	1	4	-45.0	0.1	-40.9	-21.25	19.60
5720	Non HT20, 6 to 54 Mbps	1	4	-42.8	0.1	-38.7	-21.25	17.40

6dBi Antenna Gain

Frequency (MHz)	Mode	Tx Paths	Correlated Antenna Gain (dBi)	Tx 1 Spur Power (dBm)	Tx 2 Spur Power (dBm)	Total Conducted Spur (dBm)	Limit (dBm)	Margin (dB)
5500	Non HT20, 6 to 54 Mbps	1	6	-58.2	0.1	-52.1	-21.25	30.80
5560	Non HT20, 6 to 54 Mbps	1	6	-57.2	0.1	-51.1	-21.25	29.80
5700	Non HT20, 6 to 54 Mbps	1	6	-45.0	0.1	-38.9	-21.25	17.60
5720	Non HT20, 6 to 54 Mbps	1	6	-42.8	0.1	-36.7	-21.25	15.40

13dBi Antenna Gain

Frequency (MHz)	Mode	Tx Paths	Correlated Antenna Gain (dBi)	Tx 1 Spur Power (dBm)	Tx 2 Spur Power (dBm)	Total Conducted Spur (dBm)	Limit (dBm)	Margin (dB)
5500	Non HT20, 6 to 54 Mbps	1	13	-58.2	0.1	-45.1	-21.25	23.80
5560	Non HT20, 6 to 54 Mbps	1	13	-57.2	0.1	-44.1	-21.25	22.80
5700	Non HT20, 6 to 54 Mbps	1	13	-48.3	0.1	-35.2	-21.25	13.90
5720	Non HT20, 6 to 54 Mbps	1	13	-42.8	0.1	-29.7	-21.25	8.40

Conducted Spurs Peak, 5720 MHz, Non HT20, 6 to 54 Mbps



Antenna A

A.6 Conducted Bandedge

15.407(b) Undesirable emission limits. Except as shown in paragraph (b)(7) of this section, the maximum emissions outside of the frequency bands of operation shall be attenuated in accordance with the following limits:

- (3) For transmitters operating in the 5.47-5.725 GHz band: All emissions outside of the 5.47-5.725 GHz band shall not exceed an e.i.r.p. of -27 dBm/MHz.
- (6) Unwanted emissions below 1 GHz must comply with the general field strength limits set forth in §15.209.
- (7) The provisions of §15.205 apply to intentional radiators operating under this section.
- (8) When measuring the emission limits, the nominal carrier frequency shall be adjusted as close to the upper and lower frequency band edges as the design of the equipment permits

15.205 / 15.209 - Radiated emissions which fall in the restricted bands, as defined in Section 15.205(a), must also comply with the radiated emission limits specified in Section 15.209(a) (see Section 15.205(c)).

Use formula below to substitute conducted measurements in place of radiated measurements

$$E[\text{dB}\mu\text{V}/\text{m}] = \text{EIRP}[\text{dBm}] - 20 \log(d[\text{meters}]) + 104.77, \text{ where } E = \text{field strength and } d = 3 \text{ meter}$$

- 1) Average Plot, Limit = -41.25 dBm eirp
- 2) Peak plot, Limit = -21.25 dBm eirp

KDB 789033 D02 General UNII Test Procedures New Rules v02r01

2. Unwanted Emissions that fall Outside of the Restricted Bands

- a) For all measurements, follow the requirements in II.G.3. “*General Requirements for Unwanted Emissions Measurements.*”
- b) At frequencies below 1000 MHz, use the procedure described in II.G.4. “*Procedure for Unwanted Emissions Measurements Below 1000 MHz.*”
- c) At frequencies above 1000 MHz, use the procedure for maximum emissions described in II.G.5., “*Procedure for Unwanted Emissions Measurements Above 1000 MHz.*”
- (i) Sections 15.407(b)(1-3) specifies the unwanted emissions limit for the U-NII-1 and U-NII-2 bands. As specified, emissions above 1000 MHz that are outside of the restricted bands are subject to a peak emission limit of -27 dBm/MHz.³

Conducted Band Edge Test Procedure

KDB 789033 D02 General UNII Test Procedures New Rules v02r01

Ref. ANSI C63.10: 2013

Conducted Spurious Emissions

Test Procedure

1. Connect the antenna port(s) to the spectrum analyzer input.
2. Place the radio in continuous transmit mode
3. Configure Spectrum analyzer as per test parameters below (be sure to enter all losses between the transmitter output and the spectrum analyzer).
4. Use the peak marker function to determine the maximum spurs amplitude level.
5. The “measure-and-sum technique” is used for measuring in-band transmit power of a device. In the measure-and-sum approach, the conducted emission level is measured at each antenna port. The measured results at the various antenna ports are then summed mathematically to determine the total emission level from the device. Summing is performed in linear power units. The worst case output is recorded. (see ANSI C63.10:2013 section 14.3.2.2)
6. Capture graphs and record pertinent measurement data.

Ref. ANSI C63.10: 2013 section 12.7.6 (Peak) and 12.7.7.2 (Average)

KDB 789033 D02 General UNII Test Procedures New Rules v02r01, Sec. 5 (Peak), Sec. 6 (Average Method AD)

Conducted Spurious Emissions

Test parameters

Peak	Average
RBW = 1 MHz	RBW = 1 MHz
VBW \geq 3 MHz	VBW \geq 3 MHz
Sweep = Auto	Sweep = Auto
Detector = Peak	Detector = RMS
Trace = Max Hold.	Power Averaging

Samples, Systems, and Modes

System Number	Description	Samples	System under test	Support equipment
1	EUT	S01	<input checked="" type="checkbox"/>	<input type="checkbox"/>
	Support	NA	<input type="checkbox"/>	<input checked="" type="checkbox"/>

Tested By : Johanna Knudsen	Date of testing: 22-Nov-19 to 22-Nov-19
Test Result : PASS	

Test Equipment

See Appendix C for list of test equipment

Conducted Bandedge Average Table

4dBi Antenna Gain

Frequency (MHz)	Mode	Tx Paths	Correlated Antenna Gain (dBi)	Tx 1 Bandedge Level (dBm)	Duty Cycle Correction (dB)	Total Tx Bandedge Level (dBm)	Limit (dBm)	Margin (dB)
5.500								
	Non HT20, 6 to 54 Mbps	1	4	-57.7	0.1	-53.6	-41.25	12.30

6dBi Antenna Gain

Frequency (MHz)	Mode	Tx Paths	Correlated Antenna Gain (dBi)	Tx 1 Bandedge Level (dBm)	Duty Cycle Correction (dB)	Total Tx Bandedge Level (dBm)	Limit (dBm)	Margin (dB)
5.500								
	Non HT20, 6 to 54 Mbps	1	6	-57.7	0.1	-51.6	-41.25	10.30

13dBi Antenna Gain

Frequency (MHz)	Mode	Tx Paths	Correlated Antenna Gain (dBi)	Tx 1 Bandedge Level (dBm)	Duty Cycle Correction (dB)	Total Tx Bandedge Level (dBm)	Limit (dBm)	Margin (dB)
5.500								
	Non HT20, 6 to 54 Mbps	1	13	-57.7	0.1	-44.6	-41.25	3.30



Conducted Bandedge Average, 5500 MHz, Non HT20, 6 to 54 Mbps



Antenna A

Conducted Bandedge Peak Table

4dBi Antenna Gain

Frequency (MHz)	Mode	Tx Paths	Correlated Antenna Gain (dBi)	Tx 1 Bandedge Level (dBm)	Total Tx Bandedge Level (dBm)	Limit (dBm)	Margin (dB)
5500	Non HT20, 6 to 54 Mbps	1	4	-38.4	-34.3	-21.25	13.00
5700	Non HT20, 6 to 54 Mbps	1	4	-33.4	-29.3	-21.25	8.00

6dBi Antenna Gain

Frequency (MHz)	Mode	Tx Paths	Correlated Antenna Gain (dBi)	Tx 1 Bandedge Level (dBm)	Total Tx Bandedge Level (dBm)	Limit (dBm)	Margin (dB)
5500	Non HT20, 6 to 54 Mbps	1	6	-38.4	-32.3	-21.25	11.00
5700	Non HT20, 6 to 54 Mbps	1	6	-33.4	-27.3	-21.25	6.00



13dBi Antenna Gain

Frequency (MHz)	Mode	Tx Paths	Correlated Antenna Gain (dBi)	Tx 1 Bandedge Level (dBm)	Total Tx Bandedge Level (dBm)	Limit (dBm)	Margin (dB)
5500	Non HT20, 6 to 54 Mbps	1	13	-38.4	-25.3	-21.25	4.00
5700	Non HT20, 6 to 54 Mbps	1	13	-38.6	-25.5	-21.25	4.20



Conducted Bandedge Peak, 5500 MHz, Non HT20, 6 to 54 Mbps



Antenna A

Conducted Bandedge Peak, 5700 MHz, Non HT20, 6 to 54 Mbps

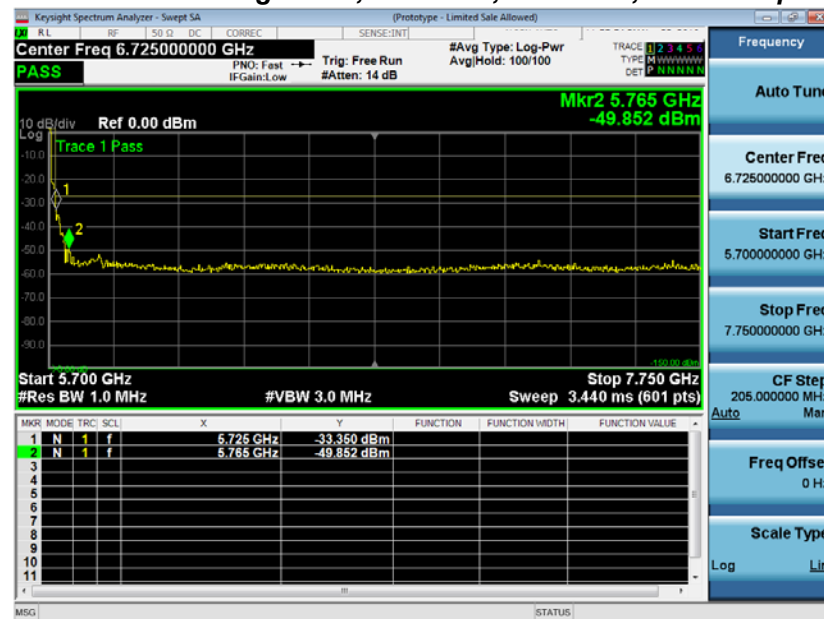

Antenna A

Appendix B: Emission Test Results

Testing Laboratory: Cisco Systems, Inc., 125 West Tasman Drive, San Jose, CA 95134, USA

Radiated Emission Setup Diagram-Below 1G

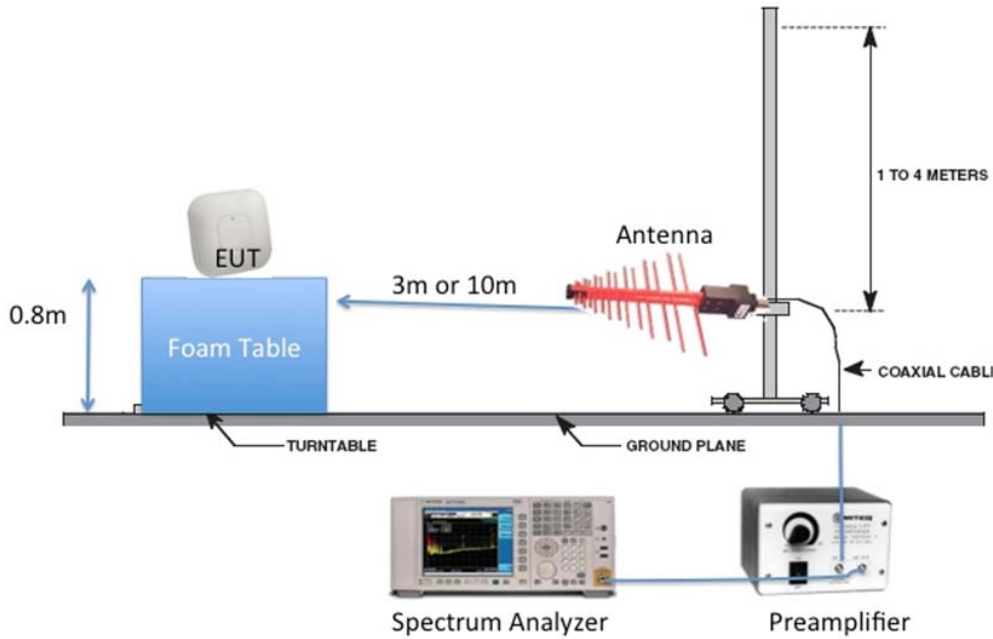

Radiated Emission Setup Diagram-Above 1G

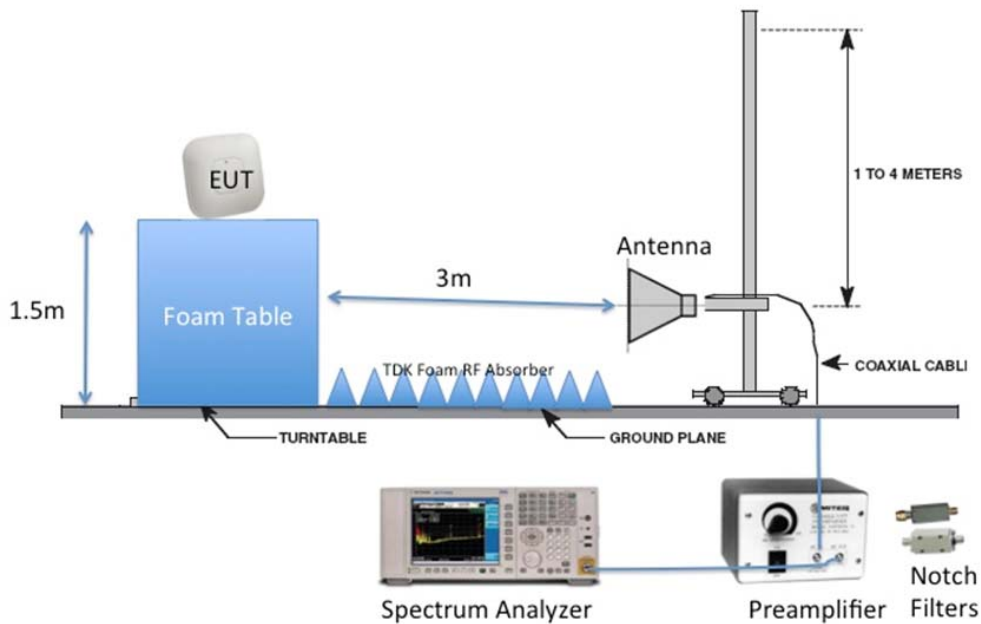

B.1 Radiated Spurious Emissions

Not covered by the scope of this test report.

B.2 Receiver Spurious Emissions

Not covered by the scope of this test report.

B.3 Radiated Emissions 30MHz to 1GHz

Not covered by the scope of this test report.

B.4 AC Conducted Emissions

Not covered by the scope of this test report.

Appendix C: List of Test Equipment Used to perform the test

Equip#	Manufacturer/ Model	Description	Last Cal	Next Cal	Test Item
CIS057477	Cisco ATIL	Automation Test Insertion Loss	Cal Not Required		A1 thru A8
CIS055109	Agilent N9030A-550	PXA Signal Analyzer, 3Hz to 50GHz	18-Jul-19	18-Jul-20	A1 thru A8
CIS055093	National Instruments PXI-1042Q	Chassis	Cal Not Required		A1 thru A8
CIS057238	National Instruments PXI-8115	Embedded Controller	Cal Not Required		A1 thru A8
CIS057247	National Instruments PXI-2796	40 GHz Dual 6x1 Multiplexer (SP6T)	Cal Not Required		A1 thru A8
CIS056092	National Instruments PXI-2796	40 GHz Dual 6x1 Multiplexer (SP6T)	Cal Not Required		A1 thru A8
CIS057248	National Instruments PXI-2799	Switch 1x1	Cal Not Required		A1 thru A8
CIS051636	Keysight N5182B	MXG X-Series RF Vector Signal Generator	30-Aug-19	30-Aug-20	A1 thru A8
CIS007329	Omega CT485B	Chart Recorder	18-Feb-19	18-Feb-20	A1 thru A8
CIS056329	Pasternack PE5019-1	Torque wrench	28-Feb-19	28-Feb-20	A1 thru A8
CIS049389	Rohde & Schwarz NRP2	Power Meter	25-Nov-19	25-Nov-20	A1 thru A8

Appendix D: Abbreviation Key and Definitions

The following table defines abbreviations used within this test report.

Abbreviation	Description	Abbreviation	Description
EMC	Electro Magnetic Compatibility	°F	Degrees Fahrenheit
EMI	Electro Magnetic Interference	°C	Degrees Celsius
EUT	Equipment Under Test	Temp	Temperature
ITE	Information Technology Equipment	S/N	Serial Number
TAP	Test Assessment Schedule	Qty	Quantity
ESD	Electro Static Discharge	emf	Electromotive force
EFT	Electric Fast Transient	RMS	Root mean square
EDCS	Engineering Document Control System	Qp	Quasi Peak
Config	Configuration	Av	Average
CIS#	Cisco Number (unique identification number for Cisco test equipment)	Pk	Peak
Cal	Calibration	kHz	Kilohertz (1x10 ³)
EN	European Norm	MHz	MegaHertz (1x10 ⁶)
IEC	International Electro technical Commission	GHz	Gigahertz (1x10 ⁹)
CISPR	International Special Committee on Radio Interference	H	Horizontal
CDN	Coupling/Decoupling Network	V	Vertical
LISN	Line Impedance Stabilization Network	dB	decibel
PE	Protective Earth	V	Volt
GND	Ground	kV	Kilovolt (1x10 ³)
L1	Line 1	μV	Microvolt (1x10 ⁻⁶)
L2	Line2	A	Amp
L3	Line 3	μA	Micro Amp (1x10 ⁻⁶)
DC	Direct Current	mS	Milli Second (1x10 ⁻³)
RAW	Uncorrected measurement value, as indicated by the measuring device	μS	Micro Second (1x10 ⁻⁶)
RF	Radio Frequency	μS	Micro Second (1x10 ⁻⁶)
SLCE	Signal Line Conducted Emissions	m	Meter
Meas dist	Measurement distance	Spec dist	Specification distance
N/A or NA	Not Applicable	SL	Signal Line (or Telecom Line)
P	Power Line	L	Live Line
N	Neutral Line	R	Return
S	Supply	AC	Alternating Current

Appendix E: Photographs of Test Setups

EUT Photos have been omitted from this test report. Photos can be found in the supplementary exhibit included in the submission and EDCS# 18337365.

Appendix F: Software Used to Perform Testing

Cisco Internal LabView Radio Test Automation Software – RF Automation Main rev57
Cisco Internal LabView Radio Test Automation Software – Report Generation Main rev51

Appendix G: Test Procedures

Measurements were made in accordance with

- KDB 789033 - D02 General UNII Test Procedures New Rules v02r01
- KDB 662911 - MIMO
- ANSI C63.4 2014 Unintentional Radiators
- ANSI C63.10 2013 Intentional Radiators

Test procedures are summarized below:

FCC 5GHz Test Procedures	EDCS # 1445048
FCC 5GHz RSE Test Procedures	EDCS # 1511600

Appendix H: Scope of Accreditation (A2LA certificate number 1178-01)

The scope of accreditation of Cisco Systems, Inc. can be found on the A2LA web page at:

<http://www.a2la.org/scopepdf/1178-01.pdf>

Appendix I: Test Assessment Plan

Compliance Test Plan (Excel) EDCS# 18216607
Radio Test Plan: EDCS# 18486508

Appendix J: Worst Case Justification

N/A

Appendix K: UUT Software Info

Cisco AP Software, (ap1g6a), [build-lnx-059:/san2/BUILD/workspace/Nightly-Cheetah-ap1g6a-mfg-c171_throttle]
Technical Support: <http://www.cisco.com/techsupport>
Copyright (c) 1986-2019 by Cisco Systems, Inc.
Compiled Wed Nov 13 07:45:59 PST 2019

ROM: Bootstrap program is U-Boot boot loader
BOOTLDR: U-Boot boot loader Version 119