



## Dynamic Frequency Selection (DFS) Test Report

### C9130AXE-(X)

### Cisco Catalyst C9130AX Series

(x=A, B)

FCC ID: LDK948342197

IC: 2461N-948342197

**5250-5350, 5470-5725 MHz**

Against the following Specifications:



**CFR47 Part 15.407**

**RSS247**

**Cisco Systems**

170 West Tasman Drive

San Jose, CA 95134

	
<b>Author:</b> Johanna Knudsen <b>Tested By:</b> Johanna Knudsen	<b>Approved By:</b> Gerard Thorpe <b>Title:</b> Manager – Radio Compliance & Certifications <b>Revision:</b> 4

This report replaces any previously entered test report under EDCS – **18337252**. This test report has been electronically authorized and archived using the CISCO Engineering Document Control system.



**SECTION 1: OVERVIEW .....3**

**SECTION 2: ASSESSMENT INFORMATION .....4**

    2.1 GENERAL .....4

    2.2 DATE OF TESTING .....6

    2.3 REPORT ISSUE DATE .....6

    2.4 TESTING FACILITIES .....6

    2.5 EQUIPMENT ASSESSED (EUT) .....6

**SECTION 3: RESULT SUMMARY .....7**

    3.1 RESULTS SUMMARY TABLE .....7

**SECTION 4: SAMPLE DETAILS .....8**

    4.1 SAMPLE DETAILS .....8

    4.2 SYSTEM DETAILS .....8

    4.3 MODE OF OPERATION DETAILS .....8

**APPENDIX A: DYNAMIC FREQUENCY SELECTION (DFS) .....9**

    A.1 UNII DEVICE DESCRIPTION .....9

    A.2 DFS DETECTION THRESHOLDS .....11

    A.3 RADAR TEST WAVEFORMS .....12

**APPENDIX B: DYNAMIC FREQUENCY SELECTION / TEST RESULTS .....16**

    CALIBRATION PLOTS .....18

    B.1 TEST PROCEDURE/RESULTS .....35

    B.2 UNII DETECTION BANDWIDTH .....36

    B.3 INITIAL CHANNEL AVAILABILITY CHECK TIME .....50

    B.4 RADAR BURST AT THE BEGINNING OF THE CHANNEL AVAILABILITY CHECK TIME .....51

    B.5 RADAR BURST AT THE END OF THE CHANNEL AVAILABILITY CHECK TIME .....52

    B.6 IN-SERVICE MONITORING FOR CHANNEL MOVE TIME, CHANNEL CLOSING TRANSMISSION TIME AND  
NON-OCCUPANCY PERIOD .....53

    B.7 STATISTICAL PERFORMANCE CHECK .....56

**APPENDIX C: LIST OF TEST EQUIPMENT USED TO PERFORM THE TEST .....242**

**APPENDIX D: PHOTOGRAPHS OF TEST SETUPS .....243**

**APPENDIX E: SOFTWARE USED TO PERFORM TESTING .....243**

**APPENDIX F: TEST PROCEDURES .....243**

**APPENDIX G: SCOPE OF ACCREDITATION (A2LA CERTIFICATE NUMBER 1178-01) .....243**

**APPENDIX H: TEST ASSESSMENT PLAN .....243**

**APPENDIX I: WORST CASE JUSTIFICATION .....243**

**APPENDIX J: UUT SOFTWARE INFO .....243**



## **Section 1: Overview**

The samples were assessed against the tests detailed in section 3 under the requirements of the following specifications:

<b>Specifications:</b>
CFR47 Part 15.407 RSS-247

## Section 2: Assessment Information

### 2.1 General

This report contains an assessment of an apparatus against Electromagnetic Compatibility Standards based upon tests carried out on the samples submitted. The testing was performed by and for the use of Cisco systems Inc:

With regard to this assessment, the following points should be noted:

- a) The results contained in this report relate only to the items tested and were obtained in the period between the date of the initial assessment and the date of issue of the report. Manufactured products will not necessarily give identical results due to production and measurement tolerances.
- b) The apparatus was set up and exercised using the configuration and modes of operation defined in this report only.
- c) Where relevant, the apparatus was only assessed using the susceptibility criteria defined in this report and the Test Assessment Plan (TAP).
- d) All testing was performed under the following environmental conditions:
  - Temperature 15°C to 35°C (54°F to 95°F)
  - Atmospheric Pressure 860mbar to 1060mbar (25.4" to 31.3")
  - Humidity 10% to 75\*%
- e) All AC testing was performed at one or more of the following supply voltages:
  - 110V 60 Hz (+/-20%)

### Units of Measurement

The units of measurements defined in the appendices are reported in specific terms, which are test dependent. Where radiated measurements are concerned these are defined at a particular distance. Basic voltage measurements are defined in units of [dBuV]

As an example, the basic calculation for all measurements is as follows:

$$\text{Emission level [dBuV]} = \text{Indicated voltage level [dBuV]} + \text{Cable Loss [dB]} + \text{Other correction factors [dB]}$$

The combinations of correction factors are dependent upon the exact test configurations [see test equipment lists for further details] and may include:-

Antenna Factors, Pre Amplifier Gain, LISN Loss, Pulse Limiter Loss and Filter Insertion Loss..

Note: to convert the results from dBuV/m to uV/m use the following formula:-

$$\text{Level in uV/m} = \text{Common Antilogarithm} [(X \text{ dBuV/m})/20] = Y \text{ uV/m}$$

## Measurement Uncertainty Values

voltage and power measurements	± 2 dB
conducted EIRP measurements	± 1.4 dB
radiated measurements	± 3.2 dB
frequency measurements	± 2.4 10 <sup>-7</sup>
temperature measurements	± 0.54°
humidity measurements	± 2.3%
DC and low frequency measurements	± 2.5%

Where relevant measurement uncertainty levels have been estimated for tests performed on the apparatus. This uncertainty represents an expanded uncertainty expressed at approximately the 95% confidence level using a coverage factor of k=2.

## Radiated emissions (expanded uncertainty, confidence interval 95%)

30 MHz - 300 MHz	+/- 3.8 dB
300 MHz - 1000 MHz	+/- 4.3 dB
1 GHz - 10 GHz	+/- 4.0 dB
10 GHz - 18GHz	+/- 8.2 dB
18GHz - 26.5GHz	+/- 4.1 dB
26.5GHz - 40GHz	+/- 3.9 dB

## Conducted emissions (expanded uncertainty, confidence interval 95%)

30 MHz – 40GHz	+/- 0.38 dB
----------------	-------------

A product is considered to comply with a requirement if the nominal measured value is below the limit line. The product is considered to not be in compliance in case the nominal measured value is above the limit line.

This report must not be reproduced except in full, without written approval of Cisco Systems.

**2.2 Date of testing**

15-OCT-19 - 05-DEC-19

**2.3 Report Issue Date**

30-JAN-20

Cisco uses an electronic system to issue, store and control the revision of test reports. This system is called the Engineering Document Control System 13253354. The actual report issue date is embedded into the original file on EDCS. Any copies of this report, either electronic or paper, that are not on EDCS must be considered uncontrolled.

**2.4 Testing facilities**

This assessment was performed by:

**Testing Laboratory**

Cisco Systems, Inc.,  
125 West Tasman Drive  
San Jose, CA 95134, USA

**Registration Numbers for Industry Canada**

<b>Cisco System Site</b>	<b>Address</b>	<b>Site Identifier</b>
Building P, 10m Chamber	125 West Tasman Dr San Jose, CA 95134	Company #: 2461N-2
Building P, 5m Chamber	125 West Tasman Dr San Jose, CA 95134	Company #: 2461N-1
Building I, 5m Chamber	285 W. Tasman Drive San Jose, California 95134	Company #: 2461M-1

**Test Engineers**

Johanna Knudsen

**2.5 Equipment Assessed (EUT)**

C9130AXE-B



### Section 3: Result Summary

#### 3.1 Results Summary Table

<b>Basic Standard</b>	<b>Technical Requirements / Details</b>	<b>Result</b>
FCC 15.407 RSS-247	Dynamic Frequency Selection (DFS) Detection Threshold	Pass
FCC 15.407 RSS-247	Channel Availability Check Time	Pass
FCC 15.407 RSS-247	Channel Move Time	Pass
FCC 15.407 RSS-247	Channel Closing Time	Pass
FCC 15.407 RSS-247	Non-Occupancy Period	Pass
FCC 15.407 RSS-247	U-NII Detection Bandwidth	Pass

## Section 4: Sample Details

Note: Each sample was evaluated to ensure that its condition was suitable to be used as a test sample prior to the commencement of testing.

### 4.1 Sample Details

Sample No.	Equipment Details	Manufacturer	Hardware Rev.	Firmware Rev.	Software Rev.	Serial Number
S01	C9130AXE-B	Cisco Systems, Inc	800-106171-01, P1A-2	NA	NA	KWC233200WT
S02	Support Laptop	Asus	FX504G	NA	NA	JANRCX002576412

### 4.2 System Details

System Number	Description	Sample Description	Samples	System under test	Support equipment
1	Used for 20, 40, 80MHz, and 160MHz testing	C9130AXE-B	S01	<input checked="" type="checkbox"/>	<input type="checkbox"/>
		Support Laptop	S02	<input type="checkbox"/>	<input checked="" type="checkbox"/>

### 4.3 Mode of Operation Details

Mode#	Description	Comments
1	20MHz BW DFS Tests	DFS Tests with traffic: 24% Traffic Loading using IPERF  Image: Cisco AP Software, (ap1g6a), [sjc-ads-2610:/nobackup/rthangac/work/gh_c8_20sep/router] Compiled Mon Sep 23 05:43:03 PDT 2019 ROM: Bootstrap program is U-Boot boot loader BOOTLDR: U-Boot boot loader Version 115
2	40MHz BW DFS Tests	DFS Tests with traffic: 20% Traffic Loading using IPERF  Image: Cisco AP Software, (ap1g6a), [sjc-ads-2610:/nobackup/rthangac/work/gh_c8_20sep/router] Compiled Mon Sep 23 05:43:03 PDT 2019 ROM: Bootstrap program is U-Boot boot loader BOOTLDR: U-Boot boot loader Version 115
3	80MHz BW DFS Tests	DFS Tests with traffic: 18% Traffic Loading using IPERF  Image: Cisco AP Software, (ap1g6a), [sjc-ads-2610:/nobackup/rthangac/work/gh_c8_20sep/router] Compiled Mon Sep 23 05:43:03 PDT 2019 ROM: Bootstrap program is U-Boot boot loader BOOTLDR: U-Boot boot loader Version 115
4	160MHz BW DFS Tests	DFS tests with traffic: 36% Traffic Loading using IPERF  Image: Cisco AP Software, (ap1g6a), [build-lnx-059:/san2/BUILD/workspace/Nightly-Cheetah-ap1g6a-mfg-c171_th rattle] Compiled Tue Oct 22 08:04:29 PDT 2019 ROM: Bootstrap program is U-Boot boot loader BOOTLDR: U-Boot boot loader Version 118





## **Appendix A: Dynamic Frequency Selection (DFS)**









15.407: U-NII devices operating in the 5.25-5.35 GHz band and the 5.47-5.725 GHz band shall employ a TPC mechanism. The U-NII device is required to have the capability to operate at least 6 dB below the mean EIRP value of 30 dBm. A TPC mechanism is not required for systems with an e.i.r.p. of less than 500 mW.

U-NII devices operating in the 5.25-5.35 GHz and 5.47-5.725 GHz bands shall employ a DFS radar detection mechanism to detect the presence of radar systems and to avoid co-channel operation with radar systems.

### **A.1 UNII Device Description**

Refer to the Radio Theory of Operation for supported modes. The modes included in this report represent the worst case data for all modes. The following antennas are supported by this product series. The data included in this report represent the worst case data for all antennas.

*List of External Antennas Supported on C9130AXE*

Part Number	Description	Gain
C-ANT9101=	Ceiling Mount Omni Self-Identifying Antenna with Bluetooth, 8-port, with DART connectors.	2 dBi (2.4 GHz) 6 dBi (5 GHz) 3 dBi (BLE)
C-ANT9102=	Pole or Wall Mount Omni Self-Identifying Antenna with Bluetooth, 8-port, with DART connectors.	4 dBi (2.4 GHz) 4 dBi (5 GHz) 4 dBi (BLE)
C-ANT9103=	Pole or Wall mount 75° Directional Self-Identifying Antenna with Bluetooth, 8-port, with DART connectors.	6 dBi (2.4 GHz) 6 dBi (5 GHz) 6 dBi (BLE)
AIR-ANT2513P4M-N=	Patch Antenna, 4-port, with N connectors.  <b>Note</b> <u>Connect to AP using AIR-CAB003-D8-N=.</u>	13 dBi (2.4 GHz) 13 dBi (5 GHz) 13 dBi (BLE)
AIR-ANT2524V4C-R=	Ceiling Mount Omni Antenna, 4-port, with RP-TNC connectors.  <b>Note</b> <u>Connect to AP using AIR-CAB002-D8-R=.</u>	2 dBi (2.4 GHz) 4 dBi (5 GHz)
AIR-ANT2524V4C-RS=	Ceiling Mount Omni Self-Identifying Antenna, 4-port, with RP-TNC connectors.  <b>Note</b> <u>Connect to AP using AIR-CAB002-D8-R=.</u>	2 dBi (2.4 GHz) 4 dBi (5 GHz)
AIR-ANT2544V4M-R=	Wall Mount Omni Antenna, 4-port, with RP-TNC connectors.  <b>Note</b> <u>Connect to AP using AIR-CAB002-D8-R=.</u>	4 dBi (2.4 GHz) 4 dBi (5 GHz)
AIR-ANT2544V4M-RS=	Wall Mount Omni Self-Identifying Antenna, 4-port, with RP-TNC connectors.  <b>Note</b> <u>Connect to AP using AIR-CAB002-D8-R=.</u>	4 dBi (2.4 GHz) 4 dBi (5 GHz)
AIR-ANT2566D4M-R=	60° Patch Antenna, 4-port, with RP-TNC connectors. <sup>1</sup>  <b>Note</b> <u>Connect to AP using AIR-CAB002-D8-R=.</u>	6 dBi (2.4 GHz) 6 dBi (5 GHz)
AIR-ANT2566D4M-RS=	60° Patch Self-Identifying Antenna, 4-port, with RP-TNC connectors.  <b>Note</b> <u>Connect to AP using AIR-CAB002-D8-R=.</u>	6 dBi (2.4 GHz) 6 dBi (5 GHz)
AIR-ANT2566P4W-R=	Directional Antenna, 4-port, with RP-TNC connectors.  <b>Note</b> <u>Connect to AP using AIR-CAB002-D8-R=.</u>	6 dBi (2.4 GHz) 6 dBi (5 GHz)
AIR-ANT2566P4W-RS=	Directional Self-Identifying Antenna, 4-port, with RP-TNC connectors.  <b>Note</b> <u>Connect to AP using AIR-CAB002-D8-R=.</u>	6 dBi (2.4 GHz) 6 dBi (5 GHz)

The maximum EIRP of the 5GHz equipment is 29 dBm, and the minimum possible EIRP is 10 dBm. Above are the available 50 ohm antenna assemblies and their corresponding gains. 4dBi gain was used to set the -60 dBm threshold level during calibration of the test setup. There was also an additional cable loss of 2dB, so some test cases were performed at -58dBm.

System testing was performed with IPERF traffic that streams continuously from the Master to the Client IP based system. The Master requires 122.4s seconds to complete its power-on cycle.

Information regarding the parameters of the detected Radar Waveforms is not available to the end user.

For the 5250-5350 MHz and 5470-5725 MHz bands, the Master device provides, on aggregate, uniform loading of the spectrum across all devices by selecting an operating channel among the available channels using a random algorithm.

## A.2 DFS Detection Thresholds

### 1. Interference Threshold values, Master or Client incorporating In-Service Monitoring

Maximum Transmit Power	Value (See Notes 1, 2, and 3)
EIRP $\geq$ 200 milliwatt	-64 dBm
EIRP < 200 milliwatt and power spectral density < 10 dBm/MHz	-62 dBm
EIRP < 200 milliwatt that do not meet the power spectral density requirement	-64 dBm
<p><b>Note 1:</b> This is the level at the input of the receiver assuming a 0 dBi receive antenna.</p> <p><b>Note 2:</b> Throughout these test procedures an additional 1 dB has been added to the amplitude of the test transmission waveforms to account for variations in measurement equipment. This will ensure that the test signal is at or above the detection threshold level to trigger a DFS response.</p> <p><b>Note3:</b> EIRP is based on the highest antenna gain. For MIMO devices refer to KDB Publication 662911 D01 v02r01.</p>	

### 2. DFS Response requirement values

Parameter	Value
<i>Non-occupancy period</i>	Minimum 30 minutes
<i>Channel Availability Check Time</i>	60 seconds
<i>Channel Move Time</i>	10 seconds See Note 1.
<i>Channel Closing Transmission Time</i>	200 milliseconds + an aggregate of 60 milliseconds over remaining 10 second period. See Notes 1 and 2.
<i>U-NII Detection Bandwidth</i>	Minimum 100% of the U-NII 99% transmission power bandwidth. See Note 3.
<p><b>Note 1:</b> <i>Channel Move Time</i> and the <i>Channel Closing Transmission Time</i> should be performed with Radar Type 0. The measurement timing begins at the end of the Radar Type 0 burst.</p> <p><b>Note 2:</b> The <i>Channel Closing Transmission Time</i> is comprised of 200 milliseconds starting at the beginning of the <i>Channel Move Time</i> plus any additional intermittent control signals required to facilitate a <i>Channel</i> move (an aggregate of 60 milliseconds) during the remainder of the 10 second period. The aggregate duration of control signals will not count quiet periods in between transmissions.</p> <p><b>Note 3:</b> During the <i>U-NII Detection Bandwidth</i> detection test, radar type 0 should be used. For each frequency step the minimum percentage of detection is 90 percent. Measurements are performed with no data traffic.</p>	

### A.3 Radar Test Waveforms

This section provides the parameters for required test waveforms, minimum percentage of successful detections, and the minimum number of trials that must be used for determining DFS conformance. Step intervals of 0.1 microsecond for Pulse Width, 1 microsecond for PRI, 1 MHz for chirp width and 1 for the number of pulses will be utilized for the random determination of specific test waveforms.

#### 1. Short Pulse Radar Test Waveforms

Radar Type	Pulse Width (μsec)	PRI (μsec)	Number of Pulses	Minimum Percentage of Successful Detection	Minimum Numbers of Trials
0	1	1428	18	See Note 1	See Note 1
1	1	Test A: 15 unique PRI values randomly selected from the list of 23 PRI values in Table 5a	Roundup $\left\{ \begin{array}{l} \left( \frac{1}{360} \right) \cdot \\ \left( \frac{19 \cdot 10^6}{PRI_{\mu sec}} \right) \end{array} \right\}$	60%	30
		Test B: 15 unique PRI values randomly selected within the range of 518-3066 μsec, with a minimum increment of 1 μsec, excluding PRI values selected in Test A			
2	1-5	150-230	23-29	60%	30
3	6-10	200-500	16-18	60%	30
4	11-20	200-500	12-16	60%	30
Aggregate (Radar Types 1-4)				80%	120
<b>Note 1:</b> Short Pulse Radar Type 0 shall only be used for the channel availability and detection bandwidth tests. It should be noted that any of the radar test waveforms 0 – 4 can be used for the channel availability and detection bandwidth tests.					

A minimum of 30 unique waveforms are required for each of the Short Pulse Radar Types 2 through 4. If more than 30 waveforms are used for Short Pulse Radar Types 2 through 4, then each additional waveform must also be unique and not repeated from the previous waveforms. If more than 30 waveforms are used for Short Pulse Radar Type 1, then each additional waveform is generated with Test B and must also be unique and not repeated from the previous waveforms in Tests A or B.



For example if in Short Pulse Radar Type 1 Test B a PRI of 3066  $\mu$ sec is selected, the number of pulses would be  
 $\text{Roundup}\left\{\left(\frac{1}{360}\right) \cdot \left(\frac{19 \cdot 10^6}{3066}\right)\right\} = \text{Roundup}\{17.2\} = 18$

**Table 5a – Pulse Repetition Intervals Values for Test A**

<b>Pulse Repetition Frequency Number</b>	<b>Pulse Repetition Frequency (Pulses Per Second)</b>	<b>Pulse Repetition Interval (Microseconds)</b>
1	1930.5	518
2	1858.7	538
3	1792.1	558
4	1730.1	578
5	1672.2	598
6	1618.1	618
7	1567.4	638
8	1519.8	658
9	1474.9	678
10	1432.7	698
11	1392.8	718
12	1355.0	738
13	1319.3	758
14	1285.3	778
15	1253.1	798
16	1222.5	818
17	1193.3	838
18	1165.6	858
19	1139.0	878
20	1113.6	898
21	1089.3	918
22	1066.1	938
23	326.2	3066

The aggregate is the average of the percentage of successful detections of Short Pulse Radar Types 1-4. For example, the following table indicates how to compute the aggregate of percentage of successful detections.

<b>Radar Type</b>	<b>Number of Trials</b>	<b>Number of Successful Detections</b>	<b>Minimum Percentage of Successful Detection</b>
1	35	29	82.9%
2	30	18	60%
3	30	27	90%
4	50	44	88%
Aggregate (82.9% + 60% + 90% + 88%)/4 = 80.2%			

## 2. Long Pulse Radar Test Waveform

Radar Type	Pulse Width (µsec)	Chirp Width (MHz)	PRI (µsec)	Number of Pulses per Burst	Number of Bursts	Minimum Percentage of Successful Detection	Minimum Trials
5	50-100	5-20	1000- 2000	1-3	8-20	80%	30

The parameters for this waveform are randomly chosen. Thirty unique waveforms are required for the Long Pulse radar test signal. If more than 30 waveforms are used for the Long Pulse radar test signal, then each additional waveform must also be unique and not repeated from the previous waveforms.

Each waveform is defined as follows:

- 1) The transmission period for the Long Pulse Radar test signal is 12 seconds.
- 2) There are a total of 8 to 20 Bursts in the 12 second period, with the number of Bursts being randomly chosen. This number is Burst Count.
- 3) Each Burst consists of 1 to 3 pulses, with the number of pulses being randomly chosen. Each Burst within the 12 second sequence may have a different number of pulses.
- 4) The pulse width is between 50 and 100 microseconds, with the pulse width being randomly chosen. Each pulse within a Burst will have the same pulse width. Pulses in different Bursts may have different pulse widths.
- 5) Each pulse has a linear FM chirp between 5 and 20 MHz, with the chirp width being randomly chosen. Each pulse within a Burst will have the same chirp width. Each pulse within a transmission period will have the same chirp width. The chirp is centered on the pulse. For example, with a radar frequency of 5300 MHz and a 20 MHz chirped signal, the chirp starts at 5290 MHz and ends at 5310 MHz.
- 6) If more than one pulse is present in a Burst, the time between the pulses will be between 1000 and 2000 microseconds, with the time being randomly chosen. If three pulses are present in a Burst, the time between the first and second pulses is chosen independently of the time between the second and third pulses.
- 7) The 12 second transmission period is divided into even intervals. The number of intervals is equal to Burst Count. Each interval is of length  $(12,000,000 / \text{Burst Count})$  microseconds. Each interval contains one Burst. The start time for the Burst, relative to the beginning of the interval, is between 1 and  $[(12,000,000 / \text{Burst Count}) - (\text{Total Burst Length}) + (\text{One Random PRI Interval})]$  microseconds, with the start time being randomly chosen. The step interval for the start time is 1 microsecond. The start time for each Burst is chosen randomly.

### A representative example of a Long Pulse radar test waveform:

- 1) The total test signal length is 12 seconds.
- 2) 8 Bursts are randomly generated for the Burst Count.
- 3) Burst 1 has 2 randomly generated pulses.
- 4) The pulse width (for both pulses) is randomly selected to be 75 microseconds.
- 5) The PRI is randomly selected to be at 1213 microseconds.
- 6) Bursts 2 through 8 are generated using steps 3 – 5.
- 7) Each Burst is contained in even intervals of 1,500,000 microseconds. The starting location for Pulse 1, Burst 1 is randomly generated (1 to 1,500,000 minus the total Burst 1 length + 1 random PRI interval) at the 325,001 microsecond step. Bursts 2 through 8 randomly fall in successive 1,500,000 microsecond intervals (i.e. Burst 2 falls in the 1,500,001 – 3,000,000 microsecond range).

**Graphical Representation of a Long Pulse radar Test Waveform**

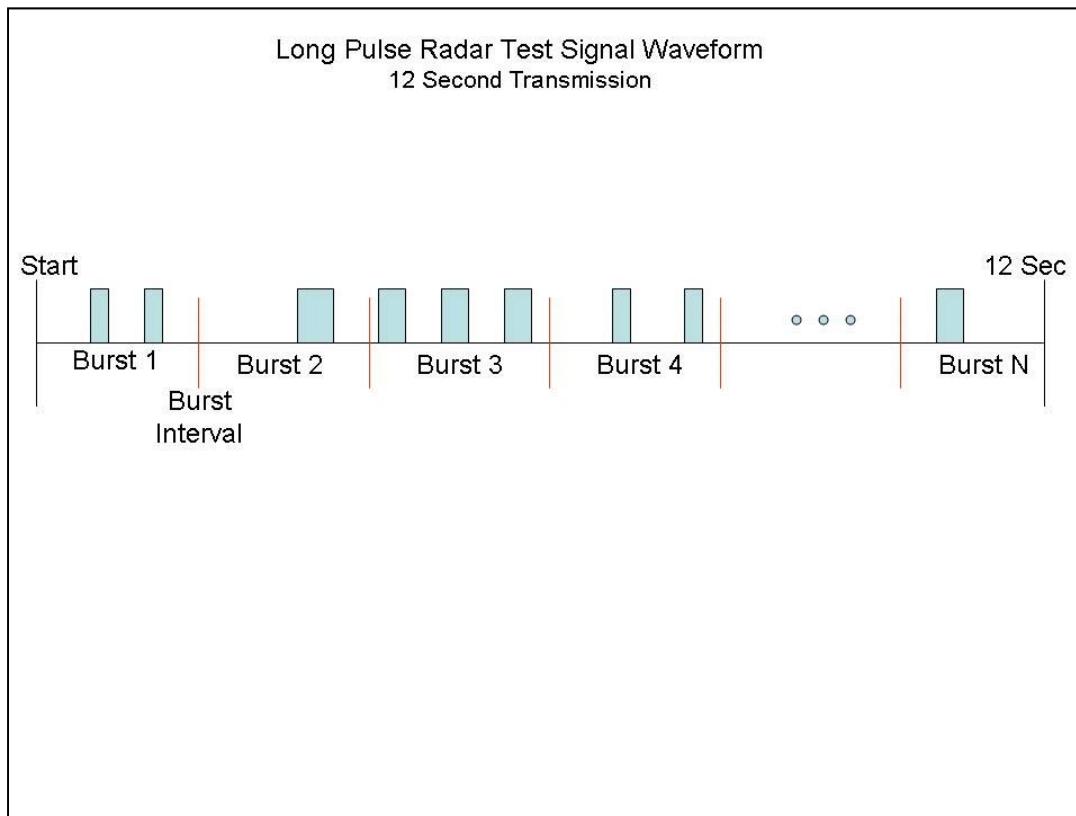

**3. Long Pulse Radar Test Waveform**

Radars Type	Pulse Width (µsec)	PRI (µsec)	Pulses per Hop	Hopping Rate (kHz)	Hopping Sequence Length (msec)	Minimum Percentage of Successful Detection	Minimum Trials
6	1	333	9	.333	300	70%	30

For the Frequency Hopping Radar Type, the same *Burst* parameters are used for each waveform. The hopping sequence is different for each waveform and a 100-length segment is selected<sup>1</sup> from the hopping sequence defined by the following algorithm:

The first frequency in a hopping sequence is selected randomly from the group of 475 integer frequencies from 5250 – 5724 MHz. Next, the frequency that was just chosen is removed from the group and a frequency is randomly selected from the remaining 474 frequencies in the group. This process continues until all 475 frequencies are chosen for the set. For selection of a random frequency, the frequencies remaining within the group are always treated as equally likely.



## Appendix B: Dynamic Frequency Selection / Test Results

### Standards Reference

FCC 15.407 / RSS-247

### Test Procedure

Ref. KDB 905462 D02 UNII DFS Compliance Procedures New Rules v02

DFS Test parameters
Span = 0 Hz
RBW ≥ 3 MHz
VBW ≥ 3 MHz
Detector = Peak
Trace = Single Sweep

### Samples, Systems, and Modes

System Number	Description	Samples	System under test	Support equipment
1	EUT	S01	<input checked="" type="checkbox"/>	<input type="checkbox"/>
	Support	S02	<input type="checkbox"/>	<input checked="" type="checkbox"/>

<b>Tested By :</b> Johanna Knudsen	<b>Date of testing:</b> 15-OCT-19 - 05-DEC-19
<b>Test Result : PASS</b>	

### Test Equipment

See Appendix C for list of test equipment



The following equipment setup was used to calibrate the conducted Radar Waveform. A spectrum analyzer was used to establish the test signal level for each radar type. During this process there were no transmissions by either the Master or Client Device. The spectrum analyzer was switched to the zero span (Time Domain) mode at the frequency of the Radar Waveform generator. Peak detection was utilized. The spectrum analyzer resolution bandwidth (RBW) and video bandwidth (VBW) were set to 3 MHz.

The signal generator amplitude was set so that the power level measured at the spectrum analyzer was -63dBm.

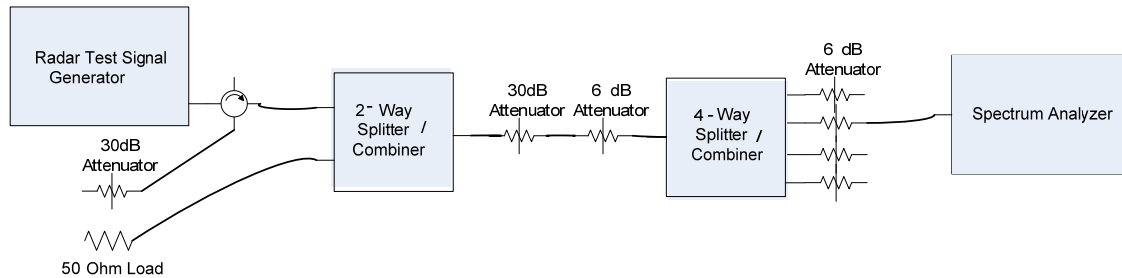

**Conducted Calibration Setup**



**Calibration Plots**

Following are the calibration plots for each of the required radar waveforms.

**Calibration Plots – Bandwidth 20**

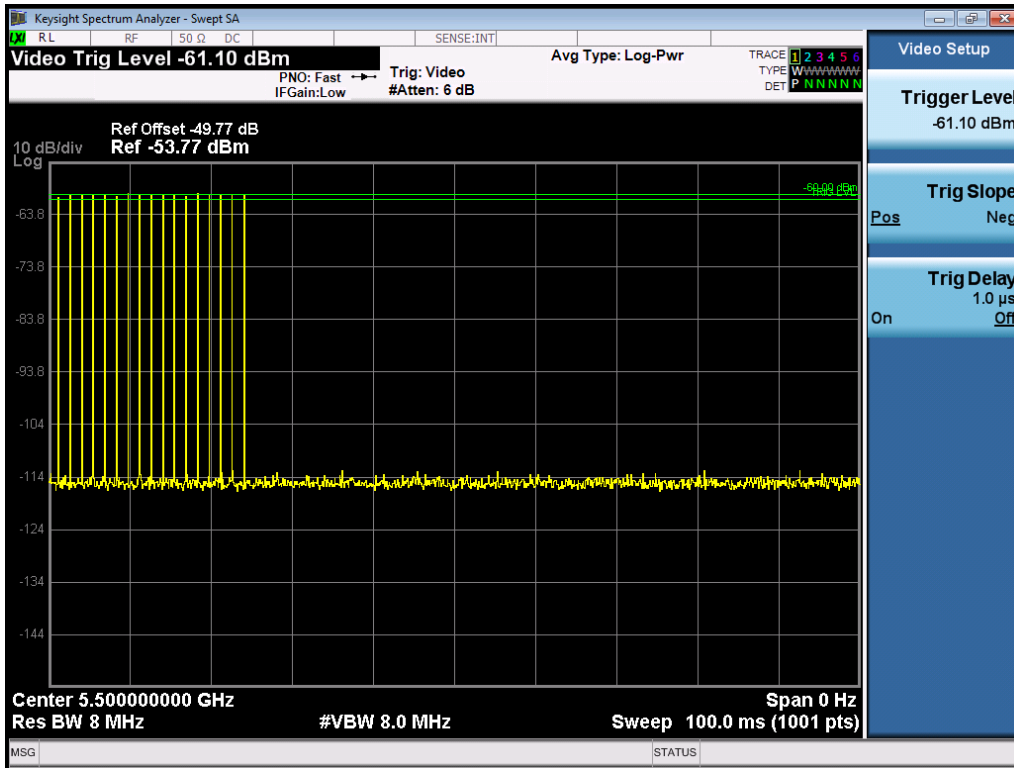

**USA Bin 0 Radar Calibration BW20**

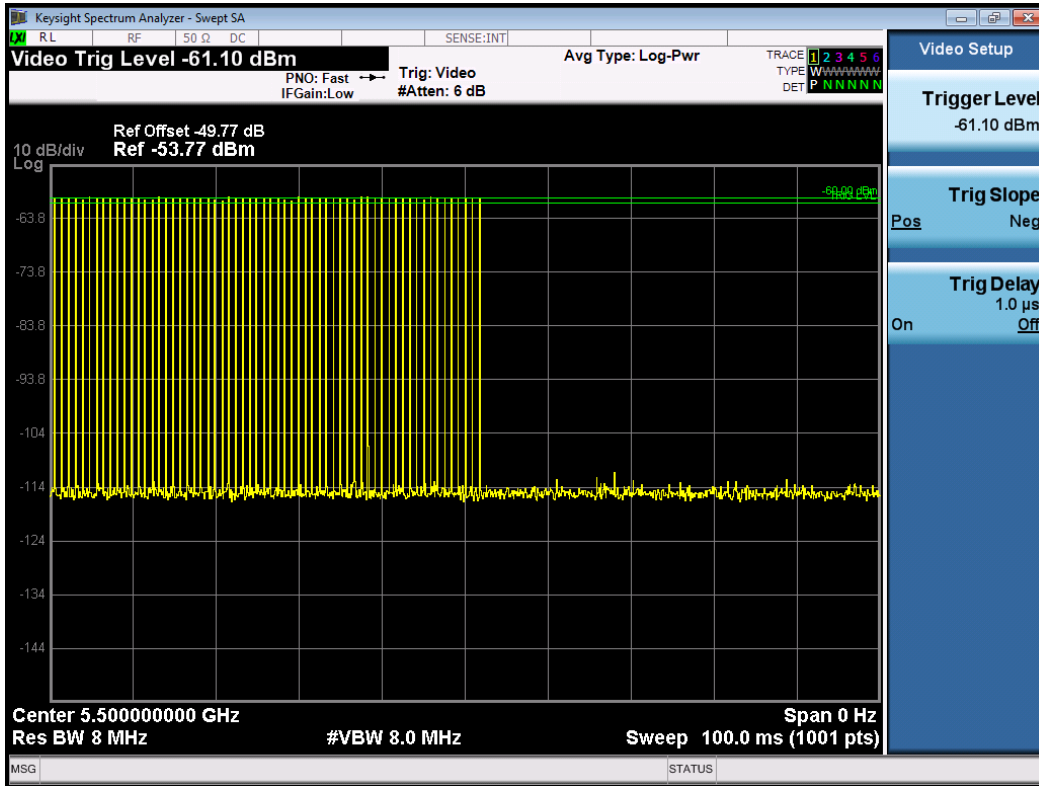

USA Bin 1A Radar Calibration BW20

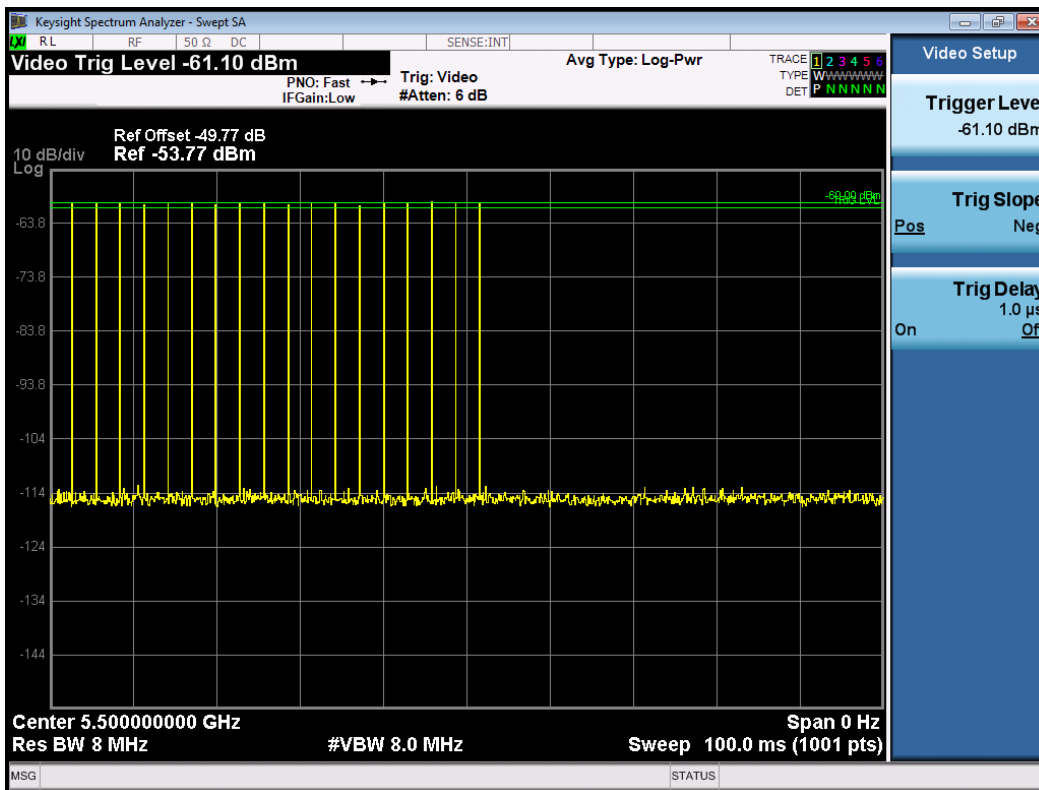

USA Bin 1B Radar Calibration BW20

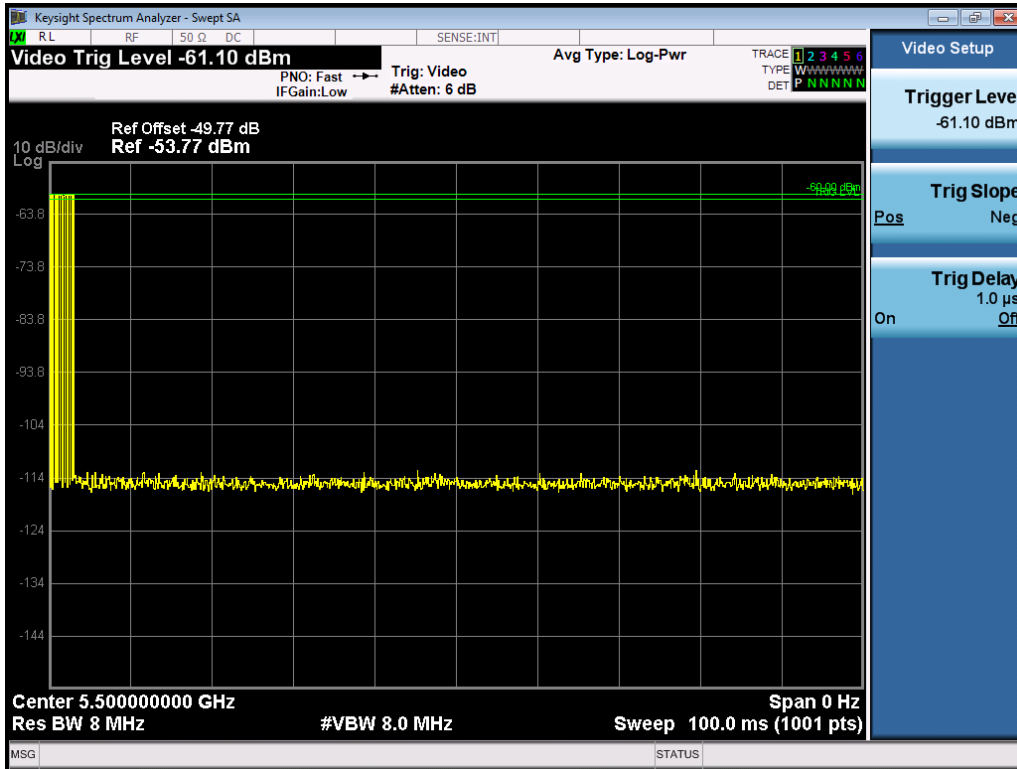

USA Bin 2 Radar Calibration BW20

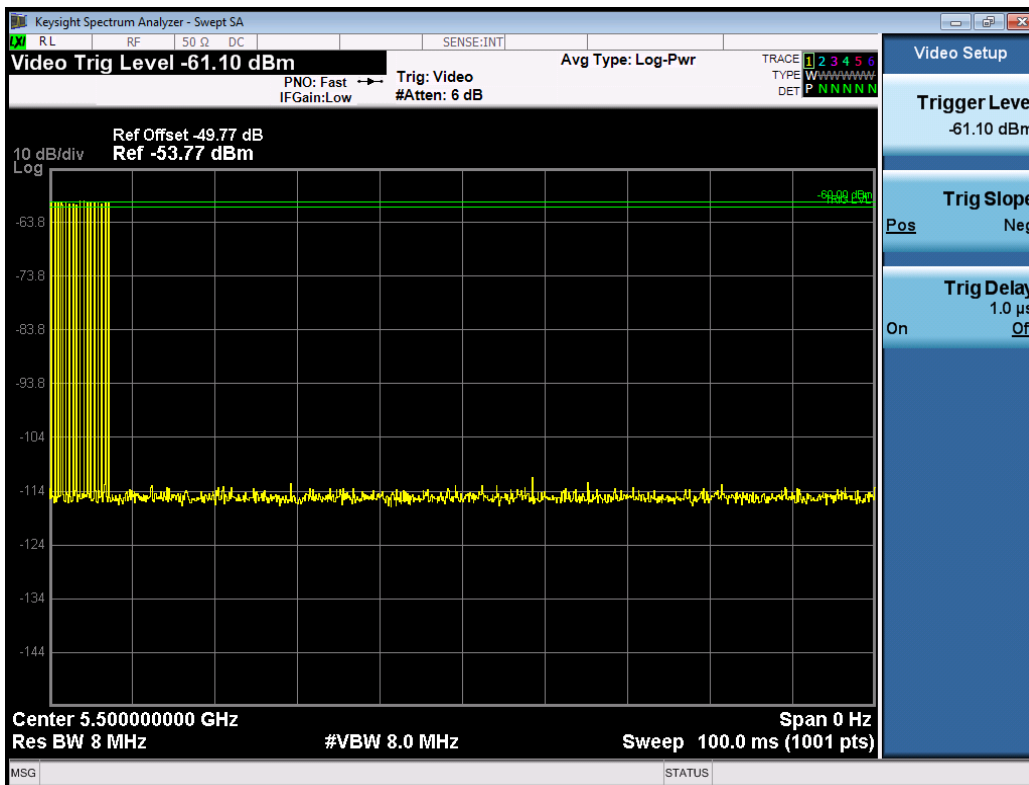

USA Bin 3 Radar Calibration BW20

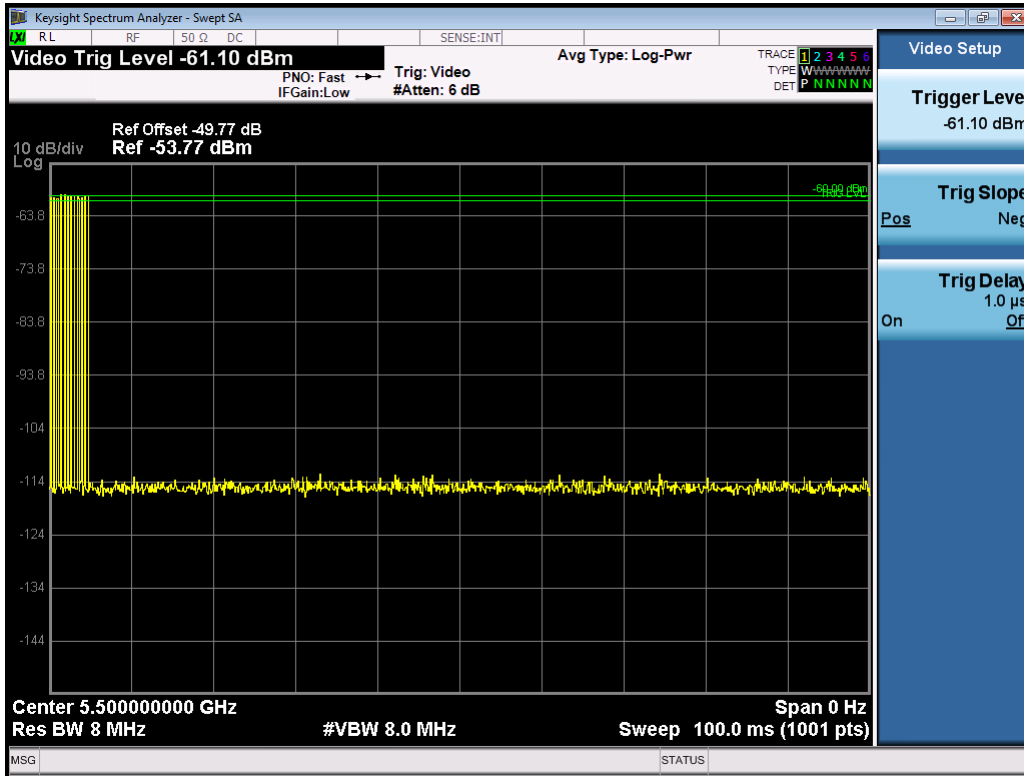

**USA Bin 4 Radar Calibration BW20**

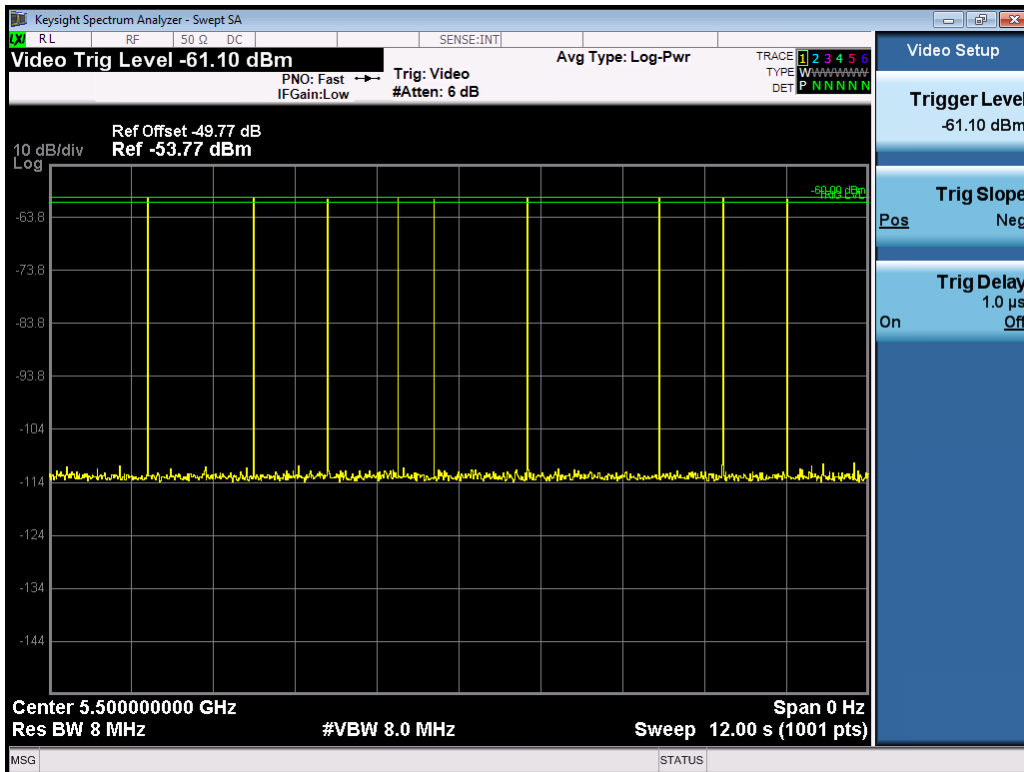

**USA Bin 5 Radar Calibration BW20**

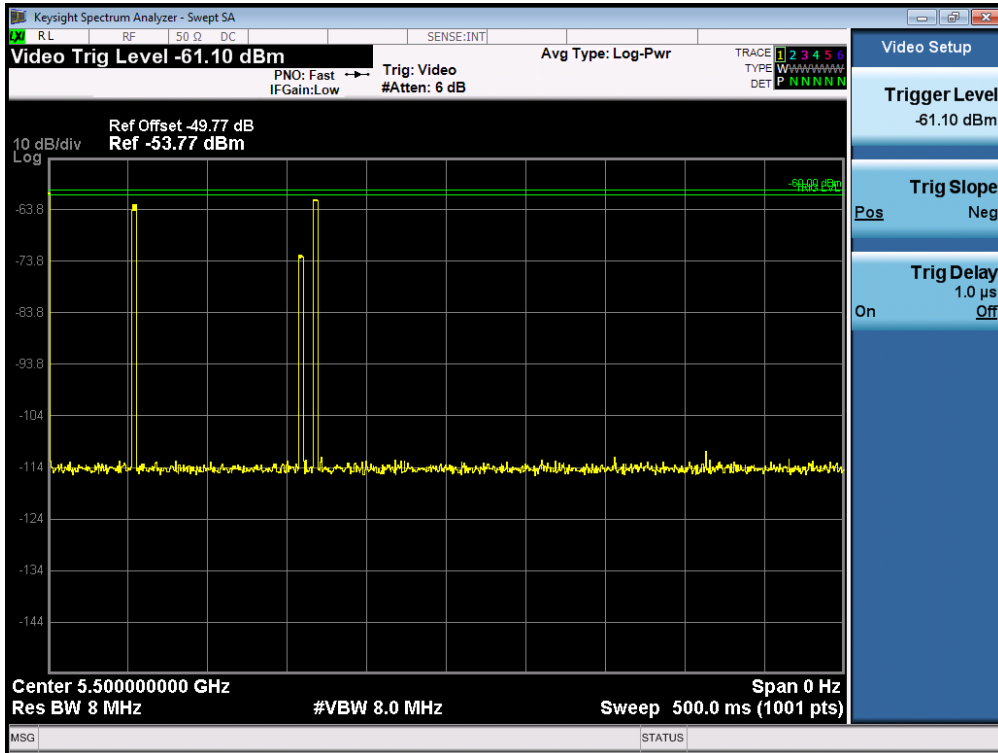

**USA Frequency Hopping Radar Calibration BW20**



Calibration Plots – Bandwidth 40

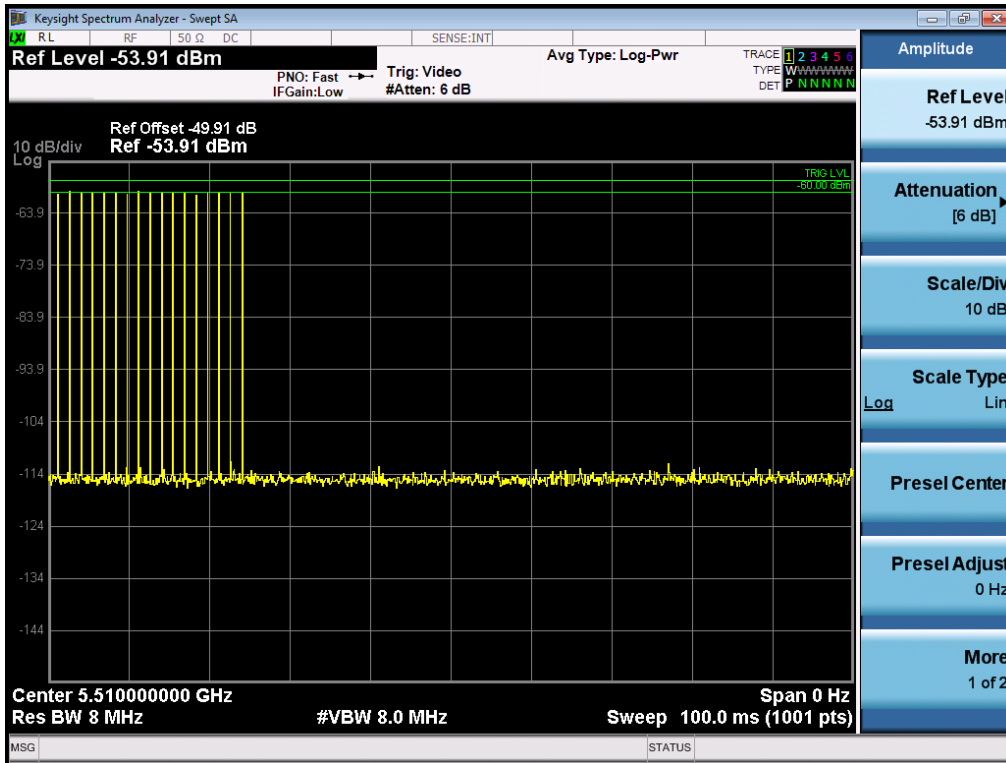

**USA Bin 0 Radar Calibration BW40**

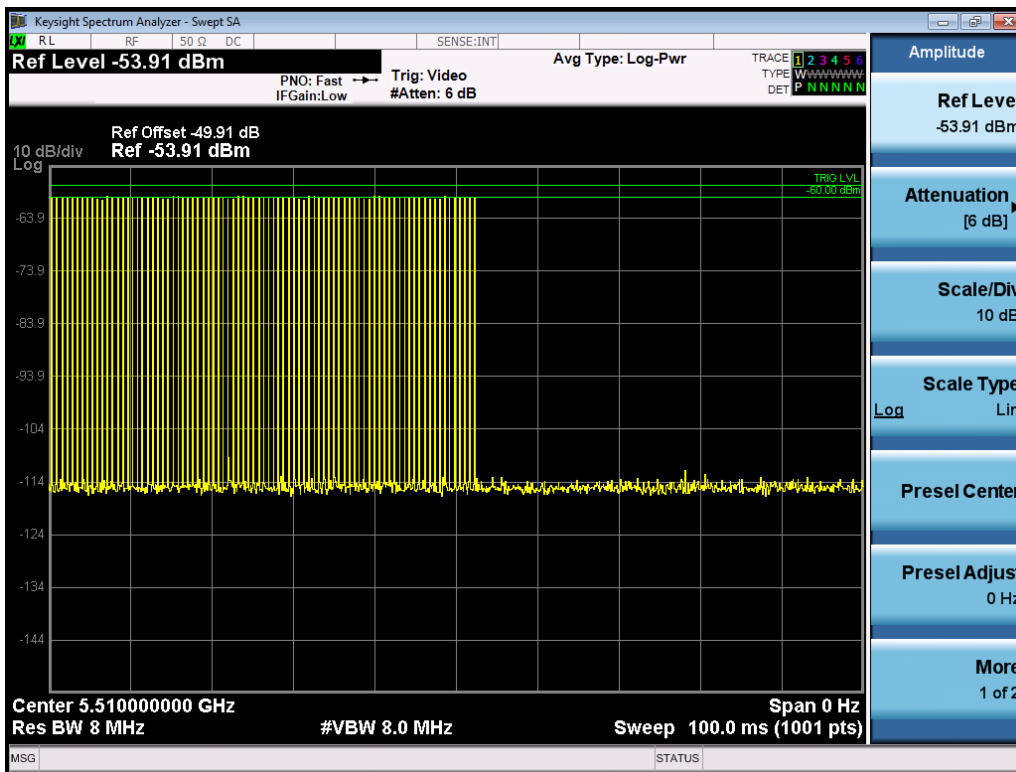

**USA Bin 1A Radar Calibration BW40**

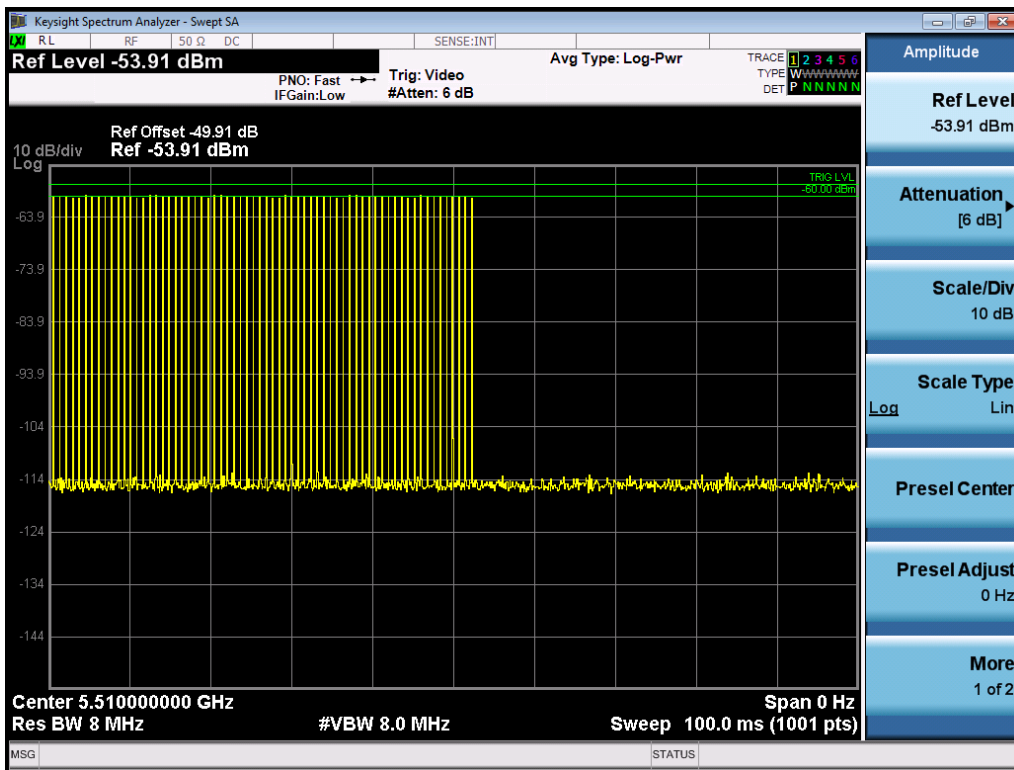

**USA Bin 1B Radar Calibration BW40**

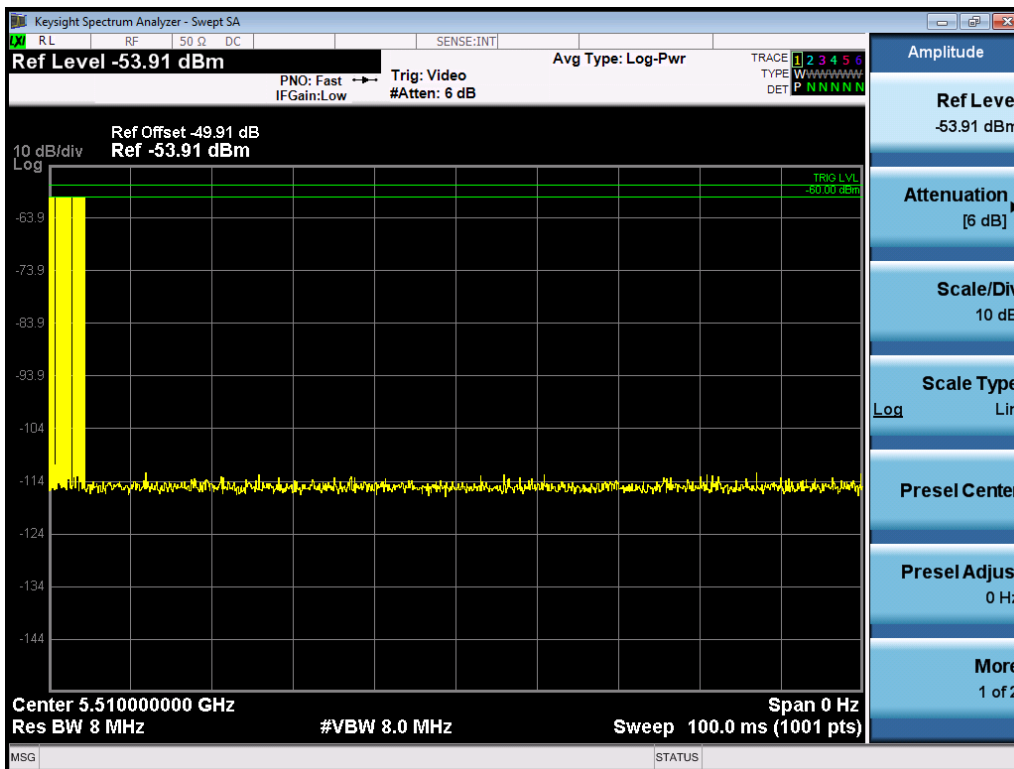

**USA Bin 2 Radar Calibration BW40**



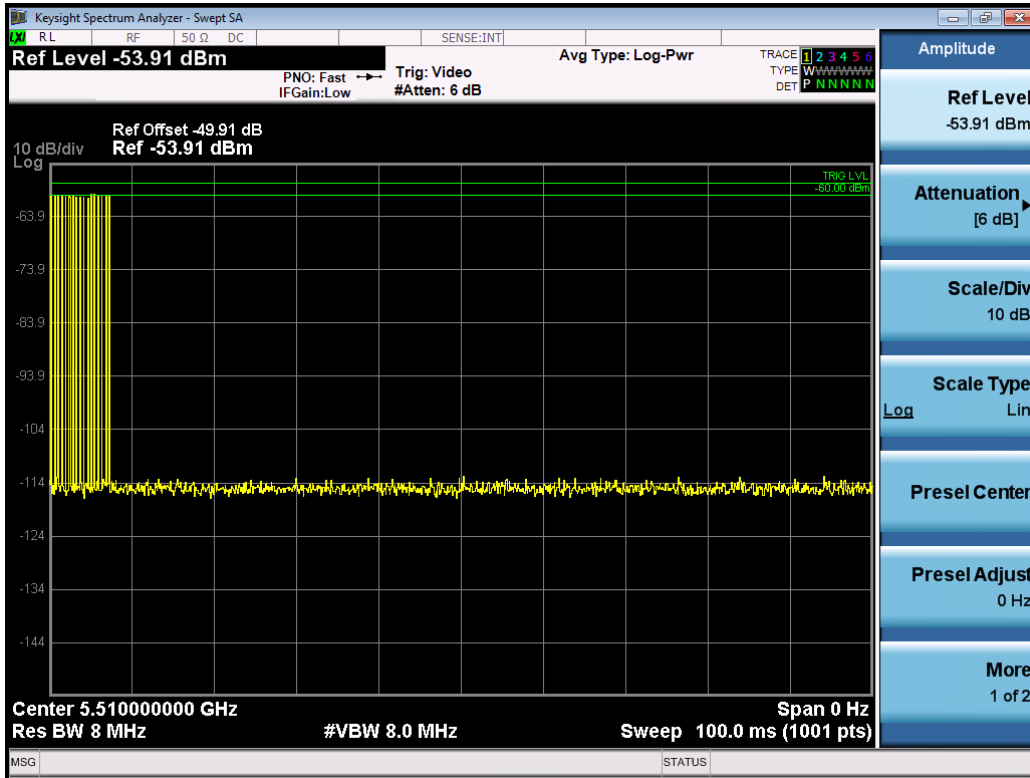

**USA Bin 3 Radar Calibration BW40**

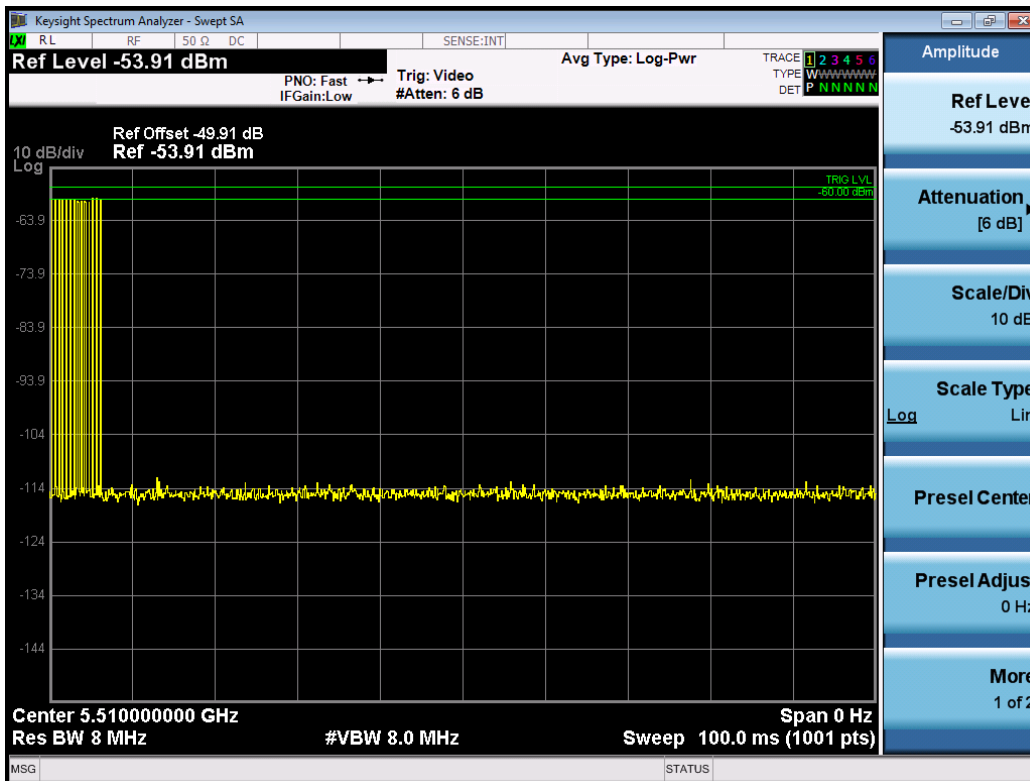

**USA Bin 4 Radar Calibration BW40**

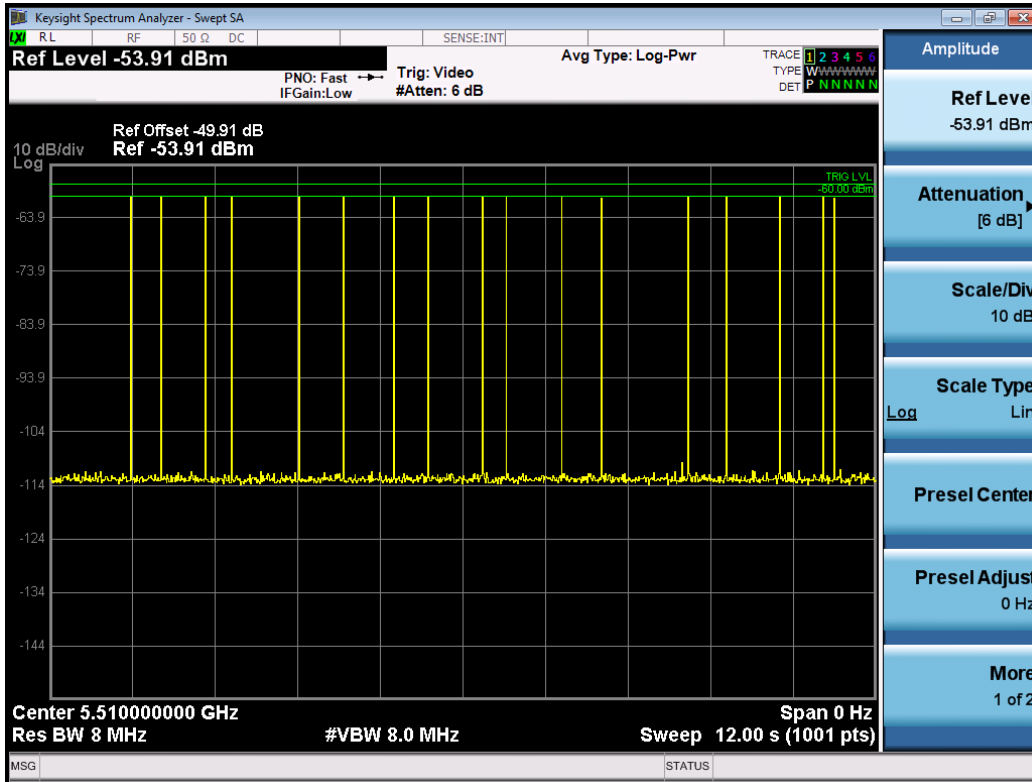

**USA Bin 5 Radar Calibration BW40**

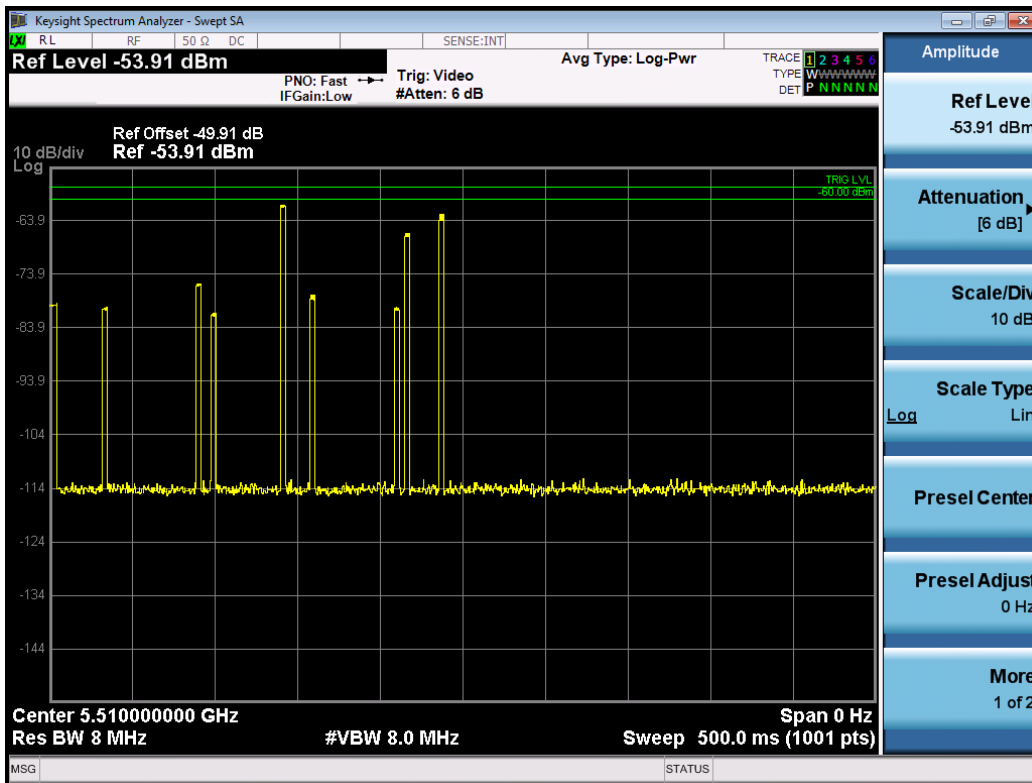

**USA Frequency Hopping Radar Calibration BW40**



Calibration Plots – Bandwidth 80

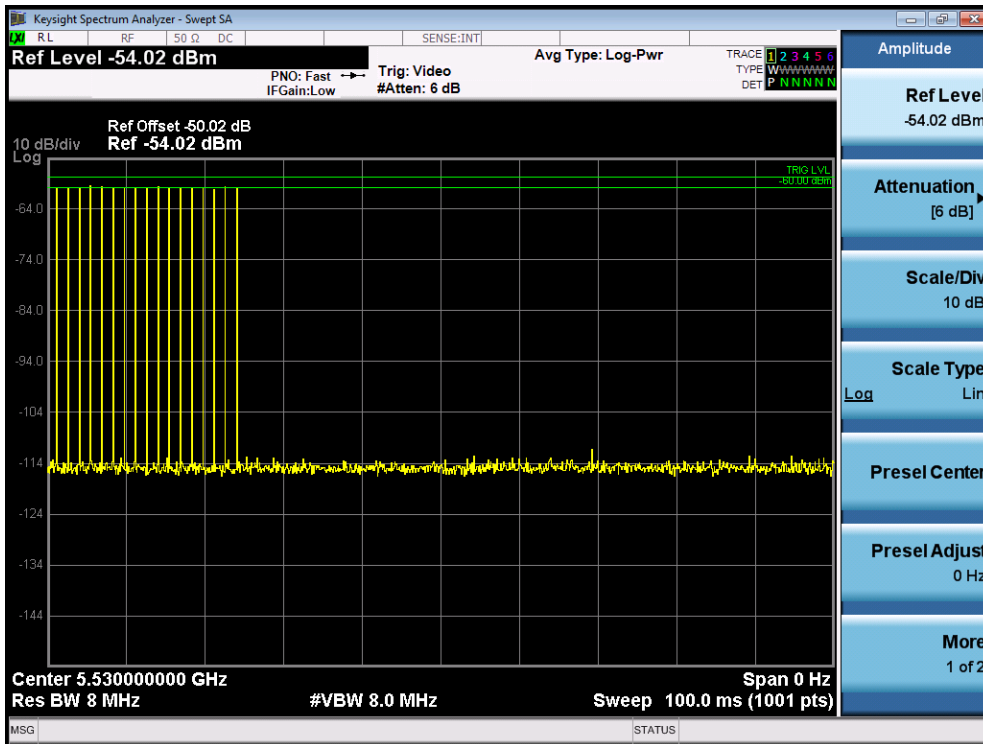

USA Bin 0 Radar Calibration BW80

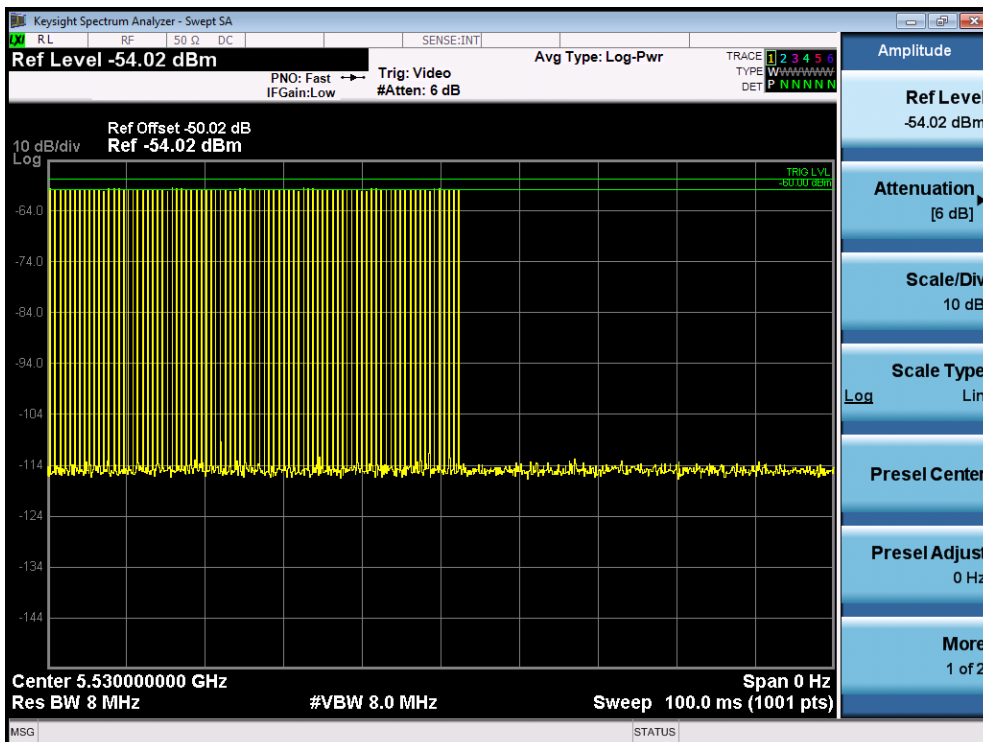

USA Bin 1A Radar Calibration BW80

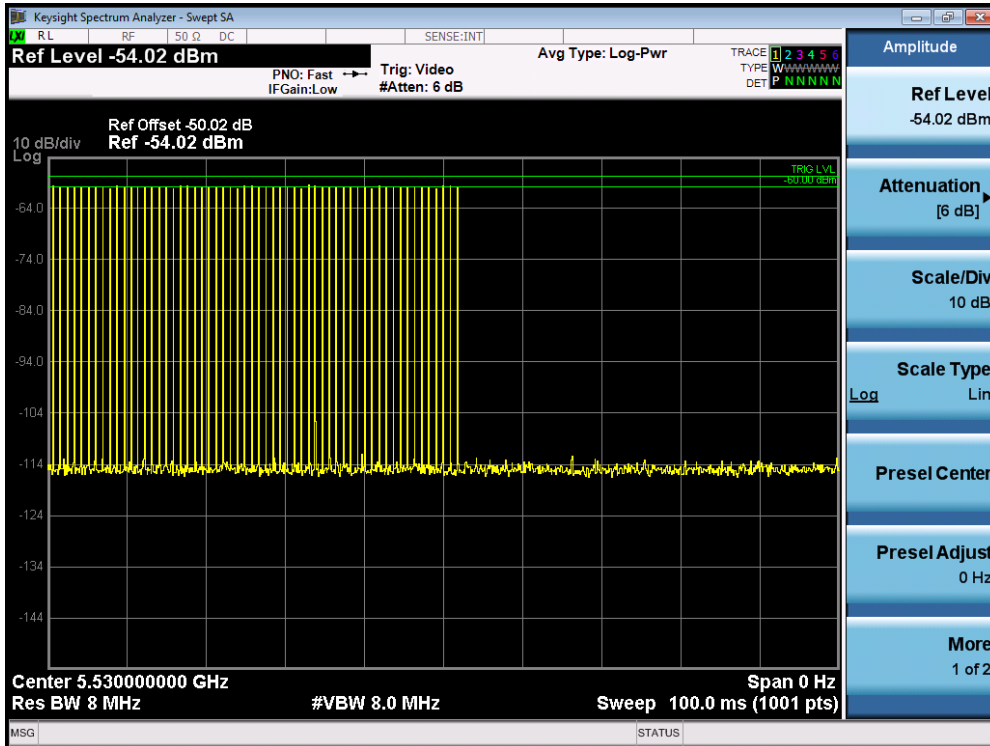

**USA Bin 1B Radar Calibration BW80**

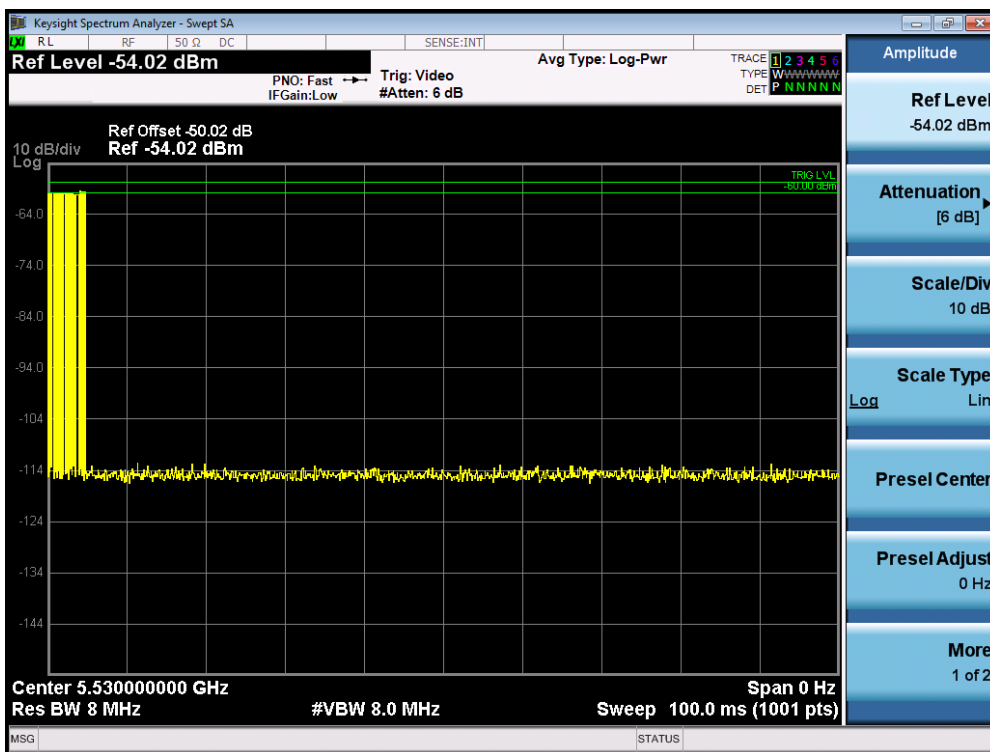

**USA Bin 2 Radar Calibration BW80**

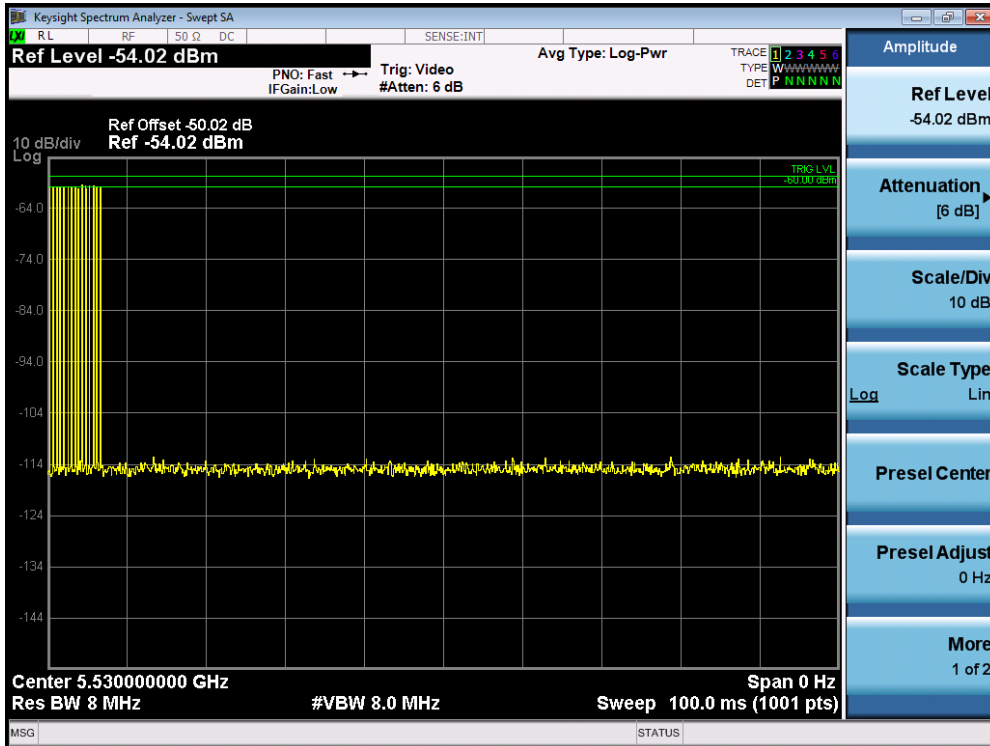

**USA Bin 3 Radar Calibration BW80**

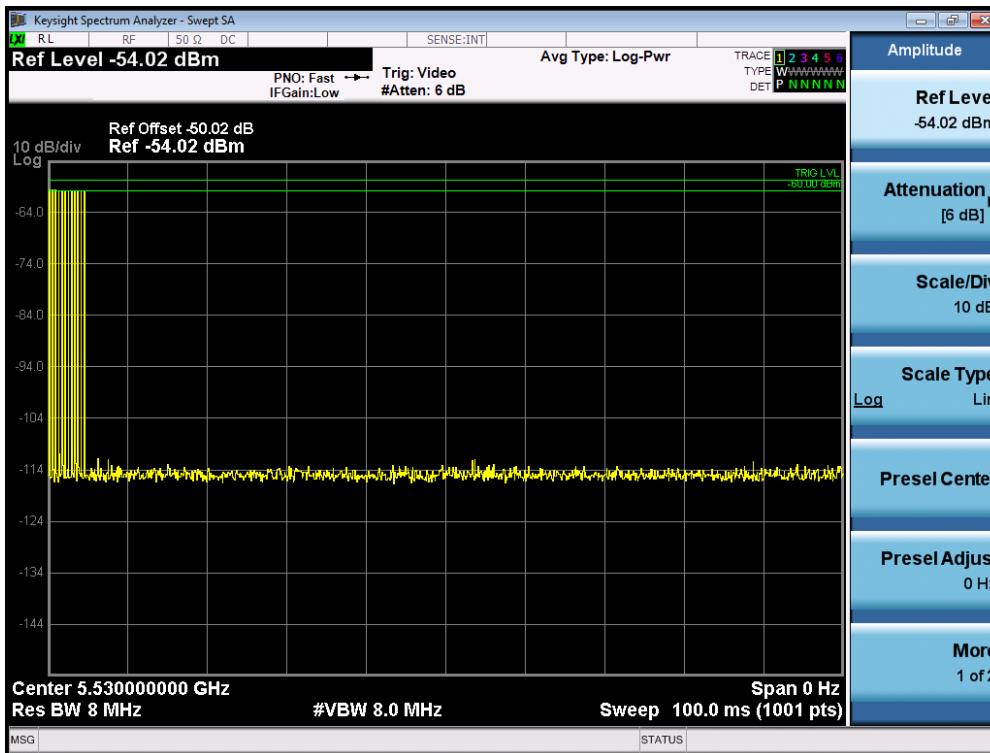

**USA Bin 4 Radar Calibration BW80**

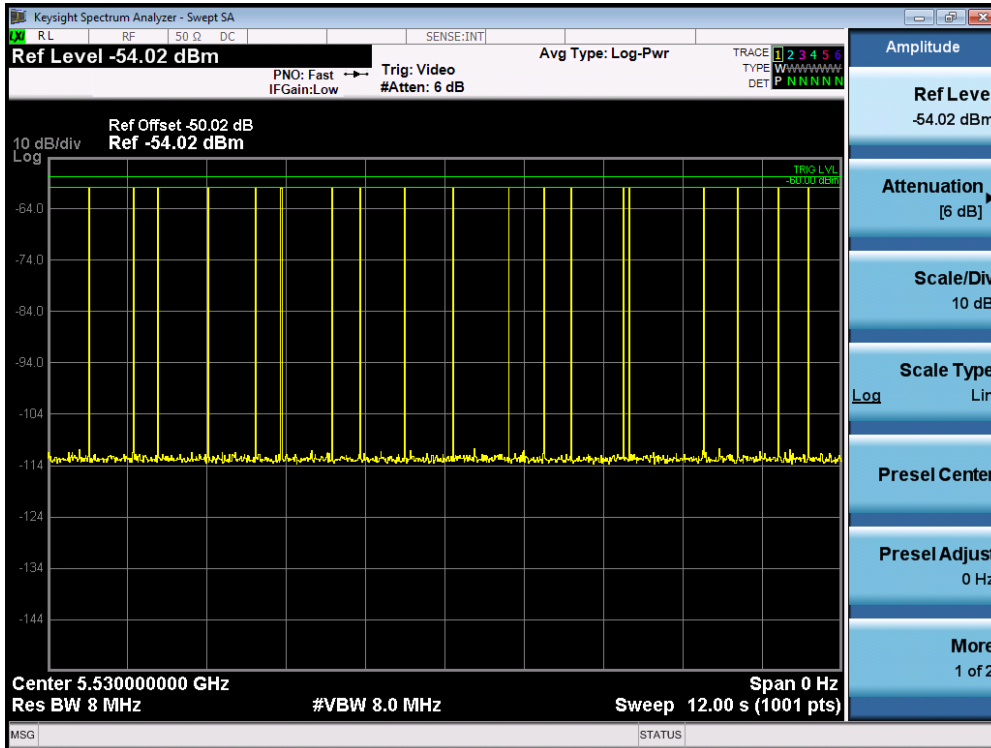

**USA Bin 5 Radar Calibration BW80**

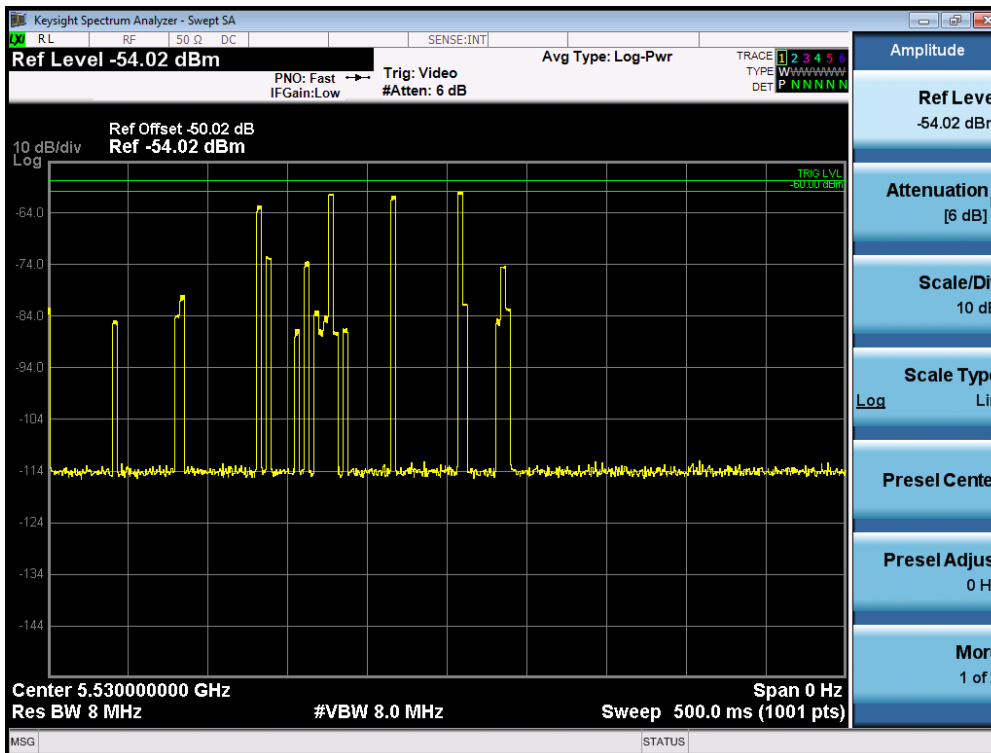

**USA Frequency Hopping Radar Calibration BW80**



Calibration Plots – Bandwidth 160

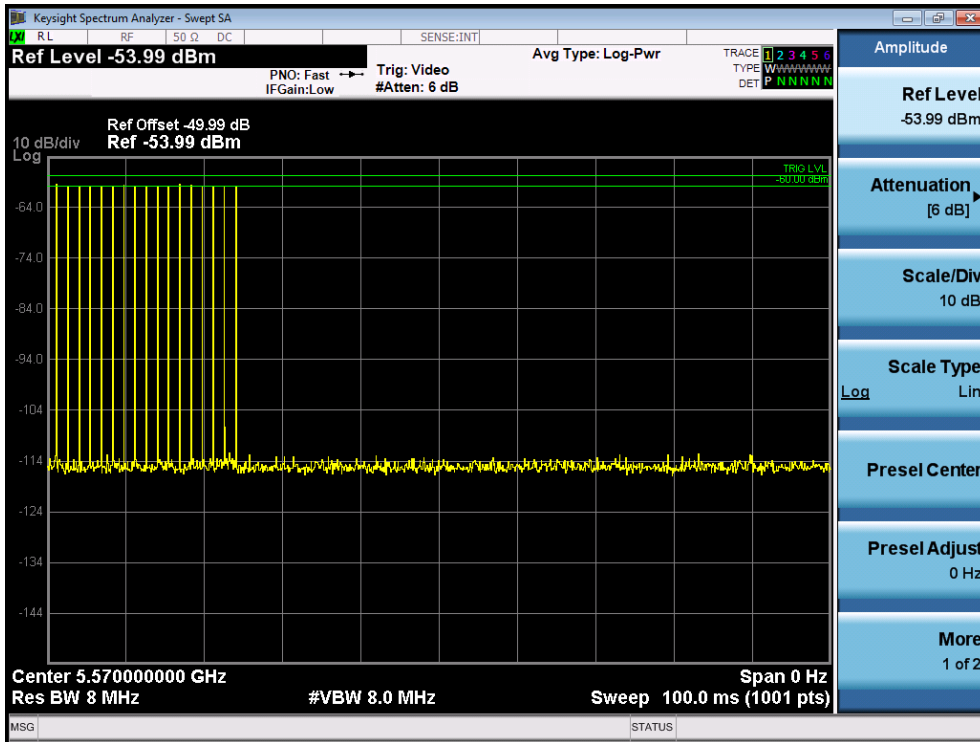

USA Bin 0 Radar Calibration BW160

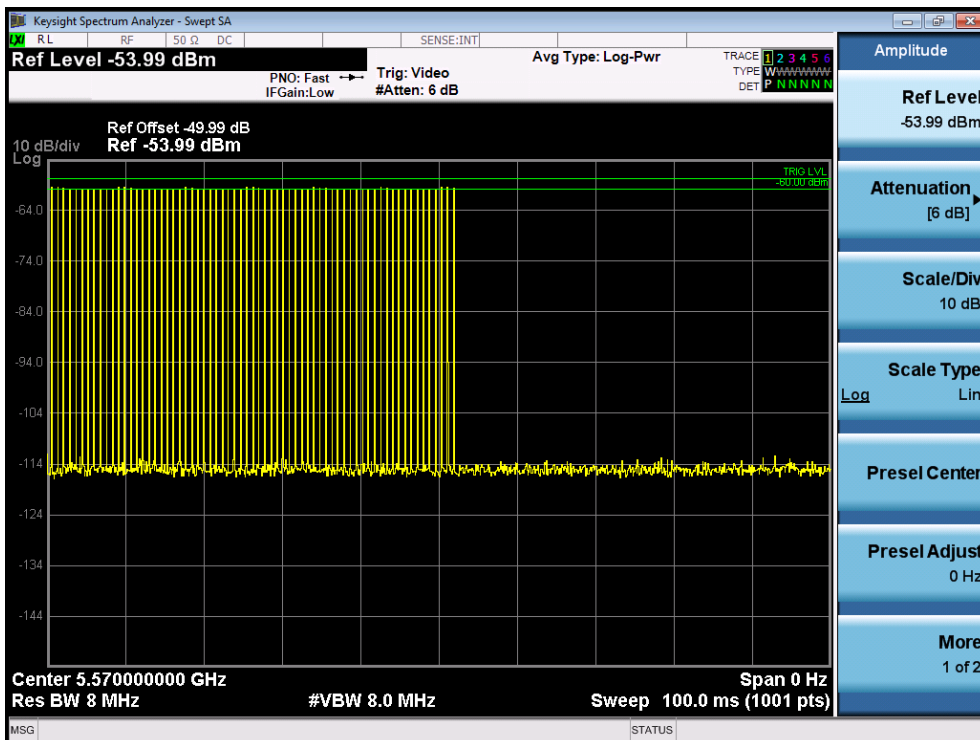

USA Bin 1A Radar Calibration BW160

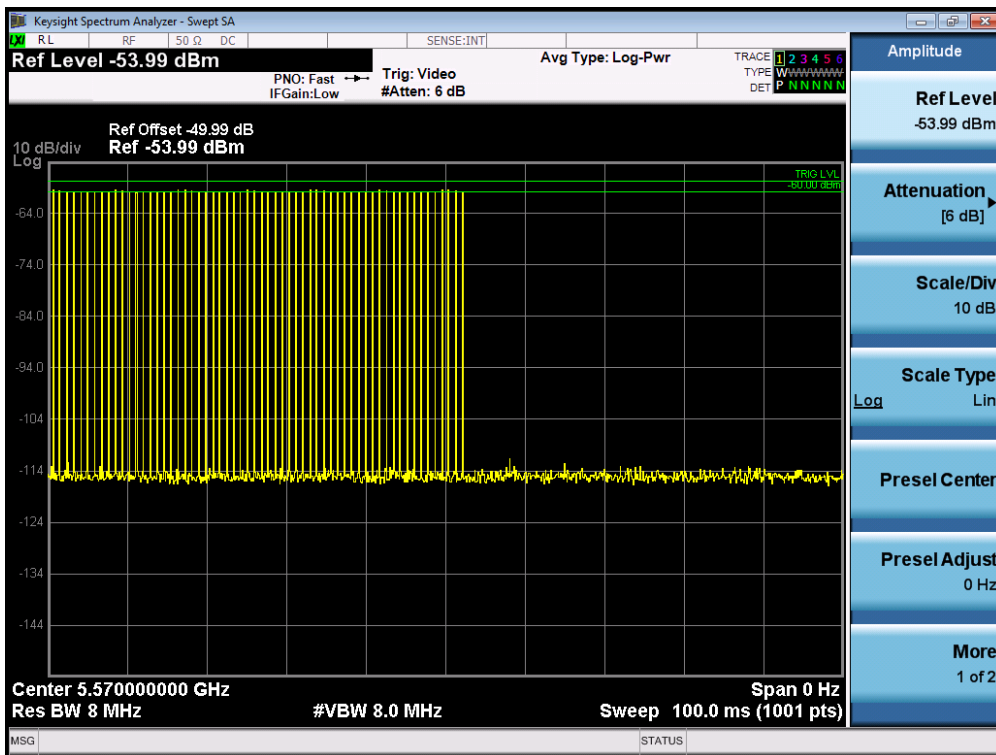

USA Bin 1B Radar Calibration BW160

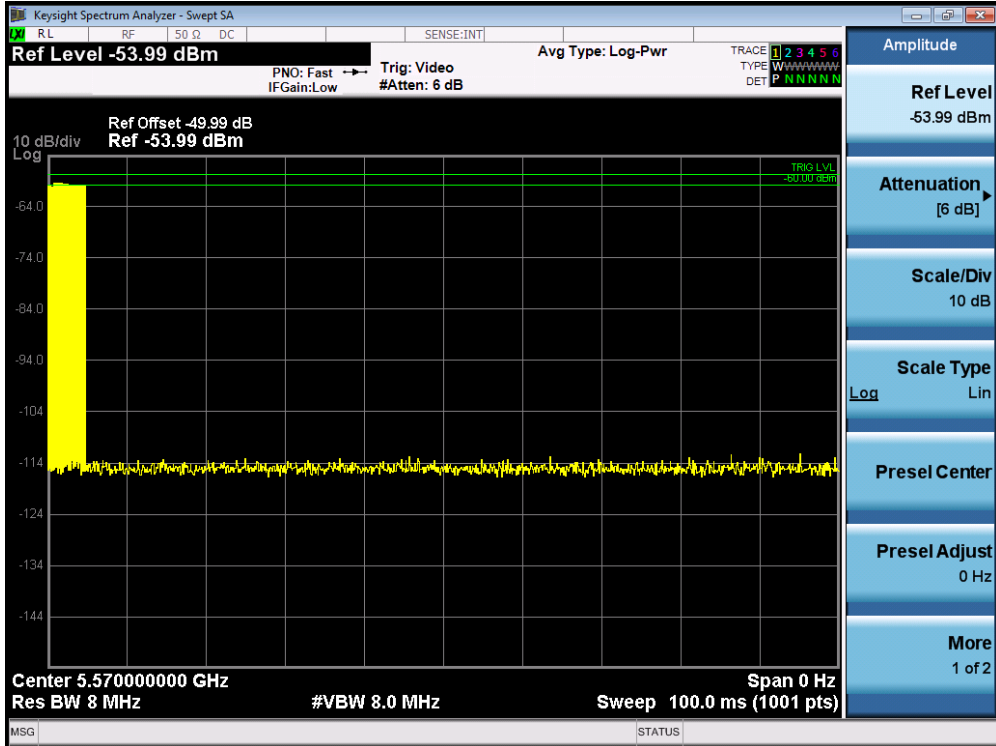

USA Bin 2 Radar Calibration BW160



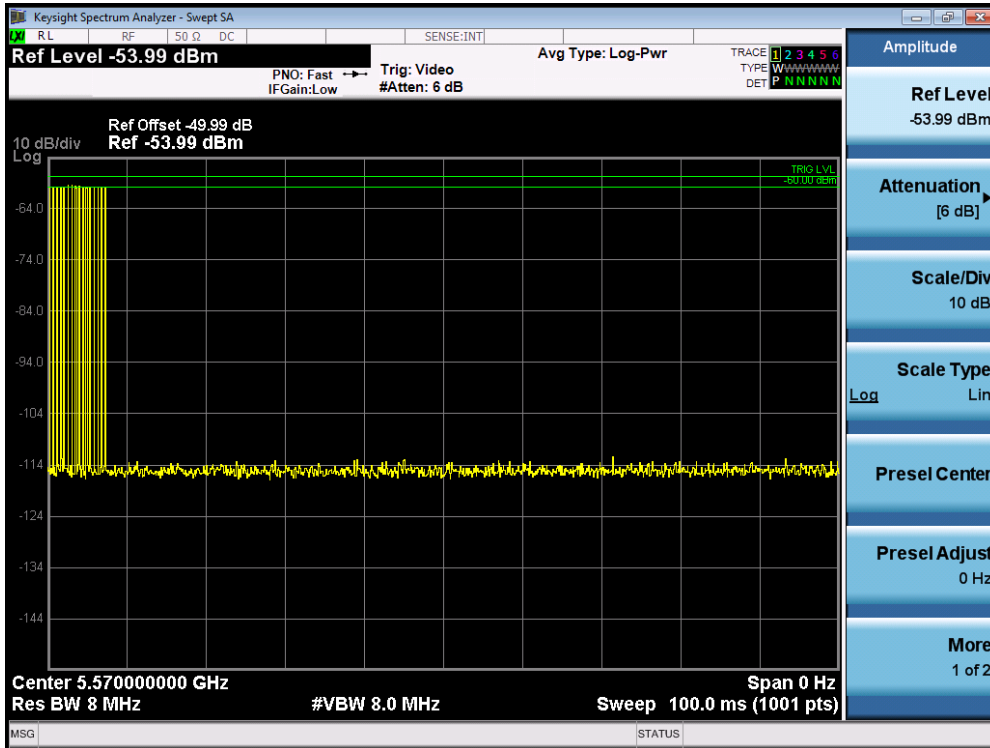

USA Bin 3 Radar Calibration BW160

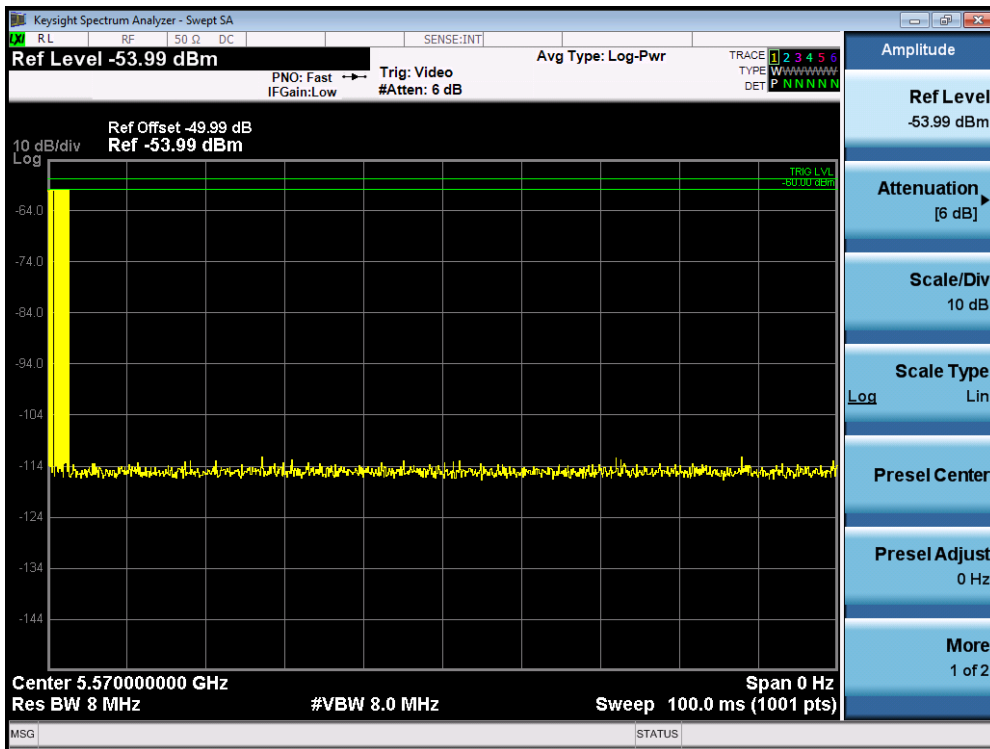

USA Bin 4 Radar Calibration BW160

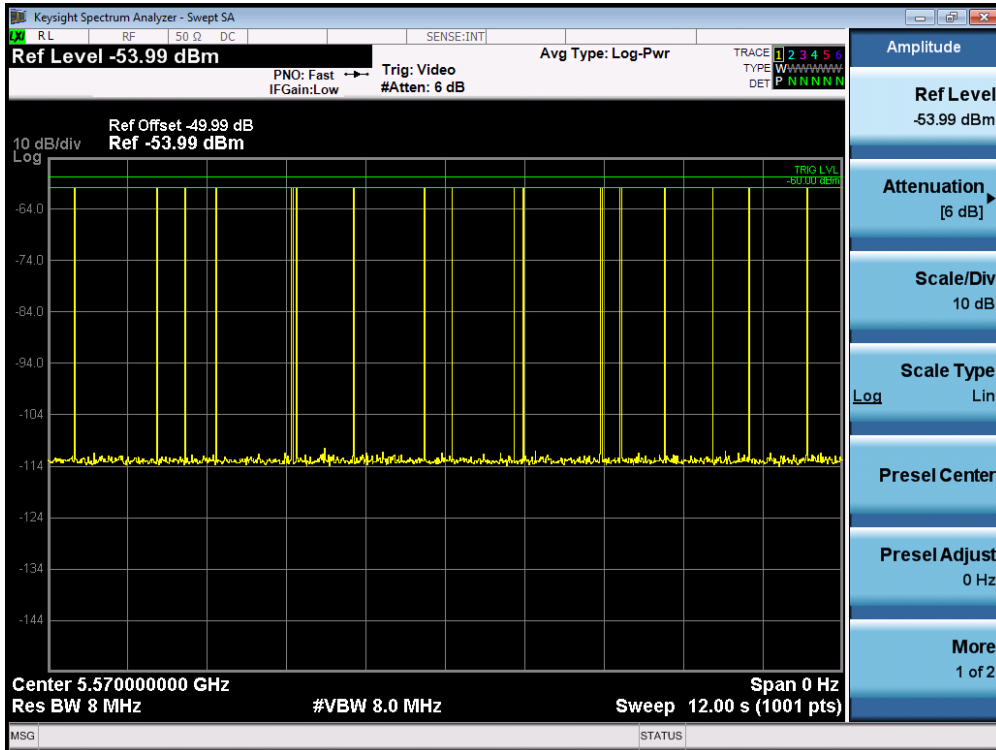

**USA Bin 5 Radar Calibration BW160**

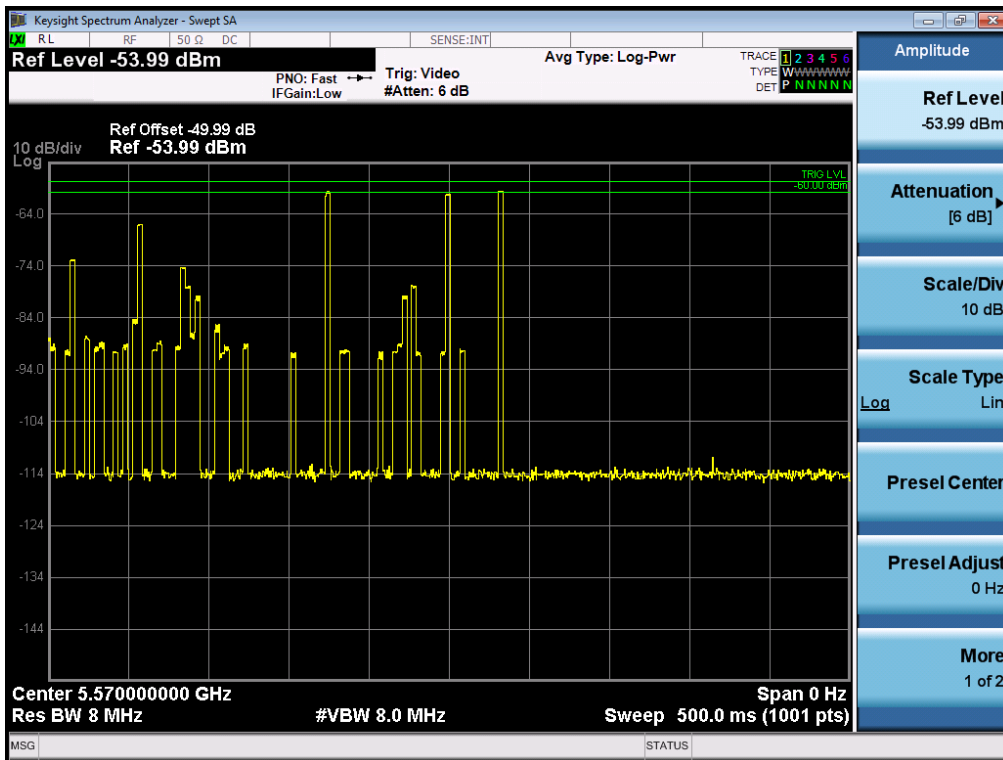

**USA Frequency Hopping Radar Calibration BW160**

**B.1 Test Procedure/Results**

A spectrum analyzer is used as a monitor to verify that the UUT has vacated the Channel within the (Channel Closing Transmission Time and Channel Move Time) and does not transmit on a Channel during the Non-Occupancy Period after the detection and Channel move. It is also used to monitor UUT transmissions during the Channel Availability Check Time.

Following is the test setup used to generate the Radar Waveforms, and for all DFS tests described herein.

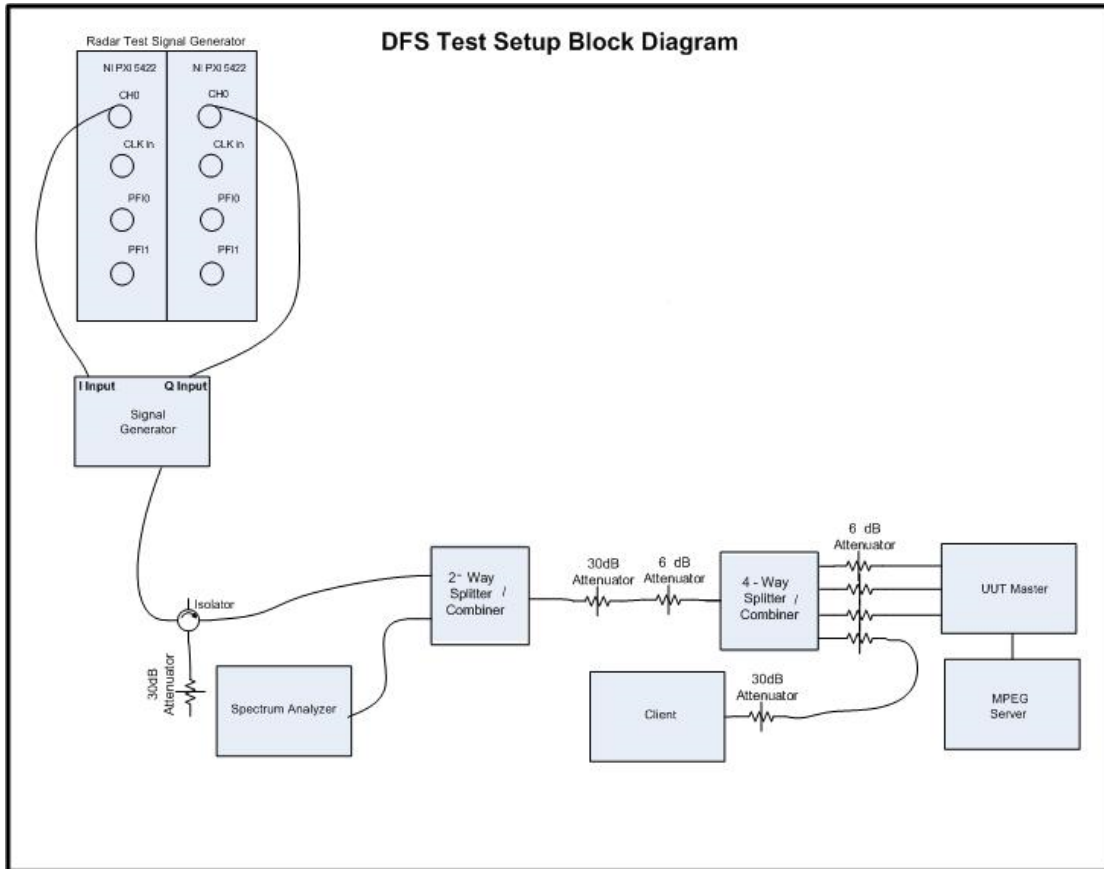

**Conducted Setup: Radar Test Waveforms are injected into the Master**

## B.2 UNII Detection Bandwidth

### Test Procedure

**Ref.** KDB 905462 D02 UNII section 7.8.1

All DFS testing was done at 5500 MHz. The 99% channel bandwidth for 20MHz signals is 16 MHz, the the 99% channel bandwidth for 40MHz signals is 36 MHz, the 99% channel bandwidth for 80MHz signals is 76, and the 99% channel bandwidth for 160MHz signals is 78MHz per 80MHz section. See the 99% OBW section included below.

The generating equipment is configured as shown in the Conducted Test Setup above. A single *Burst* of the desired radar profile is produced at 5500MHz at a -63dBm level. Please note, there was 2dB of additional cable loss. Some radar signal levels are listed as -58dBm (lowest antenna gain plus 2dB of cable loss). The UUT is set up as a standalone device (no associated Client and no traffic).

A single radar Burst is generated for a minimum of 10 trials, and the response of the UUT is noted. The UUT must detect the Radar Waveform 90% or more of the time.

The radar frequency is increased in 1 MHz steps, repeating the above test sequence, until the detection rate falls below 90%. The highest frequency at which detection is greater than or equal to 90% is denoted as  $F_H$ .

The radar frequency is decreased in 1 MHz steps, repeating the above test sequence, until the detection rate falls below 90%. The lowest frequency at which detection is greater than or equal to 90% is denoted as  $F_L$ .

The U-NII Detection Bandwidth is calculated as follows:

$$\text{U-NII Detection Bandwidth} = F_H - F_L$$

The U-NII Detection Bandwidth must be at least 100% of the UUT transmitter 99% power bandwidth (16 MHz for 20MHz signals, 36 MHz for 40 MHz signals, 76 MHz for 80 MHz, and 78MHz for each 80+80 section of the 160MHz signals otherwise, the UUT does not comply with DFS requirements.

**99% Occupied Bandwidth**

<b>Frequency (MHz)</b>	<b>Mode</b>	<b>Data Rate (Mbps)</b>	<b>99% BW (MHz)</b>
5500	Non HT20, 6Mbps	6	16
5510	HT/VHT40, M0	m0	36
5530	VHT80, M0x1	m0x1	76
5570	HE160, m0h1	m0h1	78*

\*160MHz channel is split between different antenna paths. The lower 80MHz portion of the channel is transmitted on the ABCD antenna ports while the upper 80MHz portion is transmitted on the EFGH ports. Each 80MHz section was tested individually. 99% BW therefore shows a value of 78%.



**20MHz UNII Detection Bandwidth**

USA Bin 0												power=-60dB		
Radar Frequency	DFS Detection Trials (1=Detection, Blank= No Detection)											Detection Rate (%)	Detection Bandwidth (MHz)	Limit (MHz)
	1	2	3	4	5	6	7	8	9	10				
5490	0	1	1	1	1	1	1	1	1	1	1	90	20	18
5491	1	1	1	1	1	1	1	1	1	1	1	100		
5492	1	1	1	1	1	1	1	1	1	1	1	100		
5493	1	1	1	1	1	1	1	1	1	1	1	100		
5494	1	1	1	1	1	1	1	1	1	1	1	100		
5495	1	1	1	1	1	1	1	1	1	1	1	100		
5496	1	1	1	1	1	1	1	1	1	1	1	100		
5497	1	1	1	1	1	1	1	1	1	1	1	100		
5498	1	1	1	1	1	1	1	1	1	1	1	100		
5499	1	1	1	1	1	1	1	1	1	1	1	100		
5500	1	1	1	1	1	1	1	1	1	1	1	100		
5501	1	1	1	1	1	1	1	1	1	1	1	100		
5502	1	1	1	1	1	1	1	1	1	1	1	100		
5503	1	1	1	1	1	1	1	1	1	1	1	100		
5504	1	1	1	1	1	1	1	1	1	1	1	100		
5505	1	1	1	1	1	1	1	1	1	1	1	100		
5506	1	1	1	1	1	1	1	1	1	1	1	100		
5507	1	1	1	1	1	1	1	1	1	1	1	100		
5508	1	1	1	1	1	1	1	1	1	1	1	100		
5509	1	1	1	1	1	1	1	1	1	1	1	100		
5510	1	1	1	1	1	1	1	1	1	1	1	100		



**40MHz UNII Detection Bandwidth**

**USA Bin 0**

power=-60dB

Radar Frequency	DFS Detection Trials (1=Detection, Blank= No Detection)											Detection Rate (%)	Detection Bandwidth (MHz)	Limit (MHz)
	1	2	3	4	5	6	7	8	9	10				
5490	0	1	1	1	1	1	1	1	1	1	1	90	40	36
5491	1	1	1	1	1	1	1	1	1	1	1	100		
5492	1	1	1	1	1	1	1	1	1	1	1	100		
5493	1	1	1	1	1	1	1	1	1	1	1	100		
5494	1	1	1	1	1	1	1	1	1	1	1	100		
5495	1	1	1	1	1	1	1	1	1	1	1	100		
5496	1	1	1	1	1	1	1	1	1	1	1	100		
5497	1	1	1	1	1	1	1	1	1	1	1	100		
5498	1	1	1	1	1	1	1	1	1	1	1	100		
5499	1	1	1	1	1	1	1	1	1	1	1	100		
5500	1	1	1	1	1	1	1	1	1	1	1	100		
5501	1	1	1	1	1	1	1	1	1	1	1	100		
5502	1	1	1	1	1	1	1	1	1	1	1	100		
5503	1	1	1	1	1	1	1	1	1	1	1	100		
5504	1	1	1	1	1	1	1	1	1	1	1	100		
5505	1	1	1	1	1	1	1	1	1	1	1	100		
5506	1	1	1	1	1	1	1	1	1	1	1	100		
5507	1	1	1	1	1	1	1	1	1	1	1	100		
5508	1	1	1	1	1	1	1	1	1	1	1	100		
5509	1	1	1	1	1	1	1	1	1	1	1	100		
5510	1	1	1	1	1	1	1	1	1	1	1	100		
5511	1	1	1	1	1	1	1	1	1	1	1	100		
5512	1	1	1	1	1	1	1	1	1	1	1	100		
5513	1	1	1	1	1	1	1	1	1	1	1	100		
5514	1	1	1	1	1	1	1	1	1	1	1	100		
5515	1	1	1	1	1	1	1	1	1	1	1	100		
5516	1	1	1	1	1	1	1	1	1	1	1	100		
5517	1	1	1	1	1	1	1	1	1	1	1	100		
5518	1	1	1	1	1	1	1	1	1	1	1	100		
5519	1	1	1	1	1	1	1	1	1	1	1	100		
5520	1	1	1	1	1	1	1	1	1	1	1	100		
5521	1	1	1	1	1	1	1	1	1	1	1	100		
5522	1	1	1	1	1	1	1	1	1	1	1	100		
5523	1	1	1	1	1	1	1	1	1	1	1	100		
5524	1	1	1	1	1	1	1	1	1	1	1	100		
5525	1	1	1	1	1	1	1	1	1	1	1	100		
5526	1	1	1	1	1	1	1	1	1	1	1	100		



5527	1	1	1	1	1	1	1	1	1	1	100
5528	1	1	1	1	1	1	1	1	1	1	100
5529	1	1	1	1	1	1	1	1	1	1	100
5530	1	1	1	1	1	1	1	1	1	1	100





**80MHz UNII Detection Bandwidth**

USA Bin 0												power=-58dB		
Radar Frequency	DFS Detection Trials (1=Detection, Blank= No Detection)											Detection Rate (%)	Detection Bandwidth (MHz)	Limit (MHz)
	1	2	3	4	5	6	7	8	9	10				
5490	0	1	1	0	1	1	1	1	1	1	80	78	76	
5491	1	1	1	1	1	1	1	1	1	1	100			
5492	1	1	1	1	1	1	1	1	1	1	100			
5493	1	1	1	1	1	1	1	1	1	1	100			
5494	1	1	1	1	1	1	1	1	1	1	100			
5495	1	1	1	1	1	1	1	1	1	1	100			
5496	1	1	1	1	1	1	1	1	1	1	100			
5497	1	1	1	1	1	1	1	1	1	1	100			
5498	1	1	1	1	1	1	1	1	1	1	100			
5499	1	1	1	1	1	1	1	1	1	1	100			
5500	1	1	1	1	1	1	1	1	1	1	100			
5501	1	1	1	1	1	1	1	1	1	1	100			
5502	1	1	1	1	1	1	1	1	1	1	100			
5503	1	1	1	1	1	1	1	1	1	1	100			
5504	1	1	1	1	1	1	1	1	1	1	100			
5505	1	1	1	1	1	1	1	1	1	1	100			
5506	1	1	1	1	1	1	1	1	1	1	100			
5507	1	1	1	1	1	1	1	1	1	1	100			
5508	1	1	1	1	1	1	1	1	1	1	100			
5509	1	1	1	1	1	1	1	1	1	1	100			
5510	1	1	1	1	1	1	1	1	1	1	100			
5511	1	1	1	1	1	1	1	1	1	1	100			
5512	1	1	1	1	1	1	1	1	1	1	100			
5513	1	1	1	1	1	1	1	1	1	1	100			
5514	1	1	1	1	1	1	1	1	1	1	100			
5515	1	1	1	1	1	1	1	1	1	1	100			
5516	1	1	1	1	1	1	1	1	1	1	100			
5517	1	1	1	1	1	1	1	1	1	1	100			
5518	1	1	1	1	1	1	1	1	1	1	100			
5519	1	1	1	1	1	1	1	1	1	1	100			
5520	1	1	1	1	1	1	1	1	1	1	100			
5521	1	1	1	1	1	1	1	1	1	1	100			
5522	1	1	1	1	1	1	1	1	1	1	100			
5523	1	1	1	1	1	1	1	1	1	1	100			
5524	1	1	1	1	1	1	1	1	1	1	100			
5525	1	1	1	1	1	1	1	1	1	1	100			



5526	1	1	1	1	1	1	1	1	1	1	100
5527	1	1	1	1	1	1	1	1	1	1	100
5528	1	1	1	1	1	1	1	1	1	1	100
5529	1	1	1	1	1	1	1	1	1	1	100
5530	1	1	1	1	1	1	1	1	1	1	100
5531	1	1	1	1	1	1	1	1	1	1	100
5532	1	1	1	1	1	1	1	1	1	1	100
5533	1	1	1	1	1	1	1	1	1	1	100
5534	1	1	1	1	1	1	1	1	1	1	100
5535	1	1	1	1	1	1	1	1	1	1	100
5536	1	1	1	1	1	1	1	1	1	1	100
5537	1	1	1	1	1	1	1	1	1	1	100
5538	1	1	1	1	1	1	1	1	1	1	100
5539	1	1	1	1	1	1	1	1	1	1	100
5540	1	1	1	1	1	1	1	1	1	1	100
5541	1	1	1	1	1	1	1	1	1	1	100
5542	1	1	1	1	1	1	1	1	1	1	100
5543	1	1	1	1	1	1	1	1	1	1	100
5544	1	1	1	1	1	1	1	1	1	1	100
5545	1	1	1	1	1	1	1	1	1	1	100
5546	1	1	1	1	1	1	1	1	1	1	100
5547	1	1	1	1	1	1	1	1	1	1	100
5548	1	1	1	1	1	1	1	1	1	1	100
5549	1	1	1	1	1	1	1	1	1	1	100
5550	1	1	1	1	1	1	1	1	1	1	100
5551	1	1	1	1	1	1	1	1	1	1	100
5552	1	1	1	1	1	1	1	1	1	1	100
5553	1	1	1	1	1	1	1	1	1	1	100
5554	1	1	1	1	1	1	1	1	1	1	100
5555	1	1	1	1	1	1	1	1	1	1	100
5556	1	1	1	1	1	1	1	1	1	1	100
5557	1	1	1	1	1	1	1	1	1	1	100
5558	1	1	1	1	1	1	1	1	1	1	100
5559	1	1	1	1	1	1	1	1	1	1	100
5560	1	1	1	1	1	1	1	1	1	1	100
5561	1	1	1	1	1	1	1	1	1	1	100
5562	1	1	1	1	1	1	1	1	1	1	100
5563	1	1	1	1	1	1	1	1	1	1	100
5564	1	1	1	1	1	1	1	1	1	1	100
5565	1	1	1	1	1	1	1	1	1	1	100
5566	1	1	1	1	1	1	1	1	1	1	100
5567	1	1	1	1	1	1	1	1	1	1	100
5568	1	1	1	1	1	1	1	1	1	1	100



5569	1	1	1	1	1	1	1	1	1	1	100		
5570	1	1	1	1	1	1	1	1	1	1	100		



**160MHz UNII Detection Bandwidth (upper portion of 80+80)**

<b>USA Bin 0</b>	<b>DFS Detection Trials (1=Detection, Blank= No Detection)</b>											<b>power=-58dB</b>	
<b>Radar Frequency</b>	<b>1</b>	<b>2</b>	<b>3</b>	<b>4</b>	<b>5</b>	<b>6</b>	<b>7</b>	<b>8</b>	<b>9</b>	<b>10</b>	<b>Detection Rate (%)</b>	<b>Detection Bandwidth (MHz)</b>	<b>Limit (MHz)</b>
5250	0	1	1	1	1	1	1	1	1	1	90	80	78
5251	1	1	1	1	1	1	1	1	1	1	100		
5252	1	1	1	1	1	1	1	1	1	1	100		
5253	1	1	1	1	1	1	1	1	1	1	100		
5254	1	1	1	1	1	1	1	1	1	1	100		
5255	1	1	1	1	1	1	1	1	1	1	100		
5256	1	1	1	1	1	1	1	1	1	1	100		
5257	1	1	1	1	1	1	1	1	1	1	100		
5258	1	1	1	1	1	1	1	1	1	1	100		
5259	1	1	1	1	1	1	1	1	1	1	100		
5260	1	1	1	1	1	1	1	1	1	1	100		
5261	1	1	1	1	1	1	1	1	1	1	100		
5262	1	1	1	1	1	1	1	1	1	1	100		
5263	1	1	1	1	1	1	1	1	1	1	100		
5264	1	1	1	1	1	1	1	1	1	1	100		
5265	1	1	1	1	1	1	1	1	1	1	100		
5266	1	1	1	1	1	1	1	1	1	1	100		
5267	1	1	1	1	1	1	1	1	1	1	100		
5268	1	1	1	1	1	1	1	1	1	1	100		
5269	1	1	1	1	1	1	1	1	1	1	100		
5270	1	1	1	1	1	1	1	1	1	1	100		
5271	1	1	1	1	1	1	1	1	1	1	100		
5272	1	1	1	1	1	1	1	1	1	1	100		
5273	1	1	1	1	1	1	1	1	1	1	100		
5274	1	1	1	1	1	1	1	1	1	1	100		
5275	1	1	1	1	1	1	1	1	1	1	100		
5276	1	1	1	1	1	1	1	1	1	1	100		
5277	1	1	1	1	1	1	1	1	1	1	100		
5278	1	1	1	1	1	1	1	1	1	1	100		
5279	1	1	1	1	1	1	1	1	1	1	100		
5280	1	1	1	1	1	1	1	1	1	1	100		
5281	1	1	1	1	1	1	1	1	1	1	100		
5282	1	1	1	1	1	1	1	1	1	1	100		
5283	1	1	1	1	1	1	1	1	1	1	100		
5284	1	1	1	1	1	1	1	1	1	1	100		
5285	1	1	1	1	1	1	1	1	1	1	100		
5286	1	1	1	1	1	1	1	1	1	1	100		
5287	1	1	1	1	1	1	1	1	1	1	100		



5288	1	1	1	1	1	1	1	1	1	1	100
5289	1	1	1	1	1	1	1	1	1	1	100
5290	1	1	1	1	1	1	1	1	1	1	100
5291	1	1	1	1	1	1	1	1	1	1	100
5292	1	1	1	1	1	1	1	1	1	1	100
5293	1	1	1	1	1	1	1	1	1	1	100
5294	1	1	1	1	1	1	1	1	1	1	100
5295	1	1	1	1	1	1	1	1	1	1	100
5296	1	1	1	1	1	1	1	1	1	1	100
5297	1	1	1	1	1	1	1	1	1	1	100
5298	1	1	1	1	1	1	1	1	1	1	100
5299	1	1	1	1	1	1	1	1	1	1	100
5300	1	1	1	1	1	1	1	1	1	1	100
5301	1	1	1	1	1	1	1	1	1	1	100
5302	1	1	1	1	1	1	1	1	1	1	100
5303	1	1	1	1	1	1	1	1	1	1	100
5304	1	1	1	1	1	1	1	1	1	1	100
5305	1	1	1	1	1	1	1	1	1	1	100
5306	1	1	1	1	1	1	1	1	1	1	100
5307	1	1	1	1	1	1	1	1	1	1	100
5308	1	1	1	1	1	1	1	1	1	1	100
5309	1	1	1	1	1	1	1	1	1	1	100
5310	1	1	1	1	1	1	1	1	1	1	100
5311	1	1	1	1	1	1	1	1	1	1	100
5312	1	1	1	1	1	1	1	1	1	1	100
5313	1	1	1	1	1	1	1	1	1	1	100
5314	1	1	1	1	1	1	1	1	1	1	100
5315	1	1	1	1	1	1	1	1	1	1	100
5316	1	1	1	1	1	1	1	1	1	1	100
5317	1	1	1	1	1	1	1	1	1	1	100
5318	1	1	1	1	1	1	1	1	1	1	100
5319	1	1	1	1	1	1	1	1	1	1	100
5320	1	1	1	1	1	1	1	1	1	1	100
5321	1	1	1	1	1	1	1	1	1	1	100
5322	1	1	1	1	1	1	1	1	1	1	100
5323	1	1	1	1	1	1	1	1	1	1	100
5324	1	1	1	1	1	1	1	1	1	1	100
5325	1	1	1	1	1	1	1	1	1	1	100
5326	1	1	1	1	1	1	1	1	1	1	100
5327	1	1	1	1	1	1	1	1	1	1	100
5328	1	1	1	1	1	1	1	1	1	1	100
5329	1	1	1	1	1	1	1	1	1	1	100
5330	1	1	1	1	1	1	1	1	1	1	100



**160MHz UNII Detection Bandwidth (lower portion of 80+80)**

USA Bin 0	DFS Detection Trials (1=Detection, Blank= No Detection)											power=-58dB	
Radars Frequency	1	2	3	4	5	6	7	8	9	10	Detection Rate (%)	Detection Bandwidth (MHz)	Limit (MHz)
5490	1	1	1	1	1	1	1	1	1	1	100	80	78
5491	1	1	1	1	1	1	1	1	1	1	100		
5492	1	1	1	1	1	1	1	1	1	1	100		
5493	1	1	1	1	1	1	1	1	1	1	100		
5494	1	1	1	1	1	1	1	1	1	1	100		
5495	1	1	1	1	1	1	1	1	1	1	100		
5496	1	1	1	1	1	1	1	1	1	1	100		
5497	1	1	1	1	1	1	1	1	1	1	100		
5498	1	1	1	1	1	1	1	1	1	1	100		
5499	1	1	1	1	1	1	1	1	1	1	100		
5500	1	1	1	1	1	1	1	1	1	1	100		
5501	1	1	1	1	1	1	1	1	1	1	100		
5502	1	1	1	1	1	1	1	1	1	1	100		
5503	1	1	1	1	1	1	1	1	1	1	100		
5504	1	1	1	1	1	1	1	1	1	1	100		
5505	1	1	1	1	1	1	1	1	1	1	100		
5506	1	1	1	1	1	1	1	1	1	1	100		
5507	1	1	1	1	1	1	1	1	1	1	100		
5508	1	1	1	1	1	1	1	1	1	1	100		
5509	1	1	1	1	1	1	1	1	1	1	100		
5510	1	1	1	1	1	1	1	1	1	1	100		
5511	1	1	1	1	1	1	1	1	1	1	100		
5512	1	1	1	1	1	1	1	1	1	1	100		
5513	1	1	1	1	1	1	1	1	1	1	100		
5514	1	1	1	1	1	1	1	1	1	1	100		
5515	1	1	1	1	1	1	1	1	1	1	100		
5516	1	1	1	1	1	1	1	1	1	1	100		
5517	1	1	1	1	1	1	1	1	1	1	100		
5518	1	1	1	1	1	1	1	1	1	1	100		
5519	1	1	1	1	1	1	1	1	1	1	100		
5520	1	1	1	1	1	1	1	1	1	1	100		
5521	1	1	1	1	1	1	1	1	1	1	100		
5522	1	1	1	1	1	1	1	1	1	1	100		
5523	1	1	1	1	1	1	1	1	1	1	100		
5524	1	1	1	1	1	1	1	1	1	1	100		
5525	1	1	1	1	1	1	1	1	1	1	100		
5526	1	1	1	1	1	1	1	1	1	1	100		
5527	1	1	1	1	1	1	1	1	1	1	100		



5528	1	1	1	1	1	1	1	1	1	1	100
5529	1	1	1	1	1	1	1	1	1	1	100
5530	1	1	1	1	1	1	1	1	1	1	100
5531	1	1	1	1	1	1	1	1	1	1	100
5532	1	1	1	1	1	1	1	1	1	1	100
5533	1	1	1	1	1	1	1	1	1	1	100
5534	1	1	1	1	1	1	1	1	1	1	100
5535	1	1	1	1	1	1	1	1	1	1	100
5536	1	1	1	1	1	1	1	1	1	1	100
5537	1	1	1	1	1	1	1	1	1	1	100
5538	1	1	1	1	1	1	1	1	1	1	100
5539	1	1	1	1	1	1	1	1	1	1	100
5540	1	1	1	1	1	1	1	1	1	1	100
5541	1	1	1	1	1	1	1	1	1	1	100
5542	1	1	1	1	1	1	1	1	1	1	100
5543	1	1	1	1	1	1	1	1	1	1	100
5544	1	1	1	1	1	1	1	1	1	1	100
5545	1	1	1	1	1	1	1	1	1	1	100
5546	1	1	1	1	1	1	1	1	1	1	100
5547	1	1	1	1	1	1	1	1	1	1	100
5548	1	1	1	1	1	1	1	1	1	1	100
5549	1	1	1	1	1	1	1	1	1	1	100
5550	1	1	1	1	1	1	1	1	1	1	100
5551	1	1	1	1	1	1	1	1	1	1	100
5552	1	1	1	1	1	1	1	1	1	1	100
5553	1	1	1	1	1	1	1	1	1	1	100
5554	1	1	1	1	1	1	1	1	1	1	100
5555	1	1	1	1	1	1	1	1	1	1	100
5556	1	1	1	1	1	1	1	1	1	1	100
5557	1	1	1	1	1	1	1	1	1	1	100
5558	1	1	1	1	1	1	1	1	1	1	100
5559	1	1	1	1	1	1	1	1	1	1	100
5560	1	1	1	1	1	1	1	1	1	1	100
5561	1	1	1	1	1	1	1	1	1	1	100
5562	1	1	1	1	1	1	1	1	1	1	100
5563	1	1	1	1	1	1	1	1	1	1	100
5564	1	1	1	1	1	1	1	1	1	1	100
5565	1	1	1	1	1	1	1	1	1	1	100
5566	1	1	1	1	1	1	1	1	1	1	100
5567	1	1	1	1	1	1	1	1	1	1	100
5568	1	1	1	1	1	1	1	1	1	1	100
5569	1	1	1	1	1	1	1	1	1	1	100
5570	1	1	1	1	1	1	1	1	1	1	100



**160MHz UNII Detection Bandwidth (upper portion of 80+80)**

USA Bin 0	DFS Detection Trials (1=Detection, Blank= No Detection)											power=-58dB	
Radar Frequency	1	2	3	4	5	6	7	8	9	10	Detection Rate (%)	Detection Bandwidth (MHz)	Limit (MHz)
5570	1	1	1	1	1	1	1	1	1	1	100	80	78
5571	1	1	1	1	1	1	1	1	1	1	100		
5572	1	1	1	1	1	1	1	1	1	1	100		
5573	1	1	1	1	1	1	1	1	1	1	100		
5574	1	1	1	1	1	1	1	1	1	1	100		
5575	1	1	1	1	1	1	1	1	1	1	100		
5576	1	1	1	1	1	1	1	1	1	1	100		
5577	1	1	1	1	1	1	1	1	1	1	100		
5578	1	1	1	1	1	1	1	1	1	1	100		
5579	1	1	1	1	1	1	1	1	1	1	100		
5580	1	1	1	1	1	1	1	1	1	1	100		
5581	1	1	1	1	1	1	1	1	1	1	100		
5582	1	1	1	1	1	1	1	1	1	1	100		
5583	1	1	1	1	1	1	1	1	1	1	100		
5584	1	1	1	1	1	1	1	1	1	1	100		
5585	1	1	1	1	1	1	1	1	1	1	100		
5586	1	1	1	1	1	1	1	1	1	1	100		
5587	1	1	1	1	1	1	1	1	1	1	100		
5588	1	1	1	1	1	1	1	1	1	1	100		
5589	1	1	1	1	1	1	1	1	1	1	100		
5590	1	1	1	1	1	1	1	1	1	1	100		
5591	1	1	1	1	1	1	1	1	1	1	100		
5592	1	1	1	1	1	1	1	1	1	1	100		
5593	1	1	1	1	1	1	1	1	1	1	100		
5594	1	1	1	1	1	1	1	1	1	1	100		
5595	1	1	1	1	1	1	1	1	1	1	100		
5596	1	1	1	1	1	1	1	1	1	1	100		
5597	1	1	1	1	1	1	1	1	1	1	100		
5598	1	1	1	1	1	1	1	1	1	1	100		
5599	1	1	1	1	1	1	1	1	1	1	100		
5600	1	1	1	1	1	1	1	1	1	1	100		
5601	1	1	1	1	1	1	1	1	1	1	100		
5602	1	1	1	1	1	1	1	1	1	1	100		
5603	1	1	1	1	1	1	1	1	1	1	100		
5604	1	1	1	1	1	1	1	1	1	1	100		
5605	1	1	1	1	1	1	1	1	1	1	100		
5606	1	1	1	1	1	1	1	1	1	1	100		
5607	1	1	1	1	1	1	1	1	1	1	100		





5608	1	1	1	1	1	1	1	1	1	1	100
5609	1	1	1	1	1	1	1	1	1	1	100
5610	1	1	1	1	1	1	1	1	1	1	100
5611	1	1	1	1	1	1	1	1	1	1	100
5612	1	1	1	1	1	1	1	1	1	1	100
5613	1	1	1	1	1	1	1	1	1	1	100
5614	1	1	1	1	1	1	1	1	1	1	100
5615	1	1	1	1	1	1	1	1	1	1	100
5616	1	1	1	1	1	1	1	1	1	1	100
5617	1	1	1	1	1	1	1	1	1	1	100
5618	1	1	1	1	1	1	1	1	1	1	100
5619	1	1	1	1	1	1	1	1	1	1	100
5620	1	1	1	1	1	1	1	1	1	1	100
5621	1	1	1	1	1	1	1	1	1	1	100
5622	1	1	1	1	1	1	1	1	1	1	100
5623	1	1	1	1	1	1	1	1	1	1	100
5624	1	1	1	1	1	1	1	1	1	1	100
5625	1	1	1	1	1	1	1	1	1	1	100
5626	1	1	1	1	1	1	1	1	1	1	100
5627	1	1	1	1	1	1	1	1	1	1	100
5628	1	1	1	1	1	1	1	1	1	1	100
5629	1	1	1	1	1	1	1	1	1	1	100
5630	1	1	1	1	1	1	1	1	1	1	100
5631	1	1	1	1	1	1	1	1	1	1	100
5632	1	1	1	1	1	1	1	1	1	1	100
5633	1	1	1	1	1	1	1	1	1	1	100
5634	1	1	1	1	1	1	1	1	1	1	100
5635	1	1	1	1	1	1	1	1	1	1	100
5636	1	1	1	1	1	1	1	1	1	1	100
5637	1	1	1	1	1	1	1	1	1	1	100
5638	1	1	1	1	1	1	1	1	1	1	100
5639	1	1	1	1	1	1	1	1	1	1	100
5640	1	1	1	1	1	1	1	1	1	1	100
5641	1	1	1	1	1	1	1	1	1	1	100
5642	1	1	1	1	1	1	1	1	1	1	100
5643	1	1	1	1	1	1	1	1	1	1	100
5644	1	1	1	1	1	1	1	1	1	1	100
5645	1	1	1	1	1	1	1	1	1	1	100
5646	1	1	1	1	1	1	1	1	1	1	100
5647	1	1	1	1	1	1	1	1	1	1	100
5648	1	1	1	1	1	1	1	1	1	1	100
5649	1	1	1	1	1	1	1	1	1	1	100
5650	1	1	1	1	1	1	1	1	1	1	100



**B.3 Initial Channel Availability Check Time**

The tests that the UUT does not emit beacon, control, or data signals on the test Channel until the power-up sequence has been completed and the U-NII device checks for Radar Waveforms for one minute on the test Channel. This test does not use any Radar Waveforms.

The U-NII device is powered on and instructed to operate at 5500 MHz. At the same time the UUT is powered on, the spectrum analyzer is set to zero span mode with a 3 MHz resolution bandwidth at 5500MHz with a 2.5 minute sweep time. The analyzer's sweep will be started the same time power is applied to the U-NII device.

The UUT should not transmit any beacon or data transmissions until at least 1 minute after the completion of the power-on cycle.

The initial power up time of the UUT is indicated by marker 1 in the plot. Initial beacons/data transmissions are indicated by marker 2.

**Initial Channel Availability Check Time**

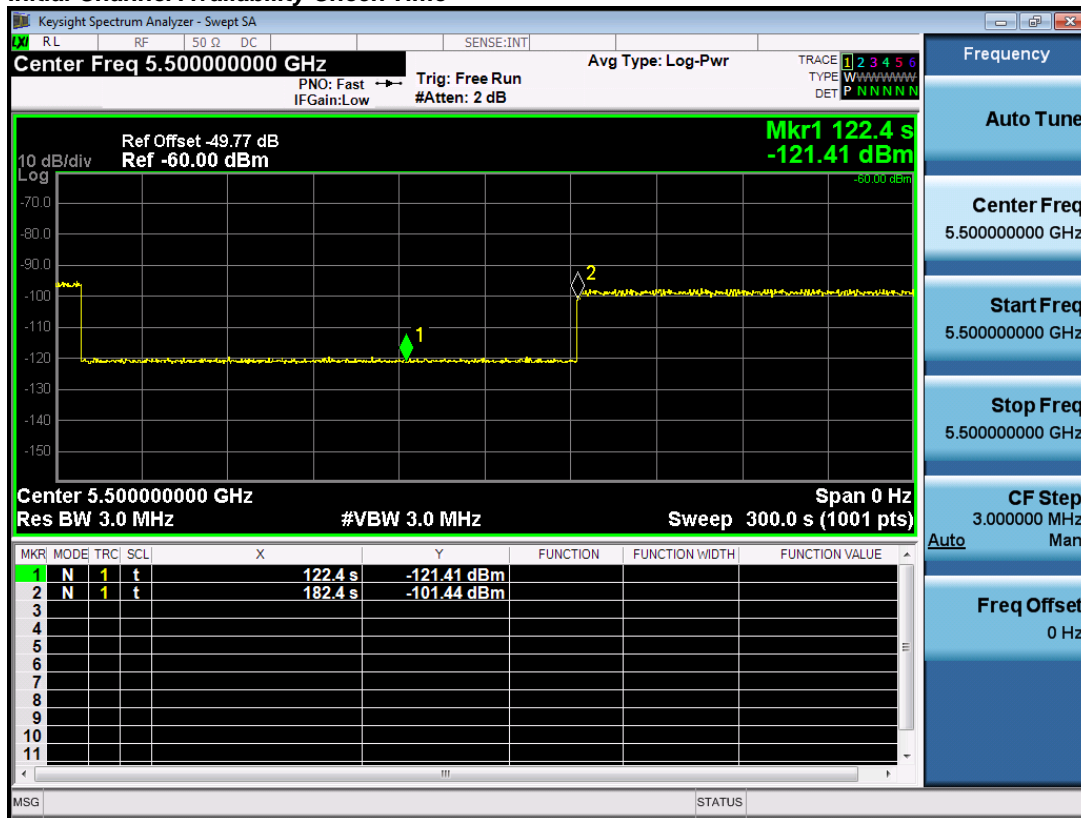

**BW20**



**B.4 Radar Burst at the Beginning of the Channel Availability Check Time**

The steps below define the procedure to verify successful radar detection on the selected Channel during a period equal to the Channel Availability Check Time and avoidance of operation on that Channel when a radar Burst with a level equal to the DFS Detection Threshold + 1 dB (-63dBm) occurs at the beginning of the Channel Availability Check Time.

The UUT is powered on at  $T_0$ .  $T_1$  denotes the instant when the UUT has completed its power-up sequence. The Channel Availability Check Time commences at instant  $T_1$  and will end no sooner than  $T_1 + 60$  seconds.

A single Burst of short pulse of radar type 0 at -63 dBm will commence within a 6 second window starting at  $T_1$ .

Visual indication on the UUT of successful detection of the radar Burst will be recorded and reported. Observation of emissions at 5500MHz will continue for 2.5 minutes after the radar Burst has been generated.

Verify that during the 2.5 minute measurement window no UUT transmissions occurred at 5500MHz.

**Radar Burst at the Beginning of the Channel Availability Check Time**

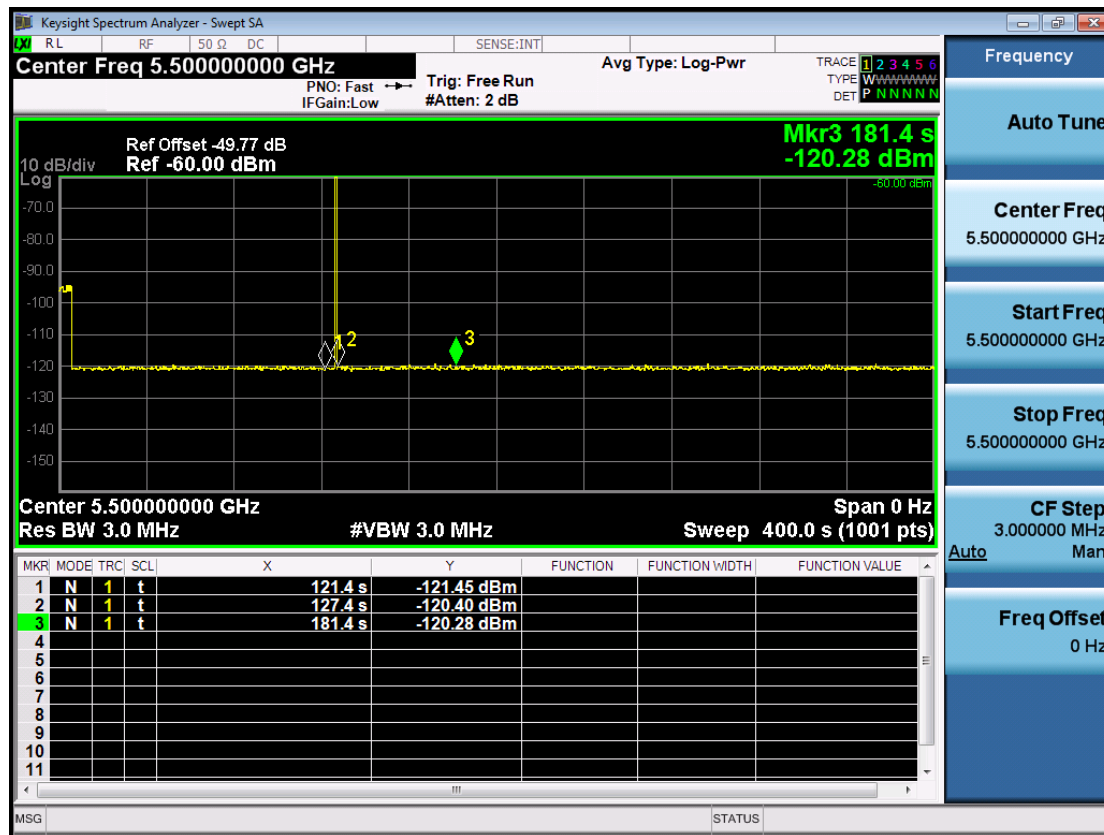

**BW20**



**B.5 Radar Burst at the End of the Channel Availability Check Time**

The steps below define the procedure to verify successful radar detection on the selected Channel during a period equal to the Channel Availability Check Time and avoidance of operation on that Channel when a radar Burst with a level equal to the DFS Detection Threshold + 1 dB (-63dBm) occurs at the end of the Channel Availability Check Time.

The UUT is powered on at  $T_0$ .  $T_1$  denotes the instant when the UUT has completed its power-up sequence. The Channel Availability Check Time commences at instant  $T_1$  and will end no sooner than  $T_1 + 60$  seconds.

A single Burst of short pulse of radar type 0 at -63 dBm will commence within a 6 second window starting at  $T_1 + 54$  seconds.

Visual indication on the UUT of successful detection of the radar Burst will be recorded and reported. Observation of emissions at 5500MHz will continue for 2.5 minutes after the radar Burst has been generated.

Verify that during the 2.5 minute measurement window no UUT transmissions occurred at 5500MHz.

**Radar Burst at the End of the Channel Availability Check Time**

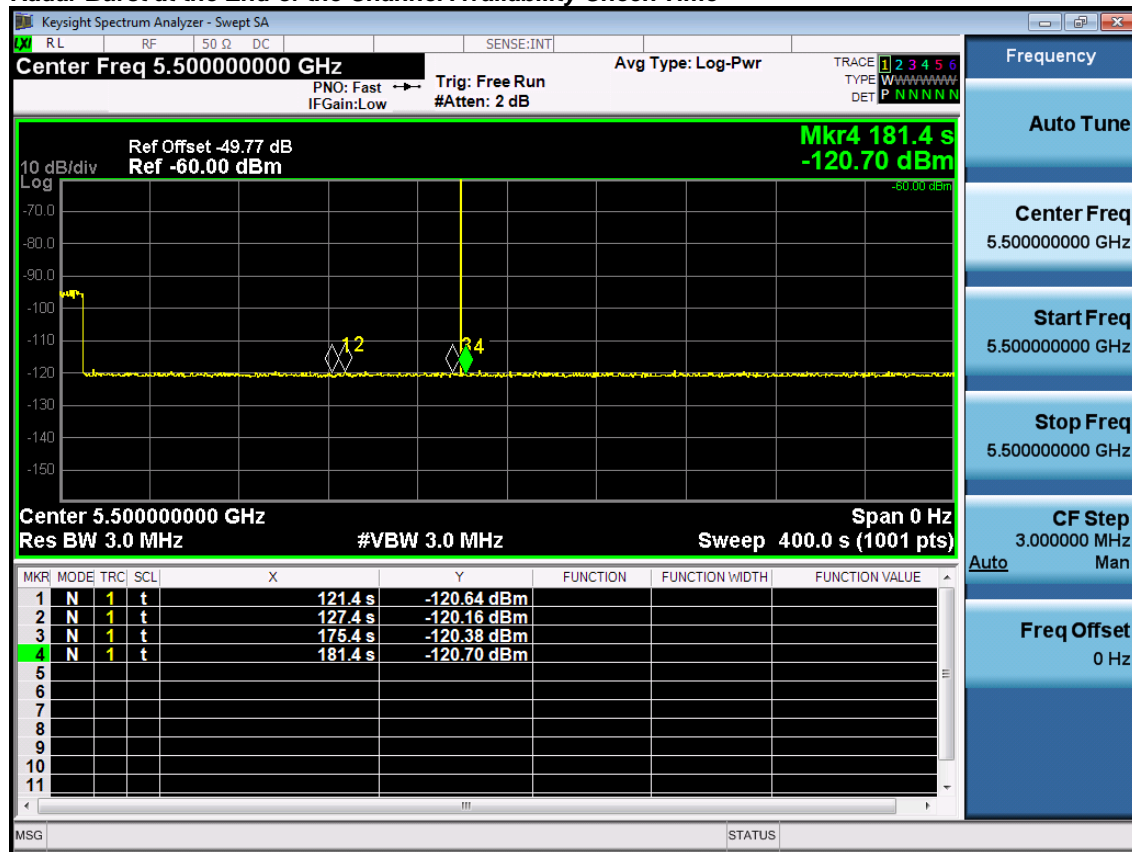

**BW20**



**B.6 In-Service Monitoring for Channel Move Time, Channel Closing Transmission Time and Non-Occupancy Period**

These tests define how the following DFS parameters are verified during In-Service Monitoring; Channel Closing Transmission Time, Channel Move Time, and Non-Occupancy Period.

The steps below define the procedure to determine the above mentioned parameters when a radar Burst with a level equal to the DFS Detection Threshold + 1dB (-63dBm) is generated on the Operating Channel of the U-NII device.

A U-NII device operating as a Client Device will associate with the UUT (Master) at 5500 MHz.

At time  $T_0$  the Radar Waveform generator sends a Burst of pulses for radar type 0 at -63dBm.

Observe the transmissions of the UUT at the end of the radar Burst on the Operating Channel for duration greater than 10 seconds. Measure and record the transmissions from the UUT during the observation time (Channel Move Time). Compare the Channel Move Time and Channel Closing Transmission Time results to the limits defined in the *DFS Response requirement values table*.

**Channel Closing Transmission Time for Type 0 radar**

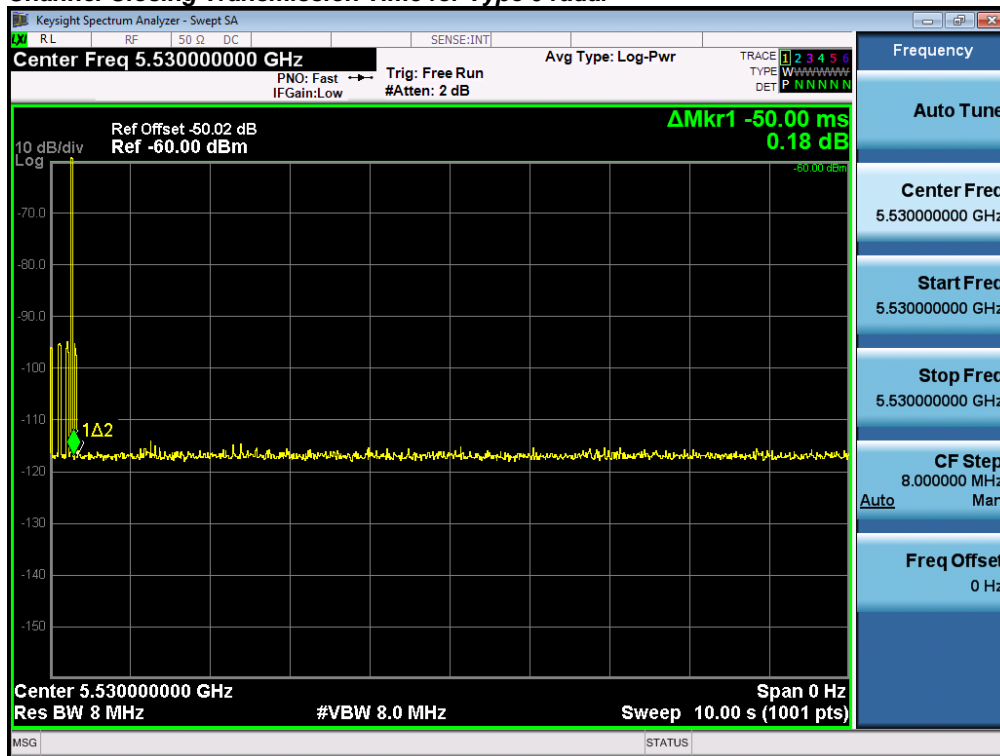

**BW80**



**Channel Move Time, Channel Closing Transmission Time for Type 0 radar**

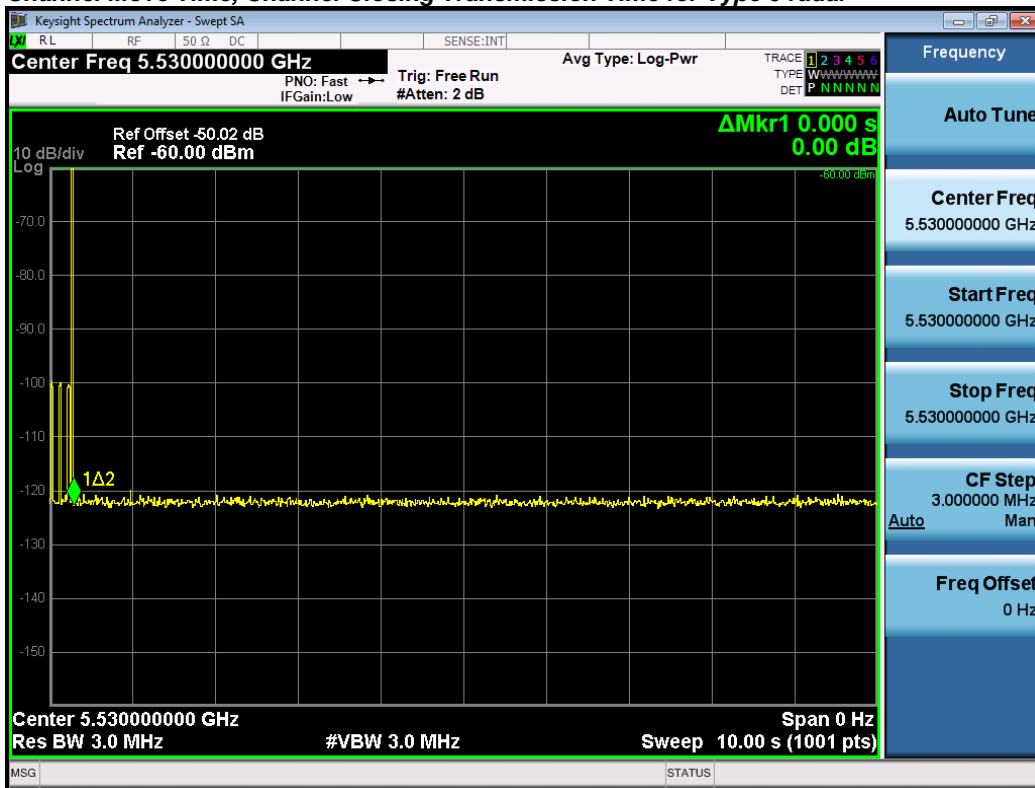

**BW80**



Measure the UUT for more than 30 minutes following the channel close/move time to verify that the UUT does not resume any transmissions on this Channel.

**30 Minute Non-Occupancy Period (using Type 0 radar)**

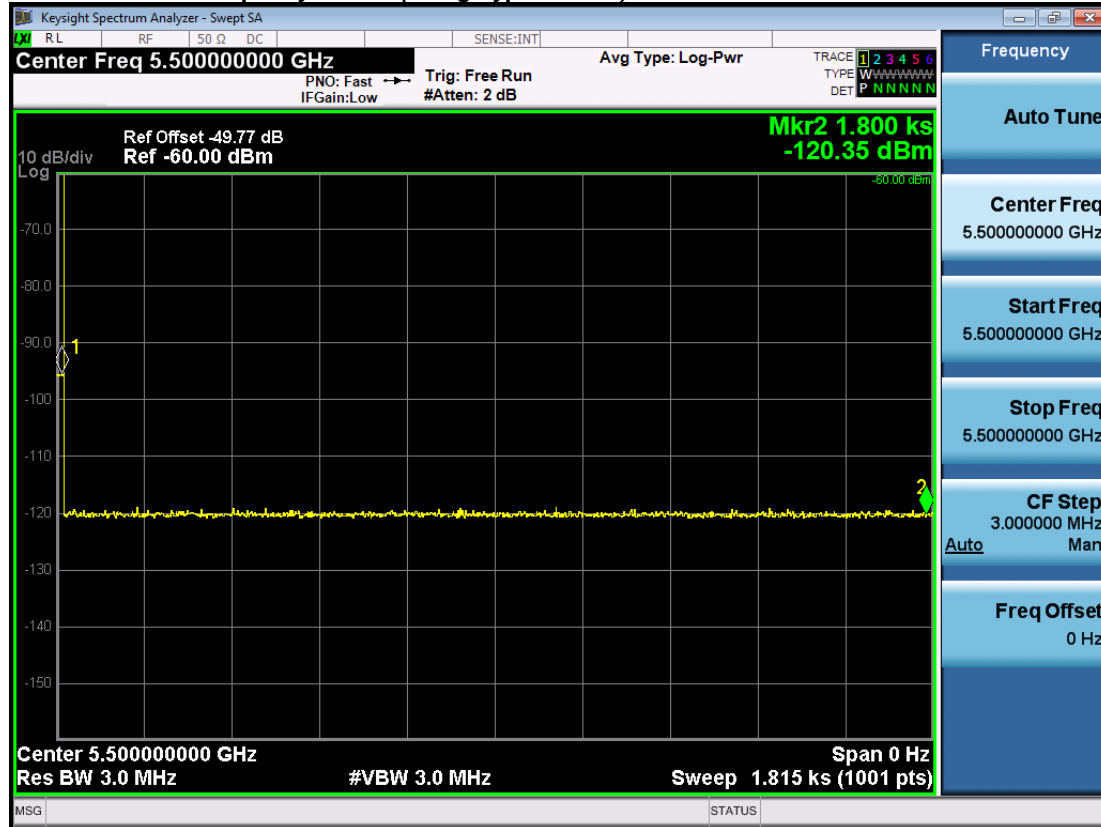

**BW20**

## **B.7 Statistical Performance Check**

The steps below define the procedure to determine the minimum percentage of detection when a radar burst with a level equal to the DFS Detection Threshold + 1dB (-63dBm) is generated on the Operating Channel of the U-NII device.

A U-NII device operating as a Client Device will associate with the UUT (Master) at 5500 MHz.

The Radar Waveform generator sends the individual waveform for each of the radar types 1-6 at -63dbm. Statistical data will be gathered to determine the ability of the device to detect the radar test waveforms. The device can utilize a test mode to demonstrate when detection occurs to prevent the need to reset the device between trial runs. The percentage of successful detection is calculated by:

$$\frac{\textit{TotalWaveformDetections}}{\textit{TotalWaveformTrials}} \times 100 = \text{Probability of Detection Radar Waveform}$$

The Minimum number of trails, minimum percentage of successful detection and the average minimum percentage of successful detection are found in the *Radar Test Waveforms* section. The data represents the worst case detection for 20 MHz, 40 MHz, and 80 MHz signal bandwidths.



**Channel 5500 MHz, 20MHz BW, Statistical Performance****USA Bin 1A/1B**

freq=5500, rate=6, bw=18.0

Trial	Frequency	Pulses	PW (uS)	PRI (uS)	1=Detection 0=No Detection	Detection Percentage	Limit
1	5490	18	1	3066	1	93.3%	60.0%
2	5490	76	1	698	1		
3	5492	65	1	818	1		
4	5492	78	1	678	1		
5	5494	83	1	638	1		
6	5494	92	1	578	1		
7	5495	67	1	798	1		
8	5495	89	1	598	1		
9	5496	83	1	638	1		
10	5496	92	1	578	1		
11	5497	59	1	898	1		
12	5497	62	1	858	1		
13	5498	102	1	518	1		
14	5498	65	1	818	1		
15	5500	68	1	778	1		
16	5500	27	1	2021	1		
17	5502	19	1	2836	1		
18	5502	18	1	2990	0		
19	5503	20	1	2772	1		
20	5503	81	1	657	1		
21	5504	26	1	2109	1		
22	5504	18	1	2989	1		
23	5505	32	1	1692	1		
24	5505	19	1	2856	1		
25	5506	39	1	1383	1		
26	5506	40	1	1353	1		
27	5508	83	1	641	1		
28	5508	52	1	1022	1		
29	5510	23	1	2393	1		
30	5510	18	1	3054	0		



**USA Bin 1A/1B**

freq=5500, rate=6, bw=18.0

Trial	Frequency	Pulses	PW (uS)	PRI (uS)	1=Detection 0=No Detection	Detection Percentage	Limit
1	5490	59	1	898	1	100.0%	60.0%
2	5490	59	1	898	1		
3	5492	72	1	738	1		
4	5492	68	1	778	1		
5	5494	18	1	3066	1		
6	5494	58	1	918	1		
7	5495	18	1	3066	1		
8	5495	68	1	778	1		
9	5496	102	1	518	1		
10	5496	57	1	938	1		
11	5497	62	1	858	1		
12	5497	83	1	638	1		
13	5498	72	1	738	1		
14	5498	18	1	3066	1		
15	5500	61	1	878	1		
16	5500	31	1	1726	1		
17	5502	85	1	628	1		
18	5502	22	1	2430	1		
19	5503	23	1	2316	1		
20	5503	27	1	1970	1		
21	5504	22	1	2449	1		
22	5504	30	1	1812	1		
23	5505	63	1	850	1		
24	5505	24	1	2287	1		
25	5506	43	1	1228	1		
26	5506	98	1	541	1		
27	5508	19	1	2827	1		
28	5508	19	1	2813	1		
29	5510	36	1	1490	1		
30	5510	19	1	2797	1		



**USA Bin  
2**

freq=5500, rate=6, bw=18.0

Trial	Frequency	Pulses	PW (uS)	PRI (uS)	1=Detection 0=No Detection	Detection Percentage	Limit
1	5490	23	3.2	222	1	73.3%	60.0%
2	5490	28	3.2	176	0		
3	5492	25	3	224	1		
4	5492	28	3.7	165	0		
5	5494	26	2.1	190	1		
6	5494	23	1.9	189	0		
7	5495	28	3.6	215	1		
8	5495	27	3.1	204	0		
9	5496	24	3.8	170	1		
10	5496	28	2	179	1		
11	5497	27	2.2	182	1		
12	5497	24	4.5	155	1		
13	5498	29	3.2	205	1		
14	5498	28	3.8	164	1		
15	5500	26	4.2	172	1		
16	5500	25	1.3	153	1		
17	5502	27	2.1	230	1		
18	5502	23	2.7	207	1		
19	5503	26	1.6	225	1		
20	5503	27	1.7	150	1		
21	5504	23	2.8	217	0		
22	5504	26	3.5	167	1		
23	5505	26	4.5	220	0		
24	5505	26	1.9	220	1		
25	5506	25	3.7	224	0		
26	5506	25	1.9	156	1		
27	5508	27	1.9	188	1		
28	5508	29	2.6	177	1		
29	5510	29	1.4	229	0		
30	5510	26	3.7	195	1		



**USA Bin**

**3**

freq=5500, rate=6, bw=18.0

Trial	Frequency	Pulses	PW (uS)	PRI (uS)	1=Detection 0=No Detection	Detection Percentage	Limit
1	5490	17	6.9	455	1	83.3%	60.0%
2	5490	18	7.5	272	1		
3	5492	17	6.8	292	0		
4	5492	18	7.1	394	1		
5	5494	17	10	407	1		
6	5494	17	6.2	451	1		
7	5495	17	9	387	0		
8	5495	17	7.6	293	1		
9	5496	18	6.6	387	0		
10	5496	16	7.3	450	1		
11	5497	17	8.8	273	1		
12	5497	17	9.7	208	0		
13	5498	18	9.4	290	1		
14	5498	18	8.1	394	1		
15	5500	16	7.3	230	1		
16	5500	18	6.5	337	1		
17	5502	17	8.1	459	1		
18	5502	17	10	222	1		
19	5503	17	8.9	235	1		
20	5503	17	9.2	373	1		
21	5504	18	9.2	279	1		
22	5504	17	7.8	447	1		
23	5505	18	9.9	240	1		
24	5505	16	9.2	305	1		
25	5506	16	7.2	204	1		
26	5506	16	8.8	291	1		
27	5508	18	8.7	325	1		
28	5508	18	7.4	297	1		
29	5510	16	9.9	342	0		
30	5510	18	8.5	295	1		

**USA Bin  
4**

freq=5500, rate=6, bw=18.0

Trial	Frequency	Pulses	PW (uS)	PRI (uS)	1=Detection 0=No Detection	Detection Percentage	Limit
1	5490	16	19.6	338	0	70.0%	60.0%
2	5490	16	14.1	279	1		
3	5492	16	14.7	221	0		
4	5492	15	15.1	261	1		
5	5494	15	14.9	350	1		
6	5494	15	17.2	318	1		
7	5495	14	16.6	229	0		
8	5495	15	13	291	1		
9	5496	15	14.4	462	1		
10	5496	15	16.4	272	0		
11	5497	14	13.3	201	1		
12	5497	12	16.8	218	1		
13	5498	13	13.6	391	1		
14	5498	13	14.7	231	1		
15	5500	16	11.9	341	0		
16	5500	15	18.6	362	1		
17	5502	13	16.3	496	1		
18	5502	12	18.9	317	1		
19	5503	16	11.7	216	0		
20	5503	12	14.2	462	1		
21	5504	12	11.3	445	1		
22	5504	13	14.5	408	1		
23	5505	12	16.3	350	1		
24	5505	14	16.6	358	1		
25	5506	14	19.7	436	0		
26	5506	12	12.7	421	1		
27	5508	12	15.1	326	0		
28	5508	16	19.1	228	1		
29	5510	16	18.2	288	0		
30	5510	14	19.5	345	1		



**USA  
Bin 5**

freq=5500, rate=6, bw=18.0

Trial	Burst #	Pulses	Frequency (MHz)	Chirp (MHz)	PW (uS)	Inter-pulse spacing (uS)	Inter-pulse spacing (uS)	Pulse Start (S)	1=Detection 0=No Detection	Detection Percentage	Limit
1	1	1	5495	10	70			0.489816	1	96.7%	80.0%
2	1	2	5499	20	90	1549		0.59369	1		
3	1	2	5495.8	12	90	1530		0.574159	1		
4	1	3	5495.8	12	95	1535	1395	0.017262	1		
5	1	2	5497	15	100	1351		0.301778	1		
6	1	2	5494.2	8	55	1696		0.260997	1		
7	1	1	5496.2	13	85			0.83143	1		
8	1	1	5498.6	19	85			0.816349	0		
9	1	2	5493	5	70	1241		0.817617	1		
10	1	1	5495	10	65			0.37033	1		
11	1	3	5500	17	80	1247	1130	0.773442	1		
12	1	1	5500	12	55			0.379452	1		
13	1	1	5500	16	70			0.08412	1		
14	1	3	5500	12	90	1961	1746	0.913824	1		
15	1	3	5500	13	55	1776	1504	0.071949	1		
16	1	2	5500	6	85	1073		0.757266	1		
17	1	2	5500	6	90	1209		0.797544	1		
18	1	2	5500	6	70	1920		0.261071	1		
19	1	1	5500	9	60			1.140646	1		
20	1	1	5500	20	75			0.860837	1		
21	1	3	5505	10	70	1328	1909	0.459015	1		
22	1	3	5505.8	8	70	1387	1608	0.320261	1		
23	1	2	5501.4	19	55	1002		0.309452	1		
24	1	1	5505.4	9	75			0.300277	1		
25	1	1	5503.8	13	100			1.344128	1		
26	1	3	5504.6	11	60	1162	1706	0.271822	1		
27	1	3	5502.6	16	75	1581	1058	0.363597	1		
28	1	1	5501	20	50			0.14248	1		
29	1	2	5501.4	19	100	1565		1.1779	1		
30	1	3	5502.6	16	100	1793	1299	0.627173	1		



## USA Frequency Hopping

freq=5500, rate=6, bw=18.0

Trial	Hop #	Freq (GHz)	Pulse Start (mS)	1=Detection 0=No Detection	Detection Percentage	Limit
1	11	5503	33	1	96.7%	70.0%
2	4	5498	12	1		
3	1	5493	3	1		
4	39	5496	117	1		
5	3	5492	9	1		
6	0	5509	0	1		
7	14	5492	42	1		
8	16	5501	48	1		
9	19	5506	57	1		
10	18	5500	54	1		
11	32	5506	96	1		
12	3	5500	9	1		
13	1	5499	3	1		
14	6	5491	18	1		
15	11	5499	33	1		
16	30	5498	90	1		
17	2	5498	6	1		
18	6	5509	18	1		
19	50	5502	150	1		
20	9	5507	27	1		
21	7	5495	21	1		
22	0	5495	0	1		
23	1	5500	3	1		
24	41	5507	123	1		
25	31	5492	93	1		
26	24	5499	72	1		
27	14	5493	42	1		
28	14	5501	42	0		
29	16	5507	48	1		
30	2	5507	6	1		

In addition an average minimum percentage of successful detection across all four Short pulse radar test waveforms is required and is calculated as follows:

$$\frac{P_d 1 + P_d 2 + P_d 3 + P_d 4}{4} = (93.3\% + 100.0\% + 73.3\% + 83.3\% + 70.0)/5 = 84.0\% (>80\%)$$



## USA Bin 5 Trial #1

Burst #	Pulses	Frequency (MHz)	Chirp (MHz)	PW (uS)	Inter-pulse spacing (uS)	Inter-pulse spacing (uS)	Pulse Start (S)
1	1	5495	10	70			0.489816
2	1	5495	10	85			1.11684
3	1	5495	10	85			1.89484
4	1	5495	10	75			3.037734
5	3	5495	10	65	1939	1738	4.243484
6	1	5495	10	65			5.236859
7	3	5495	10	70	1629	1484	6.353214
8	1	5495	10	95			6.656281
9	1	5495	10	80			7.922814
10	1	5495	10	70			8.99099
11	2	5495	10	75	1530		9.87678
12	1	5495	10	70			10.547445
13	2	5495	10	50	1801		11.362628

## USA Bin 5 Trial #2

Burst #	Pulses	Frequency (MHz)	Chirp (MHz)	PW (uS)	Inter-pulse spacing (uS)	Inter-pulse spacing (uS)	Pulse Start (S)
1	2	5499	20	90	1549		0.59369
2	3	5499	20	85	1485	1182	0.991797
3	2	5499	20	50	1036		1.547372
4	2	5499	20	75	1713		2.658283
5	2	5499	20	90	1806		3.229044
6	2	5499	20	60	1686		3.782166
7	1	5499	20	90			4.717422
8	3	5499	20	85	1936	1802	5.449195
9	3	5499	20	90	1346	1720	6.268293
10	2	5499	20	95	1779		7.135206
11	2	5499	20	80	1781		7.571759
12	2	5499	20	90	1995		8.399745
13	1	5499	20	50			9.080698
14	3	5499	20	90	1675	1155	10.162553
15	3	5499	20	85	1300	1176	11.155355
16	3	5499	20	70	1901	1965	11.581509

## USA Bin 5 Trial #3

Burst #	Pulses	Frequency (MHz)	Chirp (MHz)	PW (uS)	Inter-pulse spacing (uS)	Inter-pulse spacing (uS)	Pulse Start (S)
1	2	5495.8	12	90	1530		0.574159
2	3	5495.8	12	75	1343	1653	2.903317
3	3	5495.8	12	90	1837	1834	4.314833





4	2	5495.8	12	55	1446		5.047631
5	3	5495.8	12	75	1000	1608	6.828323
6	3	5495.8	12	50	1899	1231	7.921932
7	3	5495.8	12	90	1070	1111	10.071807
8	2	5495.8	12	50	1289		10.707283

## USA Bin 5 Trial #4

Burst #	Pulses	Frequency (MHz)	Chirp (MHz)	PW (uS)	Inter-pulse spacing (uS)	Inter-pulse spacing (uS)	Pulse Start (S)
1	3	5495.8	12	95	1535	1395	0.017262
2	3	5495.8	12	50	1439	1965	1.575935
3	2	5495.8	12	50	1484		2.965779
4	2	5495.8	12	65	1237		3.843581
5	1	5495.8	12	55			5.307687
6	3	5495.8	12	70	1818	1890	6.098554
7	1	5495.8	12	95			7.467295
8	3	5495.8	12	65	1057	1471	7.646765
9	2	5495.8	12	70	1320		9.555221
10	2	5495.8	12	55	1821		10.255844
11	3	5495.8	12	95	1336	1241	11.639124

## USA Bin 5 Trial #5

Burst #	Pulses	Frequency (MHz)	Chirp (MHz)	PW (uS)	Inter-pulse spacing (uS)	Inter-pulse spacing (uS)	Pulse Start (S)
1	2	5497	15	100	1351		0.301778
2	3	5497	15	55	1448	1815	1.985012
3	2	5497	15	95	1082		2.456504
4	1	5497	15	85			4.352863
5	3	5497	15	90	1527	1515	5.081552
6	2	5497	15	85	1739		5.92749
7	3	5497	15	75	1579	1070	6.58187
8	2	5497	15	95	1600		8.708222
9	2	5497	15	90	1499		9.097534
10	2	5497	15	75	1323		10.05931
11	3	5497	15	85	1155	1969	10.991096

## USA Bin 5 Trial #6

Burst #	Pulses	Frequency (MHz)	Chirp (MHz)	PW (uS)	Inter-pulse spacing (uS)	Inter-pulse spacing (uS)	Pulse Start (S)
1	2	5494.2	8	55	1696		0.260997
2	3	5494.2	8	75	1027	1310	1.6798
3	2	5494.2	8	80	1845		3.573438
4	2	5494.2	8	55	1398		4.081377
5	3	5494.2	8	95	1662	1336	5.923117



6	2	5494.2	8	90	1450	6.964493
7	1	5494.2	8	80		7.896429
8	2	5494.2	8	95	1314	8.605607
9	1	5494.2	8	60		9.760878
10	2	5494.2	8	95	1372	11.281459

## USA Bin 5 Trial #7

Burst #	Pulses	Frequency (MHz)	Chirp (MHz)	PW (uS)	Inter-pulse spacing (uS)	Inter-pulse spacing (uS)	Pulse Start (S)
1	1	5496.2	13	85			0.83143
2	2	5496.2	13	55	1794		1.527059
3	3	5496.2	13	85	1360	1642	3.557324
4	3	5496.2	13	60	1272	1838	5.544686
5	2	5496.2	13	70	1045		6.307607
6	2	5496.2	13	85	1707		8.565031
7	1	5496.2	13	80			10.081091
8	2	5496.2	13	90	1751		10.761845

## USA Bin 5 Trial #8

Burst #	Pulses	Frequency (MHz)	Chirp (MHz)	PW (uS)	Inter-pulse spacing (uS)	Inter-pulse spacing (uS)	Pulse Start (S)
1	1	5498.6	19	85			0.816349
2	2	5498.6	19	75	1412		1.963375
3	3	5498.6	19	75	1690	1199	3.170328
4	1	5498.6	19	85			4.584363
5	2	5498.6	19	85	1723		4.965032
6	1	5498.6	19	85			6.205693
7	2	5498.6	19	65	1471		8.186457
8	3	5498.6	19	55	1552	1749	8.94812
9	1	5498.6	19	70			10.379105
10	3	5498.6	19	80	1061	1550	11.304215

## USA Bin 5 Trial #9

Burst #	Pulses	Frequency (MHz)	Chirp (MHz)	PW (uS)	Inter-pulse spacing (uS)	Inter-pulse spacing (uS)	Pulse Start (S)
1	2	5493	5	70	1241		0.817617
2	2	5493	5	65	1758		2.094944
3	1	5493	5	90			3.45565
4	3	5493	5	65	1530	1271	4.80427
5	2	5493	5	60	1815		7.389685
6	2	5493	5	55	1536		8.042336
7	1	5493	5	60			9.012729
8	3	5493	5	60	1649	1502	10.799794

## USA Bin 5 Trial #10



Burst #	Pulses	Frequency (MHz)	Chirp (MHz)	PW (uS)	Inter-pulse spacing (uS)	Inter-pulse spacing (uS)	Pulse Start (S)
1	1	5495	10	65			0.37033
2	3	5495	10	65	1951	1755	0.972135
3	3	5495	10	60	1490	1434	1.769424
4	3	5495	10	65	1311	1238	3.132917
5	2	5495	10	60	1751		3.619972
6	3	5495	10	50	1108	1692	4.890247
7	1	5495	10	75			5.17131
8	3	5495	10	95	1252	1876	6.68806
9	2	5495	10	70	1698		7.31196
10	3	5495	10	90	1649	1572	7.813692
11	2	5495	10	95	1249		8.927051
12	1	5495	10	50			9.773912
13	3	5495	10	70	1577	1689	10.944845
14	3	5495	10	90	1338	1891	11.371776

## USA Bin 5 Trial #11

Burst #	Pulses	Frequency (MHz)	Chirp (MHz)	PW (uS)	Inter-pulse spacing (uS)	Inter-pulse spacing (uS)	Pulse Start (S)
1	3	5500	17	80	1247	1130	0.773442
2	1	5500	17	80			2.041168
3	1	5500	17	70			3.267328
4	3	5500	17	75	1238	1367	3.797291
5	3	5500	17	75	1336	1795	4.377083
6	2	5500	17	55	1962		6.277853
7	1	5500	17	50			7.25072
8	3	5500	17	85	1002	1921	8.548286
9	3	5500	17	100	1989	1434	9.538255
10	2	5500	17	95	1096		10.38466
11	3	5500	17	60	1237	1567	11.619739

## USA Bin 5 Trial #12

Burst #	Pulses	Frequency (MHz)	Chirp (MHz)	PW (uS)	Inter-pulse spacing (uS)	Inter-pulse spacing (uS)	Pulse Start (S)
1	1	5500	12	55			0.379452
2	1	5500	12	60			2.009792
3	1	5500	12	80			3.977183
4	1	5500	12	95			5.281638
5	2	5500	12	70	1390		5.677272
6	1	5500	12	100			6.721739
7	1	5500	12	80			8.688774
8	1	5500	12	95			9.712292



9            2            5500            12            80            1332            11.035288  
 USA Bin 5 Trial #13

Burst #	Pulses	Frequency (MHz)	Chirp (MHz)	PW (uS)	Inter-pulse spacing (uS)	Inter-pulse spacing (uS)	Pulse Start (S)
1	1	5500	16	70			0.08412
2	2	5500	16	50	1665		1.512275
3	2	5500	16	70	1559		2.687855
4	3	5500	16	95	1055	1866	3.504191
5	2	5500	16	55	1833		5.099796
6	3	5500	16	60	1737	1371	5.699446
7	2	5500	16	90	1750		7.281952
8	1	5500	16	90			7.892176
9	2	5500	16	55	1385		9.635442
10	3	5500	16	75	2000	1439	10.614035
11	2	5500	16	65	1826		11.557418

USA Bin 5 Trial #14

Burst #	Pulses	Frequency (MHz)	Chirp (MHz)	PW (uS)	Inter-pulse spacing (uS)	Inter-pulse spacing (uS)	Pulse Start (S)
1	3	5500	12	90	1961	1746	0.913824
2	2	5500	12	60	1605		2.130965
3	1	5500	12	65			2.556481
4	3	5500	12	60	1661	1789	4.162493
5	3	5500	12	60	1751	1157	5.314181
6	1	5500	12	50			6.776853
7	1	5500	12	50			7.231205
8	3	5500	12	60	1171	1633	9.348019
9	3	5500	12	90	1355	1635	10.651782
10	1	5500	12	55			11.571566

USA Bin 5 Trial #15

Burst #	Pulses	Frequency (MHz)	Chirp (MHz)	PW (uS)	Inter-pulse spacing (uS)	Inter-pulse spacing (uS)	Pulse Start (S)
1	3	5500	13	55	1776	1504	0.071949
2	3	5500	13	65	1606	1705	1.036276
3	1	5500	13	90			2.389868
4	1	5500	13	85			3.140035
5	1	5500	13	65			4.789497
6	1	5500	13	70			5.878525
7	1	5500	13	60			6.379488
8	2	5500	13	85	1177		7.982324
9	3	5500	13	75	1023	1227	8.26621
10	2	5500	13	75	1781		9.65867



11	1	5500	13	50			10.059108
12	3	5500	13	100	1490	1207	11.858265

## USA Bin 5 Trial #16

Burst #	Pulses	Frequency (MHz)	Chirp (MHz)	PW (uS)	Inter-pulse spacing (uS)	Inter-pulse spacing (uS)	Pulse Start (S)
1	2	5500	6	85	1073		0.757266
2	1	5500	6	60			1.274291
3	2	5500	6	85	1360		2.523944
4	1	5500	6	100			2.628778
5	1	5500	6	50			4.081719
6	1	5500	6	80			4.693928
7	3	5500	6	75	1579	1382	5.414876
8	2	5500	6	95	1651		6.266224
9	1	5500	6	100			7.187293
10	3	5500	6	95	1236	1247	8.236304
11	2	5500	6	75	1301		9.203358
12	2	5500	6	85	1950		9.559386
13	3	5500	6	75	1619	1709	10.291939
14	3	5500	6	60	1573	1947	11.25247

## USA Bin 5 Trial #17

Burst #	Pulses	Frequency (MHz)	Chirp (MHz)	PW (uS)	Inter-pulse spacing (uS)	Inter-pulse spacing (uS)	Pulse Start (S)
1	2	5500	6	90	1209		0.797544
2	2	5500	6	55	1934		1.464263
3	3	5500	6	85	1185	1887	1.902882
4	3	5500	6	70	1665	1678	2.742081
5	2	5500	6	65	1021		3.83839
6	1	5500	6	75			4.578217
7	3	5500	6	50	1784	1405	5.979569
8	3	5500	6	60	1568	1395	6.235497
9	2	5500	6	55	1197		6.883438
10	3	5500	6	50	1434	1236	7.930634
11	2	5500	6	65	1856		9.204496
12	1	5500	6	60			9.709625
13	2	5500	6	70	1540		10.987229
14	3	5500	6	65	1383	1714	11.251271

## USA Bin 5 Trial #18

Burst #	Pulses	Frequency (MHz)	Chirp (MHz)	PW (uS)	Inter-pulse spacing (uS)	Inter-pulse spacing (uS)	Pulse Start (S)
1	2	5500	6	70	1920		0.261071
2	3	5500	6	50	1828	1961	1.759665



3	3	5500	6	60	1401	1293	2.57542
4	1	5500	6	75			4.309063
5	3	5500	6	95	1733	1619	4.781642
6	1	5500	6	60			6.386689
7	1	5500	6	75			6.592947
8	2	5500	6	100	1249		8.415663
9	3	5500	6	65	1793	1134	9.690813
10	1	5500	6	60			10.368498
11	3	5500	6	65	1487	1920	10.916093

## USA Bin 5 Trial #19

Burst #	Pulses	Frequency (MHz)	Chirp (MHz)	PW (uS)	Inter-pulse spacing (uS)	Inter-pulse spacing (uS)	Pulse Start (S)
1	1	5500	9	60			1.140646
2	1	5500	9	85			2.357364
3	2	5500	9	75	1738		3.077468
4	3	5500	9	70	1248	1001	5.292521
5	2	5500	9	85	1570		6.170331
6	2	5500	9	85	1549		8.362776
7	3	5500	9	90	1156	1545	9.940598
8	2	5500	9	70	1162		11.493083

## USA Bin 5 Trial #20

Burst #	Pulses	Frequency (MHz)	Chirp (MHz)	PW (uS)	Inter-pulse spacing (uS)	Inter-pulse spacing (uS)	Pulse Start (S)
1	1	5500	20	75			0.860837
2	2	5500	20	55	1564		2.377939
3	1	5500	20	60			3.950183
4	2	5500	20	90	1708		5.114278
5	2	5500	20	70	1453		5.906912
6	1	5500	20	65			7.908838
7	3	5500	20	85	1380	1276	9.318919
8	2	5500	20	75	1723		10.358057
9	1	5500	20	100			11.871842

## USA Bin 5 Trial #21

Burst #	Pulses	Frequency (MHz)	Chirp (MHz)	PW (uS)	Inter-pulse spacing (uS)	Inter-pulse spacing (uS)	Pulse Start (S)
1	3	5505	10	70	1328	1909	0.459015
2	1	5505	10	65			1.127061
3	3	5505	10	85	1999	1072	2.565463
4	1	5505	10	100			3.671627
5	1	5505	10	60			4.553291
6	1	5505	10	65			5.410037



7	1	5505	10	55			6.443264
8	2	5505	10	80	1082		7.299942
9	2	5505	10	100	1905		7.552462
10	1	5505	10	100			8.457436
11	3	5505	10	95	1535	1849	9.440681
12	3	5505	10	75	1081	1003	10.712409
13	3	5505	10	80	1377	1655	11.548783

USA Bin 5 Trial #22

Burst #	Pulses	Frequency (MHz)	Chirp (MHz)	PW (uS)	Inter-pulse spacing (uS)	Inter-pulse spacing (uS)	Pulse Start (S)
1	3	5505.8	8	70	1387	1608	0.320261
2	3	5505.8	8	100	1181	1516	2.493617
3	3	5505.8	8	85	1601	1735	4.230741
4	1	5505.8	8	85			5.686732
5	3	5505.8	8	90	1433	1695	7.110781
6	2	5505.8	8	80	1776		8.713886
7	1	5505.8	8	50			10.406775
8	3	5505.8	8	100	1348	1098	11.411578

USA Bin 5 Trial #23

Burst #	Pulses	Frequency (MHz)	Chirp (MHz)	PW (uS)	Inter-pulse spacing (uS)	Inter-pulse spacing (uS)	Pulse Start (S)
1	2	5501.4	19	55	1002		0.309452
2	2	5501.4	19	75	1522		1.811626
3	2	5501.4	19	95	1046		3.495715
4	2	5501.4	19	50	1376		4.570295
5	1	5501.4	19	100			5.457515
6	1	5501.4	19	85			6.515937
7	3	5501.4	19	50	1295	1779	7.466673
8	1	5501.4	19	55			8.934505
9	1	5501.4	19	60			9.801099
10	2	5501.4	19	100	1277		11.167691

USA Bin 5 Trial #24

Burst #	Pulses	Frequency (MHz)	Chirp (MHz)	PW (uS)	Inter-pulse spacing (uS)	Inter-pulse spacing (uS)	Pulse Start (S)
1	1	5505.4	9	75			0.300277
2	2	5505.4	9	90	1719		0.925444
3	1	5505.4	9	90			2.406206
4	1	5505.4	9	70			2.877726
5	1	5505.4	9	80			3.770984
6	2	5505.4	9	90	1776		4.925651
7	2	5505.4	9	75	1371		5.857459



8	1	5505.4	9	75			6.647606
9	2	5505.4	9	85	1825		7.92064
10	3	5505.4	9	70	1498	1203	8.424244
11	3	5505.4	9	55	1905	1278	9.67302
12	3	5505.4	9	60	1550	1730	11.072925
13	3	5505.4	9	55	1281	1625	11.514348

## USA Bin 5 Trial #25

Burst #	Pulses	Frequency (MHz)	Chirp (MHz)	PW (uS)	Inter-pulse spacing (uS)	Inter-pulse spacing (uS)	Pulse Start (S)
1	1	5503.8	13	100			1.344128
2	2	5503.8	13	80	1365		2.462984
3	1	5503.8	13	50			3.263557
4	3	5503.8	13	60	1419	1346	5.513473
5	1	5503.8	13	100			6.798378
6	2	5503.8	13	80	1043		8.083115
7	2	5503.8	13	100	1152		10.34715
8	1	5503.8	13	100			11.587456

## USA Bin 5 Trial #26

Burst #	Pulses	Frequency (MHz)	Chirp (MHz)	PW (uS)	Inter-pulse spacing (uS)	Inter-pulse spacing (uS)	Pulse Start (S)
1	3	5504.6	11	60	1162	1706	0.271822
2	1	5504.6	11	75			1.700461
3	2	5504.6	11	90	1874		2.072076
4	1	5504.6	11	100			2.661917
5	1	5504.6	11	90			4.131166
6	3	5504.6	11	60	1331	1453	4.824241
7	1	5504.6	11	70			5.340394
8	3	5504.6	11	70	1283	1870	6.247569
9	2	5504.6	11	80	1330		7.136328
10	2	5504.6	11	80	1785		8.509151
11	1	5504.6	11	80			8.908273
12	3	5504.6	11	70	1873	1483	9.480447
13	2	5504.6	11	100	1793		10.529227
14	1	5504.6	11	85			11.561108

## USA Bin 5 Trial #27

Burst #	Pulses	Frequency (MHz)	Chirp (MHz)	PW (uS)	Inter-pulse spacing (uS)	Inter-pulse spacing (uS)	Pulse Start (S)
1	3	5502.6	16	75	1581	1058	0.363597
2	2	5502.6	16	60	1856		0.978307
3	2	5502.6	16	55	1944		1.321201
4	2	5502.6	16	95	1291		2.51513





5	3	5502.6	16	55	1860	1069	2.676118
6	3	5502.6	16	55	1619	1170	3.17772
7	3	5502.6	16	80	1936	1629	3.830065
8	3	5502.6	16	95	1136	1360	4.880191
9	2	5502.6	16	100	1391		5.323811
10	3	5502.6	16	85	1720	1857	6.220506
11	3	5502.6	16	65	1416	1936	6.404535
12	2	5502.6	16	75	1632		6.997305
13	3	5502.6	16	55	1643	1428	7.951892
14	3	5502.6	16	80	1886	1212	8.799441
15	3	5502.6	16	75	1042	1569	9.318224
16	2	5502.6	16	90	1245		9.81466
17	3	5502.6	16	75	1754	1514	10.681333
18	3	5502.6	16	80	1131	1644	10.982501
19	1	5502.6	16	85			11.561933

## USA Bin 5 Trial #28

Burst #	Pulses	Frequency (MHz)	Chirp (MHz)	PW (uS)	Inter-pulse spacing (uS)	Inter-pulse spacing (uS)	Pulse Start (S)
1	1	5501	20	50			0.14248
2	3	5501	20	90	1444	1877	2.519349
3	3	5501	20	50	1858	1636	3.157963
4	1	5501	20	100			4.397565
5	1	5501	20	90			6.196524
6	3	5501	20	50	1931	1996	7.426723
7	3	5501	20	70	1706	1871	8.574732
8	1	5501	20	85			10.164301
9	2	5501	20	95	1211		11.142438

## USA Bin 5 Trial #29

Burst #	Pulses	Frequency (MHz)	Chirp (MHz)	PW (uS)	Inter-pulse spacing (uS)	Inter-pulse spacing (uS)	Pulse Start (S)
1	2	5501.4	19	100	1565		1.1779
2	3	5501.4	19	65	1581	1660	2.505046
3	1	5501.4	19	100			3.729892
4	1	5501.4	19	100			4.044823
5	3	5501.4	19	95	1770	1814	5.868866
6	1	5501.4	19	65			7.736679
7	3	5501.4	19	60	1305	1915	8.382152
8	3	5501.4	19	60	1249	1337	10.656207
9	3	5501.4	19	80	1614	1081	11.743743

## USA Bin 5 Trial #30



Burst #	Pulses	Frequency (MHz)	Chirp (MHz)	PW (uS)	Inter-pulse spacing (uS)	Inter-pulse spacing (uS)	Pulse Start (S)
1	3	5502.6	16	100	1793	1299	0.627173
2	3	5502.6	16	55	1110	1684	0.963916
3	2	5502.6	16	55	1175		1.742215
4	2	5502.6	16	80	1701		2.129867
5	2	5502.6	16	50	1783		2.650897
6	3	5502.6	16	65	1124	1814	3.560353
7	1	5502.6	16	75			4.040267
8	1	5502.6	16	65			4.54484
9	1	5502.6	16	90			5.258274
10	1	5502.6	16	70			5.906655
11	3	5502.6	16	50	1666	1759	6.62464
12	2	5502.6	16	60	1580		7.081598
13	2	5502.6	16	55	1788		7.604359
14	3	5502.6	16	70	1710	1032	8.676124
15	3	5502.6	16	95	1475	1991	9.167997
16	3	5502.6	16	55	1772	1110	9.803087
17	1	5502.6	16	55			10.585037
18	2	5502.6	16	70	1290		10.835535
19	2	5502.6	16	80	1339		11.509512

## USA Frequency Hopping Trial #1

Hop #	Freq (GHz)	Pulse Start (mS)
11	5503	33
28	5505	84
71	5500	213

## USA Frequency Hopping Trial #2

Hop #	Freq (GHz)	Pulse Start (mS)
4	5498	12
50	5500	150
57	5509	171
59	5497	177
64	5492	192

## USA Frequency Hopping Trial #3

Hop #	Freq (GHz)	Pulse Start (mS)
1	5493	3
7	5498	21
31	5497	93
32	5492	96
34	5496	102
63	5502	189
82	5506	246

## USA Frequency Hopping Trial #4

Hop #	Freq (GHz)	Pulse Start (mS)
39	5496	117
42	5493	126
55	5491	165
72	5506	216

## USA Frequency Hopping Trial #5

Hop #	Freq (GHz)	Pulse Start (mS)
3	5492	9
49	5504	147
61	5497	183

## USA Frequency Hopping Trial #6

Hop #	Freq (GHz)	Pulse Start (mS)
0	5509	0
36	5500	108
50	5503	150

## USA Frequency Hopping Trial #7

Hop #	Freq (GHz)	Pulse Start (mS)
14	5492	42
18	5501	54
46	5498	138
76	5502	228

## USA Frequency Hopping Trial #8

Hop #	Freq (GHz)	Pulse Start (mS)
16	5501	48
84	5493	252

## USA Frequency Hopping Trial #9

Hop #	Freq (GHz)	Pulse Start (mS)
19	5506	57
44	5502	132
55	5501	165
64	5497	192
99	5493	297

## USA Frequency Hopping Trial #10

Hop #	Freq (GHz)	Pulse Start (mS)
18	5500	54
26	5495	78
45	5507	135
71	5508	213

## USA Frequency Hopping Trial #11

Hop #	Freq (GHz)	Pulse Start (mS)
32	5506	96
55	5493	165
72	5495	216
89	5504	267
91	5499	273

## USA Frequency Hopping Trial #12

Hop #	Freq (GHz)	Pulse Start (mS)
3	5500	9
15	5492	45
32	5502	96
55	5493	165
79	5506	237

## USA Frequency Hopping Trial #13

Hop #	Freq (GHz)	Pulse Start (mS)
1	5499	3
9	5506	27
63	5508	189
71	5503	213
91	5500	273

## USA Frequency Hopping Trial #14

Hop #	Freq (GHz)	Pulse Start (mS)
6	5491	18
8	5496	24
36	5495	108
79	5493	237

## USA Frequency Hopping Trial #15

Hop #	Freq (GHz)	Pulse Start (mS)
11	5499	33
13	5506	39
29	5503	87
35	5493	105
50	5509	150
59	5498	177

## USA Frequency Hopping Trial #16

Hop #	Freq (GHz)	Pulse Start (mS)
30	5498	90
53	5507	159
59	5508	177
73	5503	219
98	5501	294

## USA Frequency Hopping Trial #17

Hop #	Freq (GHz)	Pulse Start (mS)
2	5498	6
6	5491	18
58	5494	174

## USA Frequency Hopping Trial #18

Hop #	Freq (GHz)	Pulse Start (mS)
6	5509	18
58	5504	174

## USA Frequency Hopping Trial #19



Hop #	Freq (GHz)	Pulse Start (mS)
50	5502	150
59	5496	177
61	5499	183
88	5491	264

## USA Frequency Hopping Trial #20

Hop #	Freq (GHz)	Pulse Start (mS)
9	5507	27
56	5499	168
73	5500	219

## USA Frequency Hopping Trial #21

Hop #	Freq (GHz)	Pulse Start (mS)
7	5495	21
12	5496	36
35	5506	105
53	5497	159
99	5507	297

## USA Frequency Hopping Trial #22

Hop #	Freq (GHz)	Pulse Start (mS)
0	5495	0
21	5493	63
27	5500	81
43	5501	129
48	5496	144
50	5491	150
73	5494	219

## USA Frequency Hopping Trial #23

Hop #	Freq (GHz)	Pulse Start (mS)
1	5500	3
54	5507	162
63	5493	189
80	5495	240

## USA Frequency Hopping Trial #24

Hop #	Freq (GHz)	Pulse Start (mS)
41	5507	123
64	5509	192
65	5493	195
84	5496	252

85	5508	255
91	5495	273

## USA Frequency Hopping Trial #25

Hop #	Freq (GHz)	Pulse Start (mS)
31	5492	93
40	5496	120
48	5508	144
67	5509	201
85	5498	255

## USA Frequency Hopping Trial #26

Hop #	Freq (GHz)	Pulse Start (mS)
24	5499	72
34	5500	102
39	5491	117
45	5498	135
46	5505	138
86	5495	258

## USA Frequency Hopping Trial #27

Hop #	Freq (GHz)	Pulse Start (mS)
14	5493	42
28	5491	84
34	5500	102
70	5498	210
97	5502	291

## USA Frequency Hopping Trial #28

Hop #	Freq (GHz)	Pulse Start (mS)
14	5501	42
50	5507	150
86	5492	258

## USA Frequency Hopping Trial #29

Hop #	Freq (GHz)	Pulse Start (mS)
16	5507	48
23	5496	69
83	5503	249
89	5501	267
98	5492	294

## USA Frequency Hopping Trial #30

Hop #	Freq (GHz)	Pulse Start (mS)
-------	------------	------------------



2	5507	6
25	5491	75
83	5496	249





**Channel 5510 MHz, 40MHz BW, Statistical Performance**

**USA Bin 1A/1B**

freq=5510, rate=m0, bw=36.0

Trial	Frequency	Pulses	PW (uS)	PRI (uS)	1=Detection 0=No Detection	Detection Percentage	Limit
1	5490	74	1	718	0	96.7%	60.0%
2	5490	59	1	898	1		
3	5493	58	1	918	1		
4	5493	67	1	798	1		
5	5496	95	1	558	1		
6	5496	70	1	758	1		
7	5499	68	1	778	1		
8	5499	18	1	3066	1		
9	5502	63	1	838	1		
10	5502	67	1	798	1		
11	5505	95	1	558	1		
12	5505	67	1	798	1		
13	5508	99	1	538	1		
14	5508	57	1	938	1		
15	5510	63	1	838	1		
16	5510	32	1	1656	1		
17	5512	93	1	568	1		
18	5512	45	1	1178	1		
19	5515	19	1	2858	1		
20	5515	45	1	1182	1		
21	5518	39	1	1388	1		
22	5518	21	1	2585	1		
23	5521	33	1	1644	1		
24	5521	43	1	1234	1		
25	5524	19	1	2917	1		
26	5524	46	1	1154	1		
27	5527	26	1	2039	1		
28	5527	46	1	1148	1		
29	5530	40	1	1330	1		
30	5530	31	1	1738	1		



**USA Bin 1A/1B**

freq=5510, rate=m0, bw=36.0

Trial	Frequency	Pulses	PW (uS)	PRI (uS)	1=Detection 0=No Detection	Detection Percentage	Limit
1	5490	57	1	938	1	96.7%	60.0%
2	5490	61	1	878	1		
3	5493	102	1	518	1		
4	5493	59	1	898	1		
5	5496	86	1	618	1		
6	5496	68	1	778	1		
7	5499	63	1	838	1		
8	5499	62	1	858	1		
9	5502	95	1	558	1		
10	5502	18	1	3066	0		
11	5505	78	1	678	1		
12	5505	67	1	798	1		
13	5508	95	1	558	1		
14	5508	18	1	3066	1		
15	5510	59	1	898	1		
16	5510	25	1	2125	1		
17	5512	20	1	2765	1		
18	5512	45	1	1180	1		
19	5515	46	1	1171	1		
20	5515	47	1	1132	1		
21	5518	20	1	2777	1		
22	5518	53	1	1000	1		
23	5521	22	1	2405	1		
24	5521	25	1	2155	1		
25	5524	21	1	2634	1		
26	5524	50	1	1056	1		
27	5527	69	1	776	1		
28	5527	36	1	1481	1		
29	5530	21	1	2596	1		
30	5530	37	1	1434	1		

**USA Bin  
2**

freq=5510, rate=m0, bw=36.0

Trial	Frequency	Pulses	PW (uS)	PRI (uS)	1=Detection 0=No Detection	Detection Percentage	Limit
1	5490	24	2.6	171	1	90.0%	60.0%
2	5490	24	2.5	189	0		
3	5493	26	2.9	227	1		
4	5493	25	3.6	218	1		
5	5496	28	3.4	212	1		
6	5496	23	3.9	175	1		
7	5499	24	2	172	1		
8	5499	28	3.3	181	1		
9	5502	23	3.3	227	1		
10	5502	28	2.4	179	1		
11	5505	27	4.6	162	0		
12	5505	28	4.3	198	1		
13	5508	26	2.6	199	0		
14	5508	28	4.9	169	1		
15	5510	28	4.8	216	1		
16	5510	27	4.6	203	1		
17	5512	28	4.1	222	1		
18	5512	23	3.2	215	1		
19	5515	24	4	164	1		
20	5515	25	1.5	206	1		
21	5518	26	2.7	174	1		
22	5518	27	4.9	186	1		
23	5521	25	1.1	209	1		
24	5521	25	1.7	192	1		
25	5524	24	3.5	226	1		
26	5524	25	2.8	174	1		
27	5527	24	4.7	228	1		
28	5527	26	4.3	197	1		
29	5530	26	2.3	188	1		
30	5530	28	3.6	204	1		

**USA Bin  
3**

freq=5510, rate=m0, bw=36.0

Trial	Frequency	Pulses	PW (uS)	PRI (uS)	1=Detection 0=No Detection	Detection Percentage	Limit
1	5490	18	7.9	323	1	83.3%	60.0%
2	5490	16	9	355	0		
3	5493	18	7	290	1		
4	5493	16	8.8	206	1		
5	5496	16	7.4	246	1		
6	5496	17	9.8	263	1		
7	5499	16	9	377	1		
8	5499	16	9.3	248	1		
9	5502	17	7.7	206	1		
10	5502	17	8.9	464	1		
11	5505	16	6.3	476	1		
12	5505	17	6.9	395	1		
13	5508	18	8	432	1		
14	5508	17	7.3	267	0		
15	5510	18	6.4	408	1		
16	5510	18	7.1	478	1		
17	5512	17	7	340	0		
18	5512	17	9.4	370	1		
19	5515	17	6.1	307	0		
20	5515	17	6.9	492	1		
21	5518	16	8.2	369	1		
22	5518	16	9.8	493	1		
23	5521	17	9.7	210	1		
24	5521	16	9.6	458	1		
25	5524	16	8.6	489	1		
26	5524	17	8.9	479	0		
27	5527	17	9.2	219	1		
28	5527	18	7.9	291	1		
29	5530	17	8.7	355	1		
30	5530	17	6.8	470	1		

**USA Bin****4**

freq=5510, rate=m0, bw=36.0

Trial	Frequency	Pulses	PW (uS)	PRI (uS)	1=Detection 0=No Detection	Detection Percentage	Limit
1	5490	15	16.6	241	1	86.7%	60.0%
2	5490	16	19.4	286	1		
3	5493	13	14.1	477	1		
4	5493	16	14.7	238	1		
5	5496	15	17.5	436	1		
6	5496	16	19.3	337	1		
7	5499	16	12.4	300	1		
8	5499	16	11.9	201	1		
9	5502	16	14.7	409	1		
10	5502	14	15.9	304	1		
11	5505	12	18.5	311	0		
12	5505	12	11.7	221	1		
13	5508	13	18.9	289	1		
14	5508	13	14.2	383	1		
15	5510	16	15.3	285	0		
16	5510	14	13	368	1		
17	5512	15	11.4	403	1		
18	5512	14	18.3	224	1		
19	5515	13	19.8	439	1		
20	5515	12	12.6	402	1		
21	5518	15	13.1	469	1		
22	5518	16	17.4	282	1		
23	5521	13	18	420	1		
24	5521	12	12.2	471	0		
25	5524	12	17.3	497	1		
26	5524	15	19.8	378	1		
27	5527	14	18.4	473	1		
28	5527	13	12.1	487	1		
29	5530	16	13.9	359	1		
30	5530	14	18.6	211	0		



**USA  
Bin  
5**

freq=5510, rate=m0, bw=36.0

Trial	Burst #	Pulses	Frequency (MHz)	Chirp (MHz)	PW (uS)	Inter-pulse spacing (uS)	Inter-pulse spacing (uS)	Pulse Start (S)	1=Detection 0=No Detection	Detection Percentage	Limit
1	1	1	5498.8	17	80			0.277812	1	100.0%	80.0%
2	1	1	5496	10	65			1.302736	1		
3	1	3	5494.8	7	95	1974	1497	0.237217	1		
4	1	3	5498.4	16	50	1337	1267	0.854053	1		
5	1	2	5496.4	11	60	1312		1.01104	1		
6	1	1	5495.2	8	85			0.481287	1		
7	1	3	5497.6	14	100	1401	1004	0.949106	1		
8	1	1	5498	15	50			0.034463	1		
9	1	1	5496	10	80			0.57657	1		
10	1	3	5497.2	13	50	1215	1123	0.124971	1		
11	1	1	5510	7	70			0.501386	1		
12	1	1	5510	19	90			0.169372	1		
13	1	3	5510	16	85	1366	1311	0.453745	1		
14	1	3	5510	9	75	1595	1611	0.578435	1		
15	1	3	5510	20	100	1090	1708	0.718705	1		
16	1	1	5510	11	70			0.595195	1		
17	1	2	5510	12	90	1522		1.014452	1		
18	1	1	5510	16	85			0.641739	1		
19	1	1	5510	19	50			0.54935	1		
20	1	3	5510	14	85	1043	1118	0.077513	1		
21	1	1	5524.4	9	75			0.707202	1		
22	1	3	5525.2	7	50	1697	1338	0.244837	1		
23	1	2	5524	10	50	1631		0.567593	1		
24	1	2	5525.2	7	60	1236		1.117329	1		
25	1	2	5520	20	90	1915		0.758801	1		
26	1	2	5524	10	85	1694		0.064195	1		
27	1	1	5520.8	18	75			0.080756	1		
28	1	2	5520	20	100	1565		0.122576	1		
29	1	1	5521.2	17	95			0.42912	1		
30	1	1	5523.6	11	60			0.042081	1		

freq=5510, rate=m0,  
bw=36.0**USA Frequency Hopping**

Trial	Hop #	Freq (GHz)	Pulse Start (mS)	1=Detection 0=No Detection	Detection Percentage	Limit
1	3	5492	9	1	100.0%	70.0%
2	15	5523	45	1		
3	27	5517	81	1		
4	15	5504	45	1		
5	21	5496	63	1		
6	6	5518	18	1		
7	4	5505	12	1		
8	2	5501	6	1		
9	8	5516	24	1		
10	20	5493	60	1		
11	6	5513	18	1		
12	1	5503	3	1		
13	5	5513	15	1		
14	3	5523	9	1		
15	24	5521	72	1		
16	25	5499	75	1		
17	79	5524	237	1		
18	52	5493	156	1		
19	7	5528	21	1		
20	23	5528	69	1		
21	9	5516	27	1		
22	8	5527	24	1		
23	0	5500	0	1		
24	14	5507	42	1		
25	13	5494	39	1		
26	13	5524	39	1		
27	5	5511	15	1		
28	4	5516	12	1		
29	7	5501	21	1		
30	13	5505	39	1		

**Channel 5510 MHz, 40MHz BW, Statistical Performance**

In addition an average minimum percentage of successful detection across all four Short pulse radar test waveforms is required and is calculated as follows:

$$\frac{P_d 1 + P_d 2 + P_d 3 + P_d 4}{4} = (96.7\% + 96.7\% + 90.0\% + 83.3\% + 86.7)/5 = 90.7\% (>80\%)$$



## USA Bin 5 Trial #1

Burst #	Pulses	Frequency (MHz)	Chirp (MHz)	PW (uS)	Inter-pulse spacing (uS)	Inter-pulse spacing (uS)	Pulse Start (S)
1	1	5498.8	17	80			0.277812
2	1	5498.8	17	80			0.839129
3	3	5498.8	17	65	1559	1591	1.772928
4	3	5498.8	17	85	1180	1534	2.738069
5	3	5498.8	17	60	1544	1696	3.185546
6	1	5498.8	17	50			3.850013
7	2	5498.8	17	90	1510		5.035835
8	2	5498.8	17	60	1274		5.35228
9	2	5498.8	17	85	1879		6.586976
10	2	5498.8	17	90	1054		6.856042
11	3	5498.8	17	90	1250	1626	8.033771
12	3	5498.8	17	95	1210	1052	8.830176
13	2	5498.8	17	100	1974		9.458316
14	1	5498.8	17	50			9.860508
15	1	5498.8	17	50			10.693889
16	2	5498.8	17	90	1856		11.854423

## USA Bin 5 Trial #2

Burst #	Pulses	Frequency (MHz)	Chirp (MHz)	PW (uS)	Inter-pulse spacing (uS)	Inter-pulse spacing (uS)	Pulse Start (S)
1	1	5496	10	65			1.302736
2	2	5496	10	65	1928		2.746087
3	2	5496	10	70	1388		3.017665
4	3	5496	10	55	1005	1053	4.518475
5	1	5496	10	55			6.33579
6	1	5496	10	70			8.56943
7	1	5496	10	85			10.212788
8	3	5496	10	80	1770	1697	11.547939

## USA Bin 5 Trial #3

Burst #	Pulses	Frequency (MHz)	Chirp (MHz)	PW (uS)	Inter-pulse spacing (uS)	Inter-pulse spacing (uS)	Pulse Start (S)
1	3	5494.8	7	95	1974	1497	0.237217
2	1	5494.8	7	85			1.361581
3	1	5494.8	7	80			1.952972
4	3	5494.8	7	85	1954	1904	2.837777
5	1	5494.8	7	90			4.489647
6	3	5494.8	7	75	1977	1231	5.229771
7	1	5494.8	7	85			6.250089
8	2	5494.8	7	60	1720		6.927847





9	3	5494.8	7	75	1220	1956	7.897961
10	3	5494.8	7	90	1989	1449	8.669156
11	1	5494.8	7	85			9.775609
12	2	5494.8	7	75	1134		10.169374
13	2	5494.8	7	90	1072		11.975506

## USA Bin 5 Trial #4

Burst #	Pulses	Frequency (MHz)	Chirp (MHz)	PW (uS)	Inter-pulse spacing (uS)	Inter-pulse spacing (uS)	Pulse Start (S)
1	3	5498.4	16	50	1337	1267	0.854053
2	2	5498.4	16	75	1467		1.338698
3	3	5498.4	16	100	1183	1989	1.918933
4	2	5498.4	16	90	1228		2.861848
5	2	5498.4	16	60	1095		4.212236
6	3	5498.4	16	65	1556	1207	4.755452
7	3	5498.4	16	75	1876	1247	5.669156
8	1	5498.4	16	50			6.517969
9	3	5498.4	16	100	1116	1994	7.584415
10	3	5498.4	16	55	1813	1717	9.150576
11	2	5498.4	16	75	1218		9.497424
12	3	5498.4	16	65	1093	1190	10.498499
13	2	5498.4	16	75	1760		11.227439

## USA Bin 5 Trial #5

Burst #	Pulses	Frequency (MHz)	Chirp (MHz)	PW (uS)	Inter-pulse spacing (uS)	Inter-pulse spacing (uS)	Pulse Start (S)
1	2	5496.4	11	60	1312		1.01104
2	1	5496.4	11	65			1.569879
3	1	5496.4	11	80			3.585195
4	1	5496.4	11	70			4.756514
5	1	5496.4	11	95			5.900406
6	3	5496.4	11	55	1265	1644	6.941385
7	1	5496.4	11	90			7.41979
8	3	5496.4	11	55	1939	1008	9.034906
9	3	5496.4	11	55	1611	1104	9.686948
10	3	5496.4	11	75	1855	1891	11.553534

## USA Bin 5 Trial #6

Burst #	Pulses	Frequency (MHz)	Chirp (MHz)	PW (uS)	Inter-pulse spacing (uS)	Inter-pulse spacing (uS)	Pulse Start (S)
1	1	5495.2	8	85			0.481287
2	1	5495.2	8	70			1.200201
3	3	5495.2	8	65	1762	1242	1.77249
4	1	5495.2	8	50			2.782447



5	3	5495.2	8	90	1236	1215	3.070665
6	1	5495.2	8	50			3.859438
7	2	5495.2	8	80	1816		4.26761
8	1	5495.2	8	100			5.252861
9	3	5495.2	8	90	1753	1304	5.774358
10	1	5495.2	8	80			6.93058
11	2	5495.2	8	55	1317		7.483337
12	2	5495.2	8	70	1463		8.201659
13	1	5495.2	8	50			8.793979
14	3	5495.2	8	65	1449	1723	9.251653
15	3	5495.2	8	100	1707	1892	10.317925
16	2	5495.2	8	75	1523		10.777576
17	3	5495.2	8	80	1959	1444	11.950703

## USA Bin 5 Trial #7

Burst #	Pulses	Frequency (MHz)	Chirp (MHz)	PW (uS)	Inter-pulse spacing (uS)	Inter-pulse spacing (uS)	Pulse Start (S)
1	3	5497.6	14	100	1401	1004	0.949106
2	3	5497.6	14	75	1187	1869	1.505839
3	3	5497.6	14	65	1569	1702	3.440402
4	1	5497.6	14	95			4.704601
5	2	5497.6	14	75	1894		5.411245
6	3	5497.6	14	55	1370	1771	7.0641
7	3	5497.6	14	100	1338	1955	7.797803
8	2	5497.6	14	100	1954		9.536957
9	2	5497.6	14	75	1222		9.770222
10	2	5497.6	14	90	1442		11.727182

## USA Bin 5 Trial #8

Burst #	Pulses	Frequency (MHz)	Chirp (MHz)	PW (uS)	Inter-pulse spacing (uS)	Inter-pulse spacing (uS)	Pulse Start (S)
1	1	5498	15	50			0.034463
2	2	5498	15	100	1983		1.320407
3	1	5498	15	85			2.315472
4	2	5498	15	100	1697		2.914431
5	2	5498	15	70	1382		3.586621
6	1	5498	15	100			5.059715
7	2	5498	15	75	1744		5.864193
8	2	5498	15	100	1839		6.845049
9	1	5498	15	65			7.687686
10	2	5498	15	70	1373		8.111724
11	3	5498	15	80	1628	1174	9.356095
12	1	5498	15	60			9.449308
13	1	5498	15	60			10.626052



14            3            5498            15            50            1183            1547            11.377684  
 USA Bin 5 Trial #9

Burst #	Pulses	Frequency (MHz)	Chirp (MHz)	PW (uS)	Inter-pulse spacing (uS)	Inter-pulse spacing (uS)	Pulse Start (S)
1	1	5496	10	80			0.57657
2	3	5496	10	95	1754	1519	1.045377
3	1	5496	10	75			1.766861
4	3	5496	10	75	1599	1255	3.191718
5	1	5496	10	100			3.835989
6	2	5496	10	90	1290		4.363615
7	2	5496	10	100	1426		5.977772
8	3	5496	10	65	1315	1796	6.810127
9	1	5496	10	60			6.889072
10	1	5496	10	70			8.300517
11	2	5496	10	90	1303		8.639131
12	1	5496	10	70			9.849136
13	2	5496	10	90	1304		10.363157
14	2	5496	10	90	1334		11.311122

USA Bin 5 Trial #10

Burst #	Pulses	Frequency (MHz)	Chirp (MHz)	PW (uS)	Inter-pulse spacing (uS)	Inter-pulse spacing (uS)	Pulse Start (S)
1	3	5497.2	13	50	1215	1123	0.124971
2	3	5497.2	13	60	1355	1500	1.743139
3	1	5497.2	13	75			2.702521
4	1	5497.2	13	70			3.65844
5	1	5497.2	13	90			4.751776
6	1	5497.2	13	100			5.003871
7	1	5497.2	13	60			6.71641
8	1	5497.2	13	50			7.07208
9	1	5497.2	13	100			8.185631
10	1	5497.2	13	90			9.981112
11	3	5497.2	13	95	1869	1845	10.221187
12	3	5497.2	13	95	1055	1143	11.921556

USA Bin 5 Trial #11

Burst #	Pulses	Frequency (MHz)	Chirp (MHz)	PW (uS)	Inter-pulse spacing (uS)	Inter-pulse spacing (uS)	Pulse Start (S)
1	1	5510	7	70			0.501386
2	2	5510	7	70	1468		1.165369
3	2	5510	7	100	1927		1.853672
4	2	5510	7	100	1498		3.177141
5	2	5510	7	55	1286		3.468829



6	2	5510	7	95	1258		4.288514
7	1	5510	7	75			5.194976
8	1	5510	7	80			5.854046
9	3	5510	7	70	1666	1586	6.741605
10	2	5510	7	70	1022		7.329882
11	2	5510	7	100	1072		8.582997
12	3	5510	7	70	1998	1614	9.228684
13	2	5510	7	95	1672		10.235165
14	2	5510	7	95	1043		11.162043
15	1	5510	7	65			11.217618

USA Bin 5 Trial #12

Burst #	Pulses	Frequency (MHz)	Chirp (MHz)	PW (uS)	Inter-pulse spacing (uS)	Inter-pulse spacing (uS)	Pulse Start (S)
1	1	5510	19	90			0.169372
2	2	5510	19	85	1367		2.629235
3	3	5510	19	70	1703	1878	3.555867
4	1	5510	19	85			4.881935
5	1	5510	19	85			6.104688
6	1	5510	19	55			7.78136
7	1	5510	19	60			9.039133
8	1	5510	19	90			10.978613

USA Bin 5 Trial #13

Burst #	Pulses	Frequency (MHz)	Chirp (MHz)	PW (uS)	Inter-pulse spacing (uS)	Inter-pulse spacing (uS)	Pulse Start (S)
1	3	5510	16	85	1366	1311	0.453745
2	2	5510	16	50	1922		1.710812
3	1	5510	16	75			2.191098
4	3	5510	16	60	1158	1710	3.065937
5	1	5510	16	80			3.669694
6	1	5510	16	65			4.65843
7	1	5510	16	70			5.273057
8	1	5510	16	65			6.751964
9	1	5510	16	70			7.41562
10	3	5510	16	60	1714	1442	8.439635
11	3	5510	16	85	1669	1960	8.63144
12	3	5510	16	55	1546	1051	9.588934
13	3	5510	16	95	1472	1651	10.43196
14	3	5510	16	55	1655	1291	11.520209

USA Bin 5 Trial #14

Burst #	Pulses	Frequency (MHz)	Chirp (MHz)	PW (uS)	Inter-pulse spacing (uS)	Inter-pulse spacing (uS)	Pulse Start (S)
---------	--------	-----------------	-------------	---------	--------------------------	--------------------------	-----------------



1	3	5510	9	75	1595	1611	0.578435
2	1	5510	9	100			1.345755
3	1	5510	9	70			2.004081
4	2	5510	9	90	1558		3.661637
5	1	5510	9	55			4.336212
6	1	5510	9	95			5.287131
7	2	5510	9	60	1308		5.896004
8	3	5510	9	70	1631	1844	7.039439
9	3	5510	9	100	1265	1322	7.881291
10	2	5510	9	65	1096		8.311787
11	1	5510	9	100			9.375501
12	2	5510	9	85	1481		10.512173
13	3	5510	9	90	1922	1881	11.517059

## USA Bin 5 Trial #15

Burst #	Pulses	Frequency (MHz)	Chirp (MHz)	PW (uS)	Inter-pulse spacing (uS)	Inter-pulse spacing (uS)	Pulse Start (S)
1	3	5510	20	100	1090	1708	0.718705
2	2	5510	20	65	1790		1.119193
3	1	5510	20	85			2.240347
4	3	5510	20	80	1891	1521	3.328025
5	1	5510	20	80			3.635697
6	2	5510	20	60	1631		4.98389
7	2	5510	20	90	1035		5.476632
8	1	5510	20	90			6.587831
9	3	5510	20	65	1844	1348	7.291516
10	2	5510	20	55	1199		8.213115
11	1	5510	20	55			8.612684
12	3	5510	20	80	1938	1801	9.476755
13	2	5510	20	85	1260		10.779354
14	1	5510	20	60			11.588102

## USA Bin 5 Trial #16

Burst #	Pulses	Frequency (MHz)	Chirp (MHz)	PW (uS)	Inter-pulse spacing (uS)	Inter-pulse spacing (uS)	Pulse Start (S)
1	1	5510	11	70			0.595195
2	1	5510	11	95			2.985832
3	1	5510	11	65			3.91105
4	2	5510	11	80	1264		5.107414
5	2	5510	11	75	1563		6.795874
6	2	5510	11	65	1550		8.770394
7	1	5510	11	60			9.011981
8	2	5510	11	100	1427		11.849576

## USA Bin 5 Trial #17



Burst #	Pulses	Frequency (MHz)	Chirp (MHz)	PW (uS)	Inter-pulse spacing (uS)	Inter-pulse spacing (uS)	Pulse Start (S)
1	2	5510	12	90	1522		1.014452
2	3	5510	12	90	1823	1943	2.353193
3	3	5510	12	55	1067	1856	3.776202
4	1	5510	12	75			5.979655
5	2	5510	12	100	1984		6.540873
6	2	5510	12	65	1492		8.583447
7	2	5510	12	60	1931		9.836416
8	3	5510	12	70	1468	1725	10.545772

## USA Bin 5 Trial #18

Burst #	Pulses	Frequency (MHz)	Chirp (MHz)	PW (uS)	Inter-pulse spacing (uS)	Inter-pulse spacing (uS)	Pulse Start (S)
1	1	5510	16	85			0.641739
2	3	5510	16	100	1271	1471	1.361722
3	3	5510	16	95	1482	1908	1.948984
4	1	5510	16	90			2.732211
5	2	5510	16	70	1626		2.830753
6	3	5510	16	55	1364	1572	3.675831
7	3	5510	16	65	1569	1580	4.532607
8	3	5510	16	65	1771	1148	5.172864
9	2	5510	16	95	1697		6.156586
10	3	5510	16	75	1912	1670	6.781827
11	2	5510	16	100	1909		7.491432
12	3	5510	16	55	1392	1010	8.160821
13	3	5510	16	65	1113	1145	8.91133
14	1	5510	16	95			9.633555
15	1	5510	16	60			10.540871
16	2	5510	16	100	1520		11.173778
17	1	5510	16	80			11.419325

## USA Bin 5 Trial #19

Burst #	Pulses	Frequency (MHz)	Chirp (MHz)	PW (uS)	Inter-pulse spacing (uS)	Inter-pulse spacing (uS)	Pulse Start (S)
1	1	5510	19	50			0.54935
2	2	5510	19	85	1811		1.273438
3	2	5510	19	65	1950		2.363444
4	3	5510	19	80	1679	1323	3.138737
5	1	5510	19	95			3.959294
6	2	5510	19	80	1338		4.751871
7	2	5510	19	50	1107		4.981837
8	3	5510	19	60	1206	1204	5.769438



9	3	5510	19	95	1476	1398	6.987692
10	3	5510	19	85	1273	1231	7.597449
11	1	5510	19	85			8.230698
12	1	5510	19	75			9.244036
13	2	5510	19	95	1490		10.103798
14	2	5510	19	65	1495		10.872695
15	2	5510	19	60	1439		11.536978

## USA Bin 5 Trial #20

Burst #	Pulses	Frequency (MHz)	Chirp (MHz)	PW (uS)	Inter-pulse spacing (uS)	Inter-pulse spacing (uS)	Pulse Start (S)
1	3	5510	14	85	1043	1118	0.077513
2	3	5510	14	60	1953	1227	1.86486
3	3	5510	14	60	1577	1756	2.322736
4	2	5510	14	50	1680		3.153416
5	1	5510	14	65			4.502178
6	2	5510	14	50	1119		5.467398
7	2	5510	14	90	1285		6.263288
8	2	5510	14	100	1326		7.703943
9	3	5510	14	95	1723	1287	8.03467
10	3	5510	14	70	1374	1770	9.754273
11	1	5510	14	95			10.676433
12	1	5510	14	70			11.814172

## USA Bin 5 Trial #21

Burst #	Pulses	Frequency (MHz)	Chirp (MHz)	PW (uS)	Inter-pulse spacing (uS)	Inter-pulse spacing (uS)	Pulse Start (S)
1	1	5524.4	9	75			0.707202
2	2	5524.4	9	80	1906		2.037956
3	1	5524.4	9	80			3.153815
4	1	5524.4	9	90			4.019813
5	1	5524.4	9	95			4.625734
6	1	5524.4	9	80			5.73951
7	1	5524.4	9	75			6.592596
8	2	5524.4	9	95	1452		8.703353
9	1	5524.4	9	90			8.912704
10	3	5524.4	9	50	1897	1982	10.167947
11	1	5524.4	9	85			11.276649

## USA Bin 5 Trial #22

Burst #	Pulses	Frequency (MHz)	Chirp (MHz)	PW (uS)	Inter-pulse spacing (uS)	Inter-pulse spacing (uS)	Pulse Start (S)
1	3	5525.2	7	50	1697	1338	0.244837
2	2	5525.2	7	100	1384		0.992345



3	3	5525.2	7	75	1323	1474	1.350834
4	3	5525.2	7	60	1917	1952	2.484476
5	3	5525.2	7	80	1318	1141	2.94022
6	2	5525.2	7	80	1126		3.572448
7	3	5525.2	7	55	1600	1342	3.792193
8	2	5525.2	7	70	1351		4.637762
9	2	5525.2	7	55	1054		5.416376
10	1	5525.2	7	80			5.941438
11	3	5525.2	7	80	1053	1203	6.751434
12	3	5525.2	7	80	1019	1808	7.210765
13	2	5525.2	7	100	1198		8.182601
14	3	5525.2	7	80	1354	1729	8.83051
15	1	5525.2	7	60			9.243929
16	3	5525.2	7	60	1796	1794	9.623683
17	1	5525.2	7	55			10.348578
18	1	5525.2	7	100			11.321794
19	3	5525.2	7	90	1347	1227	11.881734

## USA Bin 5 Trial #23

Burst #	Pulses	Frequency (MHz)	Chirp (MHz)	PW (uS)	Inter-pulse spacing (uS)	Inter-pulse spacing (uS)	Pulse Start (S)
1	2	5524	10	50	1631		0.567593
2	2	5524	10	50	1900		2.341631
3	1	5524	10	85			3.777428
4	1	5524	10	80			4.895554
5	2	5524	10	80	1591		5.5128
6	1	5524	10	95			7.806962
7	2	5524	10	100	1124		8.579724
8	1	5524	10	50			10.341936
9	1	5524	10	80			11.765676

## USA Bin 5 Trial #24

Burst #	Pulses	Frequency (MHz)	Chirp (MHz)	PW (uS)	Inter-pulse spacing (uS)	Inter-pulse spacing (uS)	Pulse Start (S)
1	2	5525.2	7	60	1236		1.117329
2	1	5525.2	7	65			1.982345
3	3	5525.2	7	65	1739	1067	2.903819
4	2	5525.2	7	100	1329		3.900215
5	3	5525.2	7	85	1950	1366	5.838072
6	1	5525.2	7	70			6.319584
7	2	5525.2	7	75	1296		7.427899
8	1	5525.2	7	65			9.460622
9	2	5525.2	7	50	1270		10.063994
10	3	5525.2	7	80	1693	1166	10.962338





## USA Bin 5 Trial #25

Burst #	Pulses	Frequency (MHz)	Chirp (MHz)	PW (uS)	Inter-pulse spacing (uS)	Inter-pulse spacing (uS)	Pulse Start (S)
1	2	5520	20	90	1915		0.758801
2	2	5520	20	65	1923		1.673161
3	1	5520	20	85			3.049865
4	2	5520	20	80	1502		3.885893
5	1	5520	20	90			4.960446
6	3	5520	20	80	1206	1410	6.134034
7	3	5520	20	50	1565	1522	6.554786
8	1	5520	20	60			8.042345
9	1	5520	20	100			9.65914
10	1	5520	20	50			10.488014
11	1	5520	20	75			11.008318

## USA Bin 5 Trial #26

Burst #	Pulses	Frequency (MHz)	Chirp (MHz)	PW (uS)	Inter-pulse spacing (uS)	Inter-pulse spacing (uS)	Pulse Start (S)
1	2	5524	10	85	1694		0.064195
2	3	5524	10	75	1686	1582	1.170829
3	2	5524	10	100	1486		2.3717
4	1	5524	10	55			3.54212
5	3	5524	10	75	1090	1003	4.05631
6	3	5524	10	70	1147	1180	5.895192
7	3	5524	10	90	1404	1135	6.530272
8	3	5524	10	90	1461	1615	7.808665
9	2	5524	10	55	1641		8.285012
10	3	5524	10	80	1708	1585	9.615666
11	3	5524	10	85	1242	1409	10.803747
12	2	5524	10	90	1725		11.276255

## USA Bin 5 Trial #27

Burst #	Pulses	Frequency (MHz)	Chirp (MHz)	PW (uS)	Inter-pulse spacing (uS)	Inter-pulse spacing (uS)	Pulse Start (S)
1	1	5520.8	18	75			0.080756
2	2	5520.8	18	65	1667		1.895901
3	3	5520.8	18	70	1518	1388	2.861873
4	1	5520.8	18	65			3.642826
5	2	5520.8	18	80	1777		5.339366
6	1	5520.8	18	90			6.260865
7	2	5520.8	18	80	1247		6.660955
8	2	5520.8	18	60	1935		8.07795
9	2	5520.8	18	85	1193		9.27208



10	1	5520.8	18	60		10.465948
11	2	5520.8	18	75	1609	11.499907

## USA Bin 5 Trial #28

Burst #	Pulses	Frequency (MHz)	Chirp (MHz)	PW (uS)	Inter-pulse spacing (uS)	Inter-pulse spacing (uS)	Pulse Start (S)
1	2	5520	20	100	1565		0.122576
2	1	5520	20	85			0.880474
3	1	5520	20	65			1.553232
4	2	5520	20	80	1759		2.025973
5	2	5520	20	80	1659		2.931706
6	2	5520	20	95	1179		3.03098
7	1	5520	20	95			3.963453
8	3	5520	20	75	1013	1068	4.741613
9	1	5520	20	55			4.948259
10	2	5520	20	55	1883		5.862093
11	2	5520	20	85	1167		6.56653
12	3	5520	20	70	1227	1293	7.024063
13	3	5520	20	50	1405	1730	7.441472
14	1	5520	20	70			7.892734
15	2	5520	20	70	1225		8.667244
16	1	5520	20	75			9.07631
17	2	5520	20	65	1979		9.80849
18	2	5520	20	60	1800		10.317746
19	3	5520	20	70	1326	1215	11.070465
20	2	5520	20	60	1161		11.675632

## USA Bin 5 Trial #29

Burst #	Pulses	Frequency (MHz)	Chirp (MHz)	PW (uS)	Inter-pulse spacing (uS)	Inter-pulse spacing (uS)	Pulse Start (S)
1	1	5521.2	17	95			0.42912
2	3	5521.2	17	80	1125	1531	1.266486
3	2	5521.2	17	95	1993		2.374016
4	3	5521.2	17	55	1572	1320	4.22436
5	3	5521.2	17	100	1685	1221	4.440697
6	1	5521.2	17	75			6.357325
7	1	5521.2	17	95			7.445717
8	3	5521.2	17	95	1789	1369	8.687285
9	1	5521.2	17	70			9.019925
10	3	5521.2	17	95	1728	1266	10.433235
11	1	5521.2	17	75			11.086973

## USA Bin 5 Trial #30



Burst #	Pulses	Frequency (MHz)	Chirp (MHz)	PW (uS)	Inter-pulse spacing (uS)	Inter-pulse spacing (uS)	Pulse Start (S)
1	1	5523.6	11	60			0.042081
2	2	5523.6	11	80	1693		1.422578
3	2	5523.6	11	50	1315		2.724962
4	3	5523.6	11	85	1160	1732	3.466092
5	3	5523.6	11	100	1975	1632	4.441871
6	2	5523.6	11	95	1155		5.688568
7	3	5523.6	11	65	1164	1060	6.996487
8	1	5523.6	11	100			8.164451
9	2	5523.6	11	95	1583		8.960696
10	2	5523.6	11	85	1765		9.818373
11	3	5523.6	11	60	1296	1503	11.574381

## USA Frequency Hopping Trial #1

Hop #	Freq (GHz)	Pulse Start (mS)
3	5492	9
19	5524	57
29	5498	87
30	5528	90
74	5509	222
85	5522	255
90	5527	270

## USA Frequency Hopping Trial #2

Hop #	Freq (GHz)	Pulse Start (mS)
15	5523	45
24	5503	72
43	5520	129
46	5513	138
62	5504	186
70	5516	210
73	5508	219
98	5498	294

## USA Frequency Hopping Trial #3

Hop #	Freq (GHz)	Pulse Start (mS)
27	5517	81
96	5506	288

## USA Frequency Hopping Trial #4

Hop #	Freq (GHz)	Pulse Start (mS)
15	5504	45
39	5525	117
58	5513	174
68	5519	204
75	5522	225
76	5500	228
85	5518	255

## USA Frequency Hopping Trial #5

Hop #	Freq (GHz)	Pulse Start (mS)
21	5496	63
26	5524	78
37	5498	111
41	5522	123
43	5510	129

45	5518	135
50	5509	150
55	5504	165
63	5526	189
68	5508	204
86	5519	258
90	5507	270

## USA Frequency Hopping Trial #6

Hop #	Freq (GHz)	Pulse Start (mS)
6	5518	18
7	5522	21
9	5524	27
22	5495	66
70	5510	210
75	5497	225
79	5517	237

## USA Frequency Hopping Trial #7

Hop #	Freq (GHz)	Pulse Start (mS)
4	5505	12
42	5515	126
63	5493	189
84	5509	252
88	5521	264

## USA Frequency Hopping Trial #8

Hop #	Freq (GHz)	Pulse Start (mS)
2	5501	6
37	5510	111
38	5527	114
53	5509	159
59	5492	177
76	5499	228
83	5514	249
93	5521	279

## USA Frequency Hopping Trial #9

Hop #	Freq (GHz)	Pulse Start (mS)
8	5516	24
9	5510	27
15	5527	45
18	5513	54
21	5523	63

22	5492	66
32	5526	96
62	5521	186
64	5503	192
72	5515	216
85	5512	255

## USA Frequency Hopping Trial #10

Hop #	Freq (GHz)	Pulse Start (mS)
20	5493	60
40	5502	120
76	5517	228
85	5509	255
88	5516	264

## USA Frequency Hopping Trial #11

Hop #	Freq (GHz)	Pulse Start (mS)
6	5513	18
60	5494	180
67	5514	201
85	5511	255
87	5518	261
90	5525	270
99	5517	297

## USA Frequency Hopping Trial #12

Hop #	Freq (GHz)	Pulse Start (mS)
1	5503	3
3	5512	9
7	5523	21
39	5496	117
40	5515	120
64	5506	192
68	5498	204
69	5517	207
72	5520	216
85	5527	255
95	5494	285

## USA Frequency Hopping Trial #13

Hop #	Freq (GHz)	Pulse Start (mS)
5	5513	15
23	5523	69
24	5527	72



35	5517	105
37	5521	111
51	5505	153
59	5493	177
62	5515	186
63	5510	189
69	5494	207
78	5503	234
92	5511	276
95	5525	285

## USA Frequency Hopping Trial #14

Hop #	Freq (GHz)	Pulse Start (mS)
3	5523	9
7	5501	21
24	5506	72
26	5500	78
36	5515	108
41	5494	123
44	5513	132
68	5496	204
77	5510	231

## USA Frequency Hopping Trial #15

Hop #	Freq (GHz)	Pulse Start (mS)
24	5521	72
25	5495	75
32	5501	96
34	5494	102
36	5526	108
40	5525	120
43	5508	129
44	5522	132
75	5515	225
95	5492	285
99	5507	297

## USA Frequency Hopping Trial #16

Hop #	Freq (GHz)	Pulse Start (mS)
25	5499	75
29	5524	87
76	5517	228
87	5520	261
92	5495	276

## USA Frequency Hopping Trial #17

	Freq	Pulse Start
Hop #	(GHz)	(mS)
79	5524	237
83	5513	249
92	5497	276

## USA Frequency Hopping Trial #18

	Freq	Pulse Start
Hop #	(GHz)	(mS)
52	5493	156
61	5527	183
62	5508	186

## USA Frequency Hopping Trial #19

	Freq	Pulse Start
Hop #	(GHz)	(mS)
7	5528	21
70	5504	210
99	5517	297

## USA Frequency Hopping Trial #20

	Freq	Pulse Start
Hop #	(GHz)	(mS)
23	5528	69
29	5524	87
32	5504	96
56	5508	168
59	5498	177
72	5512	216
81	5501	243
88	5523	264
89	5496	267

## USA Frequency Hopping Trial #21

	Freq	Pulse Start
Hop #	(GHz)	(mS)
9	5516	27
29	5526	87
79	5494	237
90	5502	270

## USA Frequency Hopping Trial #22

	Freq	Pulse Start
Hop #	(GHz)	(mS)
8	5527	24
20	5508	60
26	5501	78
31	5520	93



35	5523	105
43	5495	129
46	5525	138
50	5509	150
62	5492	186
74	5515	222
99	5526	297

## USA Frequency Hopping Trial #23

Hop #	Freq (GHz)	Pulse Start (mS)
0	5500	0
7	5493	21
33	5518	99
34	5508	102
48	5523	144
51	5525	153
63	5498	189
76	5526	228
86	5515	258
87	5516	261
98	5505	294

## USA Frequency Hopping Trial #24

Hop #	Freq (GHz)	Pulse Start (mS)
14	5507	42
16	5501	48
30	5493	90
37	5497	111
50	5494	150
51	5514	153
76	5510	228
86	5526	258

## USA Frequency Hopping Trial #25

Hop #	Freq (GHz)	Pulse Start (mS)
13	5494	39
25	5522	75
31	5493	93
36	5511	108
58	5505	174
64	5526	192
71	5503	213
99	5495	297

## USA Frequency Hopping Trial #26



Hop #	Freq (GHz)	Pulse Start (mS)
13	5524	39
72	5511	216
73	5506	219
74	5523	222
78	5494	234

## USA Frequency Hopping Trial #27

Hop #	Freq (GHz)	Pulse Start (mS)
5	5511	15
9	5527	27
23	5503	69
28	5496	84
57	5517	171
66	5526	198
72	5523	216
73	5520	219
77	5509	231
80	5513	240
85	5506	255
88	5521	264

## USA Frequency Hopping Trial #28

Hop #	Freq (GHz)	Pulse Start (mS)
4	5516	12
6	5509	18
12	5507	36
22	5528	66
31	5526	93
35	5500	105
36	5495	108
49	5505	147
57	5523	171
60	5497	180
68	5506	204
74	5496	222

## USA Frequency Hopping Trial #29

Hop #	Freq (GHz)	Pulse Start (mS)
7	5501	21
11	5518	33
36	5528	108
38	5521	114



42	5512	126
53	5520	159
79	5511	237
80	5494	240
90	5523	270

## USA Frequency Hopping Trial #30

Hop #	Freq (GHz)	Pulse Start (mS)
13	5505	39
22	5519	66
36	5501	108
40	5504	120
57	5518	171
66	5510	198
78	5508	234
96	5514	288



**Channel 5530 MHz, 80MHz BW, Statistical Performance**

**USA Bin 1A/1B**

freq=5530, rate=m0x1, bw=76.0

Trial	Frequency	Pulses	PW (uS)	PRI (uS)	1=Detection 0=No Detection	Detection Percentage	Limit
1	5490	78	1	678	1	96.7%	60.0%
2	5490	57	1	938	1		
3	5496	86	1	618	1		
4	5496	81	1	658	1		
5	5502	83	1	638	1		
6	5502	62	1	858	1		
7	5508	57	1	938	1		
8	5508	72	1	738	1		
9	5514	102	1	518	1		
10	5514	89	1	598	1		
11	5520	76	1	698	1		
12	5520	86	1	618	1		
13	5526	74	1	718	0		
14	5526	62	1	858	1		
15	5530	59	1	898	1		
16	5530	97	1	545	1		
17	5534	45	1	1179	1		
18	5534	43	1	1249	1		
19	5540	70	1	759	1		
20	5540	41	1	1306	1		
21	5546	24	1	2228	1		
22	5546	48	1	1108	1		
23	5552	38	1	1414	1		
24	5552	65	1	815	1		
25	5558	30	1	1783	1		
26	5558	19	1	2798	1		
27	5564	20	1	2683	1		
28	5564	30	1	1804	1		
29	5570	19	1	2864	1		
30	5570	32	1	1694	1		



**USA Bin 1A/1B**

freq=5530, rate=m0x1, bw=76.0

Trial	Frequency	Pulses	PW (uS)	PRI (uS)	1=Detection 0=No Detection	Detection Percentage	Limit
1	5490	99	1	538	1	93.3%	60.0%
2	5490	59	1	898	1		
3	5496	68	1	778	1		
4	5496	59	1	898	1		
5	5502	89	1	598	1		
6	5502	18	1	3066	1		
7	5508	63	1	838	1		
8	5508	92	1	578	1		
9	5514	65	1	818	1		
10	5514	65	1	818	1		
11	5520	62	1	858	1		
12	5520	70	1	758	1		
13	5526	70	1	758	1		
14	5526	68	1	778	1		
15	5530	74	1	718	0		
16	5530	20	1	2672	1		
17	5534	23	1	2306	1		
18	5534	22	1	2503	1		
19	5540	36	1	1483	1		
20	5540	18	1	3042	1		
21	5546	18	1	2977	1		
22	5546	65	1	815	1		
23	5552	23	1	2375	1		
24	5552	28	1	1903	1		
25	5558	39	1	1365	1		
26	5558	20	1	2730	1		
27	5564	27	1	1970	1		
28	5564	43	1	1229	1		
29	5570	21	1	2629	1		
30	5570	37	1	1464	0		



**USA Bin  
2**

freq=5530, rate=m0x1, bw=76.0

Trial	Frequency	Pulses	PW (uS)	PRI (uS)	1=Detection 0=No Detection	Detection Percentage	Limit
1	5490	28	3.7	229	1	80.0%	60.0%
2	5490	24	5	227	1		
3	5496	28	2.5	229	1		
4	5496	24	3.6	191	1		
5	5502	23	5	220	1		
6	5502	23	2.2	164	0		
7	5508	29	2.4	155	1		
8	5508	24	3.1	218	1		
9	5514	24	1.7	192	1		
10	5514	28	4.9	189	0		
11	5520	26	2.3	206	1		
12	5520	27	2.6	208	1		
13	5526	26	2.2	205	1		
14	5526	27	4.1	169	1		
15	5530	26	3.2	161	1		
16	5530	26	1.9	166	1		
17	5534	23	1.6	201	1		
18	5534	23	2.1	178	1		
19	5540	28	4.1	164	1		
20	5540	27	2.2	230	1		
21	5546	25	4.9	157	1		
22	5546	24	4.5	190	1		
23	5552	27	4.4	175	0		
24	5552	25	4.4	172	1		
25	5558	29	1	164	0		
26	5558	25	2.6	216	1		
27	5564	26	4.8	157	0		
28	5564	26	4.2	216	1		
29	5570	23	4.9	164	0		
30	5570	24	1.8	206	1		



**USA Bin  
3**

freq=5530, rate=m0x1, bw=76.0

Trial	Frequency	Pulses	PW (uS)	PRI (uS)	1=Detection 0=No Detection	Detection Percentage	Limit
1	5490	17	9.8	290	1	86.7%	60.0%
2	5490	17	9.7	272	1		
3	5496	18	8.3	294	1		
4	5496	16	9.4	471	1		
5	5502	17	9.7	340	1		
6	5502	17	6.8	362	1		
7	5508	16	7.7	249	1		
8	5508	18	6.4	314	1		
9	5514	18	6.7	287	1		
10	5514	18	8.8	225	1		
11	5520	18	7.6	388	1		
12	5520	18	8.1	460	1		
13	5526	18	8.9	454	1		
14	5526	16	6	249	1		
15	5530	17	8.6	288	1		
16	5530	17	6.4	384	0		
17	5534	16	9.7	401	1		
18	5534	18	7.2	227	1		
19	5540	17	8.3	300	1		
20	5540	18	6.4	246	1		
21	5546	18	6.4	302	1		
22	5546	18	7	461	1		
23	5552	16	7.8	336	1		
24	5552	18	6.9	327	0		
25	5558	18	9.9	331	1		
26	5558	17	7.3	302	1		
27	5564	18	9.5	200	1		
28	5564	18	9.7	274	1		
29	5570	17	9.1	483	0		
30	5570	16	8.1	303	0		

**USA Bin****4**

freq=5530, rate=m0x1, bw=76.0

Trial	Frequency	Pulses	PW (uS)	PRI (uS)	1=Detection 0=No Detection	Detection Percentage	Limit
1	5490	13	12.8	220	1	90.0%	60.0%
2	5490	13	14.3	267	1		
3	5496	15	11.8	283	1		
4	5496	13	16.9	463	1		
5	5502	15	17.4	452	1		
6	5502	12	15.7	424	1		
7	5508	12	12.3	495	1		
8	5508	16	13.5	479	0		
9	5514	15	17	492	1		
10	5514	13	15.8	414	1		
11	5520	15	16.6	287	1		
12	5520	14	19.4	279	1		
13	5526	14	18.4	286	1		
14	5526	12	13.1	299	1		
15	5530	14	13.3	257	1		
16	5530	13	14.6	487	1		
17	5534	16	11.6	414	0		
18	5534	14	13.2	482	1		
19	5540	12	13.6	235	0		
20	5540	12	18.7	350	1		
21	5546	13	18.2	400	1		
22	5546	14	11.6	364	1		
23	5552	12	18.8	330	1		
24	5552	15	14.7	427	1		
25	5558	15	17.5	203	1		
26	5558	12	12.5	449	1		
27	5564	14	12.3	379	1		
28	5564	15	16.9	276	1		
29	5570	14	19	417	1		
30	5570	13	17.8	268	1		





USA  
Bin  
5

freq=5530, rate=m0x1, bw=76.0

Trial	Burst #	Pulses	Frequency (MHz)	Chirp (MHz)	PW (uS)	Inter-pulse spacing (uS)	Inter-pulse spacing (uS)	Pulse Start (S)	1=Detection 0=No Detection	Detection Percentage	Limit
1	1	2	5494.4	6	90	1878		0.527538	1	100.0%	80.0%
2	1	3	5495.2	8	55	1269	1165	0.515975	1		
3	1	3	5494.8	7	70	1466	1926	0.708538	1		
4	1	2	5498	15	90	1126		0.379861	1		
5	1	1	5500	20	100			0.544421	1		
6	1	1	5495.6	9	65			0.410507	1		
7	1	2	5498.8	17	65	1312		0.834105	1		
8	1	2	5500	20	50	1390		0.258487	1		
9	1	1	5498.8	17	85			0.021272	1		
10	1	1	5499.6	19	55			1.092394	1		
11	1	2	5530	13	55	1619		0.543511	1		
12	1	3	5530	14	95	1446	1524	1.013737	1		
13	1	3	5530	19	60	1783	1086	0.113887	1		
14	1	1	5530	16	55			0.493028	1		
15	1	3	5530	6	50	1895	1068	0.624269	1		
16	1	3	5530	7	80	1620	1793	0.346691	1		
17	1	3	5530	8	60	1302	1612	0.401274	1		
18	1	3	5530	15	60	1223	1333	0.433776	1		
19	1	2	5530	10	100	1605		0.589135	1		
20	1	3	5530	15	95	1940	1838	0.509965	1		
21	1	3	5563.2	12	90	1750	1321	0.000314	1		
22	1	1	5562	15	75			0.310557	1		
23	1	2	5565.6	6	65	1739		0.648253	1		
24	1	1	5562.4	14	75			0.68883	1		
25	1	2	5565.2	7	80	1335		0.340653	1		
26	1	1	5562.4	14	95			0.292705	1		
27	1	2	5565.2	7	80	1922		0.307929	1		
28	1	2	5564	10	55	1334		0.63894	1		
29	1	1	5560	20	85			0.262217	1		
30	1	3	5566	5	55	1843	1449	0.544306	1		

In addition an average minimum percentage of successful detection across all four Short pulse radar test waveforms is required and is calculated as follows:

$$\frac{P_d 1 + P_d 2 + P_d 3 + P_d 4}{4} = (96.7\% + 93.3\% + 80.0\% + 86.7\% + 90.0)/5 = 89.3\% (>80\%)$$

**USA Frequency Hopping**

freq=5530, rate=m0x1, bw=76.0

Trial	Hop #	Freq (GHz)	Pulse Start (mS)	1=Detection 0=No Detection	Detection Percentage	Limit
1	6	5514	18	1	100.0%	70.0%
2	39	5511	117	1		
3	7	5531	21	1		
4	11	5504	33	1		
5	5	5548	15	1		
6	0	5534	0	1		
7	0	5517	0	1		
8	2	5512	6	1		
9	11	5492	33	1		
10	16	5540	48	1		
11	7	5554	21	1		
12	14	5566	42	1		
13	3	5530	9	1		
14	5	5500	15	1		
15	2	5531	6	1		
16	21	5499	63	1		
17	0	5527	0	1		
18	6	5562	18	1		
19	4	5568	12	1		
20	2	5548	6	1		
21	0	5509	0	1		
22	0	5516	0	1		
23	7	5532	21	1		
24	18	5523	54	1		
25	5	5511	15	1		
26	13	5496	39	1		
27	16	5547	48	1		
28	3	5521	9	1		
29	12	5538	36	1		
30	0	5502	0	1		



## USA Bin 5 Trial #1

Burst #	Pulses	Frequency (MHz)	Chirp (MHz)	PW (uS)	Inter-pulse spacing (uS)	Inter-pulse spacing (uS)	Pulse Start (S)
1	2	5494.4	6	90	1878		0.527538
2	3	5494.4	6	55	1143	1077	1.639071
3	3	5494.4	6	55	1166	1252	3.717444
4	1	5494.4	6	90			4.447025
5	3	5494.4	6	75	1972	1474	5.584445
6	1	5494.4	6	50			6.88831
7	2	5494.4	6	90	1563		8.258724
8	2	5494.4	6	90	1777		10.133846
9	3	5494.4	6	55	1446	1345	11.708298

## USA Bin 5 Trial #2

Burst #	Pulses	Frequency (MHz)	Chirp (MHz)	PW (uS)	Inter-pulse spacing (uS)	Inter-pulse spacing (uS)	Pulse Start (S)
1	3	5495.2	8	55	1269	1165	0.515975
2	2	5495.2	8	80	1093		1.580578
3	2	5495.2	8	90	1891		2.107772
4	1	5495.2	8	70			3.1572
5	3	5495.2	8	95	1728	1970	3.271678
6	3	5495.2	8	75	1865	1175	4.306539
7	3	5495.2	8	50	1089	1506	4.861364
8	2	5495.2	8	65	1262		5.741421
9	2	5495.2	8	80	1239		7.116134
10	3	5495.2	8	90	1369	1579	7.581007
11	2	5495.2	8	60	1060		8.164062
12	1	5495.2	8	75			9.507295
13	1	5495.2	8	80			10.161097
14	1	5495.2	8	75			10.74644
15	3	5495.2	8	95	1399	1491	11.741783

## USA Bin 5 Trial #3

Burst #	Pulses	Frequency (MHz)	Chirp (MHz)	PW (uS)	Inter-pulse spacing (uS)	Inter-pulse spacing (uS)	Pulse Start (S)
1	3	5494.8	7	70	1466	1926	0.708538
2	1	5494.8	7	100			0.970549
3	2	5494.8	7	65	1320		2.258233
4	3	5494.8	7	50	1333	1336	2.778225
5	2	5494.8	7	65	1703		3.725614
6	1	5494.8	7	95			5.155361
7	2	5494.8	7	90	1221		6.306268
8	1	5494.8	7	65			6.660123



9	1	5494.8	7	70			7.430482
10	3	5494.8	7	60	1860	1635	8.50408
11	1	5494.8	7	75			9.246205
12	3	5494.8	7	70	1100	1428	10.359219
13	1	5494.8	7	65			11.90085

## USA Bin 5 Trial #4

Burst #	Pulses	Frequency (MHz)	Chirp (MHz)	PW (uS)	Inter-pulse spacing (uS)	Inter-pulse spacing (uS)	Pulse Start (S)
1	2	5498	15	90	1126		0.379861
2	1	5498	15	90			1.347996
3	2	5498	15	85	1471		1.600105
4	3	5498	15	65	1726	1072	2.963993
5	1	5498	15	90			3.236537
6	1	5498	15	65			4.786729
7	3	5498	15	60	1602	1126	5.31217
8	1	5498	15	90			5.886672
9	2	5498	15	85	1444		7.051867
10	1	5498	15	75			7.330334
11	1	5498	15	75			8.616474
12	2	5498	15	95	1176		8.870037
13	3	5498	15	70	1335	1503	10.036747
14	3	5498	15	90	1240	1759	10.837323
15	2	5498	15	55	1557		11.501146

## USA Bin 5 Trial #5

Burst #	Pulses	Frequency (MHz)	Chirp (MHz)	PW (uS)	Inter-pulse spacing (uS)	Inter-pulse spacing (uS)	Pulse Start (S)
1	1	5500	20	100			0.544421
2	3	5500	20	55	1972	1267	1.144652
3	1	5500	20	65			2.068155
4	2	5500	20	70	1656		3.220583
5	2	5500	20	100	1060		4.131996
6	1	5500	20	95			4.951395
7	1	5500	20	85			5.371207
8	1	5500	20	100			6.5713
9	1	5500	20	75			7.098462
10	1	5500	20	55			8.385852
11	1	5500	20	95			8.804789
12	1	5500	20	65			9.49053
13	2	5500	20	60	1810		10.554968
14	3	5500	20	70	1493	1725	11.676705

## USA Bin 5 Trial #6



Burst #	Pulses	Frequency (MHz)	Chirp (MHz)	PW (uS)	Inter-pulse spacing (uS)	Inter-pulse spacing (uS)	Pulse Start (S)
1	1	5495.6	9	65			0.410507
2	3	5495.6	9	85	1203	1988	1.290941
3	1	5495.6	9	65			2.091898
4	2	5495.6	9	100	1357		2.749053
5	1	5495.6	9	50			3.429018
6	3	5495.6	9	100	1789	1909	3.693703
7	2	5495.6	9	85	1188		4.514458
8	2	5495.6	9	80	1764		5.078162
9	1	5495.6	9	75			6.191743
10	3	5495.6	9	90	1530	1654	6.381576
11	1	5495.6	9	60			7.728762
12	2	5495.6	9	85	1513		8.459007
13	3	5495.6	9	65	1581	1580	8.527995
14	1	5495.6	9	95			9.55244
15	2	5495.6	9	85	1189		10.379388
16	3	5495.6	9	50	1228	1875	11.247925
17	1	5495.6	9	65			11.564037

## USA Bin 5 Trial #7

Burst #	Pulses	Frequency (MHz)	Chirp (MHz)	PW (uS)	Inter-pulse spacing (uS)	Inter-pulse spacing (uS)	Pulse Start (S)
1	2	5498.8	17	65	1312		0.834105
2	1	5498.8	17	75			2.610015
3	2	5498.8	17	65	1468		3.530728
4	1	5498.8	17	50			5.159707
5	3	5498.8	17	90	1311	1419	5.515037
6	3	5498.8	17	55	1103	1686	7.830209
7	3	5498.8	17	55	1277	1032	9.322097
8	2	5498.8	17	80	1730		9.635388
9	1	5498.8	17	95			10.94383

## USA Bin 5 Trial #8

Burst #	Pulses	Frequency (MHz)	Chirp (MHz)	PW (uS)	Inter-pulse spacing (uS)	Inter-pulse spacing (uS)	Pulse Start (S)
1	2	5500	20	50	1390		0.258487
2	3	5500	20	80	1776	1316	1.329913
3	2	5500	20	65	1450		1.871413
4	3	5500	20	100	1446	1204	3.194983
5	3	5500	20	50	1483	1816	3.903329
6	2	5500	20	50	1957		4.272836
7	1	5500	20	80			5.012536



8	1	5500	20	70			5.889243
9	2	5500	20	65	1562		6.416126
10	1	5500	20	60			7.387619
11	1	5500	20	85			8.694163
12	2	5500	20	85	1381		8.892206
13	3	5500	20	95	1418	1403	9.666278
14	3	5500	20	65	1543	1362	10.908297
15	2	5500	20	90	1066		11.462236

USA Bin 5 Trial #9

Burst #	Pulses	Frequency (MHz)	Chirp (MHz)	PW (uS)	Inter-pulse spacing (uS)	Inter-pulse spacing (uS)	Pulse Start (S)
1	1	5498.8	17	85			0.021272
2	3	5498.8	17	85	1291	1973	0.950823
3	1	5498.8	17	65			2.021708
4	2	5498.8	17	50	1687		2.730079
5	2	5498.8	17	80	1121		3.406177
6	2	5498.8	17	80	1829		4.265546
7	1	5498.8	17	60			4.761987
8	1	5498.8	17	55			5.986279
9	1	5498.8	17	50			6.294157
10	1	5498.8	17	90			6.871096
11	1	5498.8	17	50			7.90471
12	1	5498.8	17	100			8.521112
13	1	5498.8	17	50			9.116233
14	2	5498.8	17	90	1645		10.454264
15	2	5498.8	17	100	1757		11.110256
16	3	5498.8	17	95	1387	1224	11.705323

USA Bin 5 Trial #10

Burst #	Pulses	Frequency (MHz)	Chirp (MHz)	PW (uS)	Inter-pulse spacing (uS)	Inter-pulse spacing (uS)	Pulse Start (S)
1	1	5499.6	19	55			1.092394
2	3	5499.6	19	50	1596	1073	1.248938
3	3	5499.6	19	70	1332	1882	2.983547
4	1	5499.6	19	90			4.064539
5	3	5499.6	19	60	1699	1908	5.881433
6	1	5499.6	19	85			6.478791
7	3	5499.6	19	75	1331	1706	7.339107
8	2	5499.6	19	80	1156		8.609498
9	2	5499.6	19	55	1097		10.185462
10	2	5499.6	19	90	1750		11.787754

USA Bin 5 Trial #11



Burst #	Pulses	Frequency (MHz)	Chirp (MHz)	PW (uS)	Inter-pulse spacing (uS)	Inter-pulse spacing (uS)	Pulse Start (S)
1	2	5530	13	55	1619		0.543511
2	1	5530	13	95			1.009273
3	3	5530	13	80	1480	1489	1.446746
4	2	5530	13	100	1989		2.72487
5	3	5530	13	70	1291	1978	3.239586
6	1	5530	13	50			3.73238
7	2	5530	13	65	1130		4.534495
8	3	5530	13	100	1045	1217	5.64446
9	1	5530	13	60			6.190389
10	3	5530	13	55	1038	1561	6.398731
11	3	5530	13	100	1574	1257	7.322688
12	2	5530	13	50	1633		8.230231
13	2	5530	13	90	1250		8.890569
14	3	5530	13	50	1930	1571	9.59286
15	1	5530	13	70			10.405098
16	1	5530	13	80			11.113083
17	1	5530	13	75			11.784097

## USA Bin 5 Trial #12

Burst #	Pulses	Frequency (MHz)	Chirp (MHz)	PW (uS)	Inter-pulse spacing (uS)	Inter-pulse spacing (uS)	Pulse Start (S)
1	3	5530	14	95	1446	1524	1.013737
2	3	5530	14	95	1684	1543	1.458759
3	1	5530	14	55			3.161276
4	3	5530	14	90	1416	1184	3.508104
5	2	5530	14	85	1954		4.896298
6	1	5530	14	75			5.625368
7	2	5530	14	100	1093		7.208913
8	3	5530	14	50	1648	1563	7.660345
9	3	5530	14	50	1569	1110	8.752077
10	2	5530	14	80	1259		10.119826
11	3	5530	14	90	1887	1908	11.593608

## USA Bin 5 Trial #13

Burst #	Pulses	Frequency (MHz)	Chirp (MHz)	PW (uS)	Inter-pulse spacing (uS)	Inter-pulse spacing (uS)	Pulse Start (S)
1	3	5530	19	60	1783	1086	0.113887
2	2	5530	19	90	1954		1.406715
3	3	5530	19	60	1355	1940	2.152663
4	1	5530	19	65			3.019516
5	2	5530	19	95	1774		3.922236



6	2	5530	19	60	1996		4.607863
7	3	5530	19	100	1142	1128	5.020326
8	2	5530	19	70	1836		5.910548
9	2	5530	19	80	1096		6.443912
10	3	5530	19	60	1283	1861	7.822308
11	1	5530	19	95			8.171149
12	1	5530	19	70			9.38122
13	2	5530	19	50	1789		9.668928
14	1	5530	19	70			10.738741
15	1	5530	19	55			11.903242

## USA Bin 5 Trial #14

Burst #	Pulses	Frequency (MHz)	Chirp (MHz)	PW (uS)	Inter-pulse spacing (uS)	Inter-pulse spacing (uS)	Pulse Start (S)
1	1	5530	16	55			0.493028
2	2	5530	16	100	1029		1.320723
3	1	5530	16	95			1.942838
4	3	5530	16	80	1586	1241	2.585506
5	1	5530	16	75			3.514333
6	3	5530	16	80	1686	1035	3.85973
7	1	5530	16	85			4.414926
8	1	5530	16	95			5.129639
9	1	5530	16	65			6.059973
10	1	5530	16	75			6.573523
11	3	5530	16	90	1956	1053	7.356261
12	1	5530	16	100			8.075724
13	2	5530	16	70	1438		8.592101
14	3	5530	16	100	1694	1161	9.325854
15	2	5530	16	100	1389		10.433984
16	1	5530	16	100			10.667761
17	3	5530	16	75	1641	1194	11.797761

## USA Bin 5 Trial #15

Burst #	Pulses	Frequency (MHz)	Chirp (MHz)	PW (uS)	Inter-pulse spacing (uS)	Inter-pulse spacing (uS)	Pulse Start (S)
1	3	5530	6	50	1895	1068	0.624269
2	2	5530	6	95	1861		1.042699
3	1	5530	6	90			1.504321
4	3	5530	6	75	1523	1201	2.169295
5	1	5530	6	85			2.565634
6	2	5530	6	85	1735		3.622865
7	1	5530	6	70			4.054572
8	1	5530	6	85			4.585251
9	2	5530	6	55	1394		5.188074





10	3	5530	6	90	1805	1557	6.27199
11	3	5530	6	65	1143	1541	6.620955
12	2	5530	6	55	1093		7.065377
13	3	5530	6	85	1044	1960	7.905573
14	2	5530	6	100	1611		8.311902
15	2	5530	6	55	1897		9.431744
16	1	5530	6	65			9.725613
17	1	5530	6	60			10.191194
18	1	5530	6	95			11.240778
19	1	5530	6	75			11.519393

## USA Bin 5 Trial #16

Burst #	Pulses	Frequency (MHz)	Chirp (MHz)	PW (uS)	Inter-pulse spacing (uS)	Inter-pulse spacing (uS)	Pulse Start (S)
1	3	5530	7	80	1620	1793	0.346691
2	3	5530	7	95	1251	1643	1.006127
3	3	5530	7	100	1670	1573	1.755908
4	3	5530	7	60	1726	1899	2.519531
5	2	5530	7	60	1314		3.034848
6	2	5530	7	90	1718		4.136321
7	3	5530	7	65	1246	1484	4.630582
8	3	5530	7	100	1790	1757	5.496627
9	1	5530	7	95			6.471566
10	1	5530	7	85			6.867067
11	3	5530	7	60	1532	1349	7.587798
12	2	5530	7	95	1197		8.264838
13	3	5530	7	85	1586	1550	9.741896
14	3	5530	7	50	1861	1038	10.299822
15	2	5530	7	75	1364		10.581939
16	1	5530	7	65			11.801069

## USA Bin 5 Trial #17

Burst #	Pulses	Frequency (MHz)	Chirp (MHz)	PW (uS)	Inter-pulse spacing (uS)	Inter-pulse spacing (uS)	Pulse Start (S)
1	3	5530	8	60	1302	1612	0.401274
2	2	5530	8	100	1437		0.725527
3	2	5530	8	50	1772		1.788534
4	1	5530	8	80			1.921055
5	1	5530	8	100			2.67382
6	2	5530	8	100	1498		3.04689
7	1	5530	8	85			3.899341
8	1	5530	8	95			4.771206
9	1	5530	8	100			5.040612
10	2	5530	8	90	1833		5.770709



11	1	5530	8	100			6.147812
12	3	5530	8	90	1535	1057	6.797864
13	1	5530	8	50			7.699988
14	2	5530	8	70	1418		7.989422
15	3	5530	8	100	1069	1248	8.437558
16	3	5530	8	65	1639	1478	9.146754
17	1	5530	8	100			10.010449
18	1	5530	8	100			10.382854
19	1	5530	8	60			10.917882
20	1	5530	8	90			11.747175

USA Bin 5 Trial #18

Burst #	Pulses	Frequency (MHz)	Chirp (MHz)	PW (uS)	Inter-pulse spacing (uS)	Inter-pulse spacing (uS)	Pulse Start (S)
1	3	5530	15	60	1223	1333	0.433776
2	1	5530	15	80			0.956318
3	3	5530	15	90	1487	1637	1.383687
4	3	5530	15	70	1603	1211	2.092619
5	2	5530	15	50	1027		2.487926
6	2	5530	15	85	1748		3.430019
7	1	5530	15	95			3.763351
8	2	5530	15	65	1811		4.715886
9	3	5530	15	85	1626	1194	4.917817
10	3	5530	15	95	1187	1749	5.545551
11	1	5530	15	95			6.338605
12	3	5530	15	80	1054	1011	6.912983
13	2	5530	15	60	1421		7.610881
14	3	5530	15	55	1010	1545	8.227889
15	1	5530	15	70			8.53177
16	3	5530	15	100	1024	1720	9.085238
17	2	5530	15	70	1749		10.097047
18	3	5530	15	75	1034	1485	10.573944
19	2	5530	15	70	1539		11.022919
20	1	5530	15	95			11.73574

USA Bin 5 Trial #19

Burst #	Pulses	Frequency (MHz)	Chirp (MHz)	PW (uS)	Inter-pulse spacing (uS)	Inter-pulse spacing (uS)	Pulse Start (S)
1	2	5530	10	100	1605		0.589135
2	1	5530	10	75			0.711594
3	2	5530	10	85	1497		1.807914
4	2	5530	10	55	1393		2.15574
5	2	5530	10	95	1952		3.192012
6	1	5530	10	75			3.676446



7	3	5530	10	50	1251	1878	4.360898
8	1	5530	10	50			5.121686
9	1	5530	10	90			5.365447
10	3	5530	10	95	1283	1978	6.433461
11	1	5530	10	100			7.059527
12	1	5530	10	85			7.709406
13	1	5530	10	75			8.504651
14	3	5530	10	80	1772	1929	9.212628
15	2	5530	10	50	1359		9.750792
16	2	5530	10	100	1682		10.250711
17	3	5530	10	55	1484	1760	10.85004
18	3	5530	10	85	2000	1586	11.563178

## USA Bin 5 Trial #20

Burst #	Pulses	Frequency (MHz)	Chirp (MHz)	PW (uS)	Inter-pulse spacing (uS)	Inter-pulse spacing (uS)	Pulse Start (S)
1	3	5530	15	95	1940	1838	0.509965
2	3	5530	15	95	1769	1101	0.76879
3	2	5530	15	85	1695		1.414154
4	2	5530	15	90	1354		2.293782
5	2	5530	15	75	1230		3.04768
6	3	5530	15	65	1234	1135	3.367971
7	1	5530	15	70			4.374865
8	1	5530	15	90			4.824749
9	1	5530	15	50			5.44855
10	2	5530	15	80	1292		6.120179
11	1	5530	15	65			7.235769
12	3	5530	15	80	1864	1340	7.354004
13	2	5530	15	65	1247		8.001101
14	3	5530	15	85	1638	1957	9.106388
15	2	5530	15	70	1186		9.859695
16	2	5530	15	85	1680		10.330584
17	1	5530	15	75			11.288589
18	1	5530	15	85			11.630254

## USA Bin 5 Trial #21

Burst #	Pulses	Frequency (MHz)	Chirp (MHz)	PW (uS)	Inter-pulse spacing (uS)	Inter-pulse spacing (uS)	Pulse Start (S)
1	3	5563.2	12	90	1750	1321	0.000314
2	1	5563.2	12	90			1.454488
3	2	5563.2	12	80	1889		2.944788
4	3	5563.2	12	70	1422	1075	4.077754
5	2	5563.2	12	90	1536		5.310916
6	3	5563.2	12	50	1993	1594	5.931146



7	3	5563.2	12	60	1464	1036	6.662208
8	3	5563.2	12	65	1286	1003	8.222027
9	1	5563.2	12	70			9.193592
10	2	5563.2	12	85	1209		10.744248
11	1	5563.2	12	50			11.15355

## USA Bin 5 Trial #22

Burst #	Pulses	Frequency (MHz)	Chirp (MHz)	PW (uS)	Inter-pulse spacing (uS)	Inter-pulse spacing (uS)	Pulse Start (S)
1	1	5562	15	75			0.310557
2	1	5562	15	50			1.541519
3	3	5562	15	75	1416	1516	2.589422
4	2	5562	15	50	1537		4.734921
5	2	5562	15	65	1658		5.013169
6	3	5562	15	70	1200	1311	7.061175
7	3	5562	15	70	1882	1839	8.245046
8	2	5562	15	90	1216		9.193944
9	1	5562	15	65			9.783008
10	1	5562	15	50			11.057262

## USA Bin 5 Trial #23

Burst #	Pulses	Frequency (MHz)	Chirp (MHz)	PW (uS)	Inter-pulse spacing (uS)	Inter-pulse spacing (uS)	Pulse Start (S)
1	2	5565.6	6	65	1739		0.648253
2	1	5565.6	6	80			0.780455
3	1	5565.6	6	85			1.83148
4	1	5565.6	6	55			2.503886
5	2	5565.6	6	80	1051		3.366461
6	3	5565.6	6	60	1347	1546	4.398261
7	2	5565.6	6	90	1531		4.768579
8	1	5565.6	6	80			5.934526
9	1	5565.6	6	80			6.602774
10	2	5565.6	6	100	1948		6.99766
11	2	5565.6	6	100	1959		8.019074
12	2	5565.6	6	60	1280		8.879092
13	2	5565.6	6	90	1691		9.564135
14	3	5565.6	6	65	1003	1159	10.455576
15	2	5565.6	6	50	1813		10.517556
16	1	5565.6	6	75			11.631168

## USA Bin 5 Trial #24

Burst #	Pulses	Frequency (MHz)	Chirp (MHz)	PW (uS)	Inter-pulse spacing (uS)	Inter-pulse spacing (uS)	Pulse Start (S)
1	1	5562.4	14	75			0.68883



2	2	5562.4	14	90	1248		1.512197
3	3	5562.4	14	85	1660	1457	3.687802
4	1	5562.4	14	90			5.929181
5	1	5562.4	14	90			7.321654
6	2	5562.4	14	60	1477		8.786836
7	1	5562.4	14	70			9.475945
8	3	5562.4	14	55	1737	1037	11.634014

## USA Bin 5 Trial #25

Burst #	Pulses	Frequency (MHz)	Chirp (MHz)	PW (uS)	Inter-pulse spacing (uS)	Inter-pulse spacing (uS)	Pulse Start (S)
1	2	5565.2	7	80	1335		0.340653
2	3	5565.2	7	50	1633	1355	1.01253
3	1	5565.2	7	50			1.833707
4	2	5565.2	7	75	1869		2.201633
5	1	5565.2	7	50			3.087074
6	3	5565.2	7	55	1339	1479	3.732144
7	2	5565.2	7	50	1608		4.751195
8	1	5565.2	7	55			5.516413
9	3	5565.2	7	90	1117	1388	5.759574
10	3	5565.2	7	55	1899	1692	6.354937
11	1	5565.2	7	85			7.639202
12	2	5565.2	7	55	1637		7.817663
13	1	5565.2	7	50			9.158608
14	1	5565.2	7	100			9.761792
15	1	5565.2	7	90			9.896923
16	3	5565.2	7	60	1066	1387	10.816191
17	1	5565.2	7	65			11.375738

## USA Bin 5 Trial #26

Burst #	Pulses	Frequency (MHz)	Chirp (MHz)	PW (uS)	Inter-pulse spacing (uS)	Inter-pulse spacing (uS)	Pulse Start (S)
1	1	5562.4	14	95			0.292705
2	3	5562.4	14	90	1772	1876	0.983444
3	2	5562.4	14	75	1492		1.537029
4	2	5562.4	14	80	1927		2.57433
5	1	5562.4	14	100			3.134446
6	3	5562.4	14	80	1421	1780	4.013827
7	1	5562.4	14	95			4.588466
8	2	5562.4	14	60	1232		5.608851
9	1	5562.4	14	50			6.420384
10	2	5562.4	14	75	1438		6.803991
11	1	5562.4	14	65			8.017531
12	1	5562.4	14	95			8.427424



13	2	5562.4	14	90	1707		9.612219
14	2	5562.4	14	55	1631		10.110934
15	3	5562.4	14	100	1423	1801	10.538354
16	2	5562.4	14	95	1334		11.634823

## USA Bin 5 Trial #27

Burst #	Pulses	Frequency (MHz)	Chirp (MHz)	PW (uS)	Inter-pulse spacing (uS)	Inter-pulse spacing (uS)	Pulse Start (S)
1	2	5565.2	7	80	1922		0.307929
2	3	5565.2	7	70	1012	1151	1.20888
3	3	5565.2	7	80	1466	1299	1.850834
4	2	5565.2	7	90	1189		2.439746
5	2	5565.2	7	60	1741		3.730245
6	3	5565.2	7	60	1772	1360	4.227358
7	3	5565.2	7	50	1720	1472	5.39292
8	2	5565.2	7	95	1741		5.622803
9	3	5565.2	7	100	1373	1109	6.760101
10	3	5565.2	7	95	1521	1882	7.954003
11	3	5565.2	7	55	1107	1567	8.136487
12	3	5565.2	7	55	1115	1509	8.847757
13	2	5565.2	7	80	1246		9.892496
14	3	5565.2	7	75	1431	1421	10.976451
15	3	5565.2	7	65	1680	1891	11.368307

## USA Bin 5 Trial #28

Burst #	Pulses	Frequency (MHz)	Chirp (MHz)	PW (uS)	Inter-pulse spacing (uS)	Inter-pulse spacing (uS)	Pulse Start (S)
1	2	5564	10	55	1334		0.63894
2	2	5564	10	85	1919		1.33338
3	2	5564	10	90	1017		2.445069
4	3	5564	10	95	1874	1917	3.304365
5	2	5564	10	70	1155		4.236326
6	2	5564	10	75	1351		4.896633
7	2	5564	10	75	1019		5.24871
8	3	5564	10	90	1224	1505	6.321663
9	2	5564	10	85	1495		6.961499
10	1	5564	10	80			7.8533
11	3	5564	10	85	1724	1284	8.771069
12	2	5564	10	70	1408		9.461523
13	2	5564	10	95	1388		11.024664
14	2	5564	10	65	1937		11.207944

## USA Bin 5 Trial #29



Burst #	Pulses	Frequency (MHz)	Chirp (MHz)	PW (uS)	Inter-pulse spacing (uS)	Inter-pulse spacing (uS)	Pulse Start (S)
1	1	5560	20	85			0.262217
2	1	5560	20	50			0.757453
3	1	5560	20	80			1.561489
4	1	5560	20	60			2.321394
5	2	5560	20	50	1531		2.696263
6	3	5560	20	50	1081	1829	3.632351
7	3	5560	20	85	1922	1531	4.322763
8	1	5560	20	55			4.639768
9	2	5560	20	75	1795		5.162327
10	2	5560	20	65	1355		6.298924
11	2	5560	20	65	1047		6.850496
12	1	5560	20	55			7.260507
13	1	5560	20	50			7.804787
14	3	5560	20	75	1610	1542	8.29778
15	3	5560	20	55	1602	1845	9.097226
16	1	5560	20	85			9.776687
17	3	5560	20	55	1691	1899	10.501919
18	2	5560	20	50	1496		11.127744
19	2	5560	20	75	1288		11.726423

## USA Bin 5 Trial #30

Burst #	Pulses	Frequency (MHz)	Chirp (MHz)	PW (uS)	Inter-pulse spacing (uS)	Inter-pulse spacing (uS)	Pulse Start (S)
1	3	5566	5	55	1843	1449	0.544306
2	3	5566	5	60	1166	1804	0.623703
3	1	5566	5	65			1.341141
4	1	5566	5	100			2.370306
5	3	5566	5	55	1585	1546	2.675094
6	2	5566	5	75	1361		3.059241
7	3	5566	5	80	1959	1041	3.602287
8	1	5566	5	55			4.368394
9	3	5566	5	65	1228	1435	4.93359
10	1	5566	5	50			5.995785
11	2	5566	5	70	1851		6.021805
12	3	5566	5	75	1227	1719	7.127389
13	1	5566	5	100			7.501269
14	2	5566	5	100	1734		8.096501
15	1	5566	5	95			8.506332
16	3	5566	5	50	1003	1006	9.22063
17	2	5566	5	80	1444		9.711304
18	1	5566	5	70			10.208561



19	3	5566	5	80	1628	1381	11.309908
20	3	5566	5	50	1355	1253	11.610829





## USA Frequency Hopping Trial #1

Hop #	Freq (GHz)	Pulse Start (mS)
6	5514	18
9	5512	27
10	5552	30
15	5560	45
17	5541	51
19	5540	57
38	5496	114
42	5557	126
44	5522	132
51	5556	153
55	5493	165
94	5527	282

## USA Frequency Hopping Trial #2

Hop #	Freq (GHz)	Pulse Start (mS)
39	5511	117
54	5568	162
62	5525	186
63	5541	189
70	5557	210
72	5529	216
74	5519	222
79	5567	237
89	5553	267

## USA Frequency Hopping Trial #3

Hop #	Freq (GHz)	Pulse Start (mS)
7	5531	21
9	5545	27
11	5554	33
19	5516	57
30	5544	90
39	5563	117
41	5562	123
46	5549	138
55	5551	165
63	5522	189
64	5498	192
71	5557	213
73	5504	219

## USA Frequency Hopping Trial #4

Hop #	Freq (GHz)	Pulse Start (mS)
11	5504	33
19	5513	57
25	5549	75
26	5538	78
28	5541	84
41	5520	123
43	5495	129
46	5554	138
49	5497	147
66	5503	198
67	5506	201
68	5567	204
71	5545	213
85	5508	255

## USA Frequency Hopping Trial #5

Hop #	Freq (GHz)	Pulse Start (mS)
5	5548	15
13	5535	39
15	5567	45
18	5533	54
37	5515	111
46	5504	138
48	5529	144
54	5506	162
65	5521	195
67	5493	201
71	5538	213
79	5557	237
81	5550	243
97	5541	291

## USA Frequency Hopping Trial #6

Hop #	Freq (GHz)	Pulse Start (mS)
0	5534	0
18	5552	54
20	5536	60
32	5522	96
38	5498	114
48	5512	144
56	5544	168
60	5518	180



65	5537	195
66	5557	198
69	5539	207
70	5508	210
76	5551	228
97	5500	291

## USA Frequency Hopping Trial #7

Hop #	Freq (GHz)	Pulse Start (mS)
0	5517	0
11	5508	33
13	5516	39
14	5542	42
35	5545	105
39	5515	117
40	5548	120
43	5527	129
44	5506	132
54	5524	162
55	5523	165
63	5501	189
65	5550	195
68	5541	204
82	5540	246
86	5521	258
88	5552	264
90	5509	270
99	5530	297

## USA Frequency Hopping Trial #8

Hop #	Freq (GHz)	Pulse Start (mS)
2	5512	6
3	5544	9
18	5531	54
21	5547	63
32	5510	96
34	5515	102
35	5567	105
36	5524	108
42	5538	126
46	5532	138
47	5526	141
52	5522	156
59	5528	177

66	5559	198
93	5500	279

## USA Frequency Hopping Trial #9

Hop #	Freq (GHz)	Pulse Start (mS)
11	5492	33
12	5563	36
23	5561	69
26	5507	78
33	5522	99
55	5494	165
56	5542	168
76	5519	228
82	5499	246
88	5555	264
90	5496	270
91	5557	273
96	5504	288
98	5516	294

## USA Frequency Hopping Trial #10

Hop #	Freq (GHz)	Pulse Start (mS)
16	5540	48
22	5503	66
28	5563	84
33	5519	99
42	5557	126
46	5531	138
49	5562	147
52	5555	156
56	5500	168
60	5517	180
61	5498	183
77	5550	231
81	5565	243
82	5508	246
85	5521	255

## USA Frequency Hopping Trial #11

Hop #	Freq (GHz)	Pulse Start (mS)
7	5554	21
12	5519	36
14	5504	42
19	5506	57

31	5522	93
34	5545	102
38	5518	114
40	5548	120
47	5525	141
50	5534	150
51	5558	153
55	5568	165
59	5544	177
63	5567	189
64	5556	192
65	5510	195
66	5498	198
73	5493	219
77	5502	231
87	5539	261
92	5503	276
94	5512	282
98	5540	294

## USA Frequency Hopping Trial #12

Hop #	Freq (GHz)	Pulse Start (mS)
14	5566	42
36	5505	108
38	5553	114
40	5563	120
47	5557	141
48	5498	144
59	5528	177
60	5496	180
69	5520	207
77	5504	231
80	5515	240
81	5508	243
82	5550	246
88	5561	264
89	5545	267
92	5558	276
93	5507	279
96	5526	288

## USA Frequency Hopping Trial #13

Hop #	Freq (GHz)	Pulse Start (mS)
3	5530	9



5	5508	15
13	5518	39
19	5531	57
20	5550	60
27	5544	81
37	5540	111
38	5507	114
46	5566	138
49	5495	147
53	5513	159
55	5506	165
56	5559	168
60	5502	180
61	5498	183
70	5505	210
85	5562	255
97	5551	291
99	5529	297

## USA Frequency Hopping Trial #14

Hop #	Freq (GHz)	Pulse Start (mS)
5	5500	15
6	5507	18
10	5514	30
20	5523	60
21	5559	63
26	5494	78
49	5545	147
53	5495	159
58	5506	174
60	5508	180
67	5521	201
72	5551	216
73	5549	219
75	5531	225
77	5557	231
81	5517	243
82	5550	246
86	5556	258
88	5510	264
99	5512	297

## USA Frequency Hopping Trial #15

Hop #	Freq (GHz)	Pulse Start (mS)
-------	------------	------------------



2	5531	6
10	5547	30
12	5513	36
16	5548	48
33	5567	99
57	5511	171
63	5498	189
64	5554	192
70	5506	210
75	5537	225
76	5523	228
81	5521	243
82	5532	246
83	5529	249
84	5517	252
90	5495	270
98	5503	294

## USA Frequency Hopping Trial #16

Hop #	Freq (GHz)	Pulse Start (mS)
21	5499	63
29	5532	87
30	5545	90
33	5553	99
45	5517	135
47	5509	141
50	5554	150
57	5551	171
63	5531	189
67	5566	201
73	5536	219
75	5556	225
80	5520	240
82	5515	246
85	5521	255
95	5512	285

## USA Frequency Hopping Trial #17

Hop #	Freq (GHz)	Pulse Start (mS)
0	5527	0
6	5492	18
13	5541	39
22	5556	66
27	5549	81



29	5516	87
45	5560	135
48	5515	144
54	5511	162
67	5564	201
86	5513	258
94	5502	282
96	5544	288

## USA Frequency Hopping Trial #18

Hop #	Freq (GHz)	Pulse Start (mS)
6	5562	18
12	5541	36
13	5552	39
16	5500	48
23	5565	69
34	5550	102
35	5532	105
40	5504	120
42	5563	126
52	5561	156
61	5557	183
62	5497	186
63	5533	189
66	5512	198
71	5544	213
78	5531	234
80	5555	240
84	5548	252
97	5526	291
99	5506	297

## USA Frequency Hopping Trial #19

Hop #	Freq (GHz)	Pulse Start (mS)
4	5568	12
7	5513	21
12	5566	36
19	5556	57
24	5518	72
29	5494	87
31	5545	93
33	5495	99
36	5506	108
42	5528	126





58	5530	174
73	5562	219
75	5502	225
88	5511	264
94	5557	282

## USA Frequency Hopping Trial #20

Hop #	Freq (GHz)	Pulse Start (mS)
2	5548	6
7	5523	21
26	5528	78
32	5558	96
39	5511	117
41	5521	123
61	5509	183
68	5564	204
71	5530	213
73	5497	219
86	5500	258
87	5567	261
90	5545	270
92	5516	276
94	5561	282

## USA Frequency Hopping Trial #21

Hop #	Freq (GHz)	Pulse Start (mS)
0	5509	0
5	5534	15
6	5516	18
7	5545	21
9	5538	27
19	5494	57
21	5528	63
32	5549	96
33	5542	99
34	5523	102
44	5530	132
45	5496	135
48	5502	144
59	5514	177
67	5543	201
68	5507	204
76	5492	228
80	5547	240



96	5563	288
99	5519	297

## USA Frequency Hopping Trial #22

Hop #	Freq (GHz)	Pulse Start (mS)
0	5516	0
2	5538	6
4	5522	12
7	5540	21
12	5566	36
13	5568	39
14	5495	42
20	5557	60
24	5527	72
30	5542	90
33	5551	99
36	5541	108
44	5507	132
48	5518	144
57	5550	171
63	5563	189
70	5544	210
72	5567	216
78	5523	234
89	5546	267
94	5553	282

## USA Frequency Hopping Trial #23

Hop #	Freq (GHz)	Pulse Start (mS)
7	5532	21
8	5535	24
13	5537	39
17	5562	51
18	5505	54
37	5515	111
45	5498	135
60	5564	180
61	5545	183
69	5525	207
79	5511	237
82	5500	246
89	5553	267
90	5533	270
95	5492	285

96	5555	288
97	5566	291

## USA Frequency Hopping Trial #24

Hop #	Freq (GHz)	Pulse Start (mS)
18	5523	54
26	5544	78
32	5551	96
41	5520	123
43	5553	129
58	5563	174
67	5509	201
82	5561	246
98	5493	294

## USA Frequency Hopping Trial #25

Hop #	Freq (GHz)	Pulse Start (mS)
5	5511	15
12	5513	36
13	5541	39
30	5539	90
37	5492	111
39	5555	117
47	5540	141
48	5510	144
57	5494	171
58	5496	174
77	5493	231
85	5532	255
89	5534	267

## USA Frequency Hopping Trial #26

Hop #	Freq (GHz)	Pulse Start (mS)
13	5496	39
23	5507	69
26	5552	78
27	5538	81
34	5543	102
39	5505	117
40	5532	120
45	5534	135
49	5529	147
52	5522	156
55	5518	165



56	5536	168
58	5495	174
61	5503	183
96	5502	288

## USA Frequency Hopping Trial #27

Hop #	Freq (GHz)	Pulse Start (mS)
16	5547	48
19	5538	57
23	5532	69
24	5564	72
29	5517	87
33	5528	99
36	5496	108
38	5505	114
42	5543	126
54	5554	162
61	5540	183
71	5503	213
78	5544	234
90	5551	270
93	5539	279

## USA Frequency Hopping Trial #28

Hop #	Freq (GHz)	Pulse Start (mS)
3	5521	9
12	5508	36
18	5547	54
23	5529	69
26	5492	78
31	5516	93
32	5501	96
38	5542	114
44	5500	132
46	5558	138
49	5494	147
50	5531	150
63	5566	189
67	5497	201
69	5532	207
72	5503	216
77	5496	231
79	5555	237
83	5499	249



86	5502	258
98	5520	294
99	5505	297

## USA Frequency Hopping Trial #29

Hop #	Freq (GHz)	Pulse Start (mS)
12	5538	36
13	5520	39
24	5494	72
28	5529	84
33	5564	99
35	5548	105
36	5534	108
44	5525	132
53	5512	159
56	5559	168
57	5505	171
67	5561	201
75	5506	225
77	5554	231
80	5547	240
88	5507	264
89	5536	267
98	5563	294

## USA Frequency Hopping Trial #30

Hop #	Freq (GHz)	Pulse Start (mS)
0	5502	0
7	5518	21
10	5540	30
12	5493	36
19	5497	57
20	5495	60
21	5499	63
24	5568	72
37	5496	111
46	5510	138
56	5545	168
60	5529	180
67	5562	201
75	5515	225
77	5526	231
81	5492	243

**Channel 5250 MHz, 160MHz BW, Statistical Performance (upper section of 80+80)****USA Bin 1A/1B**

freq=5290, rate=m0x1, bw=78.0

Trial	Frequency	Pulses	PW (uS)	PRI (uS)	1=Detection 0=No Detection	Detection Percentage	Limit
1	5250	18	1	3066	1	100.0%	60.0%
2	5250	99	1	538	1		
3	5256	61	1	878	1		
4	5256	59	1	898	1		
5	5262	61	1	878	1		
6	5262	57	1	938	1		
7	5268	65	1	818	1		
8	5268	70	1	758	1		
9	5274	70	1	758	1		
10	5274	99	1	538	1		
11	5280	67	1	798	1		
12	5280	72	1	738	1		
13	5286	74	1	718	1		
14	5286	61	1	878	1		
15	5290	81	1	658	1		
16	5290	30	1	1798	1		
17	5294	27	1	1972	1		
18	5294	19	1	2801	1		
19	5300	24	1	2236	1		
20	5300	57	1	936	1		
21	5306	30	1	1800	1		
22	5306	20	1	2706	1		
23	5312	41	1	1299	1		
24	5312	29	1	1860	1		
25	5318	33	1	1632	1		
26	5318	88	1	603	1		
27	5324	94	1	565	1		
28	5324	27	1	1959	1		
29	5330	19	1	2874	1		
30	5330	21	1	2637	1		

**USA Bin 1A/1B**

freq=5290, rate=m0x1, bw=78.0

Trial	Frequency	Pulses	PW (uS)	PRI (uS)	1=Detection 0=No Detection	Detection Percentage	Limit
1	5250	78	1	678	1	100.0%	60.0%
2	5250	65	1	818	1		
3	5256	81	1	658	1		
4	5256	70	1	758	1		
5	5262	65	1	818	1		
6	5262	74	1	718	1		
7	5268	67	1	798	1		
8	5268	92	1	578	1		
9	5274	95	1	558	1		
10	5274	76	1	698	1		
11	5280	67	1	798	1		
12	5280	92	1	578	1		
13	5286	18	1	3066	1		
14	5286	81	1	658	1		
15	5290	92	1	578	1		
16	5290	50	1	1059	1		
17	5294	25	1	2143	1		
18	5294	45	1	1198	1		
19	5300	23	1	2388	1		
20	5300	25	1	2184	1		
21	5306	23	1	2371	1		
22	5306	20	1	2754	1		
23	5312	35	1	1518	1		
24	5312	72	1	739	1		
25	5318	29	1	1860	1		
26	5318	19	1	2921	1		
27	5324	36	1	1482	1		
28	5324	23	1	2313	1		
29	5330	22	1	2499	1		
30	5330	62	1	857	1		



**USA Bin**  
**2**

freq=5290, rate=m0x1, bw=78.0

Trial	Frequency	Pulses	PW (uS)	PRI (uS)	1=Detection 0=No Detection	Detection Percentage	Limit
1	5250	24	2	201	1	100.0%	60.0%
2	5250	25	5	165	1		
3	5256	25	1.7	212	1		
4	5256	27	1.5	155	1		
5	5262	24	4.4	227	1		
6	5262	27	3.5	209	1		
7	5268	28	3.7	150	1		
8	5268	23	1.7	178	1		
9	5274	25	2.1	214	1		
10	5274	29	1.2	189	1		
11	5280	27	4.9	172	1		
12	5280	27	3	217	1		
13	5286	28	1.4	219	1		
14	5286	29	1.3	193	1		
15	5290	26	1.9	184	1		
16	5290	24	4.4	179	1		
17	5294	25	4.9	179	1		
18	5294	29	1.4	170	1		
19	5300	25	2.6	192	1		
20	5300	27	4.6	204	1		
21	5306	28	4.2	191	1		
22	5306	24	3.3	184	1		
23	5312	24	3.6	209	1		
24	5312	23	2.4	167	1		
25	5318	27	2.9	206	1		
26	5318	23	2.6	168	1		
27	5324	29	1.3	223	1		
28	5324	23	4.8	177	1		
29	5330	23	1.9	179	1		
30	5330	23	4	224	1		



**USA Bin****3**

freq=5290, rate=m0x1, bw=78.0

Trial	Frequency	Pulses	PW (uS)	PRI (uS)	1=Detection 0=No Detection	Detection Percentage	Limit
1	5250	18	6.1	450	1	100.0%	60.0%
2	5250	16	6.1	323	1		
3	5256	17	7.9	295	1		
4	5256	18	6.4	457	1		
5	5262	17	9.8	276	1		
6	5262	17	8.8	440	1		
7	5268	18	7.9	394	1		
8	5268	16	9.3	276	1		
9	5274	16	10	362	1		
10	5274	17	9.1	421	1		
11	5280	18	7	348	1		
12	5280	16	8.5	340	1		
13	5286	16	7.8	231	1		
14	5286	17	6.3	339	1		
15	5290	17	9.8	451	1		
16	5290	17	8.4	349	1		
17	5294	18	6.2	270	1		
18	5294	16	7.6	432	1		
19	5300	16	6.3	437	1		
20	5300	16	9.5	226	1		
21	5306	16	7.7	207	1		
22	5306	16	6.4	306	1		
23	5312	17	7.7	481	1		
24	5312	16	8.6	299	1		
25	5318	18	8.8	434	1		
26	5318	17	6.3	377	1		
27	5324	18	9.1	417	1		
28	5324	17	9.3	289	1		
29	5330	16	7.1	362	1		
30	5330	18	7.3	256	1		



**USA Bin  
4**

freq=5290, rate=m0x1, bw=78.0

Trial	Frequency	Pulses	PW (uS)	PRI (uS)	1=Detection 0=No Detection	Detection Percentage	Limit
1	5250	15	19.6	335	1	100.0%	60.0%
2	5250	14	15.8	263	1		
3	5256	13	13.5	349	1		
4	5256	14	13.6	231	1		
5	5262	16	11.4	420	1		
6	5262	15	12.8	458	1		
7	5268	14	16.7	274	1		
8	5268	16	12.4	280	1		
9	5274	13	17.5	423	1		
10	5274	16	15.3	496	1		
11	5280	12	14	424	1		
12	5280	15	12.6	309	1		
13	5286	13	11.7	304	1		
14	5286	15	12.4	245	1		
15	5290	15	19.2	417	1		
16	5290	14	16.4	229	1		
17	5294	16	19.5	304	1		
18	5294	12	17.9	483	1		
19	5300	14	12.1	460	1		
20	5300	15	14.2	432	1		
21	5306	15	16	366	1		
22	5306	14	17.4	492	1		
23	5312	16	16.2	302	1		
24	5312	13	16.5	259	1		
25	5318	13	11.3	257	1		
26	5318	14	11.3	260	1		
27	5324	14	13.2	253	1		
28	5324	16	11.6	452	1		
29	5330	13	17.3	312	1		
30	5330	12	17.8	372	1		

In addition an average minimum percentage of successful detection across all four Short pulse radar test waveforms is required and is calculated as follows:

$$\frac{P_d 1 + P_d 2 + P_d 3 + P_d 4}{4} = (100.0\% + 100.0\% + 100.0\% + 100.0\% + 100.0\%)/5 = 100.0\% (>80\%)$$



**USA  
Bin 5**

freq=5290, rate=m0x1, bw=78.0

Trial	Burst #	Pulses	Frequency (MHz)	Chirp (MHz)	PW (uS)	Inter-pulse spacing (uS)	Inter-pulse spacing (uS)	Pulse Start (S)	1=Detection 0=No Detection	Detection Percentage	Limit
1	1	1	5256.2	13	70			0.037908	1	100.0%	80.0%
2	1	1	5254.6	9	65			0.382584	1		
3	1	3	5257.8	17	95	1668	1123	0.518814	1		
4	1	3	5258.6	19	100	1762	1443	0.761306	1		
5	1	1	5258.2	18	95			0.015409	1		
6	1	1	5255.4	11	70			0.343618	1		
7	1	1	5253.4	6	80			0.087401	1		
8	1	3	5257.8	17	90	1830	1577	0.499066	1		
9	1	3	5257.4	16	70	1275	1436	0.344055	1		
10	1	2	5253.8	7	50	1862		0.441688	1		
11	1	1	5290	15	65			0.48785	1		
12	1	3	5290	6	85	1069	1518	0.355712	1		
13	1	1	5290	5	75			1.211562	1		
14	1	2	5290	6	100	1631		0.084936	1		
15	1	2	5290	10	60	1991		0.200873	1		
16	1	1	5290	20	65			0.265157	1		
17	1	2	5290	20	100	1907		0.069398	1		
18	1	2	5290	19	55	1203		0.362932	1		
19	1	1	5290	15	95			0.244281	1		
20	1	2	5290	10	55	1398		0.247958	1		
21	1	2	5323.8	13	100	1376		0.242456	1		
22	1	2	5325	10	65	1776		0.646263	1		
23	1	2	5326.2	7	95	1099		0.592037	1		
24	1	3	5325.4	9	90	1691	1538	0.088251	1		
25	1	2	5321.8	18	80	1286		0.35724	1		
26	1	3	5322.2	17	80	1264	1625	1.467184	1		
27	1	1	5323.4	14	95			0.427118	1		
28	1	3	5321	20	75	1068	1443	0.044287	1		
29	1	3	5321.8	18	65	1720	1102	0.379658	1		
30	1	2	5325	10	65	1193		0.090318	1		

**USA Frequency Hopping**

freq=5290, rate=m0x1, bw=78.0

Trial	Hop #	Freq (GHz)	Pulse Start (mS)	1=Detection 0=No Detection	Detection Percentage	Limit
1	0	5305	0	1	100.0%	70.0%
2	4	5274	12	1		
3	6	5300	18	1		
4	6	5313	18	1		
5	10	5304	30	1		
6	4	5273	12	1		
7	21	5270	63	1		
8	5	5268	15	1		
9	1	5315	3	1		
10	7	5251	21	1		
11	5	5274	15	1		
12	1	5251	3	1		
13	4	5329	12	1		
14	6	5286	18	1		
15	0	5287	0	1		
16	3	5256	9	1		
17	5	5268	15	1		
18	4	5292	12	1		
19	3	5290	9	1		
20	2	5294	6	1		
21	7	5300	21	1		
22	9	5304	27	1		
23	9	5285	27	1		
24	1	5259	3	1		
25	8	5276	24	1		
26	5	5316	15	1		
27	9	5283	27	1		
28	2	5322	6	1		
29	7	5283	21	1		
30	1	5255	3	1		



## USA Bin 5 Trial #1

Burst #	Pulses	Frequency (MHz)	Chirp (MHz)	PW (uS)	Inter-pulse spacing (uS)	Inter-pulse spacing (uS)	Pulse Start (S)
1	1	5256.2	13	70			0.037908
2	1	5256.2	13	100			1.907966
3	3	5256.2	13	80	1847	1297	3.18229
4	3	5256.2	13	65	1330	1953	4.073659
5	2	5256.2	13	60	1104		5.529196
6	3	5256.2	13	80	1433	1936	7.307825
7	3	5256.2	13	65	1889	1319	8.183533
8	2	5256.2	13	60	1186		9.626748
9	1	5256.2	13	95			10.684585

## USA Bin 5 Trial #2

Burst #	Pulses	Frequency (MHz)	Chirp (MHz)	PW (uS)	Inter-pulse spacing (uS)	Inter-pulse spacing (uS)	Pulse Start (S)
1	1	5254.6	9	65			0.382584
2	2	5254.6	9	95	1578		0.948638
3	2	5254.6	9	95	1963		1.824494
4	3	5254.6	9	95	1194	1365	2.701388
5	1	5254.6	9	90			3.752468
6	1	5254.6	9	80			4.289183
7	3	5254.6	9	90	1231	1746	5.850166
8	2	5254.6	9	95	1980		6.543317
9	2	5254.6	9	90	1000		7.071371
10	3	5254.6	9	100	1785	1493	7.743932
11	3	5254.6	9	55	1567	1013	8.593879
12	3	5254.6	9	80	1298	1522	9.756762
13	2	5254.6	9	85	1805		10.734173
14	3	5254.6	9	90	1181	1510	11.889441

## USA Bin 5 Trial #3

Burst #	Pulses	Frequency (MHz)	Chirp (MHz)	PW (uS)	Inter-pulse spacing (uS)	Inter-pulse spacing (uS)	Pulse Start (S)
1	3	5257.8	17	95	1668	1123	0.518814
2	1	5257.8	17	70			1.25618
3	1	5257.8	17	95			1.577177
4	2	5257.8	17	70	1744		2.395992
5	1	5257.8	17	85			3.084726
6	1	5257.8	17	70			3.775976
7	2	5257.8	17	60	1440		4.058531
8	1	5257.8	17	75			4.886304
9	2	5257.8	17	75	1861		5.521465



10	3	5257.8	17	60	1778	1814	6.075429
11	1	5257.8	17	95			6.663966
12	1	5257.8	17	55			7.346259
13	3	5257.8	17	80	1408	1891	8.048121
14	2	5257.8	17	50	1873		8.610227
15	1	5257.8	17	75			9.118376
16	2	5257.8	17	100	1577		10.084056
17	3	5257.8	17	50	1443	1143	10.488555
18	3	5257.8	17	85	1520	1268	10.834604
19	1	5257.8	17	65			11.805918

## USA Bin 5 Trial #4

Burst #	Pulses	Frequency (MHz)	Chirp (MHz)	PW (uS)	Inter-pulse spacing (uS)	Inter-pulse spacing (uS)	Pulse Start (S)
1	3	5258.6	19	100	1762	1443	0.761306
2	2	5258.6	19	65	1563		1.376869
3	3	5258.6	19	80	1035	1137	3.065785
4	3	5258.6	19	90	1129	1966	4.258191
5	2	5258.6	19	85	1141		5.464751
6	2	5258.6	19	55	1529		6.083695
7	2	5258.6	19	60	1158		8.119455
8	1	5258.6	19	65			9.097236
9	3	5258.6	19	85	1276	1638	9.718549
10	1	5258.6	19	80			11.669684

## USA Bin 5 Trial #5

Burst #	Pulses	Frequency (MHz)	Chirp (MHz)	PW (uS)	Inter-pulse spacing (uS)	Inter-pulse spacing (uS)	Pulse Start (S)
1	1	5258.2	18	95			0.015409
2	2	5258.2	18	100	1814		1.816548
3	1	5258.2	18	50			3.940419
4	1	5258.2	18	90			5.350849
5	1	5258.2	18	60			6.96003
6	2	5258.2	18	95	1013		8.311405
7	3	5258.2	18	60	1464	1538	9.837434
8	2	5258.2	18	70	1529		11.929222

## USA Bin 5 Trial #6

Burst #	Pulses	Frequency (MHz)	Chirp (MHz)	PW (uS)	Inter-pulse spacing (uS)	Inter-pulse spacing (uS)	Pulse Start (S)
1	1	5255.4	11	70			0.343618
2	1	5255.4	11	65			1.196059
3	3	5255.4	11	95	1323	1084	1.902454
4	3	5255.4	11	95	1992	1753	2.682902



5	3	5255.4	11	85	1661	1976	3.140761
6	2	5255.4	11	80	1726		3.90922
7	2	5255.4	11	80	1816		4.477728
8	1	5255.4	11	80			5.047132
9	3	5255.4	11	55	1591	1790	6.069157
10	3	5255.4	11	55	1019	1636	6.701601
11	2	5255.4	11	85	1573		7.179835
12	1	5255.4	11	60			8.057074
13	1	5255.4	11	60			8.696004
14	2	5255.4	11	85	1148		9.411191
15	2	5255.4	11	70	1177		10.140425
16	2	5255.4	11	100	1084		10.963844
17	3	5255.4	11	70	1263	1327	11.309612

## USA Bin 5 Trial #7

Burst #	Pulses	Frequency (MHz)	Chirp (MHz)	PW (uS)	Inter-pulse spacing (uS)	Inter-pulse spacing (uS)	Pulse Start (S)
1	1	5253.4	6	80			0.087401
2	1	5253.4	6	70			1.092982
3	2	5253.4	6	55	1280		1.764636
4	3	5253.4	6	95	1283	1253	2.955723
5	1	5253.4	6	70			3.862483
6	1	5253.4	6	70			4.15792
7	2	5253.4	6	80	1841		5.250735
8	3	5253.4	6	65	1639	1971	6.120849
9	3	5253.4	6	80	1684	1641	6.696873
10	3	5253.4	6	85	1676	1673	7.265414
11	1	5253.4	6	90			8.112721
12	2	5253.4	6	55	1276		9.323446
13	1	5253.4	6	60			10.116143
14	2	5253.4	6	80	1139		11.048679
15	2	5253.4	6	90	1146		11.31978

## USA Bin 5 Trial #8

Burst #	Pulses	Frequency (MHz)	Chirp (MHz)	PW (uS)	Inter-pulse spacing (uS)	Inter-pulse spacing (uS)	Pulse Start (S)
1	3	5257.8	17	90	1830	1577	0.499066
2	1	5257.8	17	85			1.168808
3	3	5257.8	17	55	1407	1835	1.299015
4	1	5257.8	17	95			2.126315
5	3	5257.8	17	65	1964	1455	2.556166
6	2	5257.8	17	100	1221		3.144734
7	2	5257.8	17	90	1606		3.874729
8	3	5257.8	17	70	1776	1163	4.214972



9	1	5257.8	17	80			4.8331
10	1	5257.8	17	75			5.50461
11	2	5257.8	17	90	1441		6.357344
12	2	5257.8	17	50	1004		6.677868
13	3	5257.8	17	95	1646	1299	7.548835
14	1	5257.8	17	75			8.129046
15	1	5257.8	17	55			8.806123
16	2	5257.8	17	55	1584		9.217924
17	1	5257.8	17	100			9.996133
18	3	5257.8	17	95	1401	1002	10.673108
19	3	5257.8	17	70	1482	1743	11.365683
20	1	5257.8	17	80			11.669701

## USA Bin 5 Trial #9

Burst #	Pulses	Frequency (MHz)	Chirp (MHz)	PW (uS)	Inter-pulse spacing (uS)	Inter-pulse spacing (uS)	Pulse Start (S)
1	3	5257.4	16	70	1275	1436	0.344055
2	1	5257.4	16	60			1.136
3	2	5257.4	16	55	1359		2.24475
4	2	5257.4	16	100	1166		2.603173
5	2	5257.4	16	100	1778		3.445191
6	3	5257.4	16	80	1671	1925	4.935819
7	1	5257.4	16	80			5.930923
8	1	5257.4	16	55			6.539969
9	1	5257.4	16	75			7.317599
10	2	5257.4	16	95	1816		7.985332
11	1	5257.4	16	55			9.06719
12	3	5257.4	16	85	1801	1070	9.990158
13	1	5257.4	16	75			11.076452
14	2	5257.4	16	60	1929		11.527866

## USA Bin 5 Trial #10

Burst #	Pulses	Frequency (MHz)	Chirp (MHz)	PW (uS)	Inter-pulse spacing (uS)	Inter-pulse spacing (uS)	Pulse Start (S)
1	2	5253.8	7	50	1862		0.441688
2	3	5253.8	7	50	1650	1477	1.632166
3	3	5253.8	7	80	1151	1450	2.78799
4	3	5253.8	7	75	1233	1887	3.272253
5	2	5253.8	7	90	1605		4.137231
6	2	5253.8	7	55	1640		5.763552
7	1	5253.8	7	100			6.112854
8	2	5253.8	7	80	1176		7.44026
9	2	5253.8	7	65	1041		8.231022
10	1	5253.8	7	80			9.692628





11	1	5253.8	7	50			10.650639
12	2	5253.8	7	85	1202		11.498865

## USA Bin 5 Trial #11

Burst #	Pulses	Frequency (MHz)	Chirp (MHz)	PW (uS)	Inter-pulse spacing (uS)	Inter-pulse spacing (uS)	Pulse Start (S)
1	1	5290	15	65			0.48785
2	2	5290	15	50	1741		1.540343
3	2	5290	15	90	1003		3.494541
4	3	5290	15	85	1078	1665	4.830954
5	1	5290	15	65			7.444481
6	1	5290	15	50			8.357126
7	1	5290	15	60			10.461664
8	3	5290	15	90	1611	1978	11.175103

## USA Bin 5 Trial #12

Burst #	Pulses	Frequency (MHz)	Chirp (MHz)	PW (uS)	Inter-pulse spacing (uS)	Inter-pulse spacing (uS)	Pulse Start (S)
1	3	5290	6	85	1069	1518	0.355712
2	3	5290	6	65	1597	1458	1.593941
3	2	5290	6	95	1391		1.769658
4	2	5290	6	60	1514		3.214189
5	2	5290	6	65	1345		3.664847
6	2	5290	6	85	1148		4.911115
7	1	5290	6	90			5.996135
8	1	5290	6	60			6.472216
9	2	5290	6	95	1174		7.196476
10	1	5290	6	55			7.902885
11	2	5290	6	70	1752		9.340278
12	2	5290	6	65	1634		10.058493
13	1	5290	6	85			11.105731
14	3	5290	6	90	1878	1184	11.557883

## USA Bin 5 Trial #13

Burst #	Pulses	Frequency (MHz)	Chirp (MHz)	PW (uS)	Inter-pulse spacing (uS)	Inter-pulse spacing (uS)	Pulse Start (S)
1	1	5290	5	75			1.211562
2	1	5290	5	65			2.209042
3	3	5290	5	80	1792	1131	3.50696
4	3	5290	5	90	1756	1855	4.546598
5	3	5290	5	80	1999	1984	6.417073
6	3	5290	5	85	1771	1718	7.626876
7	1	5290	5	85			8.47839
8	1	5290	5	55			10.123996



9                    1                    5290                    5                    80                    11.43274  
 USA Bin 5 Trial #14

Burst #	Pulses	Frequency (MHz)	Chirp (MHz)	PW (uS)	Inter-pulse spacing (uS)	Inter-pulse spacing (uS)	Pulse Start (S)
1	2	5290	6	100	1631		0.084936
2	2	5290	6	70	1955		1.116207
3	1	5290	6	65			2.138588
4	1	5290	6	55			3.653949
5	2	5290	6	60	1189		4.818729
6	3	5290	6	55	1991	1322	5.294067
7	2	5290	6	100	1979		6.431733
8	3	5290	6	60	1449	1991	7.132886
9	3	5290	6	90	1014	1091	8.76599
10	2	5290	6	80	1738		9.855622
11	3	5290	6	85	1809	1843	10.058629
12	2	5290	6	100	1244		11.378739

USA Bin 5 Trial #15

Burst #	Pulses	Frequency (MHz)	Chirp (MHz)	PW (uS)	Inter-pulse spacing (uS)	Inter-pulse spacing (uS)	Pulse Start (S)
1	2	5290	10	60	1991		0.200873
2	3	5290	10	90	1279	1994	1.711089
3	1	5290	10	95			2.321807
4	2	5290	10	100	1352		3.847486
5	2	5290	10	55	1472		4.903555
6	2	5290	10	90	1298		5.96943
7	3	5290	10	75	1233	1380	7.525173
8	3	5290	10	95	1601	1317	8.064918
9	2	5290	10	80	1974		9.225276
10	2	5290	10	100	1739		10.807377
11	3	5290	10	50	1639	1072	11.725147

USA Bin 5 Trial #16

Burst #	Pulses	Frequency (MHz)	Chirp (MHz)	PW (uS)	Inter-pulse spacing (uS)	Inter-pulse spacing (uS)	Pulse Start (S)
1	1	5290	20	65			0.265157
2	1	5290	20	80			1.24071
3	3	5290	20	75	1441	1086	2.03079
4	1	5290	20	60			3.3217
5	1	5290	20	60			3.974649
6	3	5290	20	60	1815	1006	4.93092
7	1	5290	20	50			6.423165
8	3	5290	20	55	1599	1334	6.513554



9	3	5290	20	50	1777	1097	7.784892
10	1	5290	20	65			9.1043
11	3	5290	20	75	1830	1832	9.86928
12	3	5290	20	80	1344	1031	10.853278
13	1	5290	20	85			11.106088

## USA Bin 5 Trial #17

Burst #	Pulses	Frequency (MHz)	Chirp (MHz)	PW (uS)	Inter-pulse spacing (uS)	Inter-pulse spacing (uS)	Pulse Start (S)
1	2	5290	20	100	1907		0.069398
2	2	5290	20	50	1133		1.790595
3	2	5290	20	70	1808		3.009529
4	2	5290	20	50	1175		4.128055
5	3	5290	20	95	1159	1481	5.62305
6	3	5290	20	65	1662	1076	6.987934
7	3	5290	20	55	1542	1748	8.653162
8	2	5290	20	90	1400		10.562907
9	1	5290	20	80			11.77477

## USA Bin 5 Trial #18

Burst #	Pulses	Frequency (MHz)	Chirp (MHz)	PW (uS)	Inter-pulse spacing (uS)	Inter-pulse spacing (uS)	Pulse Start (S)
1	2	5290	19	55	1203		0.362932
2	2	5290	19	50	1223		1.191457
3	2	5290	19	100	1077		1.762347
4	3	5290	19	75	1925	1501	2.137223
5	3	5290	19	55	1361	1630	3.079839
6	1	5290	19	50			3.833163
7	3	5290	19	85	1141	1187	4.418973
8	1	5290	19	85			5.398974
9	3	5290	19	70	1385	1836	6.103826
10	1	5290	19	55			6.712911
11	3	5290	19	55	1515	1539	7.622607
12	1	5290	19	55			8.012068
13	3	5290	19	55	1840	1610	8.847173
14	2	5290	19	85	1961		9.258699
15	1	5290	19	50			10.195104
16	1	5290	19	85			10.948038
17	2	5290	19	90	1641		11.317228

## USA Bin 5 Trial #19

Burst #	Pulses	Frequency (MHz)	Chirp (MHz)	PW (uS)	Inter-pulse spacing (uS)	Inter-pulse spacing (uS)	Pulse Start (S)
1	1	5290	15	95			0.244281



2	3	5290	15	100	1501	1042	1.31476
3	1	5290	15	75			1.694841
4	1	5290	15	95			2.093913
5	3	5290	15	100	1244	1150	3.173513
6	3	5290	15	90	1005	1094	3.726689
7	1	5290	15	50			4.350708
8	3	5290	15	85	1164	1251	5.204492
9	3	5290	15	85	1562	1898	5.516842
10	2	5290	15	50	1535		6.256922
11	3	5290	15	50	1863	1918	6.783579
12	3	5290	15	70	1593	1894	7.426467
13	3	5290	15	90	1384	1240	8.570227
14	1	5290	15	95			9.025214
15	3	5290	15	95	1188	1184	9.643178
16	1	5290	15	90			10.294015
17	1	5290	15	95			10.782518
18	1	5290	15	50			11.846385

## USA Bin 5 Trial #20

Burst #	Pulses	Frequency (MHz)	Chirp (MHz)	PW (uS)	Inter-pulse spacing (uS)	Inter-pulse spacing (uS)	Pulse Start (S)
1	2	5290	10	55	1398		0.247958
2	1	5290	10	95			1.904656
3	1	5290	10	55			3.00006
4	1	5290	10	50			3.420969
5	3	5290	10	55	1622	1123	4.993514
6	3	5290	10	65	1590	1736	5.699678
7	2	5290	10	65	1272		6.684597
8	3	5290	10	50	1409	1563	8.184983
9	1	5290	10	80			9.282177
10	3	5290	10	75	1869	1124	9.866541
11	3	5290	10	100	1552	1807	11.015356

## USA Bin 5 Trial #21

Burst #	Pulses	Frequency (MHz)	Chirp (MHz)	PW (uS)	Inter-pulse spacing (uS)	Inter-pulse spacing (uS)	Pulse Start (S)
1	2	5323.8	13	100	1376		0.242456
2	2	5323.8	13	55	1270		1.710805
3	1	5323.8	13	95			2.56141
4	2	5323.8	13	60	1299		2.871665
5	3	5323.8	13	80	1691	1580	4.052652
6	3	5323.8	13	95	1263	1244	4.839322
7	1	5323.8	13	80			5.474344
8	1	5323.8	13	60			6.640292



9	1	5323.8	13	70			7.136592
10	3	5323.8	13	65	1986	1240	7.808521
11	3	5323.8	13	50	1287	1652	9.019687
12	3	5323.8	13	100	1894	1691	10.094018
13	3	5323.8	13	50	1035	1292	11.006306
14	3	5323.8	13	75	1462	1832	11.263153

## USA Bin 5 Trial #22

Burst #	Pulses	Frequency (MHz)	Chirp (MHz)	PW (uS)	Inter-pulse spacing (uS)	Inter-pulse spacing (uS)	Pulse Start (S)
1	2	5325	10	65	1776		0.646263
2	1	5325	10	55			1.161884
3	3	5325	10	70	1853	1879	1.367461
4	1	5325	10	95			2.189313
5	1	5325	10	65			3.230601
6	3	5325	10	90	1632	1719	3.45561
7	1	5325	10	95			4.389045
8	1	5325	10	65			5.072125
9	3	5325	10	90	1728	1820	5.764772
10	3	5325	10	65	1344	1940	6.611002
11	1	5325	10	50			6.887537
12	2	5325	10	80	1126		7.866064
13	1	5325	10	50			8.270689
14	3	5325	10	50	1136	1668	8.749031
15	3	5325	10	60	1717	1056	9.460519
16	3	5325	10	85	1603	1641	10.635623
17	3	5325	10	70	1178	1273	10.711978
18	1	5325	10	85			11.461271

## USA Bin 5 Trial #23

Burst #	Pulses	Frequency (MHz)	Chirp (MHz)	PW (uS)	Inter-pulse spacing (uS)	Inter-pulse spacing (uS)	Pulse Start (S)
1	2	5326.2	7	95	1099		0.592037
2	3	5326.2	7	95	1924	1352	1.379797
3	3	5326.2	7	90	1441	1823	3.363312
4	3	5326.2	7	65	1783	1705	3.934318
5	1	5326.2	7	100			5.685618
6	3	5326.2	7	70	1347	1347	6.689242
7	3	5326.2	7	95	1754	1938	7.430135
8	2	5326.2	7	65	1825		9.345079
9	2	5326.2	7	85	1596		10.525954
10	2	5326.2	7	70	1987		11.796205

## USA Bin 5 Trial #24



Burst #	Pulses	Frequency (MHz)	Chirp (MHz)	PW (uS)	Inter-pulse spacing (uS)	Inter-pulse spacing (uS)	Pulse Start (S)
1	3	5325.4	9	90	1691	1538	0.088251
2	3	5325.4	9	80	1092	1971	1.274234
3	1	5325.4	9	65			2.105384
4	3	5325.4	9	100	1267	1620	2.302697
5	2	5325.4	9	50	1546		3.436003
6	3	5325.4	9	55	1912	1628	3.844454
7	2	5325.4	9	95	1139		4.83428
8	1	5325.4	9	75			5.372083
9	1	5325.4	9	50			5.777346
10	1	5325.4	9	65			6.603095
11	3	5325.4	9	55	1226	1974	7.58946
12	1	5325.4	9	60			7.978255
13	3	5325.4	9	85	1166	1982	8.827486
14	3	5325.4	9	85	1408	1348	9.588541
15	2	5325.4	9	85	1267		10.288663
16	1	5325.4	9	80			10.672097
17	1	5325.4	9	65			11.638039

## USA Bin 5 Trial #25

Burst #	Pulses	Frequency (MHz)	Chirp (MHz)	PW (uS)	Inter-pulse spacing (uS)	Inter-pulse spacing (uS)	Pulse Start (S)
1	2	5321.8	18	80	1286		0.35724
2	3	5321.8	18	50	1145	1013	1.021077
3	3	5321.8	18	70	1370	1526	1.612379
4	2	5321.8	18	60	1699		2.762702
5	2	5321.8	18	85	1716		3.309568
6	3	5321.8	18	70	1772	1675	4.611743
7	3	5321.8	18	85	1873	1248	5.306425
8	3	5321.8	18	95	1240	1262	6.306776
9	2	5321.8	18	90	1442		6.958766
10	3	5321.8	18	50	1833	1041	7.233168
11	3	5321.8	18	75	1101	1690	8.075873
12	3	5321.8	18	55	1620	1089	9.350014
13	2	5321.8	18	75	1502		9.664032
14	2	5321.8	18	50	1839		11.107811
15	3	5321.8	18	70	1706	1147	11.725497

## USA Bin 5 Trial #26

Burst #	Pulses	Frequency (MHz)	Chirp (MHz)	PW (uS)	Inter-pulse spacing (uS)	Inter-pulse spacing (uS)	Pulse Start (S)
1	3	5322.2	17	80	1264	1625	1.467184



2	2	5322.2	17	55	1512		2.102188
3	3	5322.2	17	100	1907	1873	3.695499
4	3	5322.2	17	85	1665	1245	4.714832
5	3	5322.2	17	85	1756	1235	6.911051
6	3	5322.2	17	100	1285	1398	7.756706
7	2	5322.2	17	55	1586		9.39208
8	1	5322.2	17	70			11.128968

## USA Bin 5 Trial #27

Burst #	Pulses	Frequency (MHz)	Chirp (MHz)	PW (uS)	Inter-pulse spacing (uS)	Inter-pulse spacing (uS)	Pulse Start (S)
1	1	5323.4	14	95			0.427118
2	3	5323.4	14	85	1184	1526	1.197253
3	3	5323.4	14	80	1505	1881	2.52234
4	2	5323.4	14	55	1792		3.056781
5	2	5323.4	14	75	1919		3.751783
6	3	5323.4	14	55	1265	1282	4.830763
7	3	5323.4	14	65	1111	1454	6.12733
8	1	5323.4	14	60			6.691578
9	3	5323.4	14	50	1236	1462	7.910122
10	1	5323.4	14	80			8.411508
11	1	5323.4	14	85			10.075572
12	2	5323.4	14	70	1198		10.641235
13	3	5323.4	14	60	1238	1759	11.215531

## USA Bin 5 Trial #28

Burst #	Pulses	Frequency (MHz)	Chirp (MHz)	PW (uS)	Inter-pulse spacing (uS)	Inter-pulse spacing (uS)	Pulse Start (S)
1	3	5321	20	75	1068	1443	0.044287
2	1	5321	20	75			1.487441
3	2	5321	20	50	1635		1.751974
4	1	5321	20	65			3.249024
5	2	5321	20	70	1672		3.955499
6	1	5321	20	50			4.86541
7	1	5321	20	60			5.201836
8	2	5321	20	95	1649		6.815113
9	1	5321	20	100			6.918093
10	2	5321	20	70	1348		7.96061
11	2	5321	20	70	1706		8.574341
12	3	5321	20	55	1652	1102	9.613166
13	2	5321	20	100	1120		10.991648
14	1	5321	20	90			11.294298

## USA Bin 5 Trial #29



Burst #	Pulses	Frequency (MHz)	Chirp (MHz)	PW (uS)	Inter-pulse spacing (uS)	Inter-pulse spacing (uS)	Pulse Start (S)
1	3	5321.8	18	65	1720	1102	0.379658
2	1	5321.8	18	100			1.356563
3	1	5321.8	18	95			1.95668
4	2	5321.8	18	80	1316		2.737214
5	1	5321.8	18	60			3.540696
6	1	5321.8	18	95			4.449509
7	2	5321.8	18	60	1150		4.658169
8	1	5321.8	18	95			5.542783
9	2	5321.8	18	95	1983		6.352761
10	1	5321.8	18	85			7.414639
11	3	5321.8	18	95	1503	1199	7.764964
12	1	5321.8	18	95			8.903776
13	3	5321.8	18	70	1287	1258	9.641242
14	1	5321.8	18	65			10.485507
15	2	5321.8	18	100	1055		11.182251
16	3	5321.8	18	95	1433	1802	11.744605

## USA Bin 5 Trial #30

Burst #	Pulses	Frequency (MHz)	Chirp (MHz)	PW (uS)	Inter-pulse spacing (uS)	Inter-pulse spacing (uS)	Pulse Start (S)
1	2	5325	10	65	1193		0.090318
2	1	5325	10	85			2.231497
3	2	5325	10	65	1837		3.702594
4	2	5325	10	55	1863		4.788421
5	3	5325	10	75	1235	1189	7.46137
6	2	5325	10	100	1690		8.478924
7	1	5325	10	50			9.858372
8	3	5325	10	90	1114	1669	11.26694



## USA Frequency Hopping Trial #1

Hop #	Freq (GHz)	Pulse Start (mS)
0	5305	0
2	5302	6
8	5284	24
22	5263	66
38	5321	114
60	5274	180
72	5297	216
74	5309	222
75	5254	225
80	5266	240
82	5308	246
88	5299	264
92	5323	276
93	5328	279

## USA Frequency Hopping Trial #2

Hop #	Freq (GHz)	Pulse Start (mS)
4	5274	12
5	5288	15
10	5277	30
12	5317	36
15	5323	45
18	5310	54
22	5327	66
24	5265	72
34	5319	102
44	5291	132
58	5321	174
81	5302	243
82	5261	246
83	5312	249
84	5284	252
94	5253	282
99	5292	297

## USA Frequency Hopping Trial #3

Hop #	Freq (GHz)	Pulse Start (mS)
6	5300	18
11	5269	33
12	5279	36
23	5270	69

25	5263	75
34	5303	102
47	5302	141
50	5324	150
52	5308	156
61	5284	183
79	5299	237
80	5293	240
84	5314	252
90	5304	270
97	5325	291

**USA Frequency Hopping Trial #4**

Hop #	Freq (GHz)	Pulse Start (mS)
6	5313	18
10	5269	30
14	5316	42
17	5302	51
19	5296	57
20	5307	60
27	5320	81
29	5327	87
35	5310	105
45	5257	135
50	5277	150
51	5285	153
66	5268	198
76	5298	228
80	5328	240
86	5287	258
87	5317	261
94	5311	282
96	5260	288
98	5295	294
99	5284	297

**USA Frequency Hopping Trial #5**

Hop #	Freq (GHz)	Pulse Start (mS)
10	5304	30
11	5265	33
21	5312	63
34	5277	102
50	5323	150
59	5255	177



61	5305	183
83	5311	249
94	5321	282
95	5261	285

## USA Frequency Hopping Trial #6

Hop #	Freq (GHz)	Pulse Start (mS)
4	5273	12
6	5303	18
10	5265	30
13	5309	39
20	5260	60
22	5279	66
26	5300	78
29	5292	87
32	5276	96
54	5325	162
57	5263	171
62	5328	186
76	5286	228
81	5270	243
84	5274	252
88	5271	264
92	5312	276
95	5313	285

## USA Frequency Hopping Trial #7

Hop #	Freq (GHz)	Pulse Start (mS)
21	5270	63
26	5328	78
38	5278	114
48	5285	144
53	5297	159
55	5301	165
70	5254	210
78	5295	234
83	5289	249

## USA Frequency Hopping Trial #8

Hop #	Freq (GHz)	Pulse Start (mS)
5	5268	15
8	5292	24
15	5316	45
16	5329	48



19	5289	57
22	5302	66
26	5321	78
31	5312	93
43	5306	129
45	5283	135
47	5284	141
54	5322	162
72	5309	216
74	5254	222
77	5255	231
78	5308	234
79	5261	237
92	5277	276
98	5270	294
99	5303	297

## USA Frequency Hopping Trial #9

Hop #	Freq (GHz)	Pulse Start (mS)
1	5315	3
6	5290	18
19	5284	57
22	5261	66
26	5295	78
40	5299	120
47	5288	141
53	5303	159
61	5254	183
64	5289	192
70	5283	210
72	5252	216
74	5280	222
76	5262	228
83	5256	249
84	5266	252
94	5285	282

## USA Frequency Hopping Trial #10

Hop #	Freq (GHz)	Pulse Start (mS)
7	5251	21
9	5261	27
22	5286	66
23	5310	69
30	5323	90

42	5301	126
44	5313	132
45	5252	135
47	5306	141
56	5311	168
57	5287	171
64	5277	192
70	5271	210
73	5317	219
74	5319	222
79	5253	237
80	5309	240
87	5285	261
88	5305	264

## USA Frequency Hopping Trial #11

Hop #	Freq (GHz)	Pulse Start (mS)
5	5274	15
23	5308	69
30	5253	90
31	5293	93
34	5280	102
35	5304	105
38	5321	114
39	5322	117
42	5262	126
45	5310	135
51	5284	153
54	5263	162
64	5289	192
66	5327	198
67	5312	201
74	5296	222
75	5276	225
83	5265	249
84	5316	252
93	5306	279

## USA Frequency Hopping Trial #12

Hop #	Freq (GHz)	Pulse Start (mS)
1	5251	3
2	5284	6
5	5265	15
9	5271	27



17	5267	51
18	5303	54
22	5252	66
23	5254	69
24	5263	72
33	5253	99
38	5287	114
54	5293	162
62	5294	186
64	5311	192
69	5278	207
72	5305	216
74	5300	222
80	5306	240
82	5269	246
87	5255	261
88	5289	264
91	5301	273
93	5266	279
96	5329	288
97	5316	291

**USA Frequency Hopping Trial #13**

Hop #	Freq (GHz)	Pulse Start (mS)
4	5329	12
5	5275	15
7	5301	21
12	5285	36
13	5308	39
21	5257	63
40	5288	120
45	5268	135
55	5279	165
61	5266	183
66	5286	198
68	5267	204
70	5289	210
72	5265	216
74	5316	222
75	5299	225
76	5255	228
77	5318	231
79	5313	237
87	5303	261



91	5278	273
93	5262	279
99	5311	297

## USA Frequency Hopping Trial #14

Hop #	Freq (GHz)	Pulse Start (mS)
6	5286	18
10	5292	30
11	5317	33
29	5297	87
35	5326	105
37	5288	111
41	5327	123
47	5328	141
58	5271	174
63	5302	189
71	5293	213
74	5275	222
87	5273	261
91	5272	273
95	5281	285

## USA Frequency Hopping Trial #15

Hop #	Freq (GHz)	Pulse Start (mS)
0	5287	0
5	5328	15
10	5293	30
23	5269	69
30	5315	90
31	5272	93
41	5301	123
42	5311	126
43	5299	129
49	5286	147
51	5253	153
57	5267	171
60	5264	180
61	5284	183
66	5271	198
85	5327	255
93	5314	279
98	5256	294

## USA Frequency Hopping Trial #16



Hop #	Freq (GHz)	Pulse Start (mS)
3	5256	9
13	5294	39
22	5273	66
25	5260	75
33	5257	99
35	5280	105
37	5269	111
53	5326	159
60	5281	180
65	5261	195
79	5275	237
82	5318	246
83	5271	249
89	5268	267
92	5254	276
94	5298	282
96	5258	288

## USA Frequency Hopping Trial #17

Hop #	Freq (GHz)	Pulse Start (mS)
5	5268	15
9	5322	27
10	5283	30
15	5259	45
17	5289	51
21	5257	63
22	5262	66
25	5293	75
36	5313	108
40	5275	120
42	5323	126
45	5311	135
53	5267	159
55	5305	165
63	5290	189
68	5252	204
70	5296	210
75	5307	225
76	5264	228
81	5260	243
92	5298	276

## USA Frequency Hopping Trial #18





Hop #	Freq (GHz)	Pulse Start (mS)
4	5292	12
6	5305	18
11	5275	33
13	5256	39
19	5255	57
36	5281	108
47	5295	141
62	5315	186
64	5309	192
71	5282	213
80	5301	240
82	5317	246
89	5328	267
94	5257	282
99	5254	297

## USA Frequency Hopping Trial #19

Hop #	Freq (GHz)	Pulse Start (mS)
3	5290	9
8	5314	24
12	5271	36
24	5296	72
25	5293	75
31	5309	93
46	5255	138
51	5258	153
54	5328	162
56	5284	168
58	5327	174
60	5292	180
77	5272	231
78	5276	234
83	5252	249
88	5283	264
89	5278	267
91	5313	273

## USA Frequency Hopping Trial #20

Hop #	Freq (GHz)	Pulse Start (mS)
2	5294	6
20	5280	60
24	5283	72



32	5265	96
49	5257	147
60	5298	180
69	5329	207
73	5303	219
76	5314	228
82	5318	246

## USA Frequency Hopping Trial #21

Hop #	Freq (GHz)	Pulse Start (mS)
7	5300	21
8	5275	24
10	5305	30
13	5313	39
21	5304	63
29	5297	87
30	5267	90
32	5280	96
37	5322	111
39	5289	117
49	5251	147
57	5308	171
71	5293	213
75	5285	225
78	5283	234
87	5257	261
88	5287	264
91	5279	273
93	5310	279
94	5255	282

## USA Frequency Hopping Trial #22

Hop #	Freq (GHz)	Pulse Start (mS)
9	5304	27
11	5288	33
13	5264	39
19	5293	57
26	5261	78
35	5315	105
36	5266	108
38	5255	114
39	5269	117
45	5292	135
55	5329	165



66	5298	198
72	5301	216
77	5253	231
81	5258	243
85	5272	255
89	5263	267
92	5320	276
94	5267	282

## USA Frequency Hopping Trial #23

Hop #	Freq (GHz)	Pulse Start (mS)
9	5285	27
12	5324	36
22	5316	66
25	5317	75
26	5279	78
45	5293	135
47	5306	141
50	5286	150
57	5321	171
61	5252	183
73	5302	219
74	5280	222
85	5274	255
90	5315	270
92	5325	276
97	5261	291
98	5260	294

## USA Frequency Hopping Trial #24

Hop #	Freq (GHz)	Pulse Start (mS)
1	5259	3
12	5292	36
14	5285	42
17	5273	51
20	5300	60
30	5271	90
32	5322	96
35	5279	105
44	5284	132
45	5278	135
46	5299	138
49	5261	147
53	5264	159



57	5316	171
63	5274	189
85	5329	255
95	5306	285

## USA Frequency Hopping Trial #25

Hop #	Freq (GHz)	Pulse Start (mS)
8	5276	24
11	5290	33
14	5255	42
15	5251	45
16	5279	48
19	5309	57
21	5317	63
30	5289	90
37	5253	111
53	5302	159
54	5314	162
70	5278	210
73	5281	219
74	5325	222
75	5294	225
76	5283	228
79	5261	237
82	5291	246
85	5273	255
87	5265	261
91	5275	273

## USA Frequency Hopping Trial #26

Hop #	Freq (GHz)	Pulse Start (mS)
5	5316	15
7	5279	21
19	5268	57
22	5259	66
27	5267	81
29	5315	87
33	5324	99
35	5289	105
54	5262	162
59	5305	177
66	5325	198
68	5286	204
74	5284	222

77	5328	231
81	5252	243
85	5295	255
88	5294	264
90	5263	270
91	5320	273
92	5270	276
95	5266	285

## USA Frequency Hopping Trial #27

Hop #	Freq (GHz)	Pulse Start (mS)
9	5283	27
13	5328	39
20	5301	60
21	5313	63
23	5253	69
30	5281	90
51	5252	153
55	5302	165
57	5282	171
60	5303	180
75	5288	225
81	5273	243
98	5286	294

## USA Frequency Hopping Trial #28

Hop #	Freq (GHz)	Pulse Start (mS)
2	5322	6
19	5320	57
36	5281	108
38	5257	114
47	5267	141
56	5295	168
58	5316	174
59	5315	177
67	5255	201
79	5317	237
82	5279	246
86	5291	258
87	5286	261
89	5277	267
92	5303	276

## USA Frequency Hopping Trial #29



Hop #	Freq (GHz)	Pulse Start (mS)
7	5283	21
8	5296	24
17	5251	51
20	5290	60
21	5285	63
35	5261	105
47	5288	141
49	5256	147
50	5318	150
52	5327	156
59	5297	177
75	5305	225
78	5274	234
82	5309	246
93	5298	279
95	5286	285

## USA Frequency Hopping Trial #30

Hop #	Freq (GHz)	Pulse Start (mS)
1	5255	3
5	5276	15
15	5314	45
19	5321	57
21	5328	63
22	5323	66
26	5275	78
33	5309	99
34	5305	102
39	5279	117
40	5259	120
41	5297	123
50	5272	150
53	5310	159
67	5253	201
68	5299	204
69	5306	207
72	5289	216
75	5294	225
76	5296	228
77	5302	231



**Channel 5570 MHz, 160MHz BW, Statistical Performance (lower section of 80+80)**

**USA Bin 1A/1B**

freq=5530, rate=m0x1, bw=76.0

Trial	Frequency	Pulses	PW (uS)	PRI (uS)	1=Detection 0=No Detection	Detection Percentage	Limit
1	5490	59	1	898	1	100.0%	60.0%
2	5490	86	1	618	1		
3	5496	70	1	758	1		
4	5496	99	1	538	1		
5	5502	18	1	3066	1		
6	5502	81	1	658	1		
7	5508	72	1	738	1		
8	5508	86	1	618	1		
9	5514	58	1	918	1		
10	5514	57	1	938	1		
11	5520	70	1	758	1		
12	5520	89	1	598	1		
13	5526	89	1	598	1		
14	5526	70	1	758	1		
15	5530	74	1	718	1		
16	5530	24	1	2257	1		
17	5534	34	1	1571	1		
18	5534	68	1	786	1		
19	5540	59	1	905	1		
20	5540	45	1	1187	1		
21	5546	74	1	717	1		
22	5546	23	1	2343	1		
23	5552	33	1	1623	1		
24	5552	35	1	1510	1		
25	5558	24	1	2229	1		
26	5558	24	1	2237	1		
27	5564	38	1	1400	1		
28	5564	42	1	1264	1		
29	5570	18	1	3007	1		
30	5570	50	1	1063	1		



**USA Bin 1A/1B**

freq=5530, rate=m0x1, bw=76.0

Trial	Frequency	Pulses	PW (uS)	PRI (uS)	1=Detection 0=No Detection	Detection Percentage	Limit
1	5490	86	1	618	1	100.0%	60.0%
2	5490	76	1	698	1		
3	5496	70	1	758	1		
4	5496	76	1	698	1		
5	5502	81	1	658	1		
6	5502	81	1	658	1		
7	5508	61	1	878	1		
8	5508	92	1	578	1		
9	5514	65	1	818	1		
10	5514	99	1	538	1		
11	5520	81	1	658	1		
12	5520	102	1	518	1		
13	5526	76	1	698	1		
14	5526	99	1	538	1		
15	5530	70	1	758	1		
16	5530	70	1	764	1		
17	5534	48	1	1119	1		
18	5534	73	1	729	1		
19	5540	24	1	2278	1		
20	5540	39	1	1359	1		
21	5546	88	1	602	1		
22	5546	21	1	2555	1		
23	5552	24	1	2282	1		
24	5552	45	1	1188	1		
25	5558	20	1	2693	1		
26	5558	29	1	1855	1		
27	5564	39	1	1359	1		
28	5564	47	1	1125	1		
29	5570	49	1	1084	1		
30	5570	39	1	1361	1		





**USA Bin**  
**2**

freq=5530, rate=m0x1, bw=76.0

Trial	Frequency	Pulses	PW (uS)	PRI (uS)	1=Detection 0=No Detection	Detection Percentage	Limit
1	5490	26	3	222	1	100.0%	60.0%
2	5490	28	1.3	207	1		
3	5496	27	4.4	170	1		
4	5496	26	1.1	211	1		
5	5502	25	3.5	164	1		
6	5502	26	4.9	201	1		
7	5508	29	1.3	209	1		
8	5508	28	2.2	208	1		
9	5514	28	5	193	1		
10	5514	29	2.1	215	1		
11	5520	28	3.4	208	1		
12	5520	24	5	192	1		
13	5526	25	3.3	177	1		
14	5526	23	2.9	227	1		
15	5530	28	2.2	215	1		
16	5530	24	3.6	208	1		
17	5534	28	2.1	173	1		
18	5534	29	1.3	220	1		
19	5540	25	3.4	227	1		
20	5540	29	3.2	151	1		
21	5546	26	4.3	225	1		
22	5546	27	2.7	210	1		
23	5552	24	4.6	230	1		
24	5552	27	2.4	160	1		
25	5558	23	4.3	175	1		
26	5558	25	2	156	1		
27	5564	24	1.9	198	1		
28	5564	24	3.6	198	1		
29	5570	28	2.3	172	1		
30	5570	24	4.9	229	1		

**USA Bin  
3**

freq=5530, rate=m0x1, bw=76.0

Trial	Frequency	Pulses	PW (uS)	PRI (uS)	1=Detection 0=No Detection	Detection Percentage	Limit
1	5490	17	9.6	300	1	100.0%	60.0%
2	5490	16	8	494	1		
3	5496	17	9.8	461	1		
4	5496	18	8.7	296	1		
5	5502	18	7.5	318	1		
6	5502	17	8.1	225	1		
7	5508	17	7.5	271	1		
8	5508	17	9.6	435	1		
9	5514	16	8.6	357	1		
10	5514	16	9.6	324	1		
11	5520	18	8.4	382	1		
12	5520	17	6.1	438	1		
13	5526	17	7	215	1		
14	5526	18	8	204	1		
15	5530	18	7	207	1		
16	5530	16	7.8	352	1		
17	5534	16	7.3	321	1		
18	5534	18	9.4	412	1		
19	5540	18	7.3	409	1		
20	5540	17	7.2	224	1		
21	5546	16	7.1	390	1		
22	5546	16	6.5	277	1		
23	5552	17	9.6	345	1		
24	5552	16	7.2	493	1		
25	5558	18	8.3	332	1		
26	5558	16	8.5	358	1		
27	5564	18	9.3	291	1		
28	5564	16	8.7	376	1		
29	5570	17	6.8	270	1		
30	5570	17	8.9	263	1		

**USA Bin****4**

freq=5530, rate=m0x1, bw=76.0

Trial	Frequency	Pulses	PW (uS)	PRI (uS)	1=Detection 0=No Detection	Detection Percentage	Limit
1	5490	14	12.3	351	1	100.0%	60.0%
2	5490	13	17.1	319	1		
3	5496	14	17.7	333	1		
4	5496	14	13.2	206	1		
5	5502	16	16.9	232	1		
6	5502	13	15.1	292	1		
7	5508	12	13	273	1		
8	5508	15	11.8	216	1		
9	5514	16	19.2	381	1		
10	5514	14	18.5	450	1		
11	5520	16	18.3	399	1		
12	5520	13	17.6	304	1		
13	5526	16	11.9	419	1		
14	5526	16	16	360	1		
15	5530	12	19.5	404	1		
16	5530	15	15.2	475	1		
17	5534	14	14.8	433	1		
18	5534	12	11.7	249	1		
19	5540	15	13.4	413	1		
20	5540	14	11.5	378	1		
21	5546	16	19.8	304	1		
22	5546	12	12.7	211	1		
23	5552	13	19	343	1		
24	5552	14	15.2	387	1		
25	5558	15	16.2	319	1		
26	5558	15	14.5	437	1		
27	5564	13	15.7	444	1		
28	5564	14	12.1	424	1		
29	5570	15	11.5	217	1		
30	5570	16	11.9	368	1		

In addition an average minimum percentage of successful detection across all four Short pulse radar test waveforms is required and is calculated as follows:

$$\frac{P_d 1 + P_d 2 + P_d 3 + P_d 4}{4} = (100.0\% + 100.0\% + 100.0\% + 100.0\% + 100.0\%)/5 = 100.0\% (>80\%)$$



**USA  
Bin  
5**

freq=5530, rate=m0x1, bw=76.0

Trial	Burst #	Pulses	Frequency (MHz)	Chirp (MHz)	PW (uS)	Inter-pulse spacing (uS)	Inter-pulse spacing (uS)	Pulse Start (S)	1=Detection 0=No Detection	Detection Percentage	Limit
1	1	3	5494	5	100	1727	1760	0.21942	1	100.0%	80.0%
2	1	3	5500	20	90	1491	1866	0.57701	1		
3	1	3	5497.2	13	95	1701	1527	0.718817	1		
4	1	3	5498	15	65	1280	1376	0.528805	1		
5	1	3	5495.2	8	60	1545	1909	0.243732	1		
6	1	1	5497.2	13	90			0.693085	1		
7	1	2	5497.2	13	60	1647		0.098896	1		
8	1	3	5495.6	9	90	1192	1012	0.218608	1		
9	1	2	5498.8	17	80	1735		0.437115	1		
10	1	2	5495.2	8	80	1581		0.454067	1		
11	1	3	5530	18	55	1632	1657	0.390057	1		
12	1	2	5530	16	75	1402		0.049508	1		
13	1	1	5530	14	65			0.088706	1		
14	1	1	5530	13	80			0.588809	1		
15	1	1	5530	16	100			0.224699	1		
16	1	2	5530	13	90	1005		0.522349	1		
17	1	2	5530	20	90	1672		0.204286	1		
18	1	3	5530	7	95	1228	1121	0.641095	1		
19	1	2	5530	12	70	1068		0.028618	1		
20	1	3	5530	8	80	1360	1222	0.608681	1		
21	1	1	5565.2	7	50			0.679073	1		
22	1	2	5566	5	80	1705		0.183496	1		
23	1	2	5564	10	85	1735		1.414471	1		
24	1	2	5566	5	85	1164		0.151262	1		
25	1	3	5566	5	75	1404	1764	0.346994	1		
26	1	2	5562	15	75	1444		0.883371	1		
27	1	3	5561.2	17	55	1522	1131	0.290263	1		
28	1	3	5566	5	60	1752	1573	0.310775	1		
29	1	1	5564	10	100			0.906037	1		
30	1	2	5564.8	8	100	1967		1.258259	1		



freq=5530, rate=m0x1,  
bw=76.0

**USA Frequency Hopping**

Trial	Hop #	Freq (GHz)	Pulse Start (mS)	1=Detection 0=No Detection	Detection Percentage	Limit
1	5	5553	15	1	100.0%	70.0%
2	7	5506	21	1		
3	10	5500	30	1		
4	11	5547	33	1		
5	2	5492	6	1		
6	1	5558	3	1		
7	0	5546	0	1		
8	6	5553	18	1		
9	3	5512	9	1		
10	0	5538	0	1		
11	2	5508	6	1		
12	13	5506	39	1		
13	11	5508	33	1		
14	1	5528	3	1		
15	2	5536	6	1		
16	3	5518	9	1		
17	2	5531	6	1		
18	2	5563	6	1		
19	2	5523	6	1		
20	0	5563	0	1		
21	1	5559	3	1		
22	4	5531	12	1		
23	0	5496	0	1		
24	0	5550	0	1		
25	3	5534	9	1		
26	33	5492	99	1		
27	4	5537	12	1		
28	1	5557	3	1		
29	3	5564	9	1		
30	15	5533	45	1		



## USA Bin 5 Trial #1

Burst #	Pulses	Frequency (MHz)	Chirp (MHz)	PW (uS)	Inter-pulse spacing (uS)	Inter-pulse spacing (uS)	Pulse Start (S)
1	3	5494	5	100	1727	1760	0.21942
2	3	5494	5	90	1512	1051	0.882587
3	3	5494	5	50	1289	1174	1.392912
4	3	5494	5	50	1084	1097	1.869963
5	2	5494	5	85	1621		2.627763
6	1	5494	5	60			3.001702
7	1	5494	5	75			3.806767
8	3	5494	5	65	1731	1320	4.620658
9	1	5494	5	65			4.858816
10	1	5494	5	65			5.508761
11	2	5494	5	70	1946		6.076808
12	1	5494	5	75			6.631661
13	1	5494	5	100			7.533736
14	3	5494	5	80	1581	1223	8.033662
15	1	5494	5	55			8.94361
16	2	5494	5	75	1666		9.294623
17	1	5494	5	60			9.631779
18	3	5494	5	80	1083	1796	10.712783
19	3	5494	5	60	1753	1531	10.924569
20	1	5494	5	50			11.792624

## USA Bin 5 Trial #2

Burst #	Pulses	Frequency (MHz)	Chirp (MHz)	PW (uS)	Inter-pulse spacing (uS)	Inter-pulse spacing (uS)	Pulse Start (S)
1	3	5500	20	90	1491	1866	0.57701
2	2	5500	20	100	1073		0.714561
3	2	5500	20	85	1219		1.344733
4	1	5500	20	65			2.645095
5	2	5500	20	65	1984		2.713675
6	1	5500	20	95			3.4454
7	1	5500	20	100			4.142665
8	3	5500	20	80	1304	1374	5.009681
9	1	5500	20	90			5.901703
10	1	5500	20	100			6.173744
11	3	5500	20	85	1268	1595	6.801503
12	3	5500	20	70	1104	1990	7.505661
13	1	5500	20	100			8.335477
14	1	5500	20	80			9.047741
15	2	5500	20	60	1683		9.428643
16	1	5500	20	75			10.569209



17	3	5500	20	70	1637	1531	10.959747
18	2	5500	20	75	1508		11.551954

## USA Bin 5 Trial #3

Burst #	Pulses	Frequency (MHz)	Chirp (MHz)	PW (uS)	Inter-pulse spacing (uS)	Inter-pulse spacing (uS)	Pulse Start (S)
1	3	5497.2	13	95	1701	1527	0.718817
2	2	5497.2	13	60	1978		1.264117
3	2	5497.2	13	55	1528		2.228368
4	1	5497.2	13	80			2.978037
5	1	5497.2	13	85			3.774523
6	2	5497.2	13	50	1096		4.362645
7	3	5497.2	13	60	1478	1155	5.98933
8	1	5497.2	13	70			6.290264
9	1	5497.2	13	55			6.892161
10	1	5497.2	13	85			8.325284
11	1	5497.2	13	55			9.290104
12	3	5497.2	13	85	1909	1368	9.679732
13	1	5497.2	13	65			10.865895
14	2	5497.2	13	60	1533		11.695431

## USA Bin 5 Trial #4

Burst #	Pulses	Frequency (MHz)	Chirp (MHz)	PW (uS)	Inter-pulse spacing (uS)	Inter-pulse spacing (uS)	Pulse Start (S)
1	3	5498	15	65	1280	1376	0.528805
2	2	5498	15	70	1298		0.866462
3	2	5498	15	65	1015		1.446137
4	2	5498	15	95	1292		2.202562
5	3	5498	15	80	1373	1948	2.82827
6	2	5498	15	75	1375		3.097222
7	2	5498	15	75	1783		4.040845
8	2	5498	15	70	1753		4.663828
9	2	5498	15	80	1164		4.980276
10	1	5498	15	80			5.775429
11	3	5498	15	60	1930	1617	6.292168
12	3	5498	15	80	1835	1674	6.744516
13	1	5498	15	80			7.670071
14	1	5498	15	50			7.898779
15	3	5498	15	85	1496	1883	8.873156
16	2	5498	15	85	1627		9.102015
17	1	5498	15	80			10.169682
18	1	5498	15	65			10.501595
19	2	5498	15	80	1163		10.981236
20	3	5498	15	90	1144	1268	11.848227



## USA Bin 5 Trial #5

Burst #	Pulses	Frequency (MHz)	Chirp (MHz)	PW (uS)	Inter-pulse spacing (uS)	Inter-pulse spacing (uS)	Pulse Start (S)
1	3	5495.2	8	60	1545	1909	0.243732
2	3	5495.2	8	85	1648	1243	1.520977
3	3	5495.2	8	65	1240	1489	1.854272
4	3	5495.2	8	85	1371	1517	2.894628
5	3	5495.2	8	100	1384	1376	3.656023
6	1	5495.2	8	70			4.061948
7	1	5495.2	8	75			5.519564
8	3	5495.2	8	50	1218	1844	6.170672
9	2	5495.2	8	60	1094		7.136856
10	1	5495.2	8	80			7.337233
11	1	5495.2	8	80			8.35241
12	3	5495.2	8	60	1650	1163	8.96015
13	3	5495.2	8	80	1564	1985	10.195592
14	1	5495.2	8	95			10.756817
15	3	5495.2	8	65	1079	1936	11.794214

## USA Bin 5 Trial #6

Burst #	Pulses	Frequency (MHz)	Chirp (MHz)	PW (uS)	Inter-pulse spacing (uS)	Inter-pulse spacing (uS)	Pulse Start (S)
1	1	5497.2	13	90			0.693085
2	1	5497.2	13	85			2.014966
3	1	5497.2	13	90			3.062444
4	3	5497.2	13	95	1516	1316	3.415074
5	2	5497.2	13	90	1418		4.551367
6	2	5497.2	13	70	1434		5.800619
7	1	5497.2	13	70			7.610059
8	3	5497.2	13	75	1299	1080	8.582459
9	2	5497.2	13	100	1867		9.170352
10	2	5497.2	13	60	1308		10.311682
11	2	5497.2	13	90	1094		11.017903

## USA Bin 5 Trial #7

Burst #	Pulses	Frequency (MHz)	Chirp (MHz)	PW (uS)	Inter-pulse spacing (uS)	Inter-pulse spacing (uS)	Pulse Start (S)
1	2	5497.2	13	60	1647		0.098896
2	1	5497.2	13	100			2.128178
3	2	5497.2	13	75	1478		2.886619
4	3	5497.2	13	100	1455	1081	4.228846
5	2	5497.2	13	85	1070		4.99199
6	3	5497.2	13	55	1360	1146	6.429734





7	3	5497.2	13	75	1880	1127	7.621817
8	2	5497.2	13	70	1252		8.994294
9	3	5497.2	13	50	1372	1154	9.611064
10	2	5497.2	13	75	1242		11.065269

## USA Bin 5 Trial #8

Burst #	Pulses	Frequency (MHz)	Chirp (MHz)	PW (uS)	Inter-pulse spacing (uS)	Inter-pulse spacing (uS)	Pulse Start (S)
1	3	5495.6	9	90	1192	1012	0.218608
2	1	5495.6	9	85			0.920162
3	1	5495.6	9	80			1.464654
4	2	5495.6	9	65	1685		2.717439
5	3	5495.6	9	60	1856	1379	3.161086
6	1	5495.6	9	90			4.111388
7	1	5495.6	9	65			4.674754
8	1	5495.6	9	100			5.452205
9	2	5495.6	9	100	1373		5.838223
10	1	5495.6	9	95			6.651677
11	3	5495.6	9	75	1812	1340	7.554052
12	1	5495.6	9	75			7.807902
13	3	5495.6	9	70	1395	1180	9.171656
14	1	5495.6	9	60			9.427835
15	2	5495.6	9	95	1647		10.125558
16	2	5495.6	9	80	1498		10.71843
17	1	5495.6	9	80			11.439104

## USA Bin 5 Trial #9

Burst #	Pulses	Frequency (MHz)	Chirp (MHz)	PW (uS)	Inter-pulse spacing (uS)	Inter-pulse spacing (uS)	Pulse Start (S)
1	2	5498.8	17	80	1735		0.437115
2	3	5498.8	17	85	1266	1214	1.426183
3	1	5498.8	17	95			1.961939
4	1	5498.8	17	75			2.944872
5	1	5498.8	17	50			3.868418
6	2	5498.8	17	70	1364		4.699424
7	1	5498.8	17	100			5.304975
8	1	5498.8	17	100			5.616849
9	1	5498.8	17	85			7.169264
10	3	5498.8	17	95	1694	1936	7.253991
11	3	5498.8	17	65	1144	1427	8.596377
12	1	5498.8	17	95			9.245843
13	3	5498.8	17	80	1611	1585	10.333788
14	1	5498.8	17	50			11.174104
15	1	5498.8	17	85			11.298391



## USA Bin 5 Trial #10

Burst #	Pulses	Frequency (MHz)	Chirp (MHz)	PW (uS)	Inter-pulse spacing (uS)	Inter-pulse spacing (uS)	Pulse Start (S)
1	2	5495.2	8	80	1581		0.454067
2	1	5495.2	8	65			0.661126
3	3	5495.2	8	80	1246	1507	1.462214
4	1	5495.2	8	100			2.118397
5	3	5495.2	8	55	1128	1837	2.968763
6	2	5495.2	8	50	1239		3.493634
7	3	5495.2	8	50	1218	1516	4.058126
8	3	5495.2	8	65	1269	1244	4.763312
9	2	5495.2	8	70	1459		5.285714
10	1	5495.2	8	85			5.568483
11	2	5495.2	8	100	1057		6.243833
12	2	5495.2	8	75	1596		6.638631
13	1	5495.2	8	100			7.398152
14	1	5495.2	8	90			8.072812
15	3	5495.2	8	60	1630	1300	8.957475
16	1	5495.2	8	55			9.315769
17	2	5495.2	8	95	1550		10.004162
18	3	5495.2	8	50	1480	1881	10.259392
19	3	5495.2	8	75	1847	1588	10.843961
20	2	5495.2	8	70	1785		11.932368

## USA Bin 5 Trial #11

Burst #	Pulses	Frequency (MHz)	Chirp (MHz)	PW (uS)	Inter-pulse spacing (uS)	Inter-pulse spacing (uS)	Pulse Start (S)
1	3	5530	18	55	1632	1657	0.390057
2	2	5530	18	70	1354		1.016417
3	2	5530	18	60	1253		1.771615
4	1	5530	18	60			2.589897
5	2	5530	18	95	1919		3.711948
6	1	5530	18	95			4.844104
7	1	5530	18	95			5.634508
8	1	5530	18	75			6.533076
9	2	5530	18	55	1345		7.569654
10	1	5530	18	80			8.531496
11	1	5530	18	85			9.396345
12	1	5530	18	95			10.190701
13	3	5530	18	50	1349	1964	10.664315
14	3	5530	18	65	1959	1959	11.509397

## USA Bin 5 Trial #12



Burst #	Pulses	Frequency (MHz)	Chirp (MHz)	PW (uS)	Inter-pulse spacing (uS)	Inter-pulse spacing (uS)	Pulse Start (S)
1	2	5530	16	75	1402		0.049508
2	2	5530	16	75	1123		2.68856
3	2	5530	16	75	1044		4.248808
4	3	5530	16	65	1139	1869	5.735509
5	1	5530	16	60			6.376397
6	2	5530	16	95	1695		7.971956
7	3	5530	16	80	1367	1984	9.240861
8	3	5530	16	90	1426	1970	11.852667

## USA Bin 5 Trial #13

Burst #	Pulses	Frequency (MHz)	Chirp (MHz)	PW (uS)	Inter-pulse spacing (uS)	Inter-pulse spacing (uS)	Pulse Start (S)
1	1	5530	14	65			0.088706
2	1	5530	14	55			1.004411
3	3	5530	14	70	1209	1824	1.881535
4	1	5530	14	55			2.680685
5	1	5530	14	75			3.19887
6	2	5530	14	100	1024		4.037809
7	2	5530	14	90	1206		4.466405
8	1	5530	14	90			5.035312
9	1	5530	14	60			6.289597
10	2	5530	14	60	1695		6.484242
11	1	5530	14	100			7.559421
12	1	5530	14	50			8.10231
13	3	5530	14	75	1915	1113	8.722998
14	2	5530	14	50	1651		9.407539
15	1	5530	14	60			10.255108
16	3	5530	14	70	1487	1832	11.14368
17	1	5530	14	55			11.34549

## USA Bin 5 Trial #14

Burst #	Pulses	Frequency (MHz)	Chirp (MHz)	PW (uS)	Inter-pulse spacing (uS)	Inter-pulse spacing (uS)	Pulse Start (S)
1	1	5530	13	80			0.588809
2	1	5530	13	80			1.043791
3	1	5530	13	70			1.882248
4	3	5530	13	100	1170	1044	2.672058
5	1	5530	13	90			2.958442
6	3	5530	13	95	1580	1062	4.176702
7	3	5530	13	50	1313	1819	4.55215
8	2	5530	13	65	1841		5.256082



9	1	5530	13	80			5.766288
10	1	5530	13	85			6.430704
11	1	5530	13	95			7.358898
12	1	5530	13	80			8.438027
13	3	5530	13	70	1270	1420	8.882154
14	2	5530	13	95	1880		9.493306
15	3	5530	13	50	1015	1171	10.48815
16	2	5530	13	85	1996		10.957763
17	3	5530	13	55	1480	1356	11.468685

## USA Bin 5 Trial #15

Burst #	Pulses	Frequency (MHz)	Chirp (MHz)	PW (uS)	Inter-pulse spacing (uS)	Inter-pulse spacing (uS)	Pulse Start (S)
1	1	5530	16	100			0.224699
2	2	5530	16	70	1181		2.567192
3	3	5530	16	85	1043	1103	3.742955
4	2	5530	16	50	1668		4.791294
5	1	5530	16	70			6.331185
6	3	5530	16	60	1876	1314	7.138827
7	2	5530	16	100	1035		8.237269
8	3	5530	16	95	1736	1280	10.20428
9	2	5530	16	50	1297		10.88475

## USA Bin 5 Trial #16

Burst #	Pulses	Frequency (MHz)	Chirp (MHz)	PW (uS)	Inter-pulse spacing (uS)	Inter-pulse spacing (uS)	Pulse Start (S)
1	2	5530	13	90	1005		0.522349
2	3	5530	13	100	1016	1198	1.431554
3	1	5530	13	50			2.021721
4	3	5530	13	65	1661	1476	3.56041
5	1	5530	13	80			4.091092
6	3	5530	13	65	1590	1403	5.178773
7	2	5530	13	95	1269		5.950298
8	1	5530	13	60			6.564678
9	2	5530	13	55	1574		8.039011
10	1	5530	13	80			8.755693
11	2	5530	13	60	1975		9.610062
12	2	5530	13	55	1952		10.441568
13	2	5530	13	55	1037		11.331992

## USA Bin 5 Trial #17

Burst #	Pulses	Frequency (MHz)	Chirp (MHz)	PW (uS)	Inter-pulse spacing (uS)	Inter-pulse spacing (uS)	Pulse Start (S)
1	2	5530	20	90	1672		0.204286



2	3	5530	20	95	1124	1391	1.16771
3	2	5530	20	60	1701		2.02366
4	1	5530	20	55			2.7748
5	2	5530	20	85	1744		3.659894
6	3	5530	20	55	1877	1285	4.115689
7	3	5530	20	95	1766	1697	5.072902
8	1	5530	20	80			5.76701
9	1	5530	20	90			6.228557
10	3	5530	20	90	1146	1185	7.376255
11	2	5530	20	100	1599		8.165648
12	1	5530	20	50			8.798984
13	3	5530	20	70	1534	1624	9.557536
14	1	5530	20	90			10.37561
15	2	5530	20	95	1921		11.217785
16	3	5530	20	85	1163	1635	11.571348

## USA Bin 5 Trial #18

Burst #	Pulses	Frequency (MHz)	Chirp (MHz)	PW (uS)	Inter-pulse spacing (uS)	Inter-pulse spacing (uS)	Pulse Start (S)
1	3	5530	7	95	1228	1121	0.641095
2	3	5530	7	65	1601	1310	0.804808
3	2	5530	7	100	1544		1.587862
4	2	5530	7	80	1961		2.059559
5	1	5530	7	75			2.989759
6	3	5530	7	75	1281	1702	3.336035
7	2	5530	7	50	1994		4.405611
8	1	5530	7	55			4.983419
9	1	5530	7	100			5.825445
10	3	5530	7	70	1536	1446	6.198653
11	3	5530	7	50	1383	1365	6.697683
12	3	5530	7	70	1693	1506	7.355427
13	1	5530	7	60			8.457358
14	2	5530	7	85	1620		9.007785
15	1	5530	7	95			9.92488
16	3	5530	7	85	1123	1016	10.634424
17	3	5530	7	60	1815	1747	10.815801
18	1	5530	7	95			11.560835

## USA Bin 5 Trial #19

Burst #	Pulses	Frequency (MHz)	Chirp (MHz)	PW (uS)	Inter-pulse spacing (uS)	Inter-pulse spacing (uS)	Pulse Start (S)
1	2	5530	12	70	1068		0.028618
2	3	5530	12	50	1800	1576	1.142821
3	3	5530	12	70	1298	1824	1.582638



4	3	5530	12	80	1399	1965	2.617335
5	2	5530	12	90	1467		3.269068
6	2	5530	12	80	1004		3.456183
7	3	5530	12	95	1330	1163	4.657876
8	2	5530	12	90	1280		4.709817
9	1	5530	12	95			5.799677
10	1	5530	12	55			6.180324
11	2	5530	12	70	1783		6.970822
12	1	5530	12	80			7.938414
13	2	5530	12	70	1484		8.194647
14	2	5530	12	80	1909		9.206897
15	2	5530	12	80	1327		9.34106
16	1	5530	12	100			10.217696
17	2	5530	12	50	1742		10.689219
18	3	5530	12	50	1346	1421	11.982136

## USA Bin 5 Trial #20

Burst #	Pulses	Frequency (MHz)	Chirp (MHz)	PW (uS)	Inter-pulse spacing (uS)	Inter-pulse spacing (uS)	Pulse Start (S)
1	3	5530	8	80	1360	1222	0.608681
2	3	5530	8	75	1734	1716	0.812699
3	2	5530	8	80	1498		1.479088
4	1	5530	8	50			2.455144
5	2	5530	8	95	1321		3.20538
6	2	5530	8	55	1080		3.721733
7	3	5530	8	70	1447	1128	4.209103
8	3	5530	8	100	1554	1063	5.21536
9	2	5530	8	65	1730		5.563183
10	3	5530	8	95	1600	1682	6.463417
11	2	5530	8	75	1910		6.954338
12	2	5530	8	55	1266		7.953975
13	3	5530	8	55	1861	1180	8.187086
14	3	5530	8	65	1644	1198	9.050742
15	3	5530	8	70	1389	1819	9.860159
16	2	5530	8	55	1487		10.09796
17	3	5530	8	95	1958	1518	11.328036
18	3	5530	8	85	1196	1600	11.831925

## USA Bin 5 Trial #21

Burst #	Pulses	Frequency (MHz)	Chirp (MHz)	PW (uS)	Inter-pulse spacing (uS)	Inter-pulse spacing (uS)	Pulse Start (S)
1	1	5565.2	7	50			0.679073
2	3	5565.2	7	80	1584	1404	1.973924
3	2	5565.2	7	95	1532		2.437711



4	1	5565.2	7	100			3.392099
5	3	5565.2	7	100	1104	1304	4.261015
6	1	5565.2	7	60			5.312615
7	2	5565.2	7	95	1957		6.459145
8	2	5565.2	7	85	1001		7.328338
9	3	5565.2	7	60	1563	1341	8.953572
10	1	5565.2	7	50			9.476564
11	1	5565.2	7	95			10.892149
12	3	5565.2	7	55	1191	1549	11.451423

## USA Bin 5 Trial #22

Burst #	Pulses	Frequency (MHz)	Chirp (MHz)	PW (uS)	Inter-pulse spacing (uS)	Inter-pulse spacing (uS)	Pulse Start (S)
1	2	5566	5	80	1705		0.183496
2	3	5566	5	90	1692	1615	1.122393
3	1	5566	5	50			1.492442
4	2	5566	5	60	1777		2.68414
5	1	5566	5	55			3.309421
6	2	5566	5	50	1367		4.209222
7	2	5566	5	100	1722		4.772804
8	2	5566	5	90	1009		5.068801
9	1	5566	5	80			5.673724
10	3	5566	5	95	1233	1141	6.997207
11	3	5566	5	70	1758	1496	7.315678
12	1	5566	5	95			7.906878
13	3	5566	5	50	1595	1221	8.59491
14	1	5566	5	70			9.452141
15	1	5566	5	95			10.163447
16	3	5566	5	55	1307	1731	10.984479
17	3	5566	5	85	1820	1450	11.509443

## USA Bin 5 Trial #23

Burst #	Pulses	Frequency (MHz)	Chirp (MHz)	PW (uS)	Inter-pulse spacing (uS)	Inter-pulse spacing (uS)	Pulse Start (S)
1	2	5564	10	85	1735		1.414471
2	2	5564	10	100	1402		2.966476
3	1	5564	10	60			3.212789
4	1	5564	10	90			5.99083
5	3	5564	10	90	1044	1004	6.910299
6	2	5564	10	65	1109		8.294011
7	3	5564	10	90	1109	1290	9.662517
8	3	5564	10	50	1548	1776	11.419174

## USA Bin 5 Trial #24



Burst #	Pulses	Frequency (MHz)	Chirp (MHz)	PW (uS)	Inter-pulse spacing (uS)	Inter-pulse spacing (uS)	Pulse Start (S)
1	2	5566	5	85	1164		0.151262
2	1	5566	5	70			0.952409
3	3	5566	5	80	1273	1760	1.917087
4	1	5566	5	60			2.803012
5	1	5566	5	90			3.321441
6	3	5566	5	65	1279	1009	4.312165
7	3	5566	5	55	1208	1927	4.952042
8	2	5566	5	60	1984		5.837049
9	1	5566	5	50			6.462869
10	1	5566	5	65			7.254119
11	1	5566	5	50			7.534795
12	1	5566	5	50			8.334314
13	1	5566	5	55			9.001518
14	1	5566	5	85			10.385916
15	2	5566	5	80	1526		10.561033
16	3	5566	5	60	1925	1428	11.825818

## USA Bin 5 Trial #25

Burst #	Pulses	Frequency (MHz)	Chirp (MHz)	PW (uS)	Inter-pulse spacing (uS)	Inter-pulse spacing (uS)	Pulse Start (S)
1	3	5566	5	75	1404	1764	0.346994
2	3	5566	5	70	1603	1134	1.251135
3	2	5566	5	90	1392		2.173655
4	3	5566	5	85	1221	1979	2.340208
5	2	5566	5	50	1216		3.460496
6	3	5566	5	65	1826	1880	4.381286
7	2	5566	5	50	1058		4.953114
8	1	5566	5	70			5.979338
9	3	5566	5	70	1022	1700	6.459744
10	3	5566	5	55	2000	1623	7.479207
11	2	5566	5	70	1295		7.844014
12	2	5566	5	50	1021		8.525398
13	3	5566	5	60	1186	1264	9.093213
14	3	5566	5	60	1326	1100	10.262273
15	1	5566	5	70			10.948792
16	2	5566	5	90	1887		11.585856

## USA Bin 5 Trial #26

Burst #	Pulses	Frequency (MHz)	Chirp (MHz)	PW (uS)	Inter-pulse spacing (uS)	Inter-pulse spacing (uS)	Pulse Start (S)
1	2	5562	15	75	1444		0.883371





2	1	5562	15	85			2.129818
3	1	5562	15	85			3.082508
4	2	5562	15	50	1754		3.677531
5	3	5562	15	80	1430	1747	5.305425
6	1	5562	15	85			6.251886
7	1	5562	15	60			7.656504
8	3	5562	15	65	1485	1814	9.373857
9	3	5562	15	80	1627	1849	10.407758
10	3	5562	15	50	1203	1633	11.020261

USA Bin 5 Trial #27

Burst #	Pulses	Frequency (MHz)	Chirp (MHz)	PW (uS)	Inter-pulse spacing (uS)	Inter-pulse spacing (uS)	Pulse Start (S)
1	3	5561.2	17	55	1522	1131	0.290263
2	3	5561.2	17	100	1049	1795	1.148273
3	2	5561.2	17	55	1957		1.366124
4	3	5561.2	17	80	1814	1346	2.368735
5	3	5561.2	17	50	1523	1522	2.860474
6	1	5561.2	17	70			3.427392
7	1	5561.2	17	75			4.060091
8	1	5561.2	17	80			4.473898
9	2	5561.2	17	65	1422		5.173452
10	2	5561.2	17	80	1798		5.435882
11	1	5561.2	17	65			6.285691
12	3	5561.2	17	90	1716	1816	6.651371
13	1	5561.2	17	60			7.536875
14	2	5561.2	17	50	1037		7.958272
15	1	5561.2	17	85			8.681199
16	1	5561.2	17	95			9.587114
17	1	5561.2	17	85			9.968312
18	2	5561.2	17	55	1438		10.598405
19	1	5561.2	17	90			11.307069
20	3	5561.2	17	90	1820	1509	11.420662

USA Bin 5 Trial #28

Burst #	Pulses	Frequency (MHz)	Chirp (MHz)	PW (uS)	Inter-pulse spacing (uS)	Inter-pulse spacing (uS)	Pulse Start (S)
1	3	5566	5	60	1752	1573	0.310775
2	2	5566	5	55	1010		1.528258
3	2	5566	5	60	1128		1.900669
4	3	5566	5	60	1780	1150	2.953629
5	2	5566	5	50	1352		4.491875
6	1	5566	5	95			5.0003
7	3	5566	5	75	1948	1418	6.371117



8	1	5566	5	55			6.688416
9	3	5566	5	85	1627	1411	7.860761
10	3	5566	5	90	1665	1741	8.66725
11	3	5566	5	80	1320	1712	10.048806
12	1	5566	5	95			10.347872
13	2	5566	5	100	1662		11.137991

## USA Bin 5 Trial #29

Burst #	Pulses	Frequency (MHz)	Chirp (MHz)	PW (uS)	Inter-pulse spacing (uS)	Inter-pulse spacing (uS)	Pulse Start (S)
1	1	5564	10	100			0.906037
2	3	5564	10	50	1542	1728	1.042445
3	2	5564	10	55	1978		2.059501
4	1	5564	10	85			3.215973
5	3	5564	10	85	1348	1060	4.214969
6	2	5564	10	80	1887		5.010387
7	3	5564	10	90	1222	1649	6.852273
8	2	5564	10	75	1354		7.873133
9	1	5564	10	75			8.203507
10	2	5564	10	70	1784		9.051572
11	3	5564	10	95	1619	1112	10.63189
12	1	5564	10	70			11.872145

## USA Bin 5 Trial #30

Burst #	Pulses	Frequency (MHz)	Chirp (MHz)	PW (uS)	Inter-pulse spacing (uS)	Inter-pulse spacing (uS)	Pulse Start (S)
1	2	5564.8	8	100	1967		1.258259
2	3	5564.8	8	70	1598	1420	2.316637
3	3	5564.8	8	65	1689	1786	3.620011
4	1	5564.8	8	50			4.653861
5	1	5564.8	8	50			5.916168
6	2	5564.8	8	100	1163		7.719079
7	3	5564.8	8	95	1501	1349	8.902315
8	3	5564.8	8	55	1749	1993	10.268083
9	1	5564.8	8	75			11.524606



## USA Frequency Hopping Trial #1

Hop #	Freq (GHz)	Pulse Start (mS)
5	5553	15
7	5509	21
10	5533	30
12	5506	36
15	5521	45
20	5555	60
27	5545	81
32	5547	96
43	5520	129
58	5526	174
64	5563	192
65	5496	195
72	5556	216
76	5531	228
79	5500	237
85	5552	255
87	5492	261
97	5566	291

## USA Frequency Hopping Trial #2

Hop #	Freq (GHz)	Pulse Start (mS)
7	5506	21
15	5531	45
20	5529	60
41	5509	123
44	5548	132
47	5544	141
53	5501	159
55	5504	165
62	5525	186
67	5517	201
68	5547	204
79	5542	237
85	5510	255
96	5564	288
97	5567	291

## USA Frequency Hopping Trial #3

Hop #	Freq (GHz)	Pulse Start (mS)
10	5500	30
23	5519	69



41	5568	123
49	5518	147
50	5535	150
72	5505	216
73	5553	219
86	5503	258
91	5526	273
92	5508	276
98	5524	294

## USA Frequency Hopping Trial #4

Hop #	Freq (GHz)	Pulse Start (mS)
11	5547	33
14	5494	42
17	5517	51
19	5493	57
23	5556	69
36	5538	108
51	5534	153
54	5558	162
61	5548	183
64	5502	192
66	5529	198
68	5564	204
75	5508	225
76	5522	228
78	5510	234
81	5533	243
94	5532	282

## USA Frequency Hopping Trial #5

Hop #	Freq (GHz)	Pulse Start (mS)
2	5492	6
6	5550	18
15	5562	45
18	5518	54
21	5531	63
23	5566	69
24	5541	72
32	5506	96
33	5513	99
38	5536	114
42	5523	126
43	5509	129

49	5547	147
50	5528	150
52	5564	156
59	5521	177
62	5535	186
70	5555	210
84	5538	252
95	5534	285
98	5567	294

## USA Frequency Hopping Trial #6

Hop #	Freq (GHz)	Pulse Start (mS)
1	5558	3
2	5512	6
6	5527	18
8	5518	24
10	5530	30
37	5539	111
38	5568	114
43	5564	129
44	5566	132
51	5511	153
55	5495	165
62	5531	186
67	5556	201
68	5514	204
69	5493	207
75	5529	225
79	5500	237
84	5494	252
85	5565	255
86	5525	258
88	5549	264
91	5496	273
93	5498	279

## USA Frequency Hopping Trial #7

Hop #	Freq (GHz)	Pulse Start (mS)
0	5546	0
5	5518	15
8	5555	24
25	5516	75
26	5568	78
37	5495	111



46	5502	138
54	5536	162
64	5552	192
74	5496	222
81	5510	243
84	5540	252
85	5529	255
87	5557	261

## USA Frequency Hopping Trial #8

Hop #	Freq (GHz)	Pulse Start (mS)
6	5553	18
7	5564	21
13	5560	39
18	5555	54
25	5525	75
30	5558	90
40	5505	120
48	5530	144
53	5517	159
60	5516	180
69	5550	207
78	5512	234
81	5526	243
92	5533	276

## USA Frequency Hopping Trial #9

Hop #	Freq (GHz)	Pulse Start (mS)
3	5512	9
6	5554	18
14	5519	42
15	5500	45
16	5497	48
18	5529	54
22	5553	66
25	5549	75
29	5518	87
47	5561	141
50	5568	150
54	5505	162
58	5551	174
60	5517	180
73	5534	219
90	5536	270



## USA Frequency Hopping Trial #10

Hop #	Freq (GHz)	Pulse Start (mS)
0	5538	0
1	5555	3
3	5524	9
5	5512	15
6	5559	18
17	5528	51
19	5545	57
26	5562	78
33	5560	99
40	5497	120
41	5568	123
61	5533	183
62	5544	186
70	5503	210
77	5543	231
83	5546	249
96	5507	288

## USA Frequency Hopping Trial #11

Hop #	Freq (GHz)	Pulse Start (mS)
2	5508	6
13	5510	39
17	5507	51
23	5553	69
35	5512	105
47	5523	141
51	5500	153
52	5514	156
53	5497	159
58	5527	174
70	5528	210
82	5555	246
83	5549	249
89	5541	267
92	5506	276
94	5536	282
98	5552	294

## USA Frequency Hopping Trial #12

Hop #	Freq (GHz)	Pulse Start (mS)
13	5506	39



15	5538	45
22	5551	66
24	5497	72
26	5566	78
31	5553	93
33	5516	99
37	5534	111
51	5556	153
62	5564	186
77	5509	231
87	5535	261
90	5494	270
92	5554	276

**USA Frequency Hopping Trial #13**

Hop #	Freq (GHz)	Pulse Start (mS)
11	5508	33
14	5558	42
36	5523	108
41	5564	123
60	5557	180
81	5567	243
84	5551	252
88	5504	264
95	5533	285

**USA Frequency Hopping Trial #14**

Hop #	Freq (GHz)	Pulse Start (mS)
1	5528	3
3	5516	9
7	5553	21
9	5559	27
24	5512	72
27	5525	81
30	5544	90
35	5506	105
36	5497	108
37	5495	111
48	5545	144
50	5535	150
71	5504	213
83	5543	249
84	5500	252
85	5519	255



93	5521	279
USA Frequency Hopping Trial #15		
	Freq	Pulse Start
Hop #	(GHz)	(mS)
2	5536	6
10	5509	30
21	5496	63
27	5510	81
33	5546	99
34	5544	102
35	5503	105
45	5548	135
52	5560	156
59	5506	177
66	5518	198
67	5505	201
72	5550	216
75	5515	225
78	5547	234
92	5549	276
95	5563	285

USA Frequency Hopping Trial #16		
	Freq	Pulse Start
Hop #	(GHz)	(mS)
3	5518	9
5	5566	15
7	5522	21
11	5540	33
12	5512	36
14	5505	42
24	5494	72
35	5513	105
45	5493	135
62	5501	186
65	5544	195
85	5562	255

USA Frequency Hopping Trial #17		
	Freq	Pulse Start
Hop #	(GHz)	(mS)
2	5531	6
13	5544	39
20	5546	60
40	5567	120
45	5561	135



46	5527	138
47	5559	141
55	5537	165
56	5541	168
59	5509	177
62	5517	186
72	5510	216
76	5535	228
83	5524	249
85	5512	255
99	5525	297

**USA Frequency Hopping Trial #18**

Hop #	Freq (GHz)	Pulse Start (mS)
2	5563	6
8	5521	24
9	5502	27
17	5511	51
18	5515	54
37	5545	111
38	5493	114
45	5513	135
47	5495	141
50	5501	150
57	5557	171
62	5554	186
68	5544	204
71	5533	213
74	5494	222
75	5504	225
78	5519	234
80	5527	240
83	5564	249
87	5548	261
91	5516	273

**USA Frequency Hopping Trial #19**

Hop #	Freq (GHz)	Pulse Start (mS)
2	5523	6
8	5556	24
10	5494	30
12	5528	36
13	5541	39
16	5555	48

19	5537	57
23	5522	69
35	5533	105
61	5496	183
65	5498	195
67	5558	201
68	5550	204
78	5493	234
87	5564	261
89	5562	267
90	5559	270

## USA Frequency Hopping Trial #20

Hop #	Freq (GHz)	Pulse Start (mS)
0	5563	0
2	5545	6
33	5525	99
46	5500	138
48	5524	144
49	5522	147
53	5493	159
65	5537	195
66	5544	198
73	5535	219
79	5536	237
84	5554	252
85	5538	255
90	5503	270
96	5492	288

## USA Frequency Hopping Trial #21

Hop #	Freq (GHz)	Pulse Start (mS)
1	5559	3
21	5546	63
25	5558	75
29	5553	87
30	5504	90
39	5538	117
43	5567	129
44	5557	132
46	5496	138
67	5566	201
71	5531	213
82	5555	246

84	5522	252
85	5523	255
86	5515	258
94	5513	282

## USA Frequency Hopping Trial #22

Hop #	Freq (GHz)	Pulse Start (mS)
4	5531	12
10	5499	30
14	5554	42
16	5564	48
20	5500	60
21	5511	63
27	5541	81
35	5521	105
40	5515	120
44	5543	132
54	5512	162
67	5501	201
73	5494	219
82	5565	246
96	5518	288
97	5522	291

## USA Frequency Hopping Trial #23

Hop #	Freq (GHz)	Pulse Start (mS)
0	5496	0
6	5553	18
10	5550	30
17	5511	51
22	5514	66
23	5530	69
29	5519	87
30	5498	90
56	5539	168
61	5515	183
75	5560	225
77	5547	231
78	5568	234
83	5536	249
90	5540	270
91	5513	273
95	5518	285
96	5507	288



## USA Frequency Hopping Trial #24

Hop #	Freq (GHz)	Pulse Start (mS)
0	5550	0
5	5503	15
11	5534	33
31	5496	93
34	5563	102
39	5511	117
49	5552	147
53	5531	159
55	5509	165
57	5566	171
59	5508	177
61	5541	183
74	5561	222
84	5519	252
97	5513	291
98	5559	294

## USA Frequency Hopping Trial #25

Hop #	Freq (GHz)	Pulse Start (mS)
3	5534	9
12	5558	36
16	5513	48
31	5518	93
37	5544	111
41	5540	123
49	5497	147
53	5530	159
62	5563	186
69	5545	207
78	5557	234
79	5522	237
83	5551	249
84	5524	252
85	5543	255
87	5525	261
88	5547	264
93	5507	279
96	5561	288
98	5523	294

## USA Frequency Hopping Trial #26



Hop #	Freq (GHz)	Pulse Start (mS)
33	5492	99
36	5497	108
39	5555	117
45	5520	135
53	5562	159
59	5542	177
67	5540	201
70	5503	210
74	5543	222
77	5500	231
88	5513	264
89	5544	267
91	5524	273
94	5545	282
98	5514	294

## USA Frequency Hopping Trial #27

Hop #	Freq (GHz)	Pulse Start (mS)
4	5537	12
5	5502	15
6	5545	18
9	5556	27
20	5493	60
25	5497	75
26	5522	78
28	5528	84
31	5548	93
35	5511	105
44	5527	132
47	5507	141
81	5560	243
92	5559	276

## USA Frequency Hopping Trial #28

Hop #	Freq (GHz)	Pulse Start (mS)
1	5557	3
4	5564	12
5	5504	15
8	5494	24
18	5518	54
45	5517	135
51	5537	153



58	5565	174
61	5554	183
67	5550	201
69	5549	207
77	5558	231
83	5546	249
92	5539	276
97	5527	291

## USA Frequency Hopping Trial #29

Hop #	Freq (GHz)	Pulse Start (mS)
3	5564	9
5	5529	15
9	5517	27
11	5513	33
12	5540	36
15	5541	45
20	5535	60
34	5563	102
35	5493	105
38	5528	114
46	5510	138
47	5543	141
49	5556	147
60	5534	180
61	5526	183
63	5525	189
66	5561	198
71	5499	213
74	5536	222
78	5557	234
84	5560	252
90	5552	270
93	5512	279

## USA Frequency Hopping Trial #30

Hop #	Freq (GHz)	Pulse Start (mS)
15	5533	45
20	5551	60
27	5524	81
30	5515	90
31	5539	93
35	5492	105
40	5544	120



47	5493	141
57	5532	171
64	5550	192
69	5554	207
72	5546	216
75	5538	225
79	5500	237
82	5542	246
83	5540	249
89	5531	267





**Channel 5570 MHz, 160MHz BW, Statistical Performance (upper section of 80+80)**

**USA Bin 1A/1B**

freq=5610, rate=m0x1, bw=76.0

Trial	Frequency	Pulses	PW (uS)	PRI (uS)	1=Detection 0=No Detection	Detection Percentage	Limit
1	5570	65	1	818	1	100.0%	60.0%
2	5570	57	1	938	1		
3	5576	83	1	638	1		
4	5576	78	1	678	1		
5	5582	68	1	778	1		
6	5582	86	1	618	1		
7	5588	102	1	518	1		
8	5588	58	1	918	1		
9	5594	102	1	518	1		
10	5594	61	1	878	1		
11	5600	67	1	798	1		
12	5600	102	1	518	1		
13	5606	67	1	798	1		
14	5606	59	1	898	1		
15	5610	18	1	3066	1		
16	5610	62	1	852	1		
17	5614	19	1	2874	1		
18	5614	50	1	1077	1		
19	5620	43	1	1240	1		
20	5620	19	1	2896	1		
21	5626	25	1	2114	1		
22	5626	32	1	1676	1		
23	5632	21	1	2620	1		
24	5632	29	1	1853	1		
25	5638	45	1	1188	1		
26	5638	72	1	737	1		
27	5644	81	1	659	1		
28	5644	19	1	2848	1		
29	5650	52	1	1032	1		
30	5650	31	1	1711	1		



**USA Bin 1A/1B**

freq=5610, rate=m0x1, bw=76.0

Trial	Frequency	Pulses	PW (uS)	PRI (uS)	1=Detection 0=No Detection	Detection Percentage	Limit
1	5570	95	1	558	1	100.0%	60.0%
2	5570	74	1	718	1		
3	5576	102	1	518	1		
4	5576	99	1	538	1		
5	5582	58	1	918	1		
6	5582	99	1	538	1		
7	5588	95	1	558	1		
8	5588	62	1	858	1		
9	5594	72	1	738	1		
10	5594	72	1	738	1		
11	5600	63	1	838	1		
12	5600	102	1	518	1		
13	5606	74	1	718	1		
14	5606	74	1	718	1		
15	5610	68	1	778	1		
16	5610	39	1	1363	1		
17	5614	66	1	801	1		
18	5614	25	1	2164	1		
19	5620	22	1	2439	1		
20	5620	18	1	3035	1		
21	5626	51	1	1050	1		
22	5626	21	1	2553	1		
23	5632	37	1	1440	1		
24	5632	30	1	1799	1		
25	5638	21	1	2573	1		
26	5638	34	1	1558	1		
27	5644	58	1	922	1		
28	5644	25	1	2113	1		
29	5650	31	1	1752	1		
30	5650	19	1	2787	1		

**USA Bin  
2**

freq=5610, rate=m0x1, bw=76.0

Trial	Frequency	Pulses	PW (uS)	PRI (uS)	1=Detection 0=No Detection	Detection Percentage	Limit
1	5570	26	3.8	186	1	100.0%	60.0%
2	5570	26	3.9	230	1		
3	5576	27	3.3	200	1		
4	5576	24	3.4	223	1		
5	5582	28	2.7	230	1		
6	5582	23	2.4	207	1		
7	5588	26	2.2	198	1		
8	5588	24	5	228	1		
9	5594	28	1.1	204	1		
10	5594	28	1.6	188	1		
11	5600	25	4.1	172	1		
12	5600	29	2.1	159	1		
13	5606	25	3.5	155	1		
14	5606	28	1.9	172	1		
15	5610	23	4.6	166	1		
16	5610	29	2.2	206	1		
17	5614	25	3.3	207	1		
18	5614	25	1.5	227	1		
19	5620	24	3.9	166	1		
20	5620	23	2.9	178	1		
21	5626	28	1.8	200	1		
22	5626	27	2.3	196	1		
23	5632	26	4	175	1		
24	5632	25	4.3	227	1		
25	5638	24	1.5	207	1		
26	5638	28	2.5	222	1		
27	5644	27	3.8	173	1		
28	5644	27	4.3	177	1		
29	5650	23	1.7	189	1		
30	5650	24	2.5	218	1		

**USA Bin  
3**

freq=5610, rate=m0x1, bw=76.0

Trial	Frequency	Pulses	PW (uS)	PRI (uS)	1=Detection 0=No Detection	Detection Percentage	Limit
1	5570	17	6	456	1	100.0%	60.0%
2	5570	18	7.9	407	1		
3	5576	16	7.8	476	1		
4	5576	18	9.4	323	1		
5	5582	17	10	487	1		
6	5582	16	8.1	479	1		
7	5588	17	9	211	1		
8	5588	18	7.7	262	1		
9	5594	17	6.1	337	1		
10	5594	16	7.3	383	1		
11	5600	17	8.5	329	1		
12	5600	18	6.9	476	1		
13	5606	16	8.1	315	1		
14	5606	18	8	490	1		
15	5610	18	6.4	433	1		
16	5610	16	8.5	370	1		
17	5614	17	6.7	214	1		
18	5614	17	8	225	1		
19	5620	18	7.4	462	1		
20	5620	16	7.4	452	1		
21	5626	18	6	407	1		
22	5626	16	9.5	369	1		
23	5632	16	7.2	276	1		
24	5632	18	6.6	330	1		
25	5638	17	8.8	359	1		
26	5638	18	9.3	243	1		
27	5644	18	10	210	1		
28	5644	17	7.7	414	1		
29	5650	18	8.6	209	1		
30	5650	17	7.4	466	1		

**USA Bin****4**

freq=5610, rate=m0x1, bw=76.0

Trial	Frequency	Pulses	PW (uS)	PRI (uS)	1=Detection 0=No Detection	Detection Percentage	Limit
1	5570	14	11.6	223	1	100.0%	60.0%
2	5570	12	18.3	344	1		
3	5576	14	13	289	1		
4	5576	14	14.5	415	1		
5	5582	15	18.2	470	1		
6	5582	15	13.4	351	1		
7	5588	16	19.9	385	1		
8	5588	16	15.7	374	1		
9	5594	14	11.1	255	1		
10	5594	12	15.1	230	1		
11	5600	14	11.8	296	1		
12	5600	12	16.2	478	1		
13	5606	12	12	252	1		
14	5606	16	19.7	340	1		
15	5610	16	19.7	241	1		
16	5610	12	18.8	226	1		
17	5614	16	13.9	498	1		
18	5614	15	15	356	1		
19	5620	16	11.7	313	1		
20	5620	15	19.1	403	1		
21	5626	16	15.1	272	1		
22	5626	15	16	238	1		
23	5632	15	15.6	339	1		
24	5632	16	17.7	411	1		
25	5638	14	12.4	342	1		
26	5638	12	12.3	274	1		
27	5644	15	17.1	430	1		
28	5644	14	15.8	377	1		
29	5650	14	18.8	454	1		
30	5650	14	11.6	285	1		

In addition an average minimum percentage of successful detection across all four Short pulse radar test waveforms is required and is calculated as follows:

$$\frac{P_d 1 + P_d 2 + P_d 3 + P_d 4}{4} = (100.0\% + 100.0\% + 100.0\% + 100.0\% + 100.0\%)/5 = 100.0\% (>80\%)$$



USA  
Bin  
5

freq=5610, rate=m0x1, bw=76.0

Trial	Burst #	Pulses	Frequency (MHz)	Chirp (MHz)	PW (uS)	Inter-pulse spacing (uS)	Inter-pulse spacing (uS)	Pulse Start (S)	1=Detection 0=No Detection	Detection Percentage	Limit
1	1	3	5576.8	12	75	1924	1120	0.272061	1	100.0%	80.0%
2	1	2	5578.4	16	50	1576		1.16778	1		
3	1	3	5578.4	16	90	1385	1831	0.180893	1		
4	1	2	5575.6	9	60	1649		0.081909	1		
5	1	1	5576.8	12	50			0.099292	1		
6	1	1	5574.4	6	95			0.672357	1		
7	1	2	5577.2	13	65	1473		1.055282	1		
8	1	2	5579.2	18	80	1940		0.47584	1		
9	1	2	5579.2	18	75	1120		0.721675	1		
10	1	3	5575.6	9	80	1538	1216	0.215113	1		
11	1	3	5610	20	65	1280	1929	0.221877	1		
12	1	2	5610	6	75	1862		0.03127	1		
13	1	1	5610	9	95			1.060897	1		
14	1	1	5610	18	100			0.379902	1		
15	1	2	5610	16	70	1801		1.097662	1		
16	1	2	5610	14	85	1961		0.03197	1		
17	1	1	5610	16	55			0.371896	1		
18	1	3	5610	7	95	1354	1491	0.270441	1		
19	1	2	5610	14	65	1476		0.619638	1		
20	1	2	5610	19	60	1541		0.692563	1		
21	1	3	5640.8	18	55	1603	1892	0.371707	1		
22	1	2	5643.6	11	60	1592		0.161097	1		
23	1	3	5640	20	75	1555	1326	0.046555	1		
24	1	3	5640.8	18	65	1924	1586	0.368777	1		
25	1	2	5640.8	18	50	1258		0.47552	1		
26	1	1	5643.2	12	50			0.534259	1		
27	1	2	5645.2	7	85	1628		0.431111	1		
28	1	1	5644.8	8	100			0.577327	1		
29	1	3	5644.4	9	50	1167	1032	0.348749	1		
30	1	2	5641.6	16	60	1357		0.875282	1		



freq=5610, rate=m0x1,  
bw=76.0

**USA Frequency Hopping**

Trial	Hop #	Freq (GHz)	Pulse Start (mS)	1=Detection 0=No Detection	Detection Percentage	Limit
1	0	5600	0	1	100.0%	70.0%
2	4	5612	12	1		
3	8	5596	24	1		
4	5	5599	15	1		
5	1	5647	3	1		
6	2	5607	6	1		
7	2	5608	6	1		
8	11	5633	33	1		
9	1	5622	3	1		
10	1	5635	3	1		
11	16	5602	48	1		
12	2	5626	6	1		
13	8	5625	24	1		
14	0	5583	0	1		
15	1	5579	3	1		
16	6	5575	18	1		
17	14	5589	42	1		
18	1	5643	3	1		
19	2	5622	6	1		
20	5	5572	15	1		
21	4	5612	12	1		
22	0	5647	0	1		
23	4	5589	12	1		
24	0	5580	0	1		
25	4	5641	12	1		
26	1	5591	3	1		
27	7	5587	21	1		
28	1	5604	3	1		
29	8	5591	24	1		
30	0	5582	0	1		



## USA Bin 5 Trial #1

Burst #	Pulses	Frequency (MHz)	Chirp (MHz)	PW (uS)	Inter-pulse spacing (uS)	Inter-pulse spacing (uS)	Pulse Start (S)
1	3	5576.8	12	75	1924	1120	0.272061
2	2	5576.8	12	95	1762		0.949607
3	1	5576.8	12	80			1.618094
4	3	5576.8	12	65	1572	1964	2.431535
5	3	5576.8	12	50	1566	1940	3.186463
6	3	5576.8	12	80	1699	2000	3.741281
7	2	5576.8	12	95	1997		4.266012
8	1	5576.8	12	100			5.444558
9	1	5576.8	12	80			6.135122
10	3	5576.8	12	55	1358	1212	6.57064
11	3	5576.8	12	50	1566	1995	7.383551
12	1	5576.8	12	80			8.424463
13	3	5576.8	12	85	1282	1041	9.143716
14	3	5576.8	12	70	1830	1162	9.184309
15	1	5576.8	12	80			10.574964
16	3	5576.8	12	50	1450	1052	11.217382
17	1	5576.8	12	55			11.765827

## USA Bin 5 Trial #2

Burst #	Pulses	Frequency (MHz)	Chirp (MHz)	PW (uS)	Inter-pulse spacing (uS)	Inter-pulse spacing (uS)	Pulse Start (S)
1	2	5578.4	16	50	1576		1.16778
2	3	5578.4	16	80	1355	1618	1.230749
3	1	5578.4	16	80			2.731154
4	2	5578.4	16	95	1308		3.660106
5	3	5578.4	16	65	1129	1787	5.73397
6	3	5578.4	16	90	1450	1552	7.192354
7	3	5578.4	16	85	1951	1061	7.990055
8	1	5578.4	16	95			8.564739
9	1	5578.4	16	90			10.163316
10	1	5578.4	16	70			11.211302

## USA Bin 5 Trial #3

Burst #	Pulses	Frequency (MHz)	Chirp (MHz)	PW (uS)	Inter-pulse spacing (uS)	Inter-pulse spacing (uS)	Pulse Start (S)
1	3	5578.4	16	90	1385	1831	0.180893
2	3	5578.4	16	95	1073	1639	1.735376
3	1	5578.4	16	60			2.672049
4	2	5578.4	16	90	1326		4.703704
5	2	5578.4	16	65	1842		5.414228





6	3	5578.4	16	90	1304	1861	7.052611
7	1	5578.4	16	85			7.7638
8	3	5578.4	16	90	1593	1006	9.094616
9	2	5578.4	16	70	1306		10.540733
10	2	5578.4	16	95	1909		11.495455

## USA Bin 5 Trial #4

Burst #	Pulses	Frequency (MHz)	Chirp (MHz)	PW (uS)	Inter-pulse spacing (uS)	Inter-pulse spacing (uS)	Pulse Start (S)
1	2	5575.6	9	60	1649		0.081909
2	2	5575.6	9	100	1593		1.126356
3	3	5575.6	9	70	1706	1643	1.81446
4	2	5575.6	9	60	1351		2.085729
5	2	5575.6	9	85	1671		3.033479
6	2	5575.6	9	60	1358		3.265112
7	3	5575.6	9	60	1867	1521	4.10485
8	2	5575.6	9	100	1070		4.610468
9	3	5575.6	9	70	1276	1888	5.120589
10	1	5575.6	9	55			6.172041
11	2	5575.6	9	55	1942		6.520496
12	2	5575.6	9	90	1870		7.406515
13	3	5575.6	9	90	1773	1503	7.920458
14	1	5575.6	9	55			8.403508
15	2	5575.6	9	50	1159		9.279834
16	1	5575.6	9	95			9.750134
17	3	5575.6	9	75	1570	1884	10.388692
18	1	5575.6	9	85			10.921993
19	1	5575.6	9	70			11.402331

## USA Bin 5 Trial #5

Burst #	Pulses	Frequency (MHz)	Chirp (MHz)	PW (uS)	Inter-pulse spacing (uS)	Inter-pulse spacing (uS)	Pulse Start (S)
1	1	5576.8	12	50			0.099292
2	3	5576.8	12	60	1830	1868	1.035082
3	1	5576.8	12	90			2.448476
4	2	5576.8	12	60	1807		3.397008
5	3	5576.8	12	60	1575	1397	3.825648
6	1	5576.8	12	75			4.779121
7	2	5576.8	12	80	1928		5.667257
8	1	5576.8	12	65			6.533679
9	3	5576.8	12	70	1688	1245	7.488704
10	1	5576.8	12	75			7.758077
11	2	5576.8	12	85	1119		9.102565
12	3	5576.8	12	100	1126	1735	10.154224



13	1	5576.8	12	100		11.114599
14	2	5576.8	12	95	1006	11.981863

## USA Bin 5 Trial #6

Burst #	Pulses	Frequency (MHz)	Chirp (MHz)	PW (uS)	Inter-pulse spacing (uS)	Inter-pulse spacing (uS)	Pulse Start (S)
1	1	5574.4	6	95			0.672357
2	1	5574.4	6	75			1.166345
3	3	5574.4	6	80	1015	1995	2.68159
4	1	5574.4	6	75			3.47177
5	2	5574.4	6	90	1777		3.747456
6	2	5574.4	6	85	1897		4.799552
7	1	5574.4	6	55			5.601623
8	2	5574.4	6	90	1273		6.881399
9	2	5574.4	6	95	1792		8.169325
10	3	5574.4	6	50	1981	1265	8.933836
11	3	5574.4	6	90	1365	1289	9.32023
12	3	5574.4	6	90	1507	1546	10.622693
13	1	5574.4	6	80			11.493865

## USA Bin 5 Trial #7

Burst #	Pulses	Frequency (MHz)	Chirp (MHz)	PW (uS)	Inter-pulse spacing (uS)	Inter-pulse spacing (uS)	Pulse Start (S)
1	2	5577.2	13	65	1473		1.055282
2	2	5577.2	13	65	1695		2.283453
3	2	5577.2	13	100	1413		3.94018
4	3	5577.2	13	75	1106	1656	5.662745
5	1	5577.2	13	55			7.127132
6	3	5577.2	13	95	1971	1427	7.717252
7	3	5577.2	13	80	1580	1810	9.390395
8	1	5577.2	13	95			10.597098

## USA Bin 5 Trial #8

Burst #	Pulses	Frequency (MHz)	Chirp (MHz)	PW (uS)	Inter-pulse spacing (uS)	Inter-pulse spacing (uS)	Pulse Start (S)
1	2	5579.2	18	80	1940		0.47584
2	1	5579.2	18	70			0.825247
3	2	5579.2	18	60	1473		1.657718
4	1	5579.2	18	90			2.809816
5	1	5579.2	18	95			3.919743
6	2	5579.2	18	60	1127		4.225941
7	3	5579.2	18	55	1052	1716	5.350409
8	3	5579.2	18	55	1559	1059	5.827713
9	2	5579.2	18	75	1680		6.441401



10	2	5579.2	18	90	1458		7.781306
11	1	5579.2	18	75			8.545728
12	1	5579.2	18	75			9.220508
13	2	5579.2	18	90	1124		10.027125
14	3	5579.2	18	85	1476	1821	10.668369
15	1	5579.2	18	65			11.73859

## USA Bin 5 Trial #9

Burst #	Pulses	Frequency (MHz)	Chirp (MHz)	PW (uS)	Inter-pulse spacing (uS)	Inter-pulse spacing (uS)	Pulse Start (S)
1	2	5579.2	18	75	1120		0.721675
2	2	5579.2	18	65	1173		2.029659
3	1	5579.2	18	75			3.610397
4	1	5579.2	18	60			5.023409
5	2	5579.2	18	65	1390		7.390646
6	3	5579.2	18	50	1313	1329	7.989646
7	2	5579.2	18	80	1157		9.410303
8	2	5579.2	18	95	1660		11.772358

## USA Bin 5 Trial #10

Burst #	Pulses	Frequency (MHz)	Chirp (MHz)	PW (uS)	Inter-pulse spacing (uS)	Inter-pulse spacing (uS)	Pulse Start (S)
1	3	5575.6	9	80	1538	1216	0.215113
2	2	5575.6	9	100	1834		1.309028
3	2	5575.6	9	75	1740		2.695045
4	1	5575.6	9	70			3.647799
5	1	5575.6	9	55			4.406462
6	1	5575.6	9	95			4.648467
7	3	5575.6	9	65	1455	1153	6.195764
8	2	5575.6	9	100	1307		6.980952
9	1	5575.6	9	75			7.674825
10	3	5575.6	9	90	1232	1198	8.430982
11	3	5575.6	9	60	1920	1196	9.47964
12	1	5575.6	9	50			10.884292
13	3	5575.6	9	100	1056	1810	11.884774

## USA Bin 5 Trial #11

Burst #	Pulses	Frequency (MHz)	Chirp (MHz)	PW (uS)	Inter-pulse spacing (uS)	Inter-pulse spacing (uS)	Pulse Start (S)
1	3	5610	20	65	1280	1929	0.221877
2	2	5610	20	95	1504		0.862648
3	3	5610	20	60	1556	1361	1.74771
4	3	5610	20	100	1394	1873	1.862712
5	1	5610	20	75			2.568123



6	2	5610	20	95	1519		3.222159
7	2	5610	20	65	1626		3.777667
8	3	5610	20	85	1486	1104	4.585002
9	3	5610	20	65	1265	1199	5.375669
10	2	5610	20	75	1245		5.791568
11	3	5610	20	100	1816	1029	6.420725
12	1	5610	20	75			6.936332
13	1	5610	20	90			7.758736
14	2	5610	20	70	1534		8.213152
15	2	5610	20	85	1568		8.437133
16	2	5610	20	85	1999		9.045503
17	2	5610	20	65	1236		9.69274
18	3	5610	20	75	1788	1398	10.473668
19	1	5610	20	80			10.812149
20	3	5610	20	95	1412	1430	11.60341

## USA Bin 5 Trial #12

Burst #	Pulses	Frequency (MHz)	Chirp (MHz)	PW (uS)	Inter-pulse spacing (uS)	Inter-pulse spacing (uS)	Pulse Start (S)
1	2	5610	6	75	1862		0.03127
2	2	5610	6	55	1571		1.206389
3	1	5610	6	55			1.875692
4	3	5610	6	100	1029	1685	2.5431
5	1	5610	6	60			3.021608
6	1	5610	6	55			3.556206
7	2	5610	6	85	1687		4.582173
8	1	5610	6	95			4.988494
9	3	5610	6	80	1976	1636	5.521862
10	1	5610	6	95			6.251143
11	1	5610	6	55			6.666912
12	1	5610	6	75			7.37889
13	1	5610	6	95			8.143217
14	2	5610	6	55	1868		9.137964
15	2	5610	6	55	1501		9.487681
16	3	5610	6	95	1694	1416	10.368272
17	2	5610	6	100	1447		11.305581
18	3	5610	6	65	1723	1240	11.359506

## USA Bin 5 Trial #13

Burst #	Pulses	Frequency (MHz)	Chirp (MHz)	PW (uS)	Inter-pulse spacing (uS)	Inter-pulse spacing (uS)	Pulse Start (S)
1	1	5610	9	95			1.060897
2	2	5610	9	70	1496		1.693361
3	1	5610	9	60			2.311701



4	3	5610	9	90	1749	1782	4.199527
5	1	5610	9	50			5.06305
6	3	5610	9	95	1405	1887	6.326668
7	3	5610	9	75	1467	1310	6.814386
8	2	5610	9	95	1621		8.311172
9	3	5610	9	60	1990	1666	8.811572
10	1	5610	9	95			10.764763
11	1	5610	9	75			11.104583

## USA Bin 5 Trial #14

Burst #	Pulses	Frequency (MHz)	Chirp (MHz)	PW (uS)	Inter-pulse spacing (uS)	Inter-pulse spacing (uS)	Pulse Start (S)
1	1	5610	18	100			0.379902
2	2	5610	18	100	1448		1.381552
3	3	5610	18	95	1630	1417	2.507079
4	2	5610	18	60	1468		3.504837
5	1	5610	18	85			4.508709
6	2	5610	18	70	1965		5.503904
7	2	5610	18	85	1519		6.623889
8	2	5610	18	100	1703		7.222438
9	1	5610	18	65			8.064374
10	1	5610	18	90			9.676699
11	2	5610	18	65	1421		10.374883
12	3	5610	18	50	1936	1849	11.206054

## USA Bin 5 Trial #15

Burst #	Pulses	Frequency (MHz)	Chirp (MHz)	PW (uS)	Inter-pulse spacing (uS)	Inter-pulse spacing (uS)	Pulse Start (S)
1	2	5610	16	70	1801		1.097662
2	2	5610	16	100	1347		1.440677
3	3	5610	16	70	1723	1691	3.264741
4	3	5610	16	85	1767	1233	4.696394
5	3	5610	16	100	1498	1339	4.805286
6	2	5610	16	95	1076		6.831152
7	2	5610	16	85	1303		7.67576
8	3	5610	16	90	1089	1846	8.878829
9	1	5610	16	100			10.153616
10	3	5610	16	60	1545	1628	11.216843

## USA Bin 5 Trial #16

Burst #	Pulses	Frequency (MHz)	Chirp (MHz)	PW (uS)	Inter-pulse spacing (uS)	Inter-pulse spacing (uS)	Pulse Start (S)
1	2	5610	14	85	1961		0.03197
2	2	5610	14	65	1361		1.973248



3	3	5610	14	100	1494	1199	2.317065
4	3	5610	14	75	1864	1391	4.236624
5	1	5610	14	100			5.200299
6	2	5610	14	60	1634		5.845155
7	1	5610	14	80			7.1542
8	3	5610	14	50	1627	1239	8.600012
9	2	5610	14	80	1060		9.70705
10	3	5610	14	100	1987	1426	10.671315
11	1	5610	14	80			11.42315

## USA Bin 5 Trial #17

Burst #	Pulses	Frequency (MHz)	Chirp (MHz)	PW (uS)	Inter-pulse spacing (uS)	Inter-pulse spacing (uS)	Pulse Start (S)
1	1	5610	16	55			0.371896
2	2	5610	16	85	1614		2.139852
3	2	5610	16	55	1849		3.463161
4	3	5610	16	70	1178	1991	4.728754
5	1	5610	16	55			6.044353
6	1	5610	16	75			7.358046
7	2	5610	16	50	1057		8.546009
8	1	5610	16	65			10.566339
9	3	5610	16	85	1078	1627	11.499133

## USA Bin 5 Trial #18

Burst #	Pulses	Frequency (MHz)	Chirp (MHz)	PW (uS)	Inter-pulse spacing (uS)	Inter-pulse spacing (uS)	Pulse Start (S)
1	3	5610	7	95	1354	1491	0.270441
2	1	5610	7	95			1.00604
3	3	5610	7	100	1031	1268	1.300634
4	2	5610	7	55	1154		2.125294
5	3	5610	7	95	1390	1638	2.731635
6	3	5610	7	100	1612	1371	3.724621
7	2	5610	7	70	1244		4.22506
8	1	5610	7	85			4.505027
9	1	5610	7	55			5.499973
10	3	5610	7	50	1320	1831	6.107187
11	3	5610	7	95	1005	1541	6.517402
12	3	5610	7	95	1280	1495	6.96141
13	2	5610	7	90	1926		7.918329
14	2	5610	7	75	1389		8.379975
15	2	5610	7	50	1605		8.961401
16	1	5610	7	85			9.974576
17	3	5610	7	80	1379	1781	10.590784
18	2	5610	7	100	1900		11.096947



19            1            5610            7            55            11.563889  
USA Bin 5 Trial #19

Burst #	Pulses	Frequency (MHz)	Chirp (MHz)	PW (uS)	Inter-pulse spacing (uS)	Inter-pulse spacing (uS)	Pulse Start (S)
1	2	5610	14	65	1476		0.619638
2	2	5610	14	90	1661		2.268514
3	1	5610	14	65			2.607854
4	2	5610	14	60	1170		3.859453
5	3	5610	14	50	1914	1800	5.206144
6	3	5610	14	90	1912	1892	6.424527
7	3	5610	14	80	1349	1091	7.335237
8	3	5610	14	95	1261	1821	8.997533
9	3	5610	14	75	1393	1327	10.691177
10	2	5610	14	95	1542		10.854196

USA Bin 5 Trial #20

Burst #	Pulses	Frequency (MHz)	Chirp (MHz)	PW (uS)	Inter-pulse spacing (uS)	Inter-pulse spacing (uS)	Pulse Start (S)
1	2	5610	19	60	1541		0.692563
2	1	5610	19	85			1.246645
3	3	5610	19	65	1986	1011	1.797621
4	2	5610	19	60	1057		2.736141
5	2	5610	19	95	1312		2.954554
6	3	5610	19	75	1915	1531	4.054745
7	1	5610	19	60			4.669708
8	1	5610	19	55			5.342736
9	3	5610	19	60	1872	1782	5.707619
10	2	5610	19	100	1478		6.468937
11	1	5610	19	70			7.251485
12	2	5610	19	90	1141		8.179594
13	3	5610	19	80	1022	1501	8.972116
14	3	5610	19	95	1149	1078	9.838536
15	3	5610	19	70	1554	1188	10.458824
16	1	5610	19	70			10.890729
17	1	5610	19	55			11.734487

USA Bin 5 Trial #21

Burst #	Pulses	Frequency (MHz)	Chirp (MHz)	PW (uS)	Inter-pulse spacing (uS)	Inter-pulse spacing (uS)	Pulse Start (S)
1	3	5640.8	18	55	1603	1892	0.371707
2	2	5640.8	18	90	1228		0.768994
3	3	5640.8	18	95	1911	1523	1.843459
4	2	5640.8	18	80	1918		2.384965



5	2	5640.8	18	70	1982		3.1443
6	1	5640.8	18	50			3.518335
7	2	5640.8	18	60	1504		3.890483
8	3	5640.8	18	90	1700	1880	4.645226
9	1	5640.8	18	80			5.387979
10	2	5640.8	18	95	1706		6.068115
11	2	5640.8	18	55	1917		6.822765
12	2	5640.8	18	50	1145		7.487307
13	1	5640.8	18	60			7.705089
14	2	5640.8	18	85	1239		8.376248
15	1	5640.8	18	50			9.054842
16	3	5640.8	18	75	1451	1818	9.868436
17	1	5640.8	18	90			10.490686
18	2	5640.8	18	50	1598		11.134124
19	3	5640.8	18	50	1261	1751	11.597914

## USA Bin 5 Trial #22

Burst #	Pulses	Frequency (MHz)	Chirp (MHz)	PW (uS)	Inter-pulse spacing (uS)	Inter-pulse spacing (uS)	Pulse Start (S)
1	2	5643.6	11	60	1592		0.161097
2	3	5643.6	11	55	1363	1990	1.024138
3	3	5643.6	11	80	1045	1809	1.332309
4	3	5643.6	11	95	1868	1323	2.315312
5	2	5643.6	11	90	1157		2.763677
6	3	5643.6	11	55	1159	1707	3.181389
7	2	5643.6	11	95	1365		4.043134
8	3	5643.6	11	60	1754	1350	4.21789
9	3	5643.6	11	70	1343	1516	5.211302
10	1	5643.6	11	95			5.633969
11	3	5643.6	11	55	1770	1292	6.36982
12	2	5643.6	11	90	1776		6.795774
13	2	5643.6	11	50	1839		7.28934
14	2	5643.6	11	65	1554		8.311761
15	3	5643.6	11	90	1765	1211	8.739537
16	2	5643.6	11	50	1738		9.340274
17	2	5643.6	11	90	1612		9.838764
18	3	5643.6	11	65	1817	1992	10.34409
19	3	5643.6	11	85	1421	1730	11.035513
20	1	5643.6	11	80			11.665968

## USA Bin 5 Trial #23

Burst #	Pulses	Frequency (MHz)	Chirp (MHz)	PW (uS)	Inter-pulse spacing (uS)	Inter-pulse spacing (uS)	Pulse Start (S)
1	3	5640	20	75	1555	1326	0.046555





2	3	5640	20	75	1083	1225	1.364156
3	3	5640	20	55	1389	1870	2.107843
4	2	5640	20	60	1235		2.95836
5	1	5640	20	50			3.75452
6	3	5640	20	85	1205	1866	4.847883
7	1	5640	20	55			5.782177
8	1	5640	20	90			7.004129
9	1	5640	20	85			7.592125
10	3	5640	20	60	1812	1466	8.514212
11	3	5640	20	100	1540	1397	9.888321
12	2	5640	20	55	1083		10.32725
13	1	5640	20	100			11.611268

USA Bin 5 Trial #24

Burst #	Pulses	Frequency (MHz)	Chirp (MHz)	PW (uS)	Inter-pulse spacing (uS)	Inter-pulse spacing (uS)	Pulse Start (S)
1	3	5640.8	18	65	1924	1586	0.368777
2	1	5640.8	18	95			1.607638
3	1	5640.8	18	75			2.40984
4	1	5640.8	18	80			3.871966
5	3	5640.8	18	55	1005	1283	4.319648
6	2	5640.8	18	75	1620		5.309837
7	3	5640.8	18	50	1159	1373	6.891159
8	3	5640.8	18	85	1359	1966	7.385397
9	3	5640.8	18	95	1965	1123	8.562916
10	2	5640.8	18	70	1294		9.007219
11	3	5640.8	18	60	1942	1532	10.66665
12	2	5640.8	18	75	1853		11.07882

USA Bin 5 Trial #25

Burst #	Pulses	Frequency (MHz)	Chirp (MHz)	PW (uS)	Inter-pulse spacing (uS)	Inter-pulse spacing (uS)	Pulse Start (S)
1	2	5640.8	18	50	1258		0.47552
2	2	5640.8	18	70	1859		2.07699
3	2	5640.8	18	80	1165		3.612472
4	3	5640.8	18	75	1210	1624	5.019901
5	3	5640.8	18	85	1449	1220	6.171963
6	2	5640.8	18	50	1326		8.002133
7	2	5640.8	18	85	1800		9.681985
8	1	5640.8	18	85			11.537776

USA Bin 5 Trial #26

Burst #	Pulses	Frequency (MHz)	Chirp (MHz)	PW (uS)	Inter-pulse spacing (uS)	Inter-pulse spacing (uS)	Pulse Start (S)
---------	--------	-----------------	-------------	---------	--------------------------	--------------------------	-----------------



1	1	5643.2	12	50			0.534259
2	1	5643.2	12	80			1.553114
3	3	5643.2	12	100	1420	1023	2.620141
4	3	5643.2	12	95	1158	1965	3.311821
5	2	5643.2	12	60	1348		4.32831
6	2	5643.2	12	50	1864		5.18044
7	1	5643.2	12	75			6.298282
8	3	5643.2	12	70	1367	1161	6.570298
9	2	5643.2	12	90	1656		7.497531
10	2	5643.2	12	50	1266		8.436665
11	1	5643.2	12	75			9.386118
12	2	5643.2	12	100	1276		10.229771
13	1	5643.2	12	90			11.491283

## USA Bin 5 Trial #27

Burst #	Pulses	Frequency (MHz)	Chirp (MHz)	PW (uS)	Inter-pulse spacing (uS)	Inter-pulse spacing (uS)	Pulse Start (S)
1	2	5645.2	7	85	1628		0.431111
2	2	5645.2	7	60	1794		2.308447
3	2	5645.2	7	90	1071		3.743868
4	3	5645.2	7	55	1318	1516	4.958609
5	3	5645.2	7	60	1259	1216	5.615475
6	2	5645.2	7	85	1170		7.331219
7	1	5645.2	7	65			9.13154
8	1	5645.2	7	55			10.226719
9	1	5645.2	7	60			11.479927

## USA Bin 5 Trial #28

Burst #	Pulses	Frequency (MHz)	Chirp (MHz)	PW (uS)	Inter-pulse spacing (uS)	Inter-pulse spacing (uS)	Pulse Start (S)
1	1	5644.8	8	100			0.577327
2	3	5644.8	8	80	1937	1516	0.991889
3	1	5644.8	8	90			2.519076
4	3	5644.8	8	65	1562	1285	2.832135
5	2	5644.8	8	85	1864		3.791403
6	2	5644.8	8	65	1939		5.303794
7	3	5644.8	8	90	1097	1680	5.852572
8	2	5644.8	8	65	1052		6.558569
9	3	5644.8	8	55	1434	1828	7.718503
10	1	5644.8	8	55			9.188391
11	2	5644.8	8	80	1766		9.350069
12	1	5644.8	8	50			10.201238
13	1	5644.8	8	60			11.979474

## USA Bin 5 Trial #29



Burst #	Pulses	Frequency (MHz)	Chirp (MHz)	PW (uS)	Inter-pulse spacing (uS)	Inter-pulse spacing (uS)	Pulse Start (S)
1	3	5644.4	9	50	1167	1032	0.348749
2	1	5644.4	9	100			1.136987
3	3	5644.4	9	100	1404	1954	1.902601
4	1	5644.4	9	100			2.508336
5	2	5644.4	9	70	1594		2.792715
6	1	5644.4	9	90			3.82645
7	3	5644.4	9	60	1898	1741	4.611316
8	1	5644.4	9	100			5.166582
9	3	5644.4	9	85	1671	1450	5.348307
10	1	5644.4	9	85			6.343802
11	1	5644.4	9	70			6.771256
12	1	5644.4	9	70			7.711742
13	3	5644.4	9	80	1589	1426	8.465862
14	2	5644.4	9	90	1867		8.982135
15	3	5644.4	9	90	1330	1893	9.462369
16	1	5644.4	9	60			10.274471
17	2	5644.4	9	85	1436		10.904089
18	2	5644.4	9	50	1930		11.791479

## USA Bin 5 Trial #30

Burst #	Pulses	Frequency (MHz)	Chirp (MHz)	PW (uS)	Inter-pulse spacing (uS)	Inter-pulse spacing (uS)	Pulse Start (S)
1	2	5641.6	16	60	1357		0.875282
2	2	5641.6	16	55	1602		1.72883
3	1	5641.6	16	60			2.153599
4	1	5641.6	16	85			3.550557
5	3	5641.6	16	50	1825	1543	4.811097
6	3	5641.6	16	65	1931	1604	5.379435
7	2	5641.6	16	80	1633		6.042805
8	3	5641.6	16	65	1130	1059	7.169887
9	2	5641.6	16	65	1455		8.667055
10	3	5641.6	16	60	1436	1525	9.382175
11	3	5641.6	16	60	1971	1360	10.941892
12	3	5641.6	16	70	1722	1823	11.724467



## USA Frequency Hopping Trial #1

Hop #	Freq (GHz)	Pulse Start (mS)
0	5600	0
2	5647	6
21	5574	63
24	5602	72
38	5632	114
44	5630	132
47	5603	141
48	5612	144
49	5617	147
53	5599	159
62	5604	186
64	5622	192
65	5582	195
87	5611	261
90	5640	270

## USA Frequency Hopping Trial #2

Hop #	Freq (GHz)	Pulse Start (mS)
4	5612	12
12	5582	36
25	5641	75
31	5620	93
37	5574	111
57	5579	171
58	5643	174
64	5614	192
67	5607	201
70	5589	210
73	5586	219
75	5593	225
91	5572	273
96	5647	288

## USA Frequency Hopping Trial #3

Hop #	Freq (GHz)	Pulse Start (mS)
8	5596	24
10	5624	30
15	5600	45
23	5591	69
40	5633	120
42	5572	126



54	5629	162
58	5614	174
59	5610	177
67	5587	201
70	5599	210
72	5611	216
73	5644	219
74	5585	222
75	5592	225
78	5625	234
82	5639	246
92	5586	276
93	5602	279
96	5642	288

## USA Frequency Hopping Trial #4

Hop #	Freq (GHz)	Pulse Start (mS)
5	5599	15
8	5581	24
13	5598	39
20	5630	60
33	5582	99
35	5576	105
38	5586	114
42	5578	126
44	5585	132
46	5648	138
47	5645	141
55	5577	165
63	5621	189
73	5589	219
77	5572	231
79	5580	237
90	5615	270

## USA Frequency Hopping Trial #5

Hop #	Freq (GHz)	Pulse Start (mS)
1	5647	3
18	5580	54
19	5585	57
24	5624	72
26	5642	78
29	5577	87
31	5581	93



44	5594	132
55	5615	165
56	5579	168
69	5608	207
70	5616	210
73	5607	219
85	5606	255
86	5643	258
90	5613	270

## USA Frequency Hopping Trial #6

Hop #	Freq (GHz)	Pulse Start (mS)
2	5607	6
3	5636	9
11	5613	33
15	5648	45
40	5618	120
42	5632	126
43	5585	129
49	5580	147
51	5609	153
64	5640	192
71	5573	213
88	5586	264
96	5590	288
99	5614	297

## USA Frequency Hopping Trial #7

Hop #	Freq (GHz)	Pulse Start (mS)
2	5608	6
5	5642	15
10	5575	30
19	5582	57
20	5629	60
22	5605	66
25	5637	75
28	5619	84
30	5640	90
46	5600	138
54	5598	162
63	5603	189
73	5586	219
76	5625	228
81	5616	243



90	5574	270
91	5612	273
94	5594	282
95	5576	285

## USA Frequency Hopping Trial #8

Hop #	Freq (GHz)	Pulse Start (mS)
11	5633	33
14	5634	42
26	5643	78
29	5625	87
30	5573	90
50	5576	150
57	5629	171
58	5641	174
71	5596	213
74	5581	222
77	5631	231
78	5610	234
84	5619	252
86	5594	258
92	5603	276
94	5622	282
96	5642	288
97	5644	291

## USA Frequency Hopping Trial #9

Hop #	Freq (GHz)	Pulse Start (mS)
1	5622	3
7	5609	21
11	5624	33
14	5582	42
22	5614	66
29	5643	87
30	5586	90
34	5641	102
39	5600	117
47	5615	141
52	5574	156
67	5645	201
70	5620	210
73	5625	219
74	5605	222
77	5632	231



81	5601	243
83	5579	249
98	5626	294

## USA Frequency Hopping Trial #10

Hop #	Freq (GHz)	Pulse Start (mS)
1	5635	3
13	5637	39
17	5611	51
20	5622	60
38	5615	114
40	5591	120
49	5596	147
53	5594	159
59	5572	177
61	5580	183
75	5578	225
79	5617	237
80	5636	240
83	5589	249
91	5613	273
99	5588	297

## USA Frequency Hopping Trial #11

Hop #	Freq (GHz)	Pulse Start (mS)
16	5602	48
31	5645	93
36	5623	108
37	5587	111
38	5625	114
47	5643	141
57	5578	171
72	5635	216
75	5605	225
81	5629	243
83	5579	249
88	5648	264
89	5598	267
96	5640	288

## USA Frequency Hopping Trial #12

Hop #	Freq (GHz)	Pulse Start (mS)
2	5626	6
3	5611	9



14	5585	42
22	5614	66
28	5606	84
42	5640	126
46	5644	138
48	5615	144
52	5616	156
54	5594	162
60	5586	180
62	5627	186
83	5580	249
93	5645	279
94	5579	282
96	5646	288

## USA Frequency Hopping Trial #13

Hop #	Freq (GHz)	Pulse Start (mS)
8	5625	24
13	5578	39
33	5630	99
40	5580	120
44	5592	132
57	5585	171
63	5610	189
71	5609	213
73	5618	219
74	5623	222
75	5589	225
83	5597	249
89	5612	267
97	5593	291
98	5647	294

## USA Frequency Hopping Trial #14

Hop #	Freq (GHz)	Pulse Start (mS)
0	5583	0
9	5629	27
10	5632	30
21	5572	63
25	5581	75
30	5599	90
35	5575	105
36	5625	108
38	5585	114



42	5631	126
55	5647	165
61	5602	183
65	5617	195
78	5615	234

## USA Frequency Hopping Trial #15

Hop #	Freq (GHz)	Pulse Start (mS)
1	5579	3
18	5585	54
19	5590	57
22	5587	66
28	5597	84
35	5628	105
39	5606	117
62	5622	186
68	5583	204
69	5625	207
71	5619	213
75	5580	225
76	5648	228
77	5620	231
79	5644	237
85	5609	255
89	5642	267
95	5572	285
96	5624	288

## USA Frequency Hopping Trial #16

Hop #	Freq (GHz)	Pulse Start (mS)
6	5575	18
8	5581	24
18	5587	54
20	5608	60
36	5592	108
37	5577	111
45	5594	135
51	5579	153
59	5630	177
68	5620	204
74	5596	222
75	5598	225

## USA Frequency Hopping Trial #17



Hop #	Freq (GHz)	Pulse Start (mS)
14	5589	42
15	5636	45
28	5574	84
44	5627	132
50	5619	150
51	5623	153
66	5625	198
75	5629	225
88	5575	264
94	5621	282

## USA Frequency Hopping Trial #18

Hop #	Freq (GHz)	Pulse Start (mS)
1	5643	3
2	5635	6
13	5622	39
17	5626	51
25	5607	75
26	5600	78
27	5634	81
29	5620	87
36	5628	108
44	5642	132
48	5609	144
51	5633	153
55	5639	165
56	5627	168
57	5617	171
60	5608	180
65	5576	195
66	5580	198
67	5625	201
84	5606	252
88	5629	264
89	5619	267
95	5613	285

## USA Frequency Hopping Trial #19

Hop #	Freq (GHz)	Pulse Start (mS)
2	5622	6
10	5642	30
11	5601	33



23	5639	69
34	5578	102
44	5581	132
45	5605	135
49	5637	147
53	5638	159
54	5628	162
55	5629	165
57	5640	171
59	5624	177
72	5608	216
74	5632	222
85	5644	255
86	5643	258
88	5615	264
92	5600	276
93	5597	279
99	5594	297

**USA Frequency Hopping Trial #20**

Hop #	Freq (GHz)	Pulse Start (mS)
5	5572	15
9	5600	27
13	5594	39
17	5588	51
19	5643	57
20	5620	60
23	5641	69
25	5616	75
33	5590	99
57	5574	171
60	5583	180
61	5586	183
80	5624	240
93	5595	279

**USA Frequency Hopping Trial #21**

Hop #	Freq (GHz)	Pulse Start (mS)
4	5612	12
26	5628	78
33	5623	99
39	5609	117
49	5607	147
56	5574	168

68	5578	204
69	5584	207
74	5605	222
79	5611	237
85	5604	255
96	5577	288
97	5645	291

## USA Frequency Hopping Trial #22

Hop #	Freq (GHz)	Pulse Start (mS)
0	5647	0
3	5622	9
5	5611	15
13	5621	39
19	5590	57
21	5591	63
22	5648	66
36	5626	108
38	5620	114
41	5577	123
42	5607	126
46	5627	138
48	5593	144
56	5636	168
61	5594	183
63	5578	189
69	5628	207
74	5644	222
77	5625	231
78	5583	234
92	5579	276
96	5619	288
97	5612	291

## USA Frequency Hopping Trial #23

Hop #	Freq (GHz)	Pulse Start (mS)
4	5589	12
8	5604	24
18	5619	54
23	5613	69
26	5616	78
31	5610	93
37	5625	111
52	5636	156



54	5586	162
57	5584	171
58	5590	174
59	5602	177
60	5621	180
62	5595	186
76	5580	228
77	5576	231
86	5627	258
89	5572	267
98	5624	294

**USA Frequency Hopping Trial #24**

Hop #	Freq (GHz)	Pulse Start (mS)
0	5580	0
2	5586	6
6	5574	18
12	5585	36
22	5588	66
25	5612	75
33	5603	99
34	5644	102
39	5591	117
45	5598	135
52	5614	156
69	5626	207
76	5625	228
77	5575	231
85	5597	255

**USA Frequency Hopping Trial #25**

Hop #	Freq (GHz)	Pulse Start (mS)
4	5641	12
5	5609	15
7	5638	21
16	5628	48
21	5573	63
24	5621	72
31	5627	93
47	5617	141
49	5631	147
52	5630	156
69	5574	207
81	5626	243

85	5611	255
97	5636	291
99	5599	297

## USA Frequency Hopping Trial #26

Hop #	Freq (GHz)	Pulse Start (mS)
1	5591	3
3	5580	9
12	5607	36
22	5630	66
23	5623	69
27	5602	81
29	5622	87
30	5604	90
37	5574	111
47	5615	141
67	5586	201
69	5643	207
79	5629	237
81	5628	243
85	5575	255
88	5572	264
97	5608	291

## USA Frequency Hopping Trial #27

Hop #	Freq (GHz)	Pulse Start (mS)
7	5587	21
10	5590	30
15	5642	45
29	5604	87
38	5630	114
40	5623	120
43	5600	129
46	5633	138
50	5594	150
52	5591	156
58	5626	174
65	5607	195
66	5647	198
67	5577	201
81	5638	243
82	5578	246
90	5597	270

## USA Frequency Hopping Trial #28

Hop #	Freq (GHz)	Pulse Start (mS)
1	5604	3
3	5601	9
10	5633	30
13	5636	39
22	5609	66
34	5622	102
59	5634	177
66	5587	198
69	5577	207
83	5617	249
92	5584	276
93	5603	279
95	5616	285

## USA Frequency Hopping Trial #29

Hop #	Freq (GHz)	Pulse Start (mS)
8	5591	24
13	5618	39
14	5648	42
30	5643	90
41	5628	123
45	5635	135
49	5644	147
50	5598	150
62	5599	186
71	5647	213
75	5627	225
77	5614	231
82	5582	246
87	5636	261

## USA Frequency Hopping Trial #30

Hop #	Freq (GHz)	Pulse Start (mS)
0	5582	0
22	5581	66
27	5623	81
50	5577	150
52	5602	156
57	5626	171
63	5575	189
74	5615	222
93	5629	279





95      5601      285



### Appendix C: List of Test Equipment Used to perform the test

Equip#	Manufacturer/ Model	Description	Last Cal	Next Cal
57478	Cisco ATIL	Automation Test Insertion Loss	Cal Not Required	
55096	National Instruments PXI-1042Q	Chassis	Cal Not Required	
57239	National Instruments PXI-8115	Embedded Controller	Cal Not Required	
57225	National Instruments PXI-5422	200 MS/s, 16-bit Arbitrary Waveform Generator	2-Oct-19	2-Oct-20
57226	National Instruments PXI-5422	200 MS/s, 16-bit Arbitrary Waveform Generator	2-Oct-19	2-Oct-20
57250	National Instruments PXI-2796	40 GHz Dual 6x1 Multiplexer (SP6T)	Cal Not Required	
56093	National Instruments PXI-2796	40 GHz Dual 6x1 Multiplexer (SP6T)	Cal Not Required	
57251	National Instruments PXI-2799	Switch 1x1	Cal Not Required	
53615	Agilent N9030A-550	PXA Signal Analyzer, 3Hz to 50GHz	16-Jul-19	16-Jul-20
49515	Keysight N5182B	MXG X-Series RF Vector Signal Generator	26-Sep-19	26-Sep-20
7329	Omega CT485B	Chart Recorder	18-Feb-19	18-Feb-20
56329	Pasternack PE5019-1	Torque wrench	28-Feb-19	28-Feb-20
47283	HUBER + SUHNER Sucoflex 102E	40GHz Cable K Connector	20-Jun-19	20-Jun-20
49428*	Mini-Circuits ZFSC-2-10G	SPLITTER, 2-10GHZ	27-Nov-19	27-Nov-20
55585	AEROFLEX BWS30-W2	30dB SMA Attenuator	13-Aug-19	13-Aug-20
49429	Mini-Circuits ZFSC-2-10G	SPLITTER, 2-10GHZ	25-Jan-19	25-Jan-20
54623	Megaphase RA08-S1S1-18	SMA Cable	2-Aug-19	2-Aug-20
54674	Megaphase RA08-S1S1-12	SMA Cable	2-Aug-19	2-Aug-20
54607*	Pulsar PS4-09-452/4S	Splitter	27-Nov-19	27-Nov-20
55559	Mini-Circuits ZFSC-2-10G	SPLITTER, 2-10GHZ	27-Jun-19	27-Jun-20
55366	Pulsar PS4-09-452/4S	Splitter	12-Apr-19	12-Apr-20
54620	Megaphase RA08-S1S1-12	SMA Cable	2-Aug-19	2-Aug-20
54616	Megaphase RA08-S1S1-12	SMA Cable	2-Aug-19	2-Aug-20
54614	Megaphase RA08-S1S1-12	SMA Cable	2-Aug-19	2-Aug-20
54617	Megaphase RA08-S1S1-12	SMA Cable	2-Aug-19	2-Aug-20
45162	KRYTAR 1850	500MHz to 18.5 GHz SMA Directional Coupler	30-Apr-19	30-Apr-20
44583	Mini-Circuits ZFSC-2-10G	SPLITTER, 2-10GHZ	18-Jun-19	18-Jun-20
54615	Megaphase	RA08-S1S1-12	1-Aug-19	1-Aug-20
54611	Megaphase	RA08-S1S1-12	1-Aug-19	1-Aug-20
56062	Pulsar	PS4-09-452/4S	12-Apr-19	12-Apr-20
56109	Pasternack PE6072	SMA 50 Ohm Termination	30-Jan-19	30-Jan-20
54408	HUBER + SUHNER Sucoflex 102E	40GHz Cable K Connector	20-Jun-19	20-Jun-20
54011	Aeroflex/Weinschel 3054	Variable Attenuator 10-60dB 6GHz	12-Apr-19	12-Apr-20
54405	HUBER + SUHNER Sucoflex 102	RF Cable 2.4mm - N Type 18GHz	24-Apr-19	24-Apr-20
54695*	DITOM D3C2060	Splitter	27-Nov-19	27-Nov-20

\*please note, testing was paused while CIS#49428, CIS#54607, and CIS#54695 were calibrated



## Appendix D: Photographs of Test Setups

EUT Photos have been omitted from this test report. Photos can be found in the supplementary exhibit included in the submission and EDCS# 18337365.

## Appendix E: Software Used to Perform Testing

Cisco Internal LabView Radio Test Automation Software – DFS Automation Main rev29, 47

## Appendix F: Test Procedures

Measurements were made in accordance with

- KDB 905462 D02 UNII DFS Compliance Procedures New Rules v02
- RSS-247 section A9.3a allows the use of applicable FCC KDBs

Test procedures are summarized below:

FCC DFS Test Procedures	EDCS # 1445052
-------------------------	----------------

## Appendix G: Scope of Accreditation (A2LA certificate number 1178-01)

The scope of accreditation of Cisco Systems, Inc. can be found on the A2LA web page at:

<http://www.a2la.org/scopepdf/1178-01.pdf>

## Appendix H: Test Assessment Plan

Compliance Test Plan (Excel) EDCS# 18216607

Radio Test Plan: EDCS# 18486508

## Appendix I: Worst Case Justification

N/A

## Appendix J: UUT Software Info

Cisco AP Software, (ap1g6a), [sjc-ads-2610:/nobackup/rthangac/work/gh\_c8\_20sep/router]

Technical Support: <http://www.cisco.com/techsupport>

Copyright (c) 1986-2019 by Cisco Systems, Inc.

Compiled Mon Sep 23 05:43:03 PDT 2019

ROM: Bootstrap program is U-Boot boot loader

BOOTLDR: U-Boot boot loader Version 115

Cisco AP Software, (ap1g6a), [build-lnx-059:/san2/BUILD/workspace/Nightly-Cheetah-ap1g6a-mfg-c171\_throttle]

Technical Support: <http://www.cisco.com/techsupport>

Copyright (c) 1986-2019 by Cisco Systems, Inc.

Compiled Tue Oct 22 08:04:29 PDT 2019

ROM: Bootstrap program is U-Boot boot loader

BOOTLDR: U-Boot boot loader Version 118