



CEED 3700 User Guide

Release 2.2

R&D Office:

SEZ Unit, Cessna Business Park, Kadubeesanahalli Village,
Varthur Hobli, Sarjapur - Marathahalli Outer ring road,
Bangalore - 560087
Karnataka
India

Text Part Number:

THE SPECIFICATIONS AND INFORMATION REGARDING THE PRODUCTS IN THIS MANUAL ARE SUBJECT TO CHANGE WITHOUT NOTICE. ALL STATEMENTS, INFORMATION, AND RECOMMENDATIONS IN THIS MANUAL ARE BELIEVED TO BE ACCURATE BUT ARE PRESENTED WITHOUT WARRANTY OF ANY KIND, EXPRESS OR IMPLIED. USERS MUST TAKE FULL RESPONSIBILITY FOR THEIR APPLICATION OF ANY PRODUCTS.

THE SOFTWARE LICENSE AND LIMITED WARRANTY FOR THE ACCOMPANYING PRODUCT ARE SET FORTH IN THE INFORMATION PACKET THAT SHIPPED WITH THE PRODUCT AND ARE INCORPORATED HEREIN BY THIS REFERENCE. IF YOU ARE UNABLE TO LOCATE THE SOFTWARE LICENSE OR LIMITED WARRANTY, CONTACT YOUR CISCO REPRESENTATIVE FOR A COPY.

The Cisco implementation of TCP header compression is an adaptation of a program developed by the University of California, Berkeley (UCB) as part of UCB's public domain version of the UNIX operating system. All rights reserved. Copyright © 1981, Regents of the University of California.

NOTWITHSTANDING ANY OTHER WARRANTY HEREIN, ALL DOCUMENT FILES AND SOFTWARE OF THESE SUPPLIERS ARE PROVIDED "AS IS" WITH ALL FAULTS. CISCO AND THE ABOVE-NAMED SUPPLIERS DISCLAIM ALL WARRANTIES, EXPRESSED OR IMPLIED, INCLUDING, WITHOUT LIMITATION, THOSE OF MERCHANTABILITY, FITNESS FOR A PARTICULAR PURPOSE AND NONINFRINGEMENT OR ARISING FROM A COURSE OF DEALING, USAGE, OR TRADE PRACTICE.

IN NO EVENT SHALL CISCO OR ITS SUPPLIERS BE LIABLE FOR ANY INDIRECT, SPECIAL, CONSEQUENTIAL, OR INCIDENTAL DAMAGES, INCLUDING, WITHOUT LIMITATION, LOST PROFITS OR LOSS OR DAMAGE TO DATA ARISING OUT OF THE USE OR INABILITY TO USE THIS MANUAL, EVEN IF CISCO OR ITS SUPPLIERS HAVE BEEN ADVISED OF THE POSSIBILITY OF SUCH DAMAGES.

Cisco and the Cisco logo are trademarks or registered trademarks of Cisco and/or its affiliates in the U.S. and other countries. To view a list of Cisco trademarks, go to this URL: www.cisco.com/go/trademarks. Third-party trademarks mentioned are the property of their respective owners. The use of the word partner does not imply a partnership relationship between Cisco and any other company. (1110R)

Any Internet Protocol (IP) addresses used in this document are not intended to be actual addresses. Any examples, command display output, and figures included in the document are shown for illustrative purposes only. Any use of actual IP addresses in illustrative content is unintentional and coincidental.

CEED 3700 User Guide

© 2014 Cisco Systems, Inc. All rights reserved.

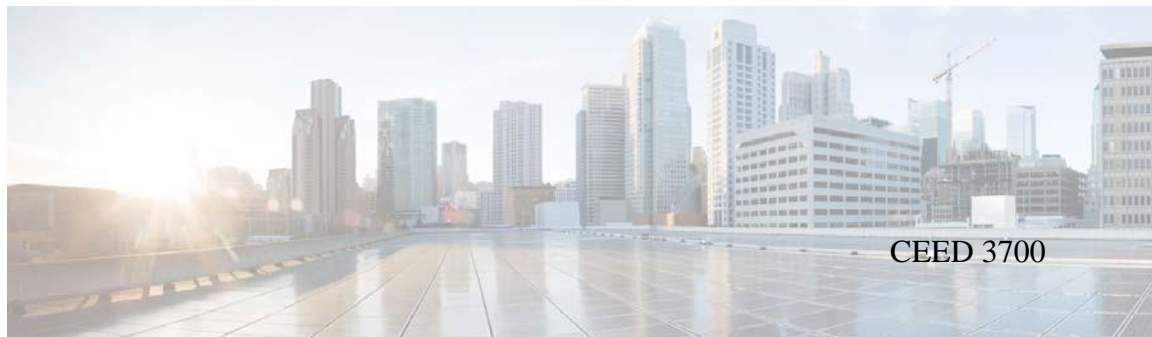

User Guide Index

CHAPTER 1

Introduction 1-1

- CEED Operating Environment Overview 1-1
- Installation Prerequisites 1-3
 - CEED 3700 Components and Prerequisites 1-3
 - Safety Guidelines 1-4
- Usage Guidelines and Restrictions 1-5
- CEED 3700 Hardware Summary 1-7

CHAPTER 2

Installation 2-1

- Mounting Prerequisites 2-1
- Mounting of the CEED 3700 2-1
- Accessories, Peripherals and Cable Assembly 2-6
 - External Wiring and Placement of Accessories 2-6
 - Assembling of the Accessories 2-8

CHAPTER 3

Configuring LAN and Connectivity 3-1

- Configuring LAN 3-1
- Powering On CEED 3700 3-3

CHAPTER 4

Configuring CEED 3700 Software 4-1

- First Time Log in 4-1

CHAPTER 5

Configuring the Browser 5-1

- Launching the Browser 5-1
- Verification of the Browser Settings 5-3

CHAPTER 6

Configuring the Router 6-1

- Configuring WAN 6-1
- Configuring 3G 6-5

REVIEW DRAFT—CISCO CONFIDENTIAL

Configuring Wi-Fi **6-6**
Powering Down/Shutting Down the CEED 3700 **6-7**

CHAPTER 7

Configuring the Live Session **7-1**
 Hosting a WebEx Session **7-1**
 Joining a WebEx Session **7-3**
 Verification of the Accessories **7-4**



Introduction

This chapter describes the overview and the operating environment overview and installation prerequisites of the CEED 3700 and contains the following sections:

This section contains the following sections:

- [CEED Operating Environment Overview](#)
- [Installation Prerequisites](#)
- [Usage Guidelines and Restrictions](#)
- [CEED 3700 Hardware Summary](#)

CEED Operating Environment Overview

This section provides a detailed overview of CEED 3700 and its operating environment.

CEED 3700 series is a comprehensive integrated and open platform designed to leverage collaboration and live content video to enable session. It is a high end reliable router with video conferencing capability. It includes an intelligent edge device and leverages cloud capabilities of Cisco to deliver secure, high definition video using the latest collaboration tools from the cloud.

REVIEW DRAFT—CISCO CONFIDENTIAL

At one end CEED is connected. Other end can be a CEED, Desktop or Laptops

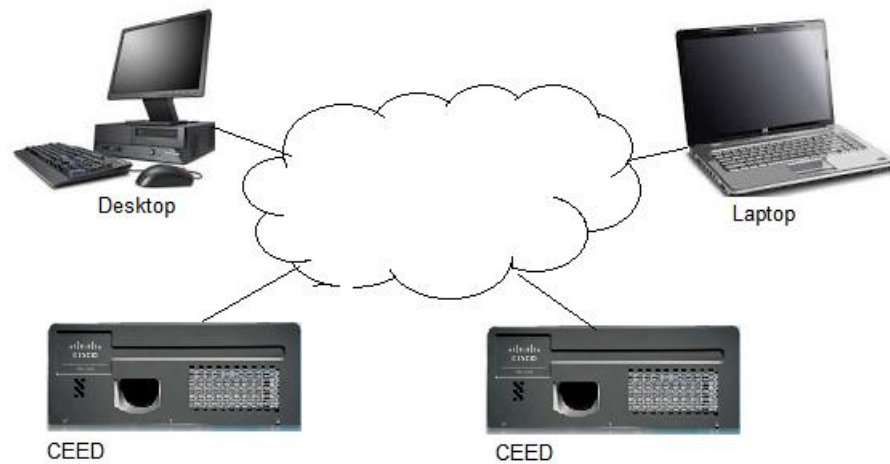

The CEED 3700 provides additional capabilities such as:

- 4th Generation Intel Processor.
- Operating temperature between (0°C to 40 °C).
- Projection lamp light brightness of 3000 Lumen for 4000 hours in standard mode and up to 6000 hours in Eco Mode.
- Field Replaceable Unit (FRU) based projection lamp.
- 3G Wireless Capability with Subscriber Identified Module (SIM)/ User Identify Module (UIM).

REVIEW DRAFT—CISCO CONFIDENTIAL

Installation Prerequisites

This section describes how to install CEED 3700 unit, precautions, prerequisites and unpacking of the CEED 3700 unit and contains the following sections:

- [CEED 3700 Components and Prerequisites, page 1-3](#)
- [Safety Guidelines, page 1-4](#)
- [Usage Guidelines and Restrictions, page 1-5](#)

CEED 3700 Components and Prerequisites

The prerequisites and the required components to install the CEED 3700 are as follows:

- 100 V to 240V, 5 Amps Uninterrupted Power Supply (UPS)
- 1 Mbps Internet Leased Line (ILL) with static IP availability

**Note**

You need a minimum of /30 public IP pool provided the connection is coming directly on the Ethernet. In case where the connection is coming on serial link, you will need an Ethernet modem and this needs a /29 Public IP pool.

- 3G SIM for 3G Internet Access
- Power Socket for CEED unit with required earthing.
- Manually retractable projection screen
- CAT-6 cable - approximately 10 feet or as required at site
- Power socket for the speakers
- Coach Bolts
- Screw Driver Set
- Allen Key set
- Hammer and Drill Set (manual as well as power-driven)

REVIEW DRAFT—CISCO CONFIDENTIAL**Safety Guidelines**

CEED 3700 series in a single package that contains the items that are listed in the table [List of CEED 3700 Package Items](#).

 **Warning** Ensure that never use defective parts or test the equipment with different parts that are not listed.

 **Warning** Do not replace any part that are not listed in prerequisites or in the unpacking section

 **Warning** Read the installation instructions before connecting the system to the power source. If an item in the box is damaged or missing, contact your Cisco representative

 **Caution** Be aware of the size and weight of the CEED 3700 when mounting. Ensure that the mounting location can safely support the weight. Please use the appropriate type of screws, electric drills and screw drivers to install the unit.

Read the installation instructions before connecting the system to the power source

 **Warning** This product requires short-circuit (over-current) protection, to be provided as part of the building installation. Install only in accordance with national and local wiring regulations.

 **Warning** The plug-socket combination must be accessible at all times, because it serves as the main disconnecting device.

 **Warning** Only trained and qualified personnel should be allowed to install, replace, or service this equipment.

 **Warning** Covers are integral part of safety design of the product. Do not operate without the covers installed.

 **Warning** The area must be known to be nonhazardous before installing, servicing, or replacing the unit.

 **Warning** This equipment must be grounded. Never defeat the ground conductor or operate the equipment in the absence of a suitably installed ground conductor. Contact the appropriate electrical inspection authority or an electrician if you are uncertain that suitable grounding is available.

REVIEW DRAFT—CISCO CONFIDENTIAL**Warning**

There is the danger of explosion if the battery is replaced incorrectly. Replace the battery only with the same or equivalent type recommended by the manufacturer. Dispose of used batteries according to the manufacturer's instructions

**Warning**

Before using the CEED device, read the user's manuals to ensure correct usage. Incorrect handling of this product could possibly result in personal injury or physical damage. The manufacturer assumes no responsibility for any damage caused by mishandling that is beyond normal usage defined in these manuals of this product

**Caution**

Be cautious of high temperatures of the CEED. High temperatures are generated when the lamp is lit. It could result in fire or burn. Use special caution in households where children are present.

Usage Guidelines and Restrictions

**Warning**

This section describes the usage guidelines and restrictions while using CEED 3700.

**Warning**

The warranty will be void if one or more points in this section is violated.

**Warning**

Do not change the user name or password.

**Warning**

Do not install any third party software or update the system settings.

- CEED 3700 is not a permanent storage device.
- Do not operate CEED 3700 if a problem should occur.
 - Abnormal operations such as smoke, strange odor, no image, no sound, excessive sound, damaged casing or elements or cables, penetration of liquids or foreign matter, etc. can cause a fire or electrical shock. In such case, immediately turn off the power switch and then disconnect the power plug from the power outlet. After making sure that the smoke or odor has stopped, contact your account manager. Never attempt to make repairs yourself because this could be dangerous.
- Do not disassemble or modify.
 - Modification and/or disassembly of the equipment or accessories could result in fire or electrical shock.
 - Never open the cabinet.
- Do not give the CEED any shock or impact.
 - If the CEED is shocked and/or broken, it could result in an injury, and continued use could result in fire or electrical shock.

REVIEW DRAFT—CISCO CONFIDENTIAL

- If the CEED is shocked, immediately turn off the power switch, disconnect the power plug from the power outlet and contact your Cisco representative.
- The CEED 3700 device “**must be**” installed on a RCC or equivalent ceiling with provided mounting brackets and accessories. Do not place CEED 3700 on an unstable surface
 - Do not place the CEED on an unstable, slant or vibrant surface such as a wobbly or inclined stand.
- Do not touch the surface of the lens, air fans and ventilation openings during use or immediately after use to prevent a burn.
- Ensure to give ample of ventilation space for the CEED 3700 device.
- Do not operate CEED 3700 continuously for more than 4 hours. Ensure that you **turn off** the CEED 3700 device every 4 hours for about 30 minutes
- Avoid a high temperature operating environment.
- The heat could have adverse influence on the cabinet of the CEED3700 and other parts. Do not place the CEED3700, the remote control and other parts in direct sunlight or near a hot object such as heater, etc
- Keep enough space between the CEED 3700 device and other objects such as walls.
- Do not place any objects on or near the lens, air fans and ventilation openings of the CEED3700.
 - Never block the air fan and ventilation openings.
- Do not cover the CEED3700 with a tablecloth, etc. Do not place the CEED 3700 on a carpet or bedding.
- Use only the correct power cord and the correct power outlet.
 - Incorrect power supply could result in fire or electrical shock.
 - Use only the correct power outlet depending on the indication on the CEED 3700 and the safety standard.
- Be sure to connect with ground wire.
 - Connect the ground terminal of AC inlet of this unit with the ground terminal provided at the building using the correct power cord; otherwise, fire or electric shock can result.
- Avoid a smoky, humid or dusty place.
 - Placing the CEED 3700 in a smoke, a highly humid, dusty place, oily soot or corrosive gas could result in fire or electrical shock. High dust environment will also result in quick clogging of the ventilation system and result in lamp shutdown.
 - Do not place the CEED 3700 near a smoky, humid or dusty place (ex. a smoking space, a kitchen, a beach, etc.). Do not place the CEED3700 outdoors.
 - Do not use a humidifier near the CEED3700.
- Avoid Magnetism.
 - Avoid any magnetic contact that is not shielded or protected on or near the CEED3700 itself. (ie., Magnetic Security Devices, or other CEED accessory that contains magnetic material that has not been provided by the manufacture etc.) Magnetic objects may cause interruption of the internal mechanical performance of the CEED 3700, which may interfere with cooling fans speed or stopping, and may cause the CEED3700 to completely shut down.
- The CEED 3700 should not go in sleep mode. Adjust your Power Management options accordingly through the power management options during the set up.
- Do not allow CEED 3700 to install updates automatically from the Internet and restart.

REVIEW DRAFT—CISCO CONFIDENTIAL

CEED 3700 Hardware Summary

The table 1-1 describes the materials that are packaged with CEED 3700 unit in a single package.

**Note**

Ensure that all parts are in the package. Contact your Cisco representative within 2 weeks for any missing parts.

**Caution**

Do not use defective parts or use replacement parts that do not conform to specification. Make sure only authorized personnel can open the package.

**Note**

Keep the original packaging materials for future shipment. Ensure to use original packaging material.

Table 1-1 List of CEED 3700 Package Items

Item	Number	Size
Mounting kit (Top Side)	1	246x130x547 mm (low)
Mounting kit (Bottom Side)	1	210x200x625 mm (low)
CEED 3700	1	440x315x135 mm (low)
AC Power Cord	1	2.5 meters
Speakers one pair	1	NA
Speaker Adapter	1	Available along speaker
Speaker Extension Cable	1	10 meters
Speaker to Speaker inter connection cable	1	10 meters
Remote for projection	1	NA
Keyboard	1	Wireless Keyboard
Mouse	1	Wireless Mouse

REVIEW DRAFT—CISCO CONFIDENTIAL

Item	Number	Size
Wireless Dongle	1	NA
Microphone	2	Wired microphone
Microphone Extension Cable	2	10 meters
Microphone Splitters	1	NA
Camera	2	Wired Camera
Active USB Extension Cable	2	10 meters
RJ45 cable from Router to Mother board (Pre-installed in the unit)	1	50 cm
Anchor Bolts	4	M 10
Allen Screws with washer	4	M 10 x 10 mm
Bolt with washer	2	M12 x 70 mm
Nut	2	M12
Router 3G Antenna*	2	Router Antennas (*Provided only if 3G Option is selected while ordering)
Wi-Fi antenna	1	Router Antenna
Remote Batteries*	1	3V, model:CR2025
Keyboard and Mouse Batteries*	3	2 AAA (keyboard batteries)* and 1 AA (Mouse batteries)*

**Note**

The batteries are either pre-installed or to be procured by the installation partner at the time of installation.



Installation

This chapter describes the installation/mounting of the CEED3700 (CEED 3700) and contains the following sections:

This section contains the following sections:

- [Mounting Prerequisites, page 2-1](#)
- [Mounting of the CEED 3700, page 2-1](#)
- [Accessories, Peripherals and Cable Assembly, page 2-6](#)

Mounting Prerequisites

- CEED 3700 is optimally designed for a room size of 20*20 ft. Any deviations shall be suitably notified and prior approval on the installation with partners (The document assumes a size of 20*20 ft room. Actual position may vary depending on the implementation and other details)
- CEED is placed at 10 to 13 feet from the screen.
- Ensure the ceiling is strong enough with reinforced concrete (RCC) or steel structures and is capable of taking at least 20 Kilograms (Kg) of load.
- Ensure ambient room lighting for proper image capture and better image projections.
- Use drapes or opaque curtains to block excess light in the room that will interfere the image projection.



Caution

Ensure that all [“Installation Prerequisites”](#) section on page 1-2 in the [Introduction](#) chapter is adhered to without any deviations.

Mounting of the CEED 3700

To mount the CEED 3700 in the ceiling, perform the following steps:

-
- Step 1** Assign the position of the CEED (from the screen) to be mounted. Align/arrange the top portion of the mounting kit towards the ceiling as shown in [“Top portion of the Mouting Kit”](#) in [Figure 2-1](#).
Remove the portion after you mark the holes.

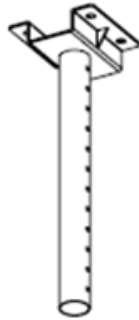
REVIEW DRAFT—CISCO CONFIDENTIAL**Figure 2-1** *Top portion of the Mounting Kit*

- Alternatively, you can also mark the holes using the template markings as shown in “[Template for the Drilling Hole](#)” in [Figure 2-2](#).

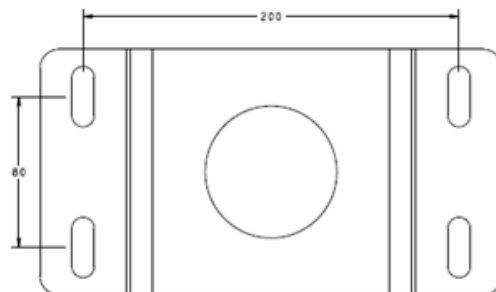
Figure 2-2 *Template for the Drilling Hole*

Step 2 Drill 12 mm diameter for the depth of 55 mm holes at the marked position.

Step 3 Insert all 4 anchor bolts one-by-one and slightly hammer to drive anchor into the drilled holes. Fix the top portion of the mounting kit and tighten the screws using the wrench/heavy duty screwdriver. See “[Fixing of the Anchor Bolts](#)” in [Figure 2-3](#).

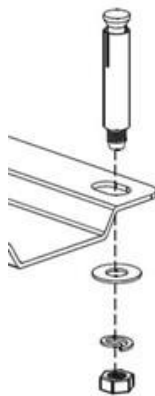
Figure 2-3 *Fixing of the Anchor Bolts*

REVIEW DRAFT—CISCO CONFIDENTIAL

Step 4 To connect all the cables, draw all the cables that are mentioned in “[List of CEED 3700 Package Items](#)” through the pipe and pull them towards the top portion of the mounting kit. See [Figure 2-4](#).



Note Ensure that respective end of cables pass through the mounting kit from the bottom.

Figure 2-4 Cable Connections through the Mounting Kit

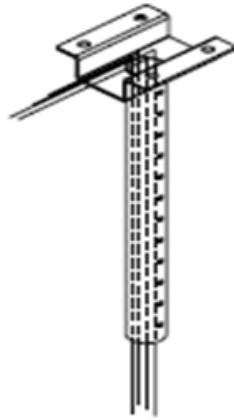

Step 5 Insert bottom portion of mounting kit to top portion of the mounting kit as shown in “[Alignment of the Top Portion and the Bottom Portion of the Mounting Kit](#)”.

Step 6 Adjust the length of the vertical slider so that the base of the CEED 3700 is above 6 feet from the ground.

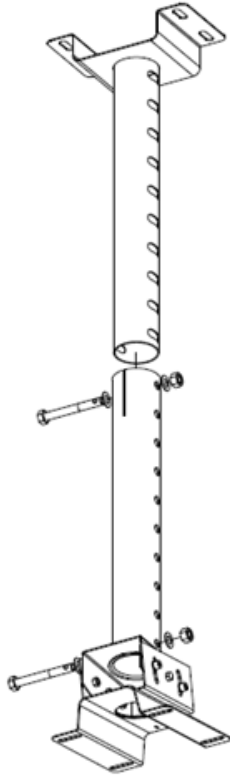
REVIEW DRAFT—CISCO CONFIDENTIAL**Figure 2-5** Alignment of the Top Portion and the Bottom Portion of the Mounting Kit

Step 7 Lock the Vertical Slider in both top and bottom side of the mounting kit. See [Figure 2-6](#)

REVIEW DRAFT—CISCO CONFIDENTIAL

Figure 2-6 Locking the Vertical Slider

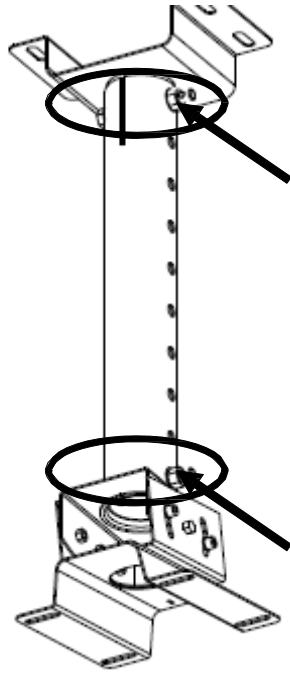

Step 8 Place CEED 3700 unit as shown in figure “CEED 3700 Placement” in Figure 2-7.



Note Ensure that the lens of the CEED 3700 is facing the screen.

Step 9 Lock the screws tightly.

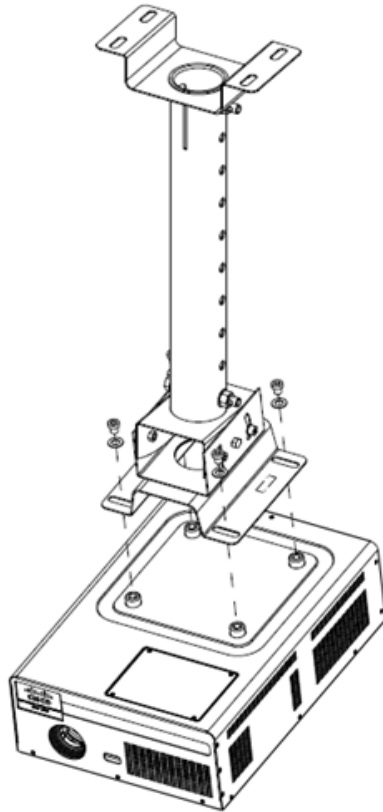
REVIEW DRAFT—CISCO CONFIDENTIAL**Figure 2-7** CEED 3700 Placement

Step 10 Complete set up looks as shown in

Accessories, Peripherals and Cable Assembly

This section describes the external wiring, all cable connections, positioning of the accessories and their connections and contains the following section:

- [External Wiring and Placement of Accessories, page 2-6](#)
- [Assembling of the Accessories, page 2-8](#)

External Wiring and Placement of Accessories

To connect and place all the accessories, peripherals and cables that are coming out of the CEED 3700 device, perform the following steps:

Note: The accessories and peripherals should be kept outside the test chamber/room using the extension cables while performing any compliance test.

Step 1 To connect accessories such as camera, microphone, keyboard, mouse and speaker follow the “[CEED 3700 External Cable Connections](#)” in [Figure 2-9](#).

REVIEW DRAFT—CISCO CONFIDENTIAL

Figure 2-9 CEED 3700 External Cable Connections

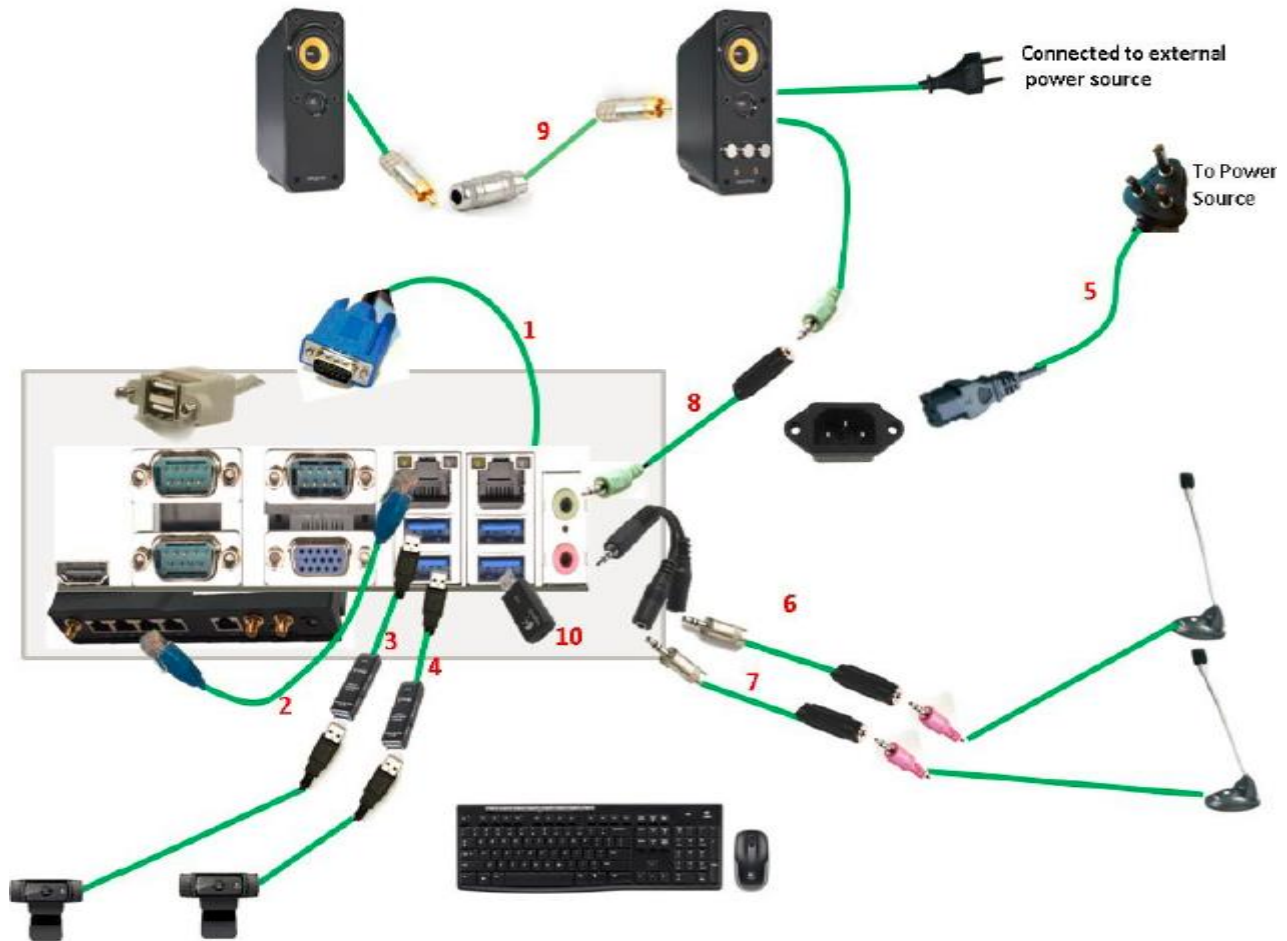

1	VGA Cable	7	Microphone extension cable
2	RJ45 male to RJ45 male	8	Speaker extension cable
3	Active USB extension cable	9	RCA cable
4	Active USB extension cable	10	Wireless KB and Mouse Dongle
5	AC Powercord		

Step 2 Allocate appropriate positions to the accessories.

Assembling of the Accessories

This section describes how to connect camera, microphone and speakers to CEED 3700.

VGA

Connect the VGA cable to the CEED back panel VGA port. Refer number 1 in [Figure 2-9](#)

Camera

To connect the camera 1 and camera 2 to the CEED 3700 back panel, perform the following steps:

-
- Step 1** Connect the Camera 1 and Camera 2 to Active USB extension cable. Refer number 3 and number 4 in [Figure 2-9](#) for connection.
 - Step 2** Insert the USB extension cable in the USB port in the CEED 3700 back panel as shown in [Figure 2-9](#)
 - Step 3** Place the camera in the appropriate position.
 - Step 4** Secure the camera position with appropriate nuts, bolts and screws.
-

Speakers

To connect the speakers to the CEED 3700 back panel, perform the following steps:

-
- Step 1** Connect the speakers to the audio extension cable. Refer number 8 and number 9 as shown in [Figure 2-9](#).
 - Step 2** Insert the audio extension cables in Audio port (Lime Color).
 - Step 3** Place the speakers at a suitable height on the wall for the sound to be audible as shown in [Figure 2-9](#). Note that the height will differ at each site.
 - Step 4** Secure the speakers with appropriate brackets and screws.
 - Step 5** Connect the speakers to the power outlet.

 **Note** The power cord provided with the speakers in the CEED 3700 package items are to be used only in *India*. For other countries use your respective adapters/converters for the power cord.

REVIEW DRAFT—CISCO CONFIDENTIAL

Microphone

-
- Step 1** Connect the microphone splitter to the microphone. Refer number 6 and number 7 as shown in [Figure 2-9](#).
 - Step 2** Connect the microphone extension cable to the splitter.
 - Step 3** Connect the microphone wire to the other end of the microphone extension cable
 - Step 4** Insert audio extension cables into Audio port (Pink Color).
 - Step 5** Place the microphones at suitable locations such that it is easily accessible as shown in [Figure 2-9](#).
-

Keyboard and Mouse

CEED 3700 comes with the wireless keyboard and wireless mouse. Plug-in the appropriate respective dongle in the USB port of the CEED 3700 back panel. Refer number 10 as shown in [Figure 2-9](#).

Screen

To connect the projection screen to the CEED 3700, perform the following steps:

-
- Step 1** Vertically place the screen parallel to the wall. Placement of the screen should be such that the lens of the CEED 3700 projects on the screen.
 - Step 2** Secure the screen to the wall with screws.
-



Note Screen is not part of the CEED 3700 package items. To be procured by the installation partner.



Configuring LAN and Connectivity

This chapter describes the how to configure Local Area Network and its related connectivity to the CEED 3700 device and how to power on the CEED 3700. This chapter contains the following sections:

- [Configuring LAN](#)
- [Powering On CEED 3700](#)

Configuring LAN

To connect the RJ45 cable to the specific ports, perform the following steps:

-
- Step 1** Connect RJ45 cable from the modem to the CEED 3700 WAN port in CEED 3700 back panel.

REVIEW DRAFT—QISCO CONFIDENTIAL

Figure 3-1 CEED 3700 Back Panel

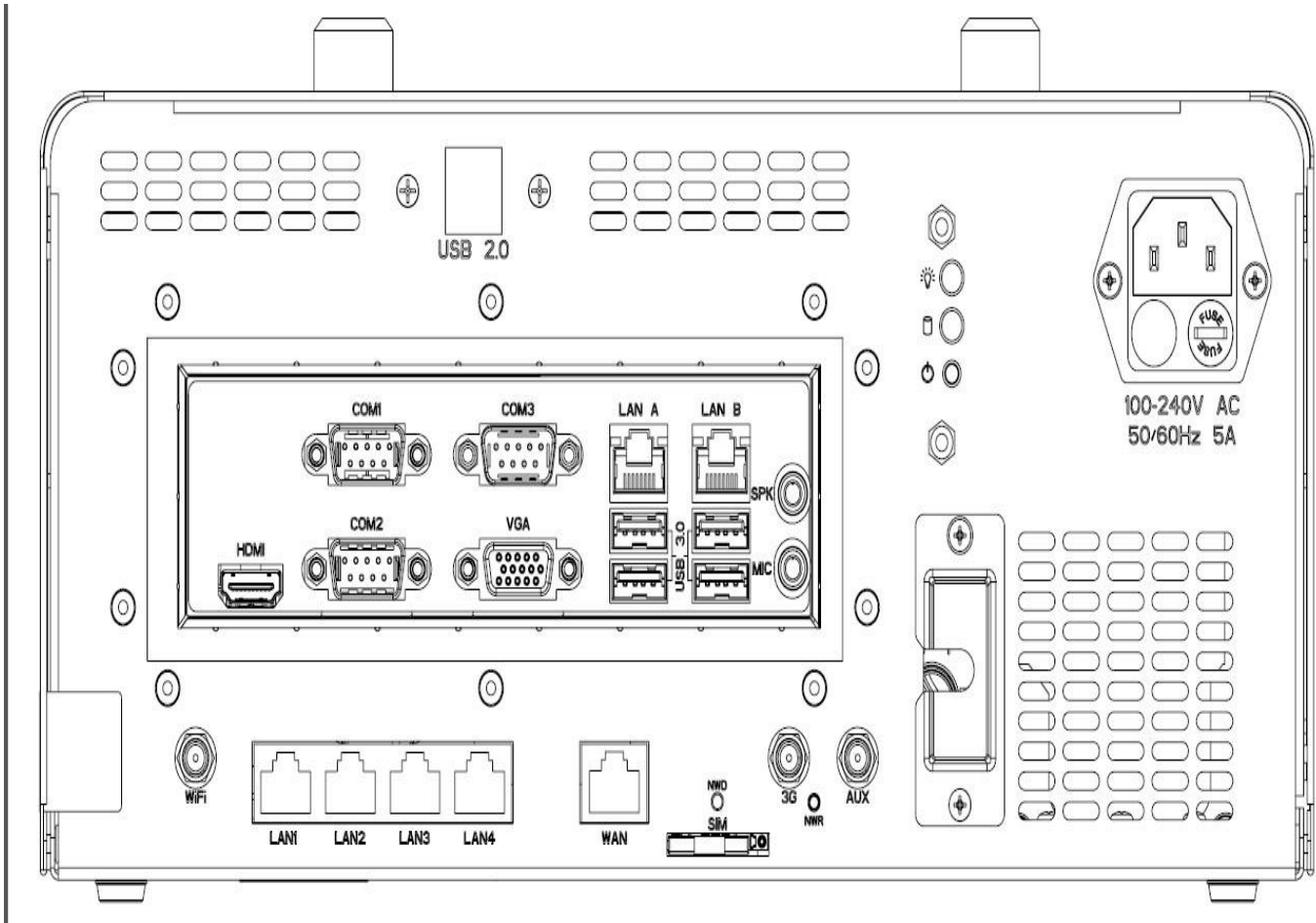

- Step 2** Connect RJ 45 cable provided with the CEED 3700 package item from LAN1 port in the back panel to the LAN A port. See [CEED 3700 Back Panel](#) in [Figure 3-1](#).
- Step 3** Connect the Wi-Fi Antenna to the Wi-Fi Antenna port.
- Step 4** Connect the one 3G Antenna to 3G port.
- Step 5** Connect the other 3G antenna to the AUX port.
- Step 6** Insert a 3G SIM in the SIM slot.



Note

RJ45 cable from the modem to CEED 3700 is not provided with the CEED packaging items. The deployment partner has to procure the RJ45 cable as the length may be different in each location.

Powering On CEED 3700

**Caution**

All cables, peripherals and accessories to be connected securely before power-on.

This section describes how to power on the CEED 3700 after connecting the power cord.

-
- Step 1** Press the power switch once. See [Power Switch](#) in [Figure 3-2](#).

Figure 3-2 *Power Switch*



- Step 2** Turn on the projection system using the remote or the projection ON/OFF switch at the bottom of CEED 3700.
-



Configuring CEED 3700 Software

This chapter describes how to configure the CEED 3700 software, first time login and subsequent login sessions using the CEED 3700. This configuration is a one-time process to be performed during the first time login only.



Note

The following sections assumes that you have removed the plastic sheet covering the back panel of the CEED 3700 and CEED 3700 powered on.

First Time Log in

To complete the configuration of CEED 3700, perform the following steps after you first login.

- Step 1** After you power on the setup screen will appear as shown in “Setup Screen” figure [Figure 4-1](#)

Figure 4-1 Setup Screen

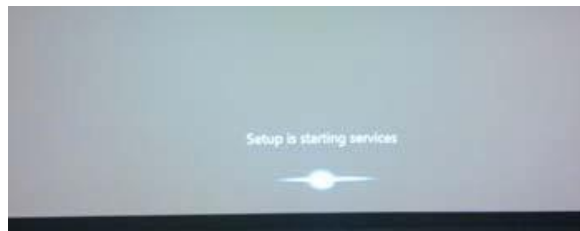

- Step 2** Wait for 20-30 seconds for the setup process screen to appear as shown in “Setup Process” in [Figure 4-2](#)

Figure 4-2 Setup Process



- Step 3** Once the system has installed the required devices 100%, Windows 7 professional license starts its installation process. The windows 7 licence screen as appears.

REVIEW DRAFT—CISCO CONFIDENTIAL

- Step 4** From the Country or region drop-down list, choose **India**.
- Step 5** From the Time and Currency drop-down list, choose your country. For example, **English (India)**
- Step 6** From the Keyboard layout drop-down list, choose **US** and click **Next**.
- For Steps 4 to 6 see figure [Figure 4-3](#).

Figure 4-3 Windows 7 License Screen



- Step 7** Enter the desired Username. For example, CEED.
- Type the computer name field will auto-populate with the “username-PC”. For example CEED-PC. See [Figure 4-4](#).

Figure 4-4 Username



- Step 8** Click **Next**. Set a Password for your account screen appears. See [Figure 4-5](#).

REVIEW DRAFT—CISCO CONFIDENTIAL**Figure 4-5 Set a password for your account**

Step 9 In the Type a Password field, type a password. For example, xyzabc

Step 10 Re-type your password, in the Re-Type password field.

Step 11 (Optional) Enter the hint for your password.

Step 12 Click **Next**.

Step 13 Type your Windows Product Key screen appears. See [Figure 4-6](#)

Step 14 Click **Skip**.



Caution Do not enter the product key

Step 15 Uncheck the **Automatically activate windows when I'm Online** check box.

Figure 4-6 Product Key

Step 16 Check the radio button **I accept the license terms** and then click **Next**. See [Figure 4-7](#)

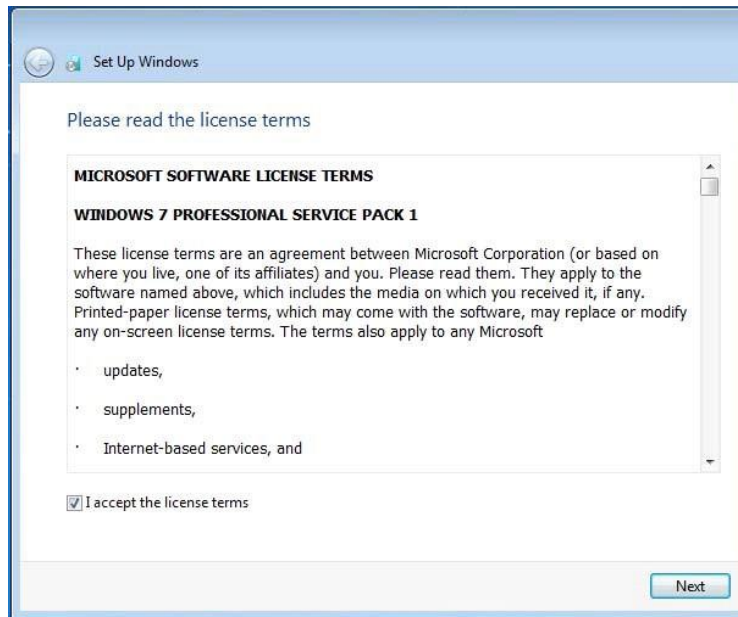
REVIEW DRAFT—CISCO CONFIDENTIAL**Figure 4-7** *Accepting Windows Licence*

Step 17 Click **Next**.

Step 18 Review your Date and Time settings on the window that appears as shown in “Set Date and Time” in [Figure 4-8](#).

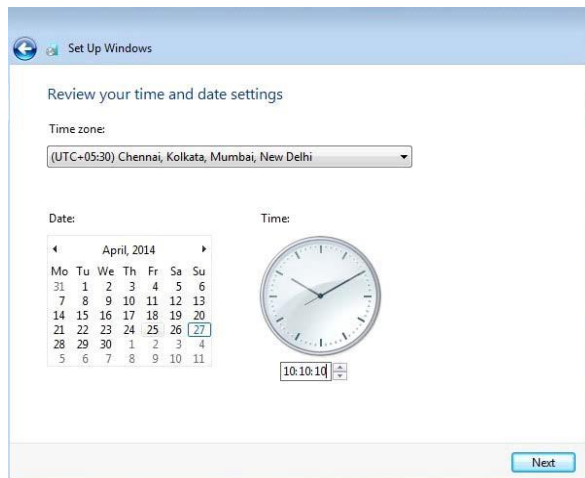
Figure 4-8 *Set Date and Time*

Step 19 Set your **Time Zone**. For example, (UTC +5.30) Chennai, Kolkata, Mumbai, New Delhi, if you have selected India as your country in Step 4.

Step 20 Set the current **Date and Time**.

Step 21 Click **Next**.

Step 22 Select **Public network** from **select your computer's current location**. See [Figure 4-9](#)

REVIEW DRAFT—CISCO CONFIDENTIAL**Note**

This Window will not appear if LAN is not connected to CEED 3700. Select **Public network** whenever LAN cable is connected

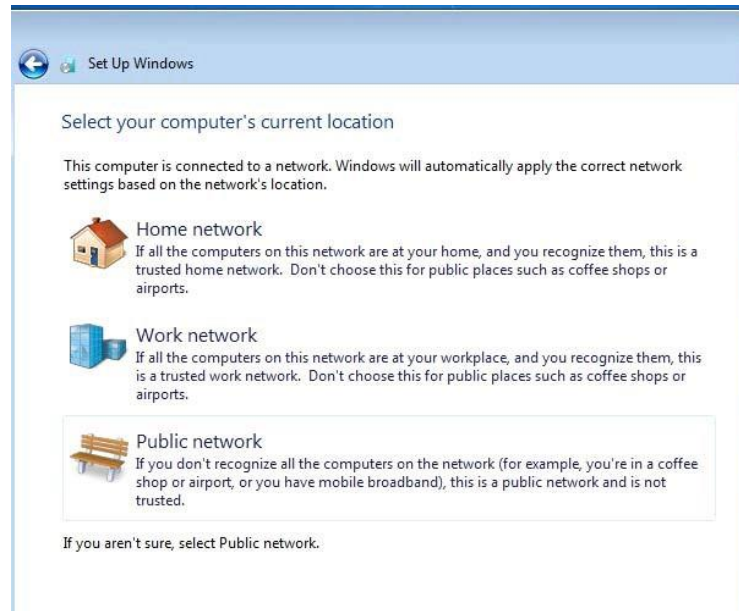
Figure 4-9 Set Up Windows

Step 23 Windows Desktop Screen with windows logo appears see “Windows Desktop” in Figure 4-10.

Figure 4-10 Windows Desktop

Step 24 Click the **Start** button, enter “Microsoft Security Essentials” in the search box, and open “Microsoft Security Essentials” application. See Figure 4-11.

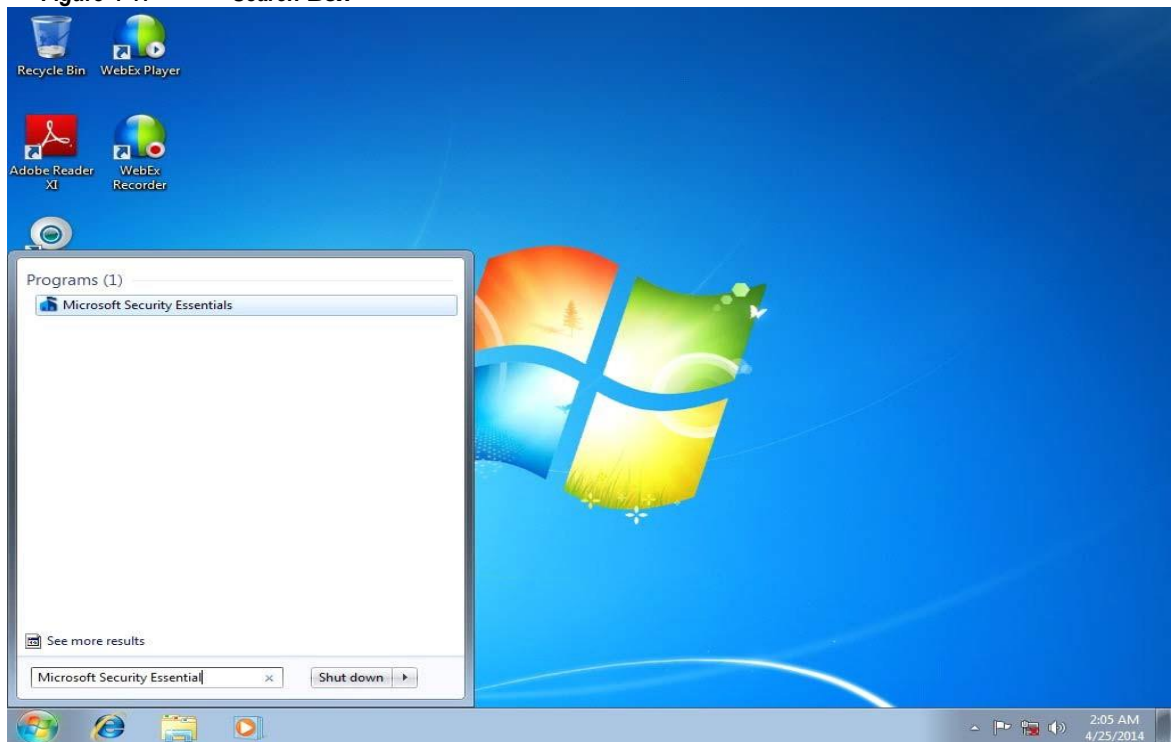
REVIEW DRAFT—CISCO CONFIDENTIAL**Figure 4-11 Search Box**

Step 25 Wait for a few seconds before **Microsoft Security Essentials** screen pop up on the desktop as shown in [Figure 4-12](#).

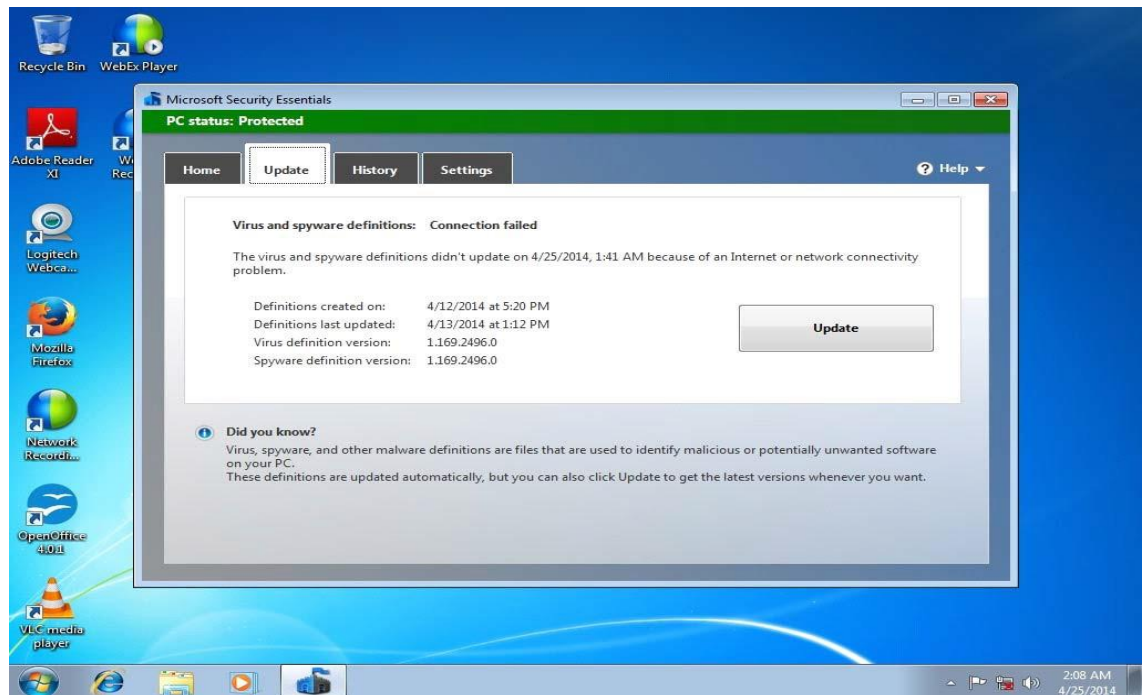
Figure 4-12 Microsoft Security Essentials

Step 26 Click **Update** tab to update the latest Virus and Spyware definition.

**Note**

Ensure that CEED 3700 is connected to the Internet while you perform the Step 26.

REVIEW DRAFT—CISCO CONFIDENTIAL

Step 27 To activate windows right-click on **My Computers** and then choose **Properties** from the drop-down menu. See [Figure 4-13](#).

Figure 4-13 *Properties*

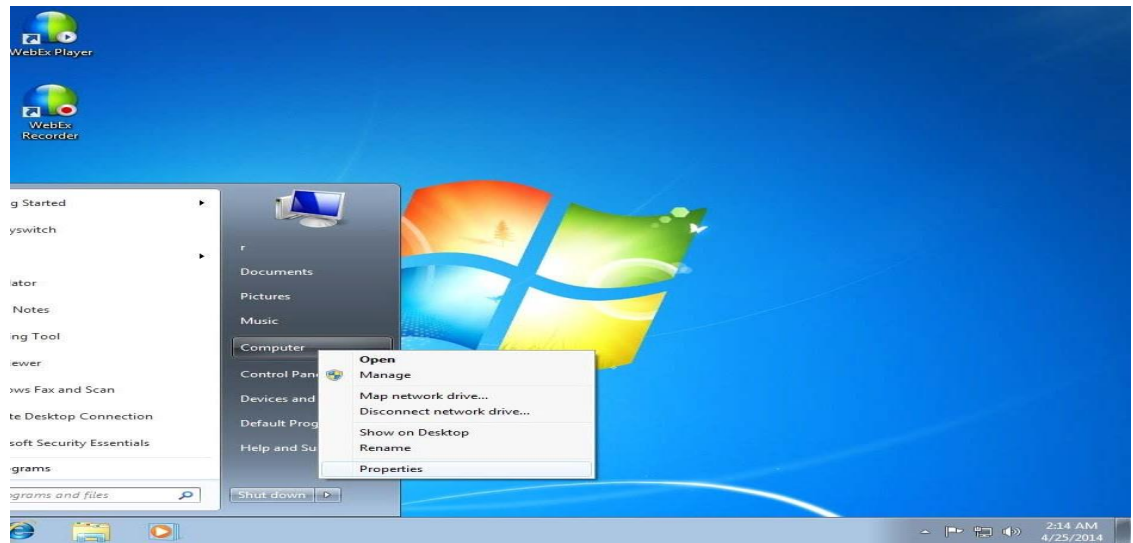

A System Screen appears where you can **change the product key**. See [Figure 4-14](#).

Figure 4-14 *System Screen*

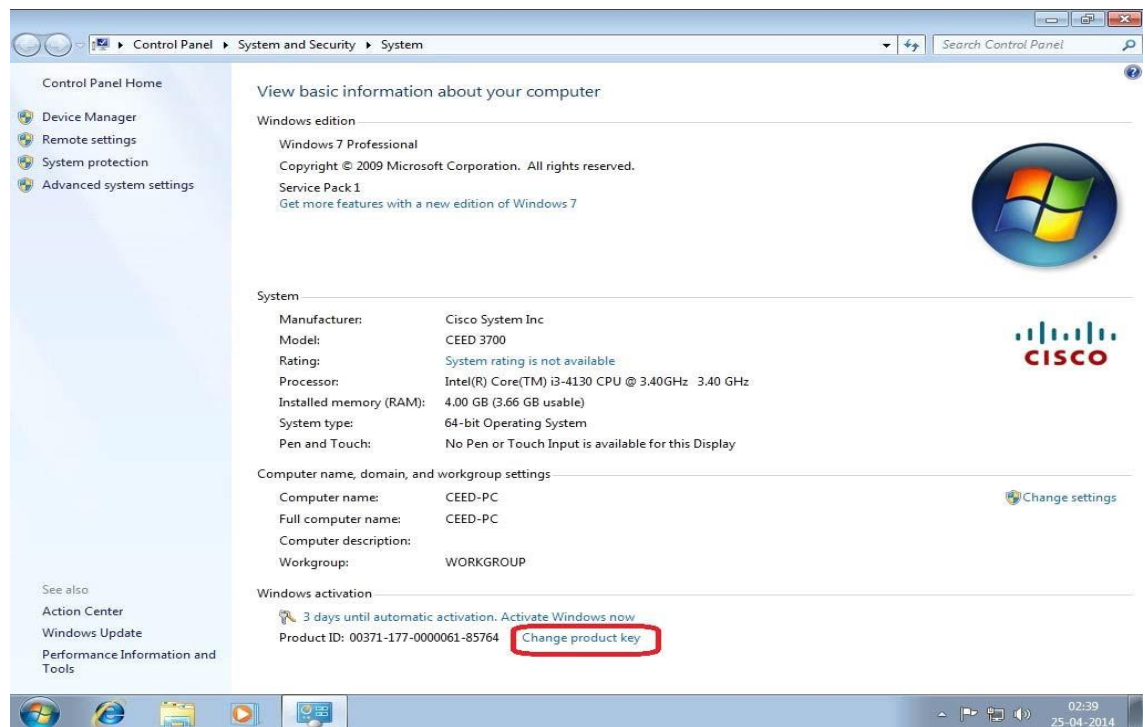

Step 28 To change the product Key, click **Change Product key**.

A Windows Activation Screen appears. See [Figure 4-15](#).

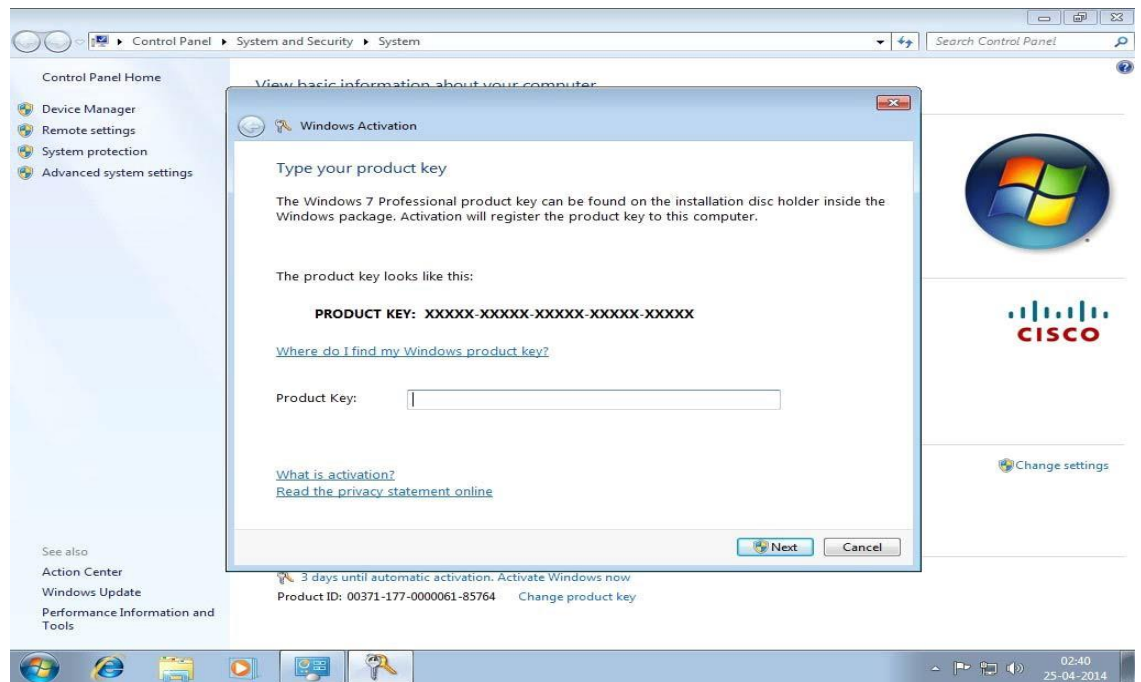
REVIEW DRAFT—CISCO CONFIDENTIAL**Figure 4-15 Windows Activation**

Step 29 Enter the Product Key in the Product key field.



Note The product key is an alphanumeric key which is found in the CEED Box

A Windows Activation with activating windows appears. See [Figure 4-16](#).

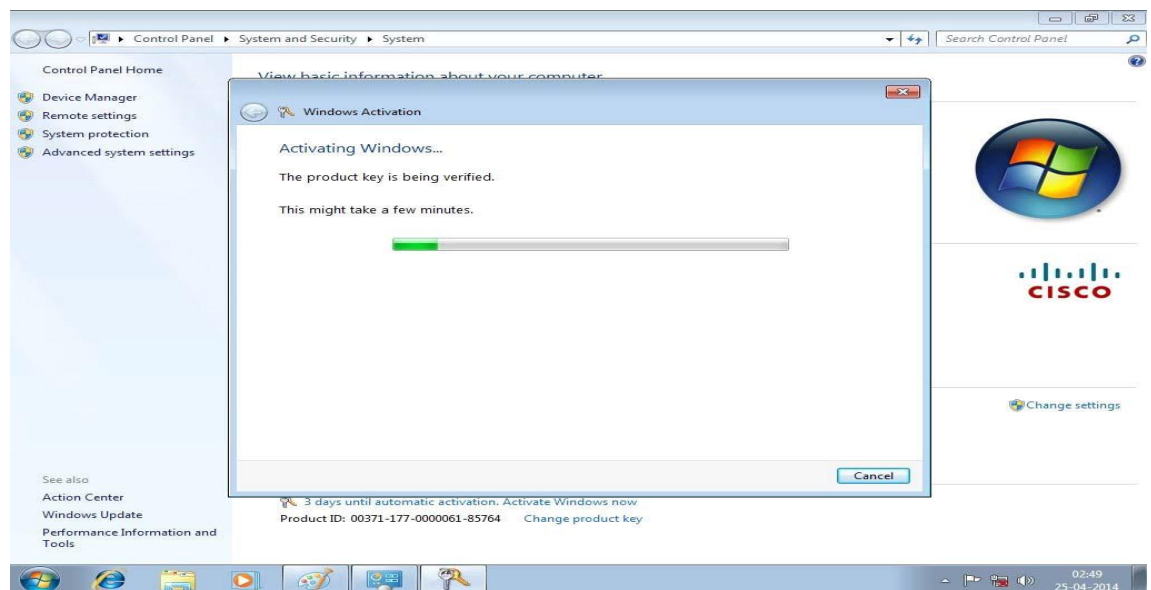
Figure 4-16 Activating Windows

REVIEW DRAFT-CISCO CONFIDENTIAL

Step 30 After a few minutes the **Windows is activated** screen appears as shown in [Figure 4-17](#)

Figure 4-17 Activated Windows

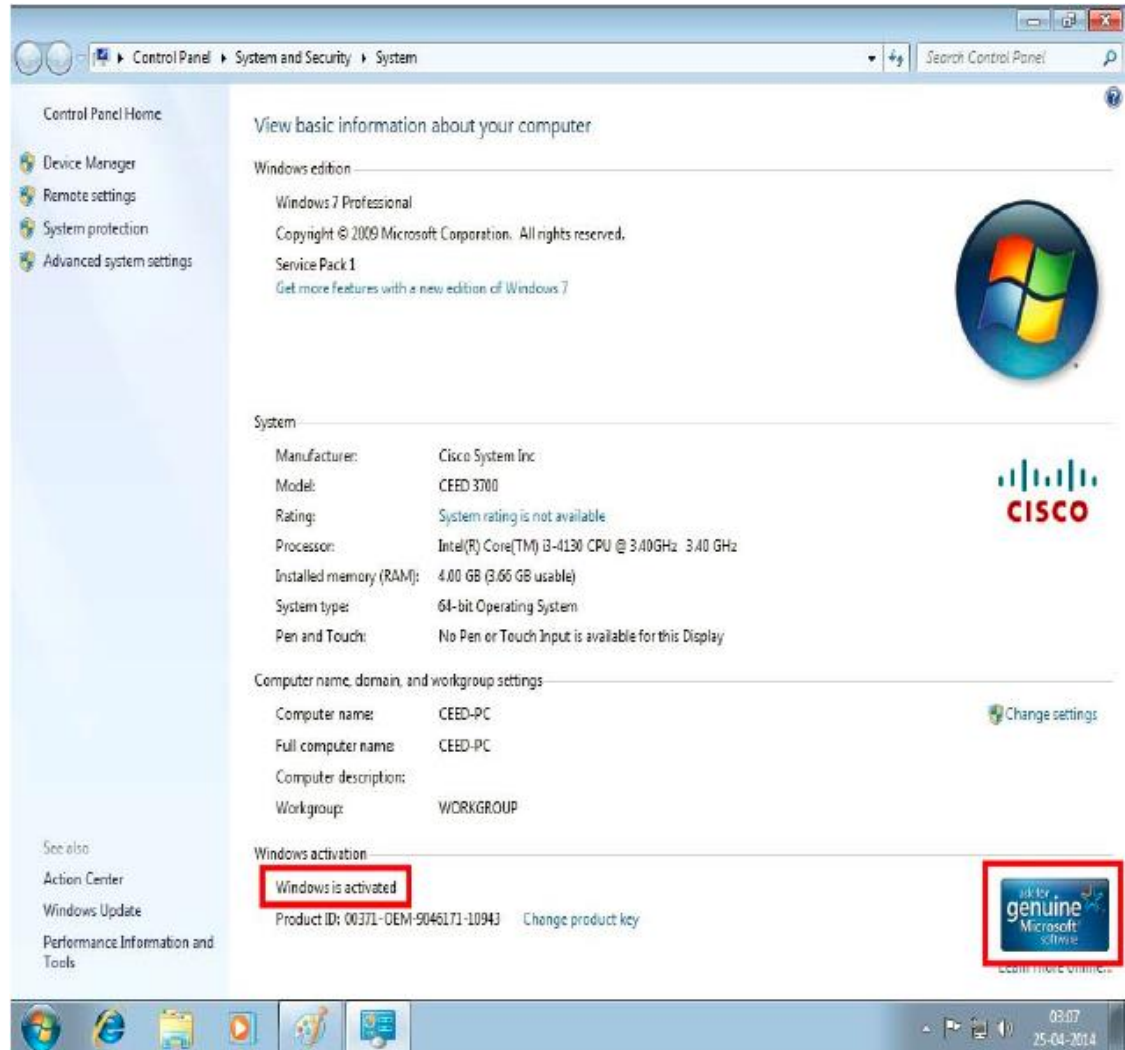



Configuring the Browser

This chapter describes about how to configure the CEED3700 (CEED 3700 browser (Internet Explorer 8.0) and contains the following sections

- [Launching the Browser, page 5-1](#)
- [Verification of the Browser Settings, page 5-3](#)

Launching the Browser

To launch the browser in CEED 3700, perform the following steps:

-
- Step 1** Power on the CEED 3700 device by pressing the *Power Switch* once.
 - Step 2** Enter the Username in the Username field. For example, Cisco
 - Step 3** Enter the Password in the password field. For example, 1234
 - Step 4** Click the Internet Explorer e icon to launch the browser
 - Step 5** From the browser menu bar, click **Tools**. (See Figure [Figure 5-1](#))
Alternatively, you can press **Alt + F** simultaneously in your keyboard to open the Tools Menu.

Figure 5-1 Tools Menu

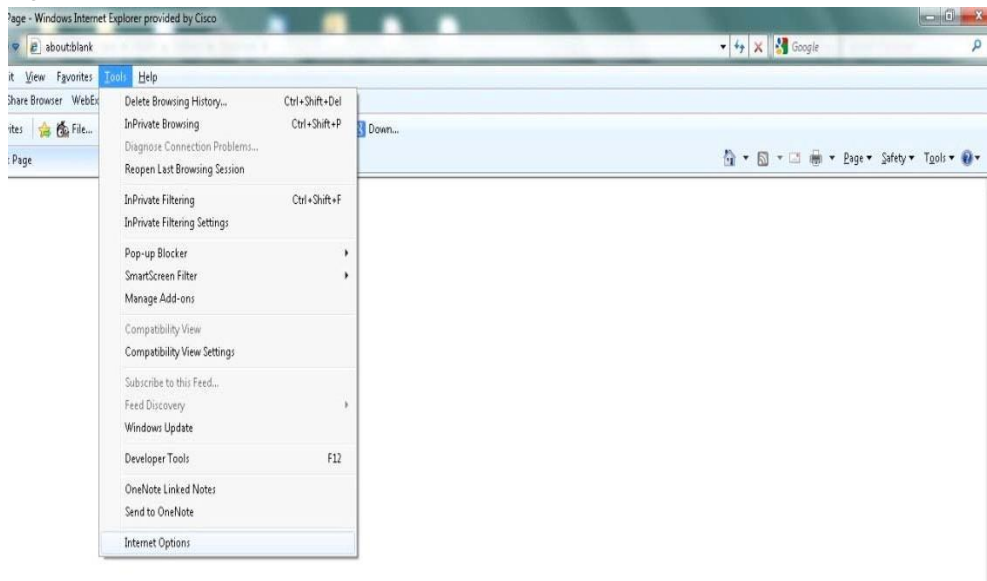

Step 6 From **Tools** menu, choose **Internet Options**. (See [Figure 5-1 Tools Menu](#))

Step 7 Click **Internet Options**.

A **Internet Options** dialog box opens. (See [Figure 5-2 Internet Options](#))

Step 8 Enter the homepage address or URL in the **homepage** field. For example, <http://kssa.webex.com>

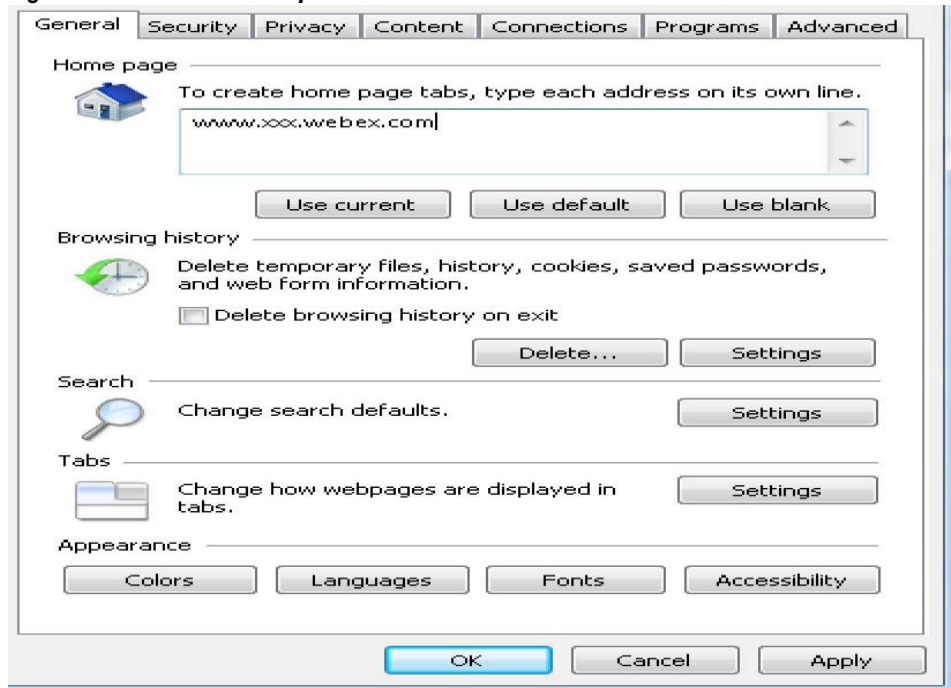

Note This URL or homepage address will be provided by the Cisco Representative or the partner during the installation.

REVIEW DRAFT—CISCO CONFIDENTIAL**Figure 5-2** Internet Options

Step 9 Click **OK**.

Step 10 Restart the browser.

Verification of the Browser Settings

To verify your browser settings, perform the following steps:

**Note**

Ensure the CEED 3700 device is powered ON. If not power ON the CEED device as given in [Step 1](#).

Step 1 Check the Back Panel LED indicators functionality which is as follows:

- Link LED glow continuously

Step 2 To login to enter the Username and password.

Step 3 Click the Internet Explorer icon  to launch the browser

The homepage (CEED Page) must open with your default address/URL that you have set in [Step 8](#) of last section.

**Note**

If the default page does not open, repeat the tasks in [Launching the Browser](#) section.



Configuring the Router

This chapter describes how to configure the router for the CEED 3700. This chapter contains the following:

- [Configuring WAN](#)
- [Configuring 3G](#)
- [Configuring Wi-Fi](#)
- [Powering Down/Shutting Down the CEED 3700](#)

This chapter assumes that the following prerequisites have been completed.

- At least 1 Mbps Internet Leased Line with Static Public IP for WAN interface is available.
- The Internet link should have an Ethernet hand-off.

Configuring WAN

To configure the WAN in the router, perform the following steps:

-
- Step 1** Connect RJ45 cable from the modem to the CEED 3700 WAN port in CEED 3700 back panel.
 - Step 2** Connect RJ 45 cable provided with the CEED 3700 package item from LAN1 port in the back panel to the LAN A port. See [CEED 3700 Back Panel](#) in [Figure 6-1](#).

REVIEW DRAFT—CISCO CONFIDENTIAL

Figure 6-1 CEED 3700 Back Panel

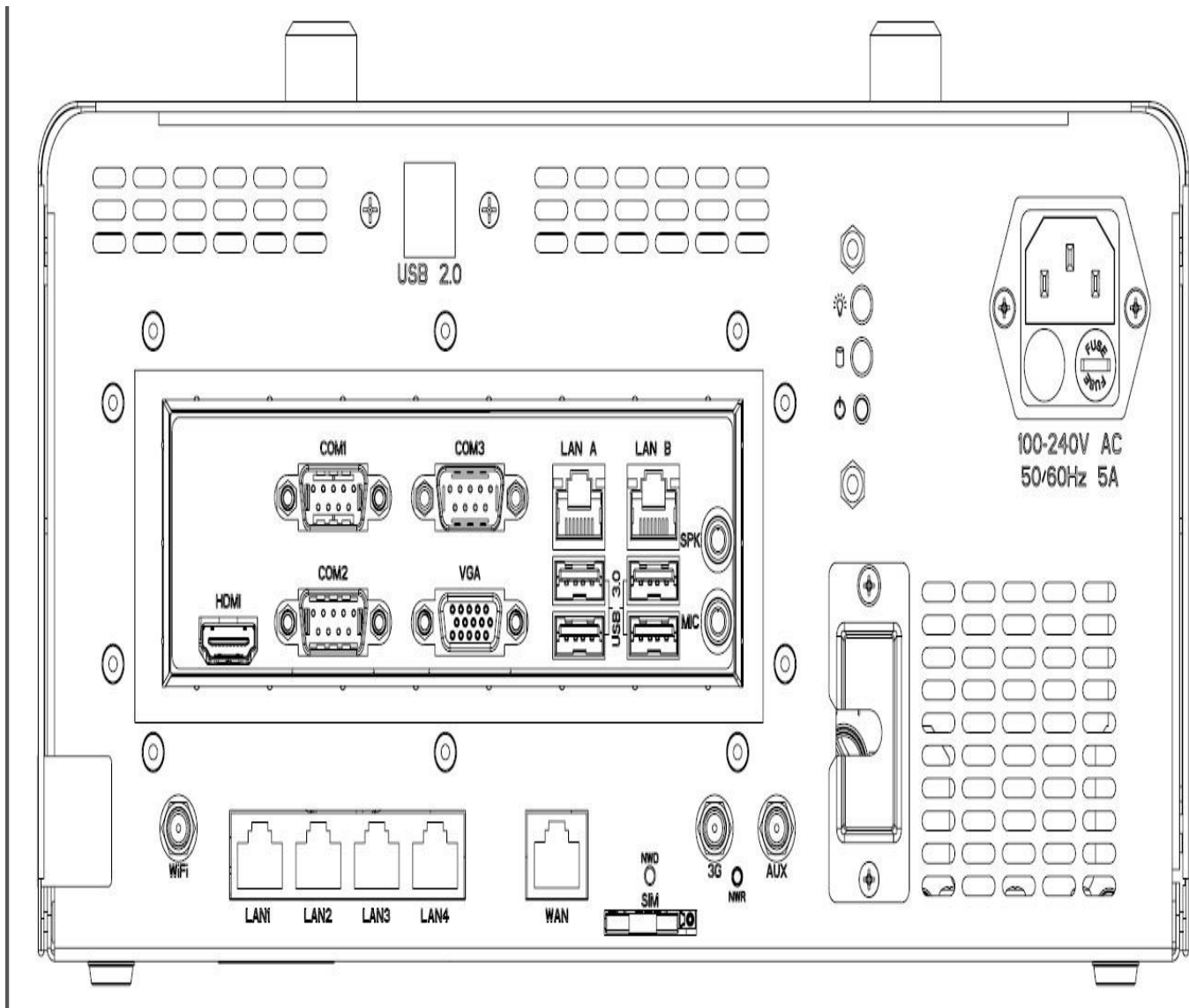

- Step 3** Click Windows **Start** button, choose **All Programs** and then click **Internet Explorer** to open the web browser.
- Step 4** Enter the IP address of the router in the web address bar and then press **Enter**. The default IP address is 192.168.1.1.

An Authentication required dialog box appears as shown in [Figure 6-2](#).

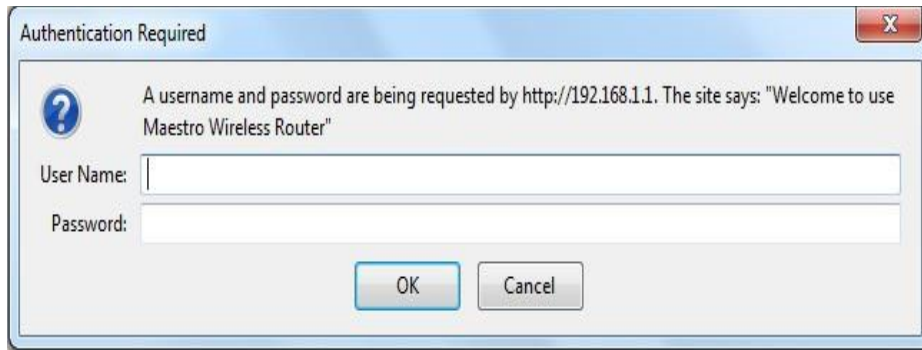
REVIEW DRAFT—CISCO CONFIDENTIAL**Figure 6-2** Authentication Required

- Step 5** Enter the Username and password in the Username and password field respectively. The default username is admin and the password is admin
- Step 6** Click **OK**.
- Step 7** The Router homepage appears as shown in “Router Home Page” in Figure 6-3.

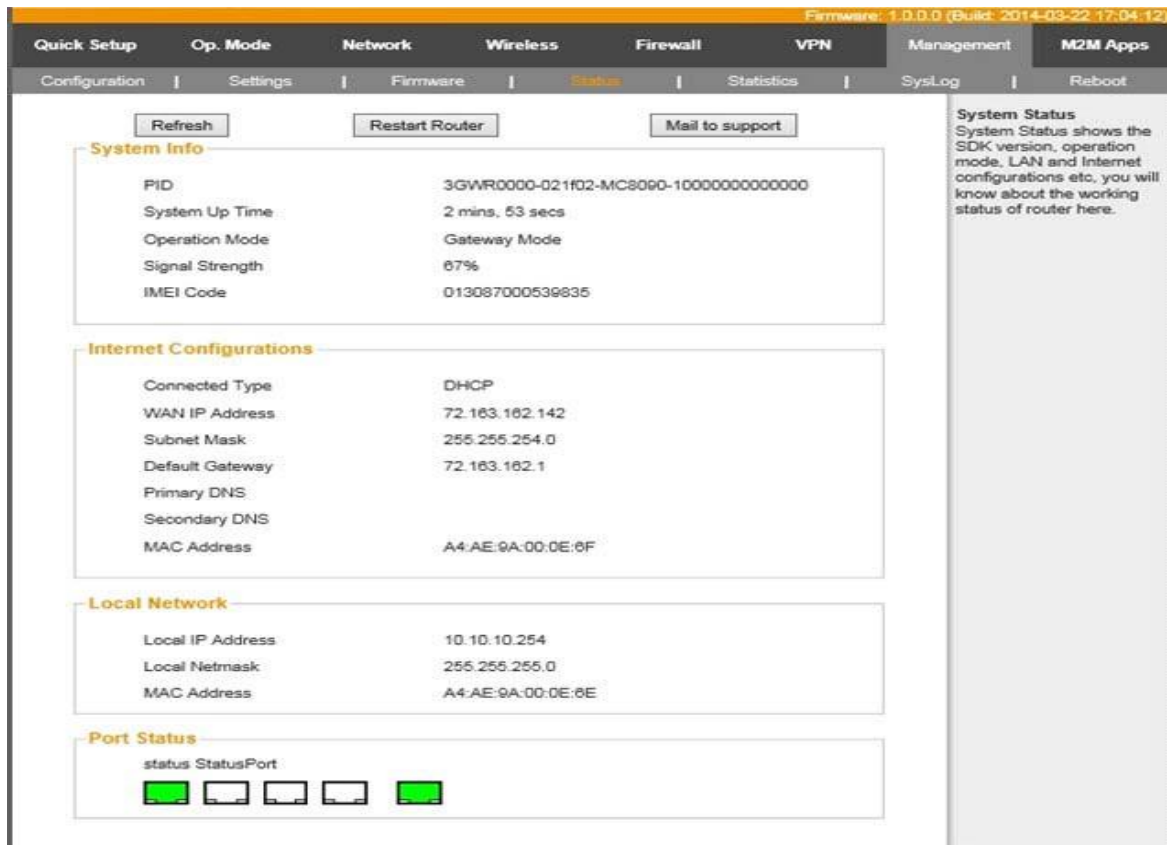
Figure 6-3 Router Home Page

- Step 8** Click **Op.mode** tab to change the WAN mode to WAN Main, Cellular Back up.
- Step 9** Select the **WAN Main, Cellular Back up** radio button as shown in “Op.Mode” in Figure 6-4.

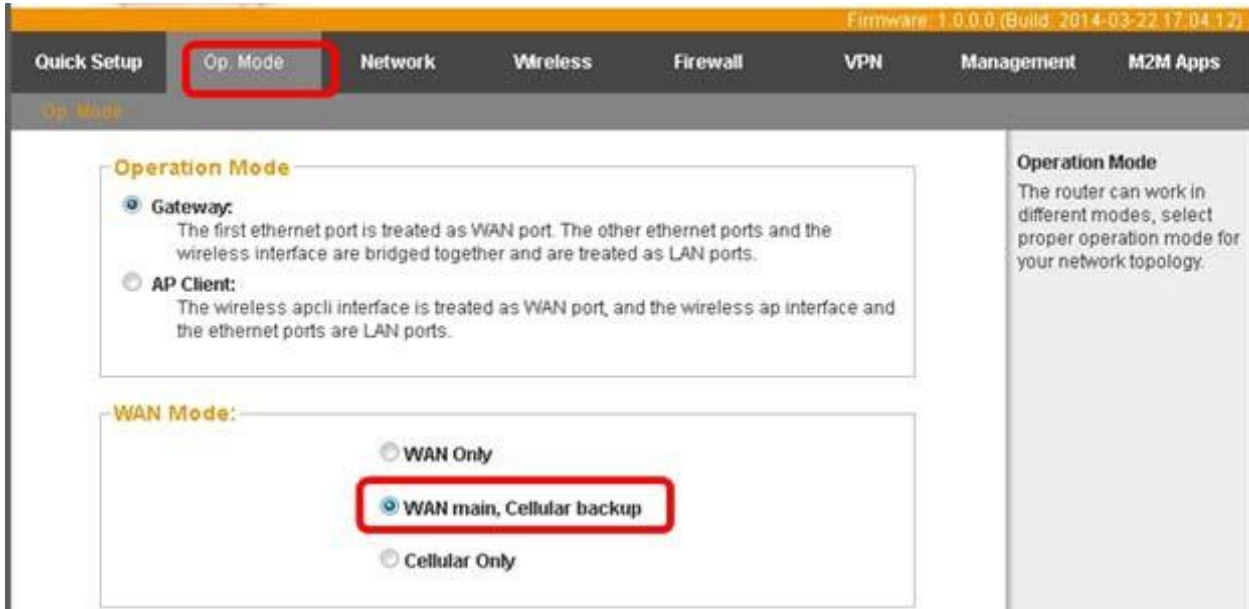
REVIEW DRAFT—CISCO CONFIDENTIAL**Figure 6-4 Op.Mode**

- Step 10** Click Apply and then wait for the settings to be applied.
- Step 11** Press F5 to refresh the browser.
- Step 12** Click Network tab, choose WAN to set up the static IP on WAN.
The router page as shown in [Figure 6-5](#) appears.

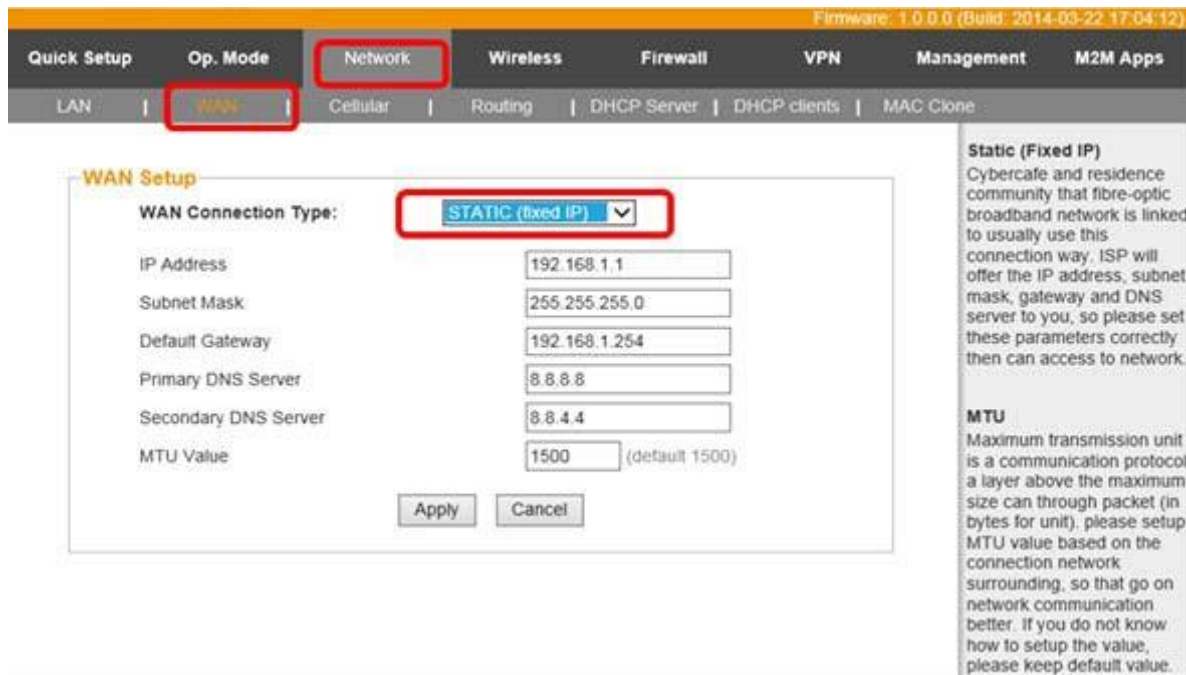
Figure 6-5 Network Tab

- Step 13** From the WAN Connection Type drop-down list, choose STATIC (Fixed IP)

REVIEW DRAFT—CISCO CONFIDENTIAL

The IP Address, Subnet Mask, Default Gateway, Primary DNS Server, Secondary DNS Server and MTU value fields will be enabled.

- Step 14** Enter the values that you have obtained from the Service Provider in the IP address, Subnet Mask, Default Gateway, Primary DNS Server, Secondary DNS Server.
- Step 15** The MTU Value is set to default 1500.
- Step 16** Click **Apply** and wait for the settings to be applied.

Configuring 3G

To configure 3G network in the router, perform the following steps:

- Step 1** Perform [Step 1 to Step 7](#) in the section [Configuring WAN](#), page 6-1.
- Step 2** Click **Network** tab and then choose **Cellular** as shown in “Cellular Tab” in [Figure 6-6](#).

Figure 6-6 Cellular Tab

Cellular Setup

ISP: Airtel

PIN Code:

Access point name: airtelgprs.com

Dial number: *99***1#

User name: a

Password: •

MTU Value: 1490 (default 1490)

Apply Cancel

3G
The third mobile communication.

MTU
Maximum transmission unit is a communication protocol a layer above the maximum size can through packet (in bytes for unit). please setup MTU value based on the connection network surrounding, so that go on network communication better. If you do not know how to setup the value, please keep default value.

- Step 3** From the IPS drop-down list, choose the service provider. For example, Airtel.
- Step 4** If your Service provider is not listed in the drop-down menu, enter the service provider’s name manually.
- Step 5** In the Access point name, dial number , user name and password fields enter the respective values provided by the service provider.
- Step 6** Click **Apply** and wait for the changes to be applied.

REVIEW DRAFT—CISCO CONFIDENTIAL

Configuring Wi-Fi

To configure Wi-Fi set up in the router, perform the following steps:

- Step 1** Perform [Step 1](#) to [Step 7](#) in the section [Configuring WAN](#), page 6-1.
Click **Wireless** tab and then choose **Basic** as shown in “Wireless Tab” in [Figure 6-7](#).

Figure 6-7 Wireless Tab

The screenshot displays the Cisco router's configuration interface for the Wireless tab. The 'Basic' sub-tab is selected. The 'Wireless Network' section includes the following settings: 'Radio On/Off' is set to 'WiFi OFF'; 'Network Mode' is set to '11b/g/n mixed mode'; 'SSID' is set to 'Cisco-CEED'; 'Broadcast Network Name (SSID)' has 'Enable' selected; 'BSSID' is 'A4:AE:9A:00:0E:6E'; and 'Frequency (Channel)' is set to 'AutoSelect'. The 'HT Physical Mode' section shows 'Channel BandWidth' set to '20/40' and 'Guard Interval' set to 'Auto'. At the bottom, the 'Apply' button is highlighted. On the right side, there are informational sections: 'Wireless Settings' (parameters like SSID, frequency, network mode), 'Radio On/Off' (instructions on turning WiFi on/off), 'Network Mode' (instructions on choosing network modes), and 'Network Name (SSID)' (definition of SSID).

- Step 2** In the SSID field, enter Cisco-CEED.
Step 3 Click **Apply** and then wait for settings to be applied.
Step 4 Press F5 to refresh the browser.
Step 5 Click **Wireless** Tab to change the Wi-Fi password

REVIEW DRAFT—CISCO CONFIDENTIAL

Figure 6-8 Wireless Tab

The screenshot shows the CEED 3700 web interface with the following details:

- Navigation:** The 'Wireless' tab is selected in the top menu. Below it, the 'Security' sub-tab is also selected.
- Security Mode:** Set to 'WPA-PSK/WPA2-PSK'.
- WPA Algorithms:** Radio buttons for TKIP, AES, and TKIPAES are shown, with TKIPAES selected.
- Pass Phrase:** The text 'cisco@123' is entered in the field.
- Key Renewal Interval:** Set to 3600 seconds (range 0 ~ 4194303).
- Access Policy:** The 'Policy' dropdown is set to 'Disable'.
- Buttons:** 'Save', 'Apply', and 'Cancel' buttons are at the bottom, with 'Apply' highlighted.
- Right Panel:** Contains 'Wireless Security Settings' (instructions on setting security mode and encryption), 'WPA' (description of pre-sharing key), and 'WPA1/WPA2' (comparison of encryption methods).

- Step 6** Click **Security**.
- Step 7** In the **Pass phrase** field, enter *cisco@123* to set the password.
- Step 8** Click **Apply** and wait for the changes to be applied.
- Step 9** Press **F5** to refresh the browser.
- Step 10** Reboot the CEED 3700 device.

Powering Down/Shutting Down the CEED 3700

To shut down the CEED 3700 device, perform the following tasks:

- Step 1** Close all applications and wait for all applications to shutdown
- Step 2** Click **Start** button 
- Step 3** Click **Shut down**.
- Step 4** Wait for the display to turn off.
- Step 5** Wait for the projection fan to stop (Step 1 and Step 4 will take about 2-3 minutes)
- Step 6** Turn off the AC Power Switch in the wall power outlet.

REVIEW DRAFT—CISCO CONFIDENTIAL

Configuring the Live Session

This chapter describes how to schedule and join the live session. It also describes about the accessories that are enabled during a session and troubleshooting techniques. This chapter includes the following sections:

- Hosting a WebEx Session
- Joining a WebEx Session
- Verification of the Accessories

Hosting a WebEx Session (HOST)

Step 1 Log into WebEx Meeting Center site: <http://kssa.webex.com>

Step 2 Click on My WebEx. 

Step 3 Log into WebEx account using the following credentials:

User Name: [hoskote](#)

Password: [Edu@123](#)

Log in to your account

Username:

Password:

[Forgot your password?](#)

Keep me logged in

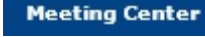
Step 4 Click on Meeting Center. 

Step 5 Click on Schedule a Meeting (Marked in Red in the below figure).

REVIEW DRAFT—CISCO CONFIDENTIAL

Join an Unlisted Meeting

To join an unlisted meeting, type the meeting number that your host gave to you, then click **Join Now**.

Meeting number:

POWERED BY
Cisco WebEx
Technology

© 2014 Cisco and/or its affiliates. All rights reserved. www.webex.com
[Privacy](#) | [Terms of Service](#) | [Request information about WebEx services](#)

- Step 6 Enter a Meeting Topic (For example: Test).
- Step 7 Set Session password as 1234 and confirm the same.
- Step 8 Set date and time.
- Step 9 Audio conference type should always be “Use VoIP only”.

Schedule a Meeting

To set advanced meeting options, go to [Advanced Scheduler](#)

* Meeting topic:

Password: Confirm password:

Date: May 12 2014

Time: 12 30 am pm [Mumbai Time](#)

Duration: 1 hr 0 min

Attendees: [Use address book...](#)

Send a copy of the invitation email to me

Audio conference: Use VoIP only [Change audio conference...](#)

- Step 10 Click on Start Now. . This will start the WebEx session.

Note: If this is the first time WebEx is running on your computer, you will be prompted to install the WebEx software via ActiveX. Install it.

- Step 11 Turn on the video by clicking the video icon 

- Step 12 Note the Meeting number (marked in Red).

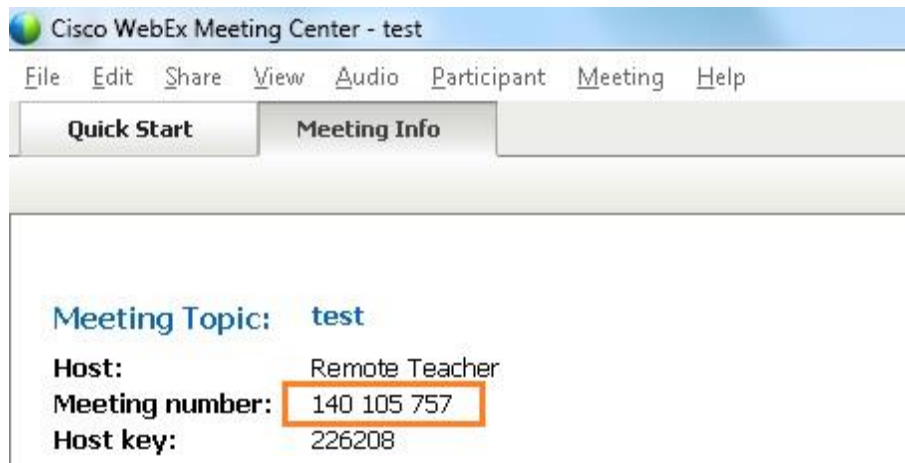
REVIEW DRAFT—CISCO CONFIDENTIAL**Joining a WebEx Session (Participant / Attendee)**

- Step 1 Log in to WebEx Meeting Center site: <http://kssa.webex.com>
- Step 2 Click on Meeting Center. **Meeting Center**
- Step 3 Note down the Meeting number from the Meeting Info tab in Host login (**Refer Step 12 of Hosting a WebEx Session**).
- Step 4 Enter the Meeting number (in the box marked in Red) and click Join Now (marked in Blue).



- Step 5 Enter the required login info: Name, email and password. Password will be 1234 (**Refer Step 7 of Hosting a WebEx Session**).

REVIEW DRAFT—CISCO CONFIDENTIAL
CISCO CONFIDENTIAL

● It's time to join!

If you are the host, [start your meeting](#).

Your name:

Email address:

Meeting password:

[\(Clear my information\)](#)

I would like to take a free WebEx trial (email required).

Step 6 Click on Join. This will start the WebEx session for attendee.

Note: If this is the first time WebEx is running on your computer, you will be prompted to install the WebEx software via ActiveX. Install it.

Step 7 A pop up to Join the Integrated Voice Conference appears. Click on Yes.



Step 8 Turn on the video by clicking the video icon



Note: This document is grounded on WebEx Meeting center. If WebEx Training center is used, the only change would be to click on Training center instead of Meeting center (wherever applicable).

Verification of the Accessories

To verify the accessories (Camera/Microphone) perform the following steps:

- Step 1 Microphone 1 and 2 on CEED 3700 is audible on the speakers. Both microphones are tested for its individual effect.
- a. If the microphone is not audible, make sure you have selected the right microphone.
 - b. Click **Audio** from the menu bar, choose the appropriate microphone from the drop-down menu to make the microphone audible.
If the above steps does not seem to work, troubleshoot with the following tasks.
 - c. Click windows **Start** button. Choose **Control Panel**.
Adjust your computer settings window appears.
 - d. Click **Hardware and Sound**.
 - e. From the list, click **Sound**.
A sound dialog box appears
 - f. From the playback tab, choose the appropriate output and click OK.
 - g. From the Microphone tab, choose the appropriate Microphone output and click OK.
- Step 2 Verify the camera image is visible on the training screen (projection screen) of CEED 3700 device.
- Step 3 Change the camera as shown in the figure below to test the second camera from CEED 3700. To change of camera view, perform the following steps:
- a. Click **Set Video Options** in the participants bar as shown in “Set Video Options” in Figure 7-4

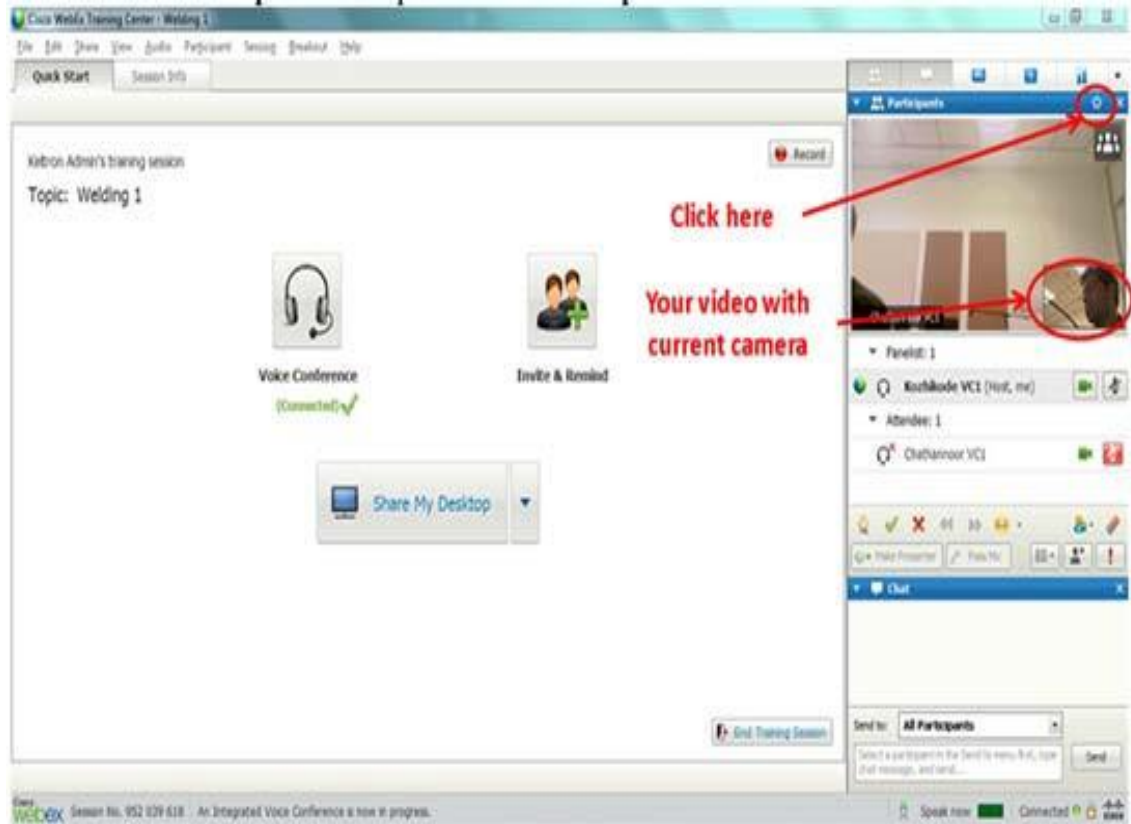
REVIEW DRAFT—CISCO CONFIDENTIAL**Figure 7-4 Set Video Options**

- b. A Video options dialog box appears as shown in Figure 7-5.

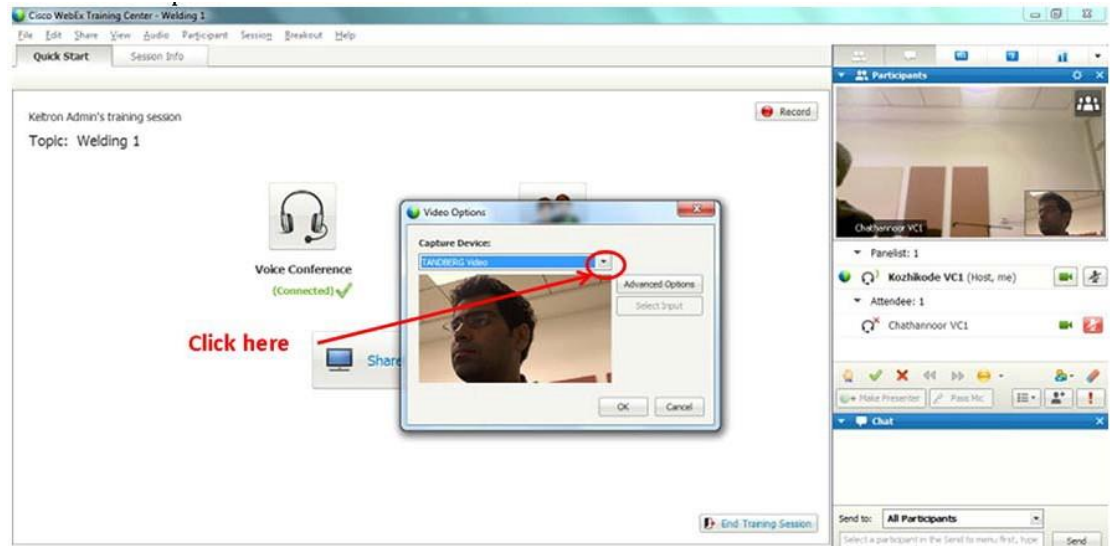
Figure 7-5 Video Options

- c. Click the drop-down arrow as shown in Figure 7-5 next to the present camera name.
- d. Select the second camera name as shown in "Capture Device" in Figure 7-6.

REVIEW DRAFT—CISCO CONFIDENTIAL

REVIEW DRAFT—CISCO CONFIDENTIAL

Figure 7-6 Capture Device

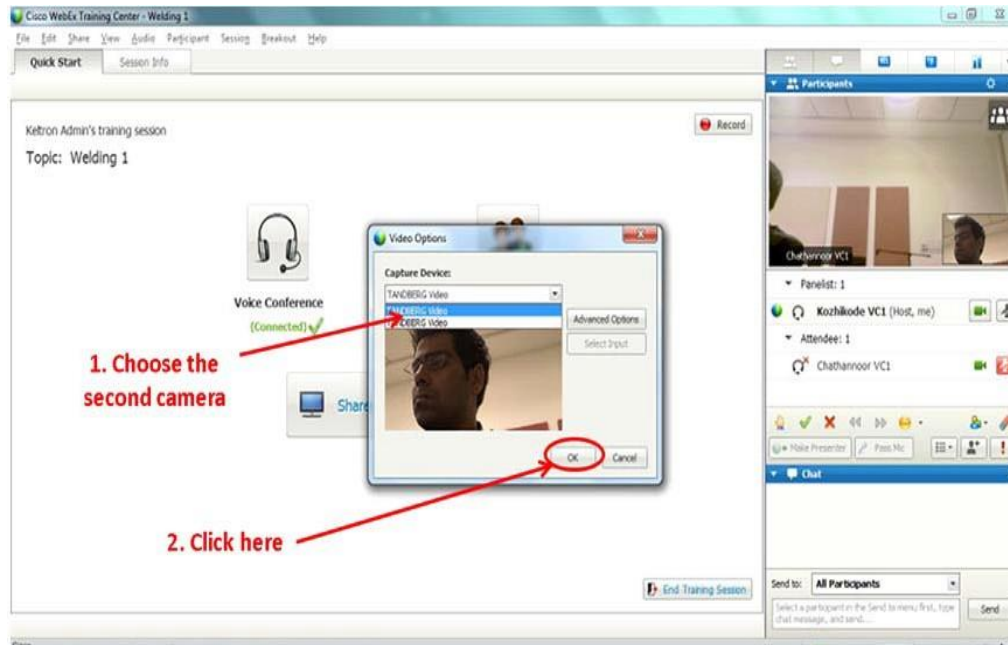

- e. Click OK.
- f. The video from the second camera will appear in the small window as shown in “Second Camera Transmission” in Figure 7-7.

Figure 7-7 Second Camera Transmission

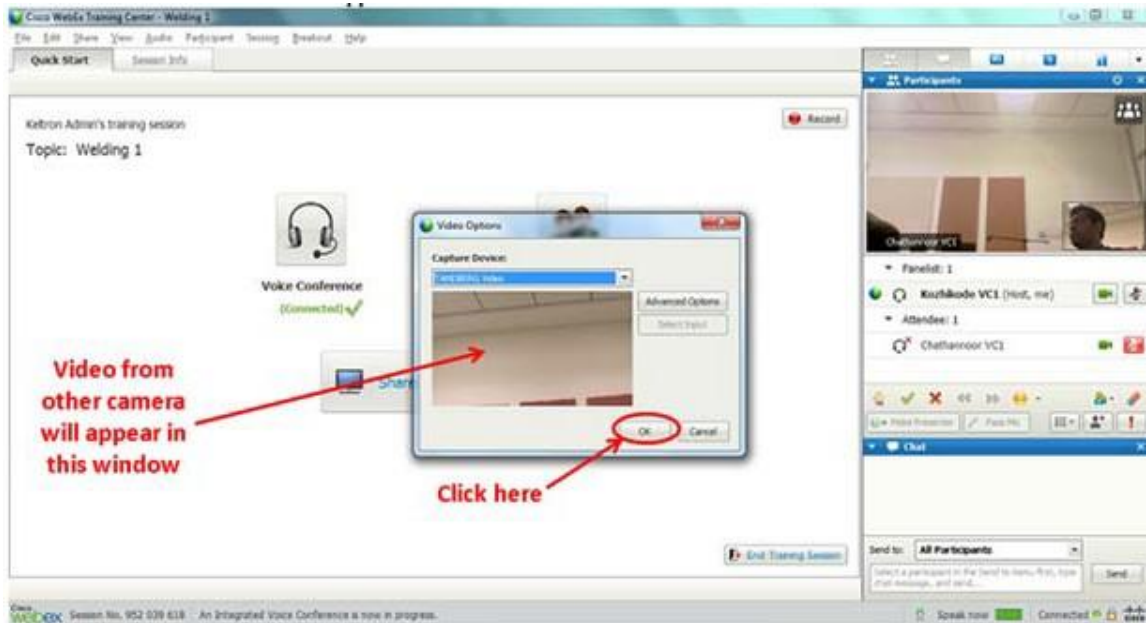

The attendee is set to attend the live session.

FEDERAL COMMUNICATIONS COMMISSION INTERFERENCE STATEMENT

This equipment has been tested and found to comply with the limits for a Class B digital device, pursuant to Part 15 of the FCC Rules. These limits are designed to provide reasonable protection against harmful interference in a residential installation. This equipment generates, uses and can radiate radio frequency energy and, if not installed and used in accordance with the instructions, may cause harmful interference to radio communications. However, there is no guarantee that interference will not occur in a particular installation. If this equipment does cause harmful interference to radio or television reception, which can be determined by turning the equipment off and on, the user is encouraged to try to correct the interference by one or more of the following measures:

- Reorient or relocate the receiving antenna.
- Increase the separation between the equipment and receiver.
- Connect the equipment into an outlet on a circuit different from that to which the receiver is connected.
- Consult the dealer or an experienced radio/TV technician for help.

CAUTION:

Any changes or modifications not expressly approved by the party responsible for compliance could void the user's authority to operate the equipment.

This device complies with part 15 of the FCC Rules. Operation is subject to the following two conditions: (1) This device may not cause harmful interference, and (2) this device must accept any interference received, including interference that may cause undesired operation.

FCC RF Radiation Exposure Statement:

1. This Transmitter must not be co-located or operating in conjunction with any other antenna or transmitter.
2. This equipment complies with FCC RF radiation exposure limits set forth for an uncontrolled environment.

This equipment should be installed and operated with a minimum distance of 20 centimeters between the radiator and your body.