



## Test Report

# AIR-AP4800-B-K9

Cisco Aironet 802.11ac Dual Band Access Points

FCC ID: LDKBRB4K1779

**5250-5350 MHz**

Against the following Specifications:

CFR47 Part 15.407



Cisco Systems

170 West Tasman Drive

San Jose, CA 95134

<b>Author:</b> Jose Aguirre <b>Tested By:</b> Jose Aguirre	<b>Approved By:</b> Gerard Thorpe <b>Title:</b> Mgr, Engineering <b>Revision:</b> 2

This report replaces any previously entered test report under EDSCS – **12749693**. This test report has been electronically authorized and archived using the CISCO Engineering Document Control system.



This test report has been electronically authorized and archived using the CISCO Engineering Document Control system.

<b>SECTION 1: OVERVIEW</b> .....	<b>3</b>
<b>SECTION 2: ASSESSMENT INFORMATION</b> .....	<b>4</b>
2.1 GENERAL.....	4
2.2 DATE OF TESTING .....	6
2.3 REPORT ISSUE DATE .....	6
2.4 TESTING FACILITIES .....	6
2.5 EQUIPMENT ASSESSED (EUT).....	6
2.6 EUT DESCRIPTION .....	7
<b>SECTION 3: RESULT SUMMARY</b> .....	<b>10</b>
3.1 RESULTS SUMMARY TABLE .....	10
<b>SECTION 4: SAMPLE DETAILS</b> .....	<b>12</b>
4.1 SAMPLE DETAILS .....	10
4.2 SYSTEM DETAILS .....	10
4.3 MODE OF OPERATION DETAILS .....	10
<b>APPENDIX A: EMISSION TEST RESULTS</b> .....	<b>13</b>
CONDUCTED TEST SETUP DIAGRAM .....	13
TARGET MAXIMUM CHANNEL POWER.....	13
A.1 99% AND 26DB BANDWIDTH .....	15
A.2 MAXIMUM CONDUCTED OUTPUT POWER/ POWER SPECTRAL DENSITY.....	18
A.3 CONDUCTED SPURIOUS EMISSIONS .....	32
A.4 CONDUCTED BANDEDGE .....	46
<b>APPENDIX B: EMISSION TEST RESULTS</b> .....	<b>59</b>
RADIATED EMISSION SETUP DIAGRAM-BELOW 1G .....	59
B.1 RADIATED SPURIOUS EMISSIONS.....	60
B.2 RADIATED EMISSIONS 30MHZ TO 1GHZ.....	70
B.3 AC CONDUCTED EMISSIONS.....	65
<b>APPENDIX C: LIST OF TEST EQUIPMENT USED TO PERFORM THE TEST</b> .....	<b>68</b>
<b>APPENDIX E: ABBREVIATION KEY AND DEFINITIONS</b> .....	<b>78</b>



**Section 1: Overview**

The samples were assessed against the tests detailed in section 3 under the requirements of the following specifications:

<b>Specifications:</b>
CFR47 Part 15.407

Measurements were made in accordance with

- ANSI C63.10:2013
- KDB 789033 D02 General UNII Test Procedures New Rules v02r01
- KDB 662911 D01 Multiple Transmitter Output v02r01



## Section 2: Assessment Information

### 2.1 General

This report contains an assessment of an apparatus against Electromagnetic Compatibility Standards based upon tests carried out on the samples submitted. The testing was performed by and for the use of Cisco systems Inc:

With regard to this assessment, the following points should be noted:

- a) The results contained in this report relate only to the items tested and were obtained in the period between the date of the initial assessment and the date of issue of the report. Manufactured products will not necessarily give identical results due to production and measurement tolerances.
- b) The apparatus was set up and exercised using the configuration and modes of operation defined in this report only.
- c) Where relevant, the apparatus was only assessed using the susceptibility criteria defined in this report and the Test Assessment Plan (TAP).
- d) All testing was performed under the following environmental conditions:

Temperature	15°C to 35°C (54°F to 95°F)
Atmospheric Pressure	860mbar to 1060mbar (25.4" to 31.3")
Humidity	10% to 75*%
- e) All AC testing was performed at one or more of the following supply voltages:  
110V 60 Hz (+/-20%)

### Units of Measurement

The units of measurements defined in the appendices are reported in specific terms, which are test dependent. Where radiated measurements are concerned these are defined at a particular distance. Basic voltage measurements are defined in units of [dBuV]

As an example, the basic calculation for all measurements is as follows:

$$\text{Emission level [dBuV]} = \text{Indicated voltage level [dBuV]} + \text{Cable Loss [dB]} + \text{Other correction factors [dB]}$$

The combinations of correction factors are dependent upon the exact test configurations [see test equipment lists for further details] and may include:-

Antenna Factors, Pre Amplifier Gain, LISN Loss, Pulse Limiter Loss and Filter Insertion Loss

Note: to convert the results from dBuV/m to uV/m use the following formula:-

$$\text{Level in uV/m} = \text{Common Antilogarithm} [(X \text{ dBuV/m})/20] = Y \text{ uV/m}$$



## Measurement Uncertainty Values

voltage and power measurements	± 2 dB
conducted EIRP measurements	± 1.4 dB
radiated measurements	± 3.2 dB
frequency measurements	± 2.4 10 <sup>-7</sup>
temperature measurements	± 0.54°
humidity measurements	± 2.3%
DC and low frequency measurements	± 2.5%

Where relevant measurement uncertainty levels have been estimated for tests performed on the apparatus. This uncertainty represents an expanded uncertainty expressed at approximately the 95% confidence level using a coverage factor of k=2.

## Radiated emissions (expanded uncertainty, confidence interval 95%)

30 MHz - 300 MHz	+/- 3.8 dB
300 MHz - 1000 MHz	+/- 4.3 dB
1 GHz - 10 GHz	+/- 4.0 dB
10 GHz - 18GHz	+/- 8.2 dB
18GHz - 26.5GHz	+/- 4.1 dB
26.5GHz - 40GHz	+/- 3.9 dB

## Conducted emissions (expanded uncertainty, confidence interval 95%)

30 MHz – 40GHz	+/- 0.38 dB
----------------	-------------

A product is considered to comply with a requirement if the nominal measured value is below the limit line. The product is considered to not be in compliance in case the nominal measured value is above the limit line.

**This report must not be reproduced except in full, without written approval of Cisco Systems.**

**2.2 Date of testing**

1-Nov-17 - 20-Mar-18

**2.3 Report Issue Date**

22-Mar-18

Cisco uses an electronic system to issue, store and control the revision of test reports. This system is called the Engineering Document Control System 12749692. The actual report issue date is embedded into the original file on EDCS. Any copies of this report, either electronic or paper, that are not on EDCS must be considered uncontrolled.

**2.4 Testing facilities**

This assessment was performed by:

**Testing Laboratory**

Cisco Systems, Inc.,  
125 West Tasman Drive  
San Jose, CA 95134, USA

**Registration Numbers for Industry Canada**

<b>Cisco System Site</b>	<b>Address</b>	<b>Site Identifier</b>
Building P, 10m Chamber	125 West Tasman Dr San Jose, CA 95134	Company #: 2461N-2
Building P, 5m Chamber	125 West Tasman Dr San Jose, CA 95134	Company #: 2461N-1
Building I, 5m Chamber	285 W. Tasman Drive San Jose, California 95134	Company #: 2461M-1

**Test Engineers**

Jose Aguirre

**2.5 Equipment Assessed (EUT)**

AIR-AP4800-B-K9



## 2.6 EUT Description

The Cisco Aironet 802.11ac Radio supports the following modes of operation. The modes are further defined in the radio Theory of Operation. The modes included in this report represent the worst case data for all modes.

802.11n/ac - Non HT20, One Antenna, 6 to 54 Mbps  
802.11n/ac - Non HT20, Two Antennas, 6 to 54 Mbps  
802.11n/ac - Non HT20, Three Antennas, 6 to 54 Mbps  
802.11n/ac - Non HT20, Four Antennas, 6 to 54 Mbps

802.11n/ac - Non HT20 Beam Forming, Two Antennas, 6 to 54 Mbps  
802.11n/ac - Non HT20 Beam Forming, Three Antennas, 6 to 54 Mbps  
802.11n/ac - Non HT20 Beam Forming, Four Antennas, 6 to 54 Mbps

802.11n/ac - HT/VHT20, One Antenna, M0 to M7  
802.11n/ac - HT/VHT20, Two Antennas, M0 to M7  
802.11n/ac - HT/VHT20, Two Antennas, M8 to M15  
802.11n/ac - HT/VHT20, Three Antennas, M0 to M7  
802.11n/ac - HT/VHT20, Three Antennas, M8 to M15  
802.11n/ac - HT/VHT20, Three Antennas, M16 to M23  
802.11n/ac - HT/VHT20, Four Antennas, M0 to M7  
802.11n/ac - HT/VHT20, Four Antennas, M8 to M15  
802.11n/ac - HT/VHT20, Four Antennas, M16 to M23

802.11n/ac - HT/VHT20 Beam Forming, Two Antennas, M0 to M7  
802.11n/ac - HT/VHT20 Beam Forming, Two Antennas, M8 to M15  
802.11n/ac - HT/VHT20 Beam Forming, Three Antennas, M0 to M7  
802.11n/ac - HT/VHT20 Beam Forming, Three Antennas, M8 to M15  
802.11n/ac - HT/VHT20 Beam Forming, Three Antennas, M16 to M23  
802.11n/ac - HT/VHT20 Beam Forming, Four Antennas, M0 to M7  
802.11n/ac - HT/VHT20 Beam Forming, Four Antennas, M8 to M15  
802.11n/ac - HT/VHT20 Beam Forming, Four Antennas, M16 to M23

802.11n/ac - HT/VHT20 STBC, Two Antennas, M0 to M7  
802.11n/ac - HT/VHT20 STBC, Three Antennas, M0 to M7  
802.11n/ac - HT/VHT20 STBC, Four Antennas, M0 to M7

802.11n/ac - Non HT40 Duplicate, One Antenna, 6 to 54 Mbps  
802.11n/ac - Non HT40 Duplicate, Two Antennas, 6 to 54 Mbps  
802.11n/ac - Non HT40 Duplicate, Three Antennas, 6 to 54 Mbps  
802.11n/ac - Non HT40 Duplicate, Four Antennas, 6 to 54 Mbps

802.11n/ac - HT/VHT40, One Antenna, M0 to M7  
802.11n/ac - HT/VHT40, Two Antennas, M0 to M7  
802.11n/ac - HT/VHT40, Two Antennas, M8 to M15  
802.11n/ac - HT/VHT40, Three Antennas, M0 to M7  
802.11n/ac - HT/VHT40, Three Antennas, M8 to M15  
802.11n/ac - HT/VHT40, Three Antennas, M16 to M23  
802.11n/ac - HT/VHT40, Four Antennas, M0 to M7  
802.11n/ac - HT/VHT40, Four Antennas, M8 to M15  
802.11n/ac - HT/VHT40, Four Antennas, M16 to M23

802.11n/ac - HT/VHT40 Beam Forming, Two Antennas, M0 to M7  
802.11n/ac - HT/VHT40 Beam Forming, Two Antennas, M8 to M15  
802.11n/ac - HT/VHT40 Beam Forming, Three Antennas, M0 to M7  
802.11n/ac - HT/VHT40 Beam Forming, Three Antennas, M8 to M15  
802.11n/ac - HT/VHT40 Beam Forming, Three Antennas, M16 to M23  
802.11n/ac - HT/VHT40 Beam Forming, Four Antennas, M0 to M7  
802.11n/ac - HT/VHT40 Beam Forming, Four Antennas, M8 to M15



802.11n/ac - HT/VHT40 Beam Forming, Four Antennas, M16 to M23

802.11n/ac - HT/VHT40 STBC, Two Antennas, M0 to M7  
802.11n/ac - HT/VHT40 STBC, Three Antennas, M0 to M7  
802.11n/ac - HT/VHT40 STBC, Four Antennas, M0 to M7

802.11n/ac - Non HT80 Duplicate, One Antenna, 6 to 54 Mbps  
802.11n/ac - Non HT80 Duplicate, Two Antennas, 6 to 54 Mbps  
802.11n/ac - Non HT80 Duplicate, Three Antennas, 6 to 54 Mbps  
802.11n/ac - Non HT80 Duplicate, Four Antennas, 6 to 54 Mbps

802.11ac - VHT80, One Antenna, M0.1 to M9.1  
802.11ac - VHT80, Two Antennas, M0.1 to M9.1  
802.11ac - VHT80, Two Antennas, M0.2 to M9.2  
802.11ac - VHT80, Three Antennas, M0.1 to M9.1  
802.11ac - VHT80, Three Antennas, M0.2 to M9.2  
802.11ac - VHT80, Three Antennas, M0.3 to M9.3  
802.11ac - VHT80, Four Antennas, M0.1 to M9.1  
802.11ac - VHT80, Four Antennas, M0.2 to M9.2  
802.11ac - VHT80, Four Antennas, M0.3 to M9.3

802.11ac - VHT80 Beam Forming, Two Antennas, M0.1 to M9.1  
802.11ac - VHT80 Beam Forming, Two Antennas, M0.2 to M9.2  
802.11ac - VHT80 Beam Forming, Three Antennas, M0.1 to M9.1  
802.11ac - VHT80 Beam Forming, Three Antennas, M0.2 to M9.2  
802.11ac - VHT80 Beam Forming, Three Antennas, M0.3 to M9.3  
802.11ac - VHT80 Beam Forming, Four Antennas, M0.1 to M9.1  
802.11ac - VHT80 Beam Forming, Four Antennas, M0.2 to M9.2  
802.11ac - VHT80 Beam Forming, Four Antennas, M0.3 to M9.3

802.11ac - VHT80 STBC, Two Antennas, M0.1 to M9.1  
802.11ac - VHT80 STBC, Three Antennas, M0.1 to M9.1  
802.11ac - VHT80 STBC, Four Antennas, M0.1 to M9.1

802.11n/ac - Non HT160, One Antenna, 6 to 54 Mbps  
802.11n/ac - Non HT160, Two Antennas, 6 to 54 Mbps  
802.11n/ac - Non HT160, Three Antennas, 6 to 54 Mbps  
802.11n/ac - Non HT160, Four Antennas, 6 to 54 Mbps

802.11ac - VHT160, One Antenna, M0.1 to M9.1  
802.11ac - VHT160, Two Antennas, M0.1 to M9.1  
802.11ac - VHT160, Two Antennas, M0.2 to M9.2  
802.11ac - VHT160, Three Antennas, M0.1 to M9.1  
802.11ac - VHT160, Three Antennas, M0.2 to M9.2  
802.11ac - VHT160, Three Antennas, M0.3 to M9.3  
802.11ac - VHT160, Four Antennas, M0.1 to M9.1  
802.11ac - VHT160, Four Antennas, M0.2 to M9.2  
802.11ac - VHT160, Four Antennas, M0.3 to M9.3

802.11ac - VHT160 Beam Forming, Two Antennas, M0.1 to M9.1  
802.11ac - VHT160 Beam Forming, Two Antennas, M0.2 to M9.2  
802.11ac - VHT160 Beam Forming, Three Antennas, M0.1 to M9.1  
802.11ac - VHT160 Beam Forming, Three Antennas, M0.2 to M9.2  
802.11ac - VHT160 Beam Forming, Three Antennas, M0.3 to M9.3  
802.11ac - VHT160 Beam Forming, Four Antennas, M0.1 to M9.1  
802.11ac - VHT160 Beam Forming, Four Antennas, M0.2 to M9.2  
802.11ac - VHT160 Beam Forming, Four Antennas, M0.3 to M9.3

802.11ac - VHT160 STBC, Two Antennas, M0.1 to M9.1





802.11ac - VHT160 STBC, Three Antennas, M0.1 to M9.1  
 802.11ac - VHT160 STBC, Four Antennas, M0.1 to M9.1

The following antennas are supported by this product series.  
 The data included in this report represent the worst case data for all antennas.

Radio	Frequency	HOST PID   Part Number - Please align Host(s) with antenna(s)	ANTENNA PID   Part Number	Antenna Type	Antenna Gain (includes antenna cable loss)
2.4 GHz BLE	2.4 GHz	TX/RX: Internal	BLE	Single port, single band omni	2.5 dBi
WIFI: 5 GHz XOR	5 GHz	Micro-Cell: Internal	NA	Quad port, single band directional	5 dBi
WIFI: 2.4GHz XOR & 5 GHz Only	2.4 & 5 GHz	Macro-Cell: Internal	NA	Qual port, dual band Omni	2.5 dBi/3.5 dBi
WIFI: RX Only 2.4GHz XOR & 5 GHz XOR	2.4 & 5 GHz	Location Antenna Array	NA	Qual port   Circular Array + Omni Elements	RX Only



### Section 3: Result Summary

#### 3.1 Results Summary Table

##### Conducted emissions

Basic Standard	Technical Requirements / Details	Result
FCC 15.407	<p><b>99% &amp; 26 dB Bandwidth:</b> The 99% occupied bandwidth is the frequency bandwidth such that, below its lower and above its upper frequency limits, the mean powers are each equal to 0.5% of the total mean power of the given emission. There is no limit for 99% OBW.</p> <p>The 26 dB emission is the width of the emission that is constrained by the frequencies associated with the two outermost amplitude points (upper and lower frequencies) that are attenuated by 26 dB relative to the maximum level measured in the fundamental emission.</p>	Pass
FCC 15.407	<p><b>Output Power:</b> For the 5.25-5.35 GHz and 5.47-5.725 GHz bands, the maximum conducted output power over the frequency bands of operation shall not exceed the lesser of 250 mW or 11 dBm + 10 log B, where B is the 26 dB emission bandwidth in megahertz. If transmitting antennas of directional gain greater than 6 dBi are used, both the maximum conducted output power and the maximum power spectral density shall be reduced by the amount in dB that the directional gain of the antenna exceeds 6 dBi.</p>	Pass
FCC 15.407	<p><b>Power Spectral Density:</b> The maximum power spectral density shall not exceed 11 dBm in any 1 megahertz band. If transmitting antennas of directional gain greater than 6 dBi are used, both the maximum conducted output power and the maximum power spectral density shall be reduced by the amount in dB that the directional gain of the antenna exceeds 6 dBi.</p>	Pass
FCC 15.407	<p><b>Conducted Spurious Emissions / Band-Edge:</b> For transmitters operating in the 5.25-5.35 GHz band: all emissions outside of the 5.15-5.35 GHz band shall not exceed an EIRP of -27dBm/MHz.</p>	Pass
FCC 15.407 FCC 15.209 FCC 15.205	<p><b>Restricted band:</b> Unwanted emissions must comply with the general field strength set forth in FCC 15.209.</p>	Pass

**Radiated Emissions (General requirements)**

<b>Basic Standard</b>	<b>Technical Requirements / Details</b>	<b>Result</b>
FCC 15.407 FCC 15.209 FCC 15.205	<b>TX Spurious Emissions:</b> Except as provided elsewhere in this subpart, the emissions from an intentional radiator shall not exceed the field strength levels specified in the filed strength limits table in this section.	Pass
FCC 15.207	<b>AC conducted Emissions:</b> Except when the requirements applicable to a given device state otherwise, for any radio apparatus equipped to operate from the public utility AC power supply, either directly or indirectly (such as with a battery charger), the radio frequency voltage of emissions conducted back onto the AC power lines in the frequency range of 0.15 MHz to 30 MHz shall not exceed the limits shown in the table in these sections. The more stringent limit applies at the frequency range boundaries.	Pass

\* MPE calculation is recorded in a separate report



## Section 4: Sample Details

Note: Each sample was evaluated to ensure that its condition was suitable to be used as a test sample prior to the commencement of testing.

### 4.1 Sample Details

Sample No.	Equipment Details	Manufacturer	Hardware Rev.	Firmware Rev.	Software Rev.	Serial Number
S01	AIR-AP4800-B-K9	Cisco Systems	P2	9.1.8.1	build-lnx-064	FOC21291N04
S02*	AIR-PWR50 341-100460-001	Delta	A0	NA	NA	DAB2016S1GQ

(\*) S02 is support equipment Power supply for EUT S01

### 4.2 System Details

System #	Description	Samples
1	AIR-AP4800-B-K9	S01
2	AIR-PWR50 341-100460-001	S02

### 4.3 Mode of Operation Details

Mode#	Description	Comments
1	Continuous Transmitting	Continuous Transmitting $\geq 98\%$ duty cycle

All measurements were made in accordance with

- ANSI C63.10:2013
- KDB 789033 D02 General UNII Test Procedures New Rules v02r01
- KDB 662911 D01 Multiple Transmitter Output v02r01

## Appendix A: Emission Test Results

### Conducted Test Setup Diagram

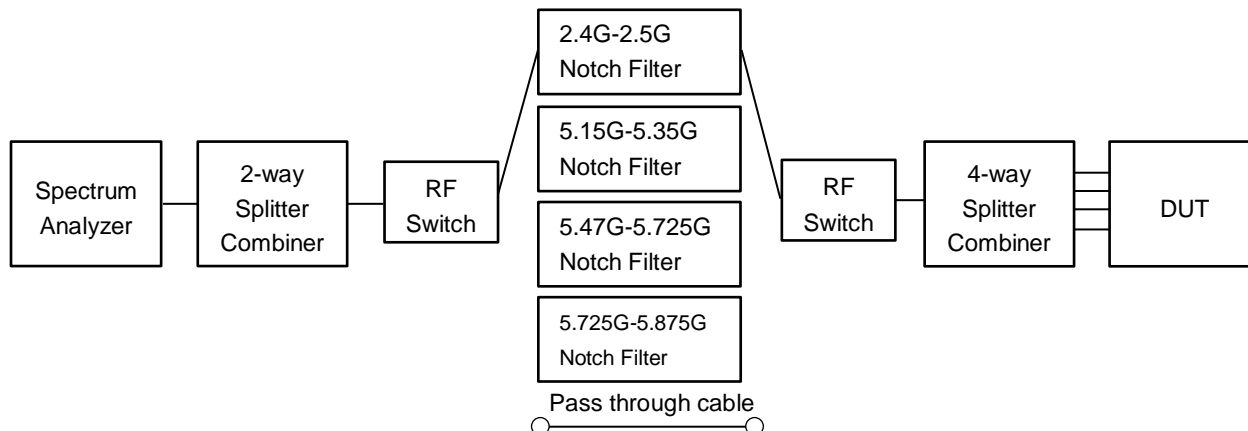

### Target Maximum Channel Power

The following table details the maximum supported Total Channel Power for all operating modes.

Operating Mode	Maximum Channel Power (dBm)			
	Frequency (MHz)			
	5250			
Non HT160 Duplicate, 6 to 54 Mbps	15			
VHT160, M0 to M23, M0 to M9 1-4ss	19			
VHT160 Beam Forming, M0 to M23, M0 to M9 1-4ss	19			
VHT160 STBC, M0 to M9 2ss	19			
	5260	5300	5320	
Non HT20, 6 to 54 Mbps	18	19	19	
Non HT20 Beam Forming, 6 to 54 Mbps	18	19	19	
HT/VHT20, M0 to M23, M0 to M9 1-4ss	22	21	21	
HT/VHT20 Beam Forming, M0 to M23, M0 to M9 1-4ss	22	21	21	
HT/VHT20 STBC, M0 to M7	20	21	21	
	5270	5310		
Non HT40 Duplicate, 6 to 54 Mbps	20	18		
HT/VHT40, M0 to M23, M0 to M9 1-4ss	22	21		
HT/VHT40 Beam Forming, M0 to M23, M0 to M9 1-4ss	22	20		
HT/VHT40 STBC, M0 to M7	22	21		
	5290			
Non HT80 Duplicate, 6 to 54 Mbps	17			
VHT80, M0 to M9, M0 to M9 1-2ss	20			
VHT80 Beam Forming, M0 to M23, M0 to M9 1-4ss	20			



VHT80 STBC, M0 to M9 2ss	20			
--------------------------	----	--	--	--



## A.1 99% and 26dB Bandwidth

**FCC 15.407** The 99% occupied bandwidth is the frequency bandwidth such that, below its lower and above its upper frequency limits, the mean powers are each equal to 0.5% of the total mean power of the given emission. There is no limit for 99% OBW.

The 26 dB emission is the width of the emission that is constrained by the frequencies associated with the two outermost amplitude points (upper and lower frequencies) that are attenuated by 26 dB relative to the maximum level measured in the fundamental emission.

### Test Procedure

Ref. ANSI C63.10: 2013 Section 6.9.3

<b>99% BW and EBW (-26dB)</b>
Test Procedure
<ol style="list-style-type: none"> <li>1. Set the radio in the continuous transmitting mode.</li> <li>2. Allow the trace to stabilize.</li> <li>3. Setting the x-dB bandwidth mode to -26dB and OBW power function to 99% within the measurement set up function.</li> <li>4. Select the automatic OBW measurement function of an instrument to perform bandwidth measurement.</li> <li>5. Capture graphs and record pertinent measurement data.</li> </ol>

Ref. ANSI C63.10: 2013 Section 6.9.3

<b>99% BW and EBW (-26dB)</b>
Test parameters
Span = 1.5 x to 5.0 times OBW RBW = approx. 1% to 5% of the OBW VBW ≥ 3 x RBW Detector = Peak or where practical sample shall be used Trace = Max. Hold

System Number	Description	Samples	System under test	Support equipment
1	EUT	S01	<input checked="" type="checkbox"/>	<input type="checkbox"/>
	Support	S02	<input type="checkbox"/>	<input checked="" type="checkbox"/>

<b>Tested By :</b> Jose Aguirre	<b>Date of testing:</b> 1-Nov-17 - 20-Mar-18
<b>Test Result : PASS</b>	

See Appendix C for list of test equipment



Frequency (MHz)	Mode	Data Rate (Mbps)	26dB BW (MHz)	99% BW (MHz)
5250	Non HT160 Duplicate, 6 to 54 Mbps	6	163.8	155.375
	VHT160, M0 to M23, M0 to M9 1-4ss	m0x1	164.8	155.295
5260	<b>Non HT20, 6 to 54 Mbps</b>	<b>6</b>	<b>22.4</b>	<b>17.822</b>
	HT/VHT20, M0 to M23, M0 to M9 1-4ss	m0	22.4	18.488
5270	Non HT40 Duplicate, 6 to 54 Mbps	6	43.4	37.117
	HT/VHT40, M0 to M23, M0 to M9 1-4ss	m0	43.2	36.764
5290	Non HT80 Duplicate, 6 to 54 Mbps	6	84.1	76.331
	VHT80, M0 to M23, M0 to M9 1-4ss	m0x1	82.2	76.439
5300	Non HT20, 6 to 54 Mbps	6	21.7	17.828
	HT/VHT20, M0 to M23, M0 to M9 1-4ss	m0	22.1	18.504
5310	Non HT40 Duplicate, 6 to 54 Mbps	6	43.6	37.016
	HT/VHT40, M0 to M23, M0 to M9 1-4ss	m0	43.2	36.679
5320	Non HT20, 6 to 54 Mbps	6	21.7	17.839
	HT/VHT20, M0 to M23, M0 to M9 1-4ss	m0	22.3	18.474





**26dB / 99% Bandwidth, 5260 MHz, Non HT20, 6 to 54 Mbps**

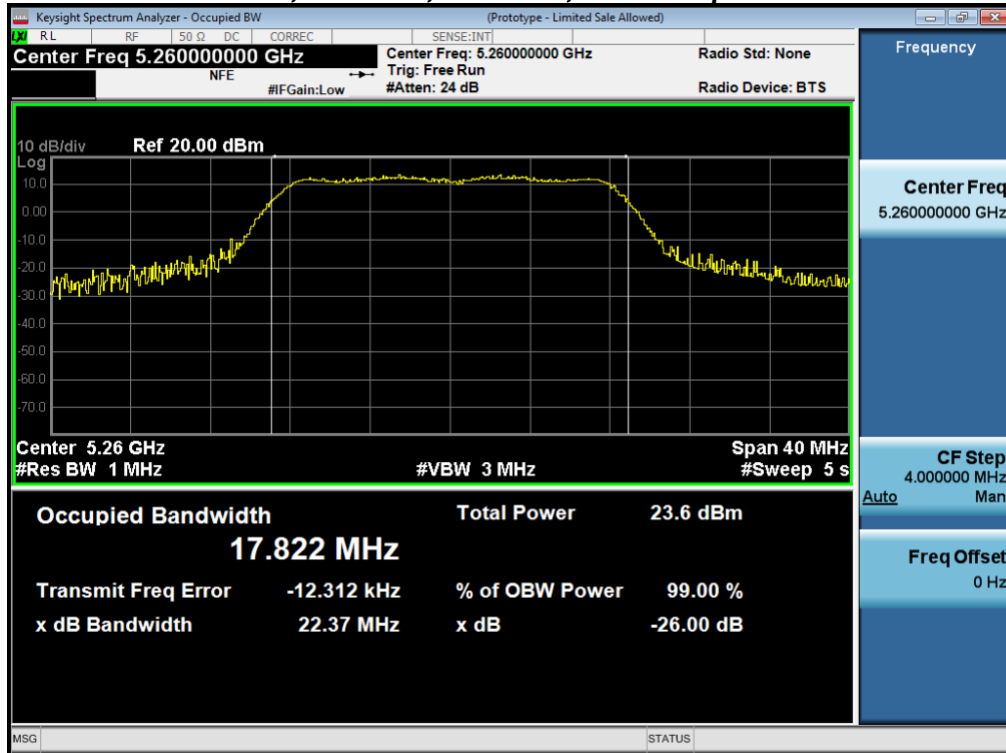



## A.2 Maximum Conducted Output Power/ Power Spectral Density

**15.407 (2)** For the 5.25-5.35 GHz and 5.47-5.725 GHz bands, the maximum conducted output power over the frequency bands of operation shall not exceed the lesser of 250 mW or 11 dBm + 10 log B, where B is the 26 dB emission bandwidth in megahertz. In addition, the maximum power spectral density shall not exceed 11 dBm in any 1 megahertz band. If transmitting antennas of directional gain greater than 6 dBi are used, both the maximum conducted output power and the maximum power spectral density shall be reduced by the amount in dB that the directional gain of the antenna exceeds 6 dBi.

**15.407 (5)** The maximum power spectral density is measured as a conducted emission by direct connection of a calibrated test instrument to the equipment under test. If the device cannot be connected directly, alternative techniques acceptable to the Commission may be used. Measurements in the 5.15-5.25 GHz, 5.25-5.35 GHz, and the 5.47-5.725 GHz bands are made over a bandwidth of 1 MHz or the 26 dB emission bandwidth of the device, whichever is less. A narrower resolution bandwidth can be used, provided that the measured power is integrated over the full reference bandwidth.

Referencing “644545 D03 Guidance for IEEE 802.11ac v01”, covering signals that cross the boundary between two adjacent UNII bands, the FCC describes a procedure to measure EBW, power, and PSD in each UNII band. For the case of a 160MHz signal equally distributed between UNII-1 and UNII-2a, we apply the following alternate procedure.

Rather than measure:

- The half of the signal in UNII-1, measured against the 30dBm power / 17dBm/MHz PSD limits
- The half of the signal in UNII-2a, measured against the 24dBm power / 11dBm/MHz PSD limits

If a 160MHz signal (equally distributed between the two bands) produces a total power of 27dBm across the entire 160 MHz EBW, the total power in each band would be half of the total, or 24dBm (which meets both the UNII-1 and UNII-2a limits), and would have a PSD no greater than 11dBm/MHz in either sub-band.

Given these facts, we have measured the complete 160 MHz EBW (across both sub-bands) against 27dBm power and 11dBm/MHz PSD limits, rather than individual sub band measurements against the individual sub band limits.”

### Test Procedure

Ref. KDB 789033 D02 General UNII Test Procedures New Rules v02r01  
ANSI C63.10: 2013

<b>Output Power</b> Test Procedure
<ol style="list-style-type: none"> <li>1. Set the radio in the continuous transmitting mode at full power</li> <li>2. Compute power by integrating the spectrum across the EBW (or alternatively entire 99% OBW) of the signal using the instrument’s band power measurement function. The integration shall be performed using the spectrum analyzer band-power measurement function with band limits set equal to the EBW or the OBW band edges.</li> <li>3. Capture graphs and record pertinent measurement data.</li> </ol>

Ref. KDB 789033 D02 General UNII Test Procedures New Rules v02r01  
ANSI C63.10: 2013 section 12.3.2.2 Method SA-1

<b>Output Power</b> Test parameters
Span = >1.5 times the OBW RBW = 1MHz VBW ≥ 3 x RBW Sweep = Auto couple Detector = sample Trace = Trace Average 100

The “measure-and-sum technique” is used for measuring in-band transmit power of a device. In the measure-and-sum approach, the conducted emission level is measured at each antenna port. The measured results at the various antenna ports are then summed mathematically to determine the total emission level from the device. Summing is performed in linear power units. (See ANSI C63.10 section 14.3.2.2)



System Number	Description	Samples	System under test	Support equipment
1	EUT	S01	<input checked="" type="checkbox"/>	<input type="checkbox"/>
	Support	S02	<input type="checkbox"/>	<input checked="" type="checkbox"/>

<b>Tested By :</b> Jose Aguirre	<b>Date of testing:</b> 1-Nov-17 - 20-Mar-18
<b>Test Result : PASS</b>	

See Appendix C for list of test equipment



## Maximum Output Power

Frequency (MHz)	Mode	Tx Paths	Correlated Antenna Gain (dBi)	Tx 1 Max Power (dBm)	Tx 2 Max Power (dBm)	Tx 3 Max Power (dBm)	Tx 4 Max Power (dBm)	Total Tx Channel Power (dBm)	Limit (dBm)	Margin (dB)
5250	Non HT160 Duplicate, 6 to 54 Mbps	1	4	12.3				12.3	23.8	11.5
	Non HT160 Duplicate, 6 to 54 Mbps	2	4	10.0	10.2			13.1	23.8	10.7
	Non HT160 Duplicate, 6 to 54 Mbps	3	4	10.0	10.2	10.3		14.9	23.8	8.9
	Non HT160 Duplicate, 6 to 54 Mbps	4	4	9.0	9.2	9.4	9.0	15.2	23.8	8.6
	VHT160, M0 to M7, M0 to M9 1ss	1	4	15.1				15.1	23.8	8.7
	VHT160, M0 to M7, M0 to M9 1ss	2	4	15.1	15.3			18.2	23.8	5.6
	VHT160, M0 to M7, M0 to M9 1ss	3	4	14.0	14.2	14.4		19	23.8	4.8
	VHT160, M0 to M7, M0 to M9 1ss	4	4	12.9	13.0	13.2	12.8	19	23.8	4.8
	VHT160, M8 to M15, M0 to M9 2ss	2	4	15.1	15.3			18.2	23.8	5.6
	VHT160, M8 to M15, M0 to M9 2ss	3	4	14.0	14.2	14.4		19	23.8	4.8
	VHT160, M8 to M15, M0 to M9 2ss	4	4	12.9	13.0	13.2	12.8	19	23.8	4.8
	VHT160, M16 to M23, M0 to M9 3ss	3	4	14.0	14.2	14.4		19	23.8	4.8
	VHT160, M16 to M23, M0 to M9 3ss	4	4	12.9	13.0	13.2	12.8	19	23.8	4.8
	VHT160 Beam Forming, M0 to M7, M0 to M9 1ss	2	7	12.9	13.0			16	23.8	7.8
	VHT160 Beam Forming, M0 to M7, M0 to M9 1ss	3	9	9.8	9.9	10.0		14.7	23.8	9.1
	VHT160 Beam Forming, M0 to M7, M0 to M9 1ss	4	10	7.8	8.0	8.1	7.7	13.9	23.8	9.9
	VHT160 Beam Forming, M8 to M15, M0 to M9 2ss	2	4	15.1	15.3			18.2	23.8	5.6
	VHT160 Beam Forming, M8 to M15, M0 to M9 2ss	3	6	12.9	13.0	13.2		17.8	23.8	6
	VHT160 Beam Forming, M8 to M15, M0 to M9 2ss	4	7	10.7	10.9	10.9	10.6	16.8	23.8	7
	VHT160 Beam Forming, M16 to M23, M0 to M9 3ss	3	4	14.0	14.2	14.4		19	23.8	4.8
	VHT160 Beam Forming, M16 to M23, M0 to M9 3ss	4	5	12.9	13.0	13.2	12.8	19	23.8	4.8
	VHT160 STBC, M0 to M9 2ss	2	4	15.1	15.3			18.2	23.8	5.6
	VHT160 STBC, M0 to M9 2ss	3	4	14.0	14.2	14.4		19	23.8	4.8
VHT160 STBC, M0 to M9 2ss	4	4	12.9	13.0	13.2	12.8	19	23.8	4.8	
5260	Non HT20, 6 to 54 Mbps	1	4	15.2				15.2	24.0	8.8
	Non HT20, 6 to 54 Mbps	2	4	15.2	15.5			18.4	24.0	5.6
	Non HT20, 6 to 54 Mbps	3	4	12.8	13.2	13.1		17.8	24.0	6.2
	Non HT20, 6 to 54 Mbps	4	4	10.8	11.1	10.9	10.5	16.9	24.0	7.1
	Non HT20 Beam Forming, 6 to 54 Mbps	2	7	15.2	15.5			18.4	23.0	4.6
	Non HT20 Beam Forming, 6 to 54 Mbps	3	9	12.8	13.2	13.1		17.8	21.0	3.2
	Non HT20 Beam Forming, 6 to 54 Mbps	4	10	10.8	11.1	10.9	10.5	16.9	20.0	3.1
	HT/VHT20, M0 to M7, M0 to M9 1ss	1	4	15.4				15.4	24.0	8.6
	HT/VHT20, M0 to M7, M0 to M9 1ss	2	4	15.4	15.7			18.6	24.0	5.4



	HT/VHT20, M0 to M7, M0 to M9 1ss	3	4	13.1	13.5	13.4		18.1	24.0	5.9
	HT/VHT20, M0 to M7, M0 to M9 1ss	4	4	11.0	11.3	11.1	10.7	17.1	24.0	6.9
	HT/VHT20, M8 to M15, M0 to M9 2ss	2	4	15.4	15.7			18.6	24.0	5.4
	HT/VHT20, M8 to M15, M0 to M9 2ss	3	4	15.4	15.7	15.8		20.4	24.0	3.6
	HT/VHT20, M8 to M15, M0 to M9 2ss	4	4	14.2	14.6	14.5	13.1	20.2	24.0	3.8
	HT/VHT20, M16 to M23, M0 to M9 3ss	3	4	15.4	15.7	15.8		20.4	24.0	3.6
	HT/VHT20, M16 to M23, M0 to M9 3ss	4	4	15.4	15.7	15.8	15.5	21.6	24.0	2.4
	HT/VHT20 Beam Forming, M0 to M7, M0 to M9 1ss	2	7	15.4	15.7			18.6	23.0	4.4
	HT/VHT20 Beam Forming, M0 to M7, M0 to M9 1ss	3	9	13.1	13.5	13.4		18.1	21.0	2.9
	HT/VHT20 Beam Forming, M0 to M7, M0 to M9 1ss	4	10	11.0	11.3	11.1	10.7	17.1	20.0	2.9
	HT/VHT20 Beam Forming, M8 to M15, M0 to M9 2ss	2	4	15.4	15.7			18.6	24.0	5.4
	HT/VHT20 Beam Forming, M8 to M15, M0 to M9 2ss	3	6	15.4	15.7	15.8		20.4	24.0	3.6
	HT/VHT20 Beam Forming, M8 to M15, M0 to M9 2ss	4	7	14.2	14.6	14.5	13.1	20.2	23.0	2.8
	HT/VHT20 Beam Forming, M16 to M23, M0 to M9 3ss	3	4	15.4	15.7	15.8		20.4	24.0	3.6
	HT/VHT20 Beam Forming, M16 to M23, M0 to M9 3ss	4	5	15.4	15.7	15.8	15.5	21.6	24.0	2.4
	HT/VHT20 STBC, M0 to M7	2	4	15.4	15.7			18.6	24.0	5.4
	HT/VHT20 STBC, M0 to M7	3	4	15.4	15.7	15.8		20.4	24.0	3.6
	HT/VHT20 STBC, M0 to M7	4	4	14.2	14.6	14.5	13.1	20.2	24.0	3.8
5270	Non HT40 Duplicate, 6 to 54 Mbps	1	4	16.4				16.4	23.9	7.5
	Non HT40 Duplicate, 6 to 54 Mbps	2	4	16.4	16.8			19.6	23.9	4.3
	Non HT40 Duplicate, 6 to 54 Mbps	3	4	15.2	15.7	15.6		20.3	23.9	3.6
	Non HT40 Duplicate, 6 to 54 Mbps	4	4	13.0	13.3	13.3	13.2	19.2	23.9	4.7
	HT/VHT40, M0 to M7, M0 to M9 1ss	1	4	15.2				15.2	23.9	8.7
	HT/VHT40, M0 to M7, M0 to M9 1ss	2	4	15.2	15.7			18.5	23.9	5.4
	HT/VHT40, M0 to M7, M0 to M9 1ss	3	4	15.2	15.7	15.7		20.3	23.9	3.6
	HT/VHT40, M0 to M7, M0 to M9 1ss	4	4	14.0	14.4	14.4	13.1	20.0	23.9	3.9
	HT/VHT40, M8 to M15, M0 to M9 2ss	2	4	15.2	15.7			18.5	23.9	5.4
	HT/VHT40, M8 to M15, M0 to M9 2ss	3	4	15.2	15.7	15.7		20.3	23.9	3.6
	HT/VHT40, M8 to M15, M0 to M9 2ss	4	4	15.2	15.7	15.7	15.4	21.5	23.9	2.4
	HT/VHT40, M16 to M23, M0 to M9 3ss	3	4	15.2	15.7	15.7		20.3	23.9	3.6
	HT/VHT40, M16 to M23, M0 to M9 3ss	4	4	15.2	15.7	15.7	15.4	21.5	23.9	2.4
	HT/VHT40 Beam Forming, M0 to M7, M0 to M9 1ss	2	7	15.2	15.7			18.5	22.9	4.4
	HT/VHT40 Beam Forming, M0 to M7, M0 to M9 1ss	3	9	14.0	14.4	14.4		19.0	20.9	1.9
	<b>HT/VHT40 Beam Forming, M0 to M7, M0 to M9 1ss</b>	<b>4</b>	<b>10</b>	<b>11.9</b>	<b>12.2</b>	<b>12.2</b>	<b>11.9</b>	<b>18.1</b>	<b>19.9</b>	<b>1.8</b>
	HT/VHT40 Beam Forming, M8 to M15, M0 to M9 2ss	2	4	15.2	15.7			18.5	23.9	5.4
	HT/VHT40 Beam Forming, M8 to M15, M0 to M9 2ss	3	6	15.2	15.7	15.7		20.3	23.9	3.6
	HT/VHT40 Beam Forming, M8 to M15, M0 to M9 2ss	4	7	14.0	15.6	14.5	14.3	20.7	22.9	2.2
	HT/VHT40 Beam Forming, M16 to M23, M0 to M9 3ss	3	4	15.2	15.7	15.7		20.3	23.9	3.6
HT/VHT40 Beam Forming, M16 to M23, M0 to M9 3ss	4	5	15.2	15.7	15.7	15.4	21.5	23.9	2.4	
HT/VHT40 STBC, M0 to M7	2	4	15.2	15.7			18.5	23.9	5.4	



	HT/VHT40 STBC, M0 to M7	3	4	15.2	15.7	15.7		20.3	23.9	3.6
	HT/VHT40 STBC, M0 to M7	4	4	15.2	15.7	15.7	15.4	21.5	23.9	2.4
5290	Non HT80 Duplicate, 6 to 54 Mbps	1	4	14.9				14.9	23.8	8.9
	Non HT80 Duplicate, 6 to 54 Mbps	2	4	13.6	13.7			16.7	23.8	7.1
	Non HT80 Duplicate, 6 to 54 Mbps	3	4	12.5	12.5	12.7		17.3	23.8	6.5
	Non HT80 Duplicate, 6 to 54 Mbps	4	4	11.4	11.4	11.5	11.1	17.4	23.8	6.4
	VHT80, M0 to M9 1ss	1	4	15.5				15.5	23.8	8.3
	VHT80, M0 to M9 1ss	2	4	15.5	15.7			18.6	23.8	5.2
	VHT80, M0 to M9 1ss	3	4	14.3	15.7	14.5		19.6	23.8	4.2
	VHT80, M0 to M9 1ss	4	4	13.2	13.2	13.3	12.9	19.2	23.8	4.6
	VHT80, M0 to M9 2ss	2	4	15.5	15.7			18.6	23.8	5.2
	VHT80, M0 to M9 2ss	3	4	14.3	15.7	14.5		19.6	23.8	4.2
	VHT80, M0 to M9 2ss	4	4	13.2	13.2	13.3	12.9	19.2	23.8	4.6
	VHT80, M0 to M9 3ss	3	4	14.3	15.7	14.5		19.6	23.8	4.2
	VHT80, M0 to M9 3ss	4	4	13.2	13.2	13.3	12.9	19.2	23.8	4.6
	VHT80 Beam Forming, M0 to M7, M0 to M9 1ss	2	7	13.2	13.2			16.2	22.8	6.6
	VHT80 Beam Forming, M0 to M7, M0 to M9 1ss	3	9	10.1	10.2	10.2		14.9	20.8	5.9
	VHT80 Beam Forming, M0 to M7, M0 to M9 1ss	4	10	8.1	8.1	8.2	7.9	14.1	19.8	5.7
	VHT80 Beam Forming, M8 to M15, M0 to M9 2ss	2	4	15.5	15.7			18.6	23.8	5.2
	VHT80 Beam Forming, M8 to M15, M0 to M9 2ss	3	6	13.2	13.2	13.3		18.0	23.8	5.8
	VHT80 Beam Forming, M8 to M15, M0 to M9 2ss	4	7	11.0	11.1	11.2	10.7	17.0	22.8	5.8
	VHT80 Beam Forming, M16 to M23, M0 to M9 3ss	3	4	14.3	15.7	14.5		19.6	23.8	4.2
VHT80 Beam Forming, M16 to M23, M0 to M9 3ss	4	5	12.0	12.0	12.1	11.8	18.0	23.8	5.8	
VHT80 STBC, M0 to M9 2ss	2	4	15.5	15.7			18.6	23.8	5.2	
VHT80 STBC, M0 to M9 2ss	3	4	14.3	15.7	14.5		19.6	23.8	4.2	
VHT80 STBC, M0 to M9 2ss	4	4	13.2	13.2	13.3	12.9	19.2	23.8	4.6	
5300	Non HT20, 6 to 54 Mbps	1	4	15.7				15.7	24.0	8.3
	Non HT20, 6 to 54 Mbps	2	4	15.7	16.0			18.9	24.0	5.1
	Non HT20, 6 to 54 Mbps	3	4	13.3	13.6	13.6		18.3	24.0	5.7
	Non HT20, 6 to 54 Mbps	4	4	10.4	10.6	10.5	10.3	16.5	24.0	7.5
	Non HT20 Beam Forming, 6 to 54 Mbps	2	7	15.7	16.0			18.9	23.0	4.1
	Non HT20 Beam Forming, 6 to 54 Mbps	3	9	13.3	13.6	13.6		18.3	21.0	2.7
	Non HT20 Beam Forming, 6 to 54 Mbps	4	10	10.4	10.6	10.5	10.3	16.5	20.0	3.5
	HT/VHT20, M0 to M7, M0 to M9 1ss	1	4	15.8				15.8	24.0	8.2
	HT/VHT20, M0 to M7, M0 to M9 1ss	2	4	15.8	16.1			19.0	24.0	5.0
	HT/VHT20, M0 to M7, M0 to M9 1ss	3	4	13.5	13.7	13.8		18.4	24.0	5.6
	HT/VHT20, M0 to M7, M0 to M9 1ss	4	4	11.5	11.7	11.6	11.4	17.6	24.0	6.4
	HT/VHT20, M8 to M15, M0 to M9 2ss	2	4	15.8	16.1			19.0	24.0	5.0
	HT/VHT20, M8 to M15, M0 to M9 2ss	3	4	15.8	16.1	16.1		20.8	24.0	3.2



	HT/VHT20, M8 to M15, M0 to M9 2ss	4	4	14.6	14.9	14.9	13.4	20.5	24.0	3.5
	HT/VHT20, M16 to M23, M0 to M9 3ss	3	4	15.8	16.1	16.1		20.8	24.0	3.2
	HT/VHT20, M16 to M23, M0 to M9 3ss	4	4	14.6	16.1	14.9	14.7	21.1	24.0	2.9
	HT/VHT20 Beam Forming, M0 to M7, M0 to M9 1ss	2	7	15.8	16.1			19.0	23.0	4.0
	HT/VHT20 Beam Forming, M0 to M7, M0 to M9 1ss	3	9	13.5	13.7	13.8		18.4	21.0	2.6
	HT/VHT20 Beam Forming, M0 to M7, M0 to M9 1ss	4	10	11.5	11.7	11.6	11.4	17.6	20.0	2.4
	HT/VHT20 Beam Forming, M8 to M15, M0 to M9 2ss	2	4	15.8	16.1			19.0	24.0	5.0
	HT/VHT20 Beam Forming, M8 to M15, M0 to M9 2ss	3	6	15.8	16.1	16.1		20.8	24.0	3.2
	HT/VHT20 Beam Forming, M8 to M15, M0 to M9 2ss	4	7	14.6	14.9	14.9	13.4	20.5	23.0	2.5
	HT/VHT20 Beam Forming, M16 to M23, M0 to M9 3ss	3	4	15.8	16.1	16.1		20.8	24.0	3.2
	HT/VHT20 Beam Forming, M16 to M23, M0 to M9 3ss	4	5	14.6	16.1	14.9	14.7	21.1	24.0	2.9
	HT/VHT20 STBC, M0 to M7	2	4	15.8	16.1			19.0	24.0	5.0
	HT/VHT20 STBC, M0 to M7	3	4	15.8	16.1	16.1		20.8	24.0	3.2
	HT/VHT20 STBC, M0 to M7	4	4	14.6	14.9	14.9	13.4	20.5	24.0	3.5
5310	Non HT40 Duplicate, 6 to 54 Mbps	1	4	15.5				15.5	23.9	8.4
	Non HT40 Duplicate, 6 to 54 Mbps	2	4	13.2	13.6			16.4	23.9	7.5
	Non HT40 Duplicate, 6 to 54 Mbps	3	4	13.2	13.6	13.6		18.2	23.9	5.7
	Non HT40 Duplicate, 6 to 54 Mbps	4	4	12.4	12.7	12.7	11.4	18.4	23.9	5.5
	HT/VHT40, M0 to M7, M0 to M9 1ss	1	4	15.7				15.7	23.9	8.2
	HT/VHT40, M0 to M7, M0 to M9 1ss	2	4	15.7	16.1			18.9	23.9	5.0
	HT/VHT40, M0 to M7, M0 to M9 1ss	3	4	14.5	14.9	14.8		19.5	23.9	4.4
	HT/VHT40, M0 to M7, M0 to M9 1ss	4	4	14.5	14.9	14.8	13.5	20.5	23.9	3.4
	HT/VHT40, M8 to M15, M0 to M9 2ss	2	4	15.7	16.1			18.9	23.9	5.0
	HT/VHT40, M8 to M15, M0 to M9 2ss	3	4	14.5	14.9	14.8		19.5	23.9	4.4
	HT/VHT40, M8 to M15, M0 to M9 2ss	4	4	14.5	14.9	14.8	14.7	20.7	23.9	3.2
	HT/VHT40, M16 to M23, M0 to M9 3ss	3	4	14.5	14.9	14.8		19.5	23.9	4.4
	HT/VHT40, M16 to M23, M0 to M9 3ss	4	4	14.5	14.9	14.8	14.7	20.7	23.9	3.2
	HT/VHT40 Beam Forming, M0 to M7, M0 to M9 1ss	2	7	14.5	14.9			17.7	22.9	5.2
	HT/VHT40 Beam Forming, M0 to M7, M0 to M9 1ss	3	9	12.3	12.5	12.6		17.2	20.9	3.7
	HT/VHT40 Beam Forming, M0 to M7, M0 to M9 1ss	4	10	9.4	9.6	9.5	9.4	15.5	19.9	4.4
	HT/VHT40 Beam Forming, M8 to M15, M0 to M9 2ss	2	4	15.7	16.1			18.9	23.9	5.0
	HT/VHT40 Beam Forming, M8 to M15, M0 to M9 2ss	3	6	14.5	14.9	14.8		19.5	23.9	4.4
	HT/VHT40 Beam Forming, M8 to M15, M0 to M9 2ss	4	7	10.4	10.6	10.6	10.4	16.5	22.9	6.4
	HT/VHT40 Beam Forming, M16 to M23, M0 to M9 3ss	3	4	14.5	14.9	14.8		19.5	23.9	4.4
HT/VHT40 Beam Forming, M16 to M23, M0 to M9 3ss	4	5	14.5	14.9	14.8	13.5	20.5	23.9	3.4	
HT/VHT40 STBC, M0 to M7	2	4	15.7	16.1			18.9	23.9	5.0	
HT/VHT40 STBC, M0 to M7	3	4	14.5	14.9	14.8		19.5	23.9	4.4	
HT/VHT40 STBC, M0 to M7	4	4	14.5	14.9	14.8	14.7	20.7	23.9	3.2	



5320	Non HT20, 6 to 54 Mbps	1	4	15.5				15.5	24.0	8.5
	Non HT20, 6 to 54 Mbps	2	4	15.5	15.8			18.7	24.0	5.3
	Non HT20, 6 to 54 Mbps	3	4	13.4	13.5	13.6		18.3	24.0	5.7
	Non HT20, 6 to 54 Mbps	4	4	10.5	10.6	10.6	10.5	16.6	24.0	7.4
	Non HT20 Beam Forming, 6 to 54 Mbps	2	7	15.5	15.8			18.7	23.0	4.3
	Non HT20 Beam Forming, 6 to 54 Mbps	3	9	12.5	12.5	12.4		17.2	21.0	3.8
	Non HT20 Beam Forming, 6 to 54 Mbps	4	10	9.6	9.6	9.5	9.6	15.6	20.0	4.4
	HT/VHT20, M0 to M7, M0 to M9 1ss	1	4	15.7				15.7	24.0	8.3
	HT/VHT20, M0 to M7, M0 to M9 1ss	2	4	15.7	16.0			18.9	24.0	5.1
	HT/VHT20, M0 to M7, M0 to M9 1ss	3	4	13.5	13.6	13.8		18.4	24.0	5.6
	HT/VHT20, M0 to M7, M0 to M9 1ss	4	4	11.6	11.7	11.6	11.6	17.6	24.0	6.4
	HT/VHT20, M8 to M15, M0 to M9 2ss	2	4	15.7	16.0			18.9	24.0	5.1
	HT/VHT20, M8 to M15, M0 to M9 2ss	3	4	15.7	16.0	16.1		20.7	24.0	3.3
	HT/VHT20, M8 to M15, M0 to M9 2ss	4	4	14.7	14.8	15.0	13.5	20.6	24.0	3.4
	HT/VHT20, M16 to M23, M0 to M9 3ss	3	4	15.7	16.0	16.1		20.7	24.0	3.3
	HT/VHT20, M16 to M23, M0 to M9 3ss	4	4	14.6	16.1	14.9	14.6	21.1	24.0	2.9
	HT/VHT20 Beam Forming, M0 to M7, M0 to M9 1ss	2	7	15.7	16.0			18.9	23.0	4.1
	HT/VHT20 Beam Forming, M0 to M7, M0 to M9 1ss	3	9	12.5	12.6	12.6		17.3	21.0	3.7
	HT/VHT20 Beam Forming, M0 to M7, M0 to M9 1ss	4	10	9.8	9.7	9.7	9.8	15.8	20.0	4.2
	HT/VHT20 Beam Forming, M8 to M15, M0 to M9 2ss	2	4	15.7	16.0			18.9	24.0	5.1
	HT/VHT20 Beam Forming, M8 to M15, M0 to M9 2ss	3	6	15.7	16.0	16.1		20.7	24.0	3.3
	HT/VHT20 Beam Forming, M8 to M15, M0 to M9 2ss	4	7	12.5	12.6	12.6	12.6	18.6	23.0	4.4
	HT/VHT20 Beam Forming, M16 to M23, M0 to M9 3ss	3	4	15.7	16.0	16.1		20.7	24.0	3.3
	HT/VHT20 Beam Forming, M16 to M23, M0 to M9 3ss	4	5	14.6	16.1	14.9	14.6	21.1	24.0	2.9
	HT/VHT20 STBC, M0 to M7	2	4	15.7	16.0			18.9	24.0	5.1
	HT/VHT20 STBC, M0 to M7	3	4	15.7	16.0	16.1		20.7	24.0	3.3
	HT/VHT20 STBC, M0 to M7	4	4	14.7	14.8	15.0	13.5	20.6	24.0	3.4





**Maximum Transmit Output Power, 5270 MHz, HT/VHT40 Beam Forming, M0 to M7, M0 to M9 1ss**

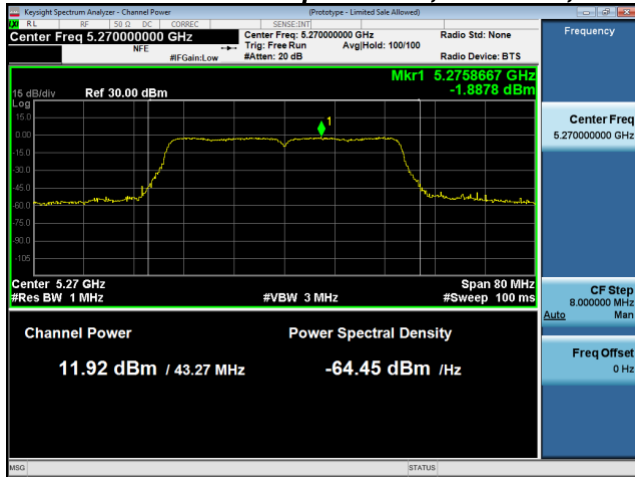

**Antenna A**

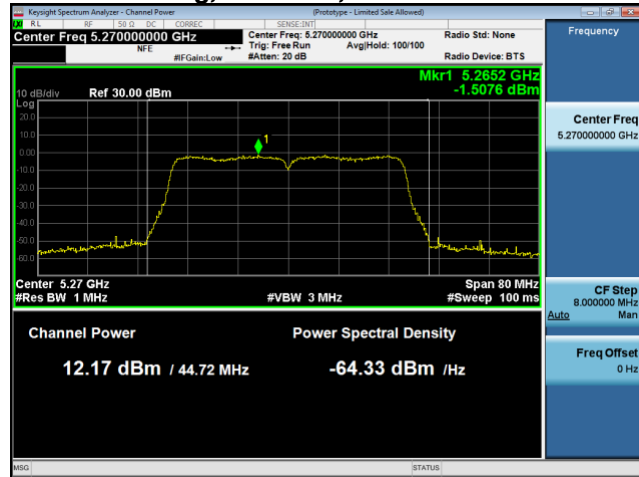

**Antenna B**

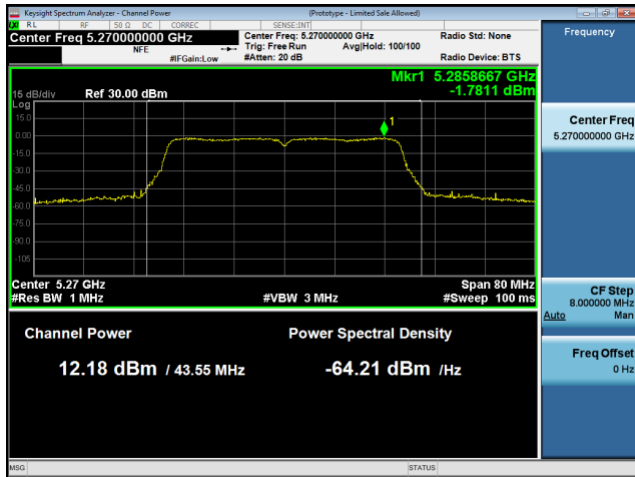

**Antenna C**

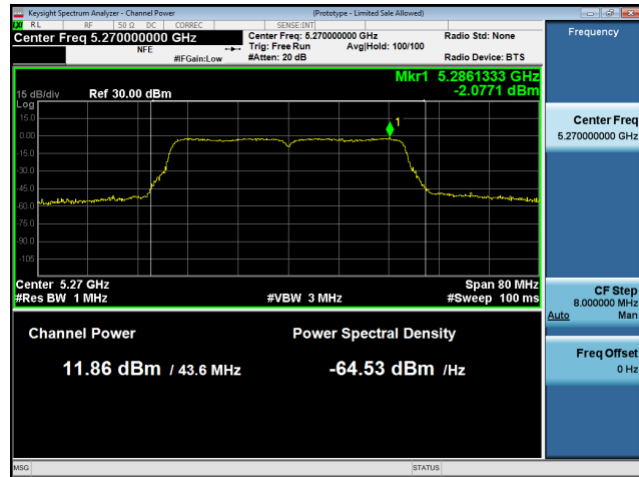

**Antenna D**



## Power Spectral Density

Frequency (MHz)	Mode	Tx Paths	Correlated Antenna Gain (dBi)	Tx 1 PSD (dBm/MHz)	Tx 2 PSD (dBm/MHz)	Tx 3 PSD (dBm/MHz)	Tx 4 PSD (dBm/MHz)	Total PSD (dBm/MHz)	Limit (dBm/MHz)	Margin (dB)
5250	Non HT160 Duplicate, 6 to 54 Mbps	1	4	-7.3				-7.3	16.8	24.1
	Non HT160 Duplicate, 6 to 54 Mbps	2	7	-9.7	-9.6			-6.6	15.8	22.4
	Non HT160 Duplicate, 6 to 54 Mbps	3	9	-9.7	-9.6	-9.7		-4.9	13.8	18.7
	Non HT160 Duplicate, 6 to 54 Mbps	4	10	-10.4	-10.7	-10.4	-11.0	-4.6	12.8	17.4
	VHT160, M0 to M7, M0 to M9 1ss	1	4	-5.2				-5.2	16.8	22.0
	VHT160, M0 to M7, M0 to M9 1ss	2	7	-5.2	-5.0			-2.1	15.8	17.9
	VHT160, M0 to M7, M0 to M9 1ss	3	9	-6.0	-6.2	-6.0		-1.3	13.8	15.1
	VHT160, M0 to M7, M0 to M9 1ss	4	10	-7.5	-7.4	-7.2	-7.7	-1.4	12.8	14.2
	VHT160, M8 to M15, M0 to M9 2ss	2	4	-5.2	-5.0			-2.1	16.8	18.9
	VHT160, M8 to M15, M0 to M9 2ss	3	6	-6.0	-6.2	-6.0		-1.3	16.8	18.1
	VHT160, M8 to M15, M0 to M9 2ss	4	7	-7.5	-7.4	-7.2	-7.7	-1.4	15.8	17.2
	VHT160, M16 to M23, M0 to M9 3ss	3	4	-6.0	-6.2	-6.0		-1.3	16.8	18.1
	VHT160, M16 to M23, M0 to M9 3ss	4	5	-7.5	-7.4	-7.2	-7.7	-1.4	16.8	18.2
	VHT160 Beam Forming, M0 to M7, M0 to M9 1ss	2	7	-7.5	-7.4			-4.4	15.8	20.2
	VHT160 Beam Forming, M0 to M7, M0 to M9 1ss	3	9	-10.5	-10.4	-10.5		-5.7	13.8	19.5
	VHT160 Beam Forming, M0 to M7, M0 to M9 1ss	4	10	-12.4	-12.4	-12.2	-12.8	-6.4	12.8	19.2
	VHT160 Beam Forming, M8 to M15, M0 to M9 2ss	2	4	-5.2	-5.0			-2.1	16.8	18.9
	VHT160 Beam Forming, M8 to M15, M0 to M9 2ss	3	6	-7.5	-7.4	-7.2		-2.6	16.8	19.4
	VHT160 Beam Forming, M8 to M15, M0 to M9 2ss	4	7	-9.5	-9.6	-9.7	-9.9	-3.7	15.8	19.5
	VHT160 Beam Forming, M16 to M23, M0 to M9 3ss	3	4	-6.0	-6.2	-6.0		-1.3	16.8	18.1
	VHT160 Beam Forming, M16 to M23, M0 to M9 3ss	4	5	-7.5	-7.4	-7.2	-7.7	-1.4	16.8	18.2
	VHT160 STBC, M0 to M9 2ss	2	4	-5.2	-5.0			-2.1	16.8	18.9
VHT160 STBC, M0 to M9 2ss	3	6	-6.0	-6.2	-6.0		-1.3	16.8	18.1	
VHT160 STBC, M0 to M9 2ss	4	7	-7.5	-7.4	-7.2	-7.7	-1.4	15.8	17.2	
5260	Non HT20, 6 to 54 Mbps	1	4	4.8				4.8	11.0	6.2
	Non HT20, 6 to 54 Mbps	2	7	4.8	5.1			8.0	10.0	2.0
	Non HT20, 6 to 54 Mbps	3	9	2.2	2.6	2.8		7.3	8.0	0.7
	Non HT20, 6 to 54 Mbps	4	10	0.1	0.2	0.4	0.0	6.2	7.0	0.8
	Non HT20 Beam Forming, 6 to 54 Mbps	2	7	4.8	5.1			8.0	10.0	2.0
	Non HT20 Beam Forming, 6 to 54 Mbps	3	9	2.2	2.6	2.8		7.3	8.0	0.7
	Non HT20 Beam Forming, 6 to 54 Mbps	4	10	0.1	0.2	0.4	0.0	6.2	7.0	0.8
	HT/VHT20, M0 to M7, M0 to M9 1ss	1	4	4.6				4.6	11.0	6.4
	HT/VHT20, M0 to M7, M0 to M9 1ss	2	7	4.6	4.7			7.7	10.0	2.3



	HT/VHT20, M0 to M7, M0 to M9 1ss	3	9	2.4	2.6	2.5		7.3	8.0	0.7
	HT/VHT20, M0 to M7, M0 to M9 1ss	4	10	0.0	0.3	0.3	-0.3	6.1	7.0	0.9
	HT/VHT20, M8 to M15, M0 to M9 2ss	2	4	4.6	4.7			7.7	11.0	3.3
	HT/VHT20, M8 to M15, M0 to M9 2ss	3	6	4.6	4.7	5.0		9.5	11.0	1.5
	HT/VHT20, M8 to M15, M0 to M9 2ss	4	7	3.2	3.9	3.6	2.2	9.3	10.0	0.7
	HT/VHT20, M16 to M23, M0 to M9 3ss	3	4	4.6	4.7	5.0		9.5	11.0	1.5
	HT/VHT20, M16 to M23, M0 to M9 3ss	4	5	4.6	4.7	5.0	4.6	10.7	11.0	0.3
	HT/VHT20 Beam Forming, M0 to M7, M0 to M9 1ss	2	7	4.6	4.7			7.7	10.0	2.3
	HT/VHT20 Beam Forming, M0 to M7, M0 to M9 1ss	3	9	2.4	2.6	2.5		7.3	8.0	0.7
	HT/VHT20 Beam Forming, M0 to M7, M0 to M9 1ss	4	10	0.0	0.3	0.3	-0.3	6.1	7.0	0.9
	HT/VHT20 Beam Forming, M8 to M15, M0 to M9 2ss	2	4	4.6	4.7			7.7	11.0	3.3
	HT/VHT20 Beam Forming, M8 to M15, M0 to M9 2ss	3	6	4.6	4.7	5.0		9.5	11.0	1.5
	HT/VHT20 Beam Forming, M8 to M15, M0 to M9 2ss	4	7	3.2	3.9	3.6	2.2	9.3	10.0	0.7
	HT/VHT20 Beam Forming, M16 to M23, M0 to M9 3ss	3	4	4.6	4.7	5.0		9.5	11.0	1.5
	HT/VHT20 Beam Forming, M16 to M23, M0 to M9 3ss	4	5	4.6	4.7	5.0	4.6	10.7	11.0	0.3
	HT/VHT20 STBC, M0 to M7	2	4	4.6	4.7			7.7	11.0	3.3
	HT/VHT20 STBC, M0 to M7	3	6	4.6	4.7	5.0		9.5	11.0	1.5
	HT/VHT20 STBC, M0 to M7	4	7	3.2	3.9	3.6	2.2	9.3	10.0	0.7
5270	Non HT40 Duplicate, 6 to 54 Mbps	1	4	2.9				2.9	10.9	8.0
	Non HT40 Duplicate, 6 to 54 Mbps	2	7	2.9	3.2			6.1	9.9	3.8
	Non HT40 Duplicate, 6 to 54 Mbps	3	9	1.9	2.3	2.2		6.9	7.9	1.0
	Non HT40 Duplicate, 6 to 54 Mbps	4	10	-0.4	-0.3	0.1	-0.1	5.8	6.9	1.1
	HT/VHT40, M0 to M7, M0 to M9 1ss	1	4	1.4				1.4	10.9	9.5
	HT/VHT40, M0 to M7, M0 to M9 1ss	2	7	1.4	2.0			4.7	9.9	5.2
	HT/VHT40, M0 to M7, M0 to M9 1ss	3	9	1.4	2.0	2.0		6.6	7.9	1.3
	HT/VHT40, M0 to M7, M0 to M9 1ss	4	10	0.2	0.8	0.4	-0.6	6.2	6.9	0.7
	HT/VHT40, M8 to M15, M0 to M9 2ss	2	4	1.4	2.0			4.7	10.9	6.2
	HT/VHT40, M8 to M15, M0 to M9 2ss	3	6	1.4	2.0	2.0		6.6	10.9	4.3
	HT/VHT40, M8 to M15, M0 to M9 2ss	4	7	1.4	2.0	2.0	1.4	7.7	9.9	2.2
	HT/VHT40, M16 to M23, M0 to M9 3ss	3	4	1.4	2.0	2.0		6.6	10.9	4.3
	HT/VHT40, M16 to M23, M0 to M9 3ss	4	5	1.4	2.0	2.0	1.4	7.7	10.9	3.2
	HT/VHT40 Beam Forming, M0 to M7, M0 to M9 1ss	2	7	1.4	2.0			4.7	9.9	5.2
	HT/VHT40 Beam Forming, M0 to M7, M0 to M9 1ss	3	9	0.2	0.8	0.4		5.2	7.9	2.7
	HT/VHT40 Beam Forming, M0 to M7, M0 to M9 1ss	4	10	-1.9	-1.5	-1.8	-2.1	4.2	6.9	2.7
	HT/VHT40 Beam Forming, M8 to M15, M0 to M9 2ss	2	4	1.4	2.0			4.7	10.9	6.2
	HT/VHT40 Beam Forming, M8 to M15, M0 to M9 2ss	3	6	1.4	2.0	2.0		6.6	10.9	4.3
	HT/VHT40 Beam Forming, M8 to M15, M0 to M9 2ss	4	7	0.2	1.8	0.7	0.8	6.9	9.9	3.0
	HT/VHT40 Beam Forming, M16 to M23, M0 to M9 3ss	3	4	1.4	2.0	2.0		6.6	10.9	4.3
	HT/VHT40 Beam Forming, M16 to M23, M0 to M9 3ss	4	5	1.4	2.0	2.0	1.4	7.7	10.9	3.2
	HT/VHT40 STBC, M0 to M7	2	4	1.4	2.0			4.7	10.9	6.2
	HT/VHT40 STBC, M0 to M7	3	6	1.4	2.0	2.0		6.6	10.9	4.3



	HT/VHT40 STBC, M0 to M7	4	7	1.4	2.0	2.0	1.4	7.7	9.9	2.2
5290	Non HT80 Duplicate, 6 to 54 Mbps	1	4	-2.1				-2.1	10.8	12.9
	Non HT80 Duplicate, 6 to 54 Mbps	2	7	-3.0	-2.8			0.1	9.8	9.7
	Non HT80 Duplicate, 6 to 54 Mbps	3	9	-4.4	-4.2	-4.4		0.4	7.8	7.4
	Non HT80 Duplicate, 6 to 54 Mbps	4	10	-5.6	-5.4	-5.3	-5.7	0.5	6.8	6.3
	VHT80, M0 to M9 1ss	1	4	-1.9				-1.9	10.8	12.7
	VHT80, M0 to M9 1ss	2	7	-1.9	-1.9			1.1	9.8	8.7
	VHT80, M0 to M9 1ss	3	9	-3.3	-1.8	-3.0		2.1	7.8	5.7
	VHT80, M0 to M9 1ss	4	10	-4.2	-4.1	-4.1	-4.6	1.8	6.8	5.0
	VHT80, M0 to M9 2ss	2	4	-1.9	-1.9			1.1	10.8	9.7
	VHT80, M0 to M9 2ss	3	6	-3.3	-1.8	-3.0		2.1	10.8	8.7
	VHT80, M0 to M9 2ss	4	7	-4.2	-4.1	-4.1	-4.6	1.8	9.8	8.0
	VHT80, M0 to M9 3ss	3	4	-3.3	-1.8	-3.0		2.1	10.8	8.7
	VHT80, M0 to M9 3ss	4	5	-4.2	-4.1	-4.1	-4.6	1.8	10.8	9.0
	VHT80 Beam Forming, M0 to M7, M0 to M9 1ss	2	7	-4.2	-4.1			-1.1	9.8	10.9
	VHT80 Beam Forming, M0 to M7, M0 to M9 1ss	3	9	-7.2	-7.0	-7.1		-2.3	7.8	10.1
	VHT80 Beam Forming, M0 to M7, M0 to M9 1ss	4	10	-9.4	-9.1	-9.3	-9.5	-3.3	6.8	10.1
	VHT80 Beam Forming, M8 to M15, M0 to M9 2ss	2	4	-1.9	-1.9			1.1	10.8	9.7
	VHT80 Beam Forming, M8 to M15, M0 to M9 2ss	3	6	-4.2	-4.1	-4.1		0.6	10.8	10.2
	VHT80 Beam Forming, M8 to M15, M0 to M9 2ss	4	7	-6.2	-6.3	-6.3	-6.7	-0.4	9.8	10.2
	VHT80 Beam Forming, M16 to M23, M0 to M9 3ss	3	4	-3.3	-1.8	-3.0		2.1	10.8	8.7
VHT80 Beam Forming, M16 to M23, M0 to M9 3ss	4	5	-5.6	-5.4	-5.5	-5.8	0.4	10.8	10.4	
VHT80 STBC, M0 to M9 2ss	2	4	-1.9	-1.9			1.1	10.8	9.7	
VHT80 STBC, M0 to M9 2ss	3	6	-3.3	-1.8	-3.0		2.1	10.8	8.7	
VHT80 STBC, M0 to M9 2ss	4	7	-4.2	-4.1	-4.1	-4.6	1.8	9.8	8.0	
5300	Non HT20, 6 to 54 Mbps	1	4	5.4				5.4	11.0	5.6
	Non HT20, 6 to 54 Mbps	2	7	5.4	5.9			8.7	10.0	1.3
	Non HT20, 6 to 54 Mbps	3	9	2.9	3.1	3.1		7.8	8.0	0.2
	Non HT20, 6 to 54 Mbps	4	10	-0.1	0.2	-0.3	-0.3	5.9	7.0	1.1
	Non HT20 Beam Forming, 6 to 54 Mbps	2	7	5.4	5.9			8.7	10.0	1.3
	Non HT20 Beam Forming, 6 to 54 Mbps	3	9	2.9	3.1	3.1		7.8	8.0	0.2
	Non HT20 Beam Forming, 6 to 54 Mbps	4	10	-0.1	0.2	-0.3	-0.3	5.9	7.0	1.1
	HT/VHT20, M0 to M7, M0 to M9 1ss	1	4	5.1				5.1	11.0	5.9
	HT/VHT20, M0 to M7, M0 to M9 1ss	2	7	5.1	5.6			8.4	10.0	1.6
	HT/VHT20, M0 to M7, M0 to M9 1ss	3	9	2.7	3.1	3.0		7.7	8.0	0.3
	HT/VHT20, M0 to M7, M0 to M9 1ss	4	10	0.7	1.3	0.6	0.6	6.8	7.0	0.2
	HT/VHT20, M8 to M15, M0 to M9 2ss	2	4	5.1	5.6			8.4	11.0	2.6
	HT/VHT20, M8 to M15, M0 to M9 2ss	3	6	5.1	5.6	5.4		10.1	11.0	0.9
HT/VHT20, M8 to M15, M0 to M9 2ss	4	7	3.8	4.0	4.2	2.7	9.7	10.0	0.3	
HT/VHT20, M16 to M23, M0 to M9 3ss	3	4	5.1	5.6	5.4		10.1	11.0	0.9	



	HT/VHT20, M16 to M23, M0 to M9 3ss	4	5	3.7	5.3	4.0	3.9	10.3	11.0	0.7
	HT/VHT20 Beam Forming, M0 to M7, M0 to M9 1ss	2	7	5.1	5.6			8.4	10.0	1.6
	HT/VHT20 Beam Forming, M0 to M7, M0 to M9 1ss	3	9	2.7	3.1	3.0		7.7	8.0	0.3
	HT/VHT20 Beam Forming, M0 to M7, M0 to M9 1ss	4	10	0.7	1.3	0.6	0.6	6.8	7.0	0.2
	HT/VHT20 Beam Forming, M8 to M15, M0 to M9 2ss	2	4	5.1	5.6			8.4	11.0	2.6
	HT/VHT20 Beam Forming, M8 to M15, M0 to M9 2ss	3	6	5.1	5.6	5.4		10.1	11.0	0.9
	HT/VHT20 Beam Forming, M8 to M15, M0 to M9 2ss	4	7	3.8	4.0	4.2	2.7	9.7	10.0	0.3
	HT/VHT20 Beam Forming, M16 to M23, M0 to M9 3ss	3	4	5.1	5.6	5.4		10.1	11.0	0.9
	HT/VHT20 Beam Forming, M16 to M23, M0 to M9 3ss	4	5	3.7	5.3	4.0	3.9	10.3	11.0	0.7
	HT/VHT20 STBC, M0 to M7	2	4	5.1	5.6			8.4	11.0	2.6
	HT/VHT20 STBC, M0 to M7	3	6	5.1	5.6	5.4		10.1	11.0	0.9
	HT/VHT20 STBC, M0 to M7	4	7	3.8	4.0	4.2	2.7	9.7	10.0	0.3
5310	Non HT40 Duplicate, 6 to 54 Mbps	1	4	1.8				1.8	10.9	9.1
	Non HT40 Duplicate, 6 to 54 Mbps	2	7	-0.1	0.2			3.1	9.9	6.8
	Non HT40 Duplicate, 6 to 54 Mbps	3	9	-0.1	0.2	0.0		4.8	7.9	3.1
	Non HT40 Duplicate, 6 to 54 Mbps	4	10	-1.0	-0.8	-0.6	-2.3	4.9	6.9	2.0
	HT/VHT40, M0 to M7, M0 to M9 1ss	1	4	1.9				1.9	10.9	9.0
	HT/VHT40, M0 to M7, M0 to M9 1ss	2	7	1.9	2.3			5.1	9.9	4.8
	HT/VHT40, M0 to M7, M0 to M9 1ss	3	9	0.6	0.9	1.2		5.7	7.9	2.2
	HT/VHT40, M0 to M7, M0 to M9 1ss	4	10	0.7	1.0	0.8	-0.2	6.6	6.9	0.3
	HT/VHT40, M8 to M15, M0 to M9 2ss	2	4	1.9	2.3			5.1	10.9	5.8
	HT/VHT40, M8 to M15, M0 to M9 2ss	3	6	0.6	0.9	1.2		5.7	10.9	5.2
	HT/VHT40, M8 to M15, M0 to M9 2ss	4	7	0.6	0.9	1.2	1.0	7.0	9.9	2.9
	HT/VHT40, M16 to M23, M0 to M9 3ss	3	4	0.6	0.9	1.2		5.7	10.9	5.2
	HT/VHT40, M16 to M23, M0 to M9 3ss	4	5	0.6	0.9	1.2	1.0	7.0	10.9	3.9
	HT/VHT40 Beam Forming, M0 to M7, M0 to M9 1ss	2	7	0.7	1.0			3.9	9.9	6.0
	HT/VHT40 Beam Forming, M0 to M7, M0 to M9 1ss	3	9	-1.6	-1.1	-1.2		3.5	7.9	4.4
	HT/VHT40 Beam Forming, M0 to M7, M0 to M9 1ss	4	10	-4.5	-4.2	-4.2	-4.3	1.7	6.9	5.2
	HT/VHT40 Beam Forming, M8 to M15, M0 to M9 2ss	2	4	1.9	2.3			5.1	10.9	5.8
	HT/VHT40 Beam Forming, M8 to M15, M0 to M9 2ss	3	6	0.7	1.0	0.8		5.6	10.9	5.3
	HT/VHT40 Beam Forming, M8 to M15, M0 to M9 2ss	4	7	-3.5	-3.1	-3.2	-3.5	2.7	9.9	7.2
	HT/VHT40 Beam Forming, M16 to M23, M0 to M9 3ss	3	4	0.6	0.9	1.2		5.7	10.9	5.2
	HT/VHT40 Beam Forming, M16 to M23, M0 to M9 3ss	4	5	0.7	1.0	0.8	-0.2	6.6	10.9	4.3
	HT/VHT40 STBC, M0 to M7	2	4	1.9	2.3			5.1	10.9	5.8
	HT/VHT40 STBC, M0 to M7	3	6	0.6	0.9	1.2		5.7	10.9	5.2
HT/VHT40 STBC, M0 to M7	4	7	0.6	0.9	1.2	1.0	7.0	9.9	2.9	



5320	Non HT20, 6 to 54 Mbps	1	4	4.9				4.9	11.0	6.1
	Non HT20, 6 to 54 Mbps	2	7	4.9	5.5			8.2	10.0	1.8
	Non HT20, 6 to 54 Mbps	3	9	2.8	3.0	2.9		7.7	8.0	0.3
	Non HT20, 6 to 54 Mbps	4	10	0.0	0.1	0.1	0.1	6.1	7.0	0.9
	Non HT20 Beam Forming, 6 to 54 Mbps	2	7	4.9	5.5			8.2	10.0	1.8
	Non HT20 Beam Forming, 6 to 54 Mbps	3	9	1.9	1.8	1.9		6.6	8.0	1.4
	Non HT20 Beam Forming, 6 to 54 Mbps	4	10	-0.9	-1.1	-1.2	-0.9	5.0	7.0	2.0
	HT/VHT20, M0 to M7, M0 to M9 1ss	1	4	4.6				4.6	11.0	6.4
	HT/VHT20, M0 to M7, M0 to M9 1ss	2	7	4.6	5.3			8.0	10.0	2.0
	HT/VHT20, M0 to M7, M0 to M9 1ss	3	9	2.6	2.8	3.0		7.6	8.0	0.4
	<b>HT/VHT20, M0 to M7, M0 to M9 1ss</b>	<b>4</b>	<b>10</b>	<b>0.7</b>	<b>0.9</b>	<b>0.9</b>	<b>0.9</b>	<b>6.9</b>	<b>7.0</b>	<b>0.1</b>
	HT/VHT20, M8 to M15, M0 to M9 2ss	2	4	4.6	5.3			8.0	11.0	3.0
	HT/VHT20, M8 to M15, M0 to M9 2ss	3	6	4.6	5.3	5.2		9.8	11.0	1.2
	HT/VHT20, M8 to M15, M0 to M9 2ss	4	7	4.1	3.9	4.3	2.9	9.9	10.0	0.1
	HT/VHT20, M16 to M23, M0 to M9 3ss	3	4	4.6	5.3	5.2		9.8	11.0	1.2
	HT/VHT20, M16 to M23, M0 to M9 3ss	4	5	4.1	5.2	4.2	3.7	10.4	11.0	0.6
	HT/VHT20 Beam Forming, M0 to M7, M0 to M9 1ss	2	7	4.6	5.3			8.0	10.0	2.0
	HT/VHT20 Beam Forming, M0 to M7, M0 to M9 1ss	3	9	1.5	1.8	1.8		6.5	8.0	1.5
	HT/VHT20 Beam Forming, M0 to M7, M0 to M9 1ss	4	10	-1.1	-1.1	-1.2	-0.8	5.0	7.0	2.0
	HT/VHT20 Beam Forming, M8 to M15, M0 to M9 2ss	2	4	4.6	5.3			8.0	11.0	3.0
	HT/VHT20 Beam Forming, M8 to M15, M0 to M9 2ss	3	6	4.6	5.3	5.2		9.8	11.0	1.2
	HT/VHT20 Beam Forming, M8 to M15, M0 to M9 2ss	4	7	1.5	1.8	1.8	1.6	7.7	10.0	2.3
	HT/VHT20 Beam Forming, M16 to M23, M0 to M9 3ss	3	4	4.6	5.3	5.2		9.8	11.0	1.2
	HT/VHT20 Beam Forming, M16 to M23, M0 to M9 3ss	4	5	4.1	5.2	4.2	3.7	10.4	11.0	0.6
	HT/VHT20 STBC, M0 to M7	2	4	4.6	5.3			8.0	11.0	3.0
	HT/VHT20 STBC, M0 to M7	3	6	4.6	5.3	5.2		9.8	11.0	1.2
	HT/VHT20 STBC, M0 to M7	4	7	4.1	3.9	4.3	2.9	9.9	10.0	0.1



**Power Spectral Density, 5320 MHz, HT/VHT20, M0 to M7, M0 to M9 1ss**

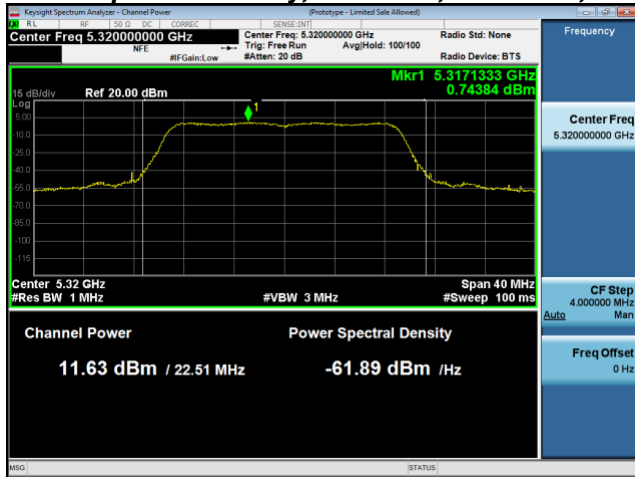

**Antenna A**

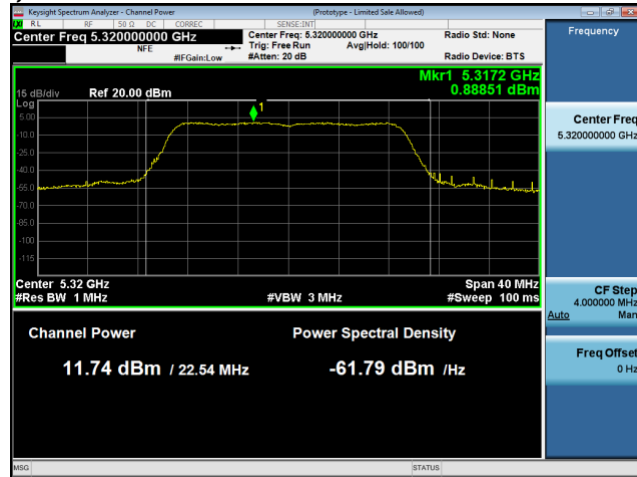

**Antenna B**

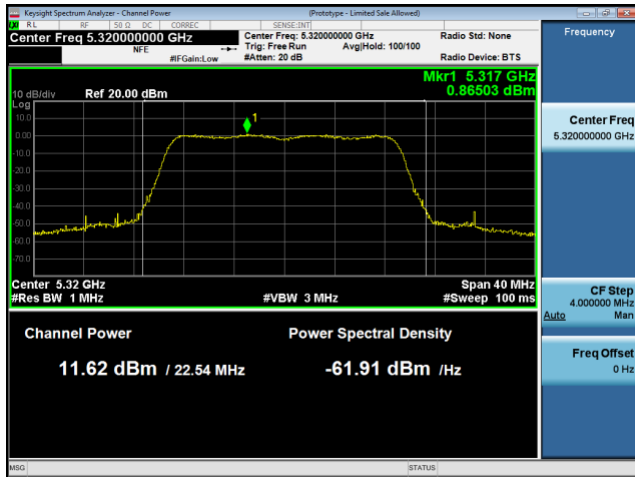

**Antenna C**

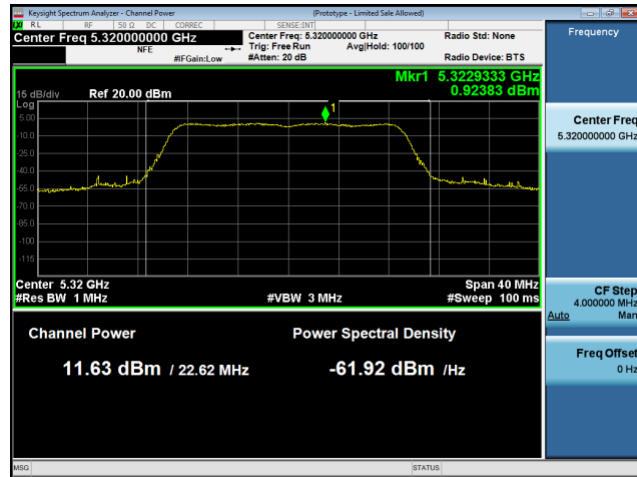

**Antenna D**



### A.3 Conducted Spurious Emissions

**15.407 (b) Undesirable emission limits.** Except as shown in paragraph (b) (7) of this section, the maximum emissions outside of the frequency bands of operation shall be attenuated in accordance with the following limits:

- (2) For transmitters operating in the 5.25-5.35 GHz band: All emissions outside of the 5.15-5.35 GHz band shall not exceed an e.i.r.p. of -27 dBm/MHz.
- (6) Unwanted emissions below 1 GHz must comply with the general field strength limits set forth in §15.209.
- (7) The provisions of §15.205 apply to intentional radiators operating under this section.

Use formula below to substitute conducted measurements in place of radiated measurements

$$E[\text{dB}\mu\text{V}/\text{m}] = \text{EIRP}[\text{dBm}] - 20 \log(d[\text{meters}]) + 104.77, \text{ where } E = \text{field strength and } d = 3 \text{ meter}$$

- 1) Average Plot, Limit= -41.25 dBm eirp
- 2) Peak plot, Limit = -21.25 dBm eirp

#### Test Procedure

Ref. KDB 789033 D02 General UNII Test Procedures New Rules v02r01  
ANSI C63.10: 2013

#### Conducted Spurious Emissions

##### Test Procedure

1. Connect the antenna port(s) to the spectrum analyzer input.
2. Place the radio in continuous transmit mode. Use the procedures in KDB 789033 D02 General UNII Test Procedures New Rules v02r01 to substitute conducted measurements in place of radiated measurements.
3. Configure Spectrum analyzer as per test parameters below (be sure to enter all losses between the transmitter output and the spectrum analyzer).
4. Record the marker waveform peak to spur difference. Also measure any emissions in the restricted bands.
5. The “measure-and-sum technique” is used for measuring in-band transmit power of a device. In the measure-and-sum approach, the conducted emission level is measured at each antenna port. The measured results at the various antenna ports are then summed mathematically to determine the total emission level from the device. Summing is performed in linear power units. The worst case output is recorded.
6. Capture graphs and record pertinent measurement data.

Ref. KDB 789033 D02 General UNII Test Procedures New Rules v02r01  
ANSI C63.10: 2013 section 12.7.7.3 (average) & 12.7.6 (peak)

#### Conducted Spurious Emissions

##### Test parameters

Span = 30MHz to 18GHz / 18GHz to 40GHz  
RBW = 1 MHz  
VBW ≥ 3 x RBW  
Sweep = Auto couple  
Detector = Peak / Average  
Trace = Max Hold.

System Number	Description	Samples	System under test	Support equipment
1	EUT	S01	<input checked="" type="checkbox"/>	<input type="checkbox"/>
	Support	S02	<input type="checkbox"/>	<input checked="" type="checkbox"/>

#### Tested By :

Jose Aguirre

#### Date of testing:

1-Nov-17 - 20-Mar-18

#### Test Result : PASS

See Appendix C for list of test equipment

**Conducted Spurs Average Upper, All Antennas**



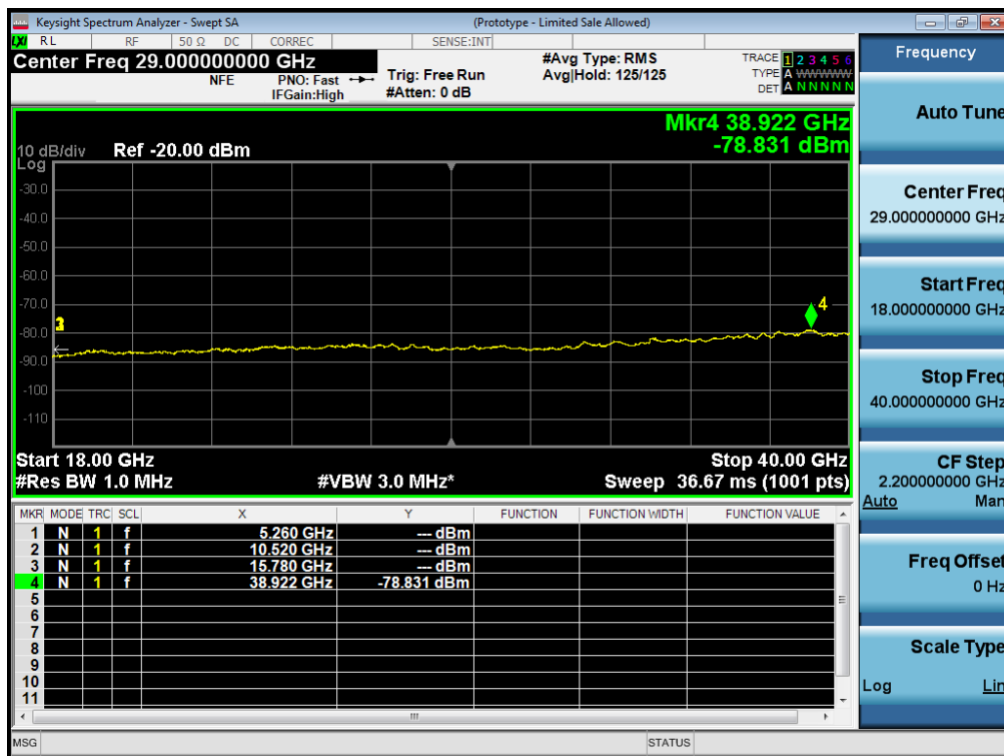

**Conducted Spurs Peak Upper, All Antennas**

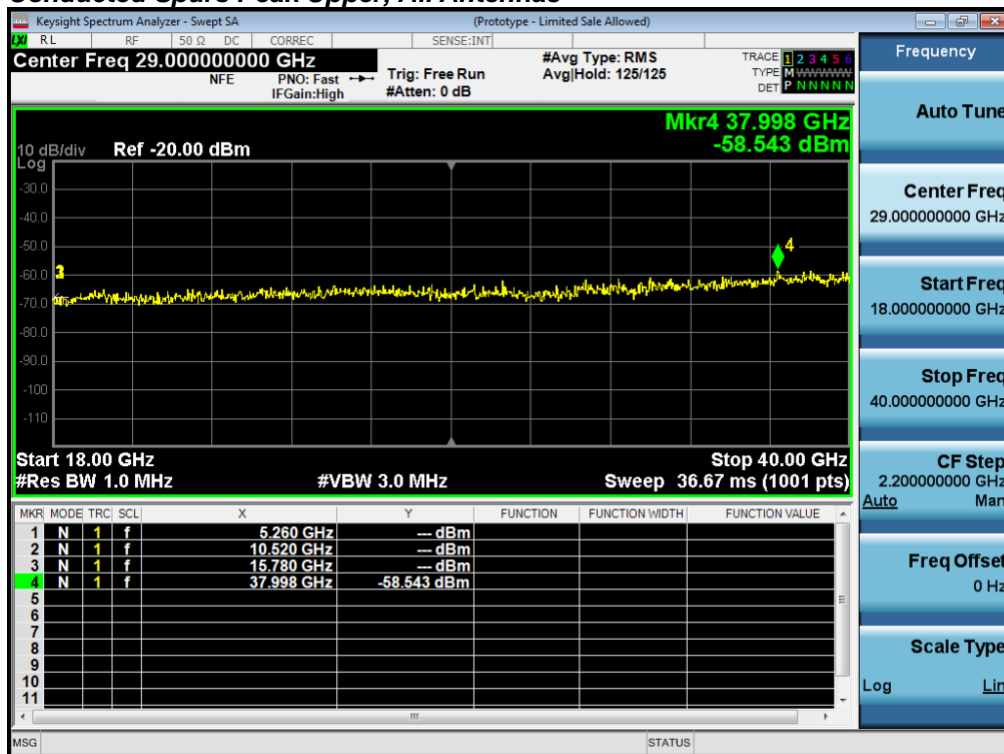

No emissions seen above 18GHz. The plots above are representative of all modes tested.



## Average Measuremnets.

Frequency (MHz)	Mode	Tx Paths	Correlated Antenna Gain (dBi)	Tx 1 Spur Power (dBm)	Tx 2 Spur Power (dBm)	Tx 3 Spur Power (dBm)	Tx 4 Spur Power (dBm)	Total Conducted Spur (dBm)	Limit (dBm)	Margin (dB)
5250	Non HT160 Duplicate, 6 to 54 Mbps	1	4	-50.8				-46.8	-41.45	5.4
	Non HT160 Duplicate, 6 to 54 Mbps	2	4	-51.1	-56.1			-45.9	-41.45	4.5
	Non HT160 Duplicate, 6 to 54 Mbps	3	4	-51.1	-56.1	-56.7		-45.1	-41.45	3.6
	Non HT160 Duplicate, 6 to 54 Mbps	4	4	-57.3	-56.3	-57.0	-57.6	-47.0	-41.45	5.6
	VHT160, M0 to M7, M0 to M9 1ss	1	4	-53.8				-49.8	-41.45	8.3
	VHT160, M0 to M7, M0 to M9 1ss	2	4	-53.8	-53.6			-46.7	-41.45	5.2
	VHT160, M0 to M7, M0 to M9 1ss	3	4	-56.2	-56.2	-55.7		-47.3	-41.45	5.8
	VHT160, M0 to M7, M0 to M9 1ss	4	4	-58.3	-58.0	-57.8	-57.0	-47.7	-41.45	6.3
	VHT160, M8 to M15, M0 to M9 2ss	2	4	-53.8	-53.6			-46.7	-41.45	5.2
	VHT160, M8 to M15, M0 to M9 2ss	3	4	-56.2	-56.2	-55.7		-47.3	-41.45	5.8
	VHT160, M8 to M15, M0 to M9 2ss	4	4	-58.3	-58.0	-57.8	-57.0	-47.7	-41.45	6.3
	VHT160, M16 to M23, M0 to M9 3ss	3	4	-56.2	-56.2	-55.7		-47.3	-41.45	5.8
	VHT160, M16 to M23, M0 to M9 3ss	4	4	-58.3	-58.0	-57.8	-57.0	-47.7	-41.45	6.3
	VHT160 Beam Forming, M0 to M7, M0 to M9 1ss	2	7	-58.3	-58.0			-48.1	-41.45	6.7
	VHT160 Beam Forming, M0 to M7, M0 to M9 1ss	3	9	-61.4	-61.2	-61.2		-47.5	-41.45	6.0
	VHT160 Beam Forming, M0 to M7, M0 to M9 1ss	4	10	-65.7	-65.8	-66.0	-62.0	-48.5	-41.45	7.0
	VHT160 Beam Forming, M8 to M15, M0 to M9 2ss	2	4	-53.8	-53.6			-46.7	-41.45	5.2
	VHT160 Beam Forming, M8 to M15, M0 to M9 2ss	3	6	-58.3	-58.0	-57.8		-47.3	-41.45	5.8
	VHT160 Beam Forming, M8 to M15, M0 to M9 2ss	4	7	-60.7	-60.3	-60.8	-60.7	-47.6	-41.45	6.2
	VHT160 Beam Forming, M16 to M23, M0 to M9 3ss	3	4	-56.2	-56.2	-55.7		-47.3	-41.45	5.8
VHT160 Beam Forming, M16 to M23, M0 to M9 3ss	4	5	-58.3	-58.0	-57.8	-57.0	-46.7	-41.45	5.3	
VHT160 STBC, M0 to M9 2ss	2	4	-53.8	-53.6			-46.7	-41.45	5.2	
VHT160 STBC, M0 to M9 2ss	3	4	-56.2	-56.2	-55.7		-47.3	-41.45	5.8	
VHT160 STBC, M0 to M9 2ss	4	4	-58.3	-58.0	-57.8	-57.0	-47.7	-41.45	6.3	
5260	Non HT20, 6 to 54 Mbps	1	4	-56.8				-52.8	-41.25	11.6
	Non HT20, 6 to 54 Mbps	2	4	-56.8	-56.4			-49.6	-41.25	8.3
	Non HT20, 6 to 54 Mbps	3	4	-60.8	-60.7	-60.9		-52.0	-41.25	10.8
	Non HT20, 6 to 54 Mbps	4	4	-61.5	-61.1	-61.5	-61.6	-51.4	-41.25	10.2
	Non HT20 Beam Forming, 6 to 54 Mbps	2	7	-56.8	-56.4			-46.6	-41.25	5.3
	Non HT20 Beam Forming, 6 to 54 Mbps	3	9	-60.8	-60.7	-60.9		-47.0	-41.25	5.8
	Non HT20 Beam Forming, 6 to 54 Mbps	4	10	-61.5	-61.1	-61.5	-61.6	-45.4	-41.25	4.2
	HT/VHT20, M0 to M7, M0 to M9 1ss	1	4	-56.7				-52.7	-41.25	11.5
	HT/VHT20, M0 to M7, M0 to M9 1ss	2	4	-56.7	-56.4			-49.5	-41.25	8.3



	HT/VHT20, M0 to M7, M0 to M9 1ss	3	4	-60.5	-60.5	-60.5		-51.7	-41.25	10.5
	HT/VHT20, M0 to M7, M0 to M9 1ss	4	4	-61.4	-61.1	-61.3	-61.5	-51.3	-41.25	10.1
	HT/VHT20, M8 to M15, M0 to M9 2ss	2	4	-56.7	-56.4			-49.5	-41.25	8.3
	HT/VHT20, M8 to M15, M0 to M9 2ss	3	4	-56.7	-56.4	-56.6		-47.8	-41.25	6.5
	HT/VHT20, M8 to M15, M0 to M9 2ss	4	4	-59.7	-59.9	-59.8	-57.3	-49.0	-41.25	7.8
	HT/VHT20, M16 to M23, M0 to M9 3ss	3	4	-56.7	-56.4	-56.6		-47.8	-41.25	6.5
	HT/VHT20, M16 to M23, M0 to M9 3ss	4	4	-56.7	-56.4	-56.6	-56.8	-46.6	-41.25	5.4
	HT/VHT20 Beam Forming, M0 to M7, M0 to M9 1ss	2	7	-56.7	-56.4			-46.5	-41.25	5.3
	HT/VHT20 Beam Forming, M0 to M7, M0 to M9 1ss	3	9	-60.5	-60.5	-60.5		-46.7	-41.25	5.5
	HT/VHT20 Beam Forming, M0 to M7, M0 to M9 1ss	4	10	-61.4	-61.1	-61.3	-61.5	-45.3	-41.25	4.1
	HT/VHT20 Beam Forming, M8 to M15, M0 to M9 2ss	2	4	-56.7	-56.4			-49.5	-41.25	8.3
	HT/VHT20 Beam Forming, M8 to M15, M0 to M9 2ss	3	6	-56.7	-56.4	-56.6		-45.8	-41.25	4.5
	HT/VHT20 Beam Forming, M8 to M15, M0 to M9 2ss	4	7	-59.7	-59.9	-59.8	-57.3	-46.0	-41.25	4.8
	HT/VHT20 Beam Forming, M16 to M23, M0 to M9 3ss	3	4	-56.7	-56.4	-56.6		-47.8	-41.25	6.5
	HT/VHT20 Beam Forming, M16 to M23, M0 to M9 3ss	4	5	-56.7	-56.4	-56.6	-56.8	-45.6	-41.25	4.4
	HT/VHT20 STBC, M0 to M7	2	4	-56.7	-56.4			-49.5	-41.25	8.3
	HT/VHT20 STBC, M0 to M7	3	4	-56.7	-56.4	-56.6		-47.8	-41.25	6.5
	HT/VHT20 STBC, M0 to M7	4	4	-59.7	-59.9	-59.8	-57.3	-49.0	-41.25	7.8
5270	Non HT40 Duplicate, 6 to 54 Mbps	1	4	-56.2				-52.2	-41.35	10.9
	Non HT40 Duplicate, 6 to 54 Mbps	2	4	-56.2	-55.8			-49.0	-41.35	7.6
	Non HT40 Duplicate, 6 to 54 Mbps	3	4	-56.4	-56.0	-56.2		-47.4	-41.35	6.1
	Non HT40 Duplicate, 6 to 54 Mbps	4	4	-56.8	-56.3	-56.5	-56.8	-46.6	-41.35	5.2
	HT/VHT40, M0 to M7, M0 to M9 1ss	1	4	-56.5				-52.5	-41.35	11.2
	HT/VHT40, M0 to M7, M0 to M9 1ss	2	4	-56.5	-55.9			-49.2	-41.35	7.8
	HT/VHT40, M0 to M7, M0 to M9 1ss	3	4	-56.5	-55.9	-56.2		-47.4	-41.35	6.1
	HT/VHT40, M0 to M7, M0 to M9 1ss	4	4	-60.0	-59.8	-60.2	-57.0	-49.0	-41.35	7.7
	HT/VHT40, M8 to M15, M0 to M9 2ss	2	4	-56.5	-55.9			-49.2	-41.35	7.8
	HT/VHT40, M8 to M15, M0 to M9 2ss	3	4	-56.5	-55.9	-56.2		-47.4	-41.35	6.1
	HT/VHT40, M8 to M15, M0 to M9 2ss	4	4	-56.5	-55.9	-56.2	-56.4	-46.2	-41.35	4.9
	HT/VHT40, M16 to M23, M0 to M9 3ss	3	4	-56.5	-55.9	-56.2		-47.4	-41.35	6.1
	HT/VHT40, M16 to M23, M0 to M9 3ss	4	4	-56.5	-55.9	-56.2	-56.4	-46.2	-41.35	4.9
	HT/VHT40 Beam Forming, M0 to M7, M0 to M9 1ss	2	7	-56.5	-55.9			-46.2	-41.35	4.8
	HT/VHT40 Beam Forming, M0 to M7, M0 to M9 1ss	3	9	-60.0	-59.8	-60.2		-46.2	-41.35	4.9
	HT/VHT40 Beam Forming, M0 to M7, M0 to M9 1ss	4	10	-60.8	-60.4	-60.5	-60.8	-44.6	-41.35	3.3
	HT/VHT40 Beam Forming, M8 to M15, M0 to M9 2ss	2	4	-56.5	-55.9			-49.2	-41.35	7.8
	HT/VHT40 Beam Forming, M8 to M15, M0 to M9 2ss	3	6	-56.5	-55.9	-56.2		-45.4	-41.35	4.1
	<b>HT/VHT40 Beam Forming, M8 to M15, M0 to M9 2ss</b>	<b>4</b>	<b>7</b>	<b>-56.7</b>	<b>-59.1</b>	<b>-56.4</b>	<b>-56.8</b>	<b>-44.1</b>	<b>-41.35</b>	<b>2.8</b>
	HT/VHT40 Beam Forming, M16 to M23, M0 to M9 3ss	3	4	-56.5	-55.9	-56.2		-47.4	-41.35	6.1
HT/VHT40 Beam Forming, M16 to M23, M0 to M9 3ss	4	5	-56.5	-55.9	-56.2	-56.4	-45.2	-41.35	3.9	
HT/VHT40 STBC, M0 to M7	2	4	-56.5	-55.9			-49.2	-41.35	7.8	
HT/VHT40 STBC, M0 to M7	3	4	-56.5	-55.9	-56.2		-47.4	-41.35	6.1	



	HT/VHT40 STBC, M0 to M7	4	4	-56.5	-55.9	-56.2	-56.4	-46.2	-41.35	4.9
5290	Non HT80 Duplicate, 6 to 54 Mbps	1	4	-50.7				-46.7	-41.45	5.3
	Non HT80 Duplicate, 6 to 54 Mbps	2	4	-50.9	-56.2			-45.8	-41.45	4.3
	Non HT80 Duplicate, 6 to 54 Mbps	3	4	-56.9	-56.3	-56.7		-47.9	-41.45	6.4
	Non HT80 Duplicate, 6 to 54 Mbps	4	4	-57.0	-56.4	-56.8	-57.2	-46.8	-41.45	5.4
	VHT80, M0 to M9 1ss	1	4	-56.1				-52.1	-41.45	10.7
	VHT80, M0 to M9 1ss	2	4	-56.1	-55.7			-48.9	-41.45	7.4
	VHT80, M0 to M9 1ss	3	4	-56.4	-59.5	-56.1		-48.3	-41.45	6.9
	VHT80, M0 to M9 1ss	4	4	-60.4	-60.1	-60.2	-60.3	-50.2	-41.45	8.8
	VHT80, M0 to M9 2ss	2	4	-56.1	-55.7			-48.9	-41.45	7.4
	VHT80, M0 to M9 2ss	3	4	-56.4	-59.5	-56.1		-48.3	-41.45	6.9
	VHT80, M0 to M9 2ss	4	4	-60.4	-60.1	-60.2	-60.3	-50.2	-41.45	8.8
	VHT80, M0 to M9 3ss	3	4	-56.4	-59.5	-56.1		-48.3	-41.45	6.9
	VHT80, M0 to M9 3ss	4	4	-60.4	-60.1	-60.2	-60.3	-50.2	-41.45	8.8
	VHT80 Beam Forming, M0 to M7, M0 to M9 1ss	2	7	-60.4	-60.1			-50.2	-41.45	8.8
	VHT80 Beam Forming, M0 to M7, M0 to M9 1ss	3	9	-60.9	-60.5	-60.6		-46.9	-41.45	5.4
	VHT80 Beam Forming, M0 to M7, M0 to M9 1ss	4	10	-65.8	-65.9	-65.9	-61.7	-48.4	-41.45	6.9
	VHT80 Beam Forming, M8 to M15, M0 to M9 2ss	2	4	-56.1	-55.7			-48.9	-41.45	7.4
	VHT80 Beam Forming, M8 to M15, M0 to M9 2ss	3	6	-60.4	-60.1	-60.2		-49.5	-41.45	8.0
	VHT80 Beam Forming, M8 to M15, M0 to M9 2ss	4	7	-60.8	-60.3	-60.7	-61.1	-47.7	-41.45	6.2
	VHT80 Beam Forming, M16 to M23, M0 to M9 3ss	3	4	-56.4	-59.5	-56.1		-48.3	-41.45	6.9
VHT80 Beam Forming, M16 to M23, M0 to M9 3ss	4	5	-60.6	-60.2	-60.5	-60.7	-49.5	-41.45	8.0	
VHT80 STBC, M0 to M9 2ss	2	4	-56.1	-55.7			-48.9	-41.45	7.4	
VHT80 STBC, M0 to M9 2ss	3	4	-56.4	-59.5	-56.1		-48.3	-41.45	6.9	
VHT80 STBC, M0 to M9 2ss	4	4	-60.4	-60.1	-60.2	-60.3	-50.2	-41.45	8.8	
5300	Non HT20, 6 to 54 Mbps	1	4	-56.7				-52.7	-41.25	11.5
	Non HT20, 6 to 54 Mbps	2	4	-56.7	-56.3			-49.5	-41.25	8.2
	Non HT20, 6 to 54 Mbps	3	4	-60.5	-60.3	-60.3		-51.6	-41.25	10.3
	Non HT20, 6 to 54 Mbps	4	4	-61.3	-61.0	-61.2	-61.4	-51.2	-41.25	10.0
	Non HT20 Beam Forming, 6 to 54 Mbps	2	7	-56.7	-56.3			-46.5	-41.25	5.2
	Non HT20 Beam Forming, 6 to 54 Mbps	3	9	-60.5	-60.3	-60.3		-46.6	-41.25	5.3
	Non HT20 Beam Forming, 6 to 54 Mbps	4	10	-61.3	-61.0	-61.2	-61.4	-45.2	-41.25	4.0
	HT/VHT20, M0 to M7, M0 to M9 1ss	1	4	-56.7				-52.7	-41.25	11.5
	HT/VHT20, M0 to M7, M0 to M9 1ss	2	4	-56.7	-56.3			-49.5	-41.25	8.2
	HT/VHT20, M0 to M7, M0 to M9 1ss	3	4	-60.5	-60.4	-60.2		-51.6	-41.25	10.3
	HT/VHT20, M0 to M7, M0 to M9 1ss	4	4	-61.1	-60.8	-61.0	-61.1	-51.0	-41.25	9.7
	HT/VHT20, M8 to M15, M0 to M9 2ss	2	4	-56.7	-56.3			-49.5	-41.25	8.2
	HT/VHT20, M8 to M15, M0 to M9 2ss	3	4	-56.7	-56.3	-56.5		-47.7	-41.25	6.5
	HT/VHT20, M8 to M15, M0 to M9 2ss	4	4	-59.7	-59.6	-60.0	-57.2	-48.9	-41.25	7.7
HT/VHT20, M16 to M23, M0 to M9 3ss	3	4	-56.7	-56.3	-56.5		-47.7	-41.25	6.5	



	HT/VHT20, M16 to M23, M0 to M9 3ss	4	4	-56.9	-58.8	-56.8	-57.0	-47.3	-41.25	6.0
	HT/VHT20 Beam Forming, M0 to M7, M0 to M9 1ss	2	7	-56.7	-56.3			-46.5	-41.25	5.2
	HT/VHT20 Beam Forming, M0 to M7, M0 to M9 1ss	3	9	-60.5	-60.4	-60.2		-46.6	-41.25	5.3
	HT/VHT20 Beam Forming, M0 to M7, M0 to M9 1ss	4	10	-61.1	-60.8	-61.0	-61.1	-45.0	-41.25	3.7
	HT/VHT20 Beam Forming, M8 to M15, M0 to M9 2ss	2	4	-56.7	-56.3			-49.5	-41.25	8.2
	HT/VHT20 Beam Forming, M8 to M15, M0 to M9 2ss	3	6	-56.7	-56.3	-56.5		-45.7	-41.25	4.5
	HT/VHT20 Beam Forming, M8 to M15, M0 to M9 2ss	4	7	-59.7	-59.6	-60.0	-57.2	-45.9	-41.25	4.7
	HT/VHT20 Beam Forming, M16 to M23, M0 to M9 3ss	3	4	-56.7	-56.3	-56.5		-47.7	-41.25	6.5
	HT/VHT20 Beam Forming, M16 to M23, M0 to M9 3ss	4	5	-56.9	-58.8	-56.8	-57.0	-46.3	-41.25	5.0
	HT/VHT20 STBC, M0 to M7	2	4	-56.7	-56.3			-49.5	-41.25	8.2
	HT/VHT20 STBC, M0 to M7	3	4	-56.7	-56.3	-56.5		-47.7	-41.25	6.5
	HT/VHT20 STBC, M0 to M7	4	4	-59.7	-59.6	-60.0	-57.2	-48.9	-41.25	7.7
5310	Non HT40 Duplicate, 6 to 54 Mbps	1	4	-56.5				-52.5	-41.35	11.2
	Non HT40 Duplicate, 6 to 54 Mbps	2	4	-57.0	-56.4			-49.7	-41.35	8.3
	Non HT40 Duplicate, 6 to 54 Mbps	3	4	-57.0	-56.4	-56.7		-47.9	-41.35	6.6
	Non HT40 Duplicate, 6 to 54 Mbps	4	4	-60.5	-60.2	-60.4	-57.3	-49.4	-41.35	8.0
	HT/VHT40, M0 to M7, M0 to M9 1ss	1	4	-56.5				-52.5	-41.35	11.2
	HT/VHT40, M0 to M7, M0 to M9 1ss	2	4	-56.5	-56.1			-49.3	-41.35	7.9
	HT/VHT40, M0 to M7, M0 to M9 1ss	3	4	-56.7	-56.2	-56.4		-47.7	-41.35	6.3
	HT/VHT40, M0 to M7, M0 to M9 1ss	4	4	-59.9	-59.6	-59.8	-56.9	-48.8	-41.35	7.5
	HT/VHT40, M8 to M15, M0 to M9 2ss	2	4	-56.5	-56.1			-49.3	-41.35	7.9
	HT/VHT40, M8 to M15, M0 to M9 2ss	3	4	-56.7	-56.2	-56.4		-47.7	-41.35	6.3
	HT/VHT40, M8 to M15, M0 to M9 2ss	4	4	-56.7	-56.2	-56.4	-56.8	-46.5	-41.35	5.1
	HT/VHT40, M16 to M23, M0 to M9 3ss	3	4	-56.7	-56.2	-56.4		-47.7	-41.35	6.3
	HT/VHT40, M16 to M23, M0 to M9 3ss	4	4	-56.7	-56.2	-56.4	-56.8	-46.5	-41.35	5.1
	HT/VHT40 Beam Forming, M0 to M7, M0 to M9 1ss	2	7	-59.9	-59.6			-49.7	-41.35	8.4
	HT/VHT40 Beam Forming, M0 to M7, M0 to M9 1ss	3	9	-60.5	-60.3	-60.3		-46.6	-41.35	5.2
	HT/VHT40 Beam Forming, M0 to M7, M0 to M9 1ss	4	10	-61.3	-65.2	-61.1	-61.4	-45.9	-41.35	4.6
	HT/VHT40 Beam Forming, M8 to M15, M0 to M9 2ss	2	4	-56.5	-56.1			-49.3	-41.35	7.9
	HT/VHT40 Beam Forming, M8 to M15, M0 to M9 2ss	3	6	-59.9	-59.6	-59.8		-49.0	-41.35	7.6
	HT/VHT40 Beam Forming, M8 to M15, M0 to M9 2ss	4	7	-61.2	-60.7	-61.0	-61.3	-48.0	-41.35	6.7
	HT/VHT40 Beam Forming, M16 to M23, M0 to M9 3ss	3	4	-56.7	-56.2	-56.4		-47.7	-41.35	6.3
HT/VHT40 Beam Forming, M16 to M23, M0 to M9 3ss	4	5	-59.9	-59.6	-59.8	-56.9	-47.8	-41.35	6.5	
HT/VHT40 STBC, M0 to M7	2	4	-56.5	-56.1			-49.3	-41.35	7.9	
HT/VHT40 STBC, M0 to M7	3	4	-56.7	-56.2	-56.4		-47.7	-41.35	6.3	
HT/VHT40 STBC, M0 to M7	4	4	-56.7	-56.2	-56.4	-56.8	-46.5	-41.35	5.1	



5320	Non HT20, 6 to 54 Mbps	1	4	-56.7				-52.7	-41.25	11.5
	Non HT20, 6 to 54 Mbps	2	4	-56.7	-56.4			-49.5	-41.25	8.3
	Non HT20, 6 to 54 Mbps	3	4	-60.4	-60.1	-60.2		-51.5	-41.25	10.2
	Non HT20, 6 to 54 Mbps	4	4	-61.1	-60.9	-61.2	-61.3	-51.1	-41.25	9.9
	Non HT20 Beam Forming, 6 to 54 Mbps	2	7	-56.7	-56.4			-46.5	-41.25	5.3
	Non HT20 Beam Forming, 6 to 54 Mbps	3	9	-60.6	-60.5	-60.6		-46.8	-41.25	5.5
	Non HT20 Beam Forming, 6 to 54 Mbps	4	10	-61.3	-65.1	-61.3	-61.4	-46.0	-41.25	4.7
	HT/VHT20, M0 to M7, M0 to M9 1ss	1	4	-56.8				-52.8	-41.25	11.6
	HT/VHT20, M0 to M7, M0 to M9 1ss	2	4	-56.8	-56.5			-49.6	-41.25	8.4
	HT/VHT20, M0 to M7, M0 to M9 1ss	3	4	-59.7	-59.9	-60.2		-51.2	-41.25	9.9
	HT/VHT20, M0 to M7, M0 to M9 1ss	4	4	-60.9	-60.7	-60.7	-61.0	-50.8	-41.25	9.6
	HT/VHT20, M8 to M15, M0 to M9 2ss	2	4	-56.8	-56.5			-49.6	-41.25	8.4
	HT/VHT20, M8 to M15, M0 to M9 2ss	3	4	-56.8	-56.5	-56.5		-47.8	-41.25	6.6
	HT/VHT20, M8 to M15, M0 to M9 2ss	4	4	-58.9	-59.0	-59.6	-57.3	-48.6	-41.25	7.3
	HT/VHT20, M16 to M23, M0 to M9 3ss	3	4	-56.8	-56.5	-56.5		-47.8	-41.25	6.6
	HT/VHT20, M16 to M23, M0 to M9 3ss	4	4	-57.0	-58.0	-56.8	-57.0	-47.2	-41.25	5.9
	HT/VHT20 Beam Forming, M0 to M7, M0 to M9 1ss	2	7	-56.8	-56.5			-46.6	-41.25	5.4
	HT/VHT20 Beam Forming, M0 to M7, M0 to M9 1ss	3	9	-60.5	-60.5	-60.6		-46.8	-41.25	5.5
	HT/VHT20 Beam Forming, M0 to M7, M0 to M9 1ss	4	10	-61.4	-64.5	-61.4	-61.5	-46.0	-41.25	4.8
	HT/VHT20 Beam Forming, M8 to M15, M0 to M9 2ss	2	4	-56.8	-56.5			-49.6	-41.25	8.4
	HT/VHT20 Beam Forming, M8 to M15, M0 to M9 2ss	3	6	-56.8	-56.5	-56.5		-45.8	-41.25	4.6
	HT/VHT20 Beam Forming, M8 to M15, M0 to M9 2ss	4	7	-60.5	-60.5	-60.6	-60.5	-47.5	-41.25	6.3
	HT/VHT20 Beam Forming, M16 to M23, M0 to M9 3ss	3	4	-56.8	-56.5	-56.5		-47.8	-41.25	6.6
	HT/VHT20 Beam Forming, M16 to M23, M0 to M9 3ss	4	5	-57.0	-58.0	-56.8	-57.0	-46.2	-41.25	4.9
	HT/VHT20 STBC, M0 to M7	2	4	-56.8	-56.5			-49.6	-41.25	8.4
	HT/VHT20 STBC, M0 to M7	3	4	-56.8	-56.5	-56.5		-47.8	-41.25	6.6
HT/VHT20 STBC, M0 to M7	4	4	-58.9	-59.0	-59.6	-57.3	-48.6	-41.25	7.3	



**Conducted Spurs Average, 5270 MHz, HT/VHT40 Beam Forming, M8 to M15, M0 to M9 2ss**

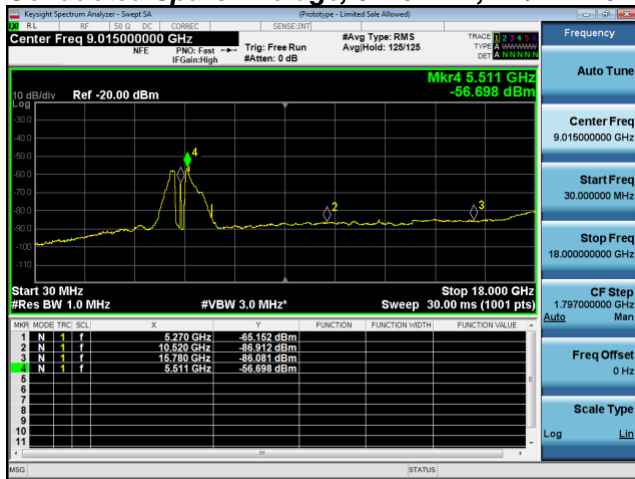

**Antenna A**

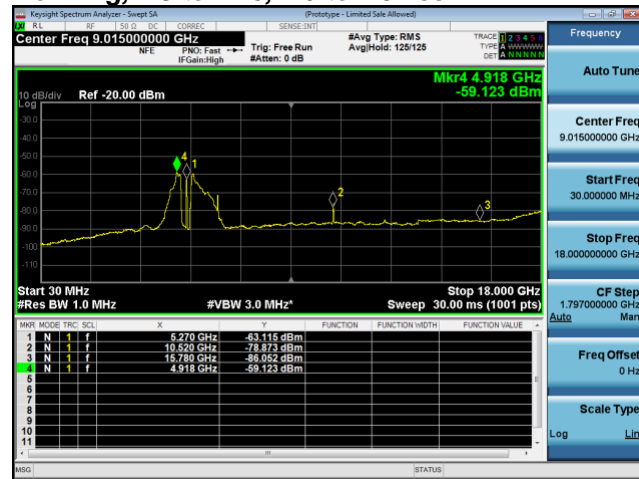

**Antenna B**

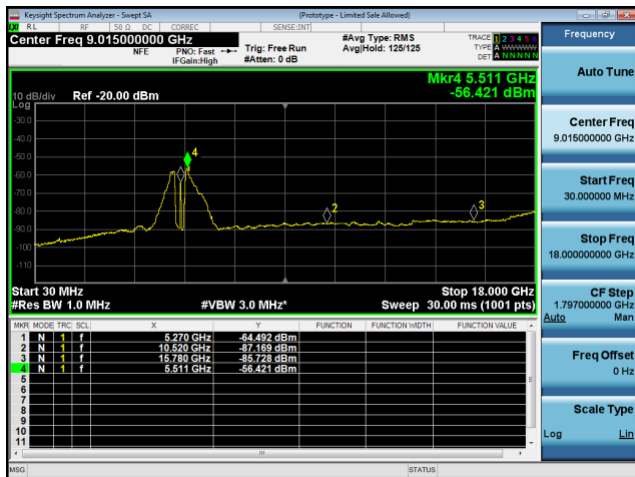

**Antenna C**

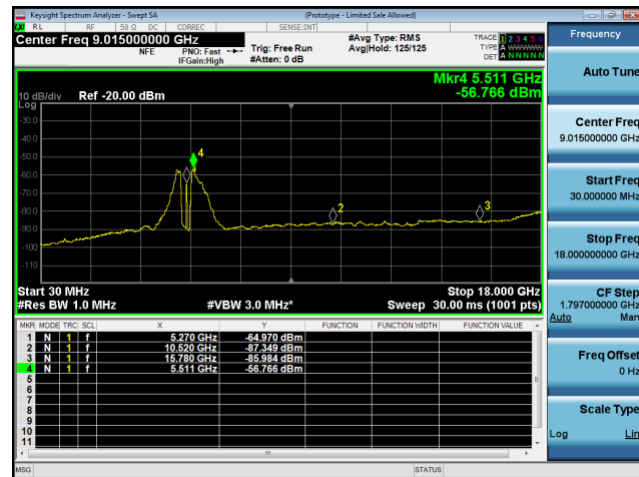

**Antenna D**





## Peak Measurements

Frequency (MHz)	Mode	Tx Paths	Correlated Antenna Gain (dBi)	Tx 1 Spur Power (dBm)	Tx 2 Spur Power (dBm)	Tx 3 Spur Power (dBm)	Tx 4 Spur Power (dBm)	Total Conducted Spur (dBm)	Limit (dBm)	Margin (dB)
5250	Non HT160 Duplicate, 6 to 54 Mbps	1	4	-36.2				-32.2	-21.45	10.8
	Non HT160 Duplicate, 6 to 54 Mbps	2	4	-40.9	-44.5			-35.3	-21.45	13.9
	Non HT160 Duplicate, 6 to 54 Mbps	3	4	-40.9	-44.5	-44.9		-34.3	-21.45	12.8
	Non HT160 Duplicate, 6 to 54 Mbps	4	4	-46.9	-46.3	-46.2	-45.7	-36.2	-21.45	14.8
	VHT160, M0 to M7, M0 to M9 1ss	1	4	-35.2				-31.2	-21.45	9.8
	<b>VHT160, M0 to M7, M0 to M9 1ss</b>	<b>2</b>	<b>4</b>	<b>-35.2</b>	<b>-34.9</b>			<b>-28.0</b>	<b>-21.45</b>	<b>6.6</b>
	VHT160, M0 to M7, M0 to M9 1ss	3	4	-38.4	-37.6	-38.9		-29.5	-21.45	8.0
	VHT160, M0 to M7, M0 to M9 1ss	4	4	-42.6	-41.5	-41.4	-40.2	-31.3	-21.45	9.9
	VHT160, M8 to M15, M0 to M9 2ss	2	4	-35.2	-34.9			-28.0	-21.45	6.6
	VHT160, M8 to M15, M0 to M9 2ss	3	4	-38.4	-37.6	-38.9		-29.5	-21.45	8.0
	VHT160, M8 to M15, M0 to M9 2ss	4	4	-42.6	-41.5	-41.4	-40.2	-31.3	-21.45	9.9
	VHT160, M16 to M23, M0 to M9 3ss	3	4	-38.4	-37.6	-38.9		-29.5	-21.45	8.0
	VHT160, M16 to M23, M0 to M9 3ss	4	4	-42.6	-41.5	-41.4	-40.2	-31.3	-21.45	9.9
	VHT160 Beam Forming, M0 to M7, M0 to M9 1ss	2	7	-42.6	-41.5			-32.0	-21.45	10.6
	VHT160 Beam Forming, M0 to M7, M0 to M9 1ss	3	9	-49.3	-48.5	-48.5		-35.0	-21.45	13.5
	VHT160 Beam Forming, M0 to M7, M0 to M9 1ss	4	10	-52.4	-52.9	-53.0	-51.0	-36.2	-21.45	14.8
	VHT160 Beam Forming, M8 to M15, M0 to M9 2ss	2	4	-35.2	-34.9			-28.0	-21.45	6.6
	VHT160 Beam Forming, M8 to M15, M0 to M9 2ss	3	6	-42.6	-41.5	-41.4		-31.0	-21.45	9.6
	VHT160 Beam Forming, M8 to M15, M0 to M9 2ss	4	7	-47.2	-46.3	-45.7	-47.0	-33.5	-21.45	12.0
	VHT160 Beam Forming, M16 to M23, M0 to M9 3ss	3	4	-38.4	-37.6	-38.9		-29.5	-21.45	8.0
VHT160 Beam Forming, M16 to M23, M0 to M9 3ss	4	5	-42.6	-41.5	-41.4	-40.2	-30.3	-21.45	8.9	
VHT160 STBC, M0 to M9 2ss	2	4	-35.2	-34.9			-28.0	-21.45	6.6	
VHT160 STBC, M0 to M9 2ss	3	4	-38.4	-37.6	-38.9		-29.5	-21.45	8.0	
VHT160 STBC, M0 to M9 2ss	4	4	-42.6	-41.5	-41.4	-40.2	-31.3	-21.45	9.9	
5260	Non HT20, 6 to 54 Mbps	1	4	-45.7				-41.7	-21.25	20.5
	Non HT20, 6 to 54 Mbps	2	4	-45.7	-46.1			-38.9	-21.25	17.6
	Non HT20, 6 to 54 Mbps	3	4	-49.6	-50.2	-50.8		-41.4	-21.25	20.2
	Non HT20, 6 to 54 Mbps	4	4	-50.6	-50.2	-50.2	-50.8	-40.4	-21.25	19.2
	Non HT20 Beam Forming, 6 to 54 Mbps	2	7	-45.7	-46.1			-35.9	-21.25	14.6
	Non HT20 Beam Forming, 6 to 54 Mbps	3	9	-49.6	-50.2	-50.8		-36.4	-21.25	15.2
	Non HT20 Beam Forming, 6 to 54 Mbps	4	10	-50.6	-50.2	-50.2	-50.8	-34.4	-21.25	13.2
	HT/VHT20, M0 to M7, M0 to M9 1ss	1	4	-43.8				-39.8	-21.25	18.6
	HT/VHT20, M0 to M7, M0 to M9 1ss	2	4	-43.8	-45.9			-37.7	-21.25	16.5





	HT/VHT20, M0 to M7, M0 to M9 1ss	3	4	-49.4	-48.7	-50.2		-40.6	-21.25	19.4
	HT/VHT20, M0 to M7, M0 to M9 1ss	4	4	-51.1	-50.1	-50.9	-50.6	-40.6	-21.25	19.4
	HT/VHT20, M8 to M15, M0 to M9 2ss	2	4	-43.8	-45.9			-37.7	-21.25	16.5
	HT/VHT20, M8 to M15, M0 to M9 2ss	3	4	-43.8	-45.9	-46.4		-36.4	-21.25	15.2
	HT/VHT20, M8 to M15, M0 to M9 2ss	4	4	-48.3	-48.0	-49.6	-46.8	-38.0	-21.25	16.8
	HT/VHT20, M16 to M23, M0 to M9 3ss	3	4	-43.8	-45.9	-46.4		-36.4	-21.25	15.2
	HT/VHT20, M16 to M23, M0 to M9 3ss	4	4	-43.8	-45.9	-46.4	-45.4	-35.2	-21.25	14.0
	HT/VHT20 Beam Forming, M0 to M7, M0 to M9 1ss	2	7	-43.8	-45.9			-34.7	-21.25	13.5
	HT/VHT20 Beam Forming, M0 to M7, M0 to M9 1ss	3	9	-49.4	-48.7	-50.2		-35.6	-21.25	14.4
	HT/VHT20 Beam Forming, M0 to M7, M0 to M9 1ss	4	10	-51.1	-50.1	-50.9	-50.6	-34.6	-21.25	13.4
	HT/VHT20 Beam Forming, M8 to M15, M0 to M9 2ss	2	4	-43.8	-45.9			-37.7	-21.25	16.5
	HT/VHT20 Beam Forming, M8 to M15, M0 to M9 2ss	3	6	-43.8	-45.9	-46.4		-34.4	-21.25	13.2
	HT/VHT20 Beam Forming, M8 to M15, M0 to M9 2ss	4	7	-48.3	-48.0	-49.6	-46.8	-35.0	-21.25	13.8
	HT/VHT20 Beam Forming, M16 to M23, M0 to M9 3ss	3	4	-43.8	-45.9	-46.4		-36.4	-21.25	15.2
	HT/VHT20 Beam Forming, M16 to M23, M0 to M9 3ss	4	5	-43.8	-45.9	-46.4	-45.4	-34.2	-21.25	13.0
	HT/VHT20 STBC, M0 to M7	2	4	-43.8	-45.9			-37.7	-21.25	16.5
	HT/VHT20 STBC, M0 to M7	3	4	-43.8	-45.9	-46.4		-36.4	-21.25	15.2
	HT/VHT20 STBC, M0 to M7	4	4	-48.3	-48.0	-49.6	-46.8	-38.0	-21.25	16.8
5270	Non HT40 Duplicate, 6 to 54 Mbps	1	4	-45.2				-41.2	-21.35	19.9
	Non HT40 Duplicate, 6 to 54 Mbps	2	4	-45.2	-44.7			-37.9	-21.35	16.6
	Non HT40 Duplicate, 6 to 54 Mbps	3	4	-46.3	-45.2	-46.1		-37.1	-21.35	15.7
	Non HT40 Duplicate, 6 to 54 Mbps	4	4	-45.4	-45.7	-45.8	-46.8	-35.9	-21.35	14.5
	HT/VHT40, M0 to M7, M0 to M9 1ss	1	4	-46.6				-42.6	-21.35	21.3
	HT/VHT40, M0 to M7, M0 to M9 1ss	2	4	-46.6	-46.1			-39.3	-21.35	18.0
	HT/VHT40, M0 to M7, M0 to M9 1ss	3	4	-46.6	-46.1	-45.5		-37.3	-21.35	15.9
	HT/VHT40, M0 to M7, M0 to M9 1ss	4	4	-48.9	-49.2	-49.7	-46.3	-38.3	-21.35	16.9
	HT/VHT40, M8 to M15, M0 to M9 2ss	2	4	-46.6	-46.1			-39.3	-21.35	18.0
	HT/VHT40, M8 to M15, M0 to M9 2ss	3	4	-46.6	-46.1	-45.5		-37.3	-21.35	15.9
	HT/VHT40, M8 to M15, M0 to M9 2ss	4	4	-46.6	-46.1	-45.5	-46.1	-36.0	-21.35	14.7
	HT/VHT40, M16 to M23, M0 to M9 3ss	3	4	-46.6	-46.1	-45.5		-37.3	-21.35	15.9
	HT/VHT40, M16 to M23, M0 to M9 3ss	4	4	-46.6	-46.1	-45.5	-46.1	-36.0	-21.35	14.7
	HT/VHT40 Beam Forming, M0 to M7, M0 to M9 1ss	2	7	-46.6	-46.1			-36.3	-21.35	15.0
	HT/VHT40 Beam Forming, M0 to M7, M0 to M9 1ss	3	9	-48.9	-49.2	-49.7		-35.5	-21.35	14.1
	HT/VHT40 Beam Forming, M0 to M7, M0 to M9 1ss	4	10	-50.1	-49.9	-49.7	-50.5	-34.0	-21.35	12.7
	HT/VHT40 Beam Forming, M8 to M15, M0 to M9 2ss	2	4	-46.6	-46.1			-39.3	-21.35	18.0
	HT/VHT40 Beam Forming, M8 to M15, M0 to M9 2ss	3	6	-46.6	-46.1	-45.5		-35.3	-21.35	13.9
	HT/VHT40 Beam Forming, M8 to M15, M0 to M9 2ss	4	7	-46.6	-48.4	-46.4	-45.5	-33.6	-21.35	12.2
	HT/VHT40 Beam Forming, M16 to M23, M0 to M9 3ss	3	4	-46.6	-46.1	-45.5		-37.3	-21.35	15.9
HT/VHT40 Beam Forming, M16 to M23, M0 to M9 3ss	4	5	-46.6	-46.1	-45.5	-46.1	-35.0	-21.35	13.7	
HT/VHT40 STBC, M0 to M7	2	4	-46.6	-46.1			-39.3	-21.35	18.0	
HT/VHT40 STBC, M0 to M7	3	4	-46.6	-46.1	-45.5		-37.3	-21.35	15.9	



	HT/VHT40 STBC, M0 to M7	4	4	-46.6	-46.1	-45.5	-46.1	-36.0	-21.35	14.7
5290	Non HT80 Duplicate, 6 to 54 Mbps	1	4	-41.1				-37.1	-21.45	15.7
	Non HT80 Duplicate, 6 to 54 Mbps	2	4	-40.6	-46.1			-35.5	-21.45	14.1
	Non HT80 Duplicate, 6 to 54 Mbps	3	4	-46.8	-45.8	-44.4		-36.8	-21.45	15.3
	Non HT80 Duplicate, 6 to 54 Mbps	4	4	-46.6	-46.0	-46.6	-47.0	-36.5	-21.45	15.1
	VHT80, M0 to M9 1ss	1	4	-46.2				-42.2	-21.45	20.8
	VHT80, M0 to M9 1ss	2	4	-46.2	-45.5			-38.8	-21.45	17.4
	VHT80, M0 to M9 1ss	3	4	-46.1	-48.6	-46.2		-38.1	-21.45	16.6
	VHT80, M0 to M9 1ss	4	4	-49.3	-50.4	-49.5	-49.1	-39.5	-21.45	18.1
	VHT80, M0 to M9 2ss	2	4	-46.2	-45.5			-38.8	-21.45	17.4
	VHT80, M0 to M9 2ss	3	4	-46.1	-48.6	-46.2		-38.1	-21.45	16.6
	VHT80, M0 to M9 2ss	4	4	-49.3	-50.4	-49.5	-49.1	-39.5	-21.45	18.1
	VHT80, M0 to M9 3ss	3	4	-46.1	-48.6	-46.2		-38.1	-21.45	16.6
	VHT80, M0 to M9 3ss	4	4	-49.3	-50.4	-49.5	-49.1	-39.5	-21.45	18.1
	VHT80 Beam Forming, M0 to M7, M0 to M9 1ss	2	7	-49.3	-50.4			-39.8	-21.45	18.4
	VHT80 Beam Forming, M0 to M7, M0 to M9 1ss	3	9	-50.7	-50.1	-49.1		-36.1	-21.45	14.7
	VHT80 Beam Forming, M0 to M7, M0 to M9 1ss	4	10	-54.4	-53.4	-54.0	-51.3	-37.1	-21.45	15.6
	VHT80 Beam Forming, M8 to M15, M0 to M9 2ss	2	4	-46.2	-45.5			-38.8	-21.45	17.4
	VHT80 Beam Forming, M8 to M15, M0 to M9 2ss	3	6	-49.3	-50.4	-49.5		-38.9	-21.45	17.5
	VHT80 Beam Forming, M8 to M15, M0 to M9 2ss	4	7	-50.3	-50.2	-50.0	-50.9	-37.3	-21.45	15.9
	VHT80 Beam Forming, M16 to M23, M0 to M9 3ss	3	4	-46.1	-48.6	-46.2		-38.1	-21.45	16.6
VHT80 Beam Forming, M16 to M23, M0 to M9 3ss	4	5	-50.0	-48.4	-50.1	-50.7	-38.7	-21.45	17.2	
VHT80 STBC, M0 to M9 2ss	2	4	-46.2	-45.5			-38.8	-21.45	17.4	
VHT80 STBC, M0 to M9 2ss	3	4	-46.1	-48.6	-46.2		-38.1	-21.45	16.6	
VHT80 STBC, M0 to M9 2ss	4	4	-49.3	-50.4	-49.5	-49.1	-39.5	-21.45	18.1	
5300	Non HT20, 6 to 54 Mbps	1	4	-45.8				-41.8	-21.25	20.6
	Non HT20, 6 to 54 Mbps	2	4	-45.8	-45.3			-38.5	-21.25	17.3
	Non HT20, 6 to 54 Mbps	3	4	-48.4	-49.0	-49.5		-40.2	-21.25	18.9
	Non HT20, 6 to 54 Mbps	4	4	-51.3	-51.0	-50.4	-50.5	-40.8	-21.25	19.5
	Non HT20 Beam Forming, 6 to 54 Mbps	2	7	-45.8	-45.3			-35.5	-21.25	14.3
	Non HT20 Beam Forming, 6 to 54 Mbps	3	9	-48.4	-49.0	-49.5		-35.2	-21.25	13.9
	Non HT20 Beam Forming, 6 to 54 Mbps	4	10	-51.3	-51.0	-50.4	-50.5	-34.8	-21.25	13.5
	HT/VHT20, M0 to M7, M0 to M9 1ss	1	4	-45.6				-41.6	-21.25	20.4
	HT/VHT20, M0 to M7, M0 to M9 1ss	2	4	-45.6	-45.9			-38.7	-21.25	17.5
	HT/VHT20, M0 to M7, M0 to M9 1ss	3	4	-50.2	-49.2	-49.6		-40.9	-21.25	19.6
	HT/VHT20, M0 to M7, M0 to M9 1ss	4	4	-50.8	-50.5	-51.0	-50.4	-40.6	-21.25	19.4
	HT/VHT20, M8 to M15, M0 to M9 2ss	2	4	-45.6	-45.9			-38.7	-21.25	17.5
	HT/VHT20, M8 to M15, M0 to M9 2ss	3	4	-45.6	-45.9	-46.6		-37.2	-21.25	16.0
HT/VHT20, M8 to M15, M0 to M9 2ss	4	4	-48.9	-48.4	-48.6	-46.8	-38.1	-21.25	16.8	
HT/VHT20, M16 to M23, M0 to M9 3ss	3	4	-45.6	-45.9	-46.6		-37.2	-21.25	16.0	



	HT/VHT20, M16 to M23, M0 to M9 3ss	4	4	-46.4	-47.6	-46.1	-45.1	-36.2	-21.25	14.9
	HT/VHT20 Beam Forming, M0 to M7, M0 to M9 1ss	2	7	-45.6	-45.9			-35.7	-21.25	14.5
	HT/VHT20 Beam Forming, M0 to M7, M0 to M9 1ss	3	9	-50.2	-49.2	-49.6		-35.9	-21.25	14.6
	HT/VHT20 Beam Forming, M0 to M7, M0 to M9 1ss	4	10	-50.8	-50.5	-51.0	-50.4	-34.6	-21.25	13.4
	HT/VHT20 Beam Forming, M8 to M15, M0 to M9 2ss	2	4	-45.6	-45.9			-38.7	-21.25	17.5
	HT/VHT20 Beam Forming, M8 to M15, M0 to M9 2ss	3	6	-45.6	-45.9	-46.6		-35.2	-21.25	14.0
	HT/VHT20 Beam Forming, M8 to M15, M0 to M9 2ss	4	7	-48.9	-48.4	-48.6	-46.8	-35.1	-21.25	13.8
	HT/VHT20 Beam Forming, M16 to M23, M0 to M9 3ss	3	4	-45.6	-45.9	-46.6		-37.2	-21.25	16.0
	HT/VHT20 Beam Forming, M16 to M23, M0 to M9 3ss	4	5	-46.4	-47.6	-46.1	-45.1	-35.2	-21.25	13.9
	HT/VHT20 STBC, M0 to M7	2	4	-45.6	-45.9			-38.7	-21.25	17.5
	HT/VHT20 STBC, M0 to M7	3	4	-45.6	-45.9	-46.6		-37.2	-21.25	16.0
	HT/VHT20 STBC, M0 to M7	4	4	-48.9	-48.4	-48.6	-46.8	-38.1	-21.25	16.8
5310	Non HT40 Duplicate, 6 to 54 Mbps	1	4	-46.8				-42.8	-21.35	21.5
	Non HT40 Duplicate, 6 to 54 Mbps	2	4	-46.2	-46.6			-39.4	-21.35	18.0
	Non HT40 Duplicate, 6 to 54 Mbps	3	4	-46.2	-46.6	-46.4		-37.6	-21.35	16.3
	Non HT40 Duplicate, 6 to 54 Mbps	4	4	-50.0	-50.0	-50.3	-47.2	-39.2	-21.35	17.8
	HT/VHT40, M0 to M7, M0 to M9 1ss	1	4	-45.7				-41.7	-21.35	20.4
	HT/VHT40, M0 to M7, M0 to M9 1ss	2	4	-45.7	-45.7			-38.7	-21.35	17.3
	HT/VHT40, M0 to M7, M0 to M9 1ss	3	4	-46.1	-45.9	-46.0		-37.2	-21.35	15.9
	HT/VHT40, M0 to M7, M0 to M9 1ss	4	4	-49.3	-48.9	-48.7	-46.9	-38.3	-21.35	17.0
	HT/VHT40, M8 to M15, M0 to M9 2ss	2	4	-45.7	-45.7			-38.7	-21.35	17.3
	HT/VHT40, M8 to M15, M0 to M9 2ss	3	4	-46.1	-45.9	-46.0		-37.2	-21.35	15.9
	HT/VHT40, M8 to M15, M0 to M9 2ss	4	4	-46.1	-45.9	-46.0	-45.4	-35.8	-21.35	14.5
	HT/VHT40, M16 to M23, M0 to M9 3ss	3	4	-46.1	-45.9	-46.0		-37.2	-21.35	15.9
	HT/VHT40, M16 to M23, M0 to M9 3ss	4	4	-46.1	-45.9	-46.0	-45.4	-35.8	-21.35	14.5
	HT/VHT40 Beam Forming, M0 to M7, M0 to M9 1ss	2	7	-49.3	-48.9			-39.1	-21.35	17.7
	HT/VHT40 Beam Forming, M0 to M7, M0 to M9 1ss	3	9	-50.2	-49.1	-50.5		-36.1	-21.35	14.8
	HT/VHT40 Beam Forming, M0 to M7, M0 to M9 1ss	4	10	-51.2	-54.3	-48.8	-51.3	-35.0	-21.35	13.6
	HT/VHT40 Beam Forming, M8 to M15, M0 to M9 2ss	2	4	-45.7	-45.7			-38.7	-21.35	17.3
	HT/VHT40 Beam Forming, M8 to M15, M0 to M9 2ss	3	6	-49.3	-48.9	-48.7		-38.2	-21.35	16.8
	HT/VHT40 Beam Forming, M8 to M15, M0 to M9 2ss	4	7	-50.7	-49.5	-51.0	-51.1	-37.5	-21.35	16.2
	HT/VHT40 Beam Forming, M16 to M23, M0 to M9 3ss	3	4	-46.1	-45.9	-46.0		-37.2	-21.35	15.9
	HT/VHT40 Beam Forming, M16 to M23, M0 to M9 3ss	4	5	-49.3	-48.9	-48.7	-46.9	-37.3	-21.35	16.0
	HT/VHT40 STBC, M0 to M7	2	4	-45.7	-45.7			-38.7	-21.35	17.3
	HT/VHT40 STBC, M0 to M7	3	4	-46.1	-45.9	-46.0		-37.2	-21.35	15.9
HT/VHT40 STBC, M0 to M7	4	4	-46.1	-45.9	-46.0	-45.4	-35.8	-21.35	14.5	



5320	Non HT20, 6 to 54 Mbps	1	4	-46.3				-42.3	-21.25	21.1
	Non HT20, 6 to 54 Mbps	2	4	-46.3	-45.7			-39.0	-21.25	17.7
	Non HT20, 6 to 54 Mbps	3	4	-49.4	-48.6	-49.5		-40.4	-21.25	19.1
	Non HT20, 6 to 54 Mbps	4	4	-50.5	-50.7	-49.7	-48.6	-39.8	-21.25	18.5
	Non HT20 Beam Forming, 6 to 54 Mbps	2	7	-46.3	-45.7			-36.0	-21.25	14.7
	Non HT20 Beam Forming, 6 to 54 Mbps	3	9	-48.2	-49.2	-50.2		-35.4	-21.25	14.1
	Non HT20 Beam Forming, 6 to 54 Mbps	4	10	-51.5	-52.5	-51.0	-49.6	-35.0	-21.25	13.8
	HT/VHT20, M0 to M7, M0 to M9 1ss	1	4	-46.6				-42.6	-21.25	21.4
	HT/VHT20, M0 to M7, M0 to M9 1ss	2	4	-46.6	-45.9			-39.2	-21.25	18.0
	HT/VHT20, M0 to M7, M0 to M9 1ss	3	4	-48.7	-49.4	-49.2		-40.3	-21.25	19.1
	HT/VHT20, M0 to M7, M0 to M9 1ss	4	4	-49.8	-50.6	-50.1	-47.2	-39.2	-21.25	17.9
	HT/VHT20, M8 to M15, M0 to M9 2ss	2	4	-46.6	-45.9			-39.2	-21.25	18.0
	HT/VHT20, M8 to M15, M0 to M9 2ss	3	4	-46.6	-45.9	-45.4		-37.2	-21.25	15.9
	HT/VHT20, M8 to M15, M0 to M9 2ss	4	4	-47.5	-48.2	-49.3	-46.4	-37.7	-21.25	16.5
	HT/VHT20, M16 to M23, M0 to M9 3ss	3	4	-46.6	-45.9	-45.4		-37.2	-21.25	15.9
	HT/VHT20, M16 to M23, M0 to M9 3ss	4	4	-45.2	-48.1	-46.8	-46.5	-36.5	-21.25	15.3
	HT/VHT20 Beam Forming, M0 to M7, M0 to M9 1ss	2	7	-46.6	-45.9			-36.2	-21.25	15.0
	HT/VHT20 Beam Forming, M0 to M7, M0 to M9 1ss	3	9	-50.1	-49.6	-49.1		-35.8	-21.25	14.6
	HT/VHT20 Beam Forming, M0 to M7, M0 to M9 1ss	4	10	-51.3	-53.0	-51.3	-50.8	-35.5	-21.25	14.3
	HT/VHT20 Beam Forming, M8 to M15, M0 to M9 2ss	2	4	-46.6	-45.9			-39.2	-21.25	18.0
	HT/VHT20 Beam Forming, M8 to M15, M0 to M9 2ss	3	6	-46.6	-45.9	-45.4		-35.2	-21.25	13.9
	HT/VHT20 Beam Forming, M8 to M15, M0 to M9 2ss	4	7	-50.1	-49.6	-49.1	-49.0	-36.4	-21.25	15.2
	HT/VHT20 Beam Forming, M16 to M23, M0 to M9 3ss	3	4	-46.6	-45.9	-45.4		-37.2	-21.25	15.9
	HT/VHT20 Beam Forming, M16 to M23, M0 to M9 3ss	4	5	-45.2	-48.1	-46.8	-46.5	-35.5	-21.25	14.3
	HT/VHT20 STBC, M0 to M7	2	4	-46.6	-45.9			-39.2	-21.25	18.0
	HT/VHT20 STBC, M0 to M7	3	4	-46.6	-45.9	-45.4		-37.2	-21.25	15.9
	HT/VHT20 STBC, M0 to M7	4	4	-47.5	-48.2	-49.3	-46.4	-37.7	-21.25	16.5



**Conducted Spurs Peak, 5250 MHz, VHT160, M0 to M7, M0 to M9 1ss**

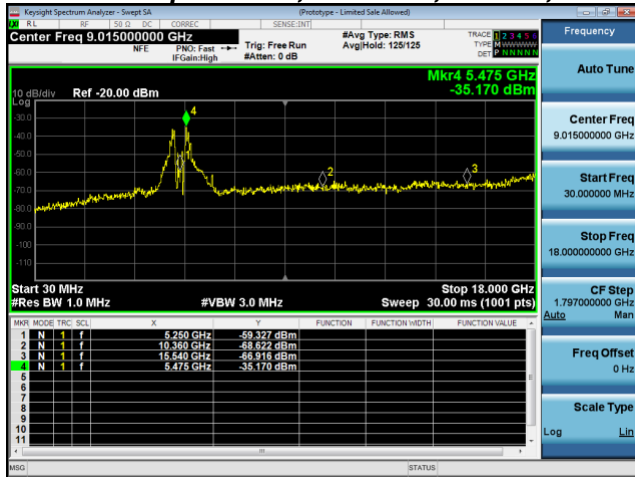

**Antenna A**

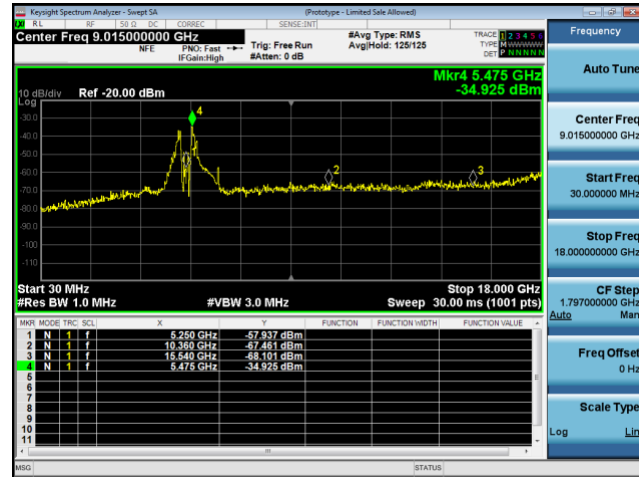

**Antenna B**



## A.4 Conducted Bandedge

**15.205 / 15.209** - Radiated emissions which fall in the restricted bands, as defined in Section 15.205(a), must also comply with the radiated emission limits specified in Section 15.209(a) (see Section 15.205(c)).

Use formula below to substitute conducted measurements in place of radiated measurements

$$E[\text{dB}\mu\text{V}/\text{m}] = \text{EIRP}[\text{dBm}] - 20 \log(d[\text{meters}]) + 104.77, \text{ where } E = \text{field strength and } d = 3 \text{ meter}$$

- 1) Average Plot, Limit= -41.25 dBm eirp
- 2) Peak plot, Limit = -21.25 dBm eirp

### Test Procedure

Ref. KDB 789033 D02 General UNII Test Procedures New Rules v02r01  
ANSI C63.10: 2013

<p><b>Conducted Bandedge</b> Test Procedure</p>
<ol style="list-style-type: none"> <li>1. Connect the antenna port(s) to the spectrum analyzer input.</li> <li>2. Place the radio in continuous transmit mode. Use the procedures in ANSI C63.10: 2013 to substitute conducted measurements in place of radiated measurements.</li> <li>3. Configure Spectrum analyzer as per test parameters below (be sure to enter all losses between the transmitter output and the spectrum analyzer).</li> <li>4. Place a marker at the end of the restricted band closest to the transmit frequency to show compliance. Also measure any emissions in the restricted bands.</li> <li>5. The “measure-and-sum technique” is used for measuring in-band transmit power of a device. In the measure-and-sum approach, the conducted emission level is measured at each antenna port. The measured results at the various antenna ports are then summed mathematically to determine the total emission level from the device. Summing is performed in linear power units. The worst case output is recorded.</li> <li>6. Place a marker at the end of the restricted band closest to the transmit frequency to show compliance. Also measure any emissions in the restricted bands</li> <li>7. Capture graphs and record pertinent measurement data.</li> </ol>

Ref. ANSI C63.10: 2013 section 12.7.6 (peak) & 12.7.7.3 (average, Method VB-A (Alternative))

<p><b>Conducted Bandedge</b> Test parameters restricted Band</p>
<p>RBW = 1 MHz VBW ≥ 3 x RBW for Peak, 100Hz for Average Sweep = Auto couple Detector = Peak Trace = Max Hold.</p>

System Number	Description	Samples	System under test	Support equipment
1	EUT	S01	<input checked="" type="checkbox"/>	<input type="checkbox"/>
	Support	S02	<input type="checkbox"/>	<input checked="" type="checkbox"/>

<p><b>Tested By :</b> Jose Aguirre</p>	<p><b>Date of testing:</b> 1-Nov-17 - 20-Mar-18</p>
<p><b>Test Result : PASS</b></p>	

See Appendix C for list of test equipment



## Average Measurements

Frequency (MHz)	Mode	Tx Paths	Correlated Antenna Gain (dBi)	Tx 1 Bandedge Level (dBm)	Tx 2 Bandedge Level (dBm)	Tx 3 Bandedge Level (dBm)	Tx 4 Bandedge Level (dBm)	Total Tx Bandedge Level (dBm)	Limit (dBm)	Margin (dB)
5250	Non HT160 Duplicate, 6 to 54 Mbps	1	4	-46.7				-42.7	-41.45	1.3
	Non HT160 Duplicate, 6 to 54 Mbps	2	4	-49.4	-51.3			-43.2	-41.45	1.8
	Non HT160 Duplicate, 6 to 54 Mbps	3	4	-49.4	-51.3	-53.4		-42.3	-41.45	0.8
	Non HT160 Duplicate, 6 to 54 Mbps	4	4	-54.8	-52.0	-53.9	-54.3	-43.6	-41.45	2.1
	VHT160, M0 to M7, M0 to M9 1ss	1	4	-49.7				-45.7	-41.45	4.3
	VHT160, M0 to M7, M0 to M9 1ss	2	4	-49.7	-48.2			-41.9	-41.45	0.4
	VHT160, M0 to M7, M0 to M9 1ss	3	4	-51.4	-50.4	-51.0		-42.1	-41.45	0.7
	VHT160, M0 to M7, M0 to M9 1ss	4	4	-53.5	-51.8	-53.0	-52.5	-42.6	-41.45	1.2
	VHT160, M8 to M15, M0 to M9 2ss	2	4	-49.7	-48.2			-41.9	-41.45	0.4
	VHT160, M8 to M15, M0 to M9 2ss	3	4	-51.4	-50.4	-51.0		-42.1	-41.45	0.7
	VHT160, M8 to M15, M0 to M9 2ss	4	4	-53.5	-51.8	-53.0	-52.5	-42.6	-41.45	1.2
	VHT160, M16 to M23, M0 to M9 3ss	3	4	-51.4	-50.4	-51.0		-42.1	-41.45	0.7
	VHT160, M16 to M23, M0 to M9 3ss	4	4	-53.5	-51.8	-53.0	-52.5	-42.6	-41.45	1.2
	VHT160 Beam Forming, M0 to M7, M0 to M9 1ss	2	7	-53.5	-51.8			-42.6	-41.45	1.1
	VHT160 Beam Forming, M0 to M7, M0 to M9 1ss	3	9	-56.9	-55.0	-56.3		-42.2	-41.45	0.8
	VHT160 Beam Forming, M0 to M7, M0 to M9 1ss	4	10	-59.3	-57.7	-58.7	-58.5	-42.5	-41.45	1.0
	VHT160 Beam Forming, M8 to M15, M0 to M9 2ss	2	4	-49.7	-48.2			-41.9	-41.45	0.4
	VHT160 Beam Forming, M8 to M15, M0 to M9 2ss	3	6	-53.5	-51.8	-53.0		-41.9	-41.45	0.5
	VHT160 Beam Forming, M8 to M15, M0 to M9 2ss	4	7	-56.2	-54.1	-55.5	-55.7	-42.3	-41.45	0.8
	VHT160 Beam Forming, M16 to M23, M0 to M9 3ss	3	4	-51.4	-50.4	-51.0		-42.1	-41.45	0.7
VHT160 Beam Forming, M16 to M23, M0 to M9 3ss	4	5	-53.5	-51.8	-53.0	-52.5	-41.6	-41.45	0.2	
VHT160 STBC, M0 to M9 2ss	2	4	-49.7	-48.2			-41.9	-41.45	0.4	
VHT160 STBC, M0 to M9 2ss	3	4	-51.4	-50.4	-51.0		-42.1	-41.45	0.7	
VHT160 STBC, M0 to M9 2ss	4	4	-53.5	-51.8	-53.0	-52.5	-42.6	-41.45	1.2	
5290	Non HT80 Duplicate, 6 to 54 Mbps	1	4	-47.8				-43.8	-41.45	2.3
	Non HT80 Duplicate, 6 to 54 Mbps	2	4	-49.3	-51.9			-43.4	-41.45	1.9
	Non HT80 Duplicate, 6 to 54 Mbps	3	4	-53.2	-53.3	-52.0		-44.0	-41.45	2.6
	Non HT80 Duplicate, 6 to 54 Mbps	4	4	-54.5	-54.2	-52.5	-54.4	-43.8	-41.45	2.3
	VHT80, M0 to M9 1ss	1	4	-49.9				-45.9	-41.45	4.5
	VHT80, M0 to M9 1ss	2	4	-49.9	-49.7			-42.8	-41.45	1.3
	VHT80, M0 to M9 1ss	3	4	-51.1	-50.3	-50.0		-41.7	-41.45	0.2
	VHT80, M0 to M9 1ss	4	4	-52.5	-53.0	-51.7	-51.4	-42.1	-41.45	0.6
	VHT80, M0 to M9 2ss	2	4	-49.9	-49.7			-42.8	-41.45	1.3





VHT80, M0 to M9 2ss	3	4	-51.1	-50.3	-50.0		-41.7	-41.45	0.2	
VHT80, M0 to M9 2ss	4	4	-52.5	-53.0	-51.7	-51.4	-42.1	-41.45	0.6	
VHT80, M0 to M9 3ss	3	4	-51.1	-50.3	-50.0		-41.7	-41.45	0.2	
VHT80, M0 to M9 3ss	4	4	-52.5	-53.0	-51.7	-51.4	-42.1	-41.45	0.6	
VHT80 Beam Forming, M0 to M7, M0 to M9 1ss	2	7	-52.5	-53.0			-42.7	-41.45	1.3	
VHT80 Beam Forming, M0 to M7, M0 to M9 1ss	3	9	-56.0	-56.1	-55.2		-42.0	-41.45	0.5	
VHT80 Beam Forming, M0 to M7, M0 to M9 1ss	4	10	-58.0	-58.7	-58.1	-58.2	-42.2	-41.45	0.8	
VHT80 Beam Forming, M8 to M15, M0 to M9 2ss	2	4	-49.9	-49.7			-42.8	-41.45	1.3	
<b>VHT80 Beam Forming, M8 to M15, M0 to M9 2ss</b>	<b>3</b>	<b>6</b>	<b>-52.5</b>	<b>-53.0</b>	<b>-51.7</b>		<b>-41.6</b>	<b>-41.45</b>	<b>0.1</b>	
VHT80 Beam Forming, M8 to M15, M0 to M9 2ss	4	7	-55.1	-55.2	-54.2	-54.6	-41.7	-41.45	0.3	
VHT80 Beam Forming, M16 to M23, M0 to M9 3ss	3	4	-51.1	-50.3	-50.0		-41.7	-41.45	0.2	
VHT80 Beam Forming, M16 to M23, M0 to M9 3ss	4	5	-54.0	-54.3	-53.1	-53.3	-42.6	-41.45	1.2	
VHT80 STBC, M0 to M9 2ss	2	4	-49.9	-49.7			-42.8	-41.45	1.3	
VHT80 STBC, M0 to M9 2ss	3	4	-51.1	-50.3	-50.0		-41.7	-41.45	0.2	
VHT80 STBC, M0 to M9 2ss	4	4	-52.5	-53.0	-51.7	-51.4	-42.1	-41.45	0.6	
5310	Non HT40 Duplicate, 6 to 54 Mbps	1	4	-47.5				-43.5	-41.35	2.2
	Non HT40 Duplicate, 6 to 54 Mbps	2	4	-54.7	-54.6			-47.6	-41.35	6.3
	Non HT40 Duplicate, 6 to 54 Mbps	3	4	-54.7	-54.6	-53.9		-45.6	-41.35	4.3
	Non HT40 Duplicate, 6 to 54 Mbps	4	4	-57.0	-56.9	-56.2	-55.9	-46.5	-41.35	5.1
	HT/VHT40, M0 to M7, M0 to M9 1ss	1	4	-52.7				-48.7	-41.35	7.4
	HT/VHT40, M0 to M7, M0 to M9 1ss	2	4	-52.7	-51.9			-45.3	-41.35	3.9
	HT/VHT40, M0 to M7, M0 to M9 1ss	3	4	-54.3	-53.1	-52.8		-44.6	-41.35	3.2
	HT/VHT40, M0 to M7, M0 to M9 1ss	4	4	-55.4	-55.0	-53.3	-53.8	-44.3	-41.35	2.9
	HT/VHT40, M8 to M15, M0 to M9 2ss	2	4	-52.7	-51.9			-45.3	-41.35	3.9
	HT/VHT40, M8 to M15, M0 to M9 2ss	3	4	-54.3	-53.1	-52.8		-44.6	-41.35	3.2
	HT/VHT40, M8 to M15, M0 to M9 2ss	4	4	-54.3	-53.1	-52.8	-52.4	-43.1	-41.35	1.7
	HT/VHT40, M16 to M23, M0 to M9 3ss	3	4	-54.3	-53.1	-52.8		-44.6	-41.35	3.2
	HT/VHT40, M16 to M23, M0 to M9 3ss	4	4	-54.3	-53.1	-52.8	-52.4	-43.1	-41.35	1.7
	HT/VHT40 Beam Forming, M0 to M7, M0 to M9 1ss	2	7	-55.4	-55.0			-45.2	-41.35	3.8
	HT/VHT40 Beam Forming, M0 to M7, M0 to M9 1ss	3	9	-58.1	-57.7	-56.4		-43.6	-41.35	2.2
	HT/VHT40 Beam Forming, M0 to M7, M0 to M9 1ss	4	10	-61.1	-62.6	-59.9	-60.7	-44.9	-41.35	3.6
	HT/VHT40 Beam Forming, M8 to M15, M0 to M9 2ss	2	4	-52.7	-51.9			-45.3	-41.35	3.9
	HT/VHT40 Beam Forming, M8 to M15, M0 to M9 2ss	3	6	-55.4	-55.0	-53.3		-43.7	-41.35	2.3
	HT/VHT40 Beam Forming, M8 to M15, M0 to M9 2ss	4	7	-60.1	-59.2	-59.2	-59.4	-46.4	-41.35	5.1
	HT/VHT40 Beam Forming, M16 to M23, M0 to M9 3ss	3	4	-54.3	-53.1	-52.8		-44.6	-41.35	3.2
HT/VHT40 Beam Forming, M16 to M23, M0 to M9 3ss	4	5	-55.4	-55.0	-53.3	-53.8	-43.3	-41.35	1.9	
HT/VHT40 STBC, M0 to M7	2	4	-52.7	-51.9			-45.3	-41.35	3.9	
HT/VHT40 STBC, M0 to M7	3	4	-54.3	-53.1	-52.8		-44.6	-41.35	3.2	
HT/VHT40 STBC, M0 to M7	4	4	-54.3	-53.1	-52.8	-52.4	-43.1	-41.35	1.7	





5320	Non HT20, 6 to 54 Mbps	1	4	-55.2				-51.2	-41.25	10.0
	Non HT20, 6 to 54 Mbps	2	4	-55.2	-54.2			-47.7	-41.25	6.4
	Non HT20, 6 to 54 Mbps	3	4	-59.1	-58.6	-59.1		-50.2	-41.25	8.9
	Non HT20, 6 to 54 Mbps	4	4	-60.8	-60.0	-60.5	-61.9	-50.7	-41.25	9.5
	Non HT20 Beam Forming, 6 to 54 Mbps	2	7	-55.2	-54.2			-44.7	-41.25	3.4
	Non HT20 Beam Forming, 6 to 54 Mbps	3	9	-59.6	-58.9	-59.9		-45.7	-41.25	4.4
	Non HT20 Beam Forming, 6 to 54 Mbps	4	10	-61.3	-63.9	-60.9	-61.9	-45.8	-41.25	4.6
	HT/VHT20, M0 to M7, M0 to M9 1ss	1	4	-54.4				-50.4	-41.25	9.1
	HT/VHT20, M0 to M7, M0 to M9 1ss	2	4	-54.4	-53.8			-47.1	-41.25	5.8
	HT/VHT20, M0 to M7, M0 to M9 1ss	3	4	-58.9	-58.3	-58.0		-49.6	-41.25	8.4
	HT/VHT20, M0 to M7, M0 to M9 1ss	4	4	-60.4	-59.3	-60.2	-60.8	-50.1	-41.25	8.9
	HT/VHT20, M8 to M15, M0 to M9 2ss	2	4	-54.4	-53.8			-47.1	-41.25	5.8
	HT/VHT20, M8 to M15, M0 to M9 2ss	3	4	-54.4	-53.8	-53.7		-45.2	-41.25	3.9
	HT/VHT20, M8 to M15, M0 to M9 2ss	4	4	-57.5	-57.1	-56.5	-57.1	-47.0	-41.25	5.8
	HT/VHT20, M16 to M23, M0 to M9 3ss	3	4	-54.4	-53.8	-53.7		-45.2	-41.25	3.9
	HT/VHT20, M16 to M23, M0 to M9 3ss	4	4	-55.5	-54.9	-55.0	-55.9	-45.3	-41.25	4.0
	HT/VHT20 Beam Forming, M0 to M7, M0 to M9 1ss	2	7	-54.4	-53.8			-44.1	-41.25	2.8
	HT/VHT20 Beam Forming, M0 to M7, M0 to M9 1ss	3	9	-60.0	-59.0	-59.6		-45.7	-41.25	4.5
	HT/VHT20 Beam Forming, M0 to M7, M0 to M9 1ss	4	10	-61.1	-63.9	-61.0	-61.9	-45.8	-41.25	4.6
	HT/VHT20 Beam Forming, M8 to M15, M0 to M9 2ss	2	4	-54.4	-53.8			-47.1	-41.25	5.8
	HT/VHT20 Beam Forming, M8 to M15, M0 to M9 2ss	3	6	-54.4	-53.8	-53.7		-43.2	-41.25	1.9
	HT/VHT20 Beam Forming, M8 to M15, M0 to M9 2ss	4	7	-60.0	-59.0	-59.6	-60.1	-46.6	-41.25	5.4
	HT/VHT20 Beam Forming, M16 to M23, M0 to M9 3ss	3	4	-54.4	-53.8	-53.7		-45.2	-41.25	3.9
	HT/VHT20 Beam Forming, M16 to M23, M0 to M9 3ss	4	5	-55.5	-54.9	-55.0	-55.9	-44.3	-41.25	3.0
	HT/VHT20 STBC, M0 to M7	2	4	-54.4	-53.8			-47.1	-41.25	5.8
	HT/VHT20 STBC, M0 to M7	3	4	-54.4	-53.8	-53.7		-45.2	-41.25	3.9
	HT/VHT20 STBC, M0 to M7	4	4	-57.5	-57.1	-56.5	-57.1	-47.0	-41.25	5.8



**Conducted Bandedge Average, 5290 MHz, VHT80 Beam Forming, M8 to M15, M0 to M9 2ss**

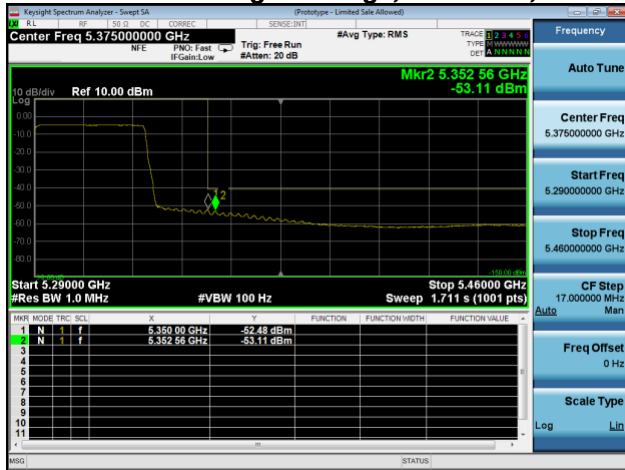

**Antenna A**

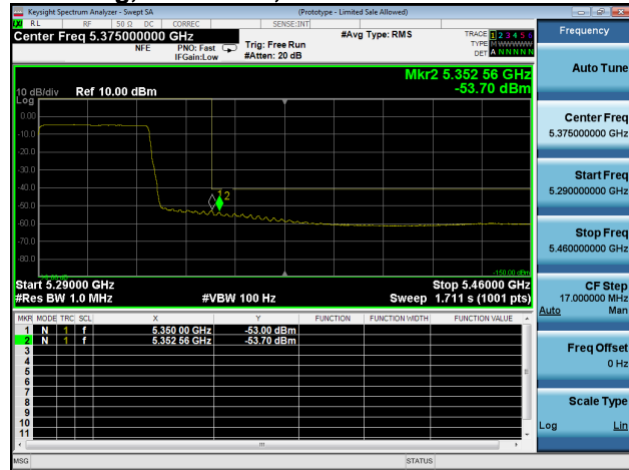

**Antenna B**

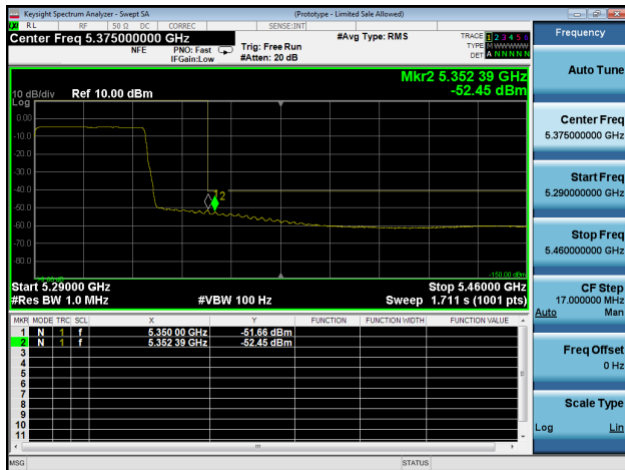

**Antenna C**



**Peak Measurements**

Frequency (MHz)	Mode	Tx Paths	Correlated Antenna Gain (dBi)	Tx 1 Bandedge Level (dBm)	Tx 2 Bandedge Level (dBm)	Tx 3 Bandedge Level (dBm)	Tx 4 Bandedge Level (dBm)	Total Tx Bandedge Level (dBm)	Limit (dBm)	Margin (dB)
5250	Non HT160 Duplicate, 6 to 54 Mbps	1	4	-33.6				-29.6	-21.45	8.2
	Non HT160 Duplicate, 6 to 54 Mbps	2	4	-41.3	-38.2			-32.5	-21.45	11.0
	Non HT160 Duplicate, 6 to 54 Mbps	3	4	-41.3	-38.2	-38.1		-30.2	-21.45	8.7
	Non HT160 Duplicate, 6 to 54 Mbps	4	4	-40.6	-42.3	-43.7	-40.0	-31.4	-21.45	9.9
	VHT160, M0 to M7, M0 to M9 1ss	1	4	-33.5				-29.5	-21.45	8.1
	VHT160, M0 to M7, M0 to M9 1ss	2	4	-33.5	-34.9			-27.1	-21.45	5.7
	VHT160, M0 to M7, M0 to M9 1ss	3	4	-33.7	-33.2	-34.9		-25.1	-21.45	3.7
	VHT160, M0 to M7, M0 to M9 1ss	4	4	-35.0	-34.2	-34.7	-34.2	-24.5	-21.45	3.0
	VHT160, M8 to M15, M0 to M9 2ss	2	4	-33.5	-34.9			-27.1	-21.45	5.7
	VHT160, M8 to M15, M0 to M9 2ss	3	4	-33.7	-33.2	-34.9		-25.1	-21.45	3.7
	VHT160, M8 to M15, M0 to M9 2ss	4	4	-35.0	-34.2	-34.7	-34.2	-24.5	-21.45	3.0
	VHT160, M16 to M23, M0 to M9 3ss	3	4	-33.7	-33.2	-34.9		-25.1	-21.45	3.7
	VHT160, M16 to M23, M0 to M9 3ss	4	4	-35.0	-34.2	-34.7	-34.2	-24.5	-21.45	3.0
	VHT160 Beam Forming, M0 to M7, M0 to M9 1ss	2	7	-35.0	-34.2			-24.6	-21.45	3.1
	VHT160 Beam Forming, M0 to M7, M0 to M9 1ss	3	9	-40.7	-40.0	-41.3		-26.9	-21.45	5.4
	VHT160 Beam Forming, M0 to M7, M0 to M9 1ss	4	10	-43.8	-40.9	-40.8	-40.9	-25.4	-21.45	4.0
	VHT160 Beam Forming, M8 to M15, M0 to M9 2ss	2	4	-33.5	-34.9			-27.1	-21.45	5.7
	VHT160 Beam Forming, M8 to M15, M0 to M9 2ss	3	6	-35.0	-34.2	-34.7		-23.8	-21.45	2.4
	VHT160 Beam Forming, M8 to M15, M0 to M9 2ss	4	7	-39.9	-38.9	-39.2	-39.1	-26.2	-21.45	4.8
	VHT160 Beam Forming, M16 to M23, M0 to M9 3ss	3	4	-33.7	-33.2	-34.9		-25.1	-21.45	3.7
VHT160 Beam Forming, M16 to M23, M0 to M9 3ss	4	5	-35.0	-34.2	-34.7	-34.2	-23.5	-21.45	2.0	
VHT160 STBC, M0 to M9 2ss	2	4	-33.5	-34.9			-27.1	-21.45	5.7	
VHT160 STBC, M0 to M9 2ss	3	4	-33.7	-33.2	-34.9		-25.1	-21.45	3.7	
VHT160 STBC, M0 to M9 2ss	4	4	-35.0	-34.2	-34.7	-34.2	-24.5	-21.45	3.0	
5290	Non HT80 Duplicate, 6 to 54 Mbps	1	4	-26.3				-22.3	-21.45	0.9
	Non HT80 Duplicate, 6 to 54 Mbps	2	4	-29.9	-27.5			-21.5	-21.45	0.1
	Non HT80 Duplicate, 6 to 54 Mbps	3	4	-30.3	-31.7	-33.3		-22.8	-21.45	1.4
	Non HT80 Duplicate, 6 to 54 Mbps	4	4	-36.0	-35.3	-35.6	-36.6	-25.8	-21.45	4.4
	VHT80, M0 to M9 1ss	1	4	-31.7				-27.7	-21.45	6.3
	VHT80, M0 to M9 1ss	2	4	-31.7	-31.3			-24.5	-21.45	3.0
	VHT80, M0 to M9 1ss	3	4	-33.8	-28.3	-33.0		-22.2	-21.45	0.8
	VHT80, M0 to M9 1ss	4	4	-34.9	-34.2	-34.4	-34.8	-24.5	-21.45	3.1
	VHT80, M0 to M9 2ss	2	4	-31.7	-31.3			-24.5	-21.45	3.0



VHT80, M0 to M9 2ss	3	4	-33.8	-28.3	-33.0		-22.2	-21.45	0.8	
VHT80, M0 to M9 2ss	4	4	-34.9	-34.2	-34.4	-34.8	-24.5	-21.45	3.1	
VHT80, M0 to M9 3ss	3	4	-33.8	-28.3	-33.0		-22.2	-21.45	0.8	
VHT80, M0 to M9 3ss	4	4	-34.9	-34.2	-34.4	-34.8	-24.5	-21.45	3.1	
VHT80 Beam Forming, M0 to M7, M0 to M9 1ss	2	7	-34.9	-34.2			-24.5	-21.45	3.1	
VHT80 Beam Forming, M0 to M7, M0 to M9 1ss	3	9	-37.0	-37.3	-37.5		-23.5	-21.45	2.0	
VHT80 Beam Forming, M0 to M7, M0 to M9 1ss	4	10	-39.3	-38.9	-39.1	-39.6	-23.2	-21.45	1.7	
VHT80 Beam Forming, M8 to M15, M0 to M9 2ss	2	4	-31.7	-31.3			-24.5	-21.45	3.0	
VHT80 Beam Forming, M8 to M15, M0 to M9 2ss	3	6	-34.9	-34.2	-34.4		-23.7	-21.45	2.3	
VHT80 Beam Forming, M8 to M15, M0 to M9 2ss	4	7	-37.9	-35.9	-36.6	-35.8	-23.5	-21.45	2.0	
VHT80 Beam Forming, M16 to M23, M0 to M9 3ss	3	4	-33.8	-28.3	-33.0		-22.2	-21.45	0.8	
VHT80 Beam Forming, M16 to M23, M0 to M9 3ss	4	5	-35.2	-34.9	-35.5	-34.3	-23.9	-21.45	2.5	
VHT80 STBC, M0 to M9 2ss	2	4	-31.7	-31.3			-24.5	-21.45	3.0	
VHT80 STBC, M0 to M9 2ss	3	4	-33.8	-28.3	-33.0		-22.2	-21.45	0.8	
VHT80 STBC, M0 to M9 2ss	4	4	-34.9	-34.2	-34.4	-34.8	-24.5	-21.45	3.1	
5310	Non HT40 Duplicate, 6 to 54 Mbps	1	4	-26.4				-22.4	-21.35	1.1
	Non HT40 Duplicate, 6 to 54 Mbps	2	4	-30.1	-31.0			-23.5	-21.35	2.2
	Non HT40 Duplicate, 6 to 54 Mbps	3	4	-30.1	-31.0	-31.8		-22.1	-21.35	0.8
	Non HT40 Duplicate, 6 to 54 Mbps	4	4	-34.7	-28.4	-31.4	-37.2	-21.7	-21.35	0.3
	HT/VHT40, M0 to M7, M0 to M9 1ss	1	4	-31.1				-27.1	-21.35	5.8
	HT/VHT40, M0 to M7, M0 to M9 1ss	2	4	-31.1	-30.5			-23.8	-21.35	2.4
	HT/VHT40, M0 to M7, M0 to M9 1ss	3	4	-33.0	-29.6	-32.4		-22.6	-21.35	1.3
	HT/VHT40, M0 to M7, M0 to M9 1ss	4	4	-34.4	-31.1	-32.6	-32.2	-22.4	-21.35	1.0
	HT/VHT40, M8 to M15, M0 to M9 2ss	2	4	-31.1	-30.5			-23.8	-21.35	2.4
	HT/VHT40, M8 to M15, M0 to M9 2ss	3	4	-33.0	-29.6	-32.4		-22.6	-21.35	1.3
	HT/VHT40, M8 to M15, M0 to M9 2ss	4	4	-33.0	-29.6	-32.4	-33.2	-21.8	-21.35	0.4
	HT/VHT40, M16 to M23, M0 to M9 3ss	3	4	-33.0	-29.6	-32.4		-22.6	-21.35	1.3
	HT/VHT40, M16 to M23, M0 to M9 3ss	4	4	-33.0	-29.6	-32.4	-33.2	-21.8	-21.35	0.4
	HT/VHT40 Beam Forming, M0 to M7, M0 to M9 1ss	2	7	-34.4	-31.1			-22.4	-21.35	1.1
	HT/VHT40 Beam Forming, M0 to M7, M0 to M9 1ss	3	9	-35.1	-35.0	-35.6		-21.5	-21.35	0.1
	HT/VHT40 Beam Forming, M0 to M7, M0 to M9 1ss	4	10	-35.2	-39.3	-37.4	-39.7	-21.5	-21.35	0.1
	HT/VHT40 Beam Forming, M8 to M15, M0 to M9 2ss	2	4	-31.1	-30.5			-23.8	-21.35	2.4
	HT/VHT40 Beam Forming, M8 to M15, M0 to M9 2ss	3	6	-34.4	-31.1	-32.6		-21.7	-21.35	0.4
	HT/VHT40 Beam Forming, M8 to M15, M0 to M9 2ss	4	7	-36.7	-34.3	-35.0	-34.0	-21.9	-21.35	0.5
	HT/VHT40 Beam Forming, M16 to M23, M0 to M9 3ss	3	4	-33.0	-29.6	-32.4		-22.6	-21.35	1.3
	HT/VHT40 Beam Forming, M16 to M23, M0 to M9 3ss	4	5	-34.4	-31.1	-32.6	-32.2	-21.4	-21.35	0.0
HT/VHT40 STBC, M0 to M7	2	4	-31.1	-30.5			-23.8	-21.35	2.4	
HT/VHT40 STBC, M0 to M7	3	4	-33.0	-29.6	-32.4		-22.6	-21.35	1.3	
HT/VHT40 STBC, M0 to M7	4	4	-33.0	-29.6	-32.4	-33.2	-21.8	-21.35	0.4	



5320	Non HT20, 6 to 54 Mbps	1	4	-32.2				-28.2	-21.25	7.0
	Non HT20, 6 to 54 Mbps	2	4	-32.2	-32.0			-25.1	-21.25	3.8
	Non HT20, 6 to 54 Mbps	3	4	-34.6	-34.2	-34.2		-25.6	-21.25	4.3
	Non HT20, 6 to 54 Mbps	4	4	-36.3	-37.0	-37.8	-37.2	-27.0	-21.25	5.8
	Non HT20 Beam Forming, 6 to 54 Mbps	2	7	-32.2	-32.0			-22.1	-21.25	0.8
	Non HT20 Beam Forming, 6 to 54 Mbps	3	9	-35.2	-34.7	-36.1		-21.5	-21.25	0.3
	Non HT20 Beam Forming, 6 to 54 Mbps	4	10	-38.9	-37.7	-38.8	-37.9	-22.3	-21.25	1.0
	HT/VHT20, M0 to M7, M0 to M9 1ss	1	4	-32.2				-28.2	-21.25	7.0
	HT/VHT20, M0 to M7, M0 to M9 1ss	2	4	-32.2	-32.0			-25.1	-21.25	3.8
	HT/VHT20, M0 to M7, M0 to M9 1ss	3	4	-34.4	-34.0	-34.3		-25.5	-21.25	4.2
	HT/VHT20, M0 to M7, M0 to M9 1ss	4	4	-36.3	-37.4	-36.8	-35.7	-26.5	-21.25	5.2
	HT/VHT20, M8 to M15, M0 to M9 2ss	2	4	-32.2	-32.0			-25.1	-21.25	3.8
	HT/VHT20, M8 to M15, M0 to M9 2ss	3	4	-32.2	-32.0	-31.9		-23.3	-21.25	2.0
	HT/VHT20, M8 to M15, M0 to M9 2ss	4	4	-34.0	-33.4	-33.7	-34.2	-23.8	-21.25	2.5
	HT/VHT20, M16 to M23, M0 to M9 3ss	3	4	-32.2	-32.0	-31.9		-23.3	-21.25	2.0
	HT/VHT20, M16 to M23, M0 to M9 3ss	4	4	-34.3	-32.0	-33.3	-33.4	-23.2	-21.25	1.9
	HT/VHT20 Beam Forming, M0 to M7, M0 to M9 1ss	2	7	-32.2	-32.0			-22.1	-21.25	0.8
	HT/VHT20 Beam Forming, M0 to M7, M0 to M9 1ss	3	9	-35.2	-35.4	-35.9		-21.7	-21.25	0.5
	HT/VHT20 Beam Forming, M0 to M7, M0 to M9 1ss	4	10	-38.3	-38.3	-38.4	-37.8	-22.2	-21.25	0.9
	HT/VHT20 Beam Forming, M8 to M15, M0 to M9 2ss	2	4	-32.2	-32.0			-25.1	-21.25	3.8
	<b>HT/VHT20 Beam Forming, M8 to M15, M0 to M9 2ss</b>	<b>3</b>	<b>6</b>	<b>-32.2</b>	<b>-32.0</b>	<b>-31.9</b>		<b>-21.3</b>	<b>-21.25</b>	<b>0.0</b>
	HT/VHT20 Beam Forming, M8 to M15, M0 to M9 2ss	4	7	-35.2	-35.4	-35.9	-35.4	-22.4	-21.25	1.2
	HT/VHT20 Beam Forming, M16 to M23, M0 to M9 3ss	3	4	-32.2	-32.0	-31.9		-23.3	-21.25	2.0
	HT/VHT20 Beam Forming, M16 to M23, M0 to M9 3ss	4	5	-34.3	-32.0	-33.3	-33.4	-22.2	-21.25	0.9
	HT/VHT20 STBC, M0 to M7	2	4	-32.2	-32.0			-25.1	-21.25	3.8
	HT/VHT20 STBC, M0 to M7	3	4	-32.2	-32.0	-31.9		-23.3	-21.25	2.0
	HT/VHT20 STBC, M0 to M7	4	4	-34.0	-33.4	-33.7	-34.2	-23.8	-21.25	2.5



**Conducted Bandedge Peak, 5320 MHz, HT/VHT20 Beam Forming, M8 to M15, M0 to M9 2ss**

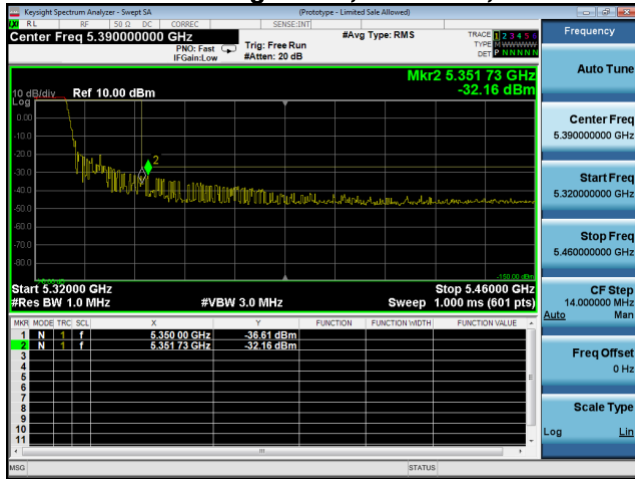

Antenna A

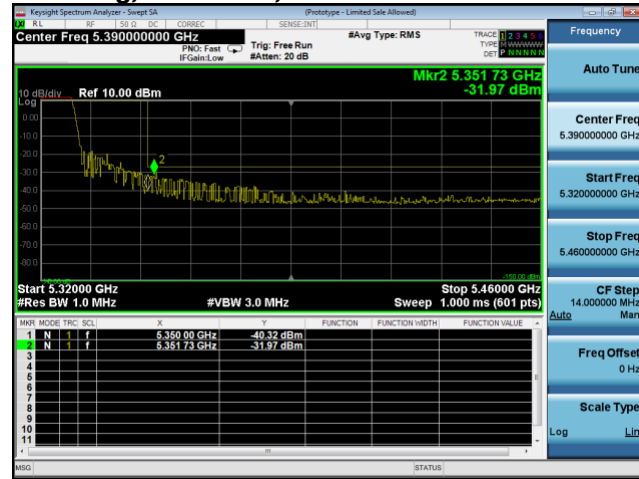

Antenna B





## A.5 Duty Cycle

The zero-span mode on a spectrum analyzer or EMI receiver if the response time and spacing between bins on the sweep are sufficient to permit accurate measurements of the ON and OFF times of the transmitted signal:

- 1) Set the center frequency of the instrument to the center frequency of the transmission.
- 2) Set  $RBW \geq OBW$  if possible; otherwise, set RBW to the largest available value.
- 3) Set  $VBW \geq RBW$ . Set detector = peak or average.

Add  $[10 \log(1/D)]$ , where D is the duty cycle, to the measured value where it is needed  
 For example, add  $[10 \log(1/0.25)] = 6 \text{ dB}$  if the duty cycle is 25%

### 20MHz BW Duty Cycle worst case m0

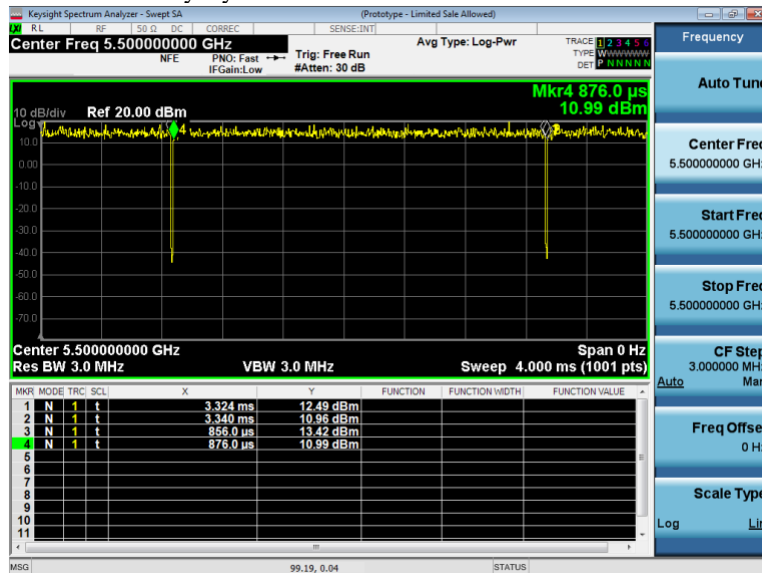

The Duty cycle is 99.2%, no correction is needed for measurements of 20MHz BW.



40MHz BW Duty Cycle worst case m0

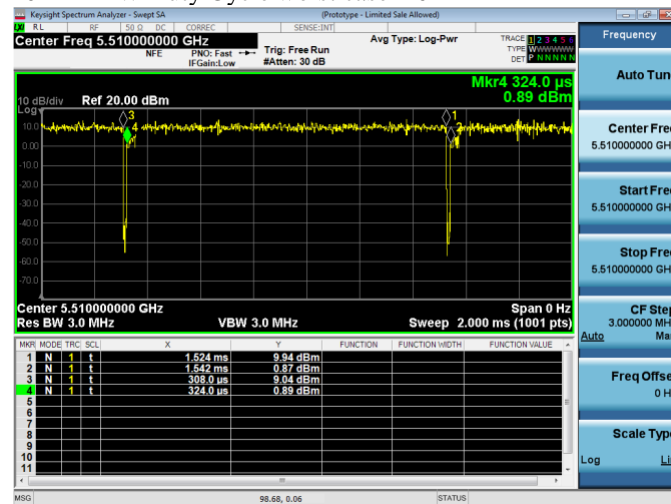

The Duty cycle of 40MHz BW is 98.7%, a 0.1dB CF is added to measurements.

Time ON = 1.524ms – 0.324ms = 1.2 ms  
 Period = 1.524ms – 0.308ms = 1.216ms  
 Duty Cycle = Time ON / Period = 1.2/1.216ms = 0.9868  
 Duty Cycle Correction factor = 10 log (1/D) = 0.06dB

80MHz BW Duty Cycle worst case m0x1

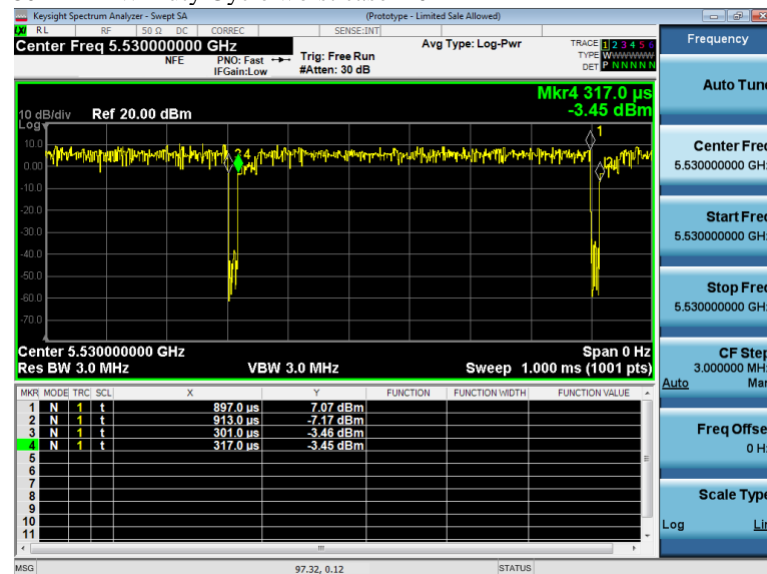

The Duty cycle of 80MHz BW is 97.3%, a 0.2dB CF is added to measurements.

Time ON = 897us – 317us = 580us  
 Period = 897us – 301us = 596us  
 Duty Cycle = Time ON / Period = 580/596us = 0.9732  
 Duty Cycle Correction factor = 10 log (1/D) = 0.12dB





## 160MHz BW Duty Cycle worst case m0x1

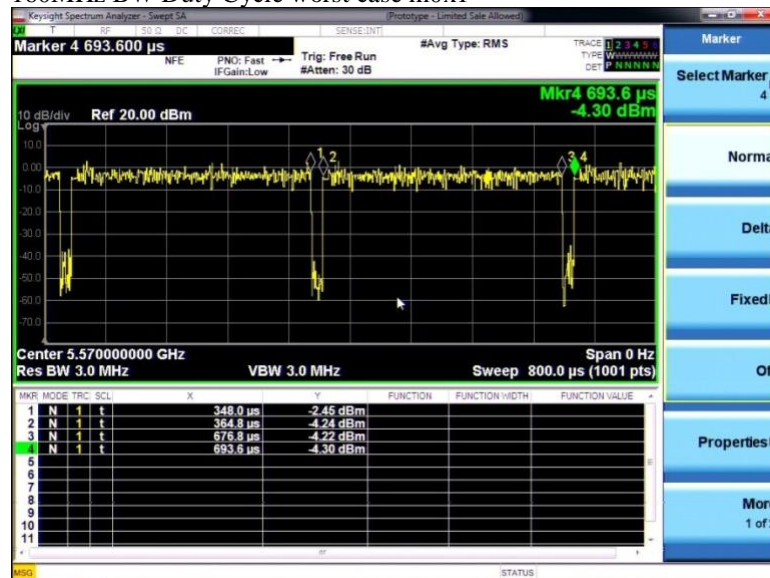

The Duty cycle of 160MHz BW is 95%, a 0.2dB CF is added to measurements.

**Time ON = 676.8us – 364.8us = 311.8us**

**Period = 676.8us – 348us = 328.8us**

**Duty Cycle = Time ON / Period = 311.8/328.8us = 0.9482**

**Duty Cycle Correction factor = 10 log (1/D) = 0.2dB**

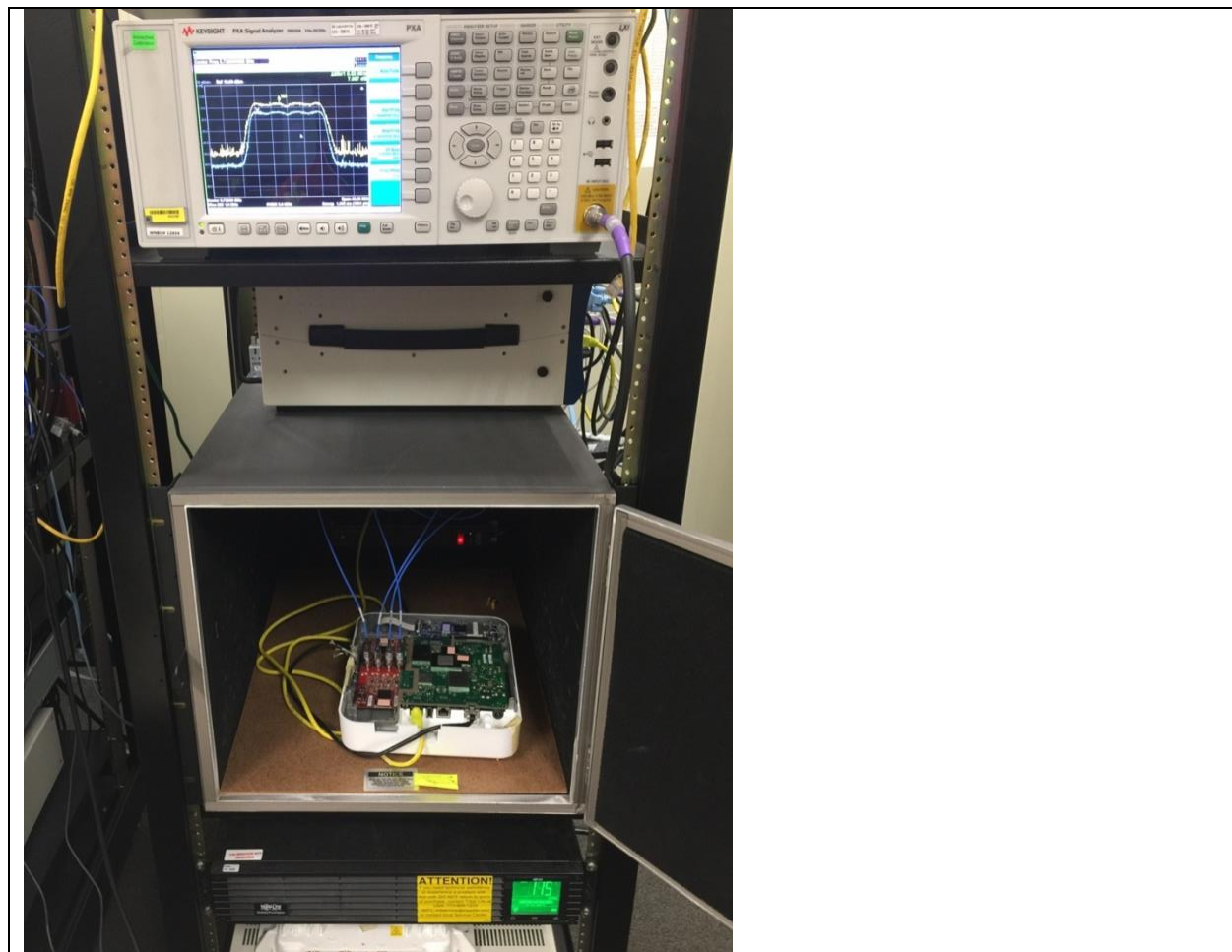

**Title:** Physical Test Arrangement Photograph

This is a dual band 2.4GHz / 5GHz device. All ports in this test set up photo are connected as all testing is automated. Section 2.6 of this test report given an overview of the different Tx antenna combinations used by this device.

### Appendix B: Emission Test Results

Testing Laboratory: Cisco Systems, Inc., 125 West Tasman Drive, San Jose, CA 95134, USA

### Radiated Emission Setup Diagram-Below 1G

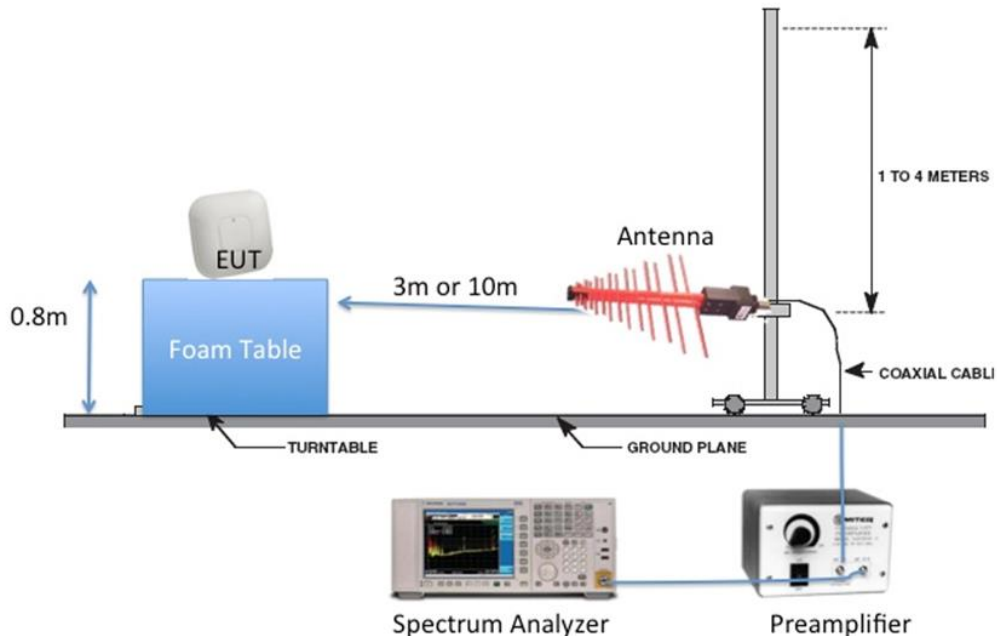

### Radiated Emission Setup Diagram-Above 1G

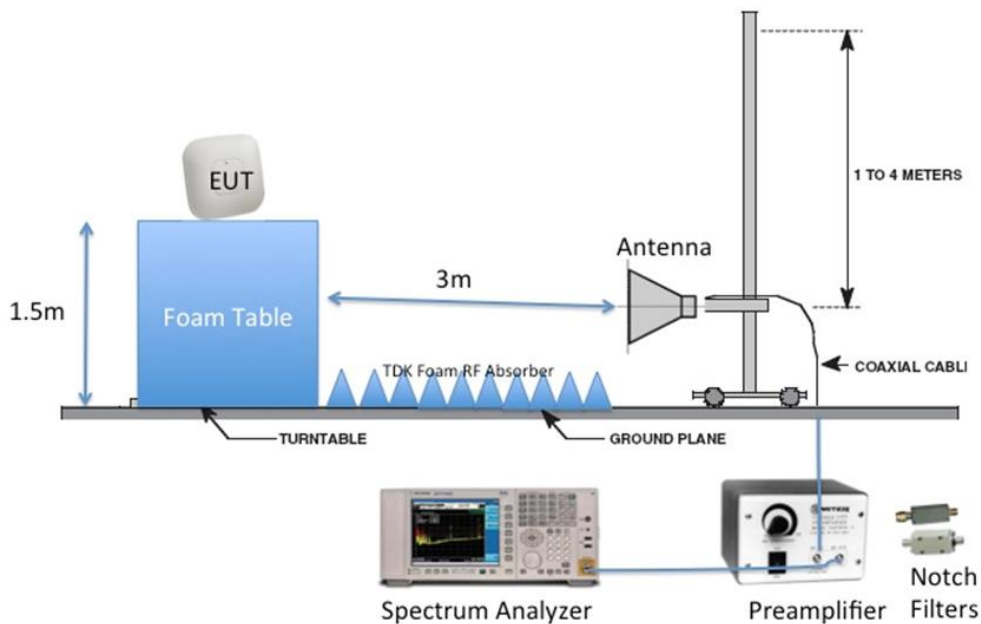



## B.1 Radiated Spurious Emissions

**15.407** (b) *Undesirable emission limits.* Except as shown in paragraph (b) (7) of this section, the maximum emissions outside of the frequency bands of operation shall be attenuated in accordance with the following limits:

(2) For transmitters operating in the 5.25-5.35 GHz band: All emissions outside of the 5.15-5.35 GHz band shall not exceed an e.i.r.p. of -27 dBm/MHz.

### 15.205 / 15.209

(7) The provisions of 15.205 apply to intentional radiators operating under this section.

(6) Unwanted emissions below 1 GHz must comply with the general field strength limits set forth in 15.209.

**Ref.** ANSI C63.10: 2013 section 12.7.6 (peak) & 12.7.7.3 (average)

Using Vasona, configure the spectrum analyzer as shown below (be sure to enter all losses between the transmitter output and the spectrum analyzer). Place the radio in continuous transmit mode.

Span:	1GHz – 18 GHz/18GHz-26G/26GHz-40GHz
Reference Level:	80 dBuV
Attenuation:	10 dB
Sweep Time:	Coupled
Resolution Bandwidth:	1MHz
Video Bandwidth:	3 MHz
Detector:	Peak / Average

Terminate the access Point RF ports with 50 ohm loads.

Maximize Turntable (find worst case table angle), Maximize Antenna (find worst case height)

Save 2 plots: 1) Average plot (Vertical and Horizontal), Limit= 54dBuV/m @3m  
 2) Peak plot (Vertical and Horizontal), Limit = 74dBuV/m @3m

Place a marker at the end of the restricted band closest to the transmit frequency to show compliance. Also measure any emissions in the restricted bands.

This report represents the worst case data for all supported operating modes and antennas. The 20MHz Channel plan is worst case. There are no measurable emissions above 18 GHz.

System Number	Description	Samples	System under test	Support equipment
1	EUT	S01	<input checked="" type="checkbox"/>	<input type="checkbox"/>
	Support	S02	<input type="checkbox"/>	<input checked="" type="checkbox"/>

<b>Tested By :</b> Jose Aguirre	<b>Date of testing:</b> 10-Feb-18 – 16-Feb-18
<b>Test Result : PASS</b>	

See Appendix C for list of test equipment

**B.1.A Transmitter Radiated Spurious Emissions-Average Worst Case**

Frequency (MHz)	Mode	Data Rate (Mbps)	Spurious Emission Level (dBuV/m)	Limit (dBuV/m)	Margin (MHz)
5260	Non HT20, 6 to 54 Mbps	6	50.0	54.0	4.0
5300	Non HT20, 6 to 54 Mbps	6	50.3	54.0	3.7
5320	Non HT20, 6 to 54 Mbps	6	50.3	54.0	3.7



**Average Radiated Transmitter Spurs, 5260MHz, 6 to 54 Mbps**

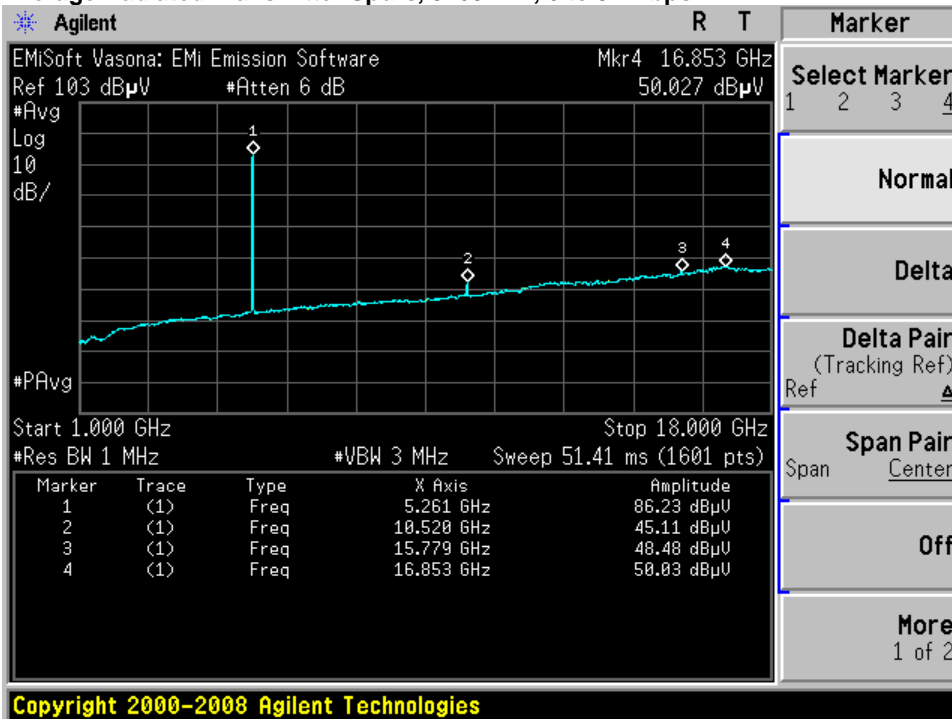

**Average Radiated Transmitter Spurs, 5300 MHz, 6 to 54 Mbps**

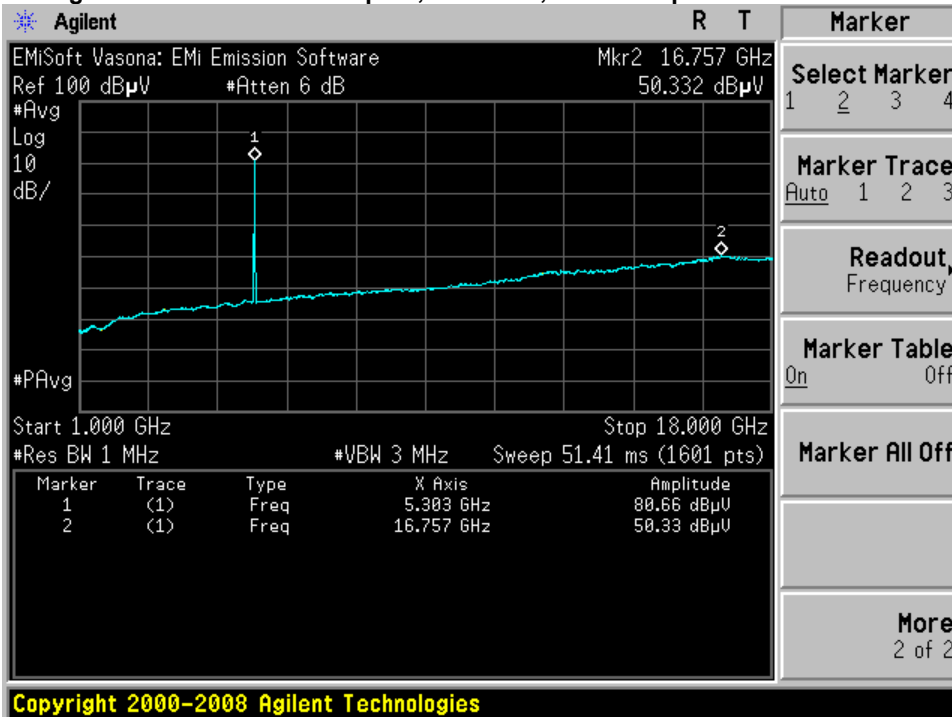



**Average Radiated Transmitter Spurs, 5320 MHz, 6 to 54 Mbps**

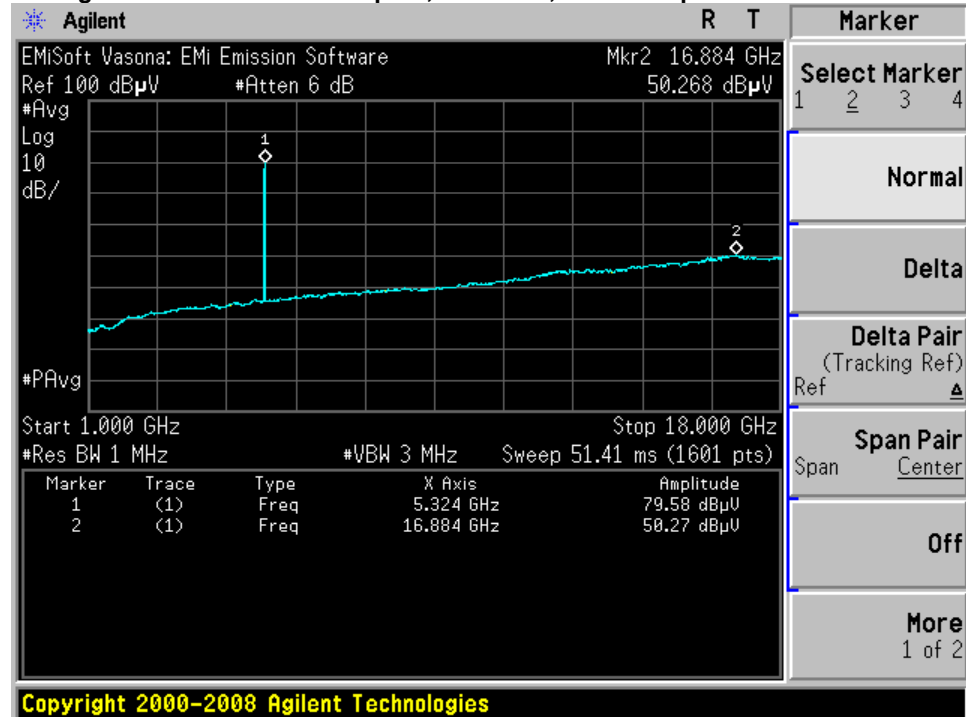



**Average Radiated Transmitter Spurs, All rates, All Modes 18GHz – 26.5GHz**

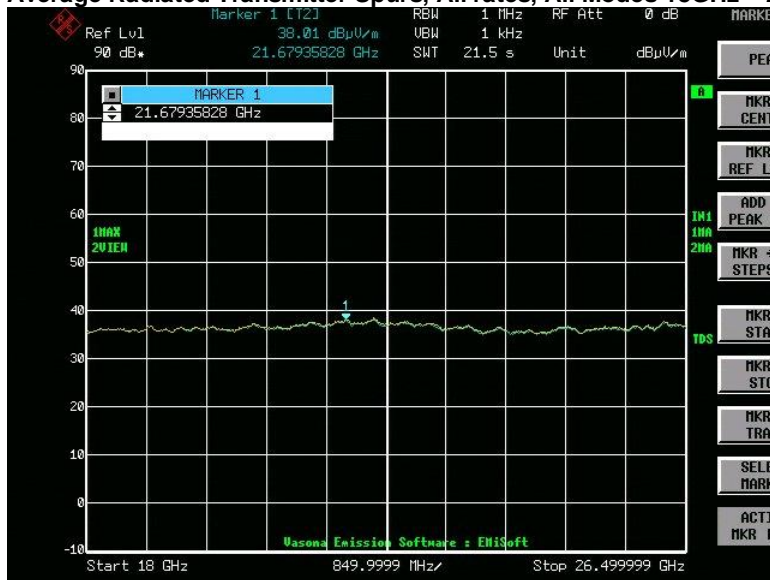

**Average Radiated Transmitter Spurs, All rates, All Modes 26.5GHz – 40GHz**

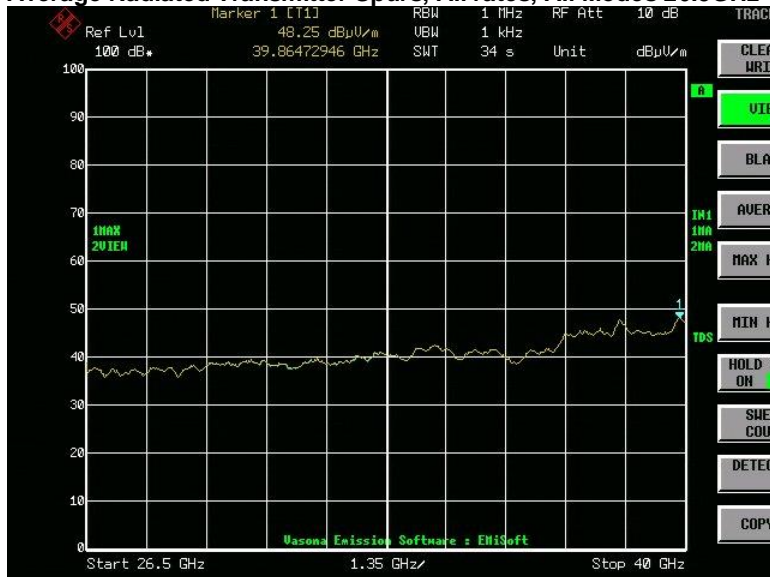

No emissions seen above 18GHz. The plots above are representative of all modes tested.



**B.1.P Transmitter Radiated Spurious Emissions-Peak Worst Case**

<b>Frequency (MHz)</b>	<b>Mode</b>	<b>Data Rate (Mbps)</b>	<b>Spurious Emission Level (dBuV/m)</b>	<b>Limit (dBuV/m)</b>	<b>Margin (MHz)</b>
5260	Non HT20, 6 to 54 Mbps	6	<b>62.2</b>	74.0	11.8
5300	Non HT20, 6 to 54 Mbps	6	<b>61.5</b>	74.0	12.5
5320	Non HT20, 6 to 54 Mbps	6	<b>61.5</b>	74.0	12.5



**Peak Radiated Transmitter Spurs, 5260 MHz, 6 to 54 Mbps**

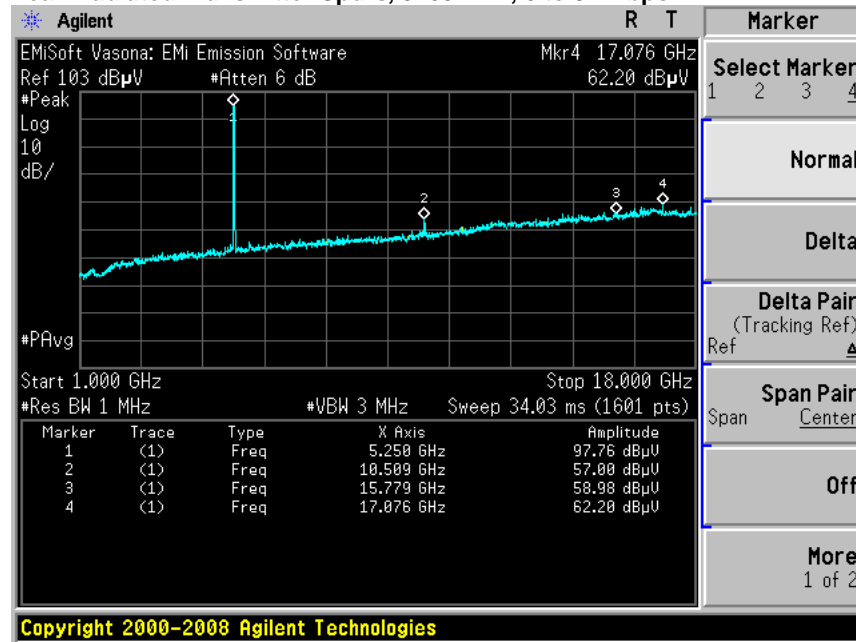

**Peak Radiated Transmitter Spurs, 5300 MHz, 6 to 54 Mbps**

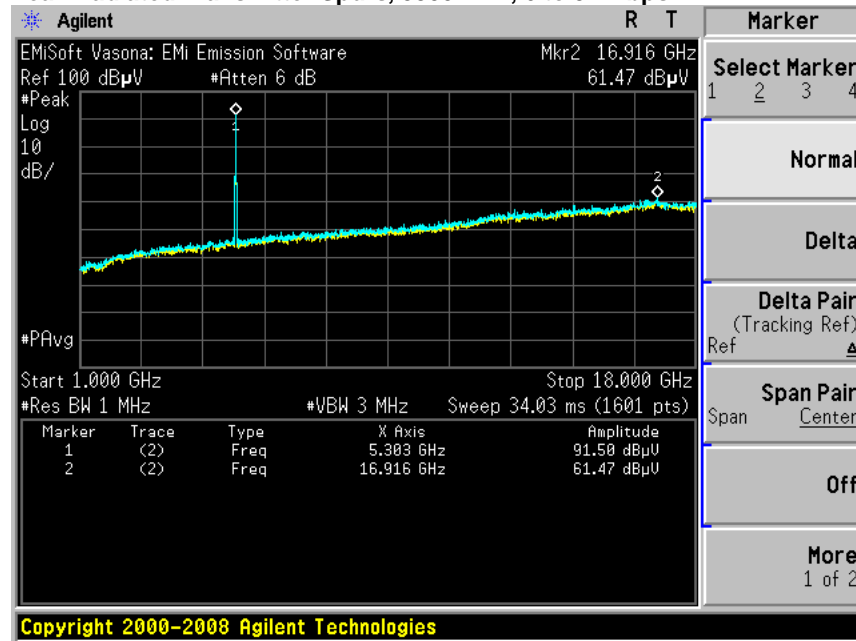



**Peak Radiated Transmitter Spurs, 5320 MHz, 6 to 54 Mbps**

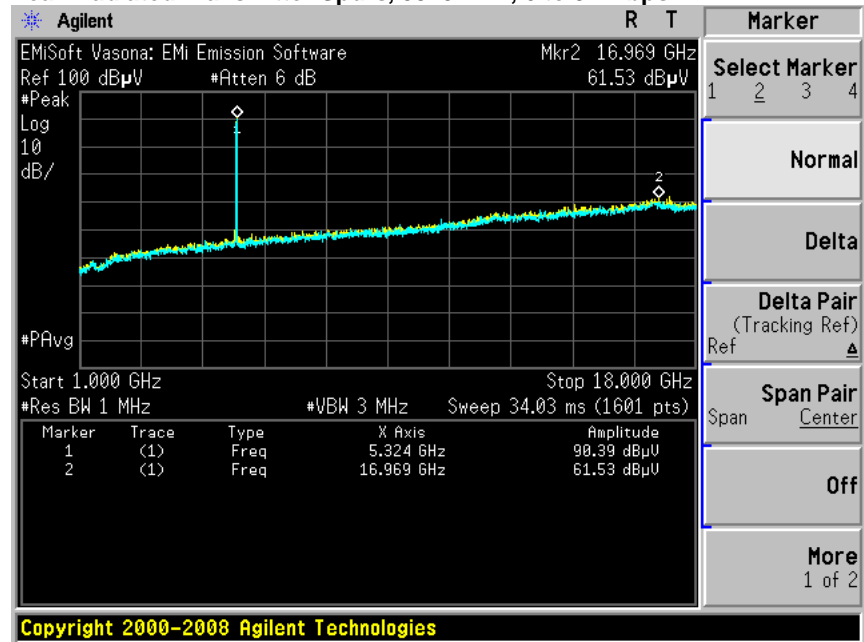



**Peak Radiated Transmitter Spurs, All rates, All Modes 18GHz to 26.5GHz**

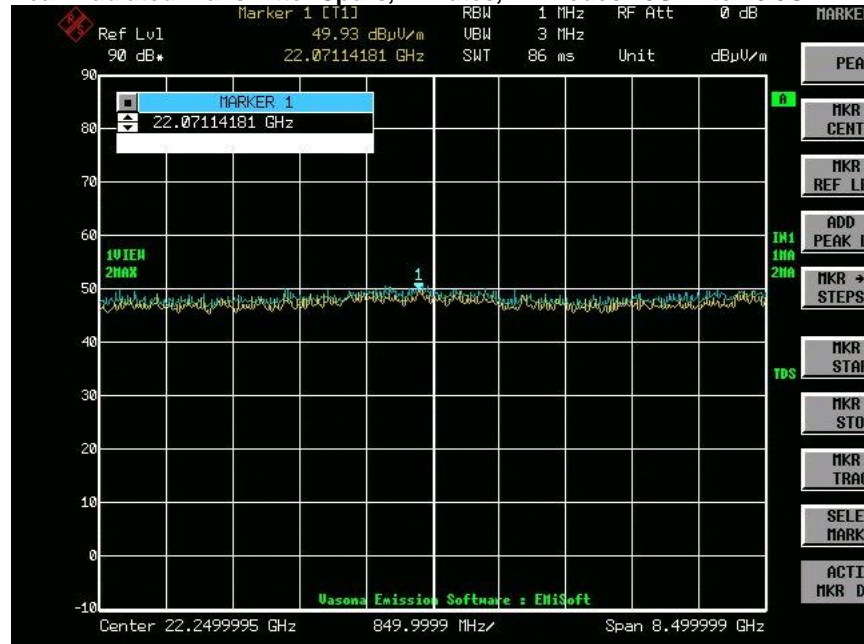

**Peak Radiated Transmitter Spurs, All rates, All Modes 26.5GHz to 40GHz**

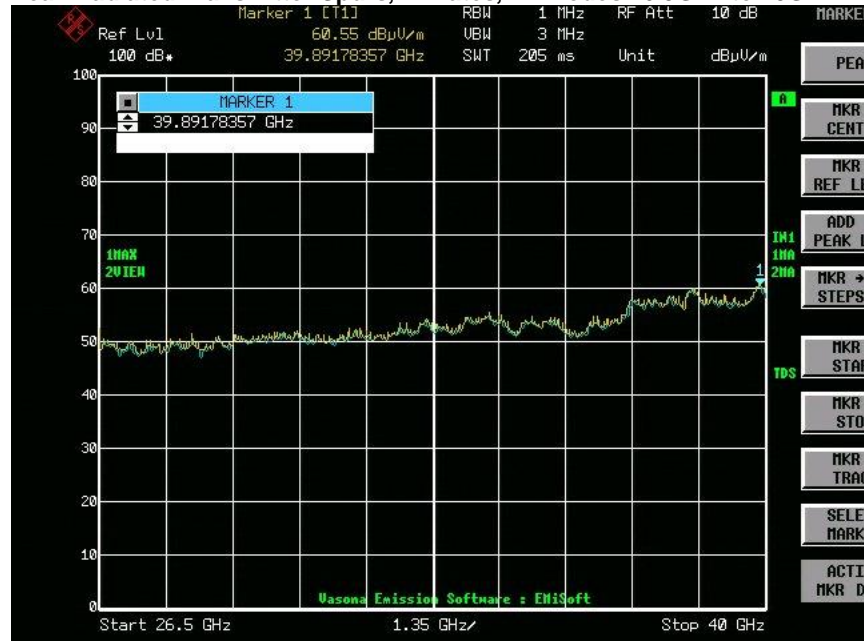



**Title:** Radiated Emissions Configuration Photograph



## B.2 Radiated Emissions 30MHz to 1GHz

### FCC 15.205 / 15.209

(7) The provisions of 15.205 apply to intentional radiators operating under this section.

(6) Unwanted emissions below 1 GHz must comply with the general field strength limits set forth in 15.209.

### Ref. ANSI C63.10: 2013 section 6.5

Using Vasona, configure the spectrum analyzer as shown below (be sure to enter all losses between the transmitter output and the spectrum analyzer). Place the radio in continuous transmit mode.

Span:	30MHz – 1GHz
Reference Level:	80 dBuV
Attenuation:	10 dB
Sweep Time:	Coupled
Resolution Bandwidth:	100kHz
Video Bandwidth:	300kHz
Detector:	Peak for Pre-scan, Quasi-Peak

Compliance shall be determined using CISPR quasi-peak detection; however, peak detection is permitted as an alternative to quasi-peak detection.

Terminate the access Point RF ports with 50 ohm loads.

Maximize Turntable (find worst case table angle), Maximize Antenna (find worst case height)

This report represents the worst case data for all supported operating modes and antennas.

System Number	Description	Samples	System under test	Support equipment
1	EUT	S01	<input checked="" type="checkbox"/>	<input type="checkbox"/>
	Support	S02	<input type="checkbox"/>	<input checked="" type="checkbox"/>

<b>Tested By :</b> Jose Aguirre	<b>Date of testing:</b> 16-Feb-18
<b>Test Result : PASS</b>	

See Appendix C for list of test equipment

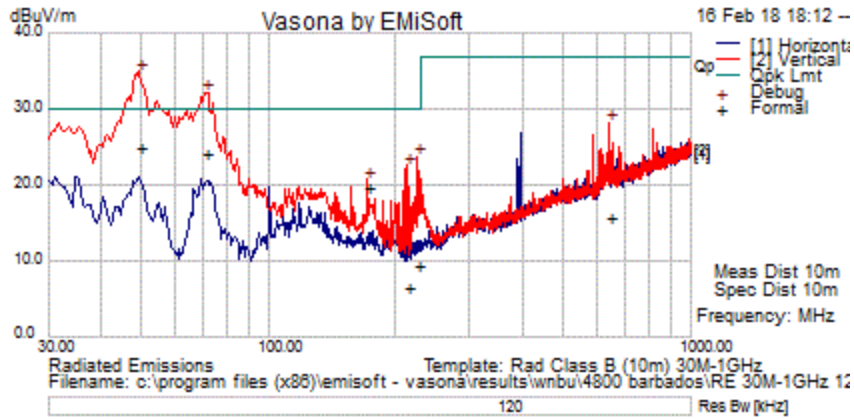

Frequency MHz	Raw dBuV	Cable Loss	AF dB	Level dBuV/m	Measurement Type	Pol	Hgt cm	Azt Deg	Limit dBuV/m	Margin dB	Pass /Fail
213.304	21.6	1.6	-16.6	6.6	Quasi Max	V	122	25	30	-23.4	Pass
644.369	21.7	2.8	-8.6	15.8	Quasi Max	V	240	25	37	-21.2	Pass
225.013	23.8	1.6	-16.1	9.3	Quasi Max	V	172	28	30	-20.7	Pass
71.218	42.8	0.9	-19.5	24.2	Quasi Max	V	192	128	30	-5.8	Pass
171.816	33.9	1.4	-15.6	19.7	Quasi Max	V	284	245	30	-10.3	Pass
49.436	43.5	0.8	-19.4	24.9	Quasi Max	V	202	338	30	-5.1	Pass



**Title:** Radiated Emissions Configuration Photograph



## B.3 AC Conducted Emissions

**FCC 15.207** Except when the requirements applicable to a given device state otherwise, for any radio apparatus equipped to operate from the public utility AC power supply, either directly or indirectly (such as with a battery charger), the radio frequency voltage of emissions conducted back onto the AC power lines in the frequency range of 0.15 MHz to 30 MHz shall not exceed the limits shown in the table in these sections. The more stringent limit applies at the frequency range boundaries.

Measurement Procedure

Accordance with ANSI C63.10:2013 section 6.2

Using Vasona, configure the spectrum analyzer as shown below (be sure to enter all losses between the transmitter output and the spectrum analyzer). Place the radio in continuous transmit mode.

Span:	150 KHz – 30 MHz
Attenuation:	10 dB
Sweep Time:	Coupled
Resolution Bandwidth:	9 KHz
Video Bandwidth:	30 KHz
Detector:	Quasi-Peak / Average

System Number	Description	Samples	System under test	Support equipment
1	EUT	S01	<input checked="" type="checkbox"/>	<input type="checkbox"/>
	Support	S02	<input type="checkbox"/>	<input checked="" type="checkbox"/>

<b>Tested By :</b> Jose Aguirre	<b>Date of testing:</b> 12-Mar-18
<b>Test Result : PASS</b>	

See separate EMC test report for test data.



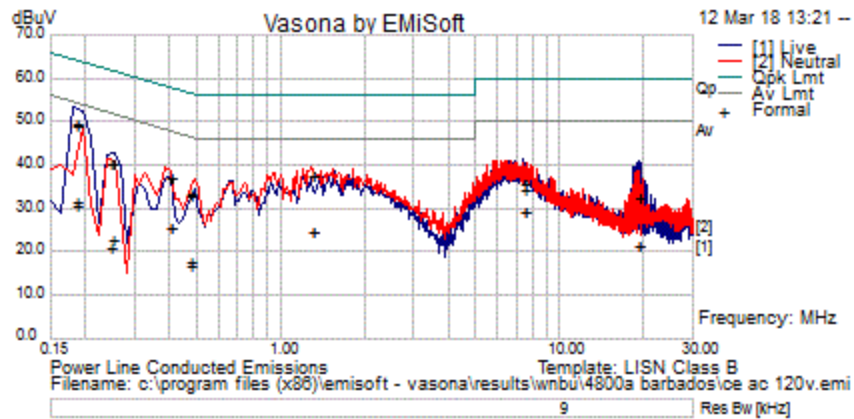

**Test Results Table**

Frequency MHz	Raw dBuV	Cable Loss	Factors dB	Level dBuV	Measurement Type	Line	Limit dBuV	Margin dB	Pass /Fail
0.405	17.1	20.1	0	37.2	Quasi Peak	Live	57.8	-20.6	Pass
0.185	28.4	20.9	0.1	49.3	Quasi Peak	Live	64.2	-14.9	Pass
1.297	17.9	19.9	0	37.9	Quasi Peak	Live	56	-18.1	Pass
0.477	13.4	19.9	0	33.4	Quasi Peak	Live	56.4	-23	Pass
0.25	20.1	20.5	0	40.7	Quasi Peak	Live	61.8	-21.1	Pass
7.45	14	20.1	0.1	34.3	Quasi Peak	Live	60	-25.7	Pass
19.18	12	20.4	0.3	32.7	Quasi Peak	Live	60	-27.3	Pass
0.186	28.6	20.9	0.1	49.5	Quasi Peak	Neutral	64.2	-14.7	Pass
7.445	15.5	20.1	0.1	35.8	Quasi Peak	Neutral	60	-24.2	Pass
0.248	19.7	20.6	0	40.3	Quasi Peak	Neutral	61.8	-21.5	Pass
19.166	11.8	20.4	0.3	32.5	Quasi Peak	Neutral	60	-27.5	Pass
1.297	17.7	19.9	0	37.7	Quasi Peak	Neutral	56	-18.3	Pass
0.405	16.9	20.1	0	37	Quasi Peak	Neutral	57.7	-20.7	Pass
0.478	13.1	19.9	0	33	Quasi Peak	Neutral	56.4	-23.3	Pass
0.405	5.5	20.1	0	25.6	Average	Live	47.8	-22.1	Pass
0.185	10	20.9	0.1	31	Average	Live	54.2	-23.3	Pass
1.297	4.8	19.9	0	24.8	Average	Live	46	-21.2	Pass
0.477	-2	19.9	0	18	Average	Live	46.4	-28.4	Pass
0.25	2.1	20.5	0	22.7	Average	Live	51.8	-29.1	Pass
7.45	8.9	20.1	0.1	29.2	Average	Live	50	-20.8	Pass
19.18	1	20.4	0.3	21.7	Average	Live	50	-28.3	Pass
0.186	10.6	20.9	0.1	31.5	Average	Neutral	54.2	-22.7	Pass
7.445	9.1	20.1	0.1	29.3	Average	Neutral	50	-20.7	Pass
0.248	0.2	20.6	0	20.8	Average	Neutral	51.8	-31	Pass
19.166	0.7	20.4	0.3	21.4	Average	Neutral	50	-28.6	Pass
1.297	4.6	19.9	0	24.6	Average	Neutral	46	-21.4	Pass
0.405	5.4	20.1	0	25.4	Average	Neutral	47.7	-22.3	Pass
0.478	-3.2	19.9	0	16.8	Average	Neutral	46.4	-29.6	Pass

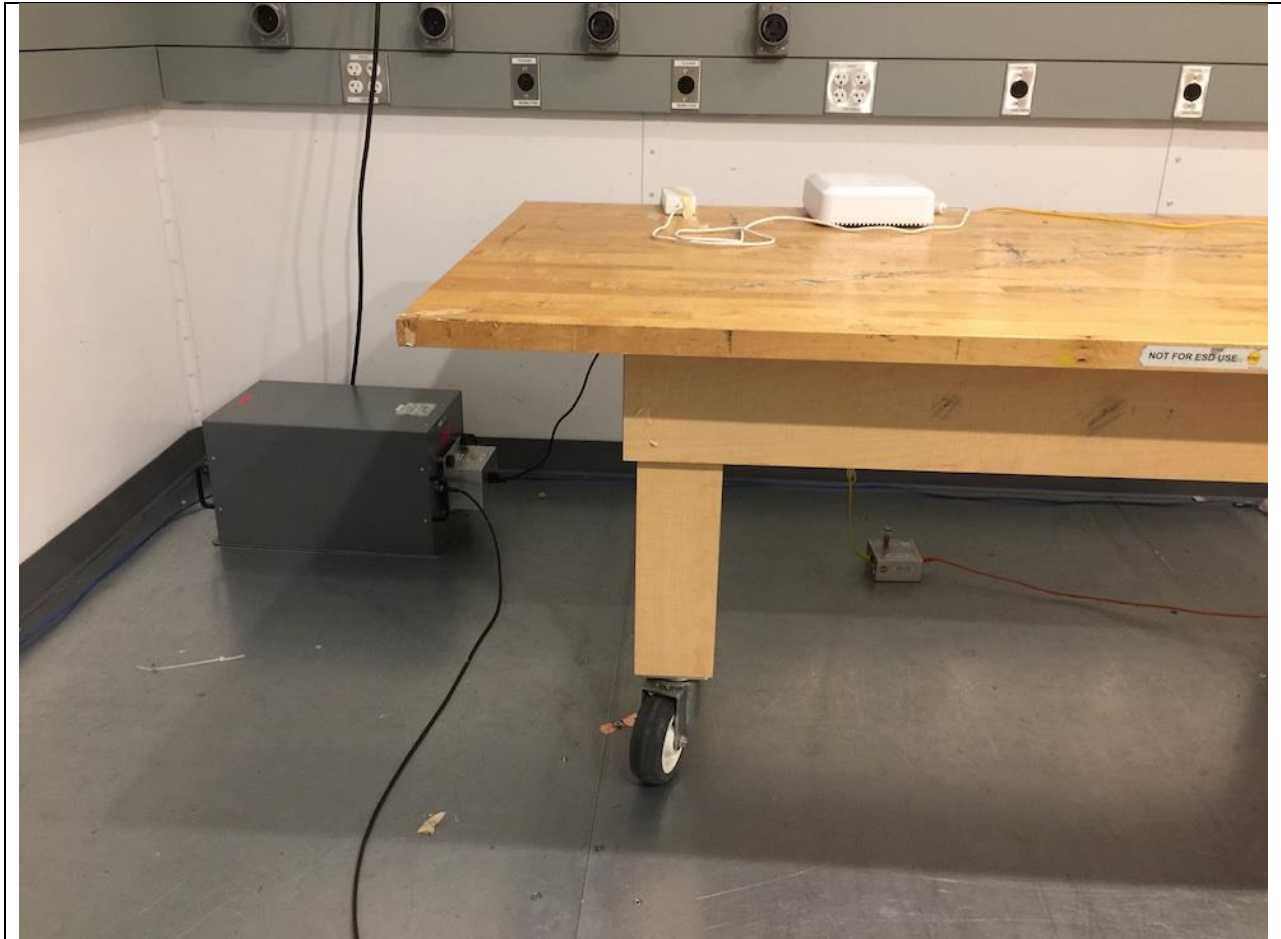

**Title:** Conducted Emissions Configuration Photograph

This is a dual band 2.4GHz / 5GHz device. All ports in this test set up photo are connected as all testing is automated. Section 2.6 of this test report given an overview of the different Tx antenna combinations used by this device.



## Appendix C: List of Test Equipment Used to perform the test

Test Equipment used for Radiated Emissions					
Equip No	Model Manufacturer	Description	Last Cal	Next Cal	Test Item
CIS008447	NSA 10m Chamber Cisco	NSA 10m Chamber	17-Oct-17	17-Oct-18	B.2
CIS021116	UFB311A-0-3540-520520 Micro-Coax	RF Coaxial Cable, to 18GHz, 354 in	19-Jan-18	19-Jan-19	B.2
CIS027233	CNE V York	Comparison Noise Emitter	Cal not required		B.2
CIS032806	JB1 Sunol Sciences	Combination Antenna	7-Jun-17	7-Jun-18	B.2
CIS037236	50CB-015 JFW	GPIB Control Box	Cal not required		B.2
CIS041979	1840 Cisco	18-40GHz EMI Test Head/Verification Fixture	30-Aug-17	30-Aug-18	B.2
CIS043124	Above 1GHz Site Cal Cisco	Above 1GHz Cspr Site Verification	15-Jan-18	15-Jan-19	B.2
CIS044940	ESU40 Rohde & Schwarz	EMI Test Receiver, 20Hz-40GHz	28-Nov-17	28-Nov-18	B.2
CIS047410	N9038A Agilent	MXE EMI Receiver 20Hz to 26.5 Ghz	31-Mar-17	31-Mar-18	B.2
CIS056154	Sucoflex 104PEA Huber + Suhner	RF N-Type cable 2 meter 18GHz	18-Jan-18	18-Jan-19	B.2
CIS001937	NSA 5m Chamber Cisco	NSA 5m Chamber	6-Feb-18	6-Feb-19	B.1
CIS007295	NSP1800-25-S1 Miteq	Broadband RF Preamp (1.0-18.0GHz,35-40dB)	13-Oct-17	13-Oct-18	B.1
CIS008024	SF106A Huber + Suhner	3 meter Sucoflex cable	10-Nov-17	10-Nov-18	B.1
CIS030443	UFB311A-0-1560-520520 Micro-Coax	RF Coaxial Cable, to 18GHz, 156 In.	10-Nov-17	10-Nov-18	B.1
CIS034075	RSG 2000 Schaffner	Reference Spectrum Generator, 1-18GHz	Cal not required		B.1
CIS037581	3117 ETS-Lindgren	Double Ridged Waveguide Horn Antenna	7-Dec-17	7-Dec-18	B.1
CIS041979	1840 Cisco	18-40GHz EMI Test Head/Verification Fixture	30-Aug-17	30-Aug-18	B.1
CIS042000	E4440A Agilent	Spectrum Analyzer	22-Aug-17	22-Aug-18	B.1
CIS044940	ESU40 Rohde & Schwarz	EMI Test Receiver, 20Hz-40GHz	28-Nov-17	28-Nov-18	B.1
CIS049413	iBTHP-5-DB9 Newport	5 inch Temp/RH/Press Sensor w/20ft cable	28-Dec-17	28-Dec-18	B.1
CIS049535	Above 1GHz Site Cal Cisco	Above 1GHz CISPR Site Validation	7-Feb-18	7-Feb-19	B.1
CIS055937	Sucoflex 106PA Huber + Suhner	N-Type 8m 18GHz Antenna Cable	10-Nov-17	10-Nov-18	B.1



Test Equipment used for AC Mains Conducted Emissions						
Equip No	Manufacturer	Model	Description	Last Cal	Next Cal	Test Item
45167	Stanley	33-428	8m Tape Measure	Cal not req	Cal not req	B.3
5687	Fluke	73 III	Digital Multimeter	11/1/2017	11/1/2018	B.3
45999	FCC	F-090527-1009-2	Lisn Adapter	6/8/2017	6/8/2018	B.3
45050	Rohde & Schwarz	ESCI	EMI Test Receiver	11/16/2017	11/16/2018	B.3
45998	FCC	F-090527-1009-1	Line Impedance Stabilization Network	6/8/2017	6/8/2018	B.3
37229	Coleman	RG-223	25ft BNC cable	4/12/2017	4/12/2018	B.3
49559	Bird	5-T-MB	5W 50 Ohm BNC Termination 4GHz	8/10/2017	8/10/2018	B.3
18963	York	CNE V	Comparison Noise Emitter, 30 - 1000MHz	Cal not req	Cal not req	B.3
54228	Newport	iBTHP-5-DB9	5 inch Temp/RH/Press Sensor w/20ft cable	2/10/2018	2/10/2019	B.3
46006	FCC	F-090527-1009-1	Line Impedance Stabilization Network	6/8/2017	6/8/2018	B.3
8510	FCC	FCC-450B-2.4-N	Instrumentation Limiter	5/16/2017	5/16/2018	B.3
46007	FCC	F-090527-1009-2	Lisn Adapter	6/8/2017	6/8/2018	B.3
49531	TTE	H785-150K-50-21378	High Pass Filter	5/3/2017	5/3/2018	B.3



Test Equipment used for RF Conducted Tests					
Equip No	Model Manufacturer	Description	Last Cal	Next Cal	Test Item
CIS053615	N9030A-550 Keysight	PXA Signal Analyzer 50 GHz	4-Apr-17	4-Apr-18	Appendix A
CIS055352	BRC50704-02 Micro-Tronics	Notch Filter 5.42 - 5.725GHz	5-Apr-17	5-Apr-18	Appendix A
CIS055579	BWS20-W2 Aeroflex	SMA 20dB Attenuator	20-Jul-17	20-Jul-18	Appendix A
CIS055577	BWS20-W2 Aeroflex	SMA 20dB Attenuator	20-Jul-17	20-Jul-18	Appendix A
CIS055353	BRC50703-02 Micro-Tronics	Notch Filter 5.15 - 5.35GHz	27-Jul-17	27-Jul-18	Appendix A
CIS055112	BRM50702-02 Micro-Tronics	Reject Band Filter	27-Jul-17	27-Jul-18	Appendix A
CIS054693	BRC50705-02 Micro-Tronics	Band Reject Filter	27-Jul-17	27-Jul-18	Appendix A
CIS054620	RA08-S1S1-12 Megaphase	SMA cable 12"	27-Jul-17	27-Jul-18	Appendix A
CIS054619	RA08-S1S1-12 Megaphase	SMA cable 12"	27-Jul-17	27-Jul-18	Appendix A
CIS054617	RA08-S1S1-12 Megaphase	SMA cable 12"	27-Jul-17	27-Jul-18	Appendix A
CIS054616	RA08-S1S1-12 Megaphase	SMA cable 12"	27-Jul-17	27-Jul-18	Appendix A
CIS054615	RA08-S1S1-12 Megaphase	SMA cable 12"	27-Jul-17	27-Jul-18	Appendix A
CIS054614	RA08-S1S1-12 Megaphase	SMA cable 12"	27-Jul-17	27-Jul-18	Appendix A
CIS054611	RA08-S1S1-12 Megaphase	SMA cable 12"	27-Jul-17	27-Jul-18	Appendix A
CIS054610	RA08-S1S1-12 MegaPhase	SMA cable 12"	27-Jul-17	27-Jul-18	Appendix A
CIS054633	F120-S1S1-48 Megaphase	SMA cable 48"	21-Sep-17	21-Sep-18	Appendix A
CIS054634	F120-S1S1-48 Megaphase	SMA cable 48"	29-Sep-17	29-Sep-18	Appendix A
CIS055929	SMSM-A2PH-012 Dynawave	12" SMA Cable	23-Oct-17	23-Oct-18	Appendix A
CIS055921	SMSM-A2PH-012 Dynawave	12" SMA Cable	23-Oct-17	23-Oct-18	Appendix A
CIS055868	SMSM-A2PH-024 Dynawave	24" SMA Cable	23-Oct-17	23-Oct-18	Appendix A
CIS055170	RFLT4WDC40GK RF Lambda	4 Way Power Divider 40GHz	22-Dec-17	22-Dec-18	Appendix A
CIS055872	SMSM-A2PH-024 Dynawave	24" SMA Cable	27-Jul-17	27-Jul-18	Appendix A
CIS055867	SMSM-A2PH-024 Dynawave	24" SMA Cable	27-Jul-17	27-Jul-18	Appendix A



## Appendix E: Abbreviation Key and Definitions

The following table defines abbreviations used within this test report.

Abbreviation	Description	Abbreviation	Description
EMC	Electro Magnetic Compatibility	°F	Degrees Fahrenheit
EMI	Electro Magnetic Interference	°C	Degrees Celsius
EUT	Equipment Under Test	Temp	Temperature
ITE	Information Technology Equipment	S/N	Serial Number
TAP	Test Assessment Schedule	Qty	Quantity
ESD	Electro Static Discharge	emf	Electromotive force
EFT	Electric Fast Transient	RMS	Root mean square
EDCS	Engineering Document Control System	Qp	Quasi Peak
Config	Configuration	Av	Average
CIS#	Cisco Number (unique identification number for Cisco test equipment)	Pk	Peak
Cal	Calibration	kHz	Kilohertz (1x10 <sup>3</sup> )
EN	European Norm	MHz	MegaHertz (1x10 <sup>6</sup> )
IEC	International Electro technical Commission	GHz	Gigahertz (1x10 <sup>9</sup> )
CISPR	International Special Committee on Radio Interference	H	Horizontal
CDN	Coupling/Decoupling Network	V	Vertical
LISN	Line Impedance Stabilization Network	dB	decibel
PE	Protective Earth	V	Volt
GND	Ground	kV	Kilovolt (1x10 <sup>3</sup> )
L1	Line 1	μV	Microvolt (1x10 <sup>-6</sup> )
L2	Line2	A	Amp
L3	Line 3	μA	Micro Amp (1x10 <sup>-6</sup> )
DC	Direct Current	mS	Milli Second (1x10 <sup>-3</sup> )
RAW	Uncorrected measurement value, as indicated by the measuring device	μS	Micro Second (1x10 <sup>-6</sup> )
RF	Radio Frequency	μS	Micro Second (1x10 <sup>-6</sup> )
SLCE	Signal Line Conducted Emissions	m	Meter
Meas dist	Measurement distance	Spec dist	Specification distance
N/A or NA	Not Applicable	SL	Signal Line (or Telecom Line)
P	Power Line	L	Live Line
N	Neutral Line	R	Return
S	Supply	AC	Alternating Current



**End**