



RADIO TEST REPORT

Report No: STS2208065W01

Issued for

Cisco Systems Inc

125 West Tasman Drive San Jose, CA 95134-1706 United States

Product Name:	UC PHONE
Brand Name:	Cisco
Model Name:	CP-8832
Series Model:	N/A
FCC ID:	LDK88322678
IC:	2461N-88322678
Test Standard:	Title 47 of the CFR, Part 15 Subpart D RSS-213 Issue 3, March 2015 RSS-Gen Issue 5, Amendment 2, February 2021

Any reproduction of this document must be done in full. No single part of this document may be reproduced without permission from STS, All Test Data Presented in this report is only applicable to presented Test sample.





TEST RESULT CERTIFICATION

Applicant's Name : Cisco Systems Inc
Address : 125 West Tasman Drive San Jose, CA 95134-1706 United States
Manufacture's Name : Cisco Systems Inc
Address : 125 West Tasman Drive San Jose, CA 95134-1706 United States

Product Description

Product Name : UC PHONE
Brand Name : Cisco
Model Name : CP-8832
Series Model : N/A
Title 47 of the CFR, Part 15. Subpart D

Test Standards : RSS-213 Issue 3, March 2015
RSS-Gen Issue 5, Amendment 2, February 2021

Test procedure : ANSI C63.17-2013

This device described above has been tested by STS and the test results show that the equipment under test (EUT) is in compliance with the FCC/IC requirements. And it is applicable only to the tested sample identified in the report.

This report shall not be reproduced except in full, without the written approval of STS, this document only be altered or revised by STS, personal only, and shall be noted in the revision of the document.

Date of Test :
Date of receipt of test item : 12 Aug. 2022
Date of performance of tests : 12 Aug. 2022 ~02 Nov. 2022
Date of Issue : 02 Nov. 2022
Test Result : Pass

Testing Engineer : Chris Chen
Technical Manager : Sean She
Authorized Signatory : Bovey Yang





TABLE OF CONTENTS	Page
1 INTRODUCTION	7
1.1 TEST FACTORY	7
1.2 MEASUREMENT UNCERTAINTY	7
2 PRODUCT INFORMATION	8
3 TEST CONFIGURATION OF EQUIPMENT UNDER TEST	9
3.1 DESCRIPTION OF NECESSARY ACCESSORIES AND SUPPORT UNITS	9
3.2 SYSTEM TEST CONFIGURATION	10
4 MEASUREMENT INSTRUMENTS	11
5 TEST ITEMS	13
5.1 ANTENNA REQUIREMENT	13
5.2 MODULATION TECHNIQUES	13
5.3 EMISSION BANDWIDTH	14
5.4 PEAK TRANSMIT POWER	19
5.5 POWER SPECTRAL DENSITY	24
5.6 POWER ADJUSTMENT FOR ANTENNA GAIN	29
5.7 AUTOMATICALLY DISCONTINUE TRANSMISSION	30
5.8 SYSTEM ACKNOWLEDGE-MENT TEST	31
5.9 MONITORING THRESHOLD	32
5.10 DURATION OF TRANSMISSION	33
5.11 SELECTED CHANNEL CONFIRMATION, POWER ACCURACY, SEGMENT OCCUPANCY	35
5.12 RANDOM WAITING	37
5.13 MONITORING REQUIREMENTS	38
5.14 MONITORING ANTENNA	39
5.15 DUPLEX CONNECTIONS	39
5.16 ALTERNATIVE MONITORING INTERVAL FOR CO-LOCATED DEVICES	40
5.17 FAIR ACCESS	40
5.18 SPURIOUS EMISSIONS	41
5.19 FRAME PERIOD	57
5.20 FREQUENCY STABILITY	58
5.21 CONDUCTED EMISSION MEASUREMENT	62
5.22 RADIATED SPURIOUS EMISSION	66



Revision History

Rev.	Issue Date	Report NO.	Effect Page	Contents
00	02 Nov. 2022	STS2208065W01	ALL	Initial Issue





SUMMARY OF TEST RESULTS

Test procedures according to the technical standards:

The following tests were conducted on a sample of the equipment for the purpose of demonstrating compliance with Part 15 Subpart D.

Requirement	FCC Part	Canada RSS-213	Test Procedure	Result
Emission Bandwidth	15.323 (a)	5.5	6.1.3	Compliant
Labeling Requirements	15.19(a)(3)	RSS-Gen	--	Compliant
Conducted Emissions	15.315 & 15.207	5.4	ANSI C63.4	Compliant
Antenna Requirements	15.317 & 15.203	RSS-Gen	Declaration	Compliant
Use digital modulation	15.319 (b)	5.1	6.1.4	Compliant
Peak transmit power	15.319 (c)	5.6	6.1.2	Compliant
Power spectral density	15.319 (d)	5.7	6.1.5	Compliant
Power adjustment for antenna gain	15.319 (e)	5.6	4.3.1	Compliant
Automatically discontinue transmission	15.319 (f)	5.2	--	Compliant
Spurious emissions conducted	15.323 (d) (1) & 15.323 (d) (2)	5.8	6.1.6	Compliant
RF Exposure	15.319 (i) & 1.1307(b), 2.1091 and 2.1093	RSS-102	ANSI/IEEE C95.1	Compliant (The test data please refer to RF exposure and RSS102 ANNEX C report)
Monitoring time	15.323 (c)(1)	5.2(1)	7.3.4	Compliant
Monitoring threshold	15.323 (c)(2)	5.2(2)	7.3	Compliant
Duration of transmission	15.323 (c)(3)	5.2(3)	8.2.2	Compliant
System acknowledgment test	15.323(c)(4)	5.2(4)	8.2.1	Compliant
Channel confirmation, Power accuracy, Segment occupancy	15.323 (c)(5)	5.2(5)	7.3.3 & 7.3.4	Compliant



Random waiting	15.323 (c)(6)	5.2(6)	8.1.3	Not Applicable
Monitoring bandwidth	15.323 (c)(7)	5.2(7)	7.4	Compliant
Monitoring reaction time	15.323 (c)(1)	5.2(7)	7.5	Compliant
Monitoring antenna	15.323 (c)(8)	5.2(8)	4	Compliant
Monitoring threshold relaxation	15.323 (c)(9)	5.2(9)	4	Not Applicable
Duplex connections	15.323 (c)(10)	5.2(10)	8.3	Not Applicable
Alternate monitoring interval	15.323 (c)(11)	5.2(11)	8.4	Not Applicable
Fair access	15.323 (c)(12)	5.2(12)	Declaration	Not Applicable
Frame period	15.323 (e)	5.2(13)	6.2.2 & 6.2.3	Compliant
Frequency stability	15.323 (f)	5.3	6.2.1	Compliant
Radiated Out of Band Emissions	15.319 (g), 15.309 (b) & FCC Part 15 Subpart B, 15.109 and 15.209	5.8	--	Compliant



1 INTRODUCTION

1.1 TEST FACTORY

SHENZHEN STS TEST SERVICES CO., LTD

Add. : A 1/F, Building B, Zhuoke Science Park, No.190 Chongqing Road, HepingShequ, Fuyong Sub-District, Bao'an District, Shenzhen, Guang Dong, China

FCC test Firm Registration Number: 625569

IC test Firm Registration Number: 12108A

A2LA Certificate No.: 4338.01

FCC Designation Number: CN1203

CAB Identifier: CN0086

1.2 MEASUREMENT UNCERTAINTY

The reported uncertainty of measurement $y \pm U$, where expanded uncertainty U is based on a standard uncertainty multiplied by a coverage factor of $k=2$, providing a level of confidence of approximately 95 %.

No.	Item	Uncertainty
1	RF output power, conducted	$\pm 0.87\text{dB}$
2	Unwanted Emissions, conducted	$\pm 2.895\text{dB}$
3	All emissions, radiated 9K-30MHz	$\pm 3.80\text{dB}$
4	All emissions, radiated 30M-1GHz	$\pm 4.09\text{dB}$
5	All emissions, radiated 1G-6GHz	$\pm 4.92\text{dB}$
6	All emissions, radiated >6G	$\pm 5.49\text{dB}$
7	Conducted Emission (9KHz-30MHz)	$\pm 2.73\text{dB}$



2 PRODUCT INFORMATION

Product Name	UC PHONE
Brand Name	Cisco
Model Name	CP-8832
Series Model	N/A
Product Differences	N/A
Hardware version number	PP
Software version number	sip8832.14-1-1MN2-83
EUT Frequency Ranges	1921.536-1928.448MHz
EUT power:	2.53 dBm
Type of Modulations	GFSK
Number of Channels	5 CH
	1921.536MHz, 1923.264MHz, 1924.992MHz, 1926.720MHz, 1928.448MHz
Antenna Type	Internal Antenna
Antenna Gain	Ant 0: -0.4dBi Ant 1: -0.4dBi
Rating	Input: Supplied by POE 44-57Vdc, 0.6A or supplied by External Power Adapter: 100-240VAC, .5A, 50-60Hz
Extreme Temp. Tolerance:	0°C to 40°C

Note: Ant 0, Ant 1 can't transmute at the same time.



3 TEST CONFIGURATION OF EQUIPMENT UNDER TEST

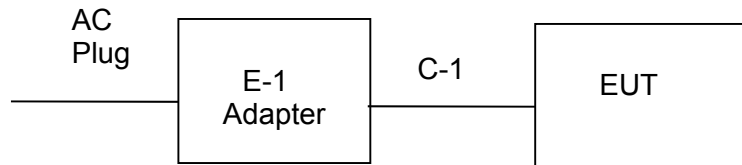

3.1 DESCRIPTION OF NECESSARY ACCESSORIES AND SUPPORT UNITS

The EUT has been tested as an independent unit together with other necessary accessories or support units. The following support units or accessories were used to form a representative test configuration during the tests.

Necessary accessories

Item	Equipment	Mfr/Brand	Model/Type No.	Length	Note
E-1	Adapter	Cisco	AN18V-59CFA	N/A	N/A
C-1	DC Cable	Cisco	N/A	200cm	N/A

Support units

Item	Equipment	Mfr/Brand	Model/Type No.	Length	Note
N/A	N/A	N/A	N/A	N/A	N/A

Note:

- (1) The support equipment was authorized by Declaration of Confirmation.
- (2) For detachable type I/O cable should be specified the length in cm in 『Length』 column.

3.2 SYSTEM TEST CONFIGURATION

Figure 1:

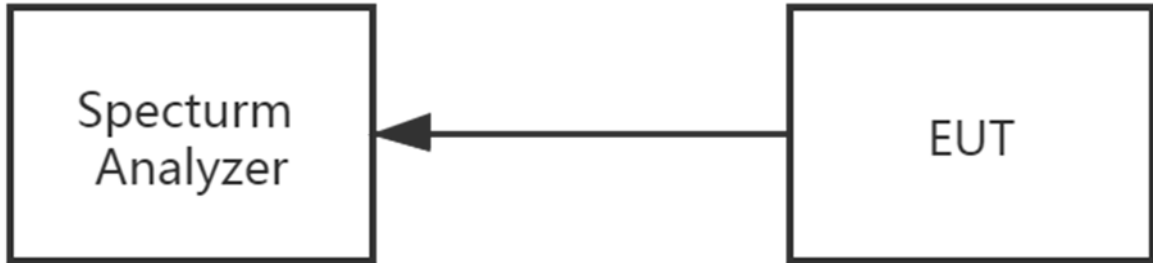
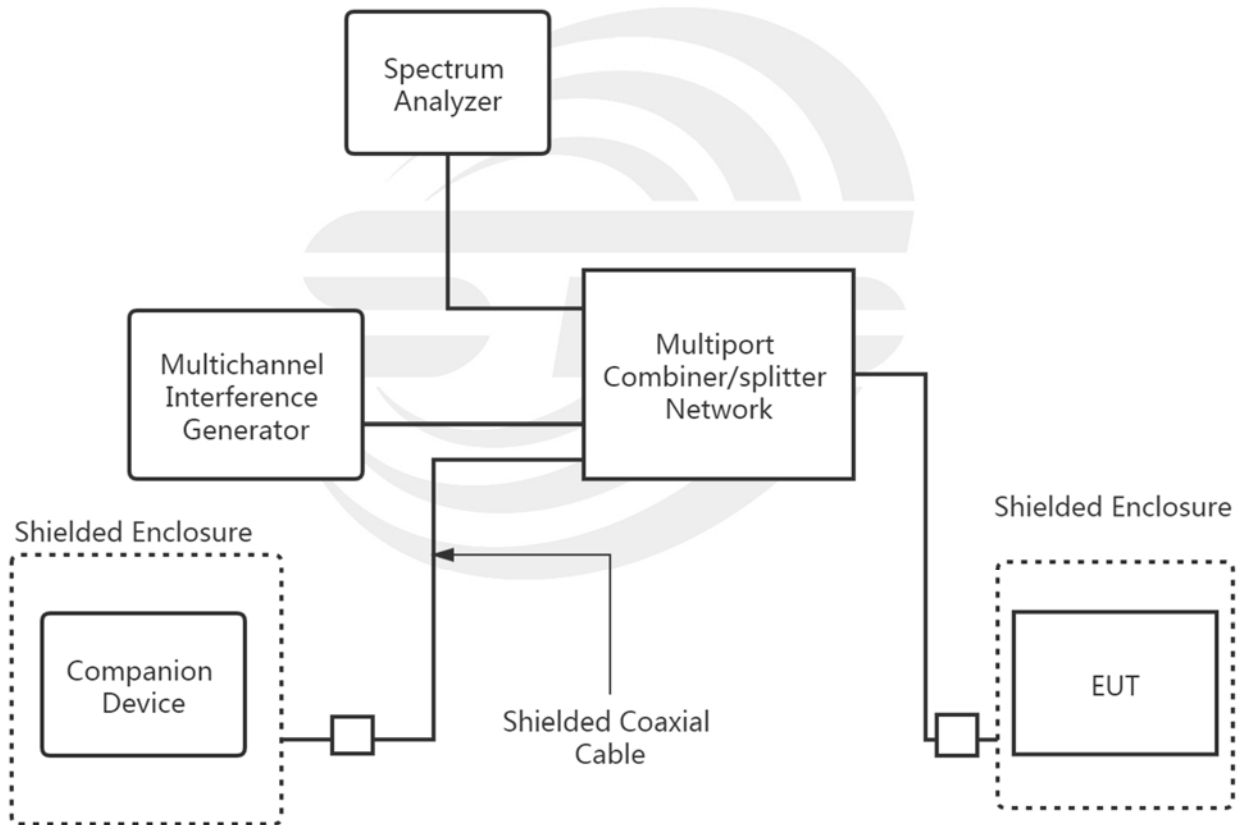

Figure 2:





4 MEASUREMENT INSTRUMENTS

Radiation Test equipment

Kind of Equipment	Manufacturer	Type No.	Serial No.	Last calibration	Calibrated until
Temperature & Humidity	SW-108	SuWei	N/A	2022.03.02	2023.03.01
Wireless Communications Test Set	R&S	CMW 500	117239	2022.03.01	2023.02.28
Pre-Amplifier(0.1M-3GHz)	EM	EM330	060665	2022.07.04	2023.07.03
Pre-Amplifier (1G-18GHz)	SKET	LNPA-01018G-45	SK2018080901	2022.09.29	2023.09.28
Positioning Controller	MF	MF-7802	MF-780208587	N/A	N/A
Signal Analyzer	R&S	FSV 40-N	101823	2022.09.29	2023.09.28
Switch Control Box	N/A	N/A	N/A	N/A	N/A
Filter Box	BALUN Technology	SU319E	BL-SZ1530051	N/A	N/A
Video Controller	SKET	FCS C-3	N/A	N/A	N/A
Bilog Antenna	TESEQ	CBL6111D	34678	2022.09.30	2024.09.29
Horn Antenna	SCHWARZBECK	BBHA 9120D	02014	2021.10.11	2023.10.10
Antenna Mast	MF	MFA-440H	N/A	N/A	N/A
Turn Table	MF	N/A	N/A	N/A	N/A
AC Power Source	APC	KDF-11010G	F214050035	N/A	N/A
DC Power Supply	Zhaoxin	RXN 605D	20R605D11010081	N/A	N/A
Test SW	EMC Test Software	15.2.0.339			

Conduction Test equipment

Kind of Equipment	Manufacturer	Type No.	Serial No.	Last calibration	Calibrated until
Test Receiver	R&S	ESCI	101427	2022.09.29	2023.09.28
LISN	R&S	ENV216	101242	2022.09.28	2023.09.27
LISN	EMCO	3810/2NM	23625	2022.09.28	2023.09.27
Temperature & Humidity	HH660	Mieo	N/A	2022.09.30	2023.09.29



RF Connected Test

Kind of Equipment	Manufacturer	Type No.	Serial No.	Last calibration	Calibrated until
Temperature & Humidity	SW-108	SuWei	N/A	2022.03.02	2023.03.01
RF Test Platform For DECT	RTX	RTX 2012 HS	1138-6122	2022.03.07	2023.03.06
Signal Generator	Agilent	N5182A	MY46240556	2022.09.28	2023.09.27
Signal Analyzer	Agilent	N9020A	MY52440124	2022.03.01	2023.02.28
Temperature & Humidity Test Chamber	Safety test	AG80L	171200018	2022.03.01	2023.02.28
Programmable Power Supply	Agilent	E3642A	MY40002025	2022.09.29	2023.09.28
Attenuator	HP	8494B	DC-18G	2022.03.02	2023.03.01
AC Power Source	APC	KDF-11010G	F214050035	N/A	N/A
Test SW	RTX2012	RTX20xx v0.9.61 A			

Equipment with a calibration date of "NCR" shown in this list was not used to make direct calibrated measurements.



5 TEST ITEMS

5.1 ANTENNA REQUIREMENT

TEST OVERVIEW

§ 15.203: An intentional radiator shall be designed to ensure that no antenna other than that furnished by the responsible party shall be used with the device. The use of a permanently attached antenna or of an antenna that uses a unique coupling to the intentional radiator shall be considered sufficient to comply with the provisions of this section. The manufacturer may design the unit so that a broken antenna can be replaced by the user, but the use of a standard antenna jack or electrical connector is prohibited.

The structure and application of the EUT were analyzed to determine compliance with Section 15.203 of the Rules. Section 15.203 states that the subject device must meet at least one of the following criteria:

- a.) Antenna must be permanently attached to the unit.
- b.) Antenna must use a unique type of connector to attach to the EUT.
- c.) Unit must be professionally installed. Installer shall be responsible for verifying that the correct antenna is employed with the unit.

TEST RESULT

The EUT as tested is compliant the criteria of §15.203&RSS-Gen. The antenna is permanently attached to the unit.

5.2 MODULATION TECHNIQUES

TEST REQUIREMENT

All transmissions must use only digital modulation techniques.

TEST PROCEDURES

Attestation of manufacturer supported by reference to relevant DECT specifications.

ATTESTATION

This device is compliant with the DECT standards described in European Standards EN 300 175-2 and EN 300 175-3. DECT transmissions are MC/TDMA/TDD (Multi carrier / Time Division Multiple Access / Time Division Duplex) using Digital GFSK modulation. For further details see operational description or relevant portions of the DECT standards.

TEST RESULTS

The EUT as tested is compliant the criteria of §15.319(b).



5.3 EMISSION BANDWIDTH
TEST OVERVIEW

§ 15.323(a): For purposes of this subpart the emission bandwidth shall be determined by measuring the width of the signal between two points, one below the carrier center frequency and one above the carrier center frequency, that are 26 dB down relative to the maximum level of the modulated carrier. Compliance with the emissions limits is based on the use of measurement instrumentation employing a peak detector function with an instrument resolutions bandwidth approximately equal to 1.0 percent of the emission bandwidth of the device under measurement.

Operation shall be contained within the 1920-1930 MHz band. The emission bandwidth shall be less than 2.5 MHz. The power level shall be as specified in §15.319(c)&RSS 213(5.5), but in no event shall the emission bandwidth be less than 50 kHz.

TEST PROCEDURE

Testing to ANSI C63.17-2013 Clause 6.1.3, which provides the test methodology for this provision.

TEST SETUP

The test setup is shown in section 3.2 figure 1.

TEST RESULTS

The Eut was compliant with this requirement.

Antenna 0

Channel	26dB BW(MHz)	99% BW(MHz)	Limit
Low(4)	1.339	1.189	50 kHz-2.5MHz
Mid(2)	1.322	1.184	
High(0)	1.332	1.186	
AVG	1.331100	1.186600	

Antenna 1

Channel	26dB BW(MHz)	99% BW(MHz)	Limit
Low(4)	1.341	1.198	50 kHz-2.5MHz
Mid(2)	1.344	1.195	
High(0)	1.343	1.202	
AVG	1.342667	1.198067	



Antenna 0

Plot 1. Emission Bandwidth, Channel 4 @ 1921.536 MHz

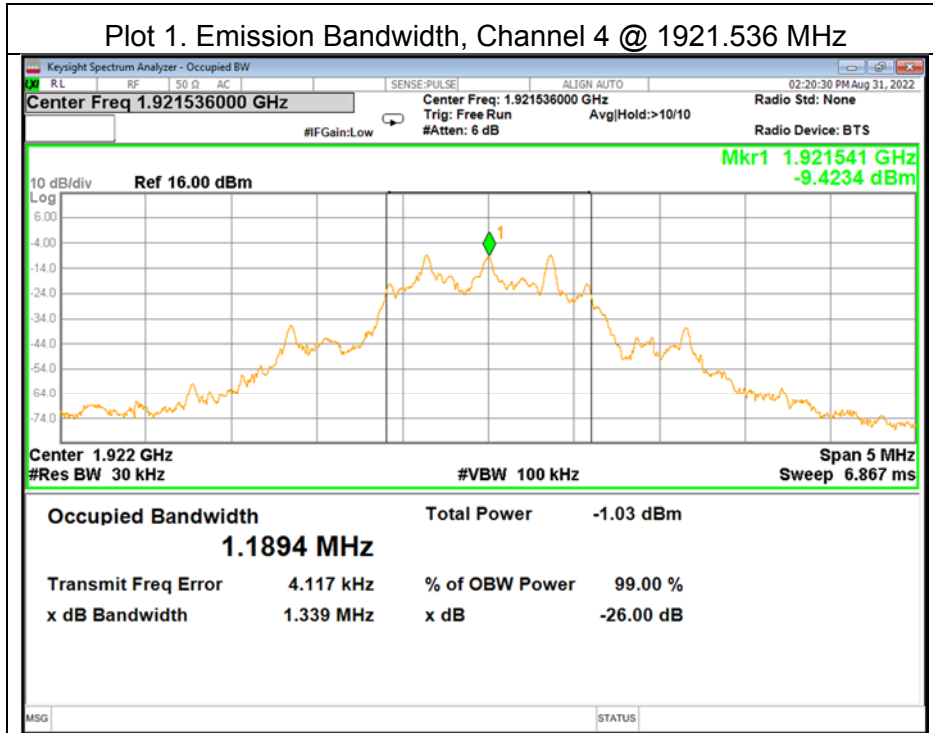

Plot 2. Emission Bandwidth, Channel 2 @ 1924.992 MHz

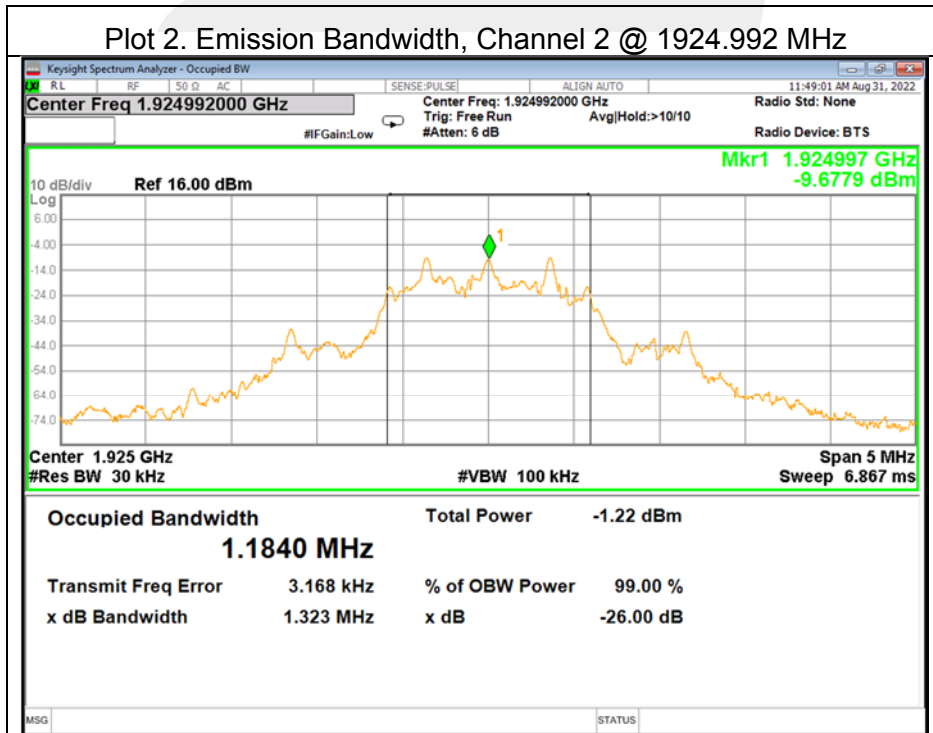



Plot 3. Emission Bandwidth, Channel 0 @ 1928.448 MHz

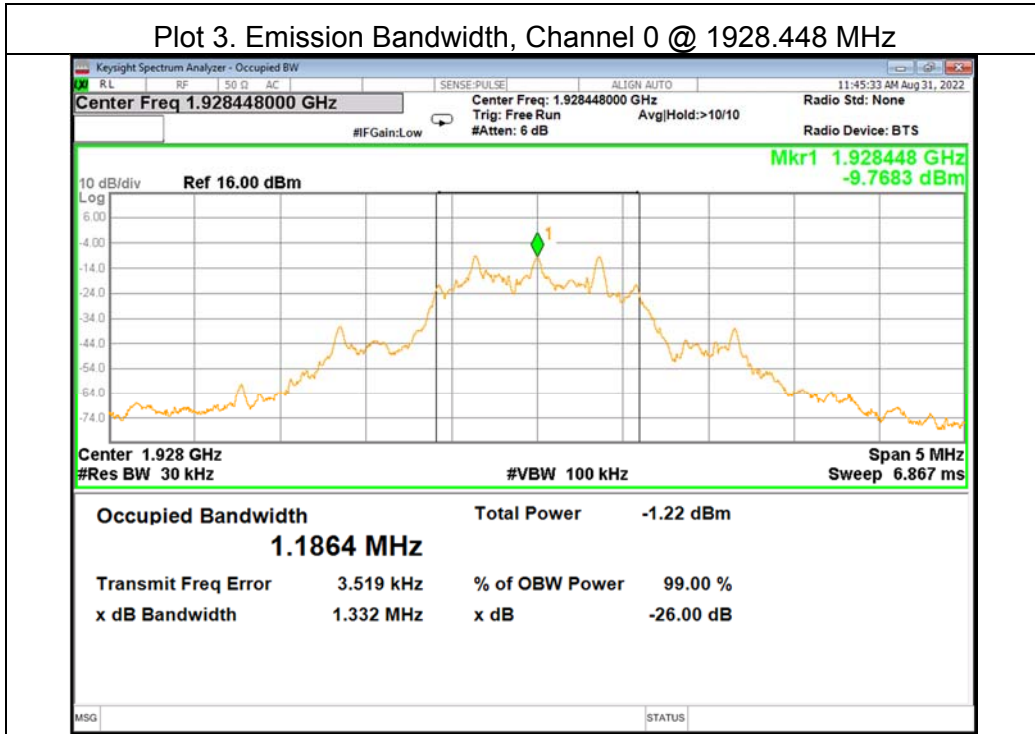



Antenna 1

Plot 1. Emission Bandwidth, Channel 4 @ 1921.536 MHz

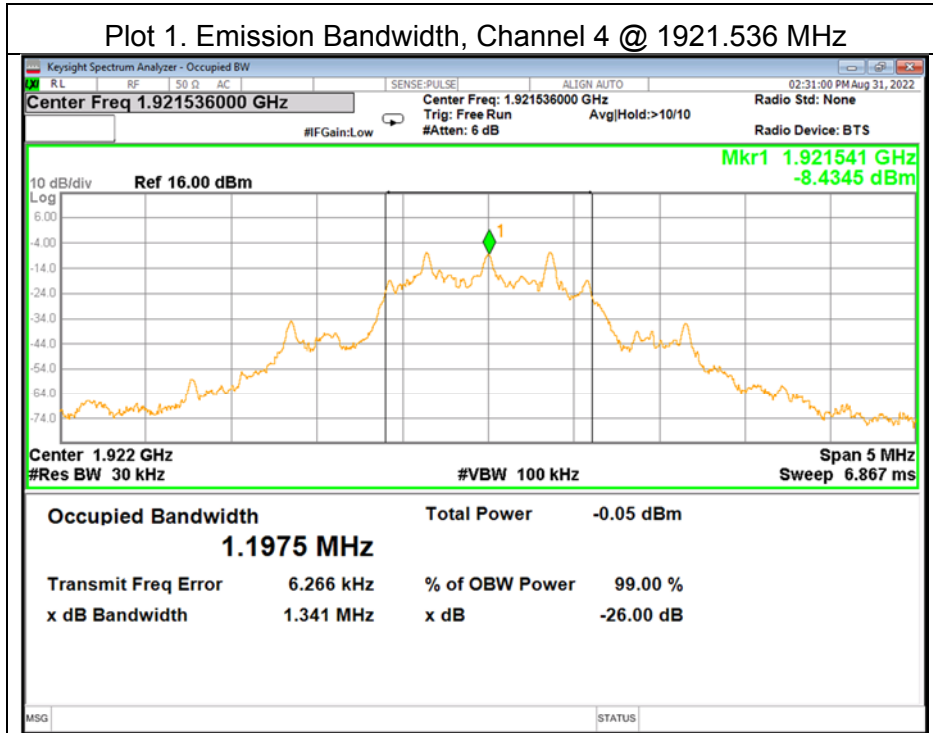

Plot 2. Emission Bandwidth, Channel 2 @ 1924.992 MHz

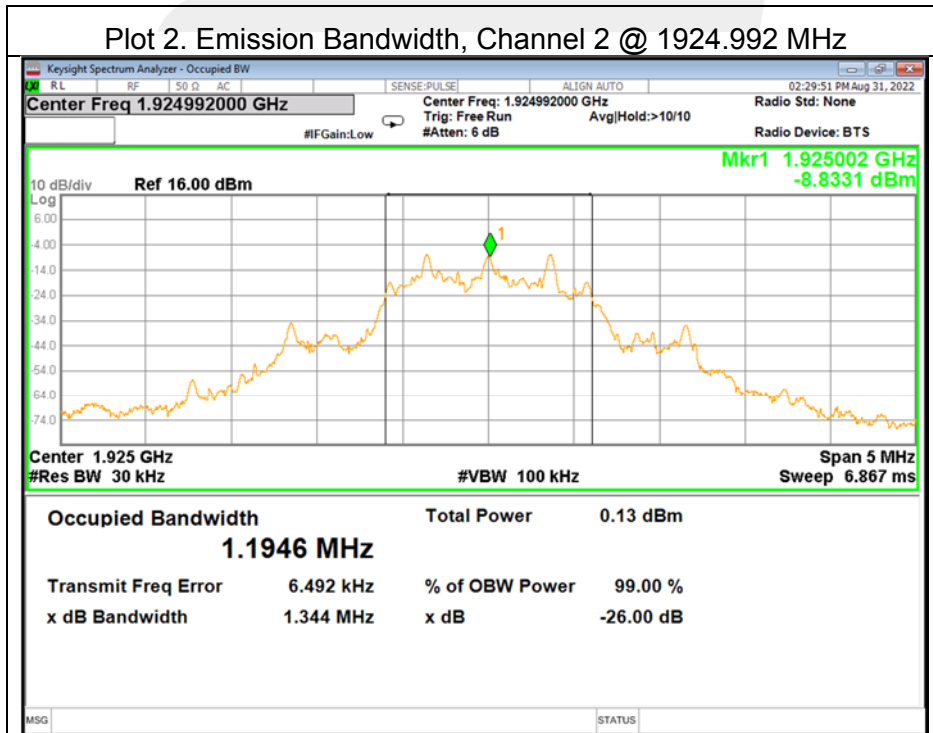



Plot 3. Emission Bandwidth, Channel 0 @ 1928.448 MHz

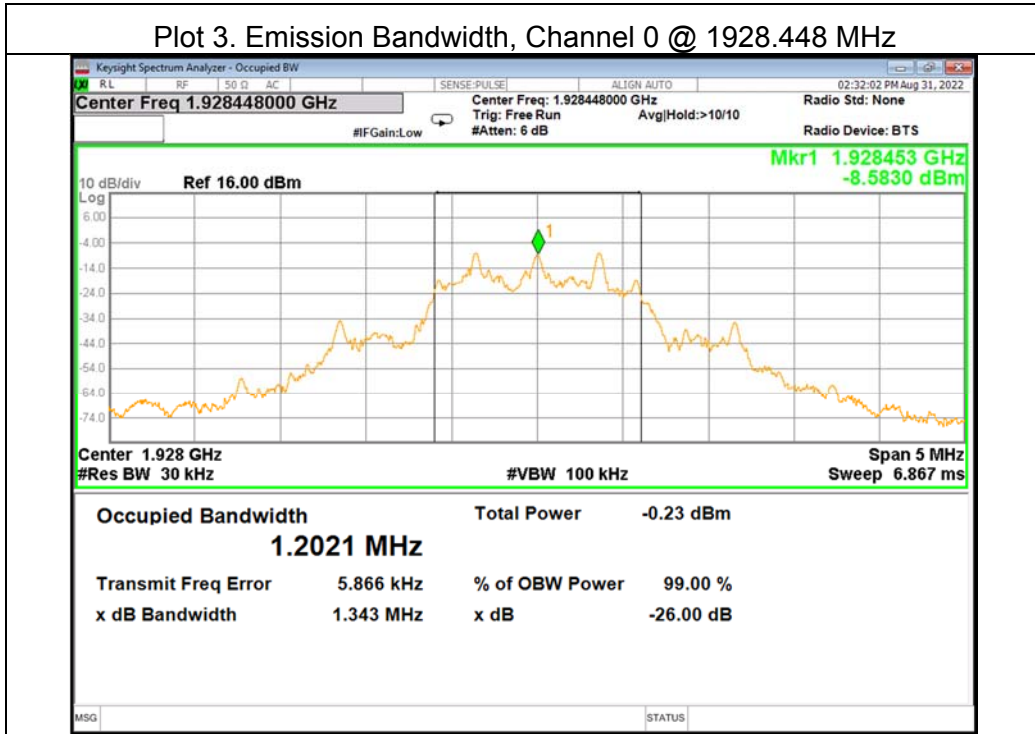



5.4 PEAK TRANSMIT POWER

TEST OVERVIEW

§15.319(c)&RSS 213(5.6): The peak transmit power shall not exceed 100 microwatts multiplied by the square root of the emission bandwidth in hertz. Peak transmit power must be measured over any interval of continuous transmission using instrumentation calibrated in terms of an rms equivalent voltage. The measurement results shall be properly adjusted for any instrument limitations, such as detector response times, limited resolution bandwidth capability when compared to the emission bandwidth, sensitivity, etc., so as to obtain a true peak measurement for the emission in question over the full bandwidth of the channel.

TEST PROCEDURE

Testing to ANSI C63.17-2013 Clause 6.1.2, which provides the test methodology for this provision. The EUT is controlled from a personal computer and set into continuous transmission mode.

TEST SETUP

The test setup is shown in section 3.2 figure 1.

TEST RESULTS

Atennna 0				
Carrier Channel	Frequency (MHz)	Measured Peak Output Power (dBm)	Limit (uw)	Limit (dBm)
Low(4)	1921.536	1.57	115715	20.63
Mid(2)	1924.992	1.46	114991	20.61
High(0)	1928.448	1.38	115373	20.62

EBWLow Channel=1339000 Hz, EBWMid Channel=1322300 Hz,
 EBWHigh Channel=1331100 Hz
 Peak Transmitter Power Limit=100 (EBW) 1/2μW

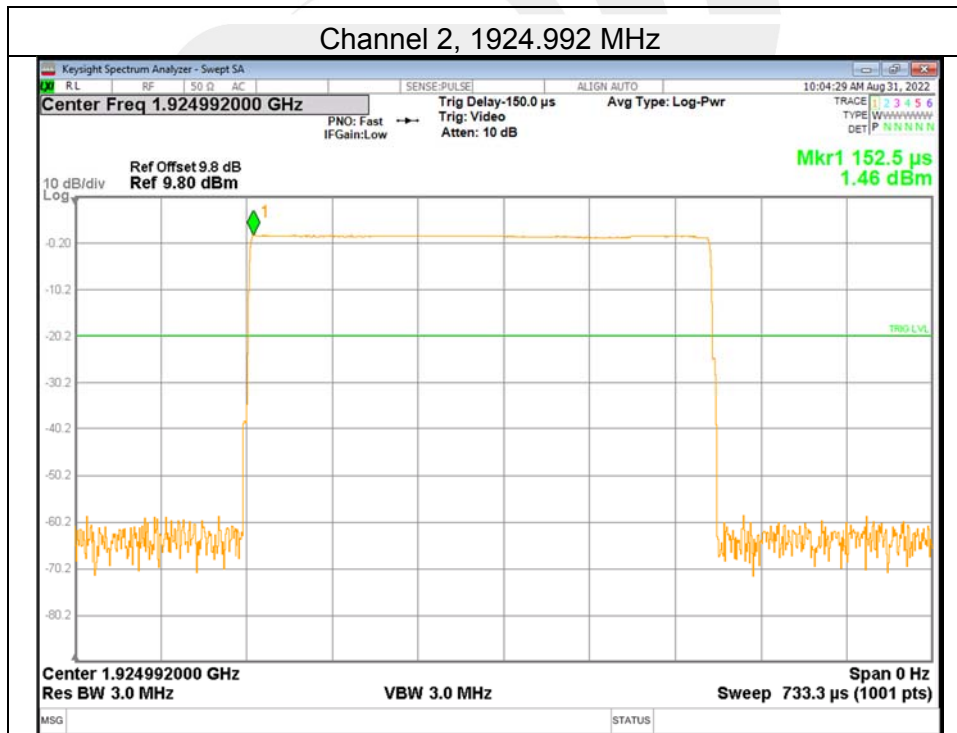
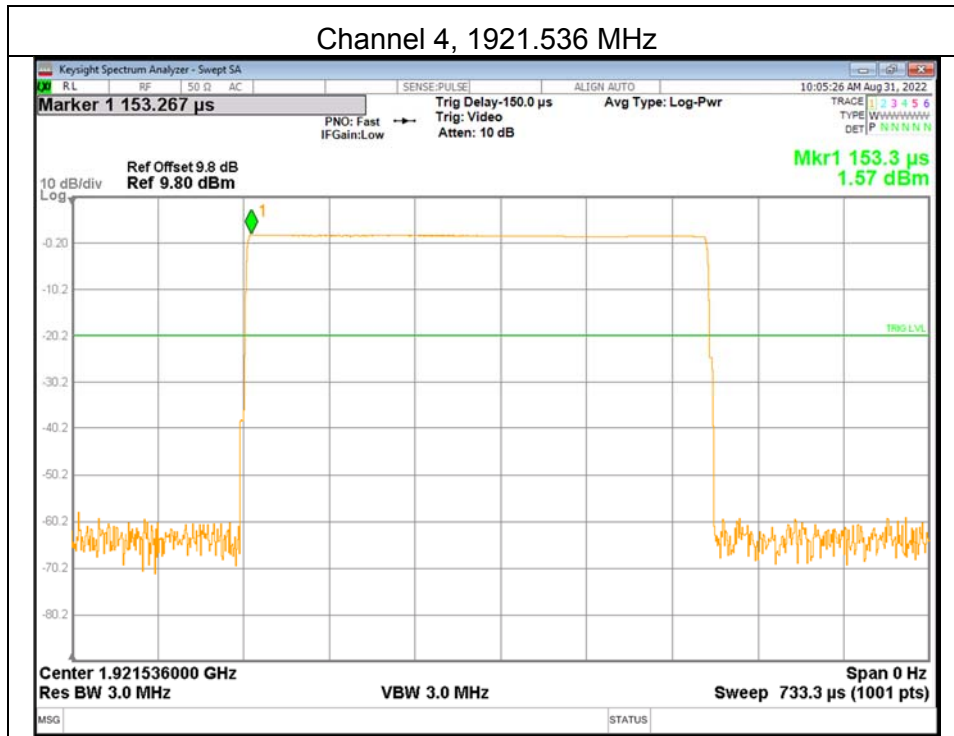

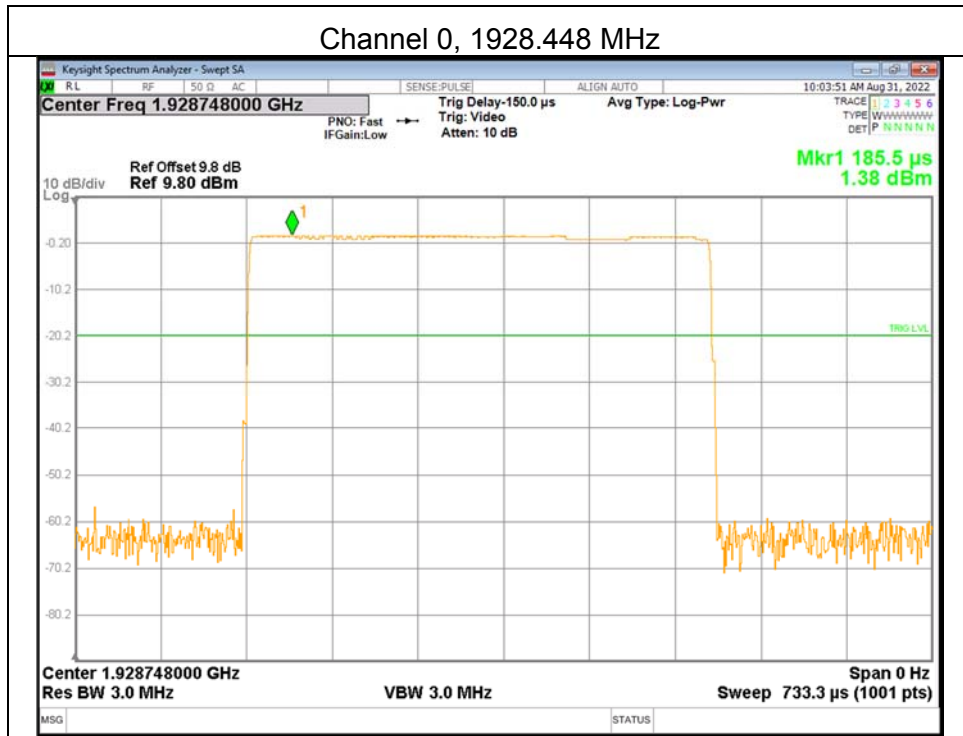



Atennna 1

Carrier Channel	Frequency (MHz)	Measured Peak Output Power (dBm)	Limit (uw)	Limit (dBm)
Low(4)	1921.536	2.53	115802	20.64
Mid(2)	1924.992	2.44	115931	20.64
High(0)	1928.448	2.41	115873	20.64

EBWLow Channel=1341000 Hz, EBWMid Channel=1344000 Hz, EBWHigh Channel=1342666.66700 Hz

Peak Transmitter Power Limit=100 (EBW) 1/2μW

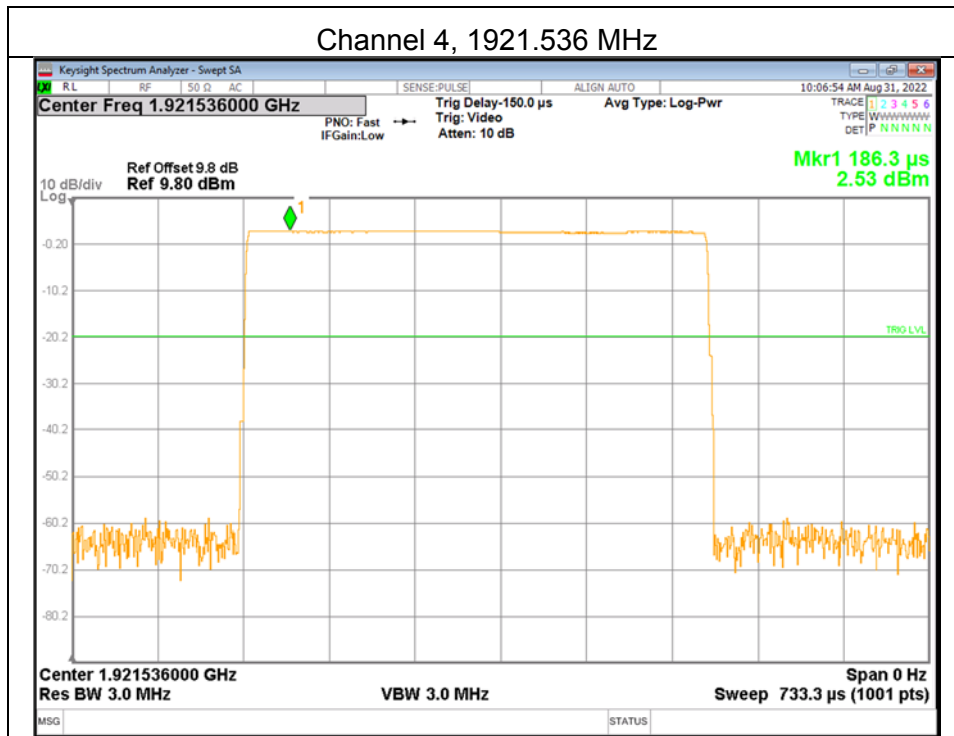

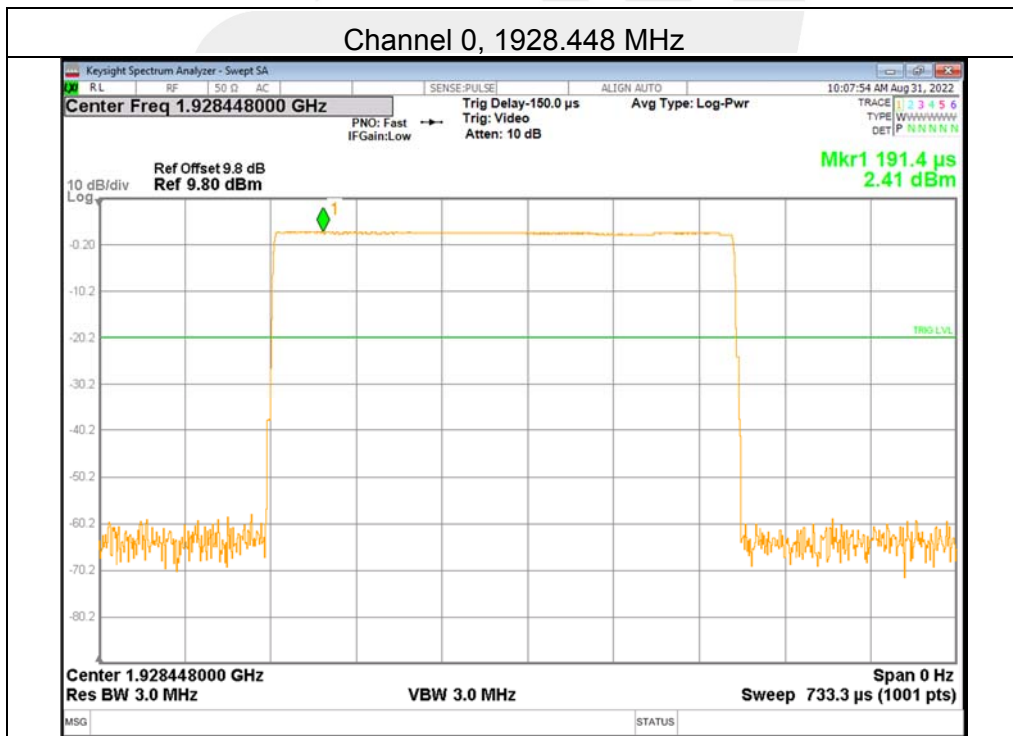
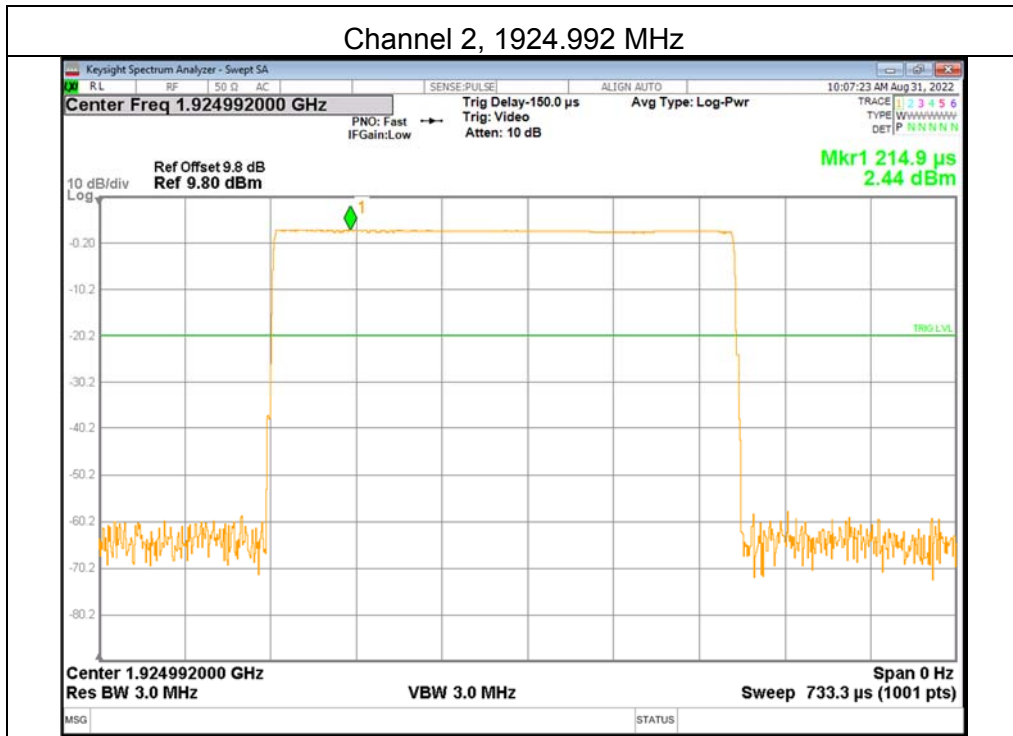



5.5 POWER SPECTRAL DENSITY
TEST OVERVIEW

§15.319(d) &RSS 213(5.7): Power spectral density shall not exceed 3 milliwatts in any 3 kHz bandwidth as measured with a spectrum analyzer having a resolution bandwidth of 3 kHz.

TEST PROCEDURE

Testing to ANSI C63.17-2013 Clause 6.1.5, which provides the test methodology for this provision.

TEST SETUP

The test setup is shown in section 3.2 figure 1.

TEST RESULTS

Antenna 0

Carrier Channel	Frequency (MHz)	Measured Peak Power Spectral Density (dBm)	Limit(mw)	Limit(dBm)
Low(4)	1921.536	-12.65	3	4.77
Mid(2)	1924.992	-12.30		
High(0)	1928.448	-13.34		

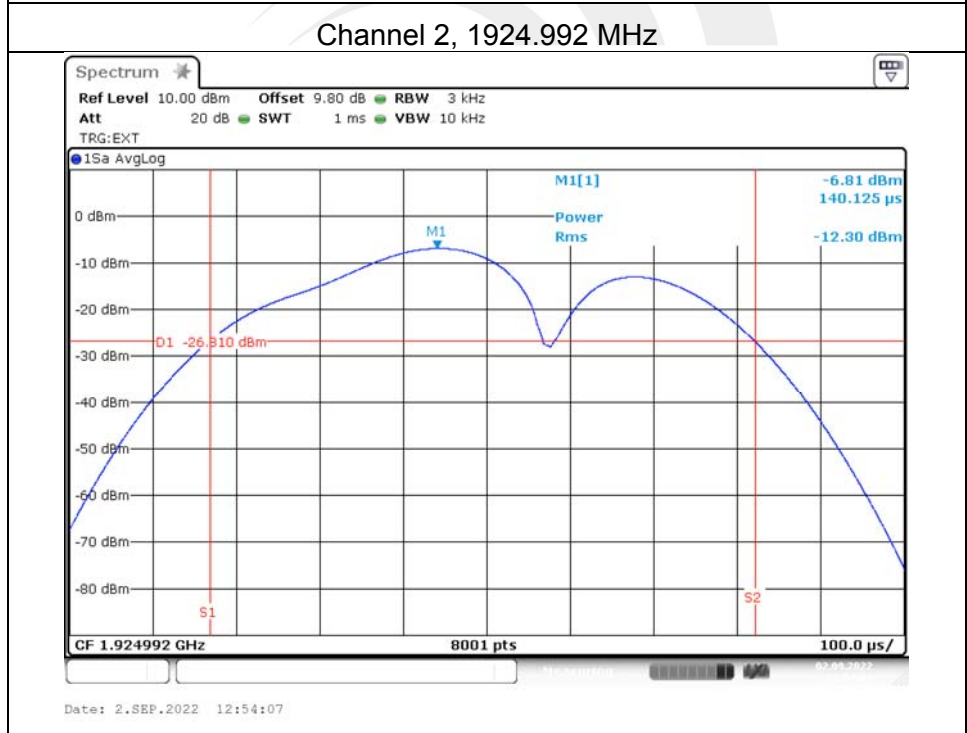
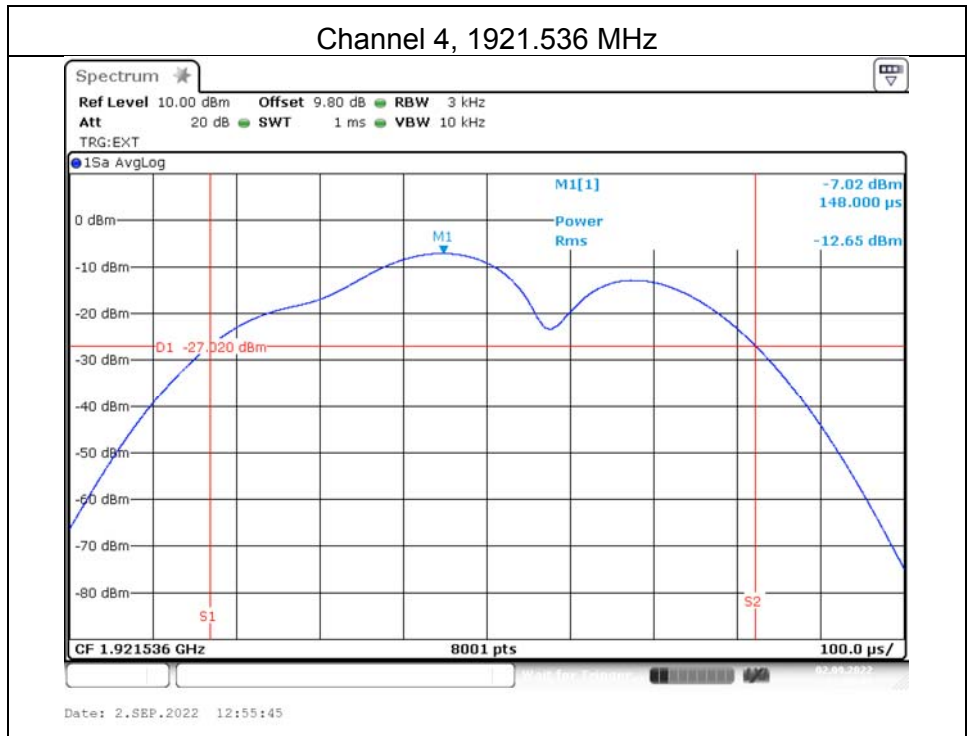

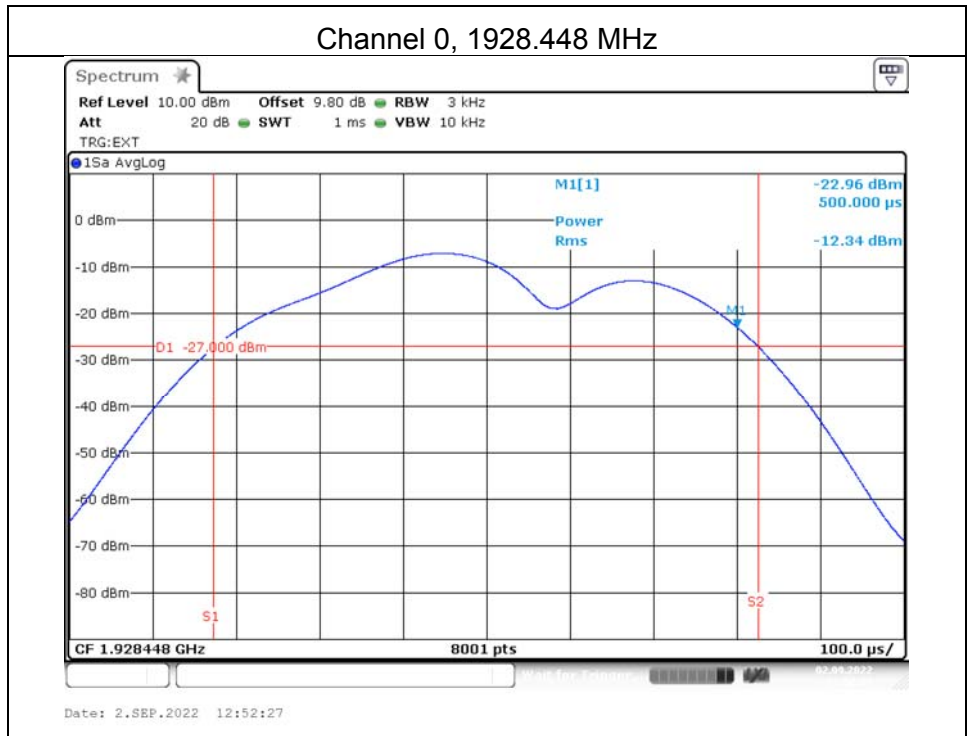



Antenna 1

Carrier Channel	Frequency (MHz)	Measured Peak Power Spectral Density (dBm)	Limit(mw)	Limit(dBm)
Low(4)	1921.536	-11.43	3	4.77
Mid(2)	1924.992	-11.33		
High(0)	1928.448	-11.40		

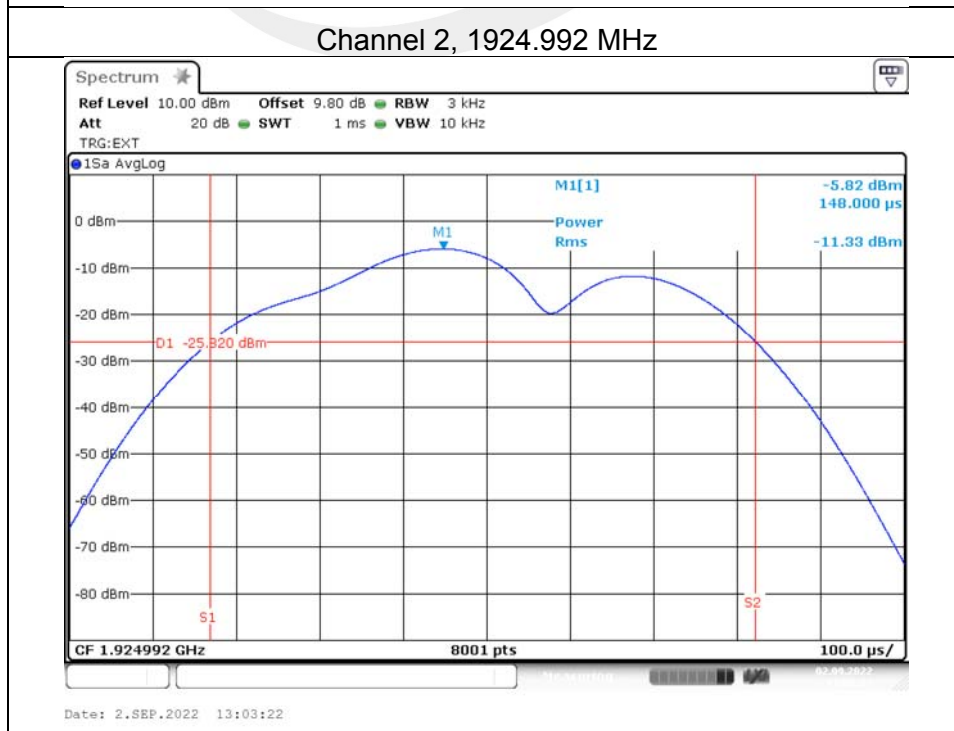
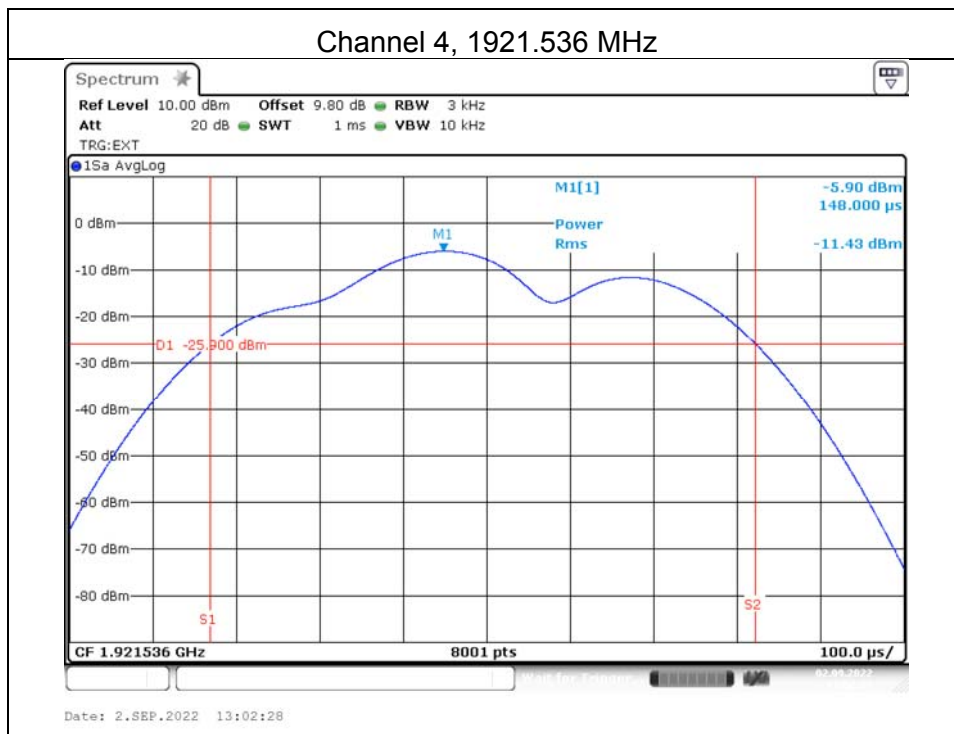

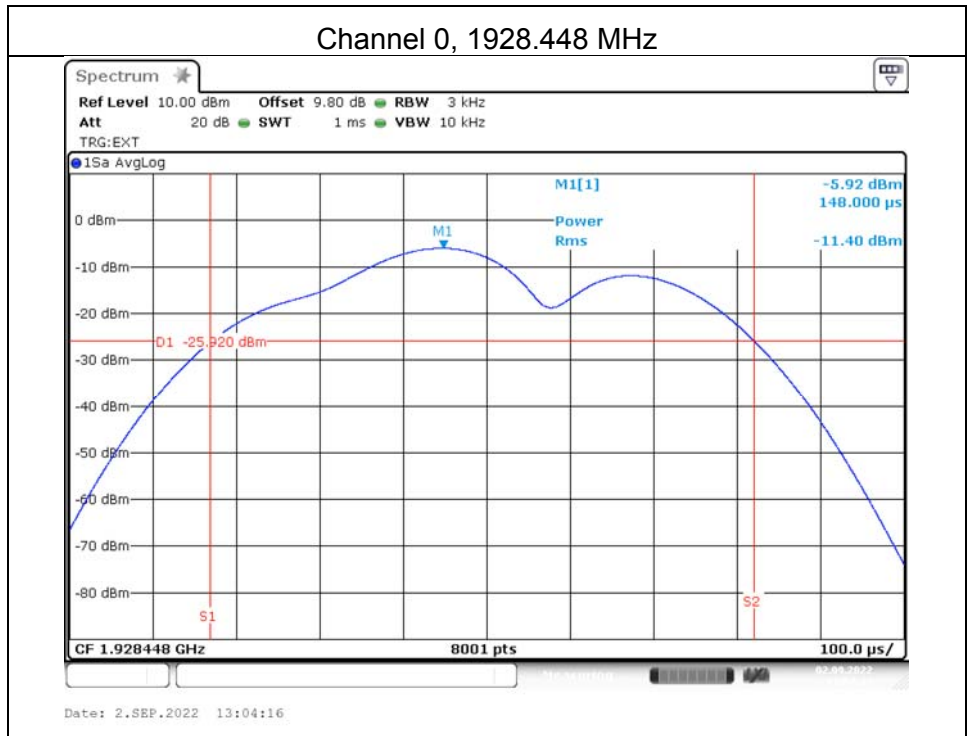



5.6 POWER ADJUSTMENT FOR ANTENNA GAIN

TEST OVERVIEW

§15.319(e) & RSS 213(5.6): The peak transmit power shall be reduced by the amount in decibels that the maximum directional gain of the antenna exceeds 3 dBi.

TEST PROCEDURE

Testing to ANSI C63.17-2013 Clause 4.3.1, which provides the test methodology for this provision.

TEST RESULT

Equipment Employs a -0.4 dBi Antenna. Max output power allowed with this gain by the EUT is 2.53dBm. The Max output power does not need to be reduced.

The Output Power complies with the Power Adjustment for Antenna Gain requirements of §15.319(e).





5.7 AUTOMATICALLY DISCONTINUE TRANSMISSION

OVERVIEW

§15.319(f) &RSS 213(5.2): The device shall automatically discontinue transmission in case of either absence of information to transmit or operational failure. These provisions are not intended to preclude transmission of control and signaling information or use of repetitive codes used by certain digital technologies to complete frame or burst intervals.

TEST RESULTS

	Test	Reaction of EUT	Result
1	Remove Power from Companion Device	A	Pass
2	Switch off the companion device	A	Pass
3	Terminate call at the companion device	NA1	Pass
4	Switch off the EUT	NA2	Pass
5	Terminate call at the EUT	NA3	Pass

A - Connection was terminated and transmission ceased.

B - Connection was terminated but the EUT transmits control or signaling information.

C - Connection was terminated but the companion device transmits control or signaling information.

NA 1 - Companion Device does not have an on/off switch for terminate call.

NA 2 - EUT does not have an on/off switch.

NA 3 – EUT does not have a switch for terminate call.



5.8 SYSTEM ACKNOWLEDGE-MENT TEST

TEST OVERVIEW

§ 15.323(c)(4) & RSS 213(5.2)(4): Once access to specific combined time and spectrum windows is obtained an acknowledgment from a system participant must be received by the initiating transmitter within one second or transmission must cease. Periodic acknowledgments must be received at least every 30 seconds or transmission must cease. Channels used exclusively for control and signaling information may transmit continuously for 30 seconds without receiving an acknowledgment, at which time the access criteria must be repeated.

TEST PROCEDURE

Measurement method according to ANSI C63.17 2013 clause 8.2.1

During testing initial transmission without acknowledgement, the signal from the EUT to the companion device is blocked by the circulator.

The test of the transmission time after loss of acknowledgements is performed by cutting off the signal from the companion device by a RF switch and measuring the time until the EUT stops transmitting.

TEST SETUP

The test setup is shown in section 3.2 figure 2.

TEST RESULTS

Antenna 0

Test	Time taken (second)	Limit (second)	Result
Initial Connection acknowledgement	0.52	1	Pass
Change of access criteria for control information	N/A	30	N/A
Transmission cease time after loss of acknowledgement	4.04	30	Pass

Antenna 1

Test	Time taken (second)	Limit (second)	Result
Initial Connection acknowledgement	0.65	1	Pass
Change of access criteria for control information	N/A	30	N/A
Transmission cease time after loss of acknowledgement	4.31	30	Pass



5.9 MONITORING THRESHOLD

TEST OVERVIEW

§15.323 (c)(2) &RSS 213(5.2)(2). The monitoring threshold must not be more than 30 dB above the thermal noise power for a bandwidth equivalent to the emission bandwidth used by the device.

§15.323 (c)(9) &RSS 213(5.2)(9). Devices that have a power output lower than the maximum permitted under this subpart may increase their monitoring detection threshold by one decibel for each one decibel that the transmitter power is below the maximum permitted.

TEST PROCEDURE

Testing to ANSI C63.17-2013 Clause 7.3, which provides the test methodology for this provision. The Clause states that the lower threshold is for devices that do not use the LIC procedure. The equation for the lower monitoring threshold is given in ANSI C63.17 Clause 4.3.4.

TEST SETUP

The test setup is shown in section 3.2 figure 2.

TEST RESULTS

Antenna 0		
Upper Threshold		
B	1331100	Hz
Mu	50	dB
Peut	1.38	dBm
TU	-43.517	dBm
Lower Threshold		
B	1331100	Hz
MI	30	dB
Peut	1.57	dBm
TL	-63.707	dBm
Antenna 1		
Upper Threshold		
B	1342667	Hz
Mu	50	dB
Peut	2.41	dBm
TU	-44.490	dBm
Lower Threshold		
B	1342667	Hz
MI	30	dB
Peut	2.53	dBm
TL	-64.610	dBm

ATTESTATION

The sensor will go into hibernation after a few minutes. It is not possible to keep a connection running very long. Therefore, this requirement is not applicable.



5.10 DURATION OF TRANSMISSION

TEST OVERVIEW

§15.323 (c)(3) & RSS 213(5.2)(3) If no signal above the threshold level is detected, transmission may commence and continue with the same emission bandwidth in the monitored time and spectrum windows without further monitoring. However, occupation of the same combined time and spectrum windows by a device or group of cooperating devices continuously over a period of time longer than 8 hours is not permitted without repeating the access criteria.

TEST PROCEDURE

Testing to ANSI C63.17-2013 Clause 4, which provides the test methodology for this provision. A communication link is established between BS and MS in a conducted mode and in a room without other US DECT devices to prevent influence from other transmissions. According to FCC Part 15.323(c)(3), the access criteria have to be verified at least every 8 hours. The following test is performed:

TEST SETUP

The test setup is shown in section 3.2 figure 2.

TEST RESULT

Antenna 0

Test ref. to ANSI C63.17:2013 clause 8.2.2	Observation result(H)	Limit(H)	Verdict
Transmission duration on same time and frequency window	0.3114	8	Pass

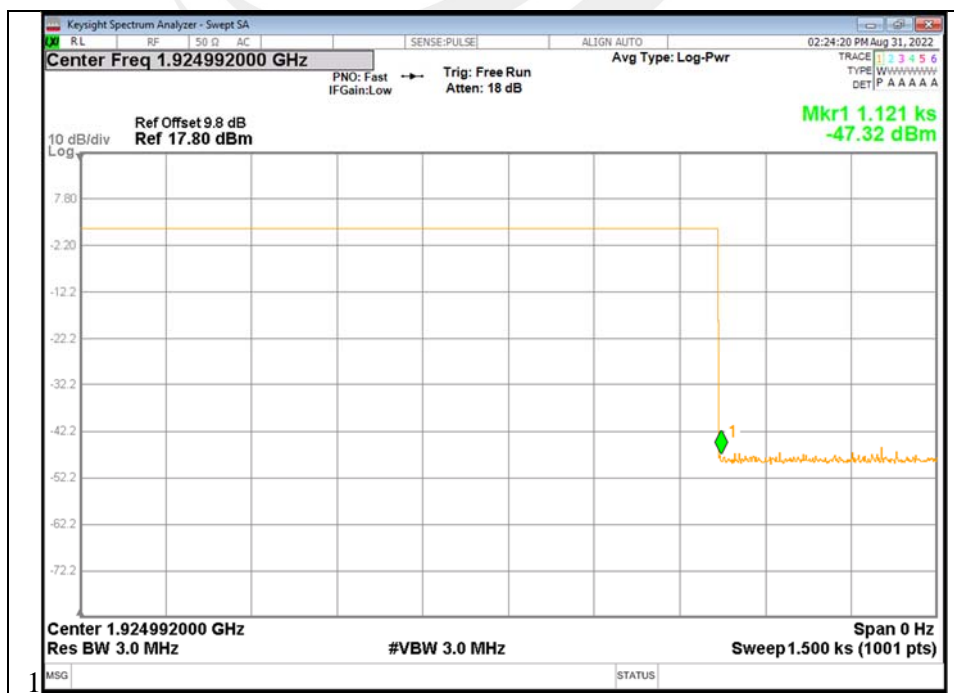



Antenna 1

Test ref. to ANSI C63.17:2013 clause 8.2.2	Observation result(H)	Limit(H)	Verdict
Transmission duration on same time and frequency window	0.2839	8	Pass

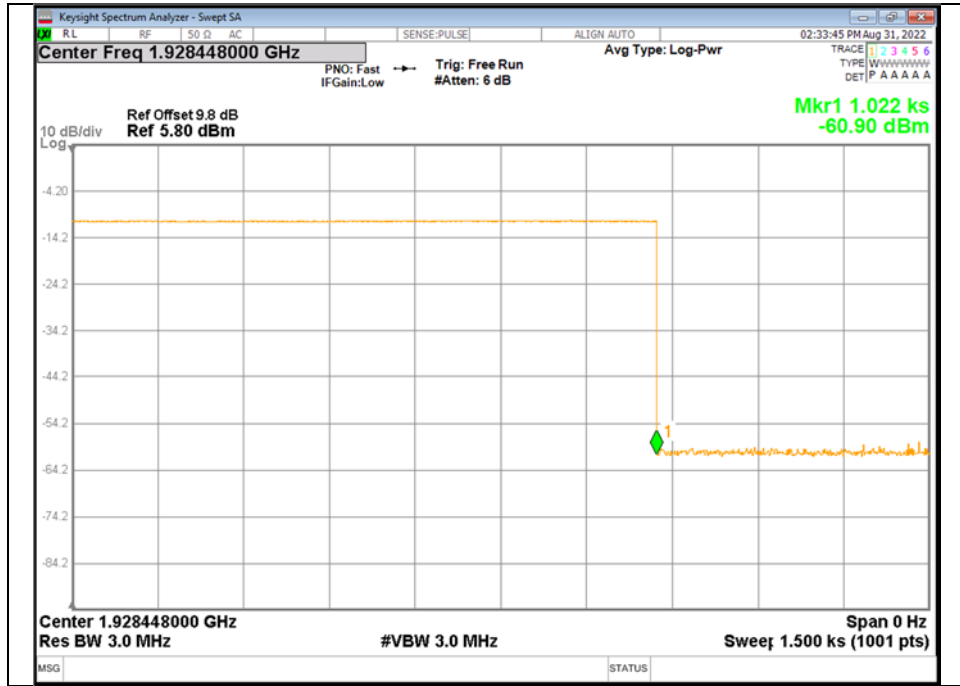



5.11 SELECTED CHANNEL CONFIRMATION, POWER ACCURACY, SEGMENT OCCUPANCY TEST OVERVIEW

§15.323 (c)(5) & RSS 213(5.2)(5) If access to spectrum is not available as determined by the above, and a minimum of 40 duplex system access channels are defined for the system, the time and spectrum windows with the lowest power level below a monitoring threshold of 50 dB above the thermal noise power determined for the emission bandwidth may be accessed. A device utilizing the provisions of this paragraph must have monitored all access channels defined for its system within the last 10 seconds and must verify, within the 20 milliseconds (40 milliseconds for devices designed to use a 20 milliseconds frame period) immediately preceding actual channel access that the detected power of the selected time and spectrum windows is no higher than the previously detected value. The power measurement resolution for this comparison must be accurate to within 6 dB. No device or group of co-operating devices located within 1 meter of each other shall during any frame period occupy more than 6 MHz of aggregate bandwidth, or alternatively, more than one third of the time and spectrum windows defined by the system.

TEST PROCEDURE

Testing to ANSI C63.17-2013 Clause 7.3.2. & 7.3.3, which provides the test methodology for this provision. The current product offers 12 duplex channels per frequency channel and therefore 12x5=60 duplex channels in total. Hence Part §15.323(c)(5) applies. The equation for the upper monitoring threshold is given in ANSI C63.17 Clause 4.3.3. Max measured interference level (dBm) = -85.02 dBm

TEST SETUP

The test setup is shown in section 3.2 figure 2.

MONITORING LIMIT THRESHOLD

The EUT's monitoring limit threshold power at the monitoring antenna terminals shall be less than a maximum, shown in Equation (3):

T_L ≤ (-174 + 10logB + M_L + P_MAX - P_EUT) dBm

M_L is a level specified by the manufacturer and is the maximum amount in decibels by which the limiting threshold may exceed thermal noise for an EUT transmitting the maximum allowed power.

Calculation of monitoring threshold limits for isochroous devices:

Lower threshold: T_L = -174 + 10log_10 B + M_L + P_MAX - P_EUT (dBm)

Where: B= Emission bandwidth (Hz)

M_L = dB the threshold may exceed thermal noise (30 for T_L)

P_MAX = 5Log_10 B - 10 (dBm)

P_EUT = Transmitted power (dBm)

Table with 6 columns: Monitor Threshold, B(Hz), M_L(dB), P_MAX(dBm), P_EUT(dBm), Threshold(dBm). Row 1: Lower threshold, 1342.667, 30, 20.64, 2.53, -64.610

Note: 1. The upper threshold is applicable as the EUT utilizes more than 20 duplex system channels



TEST RESULTS

1) LIC procedure test:

Interference (Refer to ANSI C63.17 clause 7.3.3)	Reaction fo EUT	Results
a) Apply the interference on f_1 at level $T_L+U_M+7\text{dB}$ and the interference on f_2 at level T_L+U_M . Initiate transmission and verify the transmission only on f_2 . Repeat 5 times.	EUT transmits on f_2	Pass
b) Apply the interference on f_1 at level T_L+U_M and the interference on f_2 at level $T_L+U_M+7\text{dB}$. Initiate transmission and verify the transmission only on f_1 . Repeat 5 times.	EUT transmits on f_1	Pass
c) Apply the interference on f_1 at level $T_L+U_M+1\text{dB}$ and the interference on f_2 at level $T_L+U_M-6\text{dB}$. Initiate transmission and verify the transmission only on f_2 . Repeat 5 times.	EUT transmits on f_2	Pass
d) Apply the interference on f_1 at level $T_L+U_M-6\text{dB}$ and the interference on f_2 at level $T_L+U_M+1\text{dB}$. Initiate transmission and verify the transmission only on f_2 . Repeat 5 times.	EUT transmits on f_1	Pass

2) Selected channel confirmation:

Interference (Refer to ANSI C63.17 clause 7.3.4)	Reaction fo EUT	Results
a) Apply the interference on f_1 at level T_L+U_M and no interference on f_2 . Initiate transmission and verify the transmission only on f_2 . Then terminate it.	EUT transmits on f_2	Pass
b) Apply the interference on f_2 at level T_L+U_M and immediately remove all interference from f_1 . The EUT should immediately attempt transmission f_1 (but at least 20ms after the interference on f_2 is applied), verify the transmission only on f_1 .	EUT transmits on f_1	Pass



5.12 RANDOM WAITING

TEST CRITERIA

§15.323 (c)(6)) if the selected combined time and spectrum windows are unavailable, the device may either monitor and select different windows or seek to use the same windows after waiting an amount of time, randomly chosen from a uniform random distribution between 10 and 150 milliseconds, commencing when the channel becomes available.

TEST PROCEDURE

Testing to ANSI C63.17-2013 Clause 8.1.3, which provides the test methodology for this provision.

ATTESTATION

The Manufacturer declared that this provision is not utilized by the EUT.





5.13 MONITORING REQUIREMENTS

TEST CRITERIA

§15.323 (c)(7) & RSS 213(5.2)(7) The monitoring system bandwidth must be equal to or greater than the emission bandwidth of the intended transmission and have a maximum reaction time less than $50 \times \text{SQRT}(1.25 / \text{emission bandwidth in MHz})$ microseconds for signals at the applicable threshold level but shall not be required to be less than 50 microseconds. If a signal is detected that is 6 dB or more above the applicable threshold level, the maximum reaction time shall be $35 \times \text{SQRT}(1.25 / \text{emission bandwidth in MHz})$ microseconds but shall not be required to be less than 35 microseconds.

TEST PROCEDURE

Measurement method according to ANXI C63.17 2013 clause 7.5

- Restrict the EUT to a single transmit carrier frequency f_1 , and verify that the EUT can establish a connection with no interference applied on f_1 .
- Apply time-synchronized, pulsed interference on f_1 at the pulsed level $T_L + U_M$, verify that the EUT does not establish a connection when the width of the interference pulse exceeds the largest of $50 \mu\text{s}$ and $50 \sqrt{1.25 / B} \mu\text{s}$, where B is the emission bandwidth of the EUT in megahertz.
- With the channel interference level 6dB above $T_L + U_M$, verify that the EUT does not establish a connection when the width of the interference pulse exceeds the largest of $35 \mu\text{s}$ and $35 \sqrt{1.25 / B} \mu\text{s}$, where B is the emission bandwidth of the EUT in megahertz.

Test pulse width Equation(μs)	B(bandwidth)(MHz)	Pulse width(μs)	Limit(Largest)(μs)
$50 \sqrt{1.25 / B}$	1.344	48.22	50
$35 \sqrt{1.25 / B}$	1.344	33.75	35

TEST SETUP

The test setup is shown in section 3.2 figure 2.

TEST RESULTS

1) Monitoring Bandwidth:

The antenna of the EUT used for monitoring is the same interior antenna that used for transmission, so the monitoring system bandwidth is equal to the emission bandwidth of the intended transmission.

2) Reaction Time Test:

No.	Interference Pulse width(μs)	Reaction of EUT	Observing time(μs)	Result
1	$50 \mu\text{s}$ with level $T_L + U_m$	No transmission	50	Pass
2	$35 \mu\text{s}$ with level $T_L + U_M + 6\text{dB}$	No transmission	35	Pass



5.14 MONITORING ANTENNA

TEST CRITERIA

§15.323 (c)(8) & RSS 213(5.2)(8) Transmission is intended to occupy. The following criteria must be met: (8) The monitoring system shall use the same antenna used for transmission, or an antenna that yields equivalent reception at that location.

TEST PROCEDURE

Testing to ANSI C63.17-2013 Clause 4, which provides the test methodology for this provision.

ATTESTATION

The EUT uses the same antennas for transmission and reception as for monitoring

5.15 DUPLEX CONNECTIONS

TEST CRITERIA

§15.323 (c)(10) An initiating device may attempt to establish a duplex connection by monitoring both its intended transmit and receive time and spectrum windows. If both the intended transmit and receive time and spectrum windows meet the access criteria, then the initiating device can initiate a transmission in the intended transmit time and spectrum window. If the power detected by the responding device can be decoded as a duplex connection signal from the initiating device, then the responding device may immediately begin transmitting on the receive time and spectrum window monitored by the initiating device.

TEST PROCEDURE

Testing to ANSI C63.17-2013 Clause 8.3, which provides the test methodology for this provision. The MS is the initiating device and the BS is the companion device.

TEST RESULTS

The Manufacturer declares that this provision is not utilized by the EUT.



5.16 ALTERNATIVE MONITORING INTERVAL FOR CO-LOCATED DEVICES

TEST CRITERIA

§15.323 (c)(11) & RSS 213(5.2)(11) an initiating device that is prevented from monitoring during its intended transmit window due to monitoring system blocking from the transmissions of a co-located (within one meter) transmitter of the same system, may monitor the portions of the time and spectrum windows in which they intend to receive over a period of at least 10 milliseconds. The Monitored time and spectrum window must total at least 50 percent of the 10 millisecond frame interval and the monitored spectrum must be within the 1.25 mhz frequency channel(s) already occupied by that device or co-located co-operating devices. If the access criteria is met for the intended receive time and spectrum window under the above conditions, then transmission in The intended transmit window by the initiating device may commence.

TEST PROCEDURE

Testing to ANSI C63.17-2013 Clause 8.4, which provides the test methodology for this provision. The MS is initiating device and the BS is the companion device.

TEST RESULTS

The Manufacturer declares that this provision is not utilized by the EUT.

5.17 FAIR ACCESS

TEST CRITERIA

§15.323 (c)(12) & RSS 213(5.2)(12) The provisions of (c)(10) or (c)(11) of this section shall not be used to extend the range of spectrum occupied over space or time for the purpose of denying fair access to spectrum to other devices.

TEST PROCEDURE

The manufacturer supplies an attestation.

ATTESTATION

The manufacturer declares that the EUT does not work in a mode which denies fair access to spectrum for other devices.



5.18 SPURIOUS EMISSIONS

TEST CRITERIA

§15.323(d)(1) &RSS 213(5.8.1): Out of Band Emissions

Emissions shall be attenuated below a reference power of 112 milliwatts as follows: 30 dB between the band edge and 1.25 MHz above or below the band; 50 dB between 1.25 and 2.5 MHz above or below the band; and 60 dB at 2.5 MHz or greater above or below the band.

§15.323(d)(2) &RSS 213(5.8.2): In-Band Emissions

Emissions inside the band must comply with the following emission mask: In the bands between 1B and 2B measured from the center of the emission bandwidth, the total power emitted by the device shall be at least 30 dB below the transmit power permitted for that device; in the bands between 2B and 3B measured from the center of the emission bandwidth, the total power emitted by an intentional radiator shall be at least 50 dB below the transmit power permitted for that radiator; in the bands between 3B and the band edge, the total power emitted by an intentional radiator in the measurement bandwidth shall be at least 60 dB below the transmit power permitted for that radiator. "B" is defined as the emission bandwidth of the device in hertz. Compliance with the emission limits is based on the use of measurement instrumentation employing peak detector function with an instrument resolution bandwidth approximately equal to 1.0 percent of the emission bandwidth of the device under measurement.

TEST PROCEDURE

For both in and out of band emissions the EUT was connected directly to a spectrum analyzer. The RBW of the spectrum analyzer was set to a minimum 1% of the emission band width.

TEST SETUP

The test setup is shown in section 3.2 figure 1.

TEST RESULTS

Equipment complies with the Spurious Emission limits of § 15.323(d)(1).

In-Band Emissions

Antenna 0

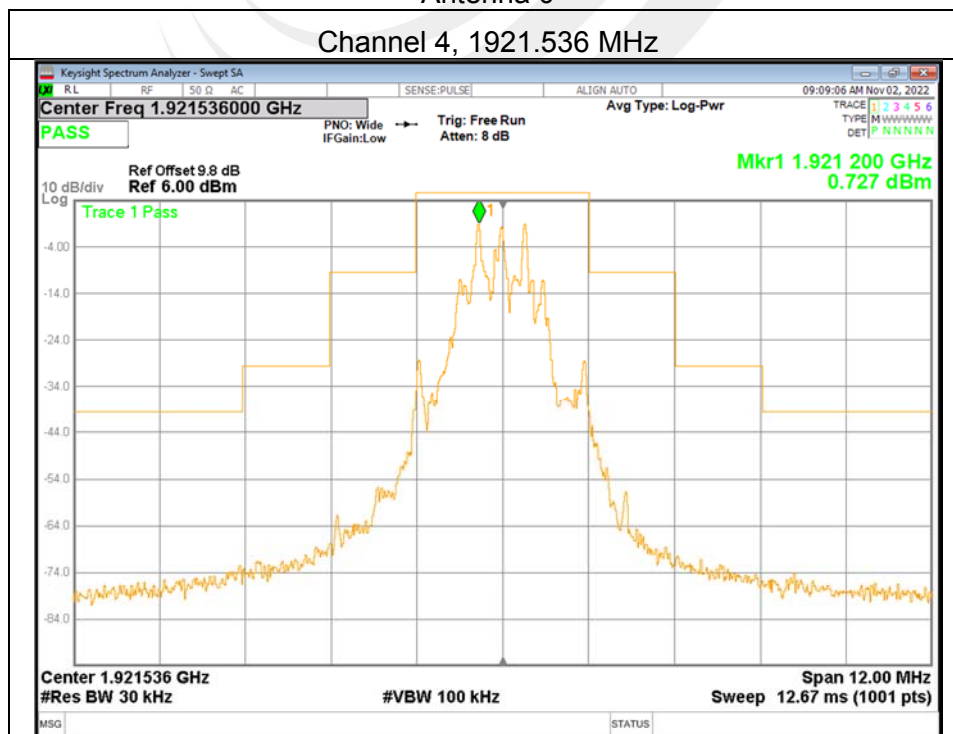

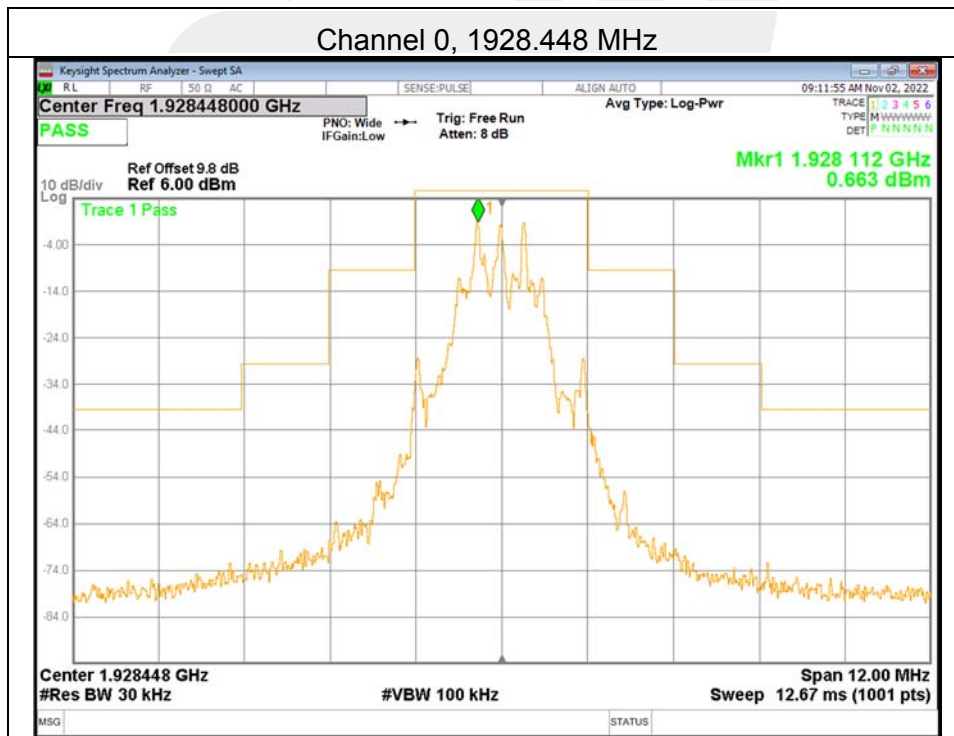
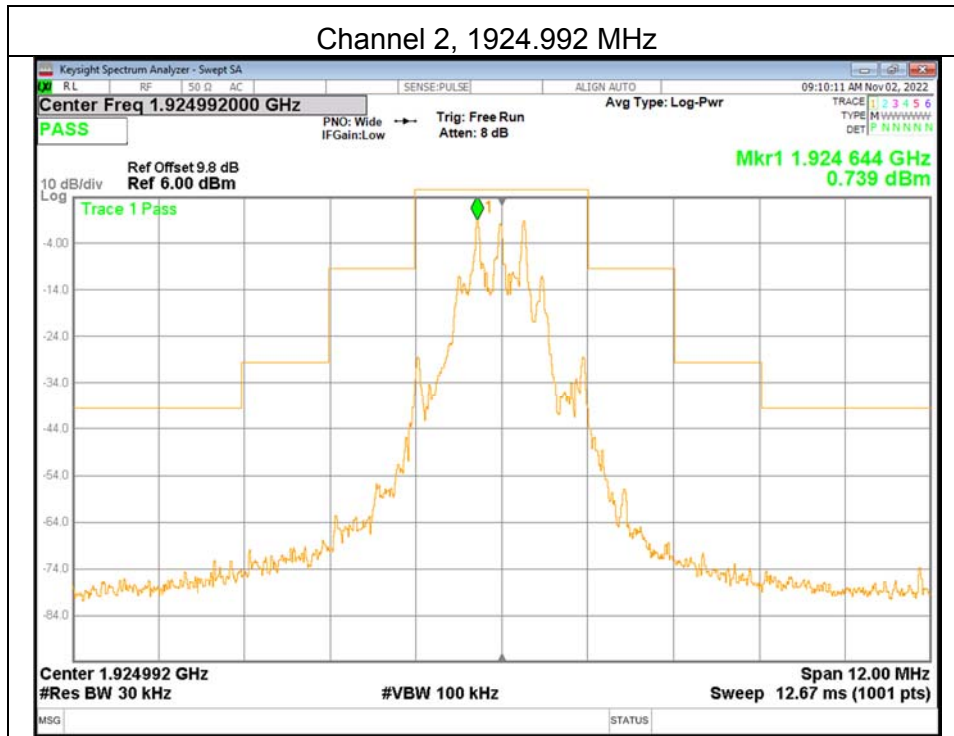



Antenna 1

Channel 4, 1921.536 MHz

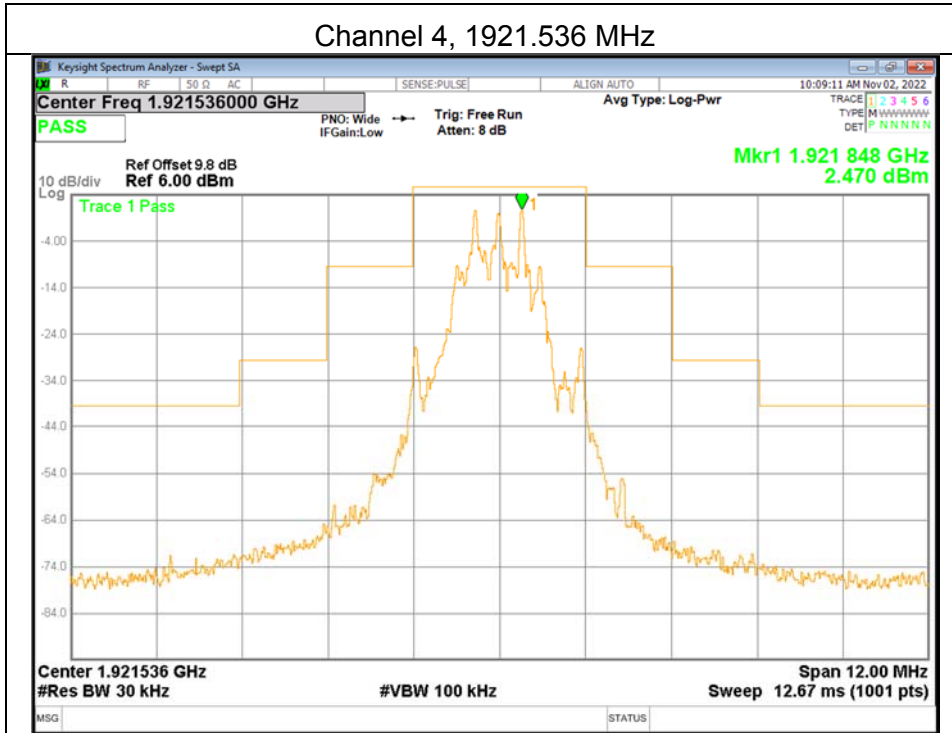

Channel 2, 1924.992 MHz

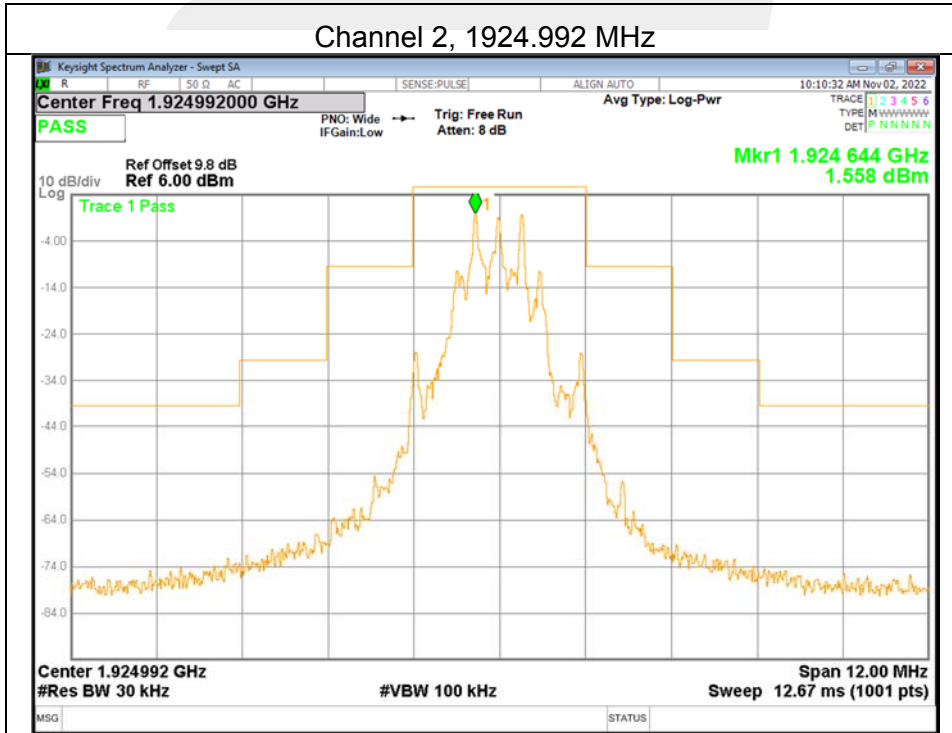

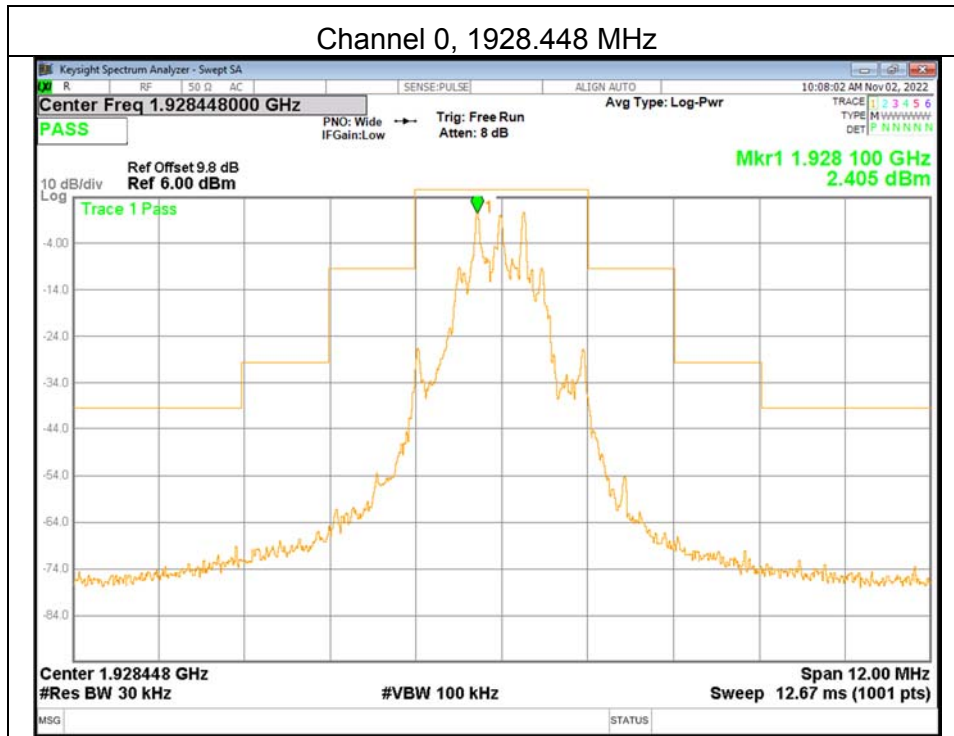



Out of Band Emissions

Antenna 0

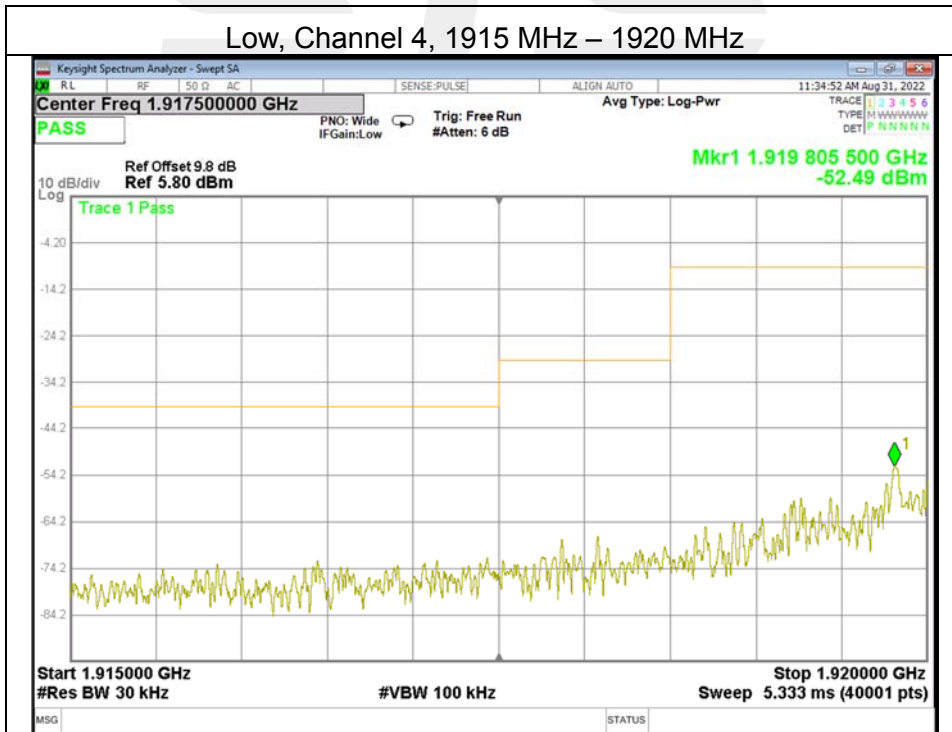
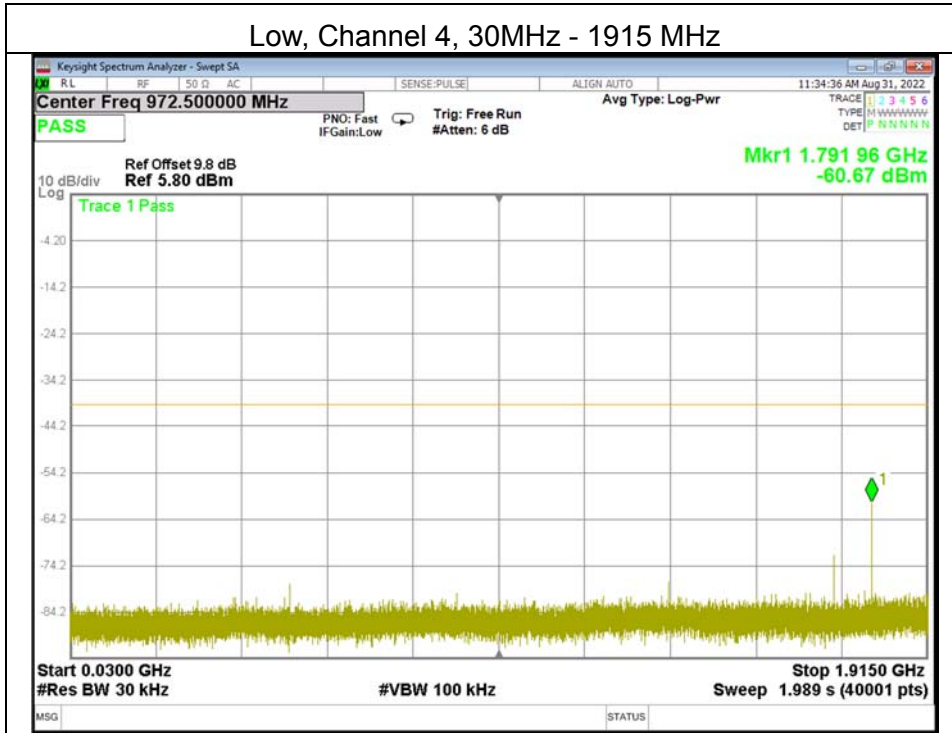

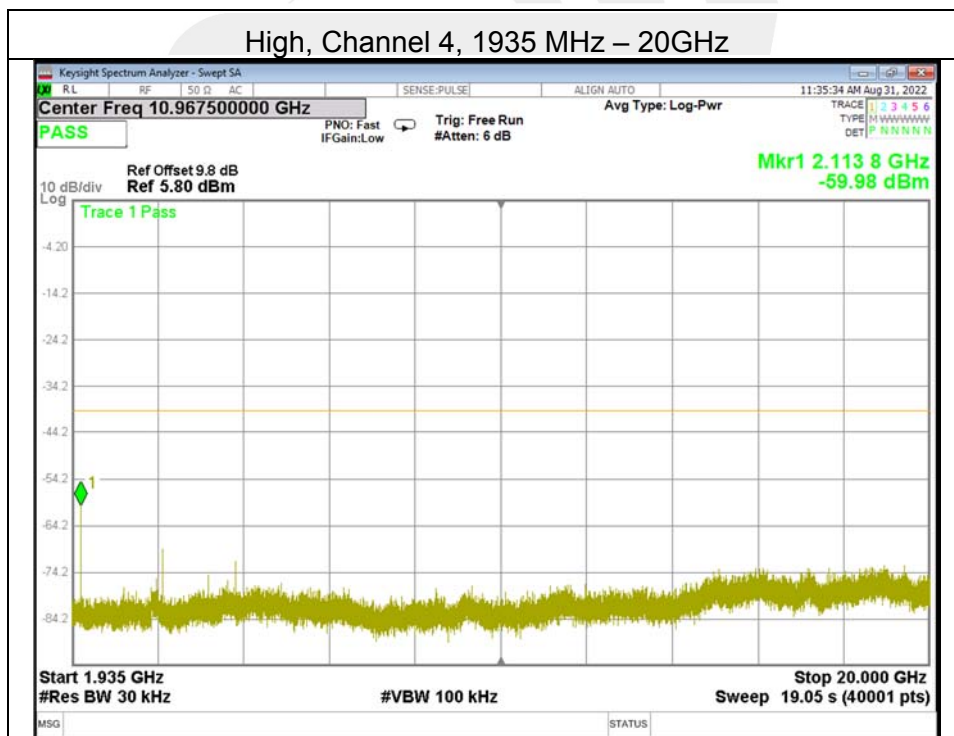
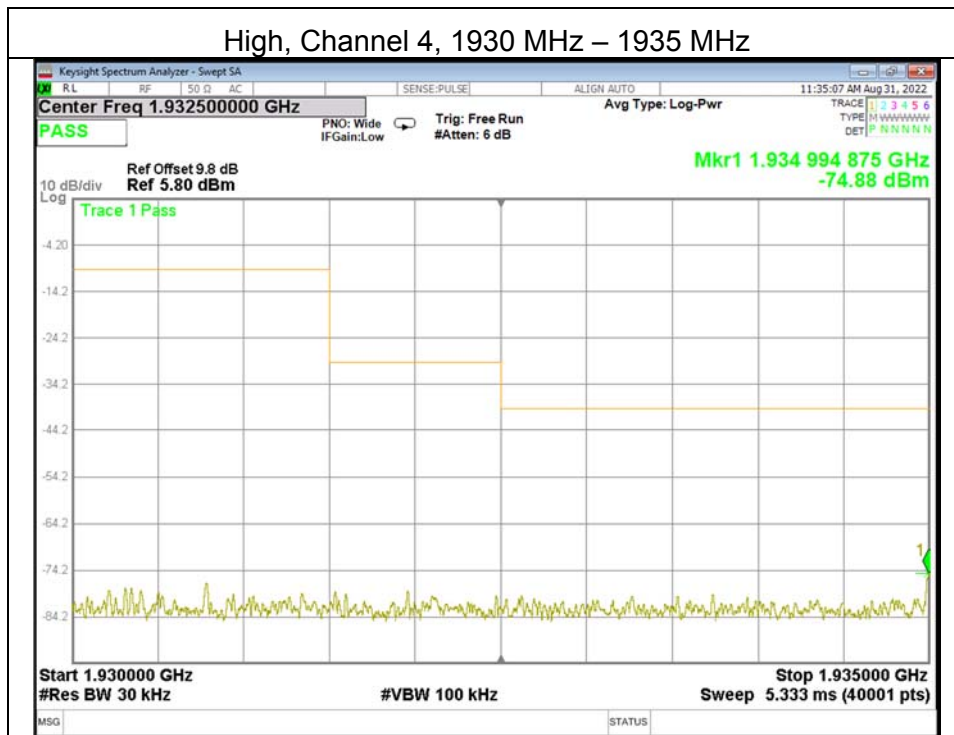

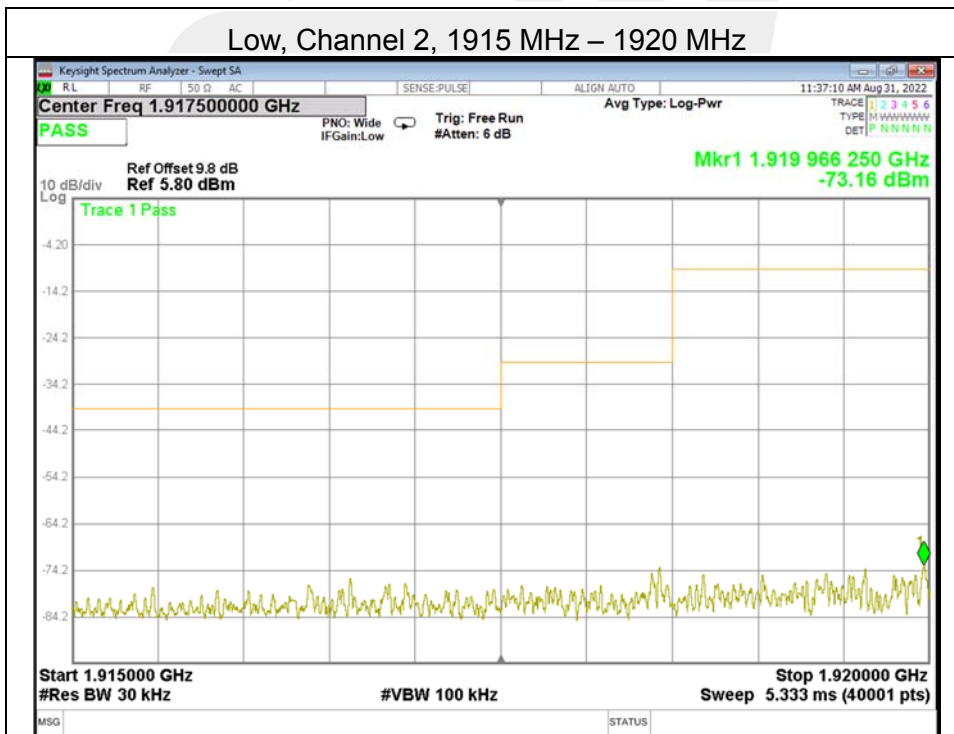
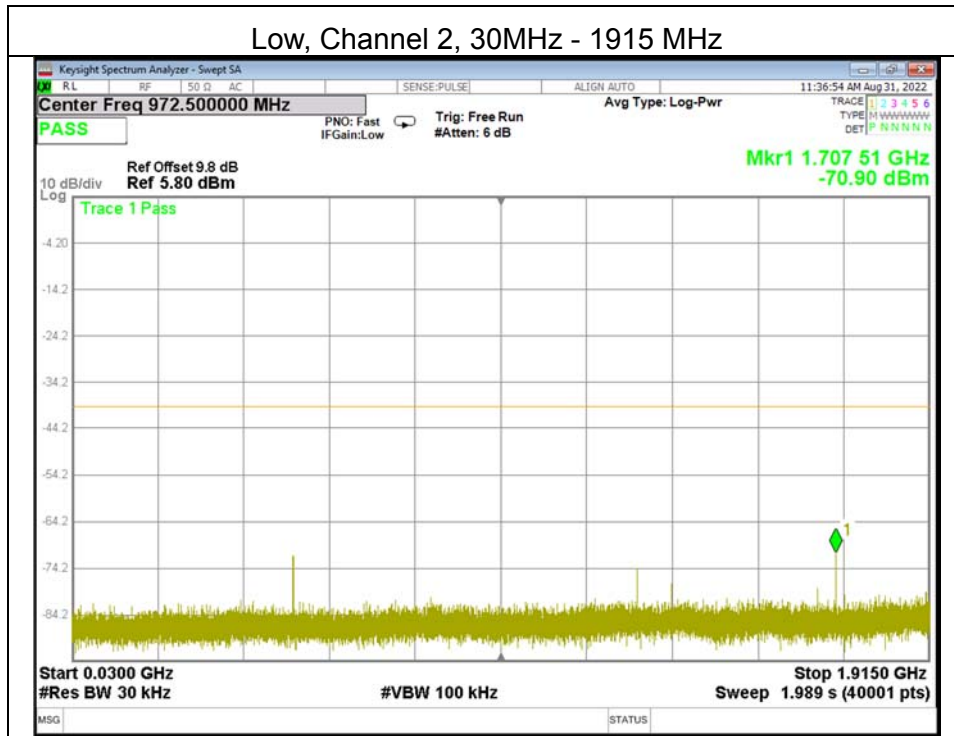

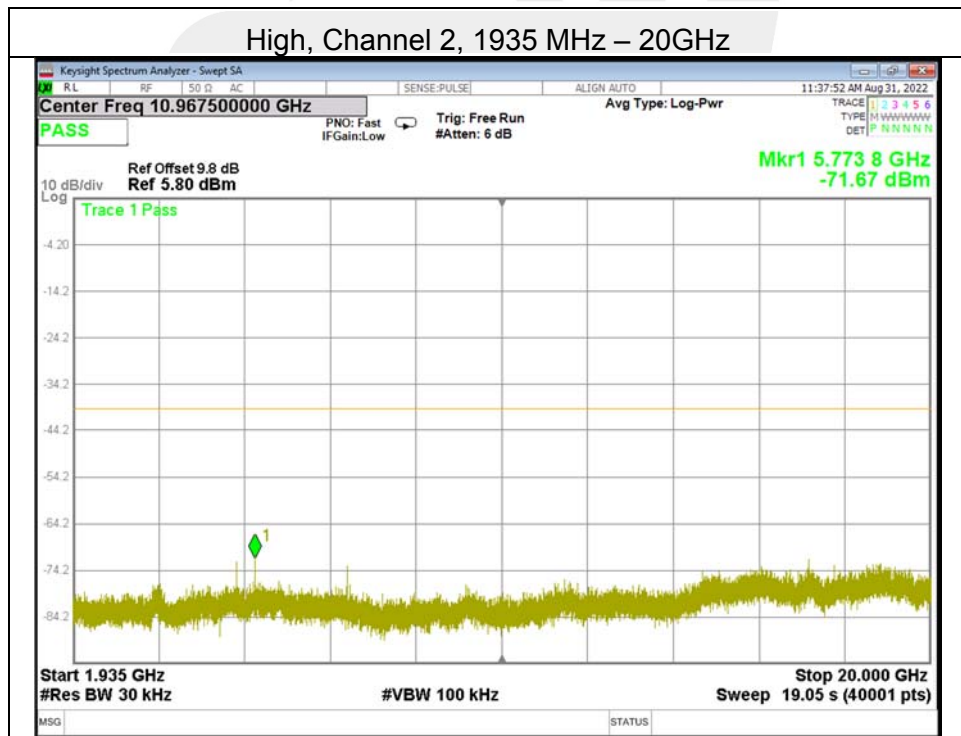
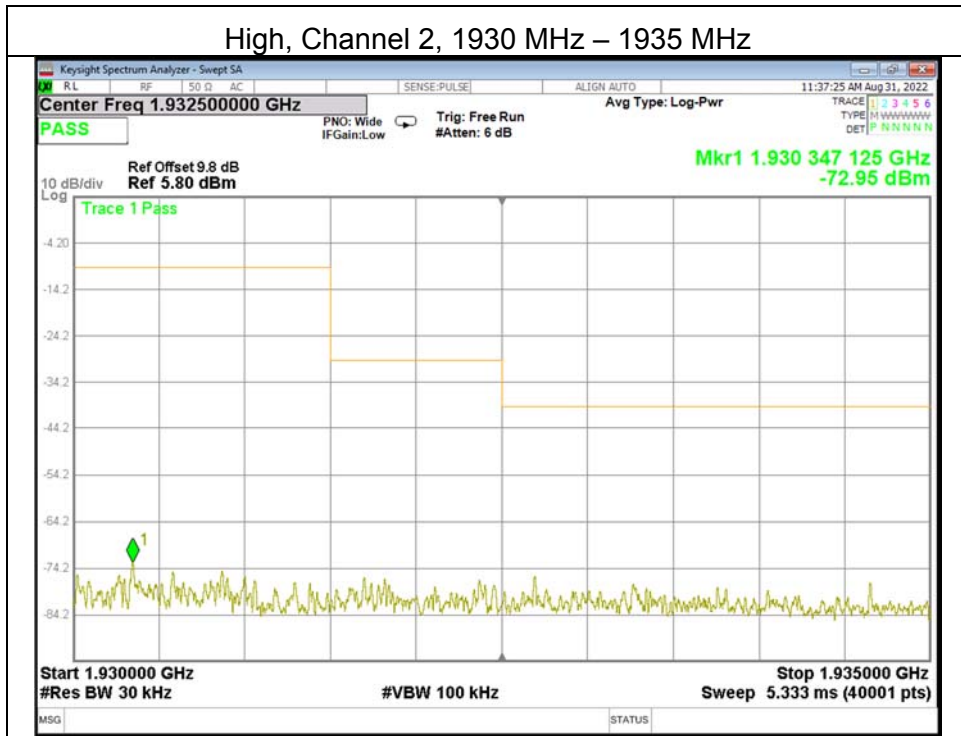

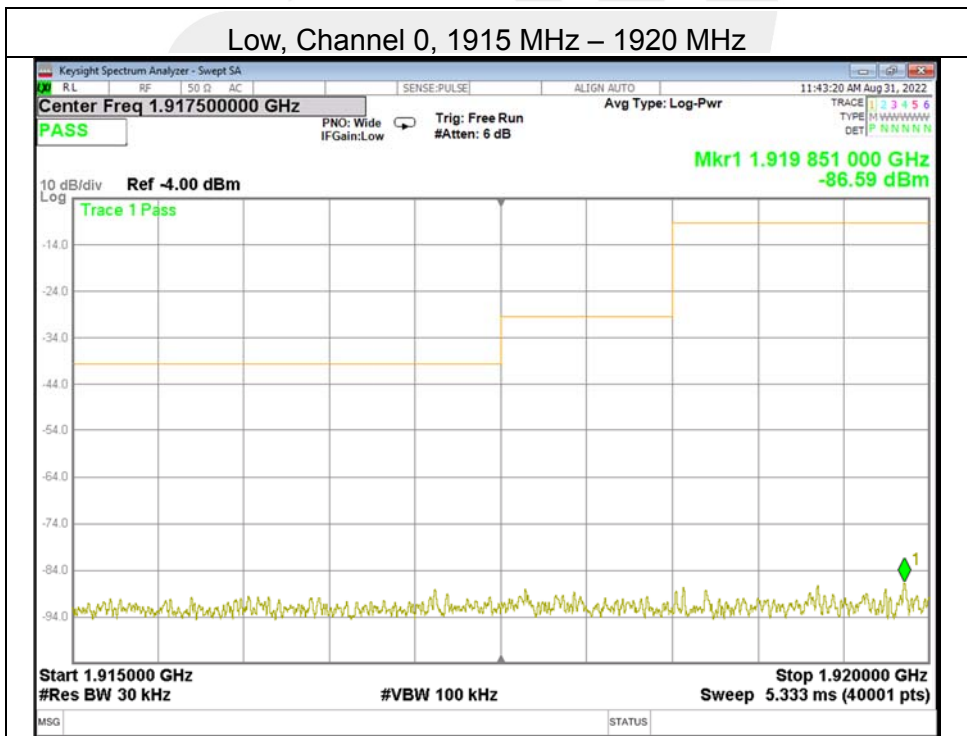
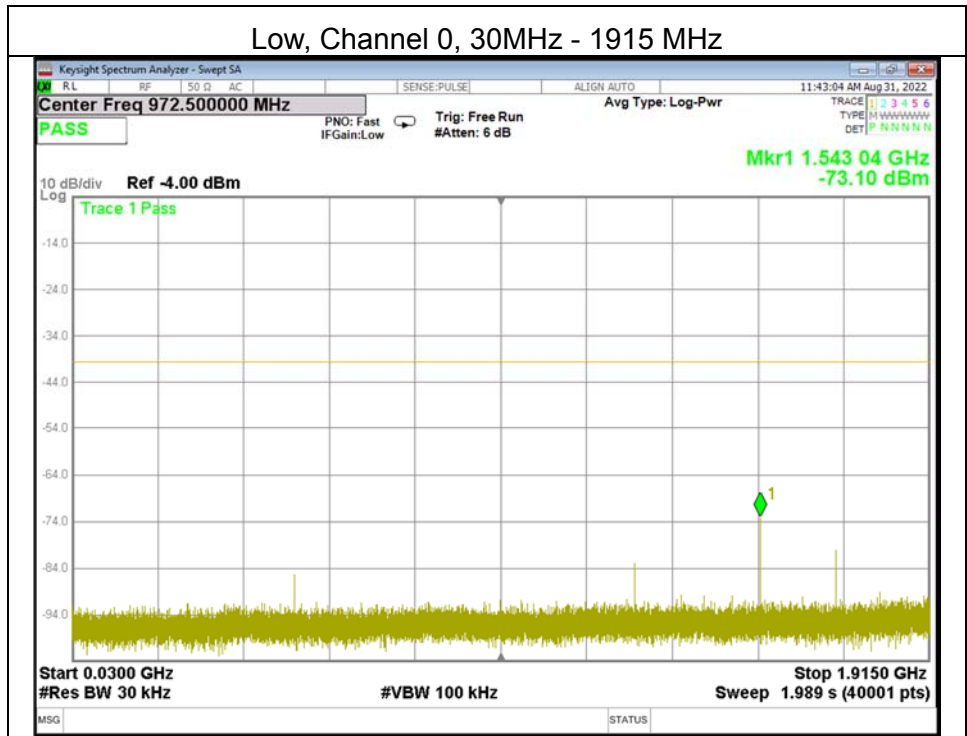

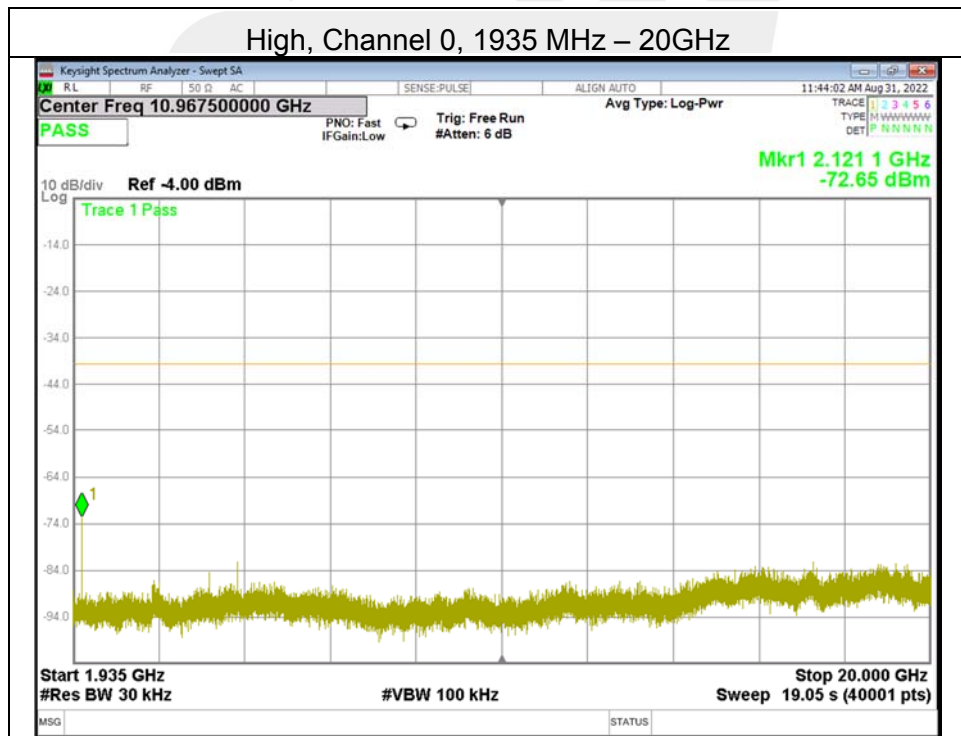
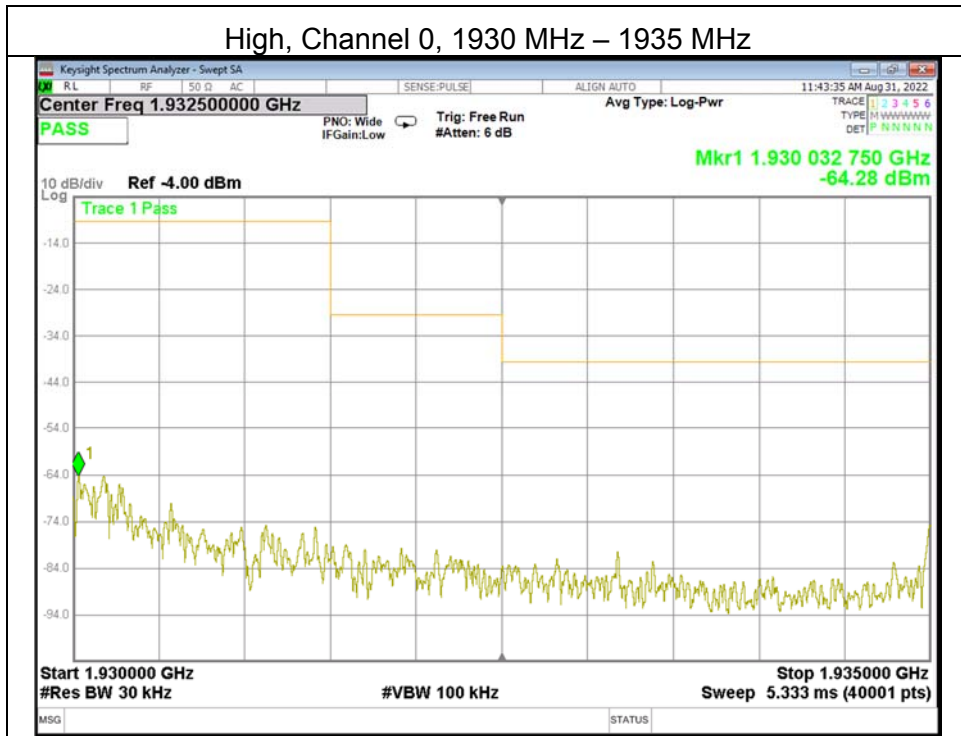



Antenna 1

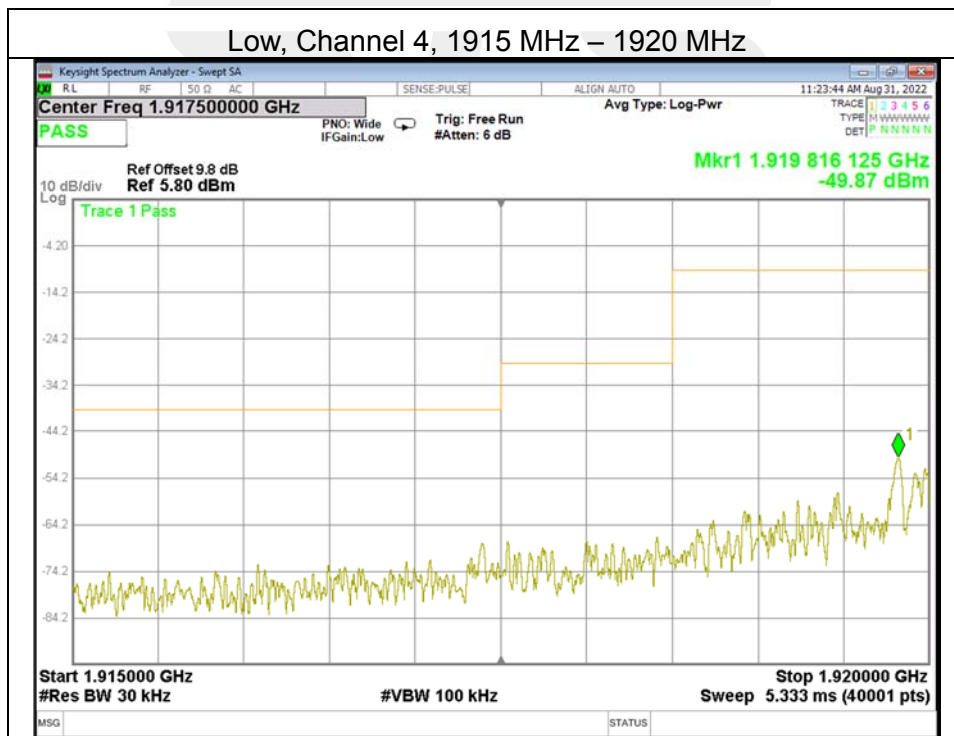
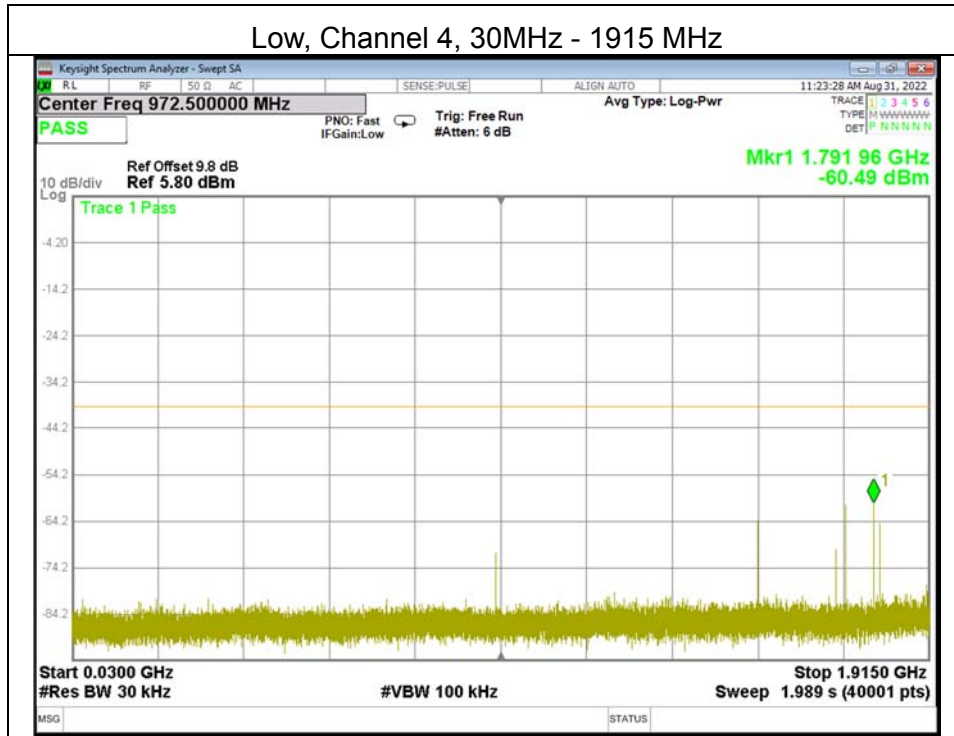

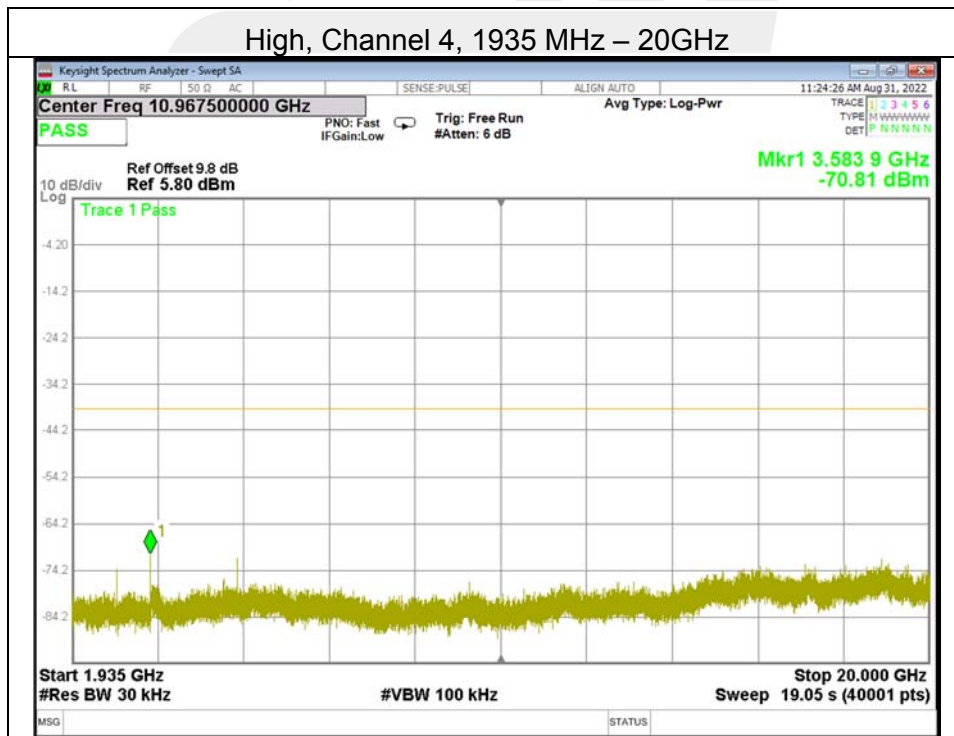
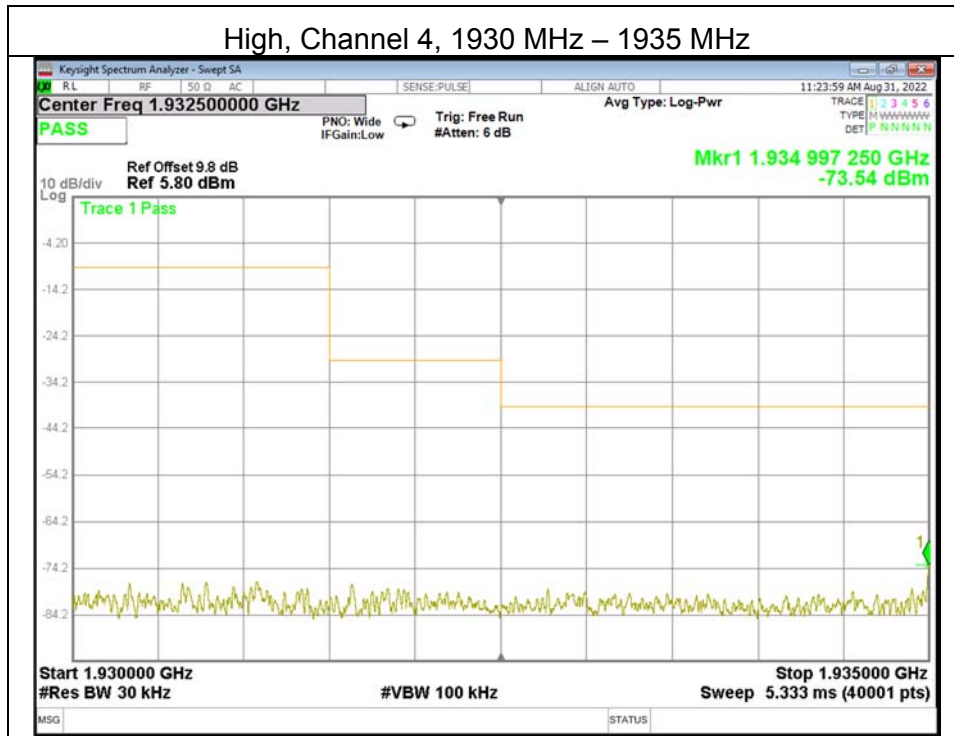

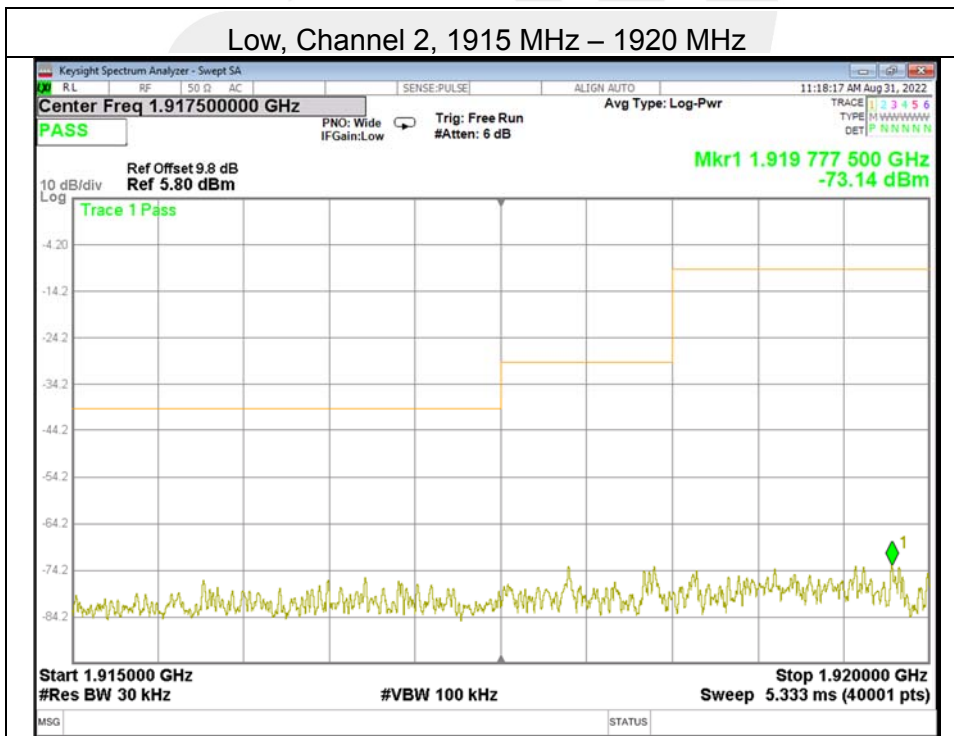
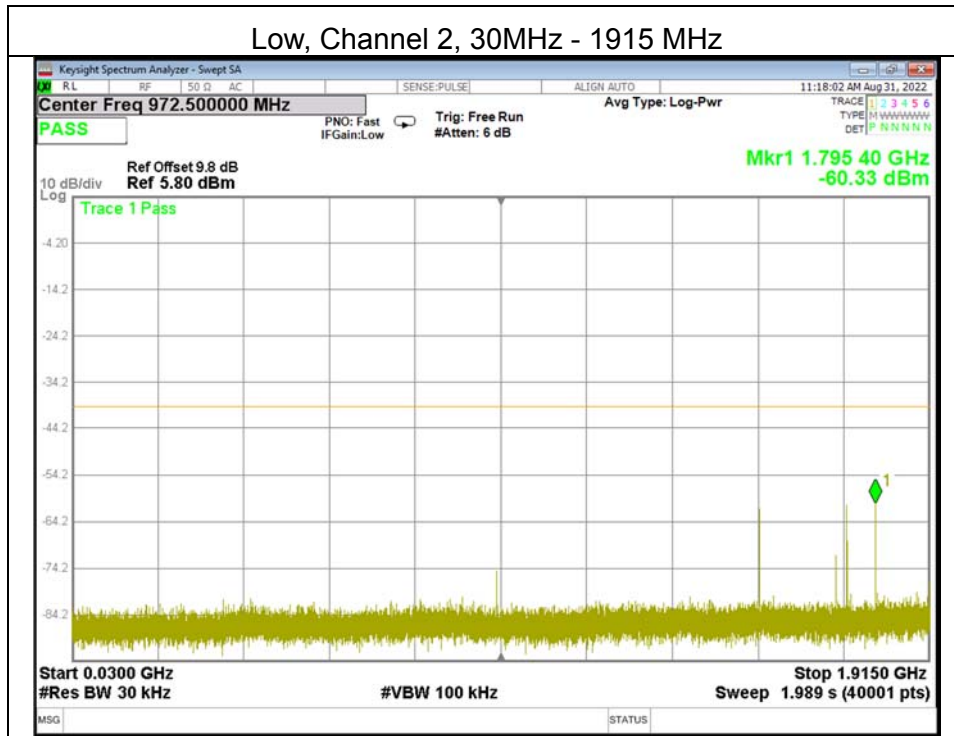

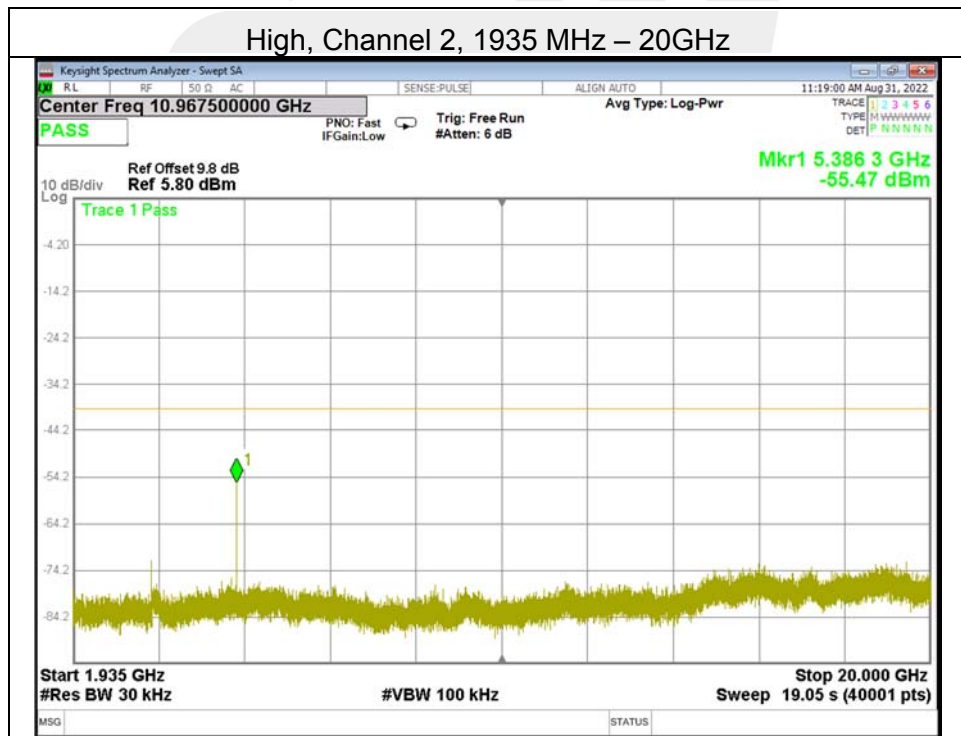
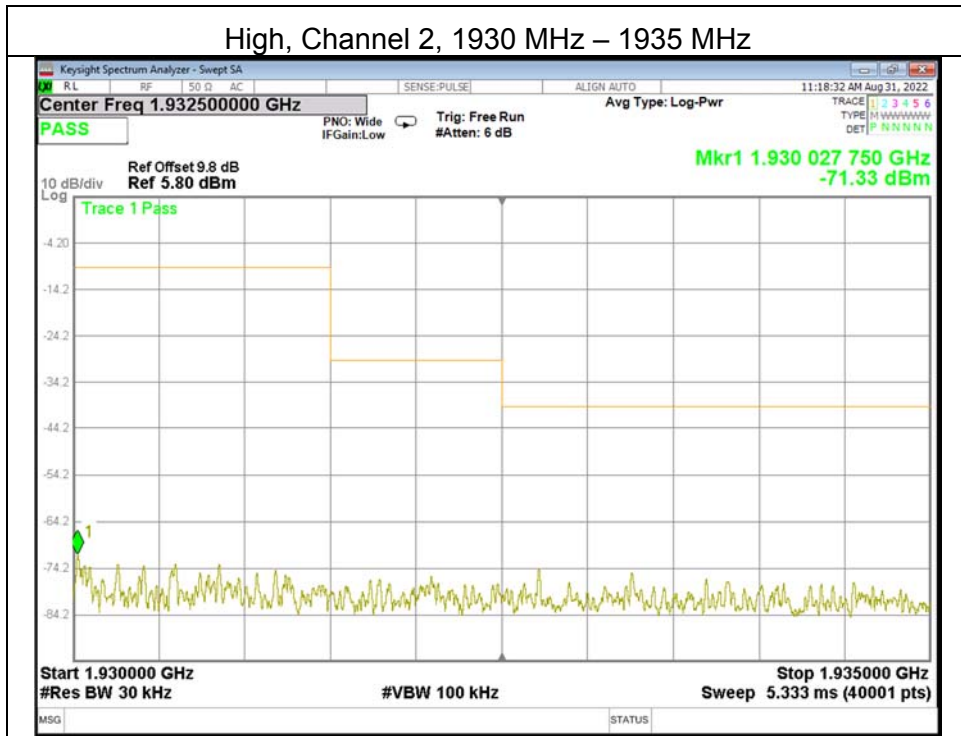

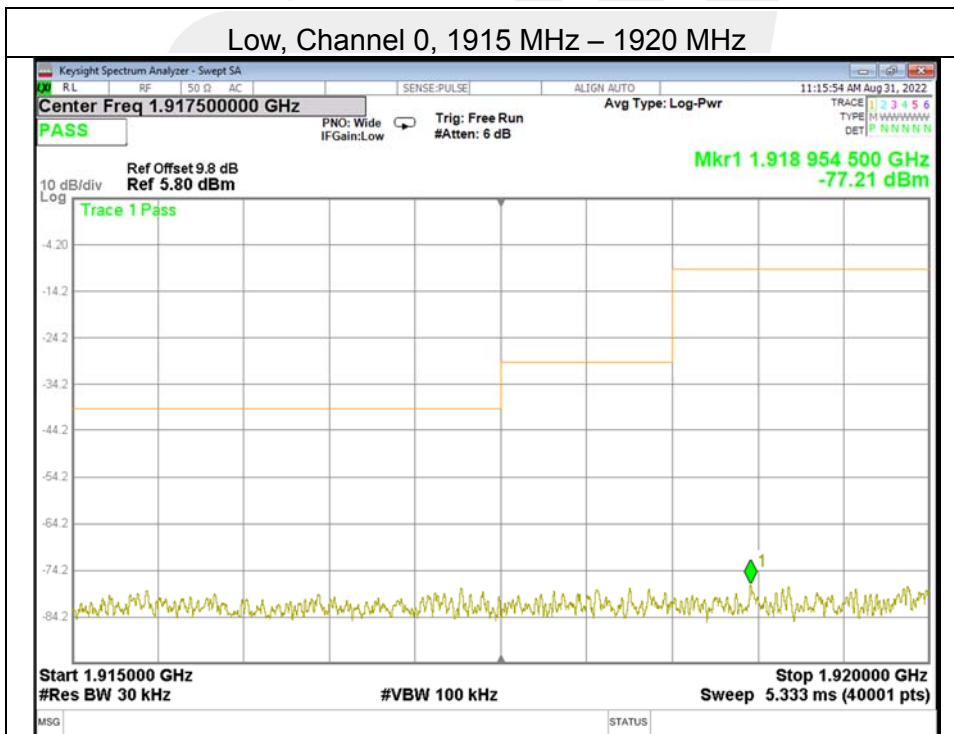
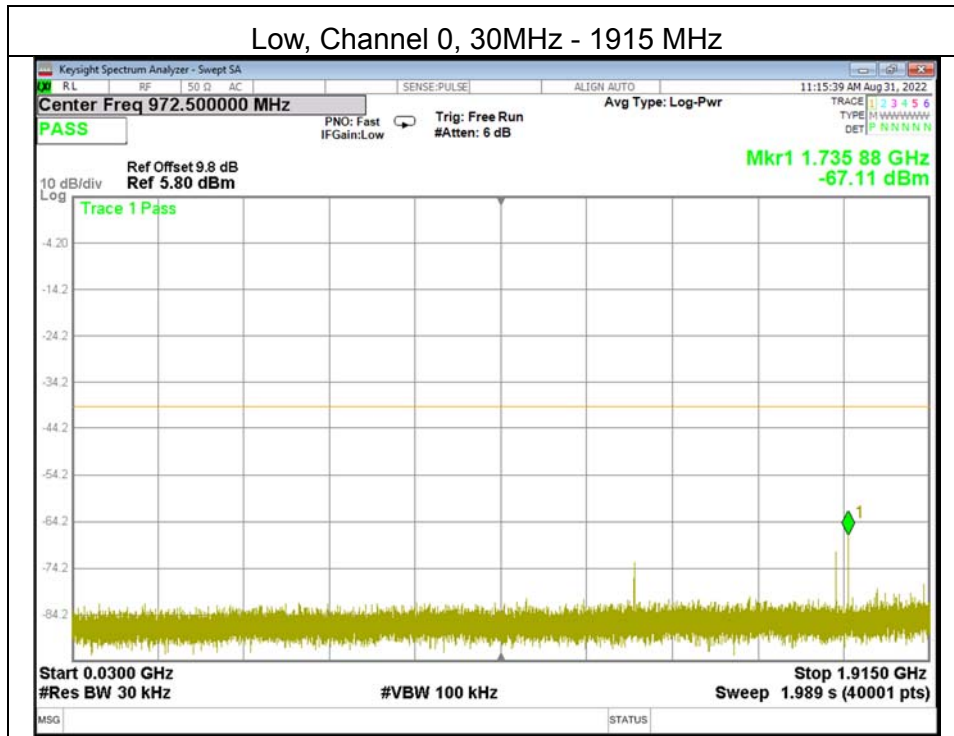

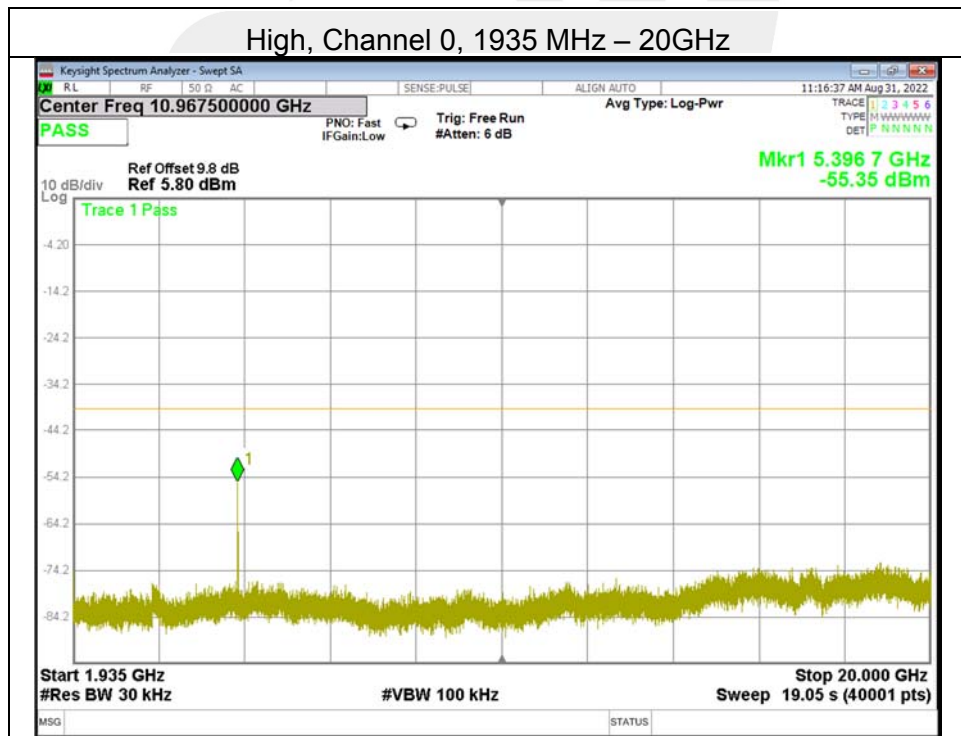
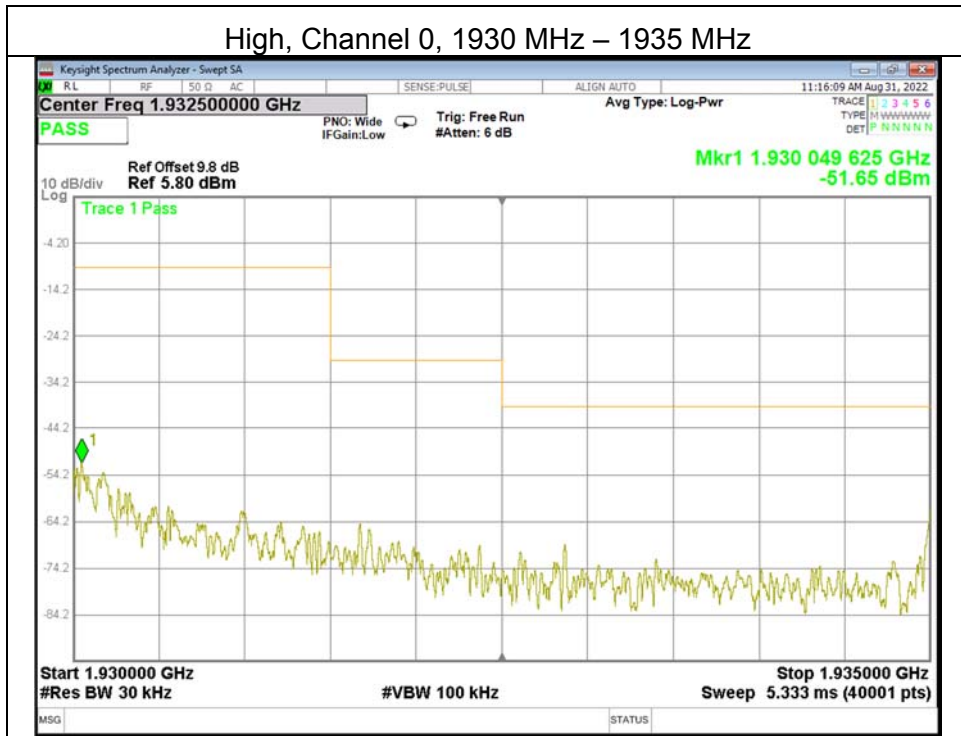



5.19 FRAME PERIOD

TEST CRITERIA

§15.323 (e) &RSS 213(5.2)(13) The frame period (a set of consecutive time slots in which the position of each time slot can be identified by reference to a synchronizing source) of an intentional radiator operating in these sub-bands shall be 20 milliseconds or 10 milliseconds/X where X is a positive whole number. Each device that implements time division for the purposes of maintaining a duplex connection on a given frequency carrier shall maintain a frame repetition rate with a frequency stability of at least 50 parts per million (ppm). Each device which further divides access in time in order to support multiple communication links on a given frequency carrier shall maintain a frame repetition rate with a frequency stability of at least 10 ppm.

Timing Jitter

§ 15.323 (e) &RSS 213(5.2)(13) Specific requirements for isochronous devices operating in the 1920–1930 MHz sub-band. The jitter (time-related, abrupt, spurious variations in the duration of the frame interval) introduced at the two ends of such a communication link shall not exceed 25 microseconds for any two consecutive transmissions. Transmissions shall be continuous in every time and spectrum window during the frame period defined for the device.

TEST LIMIT

Frame Period	20 or 10ms
Max Jitter	25µs
3 times St.Dev of Jitter	12.5µs

TEST PROCEDURE

The manufacturer supplies an attestation

TEST SETUP

The test setup is shown in section 3.2 figure 2.

TEST RESULTS

The Frame Repetition Stability is measured with the RF Test Platform for DECT. The Frame Repetition Stability is 3 times the standard deviation.

Channel	Standard Deviation(ppm)	Frame Repetition	The limit of Frame Repetition Stability(ppm)	Verdict
Middle	0.9972	2.9916	± 10	Pass

Channel	Frame Period(ms)	Max Jitter(µs)	3xStandard Deviation of Jitter(µs)	Limit(µs)		Verdict
				Max Jitter	3 times St.Dev.of Jitter	
Middle	10.0000	-0.5000	2.9916	25	12.5	Pass

Max Jitter= (1/(Frame Period+Pk-Pk)/2)-(1/Frame Period). When Pk-Pk and Frame period are in Hz.

3x St.Dev. Jitter $3 \times (1/(\text{Frame Period} + \text{St. Dev})) - (1/\text{St.Dev}) \times 10^6$



5.20 FREQUENCY STABILITY

TEST CRITERIA

§15.323 (f) &RSS 213(5.3) The frequency stability of the carrier frequency of the intentional radiator shall be maintained within ± 10 ppm over 1hour or the interval between channel access monitoring, whichever is shorter. The frequency stability shall be maintained over a temperature variation of -20° to $+50^{\circ}$ C at normal supply voltage and over a variation in the primary supply voltage of 85% to 115% of the rated supply voltage at a temperature of 200° C. For equipment that is capable only of operating from a battery, the frequency stability tests shall be performed using a new battery without any further requirement to vary supply voltage.

TEST PROCEDURE

The EUT was placed in the Environmental Chamber and support equipment are outside the chamber on a table. A CW signal was injected into the EUT at the appropriate RF level. The frequency counter option on the Spectrum Analyzer was used to measure frequency deviations.

The frequency drift was investigated for every 10° C increment until the unit is stabilized then recorded the reading in tabular format with the temperature range of -20° to $+50^{\circ}$ C.

Voltage supplied to EUT is 120VAC reference temperature was done at 20° C. The voltage was varied by $\pm 15\%$ of nominal

TEST SETUP

The test setup is shown in section 3.2 figure 1.

TEST RESULTS

The EUT was compliant with this requirement

Antenna 0
(Low Channel)

Reference Frequency (MHz)	Voltage (AC)	Temperature ($^{\circ}$ C)	Frequency (MHz)	Deviation (ppm)	Limit (ppm)
1921.536	120	50	1921.52597	5.22	± 10
		40	1921.52905	3.62	
		30	1921.52815	4.09	
		20	1921.53569	0.16	
		10	1921.53688	-0.46	
		0	1921.53367	1.21	
		-10	1921.54692	-5.68	
	-20	1921.54776	-6.12		
	102	20	1921.54765	-6.06	
	138	20	1921.55099	-7.80	



(Mid Channel)					
Reference Frequency (MHz)	Voltage (AC)	Temperature (° C)	Frequency (MHz)	Deviation (ppm)	Limit (ppm)
1924.992	120	50	1924.99388	-0.98	±10
		40	1924.99468	-1.39	
		30	1924.99672	-2.45	
		20	1925.00078	-4.56	
		10	1925.00021	-4.26	
		0	1924.99821	-3.23	
		-10	1924.98622	3.00	
		-20	1924.98264	4.86	
	102	20	1924.98932	1.39	
	138	20	1924.98451	3.89	

(High Channel)					
Reference Frequency (MHz)	Voltage (AC)	Temperature (° C)	Frequency (MHz)	Deviation (ppm)	Limit (ppm)
1928.448	120	50	1928.44162	3.31	±10
		40	1928.44127	3.49	
		30	1928.44032	3.98	
		20	1928.44321	2.48	
		10	1928.45115	-1.63	
		0	1928.44917	-0.61	
		-10	1928.44591	1.08	
		-20	1928.45182	-1.98	
	102	20	1928.45381	-3.01	
	138	20	1928.44956	-0.81	



Antenna 1

(Low Channel)					
Reference Frequency (MHz)	Voltage (AC)	Temperature (° C)	Frequency (MHz)	Deviation (ppm)	Limit (ppm)
1921.536	120	50	1921.52797	4.18	±10
		40	1921.52602	5.19	
		30	1921.52734	4.51	
		20	1921.53719	-0.62	
		10	1921.53728	-0.67	
		0	1921.53810	-1.09	
		-10	1921.54628	-5.35	
		-20	1921.54783	-6.16	
	102	20	1921.54600	-5.20	
	138	20	1921.54656	-5.50	

(Mid Channel)					
Reference Frequency (MHz)	Voltage (AC)	Temperature (° C)	Frequency (MHz)	Deviation (ppm)	Limit (ppm)
1924.992	120	50	1924.99814	-3.19	±10
		40	1924.99779	-3.01	
		30	1924.99784	-3.03	
		20	1925.00092	-4.63	
		10	1924.99998	-4.15	
		0	1925.00088	-4.61	
		-10	1924.98615	3.04	
		-20	1924.98897	1.57	
	102	20	1924.98360	4.36	
	138	20	1924.98766	2.25	



(High Channel)					
Reference Frequency (MHz)	Voltage (AC)	Temperature (° C)	Frequency (MHz)	Deviation (ppm)	Limit (ppm)
1928.448	120	50	1928.44257	2.82	±10
		40	1928.44283	2.68	
		30	1928.44411	2.02	
		20	1928.44019	4.05	
		10	1928.44894	-0.49	
		0	1928.44662	0.72	
		-10	1928.45107	-1.59	
		-20	1928.45291	-2.55	
	102	20	1928.45185	-2.00	
	138	20	1928.45197	-2.06	



5.21 CONDUCTED EMISSION MEASUREMENT POWER LINE CONDUCTED EMISSION LIMITS

Operating frequency band. In case the emission fall within the restricted band specified on Part 207(a)&RSS-Gen limit in the table below has to be followed.

FREQUENCY (MHz)	Conducted Emission limit (dBuV)	
	Quasi-peak	Average
0.15 -0.5	66 - 56 *	56 - 46 *
0.50 -5.0	56.00	46.00
5.0 -30.0	60.00	50.00

Note:

- (1) The tighter limit applies at the band edges.
- (2) The limit of " * " marked band means the limitation decreases linearly with the logarithm of the frequency in the range.

The following table is the setting of the receiver

Receiver Parameters	Setting
Attenuation	10 dB
Start Frequency	0.15 MHz
Stop Frequency	30 MHz
IF Bandwidth	9 kHz

TEST PROCEDURE

- The EUT was 0.8 meters from the horizontal ground plane and 0.4 meters from the vertical ground plane with EUT being connected to the power mains through a line impedance stabilization network (LISN). All other support equipments powered from additional LISN(s). The LISN provide 50 Ohm/ 50uH of coupling impedance for the measuring instrument.
- Interconnecting cables that hang closer than 40 cm to the ground plane shall be folded back and forth in the center forming a bundle 30 to 40 cm long.
- I/O cables that are not connected to a peripheral shall be bundled in the center. The end of the cable may be terminated, if required, using the correct terminating impedance. The overall length shall not exceed 1 m.
- LISN at least 80 cm from nearest part of EUT chassis.
- For the actual test configuration, please refer to the related Item –EUT Test Photos.

TEST SETUP

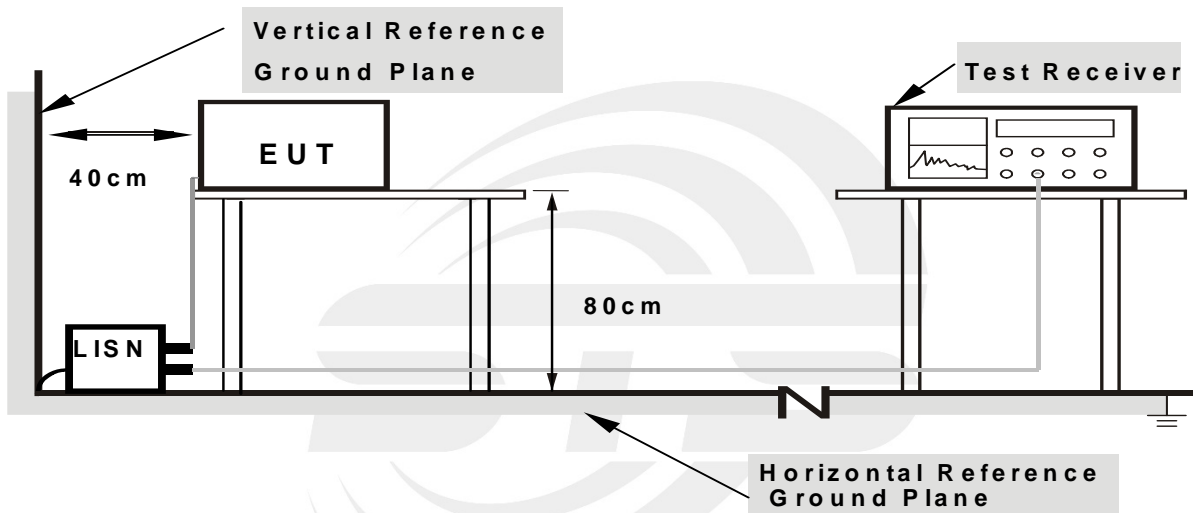

- Note: 1. Support units were connected to second LISN.**
2. Both of LISNs (AMN) are 80 cm from EUT and at least 80 cm from other units and other metal planes

EUT OPERATING CONDITIONS

The EUT was configured for testing in a typical fashion (as a customer would normally use it). The EUT has been programmed to continuously transmit during test. This operating condition was tested and used to collect the included data.



TEST RESULTS

Temperature:	26.8(C)	Relative Humidity:	59%RH
Test Voltage:	AC 120V/60Hz	Phase:	L
Test Mode:	TX Mode		

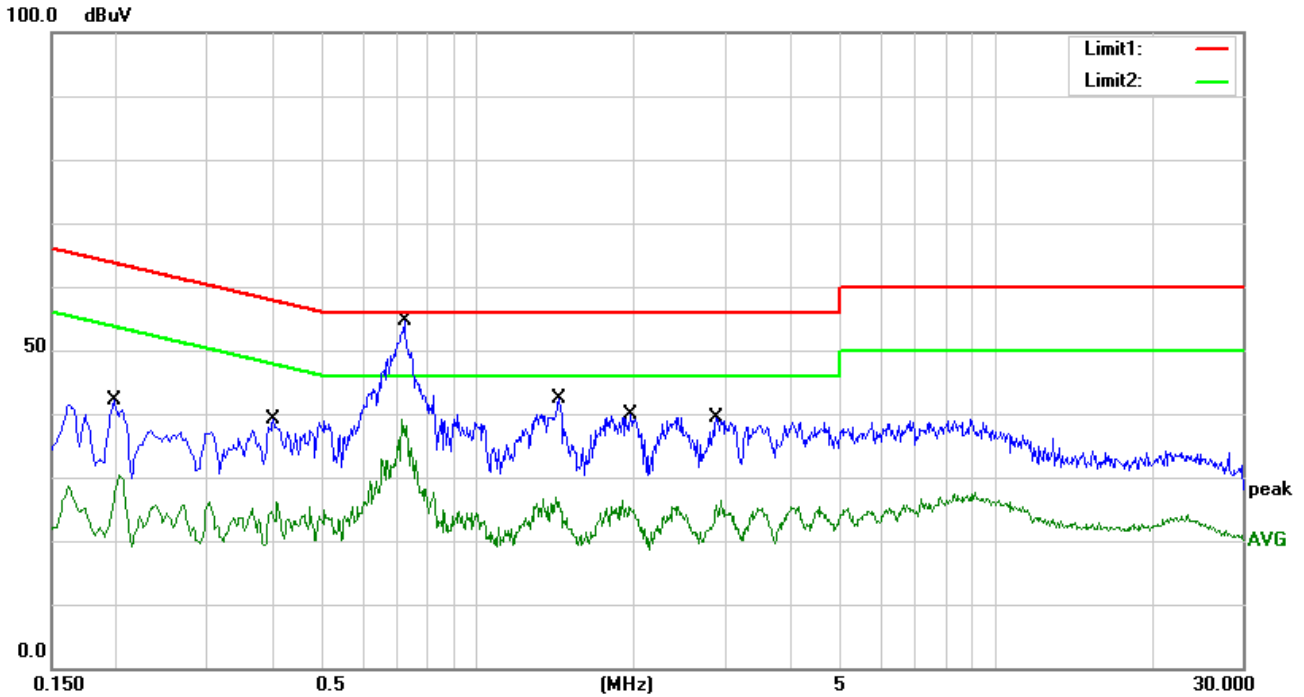

No.	Frequency (MHz)	Reading (dBuV)	Correct Factor(dB)	Result (dBuV)	Limit (dBuV)	Margin (dB)	Remark
1	0.1980	21.85	20.31	42.16	63.69	-21.53	QP
2	0.1980	10.16	20.31	30.47	53.69	-23.22	AVG
3	0.4020	18.67	20.54	39.21	57.81	-18.60	QP
4	0.4020	5.54	20.54	26.08	47.81	-21.73	AVG
5	0.7220	28.26	20.35	48.61	56.00	-7.39	QP
6	0.7220	18.88	20.35	39.23	46.00	-6.77	AVG
7	1.4340	21.96	20.30	42.26	56.00	-13.74	QP
8	1.4340	6.54	20.30	26.84	46.00	-19.16	AVG
9	1.9700	19.59	20.30	39.89	56.00	-16.11	QP
10	1.9700	6.01	20.30	26.31	46.00	-19.69	AVG
11	2.8860	19.15	20.35	39.50	56.00	-16.50	QP
12	2.8860	5.95	20.35	26.30	46.00	-19.70	AVG



Temperature:	26.8(C)	Relative Humidity:	59%RH
Test Voltage:	AC 120V/60Hz	Phase:	N
Test Mode:	TX Mode		

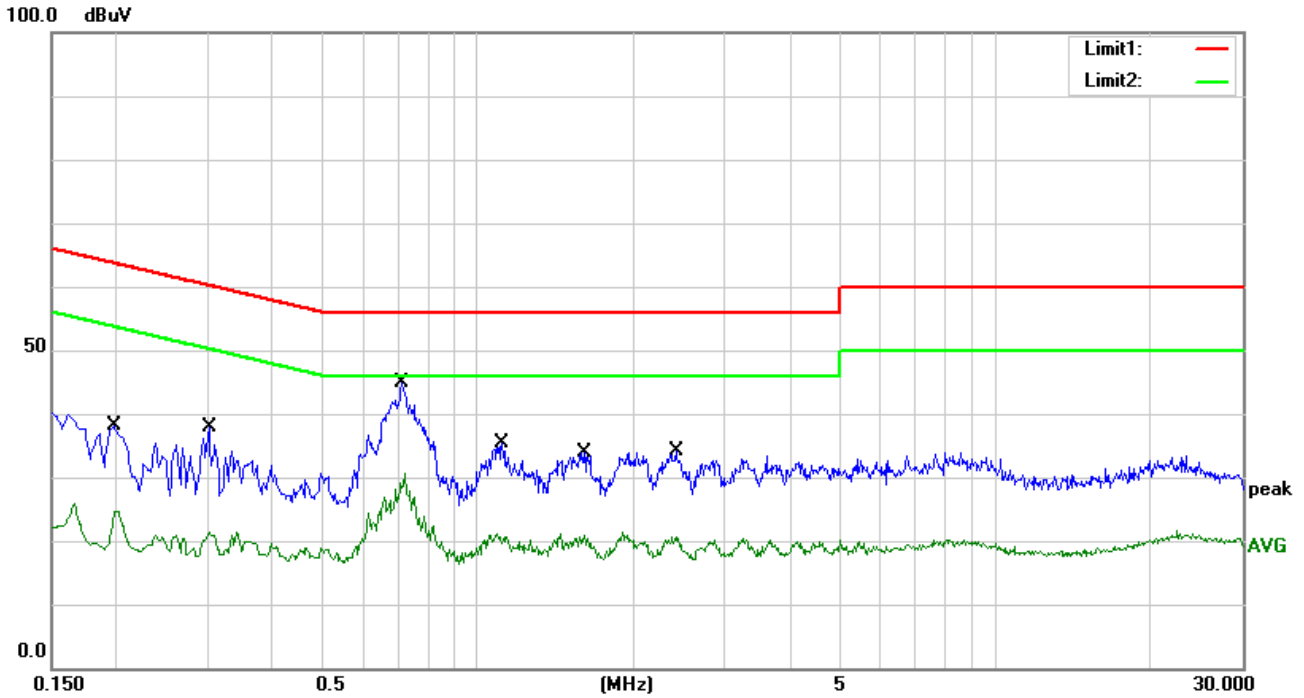

No.	Frequency (MHz)	Reading (dBuV)	Correct Factor(dB)	Result (dBuV)	Limit (dBuV)	Margin (dB)	Remark
1	0.1980	17.84	20.40	38.24	63.69	-25.45	QP
2	0.1980	5.38	20.40	25.78	53.69	-27.91	AVG
3	0.3020	17.13	20.79	37.92	60.19	-22.27	QP
4	0.3020	0.70	20.79	21.49	50.19	-28.70	AVG
5	0.7140	24.56	20.37	44.93	56.00	-11.07	QP
6	0.7140	10.36	20.37	30.73	46.00	-15.27	AVG
7	1.1140	15.08	20.31	35.39	56.00	-20.61	QP
8	1.1140	0.89	20.31	21.20	46.00	-24.80	AVG
9	1.6020	13.45	20.35	33.80	56.00	-22.20	QP
10	1.6020	1.01	20.35	21.36	46.00	-24.64	AVG
11	2.4100	13.73	20.41	34.14	56.00	-21.86	QP
12	2.4100	0.27	20.41	20.68	46.00	-25.32	AVG



5.22 RADIATED SPURIOUS EMISSION
RADIATED EMISSION LIMITS

In any 100 kHz bandwidth outside the operating frequency band. In case the emission fall within the Restricted band specified on Part15.205(a)&RSS Gen limit in the table and according to ANSI C63.10-2013 below has to be followed.

LIMITS OF RADIATED EMISSION MEASUREMENT (Frequency Range 9kHz-1000MHz)

Frequencies (MHz)	Field Strength (microlvolts/meter)	Measurement Distance (meters)
0.009~0.490	2400/F(KHz)	300
0.490~1.705	24000/F(KHz)	30
1.705~30.0	30	30
30~88	100	3
88~216	150	3
216~960	200	3
Above 960	500	3

LIMITS OF RADIATED EMISSION MEASUREMENT (Above 1000MHz)

FREQUENCY (MHz)	(dBuV/m) (at 3M)	
	PEAK	AVERAGE
Above 1000	74	54

Notes:

- (1) The limit for radiated test was performed according to FCC PART 15C.
- (2) The tighter limit applies at the band edges.
- (3) Emission level (dBuV/m)=20log Emission level (uV/m).

For Radiated Emission

Spectrum Parameter	Setting
Attenuation	Auto
Detector	Peak/AV
Start Frequency	1000 MHz(Peak/AV)
Stop Frequency	10th carrier hamonic(Peak/AV)
RB / VB (emission in restricted band)	1 MHz / 3 MHz

Receiver Parameter	Setting
Start ~ Stop Frequency	9kHz~90kHz / RB 200Hz for PK & AV
Start ~ Stop Frequency	90kHz~110kHz / RB 200Hz for QP
Start ~ Stop Frequency	110kHz~490kHz / RB 200Hz for PK & AV
Start ~ Stop Frequency	490kHz~30MHz / RB 9kHz for QP
Start ~ Stop Frequency	30MHz~1000MHz / RB 120kHz for QP



TEST PROCEDURE

- a. The measuring distance of at 3 m shall be used for measurements at frequency 0.009MHz up to 1GHz, and above 1GHz.
- b. The EUT was placed on the top of a rotating table 0.8 meters(above 1GHz is 1.5 m) above the ground at a 3 meter anechoic chamber. The table was rotated 360 degrees to determine the position of the highest radiation.
- c. The height of the equipment shall be 0.8 m(above 1GHz is 1.5 m); the height of the test antenna shall vary between 1 m to 4 m. Horizontal and vertical polarizations of the antenna are set to make the measurement
- d. The initial step in collecting conducted emission data is a spectrum analyzer peak detector mode pre-scanning the measurement frequency range. Significant peaks are then marked and then Quasi Peak detector mode re-measured.
- e. If the Peak Mode measured value compliance with and lower than Quasi Peak Mode Limit, the EUT shall be deemed to meet QP Limits and then no additional QP Mode measurement performed.
- f. For the actual test configuration, please refer to the related Item –EUT Test Photos.

Note:

Both horizontal and vertical antenna polarities were tested and performed pretest to three orthogonal axis. The worst case emissions were reported.

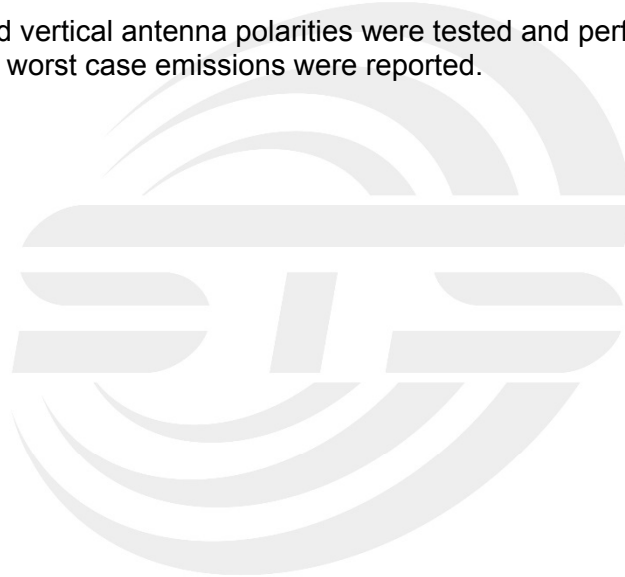

TEST SETUP

(A) Radiated Emission Test-Up Frequency Below 30MHz

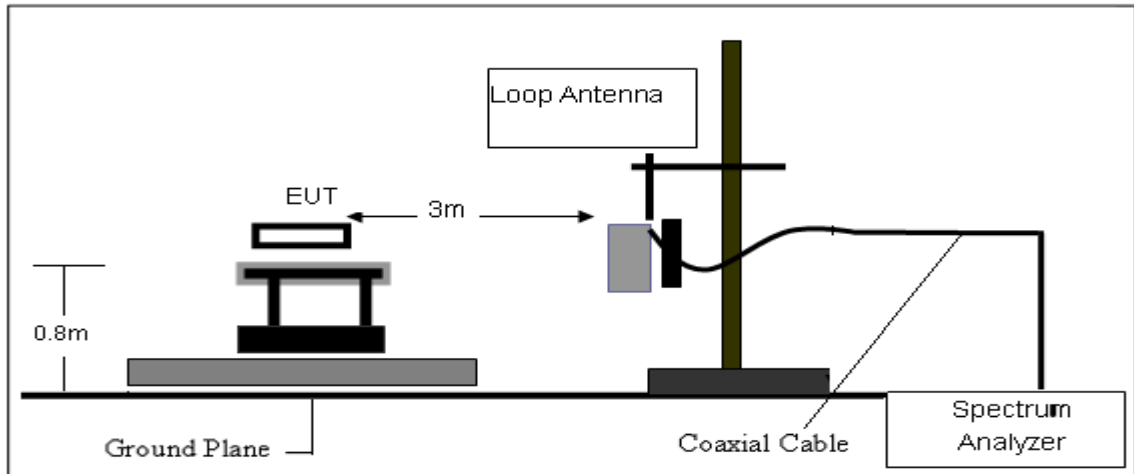

(B) Radiated Emission Test-Up Frequency 30MHz~1GHz

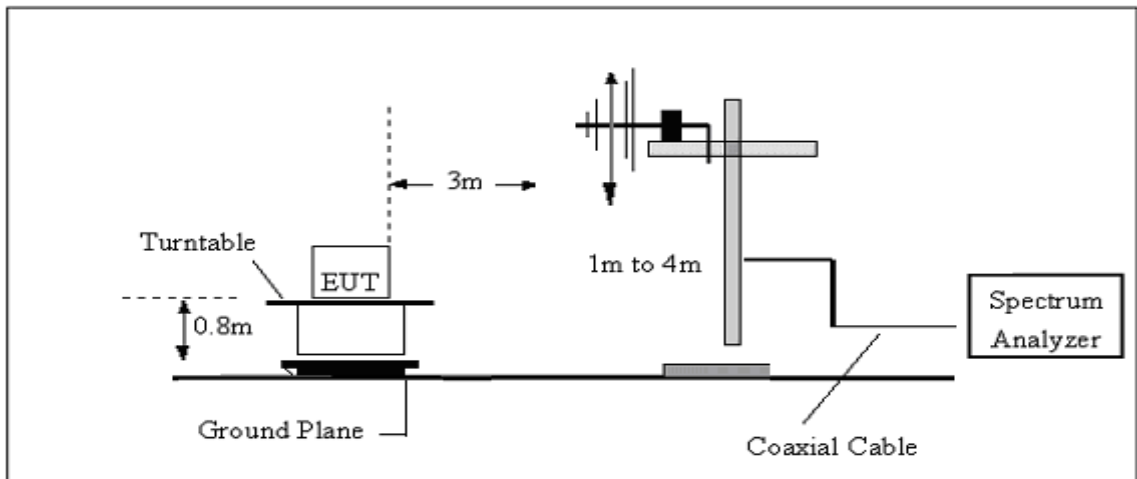

(C) Radiated Emission Test-Up Frequency Above 1GHz

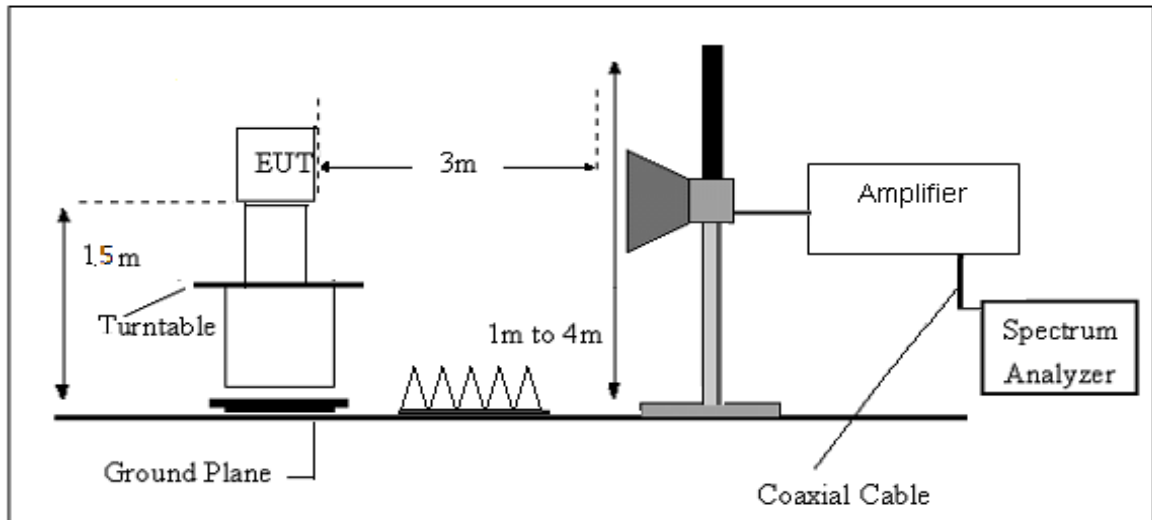

EUT OPERATING CONDITIONS

The EUT tested system was configured as the statements of 2.3 Unless otherwise a special operating condition is specified in the follows during the testing.



FIELD STRENGTH CALCULATION

The field strength is calculated by adding the Antenna Factor and Cable Factor and subtracting the Amplifier Gain and Duty Cycle Correction Factor (if any) from the measured reading. The basic equation with a sample calculation is as follows:

Margin=PL-PK L or AL- AV L; Margin only shown the worst case.

Where

PR = Peak Reading

AR = Average Reading

PL = Peak Level

AL = Average Level

AF = Antenna Factor

PK L = Peak Limit

AV L = AV Limit

For example

Frequency (MHz)	PR (dB μ V/m)	AR (dB μ V/m)	AF (dB)	PL (dB μ V/m)	AL (dB μ V/m)	PK L (dB μ V/m)	AV L (dB μ V/m)	Margin (dB)
2178	40.23	30.31	9.83	50.06	40.14	74.00	54.00	-13.86

Factor=AF+CL-AG





TEST RESULTS(30MHz – 1GHz)

Temperature:	23.6(C)	Relative Humidity:	49%RH
Test Voltage:	AC 120V/60Hz	Phase:	Horizontal
Test Mode:	TX Mode of ANT 0		

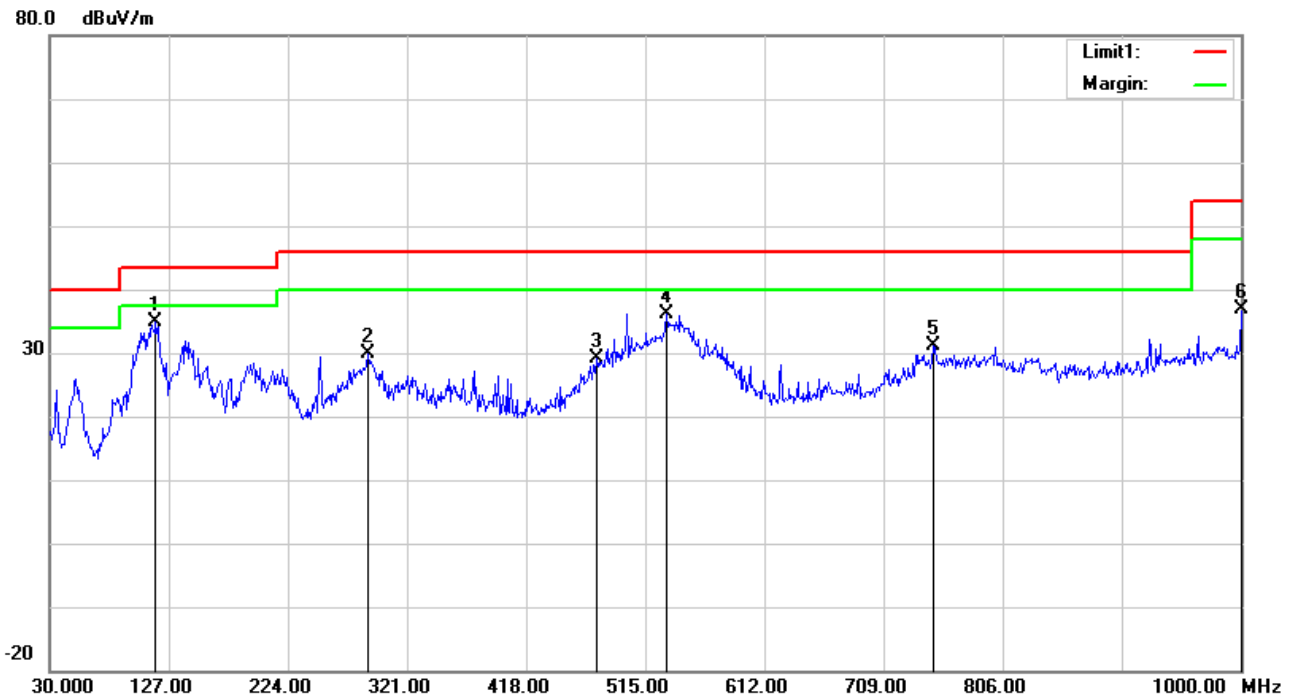

No.	Frequency (MHz)	Reading (dBuV)	Correct Factor(dB/m)	Result (dBuV/m)	Limit (dBuV/m)	Margin (dB)	Remark
1	116.3300	53.38	-18.51	34.87	43.50	-8.63	QP
2	288.9900	44.97	-15.21	29.76	46.00	-16.24	QP
3	475.2300	38.05	-8.81	29.24	46.00	-16.76	QP
4	532.4600	43.39	-7.31	36.08	46.00	-9.92	QP
5	749.7400	33.32	-2.16	31.16	46.00	-14.84	QP
6	1000.0000	34.91	2.04	36.95	54.00	-17.05	QP



Temperature:	23.6(C)	Relative Humidity:	49%RH
Test Voltage:	AC 120V/60Hz	Phase:	Vertical
Test Mode:	TX Mode of ANT 0		

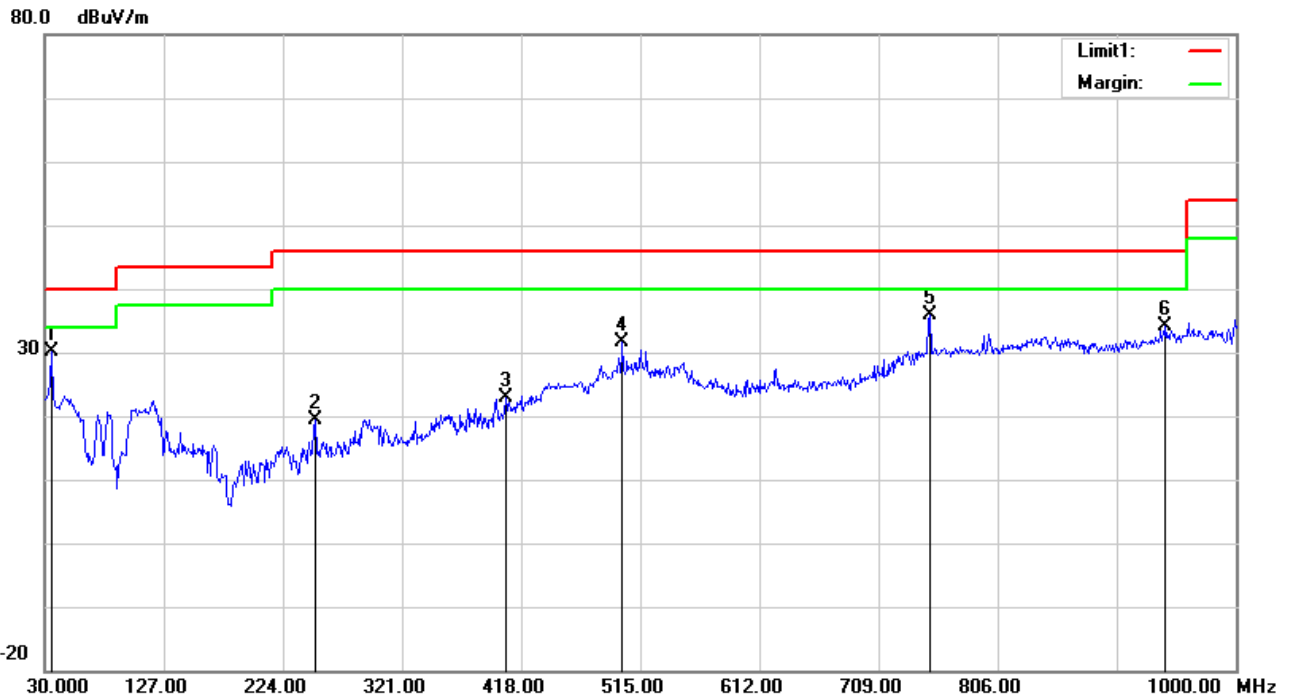

No.	Frequency (MHz)	Reading (dBuV)	Correct Factor(dB/m)	Result (dBuV/m)	Limit (dBuV/m)	Margin (dB)	Remark
1	35.8200	46.11	-15.91	30.20	40.00	-9.80	QP
2	250.1900	35.56	-16.10	19.46	46.00	-26.54	QP
3	405.3900	33.76	-10.83	22.93	46.00	-23.07	QP
4	500.4500	39.72	-8.01	31.71	46.00	-14.29	QP
5	750.7100	37.97	-2.16	35.81	46.00	-10.19	QP
6	942.7700	32.64	1.44	34.08	46.00	-11.92	QP



Temperature:	23.6(C)	Relative Humidity:	49%RH
Test Voltage:	AC 120V/60Hz	Phase:	Horizontal
Test Mode:	TX Mode of ANT 1		

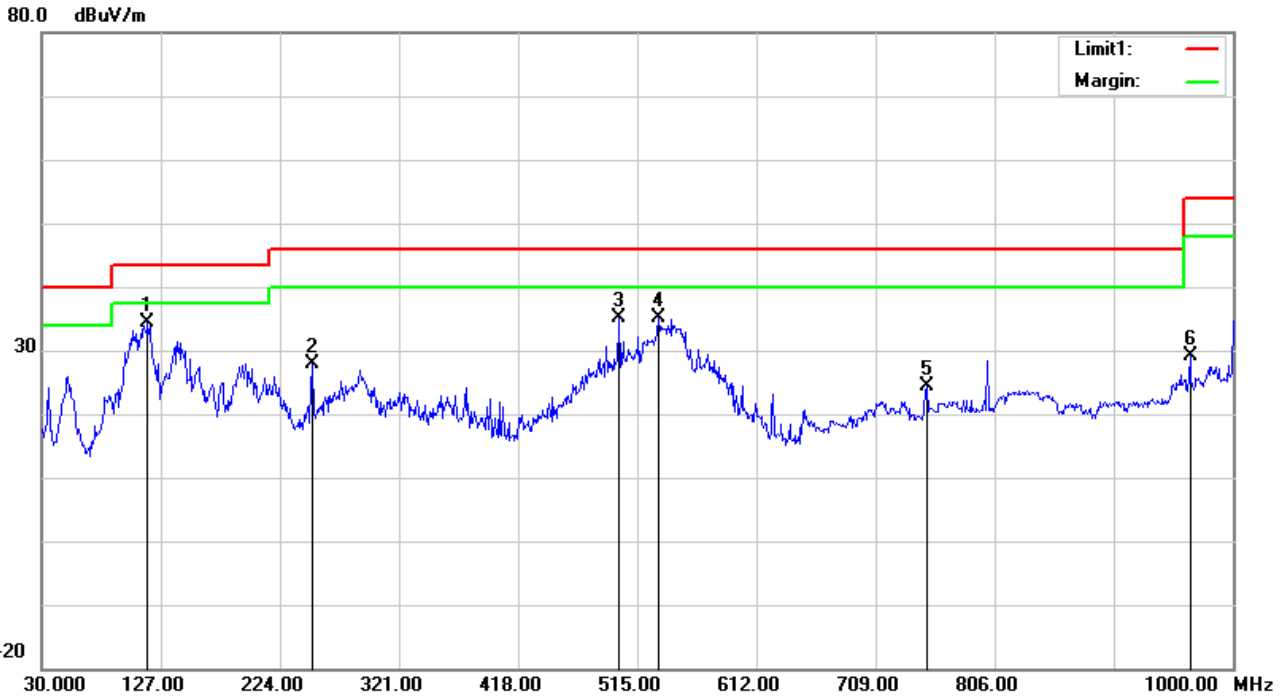

No.	Frequency (MHz)	Reading (dBuV)	Correct Factor(dB/m)	Result (dBuV/m)	Limit (dBuV/m)	Margin (dB)	Remark
1	116.3300	52.88	-18.51	34.37	43.50	-9.13	QP
2	250.1900	43.94	-16.10	27.84	46.00	-18.16	QP
3	500.4500	43.23	-8.01	35.22	46.00	-10.78	QP
4	532.4600	42.39	-7.31	35.08	46.00	-10.92	QP
5	750.7100	26.45	-2.16	24.29	46.00	-21.71	QP
6	965.0800	27.35	1.89	29.24	54.00	-24.76	QP



Temperature:	23.6(C)	Relative Humidity:	49%RH
Test Voltage:	AC 120V/60Hz	Phase:	Vertical
Test Mode:	TX Mode of ANT 1		

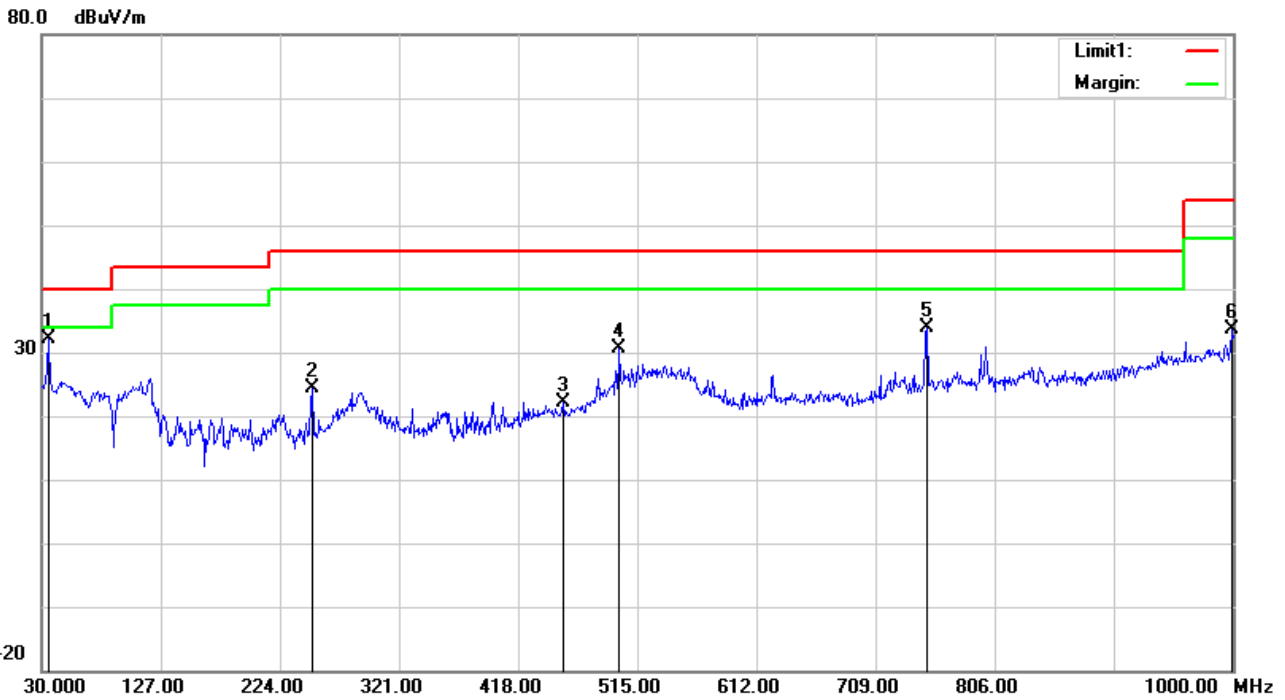

No.	Frequency (MHz)	Reading (dBuV)	Correct Factor(dB/m)	Result (dBuV/m)	Limit (dBuV/m)	Margin (dB)	Remark
1	35.8200	48.11	-15.91	32.20	40.00	-7.80	QP
2	250.1900	40.56	-16.10	24.46	46.00	-21.54	QP
3	454.8600	31.69	-9.57	22.12	46.00	-23.88	QP
4	500.4500	38.72	-8.01	30.71	46.00	-15.29	QP
5	750.7100	35.97	-2.16	33.81	46.00	-12.19	QP
6	999.0300	31.48	2.04	33.52	54.00	-20.48	QP



TEST RESULTS(Above 1GHz)

ANT 0
GFSK-Low
Horizontal

RE_FCC Test Case_FCC 15C 1GHz-18GHz

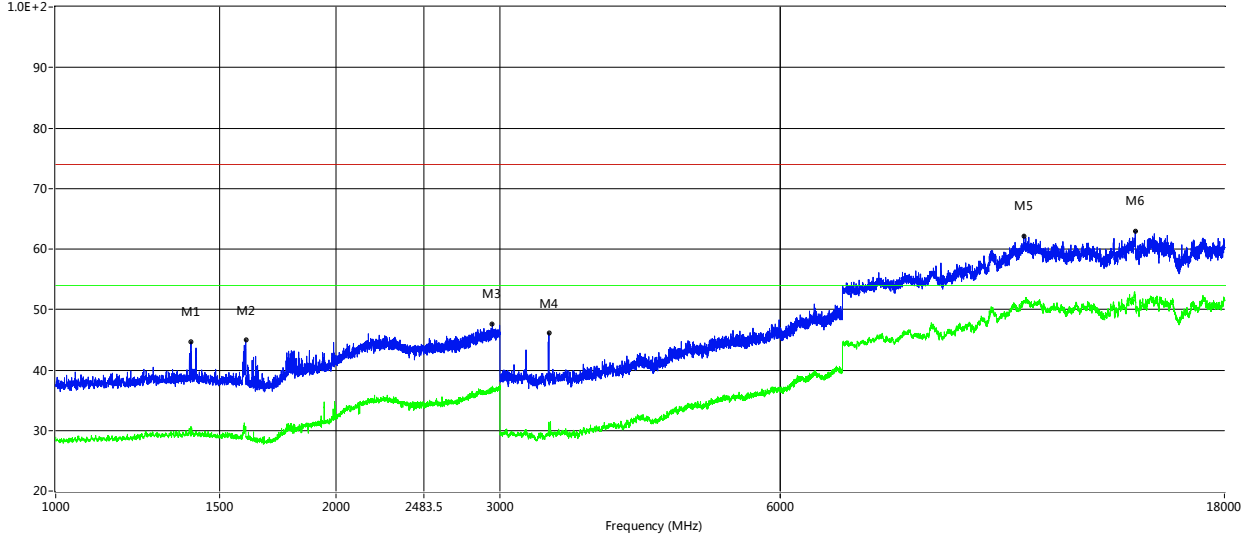

Frequency (MHz)	Peak Level (dBuV/m)	Q-peak Level (dBuV/m)	Average Level (dBuV/m)	Factor (dB)	PK Limit (dBuV/m)	QP Limit (dBuV/m)	AV Limit (dBuV/m)	Over Limit (dB)	Verdict	Verdict
1401.000	43.35	--	30.28	-0.66	74.0	--	54.0	-23.72	Horizontal	Pass
1806.500	47.49	--	33.01	0.02	74.0	--	54.0	-20.99	Horizontal	Pass
3390.000	46.78	--	31.22	-11.75	74.0	--	54.0	-22.78	Horizontal	Pass
6938.000	51.02	--	39.93	0.49	74.0	--	54.0	-14.07	Horizontal	Pass
10987.500	63.14	--	51.93	10.12	74.0	--	54.0	-2.07	Horizontal	Pass
14433.250	62.73	--	51.91	11.03	74.0	--	54.0	-2.09	Horizontal	Pass



Vertical

RE_FCC Test Case_FCC 15C 1GHz-18GHz
1.0E+2

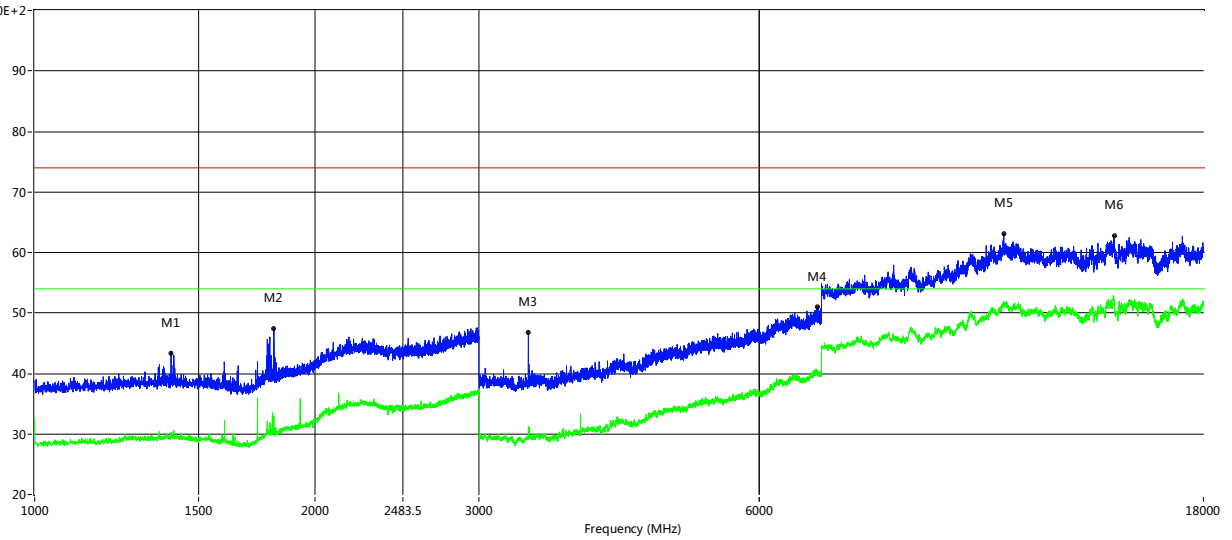

Frequency (MHz)	Peak Level (dBuV/m)	Q-peak Level (dBuV/m)	Average Level (dBuV/m)	Factor (dB)	PK Limit (dBuV/m)	QP Limit (dBuV/m)	AV Limit (dBuV/m)	Over Limit (dB)	Verdict	Verdict
1397.000	44.66	--	30.68	-0.67	74.0	--	54.0	-23.32	Vertical	Pass
1600.000	44.91	--	30.68	-0.49	74.0	--	54.0	-23.32	Vertical	Pass
2945.000	47.63	--	37.30	5.87	74.0	--	54.0	-16.70	Vertical	Pass
3386.000	46.09	--	31.37	-11.78	74.0	--	54.0	-22.63	Vertical	Pass
10960.000	62.14	--	51.25	9.91	74.0	--	54.0	-2.75	Vertical	Pass
14438.750	62.96	--	52.15	10.97	74.0	--	54.0	-1.85	Vertical	Pass



GFSK-Mid
Horizontal

RE_FCC Test Case_FCC 15C 1GHz-18GHz

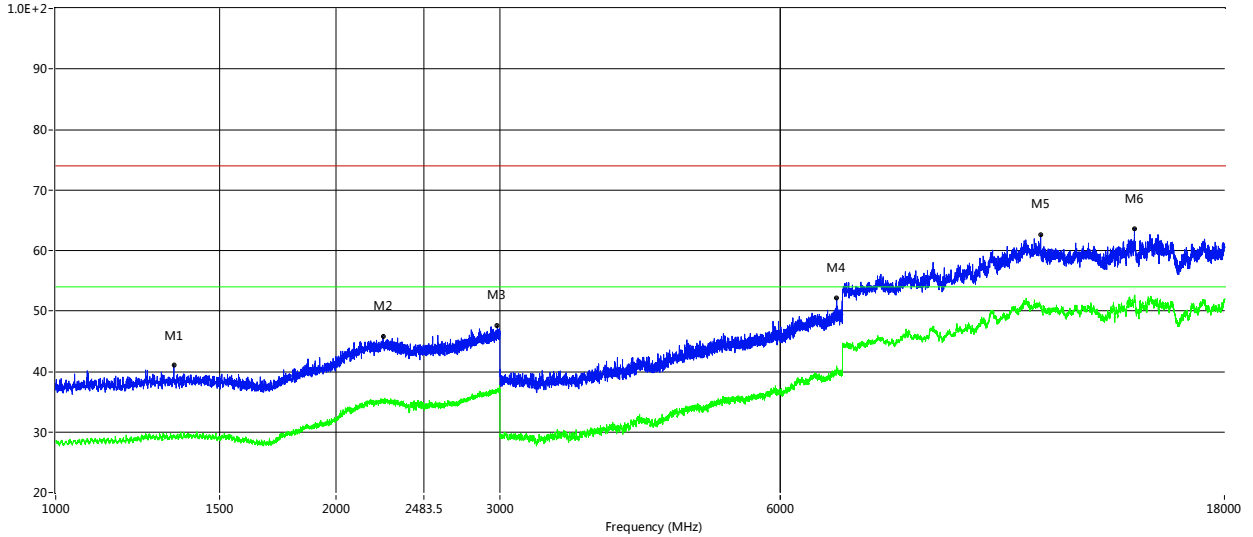

Frequency (MHz)	Peak Level (dBuV/m)	Q-peak Level (dBuV/m)	Average Level (dBuV/m)	Factor (dB)	PK Limit (dBuV/m)	QP Limit (dBuV/m)	AV Limit (dBuV/m)	Over Limit (dB)	Verdict	Verdict
1339.500	41.02	--	29.56	-0.82	74.0	--	54.0	-24.44	Horizontal	Pass
2247.000	45.78	--	35.22	4.61	74.0	--	54.0	-18.78	Horizontal	Pass
2980.500	47.61	--	36.73	6.03	74.0	--	54.0	-17.27	Horizontal	Pass
6899.000	52.15	--	40.91	0.46	74.0	--	54.0	-13.09	Horizontal	Pass
11427.500	62.66	--	50.56	9.80	74.0	--	54.0	-3.44	Horizontal	Pass
14411.250	63.60	--	52.45	11.29	74.0	--	54.0	-1.55	Horizontal	Pass



Vertical

RE_FCC Test Case_FCC 15C 1GHz-18GHz
1.0E+2

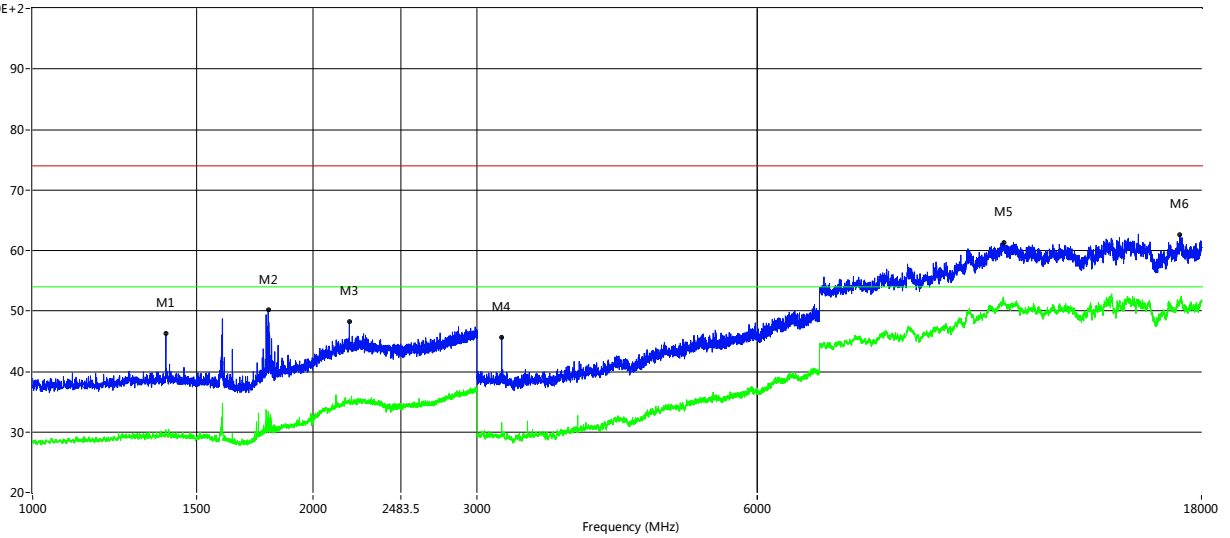

Frequency (MHz)	Peak Level (dBuV/m)	Q-peak Level (dBuV/m)	Average Level (dBuV/m)	Factor (dB)	PK Limit (dBuV/m)	QP Limit (dBuV/m)	AV Limit (dBuV/m)	Over Limit (dB)	Verdict	Verdict
1390.000	46.22	--	30.41	-0.69	74.0	--	54.0	-23.59	Vertical	Pass
1790.500	50.27	--	33.37	-0.06	74.0	--	54.0	-20.63	Vertical	Pass
2188.500	48.32	--	35.09	4.22	74.0	--	54.0	-18.91	Vertical	Pass
3190.000	45.69	--	31.56	-12.16	74.0	--	54.0	-22.44	Vertical	Pass
11042.500	61.31	--	51.78	9.99	74.0	--	54.0	-2.22	Vertical	Pass
17070.500	62.61	--	51.42	10.27	74.0	--	54.0	-2.58	Vertical	Pass



GFSK-High
Horizontal

RE_FCC Test Case_FCC 15C 1GHz-18GHz

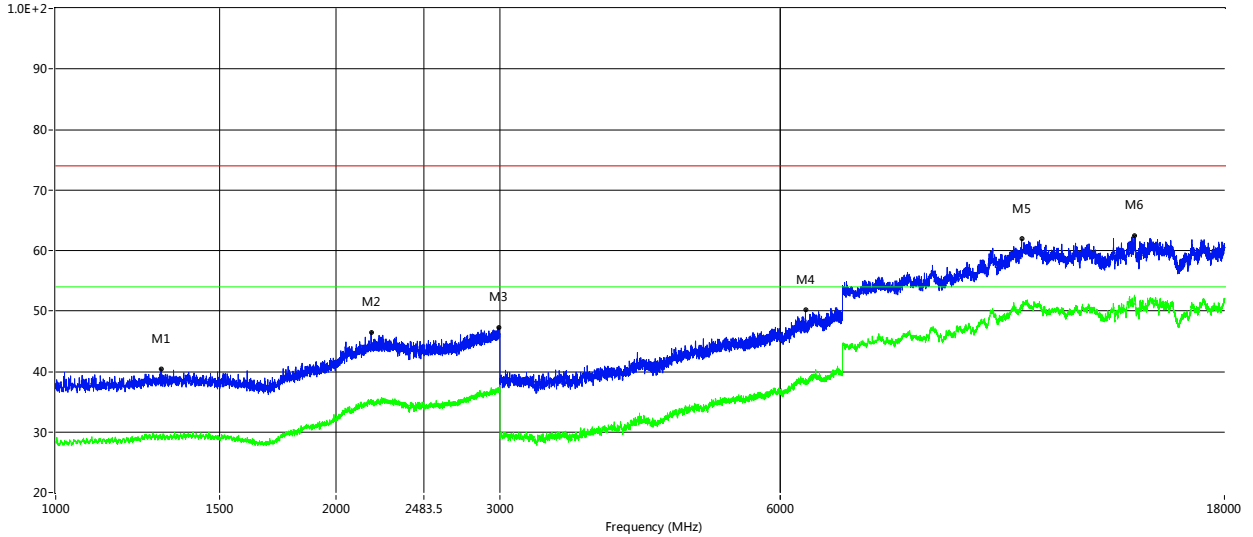

Frequency (MHz)	Peak Level (dBuV/m)	Q-peak Level (dBuV/m)	Average Level (dBuV/m)	Factor (dB)	PK Limit (dBuV/m)	QP Limit (dBuV/m)	AV Limit (dBuV/m)	Over Limit (dB)	Verdict	Verdict
1297.500	40.44	--	28.85	-0.93	74.0	--	54.0	-25.15	Horizontal	Pass
2181.500	46.47	--	35.29	4.30	74.0	--	54.0	-18.71	Horizontal	Pass
2991.500	47.31	--	36.57	6.07	74.0	--	54.0	-17.43	Horizontal	Pass
6387.000	50.19	--	38.78	-1.30	74.0	--	54.0	-15.22	Horizontal	Pass
10902.250	61.92	--	51.06	9.47	74.0	--	54.0	-2.94	Horizontal	Pass
14400.250	62.48	--	52.21	11.42	74.0	--	54.0	-1.79	Horizontal	Pass



Vertical

RE_FCC Test Case_FCC 15C 1GHz-18GHz
1.0E+2

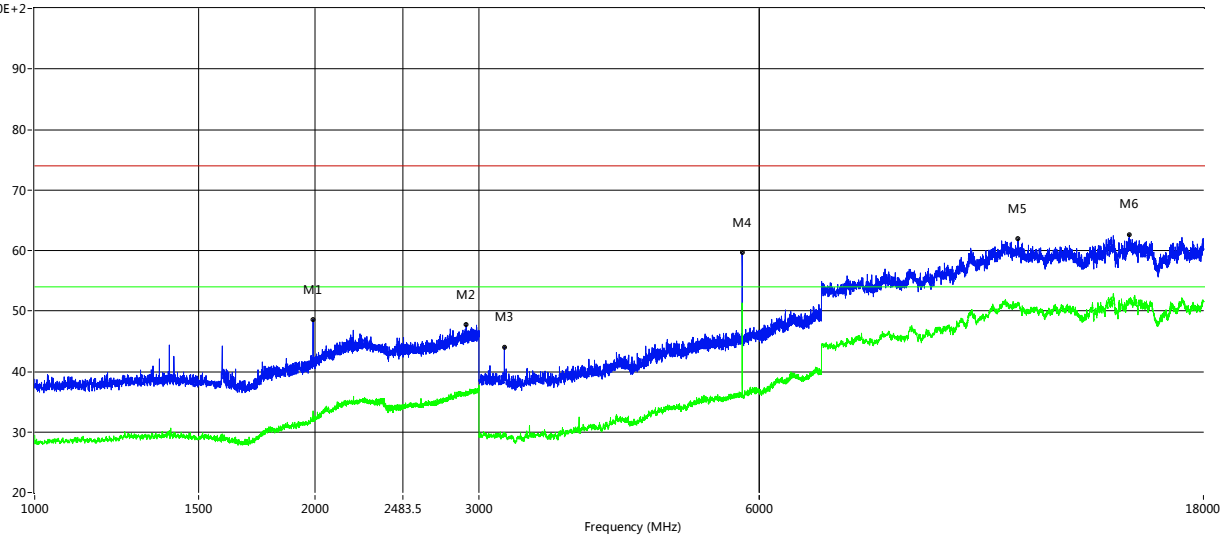

Frequency (MHz)	Peak Level (dBuV/m)	Q-peak Level (dBuV/m)	Average Level (dBuV/m)	Factor (dB)	PK Limit (dBuV/m)	QP Limit (dBuV/m)	AV Limit (dBuV/m)	Over Limit (dB)	Verdict	Verdict
1990.500	48.60	--	33.48	1.40	74.0	--	54.0	-20.52	Vertical	Pass
2906.500	47.73	--	36.39	5.65	74.0	--	54.0	-17.61	Vertical	Pass
3195.000	43.98	--	29.95	-12.14	74.0	--	54.0	-24.05	Vertical	Pass
5753.000	59.59	--	51.33	-3.95	74.0	--	54.0	-2.67	Vertical	Pass
11389.000	61.92	--	51.18	9.72	74.0	--	54.0	-2.82	Vertical	Pass
14997.000	62.60	--	51.73	10.38	74.0	--	54.0	-2.27	Vertical	Pass



ANT 1
GFSK-Low
Horizontal

RE_FCC Test Case_FCC 15C 1GHz-18GHz

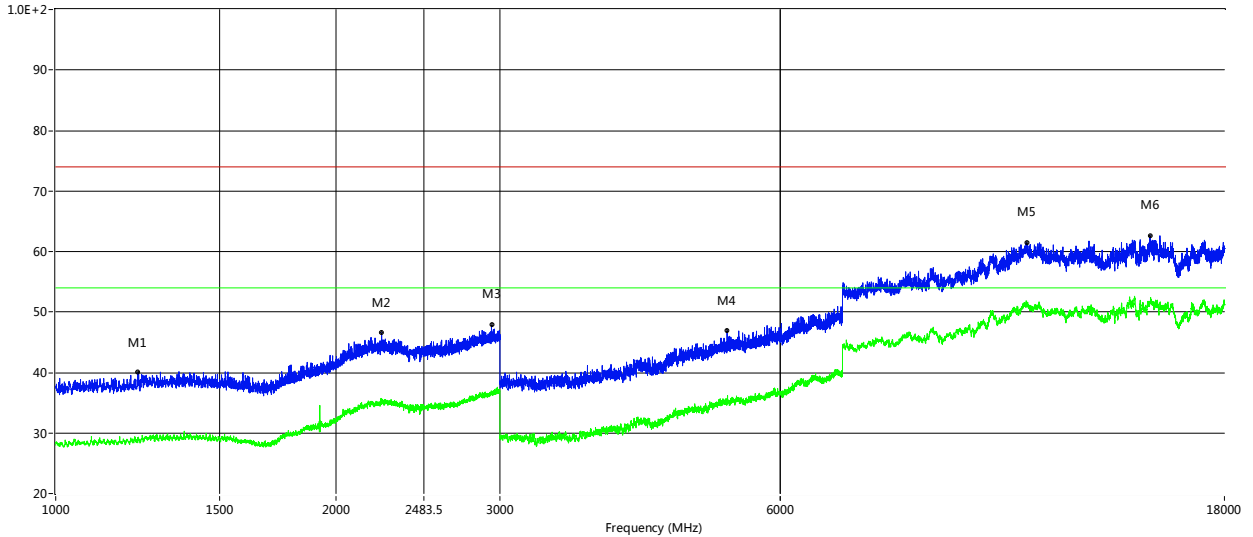

Frequency (MHz)	Peak Level (dBuV/m)	Q-peak Level (dBuV/m)	Average Level (dBuV/m)	Factor (dB)	PK Limit (dBuV/m)	QP Limit (dBuV/m)	AV Limit (dBuV/m)	Over Limit (dB)	Verdict	Verdict
1225.500	40.02	--	29.24	-1.06	74.0	--	54.0	-24.76	Horizontal	Pass
2239.000	46.58	--	35.17	4.52	74.0	--	54.0	-18.83	Horizontal	Pass
2938.500	47.86	--	36.73	5.83	74.0	--	54.0	-17.27	Horizontal	Pass
5262.000	46.91	--	35.25	-4.96	74.0	--	54.0	-18.75	Horizontal	Pass
11034.250	61.51	--	51.69	10.04	74.0	--	54.0	-2.31	Horizontal	Pass
14988.750	62.62	--	51.81	10.34	74.0	--	54.0	-2.19	Horizontal	Pass



Vertical

RE_FCC Test Case_FCC 15C 1GHz-18GHz
1.0E+2

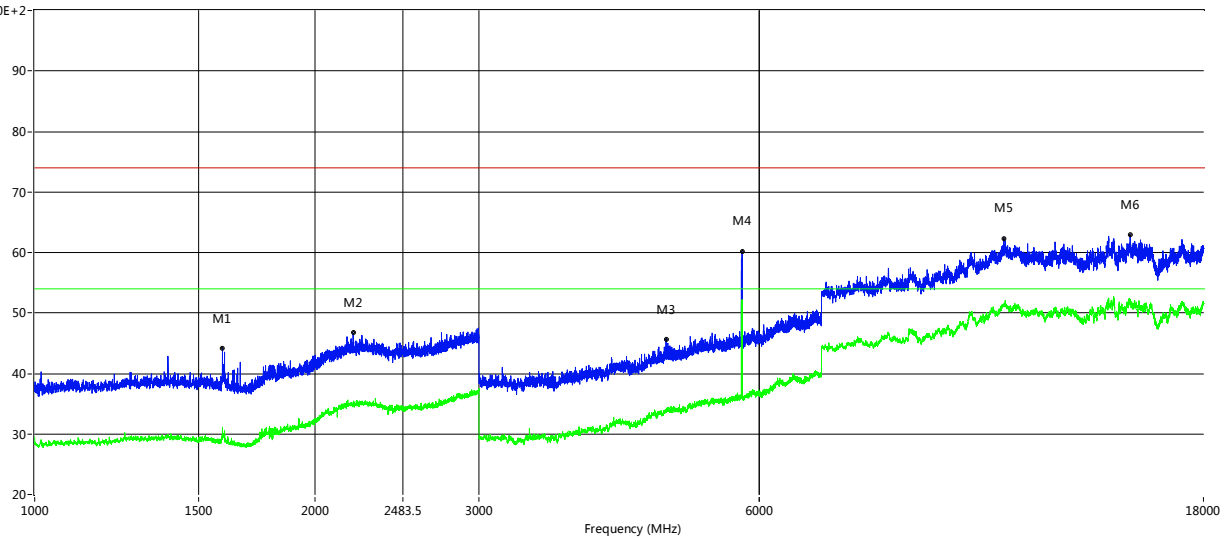

Frequency (MHz)	Peak Level (dBuV/m)	Q-peak Level (dBuV/m)	Average Level (dBuV/m)	Factor (dB)	PK Limit (dBuV/m)	QP Limit (dBuV/m)	AV Limit (dBuV/m)	Over Limit (dB)	Verdict	Verdict
1591.000	44.14	--	31.11	-0.51	74.0	--	54.0	-22.89	Vertical	Pass
2198.000	46.72	--	35.06	4.12	74.0	--	54.0	-18.94	Vertical	Pass
4766.000	45.65	--	33.94	-7.13	74.0	--	54.0	-20.06	Vertical	Pass
5752.000	60.12	--	52.20	-3.95	74.0	--	54.0	-1.80	Vertical	Pass
10982.000	62.34	--	51.03	10.08	74.0	--	54.0	-2.97	Vertical	Pass
15019.000	62.96	--	51.67	10.38	74.0	--	54.0	-2.33	Vertical	Pass



GFSK-Mid
Horizontal

RE_FCC Test Case_FCC 15C 1GHz-18GHz

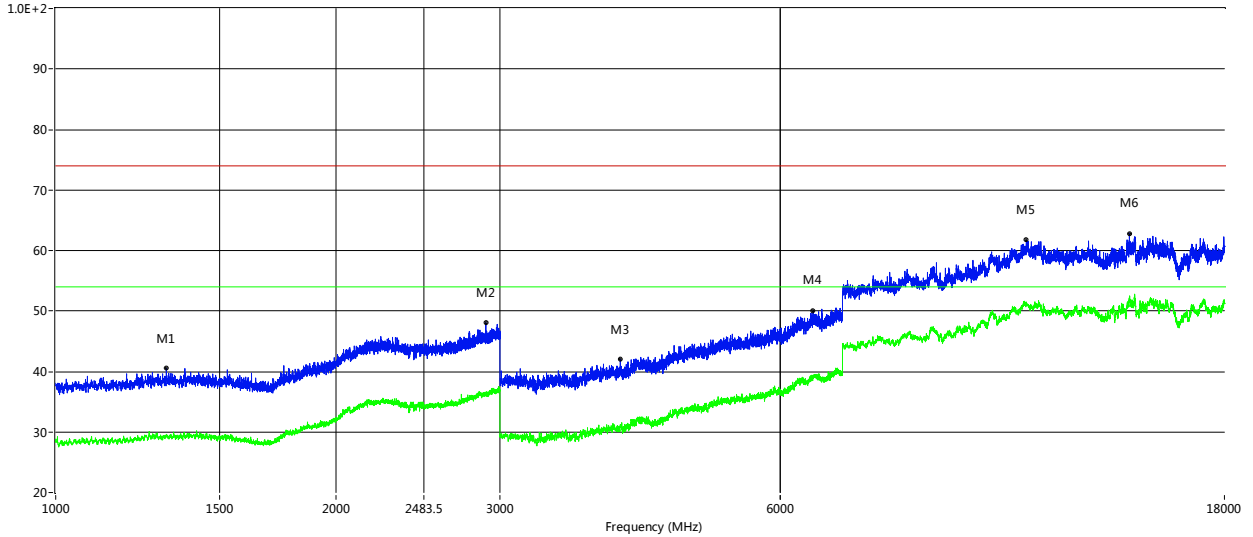

Frequency (MHz)	Peak Level (dBuV/m)	Q-peak Level (dBuV/m)	Average Level (dBuV/m)	Factor (dB)	PK Limit (dBuV/m)	QP Limit (dBuV/m)	AV Limit (dBuV/m)	Over Limit (dB)	Verdict	Verdict
1314.500	40.54	--	29.64	-0.89	74.0	--	54.0	-24.36	Horizontal	Pass
2897.000	48.08	--	36.39	5.61	74.0	--	54.0	-17.61	Horizontal	Pass
4040.000	42.01	--	31.20	-10.06	74.0	--	54.0	-22.80	Horizontal	Pass
6510.000	50.06	--	39.19	-0.41	74.0	--	54.0	-14.81	Horizontal	Pass
11031.500	61.74	--	51.46	10.05	74.0	--	54.0	-2.54	Horizontal	Pass
14232.500	62.84	--	51.88	11.35	74.0	--	54.0	-2.12	Horizontal	Pass



Vertical

RE_FCC Test Case_FCC 15C 1GHz-18GHz
1.0E+2

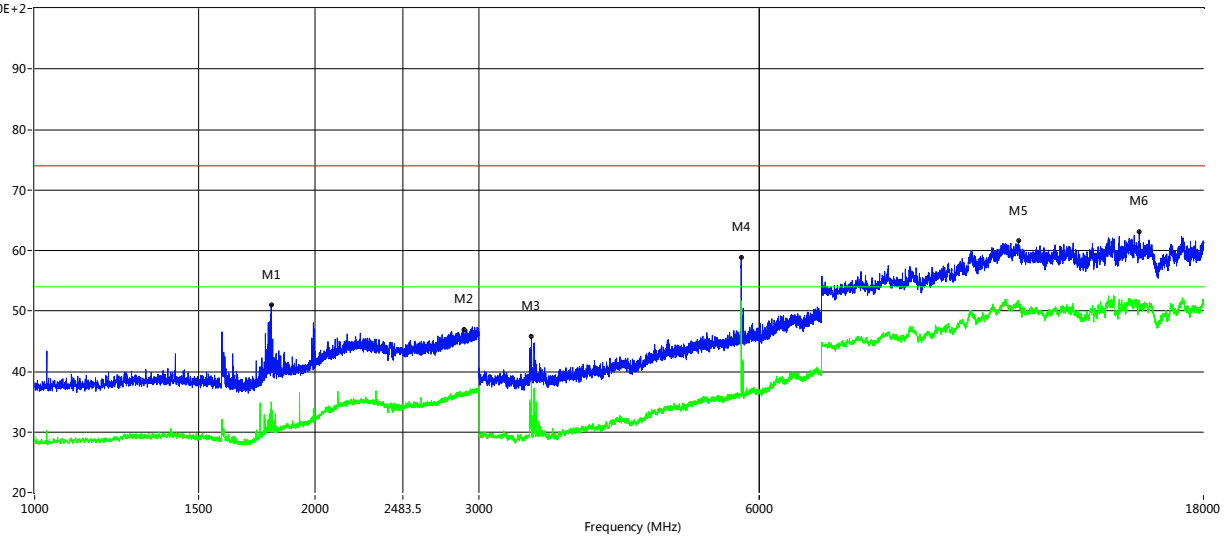

Frequency (MHz)	Peak Level (dBuV/m)	Q-peak Level (dBuV/m)	Average Level (dBuV/m)	Factor (dB)	PK Limit (dBuV/m)	QP Limit (dBuV/m)	AV Limit (dBuV/m)	Over Limit (dB)	Verdict	Verdict
1795.000	51.10	--	34.96	-0.08	74.0	--	54.0	-19.04	Vertical	Pass
2889.500	46.99	--	36.16	5.61	74.0	--	54.0	-17.84	Vertical	Pass
3417.000	45.72	--	38.48	-11.65	74.0	--	54.0	-15.52	Vertical	Pass
5739.000	58.89	--	50.84	-3.97	74.0	--	54.0	-3.16	Vertical	Pass
11397.250	61.61	--	51.17	9.74	74.0	--	54.0	-2.83	Vertical	Pass
15362.750	63.16	--	51.62	10.59	74.0	--	54.0	-2.38	Vertical	Pass



GFSK-High
Horizontal

RE_FCC Test Case_FCC 15C 1GHz-18GHz

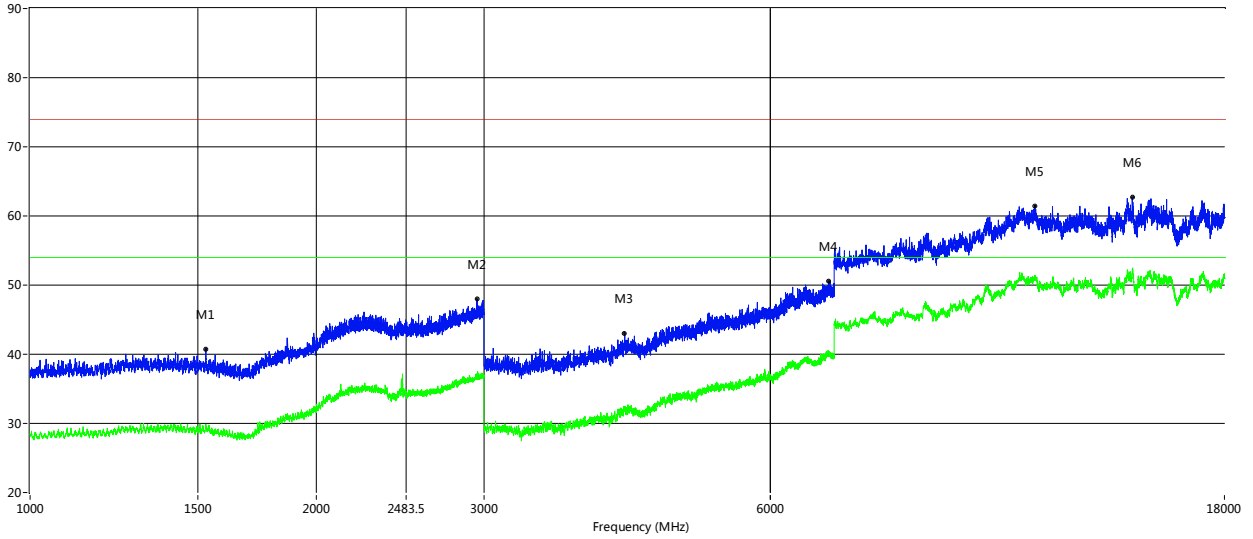

Frequency (MHz)	Peak Level (dBuV/m)	Q-peak Level (dBuV/m)	Average Level (dBuV/m)	Factor (dB)	PK Limit (dBuV/m)	QP Limit (dBuV/m)	AV Limit (dBuV/m)	Over Limit (dB)	Verdict	Verdict
1530.500	40.74	--	29.89	-0.59	74.0	--	54.0	-24.11	Horizontal	Pass
2952.500	47.98	--	36.63	5.91	74.0	--	54.0	-17.37	Horizontal	Pass
4217.000	43.01	--	31.82	-9.05	74.0	--	54.0	-22.18	Horizontal	Pass
6909.000	50.56	--	39.97	0.47	74.0	--	54.0	-14.03	Horizontal	Pass
11380.750	61.47	--	50.92	9.70	74.0	--	54.0	-3.08	Horizontal	Pass
14403.000	62.73	--	52.02	11.39	74.0	--	54.0	-1.98	Horizontal	Pass



Vertical

RE_FCC Test Case_FCC 15C 1GHz-18GHz
1.0E+2

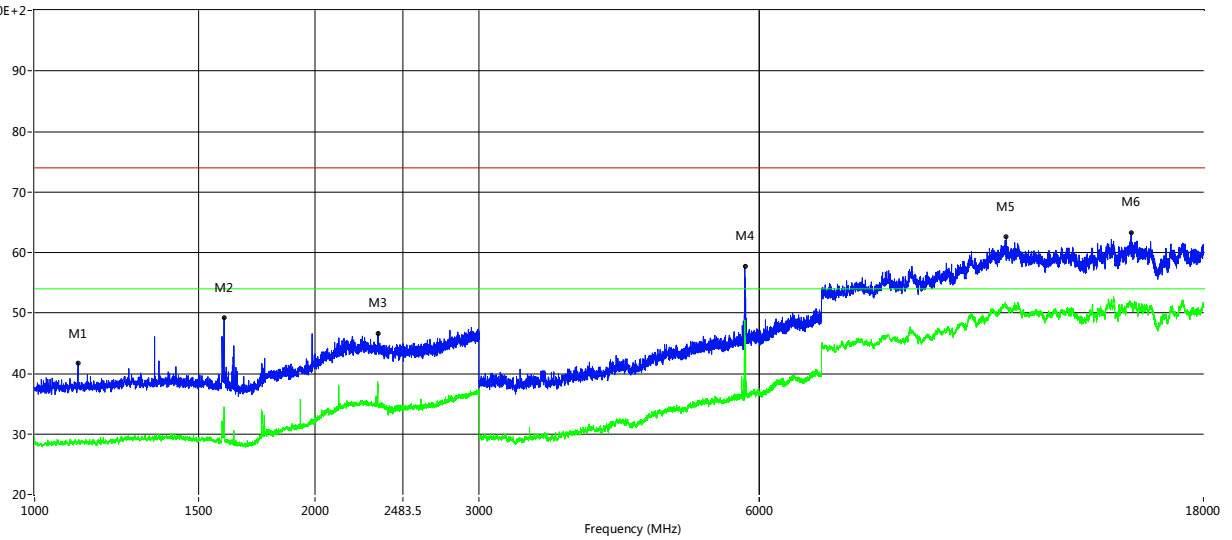

Frequency (MHz)	Peak Level (dBuV/m)	Q-peak Level (dBuV/m)	Average Level (dBuV/m)	Factor (dB)	PK Limit (dBuV/m)	QP Limit (dBuV/m)	AV Limit (dBuV/m)	Over Limit (dB)	Verdict	Verdict
1113.000	41.68	--	28.83	-1.46	74.0	--	54.0	-25.17	Vertical	Pass
1597.000	49.28	--	34.49	-0.50	74.0	--	54.0	-19.51	Vertical	Pass
2336.000	46.65	--	38.62	4.44	74.0	--	54.0	-15.38	Vertical	Pass
5792.000	57.67	--	48.85	-3.88	74.0	--	54.0	-5.15	Vertical	Pass
11059.000	62.66	--	51.11	9.90	74.0	--	54.0	-2.89	Vertical	Pass
15052.000	63.31	--	51.00	10.35	74.0	--	54.0	-3.00	Vertical	Pass



APENDIX B PHOTOS OF TEST SETUP

Note: See test photos in setup photo document for the actual connections between Product and support equipment.

※※※※※ END OF THE REPORT ※※※※※

