

|                        |                               |
|------------------------|-------------------------------|
| Product Name: UC Phone | Report No: FCC022022-5527RF2  |
| Product Model: CP-8832 | Security Classification: Open |
| Version: V1.0          | Total Page:21                 |

# TIRT Testing Report



|                     |                    |                     |  |
|---------------------|--------------------|---------------------|--|
| <b>Prepared By:</b> | <b>Checked By:</b> | <b>Approved By:</b> |  |
| Stone Tang          | Randy Lv           | Daniel Chen         |  |
| <i>Stone Tang</i>   | <i>Randy Lv</i>    | <i>Daniel Chen</i>  |  |

# FCC DFS Test Report

## FCC ID: LDK88322678

This report concerns: Original Grant

**Project No.** : 022022-5527  
**Equipment** : UC Phone  
**Brand Name** : Cisco  
**Test Model** : CP-8832  
**Series Model** : N/A  
**Applicant** : Cisco Systems Inc  
**Address** : 125 West Tasman Drive San Jose, CA 95134-1706 United States  
**Manufacturer** : Cisco Systems Inc  
**Address** : 125 West Tasman Drive San Jose, CA 95134-1706 United States  
**Factory 1** : Shenzhen Fulian Fugui Precision Industry Co., Ltd. Communication & Network Solution Business Group  
**Address 1** : 3/F, D10 Building, F8d Area Foxconn Science and Technology Industrial Park, East side of Min Qing Road, Longhua Street Longhua District, Shenzhen Guangdong 518109 China  
**Factory 2** : Fuyu Precision Component Company Limited  
**Address 2** : Lot M1 and Lot F, Quang Chau Industrial Park, VanTrung Commune, Viet Yen District, Bac Giang Province, 26171, Vietnam  
**Date of Receipt** : 2022.06.24  
**Date of Test** : 2022.06.25 ~ 2022.10.17  
**Issued Date** : 2022.10.25  
**Report Version** : V1.0  
**Test Sample** : Engineering Sample No.: 20220624018684  
**Standard(s)** : FCC CFR Title 47, Part 15, Subpart E  
FCC KDB 789033 D02 General U-NII Test Procedures New Rules v02r01  
FCC KDB 905462 D02 UNII DFS Compliance Procedures New Rules v02  
FCC KDB 905462 D03 UNII Clients Without Radar Detection New Rules v01r02

- The test result referred exclusively to the presented test model /sample.
- Without written approval of TIRT Inc. the test report shall not reproduced except in full.

Add: 101,3 # Factory Building, Gongjin Electronics Shatin Community, Kengzi Street, Pingshan District, Shenzhen, China

TEL: +86-0755-27087573

| <b>Table of Contents</b>                                    | <b>Page</b> |
|---|-------------|
| <b>REPORT ISSUED HISTORY</b>                                | <b>4</b>    |
| <b>1 . TEST FACILITY</b>                                    | <b>5</b>    |
| <b>2 . TEST ENVIRONMENT CONDITIONS</b>                      | <b>5</b>    |
| <b>3 . SUMMARY OF TEST RESULTS</b>                          | <b>5</b>    |
| <b>4 . GENERAL INFORMATION</b>                              | <b>6</b>    |
| 4.1 GENERAL DESCRIPTION OF EUT                              | 6           |
| 4.2 MAXIMUM OUTPUT POWER AND E.I.R.P.                       | 8           |
| 4.3 DESCRIPTION OF TEST MODES                               | 8           |
| <b>5 . U-NII DFS RULE REQUIREMENTS</b>                      | <b>9</b>    |
| 5.1 WORKING MODES AND REQUIRED TEST ITEMS                   | 9           |
| 5.2 TEST LIMITS AND RADAR SIGNAL PARAMETERS                 | 10          |
| <b>6 . MEASUREMENT INSTRUMENTS LIST</b>                     | <b>11</b>   |
| <b>7 . DYNAMIC FREQUENCY SELECTION (DFS)</b>                | <b>12</b>   |
| 7.1 DFS MEASUREMENT SYSTEM                                  | 12          |
| 7.2 CALIBRATION OF DFS DETECTION THRESHOLD LEVEL            | 15          |
| 7.3 DEVIATION FROM TEST STANDARD                            | 15          |
| <b>8 . TEST RESULTS</b>                                     | <b>16</b>   |
| 8.1 SUMMARY OF DFS TEST RESULT                              | 16          |
| 8.2 DFS DETECTION THRESHOLD                                 | 17          |
| 8.3 CHANNEL MOVE TIME AND CHANNEL CLOSING TRANSMISSION TIME | 18          |
| 8.4 NON-OCCUPANCY PERIOD                                    | 20          |
| <b>9 . EUT TEST PHOTO</b>                                   | <b>21</b>   |

**REPORT ISSUED HISTORY**

| Report No.        | Version | Description      | Issued Date | Note  |
|-------------------|---------|------------------|-------------|-------|
| FCC022022-5527RF2 | V1.0    | Original Report. | 2022.10.25  | Valid |

## 1. TEST FACILITY

|   |  |
|---|--|
| Company:                                | Beijing TIRT Technology Service Co.,Ltd Shenzhen   |
| Address:                                | 101, 3 # Factory Building, Gongjin Electronics Shatin Community, Kengzi Street, Pingshan District, Shenzhen, China |
| CNAS Registration Number:               | CNAS L14158  |
| A2LA Registration Number:               | 6049.01  |
| FCC Accredited Lab. Designation Number: | CN1309   |
| FCC Test Firm Registration Number:      | 825524   |
| Telephone:                              | +86-0755-27087573  |

## 2. TEST ENVIRONMENT CONDITIONS

| Test Item                         | Temperature | Humidity | Test Voltage | Tested By  |
|-----------------------------------|-------------|----------|--------------|------------|
| Dynamic Frequency Selection (DFS) | 25°C        | 61%      | PoE 12V      | Stone Tang |

## 3. SUMMARY OF TEST RESULTS

Test procedures according to the technical standard(s):

| FCC CFR Title 47, Part 15, Subpart E |  |             |          |        |
|--------------------------------------|--|-------------|----------|--------|
| Standard(s) Section                  | Test Item  | Test Result | Judgment | Remark |
| FCC 15.407(h)                        | Transmit Power Control (TPC) and Dynamic Frequency Selection (DFS) | -----       | PASS     | -----  |

## 4. GENERAL INFORMATION

### 4.1 GENERAL DESCRIPTION OF EUT

|                               |  |
|-------------------------------|--|
| Equipment                     | UC Phone   |
| Brand Name                    | Cisco  |
| Test Model                    | CP-8832  |
| Series Model                  | N/A  |
| Model Difference(s)           | N/A  |
| Power Source                  | DC Voltage supplied from PoE Injector or AC adapter.   |
| <b>Power Rating</b>           | 1# Model: CP-8832-POE<br>I/P: 44V~55V $\overline{=}$ , 12.95W, 350mA<br>O/P: 5V $\overline{=}$ 2A or 12V $\overline{=}$ 1A<br><br>2# Model: AQ18A-59CFA<br>I/P: 100-240V~ 50-60Hz 0.5A<br>O/P: 5V $\overline{=}$ 3.0A or 9V $\overline{=}$ 2.0A or 12V $\overline{=}$ 1.5A or 15V $\overline{=}$ 1.2A<br><br>3# Model: AN18V-59CFA<br>I/P: 100-240V 0.5A 50-60Hz<br>O/P: 5.0V $\overline{=}$ 3.0A or 9.0V $\overline{=}$ 2.0A or 12.0V $\overline{=}$ 1.5A or 15.0V $\overline{=}$ 1.2A<br><br>4# Model: AN18V-59CB<br>I/P: 100-240V 50-60Hz 0.5A<br>O/P: 5V $\overline{=}$ 3A or 9V $\overline{=}$ 2A or 12V $\overline{=}$ 1.5A<br><br>5# Model: AN18A-59CB<br>I/P: 100-240V~ 50-60Hz 0.5A<br>O/P: 5V $\overline{=}$ 3A or 9V $\overline{=}$ 2A or 12V $\overline{=}$ 1.5A |
| Operation Frequency Band(s)   | UNII-2A: 5250 MHz ~ 5350 MHz<br>UNII-2C: 5470 MHz ~ 5725 MHz   |
| Modulation Type               | IEEE 802.11a/n/ac: OFDM  |
| Bit Rate of Transmitter       | IEEE 802.11a: 54/48/36/24/18/12/9/6 Mbps<br>IEEE 802.11n: up to 150 Mbps<br>IEEE 802.11ac: up to 433.3 Mbps  |
| Operating Mode(s)             | <input type="checkbox"/> Master<br><input checked="" type="checkbox"/> Client device without radar detection<br><input type="checkbox"/> Client device with radar detection  |
| Maximum Output Power _UNII-2A | IEEE 802.11a: 20.56 dBm (0.1138 W)   |
| Maximum Output Power _UNII-2C | IEEE 802.11ac(VHT40): 21.57 dBm (0.1435 W)   |

**Note:**

1. For a more detailed features description, please refer to the manufacturer's specifications or the user's manual.

**2. Channel List:**

| IEEE 802.11a<br>IEEE 802.11n(HT20)<br>IEEE 802.11ac(VHT20) |                 | IEEE 802.11n(HT40)<br>IEEE 802.11ac(VHT40) |                 | IEEE 802.11ac(VHT80) |                 |
|--|-----------------|--|-----------------|----------------------|-----------------|
| UNII-2A  |                 | UNII-2A                                    |                 | UNII-2A              |                 |
| Channel  | Frequency (MHz) | Channel                                    | Frequency (MHz) | Channel              | Frequency (MHz) |
| 52   | 5260            | 54   | 5270            | 58                   | 5290            |
| 56   | 5280            | 62   | 5310            |                      |                 |
| 60   | 5300            |  |                 |                      |                 |
| 64   | 5320            |  |                 |                      |                 |

| IEEE 802.11a<br>IEEE 802.11n(HT20)<br>IEEE 802.11ac(VHT20) |                 | IEEE 802.11n(HT40)<br>IEEE 802.11ac(VHT40) |                 | IEEE 802.11ac(VHT80) |                 |
|--|-----------------|--|-----------------|----------------------|-----------------|
| UNII-2C  |                 | UNII-2C                                    |                 | UNII-2C              |                 |
| Channel  | Frequency (MHz) | Channel                                    | Frequency (MHz) | Channel              | Frequency (MHz) |
| 100  | 5500            | 102  | 5510            | 106                  | 5530            |
| 104  | 5520            | 110  | 5550            | 122                  | 5610            |
| 108  | 5540            | 118  | 5590            |                      |                 |
| 112  | 5560            | 126  | 5630            |                      |                 |
| 116  | 5580            | 134  | 5670            |                      |                 |
| 120  | 5600            |  |                 |                      |                 |
| 124  | 5620            |  |                 |                      |                 |
| 128  | 5640            |  |                 |                      |                 |
| 132  | 5660            |  |                 |                      |                 |
| 136  | 5680            |  |                 |                      |                 |
| 140  | 5700            |  |                 |                      |                 |

**3. Antenna Specification:**

| Ant. | Brand  | P/N             | Antenna Type | Connector | Gain (dBi) |
|------|--|-----------------|--------------|-----------|------------|
| 1    | <br>Shanghai Ampereco Airwave | CI8226-15-000-R | PCB          | IPEX      | 4.8        |

**Note:**

1) The antenna gain is provided by the manufacturer.

**4.2 MAXIMUM OUTPUT POWER AND E.I.R.P.**

| Frequency Band (MHz) | Max Output Power (dBm) | Antenna Gain (dBi) | Max. e.i.r.p. (dBm) | Max. e.i.r.p. (mW) |
|----------------------|------------------------|--------------------|---------------------|--------------------|
| 5250~5350            | 20.56                  | 4.8                | 25.36               | 343.558            |
| 5470~5725            | 21.57                  | 4.8                | 26.37               | 433.511            |

Note:

- 1) U-NII devices operating in the 5.25-5.35 GHz band and the 5.47-5.725 GHz band shall employ a TPC mechanism. A TPC mechanism is not required for systems with an e.i.r.p. of less than 500 mW.

**4.3 DESCRIPTION OF TEST MODES**

| Test Mode | Description                   |
|-----------|-------------------------------|
| Mode 1    | IEEE 802.11ac(VHT80): 5530MHz |



## 5. U-NII DFS RULE REQUIREMENTS

### 5.1 WORKING MODES AND REQUIRED TEST ITEMS

The manufacturer shall state whether the UUT is capable of operating as a Master and/or a Client. If the UUT is capable of operating in more than one operating mode then each operating mode shall be tested separately. See tables below for the applicability of DFS requirements for each of the operational modes.

Applicability of DFS requirements prior to use a channel

| Requirement                     | Operational Mode |                                |                             |
|---------------------------------|------------------|--------------------------------|-----------------------------|
|                                 | Master           | Client without radar detection | Client with radar detection |
| Non-Occupancy Period            | √                | √                              | √                           |
| DFS Detection Threshold         | √                | Not required                   | √                           |
| Channel Availability Check Time | √                | Not required                   | Not required                |
| U-NII Detection Bandwidth       | √                | Not required                   | √                           |

Applicability of DFS requirements during normal operation

| Requirement                       | Operational Mode |                                |                             |
|-----------------------------------|------------------|--------------------------------|-----------------------------|
|                                   | Master           | Client without radar detection | Client with radar detection |
| DFS Detection Threshold           | √                | Not required                   | √                           |
| Channel Closing Transmission Time | √                | √                              | √                           |
| Channel Move Time                 | √                | √                              | √                           |
| U-NII Detection Bandwidth         | √                | Not required                   | √                           |

| Additional requirements for devices with multiple bandwidth modes | Master Device or Client with Radar Detection | Client Without Radar Detection                       |
|---|--|--|
| U-NII Detection Bandwidth and Statistical Performance Check       | All BW modes must be tested                  | Not required   |
| Channel Move Time and Channel Closing Transmission Time           | Test using widest BW mode available          | Test using the widest BW mode available for the link |
| All other tests   | Any single BW mode                           | Not required   |

Note: Frequencies selected for statistical performance check should include several frequencies within the radar detection bandwidth and frequencies near the edge of the radar detection bandwidth. For 802.11 devices it is suggested to select frequencies in each of the bonded 20 MHz channels and the channel center frequency.

## 5.2 TEST LIMITS AND RADAR SIGNAL PARAMETERS

### DETECTION THRESHOLD VALUES

DFS Detection Thresholds for Master Devices and Client Devices with Radar Detection

| Maximum Transmit Power   | Value<br>(See Notes 1, 2 and 3) |
|--|---------------------------------|
| e.i.r.p. $\geq$ 200 milliwatt  | -64 dBm                         |
| e.i.r.p. < 200 milliwatt and power spectral density < 10 dBm/MHz                 | -62 dBm                         |
| e.i.r.p. < 200 milliwatt that do not meet the power spectral density requirement | -64 dBm                         |

**Note 1:** This is the level at the input of the receiver assuming a 0 dBi receive antenna.

**Note 2:** Throughout these test procedures an additional 1 dB has been added to the amplitude of the test transmission waveforms to account for variations in measurement equipment. This will ensure that the test signal is at or above the detection threshold level to trigger a DFS response.

**Note 3:** e.i.r.p. is based on the highest antenna gain. For MIMO devices refer to KDB Publication 662911 D01.

### TEST LIMIT

DFS Response Requirement Values

| Parameter                         | Value  |
|-----------------------------------|--|
| Non-occupancy period              | Minimum 30 minutes   |
| Channel Availability Check Time   | 60 seconds   |
| Channel Move Time                 | 10 seconds. See Note 1.  |
| Channel Closing Transmission Time | 200 milliseconds + an aggregate of 60 milliseconds over remaining 10 second period. See Notes 1 and 2. |
| U-NII Detection Bandwidth         | Minimum 100% of the UNII 99% transmission power bandwidth. See Note 3.                                 |

**Note 1:** Channel Move Time and the Channel Closing Transmission Time should be performed with Radar Type 0. The measurement timing begins at the end of the Radar Type 0 burst.

**Note 2:** The Channel Closing Transmission Time is comprised of 200 milliseconds starting at the beginning of the Channel Move Time plus any additional intermittent control signals required to facilitate a Channel move (an aggregate of 60 milliseconds) during the remainder of the 10 second period. The aggregate duration of control signals will not count quiet periods in between transmissions.

**Note 3:** During the U-NII Detection Bandwidth detection test, radar type 0 should be used. For each frequency step the minimum percentage of detection is 90 percent. Measurements are performed with no data traffic.

### PARAMETERS OF DFS TEST SIGNALS

Step intervals of 0.1 microsecond for Pulse Width, 1 microsecond for PRI, 1 MHz for chirp width and 1 for the number of pulses will be utilized for the random determination of specific test waveforms.

Short Pulse Radar Test Waveforms.

| Radar Type | Pulse Width ( $\mu$ sec) | PRI ( $\mu$ sec) | Number of Pulses | Minimum Percentage of Successful Detection | Minimum Number of Trials |
|------------|--------------------------|------------------|------------------|--|--------------------------|
| 0          | 1                        | 1428             | 18               | See Note 1                                 | See Note 1               |

Note 1: Short Pulse Radar Type 0 should be used for the detection bandwidth test, channel move time, and channel closing time tests.

**6. MEASUREMENT INSTRUMENTS LIST**

| Kind of Equipment                            | Manufacturer | Type No.                      | Serial No. | Calibrated until |
|--|--------------|-------------------------------|------------|------------------|
| Spectrum Analyzer                            | Agilent      | N9010A                        | MY52221119 | 2022/11/09       |
| Vector Signal Generator                      | Agilent      | N5182B                        | MY53051091 | 2022/11/09       |
| Temp&Humidity Recorder                       | Anymetre     | JR900                         | NA         | 2022/11/03       |
| Keysight.Signal Sudio for DFS Rader Profiles | Keysight     | N7607B Signal studio V3.0.0.0 | NA         | NA               |
| Wi-Fi Router                                 | Tp-Link      | Archer AX6000                 | NA         | NA               |

Remark: "N/A" denotes no model name, serial no. or calibration specified.  
"\*\*\*" calibration period of equipment list is three year.  
Except \* item, all calibration period of equipment list is one year.  
Wi-Fi Router's FCC ID: TE7AX6000

## 7. DYNAMIC FREQUENCY SELECTION (DFS)

### 7.1 DFS MEASUREMENT SYSTEM

#### Test Procedure

1. Master device and client device are set up by conduction method as the following configuration.
2. The client device is connected to notebook and to access a IP address on wireless connection with the master device.
3. Then the master device is connected to another notebook to access a IP address.
4. Finally, let the two IP addresses run traffic with each other through the Run flow software "Lan test" to reach 17% channel loading as below.

#### Setup for Client with injection at the Master

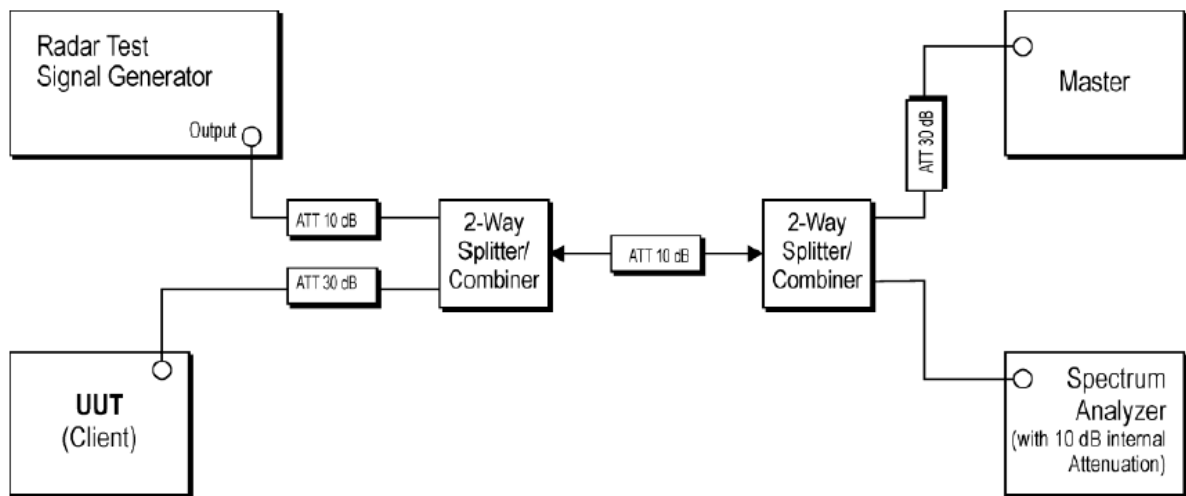

Radar Test Waveforms are injected into the Master.

**Channel Loading**

**IEEE 802.11ac(VHT80) Mode**

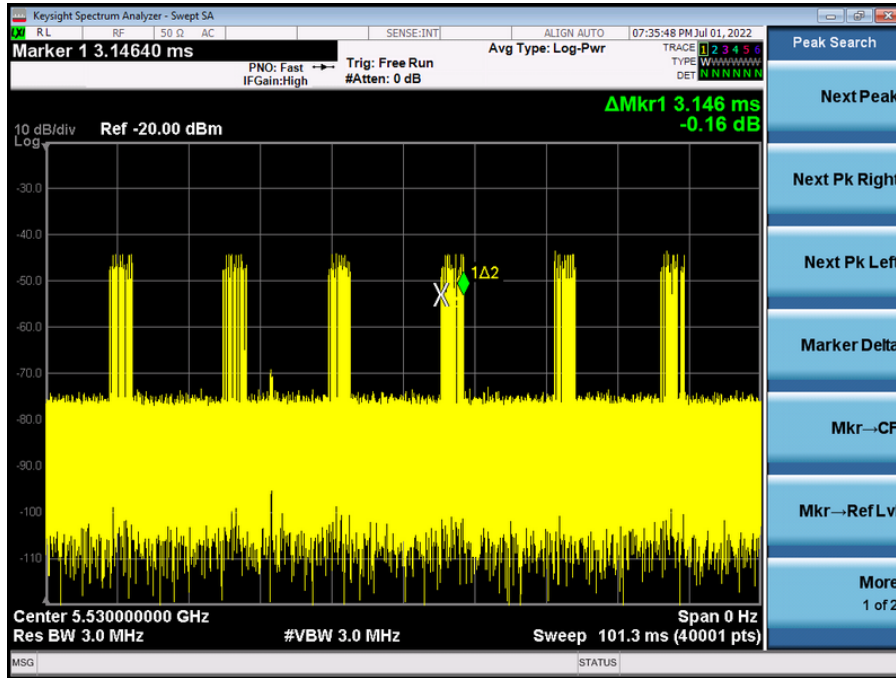

| Frequency (MHz) | Marker Delta (ms) | Number | On Time (ms) | Total Time (ms) | Duty cycle (%) | Limit (%) |
|-----------------|-------------------|--------|--------------|-----------------|----------------|-----------|
| 5530            | 3.146             | 6      | 18.876       | 101.3           | 18.63          | 17.00     |

The signal monitoring equipment consists of a spectrum analyzer set to display 8001 bins on the horizontal axis. The time-domain resolution is 2 msec / bin with a 16 second sweep time, meeting the 10 second short pulse reporting criteria. The aggregate ON time is calculated by multiplying the number of bins above a threshold during a particular observation period by the dwell time per bin, with the analyzer set to peak detection and max hold.

Should multiple RF ports be utilized for the Master and/or Slave devices (for example, for diversity or MIMO implementations), additional combiner/dividers are inserted between the Master Combiner/Divider and the pad connected to the Master Device (and/or between the Slave Combiner/Divider and the pad connected to the Slave Device). Additional pads are utilized such that there is one pad at each RF port on each EUT.

## 7.2 CALIBRATION OF DFS DETECTION THRESHOLD LEVEL

A 50 ohm load is connected in place of the spectrum analyzer, and the spectrum analyzer is connected in place of the master device and the signal generator is set to CW mode. The amplitude of the signal generator is adjusted to yield a level of -64dBm as measured on the spectrum analyzer.

Without changing any of the instrument settings, the spectrum analyzer is reconnected to the Common port of the Spectrum Analyzer Combiner/Divider. Measure the amplitude and calculate the difference from -64 dBm. Adjust the Reference Level Offset of the spectrum analyzer to this difference.

The spectrum analyzer displays the level of the signal generator as received at the antenna ports of the Master Device. The interference detection threshold may be varied from the calibrated value of -64 dBm and the spectrum analyzer will still indicate the level as received by the Master Device.

Set the signal generator to produce a radar waveform, trigger a burst manually and measure the level on the spectrum analyzer. Readjust the amplitude of the signal generator as required so that the peak level of the waveform is at a displayed level equal to the required or desired interference detection threshold. Separate signal generator amplitude settings are determined as required for each radar type.

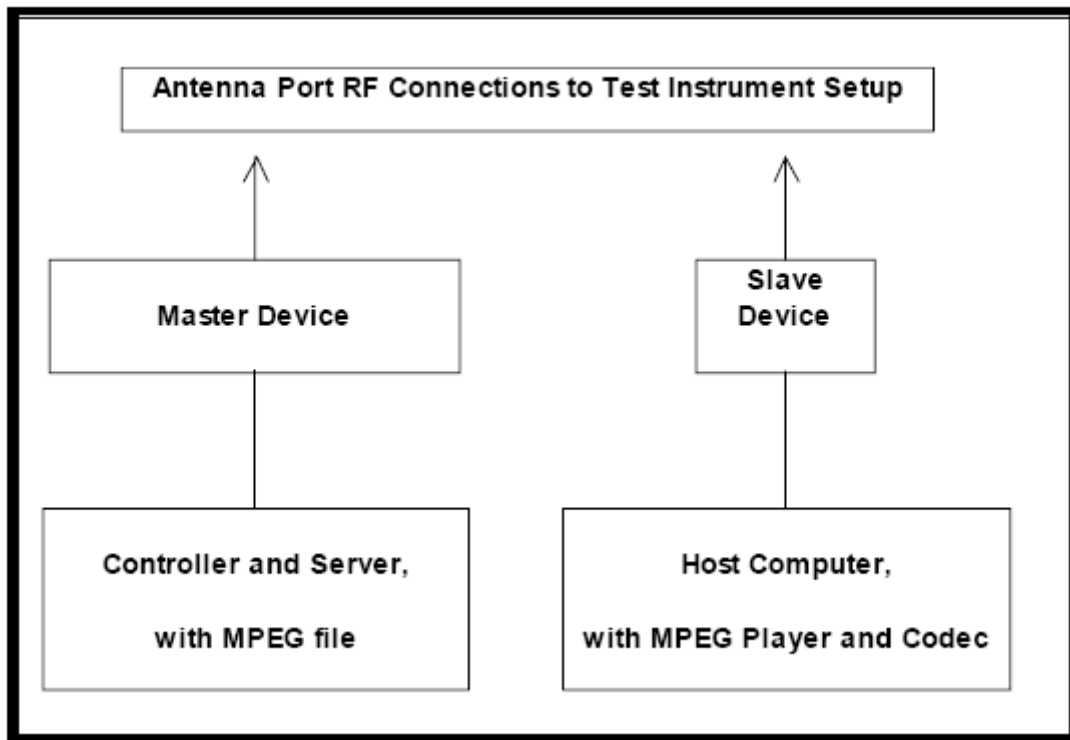

## 7.3 DEVIATION FROM TEST STANDARD

No deviation.

## 8. TEST RESULTS

### 8.1 SUMMARY OF DFS TEST RESULT

| Clause     | Test Parameter                    | Remarks    | Result |
|------------|-----------------------------------|------------|--------|
| FCC 15.407 | Channel Move Time                 | Applicable | Pass   |
|            | Channel Closing Transmission Time | Applicable | Pass   |
|            | Non-Occupancy Period              | Applicable | Pass   |



### 8.2 DFS DETECTION THRESHOLD

Calibration:

The EUT is slave equipment and it with a lowest gain is 4.8 dBi.  
 For a detection threshold level of -62dBm and the master antenna gain is 2.90 dBi, required detection threshold is -59.10 dBm (= -62+2.90).

Note: Maximum Transmit Power is less than 200 milliwatt in this report, so detection threshold level is -62dBm.

Radar Signal 0

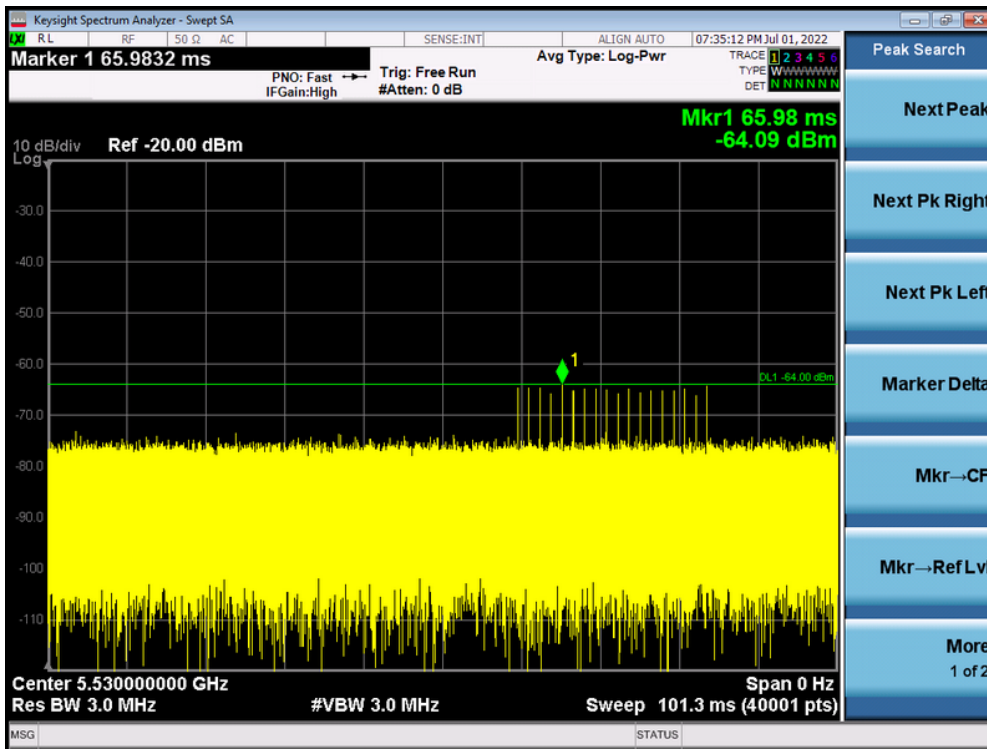

**8.3 CHANNEL MOVE TIME AND CHANNEL CLOSING TRANSMISSION TIME**

TX (IEEE 802.11ac(VHT80) Mode)

Radar signal 0

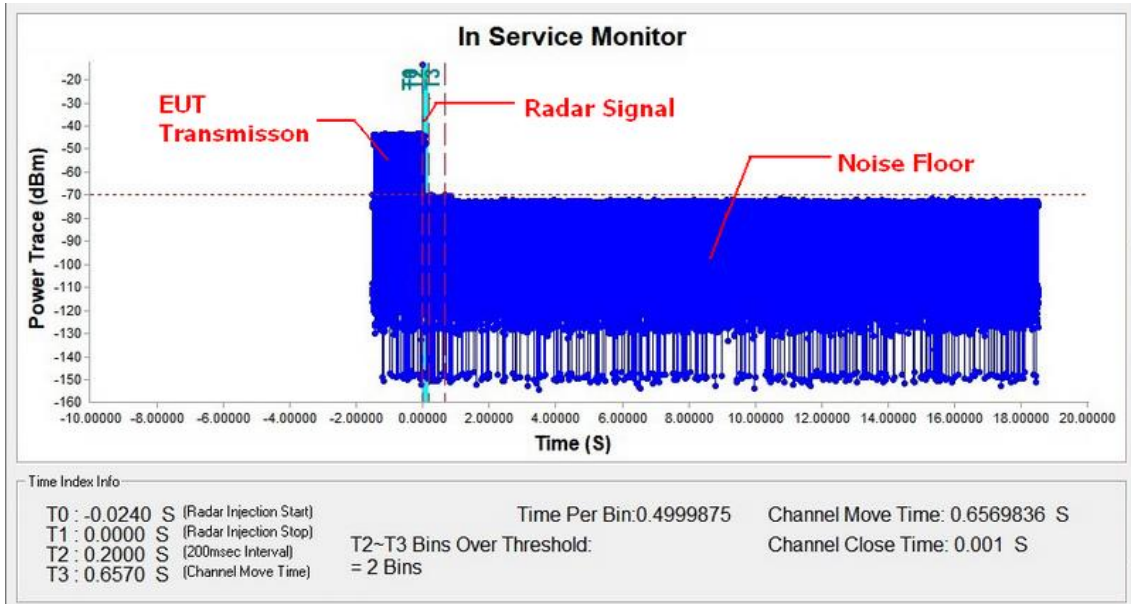

**Note:** T0 denotes the Radar Injection Start.  
 T1 denotes the start of Channel Move Time upon the end of the last Radar burst.  
 T2 denotes the data transmission time of 200ms from T1.  
 T3 denotes the end of Channel Move Time.

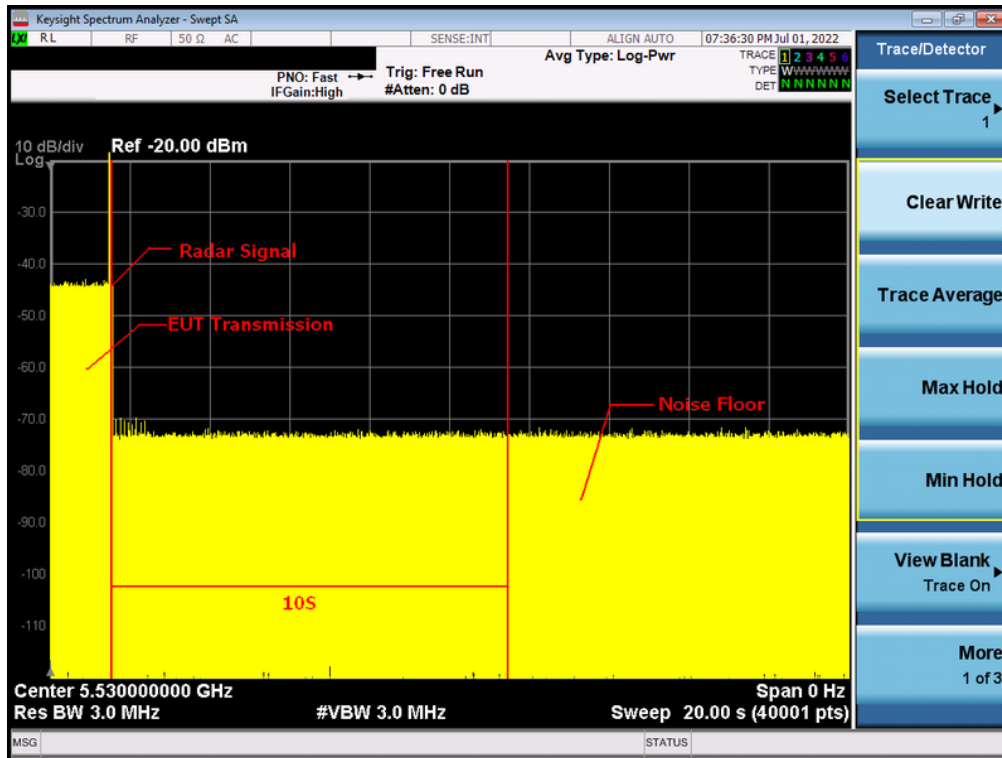

**Note:** An expanded plot for the device vacates the channel in the required 500ms

| IEEE 802.11ac(VHT80) Mode |                   |   |
|---------------------------|-------------------|---|
| Item                      | Measured Value(s) | Limit(s)  |
| Channel Move Time         | 0.6569836         | 10  |
| Channel Close Time        | 0.001             | 200 milliseconds + an aggregate of 60 milliseconds over remaining 10 second period. |



**9. EUT TEST PHOTO**

**End of Test Report**