



Dynamic Frequency Selection (DFS) Test Report

CP-7926G-W-K9

5250-5350, 5470-5725 MHz

Against the following Specifications:

CFR47 Part 15.407

RSS210

Cisco Systems

170 West Tasman Drive

San Jose, CA 95134

Author: Phillip Carranco

Approved By: Philippe Sochoux

Title: Regulatory Compliance Manager

This report replaces any previously entered test report under EDCS - 1030557



This test report has been electronically authorized and archived using the CISCO Engineering Document Control system.

2.0	DFS DETECTION THRESHOLDS	4
3.0	RADAR TEST WAVEFORMS	5
4.0	RADAR WAVEFORM CALIBRATION	8
5.0	TEST PROCEDURE/RESULTS	12

Dynamic Frequency Selection (DFS) Test Results

15.407: U-NII devices operating in the 5.25-5.35 GHz band and the 5.47-5.725 GHz band shall employ a TPC mechanism. The U-NII device is required to have the capability to operate at least 6 dB below the mean EIRP value of 30 dBm. A TPC mechanism is not required for systems with an e.i.r.p. of less than 500 mW.

U-NII devices operating in the 5.25-5.35 GHz and 5.47-5.725 GHz bands shall employ a DFS radar detection mechanism to detect the presence of radar systems and to avoid co-channel operation with radar systems.

1.0 UNII Device Description

1. The AIR-LAP1142N-A-K9 operates in the following bands:
 - a. 5150-5250 MHz
 - b. 5250-5350 MHz
 - c. 5470-5725 MHz
 - d. 5725-5850 MHz
2. The maximum EIRP of the 5GHz equipment is 26 dBm, and the minimum possible EIRP is -1 dBm.

The following antennas were evaluated as part of this testing process. The antennas listed reflect the maximum gain allowed for each family type of antenna:

Fixed internal Antenna, Gain: (no external antenna can be used.)
5260 - 5320MHz: 4.96dBi
5500 - 5700MHz: 5.85dBi.

3. System testing was performed with the designated WAV test file that streams full motion video at 30 frames per second from the Master to the Client IP based system.
4. This device does not exceed 27dBm eirp, so no transmit power control is implemented.
5. The Master requires 61 seconds to complete its power-on cycle.
6. Information regarding the parameters of the detected Radar Waveforms is not available to the end user.
7. For the 5250-5350 MHz and 5470-5725 MHz bands, the Master device provides, on aggregate, uniform loading of the spectrum across all devices by selecting an operating channel among the available channels using a random algorithm.



2.0 DFS Detection Thresholds

1. Interference Threshold values, Master or Client incorporating In-Service Monitoring

Maximum Transmit Power	Value (see note)
≥ 200 milliwatt	-64 dBm
< 200 milliwatt	-62 dBm
Note 1: This is the level at the input of the receiver assuming a 0 dBi receive antenna Note 2: Throughout these test procedures an additional 1 dB has been added to the amplitude of the test transmission waveforms to account for variations in measurement equipment. This will ensure that the test signal is at or above the detection threshold level to trigger a DFS response.	

2. DFS Response requirement values

Parameter	Value
<i>Non-occupancy period</i>	Minimum 30 minutes
<i>Channel Availability Check Time</i>	60 seconds
<i>Channel Move Time</i>	10 seconds See Note 1.
<i>Channel Closing Transmission Time</i>	200 milliseconds + an aggregate of 60 milliseconds over remaining 10 second period. See Notes 1 and 2.
<i>U-NII Detection Bandwidth</i>	Minimum 80% of the 99% power bandwidth See Note 3.
Note 1: The instant that the <i>Channel Move Time</i> and the <i>Channel Closing Transmission Time</i> begins is as follows: <ul style="list-style-type: none"> • For the Short pulse radar Test Signals this instant is the end of the <i>Burst</i>. • For the Frequency Hopping radar Test Signal, this instant is the end of the last radar <i>Burst</i> generated. • For the Long Pulse radar Test Signal this instant is the end of the 12 second period defining the radar transmission. Note 2: The <i>Channel Closing Transmission Time</i> is comprised of 200 milliseconds starting at the beginning of the <i>Channel Move Time</i> plus any additional intermittent control signals required to facilitate <i>Channel</i> changes (an aggregate of 60 milliseconds) during the remainder of the 10 second period. The aggregate duration of control signals will not count quiet periods in between transmissions. Note 3: During the <i>U-NII Detection Bandwidth</i> detection test, radar type 1 is used and for each frequency step the minimum percentage of detection is 90%. Measurements are performed with no data traffic.	



3.0 Radar Test Waveforms

This section provides the parameters for required test waveforms, minimum percentage of successful detections, and the minimum number of trials that must be used for determining DFS conformance. Step intervals of 0.1 microsecond for Pulse Width, 1 microsecond for PRI, 1 MHz for chirp width and 1 for the number of pulses will be utilized for the random determination of specific test waveforms.

1. Short Pulse Radar Test Waveforms

Radar Type	Pulse Width (μsec)	PRI (μsec)	Number of Pulses	Minimum Percentage of Successful Detection	Minimum Trials
1	1	1428	18	60%	30
2	1-5	150-230	23-29	60%	30
3	6-10	200-500	16-18	60%	30
4	11-20	200-500	12-16	60%	30
Aggregate (Radar Types 1-4)				80%	120

A minimum of 30 unique waveforms are required for each of the short pulse radar types 2 through 4. For short pulse radar type 1, the same waveform is used a minimum of 30 times. If more than 30 waveforms are used for short pulse radar types 2 through 4, then each additional waveform must also be unique and not repeated from the previous waveforms. The aggregate is the average of the percentage of successful detections of short pulse radar types 1-4.

2. Long Pulse Radar Test Waveform

Radar Type	Pulse Width (μsec)	Chirp Width (MHz)	PRI (μsec)	Number of Pulses per Burst	Number of Bursts	Minimum Percentage of Successful Detection	Minimum Trials
5	50-100	5-20	1000-2000	1-3	8-20	80%	30

The parameters for this waveform are randomly chosen. Thirty unique waveforms are required for the Long Pulse radar test signal. If more than 30 waveforms are used for the Long Pulse radar test signal, then each additional waveform must also be unique and not repeated from the previous waveforms.

Each waveform is defined as follows:

- 1) The transmission period for the Long Pulse Radar test signal is 12 seconds.
- 2) There are a total of 8 to 20 Bursts in the 12 second period, with the number of Bursts being randomly chosen. This number is Burst_Count.

- 3) Each Burst consists of 1 to 3 pulses, with the number of pulses being randomly chosen. Each Burst within the 12 second sequence may have a different number of pulses.
- 4) The pulse width is between 50 and 100 microseconds, with the pulse width being randomly chosen. Each pulse within a Burst will have the same pulse width. Pulses in different Bursts may have different pulse widths.
- 5) Each pulse has a linear FM chirp between 5 and 20 MHz, with the chirp width being randomly chosen. Each pulse within a Burst will have the same chirp width. Pulses in different Bursts may have different chirp widths. The chirp is centered on the pulse. For example, with a radar frequency of 5300 MHz and a 20 MHz chirped signal, the chirp starts at 5290 MHz and ends at 5310 MHz.
- 6) If more than one pulse is present in a Burst, the time between the pulses will be between 1000 and 2000 microseconds, with the time being randomly chosen. If three pulses are present in a Burst, the time between the first and second pulses is chosen independently of the time between the second and third pulses.
- 7) The 12 second transmission period is divided into even intervals. The number of intervals is equal to Burst_Count. Each interval is of length $(12,000,000 / \text{Burst_Count})$ microseconds. Each interval contains one Burst. The start time for the Burst, relative to the beginning of the interval, is between 1 and $[(12,000,000 / \text{Burst_Count}) - (\text{Total Burst Length}) + (\text{One Random PRI Interval})]$ microseconds, with the start time being randomly chosen. The step interval for the start time is 1 microsecond. The start time for each Burst is chosen independently.

A representative example of a Long Pulse radar test waveform:

- 1) The total test signal length is 12 seconds.
- 2) 8 Bursts are randomly generated for the Burst_Count.
- 3) Burst 1 has 2 randomly generated pulses.
- 4) The pulse width (for both pulses) is randomly selected to be 75 microseconds.
- 5) The PRI is randomly selected to be at 1213 microseconds.
- 6) Bursts 2 through 8 are generated using steps 3 – 5.
- 7) Each Burst is contained in even intervals of 1,500,000 microseconds. The starting location for Pulse 1, Burst 1 is randomly generated (1 to 1,500,000 minus the total Burst 1 length + 1 random PRI interval) at the 325,001 microsecond step. Bursts 2 through 8 randomly fall in successive 1,500,000 microsecond intervals (i.e. Burst 2 falls in the 1,500,001 – 3,000,000 microsecond range).

Graphical Representation of a Long Pulse radar Test Waveform

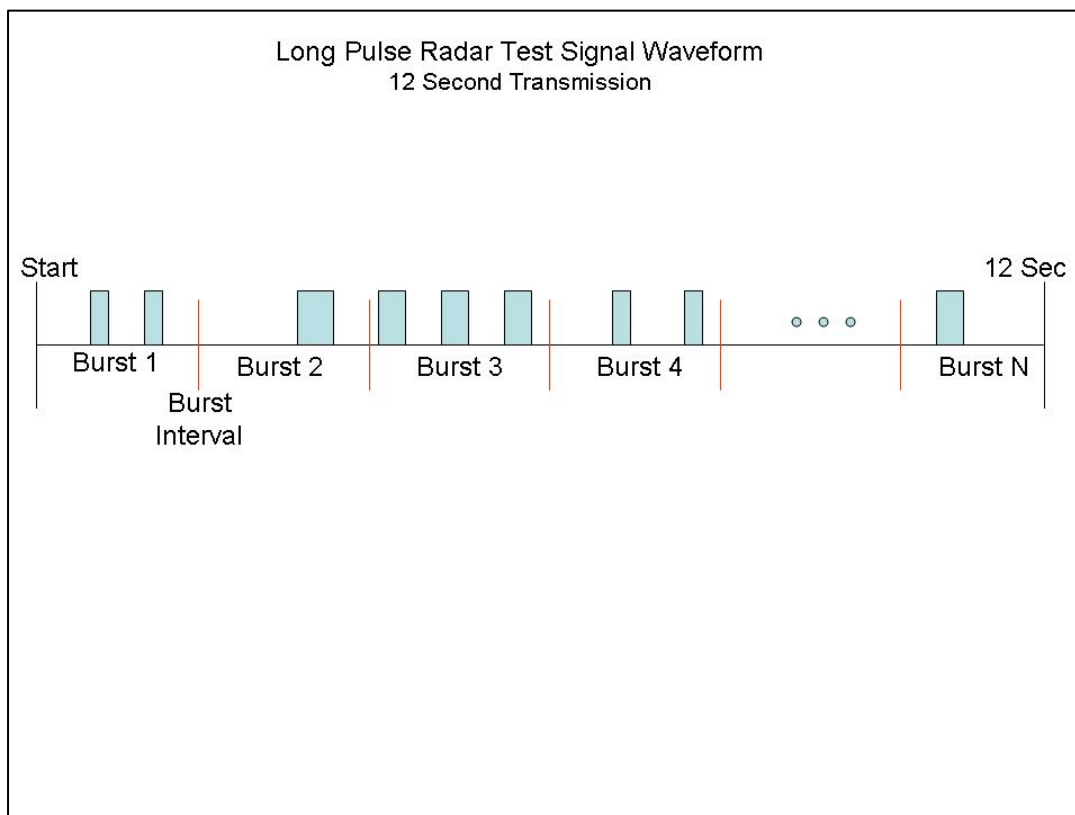

3. Frequency H

Radar Type	Pulse Width (µsec)	PRI (µsec)	Pulses per Hop	Hopping Rate (kHz)	Hopping Sequence Length (msec)	Minimum Percentage of Successful Detection	Minimum Trials
6	1	333	9	.333	300	70%	30

For the Frequency Hopping Radar Type, the same *Burst* parameters are used for each waveform. The hopping sequence is different for each waveform and a 100-length segment is selected¹ from the hopping sequence defined by the following algorithm:

The first frequency in a hopping sequence is selected randomly from the group of 475 integer frequencies from 5250 – 5724 MHz. Next, the frequency that was just chosen is removed from the group and a frequency is randomly selected from the remaining 474 frequencies in the group. This process continues until all 475 frequencies are chosen for the set. For selection of a random frequency, the frequencies remaining within the group are always treated as equally likely.

4.0 Radar Waveform Calibration

1. The following equipment setup was used to calibrate the conducted Radar Waveform. A spectrum analyzer was used to establish the test signal level for each radar type. During this process there were no transmissions by either the Master or Client Device. The spectrum analyzer was switched to the zero span (Time Domain) mode at the frequency of the Radar Waveform generator. Peak detection was utilized. The spectrum analyzer resolution bandwidth (RBW) and video bandwidth (VBW) were set to 3 MHz.

The signal generator amplitude was set so that the power level measured at the spectrum analyzer was -63dBm.

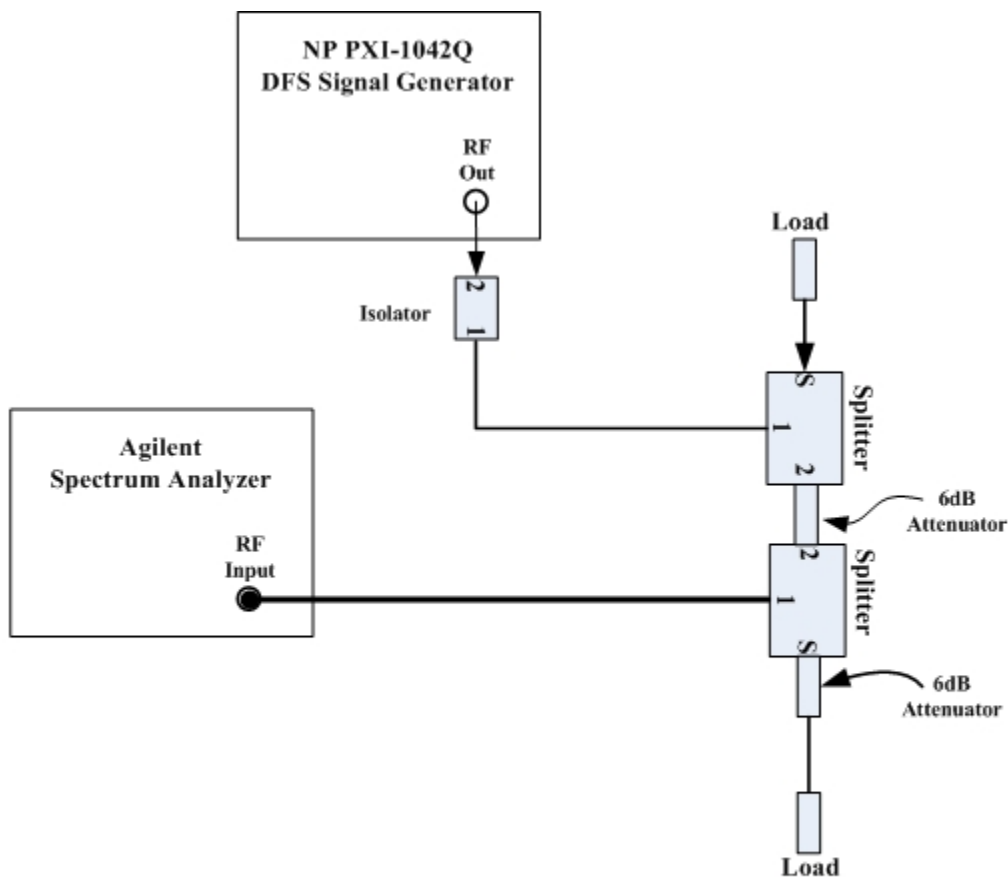

DFS Signal Calibration Configuration



Conducted Calibration Setup

Following are the calibration plots for each of the required radar waveforms.

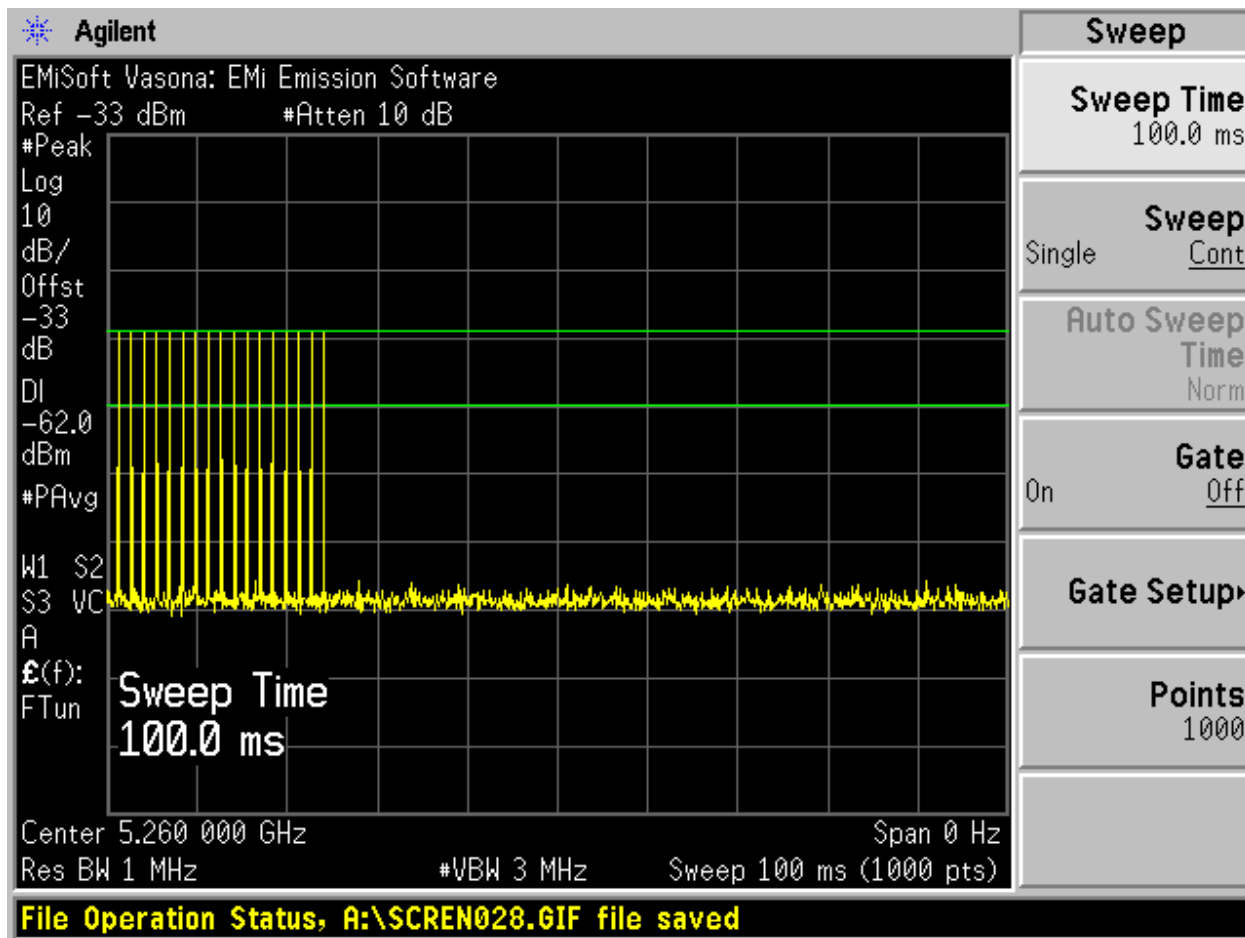

Bin 1 Radar Calibration

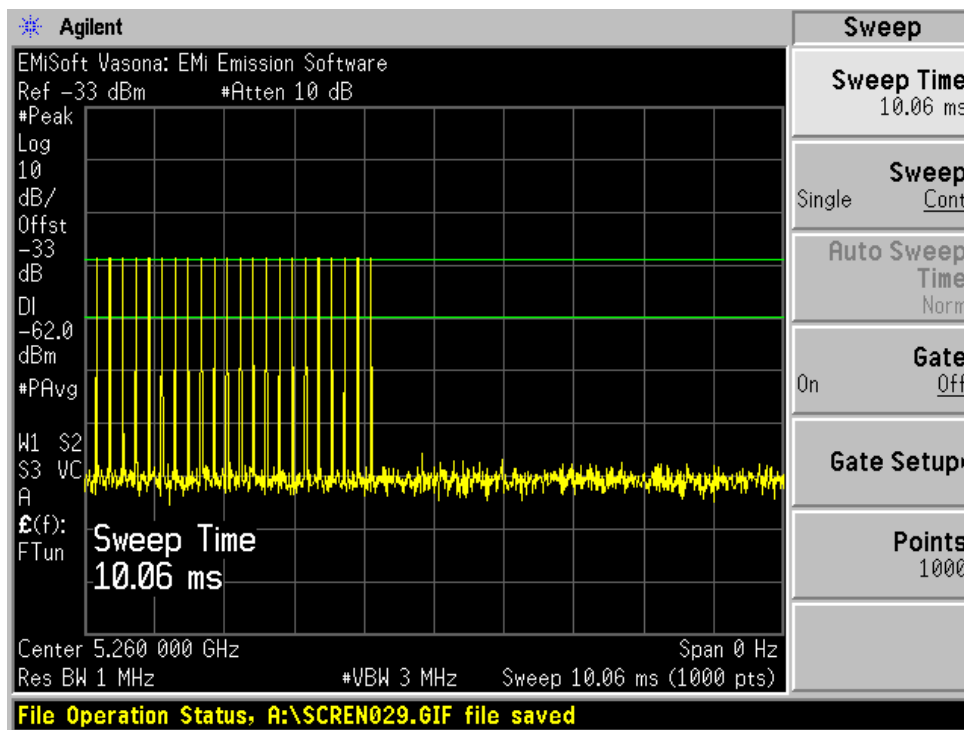

Bin 2 Radar Calibration

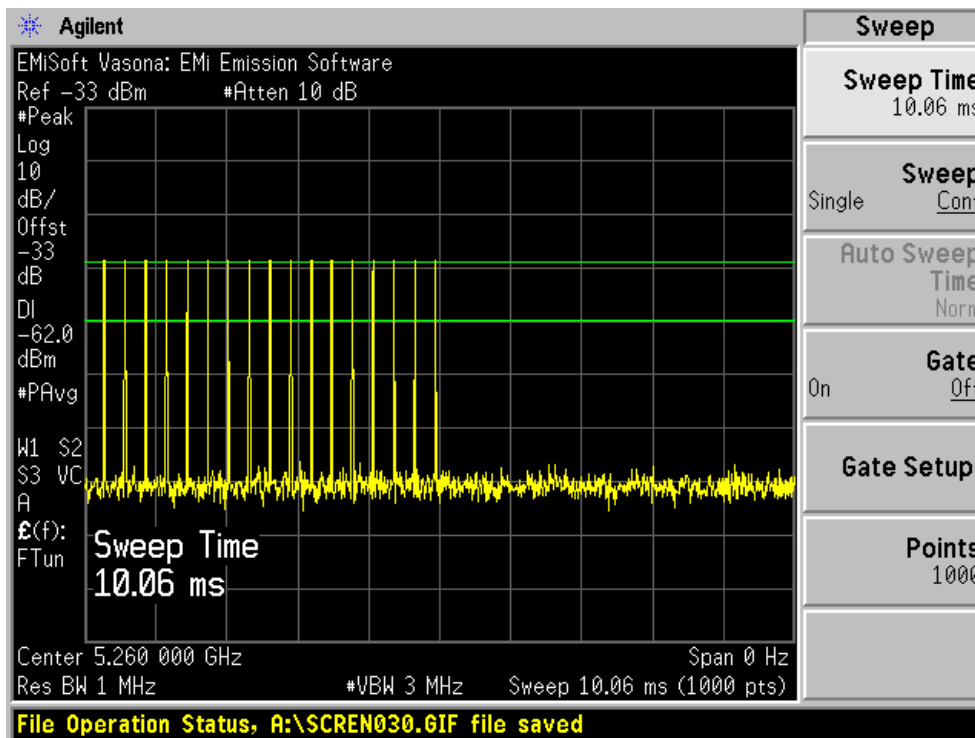

Bin 3 Radar Calibration

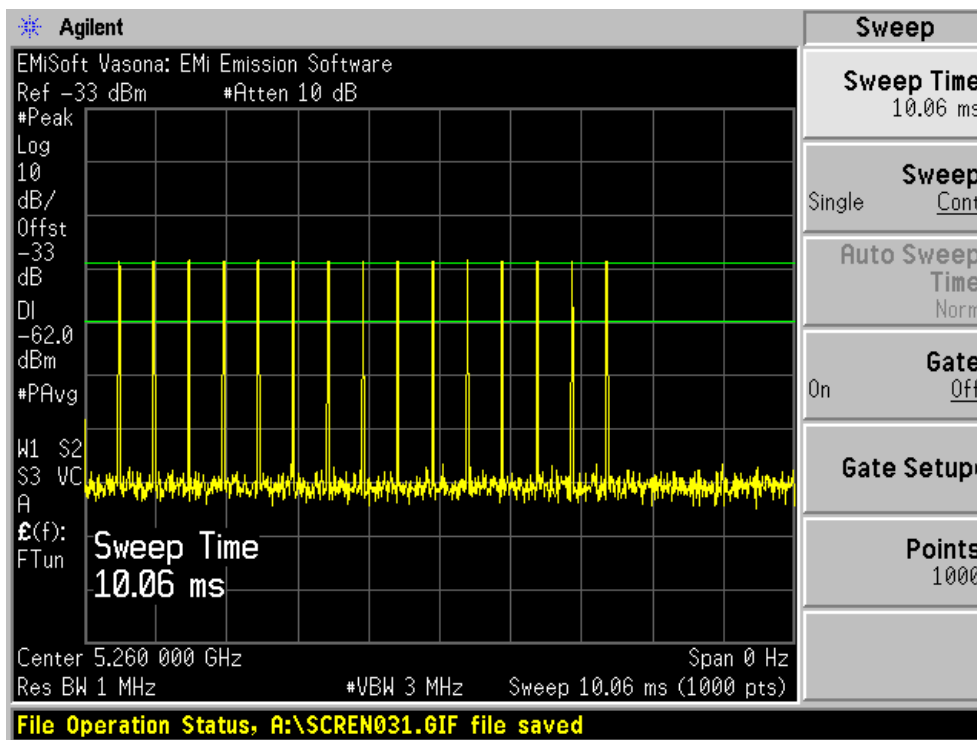

Bin 4 Radar Calibration

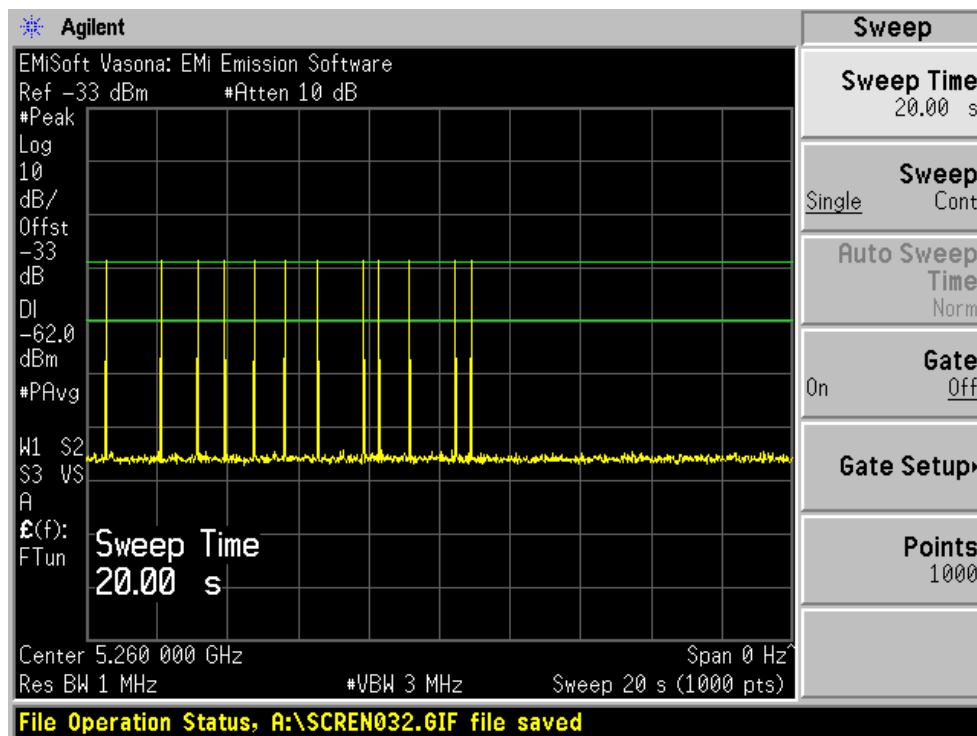

Bin 5 Radar Calibration

5.0 Test Procedure/Results

1. A spectrum analyzer is used as a monitor to verify that the UUT has vacated the Channel within the (Channel Closing Transmission Time and Channel Move Time, and does not transmit on a Channel during the Non-Occupancy Period after the detection and Channel move. It is also used to monitor UUT transmissions during the Channel Availability Check Time.
2. Following is the test setup used to generate the Radar Waveforms, and for all DFS tests described herein.

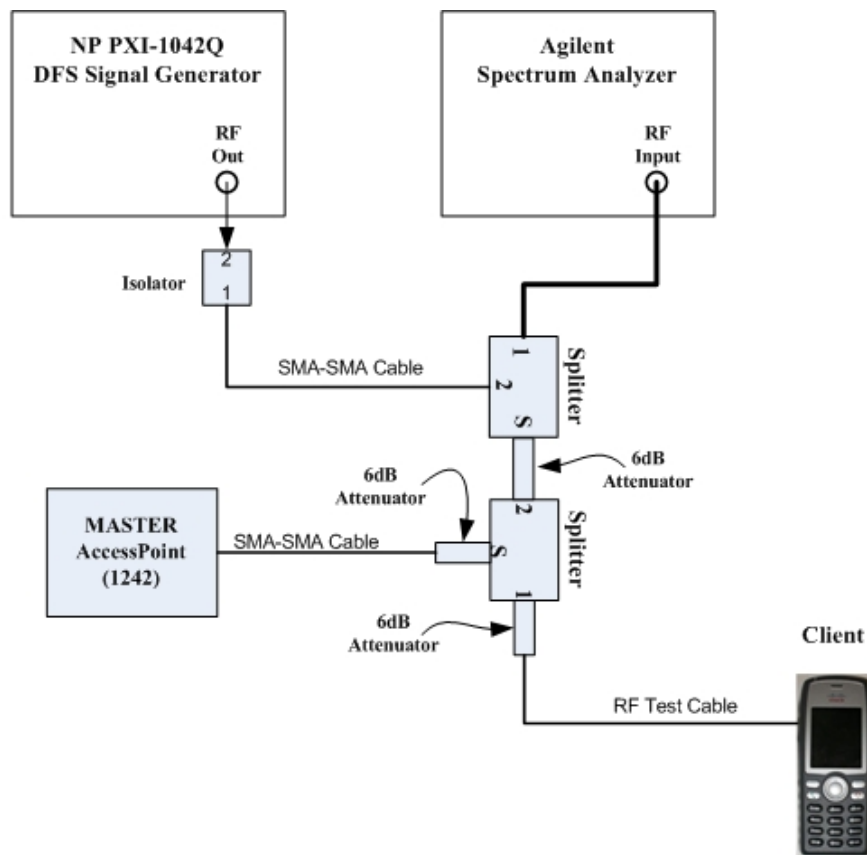

DFS Test Configuration for the CP-7926G (Client)

Conducted Setup: Radar Test Waveforms are injected into the Master

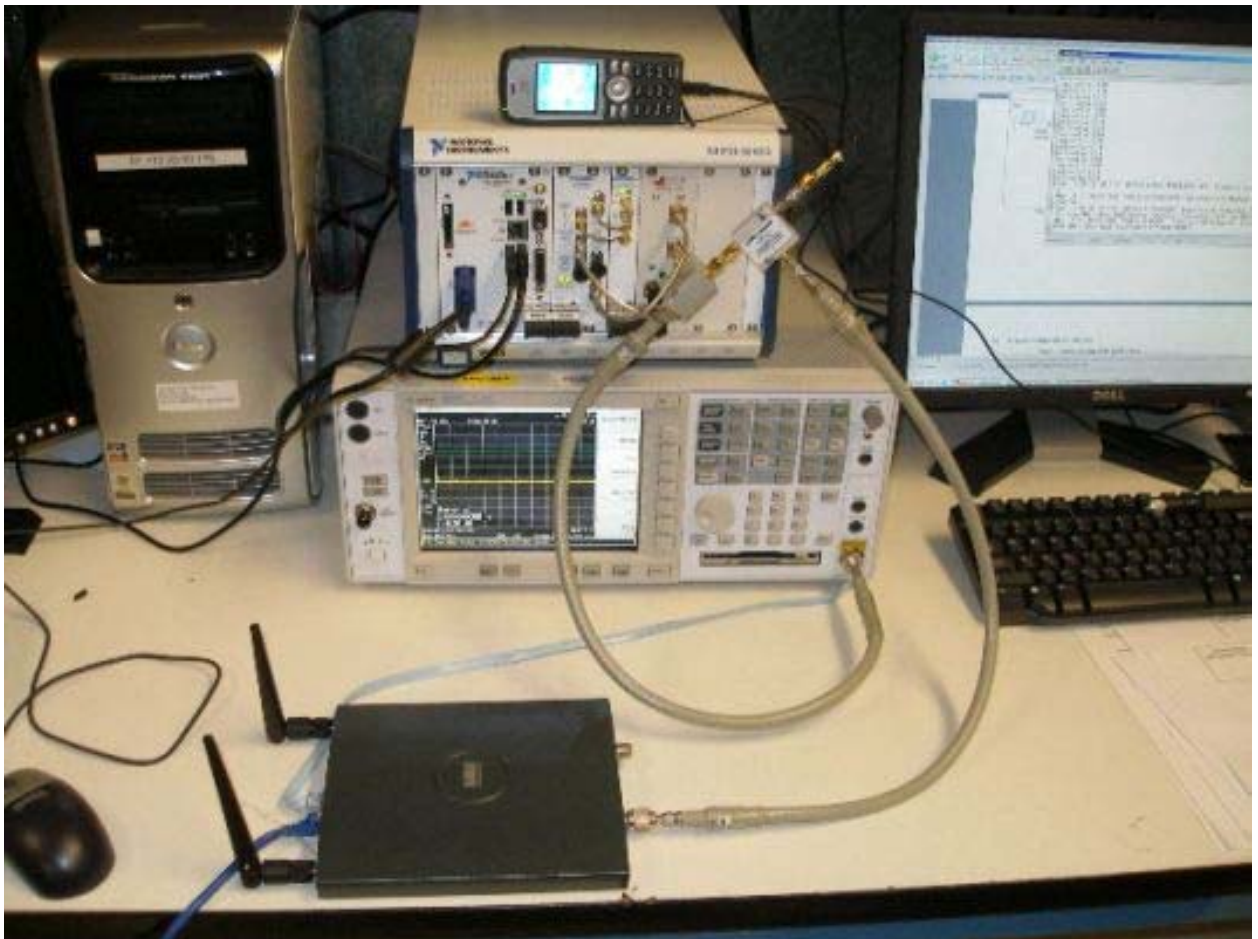

DFS Setup: UUT

The test setup is constructed of the following equipment:

Radar Test Signal Generator

National Instruments NI PXI-1042 8-Slot 3U Chassis
National Instruments NI PXI-5421 16-Bit 100MS/s Arbitrary Waveform Generator
National Instruments NI PXI-5610 2.7GHz RF Upconverter
Ascor 7206 PXI 4.9 to 6GHz Upconverter

Agilent E4440A Spectrum Analyzer

Mini-Circuits ZFSC-2-10G+ Splitter/Combiner (Qty. 2)
Mini-Circuits BW-S6W2 6dB Attenuator (Qty. 3)
CISCO 16" RF Coaxial Cable-SMA (Qty. 2)
Murata MXGS83RK3000 Special RF Test Cable (Qty. 1)
Cisco AIR-AP1242AG 802.11a/b/g (wireless master)
Cisco CP-7926G 802.11a/b/g (wireless client)

The waveform parameters from within the bounds of the signal type are selected randomly using uniform distribution.

3. In-Service Monitoring for Channel Move Time, Channel Closing Transmission Time and Non-Occupancy Period

These tests define how the following DFS parameters are verified during In-Service Monitoring; Channel Closing Transmission Time, Channel Move Time, and Non-Occupancy Period.

The steps below define the procedure to determine the above mentioned parameters when a radar Burst with a level equal to the DFS Detection Threshold + 1dB (-63dBm) is generated on the Operating Channel of the U-NII device.

A U-NII device operating as a Client Device will associate with the UUT (Master) at 5260MHz & 5500 MHz. Stream the WAV test file from the Master Device to the Client Device on the selected Channel for the entire period of the test.

At time T_0 the Radar Waveform generator sends a Burst of pulses for each of the radar types at -63dBm.

Observe the transmissions of the UUT at the end of the radar Burst on the Operating Channel for duration greater than 10 seconds. Measure and record the transmissions from the UUT during the observation time (Channel Move Time). Compare the Channel Move Time and Channel Closing Transmission Time results to the limits defined in the *DFS Response requirement values table*.



Channel Move Time, Channel Closing Transmission Time for Type 1 radar.

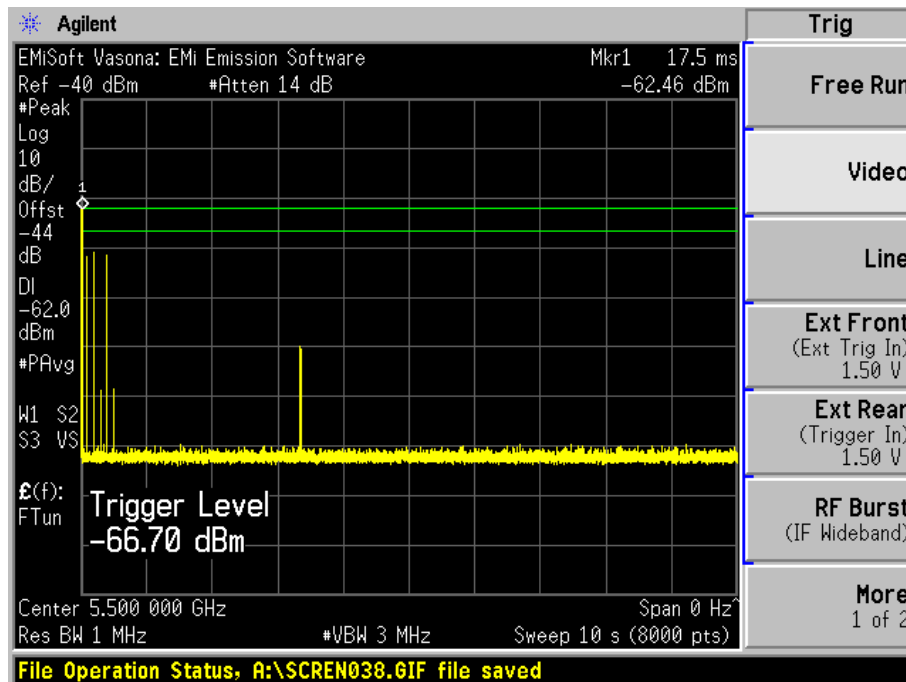
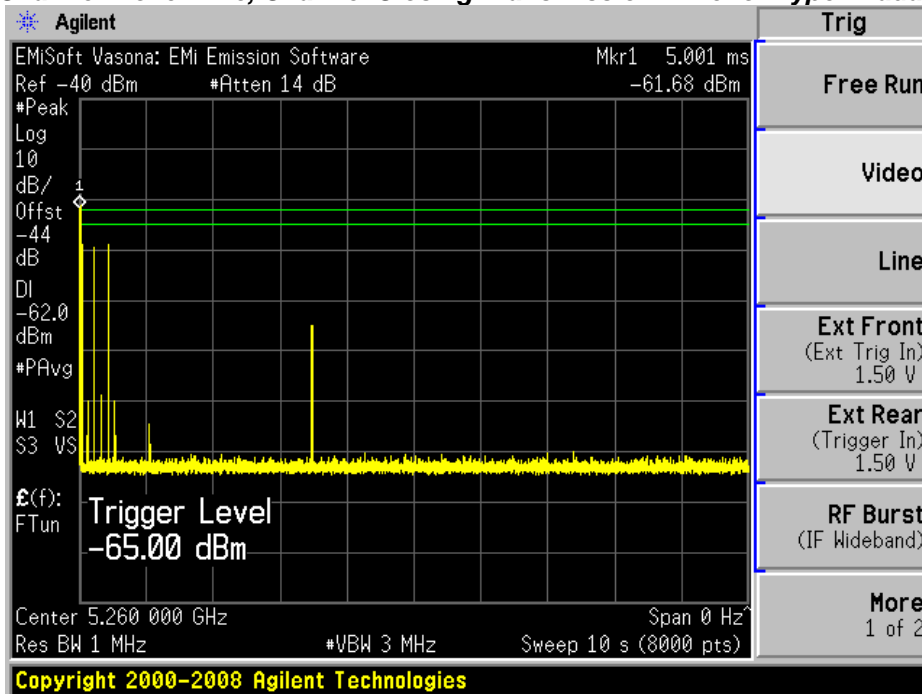

Channel Move Time, Channel Closing Transmission Time for Type 2 radar

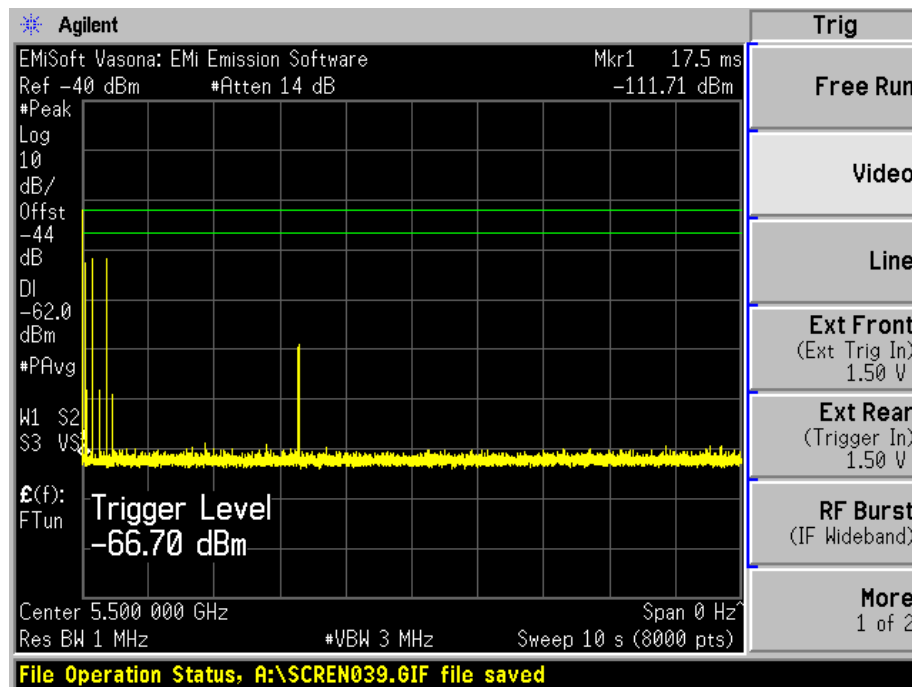
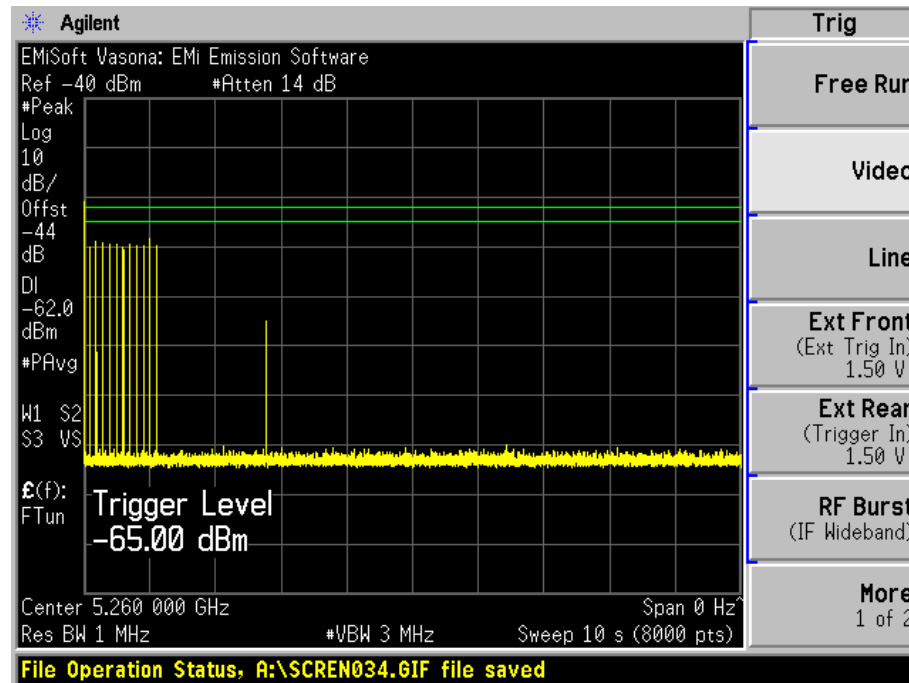

Channel Move Time, Channel Closing Transmission Time for Type 3 radar.

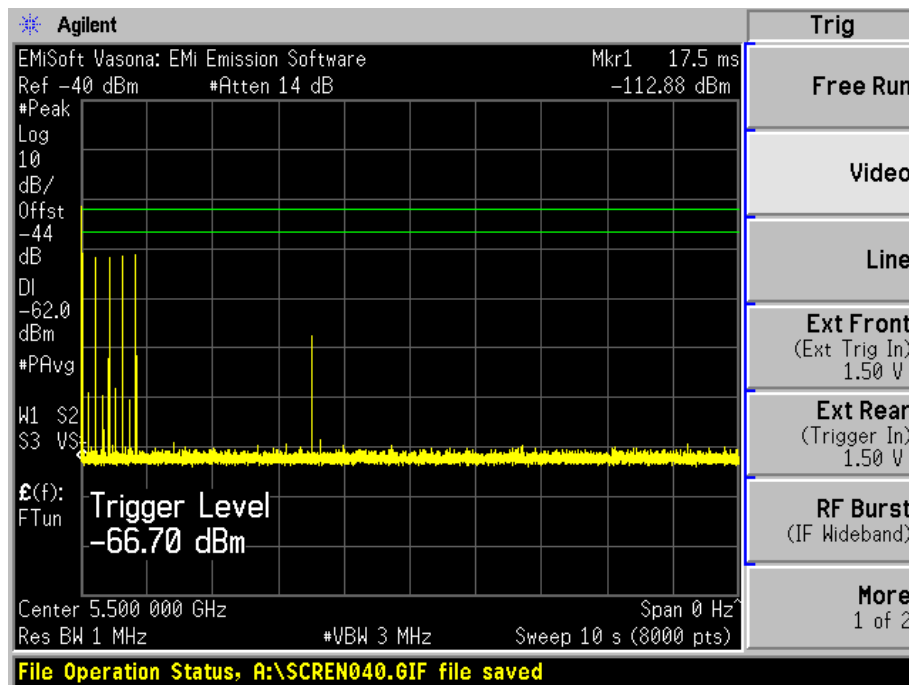
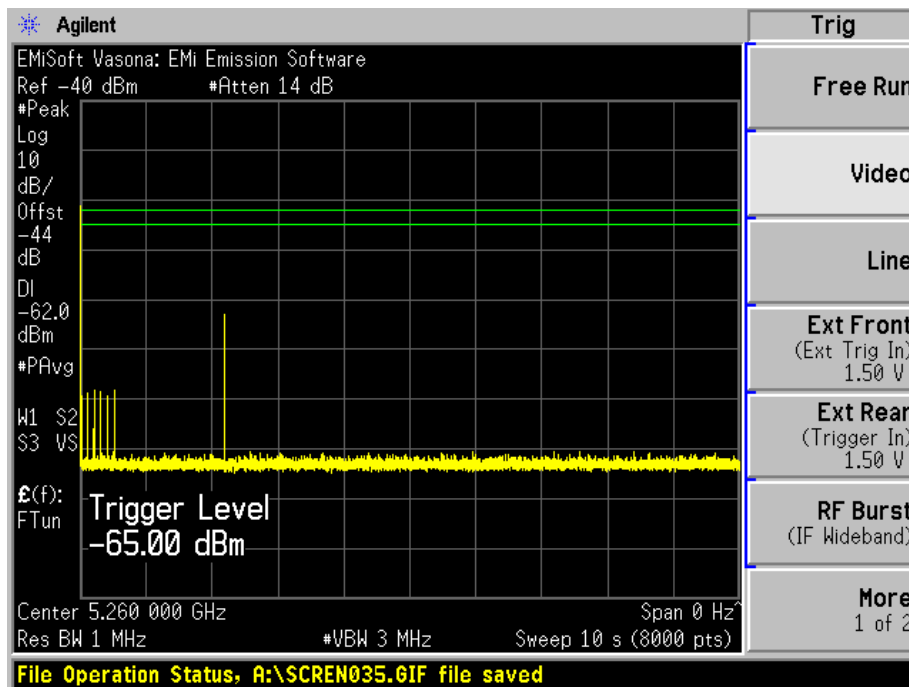



Channel Move Time, Channel Closing Transmission Time for Type 4 radar.

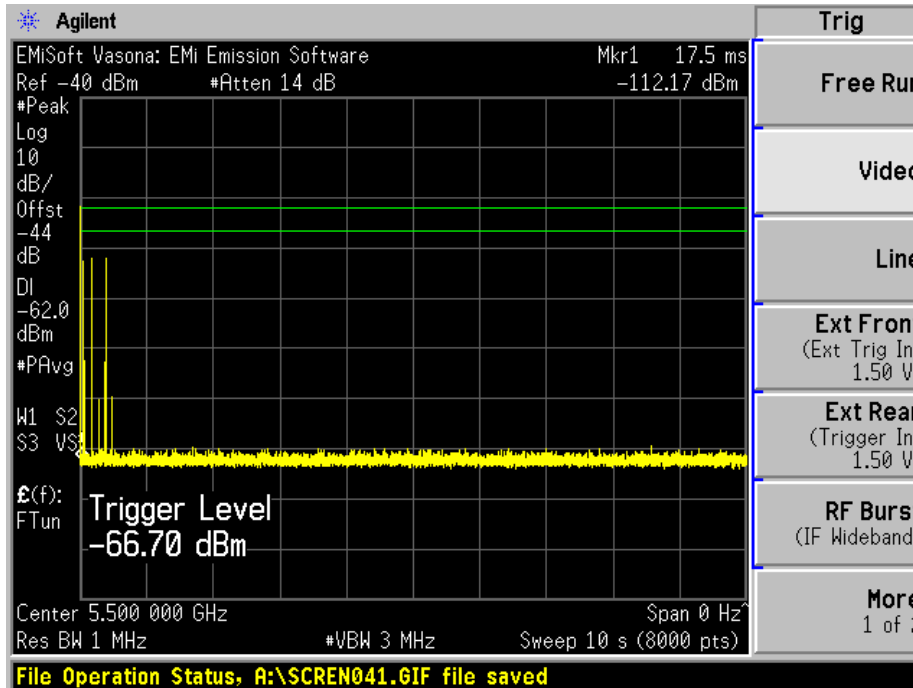
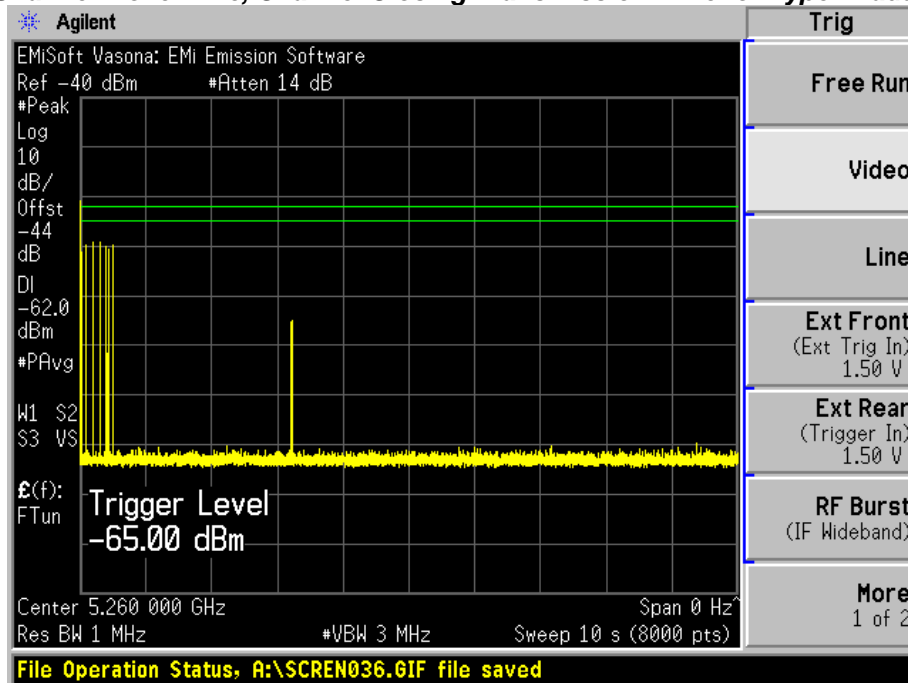



Channel Move Time, Channel Closing Transmission Time for Type 5 radar.

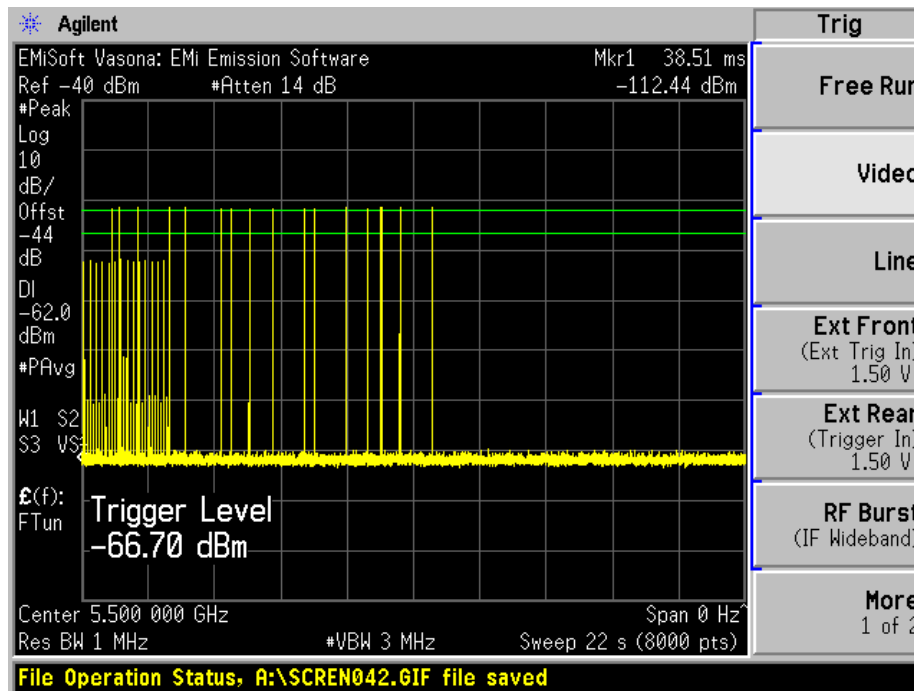
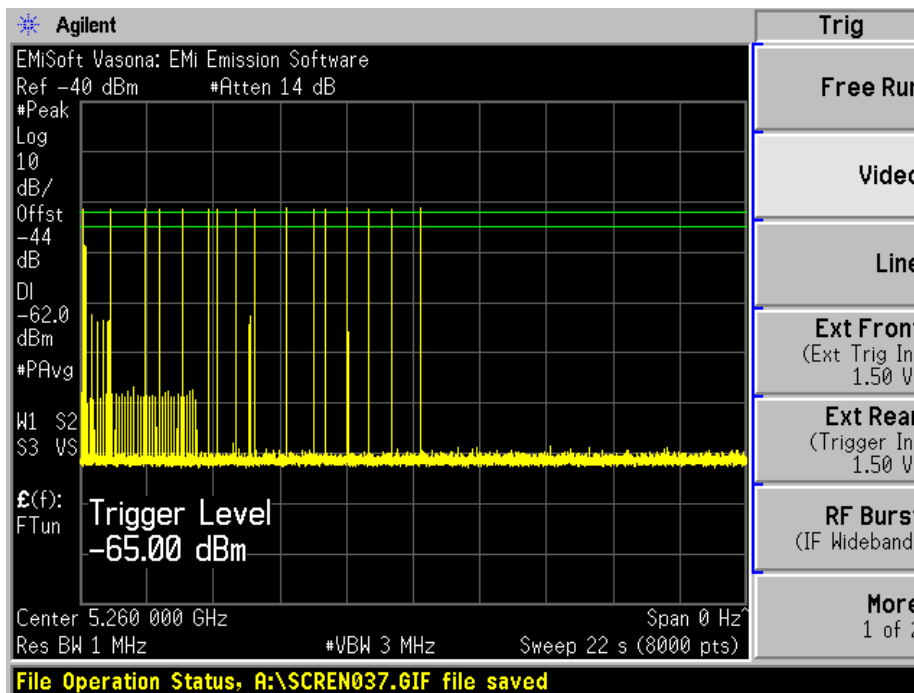



Measure the UUT for more than 30 minutes following the channel close/move time to verify that the UUT does not resume any transmissions on this Channel.

30 Minute Non-Occupancy Period (using Type 1 radar)

